



EUROPEAN
TELECOMMUNICATION
STANDARD

ETS 300 393-2

May 1996

Source: ETSI TC-RES

Reference: DE/RES-06004-2

ICS: 33.020, 33.060.50

Key words: TETRA, PDO

**Radio Equipment and Systems (RES);
Trans-European Trunked Radio (TETRA);
Packet Data Optimized (PDO);
Part 2: Air Interface (AI)**

ETSI

European Telecommunications Standards Institute

ETSI Secretariat

Postal address: F-06921 Sophia Antipolis CEDEX - FRANCE

Office address: 650 Route des Lucioles - Sophia Antipolis - Valbonne - FRANCE

X.400: c=fr, a=atlas, p=etsi, s=secretariat - **Internet:** secretariat@etsi.fr

Tel.: +33 92 94 42 00 - Fax: +33 93 65 47 16

*

Copyright Notification: No part may be reproduced except as authorized by written permission. The copyright and the foregoing restriction extend to reproduction in all media.

© European Telecommunications Standards Institute 1996. All rights reserved.

6.4.4	Radio frequency tolerance	34
6.4.5	RF Output power time mask	34
6.4.5.1	BS	36
6.4.5.2	MS	36
6.4.6	Intermodulation attenuation	36
6.4.6.1	Definition	36
6.4.6.2	BS	36
6.4.6.3	MS	36
6.4.7	Intra-BS intermodulation requirements	37
6.5	Receiver characteristics	37
6.5.1	Blocking characteristics	37
6.5.1.1	Definition	37
6.5.1.2	Specification	37
6.5.2	Spurious response rejection	38
6.5.2.1	Definition	38
6.5.2.2	Specification	38
6.5.3	Intermodulation response rejection	38
6.5.3.1	Definition	38
6.5.3.2	Specification	38
6.5.4	Unwanted conducted emissions	39
6.5.4.1	Definition	39
6.5.4.2	Specification	39
6.5.5	Unwanted radiated emissions	39
6.6	Transmitter/receiver performance	39
6.6.1	Modulation accuracy	39
6.6.1.1	Ideal case	39
6.6.1.2	Vector error magnitude requirement at symbol time	40
6.6.2	Receiver performance	40
6.6.2.1	Nominal error rates	41
6.6.2.2	Dynamic reference sensitivity performance	41
6.6.2.2.1	BS receiver performance	41
6.6.2.2.2	MS receiver performance	42
6.6.2.3	Reference interference performance	42
6.6.2.3.1	BS receiver performance	42
6.6.2.3.2	MS receiver performance	42
6.6.2.4	Static reference sensitivity performance	42
6.6.2.4.1	BS receiver performance	43
6.6.2.4.2	MS receiver performance	43
6.6.2.5	MS receiver performance for synchronisation burst acquisition	43
6.6.3	Propagation conditions	43
6.6.3.1	Propagation conditions - introduction	43
6.6.3.2	Tap-gain process types	44
6.6.3.3	Propagation models	45
7	Radio sub-system synchronisation	45
7.1	General description of synchronisation system	45
7.2	Timebase counters	45
7.2.1	Downlink	45
7.2.1.1	Timing counters	45
7.2.1.2	Values of counters	46
7.2.2	Uplink	46
7.2.2.1	Timing counters	46
7.2.2.2	Values of counters	46
7.3	Timing of transmitted signals	46
7.4	BS requirements for synchronisation	47
7.5	MS requirements for synchronisation	47
8	Channel coding	47
8.1	Introduction	47
8.2	General	47
8.2.1	Interfaces in the error control structure	47
8.2.2	Notation	49

8.2.3	Definition of error control codes	49
8.2.3.1	16-state Rate-Compatible Punctured Convolutional (RCPC) codes	49
8.2.3.1.1	Encoding by the 16-state mother code of rate 1/4.....	49
8.2.3.1.2	Puncturing of the mother code.....	50
8.2.3.1.3	Puncturing scheme of the RCPC code of rate 2/3.....	50
8.2.3.2	(K_1+16, K_1) block code	50
8.2.4	Definition of interleaving schemes.....	51
8.2.4.1	Block interleaving.....	51
8.2.5	Definition of scrambling	51
8.2.5.1	Scrambling method.....	51
8.2.5.2	Scrambling sequence	51
8.3	Error control schemes.....	52
8.3.1	Master Block CHannel (MBCH).....	52
8.3.2	Normal Block CHannel (NBCH)	52
9	Channel multiplexing	53
9.1	Logical channels for passing MAC blocks to the channel coding	53
9.2	The physical resource.....	54
9.2.1	General.....	54
9.2.2	Radio frequency channels	54
9.3	Physical channel	54
9.3.1	Sub-burst.....	54
9.3.2	Bursts	54
9.3.2.1	General	54
9.3.2.2	Modulation symbols numbering.....	55
9.3.2.3	Modulation bit numbering	55
9.3.2.4	Burst timing.....	55
9.3.3	Type of burst and burst timing.....	55
9.3.3.1	General	55
9.3.3.2	Modulation bits allocation	56
9.3.3.2.1	Uplink start sub-burst.....	56
9.3.3.2.2	Uplink even sub-burst	56
9.3.3.2.3	Uplink odd sub-burst.....	56
9.3.3.2.4	Uplink end sub-burst.....	56
9.3.3.2.5	Downlink normal sub-burst	56
9.3.3.2.6	Downlink synchronisation sub-burst	57
9.3.3.2.7	Linearisation up-link burst.....	57
9.3.3.3	Sub-burst fields.....	57
9.3.3.3.1	Frequency correction field.....	57
9.3.3.3.2	Normal training sequence	57
9.3.3.3.3	Extended training sequence	58
9.3.3.3.4	Synchronisation training sequence	58
9.3.3.3.5	Tail bits.....	58
9.3.3.3.6	Phase adjustment bits	58
9.4	Mapping of multiplexed blocks into sub-bursts	58
9.4.1	Mapping of multiplexed blocks into sub-bursts on the downlink	58
9.4.2	Mapping of multiplexed blocks into sub-bursts on the uplink.....	59
9.4.3	Timing of transmission	59
10	Radio subsystem link control.....	61
10.1	Scope.....	61
10.2	General	61
10.3	RF power control.....	62
10.3.1	Overall process	62
10.3.2	MS power control implementation	62
10.3.3	MS power control range	62
10.4	Definition of path loss formulae	63
10.4.1	Path loss parameter C1.....	63
10.4.2	Path loss parameter C2.....	63
10.4.3	Path loss parameter C3.....	64

10.4.4	Path loss parameter C4.....	64
10.5	Monitoring measurements.....	65
10.5.1	Signal strength measurement.....	65
10.6	Scanning measurement.....	65
10.6.1	Foreground scanning.....	65
10.6.2	Background scanning (optional).....	66
	10.6.2.1 Signal strength measurements.....	66
	10.6.2.2 Cell selection parameters measurement.....	66
10.6.3	Interrupting scanning.....	66
	10.6.3.1 Signal strength measurements.....	66
	10.6.3.2 Cell selection parameters measurement.....	66
10.7	Selection formulae.....	67
10.7.1	Initial cell selection.....	67
10.7.2	Cell re-selection.....	67
	10.7.2.1 Criterion for relinquishable link.....	68
	10.7.2.2 Criterion for improvable link.....	68
10.8	Measuring quality of serving cell.....	69
10.8.1	Downlink measurements.....	69
	10.8.1.1 Cell (re-)selection parameters decoding.....	69
	10.8.1.2 Signal strength.....	69
	10.8.1.3 Radio downlink counter.....	69
10.9	Radio link measurements of signal quality.....	70
10.9.1	Received signal strength.....	70
10.9.2	RDC counter.....	70
10.9.3	BER.....	70
10.9.4	MER.....	70
10.10	Control parameters.....	70
	10.10.1 Parameters.....	70
11	Connection Oriented Network Service description (CONS) (ISO/IEC 8348 and ISO/IEC 8878 delta).....	73
11.1	Introduction.....	73
11.2	Organisation of this document.....	73
11.3	Service description.....	73
11.4	ISO/IEC 8878 delta.....	74
	11.4.1 Scope and field of application.....	74
	11.4.2 References.....	74
	11.4.3 Definitions.....	74
	11.4.4 Abbreviations.....	74
	11.4.5 Overview.....	74
	11.4.5.1 Elements of the X.25/PLP 1984 used to support the OSI CONS.....	74
	11.4.5.2 General operation of the X 25 PLP 1984 for supporting the OSI CONS.....	78
11.4.6	Network connection establishment phase.....	78
	11.4.6.1 Primitive/parameter and packet field relationships.....	78
	11.4.6.2 Procedures.....	78
	11.4.6.2.1 Primitive and packet mapping.....	78
	11.4.6.2.2 NSAP addresses.....	78
	11.4.6.2.3 Receipt confirmation selection.....	78
	11.4.6.2.4 Expedited data selection.....	78
	11.4.6.2.5 QoS parameter set.....	78
	11.4.6.2.6 NS user data.....	79
11.4.7	Network connection release phase.....	79
	11.4.7.1 Primitive/Parameter and packet/field relationships.....	79
	11.4.7.2 Procedures.....	79
11.4.8	Data transfer phase: data transfer service.....	79
	11.4.8.1 Primitive/Parameter and packet/field relationship.....	79
	11.4.8.2 Procedures.....	79
11.4.9	Data transfer phase: receipt confirmation service.....	79
11.4.10	Data transfer phase: expedited data transfer service.....	79
11.4.11	Data transfer phase: reset service.....	79
11.4.12	Response to protocol violation.....	79

	11.4.13	Conformance.....	80
11.5		Annex A: X.25 1980 sub-network dependant convergence protocol (normative)	80
11.6		Annex B: Classification (normative).....	80
11.7		Annex C: Sub-network convergence protocol for use with X.25 permanent virtual circuits (normative)	80
11.8		Annex D: Protocol implementation conformance statement proforma (normative).....	80
11.9		Annex E: Additional considerations of CONS primitives (informative).....	80
11.10		Annex F: Use of X.25/PLP NPAl (informative)	80
11.11		Annex G: Transit delay calculations (informative)	80
11.12		Annex H: Example of priority negotiation (informative).....	80
11.13		Annex I: Differences between CCITT Recommendation X.223 and ISO/IEC 8878 [9] (informative).....	80
12		CONP protocol (ISO/IEC 8208 delta).....	80
	12.1	Introduction	80
	12.2	Organisation of this clause	81
	12.3	Overview of the protocol	81
	12.3.1	Position of the protocol in the network layer.....	81
	12.3.2	Services provided by the protocol	81
	12.3.3	Underlying services assumed by the protocol.....	81
	12.3.4	Services assumed from the local environment	81
	12.4	ISO/IEC 8208 delta	81
	12.4.1	Scope	81
	12.4.2	Normative references.....	82
	12.4.3	General considerations	82
	12.4.4	Procedures for restart	83
	12.4.5	Procedures for virtual call set-up and clearing	84
	12.4.6	Procedures for data and interrupt transfer	85
	12.4.7	Procedures for flow control.....	85
	12.4.8	Procedures for reset.....	85
	12.4.9	Effects of clear, reset, restart procedures on the transfer of packets	85
	12.4.10	Effects of layer 1 and 2 on the packet layer	86
	12.4.11	Error handling.....	86
	12.4.12	Packet format	86
	12.4.13	Procedures for optional user facilities	86
	12.4.14	Procedures for optional CCITT specified DTE facilities	86
	12.4.15	Format for facility field in call set-up clearing packets.....	86
	12.4.16	Format for registration field in registration packets	86
	12.4.17	Diagnostic codes.....	86
	12.4.18	Timers and re-transmission counts.....	86
	12.4.19	State diagrams	86
	12.4.20	State tables	86
	12.4.21	Annex A: Private networks	86
	12.4.22	Annex B: Differences between the first and the second editions of ISO/IEC 8208	86
	12.4.23	Amendment 1: Alternative logical channel identifier assignment.....	87
	12.5	Protocol functions	87
	12.6	Provision of the underlying protocol.....	87
	12.6.1	Mapping of the primitives	87
	12.6.2	Mapping of QoS	88
13		Specific-ConnectionLess Network Service description (S-CLNS)	88
	13.1	Introduction	88
	13.1.1	Specific connectionless service.....	89
	13.1.2	ISO principles of connectionless-mode transmission	89
	13.1.3	General principles	90
	13.1.4	Sub-addresses	90
	13.2	S-CLNS service description.....	90
	13.2.1	SAP	90
	13.2.2	Services available at the TN-SCLNS SAP	90
	13.2.3	Full and slim services.....	91
	13.2.3.1	Data transfer service	91
	13.2.3.2	Facilities provided by the service.....	91

13.3	Primitive definitions	92
13.3.1	Primitives types.....	92
13.3.2	Data transfer primitives.....	92
13.3.3	Sequence of data transfer primitives	93
13.3.4	Contents of primitives	93
13.3.4.1	Parameter definitions	93
13.3.4.2	TN-UNITDATA primitives.....	94
13.3.4.3	TN-DELIVERY primitives	95
13.3.5	State description	95
14	Protocol for providing the Specific Connectionless network service (S-CLNP).....	96
14.1	Introduction.....	96
14.2	Overview of the protocol.....	96
14.2.1	Position of the protocol in the NWK layer	96
14.2.2	Slim subset of the protocol	97
14.2.3	Addresses.....	97
14.2.4	Services provided by the protocol.....	97
14.2.4.1	Data transfer service.....	97
14.2.4.2	Facilities	98
14.2.5	Underlying services assumed by the protocol	98
14.2.6	One instance of protocol.....	98
14.2.7	Service assumed from the local environment.....	99
14.3	Overview of the PDU structures.....	99
14.4	PDU descriptions.....	100
14.4.1	General format.....	100
14.4.2	<S1-DT>and <S2-DT> PDU headers with short address.....	101
14.4.3	<S1-DT>and <S2-DT> PDU headers with long address	102
14.4.4	<S3-DT> PDU header	102
14.4.5	<S2-DEL> PDU header with short address	103
14.4.6	<S2-DEL> PDU header with long address	103
14.4.7	<S3-DEL> PDU header	104
14.5	Formats of fields.....	104
14.5.1	General principles	104
14.5.2	Fixed part fields	105
14.5.2.1	Version (4 bits).....	105
14.5.2.2	Type (4 bits)	105
14.5.2.3	Flags (4 bits)	105
14.5.2.4	Packet length (12 bits)	105
14.5.3	Address part fields	106
14.5.4	Facility part fields	106
14.5.4.1	Sub-address.....	106
14.5.4.2	Priority	106
14.5.4.3	Delivery/Storage request.....	106
14.5.4.4	Report request	107
14.5.4.5	Disposition.....	107
14.5.4.6	Multicast area selection.....	108
14.5.4.7	Time stamp	108
14.5.4.8	Packet route	108
14.5.5	Header checksum.....	109
14.5.6	User data part	109
14.6	Primitive definitions and format	109
14.7	Protocol functions.....	109
14.7.1	Data PDU composition	110
14.7.1.1	<S1-DT> PDU composition.....	111
14.7.1.2	<S2-DT> PDU composition.....	111
14.7.1.3	<S3-DT> PDU composition.....	111
14.7.1.4	Composition of facility fields.....	112
14.7.2	Delivery PDU composition	112
14.7.2.1	<S1-DEL> PDU composition	112
14.7.2.2	<S2-DEL> PDU composition	112
14.7.2.3	<S3-DEL> PDU composition	113
14.7.2.4	Composition of facility fields.....	113
14.7.3	Data PDU decomposition	113

14.7.4	Delivery PDU decomposition.....	113
14.7.5	Route PDU	114
14.7.6	Forward PDU.....	114
14.7.7	Discard PDU.....	114
14.7.8	PDU header error detection	114
14.7.9	Facility functions.....	115
14.7.9.1	Sub-addressing.....	115
14.7.9.2	Priority.....	115
14.7.9.3	D/S (delivery/storage) request.....	116
14.7.9.3.1	Delivery facility	116
14.7.9.3.2	Storage facility	116
14.7.9.4	Report request.....	116
14.7.9.5	Multicast area selection	116
14.7.9.6	Time stamping.....	116
14.7.9.7	Disposition report.....	117
14.8	Provision of the underlying service	117
14.8.1	General.....	117
14.8.2	Operation over MLE	117
14.9	Conformance	118
14.10	Algorithms for PDU header error detection function.....	118
14.10.1	Symbols used in algorithms	118
14.10.2	Arithmetic conventions	118
14.10.3	Algorithm for generating checksum parameters	118
14.10.4	Algorithms for checking checksum parameters.....	119
14.10.5	Algorithm to adjust the checksum parameter when an octet is altered.....	119
15	Mobility Management (MM): service description	120
15.1	Introduction	120
15.2	Services offered.....	120
15.3	Primitive description.....	120
15.3.1	Service state model for the MS	121
15.3.2	Service primitives for the MS.....	121
15.3.2.1	Primitives for authentication of the network.....	121
15.3.2.2	Primitives for de-registration (detach).....	121
15.3.2.3	Primitives for indication of the state of a mobile	121
15.3.2.4	Primitives for registration	122
15.3.2.5	Primitives for the energy saving mode	122
15.3.3	Primitive summary.....	122
15.3.4	Parameters definition	122
15.3.5	State description for the MS.....	123
15.3.5.1	Not updated	123
15.3.5.2	Wait updating.....	123
15.3.5.3	Updated	123
15.3.5.4	Temporary disabled.....	123
15.3.5.5	Permanently disabled	123
15.3.6	Service state diagram for the TNMM-SAP	124
16	PDO MM protocol.....	127
16.1	Introduction	127
16.2	MM procedures.....	128
16.2.1	General.....	128
16.2.2	Services provided by the protocol	128
16.2.3	Underlying services assumed by the protocol.....	128
16.2.4	Services assumed from the local environment	128
16.3	Protocol functions	128
16.3.1	Activation and control of underlying MLE Service	130
16.3.1.1	Activation procedure	130
16.3.1.2	Deactivation procedure.....	130
16.3.1.3	Maintenance procedures	131
16.3.1.3.1	Report and cancel handling	131
16.4	Registration procedure.....	131
16.4.1	MLE initiated registration procedure.....	131
16.4.1.1	Normal registration	131

16.4.2	User application initiated registration procedure.....	133
16.4.3	Infrastructure initiated registration procedure	136
16.4.4	Colliding registrations	137
16.4.5	Expiry of timer T351.....	137
16.5	De-registration procedure	137
16.6	Energy economy procedure	138
16.7	Group identity network download.....	138
16.8	MM PDUs structures and contents	139
16.8.1	MM PDU general description.....	139
16.8.2	MM PDU description tables - downlink.....	140
16.8.2.1	D-GROUP IDENTITY COMMAND.....	141
16.8.2.2	D-DISABLE	141
16.8.2.3	D-ENABLE	141
16.8.2.4	D-ENERGY SAVING.....	141
16.8.2.5	D-LOCATION UPDATE ACCEPT.....	142
16.8.2.6	N UPDATE COMMAND.....	142
16.8.2.7	D-LOCATION UPDATE REJECT	142
16.8.2.8	D-LOCATION UPDATE PROCEEDING.....	143
16.8.2.9	D-STATUS	143
16.8.3	MM PDU descriptions - uplink	143
16.8.3.1	GROUP-IDENTITY-ACKNOWLEDGE	144
16.8.3.2	U-ITSI DETACH.....	144
16.8.3.3	U-LOCATION UPDATE DEMAND.....	144
16.8.3.4	U-STATUS	145
16.9	MM information elements coding	145
16.9.1	Address extension	145
16.9.2	Class of MS	145
16.9.3	Class of usage	146
16.9.4	Disabling type	147
16.9.5	Energy Saving Mode (ESM)	147
16.9.6	Energy saving information	147
16.9.7	Location Area (LA).....	147
16.9.8	Location Area Country Code (LACC)	147
16.9.9	LA information.....	148
16.9.10	LANC	148
16.9.11	LA timer	148
16.9.12	Location update type.....	148
16.9.13	MCC.....	148
16.9.14	MNC.....	149
16.9.15	New Registered Area (NRA).....	149
16.9.16	PDU type.....	150
16.9.17	Proprietary	150
16.9.18	Reject Cause (RC).....	151
16.9.19	Request to append LA	151
16.9.20	SSI	151
16.9.21	Status.....	152
16.9.22	Subscriber class	152
16.9.23	TETRA Equipment Identity (TEI)	152
16.9.24	Type 3 element identifier	153
16.9.25	Visitor Group Short Subscriber Identity ((V)GSSI).....	153
16.10	Primitives definition	153
16.11	Parameters.....	153
16.11.1	Timers.....	153
16.11.1.1	Timer T351 -Registration response time	153
17	MLE service description.....	153
17.1	Introduction.....	153
17.2	Summary of services offered by MLE protocol	154
17.3	Detailed service descriptions.....	155
17.3.1	Services and primitives at the LMM-SAPs.....	155
17.3.1.1	Service state diagram for the LMM-m-SAP (mobile side).	156
17.3.1.2	Service primitives for the LMM-SAPs	156
17.3.2	Services and primitives at the LSCL-SAP	158

	17.3.2.1	MS attachment	158
	17.3.2.2	Data transfer	158
	17.3.2.3	Service state diagram for the LSCL SAP	159
	17.3.2.4	Service primitives for LSCL SAP	159
17.3.3		Services and primitives at the LCO-SAP	160
	17.3.3.1	Radio link establishment.....	160
	17.3.3.2	Connection restoration.....	160
	17.3.3.3	Data transfer	160
	17.3.3.4	Service state diagram for the LCO SAP	161
	17.3.3.5	Service primitives for LCO SAP.....	161
18		PDO MLE protocol	162
18.1		Introduction	162
18.2		Overview of the sub-layer	163
	18.2.1	Protocol environment	163
	18.2.2	Services and primitives offered by the MLE to the MM entity.....	164
	18.2.3	Services and primitives offered by the MLE to the SCLNP entity.....	165
	18.2.4	Services and primitives offered by the MLE to the CONP entity	165
	18.2.5	Services and primitives offered by layer 2 to MLE	166
	18.2.6	Services and primitives between the MLE and the LLME	167
	18.2.7	Protocol sequences	167
18.3		MLE functions	171
	18.3.1	Overview.....	171
	18.3.2	Access to the communication resources and activation of the MLE	172
	18.3.3	Deactivation of the MLE	172
	18.3.4	Attachment management sub entity.....	172
	18.3.4.1	Scanning of cells.....	173
	18.3.4.2	Monitoring of neighbour cells.....	173
	18.3.4.3	Surveillance of the serving cell	174
	18.3.4.4	Ranking of neighbour cells	174
		18.3.4.4.1 Ranking of monitored cells	175
		18.3.4.4.2 Ranking of scanned cells.....	175
	18.3.4.5	Criteria used during cell re-selection	175
		18.3.4.5.1 Criterion for starting the monitoring process	175
		18.3.4.5.2 Criterion for starting scanning.....	175
		18.3.4.5.3 Criterion for radio link failure	175
		18.3.4.5.4 Criterion for radio relinquishable cell... 176	
		18.3.4.5.5 Criterion for radio improvable cell	176
		18.3.4.5.6 Criterion for radio usable cell	176
		18.3.4.5.7 Criteria for initiating the cell re- selection procedures.....	176
	18.3.4.6	Initial cell selection.....	178
	18.3.4.7	Cell re-selection	179
		18.3.4.7.1 Determination of which type of re- selection to apply	180
		18.3.4.7.2 Undeclared cell re-selection	181
		18.3.4.7.3 Unannounced cell re-selection	182
		18.3.4.7.4 Announced cell re-selection - type 3... 184	
		18.3.4.7.5 Announced cell re-selection - type 2... 186	
18.3.5		Data transfer sub entity	189
	18.3.5.1	Address handling	189
		18.3.5.1.1 Link addressing.....	189
		18.3.5.1.2 Link addresses to be placed in layer 2 189	
		18.3.5.1.3 Layer 2 end point identifier.....	189
		18.3.5.1.4 Subscriber class	190
	18.3.5.2	MLE connection handling	190
	18.3.5.3	Message routing and selection of LLC services	190
		18.3.5.3.1 Selection of LLC services via TLA- SAP	190
		18.3.5.3.2 Selection of LLC services via TLB- SAP	193

		18.3.5.3.3	Selection of LLC services via TLC-SAP	193
		18.3.5.4	Routing of local control information.....	194
	18.3.6		Network broadcast sub entity	195
		18.3.6.1	Summary.....	195
		18.3.6.2	System information	195
		18.3.6.3	Message formats for system information.....	196
		18.3.6.4	Network broadcast procedures.....	196
		18.3.6.5	Neighbour cell enquiry procedure	196
	18.3.7		Management sub-entity	196
18.4			PDU descriptions.....	197
	18.4.1		Data transfer PDUs at the TLA SAP.....	197
		18.4.1.1	Protocol discriminator	197
		18.4.1.2	PDU type.....	197
		18.4.1.3	MLE service user PDUs.....	197
		18.4.1.4	MLE protocol PDUs.....	197
			18.4.1.4.1 D-NWRK-BROADCAST.....	199
			18.4.1.4.2 D-NEW-CELL.....	199
			18.4.1.4.3 D-PREPARE-FAIL.....	199
			18.4.1.4.4 D-RESTORE-ACK	199
			18.4.1.4.5 D-RESTORE-FAIL	200
			18.4.1.4.6 U-PREPARE	200
			18.4.1.4.7 U-RESTORE	201
		18.4.1.5	D-MLE-SYSINFO	201
18.5			Information elements coding	201
	18.5.1		Announced cell re-selection types supported.....	201
	18.5.2		BS service details	202
	18.5.3		Cell identifier	202
	18.5.4		Cell re-select parameters	203
	18.5.5		Cell service level	203
	18.5.6		Channel command valid	203
	18.5.7		Fail cause	204
	18.5.8		Late entry information	204
	18.5.9		LA	204
	18.5.10		Main carrier number.....	204
	18.5.11		Main carrier number extension	205
	18.5.12		Maximum MS transmit power	205
	18.5.13		Minimum RX access level	205
	18.5.14		MCC.....	205
	18.5.15		MNC.....	206
	18.5.16		Neighbour cell broadcast	206
	18.5.17		Neighbour cell information	206
	18.5.18		Neighbour cell synchronised.....	207
	18.5.19		Number of neighbour cells.....	207
	18.5.20		PDU type.....	207
	18.5.21		Protocol discriminator	207
	18.5.22		Subscriber class	208
	18.5.23		TETRA network time	208
	18.5.24		Timeshare cell information	208
18.6			Timers	209
	18.6.1		Timer T370 - Cell re-selection preparation response time	209
19			Service description for PDO layer 2.....	209
	19.1		Layer 2 service descriptions.....	209
		19.1.1	SAPs.....	209
		19.1.2	Services available at the layer 2 SAPs	210
			19.1.2.1 Services at the TLA-SAP	210
			19.1.2.2 Services at the TLB-SAP	211
			19.1.2.3 Services at the TLC-SAP	211
	19.2		Primitive definitions	211
		19.2.1	Primitives types.....	211
		19.2.2	Summary of primitives	211
			19.2.2.1 Primitives used at the TLA-SAP.....	211

	19.2.2.2	Primitives used at the TLB-SAP	212
	19.2.2.3	Primitives used at the TLC-SAP	212
19.2.3		Contents of primitives	213
	19.2.3.1	Parameter definitions	213
	19.2.3.2	TLA-SAP primitives	214
	19.2.3.2.1	TL-CONNECT primitives	214
	19.2.3.2.2	TL-DATA primitives	214
	19.2.3.2.3	TL-UNITDATA primitives	214
	19.2.3.3	TLB-SAP primitives	215
	19.2.3.3.1	TL-BROADCAST_1 primitives	215
	19.2.3.3.2	TL-BROADCAST_2 primitives	215
	19.2.3.4	TLC-SAP primitives	215
	19.2.3.4.1	TL-SCAN primitives	215
	19.2.3.4.2	TL-SERVING primitives	215
	19.2.3.4.3	TL-MONITOR primitives	215
	19.2.3.4.4	TL-SELECT primitives	216
	19.2.3.4.5	TL-ADDLIST primitives	216
20		Layer 2 PDUs and elements	216
	20.1	Overview	216
	20.2	Block structure	216
	20.2.1	Presiding block	216
	20.2.2	Following block	216
	20.2.3	Master block	217
	20.2.4	Block header	217
	20.3	PDUs	217
	20.3.1	Uplink Response (UR)	220
	20.3.2	Uplink Data, type 1 (UD1)	221
	20.3.3	Uplink Data, type 2 (UD2)	222
	20.3.4	Downlink Response, type 1 (DR1)	223
	20.3.5	Downlink Response, type 2 (DR2)	224
	20.3.6	Downlink Response, type 3 (DR3)	225
	20.3.7	Access Announce (AA)	227
	20.3.8	Downlink Data, type 1 (DD1)	228
	20.3.9	Downlink Data, type 2 (DD2)	229
	20.3.10	Wake Up (WU)	230
	20.3.11	Access Parameters (AP)	231
	20.3.12	System INformation, type 2 (SIN2)	232
	20.3.13	System INformation, type 1 (SIN1)	233
	20.4	Elements in the PDUs	233
	20.4.1	Access parameters element	234
	20.4.1.1	Access period length field	234
	20.4.1.2	Busy flag mode field	234
	20.4.1.3	Max access retries field	234
	20.4.1.4	Max data field	234
	20.4.2	Access window definition	235
	20.4.2.1	Direct priority field	235
	20.4.2.2	Max. random number for priority no x (MAXRNx)	235
	20.4.2.3	Min random number for priority no x (MINRNx)	236
	20.4.2.4	Number of Access Periods field (NAP)	236
	20.4.2.5	Priority no x field	236
	20.4.2.6	Retry Delay field (RD)	237
	20.4.3	Ack flag	237
	20.4.4	Assign element	238
	20.4.4.1	Address MASK field (AMASK)	238
	20.4.4.2	Assigned event label field	238
	20.4.4.3	LOW Duty FLAG (LOD FLAG)	238
	20.4.4.4	Random Access label FLAG (RA FLAG)	239
	20.4.4.5	Subscriber CLass field (SCL)	239
	20.4.4.6	Specimen short subscriber identity field	239
	20.4.4.7	Very Low Duty FLAG (VLD FLAG)	239
	20.4.5	Auxiliary address	239
	20.4.5.1	Address type element	240

	20.4.5.2	SAPI element	240
20.4.6		Block flags	240
20.4.7		Burst length field	241
20.4.8		Broadcast label	241
20.4.9		Common linearization time	241
20.4.10		Downlink carrier	242
20.4.11		Downlink transfer label	242
20.4.12		Fill flag	242
20.4.13		FCS flag	243
20.4.14		Frame Sequence Number (FSN)	243
	20.4.14.1	Frame Number element (FN)	243
	20.4.14.2	Reset flag element	243
20.4.15		Last flag element	244
20.4.16		More data	244
20.4.17		PDU type field	244
20.4.18		Priority field	245
20.4.19		Reserved blocks	245
20.4.20		Segment Sequence Number (SSN)	246
	20.4.20.1	SDU flag element (SDUf)	246
	20.4.20.2	Segment Number element (SN)	246
20.4.21		Random access label	246
20.4.22		RR Control (RRC)	246
	20.4.22.1	Receiver Busy Check flag (RBCf)	247
	20.4.22.2	WINDow size (WIN)	247
20.4.23		Short Subscriber Identity (SSI)	247
20.4.24		Start of reservation	247
20.4.25		System information type 1	248
20.4.26		System information type 2	248
20.4.27		Traffic list	248
	20.4.27.1	Address number x field (Ax)	249
	20.4.27.2	NO of Addresses field (NOA)	249
	20.4.27.3	Time for Data number x field (TDx)	249
20.4.28		Uplink carrier	249
20.4.29		Uplink transfer label	250
20.4.30		Wake interval parameters	250
	20.4.30.1	Stay Awake Time field (SAT)	250
	20.4.30.2	Time to operating state for LOD field (NT_LOD)	250
	20.4.30.3	Time to operating state for VLD field (NT_VLD)	251
20.4.31		Wake up label	251
21		Layer 2: Logical Link Control (LLC) protocol	251
21.1		Scope	251
21.2		Overview of LLC functions	251
21.3		General LLC procedures	253
	21.3.1	LAP.T	253
	21.3.2	LAP.T states	254
	21.3.3	LLC frame descriptions	254
	21.3.3.1	AI-frame	254
	21.3.3.2	RR-frame	254
	21.3.3.3	UI-frame	254
	21.3.4	LLC frame elements	255
	21.3.5	Sequence numbers	255
	21.3.5.1	SSN	255
	21.3.5.2	FSN	255
	21.3.6	Acknowledged frame operations	256
	21.3.6.1	Modulus	256
	21.3.6.2	Send state variable V(S)	256
	21.3.6.3	Acknowledge state variable V(A)	256
	21.3.6.4	Send sequence number N(S)	256
	21.3.6.5	Receive state variable V(R)	256
	21.3.6.6	Receive sequence number N(R)	256
21.4		LLC LAP procedures	257
	21.4.1	Summary of procedures at sending side	257

21.4.2	Summary of procedures at receiving side.....	257
21.4.3	Endpoint addressing.....	257
21.4.3.1	Primary address.....	257
21.4.4	Segmentation and sequencing.....	257
21.4.5	Establishment of unacknowledged information transfer	258
21.4.6	Establishment of acknowledged information transfer	258
21.4.7	Unacknowledged information transfer.....	259
21.4.7.1	Transmission of unacknowledged information	259
21.4.7.2	Reception of unacknowledged information.....	259
21.4.8	Acknowledged information transfer.....	260
21.4.8.1	Transmission of acknowledged information	260
21.4.8.2	Reception of acknowledged information.....	260
21.4.8.3	Receiving acknowledgements	260
21.4.8.4	Adjusting the window size.....	261
21.4.9	Extended error protection.....	261
21.4.10	Exception conditions	262
22	Layer 2 MAC protocol.....	262
22.1	Scope.....	262
22.2	Symbols used	262
22.3	Overview of layer 2	263
22.3.1	Sub-layers	263
22.3.2	Layer 2 data structures.....	263
22.3.3	Transactions.....	264
22.3.3.1	Bursts.....	265
22.3.4	Internal logical channels.....	265
22.3.4.1	Master Control CHannel (MCCH).....	266
22.3.4.2	Access Control CHannel (ACCH).....	266
22.3.4.3	Downlink Traffic CHannel (DTCH)	266
22.3.4.4	Random Access CHannel (RACH).....	266
22.3.4.5	Uplink Traffic CHannel (UTCH).....	266
22.3.5	Multi-carrier operation	266
22.3.5.1	Carrier.....	267
22.3.5.2	Master carrier	267
22.3.5.3	Slave carrier.....	267
22.3.5.4	Carrier numbers definitions	267
22.3.5.4.1	Defining ACCHs.....	267
22.3.5.4.2	Defining RACHs.....	267
22.3.5.4.3	Defining UTCH and DTCH for data transfer.....	267
22.3.6	Operating modes.....	268
22.3.7	State description.....	268
22.3.7.1	States on the MS side.....	268
22.3.7.1.1	Start state.....	268
22.3.7.1.2	Awake state	268
22.3.7.1.3	Standby state	268
22.3.7.1.4	Prepare up state	268
22.3.7.1.5	Await AP	268
22.3.7.1.6	Up transfer state	269
22.3.7.1.7	Down transfer state.....	269
22.3.7.1.8	Await RR state	269
22.3.7.2	States on the BS side	269
22.3.7.2.1	Idle state	269
22.3.7.2.2	Prepare down.....	269
22.3.7.2.3	Down transfer	269
22.3.7.2.4	Up transfer	269
22.3.7.2.5	Await RR state	269
22.4	General MAC procedures	270
22.4.1	Addressing procedures	270
22.4.1.1	Event labels	270
22.4.1.1.1	RA-label	270
22.4.1.1.2	WU-label.....	270
22.4.1.1.3	DT-label	271

		22.4.1.1.4	UT-label.....	271
		22.4.1.1.5	BR-label.....	271
	22.4.1.2		Use of SSI and event labels.....	271
	22.4.1.3		Local grouping.....	272
	22.4.1.4		Address filtering	272
		22.4.1.4.1	Address filtering on the MS side	272
		22.4.1.4.2	Address filtering on the BS side	272
22.4.2			Random access procedures.....	273
	22.4.2.1		Alternative random access methods.....	273
	22.4.2.2		Control of random access	273
	22.4.2.3		Layer 2 access priority	273
	22.4.2.4		Random access flow control.....	274
22.4.3			Control elements for data transfer	274
	22.4.3.1		Fragmenting and sequencing procedures	274
	22.4.3.2		Block flags.....	274
	22.4.3.3		Use of the fill flag	274
	22.4.3.4		Use of last fragment flag.....	275
	22.4.3.5		The use of priority in layer 2.....	275
	22.4.3.6		The use of block header	275
22.5			Uplink data transfer procedures	275
	22.5.1		Summary	275
	22.5.2		Random access procedures for uplink transfer.....	276
		22.5.2.1	Acquisition and maintenance of access rules.....	276
		22.5.2.2	Defining the access window.....	276
		22.5.2.3	Acquisition of random access rules by a low duty cycle MS.....	276
		22.5.2.4	Overview of random access procedure	276
		22.5.2.5	Choosing an access period.....	277
		22.5.2.6	Check of busy flag	277
		22.5.2.7	Creating the primary burst for random access.....	278
		22.5.2.8	Response to the random access burst	278
		22.5.2.9	Retry of random access	278
	22.5.3		Reserved uplink data transfer.....	279
		22.5.3.1	Acknowledged uplink transfer	279
			22.5.3.1.1 Overview	279
			22.5.3.1.2 MS actions after receiving a BS response	279
			22.5.3.1.3 Creating the secondary burst.....	279
			22.5.3.1.4 Downlink response to a secondary burst	280
			22.5.3.1.5 Acknowledgement.....	280
			22.5.3.1.6 Repeat last acknowledge	280
			22.5.3.1.7 Linking of transactions	280
			22.5.3.1.8 Retransmission procedures	281
		22.5.3.2	Unacknowledged uplink transfer.....	281
			22.5.3.2.1 Overview	281
			22.5.3.2.2 MS actions after receiving a BS response	281
			22.5.3.2.3 Creating the secondary burst.....	281
			22.5.3.2.4 Downlink response to a secondary burst	281
			22.5.3.2.5 Linking of transactions	282
22.6			Downlink data transfer procedures	282
	22.6.1		Summary	282
	22.6.2		Downlink data transfer	282
		22.6.2.1	Overview	282
		22.6.2.2	Creating the primary burst for downlink transaction.....	283
		22.6.2.3	Uplink response to a primary burst	283
		22.6.2.4	Create the secondary burst for downlink transfer	283
		22.6.2.5	Uplink response to a secondary burst.....	283
		22.6.2.6	Acknowledgements.....	284
		22.6.2.7	Repeat last acknowledge	284
22.6.3			Low duty cycle operation	284

	22.6.3.1	Operating modes	284
	22.6.3.2	Periodic wake-up PDUs to low duty MS	284
	22.6.3.3	Stay awake time	284
	22.6.3.4	Alerting a MS	284
	22.6.4	Re-transmission procedures	285
	22.6.5	Repetitions	285
22.7		Downlink broadcast procedures	285
	22.7.1	BS transmission of system information	285
	22.7.1.1	Master burst.....	286
	22.7.2	Mobile use of system information.....	286
	22.7.2.1	First access procedures	286
	22.7.3	Broadcast of random access parameters	286
	22.7.3.1	Access Parameters PDU (AP).....	286
	22.7.3.2	Access Announce PDU (AA)	286
	22.7.3.3	Set busy flag	287
22.8		Downlink control procedures	287
	22.8.1	Scanning	287
	22.8.2	Monitoring.....	287
	22.8.3	Measure the serving cell	287
	22.8.4	Select a radio channel.....	288
	22.8.5	Change of L2 addresses	288
Annex A (normative): Timers in MLE			289
Annex B (normative): LLC timers and constants.....			290
B.1	Timers		290
B.2	Constants		290
Annex C (normative): Mathematical definition of frame check sequence			291
Annex D (normative): MAC timers and constants			292
D.1	Timers at the MS side		292
D.2	Constants		292
Annex E (informative): Interrupting scanning method.....			293
Annex F (informative): Choice of cell re-select procedure			294
Annex G (informative): MAC example, how to choose an access period			295
G.1	Example 1		295
G.2	Example 2		295
G.3	Example 3		296
G.4	Example 4		296
Annex H (informative): MAC state transitions			298
H.1	Transitions on the MS side.....		298
H.2	Transitions on the BS side		299
Annex I (informative): The MAC channel pyramid.....			301
Annex J (informative): MAC message sequences			302

Annex K (informative):	Bibliography	307
History		308

Foreword

This European Telecommunication Standard (ETS) has been produced by the Radio Equipment and Systems (RES) Technical Committee of the European Telecommunications Standards Institute (ETSI).

This ETS is a multi-part standard and will consist of the following parts:

- Part 1: "General network design".
- Part 2: "Air Interface (AI)".**
- Part 3: "Inter-working", (DE/RES-06004-3).
- Part 4: "Gateways", (DE/RES-06004-4).
- Part 5: "Terminal equipment interface", (DE/RES-06004-5).
- Part 6: "Line connected stations", (DE/RES-06004-6).
- Part 7: "Security".
- Part 8: "Management services", (DE/RES-06004-8).
- Part 9: "Performance objectives", (DE/RES-06004-9).
- Part 10: "SDL Model of Air Interface", (DE/RES-06004-10).
- Part 11: "PICS Proforma", (DE/RES-06004-11).

Transposition dates	
Date of adoption of this ETS:	2 February 1996
Date of latest announcement of this ETS (doa):	31 August 1996
Date of latest publication of new National Standard or endorsement of this ETS (dop/e):	28 February 1997
Date of withdrawal of any conflicting National Standard (dow):	28 February 1997

Blank page

1 Scope

This ETS applies to the TETRA Packet Data Optimised (PDO) radio air interface standard with the specifications of layer 1, 2, 3, following the ISO model.

Concerning layer 1 it defines the radio aspects like modulation, radio transmission and reception, synchronisation, channel coding and multiplexing, radio link control.

It defines the layer 2 Logical Link Control (LLC) and Medium Access Control (MAC) service and protocol with the Protocol Data Units (PDUs).

Finally it specifies the layer 3 service and protocol of the packet connection mode and of the specific connectionless mode.

It defines also the service and protocol of the Mobility Management (MM) entity and of the Mobile Link Entity (MLE) sub-layer.

The annexes concern mainly the parameter values and layer 2 and 3 mechanisms.

2 Normative references

This ETS incorporates by dated and undated reference, provisions from other publications. These normative references are cited at the appropriate places in the text and the publications are listed hereafter. For dated references, subsequent amendments to or revisions of any of these publications apply to this ETS only when incorporated in it by amendment or revision. For undated references the latest edition of the publication referred to applies.

- [1] CCITT Recommendation Q.921: "ISDN User Network Interface - Data Link Layer Specification 1988 (Blue Book)".
- [2] ISO/IEC 8802-3: "Information technology - Local and metropolitan area networks - Part 3: Carrier sense multiple access with collision detection CSMA/CD access method and physical layer specifications".
- [3] ISO/IEC 7498: "Information technology - Open Systems interconnection - Basic Reference Model: The Basic Model".
- [4] ISO/IEC 8208: "Information technology - Data communications - X.25 packet Layer Protocol for Data Terminal Equipment".
- [5] ISO/IEC 8348: "Information technology - Open Systems Interconnection - Network Service Definition".
- [6] ISO/IEC 8473: "Information technology - Protocol for providing the connectionless-mode network service: Protocol specification".
- [7] ISO TR 8509: "Information processing systems - Open systems interconnection - Service conventions".
- [8] ISO 8648: "Information processing systems - Open Systems Interconnection - Internal organisation of the Network Layer".
- [9] ISO/IEC 8878: "Information technology - Telecommunications and information exchange between systems - Use of X.25 to provide the OSI Connection-mode Network Service".
- [10] ETS 300 113: "Radio Equipment and Systems (RES); Land mobile service; Technical characteristics and test conditions for non-speech and combined analogue speech/non-speech equipment with an internal or external antenna connector, intended for the transmission of data".

- [11] CCITT Recommendation X.25 (1988): "Interface between data terminal equipment (DTE) and data circuit-terminating equipment (DCE) for terminals operating in the packet mode and connected to public data networks by dedicated circuit".
- [12] ETS 300 392-1: "Radio Equipment and Systems (RES); Trans-European Trunked Radio (TETRA); Voice plus Data (V+D); Part 1: General network design".
- [13] ETS 300 392-2: "Radio Equipment and Systems (RES); Trans-European Trunked Radio (TETRA); Voice plus Data (V+D); Part 2: Air Interface (AI)".
- [14] ETS 300 393-1: "Radio Equipment and Systems (RES); Trans-European Trunked Radio (TETRA); Packet Data Optimized (PDO); Part 1: General network design".

3 Definitions, symbols and abbreviations

3.1 Definitions

For the purposes of this ETS, the following definitions apply:

access period: A time interval at which an MS is allowed to start to transmit a random access burst.

access window: A block of continuous access periods.

address mask: An overlay pattern that identifies which bits of a specimen address are considered relevant.

attached: A MS is said to be attached on a cell when the MS is camped and registered on the cell. The MS may be in idle mode, i.e. not actively processing a transaction, or in traffic mode, i.e. actively processing a transaction in reception and/or transmission.

camped: A MS is said to be camped on a cell when the MS is synchronised on the cell BS and has decoded the Master Block CHannel (MBCH) of the cell. The synchronization procedure is performed by the MAC and the interpretation of the Network information from the MBCH is performed by a procedure in the MLE. It is the MLE which decides when a MS is said to be camped on a cell.

current serving BS: The BS on one of whose channels the MS is currently operating.

event label: A short layer 2 address that can be used to replace one SSI or a group of SSI addresses.

improvable: The quality of the radio link can be improved, a better cell is found.

infrastructure: Used to denote either RPDI or SwMI.

LLC frame: An abstract data structure containing protocol control information (the LLC head), higher layer information (LLC body), and error protection information (LLC tail).

MAC burst: A connected and continuous sequence of blocks comprising one presiding block followed by zero, one or more following blocks. A MAC burst is equivalent to a MAC PDU.

Main Carrier Allocation (MCA): The list of main carriers to monitor. The main carrier allocation shall be contained in the cell re-selection parameters. Each cell shall its own main carrier allocation.

Main Control Carrier (MCC): The MCC is the carrier channel (or frequency) contained in the cell selection and re-selection parameters. The cell selection and re-selection parameters are contained in the master block on this channel. It is used to get at least a first access to the cell.

monitoring: Is the function of measuring signal quality (but not extracting broadcast information) from neighbouring cells while maintaining an uninterrupted service with the current serving cell.

preferred cell: A cell that is preferred to other cells at equal or near equal criterion.

relinquishable: The radio link shall be declared relinquishable when the criteria for release of the link are met allowing cell change procedures.

re-submission: Is an automatic repeat of a TL-DATA request primitive, if the expected TL-DATA confirmation is not received from layer 2. Re-submission is not the same as re-transmission: it is controlled by the layer-to-layer confirmation (by contrast, re-transmission uses a peer-to-peer acknowledge).

scanning: Is the function of measuring signal quality and extracting broadcast information from neighbouring cells. There are three different methods of scanning:

foreground: where scanning is the only activity and communications with the current serving cell are permanently interrupted;

background: where communications with the current serving cell are maintained in parallel with the scanning, and the scanning causes no interruption to that service;

interrupting: where the communications with the current serving cell are occasionally interrupted, but communications with the current cell are maintained in parallel with the scanning.

segment: A part of the information in a higher layer SDU. Each LLC Body contains one segment of the layer 2 SDU.

serving cell: Is the cell to which the MS is attached.

sub-burst number: The timing of sub-bursts.

subscriber class: A subscriber class has no other defined usage than offering a population subdivision. The operator defines the values and meaning of each class.

timebase: A device which determines the timing state of signals transmitted by a BS or MS.

3.2 Symbols

For the purposes of this ETS, the following symbols apply:

<AA>	Access Announce PDU
<AP>	Access Parameter PDU
<DDx>	Downlink Data type x PDU
<DRx>	Downlink Response type x PDU
<SINx>	System Information type x PDU
<UDx>	Uplink Data type x PDU
<UR>	Uplink Response PDU
<WU>	Wake Up PDU

3.3 Abbreviations

For the purposes of this ETS, the following abbreviations apply:

ACCH	Access Control CHannel
BS	Base Station
CONP	Connection Oriented Network Protocol
CRC	Cyclic Redundancy Check
DTCH	Downlink Traffic CHannel
FCS	Frame Check Sequence
FSN	Frame Sequence Number
L2	Layer 2
L3	Layer 3
LAP.T	Link Access Protocol for TETRA
LLC	Logical Link Control

LLME	Lower Layer Management Entity
LOD	LOw Duty cycle
MAC	Medium Access Control
MBCH	Master Block CHannel
MCC	Main Control Channel
MCCH	Master Control CHannel
MLE	Mobile Link Entity
MM	Mobility Management
MS	Mobile Station
NBCH	Normal Block CHannel
PDO	Packet Data Optimised
PDU	Protocol Data Unit
PUEM	Probability of Undetected Erroneous Message
RACH	Random Access CHannel
RCPC	Rate Compatible Punctured Convolutional (code)
RDC	Radio Downlink Counter
RPDI	Radio Packet Data Infrastructure
RPDN	Radio Packet Data Network
RR	Receiver Ready
SAP	Service Access Point
SCLNP	Specific Connectionless Network Protocol
SDU	Service Data Unit
SSI	Short Subscriber Identity
SSN	Segment Sequence Number
STM	STatistical Multiplexing
STMA	STatistical Multiple Access
TLA	A layer 2 SAP (TLA-SAP)
TLB	A layer 2 SAP (TLB-SAP)
TLC	A layer 2 SAP (TLC-SAP)
TNI	TETRA Network Identity
UTCH	Uplink Traffic CHannel
VLD	Very Low Duty cycle

4 Radio aspects

4.1 Introduction

This clause is an introduction to the radio aspects of TETRA PDO. It consists of a general description of the organisation of the radio-related functions with reference to the clauses where each part is specified in detail. It also introduces the reference configuration that will be used throughout this ETS.

4.2 Set of logical channels

The radio subsystem provides a certain number of logical channels as defined in clause 9. The logical channels represent the interface between the protocol and the radio.

4.3 Reference configuration

For the purpose of elaborating the specification of the radio-related functions, a reference configuration of the transmission chain is used as shown in figure 1. It should be noted that only the transmission part is specified, the receiver being specified only via the overall performance requirements. With reference to this configuration, the radio clauses address the following functional units:

- clause 9: burst building and logical channel multiplexing;
- clause 8: coding, re-ordering and interleaving, and scrambling;
- clause 5: differential encoding and modulation;
- clause 6: characteristics of transmitter and receiver.

This reference configuration also defines a number of points of vocabulary in relation to the names of bits at different levels in the configuration.

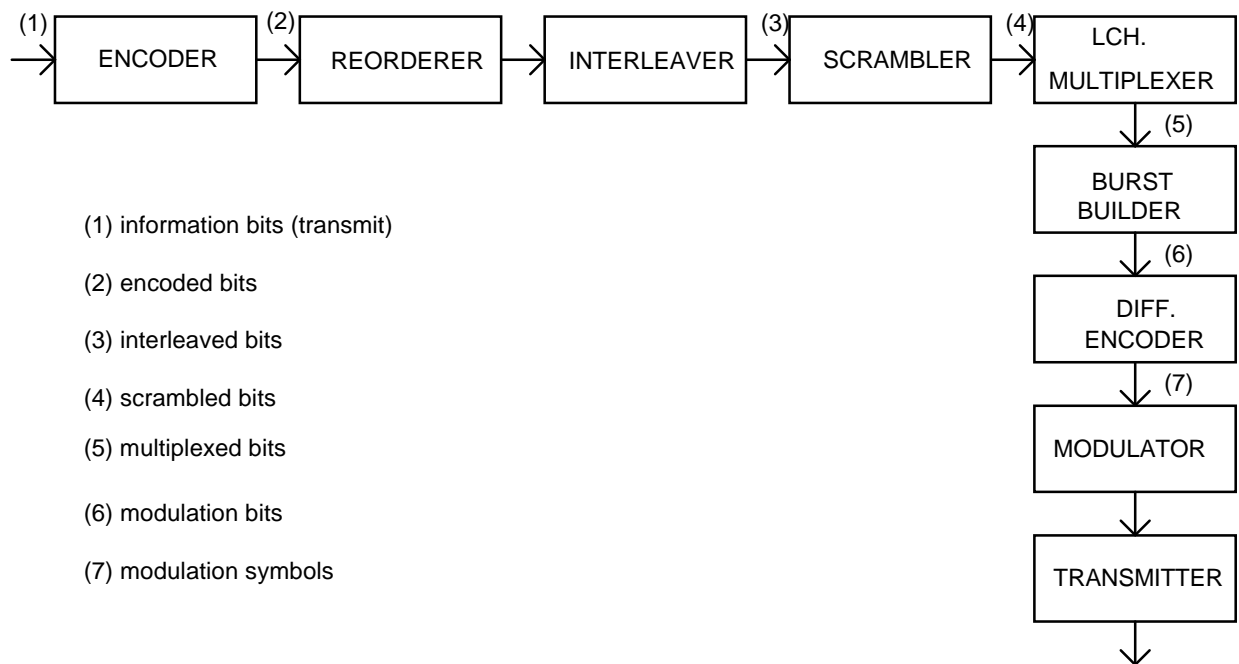

Figure 1: Reference configuration

4.4 Error control schemes

The different error control schemes are described in detail in clause 8.

4.5 Multiple access and time slot structure

The access schemes are Statistical Multiplexing (STM) for the downlink and Statistical Multiple Access (STMA) for the uplink. The carrier separation is 25 kHz.

The basic radio resources are sub-bursts, transmitting information at a modulation rate of 36 kbit/s. On the uplink there are four types of sub-bursts. On the downlink, there are two types of sub-bursts.

The following briefly introduces the structures of sub-bursts and bursts. The appropriate specifications are as in clause 9.

4.5.1 Sub-bursts

4.5.1.1 Downlink sub-bursts

On the downlink, there are two types of sub-bursts: the downlink synchronisation sub-burst, and the downlink normal sub-burst. These two sub-bursts carry 240 modulation bits, and have a duration of $20/3 \approx 6,67$ ms.

4.5.1.2 Uplink sub-bursts

On the uplink, there are four types of sub-bursts:

- the uplink start sub-burst, which carries 250 modulation bits and has a duration of $125/18 \approx 6,94$ ms;
- the uplink even sub-burst, which carries 238 modulation bits and has a duration of $119/18 \approx 6,61$ ms;
- the uplink odd sub-burst, which carries 216 modulation bits and has a duration of 6 ms;
- the uplink end sub-burst, which shall carry 4 modulation bits, and shall have a duration of $1/9 \approx 0,11$ ms.

4.5.2 Bursts

A burst is subdivided into one or more sub-bursts.

A diagrammatic representation of the burst structure is given in figure 2 for the downlink, and in figure 3 for the uplink.

4.5.2.1 Downlink bursts

On the downlink, there are two types of bursts:

- the master burst, which contains one downlink synchronisation sub-burst;
- the normal downlink burst, which contains a variable number of downlink normal sub-bursts.

4.5.2.2 Uplink bursts

On the uplink, there are two types of bursts:

- the uplink burst with normal linearization;
- the uplink burst with long linearization.

These bursts are subdivided into one uplink start sub-burst, a variable number of uplink even sub-bursts and uplink odd sub-bursts and one uplink end sub-burst.

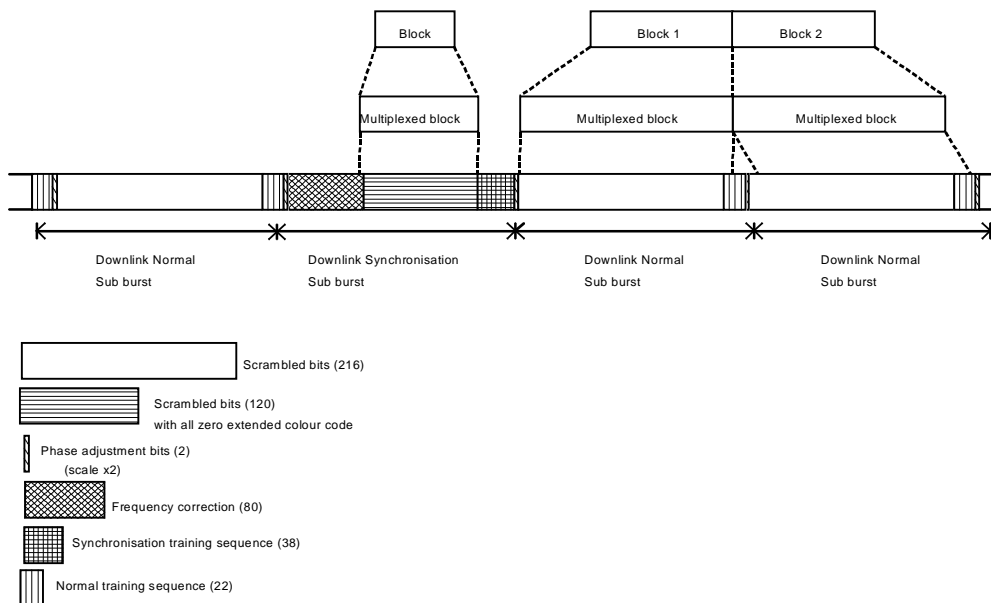

Figure 2: PDO downlink bursts

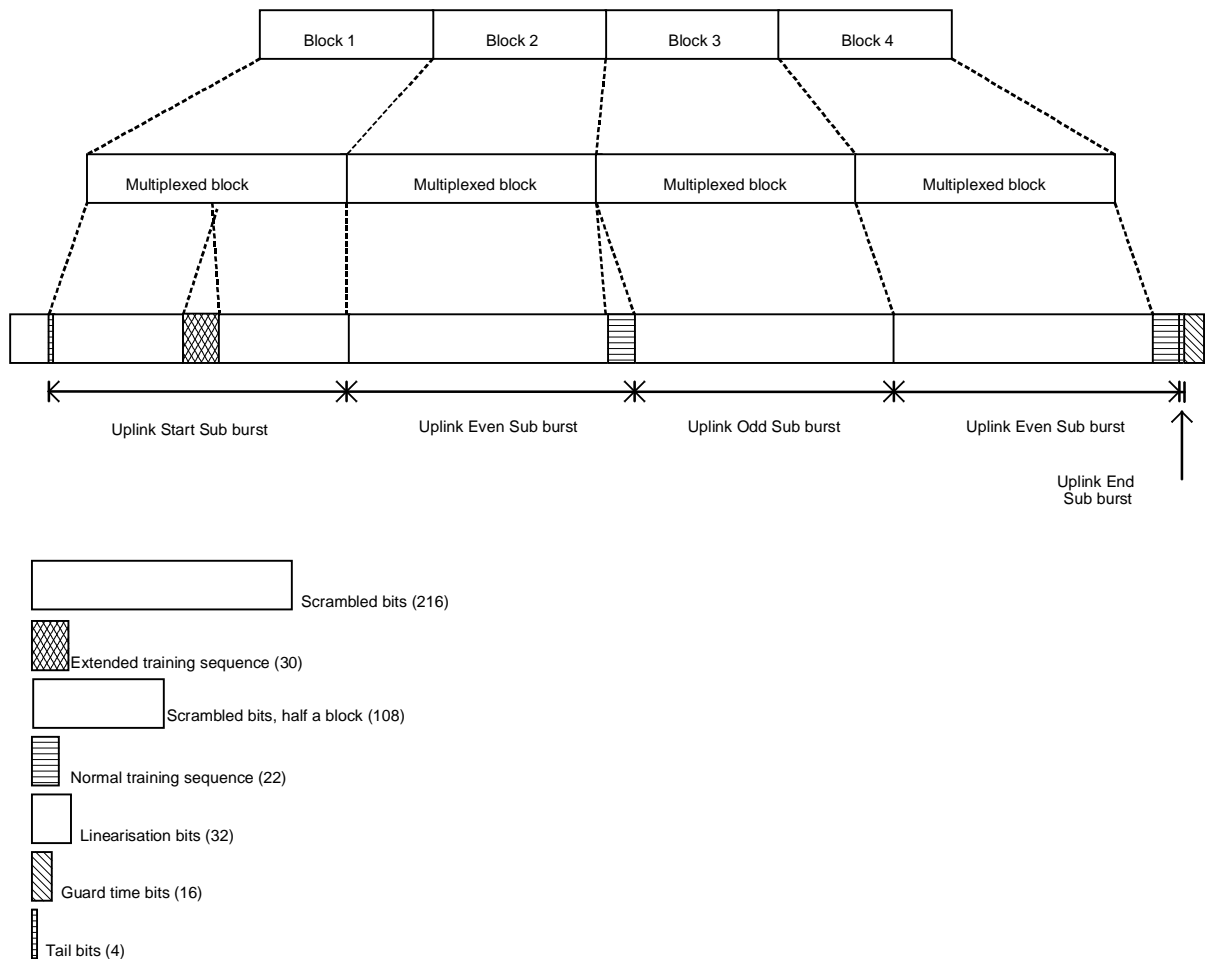

Figure 3: PDO uplink bursts

4.6 Coding, interleaving and scrambling

The coding, interleaving and scrambling schemes associated with each logical channel are specified in clause 8.

4.7 Modulation

The modulation scheme is $\pi/4$ -DQPSK with root-raised cosine modulation filter and a roll-off factor of 0,35. The modulation rate is 36 kbit/s. This scheme is specified in detail in clause 5.

4.8 Transmission and reception

The modulated stream is transmitted on a radio frequency carrier.

The specific RF channels, together with the requirements on the transmitter and the receiver characteristics are specified in clause 6.

For Base Stations (BS) and Mobile Stations (MS) power classes are as defined in clause 6.

4.9 Other radio-related functions

Transmission involves other functions. These functions, which may necessitate the handling of specific protocols between BS and MS, are the radio subsystem synchronisation, and the radio subsystem link control.

The synchronisation incorporates frequency and time acquisition by the receiver.

The requirements on synchronisation are specified in clause 7.

The radio link control incorporates adaptive power control. This function aims at the adjustment of the RF transmit power, in order to ensure that the required quality is achieved with the least possible radiated power. This function is managed by the MS. The motivations for this function are battery saving and reduction of the interference level.

4.10 Performance

Under typical urban fading conditions, i.e. multipath delays no greater than 5 μs, the quality threshold is reached at a C/I_c (co-channel interference) value of 19 dB, and the dynamic reference sensitivity level is - 106 dBm for BSs and - 103 dBm for mobile equipment. Details of performance requirements in various channel conditions are given in clause 6.

5 Modulation

5.1 Introduction

The following subclauses apply to the baseband part of the transmitter.

5.2 Modulation type

The modulation used shall be π/4-shifted Differential Quaternary Phase Shift Keying (π/4-DQPSK).

5.3 Modulation rate

The modulation rate shall be 36 kbit/s.

5.4 Modulation symbol definition

$B(m)$ denotes the modulation bit of a sequence to be transmitted, where m is the bit number. The sequence of modulation bits shall be mapped onto a sequence of modulation symbols $S(k)$, where k is the corresponding symbol number.

The modulation symbol $S(k)$ shall result from a differential encoding. This means that $S(k)$ shall be obtained by applying a phase transition $D\phi(k)$ to the previous modulation symbol $S(k-1)$, hence, in complex notation:

$$S(k) = S(k - 1) \exp(jD\phi(k))$$

$$S(0) = 1$$

The above expression for $S(k)$ corresponds to the continuous transmission of modulation symbols carried by an arbitrary number of bursts. The symbol $S(0)$ is the symbol before the first symbol of the first burst and shall be transmitted as a phase reference.

The phase transition $D\phi(k)$ shall be related to the modulation bits as given in table 1.

Table 1: Phase transitions

$B(2k-1)$	$B(2k)$	$D\phi(k)$
1	1	$-3\pi/4$
0	1	$+3\pi/4$
0	0	$+\pi/4$
1	0	$-\pi/4$

The complex modulation symbol $S(k)$ shall take one of the eight values $\exp(j n\pi/4)$, where $n = 2, 4, 6, 8$ for even k and $n = 1, 3, 5, 7$ for odd k . The constellation of the modulation symbols and the possible transitions between them are as shown in figure 4.

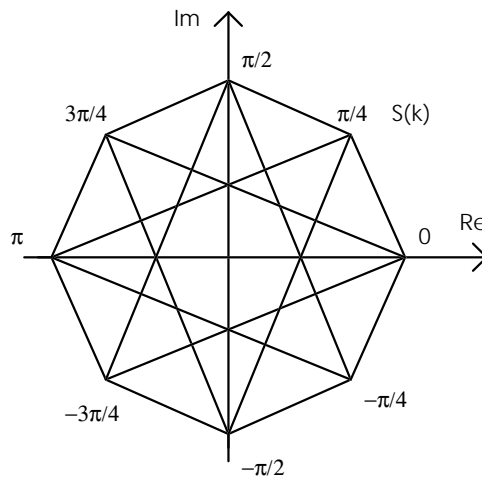

Figure 4: Modulation symbol constellation and possible transitions

5.5 Modulated signal definition

The modulated signal, at carrier frequency f_c , shall be given by:

$$M(t) = \text{Re}\{s(t) \exp(j(2\pi f_c t + \phi_0))\}$$

where:

- ϕ_0 is an arbitrary phase;
- $s(t)$ is the complex envelope of the modulated signal defined as:

$$s(t) = \sum_{k=0}^K S(k)g(t - t_k)$$

where:

- K is the maximum number of symbols;
- T is the symbol duration;
- $t_k = kT$ is the symbol time corresponding to modulation symbol $S(k)$;
- $g(t)$ is the ideal symbol waveform, obtained by the inverse Fourier transform of a square-root raised cosine spectrum $G(f)$, defined as follows:

$$G(f) = 1 \quad \text{for} \quad |f| \leq (1 - \alpha)/2T$$

$$G(f) = \sqrt{0.5(1 - \sin(\pi(2|f|T - 1)/2\alpha))} \quad \text{for} \quad (1 - \alpha)/2T \leq |f| \leq (1 + \alpha)/2T$$

$$G(f) = 0 \quad \text{for} \quad |f| \geq (1 + \alpha)/2T$$

where α is the roll-off factor, which determines the width of the transmission band at a given symbol rate.

The value of α shall be 0,35. For practical implementation, a time limited windowed version of $g(t)$, designed under the constraints given by the specified modulation accuracy and adjacent channel attenuation may be applied.

5.6 Modulation filter definition

The ideal modulation filter shall be a linear phase filter which is defined by the magnitude of its frequency response $|H(f)| = G(f)$.

5.7 Modulation block diagram

A block diagram of the modulation process is shown on figure 5. This diagram is for explanatory purposes and does not prescribe a specific implementation. The modulation filter excited by the complex Dirac impulse function $S(k)\delta(t-t_k)$ ideally has an impulse response $g(t)$.

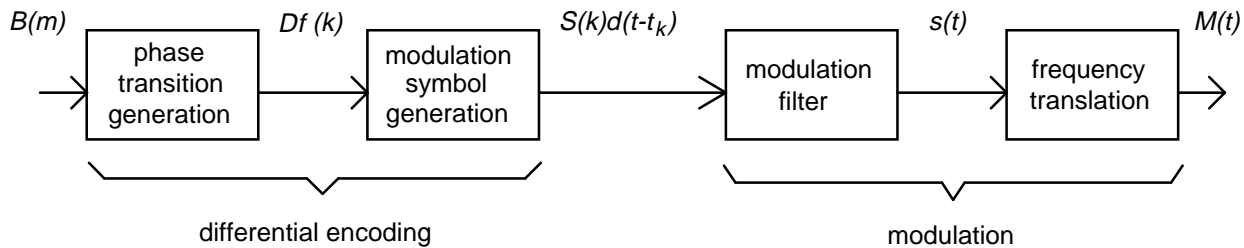

Figure 5: Block diagram of the modulation process

6 Radio transmission and reception

6.1 Introduction

This clause defines the requirements for the MS and the BS transceiver of the TETRA PDO system. This clause is applicable to TETRA systems operating at radio frequencies of 380 MHz to 520 MHz.

NOTE: The values specified in this clause are based on calculations, simulations, or existing standards. It is, therefore, essential that these values are confirmed during the validation phase. The values for the number of RF carriers, the guard band and the duplex spacing should be specified when detailed frequency allocations and band plans for TETRA are known.

6.2 Frequency bands and channel arrangement

When used in dedicated TETRA bands, TETRA MSs shall transmit in the TETRA uplink band, TETRA BSs shall transmit in the TETRA downlink band. The uplink and downlink bands are of equal width. Their edges shall be as follows:

- $F_{up, min} - F_{up, max}$ (MHz): mobile transmit, base receive;
- $F_{dw, min} - F_{dw, max}$ (MHz): base transmit, mobile receive.

The TETRA RF carrier separation shall be 25 kHz. The uplink and downlink bands are divided into N RF carriers. In order to ensure the compliance with the radio regulation outside the band, a guard band of G kHz is needed at each side of both uplink and downlink bands.

The centre frequencies of uplink RF carriers, $F_{up,c}$ shall be given by:

$$F_{up,c} = F_{up,min} + 0,001G + 0,025(c - 0,5) \text{ (MHz)}, \text{ for } c = 1, \dots, N,$$

and the corresponding centre frequency of downlink RF carriers, $F_{dw,c}$ shall be given by:

$$F_{dw,c} = F_{up,c} + D \text{ for } c = 1, \dots, N.$$

When a TETRA system is operated in frequency bands used for analogue PMR, the uplink and downlink transmit and receive centre frequencies and the duplex spacing (D) will be allocated by the National Regulatory Administration (NRA).

In all frequency bands, the uplink and downlink frequencies shall be allocated independently and with a minimum spacing of E MHz.

6.3 Reference test planes

For the purpose of testing, all TETRA stations shall have at least one antenna connector. Measurements shall be carried out at the appropriate antenna connector of the equipment as specified by the manufacturer (1T, 1R or 2 in figure 6). If the equipment is provided with a built-in duplex filter or a separate associated filter, the requirements of this standard shall be met when the measurements are carried out using the antenna connector of this filter. In case of equipment comprising several transmitters, only one transmitter shall be transmitting during all measurements, except for measuring intermodulation attenuation.

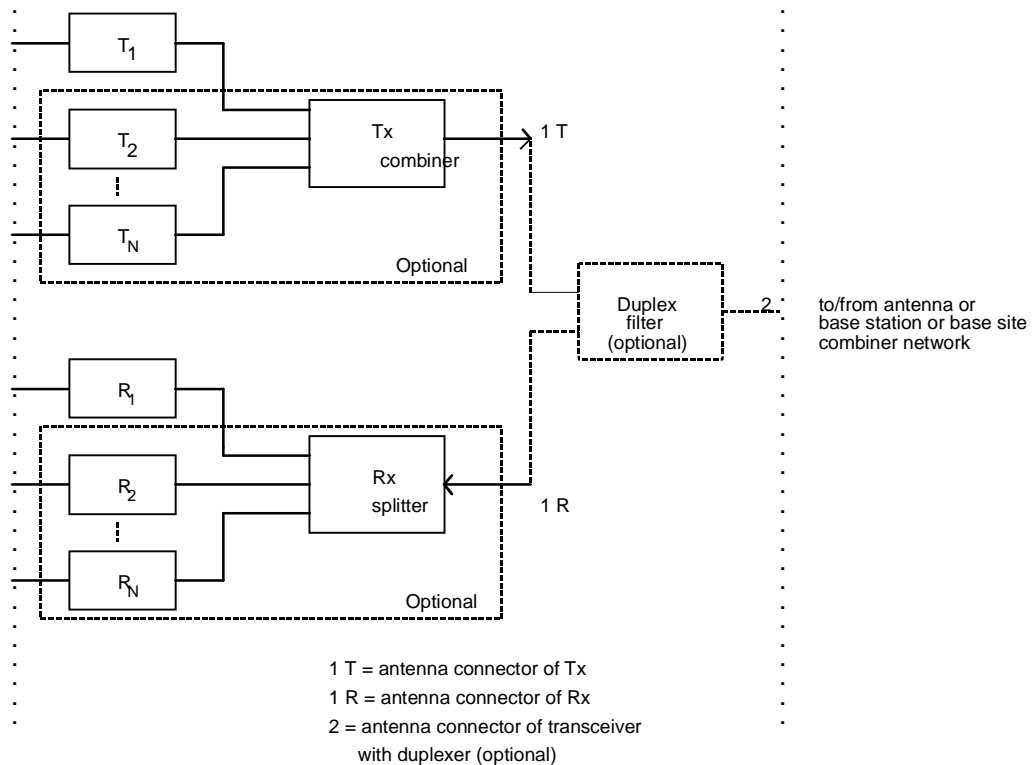

Figure 6: Reference interconnection of transmitters and receivers at BS

6.4 Transmitter characteristics

6.4.1 Output power

In the following subclauses, power is defined as the average power, measured through the square-root raised cosine filter defined in clause 5 over the scrambled bits of one transmitted burst as defined in clause 9.

The power at which MSs or BSs may operate are specified in the following subclauses.

6.4.1.1 BS

The BS transmitter nominal power shall be, according to its class, as defined in table 2:

Table 2: Nominal power of BS transmitters

Power class	Nominal power per carrier
1 (40 W)	46 dBm
2 (25 W)	44 dBm
3 (15 W)	42 dBm
4 (10 W)	40 dBm
5 (6,3 W)	38 dBm
6 (4 W)	36 dBm
7 (2,5 W)	34 dBm
8 (1,6 W)	32 dBm
9 (1 W)	30 dBm
10 (0,6 W)	28 dBm

6.4.1.2 MS

The MS nominal power shall be, according to its class, as defined in table 3:

Table 3: Nominal power of MS transmitters

Power class	Nominal power
1 (30 W)	45 dBm
2 (10 W)	40 dBm
3 (3 W)	35 dBm
4 (1 W)	30 dBm

The different power levels needed for adaptive power control (see clause 10) shall have the values as defined in table 4, starting from the minimum power control level of 15 dBm (step level 7) up to the nominal power level corresponding to the class of the particular MS as stated in table 3.

Table 4: MS power control levels

Step level	Power
1	45 dBm
2	40 dBm
3	35 dBm
4	30 dBm
5	25 dBm
6	20 dBm
7	15 dBm

6.4.2 Unwanted conducted emissions

6.4.2.1 Definitions

Unwanted emissions are defined as conducted emissions at frequencies or time intervals outside the allocated channel. The specified limits shall be met under realistic conditions, for instance under varying antenna mismatch. Unless otherwise stated, unwanted emissions are specified for an equipment in the active transmit state, i.e. whenever this equipment transmits bursts, or whenever it ramps-up and/or linearizes or ramps-down. The non-active transmit state is a state occurring during two timeslot durations (approximately 28 ms) before and after any active transmit state.

An equipment is said to be in the non-transmit state whenever it is not in the active or non-active transmit state (refer to figure 7).

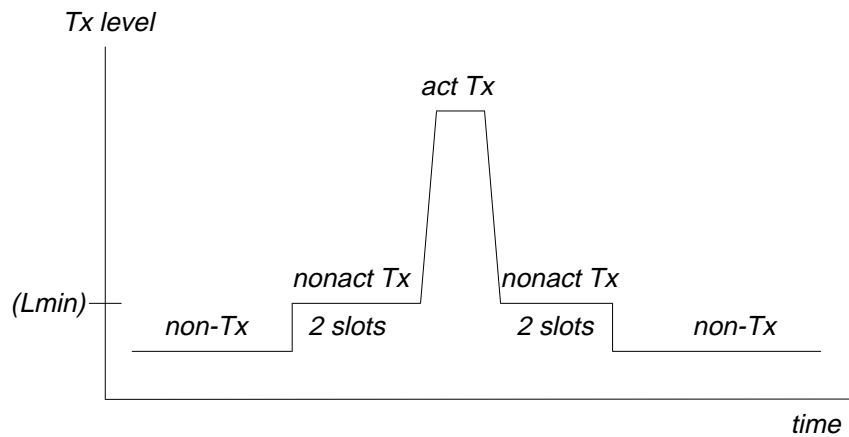

Figure 7: Schematic presentation of transmitter states

6.4.2.2 Unwanted emissions close to the carrier

The following emissions shall be measured through the square-root raised cosine filter with a roll-off factor of 0,35, as defined in clause 5.

Measurements shall be done at the nominal centre frequency and at frequency offsets specified below. When applicable, relative measurements (dBc) shall refer to the level measured at the nominal centre frequency.

6.4.2.2.1 Measurement over the useful part of the burst

The levels given in table 5 shall not be exceeded at the listed frequency offsets from the nominal carrier frequency.

Table 5: Maximum adjacent power levels

Frequency offset	Max. level
25 kHz	- 60 dBc
50 kHz	- 70 dBc
75 kHz	- 70 dBc

In any case, no requirement in excess of - 36 dBm shall apply.

The specifications assume that the centre frequency is at the above listed frequency offsets from the nominal carrier frequency. The measured values shall be averaged over the scrambled bits of the burst (see clause 9). The scrambled bits shall have a pseudo-random distribution from burst to burst.

6.4.2.2.2 Measurement during the switching transients

At the frequency offset from the nominal carrier frequency given below, peak power measurements shall be done, covering at least the ramp-up period and the ramp-down period (figure 7, periods t_1 and t_3). See subclause 6.4.5 for definition of t_1 and t_3 . The following maximum hold level for a frequency offset of 25 kHz shall not be exceeded:

- maximum level: - 50 dBc.

This requirement does not apply to linearization channels.

In any case no requirement in excess of - 36 dBm shall apply.

6.4.2.3 Unwanted emissions far from the carrier

These unwanted emissions are emissions (discrete, wideband noise, modulated or un-modulated) occurring at offsets of equal to or greater than 100 kHz from the carrier frequency, measured in the frequency range 9 kHz to 4 GHz.

- Discrete spurious:
 - the maximum allowed power for each spurious emission shall be less than - 36 dBm measured in 100 kHz bandwidth. The lower part of the spectrum (near to 9 kHz) is subject to specific measurement methods.
- Wideband noise:
 - the following wideband noise levels, measured through the modulation filter defined in subclause 5.6 should not exceed the limits shown in the following table for the power classes as stated and at the listed offsets from the nominal carrier frequency. All levels are expressed in dBc relevant to the actual transmitted power level, and in any case no limit tighter than - 70 dBm shall apply. The requirements apply symmetrically to both sides of the transmitter band.

Table 6: Wideband noise limits

Frequency offset	Maximum level			
	1W class	3W class	10W class	30W class
100 kHz - 250 kHz	- 75 dBc	- 78 dBc	- 80 dBc	- 80 dBc
250 kHz - 500 kHz	- 80 dBc	- 83 dBc	- 85 dBc	- 85 dBc
500 kHz - Receiver band edge	- 80 dBc	- 85 dBc	- 90 dBc	- 90 dBc
In receiver band and further away	- 100 dBc	- 100 dBc	- 100 dBc	- 100 dBc

6.4.2.4 Unwanted emissions during the CLCH and BLCH

The following emissions shall be measured through a square-root raised cosine filter with a roll-off factor of 0,35 as defined in clause 5.

Peak transmitter power appearing at a frequency offset from the carrier of ± 25 kHz during the CLCH and BLCH shall not exceed - 30 dBc for a maximum period of 1 ms. At all other times during the CLCH and BLCH period emissions shall not exceed - 45 dBc.

NOTE: 0 dBc refers to the transmit power during normal operation after the CLCH or BLCH.

6.4.2.5 Unwanted emissions in the non-transmit state

The specifications of subclause 6.5.4.2 apply.

6.4.3 Unwanted radiated emissions

Unwanted radiated emissions are emissions (whether modulated or un-modulated) radiated by the cabinet and structure of the equipment (MS or BS) in the non-TX state. This is also known as cabinet radiation.

The limits given in subclause 6.4.2.3 shall apply.

6.4.4 Radio frequency tolerance

The radio frequency tolerance for BSs and MSs is defined in clause 7.

6.4.5 RF Output power time mask

The transmit level versus time mask for TETRA station transmission is shown in figure 8. For the time mask as specified in the figure, the power level of 0 dBc refers to the nominal output power level of the TETRA station under consideration.

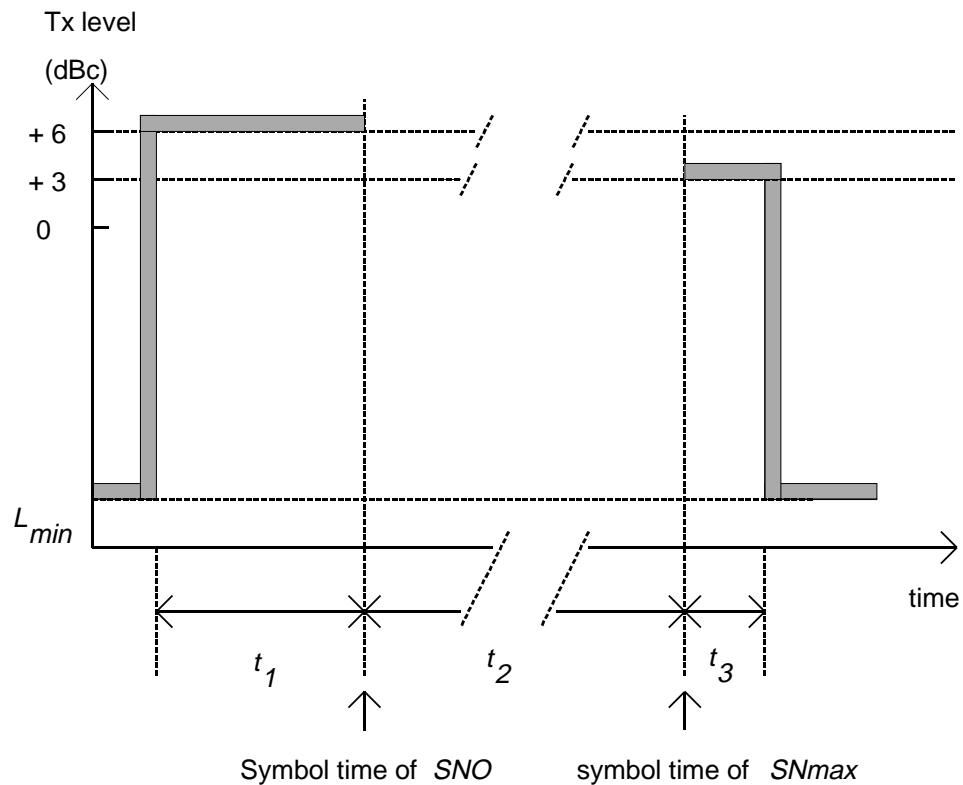

Figure 8: Transmit level versus time mask

Table 7: Transmit level versus time mask symbol durations

Burst Type	t_1	t_2	t_3
Normal uplink	16	see clause 9	7
Long uplink	72	see clause 9	7
Downlink	7	see clause 9	7
NOTE: In the case of single slot transmission. In the case of continuous downlink transmission, the start and stop bursts as defined in subclause 9.4.5.1 are included in the time t_2 of the time mask.			

Whenever bursts are consecutively transmitted by the same TETRA station on the same frequency, the transmit level versus time mask applies at the beginning of the transmission of the first burst and at the end of the transmission of the last burst.

The symbol numbers referred to as SNO and $SNmax$ are defined in clause 9. The timing of the transmitted bursts is specified in clause 7. The time periods t_1 , t_2 and t_3 , whose durations are stated in table 7, are defined in the following way:

- the time t_1 starts at the beginning of the ramp-up of the first burst, and expires just before the symbol time of SNO ;
- the time t_2 starts at the symbol time of SNO of the first burst and finishes at the symbol time of $SNmax$ of the last burst;
- the time t_3 starts just after the symbol time of $SNmax$ of the last burst and finishes at the end of the ramp-down.

In this subclause, the specifications of subclauses 6.4.1 and 6.6.1 shall apply during the time t_2 . The output power shall be measured through the square-root raised cosine filter with a roll off factor of 0,35 as defined in clause 5.

6.4.5.1 BS

The BS output power shall be at the nominal level, as specified in subclause 6.4.1.1. Power control shall not be applied to the downlink transmissions.

In the non-active transmit state the specification $L_{min} = -40$ dBc shall apply.

The peak transmit power during BLCH shall not exceed +6 dBc.

6.4.5.2 MS

The MS output power shall be able to be reduced by steps of 5 dB, down to a minimum level of 15 dBm. The power levels that can be achieved, according to the class of the MS, are detailed in subclause 6.4.1.2.

In the non-active transmit state the specification $L_{min} = -70$ dBc shall apply. In any case, no requirement more stringent than -40 dBm shall apply.

6.4.6 Intermodulation attenuation

6.4.6.1 Definition

The intermodulation attenuation is the ratio of the power level of the wanted signal to the power level of an intermodulation component. It is a measure of the capability of the transmitter to inhibit the generation of signals in its non-linear elements caused by the presence of the useful carrier and an interfering signal reaching the transmitter via its antenna.

6.4.6.2 BS

In the case of BS equipment with only one transmitter, not collocated with other radio equipment operating in the TETRA frequency band, the intermodulation attenuation shall be at least 40 dB for any intermodulation component when measured in a 30 kHz bandwidth. The interfering signal shall be un-modulated and have a frequency offset of at least 100 kHz from the carrier frequency. The power level of the interfering signal shall be 30 dB below the power level of the modulated output signal from the transmitter under test.

For all other cases, the intermodulation attenuation of the BS equipment shall be at least 70 dB for any intermodulation component when measured in a 30 kHz bandwidth. The interfering signal shall be un-modulated and have a frequency offset of at least 100 kHz from the carrier frequency. The power level of the interfering signal shall be 30 dB below the power level of the modulated output signal from the transmitter under test. If the intermodulation attenuation is achieved by additional, internal or external, isolating devices they shall be included in the measurements.

In any case no requirement more stringent than -36 dBm shall apply to intermodulation components.

All power levels stated in the cases above refer to the antenna connector of the BS described in subclause 6.4.

6.4.6.3 MS

In an MS, intermodulation may be caused when operating transmitters in the close vicinity of each other.

For an MS transmitter operating at the nominal power defined by its class, the intermodulation attenuation shall be at least 60 dB for any intermodulation component when measured in 30 kHz bandwidth. The interfering signal shall be un-modulated and have a frequency offset of at least 100 kHz from the carrier frequency. The power level of the interfering signal shall be 50 dB below the power level of the modulated output signal from the transmitter under test.

6.4.7 Intra-BS intermodulation requirements

In a BS, intermodulation may be caused by combining several transmitters and carriers to feed a single antenna.

For all transmitters of a single TETRA BS operating at the maximum allowed power, the peak power of any intermodulation components, when measured in a 30 kHz bandwidth, shall not exceed - 60 dBc in the relevant downlink frequency band. In any case no requirement more stringent than - 36 dBm shall apply.

NOTE: The value of - 60 dBc refers to the carrier power measured at the antenna connector of the BS described in subclause 6.3.

In the case where the performance is achieved by additional internal or external isolating devices (such as circulators) they shall be supplied at the time of conformance testing and shall be used for measurements.

6.5 Receiver characteristics

In this clause, the levels of the test signals are given in terms of power levels (dBm) at the antenna connector of the receiver. For the definition of power level refer to subclause 6.4.1.

Sources of test signals shall be connected in such a way that the impedance presented to the receiver input is a 50 Ω non-reactive impedance.

This requirement shall be met irrespective of whether one or more signals using a combining network are applied to the receiver simultaneously.

Static propagation conditions are assumed in all cases, for both wanted and unwanted signals.

6.5.1 Blocking characteristics

6.5.1.1 Definition

Blocking is a measure of the capability of the receiver to receive a modulated wanted input signal in the presence of an unwanted un-modulated input signal on frequencies other than those of the spurious responses or the adjacent channels, without this unwanted input signal causing a degradation of the performance of the receiver beyond a specified limit.

6.5.1.2 Specification

The blocking performance specification shall apply at all frequencies except those at which spurious responses occur (see subclause 6.5.2).

The static reference sensitivity performance as specified in subclause 6.6.2.4 shall be met when the following signals are simultaneously input to the receiver:

- a wanted signal at the nominal receive frequency f_0 , 3 dB above the static reference sensitivity level as specified in subclause 6.6.2.4;
- a continuous sine wave signal at a frequency offset from f_0 and level as defined in table 8.

Table 8: Blocking levels of the receiver

Offset from nominal Rx freq	Level of interfering signal
50 kHz to 100 kHz	- 40 dBm
100 kHz to 200 kHz	- 35 dBm
200 kHz to 500 kHz	- 30 dBm
> 500 kHz	- 25 dBm

6.5.2 Spurious response rejection

6.5.2.1 Definition

Spurious response rejection is a measure of the capability of a receiver to receive a wanted modulated signal without exceeding a given degradation due to the presence of an unwanted un-modulated signal at any other frequency at which a response is obtained, i.e. for which the blocking limit is not met.

6.5.2.2 Specification

The static reference sensitivity performance as specified in subclause 6.6.2.4 shall be met when the following signals are simultaneously applied to the receiver:

- a wanted signal at nominal receive frequency f_o , 3 dB above the static reference sensitivity level as specified in subclause 6.6.2.4;
- a continuous sine wave signal at frequency f as defined below at a level of - 45 dBm.

For any frequency within a limited frequency range, defined below at which the blocking specification of subclause 6.5.1.2 is not met. The number of such spurious responses shall not exceed $0,05 \times$ (number of frequency channels in the limited frequency range).

The limited frequency range is defined as the frequency of the local oscillator signal f_{lo} applied to the first mixer of the receiver plus or minus the sum of the intermediate frequencies (f_{i1}, \dots, f_{in}) and a half of the switching range (sr) of the receiver.

Hence the frequency f_l of the limited frequency range is:

$$f_{lo} - \sum_{j=1}^n f_{ij} - \frac{sr}{2} \leq f_l \leq f_{lo} + \sum_{j=1}^n f_{ij} + \frac{sr}{2}$$

where the receiver switching range (sr) is the maximum frequency range over which the receiver can be operated without reprogramming or realignment as declared by the manufacturer.

6.5.3 Intermodulation response rejection

6.5.3.1 Definition

Intermodulation response rejection is a measure of the capability of the receiver to receive a wanted modulated signal without exceeding a given degradation due to the presence of two or more unwanted signals with a specific frequency relationship to the wanted signal frequency as defined in ETS 300 113 [10].

6.5.3.2 Specification

The static reference sensitivity performance as specified in subclause 6.6.2.4 shall be met when the following signals are simultaneously input to the receiver:

- a wanted signal at the nominal receive frequency f_o , 3 dB above the static reference sensitivity level;
- a continuous sine wave signal at frequency f_1 and with a level of - 47 dBm;
- a pseudo-random sequence TETRA modulating a signal at frequency f_2 , with a level of - 47 dBm, such that $f_o = 2f_1 - f_2$ and $|f_2 - f_1| = 50$ kHz.

6.5.4 Unwanted conducted emissions

6.5.4.1 Definition

Unwanted emissions from the equipment when in reception are defined as conducted emissions at any frequency, when the equipment is in the non-transmit state.

6.5.4.2 Specification

The peak power emitted by the equipment shall not exceed - 57 dBm at frequencies between 9 kHz and 1 GHz and - 47 dBm at frequencies from 1 GHz to 4 GHz, as measured in the bandwidth of 30 kHz.

6.5.5 Unwanted radiated emissions

Unwanted radiated emissions are emissions radiated by the cabinet and structure of the equipment (MS or BS) in the non-TX state. This is also known as cabinet radiation.

The limits given in subclause 6.5.4.2 shall apply.

6.6 Transmitter/receiver performance

Subclause 6.6.1 specifies the modulation accuracy requirement, by setting limits on the Root Mean Square (RMS) error between the actual transmitted signal waveform and the ideal signal waveform. Subclause 6.6.2 specifies the receiver performance, assuming that transmit errors do not occur. Subclause 6.6.3 specifies all the propagation models that are defined in this ETS.

6.6.1 Modulation accuracy

The specified requirement is vector error magnitude. This does not only take into account modulation filtering linear distortion (amplitude and phase) or modulator impairments (quadrature offset, phase and linear amplitude errors in the modulation symbol constellation) but is a measure of the whole transmitter quality. It also takes into account local oscillator phase noise, filter distortion, and non-linearity of amplifiers. Vector error magnitude shall be specified at symbol time (see subclause 6.6.1.2) and the vector error magnitude requirement shall be fulfilled by the TETRA equipment with maximum and with minimum power levels (as defined in subclause 6.4.1).

6.6.1.1 Ideal case

The modulation symbol $s(t)$ transmitted by an ideal transmitter having a filter impulse response $g(t)$ is defined in clause 5.

Let $Z(k)$ denote the output of an ideal receive filter with impulse response $g^*(-t)|_{t=t_k}$. The ideal transmit and receive filters in cascade form a raised cosine Nyquist filter, having a symbol waveform going through zero at symbol duration intervals, so there is no inter-symbol interference at any instant $t = t_k$, where t_k is the symbol time corresponding to the k -th symbol (as defined in clause 5).

In this case, the output of an ideal receive filter at any instant t_k , stimulated by an ideal transmitter, will be equal to the k -th modulation symbol $S(k)$:

$$Z(k) = s(t) * g^*(-t)|_{t=t_k} = S(k)$$

In this subclause, the numbering of the modulation symbols used is the one defined in clause 9.

6.6.1.2 Vector error magnitude requirement at symbol time

Let $Z(k)$ be the output produced by observing the real transmitter through the ideal receive filter at symbol time t_k . $Z(k)$ is modelled as:

$$Z(k) = \{C_0 + [S(k) + E(k)]\} C_1 W(k)$$

where:

- $E(k)$ is the vector error of modulation symbol $S(k)$;
- $W(k) = \exp(jk\theta)$ accounts for a frequency offset giving θ radians per symbol phase rotation due to transmitter frequency inaccuracy (see clause 7). The possible amplitude variations shall be integrated in the vector error;
- C_0 is a complex constant characterising the residual carrier;
- C_1 is a complex constant representing the output amplitude and initial phase of the transmitter.

The magnitude of C_0 shall be less than 5 % of the magnitude of $S(k)$. The task of the test receiver is then to:

- estimate the symbol time for processing the receive part;
- estimate the values of C_0 , C_1 and θ . The resulting estimates shall be denoted by C_0' , C_1' and θ' respectively;
- perform a normalization of the modulation symbol $Z(k)$ accordingly. The modulation symbol that results from this normalization shall be denoted by $Z'(k)$:

$$Z'(k) = \left[Z(k) \exp(-jk\theta') / C_1' \right] - C_0'$$

With the above notations, the Sum Square Vector Error (SSVE) is defined as:

$$SSVE = \sum_{k=1}^{SNmax} | Z'(k) - S(k) |^2$$

where $SNmax$ is the number of symbols in the burst.

The RMS vector error is then computed as the square root of the sum-square vector error divided by the number of symbols in the burst:

$$RMSVE = \sqrt{SSVE / SNmax}$$

The RMS vector error in any burst shall be less than 0,1.

The peak vector error magnitude $|Z'(k) - S(k)|$ shall be less than 0,3 for any symbol.

6.6.2 Receiver performance

This subclause specifies the minimum required receiver performance in terms of Bit Error Ratio (BER), Message Erasure Rate (MER) or Probability of Undetected Erroneous Message (PUEM) (whichever is appropriate), taking into account that transmitter errors do not occur, and that the transmitter shall be tested separately (see subclause 6.6.1).

In this subclause, the levels of the test signals are given in terms of power levels (dBm) at the antenna connector of the receiver. For the definition of power level refer to subclause 6.4.1.

Three equipment classes are specified, distinguishing their intended operating environments and testing conditions. The classes have preferred operating conditions, as follows:

- **Class B** equipment is optimised for use in built-up and urban areas. The specification guarantees good performance at the reference sensitivity and interference level in static and TU50 conditions, but not in extreme propagation conditions (hilly terrain);
- **Class A** equipment is optimised for use in urban areas and in areas with hilly or mountainous terrain. It is resilient to extreme propagation conditions (hilly terrain) and is specified in static, TU50 and HT200 conditions;
- **Class E** equipment comprises an equaliser and is specified in static, TU50 and EQ200 conditions. It is not applicable to BS equipment.

6.6.2.1 Nominal error rates

This subclause describes the transmission requirements in terms of error rates in nominal conditions i.e. without interference and with an input level of - 85 dBm. The relevant propagation conditions are given in subclause 6.6.3.

Under the following propagation conditions, the BER of the non-protected bits shall have the limits given in table 9.

Table 9: Nominal error rates

Propagation model	BER	Equipment class
static	0,01 %	A, B, E
TU50	0,40 %	A, B, E
HT200	3,00 %	A
EQ200	2,00 %	E

This performance shall be maintained up to - 40 dBm input level for the static conditions, and multipath conditions. Furthermore, for static conditions, a BER of < 0,1 % shall be maintained up to - 20 dBm.

6.6.2.2 Dynamic reference sensitivity performance

The minimum required dynamic reference sensitivity performance is specified according to the logical channel, the propagation condition and the receiver class at the dynamic reference sensitivity level. The dynamic reference sensitivity level shall be:

- for MS: - 103 dBm;
- for BS: - 106 dBm.

Table 10 and table 11 give the minimum required dynamic reference sensitivity performance for TU50, HT200 or QS200 propagation conditions. For NBCH and MBCH, a PUEM < 10⁻⁵ shall be achieved at the dynamic reference sensitivity level.

6.6.2.2.1 BS receiver performance

Table 10: BS receiver performance (dynamic sensitivity)

Logical channel		Class A propagation condition		Class B propagation condition TU50
		TU50	HT200	
NBCH	MER	9 %	11 %	8 %

6.6.2.2 MS receiver performance

Table 11: MS receiver performance (dynamic sensitivity)

Logical channel		Class A and E propagation condition		Class B propagation condition	Class E propagation condition
		TU50	HT200	TU50	EQ200
MBCH	MER	8 %	11 %	8 %	22 %
NBCH	MER	8 %	11 %	8 %	21 %

6.6.2.3 Reference interference performance

The minimum required reference interference performance (for co-channel, C/I_c , or adjacent channel, C/I_a) is specified according to the logical channel, the propagation condition and the receiver class at the reference interference ratio. The reference interference ratio shall be, for BS and all types of MS:

- for co-channel interference: $C/I_c = 19$ dB;
- for adjacent channel interference: $C/I_a = - 45$ dB.

In case of co-channel interference these specifications apply for a wanted input signal level of - 85 dBm, and in case of adjacent channel interference for a wanted input signal level 3 dB above the dynamic reference sensitivity level. In any case the interference shall be a continuous TETRA random modulated signal subjected to an independent realisation of the same propagation condition as the wanted signal.

In table 12 and table 13 the performance for TU50, HT200 or EQ200 propagation conditions is given for the reference interference level. For NBCH and MBCH a PUEM < 10^{-5} shall be achieved at the reference interference level.

6.6.2.3.1 BS receiver performance

Table 12: BS receiver performance (interference)

Logical channel		Class A propagation condition		Class B propagation condition
		TU50	HT200	TU50
NBCH	MER	7 %	9,2 %	7 %

6.6.2.3.2 MS receiver performance

Table 13: MS receiver performance (interference)

Logical channel		Class A and Q propagation condition		Class B propagation condition	Class Q propagation condition
		TU50	HT200	TU50	QS200
MBCH	MER	6 %	10 %	6 %	20 %
NBCH	MER	7 %	9,2 %	7 %	20 %

6.6.2.4 Static reference sensitivity performance

The minimum required static reference sensitivity performance is specified according to the logical channel and the receiver class at the static reference sensitivity level. The static reference sensitivity level shall be:

- for MS: - 112 dBm;
- for BS: - 115 dBm.

Table 14 and table 15 give the minimum required reference sensitivity performance. For NBCH and MBCH a PUEM 10^{-5} shall be achieved at the static reference sensitivity level.

6.6.2.4.1 BS receiver performance

Table 14: BS receiver performance (static sensitivity)

Logical channel		Class A	Class B
NBCH	MER	9 %	5 %

6.6.2.4.2 MS receiver performance

Table 15: MS receiver performance (static sensitivity)

Logical channel		Class A	Class B	Class E
MBCH	MER	3 %	3 %	3 %
NBCH	MER	2,5 %	5 %	2,5 %

6.6.2.5 MS receiver performance for synchronisation burst acquisition

This subclause specifies reference sensitivity performance of a MS receiver for the acquisition of the Synchronisation (sub) Burst (SB). The performance is defined in terms of the probability PACQ of detecting a single transmitted SB and correctly decoding its MBCH information for the condition where the MS is listening on the frequency while the SB is transmitted, and where the MS is already frequency synchronised but not synchronised in terms of time slots.

Table 16: MS receiver performance for synchronisation burst acquisition

Propagation condition/equipment class	TU50 / class B	HT200 / class A
PACQ	0,8	0,8

NOTE: This specification applies for continuous and discontinuous downlink mode.

6.6.3 Propagation conditions

The following subclauses contain all the necessary information on the propagation models that are referred to in this ETS.

6.6.3.1 Propagation conditions - introduction

Radio wave propagation in the mobile radio environment is described by dispersive multipath caused by reflection, diffraction and scattering. Different paths may exist between a BS and a MS due to large distant reflectors and/or scatterers and due to scattering in the vicinity of the mobile, giving rise to a number of partial waves arriving with different amplitudes and delays. Since the mobile will be moving, a Doppler shift is associated with each partial wave, depending on the mobile's velocity and the angle of incidence. The delayed and Doppler shifted partial waves interfere at the receiver causing frequency and time selective fading on the transmitted signal.

When system bandwidth and propagation path lengths are sufficiently small (which is the case for TETRA), the resulting frequency and time selective fading process may be simulated by a simplified propagation model. Such a model exhibits only a few discrete paths which are independently fading. For practical channel simulation, stationary Gaussian processes with a power density spectrum equal to the classical Doppler spectrum are commonly assumed.

Based on extensive investigations (see annex K) some tapped delay line models which are typical for urban, rural, or hilly area propagation conditions or for quasi synchronous operation were derived. These models are defined in the following terms (see also table 17):

- number of discrete taps;
- relative delay of each tap;
- average relative power of the complex tap-gain process of each tap;
- type of the complex tap-gain process of each tap.

All stochastic tap-gain processes are mutually statistically independent.

6.6.3.2 Tap-gain process types

This subclause defines the statistical properties of the stationary complex tap-gain processes, to be applied for the propagation models, in terms of a Probability Density Function (PDF) and a Power Density Spectrum (PDS) which models the Doppler spectrum. The complex tap-gain processes, denoted by $a(t)$ and defined hereunder, are normalised to unity power.

- CLASS is the tap-gain process having a PDS equal to the classical Doppler spectrum. The real and imaginary parts of $a(t)$ exhibit an identical Gaussian PDF, an identical PDS and are mutually statistically independent. Hence $|a(t)|$ is Rayleigh distributed. The PDS of $a(t)$ is defined by:

$$S(f) = S_{CLASS}(f, f_d) = \frac{1}{\pi f_d \sqrt{1 - (f/f_d)^2}} \text{ for } -f_d < f < f_d \text{ and } S(f) = 0 \text{ elsewhere}$$

where the parameter f_d represents the maximum Doppler shift (in Hz), defined as $f_d = v/\lambda$ with the vehicle speed v (in m/s) and the wavelength λ (in m).

- STATIC(f_s) is a tap-gain process with a constant magnitude $|a(t)|=1$. The PDS of $a(t)$ is defined by:

$$S(f) = S_{STATIC}(f, f_s) = \delta(f - f_s) \tag{10}$$

where $\delta(\cdot)$ represents the Dirac delta function and f_s the Doppler shift (in Hz).

- RICE is a tap-gain process which is the sum process of the two processes CLASS and STATIC(f_s), with $f_s = 0,7 f_d$, each contributing half of the total power. Hence $|a(t)|$ is Rician distributed and the PDS is:

$$S(f) = S_{RICE}(f, f_d) = 0,5 S_{CLASS}(f, f_d) + 0,5 S_{STATIC}(f, 0,7 f_d) \tag{11}$$

6.6.3.3 Propagation models

In this subclause, the propagation models referred to in this ETS are defined. The vehicle speed x (in km/h), which affects f_d (see above), is attributed to the model designation (e.g. HT200 means Hilly Terrain for 200 km/h).

Table 17: Propagation models

Propagation model	Tap number	Relative delay (μ s)	Average relative power (dB)	Tap-gain process
Static	1	0	0	STATIC(0)
Rural Area (RAx)	1	0	0	RICE
Typical Urban (TUx)	1	0	0	CLASS
	2	5	- 22,3	CLASS
Bad Urban (BUx)	1	0	0	CLASS
	2	5	- 3,0	CLASS
Hilly Terrain (HTx)	1	0	0	CLASS
	2	15	- 8,6	CLASS
Equaliser Test (EQx)	1	0	0	CLASS
	2	11,6	0	CLASS
	3	73,2	- 10,2	CLASS
	4	99,3	- 16	CLASS

7 Radio sub-system synchronisation

This clause defines the requirements for synchronisation on the PDO TETRA radio sub-system for carrier frequencies of between 380 MHz and 520 MHz. However, it does not define the synchronisation algorithms to be used in the BS and MS. These are up to the manufacturer to specify.

7.1 General description of synchronisation system

This subclause gives a general description of the synchronisation system. Detailed requirements are given in the rest of this clause.

The BS sends signals on the downlink synchronisation sub-burst to enable the MS to synchronise itself to the BS and if necessary correct its frequency standard to be in line with that of the BS. The signals sent by the BS for these purposes are frequency correction signals and synchronisation signals.

The timings of sub-bursts are all related to a common set of counters which run continuously whether the MS and BS are transmitting or not (see subclause 7.2). Thus, once the MS has determined the correct setting of these counters, all its processes are synchronised to the current serving BS.

The MS times its transmission to the BS in line with those received from the BS.

7.2 Timebase counters

7.2.1 Downlink

7.2.1.1 Timing counters

The timing state of the signals transmitted by a BS is defined by the following counters:

- symbol number for downlink SNd (1 - 120);
- sub-burst number for downlink SBNd (1 - SBNdtot), where SBNdtot shall be the total number of transmitted downlink sub-bursts in one burst ($1 \leq \text{SBNdtot} \leq 41$).

NOTE: The value taken by SBNdtot is transmitted on sub-burst number 1 (see clause 22).

7.2.1.2 Values of counters

The relationship between these counters shall be as follows:

- SNd = increments every 500/9 μ s;
- the presiding flag shall be sent on every downlink sub-burst: whenever it takes the value of 1, SBNd is set to 1. In any other case, SBNd increments whenever SNd changes from count 120 to 1, see clause 22.

7.2.2 Uplink

7.2.2.1 Timing counters

The timing state of the signals transmitted by a MS shall be defined by the following counters:

- symbol number for uplink SNu (1 - SNumax(SBNU)), where SNumax(SBNU) shall depend on the sub-burst number SBNU (see table 18);

Table 18: Timing counters

Case	SNumax(SBNU)
SBNU = 1	125
SBNU = SBNutot	2
otherwise, (SBNU mod 2) = 0	119
otherwise, (SBNU mod 2) = 1	108

- sub-burst number for uplink SBNU (1 - SBNutot), where SBNutot is the total number of transmitted uplink sub-bursts in one burst ($2 \leq \text{SBNutot} \leq 42$). SBNutot shall be derived from the burst length (see note).

NOTE: The burst length is defined as the total number of multiplexed blocks in a burst. The value taken by the burst length is transmitted on sub-burst number 1 (see clause 22). SBNutot equals the burst length plus one.

7.2.2.2 Values of counters

The relationship between these counters shall be as follows:

- SNu increments every 500/9 μ s;
- the presiding flag shall be sent on every uplink sub-burst (see clause 22): whenever it takes the value of 1, SBNU is set to 1, and SNumax(SBNU) is set to 125 (see table 18). In any other case, SBNU increments, and SNumax(SBNU) changes accordingly (see table 18).

7.3 Timing of transmitted signals

The timing of modulation symbols transmitted by the MS and BS is defined in clause 9. This timing shall be respected even in case of discontinuous transmission.

The MS may use the timing of receipt of the synchronisation sub-burst to set up its timebase counters as follows:

- SNu is set by the timing of the training sequence on the downlink and by the start of reservation time (see clause 9).

7.4 BS requirements for synchronisation

The BS requirements for synchronisation shall be according to the following:

- a) the BS shall use a single frequency source of accuracy better than $\pm 0,2$ ppm for both frequency generation and clocking the timebase. The same source shall be used for all carriers of the BS;
- b) it is optional whether the timebase counters of different BSs are synchronised together;
- c) the channels of different carriers transmitted by a BS shall be synchronised together, i.e. controlled by the same set of counters. The timing difference between the different carriers shall be less than 1/4 symbol duration.

7.5 MS requirements for synchronisation

The MS shall only transmit to the BS if the following requirements are met.

The conditions under which the following requirements must be met shall be 3 dB below the reference sensitivity level in clause 6 and 3 dB less carrier to interference ratio than the reference interference ratio in clause 6. Static or dynamic reference sensitivity levels shall be used depending on the applied propagation conditions.

- a) the MS carrier frequency shall be accurate to within $\pm 0,2$ ppm compared to signals received from the BS (these signals will have an apparent frequency error due to BS frequency error and Doppler shift). The signal from the BS must be averaged over sufficient time that errors due to noise or interference are allowed for within the above $\pm 0,2$ ppm figure. The MS timebase shall be accurate to within ± 2 ppm;
- b) the MS shall assess the timing from the received signals from the BS, and adjust its timebase to keep it in line with that of the received signals from the BS with an accuracy of $\pm 1/2$ symbol duration.

8 Channel coding

8.1 Introduction

A reference configuration of the TETRA transmission chain is given in clause 4. According to it, this clause defines the error control process which applies to the information bits (packed in MAC blocks, see definition in ETS 300 392-2 [13], clause 13), and which provides multiplexed bits (packed in multiplexed blocks).

This clause includes the specification of encoding, re-ordering and interleaving, and scrambling, but does not specify any data processing on the receive part.

A definition of the error control process is provided for each kind of logical channel. The definition of logical channels is given in clause 9.

8.2 General

8.2.1 Interfaces in the error control structure

The definition of interfaces in the error control structure is given by figure 9.

Each logical channel shall have its own error control scheme. For each one, the information bits (eventually including a MAC header) are referred to as type-1 bits. The type-1 bits are packed in MAC blocks (see ETS 300 392-2 [13], clause 14), which are referred to as type-1 blocks: this defines interface (1) in figure 9.

The processing in the transmit part shall be as follows:

- the type-1 bits shall be encoded by a block code, providing block-encoded bits. Tail bits shall be appended to these block-encoded bits. The block-encoded bits and the tail bits are referred to as type-2 bits and shall be packed in a type-2 block: this defines interface;
- the type-2 bits shall be encoded by a convolutional code, which provides the convolutionally encoded bits. The convolutionally-encoded bits are referred to as type-3 bits and shall be packed in a type-3 block: this defines interface;
- the type-3 bits shall be reordered and interleaved, into interleaved bits: the interleaved bits are referred to as type-4 bits and shall be packed in encoded blocks (see ETS 300 392-2 [13], clause 15). Encoded blocks are referred to as type-4 blocks: this defines interface;
- the type-4 bits shall be scrambled, into type-5 bits, which compose type-5 blocks: this defines the interface. These bits shall then be mapped into multiplexed blocks. A multiplexed block shall be one of 5 different kinds: control block, broadcast block, synchronisation block, block-1, or block-2.

All these operations are made on a per type-1 block basis. The sizes of type-1 blocks and of type-5 blocks and multiplexed blocks depend on the logical channel with which they are associated.

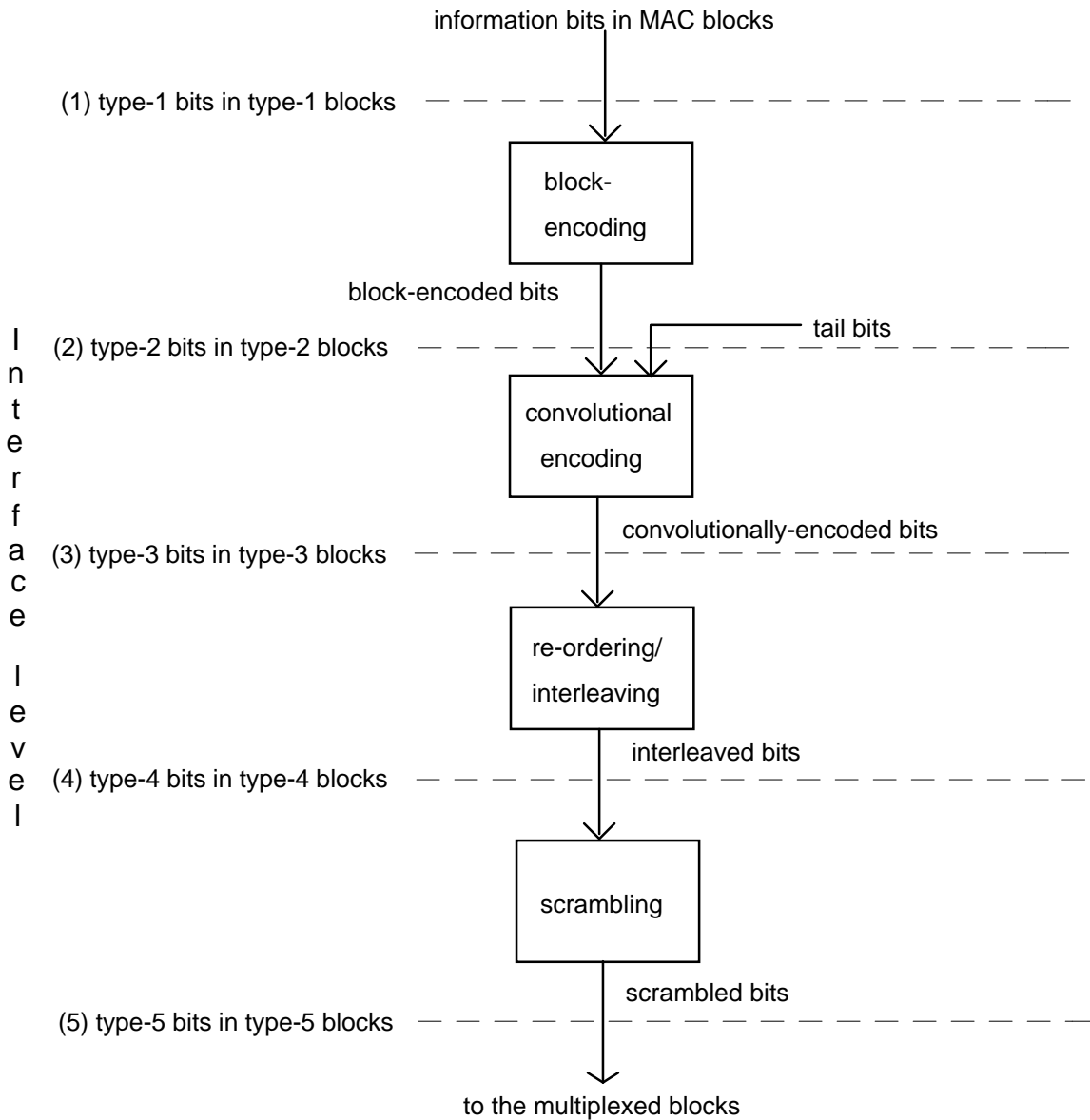

Figure 9: Interfaces in the error control structure

8.2.2 Notation

For ease of understanding, a notation for bits and blocks is given for use throughout the following subclauses:

- x is the interface number, as defined in figure 9: $x = 1, 2, 3, 4, 5$;
- n is a block number;
- $B_x(n)$ is the type- x block number n ;
- K_x is the number of bits that are carried by one type- x block;
- k is a bit number;
- $b_x(n,k)$ is the type- x bit number k in the type- x block number n ;
- alternatively $b_x(k)$ is the type- x bit number k in a type- x block (for ease of notation), with $k = 1, 2, \dots, K_x$, and $n = 1, 2, \dots$

the bits of the multiplexed blocks shall be denoted as, accordingly:

$nb(k)$: bit number k in a normal block,

$mb(k)$: bit number k in a master block.

8.2.3 Definition of error control codes

8.2.3.1 16-state Rate-Compatible Punctured Convolutional (RCPC) codes

The RCPC codes shall encode K_2 type-2 bits $b_2(1), b_2(2), \dots, b_2(K_2)$ into K_3 type-3 bits $b_3(1), b_3(2), \dots, b_3(K_3)$. This encoding shall be performed in two steps:

- encoding by a 16-state mother code of rate 1/4;
- puncturing of the mother code so to obtain a 16-state RCPC code of rate K_2/K_3 .

A general description of these two steps is given in subclauses 8.2.3.1.1 and 8.2.3.1.2, respectively. The puncturing coefficients of the 16-state RCPC code of rates 2/3 is given in subclause 8.2.3.1.3.

8.2.3.1.1 Encoding by the 16-state mother code of rate 1/4

The input to the mother code of any type-2 bit $b_2(k)$, $k = 1, 2, \dots, K_2$, implies the output, by the mother code, of 4 bits, denoted by $V(4(k-1)+i)$, $i = 1, 2, 3, 4$, which shall be calculated as follows:

Any of the 4 generator polynomials of the mother code, $G_i(D)$, $i = 1, 2, 3, 4$, can be written as:

$$G_i(D) = \sum_{j=0}^4 g_{i,j} D^j, \text{ for } i=1,2,3,4,$$

where $g_{i,j} = 0$ or 1 , $j = 0, 1, 2, 3, 4$.

This means that the encoded bits are defined by:

$$V(4(k-1)+i) = \sum_{j=0}^4 b_2(k-j) g_{i,j}, \text{ for } i=1,2,3,4, \text{ and } k=1,2,\dots,K_2$$

where the sum is meant modulo 2, and where $b_2(k-j) = 0$ for $k \leq j$.

The generator polynomials of the mother code shall be:

$$G_1(D) = 1 + D + D^4$$

$$G_2(D) = 1 + D^2 + D^3 + D^4$$

$$G_3(D) = 1 + D + D^2 + D^4$$

$$G_4(D) = 1 + D + D^3 + D^4$$

8.2.3.1.2 Puncturing of the mother code

The puncturing of the mother code into a 16-state RCPC code of rate (K_2/K_3) is achieved by selecting K_3 type-3 bits out of the $(4 K_2)$ bits encoded by the mother code. This selection shall be as follows.

Denoting by $P(1), P(2), \dots, P(t)$ the t puncturing coefficients (each one being equal to 1, 2, 3, 4, 5, 6, 7, or 8), the type-3 bits are given by:

$$b_3(j) = V(k), \text{ for } j=1, 2, \dots, K_3,$$

with

$$k = 8((i-1) \text{ div } t) + P(i - t((i-1) \text{ div } t)),$$

where i and t are defined in the following puncturing schemes.

8.2.3.1.3 Puncturing scheme of the RCPC code of rate 2/3

The $t = 3$ puncturing coefficients shall be:

$$P(1) = 1, P(2) = 2, P(3) = 5, \text{ and } i = j.$$

The K_2 type-2 bits, with $K_2 = K_1 + 16$, are then given by:

$$b_2(k) = b_1(k), \quad \text{for } k = 1, 2, \dots, K_1,$$

$$b_2(k) = f(K_1 + 16 - k), \quad \text{for } k = K_1 + 1, K_1 + 2, \dots, K_1 + 16.$$

8.2.3.2 $(K_1 + 16, K_1)$ block code

The $(K_1 + 16, K_1)$ code shall encode K_1 type-1 bits $b_1(1), b_1(2), \dots, b_1(K_1)$ into $(K_1 + 16)$ type-2 bits $b_2(1), b_2(2), \dots, b_2(K_1 + 16)$. The encoding rule shall be as follows (see CCITT Recommendation X.25 [11]).

The type-1 bits are treated as the coefficients of the polynomial:

$$M(X) = \sum_{k=1}^{K_1} b_1(k) X^{K_1 - k}$$

Let $F(X)$ be:

$$F(X) = \left[(X^{16} M(X) + X^{K_1} \sum_{i=0}^{15} X^i) \text{ mod } G(X) \right] + \sum_{i=0}^{15} X^i$$

where all operations are meant modulo 2, and $G(X)$ is the generator polynomial of the code:

$$G(X) = X^{16} + X^{12} + X^5 + 1$$

$F(X)$ is of degree 15, with coefficients denoted by $f(0), f(1), \dots, f(15)$:

$$F(X) = \sum_{i=0}^{15} f(i)X^i$$

8.2.4 Definition of interleaving schemes

8.2.4.1 Block interleaving

A (K, a) block interleaver shall re-order K_3 type-3 bits $b_3(1), b_3(2), \dots, b_3(K_3)$ into K_4 type-4 bits $b_4(1), b_4(2), \dots, b_4(K_4)$, with $K=K_3=K_4$, in the following way:

$$b_4(k) = b_3(i), \quad i = 1, 2, \dots, K,$$

with

$$k = 1 + ((a * i) \bmod K)$$

8.2.5 Definition of scrambling

8.2.5.1 Scrambling method

Scrambling shall transform K_4 type-4 bits $b_4(1), b_4(2), \dots, b_4(K_4)$ into K_5 type-5 bits $b_5(1), b_5(2), \dots, b_5(K_5)$, with $K_5=K_4$, as follows:

$$b_5(k) = b_4(k) + p(k), \quad \text{for } k = 1, 2, \dots, K_5,$$

where the addition is meant modulo 2, and $p(k)$ is the k -th bit of the scrambling sequence (see subclause 8.2.5.2).

8.2.5.2 Scrambling sequence

The scrambling sequence $\{p(k), k = 1, 2, \dots, K_5\}$ shall be generated from the 30 bits of the extended colour code $e(1), e(2), \dots, e(30)$ (see ETS 300 392-2 [13], clause 16 and clause 17), except for the MBCH, by means of linear feedback registers. For the scrambling of MBCH, all bits $e(1), e(2), \dots, e(30)$ shall be set equal to zero.

The scrambling sequence generator shall be based upon the following connection polynomial:

$$c(x) = \sum_{i=0}^{32} c_i X^i$$

with $c_i = 1$ for $i = 0, 1, 2, 4, 5, 7, 8, 10, 11, 12, 16, 22, 23, 26$ and 32 , and $c_i = 0$ elsewhere and where all operations are meant modulo 2. The resultant polynomial is therefore:

$$c(x) = 1 + X + X^2 + X^4 + X^5 + X^7 + X^8 + X^{10} + X^{11} + X^{12} + X^{16} + X^{22} + X^{23} + X^{26} + X^{32}$$

The k -th bit of the scrambling sequence is given by:

$$p(k) = \sum_{i=1}^{32} c_i p(k-i)$$

with the following initialisation:

$$p(k) = e(1-k), \quad \text{for } k = -29, -28, \dots, 0,$$

$p(k) = 1,$ for $k = -31, -30.$

8.3 Error control schemes

In this subclause the error control scheme associated with each logical channel is defined. Figure 10 gives the error control structure.

8.3.1 Master Block CHannel (MBCH)

One type-1 block contains 60 type-1 bits, $b_1(1), b_1(2), \dots, b_1(60).$

A (76, 60) block code encodes the 60 type-1 bits into 76 type-2 bits, $b_2(1), b_2(2), \dots, b_2(76).$ This code is the (K_1+16, K_1) code as defined in subclause 8.2.3.2, with $K_1 = 60.$

Four tail bits, $b_2(77), b_2(78), b_2(79), b_2(80),$ all set equal to zero, shall be appended to the 76 block encoded bits.

Bits $b_2(1), b_2(2), \dots, b_2(80)$ shall be type-2 bits.

A 16-state RCPC code with rate 2/3 (see subclause 8.2.3.1.3), shall encode the 80 type-2 bits into 120 type-3 bits $b_3(1), b_3(2), \dots, b_3(120).$

A (120, 11) block interleaver (see subclause 8.2.4.1) shall re-order the 120 type-3 bits into 120 type-4 bits $b_4(1), b_4(2), \dots, b_4(120).$

The 120 type-4 bits, $b_4(1), b_4(2), \dots, b_4(120),$ shall compose the type-4 block for MBCH. They shall be scrambled into bits $b_5(1), b_5(2), \dots, b_5(120),$ according to subclause 8.2.5.1, with the scrambling sequence as defined in subclause 8.2.5.2.

The multiplexed bits of the master block are defined as:

$mb(k) = b_5(k),$ for $k = 1, 2, \dots, 120.$

8.3.2 Normal Block CHannel (NBCH)

One type-1 block contains 124 type-1 bits $b_1(1), b_1(2), \dots, b_1(124).$

A (140, 124) block code encodes the 124 type-1 bits into 140 block-encoded bits $b_2(1), b_2(2), \dots, b_2(140).$ This code is the (K_1+16, K_1) block code as defined in subclause 8.2.3.2, with $K_1 = 124.$

Four tail bits, $b_2(141), b_2(142), b_2(143), b_2(144),$ all set equal to zero, are appended to the 140 block encoded bits.

Bits $b_2(1), b_2(2), \dots, b_2(144)$ are the type-2 bits.

A 16-state RCPC code with rate 2/3 (see subclause 8.2.3.1.3) encodes the 144 type-2 bits into 216 type-3 bits, $b_3(1), b_3(2), \dots, b_3(216).$

A (216, 101) block interleaver (see subclause 8.2.4.1) re-orders the 216 type-3 bits into 216 type-4 bits, $b_4(1), b_4(2), \dots, b_4(216).$

The 216 type-4 bits compose the type-4 block for NBCH. They shall be scrambled into bits $b_5(1), b_5(2), \dots, b_5(216),$ according to subclause 8.2.5.1, with the scrambling sequence as defined in subclause 8.2.5.2.

The multiplexed bits of the normal block are defined as:

$nb(k) = b_5(k),$ for $k = 1, 2, \dots, 216.$

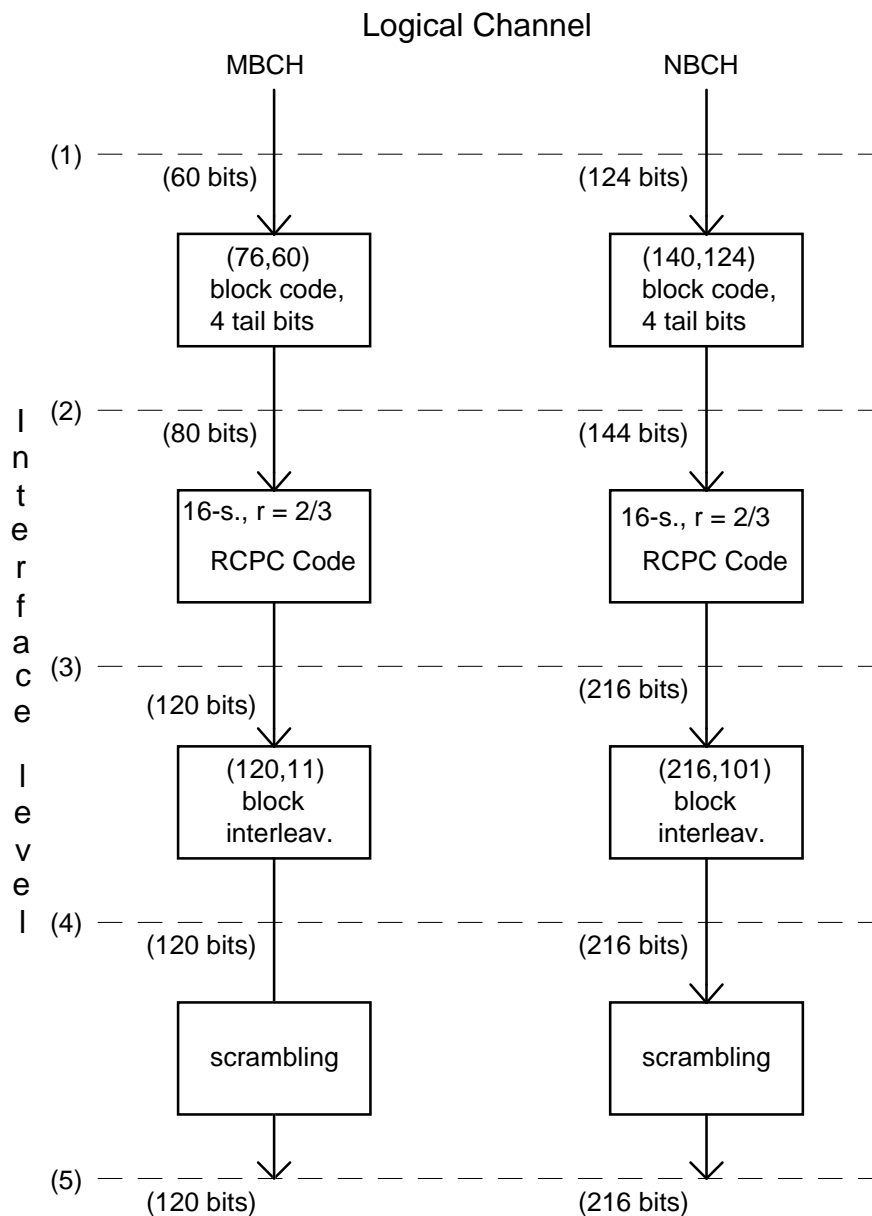

Figure 10: Error control structure for PDO logical channels

9 Channel multiplexing

This clause defines the physical channels of the radio sub-system required to support the logical channels. It includes a description of sub-bursts and the mapping from MAC bursts to sub-bursts.

9.1 Logical channels for passing MAC blocks to the channel coding

The interface between the MAC blocks and the channel coding are the logical channels. These logical channels represent the interface between the protocol and the radio subsystem series.

Two types of logical channel shall be used. The Master Block Channel (MBCH) and the Normal Block Channel (NBCH) (see figure 11).

The MBCH shall be used for the special block that fits into the Master burst. This corresponds to the <SystemINformation1> PDU in the MAC. The MBCH shall be only a downlink logical channel.

The NBCH shall be used for all other MAC blocks, presiding blocks and following blocks. That corresponds to all MAC PDUs, both on the uplink and on the downlink, except the <SystemINformation1> PDU.

For the channel coding see clause 8.

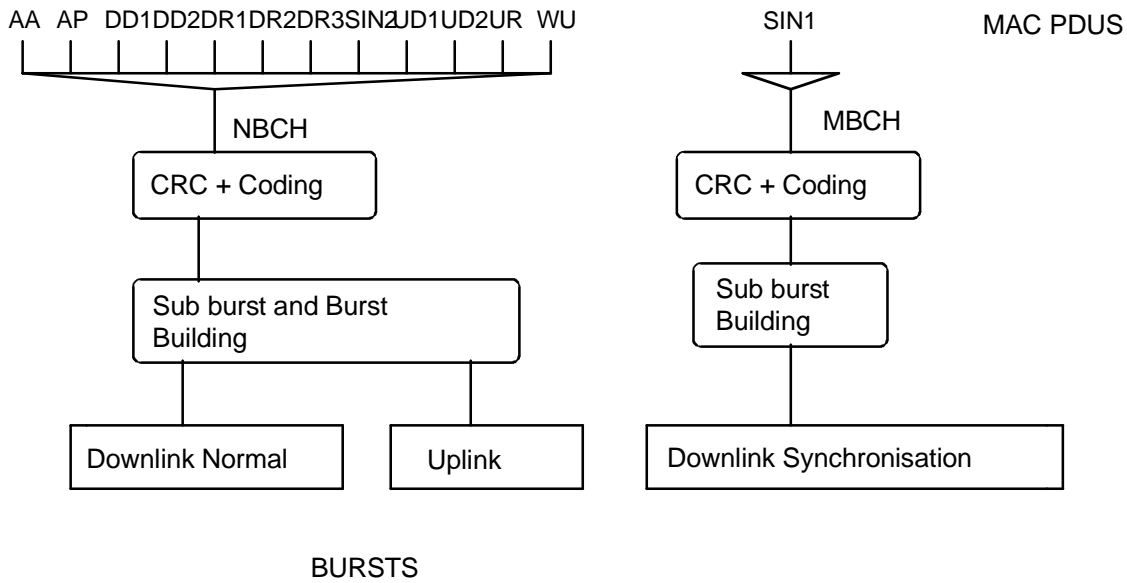

Figure 11: The NBCH and MBCH channels

9.2 The physical resource

9.2.1 General

The physical resource available to the radio sub-system is an allocation of part of the radio spectrum. This resource is partitioned both in frequency and time. Frequency is partitioned by radio frequency channels divided into bands as defined in clause 8.

9.2.2 Radio frequency channels

Clause 6 defines the radio frequency channels and allocates numbers to the radio frequency channels available to the system. Each cell shall be allocated a subset of these channels, defined as the cell allocation.

The downlink comprises radio frequency channels used in the BS to MS direction.

The uplink comprises radio frequency channels used in the MS to BS direction.

One downlink radio frequency channel of the cell allocation shall be known as the master carrier.

9.3 Physical channel

9.3.1 Sub-burst

A sub-burst is a part of a burst. It is defined by one or more sub-burst fields. One or more sub-bursts form a burst.

9.3.2 Bursts

9.3.2.1 General

A burst is a period of RF carrier that is modulated by a data stream. A burst therefore shall represent a number of coded blocks and training sequences.

The description of a physical channel will be made in terms of sub-bursts.

9.3.2.2 Modulation symbols numbering

A burst shall be divided into a number of modulation symbol duration's, depending on the type of burst and the number of sub-bursts it includes, each symbol with a duration of 1/18 ms (approximately 55,56 μ s). A particular modulation symbol within a burst shall be referenced by a Symbol Number (SN), with the first modulation symbol numbered SN1 and the last modulation symbol numbered SNmax. At the beginning of a burst, a supplementary symbol SN0 is defined. It does not carry information, but is used as phase reference for the differential modulation.

9.3.2.3 Modulation bit numbering

In the following subclauses the content of the burst is defined in terms of modulation bits.

A burst shall be divided into a number of modulation bit periods, depending on the type of burst and the number of sub-bursts it includes. A particular modulation bit within a burst shall be referenced by a Bit Number (BN), with the first modulation bit numbered BN1 and the last modulation bit numbered BNmax. At the modulator the modulation bits shall be grouped in pairs of consecutive odd and even numbered bits and each pair shall be converted into one modulation symbol as described in clause 5.

The bursts and sub-bursts always contain an even number of modulation bits.

9.3.2.4 Burst timing

The symbol time shall be defined as the instant at which the symbol wave form is at a maximum for the symbol of interest. The timing of a modulation symbol shall be determined by its symbol time.

The bits BN(2N-1) and BN(2N) shall determine the symbol SN(N) and the symbol SN(N) shall be delayed by (N+d) modulation symbol durations with respect to the start of the first sub-burst for the burst on the downlink or with respect to the start of the reserved time on the uplink, with:

N: integer (1 .. (SNmax));

d: is defined as the burst delay. The burst delay represents the delay between the start of the reserved time and the symbol time of the symbol SN1. The burst delay is expressed in modulation symbol duration and varies with the type of burst. The values of the burst delays are given in subclause 9.3.3.

The symbol time of symbol SN0 occurs one modulation symbol duration before the symbol time of the first symbol of the burst (SN1).

9.3.3 Type of burst and burst timing

9.3.3.1 General

Four types of burst exist in the system and shall be in accordance with table 19.

N is the number of multiplexed blocks in the burst (N = 1 to 41).

Table 19: Burst types

Burst type	BNmax	D (in symbol duration)	Sub-bursts
Uplink with normal linearization	254 + INT(N/2) * 238 + INT((N-1)/2) * 216	16	1 uplink Start + INT(N/2) uplink Even + INT((N-1)/2) uplink Odd + 1 uplink End
Uplink with long linearization	same as above	72	same as above
Normal downlink burst	N*240	0	N downlink Normal
Master burst	240	0	1 downlink Synchronisation

See figure 13 and figure 14 for examples of downlink and uplink bursts.

9.3.3.2 Modulation bits allocation

The bursts are divided into one or more sub-bursts and the sub-burst fields containing modulation bits of the same type. The sub-burst fields are described in subclause 9.3.3.3.

9.3.3.2.1 Uplink start sub-burst

This sub-burst shall be in the beginning of each uplink physical burst. The parts are tail bits, multiplexed block and extended training sequence. The allocation of the modulation bits in this sub-burst shall be in accordance with table 20.

Table 20: Uplink start sub-burst

Bit Number (BN) in the sub-burst	Field length (bits)	Field content	Field bits number	Definition
1 to 4	4	tail bits	$T1$ to $T4$	clause 9
5 to 112	108	scrambled bits (block 1)	$s1$ to $s108$	clause 8
113 to 142	30	extended training sequence	$x1$ to $x30$	clause 9
143 to 250	108	scrambled bits (block 1)	$s109$ to $s216$	clause 8

9.3.3.2.2 Uplink even sub-burst

This sub-burst shall contain an even multiplexed block and a regular training sequence. The allocation of the modulation bits in this sub-burst shall be in accordance with table 21.

Table 21: Uplink even sub-burst

Bit Number (BN) in the sub-burst	Field length (bits)	Field content	Field bits number	Definition
1 to 216	216	scrambled bits (even block)	$s1$ to $s216$	clause 8
217 to 238	22	normal training sequence	$N1$ to $N22$	clause 9

9.3.3.2.3 Uplink odd sub-burst

This sub-burst shall contain an odd multiplexed block. The allocation of the modulation bits in this sub-burst shall be in accordance with table 22.

Table 22: Uplink odd sub-burst

Bit Number (BN) in the sub-burst	Field length (bits)	Field content	Field bits number	Definition
1 to 216	216	scrambled bits (odd block)	$s1$ to $s216$	clause 8

9.3.3.2.4 Uplink end sub-burst

This sub-burst shall contain tail bits. The allocation of the modulation bits in this sub-burst shall be in accordance with table 23.

Table 23: Uplink end sub-burst

Bit Number (BN) in the sub-burst	Field length (bits)	Field content	Field bits number	Definition
1 to 4	4	tail bits	$T1$ to $T4$	clause 9

9.3.3.2.5 Downlink normal sub-burst

The allocation of the modulation bits in this sub-burst shall be in accordance with table 24.

Table 24: Downlink normal sub-burst

Bit Number (BN)	Field length (bits)	Field content	Field bits number	Definition
1 to 2	2	phase adjustment	<i>HK1</i> to <i>HK2</i>	subclause 9.3.3.3
3 to 218	216	scrambled bits (block)	<i>S1</i> to <i>S216</i>	clause 8
219 to 240	22	training sequence	<i>N1</i> to <i>N22</i> or <i>P1</i> to <i>P22</i>	clause 9

9.3.3.2.6 Downlink synchronisation sub-burst

The allocation of the modulation bits in the downlink synchronisation sub-burst shall be in accordance with table 25. The master burst is used by the BS to broadcast synchronisation messages and to transmit control information to the MS.

Table 25: Downlink synchronisation sub-burst

Bit Number (BN)	Field length (bits)	Field content	Field bits number	Definition
1 to 2	2	phase adjustment	<i>HK1</i> to <i>HK2</i>	subclause 9.3.3.3
3 to 82	80	frequency correction	<i>F1</i> to <i>F80</i>	clause 9
83 to 202	120	synchronisation bits	<i>SB(1)</i> to <i>SB(120)</i>	clause 8
203 to 240	38	synchronisation training sequence	<i>Y1</i> to <i>Y38</i>	clause 9

9.3.3.2.7 Linearisation up-link burst

The linearization up-link burst shall be used by the MSs to linearize their transmitters. The linearization up-link burst contains no useful bits and its timing is only determined by the time mask (see clause 6).

9.3.3.3 Sub-burst fields

9.3.3.3.1 Frequency correction field

The frequency correction field shall contain 80 bits:

$$(f_1, f_2, \dots, f_8) = (1, 1, \dots, 1);$$

$$(f_9, f_{10}, \dots, f_{72}) = (0, 0, \dots, 0);$$

$$(f_{73}, f_{74}, \dots, f_{80}) = (1, 1, \dots, 1).$$

The frequency correction field generates an un-modulated carrier at 2,25 kHz above the nominal carrier frequency, preceded and followed by a short period (4 symbol durations) of un-modulated carrier at 6,75 kHz below the nominal carrier frequency.

9.3.3.3.2 Normal training sequence

Two 22 bit normal training sequences are defined.

The normal training sequence 1 shall be:

$$(n_1, n_2, \dots, n_{22}) = (1, 1, 0, 1, 0, 0, 0, 0, 1, 1, 1, 0, 1, 0, 0, 1, 1, 1, 0, 1, 0, 0).$$

The normal training sequence 2 shall be:

$$(p_1, p_2, \dots, p_{22}) = (0, 1, 1, 1, 1, 0, 1, 0, 0, 1, 0, 0, 0, 0, 1, 1, 0, 1, 1, 1, 1, 0).$$

The training sequence used in the downlink normal sub-burst shall be as follows:

- if Busy Flag is FALSE the normal training sequence 1;
- if Busy Flag is TRUE the normal training sequence 2.

9.3.3.3.3 Extended training sequence

The extended training sequence shall be a 30 bit synchronisation word used for the uplink start sub-burst.

The extended training sequence shall be:

$$(x_1, x_2, \dots, x_{30}) = (1, 0, 0, 1, 1, 1, 0, 1, 0, 0, 0, 0, 1, 1, 1, 0, 1, 0, 0, 1, 1, 1, 0, 1, 0, 0, 0, 0, 1, 1).$$

9.3.3.3.4 Synchronisation training sequence

The synchronisation training sequence shall be a 38 bit synchronisation word used for the downlink synchronisation sub-burst.

The synchronisation training sequence shall be:

$$(y_1, y_2, \dots, y_{38}) = (1, 1, 0, 0, 0, 0, 0, 1, 1, 0, 0, 1, 1, 1, 0, 0, 1, 1, 1, 0, 1, 0, 0, 1, 1, 1, 0, 0, 0, 0, 0, 1, 1, 0, 0, 1, 1, 1).$$

9.3.3.3.5 Tail bits

The tail bit field shall contain 4 bits used for reducing the effect of filter transient response at the beginning and end of the bursts and for equalisation purposes.

The contents of the tail bit field shall be:

$$(t_1, t_2, t_3, t_4) = (1, 1, 0, 0).$$

9.3.3.3.6 Phase adjustment bits

The phase adjustment bits shall be used on the downlink bursts to provide a known phase relationship between the different training sequences of the burst, whatever is the content of the blocks.

The value of the pair of phase adjustment bits shall be set so that the phase shift $D\phi$ they generate (see clause 5) is equal to:

$$D\phi = - \sum_{n=n1}^{n2} D\phi(n)$$

where:

$D\phi(n)$ is the phase transition generated by the bits $(BN(2n-1), BN(2n))$, n_1 and n_2 are given by table 26, with respect to the bit numbering of subclause 9.4.4.2.

Table 26: Phase adjustment bits for PDO

Phase adjustment bits	n1	n2
(HK1, HK2)	2	120

9.4 Mapping of multiplexed blocks into sub-bursts

When layer 1 receives a multiplexed block it shall produce one or more sub-bursts to transmit on the defined radio carrier.

There are two sub-bursts on the downlink and four sub-bursts on the uplink. Each sub-burst is described in subclause 9.3.2.2.

9.4.1 Mapping of multiplexed blocks into sub-bursts on the downlink

The MAC burst in layer 2 shall be passed down to L1 as a number of multiplexed blocks, from the MAC PDUs (except the <SIN1> PDU), together with a set of parameters. The parameters are time to send and carrier number.

The L1 takes the multiplexed block and adds a training sequence to it. This training sequence shall be either the normal training sequence 2 (Busy Flag is TRUE) or the normal training sequence 1 (Busy Flag is FALSE). This complete sub-burst shall be transmitted at the time defined in the received parameter (time to send).

Every 150th downlink sub-burst shall be a synchronisation sub-burst. The system information in the <SIN1> PDU is mapped into the unscrambled bits in the downlink synchronisation sub-burst.

If there is nothing else to transmit L1 shall transmit dummy normal sub-bursts.

For the MAC PDUs see clause 20.

See figure 13 for two examples of downlink mapping.

9.4.2 Mapping of multiplexed blocks into sub-bursts on the uplink

The L1 receives a multiplexed block from an uplink MAC burst together with the following parameters: time to send, carrier number, block number and last block flag.

An uplink sub-burst shall be created as follows:

- IF the multiplexed block is the first block in a MAC burst THEN
 - an uplink start sub-burst shall be created and transmitted at "time to send "; or
- IF the multiplexed block has an even number THEN
 - an uplink even sub-burst shall be created and transmitted directly after the previous uplink sub-burst; or
- IF the multiplexed block has an odd number (but not number one) THEN
 - an uplink odd physical burst shall be created and transmitted directly after the previous uplink sub-burst.

IF the multiplexed block is the last block for an uplink burst THEN

an uplink end sub-burst shall be created and transmitted directly after the previous uplink sub-burst.

See figure 14 for an example of uplink mapping.

9.4.3 Timing of transmission

On the downlink the sub-bursts shall be numbered from 1 to 150. The synchronisation sub-burst has number 1 and the next downlink normal sub-burst has number 2, see figure 12.

The time on the uplink shall be related to the corresponding downlink carrier, from which the allocation of uplink time was transmitted. The uplink time is defined by the end of the downlink normal sub-burst that defines the reservation and the field START_OF_RESERVATION in this sub-burst. The value in the START_OF_RESERVATION field shall be multiplied by 8 to get the number of modulation symbols.

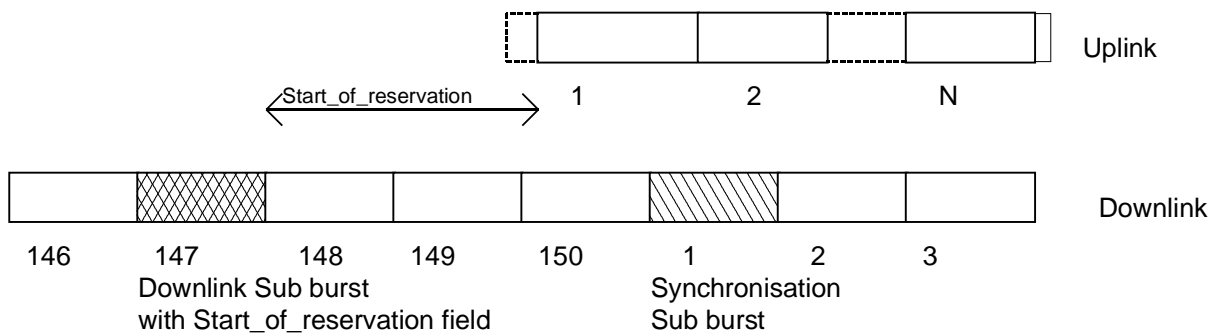

Figure 12: The start of an uplink burst and sub-burst numbering

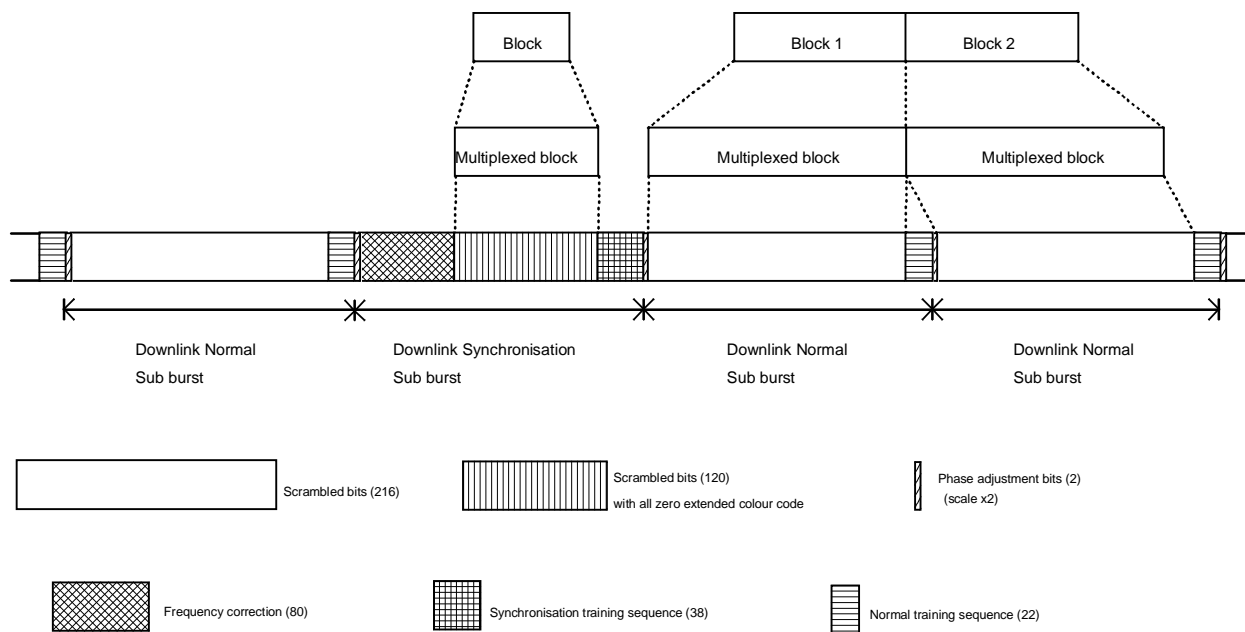

Figure 13: PDO downlink bursts

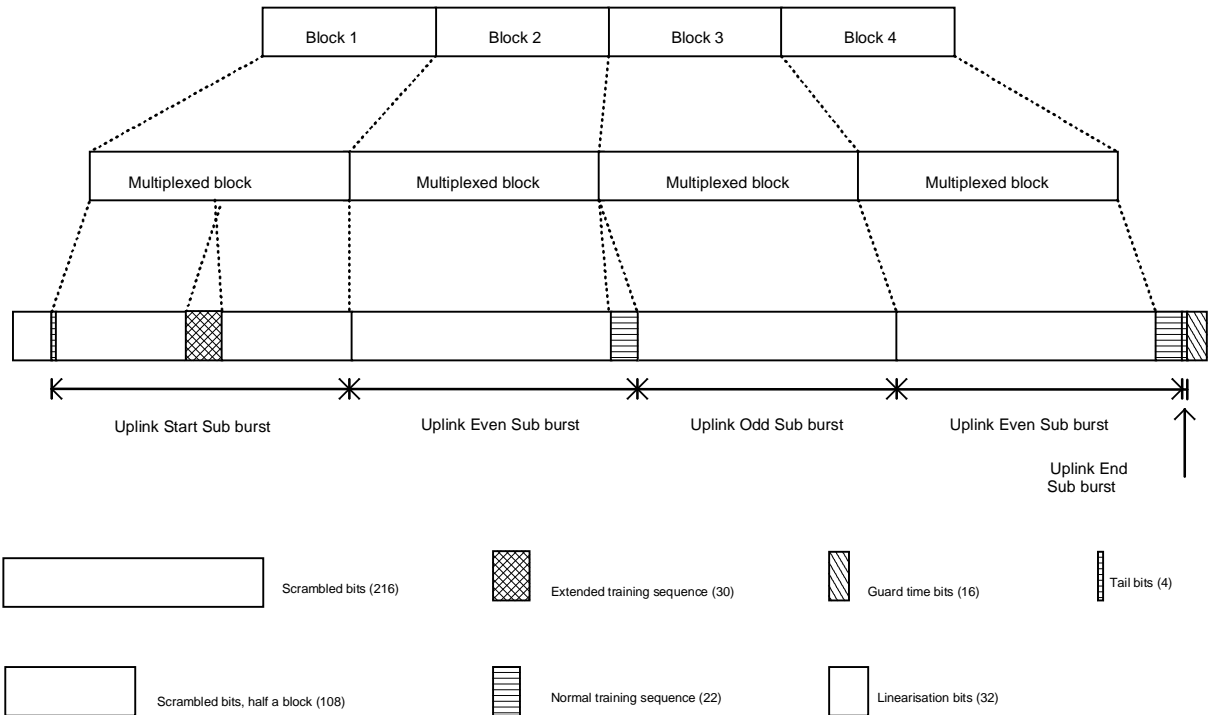

Figure 14: PDO uplink bursts

10 Radio subsystem link control

10.1 Scope

This clause specifies the radio subsystem link control implementation in MSs and BSs for PDO.

10.2 General

The following aspects of radio subsystem link control are addressed:

- RF power control;
- cell selection;
- cell re-selection;
 - undeclared;
 - unannounced;
 - announced type 2.

They support the scenarios for cell change defined in ETS 300 393-1 [14], clause 8.

Adaptive control of the RF transmit power from a MS is used, it is implemented in order to optimise the uplink performance and minimise the effects of interference. The procedures for cell selection as defined in clause 22 and clause 18 are performed by a MS not camped on a cell.

The procedures for cell re-selection are performed by a MS attached to a cell. The procedures for cell selection and re-selection define criteria allowing the MS to select a cell with which it can reliably communicate.

Three categories of cell re-selection are defined, corresponding to the three categories of connection restoration described in clause 11.

The criteria for relinquishing the link in case of cell re-selection are specified in order to provide a reliable link while avoiding any unnecessary cell change.

10.3 RF power control

10.3.1 Overall process

Adaptive RF power control shall be used by the MS. It allows the system to minimise the transmit power required by the MS whilst maintaining the quality of the radio uplink. By minimising the transmit power levels, interference to co-channel and adjacent channel users is reduced and MS power consumption could be reduced.

Adaptive RF power control shall not be used by the BS.

10.3.2 MS power control implementation

RF power control shall be implemented in the MS, the power level shall be controlled for all bursts, including the initial access.

The MAC shall use the power level supported by the MS that is the closest to P_{MS} , where P_{MS} is defined by:

$$P_{MS} = \text{MIN} (\text{MS_TXPWR_MAX_CELL}, \text{ACCESS_PARAMETER} - R_{lev});$$

where:

MS_TXPWR_MAX_CELL = Maximum MS transmit power allowed in the cell;

ACCESS_PARAMETER = Parameter for access power calculation;

R_{lev} = Averaged signal level received by the MS.

All values are expressed in dBm.

The parameters listed are transmitted on the MCCH.

NOTE: ACCESS_PARAMETER is based on BS power and configuration and on the required mean power level received at the BS.

The MS in RX or idle mode shall update P_{MS} for the current serving cell at least every 30 seconds and, in case of modification, may linearize on the time provided for common linearization at the beginning of each access window.

At least every second or when receiving the BS between 2 transmissions, the MAC shall update R_{lev} and calculate the new RF power level accordingly. The MAC shall employ the new power level at the latest immediately after the time provided for linearization at the beginning of the reserved blocks. If the resulting power level is outside the MS power control range, the closest possible level shall be used.

10.3.3 MS power control range

The detailed definition of the RF power level step size and tolerances is given in clause 6.

10.4 Definition of path loss formulae

10.4.1 Path loss parameter C1

This subclause defines the calculation of the path loss parameter C1, performed by MLE procedures. It is a direct calculation, which shall be performed for the serving cell and for a neighbour cell on which, the MS temporary may be camped. C1 is defined by:

$$C1 = R_{lev} - RXLEV_ACCESS_MIN - \text{Max} (0, MS_TXPWR_MAX_CELL - P)$$

where:

R_{lev}	=	Averaged received signal level at MS from serving cell;
$RXLEV_ACCESS_MIN$	=	Minimum acceptable received level at MS;
$MS_TXPWR_MAX_CELL$	=	Maximum MS transmit power allowed in the cell;
P	=	Maximum transmit power of the MS.

All values are expressed in dBm.

The parameters $RXLEV_ACCESS_MIN$ and MS_TXPWR_MAX shall be transmitted in the serving cell and in neighbour cells. The parameters shall be transmitted on the MBCH.

10.4.2 Path loss parameter C2

This subclause defines the calculation of the path loss parameter C2, performed by MLE procedures. It is an indirect calculation, which shall be performed for neighbour cells. C2 is defined for each neighbour carrier by:

$$C2(n) = R_{lev}(n) - RXLEV_ACCESS_MIN_MCELL(n) - \text{Max} (0, MS_TXPWR_MAX_MCELL(n) - P)$$

where:

$R_{lev}(n)$	=	Averaged received signal level at MS;
$RXLEV_ACCESS_MIN_MCELL(n)$	=	Minimum acceptable received level at MS;
$MS_TXPWR_MAX_MCELL(n)$	=	Maximum MS transmit power allowed in the cell;
P	=	Maximum transmit power of the MS.

All values are expressed in dBm and (n) indicates the nth carrier of the MCA.

The parameters $RXLEV_ACCESS_MIN_MCELL(n)$ and $MS_TXPWR_MAX_MCELL(n)$ shall be transmitted in the serving cell on NBCH.

In the case where these parameters are not known by the serving cell, the MS shall use the parameters $RXLEV_ACCESS_MIN$ and $MS_TXPWR_MAX_CELL$ of the serving cell as default values, see subclause 10.4.1. These shall be part of the MBCH parameters of the serving cell.

In the case where these parameters never have been broadcasted to the MS or if they are considered to be out of date, nominal values shall apply:

P	=	According to clause 6;
MS_TXPWR_MAX_CELL	=	40 dBm;
RXLEV_ACCESS_MIN	=	- 103 dBm;
MS_TXPWR_MAX_MCELL	=	MS_TXPWR_MAX_CELL = 40 dBm;
RXLEV_ACCESS_MIN_MCELL	=	RXLEV_ACCESS_MIN = - 103 dBm.

10.4.3 Path loss parameter C3

This subclause defines the calculation of the path loss parameter C3, performed by layer 3 MLE procedures. It shall be a weighted version of path loss parameter C1 and is defined by:

$$C3 = C1 + RESELECT_OFFSET$$

where:

RESELECT_OFFSET	=	Offset for cell re-selection of the neighbour cell or the serving cell.
------------------	---	---

All values are expressed in dBm.

The parameter RESELECT_OFFSET shall be transmitted in the serving cell and in neighbour cells. The parameters shall be transmitted on the NBCH.

10.4.4 Path loss parameter C4

This subclause defines the calculation of the path loss parameter C4, performed by layer 3 MLE procedures. It shall be a weighted version of path loss parameter C2 and C4 is defined for each carrier by:

$$C4(n) = C2(n) + RESELECT_OFFSET - (SLOW_RESELECT_HYSTERESIS \times (1 + Registration(n)))$$

where:

RESELECT_OFFSET	=	Offset for cell re-selection;
SLOW_RESELECT_HYSTERESIS	=	hysteresis applied to the cell re-selection criteria, unique in the serving cell for all carriers.
Registration(n)	=	indicates if the cell is in the MS registered area: <ul style="list-style-type: none">- 0 if in the MS registered area;- 1 if not in the MS registered area.

All values except $(1 + Registration(n))$ are expressed in dBm and (n) indicates the n^{th} carrier of the list to monitor.

The parameter Registration(n) of C4 can be computed based upon the broadcasted parameter LOCATION_AREA_MCELL(n), which indicates if the n^{th} cell is in the same location area as the serving cell. A cell shall be in the MS registered area (RA) if the MS is already registered in this location area (multiple registration) or if this cell is in the same location area as the serving cell.

The parameters RESELECT_OFFSET, SLOW_RESELECT_HYSTERESIS and LOCATION_AREA_MCELL(n) shall be transmitted in the serving cell. The parameters shall be transmitted on the Normal Block Channel (NBCH).

10.5 Monitoring measurements

The MS shall continuously take readings of the received RF signal strength from all carriers of the monitor list.

As far as possible the same number of measurement samples shall be taken for all carriers and the measurement samples uniformly distributed over the averaging period.

The MS shall perform for each carrier a running average of the received levels measured in the preceding 5 to 60 seconds or if less than 5 measurements were collected during this period on the last 5 measurements. At least every 5 seconds the MS shall (re-)calculate the parameters C2 and C4. The MS may in addition (re-)calculate the parameters C1 and C3 for all carriers of the monitoring list for which the MS has knowledge of the cell selection parameters.

A ranking list of carriers showing the highest C4 values shall be established and updated at least every minute. This list shall contain at least 3 cells, or all cells if the monitor list contains less than 3 cells.

10.5.1 Signal strength measurement

The measurements shall be performed only by the MS in idle mode.

The monitoring periods are the periods during which the MS shall perform the signal strength measurements on the list of carriers. When performing these measurements the MS is unable to receive the data transmitted by its serving cell.

The cell re-selection parameter MAX_MEAS_PERIOD_NUMBER indicates the maximum number of measurement periods per 150 sub-bursts period allowed in the cell. The cell re-selection parameter MAX_MEAS_PERIOD_DURATION indicates the maximum duration, expressed in number of downlink sub-bursts, of the monitoring period.

In the case where these parameters never have been broadcasted to the MS or if they are considered to be out of date, nominal values shall apply:

- MAX_MEAS_PERIOD_NUMBER = 3; and
- MAX_MEAS_PERIOD_DURATION = 7.

The measurement sample duration shall be at least 1 ms. Several carriers may be monitored during one monitoring period.

10.6 Scanning measurement

Scanning is a complex procedure, which shall comprise measuring of signal strength and extracting cell selection parameters from the downlink broadcast. Scanning shall be performed on one carrier at a time. There are three different methods of scanning defined:

- **foreground:** where scanning is the only activity;
- **background:** where communications with the current serving cell are maintained in parallel with the scanning, and the scanning causes no interruption to that service, this method is optional;
- **interrupting:** where communications with the current serving cell are maintained in parallel with the scanning, but the scanning causes limited interruptions to that service.

10.6.1 Foreground scanning

The MS shall do the following:

- attempt to synchronise on the scanned carrier and read its cell selection parameters. The MS shall devote all its resources to these operations. If the cell selection parameters cannot be read within 5 seconds the scanning shall be stopped;

- measure the received RF signal strength. This measurement of the scanned carrier shall be used for re-calculating the path loss criterion C1. The averaging shall be performed over a duration of at least 20 ms, subdivided in at least 5 periods of at least 4 ms as far as possible evenly spread over at least 300 ms;
- calculate for the scanned carrier the path loss criterion for cell selection C1 and C3.

The MS may perform the cell selection parameters measurements and the signal strength measurement simultaneously. Signal strength measurements performed within the 5 seconds before the start of the scanning may be used to calculate C1.

10.6.2 Background scanning (optional)

10.6.2.1 Signal strength measurements

Signal strength measurements use the procedures that are defined for monitoring.

10.6.2.2 Cell selection parameters measurement

The MS shall attempt to synchronise and read the cell selection parameters for the scanned carrier. The MS shall devote all its monitoring capability to these operations. The parameters decoded on the MBCH shall be used to calculate the path loss parameter C1 and path loss parameter C3.

The MS shall keep the information concerning the time synchronisation for the carriers of the list. This information may be used to schedule the subsequent decoding of cell selection parameters and shall be used when accessing a re-selected cell.

When a new carrier for which the synchronisation is unknown by the MS appears in the list, the MS shall devote all its monitoring capability to synchronise on this carrier and read the cell selection parameters, in priority over signal strength measurements on all other carriers. If the cell selection parameters cannot be read within 15 seconds, a re-attempt shall not take place before Attempt_number x 15 seconds after the end of the last attempt period, Attempt_number being the number of attempts already performed.

The MS shall attempt to read the cell selection parameters of each of the carriers of the list at least every minute, to confirm that it is monitoring the same cell and update the value of these parameters. If a change of identity is detected then the carrier shall be treated as a new carrier in the list. If the MBCH cannot be decoded, a re-attempt shall be made at the next available opportunities.

For initial and subsequent cell selection parameters decoding, if the cell selection parameters cannot be decoded after 5 attempts, its carrier shall be discarded from the list and any existing signal strength measurements shall be discarded.

The MS shall re-calculate the parameters C1 and C3 at least every 10 seconds for the carriers of the list.

In the case where the radio link is relinquished before the link is declared relinquishable, the MS shall check all carriers of the list, in descending order of path loss parameter C3, to see if the cell selection criterion is met. If no carrier meets this criterion, the MS shall perform the measurement of cell selection parameters measurement for unannounced cell selection on the remaining carriers.

10.6.3 Interrupting scanning

10.6.3.1 Signal strength measurements

Signal strength measurements use the procedures that are defined for monitoring. See subclause 10.5 related to monitoring.

10.6.3.2 Cell selection parameters measurement

In the case of interrupting scanning (refer to annex E), the cell selection parameters measurements shall take place as soon as the radio link is declared improvable on the serving cell.

NOTE: The MS may not be able to obtain the cell selection parameters from a neighbouring cell during the monitoring period, since the MBCH position is not fixed and the position is not aligned between different cells.

The MS shall attempt to synchronise, read the cell selection parameters and calculate the path loss parameter C1 and C3, for all carriers showing a path loss parameter C4 greater than the path loss parameter C1 of the serving cell and in descending order of parameter C4, until a carrier meeting the criteria for relinquishable link is found.

Interrupting scanning is controlled by two broadcast parameters:

- MAX_MEAS_PERIOD_NUMBER;
- MAX_MEAS_PERIOD_DURATION.

If the cell selection parameters cannot be read within the period duration for a carrier all signal strength measurements on this carrier shall be discarded.

If a cell can be found meeting the criteria for relinquishable link, the announced type 2 cell change procedure (see ETS 300 393-1 [14], clause 8) shall take place. If no cell can be found, the MS shall return to its serving cell and continue the signal strength measurements for announced type 2 cell re-selection procedure.

The MS shall keep the information concerning the time synchronisation for the carriers included the list of showing the highest C4 values. This information may be used to schedule the subsequent decoding of cell selection parameters and when accessing a re-selected cell. Whenever the MS re-calculates the parameters C2 and C4 for one of these carrier, it shall re-calculate the parameters C1 and C3 for this MCA carrier and check if the criterion for relinquishable link is met. The MS may periodically attempt to read the cell selection parameters for these carriers, to confirm that it is monitoring the same cells and update the value of these parameters.

In the case where the radio link is relinquished before the link is declared relinquishable, the MS shall first check all carriers for which the MS has kept the time synchronisation, in descending order of path loss parameter C3, to see if the cell selection criterion is met. If none of the carriers meets this criterion, the MS shall perform the cell selection parameters measurement for unprepared cell selection on the remaining carriers.

10.7 Selection formulae

10.7.1 Initial cell selection

A cell is selected if the path loss parameter C1 for the main carrier is greater than 0 and if the cell is found to be suitable according to the other service criteria defined in clause 18 (see also subclause 10.6.1).

10.7.2 Cell re-selection

When camped on a cell, if the C1 of the serving cell goes below $\text{FAST_RESELECT_THRESHOLD} + 5$, then the MS starts the interrupting scanning (see subclause 10.6.3).

If the C1 of the serving cell goes below $\text{SLOW_RESELECT_THRESHOLD} + 5$ then the MS starts monitoring the neighbouring cells (see subclause 10.5).

If C1 of the serving cell is above $\text{FAST_RESELECT_THRESHOLD} + 10$, then the interrupting scanning is stopped (see subclause 10.6.3).

If C1 of the serving cell is above $\text{SLOW_RESELECT_THRESHOLD} + 10$ then the monitoring is stopped (see subclause 10.5).

10.7.2.1 Criterion for relinquishable link

The link shall be declared relinquishable when the criterion for relinquishable link is met as described below. The declaration shall take place immediately, the appropriate cell change procedures shall take place as soon as the link is declared relinquishable (see figure 15).

The MS shall check the criterion for relinquishable link as often as the parameters C1 and C3 are (re-)calculated for one carrier.

The criterion for relinquishable link is met if the five following conditions are met simultaneously (see figure 15):

- the serving cell path loss parameter C1 falls for a period of 5 seconds below FAST_RESELECT_THRESHOLD;
- the path loss parameter C3 for a carrier exceeds the path loss parameter C3 for the serving cell by FAST_RESELECT_HYSTERESIS for a period of 5 seconds, except in the case where the cell is not in the MS Registration Area (RA), the path loss parameter C3 for a carrier shall exceed the path loss parameter C3 for the serving cell by $2 \times$ FAST_RESELECT_HYSTERESIS for a period of 5 seconds;
- the criterion for cell selection is met for this carrier;
- no cell re-selection took place within the previous 15 seconds;
- the cell selection parameters of the carrier were read within the last 60 seconds.

The parameters FAST_RESELECT_THRESHOLD and FAST_RESELECT_HYSTERESIS are part of the serving cell re-selection parameters.

In the case where the four first conditions are met but the least reading of the cell selection parameters did not took place for the carrier within the last 60 seconds, the MS shall attempt to re-decode these parameters at the next available opportunities, re-calculate the path loss parameters C1 and C3 and re-verify the cell selection criterion. If the cell selection parameters cannot be decoded after 5 attempts, any existing signal strength measurements for this carrier shall be discarded. After discarding the existing signal strength measurements, the MS should now proceed with cell re-selection based on the remaining set of suitable cells.

10.7.2.2 Criterion for improvable link

The link shall be declared improvable when the criterion for improvable link is met (figure 16). The declaration shall take place immediately. The measurement of the cell selection parameters shall take place as soon as the link is declared improvable.

In the case of interrupting scanning, the MS shall check the criterion for improvable link as often as the parameters C1 and C4 are (re-)calculated.

The criterion for improvable link is met if the three following conditions are met simultaneously (see figure 16):

- the serving cell path loss parameter C1 falls for a period of 5 seconds below SLOW_RESELECT_THRESHOLD;
- the re-selection parameter C4 for a carrier exceeds for a period of 5 seconds the serving cell path loss parameter C1;
- no cell re-selection took place within the previous 15 seconds. The parameter SLOW_RESELECT_THRESHOLD is part of the serving cell cell-re-selection parameters.

10.8 Measuring quality of serving cell

10.8.1 Downlink measurements

The MS is required to continuously perform the following measurements on the physical channel(s) to which the MS is attached.

10.8.1.1 Cell (re-)selection parameters decoding

The MS shall attempt to decode the cell selection and re-selection parameters of its serving cell at least every 30 seconds.

NOTE: If necessary this time could be increased if a very low paging rate is standardised.

After changing cell the MS shall decode the cell re-selection parameters of its new serving cell as soon as possible.

10.8.1.2 Signal strength

The MS shall measure the received RF signal strength and calculate a running average of the received level in the preceding 5 to 60 seconds or of the last 5 measurements if less than 5 measurements were collected during this period. The measurement sample duration shall be at least 1 ms.

The path loss parameter C1 shall be calculated by the MS at least every 5 seconds for the serving cell.

10.8.1.3 Radio downlink counter

The quality of the radio down link is estimated from the success rate of decoding the sub-bursts.

The MS is required to perform the following measurements to ensure the path loss to the serving cell is acceptable. The criterion for relinquishing the radio downlink is based on the radio downlink counter RDC. When a MS accesses for the first time on a cell, RDC shall be initialised to a value equal to RADIO_DOWNLINK_TIMEOUT. The RADIO_DOWNLINK_TIMEOUT parameter is part of the cell selection parameters.

If the MS is unable to decode a sub-burst, RDC shall be decreased by $N \times Ms_quality_threshold$, with $Ms_quality_threshold$ a parameter of the Mobile Subscriber Database (MSD). In the case of a successful reception of a sub-burst, RDC shall be increased by N. In any case RDC shall not exceed the value of RADIO_DOWNLINK_TIMEOUT.

NOTE: As an example, if $Ms_quality_threshold = 4$, the ratio 4 to 1 between failure and success counting gives a decreasing RDC when the message error rate exceeds 20 %.

The parameter N is a function of the mean number of time slots between two decodes of downlink sub-bursts by the MS and is obtained from the following algorithm, according to the MS mode of operation:

MS in idle mode: $N = 1$;

$N =$ mean number of sub-bursts between two paging slots assigned to the MS.

MS in RX or full duplex mode: $N = 1$;

MS in TX mode: $N = 0$.

When the mode of operation of the MS is changed, the corresponding value of N shall be calculated by the MS and used for updating RDC. RDC is valid for the cell, whatever the radio frequency channel on which the MS decodes the sub-burst.

Radio downlink failure shall be declared when the RDC falls below 0.

10.9 Radio link measurements of signal quality

The radio link measurements are used for calculating the above mentioned criteria. The radio link measurements are used to assess signal quality which is a combination of received signal strength, RDC, BER and possibly other parameters.

10.9.1 Received signal strength

The received signal strength shall be measured over the range from - 110 dBm to - 48 dBm with an absolute accuracy of ± 4 dB.

The relative accuracy between two measurements on the same carrier or on different carriers shall be ± 3 dB.

The parameters relative to signal strength shall be coded as in table 27.

Table 27: Signal strength parameter definition

Parameter value	Signal strength measured at the antenna connector (dBm)	
	from	to
0		- 110
1	- 110	- 109
2	- 109	- 108

62	- 49	- 48
63	- 48	

10.9.2 RDC counter

The signal quality measurement used shall be the RDC counter.

10.9.3 BER

The BER may be a quality measurement (passed by MAC).

10.9.4 MER

The MER may be a quality measurement (passed by MAC).

10.10 Control parameters

10.10.1 Parameters

The parameters employed by the BS to control the radio link are shown in the following tables.

Table 28 includes only the parameters used by the radio subsystem. Other parameters shall be used for the cell selection criterion (see clause 22 and clause 18) as shown in table 29.

Table 28: Cell selection parameters

Parameter name	Description
BS_COLOUR_CODE	BS colour code
MNI	Mobile Network Identity
V+D_PDO	Type of standard: V+D or PDO
MAIN_CARRIER_CHANNEL	Channel number of the main carrier channel
FREQUENCY_BAND	Frequency band of the main carrier channel
MS_TXPWR_MAX_CELL	Maximum MS transmit power allowed in the cell (coded as MS output power)
ACCESS_PARAMETER	Parameter used for calculating the access power level: - 23 dBm to - 53 dBm in 2 dB steps. 0 = - 53 dBm, 1 = - 51 dBm, ..., 15 = - 23 dBm
RXLEV_ACCESS_MIN	Minimum received level at the MS to access a cell
RESELECT_OFFSET	Offset used to calculate C3: 0 dB to 62 dB in 2 dB steps. 0 = 0 dB, 1 = 2 dB, ..., 31 = 62 dB
RADIO_DOWNLINK_TIMEOUT	Maximum value of Radio Downlink Counter (RDC): 0 to 2 160 sub-bursts, 144 sub-bursts . 0 = disable, 1 = 144 sub-bursts, 2 = 288 sub-bursts, ..., 15 = 2 160 sub-bursts

Table 29: Cell re-selection parameters

Parameter name	Description
SLOW_RESELECT_THRESHOLD	Maximum level above C1 for improvable link: 0 dB to 30 dB in 2 dB steps 0 = 0 dB, 1 = 2 dB, ..., 15 = 30 dB
FAST_RESELECT_THRESHOLD	Maximum level above C1 for relinquishable link: 0 dB to 30 dB in 2 dB steps 0 = 0 dB, 1 = 2 dB, ..., 15 = 30 dB
SLOW_RESELECT_HYSTERESIS	Hysteresis for improvable link: 0 dB to 15 dB, step 1 dB 0 = 0 dB, 1 = 1 dB, ..., 15 = 15 dB
FAST_RESELECT_HYSTERESIS	Hysteresis for relinquishable link: 0 dB to 15 dB in 1 dB steps 0 = 0 dB, 1 = 1 dB, ..., 15 = 15 dB
CHANNEL_MCELL(n)	Channel number
FREQUENCY_BAND_MCELL(n)	Frequency band of the main carrier channel
RXLEV_ACCESS_MIN_MCELL(n)	Minimum received level to access the cell
MS_TXPWR_MAX_MCELL(n)	Maximum MS transmit power in the cell
LOCATION_AREA_MCELL(n)	Indicates if the cell is in the same location area as the serving cell (1= same location area)
MAX_MEAS_PERIOD_NUMBER	Maximum number of main carrier measurement periods per 150 sub-burst period
MAX_MEAS_PERIOD_DURATION	Maximum duration of main carrier measurement periods, expressed in number x 4 sub-bursts
NOTE:	(n) indicates the n th channel of the Main Carrier Allocation (MCA), n = 1 to N.

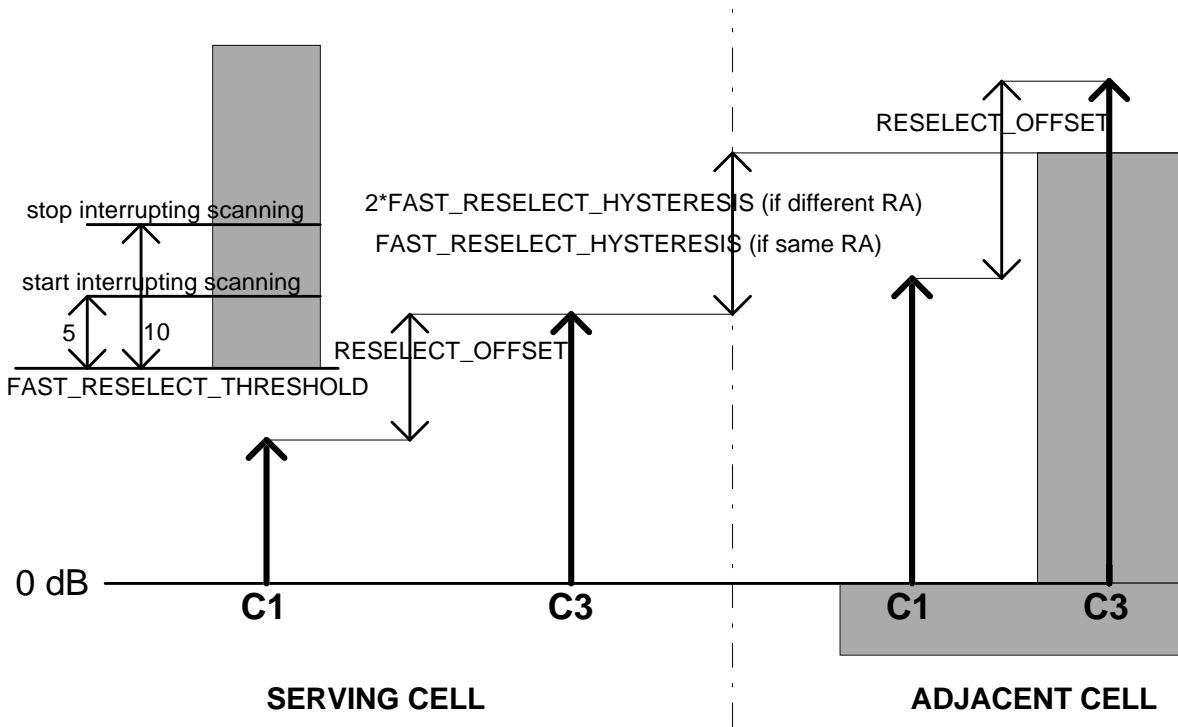

Figure 15: Criterion for relinquishable link

The shaded zones indicate the parameters values for which the cell change is not allowed.

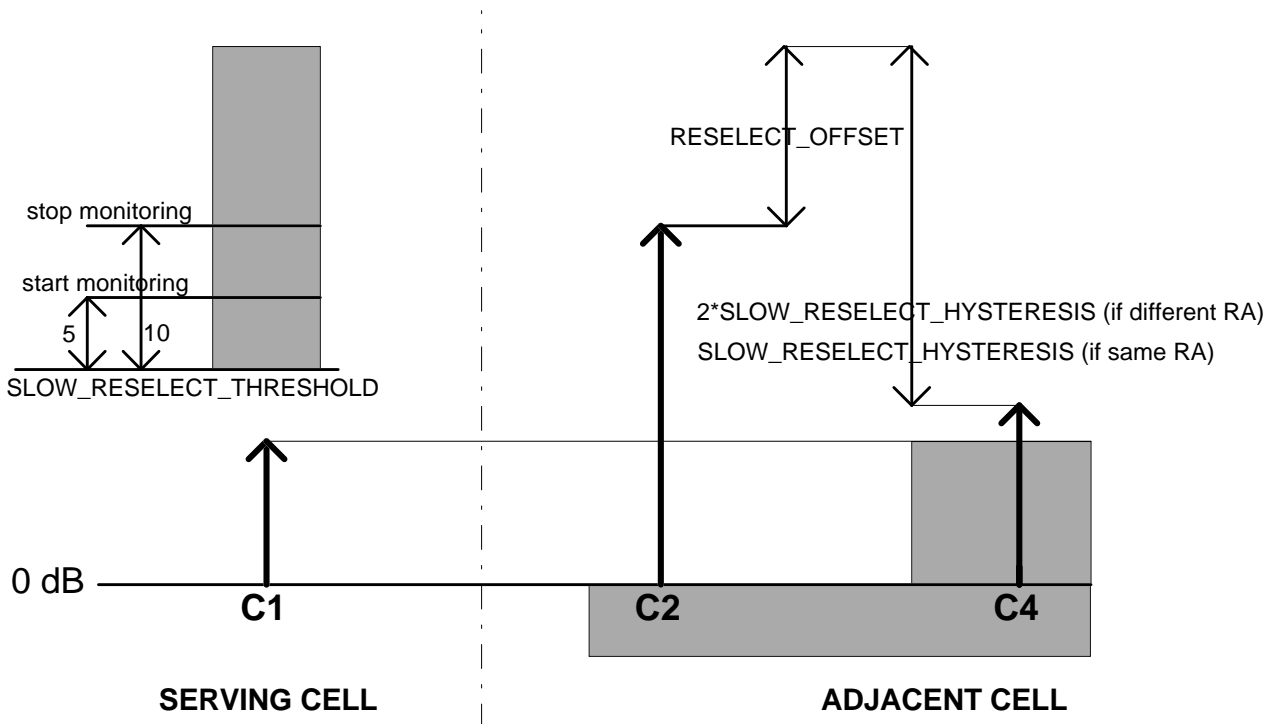

Figure 16: Criterion for improvable link

11 Connection Oriented Network Service description (CONS) (ISO/IEC 8348 and ISO/IEC 8878 delta)

11.1 Introduction

This clause which gives the service description of the TETRA connection mode CONS is based on ISO/IEC 8878 [9] and on ISO/IEC 8348 [5] network service definition. It gives the description of the relevant subclauses of ISO/IEC 8878 [9] which apply to TETRA. It describes the services offered at the layer 3 TNCO SAP.

11.2 Organisation of this document

Subclause 11.4 refers to every clause of ISO/IEC 8878 [9]. The subclauses within subclause 11.4 correspond to each clause of the ISO/IEC 8878 [9] respectively, e.g. subclause 11.4.3 corresponds to ISO/IEC 8878, clause 3. For each ISO clause, the parts that are relevant to TETRA are listed, and any specific additions or deletions are described. Where there are no changes, subclause 11.4 will simply indicate whether the ISO/IEC 8878 [9] clause applies or not.

11.3 Service description

The Service Access Point (SAP) corresponds to the TNCO SAP referred to in ETS 300 393-1 [14], clauses 9 and 10. The services offered shall be:

- virtual call set-up and clearing:
 - the procedure is described in ISO/IEC 8208 [4] and in clause 12 of this ETS during the network connection establishment phase. The call can be cleared at any time by a release phase by each side. This shall apply independently to each logical channel assigned to virtual call service. There shall be no set-up and clearing for Permanent Virtual calls (PVC);
- data transfer:
 - the user data shall be passed transparently and unaltered, the order of bits is kept. The packet transfer applies independently to each logical channel assigned to virtual call and PVC. Acknowledged data transfer can be done;
- interrupt transfer:
 - this shall allow to transmit data (1 to 32 octets) without following the flow control procedures applicable to data packets;
- reset:
 - this shall be used to reinitialise a virtual call or permanent Virtual circuit, it may be transmitted at any time;
- restart:
 - this procedure shall be used to initialise or reinitialise the packet layer interface. The service visible to the user is only the indication of a restart.

Those services correspond to a set of primitives and associated parameters described in this ETS based on ISO/IEC 8878 [9] where a mapping is given of the CONS primitives and parameters to the X.25 PLP using virtual calls. The protocol is described in ISO/IEC 8208 [4] referenced in clause 12.

The following services shall not be offered:

- diagnostic:
 - this service should be offered as a result of the reception of erroneous packet or a time out. This is used to indicate error conditions under circumstances where the usual method of indication (reset, clear, restart) are inappropriate (unrecoverable error at layer 3);

- on line facility registration:
 - on line facility registration shall be an optional facility agreed for a period of time to request registration of optional user facilities and/or to obtain the current values of such facilities;
- restart:
 - the application cannot request a restart but may receive a restart indication;
- flow control:
 - this service shall not be offered to the application but handled by CONP internally.

11.4 ISO/IEC 8878 delta

The ISO/IEC 8878 [9] refers to ISO/IEC 8208 [4] X.25/PLP (version 1990) equivalent to CCITT Recommendation X.25 (version 1988).

11.4.1 Scope and field of application

Text about "conforming 1980 implementation" is applicable to TETRA.

X.25/PLP 1980 is applicable as previously mentioned.

11.4.2 References

Applicable to TETRA.

11.4.3 Definitions

Applicable to TETRA.

11.4.4 Abbreviations

Applicable to TETRA.

11.4.5 Overview

11.4.5.1 Elements of the X.25/PLP 1984 used to support the OSI CONS

Applicable to TETRA. This is further explained below.

ISO gives a list of the packets and fields used to support the OSI CONP (see scenarios in figure 17 to figure 24 inclusive), the list does not cover all standard packets.

The following packets are used for OSI CONS:

CALL REQUEST, INCOMING CALL, CALL ACCEPTED, CALL CONNECTED, CLEAR REQUEST, CLEAR INDICATION, DATA, INTERRUPT, RECEIVE READY, RECEIVE NOT READY, REJECT, RESET REQUEST, RESET INDICATION, RESTART INDICATION (see table 30).

The following packets are not used but are essential:

CLEAR confirmation, INTERRUPT confirmation, RESET confirmation, RESTART confirmation.

This means that they have no primitive equivalent but are essential to the packets used to support the OSI CONS, then they are not reported as primitives to the user application but they are required internally.

The following packets have no relationship with the provision of the OSI CONS:

RESTART request, DIAGNOSTIC , REGISTRATION request and confirmation.

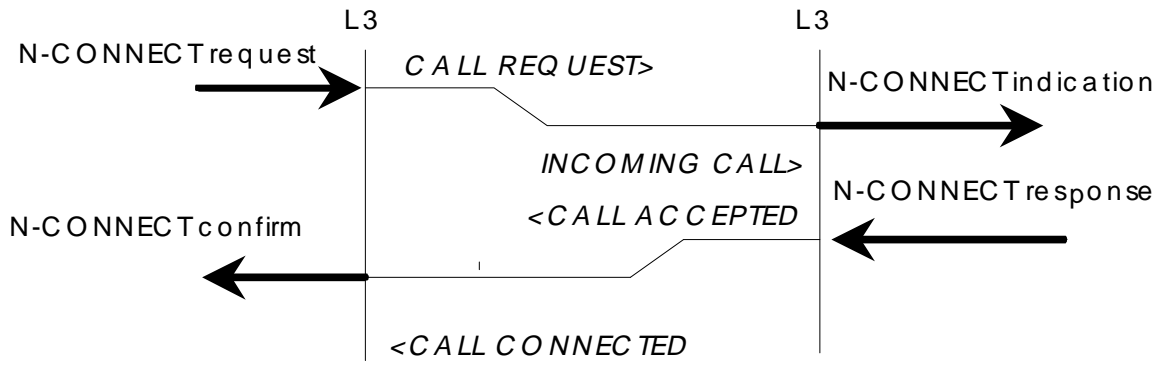

Figure 17: Connection establishment scenario

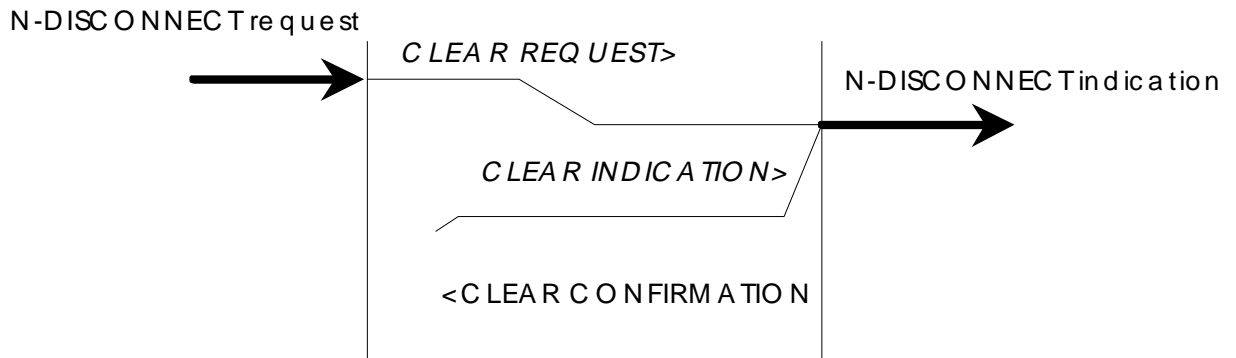

Figure 18: Disconnection scenario

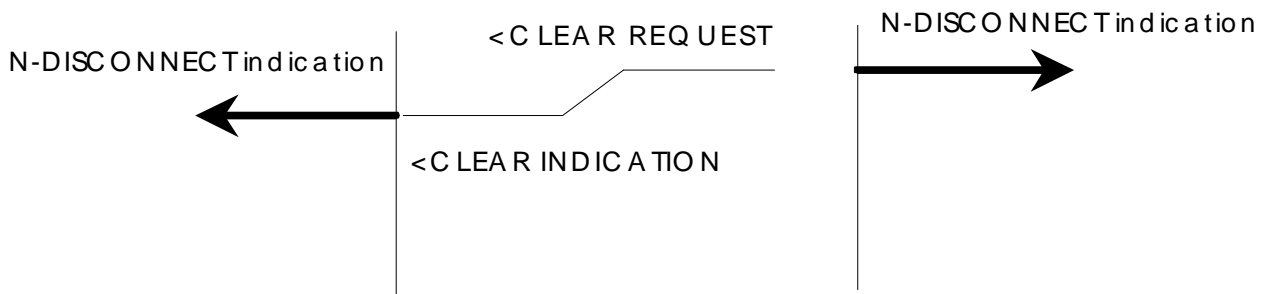

Figure 19: Error detected and disconnection scenario

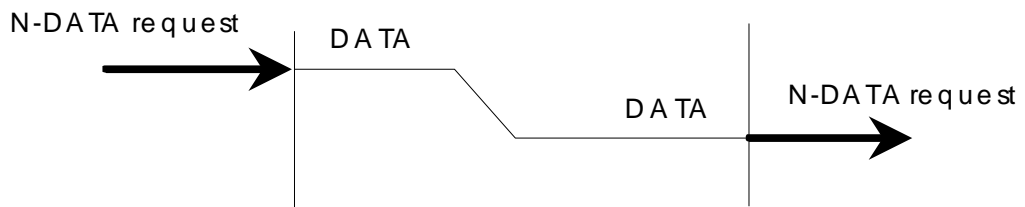

Figure 20: Data transfer scenario

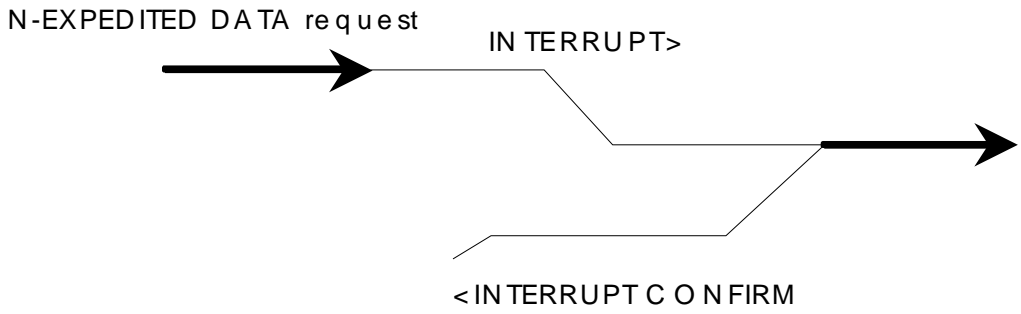

Figure 21: Expedited data transfer scenario

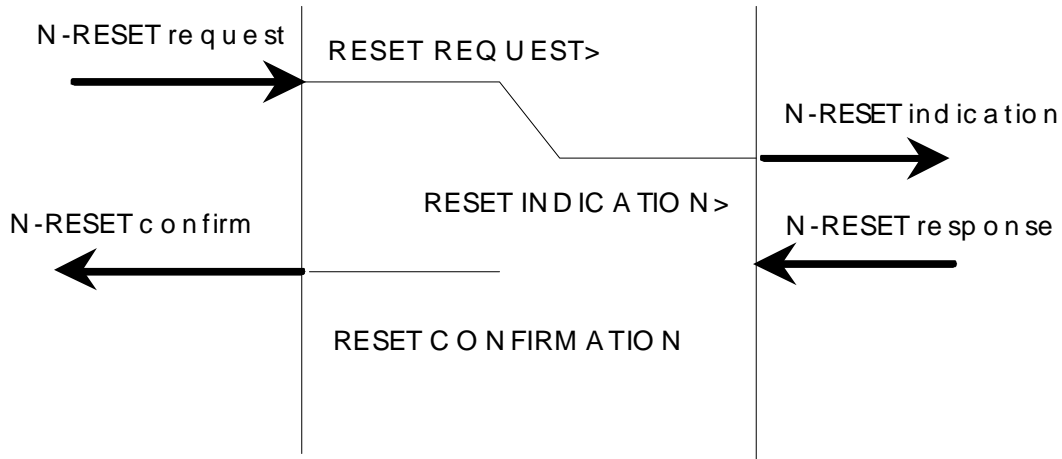

Figure 22: Reset scenario

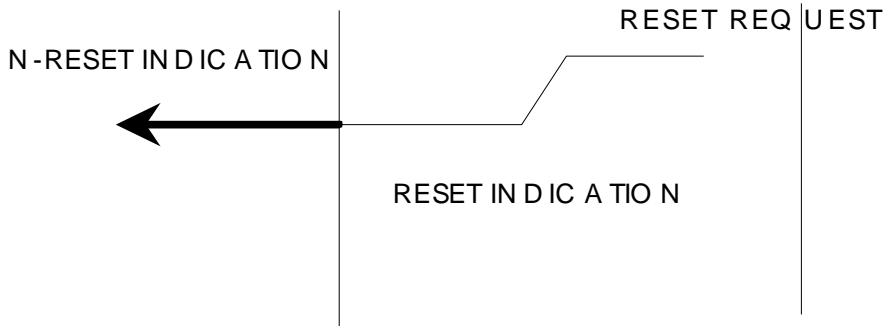

Figure 23: Error detected and reset scenario

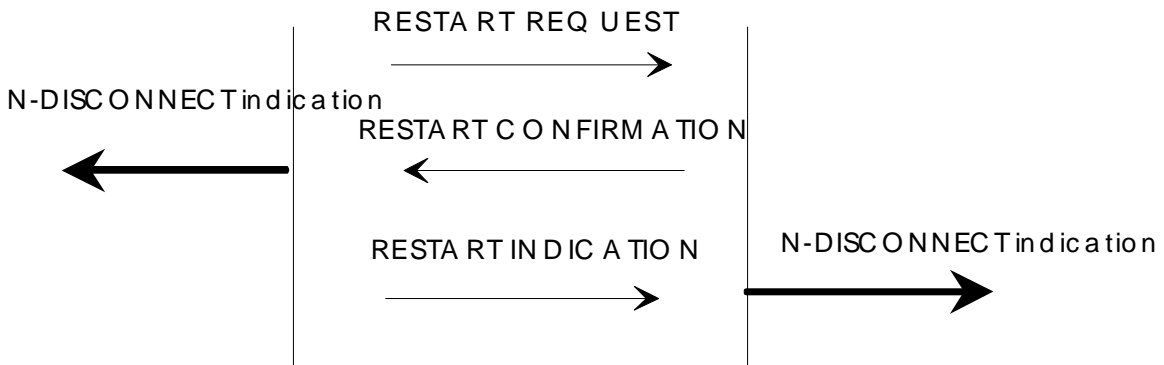

Figure 24: Restart of the connection scenario

Table 30 gives the ISO/IEC 8878 [9] primitives and the corresponding ISO/IEC 8208 [4] packets:

Table 30: Primitives and packet mapping

Packet type	ISO/IEC 8878 [9] primitive	Comment
CALL REQUEST	N-CONNECT request	see subclause 11.4
INCOMING CALL	N-CONNECT indication	
CALL ACCEPTED	N-CONNECT response	
CALL CONNECTED	N-CONNECT confirm	
CLEAR REQUEST	N-DISCONNECT request N-DISCONNECT indication	see subclause 11.4.7
CLEAR INDICATION	N-DISCONNECT indication	
CLEAR CONFIRMATION	-----	essential
DATA	N-DATA request N-DATA indication	see subclauses 11.4.9 and 11.4.8
INTERRUPT	N-EXPEDITED DATA request N-EXPEDITED DATA indication	see subclause 11.4.10
INTERRUPT CONFIRMATION	-----	essential
RECEIVE READY	-----	
RECEIVE NOT READY	-----	
REJECT	-----	
RESET REQUEST	N-RESET request N-RESET indication	see subclause 11.4.11
RESET INDICATION	N-RESET indication	
---	N-RESET response	
RESET CONFIRMATION	N-RESET confirm	essential
RESTART REQUEST	-----	
RESTART CONFIRMATION	-----	
RESTART INDICATION	N-DISCONNECT indication	
DIAGNOSTIC	-----	
REGISTRATION REQUEST	-----`	
REGISTRATION CONFIRMATION	-----	
	N-DATA ACKNOWLEDGE request	see subclause 11.4.9
	N-DATA ACKNOWLEDGE indication	see subclause 11.4.9

All the facilities activated by registration cannot be used (no registration primitive).

The following fields are not used but essential:

- logical channel identifier, packet type identifier, address length field, facility length field are set by the protocol.

This subclause lists optional user facilities and DTE facilities.

They are the only ones handled by the protocol compared to the list defined in ISO/IEC 8208 [4]:

- optional user facilities:
 - fast select;
 - fast select acceptance;
 - throughput class negotiation;
 - transit delay selection and indication;

- specified DTE facilities:
 - called address extension;
 - calling address extension;
 - end to end transit delay negotiation;
 - expedited data negotiation;
 - basic minimum throughput class negotiation;
 - priority.

11.4.5.2 General operation of the X 25 PLP 1984 for supporting the OSI CONS

Applicable to TETRA.

11.4.6 Network connection establishment phase

This subclause describes the connection primitives.

11.4.6.1 Primitive/parameter and packet field relationships

Applicable to TETRA.

11.4.6.2 Procedures

11.4.6.2.1 Primitive and packet mapping

Applicable to TETRA.

11.4.6.2.2 NSAP addresses

This subclause shows how a NSAP address is mapped to and from the address field or the address extension facility. Annex F proposes solutions for binding. This is described in ETS 300 393-1 [14], clause 6.

11.4.6.2.3 Receipt confirmation selection

Applicable to TETRA.

11.4.6.2.4 Expedited data selection

Applicable to TETRA.

11.4.6.2.5 QoS parameter set

Applicable to TETRA. This is further explained below.

ISO defines the QoS parameter which corresponds to four parameters:

- throughput from calling to called;
- throughput from called to calling;
- transit delay;
- priority;

and for each of these parameters a set of sub-parameters:

- target value;
- lowest quality acceptable value;
- available value;
- selected value.

ISO defines throughput parameters ranging from 75 bit/s through 192 000 bit/s.

ISO defines a transit delay parameter ranging from 1 ms to 65 534 ms in increments of 1 ms, (the unspecified value is allowed).

11.4.6.2.6 NS user data

Applicable to TETRA.

11.4.7 Network connection release phase

This subclause describes the disconnection primitives.

11.4.7.1 Primitive/Parameter and packet/field relationships

Applicable to TETRA but new values could be added.

11.4.7.2 Procedures

Applicable to TETRA. This is further explained below.

If an error is detected for which the action is to clear the VC, the layer 3 shall transmit a CLEAR REQUEST packet and signal an N-DISCONNECT indication primitive to the user.

If the layer 3 receives a CLEAR INDICATION packet or a RESTART INDICATION packet, it shall signal it by a N-DISCONNECT indication primitive to the user.

The combination of originator and reason parameters of the N-DISCONNECT primitive is mapped to and from the combination of the clearing cause (or restarting cause) and diagnostic cause field.

11.4.8 Data transfer phase: data transfer service

This subclause describes the DATA primitives.

11.4.8.1 Primitive/Parameter and packet/field relationship

Applicable to TETRA.

11.4.8.2 Procedures

Applicable to TETRA. This is further explained below.

The confirmation of receipt can be requested but there is no distinct packet associated with a N-DATA ACKNOWLEDGE request and a N-DATA ACKNOWLEDGE indication primitive.

A N-DATA ACKNOWLEDGE request and indication are introduced to handle the ACK mechanism.

11.4.9 Data transfer phase: receipt confirmation service

Applicable to TETRA.

11.4.10 Data transfer phase: expedited data transfer service

Applicable to TETRA.

11.4.11 Data transfer phase: reset service

Applicable to TETRA.

11.4.12 Response to protocol violation

Applicable to TETRA.

11.4.13 Conformance

Applicable to TETRA.

11.5 Annex A: X.25 1980 sub-network dependant convergence protocol (normative)

Applicable to TETRA.

11.6 Annex B: Classification (normative)

All text referring to "Conforming 1980" and "X.25/PLP - 1980" is applicable.

Applicable to TETRA.

11.7 Annex C: Sub-network convergence protocol for use with X.25 permanent virtual circuits (normative)

This annex defines a set of SNDCP procedures for use with X.25 Permanent Virtual Circuits (PVC) service. The procedures make use of the packets associated with the virtual call service, the images of these packets called image packets are encoded within X.25 DATA packets.

Applicable to TETRA.

11.8 Annex D: Protocol implementation conformance statement proforma (normative)

Applicable to TETRA.

11.9 Annex E: Additional considerations of CONS primitives (informative)

For information.

11.10 Annex F: Use of X.25/PLP NPAI (informative)

For information.

11.11 Annex G: Transit delay calculations (informative)

For information.

11.12 Annex H: Example of priority negotiation (informative)

For information.

11.13 Annex I: Differences between CCITT Recommendation X.223 and ISO/IEC 8878 [9] (informative)

For information.

12 CONP protocol (ISO/IEC 8208 delta)

12.1 Introduction

This clause which describes the connection mode protocol CONP is based on ISO/IEC 8208 [4] which specifies the procedures, formats and facilities at the packet layer for data terminal equipment based on the 1988 CCITT blue book. The standard defines from the viewpoint of the DTE the packet layer which governs the transfer of packets at a DTE/DCE or DTE/DTE interface.

This clause gives the description of the relevant subclauses of ISO/IEC 8208 [4] which apply to TETRA and the specification.

It is assumed that the Connection Mode Service (CONS) service description in clause 11 (ISO/IEC 8878 delta [9]) is applicable first as it defines TETRA CONS (for example some X.25 packets and facilities have no equivalence in CONS).

This clause describes the air interface protocol and therefore it is assumed that the underlying protocol is the Mobile Link Entity (MLE).

12.2 Organisation of this clause

Subclause 12.4 refers to every clause of ISO/IEC 8208 [4]. The subclauses correspond respectively to the clauses of the ISO/IEC 8208 [4], e.g. subclause 12.4.3 corresponds to ISO/IEC 8208 [4], clause 3. For each ISO clause, the parts that are relevant to TETRA are listed, and any specific additions or deletions are described. Where there are not detailed changes, subclause 12.4 simply indicates whether the ISO clause applies or not.

12.3 Overview of the protocol

12.3.1 Position of the protocol in the network layer

The architectural organisation of the network layer is described in ETS 300 393-1 [14], clause 5 where at layer 3 the connection mode protocol CONP should be used over the Mobile Link Entity (MLE) (see clause 17).

12.3.2 Services provided by the protocol

The CONP protocol shall provide the following services at the TNCO SAP as defined in clause 11:

- virtual call set-up call and clearing;
- data transfer;
- interrupt transfer;
- flow control;
- reset;
- restart.

The primitives which correspond to the services offered are described in clause 11.

12.3.3 Underlying services assumed by the protocol

The underlying services assumed by the protocol are those offered by the Mobile Link Entity (see clause 17).

12.3.4 Services assumed from the local environment

None presently.

12.4 ISO/IEC 8208 delta

ISO/IEC 8208 [4] gives the X.25 procedures and the packets types and formats. As described in ETS 300 393-1 [14], clause 9 the CONP PDUs are the packets defined in ISO/IEC 8208 [4] conforming to clause 11. The following subclauses refers to ISO/IEC 8208 [4] which includes addressing.

The PDUs are either built by CONP from the CONP primitives and its parameters or generated internally as a result of packet exchange received at the LCO SAP not visible at the TNCO SAP.

12.4.1 Scope

Applies to TETRA.

12.4.2 Normative references

A correspondence shall be ensured between the different versions of documents belonging to ISO and also CCITT. (The CCITT documents are issued first followed by the corresponding ISO document).

NOTE: ISO/IEC 8878 [9] which is the use of X.25 to provide the OSI connection mode network service is based on ISO/IEC 8208 [4] which is the X.25 packet layer protocol for data terminal equipment.

Table 31 shows the combinations limited to the ISO combinations.

Table 31: Document correspondence

TETRA Reference	ISO/IEC 8878 [9] version (CONS)	ISO/IEC 8208 [4] version (X.25)	Action
XXXXXXXXXXXXXXXXXX	1987 version based on ----->	1980 version	considered in this clause
XXXXXXXXXXXXXXXXXX	1987 version based on ----->	1984 version	Considered in this clause
ISO/IEC 8208 delta [4]	1987 version	1990 version (based on CCITT ver 1984 then 1988) <----- refers to	
ISO/IEC 8878 delta [9]	1992 version based on ----->	1990 version	

This clause is based on ISO/IEC 8208 [4] which refers to ISO/IEC 8878 [9].

12.4.3 General considerations

The ISO/IEC 8208 (1990) [4] is based on the 1988 CCITT book but it contains the necessary provisions for compatibility with the previous versions of X.25 1984 and 1980, the major technical differences being:

- NUI (Network User Identification) related facilities;
- RPOA (Recognised Private Operating Agencies) related facilities;
- call redirection and call deflection related facilities:
 - call deflection and Network User Identification (NUI) override were not defined;
 - NUI and RPOA facilities were not explicitly separated into subscription and negotiation facilities;
- priority and protection DTE facilities;
- coding of called and calling address extension has changed as only BCD was allowed.

The protocol sequences and associated PDUs shall be as shown in figure 25 to figure 28 inclusive.

12.4.4 Procedures for restart

Only the restart procedures defined in clause 11 shall apply to TETRA.

The PDU shall correspond to restart indication packet.

This is illustrated as follows:

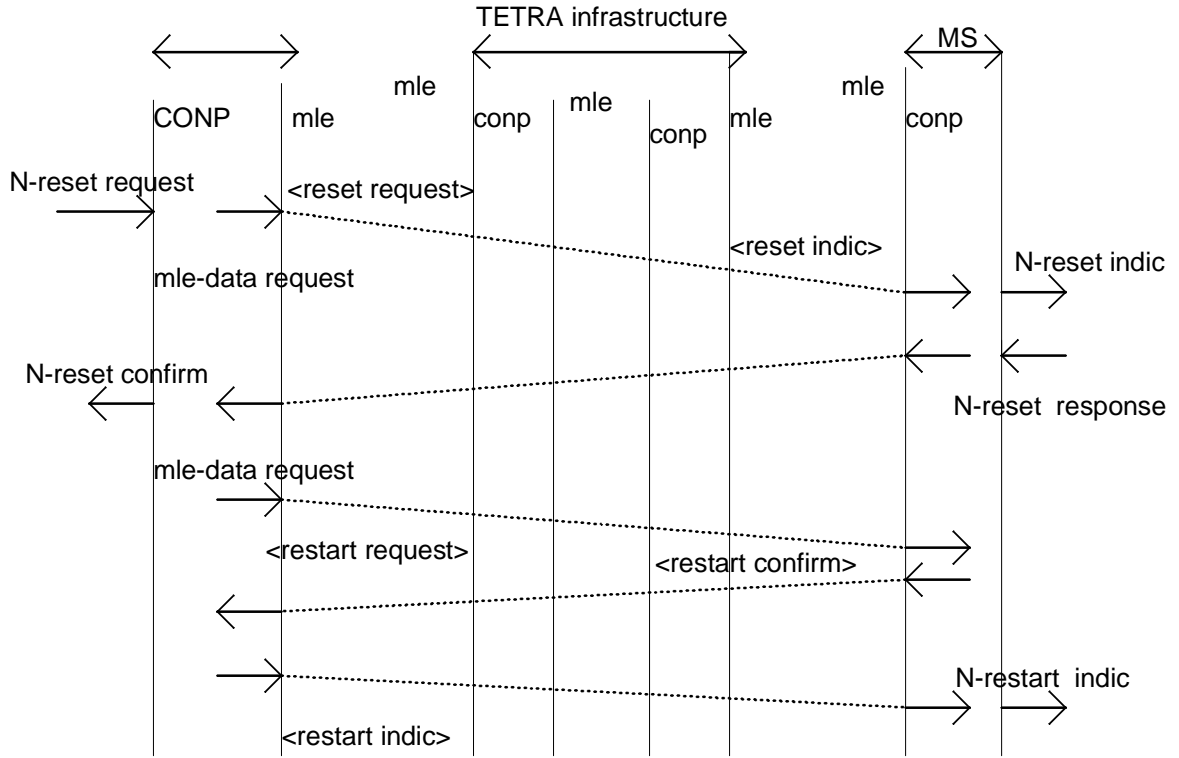

Figure 25: Reset and restart protocol sequence

12.4.5 Procedures for virtual call set-up and clearing

The PDUs shall correspond to call request, incoming call, call accepted, call connected, clear request and clear indication packets.

Applicable to TETRA according to clause 11.

This is illustrated as follows:

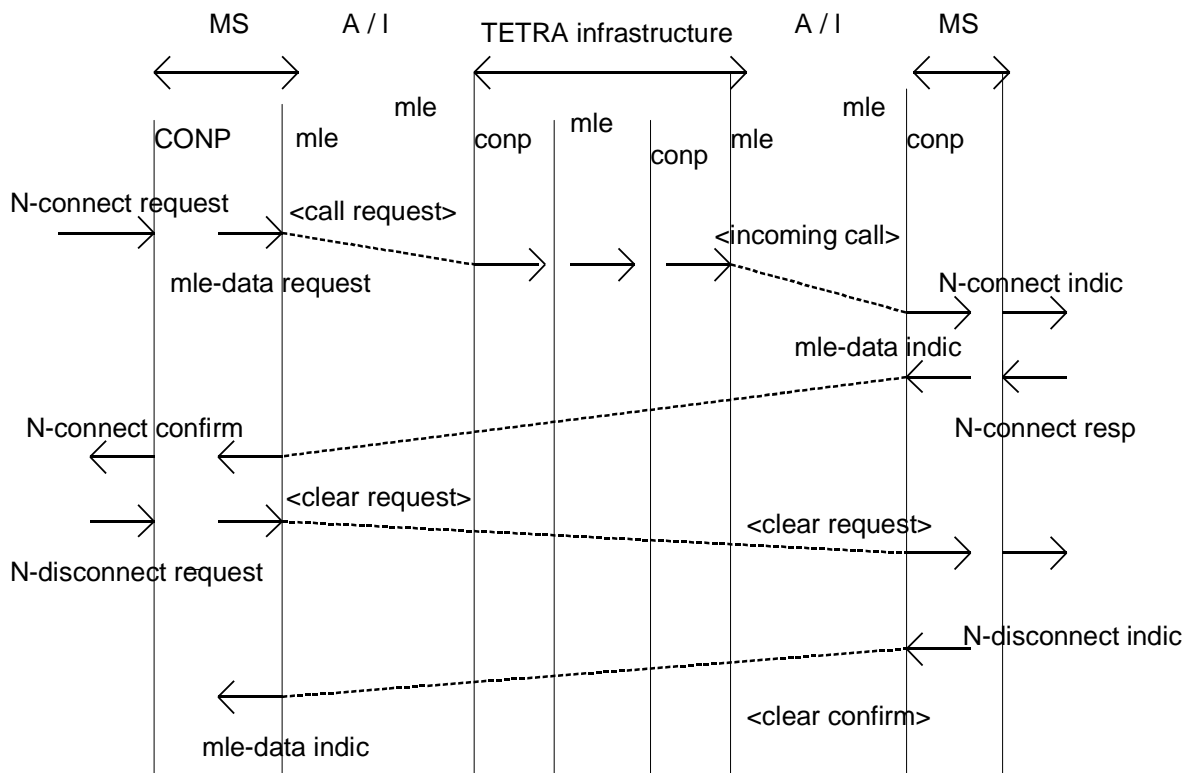

Figure 26: Connection and disconnection protocol sequence

12.4.6 Procedures for data and interrupt transfer

Delivery confirmation D bit shall be applicable.

Data mark M bit shall be applicable.

See clause 11 for applicable procedures.

The PDUs shall correspond to data and Interrupt packets.

This is illustrated as follows:

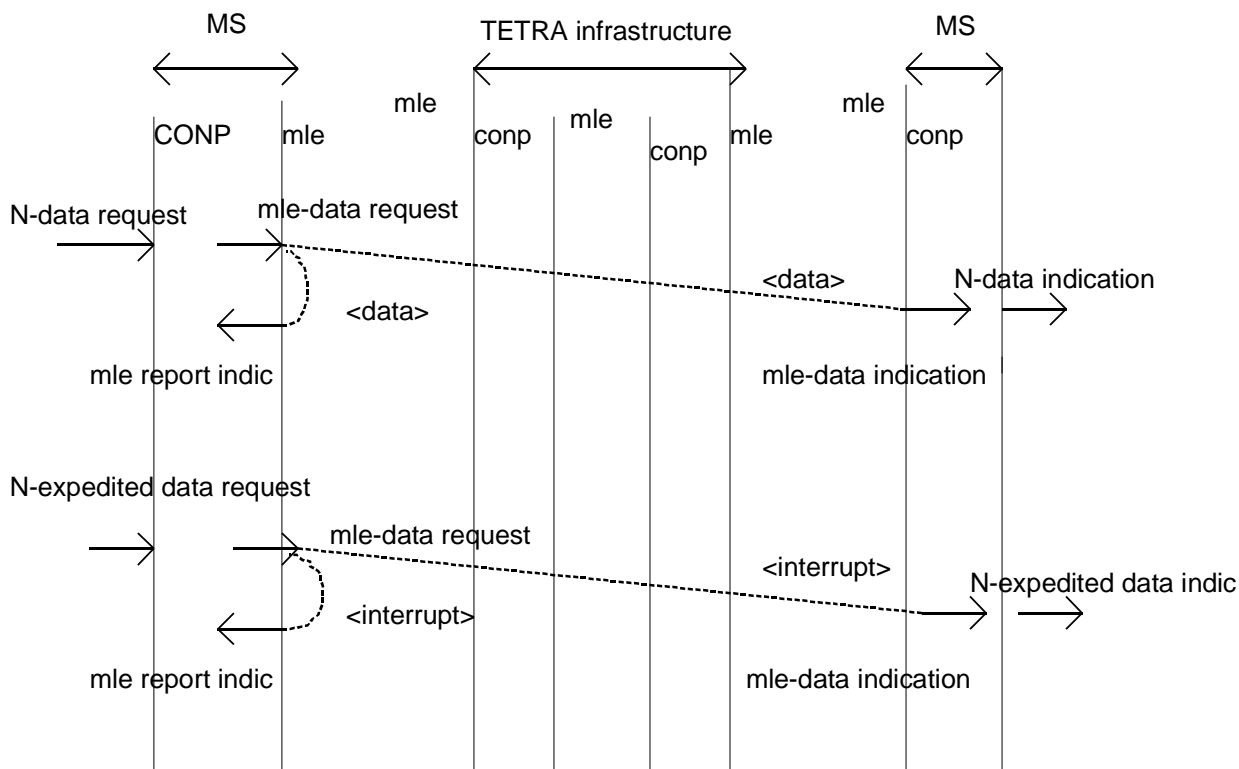

Figure 27: Data and interrupt transfer protocol sequence

12.4.7 Procedures for flow control

The procedures for flow control apply to TETRA with packet sequence numbers received and sent P(R) and P(S) and window.

12.4.8 Procedures for reset

Applicable to TETRA according to clause 11.

The PDUs shall correspond to the reset request, reset indication, reset confirm, reset response packets.

12.4.9 Effects of clear, reset, restart procedures on the transfer of packets

Applicable to TETRA according to clause 11.

12.4.10 Effects of layer 1 and 2 on the packet layer

Not applicable to TETRA.

Changes of operational states shall be indicated by use of restart, clear or reset procedures as defined in clause 11.

Provision for the underlying protocol is described further on.

12.4.11 Error handling

Applicable to TETRA except the diagnostic packet as defined in clause 11.

12.4.12 Packet format

Applicable to TETRA according to clause 11.

12.4.13 Procedures for optional user facilities

Applicable for TETRA for the optional user facilities according to clause 11.

12.4.14 Procedures for optional CCITT specified DTE facilities

Applicable for TETRA for the optional CCITT specified DTE facilities described in clause 11.

12.4.15 Format for facility field in call set-up clearing packets

Applicable to TETRA for the optional user facilities described in clause 11.

12.4.16 Format for registration field in registration packets

Not applicable to TETRA.

12.4.17 Diagnostic codes

Applicable to TETRA for the corresponding packet types.

12.4.18 Timers and re-transmission counts

Applicable to TETRA according to clause 11.

12.4.19 State diagrams

Applicable to TETRA according to clause 11.

12.4.20 State tables

Applicable to TETRA according to clause 11.

12.4.21 Annex A: Private networks

This subclause covers a DTE which is a private network accessing a public network DCE.

Not applicable to TETRA as this ETS relates to the air interface.

12.4.22 Annex B: Differences between the first and the second editions of ISO/IEC 8208

For information.

12.4.23 Amendment 1: Alternative logical channel identifier assignment

Not applicable to TETRA.

12.5 Protocol functions

The protocol functions shall be (clause 11):

- message segmentation re-assembly: the messages sent by the Application may be eventually segmented in packets in three user data fields of 4 096 bytes maximum, the standard default value being 128 bytes user data. The packet header shall be 3 or 4 bytes depending whether packet sequence numbering is performed modulo 8 or modulo 128. Packets may be eventually reassembled (sequence number) before being delivered to the application;
- packet composition and decomposition: each type of packet is built from the primitive type and the primitive parameters. The logical channel identifier, packet type identifier, packet length field and facility length field shall be added.

Some packets noted as essential are built internally to follow the standard X.25 procedures as defined in clause 11:

- receipt confirmation selection: this function shall correspond to confirmation if requested;
- expedited data selection: this function shall correspond to a facility to use the expedited data negotiation facility in some packets;
- QoS parameters check and processing: this function shall correspond to throughput class negotiation and transit delay selection and indication;
- error detection and handling: this function shall correspond to an unexpected packet or when a packet with an error in the parameters is received, or a packet is out of sequence, or a protocol error;
- fast select and fast select acceptance handling: this function authorises some packet types to contain a call user data field;
- flow control: the transmission shall be controlled separately for each direction and is based on authorisations from the receiver. A sequence numbering of data packets shall be performed. A window mechanism shall be defined as the ordered set of N set of N consecutive packet send sequence numbers P(S) of the data packets authorised to cross the interface. A delivery confirmation is also dealt by this function;
- reset: several actions shall be taken to remove the transmitted packets from the window, the lower window edge is set to zero, timers are set back to their initial value.

12.6 Provision of the underlying protocol

12.6.1 Mapping of the primitives

The CONP should be capable of operating over the Mobile Link Entity (MLE) as defined in clause 17 which manages the radio resources, the radio link and the identities.

The underlying services at the LCO SAP should be:

- for data transfer acknowledged:
 - MLE-DATA request/indication;
 - MLE-REPORT indication.
- for access to resources indication: MLE-OPEN indication.

All PVC are reset.

- indication of the non access to the resources: MLE-CLOSE indication.

All virtual calls are cleared and all PVC's are cleared.

- reset: MLE-RESET request/indication/confirm/response;
- indication of temporary unavailability of underlying service and resumption of underlying service:
 - MLE-BREAK indication;
 - MLE-RESUME indication.

This is illustrated as follows:

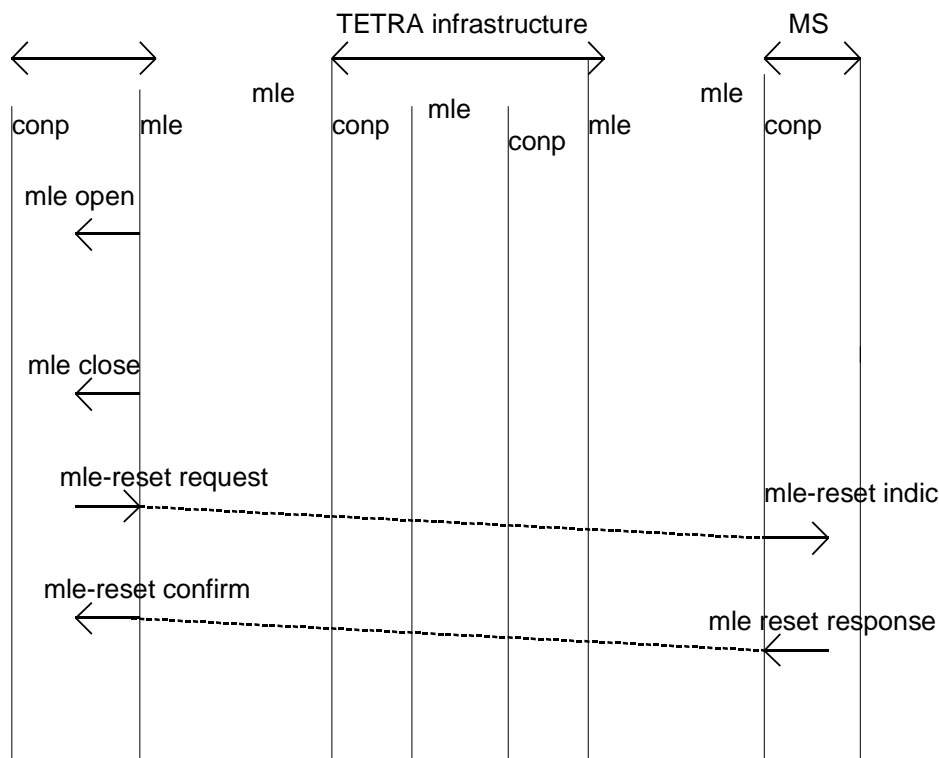

Figure 28: Access to resources and reset protocol sequence

12.6.2 Mapping of QoS

Only mapping of priority is done on the air interface as defined in quality of service.

13 Specific-ConnectionLess Network Service description (S-CLNS)

13.1 Introduction

This clause describes the connectionless mode service provided by the network layer (TETRA layer 3) to the higher layers. Normally the service user will be the transport layer, but a further convergence sub-layer may be included between this service boundary and the transport layer as described in the technical realisation in ETS 300 393-1 [14], clause 10.

The underlying protocol used to provide this connectionless service is assumed to be the TETRA specific connectionless protocol (S-CLNP), see clause 14. This may use any suitable layer 2 services, as described in the technical realisation in ETS 300 393-1 [14], clause 10.

There is no conformance of equipment to this standard. Instead, conformance shall be achieved through implementations of the assumed specific connectionless protocol (S-CLNP). Nevertheless this standard is intended to provide the basis for the definition of a conferment service boundary (e.g. an API).

This service is described in terms of SAPs and primitives.

13.1.1 Specific connectionless service

This service shall be based on the ISO connectionless-mode principles. The service boundary shall correspond to the top of the lowest network sub-layer, the sub-network access role, as defined in ISO 8648 [8]. This TETRA specific connectionless-mode transmission service shall be designed to be used as the sub-network service in the following configurations:

- a) a sub-network service that can support the requirements of the ISO connectionless protocol (ISO-CLNP) [6] with a convergence protocol;
- b) a sub-network service that can be used directly to support specific higher layer protocols (e.g. a specific transport layer protocol, or a specific mobile application);
- c) a sub-network service that can support the requirements of the Internet Protocol (IP) with the addition of a suitable convergence protocol.

These configurations are illustrated as follows:

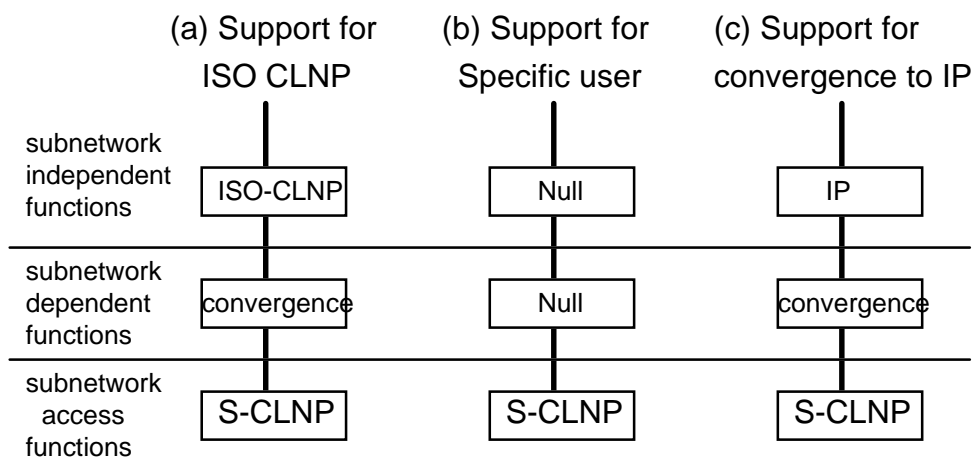

Figure 29: Alternative network layer configurations

This TETRA specific connectionless service shall incorporate additional facilities compared to the ISO network service described in ISO/IEC 8348/Addendum 1 [5]. These facilities are included to provide increased functionality in a mobile packet data environment. A so-called "SLIM" subset of the service is defined for those users who do not wish to take advantage of these additional facilities: this subset corresponds most closely to the ISO/IEC 8348 [5] service definition.

13.1.2 ISO principles of connectionless-mode transmission

This standard uses the concept of connectionless-mode transmission as defined in ISO 7498/Add 1 [3]. Connectionless-mode transmission is the transmission of a single unit of data from a source SAP to one or more destination SAPs without establishing a connection. A connectionless-mode service shall allow an entity to initiate such a transmission by performing a single service access.

An instance of the use of a connectionless-mode service does not have a clearly distinguished lifetime. In addition, the connectionless-mode service shall have the following fundamental characteristics:

- a) it requires only a pre-existing association between the peer entities involved, which determines the characteristics of the data to be transmitted, and a two-party agreement between each peer-entity and the next lower layer. No dynamic peer-to-peer agreement is involved in an instance of the use of the service;
- b) all of the information required to deliver a unit of data is presented to the layer providing the connectionless-mode service, together with the user data to be transmitted as a single service access (i.e. using a set of parameters in a single service primitive). The connectionless-mode service provider is not required to relate a given service access to any other service access.

Connectionless-mode transmission creates no relationship between service data units. A series of service data units supplied in a particular sequence to the service provider will not necessarily be delivered to the destination(s) in the same order. Instances of service failure (failure to deliver) will not necessarily be reported.

13.1.3 General principles

In order to initiate a connectionless-mode service access, there must be a pre-arranged association between service users. This refers to the a priori knowledge that each service user must have. This association is not described in this standard and it comprises the following elements:

- a) knowledge of the addresses of the peer entities;
- b) knowledge of a protocol agreed by the peer-entities for use at least for initial communication;
- c) knowledge of the probable availability of the peer-entities for communication (see note);
- d) knowledge of the quality of service on offer from the network service.

NOTE: This refers to the general availability of the peer-users, and not the short term unavailability caused by radio outage.

These associations are required to allow correct routing of the service data units by the service provider and correct interpretation of the service data units by the destination user.

13.1.4 Sub-addresses

Certain sub-addresses are reserved for ISO-CLNP and IP convergence (see clause 14).

13.2 S-CLNS service description

13.2.1 SAP

S-CLNP shall provide services to the application through one SAP. This relationship is shown as follows:

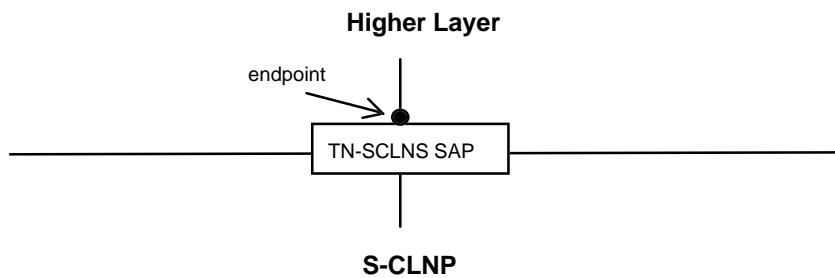

NOTE: The SCLNS service shall include a sub-address field that can be used to enable several service users to share this single endpoint.

Figure 30: SAP between higher layer and S-CLNP

Each independent instance of service shall be represented by a single service endpoint, corresponding to a single value of ITSI.

13.2.2 Services available at the TN-SCLNS SAP

The data transfer services shall provide the means whereby network Service Data Units (SDUs) are delimited and transparently transmitted from a source NSAP to a destination NSAP in a single connectionless mode service access. The maximum size of a connectionless mode SDU is defined in subclause 13.2.3.1.

Certain measures of quality are associated with each instance of connectionless mode transmission, as defined in ETS 300 393-1 [14], annex B. In addition, certain user defined facilities may be specified when using the FULL service. All of these parameters shall be agreed between the network service (NS) provider and the sending user when a connectionless-mode transmission is initiated.

All data transfers require both a source and destination address. The source address shall always be an individual TETRA address, but the destination address may be either an individual TETRA address or a group TETRA address.

The point-to-point service shall provide a connectionless-mode transmission between one source MS and one destination MS or LS.

The point-to-multipoint services shall provide a connectionless-mode transmission between one source MS or LS and one group of MSs and LSs.

13.2.3 Full and slim services

This connectionless-mode service mode shall be operated in the following modes:

- a) the FULL service, which provides data transfer plus all of the TETRA specific facilities as defined in this subclause;
- b) a SLIM subset of the service which provides data transfer, but only provides a few of the facilities defined in this subclause.

13.2.3.1 Data transfer service

The data transfer shall provide a connectionless-mode service that is the same for both the FULL service and the SLIM subset. It shall support both sending and receiving of data without connection establishment.

The maximum NSDU length shall be 2 048 bytes of user data.

NOTE 1: This service offers a sub-network service that is fully compatible with the sub-network requirements of ISO-CLNP [8], ISO-CLNP requires a minimum SDU of 512 bytes.

The data transfer service should be invoked with a TN-UNITDATA request primitive. The TN-UNITDATA confirm should provide a confirmation of a successful start to the data transfer.

NOTE 2: This infrastructure confirmation only reports success for the first data link. More detailed reports are provided as part of the FULL service with the TN-DELIVERY indication primitives.

13.2.3.2 Facilities provided by the service

The following facilities are essential, and shall be provided by both the full and slim protocol:

- a) priority;
- b) sub-addressing.

The following facilities are additional, and shall only be provided by the full protocol with a defined level of function:

- c) delivery disposition;
- d) time stamping.

The following facilities shall be provided by the full protocol, but the level of support shall be defined by the network operator:

- e) multicast;
- f) area selection;
- g) packet storage.

The details of the additional facilities offered by a given network can be negotiated and examined using the facility negotiation primitives.

13.3 Primitive definitions

13.3.1 Primitives types

Four different types of primitives should be used:

- **request:** for the higher layer to request service from the lower layer;
- **confirm:** for the lower layer providing the service to confirm that the activity has been completed;
- **indication:** for the lower layer to notify the next higher layer of any specific service related activity;
- **response:** for the higher layer to acknowledge receipt of an indication primitive from the next lower layer.

In this clause the term "higher layer" shall refer to the transport layer, and the term "lower layer" shall refer to the Mobile Link Entity (MLE).

13.3.2 Data transfer primitives

The data transmission primitives should include the following types:

- TN-UNITDATA request;
- TN-UNITDATA indication;
- TN-UNITDATA confirm;
- TN-DELIVERY indication.

The TL-UNITDATA primitives should be used for unidirectional connectionless-mode transfer. Each sequence of TL-UNITDATA primitives conveys a single network service data unit (NSDU) from one source user to one or more destination users. Each NSDU is independent in the sense that the NS provider is not required to maintain any relationship between this NSDU and any other NSDU. Each TL-UNITDATA primitive is self contained in the sense that all of the information required to deliver the NSDU is presented to the NS provider, together with the user data to be transmitted, in a single service access.

TN-UNITDATA request: this primitive should be used by the sending user to initiate a connectionless mode transmission. This primitive also allows the user to select the facilities and quality of service parameters that shall apply to this packet.

TN-UNITDATA indication: this primitive should be used to deliver one NSDU to the destination user(s). This primitive also contains facilities that are delivered to the destination user(s).

TN-UNITDATA confirm: this primitive should be the immediate response to each TN-UNITDATA request from the infrastructure. It only confirms the successful transfer of the NSDU to the infrastructure.

Following successful initiation of a connectionless mode transmission, one or more delivery disposition reports may be returned by the infrastructure, if requested with the delivery disposition facility. Each of these reports is delivered independently to the sending user with a TN-DELIVERY indication primitive. Each primitive corresponds to the receipt of one report.

TN-DELIVERY indication: should be used to supply one delivery disposition report to the sending user.

13.3.3 Sequence of data transfer primitives

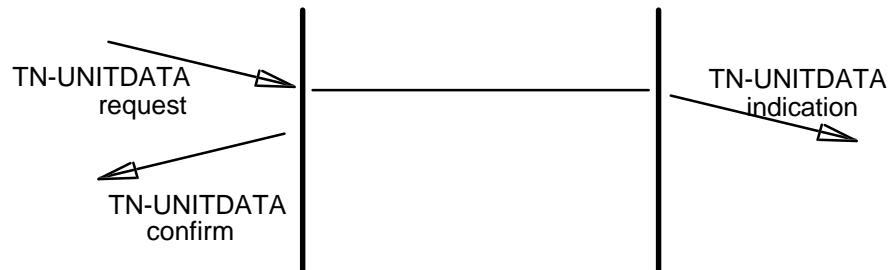

Figure 31: Sequence of primitives for basic data transfer

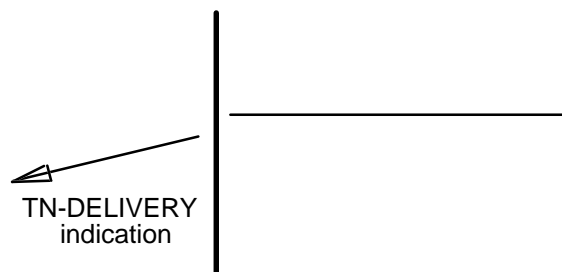

Figure 32: Sequence of primitives for delivery report

13.3.4 Contents of primitives

These layer 3 primitives are defined only for the purpose of describing the layer-to-layer interactions. Each primitive is described as an abstract list of parameters and their concrete realisation may vary between implementations. This ETS does not define a concrete structure for these primitives and no formal testing of primitives is intended.

NOTE: In order to define a conformant service, the primitive parameters should be implemented to accommodate all applicable values of the corresponding PDU fields as defined in SCLNP, see clause 14.

13.3.4.1 Parameter definitions

The following definitions apply to all of the primitives. Definitions appear in alphabetic order.

destination address: The value of ISSI or GSSI to be used for this transmission. Refer to ETS 300 393-1 [14], clause 6.

facilities: The values of all the facilities that should be used. Refer to subclause 13.2.3.2.

Network Service Data Unit (NSDU): The higher layer information that is to be transported.

NOTE: The operations across the service boundary shall be such that the layer sending the message to its peer can assume a temporal order of bits within the SDU and the (peer) layer receiving the primitive can reconstruct the message with its assumed temporal order.

Network Service Data Unit Length (NSDU Length): The length of the higher layer information. The coding of this parameter shall be a local matter and is not defined in this ETS.

protocol subset: The subset of the protocol that shall be used: FULL or SLIM.

qos: The quality of service parameters as defined in ETS 300 393-1 [14], annex B.

report: The report indicates the success or failure of a data transmission.

source address: The value of ISSI to be used for this transmission. Refer to ETS 300 393-1 [14], clause 6.

13.3.4.2 TN-UNITDATA primitives

Table 32: TN-UNITDATA primitives

Parameter	Request	Confirm	Indication	
DESTINATION ADDRESS	M	(=)	(=)	
SOURCE ADDRESS (note 3)	-	-	M	
PROTOCOL SUBSET	M	(=)	(=)	
REPORT	-	M	-	
QoS	M	(=)	(=)	
NSDU	C	-	C(=)	
NSDU LENGTH	C	-	C(=)	
FACILITIES (notes 1, 2)				
Area Selection	C	(=)	(=)	
Delivery/Store request	C	(=)	(=)	
Multicast	C	(=)	(=)	
Packet storage	C	(=)	(=)	
Priority	M	(=)	(=)	
Sub-address	M	(=)	(=)	
Time stamp (note 4)	-	-	C	
NOTE 1:	The facility parameters, except priority and sub-address, only apply when using the FULL service and shall be omitted when using the SLIM service. Refer to subclause 13.2.3.2.			
NOTE 2:	The essential facilities shall always contain valid information. The additional facilities shall always appear in the primitives but may contain invalid information.			
NOTE 3:	The source address is implicit in the request and confirm primitives, since a single instance of SCLNP is bound to one value of ITSI.			
NOTE 4:	The time stamp is added by the infrastructure. Therefore it only appears in the indication primitive.			

KEY: M: Mandatory; C: Conditional; (=): Equal to corresponding primitive; -: Not used

13.3.4.3 TN-DELIVERY primitives

Table 33: TN-DELIVERY primitives

Parameter			Indication	
DESTINATION ADDRESS (notes 1, 2)			M	
SOURCE ADDRESS (notes 1, 2, 4)			-	
NSDU (note 5)			C	
NSDU LENGTH(note 5)			C	
FACILITIES (note 3)				
Delivery/Store request			M	
Disposition Report			M	
Multicast			M	
Priority			M	
Sub-address			M	
Time stamp			M	
NOTE 1:	These mandatory parameters are equal to the parameters in the corresponding TN-UNITDATA request primitive.			
NOTE 2:	The destination address and source address will be reversed relative to the corresponding TN-UNITDATA request.			
NOTE 3:	Some of the facility parameters may contain null information in certain cases.			
NOTE 4:	The source address is implicit in the indication primitive, since a single instance of SCLNP is bound to one value of ITSI.			
NOTE 5:	The NSDU has a maximum length of 2 octets. The NSDU contains the two first octets of the original SDU. This permits a user application to distinguish uniquely between up to 65 536 transmitted SDUs if required.			

KEY: M: Mandatory; C: Conditional; (=): Equal to corresponding primitive; -: Not used

13.3.5 State description

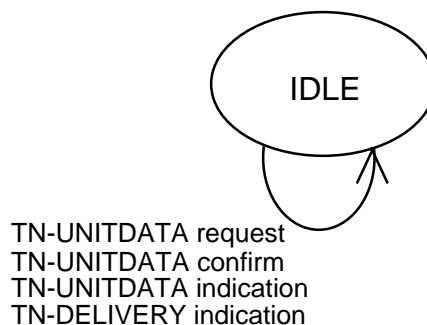

Figure 33: State transition diagram

The IDLE state represents the initial and final state of all the primitive sequences.

14 Protocol for providing the Specific Connectionless network service (S-CLNP)

14.1 Introduction

This clause defines the TETRA Specific ConnectionLess Protocol (S-CLNP). This is the Network (NWK) layer protocol that shall be used to provide the Specific ConnectionLess Network Service (SCLNS) as defined in clause 13. This clause defines the protocol functions required for operation as an end system (i.e. providing service to an end user) or as an intermediate system (e.g. as a NWK layer relay).

This clause specifies:

- procedures for the specific connectionless transmission of data and control information from one network entity to a peer network entity;
- the functional requirements for implementations claiming conformance to this ETS;
- the encoding of the PDUs used for the transmission of data and control information;
- procedures for the correct interpretation of protocol control information.

The procedures are defined in terms of:

- interactions among peer network entities through the exchange of PDUs;
- interactions between a network entity and a network service user through the exchange of network service primitives;
- interaction between a network entity and an underlying service provider through the exchange of service primitives.

For the definitions related to the reference model this clause makes use of the terms defined in ISO 7498 [3] and ETS 300 393-1 [14], clause 4.

For the definitions related to the service convention this clause makes use of the terms used in ISO TR 8509 [7].

For the definitions related to the NWK layer architecture this clause makes use of the terms used in ISO 8648 [8] and ETS 300 393-1 [14], clause 5.

For the definitions related to the NWK layer addressing this clause makes use of the terms used in ISO/IEC 8348 [5] and ETS 300 393-1 [14], clause 6.

14.2 Overview of the protocol

14.2.1 Position of the protocol in the NWK layer

The internal organisation of the NWK layer is described in ETS 300 393-1 [14], clause 5 (protocol architecture). This is closely based on the ISO definition.

The Specific Connectionless Network Protocol (S-CLNP) is designed to be used in the lower sub-layer of the NWK layer - in the role of a sub-network access protocol. A protocol which fulfils this role operates under constraints that are stated explicitly as characteristics of a specific sub-network. The operation of such a protocol contributes to the provision of a sub-network service which is specific to the sub-network concerned; this sub-network service may or may not coincide with the OSI network service.

Within a given sub-network there may be relaying and routing functions which govern the forwarding of information entirely within the sub-network itself. These relaying and routing functions are associated with the operation of this sub-network access protocol. These relaying and routing functions may extend across the addressing domain of all TETRA systems, but they are not intended to be applied outside of that domain.

The operation of this protocol is specified with respect to an underlying service which is made available through the operation of other NWK layer protocols or through the provision of a layer 2 service. The alternative underlying services assumed by this protocol are described in subclause 14.2.5.

14.2.2 Slim subset of the protocol

One subset of the full protocol is defined. This is the "slim" subset which provides a reduced service that does not provide all of the facilities. This permits a shorter protocol data unit header to be used for the air interface when it is known that these facilities are not required.

NOTE: The remaining facilities may not be selected individually. The Full protocol provides all facilities and the Slim subset provides a few of them.

14.2.3 Addresses

The "source address" and "destination address" parameters referred to in this ETS are TETRA subscriber addresses (TSI), or short subscriber addresses as described in ETS 300 393-1 [14], clause 6.

Two formats of addresses shall be used in the air interface PDUs:

- a) short addresses, based on Short Subscriber Identities (SSI);
- b) long addresses, based on (complete) TETRA Subscriber Identities (TSI).

Short addresses allow shorter PDU headers to be used (giving more protocol efficiency) for intra-TETRA calls (source and destination both in the same TETRA network).

Only the long format of address based on TSIs is used in the inter-system PDUs.

14.2.4 Services provided by the protocol

This protocol provides the TETRA specific connectionless mode network service at the SCLNS SAP as described in clause 13.

The services offered are:

- a) data transfer;
- b) facilities.

14.2.4.1 Data transfer service

The data transfer service shall be the same for both the full protocol and the slim subset. It shall support sending of user data without connection establishment. The user data shall be restricted to a maximum length of 2 048 bytes of user data. No segmentation is provided.

NOTE 1: This service offers a sub-network service that is fully compatible with the sub-network requirements of ISO.CLNP [6], ISO.CLNP requires a minimum SDU of 512 bytes.

The data transfer protocol shall provide a confirmation of uplink success of data transfer.

NOTE 2: This confirmation only reports success (or failure) for the first hop (i.e. for the packet transfer to the infrastructure). More detailed reports are also available using the delivery disposition facility. None of these reports provides a end-to-end confirmation from the peer user (i.e. from the destination).

14.2.4.2 Facilities

The following facilities are essential, and shall be provided by both the slim and the full protocol:

- a) priority;
- b) sub-addressing.

The following facilities are additional, and shall be provided by the full protocol:

- c) delivery disposition;
- d) time stamping.

The following additional facilities shall be provided by the full protocol, but this ETS does not specify the level of infrastructure provision (i.e. the allowed values may be restricted by a given implementation):

- e) multicast;
- f) area selection;
- g) packet storage.

NOTE: The structure of the full PDUs is the same, irrespective of the level of provision of a facility. Fields that correspond to non-supported additional facilities are ignored.

14.2.5 Underlying services assumed by the protocol

For the air interface, the protocol operation should be defined to use the MLE underlying service as described in clause 17. This type of operation shall be used for either MS or BS operation.

On a Line Station (LS) the underlying protocol can be either a convergence sub-layer, (e.g. an equivalent line link entity) or direct mapping to a suitable layer 2 protocol. A TETRA network operator may also provide a CONS gateway into S-CLNP.

For internal infrastructure operations, no specific underlying service is defined in this ETS.

To allow consideration of all these different cases the protocol operation is defined in subclause 14.8 with respect to an abstract underlying service. This underlying service consists of a single TSN-UNITDATA primitive which conveys the source and destination sub-network point of attachment addresses, sub-network quality of service parameters, and all of the octets of user data.

The TSN-UNITDATA primitive should only be used to describe the abstract interface between this protocol and either a real underlying sub-network or convergence sub-layer which operates over a real data link to provide the required service.

Provision of these alternative underlying services is described in subclause 14.8.

14.2.6 One instance of protocol

A single instance of S-CLNP is defined by the addresses. One instance of a sending or receiving protocol corresponds to one family of TETRA addresses as defined in ETS 300 393-1 [14], clause 7. An instance of protocol only exists when the protocol has been bound to a valid ITSI address.

An instance of sending or receiving protocol may be removed or created at any time according to this definition. For example, in an MS, the binding of addresses is controlled by the MLE, and an instance shall only be considered to exist when this binding is completed and access to underlying services has been provided, (see subclause 14.8).

14.2.7 Service assumed from the local environment

A timer service shall be provided by the Low Layer Management Entity (LLME) to allow the protocol entity to schedule events.

There are three primitives associated with the timer service:

- S-TIMER request primitive which indicates to the local environment that it should initiate a timer of the specified name and maintain it for the duration specified by the time parameter;
- S-TIMER response primitive which is initiated by the local environment to indicate that the amount of time requested by the corresponding S-TIMER request has elapsed;
- S-TIMER cancel primitive which is an indication to the local environment that the specified timer should be cancelled.

The "S-Time" parameter indicates the time duration of the specified timer.

14.3 Overview of the PDU structures

This subclause gives a summary of the structure of the specific connectionless protocol data units (S-CLNP-PDUs). Different PDU structures are defined for the air interface and the inter-system interface as described in ETS 300 393-1 [14], clause 10.

Each type of PDU shall be defined in each of the following structures:

- <S1-XXX> PDU, for the air interface uplink;
- <S2-XXX> PDU, for the air interface downlink;
- <S3-XXX> PDU, for the inter-system interface.

These different structures are defined to allow the air interface PDUs to be as short as possible.

Table 34 shows all the different PDU combinations.

Table 34: PDU combinations

	PDU structure			Options allowed (see note)		Data content
	Uplink	Downlink	ISI	Address: - Short (S) - Long(L)	Facilities: - Full (F) - Slim (S)	
Data	<S1-DT>	<S2-DT>	<S3-DT>	S,L	F,S	User Data
Delivery		<S2-DEL>	<S3-DEL>	S,L	F	None
NOTE:	These options only apply to the uplink and downlink PDUs. Inter-system Interface (ISI) PDUs always use long addresses and full facilities.					

14.4 PDU descriptions

14.4.1 General format

The general basic format of the S-CLNS PDU shall be according to table 35:

Table 35: Format of S-CLNS PDU

PDU header	Fixed Part
	Address Part
	Facilities Part
	Header Checksum (see note)
Data Part	User Data
NOTE: The header checksum only appears in inter system PDUs.	

The total size of the PDU header is variable. Both the address part and the facility part can have different lengths:

- fixed part: 3 octets;
- address part: 3 or 6 octets;
 - short addresses: 3 octets;
 - long address: 6 octets;
- facility part: 0 or N octets;
 - slim subset: 0 octets;
 - full protocol: N octets (see note).

NOTE: The length of the facility part (N) is only dependant on the PDU type and structure. N is constant for a given PDU type and structure.

Header checksum: 2 octets

Table 36 gives a detailed view of the contents of different types of PDU at the air interface:

Table 36: Contents of air interface PDUs

	Field	S1-DT PDU	S2-DT PDU	S1-DEL PDU	S2-DEL PDU
Fixed part	Version	X	X		X
	Type	X	X		X
	Flags	X	X		X
	Priority	X	X		X
	Sub-address	X	X		X
	Packet Length	X	X		X
	Field	S1-DT PDU	S2-DT PDU	S1-DEL PDU	S2-DEL PDU
Address part	Dest Address	X			X
	Source Address		X		X
	Field	S1-DT PDU	S2-DT PDU	S1-DEL PDU	S2-DEL PDU
Facility part	Del/Storage Request	X	X		X
	Rep Request	X	X		X
	Time stamp	X	X		X
	Multicast area selection	X			
	Disposition Report				X
	Field	S1-DT PDU	S2-DT PDU	S1-DEL PDU	S2-DEL PDU
Data part					
	User Data	X	X		X

NOTE: Only part of the user data is returned in the delivery PDU.

14.4.2 <S1-DT>and <S2-DT> PDU headers with short address

Table 37: <S1-DT> and <S2-DT> PDU headers with short address contents

<S1-DT>PDU header (Uplink PDU)		octet	<S2-DT>PDU header (Downlink PDU)	
Version	PDU Type	1	Version	PDU Type
Flags	Packet Length	2	Flags	Packet Length
Sub-address	Priority	3	Sub-address	Priority
Packet Length		4	Packet Length	
Destination Address		5	Source Address	
Destination Address		6	Source Address	
Destination Address		7	Source Address	
Facility part (full protocol only)				
Timestamp		8	Timestamp	
Timestamp		9	Timestamp	
Timestamp		10	Timestamp	
D/S request	Rep request	11	D/S request	Rep request
Multicast Area Selection		12	Reserved	

NOTE: The MLE sub-layer adds a source address parameter to the uplink PDU and adds a destination address parameter to the downlink PDU. Thus both source and destination addresses are available to layer 3.

14.4.3 <S1-DT>and <S2-DT> PDU headers with long address

Table 38: <S1-DT> and <S2-DT> PDU headers with long address contents

<S1-DT>PDU header (Uplink PDU)		octet	<S2-DT>PDU header (Downlink PDU)	
Version	PDU Type	1	Version	PDU Type
Flags	Packet Length	2	Flags	Packet Length
Sub-address	Priority	3	Sub-address	Priority
Packet Length		4	Packet Length	
Destination Address		5	Source Address	
Destination Address		6	Source Address	
Destination Address		7	Source Address	
Destination Address		8	Source Address	
Destination Address		9	Source Address	
Destination Address		10	Source Address	
Facility part (full protocol only)				
Timestamp		11	Timestamp	
Timestamp		12	Timestamp	
Timestamp		13	Timestamp	
D/S request	Rep request	14	D/S request	Rep request
Multicast Area Selection		15	Reserved	

NOTE: The MLE sub-layer adds a source address parameter to the uplink PDU and adds a destination address parameter to the downlink PDU. Thus both source and destination addresses are available to layer 3.

14.4.4 <S3-DT> PDU header

Table 39: <S3-DT> PDU header contents

<S3-DT>PDU HEADER (Intersystem PDU)		octet
Version	PDU Type	1
Flags	Packet Length	2
Sub-address	Priority	3
Packet Length		4
Source Address		5
Source Address		6
Source Address		7
Source Address		8
Source Address		9
Source Address		10
Destination Address		11
Destination Address		12
Destination Address		13
Destination Address		14
Destination Address		15
Destination Address		16
Timestamp		17
Timestamp		18
Timestamp		19
D/S request	Rep request	20
Multicast Area Selection		21
Packet Route		22
Header checksum		23
Header checksum		24

14.4.5 <S2-DEL> PDU header with short address

Table 40: <S2-DEL> PDU header with short address contents

<S2-DEL>PDU header (Downlink PDU)	
1	Version PDU Type
2	Flags Packet Length
3	Sub-address Priority
4	Packet Length
5	Source Address
6	Source Address
7	Source Address
8	Timestamp
9	Timestamp
10	Timestamp
11	D/S request Rep request
12	Disposition
13	

14.4.6 <S2-DEL> PDU header with long address

Table 41: <S2-DEL> PDU header with long address contents

<S2-DEL>PDU header (Downlink PDU)	
1	Version PDU Type
2	Flags Packet Length
3	Sub-address Priority
4	Packet Length
5	Source Address
6	Source Address
7	Source Address
8	Source Address
9	Source Address
10	Source Address
11	Timestamp
12	Timestamp
13	Timestamp
14	D/S request Rep request
15	Disposition
16	

14.4.7 <S3-DEL> PDU header

Table 42: <S3-DEL> PDU header contents

<S3-DEL> PDU header (Intersystem PDU)		octet
Version	PDU Type	1
Flags	Packet Length	2
Sub-address	Priority	3
Packet Length		4
Source Address		5
Source Address		6
Source Address		7
Source Address		8
Source Address		9
Source Address		10
Destination Address		11
Destination Address		12
Destination Address		13
Destination Address		14
Destination Address		15
Destination Address		16
Timestamp		17
Timestamp		18
Timestamp		19
D/S request	Rep request	20
Disposition		21
Packet Route		22
Header checksum		23
Header checksum		24

14.5 Formats of fields

14.5.1 General principles

Field codings are listed in the order of their appearance in the PDUs.

Unless otherwise stated, all fields shall be coded according to the natural binary code. The resulting value shall be arranged with most significant bit (msb) in the highest numbered bit position. Field codings may be listed in either binary (B) or hexadecimal (H) format.

When a field spans more than one octet, the order of bit values within each octet progressively decreases as the octet number increases. The lowest bit number associated with the field represents the lowest order value.

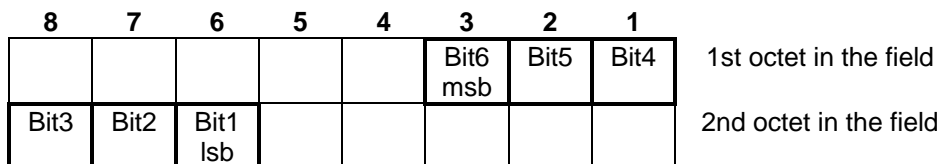

Figure 34: Field mapping

Certain elements are reserved (Res). Unless otherwise stated, these elements shall be set to binary "0".

14.5.2 Fixed part fields

14.5.2.1 Version (4 bits)

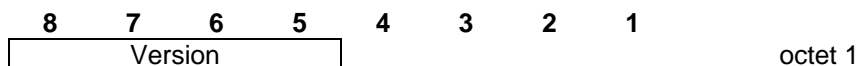

Figure 35: Version field

The version indicates:

Bit:	8	7	6	5	
	0	0	0	0	Version 0 (this ETS)

All other values reserved.

14.5.2.2 Type (4 bits)

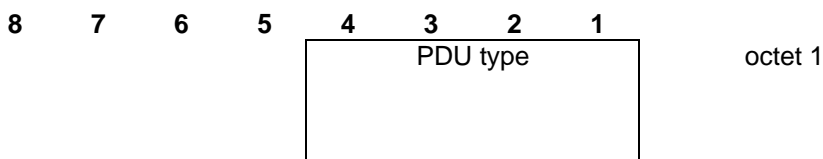

Figure 36: Type field

The PDU type indicates either:

Bit:	4	3	2	1	
	0	0	0	0	Data PDU
	0	1	0	0	Delivery PDU

All other values reserved.

14.5.2.3 Flags (4 bits)



Figure 37: Flags field

- FS flag: indicates which protocol subset applies to this PDU:
 - FS="0": FULL; or
 - FS="1" SLIM.
- LA flag: indicates length of address:
 - LS="0" Long address (6 octets);
 - LS="1" Short address (3 octets).

14.5.2.4 Packet length (12 bits)

This field indicates the total length of the data part in octets.

Range:

1 to 2 048 for User Data (Data PDUs).

14.5.3 Address part fields

Either short (3 octet) or long (6 octet) addresses as defined by LA flag.

3 octet address contains the Short Subscriber Identity (SSI).

6 octet address contains the TETRA Subscriber Identity (TSI).

Refer to ETS 300 393-1 [14], clause 6.

14.5.4 Facility part fields

14.5.4.1 Sub-address

The contents of this field is defined by the service user, and the value used shall be the same as the value supplied in the primitive parameters.

Any 4-bit value. Allowed range 0 H to F H.

Reserved values: E H IP
 F H ISO CLNP

14.5.4.2 Priority

The contents of this field is defined by the service user, and the value used shall be the same as the value supplied in the primitive parameters.

The following values of priority shall be allowed:

0 H low;

2 H medium;

4 H high;

8 H emergency.

14.5.4.3 Delivery/Storage request

The contents of this field shall be defined by the service user, and the value used shall be the same as the value supplied in the primitive parameters.

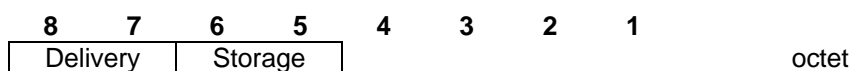

Figure 38: Delivery/Storage request field

The delivery/storage request indicates the services required for this packet:

The delivery field shall indicate either:

Bit:	8	7	
	0	0	Point-to-point
	0	1	Multicast

All other values reserved.

The storage field shall indicate either:

Bit:	6	5	
	0	0	None
	0	1	Storage A (see note)
	1	0	Storage B (see note)
	1	1	Storage for at least 72 hours (≥ 72 hours)

NOTE: The storage time indicated by these codings is implementation dependent, and is not defined by this ETS.

14.5.4.4 Report request

The contents of this field shall be defined by the service user, and the value used shall be the same as the value supplied in the primitive parameters.

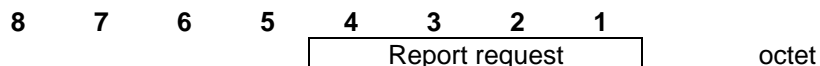

Figure 39: Report request field

The report request indicates the class of reports required for this packet. This is a bit mask that allows each class of report to be separately selected:

Bit:	4	3	2	1	
	-	-	-	x	Final delivery class reports
	-	-	x	-	All positive reports
	-	x	-	-	All negative reports
	x	-	-	-	Reserved

For each bit position, a "1" indicates that this class of report shall be supplied, and a "0" indicates that this class of report shall not be supplied.

Refer to subclause 14.5.4.5 for a list of possible disposition reports.

NOTE: Some disposition reports are classified in more than one class.

14.5.4.5 Disposition

The disposition field shall be used to code one value of report. Each report is coded in two fields. The class field is a bit mask that indicates the report class(es) to which the report belongs. The type field distinguishes the different reports within each class.

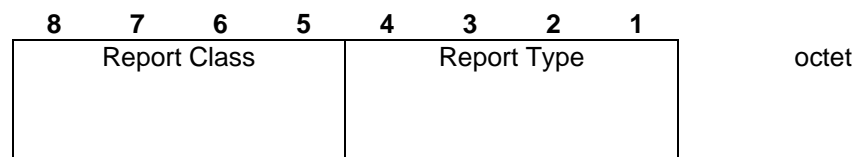

Figure 40: Disposition field

Class Type Description

8765	4321	
0011	0000	Successful delivery of pt-pt packet
0011	0010	Successful delivery of stored pt-pt packet
0011	1000	Successful multicast
0100	0000	Failed delivery - packet discarded
0100	0010	Packet deleted from store
0100	0101	Packet lost - network congestion
0100	0110	Packet lost - cause unknown

0110	0000	Packet stored for later delivery
1000	0000	Illegal service request - packet discarded
1000	0001	Multicast facility not supported - packet discarded
1000	0010	Invalid area selection - packet discarded
1000	0100	Destination address unknown - packet discarded
1100	0010	Failed delivery and packet storage not supported, packet discarded

All other values are reserved.

Class bit 5 (0001) = final delivery reports
Class bit 6 (0010) = positive reports
Class bit 7 (0100) = negative reports
Class bit 8 (1000) = error reports

This disposition report should only be produced when a packet storage is attempted. Normal delivery shall be attempted first, even if an unsupported storage option is requested.

14.5.4.6 Multicast area selection

Multicast area selection uses one octet. The contents of this field is defined by the service user, and the value used shall be the same as the value supplied in the primitive parameters.

The multicast area selection value of 00 H is reserved. This dummy value shall be used for "pt-pt" packets.

The multicast area selection values of 01 H to 0F H are reserved. These values shall be used to encode area selection values to correspond to the V+D services. The coding of these values is for further study.

All other values of multicast area selection shall only be used if "multicast" is indicated in the delivery required. The allowed values shall lie in the range 10 H to FE H and the areas associated to these values shall be agreed on a per-subscription basis.

The multicast area selection value of FF H shall be reserved and shall mean "broadcast" or "all areas". The provision of this facility shall also be agreed on a per subscription basis.

14.5.4.7 Time stamp

The time stamp field is three octets. The time stamp for each PDU shall be set equal to the "absolute network time" by the first network node to indicate the time of submission of the packet.

Absolute network time is defined as follows:

- 1) zero time (000000H) is defined as 00:00 hours, Universal Time Co-ordinates (UTC time) on January 1st of every year. Absolute network time is therefore reset each year;
- 2) absolute network time shall be incremented by one every 2 seconds, and the value of absolute network time at all network nodes shall not differ by more than 4 steps (a maximum difference of 8 seconds);
- 3) the value FFFFFFFH is reserved and shall be used to indicate an Invalid value of time stamp. This value shall be used in all <S1-DT> PDUs and by the infrastructure in the event of network malfunction;
- 4) the values F142FFH - FFFFFFFEH are reserved for future use.

14.5.4.8 Packet route

This field shall only appear in the <S3-DT> or <S3-DEL> PDU.

14.5.5 Header checksum

This field shall only appear in the <S3-DT> or <S3-DEL> PDU.

The checksum shall be calculated on the entire PDU header, and the resulting octets placed in this field.

A checksum value of zero is reserved to indicate that the checksum shall be ignored. The operation of the PDU header error detection function as described in subclause 14.7.8 ensures that the value zero does not represent a valid checksum. A non-zero value indicates that the checksum shall be processed.

14.5.6 User data part

For data PDUs, the user data shall be supplied in the same primitive (a single SDU) up to a maximum limit of 2 048 octets.

For delivery PDUs, the user data shall be the first two octets copied from the corresponding data PDUs. If the corresponding data PDU contains less than 2 octets, the delivery PDU shall contain all of the user data. These octets may be used as a packet signature.

14.6 Primitive definitions and format

All primitives are defined in clause 13.

14.7 Protocol functions

This subclause describes the functions performed as part of the protocol.

The functions depend on the role of the protocol instance, and not all the functions shall be implemented in each role. Four alternative roles are identified for S-CLNP: a send role; a receive role and two forwarding roles. Table 43 lists the requirements for each role.

NOTE: A particular implementation may be required to support more than one role, e.g. a sending role will usually be combined with a receiving role.

Table 43: Provision of protocol functions

Ref.	Function	System role			
		Send	Forward 1 MTUn	Forward 2 Infrastructure	Receive
10.1	DT PDU composition	M	-	-	-
10.2	DEL PDU composition	-	-	M	-
10.3	DT PDU decomposition	-	-	-	M
10.4	DEL PDU decomposition	M	-	-	-
10.5	Route PDU	-	M (note 3)	M	-
10.6	Forward PDU	M	M	M	-
10.7	Discard PDU	-	M (note 1)	M (note 1)	M
10.8	Header error detection	-	-	I	-
10.9	FACILITY FUNCTIONS:				
10.9.1	Sub-addressing	M (note 2)	-	-	M (note 2)
10.9.2	Priority	M (note 2)	I	I	M (note 2)
10.9.3	D/S Request	-	-	I	-
10.9.4	Report Request	-	-	M	-
10.9.5	Area selection	-	-	I	-
10.9.6	Time stamp	-	-	M	-
10.9.7	Packet storage	-	-	I	-
NOTE 1:	Protocol procedure not respected, header that cannot be analysed, PDU whose checksum is inconsistent with its content.				
NOTE 2:	Included in PDU composition and decomposition.				
NOTE 3:	Only required for multiple subscriptions (multiple TSI) attached to one MTU.				

where:

M: this function shall be implemented;

I: implementation optional;

-: not applicable.

Forward 1 designates the S-CLNP function in the MTU (MTU0 or MTU2 or MTU3).

Forward 2 designates the forward function of the S-CLNP in the TETRA infrastructure.

14.7.1 Data PDU composition

This function is responsible for the construction of a data PDU according to the rules governing the encoding of PDUs given in subclauses 14.4 and 14.5. Protocol control information required for delivering the data unit to its destination shall be determined from the current state and local information and from the parameters contained in the associated TL-UNITDATA request primitive. When a forwarding station is required to compose one type of PDU from another type (e.g. composing a <S1-DT> PDU from a <S3-DT> PDU) the protocol control information in the new PDU shall be determined from the corresponding fields in the old PDU.

In all cases, the PDU TYPE field shall be set to indicate "data", and the VERSION field shall be set to indicate "version 0" (this ETS).

The total length of the USER DATA in octets shall be determined by the originator and the result placed in the PACKET LENGTH field. This field shall not be modified when converting the PDU.

The further operations depend on the location of the composition function. For a PDU that is being composed by a MTU for submission to the air interface, the <S1-DT> PDU shall be used. For a PDU that is being composed by the infrastructure for submission to the air interface, the <S2-DT> PDU shall be used. For a PDU that is being composed by the infrastructure for submission to a Line Station (LS), the <S3-DT> PDU shall be used.

14.7.1.1 <S1-DT> PDU composition

The DESTINATION ADDRESS field shall be derived from the "destination address" parameter (field) in the associated primitive (PDU). If this destination address lies in the current network the short address format should be used. Otherwise the long address format shall be used. The LA flag shall be set according to the address type in use.

There is no source address field in uplink <S1-DT> PDUs. Instead, the source address shall be defined a priority for each instance of S-CLNP: each instance shall only be associated to a single value of ISSI.

NOTE 1: A single value of source address (ISSI) can be considered as the definition of "one instance" of S-CLNP. Refer also to subclause 14.7.5.

NOTE 2: The priority definition of the source address is locally created, e.g. in a MS this is assumed to require a binding between each particular instance of S-CLNP and the MLE.

If the full protocol is requested, the additional facility fields shall be added as defined in subclause 14.7.1.4. Otherwise these fields shall be omitted.

14.7.1.2 <S2-DT> PDU composition

The SOURCE ADDRESS field shall be derived from the "source address" parameter (field) in the associated primitive (PDU). If this source address lies in the current network the short address format should be used. Otherwise the long address format shall be used. The LA flag shall be set according to the address type in use.

There is no destination address field in downlink <S2-DT> PDUs. Instead, the destination address shall be included as a parameter to the MLE for each packet submission: each submission shall only be associated to a single value of ISSI or GSSI.

If the full protocol is requested, the additional facility fields shall be added as defined in subclause 14.7.1.4. Otherwise these fields shall be omitted.

14.7.1.3 <S3-DT> PDU composition

The SOURCE ADDRESS field shall be derived from the "source address" parameter (field) and the DESTINATION ADDRESS field shall be derived from the "destination address" parameter (field) in the associated primitive (PDU). The long address format shall be used for both addresses and the LA flag shall be set accordingly.

The facility fields shall always be included in the PDU. If the facility fields contain valid information, this shall be indicated by setting the FS FLAG, and the facility fields shall be added as defined in subclause 14.7.1.4.

In certain cases, the facility fields may contain invalid (null) information (for example, when the PDU is composed by converting a slim uplink PDU as described in subclause 14.7.6). In this case all of the facility fields shall be filled with zeros and the FS FLAG shall be cleared.

14.7.1.4 Composition of facility fields

The following facility fields shall be derived from the corresponding TN-UNITDATA request primitive:

- SUBADDRESS;
- PRIORITY;
- D/S REQUEST;
- REPORT REQUEST.

The TIMESTAMP field shall be filled with zeros by the originator of the Initial PDU. This field shall be added by the network at the first infrastructure node.

14.7.2 Delivery PDU composition

This function is responsible for the construction of a delivery PDU according to the rules governing the encoding of PDUs given in subclauses 14.4 and 14.5. Protocol control information required for delivering the data unit to its destination shall be determined from the current state and local information. There is no associated primitive. When a forwarding station is required to compose one type of PDU from another type (e.g. composing a <S2-DEL> PDU from a <S3-DEL> PDU) the protocol control information in the new PDU shall be determined from the corresponding fields in the old PDU.

Delivery PDUs shall only be composed if the delivery disposition facility has been selected in the corresponding data PDU.

NOTE: One packet may generate more than one disposition report.

The PDU TYPE field shall be set to indicate "delivery", and the VERSION field shall be set to indicate "version 0" (this ETS).

The USER DATA field shall be set equal to the first 2 octets of the user data field of the associated DATA PDU. If the associated DATA PDU contains less than 2 octets of user data, all of the user data shall be copied into the DELIVERY PDU.

The initial composition of a delivery PDU is assumed to be in the form of a <S3-DEL> PDU. Further composition operations depend on the location of the composition function. For a PDU that is being composed by the infrastructure for submission to the air interface, the <S2-DEL> PDU shall be used. For a PDU that is being composed by the infrastructure for submission to a Line Station (LS), the <S3-DEL> PDU shall be used.

14.7.2.1 <S1-DEL> PDU composition

There is no <S1-DEL> PDU.

14.7.2.2 <S2-DEL> PDU composition

The SOURCE ADDRESS field shall be derived from the "source address" field of the associated PDU. If this source address lies in the current network the short address format should be used. Otherwise the long address format shall be used. The LA flag shall be set according to the address type in use.

There is no destination address field in downlink <S2-DT> PDUs. Instead, the destination address shall be included as a parameter to the MLE for each packet submission: each submission shall only be associated to a single value of ISSI or GSSI.

The facility fields shall be added as defined in subclause 14.7.2.4.

14.7.2.3 <S3-DEL> PDU composition

The SOURCE ADDRESS field shall be derived from local information and the DESTINATION ADDRESS field shall be derived from the "source address" field of the corresponding <DT> PDU. The long address format shall be used for both addresses and the LA flag shall be set accordingly.

The facility fields shall always be included in the PDU. These fields shall always contain valid information and this shall be indicated by setting the FS FLAG. The facility fields shall be added as defined in subclause 14.7.2.4.

14.7.2.4 Composition of facility fields

The following facility fields shall be copied from the associated <S-DT> PDU:

- SUBADDRESS;
- PRIORITY;
- D/S REQUEST;
- REPORT REQUEST.

The following facility fields shall be supplied by the reporting entity:

- DISPOSITION REPORT;
- TIMESTAMP.

The TIMESTAMP field shall be set equal to absolute network time (as defined in subclause 14.5.4.7) by the reporting entity. This assumes that the reporting entity is part of the infrastructure.

14.7.3 Data PDU decomposition

This function is responsible for removing the protocol control information from the PDU header and preparing the TN-UNITDATA indication. The information for the TN-UNITDATA indication shall be determined as follows:

The "source address" parameter shall be derived from the SOURCE ADDRESS field. If the short address format was used in the PDU, the current mobile network code shall be inserted to complete the "source address" parameter. The "destination address" shall not be supplied: this shall be defined a priori for each instance of S-CLNP.

The following facility fields shall be directly copied into the corresponding TN-UNITDATA indication primitive:

- SUBADDRESS;
- PRIORITY;
- D/S REQUEST;
- REPORT REQUEST.

14.7.4 Delivery PDU decomposition

This function is responsible for removing the protocol control information from the PDU header and preparing the TN-DELIVERY indication. The information for the TN-DELIVERY indication shall be determined as follows:

The "source address" parameter shall be derived from the SOURCE ADDRESS field. If the short address format was used in the PDU, the current mobile network code shall be inserted to complete the "source address" parameter. The "destination address" shall not be supplied: this shall be defined a priori for each instance of S-CLNP.

The following facility fields shall be directly copied into the corresponding TN-DELIVERY indication primitive:

- SUBADDRESS;
- PRIORITY;
- D/S REQUEST;
- REPORT REQUEST;
- DISPOSITION REPORT.

14.7.5 Route PDU

This function determines the network entity to which a PDU should be forwarded, and the underlying service that shall be used to reach that network entity, using the DESTINATION ADDRESS field of the PDU. The results of the route PDU shall be passed to the forward PDU function (along with the PDU itself) for further processing.

14.7.6 Forward PDU

This function issues a suitable primitive to the sub-network service identified by the route PDU function. The sub-network-specific address supplied by the route PDU function identifies the next system within the sub-network domain (this may be an intermediate system or an end system).

The forward PDU shall use one of the sub-network services, and the associated primitives, described in subclause 14.8.

The forward PDU function may also be required to provide a PDU conversion function, when forwarding PDUs to or from the air interface. This conversion function is responsible for the construction of a different type of data PDU (or delivery PDU) according to the rules governing the encoding of PDUs given in subclauses 14.4 and 14.5. Protocol control information required for the output PDU shall be wholly determined from the corresponding fields in the input PDU.

When converting a slim <S1-DT> PDU into a <S3-DT> PDU the output PDU the facility fields in the output PDU have no corresponding fields in the input PDU. In this case the output facility fields shall be filled with zeros and the FS FLAG shall be cleared, in accordance with the rules defined in subclause 14.7.1.3.

14.7.7 Discard PDU

This function performs all the actions necessary to free the resources reserved by the network entity when any of the following situations (not exhaustive) is encountered:

- a) a violation of a protocol procedure has occurred;
- b) a PDU is received whose header checksum is inconsistent with its contents;
- c) a PDU is received but due to local congestion it cannot be processed;
- d) a PDU is received whose header cannot be analysed;
- e) a PDU is received whose destination address is unreachable or unknown;
- f) a PDU is received which contains an unsupported facility.

14.7.8 PDU header error detection

This function is based on the corresponding function in ISO 8473 [6].

The PDU header error detection function protects against failure of intermediate or end-system network entities due to the processing of erroneous information in the PDU header. This function is realised by a checksum computed on the entire PDU header. The checksum shall be verified at each point at which the

PDU is processed. If the checksum calculation fails, the PDU shall be discarded. If PDU header fields are modified then the checksum shall be modified so that the checksum remains valid (see note 1).

The use of the header error detection function is optional and shall be selected by the originating network-entity (see note 2). If this function is not used, the checksum field of the PDU header shall be set to zero.

If this function is selected by the originating network entity, the value of the checksum field shall cause the following formulae to be satisfied:

$$\sum_{i=1}^L a_i = 0 \quad \dots \quad (\text{mod } 255)$$

$$\sum_{i=1}^L (L - i + 1) a_i = 0 \quad \dots \quad (\text{mod } 255)$$

where L is the number of octets in the PDU header and a_i is the value of the octet in position i . The first octet in the PDU header is considered to occupy position 1.

When this function is in use, neither octet of the checksum field may be set to zero.

NOTE 1: For the purposes of this subclause, the originating network entity refers to the first network entity in the originating network that creates a PDU type that contains the header checksum field.

Annex C contains a description of algorithms which may be used to calculate the correct value of the checksum field when the PDU is created, and to update the value of the checksum field when the header is modified.

NOTE 2: To ensure that inadvertent modification of a header while a PDU is being processed by an intermediate system (e.g. due to a memory fault) may still be detected by the PDU header error function, an intermediate system network-entity does not re-compute the checksum for the entire header, even if fields are modified. Refer to the update description in annex C.

14.7.9 Facility functions

14.7.9.1 Sub-addressing

The sub-address facility is provided to allow service users to identify different higher layer protocols. This facility allows the originating service user to define any value for the SUBADDRESS field, and this value shall be preserved by all intermediate systems, such that the same numeric value of sub-address shall always be supplied to the destination user.

NOTE: The sub-address values are not standardized, and they should not be used to support any internal network functions.

14.7.9.2 Priority

The priority facility allows a PDU with a numerically higher priority value to be processed preferentially with respect to other PDUs with numerically lower priority values by both intermediate and end systems. The function is realised by the PRIORITY field in the facility part of the PDU header.

The lowest priority value is 0 H. The specific actions taken by a particular network-entity to support the priority facility is a local matter and are not specified in this ETS.

NOTE: Examples of priority processing include preferential treatment in output queues and in buffer allocations.

14.7.9.3 D/S (delivery/storage) request

The D/S request facility allows a user to request one of defined set of network operations on the data PDU. The delivery and storage choices shall be processed independently according to the following subclauses.

14.7.9.3.1 Delivery facility

The set of alternatives for this facility are defined by the DELIVERY field and are described in subclause 14.5.4.3. This facility allows the service user to indicate the type of packet delivery that should be provided for each PDU.

The point-to-point value should correspond to the use of an ITSI as the destination address. The multipoint value should correspond to the use of a GTSI as the destination address. In all cases, the DELIVERY field shall take precedence over any analysis of the DESTINATION ADDRESS with respect to all applicable forwarding functions.

This facility is closely related to the area selection facility, and the originator of the Initial PDU shall also provide a value for the AREA SELECTION field that is consistent with the delivery mode selected here (see subclause 14.7.9.5).

14.7.9.3.2 Storage facility

The set of alternatives for this facility are defined by the STORAGE field and are described in subclause 14.5.4.3. This facility allows the service user to indicate the relative level of packet storage that may be provided for each PDU.

The specific actions taken by a particular network-entity to support the packet storage facility are not specified in this ETS.

14.7.9.4 Report request

The set of alternatives for this facility are defined by the REPORT REQUEST field and are described in subclause 14.5.4.4. This facility allows the service user to indicate the type of delivery disposition reports that should be provided for each PDU.

This facility is closely related to the disposition report facility (see subclause 14.7.9.7).

14.7.9.5 Multicast area selection

The set of alternatives for this facility are defined by the AREA SELECTION field as described in subclause 14.5.4.5.

This facility allows the service user to indicate the geographic areas to be used for multicast packet delivery. When selecting point-to-point delivery the reserved point-to-point value shall be used.

The specific actions taken by a particular network-entity to support the area selection facility are not specified in this ETS.

14.7.9.6 Time stamping

The time stamp facility allows the receiving entity, and any infrastructure entities to know the time of submission of each packet. This field is set equal to the "absolute network time" by the first infrastructure node, and it shall not be modified by any other node.

The time stamp coding of "absolute network time" is defined in subclause 14.5.4.7. This value is reset every year, such that the time stamp is ambiguous for packets that remain in the network for more than 1 year.

A time stamp value that is greater than the current value of "absolute network time" should be interpreted as referring to the previous year.

A time stamp coded with the reserved "invalid" value shall be ignored.

14.7.9.7 Disposition report

This facility allows the infrastructure to generate disposition reports for data PDUs that can be used by the originating service user to monitor the progress of a PDU through the network.

This facility is closely related to the report request facility (see subclause 14.7.9.4) and all originators of delivery PDUs shall only generate delivery PDUs in accordance with the rules contained in this subclause.

Any forwarding protocol entity may generate a disposition report. The allowed values for the DELIVERY REPORT field are described in subclause 14.5.4.5.

A protocol entity shall only generate a disposition report if there is a match between the requested class (as indicated by the REPORT REQUEST field) and the REPORT CLASS sub-field. If a bit-wise logical AND of the REPORT REQUEST field and the REPORT CLASS sub-field produces a non-zero result, a delivery PDU may be generated. If it produces a zero result the disposition report shall be discarded and no delivery PDU shall be generated.

14.8 Provision of the underlying service

14.8.1 General

Convergence functions may be required to provide the underlying connectionless-mode service assumed by this protocol. If the lower layer inherently provides a connection mode service, this convergence function provides a mapping into the required services.

Convergence functions may also be required in those cases where functions assumed from the underlying service are not performed. In some cases this may require the operation of an explicit protocol.

14.8.2 Operation over MLE

The S-CLNP is intended to be capable of operating over the MLE using the services provided at the LSCL SAP (see clause 17). The MLE sub-layer manages the radio resources, the radio link and the addresses and provides convergence to the packet data optimised layer 2 (which is optimised for air interface operation).

The underlying service at the LSCL SAP consists of the primitives described in clause 17:

- **MLE- CLOSE indication** to indicate that access to the MM link has been removed;
- **MLE- OPEN indication** to inform access to the link;
- **MLE -DATA request** to send acknowledged data;
- **MLE- DATA indication** to indicate the arrival of acknowledged data;
- **MLE-UNITDATA request** to send unacknowledged data;
- **MLE-UNITDATA indication** to indicate the arrival of unacknowledged data.

When issuing primitives to the MLE, the S-CLNP shall use map the abstract TSN-UNITDATA request to either a MLE-DATA request primitive or a MLE-UNITDATA request primitive according to the following rules:

- 1) all downlink primitives that indicate "multicast" in the DELIVERY field of the PDU (full S-CLNP only) shall be mapped onto a MLE-UNITDATA request primitive;
- 2) all other cases shall be mapped to a MLE-DATA request primitive.

Equivalent mappings shall apply to primitives received from the MLE.

14.9 Conformance

For conformance to this ETS the ability to originate, manipulate and receive PDUs in accordance with the full protocol is required.

Additionally conformance to this ETS requires provision of the protocol functions described in subclause 14.7. The functions required for conformance of a particular implementation are listed in table 43.

Additionally conformance to this ETS requires adherence to the structure and encoding of PDUs as described in subclauses 14.4 and 14.5.

14.10 Algorithms for PDU header error detection function

The contents of this subclause are derived from annex C of ISO 8473 [6]. The octet numbers are modified to correspond to the S-CLNP <S3-xxx> PDUs. This is informative information.

14.10.1 Symbols used in algorithms

$C_{(0)}$, $C_{(1)}$ are variables used in the algorithm;
 i is the number (i.e. position) of an octet within the header (the position of the first octet is $i = 1$);
 O_i is the value of octet i of the PDU header;
 n is the number (i.e. position) of the first octet of the checksum parameter ($n = 23$);
 L is the length of the PDU header in octets;
 X is the value of octet one of the checksum parameter;
 Y is the value of octet two of the checksum parameter.

14.10.2 Arithmetic conventions

Addition is performed in one of the two following modes:

- a) modulo 255 arithmetic;
- b) eight-bit one's complement arithmetic in which, if any of the variables has the value minus zero (i.e. 255) it shall be regarded as though it had the value plus zero (i.e. 0).

14.10.3 Algorithm for generating checksum parameters

Construct the complete PDU header with the value of the checksum parameter field set to zero:

A:

$$C_0 \leftarrow C_1 \leftarrow 0$$

B: Process each octet of the PDU header sequentially from $i = 1$ to L by:

$$C_0 \leftarrow C_0 + O_i$$

$$C_1 \leftarrow C_1 + C_0$$

C: Calculate:

$$X \leftarrow (L - 23) C_0 - C_1 \dots \pmod{255}$$

$$Y \leftarrow (L - 22) (-C_0) + C_1 \dots \pmod{255}$$

D:

if $X = 0$, then $X \leftarrow 255$

E:

if $Y = 0$, then $Y \leftarrow 255$

F: place the values of X and Y in octets 23 and 24 respectively.

14.10.4 Algorithms for checking checksum parameters

A: If octets 23 and 24 of the PDU header both contain 0 (all bits off), then the checksum calculation has succeeded, else if either but not both of these octets contains the value zero then the checksum is incorrect; otherwise initialise:

$$C_1 \leftarrow C_0 \leftarrow C_0$$

B: Process each octet of the PDU header sequentially from $i = 1$ to L by:

$$C_0 \leftarrow C_0 \leftarrow 0$$

$$C_1 \leftarrow C_1 \leftarrow C_0$$

C: If, when all the octets have been processed

$$C_0 = C_1 = 0 \pmod{255}$$

then the checksum calculation has succeeded; otherwise the checksum calculation has failed.

14.10.5 Algorithm to adjust the checksum parameter when an octet is altered

This algorithm adjusts the checksum when an octet (such as the timestamp field) is altered. Suppose the value in octet k is changed by $Z = \text{new value} - \text{old value}$.

If X and Y denote the checksum values held in octets n and $n+1$, respectively, then adjust X and Y as follows:

If $X = 0$ and $Y = 0$ then do nothing, else if $X = 0$ or $Y = 0$ then the checksum is incorrect, else:

$$X \leftarrow (k - n - 1) Z + X \pmod{255};$$

$$Y \leftarrow (n - k) Z + Y \pmod{255};$$

If $X = 0$, then $X \leftarrow 255$; if $Y = 0$, then $Y \leftarrow 255$.

For this protocol, $n = 23$. If the octet being altered is the last octet of the timestamp field, $k = 19$. For the case where the timestamp is decreased by one unit ($z = -1$), the assignment statements for the new values of X and Y in the immediately preceding algorithm simplify to:

$$X \leftarrow Y + 5 \pmod{255};$$

$$Y \leftarrow Y - 4 \pmod{255};$$

NOTE: To derive this result, assume that when octet k has the value Z added to it then X and Y have values Z_x and Z_y added to them. For the checksum parameters to satisfy the conditions of subclause 27.7.8 both before and after the values are added, the following is required:

$$Z + Z_x + Z_y = 0 \pmod{255}; \text{ and}$$

$$(L - k + 1) Z + (L - n + 1) Z_x + (L - n) Z_y = 0 \pmod{255}.$$

Solving these equations simultaneously yields

$$Z_x = (k - n - 1) Z;$$

$$Z_y = (n - k) Z$$

15 Mobility Management (MM): service description

15.1 Introduction

This clause describes the services offered by the MM entity (see ETS 300 393-1 [14] clause 13) for the data only TETRA layer 3 air interface. The MM service boundary is a testable boundary. The SDL diagram in this clause is normative.

15.2 Services offered

The MM entity shall be a service provider for mobility service users on the layer 3 MS air interface for V+D and PDO. The services shall be made available through a TETRA Network Mobility Management SAP (TNMM-SAP) (see ETS 300 393-1 [14] clause 7) (see figure 41). The protocol description is defined in clause 16.

The services offered shall be:

- **registration:** this service shall allow a user to register manually to the network, the user shall be then informed of the result of the registration. When a user roams or migrates he shall be also informed that the MS is ready for use or that registration was not possible;
- **de-registration (detach):** this service allows a user to request cancellation of the registration, the user shall be informed of the cancellation success;
- **network authentication:** this service shall allow a user to ask for network authentication, with confirmation of success or failure;
- **change of energy saving mode:** this service shall allow the user to ask for changing the energy saving mode with confirmation;
- **information concerning state of the mobile (enable, disable):** this service shall allow a user to be aware of the temporary or permanent disabling asked by the network. The user is also made aware of the cessation of a temporary disable.

A set of primitives shall be offered to implement each of those services.

15.3 Primitive description

The services shall be provided through primitives at the TNMM-SAP. This subclause describes the primitives and their parameters.

15.3.1 Service state model for the MS

The primitives provided at the TNMM-SAP are illustrated in figure 41 below.

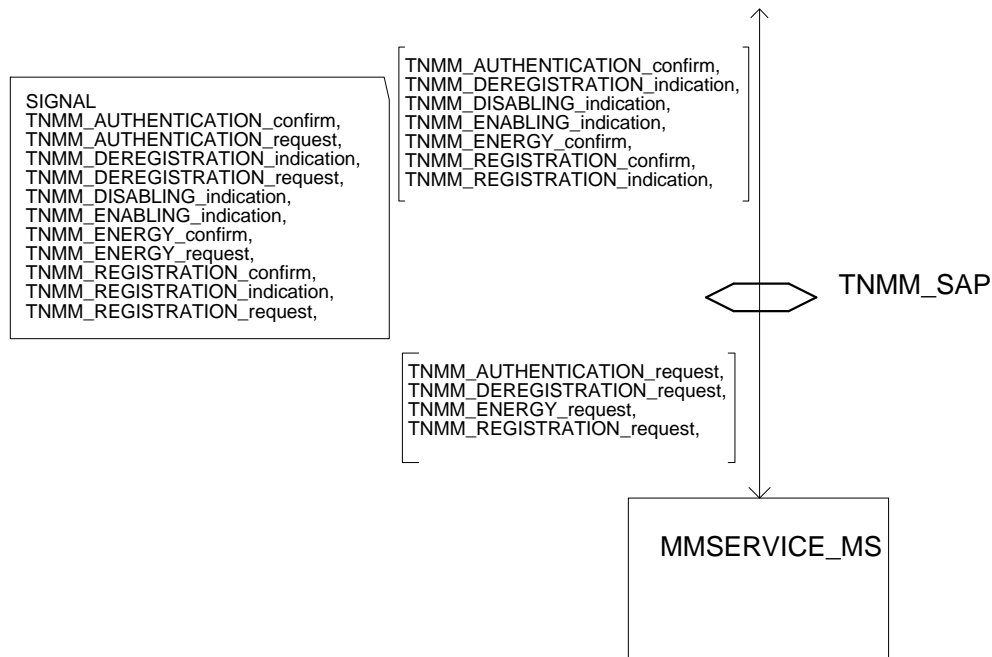

Figure 41: Registration services provided at TNMM-SAP/MS-side

15.3.2 Service primitives for the MS

The MM primitives shall be as described in the following subclauses.

15.3.2.1 Primitives for authentication of the network

TNMM-AUTHENTICATION request:

- request by the user to authenticate the TETRA infrastructure.

TNMM-AUTHENTICATION confirm:

- authentication success or failure. This shall confirm that the connected BS has or has not been authenticated as a legitimate BS.

15.3.2.2 Primitives for de-registration (detach)

TNMM-DEREGISTRATION indication:

- indication that registration has been cancelled or that registration was not possible. No services shall be available to the user.

TNMM-DEREGISTRATION request:

- request to cancel the registration, stimulated either by removing the "ITSI identity" or a "log-off" application or automatically in the power off phase.

15.3.2.3 Primitives for indication of the state of a mobile

TNMM_DISABLING_indication:

- indication that a temporary or permanent disabling of the terminal is ordered.

TNMM_ENABLING_indication:

- indication that a temporary disabling of the terminal is ordered.

15.3.2.4 Primitives for registration

TNMM-REGISTRATION request

- request by the user to make a registration.

TNMM-REGISTRATION confirm

- registration confirmed. The indication may be used to inform the user that the MS is ready for use.

TNMM-REGISTRATION indication

- it shall indicate to the user that the MS is ready for use (network initiated registration).

15.3.2.5 Primitives for the energy saving mode

TNMM_ENERGY_request

- request by the user to change or re-state to the infrastructure what energy saving mode the MS wants to use.

TNMM_ENERGY_confirm

- confirmation by the user that the changed or re-stated energy saving mode has been reported to the infrastructure.

15.3.3 Primitive summary

Table 44 shows the primitives and parameters:

Table 44: Primitives and parameters at the TNMM-SAP

Primitive		Parameters
Generic name	Specific name	
TNMM-AUTHENTICATION	confirm	result
	request	(Security related parameter)
TNMM-DEREGISTRATION	indication	result
	request	--
TNMM-DISABLING	indication	Cause
TNMM-ENABLING	indication	--
TNMM-ENERGY	request	Energy saving mode
	confirm	--
TNMM-REGISTRATION	confirm	Registration status
	indication	--
	request	ITSI, GTSIs, Registration type, Energy saving mode

15.3.4 Parameters definition

The different parameters shall be:

Authentication result: success or failure;

De-registration result: success of request (registration cancelled) or failure of registration;

Disabling cause: permanent or temporary cause;

Registration status: success or failure;

Registration type: new location area, new network, with authentication, power on, SIM in, user demand;

Energy saving mode: mode 1 to 7.

15.3.5 State description for the MS

Different states shall be used within the SDL description as described in the following subclauses.

15.3.5.1 Not updated

This state shall be used when the MS is ready for a registration request.

15.3.5.2 Wait updating

This shall be an intermediate state while the network is processing the registration request.

15.3.5.3 Updated

This shall be the state that is used while registered. The MS shall be ready for transactions or authentication request.

15.3.5.4 Temporary disabled

This state shall be used after receiving a <disable> message with parameter "temporary". The only way out of the state shall be a <enable> message.

15.3.5.5 Permanently disabled

This state shall be used after receiving a <disable> message with parameter "permanently". There shall be no way out of the state using the air interface protocol as defined in this ETS.

15.3.6 Service state diagram for the TNMM-SAP

The service state diagram for the TNMM-SAP shall be as shown in figures 42 to 45 inclusive.

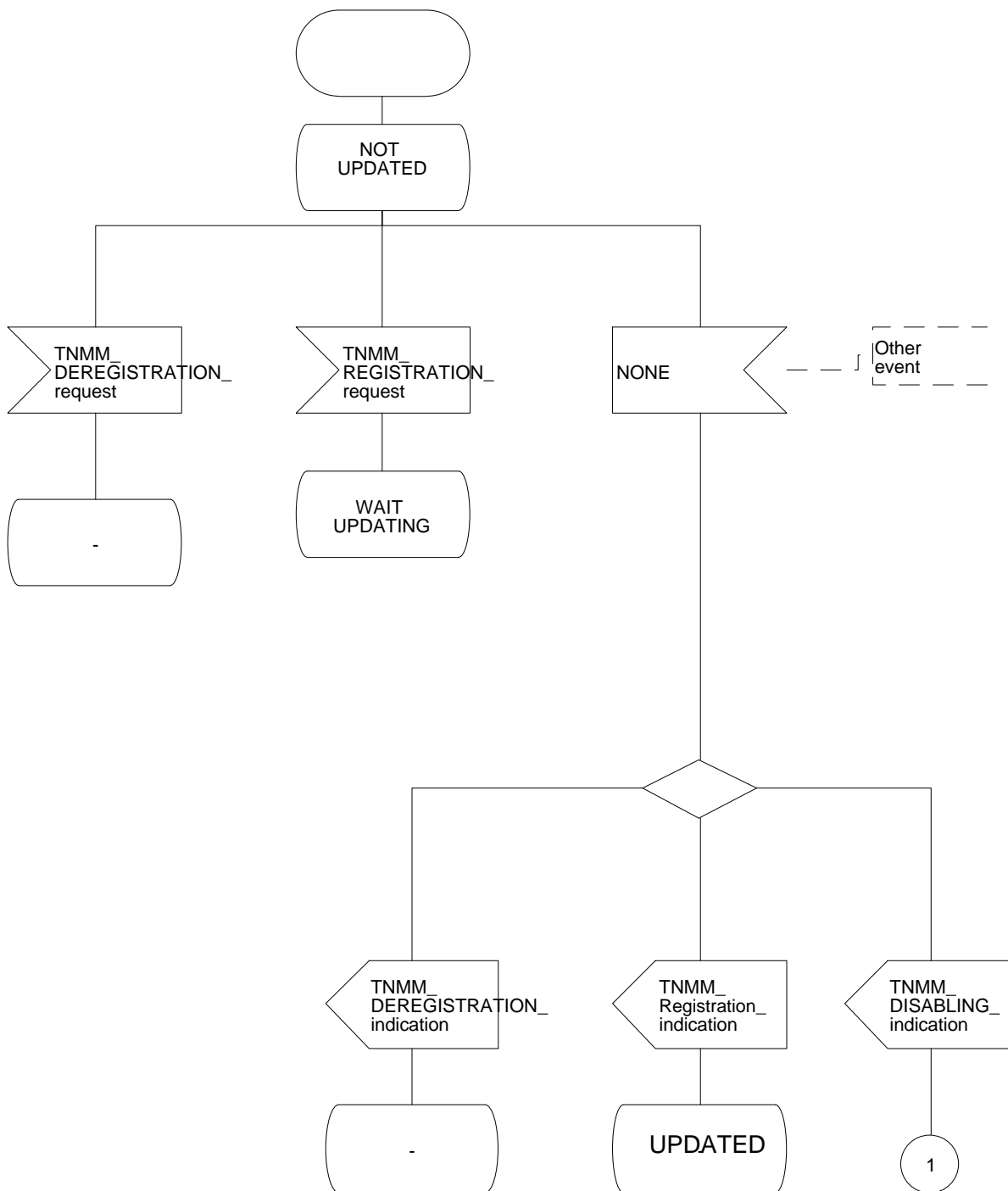

Figure 42: MM service state diagram (sheet 1 of 4)

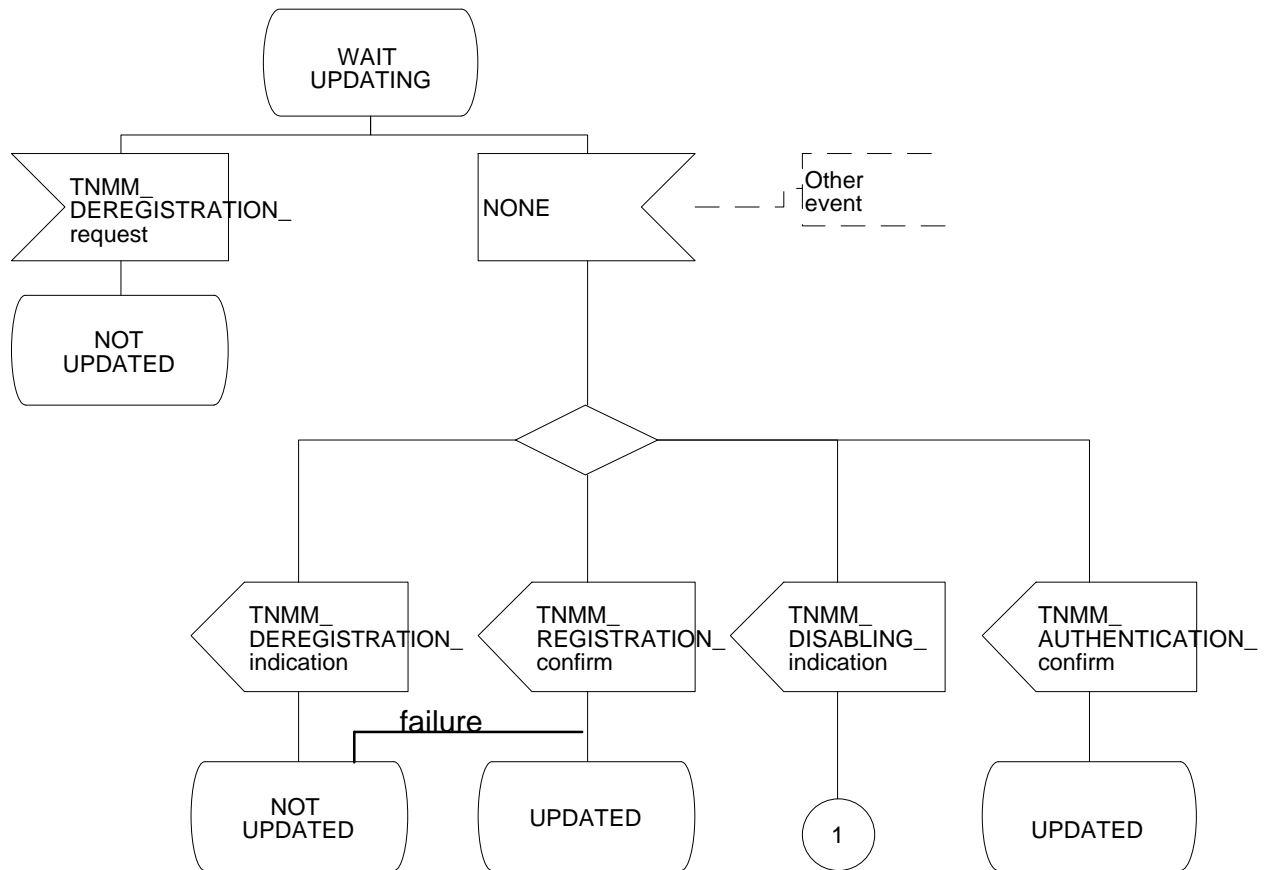

Figure 43: MM service state diagram (sheet 2 of 4)

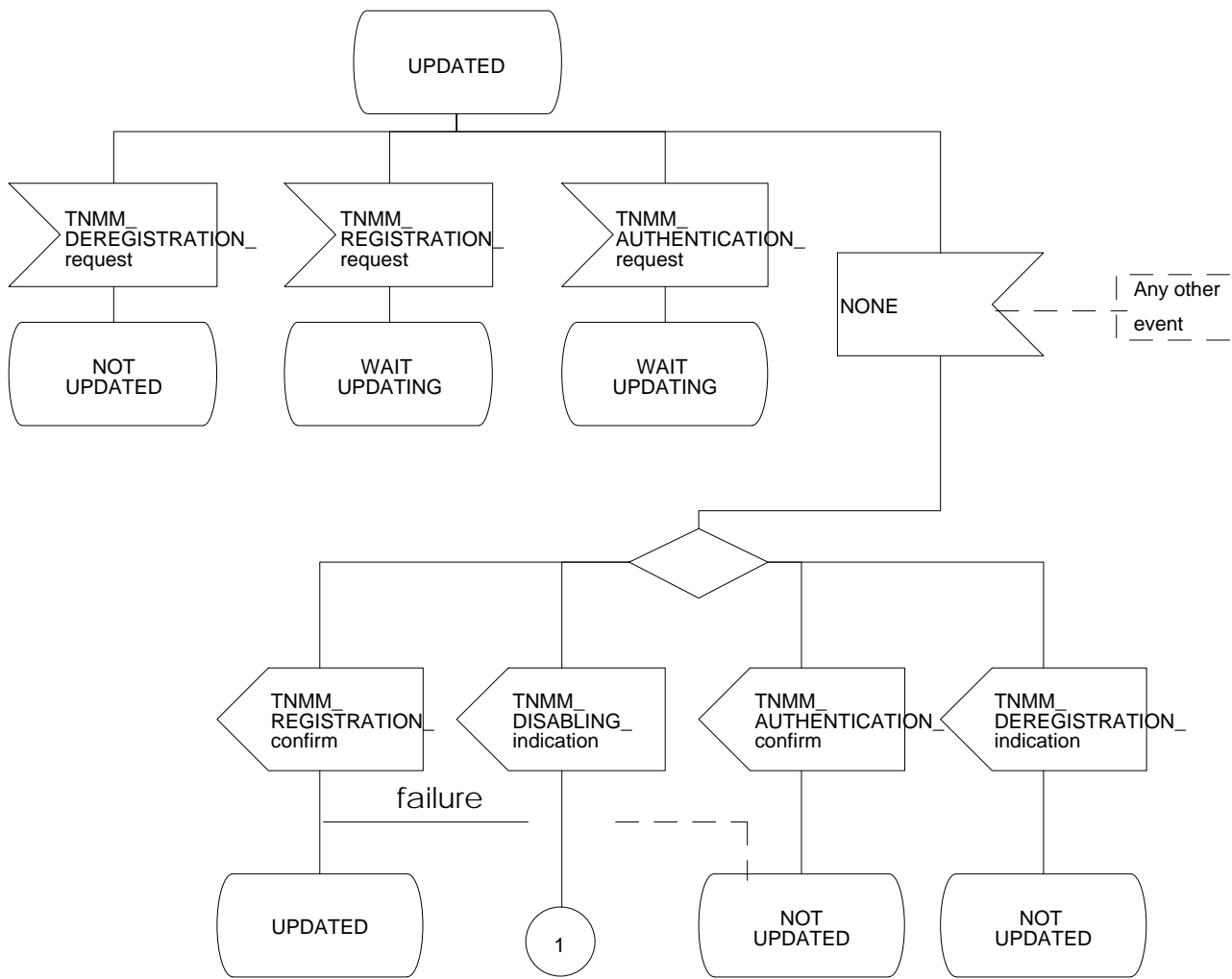
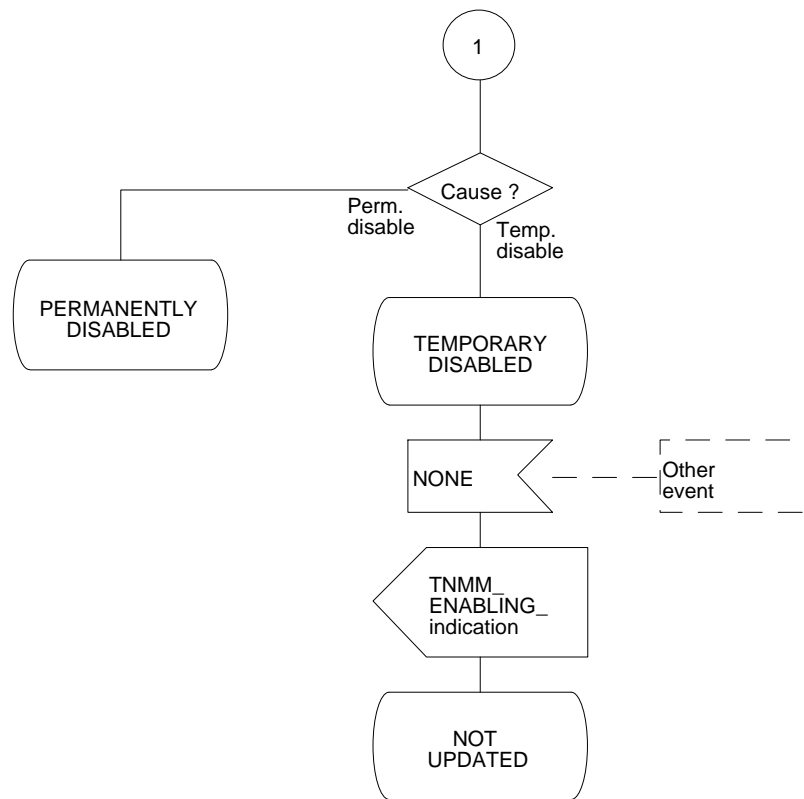

Figure 44: MM service state diagram (sheet 3 of 4)

Disabling



Energy saving

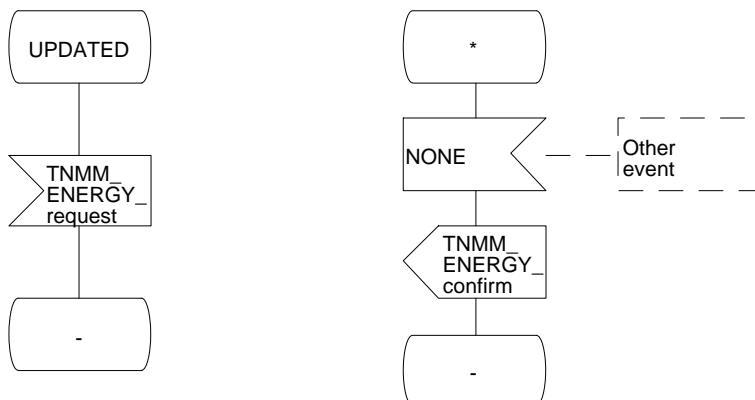

Figure 45: MM service state diagram (sheet 4 of 4)

16 PDO MM protocol

16.1 Introduction

This clause defines the TETRA MM protocol for the MS. This is the NWK layer protocol that shall be used to provide the MM service, clause 15 refers. This clause also defines the protocol functions required for operation as an end system (i.e. providing service to an end user).

This clause specifies:

- procedures for registration of a MS;
- procedures for disabling and enabling of a MS;
- procedures for negotiating the energy saving scheme to be used;
- procedures for group identity network download.

The procedures are defined in terms of:

- interactions among peer network entities through the exchange of PDUs;
- interactions between a network entity and a network service user through the exchange of network service primitives;
- interaction between a network entity and an underlying service provider through the exchange of service primitives.

16.2 MM procedures

16.2.1 General

The internal organisation of the NWK layer including the mobility management entity is described in the PDO protocol architecture's ETS 300 393-1 [14], clause 8 and clause 6.

The underlying services offered are those of the MLE, refer to clause 17 and ETS 300 393-1, clause 7.

16.2.2 Services provided by the protocol

The services offered shall be as described in clause 15:

- registration on user demand;
- enabling and disabling indication;
- de-registration due to user request;
- energy saving mode change to user request;
- download of group identities.

16.2.3 Underlying services assumed by the protocol

On the air interface the protocol shall use the MLE as defined in clause 17.

16.2.4 Services assumed from the local environment

No specific service shall be assumed from the lower layer management entity.

16.3 Protocol functions

The basic functions of the protocol for the MS shall be:

- PDU composition and decomposition;
- header error detection;
- activation of the selection of a cell sent to the MLE through an MLE-ACTIVATE request primitive at power up;
- network code check from the information passed by the MLE using an MLE-LINK indication primitive. If a location area is a new location area, then registration may be required initiated by the MM through sending a U-Location update demand PDU to the infrastructure. If a network code is a new one then registration shall be initiated by the MM. The Network may accept or reject the registration the MM shall be informed by receiving a D-Location Update Accept/ Reject;
- updating the MLE with a new registration area through an MLE-UPDATE request primitive;
- handling of exceptional procedures reported by the MLE (failures to requests);

- supply or update the SSI (ASSI or ISSI) to be used to the MLE. This information shall be in the D-Location Update accept PDU received by the MM. Also the network can download the group addresses (GSSI);
- supply or update the complete list of GSSIs to be used to the MLE. This information shall be either in the D-Location Update Accept, D-Attach/Detach Group Identity or D-Attach/Detach Group Identity Acknowledgement PDU received by the MM;
- send and receive PDUs to/from the sub-layer MLE through MLE-UNITDATA request and indication primitive. The received PDUs can be handled locally by the MM or routed to the user application;
- send and receive PDUs to/from the sub-layer MLE through MLE-PREPARE request and indication;
- update criteria with the monitoring of other possible cells using an MLE-UPDATE request primitive following an infrastructure request;
- detach handling through a TNMM DEREGISTRATION request from the user, the MM shall then send a message to the infrastructure;
- energy saving mode handling following a change requested by the user, the new value may be negotiated by the MM through transmitting it to the network in a energy saving element;
- enable/disable handling following a request from the infrastructure which shall be transmitted to the user by the MM through a TNMM-ENABLING/DISABLING indication primitive.

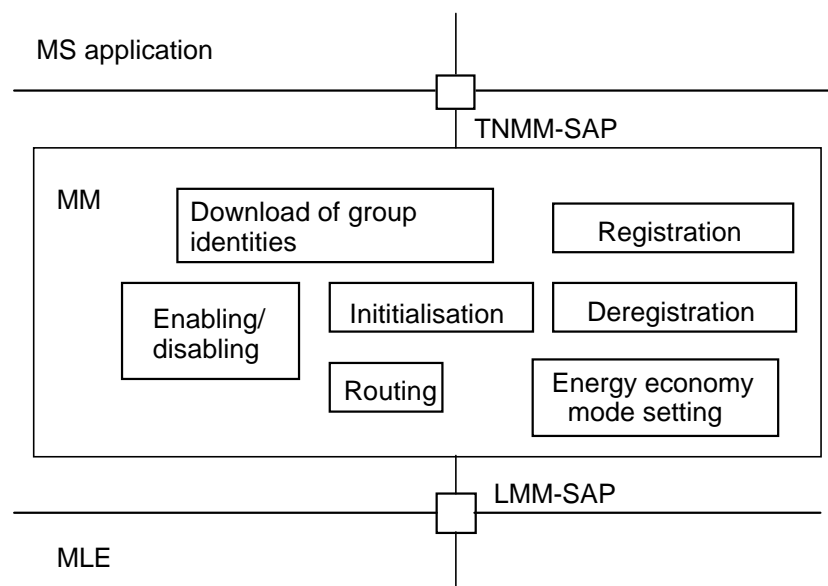

Figure 46: MM main functions on the MS

On the infrastructure side, the MM functions should be symmetrical, except activation of the selection of a cell which does not exist. Figure 46 summarises the MM functions.

The different protocol procedures are shown in the ETS case with the primitives sequences and PDU exchanges. The scenarios outlined are:

- enable/disable;
- de-registration;
- energy mode change;
- user request registration;
- network request registration;
- MLE initiated registration;
- Group identity network download.

16.3.1 Activation and control of underlying MLE Service

16.3.1.1 Activation procedure

If the MS has been permanently disabled the MS shall remain disabled at power up and shall not activate any of the protocol entities. The following describes the procedure for MSs that have not been permanently disabled, see figure 47.

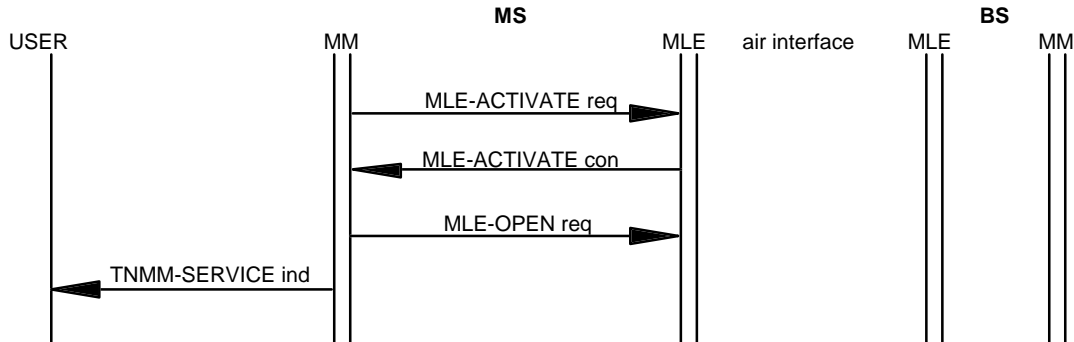

Figure 47: MM Activation procedure, Registration not supported

At power on, or similar start up, the MM shall issue an MLE-ACTIVATE request primitive. The MLE-ACTIVATE request primitive shall contain a list of valid mobile network identities.

When the MS performs cell re-selection the reception of an MLE-ACTIVATE indication shall indicate that no suitable cell has been found by the MLE. The MM entity may issue a new MLE-ACTIVATE request primitive with a revised list of cell selection parameters. If no new parameters are available MM shall then inform the user application with a TNMM-SERVICE indication primitive issuing that the MS is “out of service”.

Either at initial activation or after a new activation due to cell re-selection MM shall finally await the receipt of an MLE-ACTIVATE confirm which indicates whether MLE has successfully selected a cell.

Upon receipt of an MLE-ACTIVATE confirm primitive, the MM entity shall check whether the selected cell supports registration.

a) Registration is supported:

- the MM shall inform the user application with TNMM-SERVICE indication issuing that the MS is “in service waiting for registration”.

b) Registration is not supported:

- the MM shall open the communication resources to the other higher layer entities by issuing an MLE-OPEN request primitive. This MLE-OPEN request primitive shall be accompanied by a list of currently valid subscriber identities in an MLE-IDENTITIES request primitive. The MM shall inform the user application with TNMM-SERVICE indication indicating that the MS is “in service”. The MLE-OPEN request shall not be issued if the MS has previously been temporarily disabled and not subsequently enabled by the infrastructure.

16.3.1.2 Deactivation procedure

This procedure shall be invoked at power down or if the ITSI is detached from the MS. The MM shall issue an MLE-CLOSE request to indicate that access to the communication resources has been closed to the other higher layer entities; CONP, S-CLNP. MM shall then issue an MLE-DEACTIVATE request primitive.

16.3.1.3 Maintenance procedures

16.3.1.3.1 Report and cancel handling

The cancel and report procedure may be implemented in the MS and if used the following shall apply.

Incoming MLE-REPORT indications should indicate the following events:

- a PDU has been stored by the data link layer ready for transmission. At this stage the transmission may be cancelled using a MLE-CANCEL request and no information will be sent over the air interface;
- the first transmission of whole PDU. The BS may have received the PDU, but MS has not yet received as acknowledgement. At this stage the layer 2 process may be stopped using a MLE-CANCEL request, but MM cannot rely on the cancellation and may receive a response to the sent PDU;
- a PDU has not been successfully transmitted by layer 2 Cancellation is no longer possible, but the BS may have received the PDU correctly and MM cannot rely on the cancellation and may receive a response to the sent PDU;
- a PDU has been successfully transmitted by layer 2. Cancellation is no longer possible.

The MLE-CANCEL request can minimise the risk of adding extra load to the air interface, e.g. when a user application initiated registration request is buffered by the lower layers waiting for allowance to make random access attempt, which can take a considerable amount of time. If the user application during this waiting period, changes its decision and wants to de-register, the application shall send a TNMM-DEREGISTRATION request which will be converted to a MLE-CANCEL request depending on the status of the transmission as stated above.

16.4 Registration procedure

The registration procedures are illustrated in figures 48 to 50. Registration can be initiated by the MLE, by the user application or it can be requested by the infrastructure.

16.4.1 MLE initiated registration procedure

The MLE shall initiate registration when a cell re-selection into a different registration area is indicated from the MLE. Cell re-selection into a location area that is in a different registration area is notified to MM by the receipt of an MLE-LINK indication primitive. The MLE-LINK indication shall indicate in the MLE-Activity indicator parameter whether there is a circuit mode call active or not and shall supply the mobile network code and the mobile country code of the new cell.

16.4.1.1 Normal registration

The registration procedure can be done with or without identity exchange see ETS 300†393-1, clause 7. Identity exchange shall be required where the MS migrates to a new TETRA network.

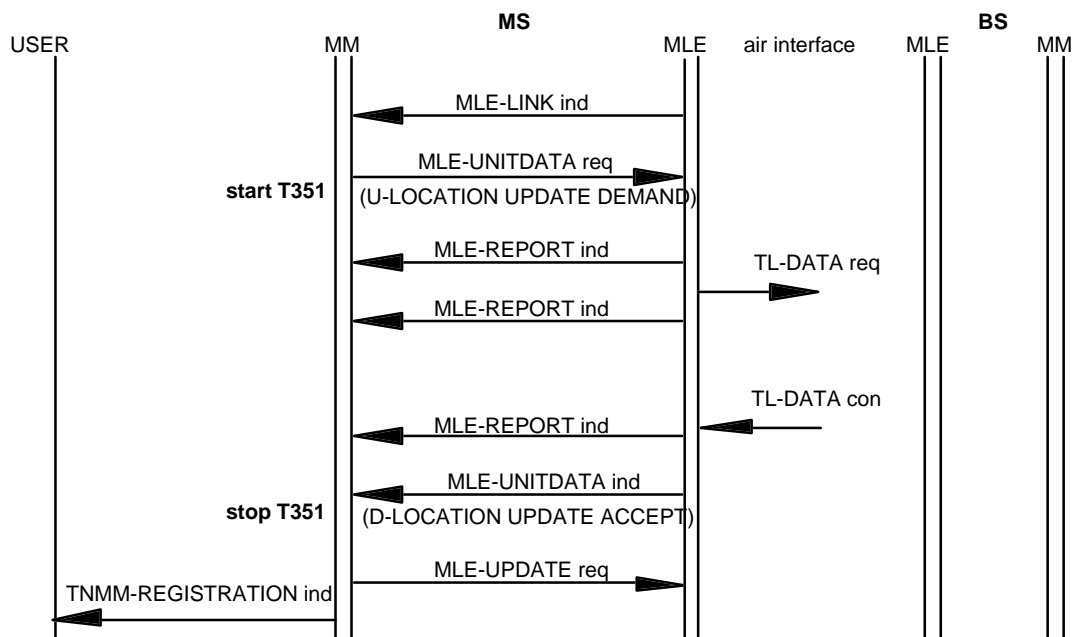

NOTE: MLE-REPORT shown in this figure applies to all scenarios where MM sends a PDU.

Figure 48: MLE initiated registration without identity exchange in the home network

a) Roaming

The MM entity shall send a U-LOCATION UPDATE DEMAND PDU to the MLE with an MLE-UNITDATA request primitive. The Location update type element in the PDU shall be set either to roaming location updating, or if there was a circuit mode call active, to call restoration roaming location updating. If “roaming location updating” PDU priority shall be set to 3 and if “call restoration roaming location updating” PDU priority shall be set to 5. Finally the PDU may include request for attachment/detachment of group identities. The PDU may also contain any energy economy mode information. The primitive parameters shall indicate which address to be appended by lower layers, either ISSI or ASSI. Timer T351 shall be started.

b) Migrating

The MM entity shall send a U-LOCATION UPDATE DEMAND PDU to the MLE with an MLE-UNITDATA request primitive. The location update type element in the PDU shall be set either to migrating location updating, or if there was a circuit mode call active, to call restoration migrating location updating. If “migrating location updating” PDU priority shall be set to 3 and if “call restoration migrating location updating” PDU priority shall be set to 5. The PDU may include the mobile network code and mobile country code of the home network of the MS, i.e. those corresponding to the ITSI. The PDU may set the location area country code to the mobile country code of the new cell and the location area network code to the mobile network code of the new cell. The PDU may also contain the class of MS and may contain any energy economy mode information. Finally the PDU may include request for attachment/detachment of group identities. The primitive parameters shall indicate to the lower layers that the address to be appended shall be the USSI. Timer T351 shall be started.

NOTE 1: In order to use the uplink resources as efficiently as possible and to avoid lower layer fragmentation Mobile Network Code (MNC), Mobile Country Code (MCC), Location Area (LA) information, class of MS, Energy Saving Mode (ESM) and attachment/detachment information should be sent in the second U-LOCATION UPDATE DEMAND rather than in the first, i.e. after D-LOCATION UPDATE PROCEEDING is received.

Upon receipt of the D-LOCATION UPDATE PROCEEDING, the MM shall extract the (V)ASSI from the SSI field and send this to the MLE by using MLE-IDENTITIES request primitive. Timer T351 shall be stopped and reset.

As the message is a response to a request made using the USSI, MM shall check whether the Mobile Country Code and the Mobile Network Code, if included, correspond to those values held in the MS. This shall be used to ensure that if two mobiles requests registrations using the same USSI that MM can distinguish between them. The MM entity shall reply with a second U-LOCATION UPDATE DEMAND PDU containing the full ITSI and any attached GTSI to the MLE with an MLE-UNITDATA request primitive. This shall have message priority 6. The Location update type element in the PDU shall be set to Demand location updating. The primitive parameters shall indicate that the address to be appended by the MAC shall be the SSI ((V)ASSI). Timer T351 shall be started.

For a) and b) the following shall apply:

Upon receipt of the D-LOCATION UPDATE ACCEPT PDU, which shall be received with an MLE-UNITDATA indication, the MM shall extract the ASSI or (V)ASSI from the SSI field. Additionally the MM shall extract attached/detached GSSIs and/or associated (V)GSSIs from the group identity location accept element, if present. MM shall inform the MLE of ASSI or (V)ASSI and valid group identities, see subclause 16.8, with an MLE-IDENTITIES request primitive. Timer T351 shall be stopped and reset. The MS MM shall issue an MLE-UPDATE request primitive confirming the cell. The MS MM may issue an updated cell monitoring/scanning list to the MS-MLE using an MLE-UPDATE request primitive. MM shall inform the user application that the MS is ready for use by issuing a TNMM-REGISTRATION indication primitive containing attached/detached GTSIs. Where an energy economy mode has been requested and the MS is not informed of the outcome of this request in the D-LOCATION UPDATE ACCEPT PDU, the information shall be conveyed in a separate D-ENERGY SAVING PDU as described in subclause 16.7.

Upon receipt of a D-LOCATION UPDATE REJECT, the MM shall analyse the reject cause. Timer T351 shall be stopped and reset. In the event that a mandatory element error or message inconsistency error is reported, the MS shall be allowed one registration retry. In the event that a ITSI unknown is reported and the SSI address used in the MAC were ASSI, the MS shall be allowed one registration retry. In this case the address to be appended by the MAC shall be ASSI and the ISSI shall be included into the PDU. In the event that one of the ciphering key reject causes is reported, the MS shall follow cipher negotiation procedures, which are outside the scope of this ETS. For all other reject reasons, and where the registration retry has resulted in a second D-LOCATION UPDATE REJECT being received, then MM shall issue an MLE-UPDATE request primitive with a revised list of cell selection parameters in order that the MLE does not select the same cell a second time. Further registration requests can be made once a new cell has been selected. In the event that the serving cell was the only cell available MM shall issue an MLE-CLOSE request to the MLE and TNMM-SERVICE indication to the TNMM-SAP indicating that the MS is "out of service". The MM shall consider the MS to be de-registered and hence apply the activation procedure as defined in subclause 16.3 in order to get into service again.

NOTE 2: When to apply the activation procedure after no service is obtained is outside the scope of this ETS.

16.4.2 User application initiated registration procedure

User application initiated registration shall be available whenever the MS is camped on a cell, i.e. has received TNMM-SERVICE indication stating that the MS is "in service waiting for registration". It shall be applied whenever an identity is attached to the MS, e.g. by inserting a SIM card. The user application initiated registration can be used at power up, at any time provided that an ITSI is available either within the MS, or can be supplied with the TNMM-REGISTRATION request primitive.

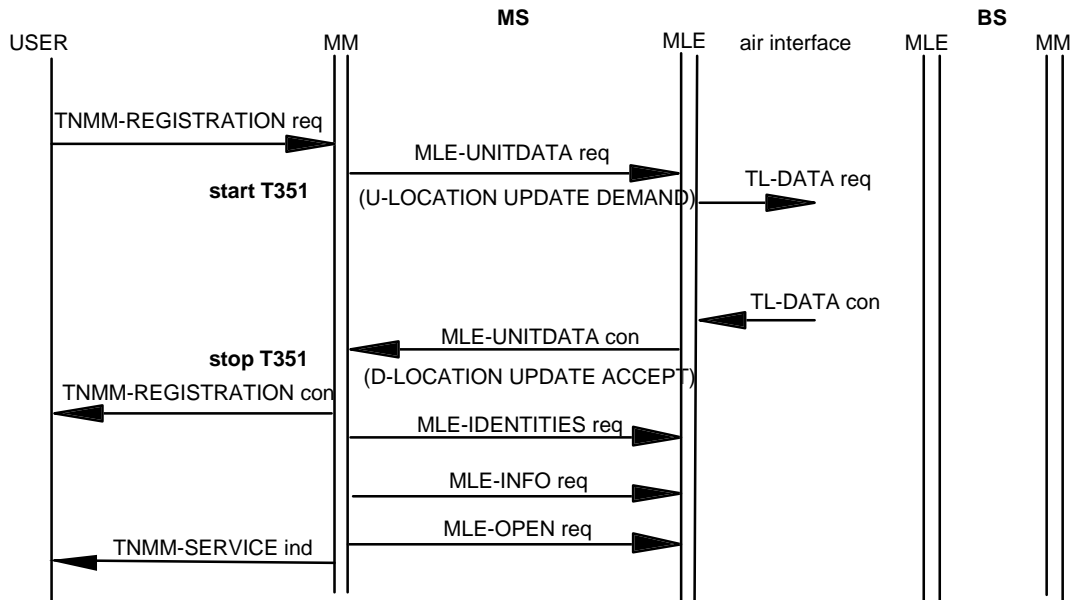

Figure 49: User application initiated registration in the home network, communication resources closed

Upon receipt of a TNMM-REGISTRATION request primitive from the user application the MS MM shall ascertain whether there is a new ITSI being attached.

a) No new ITSI

MM shall send a U-LOCATION UPDATE DEMAND PDU to the MLE with an MLE-UNITDATA request primitive. This shall have PDU priority 0.

The PDU shall set the location area country code to the mobile country code of the new cell and the location area network code to the mobile network code of the new cell. The PDU shall include the location area country code and the location area network code. The requested location area shall be appended to the current location area by setting the "request to append location area" field accordingly. The PDU shall also contain the class of mobile and any energy economy mode information. Finally the PDU may include request for download of group identities. The primitive parameters shall indicate that the address to be appended by the MAC shall be the SSI (ISSI or ASSI). Timer T351 shall be started.

b) New ITSI

MM shall send a U-LOCATION UPDATE DEMAND PDU to the MLE with an MLE-UNITDATA request primitive. This shall have message priority 6. The location update type element in the PDU shall be set to "ITSI attach". The PDU shall also contain the class of mobile and any energy economy mode information. Finally the PDU may include request for download of group identities. The primitive parameters shall indicate that the address to be appended by the MAC shall be the SSI (ISSI). Timer T351 shall be started.

c) New un-exchanged ITSI

The MM shall be required to register on a visited network using imminent identity exchange. The MM entity shall send a U-LOCATION UPDATE DEMAND PDU to the MLE with an MLE-UNITDATA request primitive. This shall have message priority 3. The location update type element in the PDU shall be set to "ITSI attach". The PDU may include the mobile network code and mobile country code of the home network of the MS, i.e. those corresponding to the ITSI. The PDU may also contain the class of mobile and any economy mode information. Finally the PDU may include request for download of group identities. The primitive parameters shall indicate to the lower layers that the address to be appended shall be the USSI. Timer T351 shall be started.

NOTE 1: In order to use the uplink resources as efficiently as possible and to avoid lower layer fragmentation MNC, MCC, LA information, class of MS, ESM and attachment/detachment information should be sent in the second U-LOCATION UPDATE DEMAND rather than in the first, i.e. after D-LOCATION UPDATE PROCEEDING is received.

Upon receipt of the D-LOCATION UPDATE PROCEEDING PDU, the MM shall extract the (V)ASSI from the SSI field and send this to the MLE by using MLE-IDENTITIES request primitive. Timer T351 shall be stopped and reset. As the message is a response to a request made using the USSI, MM shall check that the Mobile Country Code and the Mobile Network Code, if included, correspond to those values held in the MS. This shall be used to ensure that if two mobiles requests registrations using the same USSI that MM can distinguish between them. The MM entity shall reply with a second U-LOCATION UPDATE DEMAND PDU containing the Mobile Country Code, Mobile Network Code and ISSI, thus comprising the full ITSI to the MLE with an MLE-DATA request primitive. This shall have message priority 6. The Location update type element in the PDU shall be set to "Demand location updating". The primitive parameters shall indicate that the address to be appended by the MAC shall be the SSI ((V)ASSI). Timer T351 shall be started.

For a), b) and c) the following shall apply:

Upon receipt of the D-LOCATION UPDATE ACCEPT PDU, which shall be received with an MLE-UNITDATA confirm primitive, timer T351 shall be stopped and reset. MM shall extract any ASSI or (V)ASSI from the SSI field. Additionally the MM shall extract attached/detached and GSSIs and/or associated (V)GSSIs from the group identity location accept element, if present. MM shall inform the MLE of ASSI or V(ASSI) and valid group identities, see subclause 16.8, with an MLE-IDENTITIES request primitive. The MS MM shall issue an MLE-UPDATE request primitive confirming the cell. The MS MM may issue an updated cell monitoring/scanning list to the MS-MLE using MLE-UPDATE request primitive. MM shall inform the user application that the MS is ready for use by issuing a TNMM-REGISTRATION confirm primitive containing attached/detached GTSIs. Where an energy economy mode has been requested and the MS is not informed of the outcome of this request in the D-LOCATION UPDATE ACCEPT PDU, the information shall be conveyed in a separate D-ENERGY SAVING PDU as described in subclause 16.7.

If registration is successful and communication resources are closed, then the MM shall open the communication resources to the other higher layer entities by issuing an MLE-OPEN request primitive. The MLE-OPEN request shall not be issued if the MS has previously been temporarily disabled and not subsequently enabled by the infrastructure. The MM shall inform the user application with TNMM-SERVICE indication issuing that the MS is in service.

Upon receipt of a D-LOCATION UPDATE REJECT the MM shall analyse the reject cause. Timer T351 shall be stopped and reset. In the event that a mandatory element error or message inconsistency error is reported, the MS shall be allowed one registration retry. In the event that a ITSI unknown is reported and the SSI address used in the MAC were ASSI, the MS shall be allowed one registration retry. In this case the address to be appended by the MAC shall be ASSI and the ISSI shall be included into the PDU. In the event that one of the ciphering key reject causes is reported, the MS shall follow cipher negotiation procedures which are outside the scope of this ETS. For all other reject reasons, and where the registration retry has resulted in a second D-LOCATION UPDATE REJECT being received, MM shall issue a TNMM-REGISTRATION indication to the user application with the reject cause as a parameter. MM shall issue an MLE-UPDATE request primitive with a revised list of cell selection parameters in order that the MLE does not select the same cell a second time. Further registration requests can be made in response to the receipt of further TNMM-REGISTRATION requests from the user application, once a new cell has been selected. In the event that the serving cell was the only cell available, MM shall issue an MLE-CLOSE request to the MLE and TNMM-SERVICE indication to the TNMM-SAP indicating that the MS is "out of service". The MM shall consider the MS to be de-registered and hence apply the activation procedure as defined in subclause 16.3 in order to get into service again.

NOTE 2: When to apply the activation procedure after no service is obtained is outside the scope of this ETS.

16.4.3 Infrastructure initiated registration procedure

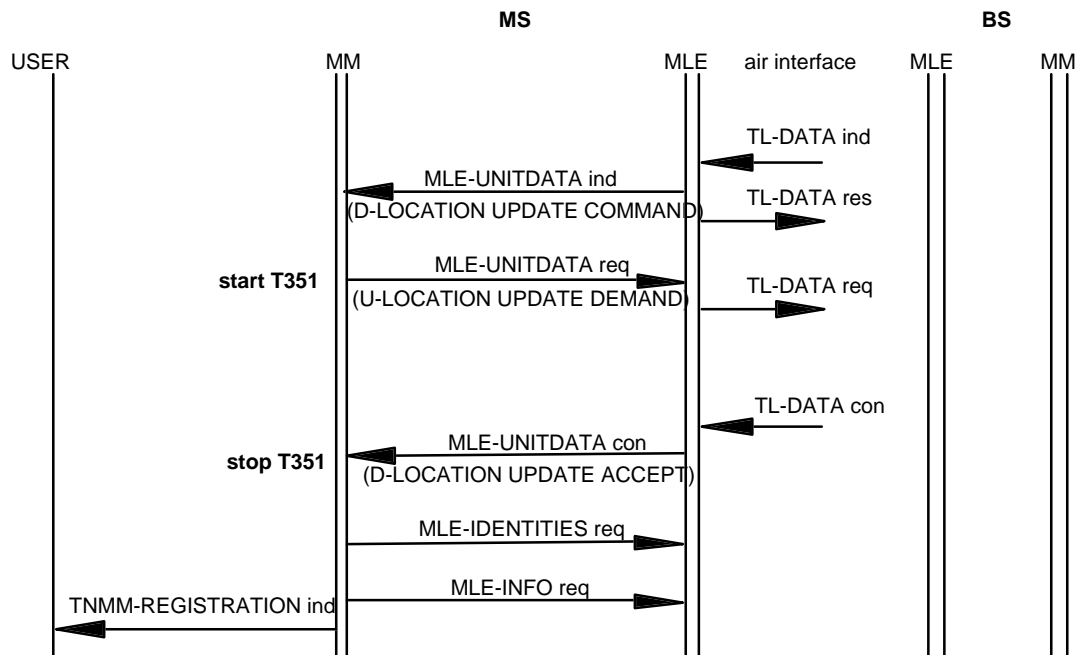

NOTE: Infrastructure initiated registration is done following information given by the MLE through an MLE-UNITDATA indication.

Figure 50: Infrastructure initiated registration

Upon receipt of a D-LOCATION UPDATE COMMAND PDU, the MS MM shall send a U-LOCATION UPDATE DEMAND PDU containing the mobile country code, mobile network code and ISSI, thus comprising the full ITSI, to the MLE with an MLE-UNITDATA request primitive. This shall have message priority 6. The location update type element in the PDU shall be set to demand location updating or disabled MS updating depending whether the MS is enabled or disabled. The primitive parameters shall indicate that the address to be appended by the MAC shall be the ASSI, if one has been issued, or the ISSI in the case where an ASSI has not been issued. If the group identity report were requested by the infrastructure, then the MM shall also send all its active group identities within the PDU and the MS shall not request a group identity report. The primitive parameters shall also indicate that the acknowledged service is to be requested from the lower layers. Timer T351 shall be started.

Upon receipt of the D-LOCATION UPDATE ACCEPT PDU, the MM shall extract any ASSI or (V)ASSI from the SSI field. Additionally the MM shall extract attached/detached GSSIs and/or associated (V)GSSIs from the group identity location accept element, if present. MM shall inform the MLE of ASSI or (V)ASSI and valid active group identities, see subclause 16.8, with an MLE-IDENTITIES request primitive. Timer T351 shall be stopped and reset. MM shall inform the user application that the MS is ready for use by issuing a TNMM-REGISTRATION indication primitive containing attached/detached GTSIs.

If a D-LOCATION UPDATE REJECT is received the MM shall analyse the reject cause. In the event that a mandatory element error or message consistency error is reported, the MS shall be allowed one registration retry. In the event that one of the ciphering key reject causes is reported, the MS shall follow cipher negotiation procedures.

NOTE 1: Cipher negotiation procedures are outside the scope of this ETS.

For all other reject reasons, and where the registration retry has resulted in a second D-LOCATION UPDATE REJECT being received, MM shall issue a TNMM-REGISTRATION indication to the user application with the reject cause as a parameter. Timer T351 shall be stopped and reset. MM shall issue an MLE-UPDATE request primitive with a revised list of cell selection parameters in order that the MLE does not select the same cell a second time. Further registration requests can be made once a new cell has been selected.

In the event that the serving cell was the only cell available MM shall issue an MLE-CLOSE request to the MLE and TNMM-SERVICE indication to the TNMM-SAP indicating that the MS is "out of service". The MM

shall consider the MS to be de-registered and hence apply the activation procedure as defined in subclause 16.3 in order to get into service again.

NOTE 2: When to apply the activation procedure after no service is obtained is outside the scope of this ETS.

16.4.4 Colliding registrations

In the event that the MS MM requests registration at the same time that the infrastructure demands that the MS MM registers, the MS MM should respond to the D-LOCATION UPDATE COMMAND PDU using the procedure defined in subclause 16.4.3. On successful outcome, MM shall inform the user application with a TNMM-REGISTRATION indication.

16.4.5 Expiry of timer T351

On the expiry of timer T351, if it is still possible to solely cancel the outstanding PDU according to subclause 16.3.1.3, MM shall issue an MLE-CANCEL request with the handle of the transmission request it corresponds to.

If it is no longer possible to solely cancel the outstanding PDU according to subclause 16.3.1.3, MM shall issue a U-ITSI DETACH PDU using the de-registration procedures described in subclause 16.6.

The MS may wish to select a new serving cell before further registration attempts should be made.

16.5 De-registration procedure

The de-registration procedure need not be applied. Examples of where the user application may request de-registration can be at power down, or if the user specific information, including the ITSI, is removed from the terminal equipment.

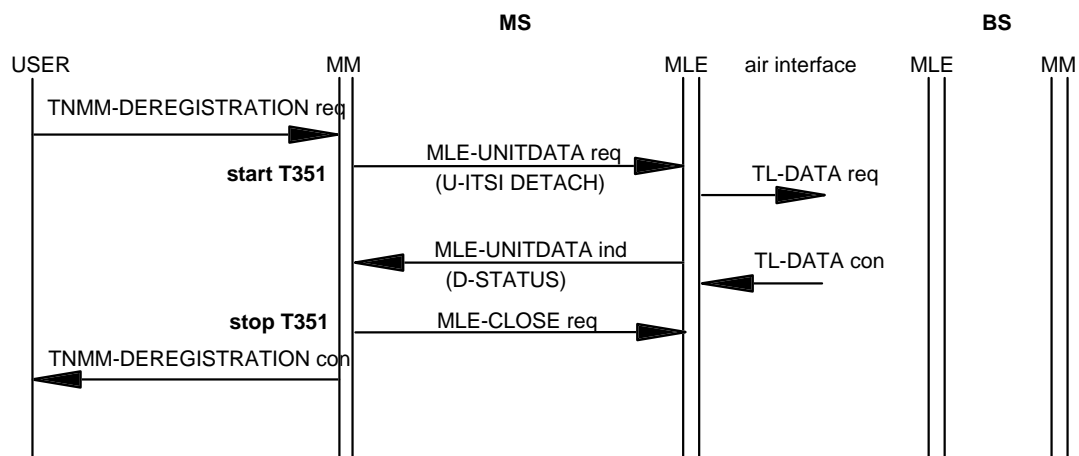

Figure 51: De-registration of MS (Detach)

Upon receipt of a TNMM-DEREGISTRATION request primitive from the user application the MS MM shall send a U-ITSI DETACH PDU to the MLE with an MLE-UNITDATA request primitive. This shall have PDU priority 3.

Upon receipt of the MLE-REPORT indication indicating that the U-ITSI DETACH PDU has been successfully or unsuccessfully transmitted by the data link layer, MM shall inform the user application of this by issuing a TNMM-REPORT indication primitive where the handle parameter is set to be TNMM-DEREGISTRATION req. It is optional for the RPDI to send D-STATUS to confirm the registration. Hence it is optional to the MS to wait the D-STATUS before deactivation shall be invoked which shall be the deactivation procedure defined in subclause 16.3.1.2.

NOTE: It is optional for the RPDI to send a D-STATUS PDU to confirm the de-registration. However the D-STATUS should be sent before acknowledgement to the U-ITSI DETACH PDU.

16.6 Energy economy procedure

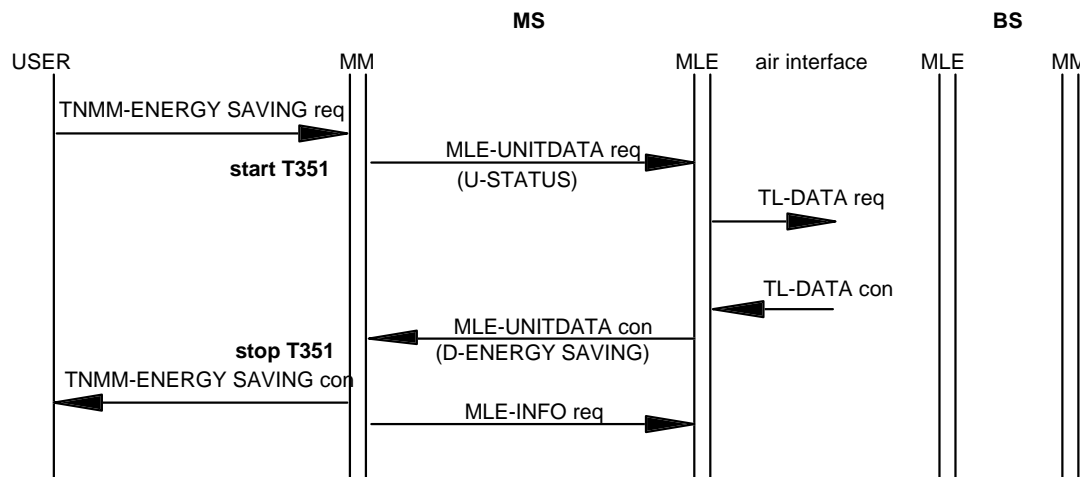

Figure 52: Change energy economy mode

This procedure shall be initiated by the MS user application upon receipt of a TNMM-ENERGY request primitive and the MS MM shall issue an MLE-UNITDATA request primitive with a U-STATUS PDU containing the “energy saving mode” element to the Infrastructure to request a specific energy economy group. This shall have PDU priority 1.

Upon receipt of a D-ENERGY SAVING PDU, the MS MM shall analyse the result of the energy economy group request given in the “status” element. If the D-ENERGY SAVING PDU informs the MS that the energy economy mode request is successful, MM shall inform the lower layers of the energy economy parameters in an MLE-INFO request primitive. The energy economy parameters shall be found in the “energy saving mode” field, which contains the energy group and energy economy start point, the latter comprising an absolute frame and multi-frame number. MM shall inform the user application with a TNMM-ENERGY confirm primitive.

If the D-ENERGY SAVING PDU informs the MS that the energy economy mode request is unsuccessful or if the “status” field indicates that the particular energy economy mode is not supported, MM may select another energy economy mode and request that from the infrastructure using the procedure above. If no acceptable energy economy mode can be found, or the “status” element indicates that no energy economy mode is supported by the infrastructure, MM shall inform the user application with a TNMM-ENERGY SAVING confirm with “reject” as a parameter.

16.7 Group identity network download

The group identity download procedure is illustrated in figure 53.

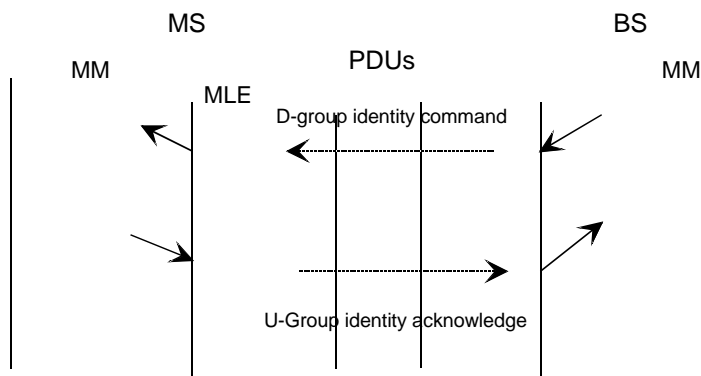

Figure 53: Procedure for group identity download

This procedure, initiated by the network, downloads group identities to the MS. The commands allow the network to add, delete list, delete all, report group identities.

16.8 MM PDUs structures and contents

16.8.1 MM PDU general description

The general format of the PDU is defined according to table 45.

The elements shall be transmitted in the order specified by the table with the top element being transmitted first (before interleaving). The content of an information element is represented by a binary value and the most significant bit of that binary value shall be transmitted first (before interleaving).

Table 45: PDU layout

Information element	Length	Value	Remark
PDU Type	5		
Type 1 element (1)	varies		See definitions below.
Type 1 element (2)	varies		See definitions below.
...etc.	...etc.		...etc.
Type 1 element (n)	varies		See definitions below.
Optional bit (O-bit)	1	0	No optional type 2 or type 3 elements follow
		1	Optional type 2 or type 3 elements follow
Presence bit (P-bit) (1)	1	0	The type 2 element (1) is not present
		1	The type 2 element (1) is present.
Type 2 element (1)	varies		See definitions below.
Presence bit (P-bit) (2)	1	0	The type 2 element (2) is not present
		1	The type 2 element (2) is present.
Type 2 element (2)	varies		See definitions below.
...etc.	...etc.		...etc.
Presence bit (P-bit) (n)	1	0	The type 2 element (n) is not present
		1	The type 2 element (n) is present.
Type 2 element (n)	varies		See Type 2 element (1)
More bit (M-bit) (1)	1	0	No type 3 elements follow
		1	Type 3 elements follow
Type 3 Element Identifier (1)	4		See definitions below.
Length indicator (1)	11	0	Reserved.
		1-2 047	Length of the following type 3 Element in bits:
Type 3 Element (1)	varies		See definitions below.
More bit (M-bit) (2)	1	0	No more type 3 elements follow
		1	More type 3 elements follow
Type 3 Element Identifier (2)	4		See Type 3 Element Identifier (1)
Length indicator (2)	11		See Length Indicator (1)
Type 3 Element (2)	varies		See Type 3 Element (1)
...etc.	...etc.		...etc.
More bit (M-bit) (n)	1	0	No more type 3 elements follow
		1	More type 3 elements follow
Type 3 Element Identifier (n)	4		See Type 3 Element Identifier (1)
Length indicator (n)	11		See Length Indicator (1)
Type 3 Element (n)	varies		See Type 3 Element (1)
More bit (M-bit) (n+1) = 0	1	0	Last M-bit (Least Significant Bit in the PDU) = 0

The element type defines the encoding rule applied to an element.

- Type 1 elements shall be placed within the PDU in a fixed order as specified in the PDU description tables. The elements shall have fixed lengths as specified in the length column or variable lengths as indicated by a preceding length element. Each Type 1 element shall either be a mandatory element or conditional to a mandatory element. Type 1 elements shall be placed before any Type 2 or Type 3 elements in the PDU. The last Type 1 element shall be followed by an O-bit. When the PDU contains any Type 2 or Type 3 elements the O-bit shall set to 1. When the PDU does not contain any Type 2 or Type 3 elements the O-bit shall be set to 0.

- Type 2 elements are optional and shall be placed within the PDU in a fixed order as specified in the PDU description tables. There shall be one P-bit preceding each Type 2 element specified for the PDU to indicate presence of that element. The P-bit shall indicate either "Type 2 element present" or "Type 2 element not present". Type 2 elements shall have fixed lengths as specified in the length column of the PDU description tables. Type 2 elements shall be placed after all Type 1 elements and before any Type 3 elements in the PDU.
- Type 3 elements are optional and shall be placed within the PDU in numerical order as specified within the 'Type 3 Element Identifier' element. Type 3 Elements shall be placed after any Type 1 and Type 2 elements. If there are any Type 3 elements specified for the PDU an M-bit shall follow the Type 1 and Type 2 elements. The M-bit shall indicate either "Type 3 element to follow" or "no Type 3 element to follow". If there are Type 3 elements to follow, they shall be preceded by a 'Type 3 Element Identifier' element and a 'Length Indicator' element in that order. A further M-bit shall follow the Type 3 element and after the last Type 3 element included the M-bit shall be set to 0 to indicate "no Type 3 element to follow". Type 3 element coding can contain sub-elements which can be either of Type 1, 2 or 3.

Element lengths, values and contents are specified in subclause 16.9 MM information elements coding and a specific element can be used either as type 1, 2 or 3 depending on the PDU.

The following rules shall apply for decoding of the PDU:

```
DECODE Type 1 Elements;
DECODE O-bit
  IF O-bit set to 'No Optional Elements are present', END;
  ELSE
    DO for all possible type 2 elements,
      DECODE P-bit
      IF P-bit set to 'Present', Decode Type 2 Element;
    END DO.
  WHILE M-bit set to 'More type 3 element follows'
    DECODE Type 3 Element
  END WHILE
END
```

The information contained in the PDU description tables which follow corresponds to the following key:

Length:	-	length of the element in bits;
Type:	-	element type (1, 2, or 3) as defined below;
C/O/M:	-	conditional/optional/mandatory information in the PDU;
Remark:	-	comment.

16.8.2 MM PDU description tables - downlink

The MM downlink PDUs are as follows:

- D-GROUP IDENTITY COMMAND;
- D-DISABLE;
- D-ENABLE;
- D-ENERGY SAVING;
- D-LOCATION UPDATE ACCEPT;
- D-LOCATION UPDATE COMMAND;
- D-LOCATION UPDATE REJECT;
- D-LOCATION UPDATE PROCEEDING;
- D-STATUS.

Their content shall be as specified in the following subclauses.

16.8.2.1 D-GROUP IDENTITY COMMAND

Message: D-group identity command
Service used: Unconfirmed data transfer, acknowledged
Response to: -
Response expected: D-Group identity acknowledge
Protocol entity: MM
Short description: This message is sent to the MS by the Infrastructure to provide network initiated downloading of group identities.

Table 46: D-GROUP IDENTITY COMMAND contents

Information element	Element length	Element type	Reference	Remark
Message identifier	4	1		
ISSI	29	1		
Command	1	1		
New GSSI		3		note
NOTE: The size of the element is $8 + m * 28$, where $m = \text{no of GSSIs}$.				

16.8.2.2 D-DISABLE

Message: D-DISABLE
Response to: -
Response expected: -
Short description: The message is sent by the Infrastructure to indicate that the MS shall be disabled (permanently or temporary).

Table 47: D-DISABLE contents

Information element	Length	Type	C/O/M	Remark
PDU Type	4	1	M	
Disabling type	1	1	M	
TETRA Equipment Identity	60	1	M	
Address Extension	24	1	M	
Proprietary		3	O	

16.8.2.3 D-ENABLE

Message: D-ENABLE
Response to: -
Response expected: -
Short description: The message is sent by the Infrastructure to indicate that the temporarily disabling shall cease.

Table 48: D-ENABLE contents

Information element	Length	Type	C/O/M	Remark
PDU Type	4	1	M	
TETRA Equipment Identity	60	1	M	
Address Extension	24	1	M	
Proprietary		3	O	

16.8.2.4 D-ENERGY SAVING

Message: D-ENERGY SAVING
Response to: U-STATUS
Response expected: -
Short description: This message shall be sent to the MS by the Infrastructure to indicate that the energy mode change is accepted or rejected.

Table 49: D-ENERGY SAVING contents

Information element	Length	Type	C/O/M	Remark
PDU Type	4	1	M	
Status	3	1	M	
Energy Saving Information	14	2	O	note
Proprietary		3	O	
NOTE:	If status contains "failure" meaning that no energy mode is supported the energy saving mode element should not be applied.			

16.8.2.5 D-LOCATION UPDATE ACCEPT

Message: D-LOCATION UPDATE ACCEPT
Response to: U-LOCATION UPDATE DEMAND
Response expected: -
Short description: The message is sent by the Infrastructure to indicate that updating in the network has been completed.

Table 50: D-LOCATION UPDATE ACCEPT contents

Information element	Length	Type	C/O/M	Remark
PDU Type	4	1	M	
Location Update Type	3	1	M	
SSI	24	2	O	
Address Extension	24	2	O	
Subscriber Class	16	2	O	
Energy Saving Information	14	2	O	
Reserved	6	2	O	
New Registered Area		3	O	Repeatable
Group Identity Location Accept		3	O	
Proprietary		3	O	

16.8.2.6 N UPDATE COMMAND

Message: D-LOCATION UPDATE COMMAND
Response to: -
Response expected: U-LOCATION UPDATE DEMAND
Short description: The message is sent by the Infrastructure to initiate a Location Update Demand in the MS.

Table 51: D-LOCATION UPDATE COMMAND contents

Information element	Length	Type	C/O/M	Remark
PDU Type	4	1	M	
Group Identity Report	1	1	M	
Reserved	1	1	M	
Reserved	10	1	C	
Address Extension	24	2	O	
Proprietary		3	O	

16.8.2.7 D-LOCATION UPDATE REJECT

Message: D-LOCATION UPDATE REJECT
Response to: U-LOCATION UPDATE DEMAND
Response expected: -
Short description: The message is sent by the Infrastructure to indicate that updating in the network is not accepted.

Table 52: D-LOCATION UPDATE REJECT contents

Information element	Length	Type	C/O/M	Remark
PDU Type	4	1	M	
Location Update Type	3	1	M	
Reject Cause	5	1	M	
Reserved	1	1	M	
Reserved	10	1	C	
Address Extension	24	2	M	
Proprietary		3	O	

16.8.2.8 D-LOCATION UPDATE PROCEEDING

Message: D-LOCATION UPDATE PROCEEDING
Response to: U-LOCATION UPDATE DEMAND
Response expected: -
Short description: The message is sent to the MS by the Infrastructure on registration at accepted migration to assign a (V) ASSI.

Table 53: D-LOCATION UPDATE PROCEEDING contents

Information element	Length	Type	C/O/M	Remark
PDU Type	4	1	M	
SSI	24	1	M	
Address Extension	24	1	M	
Proprietary		3	O	

16.8.2.9 D-STATUS

Message: D-STATUS
Response to: U-ITSI DETACH
Response expected: -
Short description: The message is sent to the MS by the Infrastructure to indicate that detachment is confirmed.

Table 54: D-STATUS contents

Information element	Length	Type	C/O/M	Remark
PDU Type	4	1	M	
Status	3	1	M	
Proprietary		3	O	

16.8.3 MM PDU descriptions - uplink

The mobility management uplink PDUs are as follows:

- U-ITSI-DETACH;
- U-LOCATION-UPDATE-DEMAND;
- U-STATUS;
- U-GROUP-IDENTITY-ACKNOWLEDGE

Their content shall be as specified in the following subclauses.

16.8.3.1 GROUP-IDENTITY-ACKNOWLEDGE

Message: U-Group identity acknowledge
Service used: Unconfirmed data transfer, acknowledged
Response to: D-Group identity command
Response expected: none
Protocol entity: MM
Short description: The message is sent by the MS to acknowledge the network initiated downloading of group identities.

Table 55: U-GROUP IDENTITY ACKNOWLEDGE contents

Information element	Element length	Element type	reference	remark
Message identifier	4	1		
Accept/reject	1	1		
Reject reason	2	2		
New GSSI		3		note
NOTE: The size of the elements is $8 + m * 28$, where $m = \text{no of GSSIs}$.				

16.8.3.2 U-ITSI DETACH

Message: U-ITSI DETACH
Response to: -
Response expected: D-STATUS
Short description: The message is sent by the MS to the Infrastructure to announce that the MS will be de-activated.

Table 56: U-ITSI DETACH contents

Information element	Length	Type	C/O/M	Remark
PDU Type	4	1	M	
Address Extension	24	2	O	
Proprietary		3	O	

16.8.3.3 U-LOCATION UPDATE DEMAND

Message: U-LOCATION UPDATE DEMAND
Response to: -
Response expected: D-LOCATION UPDATE ACCEPT/D-LOCATION UPDATE REJECT
Short description: The message is sent by the MS to the Infrastructure to request update of its location registration.

Table 57: U-LOCATION UPDATE DEMAND contents

Information element	Length	Type	C/O/M	Remark
PDU Type	4	1	M	
Location Update type	3	1	M	
Request To Append Location Area	1	1	M	
Cipher Control	1	1	M	note 1,2
Ciphering Parameters	10	1	C	
Class of MS	24	2	O	
Energy Saving Mode	3	2	O	
Location Area Information		2	O	
SSI	24	2	O	
Address Extension	24	2	O	
Group Identity Location Demand		3	O	
Group Identity Location Demand Ack		3	O	
Proprietary		3	O	
NOTE 1: Element "Ciphering Parameters" is not present if "Cipher Control" is set to 0, "ciphering off", either for a new registration or for a change of parameters, or, if "Cipher Control" is set to 1, "ciphering on" and ciphering parameters are unchanged from the present state (for example a re-registration for some other purpose. Element "ciphering parameters" is present if "Cipher Control" is set to 1, "ciphering on" for a new registration in that location area. "Cipher Control" is set to 1, "ciphering on" and new ciphering parameters are requested.				
NOTE 2: Encryption of data over the air interface in PDO is not allowed as the restriction on frame number does not secure the transmission against replay.				

16.8.3.4 U-STATUS

Message: U-STATUS
Response to:
Response expected: -
Short description: The message is sent by the MS to the Infrastructure to inform about various requests from the MS and executed actions like enable/disable.

Table 58: U-STATUS contents

Information element	Length	Type	C/O/M	Remark
PDU Type	4	1	M	
Status	3	1	M	
Energy Saving Mode	3	2	O	Used only when requesting energy economy mode
Proprietary		3	O	

16.9 MM information elements coding

16.9.1 Address extension

The address extension element shall be used to indicate the extended part of TSI address.

Table 59: Address extension element contents

Information sub-element	Length	Type	C/O/M	Remark
Mobile Country Code (MCC)	10	1	M	
Mobile Network Code (MNC)	14	1	M	

16.9.2 Class of MS

The purpose of the class of MS element shall be to indicate to the infrastructure the particularities of the MS terminal, both hardware and software. The total element length is 24 bits and the values can be given both as a bit map and as values. The decoding shall be as follows:

Table 60: Class of MS element contents

Information sub-element	Length	Value	Remark
Frequency simplex/duplex	1	0	Frequency simplex
		1	Frequency duplex
Reserved	1	0	
		1	
Concurrent multi-carrier operation	1	0	Single carrier operation
		1	Multi-carrier operation
Reserved	1	0	
		1	
End-to-end encryption	1	0	Encrypted
		1	Not encrypted
Reserved	1	0	
		1	
S-CLNP	1	0	No S-CLNP
		1	S-CLNP
CONP	1	0	No CONP
		1	CONP
Reserved	1	0	
		1	
Reserved	1	0	
		1	
Reserved	1	0	
		1	
Reserved	1	0	
		1	
Reserved	1	0	
		1	
Reserved	1	0	
		1	
Reserved	2		Bit-map reserved for future expansion
TETRA Air Interface standard version number	3	000 ₂	First edition of ETS 300 393
		001 ₂	Reserved
		...etc.	...etc.
		111 ₂	Reserved
Reserved	5		Reserved for future expansion

16.9.3 Class of usage

The purpose of the class of usage element is to define relative priority of the group identity. The class of usage has meaning only for the user application.

Table 61: Class of usage element contents

Information element	Length	Value	Remark
Class of usage	3	000 ₂	Class of usage 1
		001 ₂	Class of usage 2
		010 ₂	Class of usage 3
		011 ₂	Class of usage 4
		100 ₂	Class of usage 5
		101 ₂	Class of usage 6
		110 ₂	Class of usage 7
		111 ₂	Class of usage 8

16.9.4 Disabling type

The purpose of the disabling type element shall be to indicate which of the disabling types (i.e. temporary or permanent) is requested.

Table 62: Disabling type element contents

Information element	Length	Value	Remark
Disabling type	1	0	Temporary
		1	Permanent

16.9.5 Energy Saving Mode (ESM)

The ESM element shall be used to indicate which energy saving scheme is requested (if any).

Table 63: ESM element contents

Information element	Length	Value	Remark
ESM	3	000 ₂	Stay Alive
		001 ₂	Economy mode 1 (EG1)
		010 ₂	Economy mode 2 (EG2)
		011 ₂	Economy mode 3 (EG3)
		100 ₂	Economy mode 4 (EG4)
		101 ₂	Economy mode 5 (EG5)
		110 ₂	Economy mode 6 (EG6)
		111 ₂	Economy mode 7 (EG7)

16.9.6 Energy saving information

The energy saving information element shall be used to indicate which energy saving scheme is requested (if any) and starting point of the energy economy mode.

Table 64: Energy saving information element contents

Information sub-element	Length	Type	C/O/M	Remark
ESM	3	1	M	
Frame number	5	1	M	
Multi-frame number	6	1	M	

16.9.7 Location Area (LA)

The LA element shall be used to indicate location area.

Table 65: LA element contents

Information element	Length	Value	Remark
LA	14		

16.9.8 Location Area Country Code (LACC)

The LACC element shall be used to indicate which LACC the MS wants to use. The element shall only be signalled if it is different from the country code used in the network, i.e. the MS is migrating.

Table 66: LACC element contents

Information element	Length	Value	Remark
LACC	14		See ETS 300 391-3 [14], clause 7

16.9.9 LA information

The LA information element includes the location area information.

Table 67: LA information element contents

Information sub-element	Length	Type	C/O/M	Remark
LA	14	1	M	
LACC	10	2	O	
Location Area Network Code (LANC)	14	2	O	

16.9.10 LANC

The LANC element is used to indicate which LANC the MS wants to use. The element is only signalled if it is different from the network code used in the network, i.e. the MS is roaming.

Table 68: LANC element contents

Information element	Length	Value	Remark
LANC	14		See ETS 300 391-3 [14], clause 7

16.9.11 LA timer

The LA timer element is used to indicate the time a location area is valid.

Table 69: LA timer element contents

Information element	Length	Value	Remark
LA timer	3	000 ₂	5 min
		001 ₂	10 min
		010 ₂	15 min
		011 ₂	20 min
		100 ₂	30 min
		101 ₂	45 min
		110 ₂	60 min
		111 ₂	no timing

16.9.12 Location update type

The purpose of the location updating type element shall be to indicate what type of registration is wanted.

Table 70: Location update type element contents

Information element	Length	Value	Remark
Location update type	3	000 ₂	Roaming location updating
		001 ₂	Migrating location updating
		010 ₂	Periodic location updating
		011 ₂	ITSI attach
		100 ₂	Call restoration roaming location updating
		101 ₂	Call restoration migrating location updating
		110 ₂	Demand location updating (D-Location Update Command received)
		111 ₂	Disabled MS updating

16.9.13 MCC

The MCC element shall indicate to which MCC the MS is subscribed. The element shall only be signalled if it is different from the country code used in the network.

Table 71: MCC element contents

Information element	Length	Value	Remark
MCC	14		See ETS 300 391-3 [14], clause 7

16.9.14 MNC

The MNC element shall indicate to which MNC the MS is subscribed. The element shall only be signalled if it is different from the network code used in the network.

Table 72: MNC element contents

Information element	Length	Value	Remark
MNC	14		See ETS 300 391-3 [14], clause 7

16.9.15 New Registered Area (NRA)

The NRA element shall be used to download the location areas contained in the NRA.

Table 73: NRA element contents

Information sub-element	Length	Type	C/O/M	Remark
LA timer	3	1	M	
LA	14	1	M	
LACC	10	2	O	
LANC	14	2	O	

16.9.16 PDU type

The PDU type element shall be used to identify a up-link and down-link message. The PDU type element shall have a separate definitions in the uplink and downlink directions as shown below.

Table 74: PDU type element contents

Information element	Length	Value	Remark	
			Downlink	Uplink
PDU type	4	0000 ₂	Reserved	Reserved for U-AUTHENTICATION RESPONSE
		0001 ₂	Reserved for D-AUTHENTICATION DEMAND	U-ITSI DETACH
		0010 ₂	Reserved for D-AUTHENTICATION REJECT	U-LOCATION UPDATE DEMAND
		0011 ₂	D-DISABLE	U-STATUS
		0100 ₂	D-ENABLE	Reserved for U-AUTHENTICATION DEMAND
		0101 ₂	D-LOCATION UPDATE ACCEPT	Reserved
		0110 ₂	D-LOCATION UPDATE COMMAND	Reserved for U-AUTHENTICATION RESULT
		0111 ₂	D-LOCATION UPDATE RESULT	U-ATTACH/DETACH GROUP IDENTITY
		1000 ₂	Reserved for D-AUTHENTICATION RESPONSE	U-ATTACH/DETACH GROUP IDENTITY ACKNOWLEDGEMENT
		1001 ₂	D-LOCATION UPDATE PROCEEDING	Reserved
		1010 ₂	D-GROUP IDENTITY DOWNLOAD	U-GROUP IDENTITY ACK
		1011 ₂	Reserved	Reserved
		1100 ₂	D-ENERGY SAVING	Reserved
		1101 ₂	Reserved	Reserved
1110 ₂	Reserved	Reserved		
1111 ₂	Reserved	Reserved		

16.9.17 Proprietary

Proprietary is an optional, variable length element and shall be used to send and receive proprietary defined information appended to the PDUs.

The use, the size and the structure of the proprietary element is outside the scope of this ETS.

16.9.18 Reject Cause (RC)

The purpose of the RC element is to indicate what type of rejection has been detected.

Table 75: RC element contents

Information element	Length	Value	Remark
RC	5	00000 ₂	Reserved
		00001 ₂	ITSI unknown
		00010 ₂	illegal MS
		00011 ₂	LA not allowed
		00100 ₂	LA unknown
		00101 ₂	Network failure
		00110 ₂	Congestion
		00111 ₂	Service not supported
		01000 ₂	Service not subscribed
		01001 ₂	Mandatory element error
		01010 ₂	Message consistency error
		01011 ₂	Roaming not supported
		01100 ₂	Migration not supported
		01101 ₂	Reserved
		01110 ₂	Reserved
		01111 ₂	Reserved
		10000 ₂	Reserved
		10001 ₂	Incompatible service
		10010 ₂	Reserved
...etc.	...etc.		
11111 ₂	Reserved		

16.9.19 Request to append LA

The purpose of the request to append LA element shall be to indicate whether the MS user wants to append the new LA into the current registered area or not.

Table 76: Request to append LA element contents

Information element	Length	Value	Remark
Request to append LA	1	0	No request to append LA to registered area
		1	Request to append LA to registered area

16.9.20 SSI

The element is used to indicate the ASSI or (V)ASSI that the MS shall use in subsequent contacts with the RPDI. It can also be used during registration to explicitly inform the RPDI of the full ITSI when used in conjunction with the MCC (see subclause 16.10.2.5) and MNC (see subclause 16.10.2.6).

Table 77: SSI element content

Information element	Length	Value	Remark
SSI	24		See ETS 300 393-1 [14], clause 7

16.9.21 Status

The purpose of the status element shall be to give information on execution status of an action.

Table 78: Status element content

Information element	Length	Value	Remark
Status	3	000 ₂	Reserved
		001 ₂	Change of energy saving mode request (MS)
		010 ₂	Change of energy saving mode done successfully (RPDI)
		011 ₂	ITSI detach confirmation (RPDI)
		100 ₂	Failure
		101 ₂	Reserved
		110 ₂	Reserved
		111 ₂	Reserved

16.9.22 Subscriber class

The subscriber class element shall be used to subdivide the MS population in up to 16 classes (see definition) represented as a bit map.

Table 79: Subscriber class element

Information element	Length	Value	Remark
Class 1	1	0	Not a member
		1	Member
Class 2	1	0	Not a member
		1	Member
...etc.	1	0	...etc.
		1	...etc.
Class 16	1	0	Not a member
		1	Member

16.9.23 TETRA Equipment Identity (TEI)

The TEI element shall be used to indicate the TEI.

Information element	Length	Value	Remark
TETRA Equipment Identity	60		See ETS 300 393-1 [14], clause 6

16.9.24 Type 3 element identifier

The purpose of the Type 3 element identifier element is to indicate the type of the following Type 3 element in the PDU.

Table 80: Type 3 element identifier element contents

Information element	Length	Value	Remark
Type 3 element identifier	4	0000 ₂	Reserved
		0001 ₂	Reserved
		0010 ₂	Reserved
		0011 ₂	Reserved
		0100 ₂	Reserved
		0101 ₂	Reserved
		0110 ₂	Reserved
		0111 ₂	Reserved
		1000 ₂	Reserved
		1001 ₂	Reserved
		...etc.	Reserved
		1111 ₂	Reserved

16.9.25 Visitor Group Short Subscriber Identity ((V)GSSI)

The purpose of the (V)GSSI element shall be to indicate the (V)GSSI that the MS shall use in subsequent contacts with the RPDl.

Table 81: (V)GSSI element contents

Information element	Length	Value	Remark
(V)GSSI	24		See ETS 300 393-1 [14], clause 6

16.10 Primitives definition

Refer to clause 15 for definitions and descriptions of the primitives.

16.11 Parameters

16.11.1 Timers

16.11.1.1 Timer T351 -Registration response time

This shall be the maximum time MM is waiting for a response for a registration request. The timer T351 value shall be 30 seconds.

17 MLE service description

17.1 Introduction

This clause describes the services offered by the MLE (see ETS 300 393-1 [14], clause 8).

The assumed underlying protocol is a MLE protocol, which is assumed to be positioned in the lowest sub-layer of layer 3 (sub-layer 3.1) of the air interface stack.

The MLE services are provided through a set of SAPs, with each SAP corresponding to one type of service user (one upper layer 3 protocol).

The MLE protocol has been designed to hide most of the radio aspects of the air interface, and the resulting MLE services are intended to be comparable to non-radio (line) layer 2 protocols.

The MLE service boundary is an internal sub-layer boundary that is defined to clarify the description of the air interface layer 3. It is not intended to be a testable boundary. Conformance to this service should be achieved by providing conformance to one of the assumed MLE protocols.

17.2 Summary of services offered by MLE protocol

The MLE is a MLE service provider and provides services to MLE service users. These services should be made available through SAPs. This relationship is shown in figure 54.

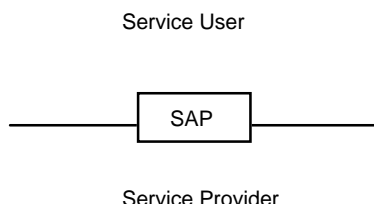

Figure 54: Relationship between a service user and a service provider

The entities listed below shall be permitted to use MLE services:

- Mobility Management (MM) entity (see ETS 300 393-1 [14], clause 7);
- Connection Oriented Network Protocol (CONP) entity (see clause 12);
- Specific Connectionless Network Protocol (S-CLNP) entity (see clause 14).

All of the permitted MLE service users need not be present. However, in order that the MLE services may be requested, at least some of the permitted MLE service users should be present. For example, a MS may choose not to implement the CONP entity. The MLE shall not be required to support the MLE service users which are not present.

The MLE services are represented by the set of MLE service primitives which are available via the various SAPs listed below:

SAP name	Upper layer 3 protocol (service user)	Reference
LMM-SAP	Mobility Management (MM)	subclause 17.3.1
LCO-SAP	Connection Oriented Network Protocol (CONP)	subclause 17.3.4
LSCL-SAP	Specific Connectionless Network Protocol (S-CLNP)	subclause 17.3.3

With the exception of the LMM SAP, the services offered at each SAP should be independent of each other, and the service at each of the other SAPs should operate using an independent set of primitives. The LMM SAP can act as a “master SAP”, enabling and disabling service provision at the other SAPs.

The LCO-SAP and LSCL-SAP may support multiple independent instances of higher protocol (multiple instances of CONP and S-CLNP, each with an independent set of primitives) but each instance must be associated with a different TSI family. All TSI families associated with CONP and S-CLNP within 1 MS shall be associated with a single instance of MM protocol.

NOTE: Multiple TSI families are the normal situation on the TETRA infrastructure side. Most MSs contain only one TSI family, but multiple TSI families co-exist in one MS. Refer to ETS 300 393-1 [14], clause 6.

Figures 55 and 56 show the service relationships relating to the MLE services.

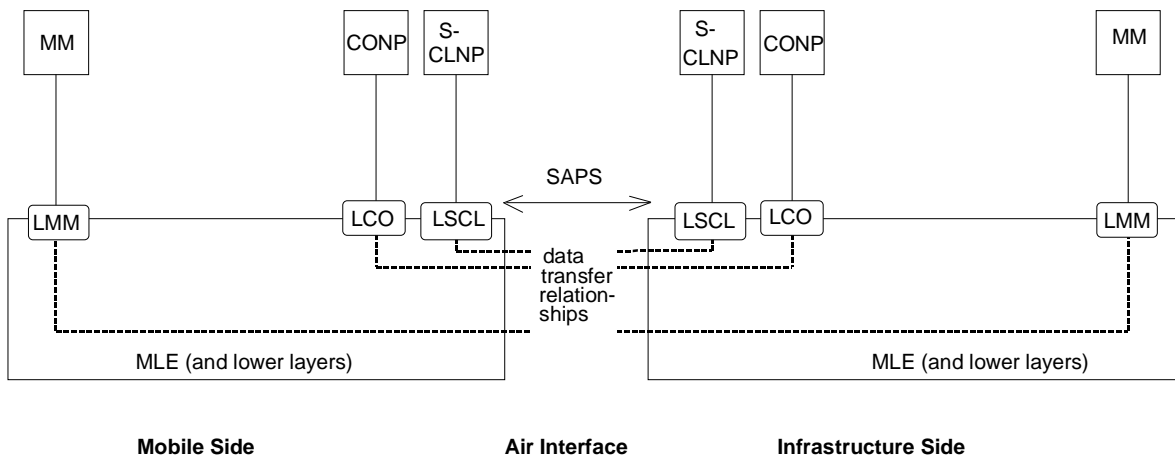

Figure 55: Services relationships offered by the MLE in the air interface

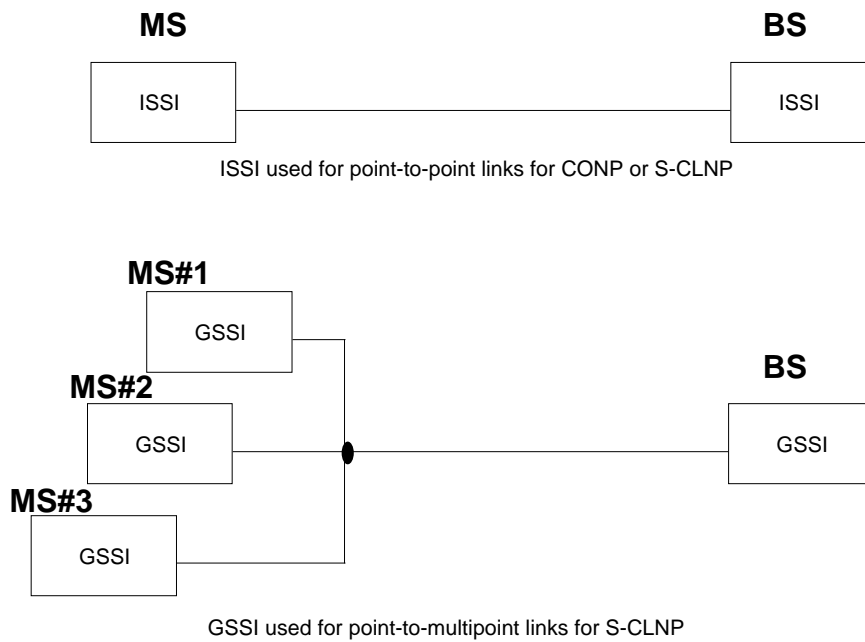

Figure 56: Address relationships with respect to MLE services

17.3 Detailed service descriptions

17.3.1 Services and primitives at the LMM-SAPs

The services offered at the LMM-SAP are not symmetrical. The LMM-SAP at the mobile side are different from the LMM-SAP at the TETRA infrastructure side. To distinguish these two SAPs, the SAP on the mobile side is indicated as LMM-m-SAP and the LMM-SAP on the TETRA infrastructure side is indicated as LMM-i-SAP.

17.3.1.1 Service state diagram for the LMM-m-SAP (mobile side)

The primitives provided by the MLE on the mobile side to the MM entity and the transactions between the states should be as shown in figure 57.

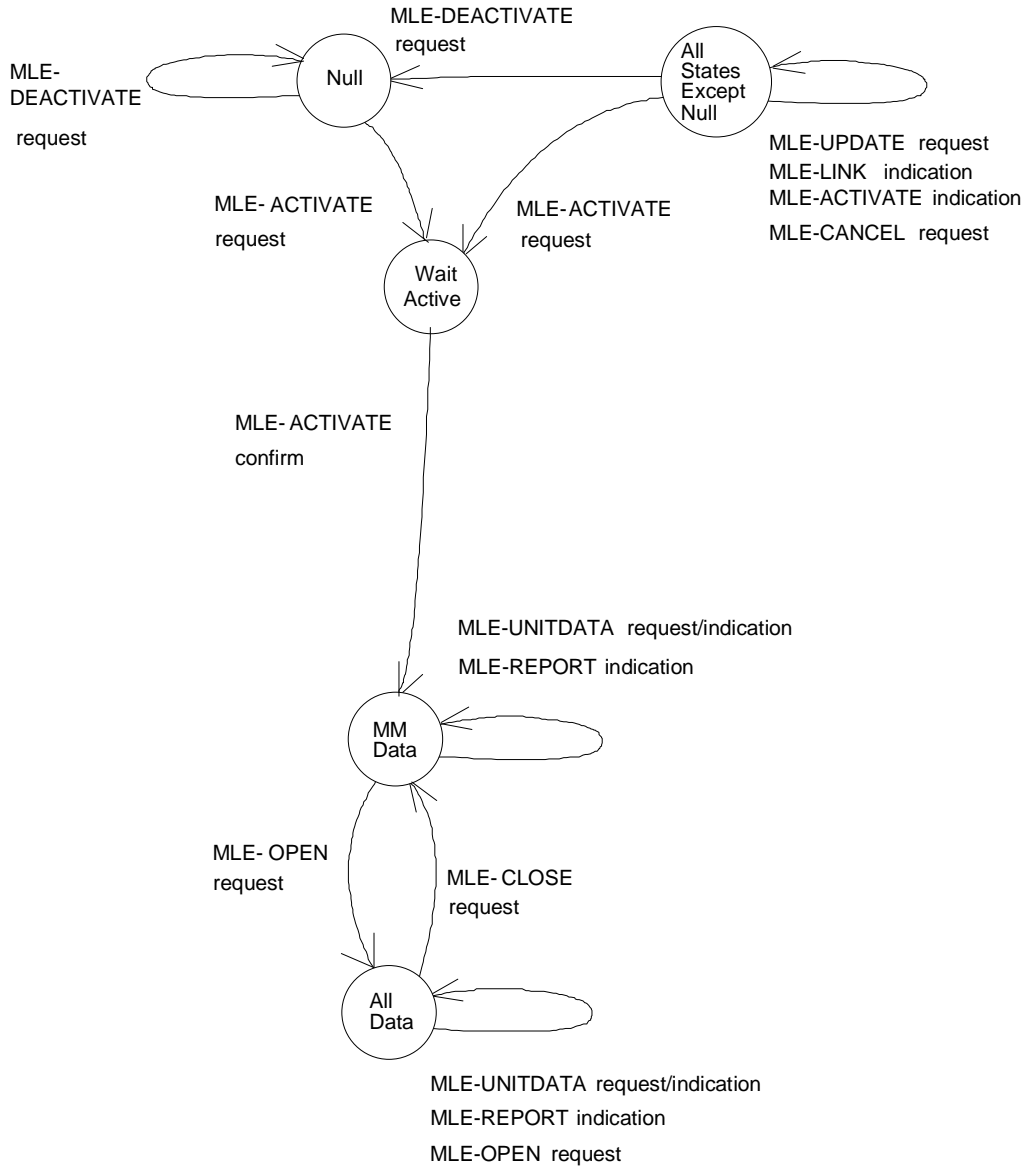

Figure 57: LMM-m SAP state transition diagram

17.3.1.2 Service primitives for the LMM-SAPs

MLE-ACTIVATE request: this should be used as a request at the mobile side to initiate the selection of a cell for communications. The request should always be made after power on and may be made at any time thereafter.

MLE-ACTIVATE confirm: this should be used as a confirmation to the MM entity at the mobile side that a cell has been selected with the required characteristics.

MLE-ACTIVATE indication: this should be used as an invitation to the MM to react as no suitable cell was found available.

MLE-CANCEL request: this may be used by the MM to delete a previous request issued but not yet transmitted. The ability to cancel should be removed when the MLE-REPORT indication is received.

MLE-CLOSE request: this should be used by the MM entity to instruct the MLE remove access communication resources for the other layer 3 entities, but keeping access to the communication resources for the MM entity.

MLE-DEACTIVATE request: this should be used by the MM entity at the mobile side to request the deactivation of all MLE procedures and to return to the NULL state. No communication resources will be available for use after this primitive has been issued.

MLE-LINK indication: this should be used by the MLE at the mobile side to indicate to MM entity information about cells, outside the Registered Area (RA).

MLE-OPEN request: this should be used by the MM entity to instruct the MLE to provide access to communication resources for other layer 3 entities than the MM after successful registration and authentication. It should also be used to supply (or update) the complete list of SSIs to be used (both ISSI and GSSI).

MLE-REPORT indication: this should be used by the MLE to report on the completion of a MLE-UNITDATA request procedure. The result of the transfer attempt is passed as a parameter. Errors detected during the MLE-UNITDATA request procedure are indicated using this primitive.

MLE-UNITDATA request: this should be used by the MM entity to request an unacknowledged data transmission.

MLE-UNITDATA indication: this should be used by the MLE to provide the MM entity with unacknowledged data which has been received.

MLE-UPDATE request: this should be used by the MM entity at the mobile side to inform the MLE about new criteria concerned with the monitoring of other possible cells.

MLE-IDENTITIES request: this primitive should be used to transfer the identities that have been received from the RPDI to the MLE.

MLE-INFO request: this primitive should be used to transfer control parameters received from the RPDI to the MLE and layer 2. These control parameters can include information on energy economy modes, master channel configurations and subscriber class.

Table 82: Primitives and parameters at the LMM-m-SAP (mobile side)

Primitives generic name	Specific name	Parameters
MLE-ACTIVATE	request	Cell characteristics, TNI
	confirm	Cell ID
	indication	TNI, channel
MLE-CANCEL	request	Handle
MLE-CLOSE	request	-
MLE-DEACTIVATE	request	-
MLE-LINK	indication	MNC, MCC, MLE-Activity indicator, Location Area, Registration type
MLE-OPEN	request	Cell ID, List of valid ITSI and GTSI plus the exchanged ISSIs and GSSIs (if appropriate)
MLE-REPORT	indication	Transfer result, returned SDU
MLE-UNITDATA	request	SDU, Layer 2 service PDU priority,
	indication	SDU
MLE-UPDATE	request	channel, MCC, MNC, suspend/reinstate, selected
MLE-IDENTITIES	request	List of GSSIs, ASSIs
MLE-INFO	request	Transfer of control parameters received from the RPDI to the MLE and layer 2

17.3.2 Services and primitives at the LSCL-SAP

The MLE protocol shall deal with the PDO specifics at the MLE-LLC service boundary.

The MLE shall tell S-CLNP that access to the communication resources is enabled or disabled, but not when the communication is temporarily broken.

At the LSCL SAP, the service primitives and state transition diagrams may be the same on both sides of the air interface.

17.3.2.1 MS attachment

The attachment of the MS shall be controlled by the MM entity and should be largely invisible to the other service users.

The MLE should issue a MLE-OPEN indication to all service users when a new radio link is opened.

17.3.2.2 Data transfer

The MLE offers only one class of data transfer to S-CLNP: unconfirmed data transfer. The data may be transferred with different grade of QoS.

Unconfirmed transfer is invoked with MLE-UNITDATA request. Quality of service parameters (including selection of extended error protection) shall be defined as part of each MLE-UNITDATA request.

17.3.2.3 Service state diagram for the LSCL SAP

The primitives provided by the MLE to the S-CLNP entities, and the state transitions visible at these SAP, should be as shown in figure 58.

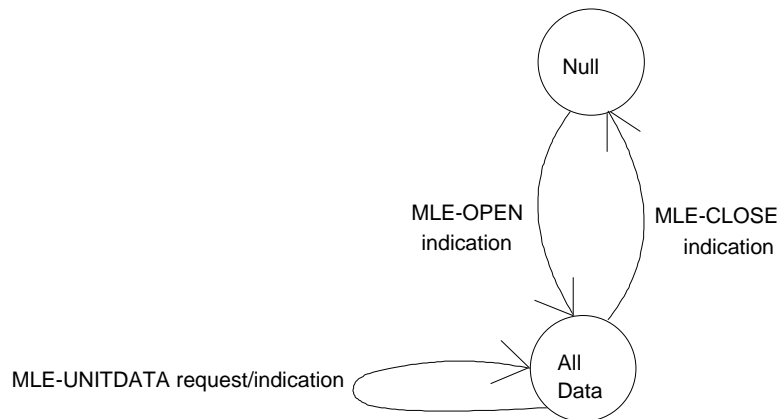

Figure 58: State transition diagram of LSCL SAP

17.3.2.4 Service primitives for LSCL SAP

The service primitives at the LSCL SAP are the following:

MLE-CLOSE indication: this should be used by the MLE entity to indicate to the higher layer entities that access to the communications resources has been removed and the MLE service users are not permitted to communicate with their peer entities.

MLE-OPEN indication: this should be used by the MLE to inform a MLE service user that they have access to the communication resources. This primitive indicates that any previous associations between peer MLE service users have not been recovered by the MLE. This primitive may be sent after recovery from a lower layer failure, a MLE-controlled cell change and when the MM entity has issued a MLE-OPEN request.

MLE-REPORT indication: this should be used by the MLE to report on the completion of a MLE-UNITDATA request procedure. The result of the transfer attempt should be passed as a parameter. Errors detected during the MLE-UNITDATA request procedure should be indicated using this primitive.

MLE-UNITDATA request: this should be used by a MLE service user to send unacknowledged data to a peer entity on the TETRA infrastructure side.

MLE-UNITDATA indication: this should be used by the MLE to indicate to a MLE service user the arrival of unacknowledged data which has been received from a peer entity on the TETRA infrastructure side.

Table 83: Primitives and parameters at the LSCL SAP

Generic name	Specific name	Parameters
MLE-CLOSE	indication	Reason
MLE-OPEN	indication	-
MLE-REPORT	indication	Transfer result, returned SDU
MLE-UNITDATA	request	SDU, QoS, Layer 2 service PDU priority,
	indication	SDU, QoS

17.3.3 Services and primitives at the LCO-SAP

The MLE protocol shall deal with the PDO specifics at the MLE-LLC service boundary.

The MLE shall tell CONP that access to the communication resources is enabled, temporarily broken, or disabled.

At these SAPs, the service primitives and state transition diagrams may be the same on both sides of the air interface.

17.3.3.1 Radio link establishment

Radio link establishment or MS attachment shall be controlled by the MM entity and should be largely invisible to the other service users.

The MLE should issue a MLE-OPEN indication to all service users when a new radio link is opened.

A radio link may be reset by any service user with a MLE-RESET request primitive, and this is reported to all service users with MLE-RESET indications. This may indicate a reset of acknowledged L2 transfer, with a possible loss of any SDUs that have not been confirmed with a MLE-REPORT indication.

17.3.3.2 Connection restoration

Connection restoration shall be all of the functions performed by the air interface protocol stack entities to recover from a break in the radio link (e.g. a radio outage).

The MLE should issue a MLE-BREAK indication primitive to all the service users when the quality becomes unacceptable, and should issue a MLE-RESUME indication primitive when the quality of received data is again acceptable after a brief period when the quality was judged unacceptable.

In some cases, an outage recovery at the MLE service boundary may be the result of a MLE-controlled cell change.

NOTE: Outage recovery may cause increased transit delay, which may be visible to the sending entity as a delayed report.

If connection restoration is unsuccessful, the link shall be fully re-established, see subclause 17.3.3.1.

17.3.3.3 Data transfer

Data transfer should be invoked with MLE-UNITDATA request asking for a layer 2 acknowledged or not acknowledged transmission. The result of the transfer should be reported to the sending entity with a MLE-REPORT indication primitive. The MLE-REPORT indication may indicate the reason for failure using the "Transfer result" parameter.

NOTE: All reports should be generated as the result of a layer 2 confirmation. For acknowledged transfer this indicates an explicit peer-to-peer acknowledge at layer 2. For unacknowledged transfer this only indicates success (or failure) of the transmission by layer 2 at the sending side-local.

QoS parameters (including selection of extended error protection) should be defined as part of each MLE-UNITDATA request.

17.3.3.4 Service state diagram for the LCO SAP

The states, primitives and state transitions visible at the LCO SAP should be shown on figure 59.

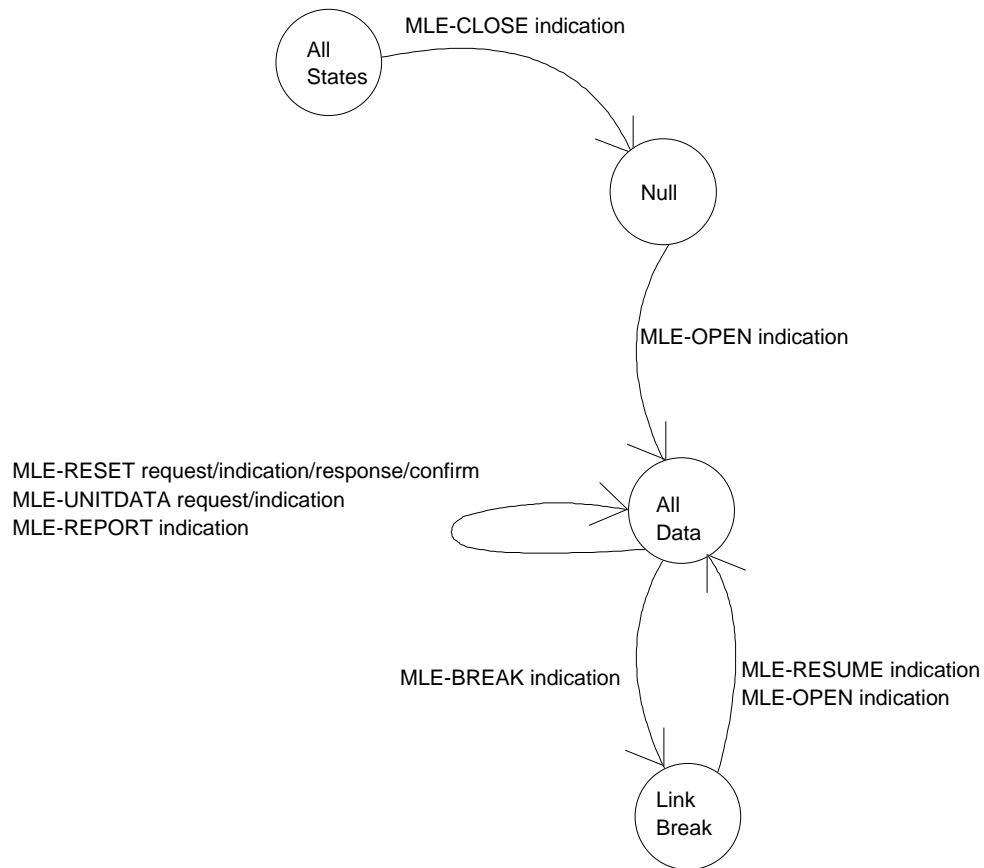

Figure 59: State transition diagram of LCO SAP

17.3.3.5 Service primitives for LCO SAP

The service primitives at the LCO SAP should be:

MLE-BREAK indication: this should be used by the MLE to inform the MLE service users that the resources needed for communication are temporarily not available. This can be due to a lower layer failure, or due to a MLE-controlled cell change.

MLE-CLOSE indication: this should be used by the MLE entity to indicate to the higher layer entities that access to the communications resources has been removed and the MLE service users are not permitted to communicate with their peer entities.

MLE-OPEN indication: this should be used by the MLE to inform a MLE service user that they have access to the communication resources. This primitive indicates that any previous associations between peer MLE service users have not been recovered by the MLE. This primitive may be sent after recovery from a lower layer failure, a MLE-controlled cell change and when the MM entity has issued a MLE-OPEN request.

MLE-REPORT indication: this should be used by the MLE to report on the completion of a MLE-UNITDATA request procedure. The result of the transfer attempt is passed as a parameter. Errors detected during the data transfer procedures (as invoked by a MLE-UNITDATA request) are indicated using this primitive.

MLE-RESET request: this primitive should be used by a MLE service user to reset the information flows of a MLE connection to a known state. For Voice and Data it also applies as a CANCEL Request which deletes previous requests issued and not yet transmitted.

MLE-RESET indication: this primitive should be used by the MLE to inform a MLE service user that the information flows of a MLE connection must be reset to a known state.

MLE-RESET response: this primitive should be used by a MLE service user to acknowledge that information flows of a MLE connection shall be reset to a known state.

MLE-RESET confirm: this primitive should be used by the MLE to inform a MLE service user that the information flows of a MLE connection have been reset to a known state.

MLE-RESUME indication: this should be used to indicate that a temporary break in access to the communications resources has been recovered. All previous associations between peer service user entities should have been successfully recovered.

MLE-UNITDATA request: this should be used by a MLE service user to send unconfirmed data to a peer entity on the TETRA infrastructure side.

MLE-UNITDATA indication: this should be used by the MLE to indicate to a MLE service user the arrival of unconfirmed data which has been received from a peer entity on the TETRA infrastructure side.

Table 84 gives the CONP primitives and the parameters of the primitives.

Table 84: Primitives and parameters at the LCO-SAP

Generic name	Specific name	Parameters
MLE-BREAK	indication	Cause
MLE-CLOSE	indication	-
MLE-OPEN	indication	-
MLE-REPORT	indication	Transfer result, Returned SDU
MLE-RESET	request indication response confirm	Reason Reason - -
MLE-RESUME	indication	-
MLE-UNITDATA	request indication	SDU, QoS, Layer 2 service PDU priority, SDU, QoS.

18 PDO MLE protocol

18.1 Introduction

This clause defines the protocol for the PDO MLE. This is the lowest sub-layer of the NWK layer as described in ETS 300 393-1 [14]. It may be used to provide sub-network services to higher NWK layer entities at the air interface according to the MLE service description (clause 17). This clause defines the MLE protocol functions required for MS operation.

This clause specifies:

- the protocol procedures;
- the protocol services;
- the PDUs and associated elements.

See clause 17 for the MLE service description (SAPs, services and primitives).

18.2 Overview of the sub-layer

The MLE protocol should be used to mask mobility and radio resources from the higher entities.

It shall provide a sub-network dependant protocol (convergence) and a sub-network access protocol to the PDO layer 2.

18.2.1 Protocol environment

The V+D MLE shall be the layer 3 sub-layer 3.1 which provides services to the layer 3 sub-layer 3.2, as shown in figure 60. This protocol shall provide services to the following higher entities:

- Mobility Management (MM) entity, see clause 16;
- Circuit Mode Control Entity (CMCE) entity, see clause 14;
- Connection Oriented Network Protocol (CONP) entity, see clause 25;
- Specific ConnectionLess Network Protocol (SCLNP) entity, see clause 27.

The MLE services shall be represented by the MLE service primitives which shall apply to the following SAPs:

- LCMC-SAP for CMCE;
- LCO-SAP for CONP;
- LSCL-SAP for SCLNP; and
- LMM-SAP for MM.

The services offered at the MM-SAP may interact with the services offered at the CMCE, CONP and SCLNP SAPs.

The underlying protocol should be the PDO layer 2, see clauses 22 and 23.

The MLE protocol may also interface to the Lower Layer Management Entity (LLME) and the interface is defined by the C-SAP. However, the exact implementation of the interface is outside the scope of this ETS.

The protocol architecture can be similar on the BS side of the air interface.

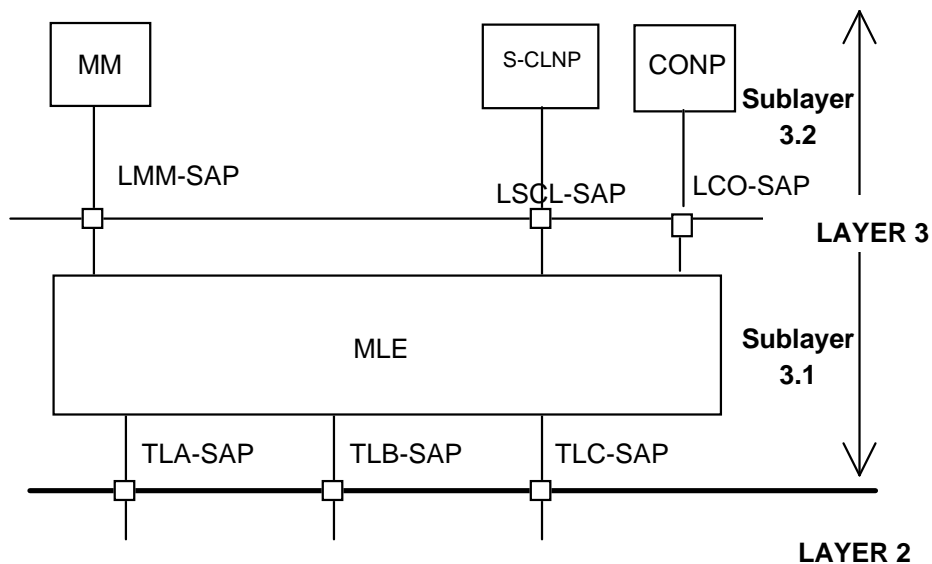

Figure 60: The MLE (sub-layer 3.1) in the MS protocol stack

The MS-MLE shall establish the basis for communication with a cell (BS) by camping on the cell and the MS-MLE shall check the quality using the information received from the layer 2. Once the cell has been found suitable by the MS-MLE, the MM entity may intervene in order to register the MS. When the cell has been registered, the MS is said to be attached and the MLE can now offer data transfer services to the CONP and SCLNP entities as well. Data transfer shall be regulated by the MM entity which may allow access for MM only or for all entities.

The MLE shall perform surveillance of the quality of the radio communication path. It may report any break or loss of the path and, when necessary it should try to re-establish the communication with the same or another BS in either the same or a different LA.

18.2.2 Services and primitives offered by the MLE to the MM entity

The services and primitives offered to the MM entity are described in clause 17.

The services offered shall be:

- a) activation of MLE procedures;
 MLE-ACTIVATE request/confirm/indication;
- b) opening of link access to other layer 3 entities;
 MLE-OPEN request;
- c) data transfer;
 MLE-UNITDATA request/indication;
 MLE-REPORT indication;
- d) closing the access to other entities;
 MLE-CLOSE request;
- e) deactivation of the MLE procedures;
 MLE-DEACTIVATE request;
- f) receiving information on a cell or LA;
 MLE-LINK indication;

- g) updating current registered area;
MLE-UPDATE request;
- h) cancellation of issued primitive requests;
MLE-CANCEL request.
- i) locking MLE while MM signalling exchange is in progress;
MLE-BUSY request;
- j) releasing MLE after completion of MM signalling exchange;
MLE-IDLE request;
- k) lower layer management;
MLE-IDENTITIES request;
MLE-INFO request.

18.2.3 Services and primitives offered by the MLE to the SCLNP entity

The services and primitives offered to the SCLNP entity are described in clause 17.

The services offered shall be:

- a) indication that access to resources is enabled;
MLE-OPEN indication;
- b) indication that access to resources is disabled;
MLE-CLOSE indication;
- c) data transfer;
MLE-UNITDATA request/indication;
MLE-REPORT indication.

18.2.4 Services and primitives offered by the MLE to the CONP entity

The services and primitives offered to the CONP entity are described in clause 17.

The service offered shall be:

- a) indication that access to resources is enabled;
MLE-OPEN indication;
- b) indication that access to resources is disabled;
MLE-CLOSE indication;
- c) indicating a temporary break in the access to the communication resources;
MLE-BREAK indication;
- d) indicating resumption in the access to the communication resources;
MLE-RESUME indication;

- e) reset procedures;
MLE-RESET request/indication/response/confirm;
- f) data transfer;
MLE-UNITDATA request/indication;
MLE-REPORT indication;
- g) cancellation of issued primitive requests;
MLE-CANCEL request.

18.2.5 Services and primitives offered by layer 2 to MLE

Layer 2 shall provide the MLE with different services, which enable the MLE to provide the services requested by its services users. The following primitives are defined for that purpose.

On the TLA-SAP the following services and primitives should be available, see clause 19 for service definitions:

- a) establishing a data link connection by using the LLC advanced link mechanism;
TL-CONNECT request/indication/response/confirm;
- b) transfer of data using a Layer 2 acknowledged service;
TL-DATA request/indication/response/confirm;
- c) disconnection of an established data link connection, i.e. an LLC advanced link;
TL-DISCONNECT request/indication /confirm;
- d) transfer of data using a Layer 2 unacknowledged service;
TL-UNITDATA request/indication;
- e) receive report information on the progress of issued request primitives and unrecoverable transmission errors detected in the data link;
TL-REPORT indication;
- f) cancellation of issued request primitives;
TL-CANCEL request.

On the TLB-SAP the following services and primitives should be available, see clause 19 for service definitions:

- a) reception of layer 3 information in the synchronisation broadcast and system information broadcast. The broadcast shall be recognised by layer 2 and forwarded to layer 3 as SDU elements inside primitives;
TL-SYNC indication;
TL-SYSINFO indication;

18.2.6 Services and primitives between the MLE and the LLME

Lower Layer Management Entity (LLME) may be used for exchanging layer-to-layer information. In the protocol stack (figure 60) the access to the LLME is modelled in the TLC-SAP.

The following primitives should be defined for this SAP:

- a) control of scanning (MS side only);
 TL-SCAN request/confirm;
 TL-SCAN-REPORT indication;
- b) selecting cell for attachment (MS side only);
 TL-SELECT request/indication/confirm;
- c) control of monitoring (MS side only);
 TL-MONITOR-LIST request;
 TL-MONITOR indication;
- d) receive quality information on the serving cell (MS side only);
 TL-MEASUREMENT indication;
- e) receive path loss information (MS side only);
 TL-REPORT indication;
- f) set-up and configure layer 2 according to commands from service SAP users (MS side only);
 TL-CONFIGURE request/confirm.

18.2.7 Protocol sequences

The basic protocol primitive sequences are shown in figure 61 to figure 63 inclusive. The operation of the protocol should be modelled as a finite state automaton governed by a state variable. A transition of the automaton should be prompted by the occurrence of an event at one of three interfaces:

- a) the interface to any of the service users (MM CONP, SCLNP);
- b) the interface to the underlying service which is the PDO layer 2;
- c) the interface to the LLME.

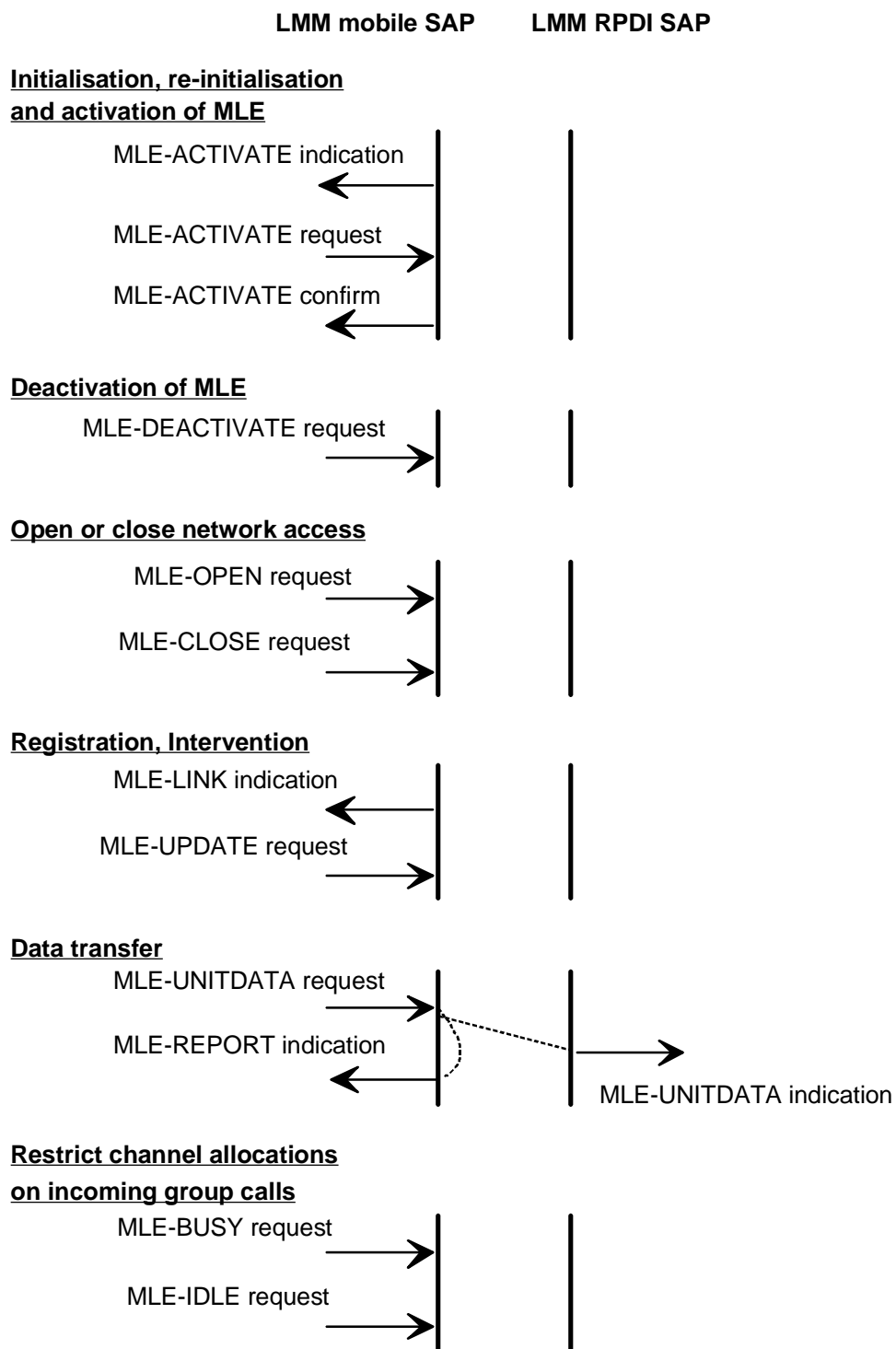

Figure 61: Primitive time sequence at the LMM-SAP

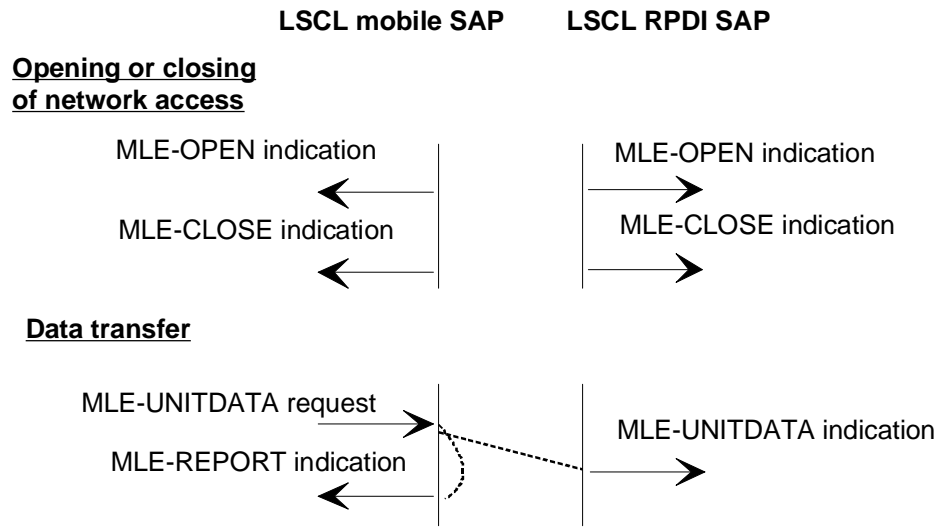

Figure 62: Primitive time sequence at the LSCL-SAP

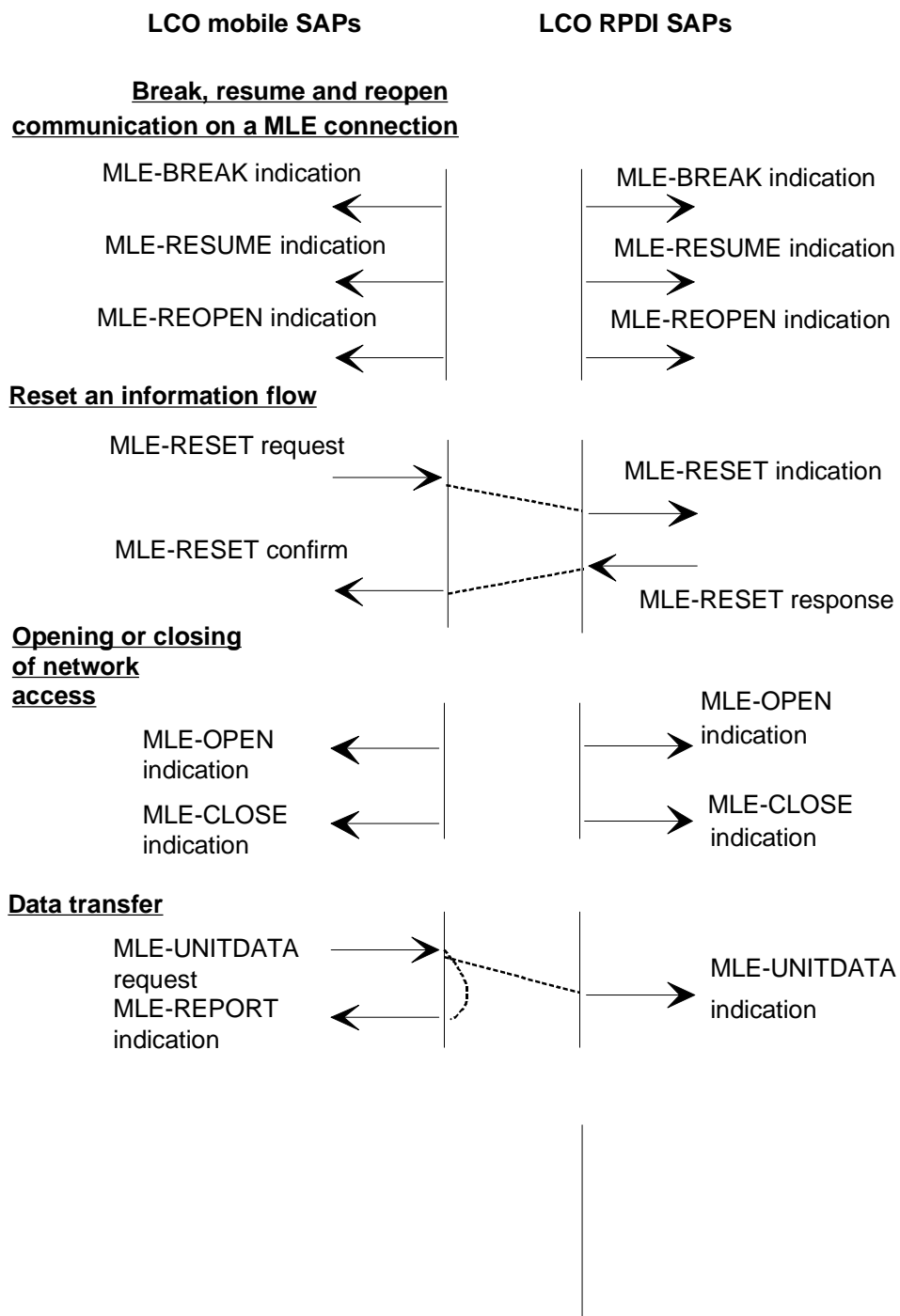

Figure 63: Primitive time sequence at the LCO-SAP

18.3 MLE functions

18.3.1 Overview

The MLE functional groups are shown as follows:

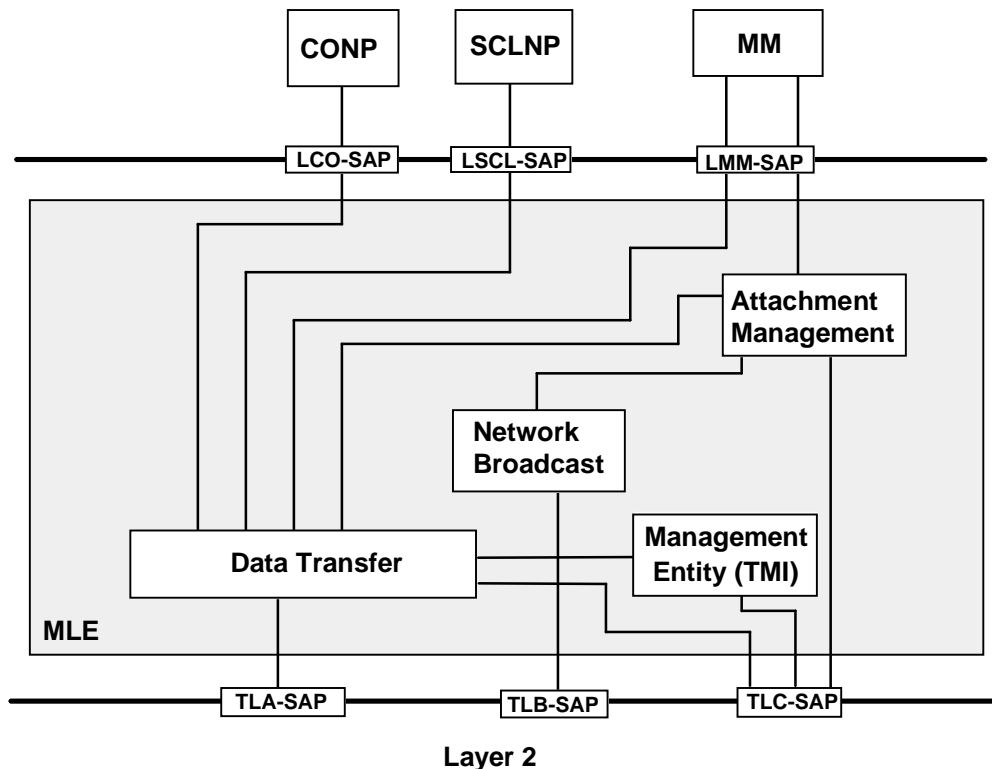

Figure 64: MLE functional model

The MLE functional entities are:

a) attachment management:

- management of monitoring and scanning procedures;
- surveillance of the serving cell quality;
- management of the ranking procedure;
- management of the cell relinquishable, improvable and usable radio criteria;
- management of the roaming announcements and declarations;
- informing upper entity CONP of broken and restored MLE connections via the data transfer sub entity.

b) data transfer:

- selection of underlying LLC service;
- address handling (ISSI, GSSI and TMI);
- informing the upper entities CONP and SCLNP of enabled and disabled access to the communication resources;
- routing and multiplexing to layer 2 service end points (including addition/removal of MLE protocol control information);
- routing and multiplexing to MLE SAPs and other MLE functional entities;
- quality of service mapping (e.g. priority, throughput, transfer service).

c) network broadcast:

- formatting and broadcasting of the network information (RPDI);
- reception and analysis of network information MS;
- configuring of MAC layer 2 with synchronisation and system information broadcast.

d) management:

- handling network management procedures, e.g. addressed to the TETRA Management Identity (TMI);
- handling local management information from the management entity to the lower layers.

18.3.2 Access to the communication resources and activation of the MLE

Access to all communication resources is controlled by the MLE, according to requests received from the MM entity.

At power on, or other start up, there is no requirement that the MLE entity shall have any prior knowledge of the suitability of any cell. In order that the MS can communicate, the MLE shall select a suitable cell. A suitable cell should be one in which the MS can reliably decode down link data, which has a high probability of uplink communication and that the MS may request and obtain service. The procedures defined in the following clauses describe methods by which the MS can select a cell. The MLE cell selection procedure is initiated by the MM entity defining the cell selection criteria (e.g. mobile network identity) in an MLE-ACTIVATE request primitive. When a suitable cell has been found the MLE issues an MLE-ACTIVATE confirm primitive to the MM to report the cell details. Initially the radio communications link may only be used for MM data transfer until the MM issues an MLE-OPEN request primitive thereby instructing the MLE to open access to the layer 3 entities. The MM entity issues the MLE-OPEN request after completion of any MM procedures (e.g. registration). An MLE-OPEN request is received by both the attachment management and the data transfer sub entities within the MLE. The opening of link access is reported to the CONP and SCLNP with an MLE-OPEN indication primitive.

NOTE: If no MM procedures are required, the MM may issue the MLE-OPEN request immediately after the MLE-ACTIVATE confirm is received.

The MLE on the MS side can take the decision to change cell from measurement processing and threshold comparisons. MM shall be informed with an MLE-LINK indication in the event that the cell re-selection results in the selection of a cell in a LA that is not in the current registration area. The parameters associated with the MLE-LINK indication inform the MM of the LA, MNC and MCC of the new cell.

18.3.3 Deactivation of the MLE

Upon receipt of an MLE-DEACTIVATE request the MLE shall cease all functions. The MLE-DEACTIVATE should be preceded by an MLE-CLOSE request to the data transfer sub entity.

18.3.4 Attachment management sub entity

The attachment management sub-entity shall be responsible for the initial cell selection and cell re-selection procedures. The initial cell selection and cell re-selection procedures comprise the functions listed below. These functions shall be activated at power on:

- management of the monitoring and scanning procedures.
- surveillance of the serving cell quality.
- management of the neighbour cell ranking procedure.
- management of the cell re-selection criteria.
- management of the cell re-selection announcements and declarations.
- informing upper entity CONP of broken and restored MLE connections via the data transfer sub entity.

Cell selection and re-selection shall only be carried out using the individual or alias subscriber identities. Cell re-selection shall not be carried out using group addresses. Any cell re-selection messages received on a GSSI shall be ignored.

Where the MS is engaged in more than one data call, the MS shall only apply the cell re-selection procedures once and not for each call in progress. Once a cell has been re-selected the COMP may restore the calls.

18.3.4.1 Scanning of cells

Scanning is where an MS is synchronised to a cell, directly measures the received power of that cell and directly obtains the broadcast and synchronisation information for that cell by decoding the BNCH and BSCH. The scanning sub function enables the MLE to directly obtain the path loss measurements from the cells. To obtain the C_1 path loss parameter from layer 2, the MS-MLE shall per cell issue a TL-SCAN request primitive to the TLC-SAP along with the parameters indicating which cell is to be scanned.

The MS-MLE shall know locally which channels the MS is capable of scanning and shall not instruct the lower layers to scan any channel that the MS-MLE knows to be outside the capabilities of the equipment. When layer 2 has completed scanning of one cell, the C_1 path loss shall be part of the report parameter of the TL-SCAN confirm primitive or of the TL-SCAN-REPORT indication primitive, both given by layer 2. The C_1 formula is defined in clause 10. The MS-MLE can use the list of neighbour cells in the D-NWRK BROADCAST PDU to specify which channels to be scanned.

There are three types of scanning defined in clause 10. These are:

- foreground, where scanning is the only activity;
- background, where communications with the current serving cell are maintained in parallel with the scanning, and the scanning causes no interruption to that service;
- interrupting, where communications with the current serving cell are maintained in parallel with the scanning, but the scanning causes limited interruptions to that service.

Scanning shall have been performed within the last 60 seconds for a scanning measurement to be considered valid.

18.3.4.2 Monitoring of neighbour cells

Monitoring is where the MS calculates the path loss parameter C_2 of neighbour cells using information about the neighbour cells broadcast by the serving cell. It differs from C_1 in that the serving cell provides the cell selection parameters for the neighbour cell. However, the MS is still required to directly measure the received power of the neighbour cell.

In order to be able to monitor the neighbour cells the MS-MLE shall have received a D-NWRK BROADCAST PDU containing a list of the neighbour cells. The procedures concerning network broadcast PDUs are dealt with in subclause 18.3.6. Once the network broadcast information has been received, the monitoring can be started by issuing a TL-MONITOR-LIST request primitive through the TLC-SAP. The TL-MONITOR-LIST request primitive informs layer 2 of the cells to be monitored. The parameters passed down with the TL-MONITOR-LIST shall be a list of channels. The MS-MLE shall know locally which channels the MS is capable of monitoring and shall not instruct the lower layers to monitor any channel that the MS-MLE knows to be outside the capabilities of the equipment. For each channel the lower layers return a TL-MONITOR indication containing the C_2 path loss parameter. C_2 is defined in clause 23.

Monitoring is a background procedure and is defined in clause 10. Monitoring shall have been performed during the last 60 seconds for a monitoring measurement to be considered valid.

If it is required to stop the monitoring process, the MLE shall issue a TL-MONITOR-LIST with an empty list as parameter.

18.3.4.3 Surveillance of the serving cell

Surveillance is the procedure whereby the MS analyses the received information on the quality of the link to the serving cell. Once the MS-MLE has chosen the serving cell, the MLE shall select that cell by issuing a TL-SELECT request primitive to the TLC-SAP. Once the cell has been selected the lower layers return a TL-SELECT confirm and periodically send TL-MEASUREMENT indication primitives containing the C_1 path loss parameter for the serving cell. The C_1 path loss parameter is described in clause 10. Additionally the surveillance sub function shall be responsible for the analysis of any network broadcast information received from the serving cell via the network broadcast sub entity.

Should the MLE receive a TL-REPORT indication from the lower layers indicating that the path to the serving cell has been lost then it shall inform the upper entity CONP by issuing an MLE-BREAK indication via the data transfer sub entity. TL-REPORT indicates that the path has been lost if the uplink or down link have failed, or, the maximum path delay has been exceeded (uplink failure and maximum path delay exceeded can only be indicated to the MS in a MAC-RESOURCE PDU from the RPDI).

If the MLE receives a TL-SELECT indication via the TLC-SAP, outside of cell re-selection, indicating that the MAC has been instructed to change channels and no response is required, the surveillance function shall note the new serving cell channel.

18.3.4.4 Ranking of neighbour cells

The ranking sub function can use the path loss measurements, C_1 and C_2 , to maintain a ranked list of neighbour cells.

The ranking algorithm shall rank the neighbour cells which have been monitored or scanned in strict order of downlink radio connection quality. The results of this algorithm can be used to determine when a cell is deemed to be radio usable, radio relinquishable or radio improvable according to subclause 18.3.4.7. The use of a ranking algorithm based only on C_1 or C_2 is essential in order to facilitate network coverage planning.

A cell shall meet the following minimum criteria in order to be included in the ranking list of neighbour cells:

- $C_1 > 0$ or $C_2 > 0$;
- if the neighbour cell is outside of the current registration area, the neighbour cell must support roaming (which is broadcast as part of the BS service details element);

NOTE: The current registration area consists of all of the LAs in which the MS is currently registered.

- if the neighbour cell has a different MCC or MNC, the neighbour cell must support migration (which is broadcast as part of the BS service details element).

If these criteria are not satisfied, an MS shall not include that cell in the ranking list and so shall not consider that cell for cell re-selection.

If the information about the LA or mobile country/network code is not broadcast by the serving cell as part of the neighbour cell information, the MS may assume that it is free to include that cell in its ranking list provided the $C_1 > 0$ or $C_2 > 0$ criterion is met.

An MS can build a valid ranking list by obtaining the cell re-selection parameters for the neighbour cells from the D-NWRK BROADCAST PDU transmitted on the serving cell. In this case, the MS shall monitor the neighbour cells specified by D-NWRK BROADCAST and shall calculate C_2 for each one using the cell re-selection parameters for the neighbour cell sent in D-NWRK BROADCAST on the serving cell. A valid ranking list can then be derived using the C_2 measurements.

An MS can also build a valid ranking list by scanning the neighbour cells to obtain the cell re-selection parameters directly. In this case, the MS shall calculate C_1 for each of the neighbour cells and shall derive a valid ranking list using the C_1 measurements.

18.3.4.4.1 Ranking of monitored cells

Ranking of monitored neighbour cells shall be based upon the received path loss parameter C2 from the layer 2 monitoring process, issued in a TL-MONITOR indication primitive.

The ranking should produce a ranked cell list which can be used as a scanning list, if the scanning function is applied. This ranked cell list may be used for making the decision of whether and when to change cell, according to subclause 18.3.4.7.

18.3.4.4.2 Ranking of scanned cells

Ranking of scanned neighbour cells shall be based upon the received path loss parameter C1 from the layer 2 scanning process, issued in a TL-SCAN confirm primitive or a TL-SCAN-REPORT indication primitive.

The ranking should produce a ranked cell list which may be used for making the decision of whether and when to change cell, according to subclause 18.3.4.7.

18.3.4.5 Criteria used during cell re-selection

The following subclauses define the criteria which shall be used to initiate the cell re-selection procedures described in subclause 18.3.4.6.

18.3.4.5.1 Criterion for starting the monitoring process

The monitoring process may be permanently enabled or enabled only when some criterion is met, e.g. the serving cell ceases to support the service level required by the MS, or, the serving cell quality falls below a pre-determined threshold. In the latter case it is assumed that the monitoring process would be disabled when the serving cell quality rises above the threshold plus some hysteresis factor. The exact method for the selection of the thresholds and hysteresis values is outside the scope of this ETS. Where the monitoring process is not permanently enabled and the MS-MLE receives system broadcast information informing it that the service level required by that MS is no longer supported, e.g. that the subscriber class that the MS belongs to is no longer able to access the system, the monitoring process should be started.

Where the monitoring process is not permanently enabled but started when a threshold value is crossed, the threshold value should be chosen to be a value greater than the threshold parameters; FAST_RESELECT_THRESHOLD, SLOW_RESELECT_THRESHOLD, to allow the MS enough time to successfully select a new cell prior to the complete loss of service from the current serving cell.

18.3.4.5.2 Criterion for starting scanning

The individual criteria for starting scanning in the different selection and re-selection procedures are defined in subclauses 18.3.4.5 and 18.3.4.6.1 to 18.3.4.6.5.

18.3.4.5.3 Criterion for radio link failure

Radio link failure occurs when the quality of the uplink or downlink radio connection falls below a certain level. A radio link failure shall be declared if any of the following events occur:

- layer 2 declares C1 path loss parameter failure ($C1 < 0$);
- an error is reported via the TL-REPORT indication primitive indicating either that the maximum path delay has been exceeded or that an uplink failure has occurred. Both of these conditions can be reported to the MS MAC from the RPDI in a MAC-RESOURCE PDU.

18.3.4.5.4 Criterion for radio relinquishable cell

A serving cell becomes radio relinquishable when the quality of the downlink radio connection falls below a certain level and there is a neighbour cell which has a downlink radio connection of sufficient quality. The following conditions shall be met simultaneously in order to declare the serving cell radio relinquishable:

- the serving cell path loss parameter C1 shall for a period of 5 s fall below FAST_RESELECT_THRESHOLD;
- the path loss parameter, C1 or C2, of at least one of the neighbour cells in the ranking list shall exceed by FAST_RESELECT_HYSTERESIS the path loss parameter, C1, of the current serving cell for a period of 5 s;
- no cell re-selection shall have taken place within the previous 15 s.

The MS-MLE shall check the criterion for serving cell relinquishment as often as one neighbour cell is scanned or monitored

18.3.4.5.5 Criterion for radio improvable cell

A serving cell becomes radio improvable when the quality of a neighbour cell downlink radio connection exceeds that of the serving cell by a certain amount. The following conditions shall be met simultaneously in order to declare the serving cell radio improvable:

- the serving cell path loss parameter, C1 shall for a period of 5 s fall below SLOW_RESELECT_THRESHOLD;
- the path loss parameter, C1 or C1, of at least one of the neighbour cells in the ranking list shall exceed by SLOW_RESELECT_HYSTERESIS the path loss parameter, C1, of the current serving cell for a period of 5 s;
- no cell re-selection shall have taken place within the previous 15 s.

The MS-MLE shall check the criterion for improving the serving cell as often as one neighbour cell is scanned or monitored.

18.3.4.5.6 Criterion for radio usable cell

A neighbour cell becomes radio usable when it has a downlink radio connection of sufficient quality. The following condition shall be met in order to declare a neighbour cell radio usable:

- the neighbour cell shall for a period of 5 s have a path loss parameter, C1 or C2, which is greater than $(\text{FAST_RESELECT_THRESHOLD} + \text{FAST_RESELECT_HYSTERESIS})$;
- no cell re-selection shall have taken place within the previous 15 s.

The MS-MLE shall check the criterion for a neighbour cell being usable each time the neighbour cell is scanned or monitored.

18.3.4.5.7 Criteria for initiating the cell re-selection procedures

Cell re-selection shall be initiated if a neighbour cell is declared radio improvable (as defined in subclause 18.3.4.7.5) and the service criteria as defined below are the same on both the serving cell and the radio improvable neighbour cell. If the service provided by the neighbour cell is lower than that provided by the serving cell, the cell re-selection may be postponed until the serving cell is declared radio relinquishable (as defined in subclause 18.3.4.7.4). If the service provided by the neighbour cell is higher than that provided by the serving cell, then the cell re-selection may be performed as soon as the neighbour cell is declared radio usable (as defined in subclause 18.3.4.7.6).

The following service criteria may be used to compare the service provided by a serving cell and a neighbour cell:

- support for subscriber class (broadcast as part of D-MLE-SYSINFO PDU);
- priority cell indication (broadcast as part of the BS service details element);
- support for CONP (broadcast as part of the BS service details element);
- support for SCLNP (broadcast as part of the BS service details element);
- cell service level (broadcast as part of D-MLE-SYNC PDU);
- whether or not the current serving cell or LA is preferred over the neighbour cell (which may be stored in the MS at subscription).

Using the above criteria, an MS may decide whether or not a neighbour cell can be considered to offer better service than the current serving cell. The following conditions shall cause the MS to rate a neighbour cell to have better service than the current serving cell:

- the MS subscriber class is supported on the neighbour cell but not on the serving cell;
- the neighbour cell is a priority cell and the serving cell is not a priority cell;
- the neighbour cell supports a service (CONP or SCLNP) which is not supported by the serving cell and the MS requires that service to be available;
- the cell service level indicates that the neighbour cell is more lightly loaded than the serving cell;
- the neighbour cell is a preferred cell (or "home cell") or belongs to a preferred LA.

In these cases the MS may choose to initiate cell re-selection as soon as the neighbour cell becomes radio usable as defined in subclause 18.3.4.7.6. If there is more than one neighbour cell which is radio usable, the MS should choose the one which gives the highest ranking in the ranking list and which best satisfies the service requirements for the MS.

The following conditions shall cause the MS to rate a neighbour cell to have lower service than the current serving cell:

- the MS subscriber class is not supported on the neighbour cell but is supported on the serving cell;
- the serving cell is a priority cell and the neighbour cell is not a priority cell;
- the serving cell supports a service (CONP or SCLNP) which is not supported by the neighbour cell and the MS requires that service to be available;
- the cell service level indicates that the serving cell is loaded more lightly than the neighbour cell;
- the serving cell is a preferred cell (or "home cell") or belongs to a preferred LA.

In these cases the MS may postpone cell re-selection until the serving cell becomes radio relinquishable as defined in subclause 18.3.4.4. If there is more than one neighbour cell which causes the serving cell to be radio relinquishable, the MS should choose the highest ranked cell in the ranking list which satisfies the service requirements for the MS.

If the neighbour cell is deemed to offer neither better service or lower service over the serving cell, the service shall be deemed to be equal and the MS shall initiate the cell re-selection procedures as soon as a neighbour cell becomes radio improvable over the current serving cell as defined in subclause 18.3.4.7.5. Note that a neighbour cell shall be deemed to be equal with respect to the above service criteria if the information is not available for either the serving or neighbour cell e.g. the cell service level may not be included in the D-NWRK BROADCAST PDU causing the service to be deemed equal with respect to cell service level.

If a neighbour cell is deemed to provide equal or better service than the current serving cell, the cell re-selection may be postponed if there is a circuit mode data call or ongoing signalling currently in progress. In this case, the cell re-selection may be postponed until the serving cell becomes radio relinquishable, even if there are neighbour cells which meet the radio improvable or radio usable criteria.

If radio link failure occurs (which can occur if there are no neighbour cells of sufficient radio connection quality to make the serving cell relinquishable), the MS may re-select any neighbour cell in the ranking list whose path loss parameter, C1 or C2, is greater than zero. If there are multiple cells in the ranking list which meet this radio criterion, the MS should choose the highest ranked cell which satisfies the service requirement for the MS. If there are no cells which meet this minimum radio criterion, the initial cell selection procedure shall be invoked.

18.3.4.6 Initial cell selection

The MS shall implement the initial cell selection procedure when the MS-MLE receives an MLE-ACTIVATE request from mobility management e.g. when not attached to a cell, at power on, or after a previous deactivation has taken place. The exact detailed implementation of the procedure and any associated algorithms is outside the scope of the ETS. The MS shall be required to fulfil certain conditions as stated below. The procedure shall be referred to as the 'initial cell selection' procedure. This does not imply that the procedure shall necessarily be different from any procedures applied for cell re-selection.

The initial cell selection procedure shall ensure that the MS selects a cell in which it can reliably decode down link data and which has a high probability of uplink communication. The minimum conditions that shall have to be met are that $C1 > 0$. Access to the network shall be conditional on the successful selection of a cell.

The procedure shall be initiated by the receipt of the MLE-ACTIVATE request primitive from the MM entity. This primitive has parameters which include the MCC and the MNC of the particular network which the MS should select. The MS-MLE shall then use this information, and initiate the foreground scanning procedure and thus obtain the path loss parameter C1 and the network broadcast information for each cell. This information can be used to produce a list of preferred cells. These cells shall then be ranked by the MS-MLE. The ranking algorithm is outside the scope of this ETS.

In the event that there are no suitable cells available when all cells in the list have been scanned, the MLE shall inform the MM entity with an MLE-ACTIVATE indication that no suitable cell has been found. The MLE shall continue the scanning of cells until a suitable cell is found, or until the MS is powered down. The exact procedures, algorithms and parameters applied for the continued scanning of cells are outside the scope of this ETS.

The MS shall select a cell which has $C1 > 0$. The MS should choose the cell which has the highest ranking according to the initial cell selection ranking procedure.

NOTE: The initial cell selection ranking procedure is not defined by this ETS.

The cell shall be selected by issuing a TL-SELECT request primitive to the TLC-SAP. The parameters of the TL-SELECT request inform the lower layers of the channel and the parameters, MS_TXPWR_MAX_CELL and RXLEV_ACCESS_MIN for the cell. Once the cell has been selected the lower layers return a TL-SELECT confirm. The MLE shall issue an MLE-ACTIVATE confirm to the MM. If registration is required in the cell, the MM shall then register. If the registration is successful or if no registration is required, the MLE may receive an MLE-UPDATE request from MM supplying information regarding updated search areas for further monitoring.

In the event that the initial cell selection is unsuccessful as a result of registration or authentication failure, MM shall instruct the MLE Attachment Management sub entity, using an MLE-UPDATE request, to suspend the ranking of that cell. This shall result in the selection of a different cell by the MLE, unless all opportunities have been used, in which case MM shall close the MLE service.

Upon receipt of the MLE-OPEN request, the MLE shall send MLE-OPEN indication to the higher layer 3 entity, CONP and SCLNP and shall initiate the serving cell surveillance procedures for the new cell as defined in subclause 18.3.4.3 and may also initiate monitoring or background/interrupting scanning of neighbour cells.

18.3.4.7 Cell re-selection

The clause defines the overall process of the cell re-selection procedure.

The cell re-selection procedure shall ensure that the MS selects a cell in which it can reliably decode down link data and in which it has a high probability of uplink communication according to the criteria in subclause 18.3.4.7. The minimum conditions which shall have to be met are that $C_1 > 0$ and, in the case of an MS in a circuit mode call that the maximum path delay is not exceeded.

NOTE: The RPDI informs the MS that maximum path delay is exceeded in a MAC-RESOURCE PDU.

If the cell re-selection procedure is unsuccessful, such that the MLE is left with no usable radio channels, the MS-MLE shall indicate this to the MM using an MLE-ACTIVATE indication. MM may give further instructions, e.g. new LAs, or, if all opportunities have been used, MM shall close the MLE services, see clause 16. When the MM eventually opens up the services again, MS-MLE shall be activated and the initial cell selection procedures as specified in subclause 18.3.4.5 shall apply.

Cell re-selection can be performed by the MS-MLE when a MS is attached to a cell in idle or traffic mode. The procedure can handle the following categories as listed below:

- undeclared;
- unannounced;
- announced type 3;
- announced type 2.

Undeclared cell re-selection is performed by the MLE when there are no calls in progress, and therefore requires no MLE signalling between the MS and the RPDI.

Unannounced cell re-selection is used when the MS is unable to or, in the case of listening to group calls, has no need to send the announcement signalling to the serving cell prior to performing the cell re-selection. The MS may attempt to recover the CONP connections on the new cell.

Announced cell re-selection is used when the MS informs the serving cell prior to the cell change, and attempts to restore the call(s) upon arrival at the new serving cell. This maximises the probability of restoring the CONP connections on the new cell. Announced cell re-selection is divided into three categories to reflect different levels of RPDI and MS functionality.

Type 3 re-selection is provided for MSs which are unable to perform background scanning of a selected neighbour cell, and which must therefore break the call(s) for a period and perform foreground scanning in order to acquire broadcast and synchronisation information for the new cell. Upon selecting the new cell, call restoration signalling can be used to restore the call(s).

Type 2 re-selection requires that the MS is able to perform background scanning of a selected neighbour cell, and is therefore in a position to immediately switch to the new cell. In type 2 the MS selects the main control channel on the new cell to perform call restoration signalling and may then be allocated a traffic channel upon successful completion of this signalling.

Unannounced and the two types of announced cell re-selection shall apply to an MS engaged in a circuit mode call or in a connection-oriented data transfer.

All MS-MLE shall support undeclared, unannounced and announced type 3 cell re-selection. An MS-MLE may also support announced type 2 cell re-selection. It is not necessary for the RPDI to know which type of cell re-selection procedures the MS can support in order for these procedures to work. The MS shall determine which types of re-selection are supported by the RPDI from the neighbour cell information element transmitted in the D-NWRK BROADCAST PDU.

If the RPDI does not support neighbour cell information in the D-NWRK BROADCAST transmission (see subclause 18.3.6), the RPDI shall only be able to support undeclared, unannounced and announced type 3 cell re-selection.

If the RPDI supports neighbour cell information in the D-NWRK BROADCAST transmission, the MS shall only attempt cell re-selection to a neighbour cell contained in the D-NWRK BROADCAST PDU.

All MLE re-selection signalling shall be sent via the TLA-SAP using the basic link acknowledged service.

18.3.4.7.1 Determination of which type of re-selection to apply

The MS shall normally perform cell re-selection as a result of building a ranking list from monitoring or scanning of neighbour cells. From the neighbour cell measurements, one of the cell re-selection criteria defined in subclause 18.3.4.7 may be met causing cell re-selection to be initiated. The cell chosen as the one to which the MS will attempt to select is known as the preferred neighbour cell.

In the case where the MS has knowledge of the neighbour cells (e.g. from the D-NWRK BROADCAST PDU or from scanning or pre-programmed at subscription), but has not yet built a valid ranking list, radio link failure may occur or the maximum path delay may be exceeded. If this happens, the MS shall apply undeclared cell re-selection if not currently participating in a connection-oriented data transfer. If the MS is participating in a call or data transfer, the MS shall apply unannounced cell re-selection.

If the MS has no knowledge of neighbour cells, the MS should apply initial cell selection procedures, but shall not attempt to restore a call on restoration of the radio link.

The MS shall initiate cell re-selection subject to the criteria specified in subclause 18.3.4.7. It shall determine which type of re-selection is to be applied (see figure 65). The type of re-selection to be employed shall depend on the following criteria:

- whether or not a CONP transfer is in progress;
- whether the transaction is point-to-point or point-to-multipoint;
- whether or not transmit permission has been granted;
- whether or not the MS has scanned the preferred neighbour cell.

The cell re-selection procedure shall be initiated after the MS has built a valid ranking list and one of the cell re-selection criteria as defined in subclause 18.3.4.7 has resulted in selection of a preferred neighbour cell. An MS shall scan the preferred neighbour cell before it can select that cell. If the MS can perform background scanning of a preferred neighbour cell, then it may attempt to use type 2 cell re-selection. Otherwise, the MS shall use unannounced or announced type 3 cell re-selection.

These decision tree for deciding which cell re-selection type to use is shown in figure 65.

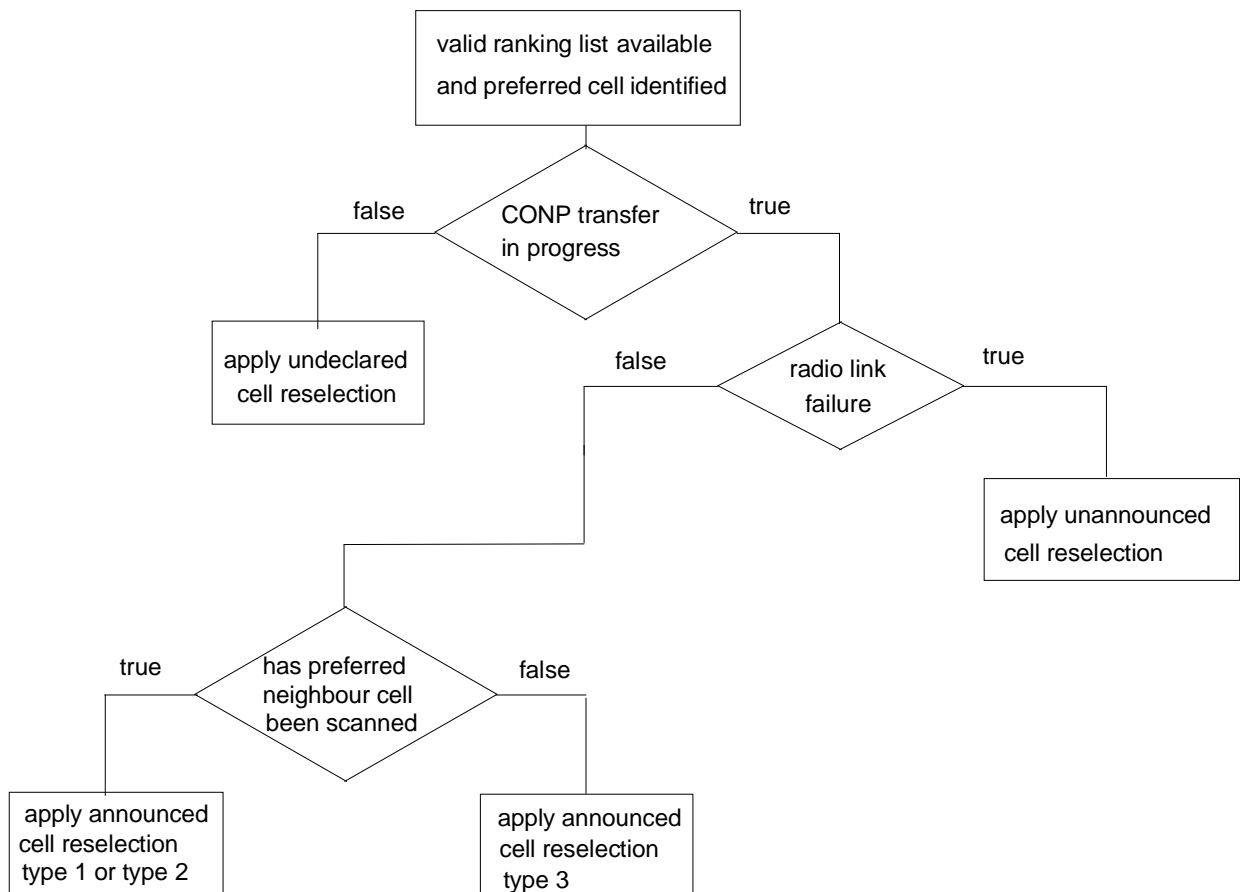

Figure 65: Decision tree to choose re-selection type

The MS may use type 2 cell re-selection according to the capabilities of the RPDI. If the RPDI does not support announced cell re-selection 2, the MS shall choose the type of cell re-selection with the smallest number which is supported by the RPDI.

18.3.4.7.2 Undeclared cell re-selection

Undeclared cell re-selection shall be initiated by an MS if it is not currently involved in any circuit mode data calls and one of the cell re-selection criteria described in subclause 18.3.4.7 is met causing a preferred neighbour cell to be selected. If cell re-selection is initiated as a result of a radio relinquishable, radio improvable or radio usable condition, a preferred neighbour cell shall have been identified by the MS-MLE. This preferred neighbour cell may or may not have been scanned by the MS-MLE before cell re-selection is initiated. If cell re-selection is initiated as a result of radio link failure, a preferred neighbour cell may not yet have been identified.

Upon initiation of the undeclared cell re-selection procedure, the MS-MLE shall perform the following actions:

- a) issue MLE-BREAK indication, informing a higher layer 3 entity such as CONP, that the radio link to the current serving cell is unavailable;
- b) issue MLE-CLOSE indication, informing the higher layer 3 entity, SCLNP, that the radio link to the current serving cell is unavailable;
- c) if no preferred neighbour cell has been selected, initiate foreground scanning of neighbour cells to select a preferred neighbour cell;
- d) if a preferred neighbour cell has been selected and background scanning of the preferred cell has not been performed, initiate foreground scanning of the preferred cell to confirm the selection;
- e) issue TL-SELECT request via the TLC-SAP to cause the MAC to switch to the main carrier of the new cell; the MAC responds with TL-SELECT confirm once the new cell has been selected.

If the new cell is in a LA outside the current registration area and if registration is required on the new cell, MLE shall inform the MM of the LA, MNC and MCC of the new cell using MLE-LINK indication. MM shall then register on the new cell.

MM shall indicate successful registration by issuing MLE-UPDATE request to MLE confirming the cell. If registration was successful or if no registration was necessary, MLE shall send MLE-REOPEN indication to the upper layer 3 entity CONP, to indicate that the radio link is once again available. MLE shall also send MLE-OPEN indication to the upper layer 3 entity, SCLNP, to indicate that the radio link is once again available.

If the registration is unsuccessful, then MM shall inform MLE using MLE-UPDATE request. MLE may attempt to select another cell from the ranking list and reapply the undeclared cell re-selection procedure described above. If there are no more cells in the ranking list, which meet the cell re-selection criteria in subclause 18.3.4.7, then MLE shall inform MM by issuing MLE-ACTIVATE indication. MM shall then close the layer 3 SAPs by issuing MLE-CLOSE request which shall cause MLE to issue MLE-CLOSE indication to the higher layer 3 entities, CONP and S-CLNP.

18.3.4.7.3 Unannounced cell re-selection

Unannounced cell re-selection shall be initiated by an MS if one of the cell re-selection criteria described in subclause 18.3.4.7 is met and unannounced cell re-selection is chosen according to the decision tree in figure 65. If cell re-selection is initiated as a result of a radio relinquishable, radio improvable or radio usable condition, a preferred neighbour cell shall have been identified by the MS-MLE. This preferred neighbour cell may or may not have been scanned by the MS-MLE before cell re-selection is initiated. If cell re-selection is initiated as a result of radio link failure, a preferred neighbour cell may not yet have been identified.

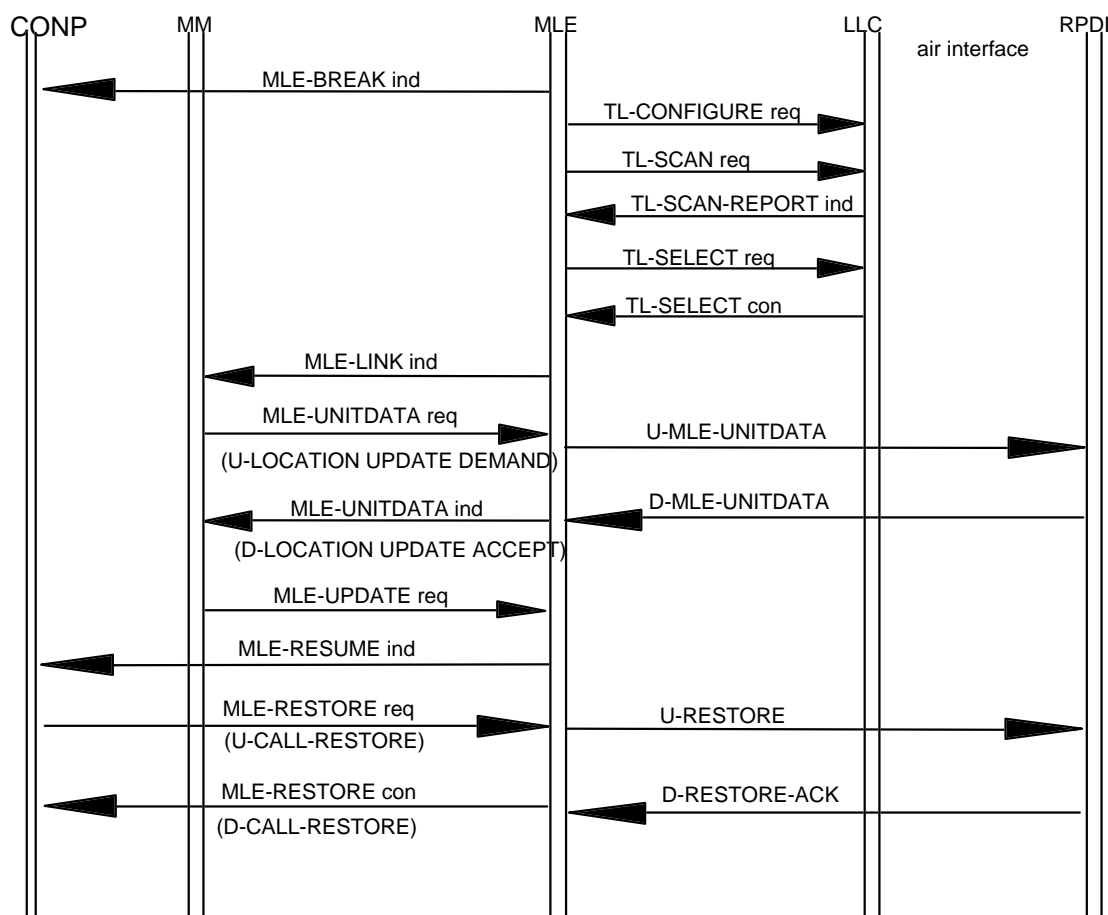

Figure 66: Unannounced cell re-selection procedure

Upon initiation of the unannounced cell re-selection procedure, the MS-MLE shall perform the following actions:

- a) issue MLE-BREAK indication, informing the higher layer 3 entity, CONP, that the radio link to the current serving cell is unavailable;
- b) issue MLE-CLOSE indication, informing the higher layer 3 entity, SCLNP, that the radio link to the current serving cell is unavailable;
- c) locally disconnect any advanced links by issuing TL-RELEASE request via the TLA-SAP to layer 2;
- d) if no preferred neighbour cell has been selected, initiate foreground scanning of neighbour cells to select a preferred neighbour cell;
- e) if a preferred neighbour cell has been selected and background scanning of the preferred cell has not been performed, initiate foreground scanning of the preferred cell to confirm the selection;
- f) issue TL-SELECT request via the TLC-SAP to cause the MAC to switch to the main carrier of the new cell; the MAC responds with TL-SELECT confirm once the new cell has been selected.

If the new cell is in a LA outside the current registration area and registration is required on the new cell, MLE shall inform MM of the LA, MNC and MCC of the new cell using MLE-LINK indication. MM shall then register.

If the registration is unsuccessful, then MM shall inform MLE using MLE-UPDATE request. MLE may attempt to select another cell from the ranking list and reapply the unannounced cell re-selection procedure described above. If there are no more cells in the ranking list, which meet the cell re-selection criteria in subclause 18.3.4.7, then MLE shall inform MM by issuing MLE-ACTIVATE indication. MM shall then close the layer 3 SAPs by issuing MLE-CLOSE request which shall cause MLE to issue MLE-CLOSE indication to the higher layer 3 entities, CONP and SCLNP. The MS may then initiate initial cell selection to find a suitable cell but shall not attempt restoration of circuit mode data calls if a suitable cell is found.

MM shall indicate successful registration by issuing MLE-UPDATE request to MLE confirming the cell. If registration was successful or if no registration was necessary, MLE shall send MLE-RESUME indication to the upper layer 3 entities, CMCE and CONP, to indicate that the radio link is once again available. MLE shall also send MLE-OPEN indication to SCLNP to indicate that the radio link is once again available.

CONP may attempt to restore any circuit mode data calls which were in existence before the cell change. CONP shall restore a data call by responding to the MLE-RESUME indication primitive with MLE-RESTORE request, containing a CONP call restoration PDU. MLE shall send a U-RESTORE PDU, containing the CONP call restoration SDU using the LLC acknowledged service. The U-RESTORE PDU shall contain each of the following elements only if the value on the new cell is different from that on the old cell:

- MCC;
- MNC;
- LA.

NOTE: The country code, network code and LA refer to the old cell.

If call restoration is successful, MLE shall receive a D-RESTORE ACK PDU from the RPDI which shall contain the CONP downlink call restoration signalling PDU. Upon receipt of the D-RESTORE ACK PDU indicating successful cell re-selection, MLE shall issue MLE-RESTORE confirm to the CONP. The MLE-RESTORE confirm primitive which is passed to CONP shall contain the CONP restoration signalling PDU.

CONP may attempt to restore multiple circuit mode data calls using the above restoration procedure for each call. Calls shall be restored one at a time with a call restoration signalling sequence for each one.

If the D-RESTORE FAIL PDU is received, it shall indicate that call restoration was unsuccessful. MLE shall then issue MLE-REOPEN indication to the CONP to indicate that the radio path is restored, but that the data call has not been restored. The D-RESTORE FAIL PDU shall not carry an SDU for any of the higher layer 3 entities.

CONP and SCLNP may re-establish packet data communications by re-sending data packets which have not yet been successfully transferred to the RPDI. On receiving MLE-RESUME indication (MLE-OPEN indication), CONP (SCLNP) may re-transmit data packets using MLE-UNITDATA request. The MLE may then establish an advanced link with the RPDI by issuing TL-CONNECT request to layer 2 to continue the data transfer on the new cell.

18.3.4.7.4 Announced cell re-selection - type 3

Announced type 3 cell re-selection shall be initiated by an MS if one of the cell re-selection criteria described in subclause 18.3.4.7 is met and announced type 3 cell re-selection is chosen according to the decision tree in figure 65. If cell re-selection is initiated as a result of a radio relinquishable, radio improvable or radio usable condition, a preferred neighbour cell shall have been identified by the MS-MLE. This preferred neighbour cell may or may not have been scanned by the MS-MLE before cell re-selection is initiated. If cell re-selection is initiated as a result of radio link failure, announced type 3 cell re-selection shall not be attempted by the MS.

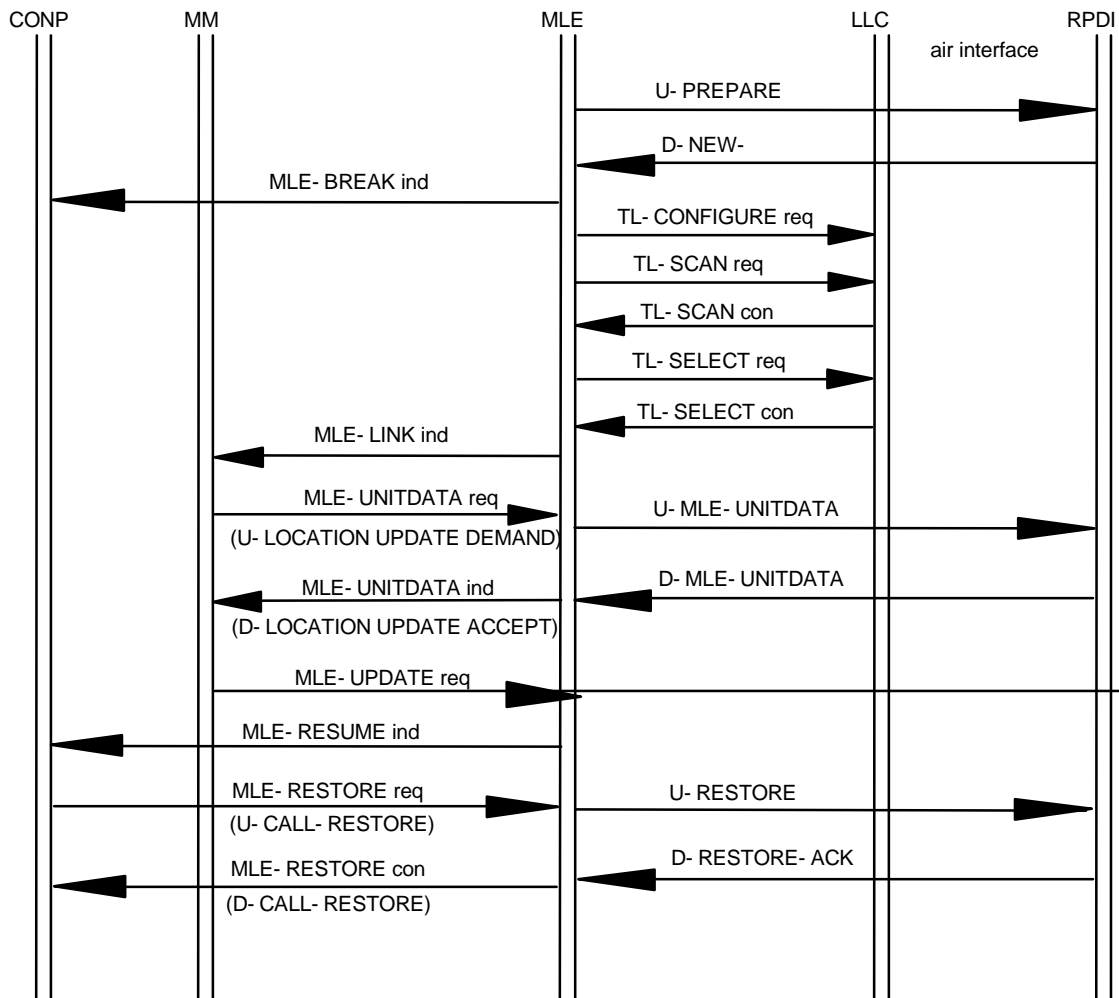

Figure 67: Announced type 3 cell re-selection procedure

Upon initiation of the announced type 3 cell re-selection procedure, the MS-MLE shall send a U-PREPARE PDU to the RPDI. The U-PREPARE PDU shall not contain the cell identifier element and the PDU shall not carry an SDU.

NOTE 1: The fact that the cell identifier element is not present in the PDU informs the RPDI that a preferred neighbour cell has not yet been selected and that the MS-MLE is attempting announced type 3 cell re-selection.

MLE shall send the U-PREPARE PDU by issuing TL-DATA request to layer 2 with the PDU priority set to 6.

NOTE 2: By transmitting the U-PREPARE PDU, the MS informs the RPDI that it is about to change cell and that the RPDI should disconnect any advanced links for that MS. The RPDI should also recognise the effect of the cell change on any circuit mode data calls that the MS is currently involved in.

MLE shall start timer, T370, and shall await the response from the RPDI. The RPDI shall respond with D-NEW CELL with the channel command valid element set either to "Change channel immediately" or "No channel change". If set to "Change channel immediately", MLE shall reset T370 and initiate the cell change procedure described below. If set to "No channel change", MLE shall restart timer, T370, and wait for another D-NEW-CELL PDU from the RPDI. If while waiting for D-NEW CELL from the RPDI, radio link failure occurs, the MS shall abandon the announcement signalling and initiate the cell change procedure immediately.

NOTE 3: The BS should not send D-NEW CELL with "channel command valid" set equal to "no channel change".

If timer, T370, expires, the MS shall immediately initiate the cell change procedure as described below.

Note that the RPDI shall not respond to U-PREPARE with D-PREPARE FAIL in the case where the MS-MLE has not indicated a preferred neighbour cell in the U-PREPARE PDU. Therefore D-PREPARE FAIL shall not be a valid response for announced type 3 cell re-selection.

Upon initiation of the cell change procedure, the MS-MLE shall:

- a) issue MLE-BREAK indication, informing the higher layer 3 entity, CONP, that the radio link to the current serving cell is unavailable;
- b) issue MLE-CLOSE indication, informing the higher layer 3 entity, SCLNP, that the radio link to the current serving cell is unavailable;
- c) locally disconnect any advanced links by issuing TL-RELEASE request via the TLA-SAP to layer 2;
- d) initiate foreground scanning of the preferred neighbour cell (which has been selected as a result of monitoring and ranking) to confirm selection;
- e) issue TL-SELECT request via the TLC-SAP to cause the MAC to switch to the main carrier of the new cell; the MAC responds with TL-SELECT confirm once the new cell has been selected.

NOTE 4: If the BS receives U-PREPARE from an MS transmitting in a circuit mode data call, the BS may remove the transmit permission by sending D-TX CEASED to the other MS(s) in the cell. Alternatively, the BS may allow the MS changing cell to keep the transmit permission for a period of time or until it selects a new cell and restores the call on that cell.

If the new cell is in a LA outside the current registration area and registration is required on the new cell, MLE shall inform MM of the LA, MNC and MCC of the new cell using MLE-LINK indication. MM shall then register.

If the registration is unsuccessful, then MM shall inform MLE using MLE-UPDATE request. MLE may attempt to select another cell from the ranking list and reapply the unannounced cell re-selection procedure described above. If there are no more cells in the ranking list, which meet the cell re-selection criteria in subclause 18.3.4.7, then MLE shall inform MM by issuing MLE-ACTIVATE indication. MM shall then close the layer 3 SAPs by issuing MLE-CLOSE request which shall cause MLE to issue MLE-CLOSE indication to the higher layer 3 entities, CONP and SCLNP. The MS may then initiate initial cell selection to find a suitable cell.

MM shall indicate successful registration by issuing MLE-UPDATE request to MLE confirming the cell. If registration was successful or if no registration was necessary, MLE shall send MLE-RESUME indication to the upper layer 3 entity, CONP, to indicate that the radio link is once again available. MLE shall also send MLE-OPEN indication to SCLNP to indicate that the radio link is once again available.

CONP may attempt to restore any circuit mode data calls which were in existence before the cell change. CONP shall restore calls by responding to the MLE-RESUME indication primitive with MLE-RESTORE request, containing a CONP call restoration PDU. MLE shall send a U-RESTORE PDU, containing the CONP call restoration SDU using the LLC acknowledged service. The U-RESTORE PDU shall contain each of the following elements only if the value on the new cell is different from that on the old cell:

- MCC;
- MNC;
- LA.

If call restoration is successful, MLE shall receive a D-RESTORE ACK PDU from the RPDI which shall contain the CONP downlink call restoration signalling PDU. Upon receipt of the D-RESTORE ACK PDU indicating successful cell re-selection, MLE shall issue MLE-RESTORE confirm to the CONP. The MLE-RESTORE confirm primitive which is passed to CONP shall contain the CONP restoration signalling PDU.

CONP may attempt to restore multiple circuit mode data calls using the above restoration procedure for each call. Calls shall be restored one at a time with a data call restoration signalling sequence for each one.

If the D-RESTORE FAIL PDU is received instead, it shall indicate that call restoration was unsuccessful. MLE shall then issue MLE-REOPEN indication to the CONP to indicate that the radio path is restored, but that the data call has not been restored. The D-RESTORE FAIL PDU shall not carry an SDU for any of the higher layer 3 entities.

CONP and SCLNP may re-establish packet data communications by re-sending data packets which have not yet been successfully transferred to the RPDI. On receiving MLE-RESUME indication (MLE-OPEN indication), CONP (SCLNP) may re-transmit data packets using MLE-UNITDATA request. The MLE may then establish an advanced link with the RPDI by issuing TL-CONNECT request to layer 2 to continue the data transfer on the new cell.

18.3.4.7.5 Announced cell re-selection - type 2

Announced type 2 cell re-selection shall be initiated by an MS if one of the cell re-selection criteria described in subclause 18.3.4.7 is met and announced type 2 cell re-selection is chosen according to the decision tree in figure 65 and announced type 2 cell re-selection is supported for the preferred neighbour cell as indicated in the D-NWRK BROADCAST PDU. A preferred neighbour cell shall have been identified by the MS-MLE and shall have been scanned prior to initiating the cell re-selection procedure. If cell re-selection is initiated as a result of radio link failure or if the preferred neighbour cell has not yet been scanned, announced type 2 cell re-selection shall not be attempted by the MS.

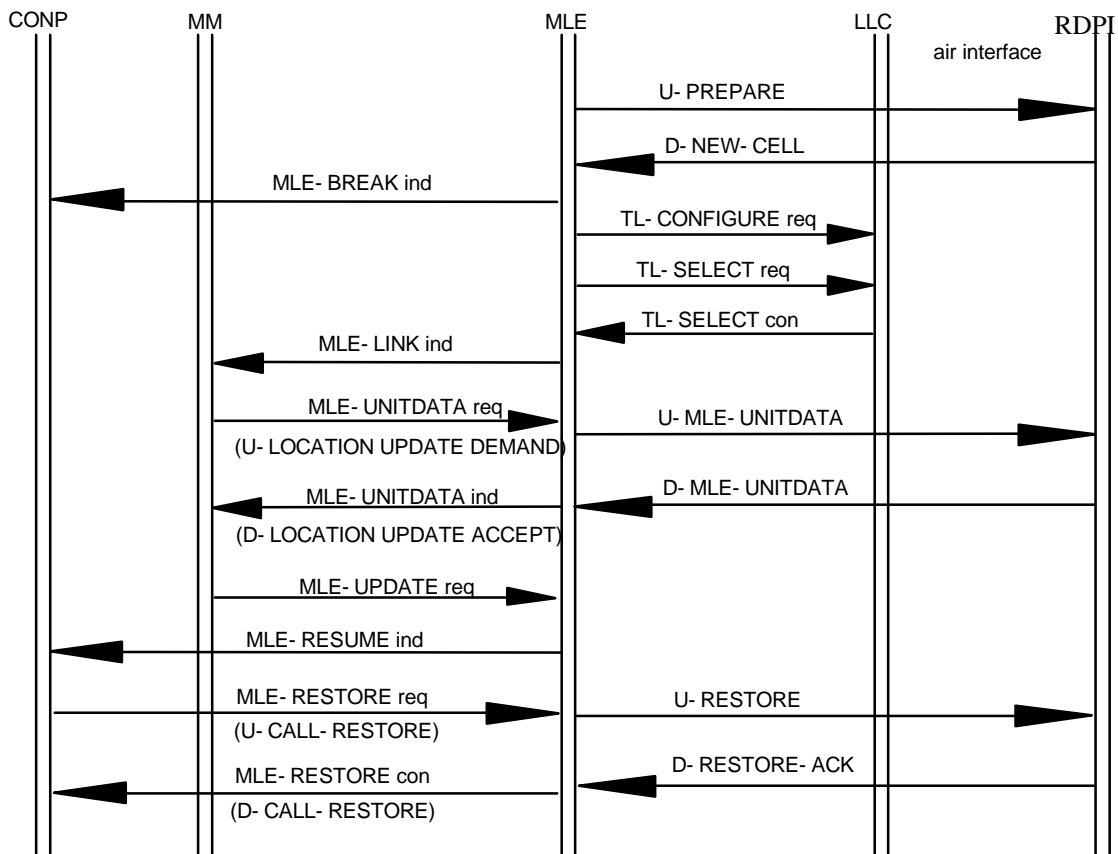

Figure 68: Announced type 2 cell re-selection procedure

Upon initiation of the announced cell re-selection type 2 procedure, the MS-MLE shall send a U-PREPARE PDU to the RPDI. The U-PREPARE PDU shall not contain an SDU. The U-PREPARE PDU shall contain the cell identifier element which shall uniquely identify a cell as defined by the D-NWRK BROADCAST.

NOTE 1: The fact that the U-PREPARE PDU contains details which identify a preferred neighbour cell informs the RPDI that the MS is attempting announced type 1 or announced type 2 cell re-selection. If the MS is already registered in the preferred neighbour cell, the RPDI may direct the MS to a channel on the new cell using a MAC channel allocation thus performing announced type 1 cell re-selection.

MLE shall send the U-PREPARE PDU by issuing TL-DATA request to layer 2 with the PDU priority set to 6.

NOTE 2: By transmitting the U-PREPARE PDU, the MS informs the RPDI that it is about to change cell and that the RPDI should disconnect any advanced links for that MS. The RPDI should also recognise the effect of the cell change on any circuit mode data calls that the MS is currently involved in.

MLE shall start timer, T370, and shall await the response from the RPDI. The RPDI shall respond with D-NEW CELL with the channel command valid element set either to "Change channel immediately", "No channel change" or "Follow MAC channel change".

If set to "Change channel immediately", MLE shall reset T370 and initiate the cell change procedure described below.

If set to "No channel change", MLE shall restart timer, T370, and wait for another D-NEW-CELL PDU from the RPDI.

The RPDI shall only respond with "Follow MAC channel change" if the MS is already registered in the new cell. In this case, the MS shall then follow the cell change procedures for announced type 1 cell re-selection.

If while waiting for D-NEW CELL from the RPDI, radio link failure occurs or timer T370 expires, the MS shall abandon the announcement signalling and shall immediately initiate the cell change procedure described below.

If the MS-MLE receives a D-PREPARE FAIL PDU from the RPDI, the MS-MLE may attempt announced cell re-selection to another neighbour cell in the ranking list which meets one of the cell re-selection criteria described in subclause 18.3.4.7. If no other cells in the ranking list meet one of the cell re-selection criteria or if announced cell re-selection fails for all available cells, MLE may continue to use the current serving cell.

Upon initiation of the cell change procedure, the MS-MLE shall:

- a) issue MLE-BREAK indication, informing the higher layer 3 entity, CONP, that the radio link to the current serving cell is unavailable;
- b) issue MLE-CLOSE indication to SCLNP to indicate that the radio link to the current serving cell is unavailable;
- c) locally disconnect any advanced links by issuing TL-RELEASE request via the TLA-SAP to layer 2;
- d) issue TL-SELECT request via the TLC-SAP to cause the MAC to switch to the main carrier of the new cell; the MAC responds with TL-SELECT confirm once the new cell has been selected.

If the new cell is in a LA outside the current registration area and registration is required on the new cell, MLE shall inform MM of the LA, MNC and MCC of the new cell using MLE-LINK indication. MM shall then register.

If the registration is unsuccessful, then MM shall inform MLE using MLE-UPDATE request. MLE may attempt to select another cell from the ranking list and reapply the unannounced cell re-selection procedure described above. If there are no more cells in the ranking list, which meet the cell re-selection criteria in subclause 18.3.4.7, then MLE shall inform MM by issuing MLE-ACTIVATE indication. MM shall then close the layer 3 SAPs by issuing MLE-CLOSE request which shall cause MLE to issue MLE-CLOSE indication to the higher layer 3 entities, CONP and S-CLNP. The MS may then initiate initial cell selection to find a suitable cell.

MM shall indicate successful registration by issuing MLE-UPDATE request to MLE confirming the cell. If registration was successful or if no registration was necessary, MLE shall send MLE-RESUME indication to the upper layer 3 entity, CONP, to indicate that the radio link is once again available. MLE shall send MLE-OPEN indication to SCLNP to indicate that the radio link is once again available.

CONP may attempt to restore any circuit mode data calls which were in existence before the cell change. CONP shall restore calls by responding to the MLE-RESUME indication primitive with MLE-RESTORE request, containing a CONP data call restoration PDU. MLE shall send a U-RESTORE PDU, containing the CONP call restoration SDU using the LLC acknowledged service. The U-RESTORE PDU shall contain each of the following elements only if the value on the new cell is different from that on the old cell:

- MCC
- MNC
- LA

If call restoration is successful, MLE shall receive a D-RESTORE ACK PDU from the RPDI which shall contain the CONP downlink call restoration signalling PDU. Upon receipt of the D-RESTORE ACK PDU indicating successful cell re-selection, MLE shall issue MLE-RESTORE confirm to CONP. The MLE-RESTORE confirm primitive which is passed to CONP shall contain the CONP restoration signalling PDU.

CONP may attempt to restore multiple circuit mode data calls using the above restoration procedure for each call. Calls shall be restored one at a time with a call restoration signalling sequence for each one.

If the D-RESTORE FAIL PDU is received instead, it shall indicate that call restoration was unsuccessful. MLE shall then issue MLE-REOPEN indication to the CONP to indicate that the radio path is restored, but that the call has not been restored. The D-RESTORE FAIL PDU shall not carry an SDU for any of the higher layer 3 entities.

CONP and SCLNP may re-establish packet data communications by re-sending data packets which have not yet been successfully transferred to the RPDI. On receiving MLE-RESUME indication (MLE-OPEN indication), CONP (SCLNP) may re-transmit data packets using MLE-UNITDATA request. The MLE may then establish an advanced link with the RPDI by issuing TL-CONNECT request to layer 2 to continue the data transfer on the new cell.

18.3.5 Data transfer sub entity

The services and primitives offered by the MLE are described in clause 17.

18.3.5.1 Address handling

The MLE manages all of the subscriber addresses (ITSIs and GTSIs) plus the management identity (TMI). These addresses and identities are described in ETS 300 393-1 [14], clause 6.

System subscriber Identities which are received or attached and detached by the MM entity should be transferred to MLE in an MLE-IDENTITIES request primitive. After being recorded locally and any lists amended, the list of currently valid short subscriber and management identities shall be transferred to the lower layers via the TLC-SAP in a TL-CONFIGURE request primitive as described in subclause 18.3.5.1.2.

18.3.5.1.1 Link addressing

The MLE defines the MAIN ADDRESS and the ADDRESS TYPE parameters in all TL-CONNECT, TL-DATA, TL-DISCONNECT and TL-UNITDATA primitives issued to layer 2. The MAIN ADDRESS shall comprise of a valid short subscriber identity SSI.

For messages containing higher layer information, the MLE sets the MAIN ADDRESS short subscriber identity parameter to a valid short subscriber identity SSI, as defined in ETS 300 393-1 clause 6. During migration, exchanged addresses shall be used, using the exchanged addresses issued by the MM in the MLE-IDENTITIES request primitive.

If there is no valid subscriber identity the MLE shall use an Un-exchanged SSI (USSI) as defined in ETS 300 393-1 [14], clause 6. An un-exchanged SSI may only be used for MM messages.

For messages from the MLE management entity, the MLE shall always add the SMI. The SMI is defined in ETS 300 393-1 [14], clause 6.

The MLE shall remove the MAIN ADDRESS and the ADDRESS TYPE parameters from all primitives received from layer 2. These parameters can be used for upward routing.

18.3.5.1.2 Link addresses to be placed in layer 2

In order to be able to filter in layer 2 those messages received by the MS that are not applicable, layer 2 requires to be informed of all addresses that are valid for this MS. The MLE shall inform layer 2 by means of a TL-CONFIGURE request the short subscriber and management identities that are valid for that MS.

In the event that a short subscriber identity ceases to be valid, then the MLE shall inform layer 2 by means of a TL-CONFIGURE request via the TLC-SAP.

18.3.5.1.3 Layer 2 end point identifier

The MLE receives the layer 2 endpoint identifier in all primitives exchanged with the layer 2. Endpoint identifier is assumed to be a local layer-to-layer matter, and are not defined in this ETS.

Endpoint identifiers are required to distinguish between multiple LLC links for a given MS to RPDI MLE pairing. This includes both multiple values of SSI and multiple cell attachments (for a given value of SSI).

18.3.5.1.4 Subscriber class

The MM informs the MLE of the MS subscriber class membership for a particular ITSI using an MLE-INFO request primitive. The MLE shall then use this value as the parameter attached to TL-UNITDATA request, TL-DATA request, TL-CONNECT request and TL-DISCONNECT request for all subsequent outgoing PDUs. The subscriber class is a bit mapped field which shall indicate which subscriber classes the MS is a member of. The values are specified in subclause 18.5. The subscriber class parameter may be allocated at subscription or registration. If the MS does not have a subscriber class from registration or subscription, the MS shall assume membership of all subscriber classes.

Where the received network broadcast information indicates that the subscriber class associated with the ITSI is not valid on a cell the MLE shall filter service requests until the subscriber class becomes valid, or a new cell is selected where the subscriber class is valid. In addition, the MLE shall only allow the higher layers to transfer PDUs which relate to existing circuit mode data calls. The MLE shall disallow PDUs relating to a new data calls, unless they have a message priority of 7, indicating an emergency data call. If an MS subscriber class is not supported by the current serving cell, the MS shall only be allowed to register on that cell, initiate emergency data calls or signalling, and receive incoming calls / signalling on that cell.

18.3.5.2 MLE connection handling

An MLE connection is the logical association of the MLE peer entities in the MS and the RPDI. The association is made by the mobile when it acquires a radio channel and camps on a cell. No explicit signalling is required in order to establish the connection.

18.3.5.3 Message routing and selection of LLC services

The service routing possibilities are shown as follows:

Table 85: Service routing

Service User	Layer 2 service used	Uplink	Downlink	SAP
CONP	point-to-point acknowledged at layer 2	ack	ack	TLA
SCLNP	pt to pt acknowledged at layer 2	ack	ack	TLA
	pt to pt unacknowledged at layer 2	unack	unack	TLA
	pt to multipoint unacknowledged at layer 2	not applicable	unack	TLA
MM	pt to pt acknowledged at layer 2	ack	ack	TLA
	pt to pt unacknowledged at layer 2	unack	unack	TLA
SYSTEM BROADCAST	pt to multipoint unacknowledged at layer 2 (system information PDU)	not applicable	unack	TLB
LOCAL MANAGEMENT	layer-to-layer exchange only	not applicable	not applicable	TLC

18.3.5.3.1 Selection of LLC services via TLA-SAP

Two types of data transfer are available at the layer 2 TLA-SAP: acknowledged and unacknowledged PDU transfer. The acknowledged service provides bi-directional data transfer, the unacknowledged service is unidirectional.

The required service shall be interpreted from the information contained in the primitives from the higher entities according to the procedures specified below.

The PDU priority shall be set by the sending higher layer 3 entity and simply passed on to layer 2 by the MLE. The PDU priority shall be equal to 3 for TL-CONNECT and 6 for TL-DISCONNECT.

Where the subscriber class associated with the ITSI is not valid at the serving cell, the data transfer sub entity shall only allow the following outgoing messages; messages associated with ongoing data calls/connections, responses to incoming data call set up requests, outgoing "emergency" data calls. Outgoing "emergency" data calls are identified as those data calls having a PDU priority level of 7. All other requests shall be rejected with an MLE-REPORT indication to the originating sub entity or higher layer entity.

a) Outgoing messages from CONP and SCLNP

The data transfer sub entity shall reject service requests from CONP and SCLNP when in state closed. When in the broken state, messages shall not be passed by the MLE.

All outgoing messages shall be subject to the following handshake procedure with the LLC. Upon receipt of the TL-CONNECT, -DISCONNECT, -DATA, or -UNITDATA request primitive the LLC shall immediately acknowledge this with a TL-REPORT indication containing the handle. The handle should be retained locally and used for routing subsequent REPORT primitives. Where the outgoing message has resulted in the MLE requesting an unacknowledged service from the LLC, the handle remains valid until a further TL-REPORT indication is received indicating that the PDU has been transmitted, or, a TL-CANCEL request is issued when the handle is deleted. Where the outgoing message has resulted in the MLE requesting an acknowledged service from the LLC, the handle remains valid until a TL-DATA confirm is received indicating that the PDU has been successfully transmitted, or, a TL-CANCEL request is issued when the handle is deleted. TL-CANCEL requests may be issued until the receipt of the second TL-REPORT indication, even though the handle remains valid in the latter case. On receipt of a TL-DATA confirm, the MLE shall issue an MLE-REPORT indication indicating successful transmission of the PDU transmitted as a result of the previous TL-DATA request on that endpoint identifier. If the TL-DATA confirm contains an SDU, this shall then be passed to the higher layers using MLE-UNITDATA indication.

On receipt of an MLE-UNITDATA request, the data transfer sub entity shall append an MLE PDU header indicating the originating SAP using the protocol discriminator field. The protocol discriminator values are defined in subclause 18.5. The data transfer sub entity shall determine the length of the PDU and pass that information to the LLC as a primitive parameter.

If the L2 service request parameter has the value "acknowledged request" then the MLE UNITDATA PDU shall be transferred to the LLC in a TL-DATA request primitive.

If the L2 service request parameter has the value "acknowledged response" then the MLE UNITDATA PDU shall be transferred to the LLC in a TL-DATA response primitive.

If the L2 service request parameter has the value "unacknowledged" then the MLE UNITDATA PDU shall be transferred to the LLC in a TL-UNITDATA-request primitive.

NOTE: Generally the packet data services CONP and SCLNP only use acknowledged request.

Where the basic link is selected the SDU shall be sent to the TLA SAP in a TL-DATA request primitive unless an unacknowledged data transfer is specifically requested, in which case the SDU shall be sent in a TL-UNITDATA request primitive.

Once the TL-DATA confirm has been received indicating that the SDU has been successfully transmitted, and no further MLE-UNITDATA requests have been received from CONP or SCLNP, and the CONP/SCLNP has no more data to send the MS-MLE may issue a TL-DISCONNECT request primitive to the TLA SAP. The MS-MLE shall not establish any more advanced links after the TL-DISCONNECT request has been sent, until either a TL-DISCONNECT confirm is received, or a TL-REPORT indication is received indicating a failure. When either of these primitives is returned, any local MLE reference to the advanced link should be deleted.

On receipt of an MLE-RESET request primitive from the CONP SAP, the data transfer sub entity shall issue a TL-CONNECT request primitive to the TLA-SAP. Upon receipt of the TL-CONNECT confirm, the data transfer sub entity shall issue an MLE-RESET confirm to the appropriate SAP.

On receipt of an MLE-RESET response primitive from the CONP SAP, the data transfer sub entity shall issue a TL-CONNECT response primitive to the TLA-SAP.

On receipt of an MLE-CANCEL request primitive either from the CONP SAP, or, from the SCLNP SAP, the data transfer sub entity shall issue a TL-CANCEL request primitive to the TLA-SAP. Once the TL-CANCEL request is issued any references to the handle in the MLE shall be deleted.

b) Incoming messages to CONP and SCLNP

If the data transfer process is in state busy then it shall check each primitive received from the LLC to see if it contains a GSSI addressed PDU with a related channel change request. If this is the case then that PDU shall be discarded, and the channel change shall not be obeyed.

On receipt of a TL-CONNECT indication, the data transfer sub entity shall establish if the TL-CONNECT indication refers to an established advanced link. This can be established by using the endpoint identifier. If the TL-CONNECT indication refers to an existing connection, the data transfer sub entity shall issue an MLE-RESET indication to the appropriate SAP and issue a TL-CONNECT response primitive to the TLA SAP. If the TL-CONNECT indication does not refer to an existing connection, the data transfer sub entity shall allocate a new connection ID and issue a TL-CONNECT response primitive to the TLA SAP.

The receipt of the TL-CONNECT confirm is dealt with in subclause 18.3.5.3.1 a) as part of the advanced link establishment and maintenance.

On receipt of a TL-DISCONNECT indication, the data transfer sub entity shall establish if the TL-DISCONNECT indication refers to an established advanced link. This can be established by using the endpoint identifier. If it does refer to an established advanced link, any local reference to that advanced link shall be deleted.

The receipt of the TL-DISCONNECT confirm is dealt with in subclause 18.3.5.3.1 a) as part of the Advanced Link establishment and maintenance.

On receipt of a TL-UNITDATA indication, the data transfer sub entity shall remove and analyse the MLE PDU header and address. The PDU header indicates the destination SAP. The data contained in the TL-UNITDATA indication shall then be routed to the correct SAP or sub entity as an MLE-UNITDATA indication primitive. Network broadcast D-NWRK BROADCAST messages shall be routed by the data transfer sub entity to the Network Broadcast sub entity. All other MLE protocol PDUs shall be handled by the attachment management sub-entity.

On receipt of a TL-DATA indication, the data transfer sub entity shall remove and analyse the MLE PDU header. The PDU header indicates the destination SAP. The data contained in the TL-DATA indication shall then be routed to the correct SAP or sub entity as an MLE-UNITDATA indication primitive.

On receipt of a TL-DATA confirm, the MLE shall issue an MLE-REPORT indication primitive to indicate successful transmission of the PDU transmitted as a result of the previous TL-DATA request on that endpoint identifier. The data transfer sub entity shall then remove and analyse the MLE PDU header. The PDU header indicates the destination SAP. The data contained in the TL-DATA confirm shall then be routed to the correct SAP or sub entity as an MLE primitive, as determined by the MLE PDU header. MLE-UNITDATA PDUs are routed to the appropriate SAP in MLE-UNITDATA indication primitives.

c) Outgoing messages from MM

All outgoing messages shall be subject to the following handshake procedure with the LLC. Upon receipt of the TL-DATA request primitive the LLC shall immediately acknowledge this with a TL-REPORT indication containing the handle. The handle should be retained locally and used for routing subsequent REPORT primitives. The handle remains valid until a TL-DATA confirm is received indicating that the PDU has been (successfully) transmitted, or, a TL-CANCEL request is issued when the handle is deleted. TL-CANCEL requests may be issued until the receipt of the second TL-REPORT indication. On receipt of TL-REPORT indication indicating successful transmission, the MLE shall issue MLE-REPORT indication to the SAP which sent the original TL-DATA request primitive to inform the higher layer 3 entity that the PDU has been successfully transmitted by layer 2.

On receipt of an MLE-UNITDATA request, the data transfer sub entity shall append an MLE PDU header indicating the originating SAP using the protocol discriminator field. The PDU header values are defined in subclause 18.4.2. The data transfer sub entity shall determine the length of the PDU and pass that information to the LLC as a primitive parameter.

The underlying service selected shall be the basic link and determined according to the L2 service parameter in the MLE-UNITDATA request primitive.

If the L2 service request parameter has the value "acknowledged request" then the MLE UNITDATA PDU shall be transferred to the LLC in a TL-DATA request primitive.

If the L2 service request parameter has the value "acknowledged response" then the MLE UNITDATA PDU shall be transferred to the LLC in a TL-DATA response primitive.

NOTE: The MM in the MS do not use the unacknowledged layer 2 service for uplink data transfer.

On receipt of an MLE-CANCEL request primitive from the MM SAP, the data transfer sub entity shall issue a TL-CANCEL request primitive to the TLA-SAP. Once the TL-CANCEL request has been issued any references to the handle in the MLE shall be deleted.

The basic link shall be used for all MM signalling call related signalling.

d) Incoming messages to MM

If the data transfer process is in state busy then it shall check each primitive received from the LLC to see if it contains a GSSI addressed PDU with a related channel change request. If this is the case then that PDU shall be discarded, and the channel change shall not be obeyed.

On receipt of a TL-UNITDATA indication, the data transfer sub entity shall remove and analyse the MLE PDU header and address. The PDU header indicates the destination SAP. The address may indicate that this is a network broadcast message. The data contained in the TL-UNITDATA indication shall then be routed to the correct SAP or sub entity as an MLE-UNITDATA indication primitive. Network broadcast D-NWRK BROADCAST messages shall be routed by the data transfer sub entity to the network broadcast sub entity. Late entry information from the D-MLE-SYSINFO PDU shall be routed to the CONP SAP.

On receipt of a TL-DATA indication, the data transfer sub entity shall remove and analyse the MLE PDU header. The PDU header indicates the destination SAP. The data contained in the TL-DATA indication shall then be routed to the correct SAP or sub entity as an MLE-UNITDATA-indication primitive.

On receipt of a TL-DATA confirm, the MLE shall issue an MLE-REPORT indication primitive to indicate successful transmission of the PDU transmitted as a result of the previous TL-DATA request on that endpoint identifier. The data transfer sub entity shall then remove and analyse the MLE PDU header. The PDU header indicates the destination SAP. The data contained in the TL-DATA indication shall then be routed to the correct SAP or sub entity as an MLE-UNITDATA-indication primitive.

18.3.5.3.2 Selection of LLC services via TLB-SAP

There are no services available at the TLB-SAP in the MS.

Data received via the TLB-SAP is routed to the network broadcast sub entity and is dealt with in subclause 18.3.6.

18.3.5.3.3 Selection of LLC services via TLC-SAP

a) Locally generated TL-CONFIGURE requests

The data transfer sub entity shall supply TL-CONFIGURE requests primitives to the TLC-SAP to inform the lower layers of the state of any MM signalling or circuit mode data calls in progress. The MLE-Activity indicator allows the lower layers to decide when to apply energy economy.

NOTE: It is possible to apply an energy economy scheme that has been notified to and agreed by the RPDI.

The TL-CONFIGURE request shall be sent with the MLE-Activity indicator parameter set when there is any explicit or implicit connection active. The TL-CONFIGURE request primitive may only be sent with the MLE Activity Indicator parameter cleared when there is no MM or circuit mode call activity.

An advanced link shall become active when one of the following occurs:

- TL-CONNECT request is sent and MLE is awaiting TL-CONNECT confirm;
- TL-CONNECT response is sent;

The advanced link shall be considered to be active until one of the following occurs:

- TL-DISCONNECT confirm is received;
- a TL-RELEASE indication is received;
- a TL-RELEASE request is sent.

A group circuit mode call remains active until it is disconnected by the MS, released by the RPDI or locally released (without any signalling with the RPDI). An individual circuit mode call remains active until it is disconnected by the MS or released by the RPDI.

b) Outgoing messages from MM

These are generally routed via the attachment management sub entity, see subclause 18.3.4.

There are two exceptions to this; The first is the MLE-IDENTITIES request primitive which contains the valid ISSI(s) and attached / detached GSSIs. The procedures for dealing with this are described in subclause 18.3.5.1. The second is the MLE-INFO request primitive which after the local recording of the subscriber class within the data transfer sub entity is transferred further to the lower layers in a TL-CONFIGURE request primitive.

c) Incoming messages to MM

These are routed via the attachment management sub entity, see subclause 18.3.4.

d) Outgoing messages from CONP and SCLNP

There are no messages routed from CONP or SCLNP to the TLC-SAP.

e) Incoming messages to CONP and SCLNP

There are no messages routed from the TLC-SAP to CONP or SCLNP.

18.3.5.4 Routing of local control information

On receipt of an MLE-OPEN request from the MM SAP, the data transfer sub entity shall issue an MLE-OPEN indication to CONP and SCLNP SAPs. The data transfer sub entity shall then open the SAPs and shall permit the transfer of data between layers. If the MLE-OPEN request is received whilst the data transfer sub entity is in state closed then the data transfer sub entity shall enter state Idle. In all other states it shall remain in that state.

On receipt of an MLE-CLOSE request from the MM SAP the data transfer sub entity shall relay this as an MLE-CLOSE indication to the CONP and SCLNP SAPs. The data transfer sub entity shall then close the SAPs and shall not permit the transfer of data between layers. The data transfer sub entity shall enter state closed, and shall remain in that state until it receives an MLE-OPEN indication.

On receipt of an MLE-BREAK indication from the attachment management sub entity, the data transfer sub entity shall relay this MLE-BREAK indication to the CONP SAP. The data transfer sub entity shall enter state broken. During a temporary link break data may be buffered in the data transfer sub entity.

On receipt of an MLE-RESUME indication from the attachment management sub entity, the data transfer sub entity shall relay this MLE-RESUME indication to the CONP SAP. The data transfer sub entity shall return to its previous state. Any data buffered in the data transfer sub entity during the temporary link break should now be (re)submitted for transmission.

On receipt of an MLE-REOPEN indication from the attachment management sub entity, the data transfer sub entity shall relay this MLE-REOPEN indication to the CONP SAP. The data transfer sub entity shall enter state idle. Any data buffered in the data transfer sub entity during the temporary link break should now be discarded.

18.3.6 Network broadcast sub entity

18.3.6.1 Summary

The system broadcast function broadcasts system information from the RPDI to all MSs.

There are two formats for this system information:

- immediate system information;
- network broadcast system information.

The immediate system information is supplied to layer 2 in the RPDI. The exact method by which the information is supplied to layer 2 is outside the scope of the ETS. At the MS the MLE-PDU shall be received by the network broadcast sub entity as a TL-SYNC indication and TL-SYSINFO indication primitives via the TLB-SAP.

The network broadcast system information and late entry information is supplied to layer 2 in the RPDI and broadcast as requested. The exact method by which the information is supplied to layer 2 is outside the scope of the ETS. At the MS the MLE-PDU shall be received by the network broadcast sub entity as a D-NWRK BROADCAST PDU with a TL-UNITDATA indication via the TLA-SAP and data transfer sub entity. The MLE is able to route the network broadcast system information to the network broadcast sub entity by virtue of the PDU header it arrives with, and the late entry information to CMCE-SAP by virtue of the PDU header it arrives with.

The RPDI shall indicate whether or not it supports transmission of the D-NWRK BROADCAST PDU using the "neighbour cell broadcast" element which is transmitted as part of the D-MLE-SYNC PDU.

System broadcast information can be received whilst the MS is scanning or is camped on a cell. The MS-MLE shall ensure that system broadcast information received whilst scanning is applied to the correct cell.

An MS may also prompt the RPDI to transmit the neighbour cell broadcast information by using the neighbour cell enquiry service as described in subclause 18.3.6.5.

18.3.6.2 System information

The system information is a series of messages that are broadcast at regular intervals from the RPDI to the MS MLEs.

The immediate system information contains the following information:

- MNC;
- MCC;
- LAC;
- subscriber class;
- BS service details;
- cell service level;
- late entry information availability.

The network broadcast system information in the D-NWRK BROADCAST PDUs contain a combination of the following information:

- frequencies of adjacent cells for cell selection and re-selection;
- parameters for roaming (measurement levels, intervals).

This information should be used by the MSs to guide the cell selection procedures.

18.3.6.3 Message formats for system information

System information messages shall be constructed according to the rules described in subclause 18.4. Each network broadcast system information may contain any combination of information elements.

18.3.6.4 Network broadcast procedures

On receiving a TL-SYNC indication primitive or a TL-SYSINFO indication primitive via the TLB-SAP, the network broadcast sub entity shall analyse the contents. The information contained within shall either be passed to attachment management, e.g. to update cell rankings, and, in the case of a new subscriber class bit map, be passed to the data transfer sub entity.

18.3.6.5 Neighbour cell enquiry procedure

An MS may prompt the RPDI to transmit the D-NWRK BROADCAST PDU by sending a U-PREPARE PDU to the RPDI. The U-PREPARE PDU shall not contain an SDU or the following optional elements:

MCC;
MNC; and
LA.

The U-PREPARE PDU shall contain the cell identifier element which shall be set to "00000₂" and which shall indicate to the RPDI that the MS is requesting transmission of the D-NWRK BROADCAST PDU.

NOTE: The MS may request transmission of the D-NWRK BROADCAST PDU because it has yet not received the neighbour cell information and the MS needs this in order to initiate cell re-selection procedures. This may occur if the current serving cell signal level is falling and the MS cannot wait for the normal D-NWRK BROADCAST broadcast to be sent.

An MS may not receive the normal D-NWRK BROADCAST broadcast, e.g. as a result of being in energy economy and it is sleeping while the D-NWRK BROADCAST is being transmitted by the RPDI.

MLE shall send the U-PREPARE PDU by issuing a TL-DATA request to layer 2 with the PDU priority state to 3.

MLE shall start timer, T370, and shall await the response from the RPDI. The RPDI shall respond by transmitting the D-NWRK BROADCAST PDU which may be individually addressed to the MS using the layer 2 acknowledged service or may be sent unacknowledged to a group address or to the broadcast address ("all ones" address).

On reception of the D-NWRK BROADCAST PDU, the MLE shall reset timer, T370. If timer, T370, expires the MS shall assume that the cell enquiry service has failed and shall wait for the RPDI to send the normal D-NWRK BROADCAST broadcast. The RPDI may also respond to the U-PREPARE PDU with a D-PREPARE-FAIL PDU which has the "Fail cause" element set equal to "Neighbour cell enquiry not available".

The RPDI shall indicate whether or not the neighbour cell enquiry service is supported using the "neighbour cell broadcast" element which is transmitted as part of the D-MLE-SYNC PDU. If the service is not supported, the MS shall not attempt to send the U-PREPARE PDU with the cell identifier set to "00000₂".

18.3.7 Management sub-entity

The management sub-entity shall be responsible for communication of management information between the MS and the RPDI. MLE PDUs to and from the management sub-entity shall have a protocol discriminator set to "110₂". The PDUs shall be transferred between the MS and the RPDI using the TETRA management identity as the source address on the uplink and as the destination address on the downlink.

No TETRA management PDUs are defined by this ETS.

18.4 PDU descriptions

The following PDU descriptions contain a mapping of the information elements into an MLE PDU specifying the length of the element, the type of the element and whether the element is mandatory, conditional or optional. The contents of the information elements themselves are further detailed in subclause 18.5.

The information contained in the PDU description tables corresponds to the following key:

Length: length of the element in bits;
Type: element type 1 or 2 as defined below;
C/O/M: conditional/optional/mandatory information in the PDU;
Remark: comment.

18.4.1 Data transfer PDUs at the TLA SAP

18.4.1.1 Protocol discriminator

The contents of an MLE PDU sent and received at the TLA-SAP shall be determined by a 3 bit protocol discriminator. The discriminator shall be the first element field in the MLE PDU.

The protocol discriminator shall determine the MLE user SAP endpoint, i.e. it is used as routing information within the MLE data transfer sub entity.

If the protocol discriminator indicates MM, CONP or SCLNP, then the MLE shall simply remove the protocol discriminator and route the SDU to the relevant upper layer 3 protocol entity.

If the protocol discriminator indicates TETRA management entity, then the MLE shall remove the protocol discriminator and route the SDU to the TETRA management functional entity within the MLE protocol entity.

If the protocol discriminator indicates MLE, then the MLE shall remove the protocol discriminator and process the remainder of the PDU according to the MLE protocol.

18.4.1.2 PDU type

When the protocol discriminator indicates the MLE protocol, a "PDU type" element shall follow which shall indicate the particular MLE protocol PDU type.

18.4.1.3 MLE service user PDUs

PDUs which have the protocol discriminator equal to one of the following: MM, SCLNP, CONP or TETRA management entity shall be defined as follows:

Table 86: MLE service PDU layout

Information element	Length	Value	Remark
Protocol discriminator	3		See subclause 18.5 for element definition
SDU	Variable		MM, CLNP, CONP or Management Entity SDU

The SDUs sent/received at the LMM-SAP, LCLS-SAP, LCO-SAP and to/from the management entity shall be transparent to the MLE. The MLE shall simply route these SDUs according to the protocol discriminator.

18.4.1.4 MLE protocol PDUs

MLE PDUs which have the protocol discriminator MLE protocol shall comprise both cell change PDUs and network broadcast PDUs.

The general format of the MLE protocol PDU is defined according to table 87.

The elements shall be transmitted in the order specified by table 87 with the top element being transmitted first (before interleaving). The content of an information element is represented by a binary value and the most significant bit of that binary value shall be transmitted first (before interleaving).

Table 87: MLE protocol PDU layout

Information element	Length	Value	Remark
Protocol discriminator	3	101 ₂	Specifies an MLE protocol PDU
PDU type	3		Specifies the particular MLE protocol PDU
Type 1 element (1)			see element definition for length & values
Type 1 element (2)			see element definition for length & values
...etc.			...etc.
Type 1 element (n)			see element definition for length & values
Optional bit (O-bit)	1	0	No type 2 elements follow
		1	Type 2 elements follow
Presence bit (P-bit) (1)	1	0	The type 2 element (1) is not present
		1	The type 2 element (1) is present
Type 2 element (1)			see element definition for length & values
Presence bit (P-bit) (2)	1	0	The type 2 element (2) is not present
		1	The type 2 element (2) is present
Type 2 element (2)			see element definition for length & values
...etc.			...etc.
Presence bit (P-bit) (n)	1	0	The type 2 element (n) is not present
		1	The type 2 element (n) is present
Type 2 element (n)			see element definition for length & values

Element type 1:

- elements of type 1 shall be identified by their fixed position in the PDU. The elements have fixed lengths as specified in the "length" column. Each type 1 element shall either be a mandatory element or conditional to a mandatory element. The type 1 elements shall also be placed before any type 2 elements.

Element type 2:

- elements of type 2 are optional and shall be identified by their order within the PDU. If one or more type 2 elements are specified for a PDU, there shall be one P-bit for each specified type 2 element and each of them shall either indicate "element present" or "element not present".

When the PDU does not contain (or cannot contain) any type 2 elements, the O-bit shall be present and set equal to 0.

The following rules shall apply for decoding of an MLE PDU:

```

DECODE Type 1 Elements;
DECODE O-bit
  IF O-bit set to "No type 2 elements follow", END.
  ELSE
    DO for all possible type 2 elements
      DECODE P-bit
      IF P-bit set to "Present", decode type 2 element
    END DO;
END.
```

The PDU type shall be used to map different messages (primitives) coming from the layer 2 at the TLA SAP onto the relevant primitives for the MLE service users and vice versa. Even in PDUs which cannot have optional elements, the O-bit shall be present. The only exceptions to this are the D-MLE SYNC and D-MLE SYSINFO PDUs.

18.4.1.4.1 D-NWRK-BROADCAST

Message: D-NWRK-BROADCAST
Response to: - / U-PREPARE
Response expected: -
Short description: Upon receipt from the RPDI, the message shall inform the MS-MLE about parameters for the serving cell and parameters for one or more neighbour cells.

Table 88: D-NWRK-BROADCAST PDU

Information element	Length	Type	C/O/M	Remark
PDU type	3	1	M	
Cell re-select parameters	16	1	M	
Cell service level	2	1	M	
TETRA Network time	48	2	O	
Number of neighbour cells	3	2	O	note 1
Neighbour cell information				note 2
NOTE 1:	If present, the element shall indicate how many "Neighbour cell information" elements follow. If not present, no neighbour cell information shall follow.			
NOTE 2:	The element definition is contained in subclause 18.5 which gives the type and length for each sub-element which is included in this element. The element shall be repeated as many times as indicated by the "Number of neighbour cells" element. There shall be no P-bit for each neighbour cell information element which is carried by this PDU.			

18.4.1.4.2 D-NEW-CELL

Message: D-NEW-CELL
Response to: U-PREPARE
Response expected: -
Short description: Upon receipt from the RPDI the message shall inform the MS-MLE that it can select a new cell as previously indicated in the U-PREPARE PDU.

Table 89: D-NEW-CELL PDU

Information element	Length	Type	C/O/M	Remark
PDU type	3	1	M	
Channel command valid	2	1	M	
SDU				note
NOTE:	The SDU is coded according to the MM protocol description. There shall be no P-bit in the PDU coding for the SDU.			

18.4.1.4.3 D-PREPARE-FAIL

Message: D-PREPARE-FAIL
Response to: U-PREPARE
Response expected: -
Short description: Upon receipt from the RPDI the message shall be used by the MS-MLE as a preparation failure, while announcing cell re-selection to the old cell.

Table 90: D-PREPARE-FAIL PDU

Information element	Length	Type	C/O/M	Remark
PDU type	3	1	M	
Fail cause	2	1	M	

18.4.1.4.4 D-RESTORE-ACK

Message: D-RESTORE-ACK
Response to: U-RESTORE
Response expected: -

Short description: Upon receipt from the RPDI, the message shall indicate to the MS-MLE an acknowledgement of the C-Plane restoration on the new selected cell.

Table 91: D-RESTORE-ACK PDU

Information element	Length	Type	C/O/M	Remark
PDU type	3	1	M	
SDU				note
NOTE:	This PDU shall carry a CONP D-CALL RESTORE PDU which can be used to restore a data call after cell re-selection.			

18.4.1.4.5 D-RESTORE-FAIL

Message: D-RESTORE-FAIL
Response to: U-RESTORE
Response expected: -
Short description: Upon receipt from the RPDI, the message shall indicate to the MS-MLE a failure in the restoration of the C-Plane on the new selected cell.

Table 92: D-RESTORE-FAIL PDU

Information element	Length	Type	C/O/M	Remark
PDU type	3	1	M	
Fail cause	2	1	M	

18.4.1.4.6 U-PREPARE

Message: U-PREPARE
Response to: -
Response expected: D-NWRK BROADCAST / D-PREPARE-FAIL
Short description: The message shall be sent on the serving cell to the RPDI by the MS-MLE, when preparation of cell re-selection to a neighbour cell is in progress.

Table 93: U-PREPARE PDU

Information element	Length	Type	C/O/M	Remark
PDU type	3	1	M	
Cell identifier	5	2	O	
SDU				note
NOTE:	The SDU may carry an MM registration PDU which is used to forward register to a new cell during announced type 2 cell re-selection. The SDU is coded according to the MM protocol description. There shall be no P-bit in the PDU coding for the SDU.			

18.4.1.4.7 U-RESTORE

Message: U-RESTORE
Response to: -
Response expected: D-RESTORE-ACK/D-RESTORE-FAIL
Short description: The message shall be sent by the MS-MLE, when restoration of the C-Plane towards a new cell is in progress.

Table 94: U-RESTORE PDU

Information element	Length	Type	C/O/M	Remark
PDU type	3	1	M	
MCC	10	2	O	note 1
MNC	14	2	O	note 1
LA	14	2	O	note 1
SDU				note 2
NOTE 1:	The element is present in the PDU if its value on the new cell is different from that on the old cell.			
NOTE 2:	This PDU shall carry a CONP U-CALL RESTORE PDU which shall be used to restore a data call after cell re-selection.			

18.4.1.5 D-MLE-SYSINFO

Message: D-MLE-SYSINFO
Response to: -
Response expected: -
Short description: This message is used for informing the MS about MLE information for the serving cell. The message can only be recognised as a MAC to MAC message.

Table 95: D-MLE-SYSINFO PDU

Information element	Length	Type	C/O/M	Remark
LA	14	1	M	
Subscriber class	16	1	M	
BS service details	12	1	M	

This PDU shall not contain an "O" bit and shall be 42 bits in length.

18.5 Information elements coding

18.5.1 Announced cell re-selection types supported

The element shall define which types of announced cell re-selection are supported by the RPD1.

Table 96: Announce cell re-selection types supported element

Information element	Length	Value	Remark
Announced cell re-selection types supported	2	00 ₂	Only announced type 3 is supported
		01 ₂	Announced type 2 and type 3 are supported

18.5.2 BS service details

The element shall contain information about which services are supported by the RPD1 on a particular cell.

Table 97: BS Service details element

Information element	Length	Value	Remark
Registration	1	0	Registration not required on this cell
		1	Registration mandatory on this cell
De-registration	1	0	De-registration not required on this cell
		1	De-registration mandatory on this cell
Priority cell	1	0	Cell is not a priority cell
		1	Cell is a priority cell
Minimum mode service	1	0	Cell may use minimum mode
		1	Cell never uses minimum mode
Migration	1	0	Migration is not supported by this cell
		1	Migration is supported by this cell
Roaming	1	0	Roaming is not supported by this cell
		1	Roaming is supported by this cell
CONP Service	1	0	Service is not available on this cell
		1	Service is available on this cell
SCLNP Service	1	0	Service is not available on this cell
		1	Service is available on this cell

18.5.3 Cell identifier

The element shall be used to identify a neighbour cell. The serving cell shall attach a cell identifier to each neighbour cell whenever the serving cell broadcasts information about that neighbour cell. The cell identifier can then be used subsequently to refer to that neighbour cell. When the RPD1 assigns a cell identifier, it shall then be able to map this identifier to a physical cell whenever the MS uses the cell identifier (for example, in a U-PREPARE PDU).

The cell identifier may also be set equal to "00000₂" to initiate the neighbour cell enquiry procedure which prompts the RPD1 to send the D-NWRK BROADCAST PDU when the MS does not yet have the neighbour cell information.

Table 98: Cell identifier element

Information element	Length	Value	Remark
Cell identifier	5	00000 ₂	Neighbour cell enquiry
		00001 ₂	Valid cell identifier
		...etc.	...etc.
		11111 ₂	Valid cell identifier

18.5.4 Cell re-select parameters

The element shall define the threshold parameters for the cell re-selection procedures in the MS.

SLOW_RESELECT_THRESHOLD is the maximum level above the FAST_RESELECT_THRESHOLD for a radio improvable link.

FAST_RESELECT_THRESHOLD is the maximum level above C1 = 0 for a radio relinquishable link.

SLOW_RESELECT_HYSTERESIS is the hysteresis for a radio improvable link.

FAST_RESELECT_HYSTERESIS is the hysteresis for a radio relinquishable link.

Table 99: Cell re-select parameters element

Information element	Length	Value	Remark
SLOW_RESELECT_THRESHOLD	4	0000 ₂	0 dB
		0001 ₂	2 dB
		...etc.	...etc.
		1111 ₂	30 dB
FAST_RESELECT_THRESHOLD	4	0000 ₂	0 dB
		0001 ₂	2 dB
		...etc.	...etc.
		1111 ₂	30 dB
SLOW_RESELECT_HYSTERESIS	4	0000 ₂	0 dB
		0001 ₂	2 dB
		...etc.	...etc.
		1111 ₂	30 dB
FAST_RESELECT_HYSTERESIS	4	0000 ₂	0 dB
		0001 ₂	2 dB
		...etc.	...etc.
		1111 ₂	30 dB

18.5.5 Cell service level

The element shall define the level of service a MS may receive in a cell. It may relate to the traffic loading in a cell.

Table 100: Cell service level element

Information element	Length	Value	Remark
Cell service level	2	00 ₂	Cell load unknown
		01 ₂	Low cell load
		10 ₂	Medium cell load
		11 ₂	High cell load

18.5.6 Channel command valid

The element shall indicate to the MS MLE when to initiate a channel change as a result of cell re-selection.

Table 101: Channel command valid element

Information element	Length	Value	Remark
Channel command valid	2	00 ₂	Follow channel allocation in MAC header
		01 ₂	Change channel immediately
		10 ₂	No channel change - wait for next D-NEW CELL
		11 ₂	Reserved

18.5.7 Fail cause

The element shall indicate to the MS the failure cause as a result of requesting an MLE service in the RPDl.

Table 102: Fail cause element

Information element	Length	Value	Remark
Fail cause	2	00 ₂	Neighbour cell enquiry not available
		01 ₂	Cell re-selection type not supported
		10 ₂	Subscriber class not allowed
		11 ₂	Restoration cannot be done on cell

18.5.8 Late entry information

The element shall indicate to the MS whether or not late entry can be supported by the cell.

Table 103: Late entry information element

Information element	Length	Value	Remark
Late entry information	1	0	Late entry not supported
		1	Late entry available

18.5.9 LA

The element shall define the LA in which a cell is located, either the serving cell or a neighbour cell.

Table 104: LA element

Information element	Length	Value	Remark
LA	14		

18.5.10 Main carrier number

The element shall define the main carrier number for a neighbour cell. See the channel allocation element in clause 22 for a full description of carrier numbering.

Table 105: Main carrier number element

Information element	Length	Value	Remark
Main carrier	12		Main carrier number of neighbour cell as defined in clause 22

18.5.11 Main carrier number extension

The element shall define extended carrier numbering information. See the channel allocation element in clause 22 for a full description of carrier numbering.

Table 106: Main carrier number extension element

Information element	Length	Value	Remark
Frequency band	4		Provision for different frequency bands as defined in clause 22
Offset	2	00 ₂	No offset
		01 ₂	+ 6,25 kHz offset
		10 ₂	- 6,25 kHz offset
		11 ₂	+ 12,5 kHz offset
Duplex spacing	3		Provision for different duplex spacing as defined in clause 22
Reverse operation	1	0	Normal
		1	Reverse

18.5.12 Maximum MS transmit power

The element shall indicate to the MS the maximum power that is allowed to be transmitted in a cell, either the serving cell or a neighbour cell.

Table 107: Maximum MS transmit power element

Information element	Length	Value	Remark
MS_TXPWR_MAX_MCELL	3	000 ₂	Reserved
		001 ₂	15 dBm
		010 ₂	20 dBm
		011 ₂	25 dBm
		100 ₂	30 dBm
		101 ₂	35 dBm
		110 ₂	40 dBm
		111 ₂	45 dBm

18.5.13 Minimum RX access level

The element shall indicate the minimum received signal level required at the RPDI in a cell, either the serving cell or a neighbour cell.

Table 108: Minimum Rx access level element

Information element	Length	Value	Remark
RXLEV_ACCESS_MIN_MCELL	4	0000 ₂	- 125 dBm
		0001 ₂	- 120 dBm
		...etc.	...etc.
		1111 ₂	- 50 dBm (5 dB steps)

18.5.14 MCC

The element shall indicate which country a cell is located in.

Table 109: MCC element

Information element	Length	Value	Remark
MCC	10		

18.5.15 MNC

The element shall indicate which network a cell is located in.

Table 110: MNC element

Information element	Length	Value	Remark
MNC	14		

18.5.16 Neighbour cell broadcast

The element shall indicate how an MS can obtain information about neighbour cells. The neighbour cell information may be broadcast by the RPDI using the D-NWRK BROADCAST PDU or the MS may use U-PREPARE to enquire for the D-NWRK BROADCAST information.

Table 111: Neighbour cell broadcast element

Information element	Length	Value	Remark
D-NWRK BROADCAST broadcast supported	1	0	Not supported
		1	Supported
D-NWRK BROADCAST enquiry supported	1	0	Not supported
		1	Supported

18.5.17 Neighbour cell information

The element shall contain information about a neighbour cell.

Table 112: Neighbour cell information element

Information element	Length	Type	C/O/M	Remark
Cell identifier	5	1	M	
Announced cell re-selection types supported	2	1	M	
Neighbour cell synchronised	1	1	M	
Cell service level	2	1	M	
Main carrier number	12	1	M	
Main carrier number extension	10	2	O	note 1
MCC	10	2	O	note 2
MNC	14	2	O	note 2
Location area	14	2	O	note 2
Maximum MS transmit power	3	2	O	note 2
Minimum RX access level	4	2	O	note 2
Subscriber class	16	2	O	note 2
BS service details	12	2	O	note 2
Timeshare cell information	5	2	O	note 3
NOTE 1:	If not present, the "Main carrier number" element shall fully define the frequency of the neighbour cell main carrier. The neighbour cell extended carrier numbering information shall be assumed to be the same as that of the serving cell.			
NOTE 2:	If not present, the neighbour cell parameter shall be assumed to be the same as that of the serving cell.			
NOTE 3:	If not present, it shall be assumed that the neighbour cell is not operating in a discontinuous mode of operation.			
NOTE 4:	For this element there shall be a P-bit for each type 2 element contained within.			

18.5.18 Neighbour cell synchronised

The element shall indicate whether or not the neighbour cell is synchronised to the serving cell.

Table 113: Neighbour cell synchronised element

Information element	Length	Value	Remark
Neighbour cell synchronised	1	0	Neighbour cell is not synchronised
		1	Neighbour cell is synchronised

18.5.19 Number of neighbour cells

The element shall indicate how many "Neighbour cell information" elements follow.

Table 114: Number of neighbour cells element

Information element	Length	Value	Remark
Number of neighbour cells	3	000 ₂	No neighbour cell information available
		001 ₂	Number of "Neighbour cell information" elements contained in this PDU
		...etc.	...etc.
		111 ₂	Number of "Neighbour cell information" elements contained in this PDU

18.5.20 PDU type

The element shall indicate the PDU type for each of the MLE protocol PDUs. The PDU type shall have a separate definition for the uplink and downlink directions as shown in the table below.

Table 115: PDU type element

Information element	Length	Value	Remark	
			<u>DOWNLINK</u>	<u>UPLINK</u>
PDU type	3	000 ₂	D-NEW CELL	U-PREPARE
		001 ₂	D-PREPARE FAIL	Reserved
		010 ₂	D-NWRK-BROADCAST	Reserved
		011 ₂	Reserved	Reserved
		100 ₂	D-RESTORE-ACK	U-RESTORE
		101 ₂	D-RESTORE-FAIL	Reserved
		110 ₂	Reserved	Reserved
		111 ₂	Reserved	Reserved

18.5.21 Protocol discriminator

The element shall indicate which protocol the PDU belongs to. MM, CONP and SCLNP PDUs are simply routed by the MLE to the relevant SAP. MLE protocol PDUs are processed by the MLE protocol entity and TETRA management entity PDUs by the TETRA management functional entity within the MLE.

Table 116: Protocol discriminator element

Information element	Length	Value	Remark
Protocol discriminator	3	000 ₂	Reserved
		001 ₂	MM protocol
		010 ₂	Reserved
		011 ₂	CONP protocol
		100 ₂	SCLNP protocol
		101 ₂	MLE protocol
		110 ₂	TETRA management entity protocol
		111 ₂	Reserved for testing

18.5.22 Subscriber class

The subscriber class element shall be used by the RPDI to indicate which subscriber classes are allowed to use this cell.

Table 117: Subscriber class element

Information element	Length	Value	Remark
Class 1	1	0	Subscriber class not allowed on cell
		1	Subscriber class allowed on cell
Class 2	1	0	Subscriber class not allowed on cell
		1	Subscriber class allowed on cell
...etc.	1	0	...etc.
		1	...etc.
Class 16	1	0	Subscriber class not allowed on cell
		1	Subscriber class allowed on cell

18.5.23 TETRA network time

The element shall indicate the absolute TETRA network time to be used for time stamping in the S-CLNP protocol.

Table 118: TETRA network time element

Information element	Length	Value	Remark
Network time	24		note 1
Local time offset	24		note 2
NOTE 1: Zero time (000000 ₁₆) is defined as 00:00 hours, Universal Time Co-ordinates (UTC time) on January 1st of every year. Each increment of this element above a value of zero shall correspond to a two second increment of the absolute network time. The values, F142FF ₁₆ to FFFFFE ₁₆ , shall be reserved. The value, FFFFFFF ₁₆ , shall be reserved and shall be used to indicate an invalid value of timestamp in the event of network malfunction.			
NOTE 2: The local time offset is coded as a signed integer and indicates the difference between the local time and the network time. The step size is the same as for the network time (i.e. two seconds) the maximum permissible offset shall be +/- 24 hours. The value, FFFFFFF ₁₆ , shall be reserved and shall be used to indicate an invalid offset.			

18.5.24 Timeshare cell information

The element shall indicate the mode of discontinuous operation for a neighbour cell. The "Discontinuous mode" field shall indicate which of the three types of discontinuous mode is in use.

If the mode is Master control channel sharing, the "Reserved frames" sub-element shall indicate how many frames are reserved for that neighbour cell.

If the mode is not Master control channel sharing, the "Reserved frames" sub-element shall be ignored by the MS.

Table 119: Timeshare cell information element

Information element	Length	Value	Remark
Discontinuous mode	2	00 ₂	Reserved
		01 ₂	Carrier sharing
		10 ₂	Master control channel sharing
		11 ₂	Traffic carrier sharing
Reserved burst per two master-bursts	3	000 ₂	1 burst reserved
		001 ₂	2 bursts reserved
		010 ₂	3 bursts reserved
		011 ₂	4 bursts reserved
		100 ₂	6 bursts reserved
		101 ₂	9 bursts reserved
		110 ₂	12 bursts reserved
		111 ₂	18 bursts reserved

18.6 Timers

18.6.1 Timer T370 - Cell re-selection preparation response time

This timer shall define the maximum time MLE shall wait for a response to U-PREPARE. The timer, T370, shall be of 5 s duration.

19 Service description for PDO layer 2

This clause describes the services offered by the layer 2 of the PDO TETRA air interface. These services are described in terms of SAPs and primitives. This service boundary is not a testable boundary.

19.1 Layer 2 service descriptions

19.1.1 SAPs

The layer 2 should provide services to the MLE through three SAPs. This relationship is shown as follows:

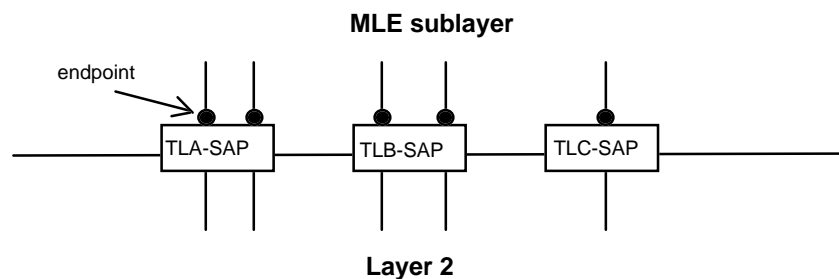

Figure 69: SAPs between Layer 2 and MLE

Figure 70 shows the service relationships relating to the layer 2 services.

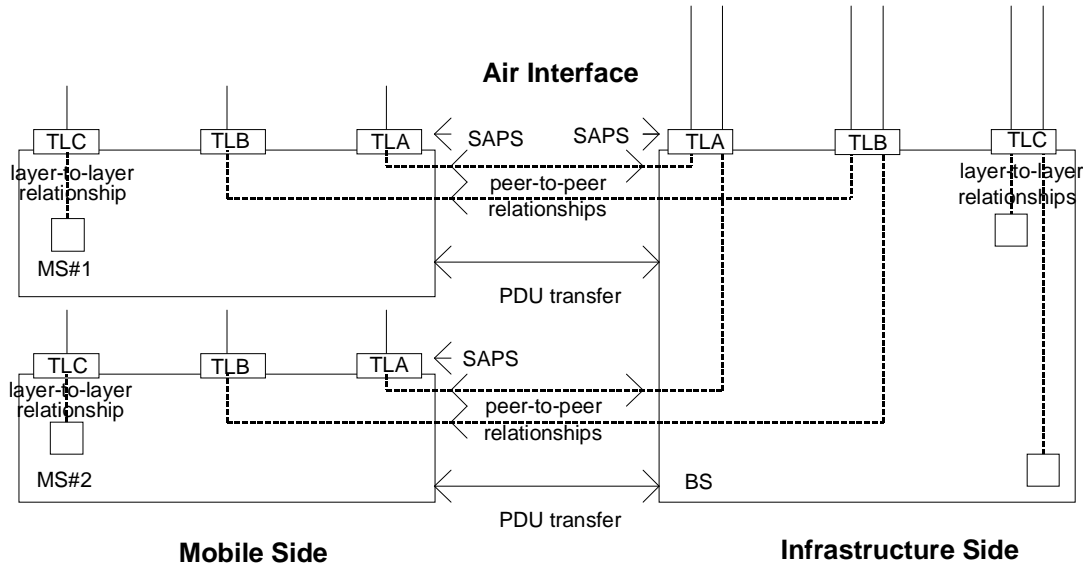

Figure 70: Services relationships offered by the layer 2 over the air interface

The peer to peer services provided by the TLA-SAP and the TLB-SAP relate to the services between one BS and the group of MSs attached to that BS. The layer-to-layer service provided by the TLC-SAP relates to services within one BS or within one MS.

Each independent instance of service is represented by a separate service endpoint. These separate endpoints are identified using endpoint identifiers as described in subclause 19.2.3.

19.1.2 Services available at the layer 2 SAPs

19.1.2.1 Services at the TLA-SAP

The TLA-SAP shall be used for addressed data transfers and for control of the layer 2 data transfer procedures. It should provide the data transfer services given in table 120.

Table 120: Services at the TLA-SAP

Service description for TLA SAP	Address	Direction
Point-to-point; acknowledged	ITSI	Both
Point-to-point; unacknowledged	ITSI	Both
Point-to-multipoint; unacknowledged	GTSI	BS to MS (note)
NOTE: This is a layer 2 restriction. A point-to-multipoint service in the direction MS to BS exists at layer 3 (this uses the layer 2 point-to-point service on the uplink).		

The point-to-point services define a relationship between one specific BS and one specific MS. Normally an MS shall only maintain a single instance (a single endpoint) of each service but during handover an MS may maintain two (or more) relationships to different BSs.

The point-to-multipoint services define a relationship between one specific BS and one specific group of MS. Normally each MS in the group shall only maintain a single instance of each service, but a MS may maintain two (or more) relationships to different BSs.

19.1.2.2 Services at the TLB-SAP

The TLB-SAP shall be used for un-addressed data transfers. These include all of the system information broadcast messages. It provides the following data transfer services:

Table 121: Services at the TLB-SAP

Service description for TLB SAP	Address	Direction
Point-to-multipoint; unacknowledged	None	BS to MS

The point-to-multipoint services define a relationship between one specific BS and all MSs that are within the coverage area of that BS (regardless of their attachment). Normally each MS in the group shall only maintain a single instance of each service, but an MS may maintain two (or more) relationships to different BSs.

19.1.2.3 Services at the TLC-SAP

The TLC-SAP shall be used for all local control messages, such as scanning control and signal quality measurements. It provides no data transfer services:

Table 122: Services at the TLC-SAP

Service description for TLC SAP	Address	Direction
Local management and control	None	Local only

The layer-to-layer services define a relationship within one specific BS or one specific MS. An MS should only maintain a single instance of each service, but a BS should maintain multiple instances, one for each attached MS.

19.2 Primitive definitions

19.2.1 Primitives types

Four different types of primitive should be used:

- **request:** for the higher layer to request service from the lower layer;
- **confirm:** for the lower layer providing the service to confirm that the activity has been completed;
- **indication:** for the lower layer to notify the next higher layer of any specific service related activity;
- **response:** for the higher layer to acknowledge receipt of an indication primitive from the next lower layer.

In this clause the term "higher layer" shall refer to the PDO MLE, and the term "lower layer" shall refer to the PDO layer 2.

19.2.2 Summary of primitives

19.2.2.1 Primitives used at the TLA-SAP

The TLA-SAP primitives all correspond to unidirectional transactions. The TL-CONNECT primitives should be used to request establishment (including a reset of the sequence numbers) of one unidirectional link (either BS to MS or MS to BS). A link must be established before it can be used. The TL-DATA primitives should be used for all (subsequent) unidirectional data transfers on the link.

The TL-UNITDATA primitives also correspond to unidirectional transfer, but in this case there are no sequence numbers and therefore these primitives can be used at any time (before, during or after link establishment).

TL-CONNECT request: this should be used to request the layer 2 to invoke establishment (or re-establishment) of a link including a reset of the acknowledged service sequence numbers.

NOTE: This reset will normally only occur when the next acknowledged message is transmitted (see clause 21).

TL-CONNECT confirm: this should be used by the layer 2 to report that it has completed a reset of the acknowledged sequence numbers.

TL-CONNECT indication: this should be used by the layer 2 to indicate that the acknowledged service sequence numbers have been reset.

TL-DATA request: this should be used to request the layer 2 to transmit an acknowledged message.

TL-DATA confirm: this should be used by the layer 2 to report that it has completed the transmission of an acknowledged message. The report should indicate if the transmission was successful or if it failed.

TL-DATA indication: this should be used by the layer 2 to deliver an acknowledged message.

TL-UNITDATA request: this should be used to request the layer 2 to transmit an unacknowledged message.

TL-UNITDATA confirm: this should be used by the layer 2 to report that it has completed the transmission of an unacknowledged message. The report parameter should indicate if the transmission was completed or abandoned.

TL-UNITDATA indication: this should be used by the layer 2 to deliver an unacknowledged message.

19.2.2.2 Primitives used at the TLB-SAP

TL-BROADCAST_1 request: this should be used at the BS side to supply a system broadcast message for transmission by the layer. The message shall be transmitted at regular intervals until a new primitive is submitted.

TL-BROADCAST_1 confirm: this should be used by the layer 2 at the BS side to report that it has completed the processing of a system broadcast message. The report parameter should indicate if the system broadcast was completed or abandoned.

TL-BROADCAST_1 indication: this should be used at the MS side to supply a received SIN1 system broadcast message.

TL-BROADCAST_2 request: this should be used at the BS side to supply a system broadcast message for transmission by the layer.

TL-BROADCAST_2 confirm: this should be used by the layer 2 at the BS side to report that it has completed the processing of a system broadcast message. The report parameter indicates if the system broadcast was completed or abandoned.

TL-BROADCAST_2 indication: this should be used at the MS side to supply a received SIN2 system broadcast message.

19.2.2.3 Primitives used at the TLC-SAP

TL-SCAN request/confirm: this should be used at the MS side to request the layer 2 to start a scan of a defined radio channel, and for the layer 2 to report the measurement results.

TL-SERVING indication: this is used at the MS side for the layer 2 to report the measurement results for the serving cell.

TL-MONITOR request/indication: this should be used at the MS side to request the layer 2 to monitor signal quality for a list of radio channels and to report the results as a series of signal quality measurements to the MLE.

TL-SELECT request/confirm: this should be used at the MS side to request the layer 2 to select the defined radio channel.

TL-ADDLIST request: this should be used at the MS side to set the addresses that the MAC uses for wake-up monitoring.

19.2.3 Contents of primitives

These layer 2 primitives are defined only for the purpose of describing the layer-to-layer interactions. Each primitive is described as an abstract list of parameters and their concrete realisation may vary between implementations. This ETS does not define a concrete structure for these primitives and no formal testing of primitives is intended.

19.2.3.1 Parameter definitions

The following definitions apply to the primitives for all SAPs. Definitions appear in alphabetic order.

Address list: a list of valid addresses that the layer is required to maintain. The list shall contain one TMI, one or more ISSI (or ASSI) and one or more GSSI (see clause 18).

Address type: a parameter that identifies the type of address contained in the "main address" parameter. The allowed values are:

- valid SSI (ISSI, ASSI or GSSI);
- un-exchanged SSI (USSI);
- valid TMI.

(See clause 20).

FCS flag: a flag to indicate if extended CRC protection shall be applied to the data.

Endpoint identifier: a local identifier that uniquely identifies one of the endpoints within one SAP. This is a local (layer-to-layer) matter: the endpoint identifier does not appear in any PDU and different endpoint identifiers may be used at the MS and BS to refer to the same layer 2 connection.

NOTE 1: The allocation and management of these endpoint identifiers are not defined in this ETS.

Main address: the value of SSI or TMI for this transaction (see ETS 300 393-1 [14], clause 21).

Priority: the ranked priority to be applied to this transaction (see ETS 300 393-1 [14], annex A).

Radio channel list: a list of all the radio channels to be scanned.

Radio channel number: a specific radio channel.

Report: the report indicates the success or failure of the requested operation (e.g. a data transfer transaction, or an acknowledged sequence number reset).

Service Data Unit (SDU): the higher layer information that is to be transported.

NOTE 2: The operations across the service boundary should be such that the layer sending the message to its peer can assume a temporal order of bits within the SDU and the (peer) layer receiving the primitive can reconstruct the message with its assumed temporal order.

Service Data Unit length (SDU length): the length of the higher layer information. The coding of this parameter is a local matter and is not defined in this ETS.

Signal quality: see clause 10.

Subscriber class: the subscriber class associated to the SSI (see annex A).

19.2.3.2 TL-SAP primitives

KEY: M: Mandatory; C: Conditional; (=): Equal to corresponding primitive; -: Not used

19.2.3.2.1 TL-CONNECT primitives

Table 123: TL-CONNECT primitives

Parameter	Request	Confirm	Indication
Endpoint identifier	M	(=)	M
Report	-	M	-

19.2.3.2.2 TL-DATA primitives

Table 124: TL-DATA primitives

Parameter	Request	Confirm	Indication
FCS flag	M	-	(=)
Endpoint identifier	M	(=)	M
Address Type	M	(=)	(=)
Main Address	M	(=)	(=)
Priority	M	-	(=)
Report	-	M	-
Subscriber Class	M	-	-
SDU	C	-	C(=)
SDU length	C	-	C(=)

19.2.3.2.3 TL-UNITDATA primitives

Table 125: TL-UNITDATA primitives

Parameter	Request	Confirm	Indication
FCS flag	M	-	(=)
Endpoint identifier	M	(=)	M
Address Type	M	(=)	(=)
Main Address	M	(=)	(=)
Priority	M	-	(=)
Report	-	M	-
Subscriber Class	M	-	-
SDU	C	-	C(=)
SDU length	C	-	C(=)

19.2.3.3 TLB-SAP primitives

19.2.3.3.1 TL-BROADCAST_1 primitives

Table 126: TL-BROADCAST_1 primitives

Parameter	Request	Confirm	Indication
Endpoint identifier	M	(=)	M
Report	-	M	-
SDU (SIN1)	C	-	C(=)
SDU length	C	-	C(=)

19.2.3.3.2 TL-BROADCAST_2 primitives

Table 127: TL-BROADCAST_2 primitives

Parameter	Request	Confirm	Indication
Endpoint identifier	M	(=)	M
Report	-	M	-
SDU (SIN2)	C	-	C(=)
SDU length	C	-	C(=)

19.2.3.4 TLC-SAP primitives

19.2.3.4.1 TL-SCAN primitives

Table 128: TL-SCAN primitives

Parameter	Request	Confirm
Endpoint identifier	M	M
Radio Channel Number	M	M
Signal Quality		M

This primitive shall only be used at the MS side.

19.2.3.4.2 TL-SERVING primitives

Table 129: TL-SERVING primitives

Parameter	Indication
Endpoint identifier	M
Signal Quality	M

This primitive shall only be used at the MS side.

19.2.3.4.3 TL-MONITOR primitives

Table 130: TL-MONITOR primitives

Parameter	Request	Indication
Endpoint identifier	M	M
Radio Channel List	M	
Radio Channel Number		M
Signal Quality		M

19.2.3.4.4 TL-SELECT primitives

Table 131: TL-SELECT primitives

Parameter	Request	Confirm		
Endpoint identifier	M	M		
Radio Channel Number	M	M		
Report	-	M	-	

This primitive shall only be used at the MS side.

19.2.3.4.5 TL-ADDLIST primitives

Table 132: TL-ADDLIST primitives

Parameter	Request			
Endpoint identifier	M			
Address List	M			

This primitive shall only be used at the MS side.

20 Layer 2 PDUs and elements

This clause describes the elements and formats for the PDUs. For L2 procedures refer to clause 22 and clause 21.

20.1 Overview

In this clause the elements and the MAC PDUs in layer 2 are described. The block structure is also described.

NOTE: Values followed by a subscript 2 in this clause represent binary values, thus: 1001_2 .

20.2 Block structure

There shall be three types of different blocks, presiding block, following block and master block.

20.2.1 Presiding block

The presiding block shall contain the following parts: Block header and PDU dependent part. For the size of different parts see figure 71. In the block header, the first flag, presiding flag, shall be set to 1.

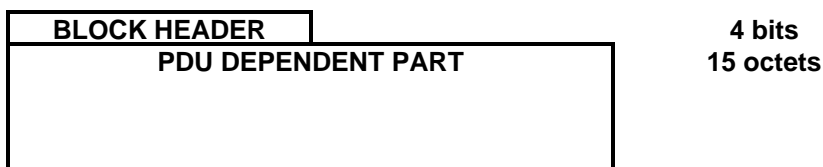

Figure 71: Structure of the presiding block

20.2.2 Following block

The following block shall contain the following parts: Block header and information part. For the size of different parts see figure 72. In the block header, the first flag, presiding flag, shall be set to 0.

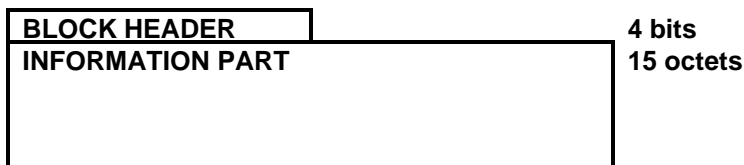

Figure 72: Structure of the following block

20.2.3 Master block

The master block shall contain only a PDU dependent part. For the size see figure 73.

NOTE: This block is only used for the <SIN1> PDU.

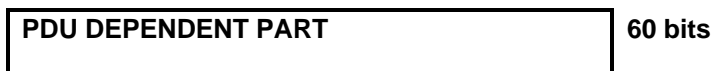

Figure 73: Structure of the master block

20.2.4 Block header

The block header shall be the first element in each block, except the master block, both presiding block and following block. The block header shall contain flags (see figure 74).

Size: 4 bits.

Allowed values:

Flag 1 Presiding flag 0 = Following block 1 = Presiding block

Flag 2-4 Reserved

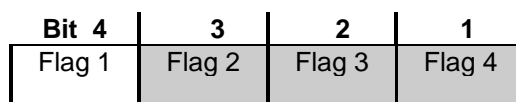

Figure 74: Block header

20.3 PDUs

The PDUs shall be sent from the MAC layer to the corresponding MAC layer at the other side of the air interface.

Each PDU shall contain one presiding block and a number of following blocks (the number of following blocks can be 0) except for the <SystemINformation1> PDU which shall contain one Master block.

There shall be five different PDU structures; Uplink fixed length PDU, Uplink variable length PDU, downlink fixed length PDU, downlink variable length PDU and Master burst PDU (see figures 75, 76 and 77). The value of the constant N222 is defined in clause 22.

Different PDUs shall contain different elements in the presiding block. When an element appears it shall always occupy the same position, except for the following elements:

- Short Subscriber Identity (SSI);
- auxiliary address;
- start of reservation;
- uplink carrier;
- downlink carrier;
- block flags;
- fill flag.

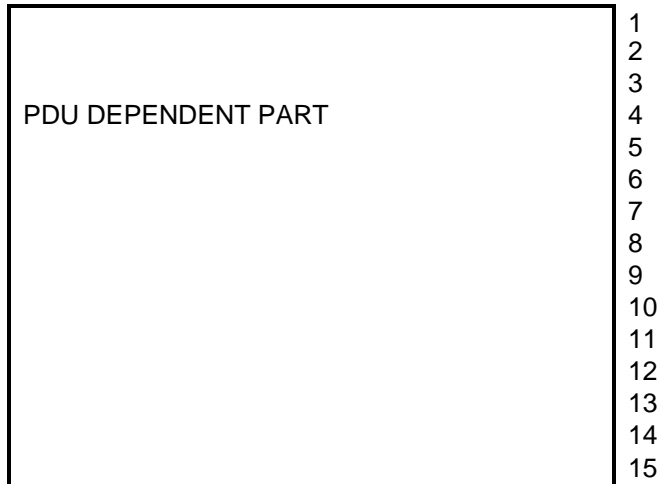

Figure 75: Structure of a fixed length PDU

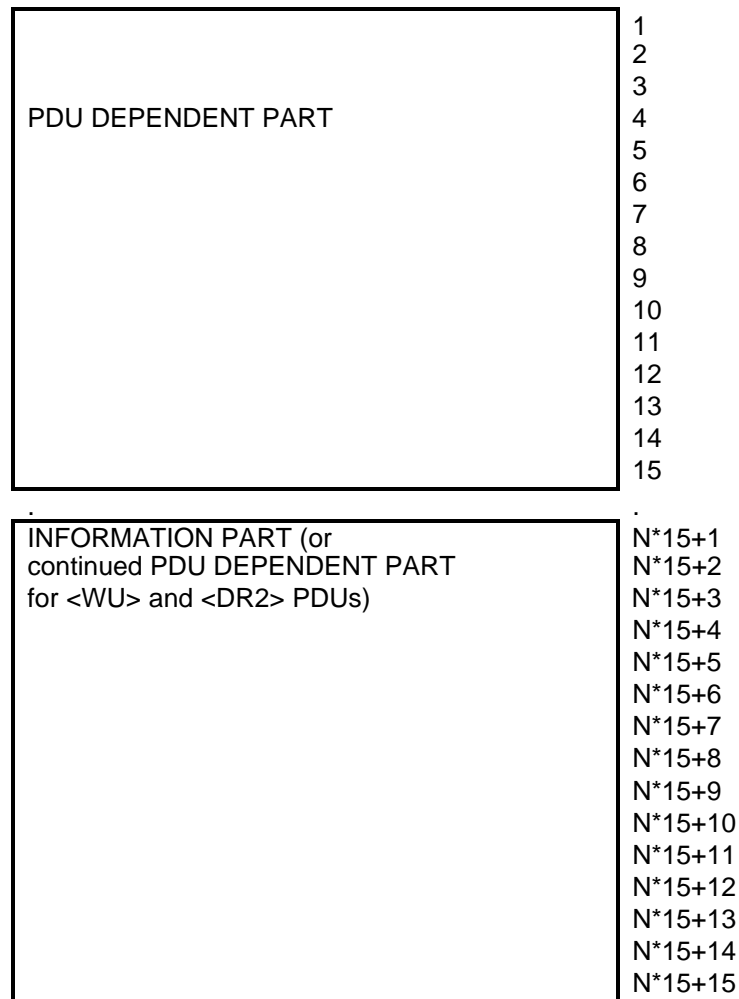

Figure 76: Structure of a variable length PDU, with N the number of following blocks

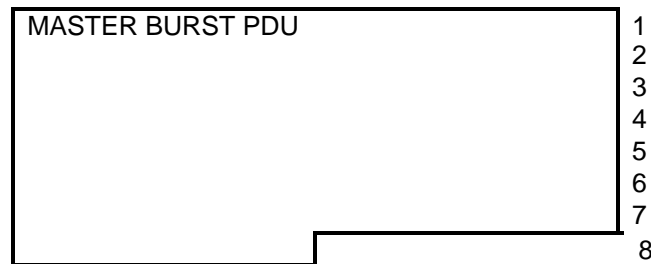

Figure 77: Structure of a master burst PDU

The different PDUs that are described in the following subclauses are:

- UR Uplink Response to downlink data (subclause 20.3.1);
- UD1 Uplink Data type 1 (subclause 20.3.2);
- UD2 Uplink Data type 2 (subclause 20.3.3);
- DR1 Downlink Response to uplink data type 1 (subclause 20.3.4);
- DR2 Downlink Response to uplink data type 2 (subclause 20.3.5);
- AA Access Announce (subclause 20.3.7);
- DD1 Downlink Data type 1 (subclause 20.3.8);
- DD2 Downlink Data type 2 (subclause 20.3.9);
- DR3 Downlink Response to uplink data type 3 (clause 21);
- WU Wake Up information for low duty MS (subclause 20.3.10);
- AP Assignment of event labels and access Parameters (subclause 20.3.11);
- SIN2 System INformation type 2 (subclause 20.3.12);
- SIN1 System INformation type 1 (subclause 20.3.13).

20.3.1 Uplink Response (UR)

This PDU (figure 78) shall be used on the uplink for responses to downlink data. This PDU is the only uplink PDU used for responses.

Direction: MS to BS

Content: PDU type = $\leq 0010_2$
 burst length = 000001_2
 Downlink Transfer label (DT-label)
 ack flag
 frame sequence number
 RR control
 block flags

Number of allowed following blocks: 0.

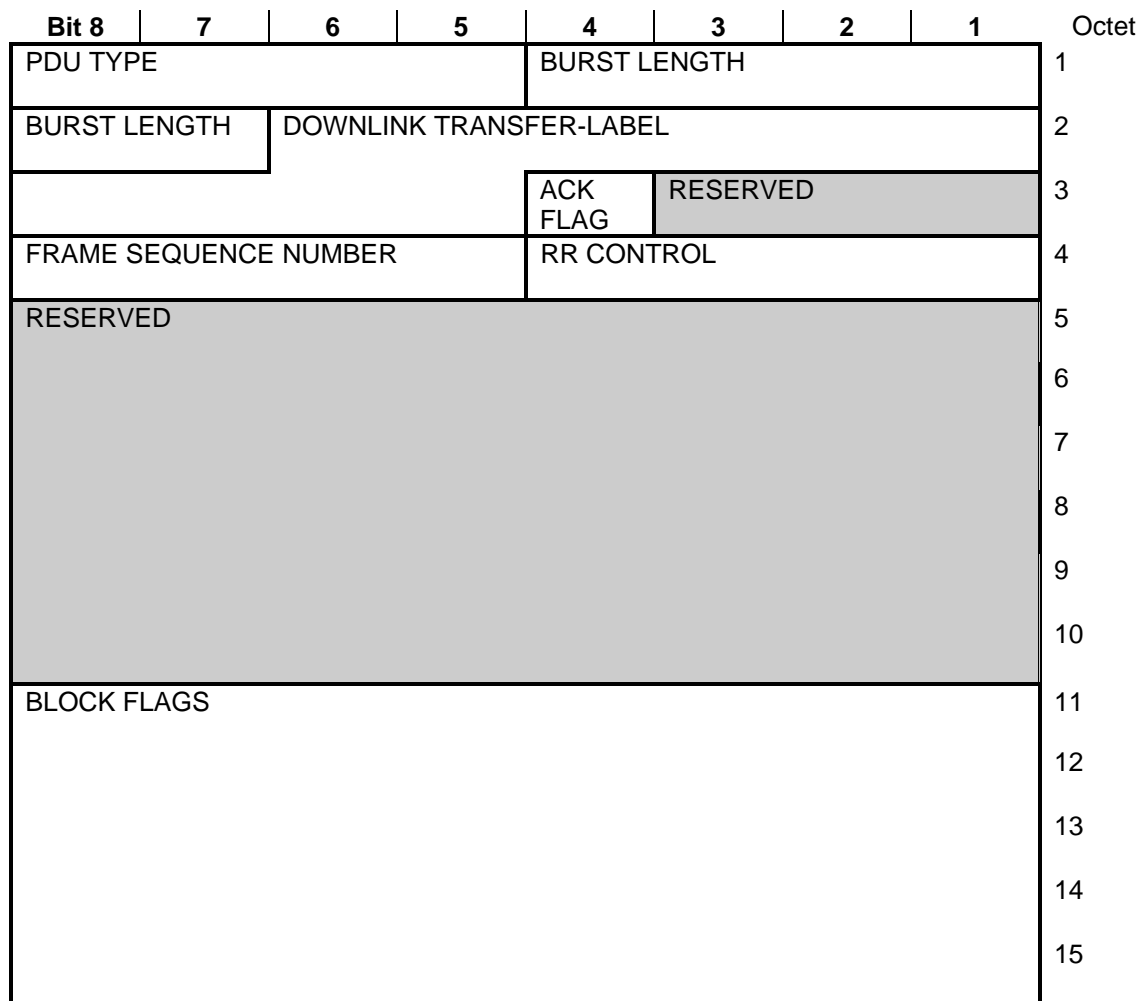

Figure 78: <UR> PDU

20.3.2 Uplink Data, type 1 (UD1)

This PDU (see figure 79) shall be used on the uplink for random access when no uplink transfer label is assigned. This PDU is normally the first PDU for an uplink transaction.

Direction: MS to BS

Content: PDU type = 0011₂
 burst length
 Random Access label (RA-label)
 more data
 PRIOrity (PRIO)
 fill flag
 ack flag
 last fragment flag
 frame check sequence flag
 frame sequence number
 segment sequence number
 Short Subscriber Identity (SSI)
 auxiliary address
 information parts (in the following blocks)

Number of allowed following blocks: 0 to N222.

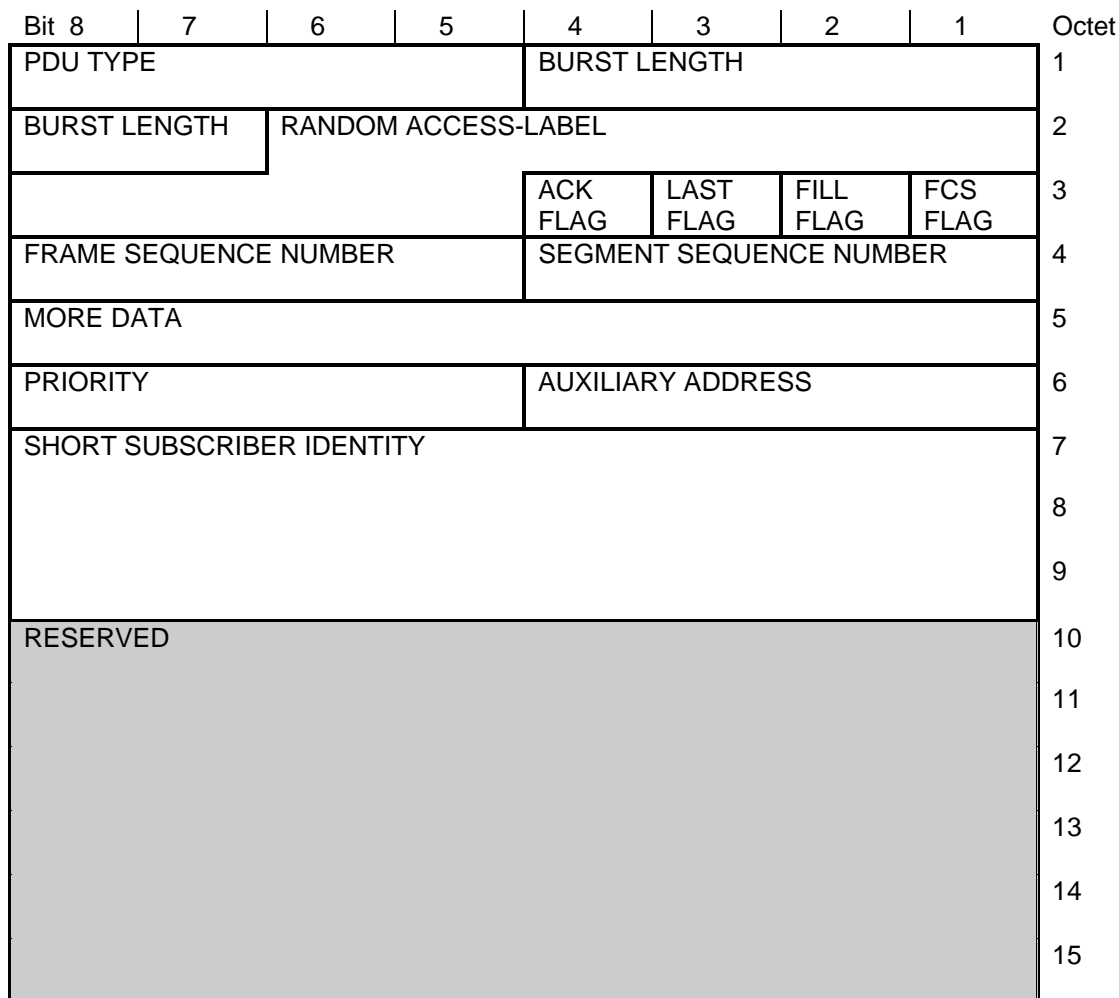

Figure 79: <UD1> PDU

20.3.3 Uplink Data, type 2 (UD2)

This PDU (see figure 80) shall be used on the uplink for data transfer when an uplink transfer label is assigned. This PDU is used for secondary PDUs in a transaction.

Direction:

Number of allowed following blocks: 0 to N222.

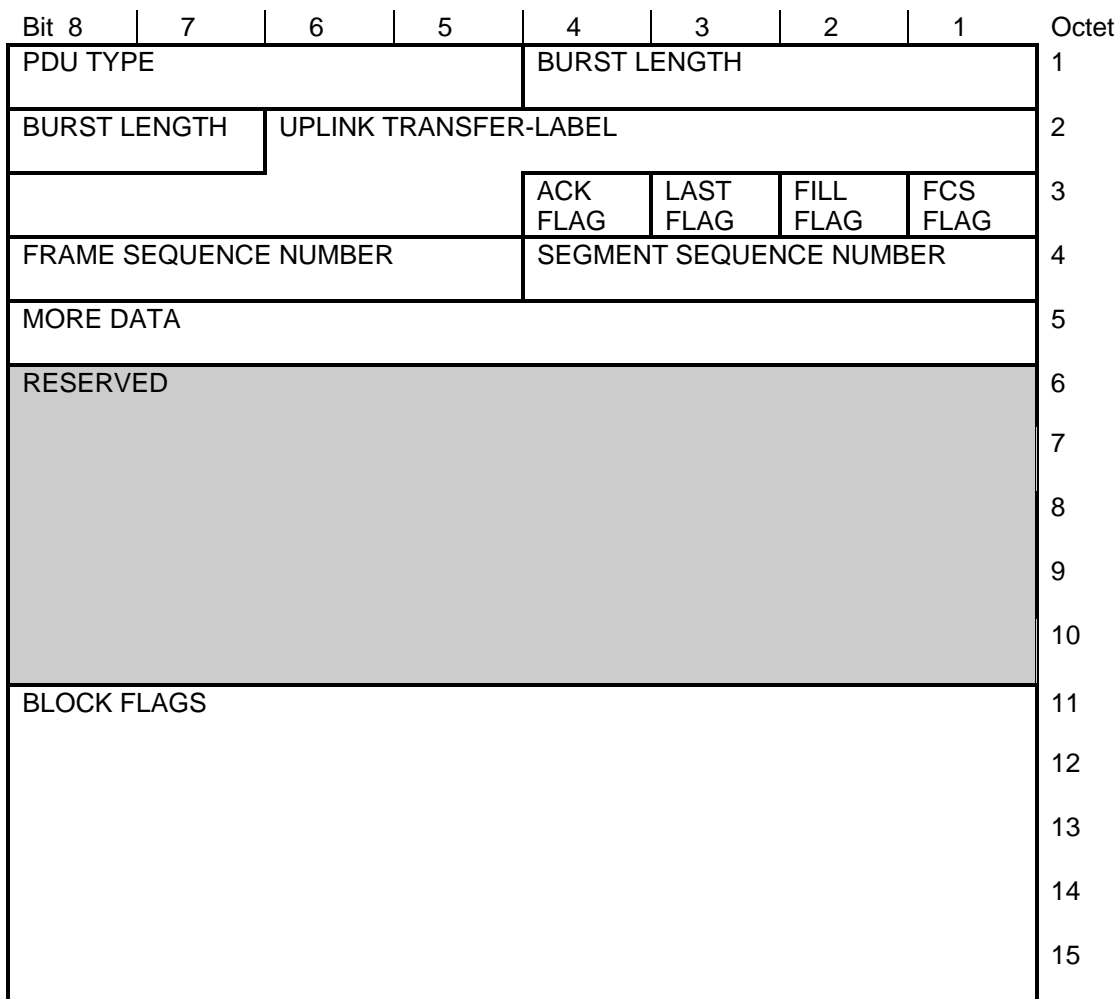

Figure 80: <UD2> PDU

20.3.4 Downlink Response, type 1 (DR1)

This PDU (see figure 81) shall be used on the downlink for responses when no uplink transfer label is assigned.

Direction: BS to MS

Content: PDU type = 0001₂
 burst length = 000001₂
 Uplink Transfer label (UT-label)
 reserved blocks
 ack flag
 frame Sequence Number
 RR control
 uplink carrier
 downlink carrier
 start of reservation
 Short Subscriber Identity (SSI)

Allowed number of following blocks: 0.

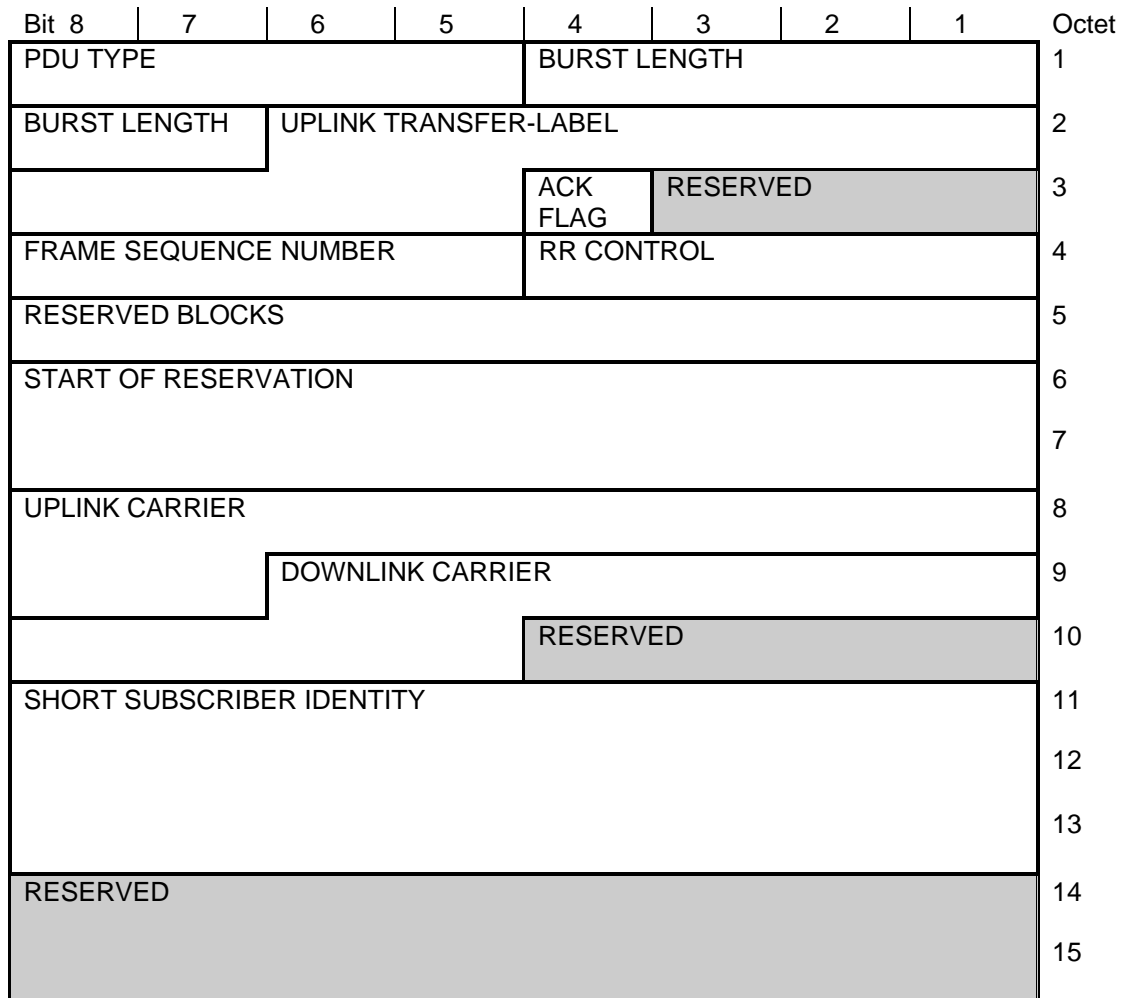

Figure 81: <DR1> PDU

20.3.5 Downlink Response, type 2 (DR2)

This PDU (see figure 82) shall be used on the downlink for responses when an uplink transfer label is assigned.

Direction: BS to MS

Content: PDU type = 0010₂
 burst length
 Uplink Transfer label (UT-label)
 reserved blocks
 ack flag
 frame sequence number
 RR control
 uplink carrier
 downlink carrier
 start of reservation
 block flags
 next uplink transfer label (in the following block)

Allowed number of following blocks: 0 or 1.

NOTE: Following block only if a new uplink transfer-label is assigned.

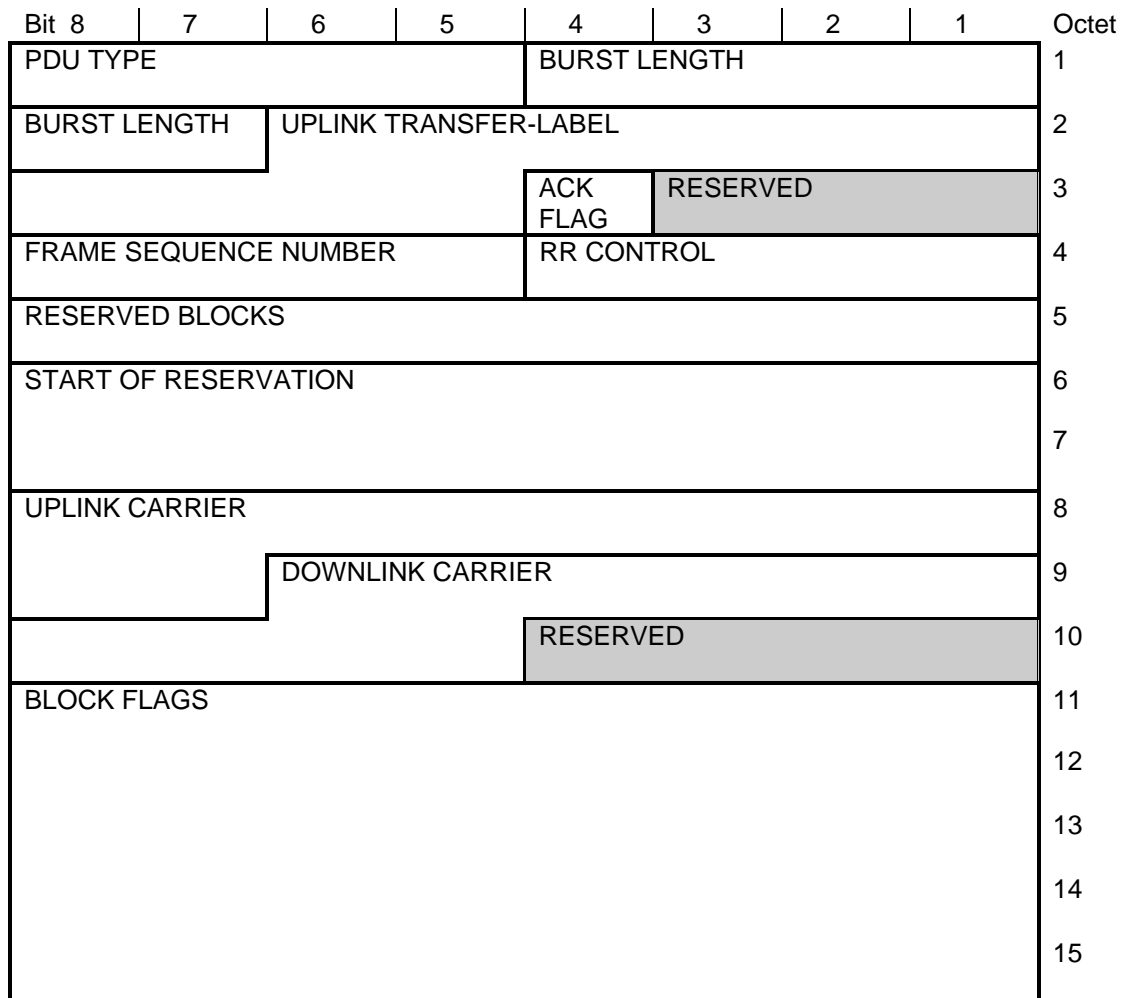

Figure 82a: <DR2> PDU

The following elements are placed in the following block.

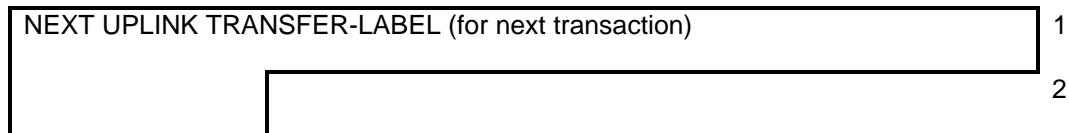

Figure 82b: <DR2> PDU

20.3.6 Downlink Response, type 3 (DR3)

This PDU shall be used on the downlink for negative acknowledge when an UT-label is not assigned and all blocks are not received correctly.

Direction: BS to MS

Content: PDU type = 0101₂
burst length
Uplink Transfer label (UT-label)
ack flag = 0₂
frame Sequence Number
RR control
reserved blocks
uplink carrier
downlink carrier
start of reservation
block flags (only 16 in the presiding block)
Short Subscriber Identity (SSI)

Allowed number of following blocks: 0 or 1.

NOTE: The possible following block contains of 24 block flags.

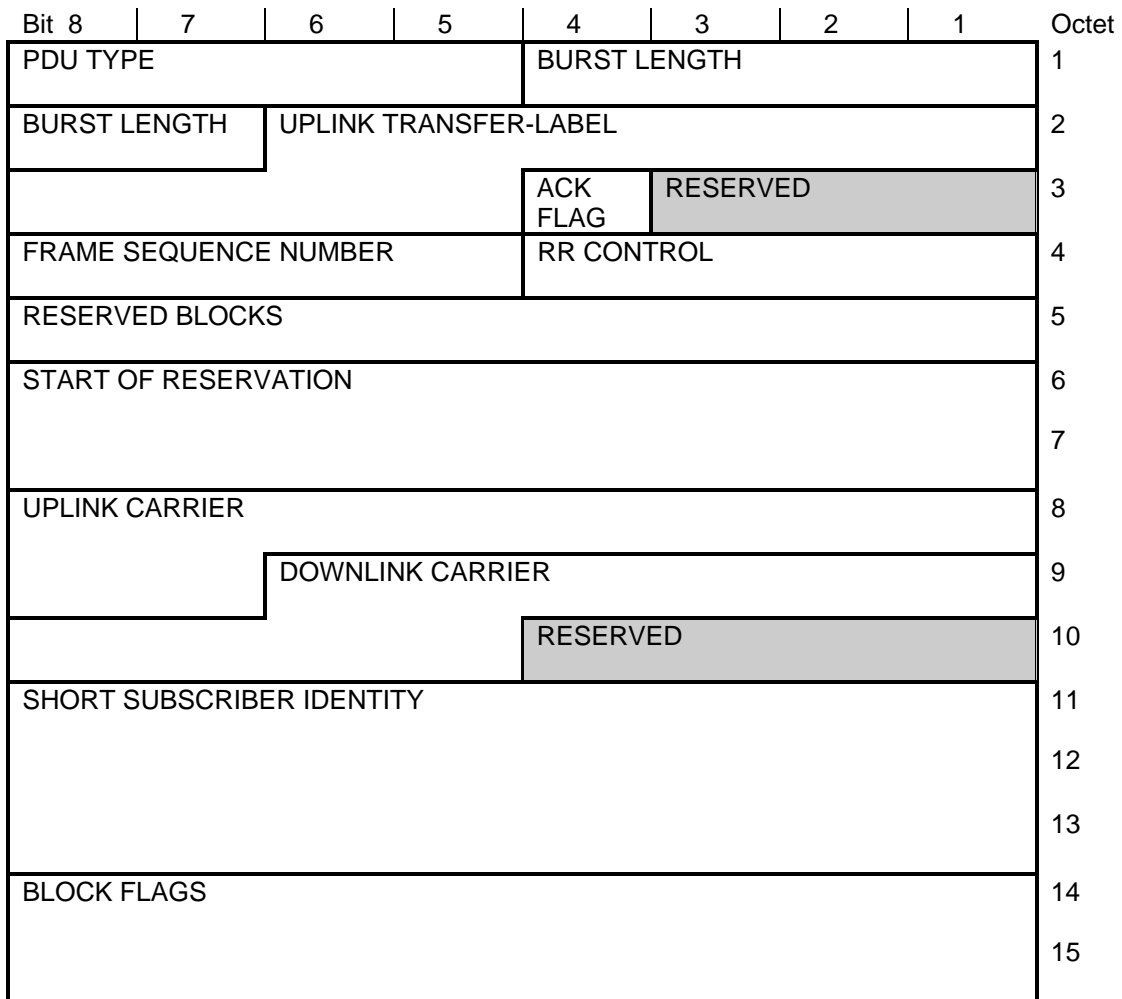

Figure 83: <DR3> PDU

20.3.7 Access Announce (AA)

This PDU (see figure 84) shall be used on the downlink to define uplink random access.

Direction: BS to MS

Content: PDU type =0110₂
 burst length =000001₂
 Random Access label (RA-label)
 uplink carrier
 common linearization time
 start of reservation
 access window definition

Allowed number of following blocks: 0.

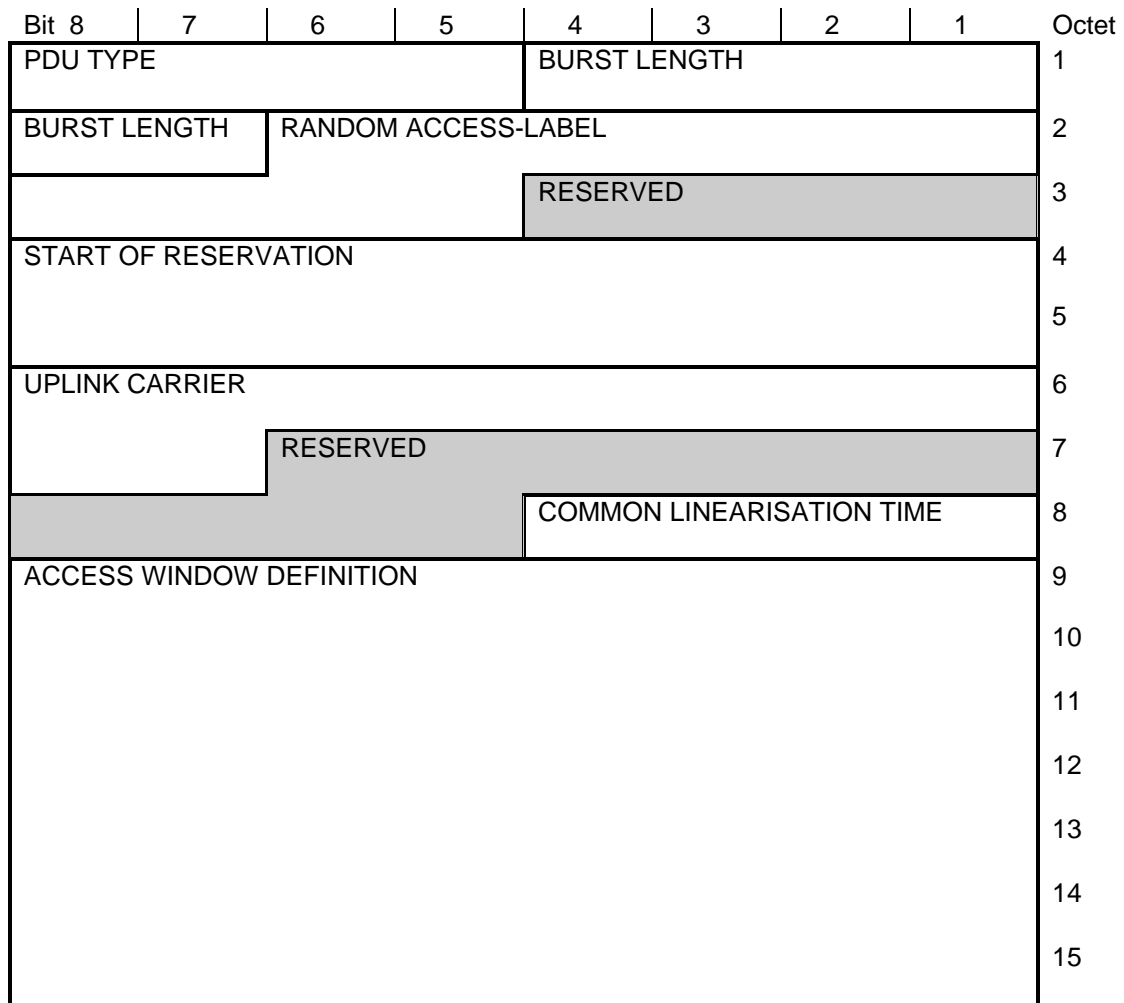

Figure 84: <AA> PDU

20.3.8 Downlink Data, type 1 (DD1)

This PDU (see figure 85) shall be used on the downlink for data transfer when no downlink transfer label is assigned. This PDU shall be used for the first PDU in a downlink transaction.

Direction: BS to MS

Content: PDU type = 0011₂
 burst length
 Downlink Transfer label (DT-label)
 fill flag
 ack flag
 last flag
 frame check sequence flag
 frame sequence number
 segment sequence number
 uplink carrier
 downlink carrier
 start of reservation
 auxiliary address
 Short Subscriber Identity (SSI)
 information parts (in the following blocks)

Allowed number of following blocks: 0 - N222.

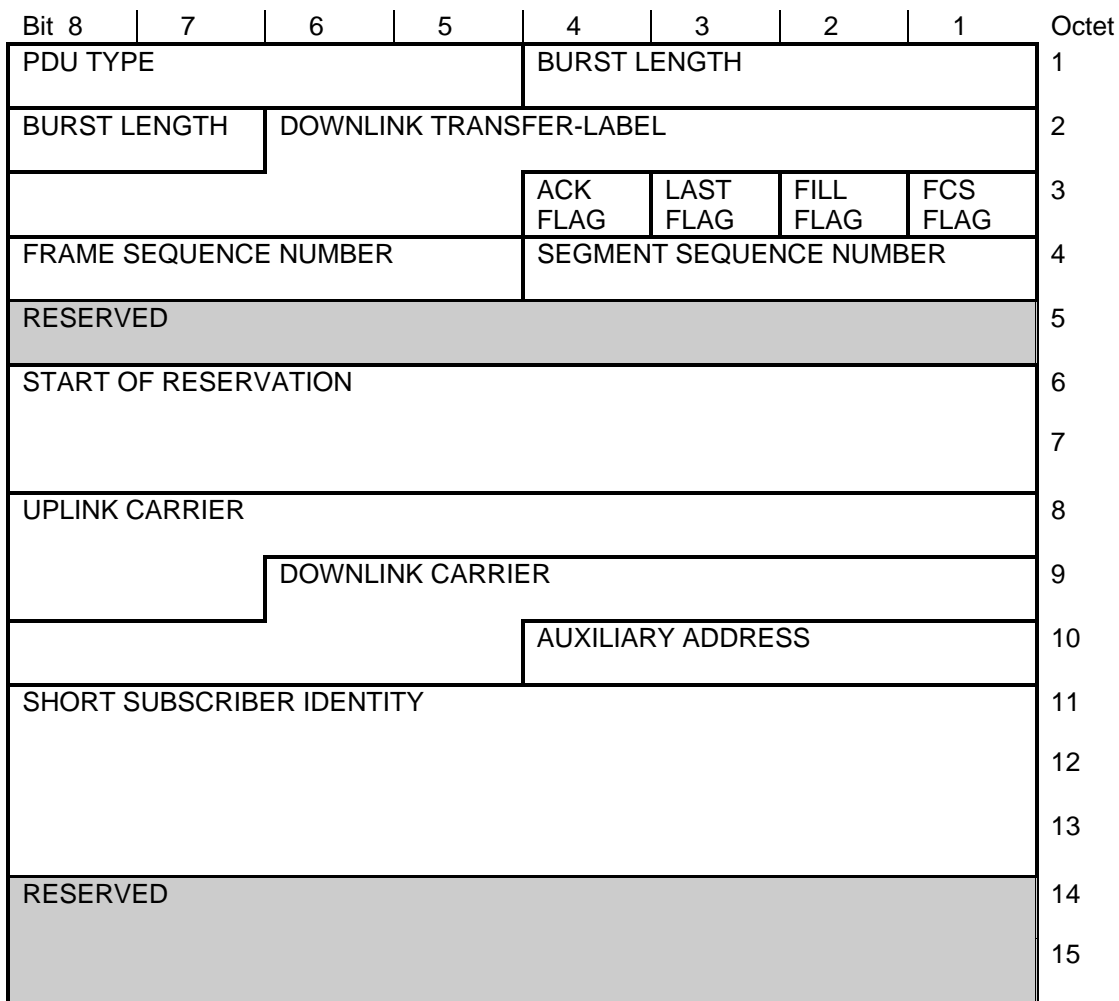

Figure 85: <DD1> PDU

20.3.9 Downlink Data, type 2 (DD2)

This PDU (see figure 86) shall be used on the downlink for data transfer when an downlink transfer label is assigned. This PDU shall be used for secondary PDUs in a downlink transaction.

Direction: BS to MS

Content: PDU type =0100₂
 burst length
 Downlink Transfer label (DT-label)
 fill flag
 ack flag
 last flag
 frame check sequence flag
 frame sequence number
 segment sequence number
 uplink carrier
 downlink carrier
 start of reservation
 block flags
 information parts (in the following blocks)

Allowed number of following blocks: 0 - N222.

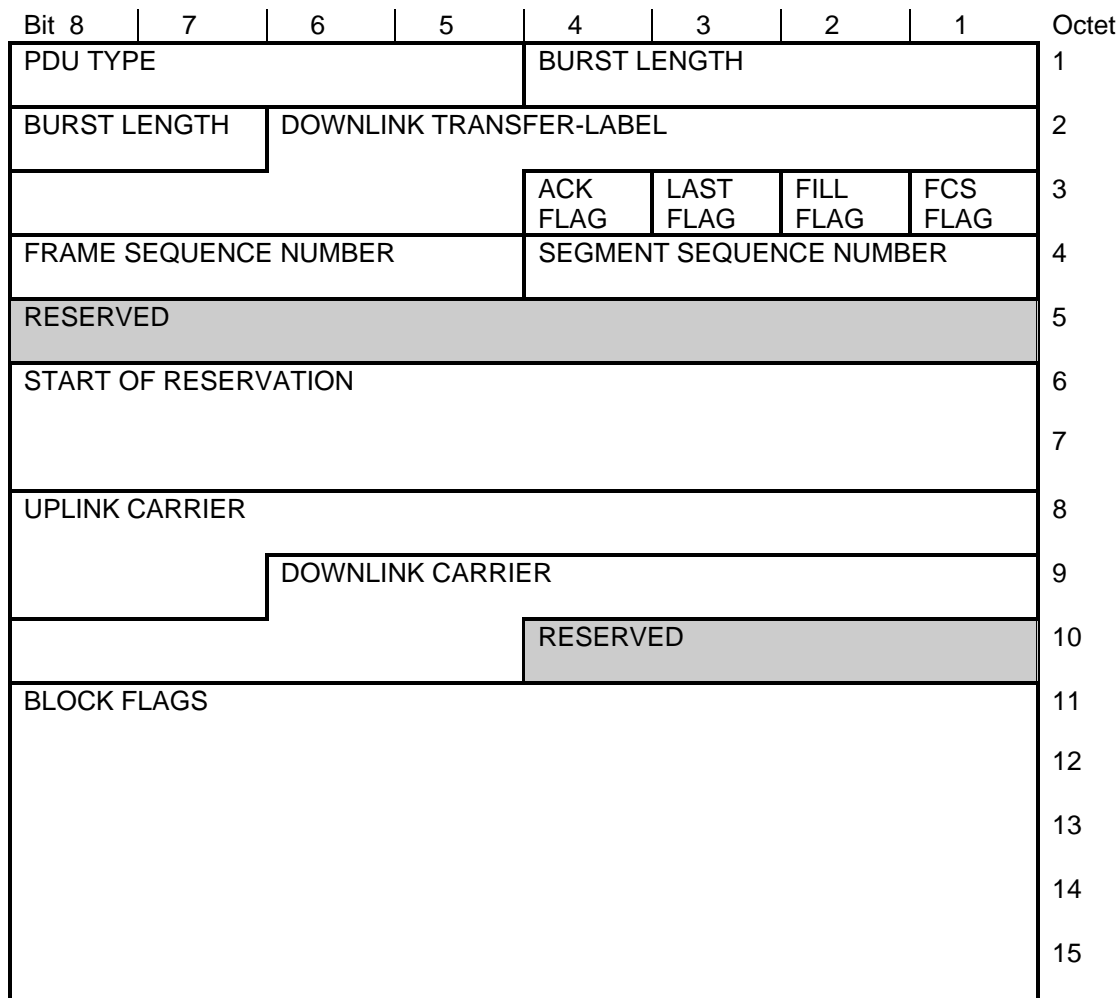

Figure 86: <DD2> PDU

20.3.10 Wake Up (WU)

This PDU (see figure 87) is used on the downlink for battery saving. This PDU defines the time a low duty MS shall stay in STANDBY state.

Direction: BS to MS

Content: PDU type = 0111₂
 burst length
 Wake Up label (WU-label)
 wake interval parameters
 traffic list

Allowed number of following blocks: 0 - N222.

NOTE: In case of following blocks these blocks contain traffic list elements.

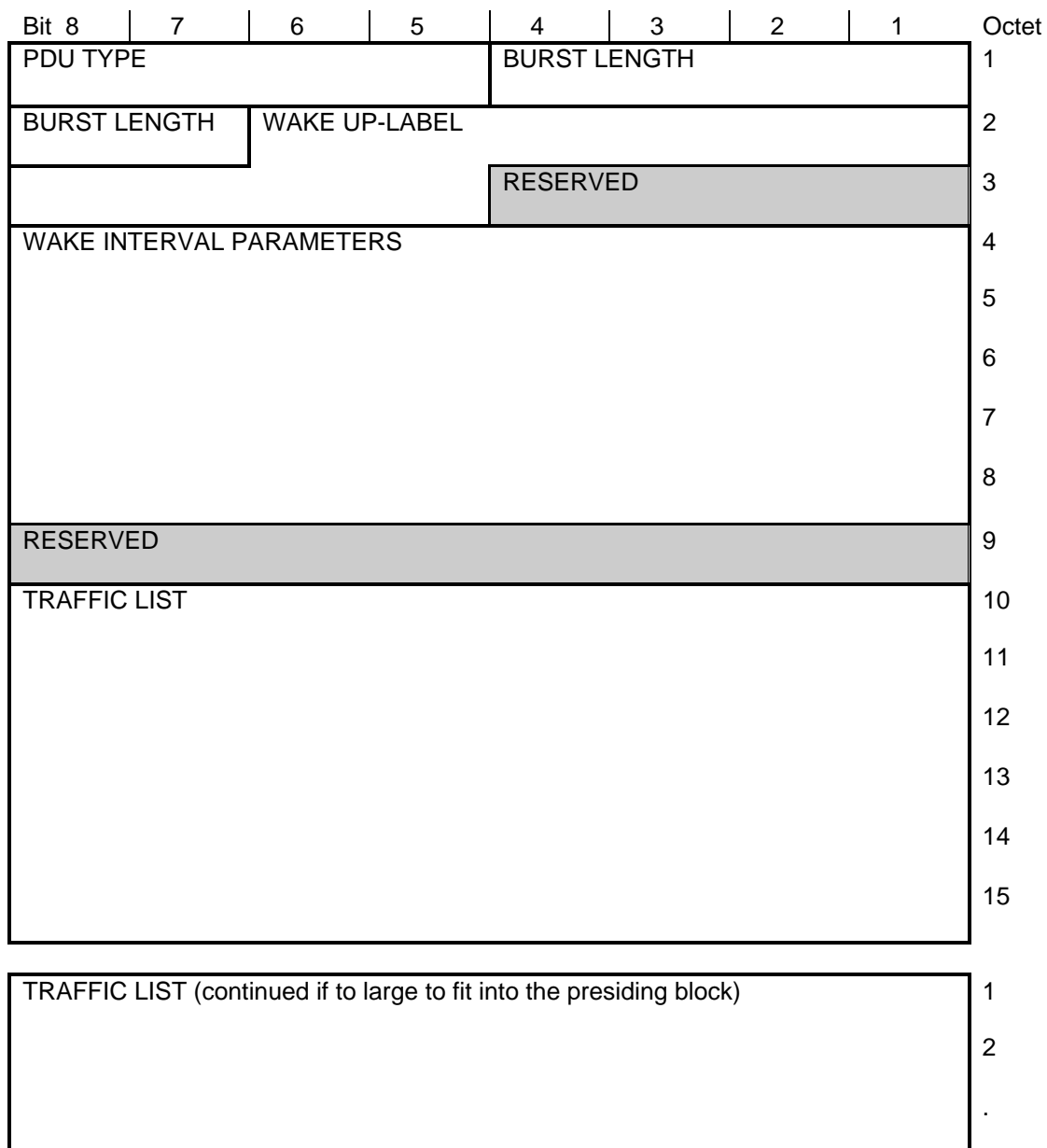

Figure 87: <WU> PDU

20.3.11 Access Parameters (AP)

This PDU (see figure 88) shall be used on the downlink to assign random access-labels and wake up-labels and for system information useful for random access.

Direction: BS to MS

Content: PDU type = 1000_2
 burst length = 000001_2
 BRoadcast label (BR-label)
 assign element
 access parameters

Allowed number of following blocks: 0.

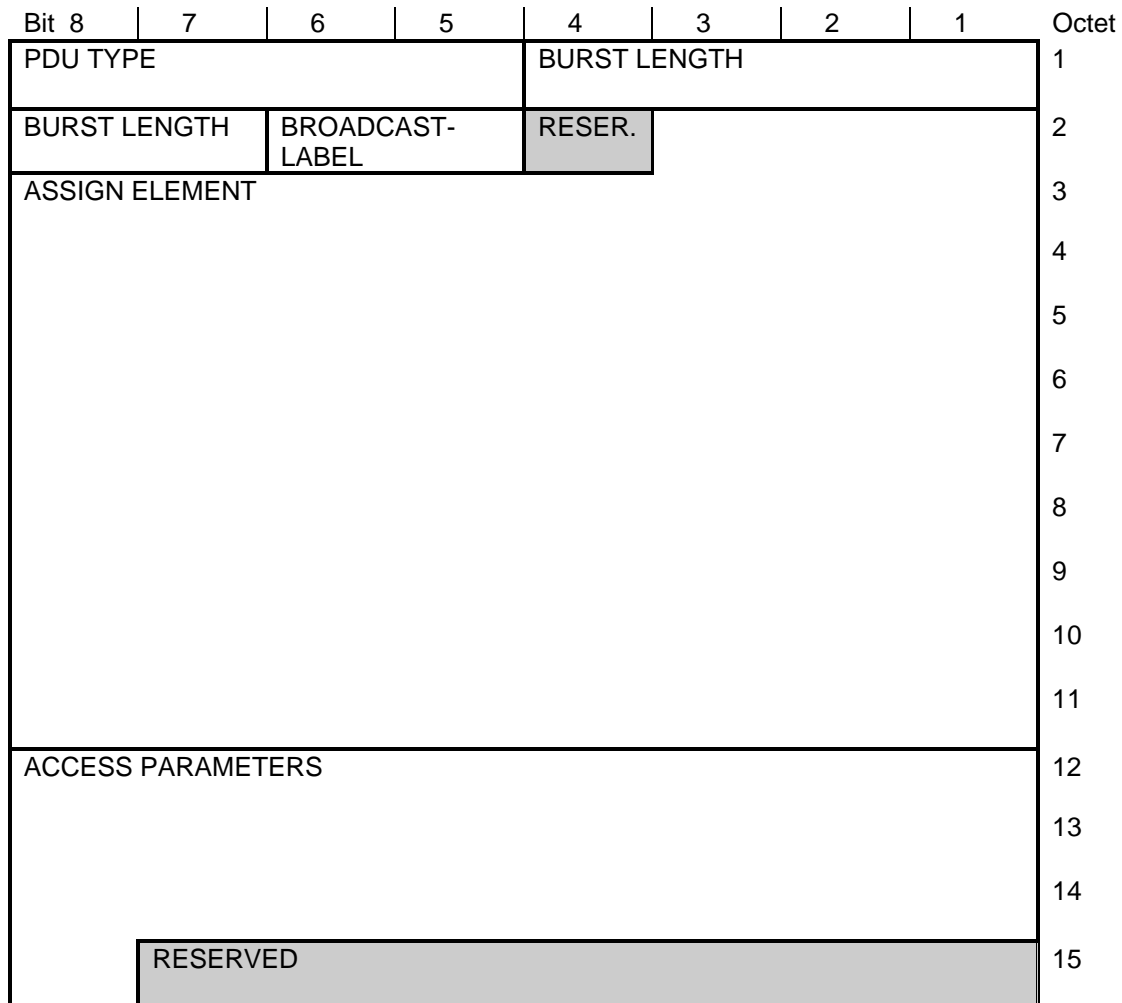

Figure 88: <AP> PDU

20.3.12 System INformation, type 2 (SIN2)

This PDU (see figure 89) shall be used on the downlink for broadcast of system information.

Direction: BS to MS

Content: PDU type = 1001₂
 burst length
 BRoadcast label (BR-label)
 fill flag
 system information type 2

Allowed number of following blocks: 0 - N222.

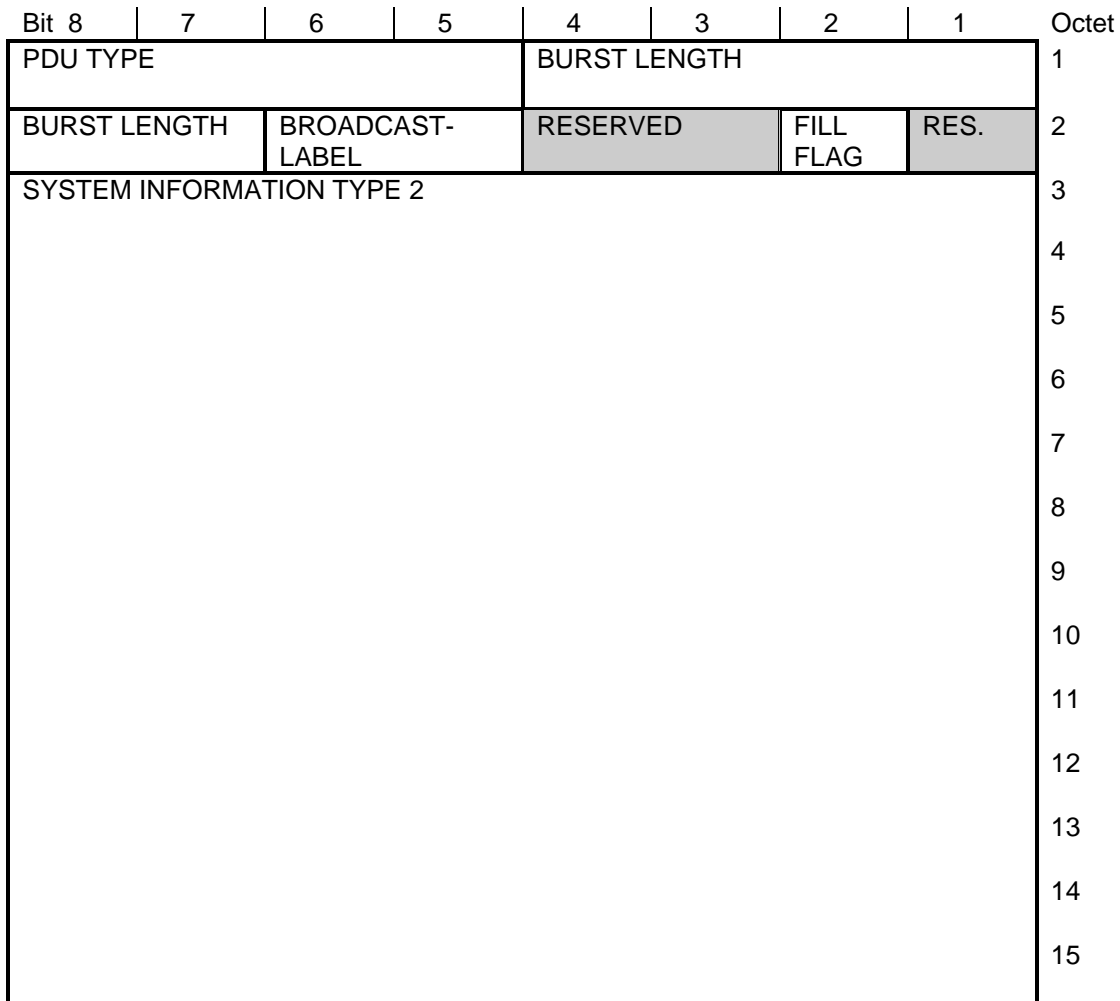

Figure 89: <SIN2> PDU

20.3.13 System INformation, type 1 (SIN1)

This PDU (see figure 90) shall be used on the downlink for broadcast of system information and shall be carried in the master burst. The information in this PDU shall be unscrambled.

Direction: BS to all MS

Content: System information type 1

Allowed number of following blocks: 0.

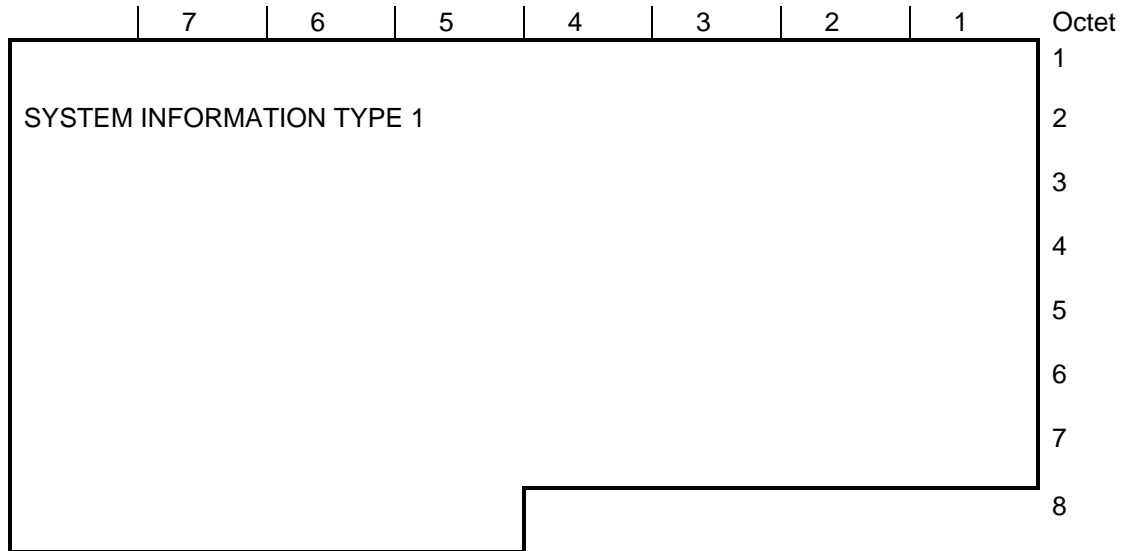

Figure 90: <SIN1> PDU

20.4 Elements in the PDUs

The elements used in the PDUs are described here. They are placed in alphabetic order. Within an element the fields are described in alphabetic order.

Unless otherwise stated, all fields shall be coded according to the natural binary code. The resulting value shall be arranged with most significant bit (msb) in the highest numbered bit position. These values are listed using decimal notation (e.g. 1111 = decimal 15).

When a field spans more than one octet, the order of bit values within each octet progressively decreases as the octet number increases. The lowest bit number associated with the field represents the lowest order value.

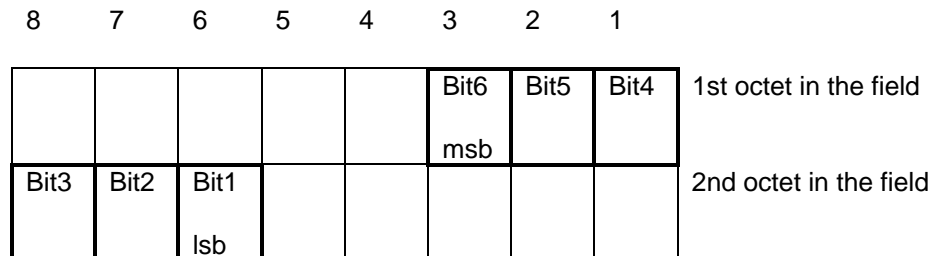

Figure 91: Field mapping

20.4.1 Access parameters element

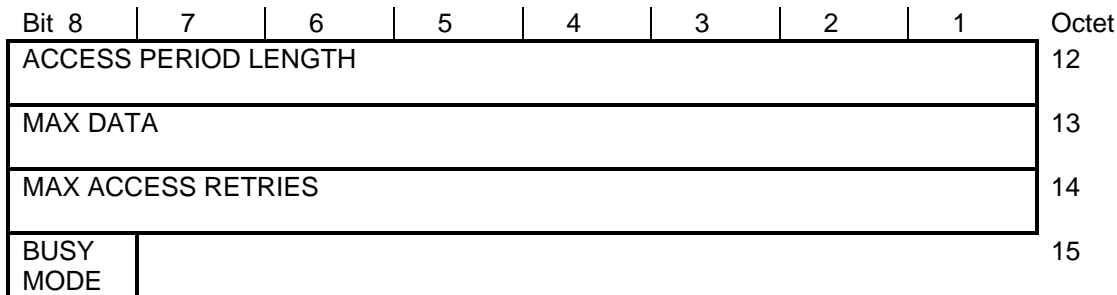

Figure 92: Access parameters element

20.4.1.1 Access period length field

This field shall define the length of one Access period. The value shall be multiplied by 8 to get the length in symbols.

Size: 8 bits.

Allowed values:

1-255 (0,44 ms to 113,3 ms).

20.4.1.2 Busy flag mode field

This field defines if the Busy Flag is in use on the downlink or not.

Size: 1 bit.

Allowed values:

0 = NOT USED;

1 = USED.

20.4.1.3 Max access retries field

This field defines the maximum number of access retries a MS is allowed.

Size: 8 bits.

Allowed values:

0 - 255 the question of a lower limit on the maximum permissible value will be studied later.

20.4.1.4 Max data field

This field defines the maximum size of a burst that a MS is allowed to start transmit in a access period.

Size: 8 bits.

Allowed values:

1 - (N222 + 1).

20.4.2 Access window definition

This element (see figure 93) defines the access periods.

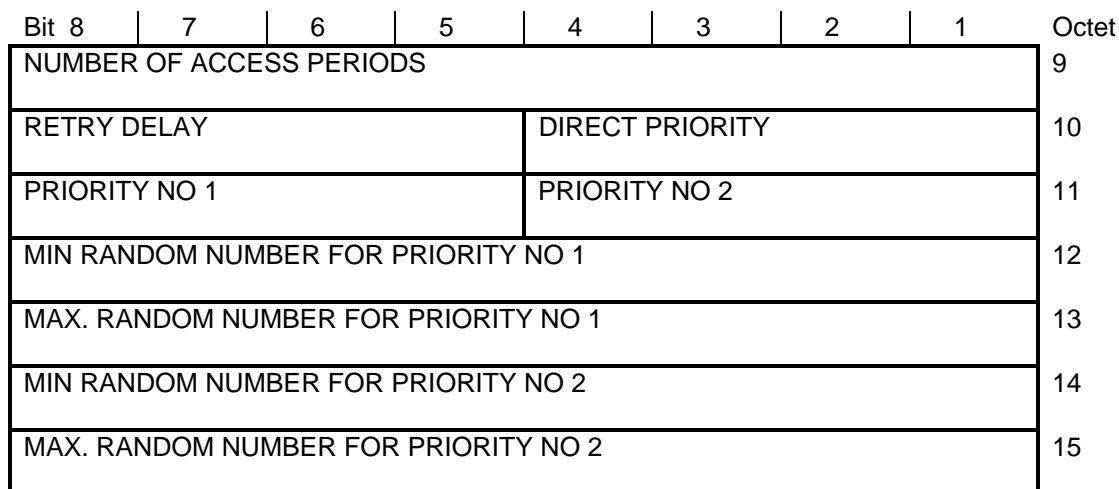

Figure 93: Access window definition element

20.4.2.1 Direct priority field

The lowest priority that shall be allowed to do direct access during this access window. See figure 94.

Size: 4 bits.

Allowed values:

0 - 15.

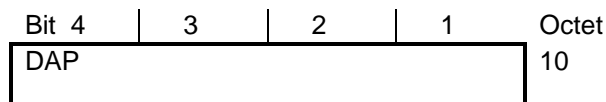

Figure 94: DAP field

20.4.2.2 Max. random number for priority no x (MAXRNx)

The maximum value for the uniform random selection of an access period (see figure 95).

NOTE: This value can be higher than NAP (see subclause 20.4.2.4).

Size: 8 bits.

Allowed values:

1 - 255.

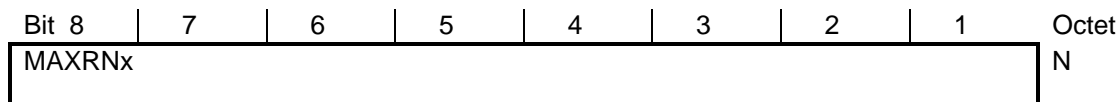

Figure 95: MAXRNx field

20.4.2.3 Min random number for priority no x (MINRNx)

The minimum value for the uniform random selection of an access period (see figure 96).

Size: 8 bits.

Allowed values:

1 - 255.

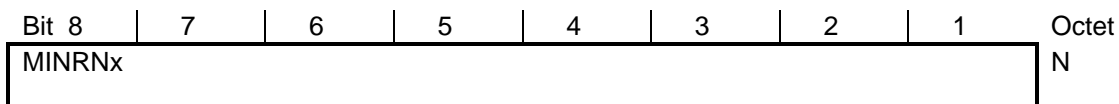

Figure 96: MINRNx field

20.4.2.4 Number of Access Periods field (NAP)

The number of access periods in the defined access window. This number shall be the same for all priorities (see figure 97).

Size: 8 bits.

Allowed values:

1 - 255.

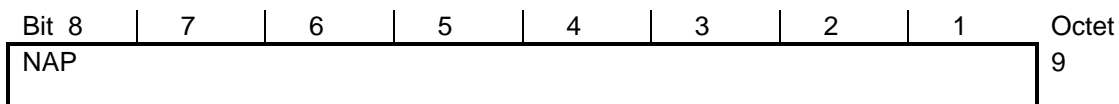

Figure 97: NAP field

20.4.2.5 Priority no x field.

The priority which the corresponding min and max. random numbers belong to (see figure 98).

Size: 4 bits.

Allowed values:

0 - 15.

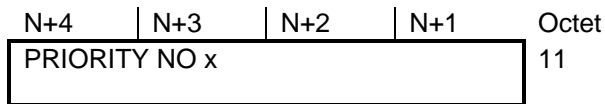

Figure 98: Priority no x field

20.4.2.6 Retry Delay field (RD)

How many PDUs of type <AA> to wait for, before retrying the random access (see figure 99).

Size: 4 bits.

Allowed values:

0 - 15.

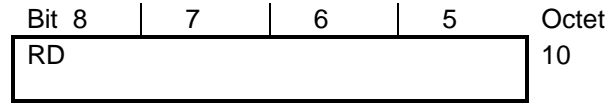

Figure 99: RD field

20.4.3 Ack flag

In the cases of acknowledged transfer this flag shall be set to 1. It shall also be set to 1 if the response PDU is an acknowledgement (see figure 100).

Size: 1 bit.

Allowed values:

0 = No acknowledge;

1 = Acknowledge.

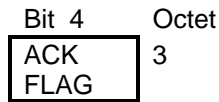

Figure 100: Ack flag

20.4.4 Assign element

This element shall be used to allocate one event label on a specific downlink (see figure 101).

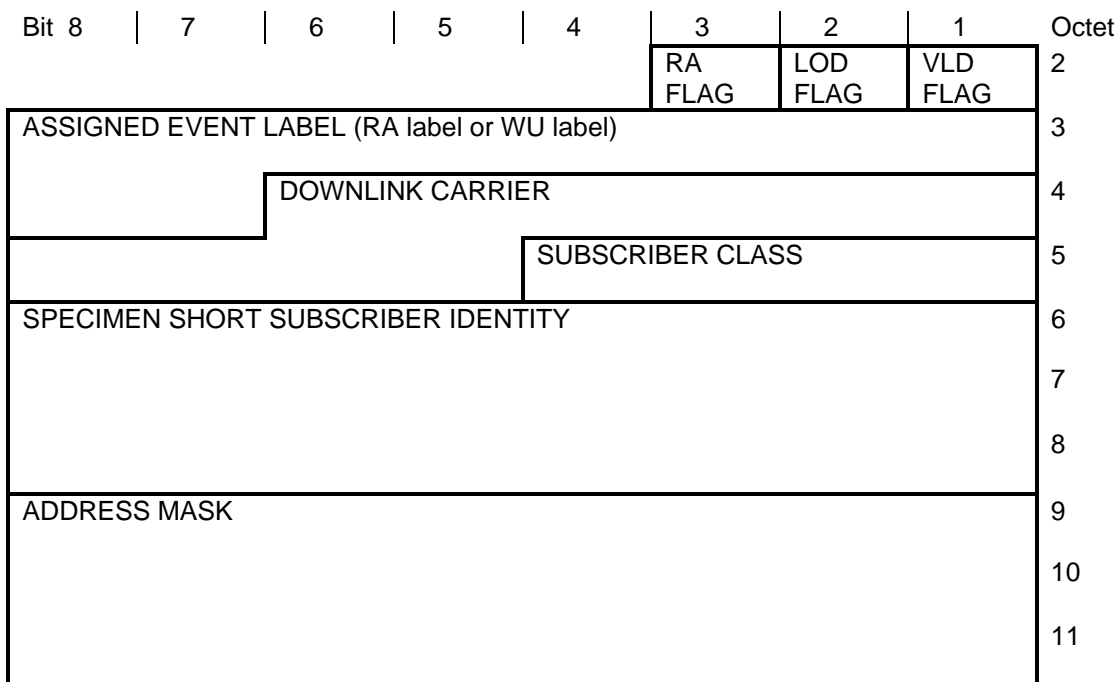

Figure 101: Assign element

20.4.4.1 Address MASK field (AMASK)

This field shall be used together with the SSI and the SUBSCRIBER CLASS to define the local group for the event label.

Size: 24 bits.

Allowed values:

0000 0000 0000 0000 0000 0000₂ to 1111 1111 1111 1111 1111 1111₂.

NOTE: 1111 1111 1111 1111 1111 1111₂ means that all bits in the SSI are masked and all MSs are addressed.

0000 0000 0000 0000 0000 0000₂ means that no bits in the SSI are masked and only the unique SSI is addressed.

20.4.4.2 Assigned event label field

The event label that shall be assigned to a local group. The label can be a RA-label or a WU label.

20.4.4.3 Low Duty FLAG (LOD FLAG)

The LOD flag defines whether the assigned event label is a wake up label valid for mobiles in low duty mode.

Size: 1 bit.

Allowed values:

0 = No assignment of Wake Up label for LOD mobiles;

1 = Assignment of Wake Up label for LOD mobiles.

20.4.4.4 Random Access label FLAG (RA FLAG)

The RA flag defines whether the assigned event label is a random access label.

Size: 1 bit.

Allowed values:

0 = No assignment of Random access label;

1 = Assignment of Random access label.

20.4.4.5 Subscriber CLass field (SCL)

This field shall be used together with the SSI and the AMASK to define the MS address for the event label grouping.

Size: 4 bits.

Allowed values:

0 - 15.

20.4.4.6 Specimen short subscriber identity field

The coding shall be the same as in subclause 20.4.23.

This field shall be used together with the AMASK and the SCL to define the MS address for the event label grouping.

20.4.4.7 Very Low Duty FLAG (VLD FLAG)

The VLD flag defines if the assigned event label is a wake up label valid for mobiles in very low duty mode.

Size: 1 bit.

Allowed values:

0 = No assignment of Wake Up label for VLD mobiles;

1 = Assignment of Wake Up label for VLD mobiles.

20.4.5 Auxiliary address

The auxiliary address shall contain the address type and a SAPI address (see figure 102).

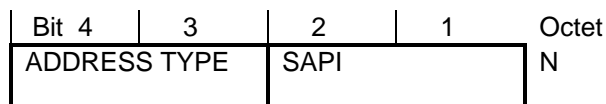

NOTE: This element appears in different positions.

Figure 102: Auxiliary address

20.4.5.1 Address type element

Size: 2 bits.

Allowed values:

- 0 = SSI;
- 1 = Un-exchanged SSI;
- 2 = TMI;
- 3 = RESERVED.

20.4.5.2 SAPI element

Size: 2 bits.

Allowed values:

0 - 3.

20.4.6 Block flags

This field (see figure 103) is a block bit map for data transmissions and responses. This labels each following block in a corresponding transaction. If the block flag is set the corresponding following block shall be included in this burst, or the corresponding following block shall be received by the other end.

Size: N222 bits.

Allowed values:

For each bit:

If a response:

- 0 = corresponding following block is not received correctly;
- 1 = corresponding following block is received correctly;

If not a response:

- 0 = corresponding following block is not included in this burst;
- 1 = corresponding following block is included in this burst.

Bit 8	7	6	5	4	3	2	1	Octet
Block no 1	Block no 2						Block no 8	N+1
Block no 9							Block no 16	N+2
Block no 17							Block no 24	N+3
Block no 25							Block no 32	N+4
Block no 33						Block no 39	Block no 40	N+5

NOTE: For the <DR3> PDU only the 16 first block flags is placed in the presiding block if there is an error in a following block of higher number than 16 a following block shall be added to the <DR3> PDU.

Figure 103: Block flags

20.4.7 Burst length field

For all PDUs the burst length value shall be the number of blocks included in this PDU. The presiding block shall be included (see figure 104).

Size: 6 bits.

Allowed values:

$$1 - (N222 + 1).$$

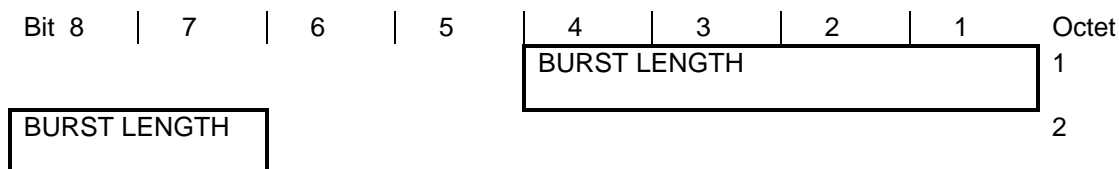

Figure 104: Burst length field

20.4.8 Broadcast label

The broadcast label shall be a number that labels a <SIN2> PDU and a <AP> PDU. The function is a version identifier (see figure 105).

Size: 2 bits.

Allowed values:

$$0 - 3.$$

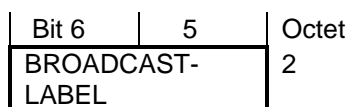

Figure 105: Broadcast label

20.4.9 Common linearization time

This parameter is the duration of time reserved for common linearization. This time starts at the START_RESERVATION time. The first access period for the defined access window starts after the common linearization time (see figure 106).

The duration is (8 * the value of this field) symbols.

Size: 4 bits.

Allowed values:

$$0 - 9 \quad (0 - 4 \text{ ms}).$$

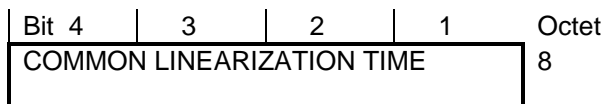

Figure 106: Common linearization time field

20.4.10 Downlink carrier

This shall be the downlink carrier on which the possible response for the reserved burst shall be transmitted (see figure 107).

Size: 10 bits.

Allowed values:

0 - 1 023.

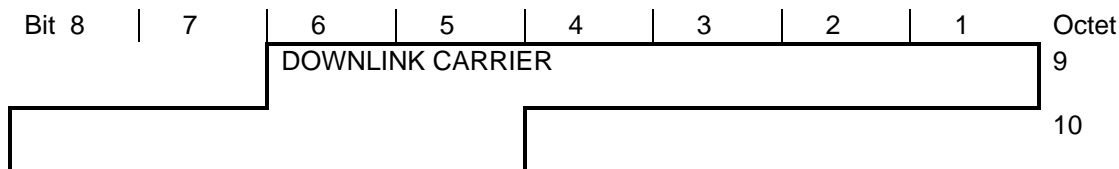

Figure 107: Downlink carrier

20.4.11 Downlink transfer label

The downlink transfer label shall be a number that is assigned for a whole downlink transaction. It is assigned by the BS in a <DD1> PDU (see figure 108).

Size: 10 bits.

Allowed values:

0 - 1 023.

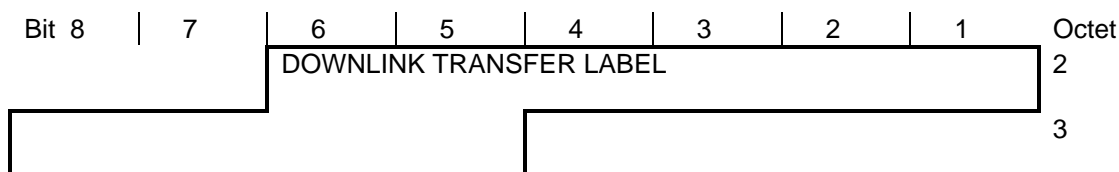

Figure 108: Downlink transfer label

20.4.12 Fill flag

The fill flag (see figure 109) shall be set if there are filling octets in the last block in a burst.

The filling octets shall be placed at the beginning of the block. The last filling octet shall have a special defined pattern 11000011₂ (pattern 1) and the other filling octets shall have another defined pattern 00111100₂ (pattern 2).

NOTE: There are no restrictions on the pattern of user data.

Size: 1 bit.

Allowed values:

0 = no filling octets in the last block;

1 = filling octets in the last block.

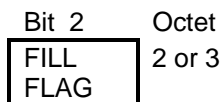

Figure 109: Fill flag

20.4.13 FCS flag

The FCS flag (see figure 110) shall be set if the optional frame check sequence is used for this frame.

Size: 1 bit.

Allowed values:

- 0 = no FCS for this LLC frame;
- 1 = FCS is used for this LLC frame.

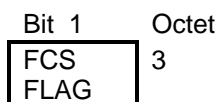

Figure 110: FCS flag

20.4.14 Frame Sequence Number (FSN)

The frame sequence number (see figure 111) shall contain a frame number element and a reset flag element.

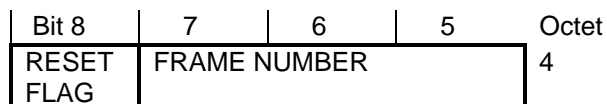

Figure 111: FSN

20.4.14.1 Frame Number element (FN)

This element shall carry the V(S) or V(R) numbers from the LLC.

Size: 3 bits.

Allowed values:

- 0 - 7.

20.4.14.2 Reset flag element

This flag shall be set when the frame number is restarted.

Size: 1 bit.

Allowed values:

- 0 = No reset of frame number;
- 1 = Reset of frame number.

20.4.15 Last flag element

This flag (see figure 112) shall be set for a burst that includes the last fragment of a LLC frame.

Size: 1 bit.

Allowed values:

0 = Not last fragment;

1 = Last fragment.

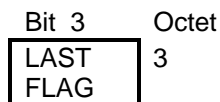

Figure 112: Last flag

20.4.16 More data

The more data field (see figure 113) shall be set to the number of blocks that the MS wants to get reserved uplink capacity for. The number of blocks requested shall include one presiding block. The PDUs that includes this field are the <UD1> PDU and the <UD2> PDU. If the parameter is 0 there is no more data.

Size: 8 bits.

Allowed values:

0 - 255.

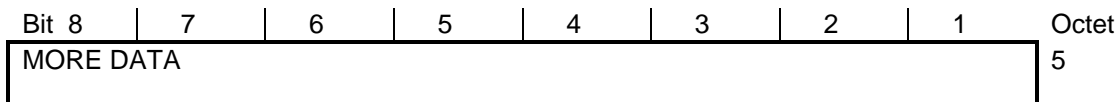

Figure 113: More data

20.4.17 PDU type field

This field (see figure 114) defines the structure of the PDU.

Size: 4 bits.

Allowed values:

Uplink:

2 = UR Uplink Response to downlink data;

3 = UD1 Uplink data type 1;

4 = UD2 Uplink data type 2;

Downlink:

1 = DR1 Downlink Response to uplink data type 1;

2 = DR2 Downlink Response to uplink data type 2;

3 = DD1 Downlink data type 1;

4 = DD2 Downlink data type 2;

- 5 = DR3 Downlink Response to uplink data type 3;
- 6 = AA Access announce;
- 7 = WU Wake up information for Low duty MS;
- 8 = AP Assignment of event label and access parameters;
- 9 = SIN2 System information type 2;
- 10 = SIN1 System information type 1.

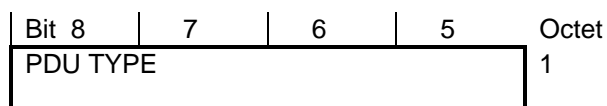

Figure 114: PDU type field

20.4.18 Priority field

The ranked priority that is associated with this uplink transaction (see figure 115).

Size: 4 bits.

Allowed values:

0 - 15.

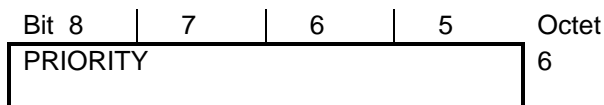

Figure 115: PRIORITY field

20.4.19 Reserved blocks

The number of reserved blocks on the uplink, including the presiding block (see figure 116).

Size: 8 bits.

Allowed values:

0 - (N222 + 1).

NOTE: Value 0 is the same as no reservation.

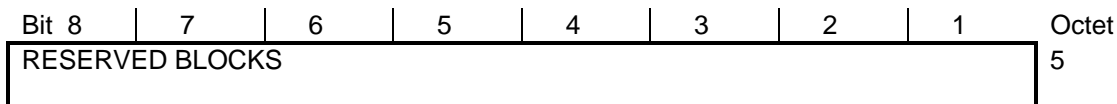

Figure 116: Reserved blocks

20.4.20 Segment Sequence Number (SSN)

The SSN is used for numbering of SDU segments (see figure 117).

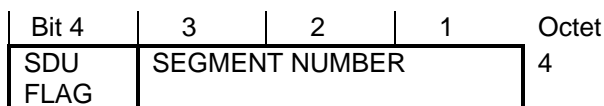

Figure 117: SSN

20.4.20.1 SDU flag element (SDUf)

This flag is set for the first segment of a SDU.

Size: 1 bit.

Allowed values:

0 = Not the first segment for this SDU;

1 = The first segment for this SDU.

20.4.20.2 Segment Number element (SN)

This element shall contain the segment number for a SDU.

Size: 3 bits.

Allowed values:

0 - 7.

20.4.21 Random access label

The random access label (see figure 118) shall be used to label the <AA> PDUs. It is assigned by the BS in an <AP> PDU to a local group mobiles.

Size: 10 bits.

Allowed values:

0 - 1 023.

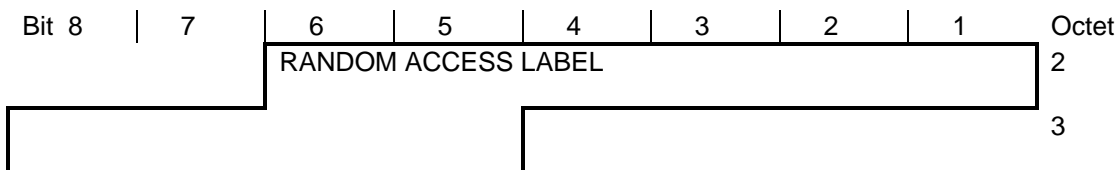

Figure 118: Random access label

20.4.22 RR Control (RRC)

The RRC field (see figure 119) shall be used to carry information for the RR frame in the LLC.

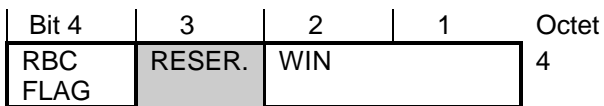

Figure 119: RRC

20.4.22.1 Receiver Busy Check flag (RBCf)

This flag shall be set if the receiving side cannot receive more LLC frames.

Size: 1 bit.

Allowed values:

0 = Receiving side accepts LLC frames;

1 = Receiving side is busy.

20.4.22.2 WINDOW size (WIN)

This element shall contain the window size which the LLC uses.

Size: 2 bits.

Allowed values:

1 - 3.

20.4.23 Short Subscriber Identity (SSI)

This is the network specific part of the TSI (see figure 120). It could be an ISSI (from ITSI), an ASSI (from ATSI) or a GSSI (from GTSI). For more details refer to clause 22.

Size: 24 bits.

Allowed values:

1 - 16 777 215.

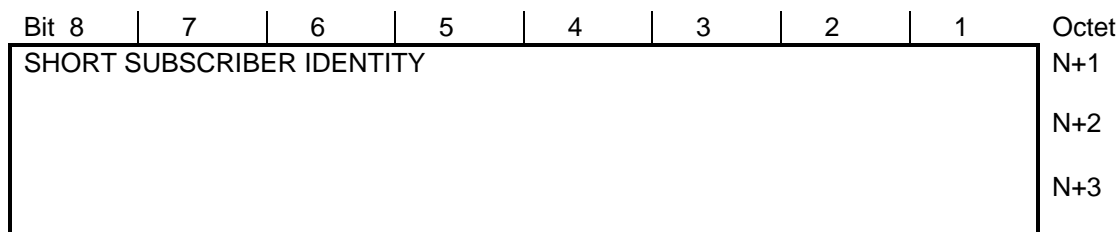

NOTE: This element appears in different positions.

Figure 120: SSI

20.4.24 Start of reservation

This element (see figure 121) defines the offset between the last symbol of the downlink sub-burst including this element and the first symbol of the reserved uplink sub-burst. e.g. the offset between a <DR1> PDU and an <UD2> PDU.

The offset is (8 * the value of this field) symbols.

The value 0 of this field has a special meaning i.e. the MS shall start the transmission of the reserved uplink burst within the maximum turnaround time.

Size: 16 bits.

Allowed values:

0 - 65 535.

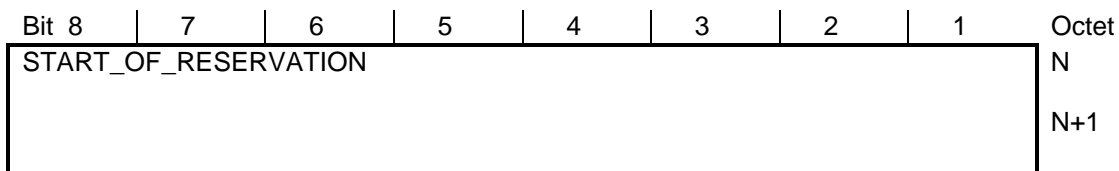

NOTE: This element can appear in different positions.

Figure 121: Start of reservation

20.4.25 System information type 1

The structure of this field is defined by L3 (see clause 18).

20.4.26 System information type 2

The structure of this field is defined by L3 (see clause 18).

20.4.27 Traffic list

This element (see figure 122) includes all addresses to MS that shall enter operating state to receive a downlink data message.

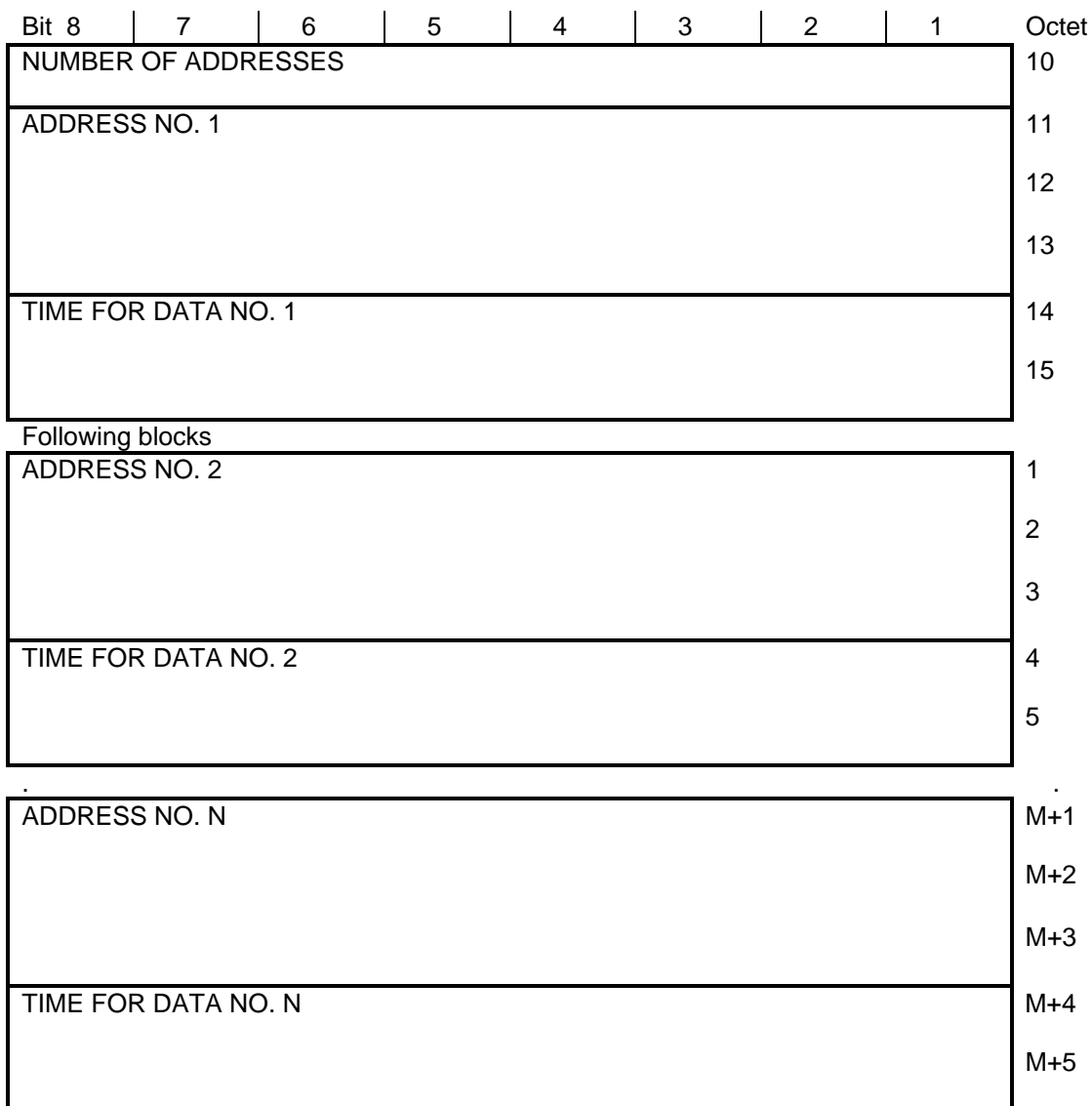

Figure 122: Traffic list element

20.4.27.1 Address number x field (Ax)

The address (SSI) for a MS or group that shall enter operating mode to receive a downlink data message.

Size: 24 bits.

Allowed values:

0 - 16 777 215.

20.4.27.2 NO of Addresses field (NOA)

The number of addresses that follows.

Size: 8 bits..

Allowed values:

0 - 121.

20.4.27.3 Time for Data number x field (TDx)

The time when the MS, corresponding to address x, shall be in operating state. The time starts (8 * the value of this field) symbols after the last bit of this burst.

Size: 16 bits.

Allowed values:

1 - 65 535.

20.4.28 Uplink carrier

This shall be the uplink carrier number on which the burst is reserved (see figure 123).

Size: 10 bits.

Allowed values:

0 - 1 023.

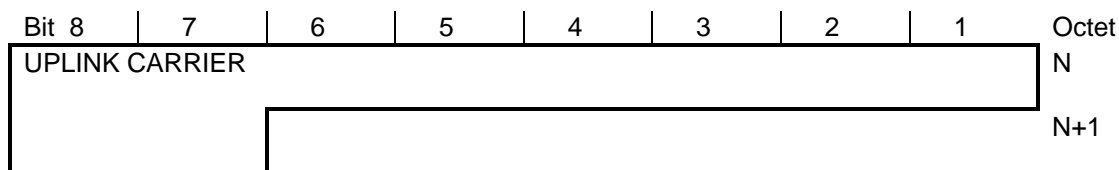

NOTE: This element can appear in different positions.

Figure 123: Uplink carrier

20.4.29 Uplink transfer label

The uplink transfer label (see figure 124) is a number that shall be assigned for a whole uplink transaction. It is assigned by the BS in a <DR1> PDU.

Size: 10 bits.

Allowed values:

0 - 1 023.

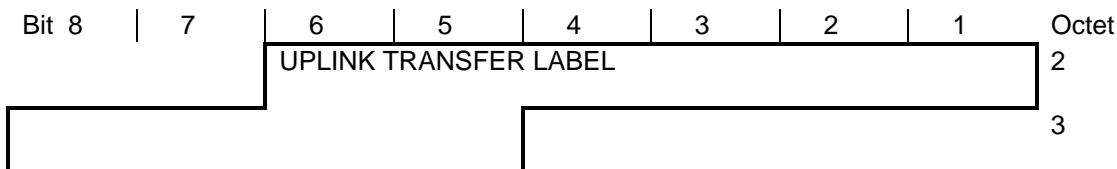

Figure 124: Uplink transfer label

20.4.30 Wake interval parameters

This element (see figure 125) defines the time when low duty MS shall be in operating state.

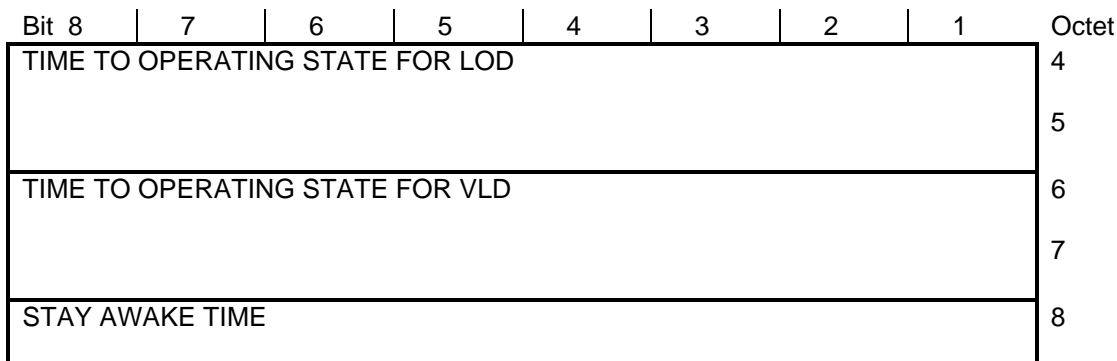

Figure 125: Wake interval parameters element

20.4.30.1 Stay Awake Time field (SAT)

This field defines how long a LOD or VLD MS shall stay in operating state after receiving or transmitting a data message.

The time is (100 * the value of this field) ms after the last symbol of this burst.

Size: 8 bits.

Allowed values:

0 - 63 (0 - 6 300 ms).

20.4.30.2 Time to operating state for LOD field (NT_LOD)

This field define the time when a LOD MS shall enter operating state.

The time is (8 * the value of this field) symbols after the last symbol of this burst.

Size: 16 bits.

Allowed values:

0 - 65 535 (0 - 29,2 s).

20.4.30.3 Time to operating state for VLD field (NT_VLD)

This field defines the time when a VLD MS shall enter operating state.

The time is (8 * the value of this field) symbols after the last bit of this burst.

Size: 16 bits.

Allowed values:

0 - 65 535 (0 - 29,1 s).

20.4.31 Wake up label

The wake up label (see figure 126) is a number that shall be used to label <WU> PDUs. It is assigned by the BS with an <AP> PDU to a local group.

Size: 10 bits.

Allowed values:

0 - 1 023.

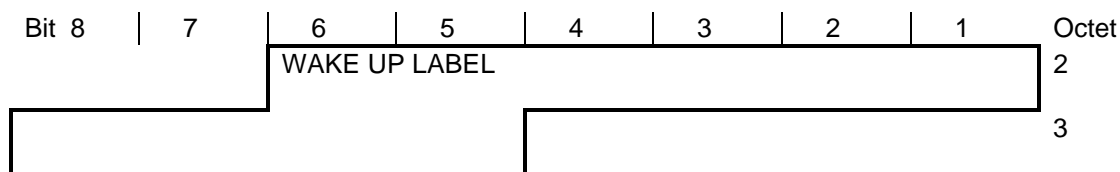

Figure 126: Wake up label

21 Layer 2: Logical Link Control (LLC) protocol

21.1 Scope

This clause describes the LLC sub-layer framing functions for the PDO air interface. These sub-layer functions are closely integrated with the MAC sub-layer and together the MAC and LLC form the air interface layer 2. The sub-layer interactions between MAC and LLC are described by direct reference to the protocol elements and no formal sub-layer boundary is defined between the LLC and MAC.

The procedures are divided into acknowledged and unacknowledged operation.

21.2 Overview of LLC functions

The LLC protocol is a layer 2 protocol for the PDO air interface. Each instance of protocol applies between one BS and either one MS or one group of MSs as defined in clause 19. A maximum of one instance of LLC protocol shall be used for each direction of data transfer between a given BS and a given MS, and all of the MS addresses shall use the same instance. If a MS wishes to establish a service to more than one BS, it shall establish separate instances of LLC protocol with each BS.

The LLC protocol provides three different services as described in clause 19. The address shall correspond to the service used: an individual address (either ISSI, ASSI or TMI) shall correspond to a point-to-point service, and a group address (GSSI) shall correspond to a point-to-multipoint service.

NOTE 1: It is the responsibility of the higher layer to supply a valid address and to invoke the appropriate service for each service request.

NOTE 2: Two separate instances of protocol may be required during handover, one for each BS.

As defined in clause 19, individually addressed transfers (either acknowledged or unacknowledged information transfer) may be invoked in either the uplink (MS to BS) or downlink (BS to MS) direction. Group addressed transfers (unacknowledged information transfer only) shall only be invoked in the downlink (BS to group of MS) direction.

NOTE 3: The LLC frame functions are only invoked as part of the addressed services provided by the TLA-SAP. The LLC sub-layer adds no functions to the services provided by the TLB-SAP and TLC-SAP.

These LLC sub-layer functions are described as a Link Access Protocol for TETRA (LAP.T) which provides both an unacknowledged and an acknowledged service. This protocol is unbalanced and a single instance of the protocol only provides a unidirectional data transmission service. This protocol can operate in either the uplink or the downlink direction and dual instances may be used to provide a bi-directional service.

Both the acknowledged service and the unacknowledged service provide the following functions:

- endpoint addressing;
- segmentation and sequencing;
- extended error protection (optional).

In addition, the acknowledged service provides the following function:

- flow control.

The data structures used by the LLC sub-layer are illustrated in figure 127 (reproduced from clause 22).

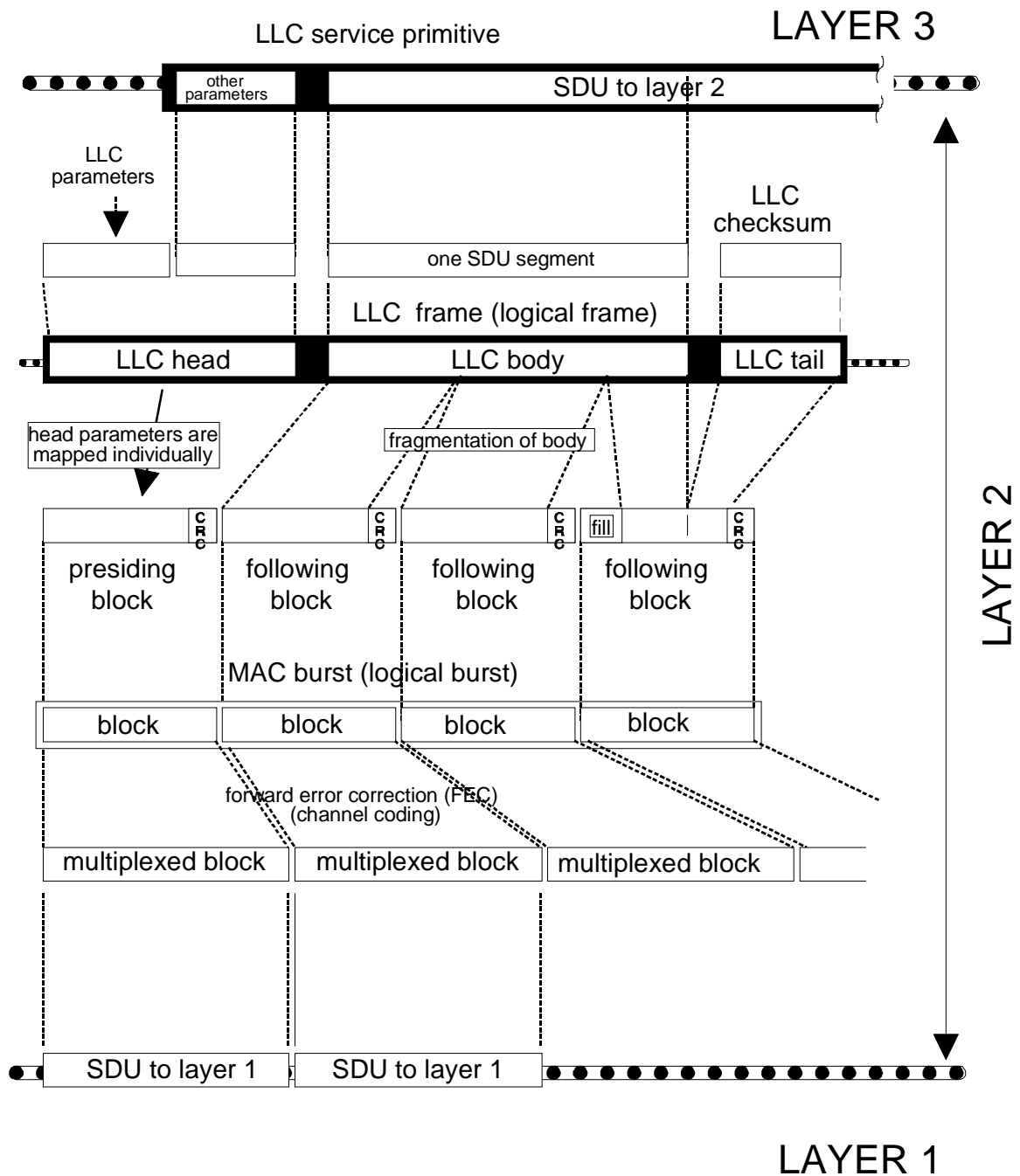

Figure 127: Layer 2 Data Structures

21.3 General LLC procedures

21.3.1 LAP.T

The LAP.T operates using virtual PDUs called LLC frames. Each LLC frame only exists as a logical grouping of elements. There is no physical PDU that corresponds to this logical group.

These LLC frame elements are supplied to the MAC sub-layer (and received from the MAC sub-layer) as a set of internal (LLC to MAC) parameters. These internal parameters then reappear as explicit elements in one or more MAC PDUs.

The following LLC procedures ignore this distinction between virtual and physical PDUs and only refers to LLC frames. A complete LLC frame is assumed to be present for all of these procedures and the management of the set of parameters to and from the MAC sub-layer are not defined in this ETS.

This link access protocol is a simplified version of the link access protocols used for line connections such as the ISDN link layer protocol, LAP.D clause 1. A simple protocol is used to avoid duplication of functions with the MAC sub-layer (because the MAC provides many of the normal LAP functions) and to minimise the total layer 2 protocol overheads.

The following frame types are used for acknowledged operation:

- AI-frame (Acknowledged Information);
- RR-frame (Receiver Ready).

The following frame types are used for unacknowledged operation:

- UI-frame (Unacknowledged Information).

21.3.2 LAP.T states

The following states are defined for LAP.T operation:

- State 0: UNCONNECTED;
- State 1: CONNECT_EXPECTED;
- State 2: CONNECT_PENDING;
- State 3: CONNECTED.

The starting state of a newly instanced LAP.T entity is the UNCONNECTED state.

Unacknowledged information transfer is allowed in any state. Acknowledged information transfer shall only be performed in the CONNECTED state or as part of the establishment or re-establishment procedure for acknowledged information transfer (see subclause 21.4.6).

21.3.3 LLC frame descriptions

21.3.3.1 AI-frame

The AI-frame shall be used to transfer sequentially numbered frames, that contain layer 3 information fields. The AI-frame shall only be used in acknowledged operation.

The AI-frame shall also be used to request a reset of the frame sequence numbers at the receiving LAP.T entity.

21.3.3.2 RR-frame

The RR-frame shall be used by a LAP.T entity to:

- a) confirm a reset of the frame sequence numbers;
- b) indicate it is ready to receive an AI-frame;
- c) acknowledge previously received AI-frames up to and including $N(R)-1$, as defined in subclause 21.4.8.2;
- d) to request a reset of the frame sequence numbers.

21.3.3.3 UI-frame

The UI-frame shall be used to transfer unacknowledged frames that contain layer 3 information fields. A UI-frame shall only be used if requested by the layer 3 entity, and UI-frames may be lost without notification to the layer 3 entity if a acknowledged link exception occurs during the transmission of the frame.

21.3.4 LLC frame elements

This subclause lists the elements used in each LLC frame (see table 133). These elements are passed to the MAC as parameters and reappear as explicit elements in one or more MAC PDU. For the details of the elements see clause 20.

Table 133: LLC frame elements

Element Name	AI frame	UI frame	RR frame
Main Address	M	M	M
Auxiliary Address	M	M	M
Frame Number	M (note 1)	-	M (note 2)
Reset flag	M	-	M
Segment Number	M	M	-
SDU flag	M	M	-
Frame Check Sequence Flag	M	M	-
RR Control	-	-	M
M = Mandatory, - = Not used. NOTE 1: The Frame number in the AI-frame is the N(S). NOTE 2: The Frame number in the RR-frame is the N(R).			

21.3.5 Sequence numbers

Two independent sequence numbers are used in the LLC frames:

- Segment Sequence Numbers (SSN);
- Frame Sequence Numbers (FSN).

21.3.5.1 SSN

Segment sequencing shall use a 3 bit segment number plus a 1 bit last segment flag.

Segment sequencing appears in both AI-frames and UI-frames. The segment number shall be used to number the segments of each SDU. It shall be reset to "0" for the first segment of each new SDU (as delivered to the LLC) and shall be incremented for each successive segment of the same SDU. When the counter overflows it shall be reset to "1".

The maximum number of segments allowed for an unacknowledged SDU is eight (8). Therefore, the counter never overflows for unacknowledged data.

NOTE: This special reset operation is used so that a single segment SDU is not confused with the last segment of a multi-segment SDU.

The segment flag shall be used to indicate the last segment of a SDU. The segment flag shall be set for the last segment of each SDU, and shall be cleared for all other segments.

EXAMPLE: Using the nomenclature {SegNum.SegFlag}, a sequence of three segments will be numbered {0.0}; {1.0}; {2.1}

21.3.5.2 FSN

Frame sequencing uses a 3 bit frame number plus a 1 bit reset flag.

Frame sequencing appears in AI-frames and RR-frames (i.e. only used for acknowledged data transfer).

Under normal conditions the frame number shall be incremented for each new segment and shall be reset to "0" whenever it overflows (i.e. it shall operate modulo 8). The frame number is used to relate the LLC acknowledgements to the corresponding AI-frames. It also provides a flow control function by defining a maximum window size for AI-frames.

The frame number may be reset at any time by the sending side by setting the RESET flag. Receipt of a set RESET flag shall cause an immediate reset at the peer and a possible loss of any unacknowledged AI-frames.

21.3.6 Acknowledged frame operations

The following operations and variables shall apply to acknowledged frame operation. These operations relate to the FSNs described in subclause 21.3.5.2.

NOTE: These operations do not relate to the SSNs.

21.3.6.1 Modulus

The modulus for acknowledged operation shall be set to 8.

All arithmetic operations on state variables and sequence numbers contained in this ETS shall be affected by the modulus operation. These operations shall only apply to acknowledged information transfer.

21.3.6.2 Send state variable V(S)

The sending side of each point-to-point acknowledged link shall have an associated V(S) when using AI-frame commands. V(S) denotes the sequence number of the next AI-frame to be transmitted. V(S) may take on the value 0 to 7. The value of V(S) shall be incremented by 1 with each successive AI-frame transmission, and shall not exceed V(A) by more than the maximum number of outstanding frames, k.

The value of k is defined each time that acknowledged operation is established. The value shall not exceed N.252.

NOTE: The parameter k is referred to as the "window size" elsewhere in this ETS.

21.3.6.3 Acknowledge state variable V(A)

The sending side of each acknowledged link endpoint shall have an associated V(A). V(A) identifies the last AI-frame that has been acknowledged by its peer: $V(A)-1$ equals the N(S) of the last acknowledged AI-frame. V(A) may take on the value 0 to 7. The value of V(A) shall be updated by the valid N(R) values received from its peer.

A valid N(R) shall be one that lies in the range $V(A) \leq N(R) \leq V(S)$.

21.3.6.4 Send sequence number N(S)

Only AI-frames shall contain N(S), the send sequence number of transmitted AI-frames. At the time that an in-sequence AI-frame is designated for transmission, the value of N(S) shall be set equal to V(S).

21.3.6.5 Receive state variable V(R)

The receiving side of each acknowledged link endpoint shall have an associated V(R). V(R) denotes the sequence number of the next-in-sequence AI-frame expected to be received. V(R) can take on the value 0 to 7. The value of V(R) shall be incremented by 1 following the receipt of an error-free, in-sequence AI-frame whose N(S) equals V(R).

21.3.6.6 Receive sequence number N(R)

All RR-frames shall contain N(R), the lowest send sequence number of the expected AI-frames. At the time that an RR-frame is designated for transmission, the value of N(R) shall be set equal to the current value of V(R). N(R) shall indicate that the acknowledged link entity transmitting the N(R) has correctly received all AI-frames up to and including (N(R) - 1).

21.4 LLC LAP procedures

21.4.1 Summary of procedures at sending side

Upon receipt of a TL-DATA request or TL-UNITDATA request, the LLC shall:

- a) segment long SDUs into a series of segments;
- b) calculate and append SSNs;
- c) calculate and append FSNs (AI-frames only);
- d) (if requested) calculate and append the extended Frame Check Sum (FCS).

The complete LLC frame shall then be passed to the MAC sub-layer.

21.4.2 Summary of procedures at receiving side

The LLC sub-layer shall normally only receive complete frames from the MAC sub-layer.

Upon receipt of a frame the LLC LAP protocol shall:

- (if used) check the extended FCS;

If the FCS is correct, or is not in use it shall:

- return a RR-frame indicating success if it is an acknowledged frame;
- reassemble long SDUs from a series of segments;

If the FCS is not correct it shall:

- discard the frame;
- if it is an acknowledged frame, return a RR-frame indicating failure;

When a complete SDU has been assembled without errors, the LLC shall immediately issue the SDU to the upper layer using a TL-DATA indication or TL-UNITDATA indication primitive.

21.4.3 Endpoint addressing

21.4.3.1 Primary address

A primary address shall appear in all LLC frames. This shall be:

- a) a valid SSI address; or
- b) an un-exchanged SSI address; or
- c) a TMI address.

The address shall be supplied by the upper layer in the TL-DATA request or TL-UNITDATA request primitive together with an ADDRESS_TYPE parameter that indicates which distinguishes between the alternatives given above.

A primary address shall appear in all AI-frames and all UI-frames.

21.4.4 Segmentation and sequencing

The gross segment length shall be defined as the combination of one segment of the (layer 3) SDU plus the Extended Frame Check Sum (FCS) when used. The LLC shall segment any service data units that would exceed the maximum gross segment length defined below.

The maximum length of each gross segment (i.e. one SDU segment including FCS) shall not exceed N.251. Each SDU segment, apart from the last segment, should contain the largest possible segment of the SDU.

NOTE: Refer to annex B for values of all constants.

All segments shall be numbered using the segment sequence numbers defined in subclause 21.3.5.1 starting from the lowest numbered octet of the SDU and ending with the highest numbered octet.

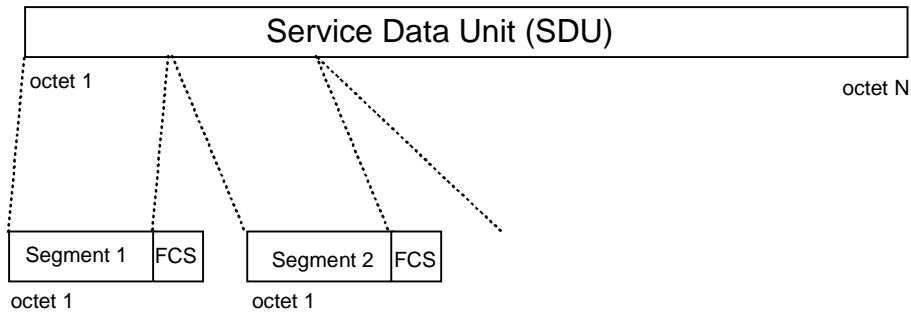

Figure 128: Segmentation

21.4.5 Establishment of unacknowledged information transfer

No establishment is required for unacknowledged information transfer.

21.4.6 Establishment of acknowledged information transfer

Acknowledged information transfer shall only be established (or re-established) by the sending side. It may be invoked in any state. It shall be invoked by any one of the following events:

- a) receipt of a TL-CONNECT request primitive;
- b) when requested by an RR-frame from the peer entity;
- c) an AI-frame exception occurs.

Following any one of these events, the sending side shall:

- a) reset all the frame sequence variables as follows:
 - set $V(S)$ and $V(A)$ to "0";
- b) reset window size, k , to "1";
- c) discard any queues of partly transmitted SDUs (note);
- d) clear any exception conditions.

NOTE: The sending side is only required to discard those AI-frames that correspond to an SDUs where one or more segments have already been transmitted. Any queue of complete un-transmitted SDUs should be preserved.

It shall then enter the CONNECT_EXPECTED state.

If there is an outstanding AI-frame (i.e. an SDU that had not been started) or upon receipt of the next TL-DATA request, the sending side shall transmit an AI-frame with the RESET flag set and shall enter the CONNECT_PENDING state.

Upon receipt of an AI-frame with the RESET flag set the peer side shall:

- a) reset all frame sequence variables as follows:
 - set $V(R)$ to "1";
- b) discard any queues of incomplete SDUs (i.e. unassembled AI-frames);
- c) set the window size, k , to a chosen valid value;
- d) clear any exception conditions.

It shall then transmit a RR-frame with the RESET flag set and containing the chosen value for k in the WIN parameter (refer to subclause 21.4.8.4). It shall then enter the CONNECTED state and issue a TL-CONNECT indicate primitive to the higher layer.

Upon receipt of an RR-frame with the RESET flag set the initiating side shall set the window size, k , to the value indicated in the WIN parameter. It shall then enter the CONNECTED state and shall issue a TL-CONNECT confirm primitive to the higher layer.

This establishment shall operate in parallel with the normal procedures for transmission of acknowledged information as described in subclause 21.4.8. In the case where the establishment procedure coincides with an AI-frame that contains a complete SDU (i.e. the non-segmented SDU case) the establishment procedure primitives shall take precedence over the data transfer primitives, and the TL-CONNECT indication and TL-CONNECT confirm primitives shall be issued before the corresponding TL-DATA indication and TL-DATA confirm primitives.

The TL-CONNECT confirm (or TL-CONNECT indication) primitives only indicate completion of the establishment procedure (the resetting of sequence numbers). In all cases a separate TL-DATA confirm (or TL-DATA indication) shall be issued corresponding to the successful transfer of a complete SDU.

21.4.7 Unacknowledged information transfer

21.4.7.1 Transmission of unacknowledged information

Unacknowledged information is passed to the LLC sub-layer using the TL-UNITDATA request primitive. The segments of this message unit shall be transmitted using a sequence of UI-frames.

An extended FCS shall be appended to all segments if requested in the TL-UNITDATA request primitive.

Only one SDU shall be processed at a time. All segments of a given SDU shall be transmitted before the next SDU is started. In the event of a MAC sub-layer failure, any uncompleted SDUs (i.e. the UI-frame transmission queue) shall be cleared. Any queues of complete (i.e. all segments un-transmitted) SDUs should be preserved.

Following successful transmission of a complete SDU, the LAP.T entity shall issue a TL-UNITDATA confirm primitive to the upper layer.

21.4.7.2 Reception of unacknowledged information

Upon receipt of a UI-frame with valid header information, the contents of the information field shall be assembled into SDUs. When a complete SDU has been assembled it shall be delivered using a TL-UNITDATA indication primitive.

If a UI-frame is received with an invalid header, or where the FCS fails, the frame shall be discarded and no further action shall be taken.

21.4.8 Acknowledged information transfer

21.4.8.1 Transmission of acknowledged information

Acknowledged information is passed to the LLC sub-layer using the TL-DATA request primitive. The segments of this message unit shall be transmitted using a sequence of AI-frames.

An extended FCS shall be appended to all segments if requested in the TL-DATA request primitive.

For each AI-frame, the control parameter N(S) shall be assigned the value V(S). V(S) shall be incremented at the end of the transmission of the AI-frame.

A separate timer T.254 shall be started at the time of transmission of each AI-frame. If timer T.254 expires for any frame, the procedures defined in subclause 21.4.10 shall be followed.

If V(S) is equal to V(A) plus k (where k is the number of outstanding AI-frames) the LAP.T entity shall not transmit any new AI-frames. Equally, if a peer busy condition has been notified, the LAP.T entity shall not transmit any new AI-frames.

In the event of a MAC sub-layer failure, all AI-frame transmission queues shall be cleared and the frame sequence numbers shall be reset in the next (new) AI-frame.

21.4.8.2 Reception of acknowledged information

Upon receipt of a valid AI-frame whose N(S) lies in the valid range $V(R) \leq N(S) \leq (V(R)+k)$, the LAP.T entity shall assemble the contents of the information field into the appropriate SDU. Following this addition, any completed and in-sequence SDUs shall be delivered to the higher layer using a TL-DATA indication primitive. SDUs shall not be delivered out of sequence.

The LAP.T shall then increment its V(R) to include all in-sequence AI-frames. V(R) shall be set to a value 1 greater than the N(S) of the highest numbered in-sequence AI-frame.

NOTE 1: The MAC may deliver AI-frames out of sequence. V(R) is only incremented when a complete and continuous sequence of AI-frames has been received. As a result, V(R) may increment by up to N.252 as a result of an out-of-sequence frame arriving (see subclause 21.4.8.4 for a description of N.252).

The LAP.T shall then return an immediate acknowledgement to the peer entity using a RR-frame. The N(R) in this RR-frame shall be set equal to the current value of V(R).

NOTE 2: An RR-frames are carried as part of the immediate MAC acknowledgement. A fast LLC process is therefore required in order to ensure that the returned value of N(R) is up-to-date.

If an AI-frame is received with an N(S) outside the valid range, or if the FCS indicates an error, then the frame shall be discarded and V(R) shall not be updated, and the LAP.T. shall return an immediate RR-frame with N(R) set equal to the current value of V(R). The WIN field shall be set to zero in the RR-frame, in order to repeat an immediate re-establishment of the link. See subclause 21.4.8.4.

21.4.8.3 Receiving acknowledgements

On receipt of a valid RR-frame, the LAP.T entity shall treat the N(R) contained in this frame as an acknowledgement for all the AI-frames it has transmitted with an N(S) up to and including the received value of N(R)-1. It shall then proceed as follows:

If the N(R) value corresponds to an expected value (i.e. a value in the expected range) the LAP.T entity shall mark all the relevant AI-frames as acknowledged and shall stop all the associated timers T.254. If the N(R) results in acknowledgement of one or more frames that complete the transmission of one or more SDUs, the LAP.T entity shall then issue an immediate TL-DATA confirm primitive to the higher layer, for each completed SDU.

If the N(R) value does not corresponds to an expected value the LAP.T entity shall take no action and all active timers shall continue to run.

21.4.8.4 Adjusting the window size

The maximum window size for normal AI-frame operation shall be defined by the receiving side whenever the frame sequence numbers are reset (i.e. whenever the link is established or re-established).

The peer entity shall set the WIN parameter to the desired value in the range 1 to N.252. This value shall remain constant in all subsequent frames.

The sending side may operate with a window size less than or equal to the value offered by the receiving entity.

This simple negotiation allows the link to operate at an agreed window size

If the WIN parameter is set to "0" in any RR frame, this shall be interpreted as a request for an immediate re-establishment of acknowledged information transfer as described in subclause 21.4.6.

21.4.9 Extended error protection

Extended error protection is provided by appending a 32 bit frame checksum to an information frame. This is an optional addition to both UI and AI-frames and shall only be appended if so indicated in the TL-DATA request or TL-UNITDATA request primitives.

NOTE 1: The FCS is not used for RR-frames.

The use of the FCS shall be indicated with the FCS flag as follows:

- FCS flag set: Cyclic Redundancy Check (CRC) used;
- FCS flag cleared: CRC not used.

The FCS generator polynomial shall be:

$$G(X) = X^{32} + X^{26} + X^{23} + X^{22} + X^{16} + X^{12} + X^{11} + X^{10} + X^8 + X^7 + X^5 + X^4 + X^2 + X^1 + 1$$

NOTE 2: This is the same generator polynomial as used in ISO 8802-3 [2].

The frame check sequence field contains a 4-octet (32 bit) field CRC value. This value is computed as a function of the following elements:

- main address element;
- one segment of the SDU.

The main address element corresponds to the equivalent element in the layer 2 primitives. This is the MS source address for uplink data transfers or the MS destination address for downlink data transfers as defined in ETS 300 393-1 [14].

The CRC value corresponding to a given frame is defined by the procedure described in annex B. The resulting 32-bits of the CRC value are placed in the FCS field so that the X^{31} term is the most significant bit of the lowest numbered octet.

NOTE 3: The bits of the FCS field are thus transmitted in the order $X^{31}, X^{30}, \dots, X^1, X^0$.

NOTE 4: The MAC layer may transmit the main address element once only (e.g. with the first segment). However, this element is logically included into every FCS-CRC in order to provide a higher level of integrity. This logical inclusion protects against MAC undetected errors (e.g. a co-channel interfered with the same event label) from producing a correct FCS result.

NOTE 5: Extended error protection is not applied to the other elements. But all elements are protected by the MAC CRC (see clause 22).

21.4.10 Exception conditions

The expire of timer T.254 shall cause an immediate re-establishment of the link:

22 Layer 2 MAC protocol

22.1 Scope

This clause describes the layer 2 MAC procedures for the PDO air interface.

These MAC procedures are divided into functional groups (see figure 129).

The four functional groups described in this clause are:

- uplink functions;
- downlink functions;
- broadcast functions; and
- control functions.

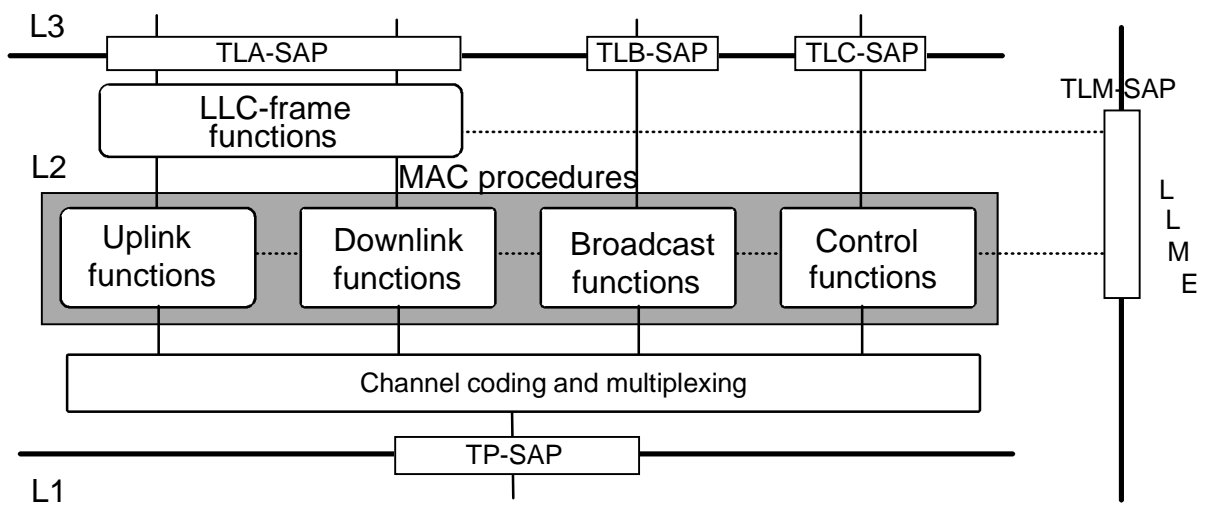

Figure 129: Grouping of layer 2 functions

The LLC frame functions are described in clause 21.

The channel coding and channel multiplexing functions are described in clause 8 and clause 9 respectively.

22.2 Symbols used

The following typographical symbols are used in this clause:

CAPITAL letters are used to denote a specific label. This can be a STATE_NAME or a FIELD_NAME. The context should make the usage clear;

<NAME> PDU, the special <brackets> are used to identify the name of a defined PDU. Details of these defined PDUs can be found in clause 20;

T2-- denotes a defined timer, and N2-- denotes a defined constant. Details of all defined timers and constants will be found in annex D.

22.3 Overview of layer 2

22.3.1 Sub-layers

This layer 2 protocol may be divided into two sub-layers:

- Logical Link Control (LLC) sub-layer (see clause 21);
- Medium Access Control (MAC) sub-layer.

NOTE: The LLC sub-layer is not used for broadcast functions and control functions.

There is no formal service boundary between these sub-layers, no primitives or SAPs are defined between them.

Between the two sub-layers LLC frames are passed together with parameters for local use, e.g. priority. One type of the LLC frames shall have only a LLC header, this is the RR-frame. In addition to the LLC frames the MAC can pass the FrameSent and FrameNotSent information to the LLC. These two types of information indicates if the LLC frame has been sent over the air interface or not. For the broadcast functions and control functions the MAC and the MLE exchange information through the TLB-SAP and the TLC-SAP using primitives described in clause 19.

Examples of MAC message sequences are given in annex K.

22.3.2 Layer 2 data structures

This protocol adopts the following ISO/IEC 7498 [3]:

- Service Data Unit (SDU);
- Protocol Data Unit (PDU);

These terms are supplemented by additional terms that are specific to this protocol:

- Logical Link Control Frame (LLC Frame);
- blocks (presiding block or following block);
- MAC burst (primary burst or secondary burst);
- multiplexed blocks.

The relationship between these data structures is shown in figure 130.

The term SDU refers to an abstract data structure that is part of a service primitive. The SDU contains the information that is being delivered to (or from) the higher layer service user.

The layer 2 SDU information is segmented (if needed) and each segment then becomes the body of the LLC frame. The LLC frame is a logical data structure (a logical PDU for the LLC sub-layer). This structure is defined to allow the addition of LLC head (containing protocol control information) and the LLC tail (containing an error protection checksum) to be appended to the body information. The complete mapping is as follows:

- SDU segment \geq LLC body;
- LLC protocol control \geq LLC head;
- error protection \geq LLC tail.

These different parts of the LLC frame shall be separated and shall be transported in MAC bursts (MAC PDUs). A MAC burst shall always start with one presiding block, which may be followed by a series of following blocks.

A MAC burst corresponds to a continuous transmission by the radio. However, each block is separately coded prior to transmission to produce a series of (larger) multiplexed blocks. These multiplexed blocks shall be then submitted individually to the layer 1 for transmission. The coding algorithm for blocks is described in clause 8.

NOTE: The layer 1 makes further additions to the multiplexed blocks before transmission to support layer 1 functions such as synchronisation. These functions are described in clause 9.

22.3.3 Transactions

A transaction is a connected series of transmissions. One transaction corresponds to the transport of one LLC frame. Uplink transactions may be linked, meaning that the next transaction follows immediately the first transaction. On the uplink, linked transactions avoid the need for a new random access.

The smallest transaction shall correspond to a single MAC burst. Longer transactions occur when multiple bursts are required, either due to segmentation of the SDU or for retransmission of erroneous blocks.

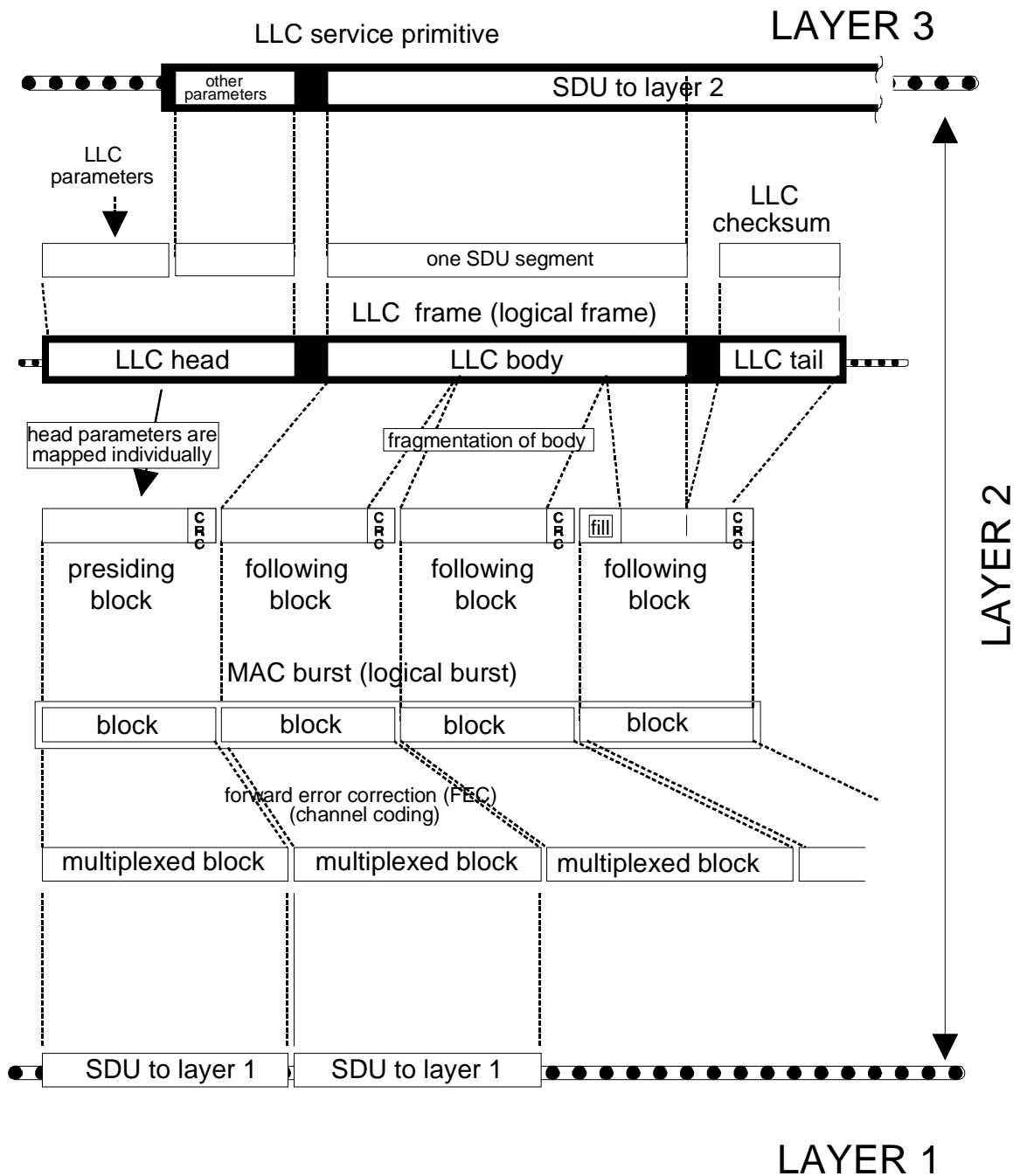

Figure 130: Layer 2 data structures

22.3.3.1 Bursts

For the definition of bursts refer to clause 9.

22.3.4 Internal logical channels

Internal logical channels refer to channels that are visible only within this layer, and these channels do not appear in the layer 2 service description. Each logical channel shall be used for a specific type of information.

There are three different logical channel types on the downlink and two on the uplink:

- Master Control CHannel (MCCH) Downlink;
- Access Control CHannel (ACCH) Downlink;
- Downlink Traffic CHannel (DTCH) Downlink;
- Random Access CHannel (RACH) Uplink;
- Uplink Traffic CHannel (UTCH) Uplink.

See annex J for the relation between the different channel types.

22.3.4.1 Master Control CHannel (MCCH)

This channel contains the master burst and other system information transmissions. Each BS shall provide one master control channel. The master control channel shall be the first channel that a MS listens to when accessing a new BS. This channel shall be used to direct the MS to the ACCH.

The MCCH shall be always placed on the master carrier. It can be in charge of several uplink carriers and several downlink carriers.

22.3.4.2 Access Control CHannel (ACCH)

This channel shall contain all of the access control information. The control information is divided into two types:

- uplink control information controls the use of RACH (i.e., random access for the MS);
- downlink control information including the initial downlink transfer to a MS and regular wake up messages for MSs in battery saving mode.

A BS shall provide at least one ACCH.

22.3.4.3 Downlink Traffic CHannel (DTCH)

On the DTCH downlink data and responses to uplink data shall be transmitted. A MS can be ordered to this type of channel with downlink control messages from an ACCH.

22.3.4.4 Random Access CHannel (RACH)

The RACH shall be used for uplink transmissions that are not reserved. All random access attempts shall use this channel.

22.3.4.5 Uplink Traffic CHannel (UTCH)

All the reserved uplink transmissions shall be transmitted on the UTCH. This includes both uplink data and responses to downlink data.

22.3.5 Multi-carrier operation

A BS can operate with one or more uplink carriers plus one or more downlink carriers.

It is possible to have an asymmetric BS (e.g. more carriers in one direction than the other direction).

There is no fixed pairing between uplink carriers and downlink carriers.

NOTE: In many cases these carriers will be assigned in pairs by a national authority (with a fixed duplex spacing). However this type of paired assignment is not to be assumed in this ETS.

22.3.5.1 Carrier

A carrier shall be a physical RF-carrier, a single frequency uplink or downlink.

Uplink carrier: a carrier used in the MS to BS direction.

Downlink carrier: a carrier used in the BS to MS direction.

22.3.5.2 Master carrier

The master carrier shall be the downlink carrier on which the master burst is transmitted and the carrier that MS first listens to. Orders to use other carriers are initiated from this carrier.

22.3.5.3 Slave carrier

All carriers on a BS that are not a master carrier shall be called slave carriers. The access to these carriers is controlled from the master carrier.

22.3.5.4 Carrier numbers definitions

To be able to use all available carriers in flexible way the BS shall define the carrier number each time it reserves time on the uplink. The BS shall also define carrier numbers as follows:

- when defining an ACCH;
- when defining a RACH;
- when defining UTCH and DTCH for data transfer.

NOTE: There can be more than one logical channel on one carrier (e.g. MCCH, ACCH and DTCH on the same carrier).

22.3.5.4.1 Defining ACCHs

The carrier number for the ACCH is defined in the <AP> PDU that is transmitted on the MCCH. The carrier for the ACCH is valid as long as the MS receives PDUs on the ACCH.

22.3.5.4.2 Defining RACHs

In the <AA> PDU the field UPLINK CARRIER shall define the carrier on which the access window is placed (i.e. RACH). After the MS has transmitted a primary burst on this carrier it shall return to the ACCH to receive the response.

If BUSY_FLAG_MODE is true then the MS shall check the BUSY_FLAG on the ACCH.

22.3.5.4.3 Defining UTCH and DTCH for data transfer

When a BS reserves time for uplink data the uplink carrier, UTCH, shall always be defined for the transmission. The BS shall also define the downlink carrier, DTCH, on which the response for the reserved uplink data is going to be transmitted.

If the transaction is finished after the response the MS shall return to monitor the ACCH. Otherwise the MS shall monitor the DTCH defined in the latest reservation.

When a BS transmits downlink MAC burst the response shall be reserved on the uplink. The carrier for the response, UTCH, is defined in the MAC burst. The carrier for the DTCH to be used for the remaining transaction is also defined in this burst. The DTCH is redefined in each MAC burst.

22.3.6 Operating modes

An MS can operate in three different Modes:

- Normal mode (NOR);
- Low Duty mode (LOD);
- Very Low Duty mode (VLD).

When an MS operates in NOR mode, the MS shall remain in the AWAKE state at all times. In this state it listens to the BS all the time and can receive a downlink message at any time or can send an uplink message using the random access procedures described in subclause 22.5.2.

A MS in LOD mode shall be normally in the STANDBY state. It changes to the AWAKE state immediately when it has anything to transmit. It also changes to the AWAKE state at the regular intervals that are defined in the <WU> PDUs. During a transaction the MS shall remain in the AWAKE state until the transaction is completed.

The VLD mode is similar to LOD mode except that the interval between successive AWAKE states is longer. This interval time is also defined by the BS in the <WU> PDU.

NOTE: An MS can change the mode of operation at any time by re-registering using a MM procedure.

22.3.7 State description

22.3.7.1 States on the MS side

On the MS side there are the following states:

- M0 start;
- M1 awake;
- M2 stand by;
- M3 prepare up;
- M4 await AP;
- M5 up transfer;
- M6 down transfer;
- M7 await RR.

22.3.7.1.1 Start state

The MS shall receive frequency correction, system information and access parameters in this state.

22.3.7.1.2 Awake state

The MS has valid access parameters. The MS is monitoring the downlink and updates the parameters that it receives in occasional <AccessAnnounce> PDUs. The first downlink data for a transaction is received in this state.

22.3.7.1.3 Standby state

The MS is in a low power consumption state. It cannot transmit or receive messages, but basic air interface support (e.g. time keeping) is maintained.

22.3.7.1.4 Prepare up state

The MS has uplink data to send but it has not got all valid parameters for the random access.

22.3.7.1.5 Await AP

The MS has chosen an access period and waits for the chosen access period to begin. The first uplink data for a transaction is transmitted in this state.

22.3.7.1.6 Up transfer state

The MS has transmitted data and is waiting for a response. The MS stays in this state until all data for this transaction is transmitted.

22.3.7.1.7 Down transfer state

The MS has received downlink data. The MS stays in this state until the whole amount of data for this transaction is received.

22.3.7.1.8 Await RR state

The MAC waits for a RR-frame from the LLC after the MAC has passed an AI frame to the LLC. The LLC shall respond with the RR-frame instantly.

22.3.7.2 States on the BS side

The following states shall refer to the interactions with one ITSI (or one GTSI). In general a single BS will be concerned with several simultaneous interactions with different ITSIs (or GTSIs) and these states are assumed to apply independently to each interaction. The management of multiple interactions is not defined in this ETS.

On the BS side there are the following states:

- B0 idle;
- B1 prepare down;
- B2 down transfer;
- B3 up transfer;
- B4 await RR.

State B3 only applies to ITSI interactions.

22.3.7.2.1 Idle state

The BS has no ongoing uplink or downlink transfer for the MS.

22.3.7.2.2 Prepare down

The BS waits for the MS to be alerted by a Wake up message.

22.3.7.2.3 Down transfer

The BS has transmitted data and waits for reserved response from the MS to the downlink data.

22.3.7.2.4 Up transfer

The BS waits for reserved uplink data from the MS.

22.3.7.2.5 Await RR state

The MAC waits for a RR-frame from the LLC after the MAC has passed an AI frame to the LLC. The LLC shall respond with the RR-frame instantly.

NOTE: Annex H shows state transitions both on the MS side and BS side.

22.4 General MAC procedures

22.4.1 Addressing procedures

22.4.1.1 Event labels

Event labels shall always be assigned by the BS, and as a general principle the BS should always maintain control of the labels. Thus each label is only assigned (to one MS or a group of MSs) for a specified period of time.

Each label shall correspond to a different "pool" of labels. The BS takes a new label from the pool, and returns it to the pool after use. Each pool needs to be large enough to endure that a label is not reused until its valid lifetime has expired. This lifetime is either the time of a transaction or a local lifetime in the MS defined by the last received PDU for the event label and a timer.

The basic functions of event labels can be summarised as follows:

short addressing: where the label is assigned to one address or to a group of addresses (e.g. address masking);

parameter addressing: where the label is assigned to specific parameters (e.g. subscriber classes);

version identifier/transaction identifier: where a change of label notifies all relevant MSs that new assignments are in force. For data transfer, a change of label identifies a new transaction.

The following event labels shall be used:

- a) RA-label (Random Access label);
- b) WU-label (Wake Up label);
- c) DT-label (Down Transfer label);
- d) UT-label (Up Transfer label);
- e) BR-label (BRoadcast label).

22.4.1.1.1 RA-label

The RA-label shall be used to label <AA> PDUs. The labels are assigned in <AP> PDUs.

The RA-label shall provide:

- short addressing;
- parameter addressing;
- version identifier.

A RA-label shall be valid for a MS as long as the MS receives an <AA> PDU with this RA-label within T205 seconds.

22.4.1.1.2 WU-label

The WU-label shall be used to label <WU> PDUs. The labels shall be assigned in <AP> PDUs, (only a small number of WU-labels are required to correspond to the maximum number of wake up groupings required by an operator).

The WU-label provides:

- short addressing;
- parameter addressing (e.g. different duty cycles: LOD or VLD);
- version identifier.

A WU-label shall be valid for a MS as long as the MS receives an <WU> PDU with this WU-label within T206 seconds.

22.4.1.1.3 DT-label

The DT-label is used to label <DD2> PDUs and <UR> PDUs. The label shall be assigned at the start of the transaction in the first <DD1> PDU. There shall be enough DT-labels to uniquely identify all concurrent downlink transactions.

The DT-label provides:

- short addressing (one ISSI or one GSSI);
- transaction identifier (to given SSI).

To maintain BS control, each DT-label shall only be assigned for one transaction (it expires at the end of the transaction). Linked transactions require separate labels.

If a BS runs out of DT-labels it can not initiate a new downlink transaction until a DT-label is free.

22.4.1.1.4 UT-label

The UT-label shall be used to label <UD2> PDUs and <DR2> PDUs. The label shall be assigned at the start of the transmit permission in the <DR1> PDU (or in a <DR3> PDU). There must be enough UT-labels to uniquely identify all concurrent uplink transactions.

This label shall provide:

- short addressing (one ISSI or one GSSI);
- transaction identifier (to given SSI).

To maintain BS control, each UT-label is only assigned for one transaction (it expires at the end of the transaction). Linked transactions require separate labels.

If a BS runs out of UT-labels it can not respond to a new initial access before an UT-label is free.

22.4.1.1.5 BR-label

The BR-label is used to label <SIN2> PDUs and <AP> PDUs. These labels are assigned (changed) by the BS without any notice. They do not provide an addressing function (the <SIN2> is addressed to all stations). The BR-label is assumed to be very small (a few bits) to distinguish different version of the system information and access parameters.

This label provides:

- version identifier (to indicate when the system information has been changed, and to ensure that system information collected from multiple bursts belongs to the same version).

22.4.1.2 Use of SSI and event labels

A SSI shall be used as the layer 2 address for each transaction. All PDUs for data transfer shall either include an SSI or an event label. Each event label is assigned by the layer 2 entity at the BS, and is only valid for one transaction within that BS.

All uplink PDUs shall include an Individual SSI (ISSI) or an equivalent valid event label

All downlink PDUs for data transfers shall include either an ISSI or a GSSI or an equivalent event label.

NOTE 1: Refer to ETS 300 393-1 [14], clause 24 for details of ISSI and GSSI.

A PDU that assigns a new event label for data transfers should include both the SSI (which is being replaced) and the new event label. Subsequent PDUs may then contain only the event label. The PDUs that assigns new labels are the <DR1> PDU, the <DD1> PDU and the <DR3> PDU.

NOTE 2: For linked transactions the new event label is assigned using the old event label.

22.4.1.3 Local grouping

Event labels may also be used to define local control groups using a technique called address masking. These "control group" event labels shall be associated with a range of addresses using a "specimen" address plus an address mask and subscriber class. Examples of local groups are:

- RA-label (Random Access label);
- WU-label (Wake Up label).

Each RA-label shall be assigned to a group of MS, where the group can be a SSI or a local group of MS. The local group for each RA-label is defined by the <AP> PDU. The address group is defined by a combination of a specimen SSI, address mask and subscriber class.

Each WU-label shall be assigned to a group of MS, where the group can be a SSI or a local group of MS. The local group for each WU-label is defined by the <AP> PDU. The address group is defined by a combination of a specimen SSI, address mask, subscriber class and type off operation (LOD mode and/or VLD mode).

22.4.1.4 Address filtering

The address filtering is used at the receiving side in a MS and BS to ignore PDUs that are not of interest for the MS or BS.

22.4.1.4.1 Address filtering on the MS side

Each MS may have more than one layer 2 address that is accepted as a valid address. If a MAC PDU is to be accepted by the MS the PDU type and the address elements shall match one of the valid layer 2 addresses. The ISSI is the minimum set of valid addresses.

For a <DD1> PDU, a <DR1> PDU or a <DR3> PDU the SSI shall be a known ISSI or GSSI. Otherwise the PDU shall be ignored.

For a <DD2> PDU the DT-label shall be a previously assigned and still valid DT-label. Otherwise the <DD2> PDU shall be ignored.

For a <DR2> PDU the UT-label shall be a previously assigned and still valid UT-label. Otherwise the <DR2> PDU shall be ignored.

For an <AA> PDU the RA-label shall be a previously assigned and still valid RA-label. Otherwise the <AA> PDU shall be ignored.

For a transaction with highest ranked priority all <AA> PDUs are valid.

For a <WU> PDU the WU-label shall be a previously assigned and still valid WU-label. Otherwise the <WU> PDU shall be ignored.

For an <AP> PDU all BR-labels are valid. If the masked SSI matches the MS ISSI and the subscriber class is valid for the MS, then remaining information in the <AP> is valid for this MS.

For a <SIN1> PDU the information is always valid.

For a <SIN2> PDU all BR-labels are valid.

22.4.1.4.2 Address filtering on the BS side

For an <UD1> PDU the RA-label shall be a previously assigned RA-label. Otherwise the <UD1> PDU can be ignored. If the RA-label is not a previously assigned RA-label it means that the MS doesn't follow the access rules.

If the <UD1> PDU has the highest ranked priority the RA-label could be an unassigned RA-label.

For an <UD2> PDU the UT-label shall be a previously defined and still valid UT-label. Otherwise the <UD2> PDU shall be ignored.

For an <UR> PDU the DT-label shall be a previously defined and still valid DT-label. Otherwise the <UR> PDU shall be ignored.

22.4.2 Random access procedures

22.4.2.1 Alternative random access methods

The random access procedures shall support two alternative access methods:

- busy flag mode (busy flag is in use); or
- no busy flag mode (busy flag is not in use).

The busy flag is a continuous downlink indication (TRUE or FALSE) that can be used to report activity on the corresponding uplink (see subclause 22.5.2).

The current mode is defined in the <AP> PDUs together with other random access parameters.

NOTE: The operating mode can be changed during normal operation.

22.4.2.2 Control of random access

The words "access period" and "access window" are used in the procedures for random access. An ACCESS PERIOD shall be a time interval at which an MS is allowed to start to transmit a Random access (an <UD1> PDU). An ACCESS WINDOW shall be a block of continuous ACCESS PERIODS.

Three different elements together control the random access protocol:

- 1) the access parameters in the <AP> PDU. These parameters are valid for a relatively long time. This <AP> PDU shall be regularly transmitted on the MCCH;
- 2) the access Announce, an <AA> PDU. This <AA> PDU defines an access window. Every window shall be defined by a unique <AA> PDU on the ACCH;
- 3) the busy flag. This is a channel status marker that shall be used to tell the MS that the defined access periods are no longer valid. Whenever the busy flag is set no MS shall be allowed to transmit (even if there are defined access periods). When operating in no busy flag mode, the busy flag shall be set to FALSE.

The <AA> PDU shall be addressed using an RA-label (see subclause 22.4.1.1.1).

22.4.2.3 Layer 2 access priority

Each random access period is assigned for use by one (or more) levels of layer 2 access priority. There is a defined priority sequence and the layer 2 access priority level defines the lowest priority access that is permitted (see ETS 300 393-1 [14], annex A).

The layer 2 access priority allows special access periods to be reserved for different layer 2 access priorities. It also allows different access rules (e.g. different flow control) to be applied to the different priorities.

22.4.2.4 Random access flow control

For flow control aspects the range over which MS shall randomly choose an access period can be independently defined. By selecting a (logical) range that is greater than the number of real (physical) access periods the number of real attempts can be gradually reduced. If an MS chooses an access period with higher number than the number of real access periods it must do another random access attempt, and this MS suffers a forced delay. With this method it is possible to control the throughput even if the random access channel is overloaded.

NOTE: Annex G shows some examples that define an access window.

22.4.3 Control elements for data transfer

22.4.3.1 Fragmenting and sequencing procedures

The MAC shall use the LLC Frame Sequence Number (FSN) to match data PDUs (UD1, UD2, DD1 and DD2), that request acknowledgements, with the corresponding responses. In this case all PDUs shall have a valid FSN.

22.4.3.2 Block flags

The block flags are used in data transfer PDUs to indicate which block numbers are included in the PDU. The block numbers are referred to one FSN which in turn refers to one LLC-frame.

The primary burst (the first data PDU of a transaction) contains no block flags. The following blocks in this PDU shall always appear in a continuous numeric sequence (therefore all block numbers can be implied from the size of the MAC burst). This applies to the <DD1> PDU on the downlink and an <UD1> PDU on the uplink.

In secondary bursts, the following blocks shall still appear in sequence, but they may be included selectively. The block flags are used to indicate which blocks are included. All blocks to retransmit shall be included before blocks that have not yet been transmitted.

In the response PDUs, the block flags shall be used to indicate selectively acknowledgements of the blocks. A set block flag indicates that the corresponding block has been successfully received.

A continuous set of block flags is always used, and this set shall contain one flag for every block in the corresponding LLC body even when the burst only contains some of the blocks from that LLC body. In general, some of the last block flags will be unused. The last valid flag is the last flag set in a PDU with the LAST_FRAGMENT set.

22.4.3.3 Use of the fill flag

The fill flag is used to indicate that the last block in a burst is not completely filled with data. This flag shall be set in any PDU that carries an unfilled last block.

In an unfilled following block, the used octets shall be placed in the octets with the highest number in the block. The unused octets in the block shall then be filled with special patterns: pattern 1 and pattern 2. The highest numbered filling octet shall contain a different pattern (pattern 2) to the other filling octets (pattern 1) to allow the number of fill octets to be identified. The fill patterns are defined in clause 20.

In a block with three fill octets; octet 1 and 2 shall have pattern 1 and octet 3 shall have pattern 2. The information octets start at octet 4.

The MAC-CRC for an unfilled block shall be calculated with the filling octets included.

The filling octets shall be removed before the LLC frame is passed up to the layer 3.

NOTE: In case of retransmission of a block with filling octets this block is always the last block in the burst.

22.4.3.4 Use of last fragment flag

The last fragment flag shall be set in the PDU that includes the last block of data from a specific LLC frame.

22.4.3.5 The use of priority in layer 2

The priority used in the MAC is the priority that is passed down from the LLC together with a LLC frame. This priority is called ranked priority.

On the MS side the ranked priority shall be checked against the priorities in the <AA> PDUs (defining the access periods) before transmitting a random access (<UD1> PDU). The MS shall follow these defined access rules.

The BS can use the ranked priority information in the <UD1> PDU to prioritise possible following uplink PDUs for this transaction.

22.4.3.6 The use of block header

There is a block header of 4 bits at the beginning of each block (before the content of the PDUs). In this block header is bit number 4 used for determine if the block is a presiding block or a following block. The MAC shall set this bit to "1" for all presiding blocks and set it to "0" for all following blocks.

The use of the other three bits is reserved.

22.5 Uplink data transfer procedures

22.5.1 Summary

The bodies of the LLC frames at the MS side are fragmented into a series of following blocks, which are then transmitted in one or more MAC PDUs. The head and tail parts of the LLC frame are placed into blocks as described in subclause 22.3.2. At the BS side, correctly received following blocks are recombined into one LLC body and then reassembled with the head and tail parameters into a complete LLC frame. The LLC frame is then passed up to the LLC. Each LLC-frame may be transmitted in one MAC burst or as a series of MAC bursts. The first burst is the primary burst and any subsequent bursts are called secondary bursts.

NOTE: Following blocks are received and acknowledged selectively, a complete MAC burst does not have to be received without errors.

For the usual case of a non-linked transaction, the primary burst uses the <UD1> PDU and this burst shall be transmitted using the random access procedures as defined in subclause 22.5.2. Any secondary bursts shall be transmitted using the reserved data transfer procedures as defined in subclause 22.5.3.

If the MS is operating with linking of transactions, as described in subclause 22.5.3.1.7, the primary PDU for the following transaction shall not use the random access procedures. The linking allows immediate use of the reservation procedures.

Every data transfer PDU (both primary and secondary bursts) can request a reservation for the transfer of the remaining number of blocks.

There are two types of uplink data transfers:

acknowledged data transfer; and

unacknowledged data transfer.

The type of transfer is indicated in all uplink bursts. The following subclauses describe both types of transfer, and the procedural differences are indicated in the relevant subclause.

22.5.2 Random access procedures for uplink transfer

22.5.2.1 Acquisition and maintenance of access rules

These random access procedures shall be used to transmit the primary burst for an unlinked transaction. The primary burst is always a <UD1> PDU, (the first burst a sequence of linked transactions also uses these procedures).

The random access procedures are dynamically controlled by each BS on a local basis using the parameters described in subclause 22.4.2 and using control groups based on local RA-labels. Every MS shall be assigned a maximum of one RA-label for each ISSI. These RA-labels are assigned by an <AP> PDU, which shall be transmitted regularly on the MCCH. The <AP> PDUs also defines the position of the ACCH that contains the <AA> PDUs for each RA-label.

After an MS has selected a specific cell it should receive the <AP> PDU, that defines the access parameters of all its current SSIs.

22.5.2.2 Defining the access window

The BS defines the access window, a number of access periods, with an <AA> PDU on the ACCH. This <AA> PDU shall be addressed with an RA-label. The RA-label shall previously have been assigned by the BS using an <AP> PDU, (see subclause 22.4.1.1.1).

An idle MS shall attempt to receive <AA> PDUs on the ACCH. It should monitor all <AA> PDUs that contain a valid RA-label. These <AA> PDUs define parameters for the random access rules. Whenever the MS receives a valid <AA> PDU the MS shall always update the included parameters.

If an MS does not receive a valid <AA> PDU during T205 seconds the MS shall return to the master control channel and wait for a new <AP> PDU.

An access window is defined to be "created" when the <AA> PDU is transmitted. The access window is "opened" when the first access period starts, and is "closed" by any of the following events:

- the busy flag is set to TRUE while the window is "open"; (BUSY FLAG MODE only);
- the last of the defined access periods has ended;
- a new <AA> PDU is received for the same RA-label.

A closing event shall always take precedence over an opening event (a closed window cannot be opened). A new definition of an access window always overrides an old access window.

NOTE: The use of a second <AA> PDU may be dangerous because it may not be received by all MSs. This should only occur in exceptional cases.

22.5.2.3 Acquisition of random access rules by a low duty cycle MS

If an MS in the STANDBY state wants to transmit an uplink <PDU>, it shall immediately enter the AWAKE state and attempt to receive an <AA> PDU.

If the MS does not receive an <AccessAnnounce> PDU with a valid RA-label within T205 seconds it shall return to the MCCH to get an <AccessParameter> PDU.

22.5.2.4 Overview of random access procedure

When a new transaction is invoked, the normal sequence of procedures for an MS doing a random access is as follows:

- 1a) if an access window is already created or open (i.e. there are valid access periods defined) the MS continues at step 2);
- 1b) if there are no valid access periods, the MS waits until it receives a valid <AA> PDU that defines valid access periods;

- 2) the MS chooses an access period;
- 3) the MS waits until the chosen access period starts;
- 4) the MS checks that the latest value of the BUSY_FLAG is FALSE. (BUSY_FLAG_MODE only);
- 5) the MS transmits an <UD1> PDU, starting in the chosen access period;
- 6) if successful, the MS receives a response, a <DR2> PDU or a <DR3> PDU. This PDU assigns an event label for the reserved part of the transaction.

NOTE: An unacknowledged PDU can be successful without receiving a response.

22.5.2.5 Choosing an access period

The MS shall choose an access period to transmit the primary burst. The way it chooses this access period depends on the defined access periods and the access priority defined for this transaction.

If there is an open access window (i.e. access periods immediately available) and the MS has higher or equal ranked priority, for this transaction, than DIRECT_PRIO then the MS shall choose the next possible access period. If a suitable access window has already been created, but not yet opened, the MS shall use this access window and shall choose an access period number between MIN_RAND and MAX_RAND with a uniform random function.

Otherwise the MS shall wait for the next <AA> PDU. When the MS receives an <AA> PDU containing a valid RA-label, it shall choose an access period number between MIN_RAND and MAX_RAND with a uniform random function.

The parameters MIN_RAND and MAX_RAND are defined in the <AA> PDU and each pair of values are linked to a minimum value of layer 2 Ranked priority, PRIO_1 and PRIO_2. If the Ranked priority for this transaction is higher or equal to PRIO_1 then the MS shall use the values for MIN_RAND and MAX_RAND that correspond to the PRIO_1, else if the Ranked priority is higher or equal to PRIO_2 then the MS shall use the MIN_RAND and MAX_RAND that correspond to PRIO_2. If the Ranked priority is less than PRIO_2 this Access Window is not valid for this transaction, the MS must await for a new <AccessAnnounce> PDU. See also annex C.

NOTE 1: PRIO_1 has a higher value than PRIO_2. If PRIO_1 is "0" then the PRIO_2 is ignored.

The range defined by MIN_RAND and MAX_RAND may be greater than the real number of access periods. If the chosen access period is greater than NO_OF_AP the chosen access is not valid and the MS shall wait for the next <AA> PDU.

NOTE 2: The use of random ranges that are greater than the access period allows flow control (see subclause 22.4.2.4).

22.5.2.6 Check of busy flag

When the busy flag is in use (busy flag mode), the MS shall check if the latest received BUSY_FLAG is FALSE before start transmitting in an access period.

The MS shall check the busy flag at a maximum of MTR ms before the chosen access period starts. MTR is the maximum allowed turn-around time for a MS.

The value of MTR is 4 ms.

If the BUSY_FLAG is TRUE, the MS shall consider the chosen access window as closed and shall wait for the next <AA> PDU.

NOTE: The busy flag operating mode is defined in the <AP> PDU.

In the case of no valid Access period are found within T201 seconds after the random access procedures where initiated a FrameNotSent information shall be passed to the LLC.

22.5.3 Reserved uplink data transfer

22.5.3.1 Acknowledged uplink transfer

22.5.3.1.1 Overview

The random access procedures described in subclause 22.5.2 may transfer the complete LLC frame, or may only transfer the first part of the LLC frame. Any remaining part of the LLC frame for an acknowledged uplink data transfer normally follows the sequence below.

- a) the MS transmits an <UD2> PDU at the reserved time;
- b) the BS responds with a <DR2> PDU.

If the <DR2> PDU is the last response for a transaction, and no more blocks are reserved on the uplink, the transaction shall be considered as finished.

Otherwise the <DR2> PDU will define a further reservation and the sequence continues at step a).

22.5.3.1.2 MS actions after receiving a BS response

For acknowledged data transfer the different responses to the primary (random accesses) burst are listed in subclause 22.5.2.8. Depending on the BS response the MS shall take the following actions:

Case A:

- all blocks, so far, for the LLC-frame are transferred correctly;
- if the complete LLC-frame is transferred correctly the RR frame, contained in the <DR1> PDU, shall be passed to the LLC;
- if not the complete LLC frame is transferred and there is reserved time on the uplink defined in the <DR1> PDU an <UD2> PDU shall be transmitted at the reserved time;

Case B:

- no permission to transmit. No time is reserved on the uplink for this transaction;
- the MS shall try to do a new random access;

Case C:

- some blocks are requested to be retransmitted. This case is described in more detail in subclause 22.6.4.

22.5.3.1.3 Creating the secondary burst

The MS shall create a secondary burst using the <UD2> PDU, when it has received a downlink response that reserves time on a uplink.

The burst length shall be minimum of:

- the number of blocks that is reserved on the uplink;
- the number of blocks that are still to transmit for this LLC frame, including this <UD2> PDU;
- the maximum following blocks in one burst N222.

The blocks that are included in this <UD2> PDU shall be taken in block number order. If there are blocks to be retransmitted those blocks shall be taken first.

The block flags shall be set to 1 for all block numbers that are included in this <UD2> PDU.

If the last block for this transaction is included in this <UD2> PDU the last fragment flag shall be set to 1. Otherwise the last fragment flag shall be set to 0.

If there are still more blocks to transmit as part of this transaction, the More data field shall be used to indicate the number of remaining blocks. Otherwise the More data field shall contain the value "0".

If the last block for this transaction is included in this <UD2> PDU, and there are filling octets in the last block, the filling flag shall be set to "1". Otherwise the filling flag shall be set to "0".

22.5.3.1.4 Downlink response to a secondary burst

The BS shall respond to each <UD2> PDU with a <DR2> PDU. If there was any block with error received for this transaction (and the block has not been retransmitted without errors), the Ack flag shall be cleared and the corresponding block flags shall be cleared in the <DR2> PDU.

The UT-label used in this <DR2> PDU shall be the one that was used in the <UD2> PDU.

If more blocks were requested to transmit, the MORE_DATA field is greater than 0, the BS shall reserve a new transmission time on any suitable uplink. The parameters that define the reserved time shall be filled in the response: START_OF_RESERVATION, RESERVED_BLOCKS, UPLINK_CARRIER, DOWNLINK_CARRIER.

22.5.3.1.5 Acknowledgement

If the ACK_FLAG is set to 1 in an uplink PDU, this shall be interpreted as a request for acknowledgement of the blocks in this PDU.

Each uplink PDU, <UD1> PDU or <UD2> PDU is acknowledged if the ACK_FLAG is set to 1 in the response, <DR1> PDU or <DR2> PDU, on the downlink.

When the ACK_FLAG is set to "1" in a <DR1> PDU or in a <DR2> PDU then all blocks in the so far received uplink PDU(s) are received without errors.

Blocks, of an uplink PDU, are acknowledged if the corresponding BLOCK_FLAG is set to 1 in the response, <DR2> PDU or <DR3> PDU.

22.5.3.1.6 Repeat last acknowledge

The MS can ask for the last acknowledge transmitted by the BS to be repeated if it is not received in the expected time. This request can be a <UD1> PDU or a <UD2> PDU depending on if there is reserved time on the uplink or not.

The BS shall respond with either a <DR1> PDU or a <DR2> PDU depending on the request.

22.5.3.1.7 Linking of transactions

The last <UDx> PDU for one transaction may ask for a further reservation if there is more data to send. This additional data corresponds to a new transaction.

In this event, the uplink reservation procedures shall be used for the primary burst, for all transactions except the first one in a sequence of linked transactions, (there is no need for a new random access). A new UT-label shall be assigned for this new transaction.

In the case of linking an <UD1> PDU with a new transaction the linking shall be done by assigning the UT-label with a <DR1> PDU. The UT-LABEL field is used for the new label.

In the case of linking an <UD2> PDU with a new transaction the linking shall be done by assigning a new UT-label with a <DR2> PDU. One following block containing the new UT-label is added to this <DR2> PDU each time a linking is done.

22.5.3.1.8 Retransmission procedures

If an error occurs in a block in an uplink transmission, of an <UD1> PDU or an <UD2> PDU, the BS shall transmit a <DR3> PDU or a <DR2> PDU as a request for retransmission. In these PDUs the block flag for each block with error shall be set to 0. The block flag for each correct received blocks shall be set to "1".

When an MS receives a PDU that marks some blocks with errors, the MS shall retransmit these blocks. In the <UD2> PDU that includes these blocks, the corresponding block flags shall be set to "1".

If an MS does not receive an acknowledge for some blocks within T202 seconds it shall try to transmit the blocks again. In this case the BS shall do a new random access. In this random access the assigned UT-label shall be used.

The maximum number of re-transmissions for one block is N206. If no Acknowledge is received after the N206th retransmission within T202 seconds the MS shall report to the MLE that it is not possible to communicate with this BS.

22.5.3.2 Unacknowledged uplink transfer

22.5.3.2.1 Overview

The random access procedures described in subclause 22.5.2 may transfer the complete LLC frame, or may only transfer the first part of the LLC frame. Any remaining part of the LLC frame for an unacknowledged uplink data transfer normally follows the sequence below:

- a) the MS transmits an <UD2> PDU at the reserved time;

if the <UD2> PDU is the last uplink transfer for a LLC-frame, no more blocks are requested to be reserved, the transaction shall be considered as finished;

otherwise the <UD2> PDU will request for further reservations and the sequence continues at step b);
- b) the BS reserves more uplink time with a <DR2> PDU.

22.5.3.2.2 MS actions after receiving a BS response

For unacknowledged data transfer the different responses to the primary (random access) burst are listed in subclause 22.5.2.8. Depending on the BS response the MS shall take the following actions:

Case D:

- no permission to transmit. The MS shall do a new random access and the UT label is no longer valid;

Case E:

- Permission to transmit more data.

The MS shall transmit an <UD2> PDU at the reserved time. This PDU shall contain the next blocks in turn for this LLC-frame.

22.5.3.2.3 Creating the secondary burst

See subclause 22.5.3.1.3.

22.5.3.2.4 Downlink response to a secondary burst

If the secondary burst requested for more data to be reserved the BS shall respond to the <UD2> PDU with a <DR2> PDU. There are two possible responses, with or without reserved time for a new <UD2> PDU.

- 1) The <DR2> PDU reserves a number of blocks on the uplink. The MS shall transmit the blocks in turn for transmission at this defined time.
- 2) The <DR2> PDU has value "0" in the RESERVED_BLOCKS. The MS shall regard this transaction as not completed. The MS may start again with a new random access try.

22.5.3.2.5 Linking of transactions

See subclause 22.5.3.1.7.

22.6 Downlink data transfer procedures

22.6.1 Summary

The body of the LLC frames at the BS side are fragmented into a series of following blocks, which are then transmitted in one or more MAC PDUs. The head and tail parts of the LLC frame are placed into blocks as described in subclause 22.3.2. At the MS side, correctly received following blocks are recombined into one LLC body and then reassembled with the body and tail into a complete LLC frame. The complete LLC-frame is then passed to the upper layer.

Each LLC-frame may be transmitted in one MAC burst or as a series of MAC bursts. The first burst is the primary burst and any subsequent bursts are called secondary bursts.

NOTE: Following blocks are received and acknowledged selectively, a complete MAC burst does not have to be received without errors.

The primary burst uses the <DD1> PDU and the secondary burst uses the <DD2> PDU. These PDUs shall be transmitted using the procedures in subclause 22.6.2.

There are two types of downlink data transfers:

- acknowledged data transfer; and
- unacknowledged data transfer.

The type of transfer is indicated in all downlink bursts. The following subclauses describe both types of transfer, and the procedural differences are indicated in the relevant subclause.

22.6.2 Downlink data transfer

22.6.2.1 Overview

When a new downlink data transaction is invoked the normal sequence of procedures is as follows:

- 1) the BS transmits a <DD1> PDU;
- 2) the MS transmits an <UR> PDU starting at the reserved time defined in the <DD1> PDU;
- 3) the BS transmits a <DD2> PDU;
- 4) the MS transmits an <UR> PDU starting at the reserved time defined in the <DD2> PDU;
- 5) if the transaction is not completed the sequence is repeated starting from step 3.

The sequence stops at step 2 if the transaction is finished with this <UR> PDU (all information for the transaction was transmitted in one <DD1> PDU and no errors were reported in the <UR> PDU).

For unacknowledged data, steps 2 and 4 shall be omitted.

22.6.2.2 Creating the primary burst for downlink transaction

The BS shall create a primary burst, a <DD1> PDU, using part or all of the LLC frame.

The BS shall assign a DT-label (a local event label) for the rest of the transaction.

If this is an acknowledged transaction, the BS shall reserve a transmission time for the uplink response on any suitable uplink. The following parameters shall be supplied in the <DD1> PDU to define the reserved time:

- START_OF_RESERVATION;
- UPLINK_CARRIER;
- DOWNLINK_CARRIER.

The ACK_FLAG shall also be set. The SSI field shall be set to the parameter associated with the LLC frame (as supplied with the layer 2 SDU).

If this is a single burst transaction then the LAST_FRAG flag shall be set to "1".

22.6.2.3 Uplink response to a primary burst

If the Ack flag was set in the <DD1> PDU then the MS shall create an <UR> PDU as a response. This <UR> PDU shall be transmitted at the time reserved in the <DD1> PDU.

If there was any block with error in the received <DD1> PDU, the Ack flag shall be cleared and the corresponding block flags cleared in the <UR> PDU.

The DT label that was assigned in the <DD1> PDU shall be used to label this <UR> PDU.

22.6.2.4 Create the secondary burst for downlink transfer

The BS shall create a secondary burst, a <DD2> PDU containing additional following blocks from the same LLC frame. This PDU may include a mixture of retransmitted blocks and not-transmitted blocks.

If this is an acknowledged transaction the BS shall reserve transmission time for the uplink response on any suitable uplink. The parameters that define the reserved time shall be filled in the <DD2> PDU: START_OF_RESERVATION, UPLINK_CARRIER, DOWNLINK_CARRIER. The ACK_FLAG shall also be set.

The blocks that shall be included in this <DD2> PDU shall be taken in block number order. If there are blocks to be retransmitted those blocks shall be taken first.

The block flags shall be set to 1 for all block numbers that are included in this <DD2> PDU.

If the last block for this transaction is included in this <DD2> PDU the Last Fragment flag shall be set to 1. Otherwise the last fragment flag shall be set to 0.

If the last block for this transaction is included in this <DD2> PDU, and there are filling octets in the last block, the filling flag shall be set to "1". Otherwise the Filling flag shall be set to "0".

22.6.2.5 Uplink response to a secondary burst

If the Ack flag was set in the <DD2> PDU then the MS shall create an <UR> PDU as a response. This <UR> PDU shall be transmitted at the time reserved in the <DD1> PDU.

If there was any block with error received for this transaction (and the block has not been retransmitted without errors), the Ack flag shall be cleared and the corresponding block flags shall be cleared in the <UR> PDU.

The DT-label used in this <UR> PDU shall be the one that was used in the <DD2> PDU.

22.6.2.6 Acknowledgements

If the ACK_FLAG is set to 1 in a downlink PDU, this shall be interpreted as a request for acknowledgement of the blocks in this PDU.

Each downlink PDU, <DD1> PDU or <DD2> PDU is acknowledged if the ACK_FLAG is set to 1 in the response, <UR> PDU, on the uplink.

Parts, blocks, of a downlink PDU are acknowledged if the corresponding BLOCK_FLAG is set to 1 in the response, <UR> PDU.

22.6.2.7 Repeat last acknowledge

The BS can ask for the last acknowledge transmitted by the MS to be repeated if it is not received in the expected time. This request shall be a <DD2> PDU with no following block.

The MS shall respond with an <UR> PDU.

22.6.3 Low duty cycle operation

22.6.3.1 Operating modes

An MS can operate in different modes as described in subclause 22.3.6.

When an MS operates in NOR mode, the MS remains in the AWAKE state at all times. In this state it listens to the BS all the time and it shall be prepared to receive a downlink message at any time.

An MS in LOD or VLD mode is only in AWAKE for short periods of time. When a LOD or VLD mode MS enters the AWAKE state it shall wait for a <WU> PDU to appear on the downlink. Each <WU> PDU may contain an announcement of a pending transaction for the MS. The MS shall only go back to the STANDBY state after it has received this <WU> PDU and if it is not addressed in the TRAFFIC_LIST.

22.6.3.2 Periodic wake-up PDUs to low duty MS

<WU> PDUs are transmitted regularly on the ACCH. These <WU> PDUs are addressed with an WU-label. Each PDU includes parameters that define the next time that this <WU> PDU is going to be transmitted.

Each <WU> PDU shall include a TRAFFIC_LIST. This list contains the addresses for all MSs that are required to prepare to receive a downlink data transfer. All addressed MSs shall again enter the AWAKE state at the time defined in the <WU> PDU to receive a <DD1> PDU. This time is defined individually for each addressed MS.

NOTE: The TRAFFIC_LIST can be empty.

22.6.3.3 Stay awake time

In the periodic <WU> PDU is there one parameter named STAY AWAKE TIME. This parameter defines the minimum time that a LOD mode MS (or VLD mode MS) shall stay in the AWAKE state after receiving (or transmitting) a PDU.

This time in AWAKE state makes it possible for a BS to transmit another PDU without alerting the MS again.

22.6.3.4 Alerting a MS

The method of alerting a MS for a downlink transfer depends on the operating mode of the MS.

NOTE: The BS is assumed to have knowledge of the operating mode. This is assumed to be transferred as part of the MM registration procedures.

When a BS wishes to transfer data to a MS that is in either LOD or VLD mode it shall insert the MS address into the Traffic List of the next suitable <WU> PDU. This Traffic List entry shall specify the earliest scheduled transmission time of the <DD1> PDU.

After the transmission of the <WU> PDU (to alert the MS) the BS shall transmit the <DD1> PDU at the specified transmission time. After this the data transfer shall then continue with the normal downlink transfer procedures.

When a BS wishes to transfer data to a MS that is in NOR mode, no alerting procedure is required and the BS may transmit the <DD1> PDU on the (ACCH) without warning.

22.6.4 Re-transmission procedures

If an error occurs in a block in a downlink transmission, of an <DD1> PDU or an <DD2> PDU, the MS shall transmit a <UR> PDU as a request for retransmission. In this PDU the block flag for each block with error shall be set to 0. The block flag for each correct received blocks shall be set to 1.

When a BS receives a PDU that marks some blocks with errors, the BS shall retransmit these blocks. In the <DD2> PDU that includes these blocks, the corresponding block flags shall be set to 1.

If a BS does not receive an acknowledgement for some blocks after the uplink response is reserved, it may try to transmit the blocks again.

The maximum number of re-transmissions for one block is N206. If no Acknowledge is received after the N206th retransmission the BS shall inform the MLE that the transfer was not successful. The MAC shall also pass the FrameNotSend information to the LLC.

22.6.5 Repetitions

If the BS does not receive a response for a downlink PDU, it may repeat the PDU a number of times.

For an unacknowledged downlink PDU the BS may repeat the PDU a number of times.

22.7 Downlink broadcast procedures

22.7.1 BS transmission of system information

The system information shall be transmitted in two types of PDUs, the <SIN1> PDU and the <SIN2> PDU. The <SIN1> PDU shall only be transmitted in a Master burst and has a limited number of 60 information bits.

The L3 supplies layer 2 with the information to put in these PDUs using a TL-BROADCAST_1 request or a TL-BROADCAST_2 request primitive.

The SDU in the TL-BROADCAST_1 request shall be transmitted in the <SIN1> PDU. SDU length shall have a fixed length of 60 bits. The SDU in this primitive shall be used for the periodic transmission until another TL-BROADCAST_1 is received.

A receipt of a new TL-BROADCAST_1 request overrides the parameters from an old TL-BROADCAST_1 request.

The SDU in a TL-BROADCAST_2 request shall be transmitted in one <SIN2> PDU. A TL-BROADCAST_2 request is a request for a single transmission. When the <SIN2> PDU has been transmitted a TL-BROADCAST_2 confirm primitive shall be issued to the higher layer.

If the SDU in a TL-BROADCAST_2 request do not fill the last block for this <SIN2> PDU the procedure for filling in subclause 22.4.3.3 shall be applied.

22.7.1.1 Master burst

The master burst shall be transmitted on the master carrier downlink every 150 blocks. The master burst replaces one normal downlink block. The bits in the master burst are not scrambled. The payload of the master block is carried in the master burst.

For details refer to clause 9.

22.7.2 Mobile use of system information

22.7.2.1 First access procedures

In the case of cell change, or power up, the MS shall get the following information before it can do a random access:

- frequency correction on the MCCH;
- <SIN1> PDU on the MCCH (this information is not scrambled);
- <SIN2> PDU on the MCCH;
- <AP> PDU on the MCCH, that defines a valid RA-label;
- <AA> PDU on the ACCH, that defines a valid access window.

22.7.3 Broadcast of random access parameters

22.7.3.1 Access Parameters PDU (AP)

The <AP> PDU shall be regularly transmitted on the MCCH and defines some essential parameters. It also assigns a random access label for random access and may define a wake up label for low duty cycle MS. The values of the parameters are decided as follows:

BR-label:	version number for this PDU;
RA-flag:	set if this is an assignment of a RA-label;
LOD flag:	set if this is an assignment of a WU for MS in LOD mode;
VLD flag:	set if this is an assignment of a WU for MS in VLD mode;
assigned event label:	RA-label or WU-label to be assigned;
subscriber class:	valid subscriber class for this assignment;
downlink carrier:	carrier number for the ACCH;
SSI:	valid MS address together with Address Mask;
address mask:	bit mask to be used together with the SSI.

22.7.3.2 Access Announce PDU (AA)

The <AA> PDU shall be transmitted on the ACCH. The <AA> PDU includes parameters to define an access window and the address is an RA-label. The values of the parameters are decided as follows:

RA-label:	RA-label that have be assigned by a <AP> PDU;
linearization time:	time allowed for common linearization;
start of reservation:	start of the access window;
uplink carrier:	carrier number on which this access window is defined;

number of access periods number of access periods for this access window;
retry delay: how many <AA> PDUs to wait for before retry;
direct priority: lowest allowed ranked priority for direct access.

For parameters to divide the access periods between priorities, see annex G.

All these parameters are decided by dynamic or static procedures in the BS. These procedures are not within the scope of this ETS.

22.7.3.3 Set busy flag

As soon as the BS detects that an MS transmits in a defined access period the BS shall set the BUSY_FLAG to TRUE on the ACCH.

When the BS wants to change the BUSY FLAG this decision shall be passed to the physical layer.

If the BS is operating in no busy Flag mode the BUSY_FLAG shall be set to FALSE.

22.8 Downlink control procedures

22.8.1 Scanning

When L2 receives a TL-SCAN request the L2 shall scan (scanning includes receiving broadcast information) the requested channel and return the result in a TL-SCAN confirm. The time when the scanning is performed depends on ongoing traffic and broadcasted parameters.

The L2 requests L1 to try to synchronise on a defined frequency. If the MS manages to synchronise, a TL-BROADCAST 1 indication shall be passed to the upper layer together with the TL-SCAN confirm.

The parameter signal quality in the TL-SCAN confirm shall contain measured signal strength (see clause 10 for parameter value) and may contain other types of measurements like bit error rate and message error rate calculated by L2.

If the scanning had no success (no broadcast information was found on the requested channel) the L2 shall return a TL-SCAN confirm to the upper layer. The Signal Quality parameter shall indicate that no quality was found.

22.8.2 Monitoring

When L2 receives a TL-MONITOR request the L2 shall monitor the requested list of channels for signal quality and return the result for each channel in a TL-MONITOR indication. The time when the scanning is performed depends on ongoing traffic and broadcasted parameters.

The L2 requests L1 to measure signal strength on each of the defined frequencies in the channel list. When the L2 receives the measurements from L1 the values shall be passed to the upper layer in a TL-MONITOR indication.

The parameter signal quality shall contain measured signal strength (see clause 10 for parameter value) and may contain other types of measurements.

22.8.3 Measure the serving cell

The L2 shall periodically report the measurements on the serving cell to the upper layer, with a TL-SERVING indication.

The parameter signal quality shall contain measured signal strength (see clause 10 for parameter value) and calculated radio downlink counter (how to calculate this parameter is described in clause 10) and may contain other types of measurements, like bit error rate and message error rate calculated by L2.

22.8.4 Select a radio channel

When L2 receives a TL-SELECT request the L1 shall be requested to change the downlink frequency. When L1 reports that the change is made L2 shall pass a TL-SELECT confirm to the upper layer.

22.8.5 Change of L2 addresses

When L2 receives a TL-ADDLIST request the addresses in the address list shall be used as valid L2 addresses. The list may include one or more group addresses (GSSIs).

Annex A (normative): Timers in MLE

T301: MLE Announce Timer

MS value: 1 second;

BS value: N/A;

Action on first expiry: Abort announce procedure.

Annex B (normative): LLC timers and constants

B.1 Timers

T.254 AI-frame transmission timer.

Value: 5 seconds.

Action on first expire: Re-establish link.

B.2 Constants

N.251 Maximum length of a gross segment.

The maximum length of one gross segment (i.e. one SDU segment plus the Frame Check Sequence (FCS)) is 512 octets.

NOTE: The FCS is optional. If the FCS is not used, the SDU segment may be larger.

N.252 Maximum window size for acknowledged operation.

The maximum number of outstanding unacknowledged AI-frames is 3 frames.

Annex C (normative): Mathematical definition of frame check sequence

The CRC value corresponding to a given frame is defined by the following procedure:

- 1) the logical frame is assembled, with the address element as the first 3 octets, and the SDU segment as the following octets;
- 2) the first 4 octets (first 32 bits) of the frame are complemented;
- 3) the n bits of the frame are then considered to be the coefficients of a polynomial $M(X)$ of degree $n-1$;
- 4) $M(X)$ is multiplied by X^{32} and divided by $G(X)$, producing a remainder $R(X)$ of degree less than 31;
- 5) the coefficients of $R(X)$ are considered to be a 32-bit sequence;
- 6) the 32-bit sequence is complemented and the result is the CRC.

Annex D (normative): **MAC timers and constants**

D.1 Timers at the MS side

T201 Maximum time waiting for an access period.

Value: 5 s;

Action at first expire: Pass a FrameNotSent information to the LLC and return to MCCH.

T202 Maximum time waiting for an acknowledge.

Value: 5 s;

Action at first expire: Retransmission of the unacknowledged blocks.
A new random access is needed.

After N206 expires: The transaction shall be cancelled.

T204 Random access retry delay.

Value: 5 s;

Action at first expire: Re attempt the random access transmission.

T205 Maximum time waiting for an <AccessAnnounce> PDU.

Value: 5 s;

Action at first expire: Return to MCCH.

T206 Maximum time waiting for an <WakeUp> PDU.

Value: 3 s;

Action at first expire: Return to MCCH.

D.2 Constants

N206 Maximum number of re-transmissions for the same block.

Value: 3.

N222 Maximum number of following blocks in one MAC burst.

Value: 40.

Annex E (informative): Interrupting scanning method

While in the ALL DATA state (link established, but no active transactions) the MLE can search for better quality cell at any time using the interrupting method of scanning.

To perform a slow scan the MS shall randomise its start time between two successive SIN2 broadcasts from the current serving cell.

The maximum scanning time is defined in the cell re-selection parameters element in the SIN2 system broadcast information. The following parameters are defined:

- MAX_MEAS_PERIOD_NUMBER;
- MAX_MEAS_PERIOD_DURATION.

NOTE: While searching for other BSs, a MS is assumed to be unable to receive the current BS transmissions.

Figure E.1 shows this slow scanning algorithm where:

SIN2 = System Information broadcasts type 2. This includes:

- neighbour cell identity;
- frequency of master carrier;
- load information;
- maximum scan time.

SIN interval = maximum scanning interval:

- 1 = Scanning by MS1;
- 2 = Scanning by MS2.

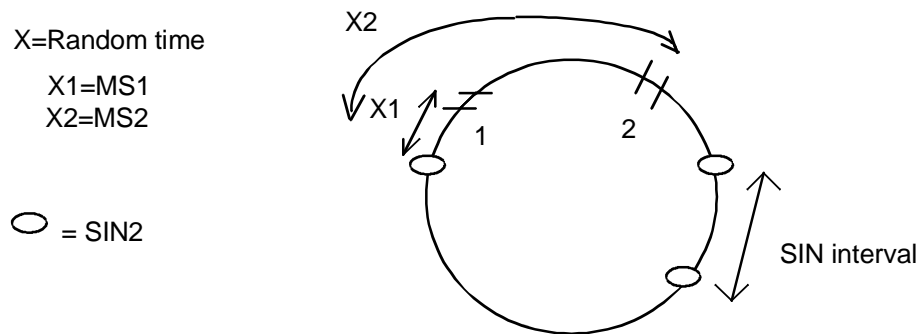

Figure E.1: Interrupting scanning method

Annex F (informative): Choice of cell re-select procedure

The announced and unannounced cell re-selection procedures allow the MS to provide some assistance to the infrastructure to support the cell re-selection. Use of these procedures is only possible if they are supported by the relevant BSs.

The following general principles are recommended:

- 1) a MS that is supporting an active CONP service (e.g. connected virtual calls) should use the announced procedures (both announced and declared if possible);
- 2) a MS that is supporting a connection oriented application (e.g. TCP) should also use announced procedure (both announced and declared if possible);
- 3) other MSs (e.g. connectionless services only) should use the unannounced procedure (declared only if possible);
- 4) if the announced and declared procedures are not supported at the old cell, but are supported at the new cell, the MS should use the unannounced procedure;
- 5) if the announced and declared procedures are supported by neither the old cell nor the new cell, the MS should use the undeclared procedure.

NOTE: Nothing in this annex mandates a MS to use the announced or unannounced procedures. A MS may choose to use the undeclared procedure in all cases.

Annex G (informative): MAC example, how to choose an access period

The following examples are provided to illustrate the use of the access period variables.

Table G.1: Access variables for the examples

Variables	Ex 1	Ex 2	Ex 3	Ex 4
NO_OF_AP	10	10	10	10
DIRECT_PRIO	0	1	3	1
PRIO_1	0	2	2	2
PRIO_2	-	0	1	0
MIN_RAND_1 (for PRIO_1)	1	1	1	1
MAX_RAND_1 (for PRIO_1)	10	6	6	6
MIN_RAND_2 (For PRIO_2)	-	7	7	7
MAX_RAND_2 (for PRIO_2)	-	10	10	20

G.1 Example 1

See table G.1 for parameters.

All MSs choose the access period in the same way independent of layer 2 ranked priority.

- If the transaction is initiated before the first access period:
 - choose randomly between access period 1 and 10;
- If the transaction is initiated during access period 1 and 9:
 - choose the next possible access period.

G.2 Example 2

See table G.1 for parameters.

MS with L2 ranked priority 0:

- if the transaction is initiated before access period 7:
 - choose randomly between access period 7 and 10.

MS with L2 ranked priority 1:

- if the transaction is initiated before access period 7:
 - choose randomly between access period 7 and 10;
- if the transaction is initiated during access period 7 and 9:
 - choose the next possible access period.

MS with L2 ranked priority 2 or higher:

- if the transaction is initiated before the first access period:
 - choose randomly between access period 1 and 6;
- if the transaction is initiated during access period 1 and 9:
 - choose the next possible access period.

G.3 Example 3

See table G.1 for parameters.

MS with L2 ranked priority 0:

no valid access periods.

MS with L2 ranked priority 1:

if the transaction is initiated before access period 7:

choose randomly between access period 7 and 10.

MS with L2 ranked priority 2:

if the transaction is initiated before the first access period:

choose randomly between access period 1 and 6;

if the transaction is initiated during access period 1 and 6:

choose randomly between access period 7 and 10.

MS with L2 ranked priority 3 or higher:

if the transaction is initiated before the first access period:

choose randomly between access period 1 and 6;

if the transaction is initiated during access period 1 and 9:

choose the next possible access period.

G.4 Example 4

See table G.1 for parameters.

MS with L2 ranked priority 0:

if the transaction is initiated before access period 7:

choose randomly between access period 7 and 20;

if the chosen access period is among 7 and 10:

use the chosen access period;
else

the chosen access period is not defined on the uplink;
wait for next access Announce.

MS with L2 Ranked priority 1:

if the transaction is initiated before access period 7:

choose randomly between access period 7 and 10;

if the transaction is initiated during access period 7 and 9:

choose the next possible access period.

MS with L2 ranked priority 2 or higher:

if the transaction is initiated before the first access period:

choose randomly between access period 1 and 6;

if the transaction is initiated during access period 1 and 9:

choose the next possible access period.

Annex H (informative): MAC state transitions

H.1 Transitions on the MS side

See figure H.1.

- P1 The MS receives an <SIN1> PDU.
- P2 The MS receives an <AP> PDU.
- P3 The MS receives a TL-DATA request primitive and there is an "open" access window known to the MS.
- P4 The Chosen Access period starts.
- P5 The MS receives the last acknowledge for this transaction.
- P6 A Low Duty MS receives an <WU> PDU.
- P7 Time to get the <WU>.
- P8 Time to get downlink data that was defined in a <WU> PDU.
- P9 The MS receives a TL-DATA request primitive and there is no "open" access window.
- P10 The MS receives an <AA> PDU.
- P11 The Access Window is closed.
- P12 Time-out. No response to uplink data.
- P13 Time-out. No <AA> PDU received within T205 seconds.
- P14 The MS receives a <DD1> PDU.
- P15 The MS receives a <DD2> PDU.
- P16 The MS receives the last <DD2> PDU for a transaction.
- P17 Time-out. No <AA> PDU or data PDU received within T205 seconds.
- P18 The MS receives an <AA> PDU.
- P19 The MS receives a <DR1> PDU or a <DR2> PDU and has more reserved data to send.
- P20 The MS receives a <SIN2> PDU.
- P21 The MS receives a <DD1> PDU (the last for this transaction).
- P22 The MAC receives a RR-frame from the LLC.

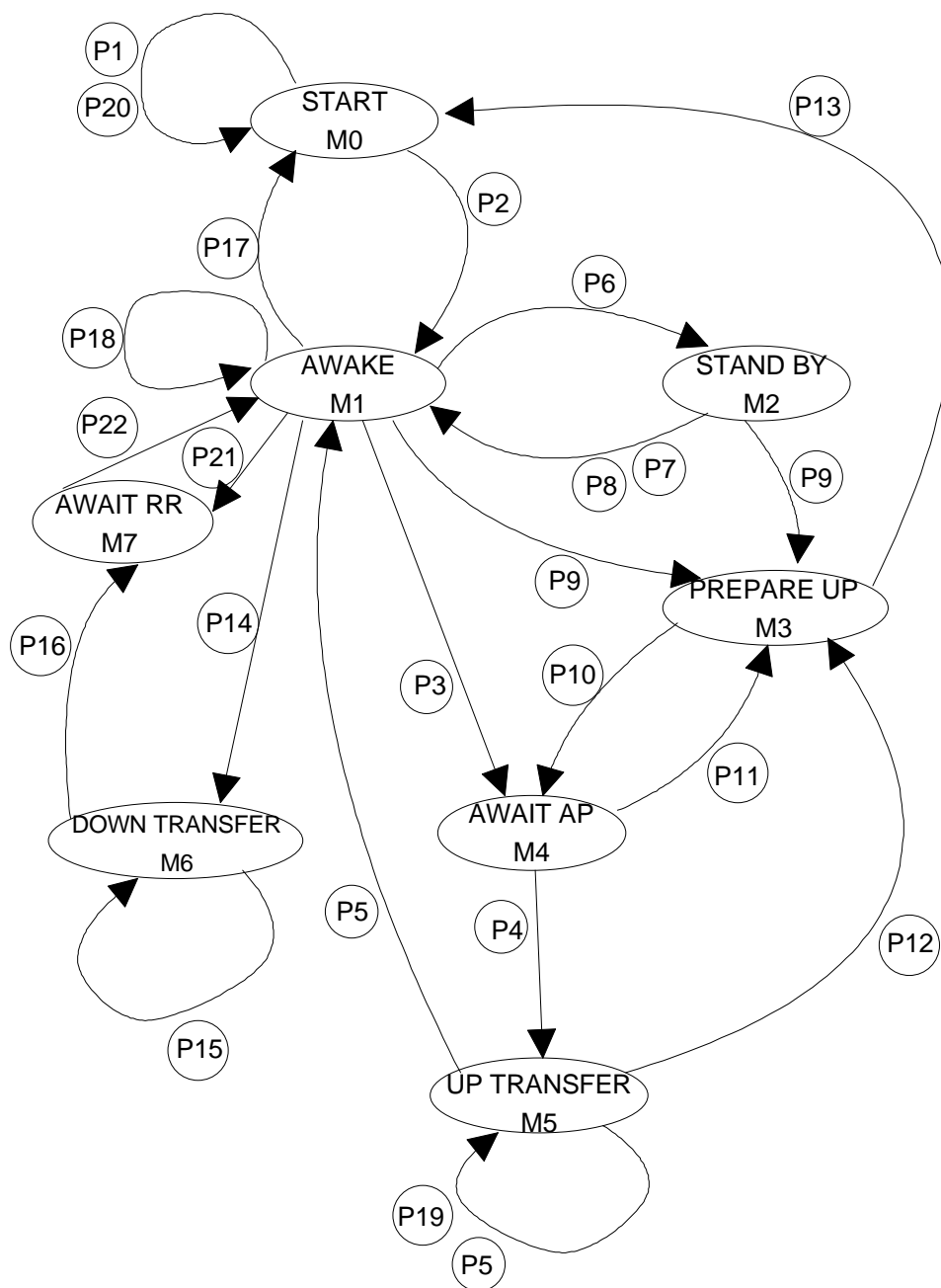

Figure H.1: States on the MS

H.2 Transitions on the BS side

See figure H.2.

- Q1 The BS receives a TL-DATA request primitive and the addressed MS is in LOD or VLD mode.
- Q2 Time-out. The time to Wake up, defined in the <WU> PDU, starts.
- Q3 The BS receives a TL-DATA request primitive and the addressed MS is in NOR mode.
- Q4 The BS receives an <UR> PDU (not the last for this transaction).
- Q5 The BS receives the last <UR> PDU for this transaction.
- Q6 The BS receives an <UD1> PDU (not the last for this transaction).
- Q7 The BS receives an <UD2> PDU (not the last for this transaction).
- Q8 The BS receives the last <UD2> PDU for this transaction.
- Q9 The BS receives an <UD1> PDU (the last for this transaction).
- Q10 The MAC receives a RR-frame from the LLC.

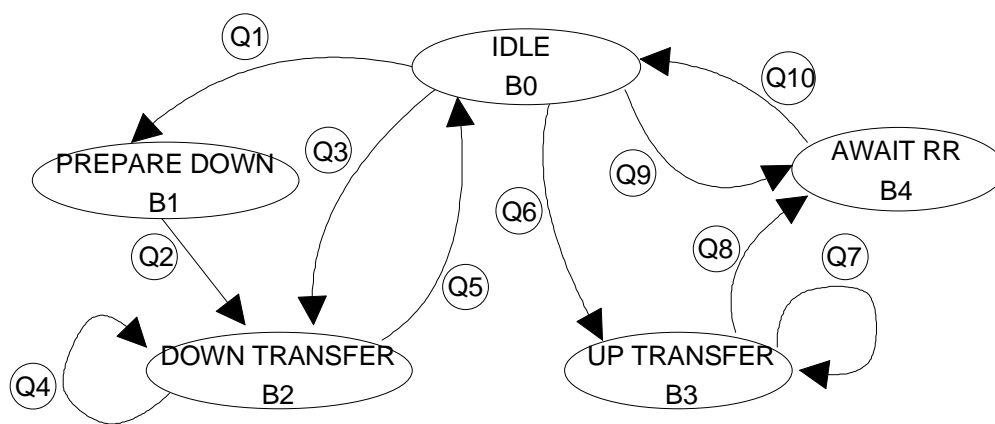

Figure H.2: States on the BS side

Annex I (informative): The MAC channel pyramid

No channel

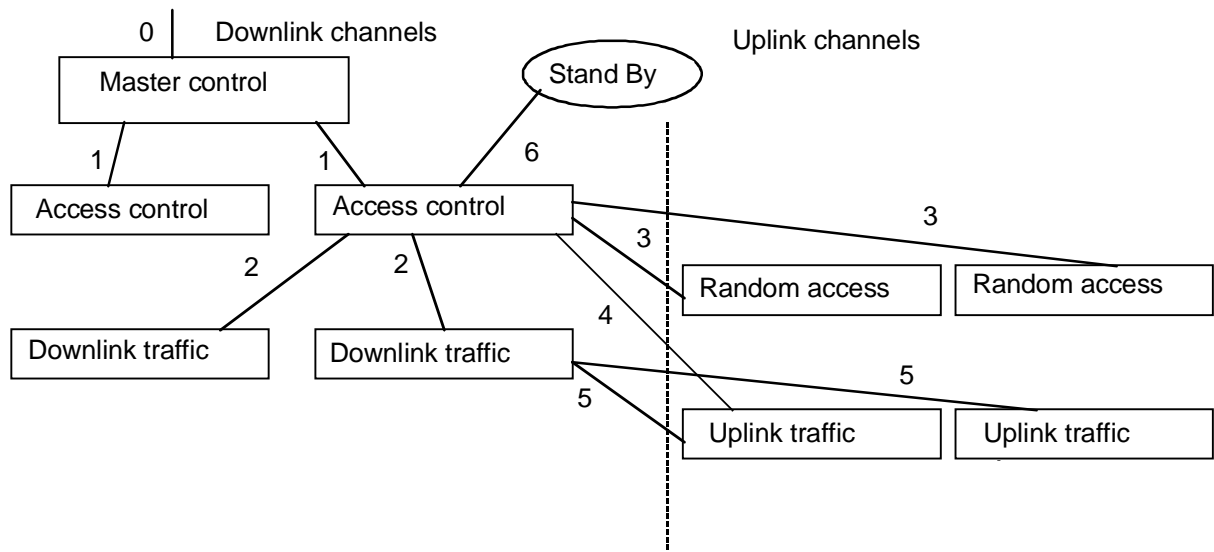

Figure I.1: The channel hierarchy

An MS is active on one channel at the time. The MS either listens on a downlink channel or transmits on an uplink channel.

The MS can change active channel in some different ways (see figure I.1):

- | | | |
|-----|-----------------------|---|
| 0) | From No Chan. to MCCH | Receiving a Master burst. |
| 0') | Back again. | Time-out. No Master bursts on the MCCH. |
| 1) | From MCCH to ACCH | Receiving an assignment of RA-label. |
| 1') | Back again. | Time-out. No messages for the RA-label. |
| 2) | From ACCH to DTCH | First downlink data for a transaction. |
| 2') | Back again | End of uplink transaction.
Time-out. No response to uplink data. |
| 3) | From ACCH to RACH | Start of random access transmission. |
| 3') | Back again | End of random access transmission. |
| 4) | From ACCH to UTCH | Start of reserved uplink data or response. |
| 4') | Back again | End of uplink transaction. |
| 5) | From DTCH to UTCH | Start of reserved uplink data or response. |
| 5') | Back again | End of reserved uplink data or response. |
| 6) | From ACCH to Stand By | Receiving a Wake Up message and not included in the Traffic list |
| 6') | Back again | Time for next Wake Up message.
The MS wants to transmit an uplink message. |

Annex J (informative): MAC message sequences

Syntax for PDUs in figures J.1 to J.14:

<PDUNAME>{FSN; BURST_LENGTH; MORE_DATA/RESERVED_BLOCKS}

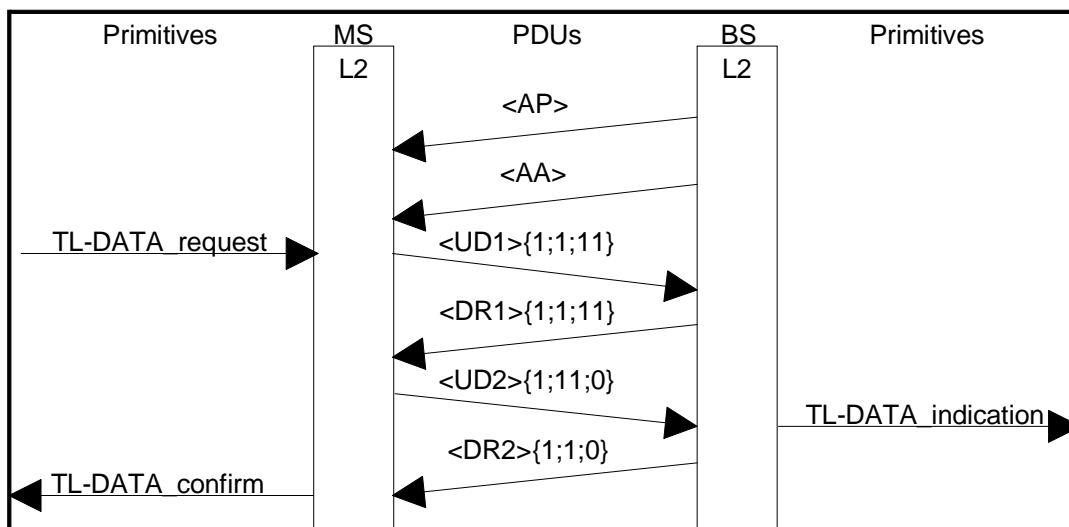

Figure J.1: Acknowledged uplink data transfer. Slotted Aloha

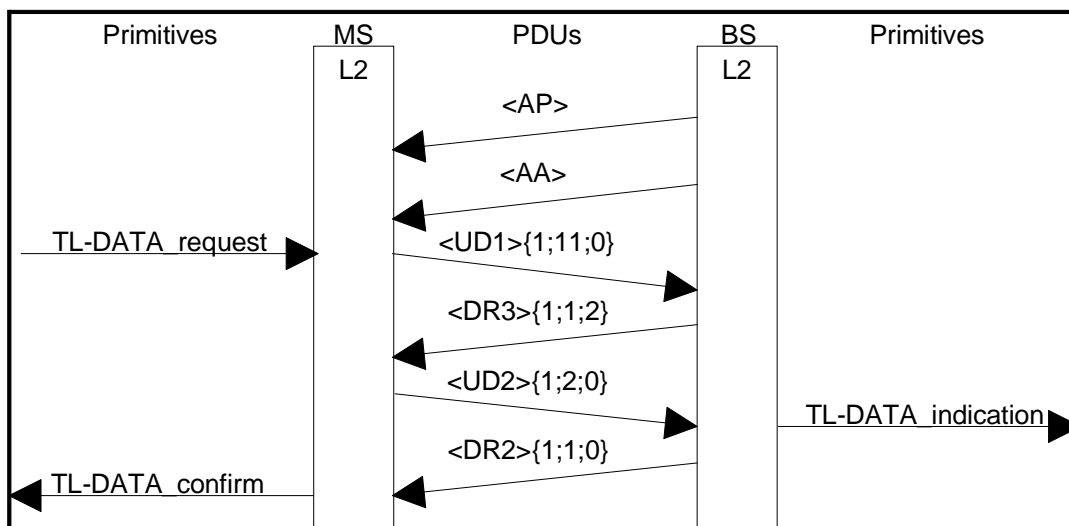

Figure J.2: Acknowledged uplink data transfer. Busy flag mode. Retransmission of one block

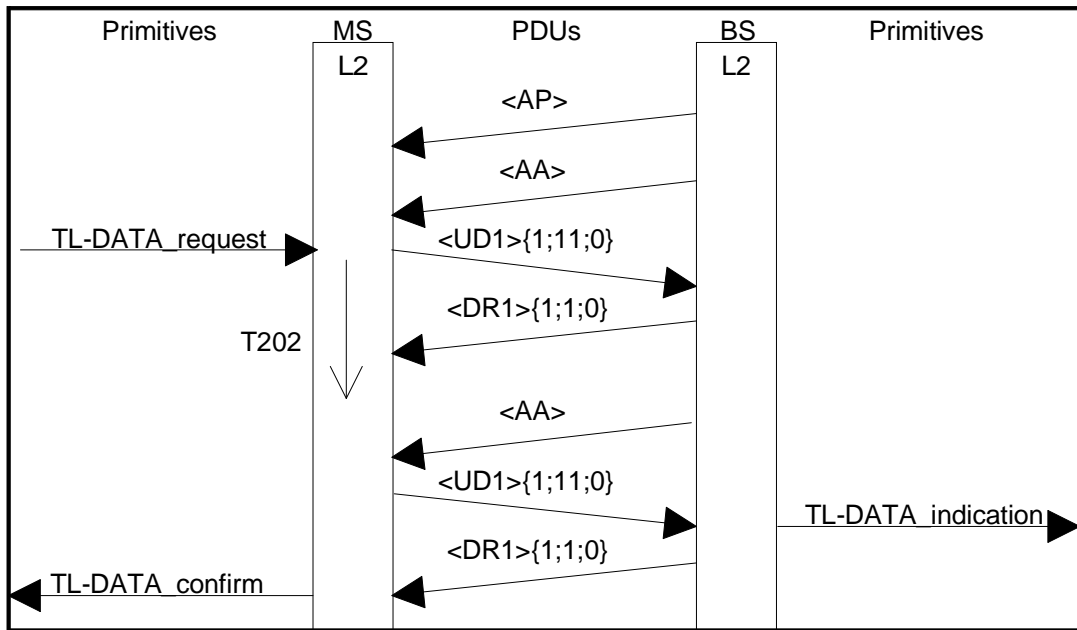

Figure J.3: Acknowledged uplink data transfer. Busy flag mode. Error in downlink response

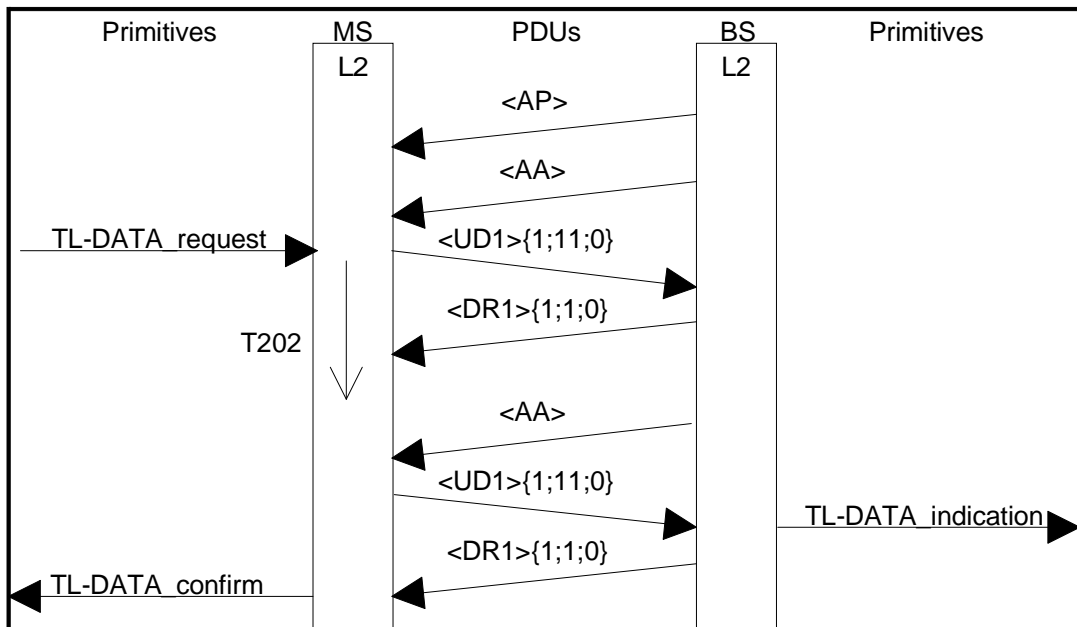

Figure J.4: Acknowledged uplink data transfer. Busy flag mode. Error in uplink data, presiding block

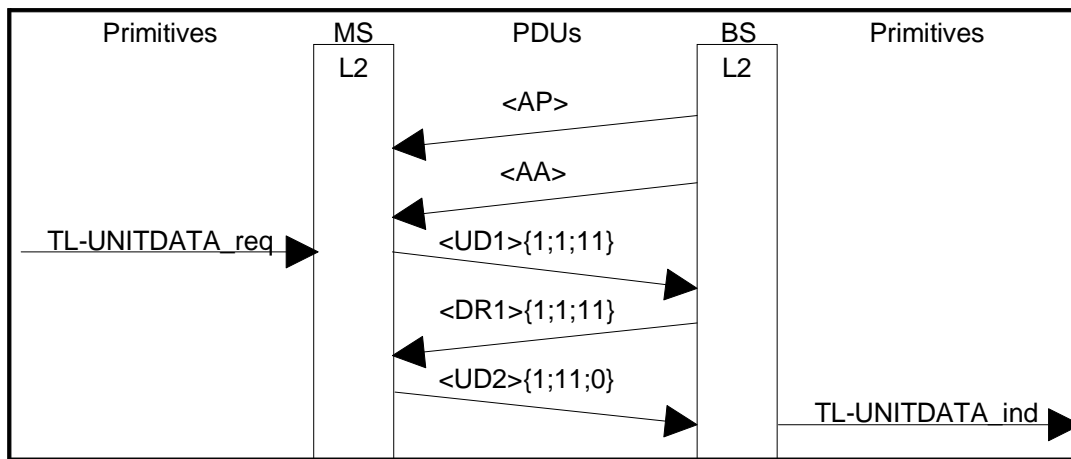

Figure J.5: Unacknowledged uplink data transfer. Slotted Aloha

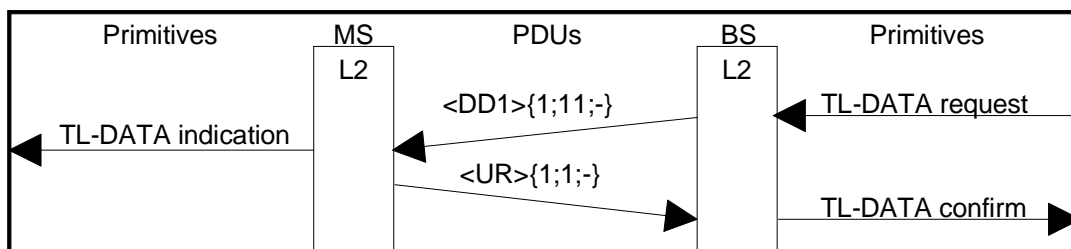

Figure J.6: Acknowledged downlink transfer

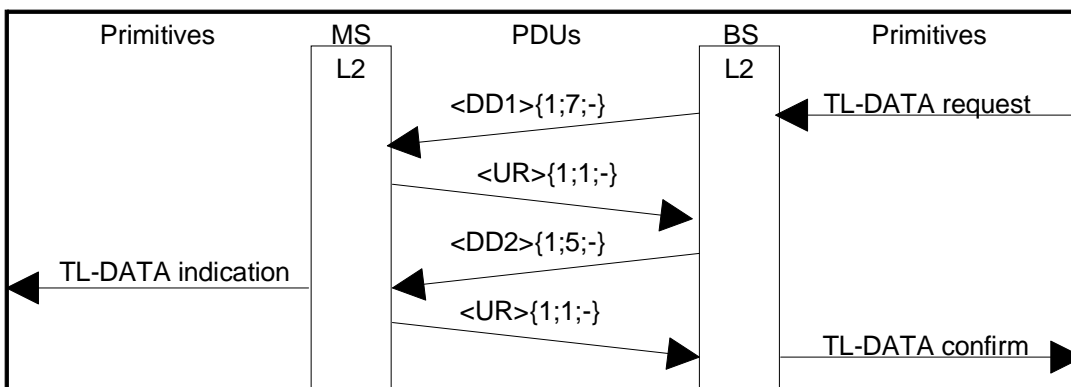

Figure J.7: Acknowledged downlink transfer. Two bursts

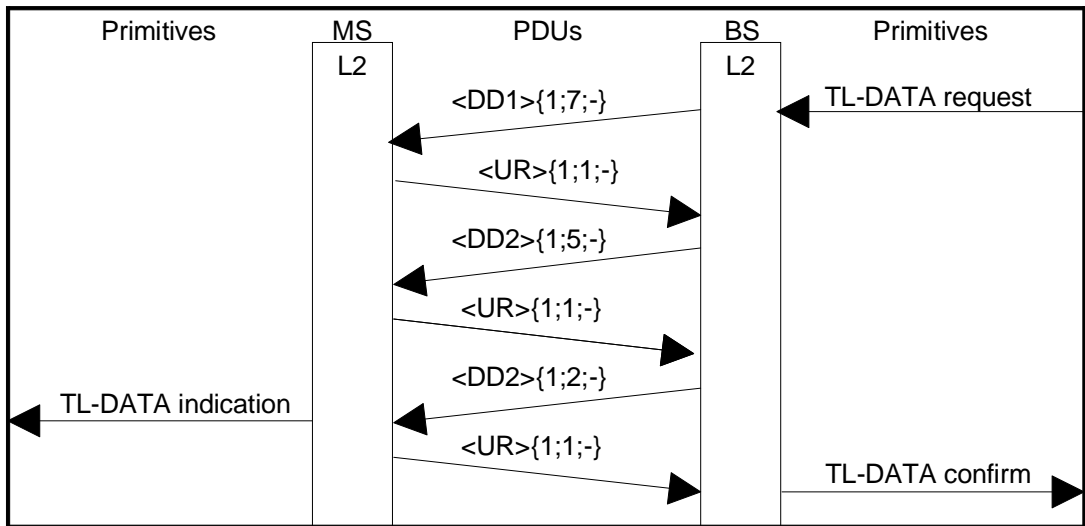

Figure J.8: Acknowledged downlink transfer. Two bursts. Retransmission of one block

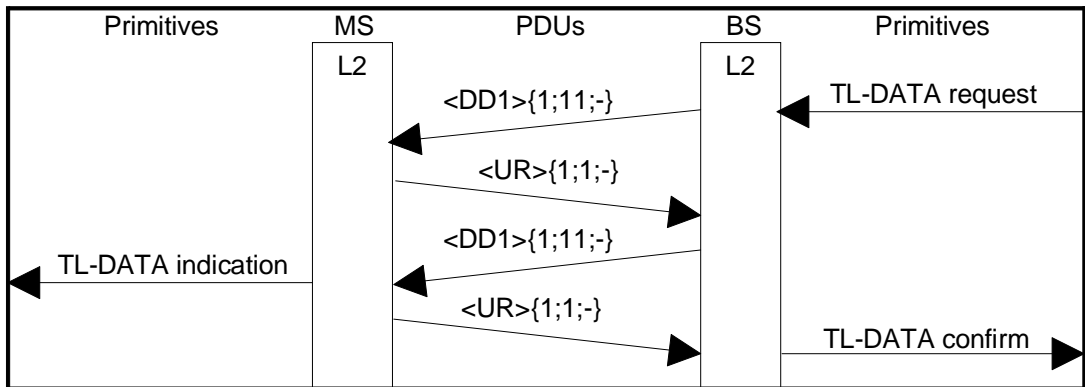

Figure J.9: Acknowledge downlink transfer. Error in uplink response

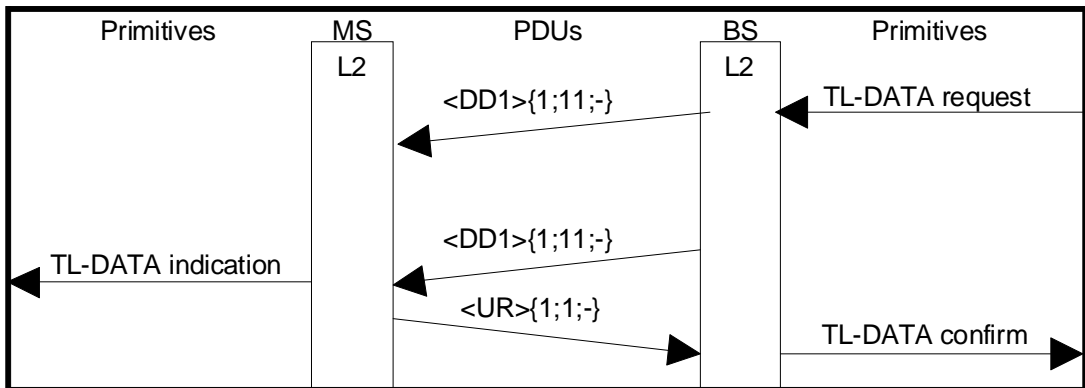

Figure J.10: Acknowledge downlink transfer. Error in downlink data, presiding block

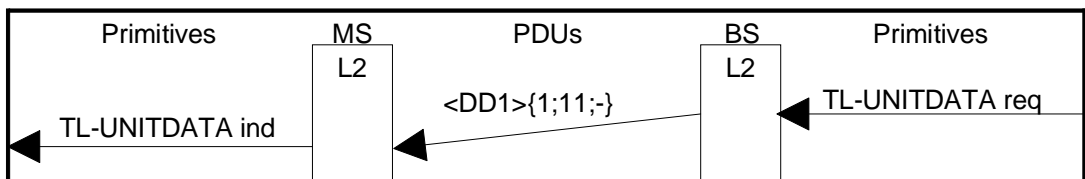

Figure J.11: Unacknowledged downlink transfer

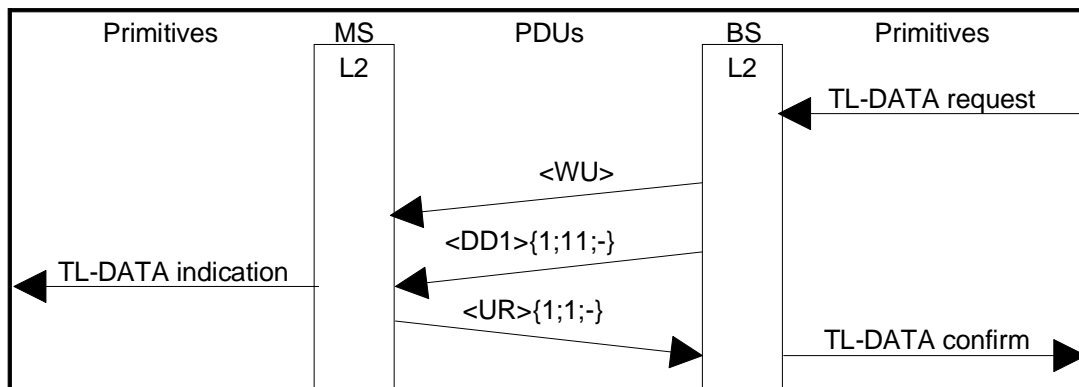

Figure J.12: Acknowledged downlink transfer. To a Low Duty MS

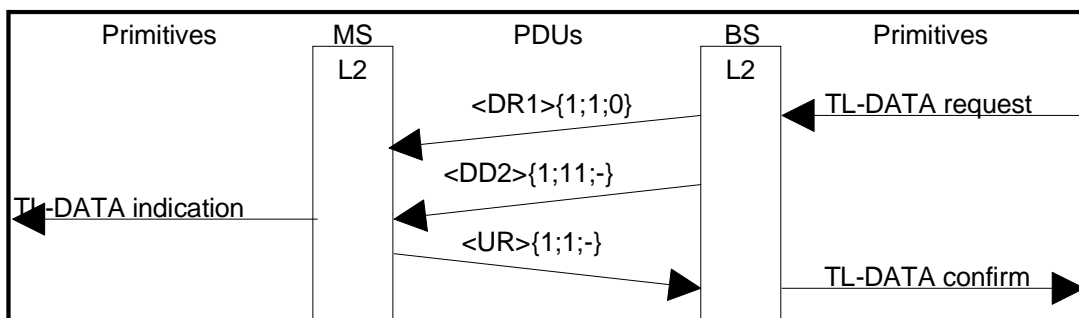

Figure J.13: Acknowledged downlink transfer. Data on another carrier than ACCH

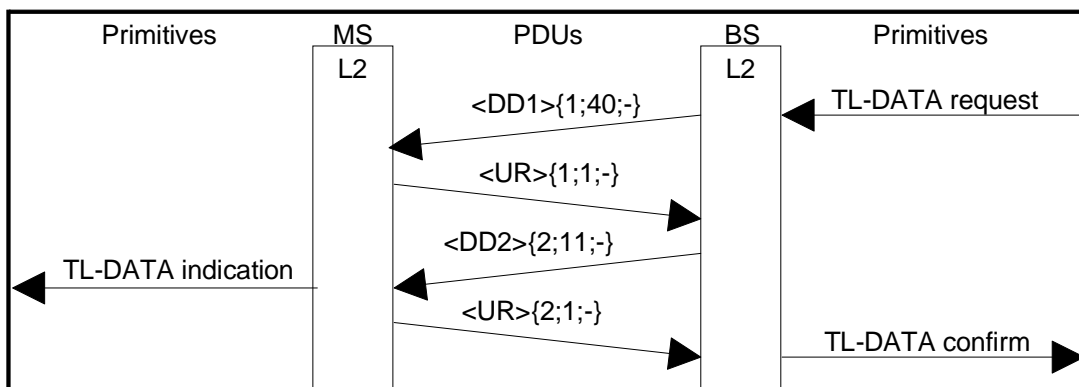

Figure J.14: Acknowledged downlink transfer. Two LLC frames

Annex K (informative): Bibliography

- Digital Land Mobile Radiocommunications, M. Failli (Ed.), Final Report 14.3.1984-13.9.1988, published by European Commission, Directorate of General Telecommunication, Information Industries and Innovation. Luxembourg. ISBN 92-825-9946-9. (1989).

History

Document history			
November 1994	Public Enquiry	PE 73:	1994-11-07 to 1995-03-03
November 1995	Vote	V 92:	1995-11-27 to 1996-01-19
May 1996	First Edition		