



**E**UROPEAN  
**T**ELECOMMUNICATION  
**S**TANDARD

**FINAL DRAFT**  
pr **ETS 300 392-12-20**  
May 1999

---

Source: TETRA

Reference: DE/TETRA-03001-12-20

ICS: 33.020

**Key words:** TETRA, radio

**Terrestrial Trunked Radio (TETRA);  
Voice plus Data (V+D);  
Part 12: Supplementary services stage 3;  
Sub-part 20: Discreet Listening (DL)**

**ETSI**

European Telecommunications Standards Institute

**ETSI Secretariat**

**Postal address:** F-06921 Sophia Antipolis CEDEX - FRANCE

**Office address:** 650 Route des Lucioles - Sophia Antipolis - Valbonne - FRANCE

**Internet:** secretariat@etsi.fr - <http://www.etsi.org>

Tel.: +33 4 92 94 42 00 - Fax: +33 4 93 65 47 16

---

**Copyright Notification:** No part may be reproduced except as authorized by written permission. The copyright and the foregoing restriction extend to reproduction in all media.

© European Telecommunications Standards Institute 1999. All rights reserved.



## Contents

Foreword.....	7
1 Scope .....	9
2 Normative references .....	10
3 Definitions and abbreviations .....	10
3.1 Definitions .....	10
3.2 General abbreviations.....	11
3.3 Supplementary service abbreviations .....	11
4 SS-DL service description .....	12
4.1 General .....	12
4.2 SS-DL services offered over the TNSSSAP .....	12
4.2.1 Services to authorized user .....	12
4.2.2 Services to the monitoring user FE7 .....	12
4.2.3 Services to monitored user .....	13
4.3 Service Primitives .....	13
4.3.1 ACTIVATE request.....	13
4.3.2 ACTIVATE ACK indication .....	13
4.3.3 INTERROGATE request .....	14
4.3.4 INTERROGATE ACK response .....	14
4.3.5 CALL-INTRUSION request .....	15
4.3.6 FORCED-REL request .....	15
4.3.7 INFO-TALKING-ITSI indication .....	15
4.3.8 INFORM indication .....	16
4.3.9 INFORM response (INFORM ACK) .....	16
4.3.10 MODIFY indication .....	16
4.3.11 MONITOR request .....	17
4.3.12 MONITORED-CALL-CLEARED indication.....	17
4.3.13 RELEASE request.....	17
4.3.14 TEMPORARY-LEAVE request.....	18
4.4 Parameter description.....	18
5 Signalling protocol for the support of SS-DL .....	20
5.1 SS-DL operational requirements.....	20
5.1.1 Monitoring User MS/LS .....	20
5.1.2 Group controlling SwMI .....	20
5.1.3 SwMI where the monitored user is registered .....	20
5.1.4 SwMI where the monitoring user is registered .....	21
5.1.5 Authorized user MS/LS.....	21
5.1.6 SwMI where the authorized user is registered .....	21
5.1.7 Monitored user home SwMI .....	21
5.2 Coding requirements.....	21
5.2.1 SS-DL PDUs .....	22
5.2.1.1 ACTIVATE PDU.....	22
5.2.1.2 ACTIVATE ACK PDU .....	23
5.2.1.3 INFO-TALKING-ITSI PDU .....	23
5.2.1.4 INFORM PDU .....	24
5.2.1.5 INFORM ACK PDU.....	25
5.2.1.6 INTERROGATE PDU .....	25
5.2.1.7 INTERROGATE ACK PDU.....	26
5.2.1.8 Monitored Call Cleared PDU .....	26
5.2.1.9 MONITOR PDU .....	26
5.2.1.10 RELEASE PDU.....	27
5.2.1.11 SS-CI-INV PDU .....	27
5.2.1.12 SS-CI-INV ACK PDU .....	27

	5.2.1.13	FORCED-REL PDU .....	28
	5.2.1.14	FORCED-REL ACK PDU .....	28
	5.2.1.15	ADD-ON PDU .....	29
5.2.2		TETRA PDU information element coding .....	29
	5.2.2.1	Activation request .....	29
	5.2.2.2	Activation state .....	30
	5.2.2.3	Activation/deactivation failure cause .....	30
	5.2.2.4	Activation/deactivation result .....	31
	5.2.2.5	Address type of monitored/monitoring/other user .....	31
	5.2.2.6	Basic service information .....	32
	5.2.2.7	Call Cleared .....	32
	5.2.2.8	Call reference .....	32
	5.2.2.9	Call in progress/New call .....	33
	5.2.2.10	Call Intrusion Activate .....	33
	5.2.2.11	Call Intrusion Activate Result .....	33
	5.2.2.12	Call Intrusion Failure Cause .....	34
	5.2.2.13	SS-DL-PDU type .....	34
	5.2.2.14	Forced release allowed .....	34
	5.2.2.15	FORCED-REL failure cause .....	35
	5.2.2.16	FORCED-REL result .....	35
	5.2.2.17	Group call only .....	35
	5.2.2.18	Interrogation failure cause .....	35
	5.2.2.19	Interrogation result .....	36
	5.2.2.20	Intrusion allowed .....	36
	5.2.2.21	MNI .....	36
	5.2.2.22	Monitored/monitoring/other/Monitoring Point user extension .....	37
	5.2.2.23	Monitored/Monitoring/Other user Short Number Address... ..	37
	5.2.2.24	Monitored/monitoring/other/Monitoring Point user SSI .....	37
	5.2.2.25	Monitored-Call-Cleared .....	37
	5.2.2.26	NO/NEVER for that call .....	38
	5.2.2.27	Single/multiple monitored user in group .....	38
	5.2.2.28	Speech Service .....	38
	5.2.2.29	SS-DL Profile .....	39
	5.2.2.30	SS-DL Profile ACK .....	39
	5.2.2.31	SS-Type .....	40
	5.2.2.32	Transmission grant .....	40
5.2.3		Additional coding requirements over the ISI .....	40
5.3		SS-DL state definitions .....	40
	5.3.1	States at the monitored user MS/LS .....	40
	5.3.2	States at the group controlling SwMI .....	41
	5.3.3	States at the SwMI where the monitored user is registered for Individual Calls .....	41
	5.3.4	States at the Authorized user MS/LS in its home SwMI .....	41
5.4		SS-DL signalling procedures .....	41
	5.4.1	Actions at the monitoring user MS/LS .....	41
	5.4.1.1	Normal procedures .....	41
	5.4.1.2	Exceptional procedures .....	42
	5.4.2	Actions at the group controlling SwMI .....	43
	5.4.2.1	Normal procedures .....	43
	5.4.2.2	Exceptional procedures .....	44
	5.4.3	Actions at the monitored user visited SwMI .....	44
	5.4.3.1	Normal procedures .....	44
	5.4.3.2	Exceptional procedures .....	44
	5.4.4	Authorized user MS/LS .....	44
	5.4.4.1	Normal Procedures .....	44
	5.4.4.2	Exceptional procedures .....	45
	5.4.5	SwMI where the authorized user MS/LS is registered .....	45
	5.4.6	Monitored user home SwMI .....	45
	5.4.6.1	Normal procedures .....	45

	5.4.6.1.1	Case where the monitored user home SwMI coincides with the SwMI where the authorized user MS/LS is registered .....	45
	5.4.6.1.2	Case where the monitored user home SwMI is different from the SwMI where the authorized user MS/LS is registered .....	45
	5.4.6.2	Exceptional procedures .....	46
5.5		SS-DL impact of inter working with other networks .....	46
5.6		Protocol interactions between SS-DL and other supplementary services and ANFs .....	46
	5.6.1	Interaction with Access Priority .....	46
	5.6.2	Interaction with Ambience Listening .....	46
	5.6.3	Interaction with Barring of Incoming Call .....	46
	5.6.4	Interaction with Barring of Outgoing Call .....	46
	5.6.5	Interaction with Call Authorized by Dispatcher .....	47
	5.6.6	Interaction with Discreet Listening .....	47
	5.6.7	Interaction with Dynamic Group Number Assignment .....	47
	5.6.8	Interaction with Late Entry .....	47
	5.6.9	Interaction with Pre-emptive Priority Call .....	47
	5.6.10	Interaction with Priority Call .....	47
	5.6.11	Interaction with Talking Party Identification .....	47
	5.6.12	Interactions with ISI Mobility Management (ANF-ISIMM) .....	47
5.7		SS-DL parameter values (timers) .....	48
Annex A (informative): Specification and Description Language (SDL) representation of procedures...			49
A.1		SDL representation of SS-DL at the monitoring user MS/LS .....	49
A.2		SDL representation of SS-DL at the group controlling SwMI .....	52
A.3		SDL representation of SS-DL at the SwMI where the monitored user is registered .....	57
A.4		SDL representation of SS-DL at the authorized user MS/LS .....	62
A.5		SDL representation of SS-DL at the authorized user SwMI .....	63
A.6		SDL representation of SS-DL at the monitored user home SwMI .....	64
Annex B (informative): Bibliography .....			65
History .....			66

Blank page

## Foreword

This final draft European Telecommunication Standard (ETS) has been produced by the ETSI Project Terrestrial Trunked Radio of the European Telecommunications Standards Institute (ETSI), and is now submitted for the Voting phase of the ETSI standards approval procedure.

This ETS is a multi-part standard and will consist of the following parts:

- Part 1: "General network design";
- Part 2: "Air Interface (AI)";
- Part 3: "Inter-working";
- Part 4: "Gateways basic operations";
- Part 5: "Terminal equipment interface";
- Part 6: "Line connected stations";
- Part 7: "Security";
- Part 9: "General supplementary services design";
- Part 10: "Supplementary services stage 1";
- Part 11: "Supplementary services stage 2";
- Part 12: "Supplementary services stage 3";**
- Part 13: "SDL Model of the Air Interface (AI)";
- Part 14: "Protocol Implementation Conformance Statement (PICS) proforma specification".

<b>Proposed transposition dates</b>	
Date of latest announcement of this ETS (doa):	3 months after ETSI publication
Date of latest publication of new National Standard or endorsement of this ETS (dop/e):	6 months after doa
Date of withdrawal of any conflicting National Standard (dow):	6 months after doa

Blank page



## 1 Scope

This European Telecommunication Standard (ETS) specifies the stage 3 description of the Supplementary Service Discreet Listening (SS-DL) for the Terrestrial Trunked Radio (TETRA).

The DL supplementary service shall enable an authorized user to listen to one or more communications between TETRA subscribers (Mobile Station (MS) or Line Station (LS)) without any indication to any user that the communication is being monitored.

As options, the authorized user shall be able to intrude into the existing call and shall be able to forcefully clear the monitored call without call owner consent (in the case of a group call).

Man-Machine Interface (MMI) and charging principles are outside the scope of this ETS.

The supplementary service stage 3 description is preceded by the stage 1 and the stage 2 description of the service, according to the method described in ITU-T Recommendation I.130 [8]. The stage 1 description specifies the service from the user's point of view. The stage 2 description identifies the functional capabilities of SS-DL and the information flows needed to support the supplementary service as specified in its stage 1 description. And the present stage 3 description specifies the protocols at the air interface and at the various Inter-System Interfaces (ISI) to support SS-DL.

NOTE: According to ITU-T Recommendation I.130 [8], the stage 3 description of any telecommunication service addresses the network implementation aspects. Consequently it comprises two steps: the specifications of all protocols at the various reference points involved in any of the service procedures (notably the service operation) are the first step of the stage 3 description, and the specifications of the functions of the corresponding network entities are its second step.

The latter have not been provided since they can be derived from the specification of the functional entity actions in the stage 2 description.

This ETS is applicable to Voice plus Data individual call or group call; more specifically to the following entities:

- the MS/LS of the monitoring user during an individual call or a group call;
- the monitoring user Switching and Management Infrastructure (SwMI) in an individual call or a group call;
- the group controlling SwMI and the participating SwMI for a group call;
- the monitored user present SwMI for an individual call;
- and, optionally, the home SwMI of the monitoring/authorized MS/LS, for managing the supplementary service DL.

## 2 Normative references

This European Telecommunications Standard incorporates, by dated or undated reference, provisions from other publications. These normative references are cited at the appropriate places in the text and the publications are listed hereafter. For dated references, subsequent amendments to, or revisions of, any of these publications apply to this European Telecommunications Standard only when incorporated in it by amendment or revision. For undated references the latest edition of the publication referred to applies.

- [1] ETS 300 392-2 "Terrestrial Trunked Radio (TETRA); Voice plus Data (V+D); Part 2: Air Interface (AI)".
- [2] ETS 300 392-3-1: "Terrestrial Trunked Radio (TETRA); Voice plus Data (V+D) Part 3: Interworking at the Inter-System Interface (ISI); Sub-part 1: General design".
- [3] ETS 300 392-3-2: "Terrestrial Trunked Radio (TETRA); Voice plus Data (V+D) Part 3: Interworking at the Inter-System Interface (ISI); Sub-part 2: Additional Network Functions Individual Call (ANF-ISIIC)".
- [4] ETS 300 392-3-3: "Terrestrial Trunked Radio (TETRA); Voice plus Data (V+D); Part 3: Interworking at the Inter-System Interface (ISI); Sub-part 3: Additional Network Functions Group Call (ANF-ISIGC)".
- [5] ETS 300 392-3-5: "Terrestrial Trunked Radio (TETRA); Voice plus Data (V+D); Part 3: Interworking at the Inter-System Interface (ISI); Sub-part 5: Additional Network Functions Mobility Management (ANF-ISIMM)".
- [6] ETS 300 392-9: "Terrestrial Trunked Radio (TETRA); Voice plus Data (V+D); Part 9: General requirements for supplementary services".
- [7] ITU-T Recommendation I.112: "Vocabulary of terms for ISDNs".
- [8] ITU-T Recommendation I.130 (1988): "Method for the characterization of telecommunication services supported by an ISSN and network capabilities of an ISDN".
- [9] ITU-T Recommendation I.210 (1993): "Principles of telecommunication services supported by an ISDN and the means to describe them".
- [10] ITU-T Recommendation Q.9: "Vocabulary of switching and signalling terms".
- [11] ITU-T Recommendation Z.100: "Specification and Description Language (SDL)".

## 3 Definitions and abbreviations

### 3.1 Definitions

For the purposes of this ETS the following definitions apply:

**Authorized user:** An identified user who is allowed to activate, deactivate and/or interrogate the SS-DL parameters.

**basic (...) service:** Any stand alone bearer service or teleservice (derived from ITU-T Recommendation I.210 [9]).

**Bearer service:** A type of telecommunication service that provides the capability for the transmission of signals between user-network interfaces. (defined in ITU-T Recommendation I.112 [7]).

**Line Station (LS):** A physical grouping that contains all of the fixed equipment that is used to obtain terrestrial access to TETRA services.

**Mobile Station (MS):** A physical grouping that contains all of the mobile equipment that is used to obtain TETRA services. By definition, a mobile station contains at least one Mobile Radio Stack (MRS).

**Monitored user:** The user who is discretely listened to.

**Monitoring user:** The authorized user who may be discretely listening to a call.

**Served user:** Monitored user

**Supplementary service:** Any service provided by a network in addition to its basic service or services (defined in ITU-T Recommendation Q.9 [10]); a supplementary service modifies or supplements a bearer service or a basic telecommunication service. Consequently, it cannot be offered to a customer as a stand alone service. It is be offered together with or in combination with a bearer service or a basic telecommunication service (except from ITU-T Recommendation I.210 [9]).

**Switching and Management Infrastructure (SwMI):** All of the TETRA equipment for a Voice plus Data (V+D) network except for subscriber terminals. The SwMI enables subscriber terminals to communicate with each other via the SwMI.

**Teleservice:** A type of telecommunications service that provides the complete capability, including terminal equipment functions, for communication between users according to agreed protocols (defined in ITU-T Recommendation I.112 [7] except for a minor change at the end).

### 3.2 General abbreviations

ANF-ISIGC	Additional Network Feature - Inter-System Interface Group Call
ANF-ISIIC	Additional Network Feature - Inter-System Interface Individual Call
ANF-ISIMM	Additional Network Feature - Inter-System Interface Mobility Management
ANF-ISISS	Additional Network Feature - Inter-System Interface Supplementary Service
FE	Functional Entity
GTSI	Group TETRA Subscriber Identity
ISI	Inter-System Interface
ITSI	Individual TETRA Subscriber Identity
LS	Line Station
MS	Mobile Station
PDU	Protocol Data Unit
ROSE	Remote Operation Service Element
SDL	Specification Design Language
SS	Supplementary Service

NOTE: The abbreviation SS is only used when referring to a specific supplementary service.

SSI	Short Subscriber Identity
SwMI	Switching and Management Infrastructure

### 3.3 Supplementary service abbreviations

AL	Ambience Listening
DL	Discreet Listening
TPI	Talking Party Identification

## **4 SS-DL service description**

### **4.1 General**

This subclause describes SS-DL specific services offered by the Circuit Mode Control Entity (CMCE) at the Supplementary Services service access point (TNSS-SAP) of the TETRA voice plus data layer 3 service boundary. The SS-DL service access point is used in conformance testing as a normative boundary in TETRA Mobile Stations (MSs) and TETRA Line Stations (LSs).

NOTE: As the present document only deals with the SS-DL, all the service primitives have been shown without a TNSS-DL-prefix e.g. the TNSS-DL-ACTIVATE request is shorten into an ACTIVATE request.

### **4.2 SS-DL services offered over the TNSSSAP**

The service offered to users of SS-DL are defined as service primitives containing service parameters. The service primitives are defined in subclauses of 4.3 and the service parameter are defined in subclause 4.4.

In addition to the defined service primitives a SwMI may response by a service not supported or a process not supported primitives as appropriate, refer prETS 300 392-3-1 [2].

NOTE: As man-machine interface or user applications are outside the scope of the present document service primitives are used to define information exchange to and from the standardized part of the MS/LS. Those primitives may be only indirectly accessible.

#### **4.2.1 Services to authorized user**

The SS-DL service primitives for the authorized user (FE3) at the MS/LS TNSS-SAP shall be:

- ACTIVATE/DEACTIVATE request;
- ACTIVATE/DEACTIVATE ACK indication;
- INTERROGATE request;
- INTERROGATE ACK indication;

Authorized user (FE3) shall be able to make SS-DL activation's, deactivations and interrogations. The activation can be on one or more individual or group identity. The interrogation can be made to one or more identity. FE2 shall acknowledge the request. FE2 shall save the SS-DL and activation state in the home SwMI of the monitored user, if the request was accepted. Upon migration of the monitored user, SS-DL profile will be transported to the visited SwMI.

#### **4.2.2 Services to the monitoring user FE7**

The SS-DL service primitives for the monitoring user (FE7) at the MS/LS TNSS-SAP shall be:

- CALL INTRUSION request;
- FORCED-REL request;
- INFO-TALKING-ITSI indication;
- INFORM indication;
- INFORM response (INFORM ACK);
- MODIFY indication;
- MONITOR request;

- MONITORED-CALL-CLEARED indication;
- RELEASE request;
- TEMPORARY LEAVE request.

**4.2.3 Services to monitored user**

There are no SS-DL service primitives for the monitored user (FE1) at the MS/LS TNSS-SAP (monitored user).

**4.3 Service Primitives**

**4.3.1 ACTIVATE request**

The ACTIVATE request primitive shall be sent to the MS/LS CMCE by the authorized user application over TNSS-SAP to activate SS-DL.

The activation process shall support one TETRA identity in a request. Optionally it may support a list and/or range of identities. Such identity/identities may be those of either individual users or of groups.

The ACTIVATE request primitive shall contain the SS-DL parameters listed in table 1.

**Table 1: Parameters for the primitive ACTIVATE request**

Parameter	Request
Basic Service Information	M
TETRA identity/identities	M (note 1)
Access priority	M
Delay timer	O
Access priority	O
Activation request	M (note 2)
NOTE 1: It is optional to support more than one identity.	
NOTE 2: There shall be only one activation request per request primitive.	

**4.3.2 ACTIVATE ACK indication**

The ACTIVATE ACK indication primitive shall be sent to the authorized user application by the MS/LS CMCE over TNSS-SAP to inform it of the result of a previous ACTIVATE request.

If the previous ACTIVATE request has been addressed to a SwMI for more than one identity, that SwMI may send its corresponding response either in one single indication which applies to all those identities or in multiple indications.

The ACTIVATE ACK indication primitive shall contain the SS-DL parameters listed in table 2.

**Table 2: Parameters for the primitive ACTIVATE ACK indication**

Parameter	Indication
Activation result	M (note 1)
TETRA identity/identities	M (note 2)
Basic Service Information	M
Access priority	O
Activation state	C (notes 1 and 3)
NOTE 1: There shall be only one activation result and one activation state per request primitive.	
NOTE 2: It is optional to support more than one identity.	
NOTE 3: Conditional on the activation result.	

**4.3.3 INTERROGATE request**

The INTERROGATE request primitive shall be sent to the MS/LS CMCE by the authorized user application by over TNSS-SAP to know the SS-DL activation status of a user.

The interrogation process shall support one TETRA identity in a request. Optionally it may support a list and/or range of identities. Such identity/identities may be those of either individual users or of groups.

The INTERROGATE request primitive shall contain the SS-DL parameters listed in table 3.

**Table 3: Parameters for the primitive INTERROGATE request**

Parameter	Request
Activate status	M
Basic Service Information	M
Access priority	O
TETRA monitored user identity/identities	M (note)
NOTE: It is optional to support more than one identity.	

**4.3.4 INTERROGATE ACK response**

The INTERROGATE ACK response primitive shall be sent to the authorized user application by the MS/LS CMCE over TNSS-SAP to inform it of the result of a previous INTERROGATE request.

If the previous request has been addressed to a SwMI for more than one identity, that SwMI may send its corresponding response either in one single request which applies to all those identities or in multiple requests.

The INTERROGATE ACK indication primitive shall contain the SS-DL parameters listed in table 4.

**Table 4: Parameters for the primitive INTERROGATE ACK indication**

Parameter	Indication
Interrogation result	M (note 1)
TETRA monitored user identity/identities	C (note 2 and note 3)
TETRA monitoring user identity/identities	C (note 3)
Access priority	C (note 3)
Basic Service Information	C (notes 1 and 3)
Activation state	C (notes 1 and 3)
NOTE 1: There shall be only one interrogation result and one activation state per indication primitive.	
NOTE 2: It is optional to support more than one identity.	
NOTE 3: Conditional on the interrogation result.	

#### 4.3.5 CALL-INTRUSION request

The CALL-INTRUSION request primitive shall be sent from the monitoring user application by the MS/LS CMCS over the TNSS-SAP to request intrusion into the call just monitored discretely. There shall be no confirmation of this request primitive since the monitoring user application will recognize the positive result of the intrusion. The CALL-INTRUSION request primitive shall contain the elements listed in table 5.

**Table 5: Parameters for the primitive CALL-INTRUSION request**

Parameter	Request
Monitoring point MNI	M
Monitoring point SSI	M
Access priority	O
CALL-INTRUSION-ACTIVATE	M
Call reference	M

#### 4.3.6 FORCED-REL request

The FORCED-REL request primitive shall be sent from the monitoring user application by the MS/LS CMCS over the TNSS-SAP to request forced release of the call either just monitored discretely or just intruded into. There is no confirmation primitive of this request since the result of the FORCED-RELEASE shall be noted by the monitoring user. The FORCED-RELEASE request primitive shall contain the elements listed in table 6.

**Table 6: Parameters for the primitive FORCED-RELEASE request**

Parameter	Request
Monitoring point MNI	C notes 1 and 3
Monitoring point SSI	C notes 1 and 3
Access priority	O
FORCED-RELEASE-ACTIVATE	M
Call reference	C: notes 2 and 3
NOTE 1:	Conditional depending upon the state of the call being discretely monitored.
NOTE 2:	Conditional depending upon the state of the call being already intruded.
NOTE 3:	Monitoring point MNI/SSI and Call reference are mutually exclusive.

#### 4.3.7 INFO-TALKING-ITSI indication

The INFO-TALKING-ITSI indication primitive shall be sent to the monitoring user application by the MS/LS CMCE over TNSS-SAP as a result of SS-DL operation to indicate the identity of the talking/sending user. The INFO-TALKING-ITSI indication primitive shall contain the SS-DL parameters listed in table 7.

**Table 7: Parameters for the primitive INFO-TALKING-ITSI indication**

Parameter	Indication
Call reference	M
Talking-user-ITSI	M
TX-Demand-Priority	M

**4.3.8 INFORM indication**

The INFORM indication primitive shall be sent to the monitoring user application by the MS/LS CMCE over TNSS-SAP as a result of SS-DL operation to inform the monitoring user that either a new call or an existing call ( in case of present activation of SS-DL) are to be monitored. The INFORM indication primitive shall contain the SS-DL parameters listed in table 8.

**Table 8: Parameters for the primitive INFORM indication**

Parameter	Indication
Call reference	M
Monitored User Identity	M
Access priority	M
Half duplex/duplex	M
Monitoring Point ITSI	M
Basic Service Information	M

**4.3.9 INFORM response (INFORM ACK)**

The INFORM response primitive shall be sent by the monitoring user application by the MS/LS CMCE over TNSS-SAP as a result of SS-DL operation. The INFORM response primitive shall either contain the SS-DL parameters listed in table 9 or contain the elements of MONITOR in SETUP.

**Table 9: Parameters for the primitive INFORM response (INFORM ACK)**

Parameter	Response
Call reference	M
Monitored User Identity	M
Monitoring Point ITSI	M
Basic Service Information	M (note)
Access priority	O
Call reject (temporary, permanent)	M
NOTE: Basic air interface resource should be reserved at that point.	

**4.3.10 MODIFY indication**

The MODIFY indication primitive shall be sent to the user application by the MS/LS CMCE over TNSS-SAP to indicate it of the result of a previous MODIFY request done by the monitored user (change of call parameters). The MODIFY indication primitive shall contain the SS-DL parameters listed in table 10. The MODIFY indication shall be sent either to warn the monitoring user of the reason why its SS-DL call is being released (new basic service for the call not within the authorized basic service activated) with a RELEASE or of the fact that the Basic Service Information has been modified but this change of service has remained within the activate parameters boundary in which case MODIFY shall be sent while DISCREET LISTENING state is maintained.

**Table 10: Parameters for the primitive MODIFY indication**

Parameter	Indication
Monitored user ITSI	M
Half duplex/Duplex	M
Basic Service Information (new service)	M



**4.3.11 MONITOR request**

The MONITOR request primitive shall be sent from the monitoring user application by the MS/LS CMCS over the TNSS-SAP to request monitoring of the call just presented in the INFORM indication. The MONITOR request primitive shall contain the elements listed in table 11.

**Table 11: Parameters for the primitive MONITOR request**

Parameter	Request
Monitoring point MNI	M
Monitoring point SSI	M
Access priority	O
Call reference	M (note)
NOTE: Basic air interface resource should be reserved at that point.	

**4.3.12 MONITORED-CALL-CLEARED indication**

The MONITORED-CALL-CLEARED (abbreviated MONED-CALL-CLRD) indication primitive shall be sent to the monitoring user application by the MS/LS CMCE over TNSS-SAP as a result of SS-DL operation to indicate that the monitored call that the monitoring user has not joined has now cleared. The MONED-CALL-CLRD indication primitive shall contain the SS-DL parameters listed in table 12.

**Table 12: Parameters for the primitive MONITORED-CALL-CLEARED indication**

Parameter	Indication
Monitored user ITSI	M
Cleared	M
Basic Service Information	M

**4.3.13 RELEASE request**

The RELEASE request primitive shall be sent by the monitoring user application to the MS/LS CMCE over TNSS-SAP to request release of the SS-DL call status without requesting full disconnect of the monitored call. The RELEASE request primitive shall contain the SS-DL parameters listed in table 13.

**Table 13: Parameters for the primitive RELEASE request**

Parameter	Request
Call reference	M
Access priority	O
Monitoring point ITSI	M
Basic Service Information	M

**4.3.14 TEMPORARY-LEAVE request**

The TEMPORARY-LEAVE request primitive shall be sent by the monitoring user application to the MS/LS CMCE over TNSS-SAP to request either temporary or permanent leave from the SS-DL call monitoring condition. The TEMPORARY-LEAVE request primitive shall contain the SS-DL parameters listed in table 14.

**Table 14: Parameters for the primitive TEMPORARY-LEAVE request**

Parameter	Request
Call reference	M
Monitoring point ITSI	M
Access priority	O
Temporary/Permanent Leave	M
Basic Service Information	M

**4.4 Parameter description**

Activation request.

That parameter shall contain the following information:

- Speech call activation:
  - 0 deactivate;
  - 1 activate;
  - 2 no change.
- Data call activation:
  - 0 deactivate;
  - 1 activate;
  - 2 no change.
- Call priority:
  - 0 no priority;
  - 1 low priority;
  - 2 pre-emptive priority;
  - 3 emergency.
- Speech encryption control:
  - 0 clear;
  - 1 encrypted;
- Communication Type:
  - 0 Point-to-point;
  - 1 Point-to-multipoint;
  - 2 point-to-point Acknowledged.

Activation result:

- 0 unsuccessful request;
- 1 successful request.

If the request has been unsuccessful, one of the following reasons shall be indicated:

- rejected for any reason;
- user not authorized;
- unknown TETRA identity;
- repetition of parameters not supported;
- protocol problem.

Activation state

That parameter shall contain the following information:

- Speech call activation:
  - 0 deactivated;
  - 1 activated.
- Data call activation:
  - 0 deactivated;
  - 1 activated.
- Call priority:
  - 0 no priority;
  - 1 low priority;
  - 2 pre-emptive priority;
  - 3 emergency.
- Speech encryption:
  - 0 clear;
  - 1 encrypted;
- Communication Type:
  - 0 Point-to-point;
  - 1 Point-to-multipoint;
  - 2 point-to-point Acknowledged.

Interrogation result:

- 0 unsuccessful request;
- 1 successful request.

If the request has been unsuccessful, one of the following reasons shall be indicated:

- rejected for any reason;
- not an authorized user;
- unknown TETRA identity;
- parameters not valid; repetition of parameters not supported;
- protocol problem.

Talking/sending party identity =

- Short Subscriber Identity (SSI);
- Short Subscriber Identity (SSI) + Address extension.

TETRA identity:

- Short Number Address (SNA);
- Short Subscriber Identity (SSI);
- Short Subscriber Identity (SSI) + Address extension.

## **5 Signalling protocol for the support of SS-DL**

### **5.1 SS-DL operational requirements**

#### **5.1.1 Monitoring User MS/LS**

The monitoring user MS/LS shall comply with the requirements in clause 14 of ETS 300 392-2 [1] which apply to the tele- and bearer services which it supports. In addition, it shall comply with the relevant call related requirements in clauses 7 to 11 of ETS 300 392-9 [6].

#### **5.1.2 Group controlling SwMI**

If the monitored user MS/LS is registered in the group controlling SwMI, this SwMI shall support this MS/LS complying with the requirements for participating in a group call in the receive mode only set in clause 14 of ETS 300 392-2 [1]. This SwMI shall also comply with the relevant call related requirements in clauses 7 to 11 of ETS 300 392-9 [6].

If the monitoring user MS/LS is registered in the group controlling SwMI, this SwMI shall support this MS/LS complying with the requirements for participating in a group call without the possibility to talk/send data, as defined in clause 14 of ETS 300 392-2 [1]. This SwMI shall also comply with the relevant call related requirements in clauses 7 to 11 of ETS 300 392-9 [6].

If the monitored user MS/LSs and the monitoring user MS/LS are not all registered in the group controlling SwMI, this SwMI shall comply with the ISI requirements necessary to support group calls, set in ETS 300 392-3-3 [4]. It shall also comply with the relevant call related requirements in clauses 9 to 11 of ETS 300 392-9 [6].

#### **5.1.3 SwMI where the monitored user is registered**

This SwMI shall support the monitored MS/LS complying with the requirements for individual calls set in subclause 5.1.1.

It shall also support the monitored user MS/LS complying with the requirements for group calls set in subclause 5.1.1 if it is different from the group controlling SwMI.

If the call is over the ISI, the SwMI where the monitored user is registered shall comply with the corresponding ISI requirements, set in ETS 300 392-3-2 [3], for individual calls and in ETS 300 392-3-3 [4], for group calls. It shall also comply with the relevant call related in clauses 9 to 11 of ETS 300 392-9 [6].

#### **5.1.4 SwMI where the monitoring user is registered**

For an individual call, this SwMI shall support the possibility for the monitoring user MS/LS to participate in the call and to receive speech/data data, as defined in ETS 300 392-2 [1] for individual calls. This SwMI shall also comply with the relevant call related requirements in clauses 7 to 11 of ETS 300 392-9 [6].

The same shall apply for group calls if this SwMI is different from the group controlling SwMI.

If the call is over the ISI, the SwMI where the monitoring user is registered shall comply with the corresponding ISI requirements, set in ETS 300 392-3-2 [3] for individual calls and in ETS 300 392-3-3 [4] for group calls. It shall also comply with the relevant call related requirements in clauses 9 to 11 of ETS 300 392-9 [6].

#### **5.1.5 Authorized user MS/LS**

The authorized user MS/LS shall comply with the call unrelated procedures defined in clause 14 of ETS 300 392-2 [1], especially in its subclause 14.5.4

#### **5.1.6 SwMI where the authorized user is registered**

This SwMI shall support the authorized user MS/LS complying with subclause 6.1.5.

If the SwMI where the authorized user is registered is different from the home SwMI of the monitored user (the monitoring user and the authorized user being coincident have the same home SwMI), it shall comply with the relevant call unrelated requirements in clauses 9 to 11 of ETS 300 392-9 [6].

#### **5.1.7 Monitored user home SwMI**

The monitored user home SwMI shall comply with the relevant call unrelated requirements in clauses 9 to 11 of ETS 300 392-9 [6].

The monitoring point for SS-DL belongs initially to either the monitored user SwMI or the group controlling SwMI; in the case where the monitored user is migrating to another SwMI, most of the information relating to the monitored user shall be carried over to the new SwMI according to Mobility Management ETS 300 392-3-5 [5]. Upon migration, the monitoring point shall also migrate to the SwMI where the monitored user has migrated; as part of this monitoring point migration, a new set-up for SS-DL shall be initiated with the MONITOR parameters to the new SwMI; in the case where the monitored user, as part of the call restoration changes its basic service, the new SwMI shall report in a MODIFY PDU the changes that have occurred.

### **5.2 Coding requirements**

The information contained in the following description tables correspond to the following key:

- Length: length of the sub-argument in bits.
- Type: element type (1, 2 or 3) described in subclause 14.7 of ETS 300 392-2 [1].
- C/O/M: conditional/optional/mandatory.
- Remark: comment.

## 5.2.1 SS-DL PDUs

### 5.2.1.1 ACTIVATE PDU

The ACTIVATE PDU may be sent by the authorized user to the monitored user home SwMI, i.e. home SwMI of the user/users for which SS-DL activation is being requested. The authorized user expects an ACTIVATE ACK as an indication (in fact a confirmation).

ACTIVATE PDU shall contain the SS-DL information elements described in table 15, where the inclusion of at least one address is mandatory.

**Table 15: ACTIVATE PDU contents**

Information element	Length	Type	C/O/M	Value	Remark
SS-Type	6	1	M		SS-DL see table 59
DL-PDU type	5	1	M		ACTIVATE see table 42
Type of address of Monitored user	2	1	M		
Monitored user short number	8	1	C		note 1
Monitored user SSI	24	1	C		note 1
Monitored user extension	24	1	C		note 1
Basic service information	8	1	M		
Activation request	8	1	M		note 2
NOTE 1: Shall be selected as defined by the information element type of address for activated user.					
NOTE 2: The information element activation request shall be valid for all addresses.					

### 5.2.1.2           ACTIVATE ACK PDU

ACTIVATE ACK PDU shall be sent by the SS-DL authorized user home SwMI.

ACTIVATE ACK PDU shall contain the SS-DL information element contained in table 16.

**Table 16: ACTIVATE ACK PDU contents**

Information element	Length	Type	C/O/M	Value	Remark
SS-Type	6	1	M		SS-DL see table 59
DL-PDU type	5	1	M		ACTIVATE ACK see table 42
Activation/deactivation result	1	1	M		
Type of address of Monitored user	2	1	M		note 2
Monitored user short number	8	1	C		notes 1 and 6
Monitored user SSI	24	1	C		note 1
Monitored user extension	24	1	C		notes 1 and 2
Activation state	6	1	C		notes 1 and 3
Activation/deactivation failure cause	3	1	C		note 4
Basic service information	8	1	C		note 5
NOTE 1:	There shall be an information element activation state for each user to be monitored.				
NOTE 2:	The information element type of address shall indicate that the information element activated user extension shall be present whenever the MNI of the authorized user is different from that of the monitored user.				
NOTE 3:	Shall be present only when the value of the information element activation result is equal to 1.				
NOTE 4:	Shall be conditional on the value of the information element activation result being equal to 0.				
NOTE 5:	Shall be present only when the value of the information element activation result is equal to 1.				
NOTE 6:	Shall be used only if SNA has been used in the ACTIVATE request.				

### 5.2.1.3           INFO-TALKING-ITSI PDU

INFO-TALKING-ITSI PDU is an information sent either by the individual call SwMI or the Group Call Controlling SwMI which contains the identity of the talking user identified by the fact that it has obtained D-TX-GRANTED. The content of the INFO-TALKING-ITSI PDU is identical to the content of TX-GRANTED PDU. The reception of this INFO-TALKING-ITSI PDU is not confirmed.

INFO-TALKING-ITSI PDU shall contain the SS-DL information element contained in table 17.

**Table 17: INFO-TALKING-ITSI PDU contents**

Information element	Length	Type	C/O/M	Value	Remark
SS-Type	6	1	M		SS-DL see table 59
DL-PDU type	5	1	M		INFO-TALKING-ITSI see table 42
Transmission grant	2	1	M		
Transmitting user address type identifier	2	1	M		See address type for coding
Transmitting user address SSI	24	1	C		See SSI for coding; note
Transmitting user address extension	24	1	C		See MNI for coding; note
Call reference	14	1	M		
Speech service	1	1	M		
NOTE:	Shall be conditional on the value of the address type.				

## 5.2.1.4 INFORM PDU

INFORM PDU is an indication sent to the MS/LS of the monitoring user by the SwMI where that monitoring user is registered. It is a call unrelated PDU as received by FE7; however, it does relate to a call being in progress in which the monitored user is involved.

The monitoring user SwMI expects one of two possible confirmation to the INFORM indication:

- INFORM ACK PDU (monitoring user has properly received the INFORM PDU and does not wish to join the call at this instant);
- U-SETUP (monitoring user wishes to join the call immediately).

INFORM PDU shall contain the SS-DL information elements described in table 18.

**Table 18: INFORM PDU contents**

Information element	Length	Type	C/O/M	Value	Remark
SS-Type	6	1	M		SS-DL see table 59
DL PDU type	5	1	M		INFORM see table 42
Call in progress/New call	1	1	M		
Monitored user/group type of address	2	1	M		
Monitored user/group short number	8	1	C		note 1
Monitored user/group SSI	24	1	C		note 1
Monitored user/group extension	24	1	C		note 1
Single/multiple monitored user in group	2	1	C		note 6
Other user type of address	2	1	M		note 2
Other user short number	8	1	C		note 3
Other user SSI	24	1	C		note 3
Other user extension	24	1	C		note 3
Call reference	14	1	M		notes 4 and 5
Monitoring Point MNI	24	1	M		
Monitoring Point SSI	24	1	M		
Basic Service Information	8	1	M		
Intrusion allowed	1	1	M		
Forced release allowed	1	1	M		
NOTE 1:	Shall be selected as defined by the information element type of address for monitored user.				
NOTE 2:	Other user is defined as the other user involved in the call in which the monitored user is involved.				
NOTE 3:	Shall be selected as defined by the information element type of address for other user.				
NOTE 4:	To be used in the monitoring user call set-up to join the call in progress.				
NOTE 5:	The message being sent call unrelated, the call reference shall be the reference in the monitored user SwMI of the call in which the monitored user is involved.				
NOTE 6:	Shall be conditional on the group nature of the call associated with the content of the basic service information element.				



### 5.2.1.5 INFORM ACK PDU

INFORM ACK PDU is sent by the monitoring user FE7 in confirmation of receipt of INFORM PDU in case the monitoring user does not wish to join the call immediately. INFORM ACK PDU is call unrelated at the FE7 side while it is in fact relating to an existing call which needs to be identified by its call reference in the monitoring user SwMI. Instead of reserving some dummy SSIs, the call reference shall be used to acknowledge the receipt of the INFORM.

INFORM ACK PDU shall contain the SS-DL information elements described in table 19.

**Table 19: INFORM ACK PDU contents**

Information element	Length	Type	C/O/M	Value	Remark
SS-Type	6	1	M		SS-DL see table 59
DL PDU type	5	1	M		INFORM ACK see table 42
NO/NEVER for that call	2	1	M		Yes corresponds to U-SETUP
Monitoring user type of address	2	1	M		Monitoring Instance Identifier of stage 2
Monitoring user short number	8	1	C		note 1
Monitoring user SSI	24	1	C		note 1
Call reference	14	1	M		note 2
Monitoring Point MNI	24	1	M		
Monitoring Point SSI	24	1	M		
Basic service information	8	1	M		
NOTE 1:	Shall be selected as defined by the information element type of address for monitored user.				
NOTE 2:	To be used in the monitoring user call set-up to join the call in progress.				

### 5.2.1.6 INTERROGATE PDU

INTERROGATE PDU may be sent by the authorized user to the monitored user home SwMI. The authorized user expects an INTERROGATE ACK PDU as a confirmation.

INTERROGATE PDU shall contain the SS-DL information elements described in table 20.

**Table 20: INTERROGATE PDU contents**

Information element	Length	Type	C/O/M	Value	Remark
SS-Type	6	1	M		SS-DL see table 59
DL PDU type	5	1	M		INTERROGATE see table 42
Type of address of Monitored user	2	1	M		
Monitored user Short Number	8	1	C		note
Monitored user SSI	24	1	C		note
Monitored user extension	24	1	C		note
NOTE:	Shall be selected as defined by the information element monitored user type of address.				

**5.2.1.7 INTERROGATE ACK PDU**

INTERROGATE ACK PDU is sent by the home SwMI of the monitored user on which a SS-DL interrogation has been previously made (by an INTERROGATE PDU).

INTERROGATE ACK PDU shall contain the SS-DL information elements described in table 21.

**Table 21: INTERROGATE ACK PDU contents**

Information element	Length	Type	C/O/M	Value	Remark
SS-Type	6	1	M		SS-DL see table 59
DL PDU type	5	1	M		INTERROGATE ACK see table 42
Interrogation result	1	1	M		
Activation/Deactivation state	6	1	C		note 2
Monitored user type of address	2	1	M		
Monitored user short number	8	1	C		note 1
Monitored user SSI	24	1	C		
Monitored user extension	24	1	C		
Basic service information	8	1	C		
Interrogation failure cause	3	1	C		note 3
NOTE 1:	Shall be selected as defined by the information element monitored user type of address.				
NOTE 2:	Shall be present only when the value of the information element interrogation result element value is equal to 1.				
NOTE 3:	Shall be present only when the value of the information element interrogation result element value is equal to 0.				

**5.2.1.8 Monitored Call Cleared PDU**

MONITORED CALL CLEARED PDU shall contain the SS-DL information elements described in table 22.

**Table 22: MONITORED CALL CLEARED INFO PDU contents**

Information element	Length	Type	C/O/M	Value	Remark
SS-Type	6	1	M		SS-DL see table 59
DL PDU type	5	1	M		MONED CALL CLEARED see table 42
Monitored-Call-Cleared	1	1	M		
Call reference	14	1	M		

**5.2.1.9 MONITOR PDU**

MONITOR PDU shall contain the SS-DL information elements described in table 23.

**Table 23: SS-DL MONITOR PDU contents**

Information element	Length	Type	C/O/M	Value	Remark
SS-Type	6	1	M		SS-DL see table 59
DL PDU type	5	1	M		MONITOR see table 42
Monitoring Point MNI	24	1	M		
Monitoring Point SSI	24	1	M		
Call reference	14	1	M		

**5.2.1.10 RELEASE PDU**

RELEASE PDU shall contain the SS-DL information elements described in table 24. This PDU is different from the DEACTIVATE PDU; SS-DL remains active but for that particular group call, SS-DL is released allowing the monitoring user to join the group call.

**Table 24: RELEASE PDU contents**

Information element	Length	Type	C/O/M	Value	Remark
SS-Type	6	1	M		SS-DL see table 59
DL PDU type	5	1	M		RELEASE note see table 42
Monitoring Point MNI	24	1	M		
Monitoring Point SSI	24	1	M		
Call reference	14	1	M		
NOTE: The same PDU is used to request release and to indicate that release has occurred.					

**5.2.1.11 SS-CI-INV PDU**

SS-CI-INV PDU shall be sent in the Facility part of the SETUP message that establishes the call.

SS-CI-INV PDU shall contain the SS-DL information elements described in table 25.

**Table 25: SS-CI-INV PDU contents**

Information element	Length	Type	C/O/M	Value	Remark
SS-Type	6	1	M	010100 <sub>2</sub>	SS-DL see table 59
DL PDU type	5	1	M		CALL INTRUSION see table 42
Call reference	14	1	M		
Monitoring Point ITSI	24	1	N		
Monitoring Point MNI	24	1	M		
Call Intrusion Activate	2	1	M		

**5.2.1.12 SS-CI-INV ACK PDU**

SS-CI-INV ACK PDU shall contain the SS-DL information elements described in table 26.

**Table 26: SS-CI-INV ACK PDU contents**

Information element	Length	Type	C/O/M	Value	Remark
SS-Type	6	1	M		SS-DL see table 59
DL PDU type	5	1	M		CALL INTRUSION ACK see table 42
Call reference	14	1	M		
Monitoring Point MNI	24	1	M		
Monitoring Point SSI	24	1	M		
Call Intrusion Activate Result	1	1	M		
Call Intrusion Failure Cause	3	1	C		note
NOTE: Shall be conditional on the call intrusion activate result information element = 1.					

**5.2.1.13 FORCED-REL PDU**

FORCED-REL PDU shall be sent in the facility field of the DISCONNECT message. It shall forcefully release all members involved in the call regardless of who the owner of the call in the case of group call is.

FORCED-REL PDU shall contain the SS-DL information elements described in table 27.

**Table 27: FORCED-REL PDU contents**

Information element	Length	Type	C/O/M	Value	Remark
SS-Type	6	1	M		SS-DL see table 59
DL PDU type	5	1	M		FORCED-REL see table 42
Call reference	14	1	C		notes 1, 2 and 3
Monitoring Point MNI	24	1	C		notes 2 and 3
Monitoring Point SSI	24	1	C		notes 2 and 3
NOTE 1:	Distinction between group call/individual call is done by the basic service information element associated with the call.				
NOTE 2:	Conditional on whether the call is already in discreet listening mode or in intrusion mode.				
NOTE 3:	Call reference and Monitoring point ITSI are mutually exclusive.				

**5.2.1.14 FORCED-REL ACK PDU**

FORCED-REL ACK PDU shall contain the SS-DL information elements described in table 28.

**Table 28: FORCED-REL ACK PDU contents**

Information element	Length	Type	C/O/M	Value	Remark
SS-Type	6	1	M		SS-DL see table 59
DL PDU type	5	1	M		FORCED-REL ACK see table 42
Call reference	14	1	M		
Monitoring Point MNI	24	1	C		notes 2 and 3
Monitoring Point SSI	24	1	C		notes 2 and 3
FORCED-REL result	1	1	M		
FORCED-REL failure cause	3	1	C		note 1
Monitored user extension	24	1	C		
NOTE 1:	Shall be conditional on result of FORCED-REL information element = 1.				
NOTE 2:	Shall be conditional on the nature of the call (discreet listening or intrusion).				
NOTE 3:	Call reference and monitoring point ITSI are mutually exclusive.				

### 5.2.1.15 ADD-ON PDU

SS-DL ADD-ON PDU shall be sent in the facility field of the U-SETUP message. It is different from the Call intrusion PDU and is used only for the case of a group call in which the monitoring user is already participating and consists only of suppressing the listen only status of that monitoring user and to allow him to request transmission. There is no need for ADD ON ACK since the monitoring user will rapidly note if he can intervene into the group call or not.

SS-DL ADD-ON PDU shall contain the SS-DL information elements described in table 29.

**Table 29: ADD-ON PDU contents**

Information element	Length	Type	C/O/M	Value	Remark
SS-Type	6	1	M		SS-DL see table 59
DL PDU type	5	1	M		ADD-ON see table 42
Call reference	14	1	M		
Group call only	1	1	M		note
NOTE: The ADD ON request will not be effective if this group call information element is not equal to 1.					

### 5.2.2 TETRA PDU information element coding

#### 5.2.2.1 Activation request

Activation request shall indicate which services are requested to be activated or deactivated including the subscription options: speech/data, monitored user identity. It shall be encoded as defined in table 30.

**Table 30: Activation request information element contents**

Information sub-element	Length	C/O/M	Value	Remark
Speech only call activation	2	M	00 <sub>2</sub>	Deactivate
			01 <sub>2</sub>	Activate
			10 <sub>2</sub>	No change (note 1)
			11 <sub>2</sub>	Reserved
Data only call activation	2	M	00 <sub>2</sub>	Deactivate
			01 <sub>2</sub>	Activate
			10 <sub>2</sub>	No change (note 1)
			11 <sub>2</sub>	Reserved
Delay	2	M	00 <sub>2</sub>	Delay 0 or not implemented
			01 <sub>2</sub>	1*TAU TAU = 300ms
			10 <sub>2</sub>	2*TAU
			11 <sub>2</sub>	3*TAU
Call Intrusion	1		0	Deactivate
			1	Activate (note 2)
Forced Release	1		0	Deactivate
			1	Activate (note 3)
NOTE 1: The information sub-elements "speech call activation" and "data call activation" shall not take the value 10 <sub>2</sub> when the information element activation request is being sent in a the profile information element defined in table.				
NOTE 2: Activates SS-CI; could be used to activate call intrusion as a separate SS.				
NOTE 3: Activates forced-release capability, an option of SS-CI; cannot be activated if SS-CI is not activated.				

NOTE: The binary value 10 defined in table 30 for the information sub-elements "speech call activation" and "data call activation", corresponding to "no change", allows to activate SS-DL for either speech or data calls without the need to define the detail of the activation request for the other type of calls.

**5.2.2.2 Activation state**

Activation state shall indicate which services are activated or deactivated, for which monitored user and for which basic service. It shall be encoded as defined in table 31.

**Table 31: Activation state information element contents**

Information sub-element	Length	C/O/M	Value	Remark
Speech call activation	1	M	0 <sub>2</sub>	Deactivated
			1 <sub>2</sub>	Activated (notes 1 and 2)
Data call activation	1	M	0 <sub>2</sub>	Deactivated
			1 <sub>2</sub>	Activated (notes 1 and 2)
Delay	1	M	0 <sub>2</sub>	Not implemented or 0
			1 <sub>2</sub>	Delay set to proper value
Call Intrusion	1	M	0 <sub>2</sub>	Not allowed
			1 <sub>2</sub>	Allowed
Forced Release	1	M	0 <sub>2</sub>	Not allowed
			1 <sub>2</sub>	Allowed
NOTE 1: Activation indicates that the SS-DL is activated for the precise basic service requested in the ACTIVATE PDU.				
NOTE 2: Activation may be set for both speech and data calls.				

**5.2.2.3 Activation/deactivation failure cause**

According to ETS 300 392-9 [6], subclause 8.4.5, as a general rule, the result of an activation or interrogation request shall be indicated in the corresponding ACK PDU (i.e. ACTIVATION ACK PDU or INTERROGATION ACK PDU) by a first information element indicating whether the result is positive or negative. If the result is positive, the value of this information element shall be equal to 1, and to 0 otherwise.

In case of negative results, activation/deactivation failure cause information elements are specified in table 32 for a result element giving the reason for failure of the corresponding request. Some of these values are valid for all services, while some values are added for SS-DL.

In the case of SS-DL, there is the additional needs to indicate that the authorized user is not allowed to monitor that particular user, that the authorized user is not allowed to monitor that specific basic service or that SS-DL is not available.

Table 32: Activation/deactivation failure cause information elements

Information element	Length	Value	Remarks
Failure reason	3 (note 1)	000 <sub>2</sub>	Rejected for any reason
		001 <sub>2</sub>	User not authorized for SS-DL
		010 <sub>2</sub>	Unknown TETRA identity
		100 <sub>2</sub>	Invalid PDU contents (notes 3 and 4)
		101 <sub>2</sub>	User authorized for SS-DL not authorized to monitor particular ITSI/GTSI (note 2)
		110 <sub>2</sub>	User authorized for SS-DL not authorized to monitor requested basic service
		111 <sub>2</sub>	SS-DL not available
NOTE 1:	This is the minimum length for this information element.		
NOTE 2:	By extension, this covers the case where the monitoring user activates its own identity/group identity.		
NOTE 3:	The PDU contents may be found invalid e.g.:		
-	when some information element values do not exist, e.g. identity not allocated, or individual identity value being a GTSI; or because;		
-	the structure of an air interface PDU is wrong, e.g. O-bit or M-bit absent (see subclause 14.7 of ETS 300 392-2 [1]).		
	See clause 11 for the use of this value.		
NOTE 4:	The value 011 is reserved and could be used if needed to indicate "already activated".		

#### 5.2.2.4 Activation/deactivation result

Activation result shall indicate whether the previous request for activation has been successful or unsuccessful as defined in table 33.

Table 33: Activation result information element contents

Information element	Length	Value	Remark
Activation result	1	0 <sub>2</sub>	Activation <u>unsuccessful</u>
		1 <sub>2</sub>	Activation <u>successful</u>

#### 5.2.2.5 Address type of monitored/monitoring/other user

The address type identifier information element shall indicate if the type of address which follows in the PDU is a SNA, a SSI or a full ITSI, as defined in table 34.

Table 34: Address type of (...) party information element contents

Information element	Length	Value	Remark
Address type	2	00 <sub>2</sub>	Short number address (SNA) note
		01 <sub>2</sub>	Short subscriber identity (SSI)
		10 <sub>2</sub>	TETRA full subscriber identity (ITSI or GTSI)
		11 <sub>2</sub>	Reserved
NOTE:	SNA is only used in PDUs presented by the user to the SwMI and not from the SwMI to the user.		

NOTE: A single information element address type has been defined in the standard for the sake of simplicity. However the definition of some PDUs, in subclause 5.2.1, is such that some values of this information element will not be used in these PDUs (e.g. the value 0 in all ACK PDUs, since none of these PDUs either includes any information element party short number address or will be sent if the identity presentation is restricted).

5.2.2.6 Basic service information

The purpose of the basic service information element shall be to inform the SwMI what basic service is requested. The element length is 8 bits. Its content shall comply with the content of table 35 identical to the content of ETS 300 392-2 [1].

Table 35: Basic service information element contents

Information sub-element	Length	Value	Remark
Circuit Mode Type (see note 1)	3	000 <sub>2</sub>	Speech: TCH/S
		001 <sub>2</sub>	Unprotected: TCH/7,2
		010 <sub>2</sub>	Low Protection: TCH/4,8, N = 1
		011 <sub>2</sub>	Low Protection: TCH/4,8, N = 4
		100 <sub>2</sub>	Low Protection: TCH/4,8, N = 8
		101 <sub>2</sub>	High Protection: TCH/2,4, N = 1
		110 <sub>2</sub>	High Protection: TCH/2,4, N = 4
Encryption Flag (see note 2)	1	0	Clear Mode
		1	TETRA end-to-end encryption
Communication Type	2	00 <sub>2</sub>	Point-to-point
		01 <sub>2</sub>	Point-to-multipoint
		10 <sub>2</sub>	Point-to-multipoint Acknowledged
		11 <sub>2</sub>	Broadcast
Slots per frame (see note 3)	2	00 <sub>2</sub>	One slot
		01 <sub>2</sub>	Two slots
		10 <sub>2</sub>	Three slots
		11 <sub>2</sub>	Four slots
NOTE 1:	Indicates the TCH type and the interleaving depth N (see clause 8).		
NOTE 2:	Indicates whether the circuit mode speech or data is end-to-end encrypted.		
NOTE 3:	Indicates the required bit rate for a circuit mode data call. For TCH/7,2, TCH/4,8 and TCH/2,4 the resulting bit rate is the TCH bit rate multiplied by the number of slots per frame. (e.g. TCH/7,2 in four time slots per frame gives a circuit mode data rate of 28,8 kbit/s). For TCH/S this element shall be present (set to 0).		

5.2.2.7 Call Cleared

The content of the Call Cleared information element shall be as specified in table 36.

Table 36: Call cleared information element contents

Information element	Length	Value	Remark
Call cleared	2	00 <sub>2</sub>	Call not cleared
		11 <sub>2</sub>	Call cleared

5.2.2.8 Call reference

The purpose of the call reference element shall be to uniquely identify a specific call; its information element content is given in table 37.

Table 37: Call reference information element contents

Information element	Length	Value	Remark
Call reference	14		Dummy call reference
		1 <sub>10</sub> -16 383 <sub>10</sub>	Identifies call uniquely



### 5.2.2.9 Call in progress/New call

Call in progress/New call allows to distinguish between presentation to the monitoring user of a new call and a call in progress; the content of this information element shall as be as specified in table 38.

**Table 38: Call in progress/New call information element contents**

Information element	Length	Value	Remark
Call in progress/new call	1	0 <sub>2</sub>	Call in progress
		1 <sub>2</sub>	New call

### 5.2.2.10 Call Intrusion Activate

Call Intrusion Activate information element allows to choose among the different parameters of a normal call intrusion, i.e. call intrusion resulting in either a three party conference call or call connected between monitored user and monitoring user, the other user being isolated; call intrusion is either presented with or without notification. Call Intrusion Activate information element content shall be as specified in table 39.

**Table 39: Call Intrusion Activate information element contents**

Information element	Length	Value	Remark
Call Intrusion Activate	2	00 <sub>2</sub>	Call Intrusion resulting in other user isolation/notification of impending CI (note 2)
		01 <sub>2</sub>	Call Intrusion resulting in other user isolation/no notification (notes 1, 2 and 3)
		10 <sub>2</sub>	Call intrusion resulting in monitoring user hearing and talking to both monitored user and to other user/no notification (note 4)
		11 <sub>2</sub>	Call intrusion resulting in monitoring user hearing and talking to both monitored user and to other user/notification (note 4)
NOTE 1:	Normal SS-DL operation will assume this value for the information element.		
NOTE 2:	Monitoring user is always assumed to have the highest call intrusion capability level, higher than any monitored user to be intruded.		
NOTE 3:	This mode of operation results in resource saving (no conference bridge).		
NOTE 4:	This mode of operation results in high usage of resources (up to 2x4 slots).		

### 5.2.2.11 Call Intrusion Activate Result

Call Intrusion result shall indicate whether the previous request for call intrusion has been successful or unsuccessful as defined in table 40.

**Table 40: Call Intrusion result information element contents**

Information element	Length	Value	Remark
Call Intrusion result	1	0 <sub>2</sub>	Call Intrusion <u>unsuccessful</u>
		1 <sub>2</sub>	Call Intrusion <u>successful</u>

**5.2.2.12 Call Intrusion Failure Cause**

Call Intrusion Failure Cause gives the reasons for the unsuccessful call intrusion. The Call Intrusion Failure Cause Information element content shall be as specified in table 41.

**Table 41: Call Intrusion Failure Cause information element contents**

Information element	Length	Value	Remark
Call Intrusion Failure Cause	3	000 <sub>2</sub>	Call Intrusion Not supported
		001 <sub>2</sub>	Call Intrusion Not allowed
		010 <sub>2</sub>	No call to intrude/call disconnected
		011 <sub>2</sub>	Data call
		100 <sub>2</sub>	Conference call not available
		101 <sub>2</sub>	Wrong SS-CI PDU
		110 <sub>2</sub>	Call ID not activated under SS-DL
		111 <sub>2</sub>	Call already intruded by other SS-DL monitoring user

**5.2.2.13 SS-DL-PDU type**

SS-DL-PDU type indicates the type of the DL PDUs as defined in table 42. This table allows to be referred to from all other PDUs table in this ETS.

**Table 42: DL PDU information element contents**

Information element	Length	Value	Remark
TPI PDU type	5	00000 <sub>2</sub>	Refer ETS 300 392-9 [6]
		00001 <sub>2</sub>	Refer ETS 300 392-9 [6]
		00010 <sub>2</sub>	ACTIVATE
		00011 <sub>2</sub>	ACTIVATE ACK
		00100 <sub>2</sub>	INFORM
		00101 <sub>2</sub>	INFORM ACK
		00110 <sub>2</sub>	INTERROGATE
		00111 <sub>2</sub>	INTERROGATE ACK
		01000 <sub>2</sub>	MONITOR
		01001 <sub>2</sub>	ADD ON
		01010 <sub>2</sub>	CALL-INTRUSION INV
		01011 <sub>2</sub>	CALL-INTRUSION INV ACK
		01100 <sub>2</sub>	FORCED-REL
		01101 <sub>2</sub>	FORCED-REL ACK
		01110 <sub>2</sub>	INFO-TALKING-ITSI
		01111 <sub>2</sub>	MONITORED-CALL-CLEARED
		1xxxx <sub>2</sub>	Reserved

**5.2.2.14 Forced release allowed**

Forced release allowed indicates to the monitoring user if it is allowed to force release the call that is just presented; the content of that information element shall be as specified in table 43.

**Table 43: Forced release information element contents**

Information element	Length	Value	Remark
Forced release allowed	1	0 <sub>2</sub>	Forced release not allowed
		1 <sub>2</sub>	Forced release allowed

### 5.2.2.15 FORCED-REL failure cause

FORCED-REL failure cause information element describes to the monitoring user the reason of the forced release failure; the FORCED-REL information element content shall be as specified in table 44.

**Table 44: FORCED-REL information element contents**

Information element	Length	Value	Remark
FORCED-REL Failure Cause	3	000 <sub>2</sub>	FORCED-REL Not supported
		001 <sub>2</sub>	FORCED-REL Not allowed
		010 <sub>2</sub>	No call to release/call already disconnected
		011 <sub>2</sub>	Call intrusion not invoked
		100 <sub>2</sub>	Wrong call ID
		101 <sub>2</sub>	Wrong SS-CI PDU
		110 <sub>2</sub>	Call ID not activated under SS-DL
		111 <sub>2</sub>	Reserved

### 5.2.2.16 FORCED-REL result

Forced-rel result shall indicate whether the previous request for forced-rel has been successful or unsuccessful as defined in table 45.

**Table 45: Forced-Rel result information element contents**

Information element	Length	Value	Remark
Forced-Rel result	1	0 <sub>2</sub>	Forced-Rel <u>unsuccessful</u>
		1 <sub>2</sub>	Forced-Rel <u>successful</u>

### 5.2.2.17 Group call only

Group call only shall indicate the group call only nature of the call; this information element is derived from the parameters of the basic service (point-to-point or point-to-multipoint) and may be considered as redundant; the information element contents shall be as specified in table 46.

**Table 46: Group call only information element contents**

Information element	Length	Value	Remark
Group call only	1	0 <sub>2</sub>	Any call
		1 <sub>2</sub>	Group call only

### 5.2.2.18 Interrogation failure cause

According to ETS 300 392-9 [6], subclause 8.4.5, as a general rule, the result of an interrogation request shall be indicated in the corresponding ACK PDU (i.e. INTERROGATION ACK PDU) by a first information element indicating whether the result is positive or negative. If the result is positive, the value of this information element shall be equal to 1, and to 0 otherwise.

In case of negative results, interrogation failure cause information elements are specified in table 47 for a result element giving the reason for failure of the corresponding request. Some of these values are valid for all services, while some values are added for SS-DL.

In the case of SS-DL, there is the additional needs to indicate that the authorized user has not been subscribed to that supplementary service, to that option or to that basic service.

**Table 47: Interrogation failure cause information elements**

Information element	Length	Value	Remarks
Failure reason	3 (note 1)	000 <sub>2</sub>	Rejected for any reason
		001 <sub>2</sub>	User not authorized for SS-DL
		010 <sub>2</sub>	Unknown TETRA identity
		011 <sub>2</sub>	Incomplete information
		100 <sub>2</sub>	Invalid PDU contents (note 3)
		101 <sub>2</sub>	User authorized for SS-DL not authorized to monitor particular ITSI/GTSI (note 2)
		110 <sub>2</sub>	User authorized for SS-DL not authorized to monitor requested basic service
		111 <sub>2</sub>	SS-DL not available
NOTE 1:	This is the minimum length for this information element.		
NOTE 2:	By extension, this covers the case where the monitoring user interrogates its own identity/group identity.		
NOTE 3:	The PDU contents may be found invalid e.g.: - when some information element values do not exist, e.g. identity not allocated, or individual identity value being a GTSI. See clause 11 for the use of this value.		

**5.2.2.19 Interrogation result**

Interrogation result shall indicate whether the previous request for interrogation has been successful or unsuccessful as defined in table 48.

**Table 48: Interrogation result information element contents**

Information element	Length	Value	Remark
Interrogation result	1	0 <sub>2</sub>	Interrogation <u>unsuccessful</u>
		1 <sub>2</sub>	Interrogation <u>successful</u>

**5.2.2.20 Intrusion allowed**

Intrusion allowed indicates to the monitoring user if it is allowed to intrude into the call that is just presented; the content of that information element shall be as specified in table 49.

**Table 49: Intrusion allowed information element contents**

Information element	Length	Value	Remark
Intrusion allowed	1	0 <sub>2</sub>	Intrusion not allowed
		1 <sub>2</sub>	Intrusion allowed

**5.2.2.21 MNI**

See below monitored/monitoring/other/Monitoring Point user extension.

**5.2.2.22 Monitored/monitoring/other/Monitoring Point user extension**

Monitored/monitoring/other user extension shall indicate the extended part of the TSI (i.e. the MNI) of this user, as defined in table 50.

**Table 50: Monitored/monitoring/other/Monitoring Point user extension information element contents**

Information element	Length	Value	Remark
Country Code	10		See ETS 300 392-1 [6] clause 7
Network Code	14		See ETS 300 392-1 [6] clause 7

**5.2.2.23 Monitored/Monitoring/Other user Short Number Address**

Monitored/monitoring/other user short number address shall refer to the Short Number Address (SNA) defined for this user. SNA shall be used only in the case of PDUs from the user towards the SwMIs and shall not be used for PDUs from SwMIs to users. It shall be encoded as defined in table 51.

**Table 51: Monitored/monitoring/other user information element contents**

Information element	Length	Value	Remark
Monitored/monitoring/other user short number address (SNA)	8	0-255 <sub>10</sub>	See ETS 300 392-1 [6] clause 7.

**5.2.2.24 Monitored/monitoring/other/Monitoring Point user SSI**

Monitored/monitoring/other user short subscriber identity shall indicate the Short subscriber identity (SSI) address as defined in table 52.

**Table 52: Monitored/monitoring/other/Monitoring Point user short subscriber identity information element contents**

Information element	Length	Value	Remark
Short subscriber identity	24		See ETS 300 392-1 [6] clause 7

**5.2.2.25 Monitored-Call-Cleared**

Monitored-Call-Cleared shall indicate the monitored call clearing to the monitoring user even though the monitoring user had not joined the call; the content of that information element shall be as specified in table 53.

**Table 53: Monitored-Call-Cleared information element contents**

Information element	Length	Value	Remark
Monitored-Call-Cleared	1	0 <sub>2</sub>	Individual call clear
		1 <sub>2</sub>	Group call clear

**5.2.2.26 NO/NEVER for that call**

NO/NEVER for that call information element indicates that while the monitoring user has properly received and recognized the INFORM PDU, it is not willing to join into the call presented to him either temporarily (NO) or permanently (NEVER); the content of that information element shall be as specified in table 54.

**Table 54: NO/NEVER for that call information element contents**

Information element	Length	Value	Remark
NO for that call	2	00 <sub>2</sub>	Invalid (note)
		01 <sub>2</sub>	Monitoring user does not wish to join the call at this time
		10 <sub>2</sub>	Monitoring user does not wish to join the call at this time
		11 <sub>2</sub>	Monitoring user does not wish to join the call at any time
NOTE:	When monitoring user wishes to join the call, it sends a MONITOR PDU in a SETUP which is another ACK of the INFORM PDU.		

**5.2.2.27 Single/multiple monitored user in group**

Single/multiple monitored user in group indicates to the monitoring party the fact that in a group call, there may be more than one monitored user. The content of the single/multiple monitored user in a group information element shall be as specified in table 55.

**Table 55: Single/multiple monitored user in group information element contents**

Information element	Length	Value	Remark
Single/multiple monitored user in group	2	00 <sub>2</sub>	Not a group call
		01 <sub>2</sub>	Single monitored user in group
		10 <sub>2</sub>	Reserved
		11 <sub>2</sub>	Multiple monitored users in group (note)
NOTE:	As many inform messages as different monitored user will be presented (range).		

**5.2.2.28 Speech Service**

The content of the Speech Service information element shall be as specified in table 56.

**Table 56: Speech Service information element contents**

Information element	Length	Value	Remark
Speech Service	1	0 <sub>2</sub>	TETRA encoded speech
		1 <sub>2</sub>	7,2 kbit/s unprotected data

### 5.2.2.29 SS-DL Profile

SS-DL profile is actually an ANF-ISIMM information element, sent by the home SwMI to the visited SwMI of a monitored subscriber when this monitored subscriber migrates, as part of the SS profile information. It will expect a reply from the visited SwMI.

SS-DL profile shall contain as information sub-elements the SS-DL information elements described in table 57.

**Table 57: SS-DL Profile information element contents**

Information element	Length	Type	C/O/M	Value	Remark
SS-Type	6	1	M	010100 <sub>2</sub>	SS-DL
Activation request	8	1	M		
Monitoring user address type	2	1	M		
Monitoring user SSI	24	1	C		
Monitoring user extension	24	1	C		
Basic service information	8	1	M		
Monitoring Point ITSI	24	1	M		note
NOTE: Prior to migration.					

NOTE: The information sub-elements SSI and extension which would have defined the monitored user ITSI have not been included in the information element profile, since the ANF-ISIMM PDU which carries this information element already includes this ITSI.

### 5.2.2.30 SS-DL Profile ACK

SS-DL Profile ACK is sent by the visited SwMI to the home SwMI of a monitored user as an acknowledgement of reception of PROFILE. SS-DL profile ACK PDU will be sent through ANF-ISIMM (see ETS 300 392-3-5 [5]).

SS-DL profile ACK shall contain as information sub-elements the SS-DL information elements described in table 58.

**Table 58: SS-DL Profile ACK information element contents**

Information element	Length	Type	C/O/M	Value	Remark
SS-Type	6	1	M	010100 <sub>2</sub>	SS-DL
Activation result	1	1	M		same as activate result
Support of SS-DL	1	1	M	1 <sub>2</sub>	SS-DL supported
Monitoring user address type	2	1	M		
Monitoring user SSI	24	1	C		
Monitoring user extension	24	1	C		
Basic service information	8	1	M		
Monitoring Point ITSI	24	1	M		note
NOTE: After migration.					

NOTE 1: The information elements SSI and extension which would have defined the monitored user ITSI have not been included in the information element profile ACK, since the ANF-ISIMM PDU which carries this information element already includes this ITSI.

NOTE 2: The monitoring point ITSI is coded prior to migration in the SS-DL profile and is coded after migration in the SS-DL Profile ACK

NOTE 3: The basic service information may be different in the SS-DL Profile and in the SS-DL Profile ACK, in which case a MODIFY indication shall be presented to the monitoring user.

5.2.2.31 SS-Type

Table 59: SS-Type information element contents

Information element	Length	Type	C/O/M	Value	Remark
SS-Type	6	1	M	010100 <sub>2</sub>	SS-DL

5.2.2.32 Transmission grant

The content of the transmission grant information element shall be as specified in table 60 which is identical to the content of the same PDU table content in ETS 300 392-2 [1].

Table 60: Transmission Grant information element contents

Information element	Length	Type	C/O/M	Value	Remark
Transmission Grant	2	1	M	00 <sub>2</sub>	Transmission granted
				01 <sub>2</sub>	Transmission not granted
				10 <sub>2</sub>	Transmission request queued
				11 <sub>2</sub>	Transmission granted to another user

5.2.3 Additional coding requirements over the ISI

As mandated by subclause 10.3.1 of ETS 300 392-9 [6], each SS-DL PDU sent by the authorized user (i.e. for activation/interrogation) will include the ITSI of this authorized user as indication of the source of these PDUs when they are extended over the ISI, by invoking ANF-ISISS.

The successful result shall be sent as ANF-ISISS Result APDU corresponding to the ANF-ISISS Invoke APDU used to carry the SS-DL PDU request. And again as mandated by subclause 10.3.1 of ETS 300 392-9 [6], such SS-DL PDU will include the ITSI of the authorized user as its destination.

NOTE 1: As defined in clause 9 of ETS 300 392-3-1 [2], when a SwMI does not support a activation/interrogation request but supports ANF-ISISS, it will report failure of that request in sending a ReturnError APDU with the error value corresponding to "requestNotSupported", and with the accompanying error parameter value being the set of two values:

- the binary value 010100, corresponding to the value of the information element SS type for the supplementary service DL;
- and the value corresponding to the information element SS-PDU type used for the request (see table 42 above).

NOTE 2: As defined in clause 9 of ETS 300 392-3-1 [2], when the monitored user home SwMI does not support any supplementary service over the ISI (i.e. there is no ANF-ISISS entity in this SwMI), it will reject the ANF-ISISS Invoke APDU in giving a reason of type InvokeProblem with value unrecognizedOperationReport.

5.3 SS-DL state definitions

5.3.1 States at the monitored user MS/LS

There are no SS-DL conceptual states within the monitored user MS/LS in association with a particular individual/group call. In the case where SS-DL is active, any call action done by the monitored user will result in the invocation of SS-DL.



### 5.3.2 States at the group controlling SwMI

The procedures for the group controlling SwMI are written in terms of the following conceptual states existing within the SS-DL CMCE in that SwMI in association with a particular group. There are different state machines for activation, deactivation, interrogation, invocation and operation of SS-DL.

The definition of the SS-DL invocation states for the group controlling SwMI (in association with a particular group call) is derived from the following SS-DL group controlling basic states:

- SS-DL-Active or SS-DL-Inactive (= DL-Idle);
- ADD-ON-Active or ADD-ON-Inactive;
- FORCED-REL-Active or FORCED-REL-Inactive.

If the group controlling SwMI is in the state DL-Active, SS-DL shall automatically be invoked for the (group) call upon a group call set-up with the proper parameters (basic service, GTSI,...).

### 5.3.3 States at the SwMI where the monitored user is registered for Individual Calls

The invocation and operation procedures for the SwMI where the monitored user is registered are written in terms of the following conceptual states existing within the SS-DL CMCE in that SwMI in association with a particular individual call.

NOTE: There are no activation, deactivation or interrogation procedures defined for the SwMI where the monitored user is registered.

Actually these states are the same as those within the SS-DL CMCE of a group controlling SwMI:

- DL-Inactive (= DL-Idle);
- DL-Active;
- CI-Active;
- CI-Inactive;
- FORCED-REL-Active;
- FORCED-REL-Inactive.

### 5.3.4 States at the Authorized user MS/LS in its home SwMI

- SS-DL Active; SS-DL Inactive.

## 5.4 SS-DL signalling procedures

### 5.4.1 Actions at the monitoring user MS/LS

The SDL representation of procedures at the monitoring user MS/LS is shown in clause A.1 of annex A.

#### 5.4.1.1 Normal procedures

If SS-DL has been activated and if one of the monitored user has invoked SS-DL by setting up a call or receiving a call, the monitoring user MS/LS shall receive the SS-DL INFORM; if SS-DL has been activated and the monitored call is changing of basic service and the new call parameters fall within the definition of the ss-dl activate parameters, the monitoring user MS/LS shall receive an SS-DL INFORM; if the monitored user is involved in a call, if the monitoring user who is also the authorized user activates SS-DL and the call basic service falls within the basic service defined at activate, the monitoring user shall receive the SS-DL INFORM.

The monitoring MS/LS will normally reply to the SS-DL INFORM by one of several possible replies:

- MONITOR (request) in a SETUP allowing the monitoring user to join the call discretely.
- INFORM ACK NO indicating that the monitoring user is temporarily not interested in joining the call but that information concerning that call shall be presented to the monitoring user.
- INFORM ACK NEVER indicating that the monitoring user will never join that particular call and that no information shall be presented to the monitoring user concerning that call.

Upon discretely joining the call, the monitoring user MS/LS shall be informed of the identity of the talking user either in an individual call or in a group call, whether the talking user is the monitored user of any other user involved in the call.

Upon discretely joining the call, the monitoring user MS/LS may decide to join the call non discretely; as an implementation option, the monitoring user shall be able either to activate a call intrusion for an already monitored individual call or a simple add-on for a group call.

Either after invoking call intrusion or not, the monitoring user MS/LS shall be able as an implementation option to force release of the monitored call without any warning to the users involved in the call and without the consent of the group call owner in the case of a group call.

After joining discretely the monitored call, the monitoring user shall be able to leave that monitored call temporarily and shall be able to join that call at a later time. Either after leaving the monitored call or after indicating its temporary wish not to join in the call, the monitoring user shall continue to receive any information that pertains to that call such as change of basic service, call clearance by any of the participant in the call.

While involved in the monitoring of a particular call, the monitoring user MS/LS will continue to receive INFORM relating to activity on other monitored users.

The monitoring user MS/LS is assumed to be registered in its home SwMI and is not assumed to migrate to any other SwMI.

#### **5.4.1.2 Exceptional procedures**

If the monitoring user MS/LS does not reply to the SS-DL INFORM, the SS-DL will become inactive after a time out which is implementation dependent.

In the case where two monitored users happen to be calling each other, a single Monitoring Point ITSI shall be used so that the monitoring user shall be able to recognize that the monitored users are involved in a single call.

In the case of a normal call set-up, if the monitoring user MS/LS places a call to one of the monitored user and finds it busy, the monitoring user MS/LS shall be able to activate SS-DL in order to discretely listen to the call in progress.

Failure causes in reply to activate and/or interrogate give details of the reasons for no success of those primitive invocations.

## 5.4.2 Actions at the group controlling SwMI

The SDL representation of procedures at the group controlling SwMI is shown in clause A.2 of annex A.

### 5.4.2.1 Normal procedures

The group controlling SwMI shall be in charge to set up and maintain a call extending over two or more SwMIs and shall be the group home SwMI.

Group call set-up between SwMIs shall be set up as a logical star configuration where the controlling SwMI shall be the centre of the star.

When a user be it a monitored user or an other user sets up a group call, the controlling SwMI shall establish the call regardless of whether the calling user is located or not in its home SwMI and regardless of whether the calling user is a member of the group or not. Some called users may be located in the controlling SwMI. In the case where the originating SwMI is also the home SwMI of the group, the originating SwMI is also then the controlling SwMI.

In the case where the monitored user is the calling user, the group controlling SwMI shall check whether SS-DL is activated for that user, shall check if the call is set up with the parameters that make it a SS-DL call (basic service, group call) and shall present the SS-DL INFORM towards the home SwMI of the monitoring user. The group controlling SwMI shall wait for the reply of the monitoring user and shall recognize the different forms of replies set-up, inform ack no, inform ack never and no reply; the group controlling SwMI shall act according to the replies and shall recognize the discreet nature of the listening.

In the case where calls are already in progress and that SS-DL becomes activated, the group controlling SwMI shall inform the monitoring user home SwMI of all calls where monitored users are involved and shall act for each call according to the replies received from the monitoring user SwMI (set up, NO, NEVER).

In the case where the monitored user is the called user, the group controlling SwMI shall check whether SS-DL is activated for that user, shall check if the call is set up with the parameters that make it a SS-DL call (basic service, group call) and shall present the SS-DL INFORM towards the home SwMI of the monitoring user. The group controlling SwMI shall wait for the reply of the monitoring user and shall recognize the different forms of replies set-up, inform ack no, inform ack never and no reply; the group controlling SwMI shall act according to the replies and shall recognize the discreet nature of the listening.

The group controlling SwMI shall continuously monitor changes in call parameters and shall present to the monitoring user SS-DL INFORM in the case where the call already in progress becomes an SS-DL call.

In the case where the call in progress is cleared without the monitoring user having joined the call, the group controlling SwMI shall generate a monitored call cleared info and will clear its own reference to that call.

The group controlling SwMI will keep a Monitoring Point ITSI as an address for the monitoring user to join in that call in progress.

In the case where SS-DL is activated after calls to be monitored have been already in progress, when the monitoring user activates SS-DL, the group controlling SwMI will present a series of INFORM indicating each call to be monitored and shall wait for replies to each of those INFORM.

In the case where an SS-DL call is in progress, the group controlling SwMI shall follow the transmission grants and shall identify towards the monitoring user the ITSI of each new talking user (monitored user or any other user).

In case of migration of the monitored user towards a new visited SwMI, the group controlling SwMI shall present to that new visited SwMI the monitored user SS-DL profile (monitoring user, Basic Service Information, type of call).

In case of disconnect request from the monitored user, the group SwMI shall monitor for any return of the monitored user in that group call; in the case of the group owner disconnect, the group controlling SwMI shall release all participants in that call and shall keep SS-DL active.

In the case where the monitored user is setting up a group call for a group of which it is not a member, the group controlling SwMI shall inform the monitoring user accordingly using the individual ITSI of the monitored user and not the GTSI. Format types of addresses and migration out of the group controlling SwMI shall be continuously kept.

Upon discretely joining the call, the monitoring user MS/LS may decide to join the call non discretely; as an implementation option, the group controlling SwMI shall be able to operate a simple add-on of the monitoring user to that group call. SS-DL will remain active upon completion of that ad on but the monitored call has become a non-DL call.

Either after invoking add on or not, the group controlling SwMI shall be able, as an implementation option to recognize and to execute forced release of the monitored group call (release of all users involved in that group call) without any warning to the users involved in the call and without the consent of the group call owner. SS-DL will remain active even after the successful completion of the group call forced release.

#### **5.4.2.2 Exceptional procedures**

If the monitoring user MS/LS does not reply to the SS-DL INFORM, the SS-DL will become inactive after a time out which is implementation dependent unless SS-DL is permanently active.

Monitoring users outside of any TETRA network (PSTN, ISDN,...) shall not be accepted.

A monitoring user may simply join a group call of which it is a member and discretely listen to that group call without activating SS-DL; however, it will not be able to force release of the call and it is not informed of the events occurring for that particular call on that particular ITSI.

#### **5.4.3 Actions at the monitored user visited SwMI.**

The SDL representation of procedures at the monitored user visited SwMI is shown in clause A.3 of annex A.

##### **5.4.3.1 Normal procedures**

##### **5.4.3.2 Exceptional procedures**

#### **5.4.4 Authorized user MS/LS**

The SDL representation of procedures at the authorized user MS/LS is shown in clause A.4 of annex A.

##### **5.4.4.1 Normal Procedures**

The authorized user MS/LS shall send the ACTIVATE or INTERROGATE PDUs in a U-FACILITY PDU in filling in the appropriate value for the routing information element (see table 4 of ETS 300 392-9 [6]). This value shall correspond to the monitored user home SwMI.

Consequently in accordance with subclause 8.4.1 of ETS 300 392-9 [6], identities included in ACTIVATE, or INTERROGATE PDUs may be indicated using only their SSIs.

Such identities may also be specified using the monitored user SNA, provided that:

- SS-SNA is supported by the monitored user home SwMI; and
- SNA values have been defined against such identities for the authorized user.

The authorized user MS/LS shall receive the ACTIVATE ACK or INTERROGATE ACK PDUs in a D-FACILITY PDU.

In accordance with subclause 8.4.1 of ETS 300 392-9 [6], the authorized user MS/LS shall complement any identities indicated using only their SSIs which have been included in any received ACTIVATE ACK or INTERROGATE ACK PDU.

#### 5.4.4.2 Exceptional procedures

Sub clause 11.2 of ETS 300 392-9 [6] shall apply for the exceptional procedures at the authorized user MS/LS. In addition, that MS/LS shall recognize the failure causes mentioned in subclause 5.2.2.4 used in ACTIVATE ACK or INTERROGATE ACK PDU.

NOTE: Such failure causes may correspond to the case where the corresponding PDU is supported by the managed user home SwMI but cannot be given a positive response.

#### 5.4.5 SwMI where the authorized user MS/LS is registered

The SDL representation of procedures at the authorized user SwMI is shown in clause A.5 of annex A.

No specific procedures apply for the SwMI where the authorized user MS/LS is registered when that SwMI is different from the monitored home SwMI, beyond those specified in subclause 5.1.7.

NOTE: The SDL representation of normal procedures corresponding to the latter subclause at the SwMI where the authorized user is registered is not shown because similar to the authorized user MS/LS SDL representation.

See subclauses 5.1.5 and 5.1.6 when the SwMI where the authorized user MS/LS is registered coincides with the monitored home SwMI.

#### 5.4.6 Monitored user home SwMI

The SDL representation of procedures at the supplementary service control entity at the monitored user home SwMI is shown in clause A.6 of annex A.

##### 5.4.6.1 Normal procedures

##### 5.4.6.1.1 Case where the monitored user home SwMI coincides with the SwMI where the authorized user MS/LS is registered

The monitored user home SwMI shall:

- receive from the authorized user MS/LS the U-FACILITY PDU containing ACTIVATE or INTERROGATE PDUs;
- once it has determined the corresponding ACTIVATE or INTERROGATE ACK PDUs, it shall send them to the authorized user MS/LS. If that SwMI is also the authorized user home SwMI, in accordance with subclause 8.4.1 of ETS 300 392-9 [6], it may then indicate identities in those PDU using only their SSIs.

##### 5.4.6.1.2 Case where the monitored user home SwMI is different from the SwMI where the authorized user MS/LS is registered

The supplementary service control entity at the monitored user home SwMI shall:

- extract the ACTIVATE or INTERROGATE PDU(s) in the received ANF-ISISS ROSE Invoke APDUs specified in clause 10 of ETS 300 392-9 [6];
- process those PDUs. Notably, in accordance with subclause 8.4.1 of ETS 300 392-9 [6], the SwMI shall then complement any identities indicated using only their SSIs which have been included in such PDU(s). If the response to an ACTIVATE or INTERROGATE PDU is positive, the SwMI shall generate the corresponding ACTIVATE ACK or INTERROGATE ACK PDU respectively. If the SwMI where the authorized user MS/LS is registered is his home SwMI (present assumption of SS-DL operation), in accordance with subclause 8.4.1 of ETS 300 392-9 [6], the monitored user home SwMI may then indicate identities in those PDU using only their SSIs;
- send such ACK PDU(s) according to subclause 9.2 of ETS 300 392-9 [6]. Notably the identity of the authorized user will be added to the ACTIVATE ACK or INTERROGATE ACK PDU(s) as its(their) final destination in the corresponding ANF-ISISS PDU (see table 24 of ETS 300 392-9 [6]).

#### 5.4.6.2 Exceptional procedures

If the SwMI supports one or more of the ACTIVATE and INTERROGATE PDUs, it shall use the failure causes mentioned in subclause 5.2.1.2 in the corresponding ACK PDU(s) if it cannot give a positive response.

In addition, the exceptional procedures below shall apply:

- when the monitored user home SwMI coincides with the SwMI where the authorized user MS/LS is registered, subclause 11.2.1 of ETS 300 392-9 [6] shall apply, taking into account the fact that the support of each of the two PDUs: ACTIVATE and INTERROGATE, is mandatory for SS-DL. The information defined in that subclause 11.2.1 of ETS 300 392-9 [6] will be sent to the authorized user MS/LS in a D-FACILITY PDU. Such D-FACILITY PDU shall be individually addressed;
- when the monitored user home SwMI is different from the SwMI where the authorized user MS/LS is registered, subclause 11.1 of ETS 300 392-9 [6] shall apply, taking into account the fact that the support of each of the two PDUs: ACTIVATE and INTERROGATE, is mandatory for SS-DL.

#### 5.5 SS-DL impact of inter working with other networks

There is no SS-DL impact of inter working with other networks; on one side, discreet listening from another network is not defined; on the other side discreet listening from a TETRA network user of a non TETRA network user is not defined either.

#### 5.6 Protocol interactions between SS-DL and other supplementary services and ANFs

This subclause specifies protocol interactions with other supplementary services and ANFs for which stage 3 description standards had been published at the time of publication of the present document. For interactions with supplementary services and ANFs for which stage 3 description standards are published subsequent to the publication of the present document, see those other stage 3 description standards.

NOTE 1: Additional interactions that have no impact on the signalling protocol neither at the air interface nor at the ISI can be found in the relevant stage 1 description standards.

NOTE 2: Simultaneous conveyance of APDUs for SS-DL and another supplementary service or ANF in the same message, each in accordance with the requirements of its respective stage 3 description standard, does not, on its own, constitute a protocol interaction.

##### 5.6.1 Interaction with Access Priority

Discreet listening shall not have any interaction with SS-AP.

##### 5.6.2 Interaction with Ambience Listening

Discreet listening shall not have any interaction with ambience listening; ambience listening and discreet listening are actually mutually exclusive from a user perspective; at any given time, both SS-DL and SS-AL may be activated; however, at that particular instant of time, a user is involved in one or the other of the two SSs.

##### 5.6.3 Interaction with Barring of Incoming Call

Only outgoing calls from the monitored user will be monitored; SS-DL set up of DL shall not be considered as an incoming call to the monitored user but as a special DL call set up

##### 5.6.4 Interaction with Barring of Outgoing Call

Only incoming calls to the monitored user will be monitored.

#### **5.6.5 Interaction with Call Authorized by Dispatcher**

Interaction between SS-DL and SS-CAD shall not be allowed. A user who is authorized to make discreet listening calls shall not need authorization from a dispatcher to make a call; in the event that both SSs are registered for one user, the service provider shall be required to resolve the conflict.

#### **5.6.6 Interaction with Discreet Listening**

#### **5.6.7 Interaction with Dynamic Group Number Assignment**

Discreet listening shall not have any interaction with SS-DGNA.

#### **5.6.8 Interaction with Late Entry**

Discreet listening shall not have any interaction with SS-LE.

#### **5.6.9 Interaction with Pre-emptive Priority Call**

Discreet listening shall not have any interaction with SS-PPC. An SS-DL monitored call may be pre-empted by a PPC; this will be equivalent to a release of the first call from an SS-DL point of view and to a new call which if it fulfils the SS-DL types of services will result in a new inform and a new SS-DL call.

#### **5.6.10 Interaction with Priority Call**

Discreet listening shall not have any interaction with SS-PC.

#### **5.6.11 Interaction with Talking Party Identification**

Discreet listening shall not have any interaction with SS-TPI; SS-DL does not need TPI to operate properly. However, the activation of SS-TPI may be concurrent to the activation of the SS-DL for the same monitored user and allows to provide a more user friendly SS-DL display of the talking user identity.

#### **5.6.12 Interactions with ISI Mobility Management (ANF-ISIMM)**

When a monitored user migrates to a visited SwMI, his home SwMI shall send the following SS-DL profile information to this visited SwMI through ANF-ISIMM:

- SS-DL provided or not to the monitoring user;
- SS-DL activated or not; if yes, with which activation parameters:
  - type of basic service;
  - individual/group call;
  - monitored/monitoring user identities;
  - call intrusion/forced-release allowed.

SS-DL provision or non provision and the possible restriction of type of service to be monitored shall be sent by the home SwMI as part of ANF-ISIMM basic profile information, in the ANF-ISIMM PROFILE UPDATE PDU (see clause 30.1.37 of ETS 300 392-3-5 [5]).

The visited SwMI shall acknowledge the transfer of that information, in indicating to the home SwMI, also through ANF-ISIMM, as acknowledgement of the basic profile information, whether or not it supports:

- SS-DL as SwMI where the monitored user is now registered;
- SS-Call Intrusion as SwMI where the monitored user is registered;
- SS-Forced-Release as SwMI where the monitored user is registered.

As to the SS-DL activation possibly with activation parameters, they shall be indicated as part of the ANF-ISIMM original SS-migration profile sent by the home SwMI in the SS-DL profile information element defined in table 57, part of the ANF-ISIMM SS-PROFILE UPDATE PDU (see subclause 30.1.43 of ETS 300 392-3-5 [5]). The visited SwMI shall acknowledge the SS-DL profile information element in sending back the profile ACK information element defined in table 55, part of the ANF-ISIMM SS-PROFILE UPDATE ACK PDU (see subclause 30.1.44 of ETS 300 392-3-5 [5]). The latter shall:

- acknowledge the SS-DL activation requested for the monitored user. If the activation had been requested with optional activation parameters, the response shall take into account those supported by the visited SwMI; and
- indicate whether or not the visited SwMI supports the call intrusion and the forced-release operations.

#### **5.7 SS-DL parameter values (timers)**

The only timer defined in the SS-DL is the delay timer allowing the monitoring user to join the monitored call before call members have actually started to talk; this timer is started by the INFORM transmission and is stopped by the receipt of one of the INFORM ACK messages: MONITOR in SETUP, INFORM-ACK-NO or INFORM-ACK-NEVER. Its value is programmable from 0 (timer not supported or null) to 3\*TAU, TAU being implementation dependent.



## **Annex A (informative): Specification and Description Language (SDL) representation of procedures**

The diagrams in this annex use the Specification and Description Language defined in ITU-T Recommendation Z.100 [11].

The monitoring user MS/LS diagram represents the behaviour of a SS-DL supplementary service control entity at this MS/LS, while the diagrams for SwMI actually represent the behaviour of one SS-DL supplementary service control entity, each one operating to control either a SwMI (at the ISI) or a MS/LS (at the air interface for a MS, and its equivalent for a LS).

In accordance with the protocol model described in clause 14 of ETS 300 392-2 [1], the supplementary service control entity at a MS/LS uses the services of the air interface basic call control. The same applies for the supplementary service control entity at the SwMI where the MS/LS subscriber is registered. And for SS-DL ISI protocols, in accordance with the protocol model described in clause 8 of ETS 300 392-3-1 [2], the supplementary service control entity (at a SwMI) uses, via the co-ordination function, the services of ANF-ISIGC and/or ANF-ISIIC for call related procedures, and of Generic Functional Transport control for call unrelated procedures.

At a MS/LS, where an output symbol represents a primitive resulting from a message being received, this symbol bears the name of this message and of any SS-DL PDU received with this message.

The basic call actions associated with the sending and receiving of the air interface messages specified in ETS 300 392-2 [1] are deemed to occur. The same applies for the sending of the ANF-ISIGC messages and PDUs specified in ETS 300 392-3-3 [4] and for the sending of the ANF-ISIIC messages and PDUs specified in ETS 300 392-3-2 [3].

All basic call messages (or PDUs) with no prefix specifying whether they are air interface messages or ISI messages (or PDUs) are to be understood as being air interface messages if the users to which they are addressed are registered in the same SwMI, and as ISI messages (or ISI PDUs), otherwise.

And the suffix PDU has been omitted after the PDU names (e.g. INFORM ).

When needed, the following abbreviations are used: moning for monitoring, moned for monitored.

### **A.1 SDL representation of SS-DL at the monitoring user MS/LS**

Figure A.1 shows the behaviour of an SS-DL supplementary service control entity within the monitoring user MS/LS.

Input signals from the right and output signals to the right represent air interface messages.

Input signals from the left and output signals to the left represent primitives to/from the monitoring user.

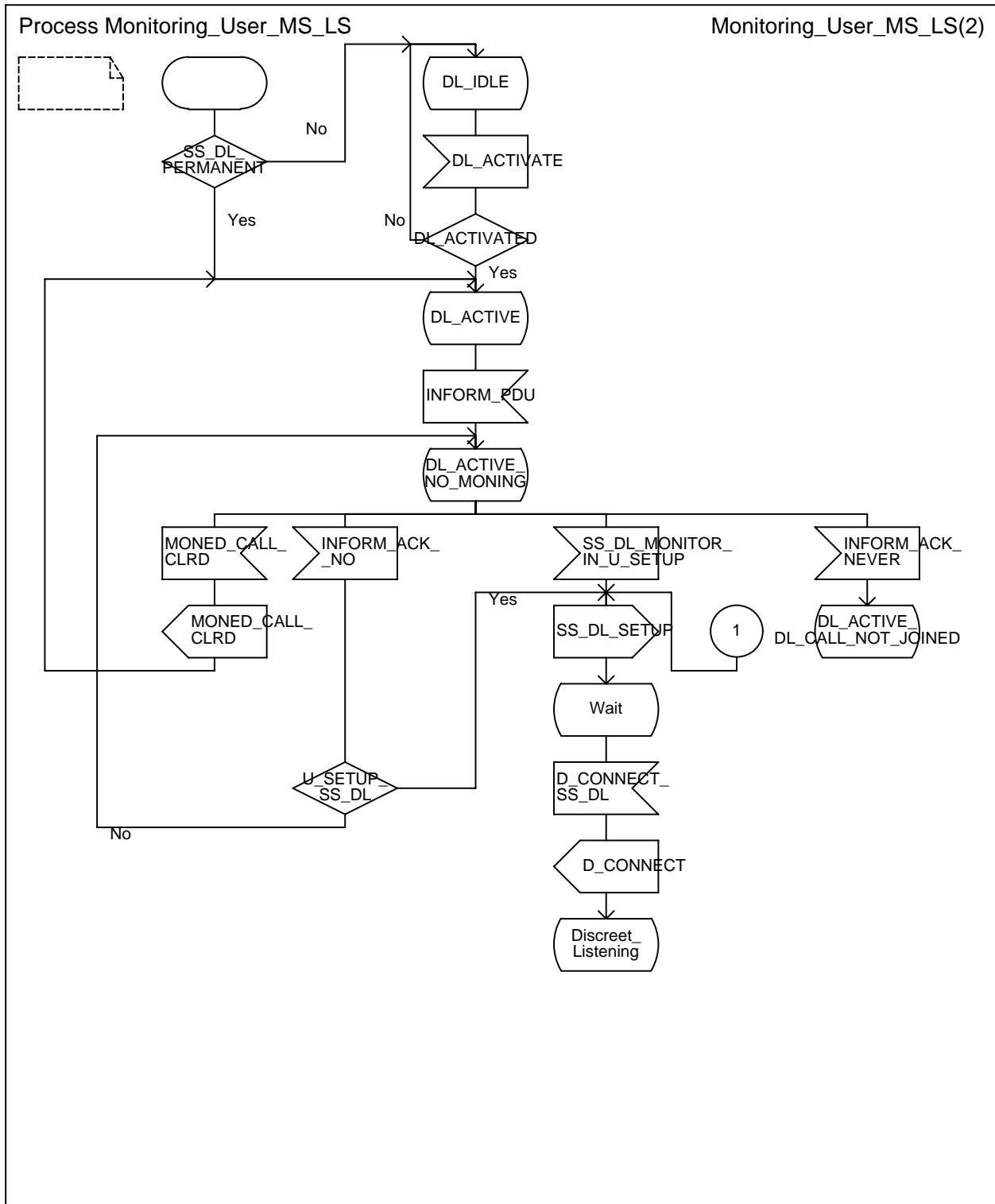

Figure A.1(sheet 1 of 2): Monitoring user MS/LS SDL

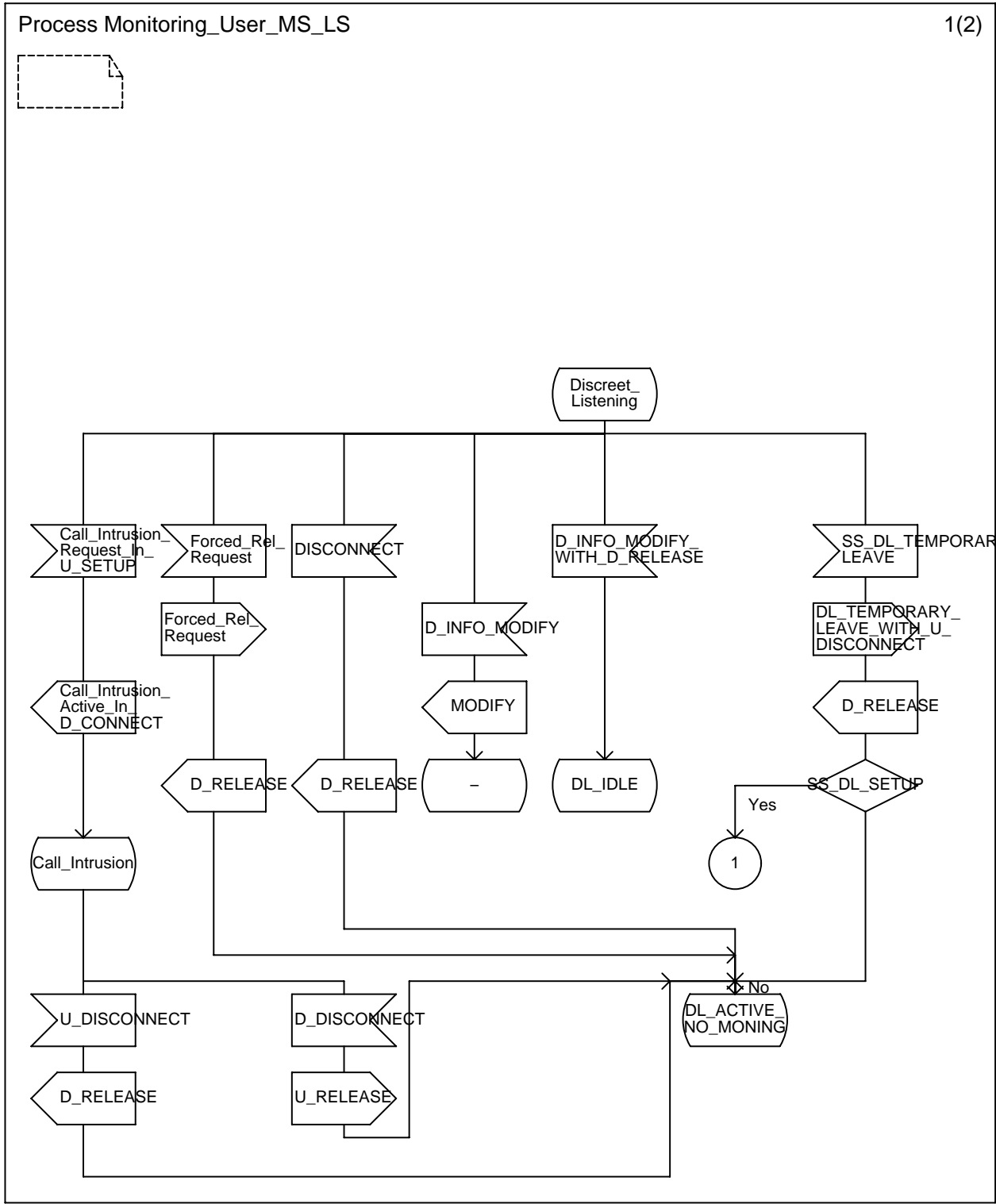

Figure A.1(sheet 2 of 2): Monitoring user MS/LS SDL

## A.2 SDL representation of SS-DL at the group controlling SwMI

Figure A.2 shows the behaviour of an SS-DL supplementary service control entity within the group controlling SwMI for the invocation and the operation of this supplementary service.

NOTE: For the behaviour of an SS-DL supplementary service control entity within the group controlling SwMI for activation, deactivation and interrogation of this supplementary service, see clauses A.7 and A.8.

Unless they are named with the prefix ISI, input signals from the right represent messages received from the MS/LS of the monitored user if this user is registered in the group controlling SwMI, or from the SwMI where this user is registered, otherwise.

Input signals from the right named with the prefix ISI represent messages received from the visited SwMI of the monitored user.

Output signals to the right, which are all named with the prefix ISI, represent messages sent to the visited SwMI of the monitored user.

Input signals from the left represent messages received from the SwMI of the monitoring user if this user is registered in the group controlling SwMI, or from the SwMI where this user is registered, otherwise.

Output signals to the left represent messages received to the MS/LS of the monitoring user if this user is registered in the group controlling SwMI, or to the SwMI where this user is registered, otherwise.

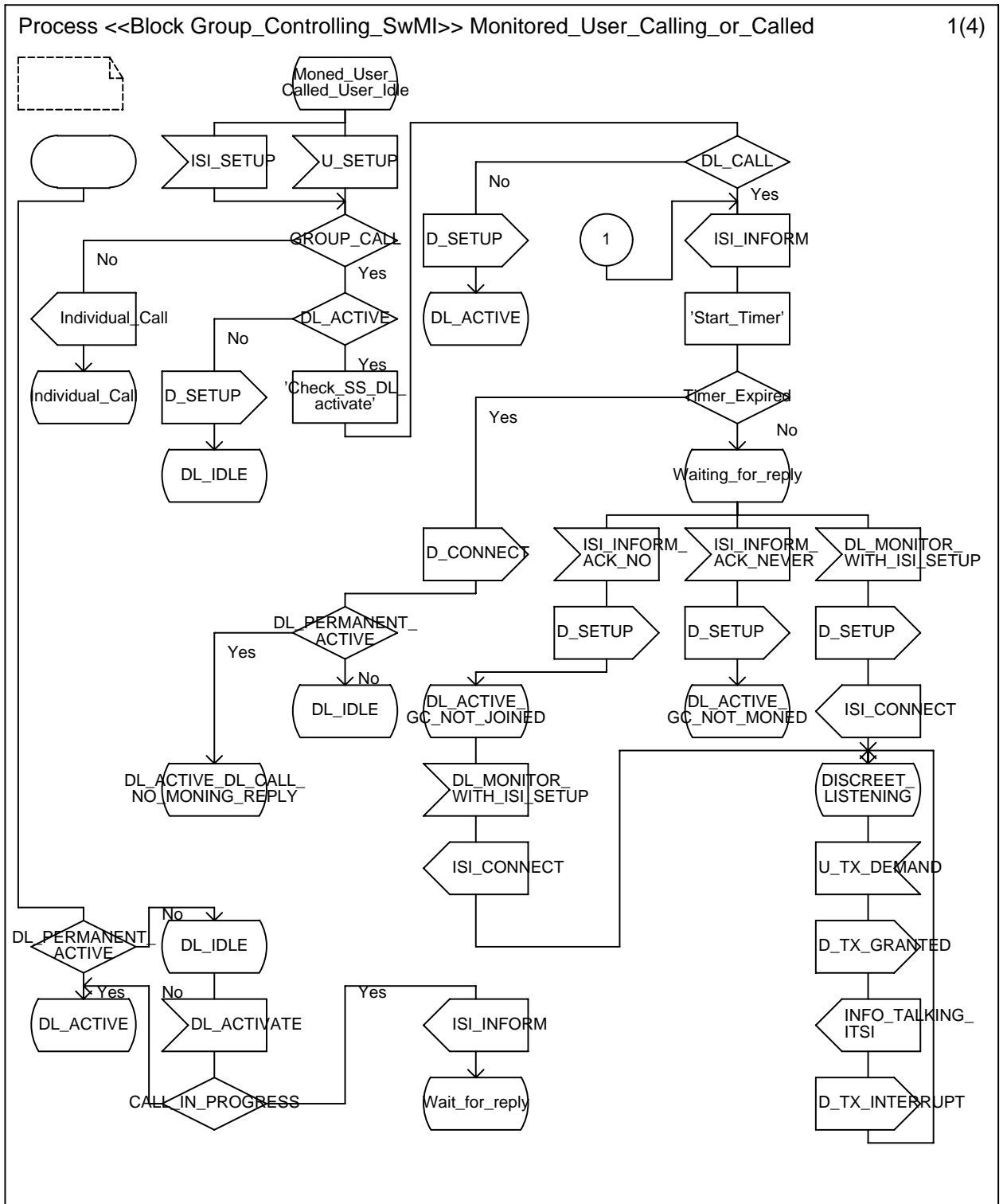

Figure A.2 (sheet 1 of 4): Group controlling SwMI SDL Monored user is the calling user

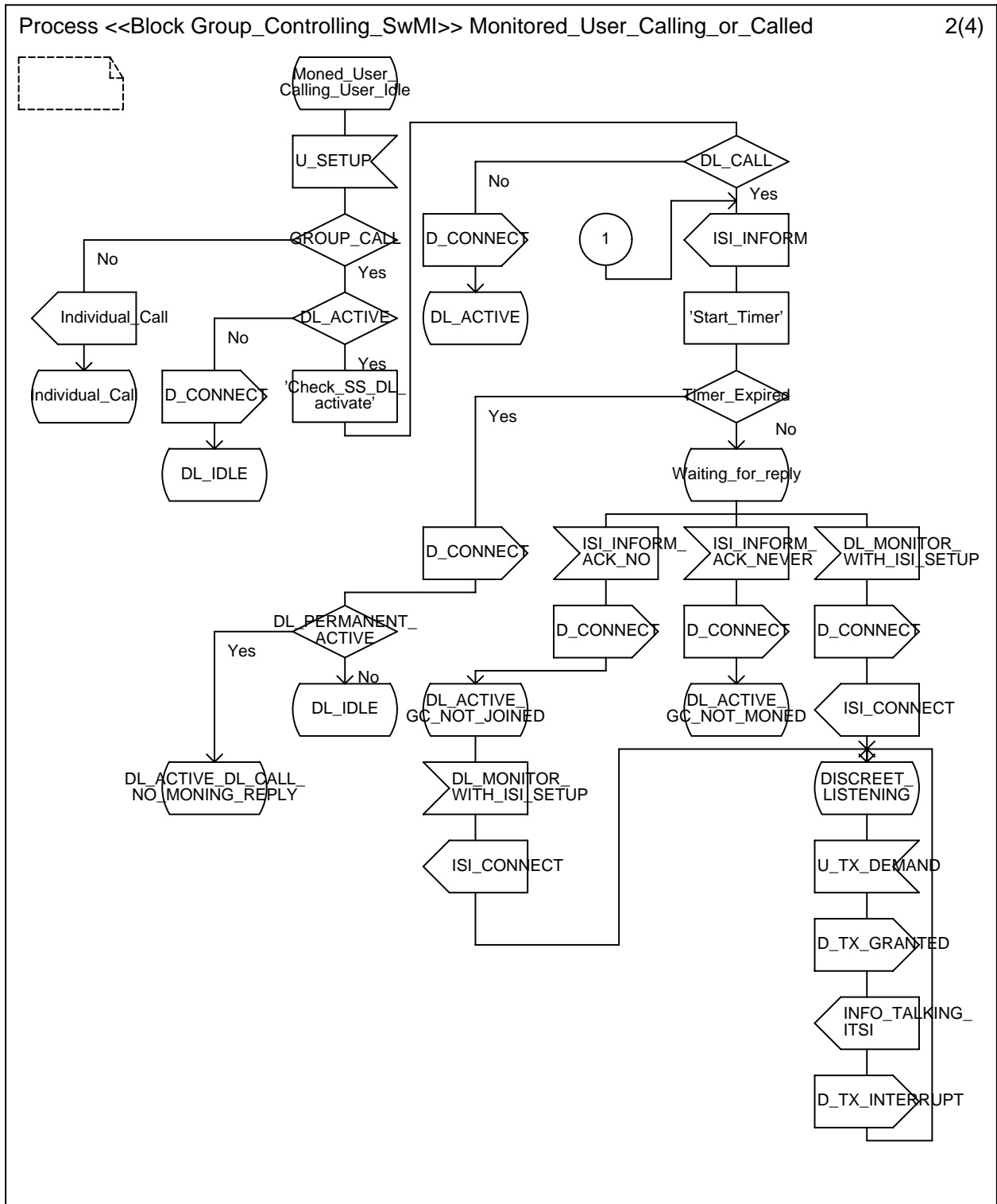

Figure A.2 (sheet 2 of 4): Group controlling SwMI SDL Monored user is the calling user

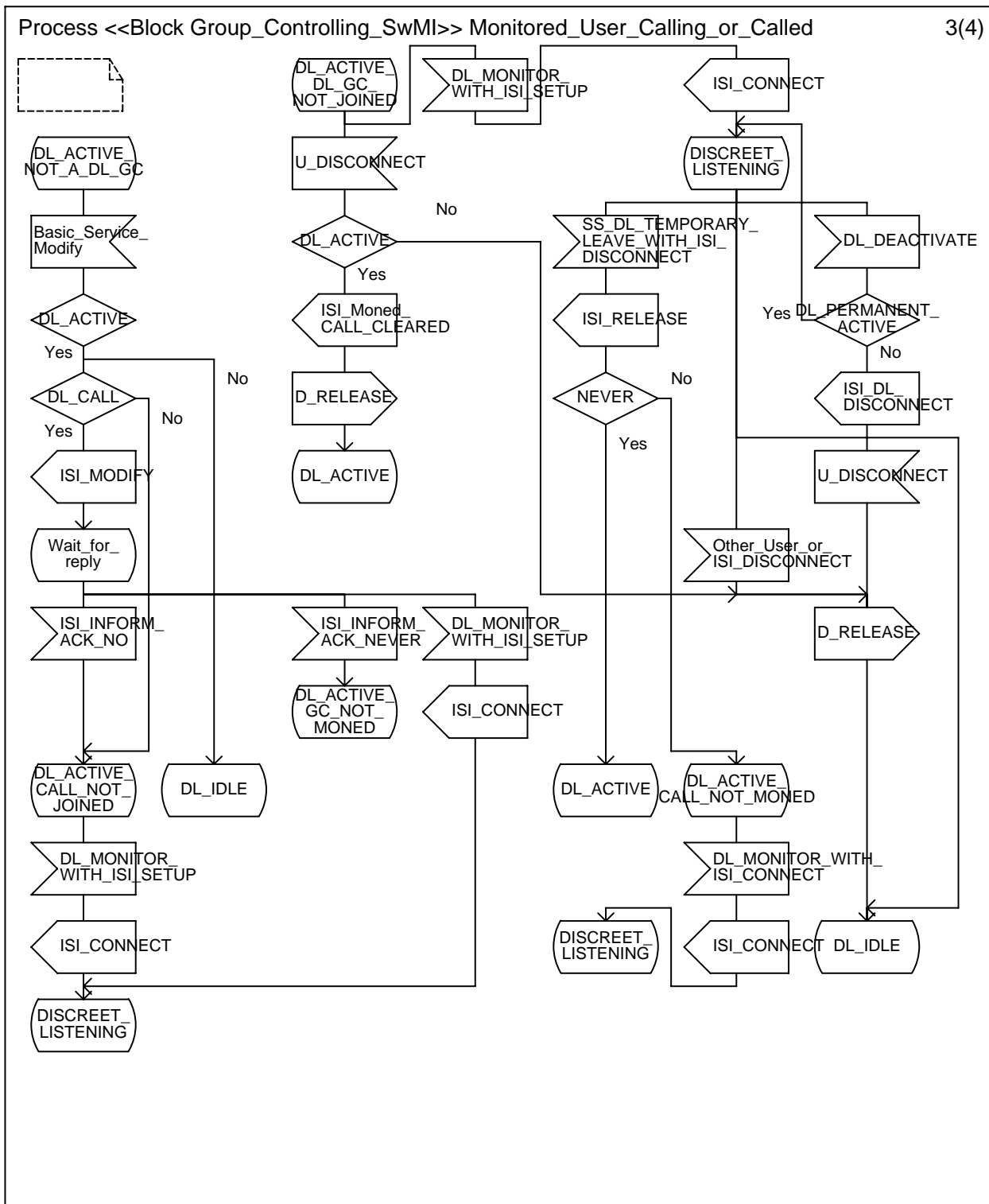

Figure A.2 (sheet 3 of 4): Group controlling SwMI SDL

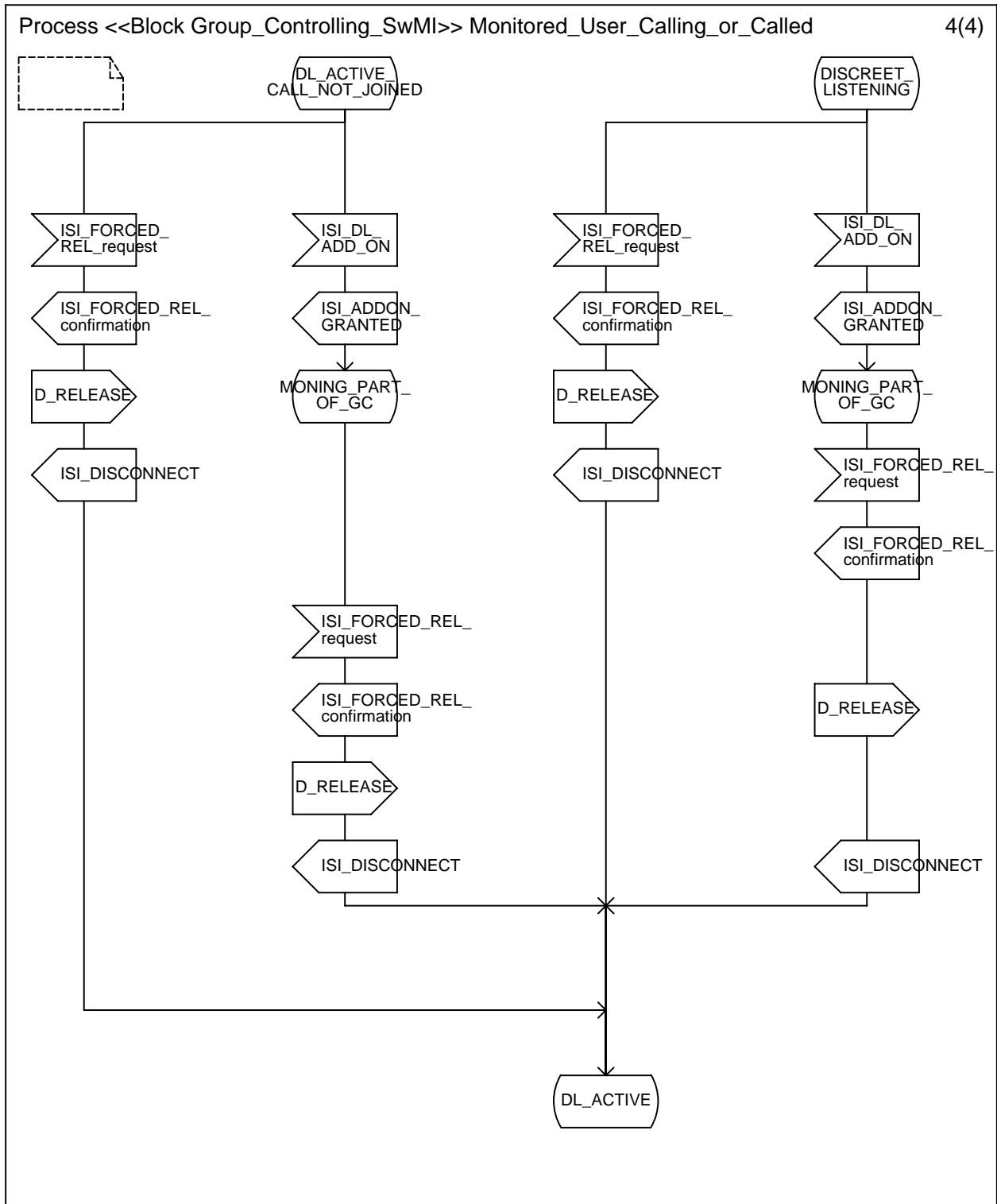

Figure A.2 (sheet 4 of 4): Group controlling SwMI SDL



**A.3 SDL representation of SS-DL at the SwMI where the monitored user is registered**

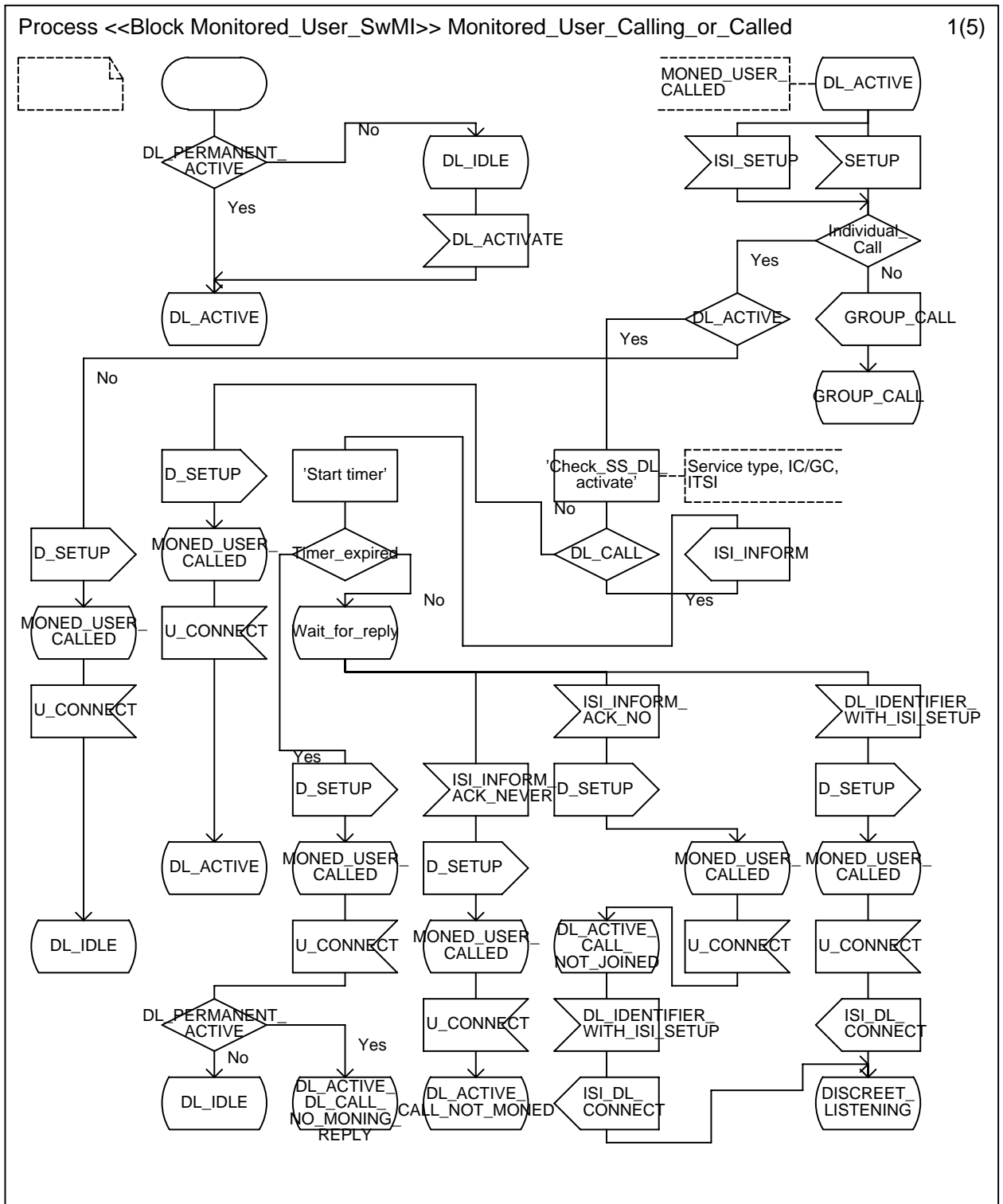

Figure A.3 (sheet 1 of 5): Monitored user visited SwMI SDL

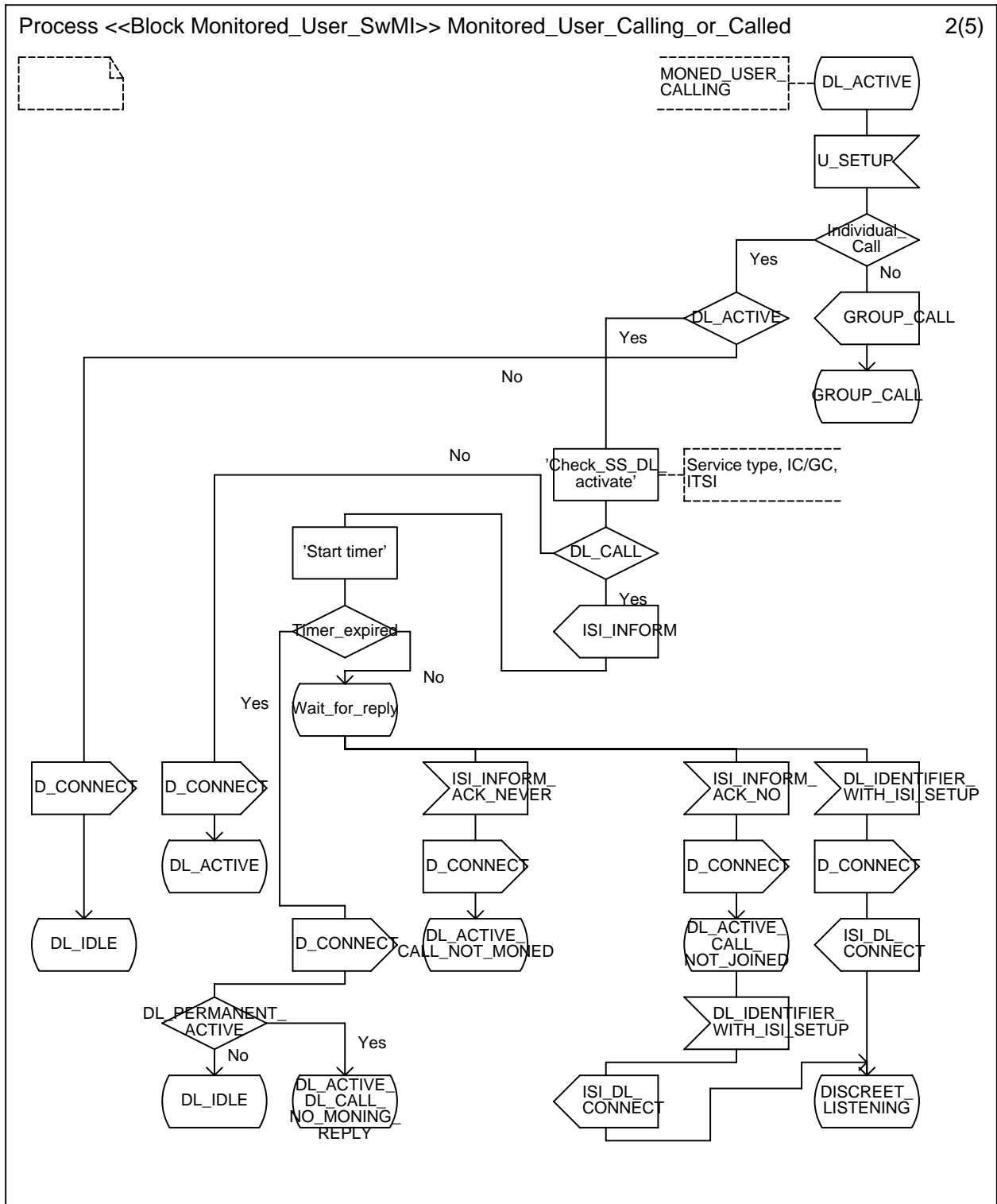

Figure A.3 (sheet 2 of 5): Monitored user visited SwMI SDL

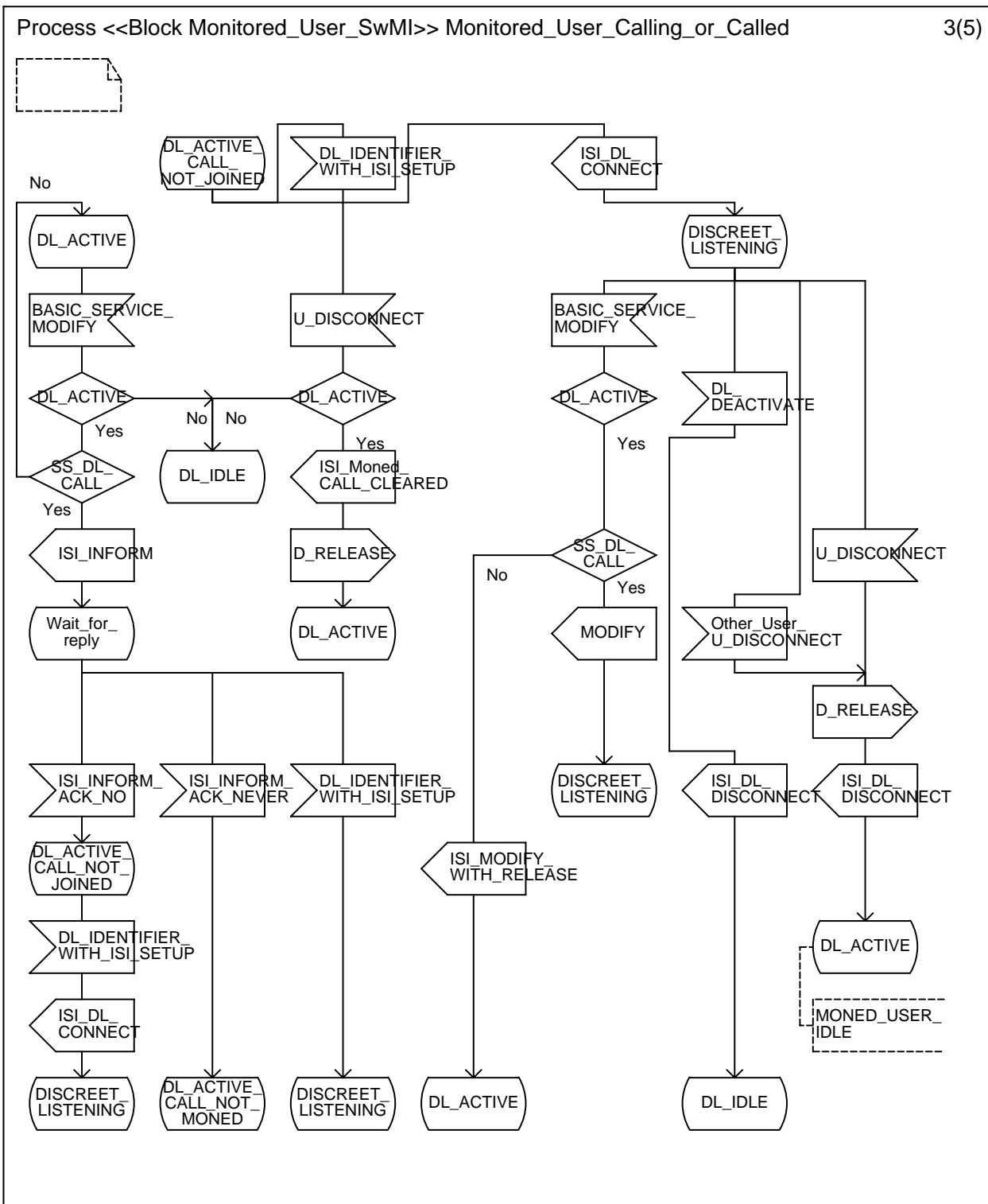

Figure A.3 (sheet 3 of 5): Monitored user registered SwMI SDL

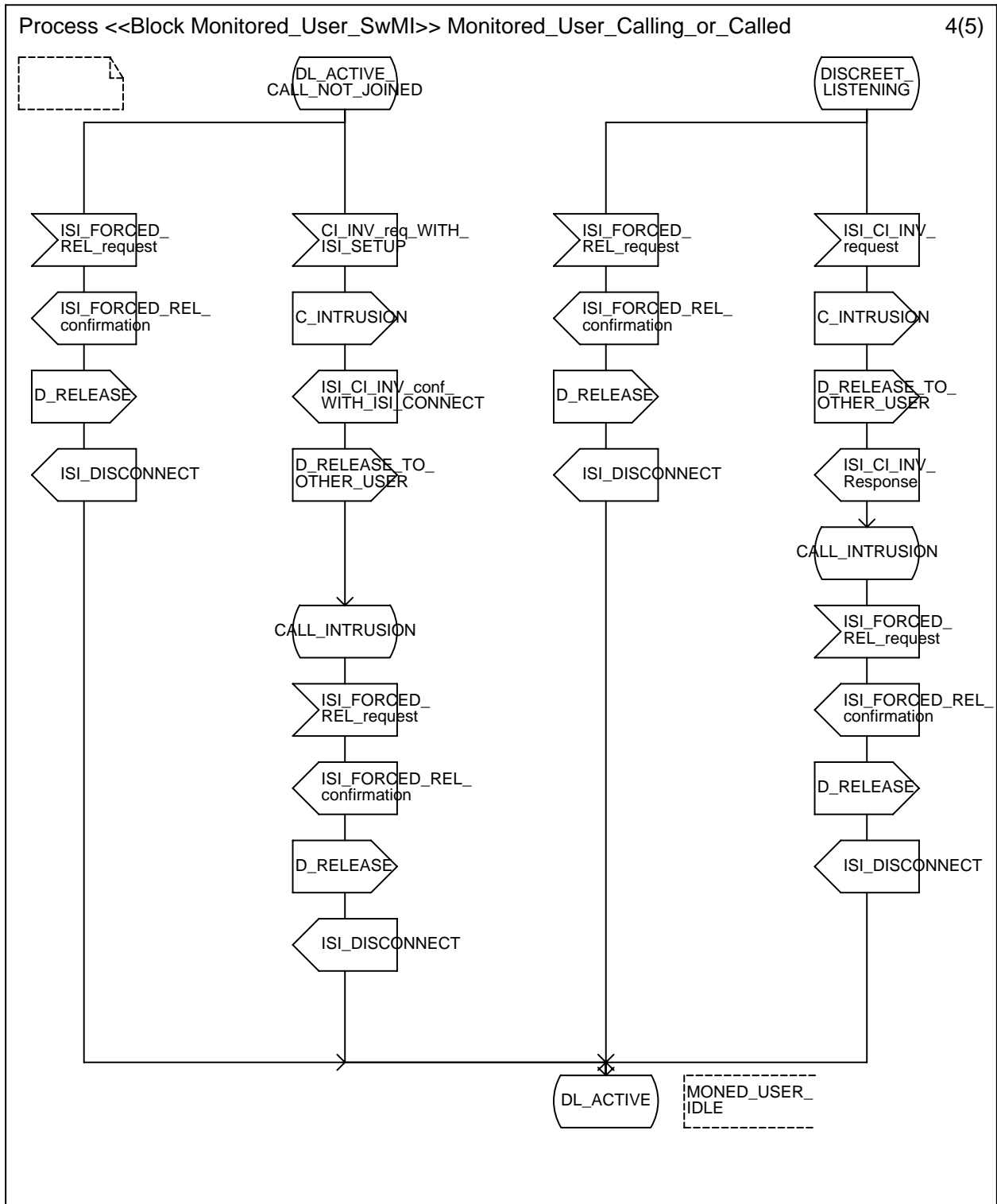

Figure A.3 (sheet 4 of 5): Monitored user registered SwMI SDL

Process <<Block Monitored\_User\_SwMI>> Monitored\_User\_Calling\_or\_Called

5(5)

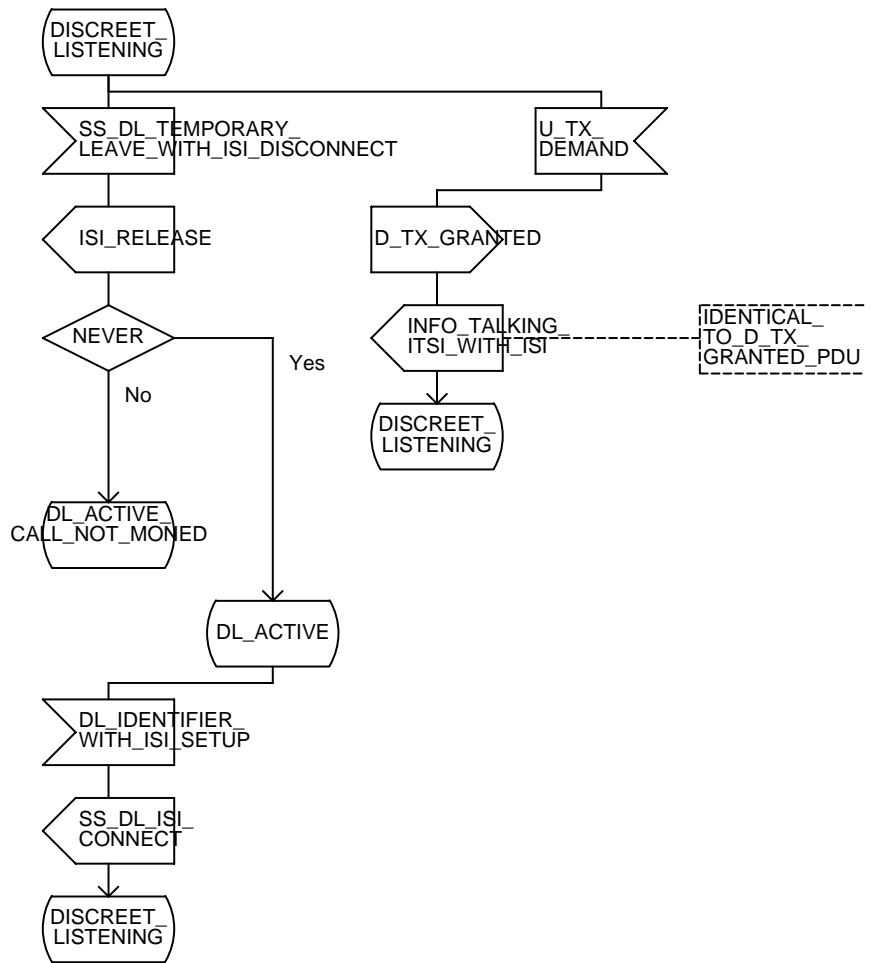
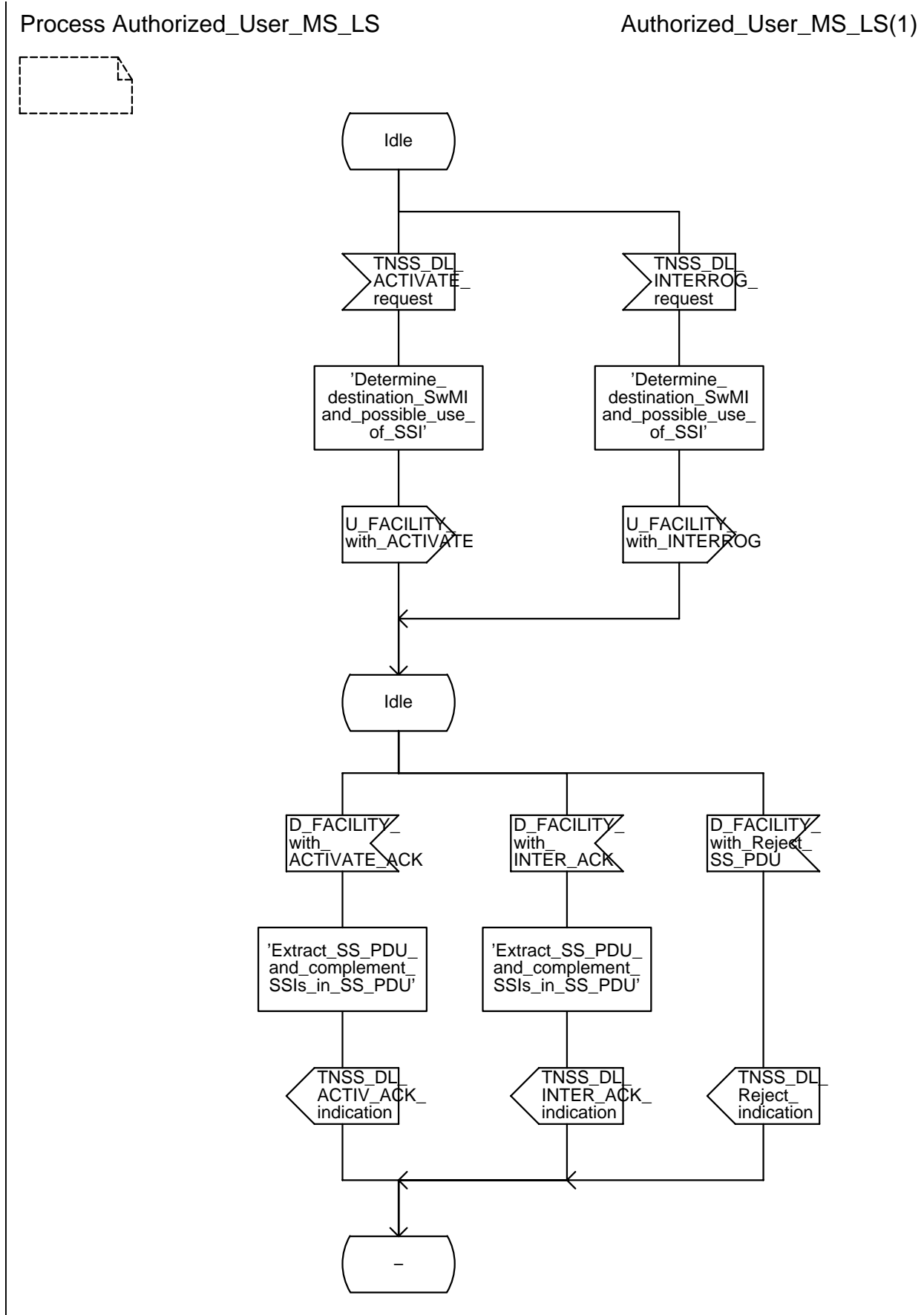

Figure A.3 (sheet 5 of 5): Monitored user registered SwMI SDL

**A.4 SDL representation of SS-DL at the authorized user MS/LS**



**Figure A.4 SDL representation of SS-DL at the authorized user MS/LS**

**A.5 SDL representation of SS-DL at the authorized user SwMI**

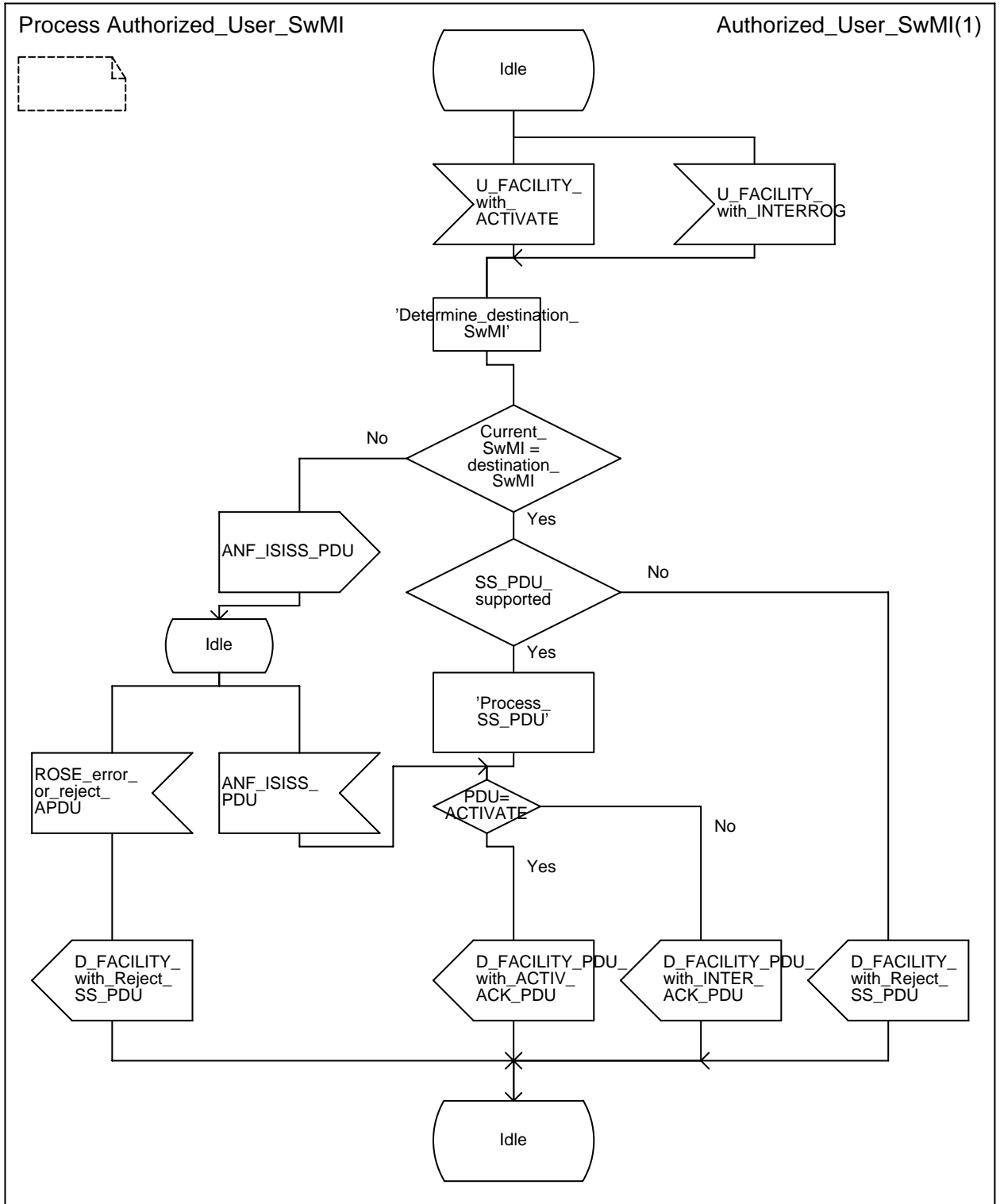

NOTE: This SDL diagram is the generic supplementary service activation; in the case of SS-DL, additional activation/activation ack flows from/to the authorized user home SwMI to/from the monitored user home SwMI are to be taken into account.

**Figure A.5: Authorized-User SwMI**

### A.6 SDL representation of SS-DL at the monitored user home SwMI

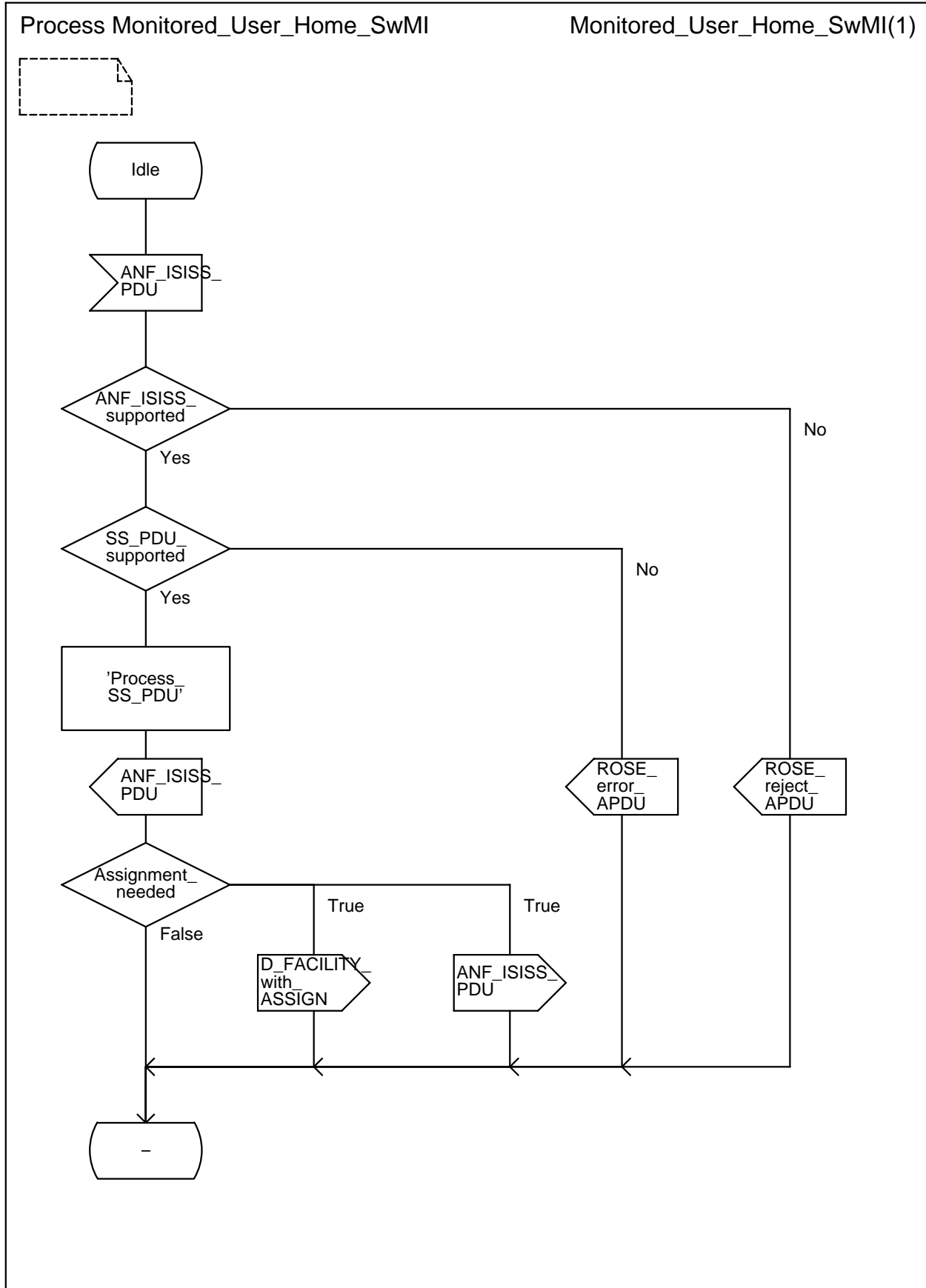

Figure A.6: SwMI where Monitored User is registered



## **Annex B (informative): Bibliography**

- ETS 300 392-10-20: "Terrestrial Trunked Radio (TETRA); Voice plus Data (V+D); Part 10: Supplementary services stage 1; Sub-part 20: Discreet listening".
- ETS 300 392-11-20: "Terrestrial Trunked Radio (TETRA); Voice plus Data (V+D); Part 11: Supplementary services stage 2; Sub-part 20: Discreet Listening (DL)".
- ETS 300 171: "Private Telecommunication Network (PTN); Specification, functional models and information flows; Control aspects of circuit mode basic services; ECMA-BCSD".
- ETS 300 426 (09/1995): "Private Telecommunication Network (PTN); Inter-exchange signaling protocol; Call intrusion supplementary service; ECMA-QSIG-CI".

## History

Document history			
December 1998	Public Enquiry	PE 9914:	1998-12-04 to 1999-04-02
May 1999	Vote	V 9931:	1999-05-17 to 1999-07-30