



# AMENDMENT

**ETS 300 347-1**  
pr A1

February 1997

---

Source: ETSI TC-SPS

Reference: RE/SPS-03035-1

ICS: 33.020

**Key words:** V interface, V5 interface, LE, AN

**This draft amendment A1, if approved, will modify  
the European Telecommunication Standard ETS 300 347-1 (1994)**

**Signalling Protocols and Switching (SPS);  
V interfaces at the digital Local Exchange (LE);  
V5.2 interface for support of Access Network (AN);  
Part 1: V5.2 interface specification**

## ETSI

European Telecommunications Standards Institute

**ETSI Secretariat**

**Postal address:** F-06921 Sophia Antipolis CEDEX - FRANCE

**Office address:** 650 Route des Lucioles - Sophia Antipolis - Valbonne - FRANCE

**X.400:** c=fr, a=atlas, p=etsi, s=secretariat - **Internet:** secretariat@etsi.fr

Tel.: +33 4 92 94 42 00 - Fax: +33 4 93 65 47 16

---

**Copyright Notification:** No part may be reproduced except as authorized by written permission. The copyright and the foregoing restriction extend to reproduction in all media.

© European Telecommunications Standards Institute 1997. All rights reserved.



## Foreword

This final draft amendment to ETS 300 347-1 (1994) has been produced by the Signalling Protocols and Switching (SPS) Technical Committee of the European Telecommunications Standards Institute (ETSI), and is now submitted for the Voting phase of the ETSI standards approval procedure.

This amendment contains changes of clauses, subclauses and annexes of ETS 300 347-1 (1994) as detailed below.

### Transfer of V5.1 amendments (ETS 300 324-1/A1)

Annex C, item 5): According to annex C, item 5), the receiving entity of an unblock request message is allowed to send no response back because it does not agree with the unblock request. But then it is not possible for the sender of the unblock request to distinguish between such a disagreement and a mismatch of the port FSMs which has to be resolved by a block-unblock sequence.

Amendment: To avoid a situation where the FSMs stay undetected misaligned, the receiver of a MPH-UBR shall respond to an unblock request within a certain time limit.

Annex C, item 12): The text concerning re-provisioning verification is clarified.

Annex C, item 13): Initial state of the ISDN user port FSM, PSTN user port FSM and PSTN protocol after system start up is not defined clearly.

Amendment: The system startup procedure is clarified. The SDL diagrams in annex L are adapted accordingly.

It is stated that the interface and the variant ID shall be checked during system startup. No procedure exists for the case of an unsuccessful check.

Amendment: The treatment of a unsuccessful system startup is be the same as in the case of an unsuccessful restart (refer to annex C, item 14 b), last paragraph).

Annex C, item 14): This item defines an asymmetrical PSTN restart procedure (master-slave relationship). This leads to a lock-up situation if the restart is required from both sides at the same point in time.

Amendment: The restart procedure is defined in a symmetrical way. The SDL diagrams in annex L are adapted accordingly.

Annex C, item 17): If TC3 expires only on one side of the V5.1 interface, a mismatch of the PSTN protocol FSMs after a re-establishment of the PSTN\_DL can persist.

Amendment: The PSTN restart procedure is added in case of a re-establishment of the PSTN\_DL.

Annex C, table C.1: "Cause for start" of Timer TC2 is wrong.  
Amendment: The cause for start is corrected.

Annex L, figure L.15.2: Figure L.15.2 is contradictory to annex C, item 13), which requires that the variant and interface ID shall be checked during system start-up. Figure L.15.2 shows only a check of the interface ID.

Amendment: Update the figure by adding a decision for the correct variant.

Editorial

- General: To be in line with existing definitions in the V5 standards, the "local manager" and "system manager" are changed to "system management" in several places.
- Clause 2: Update the normative reference to ETS 300 324-1 to include the amendment.
- Subclause 13.5: Incorrect reference given where the code sets are defined. Change to the same reference given by ETS 300 324-1.
- Subclause 15.3.3.3.4: Correction of the state "Access Operational" that should be changed to **Operational** to be in line with V5.1.
- Subclause 15.3.3.3.4: In third paragraph, change the action to go from one state to another as "return to" instead of "reset".
- Clause 16, figure 11: The invisible text is reconstituted from an earlier version.
- Subclause 16.2.4.5: A note is added about the sending of a notification to system management.
- Subclause 16.3.1.1: Reconstitute the missing part of the table.
- Subclause 16.3.2: The Link Control Function IE is defined differently in two separate places. The value given in table M.2 (00110000) is correct.
- Subclause 17.4.2.5: In table 42, the cause "V5 link unavailable (blocked)" missing. The cause with diagnostic and length is added.
- Subclause 17.4.2.6: An incorrect reference to subclause 17.5.8 is corrected.
- Subclause 17.4.2.7: There are Inconsistencies in the specification of the BCC protocol specification element "Connection incomplete". The value in table 40 is correct and figure 24 is incorrect.
- Subclause 17.5.5.2: Delete the duplicated word "entity".
- Subclause 17.5.8: Subclause 17.5.8, third paragraph, states that a message with more than two optional information elements shall be considered as too long, but in subclause 17.3.8, up to three optional information elements are possible in the AUDIT COMPLETE message in order to indicate an extent complete connection.
- Subclause 17.5.8.4: Split the subclause in two subclauses, one for mandatory and another (new) for optional repeated information elements.
- Subclause 17.6: There are inconsistencies between table 46 and table 47 in the BCC protocol. Table 46 is changed to be consistent with table 47.
- Subclause 17.7: In table 47 an unnecessary state is included for Event MDU-BCC (Allocation request) and state LEBcc0). Remove the "no state change" notation.
- Subclause 18.3.2: In table 49, MDU "reset SN req" is not used in AN. It is mentioned in the ETS only at this place and should therefore be deleted.
- Subclause 18.3.2: PROTOCOL\_ERROR PDU is missing in table 49.
- Subclause 18.4.5: Table 56 contains a wrong reference for the IE Rejection Cause.
- Subclause 18.4.6: Table 57 contains wrong references for the IE Logical C-channel identification, Sequence number and Rejection Cause.

- Subclause 18.6.2.3.1: An incorrect reference to subclause 18.6.2.2 is given.
- Subclause 18.6.6.3: Change the subclause title by adding "mandatory" to be consistent with the text.
- Subclause 18.8.2: Undefined protection protocol messages: (Wrong message name)  
The message OS SWITCH-OVER REQ is defined in state SOLE0 and SOLE2 and can therefore be replaced by OS SWITCH-OVER COM.
- Subclause 18.8.2: In table 66, the action in the protection protocol FSM contradicts subclause 18.6.2.3.1 in state SOLE0 and event MDU-prot(OS-switch-over com). Replace "-" by "MDU-prot(reset SN error ind)".
- Annex L, figure L.6: Some MDU-Protection primitives are missing for SR\_PROTECT\_SYSMGT: reset SN com, reset SN ind, reset SN ack and Protocol error indication.
- Annex L, figure L.29: Some MDU-Protection primitives are missing for SR\_PROTECT\_SYSMGT: reset SN com, reset SN ind, reset SN ack, reset SN req and Protocol error indication.
- Annex L, figure L.33.2: In the bottom diagram, the symbol for the message LINK CONTROL ACK has the wrong direction.
- Annex L, figure L.36.4: The cause for start of timer TSO4 is misalignment of sequence numbers VP(S) or VP(R) and repetition at the first timeout. Initialization of the sequence numbers V(P) or V(P) is only done in the procedure for misaligned handling according to figure L.14. This procedure is applied at the AN side and LE side.  
When a misalignment is detected and TSO4 is running, there will be no further protocol messages apart from RESET SN COM. Therefore, the sequence numbers remain in their initialization values.  
Amendment: Both figures L.13.4 and L.36.4 are corrected with a task symbol to initialize VP(S) and V(P) before start of TSO4.
- Annex L, figure L.36.5: A stop of timer TSO2 is missing in the bottom left branch.
- Annex L, figure L.36.7: In the bottom diagram, the symbol for the message RESET SN ACK has the wrong direction.
- Annex M, table M.1: The following code points missing: RESET SN COM, RESET SN ACK and PROTOCOL ERROR. Table M.1 is inconsistent with table 51.
- Annex M, table M.2: The given values for EFaddr and V5DLaddr are not in line with table 1.

### Technical

- Annex C, item 14): This item defines the PSTN restart procedure in an asymmetrical way. This can lead to a deadlock situation if the restart is requested from the AN and the LE at the same time. Therefore a symmetrical restart procedure is proposed to cope with this situation. For the V5.1 interface specification (ETS 300 324-1), the necessary changes have been introduced via an amendment. This amendment contains detailed text and SDL diagrams to provide the symmetrical PSTN restart procedure for the V5.2 interface specification.  
Amendment: The new text combines the two items 14 a) and 14 b) of annex C into one. Because of the proposed symmetry, the PSTN restart procedure becomes nearly independent of internal or external triggering. Internal triggering describes the PSTN restart within system start-up or after PSTN-DL failure. External triggering implies the PSTN restart after reception of a restart request from the control protocol entity.

As far as the SDL diagrams are concerned, the restart procedure appears as one of many other independent processes which make up the V5 system management. There are no global states for the system management (like in the V5.1 case). This independence of the triggering of the restart procedure makes it easier to cope with the necessary changes and to produce a clean version of the SDL diagrams.

Annex E, clause E.6: Link failure: in a number of exceptional cases where connections established in the AN are unusable it is not specified how the AN time slot resource manager behaves. In these cases, unnecessary messages used to de-allocate time slots may aggravate the situation due to limited processing and transfer capacity. The amendment intends to avoid different interpretation. It chooses the solution which requires the least number of messages to clear a critical situation.

Amendment: In case of a link failure recognized by the LE, the LE may block the link to make sure that the AN recognizes the situation. The AN's resource manager shall than de-allocate all time slots concerned internally. The LE does not need to send de-allocate commands for the individual time slots.

In case of AN internal fault reported by an AN FAULT message which contains both the time slot and the port layer 3 address (and, in case of ISDN, the B-channel), no de-allocate command is required to be sent by the LE. In case that the AN is not able to indicate both ends of the allocation (the AN FAULT message contains either only the time slot or the port's layer 3 address and, in case of ISDN, the B-channel) the LE shall send a de-allocate message for the allocation concerned to make sure that both ends are available for new allocations.

**Enhancement of port unblocking**

Subclause 3.1: Technical (Port state alignment procedure after interface start up):  
 Add a new definition of the Relevant user port due to the accelerated port unblocking (refer to subclause 15.4).

Subclause 15.4: Technical (Port state alignment procedure after interface start up).

<b>Proposed transposition dates</b>	
Date of latest announcement of this amendment (doa):	3 months after ETSI publication
Date of latest publication or endorsement of this amendment (dop/e):	6 months after doa
Date of withdrawal of any conflicting National Standard (dow):	6 months after doa

## Amendments

### Page 16, clause 2

Replace normative reference [8] by:

- [8] ETS 300 324-1 (1994) including amendment A1: "Signalling Protocols and Switching (SPS); V interfaces at the digital Local Exchange (LE); V5.1 interface for the support of Access Network (AN); Part 1: V5.1 interface specification".

### Page 18, subclause 3.1

Insert the following definition:

**"Relevant user port:** a user port for which a layer 3 address has been assigned to."

### Page 30

Insert a new subclause 8.7.4:

#### **"8.7.4 Flow control using LAPV5-DL mechanisms**

LAPV5-DL provides flow control mechanisms. Details are defined in clause 10.4.

NOTE: LAPV5-DL, as specified in clause 10, provides flow control mechanisms for the V5 data links using e.g. RNR or RR frames. These procedures shall also be used to control the flow of V5 messages at layer 3. This means, if one side is not able to receive V5 messages at layer 3 this should be indicated to the peer side via the existing mechanisms at layer 2 (i.e. via RNR frames).

Furthermore, if the peer layer 2 entity indicates via existing mechanisms at layer 2 that the peer side is currently in an overload situation, layer 3 shall not initiate sending of new V5 messages, but wait until the overload situation has disappeared. This includes, that re-transmission timers shall not be started until the overload situation has disappeared.

The above mechanisms require co-ordination between layer 2 and layer 3 via system management."

### Page 35, subclause 13.5

Change the reference from ETS 300 324-1 [8] to ETS 300 102-1 [6].

### Page 42, subclause 15.3.3.3.4, second paragraph

Replace the state name "Operational" (AN2.0) to "Access Operational" (AN2.0).

### Page 42, subclause 15.3.3.3.4, fourth paragraph

Replace the first sentence of the fourth paragraph by:

"For AN and LE, when in "Remote unblock" (AN1.2x, LE1.2x) state and receiving FE204 or FE203 respectively, the port state FSM is returned back to "Blocked" (AN1.0, LE1.0), and a MPH-BI sent to management."

**Page 44, subclause 15.3.3.4, last paragraph**

Change "local manager" to "system management".

**Page 44, subclause 15.3.3.5, last paragraph**

Change "local manager" to "system management".

**Page 45, subclause 15.4 and table 9**

Replace the complete text of subclause 15.4 by:

**"15.4 Control protocol**

**15.4.1 Control protocol message definition and content**

The contents of this subclause are identical to subclause 14.4.1 of ETS 300 324-1 [8].

**15.4.2 General message format and information element coding**

The contents of this subclause are identical to subclause 14.4.2 of ETS 300 324-1 [8] with the exception of table 54 of ETS 300 324-1 [8] which is modified due to two additional Control function elements required for the ISDN primary rate port, and with the exception of table 55 of ETS 300 324-1 [8] which is modified due to five additional Control function Ids for the accelerated alignment procedure. Tables 9 and 9a show the modified tables 54 and 55 of ETS 300 324-1 [8], respectively.

**Table 9: Coding of Control function element**

Bits (octet 3)							Control function element
7	6	5	4	3	2	1	
0	0	0	0	0	0	1	FE101 (activate access)
0	0	0	0	0	1	0	FE102 (activation initiated by user)
0	0	0	0	0	1	1	FE103 (DS activated)
0	0	0	0	1	0	0	FE104 (access activated)
0	0	0	0	1	0	1	FE105 (deactivate access)
0	0	0	0	1	1	0	FE106 (access deactivated)
0	0	1	0	0	0	1	FE201/202 (unblock)
0	0	1	0	0	1	1	FE203/204 (block)
0	0	1	0	1	0	1	FE205 (block request)
0	0	1	0	1	1	0	FE206 (performance grading)
0	0	1	0	1	1	1	FE207 (D-channel block)
0	0	1	1	0	0	0	FE208 (D-channel unblock)
0	0	1	1	0	0	1	FE209 (TE out of service)
0	0	1	1	0	1	0	FE210 (failure inside network)
NOTE:							All other values are reserved.



**Table 9a: Coding of Control function ID**

Bits (octet 3)							Control function ID	Optional information element considered mandatory
7	6	5	4	3	2	1		
0	0	0	0	0	0	0	Verify re-provisioning	Variant
0	0	0	0	0	0	1	Ready for reprovisioning	Variant
0	0	0	0	0	1	0	Not ready for reprovisioning	Variant, Rejection cause
0	0	0	0	0	1	1	Switch over to new variant	Variant
0	0	0	0	1	0	0	Re-provisioning started	Variant
0	0	0	0	1	0	1	Cannot re-provision	Variant, Rejection cause
0	0	0	0	1	1	0	Request variant and interface ID	-
0	0	0	0	1	1	1	Variant and Interface ID	Variant, Interface ID
0	0	0	1	0	0	0	Blocking started	-
0	0	1	0	0	0	0	Restart	-
0	0	1	0	0	0	1	Restart acknowledge	-
0	0	1	0	0	1	0	UNBLOCK ALL RELEVANT PORTS REQUEST	-
0	0	1	0	0	1	1	UNBLOCK ALL RELEVANT PORTS ACCEPTED	-
0	0	1	0	1	0	0	UNBLOCK ALL RELEVANT PORTS REJECTED	-
0	0	1	0	1	0	1	UNBLOCK ALL RELEVANT PORTS COMPLETED	-

NOTE: All other values are reserved.

**15.4.3 State definition of the control protocol**

The contents of this subclause are identical to subclause 14.4.3 of ETS 300 324-1 [8].

**15.4.4 Control protocol procedures**

The contents of this subclause are identical to subclause 14.4.4 of ETS 300 324-1 [8].

**15.4.5 Accelerated alignment of the port related protocol entities and FSMs**

Alternatively it is possible to align port states in AN and LE by the commands: "Unblock all relevant ports request". This can be accepted or rejected. After acceptance by the other side, all relevant ports are brought to the unblocked state on both sides except those considered unsuitable to be unblocked. After completion, MPH-BI is issued for each port considered to be unsuitable for unblocked state. See annex C for details."

**Page 46, figure 11**

Add the formerly "invisible" text to figure 11:

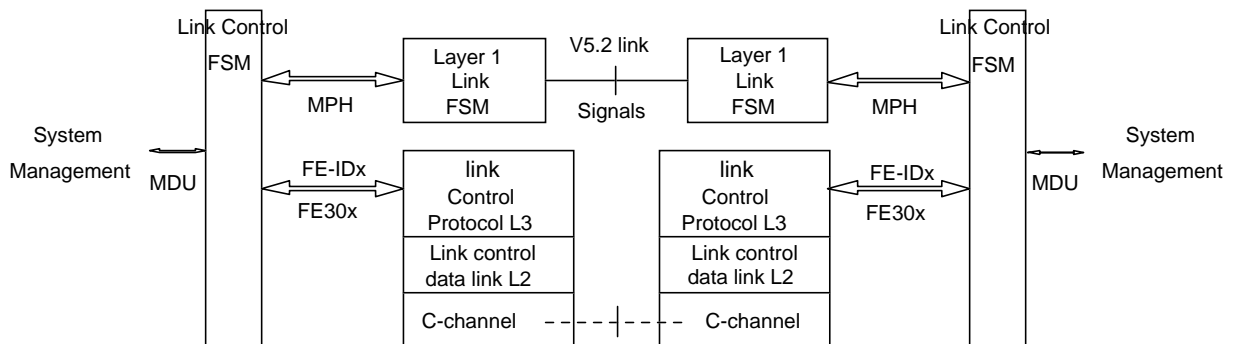

**Figure 11: Link control functional model**

**Page 53, subclause 16.2.4.1, fourth paragraph**

Change "managers" to "system management".

**Page 59, subclause 6.2.4.4, second paragraph, first sentence**

Change "system manager" to "system management".

**Page 60, table 17**

Add the following note:

"NOTE 5: Notification to system management about L1 fault."

Apply note 5 to state LE0.1 for events MDU-LUBR, FE302 and FE305.

**Page 60, subclause 16.2.4.5, second paragraph, first sentence**

Change "system manager" to "system management".

**Page 61, table 19**

Complete table 19 as follows:

**Table 19: LINK CONTROL message content**

Message Type: LINK CONTROL  
Direction: both

Information element	Reference	Direction	Type	Length
Protocol Discriminator	13.2.1	both	M	1
Layer 3 Address	16.3.2.1	both	M	2
Message Type	13.2.3	both	M	1
Link Control Function	16.3.2.2	both	M	3

**Page 62, subclause 16.3.2, table 21 and figure 14**

Change the link control function coding from "00100001" to "00110000".

**Page 79, subclause 17.4.1, third paragraph, last sentence**

Replace "renerating" by "generating".

**Page 83, subclause 17.4.2.5, second paragraph**

Add the following text to the end of the second paragraph:

"(This is not checked by the LE)"

**Page 85, table 42**

Add the following row to table 42:

Cause	Diagnostic	Length
⋮	⋮	⋮
V5 link unavailable (blocked)	V5 time slot identification or Multi-slot map information element	4 or 11

Insert the following paragraph below table 42:

"If the length of the diagnostics in the reject cause information element is not correct (i.e. does not comply with a value given in table 42), the LE shall react according to subclause 17.5.8.7."

**Page 86, subclause 17.4.2.6, third paragraph**

Replace "reject cause types" by "Protocol error cause types" twice.

**Page 86, subclause 17.4.2.6, sixth paragraph**

Replace the reference to "16.5.8" by "17.5.8".

**Page 87, table 44**

Insert the following paragraph below table 44:

"If the length of the diagnostics in the Protocol error cause information element is not correct (i.e. does not comply with a value given in table 44), the LE shall react according to subclause 17.5.8.7."

**Page 87, figure 24**

Replace the information element identifier coding "11000001" by "01000110" and figure 24 as follows:

<b>8</b>	<b>7</b>	<b>6</b>	<b>5</b>	<b>4</b>	<b>3</b>	<b>2</b>	<b>1</b>	
0	1	0	0	0	1	1	0	octet 1
Information element identifier								
Length of the information element content								octet 2
1 ext. (note)	Reason							octet 3

NOTE: Bit 8 is marked "1 ext." as this is the last octet in the extension domain. Additional octets may be defined later ("1 ext." will change to "0/1 ext.") and equipment shall be prepared to receive such additional octets although the equipment need not be able to interpret or act upon the content of these octets.

**Figure 24: Connection Incomplete information element**

**Page 91, subclause 17.5.5.2, first paragraph, first sentence**

Delete the replication of "entity".

**Page 93, subclause 17.5.8, third paragraph, first sentence**

Change the first sentence to read: "If more than 3 optional information elements...".

**Page 94, subclause 17.5.8.4, heading**

Replace the heading of subclause 17.5.8.4 by:

**"17.5.8.4 Repeated mandatory information element"**

**Page 95, top of page**

Insert a new heading before "Whenever an optional information element (...)":

**"17.5.8.4a Repeated optional information element"**

**Page 97, table 46, Timer number Tbcc3**

Replace State "LE Bcc2" by "LE Bcc0".

**Page 97, table 46, Timer number Tbcc4**

Replace State "LE Bcc3" by "LE Bcc0".

**Page 98, table 47, first row, first column**

Delete the sign "-" (indicating "no state change") for Event "MDU-BCC (Allocation request)", State "Bcc null (LEBcc0)".

**Page 106, table 49**

Change "TSO2" to "TSO3", delete row "MDU-Protection (reset SN req)" and add a new row for "PROTOCOL ERROR" as indicated below:

Name	Direction	Description
:	:	:
MDU-Protection (switch-over error ind)	PROTECT_AN --> SYS	The Protection protocol entity indicates the expiry of timer <u>TSO3</u> to the system management
:	:	:
MDU-Protection (reset SN req)	PROTECT_AN --> SYS	The Protection protocol entity indicates to system management that reset of SN has been requested by the peer entity
:	:	:
PROTOCOL ERROR	PROTECT_AN --> PROTECT_LE	Used by AN to indicate to the LE about protocol error
:	:	:

**Page 110, table 56, last row**

Replace the reference to "18.5.5" by "18.5.4".

**Page 110, table 57**

Replace the references to "17.5.1", "17.5.2" and "17.5.5" by "18.5.1", "18.5.2" and "18.5.5", respectively.

**Page 117, subclause 18.6.2.3.1, sixth paragraph**

Replace the reference to "17.6.2.2" by "18.6.2.2".

**Page 123, subclause 18.6.6.3**

Replace the heading of subclause 18.6.6.3 by:

**"18.6.6.3 Repeated mandatory information element"**

**Page 127, table 66, second row**

Modify Event "MDU-Prot.(OS switch-over com)" as indicated below:

⋮	⋮	⋮	⋮
MDU-Prot. (OS switch-over com) (NOTE 1)	OS SWITCH-OVER COM; start TSO2; SOLE1 MDU-Prot.(reset SN error ind); -	/	OS SWITCH-OVER COM; start TSO2; SOLE1
⋮	⋮	⋮	⋮

**Page 130, annex C, item 5)**

Insert at the end of item 5):

"The remote side shall react on a MPH-UBR within a time limit of 5 min with MPH-BI or MPH-UBI."

**Page 132, annex C, item 12), "Re-provisioning verification:"**

Replace the second sentence "This procedure (...) re-provisioning" by:

"This procedure avoids a situation in which ports are operational while there is a mismatch of variant ID or interface ID after re-provisioning."

**Page 133, annex C, item 13)**

Insert at the end of item 13):

"During the system startup procedure all user ports shall enter the blocked state. After the completion of the system startup procedure, all relevant ports shall go through the co-ordinated unblock procedure. In case of an unsuccessful check of the variant&interface ID a notification shall be given to the maintenance entity and the process shall be stopped. A system integrity process shall ensure that the system management is put into the SYSTEM STARTUP state repeatedly."

**Page 133, annex C, item 14)**

Replace the complete text of item 14) by:

"14) Restart procedure

The restart procedure shall be invoked by the system management in the AN or LE or by the OS. Subclauses L.1.8.4 and L.2.8.4 in annex L provide the SDL description of the restart procedure.

Only for the PSTN protocol a specific restart procedure is defined. For the control protocol, the system management shall use the port blocking procedure, if required. For the link control protocol, the system management shall use the link blocking procedure if required.

A restart procedure shall be initiated:

- a) during a system start-up as described in item 13);
- b) after a PSTN-V5DL failure as described in item 17); or
- c) if a MDU-CTRL(restart request) is received from the control protocol entity.

In case of a) and b), a MDU-CTRL(restart request) shall be sent to the control protocol entity, a MDU-CTRL(restart request) shall be sent to all PSTN protocol entities and the timers TR1 and TR2 shall be started.

In case of c), a MDU-CTRL(restart request) shall be sent to all PSTN protocol entities and the timers TR1 and TR2 shall be started.

Upon reception of the MDU-CTRL(restart complete) from the control protocol entity timer TR2 shall be stopped; upon reception of the MDU-CTRL(restart ack) indication from all PSTN protocol entities, timer TR1 shall be stopped and a MDU-CTRL(restart complete) shall be sent to the control protocol entity.

When the MDU-CTRL(restart complete) indication from the control protocol and the MDU-CTRL(restart ack) indications from all PSTN protocol entities have been received, a MDU-CTRL(restart complete) indication shall be sent to all PSTN protocol entities.

Upon expire of timer TR1 or TR2 a notification of the unsuccessful restart shall be given to the maintenance entity.

If the timer expire occurs during the system start-up, a system integrity process shall ensure that the system start-up is repeated periodically (e.g. every 5 minutes)."

**Page 134, annex C, item 17), seventh paragraph**

Replace the last sentence "A MDU-CTRL(...) of the PSTN\_DL" by:

"The PSTN restart procedure (refer to annex C, item 14) shall be invoked after the re-establishing of the PSTN\_DL. On completion of the PSTN restart a MDU-CTRL (port unblocked) shall be sent to the appropriate PSTN protocol FSMs."

**Page 135, annex C, table C.1**

Replace the Cause for start for timer TC2 and add two new timers TU1 and TU2 as indicated below:

Timer	Timer value	Cause for start	Normal stop
⋮	⋮	⋮	⋮
TC2	1 minute	<u>Expiry of TC1</u>	reception of MDL-ESTABLISH-CONFIRM or MDL-ESTABLISH-INDICATION from CONTROL-DL
⋮	⋮	⋮	⋮
TU1	100 s	MDU-CTRL(UNBLOCK ALL RELEVANT PORTS REQUEST) sent	MDU-CTRL(UNBLOCK ALL RELEVANT PORTS ACCEPTED) received
TU2	1 minute	MDU-CTRL(UNBLOCK ALL RELEVANT PORTS REQUEST) received	MDU-CTRL(UNBLOCK ALL RELEVANT PORT COMPLETED) received

**Page 136, annex C**

Add a new item:

"28) Accelerated alignment procedure

The accelerated alignment procedure allows alignment of port states without issuing block and unblock messages for each individual port. Subclauses L.1.8.7 and L.2.8.7 in annex L provide the SDL description of the accelerated alignment procedure. The procedure is defined as follows:

- a) When alignment for all ports of the interface is necessary a MDU-CTRL(UNBLOCK ALL RELEVANT PORTS REQUEST) shall be sent to the control protocol entity. Timer TU1 shall be started.

Upon reception of MDU-CTRL(UNBLOCK ALL RELEVANT PORTS ACCEPTED) from the common control protocol entity, timer TU1 shall be stopped. All relevant ports shall directly enter the unblocked state without any negotiation with the peer entity, except those that are considered unsuitable (the latter shall be blocked again for mutual re-alignment at the end of the procedure). A MDU-CTRL(UNBLOCK ALL RELEVANT PORTS COMPLETED) shall be sent to the common control protocol entity, timer TU2 shall be started.

Upon reception of MDU-CTRL(UNBLOCK ALL RELEVANT PORTS COMPLETED) from the common control protocol entity timer TU2 shall be stopped. MPH-BI shall be sent to those port status FSMs whose ports are considered unsuitable for the unblocked state.

Upon reception of MDU-CTRL(UNBLOCK ALL RELEVANT PORTS REJECTED) TU1 shall be stopped and the process abandoned. A notification shall be given to the maintenance entity.

Upon expiry of timer TU1 the process shall be abandoned. A notification shall be given to the maintenance entity.

Upon expiry of timer TU2 MPH-BI shall be sent to those port status FSMs whose ports are considered unsuitable for the unblocked state.

- b) Upon reception of a MDU-CTRL(UNBLOCK ALL RELEVANT PORTS REQUEST) a MDU-CTRL(UNBLOCK ALL RELEVANT PORTS ACCEPTED) shall be sent to the common control protocol entity. After having unblocked all relevant ports a MDU-CTRL(UNBLOCK ALL RELEVANT PORTS COMPLETED) shall be sent to the common control protocol entity and timer TU2 shall be started.
- c) If the AN or LE side after having sent MDU-CTRL(UNBLOCK ALL RELEVANT PORTS REQUEST) receives MDU-CTRL(UNBLOCK ALL RELEVANT PORTS REQUEST) before MDU-CTRL(UNBLOCK ALL RELEVANT PORTS ACCEPTED), then it shall proceed with sending a MDU-CTRL(UNBLOCK ALL RELEVANT PORTS ACCEPTED) to the common control protocol entity."

**Page 144, annex E, clause E.6**

Replace the first paragraph of clause E.6 by:

"When an AN internal failure is notified by the AN to the LE by an AN FAULT message containing the User Port Identification IE and in case of ISDN the ISDN Port Channel Identification IE as well as the V5 Time Slot Identification IE, all resources in the AN related to the connection affected are freed internally. The resource management entity in the LE shall initiate internal de-allocation for the notified bearer channel connection and shall notify the event to the PSTN/ISDN protocol entities for proper service actions to be taken.

When an AN internal failure is notified by the AN to the LE by an AN FAULT message containing either the User Port Identification IE and in case of ISDN the ISDN Port Channel Identification IE or the V5 Time Slot Identification IE but not all the IEs mentioned, the resource management entity in the LE shall initiate de-allocation for the notified bearer channel connection send a DE-ALLOCATION message to the AN and shall notify the event to the PSTN/ISDN protocol entities for proper service actions to be taken."

Page 151, annex E

Add a new clause to annex E:

**"E.10 Link failure rules**

Persistent link failures, which will be recognized generally by both sides, shall not be notified by the AN as internal failure.

If the LE sends a link block command in a LINK CONTROL message for a link containing time slots allocated to ports (e.g. in case of a link failure recognized), all resources in the AN related to the connections affected are freed internally. The resource management entity in the LE shall initiate internal de-allocation for the notified bearer channel connection and shall notify the event to the PSTN/ISDN protocol entities for proper service actions to be taken."

Page 152, annex F

Add a new subclause to annex F:

**"F.4 Example of AN and LE configuration**

Figure F.1 shows one case with two LEs and two ANs connected to each other via five V5 interfaces with the following given v5InterfaceID values: 1, 2, 3, 4, up to  $2^{24}-1$ , 16777215). LE<sub>1</sub> is connected to AN<sub>1</sub> and AN<sub>2</sub> using V5 interfaces of type both V5.1 and V5.2 to the same AN. Both LE<sub>1</sub> and LE<sub>2</sub> are connected to AN<sub>2</sub> using separate V5 interfaces of different types.

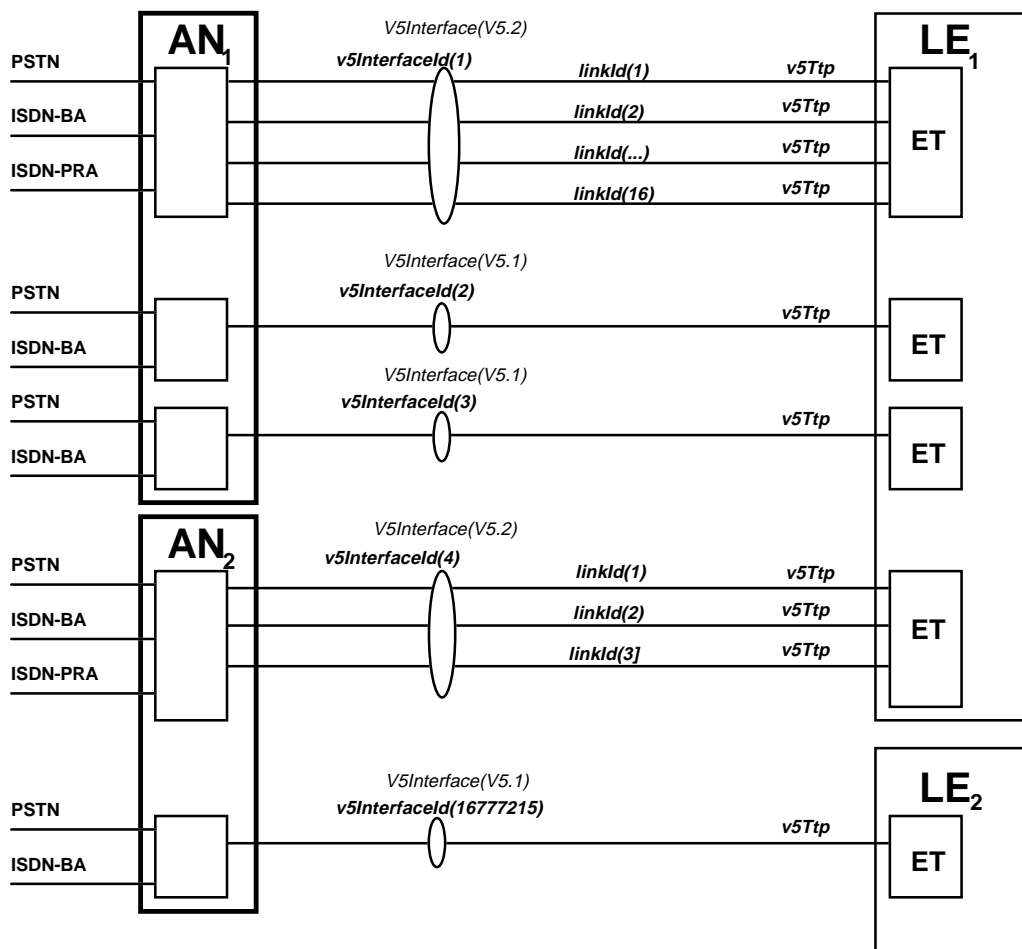

Figure F.1: A possible AN/LE configuration using the V5 standard



For V5.1 the interface ID is unique for everything related to this particular interface. The same is true for V5.2 with the difference that the linkID differs for each of the 2 048 kbit/s links.

The value of the V5Interfaceld is defined in the LE configuration management standard (ETS 300 377-1) and referred to by the AN configuration management standard (ETS 300 376-1). The value is set by the Relative Distinguished Name (RDN) of the interface. The v5Interfaceld needs to be identical on the both sides of the V5 interface to succeed with the system start-up procedures defined in annex C in ETS 300 324-1 [8].

If the network consists of more than two operators, then co-ordination of the interface ID is needed within the network before the configuration activities can start. The interface ID should be unique in the network in some way (which is not defined). It is not sufficient to be unique within the managedElement."

Page 163, figure L.6

Replace all prefixes of primitives for system management "MDU-Protection" by "MDU-Protect".

Replace "MDU-Protect(switch-over reject; cause)" by "MDU-Protect(switch-over reject ind; cause)".

Add the following MDU-Protection primitives for signal route SR\_PROTECT\_SYSMGT, upper signal list:  
 OS-switch-over com, reset SN com, reset SN ack, reset SN ind, reset SN error ind and Protocol error ind.

Add the following PDU for signal route SR\_PROTECT\_DL, right signal list: PROTOCOL ERROR.

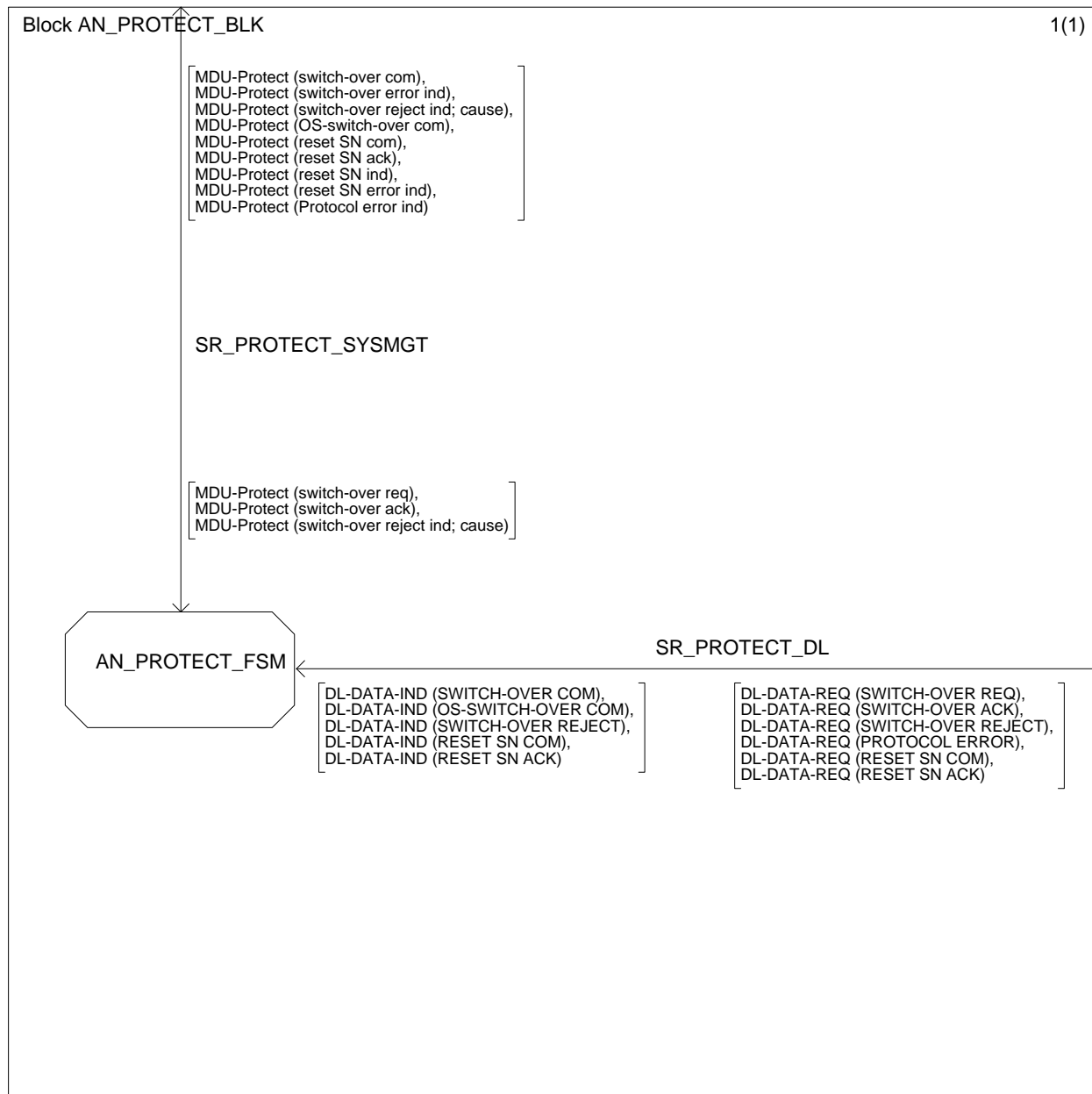

Page 194, figure L.13.4

Add the task symbol "initialize VP(S), VP(R)" before task symbol "start TSO4".

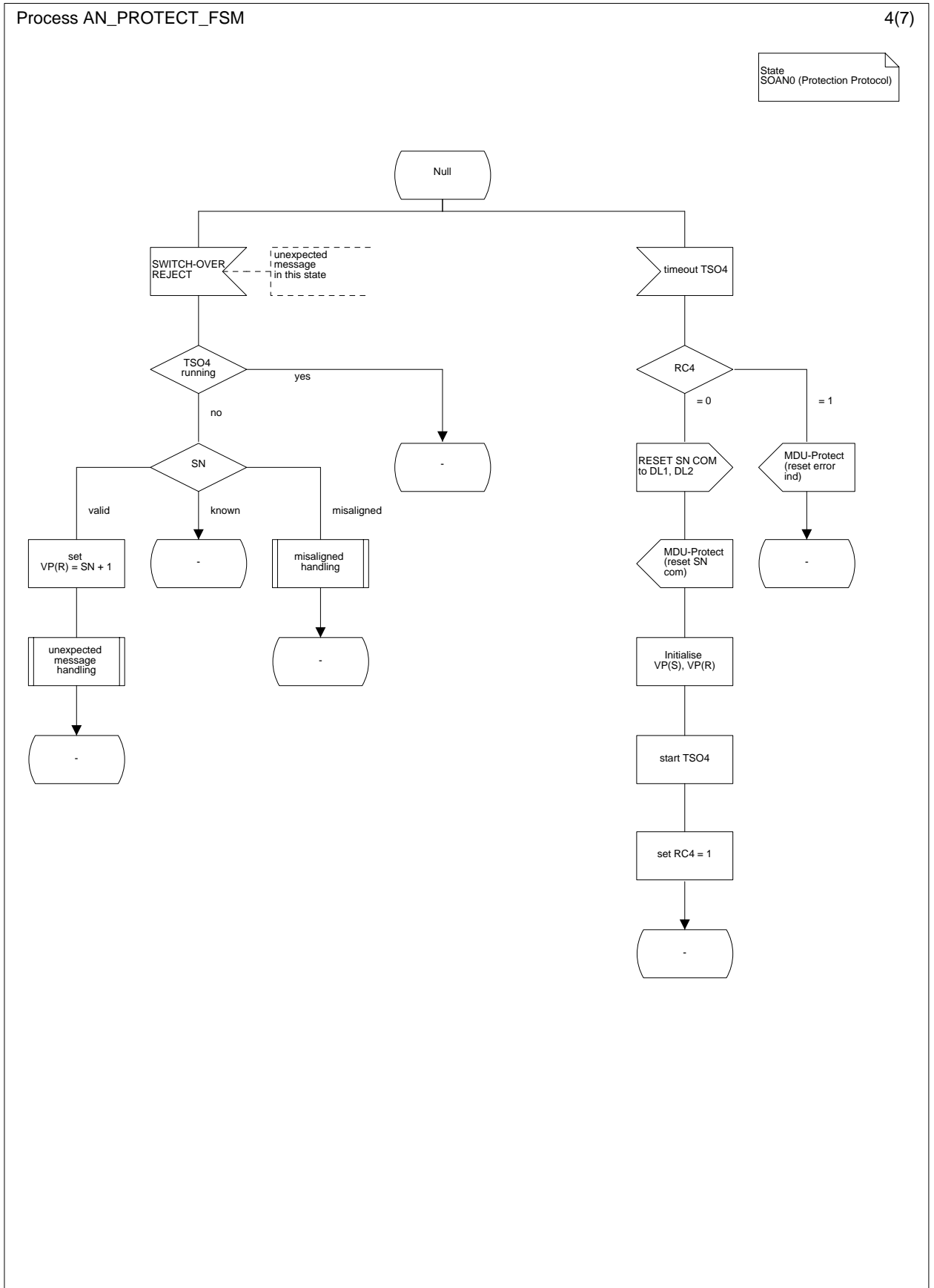

Page 200, figure L.15.2

Replace decision "ID identical" by "variant&interface ID identical".

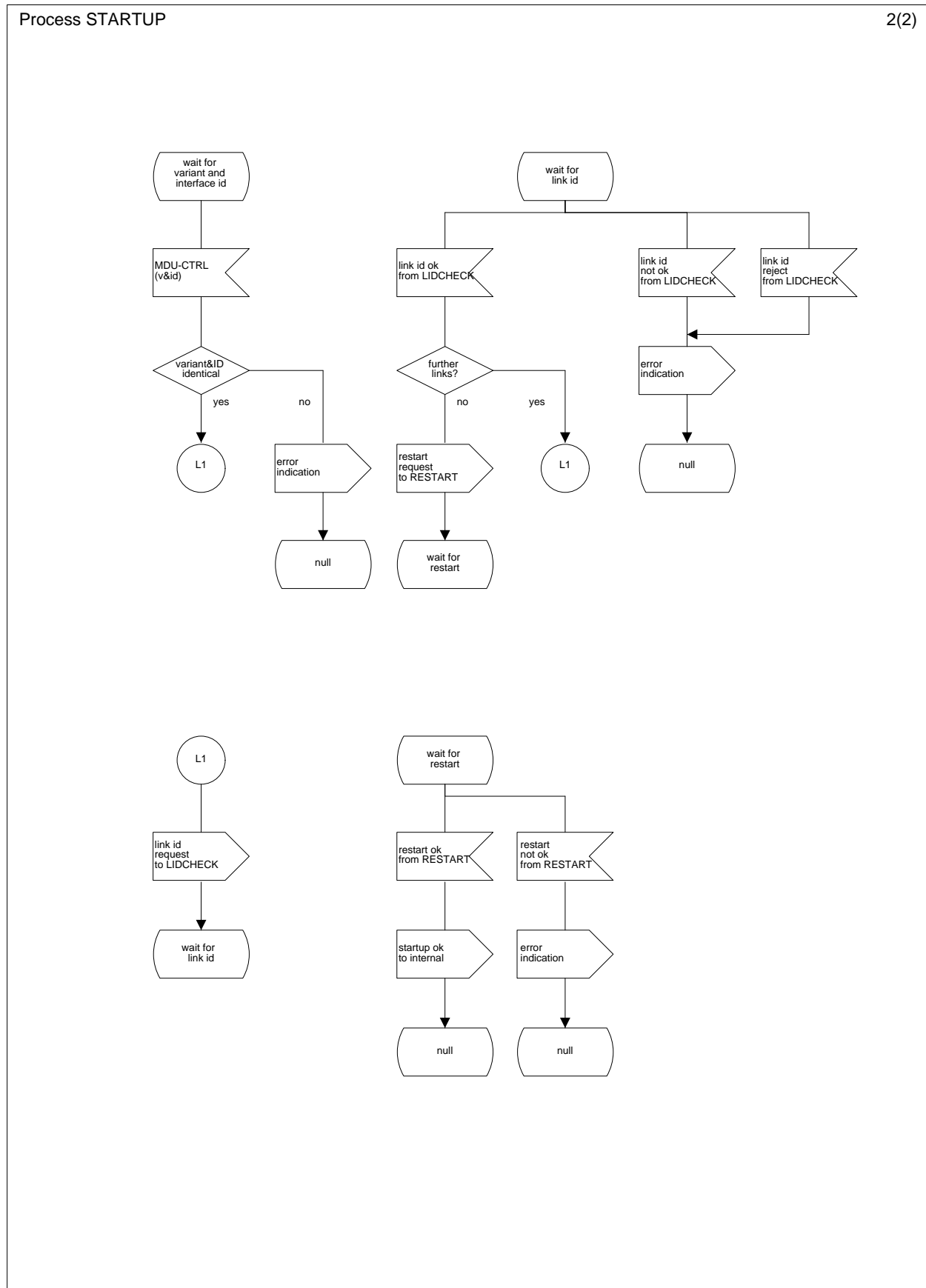

Page 205, figure L.18.1

Replace the complete figure.

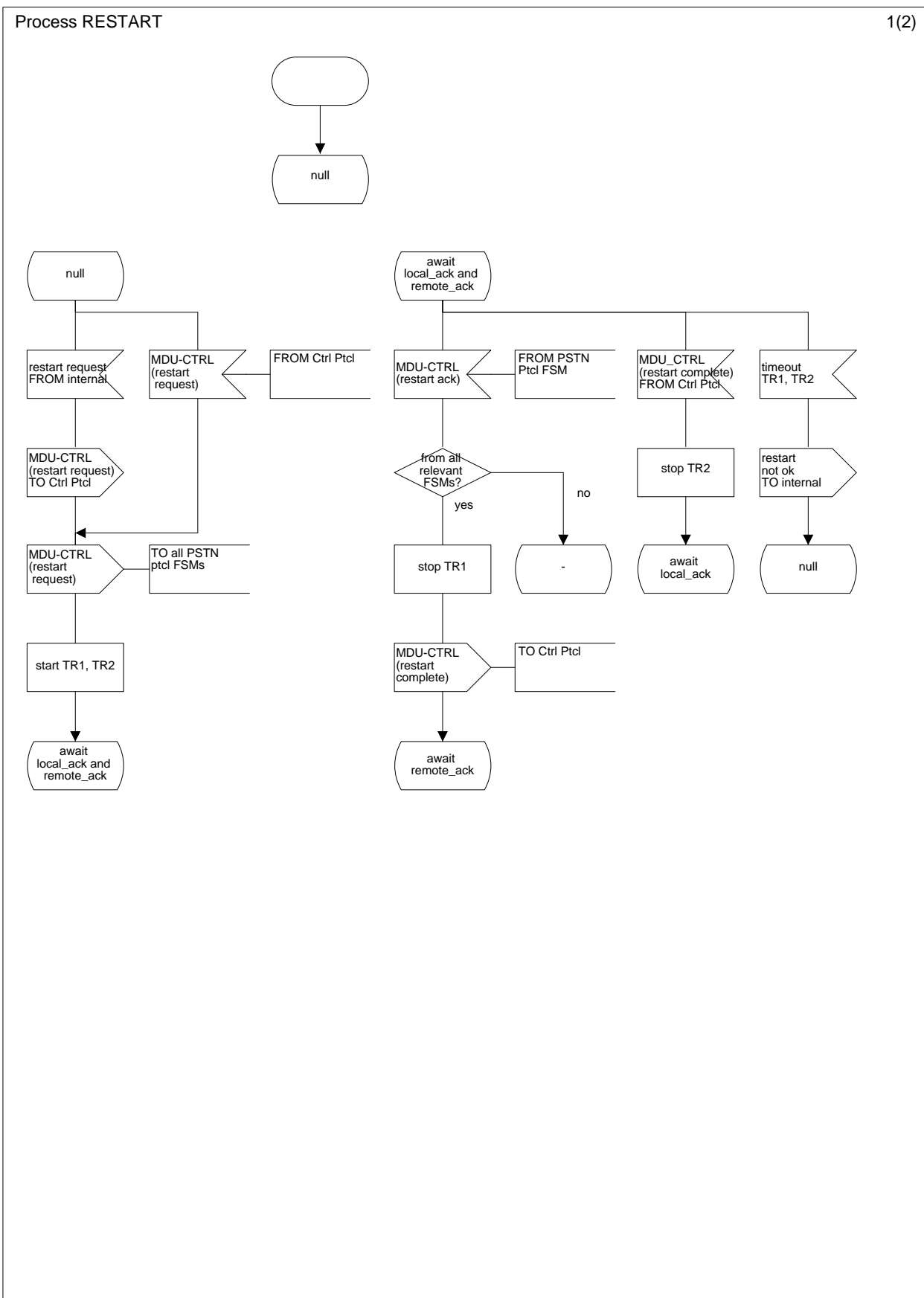

Page 206, figure L.18.2

Replace the complete figure.

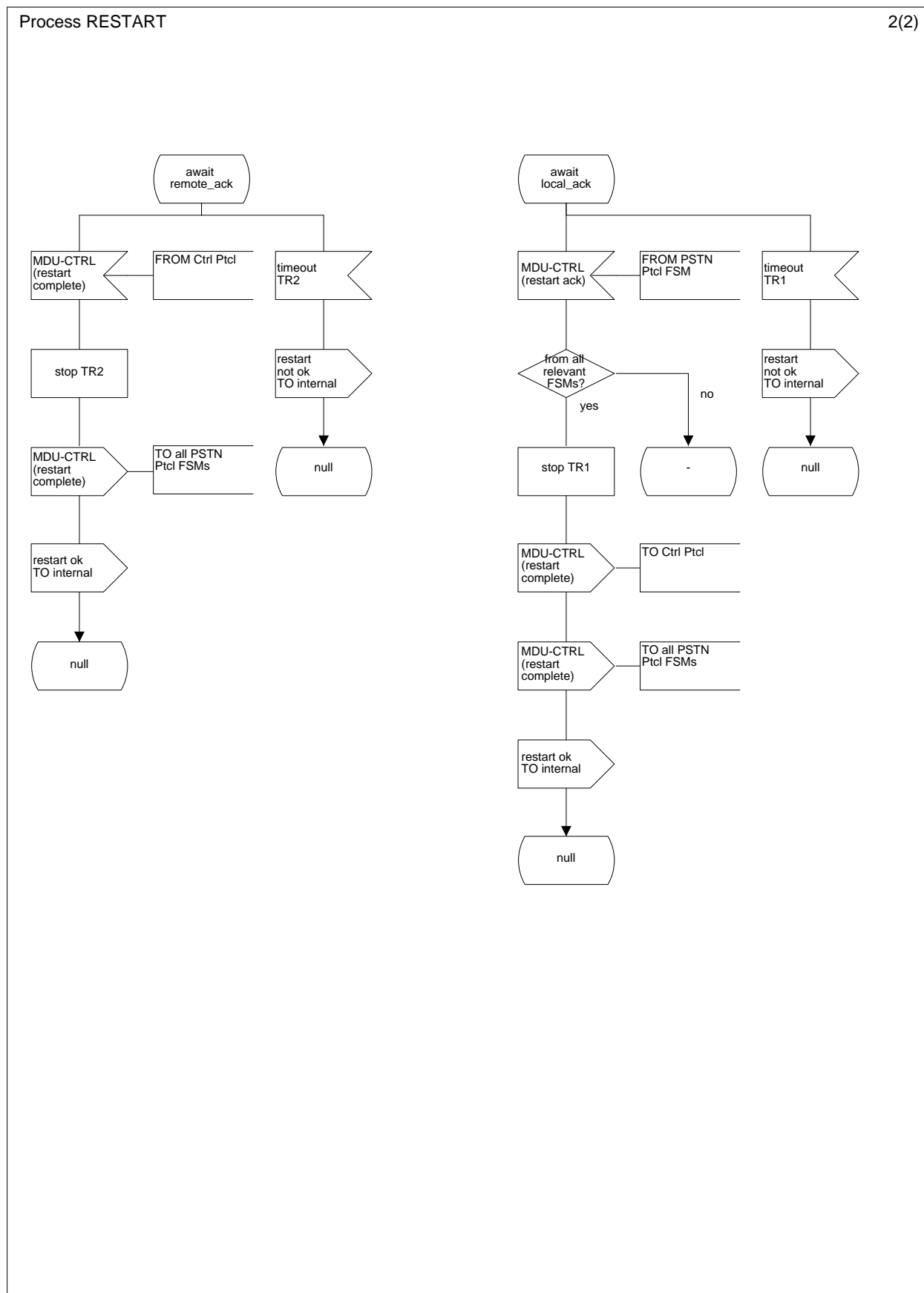

Insert a new subclause L.1.8.7 after figure L.23.3

**L.1.8.7 Accelerated port alignment procedure**

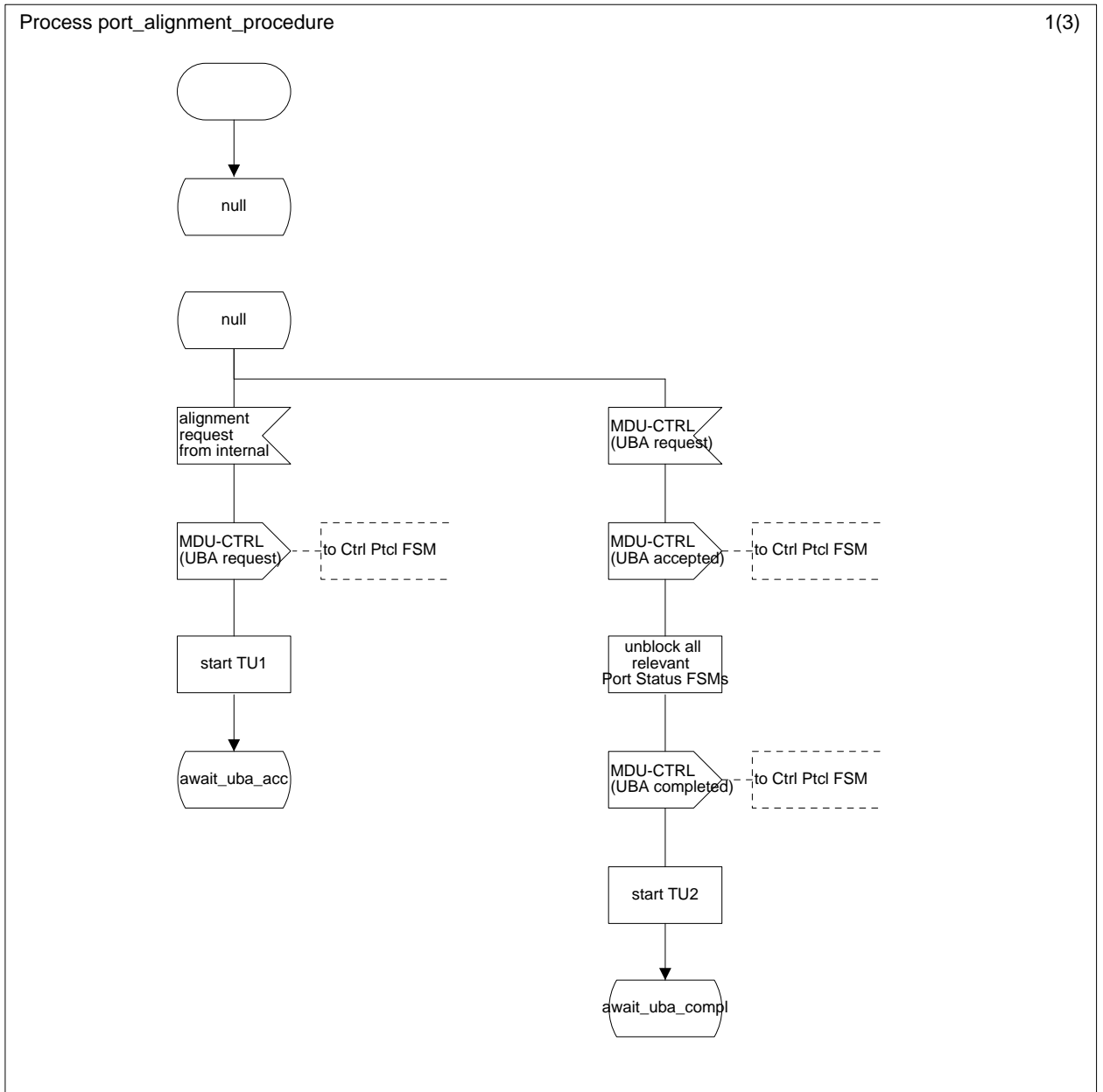

**Figure L.23a.1: Accelerated port alignment procedures AN-side (sheet 1 of 3)**

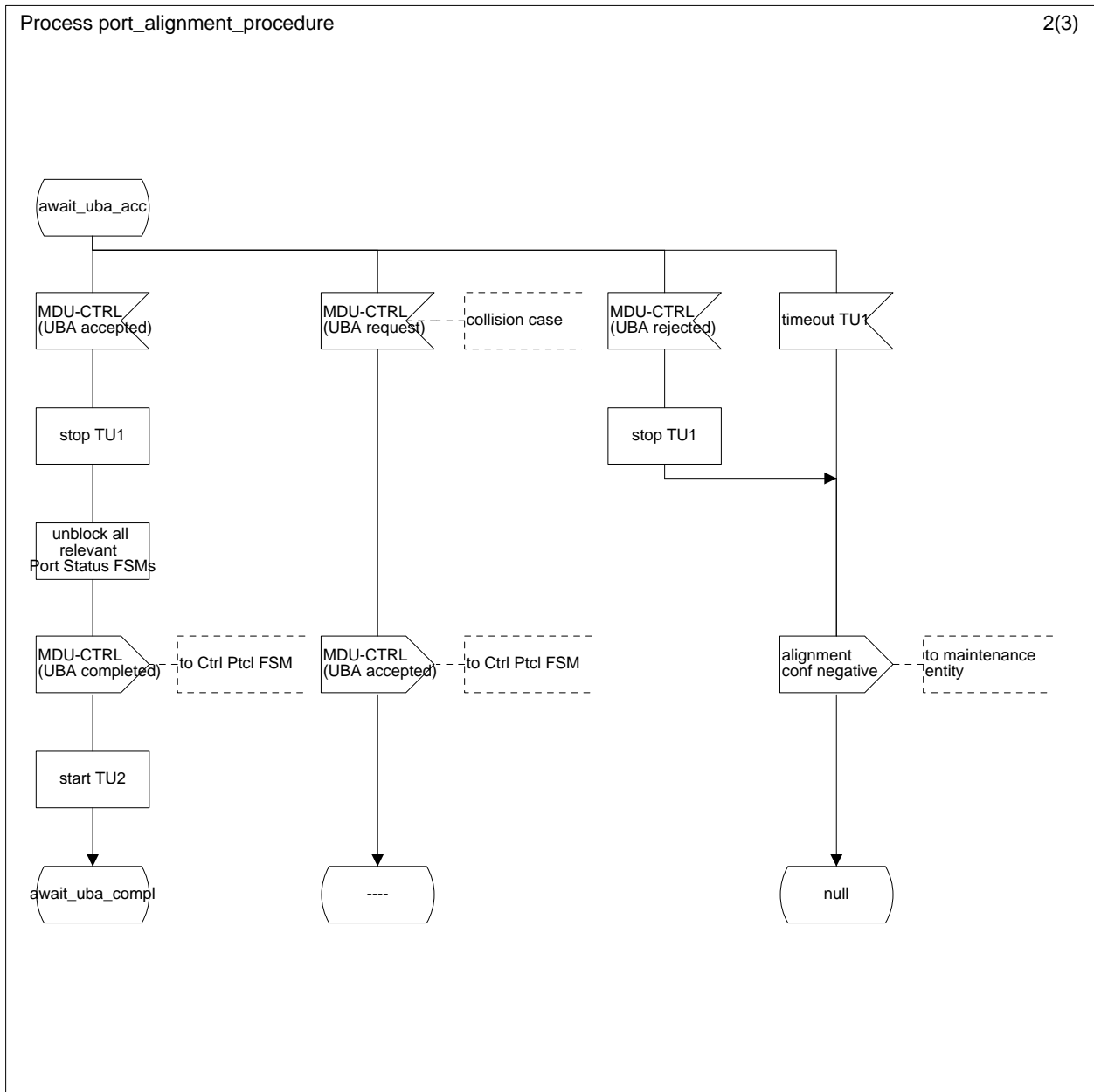

Figure L.23a.2: Accelerated port alignment procedures AN-side (sheet 2 of 3)



Process port\_alignment\_procedure

3(3)

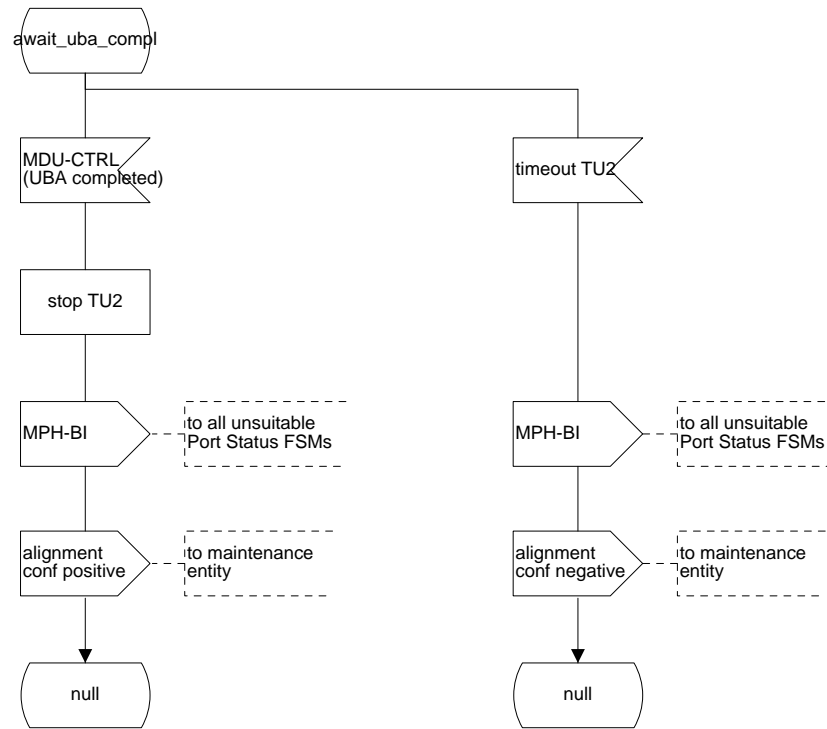

Figure L.23a.3: Accelerated port alignment procedures AN-side (sheet 3 of 3)

Page 220, figure L.29

Replace "switch-over req ind" by "switch-over req" for signal route SR\_PROTECT\_SYSMGT, upper signal list.

Add the following MDU-Protection primitives for signal route SR\_PROTECT\_SYSMGT, upper signal list: reset SN ind, reset SN com, reset SN ack, reset SN error ind and Protocol error ind.

Add the following MDU-Protection primitives for signal route SR\_PROTECT\_SYSMGT, bottom signal list: switch-over com, OS-switch-over com and reset SN req.

Delete the following MDU-Protection primitives for signal route SR\_PROTECT\_SYSMGT, bottom signal list: switch-over req.

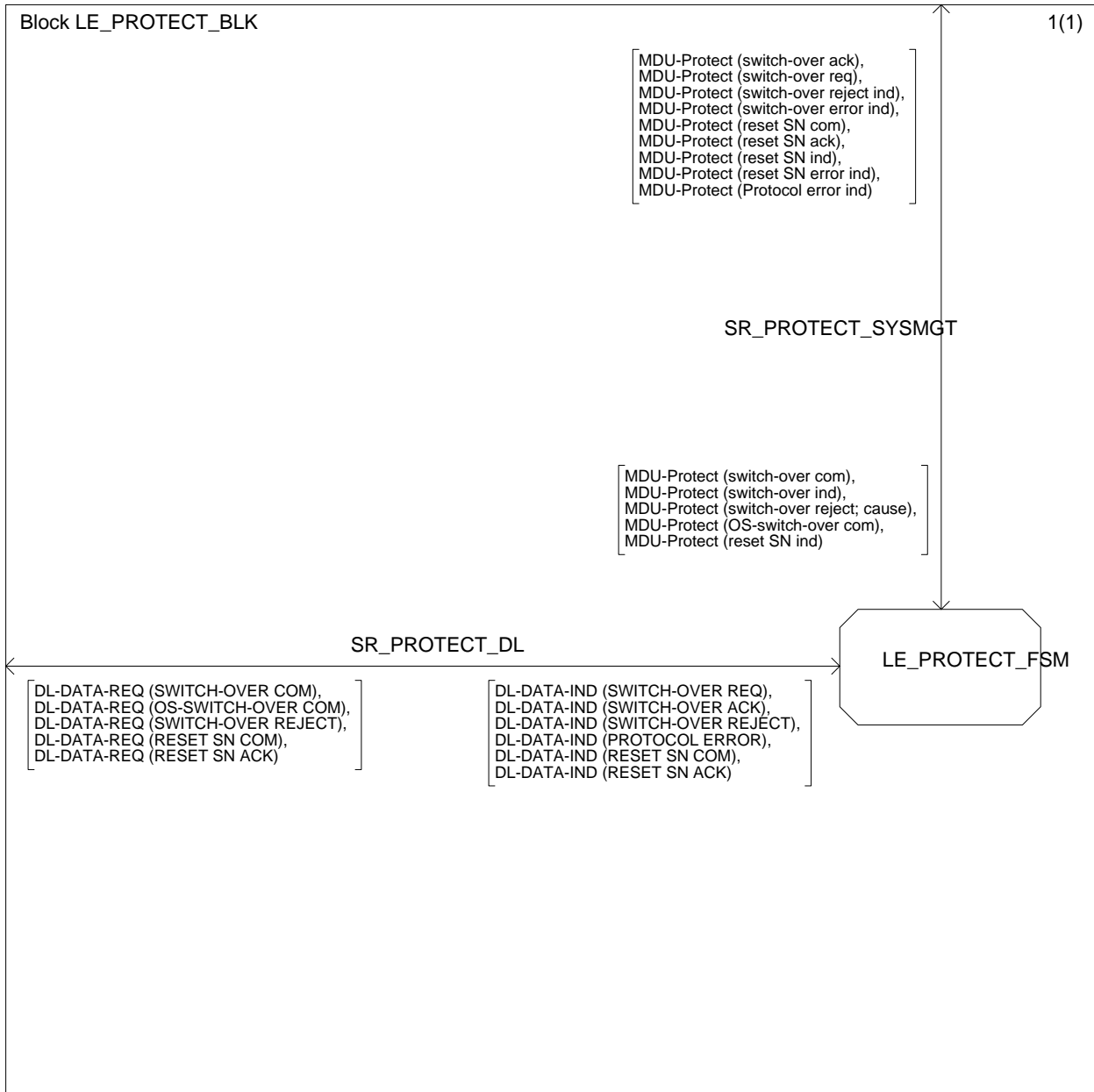

Page 229, figure L.33.2, state "IN SERVICE"

Flip the input symbol "LINK CONTROL ACK".

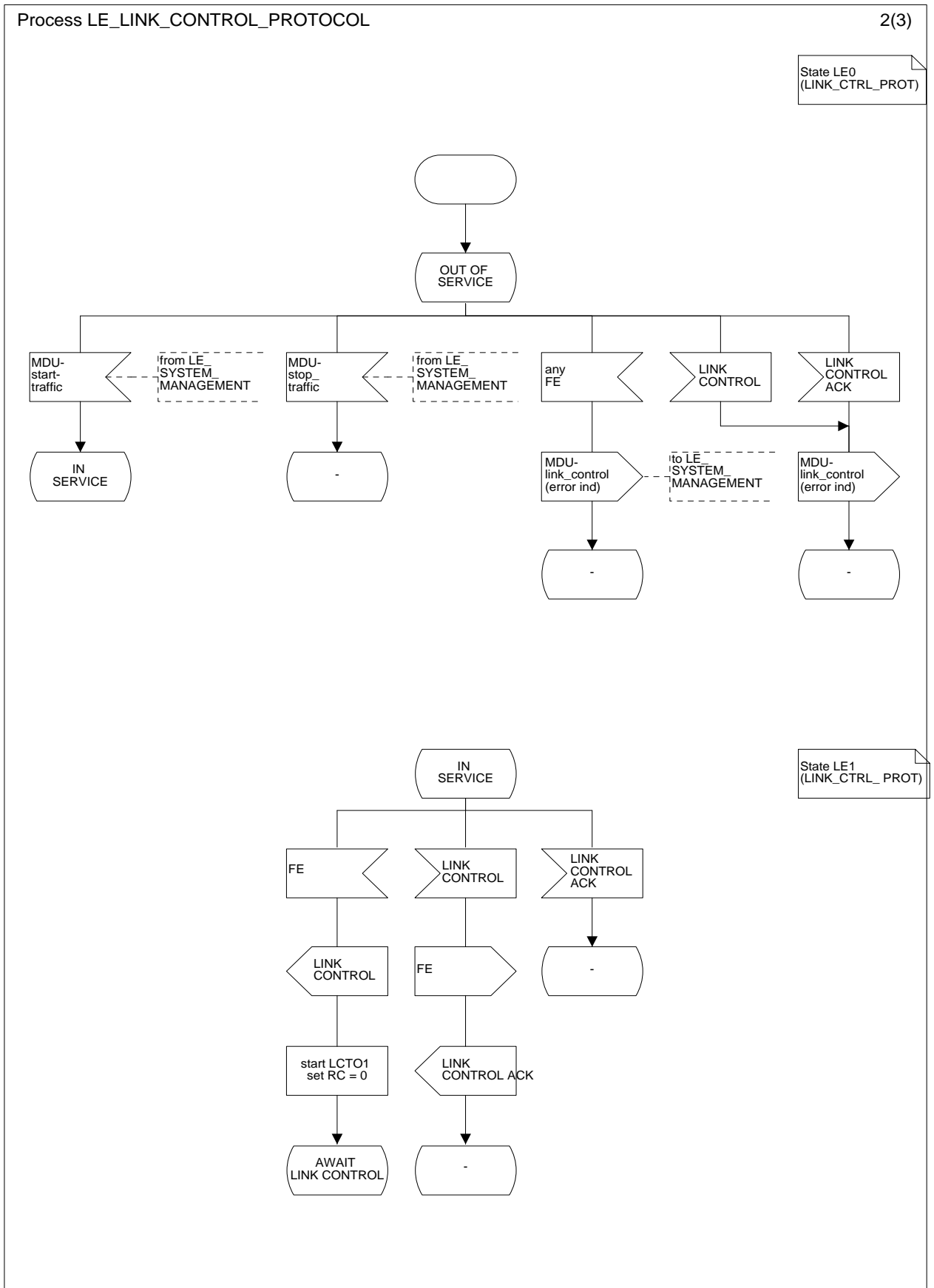

Page 246, figure L.36.4

Add the task symbol "initialize VP(S), VP(R)" before task symbol "start TSO4".

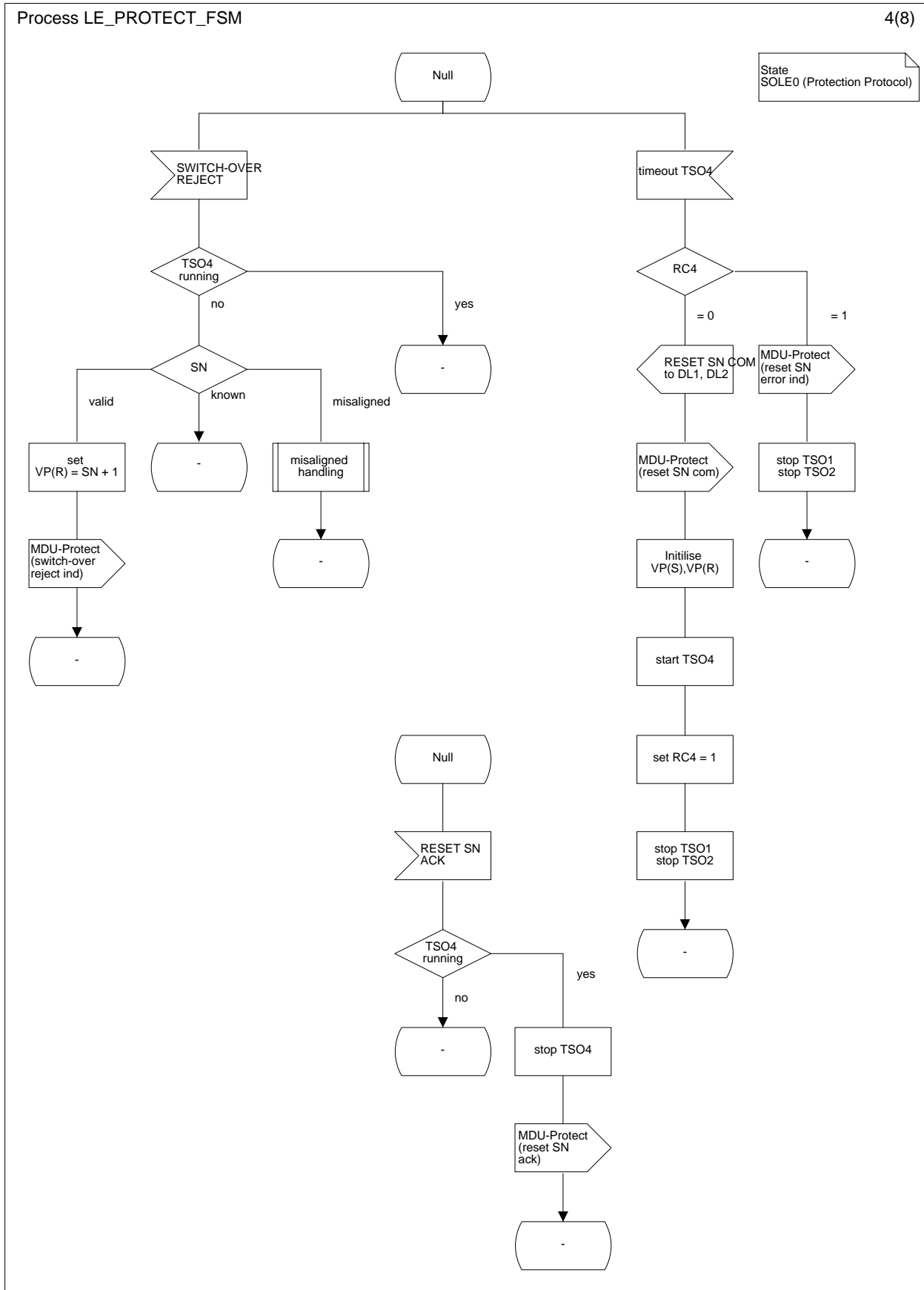

Page 247, figure L.36.5, bottom left branch

Insert "stop TSO2" into the task symbol "stop TSO1".

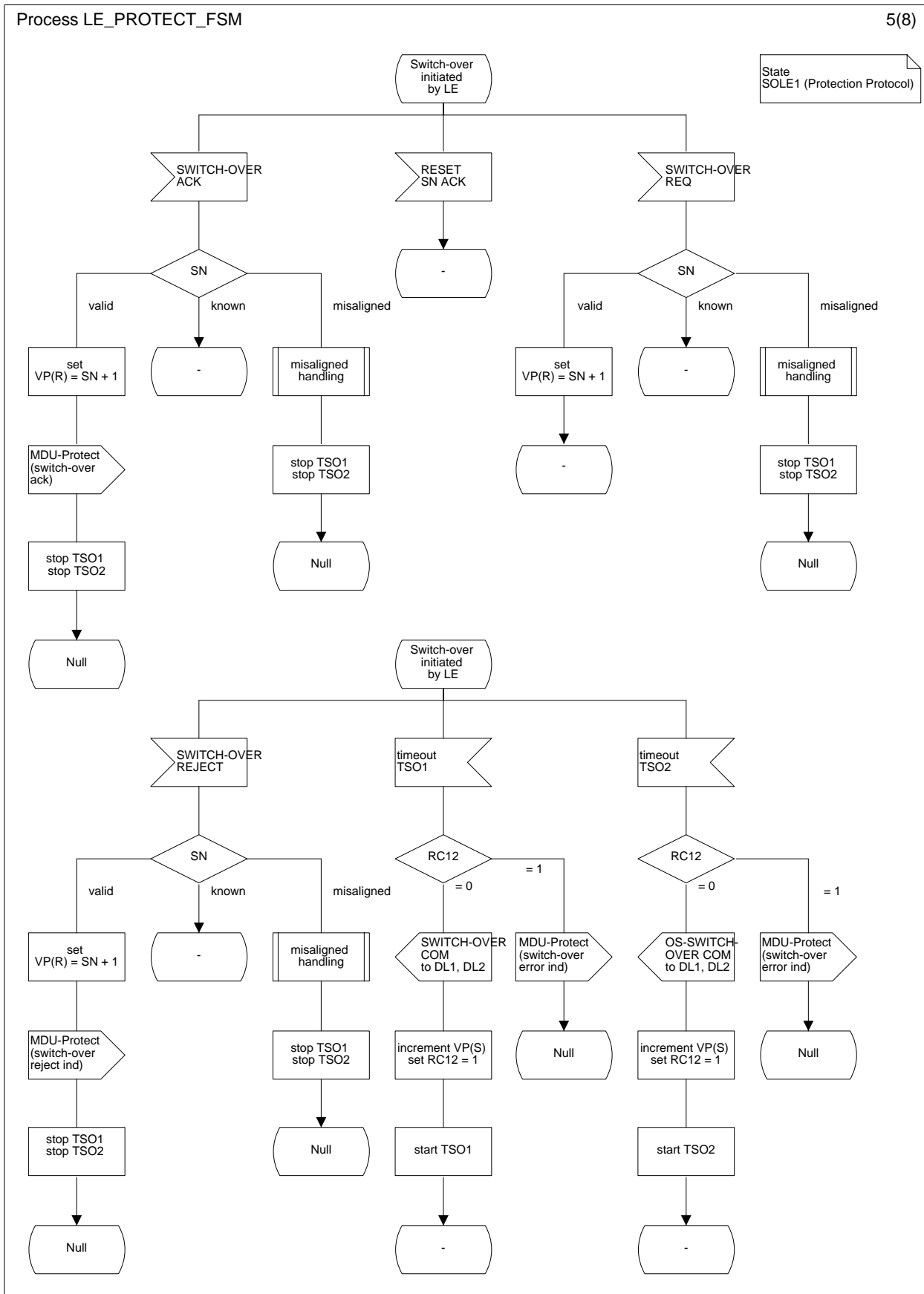

Page 249, figure L.36.7

Flip the output symbol "RESET SN ACK".

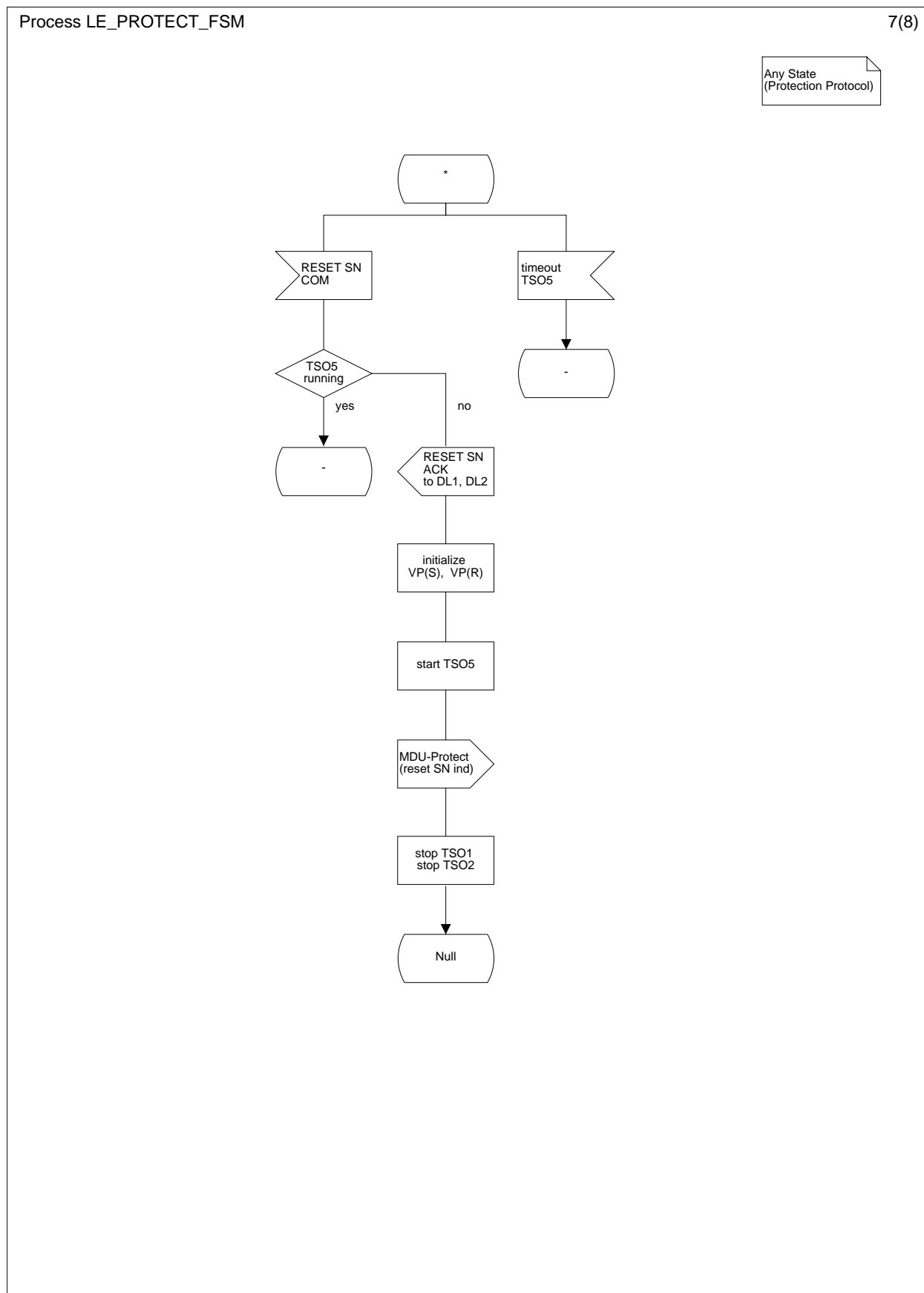

Page 255

Insert a new subclause L.2.8.7 after figure L.37.4:

"L.2.8.7 Accelerated port alignment procedure

See subclause L.1.8.7."

Page 257, figure M.2

Correct EFaddr and V5DLaddr:

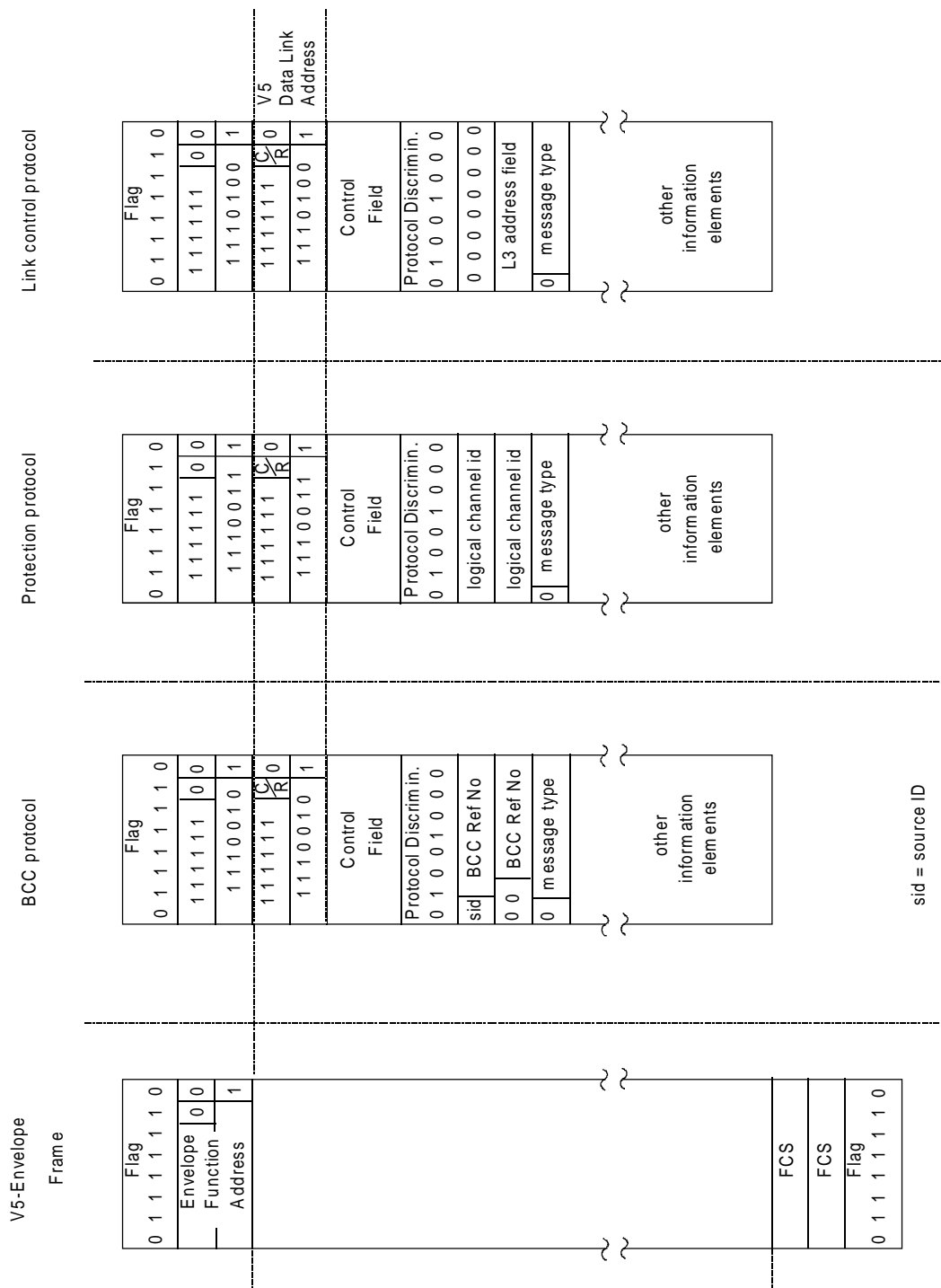

## Page 258, table M.1

Add the missing message types (RESET SN COM, RESET SN ACK and PROTOCOL ERROR):

Bits							Message types
7	6	5	4	3	2	1	
0	0	0	-	-	-	-	PSTN protocol message types
0	0	0	0	0	0	0	ESTABLISH
0	0	0	0	0	0	1	ESTABLISH ACKNOWLEDGE
0	0	0	0	0	1	0	SIGNAL
0	0	0	0	0	1	1	SIGNAL ACKNOWLEDGE
0	0	0	1	0	0	0	DISCONNECT
0	0	0	1	0	0	1	DISCONNECT COMPLETE
0	0	0	1	1	0	0	STATUS ENQUIRY
0	0	0	1	1	0	1	STATUS
0	0	0	1	1	1	0	PROTOCOL PARAMETER
0	0	1	0	-	-	-	Control protocol message types
0	0	1	0	0	0	0	PORT CONTROL
0	0	1	0	0	0	1	PORT CONTROL ACKNOWLEDGE
0	0	1	0	0	1	0	COMMON CONTROL
0	0	1	0	0	1	1	COMMON CONTROL ACKNOWLEDGE
0	0	1	1	-	-	-	Protection protocol message types
0	0	1	1	0	0	0	SWITCH-OVER REQUEST
0	0	1	1	0	0	1	SWITCH-OVER COMMAND
0	0	1	1	0	1	0	OS SWITCH-OVER COMMAND
0	0	1	1	0	1	1	SWITCH-OVER ACKNOWLEDGE
0	0	1	1	1	0	0	SWITCH-OVER REJECT
0	0	1	1	1	0	1	PROTOCOL ERROR
<u>0</u>	<u>0</u>	<u>1</u>	<u>1</u>	<u>1</u>	<u>1</u>	<u>0</u>	<u>RESET SN COMMAND</u>
<u>0</u>	<u>0</u>	<u>1</u>	<u>1</u>	<u>1</u>	<u>1</u>	<u>1</u>	<u>RESET SN ACKNOWLEDGE</u>
0	1	0	-	-	-	-	BCC protocol message types
0	1	0	0	0	0	0	ALLOCATION
0	1	0	0	0	0	1	ALLOCATION COMPLETE
0	1	0	0	0	1	0	ALLOCATION REJECT
0	1	0	0	0	1	1	DE-ALLOCATION
0	1	0	0	1	0	0	DE-ALLOCATION COMPLETE
0	1	0	0	1	0	1	DE-ALLOCATION REJECT
0	1	0	0	1	1	0	AUDIT
0	1	0	0	1	1	1	AUDIT COMPLETE
0	1	0	1	0	0	0	AN FAULT
0	1	0	1	0	0	1	AN FAULT ACKNOWLEDGE
<u>0</u>	<u>1</u>	<u>0</u>	<u>1</u>	<u>0</u>	<u>1</u>	<u>0</u>	<u>PROTOCOL ERROR</u>
0	1	1	0	-	-	-	Link control protocol message types
0	1	1	0	0	0	0	LINK CONTROL
0	1	1	0	0	0	1	LINK CONTROL ACK
NOTE:							All other values are reserved.



## Page 259, table M.2

Replace table M.2 by:

Bits								Protocol	Information element	Reference
8	7	6	5	4	3	2	1			
0	-	-	-	-	-	-	-		VARIABLE LENGTH INFORMATION ELEMENTS	
0	0	0	0	0	0	0	0	PSTN	Sequence-number	14 (13.4.7.1)
0	0	0	0	0	0	0	1	PSTN	Cadenced-ringing	14 (13.4.7.2)
0	0	0	0	0	0	1	0	PSTN	Pulsed-signal	14 (13.4.7.3)
0	0	0	0	0	0	1	1	PSTN	Steady-signal	14 (13.4.7.4)
0	0	0	0	0	1	0	0	PSTN	Digit-signal	14 (13.4.7.5)
0	0	0	1	0	0	0	0	PSTN	Recognition-time	14 (13.4.7.6)
0	0	0	1	0	0	0	1	PSTN	Enable-autonomous-acknowledge	14 (13.4.7.7)
0	0	0	1	0	0	1	0	PSTN	Disable-autonomous-acknowledge	14 (13.4.7.8)
0	0	0	1	0	0	1	1	PSTN	Cause	14 (13.4.7.9)
0	0	0	1	0	1	0	0	PSTN	Resource-unavailable	14 (13.4.7.10)
0	0	1	0	0	0	0	0	Control	Control-function-element	15.4 (14.4.2.5.4)
0	0	1	0	0	0	0	1	Control	Control-function-D	15.4 (14.4.2.5.5)
0	0	1	0	0	0	1	0	Control	Variant	15.4 (14.4.2.5.6)
0	0	1	0	0	0	1	1	Control	Interface-ID	15.4 (14.4.2.5.7)
0	0	1	1	0	0	0	0	Link control	Link control function	16.3.2.2
0	1	0	0	0	0	0	0	BCC	User port identification	17.4.2.1
0	1	0	0	0	0	0	1	BCC	ISDN port channel identification	17.4.2.2
0	1	0	0	0	0	1	0	BCC	V5 time slot identification	17.4.2.3
0	1	0	0	0	0	1	1	BCC	Multi-slot map	17.4.2.4
0	1	0	0	0	1	0	0	BCC	Reject cause	17.4.2.5
0	1	0	0	0	1	0	1	BCC	Protocol error cause	17.4.2.6
0	1	0	0	0	1	1	0	BCC	Connection incomplete	17.4.2.7
0	1	0	1	0	0	0	0	Protection	Sequence number	18.5.2
0	1	0	1	0	0	0	1	Protection	Physical C-channel identification	18.5.3
0	1	0	1	0	0	1	0	Protection	Rejection cause	18.5.4
0	1	0	1	0	0	1	1	Protection	Protocol error cause	18.5.5
1	-	-	-	-	-	-	-		SINGLE OCTET INFORMATION ELEMENTS	
1	0	0	0	X	X	X	X	PSTN	Line information	14 (13.4.6.2)
1	0	0	1	X	X	X	X	PSTN	State	14 (13.4.6.3)
1	0	1	0	X	X	X	X	PSTN	Autonomous signalling sequence	14 (13.4.6.4)
1	0	1	1	X	X	X	X	PSTN	Sequence response	14 (13.4.6.5)
1	1	0	0	0	0	0	0	PSTN	Pulse-notification	14 (13.4.6.1)
1	1	1	0	X	X	X	X	Control	Performance grading	15.4 (14.4.2.5.2)
1	1	1	1	X	X	X	X	Control	Rejection cause	15.4 (14.4.2.5.1)

NOTE 1: All other values are reserved.

NOTE 2: References within parentheses are references to relevant subclause in ETS 300 324-1 [8].

**History**

<b>Document history</b>			
September 1994	First Edition		
February 1996	Public Enquiry	PE 102:	1996-02-19 to 1996-06-14
February 1997	Vote	V 9717:	1997-02-25 to 1997-04-25