



**E**UROPEAN  
**T**ELECOMMUNICATION  
**S**TANDARD

**DRAFT**  
pr **ETS 300 133-5**

April 1996

Second Edition

---

Source: ETSI TC-RES

Reference: RE/RES-04007-5

ICS: 33.060.20 33.060.50

**Key words:** ERMES, paging, radio

**Radio Equipment and Systems (RES);  
European Radio MESSage System (ERMES);  
Part 5: Receiver conformance specification**

**ETSI**

European Telecommunications Standards Institute

**ETSI Secretariat**

**Postal address:** F-06921 Sophia Antipolis CEDEX - FRANCE

**Office address:** 650 Route des Lucioles - Sophia Antipolis - Valbonne - FRANCE

**X.400:** c=fr, a=atlas, p=etsi, s=secretariat - **Internet:** secretariat@etsi.fr

Tel.: +33 92 94 42 00 - Fax: +33 93 65 47 16

\*

---

**Copyright Notification:** No part may be reproduced except as authorized by written permission. The copyright and the foregoing restriction extend to reproduction in all media.

© European Telecommunications Standards Institute 1996. All rights reserved.



## Contents

Foreword .....	7
1 Scope .....	9
2 Normative references .....	9
3 Definitions and abbreviations .....	9
3.1 Definitions .....	9
3.2 Abbreviations .....	10
4 General test requirements .....	11
4.1 Number of receivers to be submitted for conformance testing .....	11
4.2 Normal test conditions .....	11
4.3 Extreme test conditions .....	11
4.4 Test fixture .....	11
4.5 Test paging signal .....	11
4.5.1 Successful tone-only call .....	11
4.5.2 Successful numeric message .....	12
4.5.3 Successful alphanumeric message .....	12
4.6 Interpretation of measurement results .....	12
5 RF characteristics .....	12
5.1 Performance requirements .....	12
5.2 Method of measurement .....	13
6 User functions .....	14
6.1 General .....	14
6.2 Radio identity code .....	14
6.3 Receiver paging categories .....	15
6.3.1 Tone only .....	15
6.3.2 Numeric .....	15
6.3.3 Alphanumeric .....	15
6.3.4 Transparent data .....	15
6.4 Essential functions .....	15
6.4.1 Alert functions .....	15
6.4.2 Silent mode .....	15
6.4.3 Battery low indication .....	15
6.5 Optional functions .....	15
6.5.1 Long message .....	15
6.5.2 Indication of lost message .....	16
6.5.3 Urgent message indicator .....	16
6.5.4 Message storage and retrieval .....	16
6.5.5 Memory full .....	16
6.5.6 Repeated call indication .....	16
7 Tests for essential features .....	16
7.1 Message reception in home network .....	17
7.1.1 First message in batch .....	17
7.1.2 Last message in batch .....	17
7.1.3 Message continued in next batch .....	17
7.1.4 Message in last available batch .....	17
7.1.5 Tenure of message .....	18
7.1.6 Two messages in same batch .....	18
7.1.7 Message continued in the next subsequence .....	19
7.1.8 Multioperator environment .....	19
7.2 Message reception from non-home networks .....	19
7.2.1 Message reception on all ERMES channels .....	19

7.2.2	Recognition of zone code .....	19
7.2.3	Two messages in the same batch .....	19
7.2.4	Message reception in overlap regions (BAI = 1) .....	20
7.2.5	Message reception in overlap regions (BAI=0) .....	20
7.2.6	Recognition of FSI .....	20
7.3	Maximum length message .....	21
7.4	Alert function .....	21
7.4.1	Normal operation .....	22
7.4.2	Silent mode operation .....	22
7.5	Termination of numeric messages .....	22
7.6	Termination of alphanumeric messages .....	22
7.7	Repeated call indication .....	22
7.8	Group call .....	22
7.9	Tenure of group message .....	23
7.10	Low battery indication .....	23
7.11	Battery life .....	24
7.11.1	No signals on any channel .....	24
7.11.2	Unloaded system .....	24
7.11.3	Fully loaded system .....	24
7.12	Network acquisition time .....	24
7.12.1	Time from receiver switch on .....	24
7.12.2	Time from loss of signal .....	24
7.13	RSVD Bits .....	24
8	Tests for optional features .....	25
8.1	Operation of long message option .....	25
8.2	Indication of lost message .....	25
8.3	Urgent message indicator .....	25
8.4	Message storage .....	25
8.5	Memory full .....	25
Annex A (normative):	Measurement procedures .....	26
A.1	Average measured usable sensitivity expressed as field strength under normal conditions .....	26
A.1.1	Definition .....	26
A.1.2	Method of measurement .....	26
A.2	Radiated spurious components .....	27
A.2.1	Definition .....	27
A.2.2	Method of measurement .....	27
A.3	Co-channel rejection .....	28
A.3.1	Definition .....	28
A.3.2	Method of measurement .....	28
A.4	Adjacent channel selectivity .....	29
A.4.1	Definition .....	29
A.4.2	Method of measurement .....	29
A.5	Spurious response immunity .....	30
A.5.1	Definition .....	30
A.5.2	Method of measurement .....	30
A.6	Intermodulation immunity .....	31
A.6.1	Definition .....	31
A.6.2	Method of measurement .....	31
A.7	Blocking immunity .....	32
A.7.1	Definition .....	32
A.7.2	Method of measurement .....	32
A.8	Combined multi-path and quasi-synchronous transmissions .....	33
A.8.1	Definition .....	33

A.8.2	Method of measurement.....	33
Annex B (normative):	Ancillary test data .....	35
B.1	Simulated man .....	35
B.2	Definition of unwanted test signal.....	35
B.3	Definition of reference figure .....	35
B.4	Sensitivity measurement test sites.....	36
B.4.1	Description of test sites for receiver sensitivity measurements .....	36
B.4.2	Description of an open air test site .....	36
B.4.2.1	Receiver sensitivity measurement test site characteristics .....	36
B.4.2.2	Receiver sensitivity measurement test site .....	36
B.4.2.3	Position of the equipment under test.....	37
B.4.2.4	Transmitting antenna.....	37
B.4.2.5	Calibration .....	37
B.4.2.6	Substitution antenna.....	38
B.4.2.7	Selective measuring device.....	38
B.4.3	Description of an anechoic chamber .....	39
B.5	Definition of test sites suitable for spurious emissions measurements.....	39
B.5.1	An anechoic chamber .....	39
B.5.1.1	General.....	39
B.5.1.2	Description .....	39
B.5.1.3	Influence of parasitic reflections .....	39
B.5.1.4	Calibration and mode of use .....	40
B.5.2	Open air test site suitable for emission tests .....	41
B.5.2.1	Test site characteristics for radiated emissions testing.....	42
B.5.2.2	Radiation emissions test site.....	42
B.5.2.3	Position of the equipment under test.....	43
B.5.2.4	Measuring antenna support.....	43
B.5.2.5	Measuring antenna.....	43
B.5.2.6	Substitution antenna.....	43
B.5.2.7	Radio-frequency signal generator .....	44
B.5.2.8	Selective measuring device.....	44
B.6	Description of test fixture.....	44
B.7	Measurement uncertainty.....	44
B.8	Maximum degradation in required sensitivity .....	45
B.9	Differential factors .....	45
B.9.1	General .....	45
B.9.2	Definition of numeric differential factor .....	45
B.9.3	Definition of alphanumeric differential factor.....	46
B.10	Calculations of spurious responses frequencies.....	46
B.10.1	Introduction to the method .....	46
B.11	Test time saving procedure .....	47
History.....		48

Blank page

## Foreword

This draft second edition European Telecommunication Standard (ETS) has been produced by the Radio Equipment and Systems (RES) Technical Committee of the European Telecommunications Standards Institute (ETSI), and is now submitted for the Public Enquiry phase of the ETSI standards approval procedure.

This ETS consists of 7 parts as follows:

- Part 1: "General aspects";
- Part 2: "Service aspects";
- Part 3: "Network aspects";
- Part 4: "Air interface specification";
- Part 5: "Receiver conformance specification";**
- Part 6: "Base station specification";
- Part 7: "Operation and maintenance aspects".

This part, ETS 300 133-5, specifies the receiver performance requirements and the conformance test and measurement methods.

### ETSI Interim Intellectual Property Rights (IPR) Policy

The attention of ETSI has been drawn to the IPRs listed below which are, or may become, Essential to this ETS. The IPR owner has undertaken to grant irrevocable licences on fair, reasonable and non-discriminatory terms and conditions under these IPRs pursuant to the ETSI Interim IPR Policy. Further details pertaining to these IPRs can be obtained directly from the IPR owner.

The information presently submitted is accurate to the best of ETSI's knowledge. Pursuant to the ETSI Interim IPR Policy, no investigation, including IPR searches, has been carried out by ETSI. No guarantee can thus be given as to the existence of other IPRs, which are, or may become, Essential to this ETS.

IPRs:

- EP Patent No. 0090851: Decoder for Transmitted Message Activation Codes;
- EP App. No. 89909668,9: Multiple Frequency Message System;
- EP App. No. 89913131,2: Power Conservation Method and Apparatus for a Portion of Information Signal;
- EP App. No. 92901376,1: Multiple Format Signalling Protocol for a Selective Call Receiver;
- EP App. No. 90915018,7: Nationwide Paging with Local Modes of Operation;
- EP App. No. 91904526,0 Multiple Frequency Scanning.

IPR owner:

MOTOROLA Ltd, 110 Bath Road, Slough, GB-BERKSHIRE SL1 3SZ

<b>Proposed transposition dates</b>	
Date of latest announcement of this ETS (doa):	3 months after ETSI publication
Date of latest publication of new National Standard or endorsement of this ETS (dop/e):	6 months after doa
Date of withdrawal of any conflicting National Standard (dow):	6 months after doa



## 1 Scope

This draft second edition part of the seven part European Telecommunication Standard (ETS) 300 133 defines the receiver conformance specification for the European Radio Message System (ERMES). Essential features which make up the basic version receiver of each paging receiver category and also optional receiver features are covered.

## 2 Normative references

This ETS incorporates by dated or undated reference, provisions from other publications. These normative references are cited at the appropriate places in the text and the publications are listed hereafter. For dated references subsequent amendments to, or revisions of any of these publications apply to this ETS only when incorporated in it by amendment or revision. For undated references the latest edition of the publication referred to applies.

- [1] prETS 300 133-4 (1996): "Radio Equipment and Systems (RES); European Radio Message System (ERMES); Part 4: Air interface specification".
- [2] ISO Standard 1073 parts 1 & 2: "Alphanumeric character sets for optical recognition".
- [3] ETR 028: "Radio Equipment and Systems (RES); Uncertainties in measurement of mobile radio equipment characteristics".
- [4] ITU-T Recommendation E.212: "Identification plan for land mobile stations", annex A.
- [5] prETS 300 133-2 (1996): "Radio Equipment and Systems (RES); European Radio Message System (ERMES); Part 2: Service aspects".

## 3 Definitions and abbreviations

### 3.1 Definitions

For the purposes of this part of prETS 300 133, the following definitions apply:

**basic RIC:** The prime identity of a paging receiver allocated by the network operator when service is initiated. It can not be changed without safeguards against unauthorised changes.

**batch number:** The 4 bit number corresponding to a particular batch type. Batch type A corresponds to batch number 0000. Batch type P corresponds to batch number 1111.

**channel switching:** Receiver is receiving system information on one channel and does not find its initial address in the address partition. It then switches channels and prepares to receive signals in its batch on that channel.

**codeword:** The standard information unit of 30 bits length.

**codeblock:** The unit of nine codewords used in the message partition.

**country code:** Binary representation of the country number defined in ref.ITU-T Recommendation E.212 [4]. The country code consists of 7 bits.

**external message:** A paging message sent on a network that is not the home network of the addressed pager. In this case the EB and ETI bits are set to "1".

**external receiver:** A receiver operating in a network which is not its home network.

**home network:** The operator network with which a mobile subscriber has signed a subscription.

**home operator:** The network operator to which a specific user has subscribed.

**initial address:** The 18 most significant bits of the local address.

**local address:** The number used by a network to identify the receivers subscribed to it. It consists of 22 bits. The four least significant bits of the local address denote the batch number of the receiver.

**operator code:** The number used by the system on the radio path to identify an operator within a country. It consists of 3 bits.

**operator identity:** The number used by the system on the radio path to identify the home operator of a receiver. It has a total length of 13 bits and consists of three parts, the zone code the country code and the operator code.

**paging area:** The area controlled by a paging area controller. It is the minimum area to which a mobile subscriber is permitted to subscribe in order to receive his paging messages.

**paging message:** The tone-only, numeric, alphanumeric or transparent data information sent to a paging receiver.

**paging signal:** The signal sent on the radio path to a paging receiver.

**Radio Identity Code (RIC):** The number used by the system on the radio path to identify the receiver(s) for which the paging message is intended. The RIC has a total length of 35 bits and consists of five parts: the zone code (3 bits), the country code (7 bits), the operator code (3 bits), the initial address (18 bits) and the batch number (4 bits).

**Table 1**

Operator identity			Local address	
Zone code	Country code	Operator code	Initial address	Batch number
3 bits	7 bits	3 bits	18 bits	4 bits

**reserved for future definition:** The bits indicated are not specified in this edition of the standard but may be in future editions. The bits should be set to a default value and not used to convey information. The function of any equipment is independent of these bits. No fixed pattern of reserved bits should be assumed and no combination of reserved bits should cause equipment to malfunction.

**zone code:** Binary representation of the zone number defined in ref.ITU-T Recommendation E.212 [4]. The zone code consists of 3 bits.

### 3.2 Abbreviations

For the purposes of this part of prETS 300 133, the following abbreviations apply:

AIF	Additional Information Field
All	Additional Information Indicator
AIN	Additional Information Number
AIT	Additional Information Type
APT	Address Partition Terminator
BAI	Border Area Indicator
CTA	Common Temporary Address
CTAP	Common Temporary Address Pointer
EB	External Bit
ENL	Number of LSBs to be compared when operating outside the home network
EOM	End of Message
ETI	External Traffic Indicator
FSI	Frequency Subset Indicator
HNL	Number of LSBs to be compared when operating within the home network
IA	Initial Address
MD	Message Delimiter
OPID	Operator identity
PA	Paging Area

PR	Preamble
RF	Radio Frequency
RIC	Radio Identity Code
RSVD	Reserved
SI	System Information
SSI	Supplementary System Information
SSN	Subsequence Number
SYN	synchronisation
TEM	Transverse Electro Magnetic
UMI	Urgent Message Indicator

## 4 General test requirements

### 4.1 Number of receivers to be submitted for conformance testing

One receiver shall be provided for testing.

The receiver shall be programmed with RIC number:

010 0000001 010 1100011000111001 00 0000

The frequency subset number of this receiver shall be set to 3 (0011).

### 4.2 Normal test conditions

The normal test conditions shall be temperature + 15 °C to + 35 °C and relative humidity from 20 % to 75 %, non condensing.

The normal test voltage shall be that declared by the manufacturer.

### 4.3 Extreme test conditions

The temperature range shall be - 10 °C to + 55 °C and relative humidity from 20 % to 75 %, non condensing.

The extreme test voltages shall be declared by the manufacturer.

### 4.4 Test fixture

A Test fixture (see annex B clause B.6) shall be used for all tests unless otherwise stated. Test fixtures to enable tests under extreme temperature and voltage conditions shall be provided by the manufacturer if required by the approved testing laboratory.

### 4.5 Test paging signal

The transmissions shall be in accordance with ETS 300 133-4 [1].

The batch structure used during testing shall contain one address in the address partition followed by one message in the message partition as shown in subclause 7.1.1 unless otherwise specified.

The test paging message to the receiver under test may be tone only, 10 numeric characters or 55 alphanumeric characters from the basic character set (ref.ETS 300 133-2 [5] annex B, table B.3), according to the feature under test.

For successful calls the receiver shall respond to the transmitted test paging message as follows:

#### 4.5.1 Successful tone-only call

A successful tone-only call occurs when the receiver presents an alert as declared by the manufacturer. The full error capability of the code may be used.

#### **4.5.2 Successful numeric message**

For successful numeric calls the receiver shall present the transmitted test paging message as declared by the manufacturer correctly without error. The full error capability of the code may be used. A character in error is defined as a character that differs from the transmitted character.

#### **4.5.3 Successful alphanumeric message**

For successful alphanumeric calls, the receiver shall present the transmitted test paging message as declared by the manufacturer, except as allowed in the average usable sensitivity test defined in annex A, clause A.1. The full error capability of the code may be used. A character in error is defined as a character that differs from the transmitted character.

#### **4.6 Interpretation of measurement results**

The interpretation of the results recorded in a test report for the measurements described in this ETS shall be as follows:

- a) the measured value related to the corresponding limit shall be used to determine whether the receiver meets the requirements of this ETS;
- b) the measurement uncertainty value for the measurement of each parameter shall be included in the test report;
- c) the recorded values of the measurement uncertainty shall be, for each measurement, equal to or lower than the figures given in annex B, clause B.7.

### **5 RF characteristics**

#### **5.1 Performance requirements**

The receiver supplied shall meet or exceed the performance criteria in table 2 when measured in accordance with methods of measurement defined in subclause 5.2.

Table 2

	Requirement	Method of Measurement subclause	Limit value
a)	the average usable sensitivity under normal conditions.	5.2 a)	25 dB $\mu$ V/m
b)	the maximum degradation in required sensitivity under normal conditions with a transmitter frequency offset of $\pm 200$ Hz.	5.2 c)	0 dB
c)	the maximum degradation in required sensitivity (annex B, clause B.8) under switching channel conditions.	5.2 l)	0 dB
d)	the maximum degradation in required sensitivity (annex B, clause B.8) under extreme temperature and voltage conditions.	5.2 m)	6 dB
e)	the maximum degradation in required sensitivity (annex B, clause B.8) under extreme temperature and voltage conditions with a transmitter frequency offset of $\pm 200$ Hz.	5.2 c)	6 dB
f)	co-channel rejection under normal conditions.	5.2 e)	- 10 dB
g)	adjacent channel selectivity under normal conditions.	5.2 f)	60 dB
h)	adjacent channel selectivity under extreme conditions.	5.2 f)	50 dB
j)	spurious response immunity under normal conditions.	5.2 g)	76 dB $\mu$ V/m
k)	intermodulation immunity under normal conditions.	5.2 h)	70 dB $\mu$ V/m
l)	blocking immunity or desensitisation under normal conditions.	5.2 j)	84 dB $\mu$ V/m
m)	Maximum usable input level under normal conditions.	5.2 d)	3 V/m
n)	the maximum degradation in sensitivity for combined multi-path and quasi-synchronous transmissions under normal conditions.	5.2 k)	15 dB
o)	spurious emissions under normal conditions: 30 MHz - 1 GHz; 1 GHz - 4 GHz; ERMES channels:.	5.2 b)	2 nW; 20 nW; 2 pW.

5.2 Method of measurement

Measurements shall be conducted on ERMES frequency number 8 (see ETS 300 133-4 [2], subclause 8.2) unless otherwise stated. The measurements shall be conducted according to the following steps: the transmission used for these tests shall be constructed as shown in figure 1 unless (otherwise stated):



NOTE: MESSAGE: a message appropriate to receiver under test.  
MD: message delimiter.

Figure 1

For all the measurements in this subclause sufficient time is to be allowed for the receiver to achieve synchronisation before the performance criteria are determined. This time and the time during which the receiver remains on channel after loss of signal shall be declared by the manufacturer.

- a) the average usable sensitivity expressed as the field strength shall be measured as described in annex A, clause A.1. The test site (see annex B, clause B.4) shall be complemented with a "simulated man" (see annex B, clause B.1). Any ERMES frequency may be used;
- b) the measurement procedure for spurious radiation shall be carried out as described in annex A, clause A.2;

- c) the measurement of the sensitivity shall be repeated under normal and extreme conditions together with a transmitter offset of 200 Hz in a test fixture complying with annex B, clause B.6, according to annex A, subclause A.1.2 steps b) to e).
- d) measurement of usable input level range: the receiver shall correctly present four messages out of four. The test shall be carried out in a test fixture as defined in annex B, clause B.6 with the wanted signal adjusted so that the field strength at the receiver shall be 3 V/m;
- e) measurement of the co-channel rejection shall be carried out as described in annex A, clause A.3;
- f) the measurement of the adjacent channel selectivity under normal and extreme conditions shall be carried out as described in annex A, clause A.4;
- g) the measurement of the spurious response immunity shall be carried out as described in clause A.6;
- j) the measurement of the blocking immunity or desensitisation shall be carried out as described in annex A, clause A.7;
- k) the measurements of quasi-synchronous sensitivity combined with multi-path shall be made at a simulated speed of 3 km/h. A second signal with the same data content but delayed 50  $\mu$ s, 1 dB weaker and 30 Hz Radio Frequency (RF) frequency offset shall be added. The test procedure is given in annex A, clause A.8 (see annex B, clause B.8);
- l) channel switching: the sensitivity shall be measured in an appropriate test fixture (annex B, clause B.6) with the following test signal according to annex A, subclause A.1.2 steps b) to e): a batch shall be transmitted consisting of 139 initial addresses numerically higher than the initial address of the receiver under test. This shall be immediately followed by the test message shown in subclause 7.1.1, transmitted on the appropriate channel (see ETS 300 133-4 [2], figure 2). The signal strength of both channels shall remain constant during the test. Both transmissions shall occur in batches of the same type (i.e. same batch number) within the same subsequence; both channels shall broadcast a network identity different from the receiver OPID and ETI shall be set to 1 for both channels.
- m) the measurement of the sensitivity shall be repeated under normal and extreme conditions in a test fixture complying with annex B, clause B.6, according to annex A, subclause A.1.2 steps b) to e).

## 6 User functions

### 6.1 General

Receiver functions are qualified as essential or optional.

Essential functions shall be implemented in so far as they are relevant to the particular receiver paging category. Implementation of optional functions shall be left to the manufacturers' discretion.

The basic version receiver within each receiver paging category is the receiver offering only the essential functions.

Additional functions not mentioned in this standard are permitted provided that they do not conflict with the radio interface and do not adversely affect the functions listed in this ETS.

Any additional functions incorporated into the receiver shall be declared by the manufacturer.

Each receiver shall be individually identifiable.

### 6.2 Radio identity code

Each receiver shall have one basic Radio Identity Code (RIC).

Further additional RICs may be incorporated so long as the full receiver specification is satisfied for each RIC.

Discrimination between calls on different RICs shall be offered.

### **6.3 Receiver paging categories**

#### **6.3.1 Tone only**

A receiver providing this function shall respond to at least one combination of the alert signal indicator bits. Responses to the remaining seven alert indicator bits shall (if implemented) be clearly distinguishable.

#### **6.3.2 Numeric**

A receiver including this function shall provide for the reception of a 20 digit numeric message. The numeric character set is included in ETS 300 133-2 [5] annex B. Receivers having this function shall also have the tone-only function.

#### **6.3.3 Alphanumeric**

A receiver including this function shall provide for the reception of a 400 character alphanumeric message and implement the basic character set (ref.ETS 300 133-2 [5] annex B, table B.3). Receivers having this function shall also have the numeric and the tone only functions.

As an optional feature, the pager may also include any additional character sets, as defined in ref.ETS 300 133-2 [5] annex B.

#### **6.3.4 Transparent data**

A receiver including this function shall provide for the reception of an arbitrary data message.

### **6.4 Essential functions**

#### **6.4.1 Alert functions**

Receivers shall respond to at least the type zero alert signal indicator (see ETS 300 133-4 [1], subclause 5.5.1.1) for each RIC.

Provision shall be made for manual termination of an alert signal.

#### **6.4.2 Silent mode**

It shall be possible for the user to inhibit the sounding of an audible alert. The receiver shall still receive and store paging calls even when the alert tone is set to silent mode.

#### **6.4.3 Battery low indication**

An indication shall be given of battery exhaustion.

### **6.5 Optional functions**

Optional features, if implemented, shall conform with the relevant part of ETS 300 133-4 [1]. When not defined in this part of the ETS, manufacturers shall supply test methods and results demonstrating conformance.

#### **6.5.1 Long message**

All receiver categories (other than tone-only) may be capable of handling long messages. The maximum time between the transmission of submessages shall not exceed the time between the start of an active cycle and the start of the next active cycle, defined by HNL or ENL, plus one minute.

### 6.5.2 Indication of lost message

All receiver categories, except tone-only, shall have the capability to detect message numbers (see ETS 300 133-4 [1], subclause 5.5.1) and compare the last received number with the number previously received. If there are one or more numbers missing an indication shall be given.

### 6.5.3 Urgent message indicator

Receivers shall indicate reception of an urgent message.

### 6.5.4 Message storage and retrieval

Receivers may have memory to store the information received. All receivers having this function shall be able to use the storage capacity for storing messages of varying length. It shall be possible for the stored messages to be retrieved.

### 6.5.5 Memory full

If the receiver memory is full the oldest message not protected against deletion should be erased. The memory management may be performed differently for the different RICs.

### 6.5.6 Repeated call indication

In the case where a receiver receives more than one transmission of a message an indication shall be given accordingly.

## 7 Tests for essential features

This clause defines tests covering the essential requirements of ERMES receivers. All tests shall be performed with a signal level + 30 dB relative to the average usable sensitivity. Unless otherwise stated, the tests should be carried out after the receiver has reached steady state conditions.

The test protocol used in this clause complies with ETS 300 133-4 [1]. Part of subclause 4.4 of that document is reproduced here to identify the test parameters.

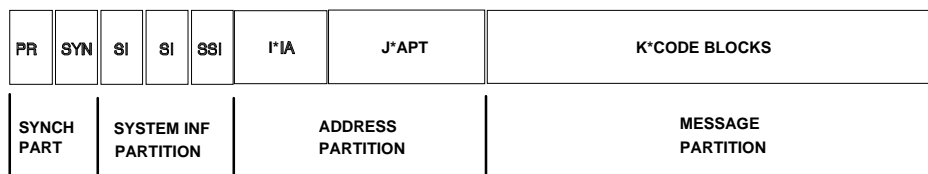

NOTE:

PR	-	preamble word
SYN	-	synchronisation word
SI	-	system information word
SSI	-	supplementary system information word
IA	-	initial address
APT	-	address partition terminator
CODEBLOCK	-	interleaved message codeword
I	-	number of initial addresses
J	-	number of address partition terminators
K	-	number of codeblocks in the message partition

Figure 2

Codeword composition of a batch satisfies the following relationships:

- $0 \leq I \leq 139$ ;
- $J = 9 - \text{MOD}\{(4+I),9\}$  where  $\text{MOD}\{M,N\} = M - N \cdot \text{INT}(M/N)$  and INT returns the integer part of a number;
- $K \leq (149 - I - J)/9$  first 15 batches of a subsequence;
- $K \leq (185 - I - J)/9$  last batch of a subsequence.



## 7.1 Message reception in home network

The purpose of this section is to ensure that the receiver can receive a message in all legitimate locations within a transmission in a multioperator environment. On channel 8, the zone and operator code details contained within the SI partition shall indicate home network transmissions to the receiver; the BAI shall be set to 0, and the FSI to 30. The channel 10 (see ETS 300 133-4 [1] subclause 8.2) shall have the same signal strength, and shall indicate a network identity different from the receiver's OPID; its BAI shall be set to 0, and its FSI to 30. The paging area code on both channels shall be set to 000000. Transmissions shall only occur in active cycles as determined by the HNL as stored in the receiver.

### 7.1.1 First message in batch

The receiver shall successfully receive a message which is located in the first possible position in the message partition. The test transmission shall be constructed as shown in figure 3.



NOTE            Message            a message appropriate to receiver under test;  
                  MD                            message delimiter.

Figure 3

### 7.1.2 Last message in batch

The receiver shall successfully receive a message which is located in the last possible position in the same batch. The test transmission shall be as shown in figure 4.



PAD -            an Initial Address, higher than the receiver under test, used to occupy start of address partition.  
 FILL -            codewords other than MD and having no EOM characters used to occupy inactive parts of the message partition.

Figure 4

### 7.1.3 Message continued in next batch

The receiver shall successfully receive a message which commences in one batch and finishes in the next. The sequence shown below has the message delimiter MD, which prefaces the message, as the last codeword in the first batch. The message is completed in the following batch:

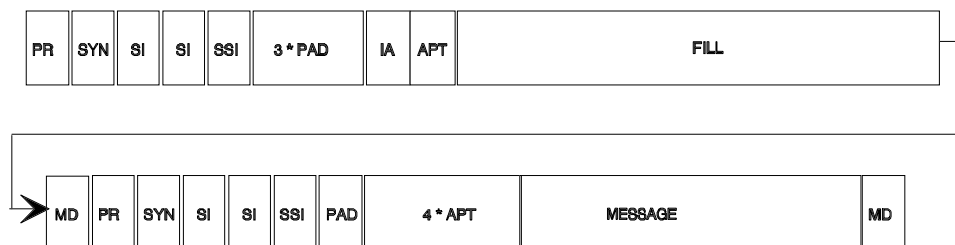

Figure 5

### 7.1.4 Message in last available batch

The receiver shall be capable of receiving a message which appears in any batch before the next addressing opportunity on that channel. The test transmission shown in figure 6 illustrates the last possible position for a message.

NOTE: This may require transmissions on channels other than number 9.



followed by 14 batches constructed as:



and a final batch of:



Figure 6

The batch containing the message should be in the subsequence following the subsequence containing the initial address.

**7.1.5 Tenure of message**

The receiver shall be sent an Initial Address (IA) with the associated message delayed by 16 batches. The receiver shall not receive the message shown in figure 7.



followed by 15 batches constructed as:



and a final batch of:

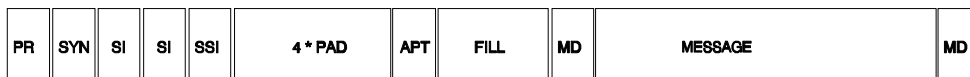

Figure 7

**7.1.6 Two messages in same batch**

The receiver shall be capable of receiving two messages in the same transmission. The following test transmission illustrates a batch containing two messages for the same IA.



Figure 8

**7.1.7 Message continued in the next subsequence**

Receiver shall successfully receive a message which commences in one subsequence and finishes in the next. The test transmission has the MD, which prefaces the message, as the last codeword in the last batch of the subsequence. The message shall be completed in the first batch of the next subsequence.

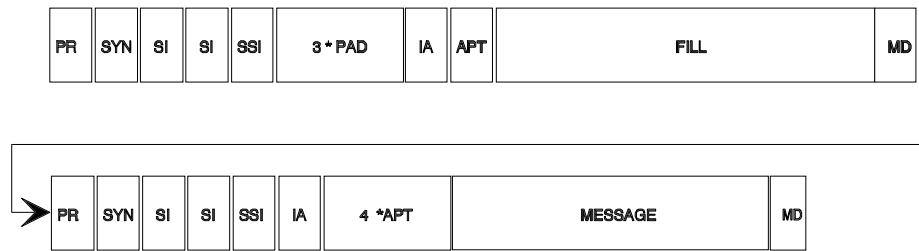

**Figure 9**

**7.1.8 Multioperator environment**

Two channels with different network identities shall be used. On one of the channels, a transmission shall be constructed which contains a message to a home receiver with the same local address as the receiver under test. The operator code in the SI partition shall be different from the home operator identity of the receiver under test. The receiver shall not receive the message.

**7.2 Message reception from non-home networks**

The purpose of this section is to ensure that the receiver can receive messages from a non-home network and in a multioperator environment. Transmissions shall only occur in active cycles as determined by the HNL and ENL as stored in the receiver.

**7.2.1 Message reception on all ERMES channels**

An external message, constructed as shown in figure 10 shall be successfully received by the receiver on each ERMES channel. The operator code shall not be recognisable to the receiver.



**Figure 10**

Bit and word synchronisation shall not be maintained between channels and at least two transmissions shall be at the extreme of allowable network co-ordination (see ETS 300 133-4 [1], subclause 12.4).

**7.2.2 Recognition of zone code**

A transmission shall be constructed which contains a message to a home receiver with the same local address as the receiver under test. The zone code in the SSI word shall be different from the home zone of the receiver. The receiver shall not receive the message.

**7.2.3 Two messages in the same batch**

The receiver shall successfully receive a message when the batch also contains a message to a home receiver with the same local address. A transmission shall be constructed as shown in figure 11. Message 1 is for the home receiver, message 2 is for the external receiver under test.

NOTE: The PAD in this case will be an initial address lower than that of the receiver under test.



Figure 11

**7.2.4 Message reception in overlap regions (BAI = 1)**

A continuous transmission indicating the home network shall be sent to the receiver. The BAI shall be set to one. The receiver shall then successfully receive two messages with different contents, one on its home channel and one on the non-home channel as illustrated in figure 12.

NOTE: The messages to be completed are in the batch containing the initial address.

Channel 8:

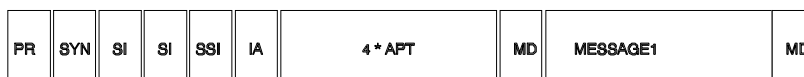

Non home channel:

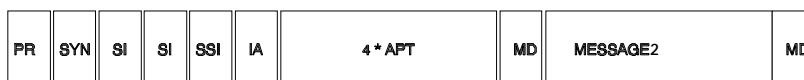

Figure 12

**7.2.5 Message reception in overlap regions (BAI=0)**

A continuous transmission indicating the home network shall be sent to the receiver. The BAI shall be set to zero. The reception quality on the channel shall then be reduced to a level corresponding to a call success rate not less than 60 %. The receiver shall then successfully receive an external message on another channel as illustrated in figure 13.

The method to simulate insufficient quality of reception (BER, codeword error rate, erroneous system information) and the time constraints shall be stated by the receiver manufacturer.

Channel 8

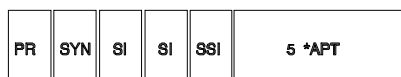

Non home channel

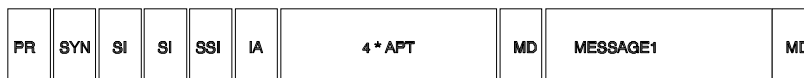

Figure 13

**7.2.6 Recognition of FSI**

The test transmission shall be as shown in this subclause.

The receiver's FSN is set to 3.

Table 3

	Channel 8	Channel 10	Expected results
step 1	FSI = 3 BAI=0 home OPID message 1	FSI = 30 BAI=0 external OPID message 2	receiver shall receive message 1
step 2	FSI = 17 BAI=0 home OPID message 1	FSI = 30 BAI=0 external OPID message 2	receiver shall receive message 1
step 3	FSI = 24 BAI=0 home OPID message 1	FSI = 30 BAI=0 external OPID message 2	receiver shall receive message 1
step 4	FSI = 28 BAI=0 home OPID message 1	FSI = 30 BAI=0 external OPID message 2	receiver shall receive message 1
step 5	FSI = 29 BAI=0 home OPID message 1	FSI = 30 BAI=0 external OPID message 2	receiver shall receive message 2

Message 1 and message 2 shall be transmitted in the same subsequence.

Message 1 shall be transmitted as described in subclause 7.1.1 ("First message in batch"). Message 2 shall be transmitted as described in subclause 7.2.1 ("Message reception on all ERMES channels "). The wording "message 1" and "message 2" refers to messages of different contents or to different alert tones.

### 7.3 Maximum length message

A receiver offering the numeric feature shall be capable of receiving a 20 character numeric message. 400 character alphanumeric messages shall be received by receivers offering the alphanumeric feature. The message shall be sent as shown in figure 14.

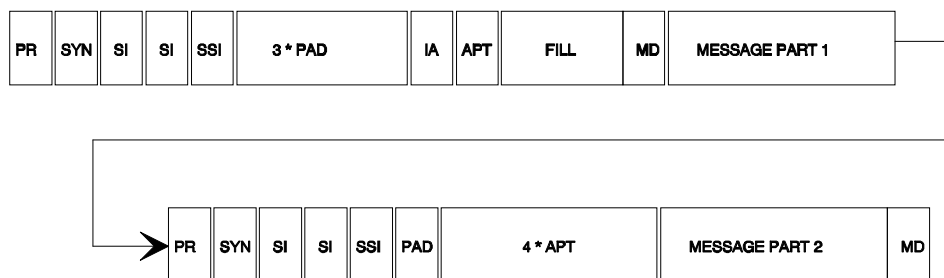

Figure 14

The message shall be split equally between the end of the first batch and the start of the next batch.

The message shall consist of every character specified in ETS 300 133-2 [5] annex B table B.3. except DC1, repeated as necessary to form a 400 character message. The receiver shall be examined to ensure the characters have been presented correctly. The control characters ESC, LF, and CR shall not cause any character to be displayed. If the control characters are used in conjunction with any other characters specified by the manufacturer, these combinations shall not be sent for this test.

### 7.4 Alert function

A message as defined in subclause 7.1.1 shall be sent to the receiver. The receiver shall successfully receive the message.

### 7.4.1 Normal operation

The receiver shall give an alert when the alert signal indicator bits in the message header are set to 000. The other alert bit combinations shall also be tested. If the receiver gives an alert to one or more of them, the alerts shall be clearly distinguishable.

### 7.4.2 Silent mode operation

The receiver shall have a switch by which it can be set to silent mode i.e. no audible alert given.

The silent mode shall not affect the receiver's other operations. The effect of all alert bit combinations in the silent mode shall be tested and compared to normal operation as defined in subclause 7.4.1.

### 7.5 Termination of numeric messages

A receiver offering a numeric feature shall not present any character of the numeric message after having received a codeword in error.

A message as defined in subclause 7.1.1 shall be sent to the receiver. The receiver shall successfully receive the message.

In the message part after the message header, 18 numeric characters shall be transmitted namely 123456789012345678. The second codeword shall contain three bits in error. The receiver shall present characters 1234. In the message header the external bit and All shall both be set to zero.

### 7.6 Termination of alphanumeric messages

A receiver offering an alphanumeric feature shall not present any subsequent character after having received in error:

- the EOM character; or
- the Message Delimiter; or
- two consecutive codewords.

NOTE: A codeword in error is defined as having three bits in error.

A message constructed as shown in figure 15 shall be sent to the receiver.



Figure 15

The receiver shall not present any subsequent characters after transmissions containing the following errors:

- a) the codeword containing the EOM is in error;
- b) the message delimiter is in error;
- c) both the codeword containing the EOM and the message delimiter are in error.

### 7.7 Repeated call indication

A message as defined in subclause 7.1.1 shall be sent to the receiver. The receiver shall successfully receive the message. The transmission shall be repeated with an identical message and message number. The receiver shall give an appropriate indication.

### 7.8 Group call

The receiver shall be capable of receiving a group message which appears in any batch before the next addressing opportunity on that channel. The transmission shown in figure 16 illustrates the last possible position for a message.



followed by 14 batches constructed as:



and a final batch of:



Figure 16

Message 1 contains the CTAP in accordance with ETS 300 133-4 [1], subclause 10.3. The receiver shall successfully respond to group messages which contains the CTA in the message header. The test shall be repeated for all values of CTAP.

**7.9 Tenure of group message**

The receiver shall not receive a group message which appears any later than the batch before the next addressing opportunity on that channel. The transmission shown in figure 17 shall be transmitted to the receiver.



followed by 15 batches constructed as:

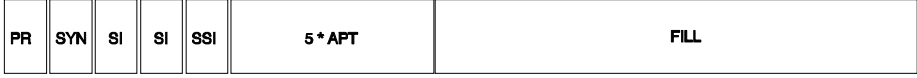

and a final batch of:

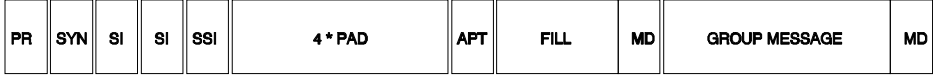

Figure 17

The contents of message 1 and the group message shall be identical to subclause 7.8. The receiver shall not respond to the group message.

**7.10 Low battery indication**

The receiver shall be supplied from a variable source set to the nominal voltage. The voltage shall be reduced to the lower extreme test voltage + 10 %. No low battery indication shall be given. The voltage shall then be reduced at a suitable rate until an indication of low battery is given. The indication shall be given before the supply voltage is reduced below the lower extreme test voltage - 10 %.

**7.11 Battery life**

Battery life under the following three conditions shall be calculated by measuring the average current consumption at the nominal battery voltage. The battery life shall be recorded as:

$$\frac{\text{nominal battery capacity}}{\text{average current consumption}}$$

The nominal battery capacity shall be stated by the manufacturer.

**7.11.1 No signals on any channel**

The receiver shall be switched on and isolated from any transmissions. The average current consumption shall be measured.

**7.11.2 Unloaded system**

The receiver shall receive the transmission illustrated in figure 18 for one subsequence per cycle. No other transmissions shall be sent.

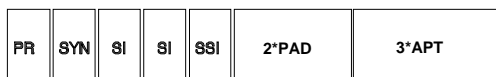

**Figure 18**

The system information shall indicate the home operator of the receiver. The average current consumption shall be measured with the BAI equal to 0 and repeated with the BAI equal to 1.

**7.11.3 Fully loaded system**

The receiver shall receive the transmission illustrated in figure 19, in every batch it is capable of receiving, on all ERMES channels.



**Figure 19**

The system information shall not indicate the home operator of the receiver and 5 % of batches shall have the External Traffic Indicator (ETI) equal to 1. The average current consumption shall be measured.

**7.12 Network acquisition time**

The time in which a receiver is unable to receive calls shall be recorded for the following conditions.

**7.12.1 Time from receiver switch on**

The transmission specified in subclause 7.1.1 shall be transmitted continuously in the appropriate batch. All other batches shall be as shown in subclause 7.11.2. The receiver shall be switched on and the time before the receiver alerts shall be recorded.

**7.12.2 Time from loss of signal**

The test signal shall be continuous messages as specified in subclause 7.12.1. The transmissions shall be suspended for a period exceeding 10 minutes. The message number shall be incremented by 1 and the time, from resumption of transmissions until the receiver gives an alert, shall be recorded.

**7.13 RSVD Bits**

Receiver behaviour shall not be modified by any combination of RSVD bit values.



## 8 Tests for optional features

This section defines tests covering some optional features of ERMES receivers. Where a receiver offers these features they shall conform with the tests in this section. All tests shall be performed with a signal level + 30 dB relative to the average usable sensitivity. Unless otherwise stated, the tests should be carried out after the receiver has reached steady state conditions.

### 8.1 Operation of long message option

Where this option is provided the manufacturer shall state the longest message that the receiver is capable of receiving. A message of this size shall be split into at least four submessages of different length. The submessages shall be transmitted to the receiver in accordance with subclause 7.1.1 and ETS 300 133-4 [1] subclause 10.4. The test shall be repeated for all combinations of Additional Information Number (AIN) and the results shall be recorded. One of the above test cases shall be repeated except that one of the submessages is transmitted after the defined time-out period specified in subclause 6.5.1 has expired. The receiver shall treat this as a lost message.

### 8.2 Indication of lost message

The receiver shall be sent a transmission as specified in subclause 7.1.1. The message number shall be increased by 4 and the message sent again to the receiver. The receiver shall indicate that messages are missing.

The receiver shall be sent a transmission as specified in subclause 7.1.1. The message number shall be replaced with the dummy value (00000) and the message sent again to the receiver. The receiver shall not indicate that messages are missing.

### 8.3 Urgent message indicator

The receiver shall be sent a transmission as specified in subclause 7.1.1. The Urgent Message Indicator (UMI) shall be equal to 1. The receiver shall indicate the reception of an urgent message.

### 8.4 Message storage

Where storage of messages is provided by the receiver the minimum capacity shown in table 4 shall be present.

Table 4

Feature	Number of messages	Storage capacity
Tone only	8	
Numeric	10	200 digits
Alphanumeric	10	1000 characters (7000 bits)

The receiver shall be sent sufficient messages to verify that the requirements are met.

### 8.5 Memory full

Where receivers are supplied with a message storage feature, the memory shall be filled by transmission of messages to the receiver. An additional message shall then be transmitted. The memory contents shall be retrieved to verify that the oldest message has been deleted and the latest message retained.

## Annex A (normative): Measurement procedures

### A.1 Average measured usable sensitivity expressed as field strength under normal conditions

#### A.1.1 Definition

The average measured usable sensitivity expressed as field strength for messages is the average of eight measurements of field strength, expressed in dB $\mu$ V/m, at the nominal frequency of the receiver and with specified test modulation which produces after demodulation a message acceptance ratio of 80 %, when the receiver is rotated in 45° increments, starting at the reference orientation.

If the test time saving procedure is used (see annex B subclause B.11), and this measurement uses a tone-only message, then the differential factor relevant to the receiver declared category (annex B, clause B.9) shall be added to the result obtained in subclause A.1.1 e).

For the purposes of this annex, the following definition shall apply:

**successful alphanumeric message:** for successful alphanumeric calls the receiver shall present a 55 character message as declared by the manufacturer with a maximum of four contiguous characters in error.

The full error capability of the code may be used. A character in error is defined as a character that differs from the transmitted character.

#### A.1.2 Method of measurement

This measurement method produces a message acceptance ratio of 80 %:

- a) a test site which fulfils the requirements of the specified frequency range of this measurement shall be used (see annex B, clause B.4). The transmitting antenna shall be oriented for vertical polarisation;

A signal generator shall be connected to the transmitting antenna. The signal generator shall be at the nominal frequency of the receiver and shall be modulated by the test paging signal (see subclause 4.5). The receiver under test shall be placed on the "simulated man" (see annex B, clause B.1) at  $1,0 \pm 0,1$  metre above ground level and oriented so that a face, declared by the manufacturer, is normal to the direction of the transmitting antenna. This is the reference orientation for the measurement.

- b) the level of the RF signal shall be such that a successful message response ratio of less than 10 % is obtained;
- c) the test paging signal shall be transmitted repeatedly while observing in each case whether or not a successful response is obtained. The input level shall be increased by 2 dB for each occasion that a successful response is not obtained. The procedure shall be continued until three consecutive successful responses are observed;
- d) the input signal level shall be reduced by 1 dB and the new value recorded. The test paging signal shall then be continuously repeated. In each case, if a response is not obtained, the input level shall be increased by 1 dB and the new value recorded. If a successful response is obtained, the input level shall not be changed until three consecutive successful responses have been observed. In this case, the input level shall be reduced by 1 dB and the new value recorded. No input signal levels shall be recorded unless preceded by a change in level. The measurement shall be stopped after 10 values have been recorded;
- e) the mean average of the dB values recorded in step d) shall be calculated;
- f) steps b) to e) above shall be repeated for the eight positions, 45° apart, of the receiver and the corresponding average values of the generator output shall be determined and noted;

- g) using the calibration of the test site (see annex B, clause B.4), the eight field strengths  $X_i$  ( $\mu\text{V}/\text{m}$ ) corresponding to the eight average values determined in step f) shall be calculated. The average measured usable sensitivity expressed as field strength  $X_{\text{mean}}$  ( $\text{dB}\mu\text{V}/\text{m}$ ) is given by:

$$X_{\text{mean}} = 20 \log_{10} \left[ \frac{8}{\sum_{i=1}^8 (1/X_i^2)} \right]^{1/2}$$

## A.2 Radiated spurious components

### A.2.1 Definition

Radiated spurious components are emissions radiated by the antenna and the cabinet of the receiver. They are specified as the radiated power of any discrete signal.

### A.2.2 Method of measurement

The method of measurement shall be as follows:

- a) a test site which fulfils the requirements of the specified frequency range of this measurement shall be used (see annex B, clause B.5). The measuring antenna as defined in annex B, subclause B.5.2.5, shall be oriented for vertical polarisation and connected to a selective measuring device (see annex B, subclause B.5.2.8). The bandwidth of the selective measuring device shall be 10 kHz if the frequency is within the ERMES band and 100 kHz if it is outside the ERMES band. The peak mode of measurement shall be selected. The specified height range of the measuring antenna above the ground plane shall be between 1,0 m and 4,0 m. The minimum height may be higher depending on the physical characteristics of the measuring antenna (practical limitations);

The receiver under test shall be placed on a non-conducting support in its standard position as declared by the manufacturer.

- b) the radiation of any spurious component shall be detected by the measuring antenna and receiver over the specified frequency range. The frequency of each spurious component shall be recorded. If the test site is disturbed by radiation coming from outside, this qualitative search may be performed in a screened room with reduced distance between the transmitter and the measuring antenna;
- c) at each frequency at which a component has been detected, the selective measuring device shall be tuned and the measuring antenna shall be raised or lowered through the height range until the maximum signal level is detected on the selective measuring device;
- d) the receiver shall be rotated up to 360° about a vertical axis, until the maximum signal is received. This position shall be recorded and the measuring antenna left in this position;
- e) the measuring antenna shall be raised or lowered again through the specified height range until a maximum is obtained. This level shall be recorded;
- f) the substitution antenna (as defined in annex B, subclause B.5.2.6) shall replace the receiver in the same position and in vertical polarisation (see annex B, subclause B.4.2.6). The substitution antenna shall be a calibrated dipole antenna and be connected to the signal generator;
- g) for each frequency at which a component has been detected, the signal generator and selective measuring device shall be tuned and the measuring antenna shall be raised or lowered through the specified height range until the maximum signal level is detected on the selective measuring device. The level of the signal generator giving the same signal level on the selective measuring device as in item e) above shall be recorded. This value, after correction due to the gain of the substitution

antenna and the cable loss between the signal generator and the substitution antenna, is the radiated spurious component at this frequency;

- h) measurements b) to g) above shall be repeated with the measuring antenna and substitution antenna oriented in horizontal polarisation.

### A.3 Co-channel rejection

#### A.3.1 Definition

Co-channel rejection is a measure of the capability of the receiver to receive a wanted modulated signal at the nominal frequency without exceeding a given degradation due to the presence of an unwanted modulated signal also at the nominal frequency.

It is defined as the ratio in dB of the level of the unwanted signal to the specified wanted signal level at the receiver input, for which the message acceptance ratio is 80 %. The wanted signal level shall correspond to the reference figure (see annex B, clause B.3).

#### A.3.2 Method of measurement

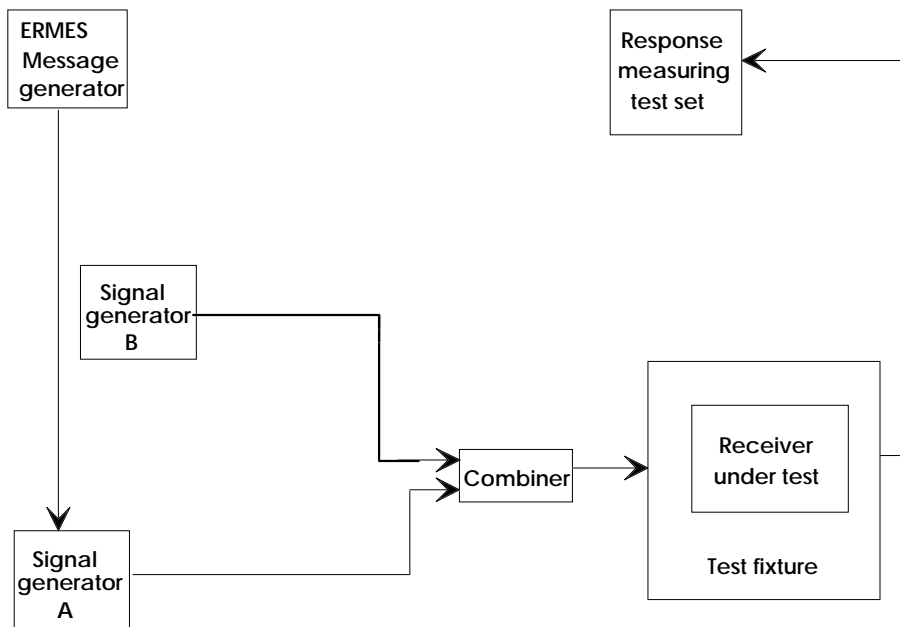

Figure A.1: Measurement arrangement

The test fixture shall meet the requirements of annex B, clause B.6.

The method of measurement shall be as follows:

- a) two signal generators A and B shall be connected to the receiver input via a combining network (see figure A.1). The wanted signal, represented by the 4-PAM/FM signal generator A, shall be a carrier frequency and shall have the test modulation as defined in subclause 4.5. The unwanted signal, represented by signal generator B, shall have the test modulation defined in annex B, clause B.2. Both input signals shall be at the nominal frequency of the receiver under test;
- b) initially, signal generator B shall be switched off. The amplitude of signal generator A shall be adjusted to the wanted signal level when measured at the input of the test fixture;
- c) generator B shall then be switched on, and its input level adjusted until a message response ratio of less than 10 % is obtained;
- d) the wanted signal shall then be transmitted whilst observing the message response ratio. The level of the unwanted signal shall be reduced in steps of 1 dB until a message response ratio of 80 % or better is obtained. The level of the unwanted signal shall then be recorded;

- e) the unwanted input signal shall then be increased by 1 dB and the new value recorded. The wanted signal shall then be continuously repeated. In each case if a response is not obtained, the level of the unwanted signal shall be reduced by 1 dB and the new value recorded. If a successful response is obtained, the level of the unwanted signal shall not be changed until three consecutive successful responses have been obtained. In this case the unwanted signal shall be increased by 1 dB and the new value recorded. No levels of the unwanted signal shall be recorded unless preceded by a change in level. The measurement shall be stopped after a total of 10 values have been recorded;
- f) the mean average of the dB values recorded in step e) shall be calculated;
- g) the co-channel rejection ratio for messages shall be recorded as the ratio in dB of the value calculated in f) to the level of the wanted signal, at the input of the test fixture.

## **A.4 Adjacent channel selectivity**

### **A.4.1 Definition**

The adjacent channel selectivity for paging messages is a measure of the capability of the receiver to receive a wanted signal at the nominal frequency modulated by a test signal, without exceeding a given degradation due to the presence of an unwanted modulated signal which differs in frequency from the wanted signal by an amount equal to the adjacent channel separation for which the equipment is intended. The wanted signal level shall correspond to the reference figure (see annex B, clause B.3). For measurements under extreme conditions the maximum degradation as specified in 6.1.d) shall be added to this reference figure.

It is defined as the lower value of the ratios in dB for the upper and lower adjacent channels of the level of the unwanted signal to the specified level of the wanted signal for which the message acceptance ratio is 80 %.

### **A.4.2 Method of measurement**

The test fixture shall comply with the requirements of annex B, clause B.6.

The method of measurement shall be as follows:

- a) two signal generators, A and B shall be connected to the receiver via a combining network (see figure A.1). The wanted signal, produced by the 4-PAM/FM signal generator A, shall be a carrier frequency and test modulation as defined in subclause 4.5. The unwanted signal, produced by signal generator B, shall have the modulation defined in annex B, clause B.2 and shall be adjusted to the frequency of the channel immediately above that of the wanted signal;
- b) initially signal generator B shall be switched off. The amplitude of signal generator A shall be adjusted to the wanted signal level when measured at the input of the test fixture;
- c) the wanted signal shall then be transmitted repeatedly and the signal generator B shall be switched on. The input level of the unwanted signal shall be adjusted until a successful message ratio of less than 10 % is obtained;
- d) the level of the unwanted signal shall be reduced by 2 dB for each occasion that a successful response is not observed. The procedure shall be continued until three consecutive successful responses are observed. The level of the input signal shall then be recorded;
- e) the unwanted input signal shall then be increased by 1 dB and the new value recorded. The wanted signal shall then be continuously repeated. In each case if a response is not obtained, the level of the unwanted signal shall be reduced by 1 dB and the new value recorded. If a successful response is obtained, the level of the unwanted signal shall not be changed until three consecutive successful responses have been obtained. In this case the unwanted signal shall be increased by 1 dB and the new value recorded. No levels of the unwanted signal shall be recorded unless preceded by a change in level. The measurement shall be stopped after a total of 10 values have been recorded;
- f) measurements a) to e) above shall be repeated with the unwanted signal at the frequency of the channel below that of the wanted signal;

- g) the adjacent channel selectivity for messages shall be recorded for the upper and lower adjacent channels as the ratio in dB of the average of the levels of the unwanted signal recorded in steps d) and e) to the level of the wanted input signal.

## **A.5 Spurious response immunity**

### **A.5.1 Definition**

The spurious response immunity for paging messages is a measure of the capability of the receiver to discriminate between the wanted signal modulated by a test signal at the nominal frequency and an unwanted signal at any other frequency at which a response is obtained. Unwanted signal frequencies shall be tested from 30 MHz to 1 GHz except for frequencies within 25 kHz of the wanted frequency. The wanted signal level shall correspond to the reference figure (see annex B, clause B.3).

Spurious response immunity is defined as the level of the unwanted signal for which the message acceptance ratio is 80 %.

### **A.5.2 Method of measurement**

The test fixture shall meet the requirements of annex B, clause B.6.

The method of measurement shall be as follows:

- a) two signal generators, A and B shall be connected to the receiver via a combining network (see figure A.1). The wanted signal, produced by the 4-PAM/FM signal generator A, shall be a carrier frequency and shall have the test modulation as defined in subclause 4.5. The unwanted signal, produced by signal generator B, shall have the signal format defined in annex B, clause B.2 and shall be adjusted to a frequency within the specified frequency range at which it is calculated that a spurious response could occur (see annex B, clause B.10);
- b) initially, signal generator B shall be switched off. The amplitude of signal generator A shall be adjusted to the wanted signal level when measured at the input of the test fixture;
- c) the wanted signal shall then be transmitted repeatedly and the signal generator B shall be switched on. The input level of the unwanted signal shall be adjusted until a successful message ratio of less than 10 % is obtained;
- d) the level of the unwanted signal shall be reduced by 2 dB for each occasion that a successful response is not observed. The procedure shall be continued until three consecutive successful responses are observed. The level of the input signal shall then be recorded;
- e) the unwanted input signal shall then be increased by 1 dB and the new value recorded. The wanted signal shall then be continuously repeated. In each case, if a response is not obtained, the level of the unwanted signal shall be reduced by 1 dB and the new value recorded. If a successful response is obtained, the level of the unwanted signal shall not be changed until three consecutive successful responses have been obtained. In this case the unwanted signal shall be increased by 1 dB and the new value recorded. No levels of the unwanted signal shall be recorded unless preceded by a change in level. The measurement shall be stopped after a total of 10 values have been recorded;
- f) the measurement shall be repeated at each frequency within the specified frequency range at which it is calculated that a spurious response could occur;
- g) the spurious response immunity for messages for the frequency concerned is the ratio in dB of the average of the levels of the unwanted signal recorded in steps d) and e) to the level of the wanted signal, plus 28 dB and expressed in dB $\mu$ V/m.

## A.6 Intermodulation immunity

### A.6.1 Definition

The intermodulation immunity for paging signals is a measure of the capability of a receiver to receive a wanted signal at the nominal frequency modulated by a test signal without exceeding a given degradation due to the presence of two or more unwanted signals with a specific frequency relationship to the wanted signal frequency.

For the purpose of this measurement it is defined as the common level of two equal unwanted signals, for which the message acceptance ratio is 80 %. The wanted signal level shall correspond to the reference figure (see annex B, clause B.3).

### A.6.2 Method of measurement

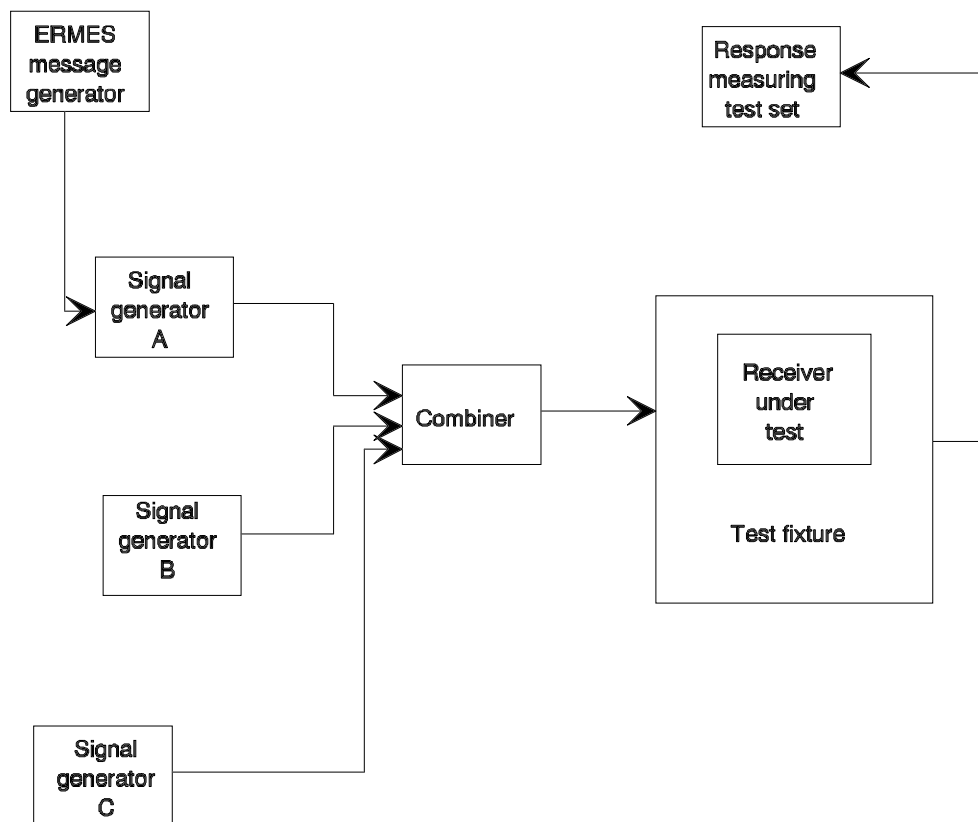

Figure A.2: Measurement arrangement (clause A.6)

The test fixture shall meet the requirements of annex B, clause B.6.

The method of measurement shall be as follows:

- three signal generators, A, B and C, shall be connected to the receiver via a combining network (see figure A.2). The wanted signal, represented by the 4-PAM/FM signal generator A, shall be a carrier frequency and shall have the test modulation as defined in subclause 4.5. The first unwanted signal, represented by the signal generator B, shall be unmodulated and adjusted to the frequency 50 kHz above the nominal frequency of the receiver. The second unwanted signal, represented by the signal generator C, shall have the test modulation as defined in annex B, clause B.2 and shall be adjusted to a frequency 100 kHz above the nominal frequency;
- initially, signal generators B and C shall be switched off and the amplitude of signal generator A shall be adjusted to the wanted signal level when measured at the input of the test fixture;
- the wanted signal shall then be transmitted repeatedly and signal generators B and C shall be switched on. The output levels of signal generators B and C shall be maintained equal and adjusted to a value such that a successful message ratio of less than 10 % is obtained;

- d) the levels of the unwanted signals shall be reduced by 2 dB for each occasion that a successful response is not observed. The procedure shall be continued until three consecutive successful responses are observed. The level of the input signal shall then be recorded;
- e) the unwanted input signals shall then be increased by 1 dB and the new value recorded. The wanted signal shall then be continuously repeated. In each case, if a response is not obtained, the level of the unwanted signals shall be reduced by 1 dB and the new value recorded. If a successful response is obtained, the level of the unwanted signals shall not be changed until three consecutive successful responses have been obtained. In this case the unwanted signals shall be increased by 1 dB and the new value recorded. No levels of the unwanted signals shall be recorded unless preceded by a change in level. The measurement shall be stopped after a total of 10 values have been recorded;
- f) the intermodulation immunity for messages shall be recorded as the ratio in dB of the average of the levels of the unwanted signals recorded in steps d) and e) to the level of the wanted signal, plus 28 dB and expressed in dB $\mu$ V/m;
- g) measurements a) to f) above shall be repeated with the unwanted signal generator B at the frequency 50 kHz below that of the wanted signal and the frequency of the unwanted signal generator C at the frequency 100 kHz below that of the wanted signal.

## A.7 Blocking immunity

### A.7.1 Definition

Blocking immunity for paging messages is a measure of the capability of the receiver to receive the wanted modulated signal at the nominal frequency without exceeding a given degradation due to the presence of an unwanted unmodulated high input signal.

It is defined as the level of the unwanted signal for which the message acceptance ratio is 80 %. The wanted signal level shall correspond to the reference figure (see annex B, clause B.3).

### A.7.2 Method of measurement

The test fixture shall meet the requirements of annex B, subclause B.6.

The method of measurement shall be as follows:

- a) two signal generators A and B shall be connected to the receiver input via a combining network (see figure A.1). The wanted signal, represented by the 4-PAM/FM signal generator A, shall be a carrier frequency and shall have the test modulation as defined in subclause 4.5;
- b) initially, the unwanted signal, represented by the signal generator B, shall be switched off and the amplitude of signal generator A shall be adjusted to the wanted signal level when measured at the input of the test fixture;
- c) the wanted signal shall then be transmitted repeatedly and the signal generator B shall be switched on. The unwanted signal shall be unmodulated and its frequency shall be selected in the range  $+ 1 \text{ MHz} \pm 10 \%$  relative to the nominal frequency of the receiver. This frequency shall be one at which no spurious response has been detected. The level of the unwanted signal shall be adjusted until a successful message ratio of less than 10 % is obtained;
- d) the level of the unwanted signal shall be reduced by 2 dB for each occasion that a successful response is not observed. The procedure shall be continued until three consecutive successful responses are observed. The level of the input signal shall then be recorded;
- e) the unwanted input signal shall then be increased by 1 dB and the new value recorded. The wanted signal shall then be continuously repeated. In each case, if a response is not obtained the level of the unwanted signal shall be reduced by 1 dB and the new value recorded. If a successful response is obtained, the level of the unwanted signal shall not be changed until three consecutive successful responses have been obtained. In this case the unwanted signal shall be increased by 1 dB and the



new value recorded. No levels of the unwanted signal shall be recorded unless preceded by a change in level. The measurement shall be stopped after a total of 10 values have been recorded;

- f) the measurements shall be repeated for frequency of the unwanted signal selected in the range - 1 MHz  $\pm$  10 %, relative to the nominal frequency of the receiver;
- g) the blocking level for messages shall be recorded as the ratio in dB of the lower value of the two measurements above, of the average of the levels of the unwanted signal recorded in steps d) and e) to the level of the wanted input signal, plus 28 dB and expressed in dB $\mu$ V/m.

## A.8 Combined multi-path and quasi-synchronous transmissions

### A.8.1 Definition

The multi-path combined with simulcast sensitivity of the receiver is the root mean square (rms.) value of the level of the stronger Rayleigh fading signal, at the receiver input, at the nominal frequency of ERMES channel 8 with normal ERMES test modulation signal and a produced successful message ratio of 80 %. The wanted signal level shall correspond to the reference figure (see annex B, clause B.3).

### A.8.2 Method of measurement

The method of measurement shall be as follows:

- a) the two 4-PAM/FM signal generators (A and B) shall be connected to the receiver under test via Rayleigh fading simulators and a combiner (see figure A.3). The signal from generator A shall be on the nominal RF frequency and the signal from generator B on the nominal frequency + 30 Hz ( $\pm$  3 Hz). The fading simulators shall be adjusted for the simulated speed of 3 km/h. The simulators shall use the classical model for Rayleigh fading and there shall be no correlation between the two simulators. The difference in contribution to the signal strength from the signal generators shall be 1 dB, (the higher signal shall come from signal generator A);

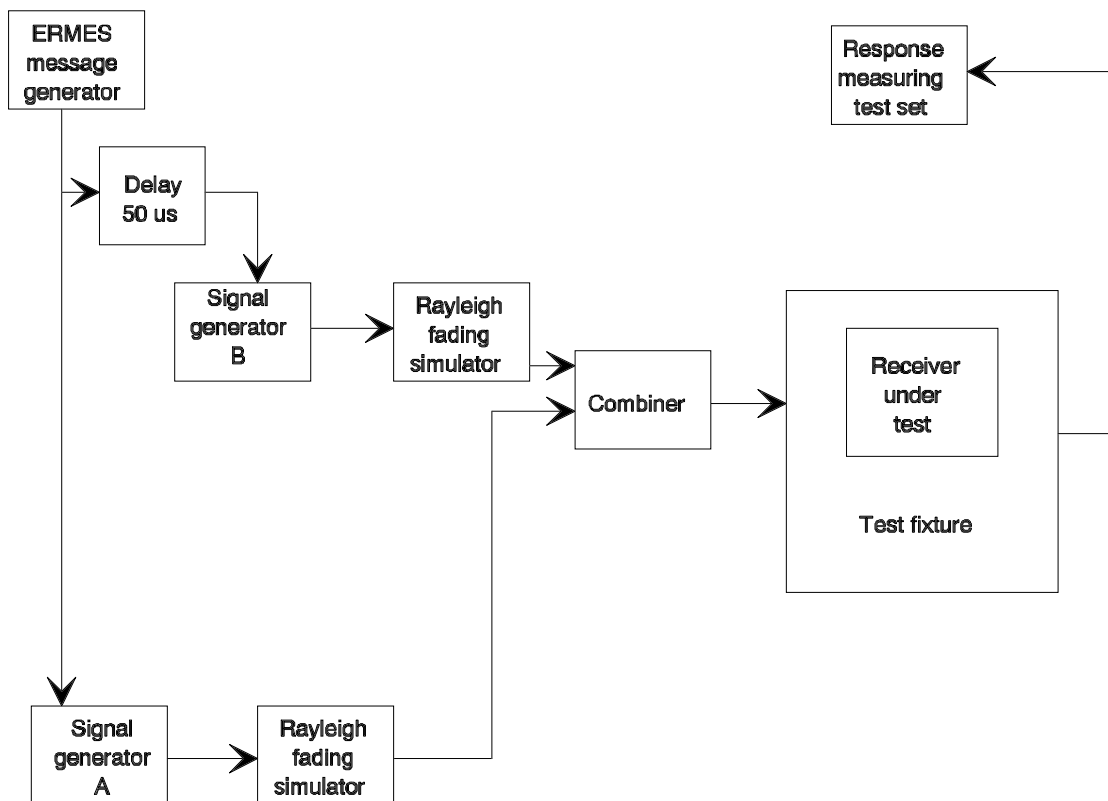

Figure A.3: Measurement set-up (clause A.8)

The test fixture shall meet the requirements of annex B, subclause B.6.

The delay between the two signals shall be 50  $\mu$ s.

- b) the method of measurement of measured usable sensitivity for messages specified in annex A, clause A.1 steps b) through e), shall then be used with the exception that 50 values instead of 10 shall be recorded;
- c) the sensitivity figure shall be recorded as the ratio in dB of the value recorded in step b) above and the reference figure (see annex B, clause B.3).

## Annex B (normative): Ancillary test data

### B.1 Simulated man

The simulated (sometimes known as "salty") man comprises a rotatable acrylic tube filled with salt water placed on the ground.

The container shall have the dimensions shown in table B.1.

**Table B.1**

Dimension	Value
Height	$1,7 \pm 0,1$ m;
Inside diameter	$300 \pm 5$ mm;
Side wall thickness	$5 \pm 0,5$ mm.

The container shall be filled with a salt (NaCl) solution of 1,5 g per litre of distilled water.

The equipment shall be fixed to the surface of the simulated man, at the appropriate height for the equipment.

### B.2 Definition of unwanted test signal

The unwanted signal shall be a carrier frequency modulated by a 400 Hz sinusoidal signal with a deviation of  $\pm 3$  kHz. The centre frequency and amplitude of this unwanted test signal shall be as specified in the respective test.

### B.3 Definition of reference figure

The reference figure is used as the basis for measurements in the appropriate test fixture. It is established according to the following procedure:

- a) the average usable sensitivity under normal conditions as measured in annex A, clause A.1, shall be noted;
- b) the difference between the value determined in a) above and the figure given in subclause 5.1.a) shall be noted;
- c) the receiver shall be placed into the test fixture (see figure B.1 and clause B.6) oriented as specified by the manufacturer;
- d) the input signal level to the test fixture required to produce a message acceptance ratio of 80 % shall be determined according to the procedure described in annex A, subclause A.1.2, steps b) to e), and shall be noted in dB $\mu$ V p.d. (potential difference);
- e) the reference figure for this test fixture is then the value noted for step d), increased by the sum of the value noted for step b) and + 3 dB.

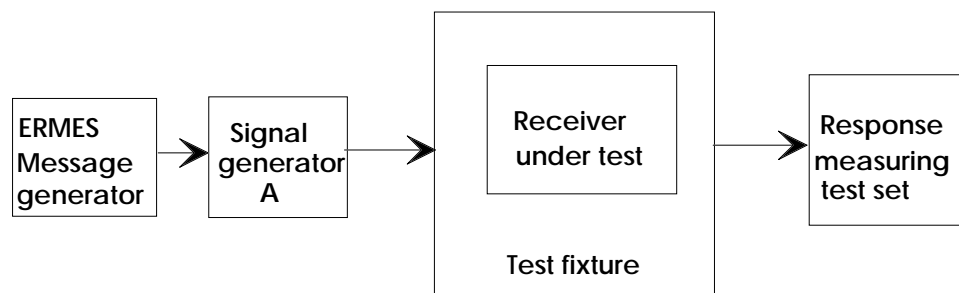

**Figure B.1: Receiver in test fixture (see clause B.6)**

## B.4 Sensitivity measurement test sites

### B.4.1 Description of test sites for receiver sensitivity measurements

One of the test sites described in this clause shall be used to perform the measurements described in annex A, clause A.1 over the ERMES frequency range. The test site shall be calibrated.

### B.4.2 Description of an open air test site

#### B.4.2.1 Receiver sensitivity measurement test site characteristics

Table B.2

Parameter	Limits
Useful frequency range:	25 MHz to 1 000 MHz
Nominal site attenuation, 30 m range:	20 dB to 46 dB for 25 MHz 36 dB to 62 dB for 169,5 MHz 52 dB to 78 dB for 1 000 MHz
NOTE:	The nominal attenuation of the 30 m test site for a half-wave dipole is 26 dB for 25 MHz, 42 dB for 169,5 MHz and 58 dB for 1 000 MHz. The actual attenuation may vary due to ground reflections.

#### B.4.2.2 Receiver sensitivity measurement test site

The receiver sensitivity measurement test site shall be on level ground with uniform electrical characteristics and be free from reflecting objects over as wide an area as possible to ensure that extraneous electromagnetic fields do not affect the accuracy of the test results.

The minimum boundary of the test site shall be an ellipse having a 60 m major axis and a 52 m minor axis. The equipment under test and the transmitting antenna shall be located at the foci. Half of the ellipse in the front half of a transmitting antenna is sufficient if the transmitting antenna is highly directional, as, for example, a corner reflector antenna.

No extraneous conducting objects having any dimension in excess of 15 cm for measurements over the frequency range of 25 MHz to 300 MHz, or 5 cm for measurements over the frequency range of 300 MHz to 1 GHz, shall be in the immediate vicinity of the equipment under test or of the main transmitting lobe of the transmitting antenna.

The suitability of a test range for this purpose may be tested (without the simulated man) by:

- a) measuring the field strength at the normal test position. The frequency and field strength used in this measurement shall be the same as that used in subclause B.4.2.5;
- b) measuring the field strength 50 cm in front of the normal test position (i.e. towards the transmitter);
- c) measuring the field strength 50 cm behind the normal test position (i.e. away from the transmitter);
- d) measuring the field strength to the left of the normal position; and
- e) measuring the field strength to the right of the normal position.

The measurements shall all be made at the nominal measurement height.

A suitable test range is defined as having reflections at least 20 dB below the nominal signal strength, therefore the measurements in b) and c) should be within  $\pm 1,0$  dB of the measurement in step a), and each of the measurements in steps d) and e) should be within  $\pm 1,2$  dB of the measurement in step a).

The distance between the vertical axis through the centre of the antenna of the equipment under test and the vertical axis through the centre of the transmitting antenna shall be at least 30 m.

### B.4.2.3 Position of the equipment under test

Considering figure B.2, the receiver under test shall be placed on the "simulated man", see clause B.1, at 1,0 m  $\pm$  0,1 m above ground level and oriented so that a face, specified by the manufacturer, is normal to the direction of the test antenna. The simulated man shall be placed on the ground with no intervening conductive ground plane. This is the reference orientation for the measurement. The response measuring test set shall be as declared by the manufacturer for the test. This may be the display of the receiver under test or may include a non-conductive acoustic tube suitable for transmitting an audible response tone from the receiver to a microphone and recording equipment.

### B.4.2.4 Transmitting antenna

The transmitting antenna shall be suitable for the transmission of linearly polarised waves. It may consist of a half-wave dipole, the length of which is adjusted for the frequency concerned. However, for practical reasons, or to increase the sensitivity of the measurements, it may be convenient to use a directional antenna such as a corner reflector.

The transmitting antenna shall be mounted at a height of between 1 m and 4 m above ground, (see figure B.2).

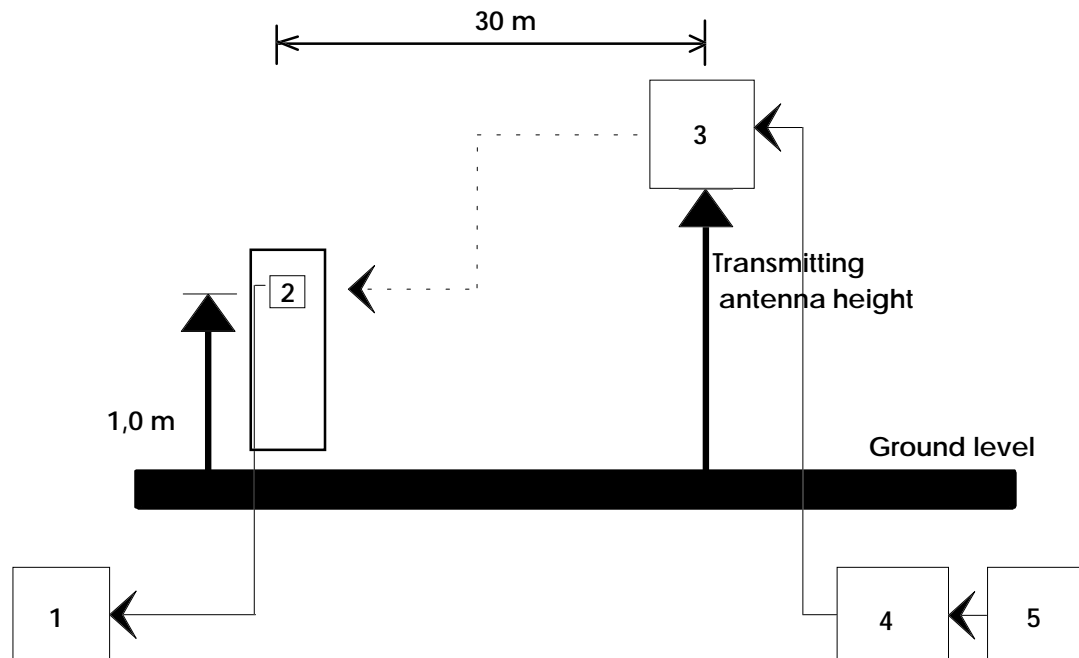

- 1) Response measuring test set.
- 2) Receiver under test.
- 3) Transmitting antenna.
- 4) Signal generator.
- 5) Message generator.

Figure B.2: Measurement arrangement for testing receiver sensitivity

### B.4.2.5 Calibration

Considering figure B.3, all equipment shall be adjusted to the frequency at which the calibration is to be measured. The transmitting antenna and the substitution antenna (see subclause B.4.2.6) shall be vertically polarised. The substitution antenna connected to the selective measuring device constitutes a calibrated field strength meter:

- a) the signal generator shall be adjusted to produce the required field strength at the substitution antenna;

- b) the nominal height of the transmitting antenna is  $3,0 \text{ m} \pm 0,2 \text{ m}$ . This shall be adjusted in order to achieve a maximum signal on the selective measuring device. If no maximum is found, then the nominal height shall be used;
- c) the signal generator level and the selective measuring device reading shall be noted, therefore, establishing a relationship between the signal generator level and the field strength at the substitution antenna;
- d) the frequency used for the calibration and for the measurement shall be monitored to ensure that the measurement is free from interfering signals.

#### B.4.2.6 Substitution antenna

The substitution antenna replaces the equipment under test during part of the measurement. The substitution antenna shall be a calibrated half-wave dipole and shall be arranged so that the centre of the substitution antenna shall coincide with the normal position of the centre of the equipment under test as shown in figure B.3.

The substitution antenna (2) shall be mounted at the end of a horizontal boom. The mounting shall permit the antenna to be positioned for measuring the vertical component of the electric field. The lower end of the antenna, when oriented for vertical polarisation and placed in the proper position, shall be at least 0,3 m above the ground.

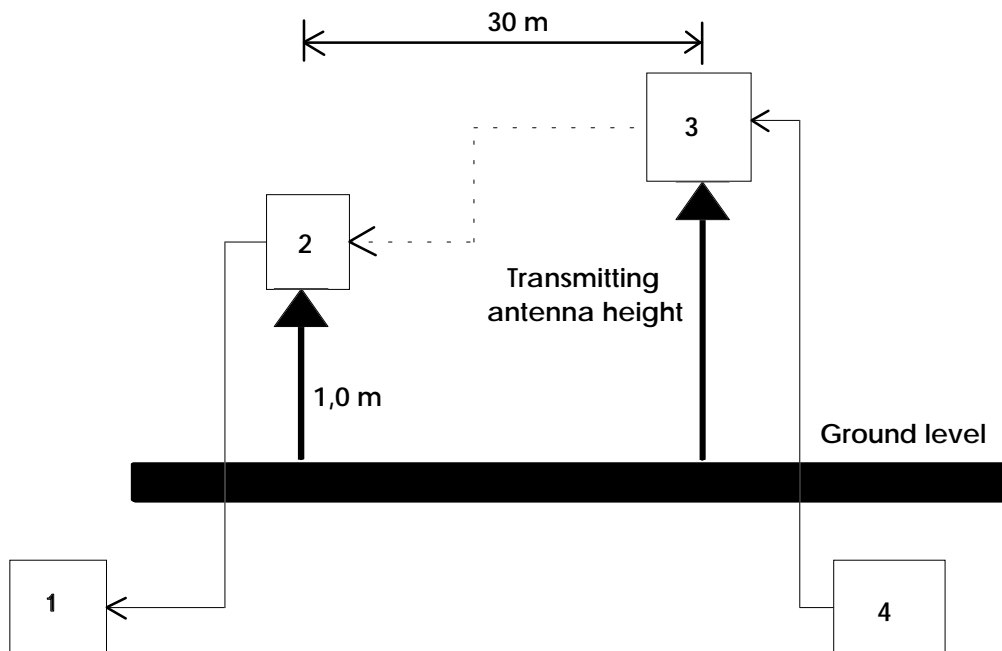

- 1) Selective measuring device.
- 2) Substitution antenna.
- 3) Transmitting antenna.
- 4) Signal generator.

**Figure B.3: Measurement arrangement for calibration of open air test site**

The cable from the substitution antenna shall be routed along the horizontal boom for at least 1 m, and should preferably extend, while being at ground level, at least 3 m beyond the minimum boundary of the test site before it is connected to the selective measuring device (1). Alternatively, the cable may be routed underground.

#### B.4.2.7 Selective measuring device

The selective measuring device may be either a frequency selective voltmeter, a spectrum analyser, or a calibrated field-strength meter, and shall be placed, together with its associated input cable, in a position such that it shall not affect the accuracy of the test results.

### **B.4.3 Description of an anechoic chamber**

An anechoic chamber as described in annex B, subclause B.5.1 may be used as a test site.

## **B.5 Definition of test sites suitable for spurious emissions measurements**

### **B.5.1 An anechoic chamber**

#### **B.5.1.1 General**

An anechoic chamber is a chamber covered inside with radio frequency absorbing material and simulating a free space environment. In addition the chamber may be shielded, in which case an environment free from interfering signals is provided. It is an alternative site on which to perform the measurements, using the radiated measurement methods described in annex A, clause A.2 in the frequency range over which it can be calibrated. Absolute measurements require a calibration of the anechoic chamber. The test antenna, equipment under test and substitution antenna are used in a way similar to that at the open air test site, but are all located at the same fixed height above the floor.

When used for receiver sensitivity measurements it should be noted that:

- a) the whole-body resonant frequency of the simulated man may be different in a free space environment of an anechoic chamber as compared with an open air test site;
- b) the electric and magnetic field profiles on the simulated man may be different in the free space environment of an anechoic chamber as compared with an open air test site.

Therefore, a careful calibration of the anechoic chamber is necessary, and a correlation to an open air site measurement with respect to the 30 m open air site described in subclause B.4.2 should be considered before an anechoic chamber can be used as a test site for sensitivity measurements with a simulated man.

#### **B.5.1.2 Description**

An anechoic chamber shall meet the requirements for shielding loss and wall return loss as shown in figure B.4. Figure B.5 shows an example of the construction of an anechoic chamber having a base area of 5 m by 10 m and a height of 5 m.

The ceiling and walls shall be coated with pyramidal absorbers approximately 1 m long. The base shall be covered with special absorbers which form the floor. The available internal dimensions of the chamber shall be 3 m x 8 m x 3 m, so that a maximum measuring distance of 5 m in the middle axis of this chamber is available. The floor absorbers reject floor reflections so that the antenna height need not be changed unless explicitly specified for the measurements. Anechoic chambers of other dimensions may be used.

Figure B.4 shows the attenuation requirements for the shielding loss required to ensure that interfering signals will be kept to a low level. In certain situations different levels of shielding loss may be satisfactory. The limits given on return loss should be maintained to ensure satisfactory operation of the anechoic chamber.

#### **B.5.1.3 Influence of parasitic reflections**

For free-space propagation in the far field, the relationship of the field strength  $X$  and the distance  $R$  is given by  $X = X_0 \times (R_0/R)$ , where  $X_0$  is the reference field strength and  $R_0$  is the reference distance. This relationship allows relative measurements to be made as all constants are eliminated within the ratio and neither cable attenuation, antenna mismatch nor antenna dimensions are of importance.

If the logarithm of the above equations is used, the deviation from the ideal curve can be easily seen because the ideal correlation of field strength and distance appears as a straight line. The deviations occurring in practice are then clearly visible. This indirect method shows quickly and easily any disturbances due to reflections and is far less difficult than the direct measurement of reflection attenuation.

With an anechoic chamber of the dimensions given above, at low frequencies below 100 MHz, there are no far field conditions, but the wall reflections are stronger, so that careful calibration is necessary. In the medium frequency range, from 100 MHz to 1 GHz, the dependence of the field strength to the distance meets the expectations very well. Above 1 GHz, because more reflections will occur, the dependence of the field strength to the distance will not correlate so closely.

**B.5.1.4 Calibration and mode of use**

The calibration and mode of use is the same as for an open air test site, the only difference being that the test antenna does not need to be raised and lowered whilst searching for a maximum, which simplifies the method of measurement.

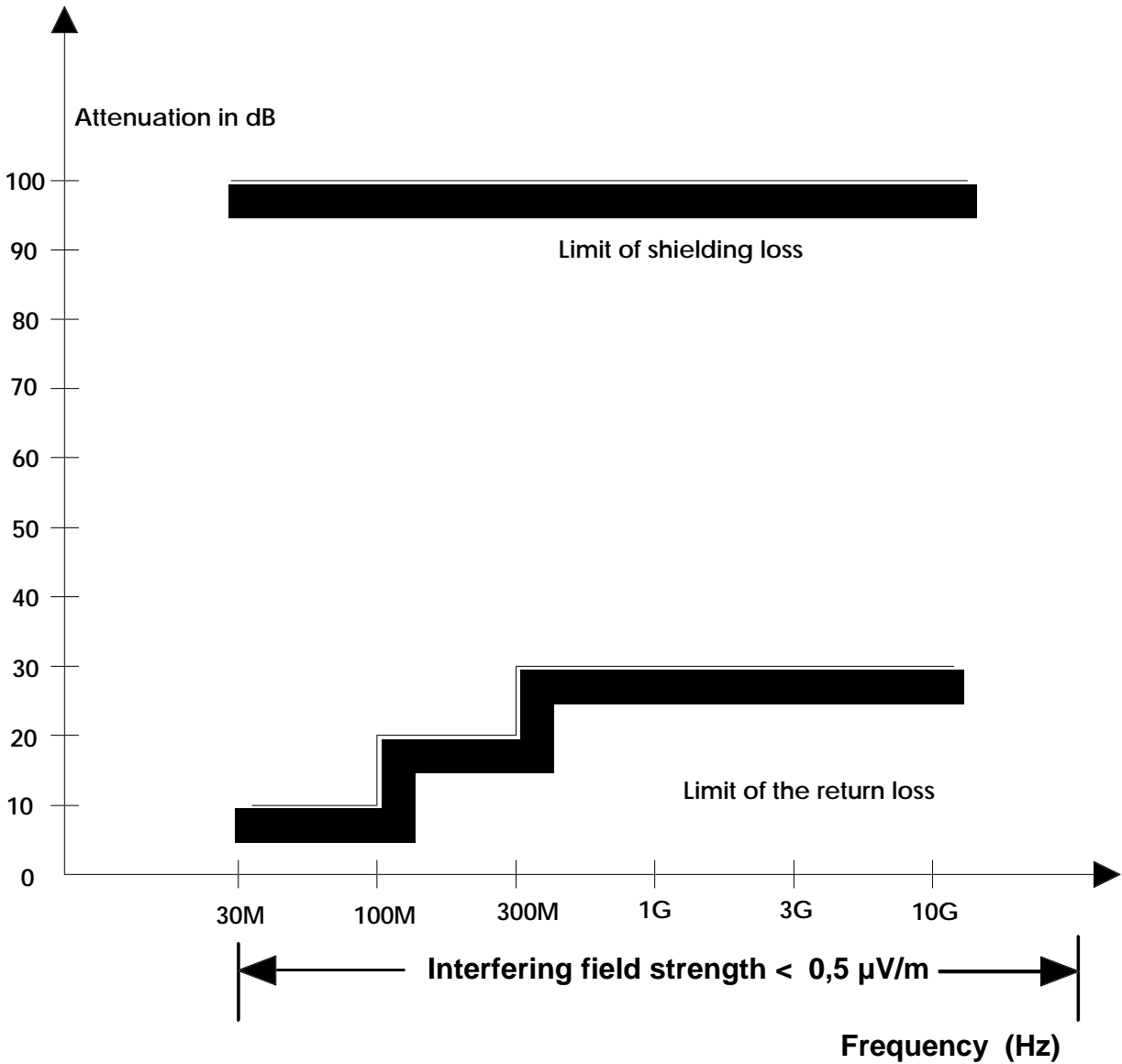

Figure B.4



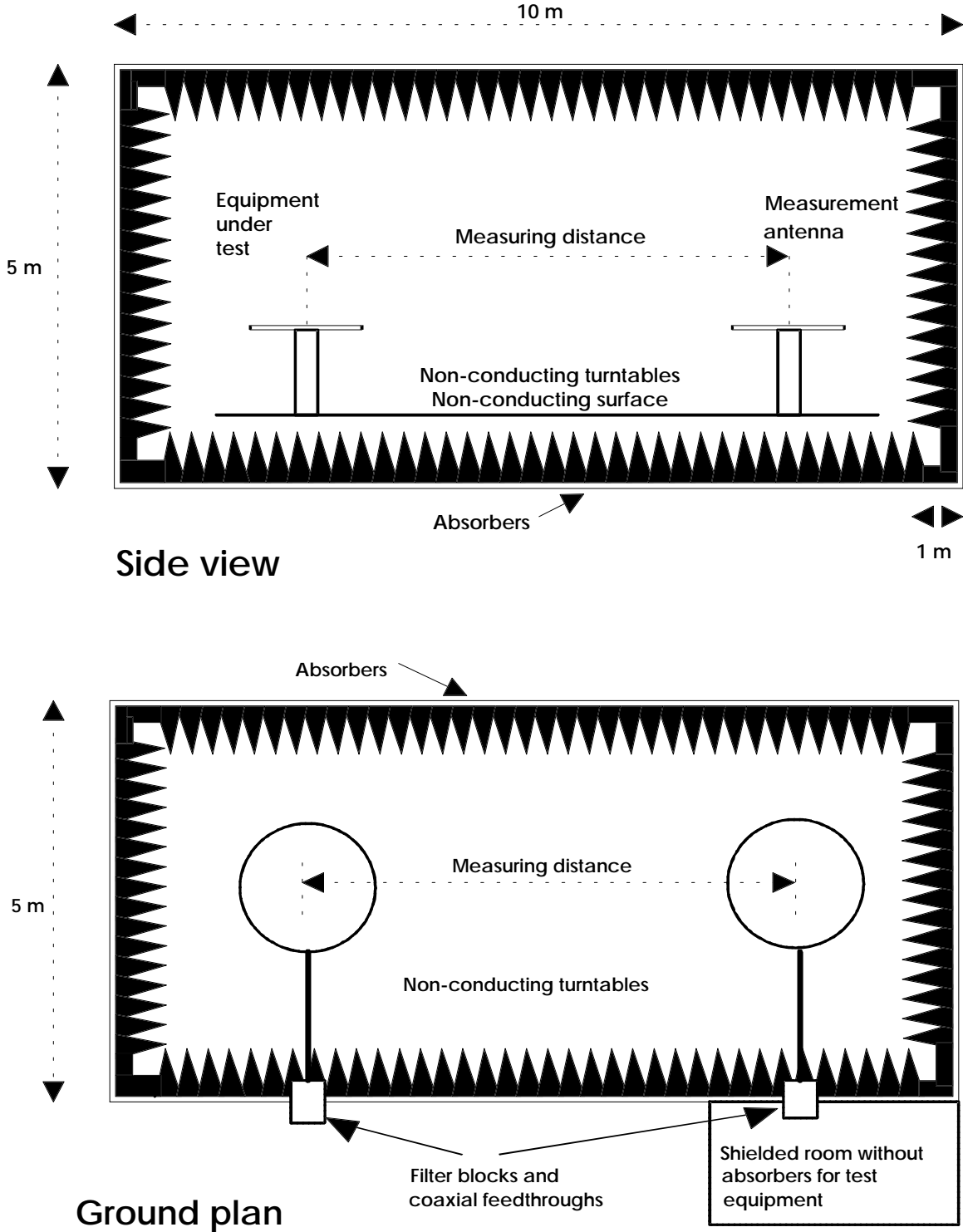

Figure B.5

**B.5.2 Open air test site suitable for emission tests**

A 3 m radiated emissions open air test site may be used to perform the measurements described in annex A, clause A.2, over the usable frequency range of the test site. The test site shall be calibrated at all measurement frequencies.

**B.5.2.1 Test site characteristics for radiated emissions testing**

**Table B.3**

Parameter	Limits
Useful frequency range:	30 MHz to 4 000 MHz
Radiation angle limits:	+ 40° to - 10°

Antennas for use at or above 1000 MHz shall be calibrated at the measuring distance at which it will be used.

**B.5.2.2 Radiation emissions test site**

The 3 m test site described provides consistent results regardless of time or location. It permits an accuracy over the useful frequency range comparable to that achievable on larger test sites, while requiring less sensitive instrumentation than on these larger sites.

The radiation test site shall be on level ground having uniform electrical characteristics and be free from reflecting objects over as wide an area as possible, to ensure that extraneous electromagnetic fields do not affect the accuracy of the test results.

A continuous ground screen (either sheet metal or wire mesh having openings no greater than 1 cm, which should maintain good electrical contact between the wires) shall be used to establish a uniformly conducting earth over part of the test site. The minimum ground screen area is shown in figure B.6.

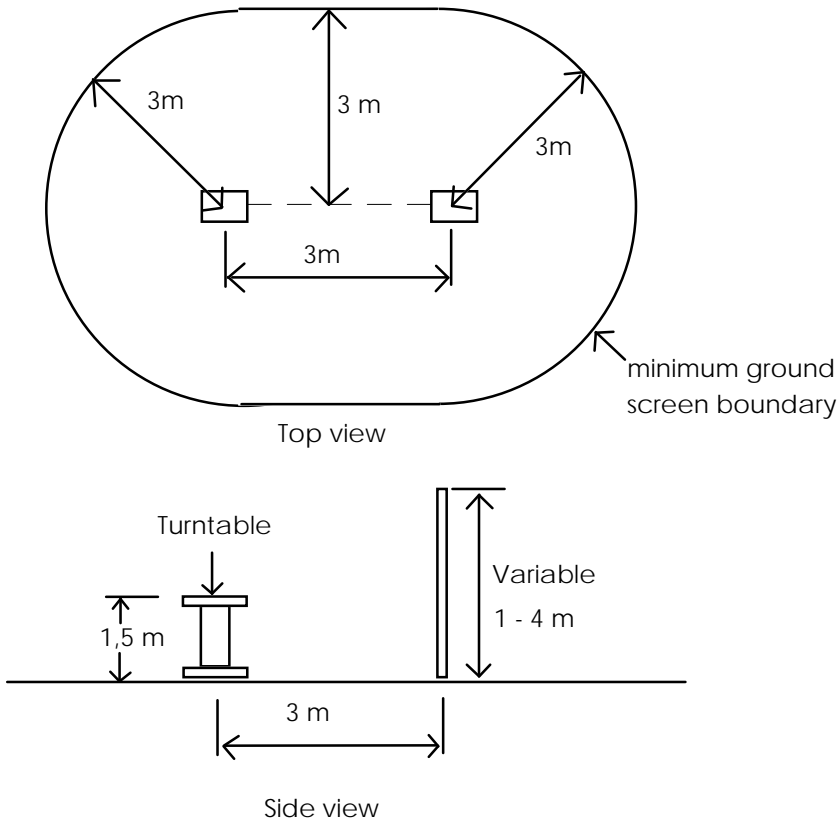

**Figure B.6: 3 m site dimensions inside the ground screen boundaries**

No extraneous conducting objects having any dimensions in excess of 5 cm should be present within the minimum ground screen boundary. Objects between the minimum ground screen boundary and the test site boundary shall not be such as to affect the test results.

The test site shall have a turntable and a support for the measuring antenna. The distance in the horizontal plane between the vertical axis through the centre of the turntable and the vertical axis through the centre of measuring antenna mounted on its support shall be 3 m. A shelter may be provided for all or

part of the test site. All such construction, except for nails, hinges, etc., having no dimension greater than 5 cm, shall be of wood, plastic, or other non-conducting material. Any wood shall be impregnated to ensure minimum water absorption.

All test equipment located above ground shall preferably be powered by batteries. If the equipment is powered from the mains, each of the mains supply cables shall be provided with a suitable radio-frequency filter. The cable connecting the filter and the measuring equipment shall be screened and shall be as short as possible. The cable connecting the filter and the supply mains shall be either screened and be at ground level, or shall be buried to a depth of approximately 30 cm.

#### **B.5.2.3 Position of the equipment under test**

The equipment in its cabinet or housing in which it normally operates shall be placed on a horizontal platform, the upper side of which is 1,5 m above the ground. The platform and its support shall be made of non-conducting material.

For equipment having an integral antenna, place the equipment on the platform in a position which is closest to its position in normal use.

For equipment having a rigid external integral antenna, the equipment shall be mounted so that the antenna is in a vertical position.

For equipment having a non-rigid external integral antenna, the antenna, shall be mounted vertically with a non-conducting support.

It shall be possible to rotate the equipment about the vertical axis through the centre of the antenna of the equipment under test. It is recommended that a platform in the form of a turntable, preferably remotely controlled, should be used for this purpose.

If the equipment has a power cable, it should extend down to the turntable, and any excess cable length should be coiled on the turntable.

#### **B.5.2.4 Measuring antenna support**

The measuring antenna support shall consist of a horizontal boom supported by a vertical pole, both being made of non-conducting material. The boom shall project at least 1 m from the vertical pole in the direction of the equipment under test and shall be arranged so that it may be raised and lowered from 1 m to 4 m.

#### **B.5.2.5 Measuring antenna**

The measuring antenna shall be suitable for the reception of linearly polarised waves. It may consist of a half-wave dipole, the length of which is adjusted for the frequency concerned. For practical reasons, however, or to increase the sensitivity of the measurements, it may be convenient to use a number of separate fixed broad band dipoles or more complex antennas.

The measuring antenna shall be mounted at the end of the horizontal boom. The mounting shall permit the antenna to be positioned for measuring both the horizontal and the vertical components of the electrical field. The lower end of the antenna, when oriented for vertical polarisation and placed in its lowest position, shall be at least 0,3 m above the ground.

The cable from the antenna shall be routed along the horizontal boom for at least 3 m and should preferably extend, while being at ground level, at least 3 m beyond the minimum boundary of the test site before it is connected to the selective measuring device. Alternatively, the cable may be routed underground.

#### **B.5.2.6 Substitution antenna**

The substitution antenna replaces the equipment under test during part of the measurement. The substitution antenna shall be a calibrated half-wave dipole and shall be arranged in a manner so that the centre of the substitution antenna shall coincide with the normal position of the centre of the equipment under test.

#### **B.5.2.7 Radio-frequency signal generator**

A well-shielded radio-frequency signal generator, with a matching or combining network (if required) and its associated output cable, shall be placed in a position such that it will not affect the accuracy of the test results, and shall be connected to and matched to the substitution antenna.

#### **B.5.2.8 Selective measuring device**

The selective measuring device may be either a frequency selective voltmeter, a spectrum analyser, or a calibrated field-strength meter, and shall be placed, together with its associated input cable, in a position such that it shall not affect the accuracy of the test results.

### **B.6 Description of test fixture**

It is useful to have available a test fixture so that measurements involving high signal levels, measurements requiring relative measurements, and measurements under extreme conditions can be readily carried out.

The test fixture shall be a radio frequency coupling device associated with an integral antenna equipment for coupling the integral antenna to a 50  $\Omega$  radio frequency terminal at the working frequencies of the equipment under test. This allows certain measurements to be performed using the conducted measurement methods. Measurements may only be performed at or near frequencies for which the test fixture has been calibrated. This calibration may be achieved by the determination of the reference figure as described in clause B.3.

In addition, the test fixture may provide:

- 1) a connection to an external power supply; and
- 2) interfaces to other relevant inputs and outputs.

The test fixture shall normally be provided by the applicant.

The performance characteristics of the test fixture shall be approved by the test laboratory and shall conform to the following basic parameters:

- a) circuitry associated with the RF coupling shall contain no active or non linear devices;
- b) the Voltage Standing Wave Ratio (VSWR) at the 50  $\Omega$  socket shall not be greater than 1,5 over the frequency range of the measurements;
- c) the coupling loss shall be substantially independent of the position of the test fixture and be substantially unaffected by the proximity of surrounding objects or people. The coupling loss shall be reproducible when the equipment under test is removed and replaced;
- d) the coupling loss shall remain substantially constant when the environmental conditions are varied.

### **B.7 Measurement uncertainty**

The measurement uncertainty should be evaluated according to the methodology described in ETR 028 [3] when applicable.

The maximum values of measurement uncertainty shown in table B.4 associated with each measurement parameter apply to all of the test cases described.

**Table B.4**

Parameter	Limit
Absolute radio frequency	$\pm 0,1$ ppm;
Bit Rate (average)	$\pm 1$ ppm;
Temperature	$\pm 2^{\circ}\text{C}$ ;
Length	$\pm 0,4$ %;
Relative Humidity	$\pm 5$ %.

The accumulated measurement uncertainties of the test system in use for the parameters to be measured should not exceed those given in table B.5. This is in order to ensure that the measurements remain within an acceptable quality.

**Table B.5: Recommended maximum acceptable uncertainties**

Measurement parameter	Maximum acceptable uncertainty
Sensitivity	$\pm 3$ dB
Two-signal measurement (stop band)	$\pm 4$ dB
Three signal measurement	$\pm 3$ dB
Radiated emissions of receivers	$\pm 6$ dB
NOTE: The uncertainty figures are valid for a confidence level of 95 %.	

## **B.8 Maximum degradation in required sensitivity**

The maximum degradation in required sensitivity is derived as follows:

- a) the reference figure (see clause B.3) is determined in a suitable test fixture (see clause B.6). Subtract 3 dB from this reference figure and note the result in dB $\mu$ V;
- b) the sensitivity is measured as in clause B.3 c) and d) under the required conditions, as described in the test, in the same test fixture and the results are noted in dB $\mu$ V;
- c) for all the results noted in b), when the figure noted in b) is more than the figure noted in a), record the difference in dB;
- d) the largest value noted in c) is defined as the maximum degradation in required sensitivity.

## **B.9 Differential factors**

### **B.9.1 General**

The usual presentation of a message today is a Liquid Crystal Display (LCD) integrated into the receiver and the usual alert function is an audible sound. During testing on a test site or in a test fixture, it would be much quicker if, instead of having to check the quality of the presented message, the tester could determine whether an audible alert has or has not been generated. Another speed advantage of the checking for an alert is that the receiver would not have to be moved in the test fixture. A further benefit, when testing at temperature extremes, is that the environmental chamber would not have to be opened to examine the message. This is especially critical at temperatures below 0°C, when it would be very difficult to avoid moisture condensing inside the chamber and on parts of the receiver.

If the signal level differential between the message presentation and the alert is determined and if tests are carried out using a suitable alert, then it is possible to calculate the signal level required for the message presentation by adding together the measurement obtained from the test using the alert and the differential previously obtained.

### **B.9.2 Definition of numeric differential factor**

The numeric differential factor is the difference between the signal level required for a receiver to recover a successful tone-only message and the signal level required to recover a successful numeric message (see subclause 4.5). It is established according to the following procedure:

- a) the receiver shall be placed into the test fixture (see clause B.6) oriented as specified by the manufacturer;
- b) a test paging signal consisting of a tone-only message shall be applied to the input of the test fixture. The test transmission shall be constructed as follows: a message constructed as in subclause 7.1.1 with the paging category bits set to 00 shall be transmitted. In the test transmission the alert bits in the message header shall be set to 000. The message shall consist only of the message header (see ETS 300 133-4 [1], subclause 5.5.1);
- c) the input signal level to the test fixture required to produce a message acceptance ratio of 80 % shall be determined according to the procedure described in annex A, subclause A.1.2, steps b) to e). The result shall be recorded in dB $\mu$ V;
- d) repeat step c), except that the test paging signal shall consist of a 10 character numeric message as described in subclause 4.5 and the acceptance of a successful numeric message shall be in accordance with the definition in subclause 4.5.2. The result shall be recorded in dB $\mu$ V;
- e) the numeric differential factor is defined as the difference between the result recorded in d) minus the result recorded in c), expressed in dB.

### B.9.3 Definition of alphanumeric differential factor

The alphanumeric differential factor is the difference between the signal level required for a receiver to recover a successful tone-only message and the signal level required to recover a successful alphanumeric message (see annex A, subclause A.1.1). It is established according to the following procedure:

- a) the receiver shall be placed into the test fixture (see clause B.6) oriented as specified by the manufacturer;
- b) a test paging signal consisting of a tone-only message (as described in annex B subclause B.9.2.b) shall be applied to the input of the test fixture;
- c) the input signal level to the test fixture required to produce a message acceptance ratio of 80 % shall be determined according to the procedure described in annex A, subclause A.1.2, steps b) to e). The result shall be recorded in dB $\mu$ V;
- d) repeat step c), except that the test paging signal shall consist of a 55 character alphanumeric message as described in annex A, subclause A.1.1 and the acceptance of a successful alphanumeric message shall be in accordance with the definition in annex A, subclause A.1.1. The result shall be recorded in dB $\mu$ V;
- e) the alphanumeric differential factor is defined as the difference between the result recorded in d) minus the result recorded in c), expressed in dB.

## B.10 Calculations of spurious responses frequencies

### B.10.1 Introduction to the method

To determine the frequencies at which spurious responses may occur the following calculations shall be made:

- a) calculation of the "limited frequency range":

the limited frequency range is equal to the frequency of the local oscillator signal ( $f_{lo}$ ) applied to the 1st. mixer of the receiver  $\pm$  the sum of the intermediate frequencies ( $if_1..if_n$ ) and half the switching range of the receiver ( $sr/2$ );

hence the limited frequency range =  $f_{lo} \pm (if_1 + if_2 + \dots + if_n + sr/2)$ ;

b) calculation of frequencies outside the limited frequency range:

a calculation of the frequencies at which spurious responses may occur outside the range determined in a) shall be made for the remaining frequency range of interest;

the frequencies outside the limited frequency range are equal to the harmonics of the frequency of the local oscillator signal ( $f_{lo}$ ) applied to the 1st mixer of the receiver  $\pm$  the numeric value of the 1st. intermediate frequency ( $if_1$ ) of the receiver;

hence the frequencies of these spurious responses =  $nf_{lo} \pm if_1$  where n is an integer greater than or equal to 2.

For the calculations a) and b) the manufacturer shall state the frequency of the receiver, the frequency of the local oscillator signal ( $f_{lo}$ ) applied to the 1st mixer of the receiver, the intermediate frequencies ( $if_1$ ,  $if_2$  etc.) and the switching range of the receiver.

NOTE: The switching range of the receiver is defined as the maximum frequency range over which the receiver can be operated without re-alignment or re-programming.

### B.11 Test time saving procedure

To reduce the time required for testing, tests may test only the tone-only function. For receivers declared to be in one of the categories tone only, numeric or alphanumeric (see subclause 6.3), a tone-only function shall be tested. For receivers in the transparent data category (see subclause 6.3.4), a manufacturer's declaration with a suitable test is required. For receivers in the numeric and alphanumeric categories, there is a differential between the performance of a receiver using the tone-only function and its declared category function, therefore it shall be necessary to correct the test result obtained using the tone-only function in order to determine the performance in its declared category. For this purpose a numeric differential factor and an alphanumeric differential factor have been defined (see annex B, clause B.9). These factors are added to the results obtained using the tone-only function in order to obtain the test result for the relevant category function. If a similar time saving procedure is used for transparent data receivers, then the test laboratory shall ensure that the method proposed in the manufacturer's declaration is satisfactory.

EXAMPLE: For the test associated with the measurement of the average usable sensitivity, the sensitivity under normal conditions using the tone-only function, a test result of 21,5 dB $\mu$ V/m was obtained. The receiver was declared to be an alphanumeric receiver and the alphanumeric differential factor was found to be 2 dB. Therefore, the alphanumeric sensitivity is then calculated to be 23,5 dB  $\mu$ V/m. Since this is below the limit set in clause 6, the receiver has passed this test.

## History

Document history	
July 1992	First Edition
April 1996	Public Enquiry PE 105: 1996-04-08 to 1996-08-30



