



EUROPEAN
TELECOMMUNICATION
STANDARD

Second FINAL DRAFT

pr **ETS 300 133-3**

September 1997

Second Edition

Source: ETSI TC-ERM

Reference: RE/ERM-RP04007-3

formerly RE/RES-04007-3

ICS: 33.020

Key words: ERMES, paging, radio, network

**Electromagnetic compatibility
and Radio spectrum Matters (ERM);
Enhanced Radio MESSage System (ERMES);
Part 3: Network aspects**

ETSI

European Telecommunications Standards Institute

ETSI Secretariat

Postal address: F-06921 Sophia Antipolis CEDEX - FRANCE

Office address: 650 Route des Lucioles - Sophia Antipolis - Valbonne - FRANCE

X.400: c=fr, a=atlas, p=etsi, s=secretariat - **Internet:** secretariat@etsi.fr

Tel.: +33 4 92 94 42 00 - Fax: +33 4 93 65 47 16

Copyright Notification: No part may be reproduced except as authorized by written permission. The copyright and the foregoing restriction extend to reproduction in all media.

© European Telecommunications Standards Institute 1997. All rights reserved.

Contents

Foreword	15
Intellectual Property Rights	16
1 Scope.....	17
2 Normative references.....	17
3 Definitions and abbreviations	18
3.1 Definitions.....	18
3.2 Abbreviations	21
4 System architecture.....	23
4.1 General	23
4.2 Telecommunication Network (TN) part.....	24
4.2.1 Functional description of PNC	24
4.2.2 Functional description of PAC	24
4.2.3 Functional description of BS	24
4.3 General description of network interfaces.....	24
4.3.1 I6 interface.....	25
4.3.2 I5 interface.....	25
4.3.3 I4 interface.....	25
4.3.4 I3 interface.....	25
4.3.5 I2 interface.....	25
4.3.6 I1 interface.....	25
4.4 Operation & maintenance network part	25
4.5 General description of O&M interfaces.....	26
5 Numbering, addressing and identification	29
5.1 General	29
5.2 Addressing and numbering	30
5.2.1 Mobile subscriber	30
5.2.1.1 Individual	30
5.2.1.1.1 One-stage selection.....	30
5.2.1.1.2 Two-stage selection.....	30
5.2.1.2 Group	31
5.2.2 Fixed subscribers	31
5.3 Identification of network functional blocks	31
5.4 Service access.....	32
5.4.1 Service numbers.....	32
5.4.2 Supplementary service identification codes	32
6 Call processing.....	33
6.1 Call processing for page input	33
6.1.1 General principles.....	33
6.1.1.1 PNC-I processing.....	35
6.1.1.2 PNC-H processing.....	36
6.1.1.3 PNC-T processing.....	37
6.1.2 Supplementary services	37
6.1.2.1 General principle.....	37
6.1.2.2 Choice of destination.....	37
6.1.2.3 Repetition.....	37
6.1.2.4 Prioritization.....	37
6.1.2.5 Multi-address.....	38

	6.1.2.6	Urgent message indication	38		
	6.1.2.7	Deferred delivery	38		
	6.1.2.8	Standard texts	38		
	6.1.2.9	Reverse charging	38		
6.1.3	Subscriber features.....		38		
	6.1.3.1	General principle.....	38		
	6.1.3.2	Diversion	38		
	6.1.3.3	Repetition.....	39		
	6.1.3.4	Message storing	39		
	6.1.3.5	Prioritization.....	39		
	6.1.3.6	Reverse charging	39		
	6.1.3.7	Temporary barring	39		
	6.1.3.8	Deferred delivery	40		
	6.1.3.9	Encryption	40		
	6.1.3.10	Roaming.....	40		
	6.1.3.11	Group call.....	40		
	6.1.3.12	Automatic retransmission of the last message number	41		
	6.1.3.13	Legitimation of all calls	41		
6.2	Call processing for access to subscriber features		41		
6.2.1	General principles.....		41		
6.2.2	Available to all calling parties		42		
	6.2.2.1	Subscriber directory	42		
6.2.3	Available to fixed subscribers.....		42		
	6.2.3.1	Address list management.....	42		
	6.2.3.2	Editing of standard text.....	42		
	6.2.3.3	Advice of accumulated call charges	42		
	6.2.3.4	Password management.....	42		
	6.2.3.5	Legitimation code management.....	43		
6.2.4	Available to mobile subscribers		43		
	6.2.4.1	Roaming.....	43		
		6.2.4.1.1	General principles.....	43	
		6.2.4.1.2	PNC-I processing.....	43	
		6.2.4.1.3	PNC-H processing	45	
	6.2.4.2	Temporary barring	46		
	6.2.4.3	Deferred delivery	47		
	6.2.4.4	Call diversion	48		
	6.2.4.5	Message retrieval	49		
	6.2.4.6	Password management.....	49		
	6.2.4.7	Legitimation code management.....	50		
	6.2.4.8	All features reset.....	50		
6.3	Call processing transaction time limits		51		
7	Access methods		52		
7.1	General		52		
	7.1.1	Generic protocol for non-interactive access mode	53		
	7.1.2	Generic protocol for interactive access mode - two-stage selection	54		
		7.1.2.1	Functional description of the protocol.....	54	
			7.1.2.1.1	Common elements (for both service numbers).....	54
			7.1.2.1.2	Protocol via Service Number 1 (SN1)....	55
			7.1.2.1.3	Protocol via Service Number 2 (SN2)....	55
		7.1.2.2	System responses and acknowledgement.....	56	
			7.1.2.2.1	General system messages	56
			7.1.2.2.2	Input prompts	56
			7.1.2.2.3	Input acknowledgements	57
			7.1.2.2.4	Help and guidance messages	58
		7.1.2.3	Input editing and typing error correction	58	
			7.1.2.3.1	The Escape command.....	58
			7.1.2.3.2	Other editing commands - terminals other than DTMF telephones.....	58

	7.1.2.4	Guidance to the calling party.....	59
	7.1.2.4.1	Help command	59
	7.1.2.4.2	Incomplete or interrupted input.....	59
	7.1.2.4.3	No input - time-out	59
	7.1.2.4.4	Invalid input.....	59
7.1.3		Generic protocol for interactive access mode - one-stage selection.....	59
	7.1.3.1	Functional description of the protocol.....	59
	7.1.3.1.1	Common elements.....	60
	7.1.3.1.2	The protocol.....	60
	7.1.3.2	System responses and acknowledgements.....	60
	7.1.3.2.1	General system message.....	61
	7.1.3.2.2	Input prompts.....	61
	7.1.3.2.3	Input acknowledgements.....	61
	7.1.3.2.4	Help and guidance messages	62
	7.1.3.3	Input editing and typing error correction	62
	7.1.3.3.1	The Escape command	62
	7.1.3.3.2	Other editing commands - terminals other than DTMF telephones	62
	7.1.3.4	Guidance to the calling party.....	62
	7.1.3.4.1	Help command	62
	7.1.3.4.2	Incomplete or interrupted input.....	63
	7.1.3.4.3	No input - time-out	63
	7.1.3.4.4	Invalid input.....	63
	7.1.4	Character conversion	63
	7.1.5	Use of special characters.....	64
7.2		Access methods applicable to each service.....	64
	7.2.1	Basic services	64
	7.2.2	Supplementary Services (SSs)	65
	7.2.2.1	Page input related SSs.....	65
	7.2.2.2	Subscriber features.....	65
	7.2.2.2.1	Subscriber directory.....	65
	7.2.2.2.2	Fixed subscribers	65
	7.2.2.2.3	Mobile subscribers.....	66
7.3		Telephonic access methods	66
	7.3.1	General	66
	7.3.1.1	Input editing and typing error correction	67
	7.3.1.2	Invoking the characters in the numeric service	67
	7.3.1.3	Invoking the characters in the alphanumeric service	67
	7.3.1.4	Guidance to the calling party.....	69
	7.3.2	One-stage selection method.....	69
	7.3.2.1	Tone-only message input.....	69
	7.3.2.1.1	Functional description of the protocol ...	69
	7.3.2.2	Numeric message input	69
	7.3.2.2.1	Functional description of the protocol ...	69
	7.3.2.2.2	System responses and acknowledgements	70
	7.3.2.3	Alphanumeric service.....	70
	7.3.2.3.1	Functional description of the protocol ...	70
	7.3.2.3.2	System responses and acknowledgements	70
	7.3.2.4	Message input with Supplementary Services (SSs).....	71
	7.3.2.4.1	Functional description of the protocol ...	71
	7.3.2.4.2	System responses and acknowledgements	71
	7.3.2.4.3	Supplementary Service (SS) sequences	71
	7.3.3	Two-stage selection method.....	72
	7.3.3.1	Tone-only message input.....	72
	7.3.3.1.1	Functional description of the protocol ...	72

	7.3.3.1.2	System responses and acknowledgements	73
	7.3.3.2	Numeric message input.....	73
	7.3.3.2.1	Functional description of the protocol....	73
	7.3.3.2.2	System responses and acknowledgements	73
	7.3.3.3	Alphanumeric message input.....	74
	7.3.3.3.1	Functional description of the protocol....	74
	7.3.3.3.2	System responses and acknowledgements	74
	7.3.3.4	Call input with supplementary services.....	74
	7.3.3.4.1	Functional description of the protocol....	74
	7.3.3.4.2	System responses and acknowledgements	75
	7.3.3.4.3	Supplementary service sequences	75
	7.3.3.5	Subscriber features for fixed subscribers	76
	7.3.3.5.1	Functional description of the protocol....	76
	7.3.3.6	Subscriber features for mobile subscribers.....	76
	7.3.3.6.1	Functional description of the protocol....	76
	7.3.3.6.2	System responses and acknowledgements	77
	7.3.3.6.3	Subscriber feature control sequences...	77
7.4	Alphanumeric terminal access methods		79
7.5	Telex access.....		79
	7.5.1	One-stage selection.....	79
	7.5.1.1	General.....	79
	7.5.1.2	Interactive mode	79
	7.5.1.2.1	Functional description of the protocol....	79
	7.5.1.3	Non-interactive mode.....	79
	7.5.1.3.1	Functional description of the protocol....	79
	7.5.2	Two-stage selection - interactive.....	79
	7.5.2.1	General.....	79
	7.5.2.1.1	System responses and acknowledgements	79
	7.5.2.1.2	Input editing and typing error correction.....	80
	7.5.2.1.3	Guidance to the calling party.....	80
	7.5.2.2	The protocol via SN1	80
	7.5.2.2.1	Interactive mode.....	80
	7.5.2.2.2	Fast interactive mode.....	80
	7.5.2.2.3	Call input related supplementary services	81
	7.5.2.3	The protocol via SN2.....	81
	7.5.2.3.1	Roaming interactive mode	81
	7.5.2.3.2	Roaming fast interactive mode.....	81
	7.5.3	Two-stage selection - non-interactive	82
	7.5.3.1	General.....	82
	7.5.3.2	The protocol via SN1	82
	7.5.3.2.1	Call input.....	82
	7.5.3.2.2	Call input related supplementary services	82
	7.5.3.3	The protocol via SN2.....	82
7.6	Message handling system access.....		83
	7.6.1	General.....	83
	7.6.2	ERMES access unit	83
	7.6.3	Structure of IP-message	83
	7.6.4	One-stage selection.....	84
	7.6.4.1	Operational procedures	84
	7.6.4.2	Call input	84
	7.6.5	Two-stage selection.....	84

	7.6.5.1	Operational procedures.....	84
	7.6.5.2	Call input.....	85
	7.6.5.3	Call input with supplementary services.....	85
	7.6.5.4	Access to subscriber features.....	85
7.7		Bureau access.....	85
7.8		Videotex access method.....	86
	7.8.1	General.....	86
	7.8.2	Message page input.....	86
7.9		ISDN Access.....	86
	7.9.1	General.....	86
	7.9.2	One-stage selection.....	87
	7.9.2.1	One-stage selection for tone-only service via ISDN.....	87
	7.9.2.2	One-stage selection for numeric service via ISDN (UUS3) ..	88
	7.9.2.3	One-stage selection for alphanumeric service via ISDN (UUS3).....	91
	7.9.2.4	One-stage selection for numeric service via ISDN (UUS1) ..	91
	7.9.2.5	One-stage selection for alphanumeric service via ISDN (UUS1).....	93
	7.9.3	Two-stage selection access type.....	93
	7.9.3.1	Two-stage selection for tone-only service via ISDN (UUS3).....	93
	7.9.3.2	Two-stage selection for numeric service via ISDN (UUS3) ..	96
	7.9.3.3	Two-stage selection for alphanumeric service via ISDN (UUS3).....	101
	7.9.3.4	Two-stage selection for numeric service via ISDN (UUS1) ..	101
	7.9.3.5	Two-stage selection for alphanumeric service via ISDN (UUS1).....	103
8		I5 interface.....	103
	8.1	General.....	103
	8.2	Universal computer protocol.....	103
	8.2.1	Introduction.....	103
	8.2.2	Operation and result.....	104
	8.2.3	Data transaction sequence.....	104
	8.2.4	Description of message format.....	105
	8.2.4.1	General.....	105
	8.2.4.2	Header.....	106
	8.2.4.3	Data field.....	106
	8.2.4.4	Checksum.....	106
	8.2.4.5	UCP version number negotiation:.....	106
	8.2.4.5.1	PNC-I supporting version 01.01 only... ..	107
	8.2.4.5.2	PNC-I supporting only lower versions than the version proposed by calling party.....	107
	8.2.4.5.3	PNC-I supporting the same version number.....	107
	8.2.4.5.4	PNC-I only supporting higher versions than the proposed one.....	107
	8.2.5	Operations provided by the Universal Computer Interface.....	107
	8.2.5.1	Enquiry operation.....	108
	8.2.5.1.1	Enquiry operation (positive result)	109
	8.2.5.1.2	Enquiry operation (negative result)	109
	8.2.5.2	Call input operation.....	109
	8.2.5.2.1	Call input operation (positive result)....	110
	8.2.5.2.2	Call input operation (negative result)...	110
	8.2.5.3	Multiple address call input operation.....	110
	8.2.5.3.1	Multiple address call input operation (positive result).....	111
	8.2.5.3.2	Multiple address call input operation (negative result).....	111

8.2.5.4	Call input with supplementary services operation	112
8.2.5.4.1	Call input with supplementary service operation (positive result)	113
8.2.5.4.2	Call input with supplementary information (negative result).....	113
8.2.5.5	Address list information operation.....	113
8.2.5.5.1	Address list information operation (positive result).....	114
8.2.5.5.2	Address list information operation (negative result).....	114
8.2.5.6	Change address list operation.....	114
8.2.5.6.1	Change address list operation (positive result).....	114
8.2.5.6.2	Change address list operation (negative result).....	114
8.2.5.7	Advice of accumulated charges operation	114
8.2.5.7.1	Advice of accumulated charges operation (positive result)	115
8.2.5.7.2	Advice of accumulated charges operation (negative result).....	115
8.2.5.8	Password management operation	115
8.2.5.8.1	Password management operation (positive result).....	115
8.2.5.8.2	Password management operation (negative result).....	115
8.2.5.9	Legitimation code management operation	115
8.2.5.9.1	Legitimation code management operation (positive result)	116
8.2.5.9.2	Legitimation code management operation (negative result).....	116
8.2.5.10	Standard text information operation	116
8.2.5.10.1	Standard text information operation (positive result).....	117
8.2.5.10.2	Standard text information operation (negative result).....	117
8.2.5.11	Change standard text operation.....	117
8.2.5.11.1	Change standard text operation (positive result).....	117
8.2.5.11.2	Change standard text operation (negative result).....	117
8.2.5.12	Request roaming information operation	118
8.2.5.12.1	Request roaming information operation (positive result).....	118
8.2.5.12.2	Request roaming information operation (negative result).....	118
8.2.5.13	Change roaming operation	118
8.2.5.13.1	Change roaming operation (positive result).....	119
8.2.5.13.2	Change roaming operation (negative result).....	119
8.2.5.14	Roaming reset operation.....	119
8.2.5.14.1	Roaming reset operation (positive result).....	119
8.2.5.14.2	Roaming reset operation (negative result).....	119
8.2.5.15	Message retrieval operation.....	119
8.2.5.15.1	Message retrieval operation (positive result).....	120
8.2.5.15.2	Message retrieval operation (negative result).....	121

8.2.5.16	Request call barring operation.....	121
8.2.5.16.1	Request call barring operation (positive result).....	121
8.2.5.16.2	Request call barring operation (negative result).....	121
8.2.5.17	Cancel call barring operation.....	121
8.2.5.17.1	Cancel call barring operation (positive result).....	122
8.2.5.17.2	Cancel call barring operation (negative result).....	122
8.2.5.18	Request call diversion operation.....	122
8.2.5.18.1	Request call diversion operation (positive result).....	122
8.2.5.18.2	Request call diversion operation (negative result).....	122
8.2.5.19	Cancel call diversion operation.....	122
8.2.5.19.1	Cancel call diversion operation (positive result).....	122
8.2.5.19.2	Cancel call diversion operation (negative result).....	122
8.2.5.20	Request deferred delivery.....	122
8.2.5.20.1	Request deferred delivery (positive result).....	123
8.2.5.20.2	Request deferred delivery (negative result).....	123
8.2.5.21	Cancel deferred delivery.....	123
8.2.5.21.1	Cancel deferred delivery (positive result).....	123
8.2.5.21.2	Cancel deferred delivery (negative result).....	123
8.2.5.22	All features reset operation.....	123
8.2.5.22.1	All features reset operation (positive result).....	123
8.2.5.22.2	All features reset operation (negative result).....	124
8.2.5.23	Call input operation with additional character set	124
8.2.5.23.1	Call input operation with specific character set (positive result)	124
8.2.5.23.2	Call input operation with specific character set (negative result)	124
8.2.5.24	UCP Version status request (OT = 23)	124
8.2.5.24.1	UCP Version status request (positive result).....	124
8.2.5.24.2	UCP Version status request (negative result).....	125
8.2.5.25	Mobile subscriber feature status request	125
8.2.5.25.1	Mobile subscriber feature status request (positive result).....	126
8.2.5.25.2	Mobile subscriber feature status request (negative result).....	126
8.2.6	Error codes.....	127
8.2.7	Error codes applicable to each operation.....	128
9	Network interworking (I4 interface)	128
9.1	General	128
9.2	Protocol stack for the I4 interface.....	129
9.2.1	Physical, link and network layers.....	129
9.2.2	Transport layer.....	129
9.2.3	Session layer	129
9.2.4	Presentation layer.....	129

	9.2.4.1	Presentation contexts	129
	9.2.5	Application layer	129
	9.2.5.1	ACSE.....	130
	9.2.5.2	ROSE	130
	9.2.5.3	Other application entities	130
9.3		PNC operations	130
	9.3.1	Introduction	130
	9.3.2	Description of operations.....	130
	9.3.2.1	General.....	130
	9.3.2.2	Pager information.....	130
	9.3.2.3	Page request.....	130
	9.3.2.4	Transmit.....	131
	9.3.2.5	Choice of destination	131
	9.3.2.6	Roaming validation	131
	9.3.2.7	Roaming reset	131
	9.3.2.8	Roaming information.....	131
	9.3.2.9	Change roaming.....	131
	9.3.2.10	Confirm change of roaming	131
	9.3.2.11	Call diversion start.....	131
	9.3.2.12	Call diversion stop.....	131
	9.3.3	Use of operations	131
9.4		Use of ACSE.....	133
9.5		Use of ROSE	134
9.6		PNC addressing	136
	9.6.1	PNC network address	136
	9.6.2	PNC layer 4, 5, 6 and application addresses.....	136
9.7		Interoperability of version 1 and version 2 systems.....	136
	9.7.1	Protocol negotiation between adjacent PNC's	136
10		I3 interface.....	137
	10.1	General description.....	137
	10.2	Functional description.....	137
	10.2.1	List of functional messages.....	137
	10.2.1.1	Paging data transfer, individual call.....	137
	10.2.1.2	Paging data transfer, group call.....	137
	10.2.1.3	Operation and maintenance messages	138
11		PAC to BS Interface (I2 interface).....	138
	11.1	General aspects and principles.....	138
	11.2	Layer 1	138
	11.3	Layer 2	138
	11.4	Layer 3	139
	11.5	Layer 4 (fragmentation).....	139
	11.5.1	General.....	139
	11.5.2	Fragmentation header	139
	11.5.3	Description	139
	11.6	Layer 7 (application)	140
	11.6.1	General.....	140
	11.6.2	Data processing	140
	11.6.3	Application header	140
	11.6.4	Transaction data.....	142
	11.6.4.1	General.....	142
	11.6.4.2	Page request transaction	142
	11.6.4.2.1	Page request operation	142
	11.6.4.2.2	Page request result.....	144
	11.6.4.3	BS time reference transaction	145
	11.6.4.3.1	BS time reference operation	145
	11.6.4.3.2	BS time reference result.....	145
	11.6.4.4	Status request transaction	146
	11.6.4.4.1	Status request operation	146

	11.6.4.4.2	Status request result.....	147
	11.6.4.5	Control command transaction.....	148
	11.6.4.5.1	Control command operation.....	148
	11.6.4.5.2	Control command result	150
	11.6.4.6	Poll request transaction	151
	11.6.4.6.1	Poll request operation	151
	11.6.4.6.2	Poll request result.....	151
	11.6.4.7	Report request transaction	152
	11.6.4.7.1	Report request operation	152
	11.6.4.7.2	Report request result	154
12		Paging network controller specification.....	156
	12.1	PNC functional description.....	156
	12.2	Database specifications	156
	12.2.1	Mobile Subscriber (MS) AdC-records database	157
	12.2.2	Mobile Subscriber (MS) RIC-message database.....	158
	12.2.3	Fixed subscriber records database	158
	12.2.4	Group database for group calls	159
	12.2.5	Closed User Group (CUG) database.....	159
	12.2.6	System addressing database	159
	12.2.6.1	PNC/PNC addressing	160
	12.2.6.2	PNC/OMC addressing.....	160
	12.2.6.3	PNC/PAC addressing	160
	12.2.7	System configuration database.....	160
	12.2.8	System status database.....	160
	12.2.9	Geographical area database	161
	12.3	Management of the I5 interface	161
	12.3.1	Configuration.....	161
	12.3.2	Processing of fault situations	161
	12.3.3	Processing of O&M data.....	161
	12.4	Management of the I4 interface	161
	12.4.1	Control of I4 passwords.....	162
	12.5	Management of the I3 interface	162
	12.6	Call acceptance principles and calculation	162
	12.6.1	General principles.....	162
	12.6.2	Definition of terms.....	163
	12.6.3	State detection and parameter calculation	165
	12.6.4	Availability and delay evaluation	166
	12.6.4.1	Availability evaluation involving only paging areas.....	166
	12.6.4.2	Availability evaluation involving only geographical areas....	166
	12.6.4.3	Availability evaluation involving paging and geographical areas	167
	12.6.4.4	Delay evaluation involving only paging areas.....	167
	12.6.4.5	Delay evaluation involving only geographical areas.....	167
	12.6.4.6	Delay evaluation involving both paging and geographical areas	168
	12.7	Universal time reference.....	168
	12.8	Translation of national character sets to the ERMES character set.....	168
	12.9	Encryption.....	168
	12.10	Transparent data calls	169
	12.11	Call queuing	169
13		Paging area controller.....	169
	13.1	General description	169
	13.2	PAC architecture	170
	13.2.1	Management of the paging area in a time division environment.....	170
	13.3	Input section (I3 interface).....	171
	13.4	Output section (I2 interface).....	171
	13.5	Control section	172
	13.5.1	Functional implementation.....	173

13.5.2	Input control	174
13.5.3	Output control.....	175
13.5.4	Allocation process.....	175
13.5.5	Example of call processing	176
13.5.5.1	Control parameters	177
13.5.5.2	Queuing procedure.....	178
13.6	Database.....	179
13.6.1	PAC traffic database in the control section.....	179
Annex A (normative):	Incompatible combinations of supplementary services	182
Annex B (normative):	SDL diagrams for call processing and I4 operations	184
B.1	General.....	184
B.2	Call processing for page input.....	184
B.3	Call processing for roaming	204
B.4	Call processing for call diversion	214
Annex C (informative):	List of access methods	215
Annex D (normative):	SDL diagrams for interactive access mode.....	216
D.1	General.....	216
D.2	For page input	216
D.3	For subscriber features	216
Annex E (normative):	PNC I4 ROSE operations.....	245
E.1	General.....	245
E.1.1	Pager information operation.....	245
E.1.1.1	Pager information operation - positive result.....	245
E.1.1.2	Pager information operation - negative result parameters.....	247
E.1.2	Choice of destination operation	247
E.1.2.1	Choice of destination operation (positive result).....	248
E.1.2.2	Choice of destination operation (negative result).....	248
E.1.3	Page request operation.....	248
E.1.3.1	Page request operation (positive result).....	249
E.1.3.2	Page request operation (negative result)	249
E.1.4	Transmit operation.....	250
E.1.4.1	Transmit operation (positive result).....	251
E.1.4.2	Transmit operation (negative result)	251
E.1.5	Roaming validation operation	251
E.1.5.1	Roaming validation operation (positive result).....	252
E.1.5.2	Roaming validation operation (negative result).....	252
E.1.6	Roaming reset operation	252
E.1.6.1	Roaming reset operation (positive result).....	252
E.1.6.2	Roaming reset operation (negative result).....	252
E.1.7	Roaming information operation.....	252
E.1.7.1	Roaming information operation (positive result)	253
E.1.7.2	Roaming information operation (negative result)	253
E.1.8	Change roaming operation.....	253
E.1.8.1	Change roaming operation (positive result)	254
E.1.8.2	Change roaming operation (negative result)	254
E.1.9	Confirm change of roaming operation	255
E.1.9.1	Confirm change of roaming operation (positive result).....	255

	E.1.9.2	Confirm change of roaming operation (negative result).....	255
E.1.10		Call diversion start operation	256
	E.1.10.1	Call diversion start operation (positive result)	256
	E.1.10.2	Call diversion start operation (negative result)	256
E.1.11		Call Diversion stop operation	256
	E.1.11.1	Call diversion stop operation (positive result)	257
	E.1.11.2	Call diversion stop operation (negative result)	257
E.2		Negative result parameters common to all operations.....	257
E.3		Use and presentation of I4 parameters.....	257
	E.3.1	General	257
	E.3.2	Description of parameters	258
		E.3.2.1 Pager information operation.....	258
		E.3.2.2 Choice of destination operation	259
		E.3.2.3 Page request operation.....	260
		E.3.2.4 Transmit operation.....	261
		E.3.2.5 Roaming validation operation	262
		E.3.2.6 Roaming reset operation	262
		E.3.2.7 Roaming information operation.....	262
		E.3.2.8 Change roaming operation.....	263
		E.3.2.9 Confirm change roaming operation.....	263
		E.3.2.10 Call diversion start operation	263
		E.3.2.11 Call diversion stop operation.....	264
Annex F (normative):		PNC I4 ROSE ASN.1 transcription.....	265
F.1		General	265
F.2		Operation types ASN.1 specification	265
Annex G (informative):		Typical I6 dialogues for the input of calls	276
History		285

Blank page

Foreword

This second final draft European Telecommunication Standard (ETS) has been produced by the Electromagnetic compatibility and Radio spectrum Matters (ERM) Technical Committee of the European Telecommunications Standards Institute (ETSI).

The final draft (January 1997) was adopted after Vote 9711. However, during the vote process, it was discovered that there were some respects in which Edition 2 was not compatible with Edition 1. These compatibility issues have been addressed and this second final draft is now resubmitted for the Voting phase of the ETSI standards approval procedure.

This ETS comprises seven parts with the generic title "Electromagnetic compatibility and Radio spectrum Matters (ERM); Enhanced Radio MESSAGE System (ERMES)". The title of each part is listed below:

Part 1: "General aspects";

Part 2: "Service aspects";

Part 3: "Network aspects";

Part 4: "Air interface specification";

Part 5: "Receiver conformance specification";

Part 6: "Base station specification";

Part 7: "Operation and maintenance aspects".

This part, ETS 300 133-3, gives a system architecture description of the Enhanced Radio MESSAGE System (ERMES), including the numbering, addressing and identification of subscribers together with call processing. This part also gives specifications for:

- methods of access to the ERMES system;
- internal interfaces within the ERMES system;
- the paging network controller;
- the paging area controller.

Proposed transposition dates	
Date of latest announcement of this ETS (doa):	3 months after ETSI publication
Date of latest publication of new National Standard or endorsement of this ETS (dop/e):	6 months after doa
Date of withdrawal of any conflicting National Standard (dow):	6 months after doa

Intellectual Property Rights

IPRs essential or potentially essential to this ETS may have been declared to ETSI. The information pertaining to these essential IPRs, if any, is publicly available for **ETSI members and non-members**, and can be found in ETR 314: *"Intellectual Property Rights (IPRs); Essential, or potentially Essential, IPRs notified to ETSI in respect of ETSI standards"*, which is available **free of charge** from the ETSI Secretariat. Latest updates are available on the ETSI Web server (<http://www.etsi.fr/ipr>).

Pursuant to the ETSI Interim IPR Policy, no investigation, including IPR searches, has been carried out by ETSI. No guarantee can be given as to the existence of other IPRs not referenced in ETR 314 (or the updates on <http://www.etsi.fr/ipr>) which are, or may be, or may become, essential to this ETS.

1 Scope

This European Telecommunication Standard (ETS) describes the network aspects of the Enhanced Radio Message System (ERMES).

2 Normative references

This ETS incorporates by dated or undated reference, provisions from other publications. These normative references are cited at the appropriate places in the text and the publications are listed hereafter. For dated references subsequent amendments to, or revisions of any of these publications apply to this ETS only when incorporated in it by amendment or revision. For undated references the latest edition of the publication referred to applies.

- [1] prETS 300 133-2 (1997): "Electromagnetic compatibility and Radio spectrum Matters (ERM); Enhanced Radio Message System (ERMES); Part 2: Service aspects".
- [2] prETS 300 133-4 (1997): "Electromagnetic compatibility and Radio spectrum Matters (ERM); Enhanced Radio Message System (ERMES); Part 4: Air interface specification".
- [3] prETS 300 133-7 (1997): "Electromagnetic compatibility and Radio spectrum Matters (ERM); Enhanced Radio Message System (ERMES); Part 7: Operation and maintenance aspects".
- [4] ITU-T Recommendation E.163: "PSTN international dialling numbers".
- [5] CEPT Recommendation T/SF 31: "Services and facilities aspects of an Integrated Services Digital Network (ISDN)".
- [6] ITU-T Recommendation F.69: "Plan for telex destination codes".
- [7] ITU-T Recommendation F.410: "Message handling services: The public message transfer service".
- [8] ITU-T Recommendation F.420: "Message handling services: The public interpersonal messaging service".
- [9] ITU-T Recommendation F.300: "Videotex service".
- [10] ITU-T Recommendation S.1: "International Telegraph Alphabet No. 2".
- [11] ITU-T Recommendation S.2: "Coding scheme using International Telegraph Alphabet No. 2 (ITA 2) to allow the transmission of capital and small letters".
- [12] ITU-T Recommendation X.400: "Message handling system and service overview".
- [13] ITU-T Recommendation X.21: "Interface between data terminal equipment (DTE) and data circuit-terminating equipment (DCE) for synchronous operation on public data networks".
- [14] ITU-T Recommendation X.25: "Interface between data terminal equipment (DTE) and data circuit-terminating equipment (DCE) for terminals operating in the packet mode and connected to public data networks by dedicated circuit".
- [15] ITU-T Recommendation X.208: "Specification of abstract syntax notation one (ASN.1)".

- [16] ITU-T Recommendation X.209: "Specification of basic encoding rules for abstract syntax notation one (ASN.1)".
- [17] ITU-T Recommendation X.213: "Network service definition for open systems interconnection for ITU-T applications".
- [18] ITU-T Recommendation X.214: "Transport service definition for open systems interconnection".
- [19] ITU-T Recommendation X.215: "Session service definition for open systems interconnection for ITU-T applications".
- [20] ITU-T Recommendation X.217: "Association control service definition for open systems interconnection for ITU-T applications".
- [21] ITU-T Recommendation X.219: "Remote operations: model, notation and service definition".
- [22] ITU-T Recommendation X.223: "Use of X.25 to provide the OSI connection-mode network service for ITU-T Applications".
- [23] ITU-T Recommendation X.224: "Transport protocol specification for Open Systems Interconnection for ITU-T Applications".
- [24] ITU-T Recommendation X.225: "Session protocol specification for Open Systems interconnection".
- [25] ITU-T Recommendation X.226: "Presentation protocol specification for Open Systems Interconnection for ITU-T Applications".
- [26] ITU-T Recommendation X.227: "Association control protocol specification for Open Systems Interconnection for ITU-T Applications".
- [27] ITU-T Recommendation X.121: "The International numbering plan for public data networks".
- [28] ITU-T Recommendation X.229: "Remote operations: Protocol specification".
- [29] ISO 7776: "Information processing systems - Data communications - High-level data link control procedures - Description of the X.25 LAPB-compatible DTE data link procedures".
- [30] ITU-T Recommendation X.135: "Speed of service (delay and throughput) performance values for public data networks when providing international packet-switched services".
- [31] ITU-T Recommendation Z.100: "Specification and description language (SDL)".
- [32] ISO 646 (1991): "Information technology - ISO 7-bit coded character set for information exchange".

3 Definitions and abbreviations

3.1 Definitions

For the purposes of this ETS, the following definitions apply:

Address Code (AdC): Identifies the Radio Identity Code (RIC) and alert signal indicator.

access method: A combination of access terminal, access network, access mode and access type.

access mode: The communication procedure between the calling party and the Paging Network Controller (PNC). It may be interactive or non-interactive.

access network: The telecommunications network to which the access terminal is connected.

access service: A set of access methods provided to a user to access a service and/or a supplementary service in the ERMES network.

access terminal: The terminal with which the user accesses the Telecommunication Network (TN). It may be for example a telephone set, a telex, a videotex terminal, a PC with modem.

access type: Corresponds to the one-stage or two-stage selection.

Authentication Code (AC): A code used by a mobile or a fixed subscriber to allow the PNC to prove that the identity stated by this subscriber is true.

basic kernel: The minimum of functionalities required for each I4 protocol layer.

calling party: A user entering paging tasks into the network.

call acceptance: The response to the calling party provided by the Home PNC (PNC-H). This response indicates whether or not the call can be accepted.

control section: Functional part of the Paging Area Controller (PAC) which mainly converts the page message flow coming from the PNC in the page request operation to the flow directed to the Base Station (BS).

Closed User Group (CUG) database: The database including the details on the membership of a CUG.

Divert AdC (DAdC): The Address Code (AdC) to which a mobile subscriber has diverted his paging messages.

external interface: An interface that is not completely contained within an operator network.

external receiver: A receiver operating in a network which is not its home network.

fixed subscriber: A calling party who is registered in an operator network and has an account for sending messages and use of subscriber features.

fixed subscriber records database: The database giving details of the features available to a particular fixed subscriber.

fragmentation: Service offered at OSI layer 4 which allows the splitting of an application packet into several smaller packets.

Geographical Area (GA): One or several paging areas in an operator network. Defined by agreements between network operators for inter network roaming or by a single operator for roaming within his own network. It is used for roaming and choice of destination supplementary services.

Group Address Code (GAdC): The address code with which a group is called.

group database: The database giving information on the members of a mobile subscriber group.

Home PNC (PNC-H): The PNC holding the subscriber registration database for a particular mobile subscriber and to which all calls for this mobile subscriber are referred for processing.

Input PNC (PNC-I): PNC that is accessed by a calling party.

internal interface: An interface that is completely contained within an operator network.

IVRx: Version number of the interface number x.

legitimisation code: A code stated by a calling party to prove that he is authorized to carry out a particular restricted operation (an operation which is not allowed to all calling parties).

mobile subscriber: A user who is registered in an operator network and receives paging messages or uses his subscriber features.

mobile subscriber AdC records database: The database giving the required information on mobile subscribers for the processing of paging calls.

mobile subscriber RIC message database: The database dealing with message numbering and storing.

MVRx: Main version number of interface number x.

network status: An estimated value of the probability that the ERMES system will proceed successfully with the paging call. It is estimated on a per call basis and depends on the availability of all the elements of the system dealing with this call attempt and on message delivery time.

network time slot: A particular configuration of an operator's network during a time slot which consists of only one Paging Area (PA) comprising every BS of the network.

one-stage selection: Access type with two phases, input AdC and input message.

operator network: All infrastructure which is the responsibility of the network operator.

Paging Area (PA): The area controlled by a PAC. It is the minimum area to which a mobile subscriber is permitted to subscribe in order to receive his paging messages.

Paging Area Controller (PAC): The functional entity controlling the BSs within one paging area.

Paging Network Controller (PNC): The central call processing unit associated with each operator's Telecommunication Network (TN). It administers subscriber registrations and performs paging tasks.

PNC-H(FS): The PNC holding the subscriber registration database for a particular fixed subscriber and to which all calls of this fixed subscriber are referred for processing.

protocol stack: A set of protocols defined to build up to the I4 interface.

roaming test message: A paging message sent automatically by the PNC-H to the roaming area when the roaming is activated.

service identification code: A two digit code used for the identification of a supplementary service or a subscriber feature.

service number: The number used to gain access to a PNC in the two-stage selection procedure.

standard text: A predefined text message associated with an identification number. The texts are defined by the network operator or may be defined by fixed subscribers.

subscriber feature: Service or supplementary service available to a subscriber according to his subscription. The feature may be activated on a registration basis or on demand. In this last case, it is activated by the subscriber, after authentication.

SVRx: Sub-version number of interface number x.

Telecommunication Network (TN): The telecommunication part of the operator network.

three state status: The criteria for the call acceptance. If the network status is above a threshold C the call is accepted. If it is below a threshold UC the call is rejected. Between these two thresholds the calling party receives information that the transmission cannot be guaranteed with the full Quality Of Service (QOS) and a confirmation of the call attempt is demanded from the calling party.

telecommunications management network: The operation and maintenance part of the operator network.

Transmit PNC (PNC-T): The PNC responsible for routing a particular paging message to the appropriate paging areas which are under its control.

two-stage selection: Access type with three phases, input service number, input AdC and input message.

user: A person or a machine initiating an access to an operator network or receiving a message through the operator network. It includes mobile subscribers, fixed subscribers and non registered customers.

user defined text message: When acknowledging a demand from a calling party, the system may offer the possibility to send a customized message giving specific information from the called party.

3.2 Abbreviations

For the purposes of this ETS, the following abbreviations apply:

AC	Authentication Code
ACK/NACK	Positive/Negative Acknowledgement
ACSE	Association Control Service Element
AdC	Address Code
ADF	Address Field
AH	Application Header
AIF	Additional Information Field
AII	Additional Information Indicator
AIN	Additional Information Number
AIT	Additional Information Type
ALERT	Alert Function for different types of alert
APT	Address Partition Terminator
ASN.1	Abstract Syntax Notation one
AU	Access Unit
BAI	Border Area Indicator
BAL	Batch Length
BS	Base Station
BSA	BS Address
BSS	Base Station Status
CHAN	CHAnel Number
COC	Control Order Command
COI	Control Order Information
CSPDN	Circuit Switched Public Data Network
CTA	Common Temporary Address
CTAP	Common Temporary Address Pointer
CUG	Closed User Group
DAdC	Divert AdC
DCE	Data Communications Equipment
DD	Deferred Delivery
DL	Distribution List
DNIC	Data Network Identification Code
DTE	Data Terminal Equipment
DTMF	Dual Tone Multi-Frequency
EB	External Bit
ECC	Error Correcting Code
EOM	End of Message
ERMES	Enhanced Radio MESSage System

ETI	External Traffic Indicator
ETY	Error TYpe
FPL	Fragmented Packet Length
FRN	Fragmentation Reference Number
FS	Fixed Subscriber
FSI	Frequency Subset Indicator
FSN	Frequency Subset Number
GA	Geographical Area
GAdC	Group AdC
HDLC	High Level Data Link Control
I2	Interface PAC-BS
I4	Interface PNC-PNC
IAB	Initial Address Buffer
IACP	Initial Address Confirmation Pointer
IASP	Initial Address Service Pointer
IDD	International Direct Dialling
IMI	Integral Message Indicator
IOMC	Interface OMC-NMC or OMC-OMC
IPM	Interpersonal Messaging
ISDN	Integrated Services Digital Network
ISO	International Standard Organization
IVR1	Interface 1 Version Number
LAPB	Link Access Protocol Balanced
LID	List Identification (text list identification)
LSB	Least Significant Bit
MD	Mediation Device
MEF	Message Field
MEL	Message Length
MHS	Message Handling System
MS	Mobile Subscriber
MSB	Most Significant Bit
MT	Message Type
NIA	Number of Initial Address
NOP	Number of Packet
OMC	Operation and Maintenance Centre
OMI	Operation and Maintenance Information
O&M	Operation and Maintenance
OPID	Operator Identity (of the home operator)
ORI	Operation or Result Identification
OS	Operation System
OSI	Open System Interconnection
PAA	PAC Address
PA	Paging Area
PAC	Paging Area Controller
PAC-OS	The part of the PAC dealing with the O&M process
PDU	Protocol Data Unit
PN	Packet Number
PNC	Paging Network Controller
PNC-H	Home PNC
PNC-H(DIV)	Divert AdC's Home PNC
PNC-H(FS)	Fixed subscriber's Home PNC
PNC-I	Input PNC
PNC-T	Transmit PNC
POA	POll request Acknowledge
PR	Priority
PRA	Page Request Acknowledge
PSPDN	Packet Switched Public Data Network
PSTN	Public Switched Telephone Network
QOS	Quality Of Service
RA	Roaming Area

RF	Radio Frequency
RIC	Radio Identity Code
ROSE	Remote Operation Service Element
RPI	Reported Parameter Information
RRI	Report Request Information
RRP	Report Request Parameter
RSVD	Reserved
RTSE	Reliable Transfer Service Element
SDL	Specification and Description Language
SDU	Service Data Unit
SA	Service Area
SF	Subscriber Feature
SI	Subscriber Identification
SIC	Service Identification Code
SN	Service Number
SRA	Status Request Acknowledge
SRT	Status Request Type
SS	Supplementary Service
SSI	Supplementary System Information
SSN	Sub-Sequence Number
SYD	System Data
TD	Transparent Data
TMN	Telecommunications Management Network
TN	Telecommunication Network
TNO	Text number (number of selected text)
TO	Tone Only
TRD	Time Reference Data
TRN	Transaction Reference Number
TPL	Transaction Packet Length
TRA	Time Reference Acknowledge
TX	Transmitter
UA	User Agent
UMI	Urgent Message Indicator
UTC	Universal Time Co-ordinated
UUI	User-to-User Information
UUS	User-to-User Signalling
VIF	Variable Information Field

4 System architecture

4.1 General

An operator network comprises two main components, the TN part and the operation and maintenance network part.

To satisfy the roaming requirements of the ERMES service aspects ETS 300 133-2 [1], the operator networks shall be connected together to provide extended coverage. Thus the composite ERMES system shall consist of two associated sets of networks. Figure 1 illustrates this aspect.

In this part, the detailed organization of the TN is described and defined including all operational entities and interfaces. The overall operational aspects of the Operation and Maintenance (O&M) network are also considered in this part especially with respect to interfacing with the TN, but detailed internal operation of the O&M network part is addressed separately in ETS 300 133-7 [3].

In this clause the network functional architecture is presented and described. The detailed description is considered in later clauses.

4.2 Telecommunication Network (TN) part

The Telecommunication Network (TN) part of the ERMES system is a set of TNs, as shown in figure 2, communicating with each other through the I4 interface.

The functional split between TN and O&M ERMES network is shown in figure 3.

Each TN is associated with a Paging Network Controller (PNC) that controls the network related features and manages the I3, I4 and I5 interfaces.

Each Paging Area Controller (PAC) is a functional block which manages one Paging Area (PA). The maximum number of PACs controlled by one PNC shall be 64.

Each PAC shall have responsibility for the Base Stations (BSs) giving the required PA radio coverage.

4.2.1 Functional description of PNC

The PNC may perform one or several of the following roles during call processing or internetworking:

- PNC-I (Input) = user's access through the telecommunication access network;
- PNC-H (Home) = management and control of the subscriber's data base (all calls to the subscriber are referred to PNC-H for processing);
- PNC-T (Transmit) = control of the radio transmission in the area(s) which is (are) under its responsibility.

Playing these roles, the PNC shall interact with other networks through the I4 interface. Any combination of roles may be performed in one PNC.

The other main functions of the PNC are management of the transmissions to paging areas and the dialogue, through the PNC-OS, with the O&M network.

4.2.2 Functional description of PAC

The main task of each PAC is to organize paging message queuing and batching, and to manage the priority of the paging messages which it delivers to the Base Stations (BSs) under its control via the I2 interface.

Each PAC receives information from the PNC through the I3 interface.

Each PAC has responsibility to manage its associated I2 interfaces.

Each PAC has responsibility to manage its database and to converse, through the PAC-OS, PNC-OS and relevant mediation functions, with the O&M network.

4.2.3 Functional description of BS

The main task of the BS is to manage the I1 interface through the transmitters. The I1 interface is described in ETS 300 133-4 [2]. The BS gives acknowledgements back to its associated PAC and provides status information through the Mediation Device (MD) to PAC-OS.

4.3 General description of network interfaces

Six system interfaces are shown in the network architecture given in figure 2. The network-related interfaces I2 to I6 are the subject of this part of the ERMES specification and is defined in detail in subsequent clauses. The I1 interface is defined in detail in ETS 300 133-4 [2].

To establish a functional description of these interfaces in line with the functional entities described previously, general descriptions of the network interfaces are given in subclauses 4.3.1 to 4.3.6.

4.3.1 I6 interface

This is the user interface. It is an external interface.

Access methods are divided in two categories; telephonic and non-telephonic. A detailed description is given in clause 7.

4.3.2 I5 interface

The interface between the I6 telecommunications access network selected by the user and the operator network is the I5 interface. This is an external interface.

The I5 interface is described in clause 8.

4.3.3 I4 interface

This is the interface between PNCs. The data connection uses a Packet Switched Public Data Network (PSPDN). A detailed description of this interface is given in clause 9.

This is an external interface.

4.3.4 I3 interface

This is the interface between the PNC and the PAC. The interface is described in clause 10.

This is an internal interface.

4.3.5 I2 interface

This is the interface between the PAC and the BS. The description of this interface is given in clause 11.

This is an internal interface.

4.3.6 I1 interface

This is the radio air interface defined in ETS 300 133-4 [2]. It is an external interface.

4.4 Operation & maintenance network part

The functional network configuration for the Telecommunication Management Network (TMN) is included in figure 3.

Two types of Operating System (OS) are depicted:

- a basic OS associated with a given network element (PAC, PNC, etc.); and
- a network OS called the Operation and Maintenance Centre (OMC), which is responsible for the O&M at a network level.

A network management function is also included in the OMC for supervising the network interworking and also for harmonizing the management choices among the operators.

In addition, the TMN contains an MD performing some decentralized functions to the BSs (data concentration and handling, protocol conversion, pre-processing).

The OMC is the centre of any network-oriented management action and it also plays an important role for co-ordinating the data exchanges between different operator networks. It implements the following higher level functions inside the O&M environment:

- network and system configuration management; software updating and back-up; operating and administrative functions;
- alarm management and synthesis; test handling; storage and processing of the alarms and test report;
- measurement of traffic data, network performance and Quality Of Service (QOS) calculations; start of the management actions;
- handling of traffic records (which may be used for billing and accounting) and their routing among the operators.

4.5 General description of O&M interfaces

Figure 4 gives the O&M interfaces corresponding to the functional configuration of figure 3. It should be noted that the MD working to the BS has been directly associated with the PAC-OS so that there is no requirement to specify an interface.

All O&M activities are controlled by the OMC. The O&M messages related to the PAC-OS and BSs are carried by I3 and I2 interfaces as well as by the OMC-PNC interface. OMC-PNC and IOMC interfaces are specifically defined for O&M.

NOTE: IOMC is the interface between OMCs, described in ETS 300 133-7 [3]. It is an external interface.

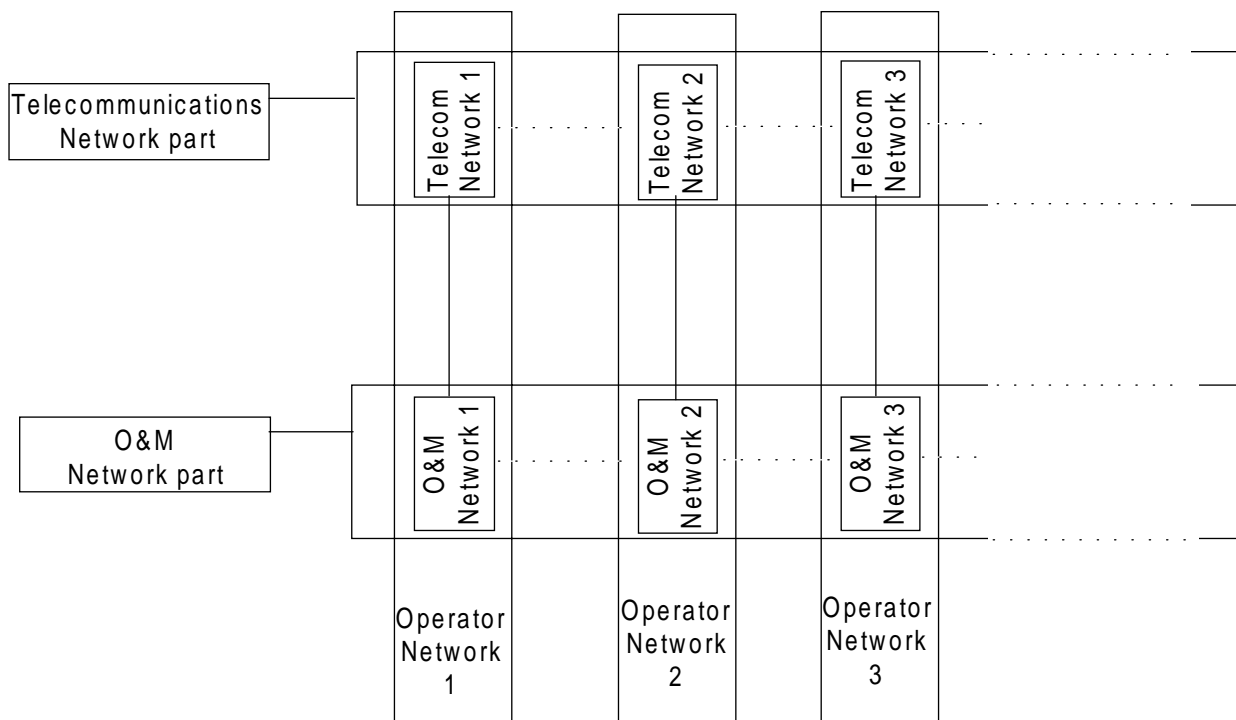

Figure 1: ERMES system architecture

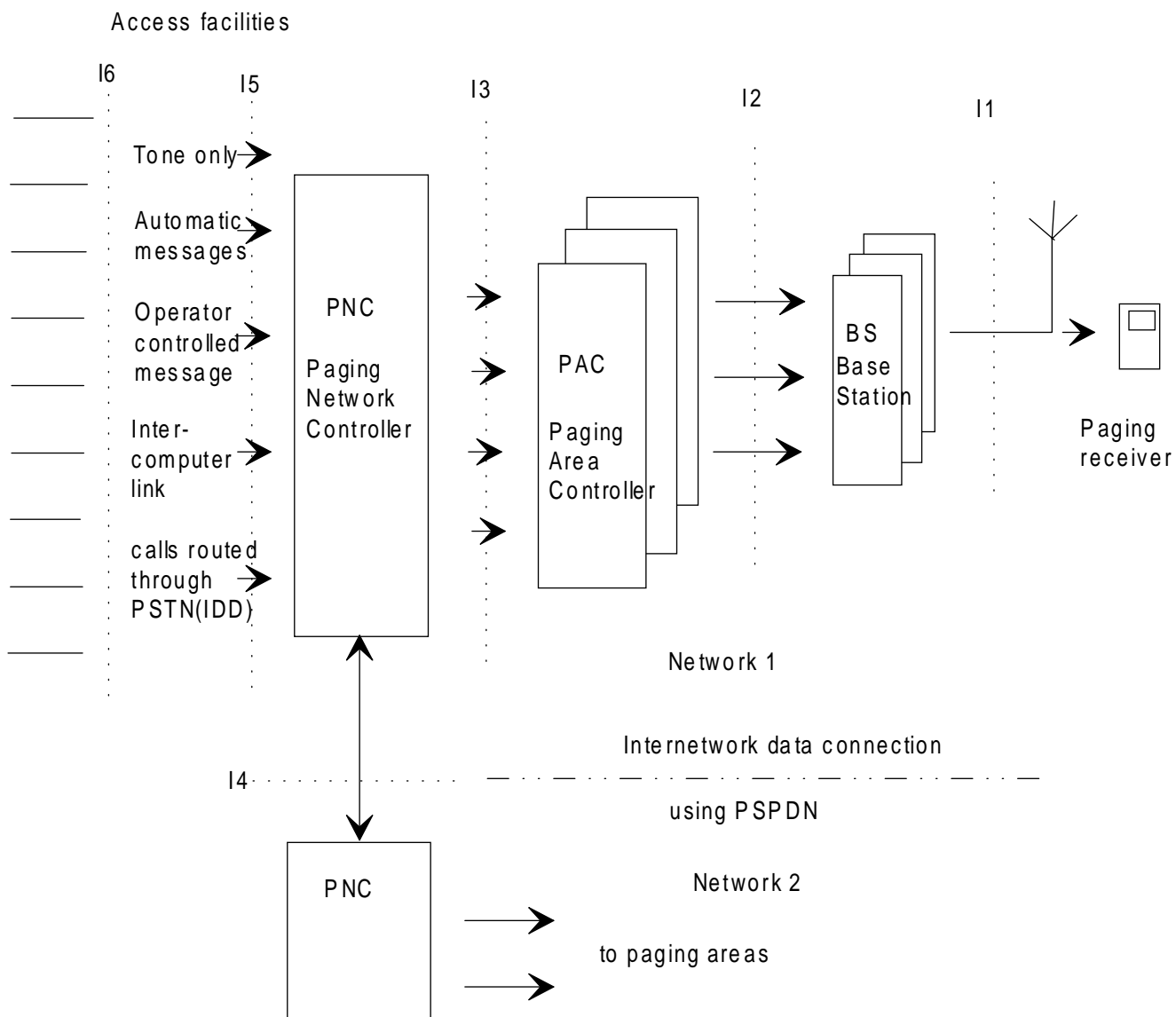

Figure 2: Functional organization of the Telecommunication Network (TN) architecture

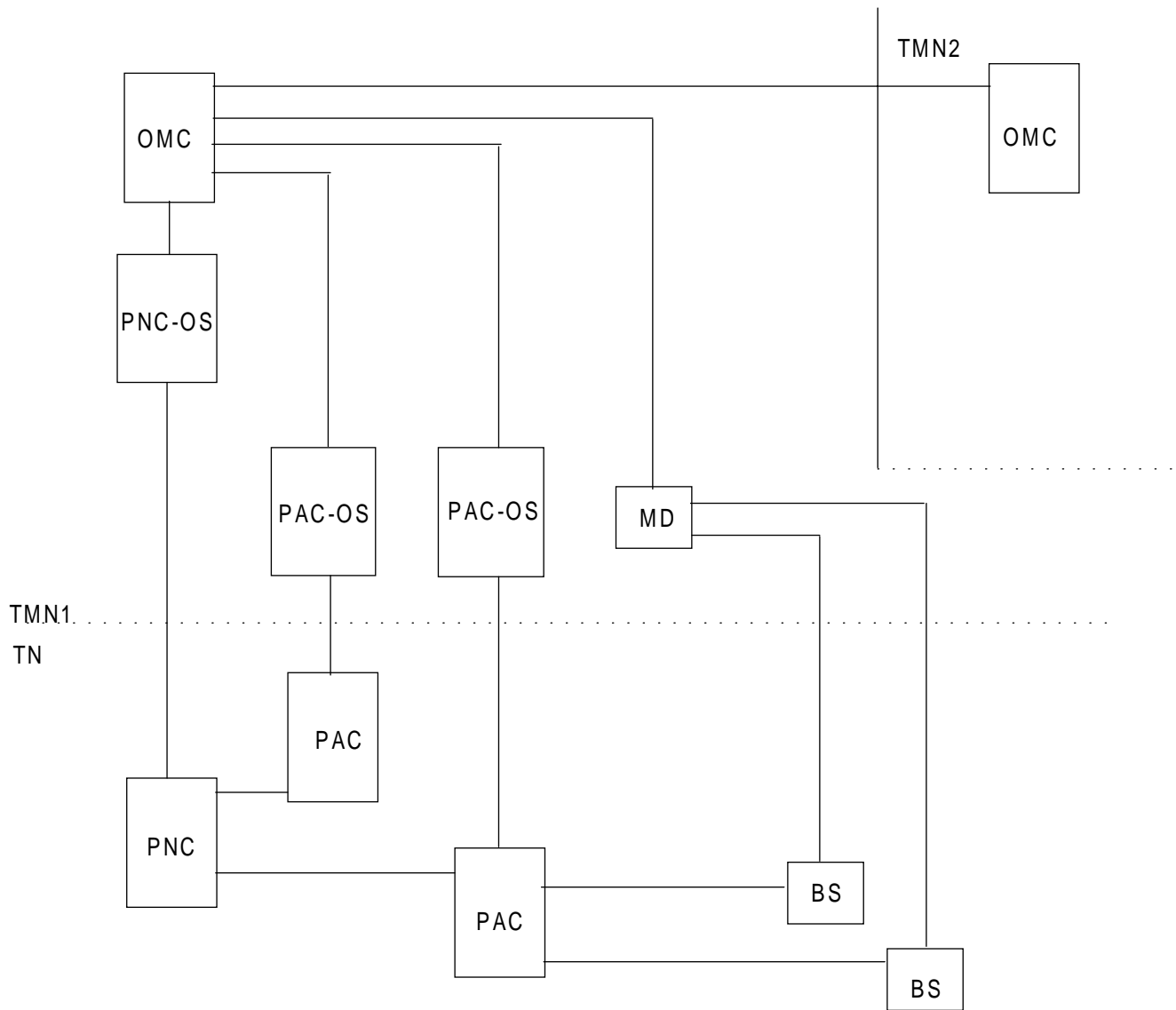

Figure 3: ERMES functional architecture

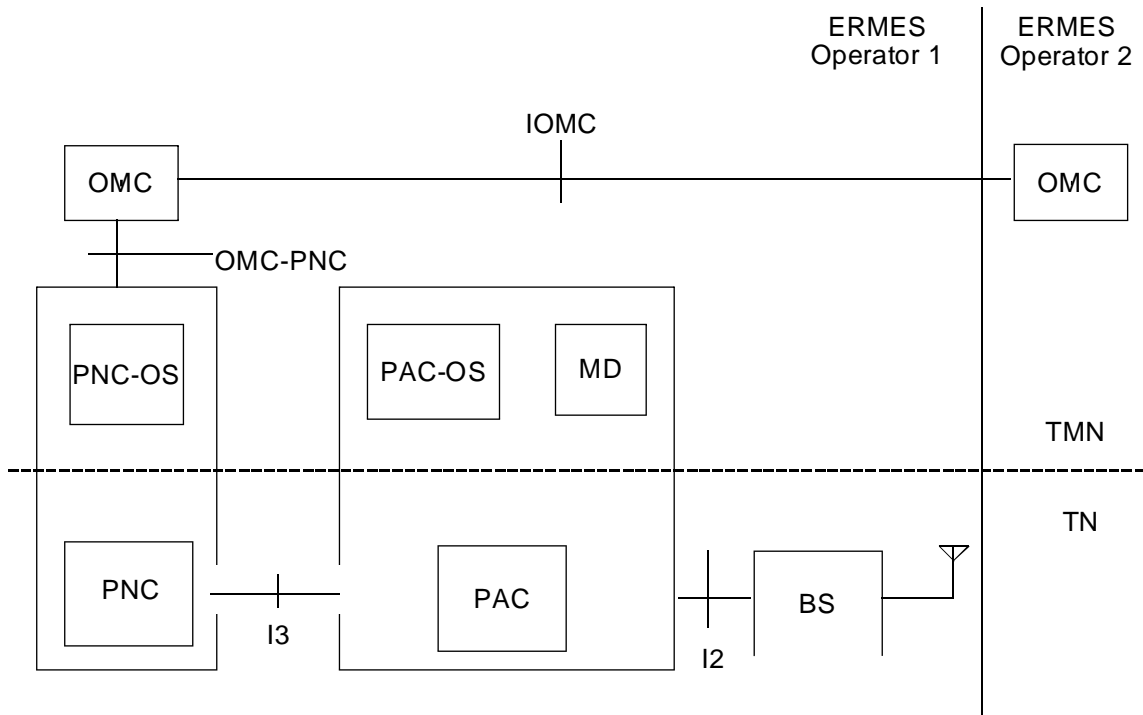

Figure 4: O&M interfaces

5 Numbering, addressing and identification

5.1 General

This subclause describes the main principles of numbering and addressing for Mobile Subscribers (MS) and defines the elements used in identification of Fixed Subscribers (FS). The relationship between the service demanded by the customer and the structure of the selection information when accessing the ERMES system is described.

Selection information is input to the access network by the calling party to gain access to the service. The calling party may be someone wishing to send a paging message to a MS or a subscriber wishing to access the system in order to change their Subscriber Features (SF). One-stage and two-stage selection procedures are available to facilitate access.

In one-stage selection the call information input to the telecommunications network establishes connection to the PNC and also identifies the Address Code (AdC). In two-stage selection the calling party first calls the PNC using a Service Number (SN) and then, after the connection has been established, sends the AdC followed by message input or SF dialogue.

Figure 5 illustrates the links between access type and selection information.

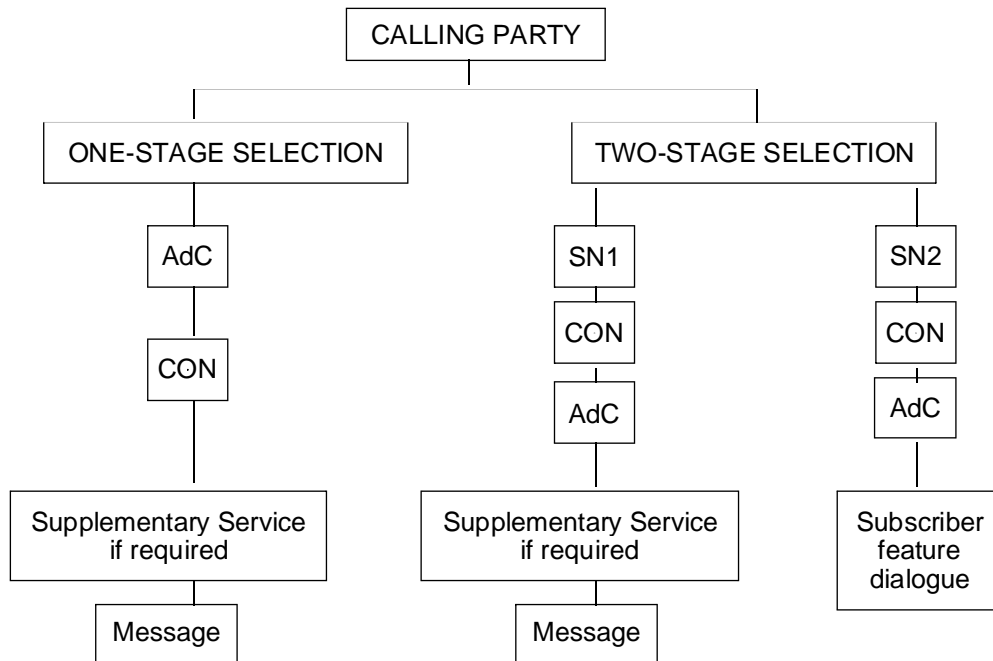

NOTE: SN1: Service Number for page input.
SN2: Service Number for subscriber features.
CON: connection established through the network access.

Figure 5: Selection information and access type

The structure of AdC is described in subclause 5.2 for both one-stage selection and two-stage selection access types. SN requirements are given in subclause 5.4.

5.2 Addressing and numbering

5.2.1 Mobile subscriber

5.2.1.1 Individual

All receivers shall be allocated at least one AdC.

5.2.1.1.1 One-stage selection

In one-stage selection the AdCs shall follow the numbering plan or the address structure of the access network. Addressing may take advantage of any special features of the access network. The use of prefixes shall be in accordance with national practice.

5.2.1.1.2 Two-stage selection

In two-stage selection the AdCs may be selected independently of the access network. Consequently the same AdC may be used throughout the ERMES system.

The AdCs for the two-stage procedure shall consist of three parts:

- 1) first part - country number:

This part consists of two or three digits and is the same as the recognized country code for Public Switched Telephone Network (PSTN) use (see ITU-T Recommendation E.163 [4]).

2) second part - network identification:

This part consists of several digits which identify the network operator within the country. The identification and number of digits depend on national agreement. The network identification shall not include any prefix.

3) third part - subscriber identification:

This part consists of the remaining digits.

A two-stage selection AdC may have up to fifteen digits as provided by the I4 interface (see clause 9).

Depending on the location of the calling party and on the access method chosen, all parts of the code may not be required.

The accessed Input PNC (PNC-I) shall differentiate, by the use of a prefix, between calls directed to receivers belonging to its own network and calls directed to receivers belonging to another network.

This prefix shall be 00 (double zero) if the called receiver belongs to a foreign network, and 0 (single zero) if the called receiver belongs to a network in the same country. In the first case, the AdC shall have all three parts, in the second case it shall have only the last two.

For access to the Home PNC (PNC-H) using the SN (subclauses 5.1 and 5.4.1) of the PNC-H, only the third part of the numbering scheme shall be required.

The international access prefix (00) and the national access prefix (0) shall be uniform throughout the ERMES network.

Neither network identification nor subscriber identification shall begin with zero.

5.2.1.2 Group

A group of receivers shall be allocated at least one Group AdC (GAdC). This GAdC shall follow the same rules as the AdC and shall have the same structure (subclause 5.2.1.1). A GAdC shall only be allocated to groups using individual Radio Identity Codes (RICs).

To identify a group (for called group indication service), a maximum of four digits shall be used for numeric messages and ten characters for alphanumeric messages. The called group indicator shall be included in the message itself.

5.2.2 Fixed subscribers

FSs shall only access their own PNC. Consequently numbering and addressing of FSs need not be harmonized.

A MS may be considered as a FS and an operator may decide whether the two numbering plans should be integrated.

5.3 Identification of network functional blocks

Each PNC shall be allocated an unambiguous PNC number. This number shall be composed of three parts:

- zone code: as defined in ETS 300 133-4 [2], annex A;
- country code: as defined in ETS 300 133-4, [2] annex A;
- operator code: for network identification.

Other network functional entities do not require harmonized identification, but the following rules shall be observed:

- PA number shall be a two-digit number;
- PAC number shall be a two-digit number;
- BS number shall have three digits maximum.

5.4 Service access

5.4.1 Service numbers

In the two-stage selection procedure Service Numbers (SN) provide access to basic and Supplementary Services (SSs).

The SN and its structure depend on the access network and the operator's policy, so it is possible to have several service numbers identifying the same service (or class of service) which is to be accessed through different access networks.

When using the telephonic access method (see clause 7), there shall be a separate SN for page input and for SFs. When using a non-telephonic access method, there may be a single SN for all services, or a separate SN for page input, according to the network operator's policy.

5.4.2 Supplementary service identification codes

When accessing an operator network, the calling party wants either to send a paging message or to access his MS features. In the first case he may want to invoke an SS related to his paging message. For that he shall use the appropriate supplementary Service Identification Code (SIC) given in table 1. In the second case, every SN dedicated to the SFs gives access to a subset of SSs identified by a SIC defined in tables 2 and 3.

The SICs shall be the same in all PNC(s) and take the form shown in tables 1, 2 and 3.

Table 1: Call input related Service Identification Codes (SIC)

71	Choice of destination
72	Repetition
73	Prioritization
74	Multi-address call
75	Urgent message
76	Deferred delivery
77	Standard text from the PNC-H
78	Standard text from the PNC-I
79	Reverse charging

Table 2: Supplementary Service (SS) identification codes for fixed subscriber's features

82	Address list management
83	Advice of accumulated charges
84	Password management
85	Legitimation code management
87	Standard text management

Table 3: Supplementary Service (SS) identification codes for MS's features

90	Roaming
91	Temporary barring
92	Diversion
93	Message retransmission
94	Password management
95	Legitimation code management
96	Deferred delivery
99	All features

In some cases the SIC may be implicitly included in the selection information. For example, it should be the case for the basic services with a standard access method or if a dedicated SN is required to allow a certain level of charge for some SSs such as call with repetition requested by the calling party.

National characteristic mnemonics or other alphanumeric identifiers may be used with alphanumeric access in place of the above numeric identifiers. It is recommended that the mnemonics used with alphanumeric access be harmonized within a network (the same for every access method).

6 Call processing

6.1 Call processing for page input

6.1.1 General principles

A calling party should normally establish a connection to a PNC with SN1 for the purpose of inputting a call request.

The PNC to which he connects plays the role of PNC-I. This PNC-I determines the called MS's PNC-H from the AdC supplied by the calling party. The PNC-H determines from the MS's database in which PNC(s) the MS has asked for his messages to be transmitted. This PNC(s) then plays the role of PNC-T.

For every call there may only be one PNC-I, one PNC-H and one or several PNC-Ts. For a local call one PNC plays all three roles.

The methods of call processing specified in this clause are normative only for those operations involving transactions over the I4 interface. The call processing for call input shall be independent of the access method of the calling party.

Depending on the access method (interactive or non-interactive) all the data linked with the call and used by the call processing are given to the PNC-I either one by one (interactive) or in one block (non-interactive). However, the call processing described below is the same for the two types of access except that some acknowledgements are not given to the calling party in case of non-interactive access. This does not affect transactions on the I4 interface.

In the following description each "demand" or "response" corresponds to one I4 operation when PNC-I does not equal PNC-H, or PNC-H does not equal PNC-T.

At first the PNC-I performs a syntax check on the AdC number.

The PNC-I transmits a "pager information" demand, including the AdC, to the PNC-H.

The PNC-H then refers to the MS's database and sends back to the PNC-I a response including parameters corresponding to the MS's database (such as receiver type, maximum message length). The results of the call acceptance calculation (described in clause 12) given according to a three state status is also returned.

In case of interactive access the PNC-I sends an acknowledgement to the calling party.

The PNC-I compares the SSs requested with the call and the MS database information.

In the case of choice of destination requested by the calling party, the PNC-I sends a "choice of destination" demand to the PNC-H, in order to recalculate the call acceptance and the PNC-H sends back a response including the new call acceptance calculation.

In the case of interactive access, the PNC-I then gives an acknowledgement to the calling party for all SSs (including the call acceptance for choice of destination). For non-interactive access the call shall be processed even if one or several of the SSs requested are not valid.

The PNC-I validates the message part to check the message length and validity of the characters. The PNC-I also converts, according to the rules described in subclauses 7.1.4 and 12.8, the national character set to the ERMES character set and sends back an acknowledgement to the calling party.

The PNC-I then sends a "page request" demand including all the parameters linked with the call to the PNC-H.

The PNC-H sends back a response to the PNC-I. The PNC-I then takes no further part in the processing of the call.

The PNC-H sends to each PNC-T a "transmit" demand including the message with all valid information such as the number of the message and the priority. Each PNC-T sends back a response to the PNC-H.

The following figures illustrate the principles of call processing. They do not give a full description of the I6 interface protocol (full details of which are given in clause 7).

NOTE: This general description of the call processing for page input describes a normal case and does not take in account all the cases of faults which could arise during this processing. All these cases are described in the SDL description given in annex B.

6.1.1.2 PNC-H processing

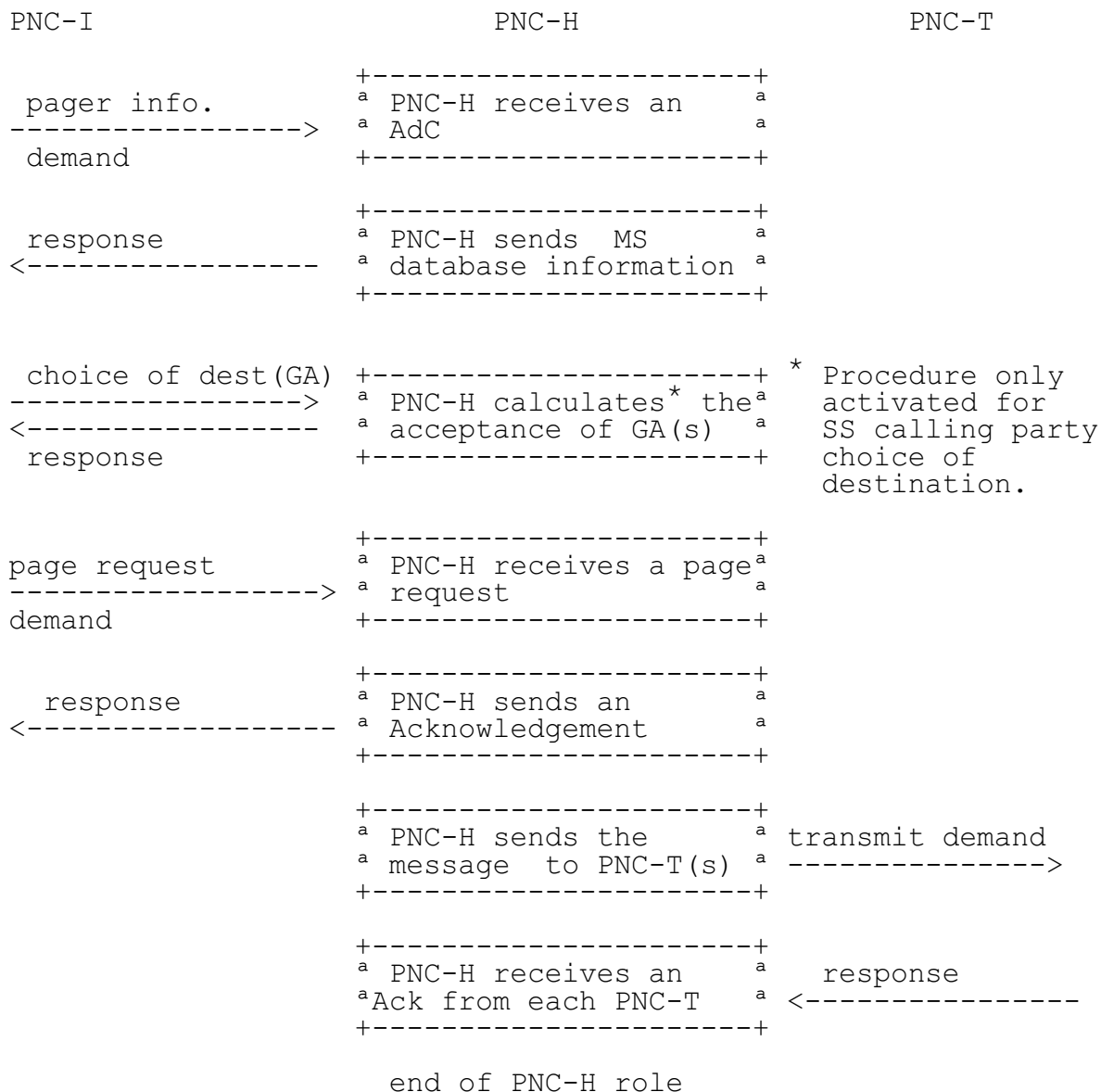

Figure 7: PNC-H processing

6.1.1.3 PNC-T processing

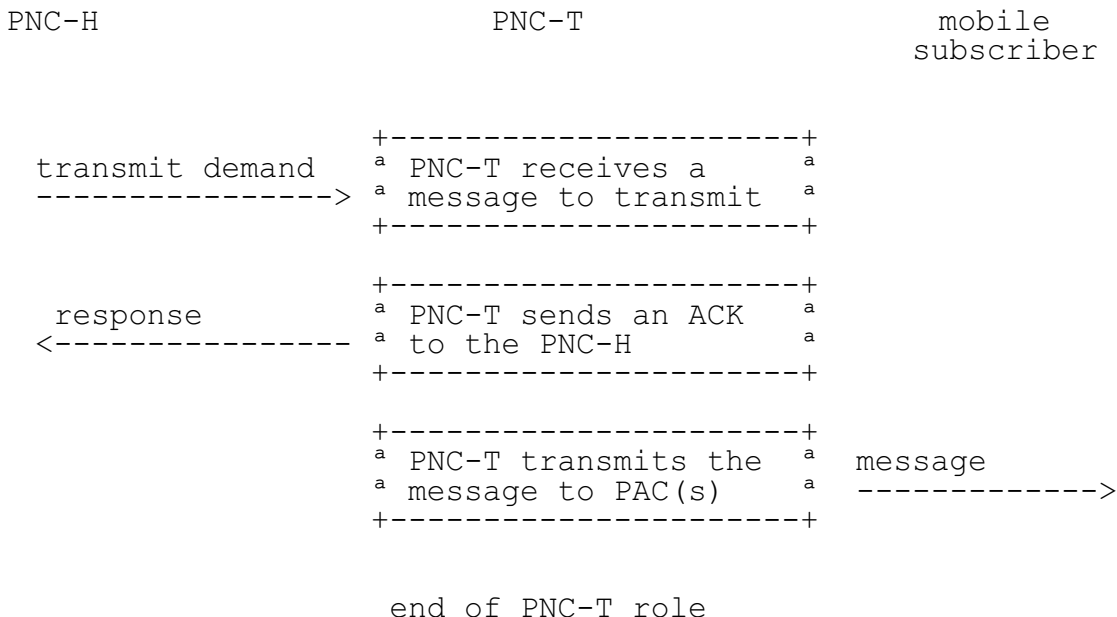

Figure 8: PNC-T processing

6.1.2 Supplementary services

6.1.2.1 General principle

SSs shall be requested by the calling party after inputting the AdC. The PNC-I compares the demand with all the SSs included in the MS database sent by the PNC-H and gives acknowledgement for these SSs. Incompatible combinations of SSs are given in annex A.

6.1.2.2 Choice of destination

When the calling party enters the choice of destination he gives the GA(s) to where he requires his call to be sent. The PNC-I shall, in this case, send to the PNC-H these requested GA(s) in order to recalculate the call acceptance corresponding to this demand. The PNC-H sends back the call acceptance result to the PNC-I. Subsequently the call processing follows the general principle. Calls cannot be accepted if information about "low network status" has been received.

6.1.2.3 Repetition

The processing follows the general principle as for the call input but after receiving the page request including the repetition demand, the PNC-H sends a sequence of transmit requests to each PNC-T. The number of requests is a parameter of the PNC-H. The total time interval between the initial request and the last one is a parameter of the PNC-H. The default value is five minutes.

Each message shall have the message number of the initial transmission.

If the MS has also requested repetition, only one sequence of retransmission shall be sent.

6.1.2.4 Prioritization

The priority provided follows the calling party demand (in some cases this demand could require a legitimisation code) and/or the MSs database information. In case of conflict the message priority is determined by the highest level of priority specifically requested by either the calling party or the MS.

Priority 1 is not compatible with deferred delivery, roaming, diversion, or choice of destination demand in case of demand outside of the home network.

6.1.2.5 Multi-address

On receiving this SS the PNC-I shall split the call into independent calls. Each call follows the general principle and the calling party may receive an acknowledgement for each AdC according to network operator policy. If the MS asked for other SSs these services shall be given according to the possibilities of each called MS database and the acknowledgements for these SSs shall also be given to the calling party according to the network operator policy.

6.1.2.6 Urgent message indication

The processing follows the general principle. The PNC-I on receiving the information from the MS database decides whether the service is possible or not and could also ask for legitimisation. The PNC-H sets the urgent message indication parameter before sending the message to the PNC-T(s).

6.1.2.7 Deferred delivery

The PNC-H shall store the message until the date and time specified by the calling party. This date and time shall be expressed according to the referenced date and time of the PNC-H. The number of the message shall be allocated when the message is sent to the PNC-T. Calls cannot be accepted if information about "low network status" has been received.

If deferred delivery has been requested by both the calling party and the MS, the latest delivery time shall be used.

6.1.2.8 Standard texts

The calling party may only access standard texts defined by either:

- a) the network operator of the PNC-I or an FS of the PNC-I; or
- b) the network operator of the PNC-H.

6.1.2.9 Reverse charging

The processing follows the general principle. The PNC-I shall verify, using the database information of the MS, if this service is allowed or not and shall send an ACK/NACK to the calling party. This calling party may then have to provide a legitimisation code.

6.1.3 Subscriber features

6.1.3.1 General principle

SFs of the MS are in his AdC subscriber records database and, according to the general principle of the call processing for page input, are sent by the PNC-H to the PNC-I. The PNC-I and the PNC-H then have to take the demand of the calling party and the demand of the MS into account. The incompatible combinations of these SFs and the SSs requested by the calling party are given in annex A.

6.1.3.2 Diversion

The PNC-I, on accessing the PNC-H of the AdC from which calls are being diverted (using the I4 operation pager information if PNC-I does not equal PNC-H) shall be informed that diversion is in operation and the AdC of the divert receiver shall be passed to the PNC-I. The PNC-I shall then access the PNC-H of the divert AdC (using the I4 operation pager information if PNC-I does not equal PNC-H) and process the call as a normal call to the divert AdC. Any SSs which are normally available for the divert AdC shall be available to the calling party with the exception of the choice of destination SS, which shall not be made available.

All other SS requests by the calling party shall be accepted by the PNC-I, even if the SS is not available for the divert AdC. Only those SSs which are available to the divert AdC shall be included in the page request from the PNC-I to the PNC-H.

If, during the period of call diversion, the MS for the divert AdC invokes call diversion, then, for the period for which call diversion has been invoked, the call shall be rejected by the PNC-H of the divert AdC.

If, during the period of call diversion, the divert AdC is taken out of service, then, during the period for which the AdC is out of service, the call shall be rejected by the PNC-H of the divert AdC.

NOTE: In the case of diversion outside the ERMES system, the procedures are beyond the scope of this ETS.

6.1.3.3 Repetition

The processing follows the general principle but after receiving the page request the PNC-H sends a sequence of transmit requests to each PNC-T. The number of requests is a parameter of the PNC-H. The total time interval between the initial request and the last one is a parameter of the PNC-H. The default value is five minutes.

Each message shall have the message number of the initial transmission.

If the calling party has also requested repetition, only one sequence of retransmission shall be sent.

6.1.3.4 Message storing

The processing follows the general principle as for the call input. The PNC-H stores the message with its number, date and time of transfer to the PNC-T(s). In case of repetition the message shall be stored only once.

6.1.3.5 Prioritization

According to the ETS 300 133-2 [1] the MS could ask for priority 1 or priority 3 (priority 2 implicit) for all messages or on a per call basis for each call.

The priority provided shall follow the calling party demand and/or the MS's database information (in some cases, e.g. requested by MS and activated by the calling party on a per call basis, this demand may require a legitimisation code). In case of conflict the message priority shall be determined by the highest level of priority specifically requested by either the calling party or by the MS.

Traffic having level 1 priority in the home network shall receive the level 2 priority when routed in a visited network.

6.1.3.6 Reverse charging

The processing follows the general principle. The PNC-I shall verify, using the database information of the MS, if this service is allowed or not and shall give this information back to the calling party. The calling party may have to input a legitimisation code.

6.1.3.7 Temporary barring

On receiving the AdC from the PNC-I, the PNC-H shall send back a response indicating that the temporary barring service is activated by the MS. This response may include the date and time for the de-activation of temporary barring or a user defined text message.

The PNC-I shall send to the calling party a standard system announcement or a standard text message (which should include details of the date and time of de-activation of temporary barring, if this information is supplied by the PNC-H), or the MS defined text message, in accordance with the information given by the PNC-H.

6.1.3.8 Deferred delivery

The PNC-H shall store the message until the date and time specified by the MS.

The message number shall be allocated when it is passed to the PNC-T(s).

Calls cannot be accepted if information about "low network status" has been received.

If deferred delivery has been requested by both the calling party and the MS, the latest delivery time shall be used.

6.1.3.9 Encryption

Encryption shall be done by the PNC-H before sending the message to the PNC-T(s).

6.1.3.10 Roaming

The processing follows the general principle as for the call input. The call acceptance shall be calculated by the PNC-H taking into account the Roaming Areas (RAs) stored in the MS database. The PNC-T(s) shall be determined taking into account the requested RAs.

6.1.3.11 Group call

MS groups may be formed either:

- by issuing each receiver with the appropriate common RIC; or
- by including the receiver's individual RIC in a group address list managed by the network operator or FS.

The FS may request that the PNC-H add a called group indicator to group messages (subclause 5.2.1.2 and ETS 300 133-2 [1], subclause 4.3.3.4).

The first category of group call (called common RIC group call) shall be treated in every respect as an individual call. The second category (called individual RIC group call) shall be allocated a GAdC and the following call processing applied.

The PNC-I shall determine, using the GAdC, the PNC-H(FS) (PNC of the FS responsible for the called group management).

The PNC-I shall check with the PNC-H(FS) the validity of the syntax of the demand (GAdC and legitimisation code if required) in the same way as any other AdC. The PNC-H(FS) shall pass back to the PNC-I the subscriber details of the GAdC (this would include the legitimisation code itself and the SSs applicable to the group).

The calling party may request any SSs required and shall input the page message, in the same way as for any other call. After entry of all the call information the PNC-I shall pass the call details and message on to the PNC-H(FS).

The PNC-H(FS) shall then validate all the AdCs within the group (some of which may belong to other PNCs).

For those AdCs within the group belonging to the PNC-H(FS), the PNC-H(FS) shall pass the call on (as a group call with the called group indicator, if applicable) to the PNC-T(s) appropriate to each AdC (using an I4 group call transmit operation as necessary).

For AdCs within the group belonging to other PNCs the PNC-H(FS) shall pass the call details (including the called group indicator, if applicable) to the appropriate PNC-Hs using an I4 group call page request operation.

After the PNC-H(FS) has passed on the call details to all the PNC-Hs appropriate to the AdCs within the group, it will have validated all the AdCs within the group and have received acknowledgements (NACK) that all the SSs requested within the call are (are not) available. This information should be passed to the PNC-I, which may provide this information to the calling party (see note).

NOTE: The normal call procedure is for the page accepted acknowledgement to be given to the calling party as soon as the message has been input. If a NACK of all the non-valid AdCs and SSs is to be given to the calling party then the page accepted acknowledgement would have to be delayed until ACK/NACKs had been received from the PNC-H(FS).

Example of group call processing is given in figure 9.

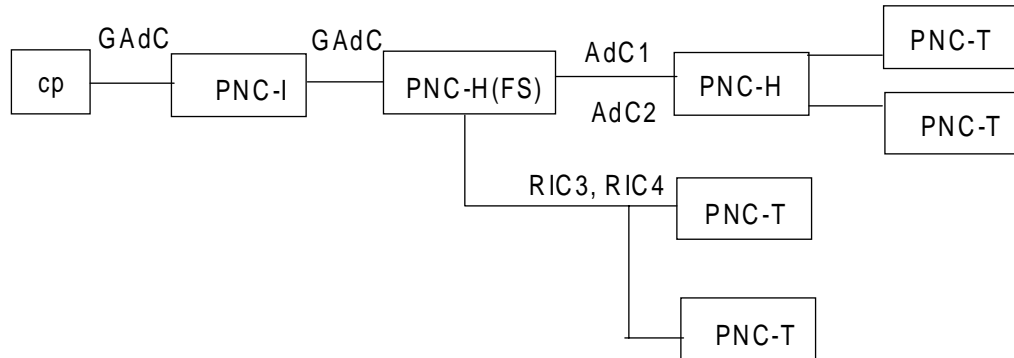

NOTE: cp = calling party.

Figure 9: Group call processing

6.1.3.12 Automatic retransmission of the last message number

The message number shall be held in the MS's RIC database. If the automatic retransmission of the last message number SS is subscribed, a flag shall be set in the MS's AdC records database.

During low traffic time, the last message number may be automatically sent by the PNC-H to these MSs. Transmission intervals shall be determined by the network operator. The low traffic time shall be defined by the network operator and indicated by the OMC or the PNC themselves.

The call processing of this SS shall follow the general principles (subclause 6.1.2.1).

This service shall not operate if either of diversion of traffic or temporary barring of incoming traffic SSs is activated.

6.1.3.13 Legitimation of all calls

This SF enables the MS to restrict the input of calls to authorized calling parties only.

After input of the AdC the calling party shall be requested to input a legitimation code.

The legitimation code input by the calling party shall be checked against the legitimation code stored in the MS database and, if valid, the call processing shall proceed according to the general principle.

6.2 Call processing for access to subscriber features

6.2.1 General principles

Normally, a subscriber establishes connection to a PNC via SN2 for the purpose of inputting an SF request.

The PNC to which he connects is defined as the PNC-I. The PNC which holds the database for the subscriber is defined as the PNC-H. For every call there shall only be one PNC-I and one PNC-H.

The call processing for SF requests shall be independent of the access method of the calling party. The methods of call processing specified are essential only for those operations involving transactions over the I4 interface.

6.2.2 Available to all calling parties

6.2.2.1 Subscriber directory

This optional facility is available to all calling parties and gives access to a catalogue or a database containing information about subscribers in the operator's network. Only information on subscribers belonging to the accessed PNC may be provided.

Since the method of implementation is left to the network operator, no harmonization of call processing is required.

6.2.3 Available to fixed subscribers

The FS always accesses via the PNC-I which equals his PNC-H, where validation of authorization may be performed.

6.2.3.1 Address list management

This optional SF gives the FS the possibility to programme lists identifying a number of MSs (who could have different PNC-Hs) enabling them to receive the same calls. The members of the list shall be validated and the SSs which are to be made available shall be defined when the list is created.

6.2.3.2 Editing of standard text

This optional SF gives the FS the possibility to define and edit standard texts in a message bank. These messages are made available to authorized calling parties (by disclosure of the legitimisation code) by the FS.

No harmonization is required for call processing.

6.2.3.3 Advice of accumulated call charges

This optional SF gives the FS the possibility to obtain the accumulated charges of his account in the operator's network.

No harmonization is required for call processing.

6.2.3.4 Password management

The network shall provide a facility for the FS to manage the password (Authentication Code (AC)) using any appropriate access method defined by the network operator. The password shall be used for authentication purposes. This SF may only be accessed directly via the PNC which is the PNC-H of the FS (i.e. PNC-I = PNC-H).

The stages of call processing for password management shall be as detailed below:

- a) the FS shall access his PNC-H using an access method on which SFs are supported;
- b) the FS shall input his AdC and AC;
- c) PNC-H shall authenticate the FS by comparing the AdC and the AC against the contents of the FS database;
- d) the FS shall indicate a password management action to the PNC-H;
- e) the PNC-H shall ask for a new password from the FS;

- f) after checking the correctness of the new password, the PNC-H shall store the new password in the FS database;
- g) the PNC shall send an appropriate SF acknowledgement to the FS.

6.2.3.5 Legitimation code management

The use of a legitimation code allows the PNC to ensure that a calling party is authorized to carry out a certain restricted operation (an operation which is not allowed to all calling parties). The calling party shall be authorized by a FS to carry out this restricted operation. The network shall provide a facility to enable the FS to manage the legitimation code using any appropriate access method defined by the network operator. This SF may only be accessed directly via the PNC which is the PNC-H of the FS (i.e. PNC-I = PNC-H).

The stages of call processing for the management of a legitimation code by a FS shall be as detailed below:

- a) the FS shall access the PNC-H using an access method on which SFs are supported;
- b) the FS shall input his AdC and AC;
- c) PNC-H shall authenticate the FS by comparing the AdC and the AC against the contents of the FS database;
- d) the FS identifies the SF and requests a change of legitimation code;
- e) the PNC shall ask for a new legitimation code from the FS;
- f) after checking the correctness of the new legitimation code, the PNC-H shall store the new legitimation code in the FS database;
- g) the PNC shall send an appropriate SF acknowledgement to the FS.

6.2.4 Available to mobile subscribers

6.2.4.1 Roaming

6.2.4.1.1 General principles

The method of call processing specified in this subclause are normative only for those operations involving transactions over the I4 interface.

A MS establishes a connection to a PNC for the purpose of inputting a roaming demand which could be a roaming information demand or a roaming modification demand (activate, de-activate, modification of the existing situation). The PNC to which he connects is determined as PNC-I.

The PNC-I determines from the AdC supplied by the MS where his database is stored. The PNC which contains this database is determined as PNC-H.

In the following descriptions each "demand" or "response" corresponds to one I4 operation when PNC-I does not equal PNC-H.

6.2.4.1.2 PNC-I processing

Figure 10 gives an overview of PNC-I processing.

PNC-I receives the AdC and the password from the MS in the interactive mode in a first step, in the non-interactive mode with other information.

PNC-I performs a syntax check on these numbers and sends the roaming validation demand (including AdC) to the PNC-H.

Receiving the identification acknowledgement, the PNC-I transmits it to the MS in case of interactive mode.

The PNC-I then receives the roaming service identification with roaming data (in the case of roaming modification demand) or without data (in the case of roaming reset or information demand) and transmits them to the PNC-H using the corresponding I4 operation if necessary.

PNC-I receives information back which is sent to the MS. In the case of roaming information demand, this response contains roaming data of the subscriber's database and the process is terminated. In the case of change roaming demand, the response informs the MS of the effects of the changes requested.

Receiving confirmation from the subscriber (in the case of change roaming demand) the PNC-I transmits it to the PNC-H.

Finally, the PNC-I receives the feature acknowledgement from the PNC-H and transmits it to the subscriber.

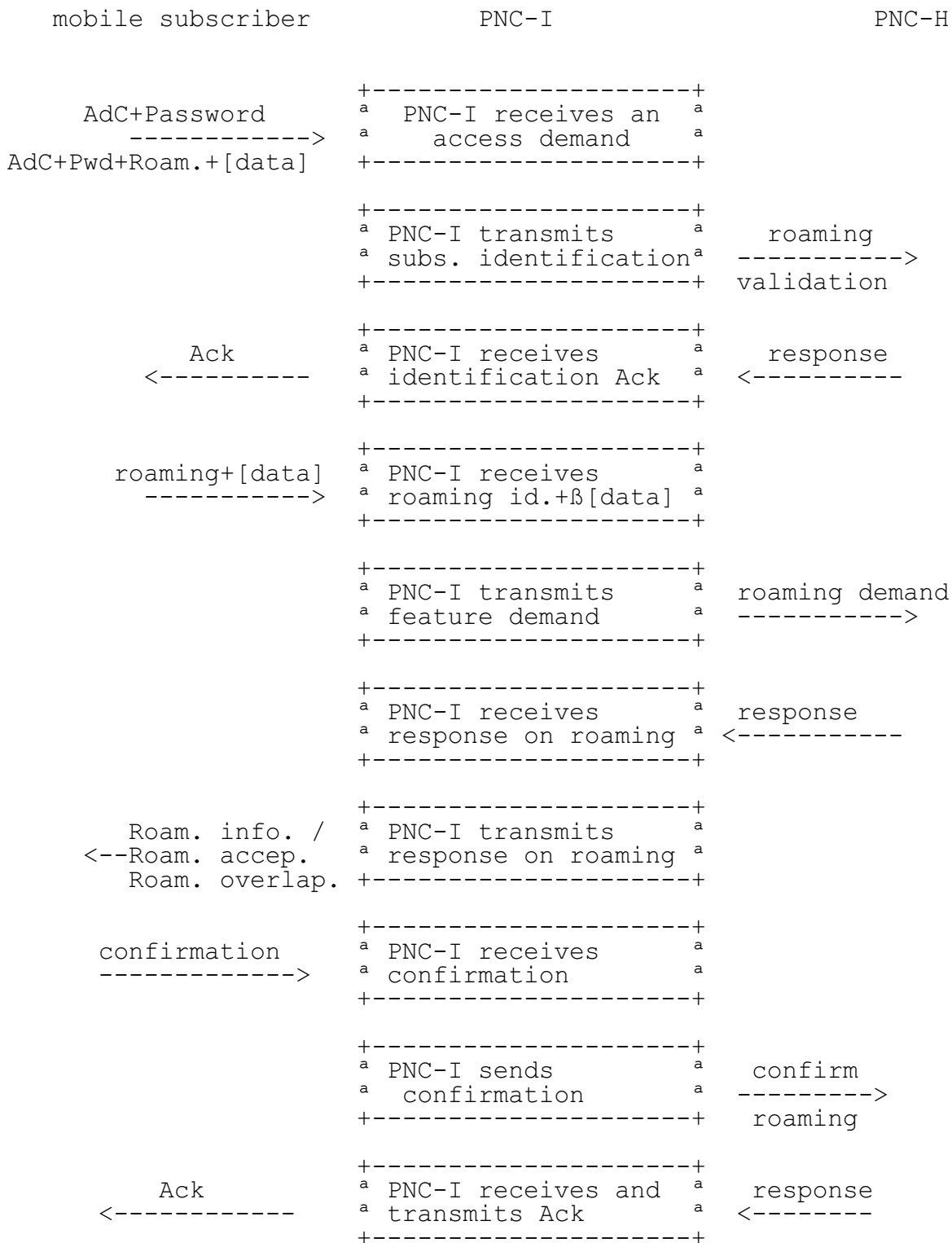

Figure 10: PNC-I processing

6.2.4.1.3 PNC-H processing

Figure 11 gives an overview of PNC-H processing.

PNC-H shall act on the reception of the AdC and control the identification of the MS using the password sent by the PNC-I.

PNC-H then sends the identification acknowledgement to the PNC-I.

After receiving the roaming demand the PNC-H consults the database of the subscriber and sends back information to the PNC-I. This response contains either all the roaming information of the database (in the case of roaming information demand) or information on correct demand and overlapping (in the case of roaming modification demand).

Receiving the confirmation (in the case of roaming modification demand) the PNC-H updates the database and sends the acknowledgement to the PNC-I.

At the start of the roaming period the PNC-H may optionally send a paging message to the MS to confirm that roaming has been activated.

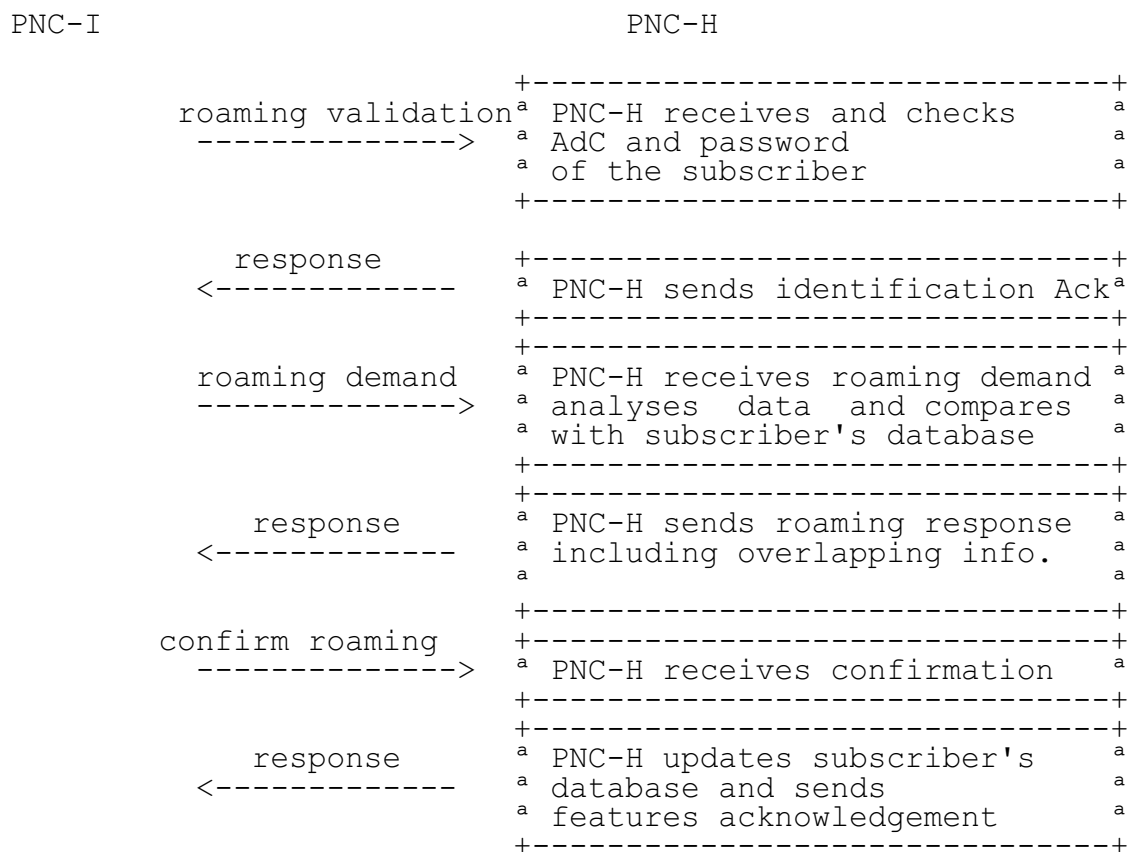

Figure 11: PNC-H processing

6.2.4.2 Temporary barring

This optional SF allows MSs to temporarily (for a specified time/date) prevent acceptance of any call, regardless of its origin. The system shall inform the calling party that temporary barring is activated and it shall offer a facility to give suitable information, e.g. duration of temporary barring of incoming traffic, to the calling party. This information may be a standard text message stored in the system or a text message programmed by the MS. This SF may only be accessed directly via the PNC, which is the PNC-H of the MS (i.e. PNC-I = PNC-H).

The MS when asking for activation of this SF shall be informed if any deferred calls are waiting to be delivered to him. These calls shall be delivered after the de-activation of the temporary barring.

Call processing of temporary barring activation (or MS initiated de-activation) shall follow the stages given below:

- a) the MS accesses his PNC-H using an access method on which SFs are supported;
- b) the MS inputs his AdC and AC;

- c) the PNC-H authenticates the MS by checking the validity of the AdC and AC against the contents of the MS's database;
- d) the MS inputs a temporary barring activation request (or a temporary barring de-activation request);
- e) in the case of a temporary barring activation request, the PNC-H shall inform the MS if any deferred calls are waiting to be delivered to him;
- f) in the case of a temporary barring activation request, the MS shall specify the duration of the barring of incoming calls and shall identify the message that shall be sent to a calling party in the case that temporary barring is active. If the MS wishes to define his own text message, suitable prompts should be provided;
- g) in the case of a temporary barring activation request, the PNC-H shall check whether the specified duration and the identified text message are in accordance with the network operator's policy. The PNC-H shall activate temporary barring for the specified duration and it shall store the related information.

In the case of a MS initiated temporary barring de-activation request, the PNC-H shall de-activate the temporary barring facility and shall start processing deferred calls (if any, and according to normal call processing for deferred calls) that were waiting to be transmitted to the MS at activation of the temporary barring facility and whose defined defer time is expired;

- h) the PNC shall send an appropriate SF acknowledge to the MS.

6.2.4.3 Deferred delivery

This optional SF enables a MS to instruct the PNC that any message being submitted should be delivered no sooner than a specified date and time. The possibility to specify date and time for Deferred Delivery (DD) may be subject to limitations set by the network operator of the PNC-H of the MS. A MS may, when activating this SF, choose to program a text message containing information about this activation for a calling party. This SF may only be accessed directly via the PNC, which is the PNC-H of the MS (i.e. PNC-I = PNC-H).

When DD is activated, the priority 1 service cannot be activated by the calling party.

Call processing of an MS DD activation (or de-activation) request shall follow the stages detailed below:

- a) the MS accesses his PNC-H using an access method on which SFs are supported;
- b) the MS inputs his AdC and AC;
- c) the PNC-H authenticates the MS by comparing the AdC and AC against the contents of the MS's database;
- d) the MS inputs either a DD activation request or a DD de-activation request. Together with the DD activation request the MS shall input the date and time before which no calls should be transmitted and the MS may input a text message, that shall be sent to a calling party in the case that DD is active;
- e) in the case of a DD activation request, the PNC-H shall check the validity of the request (i.e. is the request in accordance with the MS's database and are the specified date and time in accordance with the limitations set by the network operator). In the case of a positive check, the PNC-H shall activate the DD SF.

In the case of a DD de-activation request, the PNC-H shall compare the request with the information in the MS's database;

- f) the PNC shall send an appropriate SF acknowledge to the MS.

6.2.4.4 Call diversion

This optional SF allows the MS to divert calls to another AdC on the PNC-H of the MS or to an AdC on another PNC within the ERMES system. This SF may only be accessed via the PNC which is the PNC-H of the MS (i.e. PNC-I = PNC-H). Call diversion to systems outside of the ERMES system is possible, but is outside of the scope of this ETS.

Call diversion is applicable to an AdC.

Activation for a group using a common RIC shall affect the whole group.

For Closed User Groups (CUGs) using individual RICs it is possible to divert the call only within the CUG.

Call processing of a MS call diversion request shall follow the stages detailed below:

- a) the MS accesses his PNC-H using any of the access methods on which SFs are supported;
- b) the MS inputs his AdC and AC;
- c) the PNC-H validates the AdC and AC;
- d) the MS identifies the SF required (call diversion);
- e) the PNC-H validates that call diversion is subscribed to by the MS;
- f) the MS inputs the AdC of the receiver to which calls are to be diverted (the divert AdC);
- g) the PNC-H shall validate the divert AdC (using the I4 operation pager information if the divert AdC belongs to another PNC) and shall check that it is for the same category of receiver as the AdC from which calls are to be diverted, and that call diversion has not been activated on the divert AdC. If the paging categories are not compatible or if call diversion has been activated on the divert AdC the MS request for call diversion shall not be accepted.

Optionally, numeric calls may be diverted to an alpha-numeric AdC, the PNC-H providing translation of the character sets.

Optionally, the PNC may inform the MS of the SSs normally available to him that are not subscribed to by the MS to which calls are to be diverted;

- h) if the divert AdC is valid and is for the same category of receiver from which calls are to be diverted, the MS is requested by the PNC to input the start time and date for the diversion. The MS is then requested to input the stop time and date;
- i) when all the necessary information has been entered and validated the PNC stores the divert AdC and the start and stop times and dates for the diversion, and sends an appropriate SF acknowledgement to the MS;
- j) the MS may access his PNC-H at any time before or during the period of call diversion to cancel the diversion of calls;
- k) at the commencement of the period of call diversion the PNC-H of the originating AdC accesses the PNC-H of the divert AdC (called PNC-H(DIV)) using the I4 Operation Call Diversion Start as required.

If the divert AdC is no longer valid then all calls to the originating AdC shall be rejected. Call diversion remains available as a SF for the MS of the divert AdC for the period during which he is receiving calls on diversion. However, if he wishes to invoke call diversion then he shall be warned that to do so will suspend the diversion of calls to his AdC.

If the MS to whom calls are being diverted invokes call diversion then, during this second period of call diversion, calls received as a result of the first diversion shall be rejected.

For the period of call diversion the following SF are not available for the AdC from which calls are being diverted:

- roaming;
 - storing of messages;
 - automatic re-transmission of the last message number;
- l) at the end of call diversion, or if the MS requests call diversion to cease, the PNC-H shall access the PNC-H of the divert AdC using the I4 operation call diversion stop as required, and inform the PNC that call diversion from the indicated AdC is no longer in operation.

6.2.4.5 Message retrieval

This optional SF offers the MS the possibility to retrieve a lost message. The retrieved message shall be presented to the MS. The MS should have the possibility to choose the way of presenting the retrieved message (e.g. retransmission via the radio path, displaying on a specified terminal or retrieval by other means). This SF may only be accessed directly via the PNC, which is the PNC-H of the MS (i.e. PNC-I = PNC-H).

Call processing of a MS Message Retrieval request shall follow the stages described below:

- a) the MS accesses his PNC-H using an access method on which SFs are supported;
- b) the MS inputs his AdC and AC;
- c) the PNC-H authenticates the MS by checking the validity of the AdC and AC;
- d) the MS inputs a message retrieval request;
- e) in the case of message retrieval with re-transmission via the radio path, the PNC-H shall process the request further in the same way as an ordinary page input that is accepted from a calling party and shall forward the message(s) using the next available message number(s);
- f) the PNC shall send an appropriate SF acknowledge to the MS;
- g) when the message is retransmitted by another way than the radio path, the message shall be presented together with the original message number and the stored date/time.

6.2.4.6 Password management

The network shall provide the MS a facility to manage the password (Authentication Code (AC)) using any appropriate access method defined by the network operator. The password is used for authentication purposes. This SF may only be accessed directly via the PNC, which is the PNC-H of the MS (i.e. PNC-I = PNC-H).

The stages of call processing for password management shall be as detailed below:

- a) the MS shall access his PNC-H using an access method on which SFs are supported;
- b) the MS shall input his AdC and AC;
- c) PNC-H shall authenticate the MS by comparing the AdC and the AC against the contents of the MS's database;
- d) the MS shall indicate a password management action to the PNC-H;

- e) the PNC-H shall ask for a new password from the MS;
- f) after checking the correctness of the new password, the PNC-H shall store the new password in the MS's database;
- g) the PNC shall send an appropriate SF acknowledge to the MS.

6.2.4.7 Legitimation code management

The use of a legitimation code allows the PNC to ensure that a calling party is authorized to carry out a certain restricted operation (an operation which is not allowed to all calling parties). The calling party shall be authorized by a MS to carry out this restricted operation by disclosure of the legitimation code. The network shall provide a facility to enable the MS to manage the legitimation code using any appropriate access method defined by the network operator. This SF may only be accessed directly via the PNC which is the PNC-H of the MS (i.e. PNC-I = PNC-H).

The stages of call processing for the management of a legitimation code by a MS shall be as detailed below:

- a) the MS shall access the PNC-H using an access method on which SFs are supported;
- b) the MS shall input his AdC and AC;
- c) PNC-H shall authenticate the MS by comparing the AdC and the AC against the contents of the MS's database;
- d) the MS identifies the SF and requests a change of legitimation code;
- e) the PNC shall ask for a new legitimation code from the MS;
- f) after checking the correctness of the new legitimation code, the PNC-H shall store the new legitimation code in the MS's database;
- g) the PNC shall send an appropriate SF acknowledge to the MS.

6.2.4.8 All features reset

The system shall provide a facility to the MS to reset all his SFs to the initial default state, as defined by the network operator. This SF may only be accessed directly via the PNC, which is the PNC-H of the MS (i.e. PNC-I = PNC-H).

Call processing of a MS "All Feature Reset" request shall be as described below:

- a) the MS shall access his PNC-H using an access method on which SFs are supported;
- b) the MS inputs his AdC and AC;
- c) the PNC-H authenticates the MS by comparing the AdC and AC against the contents of the MS's database;
- d) the MS requests an All Feature Reset;
- e) the PNC-H shall reset all SFs related to the MS (roaming, temporary barring, DD and call diversion) to their initial default state, defined by the network operator;
- f) the PNC shall send an appropriate SF acknowledgement to the MS.

6.3 Call processing transaction time limits

ETS 300 133-2 [1] defines Quality Of Service (QOS) limits. When the call processing affecting a QOS limit is contained within a single PNC then the PNC shall meet the applicable limit.

In order to guarantee these QOS limits when two or more PNCs are involved in the processing of a call (i.e. when an I4 operation is involved - see clause 9), the time limits in table 4 shall be met when initiating or processing the applicable I4 transaction. The time limit specified shall be met for greater than 90 % of calls processed.

Table 4: Call processing time limits

I4 operation	Time delay limit (seconds)	
	PNC-I	PNC-H
Pager information	3	3
Choice of destination	3	3
Page request	5	5
Roaming validation	3	3
Roaming reset	3	3
Roaming information	3	3
Change roaming	3	3
Confirm change of roaming	3	3

The PNC-I time includes three elements:

- the processing time from when the user terminates the input until the applicable I4 operation is placed into the PNC I4 output queue;
- the time the transaction is queued before being transmitted to the PNC-H;
- the processing time from receiving the I4 response from the PNC-H until a response is given to the user.

NOTE: For the page request operation the response (acknowledgement) is given to the calling party before the I4 response is received from the PNC-H except, optionally, for group calls.

The PNC-H time includes two elements:

- the processing time from the receipt of the I4 operation until the applicable I4 response is placed into the PNC I4 output queue;
- the time the transaction is queued before being transmitted to the PNC-I.

The response time experienced by the user shall include the above processing times and also the transmission delay within the PSPDN. The limits for PSPDN transmission delay are detailed in ITU-T Recommendation X.135 [30].

For the transmit I4 operation the processing time limits shown in table 5 shall be met for greater than 90 % of calls processed.

Table 5: Processing time limits

I4 operation	Time delay limit (seconds)	
	PNC-H	PNC-T
Transmit	5	5

The PNC-H time includes two elements:

- the processing time from when the user terminates the input (or from the receipt of an I4 page request) until the transmit I4 operation is placed into the PNC I4 output queue;
- the time the transaction is queued before being transmitted to the PNC-T.

The PNC-T time includes two elements:

- the processing time from the receipt of the I4 operation until the applicable I4 response is placed into the PNC I4 output queue;
- the time the transaction is queued before being transmitted to the PNC-H.

For the call diversion (DIV) I4 operations the processing time limits in table 6 shall be met for greater than 90 % of calls processed.

Table 6: Processing time limits

I4 operation	Time delay limit (seconds)	
	PNC-H	PNC-H(DIV)
Call diversion start	55	
Call diversion end	5	5

The PNC-H time includes two or three elements:

- the processing time from when the call diversion is initiated or ended until the applicable I4 operation is placed into the PNC I4 output queue;
- the time the transaction is queued before being transmitted to the PNC-H(DIV);
- if the call diversion start or stop results from a MS request for immediate action - the processing time from receiving the I4 response from the PNC-H until a response is given to the MS.

The PNC-H(DIV) time includes two elements:

- the processing time from the receipt of the I4 operation until the applicable I4 response is placed into the PNC I4 output queue;
- the time the transaction is queued before being transmitted to the PNC-H.

7 Access methods

7.1 General

Facilities shall be offered to the user to gain access to the requested service and/or the SS. The access method shall depend on:

- access network;
- access type;
- access mode;
- access terminal.

A combination of these four parameters shall identify an access method. A list of some possible access methods is given in annex C. Other options may also be offered.

Access methods fall into two categories:

- telephonic (access methods 1, 2 and 3 in annex C), making use of a telephone set;
- non-telephonic, using any other type of terminal.

Procedures (dialogues) for each access method shall conform to the relevant subclause of clause 7. These procedures shall be harmonized as much as possible. An access service is defined as a set of such access methods.

When using an interactive mode, the experienced user should be able to bypass some parts of the dialogue (i.e. not to receive all the guidance from the system).

Bureau access methods shall offer access only to features already subscribed.

Access by the calling party to some SSs is only permitted by legitimisation (e.g. figure D.3.8). The access by mobile or FSs is only permitted by authentication (figure D.5).

Subclause 7.2 defines the essential and optional access methods for each service and SS. In addition the following general principles shall apply, unless stated otherwise in subclauses 7.3 to 7.9 (concerning the dedicated access methods):

- two-stage selection type shall normally be used with non-telephonic access methods;
- provision of multi-language access is not essential and shall be according to network operator's policy;
- it is not essential that all offered SSs are accessible with each access method;
- the special characters defined in subclause 7.1.5 shall be used for access methods 2 and 3 and are recommended for other access methods;
- when using one-stage selection type, only one paging call shall be allowed within the session.

To harmonize the dialogues among the different access methods, generic protocols are described in subclauses 7.1.1 to 7.1.3.

7.1.1 Generic protocol for non-interactive access mode

The access procedure is a non-interactive operation used by either automatic emitting devices or subscriber terminals, where prompt signals from the PNC are not required.

The operation for each call may be divided in the following phases:

- a) preparation:
 - preparation of the call in local mode;
- b) transmission (automatic):
 - call establishment (calling party-PNC-I);
 - information transfer;
 - ACK/NACK and call clearing.

The call may consist of one or more messages according to the network operator's policy.

The network dependent control procedures should be those which are defined for the access network on which the ERMES service is provided.

7.1.2 Generic protocol for interactive access mode - two-stage selection

The calling party may access the system via one of the two Service Numbers (SNs):

- Service Number 1 (SN1):
 - primarily intended for call input and access to call-input related SSs.
- Service Number 2 (SN2):
 - primarily intended for access to control the SFs.

SN1 and SN2 shall be provided for certain access types e.g. telephonic access. However, it is a matter of network operator's policy whether or not to permit users to input calls and access SFs from a single SN for all other types of access.

The protocol has been divided to show the principal dialogue accessible via each of the two service numbers. The optional links between them are also shown.

7.1.2.1 Functional description of the protocol

7.1.2.1.1 Common elements (for both service numbers)

After every input prompt the system starts a timer and then waits for input from the calling party. The wait time T1 is defined by the network operator. The system shall validate each character as it is input and may give an error indication if the character is invalid. The sequence is as shown in figure D.1. The system responds according to the input received as follows:

a) complete input:

The information plus terminator is received and the complete input may then be validated. For certain types of access the network operator may choose to have the system repeat the input made by the calling party and request confirmation that it is as required. This confirmation is optional and should occur where indicated in figure D.1.

b) incomplete or interrupted input (subclause 7.1.2.4.2):

No terminator is received by the system and when $t = T1$ an interrupt sequence is initiated as shown in figure D.1.

c) no input (subclause 7.1.2.4.3):

When $t = T1$, a time-out sequence is initiated as shown in figure D.1.

d) Quit command:

Depending on the access method, the Quit command may be either a single character (figure D.1) or a combination of characters (figure D.2). In either case the system normally presents the closing message and the call is terminated.

e) Escape command:

Depending on the access method, the Escape command may be either a single character (figure D.1) or a combination of characters (figure D.2). In either case the system shall delete an incomplete input or move to a previous system input prompt (subclause 7.1.2.3.1).

f) Help command:

Depending on the access method, the Help command may be either a single character (figure D.1) or a combination of characters (figure D.2). In either case the system initiates a help sequence (subclause 7.1.2.4.1).

7.1.2.1.2 Protocol via Service Number 1 (SN1)

The calling party accesses the system using SN1. A dialogue then proceeds between the calling party and the system as described in figure D.2. The optional links to the SN2 protocol are also shown.

In order to make a paging call, the calling party is required to input the AdC and message (if relevant). According to network operator's policy, a decision is then made by the calling party whether or not to make a follow-on call. When the call is completed, the system presents the closing message and the call is terminated.

The network operator may choose whether or not to support the subscriber directory and specific call input related SSs via this SN.

Call-input related SSs

The calling party may enter either:

- a) the AdC with block separator followed by the call input related SS identification code with its associated parameters with terminator; or
- b) the AdC with terminator followed by the call input related SS identification code with its associated parameters with terminator, prior to entering the message part with terminator as shown in the two examples below:

EXAMPLE 1:

System	Calling party
Enter AdC	AdC#
Enter message	*72#
Enter message	ABCDEFG#
Page accepted	

EXAMPLE 2:

System	Calling party
Enter AdC	AdC*72#
Enter message	ABCDEFG#
Page accepted	

The dialogue for each SS is shown in figures D.3.1 to D.3.8.

When the relevant details have been provided the calling party is returned to the main protocol and may then choose further SSs or may input the message as required.

Examples of typical calls via SN1 are shown in figures G.1.1 to G.1.3.

7.1.2.1.3 Protocol via Service Number 2 (SN2)

The calling party accesses the system using SN2. A dialogue then proceeds between the calling party and the system as described in figure D.5. The optional links to the SN1 protocol are also shown.

Following input of the AdC (to which the SFs are to apply) together with an AC, the calling party chooses a specific SF. The calling party may, at this point, ask for the status of a particular SF. The system selects the appropriate dialogue to direct the calling party to input the required information. Further authentication may be required for some SFs and this would be requested in the dialogue. The calling party may input an identification code to cause all SFs details to be reset (see ETS 300 133-2 [1], subclause 4.3.1.1.2).

For every SF with start and stop date and time, the calling party should be able to choose the activation moment as the starting date and time. The ending date and time may be omitted. The duration is predetermined by each operator.

The dialogue for roaming is shown in figure D.6 as this is the only mandatory SF. The calling party may change or check the status of the SFs for the required AdC.

Optionally, the network operator may permit the calling party to access more than one SF during the same call. When the caller decides to end the call the system presents the closing message and the call is terminated.

7.1.2.2 System responses and acknowledgement

This subclause specifies the general system response and acknowledgement types together with a brief description where appropriate. The specification of the format and wording for all responses and acknowledgements in every provided language is to be defined by the network operator, as is the extent of the help and guidance facilities (see also subclause 7.1.2.4).

All system responses and acknowledgements are presented by the system within a time specified by the QOS limits for the ERMES service which are contained in ETS 300 133-2 [1], subclause 6.2.

The system should be capable of recognizing inputs from the calling party made during a system response. Any input made should suppress the rest of the system response.

7.1.2.2.1 General system messages

Table 7 describes the general system messages. The network operator may choose the wording of these messages.

Table 7: General system messages

Message type	Description
Greeting message	A greeting to the calling party on initial access to the system.
Closing message	A goodbye message to the calling party before the line is disconnected. This message is normally presented in response to a calling party's decision that the call is completed.

If the system closes the call, a closing message shall be presented. It is optional for a closing message to be presented following the page accepted acknowledgement.

7.1.2.2.2 Input prompts

Tables 8 and 9 describe the input prompts generated by the system and the response normally expected from the calling party. The network operator may choose the wording of the prompts.

Table 8: Input prompts

Prompt by system	Input expected	Additional notes
Address code request	Address code	
Message request	Message	The message request input prompt may vary according to the facilities of the pager and address code selected.
Authentication request	Authentication code	
Legitimation request	Legitimation code	
Follow-on call	Decision	The network operator may also permit the calling party to input the transfer to subscriber features command.
Subscriber feature request	Identification of the Subscriber Feature	
Subscriber feature parameter request	Feature parameter	Depends on the subscriber feature selected.
More transactions request	Decision	The network operator defines the options available to the calling party.
Confirm correct	Decision	Optionally used in validation sequence where the system repeats the input received.
More help request	Decision	
Change to subscriber features request	Decision	

Table 9: Roaming input prompts

Prompt by system	Input expected	Additional notes
Geographical areas requested	Geographical areas	
Start date and time request	Start date and time	Implicit acknowledgement of acceptance of areas.
Stop date and time request	Stop date and time	
More roaming request	Decision	

7.1.2.2.3 Input acknowledgements

A positive response of call accepted or SS acknowledgement may be replaced by continuing with the protocol. The system therefore presents the next input prompt or system message. These imply an acknowledgement of the previous input as indicated in subclause 7.1.2.2.2.

A conditional acceptance may be given by the system if the network status is between the upper and lower call acceptance thresholds. On receipt of a conditional acceptance the calling party is required to confirm that he wishes to continue the input of the call. Where the calling party's input receives a negative acknowledgement, i.e. call not accepted or page not accepted, the network operator may supply additional information to the calling party describing the reasons for this response.

There are specific input acknowledgement types as shown in table 10.

Table 10: Input acknowledgement types

Acknowledgement	Explanation
Call accepted (call not accepted)	The called address is (is not) valid and the system is (is not) ready to accept the call.
Call conditionally accepted	The network status is low.
Page accepted (page not accepted)	The additional information and/or the optional features are (are not) valid and the call shall (shall not) be transmitted.
Supplementary service acknowledgement	Supplementary service is (is not) valid
Supplementary service status acknowledgement	Supplementary service is (is not) active - response to status check.
Subscriber feature acknowledgement	The feature has (has not) been successfully completed.
Authentication invalid	The authentication code input is invalid.
Legitimation invalid	The legitimation code input is invalid.
Incomplete/no input acknowledgement	This message is presented when the wait time has elapsed and either no input or an incomplete input has been received.
NOTE: The network operator may choose the acknowledgement wording.	

7.1.2.2.4 Help and guidance messages

The full extent of the help and guidance facilities are for the network operator to define. The message types shown in table 11 should be provided.

Table 11: Help and guidance message types

Message type	Description
General help message	Details of how to access the help facilities.
Input specific guidance message	Range subject to network operator's policy.
Final input opportunity	This message is appended to guidance information on the final opportunity to input information when help, interrupt, time-out sequences have been invoked or invalid information for a validation or legitimation sequences has been input.

7.1.2.3 Input editing and typing error correction

7.1.2.3.1 The Escape command

If at the system prompt the Escape command only is input, the system shall step back through the protocol to the previous input prompt. New information may then be input. The calling party may use the Escape command to step back through the protocol as far as the previous AdC request prompt.

If the Escape command is input following an incomplete input (i.e. prior to the terminator), the incomplete input shall be deleted and the calling party may then input new information.

7.1.2.3.2 Other editing commands - terminals other than DTMF telephones

Individual characters and the format of inputs are validated as they are input. The calling party may edit the input using the facilities provided on the PNC prior to the (input) terminator being input (after the terminator is input the system assumes that the input is complete). If the system finds the input is invalid, the calling party shall be prompted to make a new input or to edit the previous input (the latter is an option for the network operator).

As a minimum, the following editing facilities shall be provided:

- a) delete previous character;
- b) delete line (all characters until the previous carriage return);
- c) print line (re-display the contents of the field).

7.1.2.4 Guidance to the calling party

All system input prompts should be unambiguous and clearly describe what input the system expects from the calling party. The system presents a general help message following the greeting banner which describes how to access additional help information.

Appropriate guidance messages are presented according to the input by the calling party.

7.1.2.4.1 Help command

A help message specific to the particular input prompt is given. The full extent of the help facilities available to the calling party is a matter of network operator's policy.

7.1.2.4.2 Incomplete or interrupted input

A guidance message specific to the particular input prompts is given. The network operator may also present guidance relating to the incomplete input made by the calling party. The calling party is then re-prompted to make an input. The incomplete input made by the calling party prior to the guidance message is not affected. The network operator defines the number of times this guidance is given. A final guidance message is also presented to the calling party prior to the last input opportunity.

7.1.2.4.3 No input - time-out

A guidance message specific to the particular input prompt is given. The calling party is then re-prompted to make an input. The network operator defines the number of times this guidance is given. A final guidance message is also presented to the calling party prior to the last input opportunity.

7.1.2.4.4 Invalid input

A guidance message relating to the reasons for rejection of the input is given. The calling party is then re-prompted to make an input. The network operator defines the number of times this guidance is given. A final guidance message is presented to the calling party prior to the last input opportunity.

7.1.3 Generic protocol for interactive access mode - one-stage selection

In one-stage selection the calling party accesses the system directly using the AdC of the MS.

7.1.3.1 Functional description of the protocol

The protocol enables calling parties to make a one-stage selection call to the system in order to initiate paging calls. Call-input related SSs may also be accessed. SFs are not supported by this protocol.

The protocol is shown in figure D.4.

7.1.3.1.1 Common elements

After every input prompt the system starts a timer and then waits for input from the calling party. The wait time T1 is defined by the network operator. The system shall validate each character as it is input and may give an error indication if the character is invalid. The sequence is as shown in figure D.1. The system responds according to the input received as follows:

a) complete input:

The information plus terminator is received and the complete input may then be validated. For certain access methods the network operator may choose to have the system repeat the input made by the calling party and request confirmation that it is as required. This confirmation is optional and should occur where indicated in figure D.1.

b) incomplete or interrupted input (subclause 7.1.2.4.2):

No terminator is received by the system and when $t = T1$ an interrupt sequence is initiated as shown in figure D.1.

c) no input (subclause 7.1.2.4.3):

When $t = T1$, a time-out sequence is initiated as shown in figure D.1.

d) Quit command:

Depending on the access method, the Quit command may be either a single character (figure D.1) or a combination of characters (figure D.2). In either case the system normally presents the closing message and the call is terminated.

e) Escape command (subclause 7.1.2.3.1):

Depending on the access method, the Escape command may be either a single character (figure D.1) or a combination of characters (figure D.2). In either case the system shall delete an incomplete input or move to a previous system input prompt.

f) Help command (subclause 7.1.2.4.1):

Depending on the access method, the Help command may be either a single character (figure D.1) or a combination of characters (figure D.2). In either case the system initiates a help sequence.

7.1.3.1.2 The protocol

The protocol is as shown in figure D.4 and typical call examples are shown in figures G.2.1 to G.2.3.

7.1.3.2 System responses and acknowledgements

This subclause specifies the general system response and acknowledgement types together with a brief description where appropriate. The specification of the format and wording for all responses and acknowledgements, for each language provided, is to be defined by the network operator, as is the extent of the help and guidance facilities (see also subclause 7.1.3.4).

All system responses and acknowledgements shall be presented by the system within the times specified by the QOS limits for the ERMES service. These are defined in ETS 300 133-2 [1], subclause 6.2.

The system should be capable of recognizing input from the calling party made during a system response. Any input made should suppress the rest of the system response.

7.1.3.2.1 General system message

Table 12 describes the general system messages. The network operator may choose the wording of these messages.

Table 12: General system messages

Message type	Description
Greeting message	A greeting to the calling party on initial access to the system.
Closing message	A goodbye message to the calling party before the line is disconnected. This message is normally presented in response to a calling party's decision that the call is completed.

If the system closes the call, a closing message shall be presented. It is optional for a closing message to be presented following the page accepted acknowledgement.

7.1.3.2.2 Input prompts

Table 13 describes the input prompts generated by the system and the response normally expected from the calling party. The network operator may choose the wording of these prompts.

Table 13: Input prompts and expected responses

Prompt from the system	Input expected by the system	Additional notes
Message request	Message	The message request input prompt may vary according to the facilities of the pager and address code selected.
Legitimation request	Legitimation code	
More transactions request	Decision	The network operator defines the options available to the calling party. This is only applicable to supplementary services and not calls.
Optional Prompts:		
Confirm correct	Decision	Used in validation sequence where the system repeats the input received.
More help request	Decision	

7.1.3.2.3 Input acknowledgements

A positive response of call accepted or SS acknowledgement may be replaced by continuing with the protocol. The system therefore presents the next input prompt or system message. These imply an acknowledgement of the previous input.

A conditional acceptance may be given by the system if the network status is between the upper and lower call acceptance thresholds. On receipt of a conditional acceptance the calling party is required to confirm that he wishes to continue the input of the call.

When a negative acknowledgement is given to an input made by the calling party i.e. legitimation invalid, the network operator may supply additional information to the calling party describing the reasons for the response.

There are specific input acknowledgement types as shown in table 14 (the network operator may choose the wording of the acknowledgements).

Table 14: Input acknowledgements

Acknowledgement	Explanation
Call accepted (call not accepted)	The called address code is (is not) valid and the system is (is not) ready to accept the call.
Call conditionally accepted	The network status is low.
Page accepted (page not accepted)	The additional information and/or the optional supplementary services are (are not) valid and the call shall (shall not) be transmitted.
Legitimation invalid	The legitimation code input is invalid.
Incomplete/no input acknowledgement	The message is presented when the wait time has elapsed and either no input or an incomplete input (i.e. no terminator) has been received.
Supplementary service acknowledgement	Supplementary service is (is not) valid.

7.1.3.2.4 Help and guidance messages

The full extent of the help and guidance facilities are for the network operator to define. Message types as described in subclause 7.1.2.2.4 should be provided.

7.1.3.3 Input editing and typing error correction

7.1.3.3.1 The Escape command

If at the system prompt the Escape command only is input, the system shall step back through the protocol to the previous input prompt. New information may then be input. The calling party may use the Escape command to step back through the protocol as far as the initial system input prompt.

If the Escape command is input following an incomplete input (i.e. prior to the terminator), the incomplete input is deleted and the calling party may then input new information.

7.1.3.3.2 Other editing commands - terminals other than DTMF telephones

Individual characters and the format of inputs are validated as they are input. The calling party may edit the input using the facilities provided on the PNC prior to the (input) terminator being input. After the terminator is input the system assumes that the input is complete. If the system finds the input is invalid, the calling party shall be prompted to make a new input or to edit the previous input, (the latter is an option for the network operator).

As a minimum the following editing facilities shall be provided:

- a) delete previous character;
- b) delete line (all characters until the last carriage return);
- c) print line (re-display the contents of the field).

7.1.3.4 Guidance to the calling party

All system input prompts should be unambiguous and clearly describe what input the system expects from the calling party. The system presents a general help message following the greeting banner which describes how to access additional help information.

Appropriate guidance messages are presented according to the input by the calling party.

7.1.3.4.1 Help command

A help message specific to the particular input prompt is given. The full extent of the help facilities available to the calling party is a matter of network operator's policy.

7.1.3.4.2 Incomplete or interrupted input

A guidance message specific to the particular input prompts is given. The network operator may also present guidance relating to the incomplete input made by the calling party. The calling party is then re-prompted to make an input. The incomplete input made by the calling party prior to the guidance message is not affected. The network operator defines the number of times this guidance is given. A final guidance message is also presented to the calling party prior to the last input opportunity.

7.1.3.4.3 No input - time-out

A guidance message specific to the particular input prompt is given. The calling party is then re-prompted to make an input. The network operator defines the number of times this guidance is given. A final guidance message is also presented to the calling party prior to the last input opportunity.

7.1.3.4.4 Invalid input

A guidance message relating to the reasons for rejection of the input is given. The calling party is then re-prompted to make an input. The network operator defines the number of times this guidance is given. A final guidance message is presented to the calling party prior to the last input opportunity.

7.1.4 Character conversion

Character conversion is applicable for numeric and alphanumeric services and applies only to the message part.

NOTE: The access method may limit access to the complete ERMES character set.

Each PNC shall have a character conversion table for each access method supported by the PNC. The character conversion tables shall be defined by the operator according to national requirements.

The conversion of the characters of the message shall be done according to the following rules.

If there is an agreement between the PNC-I network operator and the PNC-H network operator (or if PNC-I = PNC-H):

- PNC-I provides access method(s) with the possibility of choosing a different character set used in the home network's receiver. From the access method, the PNC-I knows the character set selected by the calling party. For example, this information is known from the dialogue or from a specific access number;
- if the chosen character set is not the ERMES character set, then the PNC-I has to verify that the receiver of the mobile subscriber supports the corresponding character set (according to the parameters of the database) in its list. This information is included in the data given in the Pager information result operation. If it is supported, then the message is sent to the PNC-H with the appropriate conversion, according to the character set code, and with this character set code included in the Page Request operation;
- the message is sent to the PNC-T with the character set code included in the Transmit operation. The message is then transmitted through the I1 interface according to the corresponding procedure (I1 with possible choice of character set for the receiver);
- receiving the message and the character set code, the receiver can display this message according to the chosen alphabet.

If there is no agreement between the PNC-I network operator and the PNC-H network operator:

- PNC-I sends the message without conversion (transparently) to the PNC-H. The Page Request operation will then include the character set code;
- the conversion can then be done by the PNC-H which sends the message to the PNC-T;

- the PNC-T transmits the message with the character set code given by the PNC-H in the transmit operation. Receiving the message and the character set code, the receiver can display this message according to the chosen alphabet;
- if a calling party inputs a character which is not mapped by the operator to the ERMES character set then that character shall be rejected and the calling party shall be notified.

7.1.5 Use of special characters

In order to harmonize the user access to the ERMES system, figure 12 presents a set of special characters and their implementation in different access methods. The characters shall be used in the DTMF access. Their use is recommended for other access methods.

Access type Function	DTMF telephone	Alpha- numeric terminal	Telex	Videotex	MHS	ISDN UUSI	ISDN UUS3	Notes
Prefix	* and #	/	/	/	/	/	/	(note)
Block Separator	*	/	/	/	/	/or *	/or*	
Parameter Separator	*	,	,	,	,	,	,	
Terminator	#	CR or #	CR LF	CR or #	CR LF	CR or #	CR or #	
End of Message Indicator	#	^Z	CR LF NNNN	^Z		^Z	^Z	^Z = Control + Z
Help			/HELP					
Escape	* #	ESC						
Quit			++++					
Delete Character		DEL or BS	Rub Out					BS = Control + H
Delete Line		^X	XXXX X ANUL					
NOTE:	Prefix shall be at the beginning of the field. Paging messages may not start with the prefix character.							

Figure 12: Use of special characters in ERMES

More detailed descriptions of the usage of these special characters are in subclauses 7.1.2 and 7.1.3, and in the subclauses describing the associated access dialogues.

In the non-interactive access methods, the special characters used for text editing depend on the system used and are not within the scope of this ETS.

7.2 Access methods applicable to each service

The access method numbers referred to in the following subclauses are defined in annex C.

7.2.1 Basic services

Tone-only paging:

Access methods 1 and 2 are essential.

Numeric paging:

Access method 3 is essential.

Alphanumeric paging:

It is essential to provide at least one access method having an interactive mode and an alphanumeric terminal.

Transparent data paging:

This service has many similarities with alphanumeric paging and several of the access methods defined are able to support transparent data paging. However, bureau access method is not permitted.

7.2.2 Supplementary Services (SSs)

7.2.2.1 Page input related SSs

For every page input related SS, the access method shall be the same as the associated basic service. For telephonic access methods, support for DTMF shall be provided. The following shall also apply:

- valid input acknowledgement:

The full extent and the wording of the message shall be defined by the network operator and may vary according to the access method and the allowed presentation facilities. The meaning of the message shall comply with subclause 7.1.2. With non-interactive access methods this acknowledgement need not be provided.

- choice of destination:

With telephonic access methods a limitation may be imposed on the number of Geographical Areas (GAs) the calling party may request in order to utilize a simple dialogue.

- multi-address:

With telephonic access methods a limitation may be imposed on the number of addresses the calling party may request in order to utilize a simple dialogue.

- reverse charging:

This is not allowed with telephonic access methods unless implicitly included in the SN used to access the PNC.

7.2.2.2 Subscriber features

Two-stage selection shall be provided for access to SFs. One-stage selection shall not be allowed.

SF acknowledgement: the full extent and the wording of the message are to be defined by the network operator and may vary according to the access method and the allowed presentation facilities. The meaning of the message shall comply with subclause 7.1.2.

7.2.2.2.1 Subscriber directory

If an electronic directory is provided by the network operator, an interactive mode is recommended. The same access service as for alphanumeric paging service should be offered. Depending on the network operator's choice, it may be accessed via SN1 (subclause 7.1.2.1.2).

7.2.2.2.2 Fixed subscribers

Only access to the PNC where the FS is registered is permitted. For this reason there is no requirement to harmonize dialogues. However, taking into account the types of information to be managed, the appropriate access methods, normally with interactive mode, are recommended.

7.2.2.2.3 Mobile subscribers

Roaming:

Access method 3 and one non-telephonic access method with interactive mode and alphanumeric terminal are essential.

For telephonic access some limitations on the number of GAs and/or the number of periods of time may be imposed in order to simplify the dialogue (normally one GA associated with one period of time may be activated or deactivated). A status check should provide information on whether or not roaming is activated.

Temporary barring:

The provision of appropriate access method(s) shall be determined by each operator.

Deferred delivery:

The provision of appropriate access method(s) shall be determined by each operator.

Diversion:

The provision of appropriate access method(s) shall be determined by each operator.

Message retrieval:

The provision of appropriate access method(s) shall be determined by each operator. When using telephonic access method only retransmission is permitted. Deactivation is not applicable for this service. A status check shall allow the MS to receive the total number of stored messages with the message number of the latest stored message.

Password management:

Access method 3 is essential if services are provided which require the management of passwords.

Legitimation code management:

Access method 3 is essential if services are provided which require the management of legitimation codes.

All features:

The provision of appropriate access method(s) shall be determined by each operator; only deactivation and status check are allowed.

7.3 Telephonic access methods

7.3.1 General

Two access types are applicable for telephonic access: one-stage selection and two-stage selection. In one-stage selection the AdC corresponds to the telephone number used when the ERMES system is accessed. In two-stage selection the ERMES system is first accessed by using a SN. The AdC is entered when the connection to the PNC is established.

The use of Dual Tone Multi-Frequency (DTMF) is assumed except in one-stage selection for tone-only service.

7.3.1.1 Input editing and typing error correction

In the telephonic access the Escape command may be used to correct typing errors. The operation of the Escape command is described in subclause 7.1.2.3.1. The character sequence *# is used as an Escape command and the "end of message" indication is #.

7.3.1.2 Invoking the characters in the numeric service

The numeric message character set is defined in ETS 300 133-2 [1]. Figure 13 shows the keyboard layout that shall be used when inputting these characters using the DTMF telephone access method. Numbers shall be entered by a single press of the corresponding keyboard button. Non-numeric characters shall be selected by pressing and releasing the asterisk (*) as a shift character and then pressing the number corresponding to the non-numeric character. For example a numeric message 358-1234/111 is typed: **358 *4 1234 *1 111**.

/	1	SP	2	U	3
-	4	.	5	%	6
	8		8		9
*			0		#

Figure 13: Coding of ERMES numeric characters with a DTMF keypad (where SP = Space)

7.3.1.3 Invoking the characters in the alphanumeric service

An alphanumeric message may contain all the numeric characters and the capital letters from A to Z.

Figures 14 and 15 present two alternatives of how letters and non-alphanumeric characters can be coded with a DTMF telephone keyboard. Other alternatives may be defined by the network operator.

/	1	SP	2	U	3	
SP		A	B	C	D	E F
-	4	.	5	%	6	
G	H	I	J	K	L	M N
	7		8		9	
P	R	S	T	U	V	W X Y
*		0		#		
Esc	Al num	O	Q	Z		

Figure 14: CEPT T/SF guide-line proposal

/	1	SP	2	U	3	
A	B	C	D	E	F	G H I
-	4	.	5	%	6	
J	K	L	M	N	P	Q
	7		8		9	
S	T	U	V	W	Y	Z
			X			
*		0		#		
Esc	Al num	SP ?				

Figure 15: CEPT T/CS 34-15

The system has two operational modes, numeric mode and alphanumeric (alpha) mode. The default mode is numeric and the alphanumeric mode is started by the character sequence **d# where "d" is a digit indicating the type of keyboard used (d = 1 for the keyboard of figure 14 and d = 2 for the keyboard of figure 15). The "d" digit is not required if the calling party uses the default keyboard recommended by the operator. The character sequence ***# ends the alpha mode and the system returns to the numeric mode.

In the numeric mode the numbers are entered by pressing directly the keyboard buttons and non-numeric characters are selected by using the asterisk (*) as a shift character followed by the corresponding number.

In the alpha mode the number of times the button is pressed indicates the selected character. The leftmost character is selected when the button is pressed once, two pressings selects the middle character and three selects the rightmost one. The selection is confirmed by pressing the character #. When the coding presented in figure 14 is used, the sentence WELCOME AT 10.30 is typed as follows:

***# 9# 33# 555# 222# 0# 6# 33# 1#

Alpha W E L C O M E Sp

2# 8# 1# ***# 10 *5 30

A T Sp Numeric 10 . 30

The message is deleted in the alpha mode with a character sequence *#.

7.3.1.4 Guidance to the calling party

The use of recorded announcements is preferred because of the possibility of presenting more detailed information.

The system shall have a time-out function that releases the telephone line, if the calling party does not continue the typing within a defined time. A special announcement or tone shall be used as a time-out warning to inform the calling party of the element that should be entered next. The timing, the number of and the structure of the warnings is according to the operator's policy.

If the typing is not continued after the last warning, the telephone line shall be disconnected by the PNC.

7.3.2 One-stage selection method

7.3.2.1 Tone-only message input

7.3.2.1.1 Functional description of the protocol

The calling party dials the MS's tone-only AdC. The tone-only message shall be sent to the MS if the AdC is valid. The calling party shall receive the "page accepted/call not accepted" acknowledgement, and should then terminate the call.

Only one tone-only message may be sent within one phone call. If the AdC is not valid, the calling party shall be given an error indication, and should hang up the receiver before making further calls.

The PNC shall have a time-out function that disconnects the telephone line, if the calling party does not hang up the telephone within a defined time after the acknowledgement.

If one-stage selection is used, the accessed PNC is always the PNC-H of the MS.

7.3.2.2 Numeric message input

7.3.2.2.1 Functional description of the protocol

The access protocol has two phases. The calling party first dials the AdC. This first phase does not necessarily require the use of DTMF signalling.

If the AdC is not valid, the calling party shall be given an error indication, and should hang up the receiver before making further calls.

If the call is accepted, the calling party is able to access the PNC. The message and End Of Message (EOM) is entered using DTMF signalling. The PNC shall check the length of the message and that the message contains only those characters specified in the numeric character set given in ETS 300 133-2 [1]. The "Page accepted/Page not accepted" acknowledgement shall then be sent to the calling party. If the page is not accepted, the PNC shall indicate that it is ready for another message. The operator may limit the number of trials.

7.3.2.2.2 System responses and acknowledgements

The PNC shall support the responses and acknowledgements defined in subclause 7.1.3.2. The system shall provide at least the following acknowledgements:

- call accepted;
- page accepted;
- call not accepted;
- page not accepted;

and should provide the following acknowledgements:

- call conditionally accepted (transmission/delay in all areas not guaranteed);
- unable to send message because of system failure;
- time-out warning.

7.3.2.3 Alphanumeric service

7.3.2.3.1 Functional description of the protocol

The access protocol has two phases. The calling party first dials the AdC. This first phase does not necessarily require the use of DTMF signalling.

If the AdC is not valid, the calling party shall be given an error indication, and should hang up the receiver before making further calls.

If the call is accepted, the calling party is able to access the PNC. The message and EOM is entered using DTMF signalling. The PNC shall check the length of the message and that the message does not contain characters unacceptable to the receiver. The "Page accepted/Page not accepted" acknowledgement shall be sent to the calling party. If the page is not accepted, the PNC shall indicate that it is ready for another message. The operator may limit the number of trials.

7.3.2.3.2 System responses and acknowledgements

The PNC shall support the responses and acknowledgements presented in the subclause 7.1.3.2. The system shall provide at least the following acknowledgements:

- call accepted;
- page accepted;
- call not accepted;
- page not accepted;

and should provide the following acknowledgements:

- call conditionally accepted (transmission/delay in all areas not guaranteed);
- unable to send message because of system failure;
- time-out warning.

7.3.2.4 Message input with Supplementary Services (SSs)

7.3.2.4.1 Functional description of the protocol

In one-stage selection the provision of SSs is restricted to numeric access and alphanumeric access only. The SSs are selected by entering the activation prefix * and the SS identification code after the AdC. Call input related SS identification codes are as follows:

- 71 Choice of destination;
- 72 Repetition;
- 73 Prioritization;
- 74 Multi-address call;
- 75 Urgent message;
- 76 Deferred delivery;
- 77 Standard text selected from the list located in the MS's PNC-H;
- 78 Standard text selected from the list located in the calling party's PNC-I.

The additional parameters needed to activate a service are entered after the service identification code. The character * is used as the block separator and the parameter list is terminated by the character #. If the calling party keys the terminator while some of the parameters are still missing, the PNC should guide the calling party to enter the missing parameters.

It is possible to activate several SSs within one call input by entering the new activation prefix, service identification code and the list of parameters after the previous SS terminator. The operator may limit the number and the combination of services within a call.

7.3.2.4.2 System responses and acknowledgements

The PNC shall provide at least the following acknowledgements:

- SS accepted;
- SS not accepted.

7.3.2.4.3 Supplementary Service (SS) sequences

Terms in brackets are optional and the usage of the terms depends on the provision of the service.

Choice of destination:

*71*GA1(*GA2*...*GAn)#'Message'#

where GA is the geographical area identification.

Repetition:

*72#'Message'#

Prioritization:

*73*PR(*ID)#'Message'#

where PR is the priority number 1 or 3. ID is the legitimisation or AC depending on the provision of the service.

Multi-address call:

*74*AdC2(*AdC3*...*AdCn)#'Message'#

Urgent message:

*75(*ID)#'Message'#

where ID is the legitimisation or authentication code.

Deferred delivery:

*76*DDMMYY*HHMM#'Message'#

where DDMMYY means day, month, year and HHMM is hour and minute.

Standard text:

*77*TNO#

where TNO is the number of the selected text. The accessed standard text list is that provided by the operator of the PNC-H of the MS.

Standard text:

*78(*LID*ID)*TNO#

where LID is the text list identification, ID is the legitimisation code and TNO is the number of the selected text. The accessed standard text list is located in the PNC-I of the calling party.

7.3.3 Two-stage selection method

7.3.3.1 Tone-only message input

7.3.3.1.1 Functional description of the protocol

The access protocol has two phases. First the SN is dialled, and the calling party gets access to the PNC. In this first phase the calling party may use a DTMF telephone or a loop disconnect telephone depending on the telephone network used.

The AdC is keyed after the "AdC request" prompt using DTMF signalling. The terminator # shall be used at the end of the number. The PNC shall validate the AdC and send the "Call accepted/Call not accepted" acknowledgement to the calling party. The calling party shall then be requested to confirm the page with the EOM character #. If confirmed the page shall be sent and the calling party shall receive a "Page accepted" acknowledgement.

If the page is accepted, further calls may be input, if permitted by the operator. If the AdC is not valid, the calling party may be offered the opportunity of retrying with a new AdC. The operator may limit the number of trials.

Typing errors may be corrected before the EOM indication by deleting the AdC and rekeying it. The tone-only message shall not be sent if the calling party hangs up the telephone without keying the EOM character.

7.3.3.1.2 System responses and acknowledgements

The PNC shall support the responses and acknowledgements specified in subclause 7.1.2.2. The system shall provide at least the following acknowledgements:

- call accepted;
- page accepted;
- call not accepted;

and should provide the following acknowledgements:

- transmission in all areas not guaranteed;
- unable to send message because of system failure;
- time-out warning.

7.3.3.2 Numeric message input

7.3.3.2.1 Functional description of the protocol

The access protocol normally has three phases. First the SN is dialled, and the calling party gets access to the PNC. In this first phase, the calling party may use a DTMF telephone or a loop disconnect telephone depending on the telephone network used.

The AdC is keyed after the "AdC request" prompt using DTMF signalling. The terminator # shall be used at the end of the number. The PNC shall validate the AdC and send the "Call accepted/Call not accepted" acknowledgement to the calling party. If the AdC is not valid, the calling party may be offered the opportunity of retrying with a new AdC. The operator may limit the number of trials.

If the call is accepted, the message may be entered. The PNC shall check the length of the message and that the message contains only those characters specified in the numeric character set given in ETS 300 133-2 [1]. The "Page accepted/Page not accepted" acknowledgement shall then be sent to the calling party. If the page is accepted, further calls may be input if permitted by the operator. If the page is not accepted, the PNC indicates that it is ready for another message. The operator may limit the number of trials.

The user is not required to wait for the "Call accepted" acknowledgement and may continue entering the message. The PNC shall respond with the "Page accepted/not accepted" acknowledgement.

7.3.3.2.2 System responses and acknowledgements

The PNC shall support the responses and acknowledgements specified in subclause 7.1.3.2. The system shall provide at least the following acknowledgements:

- call accepted;
- page accepted;
- call not accepted;
- page not accepted;

and should provide the following acknowledgements:

- transmission in all areas not guaranteed;
- unable to send message because of system failure;
- time-out warning.

7.3.3.3 Alphanumeric message input

7.3.3.3.1 Functional description of the protocol

The access protocol has normally three phases. First the SN is dialled, and the calling party gets access to the PNC. In this first phase, the calling party may use a DTMF telephone or a loop-disconnect telephone depending on the telephone network used.

The AdC is keyed after the "AdC request" prompt using DTMF signalling. The terminator # shall be used at the end of the number. The PNC shall validate the AdC and send the "Call accepted/not accepted" acknowledgement to the calling party. If the AdC is not valid, the calling party may be offered the opportunity of retrying with a new AdC. The operator may limit the number of trials.

If the call is accepted, the message may be entered. The PNC shall check the length of the message and that the message contains only those characters specified in the numeric character set given in ETS 300 133-2 [1]. The "Page accepted/page not accepted" acknowledgement shall then be sent to the calling party. If the page is accepted, further calls may be input if permitted by the operator. If the page is not accepted, the PNC indicates that it is ready for another message. The operator may limit the number of trials.

The user is not required to wait for the "Call accepted" acknowledgement and may continue entering the message. The PNC shall respond with the "Page accepted/not accepted" acknowledgement.

7.3.3.3.2 System responses and acknowledgements

The PNC shall support the responses and acknowledgements specified in subclause 7.1.3.2. The system shall provide at least the following acknowledgements:

- call accepted;
- page accepted;
- call not accepted;
- page not accepted;

and should provide the following acknowledgements:

- transmission in all areas not guaranteed;
- unable to send message because of system failure;
- time-out warning.

7.3.3.4 Call input with supplementary services

7.3.3.4.1 Functional description of the protocol

The SSs are selected by entering the activation prefix * and the SS identification code after the AdC. The calling party shall terminate the AdC before entering the SS activation prefix. Call input related SS identification codes are as follows:

- 70 Management of the legitimisation for all calls by mobile subscribers;
- 71 Choice of destination;
- 72 Repetition;
- 73 Prioritization;
- 74 Multi-address call;
- 75 Urgent message;
- 76 Deferred delivery;
- 77 Standard text selected from the list located in the MS's PNC-H;
- 78 Standard text selected from the list located in the calling party's PNC-I.

The additional parameters needed to activate a service are entered after the service identification code. The character * is used as the block separator and the parameter list is terminated by the character #. If the calling party keys the terminator while some of the parameters are still missing, the PNC should guide the calling party to enter the missing parameters.

It is possible to activate several SSs within one call input by entering a new activation prefix, service identification code and a list of parameters after the previous SS terminator. The operator may limit the number and the combination of services within a call.

7.3.3.4.2 System responses and acknowledgements

The PNC shall provide at least the following acknowledgements:

- supplementary service accepted;
- supplementary service not accepted.

7.3.3.4.3 Supplementary service sequences

Terms in brackets are optional and the usage of the terms depends on the provision of the service.

Choice of destination:

AdC##71*GA1(*GA2*...*GAn)#'Message'#

where GA is the geographical area identification.

Repetition:

AdC##72#'Message'#

Prioritization:

AdC##73*PR(*ID)#'Message'#

where PR is the priority number 1 or 3. ID is the legitimisation or authentication code depending on the provision of the service.

Multi-address call:

There are two alternatives to enter two or more AdCs. The first one is to enter all the relevant addresses continuously separated by * and terminated by #.

AdC1*AdC2(*...*AdCn)#'Message'#

Another alternative is to enter first one AdC and append the remainder after the multi-address call service identification code.

AdC1##74*AdC2(*AdC3*...*AdCn)#'Message'#

Urgent message:

AdC##75(*ID)#'Message'#

where ID is the legitimisation or authentication code.

Deferred delivery:

AdC##76*DDMMYY*HHMM#'Message'#

where DDMMYY means day, month, year and HHMM is hour and minute.

Standard text:

AdC#*77*TNO#

where TNO is the number of the selected text. The accessed standard text list is that provided by the operator of the PNC-H of the MS.

Standard text:

AdC#*78(*LID*ID)*TNO#

where LID is the text list identification, ID is the legitimisation code and TNO is the number of the selected text. The accessed standard text list is located in the PNC-I of the calling party.

7.3.3.5 Subscriber features for fixed subscribers

7.3.3.5.1 Functional description of the protocol

The provision of a dedicated telephonic access for FSs is according to the operator's policy. The implementation of the access and the protocol is not specified within this ETS. The following service identification codes are reserved for FS access:

- 82 Address list management;
- 83 Access to the accumulated call charges;
- 84 Password management;
- 85 Legitimation code management;
- 87 Standard text management.

For call input the SS identification codes defined in subclause 7.3.3.4.1 shall be used.

7.3.3.6 Subscriber features for mobile subscribers

7.3.3.6.1 Functional description of the protocol

The SFs are accessed by first entering the AdC and the AC. After the validation of the AdC and the AC the service identification code with the service code prefix is entered. The prefix indicates the type of the process to be applied to the service. The following prefixes are used:

- * Service activation;
- # Service deactivation;
- *# Service status check.

The service identification codes are as follows:

- 90 Roaming;
- 91 Temporary barring;
- 92 Diversion;
- 93 Message retransmission;
- 94 Password management;
- 95 Legitimation code management;
- 96 Deferred delivery;
- 99 All features.

The additional parameters needed to control a service are entered after the service identification code. The character * is used as a block separator and the parameter list is terminated by the character #. If the calling party keys the terminator while some of the parameters are still missing, the PNC should guide the calling party to enter the missing parameters.

It is possible to control several SSs within one call by entering the new SS code prefix, service identification code and the list of parameters. The operator may limit the number and the combination of services within a call.

7.3.3.6.2 System responses and acknowledgements

The PNC shall provide at least the following acknowledgements:

- subscriber feature accepted;
- subscriber feature not accepted.

7.3.3.6.3 Subscriber feature control sequences

This is only a simplified description of the control sequences. The usage of the terms in brackets depends on the provision of the service.

For every SF with start and stop date and time, the calling party should be able to choose the activation moment as the starting date and time. The ending date and time may be omitted. The duration is predetermined by each operator. For instance, a roaming demand with default values shall be dialled as:

90##GA1(..... *GA_n)#

Roaming:

Activation: *90*DDMMYY*HHMM#ddmmyy*hhmm#GA1(*...*GAn)#

where DDMMYY is the starting date (day, month, year), HHMM is the starting time (hour, minute), ddmmyy is the ending date, hhmm is the ending time and GA is the geographic area.

Deactivation: #90#

Cancels all activated roaming. The system shall prompt the user to confirm the command. The command shall be confirmed by keying #, or aborted by keying *# (escape).

Deactivation: #90*DDMMYY*HHMM#ddmmyy*hhmm#GA#

A command to deactivate only a selected part of the preliminary activated roaming.

Status check: *#90#

Temporary barring:

Activation: *91*DDMMYY*HHMM#ddmmyy*hhmm(#MID)#

where DDMMYY is the starting date (day, month, year), HHMM is the starting time (hour, minute), ddmmyy is the ending date, hhmm is the ending time and MID is the message identification.

Deactivation: #91#

Status check: *#91#

Diversion:

Activation: *92*DDMMYY*HHMM#ddmmyy*hhmm#DAdC#

where DDMMYY is the starting date (day, month, year), HHMM is the starting time (hour, minute), ddmmyy is the ending date, hhmm is the ending time and DAdC is the divert AdC.

Deactivation: #92#

Status check: *#92#

Message retransmission:

Activation: *93*LN*HN#

where LN is the lowest and HN is the highest number of the messages to be sent.

Deactivation: Not valid

Status check: *#93#

The MS receives the last message number and the total number of stored messages.

Password management:

Activation: *94*NPW*NPW#

where NPW is the new password.

Deactivation: Not valid

Status check: Not valid

Legitimation code management:

Activation: *95*SIC*OLC*NLC*NLC#

where SIC is the service identification code of the associated service, OLC is the old code and NLC is the new code.

Deactivation: Not valid.

Status check: Not valid.

Deferred delivery:

Activation: *96*DDMMYY*HHMM#

where DDMMYY is day, month and year and HHMM is hour and minute.

Deactivation: #96#

Status check: *#96#

All features:

Activation: Not valid.

Deactivation: #99#

Command resets all currently activated SSs to their default values. The system shall prompt the user to confirm the command. The command shall be confirmed by keying #, or aborted by keying *# (escape).

Status check: *#99#

The MS receives a list of all activated features.

7.4 Alphanumeric terminal access methods

In these access methods, the use of an alphanumeric terminal is assumed. Depending on the access network, a modem may be required. When connected to the ISDN, the telecommunication interface of the terminal shall be in accordance with the I.4xx series of ITU-T Recommendations.

Alphanumeric terminal access methods shall, as a minimum requirement, comply with the essential sections of subclauses 7.1 and 7.2.

7.5 Telex access

7.5.1 One-stage selection

7.5.1.1 General

In one-stage selection telex access to the ERMES system, the individual telex number assigned to the MS shall be within the national telex numbering plan.

The individual telex number shall consist of digits which identify the PNC and the AdC. The composition and assignment of the individual telex number is for each operator to determine. However, the structure of the AdC shall follow subclause 5.1.

Procedures for call establishment should appear to the calling party to be the same as for any telex call.

When one-stage selection is used, the accessed PNC is always the PNC-H of the MS.

7.5.1.2 Interactive mode

7.5.1.2.1 Functional description of the protocol

The incoming call shall be answered, provided that the telex number is valid.

The protocol shall follow the generic protocol for interactive access mode presented in subclause 7.1.3.

7.5.1.3 Non-interactive mode

7.5.1.3.1 Functional description of the protocol

The incoming call shall be answered, provided that the telex number has been correctly selected.

The protocol shall follow the generic protocol for non-interactive access mode presented in subclause 7.1.1.

7.5.2 Two-stage selection - interactive

7.5.2.1 General

There are two modes of interactive telex access: an interactive mode and a fast interactive mode. The interactive mode has detailed prompting and is intended for use by callers who are unfamiliar with the input of messages via telex. The fast interactive mode is intended for use by callers who wish to prepare messages off-line and who are familiar with message input via telex and do not need the level of user-prompting provided by the interactive method of message input.

7.5.2.1.1 System responses and acknowledgements

These shall be as described in subclause 7.1.2.2.

7.5.2.1.2 Input editing and typing error correction

These shall be as described in subclause 7.1.2.3. The "rub-out" key shall be used as a delete character command. The sequence "XXXXX ANUL" shall be used as a delete line command. The terminator for each input is "carriage return, line feed". The EOM is "NNNN" on a new line.

7.5.2.1.3 Guidance to the calling party

Guidance shall be as described in subclause 7.1.2.4.

7.5.2.2 The protocol via SN1

Telex access for the input of calls is normally provided via SN1. The calling party dials SN1 (belonging to the national telex numbering plan) for the required PNC (prefixed by the international access code if required; this access code is in ITU-T Recommendation F.69 [6]) (see also subclause 7.1.2.1.2).

7.5.2.2.1 Interactive mode

After exchanging answerbacks in accordance with normal telex procedures, the system shall prompt the calling party for input, following the generic protocol defined in subclause 7.1.2.1.2.

7.5.2.2.2 Fast interactive mode

After dialling the telex Service Number SN1 and exchanging answerbacks in accordance with normal telex procedures, the caller shall input the call information in the following format:

```
C:  ZCZC
    <AdC>      (see note 1)
    <message>  (see note 5)
    NNNN
```

The system shall respond as follows:

```
S:  ZCZC
    <AdC>
    <Acknowledgement or guidance message>
    NNNN
```

NOTE 1: S and C stand respectively for System and Caller.

NOTE 2: < > indicates the content of the field and are not required.

NOTE 3: Carriage return and line feed characters are used between each line.

NOTE 4: The AdC shall conform to the ERMES numbering plan.

NOTE 5: For numeric and alphanumeric call only. The content of the messages is restricted to the appropriate character set, for numeric see ETS 300 133-2 [1] and for alphanumeric see the ITU-T telex alphanumeric character set recommendations. (ITU-T Recommendation S.1 [10], ITU-T Recommendation S.2 [11]).

NOTE 6: Several calls may be input by repeating the sequence within one session, if this facility is supported by the operator.

NOTE 7: The message is terminated by "NNNN" on a new line.

NOTE 8: The calling party inputs "++++" on a new line when he ends the transaction.

7.5.2.2.3 Call input related supplementary services

7.5.2.2.3.1 Interactive mode

After exchanging answerbacks in accordance with normal telex procedures, the system shall prompt the calling party for input, following the generic protocol as specified in 7.1.2.1.2.

"/" is to be used as a block separator and "," as a parameter separator.

7.5.2.2.3.2 Fast interactive mode

After dialling the telex service number SN1 and exchanging answerbacks according to the telex procedure, the caller shall input the call information as shown in the following example:

```
C:  ZCZC
    <AdC>/<SIC1>,<P1>,<P2>/<SIC2>
    <message>
    NNNN
```

This would initiate a call with supplementary services SIC1 and SIC2.

The system shall respond as follows:

```
S:  ZCZC
    <AdC>
    <Acknowledgement or guidance message>
    NNNN
```

Multiple SSs may be accessed by separating each service identification code by "/". Additional information relating to a SS (where applicable) follows the service identification code and each parameter is preceded by ",".

7.5.2.3 The protocol via SN2

Telex access for SFs is normally provided via SN2. The protocol followed shall be as described in subclause 7.1.2.1.3.

As roaming is the only essential SF which may be accessed from a visited PNC, examples of the protocol are given for both interactive and fast interactive modes.

7.5.2.3.1 Roaming interactive mode

After exchanging answerbacks in accordance with normal telex procedures, the dialogue then proceeds as described in figure D.6.

7.5.2.3.2 Roaming fast interactive mode

After exchanging answerbacks in accordance with normal telex procedures, the caller shall input a roaming service request as shown below:

```
C:  ZCZC
    <AdC>
    <AC>
    <90>                (see note 1)
    <Activation>       (see note 2)
    <Start date and time>
    <Stop date and time>
    <Geographical areas>
    NNNN
```

NOTE 1: <90> corresponds to the SIC for roaming.

NOTE 2: <Activation> corresponds to the function type request.

The ordering of information provided shall follow the generic protocol described in subclause 7.1.2.1.3.

The system shall respond as follows:

```
S:  ZCZC
    <AdC>
    <90>
    <Start date and time>
    <Stop date and time>
    <Geographical areas>
    <Confirm request>
    NNNN
```

7.5.3 Two-stage selection - non-interactive

7.5.3.1 General

This access method is intended for message switches, telex machine which cannot support conversational dialogue or for use by calling parties who wish to pre-format their calls off-line.

The calling party should indicate non-interactive mode with the non-interactive service request (see subclause 7.1.1).

7.5.3.2 The protocol via SN1

7.5.3.2.1 Call input

The page information format shall be as described for the fast interactive mode as presented in subclause 7.5.2.2.3.2. Automatic advice of delivery/non-delivery shall be given by the PNC-I.

7.5.3.2.2 Call input related supplementary services

Multiple supplementary services may be accessed by separating each service identification code by "/".

Additional information related to a SS (where applicable) follows the service identification code and each additional parameter is preceded by ",".

NOTE: Using the non-interactive input, it is not possible to access some SSs which require information to be passed back to the calling party.

EXAMPLE:

```
C:  ZCZC
    <AdC>/<SIC1>,<P1>,<P2>/<SIC2>/<SIC3>
    <message>
    NNNN
```

This would initiate a call with supplementary services SIC1, SIC2 and SIC3.

7.5.3.3 The protocol via SN2

This shall be as described in subclause 7.1.2.1.3 and shall conform the format of information as shown in subclause 7.5.2.3.2 for the fast interactive mode.

7.6 Message handling system access

7.6.1 General

This subclause describes the general, operational and service procedure for the provision of intercommunication between the Interpersonal Messaging (IPM) service and the ERMES service.

The communication is based on store and forward principles and allows users of the IPM service to send electronic messages to ERMES MSs. The Interpersonal Messaging Service is specified in ITU-T Recommendation X.400 [12]. The User Agents (UAs) used in the IPM service (IPM-UAs) comprise a special class of co-operating UAs.

It should be noted that the delivery times of Message Handling System (MHS) specified in ITU-T Recommendation F.410 [7] exceed those specified for the ERMES system.

In ITU-T Recommendation X.400 [12], for MHS, a user is either a person or a computer process. The user prepares messages with the assistance of a UA. The UA is a computer application process which may include functions for local editing, temporary storage and archiving.

The interaction between the user and UA is not within the scope of the ITU-T Recommendation X.400 series. Similarly the functions provided to the user by the UA (the MHS equivalent to the I6 interface) are not within the scope of this ETS.

7.6.2 ERMES access unit

The IPM service is a messaging service which may be provided on a variety of networks and allows several forms of addresses, whereas the ERMES service provides transmission of messages to MSs identified by a numeric AdC. To match the dissimilar characteristics of the two services it is necessary to provide communication via an ERMES Access Unit (AU). This is illustrated in figure 16.

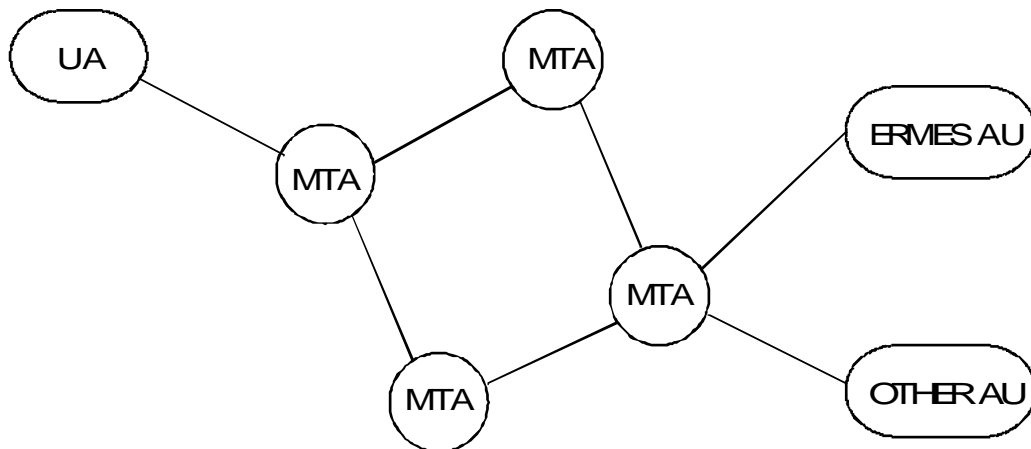

Figure 16: Functional model of MHS - ERMES interworking

The ERMES AU may be located in the PNC.

All functions needed for reliable transport of interpersonal messages (IP-messages) from the originator to the ERMES AU and vice versa are already specified in the X.400 series of ITU-T Recommendation X.400 [12].

7.6.3 Structure of IP-message

The IPM class of UAs create messages containing a content specific to the IPM.

The IP-message contains information (e.g. to, cc, subject) provided by the user which is transformed by the IPM UA into the heading of the IP-message. The main information that the user wishes to communicate is contained within the body of the IP-message.

7.6.4 One-stage selection

The one-stage selection method is recommended because it enables the calling party to take advantage of all the advanced features of the X.400 series of ITU-T Recommendations. The standardized addressing integrates the ERMES service with all major office automation systems.

7.6.4.1 Operational procedures

Messages from an IPM service user to an ERMES MS are sent as normal IP-messages with appropriate IPM elements of service (ITU-T Recommendation F.420 [8]). A MHS address shall be allocated to each ERMES MS.

When a message is received by the ERMES AU, the recipient (mobile subscriber) shall be validated against the ERMES subscription database. The message shall also be validated to ensure that the content size, content type, and/or enclosed information types are acceptable.

For numeric or alphanumeric messages the message content, if valid, shall be converted into the appropriate character set defined in ETS 300 133-2 [1]. The converted message shall be distributed to the ERMES system for transmission to the MS.

A delivery notification shall be sent back to the originating IPM service user if requested. In the event that the message cannot be delivered to the MS a non-delivery notification shall be sent back to the IPM service user, unless the IPM user has requested prevention of non-delivery notification.

7.6.4.2 Call input

The calling party has the two following alternate ways of addressing, when the paging messages are sent to the MS:

- TO: - addressing;
- CC: - addressing.

When TO: - addressing is used, the ERMES AU shall transfer the body part of the IP-message to the ERMES system for transmission to the MS.

In the CC: - addressing, the IP-message heading is to be sent to the MS. The elements of service related to the IP-message heading shall be converted into printable text. The language of this text is a national matter. The CC: - addressing could be used when the calling party wishes to confirm to the MS that a message has been sent to an electronic mailbox.

7.6.5 Two-stage selection

The two-stage selection method, if provided, is mainly intended to be used for activating the SFs for MSs, e.g. roaming.

7.6.5.1 Operational procedures

Messages from an IPM service user to an ERMES service are sent as normal IP-message with appropriate IPM elements of service (ITU-T Recommendation F.420 [8]). A MHS address shall be allocated to each ERMES two-stage selection SN. The AdC of the MS shall be included in the body part of the IP-message.

When a message is received by the ERMES AU, the recipient (mobile subscriber) shall be validated against the ERMES subscription database. The message shall also be validated to ensure that the content size, content type, and/or enclosed information types are acceptable.

For numeric or alphanumeric messages the message content, if valid, shall be converted into the appropriate character set defined in ETS 300 133-2 [1]. The converted message shall be distributed to the ERMES system for transmission to the MS.

A delivery notification shall be sent back to the originating IPM service user if requested. In the event that the message cannot be delivered to the MS a non-delivery notification shall be sent back to the IPM service user, unless the IPM user has requested prevention of non-delivery notification.

Subclause 7.6.4.1 specifies the IPM elements of service applicable to the ERMES AU, and defines the processing required.

7.6.5.2 Call input

The calling party shall access the ERMES AU SN1 by using the TO: - addressing. The AdC of the MS and the paging message are both included in the body part of the IP-message. The following call input format is recommended:

```
AdC
Message
EOM
```

The recommended special characters are defined in subclause 7.1.5.

7.6.5.3 Call input with supplementary services

The calling party shall access the ERMES AU SN1 by using the TO: - addressing. The selected ERMES SS identification codes with associated parameters shall be included into the body part of the IP-message between the AdC and the paging message as follows:

```
AdC
/SIC1, P1/SIC2, P1, P2
Paging Message
```

NOTE: SIC = Service Identification Code

P = Parameters

The recommended special characters are presented in subclause 7.1.5. The calling party may use available IPM elements of service when accessing the ERMES AU.

7.6.5.4 Access to subscriber features

The calling party shall access the ERMES AU SN2 by using the TO: - addressing. It is recommended that the order of the parameters and the usage of the special characters are in accordance with subclause 7.1. The following example shows the activation of roaming:

```
AdC
AC
90
Activation
Start date and time
Stop date and time
Geographical areas
```

NOTE: 90 = Service identification code for roaming.

7.7 Bureau access

The provision of a bureau service access method to enable access to ERMES services via an operator is optional. This access method is not harmonized.

7.8 Videotex access method

7.8.1 General

The use of a videotex terminal is assumed. As specified in ITU-T Recommendation F.300 [9], Videotex service offers interactive mode only. It is also assumed that this access method only allows two-stage selection.

The ERMES operator may benefit from all the facilities provided within the videotex network. These facilities are described in ITU-T Recommendation F.300 [9].

This access method should follow the generic protocol for two-stage selection type, interactive mode, as specified in subclause 7.1.2.

7.8.2 Message page input

In order to render the dialogue as simple and easy to handle as possible, the number of screens should be limited to what is strictly necessary. As far as the page input is concerned the number of pages depend on the type of message. For tone-only and numeric, there should be only one page. For alphanumeric messages, there should normally be two pages: the first one should allow the input of the AdC and the possible SSs; the second one, the input of the message itself. The general forms are for each operator to determine.

In addition to these basic forms, there should be additional pages which may be called for the guidance of the calling party when entering or editing his message. These pages should be specified by each operator according to the level of detail they want to provide to their customers (the minimum requirements are defined in subclause 7.1.2).

7.9 ISDN Access

7.9.1 General

Many of the possible ERMES access methods may be interfaced to the PNC via an ISDN I5 interface. Some of the possible access methods are illustrated in figure 17. The non-ISDN I6 access dialogues for these methods are defined for each access method in the relevant subclauses listed at the bottom of figure 17.

This subclause describes the I6 access dialogues for ISDN terminals, using (except in subclause 8.9.2.1) the ISDN Supplementary Services "User-To-User Signalling", services 1 and 3 as specified in CEPT Recommendation T/SF 31-7 [5].

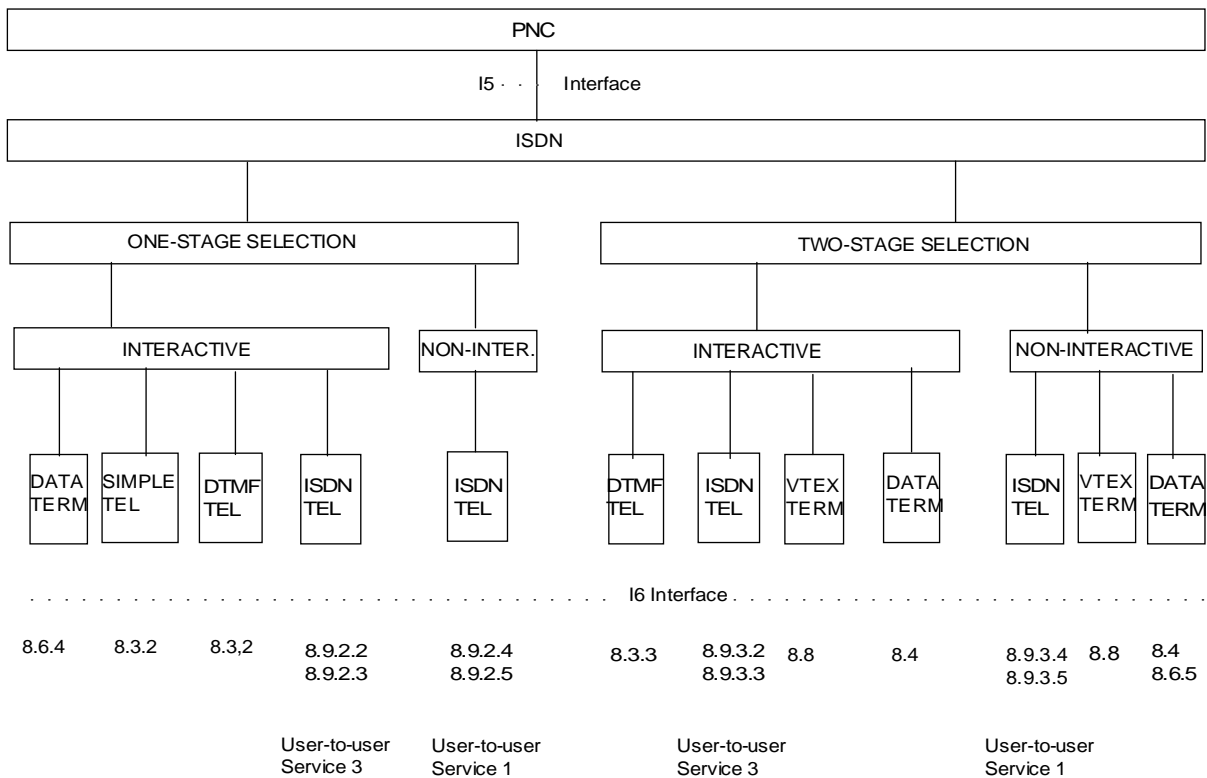

Figure 17: Access methods supported by ISDN

7.9.2 One-stage selection

7.9.2.1 One-stage selection for tone-only service via ISDN

This subclause describes the protocol used when tone-only messages are sent from an ISDN telephone not using the User-to-User signalling facility.

The calling party dials the MS's tone-only AdC. The PNC shall validate the Subscriber Identification (SI) and send the tone-only message to the MS, if the AdC is valid. The calling party shall be sent a "call accepted acknowledgement" via the B channel, and the ISDN connection may be released.

Only one tone-only message may be sent within one phone call. If the call is not accepted, the calling party should hang up the phone and try again with another AdC.

The PNC shall have a time-out function that disconnects the ISDN connection, if the telephone is not hung up within a defined time after the acknowledgement.

Examples of the one-stage selection protocol for tone-only service are given below:

1) Normal call:

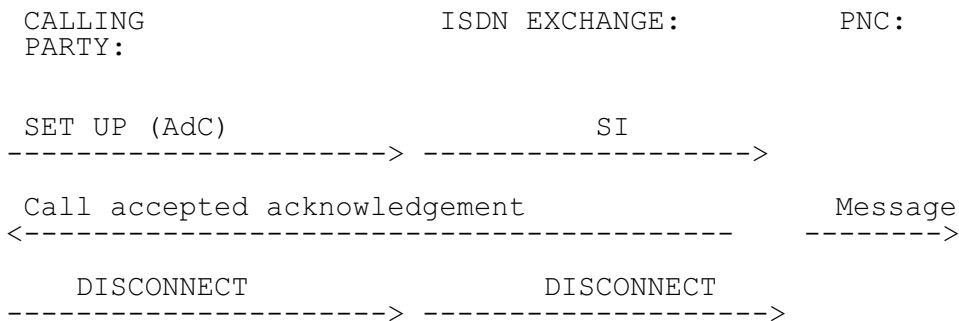

2) Call with a wrong AdC:

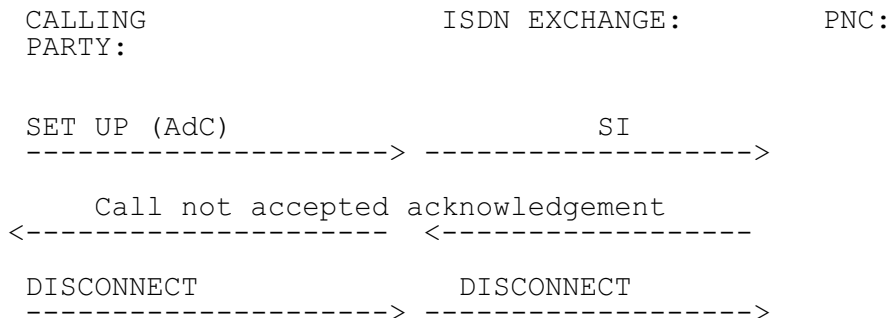

3) Call with a time-out:

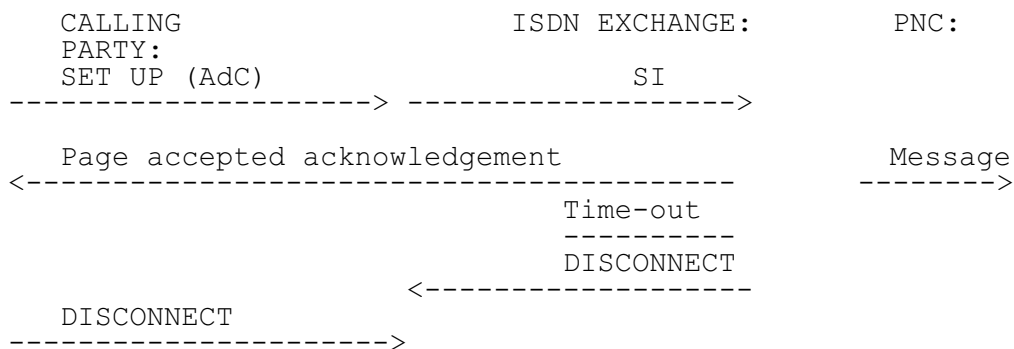

7.9.2.2 One-stage selection for numeric service via ISDN (UUS3)

This subclause describes the protocol used when numeric messages are sent using an ISDN-telephone with the UUS3 facility. The protocol takes account of:

- home area access;
- internetwork access;
- message editing.

This procedure uses the possibility to send a limited amount of information over the D channel in the ISDN networks. The possibility of sending DTMF coded information over the B channel is not described in this protocol.

Sending of messages

The following information is used when a message is sent:

- message with end of the message indication (EOM).

The PNC shall support the responses and acknowledgements specified in subclause 7.1.3.2. The system shall provide at least the following acknowledgements:

- call accepted;
- page accepted;
- call not accepted;
- page not accepted.

and should provide the following acknowledgements:

- call conditionally accepted (transmission/delay in all areas not guaranteed);
- unable to send message because of system failure;
- time-out warning.

The PNC shall have a time-out function that releases the ISDN connection if the calling party does not continue sending User to User Information (UUI) within a defined time. A special announcement (via B or D channel (UUI 3)) or tone shall be used as a time-out warning to inform the calling party of the element that should be typed in next. The timing, the number and the structure of the warnings are according to the operator's policy. The use of both recorded announcements via B channel and UUI 3 messages via D channel should be supported. The responses are sent either via B- or D- channel. If the sending of UUI is not continued after the last warning, the ISDN connection is disconnected by the PNC.

Typing errors may be corrected before the "end of the message" indication by deleting the message and retyping it. The message is not sent if the ISDN connection is released and the EOM character is missing.

The protocol

The access protocol normally has two phases. First the AdC is dialled, and then the calling party is connected to the PNC.

The PNC shall validate the AdC and if valid send the "call accepted" acknowledgement to the calling party. If the AdC is not valid a "call not accepted" acknowledgement shall be sent to the calling party and the ISDN connection is released.

If the call is accepted, the message may be sent. The PNC shall check the length of the message and that the message contains only those characters specified in the numeric character set in ETS 300 133-2 [1]. The "page accepted/page not accepted" acknowledgement shall then be sent to the calling party. If the page is not accepted, the PNC shall indicate that it is ready for another message. The operator may limit the number of trials.

Examples of one-stage selection protocol for numeric service via ISDN are given below:

1) Normal call:

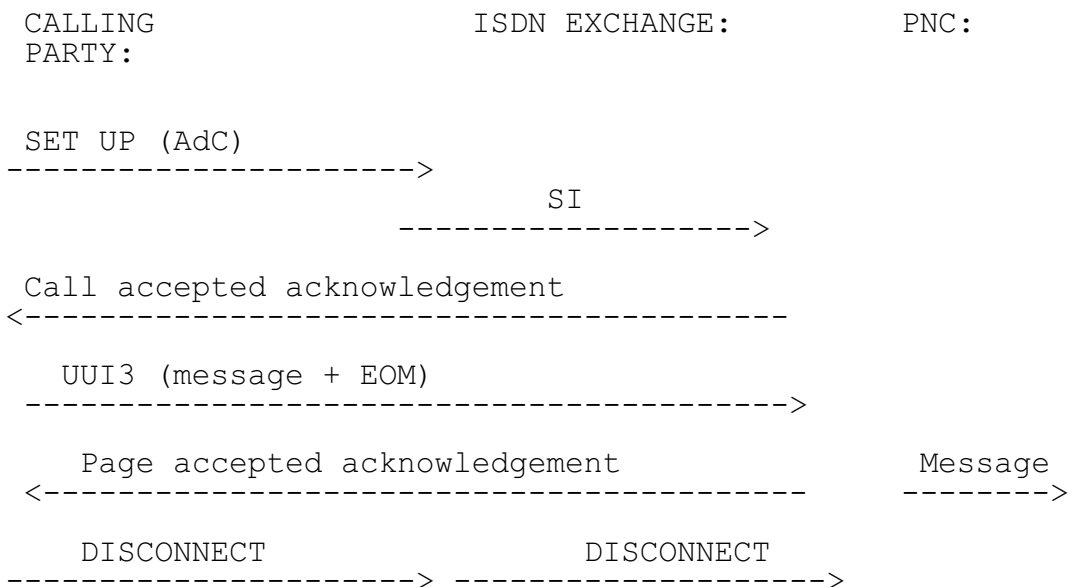

2) Call with a wrong AdC:

CALLING PARTY:	ISDN EXCHANGE:	PNC:
SET UP (AdC)	SI	
----->		
Call not accepted acknowledgement		
<-----		
DISCONNECT		
----->		

3) Call with message editing:

CALLING PARTY:	ISDN EXCHANGE:	PNC:
SET UP (AdC)	SI	
----->		
Call accepted acknowledgement		
<-----		
UII 3 (message + ESC)		
----->		
Call accepted acknowledgement		
<-----		
UII 3 (message + EOM)		
----->		
Page accepted acknowledgement		Message
<----->		
DISCONNECT	DISCONNECT	
----->		

4) Call with a non-acceptable message:

CALLING PARTY:	ISDN EXCHANGE:	PNC:
SET UP (AdC)	SI	
----->		
Call accepted acknowledgement		
<-----		
UII 3 (message + EOM)		
----->		
Page not accepted and error type		
<-----		
Call accepted acknowledgement		
<-----		
UII 3 (message + EOM)		
----->		
Page Accepted Acknowledgement		Message
<----->		
DISCONNECT	DISCONNECT	
----->		

5) Interrupted call:

CALLING PARTY:	ISDN EXCHANGE:	PNC:
<pre> SET UP (AdC) -----> SI -----> <----- Call accepted acknowledgement UUI 3 (message ...) -----> DISCONNECT -----> DISCONNECT -----> </pre>		

6) Call with a time-out:

CALLING PARTY:	ISDN EXCHANGE:	PNC:
<pre> SET UP (AdC) -----> SI -----> <----- Call accepted acknowledgement UUI 3 (message) ... + time-out -----> <----- Time-out warning Last time-out ----- <----- Page not accepted DISCONNECT -----> DISCONNECT -----> </pre>		

7.9.2.3 One-stage selection for alphanumeric service via ISDN (UUS3)

The access method for alphanumeric service is similar to the procedure for the numeric service (subclause 7.9.2.2).

7.9.2.4 One-stage selection for numeric service via ISDN (UUS1)

This subclause describes the protocol used when numeric messages are sent by using an ISDN telephone with the UUS1 facility.

This procedure uses the possibility to send a limited amount of information over the D channel in the ISDN network. The information is sent in the call set-up message and is therefore a non-interactive procedure. The possibility of sending DTMF coded information over the B channel is not described in this protocol.

Sending of messages

The following information is used when a message is sent:

- subscriber identification (SI);
- message with end of the message indication (EOM).

The PNC shall support the responses and acknowledgements specified in subclause 7.1.3.2. The system shall provide at least the following acknowledgements:

- page accepted;
- call not accepted;
- page not accepted;

and should provide the following acknowledgements:

- call conditionally accepted (transmission/delay in all areas not guaranteed);
- unable to send message because of system failure.

The use of both recorded announcements via B-channel and UUI 1 messages via D-channel should be supported. The responses are sent either via B- or D- channel.

The protocol

The access method is a non-interactive mode operation, where the SI is included in the address field of the call set-up message. The message is included in the UUI. The message is terminated by an EOM (#).

The PNC shall validate the SI and the message. If the validation is successful the message shall be transmitted to the MS and a "page accepted" acknowledgement shall be sent to the calling party. If the SI or message is not valid, a "call not accepted" or a "page not accepted" acknowledgement shall be sent to the calling party.

The calling party does not have the possibility of sending more information. Therefore the PNC shall disconnect the connection after sending the response.

Examples of one-stage selection protocol for an ISDN telephone with user-to-user signalling facility are given below:

1) Normal call:

CALLING
PARTY:

ISDN EXCHANGE:

PNC:

SET UP (AdC): UUI 1 (message + EOM)
----->

SI + UUI 1 (Message + EOM)
----->

Message
----->

OPTION 1:

Page accepted acknowledgement
<-----

DISCONNECT
<-----

OPTION 2:

DISCONNECT: UUI 1 (Page accepted acknowledgement)
<-----

2) Call with non-acceptable AdC or message:

```

CALLING          ISDN EXCHANGE:          PNC:
PARTY:

SET UP: UUI 1    (message + EOM)
----->

                SI + UU1 (message + EOM)
                ----->

```

OPTION 1:

```

    Call or page not accepted acknowledgement
<-----

```

```

                DISCONNECT
                <-----

```

OPTION 2:

```

    DISCONNECT: (UUI 1) Call or page not accepted acknowledgement
<-----

```

7.9.2.5 One-stage selection for alphanumeric service via ISDN (UUS1)

The access method for alphanumeric service is similar to the procedure for the numeric service (subclause 7.9.2.4).

7.9.3 Two-stage selection access type

7.9.3.1 Two-stage selection for tone-only service via ISDN (UUS3)

This subclause describes the protocol used when tone-only messages are sent by using an ISDN-telephone with the user-to-user signalling service 3 facility.

The protocol takes account of:

- home area access;
- internetwork access;
- message editing.

This procedure uses the possibility to send a limited amount of information over the signalling channel in the ISDN network. The possibility of sending DTMF coded information over the B channel is not described in this protocol.

Sending of messages

The following information is used when an AdC is sent:

- Address Code (AdC);
- end of the AdC indication (EOM).

The PNC shall support the responses and acknowledgements specified in subclause 7.1.3.2. The system shall provide at least the following acknowledgements:

- AdC request;
- page accepted;
- call not accepted;

and should provide the following acknowledgements:

- call conditionally accepted (transmission/delay in all areas not guaranteed);
- unable to send message because of system failure;
- time-out warning.

The PNC shall have a time-out function that releases the ISDN connection if the calling party does not continue the sending of UUI within a defined time. A special announcement (via B or D channel (UUI 3)) or tone shall be used as a time-out warning to inform the calling party of the element that should be typed in next. The timing, the number of and the structure of the warnings is according to the operator's policy. The use of both recorded announcements via B channel and UUI 3 messages via D channel should be supported. The responses are sent either via B- or D- channel. If the sending of UUI is not continued after the last warning, the ISDN connection is disconnected by the PNC.

Typing errors may be corrected before the EOM indication by deleting the AdC and retyping it.

The protocol

The access protocol has two phases. First the SN is dialled and the calling party is connected to the PNC.

The AdC is sent after the "AdC request" prompt by using UUS3. The AdC may be sent in one or more UUI 3 messages. The EOM is used at the end of the number. The PNC shall validate the AdC and if valid shall send the "page accepted" acknowledgement to the calling party. If the page is accepted, further calls may be input if permitted by the operator. If the AdC is not valid, the calling party has the possibility to retry with a new AdC. The operator may limit the number of trials.

The tone-only message is not sent if the ISDN connection is released and the EOM character is missing.

Examples of two-stage selection protocol for tone-only service via ISDN are given below:

1) Normal call:

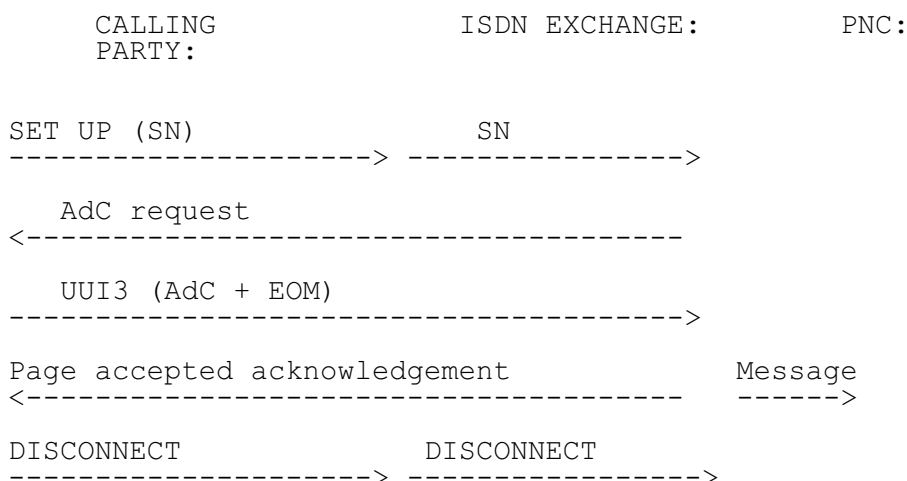

2) Call with a wrong AdC:

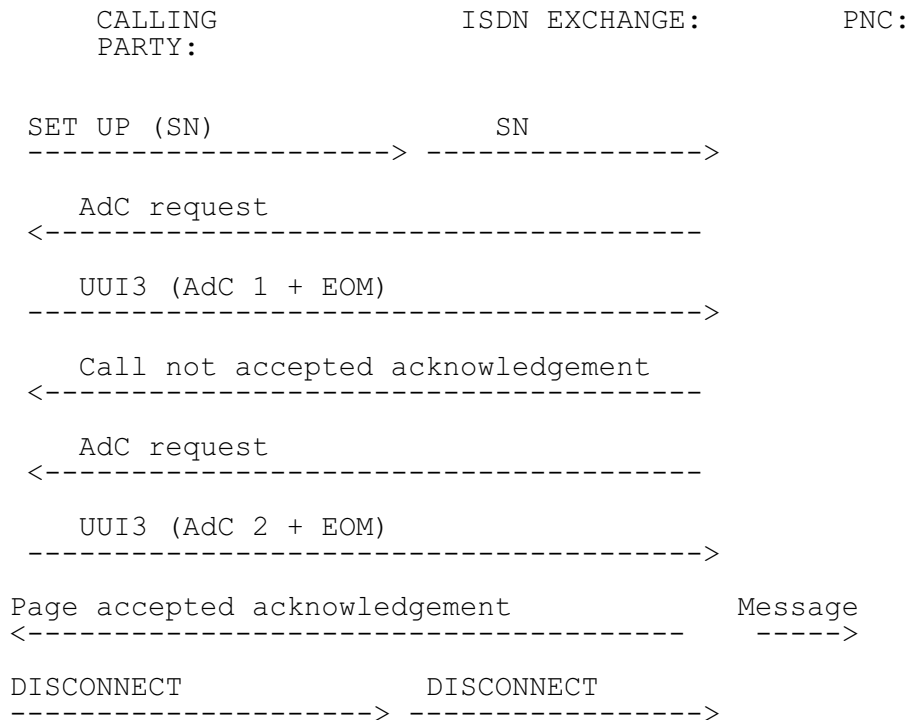

3) Call with AdC editing:

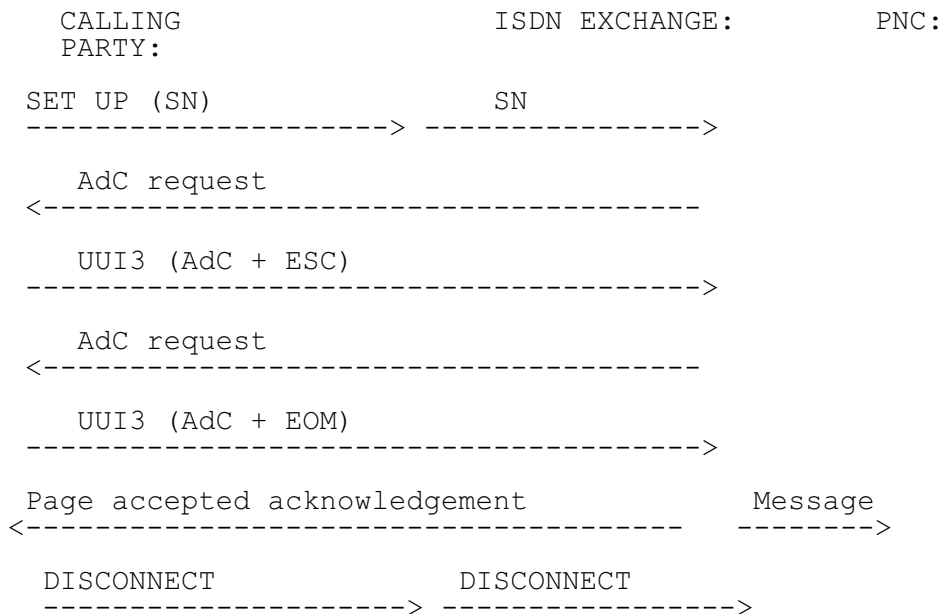

4) Interrupted call:

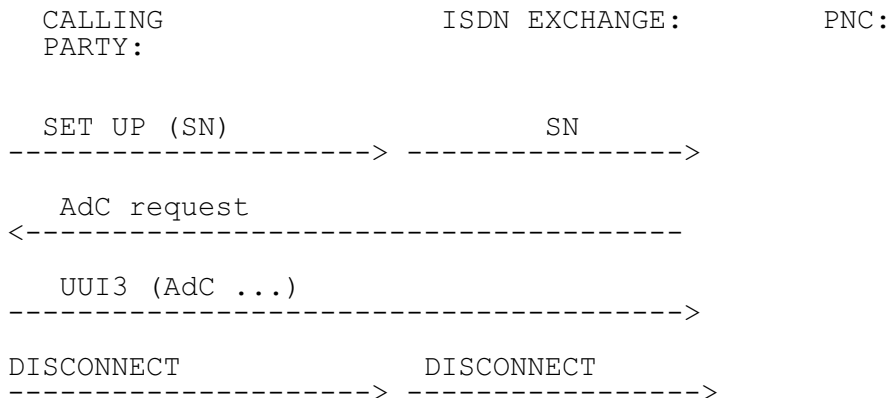

5) Call with a time-out:

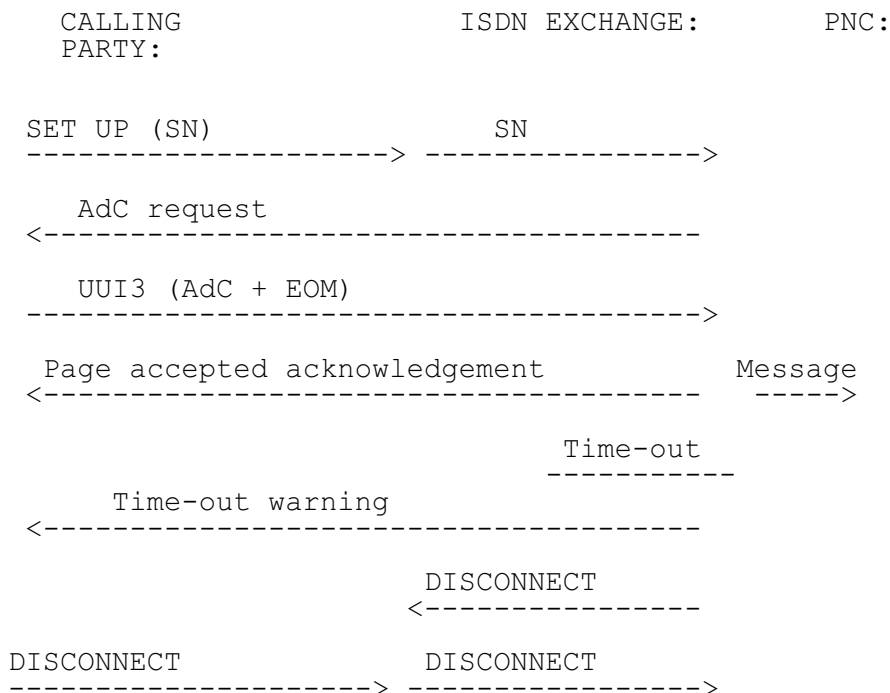

7.9.3.2 Two-stage selection for numeric service via ISDN (UUS3)

This subclause describes the protocol used when numeric messages are sent by using an ISDN telephone with the UUS3 facility. The protocol takes account of:

- home area access;
- internetwork access;
- message editing.

This procedure uses the possibility to send a limited amount of information over the signalling channel in the ISDN network. The possibility of sending DTMF coded information over the B channel is not described in this protocol.

Sending of messages

The following information is used when a message is sent:

- Address Code (AdC);
- end of the address code (EOM);
- message with end of the message indication (EOM).

The PNC shall support the responses and acknowledgements specified in subclause 7.1.3.2. The system shall provide at least the following acknowledgements:

- AdC request;
- call accepted;
- page accepted;
- call not accepted;
- page not accepted;

and should provide the following acknowledgements:

- call conditionally accepted (transmission/delay in all areas not guaranteed);
- unable to send message because of system failure;
- time-out warning.

The system has a time-out function that releases the ISDN connection if the calling party does not continue the sending of UUI within a defined time. A special announcement (via B or D channel (UUI 3)) or tone shall be used as a time-out warning to inform the calling party of the element that should be typed in next. The timing, the number of and the structure of the warnings is according to the operator's policy. The use of both recorded announcements via B channel and UUI 3 messages via D channel should be supported. The responses are sent either via B- or D- channel. If the sending of UUI is not continued after the last warning, the ISDN connection is disconnected by the PNC.

Typing errors may be corrected before the "end of the message" indication by deleting the message and retyping it. The message is not sent if the ISDN connection is released and the EOM character is missing.

The protocol

The access protocol has three phases. First the SN is dialled, and the calling party is connected to the PNC.

The AdC is sent after the "AdC request" prompt by using UUS3. The AdC may be sent in one or more UUI 3 messages. The EOM is used at the end of the AdC. The PNC shall validate the AdC and if valid shall send the "call accepted" acknowledgement to the calling party. If the AdC is not valid, the calling party has the possibility to retry with a new AdC. The operator may limit the number of trials.

If the call is accepted, the message may be sent. The PNC shall check the length of the message and that the message contains only those characters specified in the numeric character set in ETS 300 133-2 [1]. The "page accepted/page not accepted" acknowledgement shall then be sent to the calling party. If the page is accepted, further calls may be input if permitted by the operator. If the page is not accepted, the PNC shall indicate that it is ready for another message. The operator may limit the number of trials.

The user is not required to wait for the "call accepted" acknowledgement and may continue entering the message. The PNC responds with the "page accepted" acknowledgement.

Examples of two-stage selection protocol for numeric service via ISDN are given below:

1) Normal call:

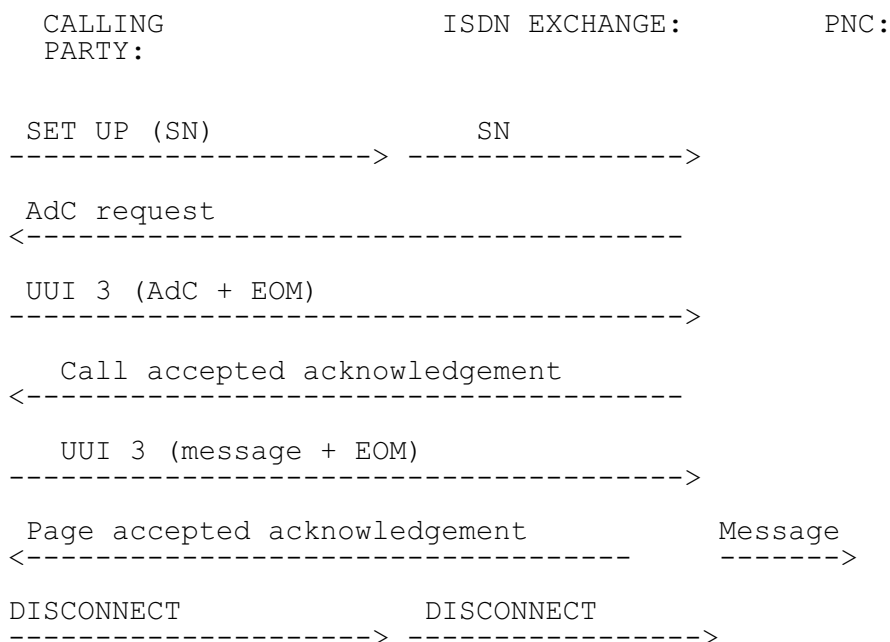

2) Call with a wrong AdC:

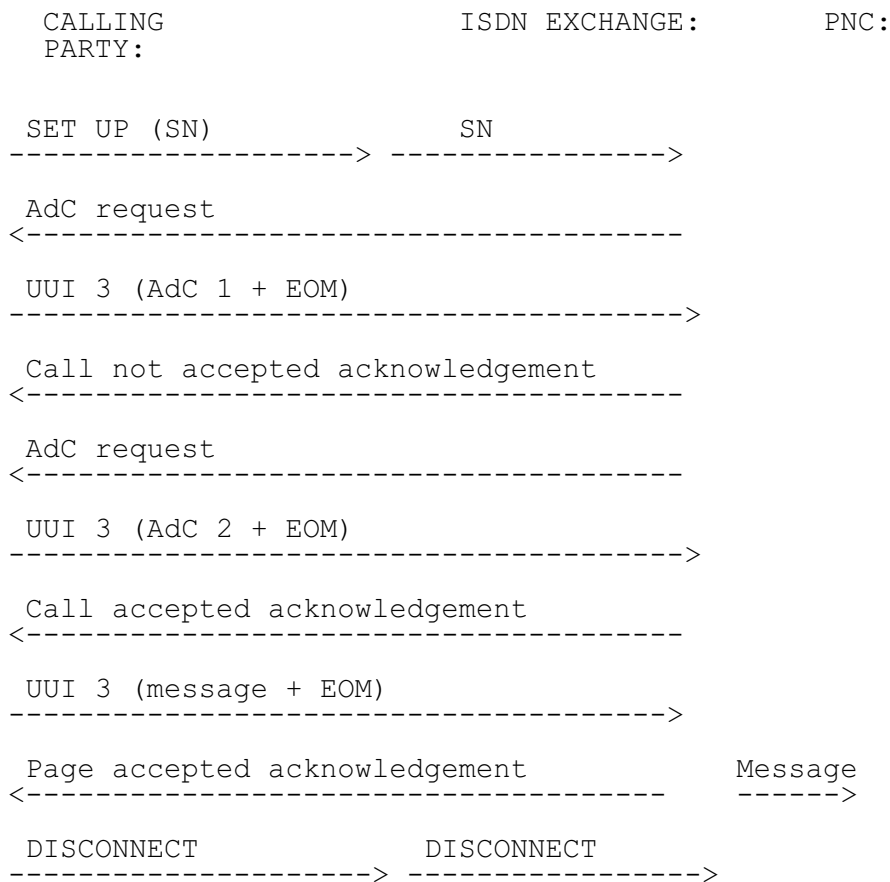

3) Call with message editing:

CALLING PARTY:	ISDN EXCHANGE:	PNC:
SET UP (SN)	SN	
----->	----->	
AdC request		
<-----		
UI 3 (AdC + EOM)		
----->		
Call accepted acknowledgement		
<-----		
UI 3 (message + ESC)		
----->		
Call accepted acknowledgement		
<-----		
UI 3 (message + EOM)		
----->		
Page accepted acknowledgement		Message
<-----		----->
DISCONNECT	DISCONNECT	
----->	----->	

4) Call with a non-acceptance message:

CALLING PARTY:	ISDN EXCHANGE:	PNC:
SET UP (SN)	SN	
----->	----->	
AdC request		
<-----		
UI 3 (AdC + EOM)		
----->		
Call accepted acknowledgement		
<-----		
UI 3 (message + EOM)		
----->		
Page not accepted and error type		
<-----		
Call accepted acknowledgement		
<-----		
UI 3 (message + EOM)		
----->		
Page accepted acknowledgement		Message
<-----		----->
DISCONNECT	DISCONNECT	
----->	----->	

5) Interrupted call:

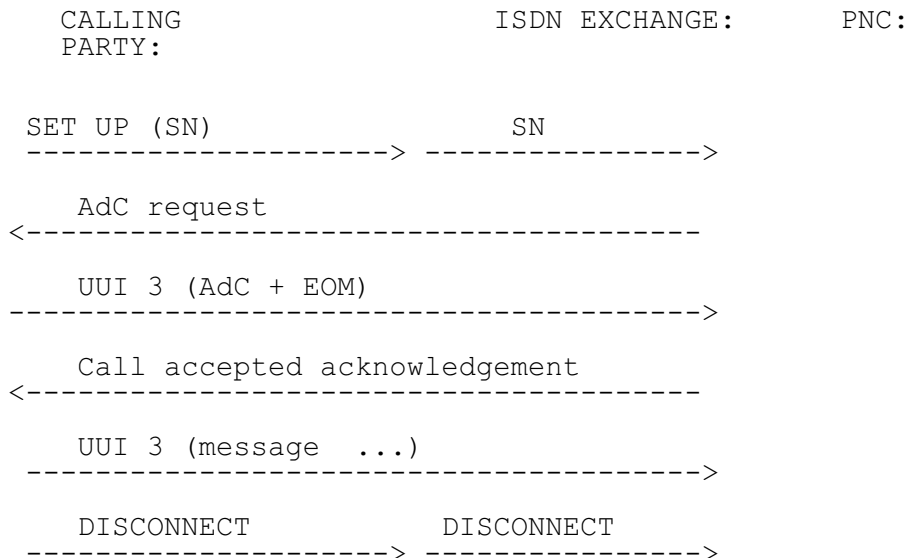

6) Continuous input:

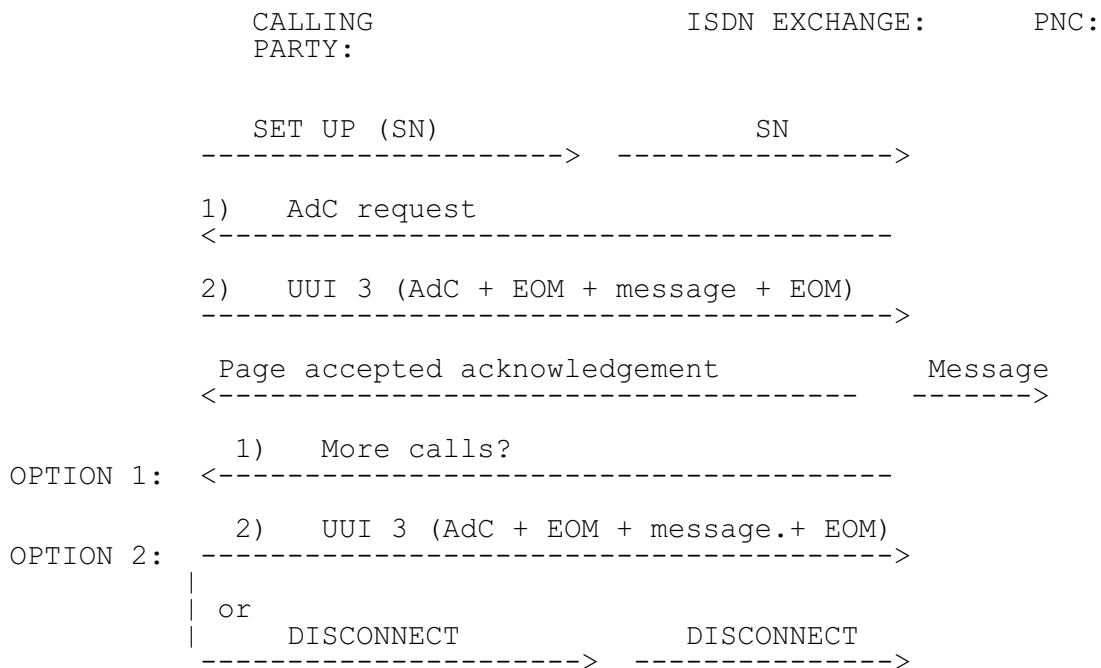

7) Call with a time-out:

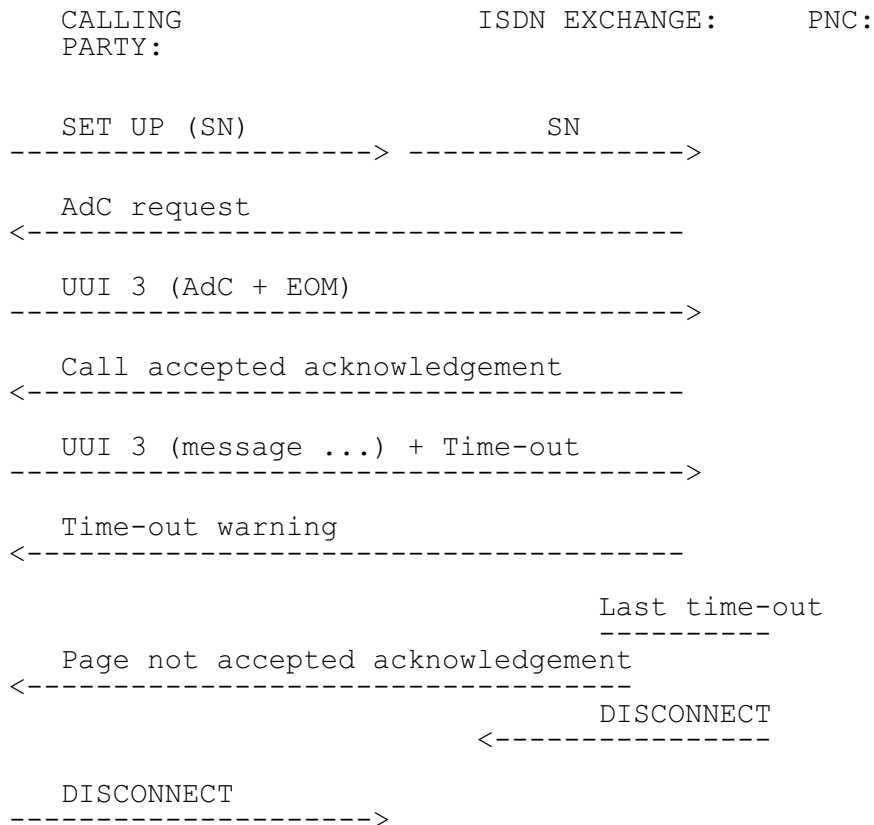
**7.9.3.3 Two-stage selection for alphanumeric service via ISDN (UUS3)**

The access method for alphanumeric service is similar to the procedure for the numeric service (subclause 7.9.3.2).

7.9.3.4 Two-stage selection for numeric service via ISDN (UUS1)

This subclause describes the protocol used when numeric messages are sent by using an ISDN telephone with the UUS1 facility.

This procedure uses the possibility to send a limited amount of information over the D channel in the ISDN network. The information is sent in the call set-up message and is therefore a non-interactive procedure.

Sending of messages

The following information is used when a message is sent:

- SN;
- Address Code (AdC) with end of AdC indication (EOM);
- Message with end of the message indication (EOM).

The PNC shall support the responses and acknowledgements specified in subclause 7.1.3.2. The system shall provide at least the following acknowledgements:

- page accepted;
- call not accepted;
- page not accepted;

and should provide the following acknowledgements:

- call conditionally accepted (transmission/delay in all areas not guaranteed);
- unable to send message because of system failure.

The use of both recorded announcements via B-channel and UII 1 messages via D-channel should be supported. The responses are sent either via B- or D- channel.

The protocol

The access method is a non-interactive mode operation, where the AdC and the message are sent in the UII field of the call set-up message. The AdC is separated from the message by an EOM (#). The message is terminated by an EOM (#).

The PNC shall validate the AdC and the message. If the validation is successful the message shall be transmitted to the MS and a "page accepted" acknowledgement shall be sent to the calling party. If the AdC or message is not valid a "call not accepted" or "page not accepted" acknowledgement shall be sent to the calling party.

The calling party does not have the possibility of sending more information. Therefore the PNC shall disconnect the connection after sending the response.

Examples of two-stage selection access protocol for an ISDN telephone with user-to-user signalling facility are given below:

1) Normal call:

CALLING PARTY:	ISDN EXCHANGE:	PNC:
----------------	----------------	------

SET UP: UII 1 (SN+AdC+EOM+Message+EOM)
 ----->

SN+UII 1 (AdC+EOM+message+EOM)
 ----->

Message
 ---->

OPTION 1:
 Page accepted acknowledgement
 <-----

DISCONNECT
 <-----

OPTION 2:
 DISCONNECT: UII 1 (Page accepted acknowledgement)
 <-----

2) Call with non-acceptance AdC and/or message:

```

CALLING          ISDN EXCHANGE:          PNC :
PARTY:

SET UP (SN): UUI 1 (AdC+EOM+message+EOM)
----->

                                SN+UU1 (AdC+EOM+message+EOM)
                                ----->

OPTION 1:
    Call or message not accepted acknowledgement
<-----

                                DISCONNECT
                                <-----

OPTION 2:
DISCONNECT: UUI 1 (Call or message not accepted acknowledgement)
<-----

```

7.9.3.5 Two-stage selection for alphanumeric service via ISDN (UUS1)

The access method for alphanumeric service is similar to the procedure for the numeric service (subclause 7.9.3.4).

8 I5 interface

8.1 General

Clause 8 describes the version 02.01 of the computer protocol (UCP) of the I5 interface

The I5 interface is the interface between the access TN and the PNC as shown in figure 2. The access TNs to the I5 interface normally comply with the relevant ITU-T Recommendations. However, the I5 interface may vary according to national variations in implementation of the networks. Access may be provided via the following networks:

- Public Switched Telephone Network (PSTN);
- Packet Switched Public Data Network (PSPDN);
- Circuit Switched Public Data Network (CSPDN);
- Integrated Services Digital Network (ISDN);
- Telex Network.

A computer interface to facilitate automation of access to ERMES services or for the provision of a gateway for other services (i.e. value-added services) is described in subclause 8.2.

8.2 Universal computer protocol

8.2.1 Introduction

This optional protocol is included in the ERMES standard to allow network operators to offer a simple standardized protocol to other systems for access to the paging service. The protocol covers the application level of the data communication between the PNC and external computer applications. In addition to the application level a simple packet structure with a communication error detection function is included. The protocol is therefore suitable to use over various public data networks e.g. as packet switched (ITU-T Recommendation X.25 [14]), circuit switched (ITU-T Recommendation X.21 [13]) and over modem connections in the public telephone network. The network related procedures are not covered by this ETS.

In addition to public access, network operators may use this protocol to provide a "gateway" to a PNC from systems which may include:

- alarm monitoring systems;
- operator bureau message input systems;
- data broadcast/narrowcast systems;
- road traffic information systems;
- existing paging networks.

Depending on the application for which the universal computer protocol is used, not all parts of the protocol may be required.

8.2.2 Operation and result

The communication on the application level is based on transactions consisting of one operation and one corresponding result. Each transaction shall be numbered in sequence from 0 to 99 using the transaction reference number. To separate different transactions from each other, each operation shall include the transaction reference number. The same transaction reference number shall be included in the corresponding result.

8.2.3 Data transaction sequence

The data transaction sequence starts with the originating application transmitting an operation and then waiting for the corresponding result. The recipient application shall validate a received message by investigating the checksum and the syntax of the message. After the validation the recipient application responds with the appropriate result.

The result for a valid operation may vary depending on the type of operation. If the operation is rejected by the recipient application, the reason shall be reported in the result to the originating application.

The received result shall also be validated regarding the checksum and syntax. If the operation and the result is valid the sequence of the transaction is complete.

For all of the cases when the originating application receives a syntactically invalid result or fails to receive a result within a timeout, the originating application shall retransmit the operation with the same transaction number as used in the previous attempt and the value of the O/R character set to "C" (upper case "C").

NOTE: The value of the timeout should not exceed the period for sending 100 messages. This value may be set dynamically depending on traffic flow. When a transaction problem has been detected, the same value of the transaction number should not be used for new transactions until a valid result has been received in response to the repeated operation or until the attempt to repeat the transaction is abandoned.

When the recipient application receives a copy of an earlier operation, i.e. an operation with the O/R character set to "C" and with the same transaction reference number and data as an earlier operation, it shall:

- send the corresponding result regardless of whether it has already sent the same result; and
- execute the action that correspond to the operation ONLY if it has not already executed this action in response to an earlier receipt of the same operation.

8.2.4 Description of message format

8.2.4.1 General

Each message, operation or result, shall consist of a main body whose format shall be as follows:

START HEADER DATA CHECKSUM STOP

The start character shall be "STX" (02hex).

The stop character shall be "ETX" (03hex).

The header and the data field consists of parameters terminated with the character "/" (2Fhex). A parameter may contain a list of items. The items shall then be separated by a character "," (2Chex).

No parameter terminator shall be sent between the STX and the header, or between the checksum and the ETX.

The separators "/" (2Fhex) and "," (2Chex) are not allowed in the content of every parameter. In every parameter the type of characters refers to IA5. Numeric characters are between 0 (30hex) and 9 (39hex).

As far as the ERMES message part parameters (NMsg, AMsg or TMsg) the following encoding shall be used by the calling machine:

For NMsg, every ERMES numeric character given in ETS 300 133-2 [1], table B.1 shall be encoded into one IA5 character according to table 15.

Table 15: IA5 character codes

B4	B3	B2	B1	IA5 character
0	0	0	0	0 (30hex)
0	0	0	1	1 (31hex)
....				...
1	0	0	1	9 (39hex)
1	0	1	0	A (41hex)
....				...
1	1	1	1	F (46hex)

For AMsg, every character given in ETS 300 133-2 [1], clause B.2 shall be encoded into two IA5 characters. The 4 Least Significant Bits (LSBs) shall be encoded according table 15 and the 3 Most Significant Bits (MSBs) shall be encoded according to table 16.

Table 16: MSB encoding

B7	B6	B5		IA5 character
0	0	0		0 (30hex)
....				...
1	1	1		7 (37hex)

The character containing the 3 MSB shall be transmitted first.

For TMsg, the data bit stream, which is left justified, shall be divided into 4 bits strings. Each of them are encoded according to table 15. Up to 3 trailing bits with value "0" are added if necessary.

These encoding methods shall apply also to the message part of the standard text as required in the appropriate operations or results.

8.2.4.2 Header

The header shall comprise four parameters with fixed length. The parameters shall be terminated with the character "/" (2Fhex). All parameters listed in table 17 are essential (E) and shall always have a value.

Table 17: Header parameters

Parameter	Type	Presence	Description
TRN	2 num. char.	E	Transaction reference number, right justified with leading zero.
LEN	5 num. char.	E	Total number of IA5 characters contained between STX and ETX, right justified with leading zeros.
O/R	Char. "O" or "R" or "C"	E	"O" indicates operation, and "R" indicates result, and "C" indicates repeated operation (same type and data).
OT	2 num. char.	E	Operation type as defined in subclause 9.2.5.

8.2.4.3 Data field

The data field varies in format and length depending on the operation or result specified in the header part. The data field consists of a number of parameters separated by the character "/" (2Fhex). When there is a list, containing multiple occurrences of the same parameter (i.e. the preceding parameter is NPL >=2) then each parameter in the list shall be separated by the character "/". A parameter may contain a list of items. The items shall then be separated by the character "," (2Chex). In the case that the operation or result terminates with empty parameters the parameters may be omitted.

Essential parameters (E) shall always have a value.

Optional (O) parameters may or may not have a value. Optional parameters with no value shall be empty parameters, this mean that two adjacent separators are present in the data field.

An parameter which is a list of length 0 (preceded by an NPL = 0), shall be an empty parameter, which means that two adjacent separators should follow the NPL

EXAMPLE:

NPL = 3	.../3/a1,b1/a2,b2/a3,b3/...
NPL = 1	.../1/a1,b1/...
NPL = 0	.../0//...

8.2.4.4 Checksum

The checksum shall be derived by the addition of all bytes of the header, data field separators and data fields. The 8 LSBs of the result is then represented as two printable characters. The character containing the 4 MSB shall be transmitted first. For example, if the checksum is 3A (hex) the representation shall be the characters "3" (33hex) and "A" (41hex).

8.2.4.5 UCP version number negotiation:

Each time a calling party wants to use a UCP version different than version 01.01, it shall start the connection by negotiating the UCP version which is going to be used during the connection.

If no negotiation process is done by the calling party at the beginning of the connection, both parties shall use UCP version 01.01.

The negotiation process is defined as:

- the calling party sends the operation with operation type 23. It specifies the UCP version number it wants to use (IVR5-CP);
- the PNC-I will reply with its proposed supported UCP version depending on the following situations.

8.2.4.5.1 PNC-I supporting version 01.01 only

The PNC-I sends a negative result with error code 03: (operation not supported by system)

The calling party may:

- proceed with the connection using the version 01.01, which will be used during the complete connection;
- disconnect and report an error to the user.

8.2.4.5.2 PNC-I supporting only lower versions than the version proposed by calling party

The PNC-I will answer a positive result indicating its highest supported version.

The calling party may:

- proceed with the connection using this version number, which will be used during the complete connection;
- decide to continue the negotiation phase by sending a new 23 operation proposing version 01.01;
- disconnect and report an error message to the user

8.2.4.5.3 PNC-I supporting the same version number

The PNC-I will answer a positive result indicating this version which will be used during the complete connection.

8.2.4.5.4 PNC-I only supporting higher versions than the proposed one

The PNC-I will respond a positive result indicating version 01.01.

The calling party may:

- proceed with the connection using version 01.01 which will be used during the complete connection;
- disconnect and report an error message to the user.

8.2.5 Operations provided by the Universal Computer Interface

The following operations are defined:

- 00 Enquiry operation;
- 01 Call input operation;
- 02 Multiple address call input operation;
- 03 Call input with SSs operation;
- 04 Address list information operation;
- 05 Change address list operation;
- 06 Advice of accumulated charges operation;
- 07 Password management operation;
- 08 Legitimation code management operation;
- 09 Standard text information operation;
- 10 Change standard text operation;

- 11 Request roaming information operation;
- 12 Change roaming information operation;
- 13 Roaming reset operation;
- 14 Message retrieval operation;
- 15 Request call barring operation;
- 16 Cancel call barring operation;
- 17 Request call diversion operation;
- 18 Cancel call diversion operation;
- 19 Request deferred delivery operation;
- 20 Cancel deferred delivery operation;
- 21 All features reset operation;
- 22 Call input operation with specific character set.
- 23 UCP version status request
- 24 Mobile subscriber feature status request
- 30 SMS message transfer operation Reference GSM03-39
- 31 SMT alert operation Reference GSM03-39
- 32 - 45 Proprietary UCP operations (may be defined by manufacturers)
- 51 Submit Short Message Reference GSM03-39
- 52 Deliver Short Message Reference GSM03-39
- 53 Deliver Notification Reference GSM03-39
- 54 (not used)
- 55 Inquiry Message Reference GSM03-39
- 56 Delete Message Reference GSM03-39
- 57 Response Inquiry Message Reference GSM03-39
- 58 Response Delete Message Reference GSM03-39
- 59 (not used)
- 60 Session Management Reference GSM03-39
- 61 Provisioning Actions Reference GSM03-39
- 95 - 99 Proprietary UCP operations (may be defined by manufacturers)

8.2.5.1 Enquiry operation

The operation is used by a calling party to obtain the status of and features related to a MS's AdC. The network operator may restrict the use of this operation.

Table 18: Enquiry operation

Parameter	Type	Presence	Description
AdC	String of num. char.	E	Address code, mobile subscriber.
OAdC	String of num. char.	O	Address code, originator.
OAC	String of char.	O	Authentication code, originator.

8.2.5.1.1 Enquiry operation (positive result)

Table 19 shows the parameters used in the positive result data field.

Table 19: Positive result data field

Parameter	Type	Presence	Description
ACK	Char. "A"	E	Positive acknowledgement.
BAS	Char. "1"	O	Barring status.
LAR	Char. "1"	O	Leg. code for all calls requested.
L1R	Char. "1"	O	Leg. code for priority 1 requested.
L3R	Char. "1"	O	Leg. code for priority 3 requested.
LCR	Char. "1"	O	Leg. code for rev. charging requested.
LUR	Char. "1"	O	Leg. code for urgent message requested.
LRR	Char "1"	O	Leg. code for repetition requested.
RT	1 num. char.	E	Receiver type: TO=1, Num.=2, Alpha.=3, Transp. data=4.
NoN	2 num. char.	O	Maximum number of num. char. accepted.
NoA	4 num. char.	O	Maximum number of alpha char. accepted.
NoB	5 num. char.	O	Maximum number of data bits accepted.

8.2.5.1.2 Enquiry operation (negative result)

Table 20 shows the parameters used in the negative result data field.

Table 20: Negative result data field

Parameter	Type	Presence	Description
NAC	Char "N"	E	Negative acknowledgement.
EC	2 num. char	E	Error code.
SM	String of char.	O	System message.

Error codes which may be returned in the operations negative result are listed in subclause 8.2.7.

8.2.5.2 Call input operation

The operation is used for call input when no SSs are requested by the calling party. Table 21 shows the parameters used in the operation data field.

Table 21: Operation data field

Parameter	Type	Presence	Description
AdC	String of num. char.	E	Address code, recipient.
OAdC	String of num. char.	O	Address code, originator.
OAC	String of char.	O	Authentication code, originator.
MT	1 numeric char. (1-4,6)	E	Message type. Associated parameters depend on the value of the message type.

Alternative 1: Tone-only: No additional parameters used.

Alternative 2:

NMsg	String of char.	O	Numeric message.
------	-----------------	---	------------------

Alternative 3:

AMsg	String of char.	O	Alphanumeric message.
------	-----------------	---	-----------------------

Alternative 4:

NB	String of num. char.	E	No. of bits in Transparent Data (TD) message.
TMsg	String of char.	O	TD message encoded into IA5 characters.
NOTE: TMsg parameter is essential if NB not equal to 0.			

NOTE: Alternative 5 (Standard Text Message) may not be used with this operation.

Alternative 6:

AMsg	String of char.	O	Alphanumeric message.
CS	2 numeric char. (00-31)	O	Character set number.

8.2.5.2.1 Call input operation (positive result)

Table 22 shows the parameters used in the positive result data field.

Table 22: Positive result data field

Parameter	Type	Presence	Description
ACK	Char. "A"	E	Positive acknowledgement.
SM	String of char.	O	System message.

8.2.5.2.2 Call input operation (negative result)

Negative result parameters, see subclause 8.2.5.1.2. Error codes which may be returned in the operations negative result are listed in subclause 8.2.7.

8.2.5.3 Multiple address call input operation

The operation is used for multiple address call input. This operation only allows standard text SS. Table 23 shows the parameters used in the operation data field.

Table 23: Operation data field

Parameter	Type	Presence	Description
NPL	String of num. char.	E	Number of parameters in the following RAd:s list.
RAd:s	1 string of num. char. or 2 strings of num. char. separated with ",",	E	List of parameters: Each parameter consists of AdC combined with optional legitimisation code for all calls.
OAdC	String of num. char.	O	Address code, originator.
OAC	String of char.	O	Authentication code, originator.
MT	1 numeric char. (1-6)	E	Message type. Associated parameters depend on the value of the message type.

Alternative 1: Tone-only: No additional parameters used.

Alternative 2:

NMsg	String of char.	O	Numeric message.
------	-----------------	---	------------------

Alternative 3:

AMsg	String of char.	O	Alphanumeric message.
------	-----------------	---	-----------------------

Alternative 4:

NB	String of num. char	E	Number of bits in the transparent data.
TMsg	String of char.	O (note)	TD message encoded into IA5 characters.
NOTE:	This parameter shall be present if NB not equal to 0.		

Alternative 5:

PNC	Char. "H" or char. "I"	O	Definition of the PNC from which the standard text shall be chosen. Char "H" represents PNC-H; char. "I" represents PNC-I.
LNo	String of num. char.	O	Standard text list number requested by the calling party.
LST	String of num. char.	O	Legitimation code for standard text.
TNo	String of num. char.	O	Standard text number requested by the calling party.

The parameters for alternative 5 are essential if the Message Type (MT) defined is standard text.

Alternative 6:

AMSG	String of char	O	Alphanumeric message.
CS	2 numeric char (00-31)	O	Additional character set number.

The parameters for alternative 6 are essential if the Message Type (MT) defined is text with additional character set.

8.2.5.3.1 Multiple address call input operation (positive result)

For positive result parameters, see subclause 8.2.5.2.1.

If any AdC listed as recipient in the operation are invalid then they may be indicated in an error report within the system message.

8.2.5.3.2 Multiple address call input operation (negative result)

For negative result parameters, see subclause 8.2.5.1.2. Error codes which may be returned in the operations negative result are listed in subclause 8.2.7.

8.2.5.4 Call input with supplementary services operation

This operation is used for call input when SSs are requested by the calling party. The operation does not support multi-address calls because of incompatibility with other SSs. Table 24 shows the parameters used in the operations data field.

Table 24: Operations data field

Parameter	Type	Presence	Description
RAd	1 String of num. char. or 2 strings of num. char. separated with ","	E	Address code, recipient, combined with optional legitimisation code for all calls.
OAdC	String of num. char.	O	Address code, originator.
OAC	String of char.	O	Authentication code, originator.
NPL	String of num. char.	E	Number of parameters in the following GA:s list (note 1).
GA:s	String of char.	O	List of additional GA:s requested by the calling party.
RP	Char "1"	O	Repetition requested.
LRP	String of num. Char.	O	Legitimation code for repetition.
PR	Char "1" or "3"	O	Priority request 1 or 3.
LPR	String of num. char.	O	Legitimation code for priority requested.
UM	Char "1"	O	Urgent message indicator request.
LUM	String of num. char.	O	Legitimation code for urgent message.
RC	Char "1"	O	Reverse charging request.
LRC	String of num. char.	O	Legitimation code for reverse charging.
DD	Char "1"	O	Deferred delivery request.
DDT	10 num. char.	O (note 2)	Deferred delivery time DDMMYYHHmm.
MT	1 num. char. (1-6)	E	Message type. Associated parameters depend on the value of the message type.
NOTE 1: If there is no GA, then NPL = 0.			
NOTE 2: Essential if DD is "1".			

Alternative 1: Tone-only shall use no additional parameters.

Alternative 2:

NMsg	String of char.	O	Numeric message.
------	-----------------	---	------------------

Alternative 3:

AMsg	String of char.	O	Alphanumeric message.
------	-----------------	---	-----------------------

Alternative 4:

NB	String of num. char	E	Number of bits in the TD.
TMsg	String of char.	O (note)	TD message encoded into IA5 characters.
NOTE: This parameter shall be present if NB not equal to 0.			

Alternative 5:

PNC	Char. "H" or char. "I"	O	Definition of the PNC from which the standard text shall be chosen. Char "H" represents PNC-H char "I" represents PNC-I.
LNo	String of num. char.	O	Standard text list number requested by the calling party.
LST	String of num. char.	O	Legitimation code for standard text.
TNo	String of num. char.	O	Standard text number requested by the calling party.

Alternative 6:

AMSG	String of char	O	Alphanumeric message.
CS	2 numeric char (00-31)	O	Additional character set number.

The parameter NB for alternative 4 is essential if MT is TD.

The parameters for alternative 5 are essential if the MT defined is standard text.

The parameters for alternative 6 are essential if the Message Type (MT) defined is text with additional character set.

8.2.5.4.1 Call input with supplementary service operation (positive result)

For positive result parameters, see subclause 8.2.5.2.1.

8.2.5.4.2 Call input with supplementary information (negative result)

For negative result parameters, see subclause 8.2.5.1.2. Error codes which may be returned in the operations negative result are listed in subclause 8.2.7.

8.2.5.5 Address list information operation

This is the operation request address list information. Table 25 shows the parameters used in the operations data field.

Table 25: Operations data field

Parameter	Type	Presence	Description
GAdC	String of num. char.	E	Group address code with which the address list is registered.
AC	String of char.	E	Authentication code.
OAdC	String of num. char.	O	Address code, originator.
OAC	String of char.	O	Authentication code, originator.

8.2.5.5.1 Address list information operation (positive result)

Table 26 shows the parameters used in the positive result data field.

Table 26: Operations data field

Parameter	Type	Presence	Description
ACK	String of char.	E	Positive acknowledgement.
NPL	String of num. char.	E	Number of parameters in the following RAd:s list.
RAd:s	1 string of num. char. or 2 strings of num. char. separated with ","	E	List of parameters. Each parameter consists of AdC combined with optional legitimisation code for all calls.
GAdC	String of num. char.	E	Group address code with which the address list is registered.
SM	String of char.	O	System message.

8.2.5.5.2 Address list information operation (negative result)

For negative result parameters, see subclause 8.2.5.1.2. Error codes which may be returned in the operations negative result are listed in subclause 8.2.7.

8.2.5.6 Change address list operation

The operation is used to change address list information. Table 27 shows the parameters used in the operations data field.

Table 27: Operations data field

Parameter	Type	Presence	Description
GAdC	String of num. char.	E	Group AdC with which the address list is registered.
AC	String of char.	E	Authentication code.
OAdC	String of num. char.	O	Address code, originator.
OAC	String of char.	O	Authentication code, originator.
NPL	String of num. char.	E	Number of parameters in the following RAd:s list.
RAd:s	1 string of num. char. or 2 strings of num. char. separated with ","	E	List of parameters. Each parameter consists of AdC combined with optional legitimisation code for all calls.
A/D	Char "A" (41hex) or char. "D" (44hex)	E	Add to/delete from fixed subscriber address list record.

8.2.5.6.1 Change address list operation (positive result)

For positive result parameters, see subclause 8.2.5.2.1.

8.2.5.6.2 Change address list operation (negative result)

For negative result parameters, see subclause 8.2.5.1.2. Error codes which may be returned in the operations negative result are listed in subclause 8.2.7.

8.2.5.7 Advice of accumulated charges operation

This is the operation request accumulated charges information for a subscription. Table 28 shows the parameters used in the operations data field.

Table 28: Operations data field

Parameter	Type	Presence	Description
AdC	String of num. char.	E	AdC for which information of accumulated charges are requested.
AC	String of char.	E	Authentication code.

8.2.5.7.1 Advice of accumulated charges operation (positive result)

Table 29 shows the parameters used in the positive result.

Table 29: Positive result

Parameter	Type	Presence	Description
ACK	String of char.	E	Positive acknowledgement.
CT	10 num. char.	E	The date and time from which the charges are accumulated DDMMYYhhmm.
AAC	String of num. char	E	Accumulated charges.
SM	String of char.	O	System message.

8.2.5.7.2 Advice of accumulated charges operation (negative result)

For negative result parameters, see subclause 8.2.5.1.2. Error codes which may be returned in the operations negative result are listed in subclause 8.2.7.

8.2.5.8 Password management operation

The operation is used by subscribers to change the AC. The parameter AC is the same as the password. Table 30 shows the parameters used in the operations data field.

Table 30: Operations data field

Parameter	Type	Presence	Description
AdC	String of num. char.	E	AdC for which the password or AC are to be changed.
AC	String of char.	E	Authentication code.
NAC	String of char.	E	New AC.

8.2.5.8.1 Password management operation (positive result)

For positive result parameters, see subclause 8.2.5.2.1.

8.2.5.8.2 Password management operation (negative result)

For negative result parameters, see subclause 8.2.5.1.2. Error codes which may be returned in the operations negative result are listed in subclause 8.2.7.

8.2.5.9 Legitimation code management operation

The operation is used to change legitimation codes for restricted operations. Table 31 shows the parameters used in the operations data field.

Table 31: Operations data field

Parameter	Type	Presence	Description
AdC	String of num. char.	E	AdC to which restricted operations may be requested.
AC	String of char.	E	Authentication code.
LAC	String of num. char.	O	New legitimisation code for all calls.
L1P	String of num. char.	O	New legitimisation. code for level 1 priority.
L3P	String of num.char.	O	New legitimisation. code for level 3 priority.
LRC	String of num.char.	O	New legitimisation code for reverse charging acceptance.
LUM	String of num.char.	O	New legitimisation code for urgent message acceptance.
LRP	String of num. Char.	O	New legitimisation code for repetition.
LST	String of num. char.	O	New legitimisation code for use of standard text.

8.2.5.9.1 Legitimisation code management operation (positive result)

For positive result parameters, see subclause 8.2.5.2.1.

8.2.5.9.2 Legitimisation code management operation (negative result)

For negative result parameters, see subclause 8.2.5.1.2. Error codes which may be returned in the operations negative result are listed in subclause 8.2.7.

8.2.5.10 Standard text information operation

This is the operation request standard texts. If the operation is restricted the calling party shall prove his authorization by sending the legitimisation code. Table 32 shows the parameters used in the operations data field.

Table 32: Operations data field

Parameter	Type	Presence	Description
LNo	String of num. char.	E	Standard text list number.
LST	String of num. char.	O	Legitimisation code for standard text.

8.2.5.10.1 Standard text information operation (positive result)

Table 33 shows the parameters used in the positive result data field.

Table 33: Positive result data field

Parameter	Type	Presence	Description
ACK	String of char.	E	Positive acknowledgement.
NPL	String of num. char.	E	Number of parameters in the following ST:s list.
ST:s	1 string of num. char. 1 string of char. and 2 optional numeric characters (00 to 31) separated with ",".	E E O (note)	List of parameters. Each parameter consists of standard text number followed by the standard text itself and the alternate character set if appropriate.
SM	String of char.	O	System message.
NOTE:	When the standard text is using the default character set this parameter shall either be absent or equal to 00. When the standard text is using an alternate character set this parameter is mandatory.		

8.2.5.10.2 Standard text information operation (negative result)

For negative result parameters, see subclause 8.2.5.1.2. Error codes which may be returned in the operations negative result are listed in subclause 8.2.7.

8.2.5.11 Change standard text operation

The operation is used by a FS to change the content of standard texts associated with their subscription. Table 34 shows the parameters used in the operations data field.

Table 34: Operations data field

Parameter	Type	Presence	Description
AdC	String of num. char.	E	AdC to which the standard text are registered.
AC	String of char.	E	Authentication code.
LNo	String of num. char.	E	Standard text list number.
TNo	String or num. char.	E	Standard text number.
STx	String of char.	E	The standard text.
CS	2 numeric characters (00 to 31)	O (note)	Additional character set number.
NOTE:	When the standard text is using the default character set this parameter shall either be absent or equal to 00. When the standard text is using an alternate character set this parameter is mandatory.		

8.2.5.11.1 Change standard text operation (positive result)

For positive result parameters, see subclause 8.2.5.2.1.

8.2.5.11.2 Change standard text operation (negative result)

For negative result parameters, see subclause 8.2.5.1.2. Error codes which may be returned in the operations negative result are listed in subclause 8.2.7.

8.2.5.12 Request roaming information operation

The operation is used by a MS to request roaming information. Table 35 shows the parameters used in the operations data field.

Table 35: Operations data field

Parameter	Type	Presence	Description
AdC	String or num. char.	E	AdC for which roaming information are requested.
AC	String of char.	E	Authentication code.

8.2.5.12.1 Request roaming information operation (positive result)

Table 36 shows the parameters used in the positive result data field.

Table 36: Positive result data field

Parameter	Type	Presence	Description
ACK	String of char.	E	Positive acknowledgement.
NPL	String of num. char.	E	Number of parameters in the following GAR:s list.
GAR:s	1 string of char. followed by 2 strings of 10 num. char. separated with ","	E	List of parameters. Each parameter consists of the name of the GA, the start time for roaming in this GA DDMMYYhhmm and the stop time (DDMMYYhhmm').
SM	String of char.	O	System message.

8.2.5.12.2 Request roaming information operation (negative result)

For negative result parameters, see subclause 8.2.5.1.2. Error codes which may be returned in the operations negative result are listed in subclause 8.2.7.

8.2.5.13 Change roaming operation

The operation is used by a MS to change roaming information registered. Table 37 shows the parameters used in the operations data field.

Table 37: Operations data field

Parameter	Type	Presence	Description
AdC	String of num. char.	E	AdC for which change of roaming information are requested.
AC	String of char.	E	Authentication code.
NPL	String of num. char.	E	Number of parameters in the following CR:s list.
CR:s	See below:	E	List of parameters. Each parameter consists of 4 items separated with "," which are described below.
GA	String of char.	E	GA to add to or delete from the subscribers roaming record.
ST	10 num. char.	O (note)	Start time for GA (DDMMYYhhmm).
SP	10 num. char.	E	Stop time for GA (DDMMYYhhmm).
A/D	Char "A" (41hex) or char "D" (44hex)	E	Add to/Delete from subscriber roaming record.
NOTE: If not present, action to be undertaken as soon as the operation is registered.			

If several periods of time are requested for the same GA, the subscriber shall have to send several parameters (one per GA and period of time).

8.2.5.13.1 Change roaming operation (positive result)

For positive result parameters, see subclause 8.2.5.2.1.

8.2.5.13.2 Change roaming operation (negative result)

For negative result parameters, see subclause 8.2.5.1.2. Error codes which may be returned in the operations negative result are listed in subclause 8.2.7.

8.2.5.14 Roaming reset operation

This operation is used by a MS to reset roaming information. Table 38 shows the parameters used in the operations data field.

Table 38: Operational data field

Parameter	Type	Presence	Description
AdC	String of num. char.	E	AdC to which roaming reset are requested.
AC	String of char.	E	Authentication code.

8.2.5.14.1 Roaming reset operation (positive result)

For positive result parameters, see subclause 8.2.5.2.1.

8.2.5.14.2 Roaming reset operation (negative result)

For negative result parameters, see subclause 8.2.5.1.2. Error codes which may be returned in the operations negative result are listed in subclause 8.2.7.

8.2.5.15 Message retrieval operation

The operation is used by a MS to request retransmission or retrieval of stored messages. Table 39 shows the parameters used in the operations data field.

Table 39: Operations data field

Parameter	Type	Presence	Description
AdC	String or num. char.	E	AdC for the mobile subscription to which messages are stored.
AC	String of char.	E	Authentication code.
MNo	1 String of num. char. 2 String of num. char. separated with ","	E	Message number to be retrieved or the first and last message numbers to be retrieved or retrieval of the last stored message, second last stored message, etc. where 0 = last stored message, -1 = second last stored message, etc. or an interval of stored messages (e.g. -2,0 = interval from the third last stored message to the last stored message, where 0 is the highest number).
R/T	Char. "R" (52hex) or Char. "T" (54hex)	E	Retrieval with positive result or retransmit on radio channel.

8.2.5.15.1 Message retrieval operation (positive result)

Table 40 shows the parameters used in the positive result data field.

Table 40: Positive result data field

Parameter	Type	Presence	Description
ACK	Char "A"	E	Positive acknowledge.
NPL	String of num. char.	E	Number of parameters in the following Msg:s list.
Msg:s	See below	O	List of parameters. Each parameter consists of several items separated with "," which are described below.
MN	String of numeric char.	E	Message number of the retrieved message.
MT	One num. char. (1-4, 6)	E	Message type. The alternative parameters below depend upon the message type.
SDT	10 num. char.	E	Stored date and time (DDMMYYhhmm).
Alternative (see below):			
SM	String of char.	O	System message
NOTE:	MT value of 5 is not used. If the message was input using the standard text feature, the complete text of the message shall be returned, using either an MT of 3 or 6 depending whether the standard text is using an additional character set or not. In the latter case, the appropriate character set number shall be returned.		

Alternative 1: Tone only: No additional parameters used.

Alternative 2:

NMsg	String of char.	O	Numeric message.
------	-----------------	---	------------------

Alternative 3:

AMsg	String of char.	O	Alphanumeric message.
------	-----------------	---	-----------------------

Alternative 4:

TMsg	String of char.	O	TD message encoded into IA5 characters.
NB	String of numeric char.	E	Number of bits in Transparent Data (TD) message.
NOTE: TMsg parameter is essential if NB not equal to 0.			

Alternative 6:

AMsg	String of char.	O	Alphanumeric message.
CS	2 num. char. (00-31)	E	Additional character set number.
NOTE: CS parameter is essential if MT value is 6.			

8.2.5.15.2 Message retrieval operation (negative result)

For negative result parameters, see subclause 8.2.5.1.2. Error codes which may be returned in the operations negative result are listed in subclause 8.2.7.

8.2.5.16 Request call barring operation

This operation is used by a MS to request call barring. Table 41 shows the parameters used in the operations data field.

Table 41: Operations data field

Parameter	Type	Presence	Description
AdC	String of num. char.	E	AdC for which call barring is requested.
AC	String of char.	E	Authentication code.
ST	10 num. char.	O (note)	Start time (DDMMYYhhmm).
SP	10 num. char.	E	Stop time (DDMMYYhhmm).
NOTE If not present, action to be undertaken as soon as the operation is registered.			

8.2.5.16.1 Request call barring operation (positive result)

For positive result parameters, see subclause 8.2.5.2.1.

8.2.5.16.2 Request call barring operation (negative result)

For negative result parameters, see subclause 8.2.5.1.2. Error codes which may be returned in the operations negative result are listed in subclause 8.2.7.

8.2.5.17 Cancel call barring operation

This operation is used by a MS to cancel call barring. Table 42 shows the parameters used in the operations data field.

Table 42: Operations data field

Parameter	Type	Presence	Description
AdC	String of num. char.	E	AdC for which call barring is cancelled.
AC	String of char.	E	Authentication code.

8.2.5.17.1 Cancel call barring operation (positive result)

For positive result parameters, see subclause 8.2.5.2.1.

8.2.5.17.2 Cancel call barring operation (negative result)

For negative result parameters, see subclause 8.2.5.1.2. Error codes which may be returned in the operations negative result are listed in subclause 8.2.7.

8.2.5.18 Request call diversion operation

This operation is used by a MS to request call diversion. Table 43 shows the parameters used in the operations data field.

Table 43: Operations data field

Parameter	Type	Presence	Description
AdC	String of num. char.	E	AdC from which calls are diverted.
AC	String of char.	E	Authentication code.
DAdC	String of char.	E	AdC to which calls are diverted.
ST	10 num. char.	O (note)	Start time DDMMYYhhmm.
SP	10 num. char.	E	Stop time DDMMYYhhmm.
NOTE:	If not present, action to be undertaken as soon as the operation is registered.		

8.2.5.18.1 Request call diversion operation (positive result)

For positive result parameters, see subclause 8.2.5.2.1.

8.2.5.18.2 Request call diversion operation (negative result)

For negative result parameters, see subclause 8.2.5.1.2. Error codes which may be returned in the operations negative result are listed in subclause 8.2.7.

8.2.5.19 Cancel call diversion operation

The operation is used by a MS to cancel call diversion. Table 44 shows the parameters used in the operations data field.

Table 44: Operations data field

Parameter	Type	Presence	Description
AdC	String of num. char.	E	AdC from which calls where diverted.
AC	String of char.	E	Authentication code.

8.2.5.19.1 Cancel call diversion operation (positive result)

For positive result parameters, see subclause 8.2.5.2.1.

8.2.5.19.2 Cancel call diversion operation (negative result)

For negative result parameters, see subclause 8.2.5.1.2. Error codes which may be returned in the operations negative result are listed in subclause 8.2.7.

8.2.5.20 Request deferred delivery

The operation is used by a MS to request DD. Table 45 shows the parameters used in the operations data field.

Table 45: Operations data field

Parameter	Type	Presence	Description
AdC	String of num. char.	E	AdC for which deferred delivery is requested.
AC	String of char.	E	Authentication Code.
ST	10 num. char	O(note)	Start time (DDMMYYhhmm).
SP	10 num. char.	E	Stop time (DDMMYYhhmm).
NOTE:	If not present , action to be undertaken as soon as the operation is registered.		

8.2.5.20.1 Request deferred delivery (positive result)

For positive result parameters, see subclause 8.2.5.2.1.

8.2.5.20.2 Request deferred delivery (negative result)

For negative result parameters, see subclause 8.2.5.1.2. Error codes which may be returned in the operations negative result are listed in subclause 8.2.7.

8.2.5.21 Cancel deferred delivery

The operation is used by a MS to cancel DD. Table 46 shows the parameters used in the operations data field.

Table 46: Operations data field

Parameter	Type	Presence	Description
AdC	String of num. char.	E	AdC for which deferred delivery is requested.
AC	String of char.	E	Authentication code.

8.2.5.21.1 Cancel deferred delivery (positive result)

For positive result parameters, see subclause 8.2.5.2.1.

8.2.5.21.2 Cancel deferred delivery (negative result)

For negative result parameters, see subclause 8.2.5.1.2. Error codes which may be returned in the operations negative result are listed in subclause 8.2.7.

8.2.5.22 All features reset operation

The operation is used by a MS to reset all his SFs to the initial default value, as defined by the network operator. Table 47 shows the parameters used in the operations data field.

Table 47: Operations data field

Parameter	Type	Presence	Description
AdC	String of num. char.	E	AdC for which all features reset is requested.
AC	String of char.	E	Authentication code.

8.2.5.22.1 All features reset operation (positive result)

For positive result parameters, see subclause 8.2.5.2.1.

8.2.5.22.2 All features reset operation (negative result)

For negative result parameters, see subclause 8.2.5.1.2. Error codes which may be returned in the operations negative result are listed in subclause 8.2.7.

8.2.5.23 Call input operation with additional character set

The operation is used for call input when no SSs are requested by the calling party and when an additional character set is used. Table 48 shows the parameters used in the operation data field.

Table 48: Operations data field

Parameter	Type	Presence	Description
AdC	String or num. char.	E	Address code, recipient.
OAdC	String or num. char.	O	Address code, originator.
OAC	String or char.	O	Authentication code, originator.
AMsg	String of char.	E	Alphanumeric message.
CS	Two numeric char. (00-31)	E	Code of character set used.

8.2.5.23.1 Call input operation with specific character set (positive result)

Table 49 shows the parameters used in the positive result data field.

Table 49: Positive result data field

Parameter	Type	Presence	Description
ACK	Char. "A"	E	Positive acknowledgement.
SM	String of char.	O	System message.

8.2.5.23.2 Call input operation with specific character set (negative result)

Negative result parameters, see subclause 8.2.5.1.2. Error codes which may be returned in the operations negative result are listed in subclause 8.2.7.

8.2.5.24 UCP Version status request (OT = 23)

This operation is used for negotiating the UCP version number used during the connection.

Table 50: Operations data field

Parameter	Type	Presence in status	Description
IVR5-CP	Two strings of 2 num. Char. Separated by a comma.	E	UCP Release Number Supported by the calling party (Consist of 2 sub parameters MVR5 and SVR5 separated with a comma).
REQ_OT	Char "S" or "N"	O	Request to Send Operation-Types supported by the PNC-I S = Send used OT:s N/no Parameter = Don't send OT.

8.2.5.24.1 UCP Version status request (positive result)

Table 51 shows the parameters used in the positive result data field.

Table 51: positive result data field

Parameter	Type	Presence in result	Description
ACK	char. "A"	E	Positive acknowledgement.
IVR5-PNC_I	5 Char.	E	UCP Release Number accepted by the PNC-I for this connection (Consist of 2 sub parameters MVR5 and SVR5 separated with a comma).
NPL	String of num. Char.	E	Number of parameters in the following OT:s-List If REQ_OT = N then NPL = 0.
OT:s	2 num. Char.	O	List of Supported Operation Type Number.
SM	string of char	O	System message.

8.2.5.24.2 UCP Version status request (negative result)

Negative result parameters, see subclause 8.2.5.1.2 Error codes which may be returned in the operation negative result are listed in subclause 8.2.7.

8.2.5.25 Mobile subscriber feature status request

The operation is used to request the status of mobile subscriber features by the calling party. Table 52 shows the parameters used in the operations data field.

Table 52: Operations data field

Parameter	Type	Presence	Description
AdC	string of num. char.	E	Address code, mobile subscriber.
AC	string of num. char.	E	Authentication code.
SSTAT	string of num. char.	O	Supplementary Services for which status information is requested: 0 = All services; 1 = All in the moment active services; 2 = Call diversion; 3 = Roaming information status; 4 = Call barring status; 5 = Deferred delivery status; 6 = Number of stored messages; Parameter not present = all services.

8.2.5.25.1 Mobile subscriber feature status request (positive result)

Table 53 shows the parameters used in the positive result data field.

Table 53: positive result data field

Parameter	Type	Presence	Description
ACK	char. "A"	E	Positive acknowledgement.
ROCNT	string of char 0...n or "N"	E	Number of the following roaming definitions (0=no request defined, N= not subscribed/not allowed).
ROA:s	1 string of char. followed by 2 strings of 10 num. char. separated with ","	O	List of parameters. Each parameter consists of the name of the GA, the start time for roaming in this GA (DDMMYYhhmm) and the stop time (DDMMYYhhmm).
CBCNT	string of char. 0...n or "N"	E	Number of the following call barring definitions (0=no request defined, N= not subscribed/not allowed).
BAR:s	2 strings of 10 num. char. separated with ","	O	List of parameters. Each parameter consists of the start time for call barring (DDMMYYhhmm) and the stop time (DDMMYYhhmm).
DECNT	string of char. 0...n or "N"	E	Number of the following deferred delivery definitions (0=no request defined, N= not subscribed/not allowed)
DEF:s	2 strings of 10 num. char. separated with ","	O	List of parameters. Each parameter consists of the start time for deferred delivery (DDMMYYhhmm) and the stop time (DDMMYYhhmm).
DICNT	string of char. 0...n or "N"	E	Number of the following diversion definitions (0=no request defined, N= not subscribed/not allowed).
DIV:s	1 string of char. followed by 2 strings of 10 num. char. separated with ","	O	List of parameters. Each parameter consists of the Divert Address code, the start time for diversion to this DAdC (DDMMYYhhmm) and the stop time (DDMMYYhhmm).
LMN	string of num. char. 0...31	O	Last message number 0 = No message has been sent.
NMESS	string of char. 0...n or "N"	O	Number of stored messages (0 = no message stored, N = not subscribed/not allowed).
SM	string of char.	O	System message.

8.2.5.25.2 Mobile subscriber feature status request (negative result)

For negative result parameters, see subclause 8.2.5.1.2. Error codes which may be returned in the operations negative result are listed in subclause 8.2.7.

8.2.6 Error codes

Table 54: Error codes

Code	Error
01	Checksum error
02	Syntax error
03	Operation not supported by system
04	Operation not allowed
05	Call barring active
06	AdC invalid
07	Authentication failure
08	Legitimation code for all calls, failure
09	GA not valid
10	Repetition not allowed
11	Legitimation code for standard text, failure
12	Priority call not allowed
13	Legitimation code for priority call, failure
14	Urgent message not allowed
15	Legitimation code for urgent message, failure
16	Reverse charging not allowed
17	Legitimation code for rev. charging, failure
18	Deferred delivery not allowed
19	New AC not valid
20	New legitimation code not valid
21	Standard text not valid
22	Time period not valid
23	Message type not supported by system
24	Message too long
25	Requested standard text not valid
26	Message type not valid for the pager type
28	Invalid character set

8.2.7 Error codes applicable to each operation

Table 55

Error code	Operation code																						
	00	01	02	03	04	05	06	07	08	09	10	11	12	13	14	15	16	17	18	19	20	21	22
01	Y	Y	Y	Y	Y	Y	Y	Y	Y	Y	Y	Y	Y	Y	Y	Y	Y	Y	Y	Y	Y	Y	Y
02	Y	Y	Y	Y	Y	Y	Y	Y	Y	Y	Y	Y	Y	Y	Y	Y	Y	Y	Y	Y	Y	Y	Y
03	Y			Y	Y	Y	Y	Y	Y	Y	Y			Y	Y	Y	Y	Y	Y	Y	Y	Y	Y
04	Y			Y	Y	Y	Y	Y	Y	Y	Y			Y	Y	Y	Y	Y	Y	Y	Y	Y	Y
05		Y	Y	Y																			Y
06	Y	Y	Y	Y	Y	Y	Y	Y	Y	Y	Y	Y	Y	Y	Y	Y	Y	Y	Y	Y	Y	Y	Y
07	Y	Y	Y	Y	Y	Y	Y	Y	Y	Y	Y	Y	Y	Y	Y	Y	Y	Y	Y	Y	Y	Y	Y
08		Y	Y	Y																			
09												Y											
10				Y																			
11			Y	Y					Y														
12				Y																			
13				Y																			
14				Y																			
15				Y																			
16				Y																			
17				Y																			
18				Y																			
19								Y															
20									Y														
21			Y	Y						Y	Y												
22												Y			Y		Y		Y				
23			Y	Y																			
24		Y	Y	Y																			Y
25			Y	Y						Y													
26		Y	Y	Y																			Y
27																							
28		Y	Y	Y																			Y

9 Network interworking (I4 interface)

9.1 General

Clause 9 describes the version 02.01 of the I4 interface.

The I4 interface is the interface over which PNCs communicate with each other, to:

- a) process calls for paging; and
- b) request information on and update MS roaming records.

This specification of the I4 interface is the minimum required. This profile is called the "basic kernel" and shall be implemented as specified (see especially subclause 9.4).

This clause covers:

- the description of the protocol stack required for the I4 interface;
- the description of the messages exchanged at application level.

The use of these messages by the applications are described in clause 6.

9.2 Protocol stack for the I4 interface

This part gives the definition of all the layers required to build up the I4 interface. The minimum of functionality is given for all the layers when this minimum is available from ITU-T. This minimum functionality does not imply that other functionalities cannot be realized in some PNCs. These extra functionalities shall never be invoked for the I4 interface.

9.2.1 Physical, link and network layers

These three layers allow the PSPDN access. They are described in ITU-T Recommendation X.25 [14].

There is no restriction on the use of virtual circuits. Each entity (PNC-I, PNC-H and PNC-T) shall be able to handle outgoing and incoming calls.

Interworking with the transport layer shall be provided in accordance with the rules described in ITU-T Recommendation X.223 [22].

9.2.2 Transport layer

The transport layer is defined in ITU-T Recommendation X.214 [18] for the service and in ITU-T Recommendation X.224 [23] for the protocol.

A class 2 protocol shall be utilized over the I4 interface. The use of expedited data is not foreseen.

9.2.3 Session layer

The session layer is defined in ITU-T Recommendation X.215 [19] for the service and in ITU-T Recommendation X.225 [24] for the protocol.

The basic kernel shall be utilized over the I4 interface. This implies the following functional units:

- establishment of a session connection;
- normal data transfer;
- release of the session connection (without negotiation).

No other functional unit is required over the I4 interface.

9.2.4 Presentation layer

The presentation layer is defined in ITU-T Recommendation X.216 [28] for the service and in ITU-T Recommendation X.226 [25] for the protocol.

Only the kernel functional unit is required over the I4 interface. The functional units dealing with the context management are not foreseen.

9.2.4.1 Presentation contexts

There shall be two presentation contexts defined for use by the presentation layer. These are I4 with object identifier 0.4.0.1.1.2.0 and ACSE with object identifier 2.2.1.0.1

The presentation context identifiers shall be unique odd integers to be chosen by the initiator according to X.226.

9.2.5 Application layer

This application layer is shared by two sub-layers and the specific part of the PNCs. These two sub-layers are Association Control Service Element (ACSE) and Remote Operation Service Element (ROSE). The specific part of the application layer is described in subclause 9.3.

9.2.5.1 ACSE

The ACSE is defined in ITU-T Recommendation X.217 [20] (for the service part) and in ITU-T Recommendation X.227 [26] (for the protocol part). The differences between X.217 and ISO 8649, described in ITU-T Recommendation X.217 [20], do not impact on the use of ACSE over the I4 interface.

9.2.5.2 ROSE

The ROSE is defined in ITU-T Recommendation X.219 [21] (for the service part) and in ITU-T Recommendation X.229 [28] (for the protocol part).

There is no sub-set defined for ROSE in the recommendations. However the following requirements may imply a reduced version for ROSE and ACSE:

- the classes 1 and 5 for the operations are not foreseen;
- the operations defined in this specification are class 2 (result and error always expected);
- only the association class 1 is taken into account;
- no linked operation.

Subclause 9.5 gives more information on the use of operations for communication between peer entities at application level.

Registration of ROSE and abstract syntax contexts (annex F) shall be agreed among network operators in accordance with the guide-lines included in ITU-T Recommendation X.208 [15], ITU-T Recommendation X.209 [16] and ITU-T Recommendation X.219 [21].

9.2.5.3 Other application entities

There is no need, especially at application level, for other entities such as Remote Transfer Service Element (RTSE). The protocol stack as defined in previous subclauses is sufficient to ensure communication between PNC entities.

9.3 PNC operations

9.3.1 Introduction

This subclause describes the operations used by applications within PNCs in order to co-operate. Annex E contains a more detailed specification of these operations (in terms of parameters) and annex F gives the Abstract Syntax Notation one (ASN.1) form. This description is the reference for the implementation.

Each I4 operation is an independent event and there is no requirement for the responding PNC to relate together the operations processed.

9.3.2 Description of operations

9.3.2.1 General

The following subclauses give generalities on the use of each operation. The name of the operation is the name of the subclause. The parameters and the expected results (positive or negative) are given in annex E. For more details for the handling of these operations by the application, refer to clause 6.

9.3.2.2 Pager information

This operation is invoked by the PNC-I to request information concerning a MS. This request is addressed to the PNC-H of the MS.

9.3.2.3 Page request

This operation is used by a PNC-I to send a message to the PNC-H. The final destination shall be a MS.

9.3.2.4 Transmit

This operation is used by the PNC-H to request the PNC-T to transmit a message to a specific mobile.

9.3.2.5 Choice of destination

This operation is invoked by the PNC-I to check on the status of the Service Area for the MS in combination with the GAs defined by the calling party using the choice of destination SS.

9.3.2.6 Roaming validation

This operation is invoked by the PNC-I to validate the AdC and AC input by an MS requesting a roaming SF transaction.

9.3.2.7 Roaming reset

This operation is invoked by the PNC-I to pass on to the PNC-H a roaming reset request input by an MS.

9.3.2.8 Roaming information

This operation is invoked by the PNC-I to pass on to the PNC-H a roaming information request input by an MS.

9.3.2.9 Change roaming

This operation is invoked by the PNC-I to request the result of roaming changes input by an MS. The roaming database held by the PNC-H is not affected by this operation.

9.3.2.10 Confirm change of roaming

This operation is invoked by the PNC-I to pass on a confirmed request for changes in roaming input by an MS. The roaming database held by the PNC-H is affected by this operation.

9.3.2.11 Call diversion start

This operation is invoked by the PNC-H of the AdC from which calls are to be diverted to inform the PNC-H of the divert AdC that call diversion has commenced.

9.3.2.12 Call diversion stop

This operation is invoked by the PNC-H of the AdC from which calls are being diverted to inform the PNC-H of the divert AdC that call diversion has ceased.

9.3.3 Use of operations

Figures 18 and 19 illustrate the exchange of operations between PNCs. These diagrams do not show the association establishment and release (subclause 9.4).

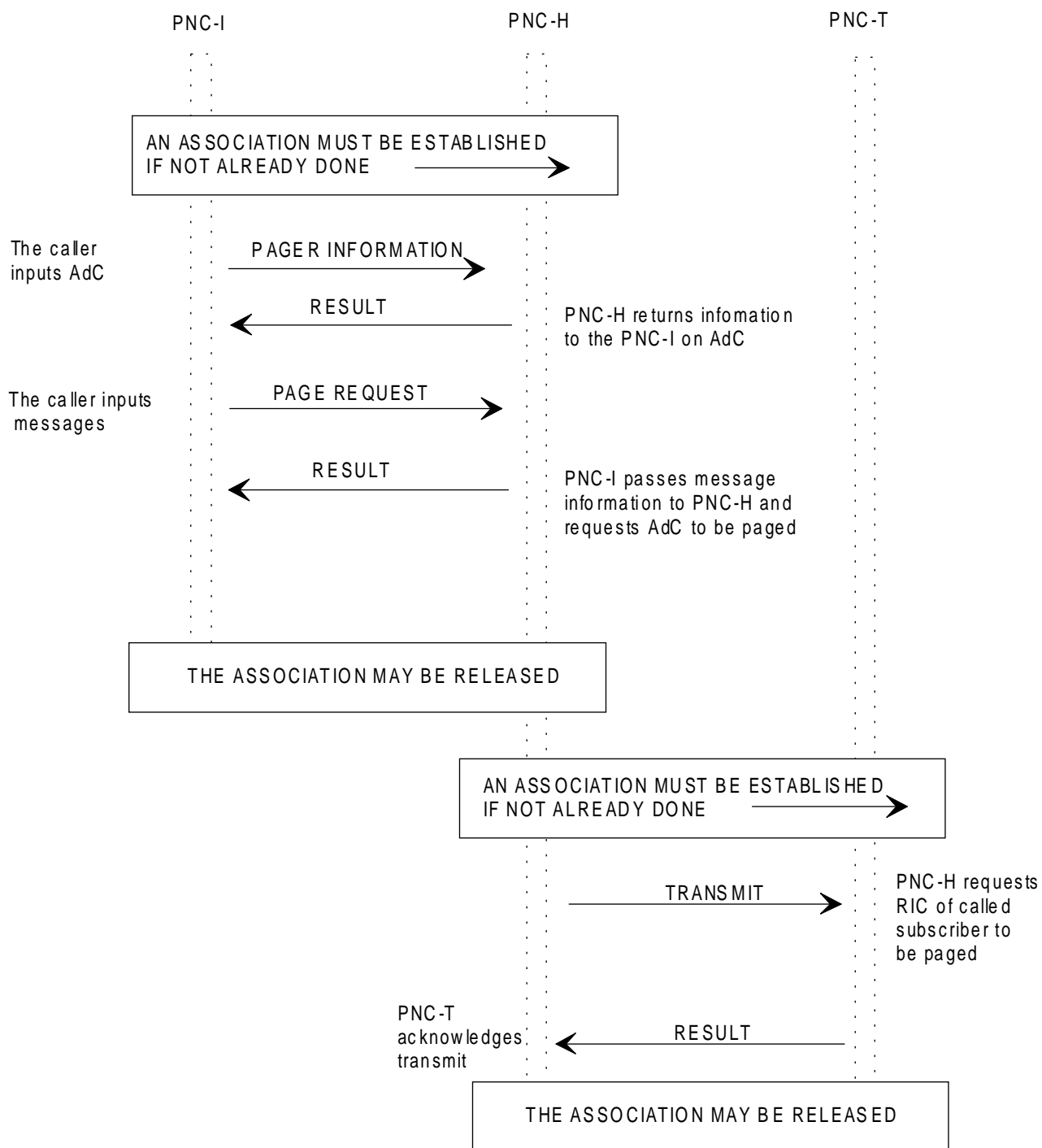

Figure 18: Flow diagram showing call processing for paging

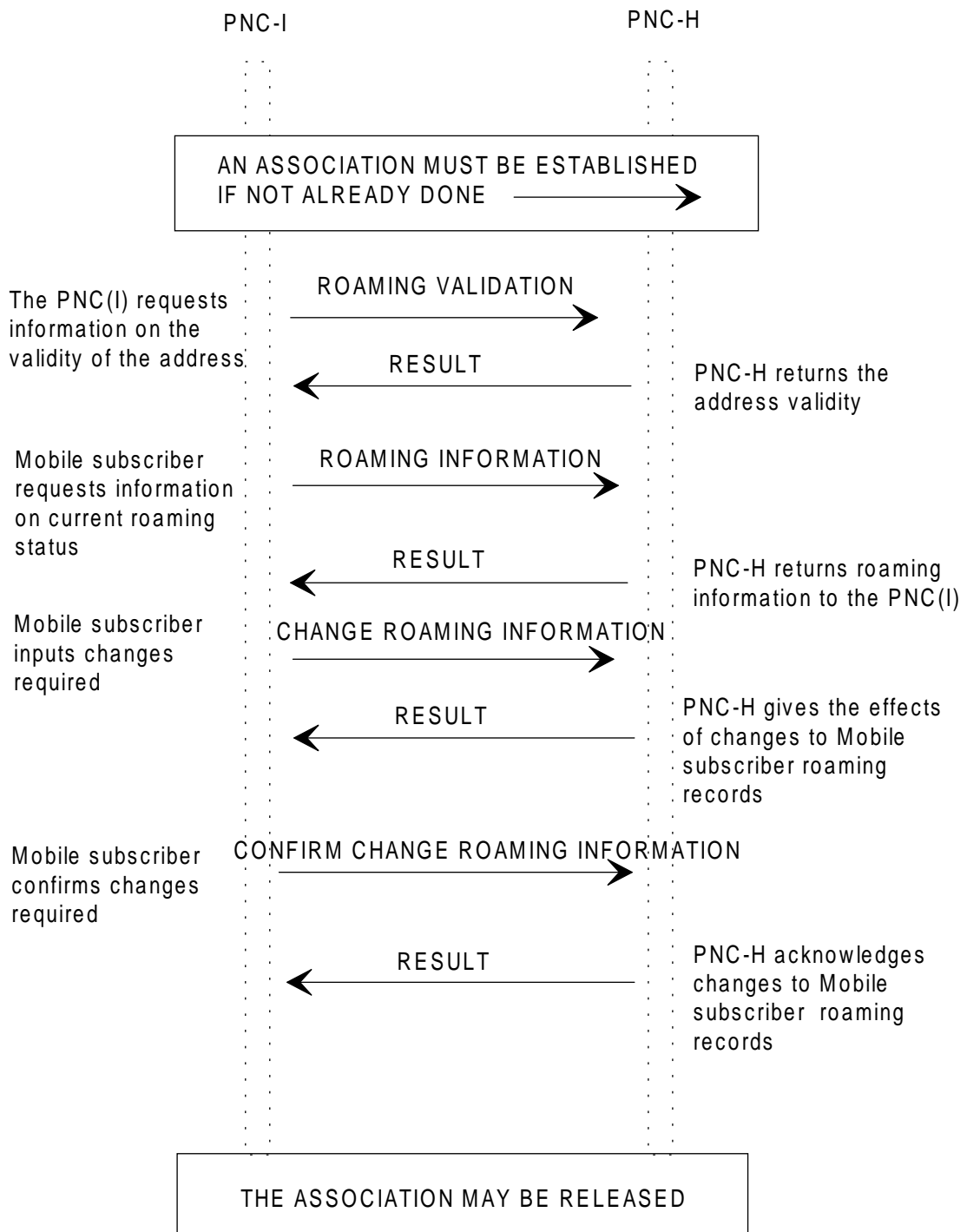

Figure 19: Flow diagram showing call processing for roaming

9.4 Use of ACSE

ACSE is used to establish an association between peer entities. This association shall be established before an operation may be invoked (association class 1). Only the entity which establishes the association may invoke operations. An association may be released only by the entity which has established the association. The peer entity may only invoke abort of the association but in this case it is possible to lose data. The abort of an association is considered as an abnormal situation.

The association may also be abnormally released by the lower layers. In this case ACSE shall report an "abort by the provider" to the upper entity.

It is not the purpose of this I4 interface specification to indicate when an association is to be released. The applications within PNCs have the liberty to decide when an association has to be established and/or released. This allows an established association to be maintained during peak periods in order to save the time required to establish association.

Information dealing with the profile is exchanged during the association establishment phase.

9.5 Use of ROSE

The ROSE entity is defined, at a service level, by ITU-T Recommendation X.219 [21]. The service provided by the ROSE entity to the application entity is described below.

During the ROSE bind operation PNCs exchange authorization information in order to ensure that no malicious calls may be handled either by authorized or non-authorized PNCs.

This information is a password stored in each PNC according to the network address of the PNC. The management of this password is described in the PNC specification and the O&M specification.

When a PNC wants to initiate an association with a peer entity, it sends as a parameter the password of the responding PNC to be accessed and the name of the initiator. The responder checks this password with the one stored in its database. If the password is correct, the responding PNC confirms the association establishment and gives back the password of the initiating PNC to the initiating PNC in order that the initiating PNC may be sure of the identity of the responding PNC.

If the password is incorrect, the called PNC shall refuse the association establishment. It may also provide information to the OMC that a malicious entity has tried to enter the ERMES system. When the password checking fails at the calling entity after receiving the association confirmation, the association shall be released by an abort request and the OMC advised.

The service description below is given only as a guide. There is no constraint on the way to realize the ROSE and application entities.

RO-Invoke

The RO-Invoke service is used by the invoker (one application entity within a PNC) to cause the invocation of an operation to be performed by the performer (the peer entity within the called PNC). Two primitives are used:

- RO-Invoke-Request from an application to the ROSE entity;
- RO-Invoke-Indication from the ROSE entity to an application.

The operation exchanged by these primitives is contained in the parameter "argument" of the primitive. An "Invoke ID" parameter issued by the caller allows the link with the results (positive or negative).

RO-Result

The RO-Result service is used by a ROSE user (an application of PNC) to reply to a previous RO-INVOKE-INDICATION in the case of a successfully performed operation. Two primitives are used:

- RO-Result-Request from an application to the ROSE entity;
- RO-Result-Indication from the ROSE entity to an application.

The "result" parameter is used to report of the success of the operation by the set of information required by the operation. The RO-Result uses the same Invoke-ID as the RO-Invoke primitive.

RO-Error

The RO-Error service is used by a ROSE user (an application of PNC) to reply to a previous RO-INVOKE-INDICATION in the case of an unsuccessfully performed operation. Two primitives are used:

- RO-Error-Request from an application to the ROSE entity;
- RO-Error-Indication from the ROSE entity to an application.

RO-Reject-U

The RO-Reject-U service is used by an application to reject a request (within a RO-Invoke-Indication) if it has detected a problem. This service may also be used by an application to reject a response (positive or negative). For the I4 interface only the first case is possible. Two primitives are used:

- RO-Reject-U-Request from an application to the ROSE entity;
- RO-Reject-U-Indication from the ROSE entity to an application.

RO-Reject-P

The RO-Reject-P service is used to advise an application of a problem detected by the ROSE provider. There is only one primitive associated to this service:

- RO-Reject-P-Indication from the ROSE entity to an application.

RO-Bind

The RO-bind service is used to allow the service of ACSE to establish an association. The RO-Bind primitive is used to exchange passwords between PNCs.

RO-Unbind

The RO-Unbind service is used to allow the service of ACSE to release an association.

Figures 20 and 21 show some combinations of these primitives.

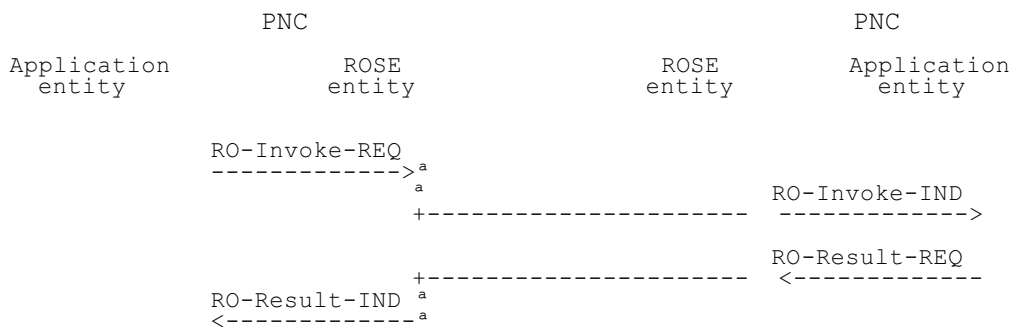

Figure 20: Operation invocation and positive report

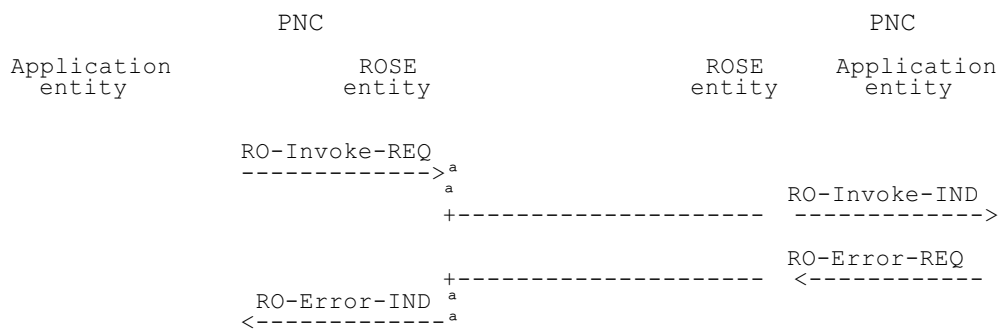

Figure 21: Operation invocation and negative report

9.6 PNC addressing

9.6.1 PNC network address

The address formats for the I4 network layer are described in annex A of ITU-T Recommendation X.213 [17].

9.6.2 PNC layer 4, 5, 6 and application addresses

The final form of addressing for I4 layers above the network layer shall be determined by agreement among network operators.

9.7 Interoperability of version 1 and version 2 systems

If two systems that are of different version numbers communicate over I4, there are compatibility issues to be noted. The two PNC's must agree on what version of the I4 protocol (IVR4) is used.

9.7.1 Protocol negotiation between adjacent PNC's

As of version 02.01, the IVR4 field will appear in both I4-Bind-Parameter and I4-Bind-Confirmation. During the establishment of the association, the target PNC answers in the I4-Bind-Confirmation with the lower of the IVR4 it received and its own IVR4. The returned IVR4 value determines the I4 version used during this association.

In the event that the initiating PNC is running a version prior to version 02.01, it will not contain IVR4 in its I4-Bind-Parameter. In this event, the responding PNC will note that it is communicating with a version 01.01 system and respond with an I4-Bind-Confirmation that does not contain the IVR4 parameter. Version 01.01 of the I4 protocol will be used during this association

In the event that the responding PNC is using a version prior to version 02.01, it may reject the bind operation due to the unknown IVR4 parameter. In this event, the initiator will retry the bind with a bind operation that does not contain an IVR4 parameter. If this succeeds, the association will continue using protocol version 01.01 as above. If this also fails, then it will be handled as a failed association in the usual manner.

If the responding PNC is prior to version 02.01 but chooses to nonetheless accept the bind containing the additional parameter, the initiating PNC will still know from the fact the the IVR4 parameter is missing from the I4-Bind-Confirmation that it is communicating with a version 01.01 system.

Note that this means that systems with an I4 protocol from version 02.01 onwards must maintain two bind operation and two bind confirmation ASN sequences for backward compatibility.

Each association can have a unique protocol version. In the event that a part of the system is upgraded while I4 associations are in progress, it is recommended that all open associations be closed and re-established after the upgrade.

10 I3 interface

10.1 General description

Clause 10 describes the version 02.01 of the I3 interface

The I3 interface is the interface over which the PNC-T communicates to the PAC.

The interface shall facilitate transport of all paging services provided for paging calls. It shall also transport control and status messages for the purpose of ensuring that the PNC knows the status of its PAC and associated BSs.

Since a standardized I3 interface is not essential this description only gives a functional specification of the data which has to be exchanged in order to fulfil the fundamental functions of the system.

10.2 Functional description

10.2.1 List of functional messages

10.2.1.1 Paging data transfer, individual call

The following list includes all the data items which may be transferred to the PAC within an individual paging call. Calls to paging groups using a common RIC are included within this functional message:

- Radio Identity Code (RIC);
- paging category;
- character set code;
- paging message (including called group indicator if present);
- urgent message indicator;
- message split indicator;
- message number;
- Highest IVR1 supported by the pager;
- alert function;
- valid Sub-Sequence Numbers (SSN) (if restricted);
- additional information type (part of);
- called group indication;
- Sub-sequence Mask (SM) if restricted;
- active cycle indication (NL) if restricted;
- Frequency Subset Number (FSN);
- priority;
- external traffic indicator;
- parameters for remote programming of pager;
- possibility for additional information to be defined in the future (RSVD).

10.2.1.2 Paging data transfer, group call

The following list includes all the data items which may be transferred to the PAC within a group paging call:

- Radio Identity Code (RIC);
- paging category;
- character set code;
- paging message (including called group indicator if present);
- urgent message indicator;
- message split indicator;
- message number;
- Highest IVR1 supported by the pager;
- alert function;
- valid Sub-Sequence Number (SSN) (if restricted);
- additional information type (part of);

- called group indication;
- Sub-sequence Mask (SM) if restricted;
- active cycle indication (NL) if restricted;
- Frequency Subset Number (FSN);
- priority;
- roaming traffic indicator;
- parameters for remote programming of pager;
- possibility for additional information to be defined in the future (RSVD).

10.2.1.3 Operation and maintenance messages

Table 56: Direction of transfer of messages

	PNC → PAC (OMC) (OS)	PAC → PNC (OS) (OMC)
Control commands	X	
Configuration modification	X	
Status request	X	
Software loading	X	
Traffic information		X
Autonomous alarm		X

Additional information on the contents and use of the above O&M messages is given in ETS 300 133-7 [3].

11 PAC to BS Interface (I2 interface)

Clause 11 describes the version 02.01 of the I2 interface.

11.1 General aspects and principles

The I2 interface is a bi-directional interface between the PAC and the BS. Each PAC is linked with all the BSs covering its own PA.

The standardized I2 interface that may be used to connect the BSs to the PAC by dedicated point-to-point links is specified in this subclause.

The I2 interface carries the services provided to the system users as specified in ETS 300 133-4 [2], as well as the operation and maintenance functions related to the network management procedures as specified in ETS 300 133-7 [3]. The main (and most time critical) data flow is from the PAC to BS, due to the paging call transmissions.

Transmissions over the PAC-BS data link shall be under the complete control of the PAC with the PAC as master and the BS as slave. This means that the BS shall not invoke any transmission without a PAC request.

The MSB of every octet shall be transmitted first.

In the following subclauses only layers 1, 2, 4 and 7 are described. Layer 1 and 2 are according to existing ITU-T/ISO standards. Layer 4 and 7 are described according to the OSI-model.

11.2 Layer 1

The DTE/DCE physical interface elements shall be X.21bis according to the ITU-T Recommendation X.25 [14], Fascicle VIII.2. The setting of bit-rate shall be adjustable.

11.3 Layer 2

The single link layer procedures across the I2 interface shall be according to in ISO/IEC 7776 [29].

The link layer shall transfer an error signal to higher layers when no response to the procedure for link set-up, link resetting or link disconnection, as described in subclauses 5.3.1, 5.3.3 and 5.6.1 of ISO 7776 [29], is received correctly.

11.4 Layer 3

Layer 3 is not used. This protocol layer is empty.

11.5 Layer 4 (fragmentation)

11.5.1 General

The layer 4 fragmentation makes it possible to divide an application packet into several small packets. The size of a packet is mainly based on the quality of the lines and the buffer sizes of the involved equipment. Layer 4 is a dedicated I2 layer.

11.5.2 Fragmentation header

Each information field in the High Level Data Link Control (HDLC) frame according to link layer procedures between signalling terminals shall contain a fragmentation header preceding the application data. The fragmentation header shall take the form shown in figure 22.

	FRN	NOP	PN	FLP	Fragmented application data
No of octets	1	1	1	2	n

NOTE: FRN (Fragmentation Reference Number): a binary number used by layer 4 to keep a complete message together.

NOP (Number Of Packets): a binary number indicating how many packets a complete message consists of.

PN (Packet Number): a binary number identifying each packet.

FPL (Fragmented Packet Length): a binary number of octets (n) in the fragmented application data field.

Figure 22: Fragmentation header

The fragmentation reference number together with number of packets and packet number enable fragmentation of application data which is contained in the application data fields.

11.5.3 Description

Fragmentation to lower layers shall only be performed when a complete frame structure, as described in subclause 11.6.4, is delivered from the application layer.

The application layer shall not receive the application packet from layer 4 until a complete frame is delivered from the lower layers. The fragmentation depends upon system parameter N1 at the link layer, "maximum number of bits in an I frame", described in ISO 7776 [29], subclause 5.7.3.

When packets are delivered from lower layers and a missing packet in a sequence of packets is discovered, the application packet shall be regarded as lost.

If a layer 4 message is not completed within the time T, or if an error signal, as described in subclause 11.3, is received from the lower layer then the fragmentation process shall be reset and the application packet regarded as lost. The length of timer T shall be greater than the time-outs at the link layer.

11.6 Layer 7 (application)

11.6.1 General

The I2 interface supports a real time application. On this level the PAC manages call processing for the paging data and also BS control and supervision (for the system and O&M data).

Each transaction between the PAC and BS comprises one operation and its corresponding result, as indicated in figure 23.

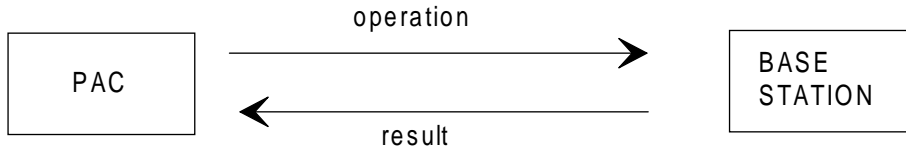

Figure 23: Layer 7 transaction

Although the I2 interface is nominally for point-to-point dedicated link operation the application layer described in this subclause has some addressing features so that the protocol may be adapted for other network configurations.

11.6.2 Data processing

There are two main functions utilizing the I2 protocol:

- paging traffic processing;
- processing of Operation and Maintenance data.

O&M data comply with the operation, maintenance and performance management categories as specified in ETS 300 133-7 [3].

A division into several transactions is shown in table 57.

Table 57: Layer 7 data processing

PAC----->BS	BS----->PAC
<u>TRAFFIC OPERATION</u>	<u>TRAFFIC RESULT</u>
Page request operation	Page request result
<u>O&M OPERATION</u>	<u>O&M RESULT</u>
BS time reference operation	BS time reference result
Control command operation	Control command result
Status request operation	Status request result
Poll request operation	Poll request result
Report request operation	Report request result

11.6.3 Application header

All I2 transactions shall start with the Application Header (AH) shown in figure 24.

	ORI	PAA	BSA	TRN	TPL
No. of octets	1	1	2	1	2

Figure 24: Application header

ORI Operation or Result Identification

Operation and results have different numbers where the MSB is used for indication ("0" for Operation, "1" for Result) described in table 58.

Table 58: Operation or Result Identification (ORI)

Number	Identification
00000001	Operation 1 = Page request
00000010	Operation 2 = BS time reference
00000011	Operation 3 = Status request
00000100	Operation 4 = Control command
00000101	Operation 5 = Poll request
00000110	Operation 6 = Report request
10000001	Result 1 = Page request
10000010	Result 2 = BS time reference
10000011	Result 3 = Status request
10000100	Result 4 = Control command
10000101	Result 5 = Poll request
10000110	Result 6 = Report request
NOTE 1:	Numbers within 0000111 - 00111111 shall be reserved for future standardized Results.
NOTE 2:	The BS shall use the result 10000000 if it receives an undefined or not implemented operation.
NOTE 3:	Numbers within 10000111 - 10111111 shall be reserved for future standardized operations.
NOTE 4:	Numbers not reserved are free for manufacturers' specific purposes.

PAA PAC address

PAA is a binary number which identifies the PAC. This address shall be unique in a paging network. The address indicates the originator for an Operation and the terminator for a Result. When PAA is not used the field shall be set to zero.

BSA BS Address

Binary number which identifies a single BS or a group of BSs. A BS may have several addresses and at least one address shall be unique to the paging network. The address indicates the terminator for an Operation and the originator for a Result. The BS shall only respond to a valid address. When BSA is not used the field shall be set to zero.

TRN Transaction reference number

Binary number generated by the PAC to identify the transaction.

The BS shall use the same number in its response.

TPL Transaction Packet Length

Binary number of octets (n) in the transaction data field.

11.6.4 Transaction data

11.6.4.1 General

Every transaction consist of one operation and its corresponding result. Each operation comprises a request from the PAC and produces a logical response from the BS.

Every result shall contain an acknowledge field. A positive result indicates that the BS has received the operation correctly and expects to perform the order. A negative acknowledge indicates that performance of the operation is not possible either because the BS received an operation that included an undefined or invalid field from the PAC, or that the BS was not able to perform due to a failure.

When further details about a BS failure are required a status request transaction may be used to inform the PAC about the type of error.

An undefined or invalid field from the PAC corresponds to an error during the exchange of information between the PAC and BS.

11.6.4.2 Page request transaction

The page request operation is used by the PAC to transmit one or several batches containing addresses and/or messages and to update the System Information (SI)/Supplementary System Information (SSI) in the batch headers of the I1 interface.

The page request result acknowledges whether the operation was performed.

If there are no addresses or messages to be sent an empty page request may be sent to update the fixed part of the SI/SSI in the batch header.

11.6.4.2.1 Page request operation

The page request operation contains all relevant data for one or several complete batches.

Only the information part (first 18 bits) of each code-word of system information, SSI, initial addresses and messages shall be sent via the I2 interface. The remaining 12 bits of error correction coding (as described in ETS 300 133-4 [2], clause 6) shall be added in the BS.

NOTE: All other invariable information on the I1 interface such as preamble, synchronization word, address partition terminator(s) and message delimiters shall be added by the BS. The interleaving of message code-words shall also be performed by the BS.

Unless otherwise stated these 18 bit words mentioned above shall be concatenated and placed in consecutive octets. Any remaining bits in the last octet in the fields shall be set to 0.

The page request frame structure shall take the form shown in figure 25.

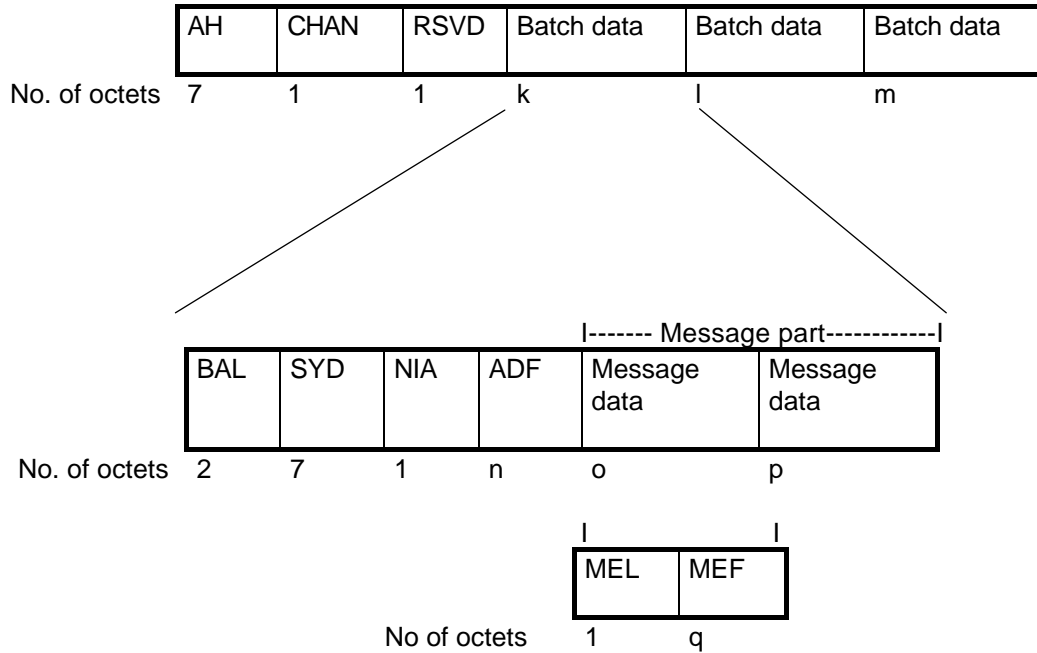

Figure 25: Page request frame structure

AH Application Header

The header is specified in subclause 11.6.3.

CHAN CHAnel Number

The Channel Number is binary coded and indicates the frequency on which the batch shall be transmitted. Channel Number is defined in ETS 300 133-4 [2], subclause 8.2.

RSVD Reserved for future definition, should be set to 0 or 1

BAL BAtch Length

This field contains the binary number of octets for the complete batch (i.e. SYD, NIA, ADF, MELs, MEFs). The field shall be repeated for each batch in the page request.

SYD SYstem Data

This field contains the SI and SSI as described in ETS 300 133-4 [2], subclause 5.3. The field shall be repeated for each batch in the page request.

NIA No of Initial Addresses

This field contains the binary number of initial addresses in the address field. As stated in ETS 300 133-4 [2], subclause 4.4, the maximum number of initial addresses in one batch is limited to 139. The field shall be repeated for each batch in the page request.

ADF ADdress Field

This field contains the initial addresses which shall be transmitted in the address partition of the requested batch. The initial addresses shall be assembled in order of transmission. The field shall be repeated for each batch in the page request.

MEL Message Length

This field contains the binary number of code-words in the following message field. Only the message (or part message) length within the same batch shall be given. MEL=0 shall be used as an Integral Message Indicator (IMI) as described below.

MEF Message Field

This field contains message code-words for transmission in the message partition of the requested batch. Message code-words shall include both message header and message data as described in ETS 300 133-4 [2], subclause 5.5.

Messages shall be assembled in the order of transmission. The message part of each batch data frame containing only complete messages (i.e. with I1 message headers) shall start and finish with an IMI. In the case of a message continued in a further batch (of the same or further sub-sequence) as described in ETS 300 133-4 [2], subclauses 10.4.1 and 10.4.2 the terminating IMI shall be omitted in the message part with the message to be continued and the commencing IMI omitted in the message part where the message does continue.

11.6.4.2.2 Page request result

Page request positive result indicates that the BS has received correctly the page request operation and expects to transmit. Page request negative result indicate to the PAC that the BS has received but may not perform the page request operation.

The page request result frame structure shall take the form shown in figure 26.

	AH	PRA	OMI
No. of octets	7	1	2

Figure 26: Page request result

AH Application Header

The header is specified in subclause 11.6.3.

PRA Page Request Acknowledge

This field is bit oriented. The MSB acknowledges and, when needed, reports if there is a failure in the BS that makes the performance of the operation impossible.

The MSB shall be set as follows:

- 0 BS may perform the operation;
- 1 BS may not perform the operation.

Bit numbers 7 to LSB indicate if there is a PAC related error that inhibits performance of the operation. If there is more than one PAC related error only the first shall be reported.

Bit numbers 7 to LSB shall be set as follows:

- 0000000 no format error;
- 0000001 mismatching TPL;
- 0000010 not valid CHAN;
- 0000011 Reserved for future definition;
- 0000100 not valid Batch data;
- 0000101 page request operation received too late.

Numbers up to 0001111 shall be reserved for future use.

Numbers not reserved are free for manufacturers' specific purposes.

OMI Operation and Maintenance Information (OMI)

This field shall, if used, include more detailed OMI about the BS. The contents of the OMI field shall be made known and agreed upon by both the PAC and the BS. If not used, the OMI field shall be set to zero.

11.6.4.3 BS time reference transaction

The BS time reference operation may be used to initiate the synchronization process of BSs transmission time in accordance with ETS 300 133-4 [2], subclause 12.3.

11.6.4.3.1 BS time reference operation

The BS time reference operation frame structure shall take the form shown in figure 27.

No. of octets	AH	TRD
	7	n

Figure 27: BS time reference operation

AH Application Header

The header is specified in subclause 11.6.3.

TRD Time Reference Data

This field shall include the necessary data to perform the operation of the synchronization process. The contents of the TRD field shall be made known and agreed upon by both the PAC and BS.

11.6.4.3.2 BS time reference result

Base station time reference positive result indicates that the BS has received correctly the BS time reference operation and expects to perform as specified.

BS time reference negative result indicates to the PAC that the BS has received but may not perform the BS time reference operation.

No. of octets	AH	TRA
	7	1

Figure 28: BS time reference result

AH Application Header

The header is specified in subclause 11.6.3.

TRA Time Reference Acknowledge

This field is bit oriented. The MSB acknowledges, and when needed, report if there is a failure in the BS that makes performance of the operation impossible.

The MSB shall be set as follows:

- 0 BS may perform the operation;
- 1 BS may not perform the operation.

Bits 7 to LSB indicate if there is a PAC related error that inhibits performance of the operation. If there is more than one PAC related error, only the first shall be reported.

Bits 7 to LSB shall be set as follows:

- 0000000 no format error;
- 0000001 mismatching TPL;
- 0000010 not valid TRD.

Numbers up to 0000111 shall be reserved for future use.

Numbers not reserved are free for manufacturers' specific purposes.

11.6.4.4 Status request transaction

The status request may be used to obtain detailed information on the status at the BS.

The status request operation shall give the PAC the opportunity to choose whether the BS reports logged or current failures.

The status request result shall enable the BS to report a table of indicated failures including:

- whether it is a logged or current failure;
- type of error;
- from which subunit at the BS the failure indication originates;
- the time when the failure occurred.

11.6.4.4.1 Status request operation

The PAC invokes the status request operation in order to get a complete status report from the BS. The status request operation frame structure shall take the form shown in figure 29.

No. of octets	AH	SRT
	7	1

Figure 29: Status request operation

AH Application Header

The header is specified in subclause 11.6.3.

SRT Status Request Type

The SRT indicates the type of status information required by the PAC:

- 00000001 current failure report;
- 00000010 logged failure report;
- 00000011 current and logged failure report.

Numbers up to 00000111 shall be reserved for future use.

Numbers not reserved are free for manufacturers' specific purposes.

11.6.4.4.2 Status request result

The BS reports its indicated status only when specifically requested by the PAC.

When the status request type is, current and/or logged failure, the status request result shall contain tables of either:

- current failures;
- logged failures; or
- current and logged failures.

When no failure exists the table shall be empty and only the Status Request Acknowledge (SRA) included in the result.

The status request result frame structure shall be as shown in figure 30. The result may consist of one or several error data fields.

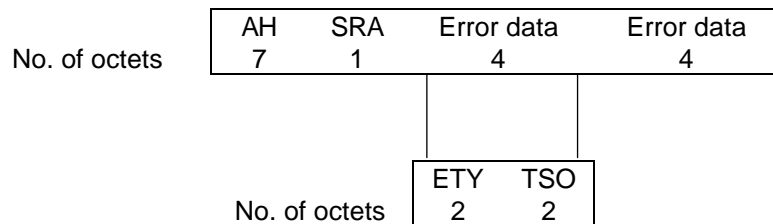

Figure 30: Status request result

AH Application Header

The header is specified in subclause 11.6.3.

SRA Status Request Acknowledge

This field is bit oriented. The MSB acknowledges, and when needed, reports if there is a failure in the BS that makes performance of the operation impossible.

The MSB shall be set as follows:

- 0 BS may perform the operation;
- 1 BS may not perform the operation.

Bits 7 to LSB indicate if there is a PAC related error that inhibits performance of the operation. If there is more than one PAC related error, only the first shall be reported.

Bits 7 to LSB shall be set as follows:

- 0000000 no format error;
- 0000010 mismatching TPL;
- 0000001 not valid SRT.

Numbers up to 0000111 shall be reserved for future use.

Numbers not reserved are free for manufacturers' specific purposes.

If a PAC related error is reported in SRA no error data shall follow.

ETY Error TYpe

This field indicates the BS error code. These codes shall be made known and agreed upon by both the PAC and BS.

TSO Time Stamp Occurrence

This field contains the time when the failure occurred. The size of the field is two octets. These octets form an integer word, and various bits of the word denote certain aspects of the time; bits 12 through MSB (16) give the hour, bits 6 through 11 give the minute and bits LSB (1) through 5 give the second (unit = 2 seconds).

11.6.4.5 Control command transaction

The control command modifies or changes the internal configuration of the BS and its subunits. The control command operation shall contain the action to be taken and necessary complementary information. The control command result shall indicate whether the required operation was successfully performed.

11.6.4.5.1 Control command operation

The PAC invokes the control command operation in order to control functions and parameters in the BS. The control command operation frame structure shall take the form shown in figure 31.

No. of octets	AH	COC	COI
	7	1	n

Figure 31: Control command operation

AH Application Header

The header is specified in subclause 11.6.3.

COC Control Order Command

This field selects what is to be controlled:

- 00000001 switch on/off - operational/standby;
- 00000010 adjust frequency offset;
- 00000011 change channel;
- 00000100 change output power;
- 00000101 adjust alarm thresholds;
- 00000110 adjust time;
- 00000111 run diagnostic;
- 00001000 turn on/off alarms;
- 00001001 change BS Address (BSA);
- 00001010 change effective sub-sequence length;
- 00001011 set time of day.

Numbers up to 01111111 shall be reserved for future use.

Numbers not reserved are free for manufacturers' specific purposes.

COI Control Order Information

This field shall, when necessary, contain information to realize the control order command.

Table 59: Control Order Information (COI)

When COC is	COI shall include
switch on/off (operational/standby)	Field 1. (one octet): contains the identity of the subunit at the BS to be switched. These subunit identity codes shall be made known and agreed upon by both the PAC and BS.
	Field 2. (one octet): the MSB shall be 0 (off) or 1 (on); bit 7 shall be 0 (standby) or 1 (operational); bits 6 to LSB shall not be used.
adjust frequency offset	Field 1. (one octet): contains the identity of the transmitter to be adjusted. These subunit (transmitter) identity codes shall be made known and agreed upon by both the PAC and BS.
	Field 2. (n octets): contains the nominal offset value. This value shall be made known and agreed upon by both the PAC and BS.
change channel	Field 1. (one octet): contains the identity of the transmitter, to be adjusted. These subunit (transmitter) identity codes shall be made known and agreed upon by both the PAC and BS.
	Field 2. (one octet): contains the change to be done and if the indicated transmitter shall be active or standby. the MSB shall be set to 0 (standby) or 1 (active); Bits 7 to LSB identify the RF channel number: 0000000 No change; 0000001 to RF channel 1, up to 0010000 RF channel 16.
change output power	Field 1. (one octet): contains the identity of the transmitter to be adjusted. These subunit (transmitter) identity codes shall be made known and agreed upon by both the PAC and BS.
	Field 2. (one octet): contains the power value that shall be made known and agreed upon by both the PAC and BS.
adjust alarm thresholds	Field 1. (two octets): contains the identity of the alarm to be adjusted. These alarm identity codes shall be made known and agreed upon by both the PAC and BS.
	Field 2. (n octets): contains the threshold value. These threshold values shall be made known and agreed upon by both the PAC and BS.
	(continued)

Table 59 (concluded): Control Order Information (COI)

When COC is	COI shall include
adjust time	Field 1. (n octets): the contents of these octets shall be made known and agreed upon by both the PAC and BS in accordance with subclause 11.6.4.3.1.
run diagnostic	Field 1. (one octet): contains the identity of the diagnostic to run. These diagnostic identity codes shall be made known and agreed upon by both the PAC and BS.
turn on/off alarms	Field 1. (two octets) identifies the alarm to be turned on/off. These alarm identity codes shall be made known and agreed upon by both the PAC and BS. When the octets are set to zero all alarms on the BS shall be cleared.
	Field 2. (one octet): the MSB shall be set to 0 (off) or 1 (on); Bits 7 to LSB shall not be used.
change BS Address (BSA)	Field 1. (three octets): contains BS old address as defined in subclause 11.6.3.
	Field 2. (three octets): contains BS new address as defined in subclause 11.6.3. This command may be used to add or delete an address by including address 0 either as the new or old address.
sub-sequence length	Field 1. (one octet): contains Channel No.(CHAN) as defined for the page request operation.
	Field 2. (one octet): contains Cycle No.(CYN) as defined for the page request operation.
	Field 3. (one octet): contains Sub-sequence No.(SSN) as defined for the page request operation.
	Field 4. (two octets): contains effective sub-sequence length in code-words (a binary coded value between 0 and 2 500).
set time of day	Field 1. (two octets): contains hours, minutes and seconds as defined in the TSO for the status request.

11.6.4.5.2 Control command result

The BS frame structure shall respond to the PAC on a control command operation. The control command result frame structure shall take the form in figure 32.

	AH	COA
No. of octets	7	1

Figure 32: Command control result

AH Application Header

The header is specified in subclause 11.6.3.

COA Control Acknowledge

This field is bit oriented. The MSB acknowledges, and when needed, report if there is a failure in the BS that makes performance of the operation impossible.

The MSB shall be set as follows:

- 0 BS may perform the operation;
- 1 BS may not perform the operation.

Bits 7 to LSB indicate if there is a PAC related error that inhibits performance of the operation. If there is more than one PAC related error, only the first shall be reported.

Bits 7 to LSB shall be set as follows:

- 0000000 no format error;
- 0000001 mismatching TPL;
- 0000010 not valid COC;
- 0000011 not valid COI.

Numbers up to 0000111 shall be reserved for future use.

Numbers not reserved are free for manufacturers' specific purposes.

11.6.4.6 Poll request transaction

The PAC invokes the poll request operation to find if the BS is in a normal or failure state. The poll request result reports whether the BS is or has been in a failure state since the last status request result was transmitted.

11.6.4.6.1 Poll request operation

The poll request operation frame structure shall take the form shown in figure 33.

No. of octets	AH
	7

Figure 33: Poll request operation

AH Application Header

The header is specified in subclause 11.6.3.

11.6.4.6.2 Poll request result

The poll request result frame structure shall take the form shown in figure 34.

No. of octets	AH	POA	BSS
	7	1	1

Figure 34: Poll request result

AH Application Header

The header is specified in subclause 11.6.3.

POA POII request Acknowledge

This field is bit oriented. The MSB acknowledges, and when needed, report if there is a failure in the BS that makes performance of the operation impossible.

The MSB shall be set as follows:

- 0 BS may perform the operation;
- 1 BS may not perform the operation.

Bits 7 to LSB indicate if there is a PAC related error that inhibits performance of the operation. If there are more than one PAC related error, only the first shall be reported.

Bits 7 to LSB shall be set as follows:

- 0000000 no format error;
- 0000001 a mismatching TPL.

Numbers up to 0000111 shall be reserved for future use.

Numbers not reserved are free for manufacturers' specific purposes.

If an error is reported in POA, no BSS shall follow.

BSS Base Station Status

This octet reports whether the BS is, or has been, into a logged or current failure state since the last status request operation.

The BSS shall be set as follows:

- 00000000 no failure at BS;
- 00000001 logged failure;
- 00000010 current failure;
- 00000011 logged and current failure.

Numbers up to 00000111 shall be reserved for future use.

Numbers not reserved are free for manufacturers' specific purposes.

11.6.4.7 Report request transaction

The report request is used to measure the state or the result of BS parameters.

The report request operation shall contain the parameter to be checked and, when needed, contain the necessary complementary information.

If the operation is successful, the Report request result shall contain the value of the requested parameter.

11.6.4.7.1 Report request operation

The report request operation frame structure shall take the form shown in figure 35.

	AH	RRP	RRI
No. of octets	7	1	n

Figure 35: Report request operation

AH Application Header

The header is specified in subclause 11.6.3.

RRP Report Request Parameter

This field defines which parameters in the BS shall be checked and shall be set as follows:

- 00000001 on/off - operational/standby status;
- 00000010 programmed frequency offset;
- 00000011 channel number;
- 00000100 output power;
- 00000101 alarm thresholds;
- 00000110 monitored time;
- 00000111 report diagnostic result;
- 00001000 alarm on/off status;
- 00001001 BS Address (BSA);
- 00001010 check effective sub-sequence length;
- 00001011 time of day check;
- 00001100 report temperature.

Numbers up to 01111111 shall be reserved for future use.

Numbers not reserved are free for manufacturers' specific purposes.

RRI Report Request Information

This field contains information about the parameter to be measured.

Table 60: Report Request Information (RRI)

When RRP is	RRI shall include
on/off (operational/standby status)	Field 1. (one octet): contains the subunit at the BS to be checked for status. These subunit identity codes shall be made known and agreed upon by both the PAC and BS.
programmed frequency offset	Field 1. (one octet): contains the identity of the transmitter that shall report its programmed frequency offset. These subunit (transmitter) identity codes shall be made known and agreed upon by both the PAC and BS.
channel No.	Field 1. (one octet): contains the identity of the transmitter that shall report its channel number(s). These subunit (transmitter) identity codes shall be made known and agreed upon by both the PAC and BS.
output power	Field 1. (one octet): contains the identity of the transmitter that shall report its output power. These subunit (transmitter) identity codes shall be made known and agreed upon by both the PAC and BS.
alarm thresholds	Field 1. (two octets): identifies the alarm that shall report its alarm threshold. These alarm identity codes shall be made known and agreed upon by both the PAC and BS.
	(continued)

Table 60 (concluded): Report Request Information (RRI)

When RRP is	RRI shall include
monitored time	The RRI field is not included
report diagnostic results	Field 1. (one octet): contains the identity of the diagnostic to run. Diagnostic identity codes shall be made known and agreed upon by both the PAC and BS.
alarm on/off status	Field 1. (two octets): contains the identity of the alarm that shall report its alarm on/off status. These alarm identity codes shall be made known and agreed upon by both the PAC and BS.
BS Address (BSA)	The RRI field is not included.
effective sub-sequence length	Field 1. (one octet): contains the Channel no(CHAN) as defined for the page request operation.
	Field 2. (one octet): contains the Cycle no(CYN) as defined for the page request operation.
	Field 3. (one octet): contains the Sub-sequence no (SSN) as defined for the page request operation.
report temperature	Field 1. (one octet): contains the subunit at the BS that shall report its temperature. These subunit identity codes shall be made known and agreed upon by both the PAC and BS.
time of day check	The RRI field is not included.

11.6.4.7.2 Report request result

The report request result frame structure shall take the form shown in figure 36.

	AH	RRA	RPI
No. of octets	7	1	n

Figure 36: Report request result

AH Application Header

The header is specified in subclause 11.6.3.

RRA Report Request Acknowledge

This field is bit oriented. The MSB acknowledges, and when needed, report if there is a failure in the BS that makes performance of the operation impossible.

The MSB shall be set as follows:

- 0 BS may perform the operation;
- 1 BS may not perform the operation.

Bits 7 to LSB indicate if there is a PAC related error that inhibits performance of the operation. If there is more than one PAC related error, only the first shall be reported.

Bits 7 to LSB shall be set as follows:

- 0000000 no format error;
- 0000001 mismatching TPL;
- 0000010 not valid RRP;
- 0000011 not valid RRI.

Numbers up to 0001111 shall be reserved for future use.

Numbers not reserved are free for manufacturers' specific purposes.

If an error is reported in RRA, no RPI shall follow.

RPI Reported Parameter Information

This field shall contain information about the measured parameter.

Table 61: Reported Parameter Information (RPI)

When RRP is	RPI shall include
on/off- operational/standby status	Field 1. (one octet): the MSB shall be set to 0 (off) or 1 (on); bit 7 shall be set to 0 (standby) or 1 (operational); bits 6 to LSB shall not be used.
programmed frequency offset	Field 1. (one octet): contains the nominal offset value. These offset value shall be made known and agreed upon by both the PAC and BS.
channel no.	Field 1. (n octets): contains a table of elements. Each element, of size one octet, is a binary number representation of the channels that the addressed transmitter serves. The MSB indicates whether it is a standby or an active transmitter. the MSB shall be set to 0 (standby) or 1 (active); bits to 7 to LSB shall be set to the Channel Number at the addressed transmitter, where: - RF channel 1 = 0000001; - RF channel 16 = 0010000.
output power	Field 1. (one octet): contains the power value. This shall be made known and agreed upon by both the PAC and BS.
alarm thresholds	Field 1. (n octets): contains the threshold value. These threshold values shall be made known and agreed upon by both the PAC and BS.
monitored time	Field 1. (n octets): the contents of this field shall be made known and agreed upon by both the PAC and BS, in accordance with subclause 11.6.4.3.1.
report diagnostic results	Field 1. (n octets): these diagnostic results shall be made known and agreed upon by both the PAC and BS.
alarm on/off status	Field 1. (one octet): the MSB shall be set to 0 (off) or 1 (on); Bits 7 to LSB shall not be used.
	(continued)

Table 61 (concluded): Reported Parameter Information (RPI)

When RRP is	RPI shall include
BS Address (BSA)	Field 1. (three octets): contains the BSA as specified in subclause 11.6.3.
effective sub-sequence length	Field 1. (two octets): contains the effective sub-sequence length in code-words (a binary coded value between 0 and 2 500).
report temperature	Field 1. (one octet): contains a temperature value. This value shall be made known and agreed upon by both the PAC and BS.
time of day check	Field 1. (two octets): includes hours, minutes and seconds as defined in the TSO for the status request (subclause 11.6.4.4.2).

12 Paging network controller specification

12.1 PNC functional description

In the system architecture, each operator's network is associated with a functional entity called the PNC. This functional entity is linked with the other operator's networks through the I4 interface, is linked with the access networks through the I5 and I6 interfaces, and distributes paging messages within its own network through the I3, I2 and I1 interfaces.

For call processing each PNC may fulfil three roles; that of PNC-H, PNC-I and PNC-T. These three roles are performed by the same PNC in the case of a local call.

The main functional processes performed by the PNC are consequently:

- management of the interfaces I3, I4, I5;
- management of its databases;
- calculation for the call acceptance; and
- management of the PNC-OMC interworking.

The PNC also carries out other functional processes as described in the following subclauses.

12.2 Database specifications

For each parameter there are two indications. The first one indicates if the parameter depends on an essential (E) or optional (O) service or facility; the second one if it is a flag (F) and if it contains more information.

12.2.1 Mobile Subscriber (MS) AdC-records database

Table 62: Mobile Subscriber (MS) AdC records database

E/O	F	Parameter	Information
E		AdC	
O	F	AdC valid/out of service	
E		RIC	
O		MSI	
O	F	Common group RIC	
O	F	Called group indication	group number/name.
E		Alert function	
E		FSN	
O	F	External traffic group	
O	F	Valid sub-sequences and cycles	relevant sub-sequences and cycle numbers.
E		Service Area (SA)	
E		Type of receiver	
O		Additional character set	list of character set codes.
E		Class of subscribed basic service	subscribed message length.
E	F	Authentication procedure	password; conditional number for reverse calling; conditional certificate identification.
E	F	Legitimation	depending on the services which need legitimation, there may be a list of legitimation codes.
E	F	Roaming	list of roaming requests which contains: - table of geographical areas; - start date, time; - stop date, time.
E		Message numbering	reference to the mobile subscriber RIC-message database.
E	F	Priority	
O		Priorities, which may be activated by calling party	
O	F	Subscription of temporary barring service	
O	F	Temporary barring	start date, time; stop date, time; MS pre-programmed text message.
O	F	Subscription of diversion	
O	F	Diversion of traffic	new mobile subscriber AdC start date, time; stop date, time.
O	F	Diversion recipient	list of original AdCs.
O	F	Reverse charging acceptance	conditional or affecting all calls.
O	F	Repetition of the message	
O	F	Message storing and retrieval	
O	F	Automatic retransmission of last message number	location of information needed (e.g. timer, number of retransmission, etc.).
O	F	Encryption	encryption key.
O	F	Urgent message indication	
O	F	Subscription of deferred delivery service	
O	F	Deferred delivery	start date, time; stop date, time; indication, if calling party should be informed; MS pre-programmed text message.
O		Number of deferred messages	
O	F	CUG	list of CUG numbers/names.
O		Location of RIC-message database	
O		Location of traffic database	
E		IVR1	the I1 version number of the pager.

12.2.2 Mobile Subscriber (MS) RIC-message database

Table 63: Mobile Subscriber (MS) RIC message database

E/O	F	Parameter	Information
E		RIC	
E		Message numbering counter	
O		List of messages which contains:	AdC; message number; message; date and time of transmission from PNC-H to PNC-T.

12.2.3 Fixed subscriber records database

Table 64: Fixed subscriber records database

E/O	F	Parameter	Information
E		AdC	
O	F	AdC valid/out of service	
E		Authentication procedure	password; conditional reverse calling number; conditional certificate identification.
E	F	Legitimation	depending on the services which need legitimation, there may be a list of legitimation codes.
O		Priorities	
O	F	CUG	list of CUG numbers/names.
O	F	Standard text	name of message bank.
O	F	Group definition	list of GAdCs.
O		Location of traffic database	
O		Accumulated charges information	

12.2.4 Group database for group calls**Table 65: Group database for group calls**

E/O	F	Parameter	Information
O		GAdC	
O	F	GAdC valid/out of service	AdCs list (list of members).
O	F	Use of GAdC only by fixed subscribers	representative (AdC), who controls the group.
O	F	Called group indication	group number/name.
E		Class of subscribed basic service	subscribed message length.
E	F	Authentication procedure	password; conditional number for reverse calling; conditional certificate identification.
E	F	Legitimation	depending on the services which need legitimation, there may be a list of legitimation codes.
E	F	Priority	
O		Priorities, which may be activated by calling party	
O	F	Subscription of temporary barring service	
O	F	Temporary barring	start date, time; stop date, time; MS pre-programmed text message.
O	F	Subscription of diversion	
O	F	Diversion of traffic	new MS AdC; start date, time; stop date, time.
O	F	Diversion recipient	list of original AdCs.
O	F	Reverse charging acceptance	conditional or affecting all calls.
O	F	Repetition of the message	
O	F	Urgent message indication	
O	F	Subscription of deferred delivery service	
O	F	Deferred delivery	start date, time; stop date, time; indication if calling party should be informed; MS pre-programmed text message.
O		Number of deferred messages	
O	F	CUG	list of CUG numbers/names.
O		Location of message database	
O		Location of traffic database	
NOTE:		If the service group call is offered, it remains optional for the network operator to decide about combinations with other services.	

12.2.5 Closed User Group (CUG) database

The CUG database shall contain the following information:

- CUG number/name;
- Representative (AdC) who controls the CUG;
- AdCs list (list of members).

12.2.6 System addressing database

The system addressing database contains addresses and passwords for other external and internal elements within the ERMES network.

12.2.6.1 PNC/PNC addressing

The addressing PNC/PNC over the I4 interface shall use the addressing capabilities of public ITU-T Recommendation X.25 [14] data networks. The PNC system addressing database therefore contains for each system/operator the addresses/number, the Data Network Identification Code (DNIC) and network address(es) (ITU-T Recommendation X.121 [27]).

Direct private circuit links between PNCs are permitted by mutual agreement between operators.

Furthermore there is included a list of the valid passwords to the different operators/systems. The password list shall be made so it accepts/contains passwords according to subclause 12.4.1.

Passwords shall only be used during the set-up of a link.

The PNC shall be advised by the OMC, which address(es) and passwords are valid. Addresses and passwords may be changed at any time.

12.2.6.2 PNC/OMC addressing

The addressing PNC/OMC is up to the operators/manufactures, since the PNC/OMC interface is an internal network interface and shall depend on the chosen transmission method (ITU-T Recommendation X.25 [14], hired lines, ISDN, etc.).

12.2.6.3 PNC/PAC addressing

The addressing PNC/PAC is up to the operators/manufacturers, since the I3 interface is an internal network interface, and shall depend on the chosen transmission method (ITU-T Recommendation X.25 [14], hired lines, ISDN, etc.).

12.2.7 System configuration database

The PNC requires a database of all the connected interfaces, e.g. I5, I4 and all other internal input and output interfaces, together with the configuration data associated with each interface (in service or out of service). However since this information is only used internally within each PNC there is no requirement to harmonize this database. This information may be retrieved and possibly modified by the OMC according to the operator's needs.

12.2.8 System status database

The following data items shall be held in the PNC system status database:

- for each PA and GA within the network controlled by the PNC:
 - availability;
 - delay:
 - priority 1 (if this service is provided);
 - priority 2;
 - priority 3 (if this service is provided);
- for other PNCs within the ERMES system:
 - status (available/not available);
- for each GA of coverage controlled by those PNCs:
 - availability;
 - delay:
 - priority 2;
 - priority 3 (if this service is provided).

See subclause 12.6 for details of the calculation of availability and delay.

This system status information may be retrieved and possibly modified by the OMC, according to the operator's needs.

12.2.9 Geographical area database

For each GA of coverage provided to home MSs on an operator's PNC a database record shall be kept relating the GAs of coverage to the operator's PAs.

For each GA of coverage provided to external MSs a GA database record shall be kept in its PNC-H holding the GA reference and the PNC controlling the GA.

For each GA of coverage which one operator provides for another operator, a database record shall be kept holding the GA identity used by the other operator and the PAs comprising the GA. The identity of a GA shall be assigned by the operator for whom the service is provided, not by the PNC holding the GA database. The identity of the PA is defined within the PNC controlling the PA.

This GA data may be retrieved and possibly modified by the OMC, according to the operator's needs.

12.3 Management of the I5 interface

The management of the I5 interface is a part of the PNC functional entity. As the PNC may be linked to several access networks, there may be one or more I5 interfaces on a PNC. The I5 management functions are:

- configuration;
- processing of fault situations;
- processing of OMI.

12.3.1 Configuration

The I5 interface is configured in accordance with the network access type parameters.

12.3.2 Processing of fault situations

There may be the following error situations in the management of the I5 interface:

- fault: no response from I5;
- action: alarm message is passed to OMC;
- fault: I5 error is active;
- action: alarm message is passed to the OMC;

12.3.3 Processing of O&M data

The PNC receives O&M data from the OMC for management of the I5 interface. Such data includes:

- configuration information (type of I5...);
- operation information (link open/not open...).

The PNC may also hold OMI on the I5 interface, which is passed on request to the OMC. This data may include:

- traffic data;
- I5 status.

12.4 Management of the I4 interface

Fault conditions on the I4 interface shall be notified to the appropriate PNC-I, H or T application process by the ROSE application service. These fault conditions shall be relayed by the PNC-OS to the associated OMC entity which shall initiate the appropriate action.

12.4.1 Control of I4 passwords

The passwords to be used by the I4 ROSE application service to authenticate inter-PNC communications shall be passed to the ROSE process by the associated OMC on initialization of the PNC. Each password shall be associated with the appropriate PNC network address within the ROSE application service.

The I4 password may only be changed via the associated OMC. When a change of password is required the associated OMC shall inform the PNC of the new password. The PNC shall accept any communications referencing the new password immediately, but shall continue to accept the previous password for a period of one hour.

The OMC shall then inform all other OMCs within the ERMES O&M network of the new passwords. Each OMC shall then inform its associated PNC. The PNC shall use the new password when establishing all further connections with the referenced PNC.

The PNC shall notify its associated OMC of any unauthorized access attempts (i.e. connection attempts using an incorrect password).

12.5 Management of the I3 interface

The management of the I3 interface is a part of the PNC functional entity. As there may be several PAs and respective PACs under the control of the PNC there are one or more I3 interfaces in one PNC.

12.6 Call acceptance principles and calculation

12.6.1 General principles

When an AdC is input by the calling party, the PNC-H shall calculate the associated availability and delay within the Service Area (SA) currently defined for the AdC (i.e. the area in which a call would be transmitted, including any current roaming PAs or GAs), before allowing the input of further call data. The formulae for these calculations are defined in subclauses 12.6.2 to 12.6.4.

Each operator shall determine an upper and a lower acceptance threshold for both availability and delay.

If the availability status and the delay status of the AdCs Service Area (SA) are both above the upper threshold then the call shall be treated as unconditionally accepted and shall proceed in the normal way.

If the availability status or the delay status is between the upper threshold and the lower threshold then the PNC-I shall be informed that the status (availability/delay) of the SA is degraded. Optionally, according to the choice of the operator, the PNC-I may inform the calling party of this (using a conditional acceptance message, subclause 7.1.2.2.3), and offer the calling party the option to abandon the call.

If the availability status and/or the delay status is below the lower threshold then the PNC-I shall be informed that the call cannot be accepted, and the calling party shall be advised accordingly.

If an operator does not wish to use the conditional acceptance procedure, the two call acceptance thresholds shall be set to the same value.

In order for the PNC-H to calculate the availability and delay of the current SA for each AdC, each PNC shall maintain a database of the availability and delay for each PA within its own network, using information provided by its associated OMC.

Each PNC shall also maintain a similar availability and delay database for each roaming GA within the ERMES system provided to its own MSs, using status information from other OMCs within the system, relayed via its associated OMC. The information on availability and delay for each GA shall be exchanged among OMCs in a quantized form as detailed in tables 66 and 67.

Table 66: Determination of availability status

Percentage Availability $\delta_{n,k}$	<15	≥ 15 <25	≥ 25 <35	≥ 35 <45	≥ 45 <55	≥ 55 <65	≥ 65 <75	≥ 75 <85	≥ 85 <95	≥ 95
Network Availability Status $AS_{n,k}$	0	1	2	3	4	5	6	7	8	9

Table 67: Determination of delay status

Percentage Delay $\mu_{n,k}$	>300	≤ 300 >275	≤ 275 >250	≤ 250 >225	≤ 225 >200	≤ 200 >175	≤ 175 >150	≤ 150 >125	≤ 125 >100	≤ 100
Network Delay Status $DS_{n,k}$	0	1	2	3	4	5	6	7	8	<u>9</u>

The network delay in the table 67 is expressed as a percentage of the message delivery time QOS limit defined in ETS 300 133-2 [1], e.g. a network delay of 200 % would mean that 10 % of calls were exceeding twice the message delivery time specified.

12.6.2 Definition of terms

This subclause defines and allocates the functions needed for call acceptance within the ERMES system.

Since the information required for the calculation of call acceptance involves the O&M network, a part of the functionality here defined is also referenced in ETS 300 133-7 [3].

In the following, the "local call" case (i.e. the call generated and transmitted entirely within a single operator's network) is considered separately from the case of a call involving at least two operators. In addition, a distinction is made between the quantities (or parameters) to be calculated or considered at telecommunication level and those referred to the O&M environment.

Subclause 12.6.3 defines the states and parameters which are detected by any single entity on the basis of its internal situation. Subclause 12.6.4 defines the method to be used in evaluating the availability and delay.

The availability and delay scheme is illustrated diagrammatically in figure 37. The figure represents the ERMES system entities and also the sub-group of entities involved in a generic call "c".

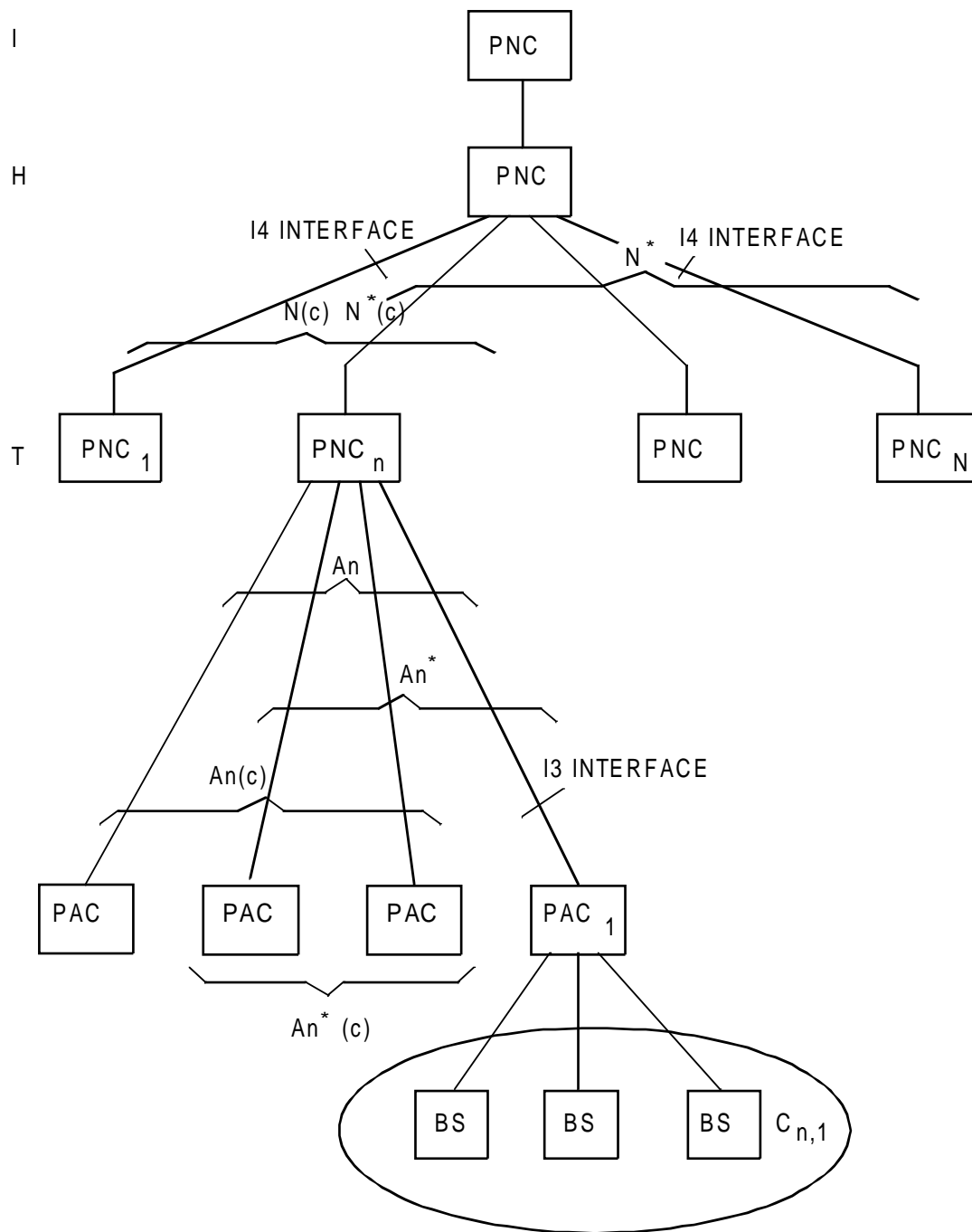

Figure 37: Availability and delay model

Let:

- N be the set of PNCs belonging to the ERMES system;
- A_n be the set of PACs associated to the PNC_n ;
- $C_{n,l}$ be the area covered by the transmitters of PAC_l , which is, by turn, associated with PNC_n ;
- $D_{n,l}$ be the equivalent density of receivers inside the nominal $PAC_{n,l}$.

NOTE: $D_{n,l}$ is a relative figure derived from the population density within $C_{n,l}$, and is estimated from demographic information. The operator may also apply other weighting factors.

If an asterisk (*) is appended to the above letters, the attribute "available" shall apply; for instance A_n^* stands for "the set of available PACs associated to the PNC_n", $C_{n,l}^*$ for "the area covered by the available transmitters of PAC_l".

Hence: $N^* \equiv \{N: SI4C_n \cdot SPNC-T_n \equiv 1\}$

$A_n^* \equiv \{l: SI3C_{n,l} \cdot SPAC_{n,l} \equiv 1\}$

where:

$SI4C_n$ is a logical variable assuming the value 0 if the interface I4 between PNC-H and PNC-T is in failure condition, 1 otherwise;

$SPNC-T_n$; $SI3C_{n,l}$; $SPAC_{n,l}$ are logical variables defined in a similar way and related respectively to PNC-T_n; I3 interface between PNC-T_n and its l-th PAC; PAC_l associated to PNC-T_n.

If a "c" between brackets (c) is added to the two sets, then they refer to a single call c, i.e. they define the set of PNCs or PACs involved in the call as destination entities. Hence, $N(c)$ means "the set of transmitting PNCs addressed by the call c"; $A_n(c)$ means "the set of PACs associated to the PNC_n and addressed by the call c".

Attributes * and (c) may apply together so $A_n^*(c)$ means "the set of available PACs associated to PNC_n and addressed by the call c".

It is easy to verify that:

$N^*(c) \equiv N^* \cap N(c)$

$A_n^*(c) \equiv A_n^* \cap A_n(c)$

Notation defined below refers to the delay mechanism affecting the delivery of a message.

$F_{n,l}$: The 90 % delay time (i.e. the time within which 90 % of calls are transmitted from receipt by the PAC) estimated for a message within PAC_l, associated to PNC_n.

Network availability and delay are estimated as a function of the above parameters.

12.6.3 State detection and parameter calculation

A list is given below of the data and parameters known or measured in the OMC, PNC-OS and PAC-OS, which are used in the calculation of availability and delay (the list includes elements also referenced in ETS 300 133-7 [3]):

- a) each PAC continuously monitors the operation state (operation, working and access situation) of its broadcasting and distribution network (base stations and relevant communication lines). This state is controlled by the O&M function "Status Control", see ETS 300 133-7 [3]. The PAC-OS updates this state when required (for reasons of failure, restoration to service, or exclusion for maintenance);
- b) each PAC-OS (described in the formula below as the l-th PAC, belonging to the n-th PNC), evaluates the 90 % delay time for transmission $F_{n,l}$. The evaluation is done periodically (for example every 15 minutes) and it is characterized per priority class of the message;

- c) each OMC (described as the OMC associated to the n-th PNC), knows the operation state of its associated PACs and that of the relevant communication links. It therefore knows the set A_n^* of PACs which may be accessed for paging message transmission. In addition it knows the operation state (i), above, of every associated PAC; hence it may calculate the equivalent number of users present in the available area $C_{n,l}^*$ of any (l-th) PAC:

$$C_{n,l}^* \cdot D_{n,l}^*$$

as well as the probability of reaching the user, given that he is in that PA (PA user visibility):

$$d_{n,l} = \frac{C_{n,l}^* \times D_{n,l}^*}{C_{n,l} \times D_{n,l}}$$

The computation is possible since the above parameters are permanently registered in the OMC; they are only modified according to events like: insertion of a new transmitter; modification of some emission power; updating of the reference densities.

Summarizing, the following data are available to any (n-th) operator:

- l-th PAC-OS:
 - operation state of its area;
 - 90 % delay time for transmission $F_{n,l}$ per priority class;
- n-th OMC:
 - available area and density $C_{n,l}^*$; $D_{n,l}^*$ per PA;
 - user visibility $\delta_{n,l}$ per PA.

12.6.4 Availability and delay evaluation

Network availability and delay may be considered independently for the purposes of call acceptance calculation. They are however linked, as explained in more detail below, in that if the delay within a PA exceeds the lower delay threshold it is considered as unavailable.

12.6.4.1 Availability evaluation involving only paging areas

For the particular case of a call which is only to be transmitted in PAs controlled by the PNC-H, the availability $S(c)$ may be evaluated by the PNC-H by using the relative density concepts:

$$S(c) = \frac{\sum_{l \in A_n^*(c)} C_{n,l}^* \cdot D_{n,l}^*}{\sum_{i \in A_n(c)} C_{n,i} \cdot D_{n,i}} \quad \dots (1)$$

It should be noted that this formula attributes a weighting factor for each PA according to the SA and the relative population density.

12.6.4.2 Availability evaluation involving only geographical areas

The GA availability status, $AS_{n,k}$, of the k-th GA within the n-th PNC is evaluated by the OMCn and exchanged with the other OMCs as described in ETS 300 133-7 [3].

The destination attributes of the call c are taken into account by the PNC-H which, by knowing $AS_{n,k}$ for each GA of the ERMES system may evaluate the network availability for that call:

$$S(c) = \frac{1}{\sum_{n \in N(c)} |G_n(c)|} \cdot \sum_{n \in N^*(c)} \sum_{k \in G_n(c)} AS_{n,k} \quad \dots (2)$$

where $|G_n(c)|$ represents the number of GAs defined inside the n -th network which are involved in call c .

It should be noted that the probability of a user being within a particular GA is not dependent on relative population density, i.e. the same probability is assumed for all the GAs involved in the call. Relative population density is only taken into account for evaluating the user visibility within a PA or GA.

12.6.4.3 Availability evaluation involving paging and geographical areas

A formula similar to (2) above could be used by the PNC-H to evaluate the availability for a call c involving both PAs and GAs, if the status of each PA is defined using its visibility in a similar way to the status for a GA. Other formulae similar to (1) may be defined by the operator if it is required to apply different weights to PAs and GAs.

12.6.4.4 Delay evaluation involving only paging areas

Probability criteria are also used for the evaluation of network delay.

For the particular case of a call which is only to be transmitted in PAs controlled by the PNC-H, $D(c)$, the associated delay, is calculated by making reference to the delay within each PAC and invoking directly the destination attributes of c . Accordingly, $D(c)$ is calculated as:

$$D(c) = \frac{1}{|A_n^*(c)|} \sum_{l \in A_n^*(c)} F_{n,l} \quad \dots (3)$$

and then related to the thresholds to determine the call acceptance.

12.6.4.5 Delay evaluation involving only geographical areas

The GA delay status $DS_{n,k}$ of the k -th GA within the n -th PNC is evaluated by the OMC_n and exchanged with the other OMCs as described in ETS 300 133-7 [3].

The PNC-H, when dealing with a call involving only GA(s) calculates the associated delay status by making reference to the delay status of the GAs involved:

$$D(c) = \frac{1}{\sum_{n \in N^*(c)} |G_n(c)|} \cdot \sum_{n \in N^*(c)} \sum_{k \in G_n(c)} DS_{n,k} \quad \dots (4)$$

Equation (4) is formally identical to (2). It represents the mean 90 % delay status for the relevant GAs involved in call c . $D(c)$ is then related to the two thresholds to determine the call acceptance.

The two thresholds may depend on the priority class.

The above formula has a "smoothing" effect on the influence of any heavily delaying directions. If only one GA out of those involved in the call is seriously congested then call transmission is still possible.

12.6.4.6 Delay evaluation involving both paging and geographical areas

A formula similar to (4) above could be used by the PNC-H to evaluate the associated delay for a call involving both PAs and GAs, if the status of each PA is defined using its delay in a similar way to the status for a GA. Other formulae may be defined by the operator if it is required to apply different weights to PAs and GAs.

12.7 Universal time reference

A number of SSs e.g. roaming, diversion of traffic, temporary barring, and DD require access to time information for activation/de-activation.

The universal time shall be used as a reference. The absolute time accuracy of a PNC shall be maintained at better than ± 1 second. This is to ensure that the difference in time between any centre and the user shall not be so great that a loss of paging message may occur.

This could happen if a subscriber were to ask for "deferred delivery" until a specified time. If the time accuracy were not sufficient, the receiver could be switched on some moments after the stored paging messages had been sent. The opposite may also happen if the subscriber switches off his receiver after requesting "deferred delivery" and there are still paging messages buffered in the transmission network.

When entering a command for service some time shall be allowed to elapse before the execution of that service. A change should therefore never be accepted for a time earlier than the message delivery time in the network (subclause 6.2.6 of ETS 300 133-2 [1]).

12.8 Translation of national character sets to the ERMES character set

When a subscriber is generating messages to be sent over a paging network different methods are accepted e.g. DTMF signalling from ordinary telephone sets, ITU-T AI5 code from a data terminal.

One method may appear to be the same in different countries but very often the interpretation of the characters might be different depending on the national character sets used in each case.

When a message is entered into the network a translation of the generated characters shall be made in the PNC-I. The translation is from the national (local) character set used to the universal character set specified in ETS 300 133-2 [1], annex B.2.

When this translation has been made no further translations shall be performed, since alphanumeric receivers used in any ERMES network shall be capable of presenting the characters according to the above mentioned table.

Problems may occur when a particular national character is missing in the ERMES table. In this case the network operator shall decide how and if the character shall be translated. If no character in the ERMES table is acceptable a special character might be replaced by a number of ERMES characters or it might be decided that no conversion will be performed. In this case the calling party shall be notified that the character has been rejected.

Different national character sets could be accepted in the same operator network. In each case the PNC-I has to be notified of the type of input terminal and alphabet which is being used. Based on this information a selection of the proper translation table may be made. A number of different translation tables may therefore exist for each network.

The types of acceptable terminals and alphanumeric characters shall be decided by the network operator.

12.9 Encryption

If the optional message encryption service is provided then encryption shall be carried out within the PNC-H of the MS. The encrypted message shall be passed to PNC-Ts as a binary message within the I4 transmit operation (if applicable).

12.10 Transparent data calls

For transparent data calls the function of character conversion shall not be performed by the PNC-I. The message shall be passed to the PNC-H as a binary message within the I4 page request operation (if applicable). The message shall then be passed to PNC-Ts as a binary message within the I4 transmit operation (if applicable).

12.11 Call queuing

Calls shall be passed by the PNC-I to the PNC-H with minimum delay. Grouping of calls for transmission over the I4 interface is permitted, provided the overall QOS time delay limits are met (subclause 6.2 of ETS 300 133-2 [1]).

Calls shall be passed by the PNC-H to the PNC-T with minimum delay. Grouping of calls for transmission over the I4 interface is permitted, provided the overall QOS time delay limits are met (subclause 6.2 of ETS 300 133-2 [1]).

Calls shall be passed by the PNC-T to the appropriate PAC(s) with minimum delay. Grouping of calls for transmission over the I3 interface is permitted, provided the overall QOS time delay limits are met. During periods of heavy traffic it may be necessary for the PNC-H and PNC-T to give priority to the processing of priority 1 calls over priority 2 calls, and similarly priority 2 calls over priority 3 calls, in order to meet the required QOS limits.

If calls cannot be transferred to the next functional entity then those calls shall be queued within the current PNC entity.

13 Paging area controller

13.1 General description

The PAC controls one PA of an operator network. Each PA may contain several base stations.

PAC deals with the traffic control process. It receives page messages from the PNC in any order, performs the necessary batching, queuing and priority management before sending page request operations to the BSs under its control. PAC functions may be subdivided into three logical parts:

- input (I3 interface);
- output (I2 interface);
- control.

The input and output sections are compliant with clauses 10 and 11 respectively. The control section implements the basic functions assigned to PAC.

PAC-OS is the basic operations system associated with the PAC (ETS 300 133-7 [3]). It deals with the O&M functions assigned to the PAC. Figure 38 shows the relationship between the PAC, PAC-OS, I2 and I3 interfaces.

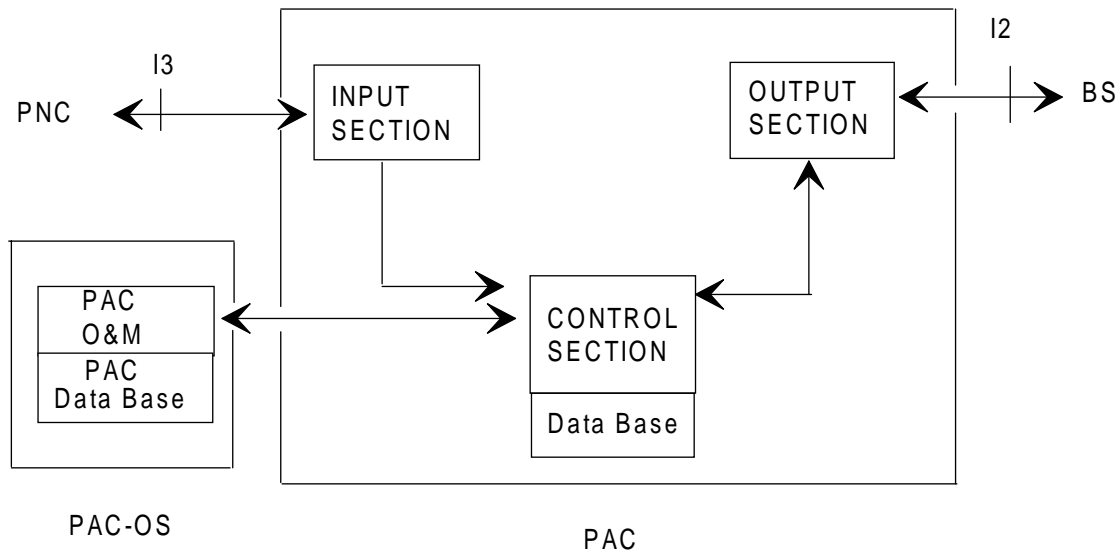

Figure 38: PAC architecture

13.2 PAC architecture

The functional entity PAC shown in figure 38 is defined by:

- the set of BSs it may address with page request operations to be transmitted;
- the set of sub-sequences and frequency channels utilized by these BSs.

The OMC may modify the PAC configuration by creating or deleting PAC entities. The only constraints on these modifications are that:

- the set of BSs identifying the new PA may be addressed by the new PAC;
- the new sub-sequence and channel assignments shall be compatible with the time and frequency plan adopted for the other PAs.

Both constraints are known by the OMC which takes the decision to define a new PA according to traffic needs. This approach also allows definition of the so-called "network time slot" as a particular case of the process.

In the network time slot the entire set of BSs in a network may be considered, at least for a single time slot on a given channel, as creating a network wide PA. The association of different groups of BSs under a single PA, even if performed within only one sub-sequence, requires complete synchronization of the transmitters involved.

The network time slot mechanism described above may be implemented either as a network PAC (as described) or as an additional PNC functionality (which implies some optional parameters to be exchanged through I3 interface). These aspects are further clarified in subclause 13.2.1.

13.2.1 Management of the paging area in a time division environment

An example of sub-sequence (time slot) allocation in a cluster of PAs is shown figure 39 (i). The assignment is performed on the same frequency channel by allocating to each PA (hexagon identified by a capital letter) a number of sub-sequences (time slots) tied to the relevant traffic needs. Similar concepts are also applicable when more than one frequency is assigned to the cluster. The sub-sequences (integer numbers identify the sub-sequence number within a cycle) are arranged in such a way that repetitions in contiguous areas are avoided. In this scheme each elementary area is associated with a PAC which controls the BSs providing the coverage.

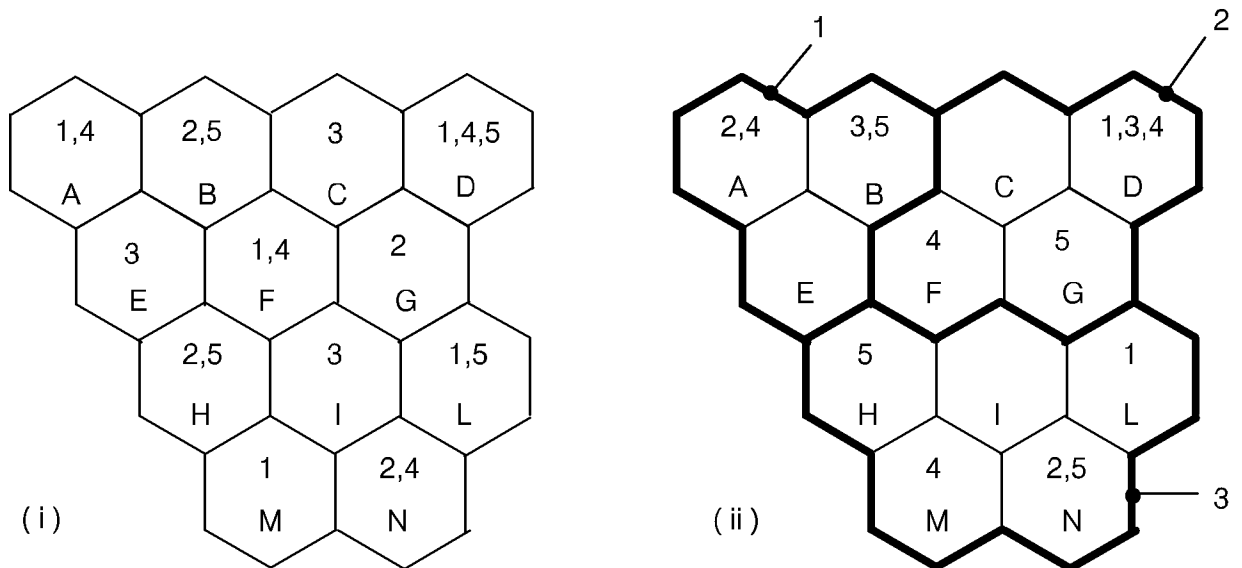

Figure 39: Allocation of sub-sequences in a time divided network

According to traffic needs and particularly to the prevailing message destination or paging subscriptions, the PA configuration may be modified to that of figure 39 (ii). In this case several elementary areas are grouped together to form areas which are assigned one (or more) slots. The network time slot is a particular case. Hence areas A, B and E are in this case assigned sub-sequences (2 and 4 to A; 3 and 5 to B) while the area A+B+E is assigned sub-sequence 1.

Control of the above regionalization may be performed in two ways:

- by defining a new PAC dealing with sub-sequence 1 in all the (synchronous) BSs belonging to A, B and E;
- by assigning the same sub-sequence 1 to the PACs A, B, E (previously working independently) under the PNC control.

If a network does not support the changeable PA feature and the network time slot concept, then a network wide message may be transmitted by sending it separately in each PA.

13.3 Input section (I3 interface)

The application functions of the I3 interface described in clause 10 consist of:

- checking the validity of the received page message;
- sending this message to the control section if there are no message errors;
- sending response to PNC (logical ACK/NACK) according to the message validity.

NOTE: the message validity concept refers to the message syntax, semantics and to the feasibility of the message transfer to the control section.

Operation at the input section shall be as shown in figure 40.

13.4 Output section (I2 interface)

The application functions of the I2 interface defined in clause 11 consist of:

- forming the page request operation;
- sending the page request operation to the set of active BSs controlled by the PAC;
- receiving the result message from the BSs involved;
- reporting to the control section the negative or positive page request result from BSs or time-out expired cases.

The decision about the actions to be started regarding the message not properly received by the BSs or not transmitted by the output section is left to the control section.

Operation at the output section shall be as shown in figure 41.

13.5 Control section

The control section plays the central role assigned to the PAC. It converts the page message flow from the PNC to the page request operation flow directed to the BSs. Accordingly it shall implement the following basic functions:

- input control;
- output control;
- allocation, queuing of the messages and accomplishment of the priority criteria;
- traffic control;
- communication with O&M.

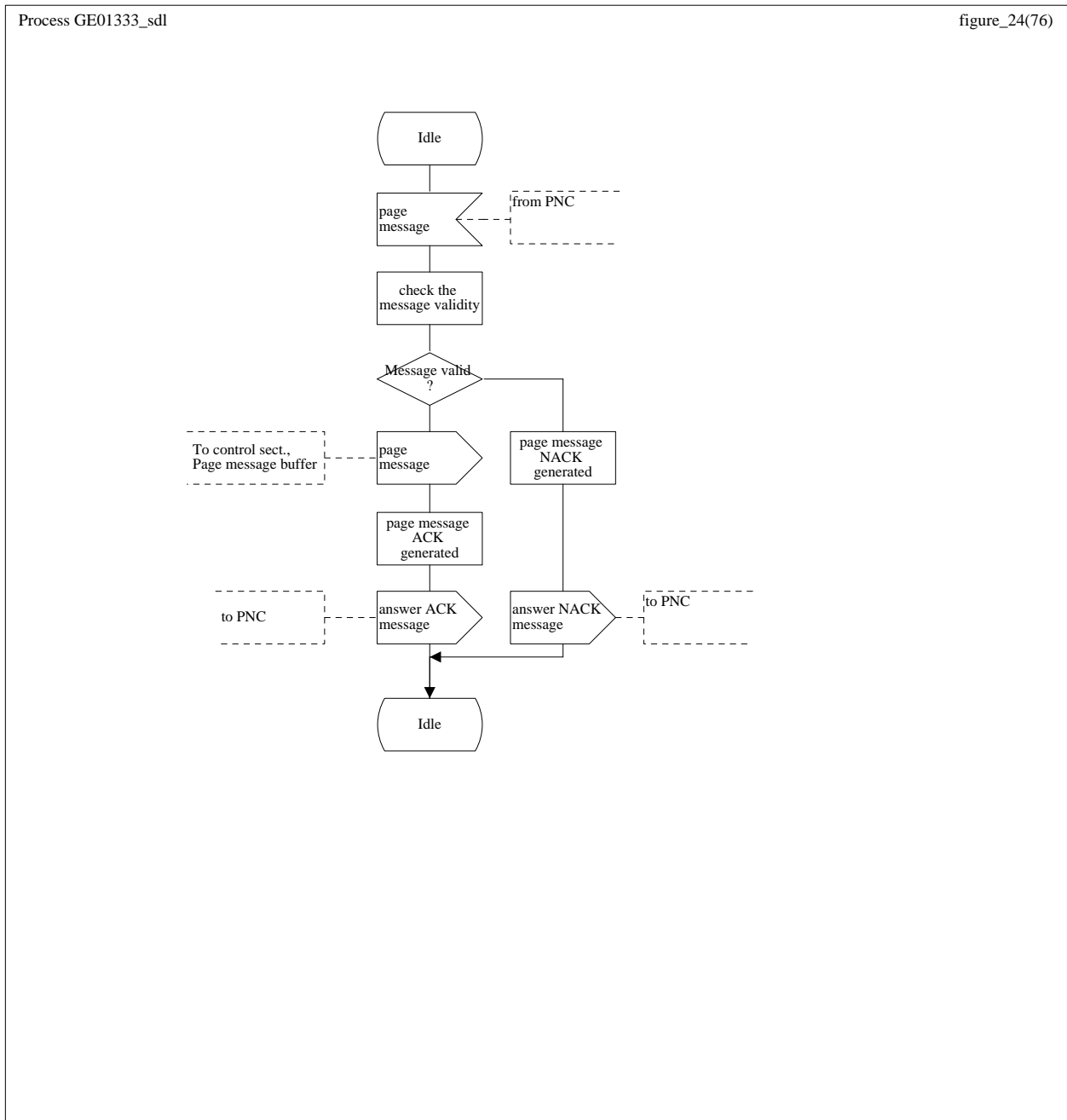

Figure 40: SDL diagram for input section - application functions

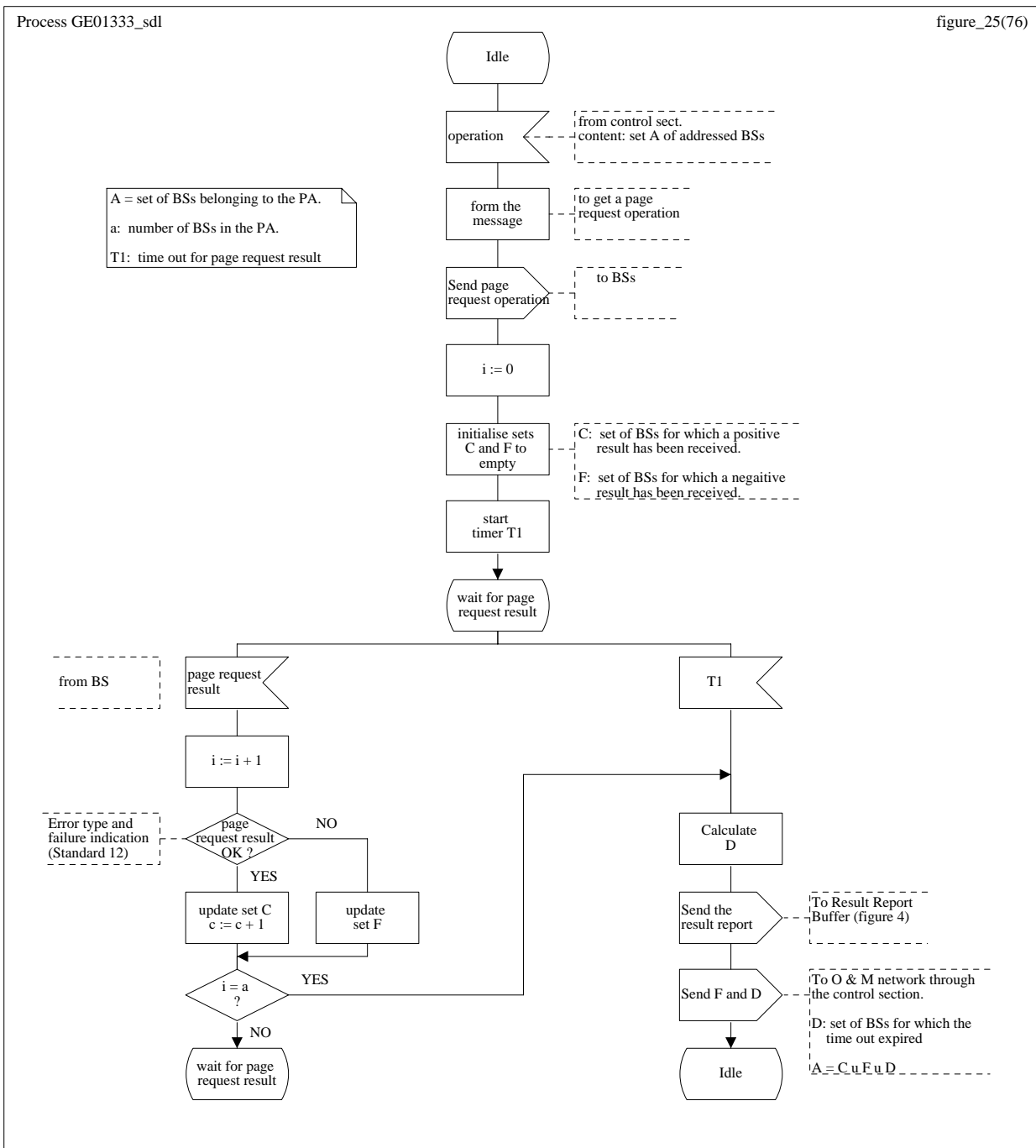

Figure 41: SDL diagram for output section - application functions

NOTE: SDL stands for Specification and Description Language, defined in the Z.100 series of ITU-T Recommendation Z.100 [31].

13.5.1 Functional implementation

The general functionality of the control section may be depicted as in figure 42 and is given as an example. Input events to the control section are shown on the upper side of the figure whilst the lower side reports the actions and results. It should be noted that the page messages, the result reports and the s_i events are served in increasing order of priority. s_i represents a sequence of instants synchronous with the batch boundaries (0,75 second). In s_i the control section shall terminate its message allocation in the i -th batch and send it to the output section. Messages and results are inserted in the queues (page message buffer and report result buffer) by the input and output sections respectively.

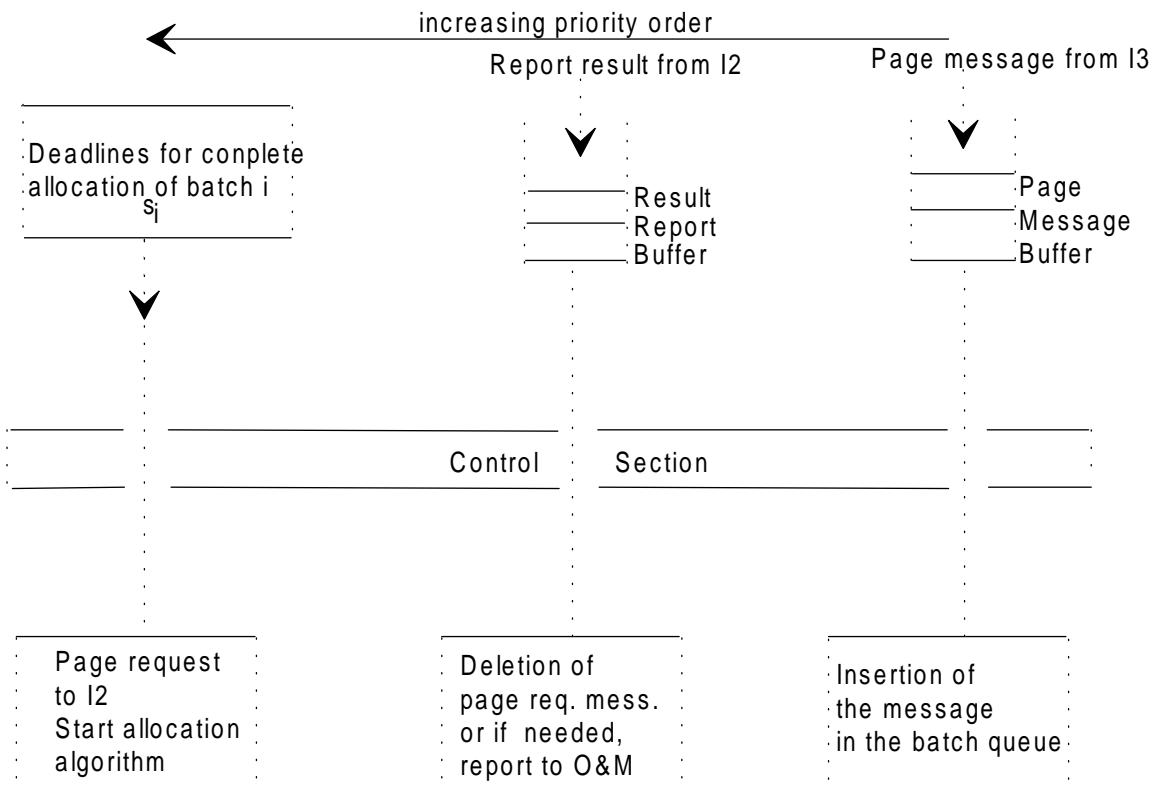

Figure 42: Functionality of the control section

Attention is drawn to the following points in figure 42:

- the input control with the page message buffer, loaded with messages from the input section. The relevant service consists in the insertion of the message in the internal queues for allocation;
- the output control, working according to the s_i deadlines for sending the page request operation to the output section and also dealing with the report result messages which cause either a deletion or a re-presentation of the page request operation in the queues;
- the allocation process control, also working according to the s_i deadline, where the allocation algorithm is started on the new $(i+1)$ -th batch (or on a new set of batches, depending on the allocation criterion).

13.5.2 Input control

The following tasks shall be performed by the input control:

- receive the page message coming from the input section;
- derive from Frequency Subset Number (FSN), the Frequency Subset Indicator (FSI) to be associated with the message;
- enter the message and the initial addresses in suitable queues according to priority.

In the case of a group call whose members are associated with different FSIs the message should be allocated and repeated for each FSI involved.

13.5.3 Output control

The following tasks shall be performed by the output control:

- a) format the data according to the page request operation format (see figure 43):
 - add the CHAnnel reference Number (CHAN);
 - add system information;
 - calculate and insert the initial address;
 - insert all the addresses in a decreasing order;
 - for each message:
 - calculate and insert the message length;
 - update message header with the needed parameters, (ETS 300 133-4 [2] subclause 5.5.1);
 - insert message header and the message content, taking into consideration the IVR1 of the network and the pager (see ETS 300 133-4 [2] subclause 5.6;
- b) send the page request operation to the output section;
- c) receive results from the output section:
 - if ACK, delete the message from the relevant buffers;
 - if NACK or time-out, delete the message from the relevant buffers and report to O&M.

NOTE: ACKs, NACKs and time-outs refer to the entire set of BSs involved in the message delivery (see also Page request result, subclause 11.6.4.2.2).

13.5.4 Allocation process

The Allocation Process is responsible for:

- a) taking the addresses and the messages to be allocated from the internal buffers;
- b) allocating them within a pre-assigned set of batches according to the following criteria:
 - priority of the messages;
 - channel efficiency;
 - time between the initial address and the message transmission starting instant;
 - constraints related to the kind of the message to be transmitted (group call, long message, individual message);
 - constraints related to the pager behaviour (e.g. limitations in the access to the cycles);
 - busy pagers (i.e. those for which a receiving transaction is in progress);

The second and third criteria concern two requirements in conflict with each other. To maximize the channel efficiency and minimize the receiver battery consumption. A trade-off has to be reached in dimensioning the control parameters.

- c) defining the long messages and take the necessary actions;
- d) dealing with the set of information connecting a decision interval for allocation to the subsequent one.

I3	PAC	I2	BS	I1
Zone code				
Country code				
Operator code RIC →	→	→	→	→
Initial address				
Batch type				
	CTAP →	→	→	→
	CTA →	→		
	CHAN →	→	→	→
FSN →	FSI →	→	→	→
PA code →	→	→	→	→
PAC Address →	→	→		
Sub sequence number(s) if limited →	SSN →	→	→	→
Cycle number(s) if limited →	Cycle number →	→	→	→
IVR1 of the pager →	IVR1 of the network →	→	→	→
	ETI →	→	→	→
SI & SSI →	→	→	→	→
	Number of initial addresses →	→	APT →	→
	Message length →	→	MD →	→
	Batch counter →	→		
	Batch length →	→		
Message number →	→	→	→	→
Roaming indicator →	EB →	→	→	→
Group call indicator →				
Priority →				
	All →	→	→	→
Page category, UMI ALERT, AIT, AIN. Message split indicator. →	VIF, AIT (include long → message indicator)	→	→	→
Remote programming of pager parameters.				
OPID for roaming →	→	→	→	→
	AIF →	→	→	→
Message data (with or without → code word format)	Message data in code → word format	→	→	→
			Synchro part →	
			ECC →	

Figure 43: Traffic data flow in the control section

13.5.5 Example of call processing

An example of call processing is given in this subclause based on a possible choice of processing control parameters and queuing procedure.

13.5.5.1 Control parameters

The following parameters are defined:

- the decision interval n_d is the number of batches which are considered together to decide the message allocation in the batches. The parameter is utilized by the message allocation algorithm: n_d may range from 1 to 16. If a balanced load situation arises among the batches, then n_d may be set to 1 (no overload between one "heavy loaded" batch and a "low loaded" batch. $n_d > 1$ should work well when an unbalanced situation is present. In general some information has to be transferred from a decision interval i to a decision interval $i+1$, for example in the case of a group call and for long messages;
- the minimum anticipation interval T_A is the minimum interval between the transmission of the page request operation to the Output section and the air transmission time of the batch contained in the operation itself. T_A represents the minimum time interval for sending the page operation to the output section in order to satisfy the correct transmission instant to the air. It is assumed that the batches sent from the control to the output section are carried one at a time as soon as the relevant message allocation is completed. In the example it is also assumed that the operation message carried by the I2 interface is formed by exactly one batch (batch counter = 1). T_A is affected by the time taken to process the batch and transmit it to the required BSs. It depends also on the grouping of batches in the output section.

Once the value of the control parameters has been chosen, a sequence of s_i is deduced. s_i corresponds to an interrupt point for the control section process and is a deadline for having completed the allocation for the batch i , having transmitted the batch i to the output section and having shifted the decision interval n_d by one batch.

Figure 44 illustrates a case in which T_A is assigned the value of 3 batch intervals and n_d is set to 4. During the time interval $s_{i-1} - s_i$, the control section allocates the messages taking into account the space available in batches A, B, C, D. In s_i , batch A is considered in final status and hence transmitted to the output section. In the same instant the n_d interval is moved to the right and batches B, C, D, E considered for message allocation.

NOTE: The mechanism described applies equally well to a frequency divided network in which a single channel (all sub-sequences) is continuously available to the BSs. In a time divided network it is better to apply the allocation process to the entire sub-sequence.

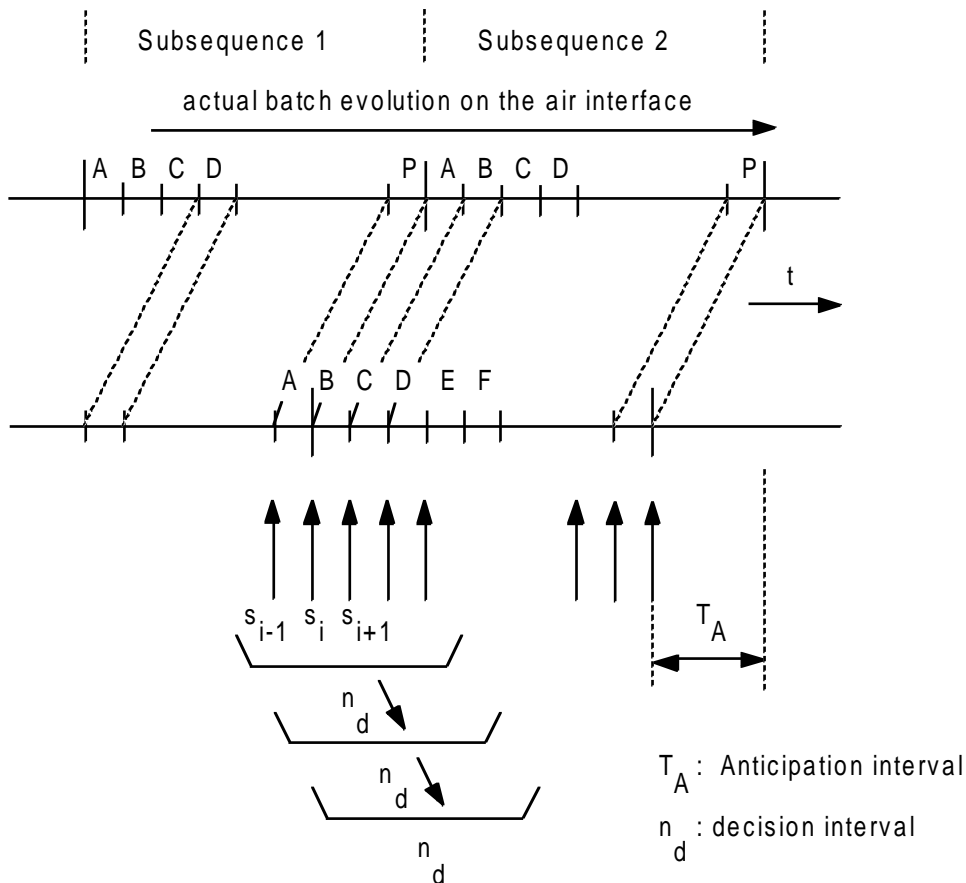

Figure 44: Time anticipation for message transmission and allocation

13.5.5.2 Queuing procedure

Figure 45 illustrates a procedure for queuing the messages and for deleting them when the result report message is received. It refers to a particular FSI (channel): a corresponding scheme has to be created by the PAC every time FSI are added. The FSI knowledge identifies the relevant sub-sequences (see the definition of a PA). The figure also identifies a number of buffers whose description implicitly explains the procedure:

- Initial Address Buffer (IAB), each is associated with a batch. It queues the initial addresses according to the three defined priority classes. The addresses are inserted and served in sequence according to the head of the line criterion. An Initial Address Service Pointer (IASP) designates the firstly arrived initial address to be served (by insertion in the relevant batch); the designated address belongs to the highest priority class among those represented in IAB in that instant. An Initial Address Confirmation Pointer (IACP) designates the first initial address to be confirmed as received by the BSs. Figure 45 shows only IABs relevant to batches A, B, C, D;
- every initial address stored in IAB unequivocally identifies (by means of a pointer) the message it is associated with stored in the message buffer;
- the message buffer stores all together and without following any ordering, the messages waiting for insertion in the batches. There need only be one message buffer per activated FSI within the PAC. Every message is identified by the initial address in the IAB;
- the message buffer as well as IABs are loaded with the page messages (from the input section) and unloaded by the control section according to the ACK flow coming back from the output section. The erasing mechanism makes use of the linking buffer described below;

- the Q buffer stores the initial addresses already sent to the pagers but whose following message (inserted in a given batch by the allocation algorithm) did not reach the BSs, due to a line error or an over-delay. The lost events are detected by a specific result report message. Every initial address stored in the Q buffer unequivocally identifies (by addressing it) the associated message which is stored in the message buffer;
- the linking buffer registers some information about the batches whose reception has not been acknowledged yet by the BSs. It is lengthening on its "head side" (left in the figure) by 1 batch element every time the batch is considered definitely formed by the allocation algorithm (instants si). The linking buffer on the other hand is shortening every time a page request message is acknowledged by a positive result report. Every batch element, say the i-th, contains two fields, these are:
 - the forward chain which is a list of the initial addresses inserted in the i-th batch for transmission. Each initial address is associated with the allocation of the relevant message (batch, sub-sequence, cycle);
 - the backward chain which is a list of the initial addresses whose associated messages has been inserted in the i-th batch. (In principle, the forward chain contains also the backward chain information, but the latter has been introduced to avoid complex scanning processes in the control section).

Handling of long messages is the responsibility of the allocation algorithm. The algorithm for message allocation along the batches shall be decided by the network operator.

The SDL diagram describing message queuing and control is shown in figure 46.

13.6 Database

For normal operation, the PAC makes use of two kinds of database (figure 38). One is contained in its control section and the other one, mainly storing configuration data, states and parameters, belongs to the PAC-OS.

13.6.1 PAC traffic database in the control section

The PAC traffic database contains the following:

- 13 message queues;
- 12 batch queues;
- internal traffic queues;
- BSs addresses belonging to the PAC;
- country code;
- operator code;
- PA code;
- Border Area Indicator (BAI);
- Supplementary System Information (SSI).

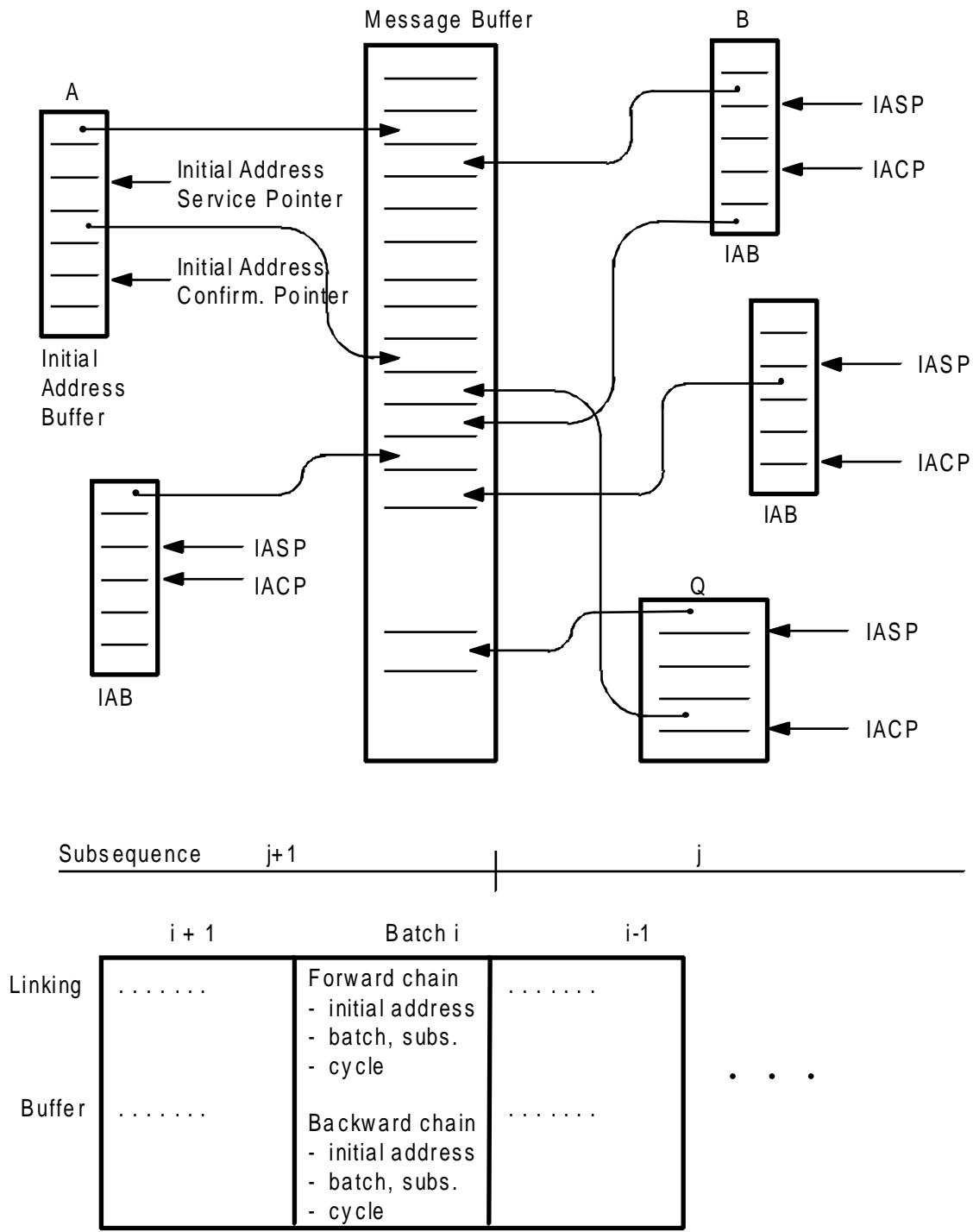

Figure 45: Message queuing and control - conceptual representation

Process GE01333_sdl

figure_30(76)

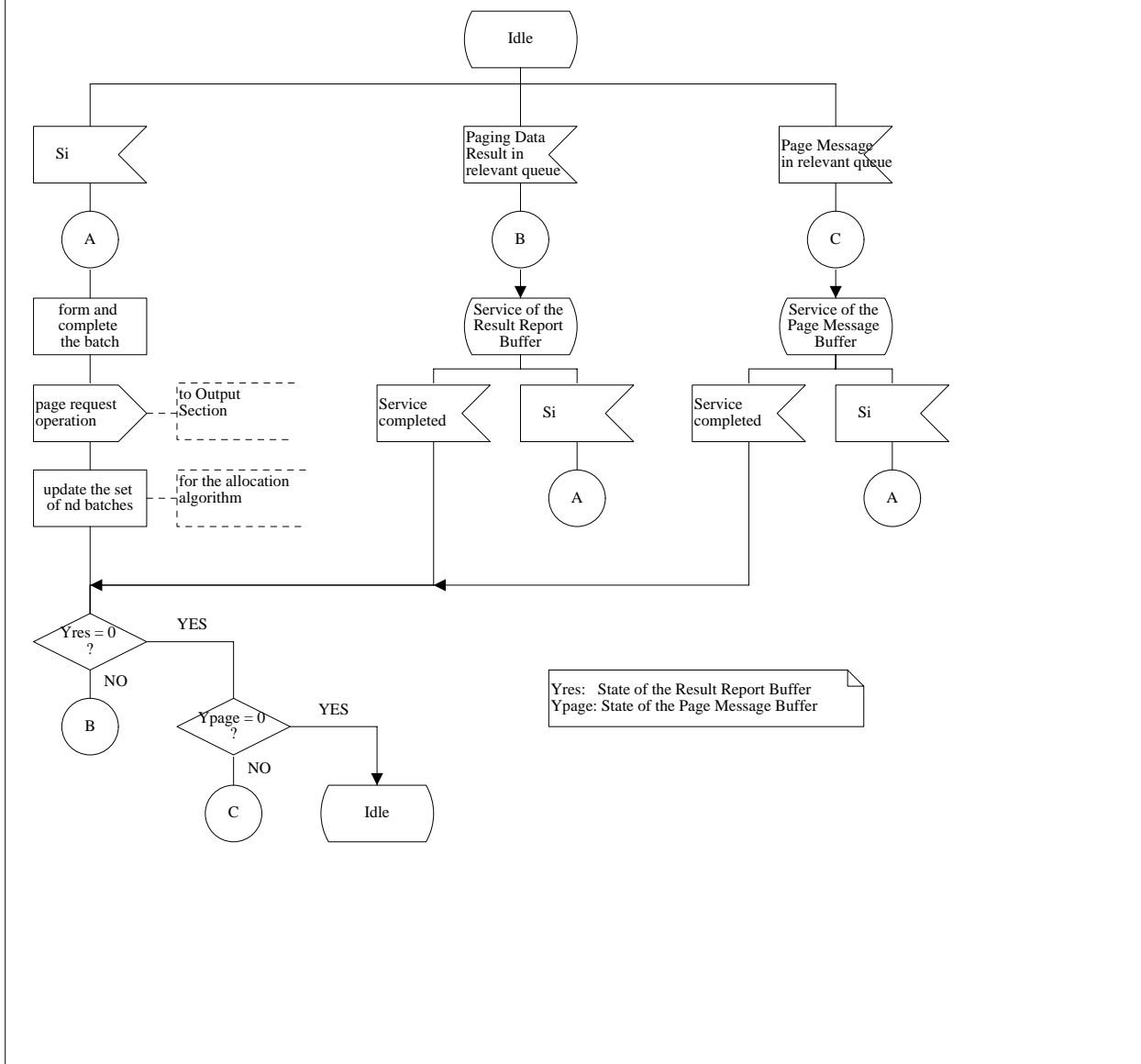

Figure 46: Message queuing and control - SDL diagram

Annex A (normative): Incompatible combinations of supplementary services

Table A.1 answers the question: if the MS has already activated a SF, which SF(s) cannot subsequently be activated by the MS and which SS(s) cannot be activated by the calling party, whilst the SF is activated.

Table A.1

Incompatible Supplementary Service or Subscriber Feature	Requested by	Subscriber Feature already activated by the mobile subscriber
Roaming	Mobile Subscriber	Diversion of traffic Temporary barring
Diversion of traffic	Mobile Subscriber	All SSs shall, if already activated, be suspended Closed user group (if the divert recipient does not belong to the CUG) Temporary barring
Choice of destination	Calling party	Diversion of traffic Priority 1 and priority 3 (if they are not offered in the requested geographical areas) Temporary barring
Repetition	Mobile Subscriber	Diversion of traffic Temporary barring
Repetition	Calling party	Diversion of traffic (if repetition is not offered by the divert recipient's PNC) Repetition activated by the mobile subscriber Temporary barring
Message storing and retrieval	Mobile Subscriber	Diversion of traffic Temporary barring
Automatic retransmission of last message number	Mobile Subscriber	Diversion of traffic Temporary barring
Priority 1	Mobile Subscriber	Roaming (outside home network) Diversion of traffic Priority 3 (see note 1) Temporary barring Deferred Delivery
Priority 1	Calling party	Roaming (outside home network) Diversion of traffic (if priority 1 is not offered by the divert recipient's PNC) Priority 1 (see note 1) Priority 3 (see note 2) Temporary barring Deferred delivery
Priority 3	Mobile Subscriber	Roaming (if priority 3 is not offered by the visited network) Diversion of traffic Priority 1 (see note 2) Temporary barring
Priority 3	Calling party	Roaming (if priority 3 is not offered by the visited network) Diversion of traffic (if priority 3 is not offered by the divert recipient's PNC) Priority 1 (see note 1) Temporary barring

(continued)

Table A.1 (concluded)

Incompatible Supplementary Service or Subscriber Feature	Requested by	Subscriber Feature already activated by the mobile subscriber
Reverse charging	Mobile Subscriber	Diversion of traffic Temporary barring
Reverse charging	Calling party	Temporary barring
Urgent message indication	Mobile Subscriber	Roaming (except if urgent message service is offered by the visited network) Diversion of traffic Temporary barring
Urgent message indication	Calling party	Roaming (except if urgent message service is offered by the visited network) Diversion of traffic (except if the pager of the divert recipient has this feature) Temporary barring
Deferred delivery	Mobile Subscriber	Diversion of traffic Automatic retransmission of last message number and priority 1 shall, if already activated, be suspended Temporary barring
Deferred delivery	Calling party	Diversion of traffic (if deferred delivery is not offered by divert recipient's PNC) Temporary barring
NOTE 1: Except if priority 1 is provided on a subscription basis and activated on a per call basis.		
NOTE 2: Except if priority 3 is provided on a subscription basis and activated on a per call basis.		

Annex B (normative): SDL diagrams for call processing and I4 operations

This annex is normative for call processing where communication over the I4 interface is involved and informative for other aspects of call processing.

B.1 General

This annex describes, using the SDL graphical representation, the call processing for paging calls, for MS control of roaming and for call diversion (clause 6). The figures also show the use of the appropriate I4 operation where communications over the I4 interface are involved during the processing of a call.

B.2 Call processing for page input

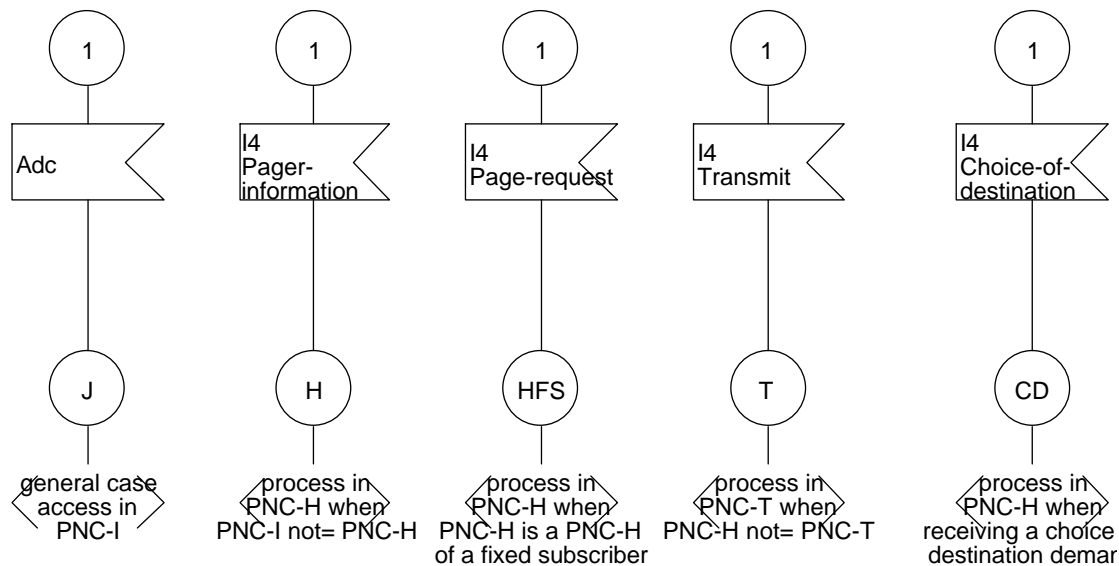

Figure B.1: Call processing for page input

Process GE01333_sdl

figure_B2_1(76)

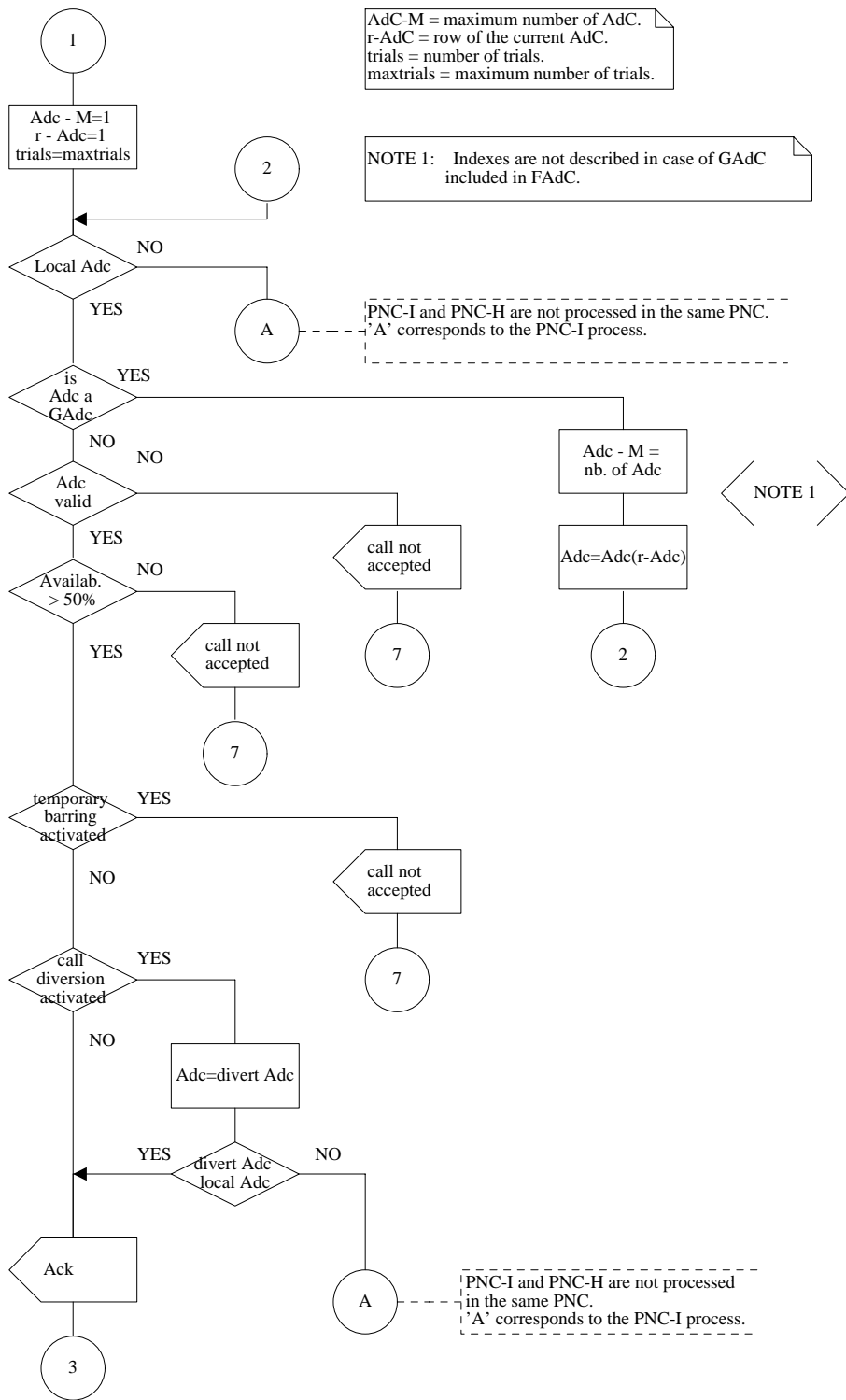

Figure B.2 (sheet 1 of 5): Call processing for page input - local call

Process GE01333_sdl

figure_B2_2(76)

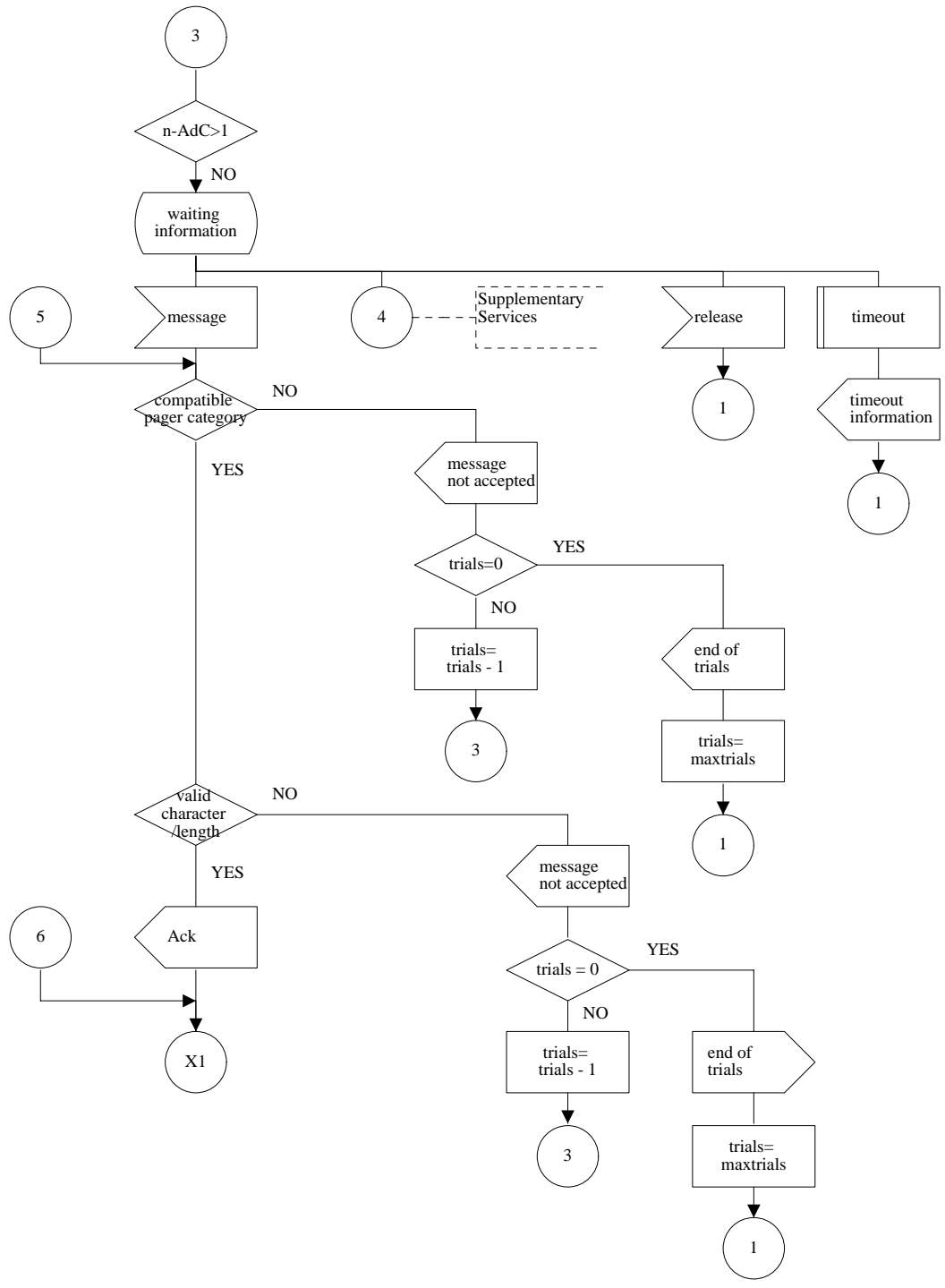

Figure B.2 (sheet 2 of 5): Call processing for page input - local call

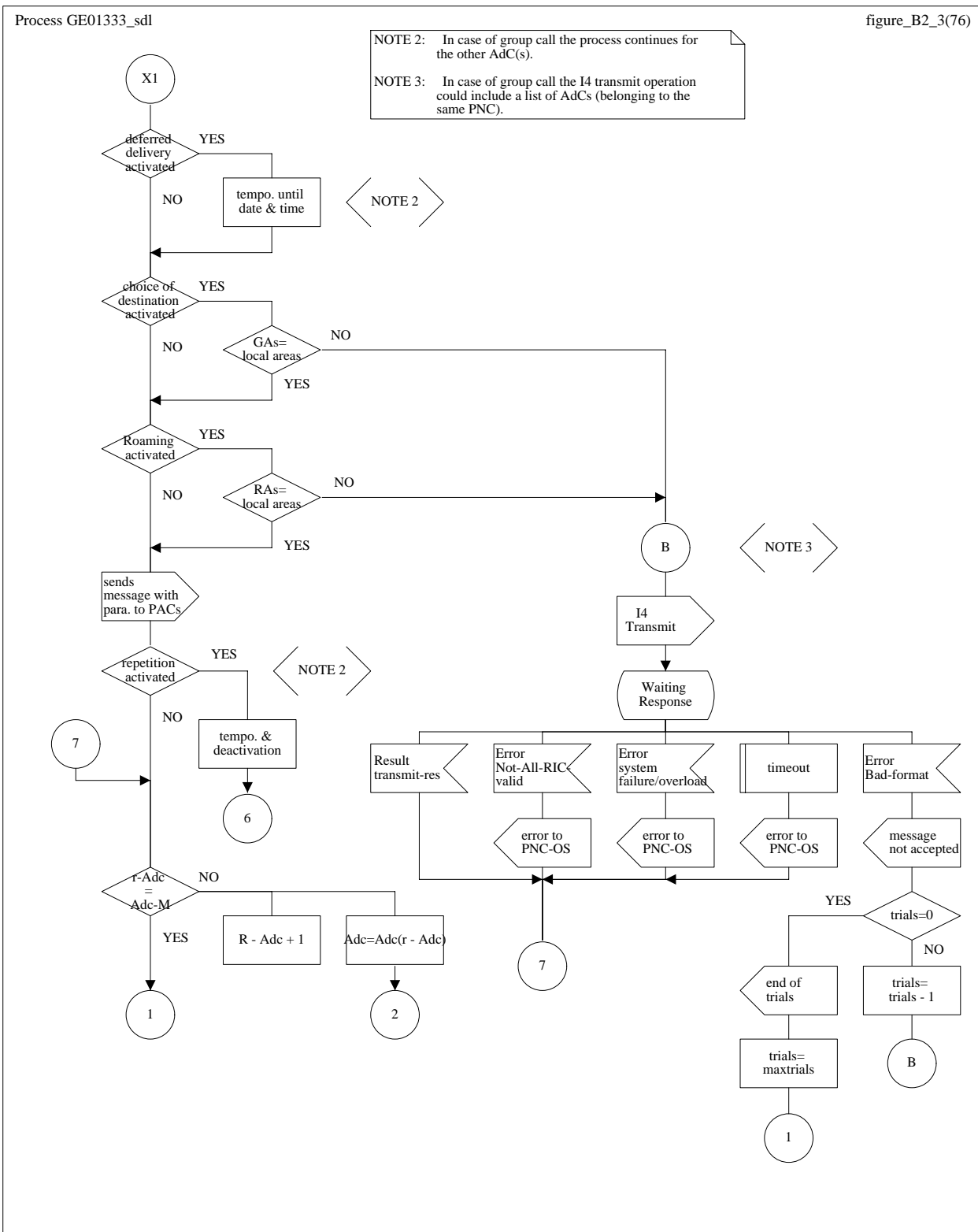

Figure B.2 (sheet 3 of 5): Call processing for page input - local call

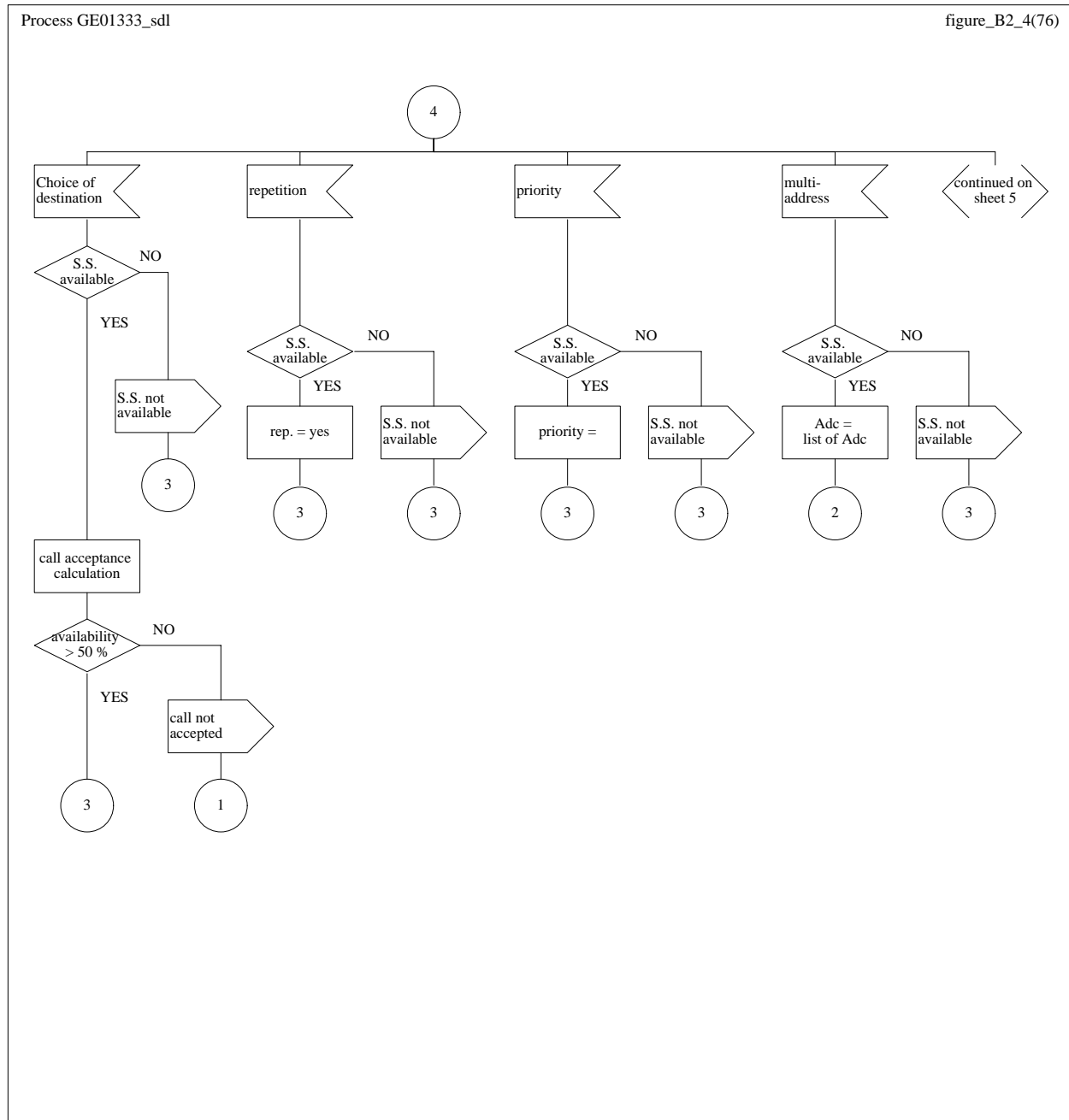

Figure B.2 (sheet 4 of 5): Call processing for page input - local call

Process GE01333_sdl

figure_B2_5(76)

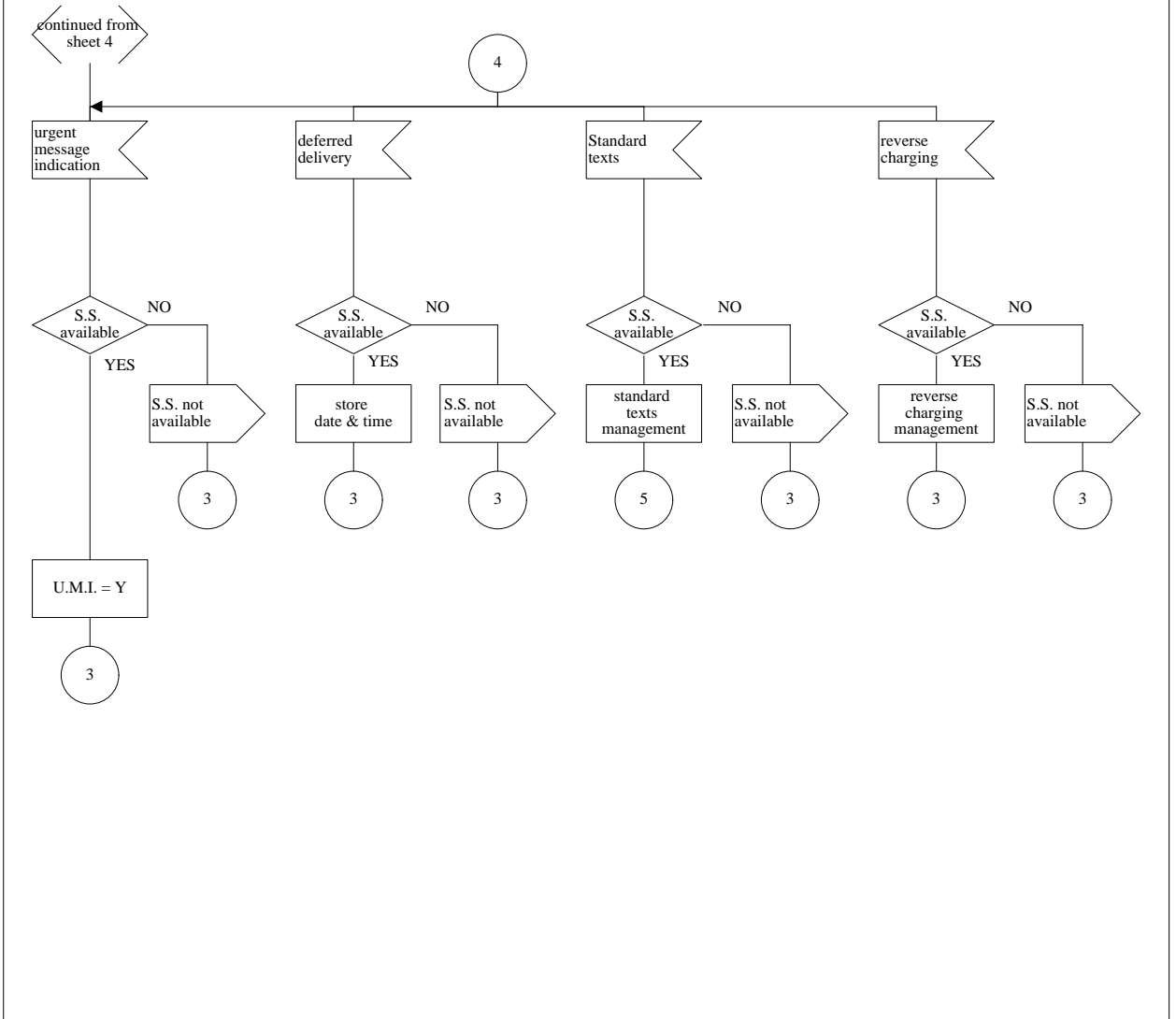

Figure B.2 (sheet 5 of 5): Call processing for page input - local call

Process GE01333_sdl

figure_B3_1(76)

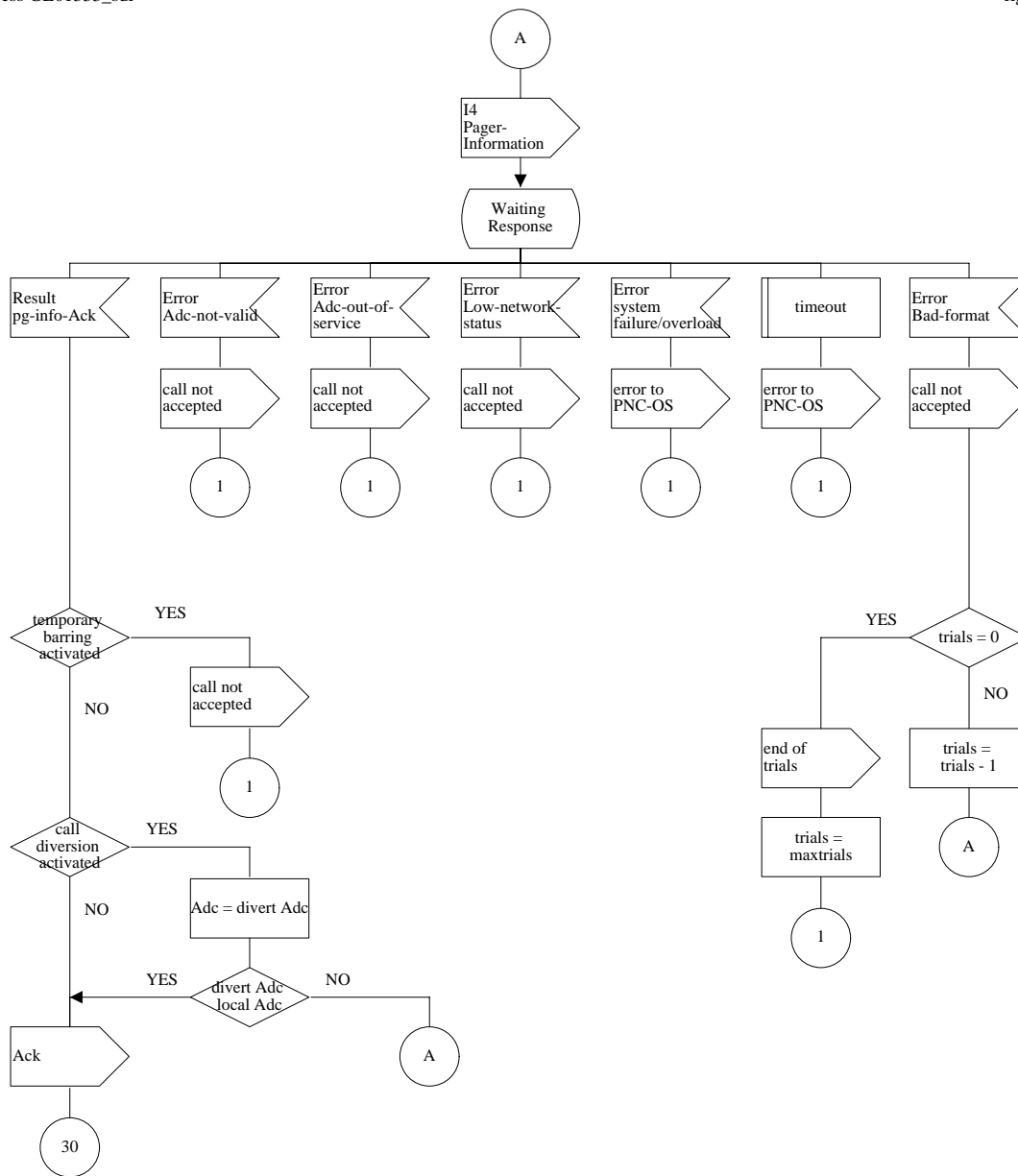

Figure B.3 (sheet 1 of 6): Call processing for page input - distant call, PNC-I

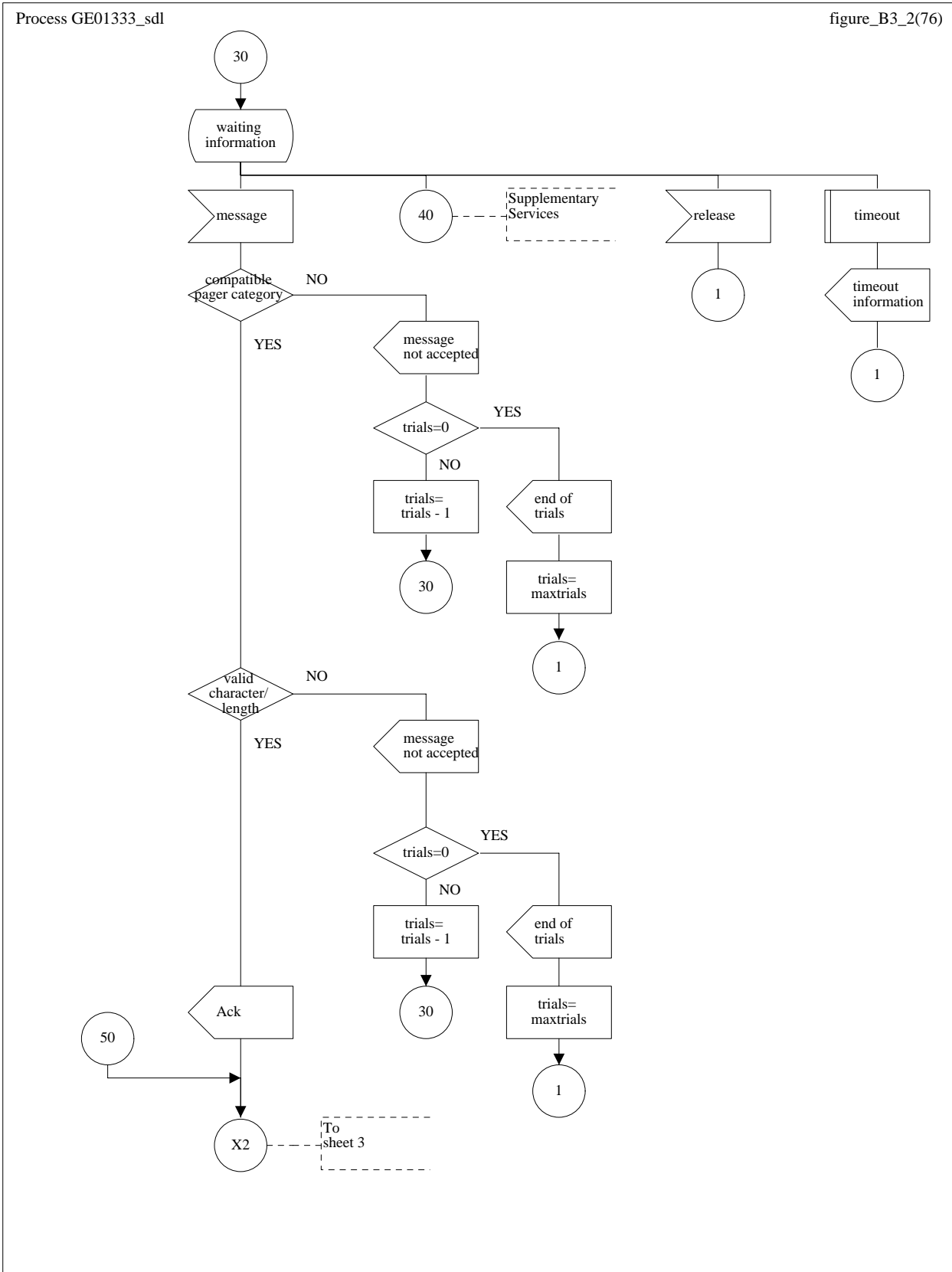

Figure B.3 (sheet 2 of 6): Call processing for page input - distant call, PNC-I

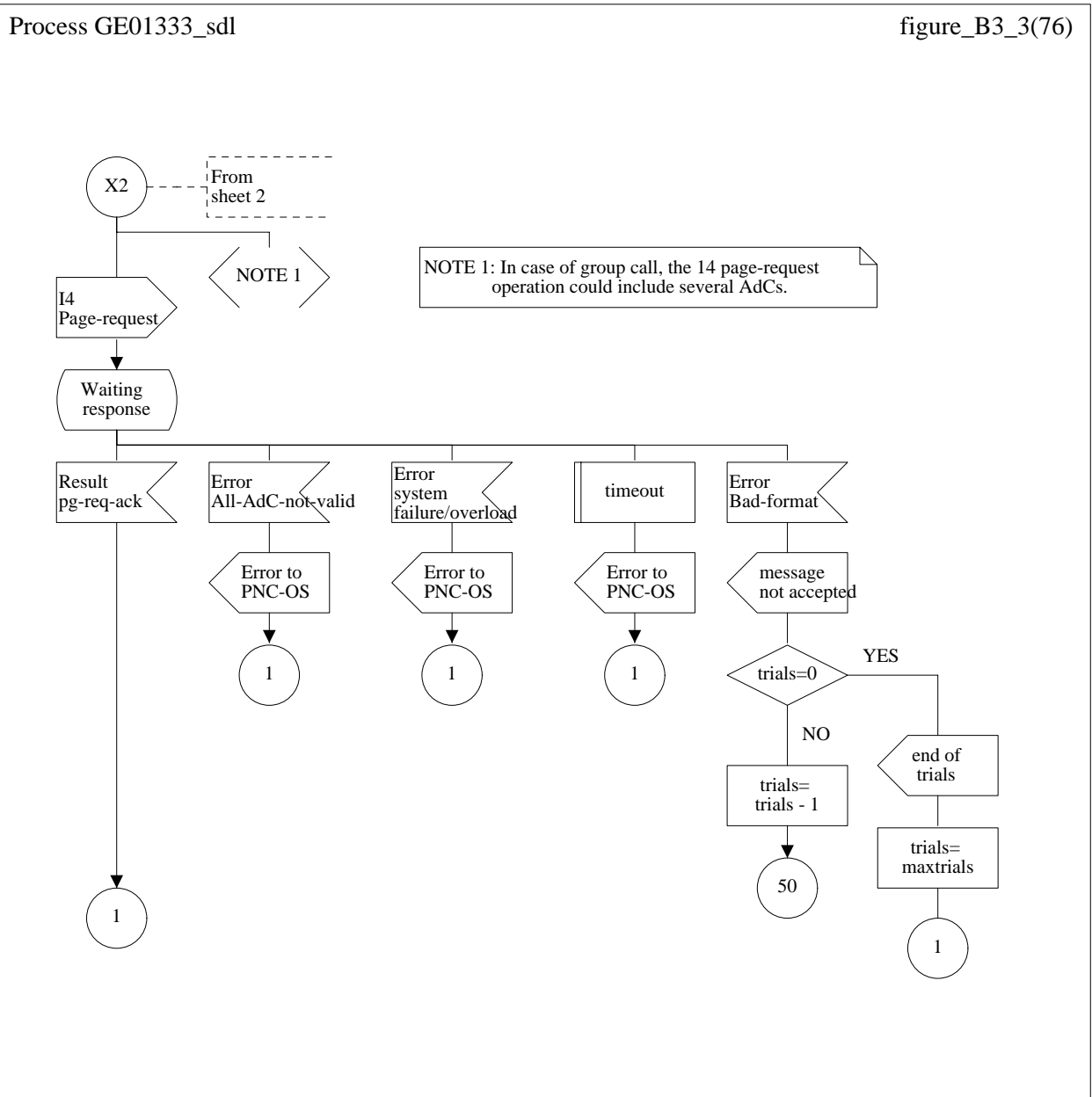

Figure B.3 (sheet 3 of 6): Call processing for page input - distant call, PNC-I

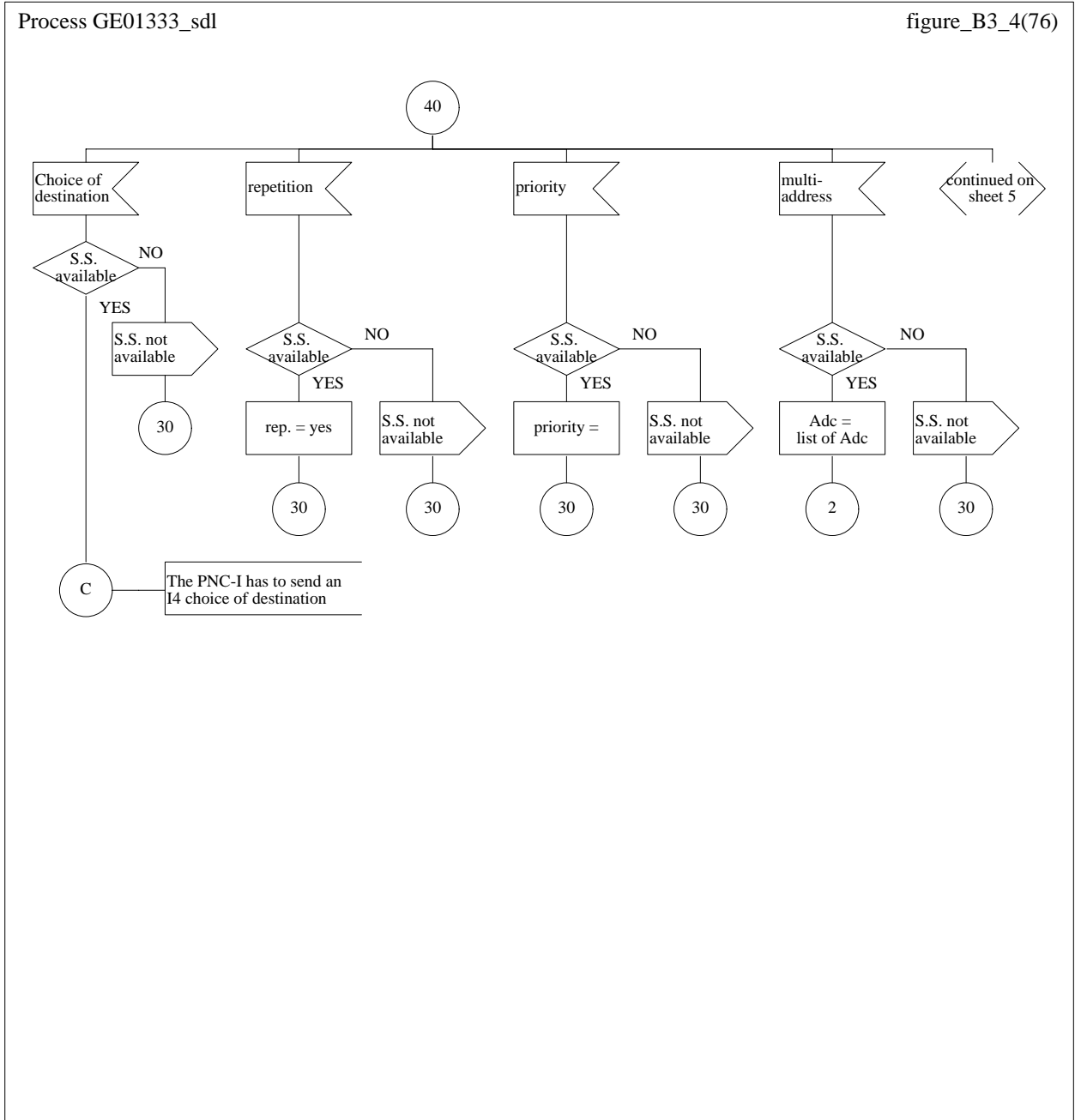

Figure B.3 (sheet 4 of 6): Call processing for page input - distant call, PNC-I

Process GE01333_sdl

figure_B3_5(76)

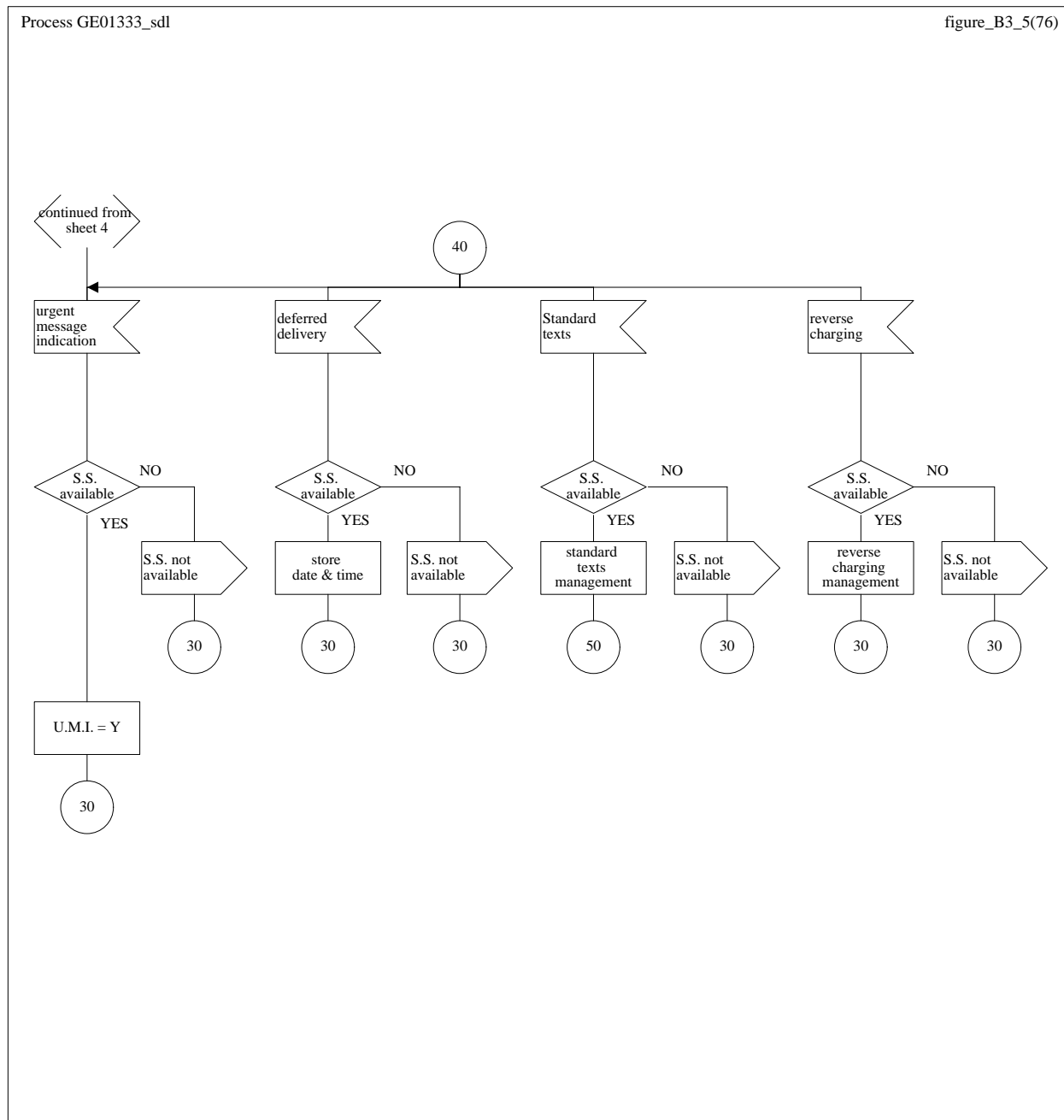

Figure B.3 (sheet 5 of 6): Call processing for page input - distant call, PNC-I

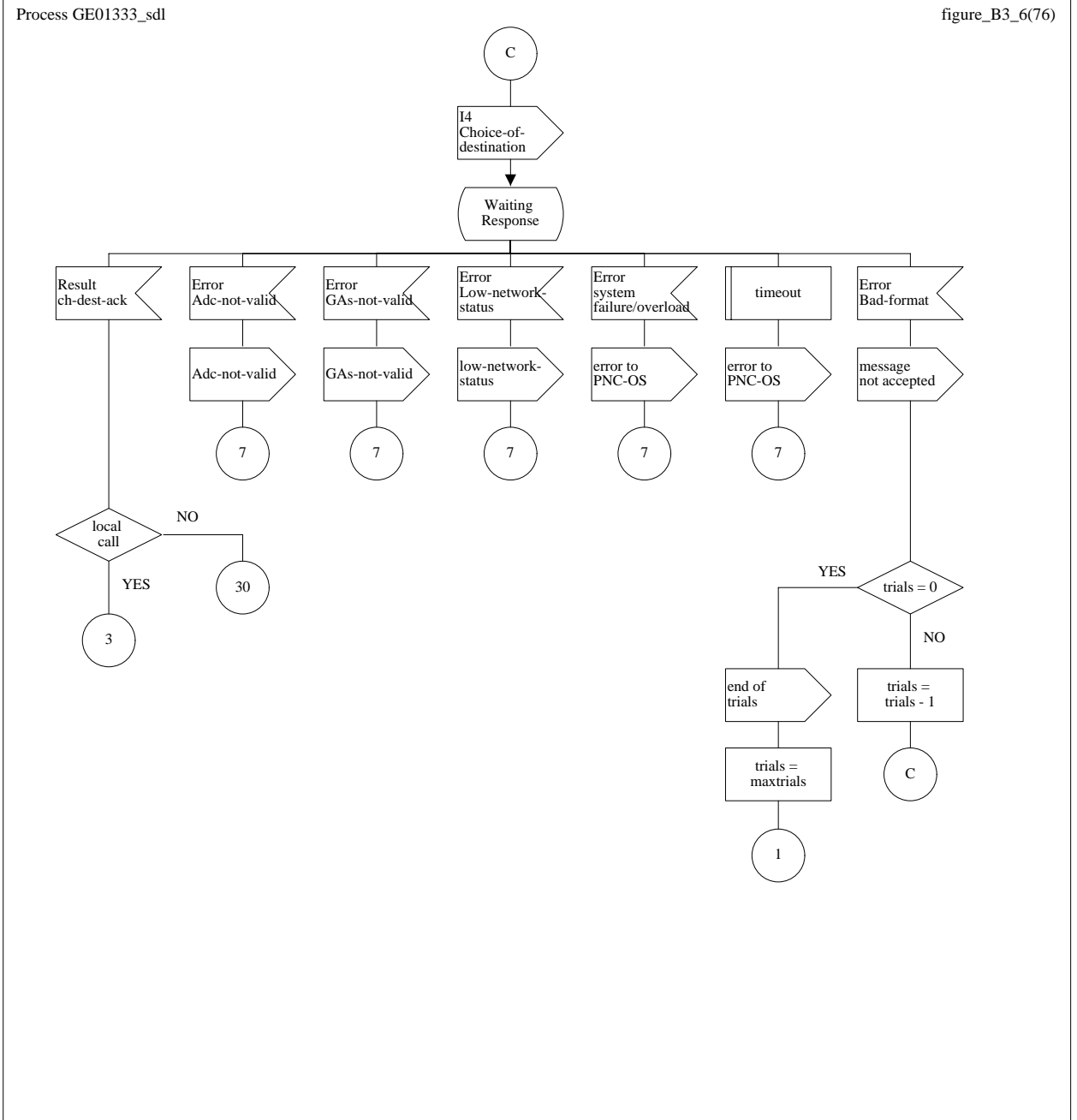

Figure B.3 (sheet 6 of 6): Call processing for page input - distant call, PNC-I

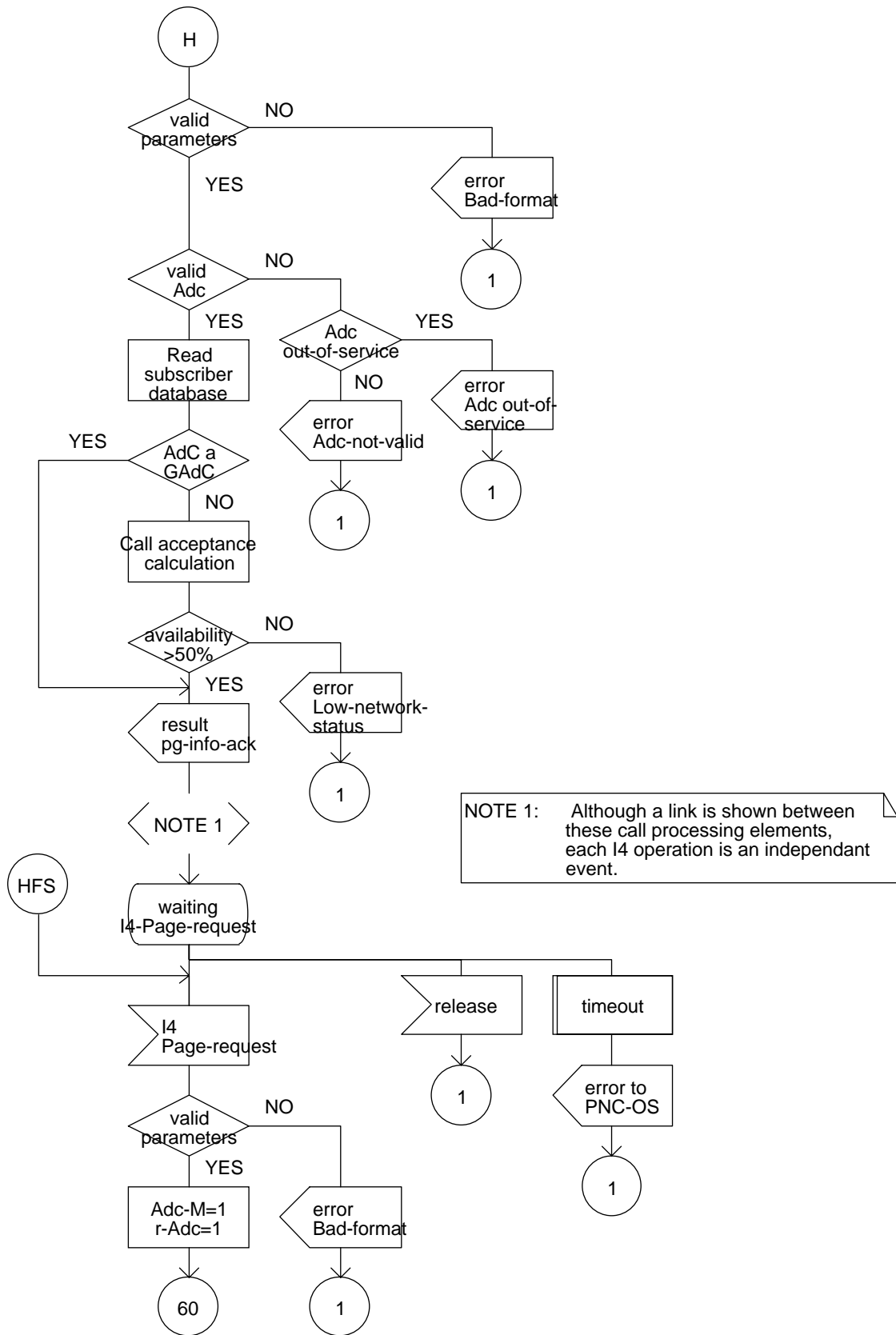

Figure B.4 (sheet 1 of 5): Call processing for page input - distant call, PNC-H

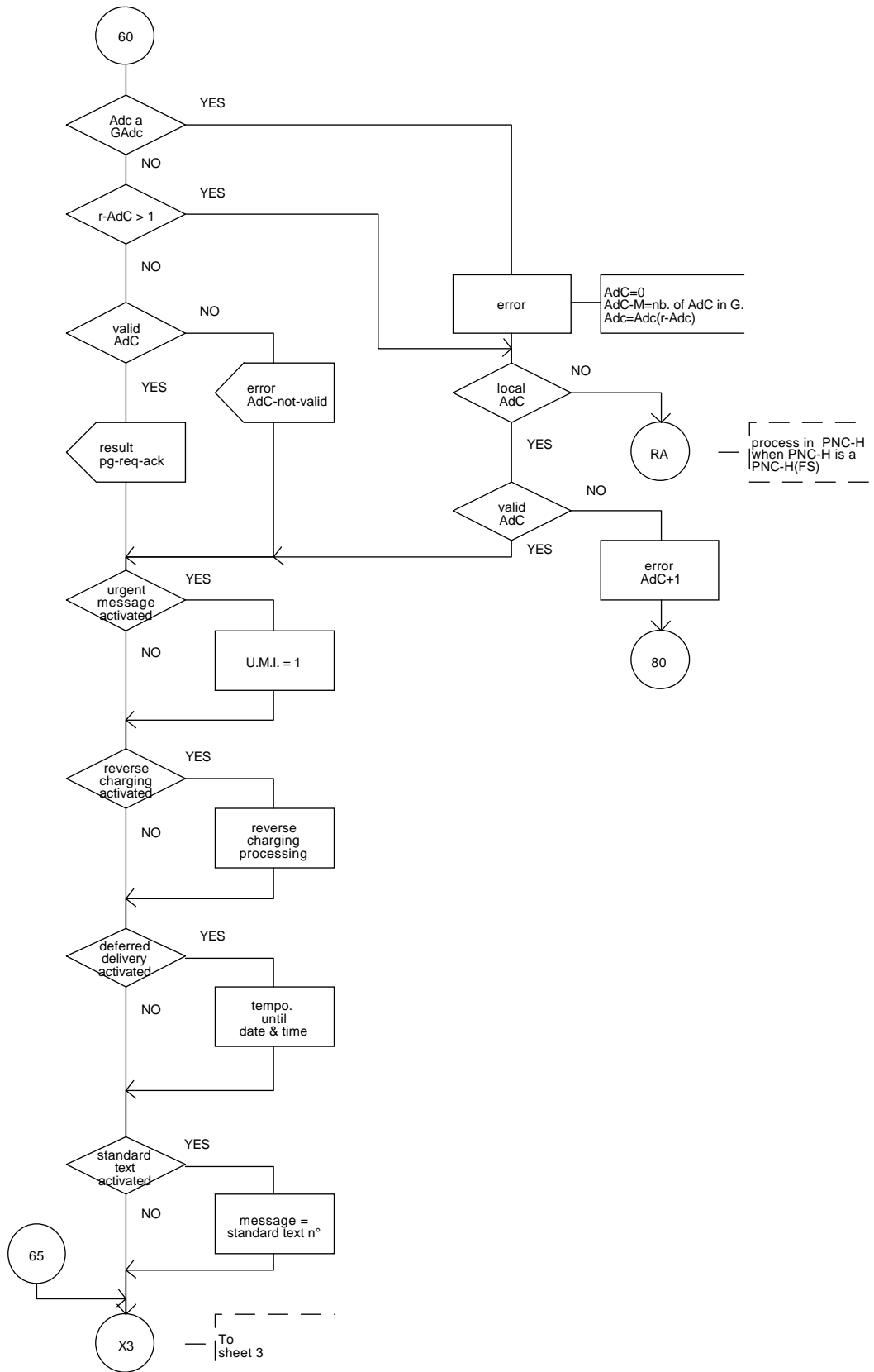

Figure B.4 (sheet 2 of 5): Call processing for page input - distant call, PNC-H

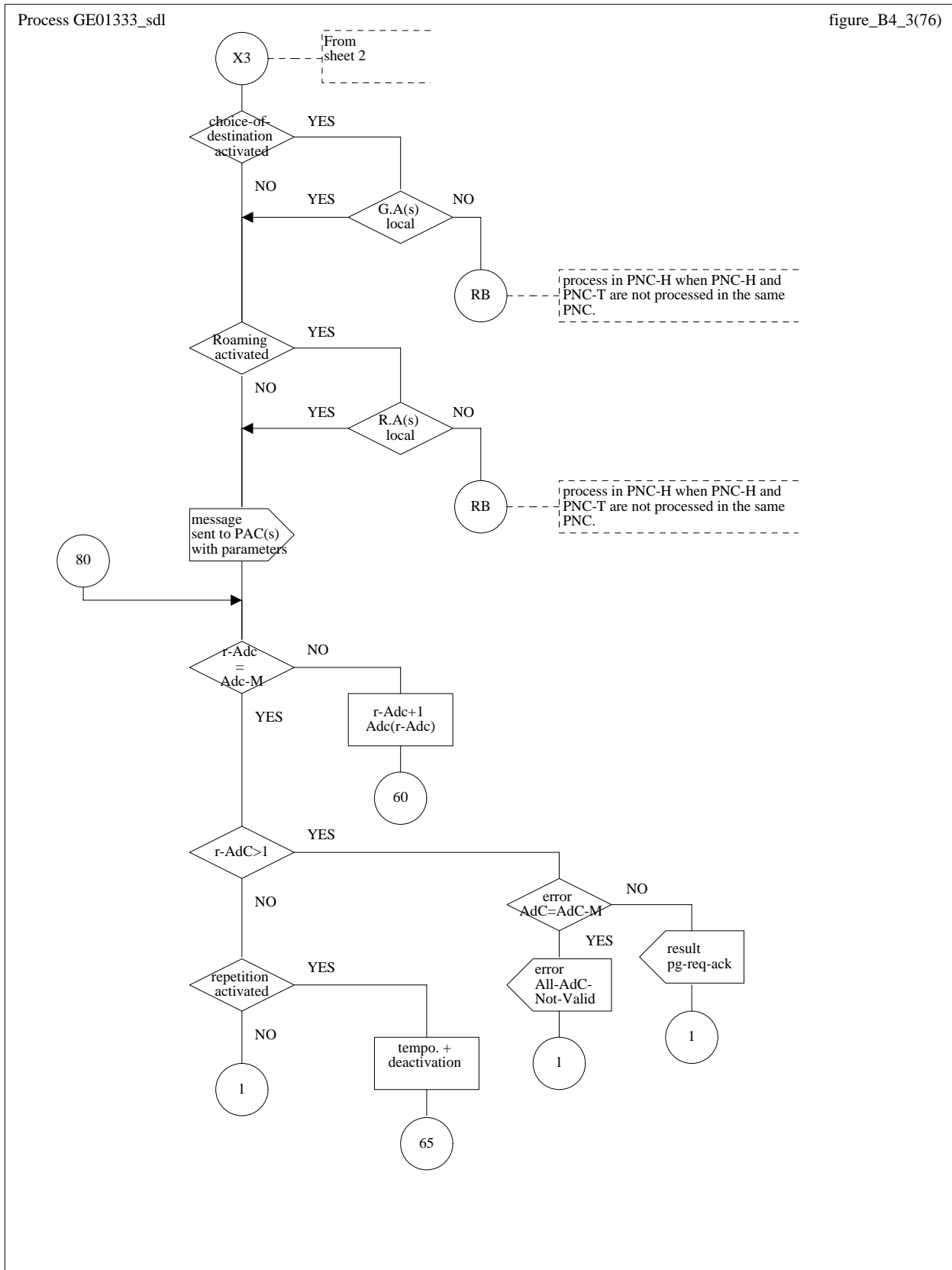

Figure B.4 (sheet 3 of 5): Call processing for page input - distant call, PNC-H

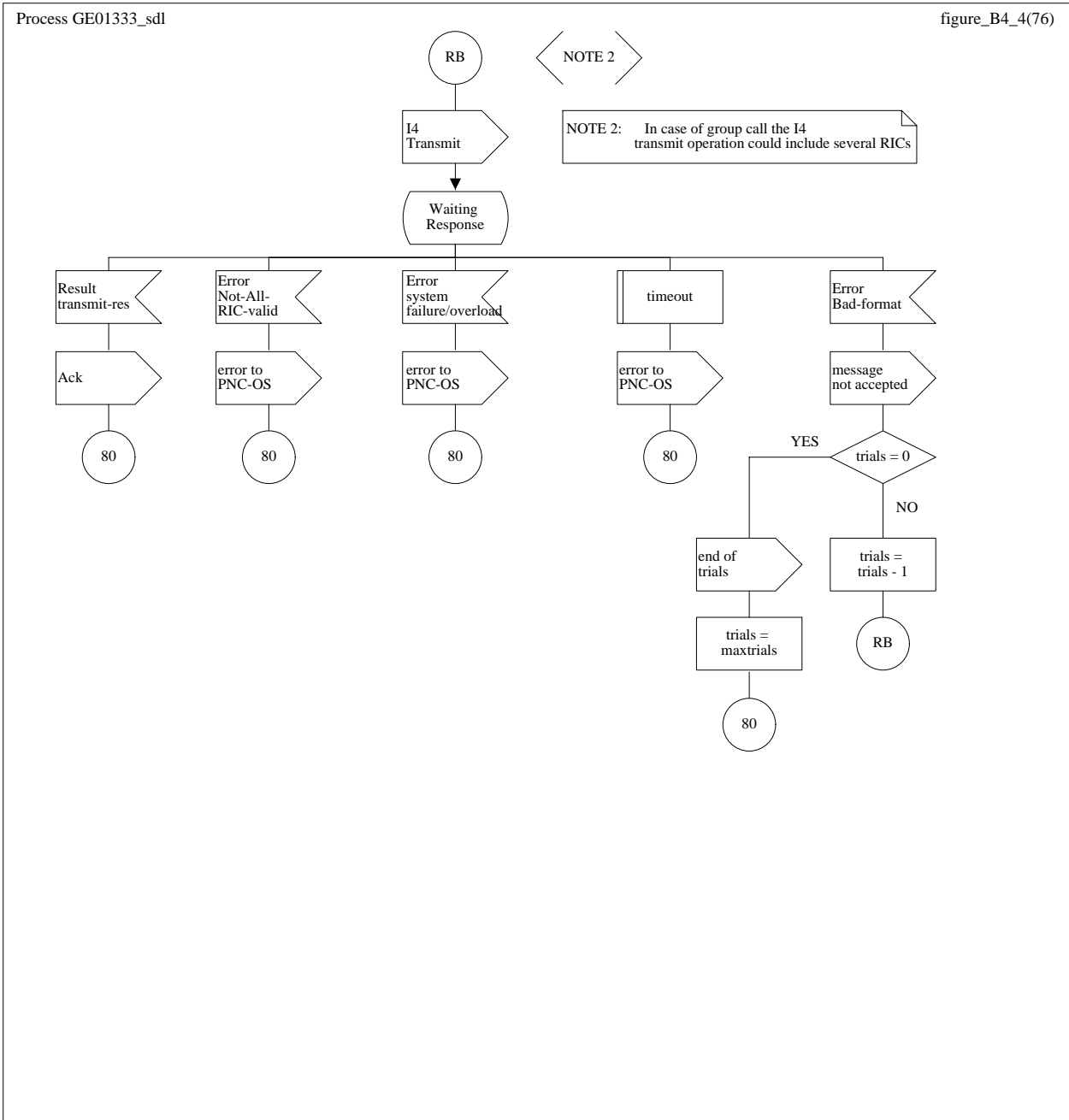

Figure B.4 (sheet 4 of 5): Call processing for page input - distant call, PNC-H

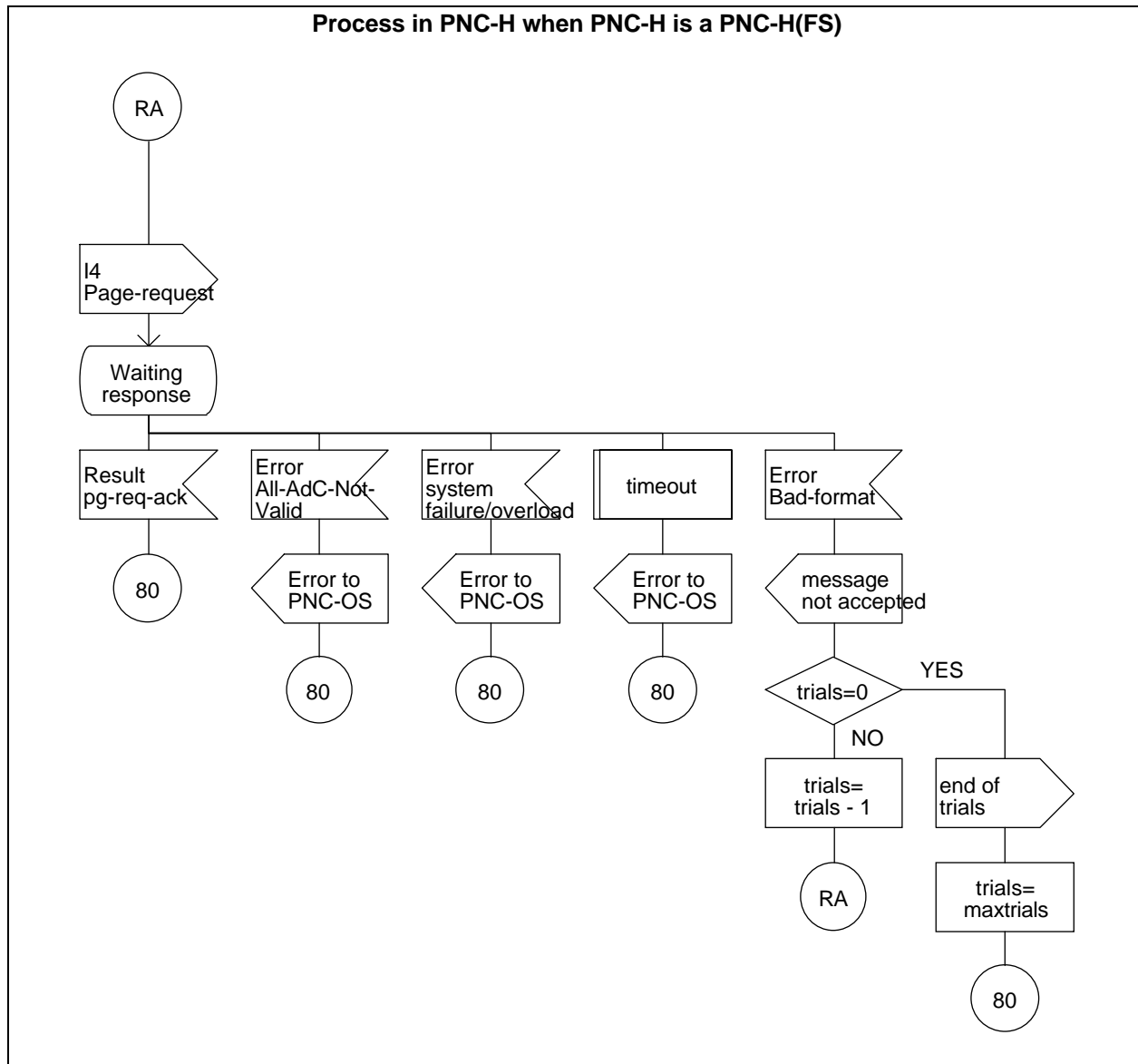

Figure B.4 (sheet 5 of 5): Call processing for page input - distant call, PNC-H

Process GE01333_sdl

figure_B5_1(76)

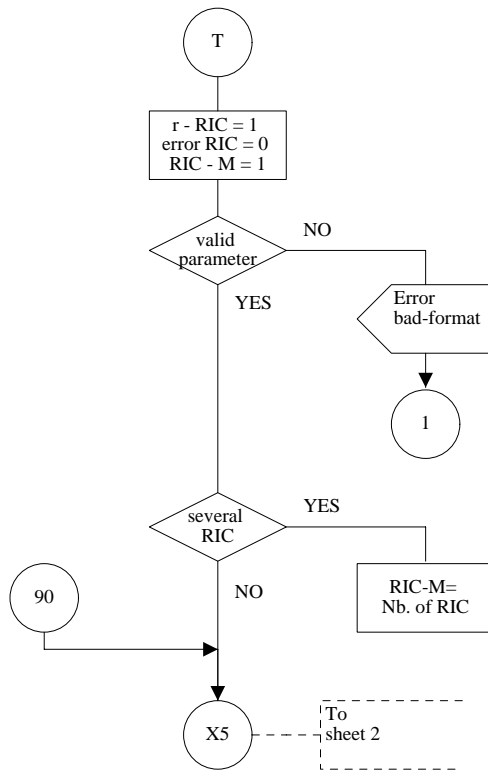

Figure B.5 (sheet 1 of 2): Call processing for page input - external call, PNC-T

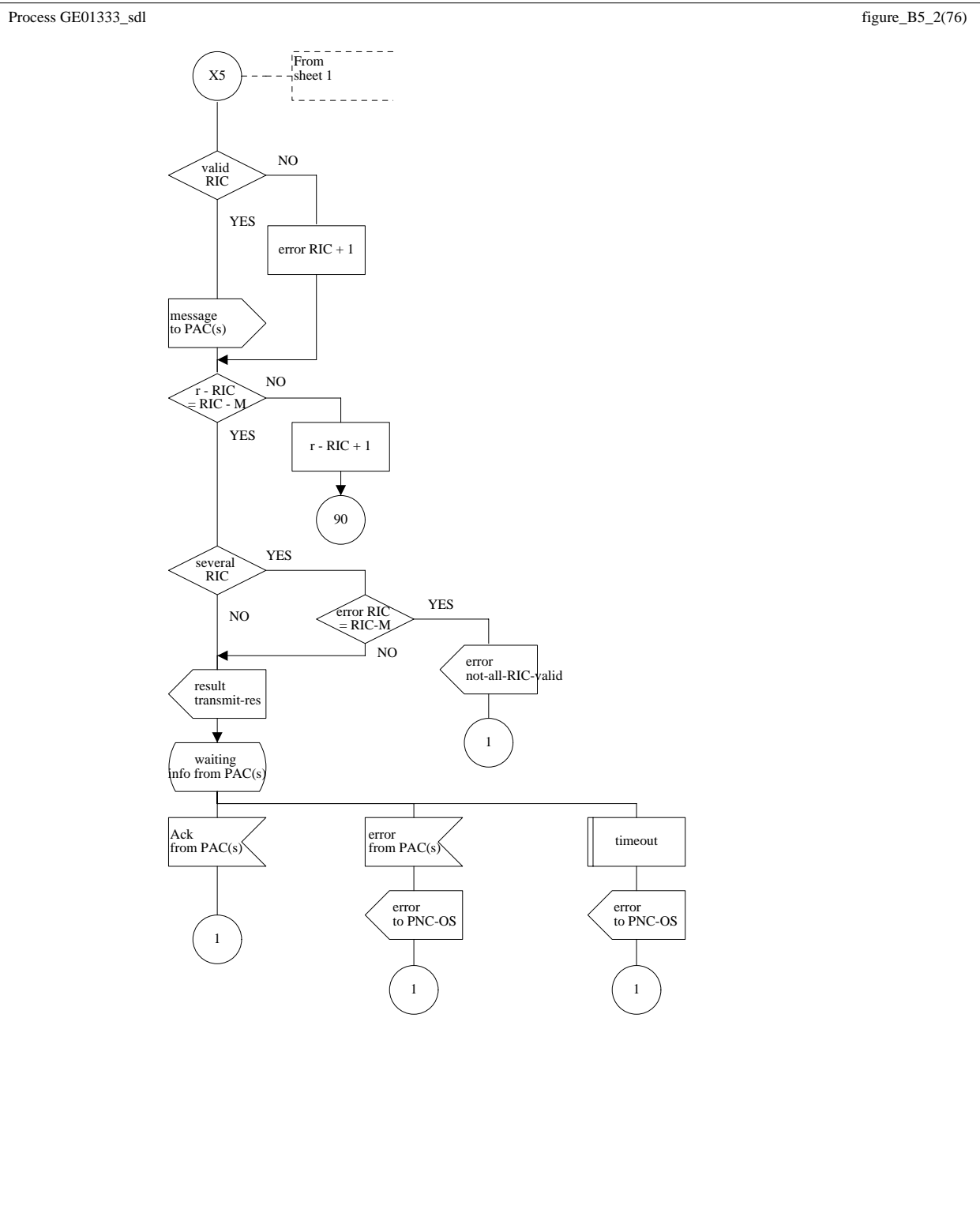

Figure B.5 (sheet 2 of 2): Call processing for page input - external call, PNC-T

Process GE01333_sdl

figure_B6(76)

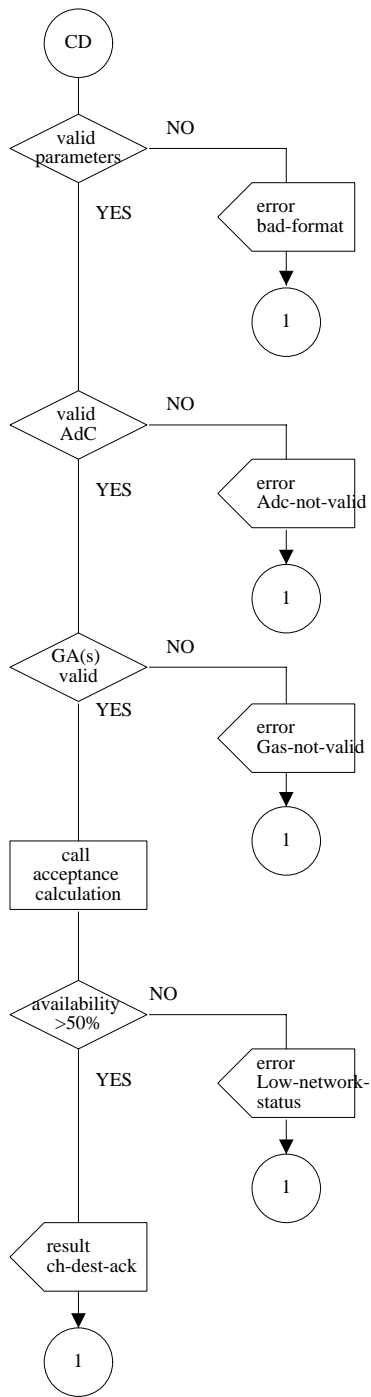

Figure B.6: Call processing for page input - distant call, choice of destination, PNC-H

B.3 Call processing for roaming

Process GE01333_sdl

figure_B7(76)

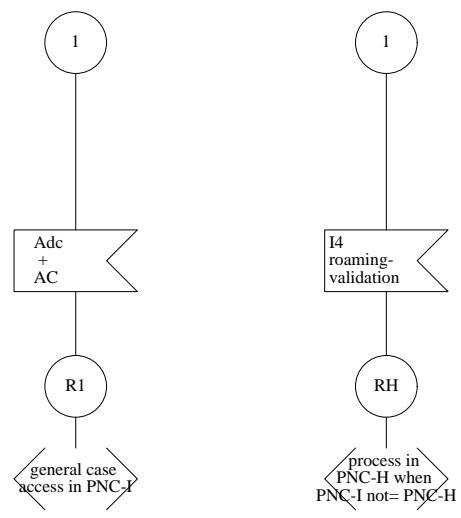

Figure B.7: Call processing for roaming

Process GE01333_sdl

figure_B8_1(76)

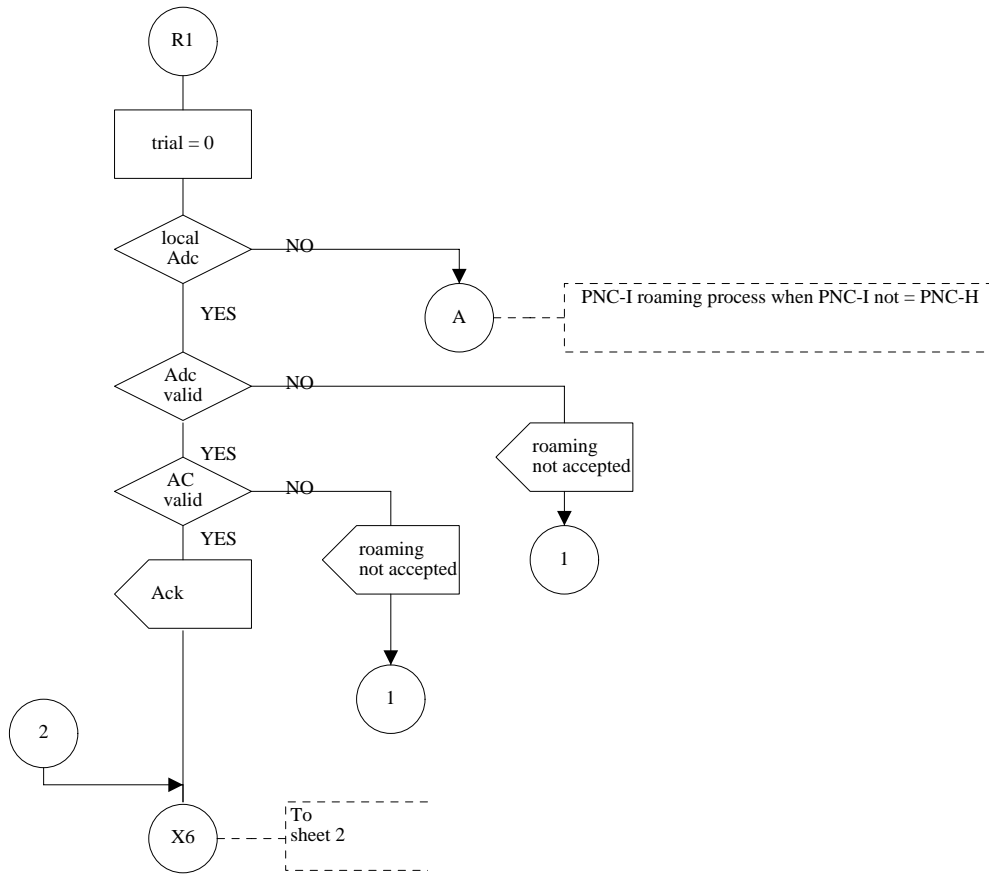

Figure B.8 (sheet 1 of 2): Call processing for roaming - local call

Process GE01333_sdl

figure_B8_2(76)

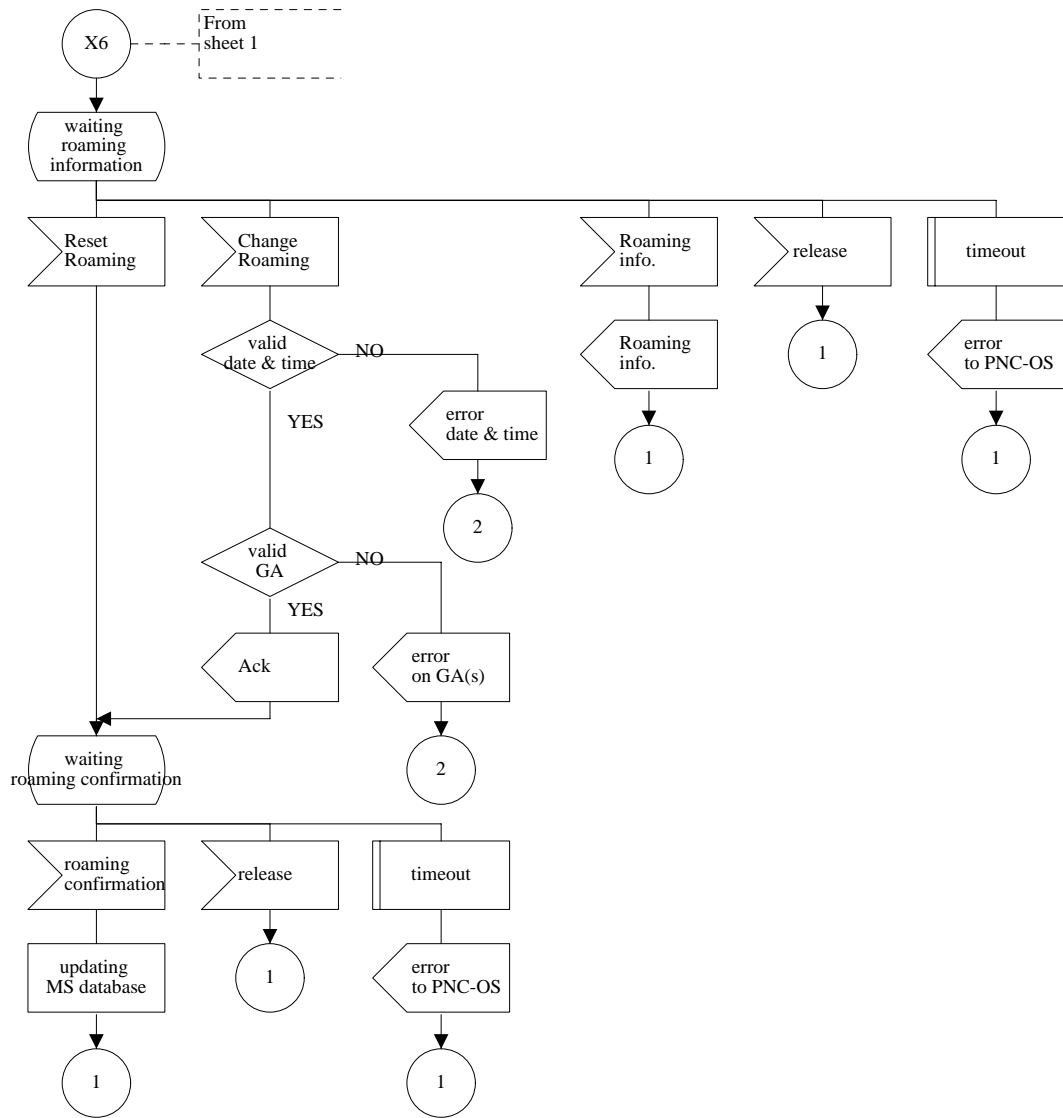

Figure B.8 (sheet 2 of 2): Call processing for roaming - local call

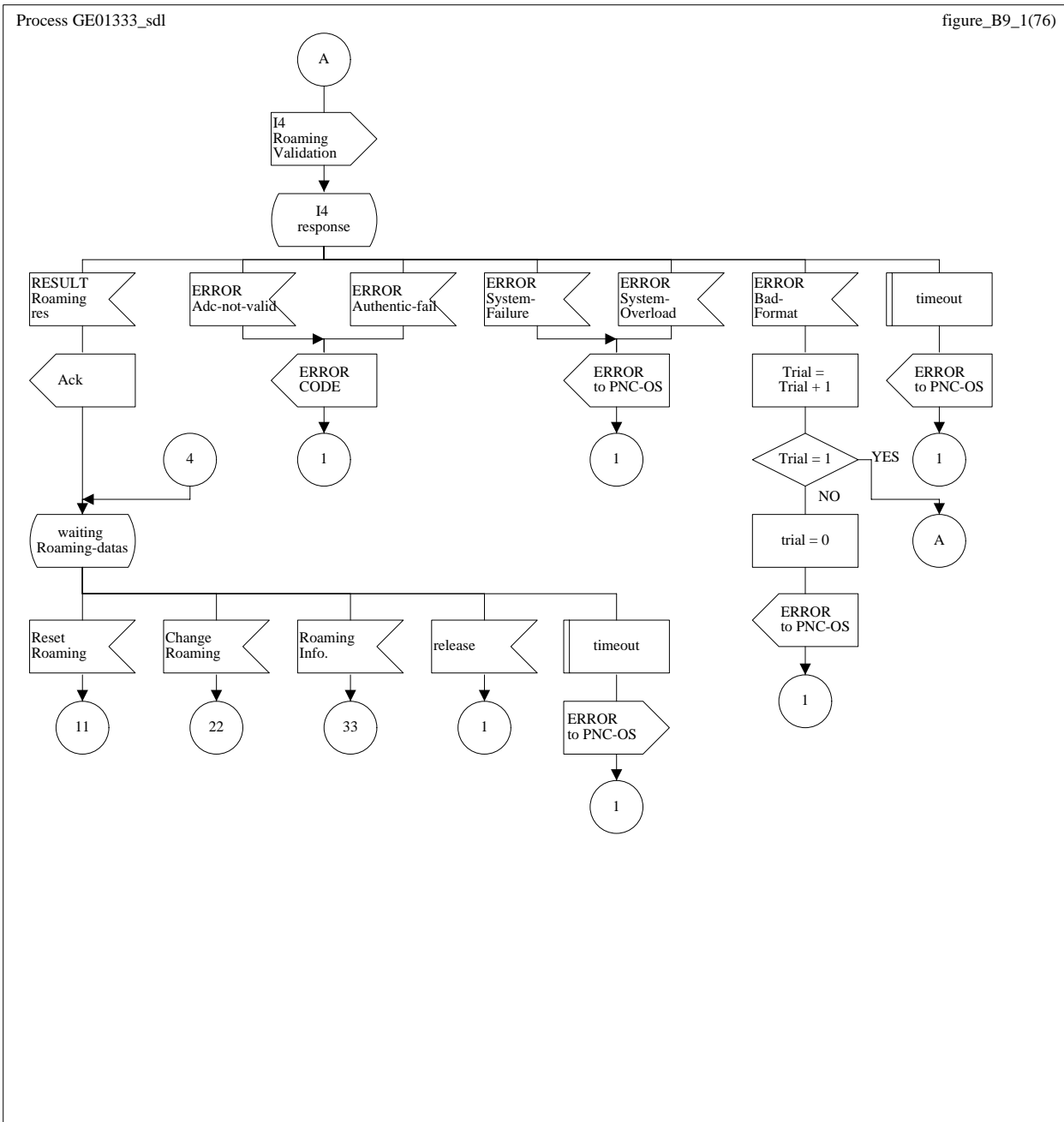

Figure B.9 (sheet 1 of 5): Call processing for roaming - distant call, PNC-I

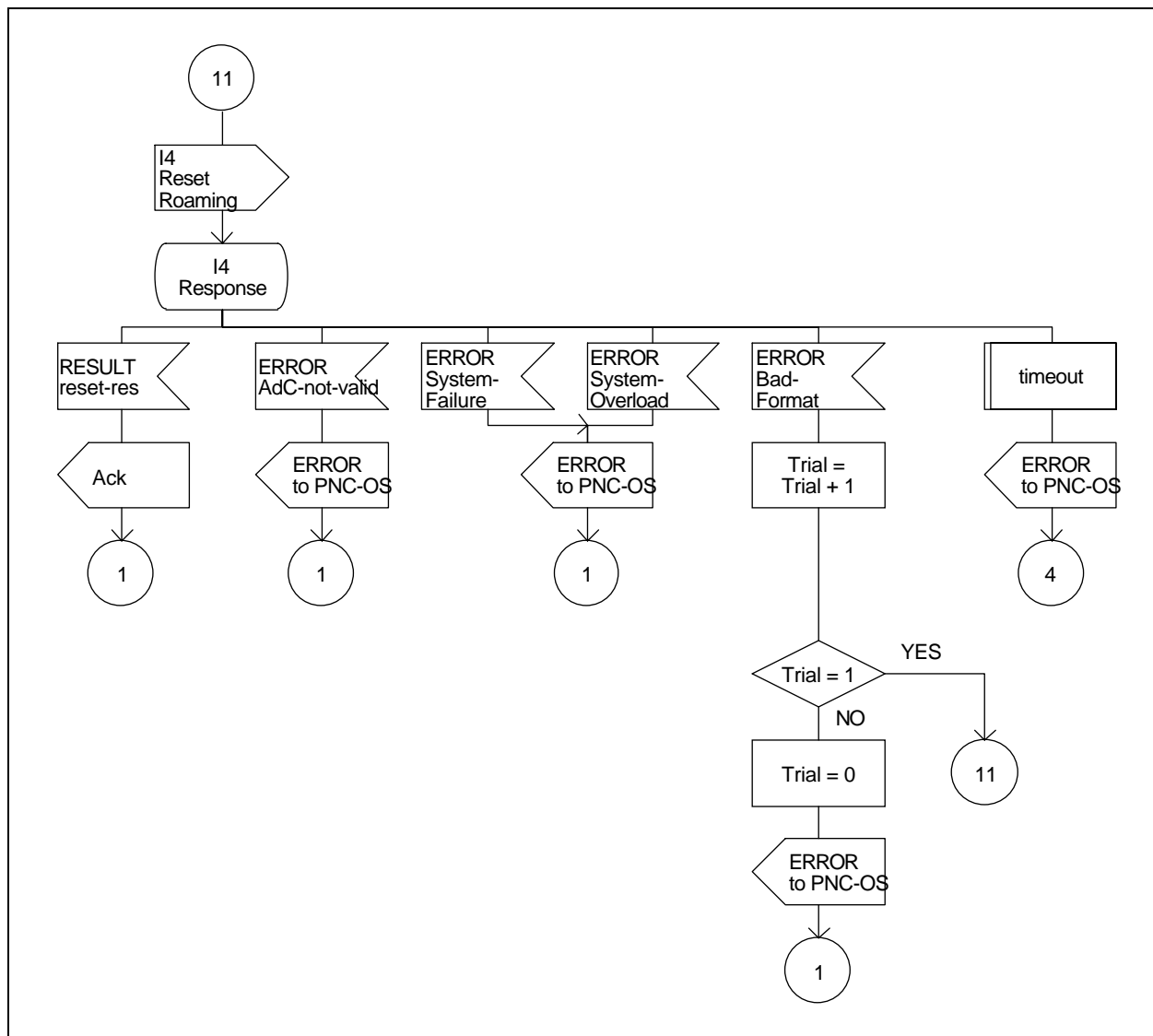

Figure B.9 (sheet 2 of 5): Call processing for roaming - distant call, PNC-I

Process GE01333_sdl

figure_B9_4(76)

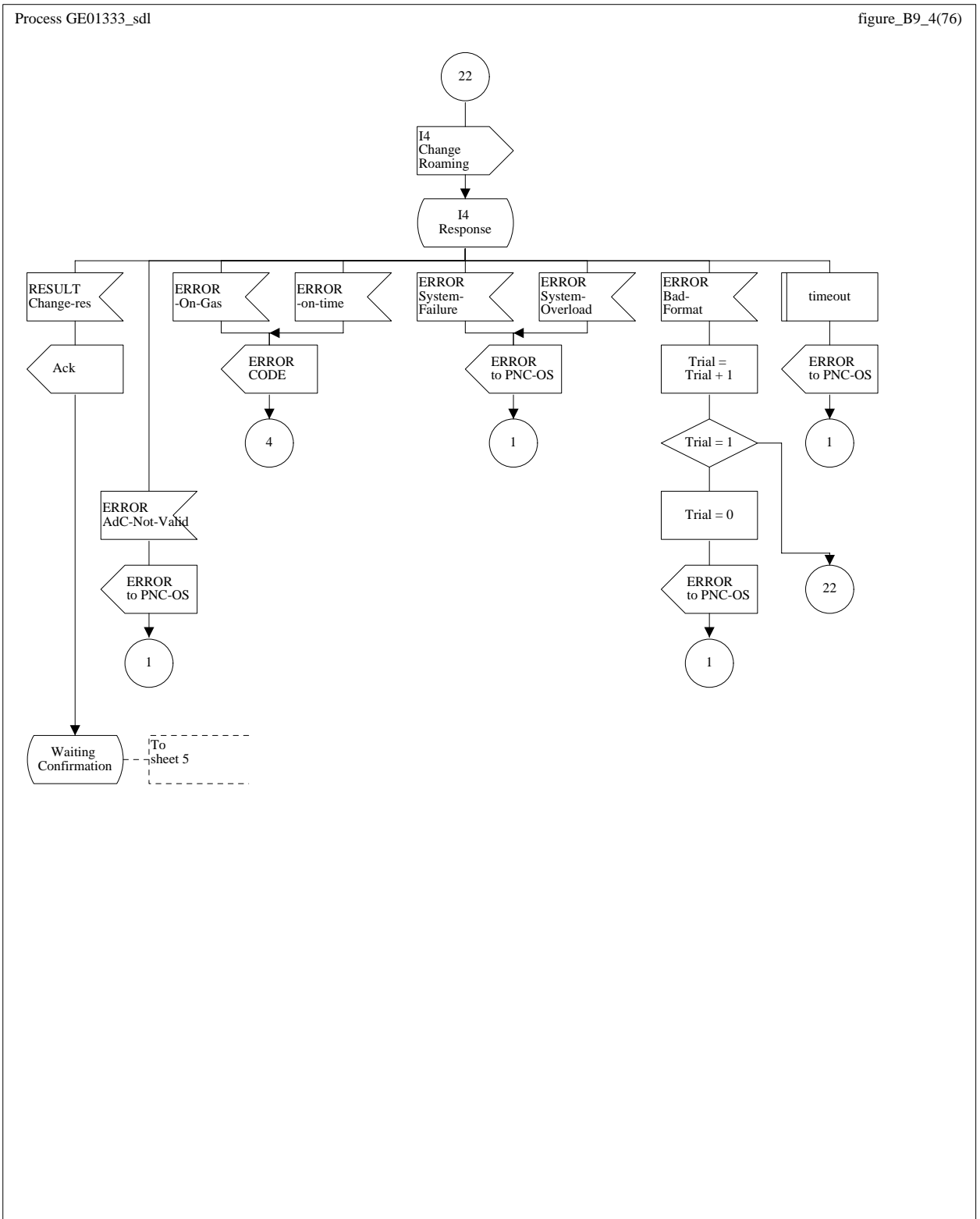

Figure B.9 (sheet 3 of 5): Call processing for roaming - distant call, PNC-I

Process GE01333_sdl

figure_B9_5(76)

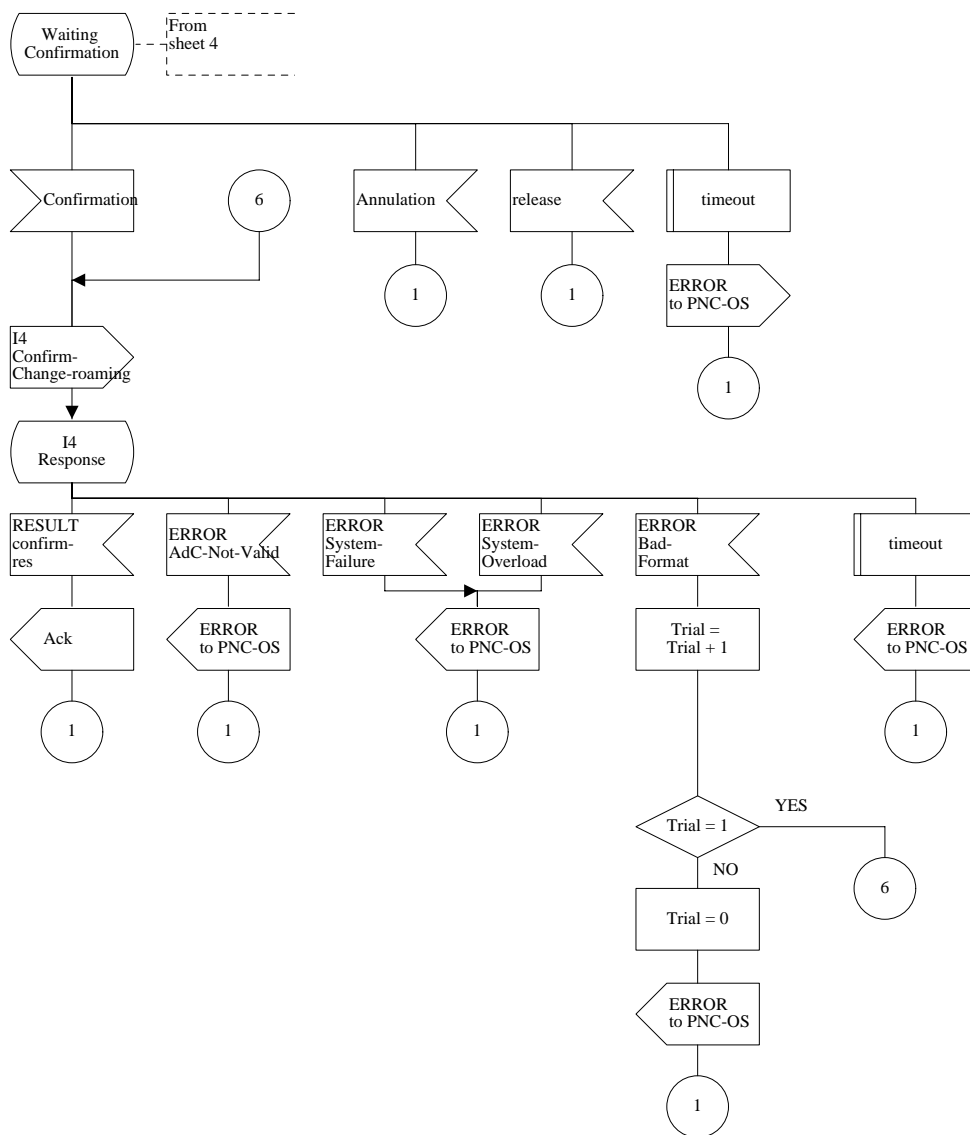

Figure B.9 (sheet 4 of 5): Call processing for roaming - distant call, PNC-I

Process GE01333_sdl

figure_B9_6(76)

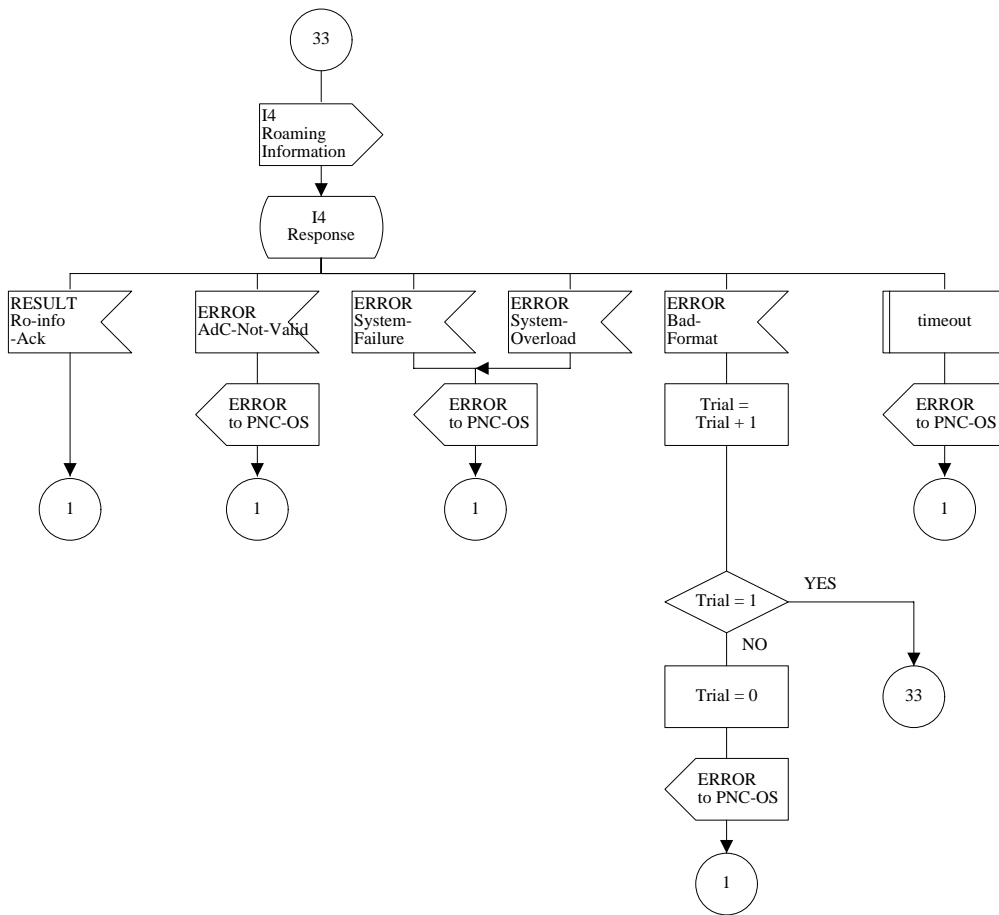

Figure B.9 (sheet 5 of 5): Call processing for roaming - distant call, PNC-I

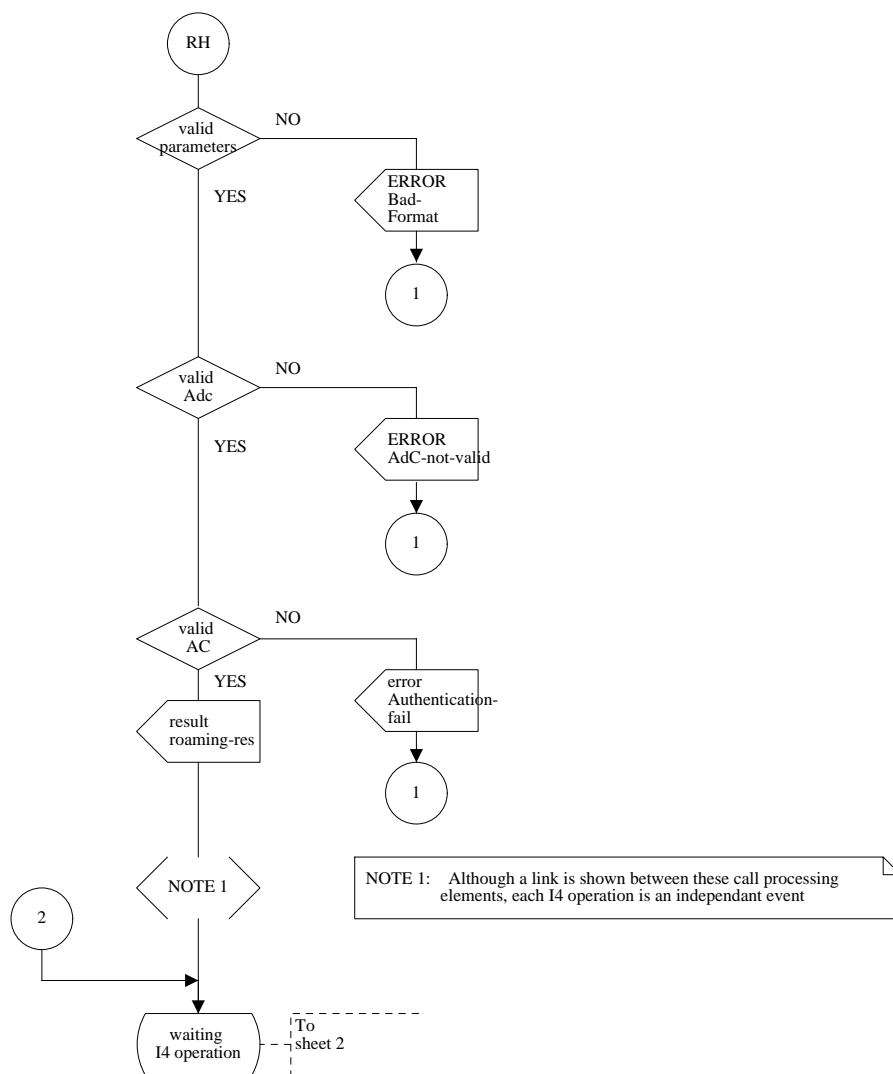

Figure B.10 (sheet 1 of 2): Call processing for roaming - distant call, PNC-H

Process GE01333_sdl

figure_B10_2(76)

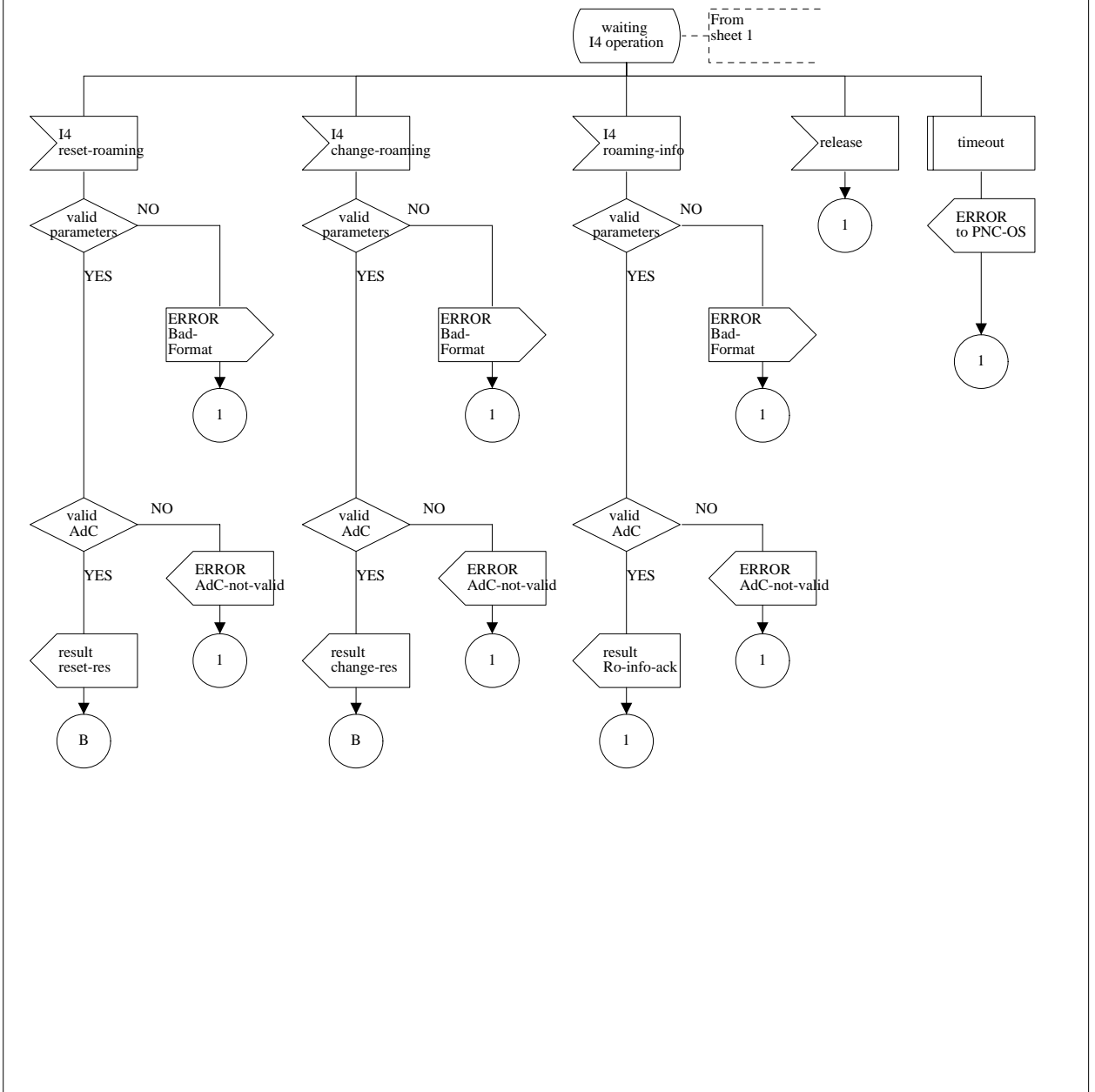

Figure B.10 (sheet 2 of 2): Call processing for roaming - distant call, PNC-H

B.4 Call processing for call diversion

Process GE01333_sdl

figure_B11(76)

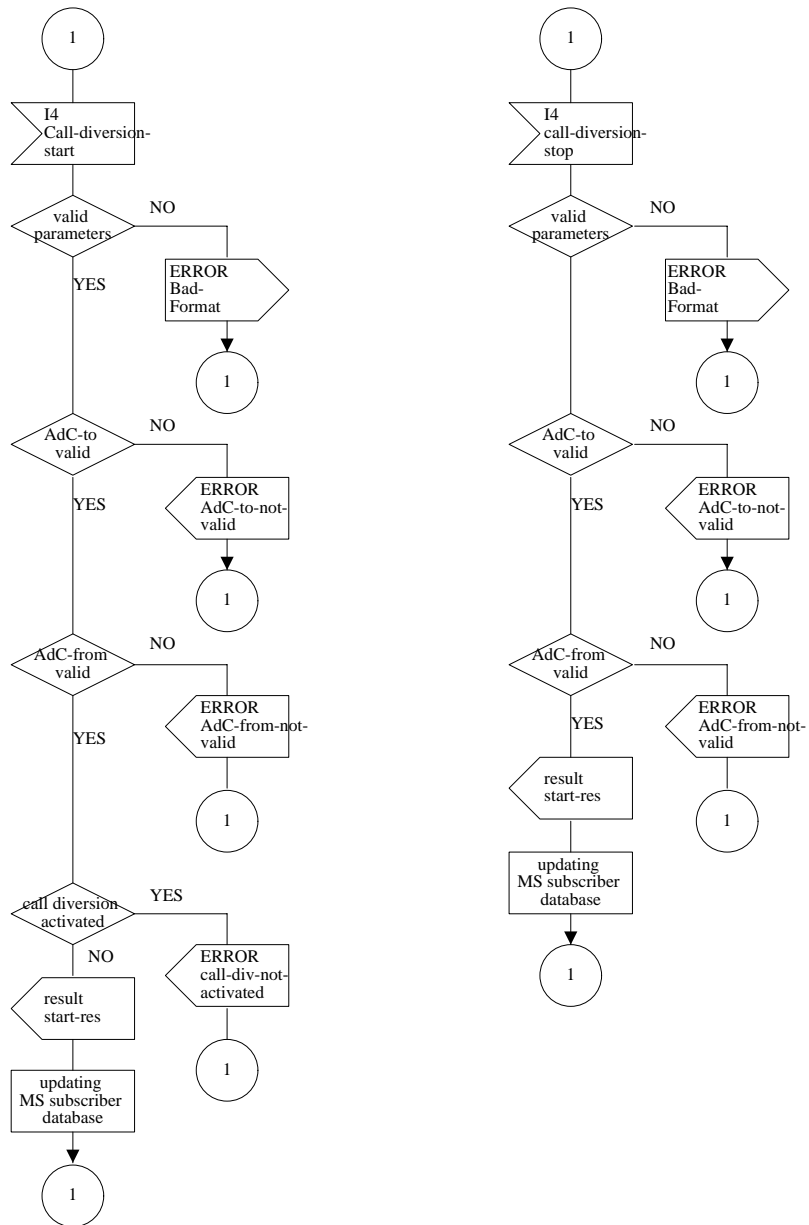

Figure B.11: Call processing for call diversion

Annex C (informative): List of access methods

This annex gives a description of some possible access methods. It shows the combination of the four parameters (network, type, mode and terminal - see clause 7) of each described access method. The access method numbers are used for reference purposes within clause 7.

Table C.1

Access Method	Access Network	Access Type	Access Mode	Access Terminal
1	PSTN	one-stage	inter-active	decadic telephone
2	PSTN	one-stage	inter-active	DTMF telephone
3	PSTN	two-stage	inter-active	DTMF telephone
4	PSTN	two-stage	inter-active	alpha-numeric terminal
5	PSTN	two-stage	non inter-active	alpha-numeric terminal
6	TELEX	one-stage	inter-active	telex terminal
7	TELEX	one-stage	non inter-active	telex terminal
8	TELEX	two-stage	inter-active	telex terminal
9	TELEX	two-stage	non inter-active	telex terminal
10	PSPDN	two-stage	inter-active	videotex terminal
11	PSPDN	two-stage	inter-active	X.25 terminal
12	PSPDN	two-stage	non inter-active	X.25 terminal
13	Bureau	two-stage	inter-active	telephone
14	CSPDN	two-stage	inter-active	CSPDN terminal
15	CSPDN	two-stage	non inter-active	CSPDN terminal
16	ISDN	one-stage	inter-active	ISDN terminal
17	ISDN	one-stage	non inter-active	ISDN terminal
18	ISDN	two-stage	inter-active	ISDN terminal
19	ISDN	two-stage	non inter-active	ISDN terminal
20	PSPDN (X.400)	two-stage	non inter-active	X.400 terminal
21	PSPDN (X.400)	one-stage	non inter-active	X.400 terminal
NOTE: CSPDN = Circuit Switched Public Data Network.				

Annex D (normative): SDL diagrams for interactive access mode

This annex is normative for access methods 1 and 2 for tone-only paging and for access method 3 for numeric paging. It is informative for all other access methods.

D.1 General

This annex describes, using the SDL graphical representation, the generic protocols for accessing the ERMES system for page input and SFs. The figures represent the dialogues between the user and the ERMES system through the I6 interface (clause 6).

D.2 For page input

Figure D.2 deals with the generic protocol for access methods using two-stage selection and an interactive access mode. Figure D.8 deals with the generic protocol for access methods using one-stage selection and an interactive access mode. Macros for character input common to both protocols are described in figure D.1.

SS dialogues are described in figures D.3.1 to D.3.8 for both one-stage and two-stage protocols.

D.3 For subscriber features

The dialogue for SFs is described in figure D.5. The dedicated part of the SFs is described only for roaming and is in figure D.6.

Process GE01333_sdl

figure_D1_1(76)

NOTE : t = timeout defined by the network operator.
Remaining trials = number of input opportunities defined by the network operator.

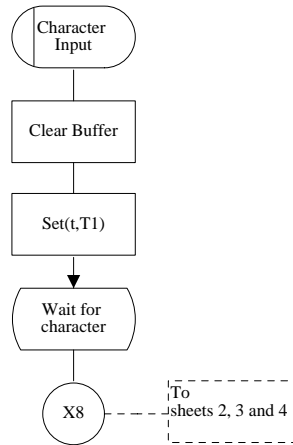

Figure D.1 (sheet 1 of 3): Calling party input macro

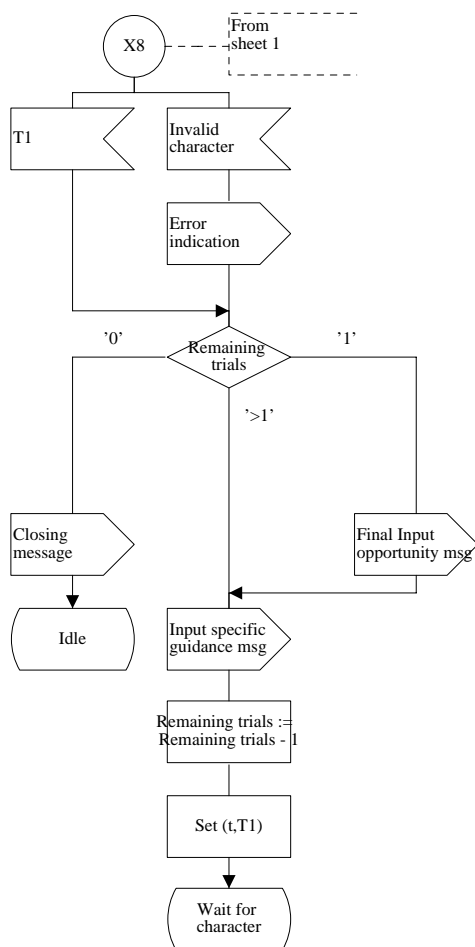

Figure D.1 (sheet 2 of 3): Calling party input macro

Process GE01333_sdl

figure_D1_3(76)

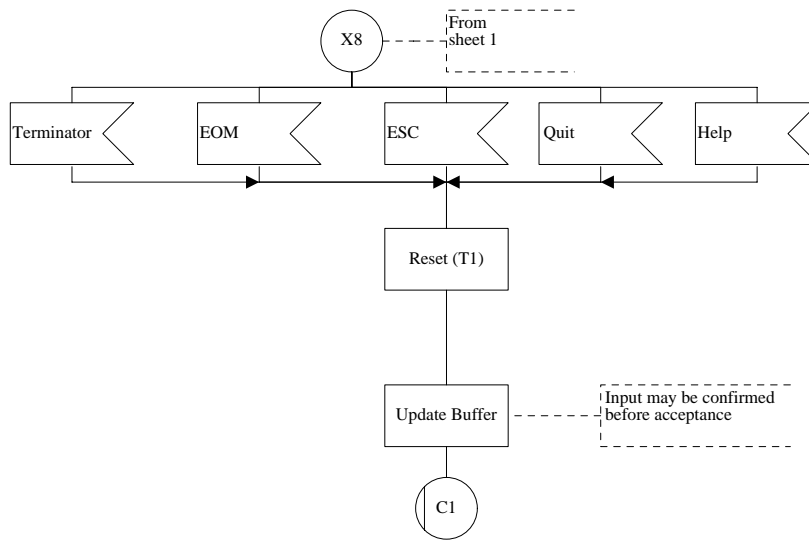

Figure D.1 (sheet 3 of 3): Calling party input macro

Process GE01333_sdl

figure_D2_1(76)

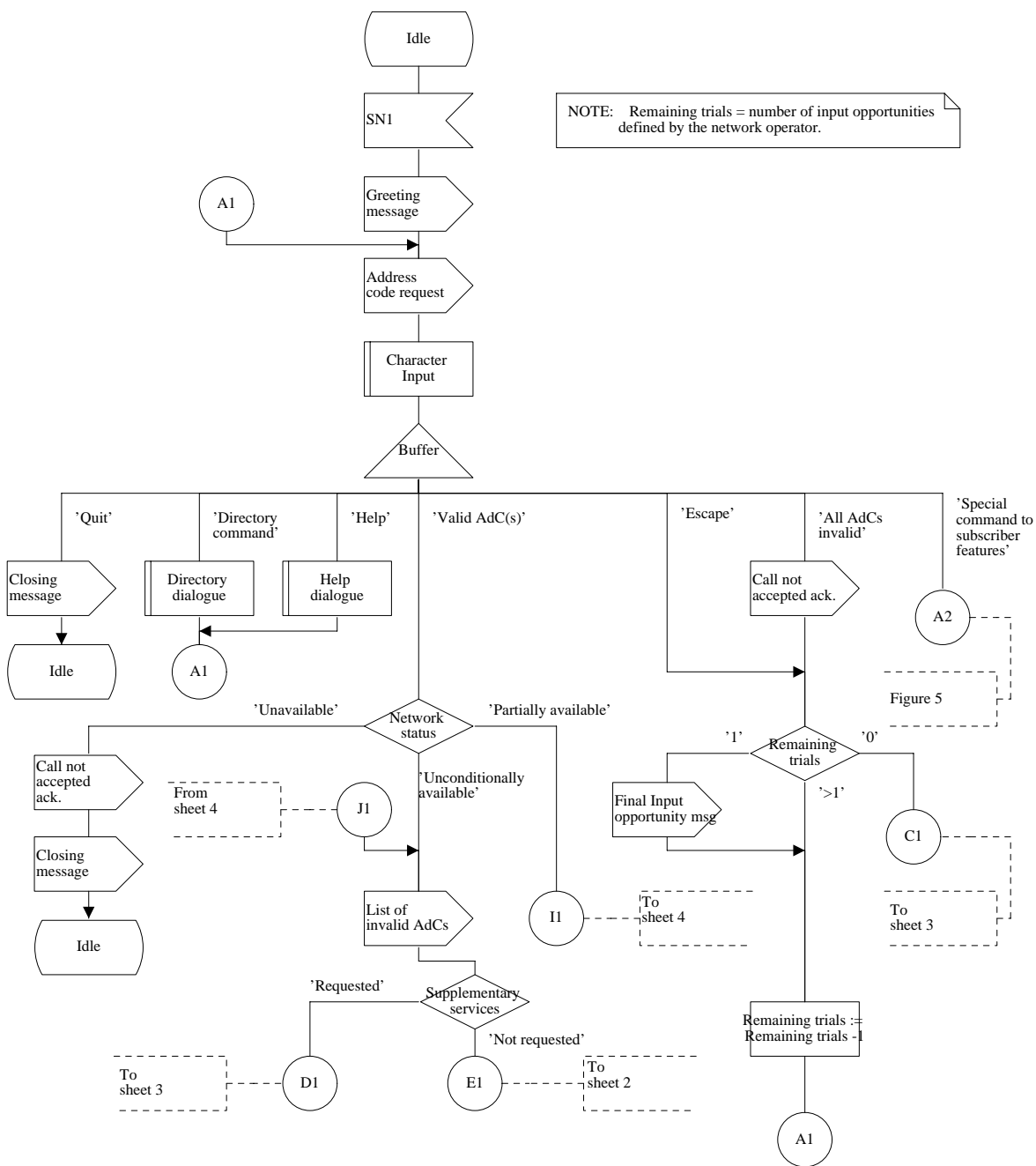

Figure D.2 (sheet 1 of 4): Two-stage selection protocol via service number 1

Process GE01333_sdl

figure_D2_2(76)

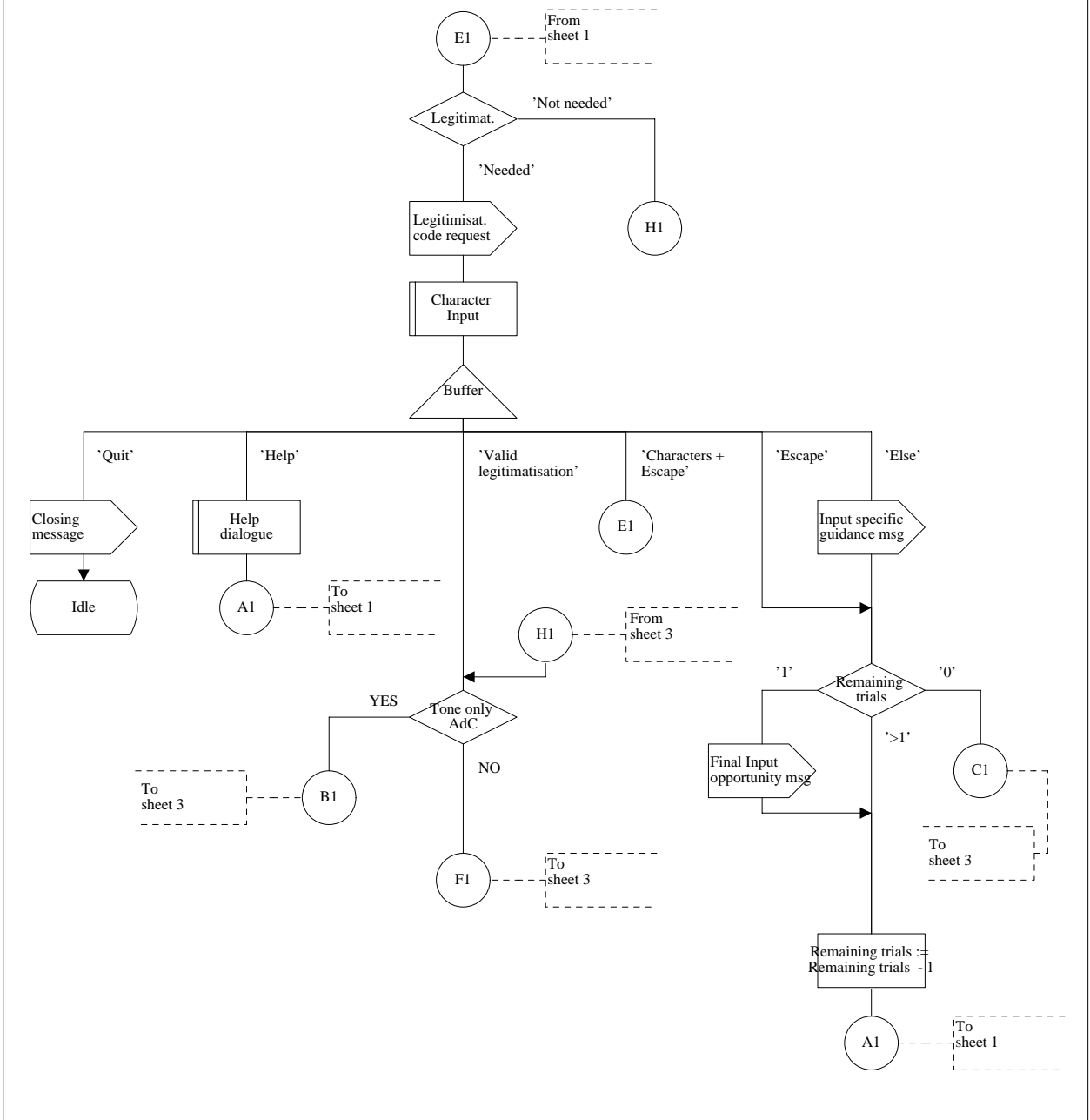

Figure D.2 (sheet 2 of 4): Two-stage selection protocol via service number 1

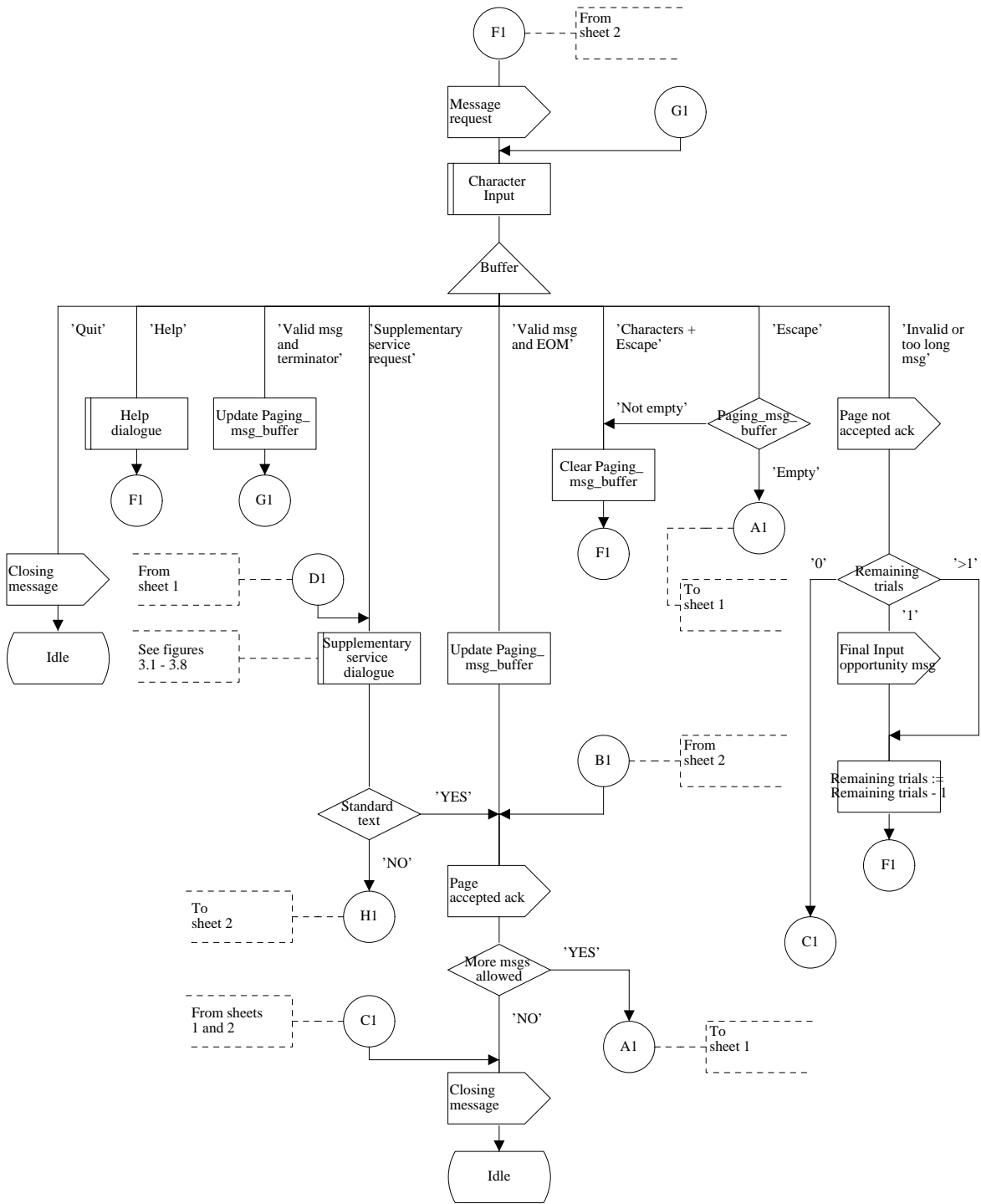

Figure D.2 (sheet 3 of 4): Two-stage selection protocol via service number 1

Process GE01333_sdl

figure_D2_4(76)

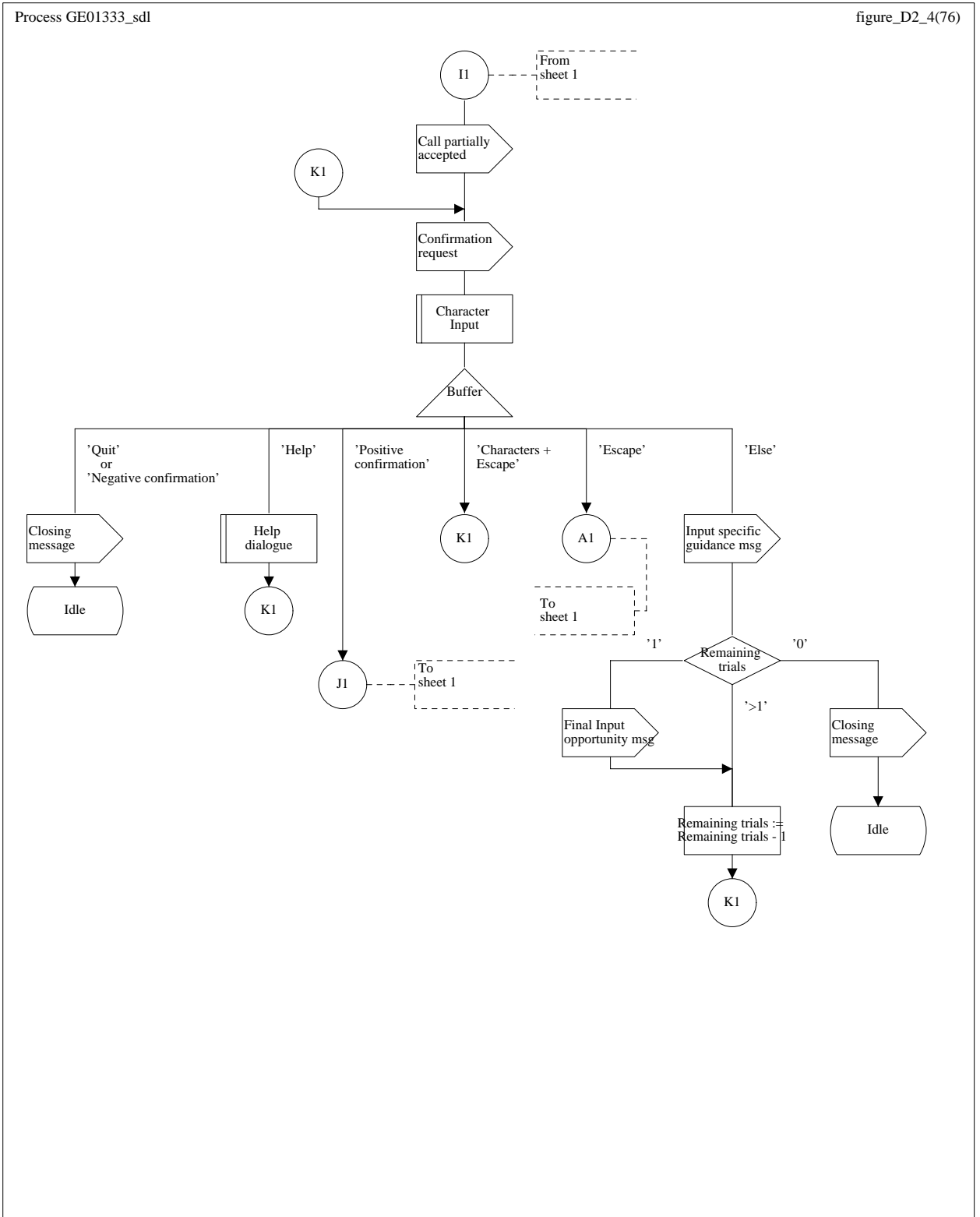

Figure D.2 (sheet 4 of 4): Two-stage selection protocol via service number 1

Process GE01333_sdl

figure_D31(76)

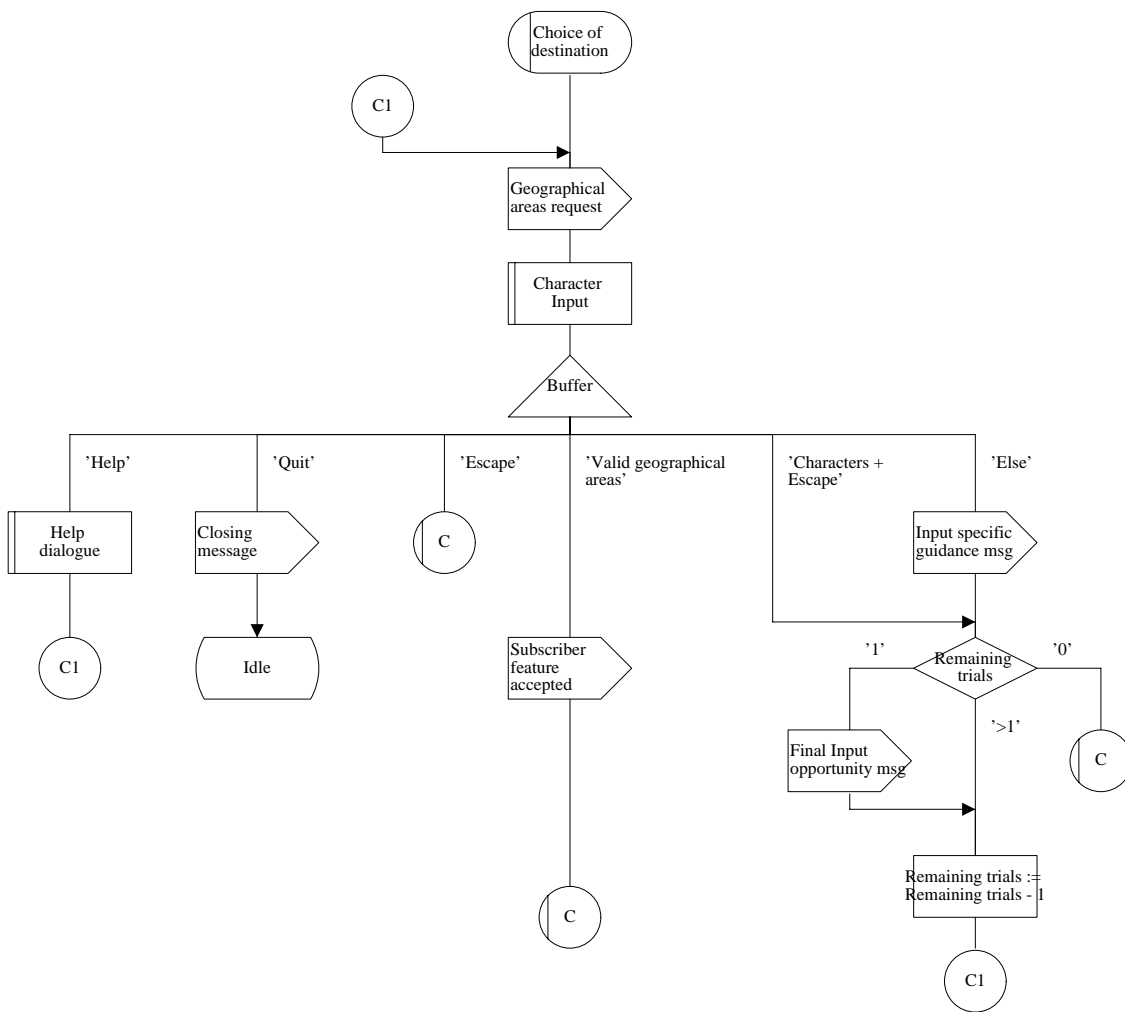

Figure D.3.1: Choice of destination

Process GE01333_sdl

figure_D32(76)

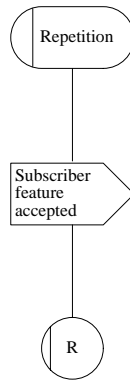

Figure D.3.2: Call repetition

Process GE01333_sdl

figure_D33_1(76)

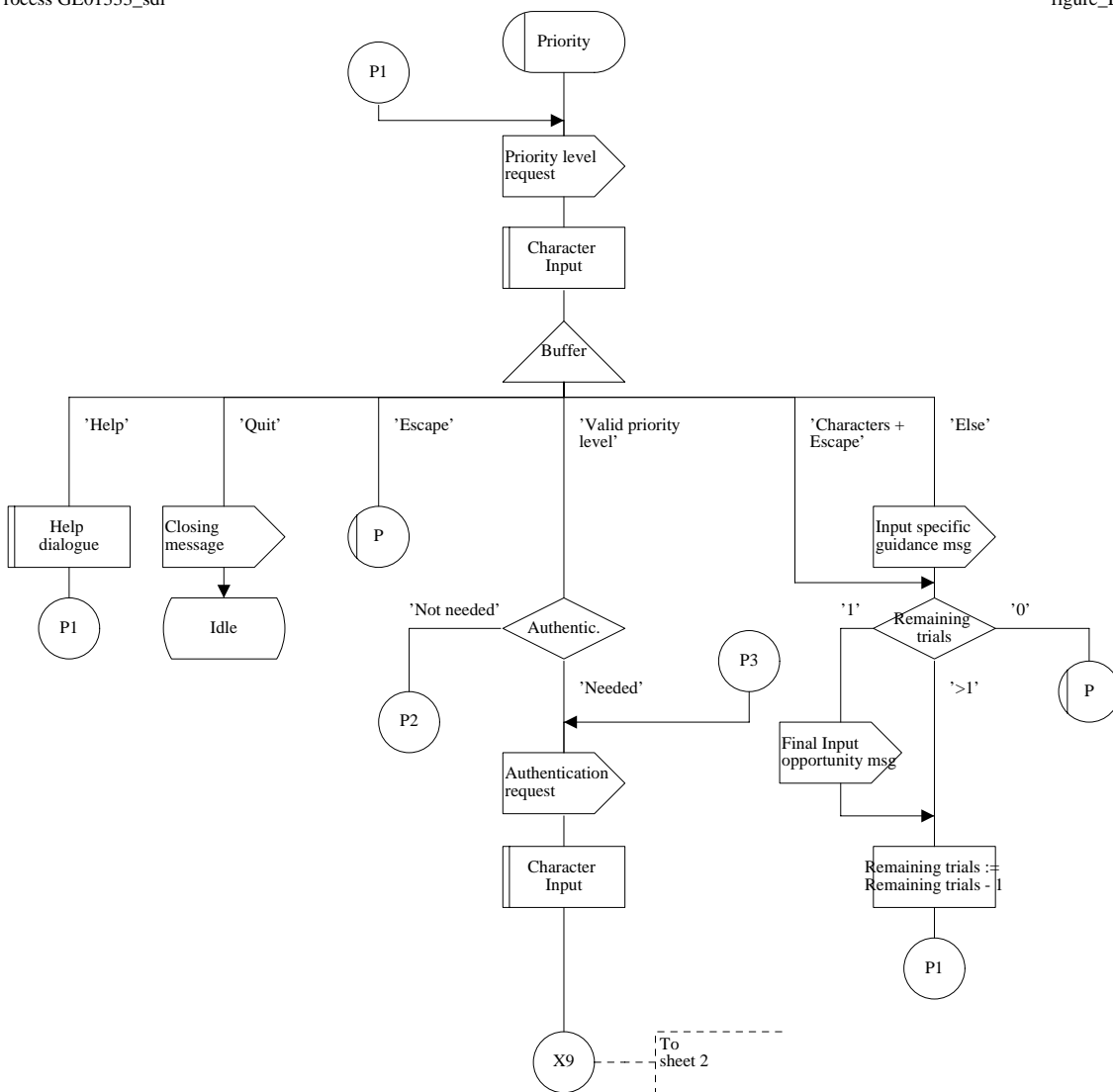

Figure D.3.3 (sheet 1 of 2): Priority

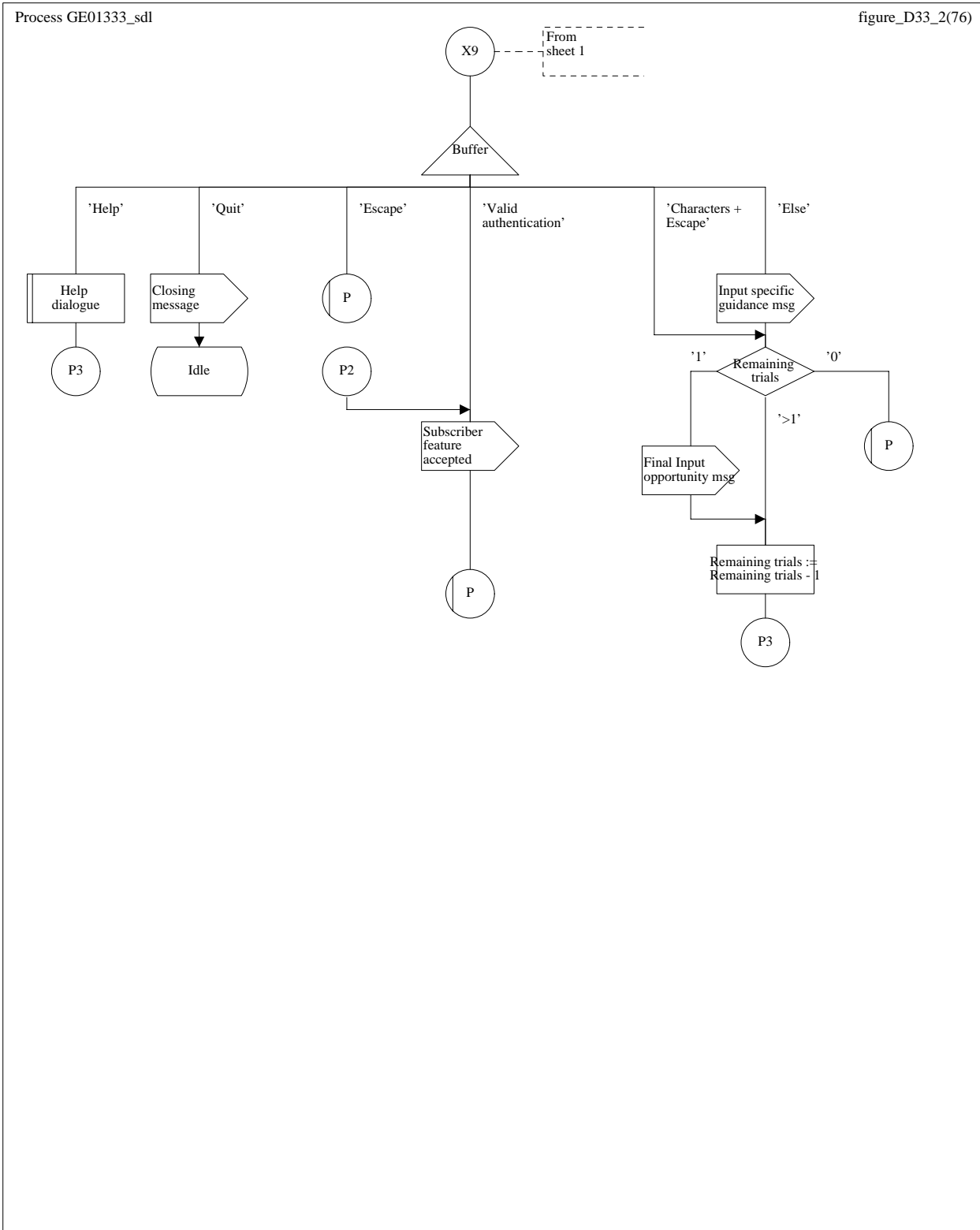

Figure D.3.3 (sheet 2 of 2): Priority

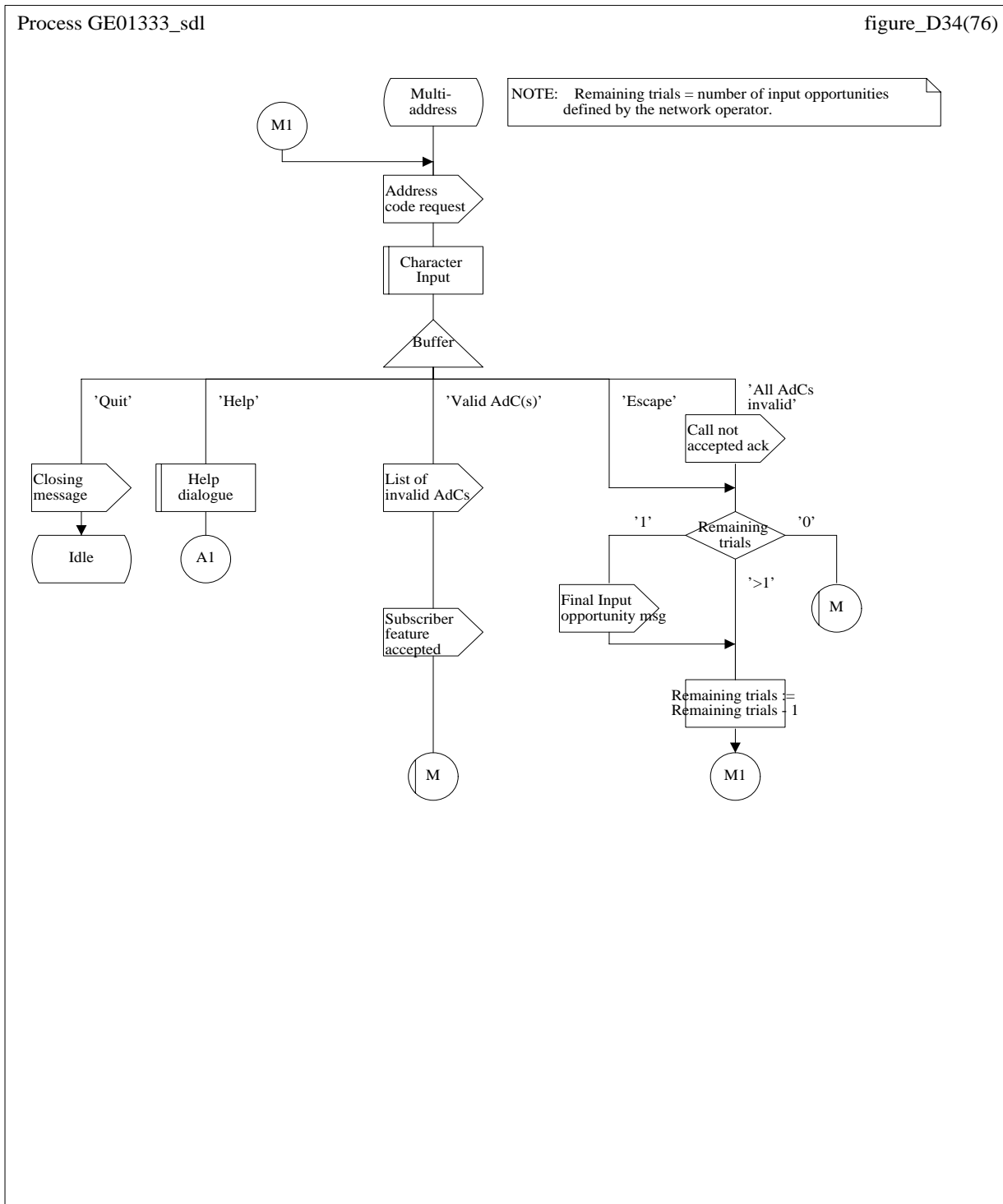

Figure D.3.4: Multi-address calls

Process GE01333_sdl

figure_D35(76)

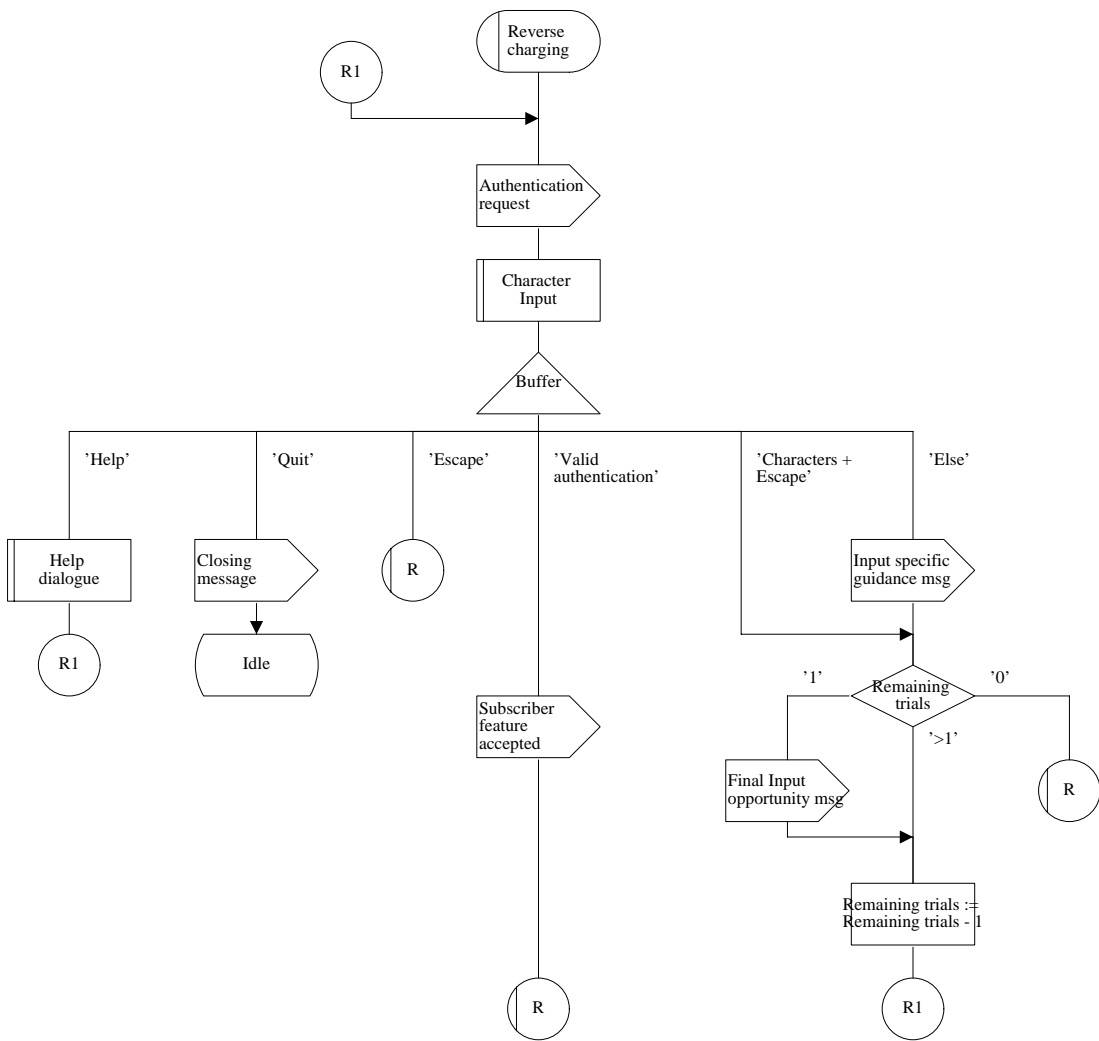

Figure D.3.5: Reverse charging request

Process GE01333_sdl

figure_D36(76)

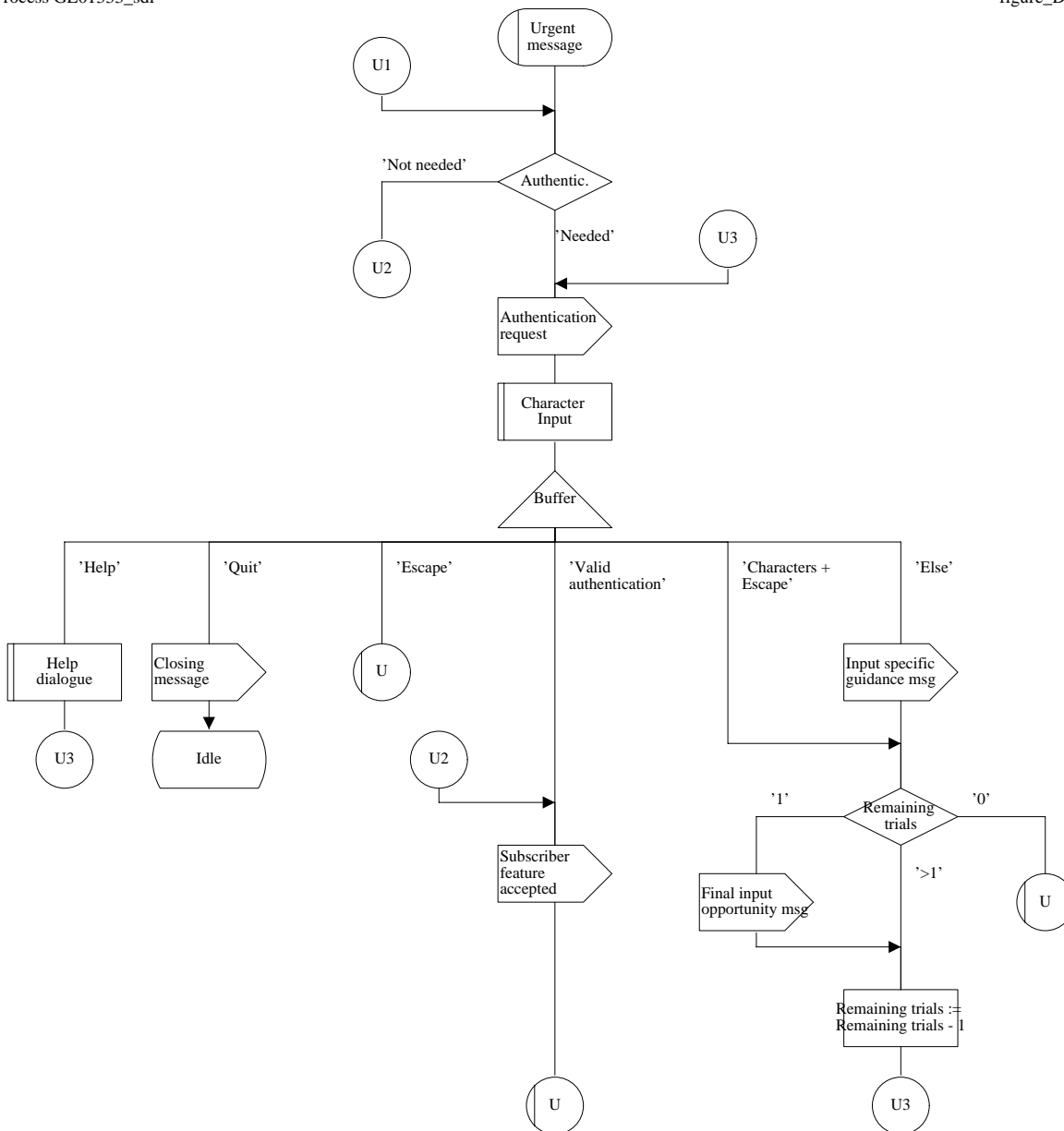

Figure D.3.6: Urgent message

Process GE01333_sdl

figure_D37(76)

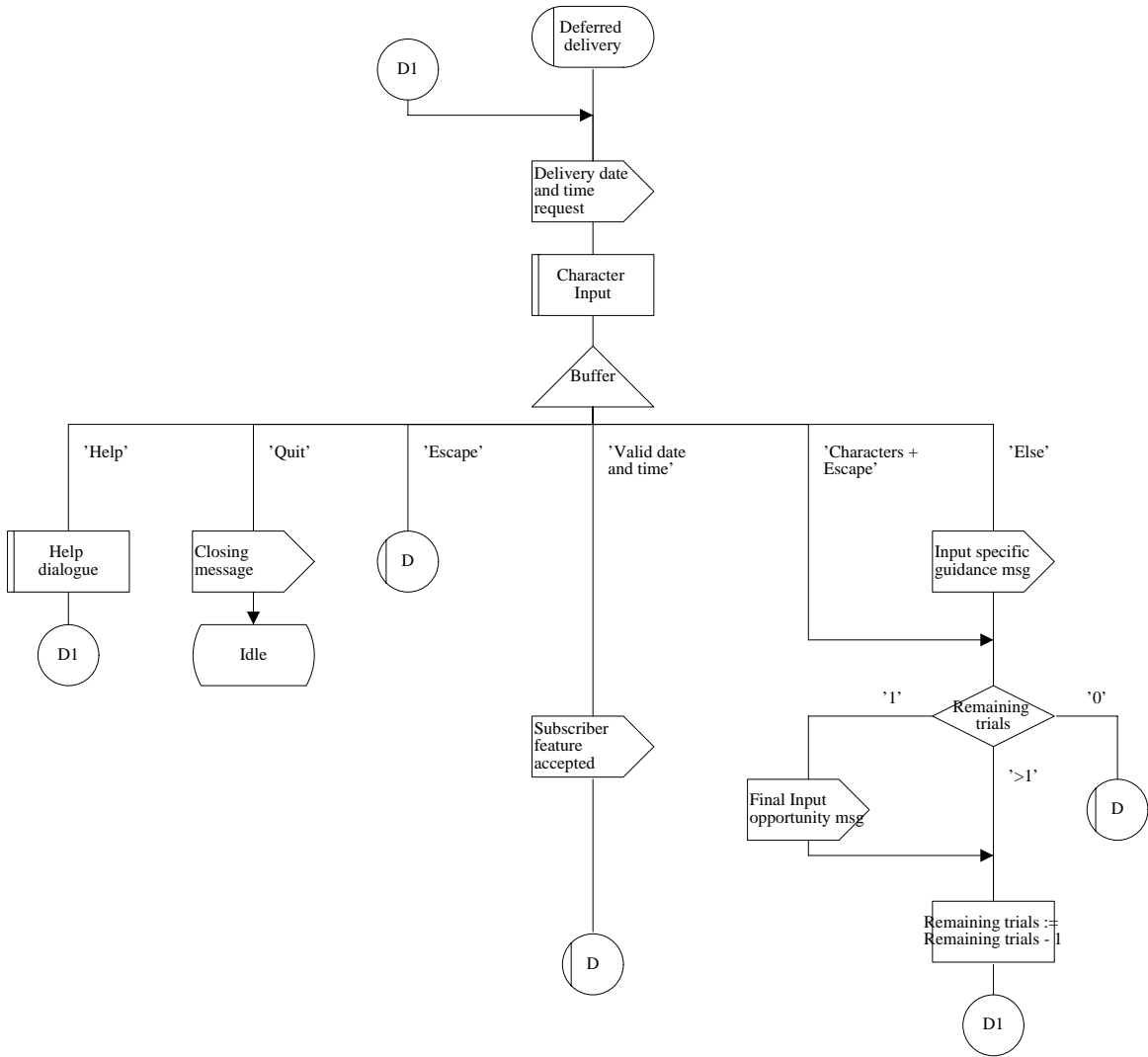

Figure D.3.7: Deferred delivery

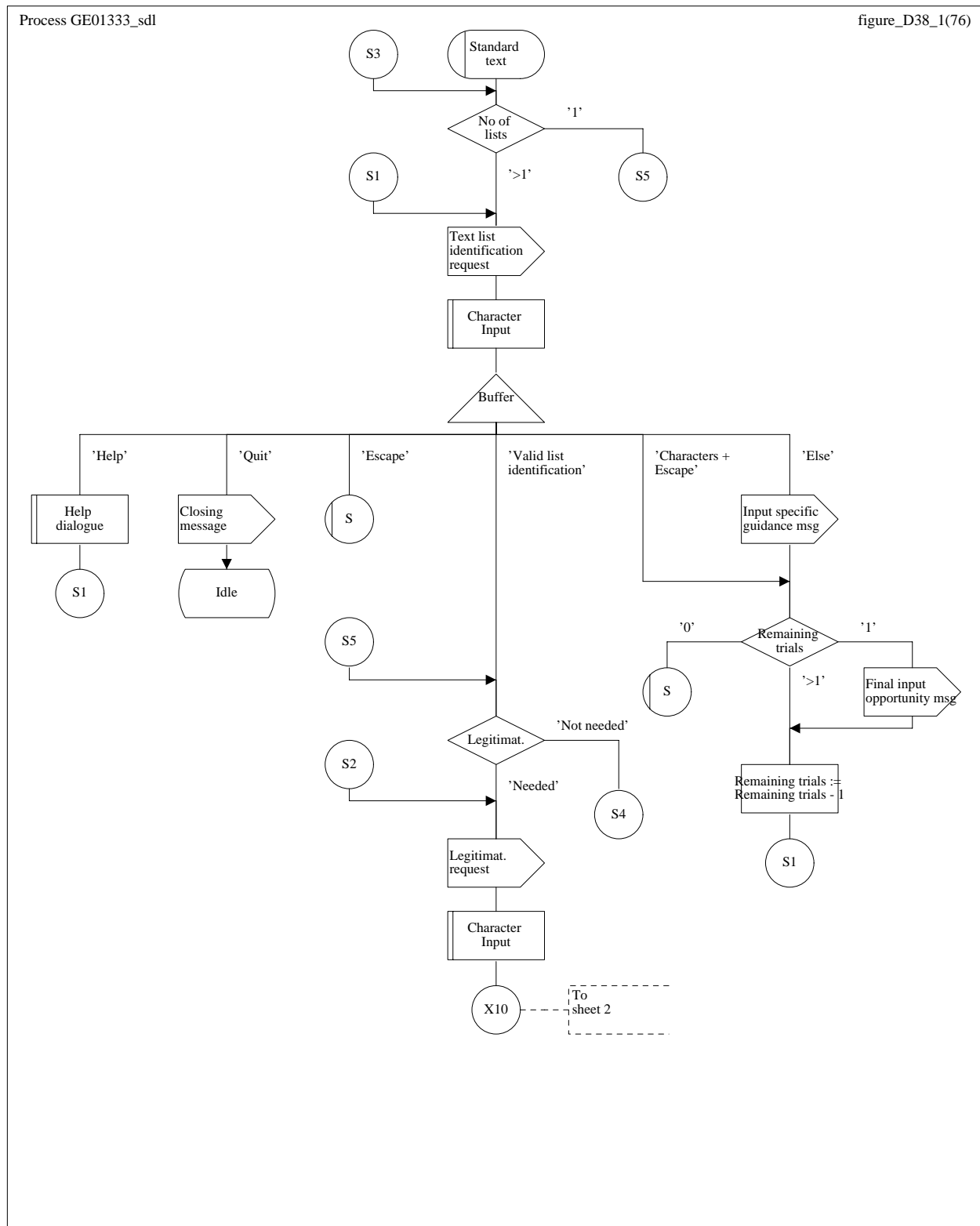

Figure D.3.8 (sheet 1 of 2): Standard text dialogue

Process GE01333_sdl

figure_D38_2(76)

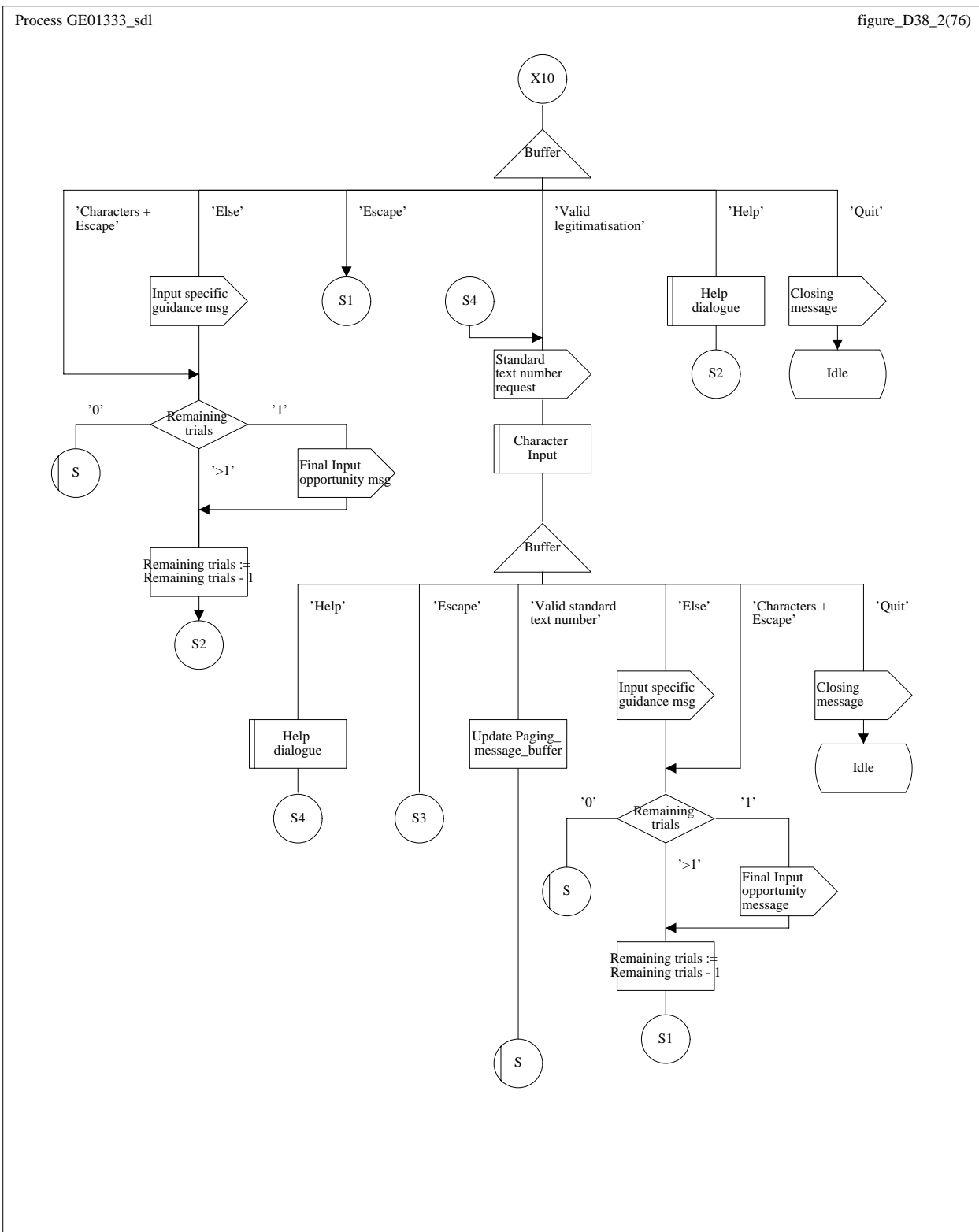

Figure D.3.8 (sheet 2 of 2): Standard text dialogue

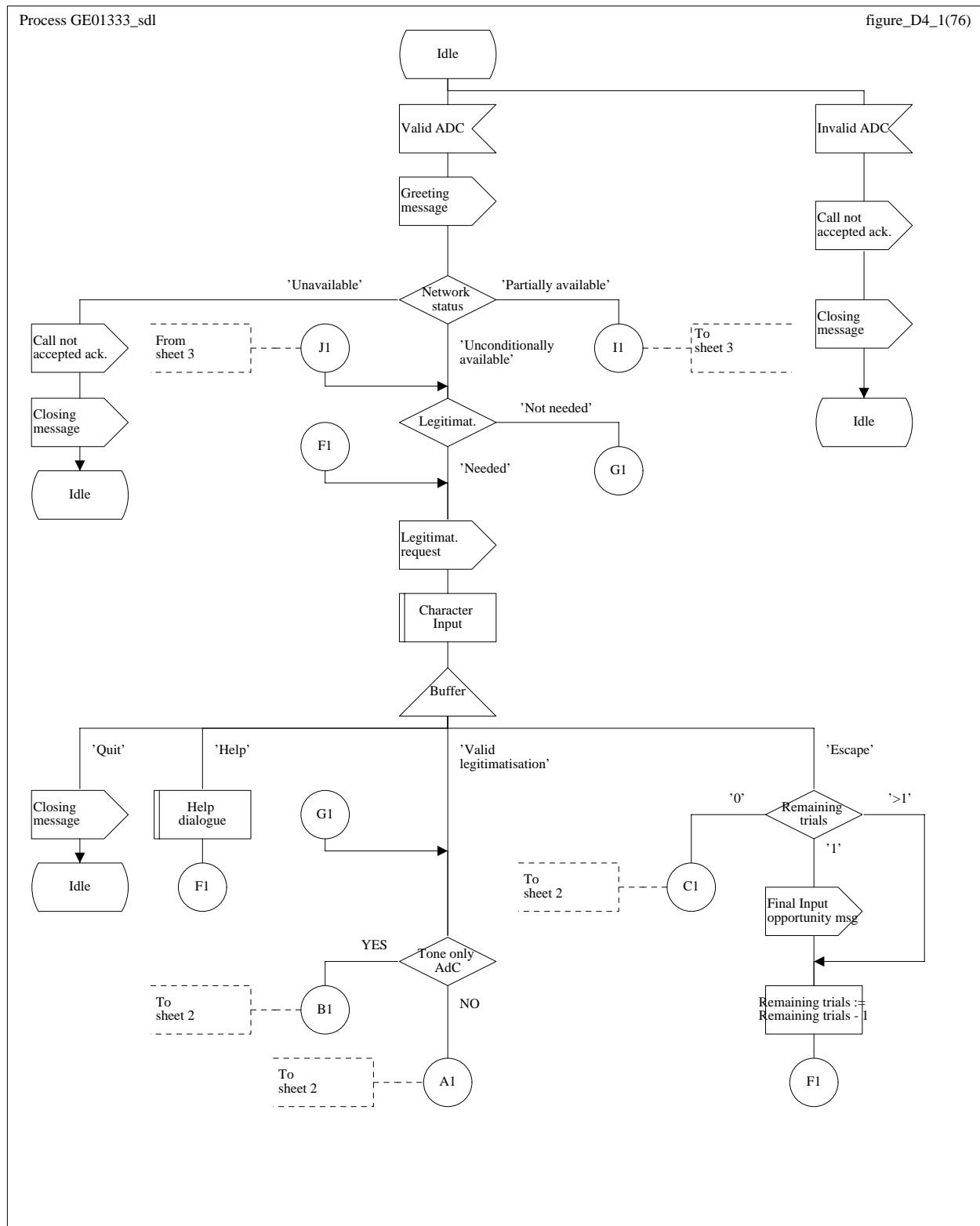

Figure D.4 (sheet 1 of 3): One-stage selection protocol for page input - interactive mode

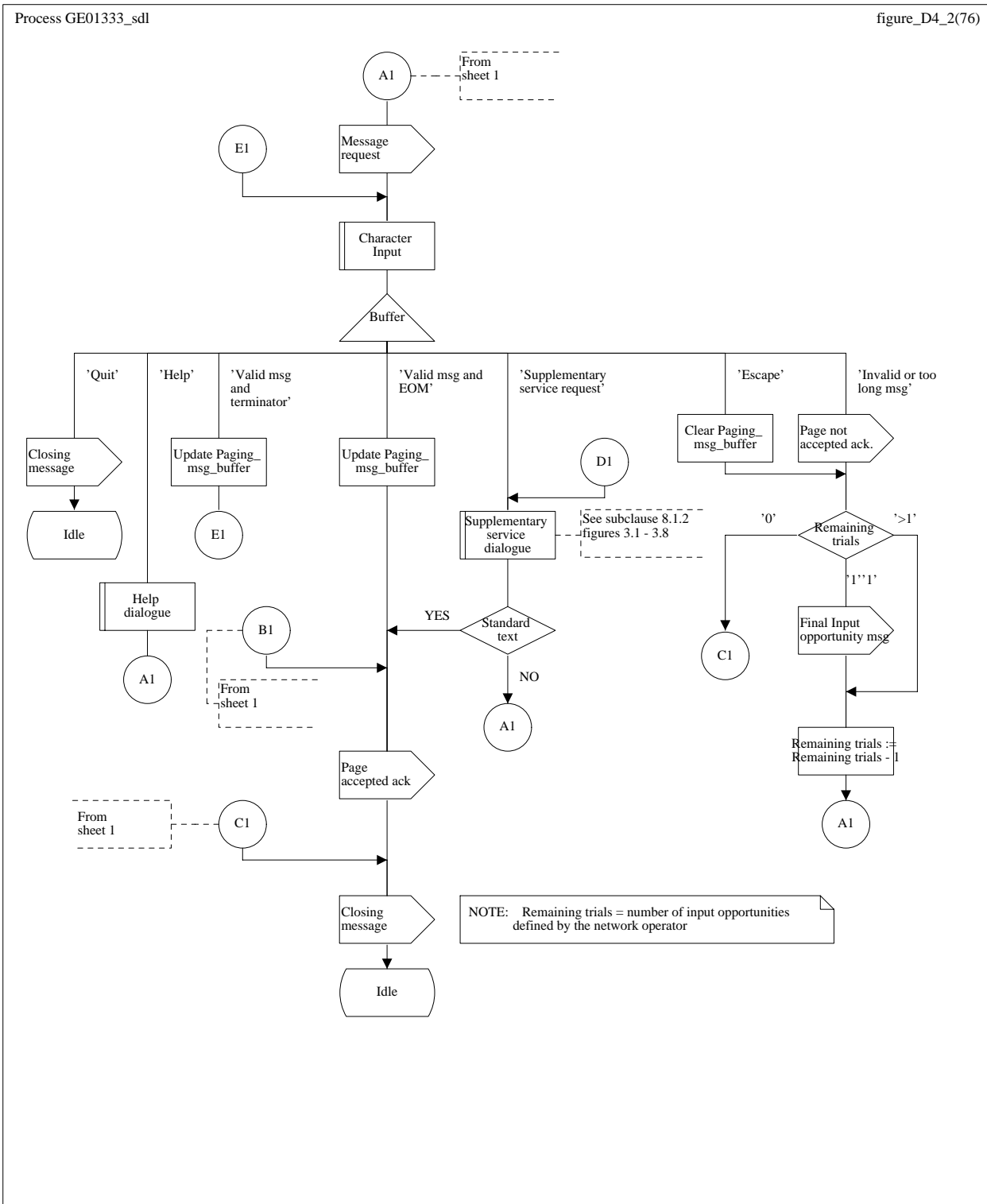

Figure D.4 (sheet 2 of 3): One-stage selection protocol for page input - interactive mode

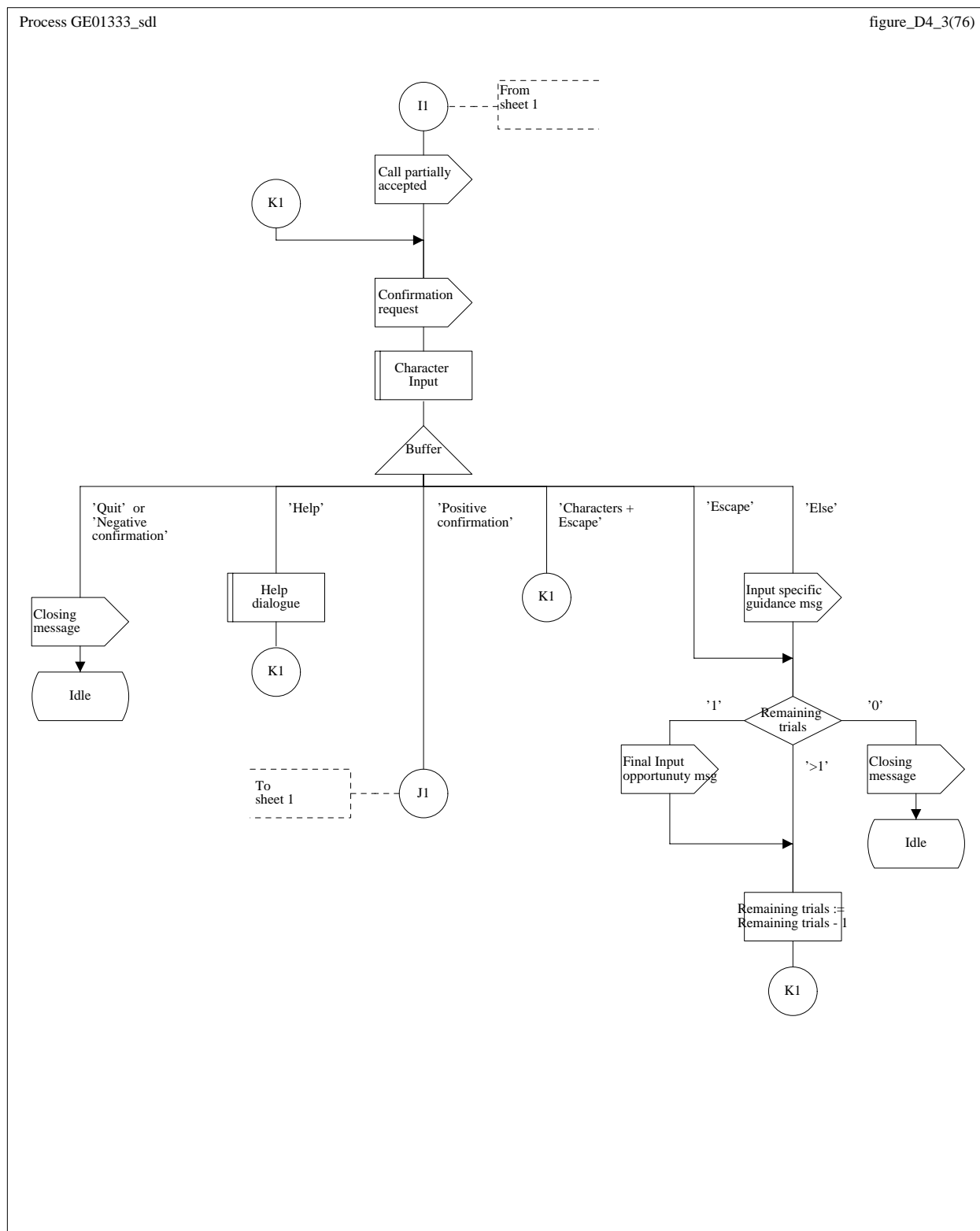

Figure D.4 (sheet 3 of 3): One-stage selection protocol for page input - interactive mode

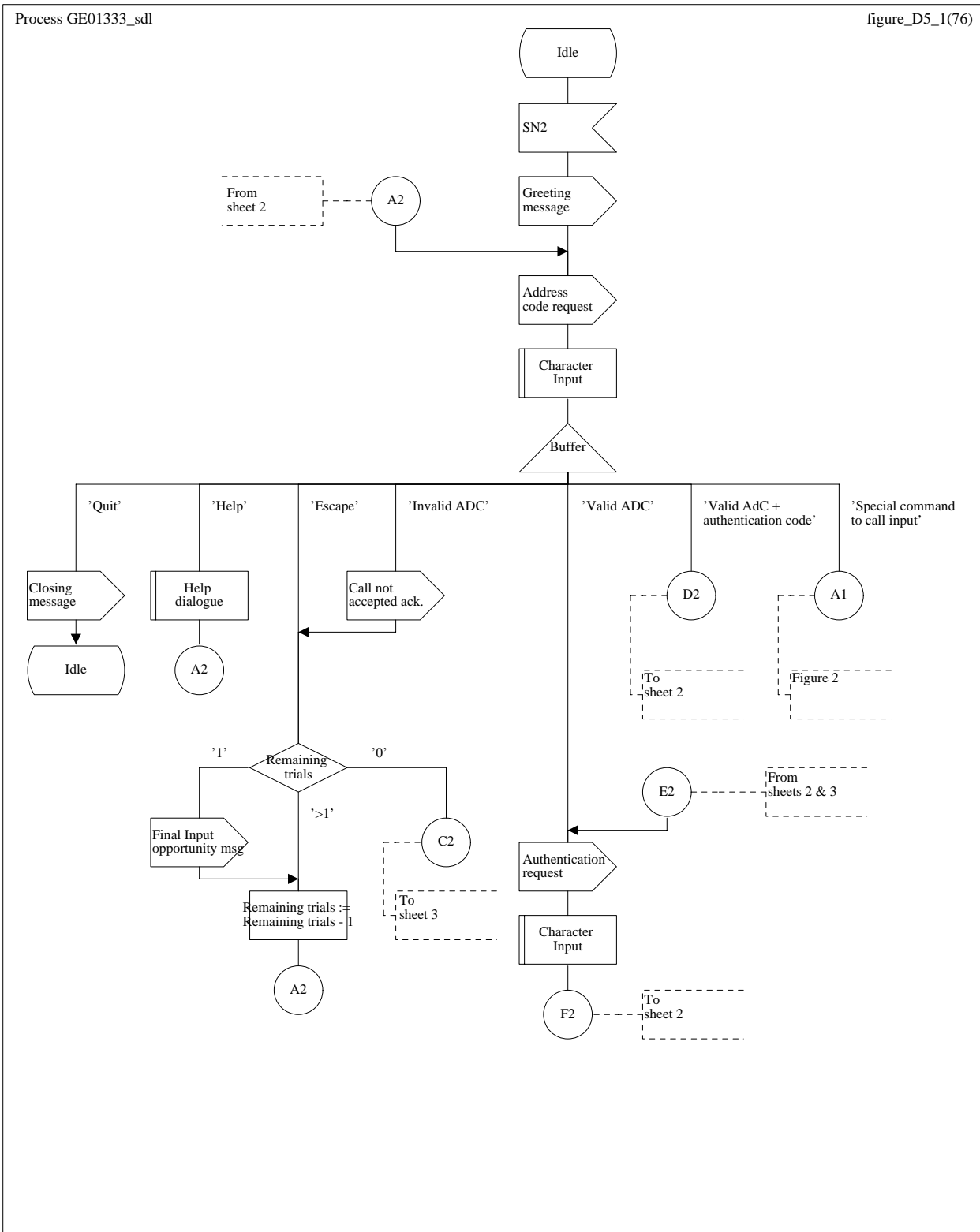

Figure D.5 (sheet 1 of 2): Two-stage selection protocol via service number 2

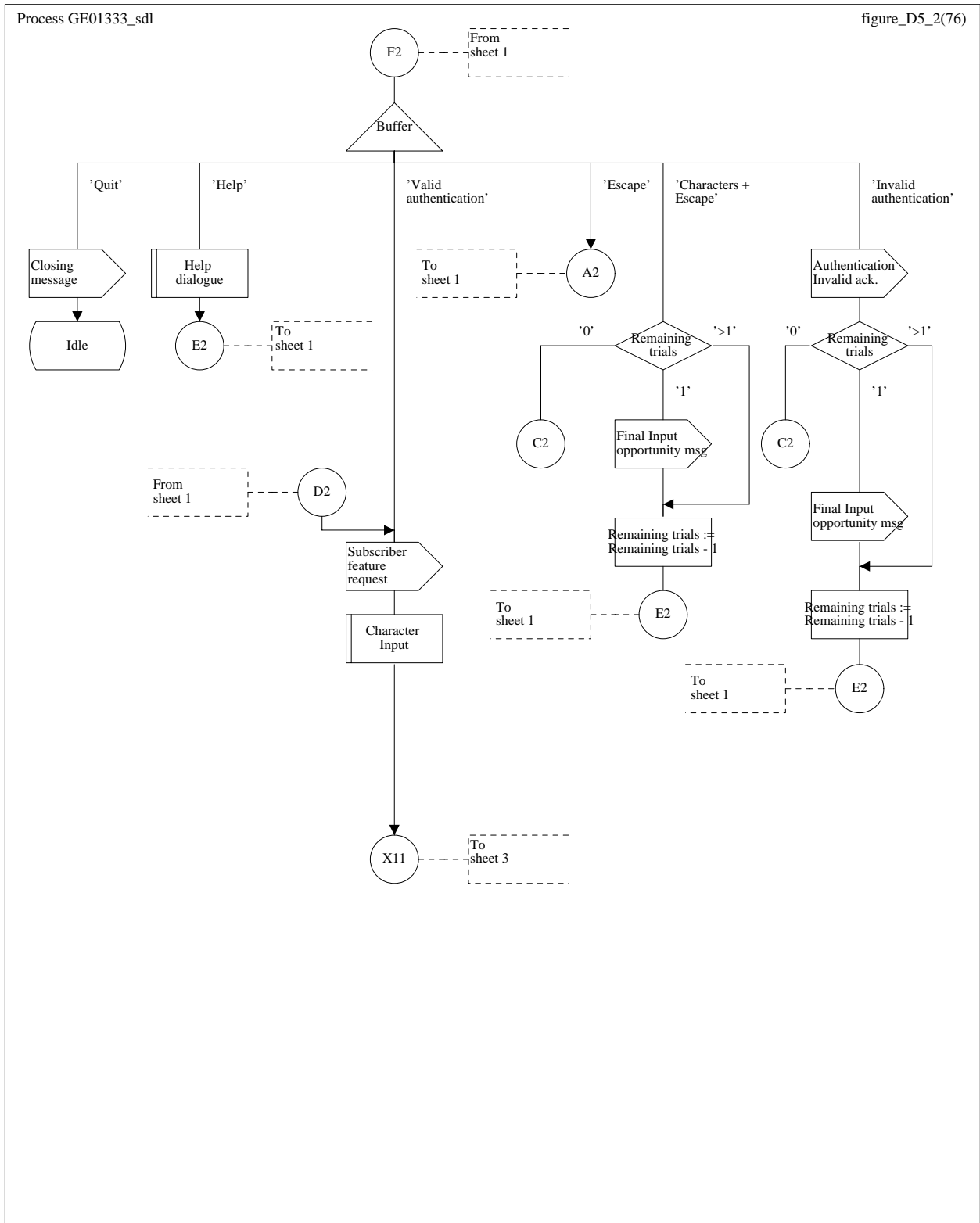

Figure D.5 (sheet 2 of 2): Two-stage selection protocol via service number 2

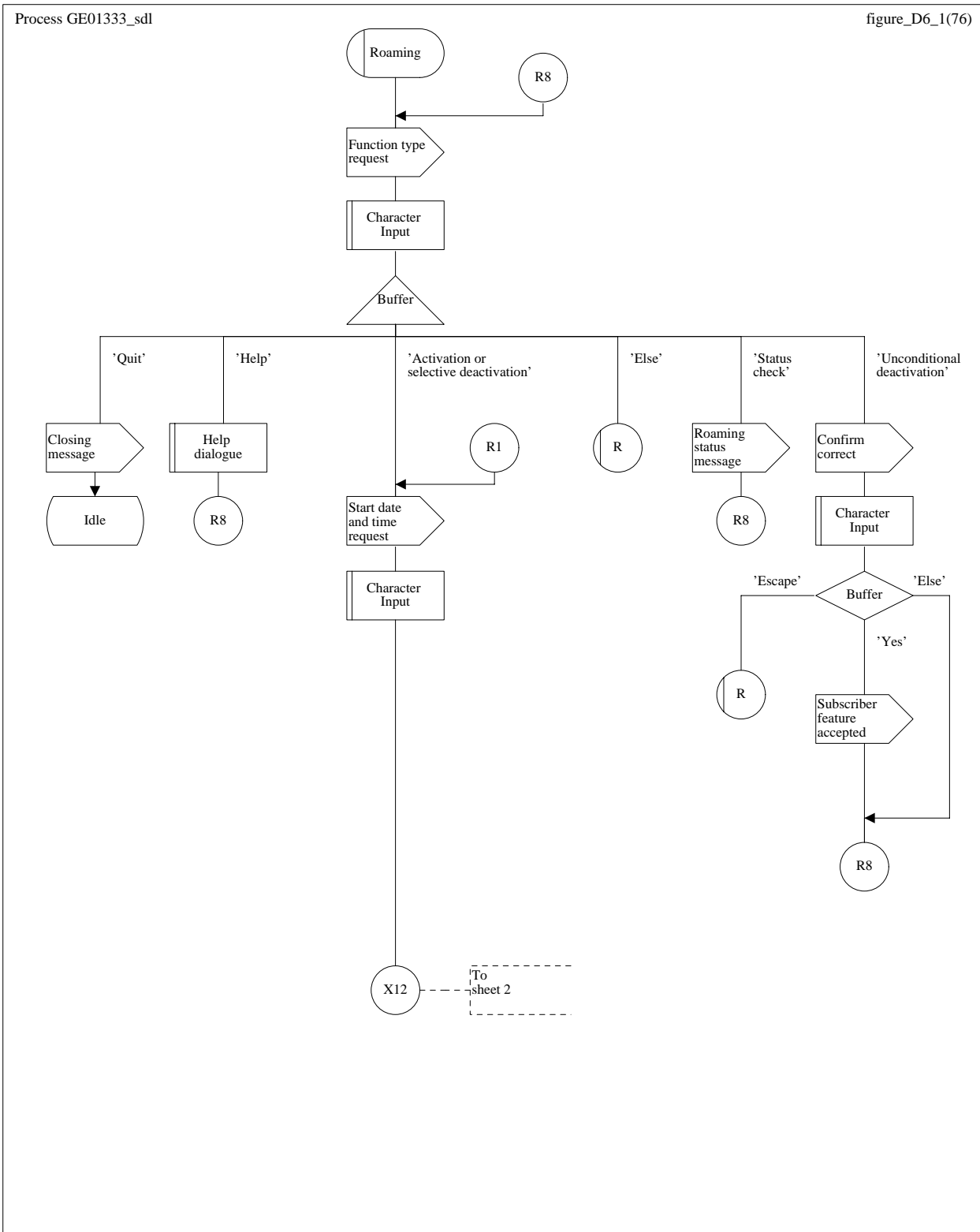

Figure D.6 (sheet 1 of 6): Roaming dialogue

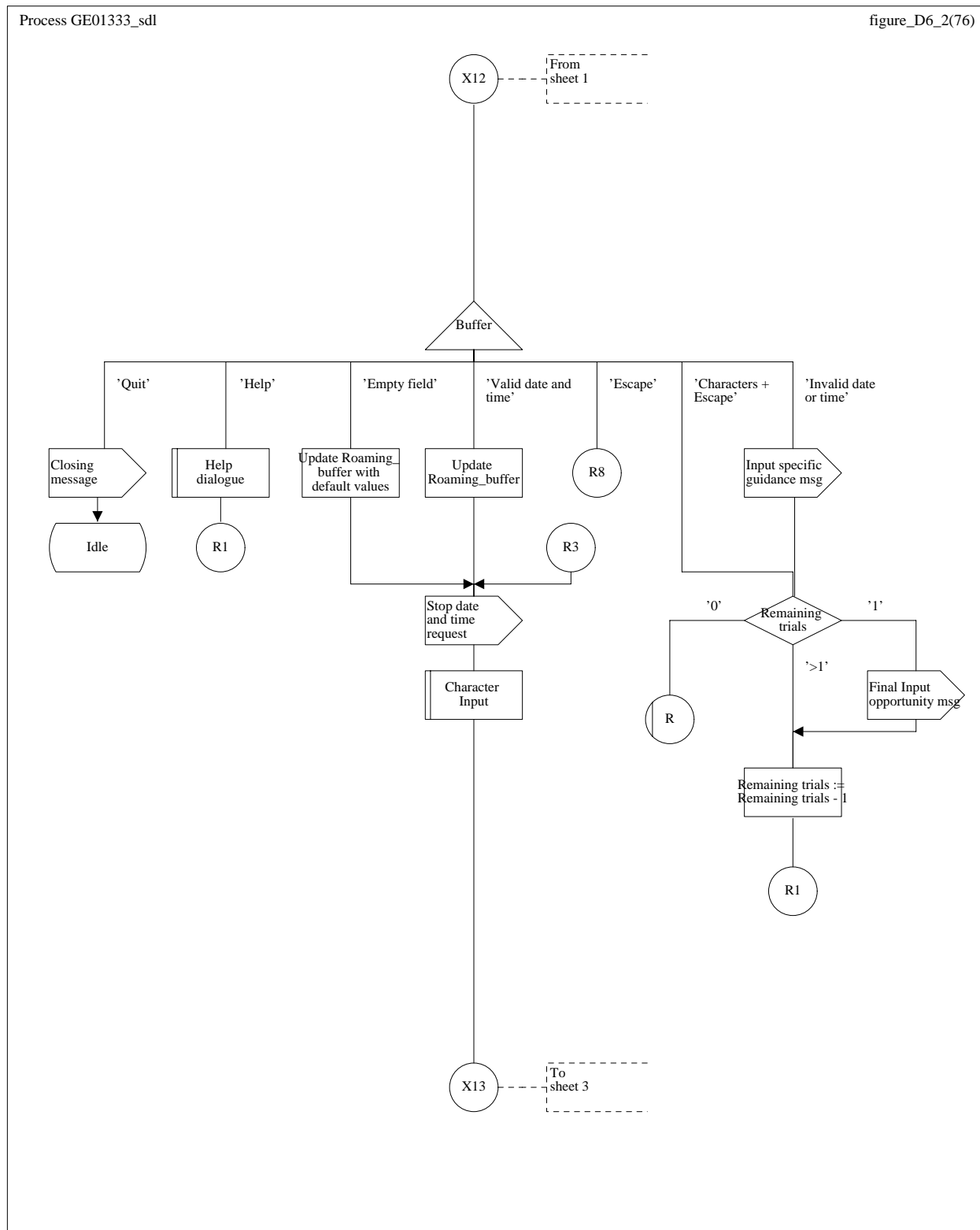

Figure D.6 (sheet 2 of 6): Roaming dialogue

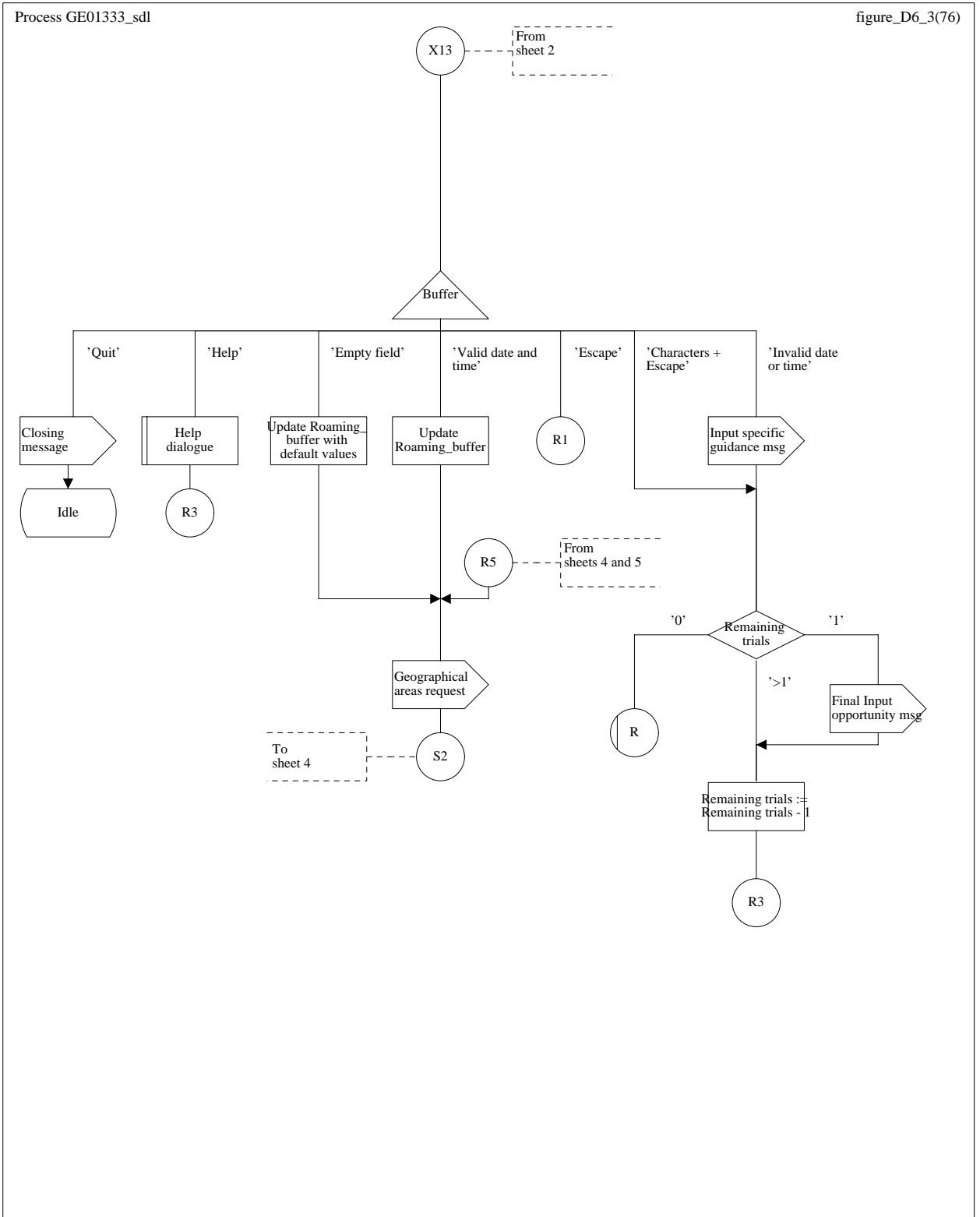

Figure D.6 (sheet 3 of 6): Roaming dialogue

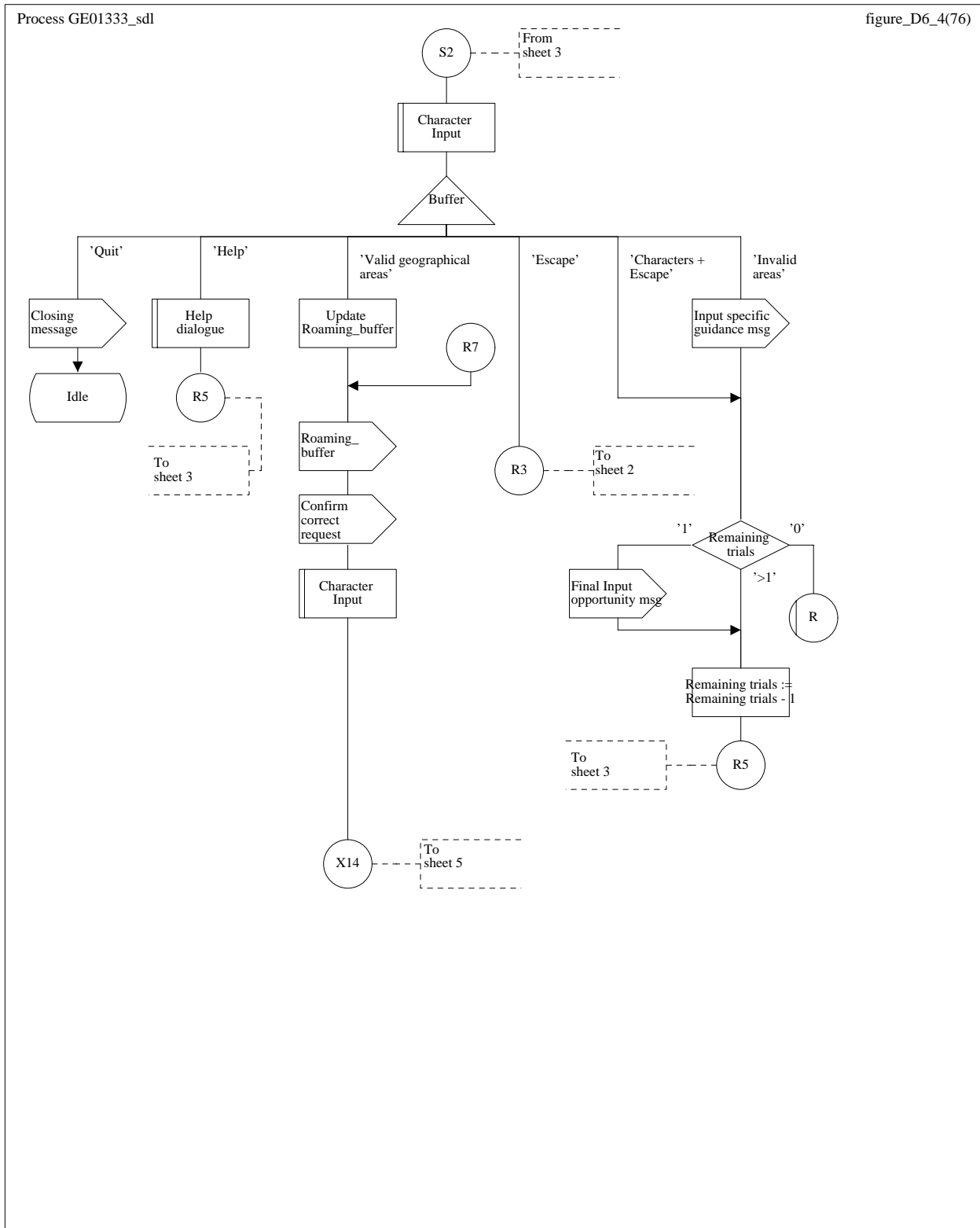

Figure D.6 (sheet 4 of 6): Roaming dialogue

Process GE01333_sdl

figure_D6_5(76)

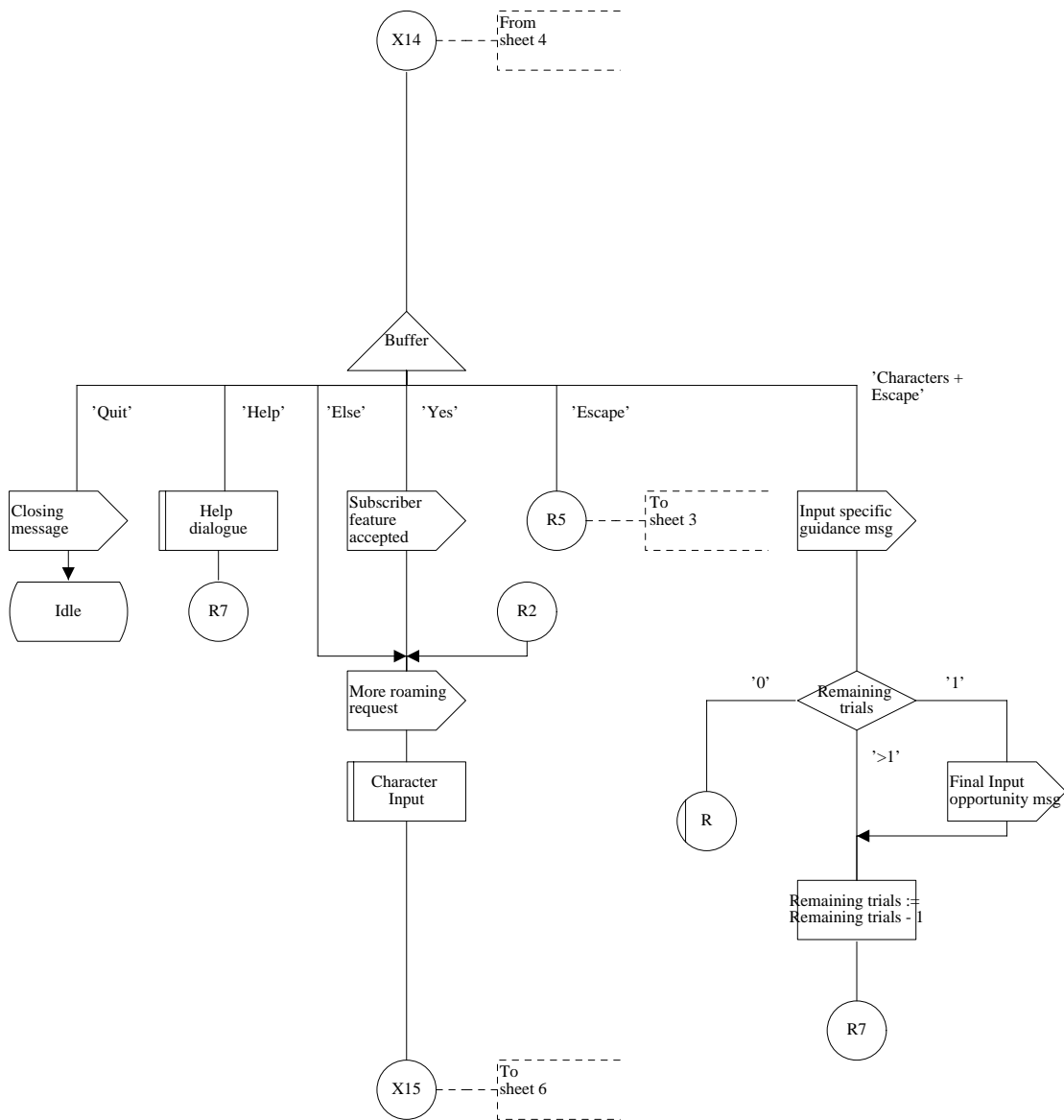

Figure D.6 (sheet 5 of 6): Roaming dialogue

Process GE01333_sdl

figure_D6_6(76)

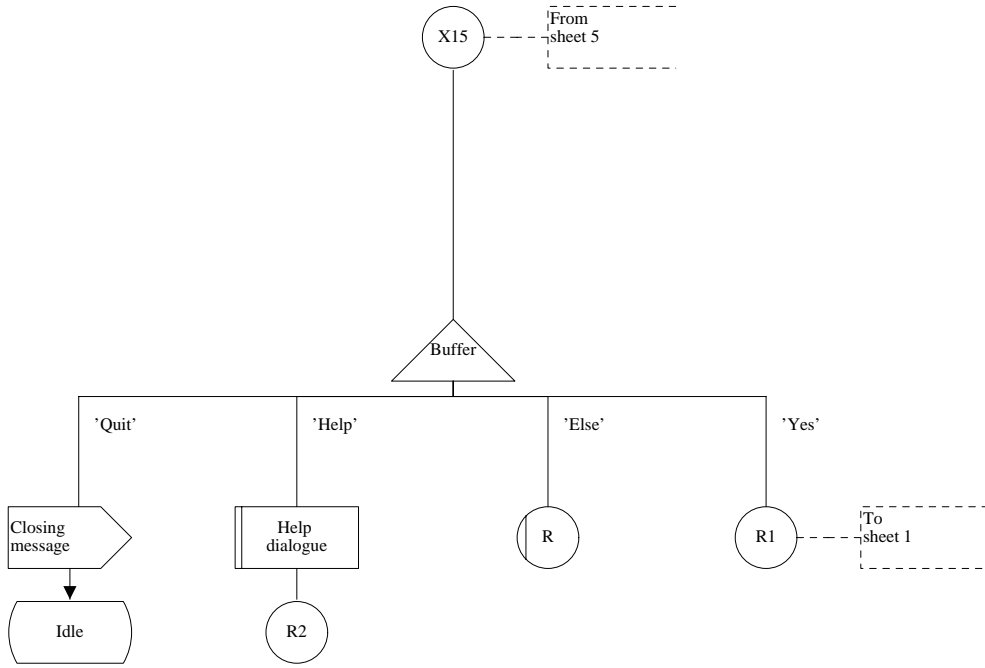

Figure D.6 (sheet 6 of 6): Roaming dialogue

Annex E (normative): PNC I4 ROSE operations**E.1 General**

The PNC I4 ROSE operations in table E.1 are defined:

Table E.1: ROSE operations

I4 ROSE OPERATION	OPERATION PARAMETER	OPERATION ACK
Pager Information	PG-info-Par	PG-info-Ack
Choice of Destination	CH-dest-Par	CH-dest-Ack
Page Request	PG-req-Par	PG-Req-Ack
Transmit	Transmit-Par	Transmit-Ack
Roaming Validation	Ro-Valid-Par	Ro-Valid-Ack
Roaming Reset	Ro-Reset-Par	Ro-Reset-Res
Roaming Information	Ro-Infor-Par	Ro-Info-Ack
Change Roaming	Ro-Change-Par	Ro-Change-Ack
Confirm Change of Roaming	Ro-Confirm-Par	Ro-Confirm-Res
Call Diversion Start	Divert-start-Par	Divert-start-Res
Call Diversion Stop	Divert-Stop-Par	Divert-Stop-Res

The operations and associated parameters are defined in the following tables. The data formats are specified in annex F.

E.1.1 Pager information operation

Table E.2 details the parameter within a Pager Information operation.

Table E.2: Operation parameters

Parameter	Parameter Type (note)	Presence in SDU	Description
AdC	Octet string	Mandatory	AdC for which information is required
NOTE: See annex F.			

E.1.1.1 Pager information operation - positive result

Table E.3 lists the parameters which may be included within a positive result to a pager information operation. The parameters listed as mandatory shall always be present, the parameters listed as optional may or may not be present depending on the SFs for the pager.

Table E.3: Positive result parameters

Choice Element	Parameter	Parameter Type (note 7)	Subsidiary information (note 8)	Presence in SDU	Description
MTB			Y TBT	MC (note 1)	Mobile invoked Temporary barring
DAdC	DAdC	Octet string	N	MC (note 1)	AdC to which calls are to be diverted
PAGER				MC (note 1)	Pager Information (Params. as below)
	PT	Integer	N	M	Pager Type (Tone, Num.,Alpha.,Trans.)
	CS	Integer	Y LCS	O	Possible character set or list of character sets (note 6)
	MC	Integer	N	O (note 2)	Maximum message length for pager
	STS	Boolean	N	M	Status of mobile sub's SA
	CL	Boolean	Y LCL	O	Legitimation required for all calls
	PR1	Boolean	Y PR1L	O	Priority 1 calls (note 3)
	PR3	Boolean	Y PR3L	O	Priority 3 calls (note 4)
	UR	Boolean.	Y URL	O	Urgent message indicator
	DD	Boolean	Y DDT	O	Deferred delivery (notes 4 and 5)
	MDD	Boolean	Y DDM	O	Mobile invoked Deferred delivery
	ST	Boolean	Y MST	O	Standard Text messages (notes 4 and 5)
	RP	Boolean	N	O	Repetition (note 4)
	RC	Boolean	Y RCL	O	Reverse charging
	GAdC	Boolean	N	O	Flag denoting AdC is a Group AdC
<p>Y = Yes, N = No, M = Mandatory, O = Optional</p> <p>NOTE 1: An MTB, DAdC or a PAGER choice element shall be present (with their respective associated data parameters, if applicable).</p> <p>NOTE 2: This parameter shall be present if the pager type is not tone-only.</p> <p>NOTE 3: Priority 1 messages cannot be accepted if the mobile has invoked DD.</p> <p>NOTE 4: This feature could vary between MSs for a given PNC-H or could be available as a standard feature for all MSs for a given PNC-H. If it is a standard feature then there is no need to transfer this parameter for each pager. The availability of such standard features could be in a parameter file (held at each PNC) of the standard facilities available for all other PNCs within the ERMES network.</p> <p>NOTE 5: Information on the maximum acceptable (deferral time /text list number) may also be included with this data element, but this information may alternatively be agreed between operators as a global limit(s) held in a local parameter file to be applied to all calls using this feature input to the PNC-I for the applicable PNC-H.</p> <p>NOTE 6: The CS parameter shall be present if the receiver has other character sets than the ERMES character set.</p> <p>NOTE 7: See annex F.</p> <p>NOTE 8: See table E.4 of subsidiary information.</p> <p>NOTE 9: The pager may have other SFs, some only available within the Home Network, others which are permanently or temporarily subscribed to by the mobile subscriber, but which are always invoked and therefore there is no need to advise the PNC-I of the details of such features.</p>					

Table E.4 lists the parameters which may be included within a positive result to a pager information operation, but may only be present if the relevant associated parameter is present within the result data. The parameters listed as mandatory shall always be present, the parameters listed as optional may or may not be present depending on the SFs for the pager.

Table E.4: Subsidiary information associated with positive result parameters

Parameter	Associated Parameter (note 1)	Presence in SDU	Description
LCS	CS	O	Character set or list of character sets of the receiver
LCL	CL	O	Legitimation Code (for all calls)
PR1L	PR1	O	Legitimation Code (for Priority 1)
URL	UR	O	Legitimation Code (for Urg.mess.ind.)
DDT	DD	O	Maximum deferral time for MS message
DDM	MDD	O	Deferred delivery MS message
TBT	MTB	O (note 2)	End of Temporary barring time
TBM	MTB	O (note 2)	Temporary barring MS message
MST	ST	O	Maximum allowable text list number
RCL	RC	O	Legitimation code (for Rev. charging)
PR3L	PR3	O	Legitimation code (for priority 3)
O = Optional			
NOTE 1: See the table E.3 of positive result parameters.			
NOTE 2: Either a TBT or a TBM parameter shall be present (or neither).			

E.1.1.2 Pager information operation - negative result parameters

The following error parameters may be returned within a negative result to a pager information operation:

- AdC not valid: An indication that the AdC within the operation request is not valid.
- AdC out of service: An indication that the AdC is temporarily out of service.
- low network status: An indication that the availability or transmission delay within the SA for the AdC is below the call acceptance threshold.

E.1.2 Choice of destination operation

Table E.5 lists the parameters which may be included within a choice of destination operation. The parameters listed as mandatory shall always be present, the parameters listed as optional may or may not be present depending on the pager features invoked by the calling party.

Table E.5: Operation parameters

Parameter	Parameter Type (note)	Presence in SDU	Description
AdC	Octet string	Mandatory	AdC to be paged
GAs	Octet string	Mandatory	List of additional GAs requested by the calling party
NOTE: See annex F.			

E.1.2.1 Choice of destination operation (positive result)

Table E.6 lists the parameters which may be included within a Choice of Destination Operation Positive Result. The parameters listed as mandatory shall always be present, the parameters listed as optional may or may not be present depending on the pager features invoked by the calling party.

Table E.6: Positive result parameters

Parameter	Parameter Type (note)	Presence in SDU	Description
ST	Boolean	Mandatory	Combined status of the MS's SA and the GAs requested within the choice of destination operation.
NOTE: See annex F.			

E.1.2.2 Choice of destination operation (negative result)

The following error parameters may be returned within a negative result to a choice of destination operation:

- AdC not valid: An indication that the AdC within the operation request is not valid.
- AdC out of service: An indication that the AdC is temporarily out of service.
- GAs not valid: An indication that one (or more) of the GAs within the operation request is not valid.
- low network status: An indication that the availability or transmission delay within the SA for the AdC is below the call acceptance threshold.

E.1.3 Page request operation

Table E.7 lists the parameters which may be included within a page request operation. The parameters listed as mandatory shall always be present, the parameters listed as optional may or may not be present depending on the pager features invoked by the calling party.

Table E.7: Operation parameters

Parameter	Choice element	Parameter Type (note 5)	Presence in SDU	Description
AdC1		Octet string	M	First Adc to be paged
AdCn		Octet string	O (note 1)	List of AdCs with-in grp.call Pg.Req.
PT		Integer	M	Pager Type (Tone, Num.,Alpha.,Trans.)
	TO	Boolean	MC (note 2)	Flag to indicate tone-only pager
	ST	Integer	MC (note 2,3)	Standard text message req.(+text no.)
	PM	Octet string	MC (note 2)	Message
CS		Integer	O	Chosen character set for message (note 4)
GAs		Octet string	O	GAs requested in in Choice dest. SS.
PR		Integer	O	Priority 1 or 3 call request
UR		Boolean	O	Urgent message indicator requested
DD		I4Time	O	Deferred delivery req. (+ del. time)
RP		Boolean	O	Repetition requested
RC		Boolean	O (note 3)	Reverse charging requested
<p>M = Mandatory, MC = Mandatory Choice, O = Optional</p> <p>NOTE 1: AdCn parameter(s) shall only be present if the page request operation is for a group call.</p> <p>NOTE 2: A PM, or an ST, or a TO parameter shall be present (ASN.1 choice elements - see annex F).</p> <p>NOTE 3: Standard text messages and reverse charging are possible for page request operations for a GAdC, but are not possible for a page request operation to individual AdCs within a group list (also in the case that the group list has only one AdC in an external network, it will be placed in the parameter "AdCn" and not in the parameter "AdC1").</p> <p>NOTE 4: The CS parameter shall be present if the character set corresponding to the message is not the ERMES character set.</p> <p>NOTE 5: See annex F.</p>				

E.1.3.1 Page request operation (positive result)

An acknowledgement parameter is included within a positive result to a page request operation.

If any AdCs within the page request (for a group call operation) are invalid then they shall be indicated in an error report within the positive result.

E.1.3.2 Page request operation (negative result)

The following error parameters may be returned within a negative result to a page request operation.

- All AdCs not valid: An indication that all AdCs (or one if only one AdC was included) within the operation are invalid.

E.1.4 Transmit operation

Table E.8 lists the parameters which may be included within a transmit operation. The parameters listed as mandatory shall always be present, the parameters listed as optional may or may not be present depending on the pager features invoked by the calling party.

Table E.8: Operation parameters

Choice element	Parameter	Parameter Type (note 8)	Presence in SDU	Description
	RIC1	Octet string	M	First RIC to be paged
	NL	Integer	O (note 1)	Transmit Cycles for RIC1 (NL value)
	SM1	Octet string	O (note 2)	Transmit Subsequ. for RIC1 (SM mask)
	FSN1	Integer	M	Frequency Sub-set Number for RIC1
	AF1	Integer	M	Alert function for RIC1
	MN1	Integer	M	Message number for RIC1
	GAs1	Octet string	M	List of GAs in which to page RIC1
	MSI1	Boolean	O	Message split indicator for RIC1
	PR1	Integer	O	Priority 1 or 3 call requested
	UMI1	Boolean	O	Urgent message indicator requested
	RICn	Octet string	O (note 3)	list of RICs for grp call Operation
	TCn	Integer	O (note 1)	Transmit Cycles for RICn (NLn value)
	TSn	Octet string	O (note 2)	Transmit Subsequ for RICn (SMn mask)
	FSNn	Integer	O (note 4)	Frequency Sub-set Number for RICn
	AFn	Integer	O (note 4)	Alert function for RICn
	MNn	Integer	O (note 4)	Message number for RICn
	GAsn	Octet string	O (note 4)	List of GAs in which to page RICn
	MSIn	Boolean	O	Message split indicator for RICn
	PRn	Integer	O	Priority 1 or 3 call requested
	UMIn	Boolean	O	Urgent message indicator requested
	ECN	Integer	M	ERMES Code Number for pager(s)
	PT	Integer	M	Pager Type (Tone, Num., Alpha., Trans.)

(continued)

Table E.8 (concluded): Operation parameters

Choice element	Parameter	Parameter Type (note 8)	Presence in SDU	Description
	CS	Integer	O	Chosen character set for message (note 7)
TO		Boolean	MC (note 5)	Flag to indicate tone-only pager
AT		Boolean	MC (note 5 and 6)	Automatic transm. of last mess. No.)
PM		Octet string	MC (note 5)	Message
<p>M = Mandatory, MC = Mandatory Choice, O = Optional</p> <p>NOTE 1: This parameter shall only be included if there is a restriction on the transmission cycles in which the call may be transmitted differ from the default value of NL=2.</p> <p>NOTE 2: This parameter shall only be included if there is a restriction on the transmission subsequences in which the call may be transmitted. (For most pagers there is no restriction).</p> <p>NOTE 3: RICn parameter(s) and associated parameters shall only be present if the transmit operation is for a group call.</p> <p>NOTE 4: These parameters shall be present if an RICn parameter is present.</p> <p>NOTE 5: A PM, or an AT, or a TO parameter shall be present (ASN.1 choice elements - see annex F).</p> <p>NOTE 6: Automatic transmission of the last message number is not applicable to group call transmit operations.</p> <p>NOTE 7: The CS parameter shall be present if the character set corresponding to the message is not the ERMES character set.</p> <p>NOTE 8: See annex F.</p>				

E.1.4.1 Transmit operation (positive result)

An acknowledgement parameter is included within a positive result to a transmit operation.

If any RICs within the transmit operation (for a group call operation) are invalid then they shall be indicated in an error report within the positive result.

E.1.4.2 Transmit operation (negative result)

The following error parameter be returned within a negative result to a transmit operation:

- All RICs not valid: An indication that all RICs (or one if only one RIC was included) within the operation are invalid.
- GAs not valid: An indication that one (or more) of the GAs within the operation request is not valid.

E.1.5 Roaming validation operation

Table E.9 lists the parameters which may be included within a roaming validation operation. The parameters listed as mandatory shall always be present.

Table E.9: Operation parameters

Parameter	Parameter Type (note)	Presence in SDU	Description
AdC	Octet string	Mandatory	AdC for which transaction is requested
AC	Octet string	Mandatory	Authentication Code
NOTE: See annex F.			

E.1.5.1 Roaming validation operation (positive result)

An acknowledgement parameter is included within a positive result to a roaming validation operation.

E.1.5.2 Roaming validation operation (negative result)

The following error parameters may be returned within a negative result to a roaming validation operation:

- AdC not valid: An indication that the AdC within the operation request is not valid.
- AdC out of service: An indication that the AdC is temporarily out of service.
- Authentication fail: An indication that the Authorization Code included within the operation is not valid.

E.1.6 Roaming reset operation

Table E.10 lists the parameters which may be included within a roaming reset operation. The parameters listed as mandatory shall always be present, the parameters listed as optional may or may not be present.

Table E.10: Operation parameters

Parameter	Parameter type(note)	Presence in SDU	Description
AdC	Octet string	Mandatory	AdC for which transaction is requested-
NOTE: See annex F.			

E.1.6.1 Roaming reset operation (positive result)

An acknowledgement parameter is included within a positive result to a roaming reset operation.

E.1.6.2 Roaming reset operation (negative result)

The following error parameter may be returned within a negative result to a roaming reset operation:

- AdC not valid: An indication that the AdC within the operation request is not valid.

E.1.7 Roaming information operation

Table E.11 lists the parameters which shall be included within a roaming information operation.

Table E.11: Operation parameters

Parameter	Parameter type (note)	Presence in SDU	Description
AdC	Octet string	Mandatory	AdC for which information is requested
NOTE: See annex F.			

E.1.7.1 Roaming information operation (positive result)

Table E.12 lists the parameters which may be included within a roaming information request operation positive result.

Table E.12: Positive result parameters

Parameter	Parameter type (note 2)	Presence in SDU	Description
GA1	Octet string	O	First GA for which a roaming record exists
ST1	I4Time	O (note 1)	Start time for roaming in GA1
SP1	I4Time	O (note 1)	Stop time for roaming in GA1
M = Mandatory, O = Optional A list with the same parameters as for GA1 follows, for all GAs for which a roaming record exists for the AdC referenced. NOTE 1: These parameters shall be present if a GA1 parameter is included in the operation result. NOTE 2: See annex F.			

E.1.7.2 Roaming information operation (negative result)

The following error parameter may be returned within a negative result to a roaming information operation:

- AdC not valid: An indication that the AdC within the operation request is not valid.

E.1.8 Change roaming operation

The change roaming operation does not result in the change of the MS's roaming records, but only allows him to see what the result of the changes requested in his roaming records would be. The MS roaming records are only changed as the result of a confirm change of roaming operation.

Table E.13 lists the parameters which may be included within a change roaming operation. The parameters listed as mandatory shall always be present, the parameters listed as optional may or may not be present.

Table E.13: Operation parameters

Parameter-	Parameter type (note)	Presence in SDU	Description
AdC	Octet string	M	AdC for which change of roaming is requested
GA1	Octet string	M	1st GA to add to/delete from mobile subscriber's roaming records
ST1	I4Time	M	Start time for change in GA1
SP1	I4Time	M	Stop time for change in GA1
A/D	Boolean	M	Add to/delete from mobile subscriber's roaming
A list with the same parameters as for GA1 follows, for all GAs for which the mobile subscriber has requested changes. M = Mandatory, O = Optional NOTE: See annex F.			

E.1.8.1 Change roaming operation (positive result)

The positive result of a change roaming operation details the dates and times during which roaming shall be provided for those GAs affected by the information input by the MS. Other roaming records may exist, but are not detailed in the result.

Table E.14 lists the parameters which may be included within a change roaming request operation positive result. The parameters listed as mandatory shall always be present, the parameters listed as optional may or may not be present.

Table E.14: Positive result parameters

Parameter-	Parameter type (note 2)	Presence in SDU	Description
GA1	Octet String	O	1st GA affected by changes requested
ST1	I4Time	O (note 1)	Start time for roaming in GA1
SP1	I4Time	O (note 1)	Stop time for roaming in GA1
A list with the same parameters as for GA1 follows, for all GAs affected by the change roaming operation. M = Mandatory, O = Optional NOTE 1: These parameters shall be present if a GA1 parameter is included in the operation result. (No roaming GA records would exist if the MS has deleted all roaming as a result of the change roaming operation). NOTE 2: See annex F.			

E.1.8.2 Change roaming operation (negative result)

The following error parameters may be returned within a negative result to a change roaming operation:

- AdC not valid: An indication that the AdC within the operation request is not valid.

- Error on GAs added: An indication that the roaming GA(s) included within the operation to be added to the MSs roaming record is (are) invalid.
- Error on GAs deleted: An indication that the roaming GA(s) included within the operation to be deleted from the MSs roaming record is (are) invalid.
- Error on start time: An indication that the start time(s) included within the operation is (are) invalid.
- Error on stop time: An indication that the stop time(s) included within the operation is (are) invalid.

E.1.9 Confirm change of roaming operation

The confirm change of roaming operation results in the amendment of the MS roaming records held on the PNC-H of the MS.

Table E.15 lists the parameters which may be included within a confirm change of roaming operation. The parameters listed as mandatory shall always be present, the parameters listed as optional may or may not be present.

Table E.15: Operation parameters

Parameter	Parameter type (note)	Presence in SDU	Description
AdC	Octet string	M	AdC for which change of roaming is confirmed
GA1	Octet	M	1st GA to add to/delete from mobile subscriber's roaming records
ST1	I4Time	M	Start time for change in GA1
SP1	I4Time	M	Stop time for change in GA1
A/D	Boolean	M	Add to/delete from mobile subs roaming
NOTE:	A list with the same parameters as for GA1 follows, for all GAs for which the mobile subscriber has confirmed changes. M = Mandatory, O = Optional See annex F.		

E.1.9.1 Confirm change of roaming operation (positive result)

An acknowledgement parameter is included within a positive result to a confirm change of roaming operation.

E.1.9.2 Confirm change of roaming operation (negative result)

The following error parameters may be returned within a negative result to a confirm change of roaming operation:

- AdC not valid: An indication that the AdC within the operation request is not valid.
- Error on GAs added: An indication that the roaming GA(s) included within the operation to be added to the MSs roaming record is (are) invalid.

- Error on GAs deleted: An indication that the roaming GA(s) included within the operation to be deleted from the MSs roaming record is (are) invalid.
- Error on start time: An indication that the start time(s) included within the operation is (are) invalid.
- Error on stop time: An indication that the stop time(s) included within the operation is (are) invalid.

E.1.10 Call diversion start operation

The call diversion start operation is invoked by the PNC-H at the start of the period of call diversion requested by the MS, when the AdC of the pager to which calls are being diverted is not homed on the same PNC as the AdC from which calls are being diverted. It is used to inform the PNC-H of the AdC to which calls are to be diverted that call diversion has been initiated.

Table E.16 lists the parameters which may be included within a call diversion start operation.

Table E.16: Operation parameters

Parameter	Parameter type (note)	Presence in SDU	Description
AdC	Octet string	Mandatory	AdC to which calls are being diverted
AdCD	Octet string	Mandatory	AdC from which calls are being diverted
NOTE: See annex F.			

E.1.10.1 Call diversion start operation (positive result)

An acknowledgement parameter is included within a positive result to a Call Diversion Start operation.

E.1.10.2 Call diversion start operation (negative result)

The following error parameters may be returned within a negative result to a call diversion start operation:

- AdC to not valid: An indication that the AdC to which calls are to be diverted is not valid.
- AdC from not valid: An indication that the AdC from which calls are to be diverted is not valid.
- Call diversion already activated: An indication that the AdC has already activated a call diversion.

E.1.11 Call Diversion stop operation

The call diversion stop operation is invoked by the PNC-H at the end of the period of call diversion requested by the MS, when the AdC of the pager to which calls are being diverted is not homed on the same PNC as the AdC from which calls are being diverted. It is used to inform the PNC-H of the AdC to which calls are being diverted that call diversion has ceased.

Table E.17 lists the parameters which may be included within a call diversion stop operation.

Table E.17: Operation parameters

Parameter	Parameter type (note)	Presence in SDU	Description
AdC	Octet string	Mandatory	AdC to which calls were being diverted
AdCD	Octet string	Mandatory	AdC from which calls were being diverted
NOTE: See annex F.			

E.1.11.1 Call diversion stop operation (positive result)

An acknowledgement parameter is included within a positive result to a Call Diversion Stop operation.

E.1.11.2 Call diversion stop operation (negative result)

The following error parameters may be returned within a negative result to a call diversion stop operation.

- AdC to not valid: An indication that the AdC to which calls are to be diverted is not valid.
- AdC from not valid: An indication that the AdC from which calls are to be diverted is not valid.

E.2 Negative result parameters common to all operations

The three error parameters listed below are common to all operations and may therefore be included within the negative result of any operation. The error results which are applicable for individual operation are listed within the description of the operation:

- System failure: The requested operation cannot be performed by the PNC due to a system failure.
- System overload: The requested operation cannot be performed by the PNC due to a processing overload condition
- Bad format: The requested operation cannot be performed by the PNC due to missing mandatory parameters within the operation request, an incorrect parameter value, or for other format-related reasons.

E.3 Use and presentation of I4 parameters

E.3.1 General

In this subclause some of the I4 ROSE parameters are defined.

In the negative result of each operation, the errors shall be coded from 1 to 17 as described in clause F.2.

Except when it is specifically described, the parameters with the octet string type shall be coded in the following way: 1 octet corresponds to the code of the character according to ETS 300 133-2 [1]. annex B, for I4 parameters and for alphanumeric messages.

The parameters with the Boolean type may be coded in three different ways. If the associated facilities can be activated either by the mobile subscriber or the calling party, the coding shall be as follows:

- TRUE if the facility has been activated by the mobile subscriber;

- FALSE if the mobile subscriber has not asked for the facility but the facility is allowed for the calling party;
- not present if the mobile subscriber has not asked for the facility and the facility is not allowed for the calling party.

In any other case, FALSE is equivalent to not present.

If an optional parameter is not present in the operation fields the associated facility is not activated or possible.

E.3.2 Description of parameters

E.3.2.1 Pager information operation

Parameter:

AdC Only the third part, subscriber identification, shall be present (subclause 5.2). AdC may be a GAdC.

Positive result:

PT shall be coded 1 for tone only, 2 for numeric, 3 for alphanumeric and 4 for transparent data.

In case of GAdC, the pager type shall correspond to the value of the "Class of subscribed basic service" included in the group calls (subclause 12.2.4).

CS shall indicate the number of the character set required.

MC shall be coded:

- 1 to 16 000 for numeric;
- 1 to 9 000 for alphanumeric;
- 1 to 65 535 for transparent data.

STS (used for the three state status concept) shall be coded TRUE in case of status higher than the upper threshold and FALSE in case of status between the upper threshold and the lower threshold (in case of status below the lower threshold this corresponds to the low network status and a negative result is sent).

In case of GAdC, STS shall be coded TRUE (even if this does not correspond to each case).

CL shall be coded TRUE if legitimisation is required.

PR1: the diagram in figure E.1 summarizes the behaviour of PNC, concerning the priority 1, when receiving a pager information operation. PR1 shall be coded as follows:

- TRUE if the mobile subscriber has asked for this facility (included in his database) and if the given status is calculated according to this priority 1 level;
- FALSE if the mobile subscriber has not asked for priority 1 and if (according to calculation made in the PNC-H) the priority 1 is allowed for the calling party (the given status is calculated according to the priority 1 level);
- not present if the mobile subscriber has not asked for priority 1 and that (according to calculation made in the PNC-H) the priority 1 is not allowed for the calling (the given status is calculated according to the priority 2 level).

PR3: shall be coded as follows (figure E.1):

- TRUE if the mobile subscriber has asked for the priority 3 (included in his database), if the status is given according to this level of priority and according to calculation the parameter PR1 is coded FALSE to indicate that priority 1 is allowed for the calling party;
- FALSE if the mobile subscriber has asked for the priority 3 (the given status is according to the priority 3 level) and if according to calculation the priority 1 is not allowed for the calling party;
- not present if the mobile subscriber has asked for the priority 3, the status is given according to the priority 2 level except if the parameter PR1 is present.

UR shall be coded TRUE if urgent message indicator is included in the mobile subscriber database.

DD shall be coded TRUE if the PNC-H of the mobile (or the mobile itself) foresees a limit for the activation of the service and the linked DDT parameter corresponds to this limit.

MDD shall be coded TRUE if the mobile subscriber has activated deferred delivery service, the linked parameter DDM corresponds to the date given by the mobile subscriber.

ST shall be coded TRUE if it is possible for the calling party to access standard text provided by the PNC-H. The linked parameter MST indicates the maximum number of these standard texts.

RP shall be coded TRUE if the repetition service is requested by the mobile subscriber with a legitimisation code. RP shall be coded FALSE if the repetition is requested without a legitimisation code.

RC shall be coded TRUE if reverse charging facility is subscribed by the mobile subscriber with a legitimisation code and shall be coded FALSE if reverse charging facility is given without any legitimisation code.

GAdC shall be coded TRUE if the requested AdC is a GAdC. In this case the STS parameter is not relevant (see definition of STS).

MTB:

- **TBT** shall be I4 time (clause F.2);
- **TBM** shall correspond to the message which informs the calling party that temporary barring is activated (see ETS 300 133-2 [1], subclause 4.3.5.1).

Divert AdC shall always be coded as a two stage AdC with all three parts as according to subclause 5.2.1.1.2

E.3.2.2 Choice of destination operation

Parameter:

AdC shall be defined as described in subclause 5.2 and shall be coded as an octet string.

GAs shall correspond to the geographical areas defined according to the operator agreement taking into account the calling party demand.

Positive result:

ST (used for the three state status concept) shall be coded TRUE in case of status higher than the upper threshold and FALSE in case of status between the upper threshold and the lower threshold (in case of status below the lower threshold this corresponds to the low network status and a negative result is sent).

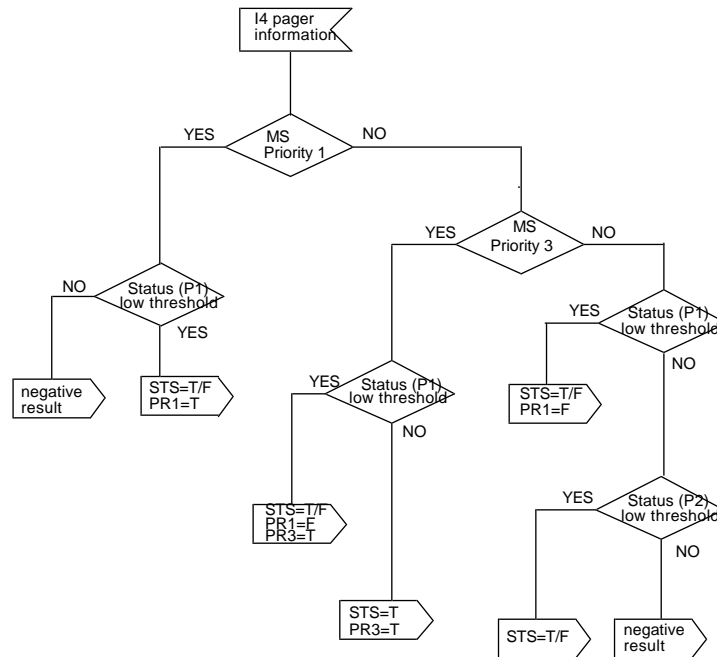

Figure E.1: PNC-H behaviour (status and priority parameter) when receiving a pager information operation

E.3.2.3 Page request operation

Parameter:

AdC1 to **AdCn**: Only the field Subscriber Identification (SI) shall be present (subclause 5.2). each AdC may be a GAdC.

PT shall be coded 1 for tone only, 2 for numeric, 3 for alphanumeric and 4 for transparent data.

CS shall indicate the number of the character set required.

TO shall be coded TRUE if the message type is a Tone Only (TO) message. In this case, there is no message part.

ST shall indicate the number of the standard text required.

PM shall correspond to the message sent by the calling party, this message is either a numeric message or an alphanumeric message or a transparent data message:

- if the message is a numeric message each numeric character shall be coded in ISO 646 [32] (and corresponds to the ERMES character);
- if the message is an alphanumeric message, each character shall be coded according to the tables described in ETS 300 133-2 [1], annex B;
- if the message is a transparent data message, data shall be grouped into octets. The end of the message shall follow the procedure described in ETS 300 133-4 [2], subclause 5.5.3.

GAs shall correspond to the geographical areas defined in the supplementary service choice of destination.

PR shall be coded 1 if the priority 1 is activated with the message, PR shall be coded 3 if the priority 3 is activated with the message.

UR shall be coded TRUE if urgent message indicator is activated.

DD shall indicate the requested date and time of the transmission of the message when deferred delivery is requested.

RP shall be coded TRUE if repetition is requested.

RC shall be coded TRUE if reverse charging is requested.

Positive result:

If there is no error the Boolean "general result" of the corresponding ASN.1 description shall be coded TRUE, otherwise this Boolean shall be coded FALSE and shall be followed by one AdC or a list of AdCs (in case of group call) combined with an error code (called "unit-error" in the ASN.1 description) according to the following list:

- 0 AdC not valid;
- 1 AdC out of service;
- 2 Low network status;
- 3 Inconsistency between AdC and the request operation parameters.

E.3.2.4 Transmit operation

Parameter:

RIC1, RICn shall be defined as described in ETS 300 133-4 [2], clause 3. bits shall be grouped into octets. Binary zeroes shall be used to fill the end of the octet string.

NL, TCn shall be an integer between 0 to 59 inclusive.

SM1, TSn shall be defined as described in ETS 300 133-4 [2], subclause 11.3.

FSN1, FSNn shall be an integer between 0 to 15 inclusive.

AF1, AFn shall be an integer between 0 to 7 inclusive.

MN1, MNn shall be an integer between 1 and 31 inclusive.

MS1, MSn shall be coded TRUE if the correspondent facility is one of the characteristics of the receiver. This type of parameter may be used by the transmitting network for the transmission of the long messages according to the specific procedure described in ETS 300 133-4 [2], subclause 10.4.

PR1 (to PRn) shall be coded 1 if the priority 1 is requested, PR1 (and PRn) shall be coded 3 if the priority 3 is requested and these priorities may be activated only if there are agreements between operators.

GAs1 (to GAsn) shall correspond to the geographical areas in which to page RIC1 (to RICn).

UMI1 (to UMIIn) shall be coded TRUE if urgent message indicator is requested.

ECN shall correspond to the number of the ERMES version of coding on I1 used by the operator. The initial value shall be coded 1, the new version shall be coded 2 and so on.

PT shall be coded 1 for tone only, 2 for numeric, 3 for alphanumeric and 4 for transparent data.

CS shall indicate the number of the character set required.

TO shall be coded TRUE if the message type is a Tone Only (TO) message.

AT shall be coded TRUE if the message corresponds to the transmission of the latest message number. In this there is no message part.

PM shall correspond to the message sent by the calling party, this message is either a numeric message or an alphanumeric message or a transparent data message:

- if the message is a numeric message each numeric character shall be coded in ISO 646 [32] (and corresponds to the ERMES character);
- if the message is an alphanumeric message, each character shall be coded according to the tables described in ETS 300 133-2 [1], Annex B;
- if the message is a transparent data message, data shall be grouped into octets. The end of the message shall follow the procedure described in ETS 300 133-4 [2], subclause 5.5.3, Message data.

Positive result:

If there are no errors at all the Boolean "general result" of the corresponding ASN.1 description shall be coded TRUE, otherwise this Boolean shall be coded FALSE and shall be followed by one RIC or a list of RICs (in case of group call) combined with an error code (called "unit-error" in the ASN.1 description) according to the following list:

- 0 RIC not valid;
- 1 RIC out of service;
- 2 Low network status;
- 3 Inconsistency between RIC and the request operation parameters.

E.3.2.5 Roaming validation operation

Parameter:

AdC shall not be a GAdC.

AC shall correspond to the code used by the subscriber to prove his identity.

NOTE: GAdC is not compatible with the roaming facility.

E.3.2.6 Roaming reset operation

Parameter:

AdC shall not be a GAdC.

NOTE: GAdC is not compatible with the roaming facility.

E.3.2.7 Roaming information operation

Parameter:

AdC shall not be a GAdC.

NOTE: GAdC is not compatible with the roaming facility.

Positive result:

GA1 shall correspond to the first geographical area for which a roaming record exists.

ST1 shall be I4 Time (clause F.2).

SP1 shall be I4 Time (clause F.2).

E.3.2.8 Change roaming operation

Parameter:

AdC shall not be a GAdC.

NOTE: GAdC is not compatible with the roaming facility.

GA1 shall correspond to the first geographical area to add to or to delete from the mobile subscriber roaming records.

ST1 shall be I4 Time (clause F.2).

SP1 shall be I4 Time (clause F.2).

A/D shall be coded TRUE for add and FALSE for delete.

Positive result:

GA1 shall correspond to the first geographical area affected by changes requested.

ST1 shall be I4 Time (clause F.2).

SP1 shall be I4 Time (clause F.2).

E.3.2.9 Confirm change roaming operation

Parameter:

AdC shall not be a GAdC

NOTE: GAdC is not compatible with the roaming facility.

GA1 shall correspond to the first geographical area to add to or to delete from the mobile subscriber roaming records.

ST1 shall be I4 Time (see clause F.2).

SP1 shall be I4 Time (see clause F.2).

A/D shall be coded TRUE for add and FALSE for delete.

E.3.2.10 Call diversion start operation

Negative result:

If both the two errors (AdC to not valid, AdC from not valid) exist, only one shall be sent.

1GAdC is not compatible with the roaming facility.

E.3.2.11 Call diversion stop operation

Negative result:

If both the two errors (AdC to not valid, AdC from not valid) exist, only one shall be sent.

Annex F (normative): PNC I4 ROSE ASN.1 transcription

F.1 General

This annex specifies the abstract syntax for the I4 interface protocol using the Abstract Syntax Notation one (ASN.1), defined in ITU-T Recommendation X.208 [15].

The encoding rules which are applicable to the defined abstract syntax are the Basic Encoding Rules for Abstract Syntax Notation one, defined in ITU-T Recommendation X.209 [16].

For each I4 parameter which has to be transferred by a I4 Protocol Data Unit (PDU) (I4 message), there is a PDU field (an ASN.1 Named Type) whose ASN.1 identifier has the same name as the corresponding parameter, except for the differences required by the ASN.1 notation (blanks between words are replaced by a hyphen "-", the first letter of the first word is lower-case and the first letter of the following words are capitalized (e.g., "choice of destination" is mapped to choice-Of-Destination"). In addition some words may be abbreviated as follows:

- info = information;
- id = identity;
- ms = mobile subscriber.

When a mandatory element is missing in any component or inner data structure, a reject component is returned (if the association still exists). The problem cause to be used is "Mis-typed parameter". When an optional element is missing in an invoke component or in an inner data structure when it is required by the context, an error component is returned; the associated type error is DataMissing.

All Times in I4 are UTC

F.2 Operation types ASN.1 specification

The ASN.1 specification of the operation types required for the I4 interface is provided in the single ASN.1 module "I4-ROSE operations" which follows.

The IVR4 and IVR1 parameters in the above sequences are integers. In order to store an IVR4 or IVR1 value such as 02.01 as an integer simply remove the decimal point and make the integer value 201 by multiplying the MVR4 (02) by 100 and add the SVR4 (01) to the result.

I4 ROSE OPERATIONS

ID ::= OBJECT IDENTIFIER

pagingDomain ID ::= (ccitt (0) identified organization (4) etsi (0) pagingDomainId (1))

-- Root for all I4 allocations:

i4 ID ::= { pagingDomain ermesI4Id (1)}

-- categories

id-mod ID ::= { i4 1 }

id-ac ID ::= { i4 2 }

id-ase ID ::= { i4 3 }

id-as ID ::= { i4 4 }

-- modules

i4-UsefulDefinitions ID ::= { id-mod 0 }

i4-Service ID ::= { id-mod 1 }

i4-Protocol ID ::= { id-mod 2 }

-- application contexts

id-ac-I4 ID ::= { id-ac 0 }

-- application service elements

id-ase-I4 ID ::= { id-ase 0 }

-- abstract syntaxes

id-as-I4 ID ::= { id-as 0 }

ROSE DEFINITIONS ::=

EXPLICIT TAGS

BEGIN

OPERATION ::= INTEGER

```

{
  pager-Information          (1),
  choice-Of-Destination     (2),
  page-Request              (3),
  roaming-Validation        (4),
  roaming-Reset             (5),
  roaming-Information       (6),
  change-Roaming            (7),
  confirm-Change-Roaming    (8),
  call-Diversion-Start      (9),
  call-Diversion-Stop       (10),
  transmit                  (11)
}

```

ERROR ::= INTEGER

```

{
    adc-Not-Valid           (1),
    adc-Out-Of-Service     (2),
    paging-Msg-Error       (3),
    system-Failure         (4),
    system-Overload        (5),
    bad-Format             (6),
    all-Adc-Not-Valid      (7),
    all-Ric-Not-Valid      (8),
    gas-Not-Valid          (9),
    authentic-Fail         (10),
    low-Network-Status     (11),
    adc-From-Not-Valid     (12),
    adc-To-Not-Valid       (13),
    error-On-Gas-Add       (14),
    error-On-Gas-Del       (15),
    error-On-Start-Time    (16),
    error-On-Stop-Time     (17),
    diversion-Already-Activated (18)
}

```

PG-Info-Par ::= PG-Address

PG-Info-Ack ::= CHOICE

```

{
    temporary-barring [0] MTB,
    divert-adc        [1] Address-Code,
    pager             [2] Pager
}

```

CH-Dest-Par ::= SEQUENCE

```

{
    adc [0] Address-Code,
    gas [1] Geo-Areas
}

```

CH-Dest-Ack ::= SEQUENCE

```

{
    availability-gas [0] BOOLEAN
}

```

PG-Req-Par ::= SEQUENCE

```

{
    adc-1 [0] Address-Code,
    adc-n [1] IMPLICIT SEQUENCE OF Address-Code OPTIONAL,
    pager-type [2] Pager-Type,
    character-set [3] INTEGER OPTIONAL,
    message [4] Pager-Message,
    gas [5] Geo-Areas OPTIONAL,
    priority [6] INTEGER
        {
            prio1 (1),
            not-used (2),
            prio3 (3)
        } OPTIONAL,
    urgent-indic [7] BOOLEAN OPTIONAL,
    def-delivery [8] I4-Time OPTIONAL,
    repeat [9] BOOLEAN OPTIONAL,
    rev-charging [10] BOOLEAN OPTIONAL
}

```

PG-Req-Ack ::= SEQUENCE

```
{
  general-result [0] BOOLEAN,
  result-per-ms [1] IMPLICIT SEQUENCE OF MS-Result OPTIONAL
}
```

RO-Valid-Par ::= SEQUENCE

```
{
  adc [0] Address-Code,
  ac [1] Authentic-Code
}
```

RO-Valid-Res ::= INTEGER (0)

RO-Reset-Par ::= PG-Address

RO-Reset-Res ::= INTEGER (0)

RO-Info-Par ::= PG-Address

RO-Info-Ack ::= RO-Info-Type

RO-Change-Par ::= RO-Change-Type

RO-Change-Ack ::= RO-Info-Type

RO-Confirm-Par ::= RO-Change-Type

RO-Confirm-Res ::= INTEGER (0)

Divert-Start-Par ::= Divert-Type

Divert-Start-Res ::= INTEGER (0)

Divert-Stop-Par ::= Divert-Type

Divert-Stop-Res ::= INTEGER (0)

Transmit-Par ::= SEQUENCE

```
{
  ric-1 [0] Ric-Record,
  ric-n [1] IMPLICIT SEQUENCE OF Ric-Record OPTIONAL,
  IVR1 [2] INTEGER,
  pt [3] Pager-Type,
  character-set [4] INTEGER OPTIONAL,
  pm [5] Transmit-Message
}
```

Transmit-Ack ::= SEQUENCE

```
{
  general-result [0] BOOLEAN,
  result-per-ric [1] IMPLICIT SEQUENCE OF Ric-Result OPTIONAL
}
```

PG-Address ::= SEQUENCE

```
{
  adc [0] Address-Code
}
```

```

Pager ::= SEQUENCE
{
    pager-type      [0]  Pager-Type,
    character-set   [1]  List-Char-Set      OPTIONAL,
    max-length      [2]  INTEGER            OPTIONAL,
    status          [3]  BOOLEAN,
    legitim-req     [4]  Legim-Value        OPTIONAL,
    priority-1      [5]  Priority-1         OPTIONAL,
    priority-3      [6]  Priority-3         OPTIONAL,
    urgent-indic    [7]  Urgent             OPTIONAL,
    deferred-delivery [8]  Def-Del          OPTIONAL,
    ms-invoke-def-del [9]  Ms-Def-Delivery   OPTIONAL,
    standard-text   [10] Standard Text     OPTIONAL,
    repetition      [11] BOOLEAN           OPTIONAL,
    reverse-charging [12] Rev-Charge       OPTIONAL,
    group-flag      [13] BOOLEAN           OPTIONAL
}

```

```

Pager-Type ::= INTEGER
{
    tone      (1),
    numeric   (2),
    alpha     (3),
    transparent (4)
}

```

```

List-Char-Set ::= SEQUENCE
{
    list-char      [0]  IMPLICIT SEQUENCE OF INTEGER
}

```

```

Legim-Value ::= SEQUENCE
{
    legim-indic      [0]  BOOLEAN,
    legim-code       [1]  I4-Legim-Code OPTIONAL
}

```

```

Priority-1 ::= SEQUENCE
{
    pr-1-indic      [0]  BOOLEAN,
    legim-code       [1]  I4-Legim-Code OPTIONAL
}

```

```

Priority-3 ::= SEQUENCE
{
    pr-3-indic      [0]  BOOLEAN,
    legim-code       [1]  I4-Legim-Code OPTIONAL
}

```

```

Urgent ::= SEQUENCE
{
    urgent-indic    [0]  BOOLEAN,
    legim-code       [1]  I4-Legim-Code OPTIONAL
}

```

```

Def-del ::= SEQUENCE
{
  def-del-indic [0] BOOLEAN,
  def-del-time [1] I4 time OPTIONAL
  def-allow [2] Def-Allow OPTIONAL
}
Standard Text ::= SEQUENCE
{
  st-indic [0] BOOLEAN
  max-text-no [1] INTEGER_
}
Ms-Def-Delivery ::= SEQUENCE
{
  ms-def-indic [0] BOOLEAN,
  ms-def-msg [1] I4-Msg OPTIONAL
}
Rev-Charge ::= SEQUENCE
{
  rev-ch-indic [0] BOOLEAN,
  legim-code [1] I4-Legim-Code OPTIONAL
}

Pager-Message ::= CHOICE
{
  tone-only [1] BOOLEAN,
  standard-txt [2] INTEGER,
  message [3] I4-Msg
}

Transmit-Message ::= CHOICE
{
  tone-only [1] BOOLEAN,
  auto-tx-l-mn [2] BOOLEAN,
  message [3] I4-Msg
}

RO-Info-Type ::= SEQUENCE
{
  ro-info [0] IMPLICIT SEQUENCE OF Def-Ro-Info
}

RO-Change-Type ::= SEQUENCE
{
  adc [0] Address-Code,
  ro-change [1] IMPLICIT SEQUENCE OF Def-Ro-Change
}

Divert-Type ::= SEQUENCE
{
  adc-to [0] Address-Code,
  adc-from [1] Address-Code
}

Geo-Areas ::= [0] IMPLICIT SEQUENCE OF Geo-Area

```

```

Ric-Record ::= SEQUENCE
{
    ric          [0] Radio-Id-Code,
    nl          [1] INTEGER OPTIONAL,
    sm          [2] OCTET STRING OPTIONAL,
    fsn         [3] INTEGER,
    af          [4] INTEGER,
    mn          [5] INTEGER,
    gas         [6] Geo-Areas,
    ms          [7] BOOLEAN OPTIONAL,
    priority-val [8] INTEGER
                {
                    prio1      (1),
                    not-used   (2),
                    prio3      (3)
                } OPTIONAL,
    ric-urgent  [9] BOOLEAN OPTIONAL
}

```

```

Ric-Result ::= SEQUENCE
{
    ric          [0] Radio-Id-Code,
    unit-error  [1] INTEGER
}

```

```

MTB ::= SEQUENCE
{
    tbt          [0] I4-Time OPTIONAL,
    tbm         [1] I4-Msg OPTIONAL
}

```

-- Def-Ro-Change is the roaming modification instruction

```

Def-Ro-Change ::= SEQUENCE
{
    ga          [0] Geo-Area,
    st          [1] I4-Time,
    sp          [2] I4-Time,
    add        [3] BOOLEAN
}

```

-- Def-Ro-Info is the roaming status description

```

Def-Ro-Info ::= SEQUENCE
{
    ga          [0] Geo-Area OPTIONAL,
    st          [1] I4-Time OPTIONAL,
    sp          [2] I4-Time OPTIONAL
}

```

```

MS-Result ::= SEQUENCE
{
    adc         [0] Address-Code,
    unit-error  [1] INTEGER
}

```

```

Def-Allow ::= SEQUENCE
{
    def-deliv   [0] BOOLEAN OPTIONAL,
}

```

```
    max-allow-defer-time [1] INTEGER,  
  }
```

```
I4-Time ::= SEQUENCE
```

```
{  
  i4-day [0] INTEGER,  
  i4-month [1] INTEGER,  
  i4-year [2] INTEGER,  
  i4-hour [3] INTEGER,  
  i4-min [4] INTEGER,  
  i4-sec [5] INTEGER  
}
```

```
Address-Code ::= OCTET STRING (SIZE(1..20))
```

```
Geo-Area ::= OCTET STRING (SIZE(1..20))
```

```
I4-Msg ::= OCTET STRING (SIZE(1..16900))
```

```
Radio-Id-Code ::= OCTET STRING (SIZE(1..20))
```

```
Authentic-Code ::= OCTET STRING (SIZE(1..20))
```

```
I4-Legim-Code ::= OCTET STRING (SIZE(1..20))
```

```
END
```

ROSE ASSOCIATION

The following module describes the parameters associated with the Bind and Unbind PDUs.

I4-ASSOCIATION DEFINITIONS ::=

BEGIN

*ExtconPDU ::= CHOICE

```
{
  bindArg          [1]  IMPLICIT I4-Bind-Param,
  bindRes          [3]  IMPLICIT I4-Bind-Failure,
  unbindArg       [4]  IMPLICIT I4-Unbind-Param,
  unbindRes       [5]  IMPLICIT I4-Unbind-Confirm,
  unbindErr       [6]  IMPLICIT I4-Unbind-Failure
}
```

I4-Bind-Param ::= SEQUENCE

```
{
  initiator-Id    [0]  Name,
  password        [1]  Password,
  operation       [2]  List-Of-Operations
  IVR4           [3]  INTEGER
}
```

I4-Bind-Conf ::= SEQUENCE

```
{
  respid         [0]  Name,
  password       [1]  Password,
  operations     [2]  List-Of-Operations,
  connect-Time  [3]  Time-When-Connected
  IVR4          [4]  INTEGER
}
```

I4-Bind-Failure ::= SEQUENCE

```
{
  failure-Reason [0]  I4-Fail-Reason
}
```

I4-Unbind-Param ::= SEQUENCE

```
{
  connect-Time  [3]  Time-When-Disconnected
}
```

I4-Unbind-Confirm ::= SEQUENCE

```
{
  disconnect-Time [3]  Time-When-Disconnected
}
```

I4-Unbind-Failure ::= SEQUENCE

```
{
  failure-Reason [0]  I4-Fail-Reason
}
```

Name ::= SEQUENCE

```
{
  operator       [0]  Operator OPTIONAL,
  bilateralAgreem [1]  BilateralAgreem OPTIONAL,
}
```

```

    dataNetworkAddress [2]  X121Address OPTIONAL
  }

```

```

Time-When-Connected      ::= UTCTime

```

```

Time-When-Disconnected ::= UTCTime

```

```

List-Of-Operations      ::= BIT STRING

```

```

{
  pager-Information      (1),
  choice-Of-Destination (2),
  page-Request           (3),
  roaming-Validation     (4),
  roaming-Reset          (5),
  roaming-Information    (6),
  change-Roaming         (7),
  confirm-Change-Roaming (8),
  call-Diversion-Start   (9),
  call-Diversion-Stop    (10),
  transmit               (11)
}

```

-- I4-Fail-reason contains one of the error indications given in the following table.

Error Indication	Reason
not-entitled	The responder is not entitled to accept a request for an association between itself and the initiator.
temporary-overload	The responder is not able to establish an association due to temporary overload.
temporary-failure	The responder is not able to establish an association due to a temporary failure (having an impact on an upper layer).
incorrect-ID-or-Password	The responder shall not accept the request to establish an association between itself and the initiator due to incorrect identity or password.
not-supported	The responder does not recognize the telecommunication subsystem type of the initiator or cannot support any of the operations suggested on the association.
not-connected	Used within an unbind failure response.

```

I4-Fail-Reason          ::= INTEGER

```

```

{
  not-Entitled          (0),
  temporary-Overload    (1),
  temporary-Failure     (2),
  incorrect-ID-Or-Password (3),
  not-Supported         (4),
}

```

not-Connected (5)
}

Operator ::= PrintableString (SIZE(0..20))

BilateralAgreem ::= PrintableString (SIZE(0..20))

X121Address ::= NumericString (SIZE(0..15))

Password ::= PrintableString (SIZE(0..20))

END

Annex G (informative): Typical I6 dialogues for the input of calls

This annex shows typical examples of dialogue through the I6 interface (some of which include SS dialogues). Figures G.1.1 to G.1.3 deal with access for call input with two-stage selection and interactive mode. Figures G.2.1 to G.2.3 deal with access for call input with one-stage selection and interactive mode.

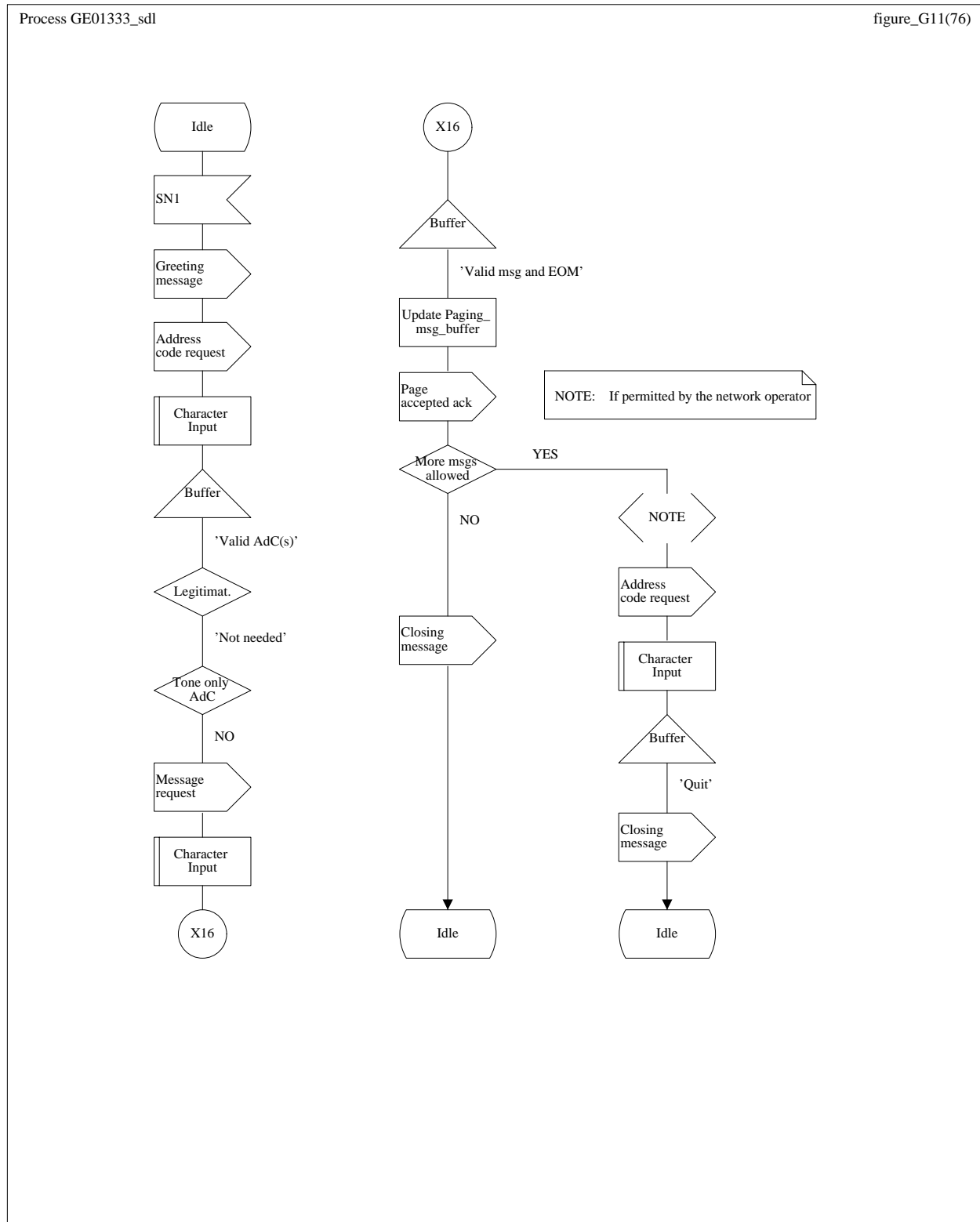

Figure G.1.1: A typical two-stage selection call with no supplementary services

Process GE01333_sdl

figure_G12_1(76)

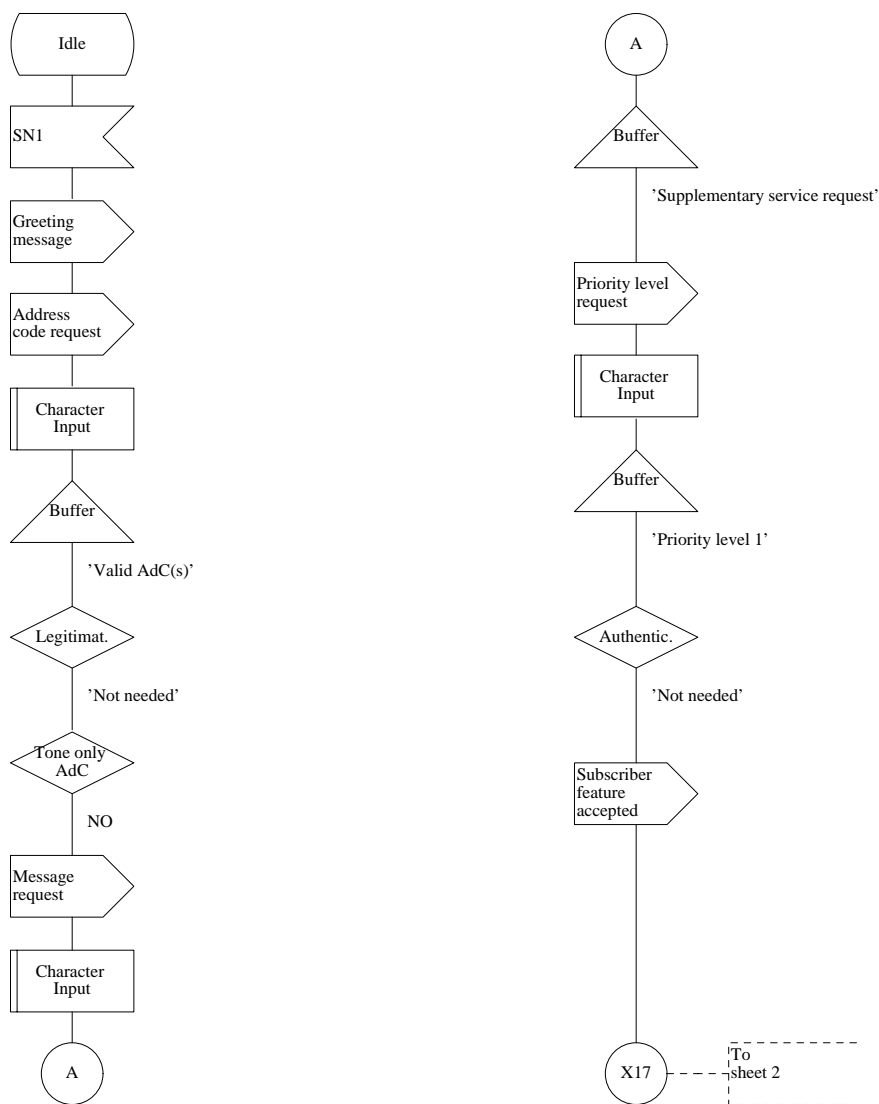

Figure G.1.2 (sheet 1 of 2): A typical two-stage selection call with level 1 priority and standard text

Process GE01333_sdl

figure_G12_2(76)

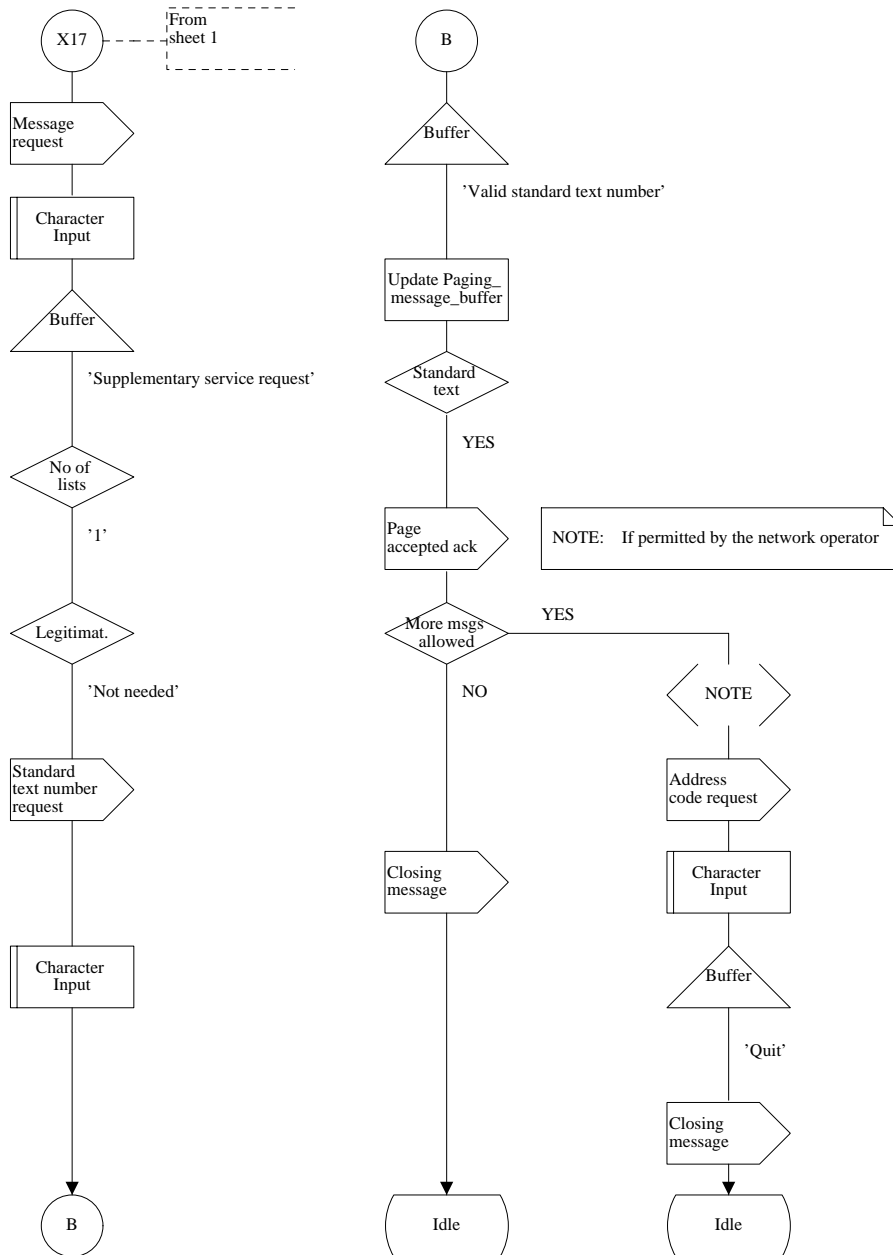

Figure G.1.2 (sheet 2 of 2): A typical two-stage selection call with level 1 priority and standard text

Process GE01333_sdl

figure_G13_1(76)

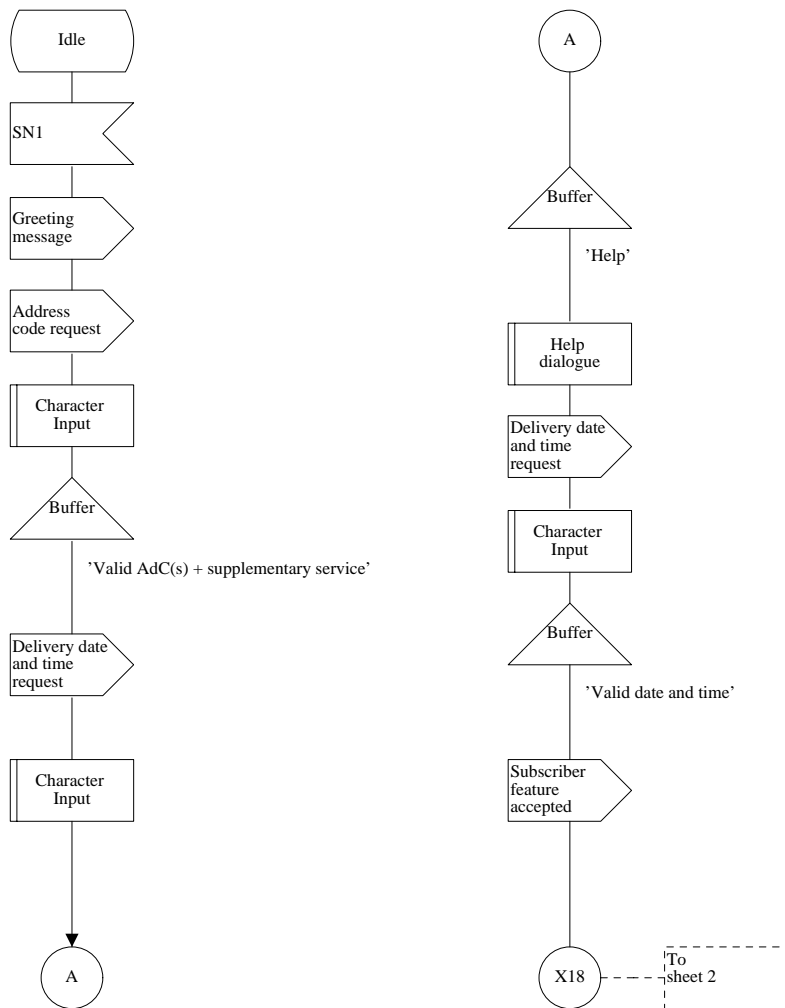

Figure G.1.3 (sheet 1 of 2): A typical two-stage selection deferred delivery tone only call with help facility

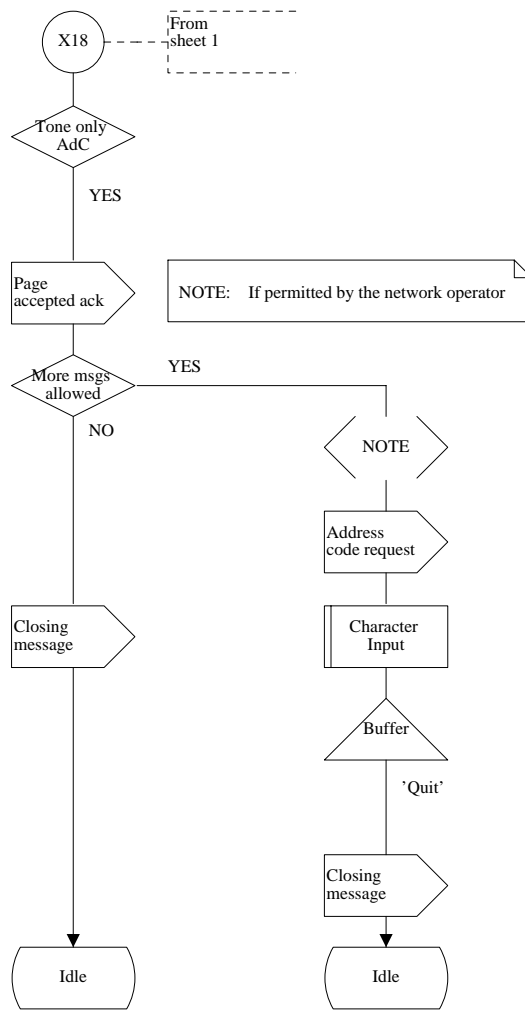

Figure G.1.3 (sheet 2 of 2): A typical two-stage selection deferred delivery tone only call with help facility

Process GE01333_sdl

figure_G21(76)

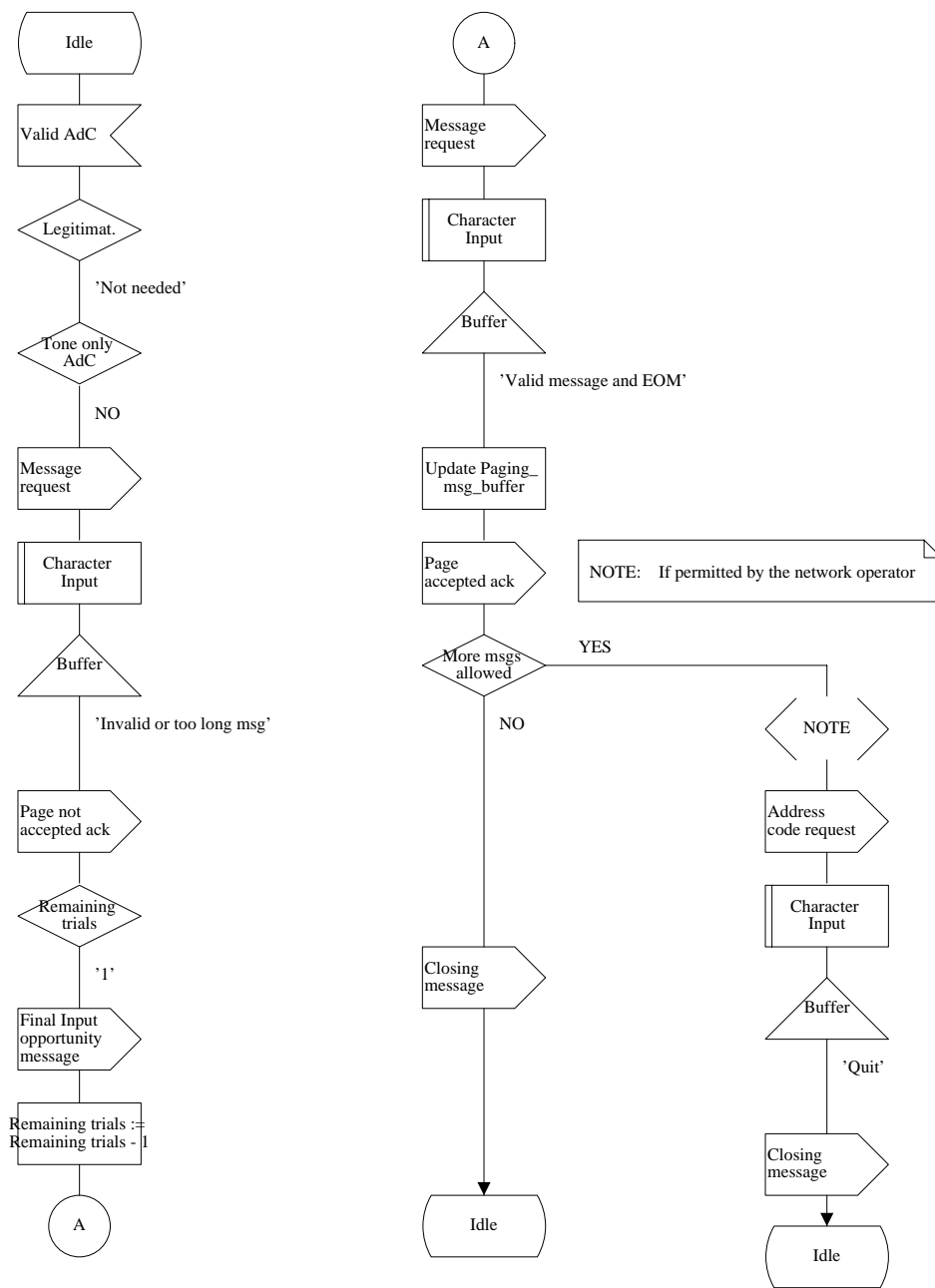

Figure G.2.1: A typical one-stage selection protocol with a correction to the message

Process GE01333_sdl

figure_G22(76)

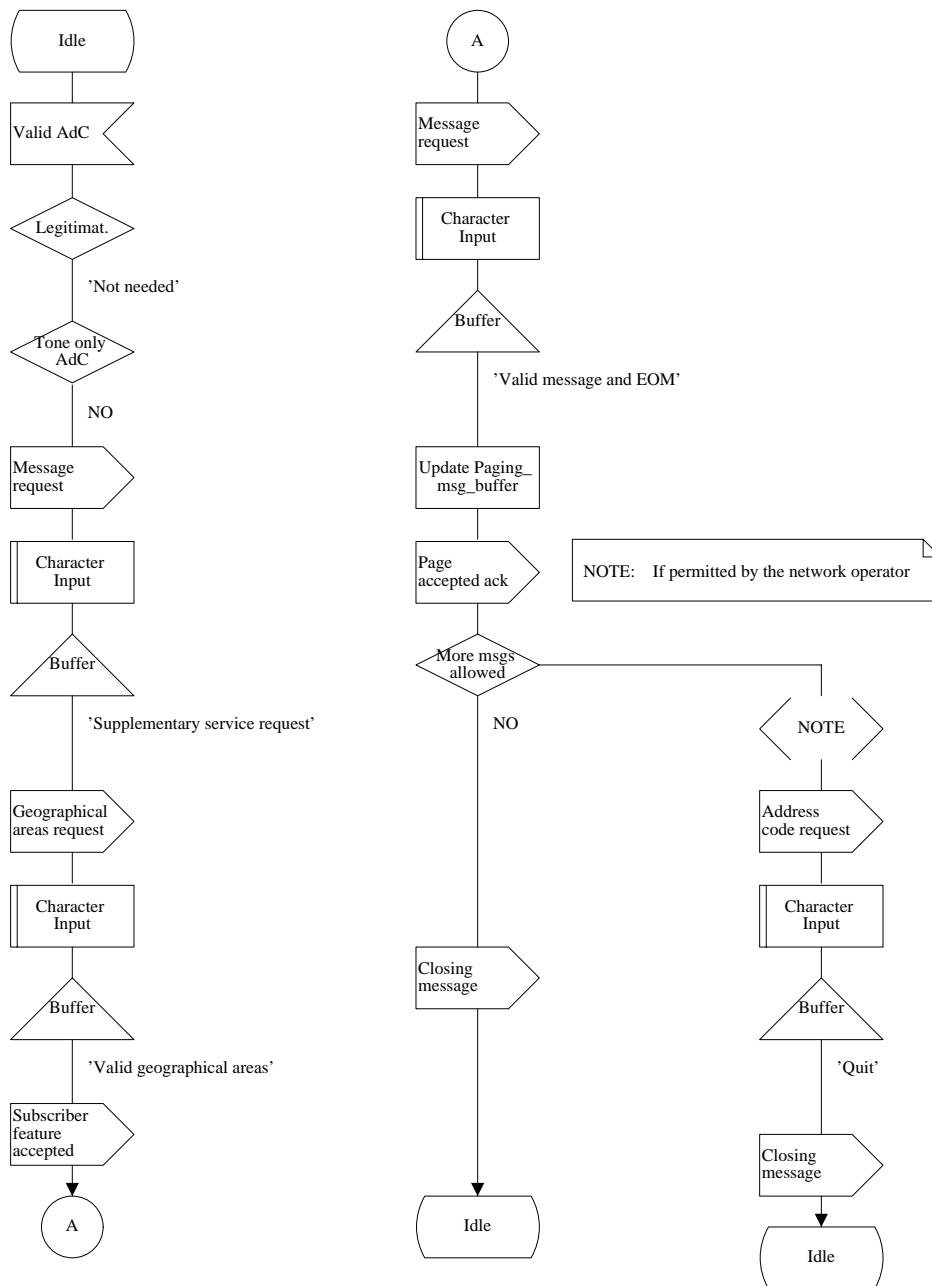

Figure G.2.2: A one-stage selection call with choice of destination

Process GE01333_sdl

figure_G23_1(76)

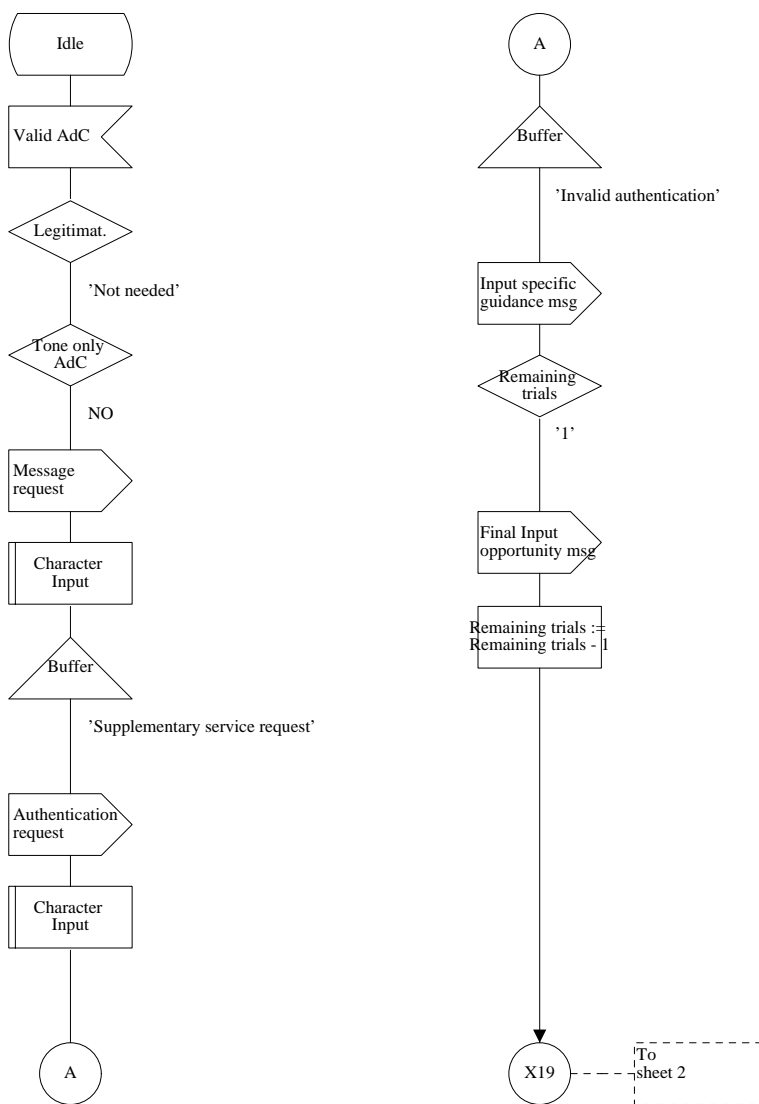

Figure G.2.3 (sheet 1 of 2): A successful one-stage selection call with unsuccessful reverse charging request

Process GE01333_sdl

figure_G23_2(76)

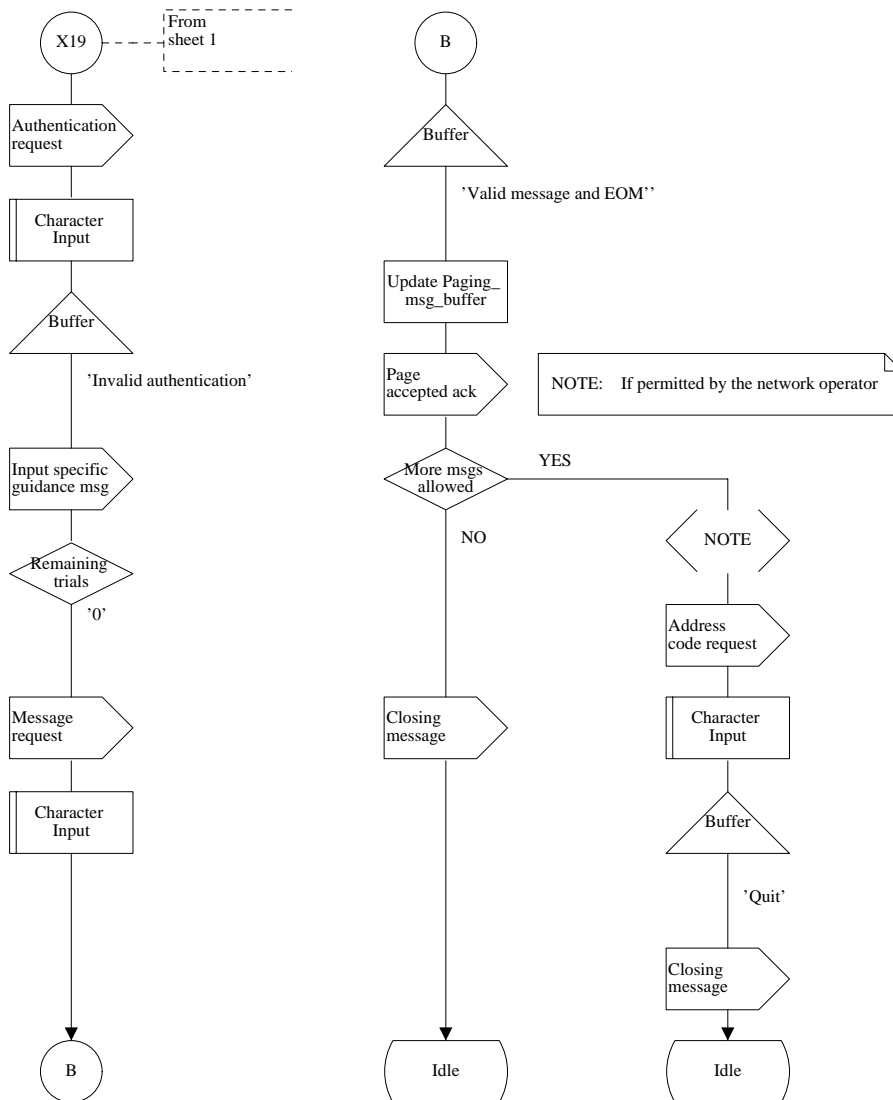

Figure G.2.3 (sheet 2 of 2): A successful one-stage selection call with unsuccessful reverse charging request

History

Document history			
July 1992	First Edition		
January 1997	Vote	V 9711:	1997-01-14 to 1997-03-14
September 1997	Second Vote	V 9744:	1997-09-02 to 1997-10-31