



EUROPEAN
TELECOMMUNICATION
STANDARD

FINAL DRAFT
pr **ETS 300 114**

February 1996

Second Edition

Source: ETSI TC-TE

Reference: RE/TE-05045

ICS: 33.020

Key words: PSTN, modems

**Public Switched Telephone Network (PSTN);
Basic Category I and Category II specifications
for modems standardized for
use on the PSTN**

ETSI

European Telecommunications Standards Institute

ETSI Secretariat

Postal address: F-06921 Sophia Antipolis CEDEX - FRANCE

Office address: 650 Route des Lucioles - Sophia Antipolis - Valbonne - FRANCE

X.400: c=fr, a=atlas, p=etsi, s=secretariat - **Internet:** secretariat@etsi.fr

Tel.: +33 92 94 42 00 - Fax: +33 93 65 47 16

*

Copyright Notification: No part may be reproduced except as authorized by written permission. The copyright and the foregoing restriction extend to reproduction in all media.

© European Telecommunications Standards Institute 1996. All rights reserved.

Contents

Foreword	7
1 Scope	9
2 Normative references	9
3 Definitions and abbreviations	11
3.1 Definitions	11
3.2 Abbreviations	12
4 Common requirements	13
4.1 General notes	13
4.2 PSTN access requirements	13
4.3 Information to be provided by the applicant	13
4.3.1 Information required for testing purposes	13
4.3.1.1 List of modes	13
4.3.1.2 Other items	13
4.3.2 Instructions for use	14
5 Requirements common to some Category II modems	14
5.1 General notes	14
5.2 Call establishment sequence based upon CCITT Recommendation V.25	14
5.2.1 For modems initiating calls	14
5.2.1.1 Calling tone generation	14
5.2.1.2 Answering tone detection	15
5.2.2 For modems answering calls	15
5.3 Test loop implementation based upon CCITT Recommendation V.54	15
5.3.1 General	15
5.3.2 Remote digital test loop (loop 2)	16
5.3.3 Local analogue test loop (loop 3)	16
5.4 Threshold of received line signal detection	16
5.5 Requirements for modems providing asynchronous to synchronous conversion based upon CCITT Recommendation V.14	17
5.5.1 General	17
5.5.2 Transmission of start-stop characters	17
5.5.2.1 Signalling rate ranges of the start-stop characters at the modem input	17
5.5.2.2 Start-stop character format	17
5.5.2.3 Asynchronous to synchronous conversion	18
5.5.2.3.1 Transmitter	18
5.5.2.3.2 Receiver	18
5.5.2.3.3 Break signal	19
5.5.2.3.3.1 Transmitter	19
5.5.2.3.3.2 Receiver	19
5.6 Performance	19
5.6.1 Overall performance	19
5.6.2 Performance in the presence of metering pulses	19
Annex A (informative): Testing methods for national variants for clause 4	21
A.1 General notes	21
Annex B (normative): Testing methods for clause 5	22
B.1 General conditions for test	22

B.2	Tests of the call establishment sequence specified in subclause 5.2	22
B.2.1	For modems initiating calls.....	22
B.2.1.1	Calling tone.....	22
B.2.1.2	Detection of answering tone	23
B.2.2	For modems answering calls	23
B.3	Tests to verify the test loop implementation specified in subclause 5.3.....	23
B.4	Tests to verify the threshold of line signal detection	23
B.5	Tests to verify the process of asynchronous to synchronous conversion specified in subclause 5.5.....	24
B.5.1	Test patterns	24
B.5.1.1	General.....	24
B.5.1.2	Standard test text.....	24
B.5.1.3	Discrete Test Characters (DTC).....	25
B.5.2	Data signalling rates.....	25
B.5.3	Tests	26
B.5.3.1	Transmitter tests.....	26
B.5.3.1.1	Omission of stop elements	26
B.5.3.1.2	Over-speed and under-speed capabilities	26
B.5.3.1.3	Arbitrary character spacing	27
B.5.3.1.4	Break signal transmission	28
B.5.3.2	Receiver tests	28
B.5.3.2.1	Over-speed capability	28
B.5.3.2.2	Under-speed capability	29
B.5.3.2.3	Character recovery.....	29
B.5.3.2.4	Break signal reception	29
B.6	Performance testing methodology.....	29
B.6.1	General.....	29
B.6.2	Definitions.....	30
B.6.3	Method of measurement	31
B.6.3.1	Test set-up.....	32
B.6.3.2	Test 1	34
B.6.3.3	Test 2.....	37
B.6.3.4	Test 3.....	38
Annex C (normative):	Description of specialised test facilities, specification of test lines for use in assessing the performance of Category II modems	39
C.1	General.....	39
C.2	Test set-up.....	39
C.2.1	Simulated PSTN conditions	40
C.3	Test Line 1 transmission characteristics	45
C.3.1	Local line simulators.....	45
C.3.2	Trunk network simulator.....	45
C.3.3	Permanent impairments.....	46
C.3.3.1	Insertion loss.....	46
C.3.3.2	White noise.....	46
C.3.3.3	Frequency offset and Phase roll	55
C.3.3.4	Phase jitter.....	55
C.3.3.5	Echo.....	55
C.3.3.6	Harmonic distortion.....	55
C.4	Test Line 2 transmission characteristics	55
C.4.1	Local line simulators.....	55
C.4.2	Trunk network simulator.....	63
C.4.3	Permanent impairments.....	63
C.4.3.1	Insertion loss.....	63
C.4.3.2	Frequency offset and phase roll	63

- C.4.3.3 Phase jitter 63
- C.4.3.4 Echo 63
- C.4.3.5 Harmonic distortion 64
- C.4.3.6 Noise floor 64

- C.5 Test Line 3 transmission characteristics 64

- Annex D (normative): Provision of test tools 65

- Annex E (informative): Example of proforma chart for information request..... 66

- Annex F (informative): Bibliography 67

- History..... 68

Blank page

Foreword

This final draft second edition European Telecommunication Standard (ETS) has been produced by the Terminal Equipment (TE) Technical Committee of the European Telecommunications Standards Institute (ETSI), and is now submitted for the Voting phase of the ETSI standards approval procedure.

This ETS is one of a series of ETSs which are applicable to modems. Details of the current series are given in clause 2 of this ETS (Normative references, numbers [1] to [7] inclusive).

This second edition was produced in order to solve some technical errors and problems that were reported on the first version, as well as to reflect the changed regulatory environment in relation to type approval. Where the first edition of the document defines in detail Category I and II approvals concept (in which only Category I approval was mandatory), this second edition still uses the Category I and II terminology. However, these documents, unlike their predecessors, which were used as the basis of the NETs 20 to 25, are not intended for regulatory application.

The regulatory approval of a modem does not require the modem to comply, for instance, with any of the V.series of CCITT/ITU-T Recommendations, nor does it require the modem to function or perform as a modem. An approved modem may or may not be in compliance with certain CCITT/ITU-T Recommendations. However since this is not tested, no assurance of interworking is implied.

Conformity to a Category II specification, which is entirely voluntary and only applicable when the supplier requests it, is only available to modems providing certain combinations of functionality based on the modem specific V.series CCITT/ITU-T Recommendations. The object of this Category II specification is to provide the user with the assurance that a modem can interwork, under most network conditions, with other compatible Category II modems.

NOTE 1: However, as the PSTN is primarily engineered to convey speech traffic, connections not permitting satisfactory data transmission can occur.

To be in conformance with the Category II specifications, and hence be called a "Category II modem" the modem needs, in addition to meeting the appropriate approval requirements, to meet the requirements given in one or more modem-specific ETS (final draft prETS 300 002 [6], ETS 300 115 [2] and final draft prETSs 300 116 to 300 118 ([3] to [5])). Certain requirements common to more than one specific ETS are included, for simplicity in clause 4 and annexes B, C and D, and are referred to (as required) in the modem-specific ETSs. The degree of compliance required by these ETSs with any V. series of CCITT/ITU-T Recommendation has been intentionally limited to that which might reasonably be considered necessary in order to provide the intended assurance of inter-working between modems. In particular, there is no requirement that the digital interface of the modem conform to any particular physical realisation or functionality, and with certain identified exceptions, there are no requirements relating to the digital interface.

For instance, the following types are examples of features which do not affect modem to modem interworking and do not prevent the modem from being in conformance with the Category II specification, as long as it meets the requirements of the appropriate modem-specific ETS:

- PC integral modems that present a bus interface;
- modems employing a proprietary auto-dialling protocol;
- "intelligent" modems that may send messages to a DTE;
- multi-mode modems that may connect to a variety of modem types.

Any modem that can be configured to meet the relevant requirements can potentially be found conforming to this Category II specification and hence be considered as a "Category II modem" for that mode of operation.

It is acceptable for a modem to be tested against Category II specifications in only some of its potential operating modes. Where this is the case, it is necessary to, in other operating modes to be used on the PSTN, meet the appropriate approval requirements. The "Instructions for Use" make it clear to the user those modes which the modem has found to comply with the requirements for contained in the Category II specification.

The requirements and the descriptions of the associated tests described in this ETS are specified to provide correct inter-working with the PSTN, minimise the risk of hazardous electrical conditions appearing on the PSTN, minimise the risk conditions occurring on the PSTN which might create hazards for those using the modem and to ensure end-to-end interpretability between modems in compatible configurations.

NOTE 2: Compliance with a modem specific ETS provides to the user an added degree of assurance of interoperability over the PSTN. However, as the PSTN is primarily engineered to convey speech traffic, connections not permitting satisfactory data transmission can occur.

Proposed transposition dates	
Date of latest announcement of this ETS (doa):	3 months after ETSI publication
Date of latest publication of new National Standard or endorsement of this ETS (dop/e):	6 months after doa
Date of withdrawal of any conflicting National Standard (dow):	6 months after doa

1 Scope

This ETS contains the technical characteristics required for end-to-end interworking over the Public Switched Telephone Network (PSTN). Clauses of this ETS also contain Category II specifications define for certain features which may be provided by some modems, but the requirements in these parts are only applicable when invoked by a modem specific ETS.

The term "modem" in the context of this ETS includes all physical implementation practices for voice band modems which are conductively connected to the PSTN.

NOTE: This implies that certain types of modems, e.g. acoustically coupled and cordless modems, are outside the scope of this ETS.

This ETS also contains descriptions of the tests to be performed in order to confirm compliance with the functional requirements contained herein. A general description of the test conditions and test requirements for clause 4 is given in annex A (informative) and for clause 5 in annex B (normative).

Annex C (normative) describes the testing facilities which a testing laboratory may need to provide.

Annex D (normative) indicates additional equipment, or software, that applicants may need to provide in order that testing to Category II can be achieved.

2 Normative references

This ETS incorporates by dated or undated reference, provisions from other publications. These normative references are cited at the appropriate places in the text and publications are listed hereafter. For dated references, subsequent amendments to or revisions of any of these publications apply to this ETS only when incorporated in it by amendment or revision. For undated references the latest edition of the publication referred to applies.

- [1] ETS 300 001: "Attachments to Public Switched Telephone Network (PSTN); General technical requirements for equipment connected to an analogue subscriber interface in the PSTN".
- [2] ETS 300 115 (1991): "Attachments to the Public Switched Telephone Network (PSTN); Category II attachment requirements for 300 bits per second duplex modems standardized for use on the PSTN [Candidate NET 21]".
- [3] Final draft prETS 300 116 (1996): "Public Switched Telephone Network (PSTN); Category II specification for 1 200 bits per second duplex modems standardized for use on the PSTN".
- [4] Final draft prETS 300 117 (1996): "Public Switched Telephone Network (PSTN); Category II specification for 2 400 bits per second duplex modems standardized for use on the PSTN".
- [5] Final draft prETS 300 118 (1996): "Public Switched Telephone Network (PSTN); Category II specification for 1 200 bits per second half-duplex and 1 200/75 bits per second asymmetrical duplex modems standardized for use on the PSTN".
- [6] Final draft prETS 300 002 (1996): "Public Switched Telephone Network (PSTN); Category II specification for 9 600 or 4 800 bits per second duplex modems standardized for use on the PSTN".
- [7] Final draft prETS 300 492 (1996): "Public Switched Telephone Network (PSTN); Category II attachment requirements for 9 600 or 4 800 bits per second duplex modems standardized for use on the PSTN".
- [8] CCITT Recommendation V.24 (1984): "List of definitions for interchange circuits between Data Terminal Equipment and Data Circuit-Terminating Equipment".

- [9] CCITT Recommendation V.14 (1988): "Transmission of start-stop characters over synchronous bearer channels".
- [10] CCITT Recommendation V.25 (1984): "Automatic answering equipment and/or parallel automatic calling equipment on the general switched telephone network including procedures for the disabling of echo control devices for both manually and automatically established calls".
- [11] CCITT Recommendation V.21 (1984): "300 bits per second duplex modem standardized for use in the General Switched Telephone Network".
- [12] CCITT Recommendation V.54 (1984): "Loop test devices for modems".
- [13] CCITT Recommendation V.4 (1984): "General structure of signals of international alphabet No. 5 code for data transmission over public telephone networks".
- [14] CCITT Recommendation S.33 (1984): "Standardization of an international text for the measurement of the margin of start-stop machines using International Alphabet No. 5".
- [15] CCITT Recommendation V.52 (1984): "Characteristics of distortion and error-rate measuring apparatus for data transmission".
- [16] CCITT Recommendation V.22 (1984): "1200 bits per second duplex modem standardized for use in the general switched telephone network and on point-to-point 2-wire leased telephone-type circuits".
- [17] CCITT Recommendation V.22bis (1988): "2400 bits per second duplex modem using the frequency division technique standardized for use on the general switched telephone network and on point-to-point 2-wire leased telephone-type circuits".
- [18] CCITT Recommendation V.23 (1984): "600/1200-baud modem standardized for use in the General Switched Telephone Network".
- [19] CCITT Recommendation V.32 (1984): "A family of 2-wire, duplex modems operating at data signalling rates up to 9600 bits/s for use on the general switched telephone network and on leased telephone type circuits".

3 Definitions and abbreviations

3.1 Definitions

For the purposes of this and other related ETSs, the following definitions apply:

answer mode: When calls are established with automatic facilities, a standard answer mode is used by the modem at the answering station. This mode consists of conventional characteristics (e.g. use of high channel carrier frequency or particular scrambler generating polynomial) complementary to those used in the standard call mode by the modem at the calling station, in order to ensure proper connection and inter-working. If calls are established on the PSTN by operators, or for leased line operation, bilateral agreement on the use of call mode and answer mode is necessary.

built-in modem: A functionally separate internal modem which is mechanically combined with a terminal.

call mode: When calls are established with automatic facilities, a standard call mode is used by the modem at the calling station. This mode consists of conventional characteristics (e.g. use of low channel carrier frequency or particular scrambler generating polynomial) complementary to those used in the standard answer mode by the modem at the answering station, in order to ensure proper connection and inter-working.

If calls are established on the PSTN by operators, or for leased line operation, a bilateral agreement on the use of call mode and answer mode is necessary.

Data Terminal Equipment (DTE): In the context of this ETS, the expression "DTE" is used to define the origin and destination of signals present at the digital interface of a modem. This expression does not require that a "commercial data terminal" be present to receive or generate such signals; a tester or any suitable device may monitor or generate such signals.

integrated modem: An internal modem which is functionally and physically merged with the terminal.

internal modem: A modem which is physically incorporated in a terminal equipment and which takes its electrical power supply from the terminal.

Different types of internal modems are defined: built-in, plug-in and integrated modems.

intra-character signalling rate: The intra-character signalling rate of a message is the signalling rate of the start element and data elements within each character of this message.

modem: A functional unit that modulates and de-modulates signals in order to enable digital data to be transmitted over analogue transmission facilities.

modem used for reference: A modem used for some of the tests specified herein or in a modem specific ETS. A modem used for reference may, at the discretion of the applicant, be provided by the testing authority or by himself. It is designed:

- to meet the requirements of the same CCITT Recommendation(s) as the modem under test, to the extent necessary for performing the tests;
- to provide the functionalities for a modem used for reference that are specified in the relevant testing clauses; and
- to provide an interface which is accessible and of a type suitable for use in the tests (e.g. CCITT Recommendation V.24 [8]).

Where the applicant has provided the modem used for reference and the test fails, the testing authority may not be in a position to determine the precise reason for failure.

modes of operation: Modes specified in a modem specific ETS, that have an influence upon line signals present at the PSTN interface.

modes of use: Modes specified in a modem specific ETS, that have an influence upon conditions present at a digital interface e.g. a "conventional" CCITT Recommendation V.24 [8] interface or a PC bus interface in the case of an integrated modem.

on-line state: An electrical condition into which, when connected to the network, a modem is placed such that it draws enough current to be capable of activating the exchange.

NOTE: Usually, a modem in the on-line condition is potentially capable of sending or receiving speech-band information to or from the network.

plug-in modem: A physically and functionally separate internal modem which is interchangeable from a terminal.

round trip delay: This is twice the time taken for a transmitted signal to be propagated to the far end of a telephone connection.

For all tests where adherence to CCITT Recommendations is being checked the requirement and test assume a round trip delay of 0 ms. The round trip delay of the test line (test line 3) being used for the tests should be determined and the results of measurement adjusted by subtracting either half the round trip delay or the round trip delay as appropriate from the value obtained before comparing it with the pass/fail limit given in this ETS.

silence: This term is used to describe periods during the hand-shaking sequences where signals are not transmitted.

The period of silence is measured using the start and finish criteria defined below. The levels refer to signals which in the relevant frequency band have an in-band power level and are expressed with respect to the normal transmitted signal level of the modem under test recorded at the point of observation.

The start of the period of silence is defined as the instant at which the transmitted signal level drops below a level that is 6 dB below the normal transmit level.

The period of silence ends the instant the transmitted signal rises above a level that is 6 dB below the normal transmit level. During the period of silence at least one instant is observed where the signal level is at least 30 dB below the normal transmit level.

3.2 Abbreviations

For the purposes of this ETS the following abbreviations apply:

AMM	Answer Mode Modem
CcT	Circuit
CMM	Call Mode Modem
DCE	Data Circuit-Terminating Equipment
DTE	Data Terminal Equipment
MCT	Modem Conformance Tester
NEL	Nominal Element Length
PSTN	Public Switched Telephone Network

4 Common requirements

4.1 General notes

This clause specifies the requirements to be met by all modems seeking conformance with Category I or Category II specifications.

4.2 PSTN access requirements

The requirements of ETS 300 001 [1] apply.

4.3 Information to be provided by the applicant

4.3.1 Information required for testing purposes

The applicant shall provide to the testing authority, at least the information indicated below:

- equipment nature (stand-alone, rack-mounted, integrated in a terminal);
- intended category (Category I and/or Category II);
- countries for which the equipment is intended for attachment.

An example proforma chart to collect this information is provided in annex E.

4.3.1.1 List of modes

The applicant shall specify those modes of the equipment relevant to operation on the PSTN and for which of them assessment of conformance is sought, and which of them are intended for use in specified countries:

- list of carrier modes;
- automatic answering;
- automatic calling;
- provision of line loop 3 during a connection;
- special features.

4.3.1.2 Other items

The applicant shall provide the following information:

- additional technical information (transmitted level, minimum received level...);
- power supply;
- environmental characteristics.

4.3.2 Instructions for use

Instructions for use shall be made available with the apparatus. The instructions for use shall include:

- a) the apparatus or types of apparatus to which the instructions apply;
- b) the modes for which only the Category I conformance has been assessed;
- c) any information specifically indicated in this ETS for inclusion in the "Instructions for use";
- d) any national restrictions on the use of the apparatus.

Any additional information that has been included shall be disregarded unless it is the subject of another ETS.

Compliance shall be checked by inspection.

5 Requirements common to some Category II modems

5.1 General notes

This clause contains requirements which are common to some of the following modem specific ETSs and could be invoked by:

- ETS 300 115 [2];
- final draft prETS 300 116 [3];
- final draft prETS 300 117 [4];
- final draft prETS 300 118 [5];
- final draft prETS 300 002 [6];
- final draft prETS 300 492 [7].

On the whole, these requirements are based upon, and do not conflict with, CCITT/ITU-T Recommendations, nevertheless some exceptions have been introduced in subclause 5.5 (for asynchronous to synchronous conversion based upon CCITT Recommendation V.14 [9]) and in subclause 5.6 (for modem performance tests).

NOTE: In the following, references are made to interchange circuits between the modem and the DTE, as defined in CCITT Recommendation V.24 [8]. DTEs using certain customized modems should not generally provide an interface with such interchange circuits. For these cases the references to CCITT Recommendation V.24 [8] type interchange circuits indicate equivalent operation of a DTE and of a modem where this exists.

5.2 Call establishment sequence based upon CCITT Recommendation V.25

5.2.1 For modems initiating calls

The requirements of this subclause shall only be mandatory when invoked by a requirement in the relevant specific ETS.

5.2.1.1 Calling tone generation

The provision of a calling tone as described in CCITT Recommendation V.25 [10] is optional. Where this facility has been provided the calling tone shall be 1 300 Hz with the exception of CCITT Recommendation V.21 [11] modems where it shall be either 980 Hz or 1 300 Hz. Multi-mode modems providing this facility shall use 1 300 Hz.

Compliance shall be checked by the method described in annex B, subclause B.2.1.1.

5.2.1.2 Answering tone detection

After completion of the dialling phase, when the calling modem or its associated automatic call establishment equipment is presented with valid answer tone in the range 2 078 Hz to 2 122 Hz indicating that the remote modem has connected to line, the modem shall not give an indication to the DTE that it is ready to operate (equivalent: turning ON Cct 107) until a single interruption of at least 55 ms has been detected in answer tone or until a valid carrier signal has been detected.

NOTE 1: Since not all modems respond with answer tone, it is strongly recommended that Category II modems are also capable of connecting to line on receipt of a valid carrier.

The exact timing of the indication in relation to the break in answer tone is a function of the specific type of modem in use. For example, inter-working would not be adversely affected if such an indication was delayed until after the receipt of valid carrier.

The behaviour of the modem, when presented with tones which are not valid answer tones is not tested.

NOTE 2: These requirements are derived from subclauses 3.18 to 3.20 of CCITT Recommendation V.25 [10]; the calling tone and calling station response, if present, should only be constrained by ETS 300 001 [1].

Compliance shall be checked by the method described in annex B, subclause B.2.1.2.

5.2.2 For modems answering calls

The requirements of this subclause shall only be mandatory when invoked by a requirement in the relevant specific ETS.

Following establishment of on-line conditions, the modem shall remain silent for a period not less than 1,8 s. The modem, or its associated automatic answering equipment, shall then transmit 2 100 Hz \pm 15 Hz. In the case where the calling station response is not present, the duration of this tone shall be 3,3 s \pm 0,7 s. This shall be followed by a silent period, the duration of which is 75 ms \pm 20 ms after which an indication shall be given to the DTE that the modem is ready to operate (equivalent: turning ON Cct 107).

NOTE 1: This requirement is derived from subclauses 4.3 & 4.4 of CCITT Recommendation V.25 [10].

NOTE 2: The level at which the tone is transmitted is constrained by ETS 300 001 [1].

NOTE 3: The answering sequence described above has the effect of disabling network echo suppressors where present. Modems requiring to disable network echo cancellers as well as network echo suppressors, are advised to transmit 180° phase reversals in the 2 100 Hz tone at 450 ms \pm 25 ms intervals.

NOTE 4: An upper limit for the silent period is not specified, so as not to preclude a modem from providing detection facilities that would identify particular types of calling device.

NOTE 5: The exact timing of the indication that the modem is ready to operate (equivalent: turning ON Cct 107) is a function of the specific type of modem in use.

Compliance shall be checked by the method described in annex B, subclause B.2.2.

5.3 Test loop implementation based upon CCITT Recommendation V.54

5.3.1 General

This describes the test loop functions which may be provided in modems.

The method of initiating such loops (e.g. manually, locally or remotely) is described in the appropriate ETS.

Figure 1 roughly indicates the function of these test loops.

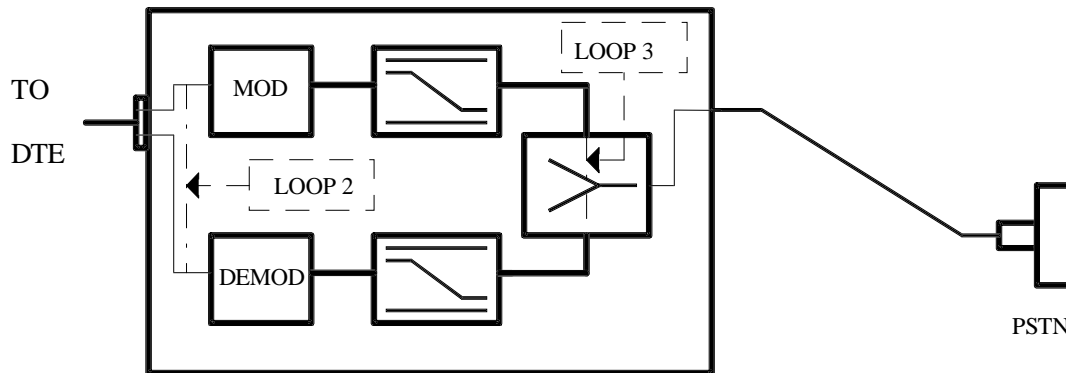

Figure 1: Test loops

5.3.2 Remote digital test loop (loop 2)

This test loop may be used for a basic test of the local modem, the network connection and the remote modem. This loop is only of practical use with full duplex modems. Once instigated, this loop causes data transmitted by the DTE to be returned back on the received data connection through the remote modem.

5.3.3 Local analogue test loop (loop 3)

This test loop may be used to establish that the local modem is functioning correctly. The implementation of this loop should ensure, that in so far as is possible, all the circuitry within the modem used for processing the signals is included in the test.

5.4 Threshold of received line signal detection

The requirements of this subclause are only mandatory when invoked by a requirement in the relevant specific ETS.

All levels shall be determined with the modem replaced by a 600 ohm non-reactive resistor.

When a valid line signal, as described in the relevant modem specific ETS, is applied to the line terminals of a modem at any level above - 43 dBm, the modem shall be capable of establishing a data connection and passing data to a DTE, to which the modem shall give an appropriate indication (e.g. equivalent to turning CcT 109 ON).

When a modem is presented with a valid line signal at a level below - 48 dBm the modem shall not establish a data connection (i.e. pass data derived from the line signal) to a DTE, to which the modem shall give an appropriate indication (e.g. equivalent to CcT 109 remaining OFF).

The lowest level at which, for a valid line signal, the modem indicates to the DTE the capability of establishing a data connection, or of passing data, shall be at least 2 dB greater than the level at which it indicates to the DTE that the capability to continue to pass data over the established connection has ceased (e.g. equivalent to turning CcT 109 OFF).

Compliance shall be checked by the method described in annex B, clause B.4.

5.5 Requirements for modems providing asynchronous to synchronous conversion based upon CCITT Recommendation V.14

5.5.1 General

This subclause defines the requirements for a Category II modem providing facilities for the conversion of asynchronous transmission to synchronous transmission without any error correction, speed conversion or flow control process. The requirements of this subclause shall only be mandatory if they are referenced by another ETS.

To comply with the requirements of subclause 5.5.2, it is necessary that the modem provide transmission of start-stop characters in at least one of the following character modes:

- a) asynchronous with 8 bits per character;
- b) asynchronous with 9 bits per character;
- c) asynchronous with 10 bits per character;
- d) asynchronous with 11 bits per character.

NOTE 1: The following requirements are derived from CCITT Recommendation V.14 [9]. If an error correction function is to be included in the modem, asynchronous to synchronous conversion as described in CCITT Recommendation V.42 (1988) should be used.

NOTE 2: For integrated modems, some of the requirements cannot be verified and therefore are the subject of an applicant's declaration of conformance.

5.5.2 Transmission of start-stop characters

5.5.2.1 Signalling rate ranges of the start-stop characters at the modem input

The process of asynchronous to synchronous conversion within the modem shall be capable of receiving characters from a DTE whose speed varies by + 1 % to - 2,5 % (referred to hereinafter as the basic rate range) from the nominal data signalling rate without any corruption of data.

Optionally, the modem may also be capable of receiving characters from a DTE whose speed varies by + 2,3 % to - 2,5 % (referred to hereinafter as the extended rate range) from the nominal data signalling rate without any corruption of data.

5.5.2.2 Start-stop character format

It shall be possible to configure the conversion process within the modem to accept one or more of the following formats:

- a) a one-unit start element, followed by six data units, and a one-unit stop element (8-bit characters);
- b) a one-unit start element, followed by seven data units, and a one-unit stop element (9-bit characters);
- c) a one-unit start element, followed by eight data units, and a one-unit stop element (10-bit characters);
- d) a one-unit start element, followed by nine data units, and a one-unit stop element (11-bit characters).

It shall be possible to transmit characters continuously or with any additional stop elements of arbitrary length between characters.

The character format selected shall be the same for both the transmitter and the receiver of the modem.

NOTE 1: It is assumed that characters presented to the modem are in accordance with CCITT Recommendation V.4 [13]. Character formats a) and d) do not conform to the International Alphabet No. 5.

NOTE 2: In each of the four formats, data units can be replaced by additional stop units. For example, format d) will allow 11-bit characters consisting of a one-unit start element, followed by eight data units and a stop element of two units to be handled.

5.5.2.3 Asynchronous to synchronous conversion

The method of handling the speed differences between the intra-character signalling rate of the start-stop characters and the data signalling rate of the synchronous bearer channel shall be by insertion or deletion of stop elements at the transmitter and re-insertion of deleted stop elements at the receiver. The means shall also be provided for transfer of continuous start polarity (break signals).

5.5.2.3.1 Transmitter

In the transmit direction the start-stop characters shall be adapted to the signalling rate of the synchronous bearer channel by:

- transmission of start and data elements in the same sequence as in the start-stop characters;
- insertion of additional stop elements in the case of under-speed of the start-stop characters;
- deletion of stop elements in the case of over-speed of the start-stop characters.

When the modem is set to operate in the basic signalling rate range, the number of stop elements deleted less the number of additional stop elements inserted (if any), measured over any eight consecutively transmitted characters, shall not be greater than one, and when the modem is set to operate in the extended signalling rate range, the number of stop elements deleted less the number of additional stop elements inserted (if any), measured over any four consecutively transmitted characters, shall not be greater than one.

Compliance shall be checked by the method described in annex B, subclauses B.5.3.1.1, B.5.3.1.2, and B.5.3.1.3.

5.5.2.3.2 Receiver

In order to recover a start-stop character structure, the receiver part of the conversion process shall regenerate the start and data elements transmitted on the synchronous bearer and restore the stop elements which have been deleted by the transmitter part of the conversion process.

The intra-character signalling rate provided by the receiving modem (to the DTE) shall be not less than the lower limit of the nominal synchronous line signalling rate and not more than the limit of the specified over-speed tolerance, viz + 1 % for the basic signalling rate range and + 2,3 % for the extended signalling rate range. The length of stop elements output to the receiving DTE shall not be reduced by more than 15,7 % in the basic signalling rate range (or 28,2 % in the extended signalling rate range), relative to the nominal synchronous line signalling rate.

For any character, the length of the start element and the lengths of each data element shall differ by no more than 6,5 % from the Nominal Element Length, "NEL", for that character as defined by the equation:

$$NEL = \frac{\text{sum of lengths of start element and data elements}}{\text{number of data elements} + 1}$$

Compliance shall be checked by the method described in annex B, subclauses B.5.3.2.1, B.5.3.2.2 and B.5.3.2.3.

5.5.2.3.3 Break signal

5.5.2.3.3.1 Transmitter

When the digital interface of the modem is presented with asynchronous data signals comprising between M and $2M + 3$ bits of "start" polarity, where M is the number of bits per character in the selected format, the modem shall transmit $2M + 3$ bits of "start" polarity. If the modem is presented with more than $2M + 3$ bits all of "start" polarity the modem shall transmit all these bits as "start" polarity.

Compliance shall be checked by the method described in annex B, subclause B.5.3.1.4.

A modem shall be presented with at least $2M$ bits of "stop" polarity after the "start" polarity break signal in order to ensure that it regains character synchronism.

5.5.2.3.3.2 Receiver

When $2M + 3$ or more bits of "start" polarity are received they shall be conveyed to the associated DTE. Character synchronism shall be regained from the next "stop" to "start" transition.

Compliance shall be checked by the method described in annex B, subclause B.5.3.2.4.

5.6 Performance

This subclause makes reference to the tests which are to be executed in order to verify the compliance of a Category II modem to the performance requirements specified in the modem specific ETS.

The requirements of this subclause shall not be mandatory unless they are referenced by a modem specific ETS.

5.6.1 Overall performance

Two different test lines have been defined for the evaluation of performance, the first one reflecting severe line conditions and the second one reflecting average local line conditions. These test lines have pre-set values of permanent impairments, to which the individual transient impairments shall be added.

The test methods and the test facilities to be used in assessing the performance of Category II modems are described in annexes B (clause B.6) and C respectively.

When subjected to the conditions defined above, the modem under test shall accumulate a percentage of error-free seconds greater than or equal to the minimum value specified in the relevant ETS.

5.6.2 Performance in the presence of metering pulses

The requirements of this subclause shall only be applicable where:

- metering pulses at nominal frequencies of either 12 kHz or 16 kHz may be provided on a customer's line;
- such metering pulses may be presented to the line interface of a modem, when connected to the customer's line;
- it is a national requirement that Category II modems work without significant degradation in the presence of such metering pulses.

Table 1 indicates whether or not such a requirement exists and, where it exists, the metering frequency, the level of the metering pulse and the impedance of the generator and load.

Table 1: Metering pulse requirements

Country	Requirements	Freq	Level/Source/Load
Austria	Yes	12 kHz	+ 10 dBV/200 Ω /200 Ω
Belgium	No	-	
Cyprus	Yes	16 kHz	
Denmark	No	-	
Finland	No	-	
France	No	-	
Germany	Yes	16 kHz	+ 22 dBm/0 Ω /200 Ω
Greece	No	-	
Iceland	No	-	
Ireland	No	-	
Italy	No	-	
Luxembourg	No	-	
Malta	No	-	
Netherlands	No	-	
Norway	No	-	
Portugal	No	-	
Spain	Yes	12 kHz	+ 9 dBm/0 Ω /200 Ω
Sweden	No	-	
Switzerland	No	-	
United Kingdom	No	-	
NOTE:	The figure for error free seconds given is based on this being in effect a permanent impairment where these metering pulses exist. Thus in practice very little error free data transmission is possible if the modem is not able to reject the metering pulses.		

When tested as described in annex B, subclause B.6.4.4, the modem shall accumulate a percentage of error free seconds greater than or equal to 95 % for each testing period.

For any country, an entry "No" in the "Requirements" column of table 1 shall be interpreted as no requirement and the tests related to this subclause shall not be performed as part of Category II conformance assessment.

Annex A (informative): Testing methods for national variants for clause 4

A.1 General notes

Since no national variations are specified, this annex contains no tests.

Annex B (normative): Testing methods for clause 5

B.1 General conditions for test

Testing environment

Except where different operating conditions are stated by the applicant, the tests shall be executed at any one combination of the environmental conditions lying within the following ranges:

- ambient temperature in the range 15°C to 35°C;
- relative humidity in the range of 25 % to 75 %;
- atmospheric pressure in the range of 86 kPa to 106 kPa.

Power supply

When an apparatus is directly powered from the mains, the voltage of the supply shall be within $\pm 5\%$ of the nominal operating voltage and the frequency within $\pm 2\%$ of the nominal frequency.

When it is powered by other means not supplied as part of the apparatus, the test shall be carried out within the limits stated by the applicant.

Measurement tolerances

Unless otherwise specified, frequency, time, voltage, current and resistance measurements specified in the tests shall be accommodated within a tolerance of $\pm 1\%$.

Modem transmit levels

With the exception of clauses in which a specific transmit level is stated, the nominal transmit level shall be - 7 dBm or, if not available, the nearest indicated level below - 7 dBm.

Calibration of the test bench

Except where alternative methods have been specified, when calibrating the test bench and its components, the effective source impedance of all generators shall be 600 ohms and all measurements shall be performed by removing the load impedance and replacing this with a 600 ohm non-reactive resistor which may, or may not, be part of the measuring instrument.

Measurements

Except where otherwise specified all measurements of signal levels shall be performed with an instrument capable of indicating the true r.m.s level of a signal contained within the frequency band from 300 Hz to 3 400 Hz.

B.2 Tests of the call establishment sequence specified in subclause 5.2

B.2.1 For modems initiating calls

B.2.1.1 Calling tone

For this test the modem configured as a Call Mode Modem (CMM) is connected to Test Line 3 (see annex C, clause C.5). After the CMM has completed the calling phase, a single tone, whose frequency is variable shall be sent back to it.

B.2.1.2 Detection of answering tone

A CMM incorporating answer tone detection shall detect the presence of answer tone when a signal, at a level of - 43 dBm and at a frequency of either 2 078 Hz or 2 122 Hz for a period of greater than 600 ms, is applied to its line terminals.

NOTE: Phase inversion of the tone at intervals of $450 \text{ ms} \pm 25 \text{ ms}$ should not preclude its detection by the CMM.

The CMM shall not indicate that it is ready to operate (equivalent: turning ON CcT 107) until the 2 100 Hz tone has been followed by silence for a minimum period of 55 ms.

B.2.2 For modems answering calls

This test shall be performed without the calling station response (calling tone) present.

For this test the modem configured as an Answer Mode Modem (AMM) shall be connected to Test Line 3 (see annex C, clause C.5).

After having detected a ringing signal and having connected to the line, the AMM shall remain silent for a period of at least 1,8 s, prior to sending an answering tone whose frequency shall be $2\ 100 \text{ Hz} \pm 15 \text{ Hz}$ and whose duration shall be $3,3 \text{ s} \pm 0,7 \text{ s}$.

The modem shall continue to indicate that it is not ready to operate (equivalent: CcT 107 remaining OFF) until answering tone has been followed by a silent period the duration of which shall be $75 \text{ ms} \pm 20 \text{ ms}$.

B.3 Tests to verify the test loop implementation specified in subclause 5.3

No tests are specified in this clause, because subclause 5.3 contains no requirements.

B.4 Tests to verify the threshold of line signal detection

For these tests the modem used for reference shall emit signals as described in the relevant ETS.

All levels shall be measured with the modem under test replaced by a 600 ohm non-reactive resistor.

During the tests given below, the modem under test shall be connected to the modem used for reference via Test Line 3 (see annex C, clause C.5). The other inherent characteristics of Test Line 3 shall remain constant, with the exception of the frequency-independent insertion loss which shall be adjusted to achieve the received levels specified below to within $\pm 0,5 \text{ dB}$.

- a) With the overall loss of Test Line 3 set so that the signal from the modem used for reference is presented to the line terminals of the modem under test at a level of - 42,5 dBm, the modem under test is caused to enter the on-line state and, after allowing time for the start up sequence to be completed (where applicable), the modem under test shall indicate that the line signal is within appropriate limits (equivalent: turning ON CcT 109) and shall be capable of passing data to the DTE.
- b) The level of the received signal is progressively reduced until the modem under test indicates that the line signal is outside the appropriate limits, (equivalent: turning OFF CcT 109). The received signal level shall be recorded, and shall not be lower than - 48,5 dBm.
For this test the rate of decrease of signal level shall not exceed 0,2 dB per second.

Tests a) and b) shall be repeated three times before proceeding to c).

- c) The level of the received signal shall now be set to be 1,7 dB higher than the lowest level recorded under b), and the modem under test caused to attempt to establish another data connection. This relative level setting shall be achieved with an accuracy of $\pm 0,3$ dB. The modem under test shall not establish a data connection or indicate to the DTE that the line signal is within appropriate limits (equivalent: CcT 109 remaining OFF).

NOTE: Where relevant, during the above test the level of answer tone transmitted may need to be adjusted so that the level presented to the line terminals of the modem under test is higher than - 42,5 dBm.

B.5 Tests to verify the process of asynchronous to synchronous conversion specified in subclause 5.5

The tests specified in this clause apply when the modem (under test) is equipped with a stop-start to synchronous conversion capability based on CCITT Recommendation V.14 [9].

B.5.1 Test patterns

B.5.1.1 General

The testing of the start-stop to synchronous converter shall, where it is available, be carried out using the character length of 10 bits (including start and stop elements). Where the start-stop to synchronous converter does not provide this character length, the tests shall be carried out in the character format with the greatest number of data bits. The tests outlined here-in-after may need to be adapted accordingly.

The number of signal elements per character is referred to here-in-after as "M".

If both the basic signalling rate range and the extended signalling rate range are implemented in the modem, the test shall be carried out using both signalling rate ranges.

Unless otherwise specified in clause B.5, the test characters shall be transmitted with even parity (see CCITT Recommendation V.4 [13]).

B.5.1.2 Standard test text

The standard test text to be used shall be the "QUICK BROWN FOX..." text in the international alphabet No. 5 (IA5), according to CCITT Recommendation S.33 [14]. Alternatively, the French version of the test text (VOYEZ LE BRICK GEANT...) as specified in CCITT Recommendation S.33 [14] may be used. Either the 64-character set version or the 95-character set version of the test texts as specified in CCITT Recommendation S.33 [14] may be used.

NOTE: IA5 is not applicable for the shortest possible character length of 8 bits. However, some commercially available data test equipment may offer the capability of generating test texts in the so-called 6-bit version of the ASCII code. Where test tools provided by the applicant are applied (see annex D), it is the applicant's responsibility to specify the alphabet used.

B.5.1.3 Discrete Test Characters (DTC)

The Discrete Test Characters (DTC) of table B.1 shall be used for various tests.

Table B.1: Discrete Test Characters (DTC)

a)	Discrete Test Characters for 8-bit character length: DTC N° 1: SRT 0 0 0 0 0 0 STP DTC N° 2: SRT 1 0 1 0 1 0 STP DTC N° 3: SRT 1 1 1 1 1 1 STP DTC N° 4: SRT 0 0 0 1 1 1 STP Presentation of these characters to be specified by the applicant.
b)	Discrete Test Characters for 9-bit character length: DTC N° 1: SRT 0 0 0 0 0 0 0 STP (character "NUL") DTC N° 2: SRT 1 0 1 0 0 1 0 STP (character "%") DTC N° 3: SRT 1 1 1 1 1 1 1 STP (character "DEL") DTC N° 4: SRT 0 0 0 0 1 1 1 STP (character "p").
c)	Discrete Test Characters for 10-bit character length: DTC N° 1: SRT 0 0 0 0 0 0 0 0 STP (character "NUL") DTC N° 2: SRT 1 0 1 0 1 0 1 0 STP (character "U") DTC N° 3: SRT 1 1 1 1 1 1 1 1 STP (character "DEL") DTC N° 4: SRT 0 0 0 0 1 1 1 1 STP (character "p").
d)	Discrete Test Characters for 11-bit character length: DTC N° 1: SRT 0 0 0 0 0 0 0 0 0 STP (character "NUL") DTC N° 2: SRT 1 0 1 0 0 1 0 1 0 STP (character "Ñ") DTC N° 3: SRT 1 1 1 1 1 1 1 1 1 STP (character "DEL") DTC N° 4: SRT 0 0 0 0 1 1 1 1 1 STP (character "p").
Legend: SRT = start element, STP = stop element	
NOTE:	The 10 bit characters specified in table B.1, c) represent the cases most commonly implemented in modems, of: one start element + seven data bits + parity bit + stop element. The 9-bit characters specified in table B.1, b) should generally be comprised of: one start element + seven data bits + one stop element (without a parity bit).

Where the test equipment is designed to generate characters comprising eight data bits rather than seven (e.g. it is a standard PC), the DTCs shall not contain parity bits for the 10-bit character length case.

NOTE: A standard PC which uses the so-called "extended (8-bit) ASCII character set" should normally display DTC N° 4 as "=" rather than "p" when configured for the 10 bit or 11 bit character set.

B.5.2 Data signalling rates

The nominal data signalling rates and the signalling rates for the basic rate range and the extended rate range can be found in table B.2. The values of these rates shall be accommodated within a tolerance of $\pm 0,1\%$ ($\pm 10^{-3}$).

Table B.2: Data signalling rate ranges

Nominal signalling rate bit/s	Basic rate range		Extended rate range	
	- 2,5 % bit/s	+ 1 % bit/s	- 2,5 % bit/s	+ 2,3 bit/s
600	585	606	585	613
1 200	1 170	1 212	1 170	1 227
2 400	2 340	2 424	2 340	2 455
4 800	4 680	4 848	4 680	4 910
9 600	9 360	9 696	9 360	9 820

B.5.3 Tests

For the tests described below, the modem under test shall be connected to the modem used for reference via the Test Line 3 (see annex C, clause C.5).

If, at the discretion of the applicant, a modem which has not been approved as Category II is being used for reference, then it shall be possible to inhibit the start-stop to synchronous converter in this modem, and to apply an external start-stop to synchronous converter, or a start-stop to synchronous converter integrated into the data test equipment.

NOTE: Some of the following tests require that the data signalling rate at the DTE-to-modem interface be identical with (except for the specified tolerance margins), or deviate only by a specific amount from, the data signalling rate. Those tests are, therefore only applicable if the *modem under test* provides a standard CCITT Recommendation V.24 [8] or similar type interface and has no buffering capability for transmitted data, or where such a buffering capability exists but can be inhibited. Where the modem is integrated into a DTE it may be required that testing software be supplied with the modem to be approved to facilitate specific functions as specified in the subclauses below.

B.5.3.1 Transmitter tests

B.5.3.1.1 Omission of stop elements

For this test the modem used for reference shall be configured to the synchronous mode of use, with internal clock source (CcT 114) or external transmitter clock source (CcT 113).

One DTC No. 3 and 20 DTCs No. 1, as specified in subclause B.5.1.3, shall be contiguously input to the modem under test (equivalent: CcT 103) and then transmitted to the modem used for reference, at the upper signalling rate limit of the selected signalling rate range as stated in table B.2. The characters as output at the received data lead of the modem used for reference (CcT 104) shall be checked for omitted stop elements.

The number of stop elements deleted less the number of additional stop elements inserted, measured over any eight consecutively received characters (basic signalling rate range) or, in any four consecutively received characters (extended signalling rate range), shall not be greater than one.

This test shall only be applicable if an accessible serial interface is provided by the modem under test.

B.5.3.1.2 Over-speed and under-speed capabilities

For this test the modem used for reference is configured to the start-stop mode of use (or to the synchronous mode of use with an external synchronous to start-stop converter connected to it).

220 blocks of the standard test text as specified in subclause B.5.1.2 shall be contiguously input to the modem under test (equivalent: CcT 103), and then transmitted to the modem used for reference at the upper data signalling rate limit of the selected signalling rate range, and thereafter 220 blocks shall be transmitted at the lower data signalling rate limit of the selected signalling rate range. These limits are as indicated in table B.2.

No data error shall occur under either test, otherwise the respective test sequence shall be repeated once. If any errors occur during the second attempt at this test sequence, the modem shall be assumed to have failed this test.

This test cannot be applied to integrated modems. Instead, the test software to be supplied with the modem (see annex D) shall make provision for the transmission of 220 contiguous blocks of the standard test text at the highest possible intra-character signalling rate.

B.5.3.1.3 Arbitrary character spacing

For this test the modem used for reference is configured to the start-stop mode of operation or to the synchronous mode of operation with an external synchronous to start-stop converter connected to it, whichever is applicable.

The following test sequence shall be input to the modem under test at the upper data signalling rate limit of the selected signalling rate range, and with every element length in accordance with this data signalling rate as indicated in table B.2 (e.g. 412,5 μ s for the basic rate range at a nominal data signalling rate of 2 400 bit/s). The characters received shall be compared to those sent. This test should be accommodated with any suitable means. The analysis of the regenerated signals should be done e.g. in utilizing a standard terminal or PC as described below.

a "clear screen" character (or string of characters, subject to the test equipment used)

followed by one DTC N° 3,

followed by 40 (DTC N° 2 + DTC N° 4) (*block #1*),

followed by a binary ONE condition of 0,15 element length,

followed by another 40 (DTC N° 2 + DTC N° 4) (*block #2*),

followed by a binary ONE condition of 0,22 element length,

followed by another 40 (DTC N° 2 + DTC N° 4) (*block #3*),

followed by a binary ONE condition of 0,33 element length,

followed by another 40 (DTC N° 2 + DTC N° 4) (*block #4*),

followed by a binary ONE condition of 0,47 element length,

followed by another 40 (DTC N° 2 + DTC N° 4) (*block #5*),

followed by a binary ONE condition of 0,68 element length,

followed by another 40 (DTC N° 2 + DTC N° 4) (*block #6*),

followed by a binary ONE condition of 1,0 element length,

followed by another 40 (DTC N° 2 + DTC N° 4) (*block #7*).

A standard terminal or PC connected to the modem used for reference (or to the external synchronous to start-stop converter), and with a character presentation of 80 characters per line, would now display seven lines with 40 "Up" (or "U≡"; see note under subclause B.5.1.3) double characters in each.

If any character is received in error, then the test shall be repeated with the exception that the binary 1 conditions between the "Up" or "U≡" double characters shall all be of the length of the binary 1 condition which preceded the double character string received in error. If, for example, transmission errors appear in the sixth 80 character block, the test shall be repeated with all 0,68 element length character spacing between the blocks of 40 double characters.

If, again, incorrect characters are received it shall be assumed that the start-stop to synchronous converter of the modem under test is working incorrectly.

If the modem under test does not provide a standard CCITT Recommendation V.24 [8] or similar type interface or is an integrated modem, the test software to be supplied with the modem shall make provision for the test pattern specified above (see annex D).

NOTE: The stop conditions of variable length between the character strings are, in practice, an extension of the stop element of the last character of the string. It should be aimed at to generate these extended stop conditions with an accuracy of $\pm 3,5\%$ (e.g. $458\ \mu\text{s}$ to $491\ \mu\text{s}$ for the stop condition after the first character string at 2 400 bits per second, basic rate range [nominal value: $474,42\ \mu\text{s}$]).

B.5.3.1.4 Break signal transmission

For this test the modem used for reference shall be configured to the synchronous mode of use, with internal or external transmitter clock source at the nominal data signalling rate.

M bits of start polarity shall be input to the modem under test, followed by 2M bits of stop polarity.

In the data received by the modem used for reference and output at the received data lead (CcT 104), a start polarity of length $2M + 3$ bits shall be output.

The test shall be repeated with $2M + 3$ bits of start polarity, followed by 2M bits of stop polarity.

$2M + 3$ bits of start polarity shall be output at the modem used for reference.

The test shall be repeated with 3M bits of start polarity, followed by 2M bits of stop polarity.

$3M \pm 1$ bits of start polarity shall be output at the modem used for reference.

B.5.3.2 Receiver tests

For the tests specified here-in-after the modem used for reference is configured to the synchronous mode of operation, with external clock source (CcT 113) (if applicable otherwise internal (CcT 114)) transmitter clock source at the nominal line signalling rate.

B.5.3.2.1 Over-speed capability

- a) 220 blocks of the standard test text, as specified in subclause B.5.1.2, shall be input to the modem used for reference, but with every eighth (for the basic range) or fourth (for the extended range) stop element omitted.

No data error shall occur in the data output by the modem under test (equivalent: CcT 104), otherwise the test shall be repeated once. If any errors occur during the second attempt, the modem shall be assumed to have failed this test.

NOTE: To ease the comparison of the received test text blocks for applications where the modem under test does not provide a standard CCITT Recommendation V.24 [8] type interface but is e.g. integrated in a DTE, the 220 transmitted blocks may be divided into suitable groups so as to facilitate the presentation of the data received in a form more appropriate for the equipment used for this test (e.g. presentation on the screen of a PC).

- b) The following test shall only be applied where the modem under test has a serial interface and when the received data is output to this interface at the nominal line signalling rate.

One arbitrary character out of a block of DTCs No. 2 output by the modem under test (equivalent: CcT 104) shall be analyzed with respect to the length of the individual elements:

- 20 blocks of 80 DTCs No. 2 shall be input to the modem used for reference (CcT 103) with every eighth (for the basic rate) or fourth (for the extended rate) stop element omitted;

- the total duration of the start element plus the data elements, divided by their number (this quotient is referred to below as the mean element length), shall not be less than the reciprocal value of the respective data signalling rate at the signalling rate range chosen, as specified in table B.2;
- each individual signal element shall differ by no more than 6,5 % from the mean element length;
- the received stop elements shall not be shorter than 84,3 % of their nominal length (the reciprocal value of the line signalling rate) for the basic signalling rate range and 71,8 % of their nominal length for the extended signalling rate range.

B.5.3.2.2 Under-speed capability

220 blocks of the standard test text as specified in subclause B.5.1.2, shall be input to the modem used for reference (CcT 103), but with an additional stop element appended to each fourth character.

No error shall occur in the data output by the modem under test (equivalent: CcT 104), otherwise the test shall be repeated once. If any errors occur during the second attempt, the modem shall be assumed to have failed this test.

B.5.3.2.3 Character recovery

1 920 (e.g. one screen of 24 lines with 80 characters each) DTCs No. 2 shall be input to the modem used for reference (CcT 103), where alternately one stop element is omitted and one additional stop element is appended (see figure B.1).

No error shall occur in the "U" characters output by the modem under test (equivalent: CcT 104), otherwise the test shall be repeated once. If any errors occur during the second attempt, the modem shall be assumed to have failed this test.

SRT 1 0 1 0 1 0 1 0 SRT 1 0 1 0 1 0 1 0 STP STP SRT 1 0 1 ...

Figure B.1: Character recovery test pattern

B.5.3.2.4 Break signal reception

2M + 3 bits of start polarity shall be input to the modem used for reference (CcT 103) at the nominal data signalling rate, followed by 2M bits of stop polarity, followed by 40 character combinations (DTC No. 2 + DTC No. 4).

The data test equipment connected to the modem under test (or the DTE into which the modem under test is integrated) shall correctly display 40 "Up" (or "U≡"; see note to subclause B.5.1.3) character combinations, otherwise the test shall be repeated once. If any errors occur during the second attempt, the modem shall be assumed to have failed this test.

B.6 Performance testing methodology

B.6.1 General

This subclause specifies the method of measuring the transmission performance of modems when compliance with Category II is sought.

For testing Category II modems, the following philosophy has been adopted:

- a) permanent impairments of pre-set values are applied on simulated connections viz white noise, insertion loss, variations in both attenuation and delay with frequency, frequency offset, phase jitter and echoes. A modem is expected to operate to a compatible modem without a significant number of errors, in the presence of these impairments;

- b) transitory impairments viz phase hits, amplitude hits, impulsive noise, transient interruptions, single tone interference, are introduced in sequence one at a time. Whilst these transitory disturbances are present, in addition to the permanent impairments listed above, the modem is permitted to produce errors, but once removed, the modem is expected to revert to "error free" data transmission.

When exposed to the conditions defined above, the modem under test shall accumulate a percentage of error-free seconds greater than or equal to the minimum value specified in the relevant ETS.

NOTE: The simulated test lines described here-in-after are mainly intended to be used for performance assessment of modems, nevertheless they could also be used for conformance tests.

B.6.2 Definitions

amplitude hit: A sudden but moderate step change in the transmission loss of a bearer circuit which persists for some minimum duration. It is defined in terms of the magnitude of the increase or decrease (in dB) and the minimum duration between successive changes.

echo: Echo may be caused by reflections at impedance mismatches or by other processes such as go-to-return crosstalk.

talker echo: Occurs when a portion of the transmitter's (talker's) signal is returned with a certain delay.

listener echo: Refers to a transmission condition in which the main received signal arrives at the receiver's (listener's) end of the connection accompanied by one or more delayed replicas (echoes) of the received signal.

Signal to Echo Ratio (SER): $10 \cdot \log (\text{power of } x(t) / \text{power of echo})$ dB where both echo and $x(t)$ are measured before addition of the echo to $x(t)$.

frequency offset: Occurs when all the components of the signal spectrum are subject to the same positive or negative frequency shift (Hz). Frequency offset occurs when the carriers of local and remote frequency division multiplexing equipments are not synchronized.

group delay/frequency characteristic: The difference between the transmission delay at the frequency under consideration and the transmission delay at the frequency where the delay is a minimum.

harmonic distortion: Distortion occurring in systems in which the output signal is not linearly related to the input signal. A simple example is a system in which the output signal $e_o(t)$ can be represented, as a function of the input signal $e_i(t)$, a power series of the form,

$$e_o(t) = a_1 e_i(t) + a_2 e_i^2(t) + a_3 e_i^3(t) + \dots$$

which, in the case of a sinusoidal input, creates second, third, etc,... order harmonics in the output.

The value of the nth harmonic: $20 \cdot \log (\text{r.m.s. voltage of nth order harmonic} / \text{r.m.s. value of the original wave plus harmonics})$ dB.

impulsive noise: The occurrence in a bearer circuit of short duration transient voltages, usually originating extraneously, and of an amplitude comparable with that of the wanted signals. Impulsive noise is characterised by the duration of the originating impulse and the amplitude of the impulse considered as the r.m.s. value of the sinusoidal signal (dBm0) whose peak value has the same amplitude as the impulse.

insertion loss: The ratio of the indicated power delivered to the termination from a generator compared with the indicated power delivered to the same termination when the network is interposed between the generator and the termination.

The insertion loss is defined in dB, as measured between equal resistances, and the following applies:

If V_i is the open circuit voltage of the generator [emf] and V_o is the voltage across the termination when the network is interposed between the generator and the termination, then the insertion loss in dB is given by the expression:

$$IL \text{ (dB)} = 20 \log_{10} \frac{V_i}{2 V_o} \text{ dB}$$

This definition thus includes the mis-match losses (and/or gains) between the network and the send and receive terminations. When using a sinusoidal generator function the insertion loss of a network may be defined at the different frequencies of interest as the Insertion Loss / frequency characteristic. For the purpose of this ETS the generator and termination impedances have 600 ohm non-reactive resistances.

insertion loss/frequency characteristic: The difference between the insertion loss at the frequency under consideration and the insertion loss at 800 Hz.

phase hit: A sudden step change in the phase characteristic of a transmission bearer circuit which persists for some minimum duration. It is defined in terms of the magnitude of the change in phase (measured in degrees) and the minimum duration between successive changes. This line impairment may occur in frequency division multiplexing systems and in digital bearer systems.

phase jitter: A cyclic variation in the phase characteristics of a transmission bearer circuit. For the purpose of this ETS, cyclic variations are limited to those occurring at rates below 300 Hz. This impairment can occur in transmission systems when the carrier frequency supplies are modulated by power related frequencies.

Phase jitter is characterised by the peak-to-peak phase shift (in degrees) and the modulating frequency(ies).

single tone: Occurs when individual frequency tones are produced within the network. Their characteristics are defined in terms of frequency (Hz), level (dBm) and, duration and pause lengths (ms). Single tones may be caused by metering tones, signalling information or other processes as such as crosstalk.

transient interruptions: Breaks in transmission or drops in the level of the signal below a designated threshold (dBm) which persist for a period of time greater than a specified duration (ms).

white noise: A random noise having a uniform and continuous spectrum power distribution over a certain bandwidth, and having an instantaneous amplitude probability which follows a gaussian distribution. The level of noise is determined in terms of the r.m.s. value (dBm) of the noise voltage measured at a defined terminating impedance. In some noise generators, this amplitude distribution may be expressed in terms of a certain crest factor. This crest factor represents the ratio of the peak to r.m.s. values of the noise signal.

B.6.3 Method of measurement

The procedure for assessing the transmission performance of Category II modems shall be as follows:

- the send level of the modem is adjusted to an indicated setting of - 7 dBm or, if not available, to the nearest indicated setting below - 7 dBm;
- a connection is established between two modems using the test set-ups defined in annex C, with the permanent impairments only;
- an initial time interval during which the connection is established and the permanent impairments are applied is required to allow for the conditions to reach stability; this time interval shall not be considered as a part of the testing period;

- the accumulated time for each testing period shall be 15 minutes for test 1, 10,5 minutes for test 2 and, when required, 2 minutes for each test 3; the time period measurement tolerance shall be $\pm 10 \%$;
- the tests shall be repeated for each mode that has been identified in the modem specific ETS for performance testing.

Three test lines have been defined, the first one (Test Line 1) reflecting severe line conditions, the second one (Test Line 2) reflecting average local line conditions. Test Lines 1 & 2 have pre-set values of permanent impairments, to which the individual transient impairments shall be added.

When exposed to the conditions defined above, the modem under test shall accumulate a time of error-free seconds greater than or equal to the minimum value specified in the relevant modem specific ETS.

The third test line (Test Line 3) is merely used to establish a connection between the modem and the testing apparatus during conformance testing.

B.6.3.1 Test set-up

The modems under compliance check shall be connected:

- on the analogue line side to the test bench according to annex C, clause C.2;
- on the DTE interface side to a test message generator and analyzer according to figure B.2; if the DTE interface is not accessible, suitable means shall be provided as outlined in annex D.

The test message generator and analyzer shall provide:

- for synchronous operation, the 511 bit test pattern according to CCITT Recommendation V.52 [15]; the errors shall be expressed in terms of error free seconds;
- for asynchronous operation, the standard test text as specified in subclause B.5.1.2; the errors shall be expressed in terms of error free seconds.

Unless otherwise stated, the levels of noise (viz. white noise, impulsive noise and single tones) shall be measured at point A of the test set-up as indicated in annex C, clause C.2.

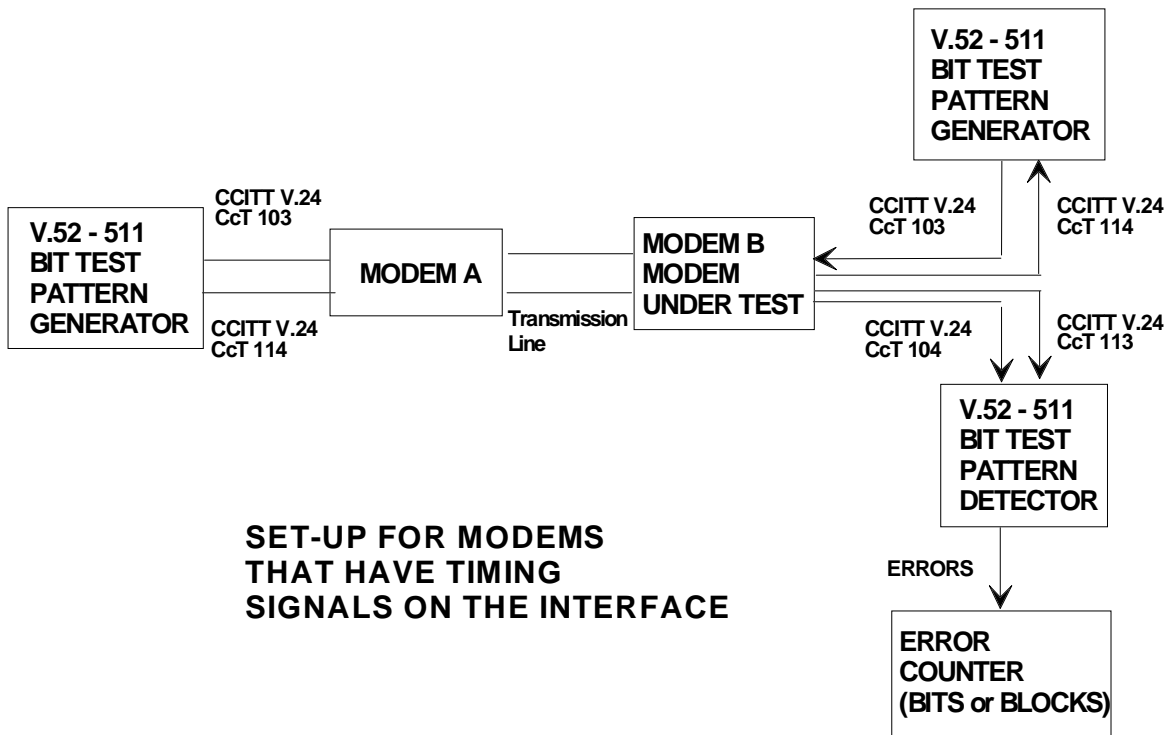
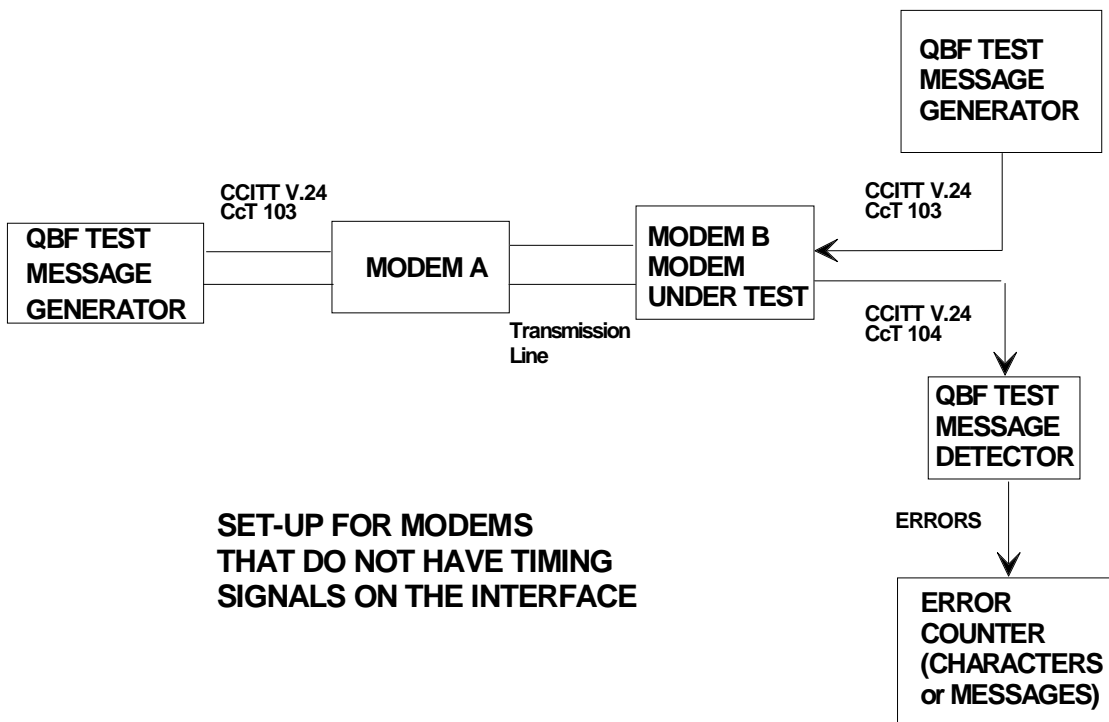

Figure B.2: Set-up for modem connection to the test generator

B.6.3.2 Test 1

This first test reflects severe line conditions.

For each individual test, the overall testing period of 15 minutes shall be divided into two contiguous sub-periods of 7,5 minutes each.

During the entire test period of 15 minutes, the following permanent impairments shall be applied as defined in annex C, clause 3 (Test Line 1):

- white noise;
- insertion loss;
- variation of insertion loss with frequency;
- variation of delay with frequency;
- phase jitter;
- echoes;
- frequency-offset and phase roll.

The frequency offset is applied with a value of $+ 4 \text{ Hz} \pm 0,1 \text{ Hz}$ during the first sub-period and with a value of $- 4 \text{ Hz} \pm 0,1 \text{ Hz}$ during the second sub-period.

Each sub-period of 7,5 minutes shall be divided into five contiguous intervals of 90 seconds each.

During a first interval of 90 seconds, only the permanent impairments shall be applied.

During a second interval of 90 seconds, 3 phase hits of $+ 30^\circ$ shall be applied, one every 30 seconds. The shape of these phase hits is defined in figure B.3.

During a third interval of 90 seconds, 3 amplitude hits of $- 3 \text{ dB}$ shall be applied, one every 30 seconds. The shape of these amplitude hits is defined in figure B.4.

During a fourth interval of 90 seconds, 3 pulses of impulsive noise with a level of $- 21 \text{ dBm}$ shall be sent, one every 30 seconds. The shape of these pulses is defined in figure B.5 (see definition).

During a fifth interval of 90 seconds, 3 transient interruptions of 5 ms each, shall be applied to the received signal, one every 30 seconds. The shape of these interruptions is defined in figure B.6.

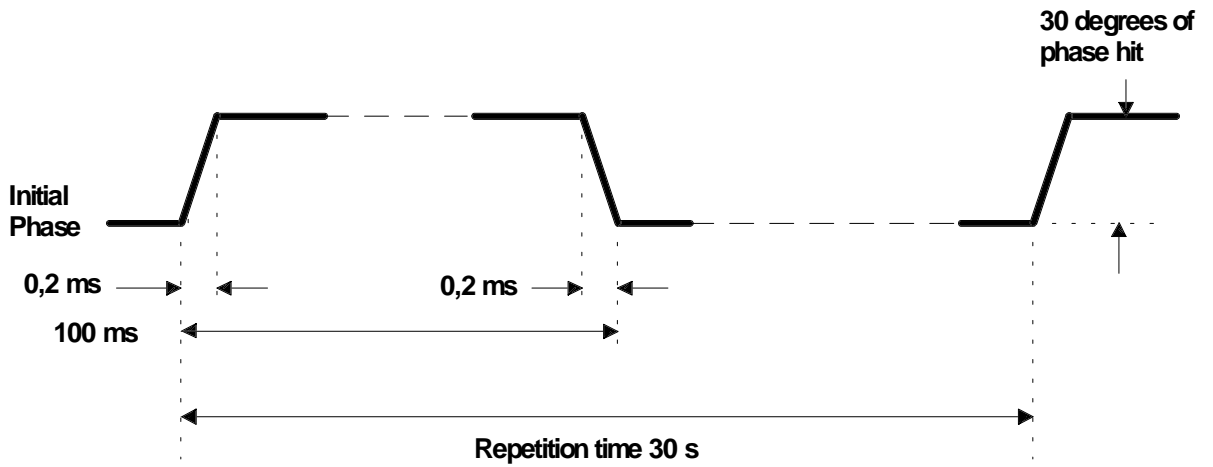

Tolerances on times 0 to 1 ms $\pm 0,05$ ms.

Other times ± 2 %.

Tolerance on degrees $\pm 2^\circ$.

Figure B.3: Phase hits

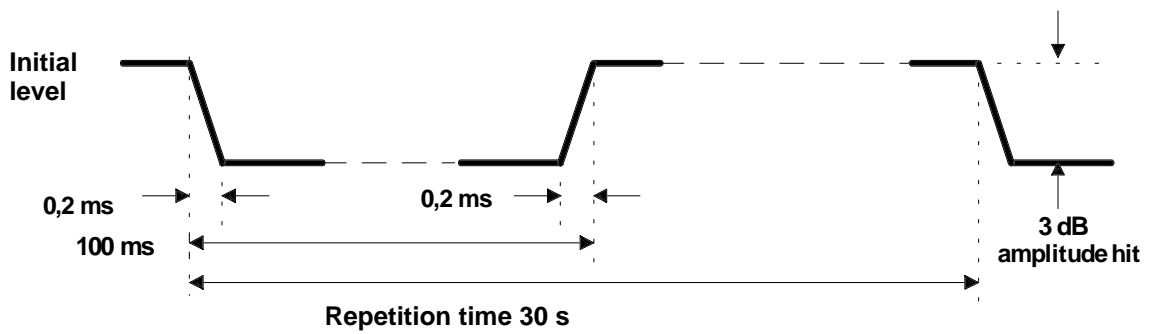

Tolerances on times 0 to 1 ms $\pm 0,05$ ms.

Other times ± 2 %.

Tolerance on level $\pm 0,5$ dB.

Figure B.4: Amplitude hits

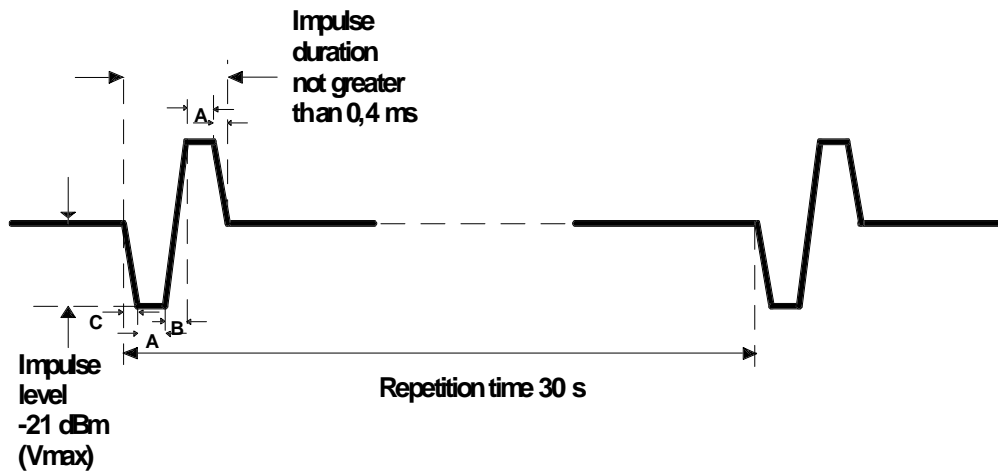

Time period: A greater than or equal to 0,1 ms
B less than or equal to 0,1 ms
C less than or equal to 0,05 ms

Over-shoot and under-shoot not to exceed 10 % of Vmax

Tolerances: On times is $\pm 2\%$
On levels is $\pm 0,5$ dB

NOTE: The peak-to-peak level of the impulse is equal to the peak-to-peak level of a sine wave having a level of - 21 dBm.

Figure B.5: Impulsive noise

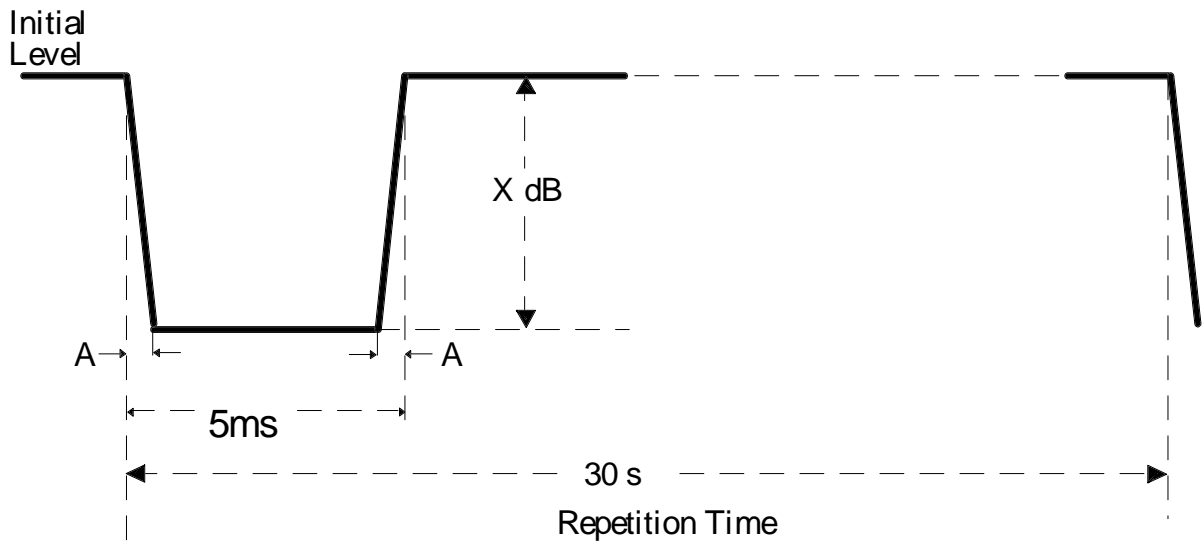

Time period A shall not be greater than 0,5 ms.

Tolerances on times: 0 to 1 ms \pm 0,05 ms.

Other times: \pm 2 %.

Other levels: \pm 0,5 dB.

NOTE: The value of X dB shall be such that the signal level at point C in figure C.1 falls below - 48 dBm during the nominal period of 5 ms. Assuming the representation given in figures C.1 and C.2 is used, the desired result should be obtained by setting X to be at least 25 dB.

Figure B.6: Transient interruptions

B.6.3.3 Test 2

This second test is intended to reflect average local line conditions.

During the entire test period of 10 minutes and 30 seconds, the following permanent impairments shall be applied as defined in annex C, clause C.4 (Test Line 2):

- insertion loss;
- variation of insertion loss with frequency;
- variation of delay with frequency;
- phase jitter;
- echoes;
- frequency-offset and phase roll.

For each individual test, the overall testing period of 10 minutes and 30 seconds shall be divided into 5 contiguous intervals as follows.

During a first interval of 90 seconds, only the permanent impairments shall be applied.

During a second interval of 90 seconds, 3 pulses of impulsive noise with a level of - 21 dBm shall be sent, one every 30 seconds. The shape of these pulses is defined in figure B.6 (see definition).

During a third interval of 90 seconds, 3 transient interruptions of 5 ms each, shall be applied to the received signal, one every 30 seconds.

During a fourth interval of 300 seconds, a single-tone sine wave with frequency varying from 300 to 3 400 Hz (continuously or in steps less than or equal to 10 Hz) shall be applied with a level of - 45 dBm.

During a fifth interval of 60 seconds, single-tone sine waves of 16 2/3, 25, 50, 100 and 150 Hz and with level - 20 dBm, shall be applied for 12 seconds each.

B.6.3.4 Test 3

This third test is only applicable, where a country has elected, by an entry in table 1 (see subclause 5.6.2), to have Category II modems checked for their susceptibility to metering pulses at the frequency or frequencies indicated in table 1. The test shall be performed for each Category II conformance assessment:

- a) once at each frequency (or each of the frequencies) given for that country;
- b) at the highest rate of data transfer for each modulation system (e.g. CCITT Recommendations V.21 [11], V.22 [16], V.22bis [17], V.23 [18], V.32 [19], etc,...);
- c) with the modem under test receiving in the high channel, where this is available.

During the entire test period of two minutes, the following permanent impairments shall be applied as defined in annex C, clause C.4 (Test Line 2 transmission characteristics):

- insertion loss;
- variation of insertion loss with frequency;
- variation of delay with frequency;
- phase jitter;
- echoes;
- frequency-offset and phase roll.

NOTE: The two following "single tones" are deduced from some national metering tones requirements where they could be sent to the subscriber modem without any filtering device.

During this interval of 120 seconds, a cadenced sinusoidal tone shall be applied as follows either:

- a) at a frequency of 12 kHz \pm 120 Hz: (pulse width = 100 ms, pause = 500 ms) and a level of 6,85 dB (2,2 V) with respect to 1,0 V when applied to 200 ohms, or;
- b) at a frequency 16 kHz \pm 100 Hz: (pulse width = 120 ms \pm 10 ms, pause = 220 ms \pm 20 ms) and a level of 22,0 dB (9,76 V) with respect to 0,775 Volt (9,77 V) when applied to 200 ohms.

The voltage is supplied via a circuit which offers negligible impedance at the metering frequency and high impedance at frequencies in the voice-band (300 Hz to 3 400 Hz).

Annex C (normative): Description of specialised test facilities, specification of test lines for use in assessing the performance of Category II modems

C.1 General

This annex defines the test lines on which the transmission performance of Category II modems shall be checked.

The format follows the general principles which have been adopted by both CCITT and CEPT in specifying test lines for comparative measurement of the performance of modems. The test lines described below are intended to ensure that Category II modems shall function in a satisfactory manner on the majority of European PSTN connections.

NOTE: The simulated Test Line 2 described here-in-after is mainly intended to be used for assessing performance of modems, nevertheless it could also be used for conformance tests in order to take advantage of some of its functionalities e.g. PSTN simulation, single tone generation, attenuation.

C.2 Test set-up

The test bench schematic (see figures C.1 & C.2) portrays a symmetrical simulation of the PSTN. This is the case in practice and is the type of representation which is desirable when evaluating modems in a non-regulatory environment. The addition of transient impairments to the signals received by the modem used for reference is likely to cause unwanted side effects and, therefore, is not required to be present. The parameters and description have been specified in a manner which is intended to be independent of the technology used to implement the test bench:

- local line simulators LL A and LL B, each capable of simulating 2 different line lengths; the characteristics of each simulated local line length are shown in figures C.9 and C.13, and proposed schematics in figure C.3;
- a trunk network simulator TNS AB capable of simulating transmission characteristics as described in clauses C.3 and C.4;
- a trunk network simulator TNS BA capable of simulating flat insertion loss and flat delay;
- 2 hybrids HYB A and HYB B for 2 wire/4 wire conversion and vice-versa; their transmission characteristics are defined in figure C.4. The balance impedance for the hybrids shall be determined as follows:
 - with the balance of the hybrid terminated in an appropriate impedance and Vline in/out (2-wire) terminated in Local Line 1 (the characteristics are given in figure C.9) which is in turn terminated in 390 ohms and 910 ohms, the loss between Vtxin (Transmit 4-wire) and Vtxres (Receive 4-wire), shall not be less than 27 dB at any frequency in the range 300 Hz to 3 400 Hz;
 - with the balance of the hybrid terminated in an appropriate impedance and Vline in/out (2-wire) terminated in Local Line 2 (the characteristics are given in figure C.13) which is in turn terminated in 390 ohms and 910 ohms, the loss between Vtxin (Transmit 4-wire) and Vtxres (Receive 4-wire), shall not be less than 23 dB at any frequency in the range 300 Hz to 3 400 Hz.
- the following attenuators: ATT1 which is used for setting the receive level of modem B, ATT2 which is used for setting the receive level of modem A, ATT3 which is used for setting the remote talker echo level, ATT4 is used for setting the local talker echo level, and ATT5 is used for setting the listener echo level;
- the following delay lines: DEL1 which is used to set the nominal delay of signals in the normal transmission path (direction AB), DEL2 which is used to set the nominal delay in return transmission path (direction BA), and DEL3 which is used to provide additional delay for the listener echo;

- AMP, a means of producing amplitude hits and transient interruptions;
- MOD, a means of producing phase jitter and phase hits;
- FREQ 1, a means of producing a frequency offset in the normal transmission path (direction AB);
- FREQ 2, a means of producing a frequency offset in the return transmission path (direction BA). By having dissimilar amounts of frequency offset in the two transmission paths Phase Roll in the remote talker echo is simulated;
- SUM a means of adding, non-inter-actively, other disturbances such as White noise, impulsive noise and single tones.

The source of the white noise shall generate a flat ($\pm 0,5$ dB) spectrum measured in a 30 Hz bandwidth from 300 Hz to 5 000 Hz. At frequencies above 5 000 Hz the noise is reduced at a rate of not less than 12 dB per Octave with respect to the level at 2 500 Hz (see figure C.6). Pseudo-random noise generators shall generate noise with a crest factor of $4,7 \pm 0,3$.

The level of the noise at point A shall be measured with the filter described in figure C.6 inserted between point A and the measuring set. The noise flat filter shall exhibit no ripple exceeding $\pm 0,5$ dB from 250 Hz to 3 000 Hz and a minimum attenuation of 20 dB at 60 Hz and 3 500 Hz.

Unless otherwise stated, the levels of noise (viz. white noise, impulsive noise and single tones) are measured at point A of figure C.2.

Alternative implementations of the test bench shall comply with all the following rules:

- a) the revision of the test bench shall have no material effect upon the result of the tests;
- b) alternative implementations of the test bench shall comply with the characteristics for the test bench as described in annex B, clause B.6 and annex C;
- c) the attenuation provided by attenuators ATT 1 to ATT 5 may be redistributed to appear anywhere within the 4-wire simulation;
- d) the delay provided by delay lines DEL 1 to DEL 3 may be redistributed to appear anywhere within the test bench, with the exception of the constraints imposed by rule;
- e) only attenuation is permitted to appear between HYB A and (RTE)IN, HYB A and (RTE)SUM, HYB B and (LTE)IN, and between HYB B and (LTE)SUM;
- f) the point at which the noise is combined with the transmitted signal shall not precede the simulations of insertion loss/frequency and group delay/frequency;
- g) (LE)SUM shall not precede FREQ 1. (LE)SUM shall precede the simulations of insertion loss/frequency and group delay/frequency.
(LE)IN shall be after the simulations of insertion loss/frequency and group delay/frequency.

C.2.1 Simulated PSTN conditions

In order for the modem to enter the data transmission mode, it shall be necessary that the test bench be capable of simulating PSTN supervisory signals, tones and protocols. This function is assigned to the block marked "Line Set-up and Hold" in the diagram of figure C.1.

This block is also assigned the function of providing DC conditions on the test lines. Figure C.6 gives a typical layout including provision for the application of metering pulses where required.

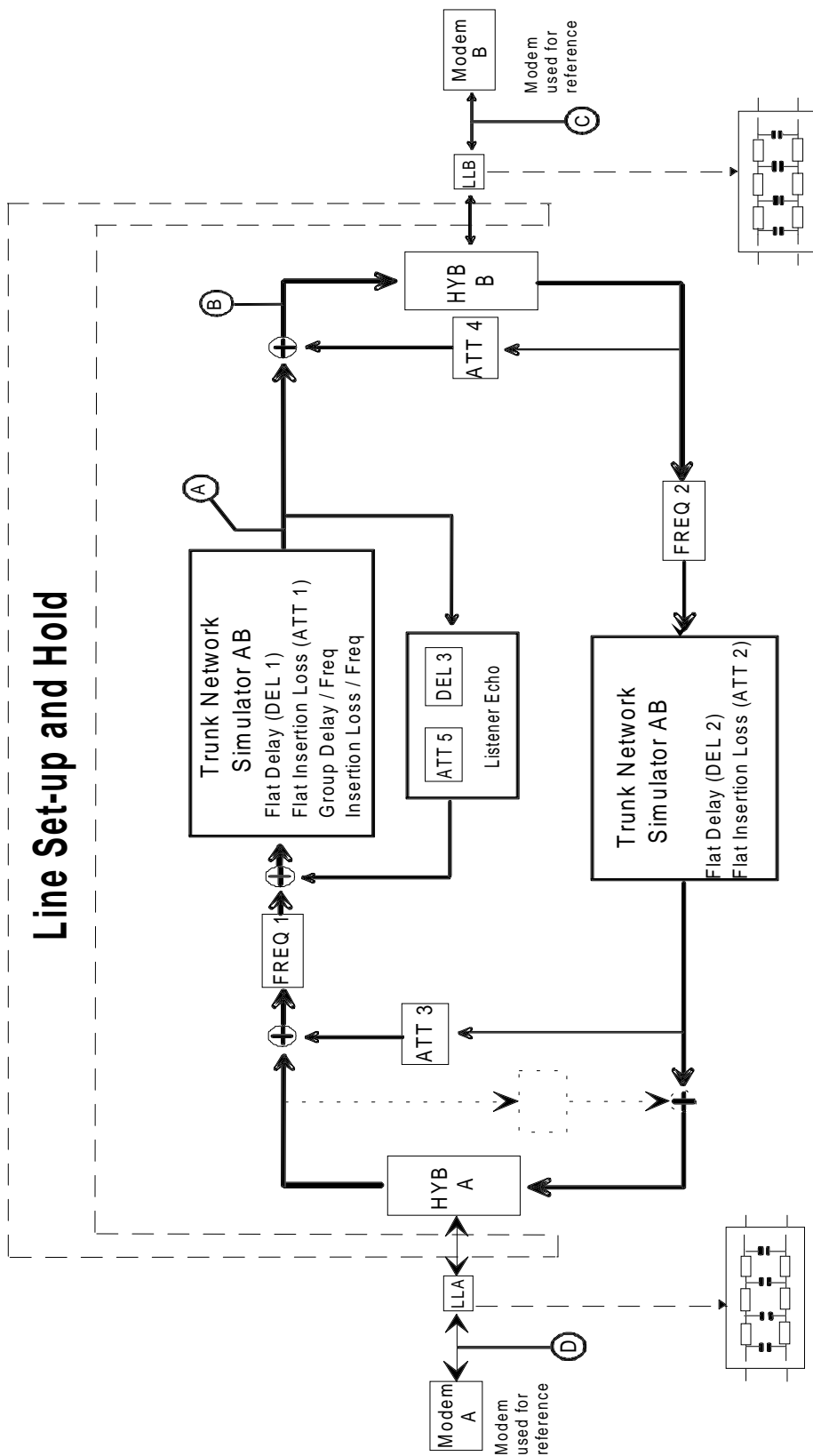

NOTE: The items shown by dotted lines are required not to be present during testing to the ETSs referenced in the scope of this ETS. They are shown to illustrate the compatibility of this Test Bench with those being suggested by ITU-T.

Figure C.1: Test bench

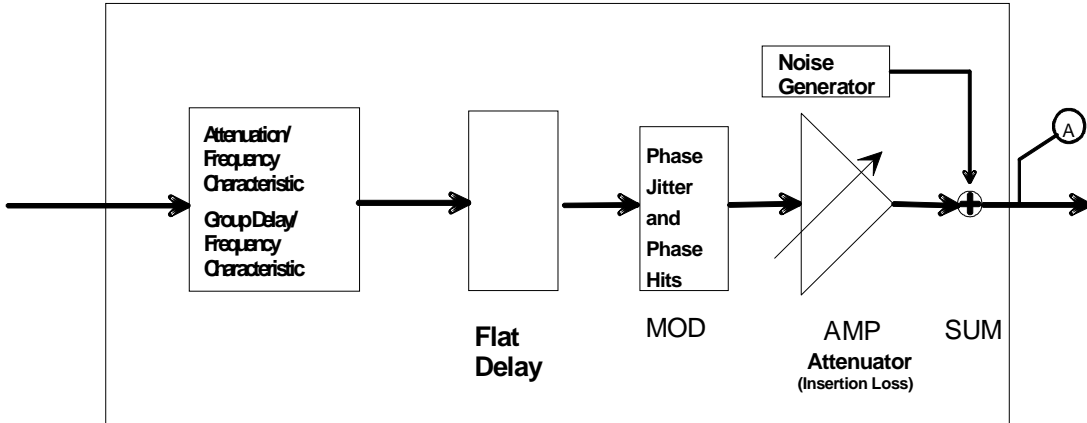

NOTE 1: For direction AB: The noise generator is the source for White Noise, Impulsive Noise and Single Tone interference. AMP is used to provide Amplitude Hits and Transient Interruptions, it can also be used to set the overall loss of the Test Line (ATT 1).

Flat delay (DEL 1) provides the nominal delay in direction AB and also provides part of the delay for the Remote Talker Echo and Listener Echo. MOD is the source of Phase Jitter and Phase Hits.

The Insertion Loss/Frequency and Group Delay/Frequency Characteristic module shape the signals to provide the Trunk Network Simulator Characteristics and provide frequency related loss and delay for both Remote Talker Echo and Listener Echo.

NOTE 2: For direction BA: This shall provide Flat Loss and Flat Delay.

Figure C.2: Trunk network simulator

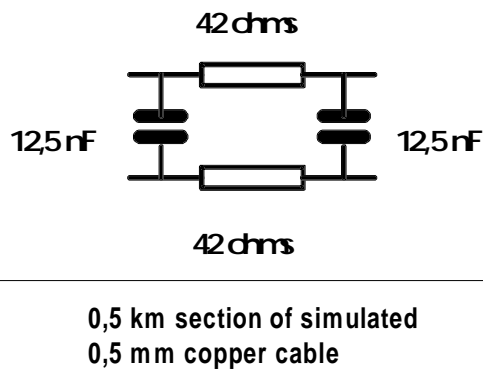

Figure C.3: Local line simulators - schematic



The following requirements apply throughout the frequency range 300 Hz to 3 400 Hz:

$$Z_{lineout} = 600 \text{ Ohm}$$

$$R_{load} = 600 \text{ Ohm}$$

$$V_{lineout}/V_{txin} = -4 \text{ dB} \pm 0,2 \text{ dB}$$

$$Z_{linein} = 600 \text{ Ohm}$$

$$V_{rxline}/V_{linein} = -4 \text{ dB} \pm 0,2 \text{ dB}$$



With both the balance of the hybrid and Vline in/out terminated in the network proposed below for Test Line 1, the loss between Vtxin and Vtxres shall not be less than 40 dB at any frequency between 300 Hz and 3 400 Hz. If a standard transformer hybrid has been used it is suggested that the hybrid balance network be constructed as follows:

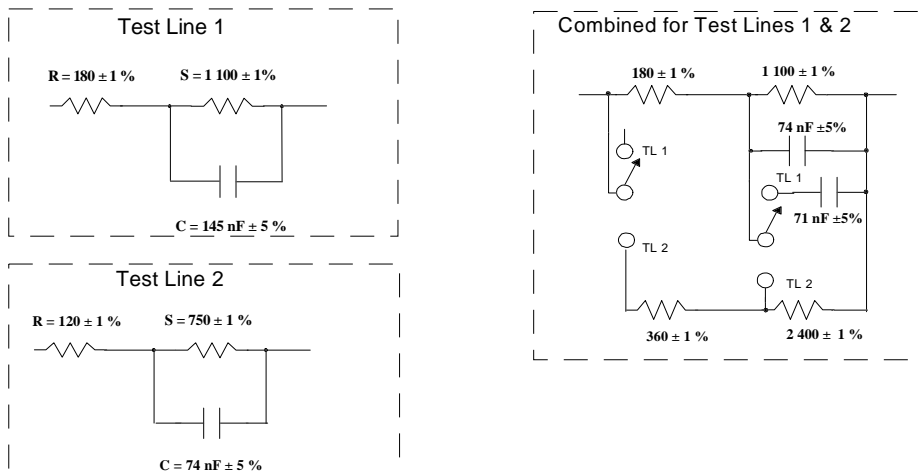
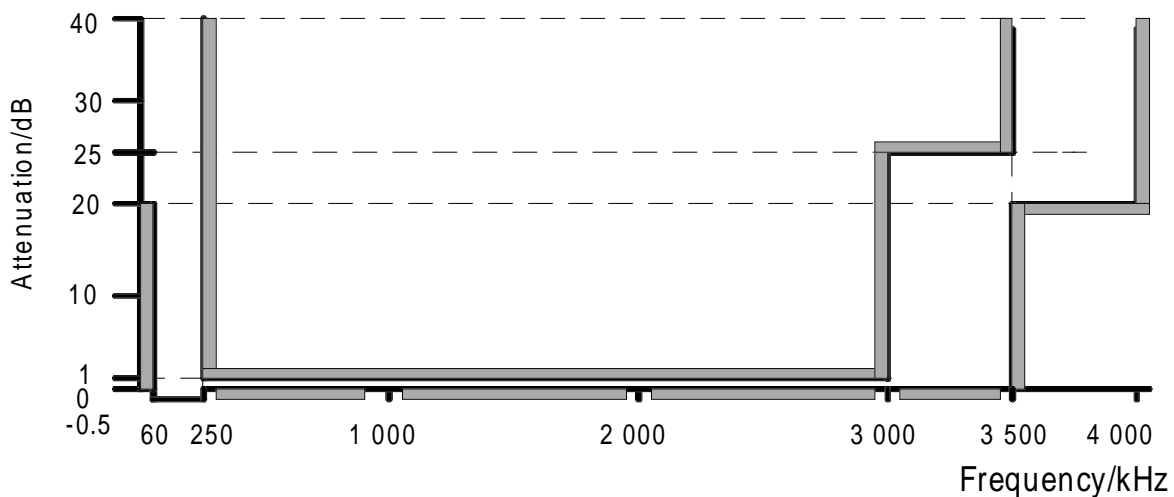
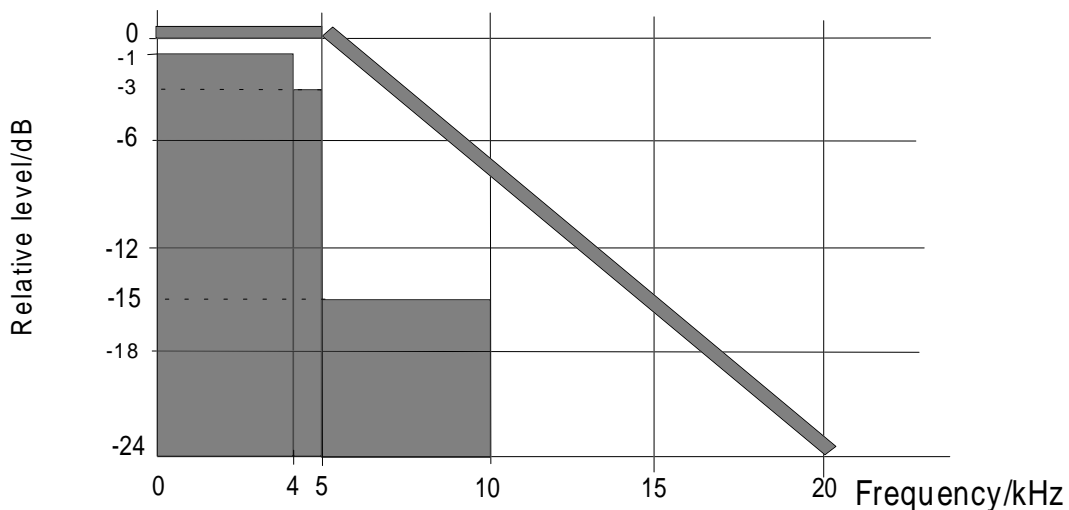

Figure C.4: Hybrid characteristics



White Noise Filter



White Noise Characteristic

It is expected that the noise will continue to decrease at a rate of not less than 12 dB per octave until a loss of at least 35 dB from the passband has been achieved.

Figure C.5: White noise characteristics and filter

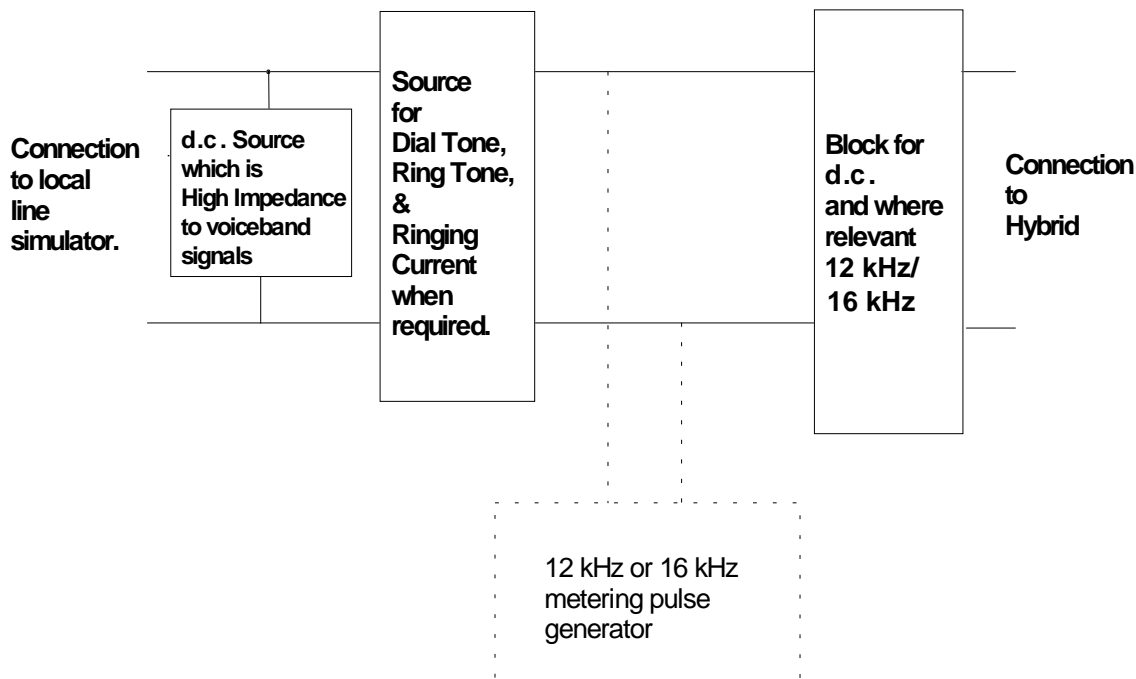

Figure C.6: Typical d.c. and meter pulse circuitry

The current provided by the d.c. source shall be equivalent to that obtained when a voltage of 48 V is connected, via 800 ohms, to the local line simulator which is in turn terminated in the impedance provided by the modem under test. The d.c. source shall have an impedance equivalent to at least 20 H, when providing a current of up to 60 mA, in the frequency range 200 Hz to 4 000 Hz.

C.3 Test Line 1 transmission characteristics

Test Line 1 which comprises local line simulators (LL A & LL B) and trunk network simulators (AB & BA), shall exhibit the characteristics for overall insertion loss and group delay shown in figures C.7 and C.8 respectively. The nominal values are given in tables C.1 and C.2.

C.3.1 Local line simulators

The local line simulators shall exhibit the characteristics shown in figure C.9 and given in table C.3.

C.3.2 Trunk network simulator

The trunk network simulator shall be adjusted to obtain modem to modem transmission characteristics as shown in figures C.10 and C.8. The nominal values of the curves are given in tables C.4 and C.2.

C.3.3 Permanent impairments

The parameters described below are applied for the complete duration of the tests, using Test Line 1.

C.3.3.1 Insertion loss

The insertion loss of Test Line 1 without echoes at 800 Hz between 600 ohms terminating impedances shall be adjusted to be $20 \text{ dB} \pm 0,2 \text{ dB}$ in both directions by adjustment of the frequency independent loss in the Trunk Network Simulator. Assuming the representation given in figure C.2 is used and that the other components attain their nominal values ATT 1 and ATT 2 would need to be set to 3,2 dB.

C.3.3.2 White noise

Where it is possible to set the transmitted power level of the modem to an indicated setting of - 7dBm, white noise, as specified in clause C.2, shall be injected into the test line to achieve a level of - 46 dBm at point A in figures C.1 & C.2. Where a modem does not have the possibility to set the transmitted power to an indicated setting of - 7 dBm, the power of the level of the white noise is adjusted to maintain a numerical difference of 39 dB between the indicated setting of the modem and the noise level at point A in figures C.1 & C.2.

Table C.1: Test line 1 - overall insertion loss frequency characteristic

Frequency kHz	Loss in dB		
	Nominal Loss	Upper Limit	Lower Limit
0,2	32,0	inf	31,4
0,3	24,1	24,5	23,7
0,4	22,0	22,4	21,6
0,5	20,9	21,2	20,5
0,6	20,1	20,5	19,8
0,7	20,1	20,5	19,7
0,8	20,0	20,4	19,6
0,9	20,1	20,5	19,7
1,0	20,2	20,6	19,8
1,1	20,4	20,9	20,0
1,2	20,7	21,2	20,2
1,3	21,0	21,6	20,5
1,4	21,3	21,9	20,9
1,5	21,7	22,3	21,2
1,6	22,1	22,7	21,6
1,7	22,6	23,2	21,9
1,8	23,0	23,7	22,4
1,9	23,5	24,2	22,9
2,0	24,0	24,7	23,3
2,1	24,5	25,2	23,8
2,2	25,1	25,9	24,4
2,3	25,7	26,5	25,0
2,4	26,3	27,1	25,6
2,5	26,8	27,6	26,1
2,6	27,7	28,5	26,7
2,7	28,4	29,2	27,4
2,8	29,1	30,0	28,2
2,9	29,8	30,6	28,8
3,0	30,7	31,6	29,7
3,1	31,5	32,4	30,5
3,2	32,2	33,2	31,2
3,3	33,1	34,1	32,1
3,4	34,1	35,1	33,1
3,5	35,7	inf	34,6
3,6	37,5	inf	36,4
3,7	39,5	inf	38,4
3,8	41,8	inf	40,6
3,9	44,2	inf	43,0
4,0	47,3	inf	46,0

A graph of this is given in figure C.7.

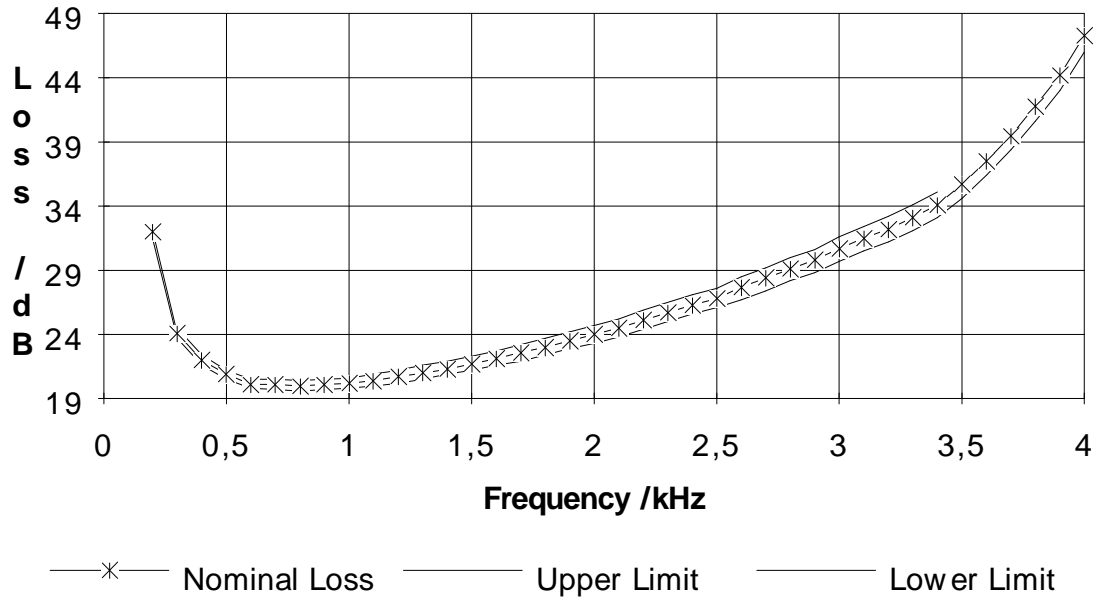

(see table C.1 for numerical data)

Figure C.7: Test line 1 - overall insertion loss frequency characteristic

Table C.2: Test line 1 - overall and trunk network group delay characteristic

Frequency kHz	Group Delay ms		
	Nominal Delay	Upper Limit	Lower Limit
0,2	not less than 8 ms		
0,3	8,0	8,4	7,6
0,4	6,9	7,25	6,56
0,5	5,5	5,78	5,23
0,6	4,4	4,62	4,18
0,7	3,4	3,57	3,23
0,8	2,8	2,94	2,66
0,9	2,0	2,10	1,90
1,0	1,5	1,58	1,43
1,1	1,0	1,05	0,95
1,2	0,7	0,74	0,67
1,3	0,4	0,42	0,38
1,4	0,3	0,32	0,28
1,5	0,2	0,21	0,19
1,6	0,1	0,11	0,09
1,7	0,1	0,11	0,03
1,8	0,0	0,00	0,00
1,9	0,1	0,11	0,03
2,0	0,1	0,11	0,05
2,1	0,1	0,11	0,09
2,2	0,1	0,15	0,09
2,3	0,2	0,21	0,15
2,4	0,2	0,21	0,19
2,5	0,3	0,32	0,28
2,6	0,4	0,42	0,38
2,7	0,5	0,53	0,47
2,8	0,8	0,84	0,76
2,9	1,1	1,16	1,04
3,0	1,5	1,58	1,42
3,1	2,0	2,10	1,90
3,2	2,6	2,73	2,47
3,3	3,2	3,36	3,04
3,4	4,0	4,20	3,80
3,5	At all frequencies above 3 400 Hz and lower than 4 000 Hz the group delay shall be not less than the group delay at 3 400 Hz.		
3,6			
3,7			
3,8			
3,9			
4,0	A graph of this is given in figure C.8.		

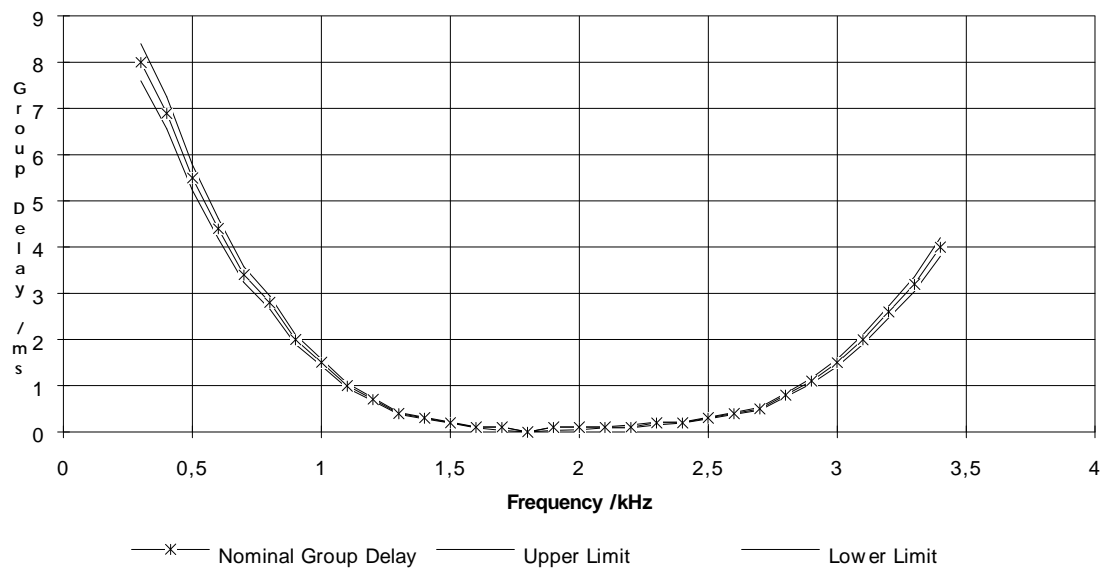

(see table C.2 for numerical data)

Figure C.8: Test line 1 - overall and trunk network group delay

Table C.3: Test line 1 - insertion loss characteristic of local line simulators

Frequency kHz	Loss in dB		
	Nominal Loss	Upper Limit	Lower Limit
0,2	3,90	3,93	3,86
0,3	3,94	3,98	3,90
0,4	4,00	4,05	3,96
0,5	4,08	4,14	4,03
0,6	4,17	4,24	4,11
0,7	4,28	4,36	4,21
0,8	4,40	4,49	4,32
0,9	4,54	4,63	4,44
1,0	4,68	4,79	4,57
1,1	4,84	4,96	4,72
1,2	5,00	5,14	4,87
1,3	5,17	5,32	5,02
1,4	5,35	5,51	5,19
1,5	5,53	5,71	5,36
1,6	5,72	5,91	5,53
1,7	5,91	6,12	5,71
1,8	6,11	6,33	5,90
1,9	6,31	6,54	6,08
2,0	6,51	6,75	6,27
2,1	6,71	6,96	6,46
2,2	6,91	7,18	6,65
2,3	7,12	7,39	6,84
2,4	7,32	7,61	7,04
2,5	7,52	7,82	7,23
2,6	7,73	8,03	7,42
2,7	7,93	8,24	7,61
2,8	8,13	8,45	7,81
2,9	8,33	8,66	8,00
3,0	8,53	8,87	8,19
3,1	8,72	9,07	8,38
3,2	8,92	9,27	8,56
3,3	9,11	9,47	8,75
3,4	9,30	9,67	8,93
3,5	9,49	9,87	9,12
3,6	9,68	10,06	9,30
3,7	9,87	10,25	9,48
3,8	10,05	10,45	9,66
3,9	10,24	10,63	9,83
4,0	10,42	10,8	10,01

A graph of this is given in figure C.9.

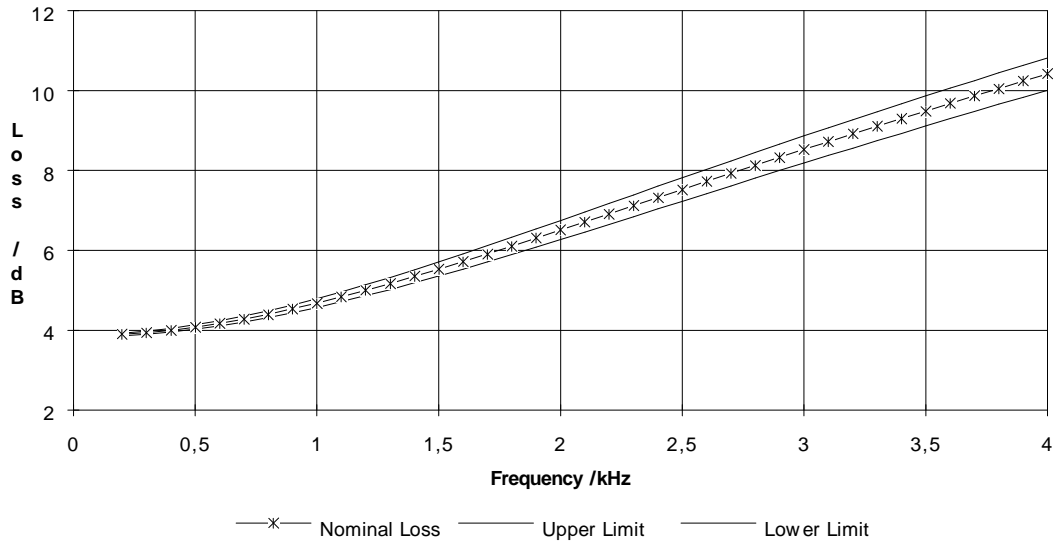

(see table C.3 for numerical data)

Figure C.9: Test line 1 simulator - insertion loss frequency characteristic for a 0,5 Cu 4,0 km simulated local line

Table C.4: Test line 1 - trunk network simulator - insertion loss frequency characteristic

Frequency kHz	Loss in dB		
	Nominal Loss	Upper Limit	Lower Limit
0,2	13,0	inf	12,5
0,3	5,0	5,3	4,7
0,4	2,8	3,1	2,5
0,5	1,5	1,8	1,2
0,6	0,6	0,9	0,3
0,7	0,3	0,5	0,1
0,8	0,0	0,2	-0,2
0,9	-0,2	0,0	-0,4
1,0	-0,4	-0,2	-0,6
1,1	-0,4	-0,2	-0,6
1,2	-0,5	-0,3	-0,7
1,3	-0,5	-0,3	-0,7
1,4	-0,5	-0,3	-0,7
1,5	-0,6	-0,4	-0,8
1,6	-0,5	-0,3	-0,7
1,7	-0,4	-0,2	-0,6
1,8	-0,4	-0,2	-0,6
1,9	-0,3	-0,1	-0,5
2,0	-0,2	0,0	-0,4
2,1	-0,1	0,1	-0,3
2,2	0,1	0,2	-0,1
2,3	0,3	0,5	0,1
2,4	0,5	0,7	0,3
2,5	0,6	0,8	0,4
2,6	0,9	1,1	0,7
2,7	1,2	1,4	1,0
2,8	1,6	1,9	1,3
2,9	1,8	2,1	1,5
3,0	2,3	2,6	2,0
3,1	2,8	3,1	2,5
3,2	3,3	3,6	3,0
3,3	3,7	4,0	3,4
3,4	4,3	4,6	4,0
3,5	5,5	5,9	5,2
3,6	6,9	inf	6,5
3,7	8,6	inf	8,2
3,8	10,5	inf	10,1
3,9	12,5	inf	12,0
4,0	15,3	inf	14,8

A graph of this is given in figure C.10.

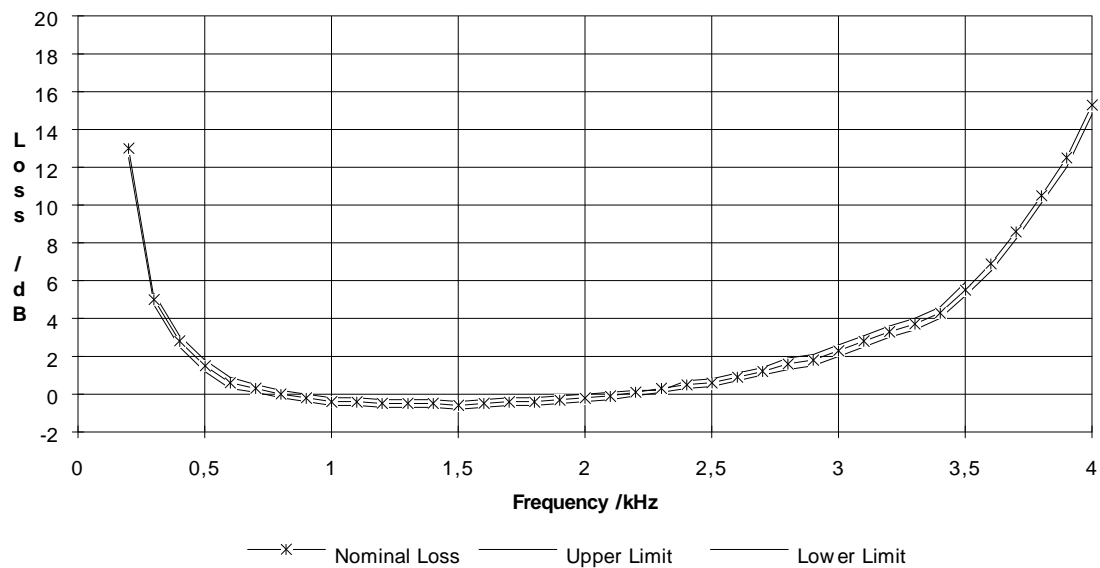

(see table C.4 for numerical data)

Figure C.10: Test line 1 - trunk network simulator - insertion loss frequency characteristic

C.3.3.3 Frequency offset and Phase roll

It shall be possible to apply a frequency offset of $\pm 4 \text{ Hz} \pm 0,1 \text{ Hz}$ and to simulate phase roll in remote talker echo equivalent to $0,2 \text{ Hz}$.

C.3.3.4 Phase jitter

The Test Line 1 shall exhibit sinusoidal phase jitter at a frequency of 100 Hz of $5^\circ \pm 0,5^\circ$ peak-to-peak.

C.3.3.5 Echo

Test Line 1 shall exhibit the following echo paths:

- a) a remote talker echo path having a delay of $50 \text{ ms} \pm 1,0 \text{ ms}$ at $1\ 800 \text{ Hz}$ and a loss of $23,8 \text{ dB} \pm 0,2 \text{ dB}$ at 800 Hz . The remote talker echo path shall contain the insertion loss/frequency and group delay/frequency characteristics required by subclause C.3.2. Assuming the representation given in figures C.1 and C.2 is used and that the other components attain their nominal values, DEL 1 and DEL 2 would need to be set to 25 ms and ATT 3 to $9,0 \text{ dB}$;
- b) a local talker echo path having a delay less than $0,2 \text{ ms} \pm 0,2 \text{ ms}$ at $1\ 800 \text{ Hz}$ and a loss of $13,4 \text{ dB} \pm 0,2 \text{ dB}$ at 800 Hz . Assuming the representation given in figures C.1 and C.2 is used and that the other components attain their nominal values, ATT 4 would need to be set to 5 dB ;
- c) a listener echo path having a delay of $50 \text{ ms} \pm 1,0 \text{ ms}$ at $1\ 800 \text{ Hz}$ and a loss of $41,8 \text{ dB} \pm 0,2 \text{ dB}$ at 800 Hz . The listener echo path shall contain the insertion loss/frequency and group delay/frequency characteristics required by subclause C.3.2. Assuming the representation given in figures C.1 and C.2 is used and that the other components attain their nominal values, DEL 3 would need to be set to 25 ms and ATT 5 to 27 dB .

For the talker echo, the loss given shall be used to calibrate the test bench and is the loss experienced by an 800 Hz sinusoidal signal injected at point C and measured at point B. For listener echo, the loss given shall be that experienced by an 800 Hz sinusoidal signal injected at point D and measured at point B. The time delays in the echo paths are measured using the same reference points but, in this case, calibrated using an $1\ 800 \text{ Hz}$ signal.

C.3.3.6 Harmonic distortion

There is no requirement to specifically simulate harmonic distortion within Test Line 1. However, the individual levels of the 2nd and 3rd harmonic shall be limited to no greater than -69 dBm measured selectively (e.g. in a 3 Hz bandwidth) with Modem A (see figure C.1) replaced by a 600 ohm sinusoidal signal generator of frequency $800 \text{ Hz} \pm 10 \text{ Hz}$ at a level of -7 dBm , and Modem B (see figure C.1) replaced by a 600 ohm selective measuring device. The same limits shall be met when the generator and the selective measuring set are transposed.

NOTE: The levels given above constrain the harmonic distortion to be no greater than 40 dB .

C.4 Test Line 2 transmission characteristics

Test Line 2 which comprises local line simulators (LL A & LL B) and trunk network simulators (AB & BA), shall exhibit the characteristics for insertion loss and group delay shown in figures C.11 and C.12 respectively. The nominal values of figure C.11 are given in table B.5.

C.4.1 Local line simulators

The local line simulators shall exhibit the characteristics shown in figure C.13 and given in table C.7.

Table C.5: Test line 2 - overall insertion loss frequency characteristic

Frequency kHz	Loss in dB		
	Nominal Loss	Upper Limit	Lower Limit
0,2	11,9	inf	11,6
0,3	11,9	12,1	11,7
0,4	11,9	12,1	11,7
0,5	11,9	12,2	11,7
0,6	11,9	12,2	11,7
0,7	12,0	12,2	11,7
0,8	12,0	12,2	11,8
0,9	12,0	12,3	11,8
1,0	12,1	12,3	11,8
1,1	12,1	12,4	11,9
1,2	12,2	12,4	11,9
1,3	12,2	12,5	11,9
1,4	12,3	12,5	12,0
1,5	12,3	12,6	12,0
1,6	12,4	12,7	12,1
1,7	12,4	12,7	12,1
1,8	12,5	12,8	12,2
1,9	12,6	12,9	12,3
2,0	12,6	12,9	12,3
2,1	12,7	13,0	12,4
2,2	12,8	13,1	12,5
2,3	12,9	13,2	12,5
2,4	13,0	13,3	12,6
2,5	13,0	13,4	12,7
2,6	13,1	13,5	12,8
2,7	13,2	13,6	12,9
2,8	13,3	13,7	13,0
2,9	13,4	13,8	13,0
3,0	13,5	13,9	13,1
3,1	13,6	14,0	13,2
3,2	13,7	14,1	13,3
3,3	13,8	14,2	13,4
3,4	13,9	14,3	13,5
3,5	14,0	inf	13,6
3,6	14,1	inf	13,7
3,7	14,3	inf	13,8
3,8	14,4	inf	13,9
3,9	14,5	inf	14,0
4,0	14,6	inf	14,1

A graph of this is given in figure C.11.

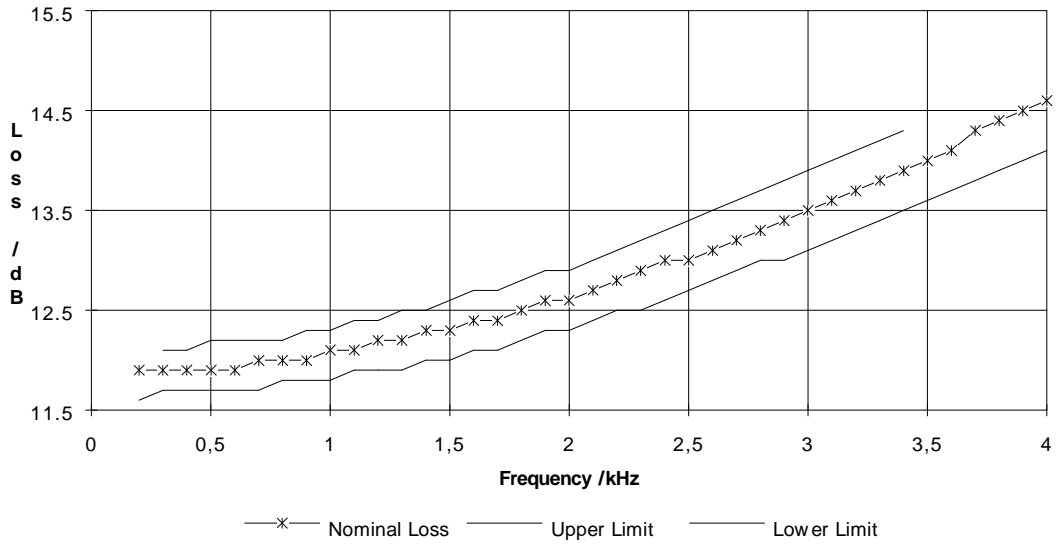

(see table C.5 for numerical data)

Figure C.11: Test line 2 - overall insertion loss frequency characteristic

Table C.6: Test line 2 - overall and trunk network group delay characteristic

Frequency kHz	Group Delay ms	
	Nominal Delay	Upper Limit
0,2	0,0	inf
0,3	0,0	0,05
0,4	0,0	0,05
0,5	0,0	0,05
0,6	0,0	0,05
0,7	0,0	0,05
0,8	0,0	0,05
0,9	0,0	0,05
1,0	0,0	0,05
1,1	0,0	0,05
1,2	0,0	0,05
1,3	0,0	0,05
1,4	0,0	0,05
1,5	0,0	0,05
1,6	0,0	0,05
1,7	0,0	0,05
1,8	0,0	0,05
1,9	0,0	0,05
2,0	0,0	0,05
2,1	0,0	0,05
2,2	0,0	0,05
2,3	0,0	0,05
2,4	0,0	0,05
2,5	0,0	0,05
2,6	0,0	0,05
2,7	0,0	0,05
2,8	0,0	0,05
2,9	0,0	0,05
3,0	0,0	0,05
3,1	0,0	0,05
3,1	0,0	0,05
3,2	0,0	0,05
3,3	0,0	0,05
3,4	0,0	0,05
3,5	0,0	inf
3,6	0,0	inf
3,7	0,0	inf
3,8	0,0	inf
3,9	0,0	inf
4,0	0,0	inf
A graph of this is given in figure C.12.		
NOTE:	The limits in the table above are with respect to any frequency at which the minimum delay actually occurs, therefore a lower limit is not required.	

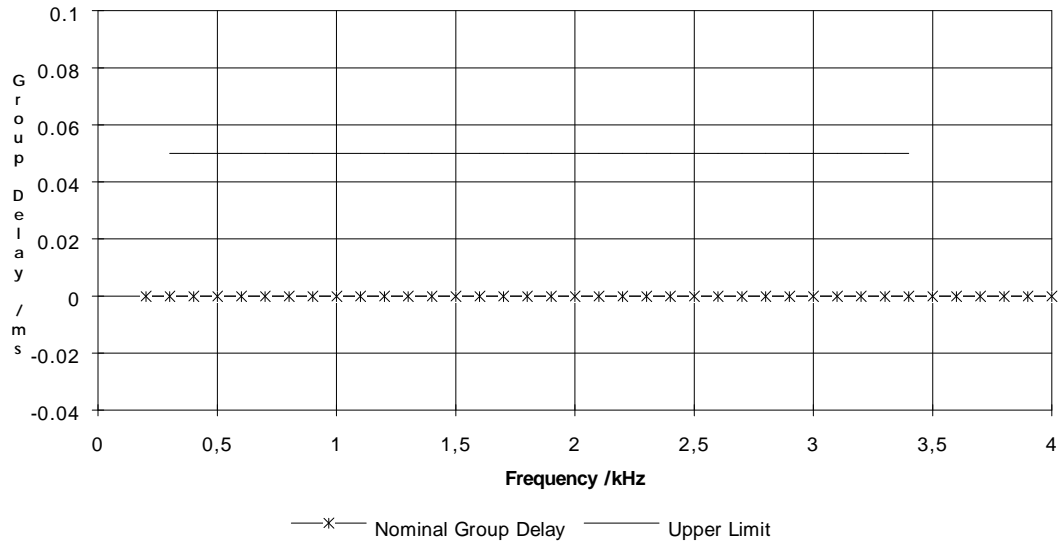

(see table C.6 for numerical data)

Figure C.12: Test line 2 - overall and trunk network group delay characteristic

Table C.7: Test line 2 - insertion loss characteristic of local line simulator

Frequency kHz	Loss in dB		
	Nominal Loss	Upper Limit	Lower Limit
0,2	1,66	1,68	1,64
0,3	1,67	1,68	1,65
0,4	1,67	1,69	1,66
0,5	1,68	1,70	1,66
0,6	1,69	1,71	1,67
0,7	1,70	1,73	1,69
0,8	1,72	1,74	1,70
0,9	1,74	1,76	1,71
1,0	1,76	1,78	1,73
1,1	1,78	1,80	1,75
1,2	1,80	1,83	1,77
1,3	1,82	1,85	1,79
1,4	1,85	1,88	1,81
1,5	1,88	1,91	1,84
1,6	1,91	1,95	1,87
1,7	1,94	1,98	1,89
1,8	1,97	2,02	1,92
1,9	2,00	2,05	1,96
2,0	2,04	2,09	1,99
2,1	2,08	2,13	2,02
2,2	2,12	2,18	2,06
2,3	2,16	2,22	2,09
2,4	2,20	2,27	2,13
2,5	2,24	2,31	2,17
2,6	2,29	2,36	2,21
2,7	2,33	2,41	2,25
2,8	2,38	2,46	2,27
2,9	2,43	2,51	2,34
3,0	2,48	2,58	2,39
3,1	2,53	2,62	2,43
3,2	2,58	2,67	2,48
3,3	2,63	2,73	2,53
3,4	2,68	2,79	2,58
3,5	2,74	2,85	2,63
3,6	2,79	2,91	2,68
3,7	2,85	2,97	2,73
3,8	2,90	3,03	2,78
3,9	2,96	3,09	2,83
4,0	3,02	3,16	2,89

A graph of this is given in figure C.13.

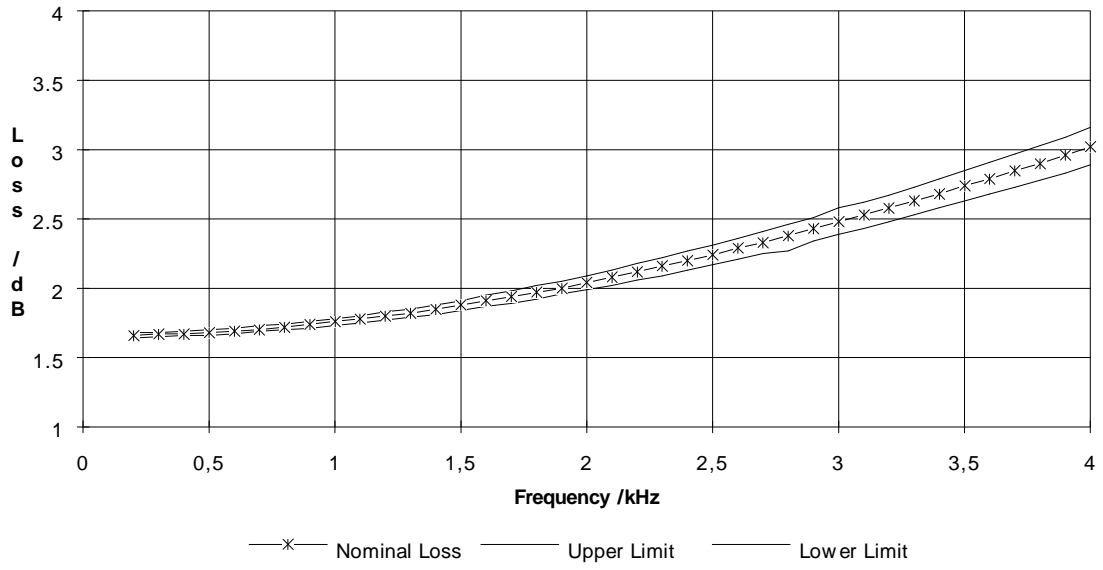

(see table C.7 for numerical data)

Figure C.13: Local line 2 simulator - insertion loss frequency characteristic

Table C.8: Test Line 2 - Trunk network simulator insertion loss frequency characteristic

Frequency kHz	Loss in dB		
	Nominal Loss	Upper Limit	Lower Limit
0,2	0,56	inf	0,36
0,3	0,56	0,76	0,36
0,4	0,56	0,76	0,36
0,5	0,56	0,76	0,36
0,6	0,56	0,76	0,36
0,7	0,56	0,76	0,36
0,8	0,56	0,76	0,36
0,9	0,56	0,76	0,36
1,0	0,56	0,76	0,36
1,1	0,56	0,76	0,36
1,2	0,56	0,76	0,36
1,3	0,56	0,76	0,36
1,4	0,56	0,76	0,36
1,5	0,56	0,76	0,36
1,6	0,56	0,76	0,36
1,7	0,56	0,76	0,36
1,8	0,56	0,76	0,36
1,9	0,56	0,76	0,36
2,0	0,56	0,76	0,36
2,1	0,56	0,76	0,36
2,2	0,56	0,76	0,36
2,3	0,56	0,76	0,36
2,4	0,56	0,76	0,36
2,5	0,56	0,76	0,36
2,6	0,56	0,76	0,36
2,7	0,56	0,76	0,36
2,8	0,56	0,76	0,36
2,9	0,56	0,76	0,36
3,0	0,56	0,76	0,36
3,1	0,56	0,76	0,36
3,2	0,56	0,76	0,36
3,3	0,56	0,76	0,36
3,4	0,56	0,76	0,36
3,5	0,56	inf	0,36
3,6	0,56	inf	0,36
3,7	0,56	inf	0,36
3,8	0,56	inf	0,36
3,9	0,56	inf	0,36
4,0	0,56	inf	0,36

A graph of this is given in figure C.14.

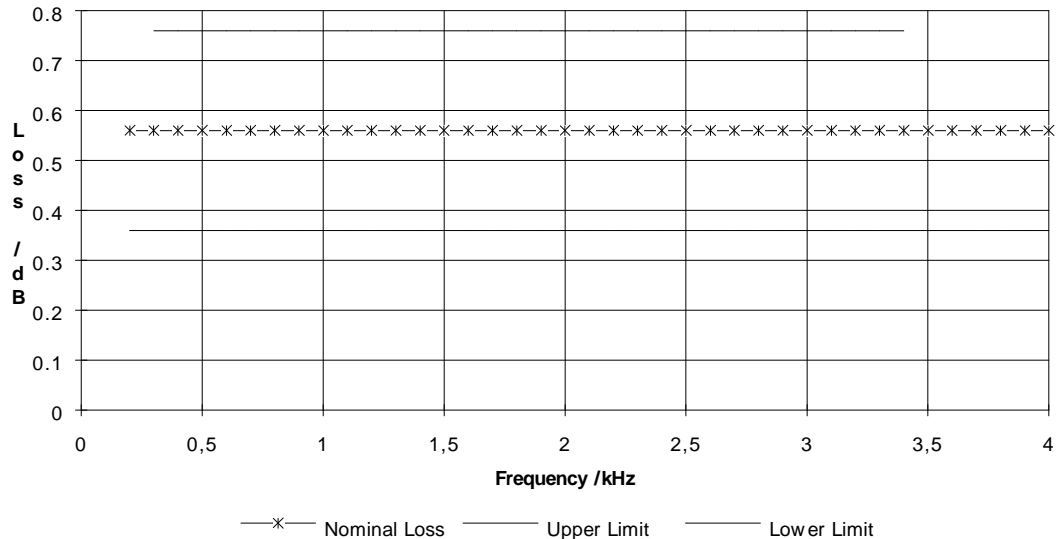

Figure C.14: Test Line 2 - Trunk network simulator - insertion loss frequency characteristic

C.4.2 Trunk network simulator

The trunk network simulator shall be adjusted to obtain modem to modem transmission characteristics as shown in figures C.12 and C.14. The nominal values of the curve of figure C.12 are given in table C.5.

C.4.3 Permanent impairments

The parameters described below are applied for the complete duration of the tests, using Test Line 2.

C.4.3.1 Insertion loss

The insertion loss of Test Line 2 without echoes shall be adjusted to be $12 \text{ dB} \pm 0,1 \text{ dB}$ at 800 Hz between 600 ohms terminating impedances in both directions by adjustment of the frequency independent loss in the Trunk Network Simulator. Assuming the representation given in figures C.1 and C.2 is used and that the other components attain their nominal values, ATT 1 and ATT 2 would need to be set to 0,6 dB.

C.4.3.2 Frequency offset and phase roll

The frequency offset of Test Line 2 shall be no more than $\pm 0,1 \text{ Hz}$ and no phase roll shall be present in the remote talker echo.

C.4.3.3 Phase jitter

The phase jitter of Test Line 2 shall be no greater than $0,5^\circ$ peak-to-peak.

C.4.3.4 Echo

Test Line 2 shall exhibit the following echoes:

- a) a remote talker echo path having a delay of $5 \text{ ms} \pm 1,0 \text{ ms}$ at 1 800 Hz and a loss of $18,8 \text{ dB} \pm 0,2 \text{ dB}$ at 800 Hz. Assuming the representation given in figures C.1 and C.2 is used and that the other components attain their nominal values, DEL 1 and DEL 2 would need to be set to 2,5 ms and ATT 3 to 11,4 dB;
- b) a local talker echo path having a delay less than $0,2 \text{ ms} \pm 0,2 \text{ ms}$ at 1 800 Hz and a loss of $12,7 \text{ dB} \pm 0,2 \text{ dB}$ at 800 Hz. Assuming the representation given in figures C.1 and C.2 is used and that the other components attain their nominal values, ATT 4 would need to be set to 7 dB; and

- c) a listener echo path having a delay of $5 \text{ ms} \pm 1,0 \text{ ms}$ at 1 800 Hz and a loss of at least 67 dB at 800 Hz. Assuming the representation given in figures C.1 and C.2 is used and that the other components attain their nominal values, DEL 3 would need to be set to 5 ms and ATT 5 to at least 60 dB.

For the talker echo, the loss given shall be used to calibrate the test bench and is the loss experienced by an 800 Hz sinusoidal signal injected at point C and measured at point B. For listener echo, the loss given shall be that experienced by an 800 Hz sinusoidal signal injected at point D and measured at point B. The time delays in the echo paths shall be measured using the same reference points but, in this case, calibrated using an 1 800 Hz signal.

C.4.3.5 Harmonic distortion

The harmonic distortion generated within the test bench should be of such a magnitude as to have no material effect upon the results of the tests. It is recommended that the individual levels of the 2nd and 3rd harmonic should be limited to no greater than - 69 dBm measured selectively (e.g. in a 3 Hz bandwidth) with Modem A (see figure C.1) replaced by a 600 ohm sinusoidal signal generator of frequency $800 \text{ Hz} \pm 10 \text{ Hz}$ at a level of - 7 dBm, and Modem B (see figure C.1) replaced by a 600 ohm selective measuring device. The same limits should be met when the generator and the selective measuring set are transposed.

NOTE: The levels given above constrain the harmonic distortion to be no greater than 50 dB.

C.4.3.6 Noise floor

The noise generated within the test bench should be of such a magnitude as to have no material effect upon the results of the tests. It is recommended that with the modem used for reference replaced with a 600 ohm resistor, the noise measured at point C in figures C.1 and C.2 using the filter shown in figure C.5 should not exceed - 60 dBm.

NOTE: This figure (- 60 dBm) may need to be revised in the light of experience. The aim should be to obtain the lowest possible figure achievable consistent with reasonable cost.

C.5 Test Line 3 transmission characteristics

This test line is used to connect during tests a modem seeking conformance to Category II and the modem used for reference whilst establishing conformance with those parts of a modem specific ETS not dealing with performance. This line shall be capable of simulating a local telephone exchange to the extent necessary to permit, where appropriate, the modem under test to originate an out-going call, or be presented with an incoming call for answering.

An exact specification of this line is not possible as practical implementations will have to accommodate various realisations of modems used for reference. The characteristics of Test Line 3 are as those of Test Line 2 with the following exceptions:

no added echoes;

no transient impairments (Phase hits, impulsive noise, etc,...).

Annex D (normative): Provision of test tools

The applicant shall provide all means which are necessary to connect the modem under test with the test equipment and to make significant signals accessible which are exchanged between the modem and a data terminal equipment (which may or may not be the test equipment).

If the access point to the modem is a standard CCITT Recommendation V.24 [8] interface with a standardized interface connector and standardized electrical characteristics, no additional means need be provided. Where this is not the case, and the test laboratory is not able to offer suitable means of adaptation, the means of conversion to a standardized interface connector and/or standardized electrical characteristics shall be provided by the applicant.

For modems in which a CCITT Recommendation V.24 [8] interface is not implemented because, for instance the modem is an integral part of another piece of apparatus, various approaches for accessing the modem functions are conceivable, e.g.:

- the applicant provides test software that permits the modem to function as specified in the test descriptions in the relevant ETS. If the DTE into which the modem is housed has a separate controllable interface, e.g. a parallel interface for the connection of a printer, the applicant may indicate which connections on this interface permit the test house to control and observe the functions of the modem when the terminal is operated with the test software.

Examples of this may be that a signal transition is instigated at one connection or between a pair of connections as soon as the modem indicates to the DTE recognition of the received data signal or as soon as a relevant control signal is conveyed from the DTE to the modem;

- if no separate controllable interface is available at the DTE, then other means shall be provided by the applicant to monitor the transfer of signals between the DTE and the modem, e.g. by deriving trigger signals from certain conditions on the address, data and control buses of microcomputer controlled equipment.

Annex E (informative): Example of proforma chart for information request

Applicant	Manufacturer
Name: Address:	Name: Address:

Equipment Identification	
Commercial designation:	
Previous application for test:	yes no
if any Testing Authority:	
date of approval:	Ref:
Category I or II:	
Countries:	
Reasons for additional test:	

Intended Category	
Category I	countries:
Category II	

Technical characteristics	
Equipment nature:	stand-alone rack-mounted internal
Modes:	carrier mode: automatic answering: automatic calling: provision of loop 3: special features:
Additional information:	transmit level: minimum received level: power supply: tolerance: ambient temperature: relative humidity:

Annex F (informative): Bibliography

The following documents have been informatively referenced in this ETS.

- CCITT Volume X, Fascicle X2 (1984): "Index of the Red Book".
- CCITT Recommendation V.42 (1988): "Error correcting protocol for modems using synchronous-to-synchronous conversion".

History

Document history			
October 1991	First Edition		
May 1995	Public Enquiry for Second Edition	PE 84:	1995-05-22 to 1995-09-15
February 1996	Vote	V 98:	1996-02-19 to 1996-04-12