



EUROPEAN
TELECOMMUNICATION
STANDARD

ETS 300 010-2

March 1997

Source: ETSI TC-TM

Reference: DE/TM-01014-3

ICS: 33.020

Key words: Cross connect, digital, management, transmission, SDH, leased line

**Transmission and Multiplexing (TM);
Synchronous cross connection equipment
64 kbit/s and n x 64 kbit/s
cross connection rate 2 048 kbit/s access ports;
Part 2: Management aspects**

ETSI

European Telecommunications Standards Institute

ETSI Secretariat

Postal address: F-06921 Sophia Antipolis CEDEX - FRANCE

Office address: 650 Route des Lucioles - Sophia Antipolis - Valbonne - FRANCE

X.400: c=fr, a=atlas, p=etsi, s=secretariat - **Internet:** secretariat@etsi.fr

Tel.: +33 4 92 94 42 00 - Fax: +33 4 93 65 47 16

Copyright Notification: No part may be reproduced except as authorized by written permission. The copyright and the foregoing restriction extend to reproduction in all media.

© European Telecommunications Standards Institute 1997. All rights reserved.

Contents

Foreword	5
1 Scope	7
2 Normative references	7
3 Abbreviations	8
4 DXC management network	10
5 Information model	10
6 Management interfaces	11
7 Applications functions	11
7.1 Fault management	11
7.1.1 Alarm surveillance	11
7.1.1.1 Principle	11
7.1.1.2 Alarm-related functions	13
7.1.2 Alarm classification	14
7.1.2.1 Alarm type	14
7.1.2.1.1 Communications alarm	14
7.1.2.1.2 Equipment alarms	14
7.1.2.1.3 Processing alarm	15
7.1.2.1.4 Environmental alarm	15
7.1.2.2 Perceived severity level	15
7.1.2.3 Alarm record	16
7.1.3 Test functions	16
7.1.3.1 Loopbacks	16
7.1.3.1.1 Loopbacks at the 2 048 kbit/s level	16
7.1.3.1.2 n x 64 kbit/s dropping function	17
7.1.3.1.3 Internal n x 64 kbit/s loopback	18
7.1.3.1.4 Loopback characteristics	18
7.1.3.1.5 Internal tests	18
7.2 Performance management	18
7.2.1 Long term performance evaluation	19
7.2.2 Short term performance evaluation	19
7.2.2.1 Elementary events for in-service measurement	19
7.2.2.1.1 Anomaly event, receive part	19
7.2.2.1.2 Anomaly event, transmit part	20
7.2.2.1.3 Defect events, receive part	20
7.2.2.1.4 Defect events, transmit part	20
7.2.2.2 Elementary events for out-of-service measurement	20
7.2.3 Condition of measurement	20
7.2.4 Performance parameters evaluation	21
7.2.5 Performance process	21
7.2.5.1 15 minute process	21
7.2.5.1.1 Option 1 - evaluation without hysteresis	22
7.2.5.1.2 Option 2 - Evaluation with hysteresis	23
7.2.5.2 24 Hour process	23
7.2.6 Performance evaluation	24
7.2.7 General performance functional diagram	25
7.3 Configuration management	26
7.3.1 Configuration management overview	26
7.3.1.0 Glossary	26
7.3.1.1 Functional architecture	27

	7.3.1.1.1	Main functions	27
	7.3.1.1.2	CAS cross-connection functions	28
	7.3.1.1.3	Transfer of unstructured CCITT Recommendation G.703 / 2 048 kbit/s.	29
	7.3.1.1.4	Synchronization function	30
	7.3.1.1.5	Time Slot 0 cross-connection functions	30
	7.3.1.1.5.1	4 kbit/s granularity	30
	7.3.1.1.5.2	64 kbit/s granularity	33
	7.3.1.2	Object classes	35
	7.3.1.3	Entities-relationships diagrams	35
7.3.2		Description of the fragments	38
	7.3.2.1	Managed element fragment	39
	7.3.2.2	Termination point fragment	42
	7.3.2.3	Cross-connection fragment	47
	7.3.2.4	Synchronization fragment	51
	7.3.2.5	Power feeding fragment	55
	7.3.2.6	Time Slot 0 cross-connection	56
	7.3.2.6.1	4 kbit/s granularity	56
	7.3.2.6.1.1	Termination point fragment	56
	7.3.2.6.1.2	Cross-Connection fragment	58
	7.3.2.6.2	64 kbit/s granularity	59
	7.3.2.6.2.1	Termination point fragment	59
	7.3.2.6.2.2	Cross-Connection fragment	63
Annex A (informative):		Management functions	65
A.1		Object classes	65
A.2		Entities-relationship diagrams	65
A.3		Cross-connection fragment	67
A.4		Management fragment	67
History		68

Foreword

This European Telecommunication Standard (ETS) has been produced by the Transmission and Multiplexing (TM) Technical Committee of the European Telecommunications Standards Institute (ETSI).

The ETS is required in order to meet the requirements of network operators and equipment manufacturers for the deployment and design of synchronous cross connect equipment to be used in synchronous digital leased line networks.

The corresponding standard for equipment used in cross connection of subrate signals is under development.

This ETS consists of 2 parts as follows:

Part 1: "Core functions and characteristics";

Part 2: "Management aspects".

Transposition dates	
Date of adoption	21 February 1997
Date of latest announcement of this ETS (doa):	30 June 1997
Date of latest publication of new National Standard or endorsement of this ETS (dop/e):	31 December 1997
Date of withdrawal of any conflicting National Standard (dow):	31 December 1997

Blank page

1 Scope

This ETS addresses management aspects of the 64 (or $n \times 64$) kbit/s cross connect. The Digital Cross Connect (DXC) equipment management functions are specified and management network architecture is described.

Part 1 of this ETS describes requirements of cross connect equipment with 2 048 kbit/s access ports for use in synchronous digital leased line networks. These requirements are limited to the basic functions, external characteristics and performance of the equipment.

The part 1 of this ETS (ETS 300 010-1[14]) defines functions and makes precise whether they are mandatory or not. If supported, a function has to be managed according to part 2 of this ETS. Part 2 of this ETS specifies when necessary the optional management characteristics (attributes, operations and notifications) of the objects.

2 Normative references

This ETS incorporates by dated or undated reference, provisions from other publications. These normative references are cited at the appropriate places in the text and the publications are listed hereafter. For dated references, subsequent amendments to or revisions of any of these publications apply to this ETS only when incorporated in it by amendment or revision. For undated references, the latest edition of the publication referred applies.

- [1] CCITT Recommendation G.703: "Physical/electrical characteristics of hierarchical digital interfaces".
- [2] CCITT Recommendation G.704: "Synchronous frame structures used at primary and secondary hierarchical levels".
- [3] ITU-T Recommendation G.826: "Error performance parameters and objectives for international, constant bit-rate digital paths at or above the primary rate".
- [4] ITU-T Recommendation M.20: "Maintenance philosophy for telecommunications networks".
- [5] ITU-T Recommendation M.2100: "Performance limits for bringing into service and maintenance of international digital paths, sections and transmission systems".
- [6] ITU-T Recommendation M.2110: "Bringing into service international digital paths, sections and transmission systems".
- [7] ITU-T Recommendation M.2120: "Digital path, section and transmission system fault detection and localization procedures".
- [8] ITU-T Recommendation M.3010: "Principles for a telecommunications management network".
- [9] ITU-T Recommendation M.3100: "Generic network information model".
- [10] ITU-T Recommendation O.151: "Error performance measuring equipment operating at the primary rate and above".
- [11] CCITT Recommendation X.710: "Common management information service definition for CCITT applications".
- [12] ITU-T Recommendation X.733: "Information technology - Open Systems Interconnection - Systems Management: Alarm reporting function".
- [13] ITU-T Recommendation G.784: "Synchronous digital hierarchy (SDH) management".

- [14] ETS 300 010-1 (1995): "Transmission and Multiplexing (TM); Synchronous cross connect equipment 64 and n x 64 kbit/s cross connection rate 2 048 kbit/s access ports. Part 1: Core functions and characteristics".
- [15] ETS 300 371 (1994): "Transmission and Multiplexing (TM); Plesiochronous Digital Hierarchy (PDH) information model for the Network Element (NE) view".
- [16] ETR 135 (1994): "Transmission and Multiplexing (TM); Network aspects and applications for a 4 (and n x 4 kbit/s) data link in a 2 048 kbit/s frame".
- [17] ETR 241: "Transmission and Multiplexing (TM); Functional architecture of 2 Mbit/s based Plesiochronous Digital Hierarchy (PDH) transport networks".
- [18] ITU-T Recommendation X.731: "Information technology - Open Systems Interconnection - Systems Management: State management function".
- [19] ETS 300 304 (1994): "Synchronous Digital Hierarchy (SDH) information model for the network element (NE) view".
- [20] ETS 300 376-1: "Signalling Protocols and Switching (SPS); Q3 interface at the Access Network (AN) for configuration management of V5 interfaces and associated user ports".

3 Abbreviations

For the purposes of this ETS, the following abbreviations apply:

2 048S	2 048 kbit/s CCITT Recommendation G.704 [2] framed Signal
2 048U	2 048 kbit/s Unstructured signal
2MB	2 Mbit/s
2ME	2 Mbit/s - External remote
2MI	2 Mbit/s - Internal local
A2, J1, J2,	reference points according to ETS 300 010-1 [14]
A-bit	bit 3, TS0 FAS
AE	Anomaly Event
AIS	2 048 kbit/s Alarm Indication Signal
AISTS16	64 kbit/s Alarm Indication Signal in TS16
BBE	Background Block Error
BBER	Background Block Error Ratio
BE	Block Error
CASXC	Channel Associated Signalling Cross Connection Function
CPU	Control Processing Unit
CRC4	Cyclic Redundancy Check procedure-4
DE	Defect Event
DFC	Defect or Failure Condition
DP	Degraded Performance
DXC	Digital Cross Connect equipment
EB	Errored Block
E-bit	Remote block error indication
EOC	Embedded Operation Channel
ES	Errored Second
ESR	Errored Second Ratio
EXBER	Excessive Bit Error Ratio
F	A management interface according to ITU-T Recommendation M.3010 [8]
FAS	Frame Alignment Signal
G1, G2, A1,	reference points according to ETS 300 010-1 [14]
G1a, G1b,	reference points according to ETS 300 010-1 [14]
G'2, A'1, A'2	reference points according to ETS 300 010-1 [14]
G2a, G2b,	reference points according to ETS 300 010-1 [14]
H	Hour
J'1, J'2, G'1,	reference points according to ETS 300 010-1 [14]
LC	Local Control interface
LMFA	Loss of Multiframe Alignment

LOF	Loss of Frame
LOS	Loss of Signal
LSYNC	Loss of Synchronization
m	m reference point according to ITU-T Recommendation M.3010 [8]
M	Mandatory
MCF	Message Communication Function
MD	Mediation Device
min	Minute
NE	Network Element
NEF	Network Element Function
NP	Normal Performance
O	Optional
OS	Operations System
OSF	Operations System Function
PI	Physical Interface
PLPT	Plesiochronous Lower order Path Termination
POH	Path Overhead
PPT	Plesiochronous Path Termination
PRBS	Pseudo Random Bit Sequence
Q	Management interface to the TMN
Q3	A management interface according to ITU-T Recommendation M.3010 [8]
Qx	A management interface between a Q-adaptation function (QAF) and a Network Element Function (NEF) according to ITU-T Recommendation M.3010 [8]
RAI	Remote Alarm Indication
RMAI	Remote Multiframe
RTR1ES	Reset Threshold for Errored Second counting
RTR1SES	Reset Threshold for Severely Errored Second
s	Second
Sa	Spare bit in TS0 NFAS
San	A spare bit in TS0 NFAS
SDH	Synchronous Digital Hierarchy
SER	Severely Errored Second ratio
SES	Severely Errored Second
T1	Internal timing signal
T4	Output timing signal
TIPI	Timing Input Physical Interface
TMN	Telecommunication Management Network
TOPI	Timing Output Physical Interface
TR1ES	Threshold 1 for Errored Second counting
TR1SES	Threshold 1 for Severely Errored Second counting
TR2ES	Threshold 2 for Errored Second counting
TR2SES	Threshold 2 for Severely Errored Second counting
TS	Time Slot
TS0 FAS	Time Slot 0 with Frame Alignment Signal
TS0 NFAS	Time Slot 0 without Frame Alignment Signal
TS16	Time Slot 16
TX/RX	Transmit/Receive
UP	Unacceptable Performance
UT	Unavailable Time
WS	Work Station
XC	Cross Connect
XCTS	Cross Connect Timing Source

NOTE: Abbreviations used in subclause 7.3 are listed in subclause 7.3.1.0.

4 DXC management network

Characterization of a Digital Cross Connect (DXC) equipment management network is derived from ITU-T Recommendation G.784 [13], especially figure 1 of that document. Figure 1 below reproduces a similar organization for the management view of management network where an Embedded Operation Channel EOC replaces the specific Synchronous Digital Hierarchy (SDH) Embedded Control Channel (ECC). This figure relates only to functional aspects and does not imply implementation or routing facilities. EOC could be either supported by a particular 64 kbit/s Time Slot (TS) or by one or some of the Sa bits of the CCITT Recommendation G.704 [2] frame Network Elements (NE) could be directly connected with a Mediation Device (MD) or via other devices, including NEs.

NOTE: Network operators may be required to provide duplication of the management interface.

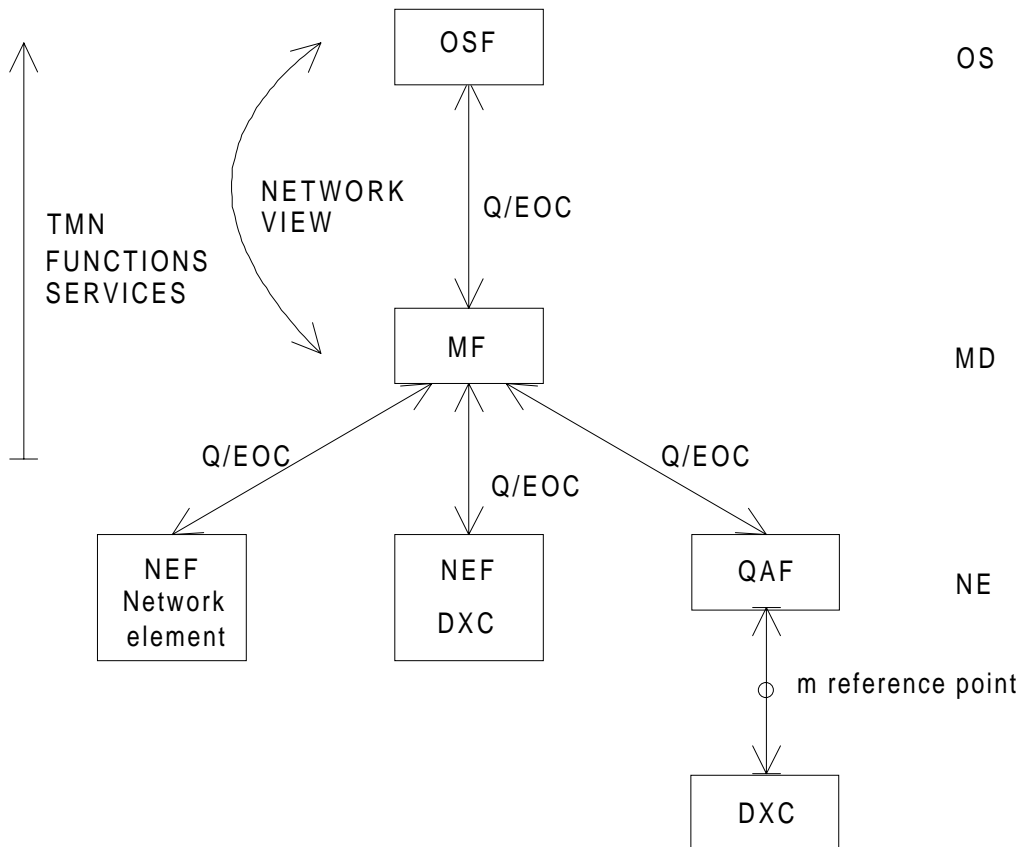

- MD Mediation Device
- MF Mediation Function
- NEF Network Element Function
- QAF Q Adapter Function
- OS Operations System
- OSF Operations System Function
- TMN Telecommunications Management Network

Figure 1: Functional view of management network

5 Information model

There is no information model in this edition of the ETS.

6 Management interfaces

The DXC shall be able to terminate and generate the cross connect management control channel(s). For this purpose, the DXC should present, according to ITU-T Recommendation M.3010 [8], the following interfaces:

Q-interface: This interface provides a management control channel between the Operations System (OS) and the DXC. Depending on the management network implementation, it could be a Qx or a Q3 interface.

There are no protocol suites in this edition of the ETS.

If this interface is not provided, an interface supporting an m-reference point shall be provided.

F-interface: This optional interface provides Work Station (WS) access to the OS via the DXC.

m-reference point: This is supported by a proprietary interface and allows, via an external Q Adaptation Function (QAF), a management connection between an OS conforming to TMN recommendations and a DXC that does not conform to TMN recommendations.

Additionally, the DXC shall provide a Local Control (LC) interface for local attachment of a proprietary management entity. This interface is concerned with:

- installation and maintenance (with changes of the DXC-configuration), in cases where the connection to the OS is interrupted or voluntarily blocked;
- local monitoring of the DXC status (without changes of the DXC-configuration).

NOTE: For the first case, means should be implemented in the DXC and/or the OS to overcome conflict/misalignment situations between the DXC configuration locally induced via the LC interface and the DXC configuration as it is stored in the OS database.

7 Applications functions

7.1 Fault management

7.1.1 Alarm surveillance

7.1.1.1 Principle

Alarm surveillance is concerned with the detection and reporting of relevant events/conditions which occur in the equipment or which are detected at equipment level. Events/conditions detected within the equipment and in the incoming signals shall be reportable. Alarms are indications that are automatically generated by the equipment or NE as the result of certain events/conditions and associated processing. The user shall have the ability to define which events/conditions generate autonomous reports. The remaining events/conditions are reportable on request.

The relevant events/conditions are derived from the Defect or Failure Conditions (DFC) given in ETS 300 010-1 [14]. The processing associated with the occurrence of DFC is described in figure 2.

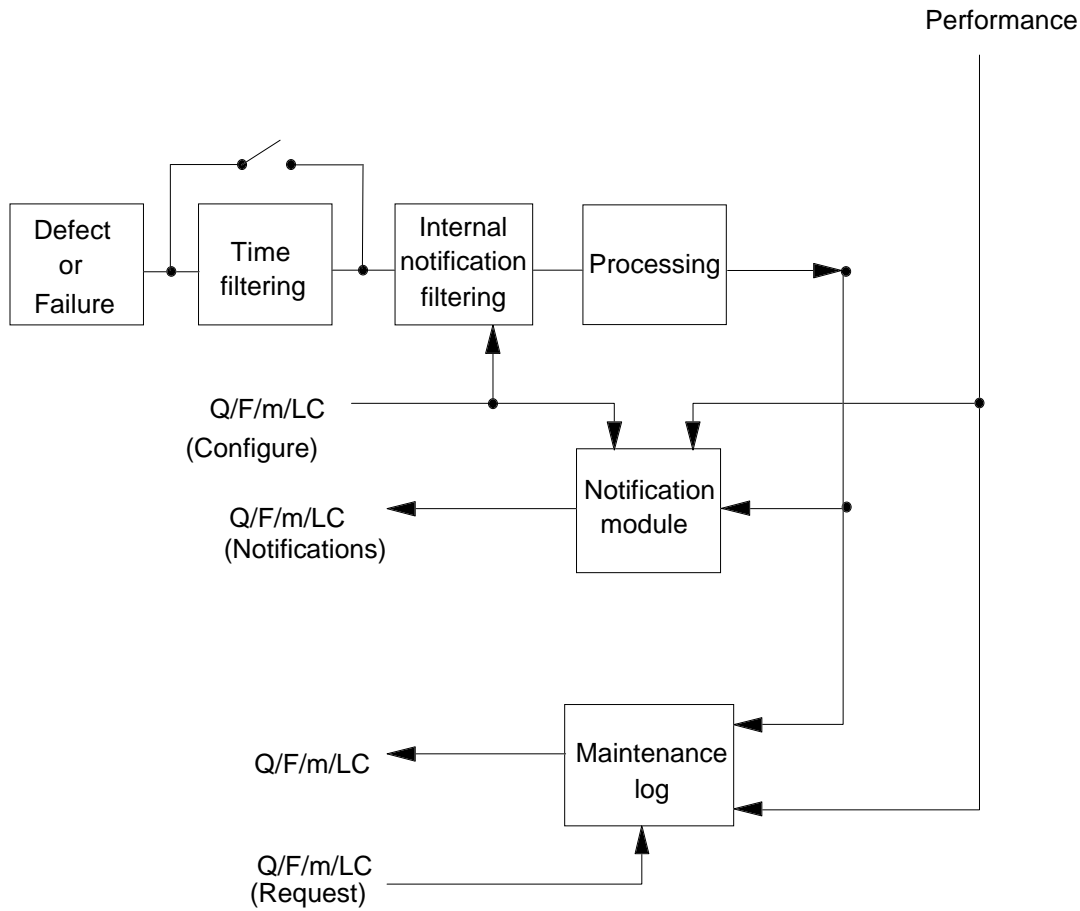

- NOTE 1: TMN requires a notification function: this may be supported either by the equipment itself or by a QAF function.
- NOTE 2: The "configure" arrow is shown according to the text of subclause 7.1.1.1. This representation does not preclude that the filtering module, internal notification module and processing module are also configurable.

Figure 2: Alarm related maintenance functions

Functions associated with the various functional blocks to figure 2 are as follows:

defect or failure: This functional block performs the elementary functions necessary for the detection of any of the defect or failure conditions specified in ETS 300 010-1 [14] or in this ETS.

time filtering: This functional block provides optional programmable time filtering, ranging from 0 to 10 s in steps of 1 s, which allows notification of a selected defect or failure condition only if its duration is greater than the predetermined value.

Internal notification

filtering: This functional block manages the sending of notifications (occurrence, disappearance of DFC) to the appropriate functional block. It also enables/disables discrimination of a given DFC depending upon its nature and if necessary, to forward it to appropriate functional blocks.

processing: This function receives the various notifications, gathers them and performs the necessary correlation in such a way that no redundant information will be needed. In addition, this function may allow provision of a diagnostic for the occurrence of a DFC. The processing functional block also generates synthetic notifications destined for the Equipment Management Function.

Notification

module: This functional block is under the control of the user who may determine the notifications required to be spontaneously transmitted to the Q/F/m interface/reference point. Also included is programmable notification filtering in the range of 0 s to 60 s in steps of 10 s.

Maintenance

log: This functional block registers all the DFCs occurring in the DXC in an allotted memory area. A stored DFC should include: nature (i.e. LOS, LFA, etc.), type, managed function, time (occurrence, clearing). The user shall have the ability to request transmission or display of stored information according to criteria which are described in subclause 7.1.1.2.

7.1.1.2 Alarm-related functions

The following alarm-related functions may be required to be supported at the equipment level:

- report autonomous alarms;
- request all alarms;
- report all alarms;
- allow/inhibit alarm reporting over any EOC;
- request status of allow/inhibit alarm reporting;
- report status of allow/inhibit alarm reporting.

The following table 1 contains the minimum list of alarm conditions (default values) described in subclause 7.1.2.

Table 1: Alarm conditions

Alarm type	Alarm condition	Mandatory/optional	Perceived severity level	
Communication	LOS	2 048U	M	Major
	EXBER		O	Pending
	LOS	2 048S	M	Critical
	LOF		M	Critical
	EXBER		O	Minor
	RAI		M	Minor
	AIS		M	Minor
	LMFA		M	Minor
	RMAI (note)		M	Minor
	AIS TS16		M	Minor
Equipment	Management link failure		O	Critical
	LSYNC		M	Major
Equipment	2MB Port		M	Major
	Power supply		M	Critical
	Cross Connection function		M	Critical
	Common logic		M	Major
	Special functions		M	Major
Processing	Misalignment database		M	Major
	Time management		O	Minor
	Alarm memory		M	Minor
	Downloading software error		O	Major
	Software corrupting		M	Major
Quality of service	Degraded performance (DP)		O	Minor
	Unacceptable performance (UP)		O	Major
NOTE:	Remote Multiframe Alarm Indication (RMAI): this alarm corresponds to the Remote Alarm Indication (RAI) in time slot 16.			

7.1.2 Alarm classification

Alarms should be classified using the alarm type categories and perceived severity defined in ITU-T Recommendation X.733 [12].

7.1.2.1 Alarm type

Five basic categories of alarms are specified. These are given in the following subclauses.

7.1.2.1.1 Communications alarm

This type of alarm includes the following defect or failure conditions which are shown with the related functional part of the 64 (or $n \times 64$) kbit/s digital cross connect equipment.

- 2 048 kbit/s unstructured;
 - loss of incoming signal;
 - excessive error ratio (bipolar coding violations) (see note).
- 2 048 kbit/s structured access port carrying signals with channel associated signalling;
 - loss of incoming signal (see subclause 11.1.1.2 of ETS 300 010-1 [14]);
 - loss of frame alignment (see subclause 10.1 of ETS 300 010-1 [14]);
 - excessive error ratio;
 - defect indication from remote end (bit3 and any additional spare bit of Time Slot 0 without Frame Alignment Signal (TS0 NFAS));
 - 2 048 kbit/s Alarm Indication Signal (AIS) received (see subclause 11.1.1.5 of ETS 300 010-1 [14]);
 - loss of multiframe alignment (bit 6 in TS16) (see subclause A.11.1.1.7 of ETS 300 010-1 [14]);
 - defect indication from remote end (see subclause A.11.1.1.9 of ETS 300 010-1 [14]);
 - AIS received in TS16 (see subclause A.11.1.1.8 of ETS 300 010-1 [14]).

The notification of each alarm shall be in accordance with the filtering values defined in the subclause 7.1.1.1.

NOTE: The detection of this alarm is optional.

- Management links.

Alarm indicating failure in management link(s), if appropriate.

- Synchronization interface(s).

Loss of synchronization signal (see subclause 11.2.1.2 of ETS 300 010-1 [14]).

7.1.2.1.2 Equipment alarms

This type of alarm includes at least the following defect or failure conditions:

Failure of a 2 048 kbit/s port

The 2 Mbit/s port (Physical Interface (PI) and Plesiochronous Path Termination (PPT) functions) shall be provided with an appropriate check procedure to detect at least the following defect/failure conditions on 2 Mbit/s port:

- TX/RX circuits, included the elastic stores;
- loss of internal timing signals from Cross Connect Timing Source (XCTS) function;
- loss of internal power feed;
- internal communication interface with common logic;
- internal interface with cross-connection function.

Power failure

This alarm shall be activated either by absence of the external power supply or a fault in the single DXC power supply unit.

Connection failure

The cross-connection function shall be provided with appropriate check procedures to detect defect/failure conditions on a 64 or n x 64 kbit/s connection. The DXC control system shall be able to indicate the part or unit of the DXC that caused the connection failure.

Timing failure

The XCTS function shall be provided with an appropriate check procedure to detect the loss of T1 signal (and/or T4 signal if required).

Common logic failure

The DXC shall be provided with appropriate check procedure to detect at least:

- defect/failure of the CPUs;
- defect of the program memory;
- defect of the data memory;
- loss of the internal power feeding.

Special function failure

Each different special function implemented in the DXC shall be provided with appropriate check procedures to detect defect/failure conditions of its functionalities. More details will be given along with the definition of the individual function.

7.1.2.1.3 Processing alarm

This type of alarm includes, where applicable, the following defect or failure conditions:

- time management;
- alarm memory (overflow);
- down loading software error;
- software corruption;
- misalignment of the data-base.

7.1.2.1.4 Environmental alarm

No particular environmental alarms are requested.

7.1.2.2 Perceived severity level

There are seven severity levels defined in ITU-T Recommendation X.733 [12] providing an indication of how it is perceived that the capability of the managed object has been affected.

The levels to be used in this context are listed and defined hereafter:

- Cleared:
This level indicates the clearing of one or more previously reported alarms;
- Indeterminate:
This level indicates that the severity level of the service affecting condition cannot be determined;

- Critical:

This level indicates that a service affecting condition occurred and that immediate remedial action is required;
- Major:

This level indicates that a service affecting condition occurred and that an urgent correction action is required;
- Minor:

This level indicates the existence of a non-service affecting condition and that the correction action should be taken in order to prevent a more serious condition (e.g. a service affecting condition);
- Warning:

This level indicates the detection of a potential or impeding service affecting condition, before any significant effect has been felt;
- Pending:

This level indicates that some alarm condition has been recognized but has not persisted long enough to qualify as a non-transient condition (as determined by some algorithm applied to the alarm condition). This does not directly cause any alarm notification.

The equipment can provide part of these seven severity levels but not necessarily all of them.

7.1.2.3 Alarm record

The 64 (or $n \times 64$) kbit/s cross connect equipment and its (local) management system shall provide an alarm record. An alarm record represents information stored in logs.

Each record should include at least the following parameters:

- managed functions;
- alarm type;
- perceived severity;
- probable cause;
- event time.

Optionally the record should include the "backed-up status" parameter. This parameter indicates whether or not the failed object has been backed up.

7.1.3 Test functions

7.1.3.1 Loopbacks

7.1.3.1.1 Loopbacks at the 2 048 kbit/s level

Referring to figure 2 of ETS 300 010-1 [14], at reference point G, the equipment shall provide local (2MI) or remote (2ME) loopbacks for the purpose of transmission section testing. The description of these two loopbacks is given in figure 3.

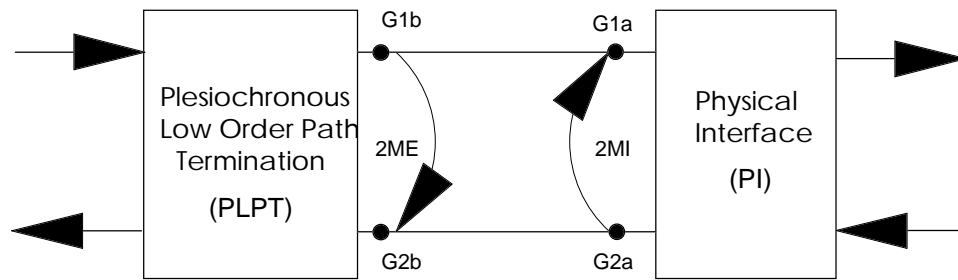

NOTE: G1b = G2b G1a = G2a
 G1a = 2 048 kbp/s Alarm Indication Signal (AIS) G2b = AIS
 G2a ignore G2b G1a ignore G1b

Figure 3: Test functions for 2 048 kbit/s access port

The provision of 2 048 kbp/s External (remote) Loopback (2ME) is mandatory while the 2 048 kbp/s Internal (local) Loopback (2MI) is an option for the equipment depending on the telecommunications organization maintenance strategy.

NOTE: Provision needs to be made to avoid activation of 2 048 kbit/s loopback when the corresponding 2 Mbit/s signal is carrying the active EOC (when used).

Upon request from a management interface, the equipment shall provide all information about the active loopbacks.

7.1.3.1.2 n x 64 kbit/s dropping function

The equipment shall provide an n x 64 kbit/s logical dropping function for test purposes for any selected n x 64 kbit/s (n=1 to 31) connection set in the equipment. This function shall be activated (or deactivated) under management system control.

Two different applications of this feature for testing n x 64 kbit/s channels are possible. One is a monitoring function (figure 4a) where data signals of both directions are broadcasted towards one or more 2 048 kbit/s access port(s), depending on the number of channels to be tested. The second test is realized in a split mode (figure 4b) where internal cross connections are set down and the two legs of the communication channels are derived towards one or more 2 048 kbit/s access port(s), depending on the number of channels to be tested.

At the end of the test the previous connections shall be restored.

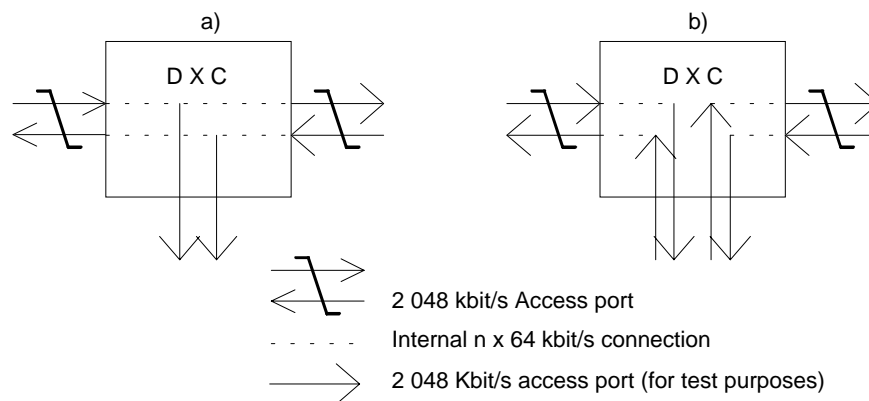

Figure 4: Description of n x 64 kbit/s dropping functions

7.1.3.1.3 Internal n x 64 kbit/s loopback

The equipment shall provide internal n x 64 kbit/s logical loopback for test purposes for any selected n x 64 kbit/s channel cross connected in the equipment. This function shall be activated (or deactivated) under management system control. Figure 5 shows the principle for n x 64 kbit/s loopback.

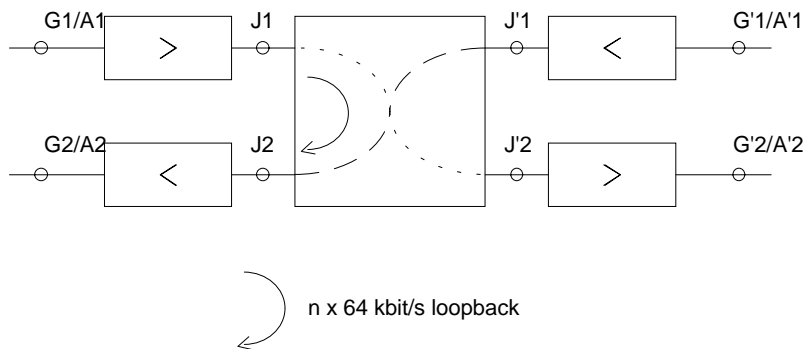

Figure 5: Principle for n x 64 kbit/s loopback

7.1.3.1.4 Loopback characteristics

For all loopbacks described in subclauses 7.1.3.1 to 7.1.3.3, the solution presented in figure 6 shall be applied.

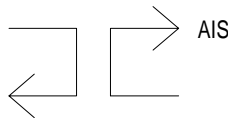

Figure 6: Type of loopback

7.1.3.1.5 Internal tests

It is considered that a monitoring function for essential parts of the 64 (or n x 64) kbit/s cross connect equipment should be provided. The parts which are concerned are:

- cross connection matrix (or equivalent);
- timing signals;
- power feed;
- common logic;
- line card;
- TMN interfaces.

7.2 Performance management

The following subclauses refer to the quality of service monitoring in 2 048 kbit/s (CCITT Recommendation G.704 [2]) paths using the Cyclic Redundancy Check procedure-4 (CRC4). Other methods for 2 048 kbit/s (CCITT Recommendation G.704 [2]) signals performance measurement may be implemented irrespective of whether they use the CRC4 procedure.

Performance management is an application function for the management of the 64 kbit/s cross connect equipment. It applies to the 2 048 kbit/s digital path level. It involves some computing functions on Anomaly Events (AE) or Defect Events (DE) which are listed later in this subclause. This function covers two different requirements related respectively to long term or short term performance evaluation.

The long term performance evaluation provides results according to ITU-T Recommendation G.826 [3]. For the DXC application this is applicable to 2 048 kbit/s CCITT Recommendation G.704 [2] structured digital paths.

The short term performance evaluation follows the principles described in ITU-T Recommendations M.20 [4], M.2100 [5], M.2110 [6] and M.2120 [7]. This is to be provided to cover at least the second of the two following situations where the equipment is involved:

- bringing-into-service a 2 048 kbit/s digital path (note);
- maintenance of a 2 048 kbit/s digital path in service.

NOTE: Alternatively, a Pseudo Random Bit Sequence (PRBS) generator and analyser according to ITU-T Recommendation O.151 [10] may be used for performance evaluation in the bringing-into-service situation.

7.2.1 Long term performance evaluation

The long term performance evaluation for CCITT Recommendation G.704 [2] framed 2 048 kbit/s signals is based on ITU-T Recommendation G.826 [3]. For this evaluation, the following parameters are considered and corresponding definitions are given in subclause 7.2.4:

- Errored Block (EB);
- Errored Second (ES);
- Severely Errored Second (SES);
- Background Block Error (BBE).

The associated computing functions are limited to the calculation of current ratio for ES, SES and BBE parameters and identified as:

- Errored Second Ratio (ESR);
- Severely Errored second Ratio (SER);
- Background Block Error Ratio (BBER).

The accumulation of performance parameters and associated ratio calculation should be made on a long term basis (e.g. 3 months or more). This does not preclude intermediate evaluation under request of the operation system but this is not considered a mandatory function. Comparison of the long term performance evaluation with the performance allocated to a given 2 048 kbit/s digital path and to the specified limits for ESR, SER and BBBER are not considered as a management function for the flexible multiplexer.

Figure 11 depicts corresponding long term performance evaluation functions.

7.2.2 Short term performance evaluation

The associated computing function requires four levels of analysis. The first one concerns the detection of elementary events which are necessary for the performance management. The second level realizes a statistical calculation based on a one second time period in order to classify each second as Normal, as an Errored Second (ES) or as a Severely Errored Second (SES). A notification module subsequently provides the necessary information to the fourth level where the corresponding quality of service is determined, individually per 2 048 kbit/s access port and for the received signal (optionally for the transmitted signal). The performance evaluation is only applicable for the period of time when the digital path is available.

7.2.2.1 Elementary events for in-service measurement

Elementary events affecting the performance of 2 048 kbit/s digital paths are classified into Anomaly Events (AE) or Defect Events (DE) according to ITU-T Recommendation M.20 [4].

7.2.2.1.1 Anomaly event, receive part

The following events shall be detected:

- Block Error (BE): CRC4 code word violation (errored CRC4 block).

7.2.2.1.2 Anomaly event, transmit part

The following event shall be detected:

- reception of E bit.

7.2.2.1.3 Defect events, receive part

The following events shall be detected:

- Loss of Frame (LOF) alignment;
- Loss of Signal (LOS).

7.2.2.1.4 Defect events, transmit part

The following event shall be detected:

- bit 3 of TS0 NFAS.

7.2.2.2 Elementary events for out-of-service measurement

The usefulness of having a test function inside the DXC able to generate/analyse a PRBS for the purpose of out-of-service performance measurement depends on the maintenance strategy of the operator. When providing this function, the equipment is able to generate unframed 2 048 kbit/s, framed 31 x 64 kbit/s (or 30 x 64 kbit/s in case of 2 048 kbit/s signals carrying channel associated signalling) PRBS signals at the level of a number of 2 048 kbit/s access ports.

The out-of-service performance measurement concerns either a bringing-into-service situation or a test process following a failure condition and repair in a point-to-point configuration or on a remote 2ME loopback (refer to subclause 7.1.3.1.1).

7.2.3 Condition of measurement

The final performance evaluation shall only be processed when the 2 048 kbit/s digital path is in the available time, i.e. disabled when determined in unavailable time.

Definition of unavailable time:

Unavailable Time (UT) for a 2 048 kbit/s digital path starts at the outset of 10 consecutive SES as shown in figure 7. A 2 048 kbit/s digital path is in a period of unavailable time if one or both directions are in the unavailable state.

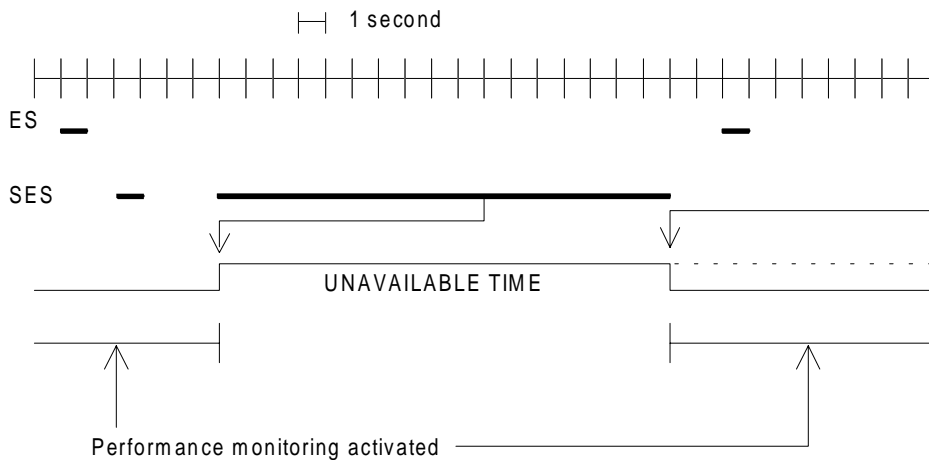

Figure 7: Definition of unavailable time

The criterion to determine if one particular second is a SES is given in table 2.

7.2.4 Performance parameters evaluation

In addition to the detection of AE and DE events (first level of the performance evaluation), the equipment shall be able to provide in-service performance parameters as shown in table 2.

The in-service performance parameters to be considered for a 2 048 kbit/s digital path using the CRC4 procedure are given in table 2.

Table 2: In-service performance parameters with CRC4

Path level	POH available to derive AE/DE data	AE/DE per second	Interpretation for receive direction	Interpretation for transmit direction
2 048 kbit/s CRC4	CRC4 E-bit FAS A-bit San-bit	≥ 1 LOF	ES + SES	
		≥ 1 LORS	ES + SES	
		≥ 1 CRC4 error(s)	ES	
		≥ 805 CRC4 errors	ES + SES	
		≥ 1 E-bit		ES
		≥ 830 E-bit		ES + SES
		≥ 1 A-bit		ES
		≥ 1 San-bit		ES
		≥ D1 A-bit		ES + SES

7.2.5 Performance process

The ES and SES are counted individually in two counters C1 and C2 for the 15 minute basis evaluation process and in two counters C3 and C4 for the 24 hour basis evaluation process.

7.2.5.1 15 minute process

ES and SES performance parameters are transmitted to the two counters C1 and C2 as indicated in figure 8. These two counters are reset at the outset of every 15 minute calculation period. TR1ES and TR1SES thresholds are associated with counters C1 and C2 respectively. Figure 9 depicts the calculation mechanism of the number of received performance parameters and consequent actions within each 15 minute period.

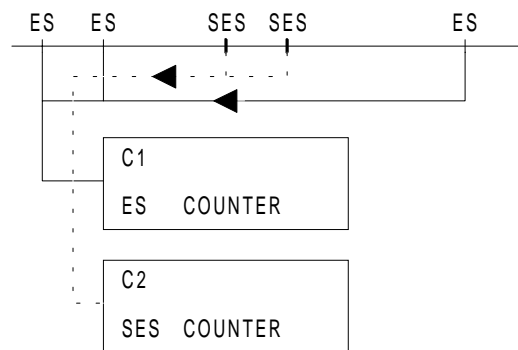

Figure 8: Counting of performance parameters

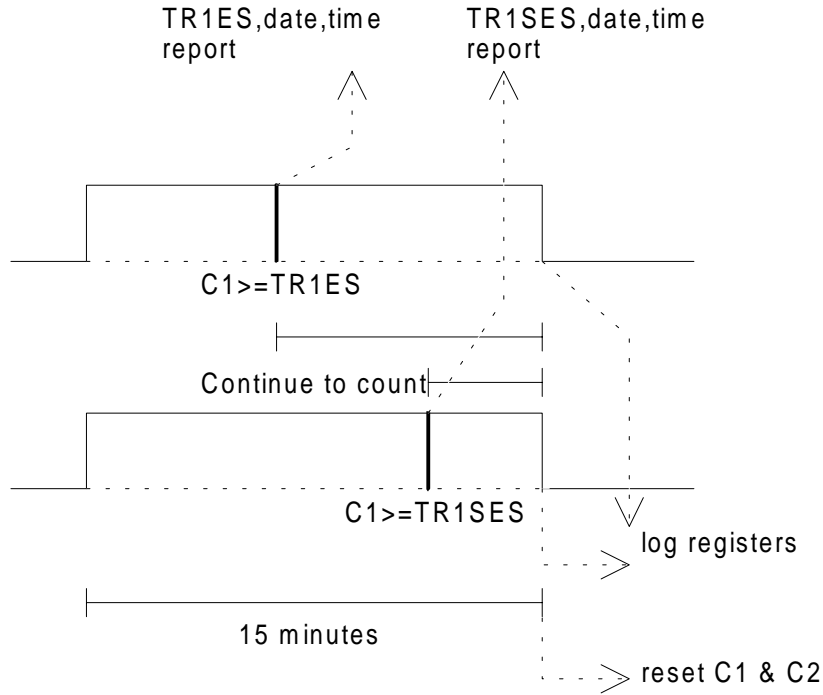

Figure 9: Consequent actions

The two options allowed for the 15 minute evaluation process are described next.

7.2.5.1.1 Option 1 - evaluation without hysteresis

When the content of counter C1 or counter C2 exceeds the thresholds TR1ES or TR1SES respectively in a given 15 minute period, a time and date stamped report is sent. The two counters continue to count the received ES or SES performance parameters. At the beginning of every 15 minute period, reports including the content of the two counters C1 and C2 are sent to the log file. This is shown in figure 10.

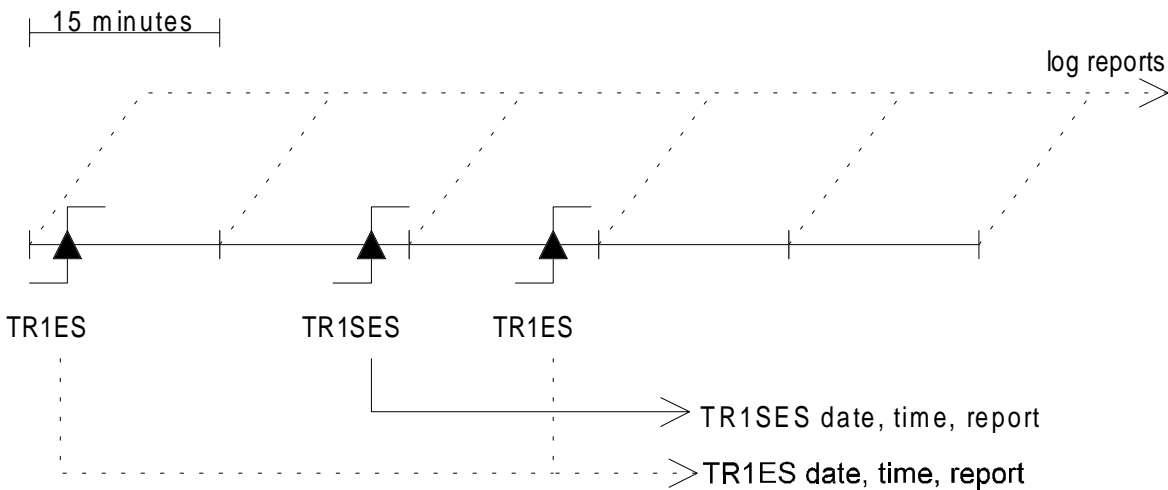

Figure 10: Performance evaluation process without hysteresis

7.2.5.1.2 Option 2 - Evaluation with hysteresis

The ES counter (C1) has two thresholds TR1ES and W, with W not greater than TR1ES. The SES counter (C2) has two thresholds TR1SES and 0.

When the content of C1 exceeds TR1ES within a period of 15 minutes, a TR1ES date and time stamped report is sent. There is no additional report sent during the following 15 minute periods until a 15 minute period with content of C1 not greater than w occurs. Then a Reset TR1ES report is sent.

When the content of C2 exceeds TR1SES within a period of 15 minutes, a TR1SES date and time stamped report is sent. There is no additional report sent during the following 15 minute periods until a 15 minute period with content of C2 equal to 0 occurs. Then a Reset TR1SES report is sent. Figure 11 depicts this mechanism.

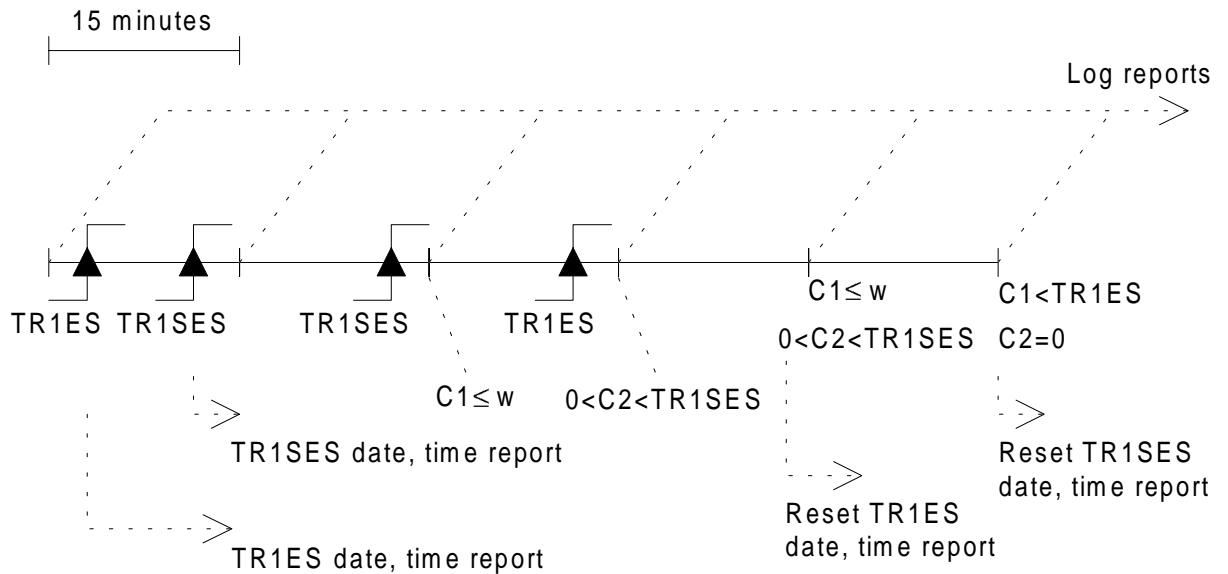

Figure 11: Performance evaluation with hysteresis

7.2.5.2 24 Hour process

The ES and SES performance parameters are transmitted to counters C3 and C4 as indicated in figure 12. These two counters are reset at the beginning of every 24 hours accumulated time. TR2ES and TR2SES thresholds are associated with counters C3 and C4 respectively. Figure 13 depicts the accumulation mechanism of received performance parameters and consequent actions within each 24 hour period.

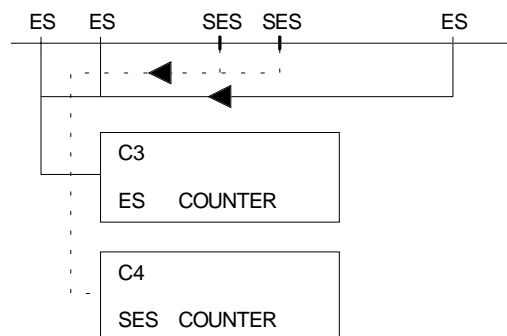

Figure 12: Performance parameter counting

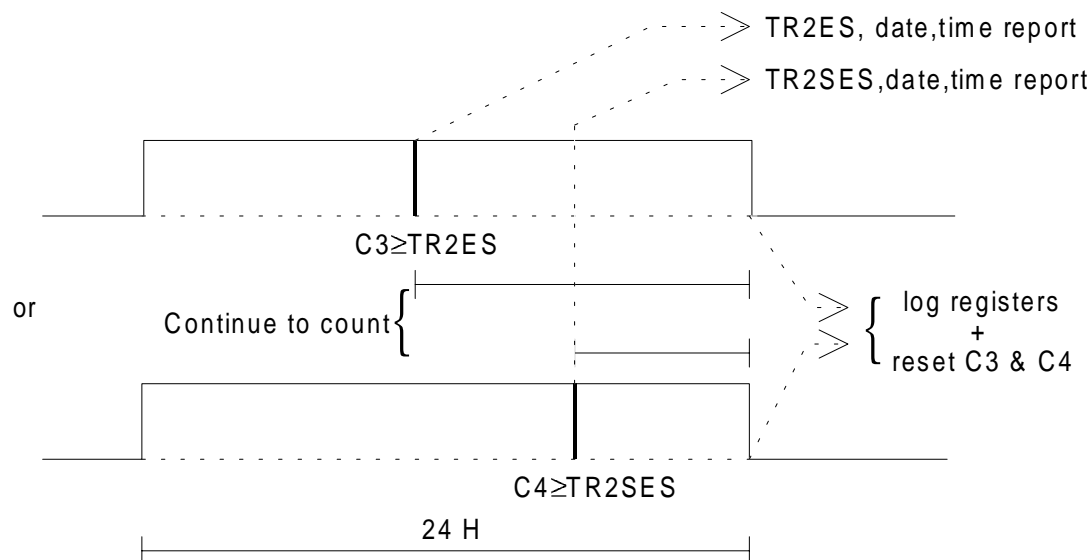

Figure 13: Consequent actions

When the content of C3 exceeds TR2ES within a period of 24 hours, a TR2ES date and time stamped report is sent. There is no additional report sent during the 24 hour period.

When the content of C4 exceeds TR2SES within a period of 24 hours, a TR2SES date and time stamped report is sent. There is no additional report sent during the 24 hour period.

7.2.6 Performance evaluation

The various states of a particular 2 048 kbit/s digital path in term of performance evaluation are:

- NP: Normal Performance;
- DP: Degraded Performance;
- UP: Unacceptable Performance.

The performance evaluation is derived from the thresholds (and optionally the reset thresholds reports) provided by the 15 minute and 24 hour processes described in subclauses 7.2.5.1 and 7.2.5.2. This is not standardized within this ETS.

7.2.7 General performance functional diagram

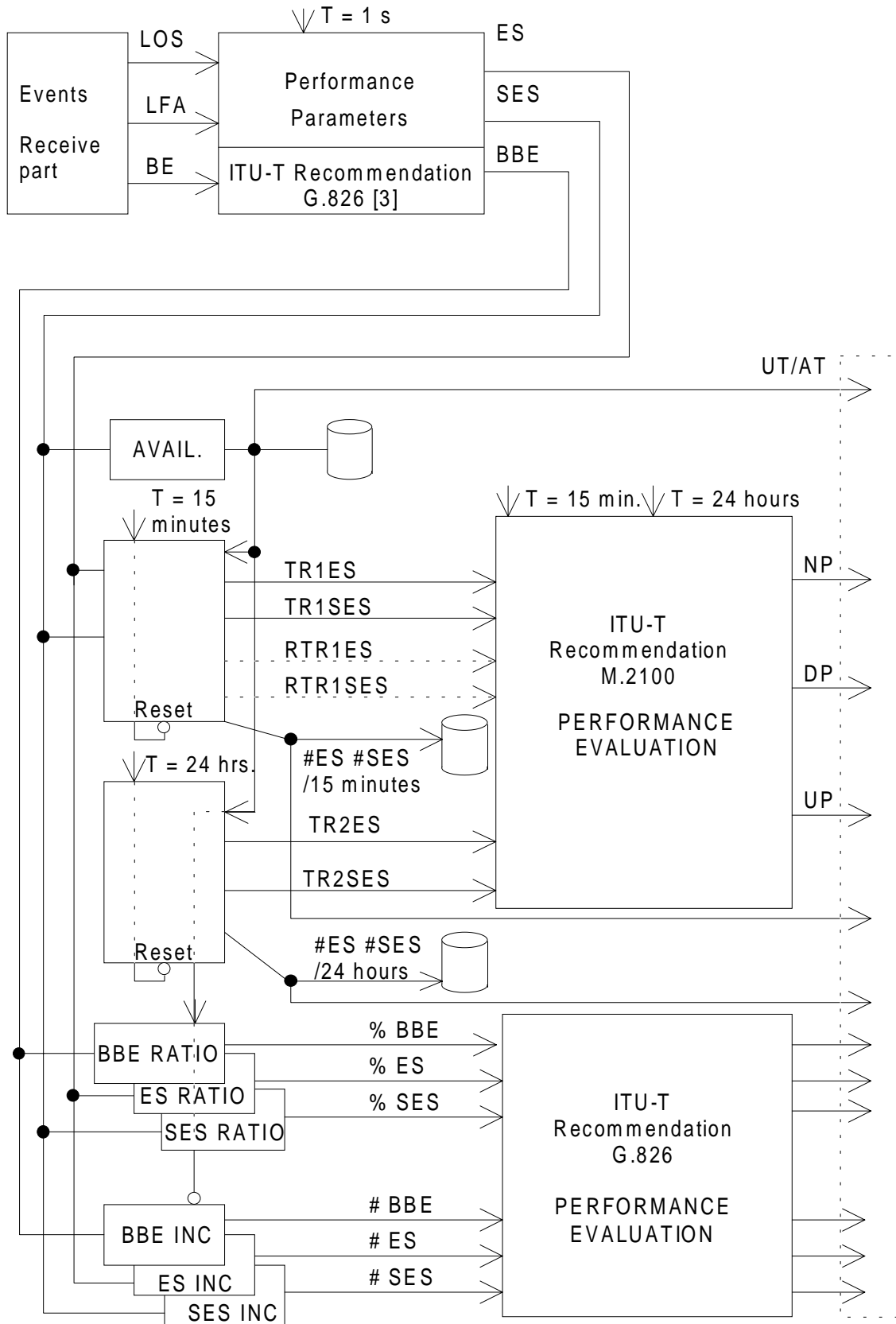

Notification module and/or maintenance log (see figure 2)

Figure 14: Performance management functional diagram

7.3 Configuration management

The configuration management is a management application that:

- can add new resources to the digital cross-connect switch;
- can delete resources from the digital cross-connect switch;
- can notify the creation or deletion of a resource;
- can query on the configuration and notifications of the resources;
- can list the attributes of the resources;
- can modify the attributes of the resources.

7.3.1 Configuration management overview

7.3.1.0 Glossary

casCrossConnection	Channel Associated Signalling Cross-Connection
casCTP	Channel Associated Signalling Connection Termination Point
casgtp	Channel Associated Signalling Group Termination Points
e0CrossConnection	64 kbit/s Cross-Connection
e0CTP	64 kbit/s Connection Termination Point
e0gtp	64 kbit/s Group Termination Points
e1	2 Mbit/s Cross-Connection
e1CTP	2 Mbit/s Connection Termination Point
e1G704ATTP	2 Mbit/s CCITT Recommendation G.704 [2] AIS Trail Termination Point
dxcc	Digital Cross-Connect Switch
dxccEquipment	Physical components of the Digital Cross-Connect Switch
dxccFabric	Digital Cross-Connect Switch Fabric
dxccPowerFeed	Digital Cross-Connect Switch Power Feed
dxccSoftware	Digital Cross-Connect Switch Software
dxccTimingGenerator	Digital Cross-Connect Switch Timing Generator
e04CrossConnection	nx4 kbit/s Cross-Connection
e04CTP	4 kbit/s Connection Termination Point
e04gtp	nx4 kbit/s group termination Point
imTP	Internal management Termination Point
lcCTP	Local management Connection Termination Point
mCTP	Reference point M Connection Termination Point
pPI1G703ITSTTP	Plesiochronous physical interface CCITT Recommendation G.703 [1] Input Timing Source Trail Termination Point
pPI1G703OTSTTP	Plesiochronous physical interface CCITT Recommendation G.703 [1] Output Timing Source Trail Termination Point
q3CTP	Q3 Connection Termination Point
sanBitsCTP	Sa Bit Connection Termination Point
ts16ATTP	Time Slot 16 AIS Trail Termination Point
ts0NFASCTP	Timeslot 0 NFAS Connection Termination Point
tSnATTP	Timeslot n Trail Termination Point
tSnCTP	Timeslot n Connection Termination Point
tSnTTP	Timeslot n Trail Termination Point
tSPProtectionGroup	Timing source protection group
tSPProtectionUnit	Timing source protection unit

7.3.1.1 Functional architecture

This chapter presents the functional blocks of the part 1 according to the concepts of ETR 241 [17] for the PDH access network. An example of the layering is shown in figure 15.

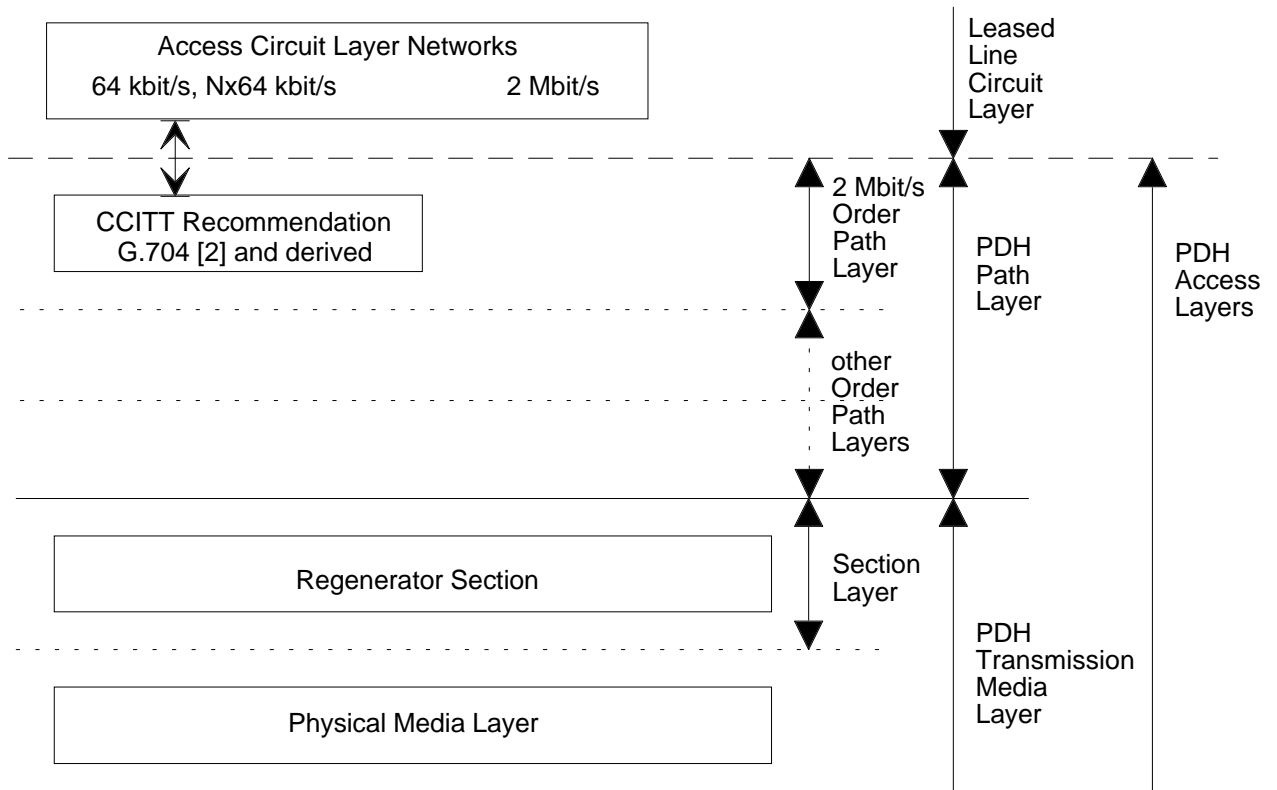

Figure 15: Example of PDH access network layers

Objects terminating regenerator section are not part of this ETS.

Special functions such as conference bridge, etc. are also out of the scope of this ETS.

The objects to be managed are shaded in grey with names in *italic bold*.

7.3.1.1.1 Main functions

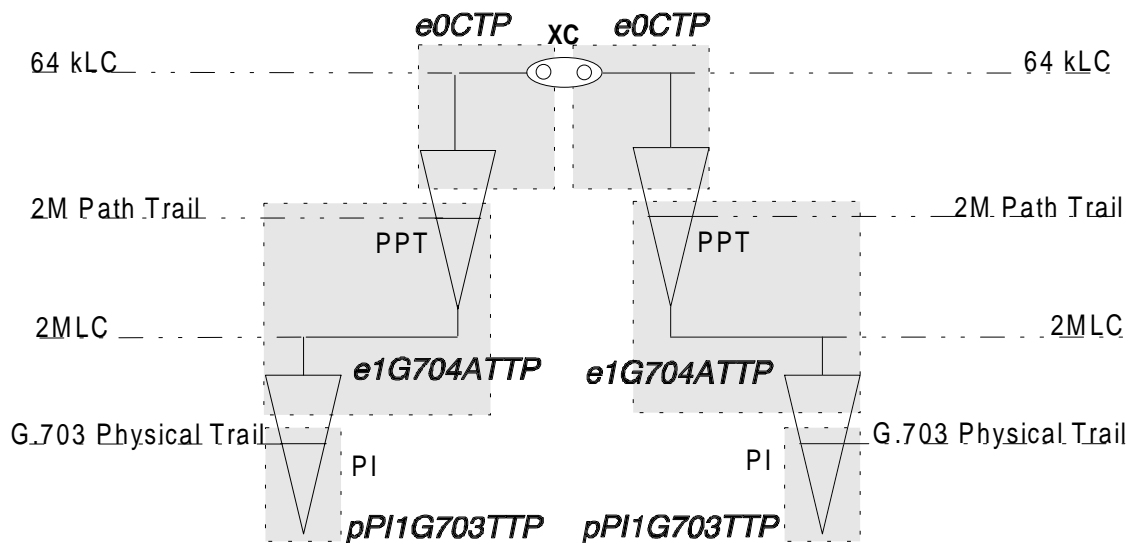

Figure 16: 64 kbit/s cross-connection

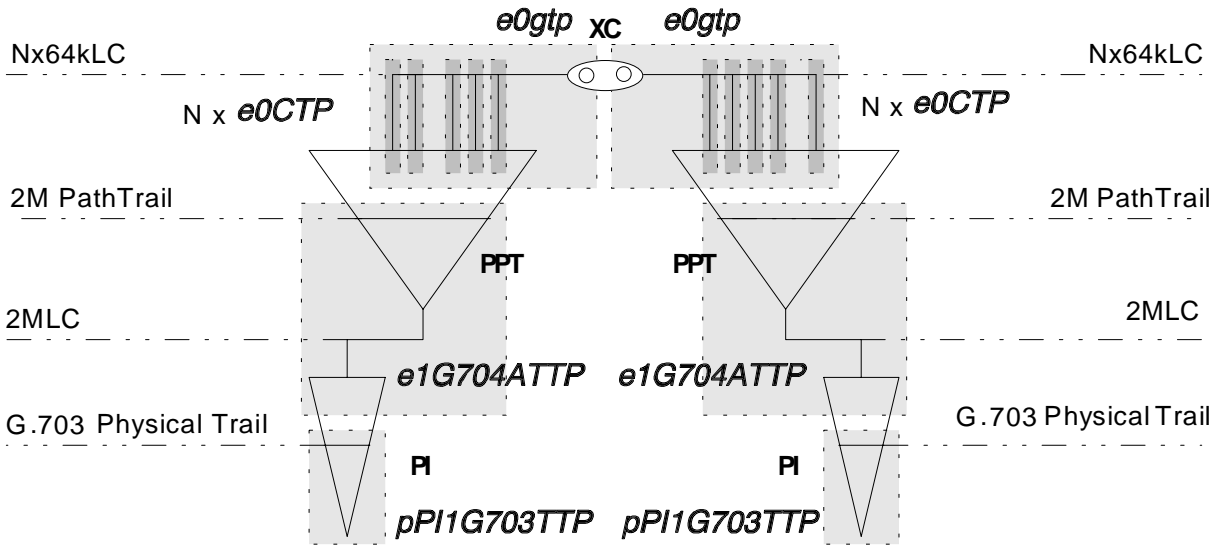

Figure 17: n x 64 kbit/s cross-connection

7.3.1.1.2 CAS cross-connection functions

Figures 18 and 19 present the CAS cross-connection functions of the digital cross-connect switch. These functions are described following the ETS 300 376-1 [20].

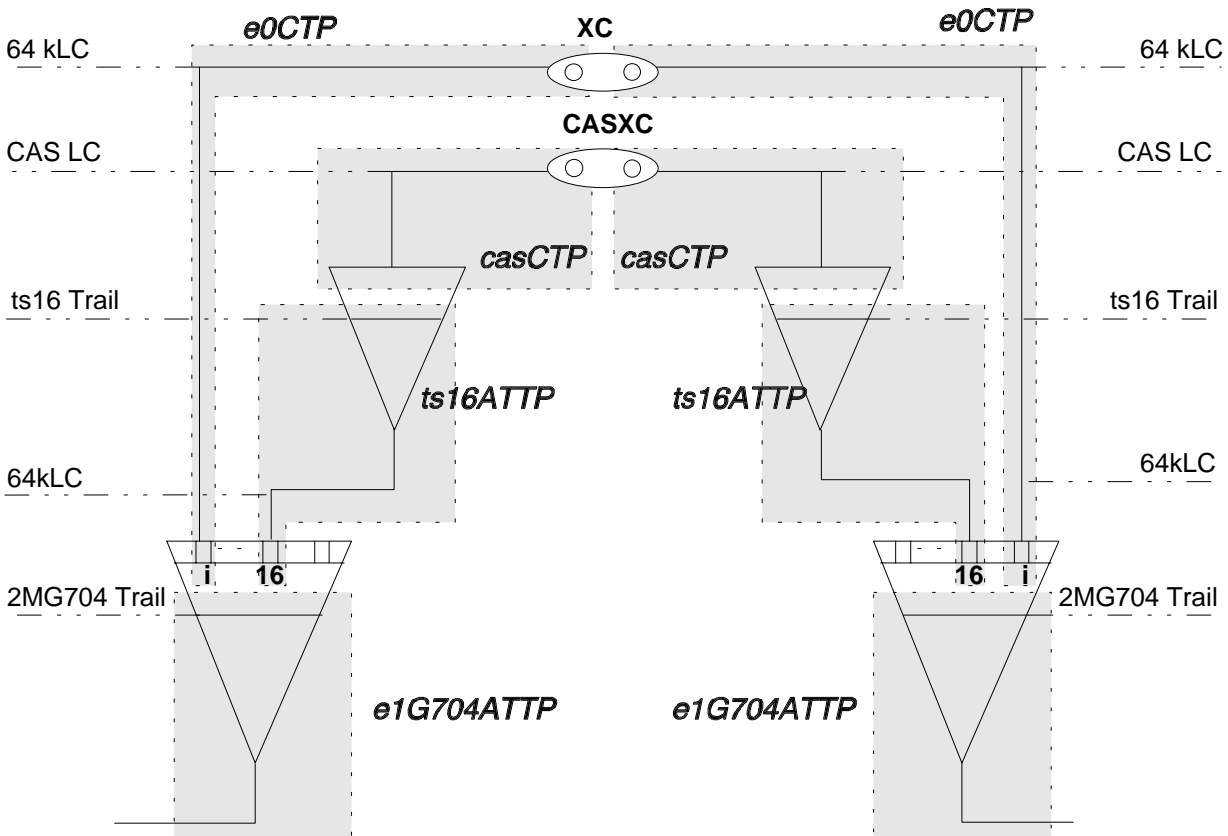

Figure 18: 64 kbit/s + CAS cross-connection

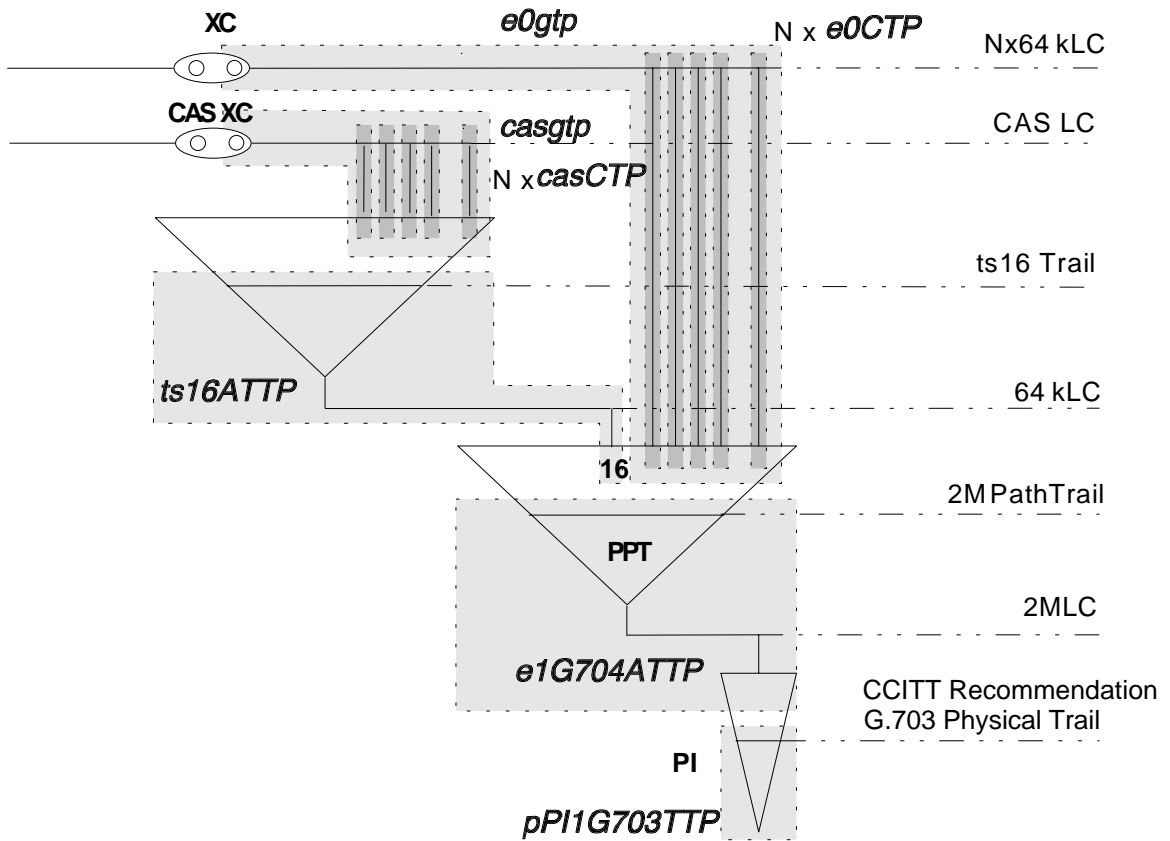

Figure 19: CAS for n x 64 kbit/s Link connection

7.3.1.1.3 Transfer of unstructured CCITT Recommendation G.703 / 2 048 kbit/s

Figure 20 shows the transfer of an unstructured CCITT Recommendation G.703 [1] / 2 048 kbit/s.

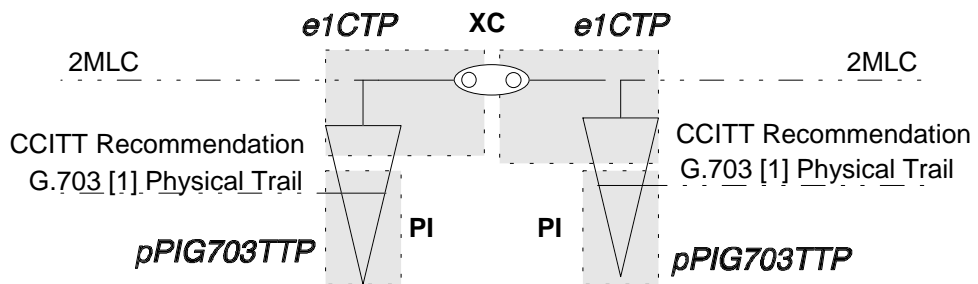

Figure 20: Transfer of an unstructured CCITT Recommendation G.703 [1] / 2 048 kbit/s

7.3.1.1.4 Synchronization function

Figure 21 presents the synchronization function of the digital cross-connect switch. This function is described in ETS 300 304 [19].

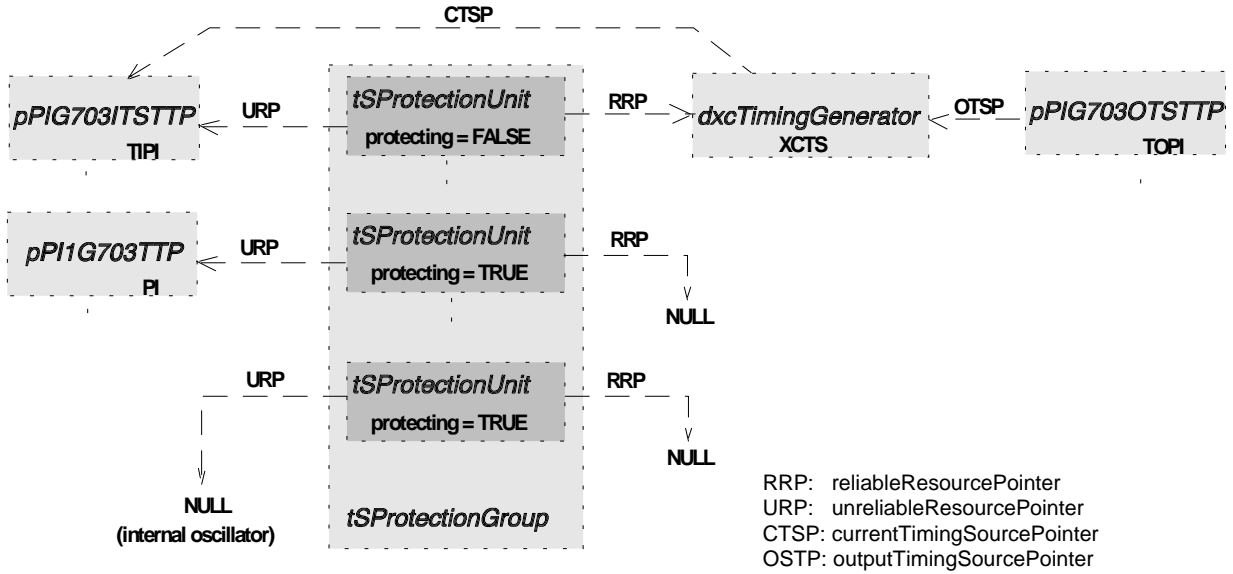

Figure 21: Synchronization

7.3.1.1.5 Time Slot 0 cross-connection functions

Two alternatives are presented here below for the management of TS0 cross-connection. They are functionally equivalent. The first one is based on a 4 kbit/s granularity and the second one is based on a 64 kbit/s granularity. Only one of these two solutions has to be supported by the manufacturer in compliance with annex D.2 and annex D.3 of part 1 of this ETS.

7.3.1.1.5.1 4 kbit/s granularity

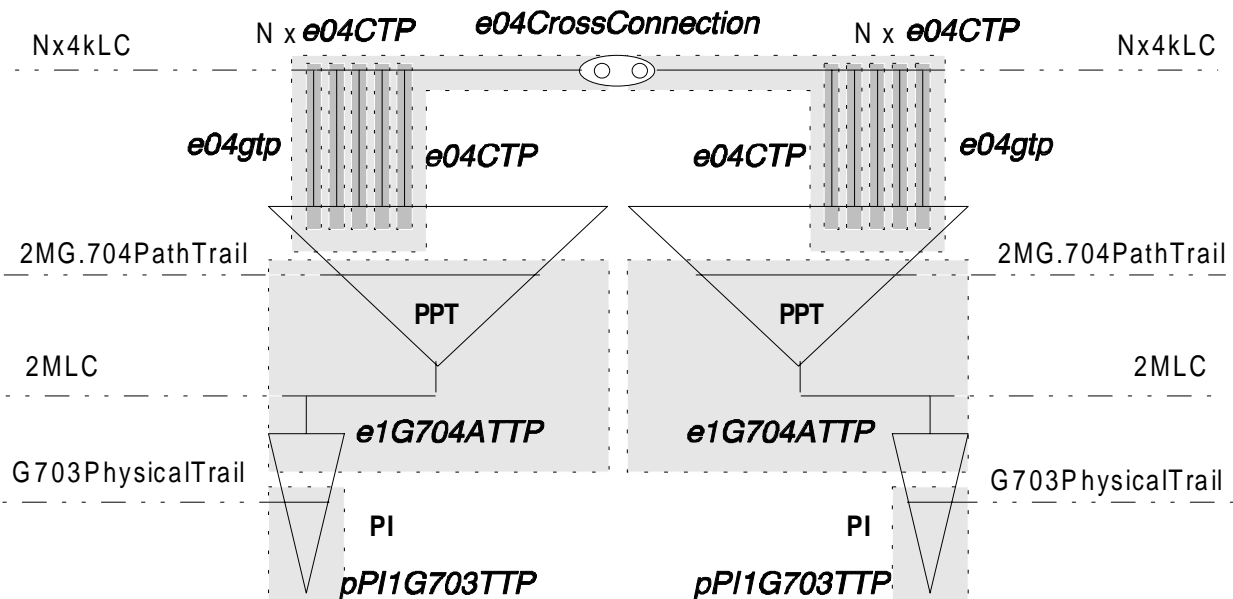

Figure 22: S_a bit cross-connection between two TS0 (see annex D.2 of ETS 300 010-1 [14])

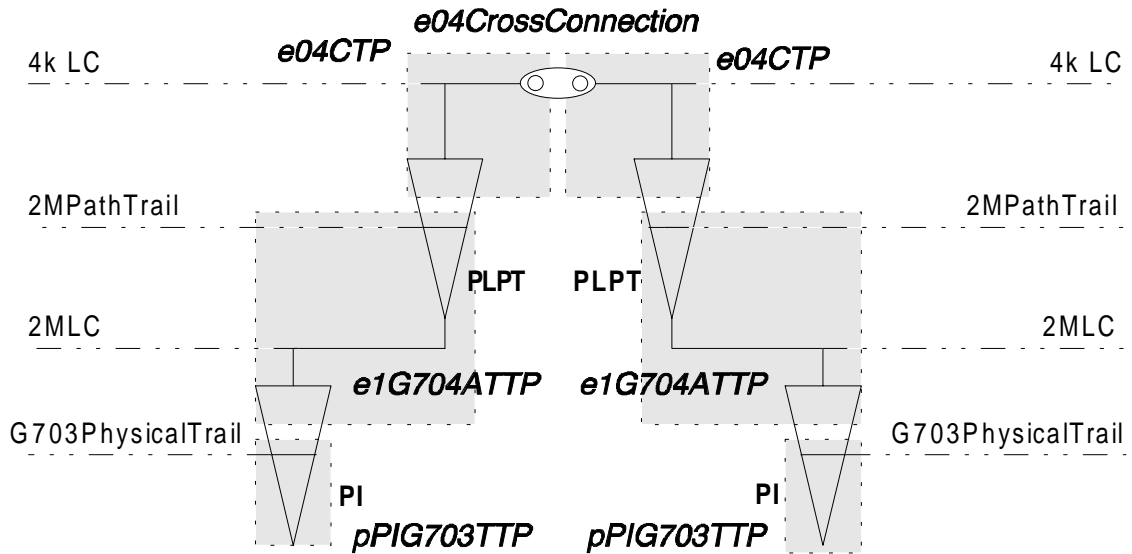

Figure 23: One S_a bit cross-connection between two TS0 (see annex D.2 of ETS 300 010-1 [14])

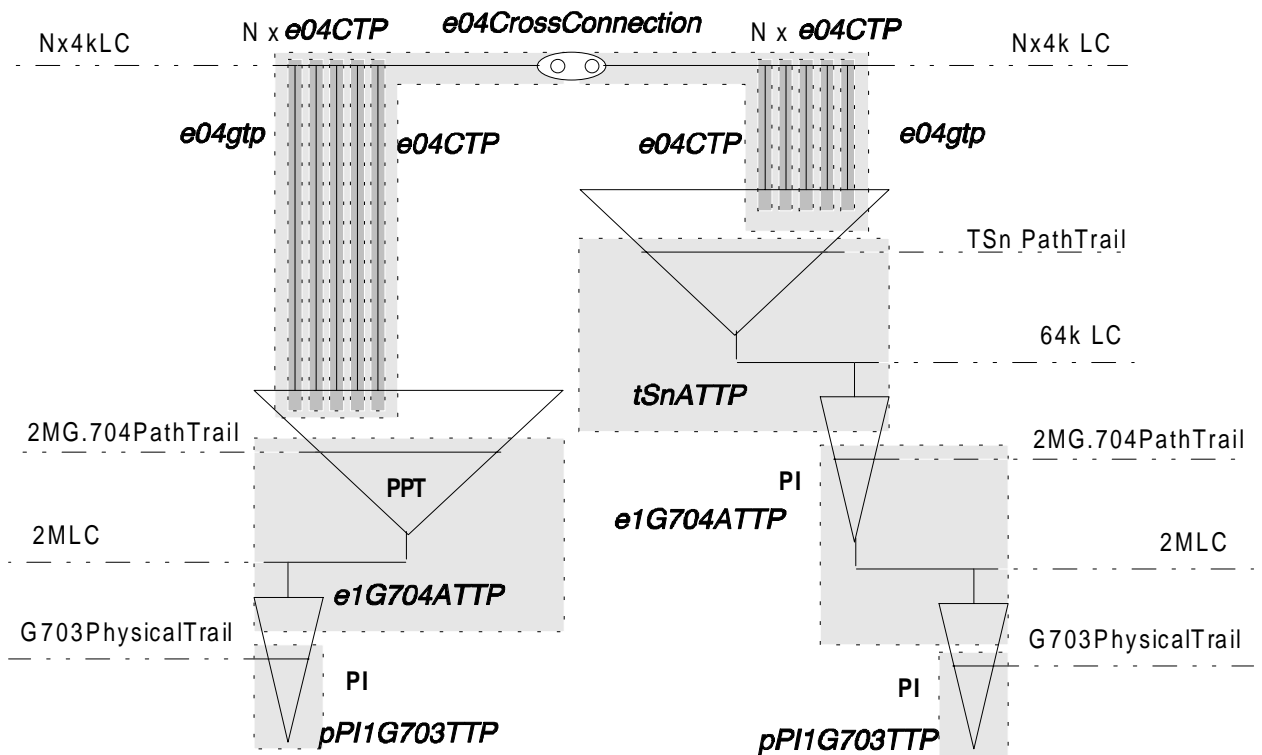

Figure 24: S_{an} bits bi-directional cross-connection between TS0 and Tsn (see annex D.3 of ETS 300 010-1 [14])

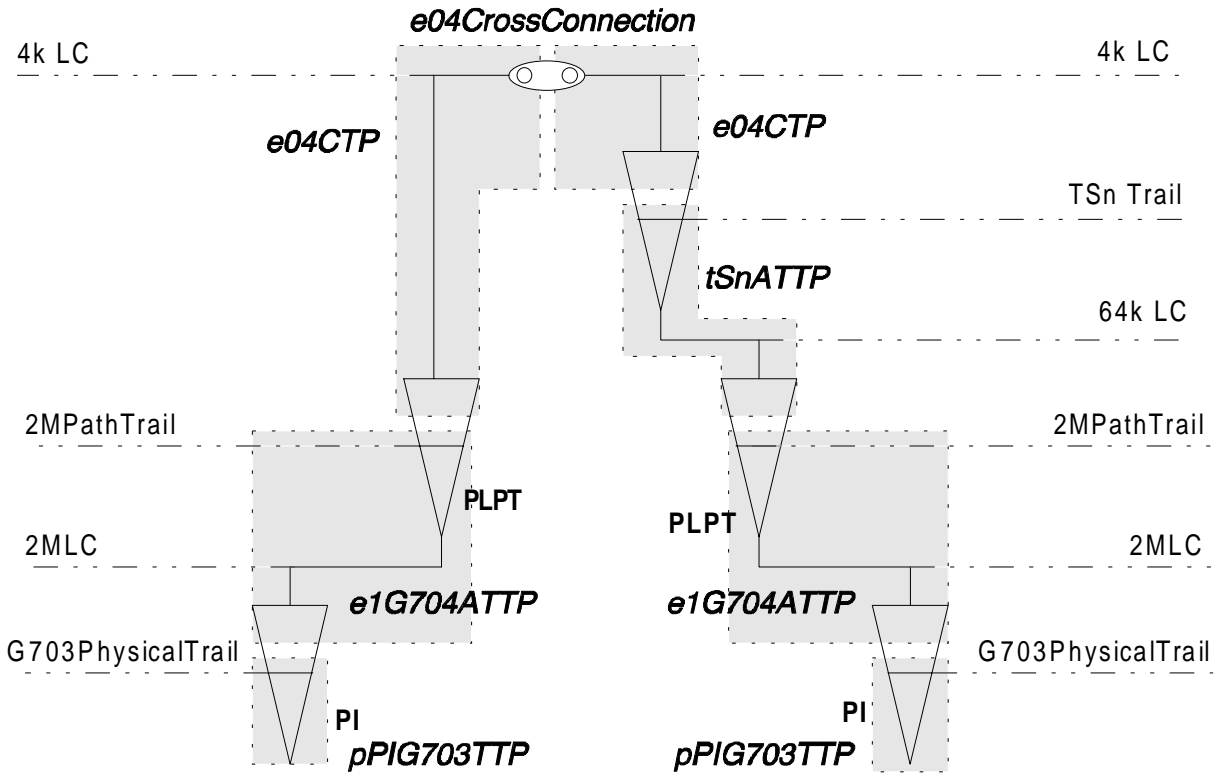

Figure 25: One S_{an} bit bi-directional cross-connection between TS0 and Tsn (see annex D.3 of ETS 300 010-1 [14])

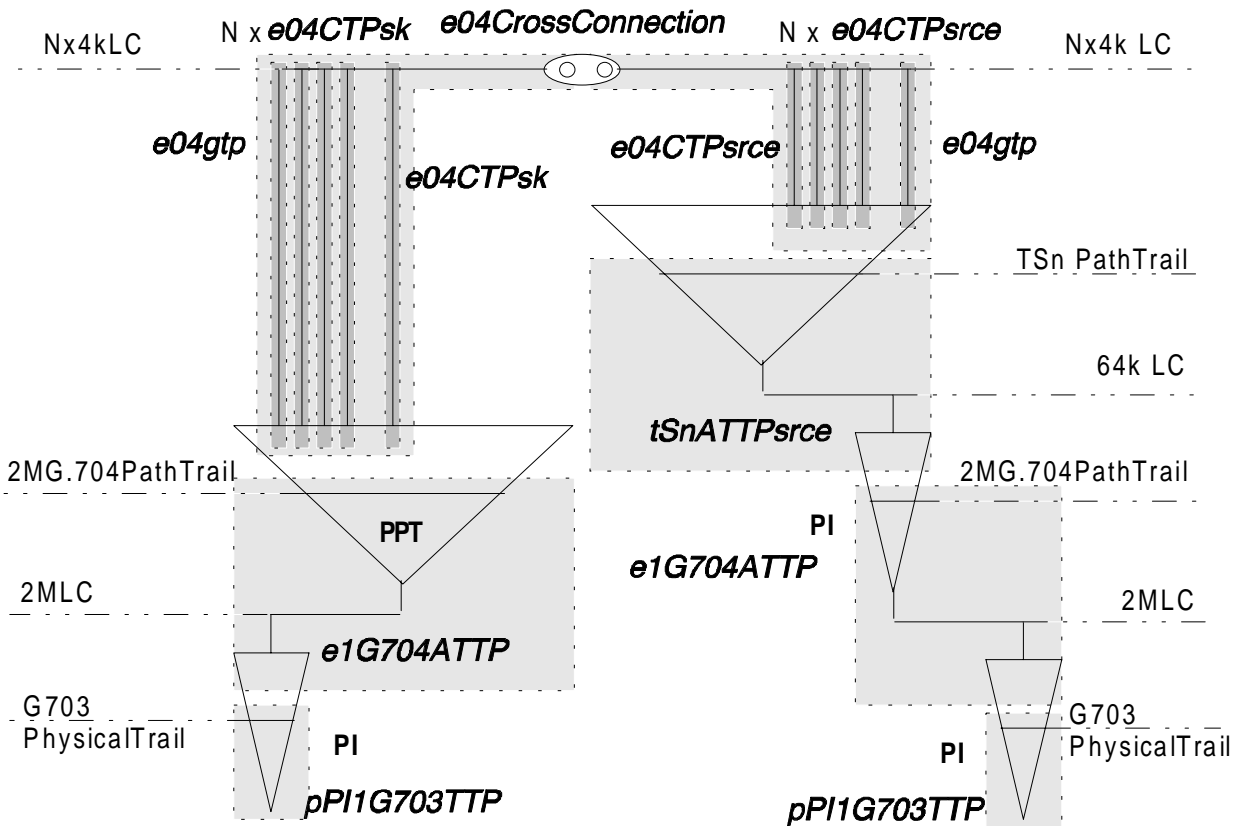

Figure 26: Uni-directional cross-connection between TS0 NFAS and Tsn (see annex D.3 of ETS 300 010-1 [14])

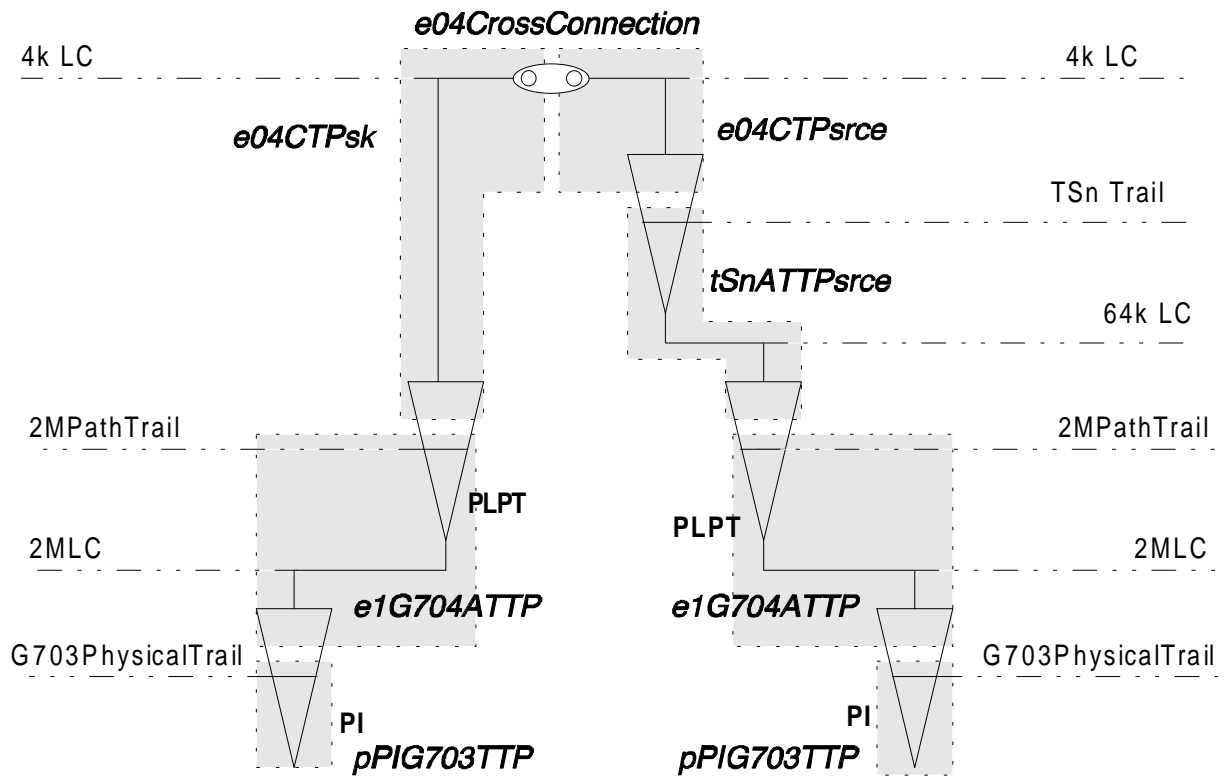

Figure 27: One bit uni-directional cross-connection between TS0 and Tsn (see annex D.3 of ETS 300 010-1 [14])

7.3.1.1.5.2 64 kbit/s granularity

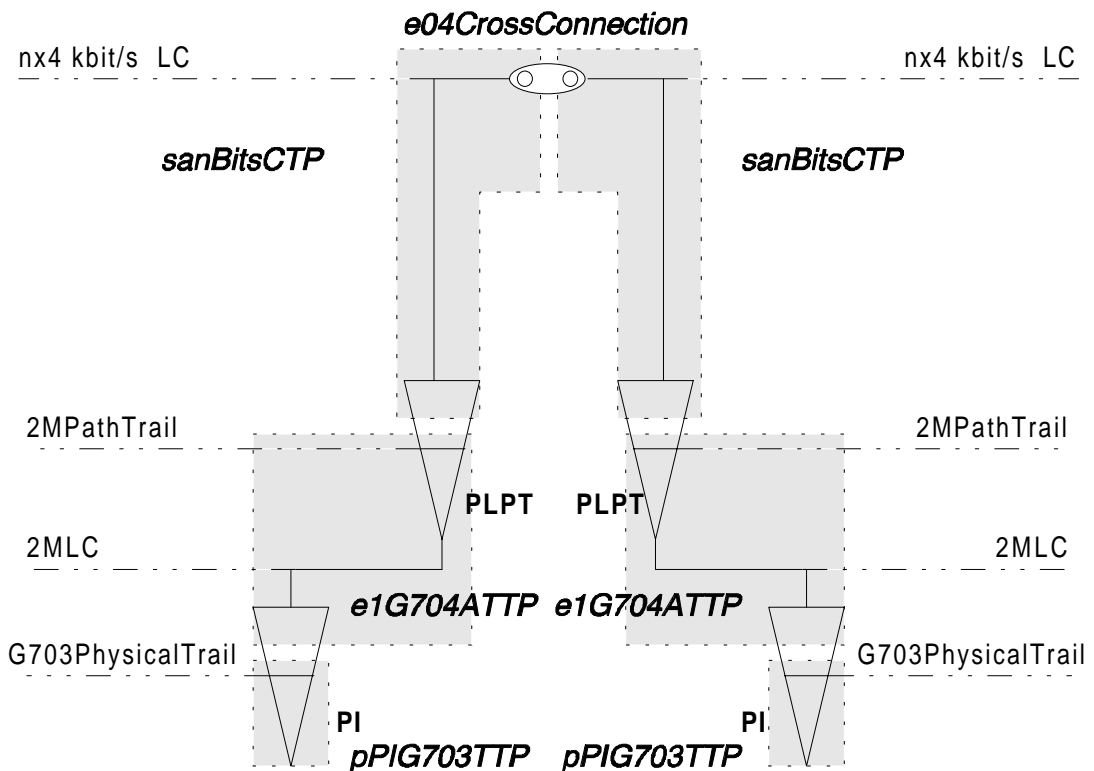

Figure 28: S_a bit cross-connection between two TS0 (see annex D.2 of ETS 300 010-1 [14])

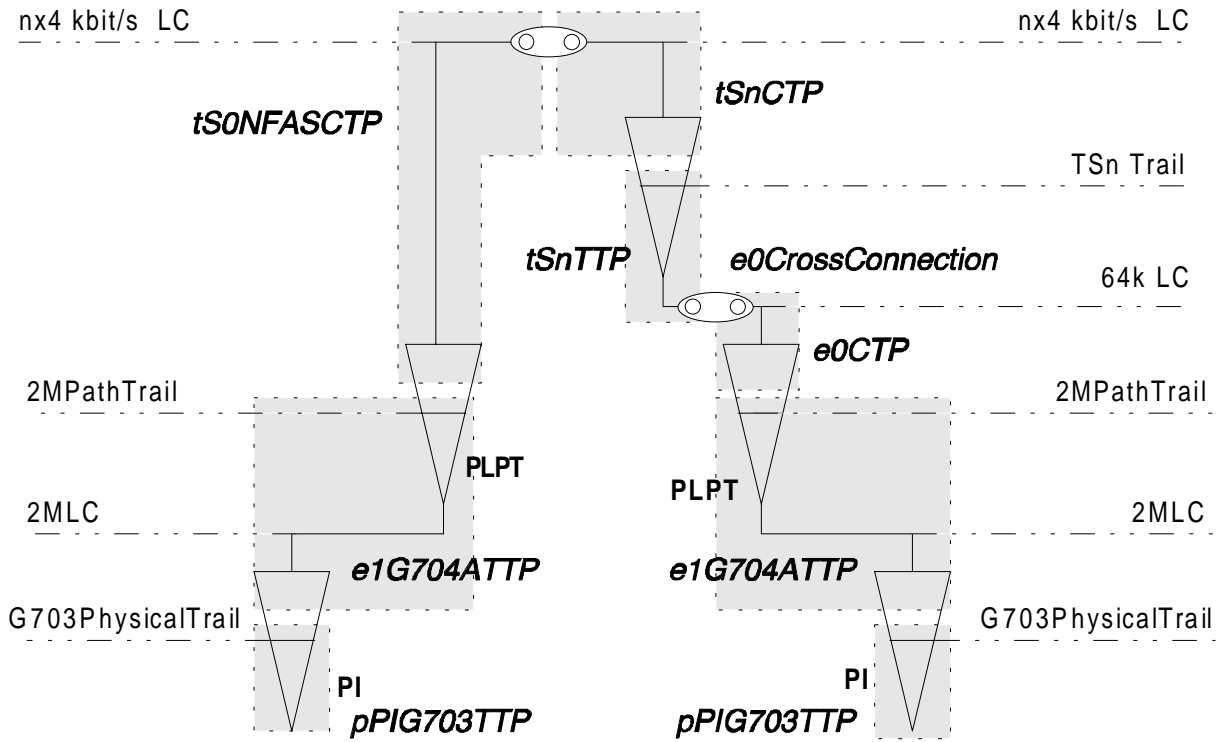

Figure 29: Bi-directional cross-connection between TS0 and Tsn (see annex D.3 of ETS 300 010-1 [14])

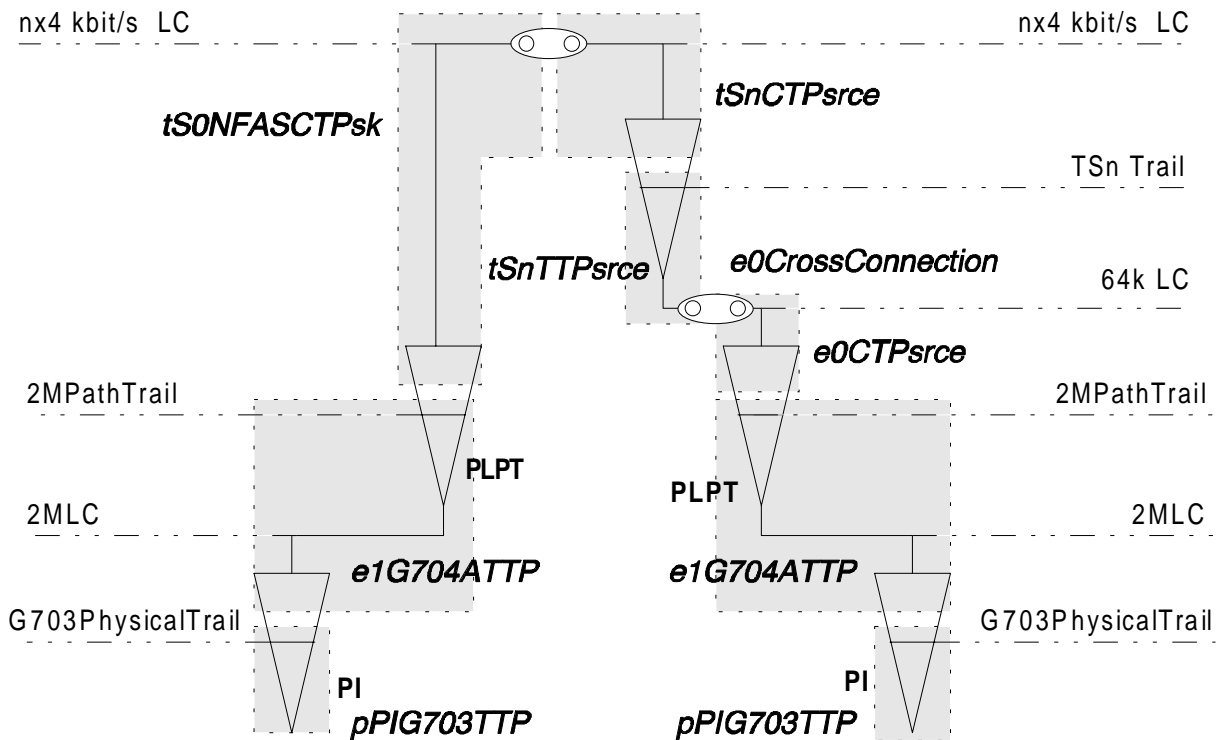

Figure 30: Uni-directional cross-connection between TS0 and Tsn (see annex D.3 of ETS 300 010-1 [14])

7.3.1.2 Object classes

Object classes will be divided into different fragments:

Managed element fragment:

dxcc;
dxccEquipement;
dxccSoftware.

Termination point fragment:

pPI1G703TTP;
e1G704ATTP;
e0CTP;
e1CTP;
casCTP;
ts16ATTP;
e04CTP;
sanBitsCTP;
tSnTTP;
tSnATTP.

Cross-connection fragment:

dxccFabric;
(four instances of fabric may exist in the digital cross-connect switch: for 64 kbit/s + CAS, for management cross-connections, for unstructured CCITT Recommendation G.703 [1] 2 048 kbit/s transfer and for Sa bits cross-connections);
e0gtp;
casgtp;
e04gtp;
e0CrossConnection;
casCrossConnection;
e1CrossConnection;
e04CrossConnection.

Synchronization fragment:

dxccTimingGenerator;
pPI1G703ITSTTP;
pPI1G703OTSTTP;
tSProtectionUnit;
tSProtectionGroup.

Power feed fragment:

dxccPowerFeed.

7.3.1.3 Entities-relationships diagrams

Figures 28 to 32 give an overview of the entity relationship for the managed objects of the digital cross-connect switch for the configuration purpose. No order of importance is implied.

In the following diagrams:

- "a" = "is associated with";
- "c" = "contains";
- "cc" = "crossconnects";
- "cp" = "is connected by connectivity pointers".

Convention applied in the following diagrams: Defined objects are in white boxes. Objects already defined but used for defining other objects are in grey boxes.

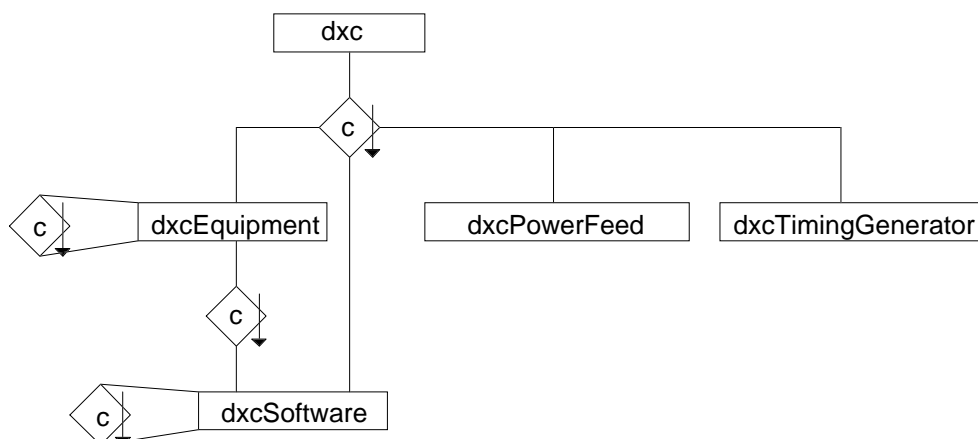

Figure 31: Entity relationship diagram. DXC managed element

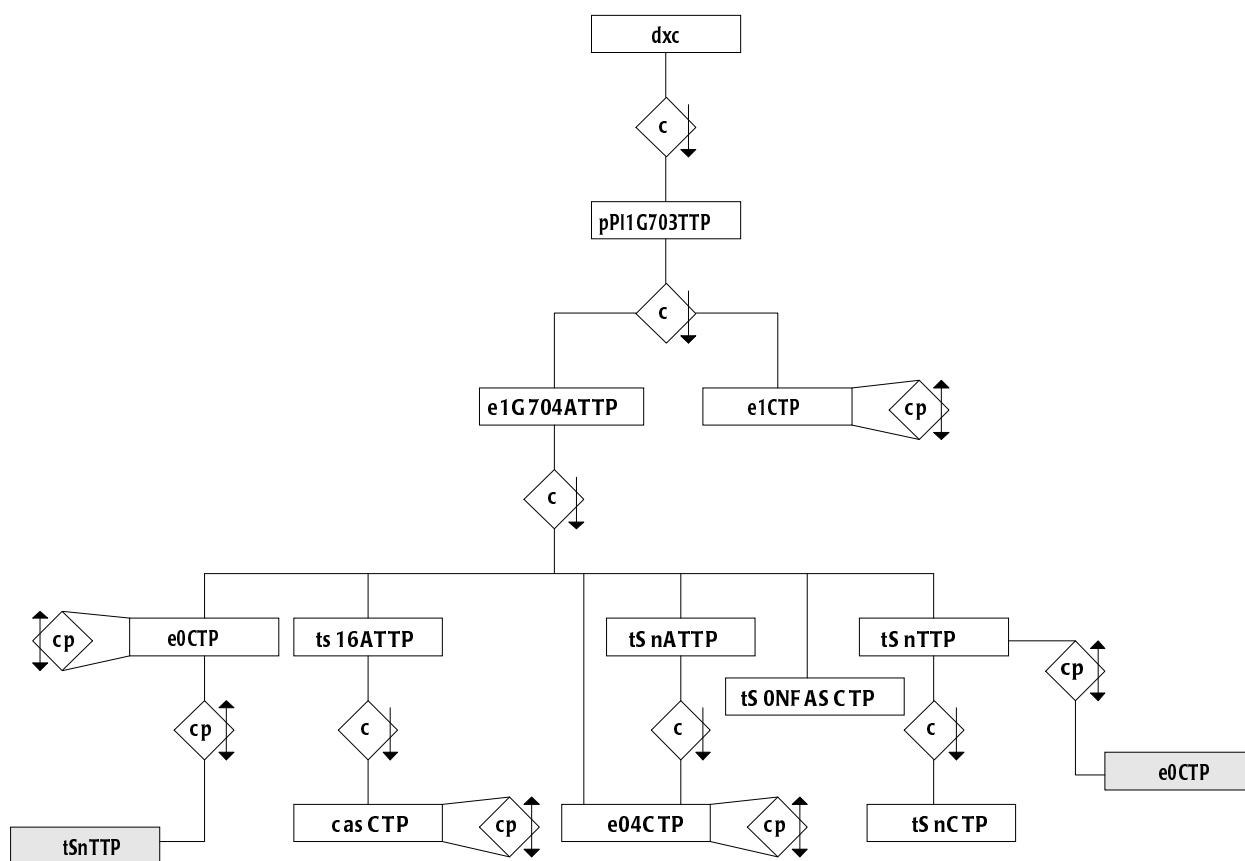

Figure 32: Entity relationship diagram. Termination points entities

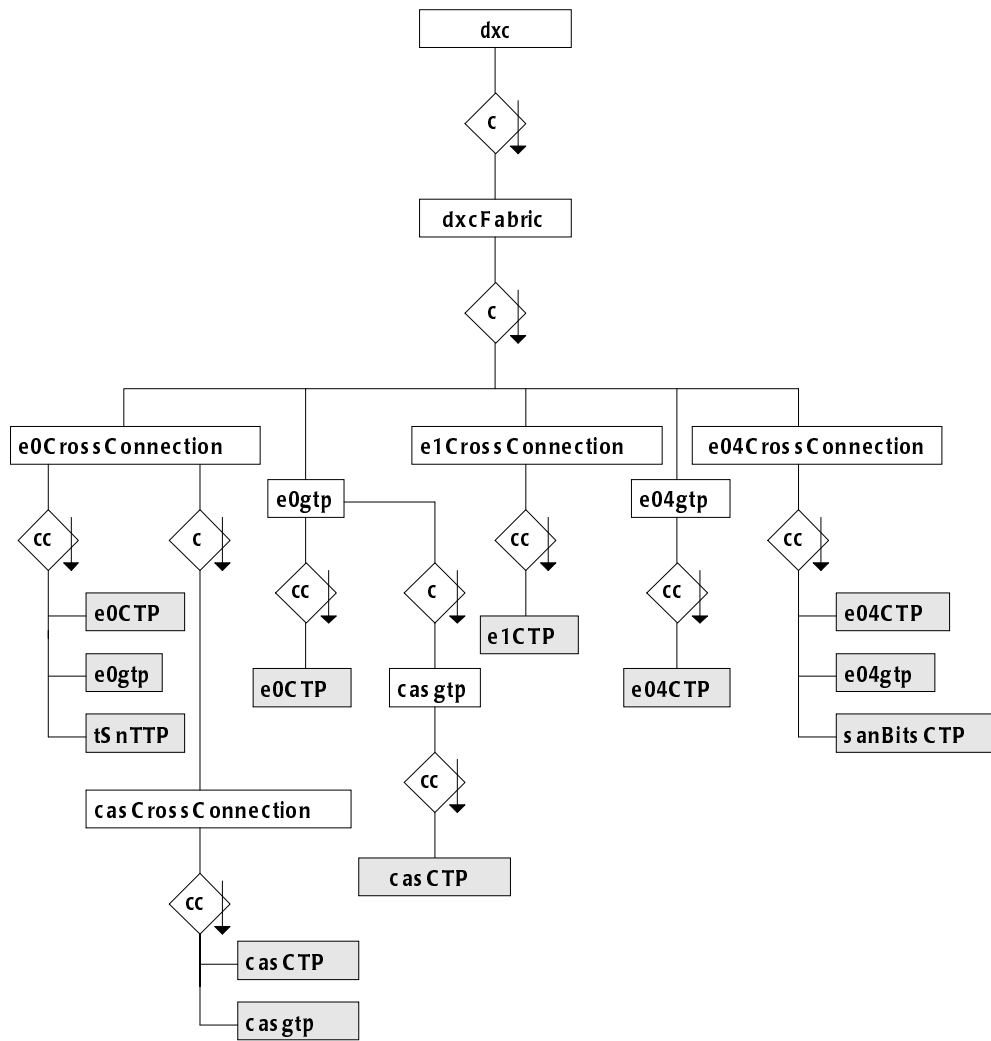

Figure 33: Entity relationship diagram. Cross-connection aspects

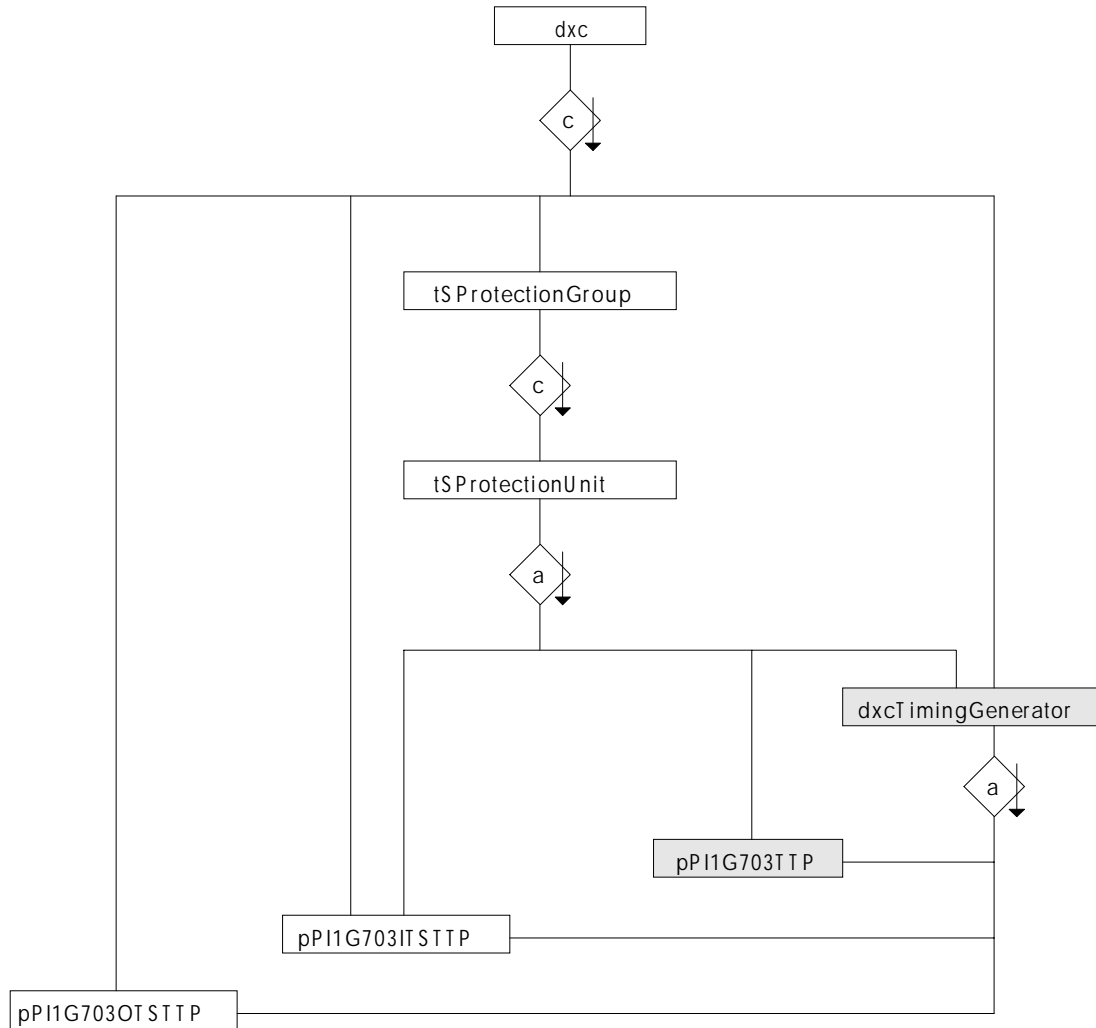

Figure 34: Entity relationship diagram. Synchronization

7.3.2 Description of the fragments

This description is not an information model but has to be considered as a specification for writing an information model. Each characteristic of the Managed Object Classes (MOCs) of the final information model shall be described here in a textual form.

Each Managed Object Class (MOC), e.g. *pPI1G703TTP*, in the final information model, contains attributes on which some management operations shall be performed. Some of these MOCs are also able to send notifications, e.g. alarm notifications.

This description gives the global behaviour of each MOC and describes the behaviour of their main attributes together with their notifications to be sent, if any, to an Operations System (OS) and operations to be performed by the OS.

The information model and this description, distinguish between a logical and a physical part of the digital cross-connect switch managed element. The logical part is supported by the physical part which is more subject to proprietary implementation but the physical part may also affect the logical part. ITU-T Recommendation M.3100 [9] uses the *equipment* object class to represent the physical components of the managed element. An instance of this object class is present in a single geographical location. The physical components of the digital cross-connect switch are represented by the *dxCEquipment* MOC.

- NOTE 1: The operations and notifications will be described according to CCITT Recommendation X.710 [11]. The [attr, etc.] syntax means that with the operations, some parameters (i.e. the attributes) of the entity can be given. The list of the attributes for each object below is intended as a reference list.
- NOTE 2: It may be interesting to mention the automatic creation/deletion of a MOC in the description. Depending on the digital cross-connect switch make-up and mode of operation, it may be possible to instantiate objects when the supporting or containing objects are instantiated.
- NOTE 3: In this description names of MOCs are written in italic.
- NOTE 4: Even though connectivity pointer attributes are of interest for the information model, they are only detailed in this description in case of special use. Each MOC of the tributary fragment, aggregate fragment and management fragment will have connectivity pointers in the final information model. These connectivity pointer attributes are fully described in ITU-T Recommendation M.3100 [9].
- NOTE 5: Cross-connection of bits 1 to 3 of time slot 0 NFAS to a selected time slot n ($n \neq 0$) is not described in this ETS.
- NOTE 6: The meaning of the Administrative State is described in each object definition, when applicable.

7.3.2.1 Managed element fragment

dx

Behaviour:

This object class represents the digital cross-connect managed element within the telecommunications network and is created at power-up. It is a specialized *managedElement* object class as defined in ITU-T Recommendation M.3100 [9].

Attributes:

- *managedElementId* = Logical identification of the DXC. This identification shall be unique within the network;
- *userLabel* = This attribute permits assignment of a user friendly name to the DXC;
- *vendorName* = This attribute identifies the vendor of the DXC;
- *version* = This attribute identifies the version of the DXC;
- *locationName* = This attributes identifies the location of the DXC;
- *alarmSeverityAssignmentProfilePointer* = The value of this attribute points to the *alarmSeverityAssignmentProfile* object which identifies the alarm severity assignment profile related to the DXC;
- states of the DXC (ITU-T Recommendation X.731 [18]): these attributes are not relevant for this ETS.

Actions:

- Modify [*userLabel*, *locationName*, *alarmSeverityAssignmentProfilePointer*];
- get [*managedElementId*, *userLabel*, *vendorName*, *version*, *locationName*, *alarmSeverityAssignmentProfilePointer*].

Notifications:

- Alarm notification: *EnvironmentalAlarm* notifications may be sent to the management system;
- attribute value change notification [attr] [[attr]...].

dxcequipment

Behaviour:

This object class represents physical components of the digital cross-connect managed element. These components may be racks, sub-racks, boards, etc. depending on the manufacturer's implementation. An automatic creation, not activated by the management system, occurs when DXC equipment is inserted at a location where no DXC equipment is expected by the management system. The management system is able to create DXC equipment at a free location.

This object is a specialized *equipment* object class as defined in ITU-T Recommendation M.3100 [9].

Attributes:

- equipmentId = Logical identification of this component. This identification shall be unique within the DXC or within another component, depending on the containment;
- userLabel = This attribute permits assignment of a user friendly name to the DXC equipment;
- vendorName = This attribute identifies the vendor of the DXC equipment;
- version = This attribute identifies the version of the DXC equipment;
- locationName = This attribute identifies the location of the DXC equipment;
- replaceable = The value of this attribute indicates if this physical component is replaceable or not;
- equipmentExpected (Null, equipmentType) = The value of this attribute indicates the type of DXC equipment expected at this location by the management system or by the manufacturer of the DXC;
- equipmentActual (Null, equipmentType) = The value of this attribute indicates the type of DXC equipment actually at this location. If the value of equipmentActual is different to the value of equipmentExpected, an equipmentAlarm with the probable cause - replaceableUnitTypeMismatch, shall be sent to the management system as in the two following cases:
 - 1) the equipmentExpected has a typeA value and the equipmentActual has a typeB value;
 - 2) the equipmentExpected has a Null value and the equipmentActual has a TypeA value. In this last case, a creation notification is also sent to the management system. When the equipmentExpected has a typeA value and the equipmentActual has a Null value (creation by the management system of the DXC equipment), an equipmentAlarm notification shall be emitted to the management system with the probableCause - replaceableUnitMissing;
- physicalConnectorList (set of (connectorType, connectorLocation, supporting)) = This attribute has one entry for each connector of the DXC equipment. For each entry, the connectorType attribute indicates the type of connector, the connectorLocation attribute indicates the location of the connector in the DXC equipment (it may also define pins within a connector) and the supporting attribute lists the termination points supported by this connector, e.g. the Physical Interface Trail Termination Point (PITTP) associated with the connector;
- affectedObjectList = This attribute lists the instances of objects affected by a change of the DXC equipment operationalState;
- alarmSeverityAssignmentProfilePointer = The value of this attribute points to the *alarmSeverityAssignmentProfile* object which identifies the alarm severity assignment profile related to the DXC equipment;
- states of the DXC equipment (ITU-T Recommendation X.731 [18]):
 - operationalState (enabled, disabled) = The operational state is set to disabled if the DXC equipment has an alarm;
 - availabilityStatus (notInstalled, inDefect, degraded, inTest, ...) = This attribute gives additional information on the availability of the DXC equipment. The operationalState of the DXC equipment may be disabled or enabled;
 - alarmStatus = When an alarm is present on the Termination Point (TP), the value of this attribute indicates the severity of the alarm.

Actions:

- Create [equipmentId, userLabel, vendorName, version, locationName, replaceable, equipmentExpected, equipmentActual, PhysicalConnectorList, affectedObjectList, alarmSeverityAssignmentProfilePointer, operationalState, availabilityStatus, alarmStatus];
- delete;
- modify [userLabel, locationName, equipmentExpected, alarmSeverityAssignmentProfilePointer,];
- get [equipmentId, userLabel, vendorName, version, locationName, replaceable, equipmentExpected, equipmentActual, PhysicalConnectorList, affectedObjectList, alarmSeverityAssignmentProfilePointer, operationalState, availabilityStatus, alarmStatus].

Notifications:

- Alarm notification: An equipmentAlarm notification shall be issued if a failure is detected on the DXC equipment. The probableCause parameter of the notification shall indicate the failure cause;
- state change notification: A stateChange Notification may be issued in case of operationalState change;
- attribute value change notification [attr] [[attr].etc.].

dxsSoftware

Behaviour:

This object class represents the logical information stored in the DXC, including programs and data tables. The object may be automatically instantiated according to the digital cross-connect switch make-up and mode of operation. This object is a specialized *software* object class as defined in ITU-T Recommendation M.3100 [9].

Attributes:

- softwareId = Logical identification of the DXC software. This identification shall be unique within the DXC or a DXC equipment or another DXC software depending on the containment;
- userLabel = This attribute permits assignment of a user friendly name to the DXC software;
- vendorName = This attribute identifies the vendor of the DXC software;
- version = This attribute identifies the version of the DXC software;
- alarmSeverityAssignmentProfilePointer = The value of this attribute points to the *alarmSeverityAssignmentProfile* object which identifies the alarm severity assignment profile related to the DXC software;
- affectedObjectList = This attribute lists the objects instances that are affected by a change of the operationalState of the DXC software;
- States of the DXC software (ITU-T Recommendation X.731 [18]):
 - operationalState (enabled, disabled) = The operational state is disabled if a failure of the DXC software occurs. A processingErrorAlarm notification is sent to the management system with the probableCause - softwareError;
 - alarmStatus = When an alarm is present on the DXC Software, the value of this attribute indicates the severity of this alarm.

Actions:

- Modify [userLabel, alarmSeverityAssignmentProfilePointer]specialize;
- get [softwareId, userLabel, vendorName, version, affectedObjectList, alarmSeverityAssignmentProfilePointer, administrativeState, operationalState, alarmStatus].

Notifications:

- Alarm notification: A processingErrorAlarm notification shall be issued if a failure of the DXC software is detected. The probableCause parameter of the notification shall indicate softwareError;
- state change notification: A stateChange Notification may be issued in case of operationalState change;
- attribute value change Notification [attr] [[attr] etc.].

7.3.2.2 Termination point fragment

pPI1G703TTP (PI functional block)

Behaviour:

This object class corresponds to the PI functional block of the functional diagram (figure 2 in ETS 300 010-1 [14]). It represents the point where the conversion between the line signal and the internal logic level plus timing is performed. This 2 048 kbit/s CCITT Recommendation G.703 [1] physical Trail Termination Point (TTP) object class is a specialization of the *pPITTPBidirectional* object class defined in ETS 300 371 [15]. This managed object may be automatically instantiated when the supporting managed object (hardware block) is instantiated, according to the digital cross-connect switch make-up and mode of operation.

Attributes:

- *pPITTPId* = Logical identification of the TTP. This identification shall be unique for a digital cross-connect switch;
- *supportedByObjectList* = The value of the *supportedByObjectList* attribute points to the *dxEquipment* (hardware block) and *dxSoftware* objects which implement the TP;
- *alarmSeverityAssignmentProfilePointer* = The value of this attribute points to the *alarmSeverityAssignmentProfile* object which identifies the alarm severity assignment profile related to this TP. If this attribute is not present, the attribute *alarmSeverityAssignmentProfilePointer* of the containing object is used;
- States of the Access Port (ITU-T Recommendation X.731 [18]):
 - *AdministrativeState* (locked, unlocked) = When the value is locked, the functions of the TP are administratively disabled, i.e. the TP does not process the signal nor detects failure of the signal. The *administrativeState* has no effect on the *operationalState*;
 - *operationalState* (enabled, disabled) = The operational state is disabled if a LOS is detected or if one of the objects pointed to by the attribute *supportedByObjectList* is in the disabled *operationalState*;
 - *alarmStatus* = When an alarm is present on the TP, the value of this attribute indicates the severity of this alarm;
- *impedance* (75, 120) = This attribute indicates the current impedance 75 ohms coaxial pair option, or a 120 ohms symmetrical pair option and, if provided, permits to select this impedance;
- *testStatus* (noTest, accessInputMonitoring, accessOutputMonitoring, accessTest, equipmentTest) = The value of this optional attribute indicates the current type of connection between the termination point and a test point of the digital cross-connect switch. This attribute is updated automatically after the test point has received a *setTestPoint* action.

Actions:

- Create [*pPITTPId*, *supportedByObjectList*, *alarmSeverityAssignmentProfilePointer*, *administrativeState*, *operationalState*, *alarmStatus*, *impedance*, *testStatus*] (no need if automatic creation);
- delete (no need if automatic deletion);
- modify [*administrativeState*, *alarmSeverityAssignmentProfilePointer*, *impedance* (if provided), *bipolarViolationCounting*];
- get [*pPITTPId*, *supportedByObjectList*, *alarmSeverityAssignmentProfilePointer*, *administrativeState*, *operationalState*, *alarmStatus*, *impedance*, *testStatus*].

Notifications:

- Alarm notification (refers to CCITT Recommendation G.703 [1] alarms): A *communicationsAlarm* notification shall be issued if a LOS is detected. The *probableCause* parameter of the notification shall indicate LOS;
- state change notification: A *stateChange* Notification may be issued in case of *operationalState* change;
- attribute value change notification [*attr*] [*attr*] etc..

e1G704ATTP (PPT functional block)

Behaviour:

This object refers to the PPT functional block of the functional diagram (figure 2 in ETS 300 010-1 [14] of this ETS). This 2 048 kbit/s CCITT Recommendation G.704 [2] AIS Trail Termination Point object class is a specialized *e1ATTPBidirectional* object class as defined in ETS 300 371 [15]. Therefore, this object includes the functions of a respective Connection Termination Point (CTP), e.g. AIS monitoring, which is not instantiated because no connectivity is provided at this level.

Attributes:

- ePDHTTPId = Logical identification of the termination point;
- alarmSeverityAssignmentProfilePointer = The value of this attribute points to the *alarmSeverityAssignmentProfile* object which identifies the alarm severity assignment profile related to this TP. If this attribute is not present, the alarmSeverityAssignmentProfilePointer of the containing object is used;
- mappingRules (adjacent, free) = The value of this attribute defines the distribution rule of the time slots in the CCITT Recommendation G.704 [2] frame;
- bit4Usage (zero, one, operational, signalling) = The value of this attribute reflects the use of the Sa bit 4 of time slot 0 without frame alignment. The operational value indicates that a *Sa bit is involved in a Time Slot 0 Cross-Connection*; the signalling value indicates that the Sa bit provides an additional far end defect or failure information;
- bit5Usage (zero, one, operational, signalling) = The value of this attribute reflects the use of the Sa bit 5 of time slot 0 without frame alignment. The operational value indicates that a *Sa bit is involved in a Time Slot 0 Cross-Connection*; the signalling value indicates that the Sa bit provides an additional far end defect or failure information.- bit6Usage (zero, one, operational, signalling) = The value of this attribute reflects the use of the Sa bit 6 of time slot 0 without frame alignment. The operational value indicates that a *Sa bit is involved in a Time Slot 0 Cross-Connection*; the signalling value indicates that the Sa bit provides an additional far end defect or failure information;
- bit7Usage (zero, one, operational, signalling) = The value of this attribute reflects the use of the Sa bit 7 of time slot 0 without frame alignment. The operational value indicates that a *Sa bit is involved in a Time Slot 0 Cross-Connection*; the signalling value indicates that the Sa bit provides an additional far end defect or failure information;
- bit8Usage (zero, one, operational, signalling) = The value of this attribute reflects the use of the Sa bit 8 of time slot 0 without frame alignment. The operational value indicates that a *Sa bit is involved in a Time Slot 0 Cross-Connection*; the signalling value indicates that the Sa bit provides an additional far end defect or failure information;
- tS16Mode (64 kbit/sData, CAS) = This attribute indicates the use of time slot 16. The 64 kbit/s data value indicates that a *e0CTP* is instantiated. The CAS value indicates that a *tS16ATTP* is instantiated;
- states of the Port (ITU-T Recommendation X.731 [18]):
 - administrativeState (locked, unlocked) = When the value is locked, the functions of the TP are administratively disabled, i.e. the TP does not process the CCITT Recommendation G.704 [2] frame anymore. This implies that alarms will no longer be monitored nor frames generated. The administrativeState has no effect on the operationalState;
 - operationalState (enabled, disabled) = the operational state is disabled if the TP is unable to process the signal (e.g. the containing object is in the disabled operationalState) or if one of the following defaults is detected:
 - Alarm Indication Signal (AIS);
 - Loss of Frame (LOF);
 - alarmStatus = The value of this attribute indicates the severity of the alarms currently on the TP.
- internalFilteringProfilePointer = The value of this attribute points to the *internalFilteringProfile* object which identifies the internal filtering profile related to this TP. If this attribute is not present, the internalFilteringProfilePointer of the containing object is used.

Operations:

- Create [ePDHTTPIId, mappingRules, bit4Usage, bit5Usage, bit6Usage, bit7Usage, bit8Usage, tS16Mode, administrativeState, operationalState, alarmStatus, internalFilteringProfilePointer];
- delete;
- modify [mappingRules, bit4Usage, bit5Usage, bit6Usage, bit7Usage, bit8Usage, tS16Mode, administrativeState, internalFilteringProfilePointer];
- get [ePDHTTPIId, mappingRules, bit4Usage, bit5Usage, bit6Usage, bit7Usage, bit8Usage, tS16Mode, administrativeState, operationalState, alarmStatus, internalFilteringProfilePointer].

Notifications:

- Alarm notification (refers to CCITT Recommendation G.704 [2] alarms). A communicationsAlarm notification shall be issued if one of the following defects or failures is detected:
 - Loss of Frame (LOF);
 - Excessive Bit Error Ratio (EBER) if specified;
 - Remote Alarm Indication (RAI) from remote end (RAI);
 - Alarm Indication Signal (AIS);
 - Remote AIS (RAIS) if provided;
 - Remote Loss of Synchronization Reference (RLSR) if provided.

The probableCause parameter of the notification shall indicate LOF, EBER, RAI, AIS, RAIS, FS, CRC4BE, RCRC4BE, RLSR respectively.

- State change notification: A stateChange Notification may be issued in case of operationalState change.

e1CTP (Connection Termination Point at 2 048 kbit/s)

Behaviour:

An instance of this object class originates and terminates a 2 048 kbit/s Link connection. It represents the 2 048 kbit/s connection termination point which is used for transparent cross-connection of 2 048 kbit/s signals (signal of the reference points O and G of the functional diagram (figure 2 in ETS 300 010-1 [14])). The detection of AIS is not required for an unstructured 2 048 kbit/s interface. This 2 048 kbit/s connection termination point object class is a specialized *e1CTPBidirectional* object class as defined in ETS 300 371 [15].

Attributes:

- ePDHCTPIId = Logical identification of the termination point;
- alarmSeverityAssignmentProfilePointer = The value of this attribute points to the *alarmSeverityAssignmentProfile* object which identifies the alarm severity assignment profile related to this TP. If this attribute is not present, the alarmSeverityAssignmentProfilePointer of the containing object is used;
- crossConnectionObjectPointer = The value of this attribute points to a *e1CrossConnection* object. When not cross-connected, the value of this attribute points to the right instance of *dxCFabric*;
- characteristicInformation (list of values to be defined) = The value of this attribute is used to verify the connectability of the connection points;
- states of the port (ITU-T Recommendation X.731 [18]):
 - administrativeState (locked, unlocked) = When the administrative state is locked, the CTP cannot be cross-connected;
 - operationalState (enabled, disabled) = the operational state is disabled if the TP is unable to process the signal (e.g. the containing object is in the disabled operationalState) or if an Alarm Indication Signal (AIS) (if relevant) is detected;
 - alarmStatus = The value of this attribute indicates the severity of the current alarm on the TP;

- currentLoopState (NULL, loopType) = The value of this attribute indicates whether a loop is present on the interface. In the case where a loop is present, the loopType value indicates the orientation of the loop (localEquipmentSide, localLineSide). A change in the value of the loopState attribute shall cause an attributeValueChange notification;
- loopSet (localEquipmentSide, localLineSide) = This attribute allows type of loop selection.

Operations:

- Create [ePDHCTPId, alarmSeverityAssignmentProfilePointer, crossConnectionObjectPointer, characteristicInformation, administrativeState, operationalState, alarmStatus, currentLoopState, loopSet];
- delete;
- modify [alarmSeverityAssignmentProfilePointer, administrativeState, loopSet];
- get [ePDHCTPId, alarmSeverityAssignmentProfilePointer, crossConnectionObjectPointer, characteristicInformation, administrativeState, operationalState, alarmStatus, currentLoopState, loopSet].

Notifications:

- Alarm notification (refers to CCITT Recommendation G.704 [2] alarms): A communicationsAlarm notification shall be issued if an Alarm Indication Signal (AIS) is detected (if relevant). The probableCause parameter of the notification shall indicate AIS;
- State change notification: A stateChange Notification may be issued in case of operationalState change.

ts16ATTP (PPT functional block)

Behaviour:

This object refers to the PPT functional block of the functional diagram (figure 2 in ETS 300 010-1 [14]) and is created when time slot 16 is used for channel associated signalling. The object includes the functions of a respective CTP (e.g. AIS monitoring) which is not instantiated because no connectivity is provided at this level. This object is a specialized *trailTerminationPoint* object class as defined in ITU-T Recommendation M.3100 [9].

Attributes:

- ttpId = Logical identification of the TP;
- alarmSeverityAssignmentProfilePointer = The value of this attribute points to the *alarmSeverityAssignmentProfile* object which identifies the alarm severity assignment profile related to this TP. If this attribute is not present, the alarmSeverityAssignmentProfilePointer attribute of the containing object (*e1G704ATTP*) is used;
- states of the port (ITU-T Recommendation X.731 [18]):
 - operationalState (enabled, disabled) = The operational state is disabled if the TP is unable to process the signal (e.g. the containing object is in the disabled operationalState) or if one of the following defaults is detected:
 - Alarm Indication Signal (AIS) (note 1);
 - Loss of MultiFrame Alignment (LMFA);
 - alarmStatus = The value of this attribute indicates the severity of the current alarms on the TP.

NOTE 1: Noted AIS TS16 in table 1.

Operations:

- Create [ttpld, alarmSeverityAssignmentProfilePointer, operationalState, alarmStatus];
- delete;
- modify [alarmSeverityAssignmentProfilePointer];
- get [ttpld, alarmSeverityAssignmentProfilePointer, operationalState, alarmStatus].

Notifications:

- Alarm notification (refers to CCITT Recommendation G.704 [2] alarms). A communicationsAlarm notification shall be issued if one of the following defects or failures is detected:
 - Alarm Indication Signal (AIS);
 - Loss of MultiFrame Alignment (LMFA);
 - Remote Alarm Indication (RAI). (note 2)

NOTE 2: Noted RMAI in table 1.

The probableCause parameter of the notification shall indicate AIS, LMFA, RAI respectively.

- State change notification: A stateChange Notification may be issued in case of operationalState change.

e0CTP (Connection Termination Point at 64 kbit/s)

Behaviour:

An instance of this object class originates and terminates a 64 kbit/s link connection. It represents the 64 kbit/s connection termination point which is used for cross-connection of 64 kbit/s signals (signals of the reference points J, and optionally K and L of the functional diagram (figure 2 in ETS 300 010-1 [14])).

This 64 kbit/s connection termination point object class is a specialized *e0CTPBidirectional* object class as defined in ETS 300 371 [15]. This managed object may be automatically instantiated when the superior managed object (*e1G704ATTP*) is instantiated, according to the digital cross-connect switch make-up and mode of operation.

Attributes:

- e0CTPId = The value of this attribute indicates the number of the time slot in the CCITT Recommendation G.704 [2] frame;
- crossConnectionObjectPointer = The value of this attribute points to a *e0CrossConnection* or a *e0gtp* object. When not cross-connected, the value of this attribute points to the right instance of *dxcfabric*;
- administrative State (locked, unlocked) = When the administrative state is locked, the CTP cannot be cross-connected.

Operations:

- Create [e0CTPId, crossConnectionObjectPointer, administrative State];
- delete;
- modify [administrative State];
- Get [e0CTPId, crossConnectionObjectPointer, administrative State].

casCTP (CAS connection point)

Behaviour:

An instance of this object class originates and terminates the Channel Associated Signalling (CAS) link connection associated with each 64 kbit/s link connection when time slot 16 is used on a CCITT Recommendation G.704 [2] Trail. It is used for cross-connection of CAS signals (reference point L signals of the functional diagram (figure 2 in ETS 300 010-1 [14])).

The CAS connection termination point object class is a specialization of the *ConnectionTerminationPointBidirectional* defined in ITU-T Recommendation M.3100 [9]. This managed object may be automatically instantiated when the superior managed object (*ts16ATTP*) is instantiated, according to the digital cross-connect switch make-up and mode of operation.

Attributes:

- *casCTPId* = Logical Identification of the Connection Point. The value of this attribute shall be equal to the number of the time slot in the a CCITT Recommendation G.704 [2] frame of the 64 kbit/s associated CTP;
- *crossConnectionObjectPointer* = The value of this attribute points to a *casCrossConnection* or a *casgtp* object. When not cross-connected, the value of this attribute points to the right instance of *dxcFabric*;
- *administrativeState* (locked, unlocked) = If the administrative state is locked, the CTP cannot be cross-connected;
- *abcdBitIdlecode* (1..F) = The value of this attribute indicates the idle code on abcd bits when not cross-connected. On aggregate side, this attribute takes the F value.

Operations:

- Create [*casCTPId*, *crossConnectionObjectPointer*, *administrativeState*, *abcdBitIdlecode*];
- delete;
- modify [*administrativeState*, *abcdBitIdlecode*];
- get [*casCTPId*, *crossConnectionObjectPointer*, *administrativeState*, *abcdBitIdlecode*].

7.3.2.3 Cross-connection fragment

***dxcFabric* (XC functional block)**

Behaviour:

The *dxcFabric* object class represents the Cross Connection (XC) functional block, the optional Channel Associated Signalling Cross Connection (CASXC) and Special Function (SF) functional blocks, and the MCF functional block of the functional diagram (figure 2 in ETS 300 010-1 [14]).

Four instances of *dxcFabric* may be instantiated depending on the characteristic information to be cross-connected.

A first instance of *dxcFabric* is mainly in charge of the establishment and release of point-to-point cross-connections for 64 kbit/s and Nx64 kbit/s signals. It also manages the assignment of Nx64 kbit/s connection termination points (*e0CTP*) to groups of termination points (*e0gtp*) that represent Nx64 kbit/s signals.

If CAS is associated with the 64 or Nx64 kbit/s signal, this instance of *fabric* is able to transparently manage the establishment and release of the CAS cross-connection at the same time as the 64 or Nx64 kbit/s cross-connection. The CAS cross-connection is only possible if a *casCTP* is associated with the TP of the aggregate side and a *castCTP* or a *sigTTP* is associated with the TP of the tributary side. Additionally, *dxcFabric* transparently manages the assignment of N CAS connection termination points (*casCTP*) to a group of termination points (*casgtp*) at the same time as the assignment of the N *e0CTP* to the *e0gtp*.

A second instance of *dxCFabric* deals with the establishment and release of cross-connections for management signals.

A third instance of *dxCFabric* is responsible for the establishment and release of cross-connections for 2 048 kbit/s signals.

A fourth instance of *dxCFabric* is in charge of the establishment and release of cross-connections for Sa bits. It also manages the assignment of N Sa bits connection termination points (*saCTP*) to a group of termination points (*sagtp*).

The *dxCFabric* object class is a closely specialized *fabric* object class as defined in ITU-T Recommendation M.3100 [9]. The instances of *dxCFabric* are automatically created at the initialization of the digital cross-connect switch.

Attributes

- fabricId = Logical identification of a *dxCFabric* object instance. This identification shall be unique for a digital cross-connect switch;
- supportedByObjectList = The value of the supportedByObjectList attribute points to the *dxCEquipment* (e.g. matrix board) and *dxCSoftware* objects which implement this instance of *dxCFabric*;
- states of the port (ITU-T Recommendation X.731 [18]):
 - administrativeState (locked, unlocked) = when the value is locked, the functions of this *dxCFabric* instance are administratively disabled, i.e. no action will be accepted to set-up or remove cross-connections neither to add/remove termination points to/from a Group Termination Point (GTP). The administrativeState has no effect on the operationalState;
 - operationalState (enabled, disabled) = The operational state is enabled if the Fabric is fully or partially operational (partially operational is indicated by the availabilityStatus attribute). The operational state is disabled if the Fabric is fully disabled. When the operational state is disabled no action can be performed by Fabric;
 - availabilityStatus (degraded, normal) = The availabilityStatus is degraded if at least one of the objects pointed to by the attribute supportedByObjectList is in the operationalState disabled but not all of them. The Fabric remains available for service (i.e. its operationalState is enabled while it is degraded).

Operations:

- Connect [];
- disconnect [];
- addTpsToGTP [];
- removeTpsFromGTP [];
- modify [administrativeState];
- get [fabricId, supportedByObjectList, administrativeState, operationalState, availabilityStatus].

e0CrossConnection

Behaviour:

The *e0CrossConnection* object class represents an assignment relationship between termination points or GTP objects at 64 kbit/s level.

A 64 or Nx64 kbit/s cross-connection is the result of a connect action on the right instance of Fabric. If a CAS is associated with the termination points to be cross-connected, a CAS cross-connection will result in the same connect action used for establishing the Nx64 kbit/s cross-connection. This CAS cross-connection is contained (named) by the 64 or Nx64 kbit/s cross-connection.

The 64 or Nx64 kbit/s cross-connection is a point to point bi-directional cross-connection. Other types of cross-connections are out of the scope of this ETS.

The *e0CrossConnection* object class is a closely specialized *crossConnection* object class as defined in ITU-T Recommendation M.3100 [9].

Attributes:

- crossConnectionId = Logical Identification number of a cross-connection. This identification shall be unique for a given Fabric;
- fromTermination = The value of this attribute points to the first TP or GTP implicated in the cross-connection;
- toTermination = The value of this attribute points to the second TP or GTP implicated in the cross-connection;
- states of the port (ITU-T Recommendation X.731 [18]):
 - administrativeState (locked, unlocked) = When the value is locked, no traffic is allowed to pass through the cross-connection;
 - operationalState (enabled, disabled) = When disabled, the cross-connection is incapable of performing its function, i.e. make traffic pass from one TP or GTP to another one.
- fromTerminationLoopback (ON, OFF) = This attribute allows the setting of a loopback on the TP or GTP pointed to by the fromTermination attribute;
- toTerminationLoopback (ON, OFF) = This attribute allows the setting of a loopback on the TP or GTP pointed to by the toTermination attribute.

Operations:

- Modify [administrativeState, fromTerminationLoopback, toTerminationLoopback];
- get [crossConnectionId, fromTermination, toTermination, administrativeState, operationalState, fromTerminationLoopback, toTerminationLoopback].

casCrossConnection

Behaviour:

The *casCrossConnection* object class represents an assignment relationship between CAS connection termination points or CAS GTP objects.

A CAS cross-connection results in the same connect action used for establishing a Nx64 kbit/s cross-connection.

The CAS cross-connection is contained (named) by the Nx64 kbit/s cross-connection.

The CAS cross-connection is a point-to-point bi-directional cross-connection. Other types of cross-connections are out of the scope of this ETS.

The *casCrossConnection* object class is a closely specialized *crossConnection* object class as defined in ITU-T Recommendation M.3100 [9].

Attributes:

- crossConnectionId = Logical Identification number of a cross-connection. This identification shall be unique for a given Fabric;
- fromTermination = The value of this attribute points to the first TP or GTP implicated in the cross-connection;
- toTermination = The value of this attribute points to the second TP or GTP implicated in the cross-connection;
- States of the Port (ITU-T Recommendation X.731 [18]):
 - administrativeState (locked, unlocked) = When the value is locked, no traffic is allowed to pass through the cross-connection;
 - operationalState (enabled, disabled) = When disabled, the cross-connection is incapable to perform its function, i.e. make traffic pass from one TP or GTP to another.

Operations:

- Modify [administrativeState];
- Get[crossConnectionId, fromTermination, toTermination, administrativeState, operationalState].

e1CrossConnection

Behaviour:

The *e1CrossConnection* object class represents an assignment relationship between Termination Points or GTP objects at 2 Mbit/s level.

A 2 Mbit/s cross-connection is the result of a connect action on the right instance of Fabric. The 2 Mbit/s CrossConnection is a point to point bi-directional cross-connection.

The *e1CrossConnection* object class is a close specialization of the *crossConnection* object class defined in ITU-T Recommendation M.3100 [9].

Attributes:

- crossConnectionId = Logical Identification number of a cross-connection. This identification shall be unique for a given Fabric;
- fromTermination = The value of this attribute points to the first TP or GTP implicated in the cross-connection;
- toTermination = The value of this attribute points to the second TP or GTP implicated in the cross-connection;
- States of the Port (ITU-T Recommendation X.731 [18]):
 - administrativeState (locked, unlocked) = When the value is locked, no traffic is allowed to pass through the cross-connection;
 - operationalState (enabled, disabled) = When disabled, the cross-connection is incapable to perform its function, i.e. make traffic pass from one TP or GTP to another.

Operations:

- Modify [administrativeState].
- Get [crossConnectionId, fromTermination, toTermination, administrativeState, operationalState].

e0gtp (64 kbit/s group termination point)

The *e0gtp* object class represents an assignment relationship between 64 kbit/s connection termination points (*e0CTP*).

If a CAS is associated to the termination points to be grouped, a CAS GTP will result in the same addTpsToGtp action used for establishing the 64 kbit/s GTP. This CAS GTP is contained (named) by the 64 kbit/s GTP.

The *e0gtp* object class is a closely specialized *gtp* object class as defined in ITU-T Recommendation M.3100 [9].

Attributes:

- gtpId = Logical Identification of the GTP. This identification shall be unique for a given Fabric;
- crossConnectionObjectPointer = The value of this attribute points to a *crossConnection* object;
- tpsInGtpList = Each value of this list points to the termination points that are grouped in the GTP.

Operations:

- Get [gtpld, crossConnectionObjectPointer, tpsInGtpList].

***casgtp* (64 kbit/s group termination point)**

The *casgtp* object class represents an assignment relationship between CAS connection termination points (*casCTP*). A CAS GTP results in the same addTpsToGTP action used for establishing a 64 kbit/s GTP. The CAS GTP is contained (named) by the 64 kbit/s GTP.

The *casgtp* object class is a closely specialized *gtp* object class as defined in ITU-T Recommendation M.3100 [9].

Attributes:

- gtpId = Logical Identification of the GTP. This identification shall be unique for a given Fabric;
- crossConnectionObjectPointer = The value of this attribute points to a *casCrossConnection* object;
- tpsInGtpList = Each value of this list points to the termination points that are grouped in the GTP.

Operations:

- Get [gtpld, crossConnectionObjectPointer, tpsInGtpList].

7.3.2.4 Synchronization fragment

***dxctimingGenerator* (Cross Connect Timing Source (XCTS) functional block)**

Behaviour:

The *dxctimingGenerator* object class is represented by the XCTS block of the functional diagram (figure 2 in ETS 300 010-1 [14]).

For the selection of a timing source, a 1:n protection mechanism is used by the way of a *tsProtectionGroup* and *tsProtectionUnits*.

The *dxctimingGenerator* object class is a closely specialized *timingGenerator* object class as defined in ETS 300 304 [19].

Only one instance of *dxctimingGenerator* exists. This instance of *dxctimingGenerator* is automatically created at the initialization of the digital cross-connect switch.

Attributes:

- timingGeneratorId = Logical identification of the *dxctimingGenerator* object instance. This identification shall be unique for a digital cross-connect switch;
- currentTimingSourcePointer = The value of this attribute points to the timing source currently in use. A value of NULL for this attribute indicates the use of the internal oscillator;
- supportedByObjectList = The value of the supportedByObjectList attribute points to the *dxcequipment* and *dxsoftware* objects which implement this instance of *dxctimingGenerator*;
- states of the timing generator (ITU-T Recommendation X.731 [18]):
 - operationalState (enabled, disabled) = The operational state is disabled if one of the objects pointed to by the attribute supportedByObjectList is in the disabled operationalState. The operationalState is not affected if a loss of synchronization reference is detected.

Operations:

- Get [timingGeneratorId, currentTimingSourcePointer, supportedByObjectList, operationalState].

Notifications:

- attributeValueChange;
- stateChange;
- Alarm notification. An equipmentAlarm notification shall be issued if a Loss of Synchronization Reference (LSR) is detected. The probableCause parameter of the notification shall indicate LSR. The default value of the perceivedSeverity associated to this probableCause in the ASAP is Critical.

pPI1G703ITSTTP (TIPI functional block)

Behaviour:

This object class corresponds to the Timing Input Physical Interface (TIPI) block of the functional diagram (figure 2 in ETS 300 010-1 [14]). It represents the external 2 048 kHz input interface and terminates a 2 048 kHz signal.

The definition of this 2 048 kHz CCITT Recommendation G.703 [1] Input Timing Source Trail Termination Point (ITSTTP) object class is close to the *timingPhysicalTerminationSink* object class defined in ETS 300 304 [19].

This managed object may be automatically instantiated when the supporting managed object is instantiated, according to the digital cross-connect switch make-up and mode of operation.

Attributes:

- iTSTTPId = Logical identification of the ITSTTP. This identification shall be unique for a digital cross-connect switch;
- accessPort = The value of this attribute has to indicate unambiguously the associated access port;
- supportedByObjectList = The value of the supportedByObjectList attribute points to the *dxEquipment* hardware block and *dxSoftware* objects which implement the ITSTTP;
- alarmSeverityAssignmentProfilePointer = The value of this attribute points to the *alarmSeverityAssignmentProfile* object which identifies the alarm severity assignment profile related to this ITSTTP. If this attribute is not present, the attribute alarmSeverityAssignmentProfilePointer of the containing object is used;
- states of the ITSTTP (ITU-T Recommendation X.731 [18]):
 - administrativeState (locked, unlocked) = When the value is locked, the functions of the ITSTTP are administratively disabled, i.e. the ITSTTP neither processes the signal nor detects failure of the signal. The administrativeState has no effect on the operationalState;
 - operationalState (enabled, disabled) = The operational state is disabled if a LOS is detected or if one of the objects pointed to by the attribute supportedByObjectList is in the disabled operationalState;
 - alarmStatus = When an alarm is present on the ITSTTP, the value of this attribute indicates the severity of the alarm.
- impedance (75, 120) = This attribute indicates the current impedance 75 ohms coaxial pair option, or a 120 ohms symmetrical pair option and, if provided, permits to select this impedance;

Actions:

- Create [iTSTTPId, accessPort, supportedByObjectList, alarmSeverityAssignmentProfile, administrativeState, operationalState, alarmStatus, impedance] (no need if automatic creation);
- delete (no need if automatic deletion);
- modify [alarmSeverityAssignmentProfile, administrativeState, impedance (if provided)];

- get [iTSTTPId, accessPort, supportedByObjectList, alarmSeverityAssignmentProfile, administrativeState, operationalState, alarmStatus, impedance].

Notifications:

- ObjectCreation;
- Object Deletion;
- Alarm notification (refers to CCITT Recommendation G.703 [1] alarms): A communicationsAlarm notification shall be issued if a Loss of Signal (LOS) is detected. The probableCause parameter of the notification shall indicate LOS;
- state change notification: A stateChange Notification may be issued in case of operationalState change;
- AttributeValueChange.

pPI1G703OTSTTP (TOPI functional block)

Behaviour:

This object class corresponds to the optional Timing Output Physical Interface (TOPI) block of the functional diagram (figure 2 in ETS 300 010-1 [14]). It represents the external 2 048 kHz output interface and originates the 2 048 kHz signal issued from the timing generator of the digital cross-connect switch.

The definition of this 2 048 kHz CCITT Recommendation G.703 [1] Output Timing Source Trail Termination Point (OTSTTP) object class is close to the *timingPhysicalTerminationSource* object class defined in ETS 300 304 [19].

This managed object may be automatically instantiated when the supporting managed object is instantiated, according to the digital cross-connect switch make-up and mode of operation.

Attributes:

- oTSTTPId = Logical identification of the OTSTTP. This identification shall be unique for a digital cross-connect switch;
- accessPort = The value of this attribute has to indicate unambiguously the associated access port;
- supportedByObjectList = The value of the supportedByObjectList attribute points to the *dxEquipment* and *dxSoftware* objects which implement the OTSTTP;
- outputTimingSourcePointer = The value of this attribute points to the *dxTimingGenerator*, states of the output timing source termination (ITU-T Recommendation X.731 [18]):
 - operationalState (enabled, disabled) = The operational state is disabled if one of the objects pointed to by the attribute supportedByObjectList is in the operationalState disabled;
- impedance (75, 120) = This attribute indicates the current impedance 75 ohms coaxial pair option, or a 120 ohms symmetrical pair option and, if provided, permits to select this impedance.

Actions:

- Create [oTSTTPId, accessPort, supportedByObjectList, outputTimingSourcePointer, operationalState, impedance] (no need if automatic creation);
- delete (no need if automatic deletion);
- modify [impedance];
- get [oTSTTPId, accessPort, supportedByObjectList, outputTimingSourcePointer, operationalState, impedance (if provided)].

Notifications:

- Object creation;
- object deletion;
- state change notification: A stateChange Notification may be issued in case of operationalState change;
- AttributeValueChange.

***tSProtectionGroup* (XCTS functional block)**

Behaviour:

The *tSProtectionGroup* object class represents the protected or protecting timing source units of the digital cross-connect switch.

This timing source protectionGroup object instance contains two or more timing source protectionUnit objects for defining a protection switching relationship where one or more standby entities provide protection for the current timing source (1:n protection mechanism).

The *tSProtectionGroup* object class is a specialized *protectionGroup* object class as defined in ETS 300 304 [19]. This managed object is automatically instantiated.

Attributes:

- protectionGroupId = Logical identification of a *protectionGroup* object instance. This identification shall be unique for a Digital cross-connect switch;
- protectionGroupType (1 + 1, m:n) = This attribute specifies whether the protection scheme used is a 1 + 1 or m:n. m:n includes the cases where m=1 and/or n=1;
- revertive (true, false) = This attribute indicates whether the protection scheme is revertible or not. If the value is true, the traffic is returned to the protected protectionUnit instance that initiated the switch after the fault clear and the waitToRestoreTime interval (if any) has expired. If the value is false, then after the fault has cleared, traffic does not revert to the protectionUnit that initiated the switch;
- supportedByObjectList = The value of the supportedByObjectList attribute points to the *dxcEquipment* and *dxcSoftware* objects which implement the TP;
- waitToRestoreTime = This attribute specifies the amount of time, in seconds, to wait after a fault clear before restoring traffic to the protected protectionUnit that initiated the switching;
- states of the (ITU-T Recommendation X.731 [18]):
 - operationalState (enabled, disabled) = The operational state reflects the switch capabilities of the protection scheme. (i.e. it becomes disabled when the NE has detected that it can no longer perform switch operations (automatic or manual)).

Operations:

- Modify [protectionGroupType, revertive, waitToRestoreTime];
- get [protectionGroupId, protectionGroupType, revertive, supportedByObjectList, waitToRestoreTime, operationalState];
- invokeProtection = This action can be used to request a lockout, a forced switch, or a manual switch on one or more protectionUnit instances contained in the protectionGroup object;
- releaseProtection = This action can be used to release a lockout, a forced switch, or a manual switch on one or more protectionUnit instances contained in the protectionGroup object.

Notifications:

- State change notification: A stateChange Notification may be issued in case of operationalState change;
- protectionSwitchReporting = This notification is emitted from the protectionGroup object to report any protection switch events, such as protection switching, protection release, lockout or release of lockout.

***tSProtectionUnit* (XCTS functional block)**

Behaviour:

The *tSProtectionUnit* object class represents a relationship between a timing source and the timing generator of the digital cross-connect switch.

The *tSProtectionUnit* object class is a specialized *syncProtectionUnit* object class as defined in ETS 300 304 [19]. This managed object may be automatically instantiated according to the make-up and mode of operation of the equipment.

Attributes:

- protectionUnitId = Logical identification of a *protectionUnit* object instance. This identification shall be unique for a timing source protection group;
- priority (1, n) = This attribute specifies the priority of the service carried on the resource associated to the protected protectionUnit instance. The value 1 indicates the highest priority;
- syncProtectionStatus (No request, Force Switch Complete to Protecting Unit, Automatic Switch Complete to Protecting Unit, Protecting Unit Failed, Protecting Unit Locked Out) = This attribute indicates the status of the protection switch:
 - No request: No request is present on the protecting unit;
 - force switch complete to protecting unit: A forced switch has been completed to this protecting unit;
 - automatic switch complete to protecting unit: An automatic switch which has been completed to this protecting Unit;
 - protecting unit failed: The protecting unit has a failure condition present;
 - protecting unit locked out: The protecting Unit has been locked out;
- protecting (true, false) = This attribute specifies the type of the protectionUnit. A value True indicates that the protectionUnit is a protecting unit. A value of false indicates that the protectionUnit is a protected unit. A change in the value of this attribute shall cause an attributeValueChange notification;
- reliableResourcePointer = The value of this attribute points to the reliable resource (*dxcTimingGenerator*) that is associated to the protectionUnit instance or is NULL;
- unreliableResourcePointer = The value of this attribute points to the unreliable resource that is associated to the protectionUnit instance.

Operations:

- Create [protectionUnitId, priority, syncProtectionStatus, protecting, reliableResourcePointer, unreliableResourcePointer];
- delete;
- modify [priority];
- get [protectionUnitId, priority, syncProtectionStatus, protecting, reliableResourcePointer, unreliableResourcePointer].

Notifications:

- attribute value change notification: An attributeValueChange notification is issued if any of the following attributes changes in value: syncProtectionStatus, protecting.

7.3.2.5 Power feeding fragment

This edition does not include this fragment.

7.3.2.6 Time Slot 0 cross-connection

7.3.2.6.1 4 kbit/s granularity

7.3.2.6.1.1 Termination point fragment

***e04CTP* (4 kbit/s Connection Termination Point)**

Behaviour:

An instance of this object class originates and terminates a 4 kbit/s Link Connection. The 4 kbit/s Connection Termination Point object class is a specialization of the ConnectionTerminationPointBidirectional defined in ITU-T Recommendation M.3100 [9].

Attributes:

- *e04CTPId* = Logical identification of the Connection Point. The value of this attribute corresponds to the bit number used in TS0 or TS_n of the CCITT Recommendation G.704 [2] frame;
- *crossConnectionObjectPointer* = The value of this attribute points to a *e04CrossConnection* or to a *e04gtp* object. When not cross-connected, the value of this attribute points to the right instance of *dxCFabric*;
- *administrativeState* (locked, unlocked) = If the administrative state is locked, the CTP cannot be cross-connected.

Operations:

- Create [*e04CTPId*, *crossConnectionObjectPointer*, *administrativeState*];
- Delete;
- Modify [*administrativeState*];
- Get [*e04CTPId*, *crossConnectionObjectPointer*, *administrativeState*].

***e04CTPsk* (4 kbit/s Connection Termination Point sink)**

Behaviour:

An instance of this object class terminates a 4 kbit/s Link Connection. The 4 kbit/s Connection Termination Point sink object class is a specialization of the ConnectionTerminationPointSink defined in ITU-T Recommendation M.3100 [9].

Attributes:

- *e04CTPId* = Logical identification of the Connection Point. The value of this attribute corresponds to the bit number used in TS0 or TS_n of the CCITT Recommendation G.704 [2] frame;
- *crossConnectionObjectPointer* = The value of this attribute points to a *e04CrossConnection* or to a *e04gtp* object. When not cross-connected, the value of this attribute points to the right instance of *dxCFabric*;
- *administrativeState* (locked, unlocked) = If the administrative state is locked, the CTP cannot be cross-connected.

Operations:

- Create [*e04CTPId*, *crossConnectionObjectPointer*, *administrativeState*];
- Delete;
- Modify [*administrativeState*];
- Get [*e04CTPId*, *crossConnectionObjectPointer*, *administrativeState*].

***e04CTPrce* (4 kbit/s Connection Termination Point Source)**

Behaviour:

An instance of this object class originates a 4 kbit/s Link Connection. The 4 kbit/s Connection Termination Point source object class is a specialization of the ConnectionTerminationPointSource defined in ITU-T Recommendation M.3100 [9].

Attributes:

- *e04CTPIId* = Logical identification of the Connection Point. The value of this attribute corresponds to the bit number used in TS0 or TS_n of the CCITT Recommendation G.704 [2] frame;
- *crossConnectionObjectPointer* = The value of this attribute points to a *e04CrossConnection* or to a *e04gtp* object. When not cross-connected, the value of this attribute points to the right instance of *dxCFabric*;
- *administrativeState* (locked, unlocked) = If the administrative state is locked, the CTP cannot be cross-connected.

Operations:

- Create [*e04CTPIId*, *crossConnectionObjectPointer*, *administrativeState*];
- Delete;
- Modify [*administrativeState*];
- Get [*e04CTPIId*, *crossConnectionObjectPointer*, *administrativeState*].

***tSnATTP* (Time Slot n Trail Termination Point)**

Behaviour:

An instance of this object class originates and terminates a trail on a given time slot ($n \neq 0$) on a CCITT Recommendation G.704 [2] Trail. This object includes the functions of a respective *e0CTP* which is not instantiated because no connectivity is provided at this level. In case of bit inhibition, the default value defined in CCITT Recommendation G.704 [2] is used. The T_{sn} Trail Termination Point object class is a specialization of the *trailTerminationPointBidirectional* defined in ITU-T Recommendation M.3100 [9].

Attributes:

- *tSnTTPIId* = Logical identification of the Termination Point. The value of this attribute corresponds to the number of the time slot in the CCITT Recommendation G.704 [2] frame.

Operations:

- Create [*tSnTTPIId*];
- Delete;
- Get [*tSnTTPIId*].

***tSnATTPsrce* (Time Slot n Trail Termination Point source)**

Behaviour:

An instance of this object class originates a trail on a given time slot ($n \neq 0$) on a CCITT Recommendation G.704 [2] Trail. This object includes the functions of a respective *e0CTPrce* which is not instantiated because no connectivity is provided at this level. In case of bit inhibition, the default value defined in CCITT Recommendation G.704 [2] is used. The T_{sn} Trail Termination Point source object class is a specialization of the *trailTerminationPointSource* defined in ITU-T Recommendation M.3100 [9].

Attributes:

- tSnTTPIId = Logical identification of the Termination Point. The value of this attribute corresponds to the number of the time slot in the CCITT Recommendation G.704 [2] frame.

Operations:

- Create [tSnTTPIId];
- Delete;
- Get [tSnTTPIId].

7.3.2.6.1.2 Cross-Connection fragment

***e04CrossConnection* (nx4 kbit/s Cross-Connection)**

Behaviour:

The e04CrossConnection object class represents an assignment relationship between 4 kbit/s Connection Termination Points or nx4 kbit/s GTP objects.

A nx4 kbit/s Cross-Connection is the result of a connect action on the right instance of Fabric. The nx4 bit/s CrossConnection is a point to point bi-directional or uni-directional Cross-Connection.

The bi-directional cross-connection is used to cover the San Bits bi-directional cross-connection between two Time Slots 0 NFAS with bits inhibition (annex D.2 of ETS 300 010-1 [14]) and between a Time Slot 0 NFAS and a Time Slot n with bits inhibition (annex D.3 of ETS 300 010-1 [14]).

The bi-directional cross-connection shall maintain the Sa bits and Sa word sequence integrity.

The uni-directional cross-connection is used to cover the uni-directional cross-connection of all bits of Time Slot 0 NFAS with bits inhibition to a Time Slot n (annex D.3 of ETS 300 010-1 [14]).

The uni-directional cross-connection shall maintain bit and octet sequence integrity.

The e04CrossConnection object class is a close specialization of the crossConnection object class defined in ITU-T Recommendation M.3100 [9].

Attributes:

- crossConnectionId = Logical Identification number of a Cross-Connection. This identification shall be unique for a given Fabric;
- directionality (unidirectional, bi-directional) = The value of this attribute indicates the directionality of the cross-connection. In a uni-directional cross-connection, the termination point or GTP pointed to by the From Termination and the termination point or GTP object pointed to by the To Termination attribute are related in such a way that traffic can flow between the termination points represented by these managed objects. In a bi-directional cross-connection, information flows in both directions;
- fromTermination = The value of this attribute points to the first TP or GTP implicated in the Cross-Connection;
- toTermination = The value of this attribute points to the second TP or GTP implicated in the Cross-Connection;
- States of the Port (ITU-T Recommendation X.731 [18]):
 - administrativeState (locked, unlocked) = When the value is locked, no traffic is allowed to pass through the Cross-Connection;
 - operationalState (enabled, disabled) = When disabled, the Cross-Connection is incapable to perform its function, i.e. make traffic pass from one TP to another one.

Operations:

- Modify [administrativeState];
- Get [crossConnectionId, directionality, fromTermination, toTermination, administrativeState, operationalState].

e04gtp (nx4 kbit/s group termination point)

The e04gtp object class represents an assignment relationship between 4 kbit/s Connection Termination Points (e04CTP).

A nx4 kbit/s GTP results of a addTpsToGTP action on the right instance of dxcFabric.

The e04gtp object class is a close specialization of the gtp object class defined in ITU-T Recommendation M.3100 [9].

Attributes:

- gtpId = Logical Identification of the GTP. This identification shall be unique for a given Fabric;
- crossConnectionObjectPointer = The value of this attribute points to a e04CrossConnection object;
- tpsInGtpList = Each value of this list points to the Termination Points that are grouped in the GTP.

Operations:

- Get [gtpId, crossConnectionObjectPointer, tpsInGtpList].

7.3.2.6.2 64 kbit/s granularity

7.3.2.6.2.1 Termination point fragment

sanBitsCTP (San Bits Connection Termination Point)

Behaviour:

An instance of this object class originates and terminates a nx4 kbit/s Link Connection on the San Bits of a Time Slot 0 NFAS. The San Bits Connection Termination Point object class is a specialization of the ConnectionTerminationPointBidirectional defined in ITU-T Recommendation M.3100 [9].

Attributes:

- sanBitsCTPId = Logical identification of the Connection Point;
- usedBitList = this attributes specifies the San Bits to be used;
- crossConnectionObjectPointer = The value of this attribute points to a e04CrossConnection object. When not cross-connected, the value of this attribute points to the right instance of dxcFabric;
- administrativeState (locked, unlocked) = If the administrative state is locked, the CTP cannot be cross-connected.

Operations:

- Create [sanBitsCTPId, usedBitList, crossConnectionObjectPointer, administrativeState];
- Delete;
- Modify [usedBitList, administrativeState];
- Get [sanBitsCTPId, usedBitList, crossConnectionObjectPointer, administrativeState].

***tS0NFASCTP* (Time Slot 0 NFAS Connection Termination Point)**

Behaviour:

An instance of this object class originates and terminates a nx4 kbit/s Link Connection on the Bits of a Time Slot 0 NFAS. The Time Slot 0 NFAS Connection Termination Point object class is a specialization of the ConnectionTerminationPointBidirectional defined in ITU-T Recommendation M.3100 [9].

Attributes:

- tS0NFASCTPId = Logical identification of the Connection Point;
- usedBitList = this attributes specifies the Bits of TS0 NFAS to be used.

Operations:

- Create [tS0NFASCTPId, usedBitList];
- Delete;
- Modify [usedBitList];
- Get [tS0NFASCTPId, usedBitList].

***tS0NFASCTPsk* (Time Slot 0 NFAS Connection Termination Point Sink)**

Behaviour:

An instance of this object class terminates a nx4 kbit/s Link Connection on the Bits of a Time Slot 0 NFAS. The Time Slot 0 NFAS Connection Termination Point Sink object class is a specialization of the ConnectionTerminationPointSink defined in ITU-T Recommendation M.3100 [9].

Attributes:

- tS0NFASCTPId = Logical identification of the Connection Point;
- usedBitList = this attributes specifies the Bits of TS0 NFAS to be used.

Operations:

- Create [tS0NFASCTPId, usedBitList];
- Delete;
- Modify [usedBitList];
- Get [tS0NFASCTPId, usedBitList].

***tSnCTP* (Time Slot n Connection Termination Point)**

Behaviour:

An instance of this object class originates and terminates a nx4 kbit/s Link Connection on the Bits of a Time Slot n. The Time Slot n Connection Termination Point object class is a specialization of the ConnectionTerminationPointBidirectional defined in ITU-T Recommendation M.3100 [9].

Attributes:

- tSnCTPId = Logical identification of the Connection Point;
- usedBitList = this attributes specifies the Bits of TSn to be used.

NOTE: To comply with functional requirement given in ETS 300 010-1 [14], it is necessary to declare a bit list in coherence with the corresponding usedBitList given in tS0NFASCTP. The necessary checking is beyond the scope of this ETS.

Operations:

- Create [tSnCTPId, usedBitList];
- Delete;
- Modify [usedBitList];
- Get [tSnCTPId, usedBitList].

***tSnCTPsrce* (Time Slot n Connection Termination Point Source)**

Behaviour:

An instance of this object class originates a nx4 kbit/s Link Connection on the Bits of a Time Slot n. The Time Slot n Connection Termination Point Source object class is a specialization of the ConnectionTerminationPointSource defined in ITU-T Recommendation M.3100 [9].

Attributes:

- tSnCTPId = Logical identification of the Connection Point;
- usedBitList = this attributes specifies the Bits of TSn to be used.

Operations:

- Create [tSnCTPId, usedBitList];
- Delete;
- Modify [usedBitList];
- Get [tSnCTPId, usedBitList].

***tSnTTP* (Time Slot n Trail Termination Point)**

Behaviour:

An instance of this object class originates and terminates a trail on a given time slot ($n \neq 0$) on a CCITT Recommendation G.704 [2] Trail. In case of bit inhibition, the default value defined in CCITT Recommendation G.704 [2] is used. The Time Slot n Trail Termination Point object class is a specialization of the trailTerminationPointBidirectional defined in ITU-T Recommendation M.3100 [9].

Attributes:

- tSnTTPId = Logical identification of the Termination Point. The value of this attribute corresponds to the number of the time slot in the CCITT Recommendation G.704 [2] frame;
- crossConnectionObjectPointer = The value of this attribute points to a e0CrossConnection object. When not cross-connected, the value of this attribute points to the right instance of dxcFabric;
- administrativeState (locked, unlocked) = If the administrative state is locked, the CTP cannot be cross-connected.

Operations:

- Create [tSnTTPId, crossConnectionObjectPointer, administrativeState];
- Delete;
- Modify [administrativeState];
- Get [tSnTTPId, crossConnectionObjectPointer, administrativeState].

***tSnTTPsrce* (Time Slot n Trail Termination Point source)**

Behaviour:

An instance of this object class originates a trail on a given time slot ($n \neq 0$) on a CCITT Recommendation G.704 [2] Trail. In case of bit inhibition, the default value defined in CCITT Recommendation G.704 [2] is used. The Time Slot n Trail Termination Point Source object class is a specialization of the trailTerminationPointSource defined in ITU-T Recommendation M.3100 [9].

Attributes:

- *tSnTTPIId* = Logical identification of the Termination Point. The value of this attribute corresponds to the number of the time slot in the CCITT Recommendation G.704 [2] frame;
- *crossConnectionObjectPointer* = The value of this attribute points to a *e0CrossConnection* object. When not cross-connected, the value of this attribute points to the right instance of *dxCFabric*;
- *administrativeState* (locked, unlocked) = If the administrative state is locked, the CTP cannot be cross-connected.

Operations:

- Create [*tSnTTPIId*, *crossConnectionObjectPointer*, *administrativeState*];
- Delete;
- Modify [*administrativeState*];
- Get [*tSnTTPIId*, *crossConnectionObjectPointer*, *administrativeState*].

***e0CTPSrce* (Connection Termination Point Source at 64 kbit/s)**

Behaviour:

An instance of this object class originates a 64 kbit/s Link Connection. It represents the 64 kbit/s Connection Termination Point which is used for cross-connection of 64 kbit/s signals (signals of the reference points J, and optionally K and L of the functional diagram (ETS 300 010-1 [14])).

This 64 kbit/s Connection Termination Point object class is a specialization of the *e0CTPSource* object class defined in the ETS 300 371 [21].

Attributes:

- *e0CTPIId* = The value of this attribute indicates the number of the time slot in the CCITT Recommendation G.704 [2] frame;
- *crossConnectionObjectPointer* = The value of this attribute points to a *e0CrossConnection* object. When not cross-connected, the value of this attribute points to the right instance of *dxCFabric*;
- *administrative State* (locked, unlocked) = When the administrative state is locked, the CTP cannot be cross-connected.

Operations:

- Create [*e0CTPIId*, *crossConnectionObjectPointer*, *administrative State*];
- Delete;
- Modify [*administrative State*];
- Get [*e0CTPIId*, *crossConnectionObjectPointer*, *administrative State*].

7.3.2.6.2.2 Cross-Connection fragment

e04CrossConnection (nx4 kbit/s Cross-Connection)

Behaviour:

The *e04CrossConnection* object class represents an assignment relationship between *nx4 kbit/s Connection Termination Points* objects.

A *nx4 kbit/s Cross-Connection* is the result of a connect action on the right instance of *Fabric*. The *nx4 kbit/s CrossConnection* is a point to point bi-directional *Cross-Connection*.

This bi-directional cross-connection is used to cover the *San Bits* bi-directional cross-connection between two *Time Slots 0 NFAS* with bits inhibition (annex D.2 of ETS 300 010-1 [14]).

The *e04CrossConnection* shall maintain the *Sa* bits and *Sa* word sequence integrity.

The *e04CrossConnection* object class is a close specialization of the *crossConnection* object class defined in ITU-T Recommendation M.3100 [9].

Attributes:

- *crossConnectionId* = Logical Identification number of a *Cross-Connection*. This identification shall be unique for a given *Fabric*;
- *fromTermination* = The value of this attribute points to the first TP implicated in the *Cross-Connection*;
- *toTermination* = The value of this attribute points to the second TP implicated in the *Cross-Connection*;
- *States of the Port* (ITU-T Recommendation X.731 [18]):
 - *administrativeState* (locked, unlocked) = When the value is locked, no traffic is allowed to pass through the *Cross-Connection*;
 - *operationalState* (enabled, disabled) = When disabled, the *Cross-Connection* is incapable to perform its function, i.e. make traffic pass from one TP to another one.

Operations:

- *Modify* [*administrativeState*];
- *Get* [*crossConnectionId*, *fromTermination*, *toTermination*, *administrativeState*, *operationalState*].

e0CrossConnection (n x 64 kbit/s Cross-Connection)

NOTE: This object receives an additional attribute: "directionality". By consequence, it replaces the *e0CrossConnection* object defined in subclause 7.3.2.3.

Behaviour:

The *e0CrossConnection* object class represents an assignment relationship between *Termination Points* or *GTP* objects at 64 kbit/s level.

A 64 or *n x 64 kbit/s Cross-Connection* is the result of a connect action on the right instance of *Fabric*. If a *CAS* is associated to the *Termination Points* to be cross-connected, a *CAS Cross-Connection* will result of the same connect action used for establishing the *n x 64 kbit/s Cross-Connection*. This *CAS Cross-Connection* is contained (named) by the 64 or *n x 64 kbit/s Cross-Connection*.

The 64 or *n x 64 kbit/s Cross-Connection* is a point to point bi-directional or uni-directional *Cross-Connection*. Other types of *Cross-Connections* are out of the scope of this ETS (special functions are not described in ETS 300 010-1 [14]).

The e0CrossConnection object class is a close specialization of the crossConnection object class defined in ITU-T Recommendation M.3100 [9].

Attributes:

- crossConnectionId = Logical Identification number of a Cross-Connection. This identification shall be unique for a given Fabric;
- fromTermination = The value of this attribute points to the first TP or GTP implicated in the Cross-Connection;
- toTermination = The value of this attribute points to the second TP or GTP implicated in the Cross-Connection;
- directionality (unidirectional, bi-directional) = The value of this attribute indicates the directionality of the cross-connection. In a uni-directional cross-connection, the termination point or GTP pointed to by the From Termination and the termination point or GTP object pointed to by the To Termination attribute are related in such a way that traffic can flow between the termination points represented by these managed objects. In a bi-directional cross-connection, information flows in both directions;
- States of the Port (ITU-T Recommendation X.731 [18]):
 - administrativeState (locked, unlocked) = When the value is locked, no traffic is allowed to pass through the Cross-Connection;
 - operationalState (enabled, disabled) = When disabled, the Cross-Connection is incapable to perform its function, i.e. make traffic pass from one TP or GTP to another one;
- fromTerminationLoopback (ON, OFF) = This attribute allows to set a loopback on the TP or GTP pointed to by the fromTermination attribute.
- toTerminationLoopback (ON, OFF) = This attribute allows to set a loopback on the TP or GTP pointed to by the toTermination attribute.

Operations:

- Modify [administrativeState, fromTerminationLoopback, toTerminationLoopback];
- Get [crossConnectionId, fromTermination, toTermination, directionality, administrativeState, operationalState, fromTerminationLoopback, toTerminationLoopback].

Annex A (informative): Management functions

A.1 Object classes

Object classes will be divided into different fragments:

Management fragment:

lcCTP;
q3CTP;
mCTP;
imTP.

A.2 Entities-relationship diagrams

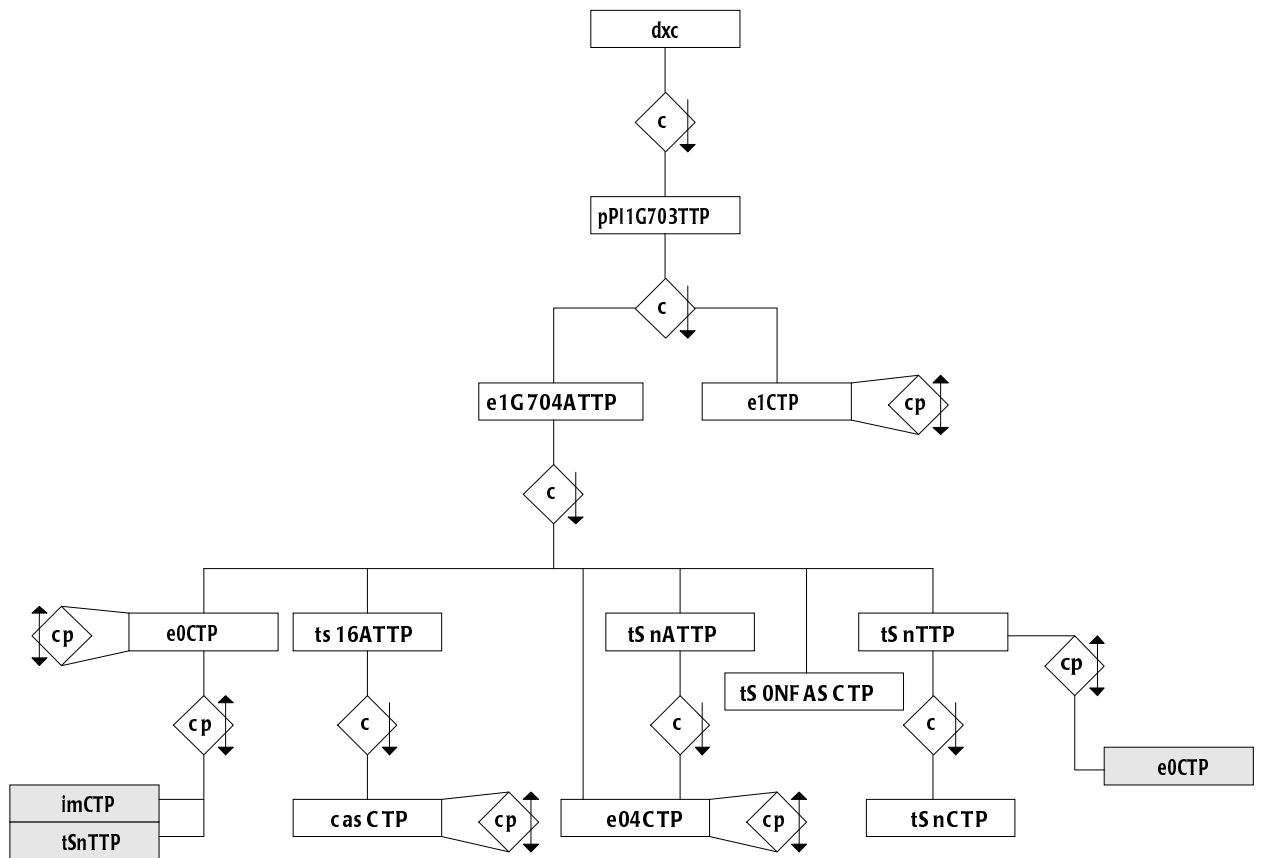

Figure A.1: Entity relationship diagram. Termination points entities

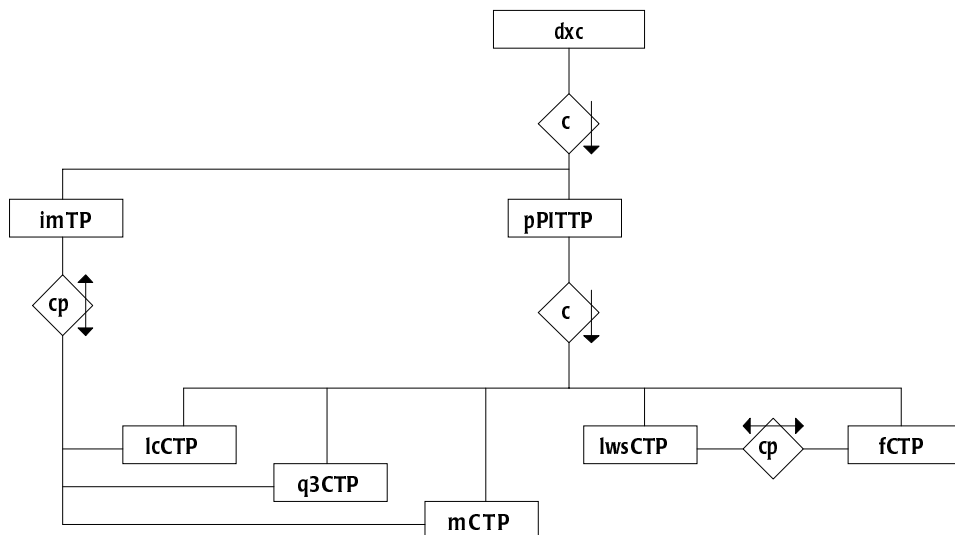

Figure A.2: Entity relationship diagram. Management entities

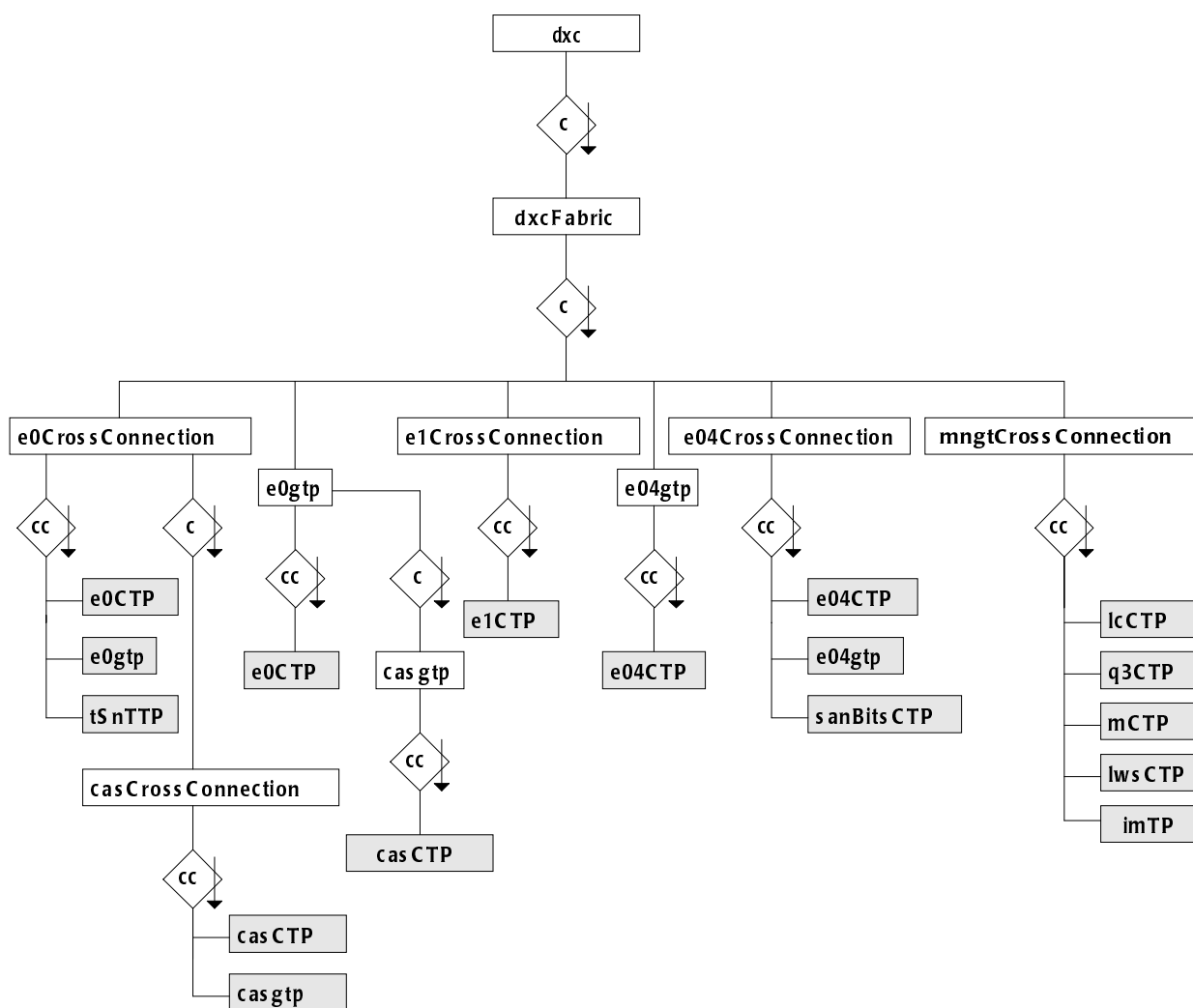

Figure A.3: Entity relationship diagram. Cross-connection aspects

A.3 Cross-connection fragment

mngtCrossConnection

Behaviour:

The *mngtCrossConnection* object class represents an assignment relationship between Termination Points objects for management of the Digital Cross-Connect Switch.

A Management cross-connection is the result of a connect action on the right instance of Fabric. The management CrossConnection is a point to point bi-directional cross-connection.

The *mngtCrossConnection* object class is a close specialization of the *crossConnection* object class defined in ITU-T Recommendation M.3100 [9].

Attributes:

- *crossConnectionId* = Logical Identification number of a cross-connection. This identification shall be unique for a given Fabric;
- *fromTermination* = The value of this attribute points to the first TP implicated in the cross-connection;
- *toTermination* = The value of this attribute points to the second TP implicated in the cross-connection;
- States of the Port (ITU-T Recommendation X.731 [18]):
 - *administrativeState* (locked, unlocked) = When the value is locked, no traffic is allowed to pass through the cross-connection;
 - *operationalState* (enabled, disabled) = When disabled, the cross-connection is incapable to perform its function, i.e. make traffic pass from one TP to another one.

Operations:

- Modify [*administrativeState*];
- Get [*crossConnectionId*, *fromTermination*, *toTermination*, *administrativeState*, *operationalState*].

A.4 Management fragment

This fragment is for further study.

History

Document history			
August 1995	Public Enquiry	PE 90:	1995-08-21 to 1995-12-15
December 1996	Vote	V 117:	1996-12-23 to 1997-02-14
March 1997	First Edition		