



GSM TECHNICAL SPECIFICATION

GSM 08.58

December 1995

Version 5.0.0

Source: ETSI TC-SMG

Reference: TS/SMG-030858Q

ICS: 33.060.50

Key words: Digital cellular telecommunications system, Global System for Mobile communications (GSM)



Digital cellular telecommunications system (Phase 2+); Base Station Controller - Base Transceiver Station (BSC - BTS) interface; Layer 3 specification (GSM 08.58)

ETSI

European Telecommunications Standards Institute

ETSI Secretariat

Postal address: F-06921 Sophia Antipolis CEDEX - FRANCE

Office address: 650 Route des Lucioles - Sophia Antipolis - Valbonne - FRANCE

X.400: c=fr, a=atlas, p=etsi, s=secretariat - **Internet:** secretariat@etsi.fr

Tel.: +33 92 94 42 00 - Fax: +33 93 65 47 16

Copyright Notification: No part may be reproduced except as authorized by written permission. The copyright and the foregoing restriction extend to reproduction in all media.

© European Telecommunications Standards Institute 1995. All rights reserved.

Contents

Foreword.....	7
1 Scope	9
1.1 Normative references	9
1.2 Abbreviations	10
2 Protocol model.....	10
3 Radio Link Layer Management Procedures	12
3.1 Link establishment indication	12
3.2 Link establishment request.....	12
3.3 Link release indication	13
3.4 Link release request.....	13
3.5 Transmission of a transparent L3-Message in acknowledged mode	14
3.6 Reception of a transparent L3-Message in acknowledged mode.....	14
3.7 Transmission of a transparent L3-Message in unacknowledged mode.....	14
3.8 Reception of a transparent L3-Message in unacknowledged mode	15
3.9 Link error indication	15
4 Dedicated channel management procedures.....	16
4.1 Channel activation	16
4.1.1 Signalling Procedure.....	16
4.1.2 Activation for Intra-Cell Channel Change.....	18
4.1.3 Activation for Asynchronous Handover.....	18
4.1.4 Activation for Synchronous Handover	18
4.2 Channel MODE MODIFY.....	19
4.3 Handover detection	19
4.4 Start of encryption.....	20
4.5 Measurement reporting.....	21
4.5.1 Basic measurement reporting.....	21
4.5.2 Measurement pre-processing.....	22
4.5.2.1 Pre-processing configuration	22
4.5.2.2 Pre-processed measurement reporting.....	22
4.6 Deactivate SACCH.....	23
4.7 Radio channel release	23
4.8 MS power control.....	24
4.9 Transmission power control	25
4.10 Connection failure.....	25
4.11 Physical context request	26
4.12 SACCH information modify.....	26
5 Common channel management procedures	27
5.1 Channel request by MS	27
5.2 Paging.....	27
5.3 Delete indication.....	28
5.4 CCCH load indication.....	28
5.5 Broadcast information modify	28
5.6 Short Message Cell Broadcast.....	29
5.7 IMMEDIATE ASSIGNMENT.....	32
6 TRX management procedures.....	33
6.1 Radio resource indication.....	33
6.2 SACCH filling information modify.....	33
6.3 Flow control.....	34

6.4	Error reporting	35
7	Error handling.....	36
7.1	General	36
7.2	Message discriminator error.....	36
7.3	Message type error.....	36
7.4	Message sequence error	36
7.5	General information element errors.....	36
7.6	Mandatory information element errors.....	37
7.7	Optional information element errors	37
7.8	Conditional information element errors	37
8	Message formats and contents.....	38
8.1	Transparent messages	39
8.2	Non-transparent messages (BSC-BTS specific messages).....	39
8.3	Radio link layer management messages.....	40
8.3.1	DATA REQUEST.....	41
8.3.2	DATA INDICATION	41
8.3.3	ERROR INDICATION	42
8.3.4	ESTABLISH REQUEST	42
8.3.5	ESTABLISH CONFIRM.....	42
8.3.6	ESTABLISH INDICATION	43
8.3.7	RELEASE REQUEST	43
8.3.8	RELEASE CONFIRM.....	44
8.3.9	RELEASE INDICATION	44
8.3.10	UNIT DATA REQUEST	45
8.3.11	UNIT DATA INDICATION	45
8.4	DEDICATED CHANNEL MANAGEMENT MESSAGES	46
8.4.1	CHANNEL ACTIVATION	47
8.4.2	CHANNEL ACTIVATION ACKNOWLEDGE	48
8.4.3	CHANNEL ACTIVATION NEGATIVE ACKNOWLEDGE	48
8.4.4	CONNECTION FAILURE INDICATION.....	49
8.4.5	DEACTIVATE SACCH	49
8.4.6	ENCRYPTION COMMAND	50
8.4.7	HANDOVER DETECTION.....	50
8.4.8	MEASUREMENT RESULT	51
8.4.9	MODE MODIFY.....	51
8.4.10	MODE MODIFY ACKNOWLEDGE	52
8.4.11	MODE MODIFY NEGATIVE ACKNOWLEDGE	52
8.4.12	PHYSICAL CONTEXT REQUEST.....	52
8.4.13	PHYSICAL CONTEXT CONFIRM.....	53
8.4.14	RF CHANNEL RELEASE.....	53
8.4.15	MS POWER CONTROL	54
8.4.16	BS POWER CONTROL.....	54
8.4.17	PREPROCESS CONFIGURE.....	55
8.4.18	PREPROCESSED MEASUREMENT RESULT	55
8.4.19	RF CHANNEL RELEASE ACKNOWLEDGE.....	55
8.4.20	SACCH INFO MODIFY.....	56
8.5	COMMON CHANNEL MANAGEMENT MESSAGES	57
8.5.1	BCCH INFORMATION.....	58
8.5.2	CCCH LOAD INDICATION.....	59
8.5.3	CHANNEL REQUIRED.....	60
8.5.4	DELETE INDICATION	60
8.5.5	PAGING COMMAND.....	61
8.5.6	IMMEDIATE ASSIGN COMMAND.....	61
8.5.7	SMS BROADCAST REQUEST.....	62
8.5.8	SMS BROADCAST COMMAND	62
8.5.9	CBCH LOAD INDICATION	63
8.6	TRX MANAGEMENT MESSAGES	63
8.6.1	RF RESOURCE INDICATION	63

8.6.2	SACCH FILLING	63
8.6.3	OVERLOAD	65
8.6.4	ERROR REPORT	65
9	Information element codings.....	66
9.1	Message discriminator.....	66
9.2	MESSAGE TYPE.....	67
9.3	Other information elements.....	68
9.3.1	Channel Number.....	69
9.3.2	Link Identifier	70
9.3.3	Activation Type	70
9.3.4	BS Power.....	71
9.3.5	Channel Identification.....	71
9.3.6	Channel Mode.....	72
9.3.7	Encryption information	74
9.3.8	Frame Number.....	75
9.3.9	Handover reference.....	75
9.3.10	L1 Information.....	75
9.3.11	L3 Information (message name).....	76
9.3.12	MS Identity	76
9.3.13	MS Power	77
9.3.14	Paging Group.....	77
9.3.15	Paging Load	77
9.3.16	Physical Context.....	78
9.3.17	Access Delay.....	78
9.3.18	RACH Load	79
9.3.19	Request Reference	80
9.3.20	Release Mode	80
9.3.21	Resource Information	81
9.3.22	RLM Cause	82
9.3.23	Starting Time	83
9.3.24	Timing Advance.....	83
9.3.25	Uplink Measurements	84
9.3.26	Cause	85
9.3.27	Measurement result number.....	89
9.3.28	Message Identifier.....	89
9.3.29	SACCH Information	90
9.3.30	System Info Type.....	91
9.3.31	MS Power Parameters.....	92
9.3.32	BS Power Parameters.....	92
9.3.33	Preprocessing Parameters.....	93
9.3.34	Preprocessed Measurements.....	93
9.3.35	Full Immediate Assign Info	94
9.3.36	SMSCB Information.....	94
9.3.37	MS Timing Offset	95
9.3.38	Erroneous Message	95
9.3.39	Full BCCH Information (message name).....	96
9.3.40	Channel Needed.....	96
9.3.41	CB Command type	97
9.3.42	SMSCB Message.....	98
9.3.43	CBCH Load Information	98
	History	99

Blank page

Foreword

This Global System for Mobile communications Technical Specification (GTS) has been produced by the Special Mobile Group (SMG) Technical Committee (TC) of the European Telecommunications Standards Institute (ETSI).

This GTS specifies the general structure of layer 3 and traffic management procedures and messages used on the A-bis interface to support signalling procedures within the digital cellular telecommunications system (Phase 2/Phase 2+).

This GTS is a TC-SMG approved GSM technical specification version 5, which contains GSM Phase 2+ enhancements/features to the version 4 GSM technical specification. The ETS from which this Phase 2+ GTS has evolved is Phase 2 GSM ETS 300 596 Edition 4 (GSM 08.58 version 4.9.0).

GTS are produced by TC-SMG to enable the GSM Phase 2+ specifications to become publicly available, prior to submission for the formal ETSI standards approval procedure to become European Telecommunications Standards (ETS). This ensures the earliest possible access to GSM Phase 2+ specifications for all Manufacturers, Network operators and implementors of the Global System for Mobile communications.

The contents of this GTS are subject to continuing work within TC-SMG and may change following formal TC-SMG approval. Should TC-SMG modify the contents of this GTS it will then be republished by ETSI with an identifying change of release date and an increase in version number as follows:

Version 5.x.y

where:

- y the third digit is incremented when editorial only changes have been incorporated in the specification;

- x the second digit is incremented for all other types of changes, i.e. technical enhancements, corrections, updates, etc.

The specification from which this GTS has been derived was originally based on CEPT documentation, hence the presentation of this GTS may not be entirely in accordance with the ETSI rules.

Reference is made within this GTS to GSM-TSs (note).

NOTE: TC-SMG has produced documents which give the technical specifications for the implementation of the digital cellular telecommunications system. Historically, these documents have been identified as GSM Technical Specifications (GSM-TSs). These TSs may have subsequently become I-ETTs (Phase 1), or ETs/ETSI Technical Reports (ETRs) (Phase 2). TC-SMG has also produced ETSI GSM TSs which give the technical specifications for the implementation of Phase 2+ enhancements of the digital cellular telecommunications system. These version 5.x.x GSM Technical Specifications may be referred to as GTs.

Blank page

1 Scope

The use and general aspects of the BAsE Station Controller (BSC) to Base Station Transceiver (BTS) interface (the A-bis interface) are given in Technical Specification GSM 08.51.

This Global System for Mobile communications Technical Specification (GTS) specifies the general structure of layer 3 and traffic management procedures and messages used on the A-bis interface to support signalling procedures as defined in Technical Specification GSM 04.08.

Network management procedures and messages for the A-bis interface are defined in Technical Specification GSM 08.59.

The functional split between BSC and BTS is defined in Technical Specification GSM 08.52. The procedures and messages required to support this split are defined in detail in this specification.

1.1 Normative references

This GTS incorporates by dated and undated reference, provisions from other publications. These normative references are cited at the appropriate places in the text and the publications are listed hereafter. For dated references, subsequent amendments to or revisions of any of these publications apply to this GTS only when incorporated in it by amendment or revision. For undated references, the latest edition of the publication referred to applies.

- [1] GSM 01.04 (ETR 100): "European digital cellular telecommunications system (Phase 2); Abbreviations and acronyms".
- [2] GSM 03.20 (ETS 300 534): "European digital cellular telecommunications system (Phase 2); Security related network functions".
- [3] GSM 04.04 (ETS 300 553): "European digital cellular telecommunications system (Phase 2); layer 1 General requirements".
- [4] GSM 04.05 (ETS 300 554): "European digital cellular telecommunications system (Phase 2); Data Link (DL) layer General aspects".
- [5] GSM 04.06 (ETS 300 555): "European digital cellular telecommunications system (Phase 2); Mobile Station - Base Station System (MS - BSS) interface Data Link (DL) layer specification".
- [6] GSM 04.08 (ETS 300 557): "European digital cellular telecommunications system (Phase 2); Mobile radio interface layer 3 specification".
- [7] GSM 04.12 (ETS 300 560): "European digital cellular telecommunications system (Phase 2); Short Message Service Cell Broadcast (SMSCB) support on the mobile radio interface".
- [8] GSM 05.02 (ETS 300 574): "European digital cellular telecommunications system (Phase 2); Multiplexing and multiple access on the radio path".
- [9] GSM 05.05 (ETS 300 577): "European digital cellular telecommunications system (Phase 2); Radio transmission and reception".
- [10] GSM 05.08 (ETS 300 578): "European digital cellular telecommunications system (Phase 2); Radio subsystem link control".

- [11] GSM 05.10 (ETS 300 579): "European digital cellular telecommunications system (Phase 2); Radio subsystem synchronisation".
- [12] GSM 08.06 (ETS 300 589): "European digital cellular telecommunications system (Phase 2); Signalling transport mechanism specification for the Base Station System - Mobile-services Switching Centre (BSS - MSC) interface".
- [13] GSM 08.08 (ETS 300 590): "European digital cellular telecommunications system (Phase 2); Mobile Switching Centre - Base Station System (MSC - BSS) interface Layer 3 specification".
- [14] GSM 08.51 (ETS 300 592): "European digital cellular telecommunications system (Phase 2); Base Station Controller - Base Transceiver Station (BSC - BTS) interface General aspects".
- [15] GSM 08.52 (ETS 300 593): "European digital cellular telecommunications system (Phase 2); Base Station Controller - Base Transceiver Station (BSC - BTS) interface principles".
- [16] GSM 08.56 (ETS 300 595): "European digital cellular telecommunications system (Phase 2); Base Station Controller - Base Transceiver Station (BSC - BTS) interface Layer 2 specification".

1.2 Abbreviations

Abbreviations used in this specification are listed in GSM 01.04

2 Protocol model

A model for L3 can be found in figure 2.1.

L2 addressing is made to TRX (or BCF) using the TEI of LAPD. Different L2 links are used for traffic management messages (RSL, Radio Signalling Link), network management messages (OML, Operation & Maintenance Link) and L2 management messages (L2ML, Layer 2 Management Link).

For traffic management, two types of signalling messages have been defined:

Transparent Messages: Messages which are forwarded by BTS without interpretation or changes.

Non-Transparent Messages: Messages which are sent only between BSC and BTS and which BTS is acting upon or which are the results of BTS actions.

In addition, the messages have been grouped into four main groups: Radio Link Layer Management, Dedicated Channel Management, Common Channel Management and TRX Management messages.

Discrimination between these types and groups is based on the Message Discriminator which is sent as the first octet in all messages. Transparent and non-transparent messages are discriminated by a transparency flag (T-bit) in the Message Discriminator. Transparent messages are merely forwarded to L2 on the radio interface.

In order to address the relevant radio channel, a Channel Number element is included to support the distribution of messages to relevant physical channels on the TRX. A Link Identifier element supports the distribution on logical links/channels on the radio interface (compare the DLCI element of the A interface, TS GSM 08.06).

All messages in this specification are to be transmitted on the A-bis interface using the I format of LAPD, except for MEASUREMENT RESULT which is sent in UI format.

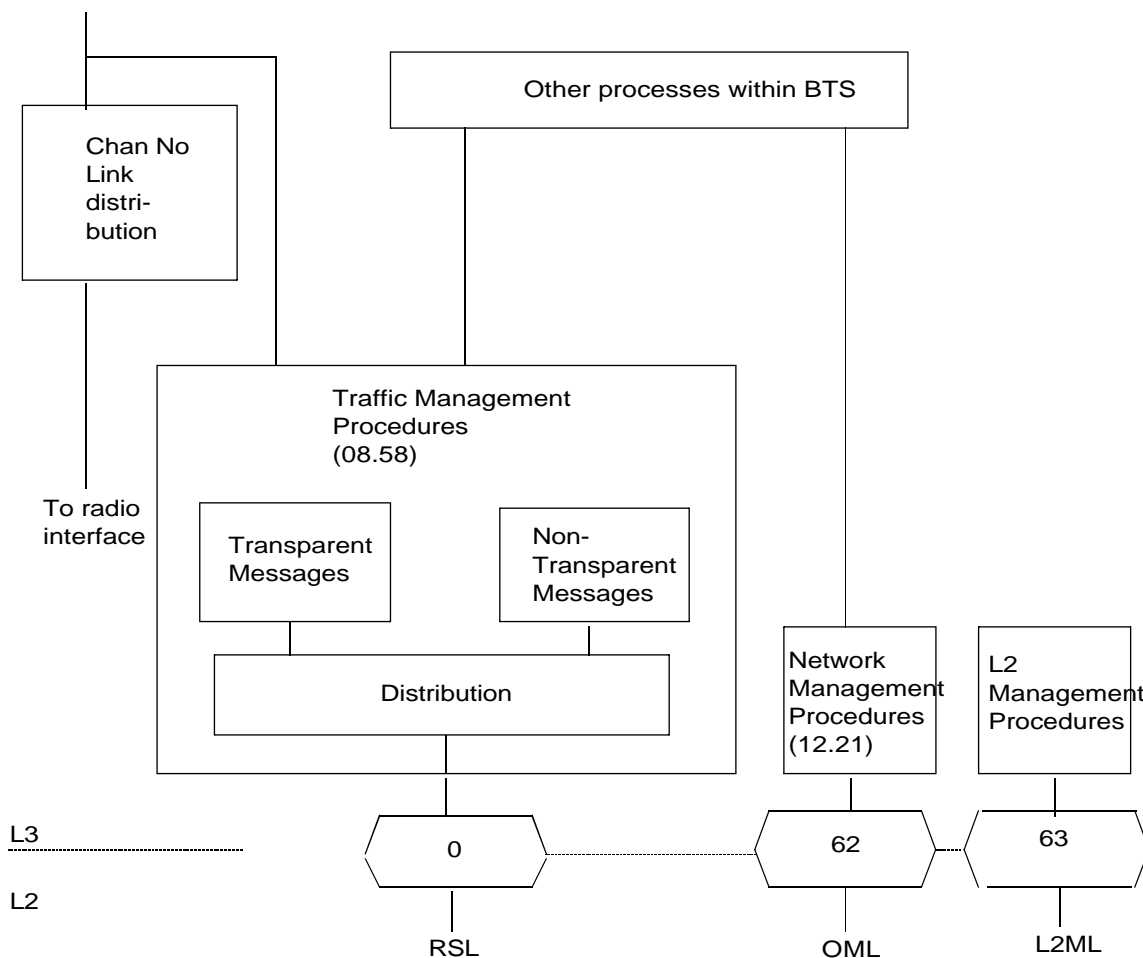

Figure 2.1/08.58: L3 model.

3 Radio Link Layer Management Procedures

This section describes procedures related to the management of a link layer connection on the radio path.

3.1 Link establishment indication

This procedure is used by BTS to indicate to BSC that a layer 2 link on the radio path has been established in multi-frame mode at the initiative of an MS. BSC can use this indication to set up an SCCP connection to MSC.

Upon reception of a SABM frame on a link on an active channel, the BTS sends an ESTablish INDication message to BSC. The message contains the contents of the information field of the SABM frame if present.

The procedure is used in all establishment cases, for all channels and all SAPIs.

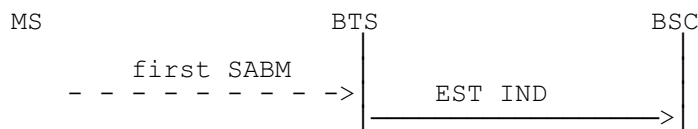

3.2 Link establishment request

This procedure is used by BSC to request the establishment of a link layer connection in multi-frame mode on the radio path.

The procedure is started by BSC sending an ESTablish REQuest message to BTS. BTS then establishes the link by sending an SABM frame. Upon reception of the acknowledgement (UA-frame) from MS, BTS sends an ESTablish CONFirm message to BSC.

In case of a failure, BTS sends a RELease INDication and an ERRor INDication message to BSC (cf TS GSM 04.06).

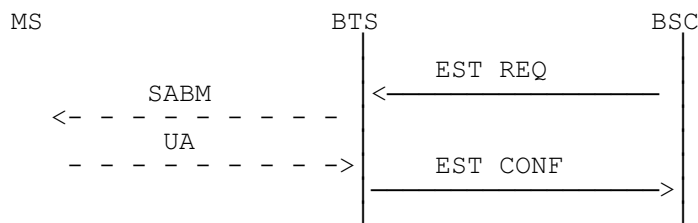

3.3 Link release indication

This procedure is used by BTS to indicate to BSC that a link layer connection on the radio path has been released at the initiative of an MS.

When receiving a DISC frame on a link layer connection in multi-frame mode, BTS sends a RELease INDication message to BSC. (If the link layer is in idle mode, BTS will send a DM frame to MS but does not notify BSC.)

Collision cases are treated as specified in Technical Specification GSM 04.06.

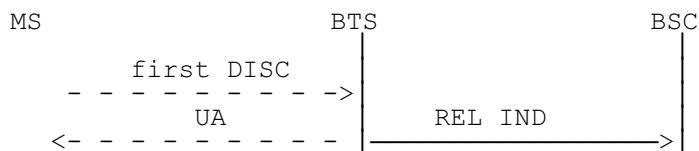

3.4 Link release request

This procedure is used by BSC to request the release of a link layer connection on the radio path.

The procedure is started by BSC sending a RELease REQuest message to BTS. BTS then sends a DISC frame to MS. When it has received the acknowledgement (UA or DM frame), BTS sends a RELease CONFirm message to BSC.

Collision cases are treated as specified in Technical Specification GSM 04.06.

If BTS has repeated the DISC frame N200 times, BTS sends a RELease INDication and an ERRor INDication message to BSC (cf TS GSM 04.06).

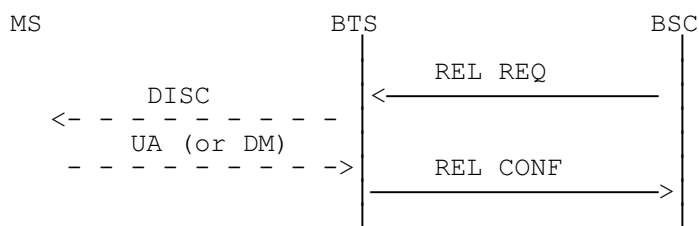

3.5 Transmission of a transparent L3-Message in acknowledged mode

This procedure is used by BSC to request the sending of a L3 message to MS in acknowledged mode.

BSC sends a DATA REQuest message to BTS. The message contains the complete L3 message to be sent in acknowledged mode.

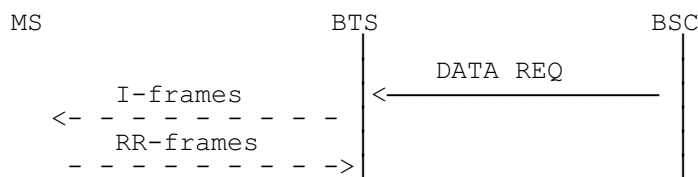

3.6 Reception of a transparent L3-Message in acknowledged mode

This procedure is used by BTS to indicate the reception of a L3 message in acknowledged mode.

BTS sends a DATA INDication message to BSC. The message contains the received L3 message.

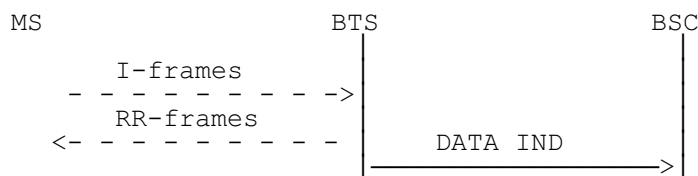

3.7 Transmission of a transparent L3-Message in unacknowledged mode

This procedure is used by BSC to request the sending of a L3 message to MS in unacknowledged mode.

BSC sends a UNIT DATA REQuest message to BTS. The message contains the L3 message to be sent to MS in unacknowledged mode.

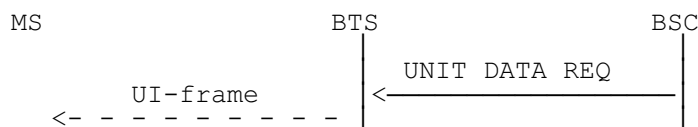

3.8 Reception of a transparent L3-Message in unacknowledged mode

This procedure is used by BTS to indicate the reception of a L3 message in unacknowledged mode.

BTS sends a UNIT DATA INDication message to BSC. The message contains the received L3 message.

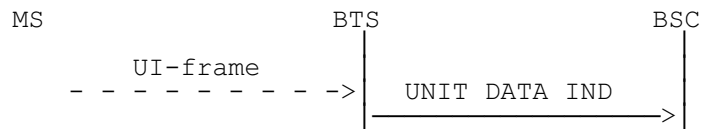

3.9 Link error indication

This procedure is used by BTS to indicate an abnormal case such as the following.

- a protocol error as specified in Technical Specification GSM 04.06, sections 5.6.4, 5.7.3 and Annex G;
- a link layer failure, i.e. the repetition of an I-frame N200 times without an acknowledgement;
- the repetition of an SABM or DISC frame N200 times without an acknowledgement;
- the reception of an SABM frame in multi-frame established state.

When such an event has occurred, BTS notifies BSC by sending an ERROR INDication message containing the relevant cause information.

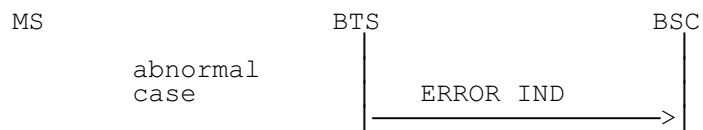

4 Dedicated channel management procedures

4.1 Channel activation

This procedure is used to activate a channel at BTS for an MS which later will be commanded to this channel by an IMMEDIATE ASSIGN, an ASSIGN CoMmanD, an ADDitional ASSIGNment or a HANdOver CoMmanD message.

In the handover case, the procedure is used between the target BSC and the target BTS to activate a channel for a subsequent handover from the old BTS.

4.1.1 Signalling Procedure

BSC determines what channel shall be used and starts up that channel at BTS by sending a CHANnel ACTIVation message to the relevant TRX. This message contains the reason for the activation (immediate assignment, assignment, asynchronous/synchronous handover, additional assignment), the identification of the channel to be used (channel no) and a complete description of the channel (full/half rate, speech/data, coding/rate adaption, hopping sequence, encryption key etc.)

If the Encryption Information field is present, the activation is done with ciphering active. If the Encryption Information element is not present, activation is done without ciphering.

After activating the channel as requested, TRX responds with the CHANnel ACTIVation ACKnowledge message. This message contains the current frame number at BTS. The frame number is used by BSC to determine the Starting Time parameter to be included in the following assignment message to MS. (A suitable number has to be added to current frame number to take all possible signalling delays into account).

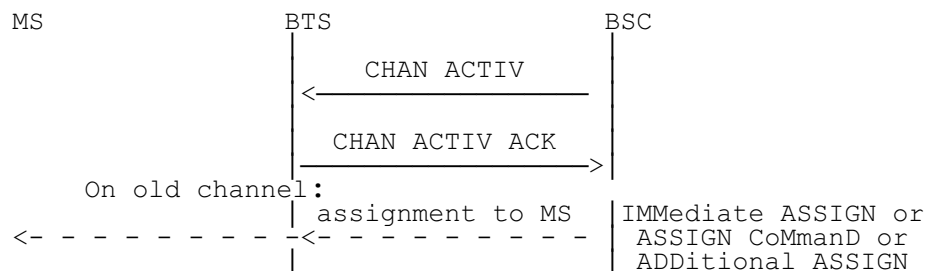

If the TRX for some reason cannot activate the resource as requested by the CHANnel Activation message, the TRX shall return a CHANnel ACTIVation Negative ACKnowledge message with the most appropriate cause value.

Possible cause values may be:

- O&M intervention (e.g. channel blocked),
- resource not available (e.g. speech coder, encryption device),
- equipment failure,
- channel already activated,
- etc.

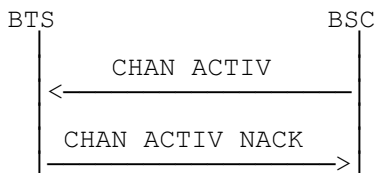

In the handover case, the procedure is initiated by the target BSC when this receives the HANdOver REQuest message from MSC (or autonomously by BSC for BSC internal handover). The BSC sends a CHANnel ACTIVation message to the relevant TRX. The message contains the Handover Reference value which can be used by the BTS to check the Handover Access from MS. After activation of the channel TRX responds with a CHANnel ACTIVation ACKnowledge message containing the current frame number at BTS.

The BSC can then determine the Starting Time parameter to be included in the HANdOver REQuest ACKnowledge message to MSC (and the HANdOver CoMmanD message to MS).

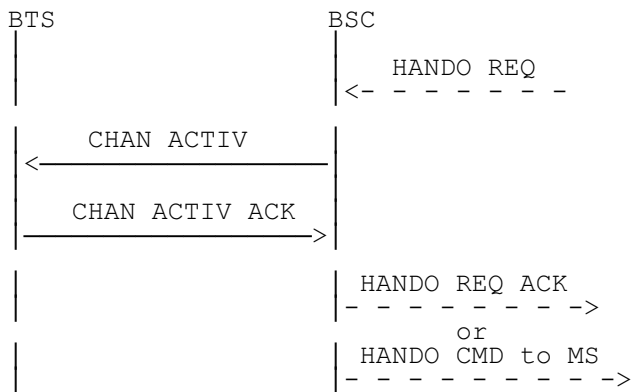

4.1.2 Activation for Intra-Cell Channel Change

This activation precedes the Immediate Assignment, Assignment or Additional assignment procedures. The Timing Advance element must be included in the CHANNEL ACTIVATION message.

BTS activates the channel and starts transmission and reception on the main channel in the indicated mode. Ciphering is started if so indicated in the encryption information.

The reception and transmission on SACCH is also started immediately.

If the BS and/or MS power elements and/or the Physical Context element are present, the reception and transmission processes and the L1-header of SACCH are initialised accordingly.

4.1.3 Activation for Asynchronous Handover

BTS starts transmission immediately on the main channel in the indicated mode and with encryption if so indicated. If the MS Power element is present the BTS may start transmission also on the SACCH.

When receiving a correct access burst with the correct handover reference, BTS starts the normal reception process on the main channel in the indicated mode and starts receiving (and sending if not started earlier) on SACCH. Deciphering is started if so indicated. The handover detection procedure towards BSC is also started.

4.1.4 Activation for Synchronous Handover

BTS starts transmission immediately on the main channel in the indicated mode and with encryption if so indicated. If the MS Power and Timing Advance element are present, BTS shall start transmission also on SACCH with the timing advance and MS power control parameters indicated. If only the MS power element is present the BTS may start transmission also on the SACCH.

When receiving a correct access burst with the correct handover reference, BTS starts the normal reception process on the main channel in the indicated mode, with deciphering applied if so indicated, and starts receiving (and sending if not started earlier) on SACCH. The handover detection procedure towards BSC is also started. Alternatively, the reception of a correctly decoded frame from the MS on the main channel, in the indicated mode and deciphering applied if so indicated, allows the start of sending on SACCH (if not already started) and starts the handover detection procedure towards the BSC.

NOTE: The activation for synchronous handover can be used for pseudo synchronised handover.

4.2 Channel MODE MODIFY

This procedure is used by BSC to request a change of the channel mode of an active channel.

BSC initiates the procedure by sending a MODE MODIFY message to BTS. The message contains the new mode to be used. After having changed to the new mode, BTS responds with a MODE MODIFY ACKnowledge message to BSC.

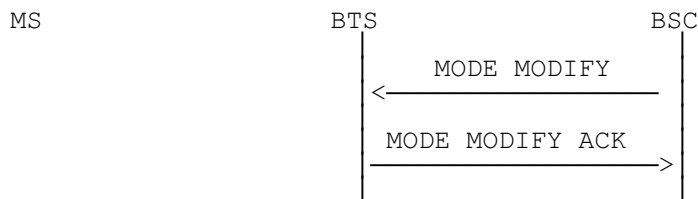

If the TRX for some reason cannot modify the channel as requested in the MODE MODIFY message, the TRX shall return a MODE MODIFY Negative ACKnowledge message with the most appropriate cause value.

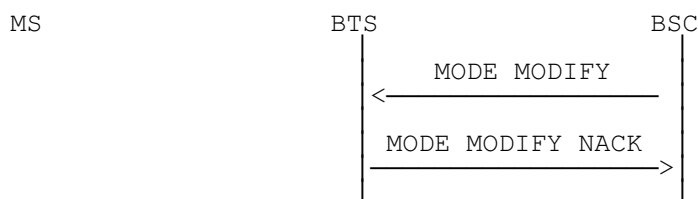

4.3 Handover detection

This procedure is used between the target BTS and BSC when a handed over MS accesses the new BTS.

The procedure is initiated by BTS upon detection of an MS on a channel activated for handover as described in 4.1.3 for the asynchronous handover and in 4.1.4 for synchronous handover.

In case of an asynchronous handover, BTS builds the PHYSical INFOrmation message as specified in Technical Specification GSM 04.08, sends the message to MS in unacknowledged mode on the main signalling link and starts timer T3105. A HANDOVer DETection message is sent to BSC. This message contains the measured delay of the access burst. If the timer expires before the reception of a correctly decoded frame from MS, BTS repeats the PHYSical INFOrmation message to MS as specified in Technical Specification GSM 04.08. If the PHYSical INFOrmation message has been repeated N_{y1} times without a correctly decoded frame being received from MS, the BTS shall send a CONNECTION FAILURE message to BSC with the cause value "handover access failure".

In case of a synchronous handover, BTS only sends a HANDOVer DETection message to BSC (no PHYSical INFOrmation message sent to MS). If the handover detection is based on the detection of an handover access burst with the correct handover reference, see 4.1.4, the measured delay of the access burst is included in the HANDOVer DETection message.

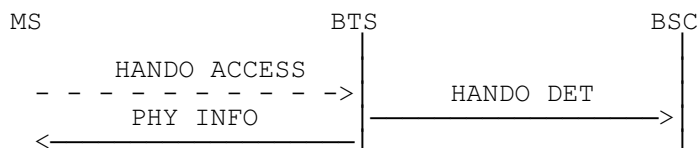

4.4 Start of encryption

This procedure is used to start encryption according to the procedure defined in Technical Specification GSM 04.08.

The procedure is initiated by BSC upon reception of the CIPHER MODE COMMAND message from MSC (see Technical Specification GSM 08.08).

BSC sends the ENCRyption CoMmanD message to the relevant TRX and channel. The message contains all information required to select and load the user data and encryption device with the appropriate key and also the complete Cipherring Mode Command message to be sent to MS.

After receipt of this message, TRX sends the CIPHERing MODE CoMmanD message to MS in unciphered form and starts deciphering as described in Technical Specifications GSM 04.08 and GSM 03.20. The start of deciphering and the sending of the Cipherring Mode Command message to MS must be done simultaneously.

When receiving the CIPHERing MODE CoMmanD, MS starts both deciphering and enciphering and sends the CIPHERing MODE CoMplete message.

TRX starts enciphering upon reception of any correct layer 2 frame which is received after start of deciphering.

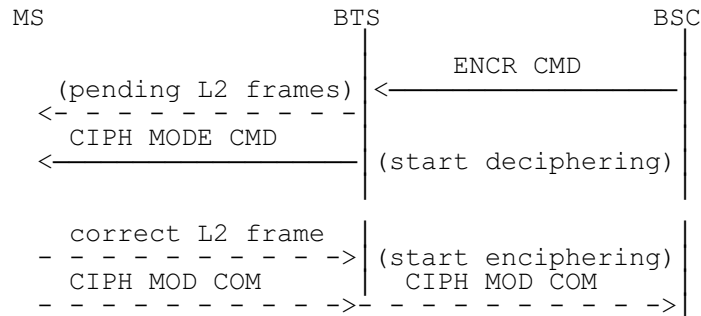

If the TRX for some reason can not perform the enciphering as requested in the ENCRYPTION COMMAND, the TRX shall return an ERROR REPORT message, e.g., with the cause "Encryption algorithm not implemented".

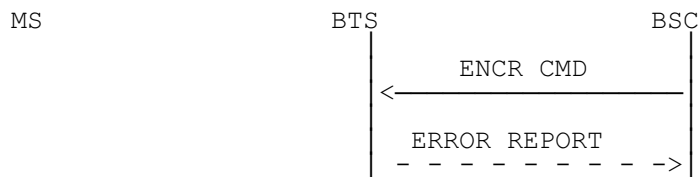

4.5 Measurement reporting

These procedures are used to report to BSC all parameters and measurement results required by BSC for handover requirement determination.

MS measures downlink received signal level and quality from the serving cell and received signal level from surrounding cells as defined in Technical Specifications GSM 05.05 and GSM 05.08. The measurement results are reported in Measurement Report messages sent in every SACCH block (every 480 ms) or, in case SACCH is used also for other signalling, in at least every second SACCH block (every 960 ms).

The TRX measures the received signal level and the quality on the uplink of the current channel. The averaging period is one SACCH block period (same as the basic period for MS).

These measurements made by MS and TRX form the basic raw data for the handover algorithms in BSC/MS. The support of forwarding this raw data over the A-bis interface is mandatory for both BTS and BSC. The procedure to be used for this basic measurement reporting is defined in section 4.5.1.

In addition, the BTS and BSC may optionally support some pre-processing in BTS of these basic measurements. The additional and optional procedures required to support this pre-processing are defined in section 4.5.2.

4.5.1 Basic measurement reporting

This procedure is used by BTS to report the results of the basic radio measurements made by MS and TRX according to Technical Specifications GSM 05.08 and GSM 05.05. The support of this procedure is mandatory in all BTS:s and all BSC:s. It is the default procedure to use unless otherwise indicated (see section 4.5.2.1 below).

TRX reports all these measurements in MEASUREMENT RESULT messages to BSC. The sending of the MEASUREMENT RESULT messages is synchronized with the reception of SACCH blocks from MS.

If an uplink SACCH block does not contain a MEASUREMENT REPORT from MS (e.g. when it sends a short message), only the uplink measurement results are included with an indication that the MS measurements are missing.

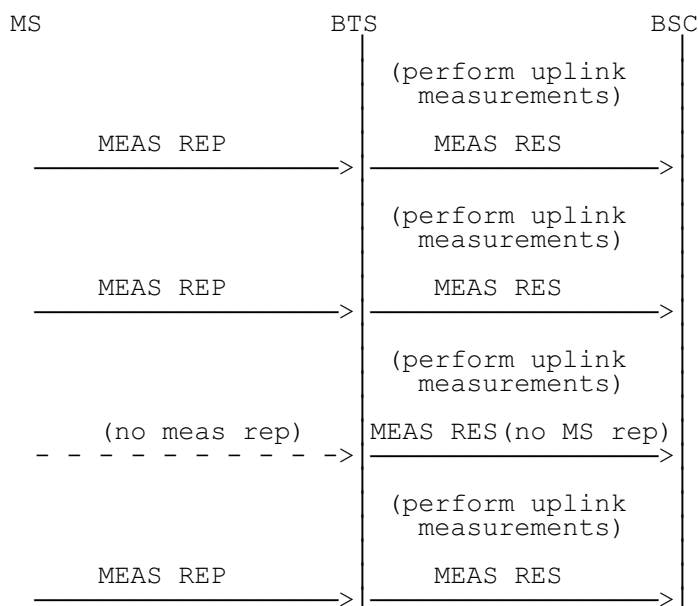

4.5.2 Measurement pre-processing

These additional and optional procedures are included to support some pre-processing in BTS of radio measurement data. When used, they may replace the basic procedure defined in section 4.5.1. However, it shall be possible to change back to the basic procedure.

Pre-processing in BTS must not affect the procedures on the A interface (e.g. the Handover Candidate Enquiry procedure).

4.5.2.1 Pre-processing configuration

This procedure is used by BSC to modify the pre-processing parameters according to reported communication conditions (e.g. degradation of the communication).

In order to change the parameters, BSC sends a PREPROCESS CONFIGURE message to BTS.

A parameter setting in the PREPROCESS CONFIGURE message indicates if the basic procedure defined in section 4.5.1 or pre-processing is to be used.

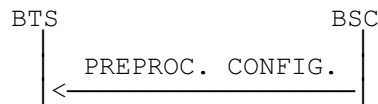

4.5.2.2 Pre-processed measurement reporting

This procedure is used by BTS to report the results of measurement pre- processing.

To report the results, BTS sends a PREPROCESSED MEASUREMENT RESULT message to BSC.

The conditions to send the message are set in the PREPROCESS CONFIGURE message.

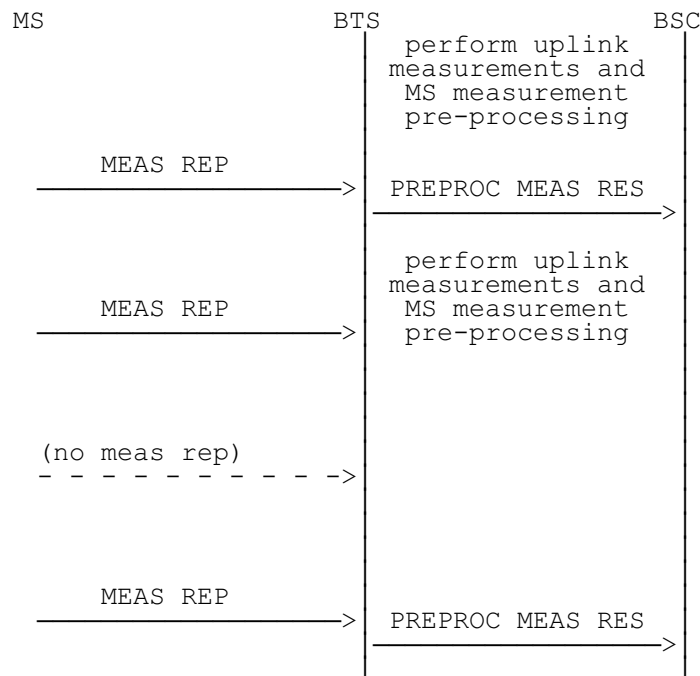

4.6 Deactivate SACCH

This procedure is used by BSC to deactivate the SACCH at BTS according to the Channel Release procedure defined in Technical Specification GSM 04.08.

When sending the Channel Release message to MS, BSC also sends the DEACTIVATE SACCH message to BTS to deactivate the SACCH (see GSM 04.08, Channel Release procedure).

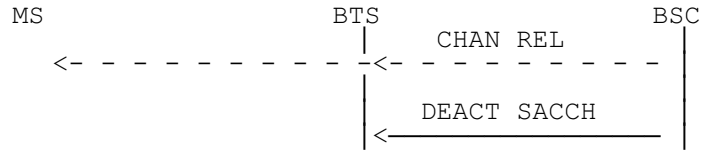

4.7 Radio channel release

This procedure is used by BSC to release a radio channel which is no longer needed.

When an activated radio channel is no longer needed, BSC sends an RF CHANnel RElease message to the relevant TRX and channel. After having released the addressed resources, the BTS sends a RF CHANnel RElease ACKnowledge to BSC.

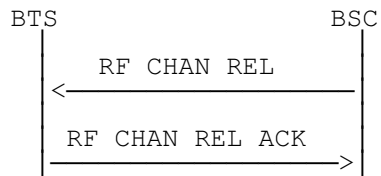

4.8 MS power control

This procedure is used by BSC to set the MS power level or the parameters required by TRX for the control of MS power.

The initial parameters are set by BSC in the CHANNEL ACTIVATION message (see Channel Activation procedure). If these parameters are to be changed for an active channel, BSC sends a MS POWER CONTROL message to TRX.

The support of the power control performed by BTS is optional.

If power control is supported by BTS and it is to be used, this is indicated by optional parameters in the MS POWER CONTROL message (or the CHANNEL ACTIVATION message). Based on the measurements performed on the uplink, TRX then attempts to keep the power control parameters within the limits set by the MS POWER CONTROL message (or by the CHANNEL ACTIVATION message) by changing the MS Power Level field of the L1 header sent to MS in each SACCH block. MS confirms the power in the uplink L1 header.

When the BTS supports MS power control the BSC can modify the MS power parameters during the connection (e.g. because of a classmark change) by sending a MS POWER CONTROL message containing the new parameters.

The MS POWER CONTROL and the CHANNEL ACTIVATION message must also contain a maximum power permitted for the MS.

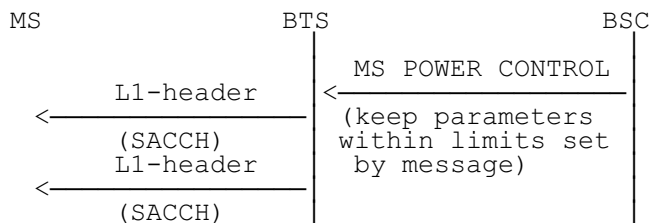

4.9 Transmission power control

This is an optional procedure which is used between BSC and BTS to set the TRX transmission power level or the parameters required by TRX for the control of TRX transmission power.

The initial parameters are set by BSC in the CHANNEL ACTIVATION message (see Channel Activation procedure). If these parameters are to be changed for an active channel, BSC sends a BS POWER CONTROL message to TRX.

The support of the power control performed by BTS is optional.

If power control is supported by BTS and it is to be used, this is indicated by optional parameters in the BS POWER CONTROL message (or the CHANNEL ACTIVATION message). Based on the Measurement Report messages sent by MS, the TRX will then attempt to keep the power control parameters within the limits set in the BS POWER CONTROL message (or by the CHANNEL ACTIVATION message) by changing the transmitted power on that channel.

The maximum power of the TRX is determined from network planning criteria. However, BSC may indicate a lower maximum power in the BS POWER CONTROL message (or the CHANNEL ACTIVATION message).



4.10 Connection failure

This procedure is used by BTS to indicate to BSC that an active connection has been broken (e.g. due to a radio link failure as defined in Technical Specification GSM 05.08).

When BTS detects that a connection has been broken, BTS sends a CONNecTion FAILure INDication message to BSC with the most proper cause value. Further actions are defined in Technical Specification GSM 04.08.

Some possible cause values are:

- radio link failure (as defined in TS GSM 05.08);
- hardware failure (e.g. transcoder failure);
- etc.



4.11 Physical context request

This is an optional procedure which allows the BSC to obtain information on the "physical context" of a radio channel just prior to a channel change. This information may be forwarded to the new TRX (possibly in another collocated cell).

The procedure is initiated by BSC sending a PHYSICAL CONTEXT REQUEST message to TRX. TRX responds with a PHYSICAL CONTEXT CONFIRM message which contains information on the "physical context" of the channel.

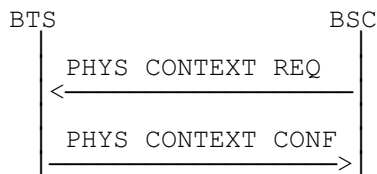

4.12 SACCH information modify

This procedure is used by the BSC to modify the SACCH filling information (System Information) sent on an individual SACCH channel. For this purpose, the BSC sends a SACCH INFO MODIFY message to the TRX. The SACCH filling information as given in the SACCH INFO MODIFY message shall be used on the indicated channel until the channel is released or the information is changed by another SACCH INFO MODIFY message.



5 Common channel management procedures

5.1 Channel request by MS

The procedure is initiated by TRX upon detection of a random access from an MS (CHANnel REQuest message from MS). TRX then sends a CHANnel ReQuireD message to BSC containing the Request Reference parameter (random number selected by MS plus some low order bits of the TDMA frame number for the access) and the measured delay of the Access Burst.

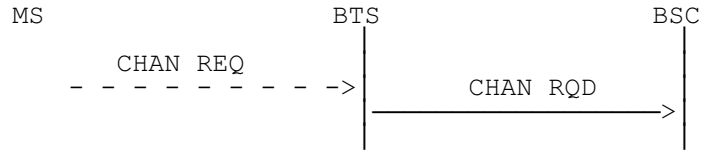

5.2 Paging

This procedure is used to request the paging of one mobile station on a given paging subchannel.

The paging of an MS is initiated by BSC sending a PAGing CoMmanD message to BTS. The message contains the MS identity (TMSI or IMSI), the paging population number of the MS and optionally an indication for the MS about which combination of channels will be needed for the subsequent transaction related to the paging.

The PAGing REQuest messages to be sent on the radio path are built and sent by BTS.

The use by BTS of the "extended paging" facilities and the general downlink scheduling of the downlink CCCH is operator dependant and is not specified in this specification. This process may also be influenced by O&M procedures.

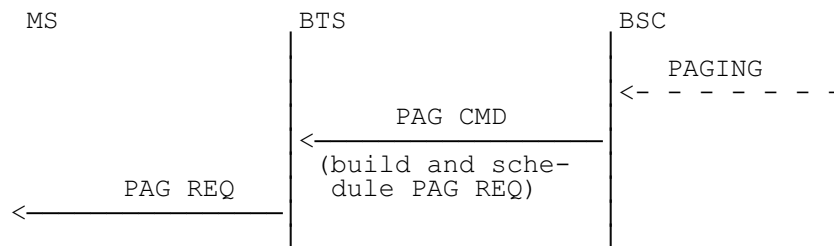

5.3 Delete indication

This procedure is used by BTS to indicate that due to overload on the downlink CCCH, an IMMEDIATE ASSIGN COMMAND has been deleted.

For that purpose BTS sends a DELETE INDICATION message to BSC.



5.4 CCCH load indication

This procedure is used by a BTS to inform the BSC of the load on a particular CCCH timeslot.

The CCCH LOAD INDICATION message is sent regularly from BTS to BSC if the load exceeds some value set by O&M. The sending rate is also set by O&M.

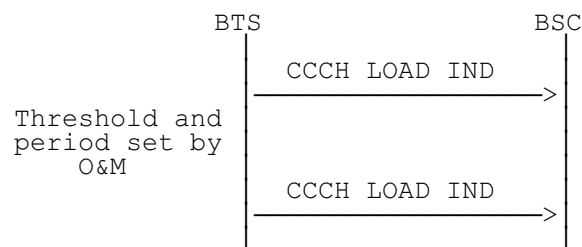

5.5 Broadcast information modify

This procedure is used by BSC to indicate to BTS the new information to be broadcast on BCCH.

For that purpose, BSC sends a BCCH INFORMATION message to BTS.



5.6 Short Message Cell Broadcast

Short Message Service Cell Broadcast messages are sent to BTS as SMS BROADCAST REQUEST or SMS BROADCAST COMMAND messages.

With the SMS BROADCAST REQUEST mode of operation, the BSC handles the queuing, repetition and transmission of the messages taking the capacity of the CBCH into account. The BSC is also responsible for the segmentation of the SMS Cell Broadcast messages on the Air interface:

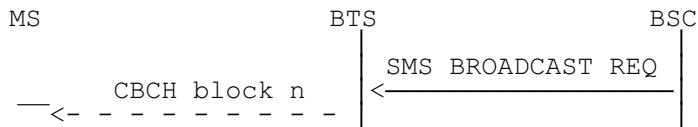

With the SMS BROADCAST COMMAND mode of operation, the BSC can request the broadcast of a complete Cell Broadcast message. The BSC handles the queuing, repetition and transmission of the messages taking the capacity of the CBCH into account. The BSC is responsible for the segmentation of the SMS Cell Broadcast messages on the Air interface:

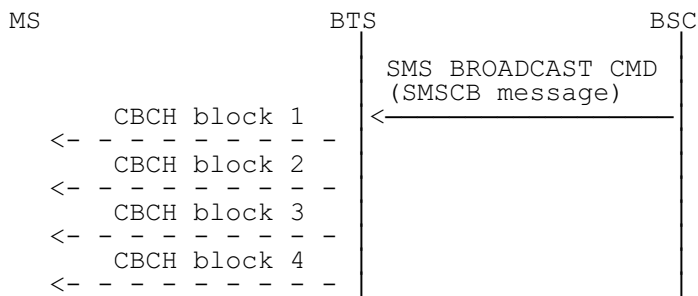

With the SMS BROADCAST COMMAND mode of operation, the BSC can also set the BTS broadcast default mode. The BTS is then responsible for transmission of a default message when no other message is to be broadcast.

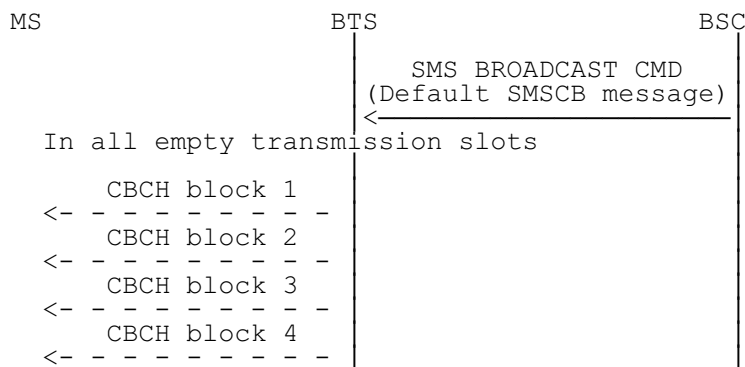

Even though BSC handles the transmission of messages taking the capacity of CBCH into account, BTS can indicate to BSC if an overflow or underflow situation is about to happen in the CBCH. With the CBCH LOAD INDICATION mode of operation, the BTS can request immediate broadcast of m (=amount indicated in the CBCH Load Information element) scheduled SMSCB messages in the underflow situation. BSC shall transmit m scheduled messages and after that continue the broadcast of messages according to its own timetable. If BTS requests more messages than BSC is possessing, then BSC shall transmit only the amount it is possessing. CBCH LOAD INDICATION mode of operation could only be applied when DRX mode is used (see TS GSM 04.12).

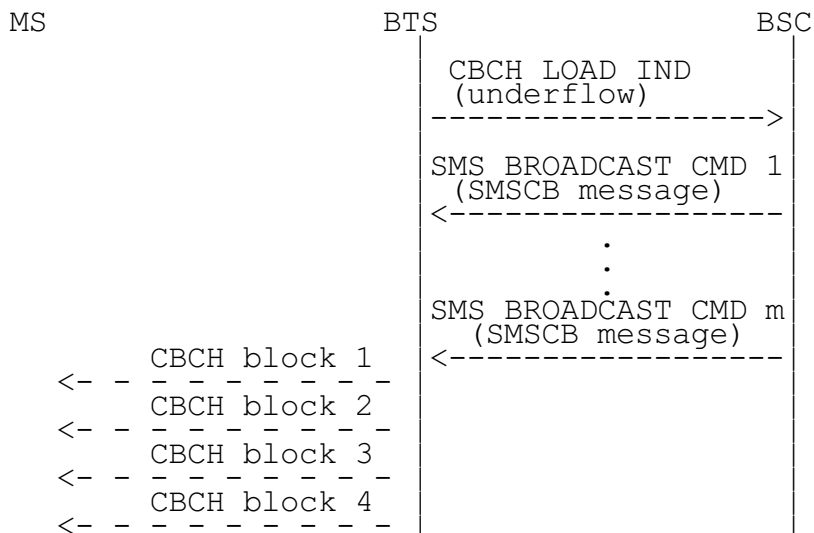
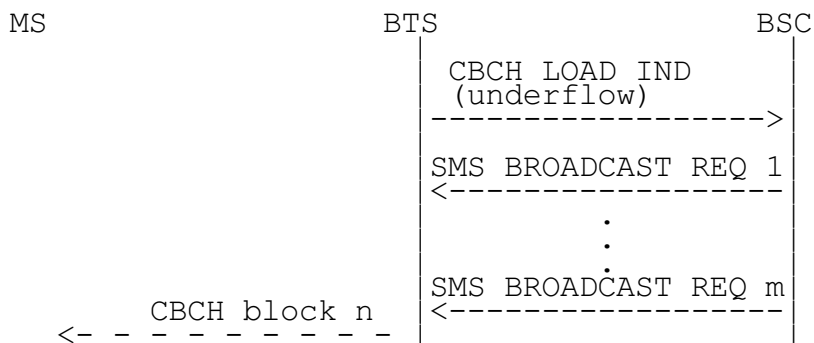

With the CBCH LOAD INDICATION mode of operation, the BTS can also request immediate stop of broadcast for a period of m (=amount indicated in the CBCH Load Information element) message slots in the overflow situation. BSC shall stop the broadcast for a period of m message slots and after that continue the broadcast of messages according to its own timetable.

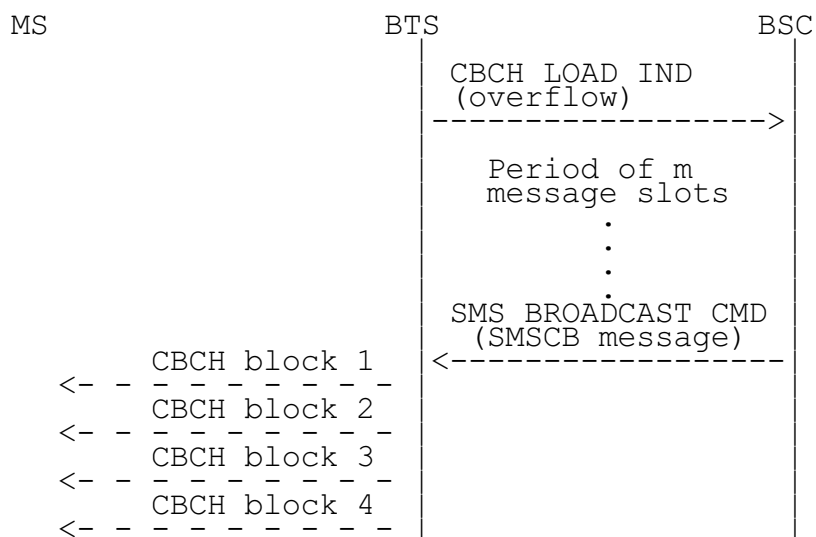
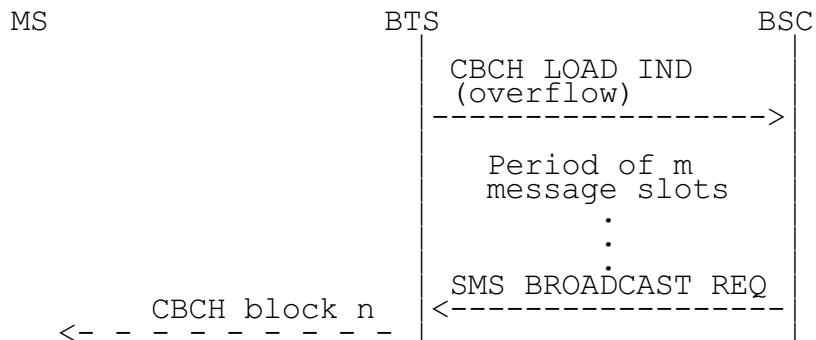

5.7 IMMEDIATE ASSIGNMENT

This procedure is used by BSC to request the transmission of an immediate assign message on downlink CCCH. To initiate the immediate assign, the BSC sends an IMMEDIATE ASSIGN COMMAND message. The message contains the complete immediate assign message as defined in Technical Specification GSM 04.08 (IMMEDIATE ASSIGNMENT or IMMEDIATE ASSIGNMENT EXTENDED or IMMEDIATE ASSIGNMENT REJECT) with the "Page Mode" element set to the value "no change". Upon receipt of the message, the BTS may transmit the immediate assignment message as received or combine several to construct the IMMEDIATE ASSIGNMENT EXTENDED or IMMEDIATE ASSIGNMENT REJECT. The BTS may also update the "Page Mode" element before transmission.

The IMMEDIATE ASSIGNMENT EXTENDED message is either sent by the BSC in the IMMEDIATE ASSIGN COMMAND, or built by the BTS from up to two IMMEDIATE ASSIGN COMMAND messages.

The IMMEDIATE ASSIGNMENT REJECT message is either sent by the BTS as received in the IMMEDIATE ASSIGN COMMAND message or built by the BTS from the contents of two or more IMMEDIATE ASSIGN COMMAND messages. For the latter case the BTS may consider request references with identical contents within the same message as duplicates and all but one may be suppressed.

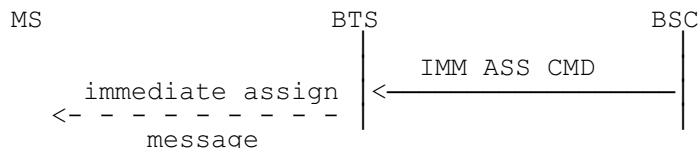

6 TRX management procedures

6.1 Radio resource indication

This procedure is used to inform BSC on the interference levels on idle channels of a TRX.

In the RF RESource INDication message, TRX reports the interference level for each of the channels which have been idle (not active) for the whole measurement period. See also Technical Specifications GSM 08.08, section 3.1.3.1 and GSM 05.08, section 3.1 e) of Appendix A.

The RF RESource INDication message is sent regularly with a rate set by O&M.

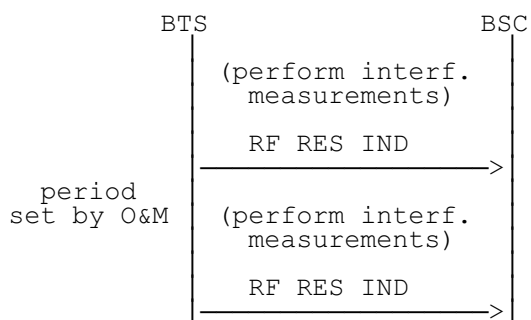

6.2 SACCH filling information modify

This procedure is used by BSC to indicate to BTS the new information to be used as filling information on SACCHs.

For that propose BSC sends a SACCH FILLing message to BTS.



6.3 Flow control

This procedure is defined to give some degree of flow control. It can be used for TRX processor overload, downlink CCCH overload and ACCH overload.

The algorithm used in BSC to control the traffic flow is as follows:

Upon receipt of the first OVERLOAD message, BSC reduces the traffic by one step and starts timers T1 and T2. During T1 all OVERLOAD messages are ignored in order not to reduce the traffic too rapidly. Reception of an OVERLOAD message after T1 but still during T2 will decrease the traffic by one more step and timers T1 and T2 are restarted. This step by step reduction of traffic is continued until maximum reduction is obtained.

If T2 expires (i.e. no OVERLOAD message was received during T2), the traffic will be increased by one step and T2 restarted. This step by step increase of traffic will be continued until full load has been resumed.

The number of steps and the method of reducing the load is considered to be implementation dependent. For example, the amount of random accesses and thereby access grants can be reduced by use of the RACH Control parameters (e.g. Access Control Class or Cell Barred) or the Cell Selection parameters (e.g. CELL-RESELECT-HYSTERESIS or RXLEV- ACCESS-MIN) in the system information messages of Technical Specification GSM 04.08.

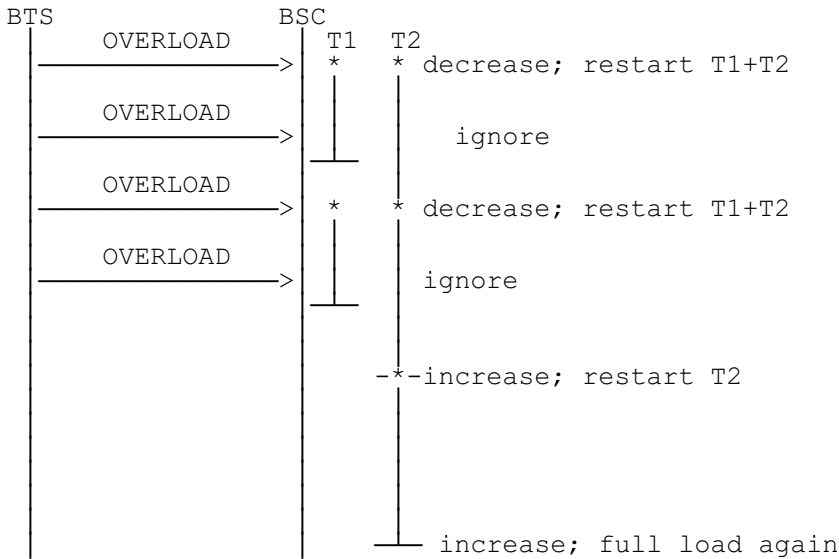

6.4 Error reporting

This procedure is used by BTS to report detected errors as described in section 7 below if they cannot be reported by any other procedure.

When TRX detects the reception of an erroneous message, it sends an ERROR REPORT message to BSC with the most appropriate cause value. In order to identify the erroneous message, the Message Type, the Channel Number, the Link Identifier and/or the complete erroneous message can be included.



7 Error handling

7.1 General

The procedures specified above apply to those messages which pass the checks described below.

The behaviour of BSC in erroneous cases is implementation dependent.

The behaviour of BTS in erroneous cases is to ignore the message and to send a report to BSC. The report can be sent in either of the following messages:

- CHANNEL ACTIVATION NACK in connection with channel activations;
- MODE MODIFY NACK in connection with a channel mode change;
- ERROR REPORT in other cases.

For procedures controlled by the BSC, and in particular procedures where the BSC sends a request for resources at the BTS and waits for an acknowledge, the implementation in the BSC must provide means for avoiding deadlock situations at the BTS as e.g. hanging resources.

7.2 Message discriminator error

A message with a non-specified message discriminator is erroneous.

7.3 Message type error

A message with a non-specified message type is considered correct, but is ignored by BTS.

7.4 Message sequence error

A message with an existing message type which is not possible according to the specification and to the state of the BTS is erroneous.

7.5 General information element errors

This category includes:

- Information element out of sequence;
- Abnormally duplicated element;
- Missing element.

A message with such an error is erroneous.

7.6 Mandatory information element errors

This includes:

- a) Non-existing element type.
- b) Information length error.
- c) Content which does not comply with the specification (value reserved for future use is considered as case d)).
- d) Value indicated as reserved for future use.
- e) Bits reserved for future use not set to 0.
- f) Content complying with specification but incompatible with the state.
- g) Content complying with the specification but inconsistent.

All cases except e) are considered erroneous.

In case e), BTS simply ignores the reserved (RFU) bits.

7.7 Optional information element errors

The same categories of errors as in previous section apply.

In cases other than b), e), f) and g), BTS ignores the element and processes the rest of the message.

Cases b), f) and g) are considered erroneous.

In case e), BTS ignores the reserved (RFU) bits.

7.8 Conditional information element errors

The same categories of errors as in section 7.6 apply.

If the conditions for presence of the element are met, the same erroneous cases as in section 7.6 apply.

If the conditions for presence of the element are not met, the same erroneous cases as in section 7.7 apply.

8 Message formats and contents

This section defines the format and contents of the messages sent over the A-bis interface. Similar coding principles as in recs. 04.08 and 08.08 are used.

For each message, the contained Information Elements are listed. For each Information Element, the following information is given:

- Name of Information Element;
- Reference section for the coding of the Information Element;
- Presence condition for the Information Element,
 - M Mandatory, must always be present;
receiver: if not present, consider message erroneous;
 - C Conditional, presence depending on e.g.
 - a) value of other element,
 - b) presence of optional element;
receiver: if not present when condition met, consider message erroneous, else accept message;
 - O Optional, receiver: present or not, accept message;
- Format of Information Element:
 - T Type only, fixed length, only Element Identifier;
 - V Value only, fixed length, no Element Identifier included;
 - TV Type and Value, fixed length, Element Identifier included;
 - TLV Type, Length and Value, variable length, Element Identifier and Length Indicator included;
- Total length of Information Element; for variable length, lower and upper limits.

NOTE: Maximum message length is determined by the N201 parameter of TS GSM 08.56.

In a message, the message discriminator is transmitted first. The purpose is to distinguish between transparent messages (T-bit set to 1) and non-transparent messages (T-bit set to 0) and also between messages related to Radio Link Layer Management, Dedicated Channel Management, Common Channel Management and TRX Management. The octets are sent in the order shown in the description of the messages and information elements.

8.1 Transparent messages

Transparent messages are used at the A-bis interface to convey layer 3 messages for the radio interface as defined in Technical Specification GSM 04.08 and for which BTS has to take or has taken no specific action. The T-bit of the Message Discriminator is set to 1.

In the uplink direction (messages from MS), all messages received in I- frames and all messages received in UI-frames except for the MEASurement REPort message are considered as transparent. They are forwarded to BSC as DATA INDication and UNIT DATA INDication messages respectively.

In the downlink direction (messages to MS) all messages as defined in Technical Specification GSM 04.08 are transparent except for the following messages, which are replaced by BSC-BTS specific messages over the A- bis interface and where BTS will send the corresponding L3 message over the radio interface after the necessary actions have been taken:

<u>Message to MS</u>	<u>Replaced on A-bis interface by</u>
CIPHERing MODe CoMmanD	ENCRyption CoMmanD
PAGing REQuest	PAGing CoMmanD
SYSTEM INFOrmation	BCCH INFOrmation and SACCH FILLing
Immediate assign (3 types)	IMMEDIATE ASSIGN COMMAND

Transparent messages are sent by BSC as DATA REQuest or UNIT DATA REQuest messages.

8.2 Non-transparent messages (BSC-BTS specific messages)

These messages are used over the A-bis interface for messages on which BTS has to take some action (BSC to BTS direction) and for messages which are the result from actions taken by BTS (BTS to BSC direction). The T-bit of the Message Discriminator is set to 0.

8.3 Radio link layer management messages

These messages are related to Radio Link Layer Management procedures. They all have the following general format:

INFORMATION ELEMENT	REFERENCE	PRESENCE	FORMAT	LENGTH
Message discriminator	9.1	M	V	1
Message type	9.2	M	V	1
Channel number	9.3.1	M	TV	2
Link Identifier	9.3.2	M	TV	2
(Information elements depending on message type)				

The messages concerned are the following :

<u>Message name</u>	<u>Reference section</u>
DATA REQuest	8.3.1
DATA INDication	8.3.2
ERROR INDication	8.3.3
ESTablish REQuest	8.3.4
ESTablish CONFirm	8.3.5
ESTablish INDication	8.3.6
RELease REQuest	8.3.7
RELease CONFirm	8.3.8
RELease INDication	8.3.9
UNIT DATA REQuest	8.3.10
UNIT DATA INDication	8.3.11

8.3.1 DATA REQUEST

This message is sent from BSC to BTS to request the sending of a message in acknowledged mode on a radio link layer connection.

INFORMATION ELEMENT	REFERENCE	PRESENCE	FORMAT	LENGTH
Message discriminator	9.1	M	V	1
Message type	9.2	M	V	1
Channel number	9.3.1	M	TV	2
Link Identifier	9.3.2	M	TV	2
L3 Information	9.3.11	M	TLV	>=3

8.3.2 DATA INDICATION

This message is sent from BTS to BSC to indicate the reception of a message in acknowledged mode on a radio link layer connection.

INFORMATION ELEMENT	REFERENCE	PRESENCE	FORMAT	LENGTH
Message discriminator	9.1	M	V	1
Message type	9.2	M	V	1
Channel number	9.3.1	M	TV	2
Link Identifier	9.3.2	M	TV	2
L3 Information	9.3.11	M	TLV	>=3

8.3.3 ERROR INDICATION

This message is sent from BTS to BSC to indicate an abnormal case for a radio link layer connection.

INFORMATION ELEMENT	REFERENCE	PRESENCE	FORMAT	LENGTH
Message discriminator	9.1	M	V	1
Message type	9.2	M	V	1
Channel number	9.3.1	M	TV	2
Link Identifier	9.3.2	M	TV	2
RLM Cause	9.3.22	M	TLV	2-4

8.3.4 ESTABLISH REQUEST

This message is sent from BSC to BTS to request the establishment of a multi-frame mode (acknowledged mode) link layer connection on the radio path.

INFORMATION ELEMENT	REFERENCE	PRESENCE	FORMAT	LENGTH
Message discriminator	9.1	M	V	1
Message type	9.2	M	V	1
Channel number	9.3.1	M	TV	2
Link Identifier	9.3.2	M	TV	2

8.3.5 ESTABLISH CONFIRM

This message is sent from BTS to BSC to confirm the establishment of a radio link layer connection in multi-frame (acknowledged) mode.

INFORMATION ELEMENT	REFERENCE	PRESENCE	FORMAT	LENGTH
Message discriminator	9.1	M	V	1
Message type	9.2	M	V	1
Channel number	9.3.1	M	TV	2
Link Identifier	9.3.2	M	TV	2

8.3.6 ESTABLISH INDICATION

This message is sent from BTS to BSC to indicate the establishment of a radio link layer connection in multi-frame mode, initiated by an MS.

INFORMATION ELEMENT	REFERENCE	PRESENCE	FORMAT	LENGTH
Message discriminator	9.1	M	V	1
Message type	9.2	M	V	1
Channel number	9.3.1	M	TV	2
Link Identifier	9.3.2	M	TV	2
L3 Information	9.3.11	O 1)	TLV	3-23

- 1) The L3 Information field is present only if the SABM frame contained a non-empty information field.

NOTE: The "establish mode" parameter appearing in TS GSM 04.06 is used only on the MS side.

8.3.7 RELEASE REQUEST

This message is sent from BSC to BTS to request the release of multi- frame mode of a radio link layer connection.

INFORMATION ELEMENT	REFERENCE	PRESENCE	FORMAT	LENGTH
Message discriminator	9.1	M	V	1
Message type	9.2	M	V	1
Channel number	9.3.1	M	TV	2
Link Identifier	9.3.2	M	TV	2
Release Mode	9.3.20	M	TV	2

8.3.8 RELEASE CONFIRM

This message is sent from BTS to BSC to confirm the release of multi- frame mode of a radio link layer connection.

INFORMATION ELEMENT	REFERENCE	PRESENCE	FORMAT	LENGTH
Message discriminator	9.1	M	V	1
Message type	9.2	M	V	1
Channel number	9.3.1	M	TV	2
Link Identifier	9.3.2	M	TV	2

8.3.9 RELEASE INDICATION

This message is sent from BTS to BSC to indicate the release of a radio link layer connection (initiated by MS).

INFORMATION ELEMENT	REFERENCE	PRESENCE	FORMAT	LENGTH
Message discriminator	9.1	M	V	1
Message type	9.2	M	V	1
Channel number	9.3.1	M	TV	2
Link Identifier	9.3.2	M	TV	2

8.3.10 UNIT DATA REQUEST

This message is sent from BSC to BTS to request the sending of a message in unacknowledged mode on a radio link layer connection.

INFORMATION ELEMENT	REFERENCE	PRESENCE	FORMAT	LENGTH
Message discriminator	9.1	M	V	1
Message type	9.2	M	V	1
Channel number	9.3.1	M	TV	2
Link Identifier	9.3.2	M	TV	2
L3 Information	9.3.11	M	TLV	3-25

8.3.11 UNIT DATA INDICATION

This message is sent from BTS to BSC to indicate the reception of a message in unacknowledged mode on a radio link layer connection.

INFORMATION ELEMENT	REFERENCE	PRESENCE	FORMAT	LENGTH
Message discriminator	9.1	M	V	1
Message type	9.2	M	V	1
Channel number	9.3.1	M	TV	2
Link Identifier	9.3.2	M	TV	2
L3 Information	9.3.11	M	TLV	3-23

8.4 DEDICATED CHANNEL MANAGEMENT MESSAGES

These messages are related to Dedicated Channel Management procedures. They all have the following general format:

INFORMATION ELEMENT	REFERENCE	PRESENCE	FORMAT	LENGTH
Message discriminator	9.1	M	V	1
Message type	9.2	M	V	1
Channel number	9.3.1	M	TV	2
(Information elements depending on message type)				

The messages concerned are the following:

<u>Message name</u>	<u>Reference section</u>
CHANnel ACTIVation	8.4.1
CHANnel ACTIVation ACKnowledge	8.4.2
CHANnel ACTIVation Negative ACK	8.4.3
CONNectioN FAILure INDication	8.4.4
DEACTIVATE SACCH	8.4.5
ENCRyptioN CoMmanD	8.4.6
HANDOver DETectioN	8.4.7
MEASurement RESult	8.4.8
MODE MODIFY REQuest	8.4.9
MODE MODIFY ACKnowledge	8.4.10
MODE MODIFY Negative ACKnowledge	8.4.11
PHYsical CONTEXT REQuest	8.4.12
PHYsical CONTEXT CONFirm	8.4.13
RF CHANnel RELEase	8.4.14
MS POWER CONTROL	8.4.15
BS POWER CONTROL	8.4.16
PREPROCecc CONFIGure	8.4.17
PREPROCessed MEASurement RESult	8.4.18
RF CHANnel RELEase ACKnowledge	8.4.19
SACCH INFO MODIFY	8.4.20

8.4.1 CHANNEL ACTIVATION

This message is sent from BSC to BTS in order to activate a radio channel. The attributes of the channel are defined in the message.

INFORMATION ELEMENT	REFERENCE	PRESENCE	FORMAT	LENGTH
Message discriminator	9.1	M	V	1
Message type	9.2	M	V	1
Channel number	9.3.1	M	TV	2
Activation Type	9.3.3	M	TV	2
Channel Mode	9.3.6	M	TLV	8-9
Channel Identification	9.3.5	O 7)	TLV	8
Encryption information	9.3.7	O 1)	TLV	>=3
Handover Reference	9.3.9	C 2)	TV	2
BS Power	9.3.4	O 3)	TV	2
MS Power	9.3.13	O 3)	TV	2
Timing Advance	9.3.24	C 3) 4)	TV	2
BS Power Parameters	9.3.32	O 5)	TLV	>=2
MS Power Parameters	9.3.31	O 5)	TLV	>=2
Physical Context	9.3.16	O 6)	TLV	>=2
SACCH Information	9.3.29	O 8)	TLV	>=3

- 1) The Encryption Information element is only included if ciphering is to be applied.
- 2) The Handover Reference element is only included if activation type is handover.
- 3) If BS Power, MS Power and/or Timing Advance elements are present, they are to be used to set the initial transmission power and the initial L1-header.
- 4) The Timing Advance element must be included if activation type is intra cell channel change.
- 5) The BS and MS Power Parameters elements are included to indicate that BS and/or MS power control is to be performed by BTS. The maximum power to be used is indicated in the BS and MS Power elements respectively.
- 6) Optional element for additional physical channel information.
- 7) Included if compatibility with phase1 is required.

- 8) Optional element for setting the SACCH filling information individually for this channel. If this element is present, the SACCH filling information as given by this element shall be used for this channel (replacing any SACCH filling information as given by the SACCH FILLING message(s)) until the channel is released or the information is changed by a SACCH INFO MODIFY message. (If this element is not present, the SACCH filling as given by the SACCH FILLING message(s) shall be used.)

8.4.2 CHANNEL ACTIVATION ACKNOWLEDGE

This message is sent from BSC to BTS to acknowledge that the requested channel activation has been completed correctly.

INFORMATION ELEMENT	REFERENCE	PRESENCE	FORMAT	LENGTH
Message discriminator	9.1	M	V	1
Message type	9.2	M	V	1
Channel number	9.3.1	M	TV	2
Frame number	9.3.8	M	TV	3

The Frame Number element is used by BSC to calculate the Starting Time parameter when required.

8.4.3 CHANNEL ACTIVATION NEGATIVE ACKNOWLEDGE

This message is sent from BTS to BSC to indicate that the channel activation could not be performed as requested.

INFORMATION ELEMENT	REFERENCE	PRESENCE	FORMAT	LENGTH
Message discriminator	9.1	M	V	1
Message type	9.2	M	V	1
Channel number	9.3.1	M	TV	2
Cause	9.3.26	M	TLV	>=3

If the Channel Activation message was received with an erroneous Channel number information element, the Channel Activation Negative Acknowledge message is returned with the Channel Number information element equal to the received (and erroneous) Channel number and the Cause value "Mandatory Information Element Error" with Diagnostics equal to the Channel number element identifier value.

8.4.4 CONNECTION FAILURE INDICATION

This message is sent from BTS to BSC to indicate that an active connection has been broken for some reason.

INFORMATION ELEMENT	REFERENCE	PRESENCE	FORMAT	LENGTH
Message discriminator	9.1	M	V	1
Message type	9.2	M	V	1
Channel number	9.3.1	M	TV	2
Cause	9.3.26	M	TLV	>=3

8.4.5 DEACTIVATE SACCH

This message is sent from BSC to BTS in order to deactivate the SACCH of an active channel.

INFORMATION ELEMENT	REFERENCE	PRESENCE	FORMAT	LENGTH
Message discriminator	9.1	M	V	1
Message type	9.2	M	V	1
Channel number	9.3.1	M	TV	2

8.4.6 ENCRYPTION COMMAND

This message is sent from BSC to BTS to start ciphering mode operation.

INFORMATION ELEMENT	REFERENCE	PRESENCE	FORMAT	LENGTH
Message discriminator	9.1	M	V	1
Message type	9.2	M	V	1
Channel number	9.3.1	M	TV	2
Encryption information	9.3.7	M	TLV	>=3
Link Identifier	9.3.2	M	TV	2
L3 Info (CIPH MOD CMD)	9.3.11	M	TLV	6

The L3 Info element contains the complete Ciphering Mode Command message as defined in Technical Specification GSM 04.08.

8.4.7 HANDOVER DETECTION

This message is sent from BTS to BSC when BTS correctly receives information from an MS on the handover activated channel.

INFORMATION ELEMENT	REFERENCE	PRESENCE	FORMAT	LENGTH
Message discriminator	9.1	M	V	1
Message type	9.2	M	V	1
Channel number	9.3.1	M	TV	2
Access Delay	9.3.17	O 1)	TV	2

- 1) The Access Delay element is included if the sending of the handover detection message was triggered by the reception of a handover access burst with the correct handover reference.

8.4.8 MEASUREMENT RESULT

This message from BTS to BSC is used to report to BSC the results of radio channel measurements made by BTS (uplink) and to convey the measurement reports from MS received on SACCH and in the L1 headers.

INFORMATION ELEMENT	REFERENCE	PRESENCE	FORMAT	LENGTH
Message discriminator	9.1	M	V	1
Message type	9.2	M	V	1
Channel number	9.3.1	M	TV	2
Measurement result number	9.3.27	M	TV	2
Uplink Measurements	9.3.25	M	TLV	>=5
BS Power	9.3.4	M	TV	2
L1 Information	9.3.10	O 1)	TV	3
L3 Info (MEAS REP)	9.3.11	O 1)	TLV	21
MS Timing Offset	9.3.37	O 2)	TV	2

- 1) The L1 Information element contains the last received L1-header (MS Power and Timing Advance) from MS and the L3 Information element contains the complete MEASUREMENT REPORT message received from MS. They are included only if received since last MEASUREMENT RESULT message.
- 2) MS Timing Offset can be optionally included to increase the accuracy of possible distance measurements.

8.4.9 MODE MODIFY

This message is sent from BSC to BTS to request a change of channel mode of an active channel.

INFORMATION ELEMENT	REFERENCE	PRESENCE	FORMAT	LENGTH
Message discriminator	9.1	M	V	1
Message type	9.2	M	V	1
Channel number	9.3.1	M	TV	2
Channel Mode	9.3.6	M	TLV	8-9

8.4.10 MODE MODIFY ACKNOWLEDGE

This message is sent from BTS to BSC to confirm the change of channel mode of an active channel.

INFORMATION ELEMENT	REFERENCE	PRESENCE	FORMAT	LENGTH
Message discriminator	9.1	M	V	1
Message type	9.2	M	V	1
Channel number	9.3.1	M	TV	2

8.4.11 MODE MODIFY NEGATIVE ACKNOWLEDGE

This message is sent from BTS to BSC to indicate that the channel mode modification could not be performed as requested.

INFORMATION ELEMENT	REFERENCE	PRESENCE	FORMAT	LENGTH
Message discriminator	9.1	M	V	1
Message type	9.2	M	V	1
Channel number	9.3.1	M	TV	2
Cause	9.3.26	M	TLV	>=3

8.4.12 PHYSICAL CONTEXT REQUEST

This message is sent from BSC to BTS to request the "physical context" of an active channel.

INFORMATION ELEMENT	REFERENCE	PRESENCE	FORMAT	LENGTH
Message discriminator	9.1	M	V	1
Message type	9.2	M	V	1
Channel number	9.3.1	M	TV	2

8.4.13 PHYSICAL CONTEXT CONFIRM

This message is sent from BTS to BSC as a response to a PHYSICAL CONTEXT REQUEST message. The message contains the "physical context" information.

INFORMATION ELEMENT	REFERENCE	PRESENCE	FORMAT	LENGTH
Message discriminator	9.1	M	V	1
Message type	9.2	M	V	1
Channel number	9.3.1	M	TV	2
BS Power	9.3.4	M	TV	2
MS Power	9.3.13	M	TV	2
Timing Advance	9.3.24	M	TV	2
Physical Context	9.3.16	O 1)	TLV	>=2

- 1) Optional element for additional physical channel information.

8.4.14 RF CHANNEL RELEASE

This message is sent from BSC to BTS to inform that a radio channel is no longer needed.

INFORMATION ELEMENT	REFERENCE	PRESENCE	FORMAT	LENGTH
Message discriminator	9.1	M	V	1
Message type	9.2	M	V	1
Channel number	9.3.1	M	TV	2

8.4.15 MS POWER CONTROL

This message is sent from BSC to BTS to change the MS power level or the parameters used by TRX to control the MS power.

INFORMATION ELEMENT	REFERENCE	PRESENCE	FORMAT	LENGTH
Message discriminator	9.1	M	V	1
Message type	9.2	M	V	1
Channel number	9.3.1	M	TV	2
MS Power	9.3.13	M	TV	2
MS Power Parameters	9.3.31	O 1)	TLV	>=2

- 1) If the MS Power Parameters element is present it indicates that the MS power control is to be performed by TRX. The MS Power element then indicates the maximum MS power to be used.

8.4.16 BS POWER CONTROL

This message is sent from BSC to BTS to change the TRX transmission power level or the parameters used by TRX to control its transmission power.

INFORMATION ELEMENT	REFERENCE	PRESENCE	FORMAT	LENGTH
Message discriminator	9.1	M	V	1
Message type	9.2	M	V	1
Channel number	9.3.1	M	TV	2
BS Power	9.3.4	M	TV	2
BS Power Parameters	9.3.32	O 1)	TLV	>=2

- 1) If the BS Power Parameters element is present it indicates that the TRX transmission power control is to be performed by TRX. The BS Power element then indicates the maximum transmission power to be used.

8.4.17 PREPROCESS CONFIGURE

This message is sent from BSC to BTS to modify the pre-processing parameters used by BTS.

INFORMATION ELEMENT	REFERENCE	PRESENCE	FORMAT	LENGTH
Message discriminator	9.1	M	V	1
Message type	9.2	M	V	1
Channel number	9.3.1	M	TV	2
Preproc. Parameters	9.3.33	M	TLV	>=3

8.4.18 PREPROCESSED MEASUREMENT RESULT

This message is used by BTS to report the results of radio parameter pre-processing.

INFORMATION ELEMENT	REFERENCE	PRESENCE	FORMAT	LENGTH
Message discriminator	9.1	M	V	1
Message type	9.2	M	V	1
Channel number	9.3.1	M	TV	2
Preproc. Measurements	9.3.34	M	TLV	>=2

8.4.19 RF CHANNEL RELEASE ACKNOWLEDGE

This message is sent from BTS to BSC as an acknowledge to a RF CHANnel RELease message.

INFORMATION ELEMENT	REFERENCE	PRESENCE	FORMAT	LENGTH
Message discriminator	9.1	M	V	1
Message type	9.2	M	V	1
Channel number	9.3.1	M	TV	2

8.4.20 SACCH INFO MODIFY

This message is sent from BSC to BTS to modify the SACCH filling information (System Information) sent on an individual SACCH channel. This new SACCH filling information shall be sent on the indicated channel until the channel is released or the information is changed by another SACCH INFO MODIFY message.

INFORMATION ELEMENT	REFERENCE	PRESENCE	FORMAT	LENGTH
Message discriminator	9.1	M	V	1
Message type	9.2	M	V	1
Channel number	9.3.1	M	TV	2
System Info Type	9.3.30	M	TV	2
L3 Info (SYS INFO)	9.3.11	O 1)	TLV	14-21
Startin Time	9.3.23	O 2)	TV	3

- 1) If the L3 Info information element is not included, this indicates that transmission of the indicated SYSTEM INFORMATION message shall be stopped, i.e. this SYSTEM INFORMATION message shall no longer be sent on this channel.
- 2) The Starting Time element is optionally used to indicate when transmission of the new information is to start and when transmission is to stop.

The System Info Type element indicates the type of SYSTEM INFORMATION message which follows in the L3 Info field.

The L3 Information element contains the relevant SYSTEM INFORMATION message as defined in Technical Specification GSM 04.08.

8.5 COMMON CHANNEL MANAGEMENT MESSAGES

These messages are related to Common Channel Management procedures. They all have the following general format:

INFORMATION ELEMENT	REFERENCE	PRESENCE	FORMAT	LENGTH
Message discriminator	9.1	M	V	1
Message type	9.2	M	V	1
Channel number	9.3.1	M	TV	2
(Information elements depending on message type)				

The messages concerned are the following:

Message name	Reference section
BCCH INFOrmation	8.5.1
CCCH LOAD INDication	8.5.2
CHANnel ReQuireD	8.5.3
DELETE INDication	8.5.4
PAGING CoMmanD	8.5.5
IMMEDIATE ASSIGN COMMAND	8.5.6
SMS BroadCast REQuest	8.5.7
SMS Broadcast Command	8.5.8
CBCH LOAD INDICATION	8.5.9

8.5.1 BCCH INFORMATION

This message is sent from BSC to BTS to indicate new information to be broadcast on BCCH.

INFORMATION ELEMENT	REFERENCE	PRESENCE	FORMAT	LENGTH
Message discriminator	9.1	M	V	1
Message type	9.2	M	V	1
Channel number	9.3.1	M	TV	2
System Info Type	9.3.30	M	TV	2
Full BCCH Info (SYS INFO)	9.3.39	O 1)	TLV	25
Starting Time	9.3.23	O 2)	TV	3

- 1) If the Full BCCH information element is not included this indicates that transmission of the indicated SYSTEM INFORMATION message shall be stopped.
- 2) The Starting Time element is optionally used to indicate when transmission of the new information is to start or when transmission is to stop.

The System Info Type element indicates the type of SYSTEM INFORMATION message which follows in the Full BCCH Information element.

The Full BCCH Information element contains the relevant SYSTEM INFORMATION message as defined in Technical Specification GSM 04.08.

8.5.2 CCCH LOAD INDICATION

This message is sent from BTS to BSC to report the current load on the indicated CCCH timeslot (random access, RACH, and paging, PCH).

INFORMATION ELEMENT	REFERENCE	PRESENCE	FORMAT	LENGTH
Message discriminator	9.1	M	V	1
Message type	9.2	M	V	1
Channel number (note)	9.3.1	M	TV	2
RACH Load	9.3.18	C 1)	TLV	>=8
Paging Load	9.3.15	C 2)	TV	3

NOTE: The BTS may set the 'Channel Number' information element in this message to either the "uplink CCCH" or the "downlink CCCH" on that timeslot number.

- 1) The RACH load information element is included only if the Channel number information indicates "uplink CCCH".
- 2) The Paging load information element is included only if the Channel number information indicates "downlink CCCH".

8.5.3 CHANNEL REQUIRED

This message is sent from BTS to BSC to indicate the reception of a CHANnel REQuest message (special access burst message) from an MS.

INFORMATION ELEMENT	REFERENCE	PRESENCE	FORMAT	LENGTH
Message discriminator	9.1	M	V	1
Message type	9.2	M	V	1
Channel number	9.3.1	M	TV	2
Request Reference	9.3.19	M	TV	4
Access Delay	9.3.17	M	TV	2
Physical Context	9.3.16	O 1)	TLV	>=2

- 1) Optional element for additional physical channel information.

The Request Reference element contains the random access reference value sent by MS in the CHANnel REQuest message and some low order bits of the absolute frame number for the reception of the access burst.

8.5.4 DELETE INDICATION

This message is sent from BTS to BSC to indicate the deletion of an access grant message (IMMEDIATE ASSIGN) due to overload of downlink CCCH.

INFORMATION ELEMENT	REFERENCE	PRESENCE	FORMAT	LENGTH
Message discriminator	9.1	M	V	1
Message type	9.2	M	V	1
Channel number	9.3.1	M	TV	2
Full Imm. Assign Info	9.3.35	M	TLV	25

8.5.5 PAGING COMMAND

This message is sent from BSC to BTS to request the paging of an MS.

INFORMATION ELEMENT	REFERENCE	PRESENCE	FORMAT	LENGTH
Message discriminator	9.1	M	V	1
Message type	9.2	M	V	1
Channel number	9.3.1	M	TV	2
Paging Group	9.3.14	M	TV	2
MS Identity	9.3.12	M	TLV	2-10
Channel Needed	9.3.40	O 1)	TV	2

- 1) If the Channel Needed element is not present, the default value is assumed to be 00 (any channel).

The Paging Group element is used by BTS to calculate the correct DRX paging block to be used for the transmission of the PAGING REQuest message as defined in Technical Specification GSM 05.02.

8.5.6 IMMEDIATE ASSIGN COMMAND

This message is sent from BSC to BTS to request the transmission of an immediate assignment message.

INFORMATION ELEMENT	REFERENCE	PRESENCE	FORMAT	LENGTH
Message discriminator	9.1	M	V	1
Message type	9.2	M	V	1
Channel number	9.3.1	M	TV	2
Full Imm. Assign Info	9.3.35	M	TLV	25

The Full Imm. Assign Info element contains the relevant immediate assignment message as defined in Technical Specification GSM 04.08 (IMMEDIATE ASSIGNMENT or IMMEDIATE ASSIGNMENT EXTENDED or IMMEDIATE ASSIGNMENT REJECT) with the "Page Mode" element set to the value "no change".

8.5.7 SMS BROADCAST REQUEST

This message is sent from BSC to BTS to request the sending of a Short Message Service Cell Broadcast message.

INFORMATION ELEMENT	REFERENCE	PRESENCE	FORMAT	LENGTH
Message discriminator	9.1	M	V	1
Message type	9.2	M	V	1
Channel number	9.3.1	M	TV	2
SMSCB Information	9.3.36	M	TV	24

The SMSCB Information element contains the complete information to be broadcast on the CBCH as defined in TS GSM 04.12 (including the Layer 2 header to be used on the radio path).

8.5.8 SMS BROADCAST COMMAND

This message is sent from BSC to BTS to command Short Message Service Cell Broadcast.

INFORMATION ELEMENT	REFERENCE	PRESENCE	FORMAT	LENGTH
Message discriminator	9.1	M	V	1
Message type	9.2	M	V	1
Channel number	9.3.1	M	TV	2
CB Command type	9.3.41	M	TV	2
SMSCB message	9.3.42	M	TLV	2-90

The CB Command type IE contains the command to be performed, allowing the BSC to:

- request immediate broadcast i.e. transmission in the next CBCH opportunity;
- set the BTS broadcast default mode.

The SMSCB message IE contains the actual message to be broadcast on the CBCH i.e. a maximum of 88 octets of data. The BTS is responsible for performing the segmentation, building the block types and padding if necessary, see TS GSM 04.12 for the message format on the radio path.

8.5.9 CBCH LOAD INDICATION

This message is sent from BTS to BSC to indicate a CBCH underflow/overflow situation in the BTS and to request the BSC to accelerate or pause the cell broadcast for a period indicated by BTS.

INFORMATION ELEMENT	REFERENCE	PRESENCE	FORMAT	LENGTH
Message discriminator	9.1	M	V	1
Message type	9.2	M	V	1
Channel number	9.3.1	M	TV	2
CBCH Load Information	9.3.43	M	TV	2

The CBCH Load Information element indicates the load situation in CBCH (underflow/overflow) and information about the requested acceleration/suspension period of cell broadcast.

8.6 TRX MANAGEMENT MESSAGES

These messages are related to TRX Management procedures. They all have the following general format (no channel number included):

INFORMATION ELEMENT	REFERENCE	PRESENCE	FORMAT	LENGTH
Message discriminator	9.1	M	V	1
Message type	9.2	M	V	1
(Information elements depending on message type)				

The messages concerned are the following:

Message name	Reference section
RF RESource INDication	8.6.1
SACCH FILLing	8.6.2
OVERLOAD	8.6.3
ERROR REPORT	8.6.4

8.6.1 RF RESOURCE INDICATION

This message is sent from BTS to BSC to indicate the interference level on idle channels of a TRX.

INFORMATION ELEMENT	REFERENCE	PRESENCE	FORMAT	LENGTH
Message discriminator	9.1	M	V	1
Message type	9.2	M	V	1
Resource Information	9.3.21	M	TLV	>=2

8.6.2 SACCH FILLING

This message is sent from BSC to BTS to indicate the new broadcast information to be used as filling information on downlink SACCH.

INFORMATION ELEMENT	REFERENCE	PRESENCE	FORMAT	LENGTH
Message discriminator	9.1	M	V	1
Message type	9.2	M	V	1
System Info Type	9.3.30	M	TV	2
L3 Info (SYS INFO)	9.3.11	O 1)	TLV	14-21
Starting Time	9.3.23	O 2)	TV	3

- 1) If the L3 Info information element is not included this indicates that transmission of the indicated SYSTEM INFORMATION message shall be stopped.
- 2) The Starting Time element is optionally used to indicate when transmission of the new information is to start and when transmission is to stop.

The System Info Type element indicates the type of SYSTEM INFORMATION message which follows in the L3 Info field.

The L3 Information element contains the relevant SYSTEM INFORMATION message as defined in Technical Specification GSM 04.08.

8.6.3 OVERLOAD

This message is sent from BTS to BSC to indicate an overload situation. Possible cause values include:

- CCCH overload,
- ACCH overload,
- processor overload.

INFORMATION ELEMENT	REFERENCE	PRESENCE	FORMAT	LENGTH
Message discriminator	9.1	M	V	1
Message type	9.2	M	V	1
Cause	9.3.26	M	TLV	>=3

8.6.4 ERROR REPORT

This message is sent from BTS to BSC to report a detected error which cannot be reported in any other message.

INFORMATION ELEMENT	REFERENCE	PRESENCE	FORMAT	LENGTH
Message discriminator	9.1	M	V	1
Message type	9.2	M	V	1
Cause	9.3.26	M	TLV	>=3
Message Identifier	9.3.28	O 1)	TV	2
Channel Number	9.3.1	O 2)	TV	2
Link identifier	9.3.2	O 3)	TV	2
Erroneous Message	9.3.38	O 4)	TLV	>=3

- 1) Used to indicate which type of message was considered erroneous.
- 2) Used to indicate for which radio channel the error is reported.
- 3) Used to indicate for which radio L2 link the error is reported.
- 4) This element may be used to carry the complete erroneous message as it was received from the BSC.

9 Information element codings

This section contains the codings of the signalling elements used. The following conventions are assumed for the sequence of transmission of bits and bytes :

- Each bit position is numbered as 1 to 8.

8	7	6	5	4	3	2	1
---	---	---	---	---	---	---	---

- The least significant bit is bit 1 and is transmitted first, followed by bits 2, 3, 4 etc.
- In an element, octets are identified by number. Octet 1 is transmitted first, then octet 2 etc.
- When a field extends over more than one octet, the order of bit values progressively decreases as the octet number increases. The least significant bit of the field is represented by the lowest numbered bit of the highest numbered octet of the field.
- For variable length elements, a length indicator is included. This indicates the number of octets following in the element.
- All spare or reserved bits are set to 0.

9.1 Message discriminator

A 1 octet field is used in all messages to discriminate between Transparent and Non-Transparent messages and also between Radio Link Layer Management, Dedicated Channel Management, Common Channel Management and TRX Management messages.

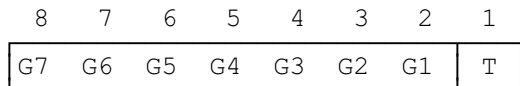

The T-bit is set to 1 to indicate that the message is to be/was considered transparent by BTS. All other messages shall have the T-bit set to 0.

The G-bits are used to group the messages as follows:

G7 G6 G5 G4 G3 G2 G1	Message Group
0 0 0 0 0 0 0	reserved
0 0 0 0 0 0 1	Radio Link Layer Management messages
0 0 0 0 1 0 0	Dedicated Channel Management messages
0 0 0 0 1 1 0	Common Channel Management messages
0 0 0 1 0 0 0	TRX Management messages

All other values are reserved for future use.

9.2 MESSAGE TYPE

The Message Type uniquely identifies the function of the message being sent. It is a single octet and coded in the following way:

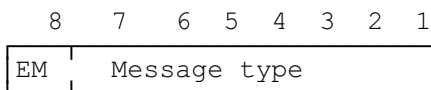

Bit 8 is the extension bit and is reserved for future use. The following message types are used (all other values are reserved):

8 7 6 5 4 3 2 1	Message	Reference
0 0 0 0 - - - -	<u>Radio Link Layer Management messages:</u>	
0 0 0 1	- DATA REQ <u>u</u> est	8.3.1
0 0 1 0	- DATA IND <u>i</u> cation	8.3.2
0 0 1 1	- ERROR IND <u>i</u> cation	8.3.3
0 1 0 0	- EST <u>a</u> blish REQ <u>u</u> est	8.3.4
0 1 0 1	- EST <u>a</u> blish CON <u>F</u> irm	8.3.5
0 1 1 0	- EST <u>a</u> blish IND <u>i</u> cation	8.3.6
0 1 1 1	- RE <u>L</u> ease REQ <u>u</u> est	8.3.7
1 0 0 0	- RE <u>L</u> ease CON <u>F</u> irm	8.3.8
1 0 0 1	- RE <u>L</u> ease IND <u>i</u> cation	8.3.9
1 0 1 0	- UN <u>I</u> T DATA REQ <u>u</u> est	8.3.10
1 0 1 1	- UN <u>I</u> T DATA IND <u>i</u> cation	8.3.11
0 0 0 1 - - - -	<u>Common Channel Management/TRX Management messages:</u>	
0 0 0 1	- BC <u>C</u> H INFO <u>r</u> mation	8.5.1
0 0 1 0	- CC <u>C</u> H LO <u>A</u> D IND <u>i</u> cation	8.5.2
0 0 1 1	- CH <u>A</u> N <u>n</u> el ReQ <u>u</u> ire <u>D</u>	8.5.3
0 1 0 0	- DE <u>L</u> ETE IND <u>i</u> cation	8.5.4
0 1 0 1	- P <u>A</u> G <u>I</u> NG Co <u>M</u> man <u>D</u>	8.5.5
0 1 1 0	- I <u>M</u> ME <u>D</u> IATE ASS <u>I</u> GN Co <u>M</u> MAN <u>D</u>	8.5.6
0 1 1 1	- S <u>M</u> S Bro <u>a</u> dC <u>a</u> st REQ <u>u</u> est	8.5.7
1 0 0 1	- R <u>F</u> RE <u>S</u> ource IND <u>i</u> cation	8.6.1
1 0 1 0	- S <u>A</u> C <u>C</u> H F <u>I</u> LL <u>i</u> ng	8.6.2
1 0 1 1	- O <u>U</u> ERLO <u>A</u> D	8.6.3
1 1 0 0	- E <u>R</u> ROR RE <u>P</u> ORT	8.6.4
1 1 0 1	- S <u>M</u> S Bro <u>a</u> dC <u>a</u> st Co <u>M</u> man <u>D</u>	8.5.8
1 1 1 0	- C <u>B</u> CH LO <u>A</u> D IND <u>i</u> cation	8.5.9
0 0 1 - - - - -	<u>Dedicated Channel Management messages:</u>	
0 0 0 0 1	- CH <u>A</u> N <u>n</u> el ACT <u>I</u> Vation	8.4.1
0 0 0 1 0	- CH <u>A</u> N <u>n</u> el ACT <u>I</u> Vation AC <u>K</u> nowledge	8.4.2
0 0 0 1 1	- CH <u>A</u> N <u>n</u> el ACT <u>I</u> Vation N <u>e</u> gative AC <u>K</u>	8.4.3
0 0 1 0 0	- Co <u>N</u> Ne <u>C</u> tion FA <u>I</u> L <u>u</u> re	8.4.4
0 0 1 0 1	- DE <u>A</u> CT <u>I</u> VATE S <u>A</u> C <u>C</u> H	8.4.5
0 0 1 1 0	- EN <u>C</u> R <u>y</u> ption Co <u>M</u> man <u>D</u>	8.4.6
0 0 1 1 1	- H <u>A</u> ND <u>O</u> ver DE <u>T</u> ection	8.4.7
0 1 0 0 0	- ME <u>A</u> S <u>u</u> rement RE <u>S</u> ult	8.4.8
0 1 0 0 1	- Mo <u>D</u> E Mo <u>D</u> IFY REQ <u>u</u> est	8.4.9
0 1 0 1 0	- Mo <u>D</u> E Mo <u>D</u> IFY AC <u>K</u> nowledge	8.4.10
0 1 0 1 1	- Mo <u>D</u> E Mo <u>D</u> IFY N <u>e</u> gative AC <u>K</u> nowledge	8.4.11
0 1 1 0 0	- P <u>H</u> Y <u>s</u> ical Co <u>N</u> TE <u>X</u> T REQ <u>u</u> est	8.4.12
0 1 1 0 1	- P <u>H</u> Y <u>s</u> ical Co <u>N</u> TE <u>X</u> T Co <u>N</u> F <u>i</u> rm	8.4.13
0 1 1 1 0	- R <u>F</u> CH <u>A</u> N <u>n</u> el RE <u>L</u> ease	8.4.14
0 1 1 1 1	- M <u>S</u> P <u>O</u> WER Co <u>N</u> T <u>R</u> OL	8.4.15

1 0 0 0 0	- BS POWER CONTROL	8.4.16
1 0 0 0 1	- PREPROCess CONFIGure	8.4.17
1 0 0 1 0	- PREPROCessed MEASurement RESult	8.4.18
1 0 0 1 1	- RF CHANnel RELEase ACKnowledge	8.4.19
1 0 1 0 0	- SACCH INFO MODIFY	8.4.20

9.3 Other information elements

The information elements used and the coding of their Element Identifier fields are:

Element Identifier bits

8 7 6 5 4 3 2 1	Element name	Reference
0 0 0 0 0 0 0 1	Channel Number	9.3.1
0 0 0 0 0 0 1 0	Link Identifier	9.3.2
0 0 0 0 0 0 1 1	Activation Type	9.3.3
0 0 0 0 0 1 0 0	BS Power	9.3.4
0 0 0 0 0 1 0 1	Channel Identification	9.3.5
0 0 0 0 0 1 1 0	Channel Mode	9.3.6
0 0 0 0 0 1 1 1	Encryption Information	9.3.7
0 0 0 0 1 0 0 0	Frame Number	9.3.8
0 0 0 0 1 0 0 1	Handover Reference	9.3.9
0 0 0 0 1 0 1 0	L1 Information	9.3.10
0 0 0 0 1 0 1 1	L3 Information	9.3.11
0 0 0 0 1 1 0 0	MS Identity	9.3.12
0 0 0 0 1 1 0 1	MS Power	9.3.13
0 0 0 0 1 1 1 0	Paging Group	9.3.14
0 0 0 0 1 1 1 1	Paging Load	9.3.15
0 0 0 1 0 0 0 0	Physical Context	9.3.16
0 0 0 1 0 0 0 1	Access Delay	9.3.17
0 0 0 1 0 0 1 0	RACH Load	9.3.18
0 0 0 1 0 0 1 1	Request Reference	9.3.19
0 0 0 1 0 1 0 0	Release Mode	9.3.20
0 0 0 1 0 1 0 1	Resource Information	9.3.21
0 0 0 1 0 1 1 0	RLM Cause	9.3.22
0 0 0 1 0 1 1 1	Starting Time	9.3.23
0 0 0 1 1 0 0 0	Timing Advance	9.3.24
0 0 0 1 1 0 0 1	Uplink Measurements	9.3.25
0 0 0 1 1 0 1 0	Cause	9.3.26
0 0 0 1 1 0 1 1	Measurement result number	9.3.27
0 0 0 1 1 1 0 0	Message Identifier	9.3.28
0 0 0 1 1 1 0 1	reserved	
0 0 0 1 1 1 1 0	System Info Type	9.3.30
0 0 0 1 1 1 1 1	MS Power Parameters	9.3.31
0 0 1 0 0 0 0 0	BS Power Parameters	9.3.32
0 0 1 0 0 0 0 1	Preprocessing Parameters	9.3.33
0 0 1 0 0 0 1 0	Preprocessed Measurements	9.3.34
0 0 1 0 0 0 1 1	reserved	
0 0 1 0 0 1 0 0	SMSCB Information	9.3.36
0 0 1 0 0 1 0 1	MS Timing Offset	9.3.37
0 0 1 0 0 1 1 0	Erroneous Message	9.3.38
0 0 1 0 0 1 1 1	Full BCCH Information	9.3.39
0 0 1 0 1 0 0 0	Channel Needed	9.3.40
0 0 1 0 1 0 0 1	CB Command type	9.3.41
0 0 1 0 1 0 1 0	SMSCB message	9.3.42
0 0 1 0 1 0 1 1	Full Immediate Assign Info	9.3.35

0 0 1 0 1 1 0 0	SACCH Information	9.3.29
0 0 1 0 1 1 0 1	CBCH Load Information	9.3.43

All other values are reserved for future use.

9.3.1 Channel Number

In the direction BSC to BTS the Channel Number parameter is used to indicate on which physical channel/subchannel the message is to be sent. In the direction BTS to BSC the Channel Number indicates on which physical channel/subchannel the message was received. It is coded in two octets as follows:

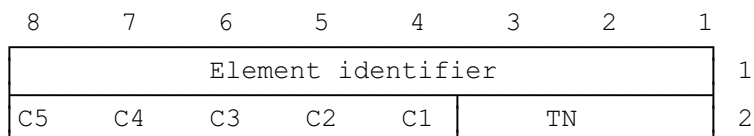

The C-bits describe the channel as follows:

C5	C4	C3	C2	C1	
0	0	0	0	1	Bm + ACCH's
0	0	0	1	T	Lm + ACCH's
0	0	1	T	T	SDCCH/4 + ACCH
0	1	T	T	T	SDCCH/8 + ACCH
1	0	0	0	0	BCCH
1	0	0	0	1	Uplink CCCH (RACH)
1	0	0	1	0	Downlink CCCH (PCH + AGCH)

The T-bits indicate, coded in binary, the sub-channel number as specified in Technical Specification GSM 05.02.

TN is time slot number, binary represented as in TS GSM 05.02.

9.3.2 Link Identifier

This element identifies the signalling channel and SAPI of the radio data link.

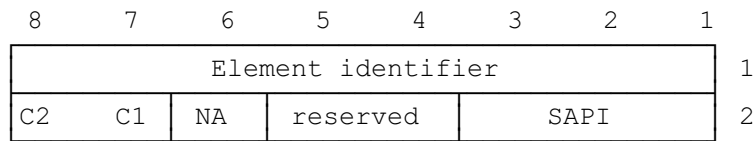

The NA bit (bit 6 in octet 2) is set to 1 to indicate that the Link Identifier is not applicable for this message. In all other cases it is set to 0.

The C-bits indicate the channel type as follows:

C2 C1

0 0 main signalling channel (FACCH or SDCCH)

0 1 SACCH

All other values are reserved for future use.

The SAPI field contains the SAPI value as defined in Technical Specification GSM 04.05.

9.3.3 Activation Type

This element is used to indicate the type of activation requested in the CHANNEL ACTIVATION message. It is coded in two octets as follows:

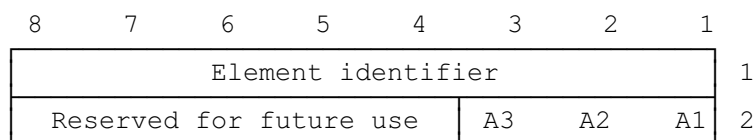

The A-bits indicate the type of activation as follows:

A3 A2 A1

- 0 0 - Activation related to intra-cell channel change
 - 0 - related to immediate assignment procedure
 - 1 - related to normal assignment procedure
- 0 1 - Activation related to inter-cell channel change (handover)
 - 0 - related to asynchronous handover procedure
 - 1 - related to synchronous handover procedure
- 1 0 0 Activation related to additional assignment procedure

All other values reserved for future use.

9.3.4 BS Power

This information element indicates the TRX transmission power level on a particular channel.

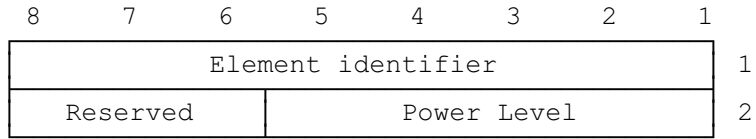

The Power Level field (octet 2) indicates the number of 2 dB steps by which the power shall be reduced from its nominal value, P_n, set by the network operator to adjust the coverage. Thus the Power Level values correspond to the following powers (relative to P_n):

Value	Power level
0 0 0 0 0	P _n
0 0 0 0 1	P _n - 2 dB
0 0 0 1 0	P _n - 4 dB
.	
.	
0 1 1 1 0	P _n - 28 dB
0 1 1 1 1	P _n - 30 dB

All other values are reserved for future use.

See also Technical Specifications GSM 05.05, section 4.1.2 and GSM 05.08, section 4.5.

9.3.5 Channel Identification

This information element describes some aspects of a channel together with its SACCH.

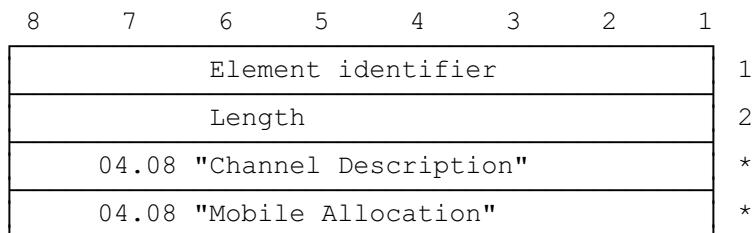

A * denotes that the whole of the 04.08 element including the element identifier and length should be included. The 04.08 "Mobile Allocation" shall for compatibility reasons be included but empty, i.e. the length shall be zero.

9.3.6 Channel Mode

This element gives information on the mode of coding/decoding and transcoding/rate adaption of a channel.

8	7	6	5	4	3	2	1	
Element identifier								1
Length								2
Reserved for future use						DTXd	DTXu	3
Speech or data indicator								4
Channel rate and type								5
Speech coding algor./data rate + transp ind								6

The DTX bits of octet 3 indicate whether DTX is applied:

- 1 DTX is applied
- 0 DTX is not applied.

DTXd indicates use of DTX in the downlink direction (BTS to MS) and DTXu indicates use of DTX in the uplink direction (MS to BTS).

The "Speech or data indicator" field (octet 4) is coded as follows:

- 0000 0001 Speech
- 0000 0010 Data
- 0000 0011 Signalling

All other values are reserved.

The "Channel rate and type" field (octet 5) is coded as follows:

- 0000 0001 SDCCH
- 0000 1000 Full rate TCH channel Bm
- 0000 1001 Half rate TCH channel Lm

All other values are reserved.

The "speech coding algorithm/data rate + transparency indicator" field (octet 6) is coded as follows:

If octet 4 indicates speech or signalling, then octet 6 is coded as follows:

0000 0000 No resources required

0000 0001 GSM speech coding algorithm version 1

All other values are reserved.

If octet 4 indicates data, then octet 6 is coded as follows:

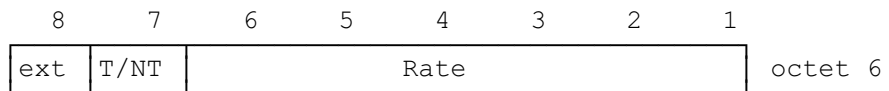

Bit 8: Reserved for extension

Bit 7: 0 Transparent service

1 Non-transparent service.

For the non-transparent service, bits 6-1 indicate the radio interface data rate:

65 4321

01 0000 12 kbit/s

01 0001 6 kbit/s

all other values are reserved.

For the transparent service, bits 6-1 indicate the data rate:

65 4321

01 0000 9.6 kbit/s

01 0001 4.8 kbit/s

01 0010 2.4 kbit/s

01 0011 1.2 kbit/s

01 0100 600 bit/s

01 0101 1200/75 bit/s (1200 network-to-MS, 75 MS-to-network)

All other values are reserved.

9.3.7 Encryption information

This element is a variable length element. It contains necessary information to control encryption devices.

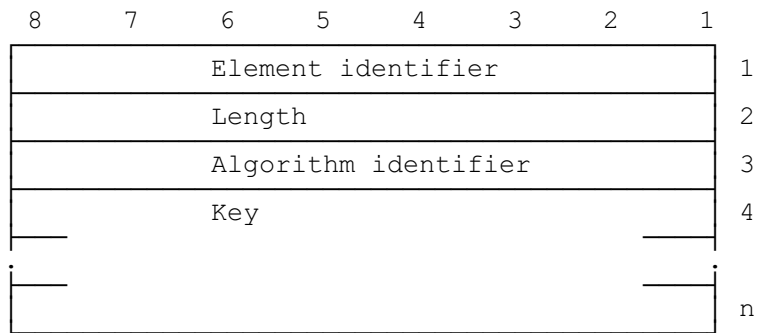

The Algorithm Identifier field (octet 3) indicates the relevant ciphering algorithm. It is coded as:

- 0000 0000 Reserved
- 0000 0001 No encryption shall be used.
- 0000 0010 GSM encryption algorithm version 1 (A5/1)
- 0000 0011 GSM A5/2
- 0000 0100 GSM A5/3
- 0000 0101 GSM A5/4
- 0000 0110 GSM A5/5
- 0000 0111 GSM A5/6
- 0000 1000 GSM A5/7

All other values are reserved

The Key field (octets 4-n) indicates the ciphering key. It shall be an integral number of octets and the length is given as the value of the Length field minus 1.

9.3.8 Frame Number

This element contains the absolute frame number (FN) modulo 42432. It is used to carry the current timing in BTS to BSC for calculation of the Starting Time parameter required in some messages.

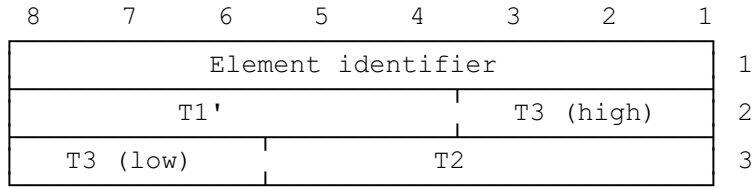

Octets 2-3 are coded as defined for octets 2-3 of the Starting Time information element of Technical Specification GSM 04.08.

9.3.9 Handover reference

The information is coded in two octets and contains the hand-over reference value.

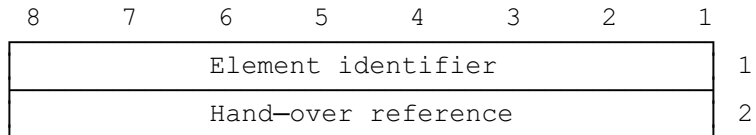

The Handover Reference octet contains the handover reference value as defined in Technical Specification GSM 04.08.

9.3.10 L1 Information

This element carries the information used in the L1 header of SACCH blocks.

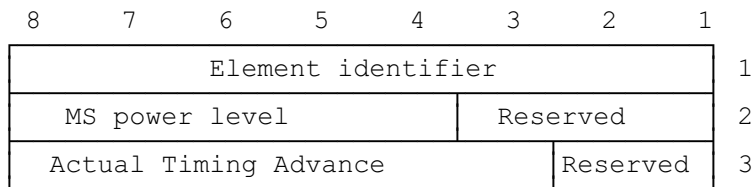

Octets 2-3 contain the L1 header information of SACCH blocks. The information fields and codings are as defined in Technical Specification GSM 04.04.

9.3.11 L3 Information (message name)

This element contains a link layer service data unit (L3 message). It is used to forward a complete L3 message as specified in Technical Specification GSM 04.08 between BTS and BSC.

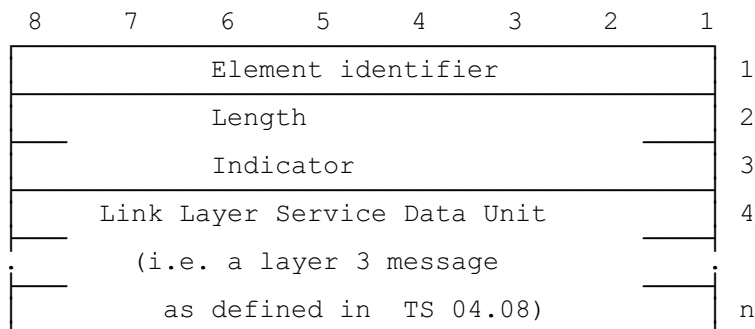

The Length Indicator field (octets 2-3) indicates in binary the remaining length of the element (octets 4-n). The most significant bit is bit 8 of octet 2 and the least significant bit is bit 1 of octet 3.

Octets 4-n contain the complete L3 message as defined in Technical Specification GSM 04.08. In the message format section, the 04.08 message name to be included is indicated within brackets.

9.3.12 MS Identity

This element carries the identity of an MS (TMSI or IMSI). It is a variable length element.

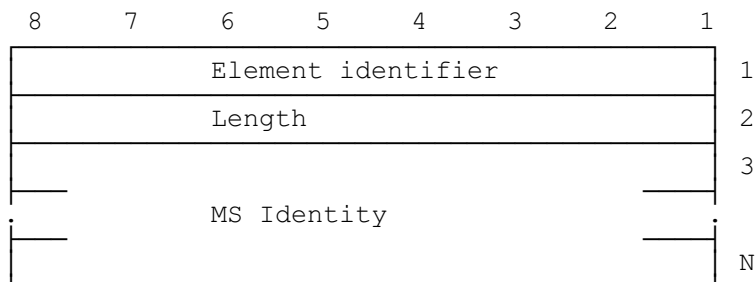

The MS Identity field (octets 3-N) is coded as specified for the Mobile Identity information element of Technical Specification GSM 04.08, octets 3-N.

9.3.13 MS Power

This element carries the power level of MS.

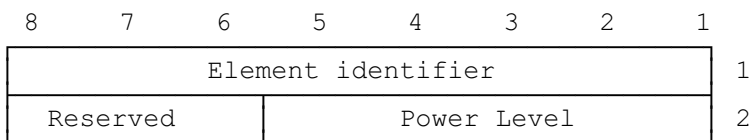

The coding and meaning of the Power Level field is as defined in Technical Specifications GSM 05.05 and GSM 05.08. See also Technical Specification GSM 04.04.

9.3.14 Paging Group

This element carries the paging population of an MS to be paged.

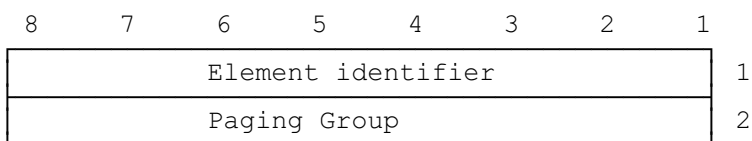

The Paging Group field (octet 2) contains the binary representation of the paging group as defined in Technical Specification GSM 05.02.

9.3.15 Paging Load

This element carries data about the load of a paging channel (PCH).

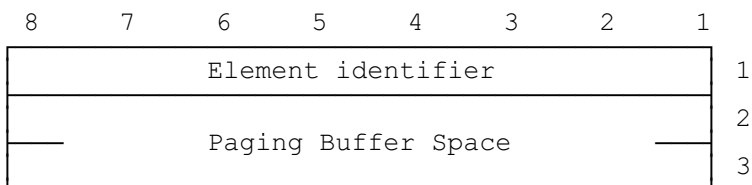

The Paging Buffer Space field (octets 2-3) indicates the remaining space for Paging Commands associated with this CCCH timeslot, given as the number of additional Paging Commands that it is possible to store. The number is binary coded with the most significant bit in bit 8 of octet 2 and the least significant bit in bit 1 of octet 3.

9.3.16 Physical Context

This element contains supplementary information on the transmission/reception process. It is a variable length element.

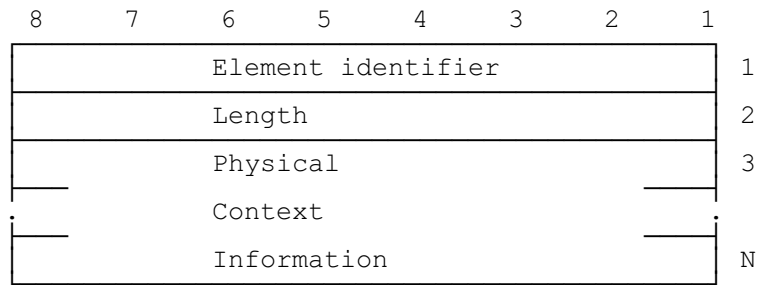

The Physical Context Information field is not specified. This information should not be analysed by BSC, but merely forwarded from one TRX/channel to another.

9.3.17 Access Delay

This element contains the delay of the access burst as measured by BTS at random access or at handover access.

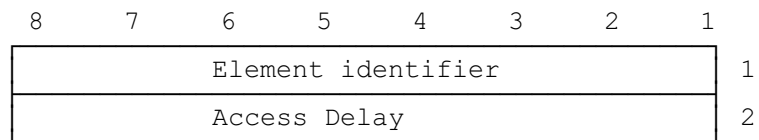

The Access Delay field contains the delay of the access burst as measured by BTS. The delay is expressed as defined for the Timing Advance TA in Technical Specification GSM 05.10 but with the range extended to 8 bits, i.e. the six least significant bits of the field correspond to the Timing Advance.

9.3.18 RACH Load

This element is used to carry information on the load of the RACH (Random Access Channel) associated with this CCCH timeslot. It is of variable length.

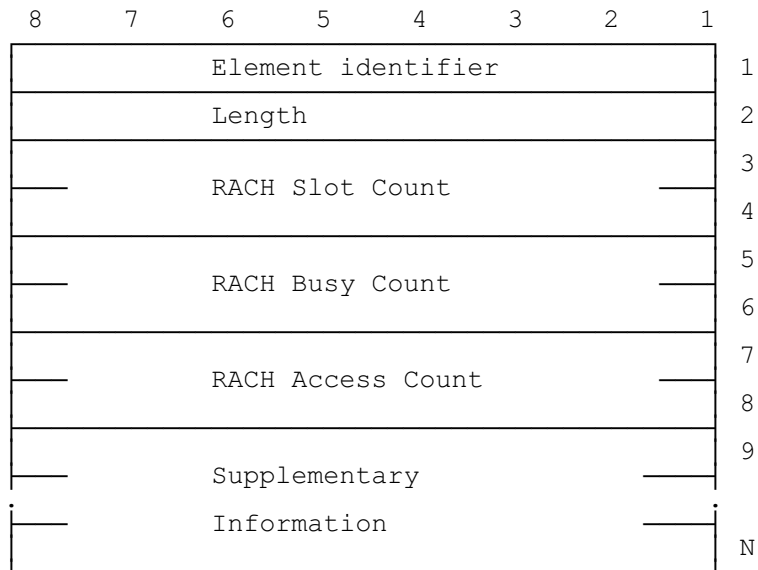

The RACH Slot Count field (octets 3-4) indicates the total number of available access slots over which the measurement (counting) was performed. The value is binary coded with the most significant bit in bit 8 of the first octet and the least significant bit in bit 1 of the second octet.

The RACH Busy Count field (octets 5-6) indicates the number of RACH burst periods during which the received signal level has exceeded a given threshold. This will give a measure of the number of "busy" random access slots. The value is binary coded with the most significant bit in bit 8 of the first octet and the least significant bit in bit 1 of the second octet.

The RACH Access Count field (octets 7-8) indicates the number of received access bursts during the same measurement period. The value is binary coded with the most significant bit in bit 8 of the first octet and the least significant bit in bit 1 of the second octet.

The busy count signal level threshold and the measurement period are parameters set by O&M.

The Supplementary Information field may carry additional operator dependent information.

9.3.19 Request Reference

This element carries the Request Reference parameters used for contention resolution on RACH.

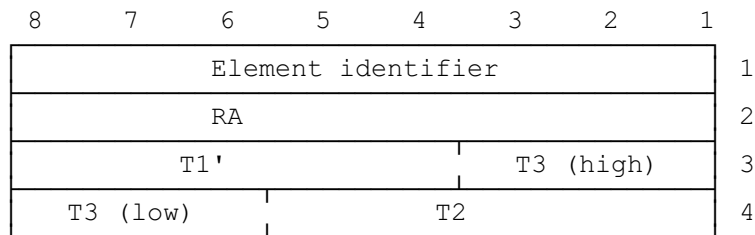

Octets 2-4 are coded as the corresponding fields of the Request Reference element of Technical Specification GSM 04.08. (Octet 2, RA, is the Random Access Information field set by MS in the CHANnel REQuest message. Octets 3-4 contain the absolute frame number modulo 42432 for the frame number when the access burst was received, see Starting Time information element of GSM 04.08).

9.3.20 Release Mode

This element is used to distinguish between normal release and local end release of the radio data link connection.

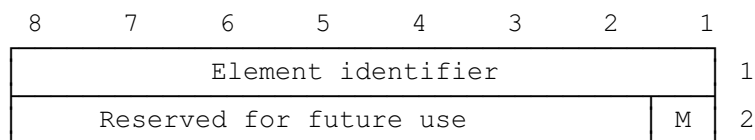

The M bit is coded as follows:

- 0 normal release
- 1 local end release

9.3.21 Resource Information

This element is used to indicate the interference level for each of the idle channels of a TRX.

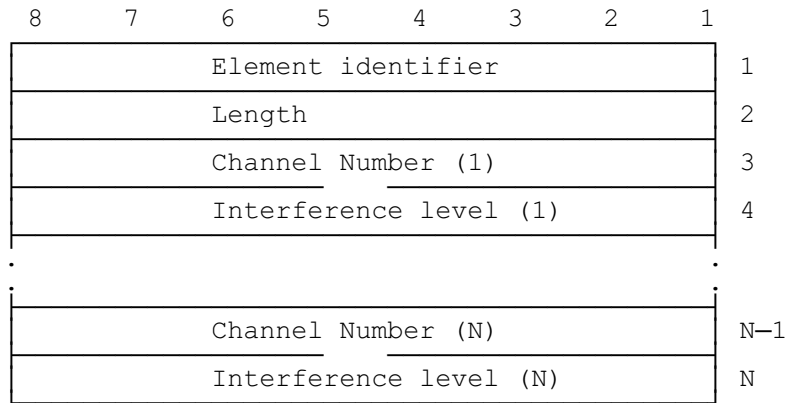

The Length field indicates in binary the remaining length of the element (octets 3-N).

Octets 3-N forms a list of Channel Numbers and Interference levels measured on the corresponding channel.

The Channel Number octet is coded as octet 2 of the Channel Number information element, section 9.3.1.

The Interference Level octet is coded as follows:

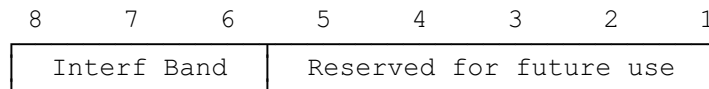

The Interf Band field (bits 6-8) indicates in binary the interference level expressed as one of five possible interference level bands as defined by O&M. The interference level is averaged over a period of Intave (parameter set by O&M, see TS GSM 05.08) immediately before the transmission of the RF RESource INDication message. See also Technical Specification GSM 08.08, section 3.1.3.1 and Technical Specification GSM 05.08, section 3.1 e) of Appendix A.

9.3.22 RLM Cause

This element is used to indicate the precise protocol error or the reason for a release on the radio link layer.

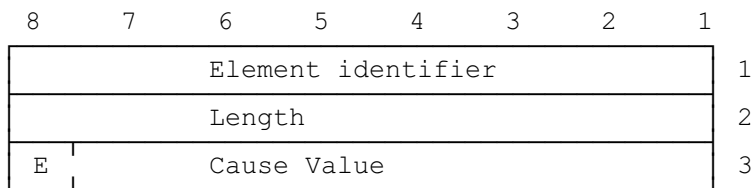

The Cause Value is a one octet field if the extension bit is set to 0. If the extension bit is set to 1, the Cause Value is a two octet field.

The Cause Value field is coded as follows:

8 7 6 5 4 3 2 1	
0 0 0 0 0 0 0 0	reserved
0 0 0 0 0 0 0 1	timer T200 expired (N200+1) times
0 0 0 0 0 0 1 0	re-establishment request
0 0 0 0 0 0 1 1	unsolicited UA response
0 0 0 0 0 1 0 0	unsolicited DM response
0 0 0 0 0 1 0 1	unsolicited DM response, multiple frame established state
0 0 0 0 0 1 1 0	unsolicited supervisory response
0 0 0 0 0 1 1 1	sequence error
0 0 0 0 1 0 0 0	U-frame with incorrect parameters
0 0 0 0 1 0 0 1	S-frame with incorrect parameters
0 0 0 0 1 0 1 0	I-frame with incorrect use of M bit
0 0 0 0 1 0 1 1	I-frame with incorrect length
0 0 0 0 1 1 0 0	frame not implemented
0 0 0 0 1 1 0 1	SABM command, multiple frame established state
0 0 0 0 1 1 1 0	SABM frame with information not allowed in this state

All other values are reserved for future use.

9.3.23 Starting Time

This element provides the starting time expressed as FN modulo 42432 (FN is absolute frame number).

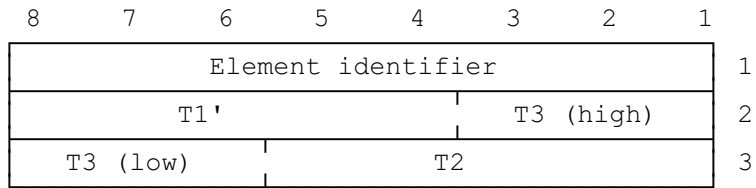

Octets 2-3 are coded as defined for octets 2-3 of the Starting Time information element of Technical Specification GSM 04.08.

9.3.24 Timing Advance

This element contains the timing advance to be used by MS in subsequent communications. It is calculated by BTS at the reception of a CHANnel REQuest message (random access burst) or a handover access burst.

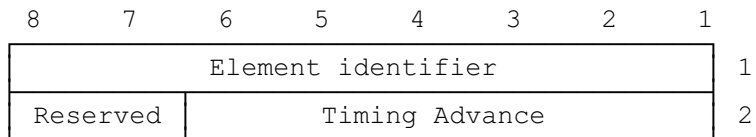

The Timing Advance field contains the timing advance TA as specified in Technical Specification GSM 05.10.

Bits 7-8 of octet 2 are reserved for future use.

9.3.25 Uplink Measurements

This element is used to report the results of the TRX measurements on the uplink radio path of an activated basic radio channel. It is of variable length.

8	7	6	5	4	3	2	1	
Element identifier								1
Length								2
rfu	DTXd	RXLEV-FULL-up						3
Reserved		RXLEV-SUB-up						4
Reserved		RXQUAL-FULL-up			RXQUAL-SUB-up			5
Supplementary								6
Measurement								.
Information								N

rfu = Reserved for Future Use.

The Length field indicates in binary the remaining length of the element (octets 3-N).

Octets 3-5 contain results from measurements made by TRX on the uplink.

The Supplementary Measurement Information field (octets 6-N) may carry additional operator dependent information.

The DTXd field (octet 3) indicates whether DTX was employed by TRX on the downlink transmission during the measurement period.

The RXLEV-FULL-up and RXLEV-SUB-up fields (octets 3-4) report the average uplink signal level as measured by TRX over the measurement period on all slots and on a subset of the slots respectively (see Technical Specification GSM 05.08, section 8.2). Each field is coded as defined in Technical Specification GSM 05.08, section 8.1.4.

The RXQUAL-FULL-up and RXQUAL-SUB-up fields (octet 5) report the average uplink quality as measured by TRX over the measurement period on all slots and on a subset of the slots respectively (see Technical Specification GSM 05.08, section 8.2). Each field is coded as defined in Technical Specification GSM 05.08, section 8.2.4.

9.3.26 Cause

The cause element is used to indicate the reason for a particular event to have occurred and is coded as shown below.

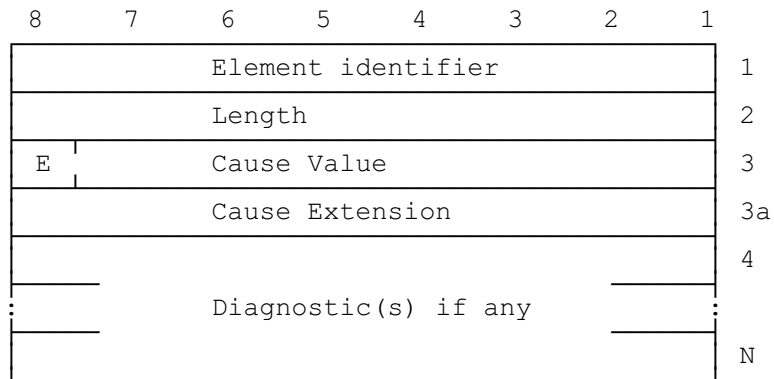

The Length field indicates in binary the remaining length of the element (octets 3-N).

The Cause Value is a single octet field (octet 3) if the extension bit E (bit 8) is set to 0. If it is set to 1 then the cause value is a 2 octet field (octets 3 and 3a).

The Cause Value is divided into two fields: a class (bits 5-7 of octet 3) and a value within the class (bits 1-4 of octet 3).

If the value of the first octet of the cause field is 1XXX 0000 then the second octet is reserved for national applications (XXX will still indicate the class).

Diagnostic information is not available for every cause, see the table below. When available, it is coded in the same way as the corresponding information element in section 9. Inclusion of diagnostics is optional.

Classes:

Class (000) : Normal event

Class (001) : Normal event

Class (010) : Resource unavailable

Class (011) : Service or option not available

Class (100) : Service or option not implemented

Class (101) : Invalid message (e.g. parameter out of range)

Class (110) : Protocol error

Class (111) : Interworking

CAUSE VALUES:

Class	Value	Cause	Diagnostics
0 0 0	- - - -	Normal Event	
0 0 0	0 0 0 0	radio interface failure	Channel Number
0 0 0	0 0 0 1	radio link failure	Channel Number
0 0 0	0 0 1 0	handover access failure	Channel Number
0 0 0	0 0 1 1	reserved for international use	
0 0 0	0 1 0 0	reserved for international use	
0 0 0	0 1 0 1	reserved for international use	
0 0 0	0 1 1 0	reserved for international use	
0 0 0	0 1 1 1	O&M intervention	
0 0 0	1 0 0 0	reserved for international use	
0 0 0	1 : : :		
0 0 0	1 1 1 0		
0 0 0	1 1 1 1	normal event, unspecified	
0 0 1	- - - -	Normal Event	
0 0 1	0 0 0 0	reserved for international use	
0 0 1	0 : : :		
0 0 1	0 1 1 1		
0 0 1	1 0 0 0	reserved for national use	
0 0 1	1 : : :		
0 0 1	1 1 1 1		
0 1 0	- - - -	Resource unavailable	
0 1 0	0 0 0 0	equipment failure	
0 1 0	0 0 0 1	radio resource not available	Channel Number
0 1 0	0 0 1 0	terrestrial channel failure	Channel Number
0 1 0	0 0 1 1	CCCH overload	Channel Number
0 1 0	0 1 0 0	ACCH overload	Channel Number
0 1 0	0 1 0 1	processor overload	
0 1 0	0 1 1 0	reserved for international use	
0 1 0	0 1 1 1	BTS not equipped	
0 1 0	1 0 0 0	remote transcoder failure	Channel Number
0 1 0	1 0 0 1	reserved for international use	
0 1 0	1 0 1 0	reserved for international use	
0 1 0	1 0 1 1	reserved for international use	
0 1 0	1 1 0 0	reserved for national use	
0 1 0	1 1 0 1	reserved for national use	
0 1 0	1 1 1 0	reserved for national use	
0 1 0	1 1 1 1	resource not available, unspecified	

Class	Value	Cause	Diagnostics
0 1 1	- - - -	Service or Option Not Available	
0 1 1	0 0 0 0	requested transcoding/rate adaption not available	Channel Number
0 1 1	0 0 0 1	reserved for international use	
0 1 1	: : : :		
0 1 1	1 1 1 0		
0 1 1	1 1 1 1	service or option not available, unspecified	
<hr/>			
1 0 0	- - - -	Service or Option Not Implemented	
1 0 0	0 0 0 0	encryption algorithm not implemented	Channel Number
1 0 0	0 0 0 1	reserved for international use	
1 0 0	0 : : :		
1 0 0	0 1 1 1		
1 0 0	1 0 0 0	reserved for national use	
1 0 0	1 : : :		
1 0 0	1 1 1 0		
1 0 0	1 1 1 1	service or option not implemented, unspecified	
<hr/>			
1 0 1	- - - -	Invalid Message	
1 0 1	0 0 0 0	radio channel already activated/allocated	Channel Number
1 0 1	0 0 0 1	reserved for international use	
1 0 1	0 : : :		
1 0 1	0 1 1 1		
1 0 1	1 0 0 0	reserved for national use	
1 0 1	1 : : :		
1 0 1	1 1 1 0		
1 0 1	1 1 1 1	invalid message, unspecified	

Class	Value	Cause	Diagnostics
1 1 0	- - - -	Protocol Error	
1 1 0	0 0 0 0	message discriminator error	Message Discrim
1 1 0	0 0 0 1	message type error	Message Type
1 1 0	0 0 1 0	message sequence error	Message Type
1 1 0	0 0 1 1	general information element error	
1 1 0	0 1 0 0	mandatory information element error	Element Identif
1 1 0	0 1 0 1	optional information element error	Element Identif
1 1 0	0 1 1 0	information element non-existent	Element Identif
1 1 0	0 1 1 1	information element length error	Element Identif
1 1 0	1 0 0 0	invalid information element contents	Inform. Element
1 1 0	1 0 0 1	reserved for international use	
1 1 0	1 0 1 0	reserved for international use	
1 1 0	1 0 1 1	reserved for international use	
1 1 0	1 1 0 0	reserved for national use	
1 1 0	1 1 0 1	reserved for national use	
1 1 0	1 1 1 0	reserved for national use	
1 1 0	1 1 1 1	protocol error, unspecified	
<hr/>			
1 1 1	- - - -	Interworking	
1 1 1	0 0 0 0	reserved for international use	
1 1 1	0 : : :		
1 1 1	0 1 1 1		
1 1 1	1 0 0 0	reserved for national use	
1 1 1	1 : : :		
1 1 1	1 1 1 0		
1 1 1	1 1 1 1	interworking, unspecified	

9.3.27 Measurement result number

This element is used by BTS to number, (on a channel), the measurement result messages sent to BSC. It is set to 0 at activation time of the channel. The numbering is modulo 256.

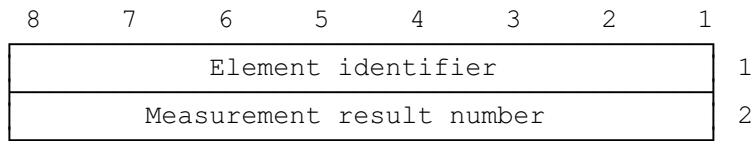

9.3.28 Message Identifier

This element is used to indicate a message type within a message.

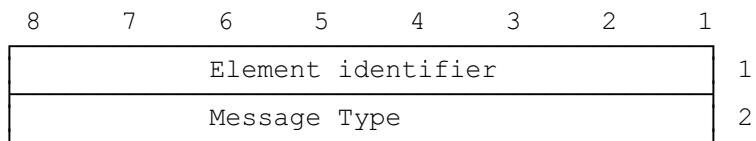

Octet 2 is coded as the Message Type information element, section 9.2.

9.3.29 SACCH Information

This element is used to carry the SACCH filling information (System Information messages) that is to be used on a specific channel.

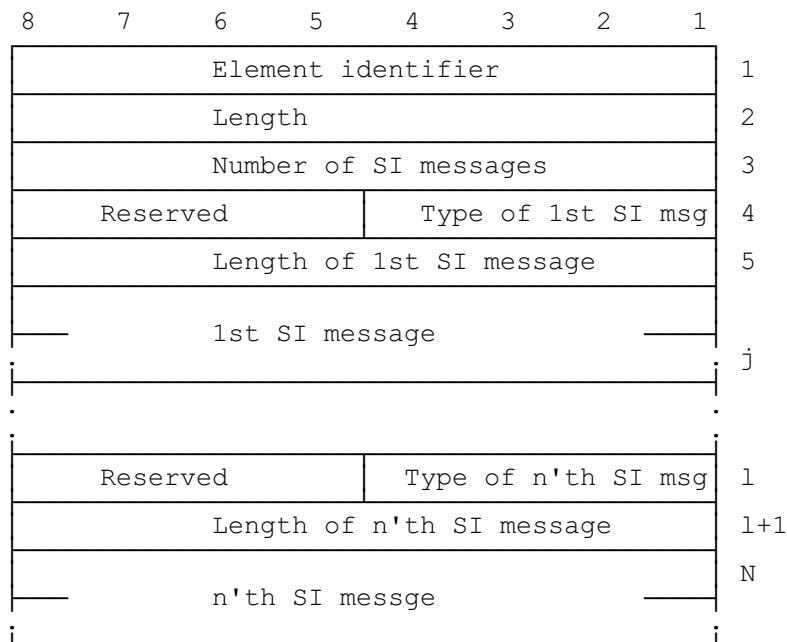

The Length field (octet 2) indicates in binary the total remaining length of the element (octets 3 - N).

The Number of SI messages field (octet 3) indicates in binary the number of System Information messages contained in the element.

The coding of each of these messages consists of a SI type field (Type of n'th SI msg), a length field (Length of n'th SI message) and a message field (n'th SI message).

The "Type of n'th msg" field indicates the type of SYSTEM INFORMATION that follows in the "n'th SI message" field. It is coded as follows:

Value	System information message
0101	SYSTEM INFORMATION 5
0110	SYSTEM INFORMATION 6
1101	SYSTEM INFORMATION 5bis
1110	SYSTEM INFORMATION 5ter

All other values are reserved.

The "Length of n'th SI message" field indicates in binary the length of the "n'th SI message" field that follows.

The "n'th SI message" field contains a complete SACCH System Information message as defined in TS GSM 04.08.

9.3.30 System Info Type

This element is used to indicate the type of SYSTEM INFORMATION message as defined in Technical Specification GSM 04.08 (SYSTEM INFORMATION 1 through 8).

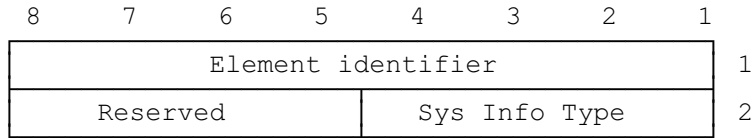

The Sys Info Field (bits 1-4 of octet 2) indicates the SYSTEM INFORMATION message. It is coded as follows:

Value	System information message
0 0 0 0	SYSTEM INFORMATION 8
0 0 0 1	SYSTEM INFORMATION 1
0 0 1 0	SYSTEM INFORMATION 2
0 0 1 1	SYSTEM INFORMATION 3
0 1 0 0	SYSTEM INFORMATION 4
0 1 0 1	SYSTEM INFORMATION 5
0 1 1 0	SYSTEM INFORMATION 6
0 1 1 1	SYSTEM INFORMATION 7
1 0 1 0	SYSTEM INFORMATION 2bis
1 0 1 1	SYSTEM INFORMATION 2ter
1 1 0 1	SYSTEM INFORMATION 5bis
1 1 1 0	SYSTEM INFORMATION 5ter

All other values are reserved.

9.3.31 MS Power Parameters

This element carries the parameters required by TRX for MS power control.

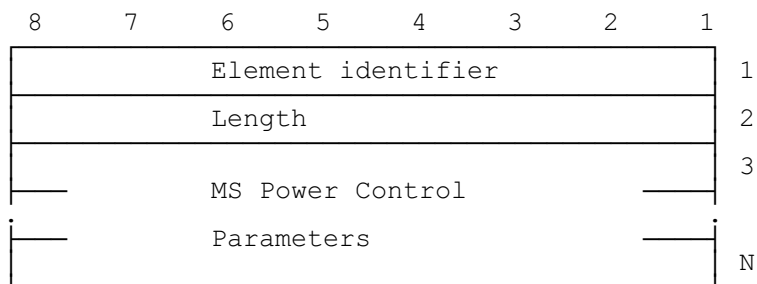

The MS Power Control Parameters field contains the parameters and limits required when MS power control is to be performed by BTS. The coding is operator dependant. Examples of possible parameters and algorithms can be found in Technical Specification GSM 05.08 (RXLEV, RX-QUAL-FULL, RX-QUAL-SUB, DISTANCE (Timing Advance) etc.).

9.3.32 BS Power Parameters

This element carries the parameters required by TRX for control of its own transmission power.

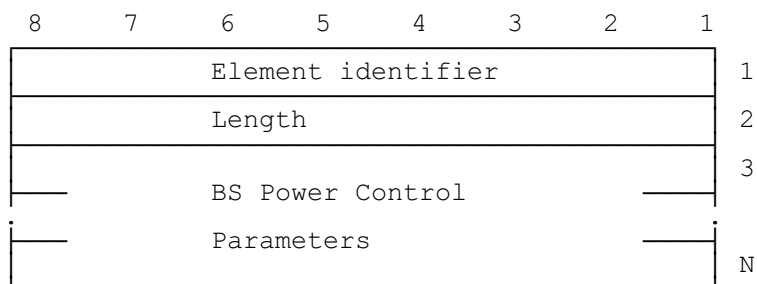

The BS Power Control Parameters field contains the parameters and limits required when TRX transmission power control is to be performed by BTS. The coding is operator dependant. Examples of possible parameters and algorithms can be found in Technical Specification GSM 05.08 (RXLEV, RX-QUAL-FULL, RX-QUAL-SUB, DISTANCE (Timing Advance) etc.).

9.3.33 Preprocessing Parameters

This element contains the parameters required by BTS for the pre-processing of radio measurement data.

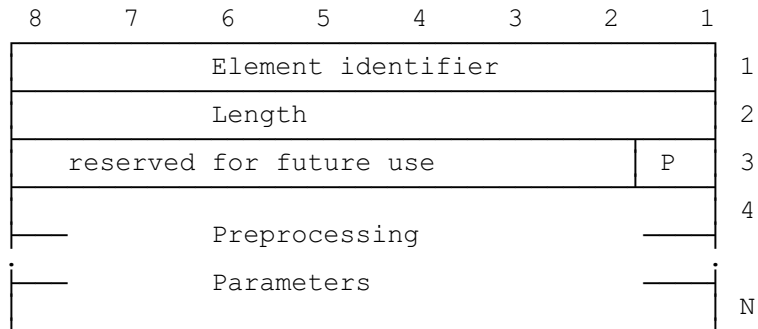

The P bit (bit 1 of octet 3) indicates whether pre-processing is to be used and it is coded as follows:

- 0 use the basic measurement reporting procedure (report raw data)
- 1 use the pre-processed measurement reporting procedure.

If pre-processing is to be used, the Preprocessing Parameters field (octets 4-N) contains the parameters required by BTS. The coding of this field is operator dependant.

9.3.34 Preprocessed Measurements

This element is used by BTS to report the results of the pre-processing of radio measurement data.

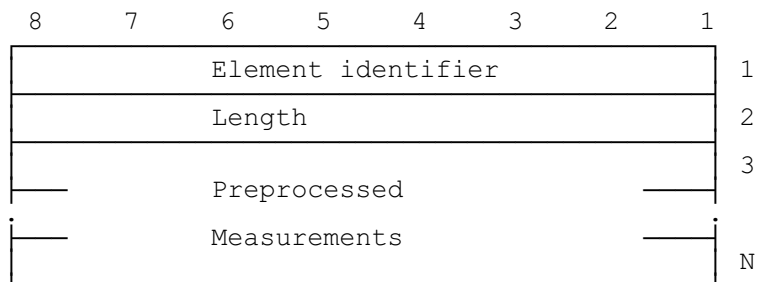

The Preprocessed Measurements field (octets 3-N) contains the results of the pre-processing in BTS. The coding of this field is operator dependant.

9.3.35 Full Immediate Assign Info

This element is used to convey a full L3 immediate assign message (3 types).

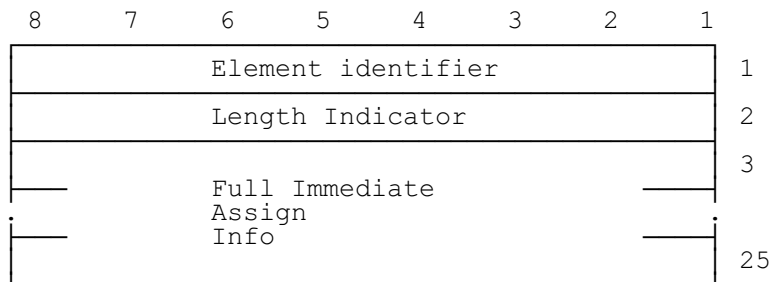

The Length Indicator field (octet 2) indicates in binary the remaining length of the element (octets 3-25).

The Full Immediate Assign Info field (octets 3-25) contains a complete immediate assign message (IMMEDIATE ASSIGN or IMMEDIATE ASSIGN EXTENDED or IMMEDIATE ASSIGN REJECT) as defined in Technical Specification GSM 04.08.

9.3.36 SMSCB Information

This element is used to convey a complete frame to be broadcast on the CBCH including the Layer 2 header for the radio path.

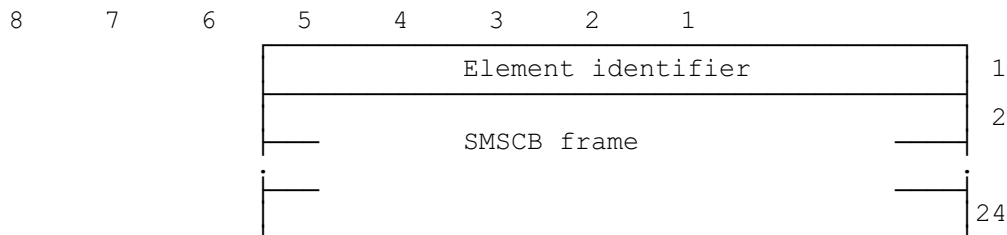

9.3.37 MS Timing Offset

The information is coded in two octets and contains the MS Timing Offset as measured by the BTS.

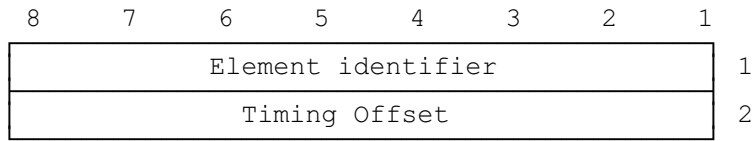

The meaning of the MS Timing Offset is as defined in Technical Specification GSM 05.10. The value of MS Timing Offset is the binary value of the 8-bit Timing Offset field (octet 2) - 63. The range of MS Timing Offset is therefore -63 to 192.

9.3.38 Erroneous Message

This information element is used to carry a complete A-bis interface message which was considered erroneous at reception.

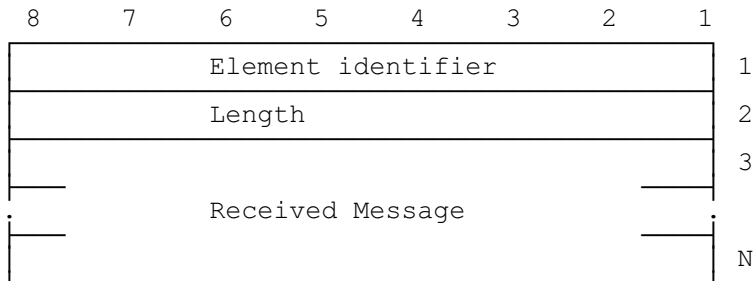

The Received Message field contains a complete A-bis interface L3 message as defined in section 8 of this specification, including Message Discriminator and Message Type.

9.3.39 Full BCCH Information (message name)

This information element contains a complete L3 message as specified in Technical Specification GSM 04.08.

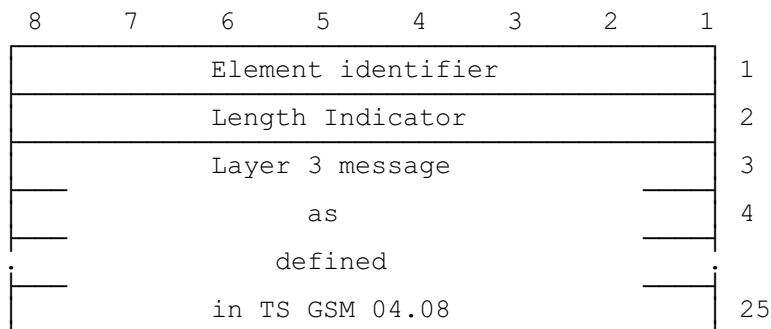

The Length Indicator field (octet 2) indicates in binary the remaining length of the element (octets 3-25). The most significant bit is bit 8 of octet 2 and the least significant bit is bit 1 of octet 2.

Octets 3-25 contain the complete L3 message as defined in Technical Specification GSM 04.08. In the message format section, the GSM 04.08 message name to be included is indicated within brackets.

9.3.40 Channel Needed

This information element is used to indicate to the mobile station which channel will be needed for the transaction linked to the paging procedure.

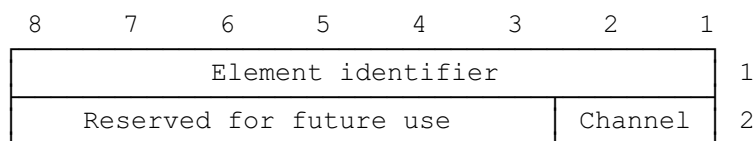

The Channel Field (bits 1-2 of octet 2) indicates the further combination of channel which will be needed. It is coded as follows:

Value	Channel Needed
0 0	Any Channel.
0 1	SDCCH.
1 0	TCH/F (Full rate).
1 1	TCH/F or TCH/H (Dual rate).

9.3.41 CB Command type

This element is used to indicate the type of broadcast requested.

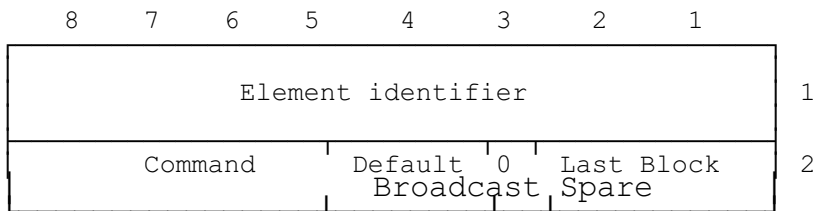

The Command Field (bits 5 to 8) indicates the command to be performed. It is coded as follows:

Value	Command
0 0 0 0	Normal message Broadcast.
1 0 0 0	Schedule message Broadcast.
1 1 1 0	Default message Broadcast.
1 1 1 1	Null message Broadcast.

All other values are reserved.

When the Command Field is different from the value 1110 (Default message Broadcast), the BTS uses the SMSCB message IE together with the Command Field and the Last Block Field to build the blocks sent on the Air interface, as defined by TS GSM 04.12. In that case bit 4 is ignored.

When the Command Field takes the value 1110 (Default message Broadcast), the BTS uses the SMSCB message IE together with the Default Broadcast Field and the Last Block Field to build the blocks sent on the Air interface, as defined by TS GSM 04.12.

The Default Broadcast Field (bit 4) is coded as follows:

Value	Default message to be broadcast
0	Normal message.
1	Null message.

The BTS uses the Last Block Field to signal to the MS the last block containing useful information as defined by TS GSM 04.12. This Field (bits 1 & 2) is coded as follows:

Value	Last Block containing useful information
00	Block 4
01	Block 1
10	Block 2
11	Block 3

9.3.42 SMSCB Message

This element is used to convey the message to be broadcast on the CBCH.

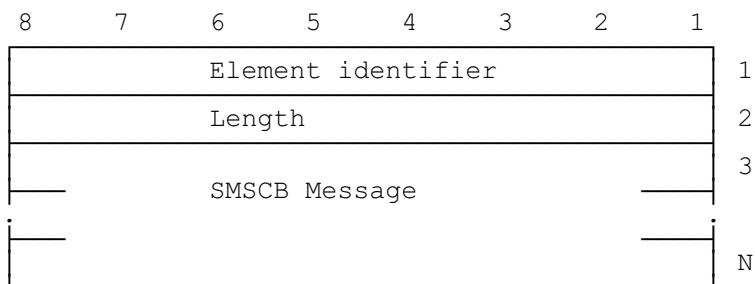

9.3.43 CBCH Load Information

This information element is used to indicate to the BSC the load situation of CBCH in the BTS.

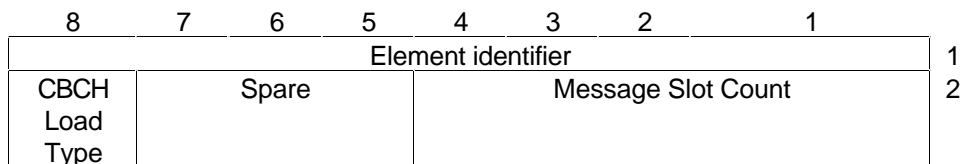

The CBCH Load Type field (bit 8 of octet 2) indicates either an underflow or an overflow situation of the CBCH in the BTS. It is coded as follows:

Value	CBCH Load Type
0	Underflow
1	Overflow

The Message Slot Count field (bits 1-4 of octet 2) indicates either the amount of SMSCB messages that are needed immediately by BTS or the amount of delay in message slots that is needed immediately by BTS depending on the value of the CBCH Load Type field. It is coded as follows:

CBCH Load Type	Message Slot Count
0	indicates the amount of SMSCB messages (1-15) that are needed immediately by BTS
1	indicates the amount of delay in message slots (1-15) that is needed immediately by BTS.

History

Document history	
November 1995	Creation of Version 5.0.0 (Version 4.9.0 + AR08.58-010 r2)
December 1995	Publication of Version 5.0.0
February 1996	Converted into Adobe Acrobat Portable Document Format (PDF)