

ETSI/GSM

Recommendation GSM 08.58

version 3.6.0

Title: Base Station Controller (BSC) to Base Transceiver Station (BTS)
Interface.

Layer 3 Specification

Date : April 1994

List of Contents :

1. Scope
2. Protocol Model
3. Radio Link Layer Management Procedures
4. Dedicated Channel Management Procedures
5. Common Channel Management Procedures
6. TRX Management Procedures
7. Error Handling
8. Message Formats and Contents
9. Information Element Codings

Original Language : English

Number of Pages : 80

1. SCOPE

The use and general aspects of the BSC to BTS interface (the A-bis interface) are given in Recommendation GSM 08.51. This recommendation specifies the general structure of layer 3 and traffic management procedures and messages used on the A-bis interface to support signalling procedures as defined in Recommendation GSM 04.08. Network management procedures and messages for the A-bis interface are defined in Recommendation GSM 08.59. The functional split between BSC and BTS is defined in recommendation 08.52. The procedures and messages required to support this split are defined in detail in this recommendation.

2. PROTOCOL MODEL

A model for L3 can be found in figure 2.1. L2 addressing is made to TRX (or BCF) using the TEI of LAPD. Different L2 links are used for traffic management messages (RSL, Radio Signalling Link), network management messages (OML, Operation & Maintenance Link) and L2 management messages (L2ML, Layer 2 Management Link). For traffic management, two types of signalling messages have been defined:
Transparent Messages: Messages which are forwarded by BTS without interpretation or changes.
Non-Transparent Messages: Messages which are sent only between BSC and BTS and which BTS is acting upon or which are the results of BTS actions.
In addition, the messages have been grouped into four main groups: Radio Link Layer Management, Dedicated Channel Management, Common Channel Management and TRX Management messages.
Discrimination between these types and groups is based on the Message Discriminator which is sent as the first octet in all messages. Transparent and non-transparent messages are discriminated by a transparency flag (T-bit) in the Message Discriminator. Transparent messages are merely forwarded to L2 on the radio interface.
In order to address the relevant radio channel, a Channel Number element is included to support the distribution of messages to relevant physical channels on the TRX. A Link Identifier element supports the distribution on logical links/channels on the radio interface (compare the DLCI element of the A interface, Rec 08.06).
All messages in this recommendation are to be transmitted on the A-bis interface using the I format of LAPD, except for "MEASUREMENT RESULT" which is sent in UI format.

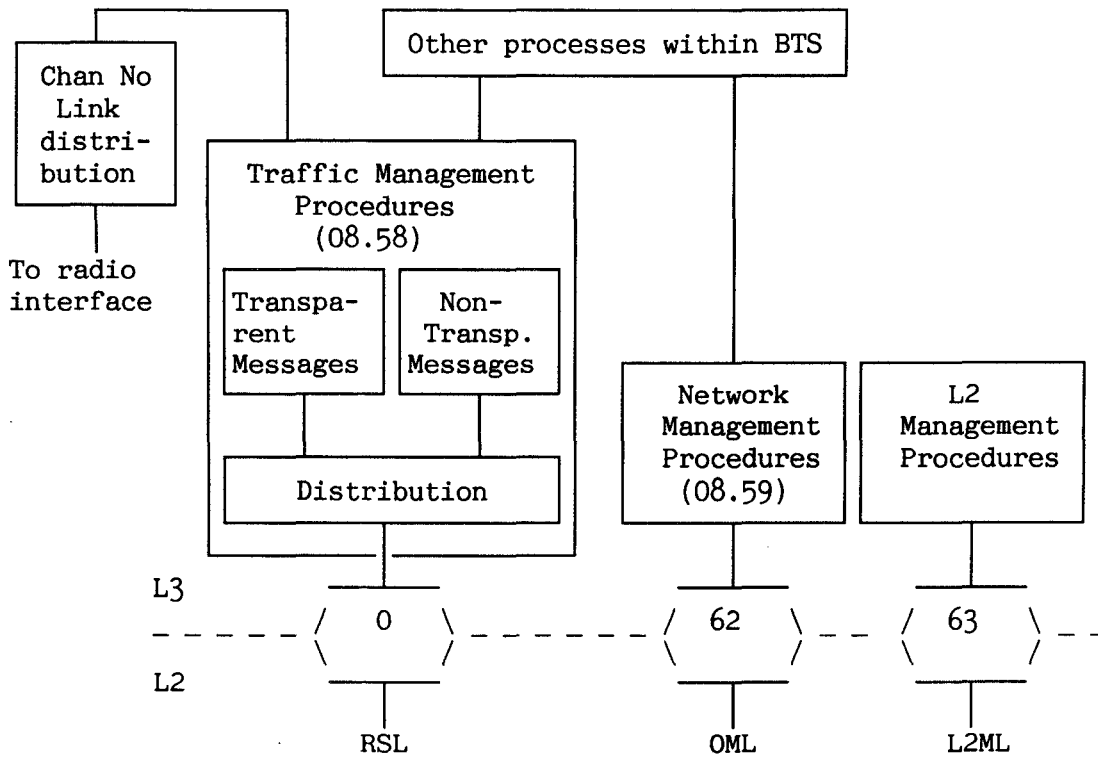

Figure 2.1/08.58 L3 model.

3. RADIO LINK LAYER MANAGEMENT PROCEDURES

This section describes procedures related to the management of a link layer connection on the radio path.

3.1 LINK ESTABLISHMENT INDICATION

This procedure is used by BTS to indicate to BSC that a layer 2 link on the radio path has been established in multi-frame mode at the initiative of an MS. BSC can use this indication to set up an SCCP connection to MSC.

Upon reception of a SABM frame on a link on an active channel, the BTS sends an ESTablish INDication message to BSC. The message contains the contents of the information field of the SABM frame if present.

The procedure is used in all establishment cases, for all channels and all SAPIs.

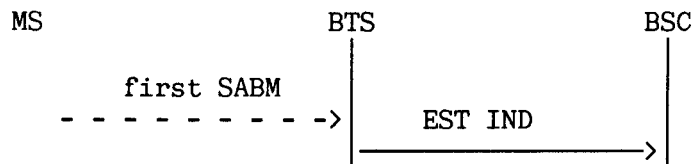

3.2 LINK ESTABLISHMENT REQUEST

This procedure is used by BSC to request the establishment of a link layer connection in multi-frame mode on the radio path.

The procedure is started by BSC sending an ESTablish REQuest message to BTS. BTS then establishes the link by sending an SABM frame. Upon reception of the acknowledgment (UA-frame) from MS, BTS sends an ESTablish CONFirm message to BSC.

In case of a failure, BTS sends a RELease INDication and an ERRor INDication message to BSC (cf Rec 04.06).

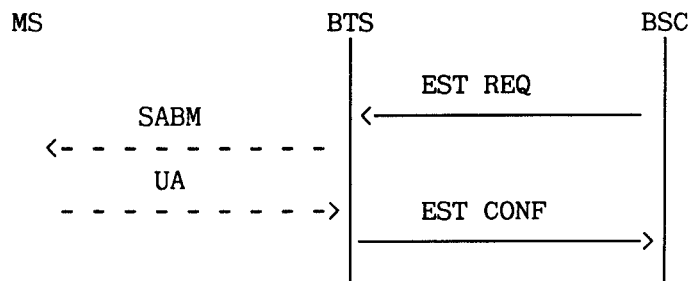

3.3 LINK RELEASE INDICATION

This procedure is used by BTS to indicate to BSC that a link layer connection on the radio path has been released at the initiative of an MS.

When receiving a DISC frame on a link layer connection in multi-frame mode, BTS sends a RELEase INDication message to BSC. (If the link layer is in idle mode, BTS will send a DM frame to MS but does not notify BSC.)

Collision cases are treated as specified in Recommendation GSM 04.06.

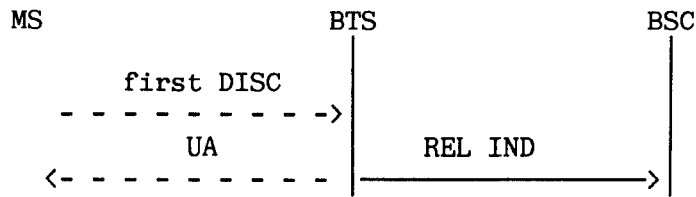

3.4 LINK RELEASE REQUEST

This procedure is used by BSC to request the release of a link layer connection on the radio path.

The procedure is started by BSC sending a RELEase REQuest message to BTS. BTS then sends a DISC frame to MS. When it has received the acknowledgement (UA or DM frame), BTS sends a RELEase CONFirm message to BSC.

Collision cases are treated as specified in Recommendation GSM 04.06.

If BTS has repeated the DISC frame N200 times, BTS sends a RELEase INDication and an ERRor INDication message to BSC (cf Rec 04.06).

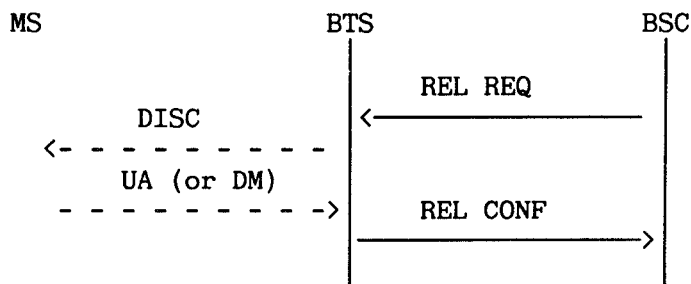

3.5 TRANSMISSION OF A TRANSPARENT L3-MESSAGE IN ACKNOWLEDGED MODE

This procedure is used by BSC to request the sending of a L3 message to MS in acknowledged mode.

BSC sends a DATA REQuest message to BTS. The message contains the complete L3 message to be sent in acknowledged mode.

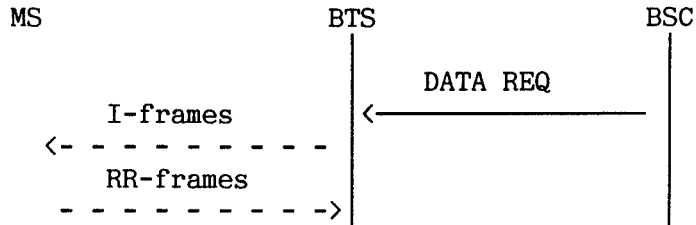

3.6 RECEPTION OF A TRANSPARENT L3-MESSAGE IN ACKNOWLEDGED MODE

This procedure is used by BTS to indicate the reception of a L3 message in acknowledged mode.

BTS sends a DATA INDication message to BSC. The message contains the received L3 message.

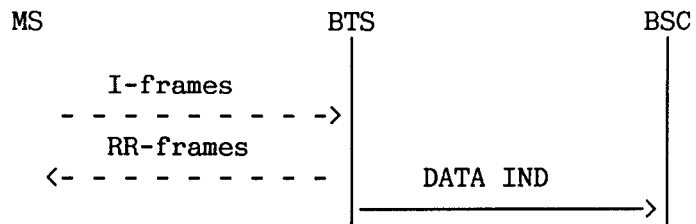

3.7 TRANSMISSION OF A TRANSPARENT L3-MESSAGE IN UNACKNOWLEDGED MODE

This procedure is used by BSC to request the sending of a L3 message to MS in unacknowledged mode.

BSC sends a UNIT DATA REQuest message to BTS. The message contains the L3 message to be sent to MS in unacknowledged mode.

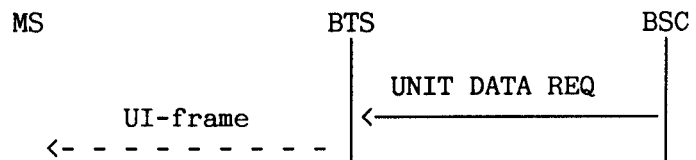

3.8 RECEPTION OF A TRANSPARENT L3-MESSAGE IN UNACKNOWLEDGED MODE

This procedure is used by BTS to indicate the reception of a L3 message in unacknowledged mode.

BTS sends a UNIT DATA INDication message to BSC. The message contains the received L3 message.

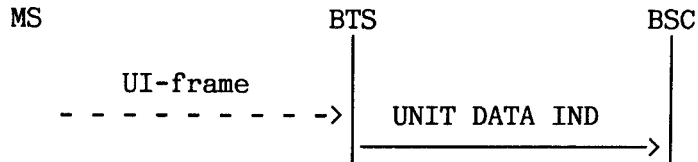

3.9 LINK ERROR INDICATION

This procedure is used by BTS to indicate an abnormal case such as the following.

- a protocol error as specified in Recommendation GSM 04.06, sections 5.6.4, 5.7.3 and Annex G;
- a link layer failure, i.e. the repetition of an I-frame N200 times without an acknowledgement;
- the repetition of an SABM or DISC frame N200 times without an acknowledgement;
- the reception of an SABM frame in multi-frame established state.

When such an event has occurred, BTS notifies BSC by sending an ERROR INDication message containing the relevant cause information.

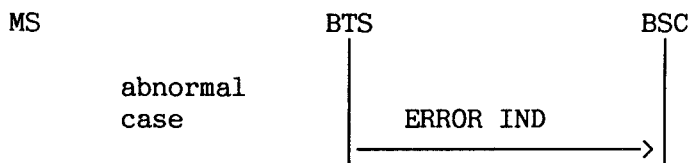

4. DEDICATED CHANNEL MANAGEMENT PROCEDURES

4.1 CHANNEL ACTIVATION

This procedure is used to activate a channel at BTS for an MS which later will be commanded to this channel by an IMMEDIATE ASSIGN, an ASSIGN CoMmanD, an ADDitional ASSIGNment or a HANdOver CoMmanD message.

In the handover case, the procedure is used between the target BSC and the target BTS to activate a channel for a subsequent handover from the old BTS.

4.1.1 Signalling Procedure

BSC determines what channel shall be used and starts up that channel at BTS by sending a CHANnel ACTIVation message to the relevant TRX. This message contains the reason for the activation (immediate assignment, assignment, asynchronous/synchronous handover, additional assignment), the identification of the channel to be used (channel no) and a complete description of the channel (full/half rate, speech/data, coding/rate adaption, hopping sequence, encryption key etc.)

If the Encryption Information field is present, the activation is done with cyphering active. If the Encryption Information element is not present, activation is done without cyphering.

After activating the channel as requested, TRX responds with the CHANnel ACTIVation ACKnowledge message. This message contains the current frame number at BTS. The frame number is used by BSC to determine the Starting Time parameter to be included in the following assignment message to MS. (A suitable number has to be added to current frame number to take all possible signalling delays into account).

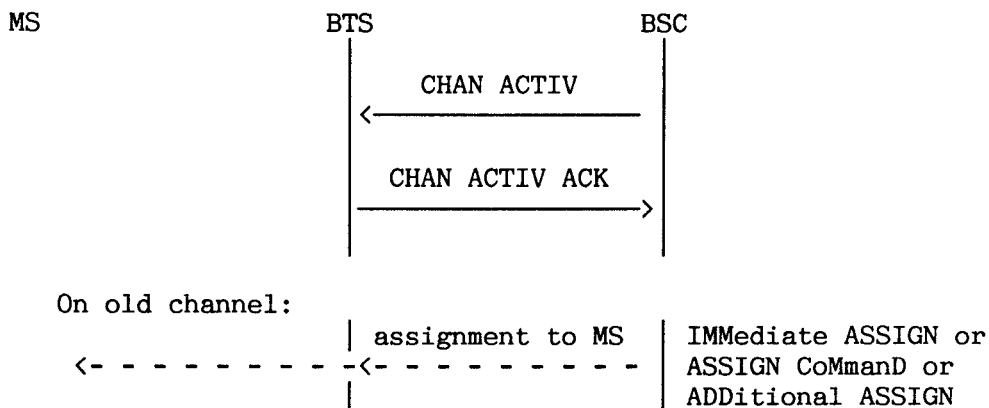

If the TRX for some reason cannot activate the resource as requested by the CHANnel Activation message, the TRX shall return a CHANnel ACTIVation Negative ACKnowledge message with the most appropriate cause value.

Possible cause values may be:

- O&M intervention (e.g. channel blocked),
- resource not available (e.g. speech coder, encryption device),
- equipment failure,
- channel already activated,
- etc.

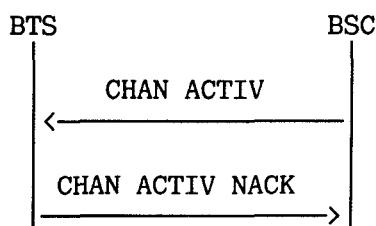

In the handover case the procedure is initiated by the target BSC when this receives the HANdOver REQuest message from MSC (or autonomously by BSC for BSC internal handover). The BSC sends a CHANnel ACTIVation message to the relevant TRX. The message contains the Handover Reference value to be checked by BTS against the Handover Access from MS. After activation of the channel TRX responds with a CHANnel ACTIVation ACKnowledge message containing the current frame number at BTS.

The BSC can then determine the Starting Time parameter to be included in the HANdOver REQuest ACKnowledge message to MSC (and the HANdOver CoMmand message to MS).

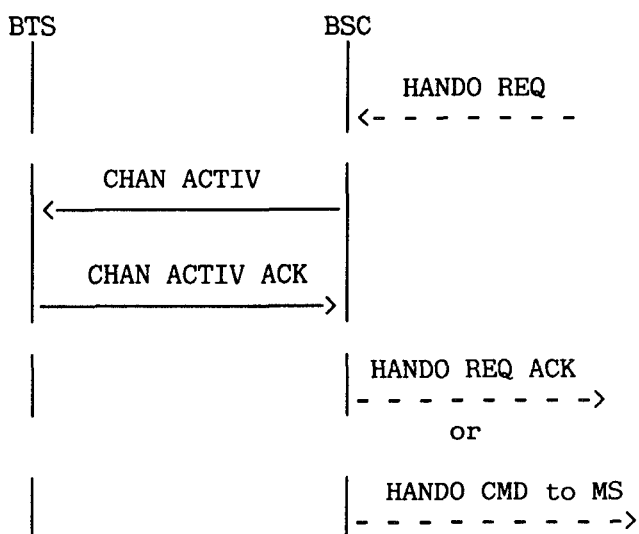

4.1.2 Activation for Intra-Cell Channel Change

This activation precedes the Immediate Assignment, Assignment or Additional assignment procedures. The Timing Advance element must be included in the CHANNEL ACTIVATION message.

BTS activates the channel and starts transmission and reception on the main channel in the indicated mode. Cyphering is started if so indicated in the encryption information.

The reception and transmission on SACCH is also started immediately.

If the BS and/or MS power elements and/or the Physical Context element are present, the reception and transmission processes and the L1-header of SACCH are initialised accordingly.

4.1.3 Activation for Asynchronous Handover

BTS starts transmission immediately on the main channel in the indicated mode and with encryption if so indicated. Transmission and reception on SACCH is not started.

When receiving a correct access burst with the correct handover reference, BTS starts the normal reception process on the main channel in the indicated mode and starts sending and receiving on SACCH. Decyphering is started if so indicated. The handover detection procedure towards BSC is also started.

4.1.4 Activation for Synchronous Handover

BTS starts transmission immediately on the main channel in the indicated mode and with encryption if so indicated. If the MS Power and Timing Advance elements are present, BTS starts transmission also on SACCH with the timing advance and MS power control parameters indicated.

When receiving a correct access burst with the correct handover reference, BTS starts the normal reception process on the main channel in the indicated mode and starts receiving (and sending if not started earlier) on SACCH. Decyphering is started if so indicated. The handover detection procedure towards BSC is also started.

4.2 CHANNEL MODE MODIFY

This procedure is used by BSC to request a change of the channel mode of an active channel.

BSC initiates the procedure by sending a MODE MODIFY message to BTS. The message contains the new mode to be used. After having changed to the new mode, BTS responds with a MODE MODIFY ACKnowledge message to BSC.

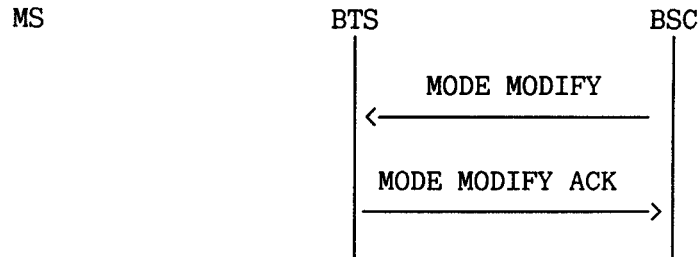

If the TRX for some reason cannot modify the channel as requested in the MODE MODIFY message, the TRX shall return a MODE MODIFY Negative ACKnowledge message with the most appropriate cause value.

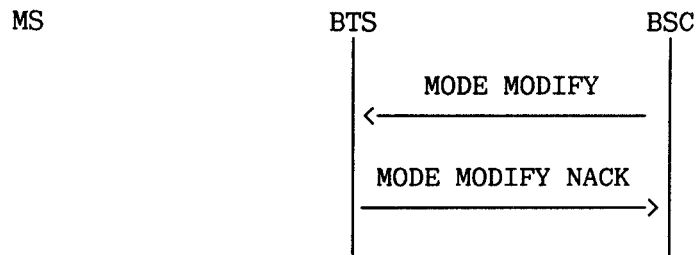

4.3 HANDOVER DETECTION

This procedure is used between the target BTS and BSC when a handed over MS accesses the new BTS.

The procedure is initiated by BTS upon detection of the handover access from an MS on a channel activated for handover access. BTS verifies the handover reference and if this is correct the following procedure is performed.

In case of an asynchronous handover, BTS builds the PHYSical INFOrmation message as specified in Recommendation GSM 04.08, sends the message to MS in unacknowledged mode on the main signalling link and starts timer T3105. A HANDOVer DETection message is sent to BSC. This message contains the measured delay at the access burst. If the timer expires before the reception of a correct frame from MS, BTS repeats the PHYSical INFOrmation message to MS as specified in Recommendation GSM 04.08. If the PHYSical INFOrmation message has been repeated N_{y1} times without a correct frame being received from MS, the BTS shall send a CONNECTION FAILURE message to BSC with the cause value "handover access failure".

In case of a synchronous handover, BTS only sends a HANDOVer DETection message to BSC (no PHYSical INFOrmation message sent to MS).

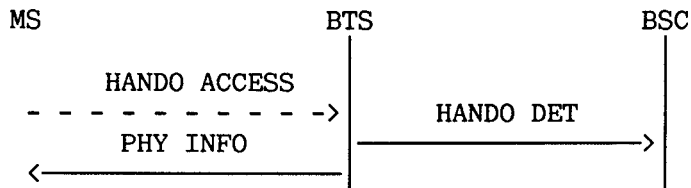

4.4 START OF ENCRYPTION

This procedure is used to start encryption according to the procedure defined in recommendation 04.08.

The procedure is initiated by BSC upon reception of the ENCRyption UPDATE message from MSC (see recommendation 08.08).

BSC sends the ENCRyption CoMmanD message to the relevant TRX and channel. The message contains all information required to select and load the user data and encryption device with the appropriate key and also the complete Cyphering Mode Command message to be sent to MS.

After receipt of this message, TRX sends the CYPHering MODe CoMmanD message to MS in uncyphered form and starts decyphering as described in recommendations 04.08 and 03.20. The start of decyphering and the sending of the Cyphering Mode Command message to MS must be done simultaneously.

When receiving the CYPHering MODe CoMmanD, MS starts both decyphering and encyphering and sends the CYPHering MODe CoMplete message.

TRX starts encyphering upon reception of any correct layer 2 frame which is received after start of decyphering.

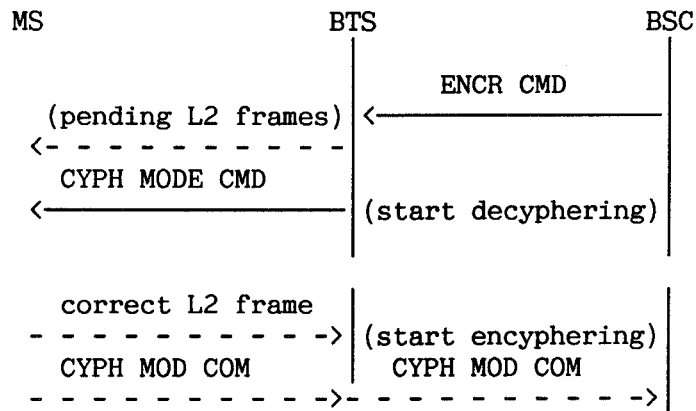

4.5 MEASUREMENT REPORTING

These procedures are used to report to BSC all parameters and measurement results required by BSC for handover requirement determination.

MS measures downlink received signal level and quality from the serving cell and received signal level from surrounding cells as defined in Recommendations GSM 05.05 and GSM 05.08. The measurement results are reported in Measurement Report messages sent in every SACCH block (every 480 ms) or, in case SACCH is used also for other signalling, in at least every second SACCH block (every 960 ms).

The TRX measures the received signal level and the quality on the uplink of the current channel. The averaging period is one SACCH block period (same as the basic period for MS).

These measurements made by MS and TRX form the basic raw data for the handover algorithms in BSC/MSC. The support of forwarding this raw data over the A-bis interface is mandatory for both BTS and BSC. The procedure to be used for this basic measurement reporting is defined in section 4.5.1.

In addition, the BTS and BSC may optionally support some pre-processing in BTS of these basic measurements. The additional and optional procedures required to support this pre-processing are defined in section 4.5.2.

4.5.1 BASIC MEASUREMENT REPORTING

This procedure is used by BTS to report the results of the basic radio measurements made by MS and TRX according to Recommendation GSM 05.08 and GSM 05.05. The support of this procedure is mandatory in all BTS:s and all BSC:s. It is the default procedure to use unless otherwise indicated (see section 4.5.2.1 below).

TRX reports all these measurements in MEASUREMENT RESULT messages to BSC. The sending of the MEASUREMENT RESULT messages is synchronized with the reception of SACCH blocks from MS.

If an uplink SACCH block does not contain a MEASUREMENT REPORT from MS (e.g. when it sends a short message), only the uplink measurement results are included with an indication that the MS measurements are missing.

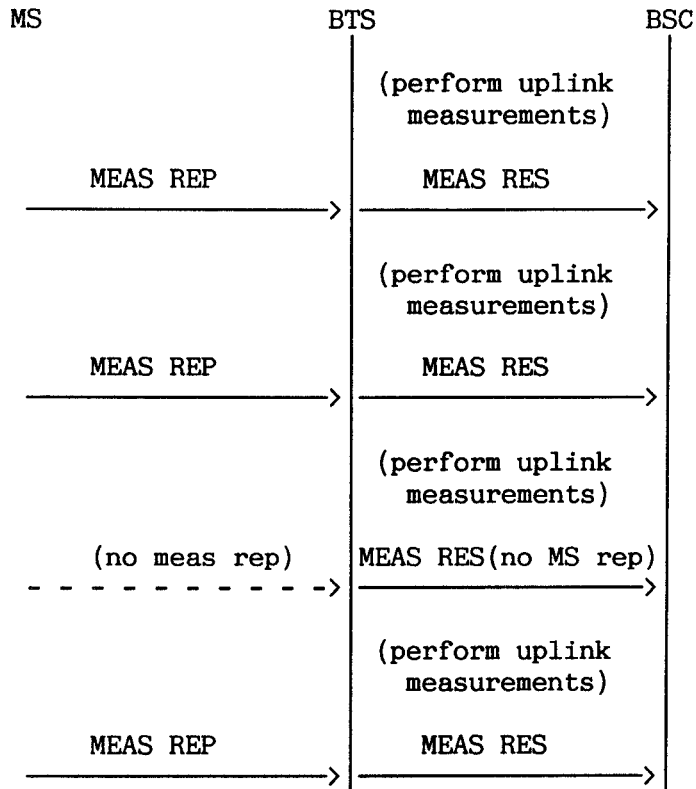

4.5.2 MEASUREMENT PRE-PROCESSING

These additional and optional procedures are included to support some pre-processing in BTS of radio measurement data. When used, they may replace the basic procedure defined in section 4.5.1. However, it shall be possible to change back to the basic procedure.

Pre-processing in BTS must not affect the procedures on the A interface (e.g. the Handover Candidate Enquiry procedure).

4.5.2.1 PRE-PROCESSING CONFIGURATION

This procedure is used by BSC to modify the pre-processing parameters according to reported communication conditions (e.g. degradation of the communication).

In order to change the parameters, BSC sends a PREPROCESS CONFIGURE message to BTS.

A parameter setting in the PREPROCESS CONFIGURE message indicates if the basic procedure defined in section 4.5.1 or pre-processing is to be used.

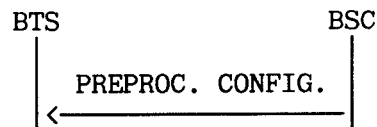

4.5.2.2 PRE-PROCESSED MEASUREMENT REPORTING

This procedure is used by BTS to report the results of measurement pre-processing.

To report the results, BTS sends a PREPROCESSED MEASUREMENT RESULT message to BSC.

The conditions to send the message are set in the PREPROCESS CONFIGURE message.

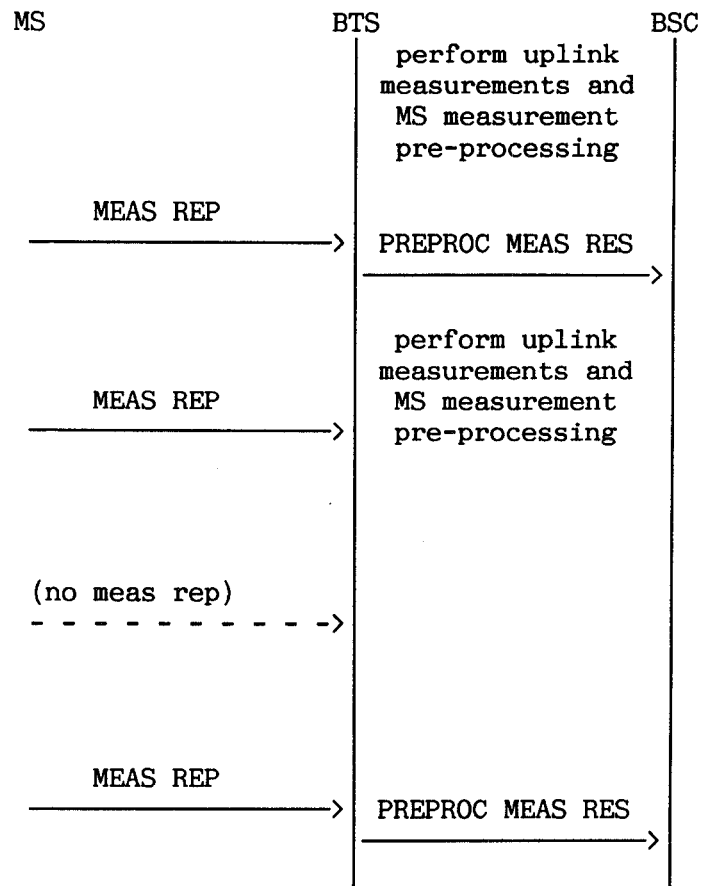

4.6 DEACTIVATE SACCH

This procedure is used by BSC to deactivate the SACCH at BTS according to the Channel Release procedure defined in Recommendation GSM 04.08.

When sending the Channel Release message to MS, BSC also sends the DEACTIVATE SACCH message to BTS to deactivate the SACCH (see GSM 04.08, Channel Release procedure).

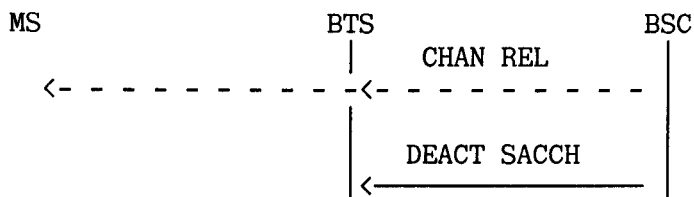

4.7 RADIO CHANNEL RELEASE

This procedure is used by BSC to release a radio channel which is no longer needed.

When an activated radio channel is no longer needed, BSC sends an RF CHANNEL RELEASE message to the relevant TRX and channel. After having released the addressed resources the BTS sends a RF CHANNEL RELEASE ACKNOWLEDGE to BSC.

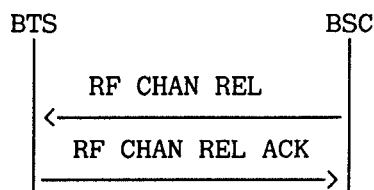

4.8 MS POWER CONTROL

This procedure is used by BSC to set the MS power level or the parameters required by TRX for the control of MS power.

The initial parameters are set by BSC in the CHANNEL ACTIVATION message (see Channel Activation procedure). If these parameters are to be changed for an active channel, BSC sends a MS POWER CONTROL message to TRX.

The support of the power control performed by BTS is optional.

If power control is supported by BTS and it is to be used, this is indicated by optional parameters in the MS POWER CONTROL message (or the CHANNEL ACTIVATION message). Based on the measurements performed on the uplink, TRX then attempts to keep the power control parameters within the limits set by the MS POWER CONTROL message (or by the CHANNEL ACTIVATION message) by changing the MS Power Level field of the L1 header sent to MS in each SACCH block. MS confirms the power in the uplink L1 header.

When the BTS supports MS power control the BSC can modify the MS power parameters during the connection (e.g. because of a classmark change) by sending a MS power control message containing the new parameters.

The MS POWER CONTROL and the CHANNEL ACTIVATION message must also contain a maximum power permitted for the MS.

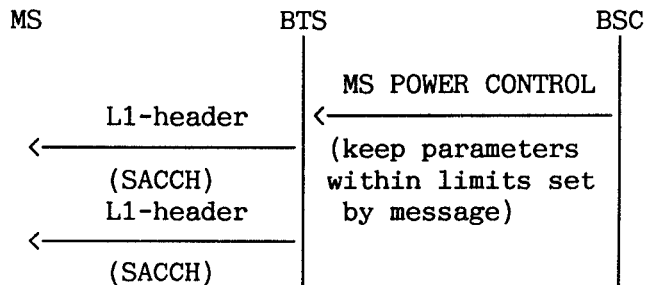

4.9 TRANSMISSION POWER CONTROL

This is an optional procedure which is used between BSC and BTS to set the TRX transmission power level or the parameters required by TRX for the control of TRX transmission power.

The initial parameters are set by BSC in the CHANNEL ACTIVATION message (see Channel Activation procedure). If these parameters are to be changed for an active channel, BSC sends a BS POWER CONTROL message to TRX.

The support of the power control performed by BTS is optional.

If power control is supported by BTS and it is to be used, this is indicated by optional parameters in the BS POWER CONTROL message (or the CHANNEL ACTIVATION message). Based on the Measurement Report messages sent by MS, the TRX will then attempt to keep the power control parameters within the limits set in the BS POWER CONTROL message (or by the CHANNEL ACTIVATION message) by changing the transmitted power on that channel.

The maximum power of the TRX is determined from network planning criteria. However, BSC may indicate a lower maximum power in the BS POWER CONTROL message (or the CHANNEL ACTIVATION message).

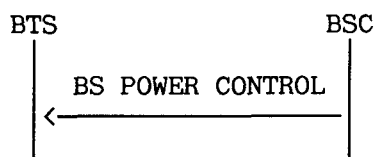

4.10 CONNECTION FAILURE

This procedure is used by BTS to indicate to BSC that an active connection has been broken (e.g. due to a radio link failure as defined in recommendation GSM 05.08).

When BTS detects that a connection has been broken, BTS sends a CONNECTION FAILURE INDICATION message to BSC with the most proper cause value. Further actions are defined in Recommendation 04.08.

Some possible cause values are:

- radio link failure (as defined in GSM 05.08);
- hardware failure (e.g. transcoder failure);
- etc.

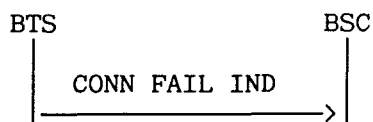

4.11 PHYSICAL CONTEXT REQUEST

This is an optional procedure which allows the BSC to obtain information on the "physical context" of a radio channel just prior to a channel change. This information may be forwarded to the new TRX (possibly in another colocated cell).

The procedure is initiated by BSC sending a PHYSICAL CONTEXT REQUEST message to TRX. TRX responds with a PHYSICAL CONTEXT CONFIRM message which contains information on the "physical context" of the channel.

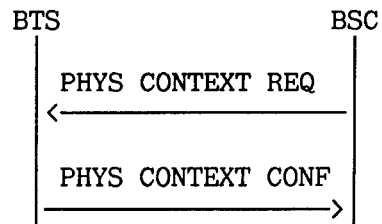

5. COMMON CHANNEL MANAGEMENT PROCEDURES

5.1 CHANNEL REQUEST BY MS

The procedure is initiated by TRX upon detection of a random access from an MS (CHANnel REQuest message from MS). TRX then sends a CHANnel ReQuireD message to BSC containing the Request Reference parameter (random number selected by MS plus some low order bits of the TDMA frame number for the access) and the measured delay of the access burst.

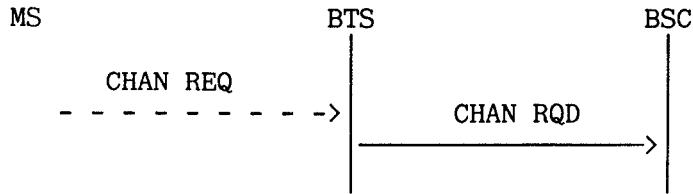

5.2 PAGING

This procedure is used to request the paging of one mobile station on a given paging subchannel.

The paging of an MS is initiated by BSC sending a PAGing CoMmanD message to BTS. The message contains the MS identity (TMSI or IMSI) and the paging population number of the MS.

The PAGing REQuest messages to be sent on the radio path are built and sent by BTS.

The use by BTS of the "extended paging" facilities and the general downlink scheduling of the downlink CCCH is operator dependant and is not specified in this recommendation. This process may also be influenced by O&M procedures.

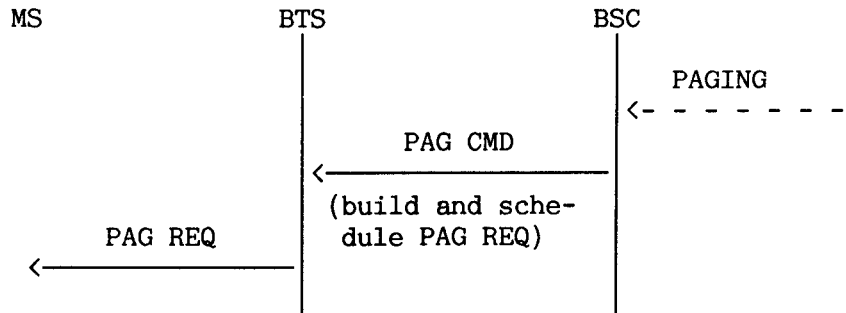

5.3 DELETE INDICATION

This procedure is used by BTS to indicate that due to overload on the downlink CCCH, a UNIT DATA REQuest (i.e. Immediate Assign message) has been deleted.

For that purpose BTS sends a DELETE INDication message to BSC.

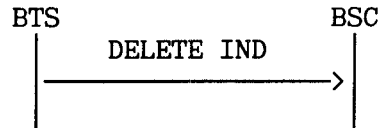

5.4 CCCH LOAD INDICATION

This procedure is used by BTS to inform BSC on the load of CCCH.

The CCCH LOAD INDication message is sent regularly from BTS to BSC if the load exceeds some value set by O&M. The sending rate is also set by O&M.

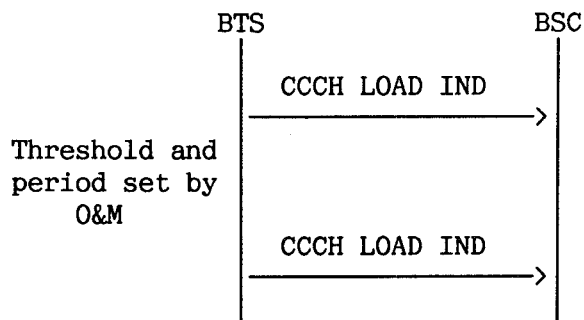

5.5 BROADCAST INFORMATION MODIFY

This procedure is used by BSC to indicate to BTS the new information to be broadcast on BCCH.

For that purpose, BSC sends a BCCH INFOrmation message to BTS.

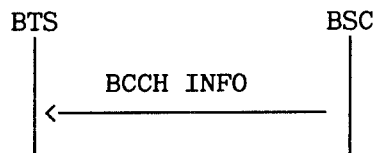

5.6 SHORT MESSAGE CELL BROADCAST

Short Message Service Cell Broadcast messages are sent to BTS as SMS BROADCAST REQUEST. The BSC handles the queuing, repetition and transmission of the messages taking the capacity of the CBCH into account.

5.7 IMMEDIATE ASSIGNMENT

This procedure is used by BSC to request the transmission of an immediate assignment message on downlink CCCH. To initiate the immediate assignment, the BSC sends an IMMEDIATE ASSIGN COMMAND message as defined in Rec. GSM 04.08 (IMMEDIATE ASSIGN or IMMEDIATE ASSIGN EXTENDED OR IMMEDIATE ASSIGN REJECT) with the "Page Mode" element set to the value "no change". Upon receipt of the message the BTS may transmit the immediate assignment as received or update the "Page Mode" element before transmission.

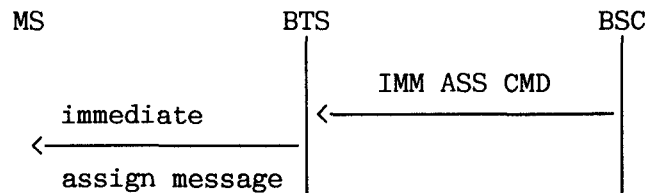

6. TRX MANAGEMENT PROCEDURES

6.1 RADIO RESOURCE INDICATION

This procedure is used to inform BSC on the interference levels on idle channels of a TRX.

In the RF RESource INDication message, TRX reports the interference level for each of the channels which have been idle (not active) for the whole measurement period. See also Recommendation GSM 08.08, section 3.1.3.1 and GSM 05.08, section 3.1 e) of Appendix A.

The RF RESource INDication message is sent regularly with a rate set by O&M.

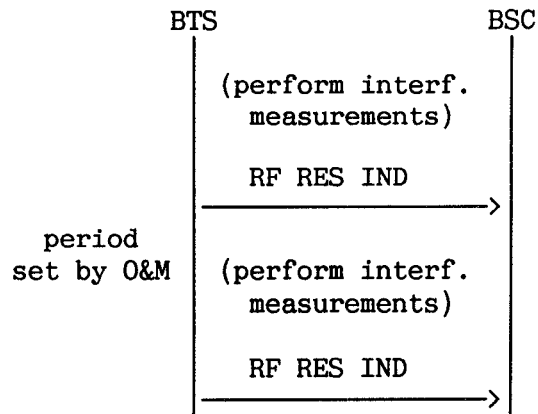

6.2 SACCH FILLING INFORMATION MODIFY

This procedure is used by BSC to indicate to BTS the new information to be used as filling information on SACCHs.

For that purpose BSC sends a SACCH FILLing message to BTS.

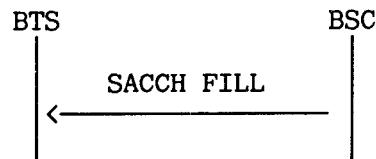

6.3 FLOW CONTROL

This procedure is defined to give some degree of flow control. It can be used for TRX processor overload, downlink CCCH overload and ACCH overload.

The algorithm used in BSC to control the traffic flow is as follows:

Upon receipt of the first OVERLOAD message, BSC reduces the traffic by one step and starts timers T1 and T2. During T1 all OVERLOAD messages are ignored in order not to reduce the traffic too rapidly. Reception of an OVERLOAD message after T1 but still during T2 will decrease the traffic by one more step and timers T1 and T2 are restarted. This step by step reduction of traffic is continued until maximum reduction is obtained.

If T2 expires (i.e. no OVERLOAD message was received during T2), the traffic will be increased by one step and T2 restarted. This step by step increase of traffic will be continued until full load has been resumed.

The number of steps and the method of reducing the load is considered to be implementation dependent. For example, the amount of random accesses and thereby access grants can be reduced by use of the RACH Control parameters (e.g. Access Control Class or Cell Barred) or the Cell Selection parameters (e.g. CELL-RESELECT-HYSTERESIS or RXLEV- ACCESS-MIN) in the system information messages of Recommendation GSM 04.08.

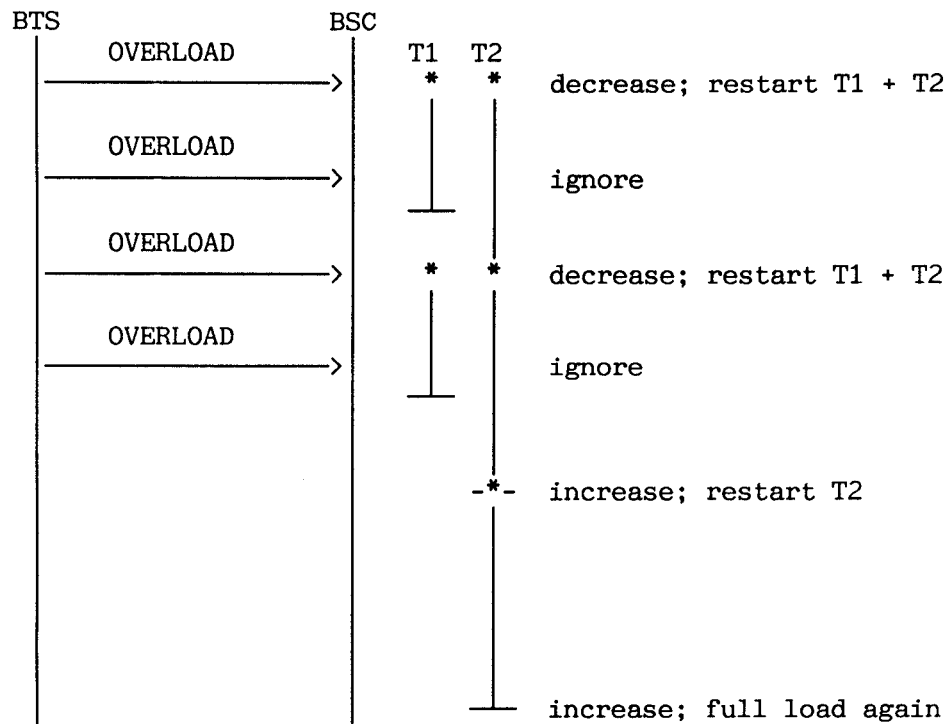

6.4 ERROR REPORTING

This procedure is used by BTS to report detected errors as described in section 7 below if they cannot be reported by any other procedure.

When TRX detects the reception of an erroneous message, it sends an ERROR REPORT message to BSC with the most appropriate cause value. In order to identify the erroneous message, the Message Type, the Channel Number, the Link Identifier and/or the complete erroneous message can be included.

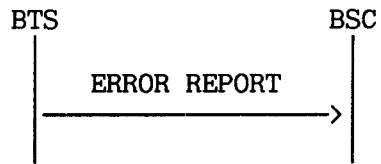

7. ERROR HANDLING

7.1 GENERAL

The procedures specified above apply to those messages which pass the checks described below.

The behaviour of BSC in erroneous cases is implementation dependent.

The behaviour of BTS in erroneous cases is to ignore the message and to send a report to BSC. The report can be sent in either of the following messages:

- CHANNEL ACTIVATION NACK in connection with channel activations;
- MODE MODIFY NACK in connection with a channel mode change;
- ERROR REPORT in other cases.

For procedures controlled by the BSC, and in particular procedures where the BSC sends a request for resources at the BTS and waits for an acknowledge, the implementation in the BSC must provide means for avoiding deadlock situations at the BTS as e.g.hanging resources.

7.2 MESSAGE DISCRIMINATOR ERROR

A message with a non-specified message discriminator is erroneous.

7.3 MESSAGE TYPE ERROR

A message with a non-specified message type is considered correct, but is ignored by BTS.

7.4 MESSAGE SEQUENCE ERROR

A message with an existing message type which is not possible according to the specification and to the state of the BTS is erroneous.

7.5 GENERAL INFORMATION ELEMENT ERRORS

This category includes:

- Information element out of sequence
- Abnormally duplicated element
- Missing element

A message with such an error is erroneous.

7.6 MANDATORY INFORMATION ELEMENT ERRORS

This includes:

- a) Non-existing element type.
- b) Information length error.
- c) Content which does not comply with the specification (value reserved for future use is considered as case d)).
- d) Value indicated as reserved for future use.
- e) Bits reserved for future use not set to 0.
- f) Content complying with specification but incompatible with the state.
- g) Content complying with the specification but inconsistent.

All cases except e) are considered erroneous.

In case e), BTS simply ignores the reserved (RFU) bits.

7.7 OPTIONAL INFORMATION ELEMENT ERRORS

The same categories of errors as in previous section apply.

In cases other than b), e), f) and g), BTS ignores the element and processes the rest of the message.

Cases b), f) and g) are considered erroneous.

In case e), BTS ignores the reserved (RFU) bits.

8. MESSAGE FORMATS AND CONTENTS

This section defines the format and contents of the messages sent over the A-bis interface. Similar coding principles as in recs. 04.08 and 08.08 are used.

Each message is described according to the following general format :

- A brief description of message use and contents.
- Information elements included in the message.
- A reference to the definition of the element coding.
- The direction in which the information element is sent.
- Type of information element, i.e. whether the information element in the message is: M mandatory or
O optional.
- Length of information element.

In every message, the message discriminator is transmitted first. The purpose is to distinguish between transparent messages (T-bit set to 1) and non-transparent messages (T-bit set to 0) and also between messages related to Radio Link Layer Management, Dedicated Channel Management, Common Channel Management and TRX Management.

In a message, the octets are sent in the order shown in the description of the messages and information elements.

8.1 TRANSPARENT MESSAGES

Transparent messages are used at the A-bis interface to convey layer 3 messages for the radio interface as defined in Recommendation GSM 04.08 and for which BTS has to take or has taken no specific action. The T- bit of the Message Discriminator is set to 1.

In the uplink direction (messages from MS), all messages received in I- frames and all messages received in UI-frames except for the

MEASurement REPort

message are considered as transparent. They are forwarded to BSC as DATA INDication and UNIT DATA INDication messages respectively.

In the downlink direction (messages to MS) all messages as defined in Recommendation GSM 04.08 are transparent except for the following messages, which are replaced by BSC-BTS specific messages over the A- bis interface and where BTS will send the corresponding L3 message over the radio interface after the necessary actions have been taken :

Message to MS	Replaced on A-bis interface by
CYPHering MODe CoMmanD	ENCRyption CoMmanD
PAGing REQuest	PAGing CoMmanD
SYSTEM INFOrmation	BCCH INFOrmation and SACCH FILLing
Immediate assign (3 different)	IMMEDIATE ASSIGN COMMAND

Transparent messages are sent by BSC as DATA REQuest or UNIT DATA REQuest messages.

8.2 NON-TRANSPARENT MESSAGES (BSC-BTS SPECIFIC MESSAGES)

These messages are used over the A-bis interface for messages on which BTS has to take some action (BSC to BTS direction) and for messages which are the result from actions taken by BTS (BTS to BSC direction). The T-bit of the Message Discriminator is set to 0.

8.3 RADIO LINK LAYER MANAGEMENT MESSAGES

These messages are related to Radio Link Layer Management procedures. They all have the following general format:

INFORMATION ELEMENT	REFERENCE	DIRECTION	TYPE	LENGTH
Message discriminator	9.1	both	M	1
Message type	9.2	both	M	1
Channel number	9.3.1	both	M	2
Link Identifier	9.3.2	both	M	2
(Information elements depending on message type)				

The messages concerned are the following :

<u>Message name</u>	<u>Reference section</u>
DATA REQuest	8.3.1
DATA INDication	8.3.2
ERROR INDication	8.3.3
ESTablish REQuest	8.3.4
ESTablish CONFirm	8.3.5
ESTablish INDication	8.3.6
RELease REQuest	8.3.7
RELease CONFirm	8.3.8
RELease INDication	8.3.9
UNIT DATA REQuest	8.3.10
UNIT DATA INDication	8.3.11

8.3.1 DATA REQUEST

This message is sent from BSC to BTS to request the sending of a message in acknowledged mode on a radio link layer connection.

INFORMATION ELEMENT	REFERENCE	DIRECTION	TYPE	LENGTH
Message discriminator	9.1	BSC-BTS	M	1
Message type	9.2	BSC-BTS	M	1
Channel number	9.3.1	BSC-BTS	M	2
Link Identifier	9.3.2	BSC-BTS	M	2
L3 Information	9.3.11	BSC-BTS	M	V

8.3.2 DATA INDICATION

This message is sent from BTS to BSC to indicate the reception of a message in acknowledged mode on a radio link layer connection.

INFORMATION ELEMENT	REFERENCE	DIRECTION	TYPE	LENGTH
Message discriminator	9.1	BTS-BSC	M	1
Message type	9.2	BTS-BSC	M	1
Channel number	9.3.1	BTS-BSC	M	2
Link Identifier	9.3.2	BTS-BSC	M	2
L3 Information	9.3.11	BTS-BSC	M	V

8.3.3 ERROR INDICATION

This message is sent from BTS to BSC to indicate an abnormal case for a radio link layer connection.

INFORMATION ELEMENT	REFERENCE	DIRECTION	TYPE	LENGTH
Message discriminator	9.1	BTS-BSC	M	1
Message type	9.2	BTS-BSC	M	1
Channel number	9.3.1	BTS-BSC	M	2
Link Identifier	9.3.2	BTS-BSC	M	2
RLM Cause	9.3.22	BTS-BSC	M	V

8.3.4 ESTABLISH REQUEST

This message is sent from BSC to BTS to request the establishment of a multi-frame mode (acknowledged mode) link layer connection on the radio path.

INFORMATION ELEMENT	REFERENCE	DIRECTION	TYPE	LENGTH
Message discriminator	9.1	BSC-BTS	M	1
Message type	9.2	BSC-BTS	M	1
Channel number	9.3.1	BSC-BTS	M	2
Link Identifier	9.3.2	BSC-BTS	M	2

8.3.5 ESTABLISH CONFIRM

This message is sent from BTS to BSC to confirm the establishment of a radio link layer connection in multi-frame (acknowledged) mode.

INFORMATION ELEMENT	REFERENCE	DIRECTION	TYPE	LENGTH
Message discriminator	9.1	BTS-BSC	M	1
Message type	9.2	BTS-BSC	M	1
Channel number	9.3.1	BTS-BSC	M	2
Link Identifier	9.3.2	BTS-BSC	M	2

8.3.6 ESTABLISH INDICATION

This message is sent from BTS to BSC to indicate the establishment of a radio link layer connection in multi-frame mode, initiated by an MS.

INFORMATION ELEMENT	REFERENCE	DIRECTION	TYPE	LENGTH
Message discriminator	9.1	BTS-BSC	M	1
Message type	9.2	BTS-BSC	M	1
Channel number	9.3.1	BTS-BSC	M	2
Link Identifier	9.3.2	BTS-BSC	M	2
L3 Information	9.3.11	BTS-BSC	O *	V

*The L3 Information field is present only if the SABM frame contained a non-empty information field.

Note: The "establish mode" parameter appearing in Rec. GSM 04.06 is used only on the MS side.

8.3.7 RELEASE REQUEST

This message is sent from BSC to BTS to request the release of multi-frame mode of a radio link layer connection.

INFORMATION ELEMENT	REFERENCE	DIRECTION	TYPE	LENGTH
Message discriminator	9.1	BSC-BTS	M	1
Message type	9.2	BSC-BTS	M	1
Channel number	9.3.1	BSC-BTS	M	2
Link Identifier	9.3.2	BSC-BTS	M	2
Release Mode	9.3.20	BSC-BTS	M	2

8.3.8 RELEASE CONFIRM

This message is sent from BTS to BSC to confirm the release of multi-frame mode of a radio link layer connection.

INFORMATION ELEMENT	REFERENCE	DIRECTION	TYPE	LENGTH
Message discriminator	9.1	BTS-BSC	M	1
Message type	9.2	BTS-BSC	M	1
Channel number	9.3.1	BTS-BSC	M	2
Link Identifier	9.3.2	BTS-BSC	M	2

8.3.9 RELEASE INDICATION

This message is sent from BTS to BSC to indicate the release of a radio link layer connection (initiated by MS).

INFORMATION ELEMENT	REFERENCE	DIRECTION	TYPE	LENGTH
Message discriminator	9.1	BTS-BSC	M	1
Message type	9.2	BTS-BSC	M	1
Channel number	9.3.1	BTS-BSC	M	2
Link Identifier	9.3.2	BTS-BSC	M	2

8.3.10 UNIT DATA REQUEST

This message is sent from BSC to BTS to request the sending of a message in unacknowledged mode on a radio link layer connection.

INFORMATION ELEMENT	REFERENCE	DIRECTION	TYPE	LENGTH
Message discriminator	9.1	BSC-BTS	M	1
Message type	9.2	BSC-BTS	M	1
Channel number	9.3.1	BSC-BTS	M	2
Link Identifier	9.3.2	BSC-BTS	M	2
L3 Information	9.3.11	BSC-BTS	M	V

8.3.11 UNIT DATA INDICATION

This message is sent from BTS to BSC to indicate the reception of a message in unacknowledged mode on a radio link layer connection.

INFORMATION ELEMENT	REFERENCE	DIRECTION	TYPE	LENGTH
Message discriminator	9.1	BTS-BSC	M	1
Message type	9.2	BTS-BSC	M	1
Channel number	9.3.1	BTS-BSC	M	2
Link Identifier	9.3.2	BTS-BSC	M	2
L3 Information	9.3.11	BTS-BSC	M	V

8.4 DEDICATED CHANNEL MANAGEMENT MESSAGES

These messages are related to Dedicated Channel Management procedures. They all have the following general format:

INFORMATION ELEMENT	REFERENCE	DIRECTION	TYPE	LENGTH
Message discriminator	9.1	both	M	1
Message type	9.2	both	M	1
Channel number	9.3.1	both	M	2
(Information elements depending on message type)				

The messages concerned are the following:

<u>Message name</u>	<u>Reference section</u>
CHANnel ACTIVation	8.4.1
CHANnel ACTIVation ACKnowledge	8.4.2
CHANnel ACTIVation Negative ACK	8.4.3
CONNECTION FAILUre INDication	8.4.4
DEACTIVATE SACCH	8.4.5
ENCRyption CoMmand	8.4.6
HANdOver DETection	8.4.7
MEASurement RESult	8.4.8
MODE MODIFY REQuest	8.4.9
MODE MODIFY ACKnowledge	8.4.10
MODE MODIFY Negative ACKnowledge	8.4.11
PHYSical CONTEXT REQuest	8.4.12
PHYSical CONTEXT CONFirm	8.4.13
RF CHANnel RELease	8.4.14
MS POWER CONTROL	8.4.15
BS POWER CONTROL	8.4.16
PREPROCecc CONFIGure	8.4.17
PREPROCeSSed MEASurement RESult	8.4.18
RF CHANnel RELease ACKnowledge	8.4.19

8.4.1 CHANNEL ACTIVATION

This message is sent from BSC to BTS in order to activate a radio channel. The attributes of the channel are defined in the message.

INFORMATION ELEMENT	REFERENCE	DIRECTION	TYPE	LENGTH
Message discriminator	9.1	BSC-BTS	M	1
Message type	9.2	BSC-BTS	M	1
Channel Number	9.3.1	BSC-BTS	M	2
Activation Type	9.3.3	BSC-BTS	M	2
Channel Mode	9.3.6	BSC-BTS	M	V
Channel Identification	9.3.5	BSC-BTS	M	V
Encryption information	9.3.7	BSC-BTS	0 1)	V
Handover Reference	9.3.9	BSC-BTS	0 2)	2
BS Power	9.3.4	BSC-BTS	0 3)	2
MS Power	9.3.13	BSC-BTS	0 3)	2
Timing Advance	9.3.24	BSC-BTS	0 3)4)	2
BS Power Parameters	9.3.32	BSC-BTS	0 5)	V
MS Power Parameters	9.3.31	BSC-BTS	0 5)	V
Physical Context	9.3.16	BSC-BTS	0 6)	V

- 1)The Encryption Information element is only included if cyphering is to be applied.
- 2)The Handover Reference element is only included in case of activation for handover.
- 3)If BS Power, MS Power and/or Timing Advance elements are present, they are to be used to set the initial transmission power and the initial L1-header.
- 4)The Timing Advance element is mandatory in case of an intra-cell change.
- 5)The BS and MS Power Parameters elements are included to indicate that BS and/or MS power control is to be performed by BTS. The maximum power to be used is indicated in the BS and MS Power elements respectively.
- 6)Optional element for additional physical channel information.

8.4.2 CHANNEL ACTIVATION ACKNOWLEDGE

This message is sent from BSC to BTS to acknowledge that the requested channel activation has been completed correctly.

INFORMATION ELEMENT	REFERENCE	DIRECTION	TYPE	LENGTH
Message discriminator	9.1	BTS-BSC	M	1
Message type	9.2	BTS-BSC	M	1
Channel number	9.3.1	BTS-BSC	M	2
Frame number	9.3.8	BTS-BSC	M	3

The Frame Number element is used by BSC to calculate the Starting Time parameter when required.

8.4.3 CHANNEL ACTIVATION NEGATIVE ACKNOWLEDGE

This message is sent from BTS to BSC to indicate that the channel activation could not be performed as requested.

INFORMATION ELEMENT	REFERENCE	DIRECTION	TYPE	LENGTH
Message discriminator	9.1	BTS-BSC	M	1
Message type	9.2	BTS-BSC	M	1
Channel number	9.3.1	BTS-BSC	M	2
Cause	9.3.26	BTS-BSC	M	V

8.4.4 CONNECTION FAILURE INDICATION

This message is sent from BTS to BSC to indicate that an active connection has been broken for some reason. It includes a cause value (e.g. radio link failure as defined in GSM 05.08).

INFORMATION ELEMENT	REFERENCE	DIRECTION	TYPE	LENGTH
Message discriminator	9.1	BTS-BSC	M	1
Message type	9.2	BTS-BSC	M	1
Channel number	9.3.1	BTS-BSC	M	2
Cause	9.3.26	BTS-BSC	M	V

8.4.5 DEACTIVATE SACCH

This message is sent from BSC to BTS in order to deactivate the SACCH of an active channel.

INFORMATION ELEMENT	REFERENCE	DIRECTION	TYPE	LENGTH
Message discriminator	9.1	BSC-BTS	M	1
Message type	9.2	BSC-BTS	M	1
Channel Number	9.3.1	BSC-BTS	M	2

8.4.6 ENCRYPTION COMMAND

This message is sent from BSC to BTS to start cyphering mode operation.

INFORMATION ELEMENT	REFERENCE	DIRECTION	TYPE	LENGTH
Message discriminator	9.1	BSC-BTS	M	1
Message type	9.2	BSC-BTS	M	1
Channel Number	9.3.1	BSC-BTS	M	2
Encryption information	9.3.7	BSC-BTS	M	V
Link Identifier	9.3.2	BSC-BTS	M	2
L3 Info (CYPH MOD CMD)	9.3.11	BSC-BTS	M	V

The L3 Info element contains the complete CYPHERing MODE CoMmanD message as defined in Recommendation GSM 04.08.

8.4.7 HANDOVER DETECTION

This message is sent from BTS to BSC when BTS detects the HANdOver ACCESS message (special access burst message) from an MS on the handover activated channel.

INFORMATION ELEMENT	REFERENCE	DIRECTION	TYPE	LENGTH
Message discriminator	9.1	BTS-BSC	M	1
Message type	9.2	BTS-BSC	M	1
Channel number	9.3.1	BTS-BSC	M	2
Access delay	9.3.17	BTS-BSC	M	2

8.4.8 MEASUREMENT RESULT

This message from BTS to BSC is used to report to BSC the results of radio channel measurements made by BTS (uplink) and to convey the measurement reports from MS received on SACCH and in the L1 headers.

INFORMATION ELEMENT	REFERENCE	DIRECTION	TYPE	LENGTH
Message discriminator	9.1	BTS-BSC	M	1
Message type	9.2	BTS-BSC	M	1
Channel number	9.3.1	BTS-BSC	M	2
Measurement result nb	9.3.27	BTS-BSC	M	2
Uplink Measurements	9.3.25	BTS-BSC	M	V
BS Power	9.3.4	BTS-BSC	M	2
L1 Information	9.3.10	BTS-BSC	O *	3
L3 Info (MEAS REP)	9.3.11	BTS-BSC	O *	V

*The L1 Information element contains the last received L1-header (MS Power and Timing Advance) from MS and the L3 Information element contains the complete MEASurement REPort message received from MS. They are included only if received since last MEASurement REsult message.

8.4.9 MODE MODIFY

This message is sent from BSC to BTS to request a change of channel mode of an active channel.

INFORMATION ELEMENT	REFERENCE	DIRECTION	TYPE	LENGTH
Message discriminator	9.1	BSC-BTS	M	1
Message type	9.2	BSC-BTS	M	1
Channel Number	9.3.1	BSC-BTS	M	2
Channel Mode	9.3.6	BSC-BTS	M	V

8.4.10 MODE MODIFY ACKNOWLEDGE

This message is sent from BTS to BSC to confirm the change of channel mode of an active channel.

INFORMATION ELEMENT	REFERENCE	DIRECTION	TYPE	LENGTH
Message discriminator	9.1	BTS-BSC	M	1
Message type	9.2	BTS-BSC	M	1
Channel Number	9.3.1	BTS-BSC	M	2

8.4.11 MODE MODIFY NEGATIVE ACKNOWLEDGE

This message is sent from BTS to BSC to indicate that the channel mode modification could not be performed as requested.

INFORMATION ELEMENT	REFERENCE	DIRECTION	TYPE	LENGTH
Message discriminator	9.1	BTS-BSC	M	1
Message type	9.2	BTS-BSC	M	1
Channel number	9.3.1	BTS-BSC	M	2
Cause	9.3.26	BTS-BSC	M	V

8.4.12 PHYSICAL CONTEXT REQUEST

This message is sent from BSC to BTS to request the "physical context" of an active channel.

INFORMATION ELEMENT	REFERENCE	DIRECTION	TYPE	LENGTH
Message discriminator	9.1	BSC-BTS	M	1
Message type	9.2	BSC-BTS	M	1
Channel Number	9.3.1	BSC-BTS	M	2

8.4.13 PHYSICAL CONTEXT CONFIRM

This message is sent from BTS to BSC as a response to a PHYSICAL CONTEXT REQUEST message. The message contains the "physical context" information.

INFORMATION ELEMENT	REFERENCE	DIRECTION	TYPE	LENGTH
Message discriminator	9.1	BTS-BSC	M	1
Message type	9.2	BTS-BSC	M	1
Channel number	9.3.1	BTS-BSC	M	2
BS Power	9.3.4	BTS-BSC	M	2
MS Power	9.3.13	BTS-BSC	M	2
Timing Advance	9.3.24	BTS-BSC	M	2
Physical Context	9.3.16	BTS-BSC	O	V

8.4.14 RF CHANNEL RELEASE

This message is sent from BSC to BTS to inform that a radio channel is no longer needed.

INFORMATION ELEMENT	REFERENCE	DIRECTION	TYPE	LENGTH
Message discriminator	9.1	BSC-BTS	M	1
Message type	9.2	BSC-BTS	M	1
Channel number	9.3.1	BSC-BTS	M	2

8.4.15 MS POWER CONTROL

This message is sent from BSC to BTS to change the MS power level or the parameters used by TRX to control the MS power.

INFORMATION ELEMENT	REFERENCE	DIRECTION	TYPE	LENGTH
Message discriminator	9.1	BSC-BTS	M	1
Message type	9.2	BSC-BTS	M	1
Channel number	9.3.1	BSC-BTS	M	2
MS Power	9.3.13	BSC-BTS	M	2
MS Power Parameters	9.3.31	BSC-BTS	O *	V

*If the MS Power Parameters element is present it indicates that the MS power control is to be performed by TRX. The MS Power element then indicates the maximum MS power to be used.

8.4.16 BS POWER CONTROL

This message is sent from BSC to BTS to change the TRX transmission power level or the parameters used by TRX to control its transmission power.

INFORMATION ELEMENT	REFERENCE	DIRECTION	TYPE	LENGTH
Message discriminator	9.1	BSC-BTS	M	1
Message type	9.2	BSC-BTS	M	1
Channel number	9.3.1	BSC-BTS	M	2
BS Power	9.3.4	BSC-BTS	M	2
BS Power Parameters	9.3.32	BSC-BTS	O *	V

*If the BS Power Parameters element is present it indicates that the TRX transmission power control is to be performed by TRX. The BS Power element then indicates the maximum transmission power to be used.

8.4.17 PREPROCESS CONFIGURE

This message is sent from BSC to BTS to modify the pre-processing parameters used by BTS.

INFORMATION ELEMENT	REFERENCE	DIRECTION	TYPE	LENGTH
Message discriminator	9.1	BSC-BTS	M	1
Message type	9.2	BSC-BTS	M	1
Channel number	9.3.1	BSC-BTS	M	2
Preproc. Parameters	9.3.33	BSC-BTS	M	V

8.4.18 PREPROCESSED MEASUREMENT RESULT

This message is used by BTS to report the results of radio parameter pre-processing.

INFORMATION ELEMENT	REFERENCE	DIRECTION	TYPE	LENGTH
Message discriminator	9.1	BTS-BSC	M	1
Message type	9.2	BTS-BSC	M	1
Channel number	9.3.1	BTS-BSC	M	2
Preproc. Measurements	9.3.34	BTS-BSC	M	V

8.4.19 RF CHANNEL RELEASE ACKNOWLEDGE

This message is sent from BTS to BSC as an acknowledge to a RF CHANNEL release message.

INFORMATION ELEMENT	REFERENCE	DIRECTION	TYPE	LENGTH
Message discriminator	9.1	BTS-BSC	M	1
Message type	9.2	BTS-BSC	M	1
Channel number	9.3.1	BTS-BSC	M	2

8.5 COMMON CHANNEL MANAGEMENT MESSAGES

These messages are related to Common Channel Management procedures. They all have the following general format:

INFORMATION ELEMENT	REFERENCE	DIRECTION	TYPE	LENGTH
Message discriminator	9.1	both	M	1
Message type	9.2	both	M	1
Channel number	9.3.1	both	M	2
(Information elements depending on message type)				

The messages concerned are the following:

<u>Message name</u>	<u>Reference section</u>
BCCH INFOrmation	8.5.1
CCCH LOAD INDication	8.5.2
CHANnel ReQUIREd	8.5.3
DELETE INDication	8.5.4
PAGING CoMmanD	8.5.5
IMMEDIATE ASSIGN COMMAND	8.5.6
SMS BroadCast REQuest	8.5.7

8.5.1 BCCH INFORMATION

This message is sent from BSC to BTS to indicate new information to be broadcast on BCCH.

INFORMATION ELEMENT	REFERENCE	DIRECTION	TYPE	LENGTH
Message discriminator	9.1	BSC-BTS	M	1
Message type	9.2	BSC-BTS	M	1
Channel Number	9.3.1	BSC-BTS	M	2
System Info Type	9.3.30	BSC-BTS	M	2
L3 Info (SYS INFO)	9.3.11	BSC-BTS	M	V
Starting Time	9.3.23	BSC-BTS	O	3

The System Info Type element indicates the type of SYSTEM INFORMATION message which follows in the L3 Info field.

The L3 Information element contains the relevant SYSTEM INFORMATION message as defined in Recommendation GSM 04.08.

8.5.2 CCCH LOAD INDICATION

This message is sent from BTS to BSC to indicate current load on CCCH (random access, RACH, and paging, PCH).

INFORMATION ELEMENT	REFERENCE	DIRECTION	TYPE	LENGTH
Message discriminator	9.1	BTS-BSC	M	1
Message type	9.2	BTS-BSC	M	1
Channel number	9.3.1	BTS-BSC	M	2
RACH Load	9.3.18	BTS-BSC	M	V
Paging Load	9.3.15	BTS-BSC	M	3

8.5.3 CHANNEL REQUIRED

This message is sent from BTS to BSC to indicate the reception of a CHANnel REQUest message (special access burst message) from an MS.

INFORMATION ELEMENT	REFERENCE	DIRECTION	TYPE	LENGTH
Message discriminator	9.1	BTS-BSC	M	1
Message type	9.2	BTS-BSC	M	1
Channel number	9.3.1	BTS-BSC	M	2
Request Reference	9.3.19	BTS-BSC	M	4
Access delay	9.3.17	BTS-BSC	M	2
Physical Context	9.3.16	BTS-BSC	0	V

The Request Reference element contains the random access reference value sent by MS in the CHANnel REQUest message and some low order bits of the absolute frame number for the reception of the access burst.

8.5.4 DELETE INDICATION

This message is sent from BTS to BSC to indicate the deletion of an access grant message (IMMediate ASSIGN) due to overload of downlink CCCH.

INFORMATION ELEMENT	REFERENCE	DIRECTION	TYPE	LENGTH
Message discriminator	9.1	BTS-BSC	M	1
Message type	9.2	BTS-BSC	M	1
Channel number	9.3.1	BTS-BSC	M	2
L3 Info (IMM ASSIGN)	9.3.11	BTS-BSC	M	V

8.5.5 PAGING COMMAND

This message is sent from BSC to BTS to request the paging of an MS.

INFORMATION ELEMENT	REFERENCE	DIRECTION	TYPE	LENGTH
Message discriminator	9.1	BSC-BTS	M	1
Message type	9.2	BSC-BTS	M	1
Channel Number	9.3.1	BSC-BTS	M	2
Paging Group	9.3.14	BSC-BTS	M	2
MS Identity	9.3.12	BSC-BTS	M	V

The Paging Group element is used by BTS to calculate the correct DRX paging block to be used for the transmission of the PAGING REQUEST message as defined in Recommendation GSM 05.02.

8.5.6 IMMEDIATE ASSIGN COMMAND

This message is sent from BSC to BTS to request the transmission of an immediate assignment message.

INFORMATION ELEMENT	REFERENCE	DIRECTION	TYPE	LENGTH
Message discriminator	9.1	BSC-BTS	M	1
Message type	9.2	BSC-BTS	M	1
Channel Number	9.3.1	BSC-BTS	M	2
Imm. Assign Info	9.3.35	BSC-BTS	M	V

The Imm.Assign Info element contains the relevant immediate assignment message as defined in Recommendation GSM 04.08 (IMMEDIATE ASSIGN or IMMEDIATE ASSIGN EXTENDED or IMMEDIATE ASSIGN REJECT) with the "Page Mode" element set to the value "no change".

8.5.7 SMS BROADCAST REQUEST

This message is sent from BSC to BTS to request the sending of Short Message Service Cell Broadcast message.

INFORMATION ELEMENT	REFERENCE	DIRECTION	TYPE	LENGTH
Message discriminator	9.1	BSC-BTS	M	1
Message type	9.2	BSC-BTS	M	1
Channel number	9.3.1	BSC-BTS	M	2
SMSCB Information	9.3.36	BSC-BTS	M	24

The SMSCB Information element contains the complete information to be broadcast on the CBCH as defined in Rec. GSM 04.12 (including the Layer 2 header to be used on the radio path).

8.6 TRX MANAGEMENT MESSAGES

These messages are related to TRX Management procedures. They all have the following general format (no channel number included):

INFORMATION ELEMENT	REFERENCE	DIRECTION	TYPE	LENGTH
Message discriminator	9.1	both	M	1
Message type	9.2	both	M	1
(Information elements depending on message type)				

The messages concerned are the following:

<u>Message name</u>	<u>Reference section</u>
RF RESource INDication	8.6.1
SACCH FILLing	8.6.2
OVERLOAD	8.6.3
ERROR REPORT	8.6.4

8.6.1 RF RESOURCE INDICATION

This message is sent from BTS to BSC to indicate the interference level on idle channels of a TRX.

INFORMATION ELEMENT	REFERENCE	DIRECTION	TYPE	LENGTH
Message discriminator	9.1	BTS-BSC	M	1
Message Type	9.2	BTS-BSC	M	1
Resource Information	9.3.21	BTS-BSC	M	V

8.6.2 SACCH FILLING

This message is sent from BSC to BTS to indicate the new broadcast information to be used as filling information on downlink SACCH.

INFORMATION ELEMENT	REFERENCE	DIRECTION	TYPE	LENGTH
Message discriminator	9.1	BSC-BTS	M	1
Message type	9.2	BSC-BTS	M	1
System Info Type	9.3.30	BSC-BTS	M	2
L3 Info (SYS INFO)	9.3.11	BSC-BTS	M	V
Starting Time	9.3.23	BSC-BTS	O	3

The System Info Type element indicates the type of SYSTEM INFORMATION message which follows in the L3 Info field.

The L3 Information element contains the relevant SYSTEM INFORMATION message as defined in Recommendation GSM 04.08.

8.6.3 OVERLOAD

This message is sent from BTS to BSC to indicate an overload situation. Possible cause values include

- CCCH overload,
- ACCH overload,
- processor overload.

INFORMATION ELEMENT	REFERENCE	DIRECTION	TYPE	LENGTH
Message discriminator	9.1	BTS-BSC	M	1
Message Type	9.2	BTS-BSC	M	1
Cause	9.3.26	BTS-BSC	M	V

8.6.4 ERROR REPORT

This message is sent from BTS to BSC to report a detected error which cannot be reported in any other message.

INFORMATION ELEMENT	REFERENCE	DIRECTION	TYPE	LENGTH
Message discriminator	9.1	BTS-BSC	M	1
Message Type	9.2	BTS-BSC	M	1
Cause	9.3.26	BTS-BSC	M	V
Message Identifier	9.3.28	BTS-BSC	O	2
Channel Number	9.3.1	BTS-BSC	O	2
Link Identifier	9.3.2	BTS-BSC	O	2
Message Indicator	9.3.29	BTS-BSC	O *	1
erroneous message	8	BTS-BSC	O *	V

*The Message Indicator information element is used to indicate that a complete message (erroneous) follows, starting in the next octet. The message that follows shall be the complete erroneous message as received from BSC, including Message Discriminator and Message Type.

9. INFORMATION ELEMENT CODINGS

This section contains the codings of the signalling elements used. The following conventions are assumed for the sequence of transmission of bits and bytes :

Each bit position is numbered as 1 to 8.

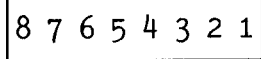

The least significant bit is bit 1 and is transmitted first, followed by bits 2, 3, 4 etc.

9.1 MESSAGE DISCRIMINATOR

A 1 octet field is used in all messages to discriminate between Transparent and Non-Transparent messages and also between Radio Link Layer Management, Dedicated Channel Management, Common Channel Management and TRX Management messages.

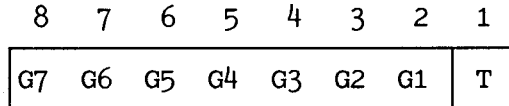

The T-bit is set to 1 to indicate that the message is to be/was considered transparent by BTS. All other messages shall have the T-bit set to 0.

The G-bits are used to group the messages as follows:

G7 G6 G5 G4 G3 G2 G1	Message Group
0 0 0 0 0 0 0	reserved
0 0 0 0 0 0 1	Radio Link Layer Management messages
0 0 0 0 1 0 0	Dedicated Channel Management messages
0 0 0 0 1 1 0	Common Channel Management messages
0 0 0 1 0 0 0	TRX Management messages

All other values are reserved for future use.

9.2 MESSAGE TYPE

The Message Type uniquely identifies the function of the message being sent. It is a single octet and coded in the following way :

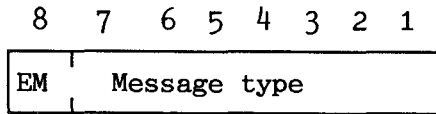

Bit 8 is the extension bit and is reserved for future use. The following message types are used (all other values are reserved):

8 7 6 5 4 3 2 1	Message	Reference
0 0 0 0 - - - -	<u>Radio Link Layer Management messages:</u>	
0 0 0 1	- DATA REQuest	8.3.1
0 0 1 0	- DATA INDication	8.3.2
0 0 1 1	- ERROR INDication	8.3.3
0 1 0 0	- ESTablish REQuest	8.3.4
0 1 0 1	- ESTablish CONFirm	8.3.5
0 1 1 0	- ESTablish INDication	8.3.6
0 1 1 1	- RElease REQuest	8.3.7
1 0 0 0	- RElease CONFirm	8.3.8
1 0 0 1	- RElease INDication	8.3.9
1 0 1 0	- UNIT DATA REQuest	8.3.10
1 0 1 1	- UNIT DATA INDication	8.3.11
0 0 0 1 - - - -	<u>Common Channel Management/TRX Management messages:</u>	
0 0 0 1	- BCCH INFOrmation	8.5.1
0 0 1 0	- CCCH LOAD INDication	8.5.2
0 0 1 1	- CHANnel ReQuireD	8.5.3
0 1 0 0	- DELETE INDication	8.5.4
0 1 0 1	- PAGING CoMmand	8.5.5
0 1 1 0	- IMMEDIATE ASSIGN COMMAND	8.5.6
0 1 1 1	- SMS BroadCast REQuest	8.5.7
1 0 0 1	- RF RESource INDication	8.6.1
1 0 1 0	- SACCH FILLing	8.6.2
1 0 1 1	- OVERLOAD	8.6.3
1 1 0 0	- ERROR REPORT	8.6.4
0 0 1 - - - -	<u>Dedicated Channel Management messages:</u>	
0 0 0 0 1	- CHANnel ACTIVation	8.4.1
0 0 0 1 0	- CHANnel ACTIVation ACKnowledge	8.4.2
0 0 0 1 1	- CHANnel ACTIVation Negative ACK	8.4.3
0 0 1 0 0	- CONNecTion FAILure	8.4.4
0 0 1 0 1	- DEACTIVATE SACCH	8.4.5
0 0 1 1 0	- ENCRyption CoMmand	8.4.6
0 0 1 1 1	- HANDOver DETection	8.4.7
0 1 0 0 0	- MEASurement RESult	8.4.8
0 1 0 0 1	- MODE MODIFY REQuest	8.4.9
0 1 0 1 0	- MODE MODIFY ACKnowledge	8.4.10
0 1 0 1 1	- MODE MODIFY Negative ACKnowledge	8.4.11
0 1 1 0 0	- PHYSical CONTEXT REQuest	8.4.12
0 1 1 0 1	- PHYSical CONTEXT CONFirm	8.4.13
0 1 1 1 0	- RF CHANnel RElease	8.4.14
0 1 1 1 1	- MS POWER CONTROL	8.4.15
1 0 0 0 0	- BS POWER CONTROL	8.4.16
1 0 0 0 1	- PREPROCess CONFIGure	8.4.17
1 0 0 1 0	- PREPROCessed MEASurement RESult	8.4.18
1 0 0 1 1	- RF CHANnel RElease ACKnowledge	8.4.19

9.3 OTHER INFORMATION ELEMENTS

If the element contains variable length fields a length indicator is included, indicating the number of octets to follow in the element.

The information elements used and their codings are :

<u>8 7 6 5 4 3 2 1</u>	<u>Element name</u>	<u>Reference</u>
0 0 0 0 0 0 0 1	Channel Number	9.3.1
0 0 0 0 0 0 1 0	Link Identifier	9.3.2
0 0 0 0 0 0 1 1	Activation Type	9.3.3
0 0 0 0 0 1 0 0	BS Power	9.3.4
0 0 0 0 0 1 0 1	Channel Identification	9.3.5
0 0 0 0 0 1 1 0	Channel Mode	9.3.6
0 0 0 0 0 1 1 1	Encryption Information	9.3.7
0 0 0 0 1 0 0 0	Frame Number	9.3.8
0 0 0 0 1 0 0 1	Handover Reference	9.3.9
0 0 0 0 1 0 1 0	L1 Information	9.3.10
0 0 0 0 1 0 1 1	L3 Information	9.3.11
0 0 0 0 1 1 0 0	MS Identity	9.3.12
0 0 0 0 1 1 0 1	MS Power	9.3.13
0 0 0 0 1 1 1 0	Paging Group	9.3.14
0 0 0 0 1 1 1 1	Paging Load	9.3.15
0 0 0 1 0 0 0 0	Physical Context	9.3.16
0 0 0 1 0 0 0 1	Access delay	9.3.17
0 0 0 1 0 0 1 0	RACH Load	9.3.18
0 0 0 1 0 0 1 1	Request Reference	9.3.19
0 0 0 1 0 1 0 0	Release Mode	9.3.20
0 0 0 1 0 1 0 1	Resource Information	9.3.21
0 0 0 1 0 1 1 0	RLM Cause	9.3.22
0 0 0 1 0 1 1 1	Starting Time	9.3.23
0 0 0 1 1 0 0 0	Timing Advance	9.3.24
0 0 0 1 1 0 0 1	Uplink Measurements	9.3.25
0 0 0 1 1 0 1 0	Cause	9.3.26
0 0 0 1 1 0 1 1	Measurement result number	9.3.27
0 0 0 1 1 1 0 0	Message Identifier	9.3.28
0 0 0 1 1 1 0 1	Message Indicator	9.3.29
0 0 0 1 1 1 1 0	System Info Type	9.3.30
0 0 0 1 1 1 1 1	MS Power Parameters	9.3.31
0 0 1 0 0 0 0 0	BS Power Parameters	9.3.32
0 0 1 0 0 0 0 1	Preprocessing Parameters	9.3.33
0 0 1 0 0 0 1 0	Preprocessed Measurements	9.3.34
0 0 1 0 0 0 1 1	Immediate Assign Info	9.3.35
0 0 1 0 0 1 0 0	SMSCB Information	9.3.36

All other values are reserved for future use.

9.3.1 Channel Number

In the direction BSC to BTS the Channel Number parameter is used to indicate on which physical channel/subchannel the message is to be sent. In the direction BTS to BSC the Channel Number indicates on which physical channel/subchannel the message was received. It is coded in two octets as follows :

8	7	6	5	4	3	2	1	
Element identifier								1
C5	C4	C3	C2	C1	TN			2

The C-bits describe the channel as follows:

C5	C4	C3	C2	C1	
0	0	0	0	1	Bm + ACCH's
0	0	0	1	T	Lm + ACCH's
0	0	1	T	T	SDCCH/4 + ACCH
0	1	T	T	T	SDCCH/8 + ACCH
1	0	0	0	0	BCCH
1	0	0	0	1	Uplink CCCH (RACH)
1	0	0	1	0	Downlink CCCH (PCH + AGCH)

The T-bits indicate, coded in binary, the sub-channel number as specified in Recommendation GSM 05.02.

TN is time slot number, binary represented as in rec. 05.02.

9.3.2 Link Identifier

This element identifies the signalling channel and SAPI of the radio data link.

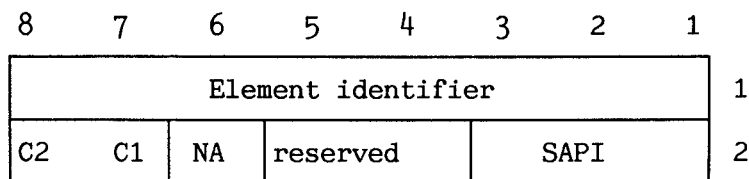

The NA bit (bit 6 in octet 2) is set to 1 to indicate that the Link Identifier is not applicable for this message. In all other cases it is set to 0.

The C-bits indicate the channel type as follows:

C2	C1	
0	0	main signalling channel (FACCH or SDCCH)
0	1	SACCH

All other values are reserved for future use.

The SAPI field contains the SAPI value as defined in Recommendation GSM 04.05.

9.3.3 Activation Type

This element is used to indicate the type of activation requested in the CHANNEL ACTIVATION message. It is coded in two octets as follows:

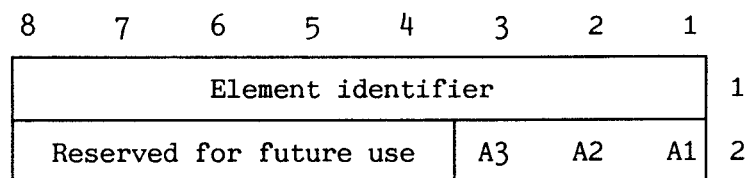

The A-bits indicate the type of activation as follows:

A3	A2	A1	
0	0		- Activation related to intra-cell channel change
	0		- related to immediate assignment procedure
	1		- related to normal assignment procedure
0	1		- Activation related to inter-cell channel change (handover)
	0		- related to asynchronous handover procedure
	1		- related to synchronous handover procedure
1	0	0	Activation related to additional assignment procedure

All other values reserved for future use.

9.3.4 BS Power

This information element indicates the TRX transmission power level on a particular channel.

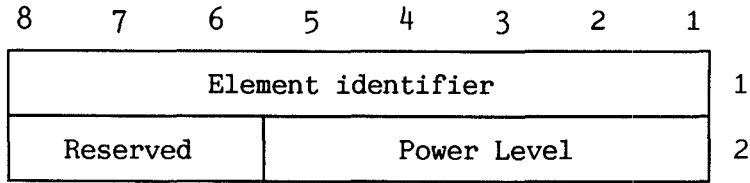

The Power Level field (octet 2) indicates the number of 2 dB steps by which the power shall be reduced from its nominal value, P_n, set by the network operator to adjust the coverage. Thus the Power Level values correspond to the following powers (relative to P_n):

<u>Value</u>	<u>Power level</u>
0 0 0 0 0	P _n
0 0 0 0 1	P _n - 2 dB
0 0 0 1 0	P _n - 4 dB
.	
.	
0 1 1 1 0	P _n - 28 dB
0 1 1 1 1	P _n - 30 dB

All other values are reserved for future use.

See also Recommendations GSM 05.05, section 4.1.2 and GSM 05.08, section 4.5.

9.3.5 Channel Identification

This information element describes a channel together with its SACCH.

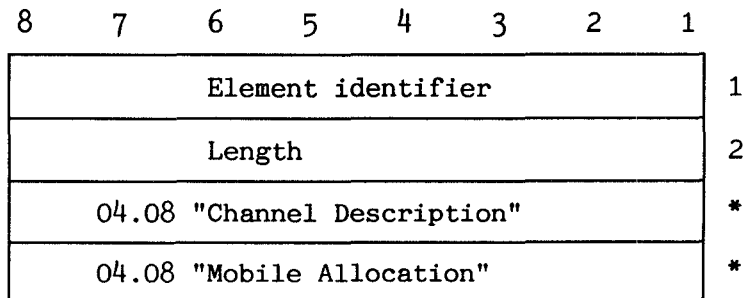

A * denotes that the whole of the 04.08 element including the element identifier and length should be included.

9.3.6 Channel Mode

This element gives information on the mode of coding/decoding and transcoding/rate adaption of a channel.

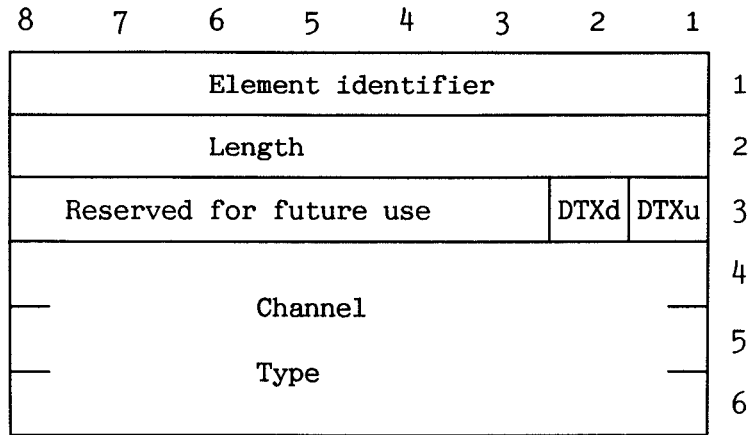

The DTX bits of octet 3 indicate whether DTX is applied:

- 1 DTX is applied
- 0 DTX is not applied.

DTXd indicates use of DTX in the downlink direction (BTS to MS) and DTXu indicates use of DTX in the uplink direction (MS to BTS).

The Channel Type field, octets 4-6, is coded as defined for octets 3-5 (with possible extension) of the Channel Type information element of Recommendation GSM 08.08.

9.3.7 Encryption information

This element is a variable length element. It contains necessary information to control encryption devices.

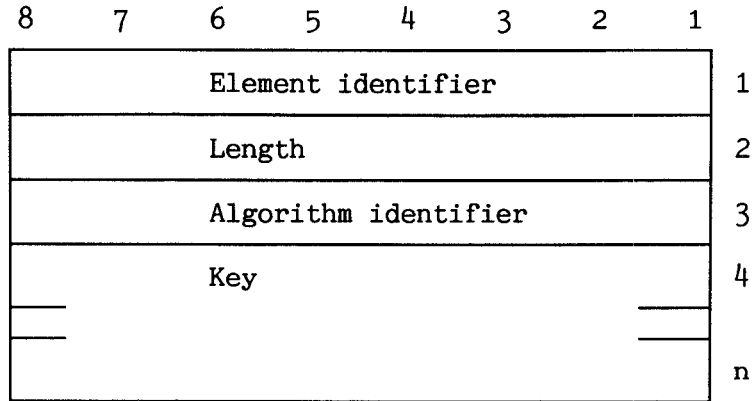

Octets 2-n are coded as the corresponding octets of the Encryption Information element of Recommendation GSM 08.08.

9.3.8 Frame Number

This element contains the absolute frame number (FN) modulo 42432. It is used to carry the current timing in BTS to BSC for calculation of the Starting Time parameter required in some messages.

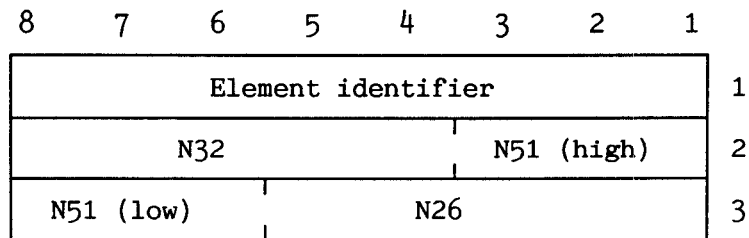

Octets 2-3 are coded as defined for octets 2-3 of the Starting Time information element of Recommendation GSM 04.08.

9.3.9 Handover reference

The information is coded in two octets and contains the hand-over reference value.

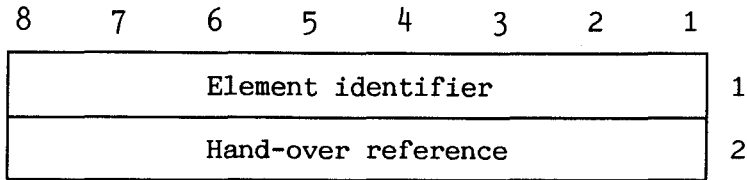

The Handover Reference octet contains the handover reference value as defined in Recommendation GSM 04.08.

9.3.10 L1 Information

This element carries the information used in the L1 header of SACCH blocks.

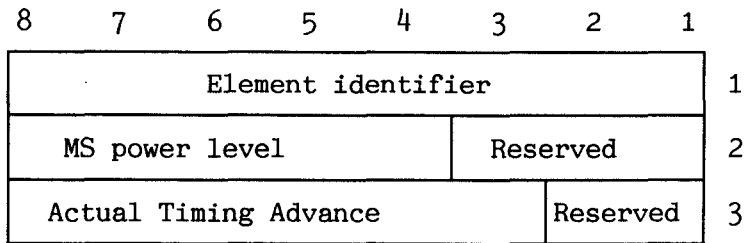

Octets 2-3 contains the L1 header information of SACCH blocks. The information fields and codings are as defined in Recommendation GSM 04.04.

9.3.11 L3 Information (message name)

This element contains a link layer service data unit (L3 message). It is used to forward a complete L3 message as specified in Recommendation GSM 04.08 between BTS and BSC.

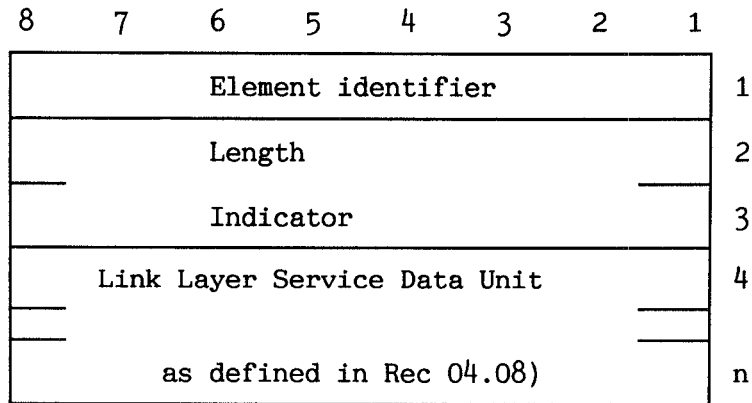

The Length Indicator field (octets 2-3) indicates in binary the remaining length of the element (octets 4-n). The most significant bit is bit 8 of octet 2 and the least significant bit is bit 1 of octet 3.

Octets 4-n contain the complete L3 message as defined in Recommendation GSM 04.08. In the message format section, the 04.08 message name to be included is indicated within brackets.

9.3.12 MS Identity

This element carries the identity of an MS (TMSI or IMSI). It is a variable length element.

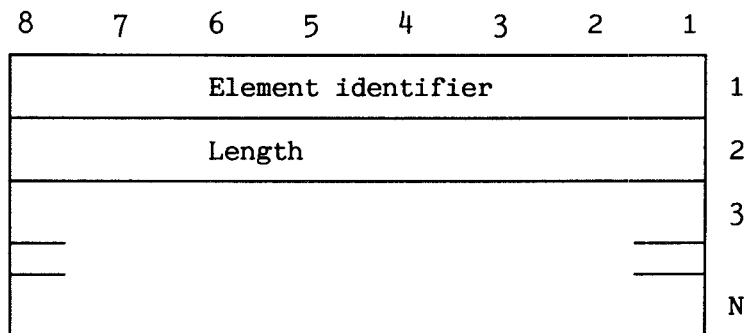

The MS Identity field (octets 3-N) is coded as specified for the Mobile Identity information element of Recommendation GSM 04.08, octets 3-N.

9.3.13 MS Power

This element carries the power level of MS.

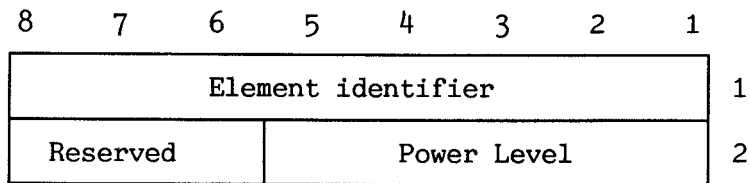

The coding and meaning of the Power Level field is as defined in Recommendations GSM 05.05 and 05.08. See also Recommendation GSM 04.04.

9.3.14 Paging Group

This element carries the paging population of an MS to be paged.

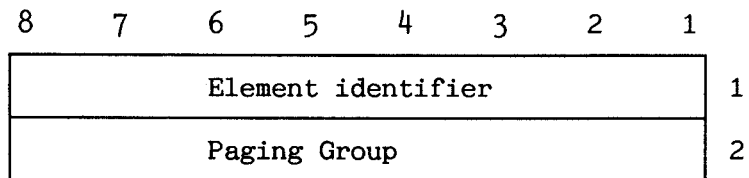

The Paging Group field (octet 2) contains the binary representation of the paging group as defined in Recommendation GSM 05.02.

9.3.15 Paging Load

This element carries data about the load of a paging channel (PCH).

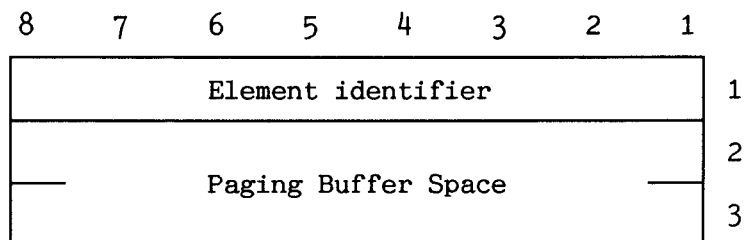

The Paging Buffer Space field (octets 2-3) indicates the remaining space for Paging Commands, given as the number of additional Paging Commands possible to store. The number is binary coded with the most significant bit in bit 8 of octet 2 and the least significant bit in bit 1 of octet 3.

9.3.16 Physical Context

This element contains supplementary information on the transmission/reception process. It is a variable length element.

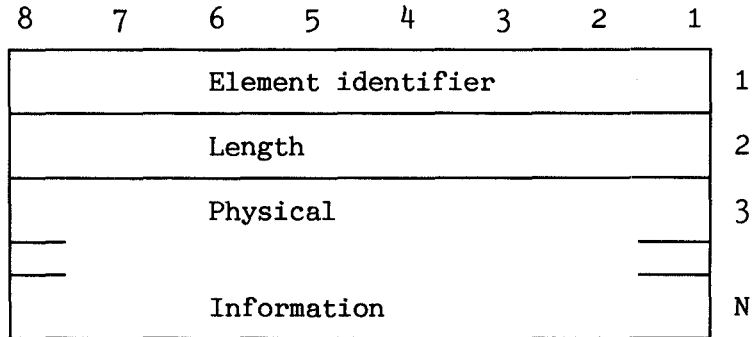

The Physical Context Information field is not specified. This information should not be analysed by BSC, but merely forwarded from one TRX/channel to another.

9.3.17 Access Delay

This element contains the delay of the access burst as measured by BTS at random access or at handover access.

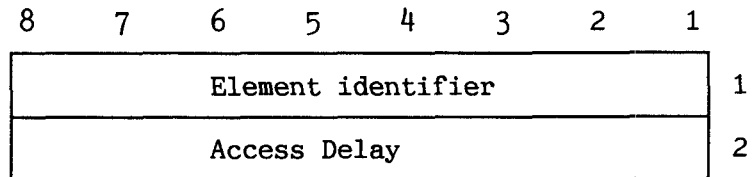

9.3.18 RACH Load

This element is used to carry information on the load of the RACH (Random Access Channel). It is of variable length.

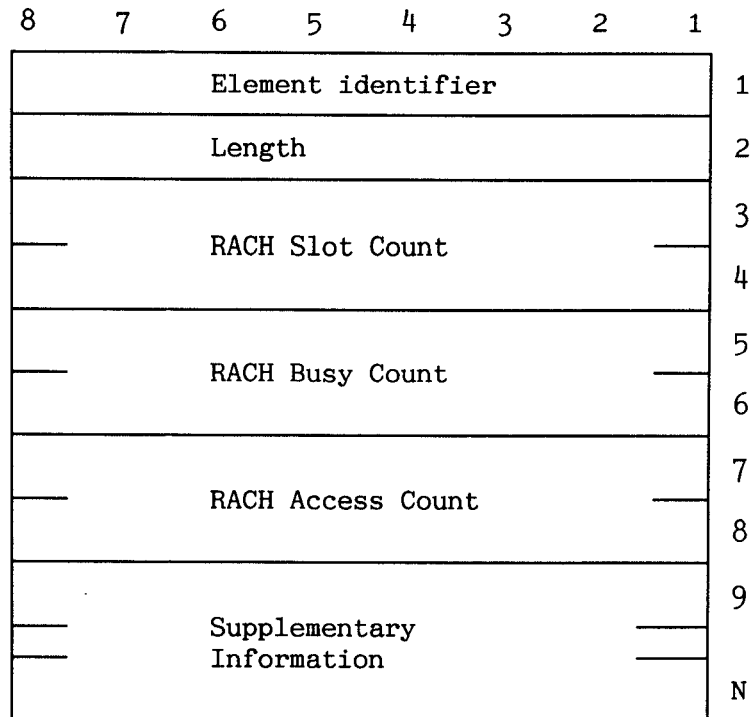

The RACH Slot Count field (octets 3-4) indicates the total number of available access slots over which the measurement (counting) was performed. The value is binary coded with the most significant bit in bit 8 of the first octet and the least significant bit in bit 1 of the second octet.

The RACH Busy Count field (octets 5-6) indicates the number of RACH burst periods during which the received signal level has exceeded a given threshold. This will give a measure of the number of "busy" random access slots. The value is binary coded with the most significant bit in bit 8 of the first octet and the least significant bit in bit 1 of the second octet.

The RACH Access Count field (octets 7-8) indicates the number of received access bursts during the same measurement period. The value is binary coded with the most significant bit in bit 8 of the first octet and the least significant bit in bit 1 of the second octet.

The busy count signal level threshold and the measurement period are parameters set by O&M.

The Supplementary Information field may carry additional operator dependent information.

9.3.19 Request Reference

This element carries the Request Reference parameters used for contention resolution on RACH.

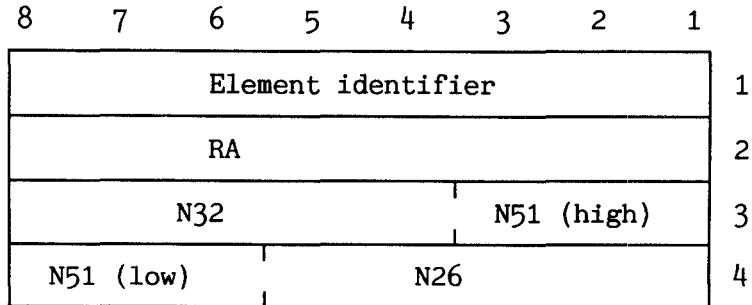

Octets 2-4 are coded as the corresponding fields of the Request Reference element of Recommendation GSM 04.08. (Octet 2, RA, is the Random Access Information field set by MS in the CHANNEL REQUEST message. Octets 3-4 contain the absolute frame number modulo 42432 for the frame number when the access burst was received, see Starting Time information element of GSM 04.08).

9.3.20 Release Mode

This element is used to distinguish between normal release and local end release of the radio data link connection.

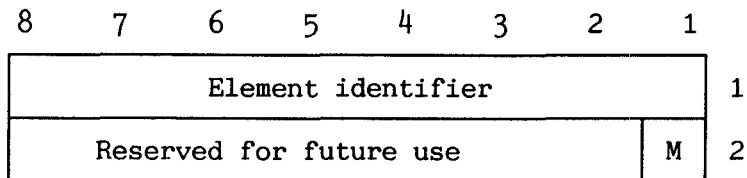

The M bit is coded as follows:

- 0 normal release
- 1 local end release

9.3.21 Resource Information

This element is used to indicate the interference level for each of the idle channels of a TRX.

8	7	6	5	4	3	2	1	
Element identifier								1
Length								2
Channel Number (1)								3
Interference level (1)								4
Channel Number (N)								N-1
Interference level (N)								N

The Length field indicates in binary the remaining length of the element (octets 3-N).

Octets 3-N forms a list of Channel Numbers and Interference levels measured on the corresponding channel.

The Channel Number octet is coded as octet 2 of the Channel Number information element, section 9.3.1.

The Interference Level octet is coded as follows:

8	7	6	5	4	3	2	1
Interf Band				Reserved for future use			

The Interf Band field (bits 6-8) indicates in binary the interference level expressed as one of five possible interference level bands as defined by O&M. The interference level is averaged over a period of Intave (parameter set by O&M, see Rec 05.08) immediately before the transmission of the RF RESource INDication message. See also Recommendation GSM 08.08, section 3.1.3.1 and Recommendation GSM 05.08, section 3.1 e) of Appendix A.

9.3.22 RLM Cause

This element is used to indicate the precise protocol error or the reason for a release on the radio link layer.

8	7	6	5	4	3	2	1	
Element identifier								1
Length								2
E	Cause Value							3

The Cause Value is a one octet field if the extension bit is set to 0. If the extension bit is set to 1, the Cause Value is a two octet field.

The Cause Value field is coded as follows:

<u>8</u>	<u>7</u>	<u>6</u>	<u>5</u>	<u>4</u>	<u>3</u>	<u>2</u>	<u>1</u>	
0	0	0	0	0	0	0	0	reserved
0	0	0	0	0	0	0	1	timer T200 expired (N200+1) times
0	0	0	0	0	0	1	0	re-establishment request
0	0	0	0	0	0	1	1	unsolicited UA response
0	0	0	0	0	1	0	0	unsolicited DM response
0	0	0	0	0	1	0	1	unsolicited DM response, multiple frame established state
0	0	0	0	0	1	1	0	unsolicited supervisory response
0	0	0	0	0	1	1	1	sequence error
0	0	0	0	1	0	0	0	U-frame with incorrect parameters
0	0	0	0	1	0	0	1	S-frame with incorrect parameters
0	0	0	0	1	0	1	0	I-frame with incorrect use of M bit
0	0	0	0	1	0	1	1	I-frame with incorrect length
0	0	0	0	1	1	0	0	frame not implemented
0	0	0	0	1	1	0	1	SABM command, multiple frame established state
0	0	0	0	1	1	1	0	SABM frame with information not allowed in this state

All other values are reserved for future use.

9.3.23 Starting Time

This element provides the starting time expressed as FN modulo 42432 (FN is absolute frame number).

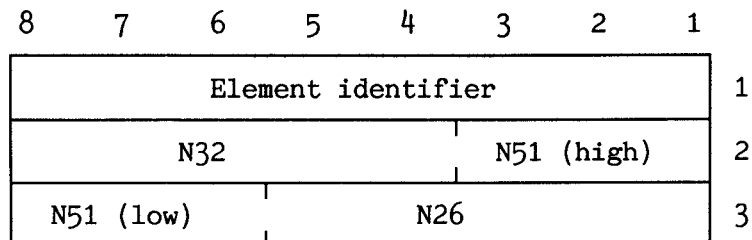

Octets 2-3 are coded as defined for octets 2-3 of the Starting Time information element of Recommendation GSM 04.08.

9.3.24 Timing Advance

This element contains the timing advance to be used by MS in subsequent communications.

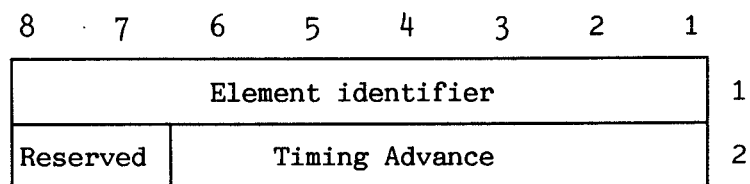

The Timing Advance field contains the timing advance TA as specified in Recommendation GSM 05.10.

Bits 7-8 of octet 2 are reserved for future use.

9.3.25 Uplink Measurements

This element is used to report the results of the TRX measurements on the uplink radio path of an activated basic radio channel. It is of variable length.

8	7	6	5	4	3	2	1	
Element identifier								1
Length								2
rfu	DTXd	RXLEV-FULL-up						3
Reserved		RXLEV-SUB-up						4
Reserved		RXQUAL-FULL-up			RXQUAL-SUB-up			5
Supplementary								6
Information								N

rfu = Reserved for Future Use.

The Length field indicates in binary the remaining length of the element (octets 3-N).

Octets 3-5 contain results from measurements made by TRX on the uplink.

The Supplementary Measurement Information field (octets 6-N) may carry additional operator dependent information.

The DTXd field (octet 3) indicates whether DTX was employed by TRX on the downlink transmission during the measurement period.

The RXLEV-FULL-up and RXLEV-SUB-up fields (octets 3-4) report the average uplink signal level as measured by TRX over the measurement period on all slots and on a subset of the slots respectively (see Recommendation GSM 05.08, section 8.2) Each fields is code as defined in Recommendation GSM 05.08, section 8.1.4.

The RXQUAL-FULL-up and RXQUAL-SUB-up fields (octet 4) reports the average uplink quality as measured by TRX over the measurement period on all slots and on a subset of the slots respectively (see Recommendation GSM 05.08, section 8.2). Each field is coded as defined in Recommendation GSM 05.08, section 8.2.4.

9.3.26 Cause

The cause element is used to indicate the reason for a particular event to have occurred and is coded as shown below.

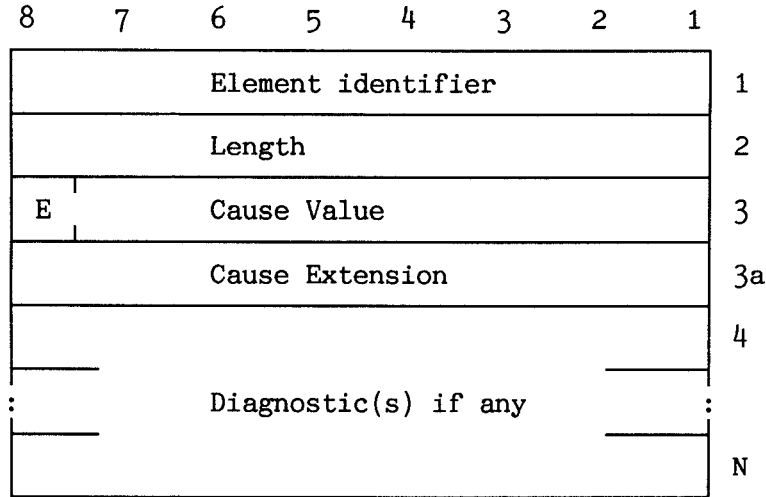

The Length field indicates in binary the remaining length of the element (octets 3-N).

The Cause Value is a single octet field (octet 3) if the extension bit E (bit 8) is set to 0. If it is set to 1 then the cause value is a 2 octet field (octets 3 and 3a).

The Cause Value is divided into two fields: a class (bits 5-7 of octet 3) and a value within the class (bits 1-4 of octet 3).

If the value of the first octet of the cause field is 1XXX 0000 then the second octet is reserved for national applications (XXX will still indicate the class).

Diagnostic information is not available for every cause, see the table below. When available, it is coded in the same way as the corresponding information element in section 9. Inclusion of diagnostics is optional.

Classes:

- Class (000) : Normal event
- Class (001) : Normal event
- Class (010) : Resource unavailable
- Class (011) : Service or option not available
- Class (100) : Service or option not implemented
- Class (101) : Invalid message (eg parameter out of range)
- Class (110) : Protocol error
- Class (111) : Interworking

CAUSE VALUES:

<u>Class</u>	<u>Value</u>	<u>Cause</u>	<u>Diagnostics</u>
0 0 0	- - - -	<u>Normal Event</u>	
0 0 0	0 0 0 0	radio interface failure	Channel nb
0 0 0	0 0 0 1	radio link failure	Channel nb
0 0 0	0 0 1 0	handover access failure	Channel nb
0 0 0	0 0 1 1	reserved for international use	
0 0 0	0 1 0 0	reserved for international use	
0 0 0	0 1 0 1	reserved for international use	
0 0 0	0 1 1 0	reserved for international use	
0 0 0	0 1 1 1	O&M intervention	
0 0 0	1 0 0 0	reserved for international use	
0 0 0	1 : : :		
0 0 0	1 1 1 0		
0 0 0	1 1 1 1	normal event, unspecified	
0 0 1	- - - -	<u>Normal Event</u>	
0 0 1	0 0 0 0	reserved for international use	
0 0 1	0 : : :		
0 0 1	0 1 1 1		
0 0 1	1 0 0 0	reserved for national use	
0 0 1	1 : : :		
0 0 1	1 1 1 1		
0 1 0	- - - -	<u>Resource unavailable</u>	
0 1 0	0 0 0 0	equipment failure	
0 1 0	0 0 0 1	radio resource not available	Channel nb
0 1 0	0 0 1 0	terrestrial channel failure	Channel nb
0 1 0	0 0 1 1	CCCH overload	Channel nb
0 1 0	0 1 0 0	ACCH overload	Channel nb
0 1 0	0 1 0 1	processor overload	
0 1 0	0 1 1 0	reserved for international use	
0 1 0	0 1 1 1	BTS not equipped	
0 1 0	1 0 0 0	remote transcoder failure	Channel nb
0 1 0	1 0 0 1	reserved for international use	
0 1 0	1 0 1 0	reserved for international use	
0 1 0	1 0 1 1	reserved for international use	
0 1 0	1 1 0 0	reserved for national use	
0 1 0	1 1 0 1	reserved for national use	
0 1 0	1 1 1 0	reserved for national use	
0 1 0	1 1 1 1	resource not available, unspecified	

<u>Class</u>	<u>Value</u>	<u>Cause</u>	<u>Diagnostics</u>
0 1 1	- - - -	<u>Service or Option Not Available</u>	
0 1 1	0 0 0 0	requested transcoding/rate adaption not available	Channel nb
0 1 1	0 0 0 1	reserved for international use	
0 1 1	: : : :		
0 1 1	1 1 1 0		
0 1 1	1 1 1 1	service or option not available, unspecified	
<hr/>			
1 0 0	- - - -	<u>Service or Option Not Implemented</u>	
1 0 0	0 0 0 0	encryption algorithm not implemented	Channel nb
1 0 0	0 0 0 1	reserved for international use	
1 0 0	0 : : :		
1 0 0	0 1 1 1		
1 0 0	1 0 0 0	reserved for national use	
1 0 0	1 : : :		
1 0 0	1 1 1 0		
1 0 0	1 1 1 1	service or option not implemented, unspecified	
<hr/>			
1 0 1	- - - -	<u>Invalid Message</u>	
1 0 1	0 0 0 0	radio channel already activated/allocated	Channel nb
1 0 1	0 0 0 1	reserved for international use	
1 0 1	0 : : :		
1 0 1	0 1 1 1		
1 0 1	1 0 0 0	reserved for national use	
1 0 1	1 : : :		
1 0 1	1 1 1 0		
1 0 1	1 1 1 1	invalid message, unspecified	

<u>Class</u>	<u>Value</u>	<u>Cause</u>	<u>Diagnostics</u>
1 1 0	- - - -	<u>Protocol Error</u>	
1 1 0	0 0 0 0	message discriminator error	Message Dis.
1 1 0	0 0 0 1	message type error	Message Type
1 1 0	0 0 1 0	message sequence error	Message Type
1 1 0	0 0 1 1	general information element error	
1 1 0	0 1 0 0	mandatory information element error	Element Iden
1 1 0	0 1 0 1	optional information element error	Element Iden
1 1 0	0 1 1 0	information element non-existent	Element Iden
1 1 0	0 1 1 1	information element length error	Element Iden
1 1 0	1 0 0 0	invalid information element contents	Inform. Elem
1 1 0	1 0 0 1	reserved for international use	
1 1 0	1 0 1 0	reserved for international use	
1 1 0	1 0 1 1	reserved for international use	
1 1 0	1 1 0 0	reserved for national use	
1 1 0	1 1 0 1	reserved for national use	
1 1 0	1 1 1 0	reserved for national use	
1 1 0	1 1 1 1	protocol error, unspecified	
<hr/>			
1 1 1	- - - -	<u>Interworking</u>	
1 1 1	0 0 0 0	reserved for international use	
1 1 1	0 : : :		
1 1 1	0 1 1 1		
1 1 1	1 0 0 0	reserved for national use	
1 1 1	1 : : :		
1 1 1	1 1 1 0		
1 1 1	1 1 1 1	interworking, unspecified	

9.3.27 Measurement result number

This element is used by BTS to number, (on a channel), the measurement result messages it sent to BSC. It is set to 0 at activation time of the channel. The numbering is modulo 256.

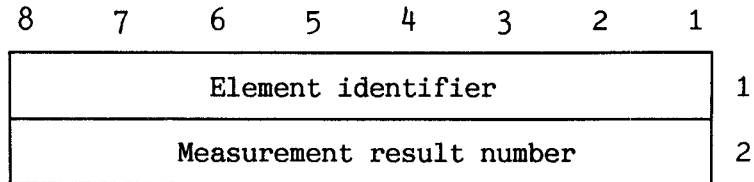

9.3.28 Message Identifier

This element is used to indicate a message type within a message.

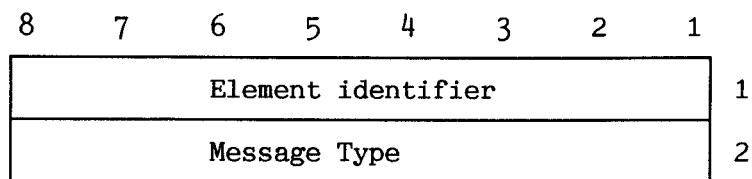

Octet 2 is coded as the Message Type information element, section 9.2.

9.3.29 Message Indicator

This element is used to indicate that a complete message as defined in section 8 follows, starting in the next octet. The element consists of only the information element identifier.

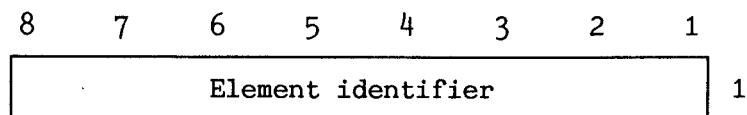

9.3.30 System Info Type

This element is used to indicate the type of SYSTEM INFORMATION message as defined in Recommendation GSM 04.08 (SYSTEM INFORMATION 1 through 8).

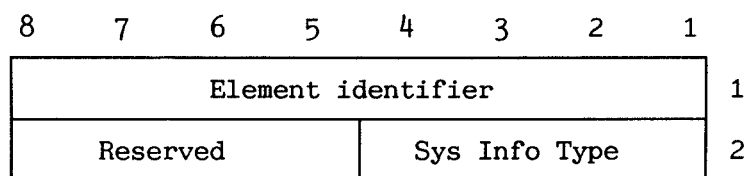

The Sys Info Field (bits 1-4 of octet 2) indicates the SYSTEM INFORMATION message. It is coded as follows:

<u>Value</u>	<u>System information message</u>
0 0 0 1	SYSTEM INFORMATION 1
0 0 1 0	SYSTEM INFORMATION 2
0 0 1 1	SYSTEM INFORMATION 3
0 1 0 0	SYSTEM INFORMATION 4
0 1 0 1	SYSTEM INFORMATION 5
0 1 1 0	SYSTEM INFORMATION 6

All other values are reserved.

9.3.31 MS Power Parameters

This element carries the parameters required by TRX for MS power control.

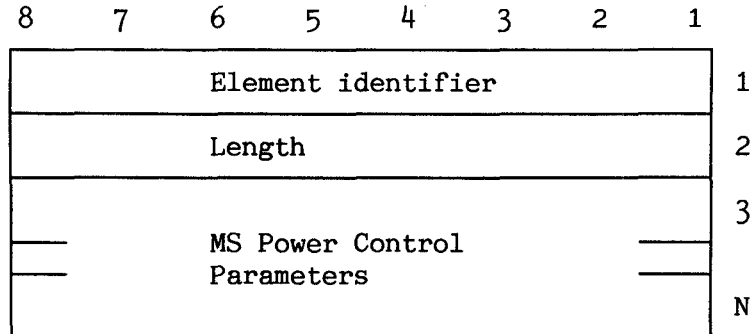

The MS Power Control Parameters field contains the parameters and limits required when MS power control is to be performed by BTS. The coding requires further elaboration. Examples of possible parameters and algorithms can be found in Recommendation GSM 05.08 (RXLEV, RX-QUAL-FULL, RX-QUAL-SUB, DISTANCE (Timing Advance) etc.).

9.3.32 BS Power Parameters

This element carries the parameters required by TRX for control of its own transmission power.

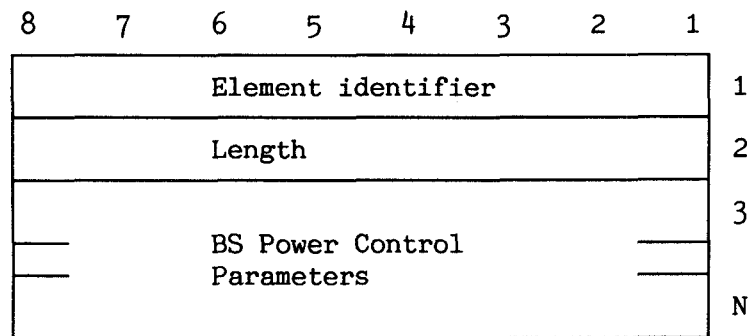

The BS Power Control Parameters field contains the parameters and limits required when TRX transmission power control is to be performed by BTS. The coding requires further elaboration. Examples of possible parameters and algorithms can be found in Recommendation GSM 05.08 (RXLEV, RX-QUAL-FULL, RX-QUAL-SUB, DISTANCE (Timing Advance) etc.).

9.3.33 Preprocessing Parameters

This element contains the parameters required by BTS for the pre-processing of radio measurement data.

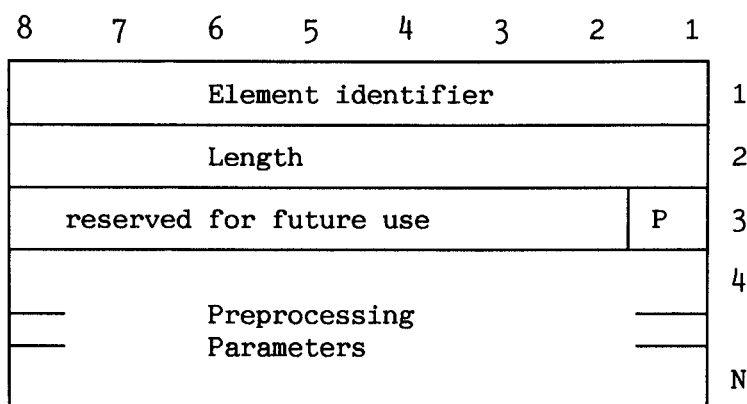

The P bit (bit 1 of octet 3) indicates whether pre-processing is to be used and it is coded as follows:

- 0 use the basic measurement reporting procedure (report raw data)
- 1 use the pre-processed measurement reporting procedure.

If pre-processing is to be used, the Preprocessing Parameters field (octets 4-N) contains the parameters required by BTS. The coding of this field requires further elaboration.

9.3.34 Preprocessed Measurements

This element is used by BTS to report the results of the pre-processing of radio measurement data.

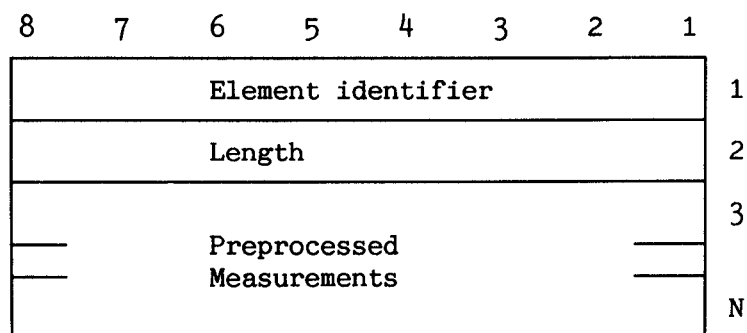

The Preprocessed Measurements field (octets 3-N) contains the results of the pre-processing in BTS. The coding of this field requires further elaboration.

9.3.35 Immediate Assign Info

This element is used to convey a complete immediate assign message (3 types).

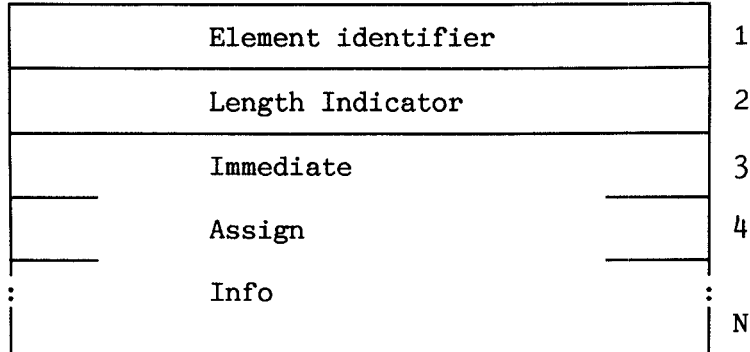

The length indicator field (octet 2) indicates in binary the remaining length of the element (octet 3 to N)

The Immediate Assign Info field (octet 3 to N) contains a complete immediate assign message (IMMEDIATE ASSIGN COOMMAND or IMMEDIATE ASSIGN EXTENDED or IMMEDIATE ASSIGN REJECT) as defined in Recommendation GSM 04.08.

9.3.36 SMSCB Information

This element is used to convey a complete frame to be broadcast on the CBCH including the Layer 2 header for the Radio path.

