

ETSI/TC SMG  
Released by : ETSI/PT 12  
Release date: February 1992

**RELEASE NOTE**

**Recommendation GSM 04.11**

**Point to Point Short Message Service Support  
on Mobile Radio Interface**

**Previously distributed version : 3.2.0 (Updated Release 1/90)  
New Released version February 92 : 3.2.0 (Release 92, Phase 1)**

**1. Reason for changes**

No changes since the previously distributed version.

---

**This page is left blank intentionally**

---

**I**NTERIM  
**E**UROPEAN  
**T**ELECOMMUNICATION  
**S**TANDARD

**2nd FINAL DRAFT**  
**prI-ETS 300 023**

February 1992

---

Source: ETSI TC-SMG

Reference: GSM 04.11

UDC: 621.396.21

**Key words:** European Digital Cellular Telecommunications System, Global System for Mobile Communications (GSM)

**European digital cellular  
telecommunications system (phase 1);  
Point-to-point short message service support  
on mobile radio interface**

**ETSI**

European Telecommunications Standards Institute

ETSI Secretariat: B.P.152 . F - 06561 Valbonne Cedex . France

TP. + 33 92 94 42 00 TF. + 33 93 65 47 16 Tx. 47 00 40 F

---

© European Telecommunications Standards Institute 1992.  
All rights reserved.

No part may be reproduced or used except as authorised by contract or other written permission. The copyright and the foregoing restriction on reproduction and use extend to all media in which the information may be embodied.



## Foreword

This second Final draft Interim European Telecommunication Standard (I-ETS) has been produced by the Special Mobile Group (SMG), a Technical Committee of the European Telecommunications Standards Institute (ETSI).

The final drafts dealing with the GSM system were adopted by vote in May 1991 but were not published. This was because amendments, agreed by ETSI TC-SMG at subsequent meetings, were made to some of the drafts. However, other drafts have not been amended since the first vote.

This updated draft is now considered to be stable enough for submission to second vote.

This I-ETS describes the short message service procedures (within the European digital cellular telecommunications system [phase 1]) necessary to relay a message on the radio path between the Mobile Station (MS) and the Mobile services Switching Centre (MSC).

Reference is made within this I-ETS to the following technical specifications (NOTE 1):

|           |   |
|-----------|---|
| GSM 03.40 | Technical realization of the point-to-point short message service.                        |
| GSM 04.01 | Mobile Station - Base Station System (MS-BSS) interface - general aspects and principles. |
| GSM 04.06 | MS-BSS data link layer specification.   |
| GSM 04.07 | Mobile radio interface signalling layer 3 - general aspects.                              |
| GSM 04.08 | Mobile radio interface - layer 3 specification.   |
| GSM 09.02 | Mobile application part specification.  |

The above specifications, together with annexes A to E of this standard, are normative.

NOTE 1: ETSI has constituted stable and consistent documents which give technical specifications for the implementation of the European digital cellular telecommunications system. Historically, these documents have been identified as "GSM recommendations".

Some of these recommendations may subsequently become Interim European Telecommunications Standards (I-ETSs) or European Telecommunication Standards (ETSs), whilst the others will be renamed ETSI-GSM Technical Specifications. These ETSI-GSM Technical Specifications are, for editorial reasons, still referred to as GSM recommendations in some current GSM documents.

The numbering and version control system used for ETSI-GSM Technical Specifications is the same as that used for GSM recommendations.

NOTE 2: Items in this draft indicated as not complete, or requiring further study or work, are not required for the Phase 1 implementation of the European digital cellular telecommunications system.

ETSI/GSM

Recommendation: GSM 04.11 version 3.2.0

Title: POINT-TO-POINT SHORT MESSAGE SERVICE SUPPORT  
ON MOBILE RADIO INTERFACE

Date: February 1992

List of contents:

- 1 General
- 2 Overview of Short Message Service Support
- 3 Service definition
- 4 Network Interfaces
- 5 CM-procedures
- 6 SM-RL-procedures
- 7 Message functional definitions and content
- 8 Message format and information elements coding

Language of original: English

Number of pages: 72 total

Main text: 38

Annex A: 4

Annex B: 12

Annex C: 3

Annex D: 8

Annex E: 7

## 1. General

This Recommendation specifies the procedures used across the mobile radio interface by the signalling layer 3 function SMC - Short Message Control and SM-RL function Short Message Relay.

## 2. Overview of Short Message Service Support

The purpose of the Short Message Service is to provide the means to transfer messages between a GSM PLMN Mobile Station and a Short Message Entity via a Service Centre, as described in Rec. GSM 03.40. The terms "MO" - mobile originating - and "MT" - mobile terminating - are used to indicate the direction in which the short message is sent.

This Recommendation describes the procedures necessary to relay a message between the MS and the MSC (and v.v), across the radio path.

The procedures are based on services provided by the Mobility Management sublayer as described in Rec. GSM 04.07/04.08.

2.1 Protocols and protocol architecture

The hierarchical model shows the layer structure of the MSC and the MS.

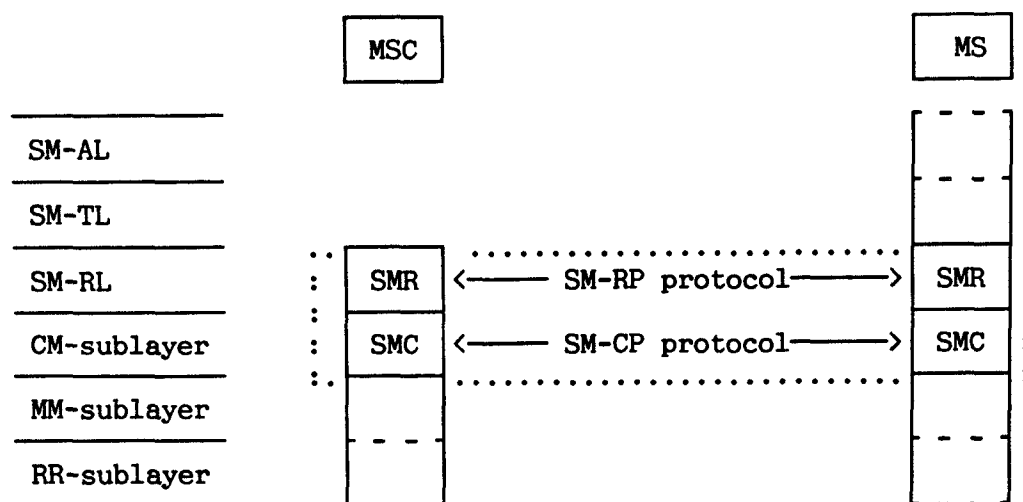

Figure 2.1/GSM 04.11: Protocol hierarchy

The CM-sublayer, in terms of the Short Message Service Support, provides services to the Short Message Relay Layer.

On the MS-side the Short Message Relay Layer provides services to the Short Message Transfer Layer. The Short Message Relay Layer is the upper layer on the network side (MSC), and the SM-user information elements are mapped to TCAP/MAP.

The peer protocol between two SMC entities is denoted SM-CP, and between two SMR entities, SM-RP.

Abbreviations:

- SM-AL : Short Message Application Layer
- SM-TL : Short Message Transfer Layer
  
- SM-RL : Short Message Relay Layer
- SM-RP : Short Message Relay Protocol
- SMR : Short Message Relay entity
  
- CM-sub : Connection Management sublayer
- SM-CP : Short Message Control Protocol
- SMC : Short Message Control entity
  
- MM-sub : Mobility Management sublayer
- RR-sub : Radio Resource Management sublayer



2.2 Use of channels

The short message will be transferred on a SDCCH or SACCH, depending on the use of a TCH;

- When a TCH is not allocated, the short message will be transferred on a SDCCH.
- If a TCH is allocated during a short message transaction on a SDCCH, the short message transfer will stop and continue on the SACCH associated with the TCH.
- If a TCH is allocated when the short message arrive, the short message will be transferred on the associated SACCH.
- When an entity using a TCH, finalize its transaction, the RR-sub. may choose to continue an ongoing short message transfer on the SACCH, or optionally transfer it to a SDCCH.

Table 2.1/GSM 04.11 summarize the use of channels during a short message transfer. Arrows indicate change of channel.

TABLE 2.1/GSM 04.11  
Channels used for short message transfer

| Channel dependency                 | Channel used              |
|------------------------------------|---------------------------|
| TCH not allocated                  | SDCCH                     |
| TCH not allocated -> TCH allocated | SDCCH -> SACCH            |
| TCH allocated                      | SACCH                     |
| TCH allocated -> TCH not allocated | SACCH -> SACCH opt. SDCCH |

## 2.3 Layer 2 SAPI 3 handling

### General rule:

The Radio Resource Management (RR ref Rec. GSM 04.08) in the Mobile Station and on the network side (i.e. in the BSC) shall establish the acknowledged mode of operation on SAPI 3 whenever needed, i.e. when a message requiring SAPI 3 transfer shall be transmitted.

RR shall control the layer 2 also for SAPI 3, and keep knowledge of the mode.

The network side may initiate release of the acknowledged mode for SAPI 3 either explicitly (by the use of DISC- and UA-frames, ref., Rec. GSM 04.06) or indirectly by channel release (ref. Rec. GSM 04.08).

### This means:

- the Mobile Station side will initiate establishment of SAPI 3 acknowledged mode in the case of Mobile originated short message transfer
- the network side will initiate establishment of SAPI 3 acknowledged mode in the case of Mobile terminated short message transfer
- The network side may choose to keep the channel and the acknowledged mode of operation to facilitate transfer of several short messages for the same Mobile Station. The queuing and scheduling function for this should reside in the MSC.

### 3. Service definition

#### 3.1 General

The layer service is described as a set of service primitives. These service primitives are abstractions and attempt to capture only those details of the interaction between the entities that are aspects of the layer service itself. A service primitive neither specifies nor constrains the implementation of entities or the interface between them.

The general syntax of a primitive is specified in Recommendation 04.01. The initials of the primitives is in line with Recommendation 04.07.

#### 3.2 Service provided by CM-sublayer

In order to support the Short Message Service, the CM-sublayer provide services to the Short Message Relay Layer.

The CM-sublayer services are provided using layer specific functions and lower layer services offered to the CM-sublayer, controlled by short message control entities called SMCs.

An SMC entity in the MS communicate with an SMC entity in the MSC by means of a peer protocol, SM-CP - Short Message Control Protocol. The arrow diagrams in annex A gives an overview of the messaging on the CM-sublayer during a short message transfer.

An MS supporting the short message service shall have a minimum of two SMC entities. This enables the MS to receive MT messages during a MO message transfer.

To ensure that an MS having the minimum of two SMC entities is able to receive MT messages during an MO message transfer, and to send MO messages during MT message transfer, parallel message transfer in the same direction is prohibited. This means that the SMC entities shall not simultaneously perform messaging in the same direction.

The MSC shall have a minimum of two SMC entities available during a MT message transfer to a mobile station, one being reserved for MO message transfer. In a MO message transfer, the MSC shall have one SMC entity reserved for handling of the incoming message.

## 3.2.1 Definition of primitives on MS side

This section defines the service primitives used on the MS side. Table 3.1/GSM 04.11 gives an overview of the service primitives and linked main parameter to the primitives. All necessary control parameters to be used in a short message transfer is defined in chapter 7. All MNSMS service primitives defined in this section are passed on a CM-connection.

TABLE 3.1/GSM 04.11  
MNSMS service primitives on MS-side

| SERVICE PRIMITIVES |      | PARAMETER          |
|--------------------|------|--------------------|
| NAME               | TYPE |                    |
| MNSMS-ABORT-       | Req  | Cause              |
| MNSMS-DATA-        | Req  | MO RP-ACK/RP-ERROR |
|                    | Ind  | MT RP-ACK/RP-ERROR |
| MNSMS-EST-         | Req  | MO RP-DATA         |
|                    | Ind  | MT RP-DATA         |
| MNSMS-ERROR-       | Ind  | Cause              |
| MNSMS-REL-         | Req  | Cause              |

## 3.2.1.1 MNSMS-ABORT-Request

A request from an SMR entity to release a CM-connection in abnormal cases.

When CM-sublayer receives this request, it may form and send the CP-ERROR message to release the connection, or it may release the connection by use of lower layer services.

## 3.2.1.2 MNSMS-DATA-Request

A request from an SMR entity to return the acknowledgement RP-ACK, or an error indication, RP-ERROR, to the Service Centre, after reception of an incoming RP-DATA.

The SMC entity forms the CP-DATA message, the user information element being the RP-ACK or RP-ERROR, and transfer the message by means of the lower layer services.

### 3.2.1.3 MNSMS-DATA-INDication

An indication used by the SMC entity to pass the user information element (RP-ACK or RP-ERROR) of a received CP-DATA message to SM-RL.

The purpose of this service is to report the outcome of a MO messaging attempt.

### 3.2.1.4 MNSMS-ESTablish-REQuest

A request from an SMR entity to transmit a RP-DATA message, containing the SM-user information elements, and implicates:

- establishment of a CM-connection for MO message transfer - passing of RP-DATA to the CM-sublayer
- transfer of the CP-DATA message containing the RP-DATA

### 3.2.1.5 MNSMS-ESTablish-INDication

An indication used by the SMC entity to pass the SM-user information (RP-DATA) of a received CP-DATA message to SM-RL, and implicates establishment of the CM-connection for MT message transfer.

### 3.2.1.6 MNSMS-ERROR-INDication

An indication used by the SMC entity to pass error information to SM-RL. The error information may be local or relayed by the CP-ERROR message.

Use of this service implicates release of both CM- and MM-connection.

### 3.2.1.7 MNSMS-RELease-REQuest

A request to release CM-connection, passed from SM-RL to CM-sublayer when receiving the response from a RP-DATA messaging attempt.

Use of this service implies release of associated MM-connection.

## 3.2.2 Definition of primitives on network side

This section defines the service primitives used on the network side. Table 3.2/GSM 04.11 gives an overview of the service primitives and linked main parameter. All MNSMS service primitives defined in this section are passed on a CM-connection.

TABLE 3.2/GSM 04.11  
MNSMS service primitives on network side

| SERVICE PRIMITIVES |      | PARAMETER          |
|--------------------|------|--------------------|
| NAME               | TYPE |                    |
| MNSMS-ABORT-       | Req  | Cause              |
| MNSMS-DATA-        | Req  | MT RP-ACK/RP-ERROR |
|                    | Ind  | MO RP-ACK/RP-ERROR |
| MNSMS-EST-         | Req  | MT RP-DATA         |
|                    | Ind  | MO RP-DATA         |
| MNSMS-ERROR-       | Ind  | Cause              |
| MNSMS-REL-         | Req  | Cause              |
| MNSMS-RES-         | Req  | MT RP-ACK/RP-ERROR |
| MNSMS-SSP-         | Req  | --                 |

### 3.2.2.1 MNSMS-ABORT-REQuest

A request from an SMR entity to release a CM-connection in abnormal cases.

When CM-sublayer receives this request, it may form and send the CP-ERROR message to release the connection, or it may release the connection by use of lower layer services.

### 3.2.2.2 MNSMS-DATA-REQuest

A request from an SMR entity to return the acknowledgement RP-ACK, or an error indication RP-ERROR, to the Mobile Station, after reception of an incoming RP-DATA.

The SMC entity forms the CP-DATA message, the user information element being the RP-ACK or RP-ERROR, and transfer the message by means of the lower layer services.

### 3.2.2.3 MNSMS-DATA-INDication

An indication used by the SMC entity to pass the user information element (RP-ACK or RP-ERROR) of a received CP-DATA message to SM-RL.

The purpose of the service element is to report the outcome of a MT messaging attempt.

### 3.2.2.4 MNSMS-ESTablish-REQuest

A request from an SMR entity to transmit a RP-DATA message, containing the SM-user information elements, and implicates:

- establishment of a CM-connection for MT transfer
- passing of RP-DATA to the CM-sublayer
- transfer of the CP-DATA message containing the RP-DATA

### 3.2.2.5 MNSMS-ESTablish-INDication

An indication used by the SMC entity to pass the SM-user information (RP-DATA) of a received CP-DATA message to SM-RL, and implicates establishment of the CM-connection for the MO message transfer.

### 3.2.2.6 MNSMS-ERROR-INDication

An indication used by the SMC entity to pass error information to SM-RL. The error information may be local or relayed by the CP-ERROR message.

Use of the service primitive implicates release of both CM- and MM- connection.

### 3.2.2.7 MNSMS-RELease-REQuest

A request to release CM-connection, passed from SM-RL to CM-sublayer when receiving the response from a RP-DATA messaging attempt.

Use of this service implies release of associated MM-connection.

### 3.2.2.8 MNSMS-RESume-REQuest

A request, including a response from the Service Centre (RP-ACK or RP-ERROR), being passed to CM-sublayer to resume operation on a suspended CM-connection.

Use of this service primitive implicates:

- establishment of a new MM-connection by the SMC entity
- relaying of RP-ACK or RP-ERROR in a CP-DATA message

### 3.2.2.9 MNSMS-SuSPend-REQuest

A suspend request passed from SM-RL to the CM-sublayer to indicate that:

- the SMC entity shall pass the MMSM-RELease-REQuest to MM-sublayer, enabling the radio resources to be released - the CM-connection shall be maintained while radio resources are released.

The purpose of the suspend/resume service is to enable the radio resources to be released during the time it takes to:

- relay the RP-DATA message from the MSC to the Service Centre, through various intermediate networks,
- process the RP-DATA message (if possible)
- returning an acknowledgement or error indication (RP-ACK or RP-ERROR) to the MSC.

Use of the suspend/resume mechanism is optional.

## 3.3 Service provided by SM-RL

In order to support the Short Message Service, the Short Message Relay Layer provide services to the Short Message Transfer Layer.

The Short Message Relay Layer services are provided using layer specific functions and lower layer services offered to the Short Message Relay Layer, controlled by short message control entities called SMRs.

An SMR entity in the MS communicate with an SMR entity in the MSC by means of a peer protocol, SM-RP - Short Message Relay Protocol. The arrow diagrams in annex C gives an overview of the messaging on the Short Message Relay Layer during a short message transfer. The diagrams in annex C indicates a layer RL. This is not a layer, but the functional interface to the fixed network. The SM-RL is the upper layer in the MSC. Consequently the service primitives passed between SM-RL and RL indicates the interworking function.

The demands to the SM-RL is as for the CM-sublayer. This means one SMR entity for each SMC entity, operating as described in section 3.2.



### 3.3.1 Definition of primitives on MS side

This section defines the service primitives used on the MS side. Table 3.3/GSM 04.11 gives an overview of the service primitives and linked main parameter. All SM-RL service primitives defined in this section are passed on a SM-RL-connection.

TABLE 3.3/GSM 04.11  
SM-RL service primitives on mobile station side

| SERVICE PRIMITIVES |      | PARAMETER        |
|--------------------|------|------------------|
| NAME               | TYPE |                  |
| SM-RL-DATA-        | Req  | see sec. 3.3.1.1 |
|                    | Ind  | see sec. 3.3.1.2 |
| SM-RL-REPORT-      | Ind  | Cause            |

#### 3.3.1.1 SM-RL-DATA-REQuest

A request from the SM-TL entity to pass the SMS-SUBMIT PDU and necessary control information to SM-RL, and implicates:

- establishment of a SM-RL-connection for MO message transfer - transfer of the RP-DATA message, containing the SMS-SUBMIT PDU, by means of services offered from lower layers

The purpose of this service is to relay the SMS-SUBMIT PDU from the mobile station to the Service Centre.

#### 3.3.1.2 SM-RL-DATA-INDication

An indication used by the SMR entity to pass the SMS-DELIVER PDU and necessary control information of a received RP-DATA message to SM-TL.

#### 3.3.1.3 SM-RL-REPORT-INDication

An indication used by the SMR entity to pass an acknowledgement (RP-ACK) or error information to SM-TL. The error information may be local or relayed by the RP-ERROR message.

### 3.3.2 Definition of primitives on network side

This section defines the service primitives used on the network side. Table 3.4/GSM 04.11 gives an overview of the service primitives and linked main parameter. All SM-RL service primitives defined in this section are passed on a SM-RL-connection.

TABLE 3.4/GSM 04.11  
SM-RL service primitives on network side

| SERVICE PRIMITIVES |      | PARAMETER      |
|--------------------|------|----------------|
| NAME               | TYPE |                |
| SM-RL-DATA-        | Req  | MT SMS-DELIVER |
|                    | Ind  | MO SMS-SUBMIT  |
| SM-RL-REPORT-      | Req  | Cause          |
|                    | Ind  | Cause          |

#### 3.3.2.1 SM-RL-DATA-REQuest

A request from RL to pass the SMS-DELIVER PDU to SM-RL, and implicates:

- establishment of a SM-RL-connection for MT message transfer
- transfer of the RP-DATA message, containing the SMS-DELIVER PDU, by means of services offered from lower layers

The purpose of this service is to relay the SMS-DELIVER PDU from the Service Centre to the mobile station.

#### 3.3.2.2 SM-RL-DATA-INDication

An indication used by the SMR entity to pass the SMS-SUBMIT PDU of a received RP-DATA message to RL.

#### 3.3.2.3 SM-RL-REPORT-REQuest

A request used by RL (the network interworking function) to relay the RP-ACK or RP-ERROR message from the network to the mobile station.

### 3.3.2.4 SM-RL-REPORT-INDication

An indication used by the SMR entity to pass an acknowledgement (RP-ACK) or error information to RL. The error information may be local or relayed by the RP-ERROR message.

## 4. Network interfaces

The procedures on SM-RL operates in tandem with the MAP procedures, see Rec. GSM 09.02 and GSM 03.40.

## 5. CM-procedures

### 5.1 General

This section describes the procedures used by the SMC entity for short message control on the Connection Management sublayer. An SMC entity communicates with a correspondant peer entity using a MM-connection.

Multiple MM-connection may be established at the same time, allowing parallell transactions. The description of the procedures are related to one single transaction.

The CM-procedures described in this section can only be performed if a MM-connection has been established between the mobile station and the network. Detailed SDL-diagrams for short message control are contained in Annex B.

### 5.2 Short Message Control states

The state transition diagram for the SMC entities on both MS-side and network side is contained in Annex B.

#### 5.2.1 SMC-states at the MS-side of the radio interface

The states described in this section is for a SMC entity in a MS, handling both mobile originated- and mobile terminated short message transfer.

##### 5.2.1.1 Idle (State 0)

This state exist when the SMC entity is in idle mode, or when a short message transfer end in a normal or abnormal way.

#### 5.2.1.2 MM-connection pending (State 1)

This state exist when the SMC has requested an MM-connection for mobile originated short message transfer.

#### 5.2.1.3 Wait for CP-ACK (State 2)

This state exist for mobile originating short message transfer when the SMC has received a confirmation that the MM-connection is established, and initiated the transfer of the CP-DATA message.

#### 5.2.1.4 MM-connection established (State 3)

This state exist in both mobile originating- and mobile terminating short message transfer when the SMC has:

- received the acknowledgement CP-ACK or
- received the message CP-DATA (including sending of the associated CP-ACK)

#### 5.2.1.5 MM-connection released (State 4)

This state exist only when the SMC entity has received a release indication from the MM-sublayer during a mobile originated short message transfer.

### 5.2.2 SMC-states at the network side of the radio interface

The states described in this section is for a SMC entity in a MSC, handling both mobile originated- and mobile terminated short message transfer.

#### 5.2.2.1 Idle (State 0)

This state exist when the SMC entity is in idle mode, or when a short message transfer end in a normal or abnormal way.

#### 5.2.2.2 MM-connection pending (State 1)

This state exist when the SMC has requested an MM-connection for mobile terminating short message transfer.

#### 5.2.2.3 Wait for CP-ACK (State 2)

This state exist for mobile terminating short message transfer when the SMC has received a confirmation that the MM-connection is established, and initiated the transfer of the CP-DATA message.

#### 5.2.2.4 MM-connection established (State 3)

This state exist in both mobile originating- and mobile terminating short message transfer when the SMC has:

- received the acknowledgement CP-ACK or
- received the message CP-DATA (including sending of the associated CP-ACK)

#### 5.2.2.5 MM-connection released (State 4)

This state exist in a mobile originated short message transfer when the SMC entity has received a suspend request from the Short Message Relay Layer and a release indication is passed to the MM-sublayer.

### 5.3 Short message transfer control procedures

The procedures needed for short message control are:

- connection establishment procedures
- short message transfer procedures
- clearing procedures
- miscellaneous procedures.

#### 5.3.1 MM-connection establishment

Before the short message transfer is initiated, the peer to peer connection between the MM-sublayers in the MS and the network (MSC) has to be established.

The SMC entity requests the MM-sublayer to establish a MM-connection, and enter the MM-Connection Pending state.

After completion of the MM-connection establishing attempt, a confirmation is given to indicate whether the MM is ready for short message transfer or not.

The MM-connection establishment is indicated to SMC entity at the network side when the short message has been received by the MM-sublayer (in line with Rec. GSM 04.08).

### 5.3.2 Initiating short message transfer

When a MM-connection is established, the SMC forwards the CP-DATA message containing the RP-DATA, sets the timer TC1\* and enters the Wait for CP-ACK state. If the timer TC1\* expires, the CP-DATA message is retransmitted and the state Wait for CP-ACK is reentered.

The CP-DATA message is only retransmitted once. If the timer TC1\* expires after a retransmission attempt, an error indication is passed to SM-RL and a MM-connection release request is passed to MM-sublayer. The Idle state is then entered.

On receipt of the CP-ACK message, the SMC resets the timer TC1\* and enters the MM-Connection Established state.

When receiving a CP-DATA message containing the RP-DATA, the SMC entity checks the parameters. If the message is accepted, the CP-ACK message is sent and the state MM-Connection Established is entered.

If the message is not accepted, the SMC entity in the MS discards the message and enters the Idle state. If the SMC entity in the network cannot accept a CP-DATA, it sends a CP-ERROR message followed by a MM-connection release request and then enters the Idle state.

### 5.3.3 Terminating short message transfer

Upon correctly receiving the CP-DATA message carrying the RP-ACK, the CP-ACK message is returned and the state MM-Connection Established is entered.

When sending the CP-DATA message carrying the RP-ACK, the timer TC1\* is set and the state Wait for CP-ACK is entered. If the MM-connection has been released, the procedure MM-connection establishment precedes this procedure.

If the timer TC1\* expires, the CP-DATA message is retransmitted and the state Wait for CP-ACK is reentered.

The CP-DATA message is only retransmitted once. If the timer TC1\* expires after a retransmission attempt, an error indication is passed to SM-RL and a MM-connection release request is passed to MM-sublayer. The Idle state is then entered.

#### 5.3.4 Suspend CM-connection

When the SMC entity in the network receives a suspend request from the Short Message Relay Layer, an MM-connection release request is issued and the state MM-Connection Released is entered.

When the suspend mechanism is used, the SMC entity of the MS receives a MM-connection released indication and the state MM-Connection Released is entered.

On both sides, the Transaction Identifier value is kept until the CM-connection is released.

#### 5.3.5 Release MM-connection

Release of the MM-connection is controlled by the SM-RL, except for erroneous conditions.

Upon receiving a release or abort request from SM-RL, the MM-connection release request is sent to MM-sublayer and the state Idle is entered.

In case of abort request, the timer TC1\* is reset before sending the MM-connection release request.

#### 5.3.6 Release CM-connection

This procedure is only used in erroneous conditions and implies release of both MM- and CM-connection.

Upon receiving the CP-ERROR message or a MM-error indication, the SMC entity pass an error indication to SM-RL and enter Idle state. In case the timer TC1\* is running, it is reset. The CP-ERROR message may only be received by the MS.

#### 5.3.7 Abnormal cases

Errors occurring in the SM-RL causes an abort request to be passed to the CM-sublayer.

When the SMC in the mobile station receives an abort request or detects an erroneous condition it may act upon, a MM-connection release request, without indication of release cause, is passed to MM-sublayer. The Short Message Relay Layer on the network side will discover this erroneous condition by expiring timers.

When the SMC on the network side receives an abort request, or detects erroneous conditions it may act upon, a CP-ERROR message indicating the cause is transferred to the MS and a MM-connection release request is passed to the MM-sublayer. The coding of the cause values in the CP-ERROR message is given in Table 8.2/GSM 04.11.

## 6. SM-RL-procedures

### 6.1 General

This section describes the procedures used by the SMR entity for short message support on the Short Message Relay Layer. An SMR entity communicates with a correspondent peer entity using a CM-connection.

Multiple CM-connection may be established at the same time, allowing parallel transactions. It is a functional one to one relation between the SMR entity and the SMC entity of the CM-sublayer. The description of the procedures are related to one single transaction.

The RL-procedures described in this section can only be performed if a CM-connection has been established between the mobile station and the network. Detailed SDL-diagrams for short message control on SM-RL are contained in Annex D.

### 6.2 Transition states of SMR entity

The state transition diagram for the SMR entities on both MS-side and network side is contained in Annex D.

#### 6.2.1 SMR-states at the MS-side of the radio interface

The states described in this section is for a SMR entity in a MS, handling both mobile originated- and mobile terminated short message transfer.

##### 6.2.1.1 Idle (State 0)

This state exist when the SMR entity is in idle mode, or when a short message transfer end in a normal or abnormal way.

##### 6.2.1.2 Wait for RP-ACK (State 1)

This state exists for mobile originating short message transfer when the SMR has passed the RP-DATA to the SMC entity and set the timer TR1M.

#### 6.2.2 SMR-states at the network side of the radio interface

The states described in this section is for a SMR entity in a MSC, handling both mobile originated- and mobile terminated short message transfer.



#### 6.2.2.1 Idle (State 0)

This state exist when the SMR entity is in idle mode, or when a short message transfer end in a normal or abnormal way.

#### 6.2.2.2 Wait for RP-ACK (State 1)

This state exists for a mobile terminating short message transfer when the SMR has passed the RP-DATA message to the SMC entity and set the timer TR1N.

#### 6.2.2.3 CM-connection suspended (State 2)

When the suspend/resume mechanism is used, the SMR entity will enter this state after passing a received RP-DATA message to RL and setting the timer TR2N.

#### 6.2.2.4 Wait to send RP-ACK (State 3)

The suspend/resume mechanism not being used, the SMR entity will enter this state after passing a received RP-DATA message to RL and setting the timer TR2N.

### 6.3 Short Message Relay procedures

The procedures needed for short message relaying are:

- connection establishment procedures
- short message relay procedures
- clearing procedures
- miscellaneous procedures

#### 6.3.1 Initiate short message relaying

When the SMR entity receives a request from SM-TL, or RL, to relay a TPDU, it form and transfer the RP-DATA message, sets the timers TR1\* and enters the state Wait for RP-ACK.

Retransmission of RP-DATA message is handled by the CM-sublayer, as described in chapter 5.

#### 6.3.2 Terminate short message relaying

MS-side

The procedure is used to terminate the short message transfer when the SMR entity is in the "Wait for RP-ACK" state.

Different actions are taken in the following situations:

- a) reception of a RP-message
- b) reception of an error indication from CM-sublayer
- c) the timer TR1M expires

In case of a) or b), the timer TR1M is reset, a report indication is passed to SM-TL and a release CM-connection request is passed to CM-sublayer.

In case c), an abort CM-connection request is passed to CM-sublayer, and a report indication is passed to SM-TL.

After completing the procedure, the SMR entity enters the Idle-mode.

Network side

- a) Mobile originated short message transfer.

The procedure is used to terminate the short message transfer when the SMR entity is in state "Wait to send RP-ACK" or state "CM-connection suspended".

When the SMR entity receives the SM-RL-Report-Request (carrying a RP-ACK or RP-ERROR message) the timer TR2N is reset, the RP-message is relayed to the MS and a CM-connection release request is passed to CM-sublayer.

Note: If the CM-connection is suspended, the Resume CM-connection procedure is invoked before the RP-message may be relayed.

If the SMR entity receives an error indication from CM-sublayer, the timer TR2N is reset, a report indication is passed to RL and the Idle-mode is entered.

If the timer TR2N expires, the SMR entity pass a CM-connection abort request to CM-sublayer, a report indication to RL and the Idle-mode is entered.

- b) Mobile terminated short message transfer.

When the SMR entity receives a RP-ACK or RP-ERROR message, or an error indication from CM, it resets the timer TR1N, passes a report indication to RL and enters the Idle-mode.

If the timer TR1N expires, the SMR entity pass an abort request to CM, a report indication to RL and the Idle-mode is entered.

### 6.3.3 Suspend CM-connection

This procedure is used when the network allows release of the radio resources while waiting for the report from the Service Centre.

### 6.3.4 Resume CM-connection

This procedure is used to resume operation on the suspended CM-connection when the SMR entity receives the report from the Service Centre.

### 6.3.5 Reception of short message

This procedure checks the parameters of a received RP-DATA message. If it is accepted, the acknowledgement RP-ACK is returned to the originator, the RP-DATA message is passed to SM-TL/RL and a CM-connection release request is passed to CM. On the network side, the SMR entity also sets the timer TR2N.

If errors are detected, which the SMR entity may act upon, an RP-ERROR message containing a proper error cause is returned to the originator and a CM-connection release request is passed to CM-sublayer. In case of major errors in the RP-DATA message, a CM-connection abort request is passed to CM-sublayer and the Idle-mode is entered.

### 6.3.6 Abnormal cases

Network side:

Timer expiry:

In the case of TR1N expiry, the SMR entity should release the CM-connection, and give an appropriate indication to the interworking function.

Error indication from SMC entity:

The SMR entity should release the CM-connection, and give an appropriate indication to the interworking function.

Format errors etc:

If the SMR entity upon receipt of a RP-DATA message detects an erroneous condition, (e.g. format errors, invalid parameters etc.) it shall return a RP-ERROR message with an appropriate cause value, and release the CM-connection.

Mobile Station side:

Timer expiry:

In the case of TR1M expiry, the SMR entity should locally release the CM-connection, and give an appropriate indication to the upper SM-TL entity.

Error indication from SMC entity:

The SMR entity should locally release the CM-connection, and give an appropriate indication to the upper SM-TL entity.

Format errors etc:

If the SMR entity upon receipt of a RP-DATA message detects an erroneous condition, (e.g. format errors, invalid parameters etc.) it shall, if possible, return a RP-ERROR message with an appropriate cause value. Else it should ignore the message and locally release the CM-connection.

## 7. Message functional definitions and content

### 7.1 General

The notation used is in line with Rec. GSM 04.08/Ch. 9, and each definition includes:

- a) A brief description of the message direction and use.
- b) A table listing the information elements in the order of their appearance in the message. For each information element the table indicates:
  - 1) A reference to the section/recommendation describing the information element.
  - 2) The direction in which the information element may be sent; MSC to MS, MS to MSC or both.
  - 3) The type of information element, i.e. whether it is - mandatory with fixed length (MF),
    - mandatory with variable length (MV),
    - optional with fixed length (OF) or
    - optional with variable length (OV).
  - 4) The length of the information element, in octets, where ? denotes an undefined maximum length.

### 7.2 Messages for short message transfer on CM

This section describes the functional definition and content of the messages sent between two SMC entities.

There are three messages defined, CP-DATA, CP-ACK and CP-ERROR.

#### 7.2.1 CP-DATA

The CP-DATA message is sent between an MSC and an MS, in both directions. The message contains the user-data, to be relayed between the CM-users, and associated parameters. See Table 7.1/ GSM 04.11.

TABLE 7.1/GSM 04.11  
CP-DATA message content

| Information element    | Reference   | Direction | Type | Length    |
|------------------------|-------------|-----------|------|-----------|
| Protocol discriminator | GSM 04.08   | both      | MF   | 1 oct.    |
| Transaction identifier | GSM 04.08   | both      | MF   |           |
| Message type           | Sec. 8.1.3  | both      | MF   | 1 oct.    |
| CP-User data           | Sec.8.1.4.1 | both      | MV   | ≤256 oct. |

### 7.2.2 CP-ACK

The CP-ACK message is sent between an MSC and an MS, in both directions, and is used to acknowledge the reception of a CP-DATA message.  
See Table 7.2/GSM 04.11.

TABLE 7.2/GSM 04.11  
CP-ACK message content

| Information element    | Reference  | Direction | Type | Length |
|------------------------|------------|-----------|------|--------|
| Protocol discriminator | GSM 04.08  | both      | MF   | 1 oct. |
| Transaction identifier | GSM 04.08  | both      | MF   |        |
| Message type           | Sec. 8.1.3 | both      | MF   | 1 oct. |

## 7.2.3 CP-ERROR

The CP-ERROR message is sent between an MSC and an MS in one directions, MSC -> MS. The message is used to convey error information from the network to the mobile station. See Table 7.3/GSM 04.11.

TABLE 7.3/GSM 04.11  
CP-ERROR message content

| Information element    | Reference   | Direction | Type | Length |
|------------------------|-------------|-----------|------|--------|
| Protocol discriminator | GSM 04.08   | n -> ms   | MF   | 1 oct. |
| Transaction identifier | GSM 04.08   | n -> ms   | MF   |        |
| Message type           | Sec. 8.1.3  | n -> ms   | MF   | 1 oct. |
| CP-Cause               | Sec.8.1.4.2 | n -> ms   | MF   | 1 oct. |

### 7.3 Messages for short message transfer on SM-RL

This section describes the functional definition and content of the messages sent between two SMR entities.

There are 3 messages defined, RP-DATA, RP-ACK and RP-ERROR.

#### 7.3.1 RP-DATA

The RP-DATA message is sent between an MSC and an MS in both direction. The message is used to relay the TPDUs. The information elements is in line with Rec. GSM 03.40. See Table 7.4/GSM 04.11.

TABLE 7.4/GSM 04.11  
RP-DATA message content

| Information element       | Reference   | Direction | Type | Length    |
|---------------------------|-------------|-----------|------|-----------|
| RP-Message type indicator | Sec 8.2.2   | both      | MF   | 3 bit     |
| RP-Priority indicator     | Sec 8.2.4   | n -> ms   | MF   | 1 bit     |
| RP-Message reference      | Sec 8.2.3   | both      | MF   | 1 oct.    |
| RP-Originator Address     | Sec 8.2.5.1 | n -> ms   | MV   | 1-13 oct. |
| RP-Destination Address    | Sec 8.2.5.2 | ms -> n   | MV   | 1-13 oct. |
| RP-User data              | Sec 8.2.5.3 | both      | MV   | ≤239 oct. |



## 7.3.2 RP-ACK

This message is used to relay the acknowledgement of a RP-DATA message reception. The information elements is in line with Rec. GSM 03.40. See Table 7.5/GSM 04.11.

TABLE 7.5/GSM 04.11  
RP-ACK message content

| Information element       | Reference | Direction | Type | Length |
|---------------------------|-----------|-----------|------|--------|
| RP-Message type indicator | Sec 8.2.2 | both      | MF   | 3 bit  |
| RP-Message reference      | Sec 8.2.3 | both      | MF   | 1 oct. |

## 7.3.3 RP-ERROR

This message is used to relay an error cause from an erroneous short message transfer attempt. The information elements is in line with Rec. GSM 03.40. See Table 7.6/GSM 04.11.

The contents of the cause field is given in Section 8.2.5.4.

TABLE 7.6/GSM 04.11  
RP-ERROR message content

| Information element       | Reference   | Direction | Type | Length   |
|---------------------------|-------------|-----------|------|----------|
| RP-Message type indicator | Sec 8.2.2   | both      | MF   | 3 bit    |
| RP-Message reference      | Sec 8.2.3   | both      | MF   | 1 oct.   |
| RP-Cause                  | Sec.8.2.5.4 | both      | MV   | 2-3 oct. |

8. Message format and information elements coding8.1 CP-messages

## 8.1.1 General

The message format and information elements coding is in line with Rec. GSM 04.08.

The message shall consist of the following parts:

- a) protocol discriminator
- b) transaction identifier
- c) message type
- d) other required information elements

## 8.1.2 Protocol Discriminator and Transaction Identifier

The Protocol Discriminator (value 1 0 0) and Transaction Identifier is described in Rec. GSM 04.08.

## 8.1.3 Message type

The purpose of the message type, together with the protocol discriminator, is to identify the function of the message being sent. The coding of message types is shown in Table 8.1/GSM 04.11.

TABLE 8.1/GSM 04.11  
Message types for short message transfer on CM

|   |   |   |   |   |   |   |   |          |
|---|---|---|---|---|---|---|---|----------|
| 7 | 6 | 5 | 4 | 3 | 2 | 1 | 0 |          |
| 0 | 0 | 0 | 0 | 0 | 0 | 0 | 1 | CP-DATA  |
| 0 | 0 | 0 | 0 | 0 | 1 | 0 | 0 | CP-ACK   |
| 0 | 0 | 0 | 1 | 0 | 0 | 0 | 0 | CP-ERROR |

## 8.1.4 Other required information elements

As for Rec. GSM 04.08, the Information Element Identifier for a given element is not sent when the element is mandatory in a message.

8.1.4.1 CP-User data element

The CP-User data element is used to carry the RPDU. It has an information element identifier, a length indicator and a data field. The data field will contain the RPDUs. The maximum length of the data field is 255 octets. The layout is indicated in figure 8.1/GSM 04.11.

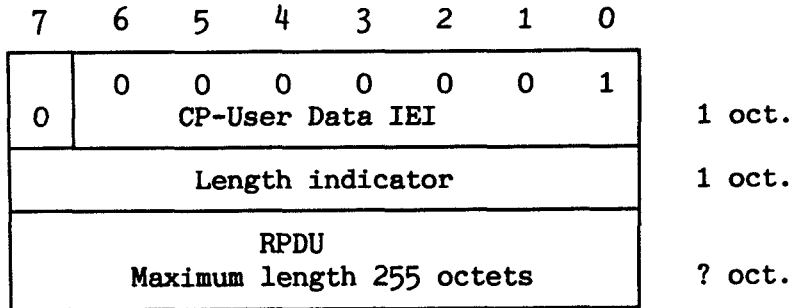

Figure 8.1/GSM 04.11. CP-User data element layout.

8.1.4.2 CP-Cause element

This element is included in the CP-ERROR message, the layout is given in figure 8.2/GSM 04.11. The error causes are listed in Table 8.2/GSM 04.11.

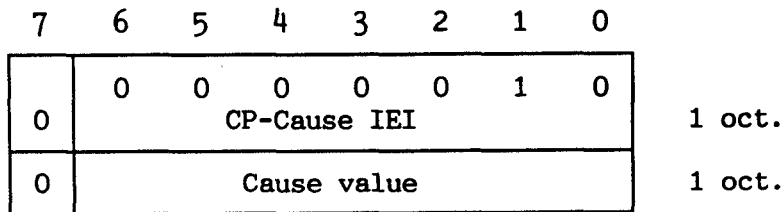

Figure 8.2/GSM 04.11. CP-Cause element layout.

TABLE 8.2/GSM 04.11  
Content and coding of CP-Cause

| Cause value   | Cause nr. | Cause  |
|---------------|-----------|--|
| 6 5 4 3 2 1 0 | #         |  |
| 0 0 1 0 0 0 1 | 17        | Network failure  |
| 0 0 1 0 1 1 0 | 22        | Congestion   |
| 1 0 1 1 1 1 1 | 95        | Invalid message, unspecified   |
| 1 1 0 0 0 0 0 | 96        | Mandatory information element error  |
| 1 1 0 0 0 0 1 | 97        | Message type non-existent or not implemented   |
| 1 1 0 0 0 1 0 | 98        | Message not compatible with the short message transfer state or message type non-existent or not implemented |
| 1 1 0 0 0 1 1 | 99        | Information element non-existent or not implemented  |
| 1 1 0 0 1 0 0 | 100       | Invalid information element contents   |
| 1 1 0 0 1 0 1 | 101       | Message not compatible with the short message transfer state   |
| 1 1 0 1 1 1 1 | 111       | Protocol error, unspecified  |

## 8.2 RP-messages

### 8.2.1 General

The coding and layout of the RP-messages is in line with GSM Rec 03.40.

The message shall consist of the following parts:

- a) message type indicator
- b) message reference
- c) other required information elements

#### 8.2.1.1 RP-DATA layout

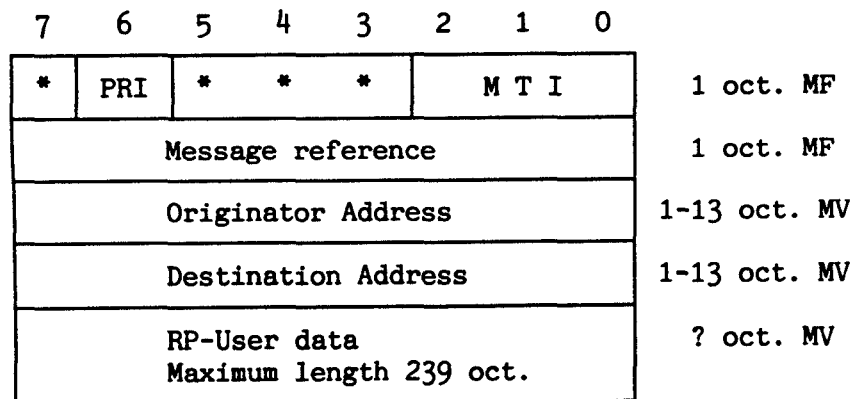

Figure 8.3/GSM 04.11. RP-DATA layout.

8.2.1.2 RP-ACK layout

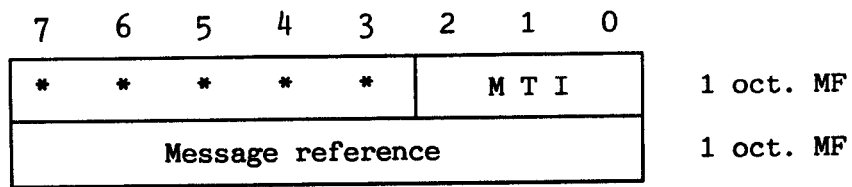

Figure 8.4/GSM 04.11. RP-ACK layout.

8.2.1.3 RP-ERROR layout

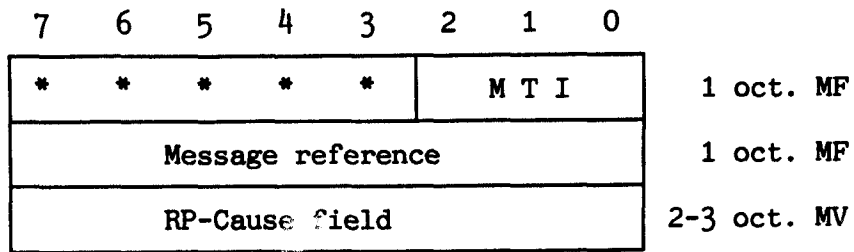

Figure 8.5/GSM 04.11. RP-ERROR layout.

8.2.2 Message type indicator (MTI)

The message type indicator, MTI, is a 3-bit field, located in the first octet of all RP-messages. The coding of the MTI is shown in Table 8.3/GSM 04.11.

TABLE 8.3/GSM 04.11  
Coding of Message Type Indicator

| Bit value<br>2 1 0 | RP-Message | Direction |
|--------------------|------------|-----------|
| 0 0 0              | RP-DATA    | ms -> n   |
| 0 0 1              | RP-DATA    | n -> ms   |
| 0 1 0              | RP-ACK     | ms -> n   |
| 0 1 1              | RP-ACK     | n -> ms   |
| 1 0 0              | RP-ERROR   | ms -> n   |
| 1 0 1              | RP-ERROR   | n -> ms   |
| 1 1 0              | Spare      | --        |
| 1 1 1              | Spare      | --        |

8.2.3 Message reference

The message reference field contains a sequence number in the range 0 through 255, and is used to link a RP-ACK message or RP-ERROR message to the associated (preceding) RP-DATA message transfer attempt.

#### 8.2.4. Priority indicator (PRI)

The priority indicator PRI is a 1-bit field indicating whether the RP-Priority Request (ref. Rec. GSM 03.40) have been carried out or not.

The priority indicator is located in bit 6 in the first octet of the RP-DATA message, and has the following coding:

|   |                              |
|---|------------------------------|
| 0 | RP-Priority Request is FALSE |
| 1 | RP-Priority Request is TRUE  |

#### 8.2.5 Other required information elements

As for Rec.GSM 04.08, the Information Element Identifier for a given element is not sent when the element is mandatory in a message.

##### 8.2.5.1 Originator address element

This element contains the originating entity address, the entity being the SC. The element corresponds to the Calling party BCD number in Rec. GSM 04.08, with identical coding.

The element may be up to 13 octets long. When no originator address is to be sent the value of the length octet of the element is set to 0.

##### 8.2.5.2 Destination address element

This element contains the destination entity address, the entity being the Service Centre. The element corresponds to the Called party BCD number in Rec. GSM 04.08, with identical coding.

This element may be up to 14 octets long and the use of it is mandatory in MO short message transfer.

##### 8.2.5.3 RP-User data element

The RP-User data field contains the TPDU and is mandatory in a RP-DATA message. The element has a variable length, up to 239 octets, the first octet sent being a length indicator.

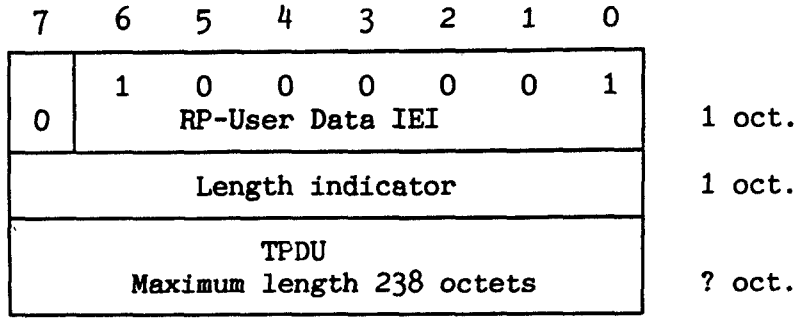

Figure 8.6/GSM 04.11. RP-User data element layout.

#### 8.2.5.4. RP-Cause element

This element is a variable length element always included the RP-ERROR message, conveying a negative result of a RP-DATA message transfer attempt. The element contains a cause value and optionally a diagnostic field giving further details of the error cause.

The coding of the cause value is given in Table 8.4/GSM 04.11. The mapping between error causes in Rec. GSM 04.11 and Rec. GSM 09.02 (MAP) is shown in Table 8.5/GSM 04.11. Parameters included in the return error from MAP (i.e. System Failure) are mapped directly into the diagnostic field.

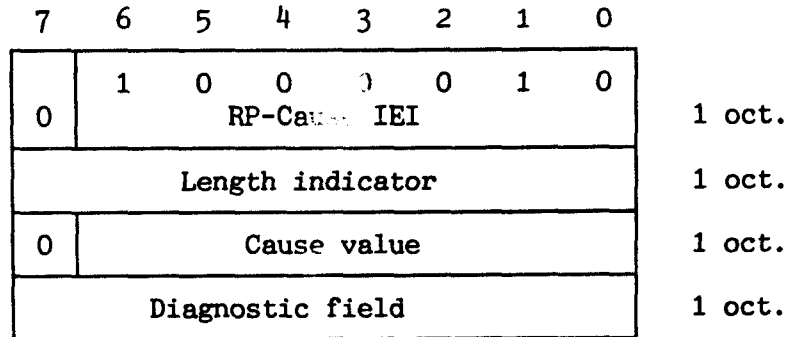

Figure 8.7/GSM 04.11. RP-Cause element layout.



TABLE 8.4/GSM 04.11  
Cause value to be contained in RP-ERROR message  
in a mobile originating SM-transfer attempt

| Cause value<br>Class value | Cause<br>number | Cause   |
|----------------------------|-----------------|---|
| 6 5 4 3 2 1 0              | #               |   |
| 0 0 0 0 0 0 1              | 1               | Unassigned (unallocated) number   |
| 0 0 0 1 0 1 0              | 10              | Call barred   |
| 0 0 0 1 0 1 1              | 11              | CUG reject  |
| 0 0 1 0 1 0 1              | 21              | Short message transfer rejected   |
| 0 0 1 1 0 1 1              | 27              | Destination out of service  |
| 0 0 1 1 1 0 0              | 28              | Unidentified subscriber   |
| 0 0 1 1 1 0 1              | 29              | Facility rejected   |
| 0 0 1 1 1 1 0              | 30              | Unknown subscriber  |
| 0 1 0 0 0 1 0              | 38              | Network out of order  |
| 0 1 0 1 0 0 1              | 41              | Temporary failure   |
| 0 1 0 1 0 1 0              | 42              | Congestion  |
| 0 1 0 1 1 1 1              | 47              | Resources unavailable, unspecified  |
| 1 0 0 0 1 0 1              | 69              | Requested facility not implemented  |
| 1 0 1 0 0 0 1              | 81              | Invalid short message transfer reference value  |
| 1 0 1 1 1 1 1              | 95              | Invalid message, unspecified  |
| 1 1 0 0 0 0 0              | 96              | Mandatory information element missing   |
| 1 1 0 0 0 0 1              | 97              | Message type non-existent or not implemented  |
| 1 1 0 0 0 1 0              | 98              | Message not compatible with short message transfer state<br>or message type non-existent or not implemented |
| 1 1 0 0 0 1 1              | 99              | Information element non-existent or not implemented   |
| 1 1 0 0 1 0 0              | 100             | Invalid information element contents  |
| 1 1 0 0 1 0 1              | 101             | Message not compatible with short message transfer state  |
| 1 1 0 1 1 1 1              | 111             | Protocol error, unspecified   |
| 1 1 1 1 1 1 1              | 127             | Interworking, unspecified   |

TABLE 8.4/GSM 04.11  
Cause value to be contained in RP-ERROR message  
in a mobile terminating SM-transfer attempt

| Cause value<br>Class value | Cause<br>number | Cause  |
|----------------------------|-----------------|--|
| 6 5 4 3 2 1 0              | #               |  |
| 0 0 1 0 1 1 0              | 22              | Memory capacity exceeded                                 |
| 1 1 0 0 0 0 0              | 96              | Mandatory information element missing                    |
| 1 1 0 0 0 1 1              | 99              | Information element non-existent or not implemented      |
| 1 1 0 0 1 0 0              | 100             | Invalid information element contents                     |
| 1 1 0 0 1 0 1              | 101             | Message not compatible with short message transfer state |
| 1 1 0 1 1 1 1              | 111             | Protocol error, unspecified                              |

8.2.6 Mapping between error causes in MAP and 04.11

TABLE 8.5/GSM 04.11  
MAP-04.11 error cause mapping.

| Return error from the MAP-proc.  | Cause value in the RP-ERROR message  |
|--|--|
| CallBarred<br>CUG_Reject<br>DataMissing<br>FacilityNotSupported<br>SystemFailure<br>UnexpectedDataValue<br>UnidentifiedSubscriber<br>UnknownServiceCentre<br>UnknownSubscriber | 10 Call barred<br>11 CUG reject<br>38 Network out of order<br>29 Facility reject<br>38 Network out of order<br>38 Network out of order<br>28 Unidentified subscriber<br>1 Unassigned number<br>30 Unknown subscriber |
| MAP operation failure<br>(e.g. reject condition,<br>timer expired or<br>transaction abort).  | 38 Network out of order  |

| Cause value in the RP-ERROR message:                                 | Return error to be included in the MAP-proc      |
|--|--|
| 22 Memory capacity exceeded<br><br>96, 99, 100, 101, 111             | MemoryCapacityExceeded<br><br>SM_DeliveryFailure |
| (local errors)<br>TR1N timeout<br>MNSMS-error-ind<br>(i e No SAPI 3) | SM_DeliveryFailure<br>" "                        |

ANNEX A

ARROW DIAGRAMS

Arrow diagram A1/A2:

The diagram reflects MO-messaging by means of interlayer service primitives and the actual messages being transferred between the layer entities.

- MNSMS-primitives indicates services provided by CM to SM-RL
- MMSM-primitives indicates services provided by MM to CM
- CP-DATA is the CM-message carrying SM-RP data units
- CP-ACK acknowledge CP-DATA reception on CM.

The difference between Diagram A1 and A2 is that use of the suspend mechanism is indicated in A1.

Arrow diagram A3:

The diagram reflects MT-messaging by means of interlayer service primitives and the actual messages being transferred between the layer entities.

- MNSMS-primitives indicates services provided by CM to SM-RL.
- MMSM-primitives indicates services provided by MM to CM.
- CP-DATA is the CM-message carrying SM-RP data units
- CP-ACK acknowledge CP-DATA reception on CM.

# Mobile Originated Messaging on CM-sublayer

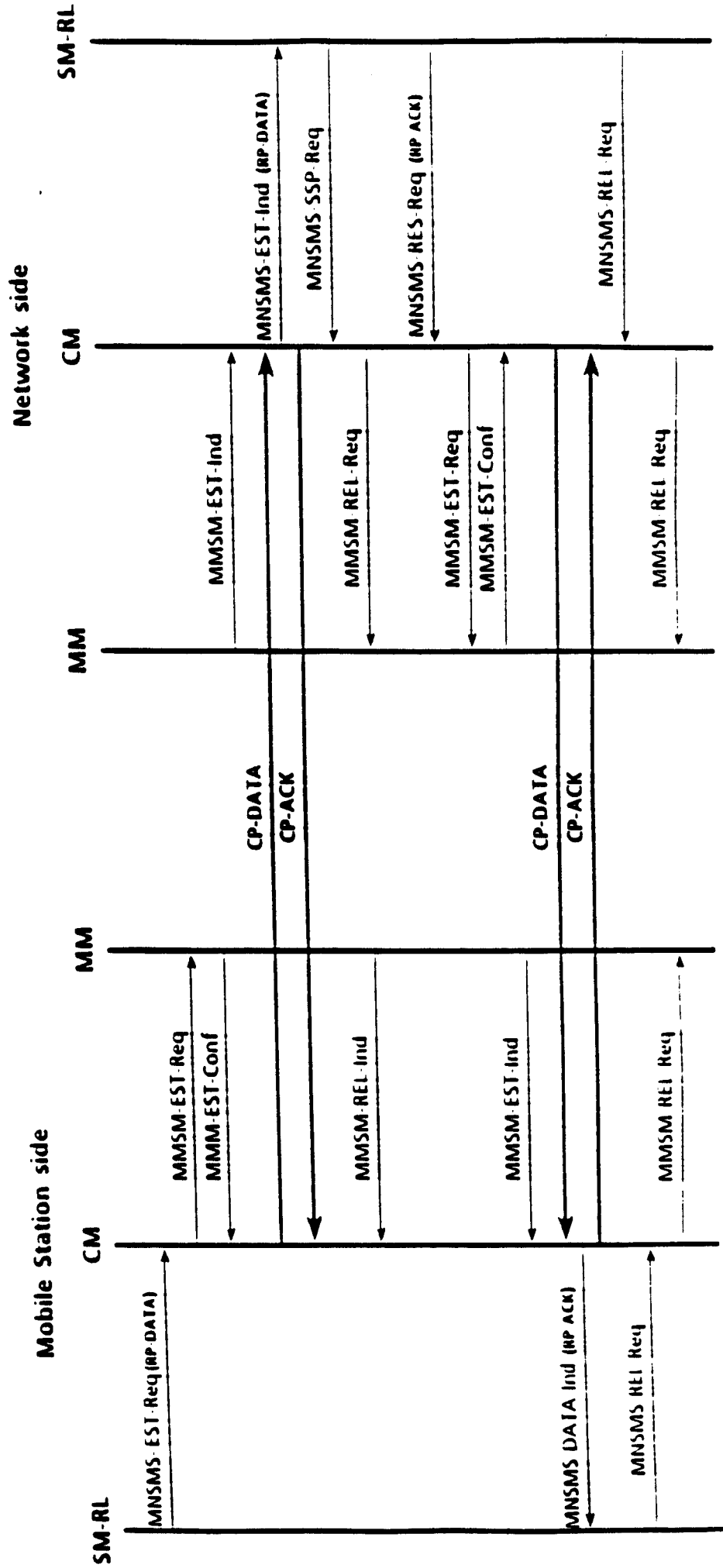

1 07000 000920 1

### Mobile Originated Messaging on CM-sublayer

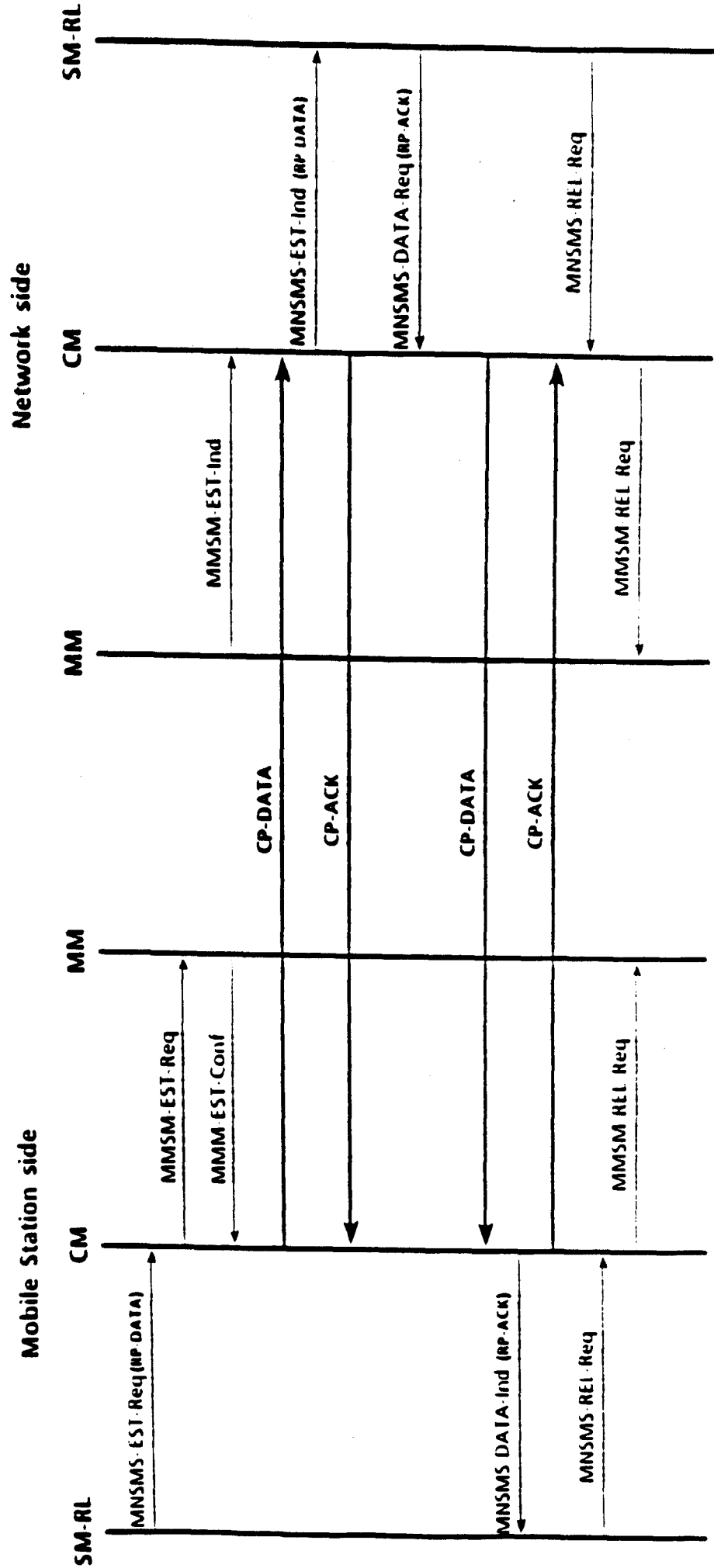

### Mobile Terminated Messaging on CM-sublayer

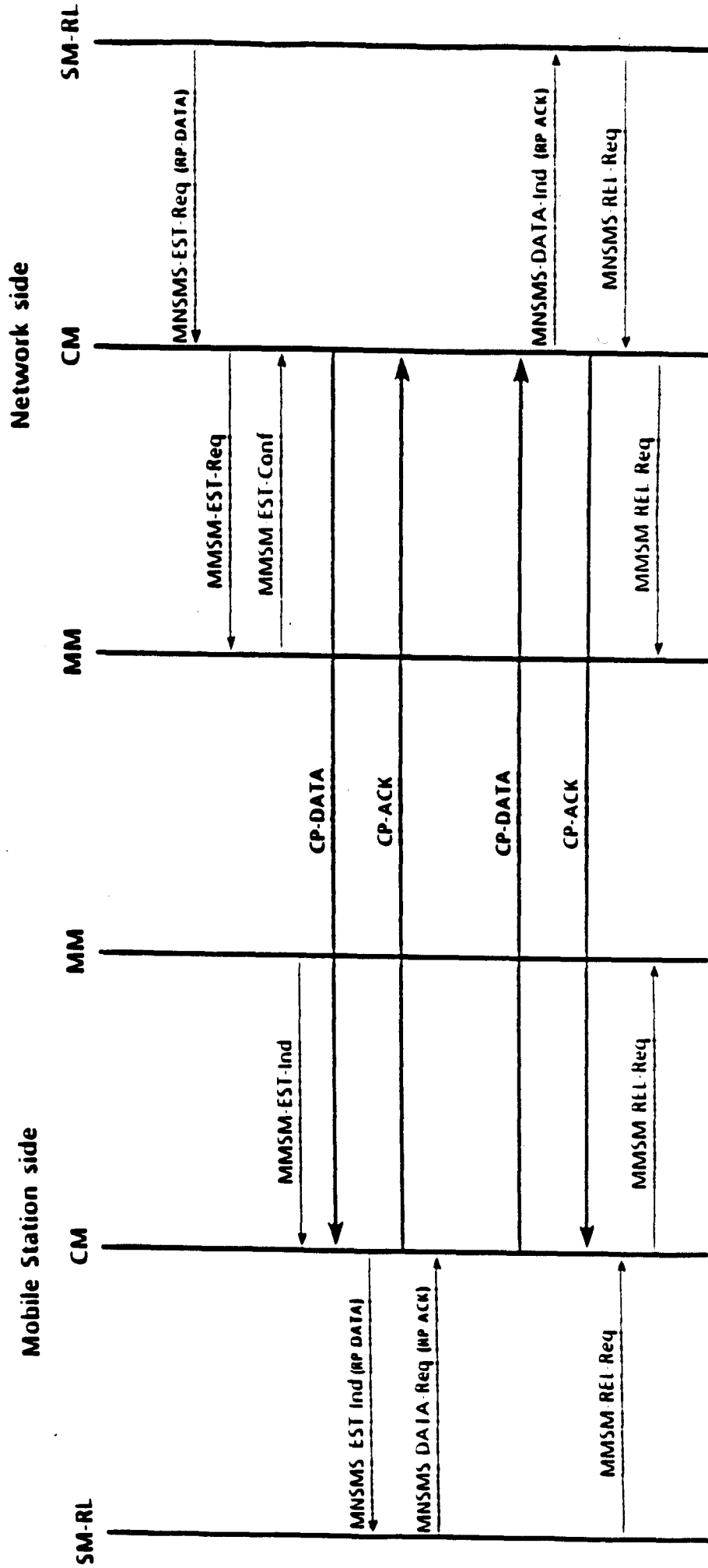

1000 880920 3

ANNEX B

SDL-DESCRIPTION OF THE CM-LAYER

B1. Introduction

This annex contains an SDL-description of the Connection Management Sublayer in terms of the Short Message Service Support. The CM-sublayer provides services to Short Message Relay Layer.

The SDLs contain a mixture of peer to peer messages and conceptual primitives between the layers SM-RL, CM and MM, as viewed by the SMC entities. SDL-1/4 shows the SMC entity on MS-side, and SDL-5/8 on the network side.

The lower layers (below MM) are transparent to an SMC entity.



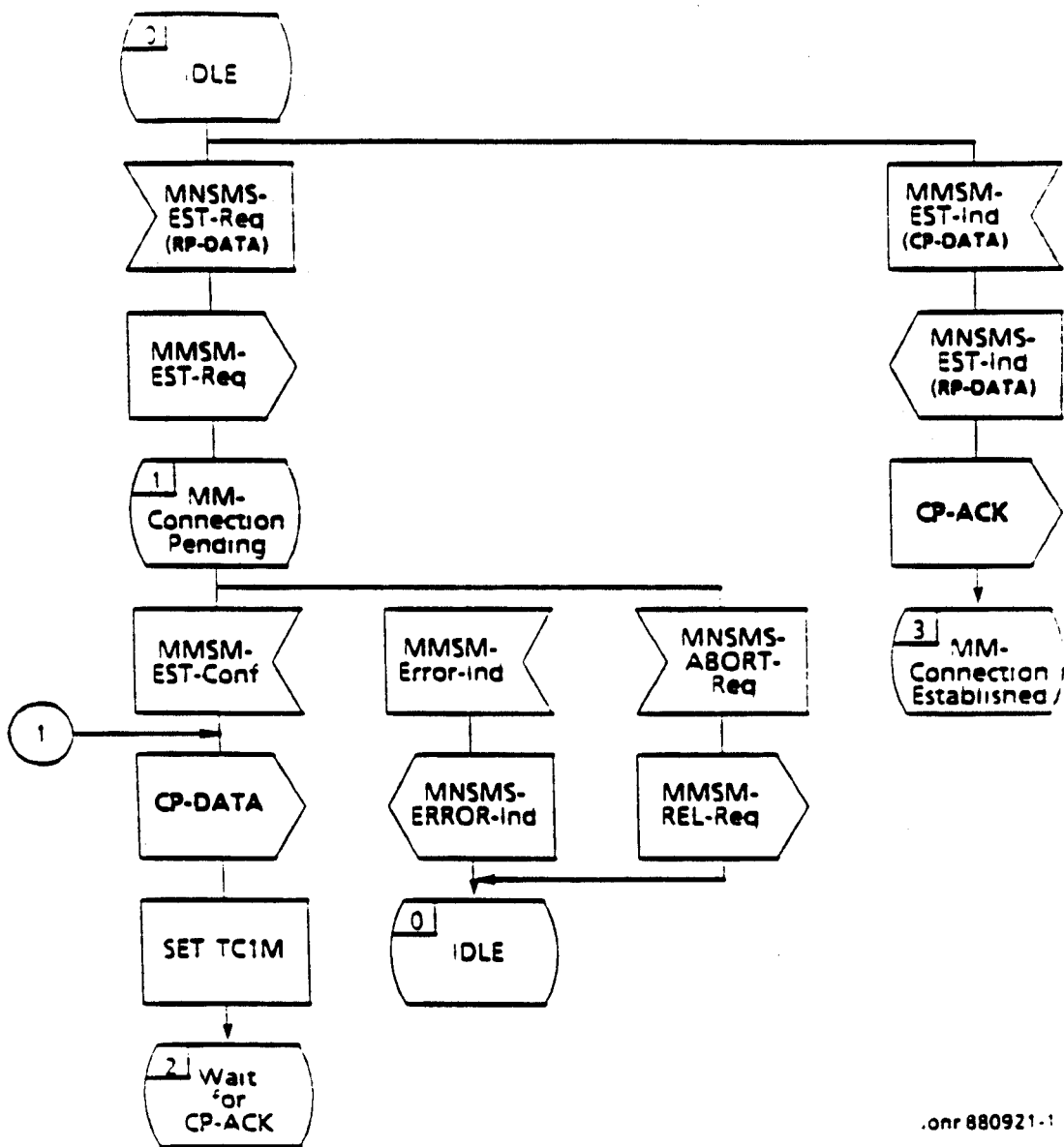

.onr 880921-1

SMC-entity on MS-side  
 Initiating message transfer  
 SDL-1

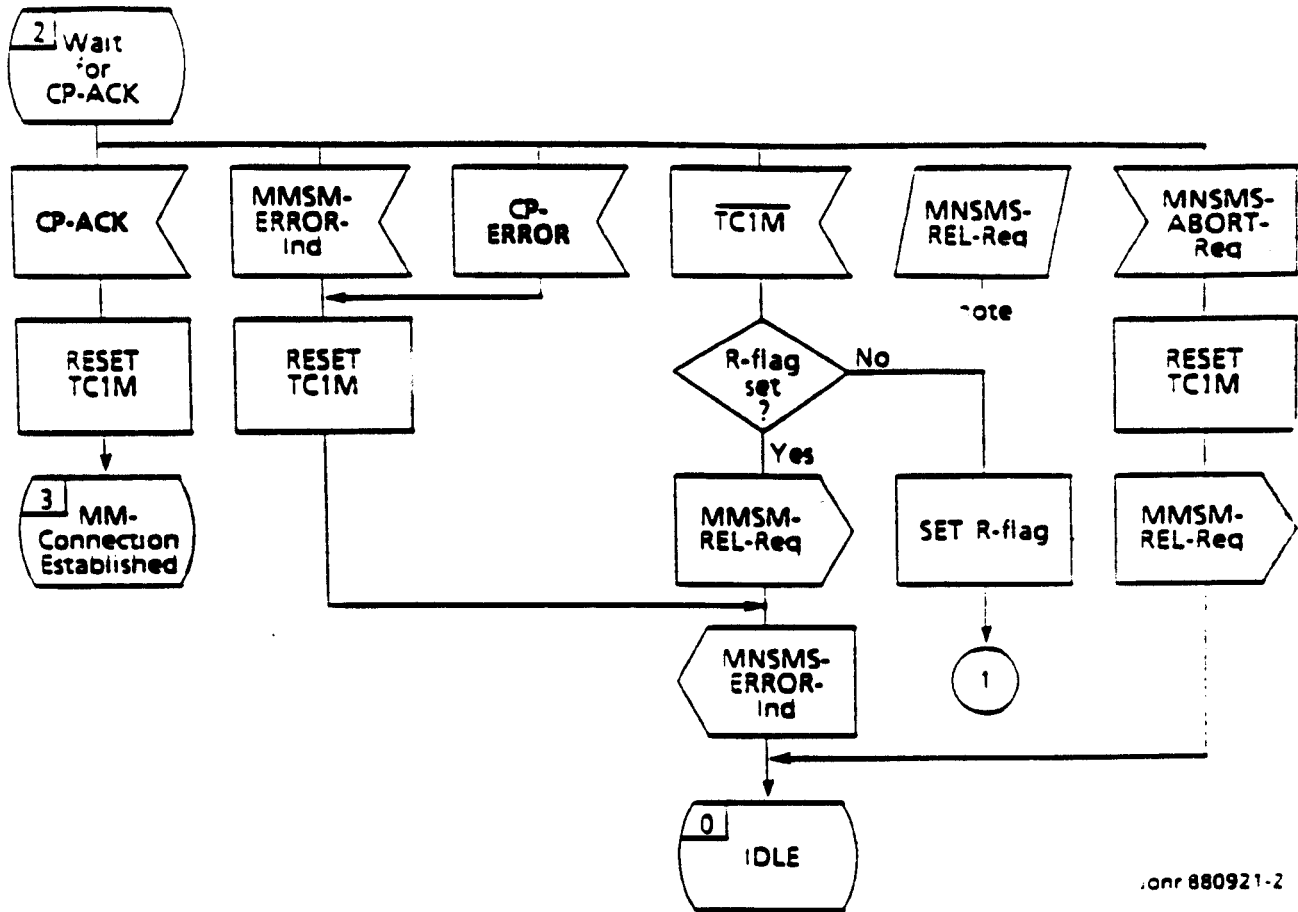

conr 880921-2

Note: The release is delayed until the next state

SMC-entity on MS-side

MM-Connection Established

SDL-2

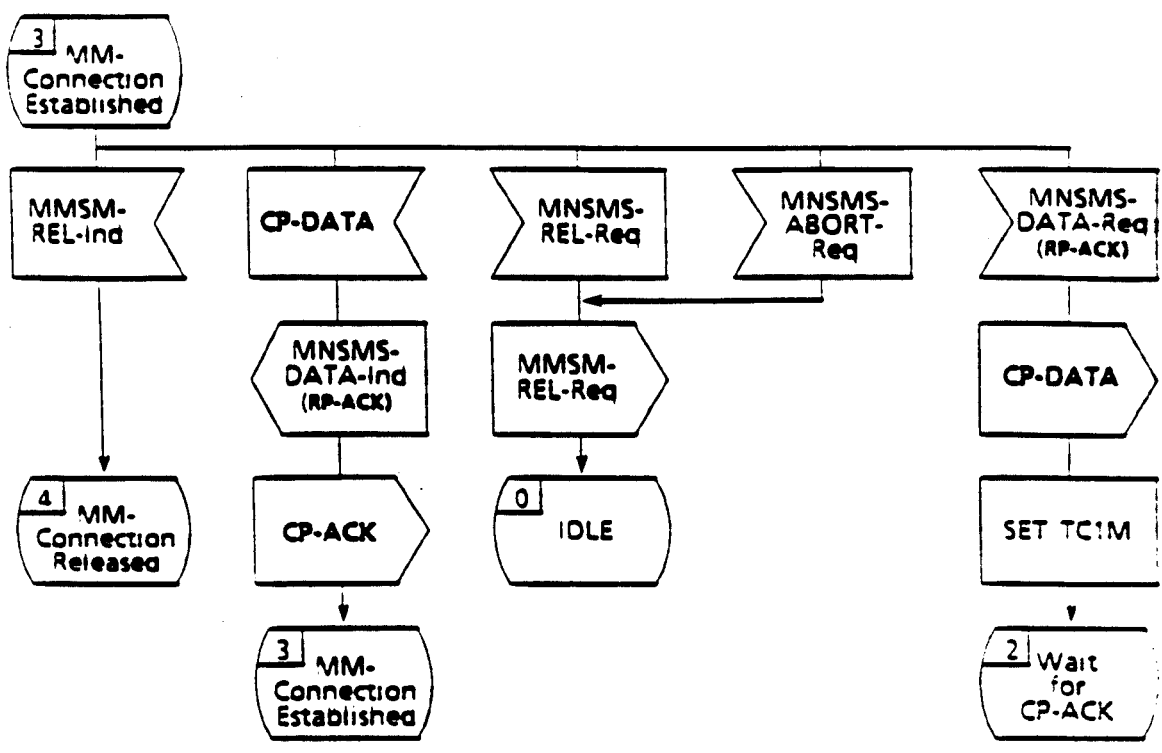

0nr 880921-3

SMC-entity on MS-side  
 MM-Connection released  
 SDL-3

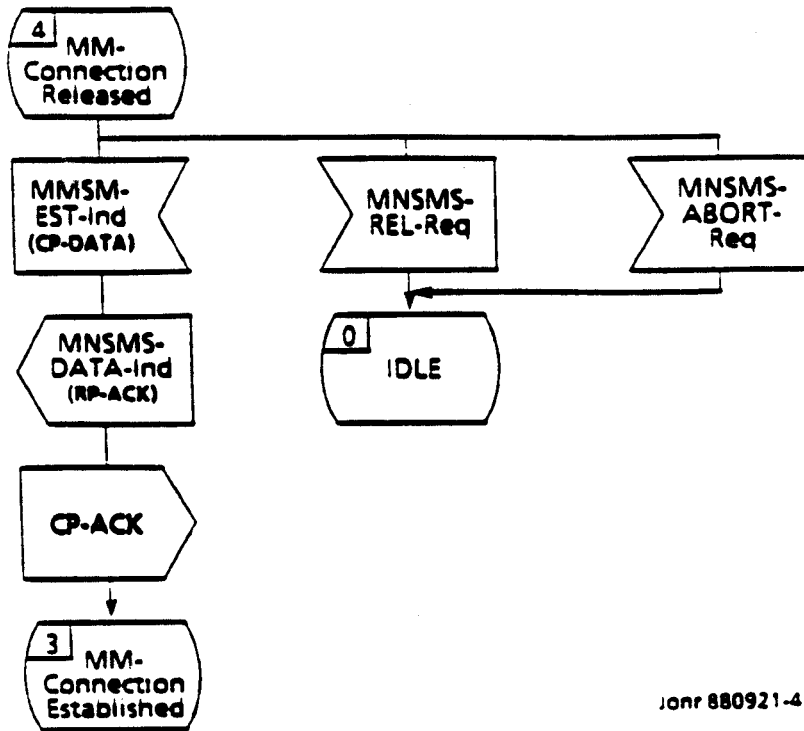

Janr 880921-4

SMC-entity on MS-side  
CM-Connection released  
SDL-4

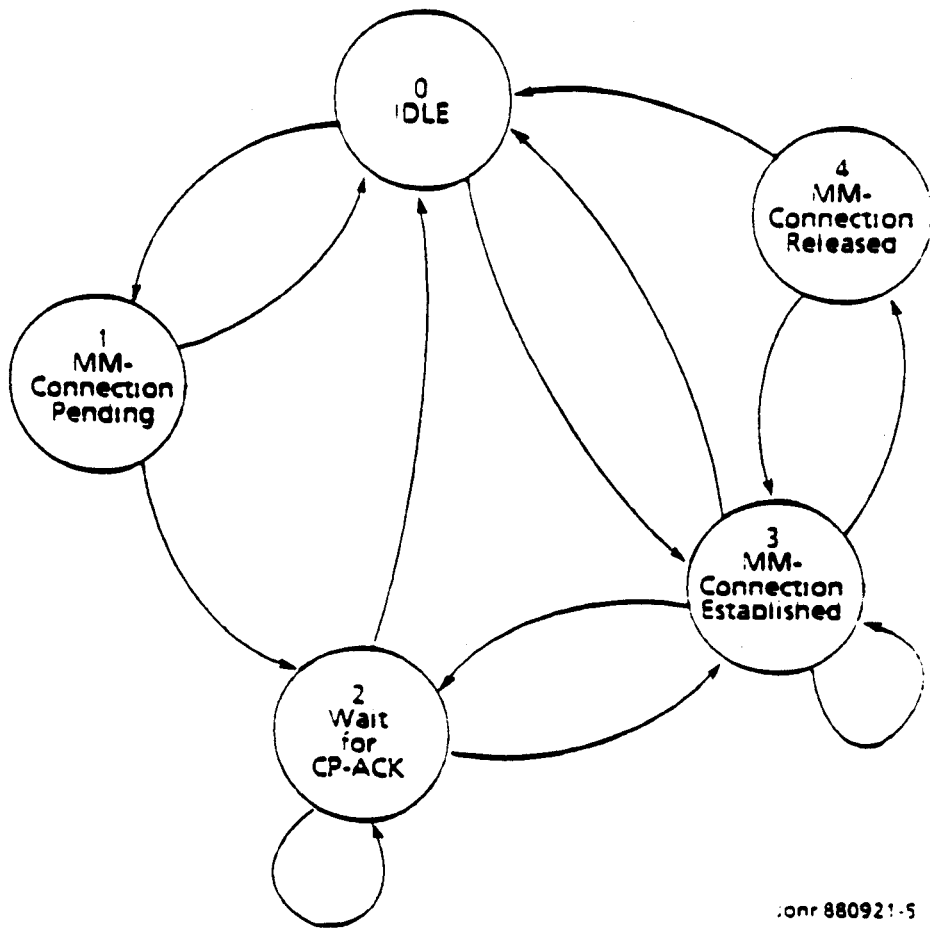

.onr 880921-5

State transition diagram  
SMC-entity on MS-side

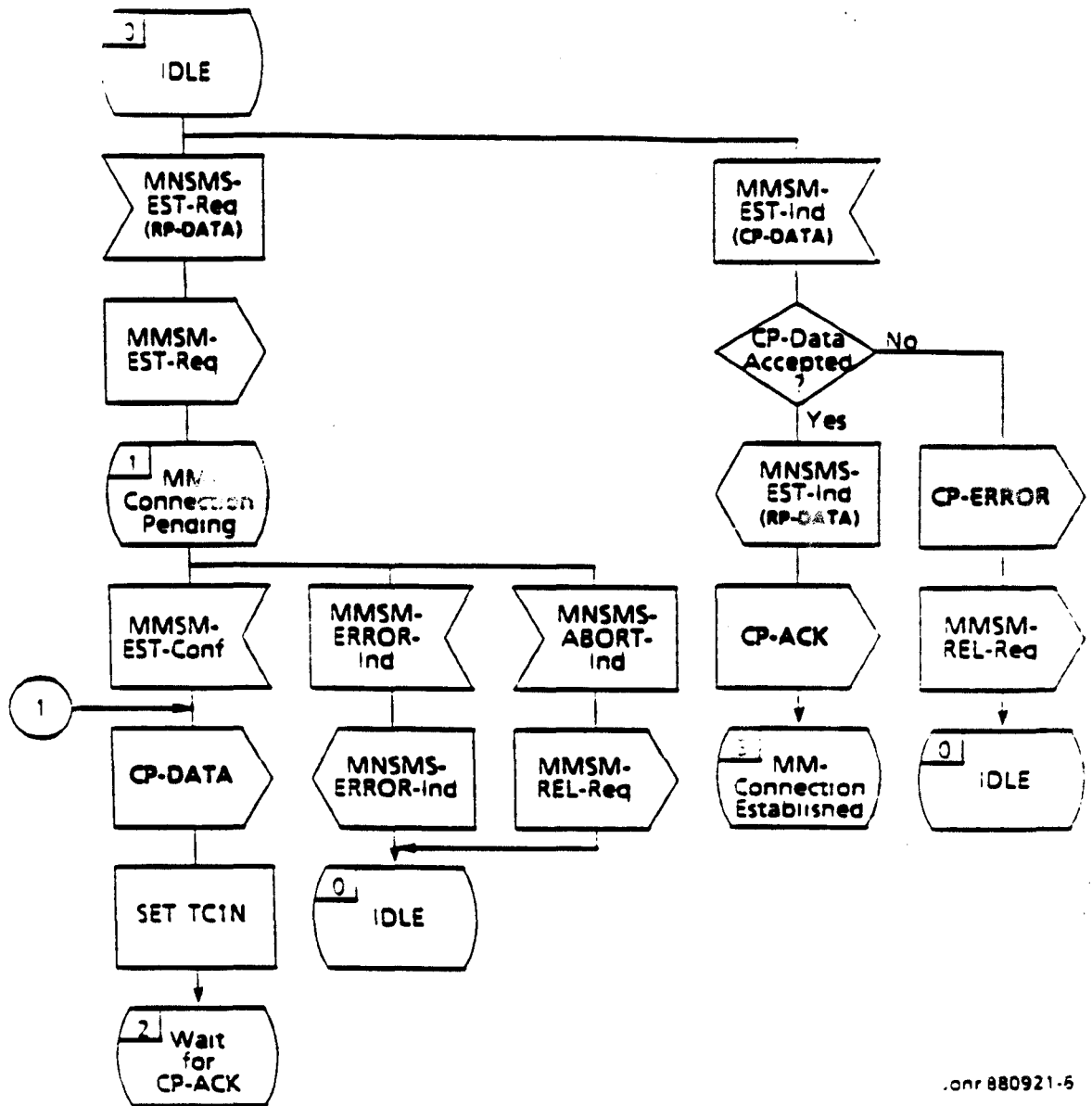

.cnr 880921-6

SMC-entity on Network side  
 Initiating message transfer  
 SDL-5

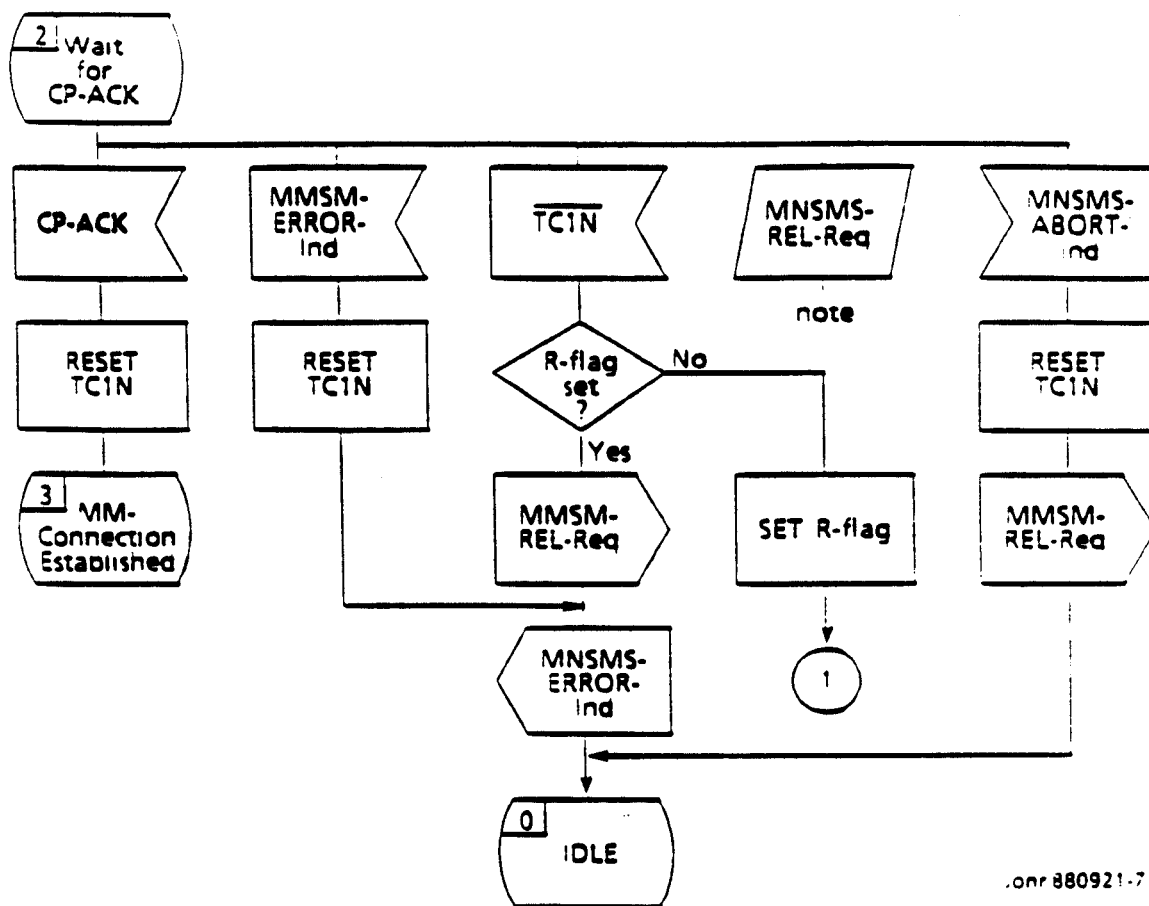

.onr 880921-7

Note: The release is delayed until the next state

SMC-entity on Network side  
 MM-Connection Established  
 SDL-6

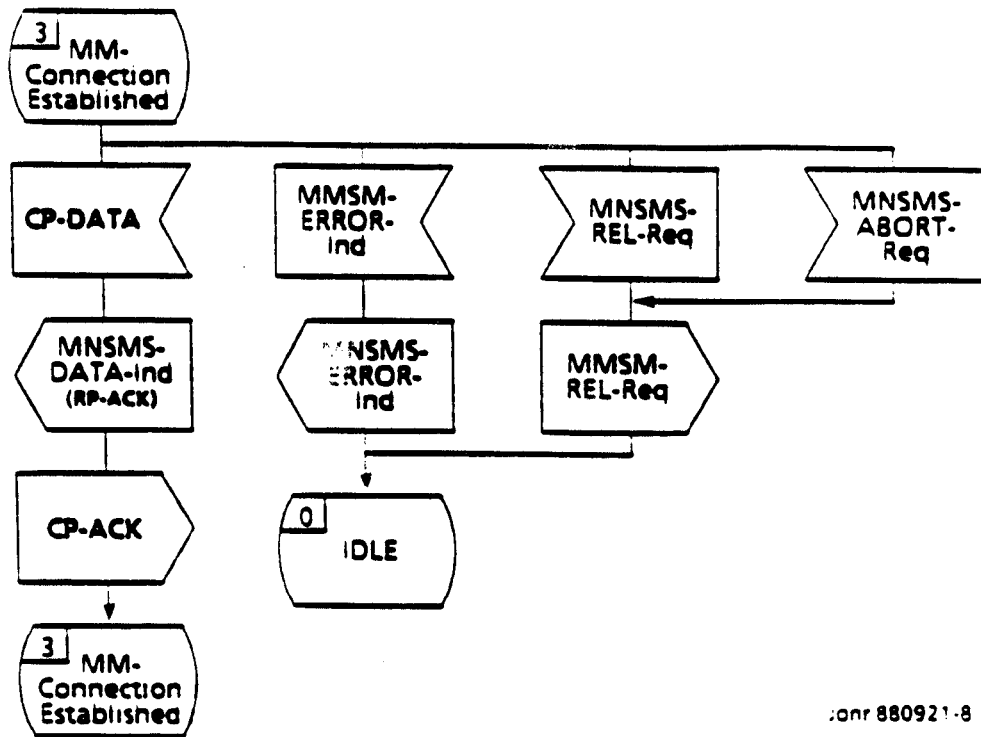

Annex 880921-8

SMC-entity on  
Network side

Message transfer  
active

SDL-7 (1 of 2)



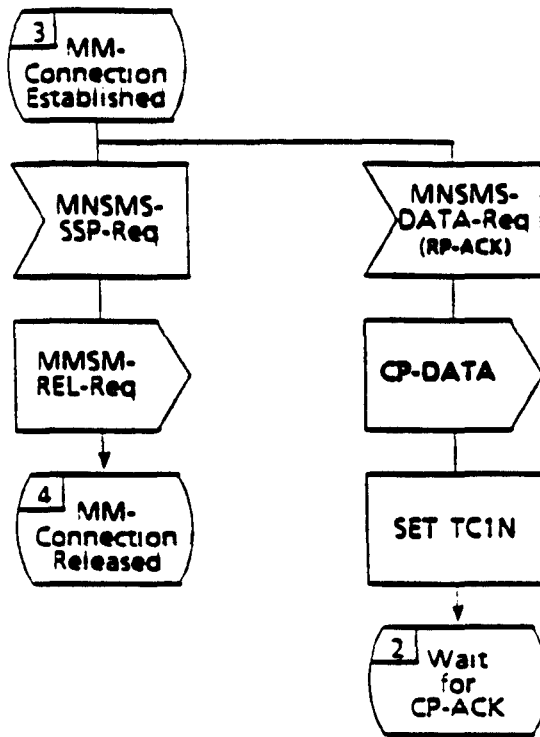

Jonr 880921-9

SMC-entity on  
Network side

Message transfer  
active

SDL-7 (2 of 2)

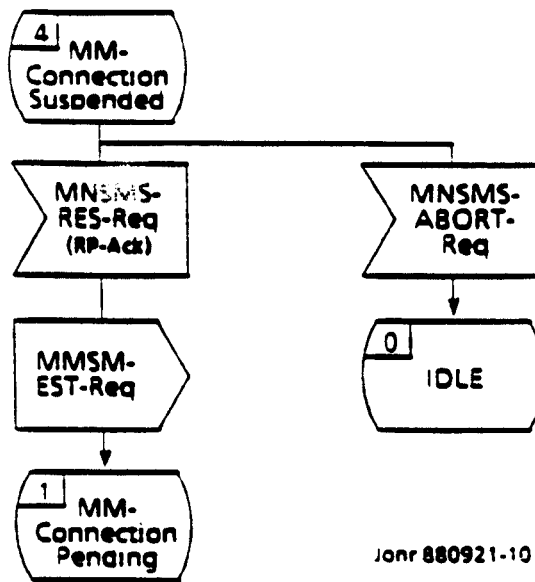

SMC-entity on  
Network side

MM-connection  
suspended

SDL-8

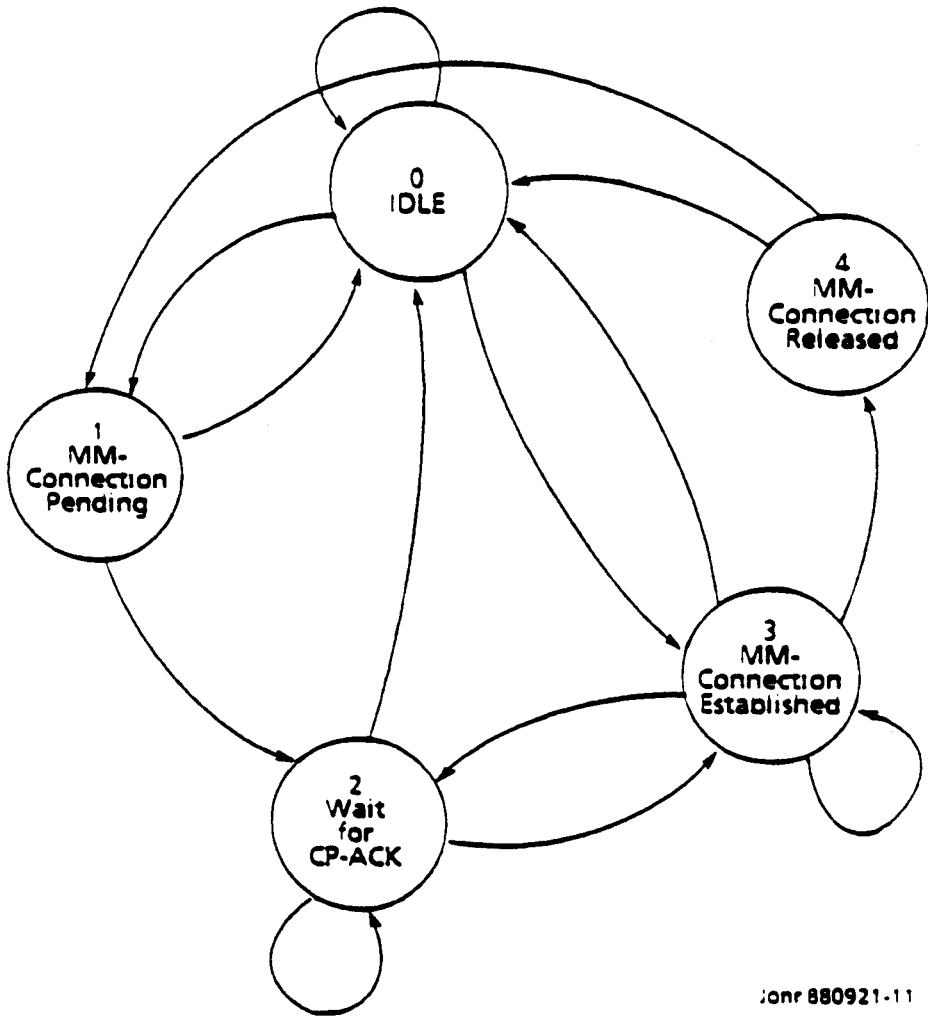

Jonr 880921-11

State transition diagram  
SMC-entity on  
Network side

## ANNEX C

## ARROW DIAGRAMS

## Arrow diagram C1:

The diagram reflects MO-messaging by means of interlayer service primitives and the actual messages being transferred between the layer entities.

- SM-RL-primitives indicates services provided by SM-RL to SM-TL and RL (\*).
- MNSMS-primitives indicates services provided by CM to SM-RL.
- RP-DATA is the SM-RL message carrying SM-TP data units
- RP-ACK acknowledge RP-DATA reception on SM-RL

## Arrow diagram C2:

The diagram reflects MT-messaging by means of interlayer service primitives and the actual messages being transferred between the layer entities.

- SM-RL-primitives indicates services provided by SM-RL to SM-TL and RL (\*).
- MNSMS-primitives indicates services provided by CM to SM-RL.
- RP-DATA is the SM-RL message carrying SM-TP data units
- RP-ACK acknowledge RP-DATA reception on SM-RL

## (\*) Note:

The SM-RL being the upper layer in the MSC, an interworking function between SM-RL-procedures and MAP-procedure is necessary. The term "RL" is used in the diagrams to indicate this function (see figure).

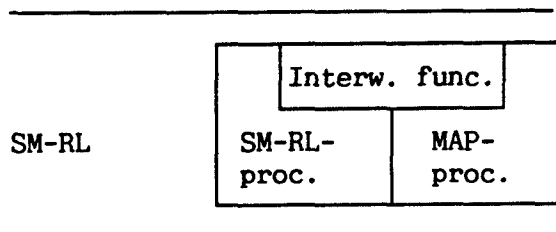

**Mobile Originated Messaging on SM-RL**

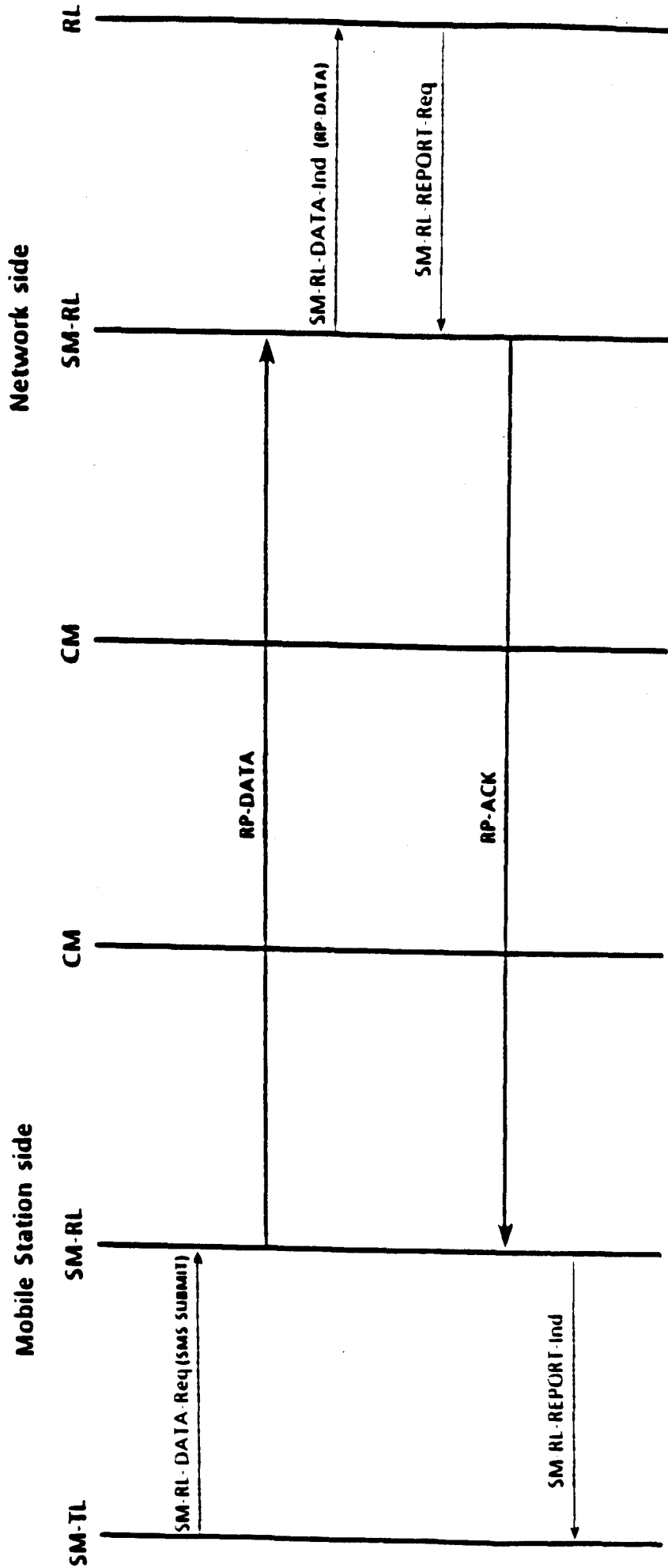

### Mobile Terminated Messaging on SM-RL

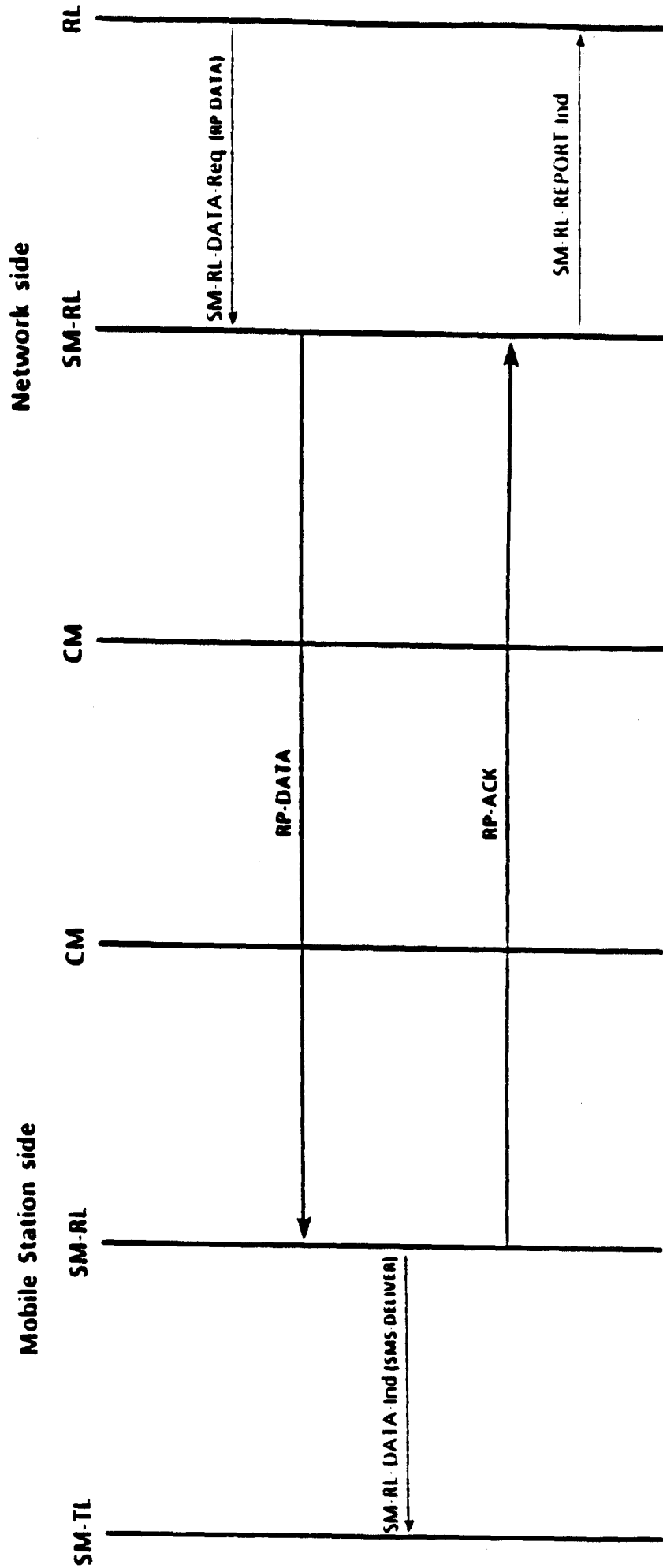

ANNEX D

SDL-DESCRIPTION OF THE SHORT MESSAGE RELAY LAYER

D1. Introduction

This annex contains an SDL-description of the Short Message Relay Layer in terms of the Short Message Service Support. The Short Message Relay Layer provides services to Short Message Transfer Layer.

The SDLs contain a mixture of peer to peer messages and conceptual primitives between the layers SM-TL, SM-RL and CM, as viewed by the SMR entities. SDL-1/2 shows the SMR entity on MS-side, and SDL-3/4 on the network side.

The lower layers (below CM) are transparent to an SMR entity.

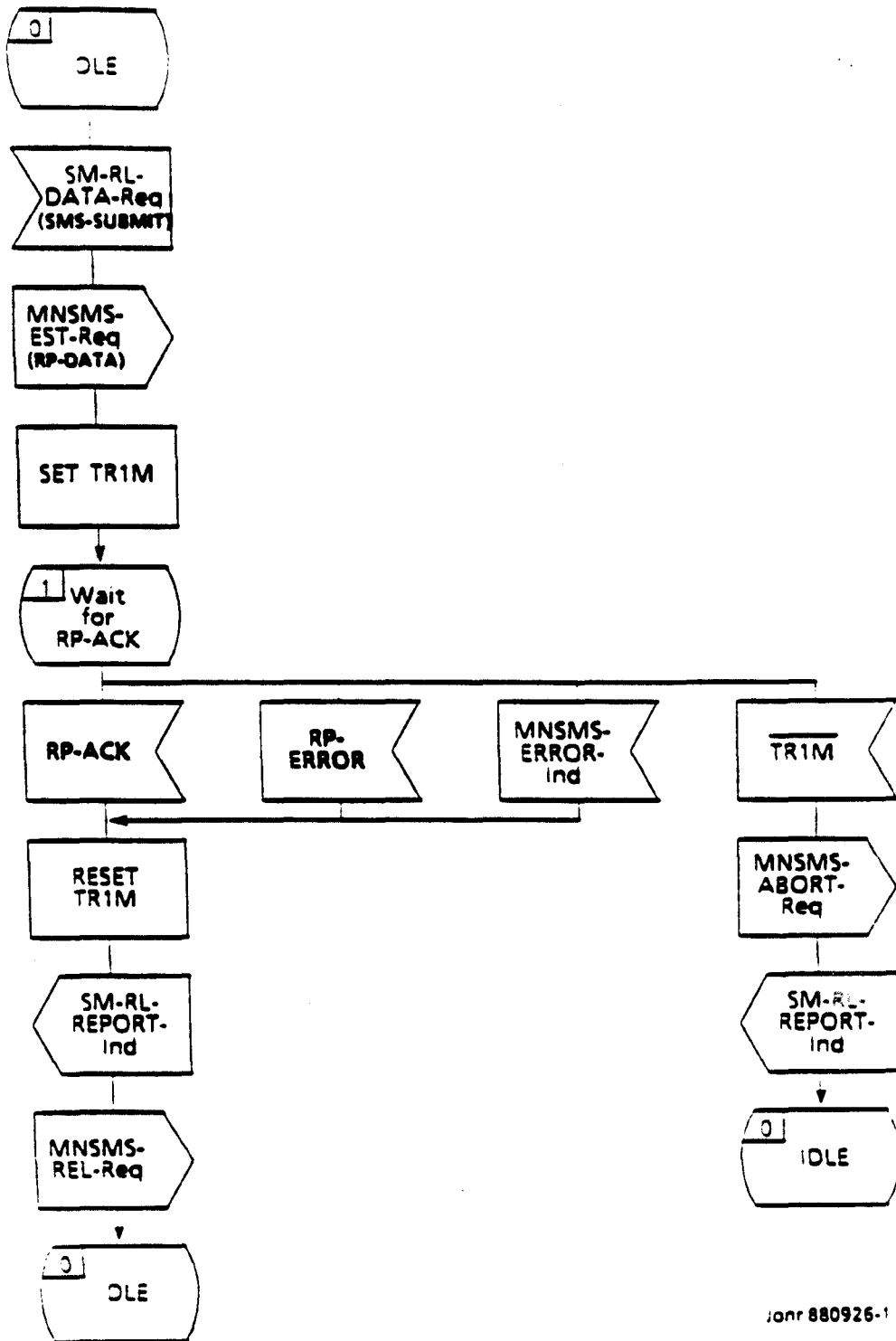

Janr 880926-1

SMR-entity on MS-side  
 MO Short Message transfer  
 SDL-1



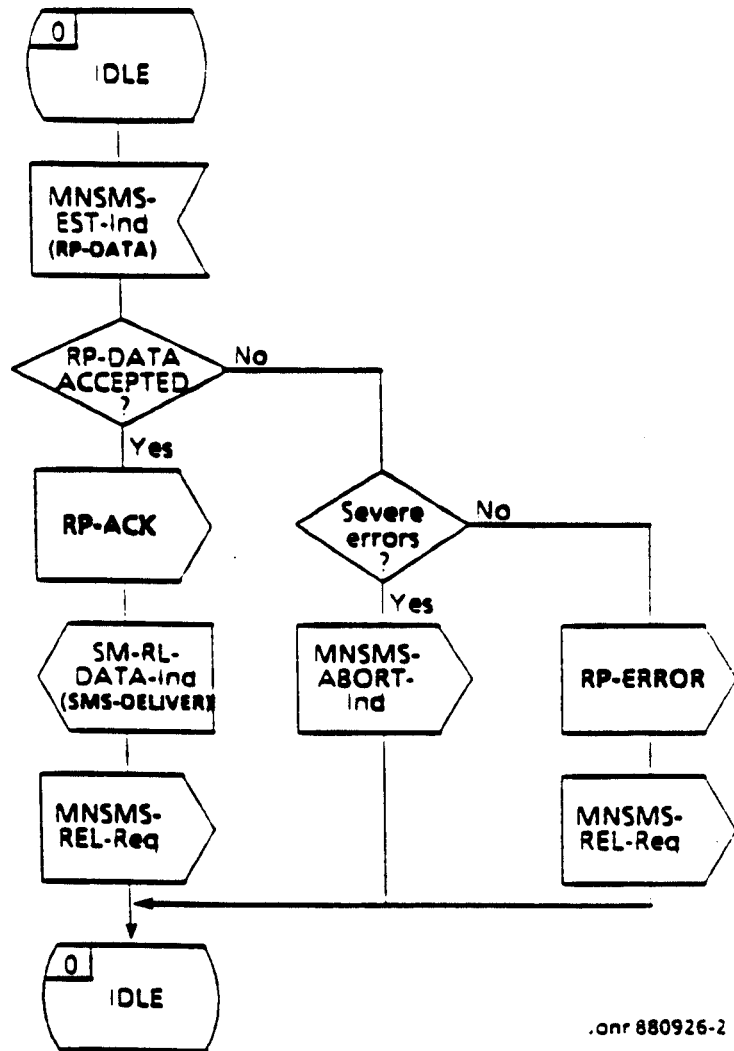

.onr 880926-2

SMR-entity on MS-side  
 MT Short Message transfer  
 SDL-2

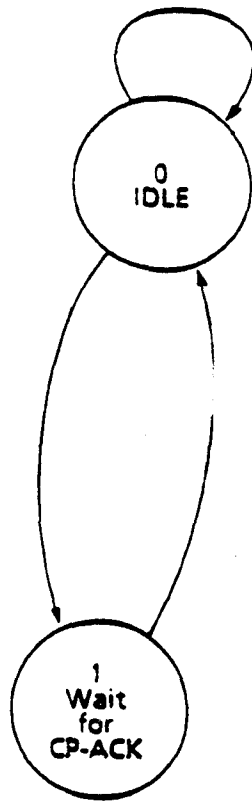

Janr 880926-3

State transition  
diagram

SMR-entity on  
MS-side

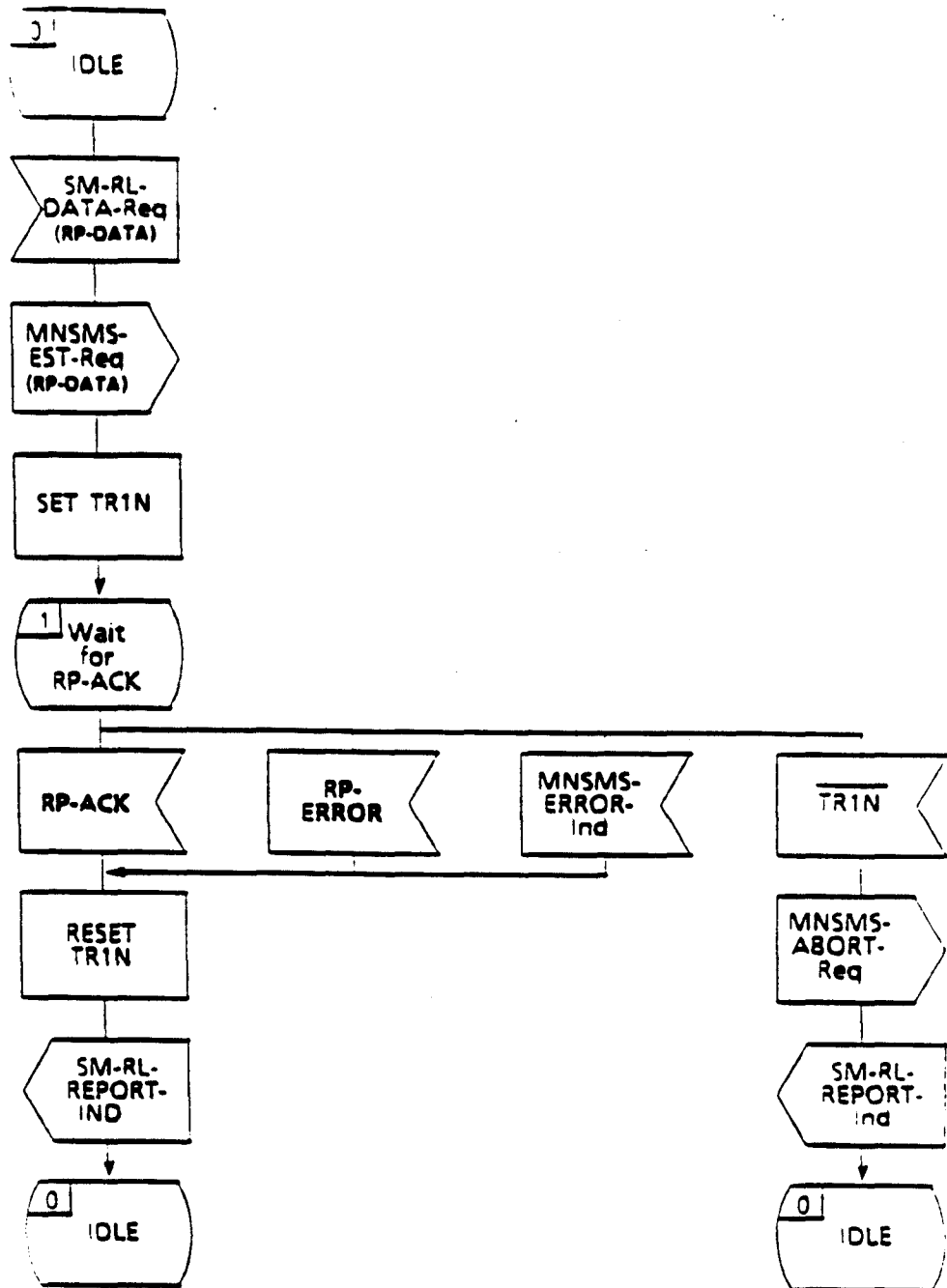

Iconr 880926-4

SMR-entity on  
Network side

MT Short Message  
Transfer

SDL-3

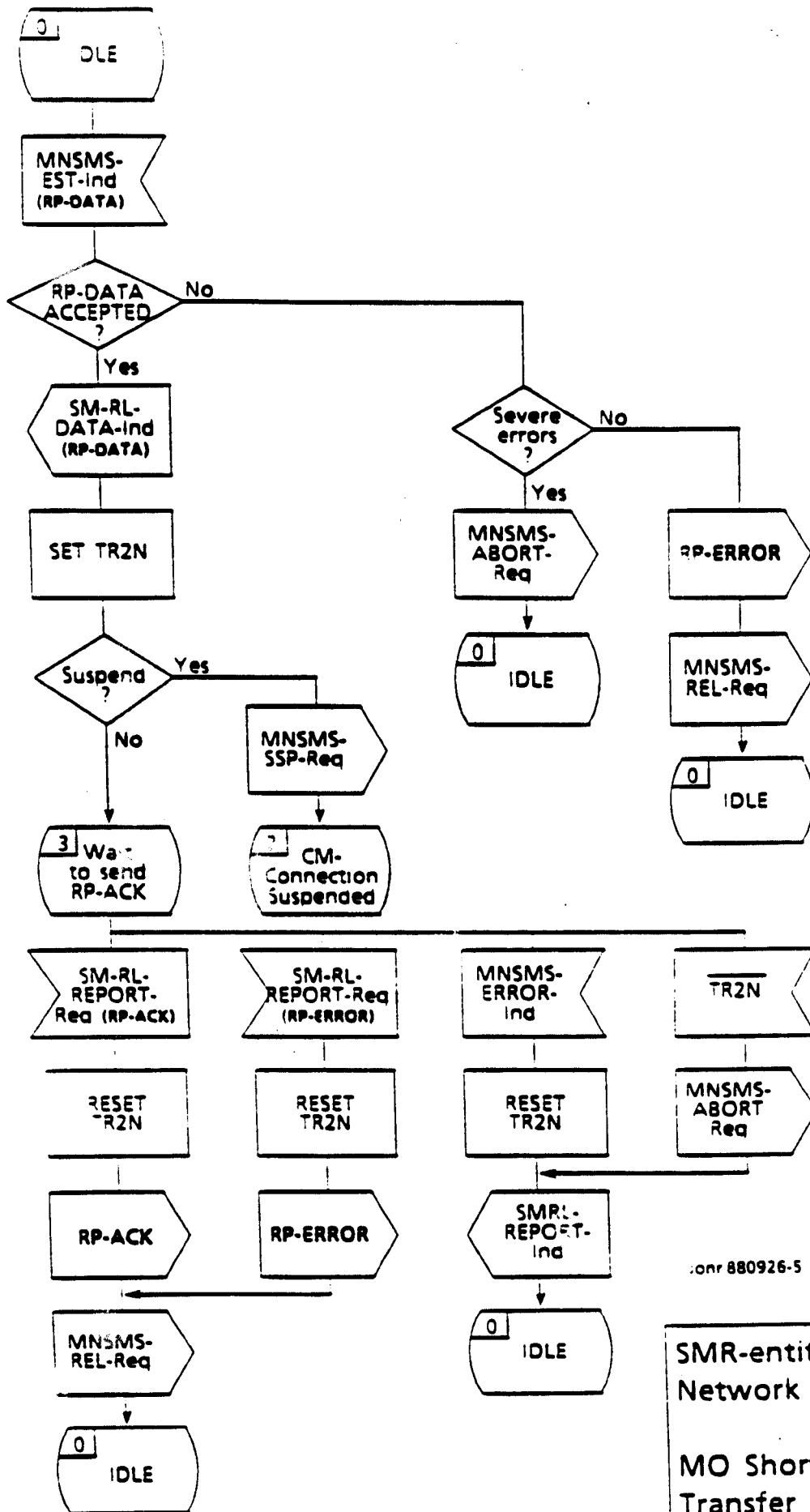

conr 880926-5

SMR-entity on Network side  
 MO Short Message Transfer  
 SDL-4 1 of 2

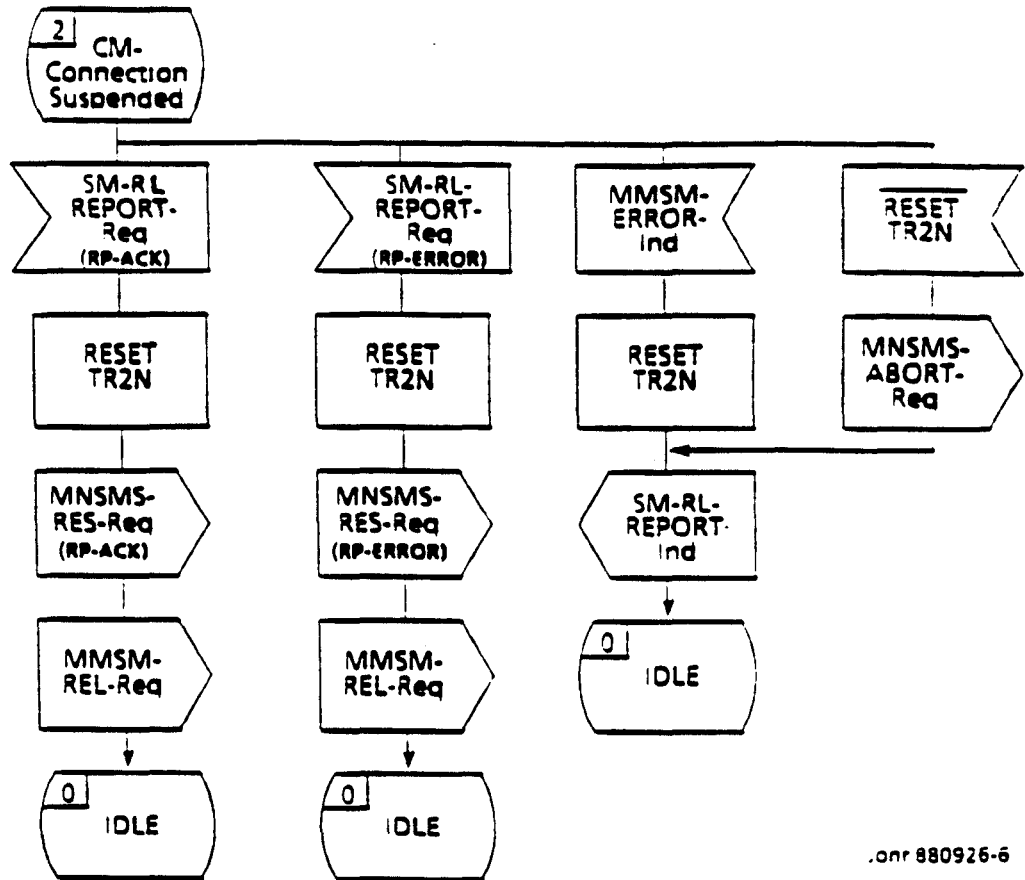

.onr 880926-6

SMR-entity on network-side  
 MO Short message transfer  
 SDL-4 2 of 2

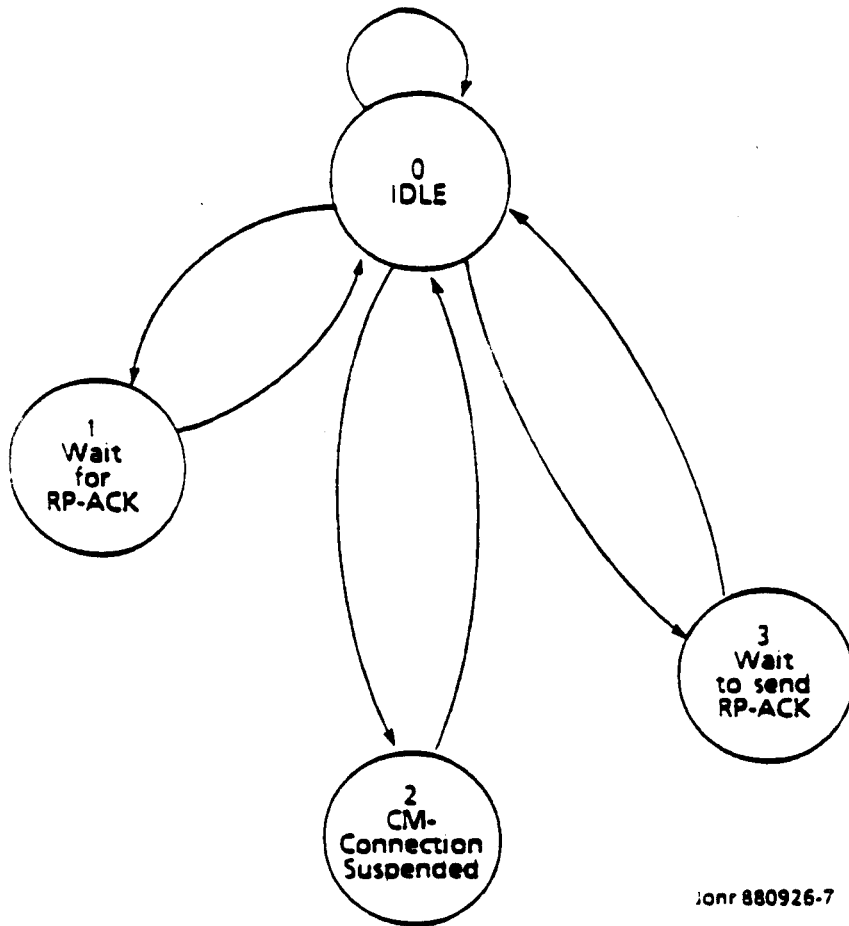

Jonr 880926-7

State transition  
diagram  
SMR-entity on  
Network-side

ANNEX E

E-1: CP-CAUSE DEFINITION

Cause no 17: "Network failure"

This cause is sent to the MS if the MSC cannot service an MS generated request because of PLMN failures, e.g. problems in MAP.

Cause no 22: "Congestion"

This cause is sent if the service request cannot be actioned because of congestion (e.g. no channel, facility busy/congested etc.).

Cause no 95: "Invalid message, unspecified"

This cause is used to report an invalid message event only when no other cause in the invalid message class applies.

Cause no 96: "Mandatory information element missing"

This cause indicates that the equipment sending this cause has received a message where a mandatory information element is missing and/or has a content error (the two cases are undistinguishable).

Cause no 97: "Message type non-existent or not implemented"

This cause indicates that the equipment sending this cause has received a message with a message type it does not recognize either because this is a message not defined or defined but not implemented by the equipment sending this cause.

Cause no 98: "Message not compatible with short message transfer state or message type non-existent or not implemented"

This cause indicates that the equipment sending this cause has received a message such that the procedures do not indicate that this is a permissible message to receive while in the short message transfer state, or a STATUS message was received indicating an incompatible short message transfer state.

Cause no 99: "Information element non-existent or not implemented"

This cause indicates that the equipment sending this cause has received a message which includes information elements not recognized because the information element identifier is not defined or it is defined but not implemented by the equipment sending the cause. However, the information element is not required to be present in the message in order for the equipment sending the cause to process the message.

Cause no 100: "Invalid information element contents"

This cause indicates that the equipment sending this cause has received an information element which it has implemented; however, one or more of the fields in the information element are coded in such a way which has not been implemented by the equipment sending this cause.

Cause no 101: "Message not compatible with short message transfer state"

This cause indicates that a message has been received which is incompatible with the short message transfer state.

Cause no 111: "Protocol error, unspecified"

This cause is used to report a protocol error event only when no other cause applies.



**RP-CAUSE DEFINITION**

E-2: Mobile originated SM-transfer

Cause no 1: "Unassigned (unallocated) number"

This cause indicates that the destination requested by the Mobile Station cannot be reached because, although the number is in a valid format, it is not currently assigned (allocated).

Cause no 10: "Call barred"

This cause indicates that the outgoing call barred service applies to the short message service for the called destination.

Cause no 11: "CUG reject"

This cause indicates that the short message transfer attempt does not pass the CUG check or that the CUG barring conditions are transgressed.

Cause no 21: "Short message transfer rejected"

This cause indicates that the equipment sending this cause does not wish to accept this short message, although it could have accepted the short message since the equipment sending this cause is neither busy nor incompatible.

Cause no 27: "Destination out of service"

This cause indicates that the destination indicated by the Mobile Station cannot be reached because the interface to the destination is not functioning correctly. The term "not functioning correctly" indicates that a signalling message was unable to be delivered to the remote user; e.g., a physical layer or data link layer failure at the remote user, user equipment off-line, etc.

Cause no 28: "Unidentified subscriber"

This cause indicates that the subscriber is not registered in the PLMN (i.e. IMSI not known)

Cause no 29: "Facility rejected"

This cause indicates that the facility requested by the Mobile Station is not supported by the PLMN.

Cause no 30: "Unknown subscriber"

This cause indicates that the subscriber is not registered in the HLR (i.e. IMSI or directory number is not allocated to a subscriber).

Cause no 38: "Network out of order"

This cause indicates that the network is not functioning correctly and that the condition is likely to last a relatively long period of time; e.g., immediately reattempting the short message transfer is not likely to be successful.

Cause no 41: "Temporary failure"

This cause indicates that the network is not functioning correctly and that the condition is not likely to last a long period of time; e.g., the Mobile Station may wish to try another short message transfer attempt almost immediately.

Cause no 42: "Congestion"

This cause indicates that the short message service cannot be serviced because of high traffic.

Cause no 47: "Resources unavailable, unspecified"

This cause is used to report a resource unavailable event only when no other cause applies.

Cause no 69: "Requested facility not implemented"

This cause indicates that the PLMN does not support the requested short message service.

Cause no 81: "Invalid short message transfer reference value"

This cause indicates that the equipment sending this cause has received a message with a short message reference which is not currently in use on the MS-network interface.

Cause no 95: "Invalid message, unspecified"

This cause is used to report an invalid message event only when no other cause in the invalid message class applies.

Cause no 96: "Mandatory information element missing"

This cause indicates that the equipment sending this cause has received a message where a mandatory information element is missing and/or has a content error (the two cases are undistinguishable).

Cause no 97: "Message type non-existent or not implemented"

This cause indicates that the equipment sending this cause has received a message with a message type it does not recognize either because this is a message not defined or defined but not implemented by the equipment sending this cause.

Cause no 98: "Message not compatible with short message transfer state or message type non-existent or not implemented"

This cause indicates that the equipment sending this cause has received a message such that the procedures do not indicate that this is a permissible message to receive while in the short message transfer state, or a STATUS message was received indicating an incompatible short message transfer state.

Cause no 99: "Information element non-existent or not implemented"

This cause indicates that the equipment sending this cause has received a message which includes information elements not recognized because the information element identifier is not defined or it is defined but not implemented by the equipment sending the cause. However, the information element is not required to be present in the message in order for the equipment sending the cause to process the message.

Cause no 100: "Invalid information element contents"

This cause indicates that the equipment sending this cause has received an information element which it has implemented; however, one or more of the fields in the information element are coded in such a way which has not been implemented by the equipment sending this cause.

Cause no 101: "Message not compatible with short message transfer state"

This cause indicates that a message has been received which is incompatible with the short message transfer state.

Cause no 111: "Protocol error, unspecified"

This cause is used to report a protocol error event only when no other cause applies.

Cause no 127: "Interworking, unspecified"

This cause indicates that there has been interworking with a network which does not provide causes for actions it takes; thus, the precise cause for a message which is being send cannot be ascertained.

E-3: Mobile terminating SM-transfer

Cause no 22: "Memory capacity exceeded"

This cause indicates that the mobile station cannot store the incoming short message due to lack of storage capacity.

Cause no 96: "Mandatory information element missing"

This cause indicates that the equipment sending this cause has received a message where a mandatory information element is missing and/or has a content error (the two cases are undistinguishable).

Cause no 99: "Information element non-existent or not implemented"

This cause indicates that the equipment sending this cause has received a message which includes information elements not recognized because the information element identifier is not defined or it is defined but not implemented by the equipment sending the cause. However, the information element is not required to be present in the message in order for the equipment sending the cause to process the message.

Cause no 100: "Invalid information element contents"

This cause indicates that the equipment sending this cause has received an information element which it has implemented; however, one or more of the fields in the information element are coded in such a way which has not been implemented by the equipment sending this cause.

Cause no 101: "Message not compatible with short message transfer state"

This cause indicates that a message has been received which is incompatible with the short message transfer state.

Cause no 111: "Protocol error, unspecified"

This cause is used to report a protocol error event only when no other cause applies.

| <b>Document history</b> |                       |  |
|-------------------------|-----------------------|--|
| <b>July 1990</b>        | <b>Public Enquiry</b> | <b>PE 12: 1990-07-09 to 1990-11-30</b> |
| <b>May 1991</b>         | <b>Vote</b>           | <b>V 6: 1991-03-11 to 1991-03-15</b>   |
| <b>February 1992</b>    | <b>Vote</b>           | <b>V 18: 1992-02-17 to 1992-04-10</b>  |
|                         |                       |  |