



**ETSI**  
**TECHNICAL**  
**REPORT**

**ETR 106**

February 1995

Second Edition

---

Source: ETSI TC-SMG

Reference: RTR/SMG-040347P

ICS: 33.060.30

**Key words:** European digital cellular telecommunications system, Global System for Mobile communications (GSM)

**European digital cellular telecommunication system (Phase 2);  
Example protocol stacks for interconnecting  
Service Centre(s) (SC) and  
Mobile-services Switching Centre(s) (MSC)  
(GSM 03.47)**

**ETSI**

European Telecommunications Standards Institute

**ETSI Secretariat**

**Postal address:** F-06921 Sophia Antipolis CEDEX - FRANCE

**Office address:** 650 Route des Lucioles - Sophia Antipolis - Valbonne - FRANCE

**X.400:** c=fr, a=atlas, p=etsi, s=secretariat - **Internet:** secretariat@etsi.fr

Tel.: +33 92 94 42 00 - Fax: +33 93 65 47 16

---

**Copyright Notification:** No part may be reproduced except as authorized by written permission. The copyright and the foregoing restriction extend to reproduction in all media.

© European Telecommunications Standards Institute 1995. All rights reserved.



## Contents

Foreword.....		5
1.1	Scope .....	7
1.2	References.....	7
1.3	Definitions and abbreviations.....	8
2	An OSI Protocol Stack For Interconnecting SCs and MSCs.....	8
2.1	Service elements on the application layer.....	9
2.2	Detailed specification of the SMRSE services.....	10
2.3	Application rules for avoiding collisions between SMR-UNBIND and the other SMRSE operations .....	22
2.3.1	Application rule set 1 Semi-permanent symmetric connection.....	22
2.3.2	Application rule set 2 Transient asymmetric connection .....	22
2.4	Timing terminology .....	23
2.5	Error Cause Mapping .....	24
3	A Protocol Stack Which Utilises an Application-Network Layer Convergence Function For Interconnecting SCs and MSCs.....	25
3.1	SMRSE Definition.....	25
3.2	ASN1 Specification.....	27
3.3	Application Rules for Avoidance of Collision of SMRSE Operations.....	32
3.3.1	Semi-permanent Connections.....	32
3.3.2	Transient Connection .....	33
3.4	Non Support of 128 bytes of NS-user-data in Network Connection and Network Connection Release phases.....	33
3.5	Error Cause Mapping .....	33
4	SS7 Protocol Stacks .....	34
4.1	Introduction.....	34
4.2	Application Layer Protocol SMS-MAP.....	34
4.2.1	Introduction.....	34
4.2.2	Protocol Stack .....	34
4.2.3	SMS-MAP Version Handling.....	34
4.2.4	Operations.....	35
4.2.5	SMS-MAP SIGNALLING SEQUENCES .....	44
4.2.6	Errors.....	48
4.2.7	SMS-MAP Parameter Data Types.....	50
4.3	Support of Application Layer Specified by section 2 of GSM 03.47.....	52
History .....		53

Blank page

## Foreword

This ETSI Technical Report (ETR) second edition has been produced by the Special Mobile Group (SMG) Technical Committee (TC) of the European Telecommunications Standards Institute (ETSI).

This ETR describes three approaches to the specification of protocol stacks of communication protocols for the purpose of relaying short messages and alerts between Short Message Service Centres and Gateway/Interworking MSCs (GMSC) for the Short Message Service (SMS) within the European digital cellular telecommunication system (phase 2).

This ETR is an informative document resulting from SMG studies which are related to the European digital cellular telecommunication system (phase 2). This ETR is used to publish material which is of an informative nature, relating to the use or the application of ETSs and is not suitable for formal adoption as an ETS.

This ETR correspond to GSM technical specification, GSM 03.47 version 4.3.1

The specification from which this ETR has been derived was originally based on CEPT documentation, hence the presentation of this ETR may not be entirely in accordance with the ETSI/PNE rules.

Reference is made within this ETR to GSM Technical Specifications (GSM-TS) (NOTE).

NOTE: TC-SMG has produced documents which give the technical specifications for the implementation of the European digital cellular telecommunications system. Historically, these documents have been identified as GSM Technical Specifications (GSM-TS). These TSs may have subsequently become I-ETSs (Phase 1), or ETSs (Phase 2), whilst others may become ETSI Technical Reports (ETRs). GSM-TSs are, for editorial reasons, still referred to in current GSM ETSs.

Blank page

## 1.1 Scope

No mandatory protocol between the Service Centre (SC) and the Mobile Switching Centre (MSC) below the transfer layer is specified by GSM; this is a matter of agreement between SC and PLMN operators.

This report specifies three approaches to the specification of protocol stacks of communication protocols for the purpose of relaying short messages and alerts between Short Message Service Centres and Gateway/Interworking MSCs (GMSC) for the Short Message Service (SMS). One approach is based upon use of the complete OSI reference model (see X.200), another approach is based upon the use of only the lower three OSI layers, and another approach is based upon the use of CCITT Signalling System No. 7 (see Q.700).

Alternative protocol stacks are specified via ASN.1 encoding rules (see X.208 and X.209). These alternative protocol stacks are examples for the implementation of the Short Message Relay Layer (SM-RL). The requirements placed upon the Short Message Relay Layer are briefly described in Section 9 of GSM 03.40.

Specifications are based upon individual contributions. Any judgement concerning functionality, completeness and advantages/disadvantages of implementation is intentionally omitted.

## 1.2 References

This ETR incorporates by dated and undated reference, provisions from other publications. These normative references are cited at the appropriate places in the text and the publications are listed hereafter. For dated references, subsequent amendments to or revisions of any of these publications apply to this ETR only when incorporated in it by amendment or revision. For undated references, the latest edition of the publication referred to applies.

- [1] GSM 01.04 (ETR 100): "European digital cellular telecommunication system (Phase 2); Definitions, abbreviations and acronyms".
- [2] GSM 03.40 (ETS 300 536): "European digital cellular telecommunication system (Phase 2); Technical realization of the Short Message Service (SMS) Point to Point (PP)".
- [3] GSM 09.02 (ETS 300 599): "European digital cellular telecommunication system (Phase 2); Mobile Application Part (MAP) specification".
- [4] GSM 12.20 (ETS 300 622): "European digital cellular telecommunication system (Phase 2); Network Management (NM) procedures and messages".
- [5] CCITT Recommendation E.164: "Numbering plan for the ISDN era".
- [6] CCITT Recommendation Q.700: "Introduction to CCITT Signalling System No.7".
- [7] CCITT Recommendation Q.931: "Integrated services digital network.(ISDN) User-Network interface layer 3 specification for basic control".
- [8] CCITT Recommendation Q.932: "Generic procedures for the control of ISDN supplementary services".
- [9] CCITT Recommendation Q.941: "ISDN user-network interface protocol profile for management".
- [10] CCITT Recommendation Q.1400: "Architecture framework for the development of signalling and organisation, administration and maintenance protocols using OSI concepts".
- [11] CCITT Recommendation X.2 (1988): "International data transmission services and optional user facilities in public data networks and ISDNs".

- [12] CCITT Recommendation X.200: "Reference Model of Open Systems Interconnection for CCITT Applications".
- [13] CCITT Recommendation X.208: "Specification of basic encoding rules for Abstract Syntax Notation One (ASN.1)".
- [14] CCITT Recommendation X.209: "Specification of Abstract Syntax Notation One (ASN.1)".
- [15] CCITT Recommendation X.215: "Session service definition for open systems interconnection for CCITT applications".
- [16] CCITT Recommendation X.216: "Presentation service definition for open systems interconnection for CCITT applications".
- [17] CCITT Recommendation X.217: "Association control service definition for open systems interconnection for CCITT applications".
- [18] CCITT Recommendation X.219: " Remote operations: model, notation and service definition".
- [19] CCITT Recommendation X.223: "Use of X.25 to provide the OSI connection-mode network service for CCITT Applications".
- [20] CCITT Recommendation X.224: "Transport protocol specification for Open Systems Interconnection for CCITT Applications".
- [21] CCITT Recommendation X.225: "Session protocol specification for Open Systems Interconnection for CCITT Applications".
- [22] CCITT Recommendation X.226: "Presentation protocol specification for Open Systems Interconnection for CCITT Applications".
- [23] CCITT Recommendation X.227: "Information technology - Open Systems Interconnection - protocol specification for the association".
- [24] CCITT Recommendation X.229: "Remote operations Protocol specification".

### 1.3 Definitions and abbreviations

Abbreviations used in this report are listed in GSM 01.04.

## 2 An OSI Protocol Stack For Interconnecting SCs and MSCs

This section specifies a stack of communication protocols in terms of the OSI Reference Model (see X.200) and therefore makes use of all seven layers for the purpose of relaying short messages and alerts between SC and MSC for the Short Message Service. The SMS application layer (layer 7) is mapped to the Presentation Layer via ACSE (see X.217 and X.227) and ROSE (see X.219 and X.229). Only the Kernel functional unit of the Presentation Layer is used. Only Kernel and Duplex functional units are used in the Session Layer (see X.215 and X.225).



## 2.1 Service elements on the application layer

An association (class 3) between SMRSEs is formed via ACSE and ROSE operations (class 2 and 5) are used to implement the Short Message Relay Layer described in Section 9 of GSM 03.40. This results into a asynchronous symmetric situation where both (the application entity in) the SC and (the application entity in) the MSC can invoke a SMRSE operation at any time.

The new SMRSE service element is first defined in this section, and then specified in ASN.1 notation in section 2.2.

### SMRSE definition

This service element defines the following services:

SMR-BIND	This operation must be invoked by that party which established the application association; only after that may the remaining SMRSE services be used. This operation reports either success or failure (result or error).
SMR-MO-DATA	This operation may be invoked by the application entity in the MSC; it is used to relay one SMS transfer layer PDU from the IWMSC to the SC. This operation reports either success or failure.
SMR-MT-DATA	This operation may be invoked by the application entity in the SC; it is used to relay one SMS transfer layer PDU from the SC to the GMSC, to be further relayed to the MS addressed. This operation reports either success or failure, after the full relay attempt to the MS.
SMR-ALERT	This operation may be invoked by the application entity in the MSC. It is used as the GMSC-to-SC indication of the fact that an MS which was previously unattainable has recovered operation. This operation does not report any outcome.
SMR-UNBIND	This operation must be invoked by that party which invoked the SMR-BIND operation, as the last SMRSE operation before releasing the application association. This operation reports success only.

Of the services defined above, SMR-MO-DATA and SMR-MT-DATA semantically mean the relay of short messages across the SC-MSC-connection; SMR-ALERT similarly implements the alerting operation. The SMR-BIND service is used to exchange identifications, passwords, etc., and in order to negotiate the usage of the other services. The SMR-UNBIND service prepares for the release of the application association.

## 2.2 Detailed specification of the SMRSE services

On the following pages, the new SMRSE service element is specified with the ASN.1 notation, together with the entire SM-RL protocol.

The Abstract Syntax Notation of  
the Short Message Relay Service Element

SMRSE

Note: The first two arcs of the object identifier are arbitrarily allocated, the name "etsi" is adopted from GSM 12.20 but the value 040 is arbitrary, and the last three arcs are allocated in this module.

1st module of 3:

SMS-UsefulDefinitions

SMS-usefulDefinitions { iso identified-organization etsi(040) mobile-domain(0) gsm-messaging(4) gsm-sms1(10) usefulDefinitions(0) }

DEFINITIONS

IMPLICIT TAGS

::=

BEGIN

EXPORTS id-ot-SC, id-ot-MSC, id-port, id-ac-so, id-ac-st, id-SMRSE, id-as-SMRSE;

IMPORTS

ID ::= OBJECT IDENTIFIER

-- root for all sms allocations

mobile-domain ID ::= { iso identified-organization etsi(40) mobile-domain(0) }

gsm-messaging ID ::= { mobile-domain gsm-messaging(4) }

gsm-sms1 ID ::= { gsm-messaging gsm-sms1(10) }

-- categories

id-mod ID ::= { gsm-messaging 1 } -- modules

id-ot ID ::= { gsm-messaging 2 } -- object type

id-pt ID ::= { gsm-messaging 3 } -- port types

id-ac ID ::= { gsm-messaging 4 } -- appl. contexts

id-ase ID ::= { gsm-messaging 5 } -- ASEs

id-as ID ::= { gsm-messaging 6 } -- abstract syntaxes

-- modules

usefulDefinitions ID ::= { gsm-sms1 0 }

relayProtocol ID ::= { gsm-sms1 1 }

relayAbstractService ID ::= { gsm-sms1 2 }

```
-- object types

id-ot-SC      ID ::= { id-ot 0 }
id-ot-MSC    ID ::= { id-ot 1 }

-- port types

id-port      ID ::= { id-pt 0 }

-- application contexts

id-ac-so ID ::= { id-ac 0 } -- SC does BIND
id-ac-st ID ::= { id-ac 1 } -- MSC does BIND

-- application service elements

id-SMRSE     ID ::= { id-ase 0 }

-- abstract syntaxes

id-as-SMRSE  ID ::= { id-as 0 }

END
```

2nd module of 3

RelayAbstractService

RelayAbstractService { iso identified-organization etsi(040) mobile-domain(0) gsm-messaging(4) gsm-sms1(10) relayAbstractService(2) }

DEFINITIONS

IMPLICIT TAGS

::=

BEGIN

-- EXPORTS everything

IMPORTS

BIND, UNBIND

FROM Remote-Operations-Notation  
{ joint-iso-ccitt remote-operations(4) notation(0) }

OBJECT, PORT, ABSTRACT-BIND, ABSTRACT-UNBIND,

ABSTRACT-OPERATION, ABSTRACT-ERROR

FROM AbstractServiceNotation  
{ joint-iso-ccitt mhs-motis(6) asdc(2) modules(0) notation(1) }

id-ot-SC, id-ot-MSC, id-port

FROM SMS-UsefulDefinitions  
{ iso identified-organization etsi(040) mobile-domain(0) gsm-messaging(4) gsm-sms1(10) usefulDefinitions(0) } ;

-- upper bound settings

ub-operator-name-length INTEGER ::= 20

ub-agreem-name-length INTEGER ::= 20

ub-X121Address-length INTEGER ::= 15

ub-password-length INTEGER ::= 20

-- Objects

-- The SC and the MSC are modelled as atomic objects, sC-Object and MSC-Object. Each object  
 -- has one port for the interconnection. ([S] and [C] indicate supply and consumption of services,  
 -- respectively).

```
sC-Object      OBJECT
                PORTS { sMR-port [C] }
                ::= id-ot-SC
```

```
mSC-Object    OBJECT
                PORTS { sMR-port [S] }
                ::= id-ot-MSC
```

-- Port

```
sMR-port      PORT
                CONSUMER INVOKES { Forward-MS-Terminated-Short-Message }
                SUPPLIER INVOKES { Forward-MS-Originated-Short-Message, Alert-
                                   SC }
                ::= id-port
```

-- Bind

```
SMR-Bind ::=
                ABSTRACT-BIND
                TO { sMR-port }
                BIND
                ARGUMENT  SMR-Bind-Parameters
                RESULT    SMR-Bind-confirm
                BIND-ERROR SMR-Bind-failure
```

-- Unbind

-- The UNBIND is a harsh release of the association: all outstanding operations are aborted, and  
 -- SMR-ALERT requests may be lost if they collide with the SMR-UNBIND request. The SC and  
 -- the MSC should negotiate (during SMR-BIND) the use of services on the association (the  
 -- operations parameter - list of operation types for the association) in such a way that no harmful  
 -- losses of operations occur.

```
SMR-Unbind ::=
                ABSTRACT-UNBIND
                FROM { sMR-port }
                UNBIND
                ARGUMENT  Time-when-connected
                RESULT    Time-when-disconnected
```

-- Association control parameters

```
SMR-Bind-Parameters ::= SEQUENCE {
    initiatorID      [0]    Name,

    password        [1]    Password OPTIONAL,

    pswNeeded       [2]    BOOLEAN,

    iniType         [3]    Telecom-System-Type,

    operations      [4]    List-of-Operations
}
}
```

-- Above and in SMR-Bind-confirm

-- initiatorID/respID: identify the initiating/responding telecommunication subsystem  
-- password: may assist in authentication  
-- pswNeeded (BIND only): requests password into SMR-Bind SMR-Bind-confirm  
-- iniType/respType: identify the types of the systems  
-- operations: lists the SM relay operations requested and supported on the association:  
-- operations listed in both the BIND and the CONFIRM may be used (i.e. this is a negotiation  
-- between SC and MSC)  
-- transient (CONFIRM only): forces the association (and the underlying connections) transient: it  
-- must be UNBOUND as soon as there are no operations to be performed

```
Name ::= SEQUENCE {
    operator          [0] Operator          OPTIONAL,
    bilateralAgreem  [1] BilateralAgreem   OPTIONAL,
    dataNetworkAddress [2] X121Address     OPTIONAL,
    iSDNAddress      SMS-Address          OPTIONAL
}
}
```

-- operator is a text string containing the name of the SC/PLMN operator. bilateralAgreem is a  
-- text string identifying the bilateral agreement between the SC and the PLMN operators which  
-- allows for this association to be established.  
-- dataNetworkAddress is the PSPDN X.121 address of the SC/MSC issuing the BIND or  
-- CONFIRM, occurring only if a PSPDN is used.  
-- iSDNAddress is the PLMN address of the SC as seen by the MSs (same datum in both BIND  
-- and CONFIRM).  
-- Any pair of subsets of these parameters may be used to identify the SC and the MSC to one  
-- another.

Operator ::= PrintableString (SIZE(0..ub-operator-name-length))

BilateralAgreem ::= PrintableString (SIZE(0..ub-agreem-name-length))

X121Address ::= NumericString (SIZE(0..ub-X121Address-length))

- SMS-Address is specified later in this module.

Password ::= PrintableString (SIZE(0..ub-password-length))

```
Telecom-System-Type ::= INTEGER {
    short-Message-Service-Centre (0),
    public-Land-Mobile-Network (1)
-- Extensions are possible: additional
-- telecommunication subsystems might adopt this
-- service element for their interconnection.
}
}
```

List-of-Operations ::=

```

BIT STRING {
  sMR-MO-Data-by-MSC (0),
  sMR-MT-Data-by-SC (1),
  sMR-Alert-by-MSC (2)
  -- Extensions are possible: additional operations may be defined within this service
  -- element. Existing systems should tolerate unknown values, but negotiate not to
  -- perform unknown operations.
}

```

```

SMR-Bind-confirm ::= SEQUENCE {
  respId [0] Name,
  password [1] Password OPTIONAL,
  respType [3] Telecom-System-Type,
  operations [4] List-of-Operations,
  transient [5] BOOLEAN,
  connectTime [6] Time-when-connected
}

```

```

SMR-Bind-failure ::= SEQUENCE {
  connect-failure-reason [0] Connect-failure,
  alternative-system [1] Name OPTIONAL
}

```

- connect-failure-reason contains one of the error indications given in the following table.
- alternative-system is included when the SC/PLMN operator wishes to indicate that the MSC/SC might try to establish an association with another SC/MSC.

Error indications	Reason
not-entitled	The responder is not entitled to accept a request for an association between itself and the initiator.
temporary-overload	The responder is not capable of establishing an association due to temporary overload.
temporary-failure	The responder is not capable of establishing an association due to a temporary failure (having impact on an entity at SM-RL or at layers above).
incorrect-ID-or-password	The responder will not accept the request to establish an association between itself and the initiator due to incorrect identity or password.
not-supported	The responder does not recognize the telecommunication subsystem type of the initiator, or cannot support any of the operations suggested on the association.

Connect-failure ::= INTEGER

```

    { not-entitled (0),
      temporary-overload (1),
      temporary-failure (2),
      incorrect-ID-or-password (3),
      not-supported (4)
    }

```

Time-when-disconnected ::= UTCTime

Time-when-connected ::= UTCTime

-- The SMR-MT-DATA operation

-- SMR-MT-DATA

Forward-MS-Terminated-Short-Message ::=

ABSTRACT-OPERATION

ARGUMENT RPDataMT

RESULT RPAck

```

ERRORS { Unknown-subscriber,
          Teleservice-not-provisioned,
          Call-barred,
          Facility-not-supported,
          Memory-capacity-exceeded,
          Absent-subscriber,
          SMS-lower-layer-capabilities-not-prov,
          Error-in-MS,
          Illegal-subscriber,
          Illegal-equipment,
          System-failure
        }

```

-- SMR-MT-DATA error alternatives listed below

Unknown-subscriber ::=

ABSTRACT-ERROR

PARAMETER RPErr

Teleservice-not-provisioned ::=

ABSTRACT-ERROR

PARAMETER RPErr

Call-barred ::=

ABSTRACT-ERROR

PARAMETER RPErr

Illegal-subscriber ::=

ABSTRACT-ERROR

PARAMETER RPErr

Illegal-equipment ::=

ABSTRACT-ERROR

PARAMETER RPErr

System-failure ::=

ABSTRACT-ERROR

PARAMETER RPErr

Facility-not-supported ::=

ABSTRACT-ERROR

PARAMETER RPErr

Memory-capacity-exceeded ::=

ABSTRACT-ERROR

PARAMETER RPErr



```
Absent-subscriber ::=
  ABSTRACT-ERROR
  PARAMETER RPErr
```

```
SMS-lower-layer-capabilities-not-prov ::=
  ABSTRACT-ERROR
  PARAMETER RPErr
```

```
Error-in-MS ::=
  ABSTRACT-ERROR
  PARAMETER RPErr
```

```
-- SMR-MT-DATA parameters
```

```
-- SMR-MT-DATA parameters
RPDataMT ::= SEQUENCE {
  mt-priority-request [0] BOOLEAN,
  mt-more-messages-to-send [1] BOOLEAN OPTIONAL,
  mt-message-reference RP-MR,
  mt-originating-address SMS-Address,
  mt-destination-address SMS-Address,
  mt-user-data RP-UD
}
```

```
-- SMR-MT-DATA acknowledgement
RPAck ::= SEQUENCE {
  message-reference RP-MR
}
```

```
RPErr ::= SEQUENCE {
  msg-waiting-set [1] BOOLEAN,
  message-reference RP-MR,
  rp-msidsn SMS-Address
  -- must be an international ISDN address
}
```

```
RP-MR ::= [APPLICATION 2] INTEGER (0..255)
```

```
RP-UD ::= [APPLICATION 3] OCTET STRING (SIZE (1..164))
```

```
-- Definition of Short Message Service address
```

```
SMS-Address ::= [APPLICATION 0] SEQUENCE {
  address-type INTEGER { unknown-type(0),
    international-number(1),
    national-number(2),
    network-specific-number(3),
    short-number(4) },
  numbering-plan INTEGER { unknown-numbering(0),
    iSDN-numbering(1),
    data-network-numbering(3),
    telex-numbering(4),
    national-numbering(8),
    private-numbering(9) },
  address-value CHOICE {
    octet-format
    SemiOctetString
    -- other formats are for further study
  }
}
```

SemiOctetString ::= OCTET STRING (SIZE(1..10)) -- each octet contains

-- two binary coded  
-- decimal digits

-- The SMR-MO-DATA and SMR-ALERT operations

-- SMR-MO-DATA

Forward-MS-Originated-Short-Message ::=

ABSTRACT-OPERATION  
ARGUMENT RPDDataMO  
RESULT RPAck  
ERRORS { SC-congestion,  
MS-not-SC-Subscriber,  
Invalid-Sme-address,  
System-failure  
}

-- SMR-ALERT

Alert-SC ::=

ABSTRACT-OPERATION  
ARGUMENT RPAAlertSC

-- SMR-MO-DATA error alternatives

SC-congestion ::=

ABSTRACT-ERROR  
PARAMETER RPErrors

MS-not-SC-Subscriber ::=

ABSTRACT-ERROR  
PARAMETER RPErrors

Invalid-Sme-address ::=

ABSTRACT-ERROR  
PARAMETER RPErrors

System-failure ::=

ABSTRACT-ERROR  
PARAMETER RPErrors

-- Parameters

-- SMR-MO-DATA parameters

RPDataMO ::= SEQUENCE {  
    mo-message-reference RP-MR,  
    mo-originating-address SMS-Address,  
    mo-user-data RP-UD  
}

-- SMR-ALERT parameters

RPAAlertSC ::= SMS-Address

-- must be an international ISDN address

END

3rd module of 3

RelayProtocol

```
RelayProtocol      { iso identified-organization etsi(040) mobile-domain(0) gsm-messaging(4) gsm-
sms1(10) relayProtocol(1) }
```

#### DEFINITIONS

#### IMPLICIT TAGS

```
::=
```

```
BEGIN
```

```
-- EXPORTS everything
```

#### IMPORTS

```
-- application service elements and application contexts
```

```
    aCSE, APPLICATION-SERVICE-ELEMENT, APPLICATION-CONTEXT
    FROM Remote-Operations-Notation-extension
        { joint-iso-ccitt remote-operations(4)
          notation-extension(2) }
```

```
    rOSE FROM Remote-Operations-APDUs
        { joint-iso-ccitt remote-operations(4) apdus(1) }
```

```
-- object identifiers
```

```
    id-ac-so, id-ac-st, id-SMRSE, id-as-SMRSE
    FROM SMS-UsefulDefinitions
    { iso identified-organization etsi(040) mobile-domain(0) gsm-messaging(4) gsm-sms1(10)
      usefulDefinitions(0) }
```

```
-- abstract service parameters
```

```
    Forward-MS-Terminated-Short-Message,
    Forward-MS-Originated-Short-Message, Alert-SC,
    SMR-Bind, SMR-Unbind,
    Unknown-subscriber, Teleservice-not-provisioned,
    Call-barred, Facility-not-supported, Absent-subscriber,
    Invalid-Sme-address, Memory-Capacity-Exceeded,
    SMS-lower-layer-capabilities-not-prov, Error-in-MS,
    Illegal-subscriber, Illegal-equipment,
    System-failure, SC-congestion, MS-not-SC-Subscriber
    FROM RelayAbstractService
    { iso identified-organization etsi(040) mobile-domain(0) gsm-messaging(4) gsm-sms1(10)
      relayAbstractService(2) } ;
```

aS-ACSE OBJECT IDENTIFIER ::=

```
{joint-iso-ccitt association-control(2)
  abstractSyntax(1) apdus(0) version (1) }
```

-- Application contexts

-- Two different application contexts are specified:

```
--   one for the case when the SC BINDs (and UNBINDs),
--   and the other for the case when the MSC BINDs (and UNBINDs).
```

-- There is only one application service element, however (see "Application service elements" below.)

sC-BINDs-and-UNBINDs

```
APPLICATION-CONTEXT
APPLICATION-SERVICE-ELEMENTS { aCSE }
BIND SMR-Bind
UNBIND SMR-Unbind
REMOTE OPERATIONS { rOSE }
INITIATOR CONSUMER OF { sMRSE }
ABSTRACT SYNTAXES { id-as-SMRSE , aS-ACSE }
::= id-ac-so
```

mSC-BINDs-and-UNBINDs

```
APPLICATION-CONTEXT
APPLICATION-SERVICE-ELEMENTS { aCSE }
BIND SMR-Bind
UNBIND SMR-Unbind
REMOTE OPERATIONS { rOSE }
RESPONDER CONSUMER OF { sMRSE }
ABSTRACT SYNTAXES { id-as-SMRSE , aS-ACSE }
::= id-ac-st
```

-- Application service elements

sMRSE APPLICATION-SERVICE-ELEMENT

```
CONSUMER INVOKES { forward-MS-Terminated-Short-Message}
SUPPLIER INVOKES { forward-MS-Originated-Short-Message,
  alert-SC }
::= id-SMRSE
```

-- Remote operations

forward-MS-Terminated-Short-Message

```
Forward-MS-Terminated-Short-Message
::= 1
```

-- Note: localValue-words omitted, since they are typically not used, and likely to be removed  
-- from the OPERATION and ERROR macros in ROSE.

forward-MS-Originated-Short-Message

```
Forward-MS-Originated-Short-Message
::= 2
```

alert-SC Alert-SC

```
::= 3
```

```
-- Remote errors

unknown-subscriber
  Unknown-subscriber
  ::= 1

teleservice-not-provisioned
  Teleservice-not-provisioned
  ::= 11

call-barred Call-barred
  ::= 13

illegal-subscriber
  Illegal-subscriber
  ::= 9

illegal-equipment
  Illegal-equipment
  ::= 44

system-failure
  System-failure
  ::= 36

facility-not-supported
  Facility-not-supported
  ::= 21

memory-capacity-exceeded
  Memory-capacity-exceeded
  ::= 22

absent-subscriber
  Absent-subscriber
  ::= 29

SMS-lower-layers-capabilities-not-prov
  SMS-lower-layer-capabilities-not-prov
  ::= 19

error-in-MS
  Error-in-MS
  ::= 20

sC-congestion
  SC-congestion
  ::= 101

mS-not-SC-Subscriber
  MS-not-SC-Subscriber
  ::= 103

invalid-sme-address
  Invalid-sme-address
  ::=104
```

END

### 2.3 Application rules for avoiding collisions between SMR-UNBIND and the other SMRSE operations

There may be a collision between the SMR-UNBIND operation and another operation. This may cause the unwanted abortion of SMR-MO-DATA or SMR-MT-DATA operations, and/or the loss of SMR-ALERT operations.

(In order to guarantee the completion of all the SMRSE operations, the Session negotiated release functional unit might have been specified on the session layer and the SMR-UNBIND mapped on that negotiated release. However, the Session negotiated release functional unit requires also the Session half duplex functional unit. The negotiated release functional unit is not used anywhere else in the GSM specifications, hence it was not adopted here either.)

The proper completion of all the SMRSE operations is guaranteed by avoiding collisions between SMR-UNBIND and other operations. This is achieved by following application rules which restrict the invocation of different operations on the association. Two alternative sets of application rules are given in 2.3.1 and 2.3.2 in the sequel; additional sets are possible.

#### 2.3.1 Application rule set 1 Semi-permanent symmetric connection

This set of application rules is to be used in situations where the connection (on all the protocol layers) between the SC and the MSC is maintained for ever.

Within the SMR-BIND service, all operations are allowed on the association; semi-permanent connection is accepted (by not forcing the connection transient). This is negotiated within the SMR-BIND service as follows:

name of parameter	value in request and report
operations	{sMR-MO-Data-by-MSC,sMR-MT-Data-by-SC, sMR-Alert-by-MSC}
transient	FALSE (in report only)

The association is used fully asymmetrically, the parties invoke SMR-MO-DATA, SMR-MT-DATA, and SMR-ALERT operations as needed.

The SMR-UNBIND operation is not normally invoked on the association.

#### 2.3.2 Application rule set 2 Transient asymmetric connection

This set of application rules is to be used e.g. in situations where one SC has connections with many MSCs or vice versa, and there is a switched data network connecting them. A data network connection (and the higher layer connections on top of it) is maintained for the duration of the relay or alert operations only.

Within the SMR-BIND service, only one type of operations is negotiated for use on the association. (As an exception, an association for both SMR-MO-DATA and SMR-ALERT is allowed below.) The operations of that type must be invoked by the initiator of the SMR-BIND. The responder of the SMR-BIND accepts the one type of operations and forces the association transient.

The following is an example of negotiating this within the SMR-BIND service; here, the SMR-MT-DATA operations are to be initiated by the SC.

name of parameter	value
iniType	short-Message-Service-Centre
respType	public-Land-Mobile-Network
operations	{ sMR-MT-Data-by-SC }
transient	TRUE

The association for SMR-MO-DATA or SMR-ALERT is negotiated according to the same principle, the MSC being the initiator of the SMR-BIND.

As an exception to the single type of operations rule, the following SMR-BIND negotiation for both SMR-MO-DATA and SMR-ALERT is allowed in this application rule set:

name of parameter	value
iniType	public-Land-Mobile-Network
respType	short-Message-Service-Centre
operations	{ sMR-MO-Data-by-MSC, sMR-Alert-by-MSC }
transient	TRUE

The association may be used for invoking operations of the negotiated type(s) as long as there are such operations to be invoked. (In other words, until all short messages or/and alerts to that direction have been relayed.)

If SMR-ALERT is not allowed on the association, the SMR-UN-BIND operation may be invoked on the association as soon as all operations on the association have been completed (by REPORT or ERROR). If SMR-ALERT is allowed, a guard time since the last SMR-ALERT invocation (if any) must have elapsed also (to guarantee that the SMR-ALERTs have been processed - there will be no responses).

This set of application rules effectively makes the association asymmetric: all operations are invoked by the same party, hence collisions are not possible.

## 2.4 Timing terminology

The overall delay of a short message relay operation between an SC and an MS may be affected i.a. by the following delays:

- transport connection establishment time between an SC and an MSC (including the time spent establishing a new network connection, if needed),
- the time needed to establish the higher layer protocol connections on top of the transport connection (including the SMR-BIND operation), and
- the time needed (request to result) for the actual remote operation (SMR-MO-DATA or SMR-MT-DATA) relaying the SM.

If semi-permanent connections are used, only the delay (c) is likely to occur.

As an aid to the organizations discussing these delays in actual implementations, the following time/count-valued constants are defined in the remainder of this section:

T-failure-delay  
 A/tr-typical-delay  
 A/tr-failure-delay  
 A/pe-typical-delay  
 A/pe-failure-delay  
 R/MO/1-typical-delay  
 R/MO/n-typical-delay  
 R/MO-failure-delay  
 R/MT-typical-delay  
 R/MT-failure-delay  
 R-OK-load  
 R-error-load  
 R/MO-OK-outstanding  
 R/MT-OK-outstanding

The delay (a) is dependent on the network being used. A delay exceeding T-failure-delay when establishing a transient transport connection should be treated as a failure, despite the worst-case delay specification of the network used.

The delay (b) for transient connections is typically A/tr-typical-delay, and a delay exceeding A/tr-failure-delay should be treated as a failure.

The delay (b) for semi-permanent connections is typically A/pe-typical-delay, and a delay exceeding A/pe-failure-delay should be treated as a failure.

The delay (c) for the SMR-MO-DATA service is typically R/MO/1-typical-delay if no other SMR-MO-DATAs are outstanding, and R/MO/n-typical-delay if there are other SMR-MO-DATAs outstanding. In either case, a delay exceeding R/MO-failure-delay should be treated as a failure.

The delay (c) is typically R/MT-typical-delay for the SMR-MT-DATA service (PLMN delays involved), and a delay exceeding R/MT-failure-delay should be treated as a failure.

Concerning throughput and overloading, a SMRSE responder is capable of processing R-OK-load SMRSE operations per minute and properly rejects (via error) up to R-error-load operations per minute if the actual processing throughput is exceeded. (Failing SMR-ALERTs do not cause any response, though.) The maximum number of outstanding SMR-MO-DATA operations on an application association must not exceed R/MO-OK-outstanding, if all operations are to be properly processed. The corresponding limitation for SMR-MT-DATAs is R/MT-OK-outstanding.

## 2.5 Error Cause Mapping

MAP	to	SC - MSC
IllegalSubscriber		illegal-subscriber
IllegalEquipment		illegal-equipment
TeleServiceNotProvisioned		teleservice-not-provisioned
SM-DeliveryFailure (#0)		memory-capacity-exceeded
SM-DeliveryFailure (#1)		error-in-MS
SM-DeliveryFailure (#2)		sms-not-provisioned
CallBarred		call-barred
DataMissing		system-failure
FacilityNotSupported		facility-not-supported
SystemFailure		system-failure
UnexpectedDataValue		system-failure
UnidentifiedSubscriber		unknown-subscriber
UnkownSubscriber		unknown-subscriber
AbsentSubscriber		absent-subscriber

SC - GMSC	to	MAP
sc-Congestion		SM-Delivery-Failure (#4)
invalid-sme-address		SM-Delivery-Failure (#5)
ms-not-sc-subscriber		SM-Delivery-Failure (#6)
system failure		SystemFailure

#0	memory capacity exceeded (MT only)
#1	equipment protocol error (MT only)
#2	equipment not SM equipped (MT only)
#4	SC-Congestion (MO only)
#5	invalid Sme address (MO only)
#6	Subscriber not SC Subscriber (MO only)



### 3 A Protocol Stack Which Utilises an Application-Network Layer Convergence Function For Interconnecting SCs and MSCs.

A convergence function (see Draft CCITT Recommendation Q.941 - Report R 22 May 1990) which maps an application entity protocol directly to the Network Layer service defined by X.213 can provide a practical alternative to ACSE, ROSE and OSI layers 6, 5 and 4 specified in Section 2.

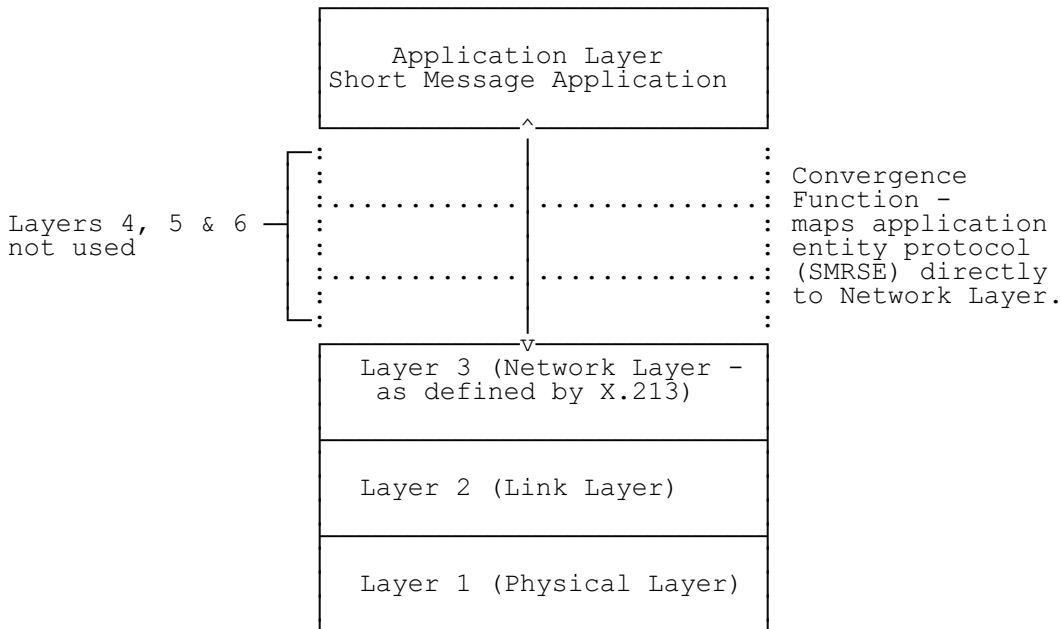

Draft CCITT Recommendation Q.941 proposes to map application layer protocols ACSE and ROSE via a convergence function to network layers defined by CCITT Recommendations Q.931 and Q.932.

The complexity of dealing with the many different network layer protocols is avoided by mapping the application protocols to the Network Layer Service defined by X.213. ACSE and ROSE are specifically defined in terms of the full OSI stack. The use of ACSE and ROSE is avoided by incorporating the functionality provided by ACSE and ROSE into SMS protocols. The convergence function is therefore embedded in SMS protocols just as the use of ACSE and ROSE is embedded into SMS protocols defined by Section 2.

#### 3.1 SMRSE Definition

The Short Message Service Relay Element (SMRSE) is defined in terms of the following service :

SMR - BIND:

This operation must be involved by the party which is responsible for establishing the application association ; only after the application association has been established may be remaining SMRSE services be used. This operation reports either success (via SMR-Bind-Confirm) or failure (via SMR-Bind-Failure).

SMR-BIND will be mapped to/from N-CONNECT request/indication with SMR-Bind parameters carried in NS-user-data (if the network layer does not support NS-user-data of 128 octets the SMR-Bind parameters may be carried by the first N-DATA request/indication following establishment of the network layer connection - see Section 3.4).

SMR-BIND-CONFIRM:

This operation must be invoked by a party to accept an application association.

SMR-BIND-CONFIRM will be mapped to/from N-CONNECT confirm/response with SMR-BIND-CONFIRM parameters carried in NS-user-data (if the network layer does not support NS-user-data of 128 octets then SMR-BIND-CONFIRM may be carried as the second N-DATA request/indication following establishment of the network layer connection - see Section 3.4).

**SMR-BIND-FAILURE:**

This operation must be invoked by a party to reject an attempted application association.

SMR-BIND-FAILURE will be mapped to/from N-DISCONNECT request/indication with SMR-BIND-FAILURE parameters carried in NS-user-data (if the network layer does not support NS-user-data of 128 octets then SMR-BIND-FAILURE parameters will not be carried by the network layer - ie NS-user-data will be discarded).

**SMR-UNBIND:**

This operation must be invoked by a party to release the application association.

SMR-UNBIND will be mapped to/from N-DISCONNECT request/indication with SMR-UNBIND parameters be carried in NS-user-data (if the network layer does not support NS-user-data of 128 octets then SMR-UNBIND parameters may be carried by the N-DATA request/indication preceding N-DISCONNECT - see Section 3.4).

**SMR-MO-DATA:**

This operation may be invoked by the application entity in the GMSC ; it is used to relay one SMS transfer layer PDU from the GMSC to the SC. This operation reports success (via RPAck) or failure (via RPError).

SMR-MO-DATA will be mapped to/from N-DATA request/indication.

**SMR-MT-DATA:**

This operation may be invoked by the application entity in the SC ; it is used to relay one SMS transfer layer PDU from the SC to the GMSC. This operation reports success (via RPAck) or failure (via RPError) after the full relay attempt to the MS.

SMR-MT-DATA will be mapped to/from N-DATA request/indication.

**SMR-ALERT:**

This operation may be invoked by the application entity in the GMSC. It is used as the GMSC-to-SC indication of the fact that an MS which was previously unattainable has recovered operation. This operation does not report any outcome.

SMR-ALERT will be mapped to/from N-DATA request/indication.

RPack:

This operation is invoked by the application entity in the GMSC or the SC ; it is used as the GMSC-to-SC indication that a particular short message has been received by an MS and as the SC-to-GMSC indication that a short message has been received by the SC.

RPack will be mapped to/from N-DATA request/indication.

RPErrror:

This operation is invoked by the application entity in the GMSC or the SC ; it is used as the GMSC-to-SC indication that a particular short message has not been successfully received by an MS and is needed as the SC-to-GMSC indication that a short message has not been successfully received by the SC.

RPErrror will be mapped to/from N-DATA request/indication.

### 3.2 ASN1 Specification

The Abstract Syntax Notation of  
the Short Message Relay Service Element

SMRSE

Note : The first two arcs of the object identifier are arbitrarily allocated, the name "etsi" is adopted from GSM 12.20 but the value 040 is arbitrary, and the last three arcs are allocated in this module.

1st module of 2:

SMS-UsefulDefinitions

```
SMS-usefulDefinitions { iso identified-organization etsi(040)
                        mobile-domain(0) gsm-messaging(4)
                        gsm-sms2(11) usefullDefinitions(0) }
```

#### DEFINITIONS

#### IMPLICIT TAGS

::=

BEGIN

#### IMPORTS

ID ::= OBJECT IDENTIFIER

-- root for all sms allocations

mobile-domain ID ::= {iso identified-organization etsi(40) mobile-domain(0) }

gsm-messaging

ID ::= { mobile-domain gsm-messaging(4) }

-- categories

gsm-sms2 ID ::= { gsm-messaging 11 }

-- modules

usefullDefinitions ID::= {gsm-sms2 0}

relayProtocol ID::= {gsm-sms2 1}

END

2nd module of 2

RelayProtocol

```
RelayProtocol      { iso identified-organization etsi(040)
                    mobile-domain(0)      gsm-messaging(4)      gsm-sms2(11)
                    relayprotocol(1) }
```

#### DEFINITIONS

#### IMPLICIT TAGS

```
::=
BEGIN
```

```
-- EXPORTS everything
```

```
-- The SMR-Bind-Parameters will be the User Data field in the N-CONNECT request/indication
-- message.
```

```
SMR-Bind-Parameters ::=
    initiatorID      [0] Name,
    password         [1] Password OPTIONAL,
    pswNeeded        [2] BOOLEAN,
    iniType           [3] Telecom-System-Type
    }
```

```
-- Above and in SMR-Bind-confirm
-- initiatorID/resplD identify the initiating/responding telecommunication subsystem
-- password may assist in authentication
-- pswneeded (BIND only) requests password into SMR-Bind SMR-Bind-confirm
-- initype/resptype identify the types of the systems
-- transient (CONFIRM only) forces the association (and the underlying connections) transient : it must
-- be UNBOUNDED as soon as there are no operations to be performed
```

```
Name ::=
    SEQUENCE {
        operator      [0] Operator      OPTIONAL,
        bilateralAgreem [1] BilateralAgreem OPTIONAL,
        dataNetworkAddress [2] X121Address OPTIONAL,
        iSDN Address   SMS-Address      OPTIONAL
    }
```

```
-- operator is a text string containing the name of the SC/PLMN operator. bilateralagreem is a text
-- string identifying the bilateral agreement between the SC and the PLMN operators which allows
-- for this association to be established.
-- dataNetworkAddress is the PSPDN X.121 address of the SC/MSC issuing the BIND or
-- CONFIRM, occurring only if a PSPDN is used.
-- iSDNAddress is the PLMN address of the SC as seen by the MSs (same datum in both BIND
-- and CONFIRM).
-- Any pair of subsets of these parameters may be used to identify the SC and the MSC to one
-- another.
```

-- upper bound settings

```
ub-operator-name-length INTEGER ::= 20
ub-agreem-name-length INTEGER ::= 20
ub-X121Address-length INTEGER ::= 15
ub-password-length INTEGER ::= 20
```

Operator ::= PrintableString (SIZE (0..ub-operator-name-length))

BilateralAgreem ::= PrintableString (SIZE (0..ub-agreem-name-length))

X121Address ::= NumericString (SIZE (0..ub-X121Address-length))

-- Definition of Short Message Service address

```
SMS-Address ::= [APPLICATION 0] SEQUENCE {
  address-type INTEGER { unknown-type (0),
                        international-number (1),
                        national-number (2),
                        network-specific-number (3),
                        short-number (4) },

  numbering-plan INTEGER { unknown-numbering (0),
                          iSDN-numbering (1),
                          data-network-numbering (3),
                          telex-numbering (4),
                          national-numbering (8),
                          private-numbering (9) },

  address-value CHOICE {
    octet-format
    SemiOctetString
    -- other formats are for further study
  }
}
```

-- each octet contains two binary coded decimal digits

```
SemiOctetString ::= OCTET STRING (SIZE (1..10))
Password ::= PrintableString(SIZE(0..ub-password-length))
```

```
Telecom-System-Type ::= INTEGER {
  short-Message-Service-Centre (0),
  public-Land-Mobile-Network (1)
  -- Extensions are possible: additional telecommunication subsystems
  -- might adopt this service element for their interconnection.
}
```

-- SMR-Bind-confirm will be the User Data in the N-CONNECT response/confirm message

```
SMR-Bind-confirm ::= SEQUENCE {
  respID [0] Name,
  password [1] Password OPTIONAL,
  respType [3] Telecom-System-Type,
  transient [5] BOOLEAN,
  connectTime [6] Time-when-connected
}
```

-- The following defines the choices and tags for the N-DISCONNECT request/indication User Data.

```
RELAYdiscs ::= CHOICE {
    bindfail [1] SMR-Bind-failure,
    unbindreq [2] SMR-Unbind
}

SMR-Bind-failure ::= SEQUENCE {
    connect-failure-reason
    [0] Connect-failure,
    alternative-system
    [1] Name OPTIONAL
}
```

-- connect-failure-reason contains one of the error given in the following table. alternative-system is included when the SC/PLMN operator wishes to indicate that the MSC/SC might try to establish an association with another SC/MSC.

-- Connection Failure Reason

-- not-entitled: The responder is not entitled to accept a request for an association between itself and the initiator.

-- temporary-overload: The responder is not capable of establishing an association due to temporary overload.

-- temporary-failure: The responder is not capable of establishing an association due to a temporary failure (having impact on an entity at SM-RL or at layers above).

-- incorrect-ID-or-password: The responder will not accept the request to establish an association between itself and the initiator due to incorrect identity or password.

-- not-supported: The responder does not recognize the telecommunication subsystem type of the initiator, or cannot support any of the operations suggested on the association.

```
Connect-failure ::= INTEGER {
    not-entitled (0),
    temporary-overload (1),
    temporary-failure (2),
    incorrect-ID-or-password (3),
    not-supported (4)
}
```

```
SMR-Unbind ::= Time-when-connected
Time-when-connected ::= UTCTime
```

-- The following defines the choices and tags for the N-DATA request/indication User Data

```
RELAYapdus ::= CHOICE {
    rpdamt [1] RPDataMT,
    rpdamo [2] RPDataMO,
    rpalertsc [3] RPAAlertSC,
    rpack [4] RPAck,
    rperror [5] RPErrror
}
```

```

RPDataMT ::= SEQUENCE {
    mt-priority-request          [0]    BOOLEAN,
    mt-more-messages-to-send    [1]    BOOLEAN OPTIONAL,
    mt-message-reference        RP-MR,
    mt-originating-address      SMS-Address,
    mt-destination-address      SMS-Address,
    mt-user-data                RP-UD
}

RPDataMO ::= SEQUENCE {
    mo-message-reference        RP-MR,
    mo-originating-address      SMS-Address,
    mo-user-data                RP-UD
}

RP-MR ::= [APPLICATION 2] INTEGER (0..255)
RP-UD ::= [APPLICATION 3] OCTET STRING (SIZE (1..164))

RPAck ::= SEQUENCE {
    message-reference          RP-MR
}

Error-reason ::= INTEGER {
    unknown-subscriber (1),
    teleservice-not-provisioned (11),
    call-barred (13),
    SMS-lower-layer-capabilities-not-prov (19),
    error-in-MS (20),
    facility-not-supported (21),
    memory-capacity-exceeded (22),
    absent-subscriber (29),
    illegal-subscriber (9),
    illegal-equipment (44),
    system-failure (36),
    sC-congestion (101),
    mS-not-SC-Subscriber (103),
    invalid-sme-address (104)
}

RPErrors ::= SEQUENCE {
    error-reason              Error-reason,
    msg-waiting-set           BOOLEAN,
    message-reference         RP-MR
}

RPAAlertSC ::= SMS-Address
-- must be an international ISDN address

```

END

### 3.3 Application Rules for Avoidance of Collision of SMRSE Operations

For the purpose of establishing the association between SMRSEs in MSC and SC then either the MSC or the SC shall be designated as the entity responsible for initiating the association by the operation SMR-Bind.

Following premature release of the association by N-DISCONNECT then either the MSC or the SC shall be designated as the entity responsible for re-establishing the association.

Following receipt of N-RESET any unacknowledged SMR-MT-DATA or SMR-MO-DATA will be retransmitted.

#### 3.3.1 Semi-permanent Connections

On a semi-permanent connection the SMR-UNBIND operation is not normally invoked following an application association.



### 3.3.2 Transient Connection

In a situation where an SC has several connections to an MSC, or an MSC has several connections to MSCs, and a public data network connection may be maintained for the duration of the relay and/or alert operations the association may be ended via SMR-UNBIND as soon as all operations on the association have been completed via RPAck or RPErrror and by some guard timer being applied following SMR-ALERT.

### 3.4 Non Support of 128 bytes of NS-user-data in Network Connection and Network Connection Release phases

It is generally intended to make the support of 128 bytes of NS-user-data mandatory (see Sections 12.2.8 and 13.2.3 of X.213). CCITT Recommendation X.2 regards provision of Fast Select as essential, thereby ensuring support of 128 bytes of NS-user-data in network connection and network connection release phases will remain a provider option. The following figures are therefore provided in order to indicate how SMR-BIND, SMR-BIND-CONFIRM and SMR-UNBIND should be mapped to/from an OSI Network Service definition which support 128 bytes of NS-user-data in network connection and network connection release phases.

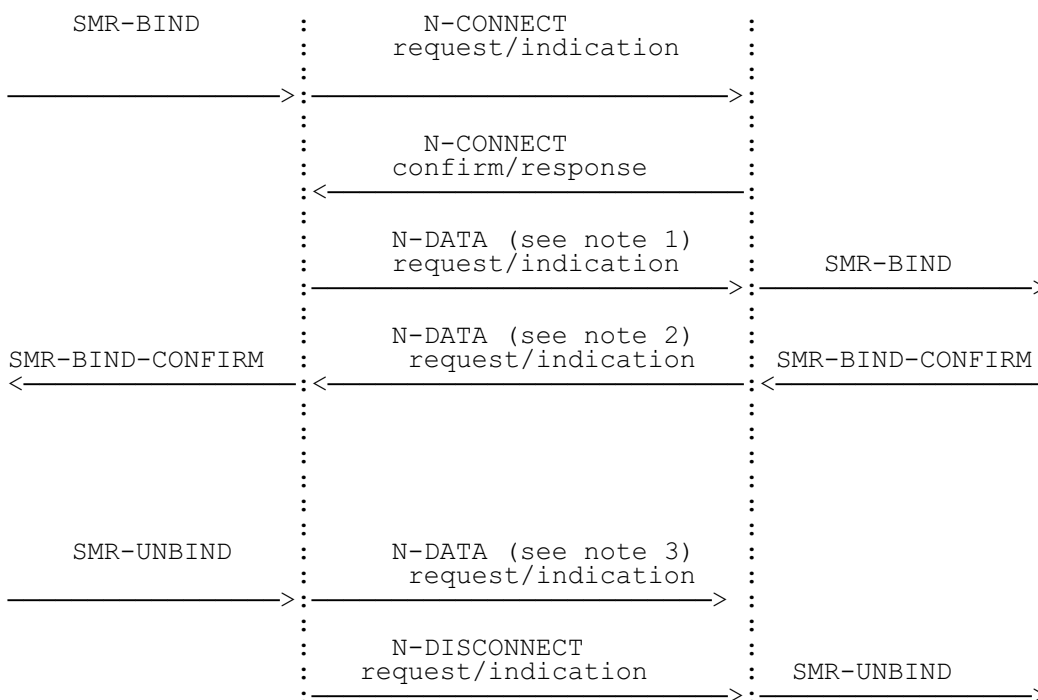

Note 1: SMR-BIND parameters are carried as NS-user-data

Note 2: SMR-BIND-CONFIRM is carried in NS-user-data

Note 3: SMR-UNBIND parameters are carried as NS-user-data

### 3.5 Error Cause Mapping

As section 2.5.

## 4 SS7 Protocol Stacks

### 4.1 Introduction

Concepts described in Q.1400 (see CCITT Study Group XI Report R219, April 1992) are followed. These concepts enable

- specification of an application layer such as SMS-MAP (see section 4.2)
- use of the protocol specified in Section 2 of GSM 03.47 to be supported (with minor modifications)

### 4.2 Application Layer Protocol SMS-MAP

#### 4.2.1 Introduction

This specification specifies a CCITT No.7 based interface for interconnecting Short Message Service Centres (SCs) and Gateway/Interworking MSCs (GMSCs and IWMSCs). The interface is based on the Mobile Application Part (MAP, GSM 09.02) protocol stack and principles.

The proposed protocol stack and specific MAP-operations (SC<--> GMSC/IWMSC) are not part of GSM 09.02, but an addition to be used in the SC-GMSC/IWMSC interface.

To separate the additions from the MAP in GSM 09.02, the additions are herein called SMS-MAP.

The SMS-MAP Operations- and SMS-MAP Signalling Procedures chapters have been divided into subchapters for interworking with MAP version 1, and MAP version 2.

Note: MAP version 2 was not finalized when this document was written. This may imply changes to the SMS-MAP version 2 operations and signalling procedures, when MAP version has been finalized.

#### 4.2.2 Protocol Stack

The SMS Mobile Application Part (SMS-MAP) provides the necessary signalling procedures required for information exchange between the network entities, GMSC/IWMSC and Service Centre (SC).

SMS-MAP uses the services of TCAP, SCCP and MTP of CCITT No.7.

Note: SMS-MAP is restricted to signalling between SCs and a GMSC/IWMSC. The SMS-MAP protocol terminates in the GMSC for SC originated short message signalling, and in the IWMSC for GSM PLMN originated short message signalling (MAP is used for short message signalling within/between PLMNs).

#### Application Entity Identification

The SSN for the Service Centre Application Entity enables co-location of an SC and a GSM MAP-AE (e.g. an MSC).

#### 4.2.3 SMS-MAP Version Handling

Interworking with MAP version 2 requires an upgraded version of SMS-MAP. For SMS-MAP (SC <--> GMSC/IWMSC) version negotiation, the principles outlined in MAP version 2 shall be used (GSM 09.02).

#### 4.2.4 Operations

##### GENERAL RULES

- Components in messages (SMS-MAP protocol violation). If a component, which according to this report shall be received in a specific message, e.g. a Result component in an End message, is received in another message, the dialogue should be aborted.
- If an operation which is not supported is received by an SMS-MAP network entity, the operation should be rejected with the InvokeProblem set to Unrecognized Operation.

##### Error handling

- Mistyped Parameter. A Reject with cause Mistyped Parameter is sent in the following cases:
  - A parameter tag is not one of those associated with the operation invoked or the type specification corresponding to the parameter tag is violated by the actual value.
  - If an SMS-MAP parameter contains a value outside the defined value range.
  - If a mandatory parameter is missing in an Invoke component.
  - If the parameter contains a value within the defined value range, but has a not permitted value, the UnexpectedDataValue Error is sent.

##### Basic Encoding Rules for SMS-GMSC

##### Length octets

##### Primitive Information Elements:

- definite short form if the actual length is less than 128
- definite long form without leading zero octets if the actual length is greater or equal to 128

##### Constructed Information Elements

- definite short form if the actual length is less than 128
- definite long form without leading zero octets if the actual length is greater or equal to 128
- indefinite form

##### Encoding of a boolean value

The boolean is FALSE if the octet is zero.

The boolean is TRUE if the octet has any non-zero value.

##### SMS-MAP VERSION 1 OPERATIONS

Forward Mobile Terminated Short Message	(SC --> GMSC)
Forward Mobile Originated Short Message	(IWMSC --> SC)
Service Centre Alert	(IWMSC --> SC)

Forward Mobile Terminated Short Message	(SC --> GMSC)
---	---------------

Operation Code=250

Class=1

ASN.1 Formal Description

```

ForwardMTShortMessage ::= OPERATION
PARAMETER              SEQUENCE{
msIsdn                 [0] IMPLICIT IsdnAddressString,
sm-RP-PRI              [1] IMPLICIT BOOLEAN,
serviceCentreAddress  [2] IMPLICIT IsdnAddressString,
sm-RP-UI               SM-RP-UI}

```

## RESULT

```

ERRORS                 {UnknownSubscriber,
                        TeleserviceNotProvisioned,
                        FacilityNotSupported,
                        CallBarred,
                        AbsentSubscriber,
                        SystemFailure,
                        UnexpectedDataValue,
                        MemoryCapacityExceeded,
                        ErrorInMS,
                        SMSLowerLayerCapabilitiesNotProvisioned,
                        IllegalMS}

```

## Comments Invoke Component:

- sm-RP-PRI and sm-RP-UI are not analyzed by the GMSC. They are sent transparently through the GMSC in the SMS-MAP operations Send Routing Information For Short Message (SM-RP-PRI), and Forward Short Message (SM-RP-UI).
- msIsdn is the destinating RP-address, and serviceCentreAddress the originating RP-address.
- serviceCentreAddress is accepted only in international E.164 number format.
- msIsdn is accepted only in national or international E.164 number format.

## Comments Error Component:

- The UnexpectedDataValue error is sent when the serviceCentreAddress is not international E.164 number, msIsdn is not national or international E.164 number.

## Mapping of errors between the Send Routing Information For Short Message (MAP) and Forward Mobile Terminated Short Message (SMS-MAP) operations

Send Routing Information For Short Message (MAP)	Forward Mobile Terminated Short Message (SMS-MAP)
--	---

Error Component received by GMSC:	Error Component to be sent by GSMC
-----------------------------------	------------------------------------

UnknownSubscriber	UnknownSubscriber
-------------------	-------------------

CallBarred	CallBarred
------------	------------

TeleServiceNotProvisioned	TeleServiceNotProvisioned
---------------------------	---------------------------

AbsentSubscriber	AbsentSubscriber
(MWD-SET=TRUE if the SC-Address already is included in the MWD-list in HLR.)	

FacilityNotSupported	FacilityNotSupported
----------------------	----------------------

SystemFailure	SystemFailure
---------------	---------------

DataMissing	SystemFailure
-------------	---------------

UnexpectedDataValue	SystemFailure
---------------------	---------------

Reject component received      SystemFailure

Abort indication received      SystemFailure

Operation Timeout              SystemFailure

Mapping of errors between the Forward Short Message (MAP) and Forward Mobile Terminated Short Message (SMS-MAP) operations

Forward Short Message (MAP)      Forward Mobile Terminated Short Message (SMS-MAP)

Error component received by GMSC:      Error component to be sent by GMSC:

AbsentSubscriber              AbsentSubscriber  
(If the Set MWD (GMSC --> HLR) successful, AbsentSubscriber with MWD-SET=TRUE is sent towards the SC.)

FacilityNotSupported              FacilityNotSupported

IllegalMS                      IllegalMS

SystemFailure                  SystemFailure

UnexpectedDataValue              SystemFailure

UnidentifiedSubscriber              SystemFailure

SM-DeliveryFailure  
with cause

memoryCapacityExceeded (0)	MemoryCapacityExceeded
msProtocolError (1)	ErrorInMS
msNotEquiped (2)	SMSLowerLayersCapabilities-NotProvisioned
unknownServiceCentre (3)	Not applicable for MT-SMS
scCongestion (4)	Not applicable for MT-SMS
invalidSmeAddress (5)	Not applicable for MT-SMS
msNotScSubscriber (6))	Not applicable for MT-SMS

Reject component received:  
with cause

'Unrecognized Operation'              FacilityNotSupported

other Reject reason              SystemFailure

Abort indication received              SystemFailure

Operation Timeout                  SystemFailure

Forward Mobile Originated Short Message (IWMSC --> SC)

Operation Code=249  
Class=1

ASN.1 Formal Description

```
ForwardMOShortMessage ::=
PARAMETER
    mlsdn
    serviceCentreAddress
    sm-RP-UI
OPERATION
SEQUENCE{
    [2]IsdnAddressString,
    [4]IsdnAddressString,
    SM-RP-UI}
```

RESULT

```
ERRORS
    {SC-Congestion,
    MSNotSCSubscriber,
    InvalidSMEAddress,
    UnexpectedDataValue}
```

Comments Invoke Component:

- mlsdn is the originating RP-address.
- serviceCentreAddress is an international E.164 number.

Mapping of errors between the Forward Mobile Originated Short Message (SMS-MAP) and Forward Short Message (MAP)

Forward Mobile Originated Short Message (SMS-MAP)	Forward Short Message (MAP)
---	-----------------------------

Error component received by IWMSC:	Error component to be sent by IWMSC:
------------------------------------	--------------------------------------

SC-Congestion	SM-DeliveryFailure with Cause: SC-Congestion
---------------	--

MSNotSCSubscriber	SM-DeliveryFailure with Cause: msNotSCSubscriber
-------------------	--

InvalidSMEAddress	SM-DeliveryFailure with Cause: invalidSMEAddress
-------------------	--

UnexpectedDataValue	SystemFailure
---------------------	---------------

Reject component received:  
with cause

'Unrecognized Operation'	SystemFailure
--------------------------	---------------

other Reject reason	SystemFailure
---------------------	---------------

Abort indication received	SystemFailure
---------------------------	---------------

Operation Timeout	SystemFailure
-------------------	---------------

Service Centre Alert (IWMSC --> SC)

Operation Code=251

Class=4

ASN.1 Formal Description

```

ServiceCentreAlert ::= OPERATION
PARAMETER              SEQUENCE{
    msIsdn              IsdnAddressString,
    serviceCentreAddress IsdnAddressString}

```

Comments Invoke Component:

- serviceCentreAddress is an international E.164 number.
- msIsdn is a national or an international E.164 number depending on in what kind of form it is received from the HLR.

#### SMS-MAP VERSION 2 OPERATIONS

```

Forward Mobile Terminated Short Message  (SC --> GMSC)
Forward Mobile Originated Short Message   (IWMSC --> SC)
Service Centre Alert                      (IWMSC --> SC)
Inform Service Centre                     (IWMSC --> SC)

```

Forward Mobile Terminated Short Message (SC --> GMSC)

Operation Code=250  
Class=1  
ASN.1 Formal Description

```

ForwardMTShortMessage ::= OPERATION
PARAMETER              SEQUENCE{
    msIsdn              [0] IMPLICIT IsdnAddressString,
    sm-RP-PRI          [1] IMPLICIT BOOLEAN,
    serviceCentreAddress [2] IMPLICIT IsdnAddressString,
    sm-RP-UI           SM-RP-UI,
    moreMessagesToSend NULL OPTIONAL}

```

#### RESULT

```

ERRORS                {UnknownSubscriber,
                       TeleserviceNotProvisioned,
                       CallBarred,
                       FacilityNotSupported,
                       AbsentSubscriber,
                       SystemFailure,
                       UnexpectedDataValue,
                       MemoryCapacityExceeded,
                       ErrorInMS,
                       SMSLowerLayerCapabilitiesNotProvisioned}

```

Comments Invoke Component:

- sm-RP-PRI and sm-RP-UI are not analysed by the GMSC. They are sent transparently through the GMSC in the SMS-MAP Operations Send Routing Information For Short Message (SM-RP-PRI), and Forward Short Message (SM-RP-UI).
- msIsdn is the destinating RP-address, and serviceCentreAddress the originating RP-address.
- serviceCentreAddress is accepted only in international E.164 number format.
- msIsdn is accepted only in national or international E.164 number format.
- The moreMessagesToSend parameter indicates if more mobile terminated Short Messages shall be sent on the opened dialogue (transaction). This controls which message the visited MSC shall report the operation outcome in, Continue or End (see chapter: SMS-MAP Signalling Sequences, SMS-MAP Version 2).

Comments Error Component:

- Error UnexpectedDataValue is sent when serviceCentreAddress is not international E.164 number, msIsdn is not national or international E.164 number.

Mapping of errors between the Send Routing Information For Short Message (MAP) and Forward Mobile Terminated Short Message (SMS-MAP) operations

Send Routing Information For Short Message (MAP)	Forward Mobile Terminated Short Message (SMS-MAP)
Error Component received by GMSC:	Error Component to be sent by GMSC:
UnknownSubscriber	UnknownSubscriber
CallBarred	CallBarred
TeleServiceNotProvisioned	TeleServiceNotProvisioned
AbsentSubscriber	AbsentSubscriber (May be sent together with an Inform-SC invoke component, See Note 1.)
FacilityNotSupported	FacilityNotSupported
SystemFailure	SystemFailure
DataMissing	SystemFailure
UnexpectedDataValue	SystemFailure
Reject component received	SystemFailure
Abort indication received	SystemFailure
Operation Timeout	SystemFailure

Note 1: The AbsentSubscriber error is empty in MAP-version 2. has been included in the MWD-list. These two components are grouped together in the same MAP-message. The same principle will be used in SMS-MAP, i.e. the AbsentSubscriber will be empty, and if received, the Inform-SC operation will be invoked towards the SC.



Mapping of errors between the Forward Short Message (MAP) and Forward Mobile Terminated Short Message (SMS-MAP) operations

Forward Short Message (MAP)	Forward Mobile Terminated Short Message (SMS-MAP)
Error component received by GMSC:	Error component to be sent by GMSC:
UnidentifiedSubscriber	SystemFailure (May be sent together with an Inform-SC invoke component, See Note 2.)
AbsentSubscriber	AbsentSubscriber (May be sent together with an Inform-SC invoke component, See Note 2.)
FacilityNotSupported	FacilityNotSupported
DataMissing	SystemFailure
SystemFailure	SystemFailure
UnexpectedDataValue	SystemFailure
SM-DeliveryFailure (with cause memoryCapacityExceeded (0), msProtocolError (1), msNotEquiped (2), unknownServiceCentre (3), scCongestion (4), invalidSmeAddress (5), msNotScSubscriber (6))	MemoryCapacityExceeded (May be sent together with an Inform-SC invoke component. See Note 2.) ErrorInMS SMSLowerLayersCapabilities-NotProvisioned Not applicable for MT-SMS Not applicable for MT-SMS Not applicable for MT-SMS Not applicable for MT-SMS
Reject component received: with cause	
Unrecognized Operation'	FacilityNotSupported
other Reject reason	SystemFailure
Abort indication received	SystemFailure
Operation Timeout	SystemFailure

Note 2: If one of the three following errors:

- 1) SM-DeliveryFailure with cause memoryCapacityExceeded
- 2) UnidentifiedSubscriber
- 3) AbsentSubscriber

is returned by the visited MSC to the GMSC, the Set MWD operation may be invoked towards HLR. If the outcome is successful, an Inform-SC invoke component should be sent together with the appropriate error component from the GMSC to the SC (see mapping above). Note that Inform-SC is not sent from HLR as a response to the Set MWD procedure (as in the Send Routing Info For SM case), and must be generated by the GMSC, if the Set MWD procedure is successful.

Forward Mobile Originated Short Message (IWMSC --> SC)

Operation Code=249  
 Class=1  
 ASN.1 Formal Description

```
ForwardMOShortMessage ::= OPERATION
PARAMETER                SEQUENCE{
    mlsdn                 [2] IsdnAddressString,
    serviceCentreAddress [4] IsdnAddressString,
    sm-RP-UI              SM-RP-UI}
```

RESULT

```
ERRORS                    {SC-Congestion,
                           MSNotSCSubscriber,
                           InvalidSMEAddress,
                           UnexpectedDataValue}
```

Comments Invoke Component:

- mlsdn is the originating RP-address.
- serviceCentreAddress is an international E.164 number.

Mapping of errors between the Forward Mobile Originated Short Message (SMS-MAP) and Forward Short Message (MAP)

Forward Mobile Originated Short Message (SMS-MAP)	Forward Short Message (MAP)
---	-----------------------------

Error component received by IWMSC:	Error component to be sent by IWMSC:
------------------------------------	--------------------------------------

SC-Congestion	SM-DeliveryFailure with Cause: SC-Congestion
---------------	--

MSNotSCSubscriber	SM-DeliveryFailure with Cause: msNotSCSubscriber
-------------------	--

InvalidSMEAddress	SM-DeliveryFailure with Cause: invalidSMEAddress
-------------------	--

UnexpectedDataValue	SystemFailure
---------------------	---------------

Reject component received: with cause

'Unrecognized Operation	SystemFailure
-------------------------	---------------

other Reject reason	SystemFailure
Abort indication received	SystemFailure
Operation Timeout	SystemFailure

Service Centre Alert (IWMSC --> SC)

Operation Code=251  
 Class=1  
 ASN.1 Formal Description

```
ServiceCentreAlert ::= OPERATION
```

PARAMETER	SEQUENCE{
msIsdn	IsdnAddressString,
serviceCentreAddress	IsdnAddressString}

RESULT

ERRORS	{SystemFailure, DataMissing, UnexpectedDataValue}
--------	---

Comments Invoke Component:

- serviceCentreAddress is an international E.164 number.
- msIsdn is a national or an international E.164 number depending on in what kind of form it is received from the HLR.

Note: Alert Service Centre has been changed to a Class3 operation in version 2.

Inform Service Centre (IWMSC --> SC)

Operation Code=248  
Class=4  
ASN.1 Formal Description

InformServiceCentre ::=	OPERATION
PARAMETER	SEQUENCE{
msIsdn	IsdnAddressString OPTIONAL,
mwStatus	MWStatus OPTIONAL)

This operation is sent to an SC to report if a subscriber has been included in the MWD-list in HLR, what MSISDN that is stored (only included if the MSISDN in the Send Routing Information For SM differs from an already stored MSISDN in the MWD-list), and report the status of the MCEF and MNRF flags in HLR. The invoke component is always grouped with an error component of the Forward Mobile Terminated Short Message operation when sent to an SC. Which error component, is described in the Mapping of Errors chapters for the Forward Mobile Terminated Short Message operation.

Comments Invoke Component:

- msIsdn is a national or an international E.164 number depending on in what kind of form it is received from the HLR.

#### 4.2.5 SMS-MAP SIGNALLING SEQUENCES

##### SMS-MAP VERSION 1 SIGNALLING PROCEDURES

###### Timers

Operation = Forward Mobile Terminated Short Message

Timer: T-fmtsm

Value: 15-180 s

Operation = Forward Mobile Originated Short Message

Timer: T-fmosm

Value: 15-30 s

Operation = Service Centre Alert

Timer: T-sca

Value: 5-10 s

###### Forward Mobile Terminated Short Message Procedure

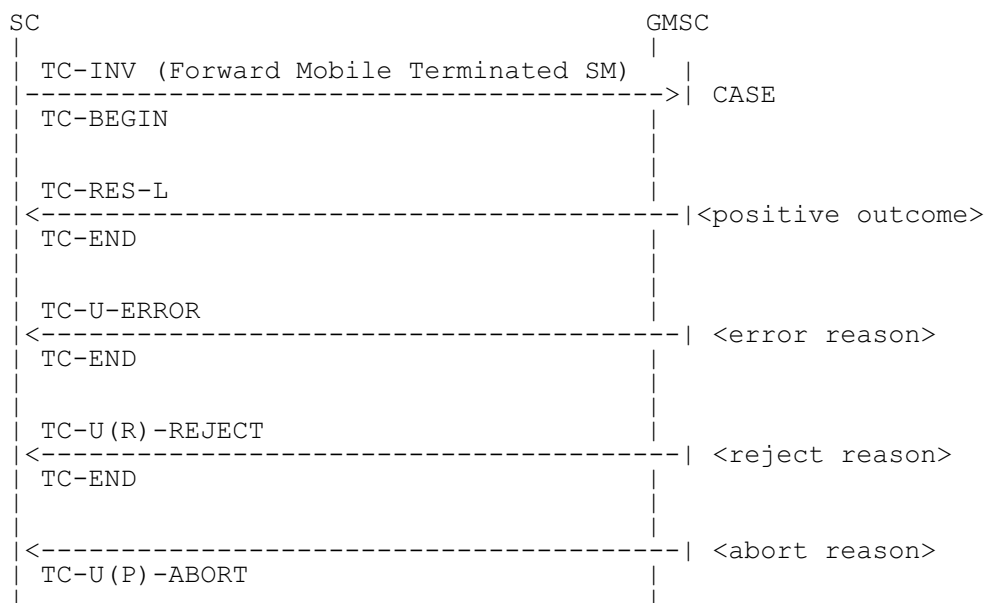

## Forward Mobile Originated Short Message Procedure

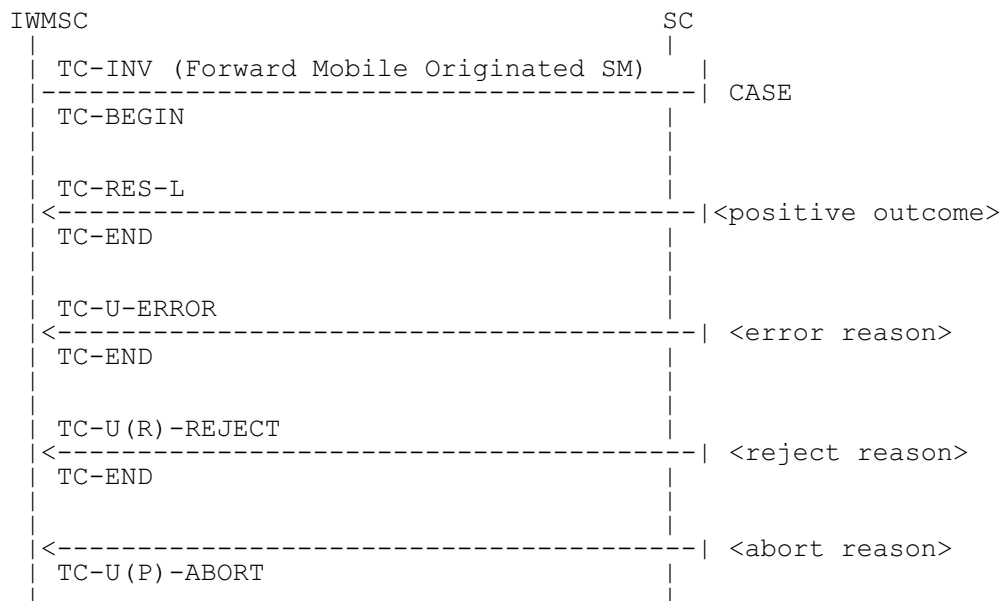

## Service Centre Alert Procedure

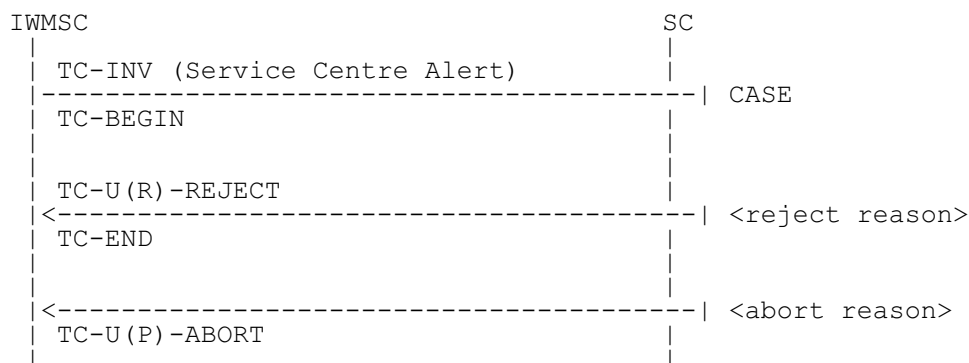

## SMS-MAP VERSION 2 SIGNALLING PROCEDURES

## Timers

Operation = Forward Mobile Terminated Short Message

Timer: T-fmtsm

Value: 15-180 s

Operation = Forward Mobile Originated Short Message

Timer: T-fmosm

Value: 15-30 s

Operation = Service Centre Alert

Timer: T-sca

Value: 5-10 s

Operation = Inform-SC

Timer: T-insc

Value: 5-10 s

Forward Mobile Terminated Short Message Procedure

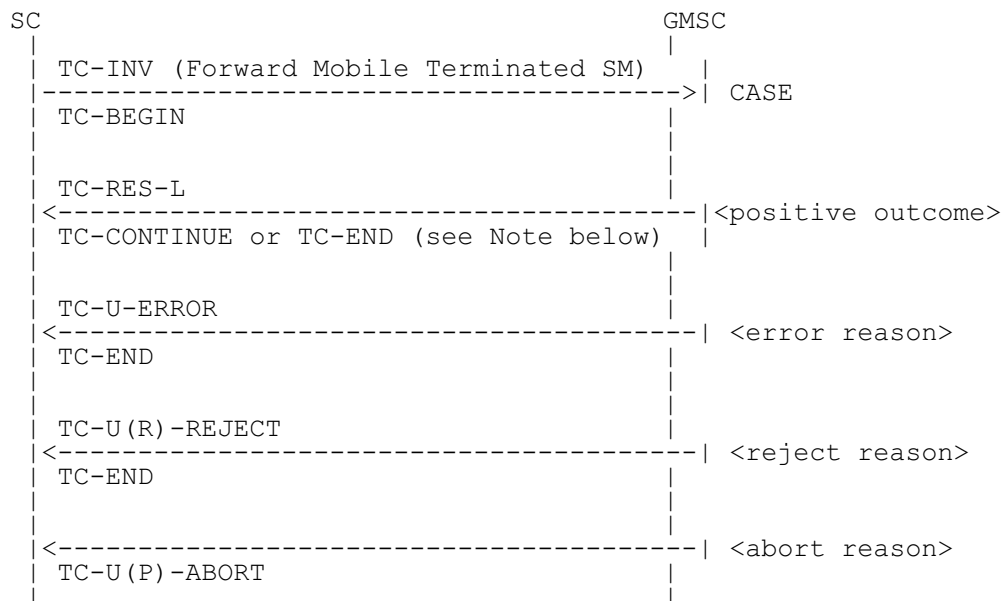

**Note:** If the 'moreMessagesToSend' flag is set to TRUE in the Forward Mobile Terminated SM invoke component, the Result component shall be sent in a Continue message. If it is set to FALSE, in an End message.

Forward Mobile Originated Short Message Procedure

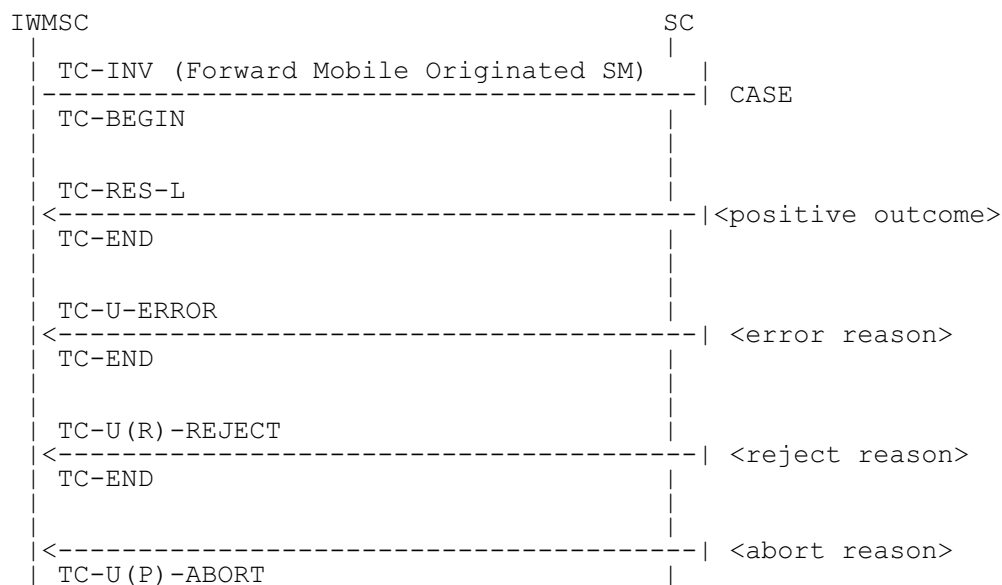

## Service Centre Alert Procedure

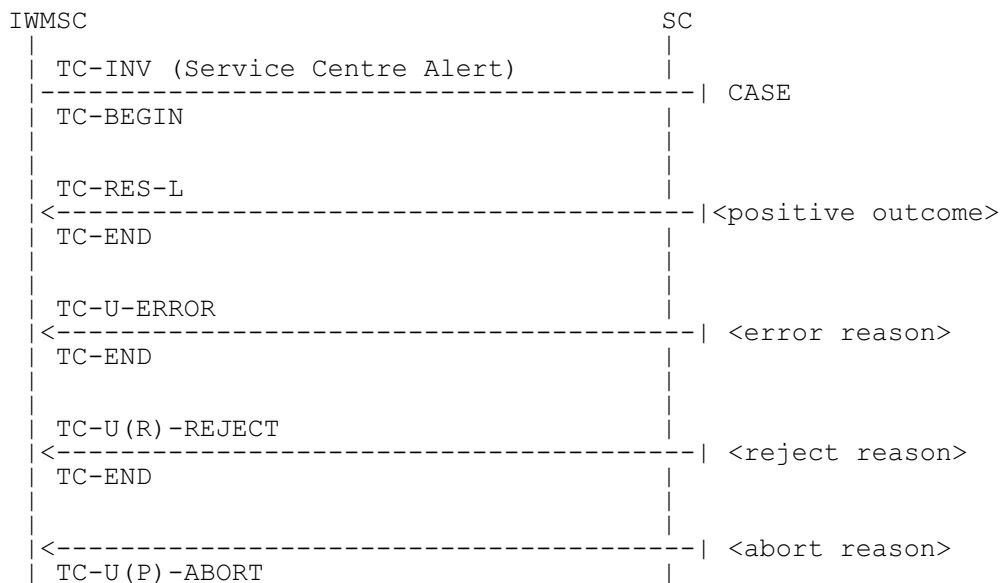

## Inform-Service Centre Procedure

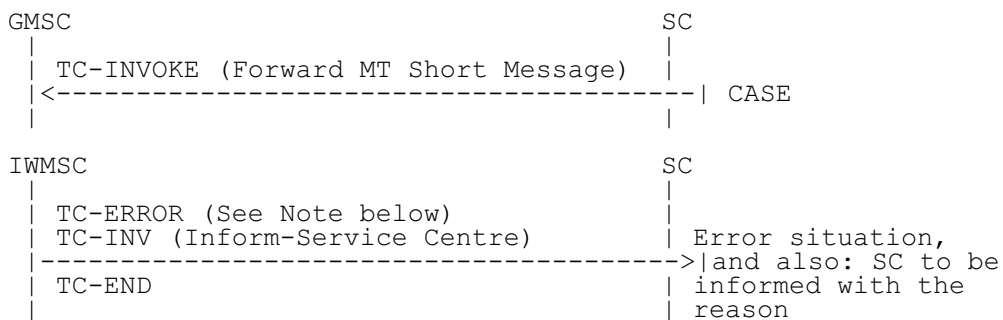

**Note:** The Inform-SC invoke component is always grouped with an error component of Forward Mobile Terminated Short Message operation, when sent to an SC. Which error component, is described in the Mapping of Errors chapters for the Forward Mobile Terminated Short Message operation.

#### 4.2.6 Errors

##### ERRORS COMMON FOR VERSION 1 AND VERSION 2

###### - CallBarred

This error is returned, when a short message delivery fails due to barring conditions attached to the subscriber. Barring conditions can be attached to the subscriber due to a active call barring supplementary service or by operator initiated barring. A parameter indicating the reason may be provided.

Error Code Value = 13

ASN.1 Formal Description

CallBarred ::= ERROR

Parameter

cause ENUMERATED {barringServiceActive (0),  
operatorBarring (1)} - optional

###### - ErrorInMS

This error is returned if a terminated short message transfer fails due to an error in the MS, e.g. protocol error.

Error Code Value = 50

ASN.1 Formal Description

ErrorInMS ::= ERROR

###### - FacilityNotSupported

This error is returned due to no provision of the short message service in the VPLMN.

Error Code Value = 21

ASN.1 Formal Description

FacilityNotSupported ::= ERROR

###### - MemoryCapacityExceeded

This error is returned if an MS has no memory capacity available to receive a mobile terminated short message.

Error Code Value = 52

ASN.1 Formal Description

MemoryCapacityExceeded ::= ERROR

###### - MSNotSCSubscriber

This error is returned if an MS that originates a short message to a certain SC, is not a subscriber in this SC.

Error Code Value = 54

ASN.1 Formal Description

MSNotSCSubscriber ::= ERROR

###### - IllegalMS

This error is returned if the authentication procedure towards an MS fails.



Error Code Value = 9

ASN.1 Formal Description  
IllegalMS ::= ERROR

- InvalidSMEAddress

This error is returned by an SC if the SME-Address included in a mobile originated short message is invalid (syntactically incorrect).

Error Code Value = 55

ASN.1 Formal Description  
IllegalMS ::= ERROR

- SC-Congestion

This error is returned by an SC if congestion occurs at reception of a mobile originated short message.

Error Code Value = 53

ASN.1 Formal Description  
SC-Congestion ::= ERROR

- SMSLowerLayersCapabilitiesNotProvisioned

This error is returned if a mobile terminated short message transfer fails due to failure in the lower layers, e.g. due to information contained in the Classmark, or the MSC not being able to establish a SAPI=3 connection towards the MS.

Error Code Value = 51

ASN.1 Formal Description  
SMSLowerLayersCapabilitiesNotProvisioned ::= ERROR

- SystemFailure

This error is returned by any network entity, when it cannot perform an operation due to failure in another entity.

Error Code Value = 34

ASN.1 Formal Description  
SystemFailure ::= ERROR  
Parameter NetworkResource OPTIONAL

NetworkResource should be set to the id of the entity responsible for the system failure condition.

- TeleserviceNotProvisioned

This error is returned if the given msIsdn number does not comprise the indicated short message service.

Error Code Value = 11

ASN.1 Formal Description  
TeleserviceNotProvisioned ::= ERROR  
No parameters.

- UnexpectedDataValue

This error is returned by any network entity, when a parameter with an unexpected data value, without type violation is received, or when an optional element appears when it is not needed in the context.

Error Code Value = 36

ASN.1 Formal Description

UnexpectedDataValue ::= ERROR

- UnknownSubscriber

This error is returned when an HLR is requested to perform an operation and no IMSI or msIsdn has been allocated in HLR for the subscriber (forwarded from GMSC to SC when this error is received by an HLR).

Error Code Value = 1

ASN.1 Formal Description

UnknownSubscriber ::= ERROR

#### VERSION 1 SPECIFIC ERRORS

- AbsentSubscriber

This error is returned when the subscriber is detached or not reachable. A parameter indicating whether or not the serviceCentreAddress has been included in the HLR message waiting list may be included.

Error Code Value = 27

ASN.1 Formal Description

AbsentSubscriber ::= ERROR  
mwd-Set BOOLEAN OPTIONAL

#### VERSION 2 SPECIFIC ERRORS

- AbsentSubscriber

This error is returned when the subscriber is detached or not reachable.

Error Code Value = 56

ASN.1 Formal Description

AbsentSubscriber ::= ERROR

### 4.2.7 SMS-MAP Parameter Data Types

#### DATA TYPES COMMON FOR VERSION 1 AND VERSION 2

AddressString

ASN.1 Formal Description

AddressString ::= OCTET STRING (SIZE (1..maxAddressLength))

a) First octet including a one bit Extension Indicator, 3 bits Nature Of Address and 4 bits Numbering Plan Indicator.

The following codes are handled by SMS-GMSC:

- Bit 8: Extension indicator

1 No extension

- Bit 7-5: Nature of address indicator

001 international number  
010 national significant number

- Bit 4-1: Numbering plan indicator

0001 ISDN/Telephony Number Plan (REC E.164)

b) Subsequent octets representing address digits encoded as a TBCD-STRING parameter.

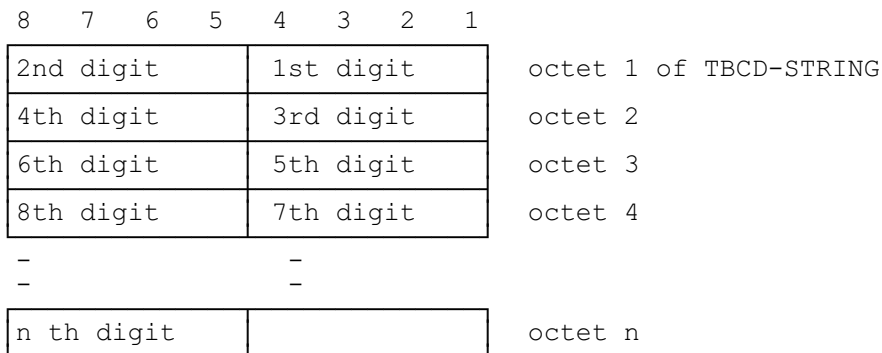

IsdnAddressString

ASN.1 Formal Description

IsdnAddressString ::= AddressString (SIZE (1..10))

Max Length = 10 octets

Coded as AddressString, but with a maximum length of 10 octets.

NetworkResource

ASN.1 Formal Description

NetworkResource ::= ENUMERATED{  
 pLMN (0),  
 hLR (1),  
 vLR (2),  
 previous-VLR (3),  
 controlling-MSC (4),  
 vMSC (5),  
 eIR (6),  
 radioSubsystem (7)}

Max Length = 1 octet

SM-RP-UI

(SM-RP-UI will be sent transparently through SMS-GMSC.)

ASN.1 Formal Description

SM-RP-UI ::= OCTET STRING (SIZE (1..maxSignalInfoLength))

maxSignalInfoLength INTEGER ::= 200 octets \*

TBCD-String

ASN.1 Formal Description

TBCD-STRING ::= OCTET STRING

- digits 0 to 9, two digits per octet,
- each digit encoded 0000 to 1001,
- 1111 used as filler when there is an odd number of digits.

Bit 4 to 1 of octet n encoding digit  $2(n-1)+1$

Bit 8 to 5 of octet n encoding digit  $2n$

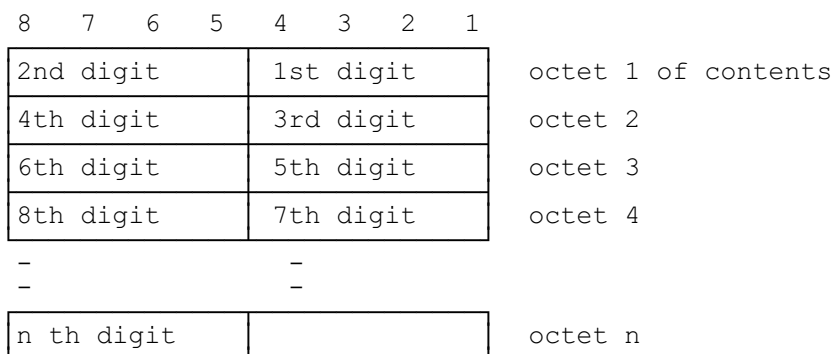

### VERSION 2 SPECIFIC DATA TYPES

#### MWStatus

#### ASN.1 Formal Description

MWStatus ::= OCTET STRING (SIZE 1)

- bits 4-7: 0000 (not used)
- bits 2-3: status of MW flags
  - 00 not set
  - 01 MNRF set
  - 10 MCEF set
  - 11 MCEF and MNRF set
- bit 1: status of MWD
  - 0 SC address not included
  - 1 SC address included

### 4.3 Support of Application Layer Specified by section 2 of GSM 03.47

Q.1400 specifies the use of OSI concepts via SS7 for the development of signalling and operations & management protocols. The protocol specified in Section 2 of this report can be carried via an SS7 protocol stack consisting of TCAP, SCCP and MTP (see Q.700 series) with minor adaptations:

- ROSE operation classes 2 and 5 are replaced by TCAP operation classes 1 and 4 respectively.
- TCAP provides a connectionless service. The services provided by SMR-BIND, SMR-BIND-CONFIRM, SMR-BIND-FAILURE and SMR-UNBIND are therefore not required and Sections 2.3 and 2.4 are not applicable.

## History

Document history	
February 1995	Second Edition
December 1995	Converted into Adobe Acrobat Portable Document Format (PDF)