

ETSI ES 283 018 V2.7.2 (2010-01)

ETSI Standard

**Telecommunications and Internet converged Services and
Protocols for Advanced Networking (TISPAN);
Resource and Admission Control:
H.248 Profile for controlling
Border Gateway Functions (BGF) in the Resource and
Admission Control Subsystem (RACS);
Protocol specification**



Reference

RES/TISPAN-03212-NGN-R2

Keywords

H.248, interface

ETSI

650 Route des Lucioles
F-06921 Sophia Antipolis Cedex - FRANCE

Tel.: +33 4 92 94 42 00 Fax: +33 4 93 65 47 16

Siret N° 348 623 562 00017 - NAF 742 C
Association à but non lucratif enregistrée à la
Sous-Préfecture de Grasse (06) N° 7803/88

Important notice

Individual copies of the present document can be downloaded from:

<http://www.etsi.org>

The present document may be made available in more than one electronic version or in print. In any case of existing or perceived difference in contents between such versions, the reference version is the Portable Document Format (PDF). In case of dispute, the reference shall be the printing on ETSI printers of the PDF version kept on a specific network drive within ETSI Secretariat.

Users of the present document should be aware that the document may be subject to revision or change of status. Information on the current status of this and other ETSI documents is available at

<http://portal.etsi.org/tb/status/status.asp>

If you find errors in the present document, please send your comment to one of the following services:

http://portal.etsi.org/chaicor/ETSI_support.asp

Copyright Notification

No part may be reproduced except as authorized by written permission.
The copyright and the foregoing restriction extend to reproduction in all media.

© European Telecommunications Standards Institute 2010.
All rights reserved.

DECT™, **PLUGTESTS™**, **UMTS™**, **TIPHON™**, the TIPHON logo and the ETSI logo are Trade Marks of ETSI registered for the benefit of its Members.

3GPP™ is a Trade Mark of ETSI registered for the benefit of its Members and of the 3GPP Organizational Partners.

LTE™ is a Trade Mark of ETSI currently being registered

for the benefit of its Members and of the 3GPP Organizational Partners.

GSM® and the GSM logo are Trade Marks registered and owned by the GSM Association.

Contents

Intellectual Property Rights	8
Foreword.....	8
1 Scope	9
2 References	9
2.1 Normative references	9
2.2 Informative references.....	10
3 Definitions and abbreviations.....	11
3.1 Definitions.....	11
3.2 Abbreviations	13
4 Applicability.....	14
4.1 Architecture.....	14
4.2 Border Gateway Guidelines	14
5 Profile description	15
5.1 Profile identification.....	15
5.2 Summary	15
5.3 Gateway Control Protocol Version	15
5.4 Connection model.....	16
5.5 Context attributes	16
5.6 Terminations.....	16
5.6.1 Termination names	16
5.6.1.1 IP Termination	16
5.6.1.1.1 Overview and prose specification.....	16
5.6.1.1.2 Syntactical Specification	19
5.6.2 Multiplexed terminations	19
5.7 Descriptors	19
5.7.1 TerminationState descriptor.....	19
5.7.2 Stream descriptor	20
5.7.2.1 LocalControl descriptor	20
5.7.3 Events descriptor	20
5.7.4 EventBuffer descriptor.....	21
5.7.5 Signals descriptor.....	21
5.7.6 DigitMap descriptor.....	22
5.7.7 Statistics descriptor	22
5.7.8 ObservedEvents descriptor	22
5.7.9 Topology descriptor.....	22
5.7.10 Error descriptor.....	23
5.8 Command API.....	23
5.8.1 Add	24
5.8.2 Modify	24
5.8.3 Subtract.....	24
5.8.4 Move.....	25
5.8.5 AuditValue.....	25
5.8.6 AuditCapabilities	25
5.8.7 Notify.....	25
5.8.8 ServiceChange	25
5.8.9 Manipulating and auditing context attributes.....	26
5.9 Generic command syntax and encoding.....	26
5.10 Transactions	27
5.11 Messages	27
5.12 Transport	27
5.13 Security	28
5.14 Packages	28
5.14.1 Overview	28

5.14.2	Package usage information	29
5.14.2.1	Generic (g)	29
5.14.2.2	Base root (root)	30
5.14.2.3	Network (nt)	31
5.14.2.4	Differentiated Services (ds).....	32
5.14.2.5	Gate Management (gm).....	33
5.14.2.6	Traffic management (tman).....	34
5.14.2.7	IP NAPT Traversal (ipnapt)	34
5.14.2.8	MPLS (mpls).....	35
5.14.2.9	VLAN (vlan).....	35
5.14.2.10	MGC Information (mgcinfo).....	36
5.14.2.11	Inactivity (it)	36
5.14.2.12	Segmentation (seg).....	37
5.14.2.13	RTP (rtp)	38
5.14.2.14	Application Data Inactivity Detection (adid)	38
5.14.2.15	IP Domain Connection (ipdc)	39
5.14.2.16	Media Gateway Overload Control (ocp).....	39
5.14.2.17	Hanging Termination Detection (hangterm)	40
5.14.2.18	Statistic Conditional Reporting (scr).....	40
5.15	Mandatory support of SDP and annex C information elements	41
5.16	Optional support of SDP and annex C information elements	42
5.17	Overview of Procedures	43
5.17.1	Overview of Session Dependent Procedures	43
5.17.1.1	Gate control.....	44
5.17.1.2	Allocation and translation of IP addresses, ports and versions (NAPT-PT)	46
5.17.1.3	Support of Hosted NAT Traversal	47
5.17.1.4	QoS marking	47
5.17.1.4.1	Copying DSCP/ToS values from the ingress to egress.....	47
5.17.1.4.2	Auditing the "Per-Hop Behaviour".....	47
5.17.1.5	Bandwidth control - Reservation, Allocation and Policing	47
5.17.1.5.1	Admission Control.....	48
5.17.1.5.2	Traffic Descriptor	48
5.17.1.5.3	Bandwidth reservation and allocation	48
5.17.1.5.4	Bandwidth policing	49
5.17.1.5.5	Non-specification of <i>tman</i> properties	49
5.17.1.6	Usage metering and statistics reporting.....	49
5.17.1.6.1	Statistics for Media/Transport-agnostic IP packets	49
5.17.1.6.2	Traffic Volume related Statistics.....	49
5.17.1.7	RTCP Handling.....	50
5.17.1.7.1	RTCP Transport Address Allocation.....	50
5.17.1.7.2	RTP/RTCP to-H.248 Stream Mapping.....	51
5.17.1.8	RTCP Forwarding	51
5.17.1.8.1	Conditions for RTCP packet policing.....	51
5.17.1.8.2	Forwarding of regular RTCP traffic	51
5.17.1.8.3	Handling of RTCP XR/HR traffic	51
5.17.1.9	Media Inactivity	51
5.17.1.10	IP Realm/Domain Indication.....	52
5.17.1.10.1	Codepoint and format/encoding	52
5.17.1.10.2	Unsuccessful indication.....	52
5.17.1.10.3	Fix assignment per termination lifetime	52
5.17.1.10.4	Number of IP Realms/Domains.....	52
5.17.1.11	Two-Stage BGF Resource Reservation.....	53
5.17.1.12	Hanging Termination Detection.....	53
5.17.1.13	Real Time Statistics Reporting.....	54
5.17.1.14	Transcoding.....	54
5.17.1.14.1	Media types and formats (Codecs)	54
5.17.1.14.2	Decision for transcoding.....	54
5.17.1.15	Void.....	54
5.17.1.16	VPN identification	55
5.17.1.16.1	VLAN marking.....	55
5.17.2	Overview of Session Independent Procedures.....	55
5.17.2.1	Introduction - Relation to TS 183 025.....	55

5.17.2.2	Session-independent procedures	55
5.17.2.3	MG Overload Control: Rate limitation of H.248 Messages from MGC-to-MG	55
5.18	Session Dependent Procedures (Command Level Details)	55
5.18.1	Add Termination.....	56
5.18.1.1	Add Termination - Remote Addr and Port Known, Select Local Addr and Port	57
5.18.1.1.1	Conditions for Address Policing: SAF, SPF, SAM, SPR, SPRR	59
5.18.1.1.2	Assigning IP Domain/Realm to Termination	60
5.18.1.1.3	Add Termination - Remote Addr and Port Known, Select Local Addr and Port - Examples.....	61
5.18.1.2	Add Termination - Select Local Addr and Port.....	62
5.18.1.2.1	Add Termination - Select Local Addr and Port - Examples	65
5.18.1.3	Add Termination - Remote Addr Known, Select Local Addr.....	66
5.18.1.3.1	Add Termination - Remote Addr Known, Select Local Addr - Examples	68
5.18.1.4	Add Termination - Select Local Addr.....	69
5.18.1.4.1	Add Termination - Select Local Addr - Examples	70
5.18.1.5	Add Termination - Remote Addr Known and Port Possibly Known, no Local Addr and Port.....	71
5.18.1.5.1	Add Termination - Remote Addr Known and Port Possibly Known, no Local Addr and Port - Examples	72
5.18.2	Session Establishment Update	72
5.18.2.1	Session Establishment Update - Remote Addr and Port Known.....	73
5.18.2.1.1	Session Establishment Update - Remote Addr and Port Known - Examples	75
5.18.2.2	Session Establishment Update - Remote Addr Known.....	78
5.18.2.2.1	Session Establishment Update - Remote Addr Known - Examples	79
5.18.2.3	Session Establishment Update - Through Connect	80
5.18.2.3.1	Session Establishment Update - Through Connect - Examples.....	82
5.18.2.4	Session Establishment Update - Select Local Port.....	83
5.18.2.4.1	Session Establishment Update - Select Local Port - Examples	86
5.18.2.5	Session Establishment Update - Bandwidth Change.....	87
5.18.2.5.1	Session Establishment Update - Bandwidth Change - Examples	89
5.18.2.6	Session Establishment Update - Delete Stream.....	89
5.18.2.6.1	Session Establishment Update - Delete Stream - Examples	92
5.18.3	Mid-Session Update.....	92
5.18.3.1	Mid-Session Update - Bandwidth Change	92
5.18.3.1.1	Mid-Session Update - Bandwidth Change - Examples.....	95
5.18.3.2	Mid-Session Update - Media Change	96
5.18.3.2.1	Mid-Session Update - Media Change - Examples.....	98
5.18.3.3	Mid-Session Update - Remote Addr/Port Change	99
5.18.3.3.1	Mid-Session Update - Remote Addr/Port Change - Examples.....	102
5.18.3.4	Mid-Session Update - Add Stream, Remote Addr and Port Known	103
5.18.3.4.1	Mid-Session Update - Add Stream, Remote Addr and Port Known - Examples.....	105
5.18.3.5	Mid-Session Update - Add Stream.....	107
5.18.3.5.1	Mid-Session Update - Add Stream - Examples	109
5.18.3.6	Mid-Session Update - Delete Stream	110
5.18.3.6.1	Mid-Session Update - Delete Stream - Examples	111
5.18.3.7	Mid-Session Update - Add Stream, Remote Addr Known and Port Possibly Known, no Local Addr and Port.....	114
5.18.3.7.1	Mid-Session Update - Add Add Stream, Remote Addr Known and Port Possibly Known, no Local Addr and Port - Examples	115
5.18.4	Auditing	116
5.18.4.1	Mid-Session Statistics Audit	116
5.18.4.1.1	Mid-Session Statistics Audit - Example	117
5.18.4.2	Mid-Session MGC Info Audit.....	118
5.18.4.2.1	Mid-Session MGC Info Audit - Example.....	119
5.18.5	Notification of MG Events	119
5.18.5.1	Notification of IP Media Stop	119
5.18.5.2	Notification of Hanging Termination.....	120
5.18.5.3	Notification of Statistic Conditional Reporting.....	121
5.18.6	Delete Session/Termination	122
5.18.6.1	Delete Session/Termination	122
5.18.6.1.1	Delete Session/Termination - Examples.....	123
5.18.6.2	Delete Session/Termination - Wildcarded Reply	126
5.18.6.2.1	Delete Session - Wildcarded Reply - Examples	126
5.19	Non-Session Related Use Cases.....	126

5.19.1	Enable MG	127
5.19.1.1	Enable MG (at MGC)	127
5.19.1.2	Enable MG (at MG)	127
5.19.1.2.1	Enable MG (at MG): Cold Boot	128
5.19.1.2.2	Enable MG (at MG): Warm Boot	129
5.19.2	Enable MGC	130
5.19.3	Disable MG (Graceful)	130
5.19.3.1	Disable MG (Graceful) (at MGC)	130
5.19.3.2	Disable MG (Graceful) (at MG)	131
5.19.4	Disable MG (Immediate)	131
5.19.4.1	Disable MG (Immediate) (at MGC)	131
5.19.4.2	Disable MG (Immediate) (at MG)	132
5.19.5	Disable MGC	132
5.19.6	Enable Termination	132
5.19.7	Disable Termination (Graceful)	132
5.19.8	Disable Termination (Immediate) (at MG)	132
5.19.9	MG Failure and Recovery	133
5.19.10	MG Termination Failure and Recovery	133
5.19.11	MGC Failure and Recovery	134
5.19.12	User Plane Failure	134
5.19.13	MGC-MG Control Association Failure and Recovery	135
5.19.14	MG Overload	137
5.19.15	MGC Overload	138
5.19.16	MGC Hand-Off	138
5.19.17	MGC Re-Direct	138
5.19.18	MG Failover	139
5.20	Session Independent Procedures (Command Level Details)	139
5.20.1	MG Registration (Cold Boot)	140
5.20.2	MG Restoration	141
5.20.3	Packages Audit	141
5.20.4	Context Audit	142
5.20.5	MG Termination Available	143
5.20.6	MG Termination Unavailable	143
5.20.7	Audit Termination State	144
5.20.8	Set ROOT Termination Events/Properties	144
5.20.9	MGC Initiated Service Restoration	145
5.20.10	Check MG Availability	145
5.20.11	MG Service Cancellation (Graceful)	146
5.20.12	MG Service Cancellation (Immediate)	146
5.20.13	MGC Hand-Off	147
5.20.14	MG Re-Registration (Hand-Off)	148
5.20.15	MG Termination OOS Graceful	148
5.20.16	MGC Overload Notification	148
5.20.17	Registration Redirect	149
5.20.18	User Plane Failure	150
5.20.19	ROOT Event Notification	151
5.20.20	MG Lost Communication (Disconnected)	151
5.20.21	MG Lost Communication (Failover)	152
5.20.22	MG Redundant Takeover (Primary)	152
5.20.23	Void	153
5.20.24	MG Re-Registration (Restart)	153
5.20.25	Wildcarded Subtract	153
5.20.26	MG Redundant Takeover (Secondary)	154
5.20.27	MGC Initiated Service Cancellation	154
5.20.28	Audit Service State	154
5.20.29	Audit ROOT Properties	154

Annex A (informative): Illustration of Gate/Pinhole Concept155

A.1	General	155
A.2	Relationships between gates and H.248 Streams	155

Annex B (informative):	Comparison between ES 283 018 V1.1.4 (Ia Profile Version 1) and TS 102 333 (GCP)	156
B.1	General	156
B.2	Differences between TS 102 333 (GCP) and ES 283 018 V1.1.4 (Ia Profile Version 1).....	156
Annex C (informative):	Comparison with Ia Profile Version 1	157
C.1	General	157
C.2	Differences between ES 283 018 V1.1.4 (Ia Profile Version 1) and ES 283 018 V2.7.1 (Ia Profile Version 2).....	157
Annex D (informative):	Illustration of an IP processing model for an H.248 (IP, IP) Context.....	159
D.1	Example model.....	159
D.2	Aspects of filter interaction	161
D.2.1	Interaction between address latching and address policing	161
Annex E (informative):	Guidelines for Ia-to-Gq' mapping	163
E.1	Guidelines for Ia-to-Gq' mapping with regards to session-independent procedures.....	163
E.1.1	Introduction	163
E.1.2	Mapping guidelines	163
E.1.2.1	Session-dependent procedures	163
E.1.2.2	Session-independent procedures	164
E.2	Guidelines for Ia-to-Gq' mapping with regards to bearer-specific events.....	164
E.2.1	Introduction	164
E.2.2	Mapping guidelines	165
E.2.2.1	Guidelines for <i>Specific Action</i> AVPs	165
E.2.2.2	Other AVPs.....	165
Annex F (informative):	Bibliography	166
Annex G (informative):	Change history	167
History		168

Intellectual Property Rights

IPRs essential or potentially essential to the present document may have been declared to ETSI. The information pertaining to these essential IPRs, if any, is publicly available for **ETSI members and non-members**, and can be found in ETSI SR 000 314: "*Intellectual Property Rights (IPRs); Essential, or potentially Essential, IPRs notified to ETSI in respect of ETSI standards*", which is available from the ETSI Secretariat. Latest updates are available on the ETSI Web server (<http://webapp.etsi.org/IPR/home.asp>).

Pursuant to the ETSI IPR Policy, no investigation, including IPR searches, has been carried out by ETSI. No guarantee can be given as to the existence of other IPRs not referenced in ETSI SR 000 314 (or the updates on the ETSI Web server) which are, or may be, or may become, essential to the present document.

Foreword

This ETSI Standard (ES) has been produced by ETSI Technical Committee Telecommunications and Internet converged Services and Protocols for Advanced Networking (TISPAN).

1 Scope

The present document defines a profile of the Gateway Control Protocol (H.248.1) to be used for controlling Border Gateway Functions (BGF), as defined in ES 282 003 [2].

2 References

References are either specific (identified by date of publication and/or edition number or version number) or non-specific.

- For a specific reference, subsequent revisions do not apply.
- Non-specific reference may be made only to a complete document or a part thereof and only in the following cases:
 - if it is accepted that it will be possible to use all future changes of the referenced document for the purposes of the referring document;
 - for informative references.

Referenced documents which are not found to be publicly available in the expected location might be found at <http://docbox.etsi.org/Reference>.

NOTE: While any hyperlinks included in this clause were valid at the time of publication ETSI cannot guarantee their long term validity.

2.1 Normative references

The following referenced documents are indispensable for the application of the present document. For dated references, only the edition cited applies. For non-specific references, the latest edition of the referenced document (including any amendments) applies.

- [1] ITU-T Recommendation H.248.1 (2005): "Gateway control protocol: Version 3" including its Amendment 1 (05/2008).
- [2] ETSI ES 282 003: "Telecommunications and Internet converged Services and Protocols for Advanced Networking (TISPAN); Resource and Admission Control Sub-System (RACS): Functional Architecture".
- [3] ITU-T Recommendation H.248.45 (2006): "Gateway control protocol: MGC information package".
- [4] ITU-T Recommendation H.460.18: "Traversal of H.323 signalling across network address translators and firewalls".
- [5] IETF RFC 5234: "Augmented BNF for Syntax Specifications: ABNF".
- [6] IETF RFC 3264: "An Offer/Answer Model with Session Description Protocol (SDP)".
- [7] IETF RFC 2663: "IP Network Address Translator (NAT) Terminology and Considerations".
- [8] ITU-T Recommendation H.248.37 (2008): "Gateway control protocol: IP NAPT traversal package".
- [9] ITU-T Recommendation H.248.54 (2007): "Gateway control protocol: MPLS support package".
- [10] ITU-T Recommendation H.248.56 (2007) Corrigendum 1 (2009): "Gateway control protocol: Packages for virtual private network support".

- [11] ITU-T Recommendation H.248.40 (2007): "Gateway Control Protocol: Application Data Inactivity Detection Package".
- [12] ITU-T Recommendation H.248.14 (2002) Revision 1 (2009): "Gateway control protocol: Inactivity timer package".
- [13] ITU-T Recommendation Q.3303.2 (2007): "Protocol at the interface between a Policy Decision Physical Entity (PD-PE) and a Policy Enforcement Physical Entity (PE-PE) (Rw Interface): H.248 Alternative".
- [14] ITU-T Recommendation H.248.11 (2002) Corrigendum 1(2008): "Gateway control protocol: Media gateway overload control package".
- [15] ITU-T Recommendation H.248.41 (2006): "Gateway control protocol: IP domain connection package".
- [16] ITU-T Recommendation H.248.52 (2008) Amendment 1 (2009): "Gateway control protocol: QoS support packages".
- [17] ITU-T Recommendation H.248.43 (2008): "Gateway control protocol: Packages for gate management and gate control".
- [18] ITU-T Recommendation H.248.53 (2008) Revision 1 (2009): "Gateway control protocol: Traffic management packages".
- [19] ETSI ES 283 018 (V1.1.4): "Telecommunications and Internet converged Services and Protocols for Advanced Networking (TISPAN); Resource and Admission Control: H.248 Profile for controlling Border Gateway Functions (BGF) in the Resource and Admission Control Subsystem (RACS); Protocol specification".
- [20] ITU-T Recommendation H.248.49 (2007): "Gateway control protocol: Session description protocol RFC and capabilities packages".
- [21] ITU-T Recommendation H.248.36 (2005): "Gateway control protocol: Hanging Termination Detection package".
- [22] ITU-T Recommendation H.248.47 (2008): "Gateway control protocol: Statistic conditional reporting package".
- [23] IETF RFC 4566: "SDP: Session Description Protocol".
- [24] IETF RFC 1123: "Requirements for Internet Hosts - Application and Support".
- [25] ITU-T Recommendation H.248.8: "Gateway control protocol: Error code and service change reason description".
- [26] IETF RFC 3605: "Real Time Control Protocol (RTCP) attribute in Session Description Protocol (SDP)".
- [27] ITU-T Recommendation H.248 Sub-series Implementors' Guide (2008): "Implementors' Guide for the H.248 Sub-series of Recommendations ("Media Gateway Control Protocol")".

2.2 Informative references

The following referenced documents are not essential to the use of the present document but they assist the user with regard to a particular subject area. For non-specific references, the latest version of the referenced document (including any amendments) applies.

- [i.1] ETSI TS 102 333: "Telecommunications and Internet converged Services and Protocols for Advanced Networking (TISPAN); Gate control protocol".
- [i.2] ETSI TS 183 025 (V2.5.1): "Telecommunications and Internet converged Services and Protocols for Advanced Networking (TISPAN); H.248 Non-call related procedures and management system interaction".

- [i.3] IETF RFC 2327: "SDP: Session Description Protocol".
- [i.4] ETSI ES 282 001: "Telecommunications and Internet converged Services and Protocols for Advanced Networking (TISPAN); NGN Functional Architecture".
- [i.5] ITU-T Recommendation V.152: "Procedures for supporting voice-band data over IP networks".
- [i.6] IETF RFC 4301: "Security Architecture for the Internet Protocol".
- [i.7] ITU-T Recommendation H.248.18: "Gateway control protocol: Package for support of multiple profiles".
- [i.8] IETF RFC 3550: "RTP: A Transport Protocol for Real-Time Applications".
- [i.9] IEEE 802.3 Ethernet Working Group.
- [i.10] ITU-T Recommendation Y.1221 (2002): "Traffic control and congestion control in IP based networks".
- [i.11] ITU-T Recommendation Y.1541 (2006): "Network performance objectives for IP-based services".
- [i.12] ETSI TS 181 005: "Telecommunications and Internet Converged Services and Protocols for Advanced Networking (TISPAN); Service and Capability Requirements".
- [i.13] ETSI TS 183 048: "Telecommunications and Internet Converged Services and Protocols for Advanced Networking (TISPAN); Resource and Admission Control System (RACS); Protocol Signalling flows specification; RACS Stage 3".
- [i.14] ETSI TS 183 017: "Telecommunications and Internet Converged Services and Protocols for Advanced Networking (TISPAN); Resource and Admission Control: DIAMETER protocol for session based policy set-up information exchange between the Application Function (AF) and the Service Policy Decision Function (SPDF); Protocol specification".
- [i.15] ITU-T H.Sup6 (Supplement 6 to ITU-T H-series Recommendations) (2006): "Decomposed gateways -Control load quantum - Busy hour context attempts (BHC0A) and busy hour session attempts (BHSA)".
- [i.16] IETF RFC 4145: "TCP-Based Media Transport in the Session Description Protocol (SDP)".

3 Definitions and abbreviations

3.1 Definitions

For the purposes of the present document, the following terms and definitions apply:

address: term used for "network address" (a.k.a. IP address)

BGF: packet-to-packet gateway for user plane media traffic

NOTE 1: The BGF performs both policy enforcement functions and NA(P)T functions under the control of the SPDF.

NOTE 2: A Border Gateway Function (BGF) provides the interface between two IP-transport domains. It may reside at the boundary between an access network and a core network or between two core networks, as defined in ES 282 001 [i.4]. The BGF has the "H.248 MG" role in the scope of this Profile.

GATE: represents a transport plane function enabling or disabling the unidirectional forwarding of IP packets under specified conditions (e.g. QoS)

NOTE: See TS 102 333 [i.1].

IP-to-IP Interworking Modes: available SDP information elements and values in the signalled SDP "media description" (mainly "m=" and "a=" lines) by the SPDF (MGC), may be used to categorize following interworking modes from BGF (MG) perspective:

- (1) **"Media-agnostic":**
 - The "m=" line values of *media type* (<media>) and *media format* (<fmt>) are not allowing to conclude for the BGF (MG) on the transported "media" information.
- (2) **"Media-aware":**
 - The "m=" line values of *media type* (<media>), *transport protocol* (<proto>) and *media format* (<fmt>) are unambiguously defining the entire protocol stack of the H.248 IP termination, i.e. the BGF (MG) knows transported "media" information and the underlying transport protocol type.
- (3) **"Transport protocol-agnostic" (or briefly "transport-agnostic"):**
 - The BGF (MG) may not conclude from signalled SDP information elements on the transported IP payload information (see note).
- (4) **"Transport protocol-aware" (or briefly "transport-aware"):**
 - The value of the IP *protocol* field is indicated by the signalled SDP information elements, e.g. by the "m=" line value of the *transport protocol* (<proto>) field.

NOTE: The BGF (MG) could principally derive the used transport protocol by analyzing the protocol field (<http://www.iana.org/assignments/protocol-numbers>) in the IP header, but such a function is beyond H.248. The BGF (MG) is still transport protocol-agnostic from H.248 point of view.

PINHOLE: configuration of two associated H.248 IP Terminations within the same H.248 Context, which allows/prohibits unidirectional forwarding of IP packets under specified conditions

NOTE 1: A pinhole may also be referred to as a "gate".

NOTE 2: E.g. address tuple.

NOTE 3: See ITU-T Recommendation H.248.37 [8].

port: term used for "transport port" (a.k.a. L4 port)

Resource and Admission Control Subsystem (RACS): provides admission control and gate control functionalities

NOTE: Including the control of NAPT and priority marking.

Service Policy Decision Function (SPDF): logical policy decision element for Service Based Policy control (SBP)

NOTE: The SPDF makes policy decisions using policy rules for Service Based Policy control (SBP). The SPDF has the "H.248 MGC" role in the scope of this Profile.

TRANSCODING: transcoding in general is the translation from one type of encoded media format to another different media format

EXAMPLE 1: G.711 A-law to μ -law or vice versa.

EXAMPLE 2: G.711 to G.726-40K.

EXAMPLE 3: G.729 to AMR with 4,75 rate.

EXAMPLE 4: G.711 to a broadband codec that operates at 256 kbps, etc.

NOTE 1: The definition of "transcoding" is according clause 3.10/ITU-T Recommendation V.152 [i.5].

NOTE 2: Transcoding belongs to the category of "media aware" IP-to-IP interworking (see above).

Transport Address: term used for the combination of an Address and a Port

3.2 Abbreviations

For the purposes of the present document, the following abbreviations apply:

ABNF	Augmented Backus-Naur Form
AC	Admission Control
AF	Application Function
AGW	Access GateWay
API	Application Programming Interface
AS	Application Specific
AVP	Attribute Value Pair
BGF	Border Gateway Function
BGW	Border GateWay
C-BGF	Core-BGF
CBR	Constant BitRate
CoAC	Context Admission Control
DSCP	Differentiated Services Code Point
GCP	Gate Control Protocol
HR	High Resolution (Report)
HW	HardWare
I-BGF	Interconnect-BGF
ID	IDentity
IP	Internet Protocol
IPsec	IP Security (RFC 4301 [i.6])
L2VPN	Layer 2 Virtual Private Network
L3VPN	Layer 3 Virtual Private Network
LD	Local Descriptor (H.248)
LS	Local Source
MG	Media Gateway
MGC	Media Gateway Controller
MID	Message Identifier (H.248)
MP	Measurement Point
MPLS	Multi Protocol Label Switching
NA	Not Applicable
NAPT	Network Address and Port Translation
NAPT-PT	NAPT and Protocol Translation
NAT	Network Address Translation
NGN	Next Generation Network
PCI	Protocol Control Information
PHB	Per-Hop Behaviour
QoS	Quality of Service
RACS	Resource and Admission Control Subsystem
RD	Remote Descriptor (H.248)
RFC	Request For Comments (IETF)
RP	Reporting Point
RS	Remote Source
RTCP	RTP Control Protocol
RTP	Real-time Transport Protocol
RTSP	Real Time Streaming Protocol
SAF	Source Address Filtering
SAM	Source Address Mask
SBP	Service Based Policy
SCTP	Stream Control Transport Protocol
SDP	Session Description Protocol
SIP	Session Initiation Protocol
SPDF	Service Policy Decision Function
SPF	Source Port Filtering
SPR	(Remote) Source Port
SPRR	(Remote) Source Port Range
SSRC	Synchronization Source (Identifier)
StAC	Stream Admission Control

TCP	Transmission Control Protocol
TISPAN	Telecommunications and Internet converged Services and Protocols for Advanced Networking
UDP	User Datagram Protocol
VBR	Variable BitRate
VLAN	Virtual LAN
VPN	Virtual Private Network
XR	eXtension Reports

NOTE: It has to be noted that there is also a different definition for "pinhole", which is used in the context of H.323 systems (see ITU-T Recommendation H.460.18 [4]). The difference is the fact that the "H.248 pinhole" and "gate" are unidirectional, whereas the "H.323 pinhole" is bidirectional.

4 Applicability

4.1 Architecture

The present document defines an H.248 Profile for the reference point between the Service Policy Decision Function (SPDF) and the Border Gateway Function (BGF), known as the Ia reference point. The SPDF interacts with the BGF to request services. This reference point is used for communication between the SPDF and a Core Border Gateway Function (C-BGF) and between the SPDF and an Interconnect Border Gateway Function (I-BGF).

Specific requirements for this reference point are described in ES 282 003 [2]. Figure 1 illustrates the architecture assumed in the present document.

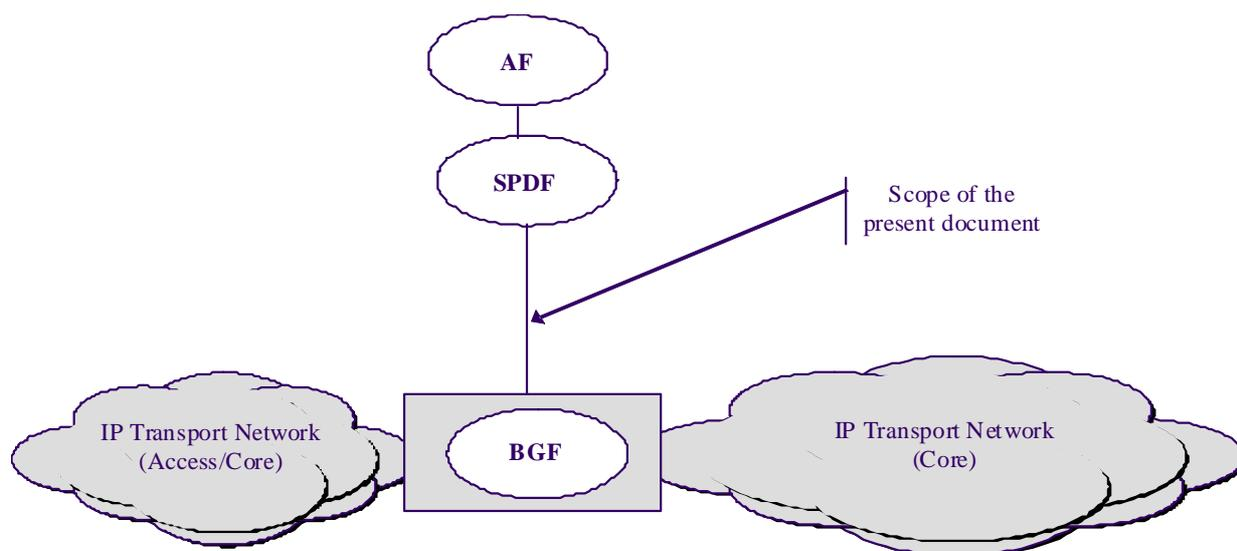

Figure 1: Reference architecture

4.2 Border Gateway Guidelines

Guidelines for usage and implementation of border gateways are described in annexes A, D and E.

5 Profile description

5.1 Profile identification

Table 1: Profile identification

Profile name:	ETSI_BGF
Version:	2

5.2 Summary

This profile supports the control of the following functionality in IP-to-IP Media Gateways:

- opening and closing gates (i.e. packets filtering depending on "IP address/port");
- allocation and translation of IP addresses and port numbers (NAPT):
 - IP realm/domain indication (via H.248.41);
 - RTCP handling;
- interworking between IPv4 and IPv6 networks (NAPT-PT);
- topology hiding;
- hosted NAT traversal;
- packet marking for outgoing traffic;
- resource allocation and bandwidth reservation:
 - one and two-stage BGF resource reservation;
- policing of incoming traffic;
- QoS and usage metering:
 - conditional statistics reporting;
- transcoding;
- detection of inactive bearer connections;
- specific call-independent procedures:
 - detection of hanging H.248 terminations; and
- BGF overload control (at H.248 interface).

5.3 Gateway Control Protocol Version

ITU-T Recommendation H.248.1 [1] Version 3.

NOTE: Version 3 of the H.248 protocol is needed, due to the possible usage of stream statistics.

5.4 Connection model

Table 2: Connection model

Maximum number of contexts:	Provisioned
Maximum number of terminations per context:	2
Allowed terminations type combinations:	(IP,IP)

5.5 Context attributes

Table 3: Context attributes

Context attribute	Supported	Values supported
Topology	No	NA
Priority Indicator	Yes	0 to15
Emergency Indicator	Yes	ON/OFF
IEPS Indicator	No	NA
ContextAttribute Descriptor	No	NA
ContextIdList Parameter	No	NA
AND/OR Context Attribute	No	NA

5.6 Terminations

5.6.1 Termination names

5.6.1.1 IP Termination

5.6.1.1.1 Overview and prose specification

The Termination ID structure shall follow the guidelines of H.248 and shall be based on four fields:

- "ip/<group>/<interface>/<id>".

The individual fields are described and defined in table 4.

Table 4: IP Termination Fields

Name	Description	Values	CHOOSE Wildcard	ALL Wildcard
ip	"ip" is a fixed prefix identifying the termination	"ip"	No	No
Group	Group of Interface and Id	Integer (0 to 255)	No	Yes
Interface	Logical or physical interface to a network to/from which the termination will be sending/receiving media. (See notes 1 and 2).	String of max 51 alphanumeric characters	Yes (see note 5)	Yes
id	Termination specific identifier (See note 3).	Non-zero 32 bit integer	Yes (see note 4)	Yes

NOTE 1: A specific <Interface> may be used together with different groups.

NOTE 2: The generic field <Interface> may relate specifically to an "IP interface", "protocol layer 2 interface" or others.

NOTE 3: The combination of Interface and Id is unique.

NOTE 4: In version 1 of this profile, there was a tacit assumption that the MGC used a CHOOSE wildcard in an ADD request command. In this version, the MGC shall always use CHOOSE in an ADD request command. If not, the MG shall reply with an error descriptor using error code #501 "Not Implemented". See also clause 5.6.1.1.1.3.

NOTE 5: The MGC shall always use CHOOSE in an ADD request command. If not, the MG shall reply with an error descriptor using error code #501 "Not Implemented".

NOTE: The SPDF has the ability to choose the address space in which the BGF will allocate an IP address for the termination by using the `ipdc/realm` property defined in the H.248.41 IP domain connection package.

H.248 wildcarding may be applied on IP Termination Identifiers. Wildcarding is limited according the two columns on the right hand side.

5.6.1.1.1 Combined usage of fields Group and Interface

There are two potential relationships between `<group>` and `<interface>` within the TerminationID structure:

- **strictly hierarchical:** a single "interface" is completely associated to a dedicated "group".

EXAMPLE 1: May be driven for instance by hardware architecture or addressing schemes with the goal of minimizing ServiceChange command load by using wildcards such as `ip/<group>/*` for potential HW failures that may lead to issuing a single ServiceChange command rather than multiple ServiceChange commands.

- **partially hierarchical:** an "interface" is distributed over multiple "groups".

EXAMPLE 2: A logical partition concept may be driven for instance for selective auditing with the goal of minimizing the AuditReply to be of a manageable size by having the MGC allocate an adequate number of terminations within a `<group>`. Therefore Audits could be paced for example: `ip/1/*`, `ip/2/*`, ..., `ip/n/*`.

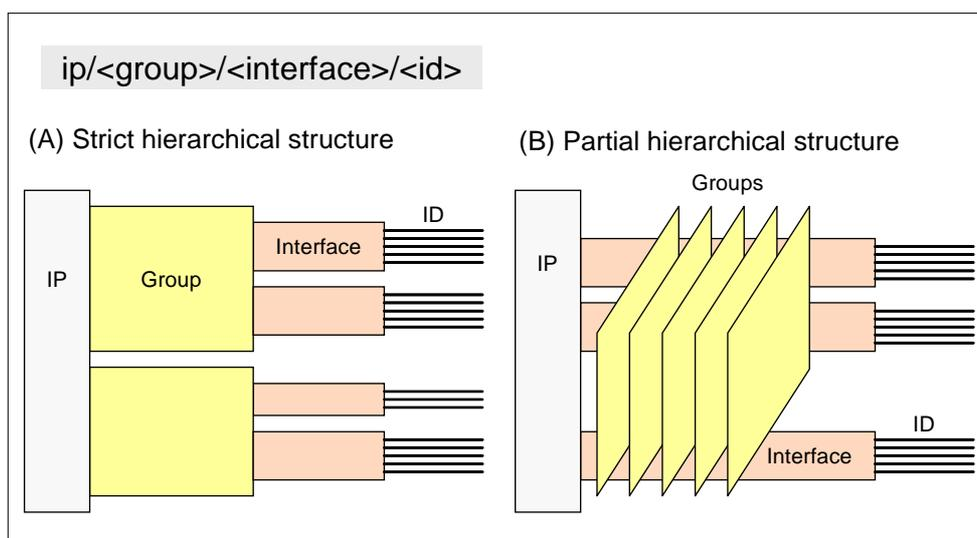

Figure 2: Group/Interface relationships for the structure of terminationIDs
Potential use cases

The following examples depict the advantages that each group/interface relationship may facilitate.

Table 5: Examples of Group/interface relationship in ServiceChange

Semantic of Termination Name	ServiceChange Command (e.g. due to a HW Failure)
Strictly hierarchical	<p>Upon a HW failure the command issued is (by MG):</p> <pre>ServiceChange=ip/1/*{Services{ Method=Forced, Reason="906" }}},</pre> <p>a single wildcarded command is possible (facilitated by a strict hierarchical relationship).</p>
Partially hierarchical	<p>Upon a HW failure the command issued is (by MG):</p> <pre>ServiceChange=ip/*/1/*{Services{ Method=Forced, Reason="906" }}}, ServiceChange=ip/*/2/*{Services{ Method=Forced, Reason="906" }}}, ... ServiceChange=ip/*/x/*{Services{ Method=Forced, Reason="906" }}}</pre> <p>... a single wildcarded command is not always possible when not using a strict hierarchical relationship</p>

Table 5a: Examples of Termination ID usage in AuditValue

Usage of Termination ID structure	AuditValue Command (e.g. Requesting a list of Context IDs present in the MG where n and N are number of contexts in the AuditValue Replies and n<<N)
Neither group nor interface levels specified in request	<p>The command (from MGC):</p> <pre>Context={AuditValue=Root{Audit{}}}</pre> <p>Returns:</p> <pre>Context=1{AuditValue=ip/1/11/101{ },AuditValue=ip/1/12/102{ }}, Context=2{AuditValue=ip/1/21/201{ },AuditValue=ip/1/22/202{ }}, Context=3{AuditValue=ip/1/31/301{ },AuditValue=ip/1/32/302{ }}, ... Context=N{AuditValue=ip/256/11/504{ },AuditValue=ip/256/12/534{ }}</pre> <p>... this could potentially return very large AuditValue Replies.</p>
Group level specified in request	<p>The command (by MGC):</p> <pre>Context={AuditValue=ip/1/*{Audit{}}}</pre> <p>Returns:</p> <pre>Context=1{AuditValue=ip/1/11/101{ },AuditValue=ip/1/12/102{ }}, ... Context=n{AuditValue=ip/1/51/121{ },AuditValue=ip/1/52/122{ }}</pre> <p>... and this command would be repeated for each group. (facilitated by loose hierarchical relationship)</p>

5.6.1.1.1.2 Optimization of call-independent procedures

The CHOOSE wildcard for "Interface" is introduced by this version of the profile.

The MGC may optimize (see note 1) call-independent procedures, e.g. based on the AuditValue command, by fully controlling the value allocation for field Group.

NOTE 1: "Optimization" could e.g. mean a load shaping function concerning H.248 processing load.

The MG may optimize (see note 2) call-independent procedures, e.g. based on the ServiceChange command, via full control over the value allocation for field Interface.

NOTE 2: "Optimization" may allow single wildcarded commands, see discussion in table 5.

5.6.1.1.1.3 Field "Id": Usage of wildcard CHOOSE or not

The CHOOSE wildcard for "Id" must be applied in the ADD.request command. It is the MGs responsibility for managing the value range of this logical resource.

5.6.1.1.2 Syntactical Specification

5.6.1.1.2.1 ABNF Grammar for H.248 Text Encoding Mode

ABNF (RFC 5234 [5]) is used for the syntax specification. The ABNF for TerminationID and relation to pathNAME is defined in annex B.2/H.248.1 [1].

ABNF coding:

```

pathNAME      = EphToken SLASH EPHsystem
EphToken      = "ip"                ; prefix
EPHsystem     = WildcardALL
               / WildcardALL SLASH Interface
               / Group SLASH WildcardALL
               / Group SLASH (Interface / WildcardCHOOSE) SLASH (Identifier / WildcardALL /
WildcardCHOOSE)
Group         = %d0-255              ; data type: INT8
Interface     = 1*51ALPHANUM
Identifier    = %d1-4294967295      ; data type: INT32
ALPHANUM     = ALPHA / DIGIT
WildcardCHOOSE = "$"
WildcardALL   = "*"

```

5.6.2 Multiplexed terminations

Table 6: Multiplexed terminations

MultiplexTerminations Supported?	No
----------------------------------	----

5.7 Descriptors

5.7.1 TerminationState descriptor

Table 7: ServiceState property

ServiceState property used:	No
-----------------------------	----

NOTE: All H.248 Terminations have a ServiceState property according to H.248.1, but explicit usage of the TerminationState Descriptor ServiceState property is not required by this Profile. ServiceState changes can still occur, however, and be indicated in ServiceChange Commands (i.e. this means that the value of the ServiceState property may be implicitly changed by ServiceChange procedures).

Table 8: EventBufferControl property

EventBufferControl property used:	No
-----------------------------------	----

5.7.2 Stream descriptor

Table 9: Stream descriptor

Maximum number of streams per termination type:	IP	5
---	----	---

Table 10: Stream configuration

Stream Configuration:	ALL configurations are allowed
-----------------------	--------------------------------

5.7.2.1 LocalControl descriptor

Table 11: LocalControl descriptor

If not generic list appropriate termination and stream types		Termination Type	Stream Type
ReserveGroup used:	No		
ReserveValue used:	No		

Table 12: Termination type

Termination Type	Stream Type	Allowed StreamMode Values
IP	RTP/AVP	SendOnly, RecvOnly, SendRecv, Inactive
	tcp	SendRecv, Inactive
	udptl	SendRecv, Inactive
	udp	SendOnly, RecvOnly, SendRecv, Inactive

NOTE: Other stream types are for further study.

5.7.3 Events descriptor

Table 13: Events descriptor

Events settable on termination types and stream types	Yes		
	If yes	Event ID	Termination Type
	See clause 5.14.2.1 • g/cause	ALL except ROOT	ANY
	See clause 5.14.2.3 • nt/netfail • nt/qualert	ALL except ROOT	ANY
	See clause 5.14.2.11 • it/ito	only ROOT	NA
	See clause 5.14.2.14 • adid/ipstop	ALL except ROOT	ANY
	See clause 5.14.2.16 • ocp/mg_overload	only ROOT	NA
	See clause 5.14.2.17 • hangterm/thb	ALL except ROOT	NA
	See clause 5.14.2.18 • scr/cr	ALL except ROOT	NA

Table 14: EventBuffer control

EventBuffer Control used:	No
---------------------------	----

Table 15: KeepActive

KeepActive used on events:	No
----------------------------	----

Table 16: Embedded events and signals

Embedded events in an Events Descriptor:	No
Embedded signals in an Events Descriptor:	No

Table 17: Regulated embedded events

Regulated Embedded events are triggered on:	None
---	------

Table 18: ResetEventsDescriptor

ResetEventsDescriptor used with events:	None
---	------

Table 19: NotifyImmediate, NotifyRegulated and NeverNotify

NotifyImmediate:	ALL events
NotifyRegulated:	None
NeverNotify:	None

5.7.4 EventBuffer descriptor

Table 20: EventBuffer descriptor

EventBuffer Descriptor used:	No
------------------------------	----

5.7.5 Signals descriptor

Table 21: Signals descriptor

Signals settable dependant on termination or streams types	Yes		
If yes	Signal ID	Termination Type	Stream Type/ID
	ipnapt/*	ALL except ROOT	ANY

Table 22: Signals lists

Signals Lists supported:	No
--------------------------	----

Table 23: Signals type and duration

Signal type and duration supported:	No
-------------------------------------	----

Table 24: Signals direction

Signal Direction supported:	No
-----------------------------	----

Table 25: NotifyCompletion and RequestID

NotifyCompletion supported:	No
RequestID Parameter Supported:	No

Table 26: Simultaneously played signals

Signals played simultaneously:	No
--------------------------------	----

Table 27: KeepActive

KeepActive used on signals:	No
-----------------------------	----

5.7.6 DigitMap descriptor

Table 28: DigitMap descriptor

DigitMaps supported:	No
----------------------	----

5.7.7 Statistics descriptor

Table 29: Statistics Descriptor

Statistics supported on:	Stream
--------------------------	--------

Table 30: Statistics Reported On Subtract

Statistics reported on Subtract:	Yes	
If yes	Statistic IDs reported:	ALL (See clause 5.14 for details)

5.7.8 ObservedEvents descriptor

Table 31: ObservedEvents descriptor

Event detection time supported:	No
---------------------------------	----

5.7.9 Topology descriptor

Table 32: Topology descriptor

Allowed triples:	NA
------------------	----

5.7.10 Error descriptor

Table 33: Error Codes sent by MGC

Supported H.248.8 Error Codes:	ALL
Supported Error Codes defined in packages:	All error codes defined in supported packages need to be supported.

Table 34: Error Codes sent by MG

Supported H.248.8 Error Codes:	ALL with exception of #514 "Media Gateway cannot send the specified announcement" #518 "Event buffer full" #519 "Out of space to store digit map" #520 "Digit Map undefined in the MG" #522 "Functionality Requested in Topology Triple Not Supported"
Supported Error Codes defined in packages:	All error codes defined in supported packages need to be supported.

5.8 Command API

Table 35 shows in which direction commands are sent, which terminations they can be associated with, and which wildcard options are supported for the specific command.

Table 35: Commands and terminations

Command	Sent By	Used on Termination Type		Wildcard Support	
		IP	ROOT	W-	O-
Add	SPDF	Yes	No	No	No
AuditCapabilities	-	-	-	-	-
AuditValue	SPDF	Yes	Yes	No	Yes
Modify	SPDF	Yes	Yes	No	No
Move	-	-	-	-	-
Notify	BGF	Yes	Yes	No	No
ServiceChange	BGF	Yes	Yes	No	No
Subtract	SPDF	Yes	No	Yes	No

Table 35 shows for which termination types a specific descriptor can be applied, and tables 36 and 37 show with which commands and replies the descriptor can be used respectively.

Table 36: Descriptors and requests

Descriptor type (see note 1)	Termination type	
	Root	IP
Audit	Yes	Yes
Error		
Events	Yes	Yes
Local		Yes
LocalControl		Yes
Media	Yes (see note 2)	Yes
ObservedEvents	Yes	Yes
Packages	Yes	
ServiceChange	Yes	Yes
Signals		Yes
Statistics		Yes
Stream		Yes
TerminationState	Yes (see note 2)	

NOTE 1: Only H.248 descriptors supported within this H.248 profile specification are shown.
NOTE 2: E.g. Base Root package properties.

Table 37: Descriptors and replies

Descriptor type (see note 1)	Termination type	
	Root	IP
Audit		
Error	Yes	Yes
Events	Yes	Yes
Local		
LocalControl (see note 2)		Yes
Media		Yes
ObservedEvents		
Packages	Yes	
Remote		
ServiceChange	Yes	Yes
Signals (see note 3)		
Statistics		Yes
Stream		Yes
TerminationState	Yes	
NOTE 1: Only H.248 descriptors supported within this H.248 profile specification are shown.		
NOTE 2: According to clause 5.8.5, auditing of mgcinfo/db in LocalControl is required.		
NOTE 3: According to clause 5.8.5, auditing of H.248 signals descriptors is not required.		

It is seen that an Error Descriptor may be returned in any command reply and thus the Error Descriptor is not included in any subsequent command reply tables.

5.8.1 Add

Table 38: Descriptors used by Add Request

Descriptors used by Add request:	Media (Stream(LocalControl, Statistics, Local, Remote)), Event, Signals
NOTE:	Statistics are enabled as default. The MGC may explicitly request or suppress statistics generation for individual streams by inclusion of the Statistics descriptor in the Add request command (see clause 7.1.15, ITU-T Recommendation H.248.1 [1]).

Table 39: Descriptors used by Add Reply

Descriptors used by Add reply:	Media (Stream (Local))
--------------------------------	------------------------

5.8.2 Modify

Table 40: Descriptors used by Modify Request

Descriptors used by Modify request:	Media (TerminationState, Stream (LocalControl, Statistics, Local, Remote)), Audit (Media (Stream (Statistics))), Signals, Event
-------------------------------------	---

Table 41: Descriptors used by Modify Reply

Descriptors used by Modify reply:	Media (Stream(Local, Statistics))
-----------------------------------	-----------------------------------

5.8.3 Subtract

Table 42: Descriptors used by Subtract Request

Descriptors used by Subtract request:	Audit() OR NONE
NOTE:	This profile version supports reporting of statistics on all streams or none of the streams. Reporting and disabling of statistics from a subset of the streams in case of multiple streams is not supported by this profile version. Termination level statistics are not supported.

Table 43: Descriptors used by Subtract Reply

Descriptors used by Subtract reply:	Media(Stream(Statistics)) OR NONE
-------------------------------------	-----------------------------------

5.8.4 Move

Table 44: Descriptors used by Move Command

Move command used:	No
--------------------	----

5.8.5 AuditValue

Table 45: AuditValue

Audited Properties:	Media(TerminationState) (see notes 1, 2) Media (Stream(LocalControl)) (see note 3)
Audited Statistics:	ALL
Audited Signals:	None
Audited Events:	None
Packages Audit possible:	Yes
NOTE 1: See note in clause 5.7.1.	
NOTE 2: These are the root/* and seg/* properties.	
NOTE 3: This is the audit for the mgcinfo/db property.	

5.8.6 AuditCapabilities

Table 46: Descriptors used by AuditCapabilities Command

AuditCapabilities command used:	No
---------------------------------	----

5.8.7 Notify

Table 47: Descriptors used by Notify Request

Descriptors used by Notify Request: Descriptors used by Notify Reply:	ObservedEvents
--	----------------

Table 47a: Descriptors used by Notify Reply

Descriptors used by Notify Reply:	None
-----------------------------------	------

5.8.8 ServiceChange

Table 48: ServiceChangeMethods and ServiceChangeReasons sent by MGC

Service Change Methods Supported	ServiceChange Reasons supported
Restart	900, 901
Handoff	903

Table 49: ServiceChangeMethods and ServiceChangeReasons sent by MG

Service Change Methods Supported	ServiceChange Reasons supported
Disconnected	900
Forced	904, 905, 906, 915
Restart	901, 902
Graceful	905, 908
Failover	909
Handoff	903

Table 50: ServiceChangeAddress

ServiceChangeAddress used:	No
----------------------------	----

Table 51: ServiceChangeDelay

ServiceChangeDelay used:	Yes	
If yes	Valid time period:	Provisioned

Table 52: ServiceChange Incomplete Flag

ServiceChange Incomplete Flag used:	No
-------------------------------------	----

Table 53: ServiceChangeVersion

Version used in ServiceChangeVersion:	3
---------------------------------------	---

Table 54: Profile Negotiation

Profile negotiation as per ITU-T Recommendation H.248.18 [i.7]:	No
---	----

Table 54a: ServiceChangeMGCIId

ServiceChangeMGCIId used:	Yes
---------------------------	-----

5.8.9 Manipulating and auditing context attributes

Table 55: Context Attributes Manipulation and Auditing

Context Attributes Manipulated:	Emergency, Priority
Context Attributes Audited:	None

5.9 Generic command syntax and encoding

Table 56: Command Encoding

Supported Encodings:	Text (see notes 1 and 2)
NOTE 1: The receiver shall be capable of receiving both Short Token Notation and Long Token Notation on an H.248 control association.	
NOTE 2: The transmitter may select between long and short token forms per H.248 control association.	

5.10 Transactions

Table 57: Maximum number of Transaction Requests/Replies/TransResponseAcks/Segment

Maximum number of Transaction Requests/Replies/TransResponseAcks/Segment Replies per message:	1
---	---

Table 58: Maximum number of Commands per Transaction Request

Maximum number of commands per Transaction request:	2
---	---

Table 59: Maximum number of Commands per Transaction Reply

Maximum number of commands per Transaction reply:	2
---	---

Table 60: Optional Commands

Commands able to be marked "Optional":	AuditValue
--	------------

Table 61: Wildcarded Commands

Commands able to be marked "Wildcarded":	Subtract
--	----------

Table 62: Transaction Timer

Transaction Timer:	Value
normalMGExecutionTime	Provisioned, changeable with Base Root Package (see clause 5.14.2)
normalMGCExecutionTime	Provisioned, changeable with Base Root Package (see clause 5.14.2)
MGOriginatedPendingLimit	Provisioned, changeable with Base Root Package (see clause 5.14.2)
MGCOriginatedPendingLimit	Provisioned, changeable with Base Root Package (see clause 5.14.2)
MGProvisionalResponseTimerValue	Provisioned, changeable with Base Root Package (see clause 5.14.2)
MGCProvisionalResponseTimerValue	Provisioned, changeable with Base Root Package (see clause 5.14.2)

5.11 Messages

It is recommended that MGC and MG names are in the form of fully qualified domain names. For example the domain name of the MGC may be of the form `mgc1.whatever.net` and the name of the MG may be of the form `mg1.whatever.net`.

The fully qualified domain name will be used by the MGC and MG as part of the "Message Identifier" in the H.248 messages which identifies the originator of the message.

5.12 Transport

Table 63: Transport

Supported Transports:	SCTP (Recommended) UDP (Optional)
-----------------------	--------------------------------------

Table 64: Segmentation

Segmentation Supported:	SCTP: Inherent in Transport UDP: Optional (dependent on support of Segmentation Package, see clause 5.14.2.12)
-------------------------	---

Table 65: Control Association

Control Association Monitoring Supported:	Monitoring mechanism is dependent on used H.248 transport (see table 63): SCTP: inherent capability of SCTP. UDP: H.248.14 (MG-driven monitoring). Empty AuditValue on ROOT (MGC-driven monitoring).
---	---

5.13 Security

Table 66: Security

Supported Security:	None
---------------------	------

5.14 Packages

This clause includes details of the mandatory and optional H.248 packages that are included in this profile. The meaning of mandatory and optional packages and their properties, signals, events, and statistics is defined in ITU-T Recommendation H.248 Sub-series Implementers' Guide [27].

5.14.1 Overview

Table 67: Mandatory Packages

Mandatory Packages		
Package Name	Package ID	Version
Generic (ITU-T Recommendation H.248.1 [1], clause E.1)	g	2
Base root (ITU-T Recommendation H.248.1 [1], clause E.2)	root	2
Network (ITU-T Recommendation H.248.1 [1], clause E.11)	nt	1
Diffserv (ITU-T Recommendation H.248.52 [16])	ds	1
Gate management (ITU-T Recommendation H.248.43 [17], appendix 1)	gm	1
Traffic management (ITU-T Recommendation H.248.53 [18])	tman	1
IP NAPT traversal (ITU-T Recommendation H.248.37 [8])	ipnapt	1
IP Domain Connection (ITU-T Recommendation H.248.41 [15])	ipdc	1

Table 68: Optional Packages

Optional Packages			
Package Name	Package ID	Version	Support dependent on
MPLS (ITU-T Recommendation H.248.54 [9])	mpls	1	Support of MPLS label stacks - i.e. Label Switched Paths terminated by the MG and related to the H.248 termination.
VLAN (ITU-T Recommendation H.248.56 [10])	vlan	1	Support of VLAN tags and/or Ethernet priorities.
MGC Information (ITU-T Recommendation H.248.45 [3])	mgcinfo	1	Support of MGC related recovery.
Inactivity Timer (ITU-T Recommendation H.248.14 [12])	it	1	Only applicable for UDP transport.
Segmentation (ITU-T Recommendation H.248.1 [1], Annex E.14)	seg	1	Applicable for UDP transport where sufficiently large messages are required to be supported.
RTP (ITU-T Recommendation H.248.1 [1], annex E.12)	rtp	1	Support of usage metering and statistics reporting. Particular package capabilities are only applicable for "media-aware" bearer connections.
Application Data Inactivity Detection (ITU-T Recommendation H.248.40 [11])	adid	1	MGC requires to be explicitly informed of a cessation of an application data flow.
Media Gateway Overload Control (ITU-T Recommendation H.248.11 [14])	ocp	1	Support of message throttling, based on rate limitation, from MGC towards MG.
Hanging Termination Detection (ITU-T Recommendation H.248.36 [21])	hangterm	1	Support of Hanging Termination Detection.
Statistics Conditional Reporting (ITU-T Recommendation H.248.47 [22])	scr	1	Support of real time reporting of specific statistics based on a particular condition. This package may be supported as an operator option.
Gate management (ITU-T Recommendation H.248.43 [17])	gm	2	Support of filtering based on source port range.

5.14.2 Package usage information

5.14.2.1 Generic (g)

Table 69: Generic package

Properties	Mandatory/Optional	Used in command	Supported Values	Provisioned Value
None				
Signals	Mandatory/Optional	Used in command		Duration Provisioned Value
None				
	Signal Parameters	Mandatory/Optional	Supported Values	Duration Provisioned Value
Events	Mandatory/Optional	Used in command		
Cause (g/cause)	M	ADD, NOTIFY		
	Event Parameters	Mandatory/Optional	Supported Values	Provisioned Value
	None			
	ObservedEvent Parameters	Mandatory/Optional	Supported Values	Provisioned Value
	General cause (Generalcause)	M	ALL	NA
	Failure cause (Failurecause)	M	ALL	NA
Statistics	Mandatory/Optional	Used in command	Supported Values	
None				
Error Codes	Mandatory/Optional			
None				

5.14.2.2 Base root (root)

Table 70: Base root package

Properties	Mandatory/Optional	Used in command	Supported Values	Provisioned Value
MaxNrOfContexts (root/maxNumberOfContexts)	O	AUDITVALUE	ALL	YES
MaxTerminationsPerContext (root/maxTerminationPerContext)	O	AUDITVALUE	ALL	YES
normalMGExecutionTime (root/normalMGExecutionTime)	O	MODIFY, AUDITVALUE	ALL	YES
normalMGCEExecutionTime (root/normalMGCEExecutionTime)	O	MODIFY, AUDITVALUE	ALL	YES
MGProvisionalResponseTimerValue (root/MGProvisionalResponseTimerValue)	O	MODIFY, AUDITVALUE	ALL	YES
MGCProvisionalResponseTimerValue (root/MGCProvisionalResponseTimerValue)	O	MODIFY, AUDITVALUE	ALL	YES
MGCOriginatedPendingLimit (root/MGCOriginatedPendingLimit)	O	MODIFY, AUDITVALUE	ALL	YES
MGOriginatedPendingLimit (root/MGOriginatedPendingLimit)	O	MODIFY, AUDITVALUE	ALL	YES
Signals	Mandatory/Optional	Used in command		Duration Provisioned Value
None				
	Signal Parameters	Mandatory/Optional	Supported Values	Duration Provisioned Value
Events	Mandatory/Optional	Used in command		
None				
	Event Parameters	Mandatory/Optional	Supported Values	Provisioned Value
	ObservedEvent Parameters	Mandatory/Optional	Supported Values	Provisioned Value
Statistics	Mandatory/Optional	Used in command	Supported Values	
None				
Error Codes	Mandatory/Optional			
None				

5.14.2.3 Network (nt)

Table 71: Network package

Properties	Mandatory/Optional	Used in command	Supported Values	Provisioned Value
Maximum jitter buffer (nt/jit)	O	ADD, MODIFY	ALL	YES
Signals	Mandatory/Optional	Used in command		Duration Provisioned Value
None				
	Signal Parameters	Mandatory/Optional	Supported Values	Duration Provisioned Value
Events	Mandatory/Optional	Used in command		
Network failure (nt/netfail)	O	ADD, MODIFY, NOTIFY		
	Event Parameters	Mandatory/Optional	Supported Values	Provisioned Value
	None	-	-	-
	ObservedEvent Parameters	Mandatory/Optional	Supported Values	Provisioned Value
	Cause (cs)	O	For further studies.	For further studies (see note)
Quality alert (nt/qualert)	O	ADD, MODIFY, NOTIFY		
	Event Parameters	Mandatory/Optional	Supported Values	Provisioned Value
	Threshold (th)	O	ALL	NA
	ObservedEvent Parameters	Mandatory/Optional	Supported Values	Provisioned Value
	Threshold (th)	O	ALL	NA
Statistics	Mandatory/Optional	Used in command	Supported Values	
Duration (nt/dur)	O	ADD, SUBTRACT, MODIFY, AUDITVALUE	ALL	
Octets sent (nt/os)	M	ADD, SUBTRACT	ALL	
	O	MODIFY, AUDITVALUE	ALL	
Octets received (nt/or)	M	ADD, SUBTRACT	ALL	
	O	MODIFY, AUDITVALUE	ALL	
Error Codes	Mandatory/Optional			
None				
NOTE: This event may be overloaded in order to address multiple failure causes (see ITU-T Recommendation H.248.1 [1] Version 3, clause E.11.5.1.2). An unambiguous distinction on MGC and MG side implies mutually agreed cause codepoints. This is a provisioning activity.				

5.14.2.4 Differentiated Services (ds)

Table 72: Differentiated Services package

Properties	Mandatory/Optional	Used in command	Supported Values	Provisioned Value
Differentiated Services Code Point (ds/dscp)	M	ADD, MODIFY	ALL	Yes (note)
Signals	Mandatory/Optional	Used in command		Duration Provisioned Value
None				
	Signal Parameters	Mandatory/Optional	Supported Values	Duration Provisioned Value
Events	Mandatory/Optional	Used in command		
None				
	Event Parameters	Mandatory/Optional	Supported Values	Provisioned Value
	ObservedEvent Parameters	Mandatory/Optional	Supported Values	Provisioned Value
Statistics	Mandatory/Optional	Used in command	Supported Values	
None				
Error Codes	Mandatory/Optional			
None				
NOTE: In accordance with ITU-T Recommendation H.248.52 [16] Differentiated Services package version 1 the provisioned value can be either:				
- Set to a specific <i>ds/dscp</i> value or,				
- Set to a value representing the H.248.52 capability to copy the dscp value received in the ingress packet to the egress packets. The copy mechanism is explicitly described in amendment 1 to ITU-T Recommendation H.248.52 [16].				

5.14.2.5 Gate Management (gm)

Table 73: Gate Management Package

Properties	Mandatory/Optional	Used in command	Supported Values	Provisioned Value
Remote Source Address Filtering (gm/saf)	M	ADD, MODIFY	ALL	NA (see note 1)
Remote Source Address Mask (gm/sam)	O	ADD, MODIFY	ALL	NA
Remote Source Port Filtering (gm/spf)	M	ADD, MODIFY	ALL	NA (see note 1)
Remote Source Port (gm/spr)	O	ADD, MODIFY	ALL	NA
Remote Source Port Range (gm/spr) (see note 3)	O	ADD, MODIFY	ALL	NA
Explicit Source Address Setting (gm/esas)	O	ADD, MODIFY	ALL	(see note 1)
Local Source Address (gm/lisa)	O	ADD, MODIFY	ALL	NA
Explicit Source Port Setting (gm/esps)	O	ADD, MODIFY	ALL	(see note 1)
Local Source Port (gm/lsp)	O	ADD, MODIFY	ALL	NA
RTP Specific Behaviour (gm/rsb)	M	ADD, MODIFY	ALL	OFF (see note 2)
Signals	Mandatory/Optional	Used in command		Duration Provisioned Value
None	-	-		-
	Signal Parameters	Mandatory/Optional	Supported Values	Duration Provisioned Value
	-	-	-	-
Events	Mandatory/Optional	Used in command		
None	-	-		
	Event Parameters	Mandatory/Optional	Supported Values	Provisioned Value
	-	-	-	-
	ObservedEvent Parameters	Mandatory/Optional	Supported Values	Provisioned Value
-	-	-	-	
Statistics	Mandatory/Optional	Used in command	Supported Values	
Discarded Packets (gm/dp)	O	ADD, MODIFY, SUBTRACT, AUDITVALUE	ALL	
Error Codes	Mandatory/Optional			
None				
NOTE 1: Default value is "OFF" in gm/1 (see ITU-T Recommendation H.248.43 [17]).				
NOTE 2: Default value must be provisioned in gm/1 (see ITU-T Recommendation H.248.43 [17]). The provisioned value in this profile shall be OFF.				
NOTE 3: This property is defined in gm/2 while all other properties exist in gm/1.				

5.14.2.6 Traffic management (tman)

Table 74: Traffic Management Package

Properties	Mandatory/Optional	Used in command	Supported Values	Provisioned Value
tman/pol	M	ADD, MODIFY	ALL	Yes
tman/pdr	M	ADD, MODIFY	ALL	NA
tman/dvt	M	ADD, MODIFY	ALL	Yes
tman/sdr	M	ADD, MODIFY	ALL	NA
tman/mbs	M	ADD, MODIFY	ALL	Yes
Signals	Mandatory/Optional	Used in command		Duration Provisioned Value
None				
	Signal Parameters	Mandatory/Optional	Supported Values	Duration Provisioned Value
Events	Mandatory/Optional	Used in command		
None				
	Event Parameters	Mandatory/Optional	Supported Values	Provisioned Value
ObservedEvent Parameters	Mandatory/Optional	Supported Values	Provisioned Value	
Statistics	Mandatory/Optional	Used in command	Supported Values	
None				
Error Codes	Mandatory/Optional			
None				

5.14.2.7 IP NAPT Traversal (ipnapt)

Table 75: IP NAPT Traversal Package

Properties	Mandatory/Optional	Used in command	Supported Values	Provisioned Value
None				
Signals	Mandatory/Optional	Used in command		Duration Provisioned Value
Latching (ipnapt/latch)	M	ADD, MODIFY		NA
	Signal Parameters	Mandatory/Optional	Supported Values	Duration Provisioned Value
	NAPT Traversal Processing (napt)	M	ALL	NA
Events	Mandatory/Optional	Used in command		
None				
	Event Parameters	Mandatory/Optional	Supported Values	Provisioned Value
ObservedEvent Parameters	Mandatory/Optional	Supported Values	Provisioned Value	
Statistics	Mandatory/Optional	Used in command	Supported Values	
None				
Error Codes	Mandatory/Optional			
None				

5.14.2.8 MPLS (mpls)

Table 76: MPLS Package

Properties	Mandatory/Optional	Used in command	Supported Values	Provisioned Value
ALL	O	ADD, MODIFY	ALL	NA
Signals	Mandatory/Optional	Used in command		Duration Provisioned Value
None				
	Signal Parameters	Mandatory/Optional	Supported Values	Duration Provisioned Value
Events	Mandatory/Optional	Used in command		
None				
	Event Parameters	Mandatory/Optional	Supported Values	Provisioned Value
	ObservedEvent Parameters	Mandatory/Optional	Supported Values	Provisioned Value
Statistics	Mandatory/Optional	Used in command	Supported Values	
None				
Error Codes	Mandatory/Optional			
None				

5.14.2.9 VLAN (vlan)

Table 77: VLAN Package

Properties	Mandatory/Optional	Used in command	Supported Values	Provisioned Value
VLAN tags (vlan/tags)	O	ADD, MODIFY	ALL (note)	Yes
Ethernet priority (vlan/pri)	O	ADD, MODIFY	ALL	Yes
Signals	Mandatory/Optional	Used in command		Duration Provisioned Value
None				
	Signal Parameters	Mandatory/Optional	Supported Values	Duration Provisioned Value
Events	Mandatory/Optional	Used in command		
None				
	Event Parameters	Mandatory/Optional	Supported Values	Provisioned Value
	ObservedEvent Parameters	Mandatory/Optional	Supported Values	Provisioned Value
Statistics	Mandatory/Optional	Used in command	Supported Values	
None				
Error Codes	Mandatory/Optional			
None				
NOTE:	"ALL" means:			
	1) value range "0 to 4095" of property VLAN tags used for VLAN tagging;			
	2) value "4096" of property VLAN tags defines the semantic for "no VLAN tagging".			

5.14.2.10 MGC Information (mgcinfo)

Table 78: MGC Information Package

Properties	Mandatory/Optional	Used in command	Supported Values	Provisioned Value
ALL	M	ADD, MODIFY, AUDITVALUE	ALL	NA
Signals	Mandatory/Optional	Used in command		Duration Provisioned Value
None				
	Signal Parameters	Mandatory/Optional	Supported Values	Duration Provisioned Value
Events	Mandatory/Optional	Used in command		
None				
	Event Parameters	Mandatory/Optional	Supported Values	Provisioned Value
	ObservedEvent Parameters	Mandatory/Optional	Supported Values	Provisioned Value
Statistics	Mandatory/Optional	Used in command	Supported Values	
None				
Error Codes	Mandatory/Optional			
None				

5.14.2.11 Inactivity (it)

Table 79: Inactivity Package

Properties	Mandatory/Optional	Used in command	Supported Values	Provisioned Value
None				
Signals	Mandatory/Optional	Used in command		Duration Provisioned Value
None				
	Signal Parameters	Mandatory/Optional	Supported Values	Duration Provisioned Value
Events	Mandatory/Optional	Used in command		
Inactivity Timeout (it/ito)	M	MODIFY, NOTIFY		
	Event Parameters	Mandatory/Optional	Supported Values	Provisioned Value
	Maximum Inactivity Time (mit)	O	ALL	Yes
	ObservedEvent Parameters	Mandatory/Optional	Supported Values	Provisioned Value
	None			
Statistics	Mandatory/Optional	Used in command	Supported Values	
None				
Error Codes	Mandatory/Optional			
None				

5.14.2.12 Segmentation (seg)

Table 80: Segmentation Package

Properties	Mandatory/Optional	Used in command	Supported Values	Provisioned Value
MGSegmentation TimerValue (seg/ MGSegmentationTimerValue)	M	AUDITVALUE, MODIFY	ALL	YES
MGCSegmentation TimerValue (seg/ MGCSegmentationTimerValue)	M	AUDITVALUE, MODIFY	ALL	YES
MGMaxPDUSize (seg/ MGMaxPDUSize)	M	AUDITVALUE, MODIFY	ALL	YES
MGCMaxPDUSize (seg/ MGCMaxPDUSize)	M	AUDITVALUE, MODIFY	ALL	YES
Signals	Mandatory/Optional	Used in command		Duration Provisioned Value
None				
	Signal Parameters	Mandatory/Optional	Supported Values	Duration Provisioned Value
Events	Mandatory/Optional	Used in command		
None				
	Event Parameters	Mandatory/Optional	Supported Values	Provisioned Value
	ObservedEvent Parameters	Mandatory/Optional	Supported Values	Provisioned Value
Statistics	Mandatory/Optional	Used in command	Supported Values	
None				
Error Codes	Mandatory/Optional			
459	M			

5.14.2.13 RTP (rtp)

Table 81: RTP Package

Properties	Mandatory/Optional	Used in command	Supported Values	Provisioned Value
None	-	-	-	-
Signals	Mandatory/Optional	Used in command		Duration Provisioned Value
None	-	-	-	-
	Signal Parameters	Mandatory/Optional	Supported Values	Duration Provisioned Value
	-	-	-	-
Events	Mandatory/Optional	Used in command		
None				
Statistics	Mandatory/Optional	Used in command	Supported Values	
Packets Sent (rtp/ps)	M	ADD, AUDITVALUE, SUBTRACT	ALL	
	O	MODIFY		
Packets Received (rtp/pr)	M	ADD, AUDITVALUE, SUBTRACT	ALL	
	O	MODIFY		
Packet Loss (rtp/pl)	M	ADD, AUDITVALUE, SUBTRACT	ALL	
	O	MODIFY		
Jitter (rtp/jit)	O	ADD, AUDITVALUE, SUBTRACT, MODIFY	ALL	
Delay (rtp/delay)	O	ADD, AUDITVALUE, SUBTRACT, MODIFY	ALL	
Octets sent (rtp/os) (see note 1)	O	ADD, AUDITVALUE, SUBTRACT, MODIFY	ALL	
Octets received (rtp/or) (see note 2)	O	ADD, AUDITVALUE, SUBTRACT, MODIFY	ALL	
Error Codes	Mandatory/Optional			
None	-			
NOTE 1: Inherited statistic from nt package. Value of rtp/os must be identical to nt/os (see clause E.12.5.2, ITU-T Recommendation H.248.1 [1]).				
NOTE 2: Inherited statistic from nt package. Value of rtp/or must be identical to nt/or (see clause E.12.5.2, ITU-T Recommendation H.248.1 [1]).				

5.14.2.14 Application Data Inactivity Detection (adid)

Table 82: Application Data Inactivity Detection Package

Properties	Mandatory/Optional	Used in command	Supported Values	Provisioned Value
None				
Signals	Mandatory/Optional	Used in command		Duration Provisioned Value
None				
	Signal Parameters	Mandatory/Optional	Supported Values	Duration Provisioned Value
Events	Mandatory/Optional	Used in command		
IP Flow Stop Detection (adid/ipstop)	M	ADD, MODIFY, NOTIFY		
	Event Parameters	Mandatory/Optional	Supported Values	Provisioned Value
	Detection Time (dt)	O	ALL	Yes
	Direction (dir)	O	ALL	Yes
	ObservedEvent Parameters	Mandatory/Optional	Supported Values	Provisioned Value
	None			
Statistics	Mandatory/Optional	Used in command	Supported Values	
None				
Error Codes	Mandatory/Optional			
None				

5.14.2.15 IP Domain Connection (ipdc)

Table 83: IP domain connection package

Properties	Mandatory/Optional	Used in command	Supported Values	Provisioned Value
IP Realm Identifier (ipdc/realm)	M	ADD, MODIFY	ALL	Yes
Signals	Mandatory/Optional	Used in command		Duration Provisioned Value
None	-	-	-	-
	Signal Parameters	Mandatory/Optional	Supported Values	Duration Provisioned Value
	-	-	-	-
Events	Mandatory/Optional	Used in command		
None	-	-	-	-
	Event Parameters	Mandatory/Optional	Supported Values	Provisioned Value
	-	-	-	-
	ObservedEvent Parameters	Mandatory/Optional	Supported Values	Provisioned Value
	-	-	-	-
Statistics	Mandatory/Optional	Used in command	Supported Values	
None	-	-	-	
Error Codes	Mandatory/Optional			
No	-			
NOTE: The ITU-T Recommendation H.248.41 [15] package definition does not specify a length limit for the ipdc/realm string. The maximum length is given by RFC 1123 [24] in case of a <i>domain name</i> format used for the property. If it is not a domain name format, then the maximum size should be up to 255. In case the MGC uses an ipdc/realm property exceeding the above defined length limitation, the MG shall reply with an error descriptor using error code #410: "Incorrect identifier".				

5.14.2.16 Media Gateway Overload Control (ocp)

Table 84: Media Gateway Overload Control Package

Properties	Mandatory/Optional	Used in command	Supported Values	Provisioned Value
None	-	-	-	-
Signals	Mandatory/Optional	Used in command		Duration Provisioned Value
None	-	-	-	-
	Signal Parameters	Mandatory/Optional	Supported Values	Duration Provisioned Value
	-	-	-	-
Events	Mandatory/Optional	Used in command		
MG_Overload (ocp/mg_overload)	M	MODIFY, NOTIFY		
	Event Parameters	Mandatory/Optional	Supported Values	Provisioned Value
	None	-	-	-
	ObservedEvent Parameters	Mandatory/Optional	Supported Values	Provisioned Value
	None	-	-	-
Statistics	Mandatory/Optional	Used in command	Supported Values	
None	-	-	-	
Error Codes	Mandatory/Optional			
None	-			

5.14.2.17 Hanging Termination Detection (hangterm)

Table 85: Hanging Termination Detection Package

Properties	Mandatory/Optional	Used in command	Supported Values	Provisioned Value
None	-	-	-	-
Signals	Mandatory/Optional	Used in command		Duration Provisioned Value
None	-	-	-	-
	Signal Parameters	Mandatory/Optional	Supported Values	Duration Provisioned Value
	-	-	-	-
Events	Mandatory/Optional	Used in command		
Termination Heartbeat (hangterm/thb)	M	ADD, MODIFY, NOTIFY		
	Event Parameters	Mandatory/Optional	Supported Values	Provisioned Value
	Timer X (timerx)	O	0,1 up	Yes
	ObservedEvent Parameters	Mandatory/Optional	Supported Values	Provisioned Value
	-	-	-	-
Statistics	Mandatory/Optional	Used in command	Supported Values	
None	-	-	-	
Error Codes	Mandatory/Optional			
No	-			

5.14.2.18 Statistic Conditional Reporting (scr)

Table 86: Statistic Conditional Reporting Package

Properties	Mandatory/Optional	Used in command	Supported Values	Provisioned Value
None	-	-	-	-
Signals	Mandatory/Optional	Used in command		Duration Provisioned Value
None	-	-	-	-
	Signal Parameters	Mandatory/Optional	Supported Values	Duration Provisioned Value
	-	-	-	-
Events	Mandatory/Optional	Used in command		
Conditional Reporting (scr/cr)	M	ADD, MODIFY, NOTIFY		
	Event Parameters	Mandatory/Optional	Supported Values:	Provisioned Value
	Statistic Identifier (si)	M	ALL	YES
	Duration (dur)	O	ALL	YES
	Period (per)	O	ALL	YES
	Maximum (max)	O	ALL	YES
	Minimum (min)	O	ALL	YES
	Normal (nor)	O	On, Off	YES
	ObservedEvent Parameters	Mandatory/Optional	Supported Values	Provisioned Value
	Statistic Identifier (si)	M	ALL	-
	Value (val)	M	ALL	-
Statistics	Mandatory/Optional	Used in command	Supported Values	
None	-	-	-	
Error Codes	Mandatory/Optional			
None	-			

5.15 Mandatory support of SDP and annex C information elements

Elements listed as mandatory shall be supported by MGC and MG but does not have to be present in all commands containing SDP. Details of which elements are included in each command are provided in clause 5.18.

Table 87: Supported SDP Information Elements

SDP Information Element	Mandatory/optional	Description
Protocol version "v=" line	Mandatory	The value must always be equal to zero: v=0
Connection "c=" line	Mandatory	The <i>network type</i> must always be "IN". The <i>address type</i> value must be "IP4" or "IP6". The <i>connection address</i> value may be underspecified with CHOOSE wildcard ("\$").
Media "m=" line	Mandatory	There are four fields (or SDP values) <media>, <port>, <proto> and <fmt> in the "m=" line (see RFC 4566 [23]; note 3). The "m=" line may be omitted from SDP (see note 6).
Media type <media>	Mandatory if "m=" line included	"-" may be used for the <i>media</i> value. The <i>media</i> value shall be specified in case of media-aware interworking (see note 2). In case MG is media aware but does not support the requested media type the MG shall reject the command with error code 515. In case MG is media agnostic and MGC specifies any other media type than "-", the MG shall reject the command with error code 515.
Transport port <port>	Mandatory if "m=" line included	The <i>port</i> value may be underspecified with CHOOSE wildcard ("\$").
Transport protocol <proto>	Mandatory if "m=" line included	In case MG is transport aware but does not support the requested transport protocol the MG shall reject the command with error code 449. In case MG is transport agnostic and MGC specifies any other transport protocol than "-", the MG shall reject the command with error code 449.
		udp Allow only L4 protocol = UDP
		tcp OR Allow only L4 protocol = TCP
		TCP (see note 8)
		RTP/AVP Allow only L4 protocol = UDP
		(see note 1)
		udptl Allow only L4 protocol = UDP
		- No transport protocol specific behaviour is required by the MG
Media format <fmt>	Mandatory if "m=" line included	"-" may be used for the <i>format list</i> value, e.g. in case of media-agnostic interworking. Other values may be used for media-aware interworking (e.g. transcoding; see clause 5.17.1.14) (see note 2). In case MG is media aware but does not support the requested media format the MG shall reject the command with error code 449. In case MG is media agnostic and MGC specifies any other media format than "-", the MG shall reject the command with error code 449.

SDP Information Element	Mandatory/optional	Description
Protocol version "v=" line	Mandatory	The value must always be equal to zero: v=0
Bandwidth "b=" line	Mandatory MUST not be used without a "m=" line.	The <i>modifier</i> value must always be "AS". This implies that the <i>bandwidth-value</i> represents the "maximum bandwidth" (see clause 5.8/ RFC 4566 [23]). The <i>bandwidth-value</i> relates therefore to the <i>peak bitrate</i> (see note 7). The <i>bandwidth-value</i> value defines the IP layer bandwidth for the specific H.248 Stream (see notes 4 and 5). For RTP flows, where RTCP resources are reserved together with the RTP resources using the "RTP Specific Behaviour" property of the Gate Management package (gm) property, the <i>bandwidth</i> value will include the bandwidth used by RTP and RTCP together.
NOTE 1: Even if the transport value is RTP, the "RTP Specific Behaviour" property of the Gate Management package (gm) shall be used to indicate whether RTCP resource reservation is also requested.		
NOTE 2: For la profile version 2 H.248 profile RFC 4566 [23] shall be used as basis. RFC 4566 [23] enables "-" as a valid character (la profile version 1 uses RFC 2327 [i.3], which does not allow the "-" in place of media type, transport and media format fields. However in the scope of la profile version 1 this was considered as an admitted SDP extension).		
NOTE 3: RFC 4566 [23] made RFC 2327 [i.3] obsolete, but the ABNF grammar did slightly change for the "m=" line: a) RFC 2327 [i.3]: m=<media> <port> <transport> <fmt list>. b) RFC 4566 [23]: m=<media> <port> <proto> <fmt> ... There is a syntactical change for the last two fields, but the semantical meaning is unchanged. See also ITU-T Recommendation H.248.49 [20], Appendix I "Comparison of SDP variants between RFC 4566 [23] and RFC 2327 [i.3]" and in particular: table I.7/H.248.49 "RFC 4566 [23] versus RFC 2327 [i.3] - SDP specification - "m=" line".		
NOTE 4: This semantic is consistent for RTP traffic (see clause 6.2/RFC 3550 [i.8]) and non-RTP traffic (see clause 5.8/RFC 4566 [23]).		
NOTE 5: It has to be noted that la profile version 1 has a different semantic (see table 81 in ES 283 018 [19]) defined, which incorporates also layer 2 bitrate. A transformation between both "b=" line usages (in case of IP-over-L2) is not straightforward because the transformation parameters are based on L2-PCI and the IP packet rate. The L2-PCI is typically constant for a dedicated L2 technology (like IP-over-IEEE 802.3 [i.9]), but the packet rate is application-specific. E.g. the IP packet rate is usually unknown at la for media-agnostic IP-to-IP interworking.		
NOTE 6: The "m=" and "b=" lines may be omitted in certain procedures, which are further described in clause 5.17.1.11.		
NOTE 7: The unit for the <i>bandwidth-value</i> (peak bitrate) is "kbit/s". The unit for the <i>peak data rate</i> (tman/pdr) is "byte/s". The "b=" line is not providing any information about the traffic characteristic, i.e. whether the traffic flow has a Constant BitRate (CBR) or Variable BitRate (VBR). The <i>bandwidth-value</i> is thus independent of the traffic characteristic and relates to the peak bitrate for CBR and VBR traffic (see also clause 5.17.1.5).		
NOTE 8: Upper case TCP is defined by RFC 4145 [i.16] and registered by IANA. Lower case tcp was introduced by la v1 and is allowed for backwards compatibility.		

5.16 Optional support of SDP and annex C information elements

NOTE: "Annex C" relates to H.248.1 [1], annex C "Tags for Media Stream Properties". Annex C information elements are not required in H.248 text encoding mode.

Table 88 summarizes the "optional" SDP information elements, according their specific usage according clause 7.1.8/H.248.1 [1]. Their usage may depend on the direction from MGC towards MG or vice versa. Details of which elements are included in each command are provided in clause 5.18.

Table 88: Optional SDP Information Elements

SDP Information Element	Optional/mandatory	Description
Origin "o=" line	Optional for MGC, Mandatory for MG	The origin line consists of six fields (<username>, <sess-id>, <sess-version>, <nettype>, <addrtype> and <unicast-address>). The MGC is not required to supply this line but shall accept it (see clause 7.1.8/ITU-T Recommendation H.248.1 [1]). The MG should populate this line as follows, e.g. o=- 0 0 IN IP4 11.9.19.65; or use the value received from the MGC.
Session Name "s=" line	Optional for MGC, Mandatory for MG	The session name "s=" line contains a single field (<session name>). The MGC is not required to supply this line but shall accept it (see clause 7.1.8/ITU-T Recommendation H.248.1 [1]). The MG should populate this line as follows, e.g. s=-; or use the value received from the MGC.
Timing "t=" line	Optional for MGC, Mandatory for MG	The time "t=" line consists of two fields (<start time> and <stop time>). The MGC is not required to supply this line but shall accept it (see clause 7.1.8/ITU-T Recommendation H.248.1 [1]). The MG should populate this line as follows, e.g. t=0 0; or use the value received from the MGC.
Attribute "a=" line	Optional for MGC, Recommended for MG	1) Application "RTCP transport address control": The attribute "a=rtcp" line may either contain (a=rtcp: <port>) or (a=rtcp: <port> <network type> <address type> <connection address>) when the "a=rtcp" line is used for RTCP port and optionally network address transmission. The MGC shall supply the "a=rtcp" line in the RD when non-default RTCP network address or transport port values are used by the peer media entity.
	Optional for MGC, optional for MG	2) Application "Media-aware interworking (transcoding)": The "a=" line provides the complementary information for the "m=" line (see table 87) with regards to a specified media type/format. For a dynamic RTP payload type, for each media information on the codec type shall be provided in a separate SDP "a=rtmpmap" line and possibly additional SDP "a=fmtp"-line(s).

5.17 Overview of Procedures

Details of Session Dependent Procedures are provided in clauses 5.18. Details of Session Independent Procedures are provided in clauses 5.19 and 5.20.

5.17.1 Overview of Session Dependent Procedures

The general procedures are related to session-dependent (also known as H.248 call-dependent) procedures. There are procedures in following categories:

- Address allocation and translation is in scope of clauses 5.17.1.2. The adaptation of addresses (latching) is the subject of clause 5.17.1.3.
- Session-dependent policing is applicable to this profile. Different policing types are classified in Appendix I of ITU-T Recommendation Q.3303.2 [13]. The specific types of address policing and traffic policing are in scope of clauses 5.17.1.1 and 5.17.1.5 respectively. Media type policing is discussed in clause 5.17.1.8.
- QoS support mechanisms are discussed in clause 5.17.1.4.
- Measurement and reporting of statistics are discussed in clause 5.17.1.6.
- RTCP handling (e.g. IP port allocation rules for RTCP) is discussed in clause 5.17.1.7.

- Detection of inactive bearer connections is in scope of clause 5.17.1.9.
- IP Realm/Domain Indication is discussed in clause 5.17.1.10.
- Two-Stage BGF Resource Reservation is discussed in clause 5.17.1.11.
- Detection of hanging H.248 Terminations is discussed in clause 5.17.1.12.
- Real Time Statistics Reporting in clause 5.17.1.13.
- Transcoding is discussed in clause 5.17.1.14.

NOTE: Annex D provides an example IP processing model for an H.248 (IP, IP) Context, indicating the IP packet processing functions behind above session-dependent procedures.

5.17.1.1 Gate control

The realization of a gate requires two ephemeral terminations. An ephemeral termination sources and/or sinks one or more media streams. Gates are direction and stream dependent.

In this profile, RTP traffic shall be controlled through a single H.248 stream, representing both the RTP and RTCP flows, if the RTP Specific Behaviour property of the Gate Management package is set to ON. In such a case, when the MG is requested to allocate a port for an RTP flow, a consecutive port for the associated RTCP flow is automatically allocated (see also clause 5.17.1.7).

In this case, monomedia sessions require one bidirectional H.248 stream on a termination, while a multi-media sessions (e.g. audio and video) would require multiple H.248 streams on a termination (one stream per media type).

The H.248 base protocol enables the MGC to choose the IP address and port on which a termination will receive media flows. In addition, the Gate Management package enables the MGC to explicitly provide the following information:

- 1) expected IP source address and port of received packets;
- 2) IP source address and port of sent packets.

The relationship between H.248 descriptors in this Profile and the addresses used in packets sent and received by the gate is indicated in table 89. Figure 2a illustrates the used naming conventions for the IP transport connection endpoints in the BGF and remote IP node.

Table 89: Relation between Packet Direction, IP Address/Port and H.248 Descriptor/Information

Packet direction	IP Address/ L4 Port	Source of Information for Transport Address values
Received by termination	Source: RS(A) RS(P)	The source of information for the expected remote source transport address RS(A,P) value is dependent on the usage of remote source filtering and hosted NAPT traversal as per table 89a.
	Destination: LD(A) LD(P)	Local destination transport address LD(A,P): Local Descriptor.
Sent by termination	Source: LS(A) LS(P)	Local source transport address LS(A,P): 1) Availability of LS information due to explicit setting of local source transport address: LocalControl Descriptor/gate management/local source address + local source port; or, if not present: 2) Availability of LS information in H.248 Local Descriptor SDP: Source address not explicitly enforced/signalled via "gm" package. The source address is determined from the local SDP (which implies a symmetrical local network address, i.e. LD(A) = LS(A)).
	Destination: RD(A) RD(P)	The source of information for the remote destination transport address RD(A,P) value is dependent on the usage of hosted NAPT traversal as per table 89b.

Table 89a: Expected Remote Source Transport Address

Expected remote source transport address RS(A,P):	Hosted NA(P)T Traversal	
	No	Yes
Filtering on Remote Source Address(es)	No	As no source filtering activated no specific RS(A,P) is expected. The BGF may determine actual RS(A) and RS(P) values by monitoring incoming IP packets.
	Yes	Alt 1. LocalControl Descriptor/gate management/remote source address mask AND/OR remote source port or remote source port range is used to determine the expected .RS(A) and RS(P) values, which allows for the peer IP node to use asymmetric network address (RS(A) ≠ RD(A)). Alt 2. Combination of gate management and Remote Descriptor, which assumes symmetrical remote network address (RS(A) = RD(A)).
		The expected remote source transport address is determined by the NAPT traversal process as described in [8]. Even if no filtering is ordered, the NAPT traversal process implies source filtering on the transport address after latching has occurred.
		1st stage (before latching): Same as in cell to the left. 2nd stage (after latching): Same as in above cell.

Table 89b: Source of Information for the Remote Destination Transport Address

Remote destination transport address RD(A,P):	Hosted NA(P)T Traversal	
	No	Yes
Source of information	The remote destination transport address is determined by the Remote Descriptor.	The remote destination transport address is determined by the NAPT traversal process as described in [8]. This implies a symmetrical remote network address, i.e. RD(A) = RS(A).

Opening and closing gates is achieved by setting the Stream mode parameter of the associated termination(s) to the appropriate values. Subtracting a termination from a context also closes the gate for all H.248 streams in the termination.

In the context of conversational services, an active session requires that both the upstream and downstream gate be opened in bi-directional mode.

Filtering on the IP source address and/or port might be implemented using the Gate Management package, or using the SDP information in the Remote Descriptor. In case the filtering is done based on the Remote Descriptor, the activation/deactivation of the filtering is configured in the MG. If the Gate Management package is used, it shall override the configured value in the MG.

NOTE: It should be noticed that the IP source address and port may not always be available to the MGC. When SIP signalling is used, the session description does not contain this information (i.e. according to RFC 3264 [6], the IP address and port present in an SDP offer indicate nothing about the source IP address and source port of RTP and RTCP packets that will be sent by the offerer). Any other protocol that uses SDP as a session description mechanism (e.g. RTSP) has the same constraints.

In such configurations, the Gate Management Package may be used as follows:

- in an IPv6 environment, the Source Address Mask property contains the 64 bits prefix of the IP address that is set in the termination's Remote Descriptor;
- in an IPv4 environment, the Source Address Mask property contains the IP address that is set in the termination's Remote Descriptor, except that a number of trailing digits may be wildcarded;
- in both cases, Source Port Filtering should not be activated.

The gate concept, together with H.248 Stream/Termination handling, is further illustrated in annex A.

5.17.1.2 Allocation and translation of IP addresses, ports and versions (NAPT-PT)

The procedures of this clause support the following NAPT-PT functionality:

- NAPT-PT functionality with "double" addresses and ports translation (both source and destination addresses and ports are translated);
- or optional NAPT-PT functionality with "single" address and port translation (either source or destination address and port translation) - applicable if the BGF has router functionality, or direct L2 connectivity with user terminals.

The H.248 base protocol enables the MGC to either choose the addresses and ports associated with a termination or to request the MG to allocate these IP addresses and ports. NAPT control on destination addresses and ports is achieved by setting the Local and Remote Descriptors according to the following principles:

- The IP and port address in the Remote Descriptors are set by the MGC according to the information received in call/session signalling (e.g. SDP in SIP INVITE and 200 OK).
- The address and port in the Local Descriptor are selected by the MG within the indicated IP address realm from MGC side (see also below).

If the BGF has router functionality, or direct L2 connectivity with the user terminals, the address and port of the Local Descriptor towards the private network may optionally be set according to the following principles:

- The IP and port address in the Local Descriptor towards the private network is provided by the MGC (instead of being selected by the MG). The MGC shall copy the Remote Descriptor of the public network into the Local Descriptor towards the private network.

The MGC has the ability to choose the address space in which the MG allocates an IP address. This is achieved by setting the IP realm identifier in the IP Domain Connection package to the appropriate value (see clause 5.17.1.10). The association of dedicated "IP address spaces" (also known as "IP address realms" or briefly "IP realms", see RFC 2663 [7]) with the IP realm identifier requires a mutual agreement between MGC and MG. This is realized via provisioning, thus beyond the scope of this Profile.

Figure 3 provides an example of "double" network address and port translation, where a session is to be established between IPv4 addresses 10.140.120.10 (private address) and 156.106.192.33 (public address).

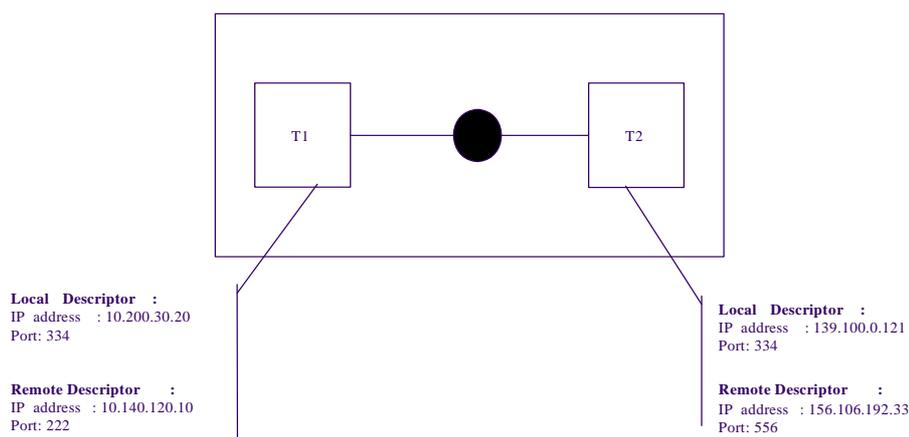

Figure 3: Network Address and Port Translation (NAPT)

For "single" network address and port translation applications, the T1 Local Descriptor address and port in figure 3 has to be changed to 156.106.192.33: 556 (equal to the T2 Remote Descriptor address and port).

NAPT control on source addresses and ports is achieved by setting the local source address and local source port properties defined in the Gate Management package to a value that differs from the actual source address of the packets received from the remote entity.

Protocol Translation (NAPT-PT) can be controlled by the MGC by adding to the same H.248 context, two terminations whose media descriptors have different address-type values in the "c=" line.

NOTE: It is recommended that the MGC takes precaution if setting up streams with both fully specified and under specified address and/or port towards the same realm in a MG, as this could otherwise lead to conflicting address or port assignments. The exact mechanism for how clashes are avoided is beyond the scope of this profile.

5.17.1.3 Support of Hosted NAT Traversal

"Hosted NAT Traversal" relates to "assisting remote NAT/NAPT traversal" for the remote (peer) IP connection endpoints from BGF/SPDF point of view. This relates to an interim NA(P)T device from BGW perspective. The remote IP address information cannot be retrieved from the Remote Descriptor. The "Hosted NAT Traversal" function is controlled by the MGC using the IP NAPT Traversal package (ipnapt). Using the napt package, the MG is requested to perform media latching, i.e. listen for incoming media and latch to the remote address information of that media.

When Hosted NAT Traversal is applied to a stream associated with multiple flows (for example RTP and RTCP), the MG shall perform individual latching and/or re-latching on the various flows. This means that an RTP and an RTCP flow of a single stream can be latched to different remote addresses and/or ports.

5.17.1.4 QoS marking

The Differentiated Services package enables the MGC to control the setting of the DSCP value for all packets leaving the MG.

5.17.1.4.1 Copying DSCP/ToS values from the ingress to egress

The copy mechanism is specified in ITU-T Recommendation H.248.52 [16].

5.17.1.4.2 Auditing the "Per-Hop Behaviour"

The Per-Hop Behaviour (PHB) concerning "MGC-signalled QoS marking" versus "copying of QoS values" may be explicitly controlled (and audited) using *Differentiated Services package version 2*, see Amendment 1 to ITU-T Recommendation H.248.52 [16].

The *Differentiated Services package version 1* does not allow to audit the behaviour, see the NOTE at the end of clause 7.6.1.3 in Amendment 1 to ITU-T Recommendation H.248.52 [16].

5.17.1.5 Bandwidth control - Reservation, Allocation and Policing

Resources are reserved independently on upstream and downstream gates. For each gate, reservation of local resources for handling incoming and outgoing traffic is achieved by setting the appropriate properties in the Local and Remote Descriptors. Only one session description shall be included in each Stream Descriptor. Hence, the ReserveValue and ReserveGroup properties should not be used.

The function of bandwidth control (which relates to bit- and byterate control in this profile) is structured in following clauses:

- Admission Control (AC; see clause 5.17.1.5.1);
- traffic descriptor (see clause 5.17.1.5.2);
- traffic reservation and allocation (see clause 5.17.1.5.3); and
- traffic policing (see clause 5.17.1.5.4).

5.17.1.5.1 Admission Control

Admission Control is defined in RACS for the BGF (MG role) level. There is no concept of a call in H.248 MGs due to the separation of call and bearers in the H.248 model, which means that AC translates in a Context Admission Control (CoAC; see also ITU-T H.Sup6 [i.15]) and Stream Admission Control (StAC) on MG side.

The StAC and CoAC is triggered with the first incoming ADD.request Command. At that point a decision is taken whether the new context can be established or not.

The StAC is triggered whenever a modification of an existing H.248 context, e.g. in terms of traffic descriptor, is requested. At that point a decision is taken whether the context modification can be accepted or not.

5.17.1.5.1.1 Admission Control in this Profile

The BGF AC is based on the requested H.248 stream level usage parameters and already established Contexts. The stream level usage parameters are given by the H.248 Media Descriptor in the ADD.request (and MODIFY.request) commands. The "usage parameters" as input for the AC of this Profile are mainly related to "bandwidth" information (see next clause on "traffic descriptor").

Specific AC algorithms could principally follow a deterministically or a statistically based multiplexing model. Concrete algorithms are implementation specific, thus out of scope of this profile.

The *result* of an admission control (here CoAC or StAC) is either an *accept* or *reject* decision.

NOTE: Step 2 in figure 4 shows an accept decision, which is implicitly given by the command reply on the ADD.request for the IP termination. A reject decision would be indicated by an appropriate H.248.8 [25] error code in the reply.

5.17.1.5.2 Traffic Descriptor

A *traffic descriptor* is the set of traffic parameters that is used to capture the traffic characteristics of an IP flow (see clause 3.2.10/ITU-T Recommendation Y.1221 [i.10]). The traffic parameters for an H.248 Stream of an H.248 IP Termination are direction-independent and given by either:

- 1) an explicit specification via:
 - the "b=" line in the SDP description of the Local Descriptor and Remote Descriptor; or
 - the properties of the Traffic Management package; or
- 2) an implicit specification via:
 - the "m=" line in the SDP description of the Local Descriptor and Remote Descriptor.

NOTE: There is no concept of a *traffic contract* explicitly used in the scope of this Profile version, because specific QoS classes (see ITU-T Recommendation Y.1541 [i.11]) are not signalled per termination. Nevertheless, the "QoS marking" information (see clause 5.17.1.4) could be used for QoS class indications, but such concepts are orthogonal to profile specifications, therefore out of scope of the present document.

5.17.1.5.3 Bandwidth reservation and allocation

5.17.1.5.3.1 SDP "b=" line for constant bitrate traffic

The amount of required bandwidth for sending packets is expressed using the "b=" line of the SDP description contained in the Remote Descriptors.

The amount of required bandwidth for receiving packets is expressed using the "b=" line of SDP description contained in the Local Descriptors or using one of the properties (*tman/pdr* or *tman/sdr*) of the traffic management package.

5.17.1.5.3.2 Properties of the Traffic Management package for variable bitrate traffic

The Traffic Management package (*tman*) should be used in case of variable bit rate traffic. There are then two semantics for some *tman* properties. All properties may be applied for bandwidth *policing*. The two properties *tman/pdr* and *tman/sdr* would be used additionally for bandwidth *reservation* (see note).

NOTE: The property *tman/pol* indicates whether just reservation is applied ("OFF"), or whether both semantics are in use ("ON"). The semantic for "OFF" is going beyond the property definition in *tman* version 1 package. This should be non-controversial because these *tman* properties may be considered as elements of a *traffic descriptor*, i.e. information elements used for admission control (besides policing).

5.17.1.5.4 Bandwidth policing

Policing of incoming traffic can be enabled using the Traffic Management package. Policing on incoming traffic can be set independently for each gate.

The properties of the Traffic Management package shall be set to values that are compatible (see note) with the "b=" line value of the local descriptor.

NOTE: The term "compatible" means that the b-line and the traffic management represent identical bandwidth value with respect to the protocol layer they are defined upon:

- Constant bit rate: b-line = *tman/pdr* = *tman/sdr*;
- Variable bit rate: b-line = *tman/pdr*.

5.17.1.5.5 Non-specification of *tman* properties

If no properties of the Traffic Management package are provided, the MG will not perform traffic policing. If only the *tman/pol* property set to ON is present, traffic policing shall not be done based on the b-line value, i.e. the policing function cannot be activated at this stage.

5.17.1.6 Usage metering and statistics reporting

Usage metering is supported by the statistics defined in the network package. Such statistics may be notified to MGC when a stream is removed (and stats explicitly requested by the MGC) or a termination is subtracted from a context (e.g. at the end of a session). They provide information about the duration of the time a termination has been in a context, the number of octets sent and received. The "number of octets" is calculated as defined in clause E.11.4 of ITU-T Recommendation H.248.1 Version 3 [1].

The number of discarded packets due to source filtering may be reported on basis of the gm/dp statistic.

5.17.1.6.1 Statistics for Media/Transport-agnostic IP packets

The available statistics for the IP streams and terminations of a dedicated context are dependent of the IP-to-IP interworking mode (see clause 3.1).

5.17.1.6.2 Traffic Volume related Statistics

5.17.1.6.2.1 General Case

The general case relates to Ia profile version 1, i.e. media-agnostic IP-to-IP interworking. Traffic volume related statistics are accessible by the *nt* package.

5.17.1.6.2.2 RTP Case

"Media-aware" IP terminations with RTP as application level framing protocol may use traffic volume based statistics via the RTP package:

- packet granularity:
RTP packets sent and/or received

NOTE: Packet level statistics could already provide useful volume measurements in case of RTP packets with constant length.

- octet granularity:
RTP octets send/received statistics are coupled with nt package statistics, i.e., these statistics are also including RTP padding, RTP header information and UDP transport overheads.

5.17.1.7 RTCP Handling

Handling of RTCP is already partially addressed by clause 5.17.1.1. This clause defines further procedures for RTCP.

5.17.1.7.1 RTCP Transport Address Allocation

5.17.1.7.1.1 Local RTCP Transport Address Allocation

In line with the recommendations of RFC 3605 [26], separate address or non-contiguous RTCP port numbers (identified via the "a=rtcp" media attribute) shall not be used by the BGF in its LD.

Local ports for RTCP are implicitly allocated by the MG whenever instructed to do so by the MGC via the gm/rsb=ON property. The MG must follow the port allocation rules as defined in clause 11/RFC 3550 [i.8], which results in the allocation of a contiguous port pair for RTP and RTCP within a single stream.

If the gm/rsb property is set to OFF, then no RTCP port is allocated in conjunction with an RTP stream. This behaviour is irrespective of the presence of the "a=rtcp" attribute in the related RD.

5.17.1.7.1.2 Remote RTCP Transport Address Representation/Usage, Implicit Allocation of IP Transport Addresses for RTCP

RTCP ports are allocated either implicitly or explicitly when support of RTCP is required. RTCP support and RTCP address and port allocation is controlled as by the gm/rsb property and the "a=rtcp" media attribute line in the Remote Descriptor. If RTCP is sent within the same stream as RTP then RTCP port allocation is handled as follows:

- gm/rsb=OFF or gm/rsb omitted.
 - RTCP support is not required. No pinhole is opened for received RTCP packets. No RTCP packets are sent and any received RTCP packets are silently discarded. This is irrespective of whether the "a=rtcp" attribute is present in the Remote Descriptor.
- gm/rsb=ON and "a=rtcp" media attribute line not present.
 - RTCP support is required. A pinhole is opened for received RTCP packets. The MG must follow the port allocation rules as defined in clause 11/RFC 3550 [i.8], which results in the allocation of a contiguous port pair for RTP and RTCP within a single stream in the Local Descriptor (see above clause 5.17.1.7.1.1). RTCP packets are sent to the same address and contiguous port number to the RTP port as specified in the Remote Descriptor.
- gm/rsb=ON and "a=rtcp" media attribute line present.
 - RTCP support is required. A pinhole is opened for received RTCP packets. The RTCP port and optionally address are explicitly identified by the included "a=rtcp" media attribute line. The MG must follow the port allocation rules as defined in clause 11/RFC 3550 [i.8], which results in the allocation of a contiguous port pair for RTP and RTCP within a single stream in the Local Descriptor (see above clause 5.17.1.7.1.1). If the "a=rtcp" media attribute line in the Remote Descriptor contains an address it is used as destination when sending RTCP packets. The destination port for RTCP packets is always explicitly identified via the "a=rtcp" media attribute line in the Remote Descriptor.

5.17.1.7.1.3 Unsuccessful transport address allocation

In line with clause 5.17.1.7.1.1, neither a fully specified RTCP port nor RTCP address are ever used by the MGC in the Local Descriptor. Therefore, unsuccessful port/address allocation can only occur due to there being insufficient resources on the MG to allocate the (contiguous) RTCP port. Unsuccessful scenarios result in the MG responding with H.248 error code #510 ("Insufficient Resources").

5.17.1.7.2 RTP/RTCP to-H.248 Stream Mapping

In line with clause 5.17.1.7.1.1, a single common H.248 stream is always used for RTP and its associated RTCP flow.

5.17.1.8 RTCP Forwarding

Every RTP session may be accompanied by RTCP control flows. Blocking (by the BGF) of such RTCP packets may violate the end-to-end RTP/RTCP protocol and/or the served applications. However, security threats or specific RTCP reports types may request for dedicated RTCP packet policing rules.

5.17.1.8.1 Conditions for RTCP packet policing

Conditions for RTCP packet policing are typically based on following n-tuple elements:

- IP *port* for RTCP flow;
- RTCP *packet type* codepoint;
- RTCP *SSRC* codepoint;
- RTCP source description information element (e.g. *CNAME* codepoint); or/and
- RTCP *block type* codepoint in case of RTCP extension reports (XR, HR).

5.17.1.8.2 Forwarding of regular RTCP traffic

"Regular" RTCP packets shall be understood in the scope of the present document as packet units with a packet type value equal to a value from the range of {192, 193, 200 to 206}. Thus, regular traffic excludes XR and HR RTCP packets. Regular RTCP packets must be basically forwarded towards the RTP endpoint.

Regular RTCP packets are unambiguously identified by the 3-tuple of {packet type, SSRC, CNAME}.

Thus, RTCP packets with e.g. an incorrect {SSRC, CNAME} combination may be blocked.

5.17.1.8.3 Handling of RTCP XR/HR traffic

Extension reports (XR) and XR-based high resolution reports, - i.e. RTCP reports with a packet type value equal to 207 -, carry measurement data from Measurement Points (MP) to Reporting Points (RP). Such measurement reports do not have necessarily an end-to-end significance, their scope may be e.g. limited to a single IP domain or "RTP network segment". The BGF may have to apply dedicated forwarding policy rules for such RTCP packets. Concrete policy rules are for further studies.

5.17.1.9 Media Inactivity

Application data inactivity detection (also known as media inactivity detection) may have multiple, different use cases as cited in ITU-T Recommendation H.248.40 [11] e.g.:

- detection of interrupted IP routes;
- detection of released RTP endpoints;
- detection of hanging SIP/RTP sessions; or
- detection of deadlocks in IP latching scenarios.

In all use cases, the *adid v1* package (with possible different *timing* and/or *direction* configurations of the detection logic) is used to report the detected inactivity.

The *adid/ipstop* event is enabled on a per H.248 IP termination basis, i.e. not on H.248 stream level. The BGF monitors all IP ports associated with the termination.

5.17.1.10 IP Realm/Domain Indication

5.17.1.10.1 Codepoint and format/encoding

The IP realm identifier (i.e. H.248 property *ipdc/realm*) may be sent to the BGF in order to indicate the IP domain/realm of the H.248 IP termination. The IP realm identifier is a flexible string and may convey a numerical IP address, domain name or mutually understood name (e.g. "in" and "out", "1" and "2", etc.) (see note). The ephemeral termination string layout ("*ip*/*<group>*/*<interface>*/*<id>*") is still used in this version of the profile but the "interface" field is always set to CHOOSE by the MGC in an Add request command and is assigned by the MG. The MG may use the "interface" field to denote a physical or logical interface on the MG.

NOTE: The usage of the IP realm identifier in this version of the profile is generalized and goes somewhat beyond the original definition (by ITU-T Recommendation H.248.41 [15]) of the identifier. This is due to following reasons:

- a) syntax: backward compatibility with Ia profile version 1 (format/encoding syntax by field "Interface" in TerminationID); and
- b) semantic: generic "domain identifier" for "domain concepts" beyond IP address spaces. Such "domain concepts" could be related to specific technologies, specific protocol layers, virtual private network types, etc.

5.17.1.10.2 Unsuccessful indication

If the value of the IP realm identifier sent by the MGC within the ITU-T Recommendation H.248.41 [15] package property cannot be recognized by the BGF, the BGF will fail to create the IP based H.248 termination and replies with an error descriptor using the error code 449 (Unsupported or Unknown Parameter or Property Value).

5.17.1.10.3 Fix assignment per termination lifetime

The MGC may or may not choose to assign IP realm identifier when communicating with the MG e.g. not sent if IP Realm configured on the MG. If the MGC assigns IP Realm then this must be communicated at termination seizure (Add). The value of IP Realm shall be applied to all streams associated with the termination. The IP Realm identifier indicates the IP domain/realm of the H.248 termination and cannot therefore be changed after the initial assignment at Add.

The IP Realm identifier cannot be subsequently changed in a Modify command once assigned to a termination. Only an identical/unchanged setting of IP realm identifier may be sent in a Modify command. If the MGC attempts to change the IP realm on an existing termination via a Modify command, the BGF will reply with an error descriptor using the error code 501 ("Not Implemented").

5.17.1.10.4 Number of IP Realms/Domains

The BGF supports typically multiple logical IP interfaces, which may belong to different IP address realms. Following principal use cases may be distinguished:

1) **Single realm:**

- All IP interfaces of the BGF, and therefore all created H.248 IP terminations, belong to the same IP address space.

2) Multiple realms (N private realms and M public realms with N+M greater or equal to two):

- The two H.248 IP terminations of an H.248 context may belong to the same IP address space or different realms.
- The BGF may be principally connected to many IP address realms. For instance, *N* private domains, or one public and *M* private domains. Furthermore there could be overlapping address spaces between multiple private domains (see note). The H.248.41 [15] package property is used to indicate each realm.

In general, if the ITU-T Recommendation H.248.41 [15] property is omitted, according to the H.248.41 [15] procedures the configured default IP realm is applied by the MG.

NOTE: Overlapping IP address spaces could be discriminated by separation e.g. via physical (IP) interfaces, via a L3VPN technology (e.g. IPsec in tunnel mode), or via a L2VPN technology (e.g. VLANs).

All above use cases are related to specific BGF deployment scenarios due to the static nature of a connection of a particular IP domain with the BGF.

5.17.1.11 Two-Stage BGF Resource Reservation

The SDP offer/answer model (see RFC 3264 [6]) allows offers and answers to be generated without "m=" and "b=" lines.

If information contained in SDP "c=" line, but not "m=" and "b=" lines is available to the MGC at the time it requests the MG to create a termination, the MGC refrains from sending "m=" and "b=" lines to the MG. In order for media plane communication to take place through the MG, the MGC must at a later stage come back with at least "m=" lines to the MG. This would typical happen at a subsequent offer/answer exchange on the SIP plane.

These actions at the Ia interface can be described with the following two-stage BGF resource reservation procedure:

- 1) MGC requests the MG to reserve an IP address (via the LD) in accordance to the specified IP realm and may also optionally reserve an IP port. In the former case, the SDP in local and/or remote descriptors does not contain "m=" nor "b=" lines. In the latter case, the SDP in local and/or remote descriptors does contain an underspecified "m=" line. The MGC does not request the MG to open any pinhole at this stage.
- 2) MGC requests the MG, in addition to the previously assigned IP address, to also allocate port(s) (if not done at stage 1) and optionally bandwidth or to optionally further specify the previously allocated port together with an optional bandwidth. The SDP in local and/or remote descriptors does contain "m=" and optionally "b=" lines. The MGC may request the MG to open pinholes at this stage.

The command level details of this procedure are specified in clauses 5.18.1 and 5.18.2.

Both stages are part of the overall session establishment phase.

5.17.1.12 Hanging Termination Detection

For the correct operation of a BGF, synchronization of termination information between the SPDF and BGF is essential for traffic, maintenance and charging purposes. In some cases, the SPDF may have lost a record of a termination but the termination is not subtracted on BGF. The hangterm/ thb event defined in ITU-T Recommendation H.248.36 [21] may be used to solve this problem. After a period of message inactivity the BGF may issue a periodic Notify command on the concerned termination and the SPDF may use this to check if it has a record of the termination or not. The time period for this Notify may be parameter driven. Optionally the hangterm/thb event may result in an audit of MGCinfo/db property in order to determine the MGC information string.

5.17.1.13 Real Time Statistics Reporting

Normally a SPDF obtains bearer related statistics through periodic auditing of the H.248 statistic descriptor or at the time of deletion of a stream or subtraction of a termination. However, in both cases, there is a time delay from when a reporting condition occurs on a BGF (e.g. a statistic threshold being passed) and the SPDF learning of the statistic. In many cases, such a delay is of no consequence. However, in some cases, the SPDF may require to be immediately informed of a given statistical threshold condition occurring. In this case, the SPDF must use the H.248.47 [22] Statistic Conditional Reporting package. This package may be applied to multiple Statistics. The SPDF should set the reporting thresholds and ranges as appropriate and must specify at least one "condition" for conditional reporting (i.e. the SPDF must signal at least one condition per requested packageID/statisticID item).

The exact Statistics and reporting conditions are determined by Operator configuration based on the application/service required.

5.17.1.14 Transcoding

Definition see clause 3.1.

5.17.1.14.1 Media types and formats (Codecs)

TS 181 005 [i.12] defines the codec services for TISPAN NGNs. There are codec recommendations in TS 181 005 [i.12] for *narrowband audio*, *wideband audio* and *video* media.

5.17.1.14.2 Decision for transcoding

The decision for transcoding may be principally reached at the beginning or later during the lifetime of a call/session. The correspondent triggers (for transcoding decisions) from BGF side would be either related to ADD or MODIFY request commands.

5.17.1.14.2.1 Decision at Stream/Termination creation

The first ADD.request (of a new Context) for a new Stream/Termination provides either a full specification (by the SPDF) of the media type and format, or an under specification, which is then completed by the BGF.

The subsequent request for the peer Stream/Termination (within this Context) is then leading to a possible transcoding decision. The BGF is comparing the SDP information elements for media description of the two H.248 Stream Descriptors:

- In case of identical media type and formats then there will be no transcoding. The BGF may even handle this Stream in media-agnostic mode.
- In case of different media type or/and formats then the BGF may decide for transcoding support or reject the request with an appropriate H.248.8 error code (e.g. due to temporarily lacking resources for transcoding).

5.17.1.14.2.2 Decision at Stream/Termination modification

MODIFY.request commands for existing Streams/Terminations may lead to a decision for transcoding.

5.17.1.15 Void

Void

5.17.1.16 VPN identification

5.17.1.16.1 VLAN marking

The BGF VLAN tagging behaviour is summarized in table 89c.

Table 89c: VLAN marking using *vlan* version 1 package

H.248 property usage		Semantic
vlan/pri	vlan/tags	Action
Sent	Value smaller than "4096" sent	Apply VLAN tagging accordingly
Sent	Not sent (use provisioned default value)	Apply VLAN tagging accordingly
Not sent (use provisioned default value)	Value smaller than "4096" sent	Apply VLAN tagging accordingly
Not sent	Not sent	Do not apply VLAN tagging
Sent or not sent	Value "4096" sent	Do not apply VLAN tagging

5.17.2 Overview of Session Independent Procedures

5.17.2.1 Introduction - Relation to TS 183 025

Session-independent procedures for ES 283 018 [19] are defined in a separate document (see TS 183 025 [i.2]), which is an overall description for all ETSI defined H.248 profile specifications, i.e. TS 183 025 [i.2] complements each profile specification.

The set of profile-applicable call-independent procedures is primarily given by the supported H.248 Command API capabilities for AuditValue (see clause 5.8.5), AuditCapabilities (see clause 5.8.6) and ServiceChange (see clause 5.8.8), and supported packages (e.g. for overload control), by each profile.

5.17.2.2 Session-independent procedures

Session-independent procedures are described in clauses 5.19 and 5.20.

5.17.2.3 MG Overload Control: Rate limitation of H.248 Messages from MGC-to-MG

The H.248.11 [14] package (see clause 5.14.2.16) may be used for controlling MG overload, by throttling and limiting the rate of H.248 messages from MGC to MG.

See clause 5.19.14 for the procedure and clause 5.20.23 for the command level details.

5.18 Session Dependent Procedures (Command Level Details)

The following clauses contain procedures which may be used to provide session handling within the MG. Within the present document a procedure constitutes a message sequence containing a Command Request and a Command Reply.

Multiple procedures may be combined within a single action e.g. one action may contain an "Add Termination - Remote Addr and Port Known, Select Local Addr and Port" procedure and an "Add Termination - Select Local Addr and Port" procedure in order to seize two IP terminations and an associated context.

Note that the Local Address and Port in these procedures may be selected by the MG or the MGC (e.g. NA(P)T less mode).

A procedure can be applied to a single stream or multiple streams within a single command.

Table 90: Session Dependant Procedures - References

Procedure	Support	Initiated By	Clause
Add Termination - Remote Addr and Port Known, Select Local Addr and Port (see note)	M	MGC	5.18.1.1
Add Termination - Select Local Addr and Port (see note)	M	MGC	5.18.1.2
Add Termination - Remote Addr Known, Select Local Addr (see note)	M	MGC	5.18.1.3
Add Termination - Select Local Addr (see note)	O	MGC	5.18.1.4
Add Termination - Remote Addr Known and Port Possibly Known, no Local Addr and Port (see note)	O	MGC	5.18.1.5
Session Establishment Update - Remote Addr and Port Known	M	MGC	5.18.2.1
Session Establishment Update - Remote Addr Known	M	MGC	5.18.2.2
Session Establishment Update - Through Connect	M	MGC	5.18.2.3
Session Establishment Update - Select Local Port	O	MGC	5.18.2.4
Session Establishment Update - Bandwidth Change	O	MGC	5.18.2.5
Session Establishment Update - Delete Stream	O	MGC	5.18.2.6
Mid-Session Update - Bandwidth Change	O	MGC	5.18.3.1
Mid-Session Update - Media Change	O	MGC	5.18.3.2
Mid-Session Update - Remote Addr/Port Change	O	MGC	5.18.3.3
Mid-Session Update - Add Stream, Remote Addr and Port Known	O	MGC	5.18.3.4
Mid-Session Update - Add Stream	O	MGC	5.18.3.5
Mid-Session Update - Delete Stream	O	MGC	5.18.3.6
Mid-Session Update - Add Stream, Remote Addr Known and Port Possibly Known, no Local Addr and Port	O	MGC	5.18.3.7
Mid-Session Statistics Audit	O	MGC	5.18.4.1
Mid-Session MGC Info Audit	O	MGC	5.18.4.2
Notification of IP Media Stop	O	MG	5.18.5.1
Notification of Hanging Termination	O	MG	5.18.5.2
Notification of Statistic Conditional Reporting	O	MG	5.18.5.3
Delete Session/Termination	M	MGC	5.18.6.1
Delete Session/Termination - Wildcarded Reply	O	MGC	5.18.6.2

NOTE: The IP real/domain indication may be implicit part of this procedure.

5.18.1 Add Termination

Within the Add Termination procedures the examples are shown as single commands operating on single terminations. The commands can be combined with other Add Termination commands within a single action. All of the Add Termination procedures can be applied to multiple streams within a single command.

The Termination Group within the Termination Name is assigned by the MGC using some local policy and this policy is out of scope for this profile. It is, however, recommended that all Terminations within a Context are assigned to the same Termination Group. The Termination Group concept is useful to avoid excessively large H.248 messages and consequential processing implications when recovery after a failover occurs i.e. at Audit of active Contexts. When performing an Add after a failover the MGC will only use Termination Groups that have been audited.

The IP Realm may be specified by the MGC using the ipdc package. If this property is not specified by the MGC, the MG shall assign a default IP Realm (see clause 5.18.1.1.2).

The Interface field of the termination ID (see clause 5.6.1.1.1) shall be assigned by the MG. The allocation algorithm is out of scope of the present document but shall be related to the corresponding IP Realm.

5.18.1.1 Add Termination - Remote Addr and Port Known, Select Local Addr and Port

Table 91: Message Contents - Add Termination - Remote Addr and Port Known, Select Local Addr and Port

Add Termination - Remote Addr and Port Known, Select Local Addr and Port								
H.248 Command	Descriptor	Descriptor	Descriptor	Properties, Events, Statistics, Signals	Connection Point Address, IP address information and Bearer Information	Support	Notes	
Add Request (MGC to MG)					Context ID = \$	M		
					Termination ID = ip/group/\$/\$	M		
	Media					M		
		Stream				O		
			Local Control			O		
				mode		O		
				ds/dscp		O		
				nt/jit		O		
				mpls/stack		O		
				vlan/tags		O		
				vlan/pri		O		
				gm/saf		O	5.18.1.1.1	
				gm/spf		O	5.18.1.1.1	
				gm/sam		O	5.18.1.1.1	
				gm/spr		O	5.18.1.1.1	
				gm/sprr		O	5.18.1.1.1	
				gm/rsb		O		
				gm/esas		O		
				gm/lsa		O		
				gm/esps		O		
				gm/lsp		O		
				mgcinfo/db		O		
				tman/pdr		O		
				tman/mbs		O		
				tman/dvt		O		
				tman/sdr		O		
				tman/pol		O		
				ipdc/realm		O	5.18.1.1.2	
			Statistics				O	See note
			Local			SDP Information Version	O	
						SDP Information Session Name	O	
						SDP Information Origin	O	
						SDP Information Timing	O	
					Address Type IP4 or IP6	M		
					Address Information IP Address = (\$ or specific)	M		
					Address Information Port = (\$ or specific)	M		
					Bearer Information Transport	M	See note 2 of table 87	
					Bearer Information Media format and type	O		
					Bearer Information Bandwidth	O		
		Remote			SDP Information Version	O		
					SDP Information Session Name	O		

Add Termination - Remote Addr and Port Known, Select Local Addr and Port							
H.248 Command	Descriptor	Descriptor	Descriptor	Properties, Events, Statistics, Signals	Connection Point Address, IP address information and Bearer Information	Support	Notes
					SDP Information Origin	O	
					SDP Information Timing	O	
					Address Type IP4 or IP6	M	
					Address Information IP Address	M	
					Address Information Port	M	
					Bearer Information Transport	M	See note 2 of table 87
					Bearer Information Media format and type	O	
					Attribute Information RTCP	O	
					Bearer Information Bandwidth	O	
	Signals			ipnapt/latch		O	
				napt		O	
	Events					O	
				g/cause		O	
				adid/ipstop		O	
				dt		O	
				dir		O	
				nt/netfail		O	
				nt/qualert		O	
				scr/cr		O	
				si		O	
				dur		O	
				per		O	
				max		O	
				min		O	
				nor		O	
				hangterm/thb		O	
				timerx		O	

NOTE: The MGC may request any statistic within those supported.

Table 92: Message Contents - Add Termination - Remote Addr and Port Known, Select Local Addr and Port Ack

Add Termination - Remote Addr and Port Known, Select Local Addr and Port Ack								
H.248 Command	Descriptor	Descriptor	Descriptor	Properties, Events, Statistics, Signals	Connection Point Address, IP address information and Bearer Information	Support	Notes	
Add Reply (MG to MGC)					Context ID=specified	M		
					Termination ID=specified	M		
	Media					M		
		Stream				O		
			Local			SDP Information Version	M	
						SDP Information Session Name	M	
						SDP Information Origin	M	
						SDP Information Timing	M	
						Address Type IP4 or IP6	M	
						Address Information IP Address	M	
						Address Information Port	M	
						Bearer Information Transport	M	
						Bearer Information Media format and type	O	
						Bearer Information Bandwidth	O	

5.18.1.1.1 Conditions for Address Policing: SAF, SPF, SAM, SPR, SPRR

Two alternative procedures are permitted depending on the source information for address and port filtering.

Procedure 1: Source Address and Port Determined from Gate Management Package properties (SAM, SPR, SPRR)

If port and address filtering are required then SAF and SPF will both be included and set to ON. If only address filtering is required then SAF is set to ON and SPF set to OFF or omitted. The combination of SAF set to OFF and SPF set to ON is not allowed.

If Remote Source Address Filtering is required (SAF=ON) then the Remote Source Address Mask must be included.

If Remote Source Port Filtering is required (SPF=ON) then the Remote Source Port and/or Remote Source Port Range must be included.

In case multiple flows are associated with a stream (for example RTP and RTCP), the settings of the SAF, SPF, SAM, SPR, and SPRR properties apply to all flows of the stream.

The latching/re-latching capability (according *ipnapt* version 1 package) might be enabled for NAT traversal support. When latching/re-latching is requested, only incoming media packets passing the source address and port filter criteria (range or specific values) shall be considered for latching. When latching/re-latching occurs, the MG will implicitly filter incoming packets based on the result of the (re)latching process, i.e. in alignment with ITU-T Recommendation H.248.37 [8] Revision 1 procedures the latching/re-latching does not change the explicit filter criteria as defined by the gm package properties.

EXAMPLE 1: The MGC sets SAF=ON, SAM=123.123.123.123, SPF=ON, no SPR, SPRR=1024-65535 and requests latching for a stream containing both RTP and RTCP. The MG will latch to first incoming RTP packet from source address 123.123.123.123 which is using a source port in the range of 1024-65535. In addition the MG will then apply implicit source filtering to the RTP flow using address 123.123.123.123 and the source port of the latched RTP packet. At first incoming RTCP packet from source address 123.123.123.123 which is using a source port in the range of 1024-65535, the MG will do a separate latch for the RTCP flow. The MG will then apply implicit source filtering to the RTCP flow using address 123.123.123.123 and the source port of the latched RTCP packet.

Procedure 2: Source Address and Port Determined from RemoteDescriptor (SDP information)

If port and address filtering are required then SAF and SPF should both be included and set to ON. If only address filtering is required then SAF must be set to ON and SPF set to OFF or omitted. The combination of SAF set to OFF and SPF set to ON is not allowed.

In case multiple flows are associated with a stream (for example RTP and RTCP), the settings of the SAF and SPF properties apply to all flows of the stream.

SAM, SPR, and SPRR are not used. The source address and source port filter values shall be determined from the received RemoteDescriptor (SDP information) or from a received packet (source address and source port) if latching/re-latching has been completed.

Using remote SDP (i.e. SDP information from H.248 RD) for filtering assumes symmetrical address and port allocation at peer media plane entity. Thus, such a filter may be ineffective, or even discard correct packets, in the case of that the peer IP endpoint is using different IP interfaces for each traffic direction (i.e. asymmetrical IP addresses).

The latching/re-latching capability (according *ipnapt* version 1 package) might be enabled for NAT traversal support. When latching/re-latching is requested SAF must be set to ON and SPF set to OFF or omitted (if SPF would be set to ON the MG could not latch to a different port as the explicit filters are applied before latching/re-latching). After (re)latching has been completed the MG will implicitly filter incoming packets based on the result of the latching/re-latching process in addition to the explicit filter criteria as defined by the gm package properties.

EXAMPLE 2: For a stream containing both RTP and RTCP flows, the MGC sets SAF=ON, no SAM, SPF=OFF, no SPR, no SPRR, address in Remote Descriptor c= line 123.123.123.123, address in Remote Descriptor a=rtcp line 123.123.123.124 and requests latching. The MG will then latch to first incoming RTP packet from source address 123.123.123.123, independently of source port and in addition apply implicit source filtering using address 123.123.123.123 and the source port of the latched RTP packet. At first incoming RTCP packet from source address 123.123.123.124 the MG will do a separate latch for the RTCP flow. The MG will then apply implicit source filtering to the RTCP flow using address 123.123.123.124 and the source port of the latched RTCP packet.

See also clause D.2 concerning a possible interaction.

5.18.1.1.2 Assigning IP Domain/Realm to Termination

The IP domain/realm of the termination is indicated through the ipdc/realm property. A default domain/realm may be provisioned and then the ipdc/realm property does not have to be specified. The <Interface> part of the termination ID is not used to indicate IP domain/realm.

The IP Realm cannot be subsequently changed in a Modify command once assigned to a termination (via the Add command). Only an identical/unchanged setting of IP realm identifier may be sent in a Modify command.

5.18.1.1.3

Add Termination - Remote Addr and Port Known, Select Local Addr and Port - Examples

```

MGC                                     MG
1 |----->
MEGACO/3 [102.168.55.54]
Transaction = 1 {
  Context = $ {
    Priority = 6,
    Add = ip/104/$/$ {
      Media {
        Stream = 1 {
          LocalControl {
            Mode=Inactive,
            ds/dscp = 1D,
            gm/saf = ON,
            gm/spf = ON,
            gm/rsb = ON,
            gm/esas = ON,
            gm/lsa = "[192.10.33.158]",
            gm/esps = ON,
            gm/lsp = 3624,
            mgcinfo/db = 16547/67,
            tman/pdr = 17500,
            tman/mbs = 1500,
            tman/dvt = 300,
            tman/sdr = 16000,
            tman/pol = ON,
            ipdc/realm = "1"
          },
          Local {
            v=0
            c=IN IP4 $
            m=- $ RTP/AVP -
            b=AS:128
          },
          Remote {
            v=0
            o=- 0 0 IN IP4 25.196.80.72
            s=-
            t=0 0
            c=IN IP4 25.196.80.72
            m=- 20000 RTP/AVP -
            b=AS:128
          }
        }
      }
    },
    Events = 1235 {
      g/cause,
      adid/ipstop,
      nt/netfail,
      nt/qualert,
      scr/cr{si="nt/os",max=10000},
      hangterm/thb {timerx =600}
    }
  }
}

2 |-----<
MEGACO/3 bs_MP_4/1
Reply = 1 {
  Context = 38924 {
    Add = ip/104/2/541 {
      Media {
        Stream = 1 {
          Local {
            v=0
            o=- 0 0 IN IP4 16.128.45.10
            s=-
            t=0 0
          }
        }
      }
    }
  }
}

```

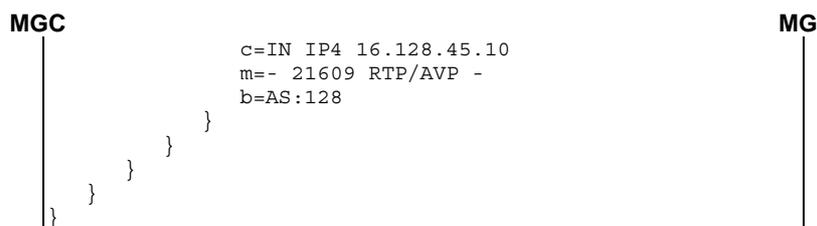

Figure 4: H.248 Message Sequence Example - Add Termination - Remote Addr and Port Known, Select Local Addr and Port

5.18.1.2 Add Termination - Select Local Addr and Port

Table 93: Message Contents - Add Termination - Select Local Addr and Port

Add Termination - Select Local Addr and Port								
H.248 Command	Descriptor	Descriptor	Descriptor	Properties, Events, Statistics, Signals	Connection Point Address, IP address information and Bearer Information	Support	Notes	
Add Request (MGC to MG)					Context ID = \$	M		
					Termination ID = ip/group/\$/\$	M		
	Media					M		
		Stream				O		
			Local Control			O		
				mode		O		
				ds/dscp		O		
				nt/jit		O		
				mpl/stack		O		
				vlan/tags		O		
				vlan/pri		O		
				gm/saf		O	5.18.1.1.1	
				gm/spf		O	5.18.1.1.1	
				gm/sam		O	5.18.1.1.1	
				gm/spr		O	5.18.1.1.1	
				gm/sprr		O	5.18.1.1.1	
				gm/rsb		O		
				gm/esas		O		
				gm/lsa		O		
				gm/esps		O		
				gm/lsp		O		
				mgcinfo/db		O		
				tman/pdr		O		
				tman/mbs		O		
				tman/dvt		O		
				tman/sdr		O		
				tman/pol		O		
				ipdc/realm		O	5.18.1.1.2	
			Statistics				O	See note
			Local			SDP Information	O	
						Version	O	
						SDP Information	O	
						Session Name	O	
					SDP Information	O		
					Origin	O		
					SDP Information	O		
					Timing	O		
					Address Type	M		
					IP4 or IP6	M		
					Address Information	M		
					IP Address = (\$ or specific)	M		

Add Termination - Select Local Addr and Port								
H.248 Command	Descriptor	Descriptor	Descriptor	Properties, Events, Statistics, Signals	Connection Point Address, IP address information and Bearer Information	Support	Notes	
					Address Information			
					Port = (\$ or specific)	M		
					Bearer Information	M	See note 2 of table 87	
					Transport			
						Bearer Information	O	
						Media format and type		
						Bearer Information	O	
						Bandwidth		
	Signals				ipnapt/latch		O	
						napt	O	
	Events						O	
						g/cause	O	
						adid/ipstop	O	
						dt	O	
						dir	O	
						nt/netfail	O	
						nt/qualert	O	
						scr/cr	O	
						si	O	
						dur	O	
per						O		
max						O		
min	O							
nor	O							
hangterm/thb						O		
					timerx	O		

NOTE: The MGC may request any statistic within those supported.

Table 94: Message Contents - Add Termination - Select Local Addr and Port Ack

Add Termination - Select Local Addr and Port Ack								
H.248 Command	Descriptor	Descriptor	Descriptor	Properties, Events, Statistics, Signals	Connection Point Address, IP address information and Bearer Information	Support	Notes	
Add Reply (MG to MGC)					Context ID=specified	M		
					Termination ID=specified	M		
	Media					M		
		Stream				O		
			Local			SDP Information Version	M	
						SDP Information Session Name	M	
						SDP Information Origin	M	
						SDP Information Timing	M	
						Address Type IP4 or IP6	M	
						Address Information IP Address	M	
						Address Information Port	M	
						Bearer Information Transport	M	
						Bearer Information Media format and type	O	
						Bearer Information Bandwidth	M	

5.18.1.2.1

Add Termination - Select Local Addr and Port - Examples

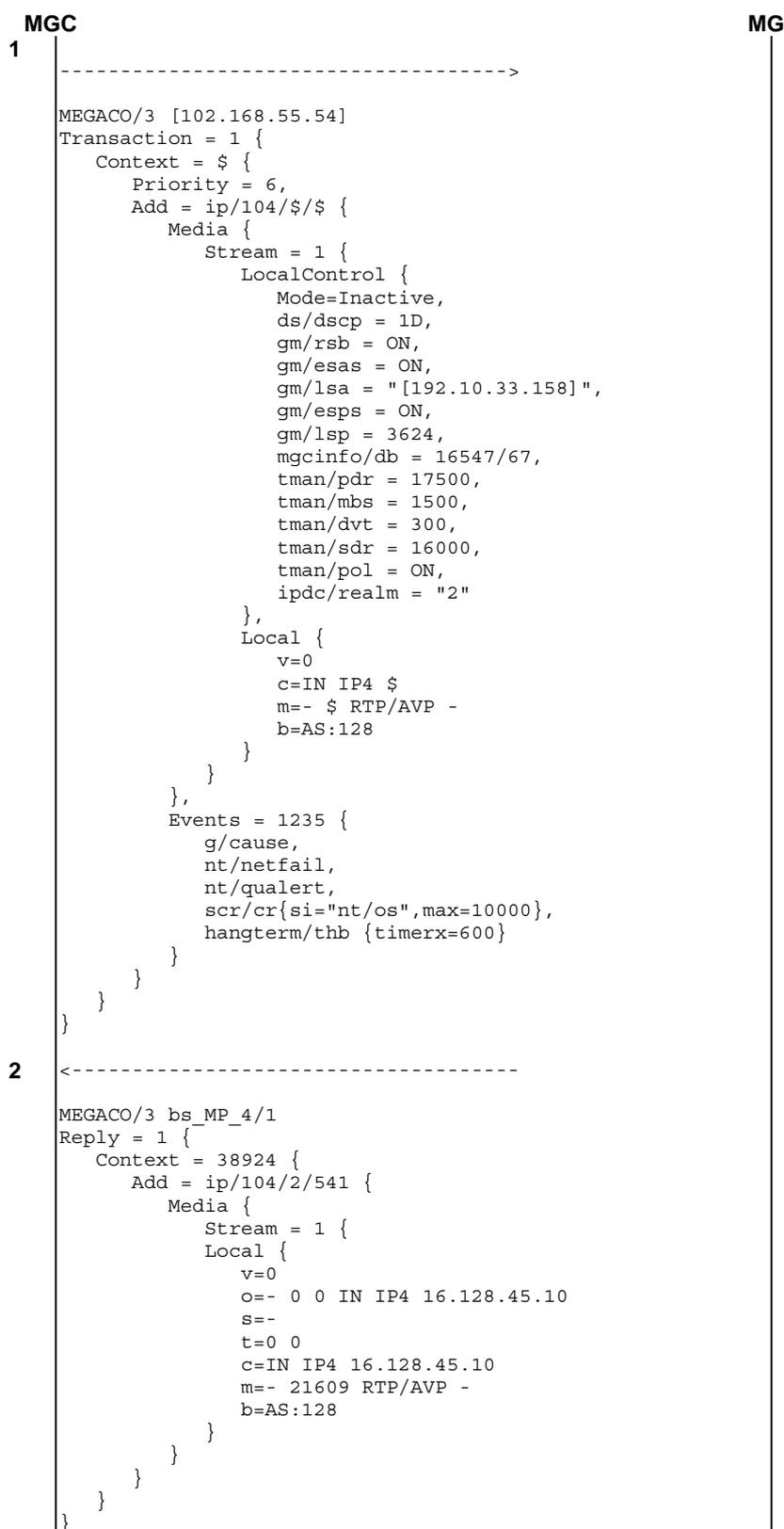

Figure 5: H.248 Message Sequence Example - Add Termination - Select Local Addr and Port

5.18.1.3 Add Termination - Remote Addr Known, Select Local Addr

Table 95: Message Contents - Add Termination - Remote Addr Known, Select Local Addr

Add Termination - Remote Addr Known, Select Local Addr								
H.248 Command	Descriptor	Descriptor	Descriptor	Properties, Events, Statistics, Signals	Connection Point Address, IP address information and Bearer Information	Support	Notes	
Add Request (MGC to MG)					Context ID = \$	M		
					Termination ID = ip/group/\$/\$	M		
		Media				M		
			Stream			O		
				Local Control		O		
					ipdc/realm	O		
				Statistics		O	See note	
				Local		SDP Information Version	O	
						SDP Information Session Name	O	
						SDP Information Origin	O	
						SDP Information Timing	O	
						Address Type IP4 or IP6	M	
						Address Information IP Address = (\$ or specific)	M	
				Remote		SDP Information Version	O	
						SDP Information Session Name	O	
						SDP Information Origin	O	
						SDP Information Timing	O	
					Address Type IP4 or IP6	M		
					Address Information IP Address	M		

NOTE: The MGC may request any statistic within those supported.

Table 96: Message Contents - Add Termination - Remote Port Known, Select Local Addr Ack

Add Termination - Remote Addr Known, Select Local Addr Ack								
H.248 Command	Descriptor	Descriptor	Descriptor	Properties, Events, Statistics, Signals	Connection Point Address, IP address information and Bearer Information	Support	Notes	
Add Reply (MG to MGC)					Context ID=specified	M		
					Termination ID=specified	M		
	Media					M		
		Stream				O		
			Local			SDP Information Version	M	
						SDP Information Session Name	M	
						SDP Information Origin	M	
						SDP Information Timing	M	
						Address Type IP4 or IP6	M	
						Address Information IP Address	M	

5.18.1.3.1

Add Termination - Remote Addr Known, Select Local Addr - Examples

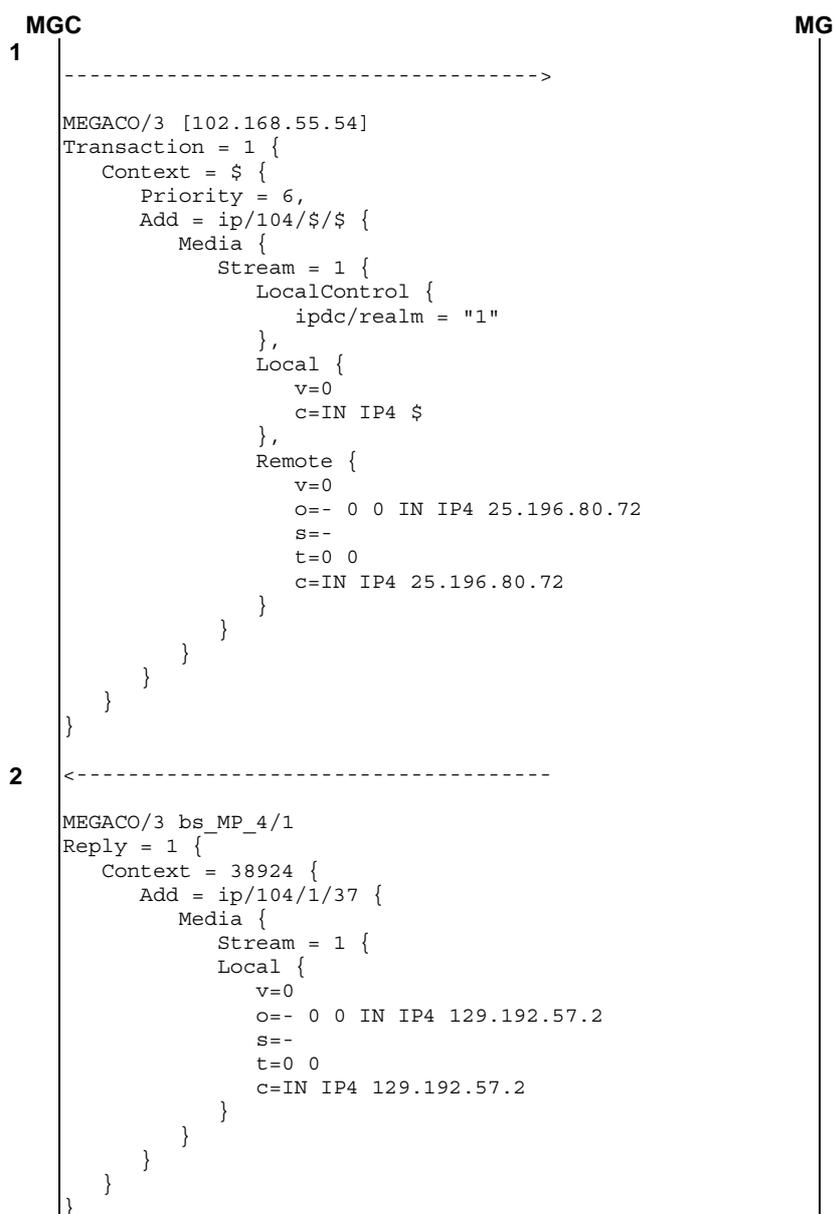

Figure 6: H.248 Message Sequence Example - Add Termination - Remote Addr Known, Select Local Addr

5.18.1.4.1 Add Termination - Select Local Addr - Examples

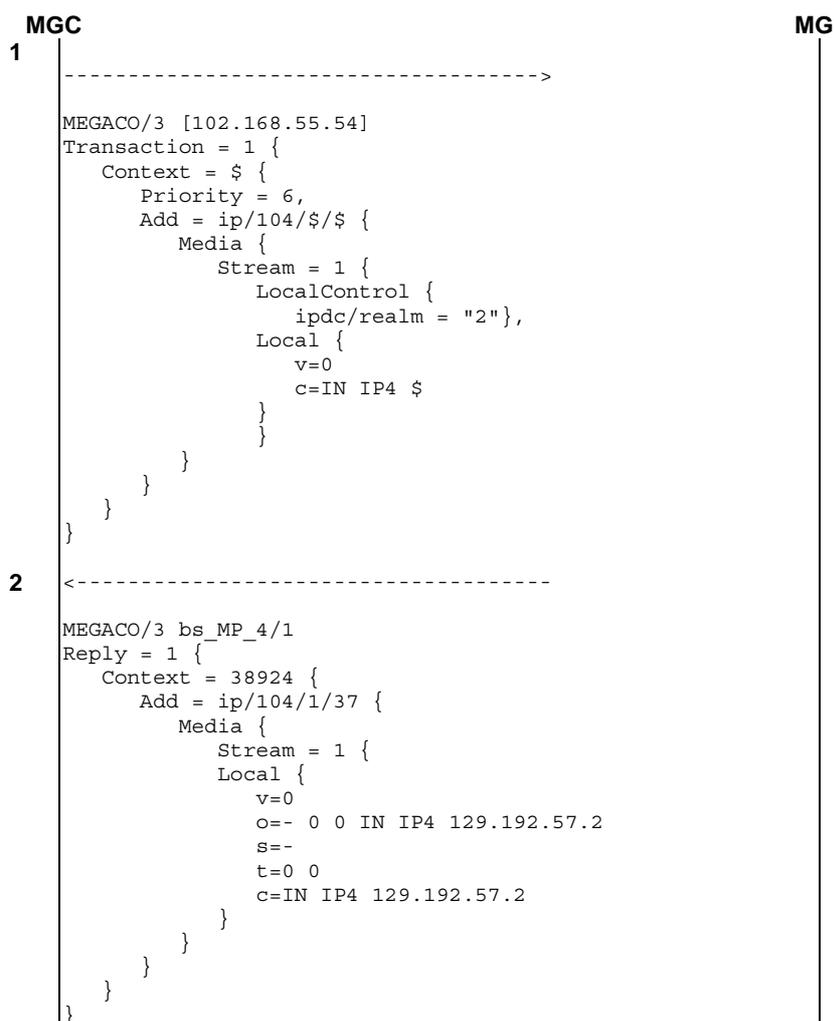

Figure 7: H.248 Message Sequence Example - Add Termination - Select Local Addr

5.18.1.5 Add Termination - Remote Addr Known and Port Possibly Known, no Local Addr and Port

Table 98a: Message Contents - Add Termination - Remote Addr Known and Port Possibly Known, no Local Addr and Port

Add Termination - Remote Addr Known and Port Possibly Known, no Local Addr and Port								
H.248 Command	Descriptor	Descriptor	Descriptor	Properties, Events, Statistics, Signals	Connection Point Address, IP address information and Bearer Information	Support	Notes	
Add Request (MGC to MG)					Context ID = \$	M		
					Termination ID = ip/group/\$/\$	M		
		Media				M		
			Stream			O		
				Local Control	ipdc/realm	O	5.18.1.1.2	
				Statistics		O	See note	
				Remote		SDP Information	O	
						Version	O	
						SDP Information Session Name	O	
						SDP Information Origin	O	
						SDP Information Timing	O	
						Address Type IP4 or IP6	M	
						Address Information IP Address	M	
						Address Information Port	O	
						Bearer Information Transport	O	See note 2 of table 87
						Bearer Information Media format and type	O	
						Attribute Information RTCP	O	
						Bearer Information Bandwidth	O	
		Events					O	
					hangterm/thb		O	
					timerx	O		

NOTE: The MGC may request any statistic within those supported.

Table 98b: Message Contents - Add Termination - Remote Addr Known and Port Possibly Known, no Local Addr and Port Ack

Add Termination - Remote Addr Known and Port Possibly Known, no Local Addr and Port Ack							
H.248 Command	Descriptor	Descriptor	Descriptor	Properties, Events, Statistics, Signals	Connection Point Address, IP address information and Bearer Information	Support	Notes
Add Reply (MG to MGC)					Context ID=specified	M	
					Termination ID=specified	M	

5.18.1.5.1 Add Termination - Remote Addr Known and Port Possibly Known, no Local Addr and Port - Examples

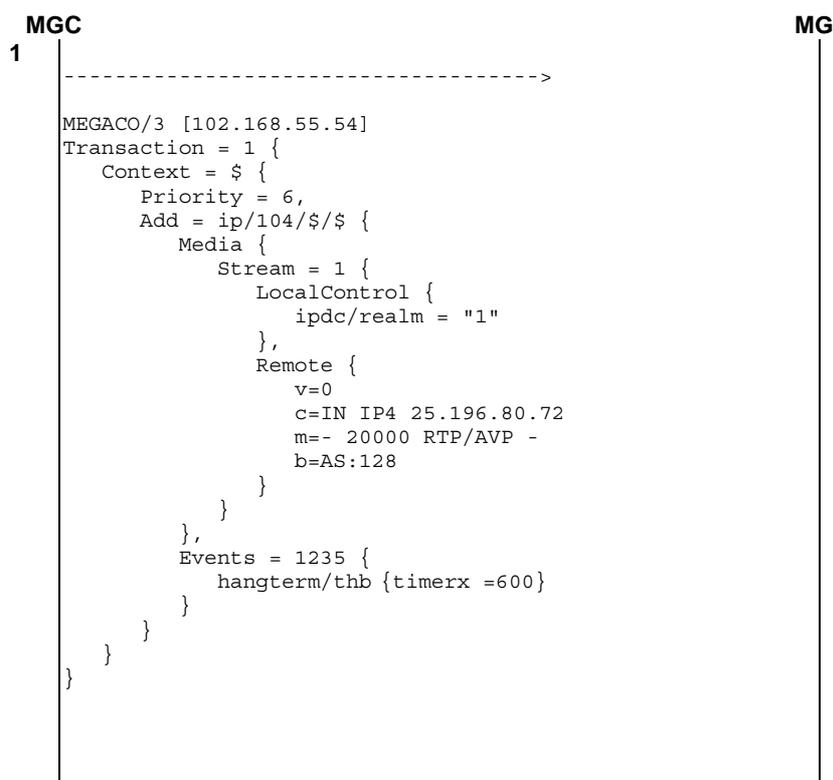

Figure 7a: H.248 Message Sequence Example - Add Termination - Remote Addr Known and Port Possibly Known, no Local Addr and Port

5.18.2 Session Establishment Update

During session establishment additional information may be required by the MG terminations in order to establish the path. Examples of these changes are the remote address and port, through connection status and change of bandwidth allocation.

5.18.2.1 Session Establishment Update - Remote Addr and Port Known

Table 99: Message Contents - Session Establishment Update - Remote Addr and Port Known

Session Establishment Update - Remote Addr and Port Known								
H.248 Command	Descriptor	Descriptor	Descriptor	Properties, Events, Statistics, Signals	Connection Point Address, IP address information and Bearer Information	Support	Notes	
Modify Request (MGC to MG)					Context ID=specified	M		
					Termination ID=specified	M		
	Media					M		
		Stream				O		
			Local Control			O		
				mode		O		
				ds/dscp		O		
				nt/jit		O		
				mpls/stack		O		
				vlan/tags		O		
				vlan/pri		O		
				gm/saf		O	5.18.1.1.1	
				gm/spf		O	5.18.1.1.1	
				gm/sam		O	5.18.1.1.1	
				gm/spr		O	5.18.1.1.1	
				gm/sprr		O	5.18.1.1.1	
				gm/rsb		O		
				gm/esas		O		
				gm/lra		O		
				gm/esps		O		
				gm/lsp		O		
				mgcinfo/db		O		
				tman/pdr		O		
				tman/mbs		O		
				tman/dvt		O		
				tman/sdr		O		
				tman/pol		O		
				ipdc/realm		O	5.18.1.1.2	
			Local				O	
					SDP Information Version		O	
					SDP Information Session Name		O	
					SDP Information Origin		O	
					SDP Information Timing		O	
				Address Type IP4 or IP6		M		
				Address Information IP Address		M		
				Address Information Port		M		
				Bearer Information Transport		M	See note 2 of table 87	
				Bearer Information Media format and type		O		
				Bearer Information Bandwidth		M		
		Remote		SDP Information Version		O		
				SDP Information Session Name		O		
				SDP Information Origin		O		

Session Establishment Update - Remote Addr and Port Known							
H.248 Command	Descriptor	Descriptor	Descriptor	Properties, Events, Statistics, Signals	Connection Point Address, IP address information and Bearer Information	Support	Notes
					SDP Information	O	
					Timing		
					Address Type	M	
					IP4 or IP6		
					Address Information	M	
					IP Address		
					Address Information	M	
					Port		
					Bearer Information	M	See note 2 of table 87
					Transport		
					Bearer Information	O	
					Media format and type		
					Bearer Information	M	
					Bandwidth		
					Attribute Information	O	
					RTCP		
	Signals					O	
				ipnapt/latch		O	
					napt	O	
	Events					O	
				adid/ipstop		O	
					dt	O	
					dir	O	
				g/cause		O	
				nt/netfail		O	
				nt/qualert		O	
				scr/cr		O	
					si	O	
					dur	O	
					per	O	
					max	O	
					min	O	
					nor	O	
				hangterm/th		O	
				b	timerx	O	

Table 100: Message Contents - Session Establishment Update - Remote Addr and Port Known Ack

Session Establishment Update - Remote Addr and Port Known, Through Connect, Bandwidth Change Ack							
H.248 Command	Descriptor	Descriptor	Descriptor	Properties, Events, Statistics, Signals	Connection Point Address, IP address information and Bearer Information	Support	Notes
Modify Reply (MG to MGC)					Context ID=specified	M	
					Termination ID=specified	M	

5.18.2.1.1 Session Establishment Update - Remote Addr and Port Known - Examples

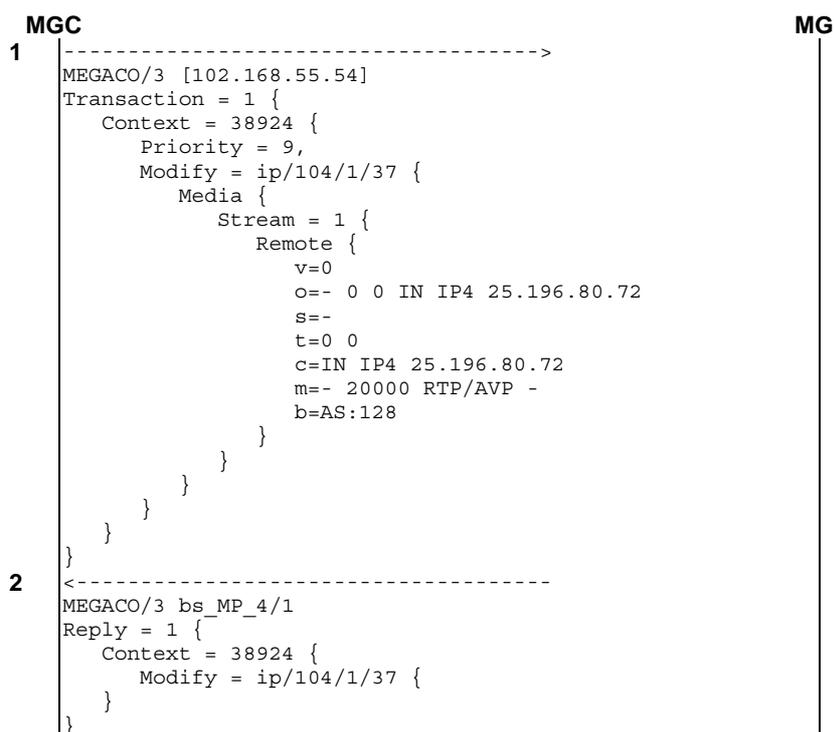

Figure 8: H.248 Message Sequence Example - Session Establishment Update - Remote Addr and Port Known

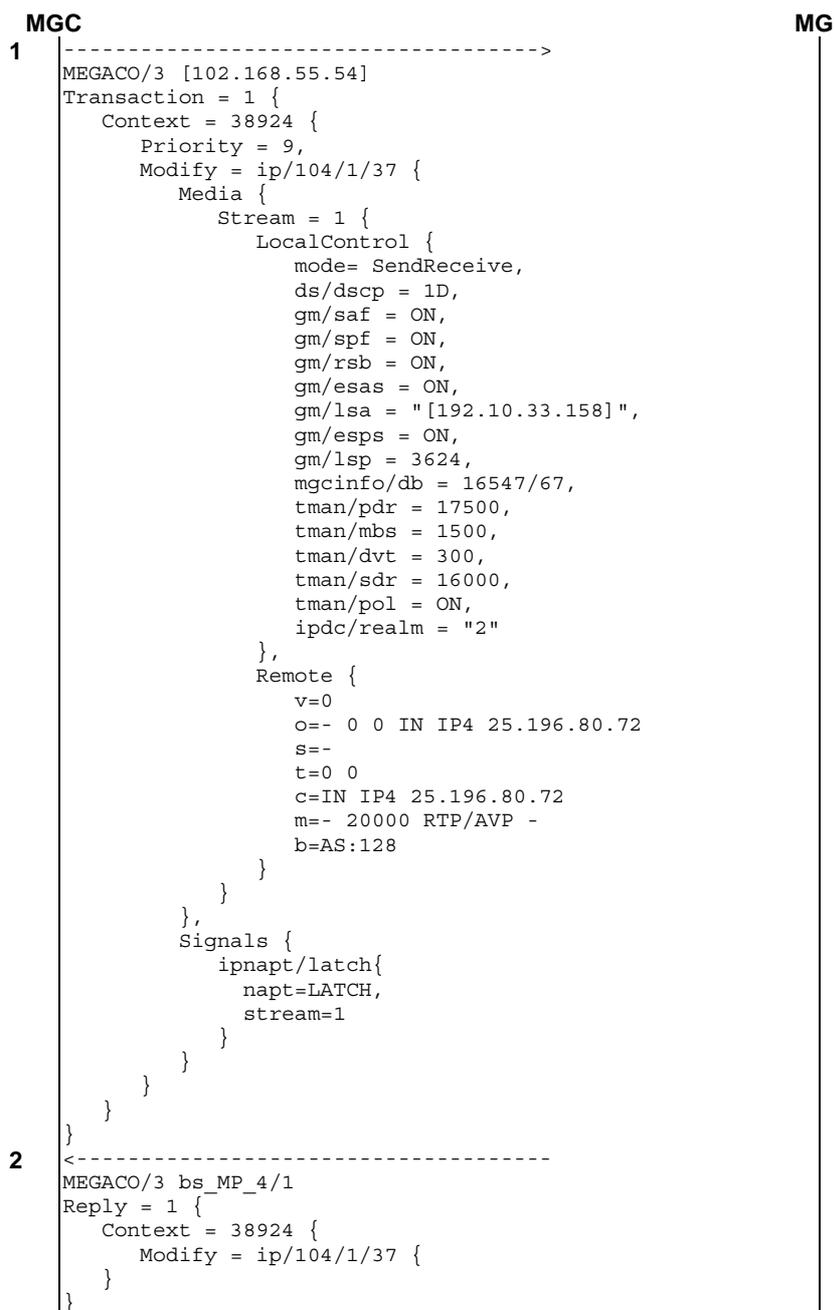

Figure 9: H.248 Message Sequence Example - Session Establishment Update - Remote Addr and Port Known, Through Connect and Latch

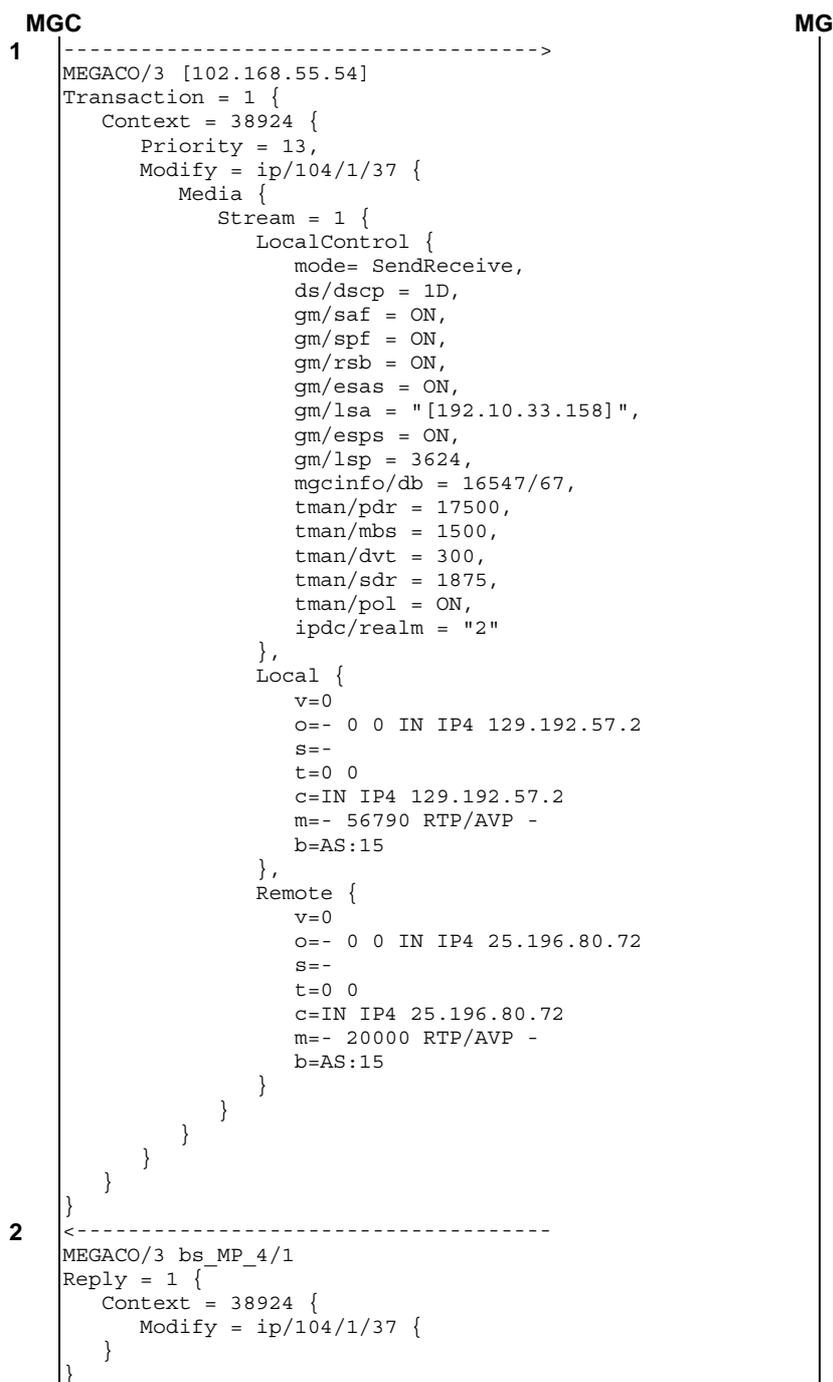

Figure 10: H.248 Message Sequence Example - Session Establishment Update - Remote Addr and Port Known, Through Connect, Bandwidth Change

5.18.2.2 Session Establishment Update - Remote Addr Known

Table 101: Message Contents - Session Establishment Update - Remote Addr Known

Session Establishment Update - Remote Addr Known								
H.248 Command	Descriptor	Descriptor	Descriptor	Properties, Events, Statistics, Signals	Connection Point Address, IP address information and Bearer Information	Support	Notes	
Modify Request (MGC to MG)					Context ID=specified	M		
					Termination ID=specified	M		
	Media						M	
		Stream					O	
			Remote				SDP Information Version	O
						SDP Information Session Name	O	
						SDP Information Origin	O	
						SDP Information Timing	O	
						Address Type IP4 or IP6	M	
				Address Information IP Address	M			

Table 102: Message Contents - Session Establishment Update - Remote Addr Known Ack

Session Establishment Update - Remote Addr Known Ack							
H.248 Command	Descriptor	Descriptor	Descriptor	Properties, Events, Statistics, Signals	Connection Point Address, IP address information and Bearer Information	Support	Notes
Modify Reply (MG to MGC)					Context ID=specified	M	
					Termination ID=specified	M	

5.18.2.2.1 Session Establishment Update - Remote Addr Known - Examples

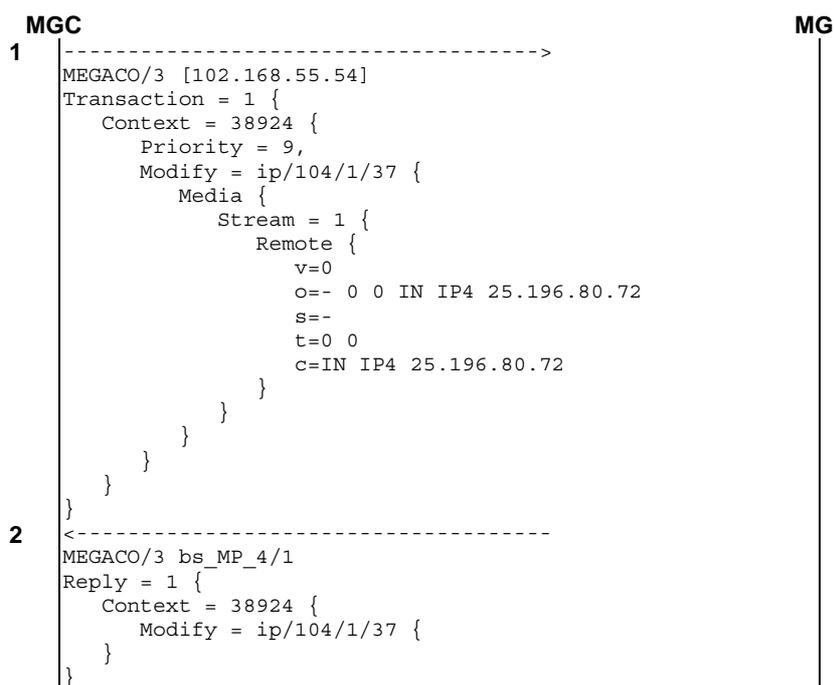

Figure 11: H.248 Message Sequence Example - Session Establishment Update -Remote Addr Known

5.18.2.3 Session Establishment Update - Through Connect

Table 103: Message Contents - Session Establishment Update - Through Connect

Session Establishment Update - Through Connect											
H.248 Command	Descriptor	Descriptor	Descriptor	Properties, Events, Statistics, Signals	Connection Point Address, IP address information and Bearer Information	Support	Notes				
Modify Request (MGC to MG)	Media	Stream	Local Control		Context ID=specified	M					
					Termination ID=specified	M					
						M					
						O					
						M					
					mode	M					
					ds/dscp	O					
					nt/jit	O					
					mpls/stack	O					
					vlan/tags	O					
					vlan/pri	O					
					gm/saf	O	5.18.1.1.1				
					gm/spf	O	5.18.1.1.1				
					gm/sam	O	5.18.1.1.1				
					gm/spr	O	5.18.1.1.1				
					gm/sprr	O	5.18.1.1.1				
					gm/rsb	O					
					gm/esas	O					
					gm/lsa	O					
					gm/esps	O					
					gm/lsp	O					
					mgcinfo/db	O					
					tman/pdr	O					
					tman/mbs	O					
					tman/dvt	O					
					tman/sdr	O					
					tman/pol	O					
					ipdc/realm	O	5.18.1.1.2				
							Local			O	
								SDP Information		O	
								Version		O	
								SDP Information		O	
								Session Name		O	
								SDP Information		O	
								Origin		O	
								SDP Information		O	
								Timing		O	
								Address Type		M	
								IP4 or IP6		M	
								Address Information		M	
				IP Address		M					
				Address Information		M					
				Port		M					
				Bearer Information		M	See note 2 of table 87.				
				Transport		M					
				Bearer Information		O					
				Media format and type		O					
				Bearer Information		M					
				Bandwidth		M					
			Remote			O					
				SDP Information		O					
				Version		O					
				SDP Information		O					
				Session Name		O					
				SDP Information		O					
				Origin		O					

Session Establishment Update - Through Connect							
H.248 Command	Descriptor	Descriptor	Descriptor	Properties, Events, Statistics, Signals	Connection Point Address, IP address information and Bearer Information	Support	Notes
					SDP Information	O	
					Timing		
					Address Type	M	
					IP4 or IP6		
					Address Information	M	
					IP Address		
					Address Information	M	
					Port		
					Bearer Information	M	See note 2 of table 87
					Transport		
					Bearer Information	O	
					Media format and type		
					Attribute Information	O	
					RTCP		
					Bearer Information	O	
					Bandwidth		
	Signals					O	
				ipnapt/latch		O	
					napt	O	
	Events					O	
				adid/ipstop		O	
					dt	O	
					dir	O	
				g/cause		O	
				nt/netfail		O	
				nt/qualert		O	
				scr/cr		O	
					si	O	
					dur	O	
					per	O	
					max	O	
					min	O	
					nor	O	
				hangterm/thb		O	
					timerx	O	

Table 104: Message Contents - Session Establishment Update - Through Connect Ack

Session Establishment Update - Through Connect Ack							
H.248 Command	Descriptor	Descriptor	Descriptor	Properties, Events, Statistics, Signals	Connection Point Address, IP address information and Bearer Information	Support	Notes
Modify Reply (MG to MGC)					Context ID=specified	M	
					Termination ID=specified	M	

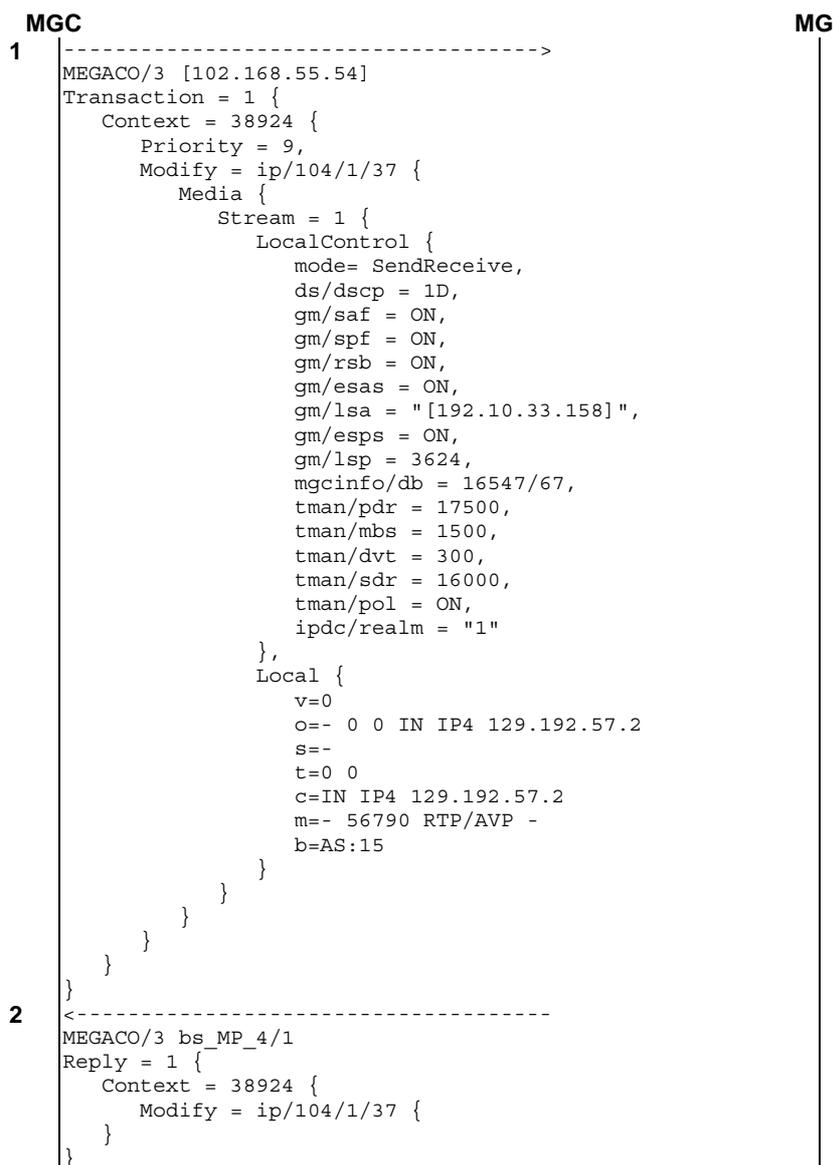

Figure 13: H.248 Message Sequence Example - Session Establishment Update - Through Connect, Bandwidth Change

5.18.2.4 Session Establishment Update - Select Local Port

Table 105: Message Contents - Session Establishment Update - Select Local Port

Session Establishment Update - Select Local Port							
H.248 Command	Descriptor	Descriptor	Descriptor	Properties, Events, Statistics, Signals	Connection Point Address, IP address information and Bearer Information	Support	Notes
Modify Request (MGC to MG)					Context ID=specified	M	
					Termination ID=specified	M	
	Media	Stream	Local Control	mode		O	
				ds/dscp		O	
				nt/jit		O	
				mpls/stack		O	
				vlan/tags		O	

Session Establishment Update - Select Local Port							
H.248 Command	Descriptor	Descriptor	Descriptor	Properties, Events, Statistics, Signals	Connection Point Address, IP address information and Bearer Information	Support	Notes
				vlan/pri		O	
				gm/saf		O	5.18.1.1.1
				gm/spf		O	5.18.1.1.1
				gm/sam		O	5.18.1.1.1
				gm/spr		O	5.18.1.1.1
				gm/sprr		O	5.18.1.1.1
				gm/rsb		O	
				gm/esas		O	
				gm/lsa		O	
				gm/esps		O	
				gm/lsp		O	
				mgcinfo/db		O	
				tman/pdr		O	
				tman/mbs		O	
				tman/dvt		O	
				tman/sdr		O	
				tman/pol		O	
				ipdc/realm		O	5.18.1.1.2
			Local		SDP Information	O	
					Version	O	
					SDP Information	O	
					Session Name	O	
					SDP Information	O	
					Origin	O	
					SDP Information	O	
					Timing	O	
					Address Type	M	
					IP4 or IP6	M	
					Address Information	M	
					IP Address	M	
					Address Information	M	
					Port = (\$ or specific)	M	
					Bearer Information	M	See note 2 of table 87
					Transport	O	
					Bearer Information	O	
					Media format and type	O	
					Bearer Information	M	
					Bandwidth	O	
	Signals					O	
				ipnapt/latch		O	
				napt		O	
	Events					O	
				adid/ipstop		O	
				dt		O	
				dir		O	
				g/cause		O	
				hangterm/th		O	
				b	timerx	O	
				nt/netfail		O	
				nt/qualert		O	
				scr/cr		O	
				si		O	
				dur		O	
				per		O	
				max		O	
				min		O	
				nor		O	

Table 106: Message Contents - Session Establishment Update - Select Local Port Ack

Session Establishment Update - Select Local Port Ack							
H.248 Command	Descriptor	Descriptor	Descriptor	Properties, Events, Statistics, Signals	Connection Point Address, IP address information and Bearer Information	Support	Notes
Modify Reply (MG to MGC)					Context ID=specified	M	
					Termination ID=specified	M	
	Media					M	
		Stream				O	
			Local			M	
					SDP Information Version	M	
					SDP Information Session Name	M	
					SDP Information Origin	M	
					SDP Information Timing	M	
					Address Type IP4 or IP6	M	
					Address Information IP Address	M	
					Address Information Port	M	
					Bearer Information Transport	M	
					Bearer Information Media format and type	O	
					Bearer Information Bandwidth	M	

5.18.2.4.1

Session Establishment Update - Select Local Port - Examples

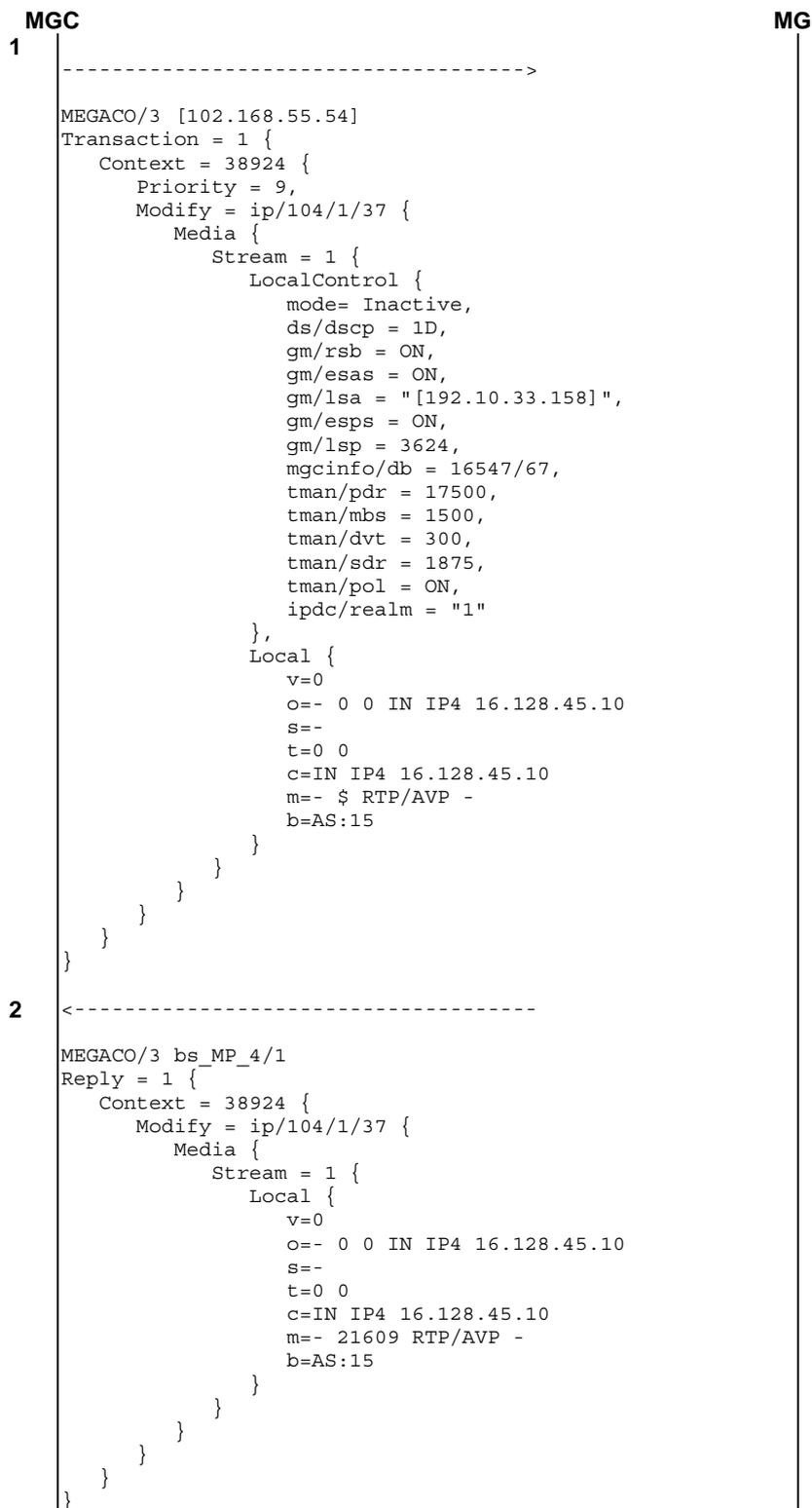

Figure 14: H.248 Message Sequence Example - Session Establishment Update - Select Local Port

5.18.2.5 Session Establishment Update - Bandwidth Change

Table 107: Message Contents - Session Establishment Update - Bandwidth Change

Session Establishment Update - Bandwidth Change												
H.248 Command	Descriptor	Descriptor	Descriptor	Properties, Events, Statistics, Signals	Connection Point Address, IP address information and Bearer Information	Support	Notes					
Modify Request (MGC to MG)					Context ID=specified	M						
					Termination ID=specified	M						
	Media	Stream		Local Control	mode		O					
					ds/dscp		O					
					nt/jit		O					
					mpls/stack		O					
					vlan/tags		O					
					vlan/pri		O					
					gm/saf		O	5.18.1.1.1				
					gm/spf		O	5.18.1.1.1				
					gm/rsb		O					
					gm/sam		O					
					gm/esas		O					
					gm/lsa		O					
					gm/esps		O					
					gm/lsp		O					
					gm/spr		O					
					gm/sprr		O					
					mgcinfo/db		O					
					tman/pdr		O					
					tman/mbs		O					
					tman/dvt		O					
					tman/sdr		O					
					tman/pol		O					
					ipdc/realm		O	5.18.1.1.2				
					Events			Local	SDP Information Version		O	
									SDP Information Session Name		O	
									SDP Information Origin		O	
									SDP Information Timing		O	
									Address Type IP4 or IP6		M	
	Address Information IP Address		M									
	Address Information Port		M									
	Bearer Information Transport		M	See note 2 of table 87								
Bearer Information Media format and type		O										
Bearer Information Bandwidth		M										
		O										
		O										
		O										
		O										
		O										

Session Establishment Update - Bandwidth Change							
H.248 Command	Descriptor	Descriptor	Descriptor	Properties, Events, Statistics, Signals	Connection Point Address, IP address information and Bearer Information	Support	Notes
				scr/cr		O	
					si	O	
					dur	O	
					per	O	
					max	O	
					min	O	
					nor	O	
				hangterm/thb		O	
					timerx	O	

Table 108: Message Contents - Session Establishment Update - Bandwidth Change Ack

Session Establishment Update - Bandwidth Change Ack							
H.248 Command	Descriptor	Descriptor	Descriptor	Properties, Events, Statistics, Signals	Connection Point Address, IP address information and Bearer Information	Support	Notes
Modify Reply (MG to MGC)					Context ID=specified	M	
					Termination ID=specified	M	

5.18.2.5.1 Session Establishment Update - Bandwidth Change - Examples

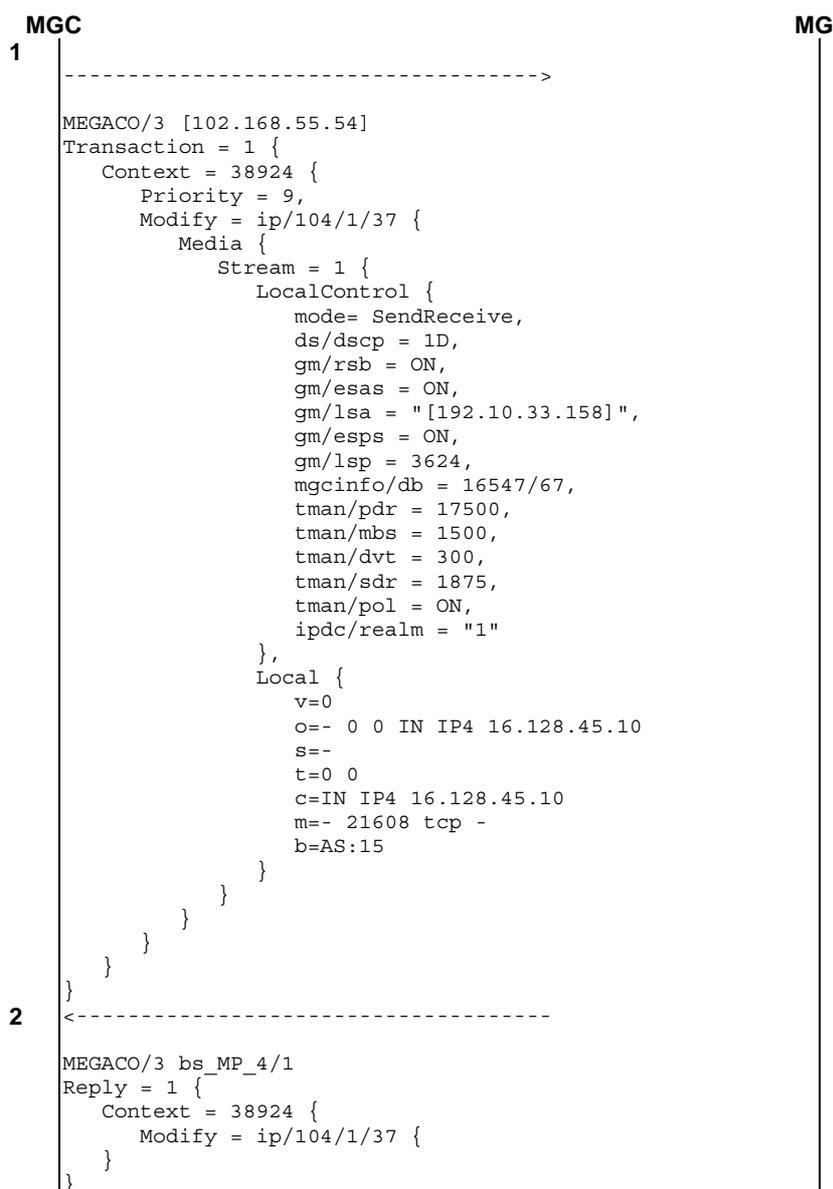

Figure 15: H.248 Message Sequence Example - Session Establishment Update - Bandwidth Change

5.18.2.6 Session Establishment Update - Delete Stream

This procedure is used when remote end SDP indicates that a sub-set of requested streams have been accepted and the remaining streams rejected. This procedure thus applies to both the accepted and rejected streams.

Session Establishment Update - Remote Addr and Port Known							
H.248 Command	Descriptor	Descriptor	Descriptor	Properties, Events, Statistics, Signals	Connection Point Address, IP address information and Bearer Information	Support	Notes
					SDP Information Origin	O	
					SDP Information Timing	O	
					Address Type IP4 or IP6	O	
					Address Type IP4 or IP6	O	
					Address Information IP Address	O	
					Address Information Port	O	
					Bearer Information Transport	O	See note 2 of table 87
					Bearer Information Media format and type	O	
					Bearer Information Bandwidth	O	
					Attribute Information RTCP	O	
	Signals					O	
				ipnapt/latch		O	
				napt		O	
	Events					O	
				adid/ipstop		O	
				dt		O	
				dir		O	
				g/cause		O	
				nt/netfail		O	
				nt/qualert		O	
				scr/cr		O	
				si		O	
				dur		O	
				per		O	
				max		O	
				min		O	
				nor		O	
				hangterm/thb		O	
				timerx		O	
NOTE 1: There will multiple instances of this descriptor.							
NOTE 2: This descriptor must be present for rejected streams and optionally present for accepted streams. In the former case, the descriptor is empty (see clause 5.18.2.6.1).							
NOTE 3: Multiple instances of this descriptor are present - one per stream. In the case of a rejected stream, the descriptor is empty (see clause 5.18.2.6.1).							

Table 108b: Message Contents - Session Establishment Update - Delete Stream Ack

Session Establishment Update - Remote Addr and Port Known, Through Connect, Bandwidth Change Ack							
H.248 Command	Descriptor	Descriptor	Descriptor	Properties, Events, Statistics, Signals	Connection Point Address, IP address information and Bearer Information	Support	Notes
Modify Reply (MG to MGC)					Context ID=specified	M	
					Termination ID=specified	M	

5.18.2.6.1 Session Establishment Update - Delete Stream - Examples

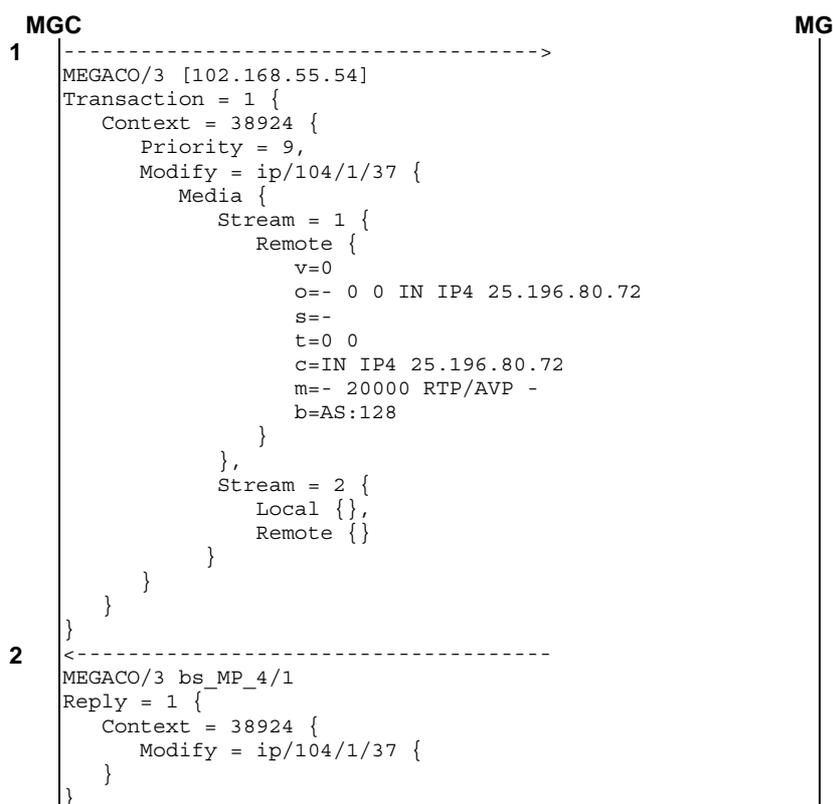

Figure 15a: H.248 Message Sequence Example - Session Establishment Update - Delete Stream

5.18.3 Mid-Session Update

During an established session changes can be performed on existing connections. Examples of these changes are the changes in the remote port, changes in the remote address and port and changes in bandwidth allocation due to changed codec.

5.18.3.1 Mid-Session Update - Bandwidth Change

Table 109: Message Contents - Mid-Session Update - Bandwidth Change

Mid-Session Update - Bandwidth Change								
H.248 Command	Descriptor	Descriptor	Descriptor	Properties, Events, Statistics, Signals	Connection Point Address, IP address information and Bearer Information	Support	Notes	
Modify Request (MGC to MG)					Context ID=specified	M		
					Termination ID=specified	M		
	Media	Stream	Local Control				M	
							O	
						mode	O	
						ds/dscp	O	
						nt/jit	O	
						mpls/stack	O	
						vlan/tags	O	
						vlan/pri	O	
gm/saf	O	5.18.1.1.1						
gm/spf	O	5.18.1.1.1						

Mid-Session Update - Bandwidth Change							
H.248 Command	Descriptor	Descriptor	Descriptor	Properties, Events, Statistics, Signals	Connection Point Address, IP address information and Bearer Information	Support	Notes
				gm/sam		O	5.18.1.1.1
				gm/spr		O	5.18.1.1.1
				gm/sprr		O	5.18.1.1.1
				gm/rsb		O	
				gm/esas		O	
				gm/lsa		O	
				gm/esps		O	
				gm/lsp		O	
				mgcinfo/db		O	
				tman/pdr		O	
				tman/mbs		O	
				tman/dvt		O	
				tman/sdr		O	
				tman/pol		O	
				ipdc/realm		O	5.18.1.1.2
			Local			O	
				SDP Information		O	
				Version		O	
				SDP Information		O	
				Session Name		O	
				SDP Information		O	
				Origin		O	
				SDP Information		O	
				Timing		O	
				Address Type		M	
				IP4 or IP6		M	
				Address Information		M	
				IP Address		M	
				Address Information		M	
				Port		M	
				Bearer Information		M	See note 2 of table 87
				Transport		M	
				Bearer Information		O	
				Media format and type		O	
				Bearer Information		M	
				Bandwidth		M	
			Remote			O	
				SDP Information		O	
				Version		O	
				SDP Information		O	
				Session Name		O	
				SDP Information		O	
				Origin		O	
				SDP Information		O	
				Timing		O	
				Address Type		M	
				IP4 or IP6		M	
				Address Information		M	
				IP Address		M	
				Address Information		M	
				Port		M	
				Bearer Information		M	See note 2 of table 87
				Transport		M	
				Bearer Information		O	
				Media format and type		O	
				Bearer Information		M	
				Bandwidth		M	
				Attribute Information		O	
				RTCP		O	

Mid-Session Update - Bandwidth Change							
H.248 Command	Descriptor	Descriptor	Descriptor	Properties, Events, Statistics, Signals	Connection Point Address, IP address information and Bearer Information	Support	Notes
	Events					O	
				adid/ipstop		O	
					dt	O	
					dir	O	
				g/cause		O	
				nt/netfail		O	
				nt/qualert		O	
				scr/cr		O	
					si	O	
					dur	O	
					per	O	
					max	O	
					min	O	
					nor	O	
				hangterm/thb		O	
					timerx	O	

Table 110: Message Contents - Mid-Session Update - Bandwidth Change Ack

Mid-Session Update - Bandwidth Change Ack							
H.248 Command	Descriptor	Descriptor	Descriptor	Properties, Events, Statistics, Signals	Connection Point Address, IP address information and Bearer Information	Support	Notes
Modify Reply (MG to MGC)					Context ID=specified	M	
					Termination ID=specified	M	

5.18.3.1.1

Mid-Session Update - Bandwidth Change - Examples

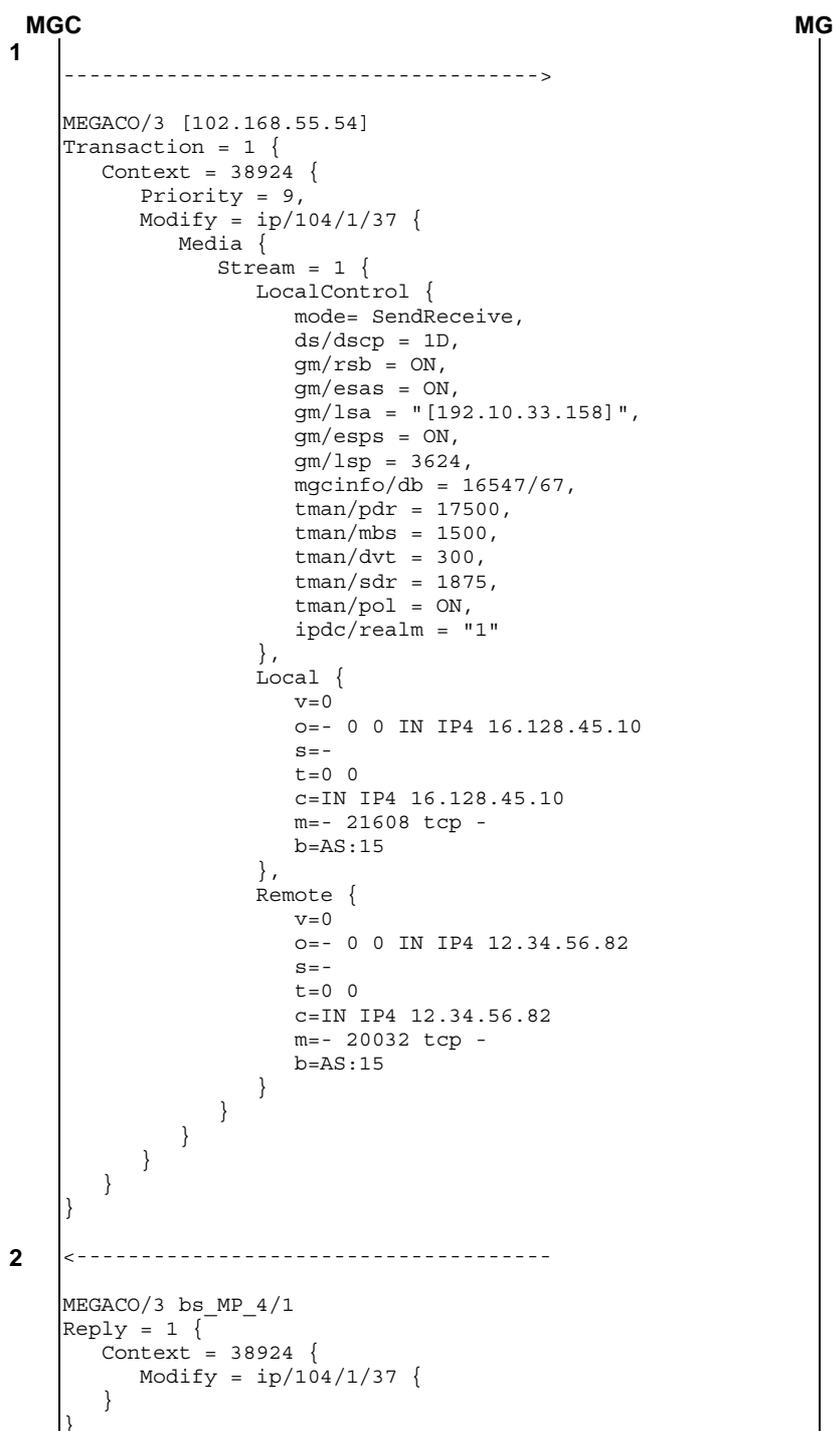

Figure 16: H.248 Message Sequence Example - Mid-Session Update - Bandwidth Change

5.18.3.2 Mid-Session Update - Media Change

Table 111: Message Contents - Mid-Session Update - Media Change

Mid-Session Update - Media Change							
H.248 Command	Descriptor	Descriptor	Descriptor	Properties, Events, Statistics, Signals	Connection Point Address, IP address information and Bearer Information	Support	Notes
Modify Request (MGC to MG)					Context ID=specified	M	
					Termination ID=specified	M	
	Media					M	
		Stream				O	
			Local Control			O	
				mode		O	
				ds/dscp		O	
				nt/jit		O	
				mpls/stack		O	
				vlan/tags		O	
				vlan/pri		O	
				gm/saf		O	5.18.1.1.1
				gm/spf		O	5.18.1.1.1
				gm/sam		O	5.18.1.1.1
				gm/spr		O	5.18.1.1.1
				gm/sprr		O	5.18.1.1.1
				gm/rsb		O	
				gm/esas		O	
				gm/lsa		O	
				gm/esps		O	
				gm/lsp		O	
				mgcinfo/db		O	
				tman/pdr		O	
				tman/mbs		O	
				tman/dvt		O	
				tman/sdr		O	
				tman/pol		O	
				ipdc/realm		O	5.18.1.1.2
			Local		SDP Information	O	
					Version		
					SDP Information	O	
					Session Name		
					SDP Information	O	
				Origin			
				SDP Information	O		
				Timing			
				Address Type	M		
				IP4 or IP6			
				Address Information	M		
				IP Address			
				Address Information	M		
				Port			
				Bearer Information	M	See note 2 of table 87	
				Transport			
				Bearer Information	O		
				Media format and type			
				Bearer Information	M		
				Bandwidth			
		Remote		SDP Information	O		
				Version			
				SDP Information	O		
				Session Name			
				SDP Information	O		
				Origin			

Mid-Session Update - Media Change							
H.248 Command	Descriptor	Descriptor	Descriptor	Properties, Events, Statistics, Signals	Connection Point Address, IP address information and Bearer Information	Support	Notes
					SDP Information Timing	O	
					Address Type IP4 or IP6	M	
					Address Information IP Address	M	
					Address Information Port	M	
					Bearer Information Transport	M	See note 2 of table 87
					Bearer Information Media format and type	O	
					Bearer Information Bandwidth	M	
					Attribute Information RTCP	O	
	Signals			ipnapt/latch		O	
					napt	O	
	Events			adid/ipstop		O	
					dt	O	
					dir	O	
				g/cause		O	
				nt/netfail		O	
				nt/qualert		O	
				scr/cr		O	
					si	O	
					dur	O	
					per	O	
					max	O	
					min	O	
					nor	O	
				hangterm/thb		O	
					timerx	O	

Table 112: Message Contents - Mid-Session Update - Media Change Ack

Mid-Session Update - Media Change Ack							
H.248 Command	Descriptor	Descriptor	Descriptor	Properties, Events, Statistics, Signals	Connection Point Address, IP address information and Bearer Information	Support	Notes
Modify Reply (MG to MGC)					Context ID=specified	M	
					Termination ID=specified	M	

5.18.3.2.1

Mid-Session Update - Media Change - Examples

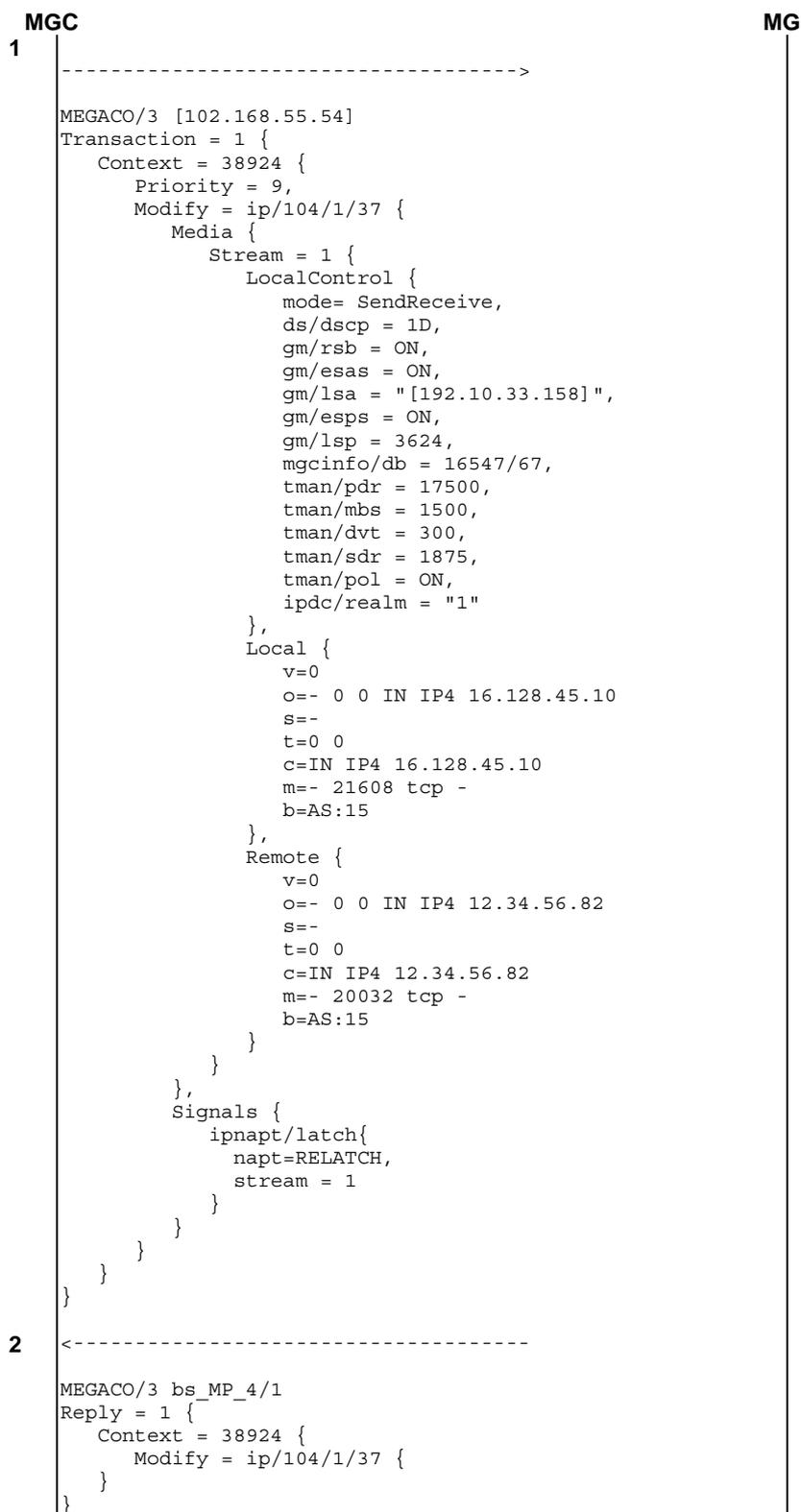

Figure 17: H.248 Message Sequence Example - Mid-Session Update - Media Change

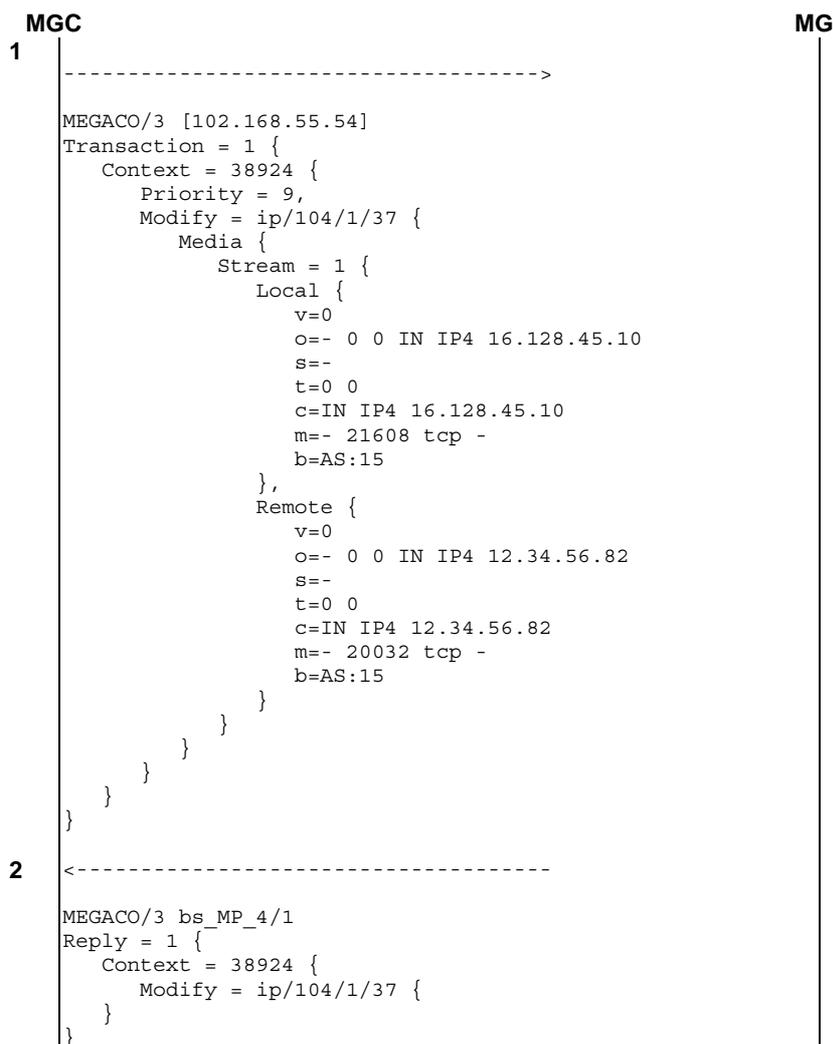

Figure 18: H.248 Message Sequence Example - Mid-Session Update - Media Change, No NAT, No change of through connection or policing (sdr)

5.18.3.3 Mid-Session Update - Remote Addr/Port Change

Table 113: Message Contents - Mid-Session Update - Remote Addr/Port Change

Mid-Session Update - Remote Addr/Port Change								
H.248 Command	Descriptor	Descriptor	Descriptor	Properties, Events, Statistics, Signals	Connection Point Address, IP address information and Bearer Information	Support	Notes	
Modify Request (MGC to MG)					Context ID=specified	M		
					Termination ID=specified	M		
	Media	Stream	Local Control				O	
							O	
						mode	O	
						ds/dscp	O	
						nt/jit	O	
						mpls/stack	O	
						vlan/tags	O	
						vlan/pri	O	
gm/saf	O	5.18.1.1.1						
gm/spf	O	5.18.1.1.1						
gm/sam	O	5.18.1.1.1						

Mid-Session Update - Remote Addr/Port Change							
H.248 Command	Descriptor	Descriptor	Descriptor	Properties, Events, Statistics, Signals	Connection Point Address, IP address information and Bearer Information	Support	Notes
				gm/spr		O	5.18.1.1.1
				gm/sprr		O	5.18.1.1.1
				gm/rsb		O	
				gm/esas		O	
				gm/lssa		O	
				gm/esps		O	
				gm/lsp		O	
				mgcinfo/db		O	
				tman/pdr		O	
				tman/mbs		O	
				tman/dvt		O	
				tman/sdr		O	
				tman/pol		O	
				ipdc/realm		O	5.18.1.1.2
			Local			O	
					SDP Information Version	O	
					SDP Information Session Name	O	
					SDP Information Origin	O	
					SDP Information Timing	O	
					Address Type IP4 or IP6	M	
					Address Information IP Address	M	
					Address Information Port	M	
					Bearer Information Transport	M	See note 2 of table 87
					Bearer Information Media format and type	O	
					Bearer Information Bandwidth	M	
			Remote		SDP Information Version	O	
					SDP Information Session Name	O	
					SDP Information Origin	O	
					SDP Information Timing	O	
					Address Type IP4 or IP6	M	
					Address Information IP Address	M	
					Address Information Port	M	
					Bearer Information Transport	M	See note 2 of table 87
					Bearer Information Media format and type	O	
					Bearer Information Bandwidth	M	
					Attribute Information RTCP	O	
	Signals					O	
				ipnapt/latch		O	
				napt		O	

Mid-Session Update - Remote Addr/Port Change							
H.248 Command	Descriptor	Descriptor	Descriptor	Properties, Events, Statistics, Signals	Connection Point Address, IP address information and Bearer Information	Support	Notes
	Events					O	
				adid/ipstop		O	
					dt	O	
					dir	O	
				g/cause		O	
				nt/netfail		O	
				nt/qualert		O	
				scr/cr		O	
					si	O	
					dur	O	
					per	O	
					max	O	
					min	O	
					nor	O	
				hangterm/thb		O	
					timerx	O	

Table 114: Message Contents - Mid-Session Update - Remote Addr/Port Change Ack

Mid-Session Update - Remote Addr/Port Change Ack							
H.248 Command	Descriptor	Descriptor	Descriptor	Properties, Events, Statistics, Signals	Connection Point Address, IP address information and Bearer Information	Support	Notes
Modify Reply (MG to MGC)					Context ID=specified	M	
					Termination ID=specified	M	

5.18.3.3.1

Mid-Session Update - Remote Addr/Port Change - Examples

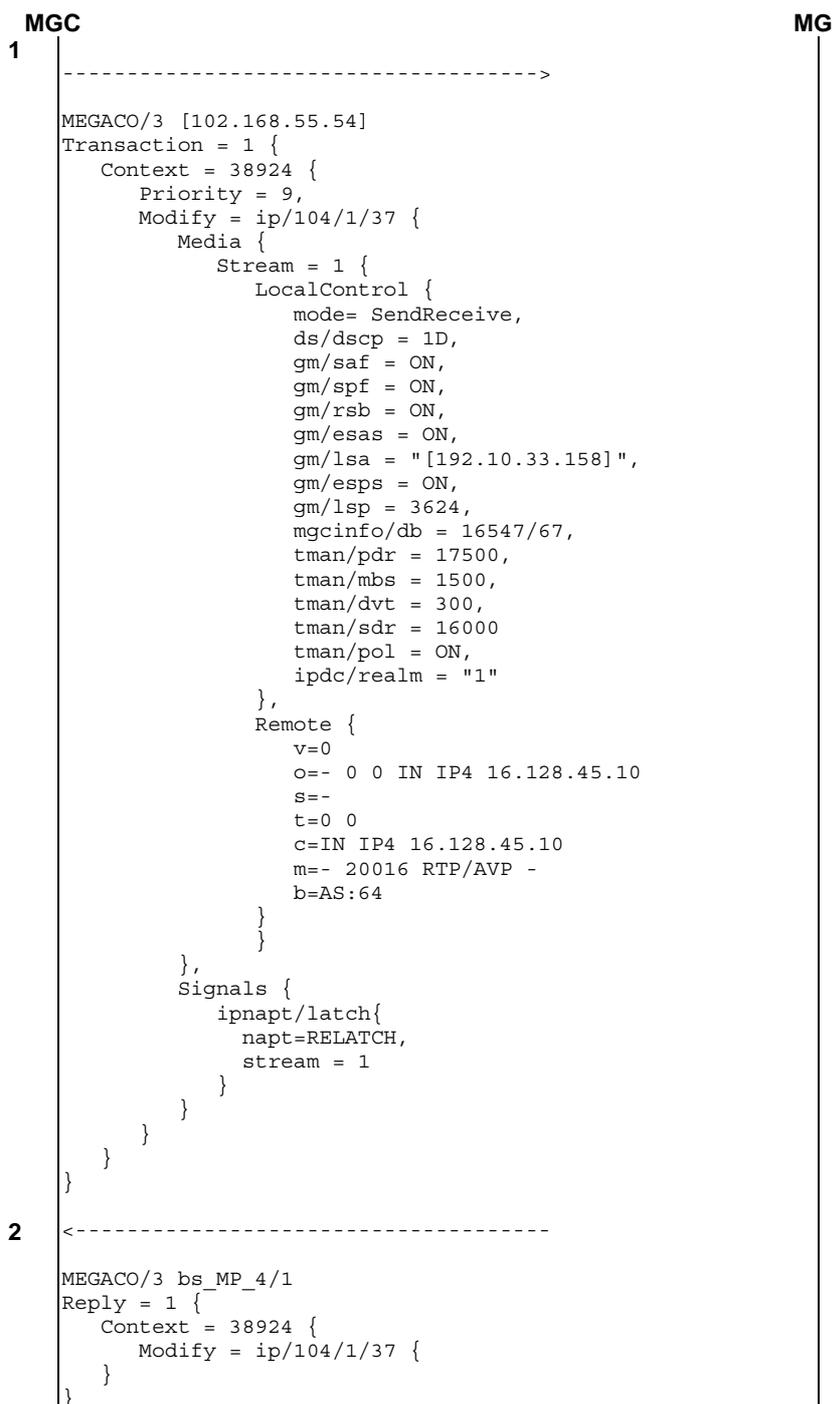

Figure 19: H.248 Message Sequence Example - Mid-Session Update - Remote Add /Port Change

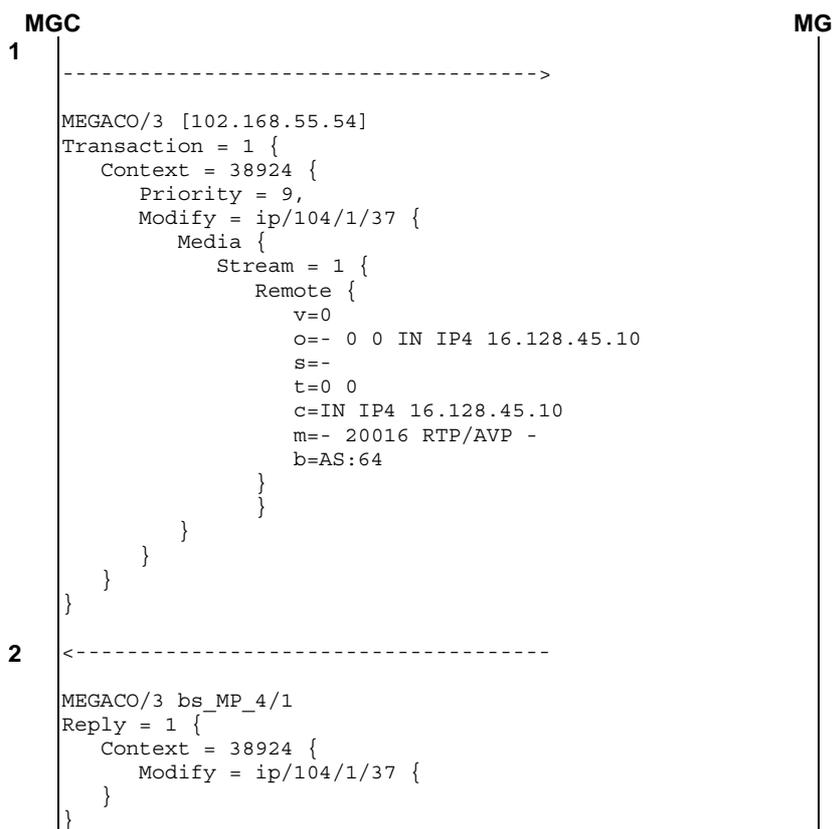

Figure 20: H.248 Message Sequence Example - Mid-Session Update - Remote Addr/Port Change, No NAT, No Bandwidth Change

5.18.3.4 Mid-Session Update - Add Stream, Remote Addr and Port Known

Table 115: Message Contents - Mid-Session Update - Add Stream, Remote Addr and Port Known

Mid-Session Update - Add Stream, Remote Addr and Port Known							
H.248 Command	Descriptor	Descriptor	Descriptor	Properties, Events, Statistics, Signals	Connection Point Address, IP address information and Bearer Information	Support	Notes
Modify Request (MGC to MG)					Context ID=specified	M	
					Termination ID=specified	M	
Media	Stream	Local Control				M	
						M	
						M	
					mode	M	
					ds/dscp	O	
					nt/jit	O	
					mpls/stack	O	
					vlan/tags	O	
					vlan/pri	O	
					gm/saf	O	5.18.1.1.1
					gm/spf	O	5.18.1.1.1
					gm/rsb	O	
					gm/esas	O	
					gm/lsa	O	
					gm/esps	O	
					gm/lsp	O	
gm/sam	O						
gm/spr	O						
gm/spr	O						

Mid-Session Update - Add Stream, Remote Addr and Port Known										
H.248 Command	Descriptor	Descriptor	Descriptor	Properties, Events, Statistics, Signals	Connection Point Address, IP address information and Bearer Information	Support	Notes			
				mgcinfo/db		O				
				tman/pdr		O				
				tman/mbs		O				
				tman/dvt		O				
				tman/sdr		O				
				tman/pol		O				
				ipdc/realm		O	5.18.1.1.2			
				Statistics		O	See note			
			Local					SDP Information Version	O	
								SDP Information Session Name	O	
								SDP Information Origin	O	
								SDP Information Timing	O	
								Address Type IP4 or IP6	M	
								Address Information IP Address= (\$ or specific)	M	
								Address Information Port=(\$ or specific)	M	
								Bearer Information Transport	M	See note 2 of table 87
								Bearer Information Media format and type	O	
								Bearer Information Bandwidth	M	
			Remote					SDP Information Version	O	
								SDP Information Session Name	O	
								SDP Information Origin	O	
								SDP Information Timing	O	
								Address Type IP4 or IP6	M	
								Address Information IP Address	M	
								Address Information Port	M	
								Bearer Information Transport	M	See note 2 of table 87
								Bearer Information Media format and type	O	
								Bearer Information Bandwidth	M	
				Attribute Information RTCP	O					
			Signals						O	
							ipnapt/latch		O	
							napt		O	
			Events						O	
adid/ipstop		O								
dt		O								
dir		O								
g/cause		O								
nt/netfail		O								
	nt/qualert		O							

Mid-Session Update - Add Stream, Remote Addr and Port Known							
H.248 Command	Descriptor	Descriptor	Descriptor	Properties, Events, Statistics, Signals	Connection Point Address, IP address information and Bearer Information	Support	Notes
				scr/cr		O	
					si	O	
					dur	O	
					per	O	
					max	O	
					min	O	
					nor	O	
				hangterm/thb		O	
					timerx	O	

NOTE: The MGC may request any statistic within those supported.

Table 116: Message Contents - Mid-Session Update - Add Stream, Remote Addr and Port Known Ack

Mid-Session Update - Add Stream, Remote Addr and Port Known Ack								
H.248 Command	Descriptor	Descriptor	Descriptor	Properties, Events, Statistics, Signals	Connection Point Address, IP address information and Bearer Information	Support	Notes	
Modify Reply (MG to MGC)					Context ID=specified	M		
					Termination ID=specified	M		
	Media					M		
		Stream				M		
			Local			SDP Information	M	
						Version		
						SDP Information	M	
						Session Name		
						SDP Information	M	
						Origin		
						SDP Information	M	
						Timing		
						Address Type	M	
						IP4 or IP6		
						Address Information	M	
					IP Address			
					Address Information	M		
					Port			
					Bearer Information	M		
					Transport			
					Bearer Information	O		
					Media format and type			
					Bearer Information	M		
					Bandwidth			

5.18.3.4.1 Mid-Session Update - Add Stream, Remote Addr and Port Known - Examples

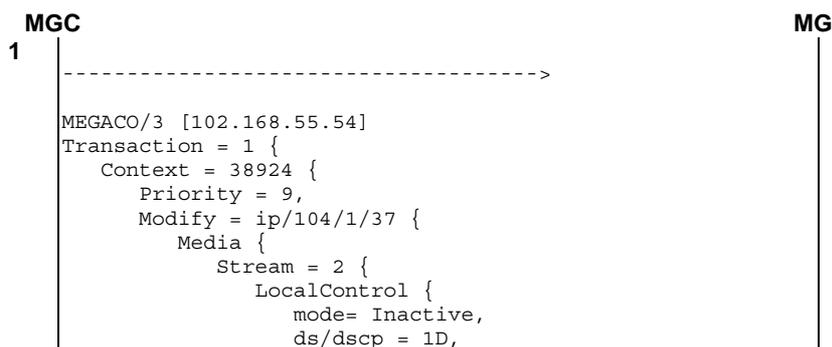

5.18.3.5 Mid-Session Update - Add Stream

Table 117: Message Contents - Mid-Session Update - Add Stream

Mid-Session Update - Add Stream								
H.248 Command	Descriptor	Descriptor	Descriptor	Properties, Events, Statistics, Signals	Connection Point Address, IP address information and Bearer Information	Support	Notes	
Modify Request (MGC to MG)					Context ID=specified	M		
					Termination ID=specified	M		
	Media					M		
		Stream				M		
			Local Control			O		
				mode		O		
				ds/dscp		O		
				nt/jit		O		
				mpls/stack		O		
				vlan/tags		O		
				vlan/pri		O		
				gm/saf		O	5.18.1.1.1	
				gm/spf		O	5.18.1.1.1	
				gm/rsb		O		
				gm/esas		O		
				gm/lsa		O		
				gm/esps		O		
				gm/lsp		O		
				gm/sam		O		
				gm/spr		O		
				gm/sprr		O		
				mgcinfo/db		O		
				tman/pdr		O		
				tman/mbs		O		
				tman/dvt		O		
				tman/sdr		O		
				tman/pol		O		
				ipdc/realm		O	5.18.1.1.2	
			Statistics				O	See note
			Local			SDP Information Version	O	
						SDP Information Session Name	O	
						SDP Information Origin	O	
						SDP Information Timing	O	
					Address Type IP4 or IP6	M		
					Address Information IP Address= (\$ or specific)	M		
					Address Information Port=(\$ or specific)	M		
					Bearer Information Transport	M	See note 2 of table 87	
					Bearer Information Media format and type	O		
					Bearer Information Bandwidth	M		
	Signals					O		
				ipnapt/latch		O		
				napt		O		
	Events					O		
				adid/ipstop		O		

Mid-Session Update - Add Stream							
H.248 Command	Descriptor	Descriptor	Descriptor	Properties, Events, Statistics, Signals	Connection Point Address, IP address information and Bearer Information	Support	Notes
					dt	O	
					dir	O	
				g/cause		O	
				nt/netfail		O	
				nt/qualert		O	
				scr/cr		O	
					si	O	
					dur	O	
					per	O	
					max	O	
					min	O	
					nor	O	
				hangterm/thb		O	
					timerx	O	

NOTE: The MGC may request any statistic within those supported.

Table 118: Message Contents - Mid-Session Update - Add Stream Ack

Mid-Session Update - Add Stream Ack								
H.248 Command	Descriptor	Descriptor	Descriptor	Properties, Events, Statistics, Signals	Connection Point Address, IP address information and Bearer Information	Support	Notes	
Modify Reply (MG to MGC)					Context ID=specified	M		
					Termination ID=specified	M		
	Media					M		
		Stream				M		
			Local			SDP Information	M	
						Version		
						SDP Information	M	
						Session Name		
						SDP Information	M	
						Origin		
						SDP Information	M	
						Timing		
						Address Type	M	
					IP4 or IP6			
					Address Information	M		
					IP Address			
					Address Information	M		
					Port			
					Bearer Information	M		
					Transport			
					Bearer Information	O		
					Media format and type			
					Bearer Information	M		
					Bandwidth			

5.18.3.5.1

Mid-Session Update - Add Stream - Examples

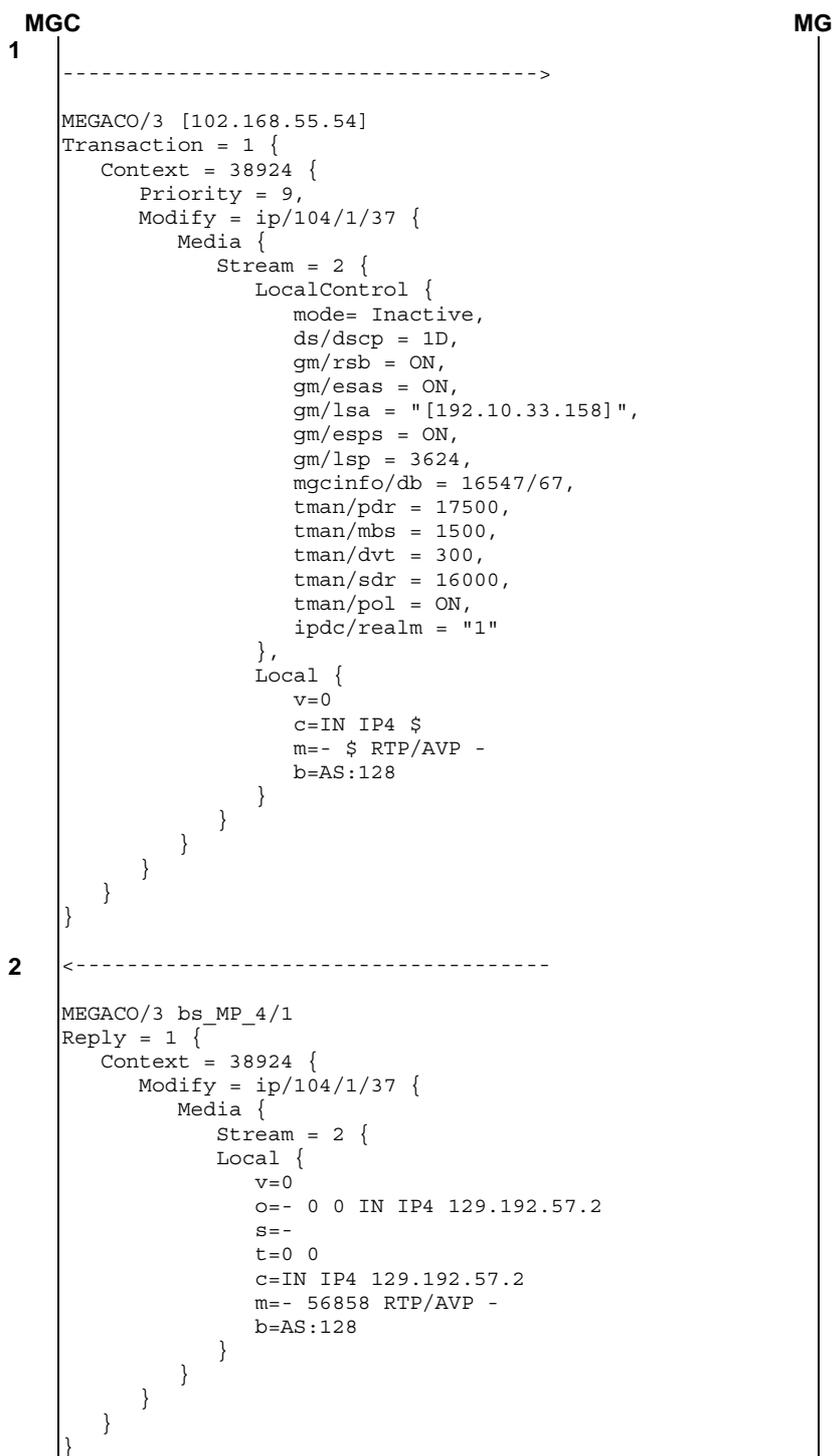

Figure 22: H.248 Message Sequence Example - Mid-Session Update - Add Stream

5.18.3.6 Mid-Session Update - Delete Stream

Table 119: Message Contents - Mid-Session Update - Delete Stream

Mid-Session Update - Delete Stream							
H.248 Command	Descriptor	Descriptor	Descriptor	Properties, Events, Statistics, Signals	Connection Point Address, IP address information and Bearer Information	Support	Notes
Modify Request (MGC to MG)					Context ID=specified	M	
					Termination ID=specified or Termination ID=*	M	
	Media					M	
		Stream				M	
			Local			M	
			Remote			M	
	Audit					O	
		Media				O	
			Stream			O	
				Statistics	*/*	O	

Table 120: Message Contents - Mid-Session Update - Delete Stream Ack

Mid-Session Update - Delete Stream Ack							
H.248 Command	Descriptor	Descriptor	Descriptor	Properties, Events, Statistics, Signals	Connection Point Address, IP address information and Bearer Information	Support	Notes
Modify Reply (MG to MGC)					Context ID=specified	M	
					Termination ID=specified	M	
	Media					O	
		Stream				O	
			Statistics			O	
				gm/dp		O	
				nt/or		O	
				nt/os		O	
				nt/dur		O	
				rtp/pl		O	
				rtp/or		O	
				rtp/os		O	
				rtp/pr		O	
				rtp/ps		O	
				rtp/jit		O	
				rtp/delay		O	

5.18.3.6.1 Mid-Session Update - Delete Stream - Examples

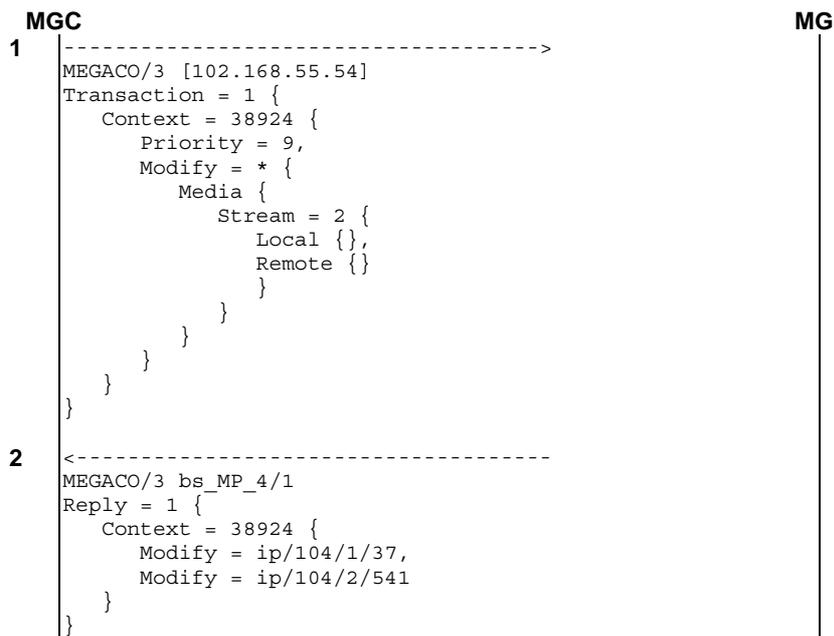

Figure 23: H.248 Message Sequence Example - Mid-Session Update - Delete Stream, No Statistics Required

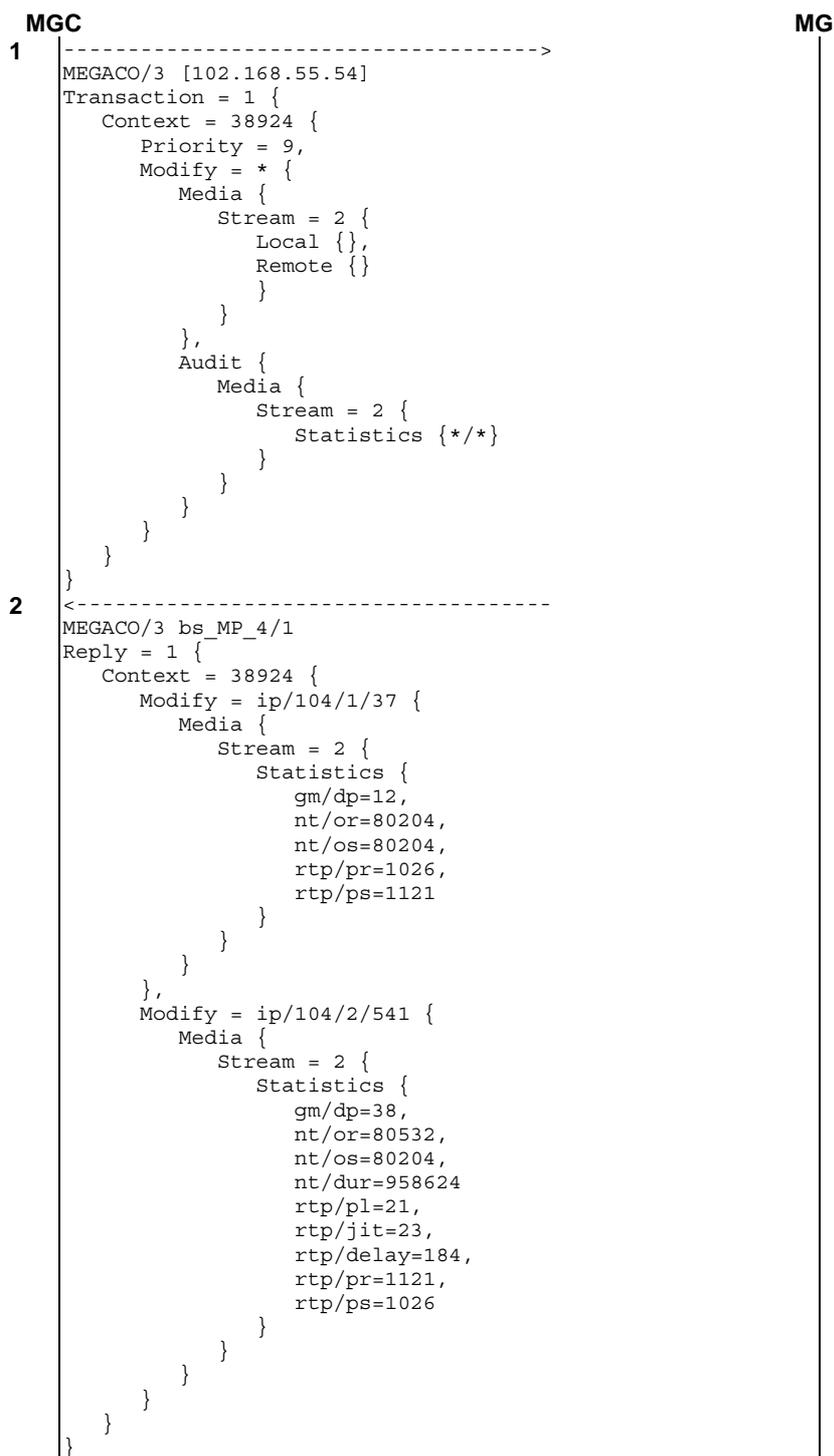

Figure 24: H.248 Message Sequence Example - Mid-Session Update - Delete Stream, Statistics Required

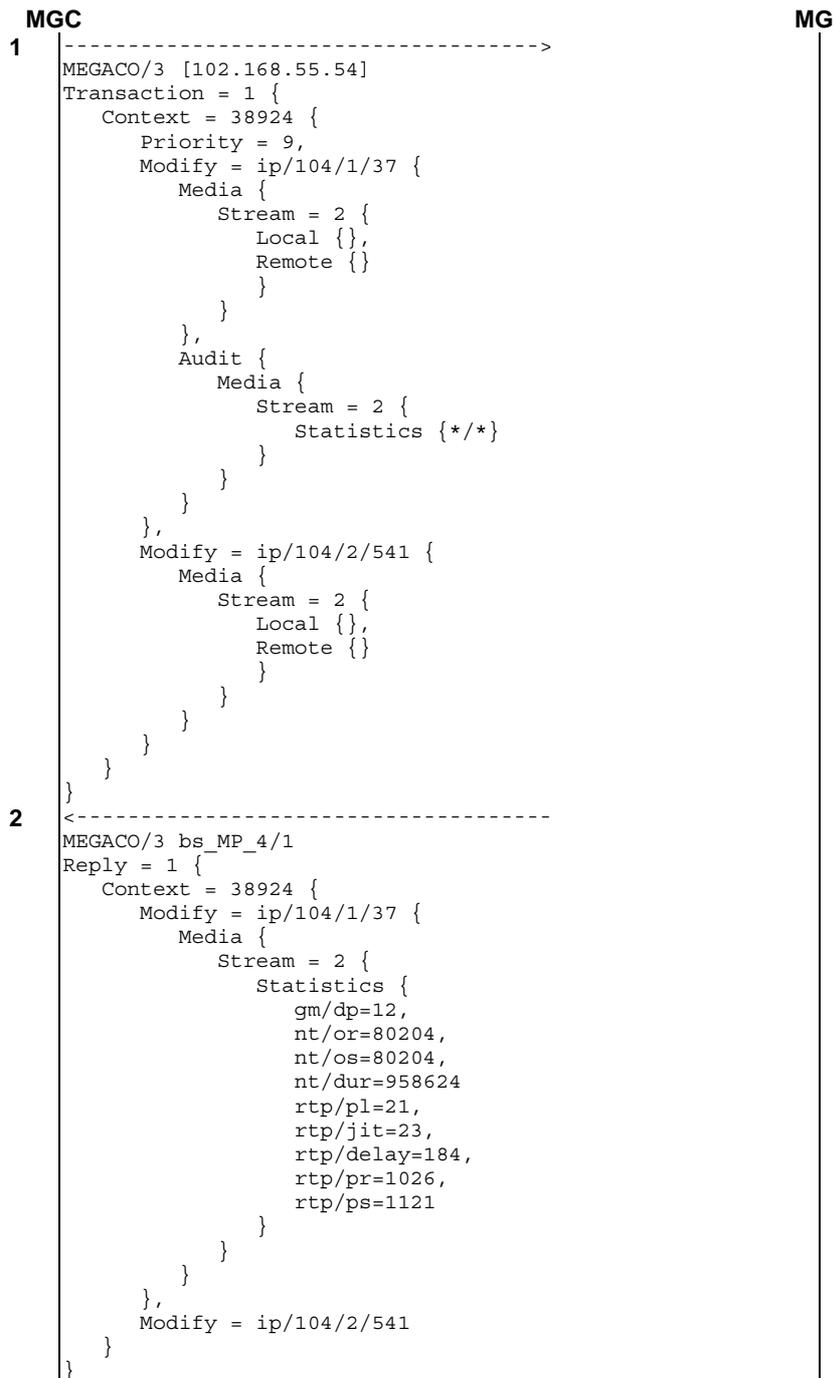

Figure 25: H.248 Message Sequence Example - Mid-Session Update - Delete Stream, Statistics Required on one Termination

5.18.3.7 Mid-Session Update - Add Stream, Remote Addr Known and Port Possibly Known, no Local Addr and Port

Table 120a: Message Contents - Mid-Session Update - Add Stream, Remote Addr Known and Port Possibly Known, no Local Addr and Port

Mid-Session Update - Add Stream, Remote Addr Known and Port Possibly Known, no Local Addr and Port								
H.248 Command	Descriptor	Descriptor	Descriptor	Properties, Events, Statistics, Signals	Connection Point Address, IP address information and Bearer Information	Support	Notes	
Modify Request (MGC to MG)					Context ID=specified	M		
					Termination ID=specified	M		
	Media					M		
		Stream				M		
			Local Control		ipdc/realm		O	5.18.1.1.2
			Statistics				O	See note
			Remote			SDP Information Version	O	
						SDP Information Session Name	O	
						SDP Information Origin	O	
						SDP Information Timing	O	
						Address Type IP4 or IP6	M	
						Address Type IP4 or IP6	M	
						Address Information IP Address	M	
						Address Information Port	O	
						Bearer Information Transport	O	See note 2 of table 87
						Bearer Information Media format and type	O	
						Bearer Information Bandwidth	O	
						Attribute Information RTCP	O	
		Events					O	
					hangterm/thb		O	
					timerx		O	

NOTE: The MGC may request any statistic within those supported.

Table 120b: Message Contents - Mid-Session Update - Add Stream, Remote Addr Known and Port Possibly Known, no Local Addr and Port Ack

Mid-Session Update - Add Stream, Remote Addr Known and Port Possibly Known, no Local Addr and Port Ack							
H.248 Command	Descriptor	Descriptor	Descriptor	Properties, Events, Statistics, Signals	Connection Point Address, IP address information and Bearer Information	Support	Notes
Modify Reply (MG to MGC)					Context ID=specified	M	
					Termination ID=specified	M	

5.18.3.7.1 Mid-Session Update - Add Add Stream, Remote Addr Known and Port Possibly Known, no Local Addr and Port - Examples

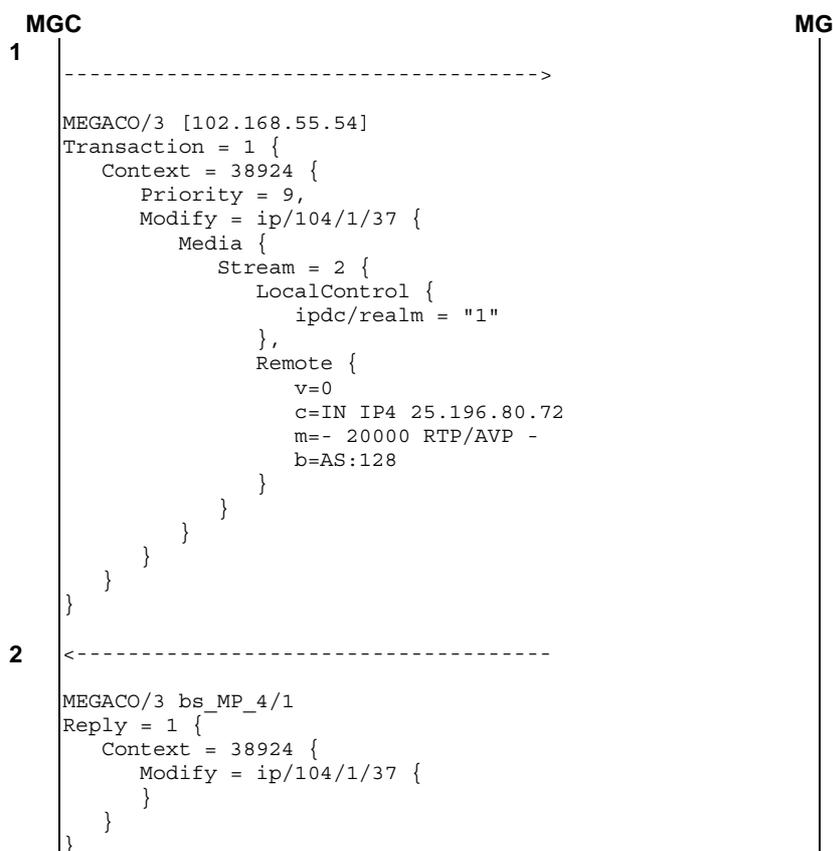

Figure 25a: H.248 Message Sequence Example - Add Stream, Remote Addr Known and Port Possibly Known, no Local Addr and Port

5.18.4 Auditing

5.18.4.1 Mid-Session Statistics Audit

Table 121: Message Contents - Mid-Session Statistics Audit

Mid-Session Statistics Audit							
H.248 Command	Descriptor	Descriptor	Descriptor	Properties, Events, Statistics, Signals	Connection Point Address, IP address information and Bearer Information	Support	Notes
AuditValue Request (MGC to MG)					Context ID=specified	M	
					Termination ID=specified or Termination ID=*	M	
	Audit					M	
		Media				M	
			Stream			M	
			Statistics	*/*	M		

Table 122: Message Contents - Mid-Session Statistics Audit Ack

Mid-Session Statistics Audit Ack							
H.248 Command	Descriptor	Descriptor	Descriptor	Properties, Events, Statistics, Signals	Connection Point Address, IP address information and Bearer Information	Support	Notes
AuditValue Reply (MG to MGC)					Context ID=specified	M	
					Termination ID=specified	M	
	Media					M	
		Stream				M	
			Statistics			M	
				gm/dp		O	
				nt/or		O	
				nt/os		O	
				nt/dur		O	
				rtp/pl		O	
				rtp/or		O	
				rtp/os		O	
				rtp/pl		M	
				rtp/pr		M	
				rtp/ps		M	
			rtp/jit		O		
			rtp/delay		O		

5.18.4.1.1 Mid-Session Statistics Audit - Example

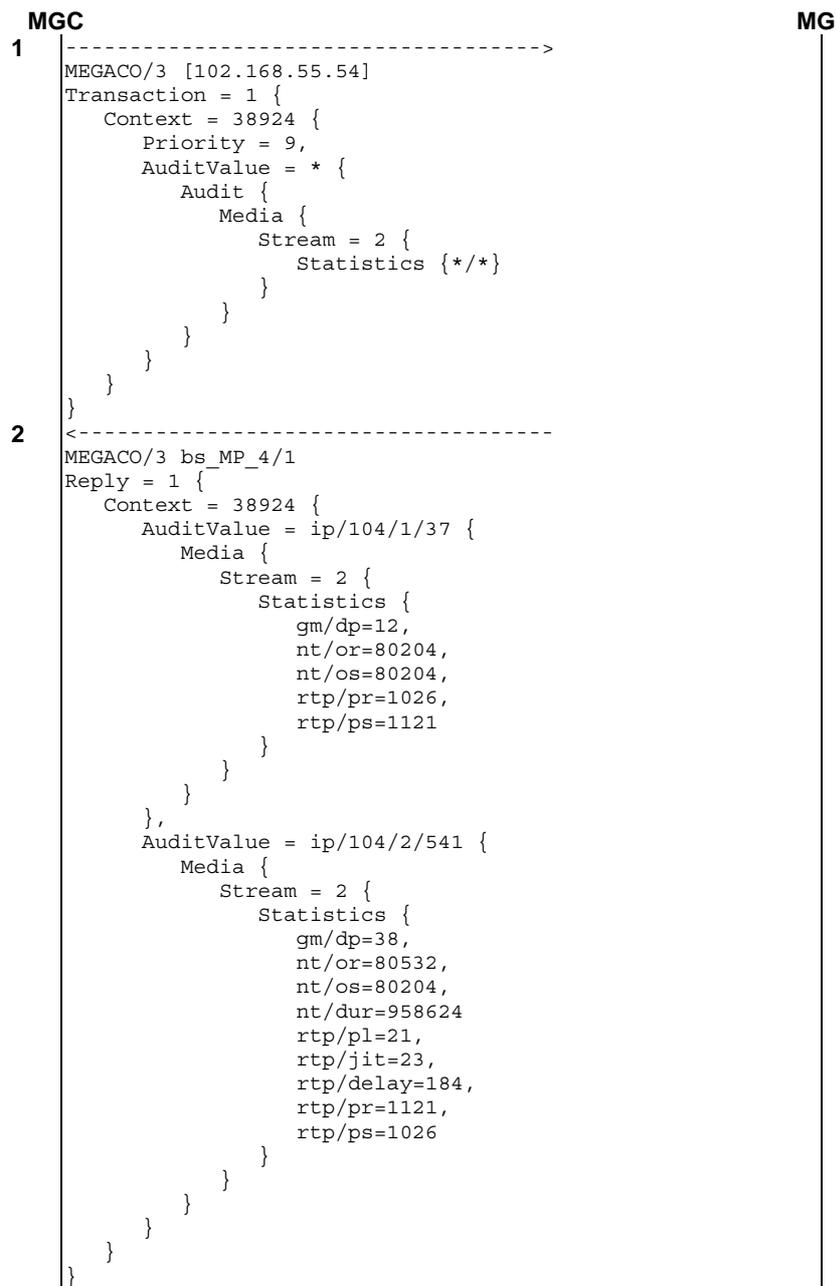

Figure 26: H.248 Message Sequence Example - Mid-Session Statistics Audit

5.18.4.2 Mid-Session MGC Info Audit

This procedure may be used by the MGC when the MGC Info is audited during an established session.

Table 122a: Message Contents - Mid-Session MGC Info Audit

Mid-Session Statistics Audit							
H.248 Command	Descriptor	Descriptor	Descriptor	Properties, Events, Statistics, Signals	Connection Point Address, IP address information and Bearer Information	Support	Notes
AuditValue Request (MGC to MG)					Context ID=specified	M	
					Termination ID=specified	M	
	Audit					M	
		Media				M	
			Stream			M	
			Local Control			M	
				mgcinfo/db		M	

Table 122b: Message Contents - Mid-Session MGC Info Audit Ack

Mid-Session Statistics Audit Ack							
H.248 Command	Descriptor	Descriptor	Descriptor	Properties, Events, Statistics, Signals	Connection Point Address, IP address information and Bearer Information	Support	Notes
AuditValue Reply (MG to MGC)					Context ID=specified	M	
					Termination ID=specified	M	
	Media					M	
		Stream				M	
			Local Control			M	
				mgcinfo/db		M	

5.18.4.2.1 Mid-Session MGC Info Audit - Example

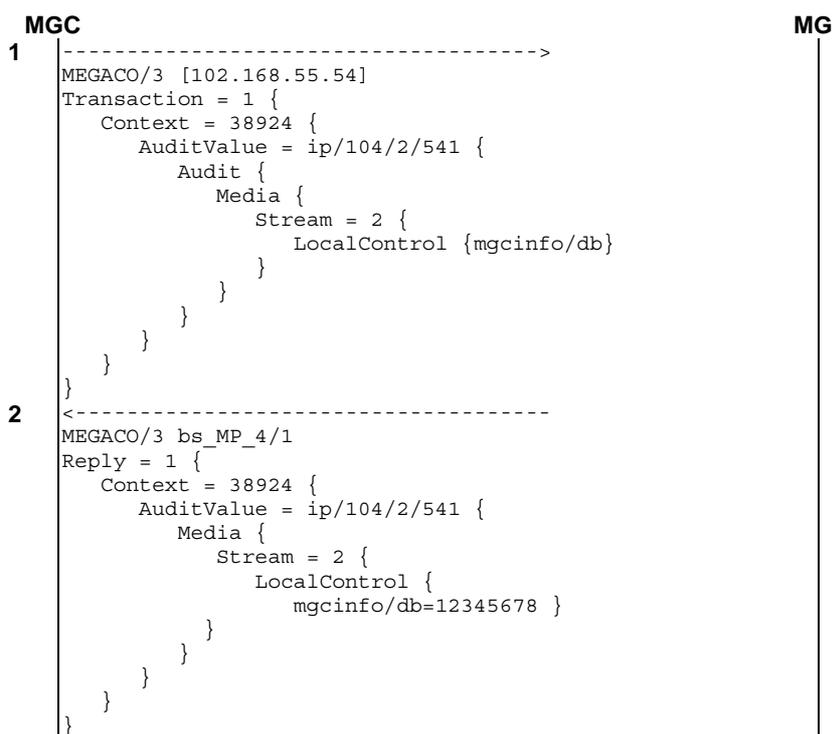

Figure 26a: H.248 Message Sequence Example - Mid-Session MGC Info Audit

5.18.5 Notification of MG Events

5.18.5.1 Notification of IP Media Stop

Table 123: Message Contents - Notification of IP Media Stop

Detection of IP Media Stop							
H.248 Command	Descriptor	Descriptor	Descriptor	Properties, Events, Statistics, Signals	Connection Point Address, IP address information and Bearer Information	Support	Notes
Notify Request (MG to MGC)					Context ID=specified	M	
					Termination ID=specified	M	
	Observed Events					M	
				adid/ipstop		M	

Table 124: Message Contents - Notification of IP Media Stop Ack

Detection of IP Media Stop Ack							
H.248 Command	Descriptor	Descriptor	Descriptor	Properties, Events, Statistics, Signals	Connection Point Address, IP address information and Bearer Information	Support	Notes
Notify Reply (MGC to MG)					Context ID=specified	M	
					Termination ID=specified	M	

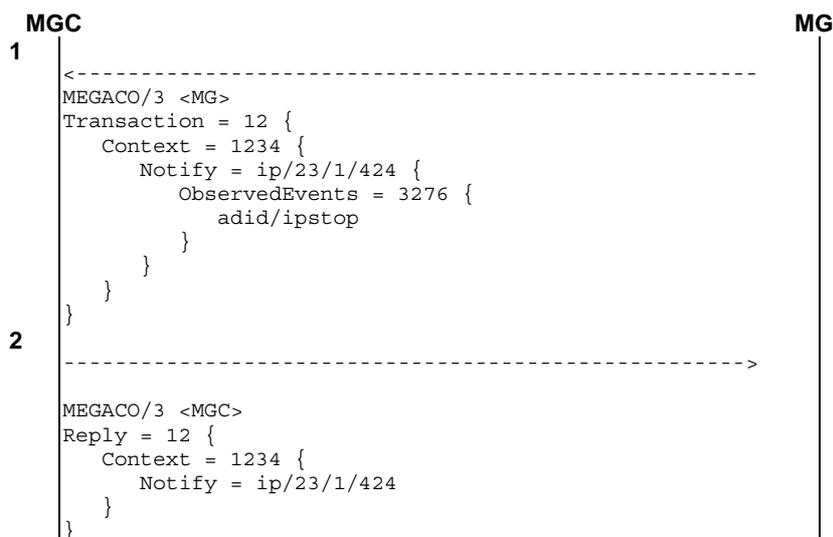

Figure 27: H.248 Message Sequence Example - Notification of IP Media Stop

5.18.5.2 Notification of Hanging Termination

Table 125: Message Contents - Notification of Hanging Termination

Detection of Hanging Termination							
H.248 Command	Descriptor	Descriptor	Descriptor	Properties, Events, Statistics, Signals	Connection Point Address, IP address information and Bearer Information	Support	Notes
Notify Request (MG to MGC)					Context ID=specified	M	
					Termination ID=specified	M	
	Observed Events					M	
				hangterm/thb		M	

Table 126: Message Contents - Notification of Hanging Termination Ack

Detection of Hanging Termination p Ack							
H.248 Command	Descriptor	Descriptor	Descriptor	Properties, Events, Statistics, Signals	Connection Point Address, IP address information and Bearer Information	Support	Notes
Notify Reply (MGC to MG)					Context ID=specified	M	
					Termination ID=specified	M	

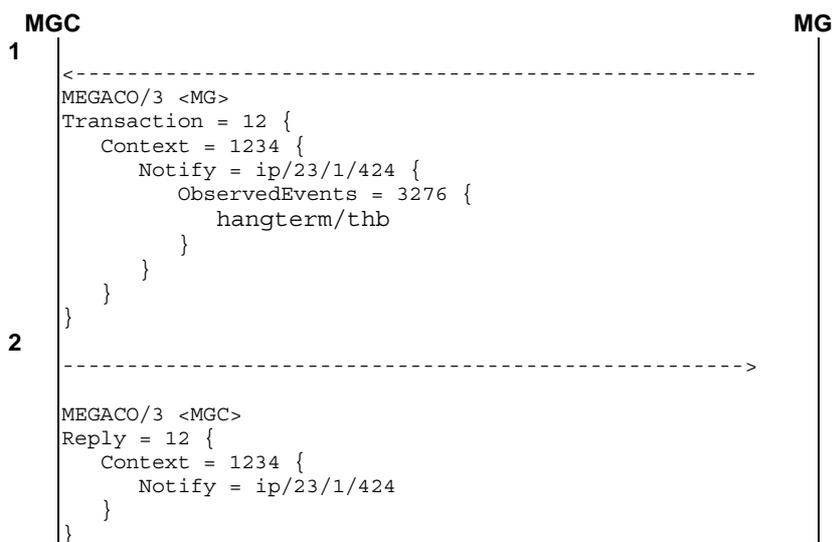

Figure 28: H.248 Message Sequence Example - Notification of Hanging Termination

5.18.5.3 Notification of Statistic Conditional Reporting

Table 127: Message Contents - Notification of Statistic Conditional Reporting

Detection of Statistic Conditional Reporting							
H.248 Command	Descriptor	Descriptor	Descriptor	Properties, Events, Statistics, Signals	Connection Point Address, IP address information and Bearer Information	Support	Notes
Notify Request (MG to MGC)					Context ID=specified	M	
					Termination ID=specified	M	
	Observed Events					M	
				scr/cr		M	
					si	M	
					val	M	

Table 128: Message Contents - Notification of Statistic Conditional Reporting Ack

Detection of Statistic Conditional Reporting p Ack							
H.248 Command	Descriptor	Descriptor	Descriptor	Properties, Events, Statistics, Signals	Connection Point Address, IP address information and Bearer Information	Support	Notes
Notify Reply (MGC to MG)					Context ID=specified	M	
					Termination ID=specified	M	

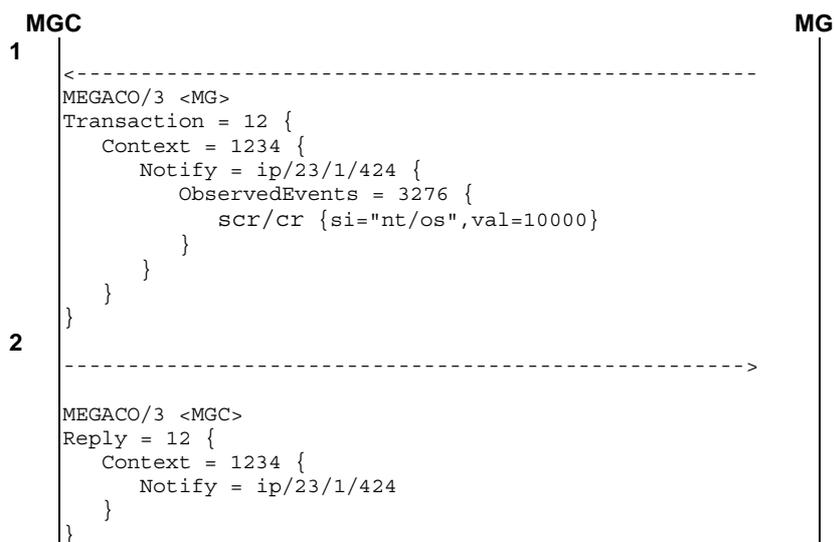

Figure 29: H.248 Message Sequence Example - Notification of Statistic Conditional Reporting

5.18.6 Delete Session/Termination

5.18.6.1 Delete Session/Termination

Table 129: Message Contents - Delete Session/Termination

Delete Session/Termination - Delete Termination							
H.248 Command	Descriptor	Descriptor	Descriptor	Properties, Events, Statistics, Signals	Connection Point Address, IP address information and Bearer Information	Support	Notes
Subtract Request (MGC to MG)					Context ID=specified	M	
					Termination ID=specified or Termination ID=*	M	
	Audit					O	

Table 130: Message Contents - Delete Session/Termination Ack

Delete Session/Termination - Delete Termination Ack							
H.248 Command	Descriptor	Descriptor	Descriptor	Properties, Events, Statistics, Signals	Connection Point Address, IP address information and Bearer Information	Support	Notes
Subtract Reply (MG to MGC)					Context ID=specified	M	
					Termination ID=specified	M	
	Media					O	
		Stream				O	
			Statistics			O	
				gm/dp		O	
				nt/or		O	
				nt/os		O	
				nt/dur		O	
				rtp/pl		O	
				rtp/or		O	
				rtp/os		O	
				rtp/pr		O	
				rtp/ps		O	
				rtp/jit		O	
				rtp/delay		O	

5.18.6.1.1 Delete Session/Termination - Examples

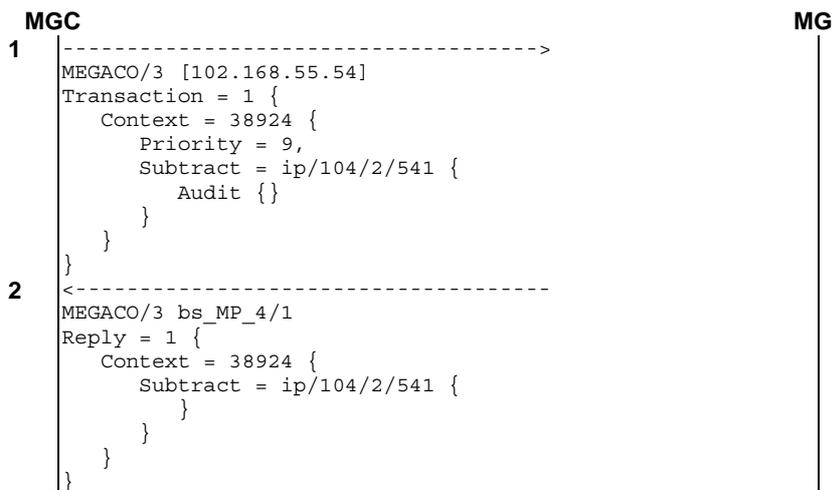

Figure 30: H.248 Message Sequence Example - Delete Session/Termination - Delete Single Termination, Statistics Not Required

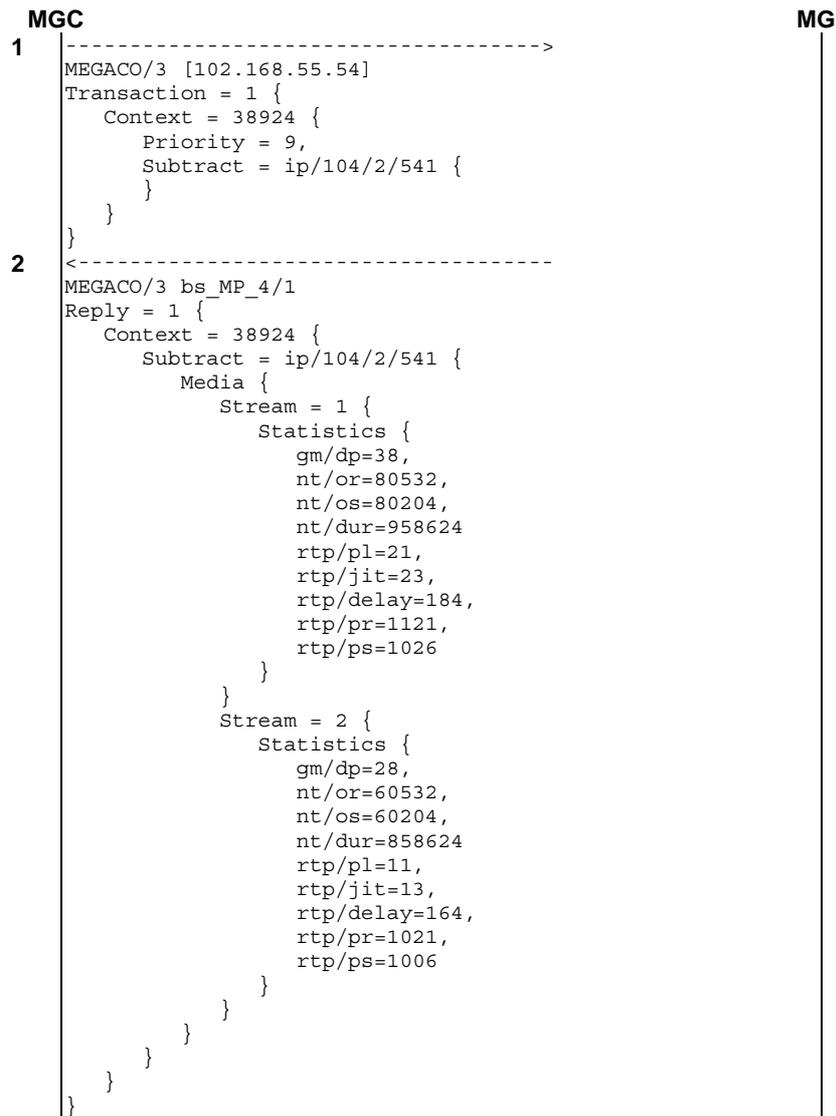

Figure 31: H.248 Message Sequence Example - Delete Session/Termination - Delete Single Termination, Statistics Required on all dependent streams

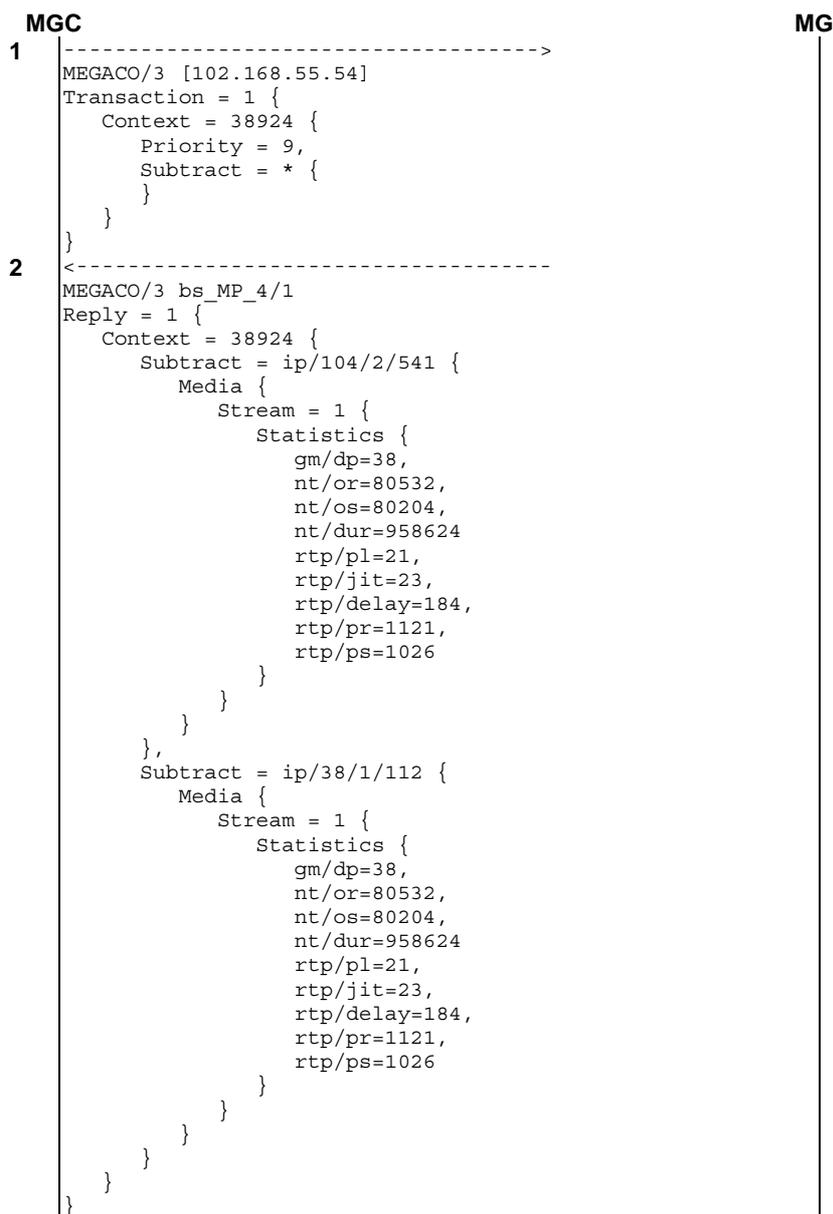

Figure 32: H.248 Message Sequence Example - Delete Session/Termination - Delete All Terminations in a Context, Statistics Required

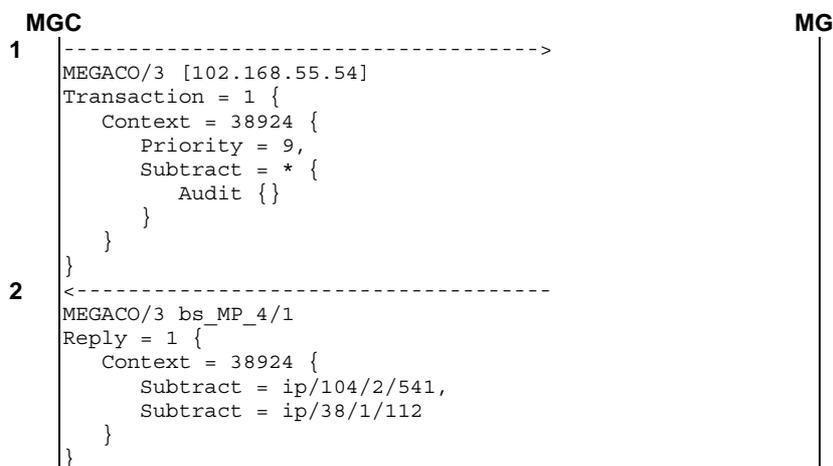

Figure 33: H.248 Message Sequence Example - Delete Session/Termination - Delete All Terminations in a Context, Statistics Not Required

5.18.6.2 Delete Session/Termination - Wildcarded Reply

Table 131: Message Contents - Delete Session/Termination - Wildcarded Reply

Delete Session/Termination - Delete Session							
H.248 Command	Descriptor	Descriptor	Descriptor	Properties, Events, Statistics, Signals	Connection Point Address, IP address information and Bearer Information	Support	Notes
Subtract Request (MGC to MG)					Context ID=specified	M	
					Termination ID= *	M	See note
	Audit					M	

NOTE: The Subtract Request will be wildcarded W.

Table 132: Message Contents - Delete Session - Wildcarded Reply Ack

Delete Session/Termination - Delete Session Ack							
H.248 Command	Descriptor	Descriptor	Descriptor	Properties, Events, Statistics, Signals	Connection Point Address, IP address information and Bearer Information	Support	Notes
Subtract Reply (MG to MGC)					Context ID=specified	M	
					Termination ID=*	M	

5.18.6.2.1 Delete Session - Wildcarded Reply - Examples

```

MGC                                     MG
1  ----->
   MEGACO/3 [102.168.55.54]
   Transaction = 1 {
     Context = 38924 {
       Priority = 9,
       W-Subtract = * {
         Audit {}
       }
     }
   }
2  <-----
   MEGACO/3 bs_MP_4/1
   Reply = 1 {
     Context = 38924 {
       Subtract = *
     }
   }

```

Figure 34: H.248 Message Sequence Example - Delete Session - Wildcarded Reply

5.19 Non-Session Related Use Cases

The following clauses are based on clauses 10.1 to 10.18 from the "TISPAN NGN Release 2; H.248 Non-Call Related Procedures and Management System Interaction" (see TS 183 025 [i.2]). Not all of the Use Cases in this TR are used by this profile. Table 133 denotes whether each of the Use Cases from the source document is Mandatory, Optional or Not Used.

Table 133: Support of Use Cases from TS 183 025 [i.2]

Use Case	Support
Enable MG (at MGC)	Mandatory
Enable MG (at MG): Cold Boot	Mandatory
Enable MG (at MG): Warm Boot	Mandatory
Enable MGC	Optional
Disable MG (Graceful) (MGC)	Optional
Disable MG (Graceful) (MG)	Optional
Disable MG (Immediate) (MGC)	Mandatory
Disable MG (Immediate) (MG)	Mandatory
Disable MGC	Mandatory
Enable Termination (MGC)	Not Used (see note)
Enable Termination (MG)	Not Used (see note)
Disable Termination (Graceful) (MGC)	Not Used (see note)
Disable Termination (Graceful) (MG)	Not Used (see note)
Disable Termination (Immediate) (MGC)	Not Used (see note)
Disable Termination (Immediate) (MG)	Mandatory
MG Failure and Recovery	Mandatory
MG Termination Failure and Recovery	Mandatory
MGC Failure and Recovery	Mandatory
User Plane Failure	Mandatory
MGC-MG Control Association Failure and Recovery	Mandatory
MG Overload	Optional
MGC Overload	Not Used
MGC Handoff	Optional
MGC Re-Direct	Optional
MG Failover	Not Used
NOTE: For this profile, only ephemeral terminations are applicable.	

Each Use Case consists of a sequence of one or more procedures. The procedures may be mandatory or optional for each use case and must be executed in the sequence order shown in the use case. The procedure names are denoted by the use of UPPER CASE letters. The procedures are described in clause 5.20.

5.19.1 Enable MG

This management primitive is applicable to both the MGC and MG. It is recommended that this primitive is initially sent to the MGC and subsequently to the MG.

5.19.1.1 Enable MG (at MGC)

This use case is triggered by management action that results in a MG being enabled at the MGC.

Table 134: Enable MG (at MGC)

Seq. Num.	Description	Support
1	There are no H.248 procedures associated with this action. The MGC simply awaits a registration from the MG (see clause 5.19.1.2).	Mandatory

5.19.1.2 Enable MG (at MG)

This use case is triggered by management action that results in a MG being brought into service. The MG will have been provisioned with the identity/address of one or more MGC(s). The H.248 procedures are dependent on whether the MG undergoes a cold or warm boot and are as follows.

5.19.1.2.1 Enable MG (at MG): Cold Boot

Table 135: Enable MG (at MG): MG Cold Boot

Seq. Num.	Description	Support
1	The MG registers with one of its (pre-provisioned) MGCs using the MG REGISTRATION (COLD BOOT) procedure. This step enables the H.248 protocol version to be negotiated as well as the support of any H.248 profiles.	Mandatory
2	In the event of there being no response to the registration request, the MG follows the procedures of clause 11.5 of ITU-T Recommendation H.248.1 [1].	Optional
3	On completion of the initial registration procedure, the MGC assumes that all physical terminations are in the NULL context and there are no existing ephemeral terminations. Thus no connection related audits are required to be performed. (see note)	Mandatory
4	The MGC may optionally perform a PACKAGES AUDIT procedure in order to determine the MG support of any optional packages in a mutually supported profile.	Optional
5	The MGC may optionally audit ROOT properties (in any mandatory and optional packages) in the MG via the AUDIT ROOT PROPERTIES procedure.	Optional
6	The MGC may optionally set properties and events (on any mandatory and optional packages in the profile) in the MG on ROOT level via the SET ROOT TERMINATION EVENTS/PROPERTIES procedure.	Optional
7	The MG may optionally inform the MGC of the state of its physical terminations via a MG TERMINATION AVAILABLE/MG TERMINATION UNAVAILABLE procedure.	Not Used
8	The MGC may optionally Audit the state of the physical terminations if it cannot be assumed that the state is in-service or out-of-service via the AUDIT TERMINATION STATE procedure.	Not Used
9	The MGC should not deblock associated circuits toward peer nodes before it has determined the true service state of the MG's circuits by one of the two procedures above.	Not Used

NOTE: For this profile, physical terminations are not applicable.

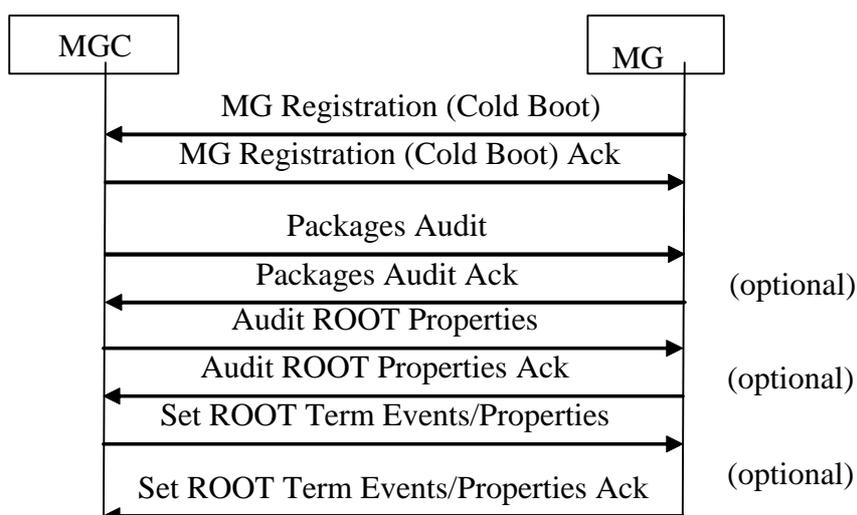

Figure 35: Procedures for Enable MG (Cold Boot)

5.19.1.2.2 Enable MG (at MG): Warm Boot

Table 136: Enable MG (at MG) : MG Warm Boot

Seq. Num.	Description	Support
1	The MG registers with one of its (pre-provisioned) MGCs using the MG RESTORATION procedure This step enables the H.248 protocol version to be negotiated as well as the support of any H.248 profiles.	Mandatory
2	In the event of there being no response to the registration request, the MG follows the procedures of clause 11.5 of H.248.1.	Optional
3	On completion of the re-registration procedure, the MGC does not assume that all physical terminations are in the NULL context and there may be existing ephemeral terminations (see note).	Mandatory
4	The MGC may optionally perform a PACKAGES AUDIT procedure in order to determine the MG support of any optional packages in a mutually supported profile.	Optional
5	The MGC may optionally audit ROOT properties (in any mandatory and optional packages) in the MG via the AUDIT ROOT PROPERTIES procedure.	Optional
6	The MGC may optionally set properties and events (in any mandatory and optional packages in the profile) in the MG on ROOT level via the SET ROOT TERMINATION EVENTS/PROPERTIES procedure.	Optional
7	The MGC may optionally perform a CONTEXT AUDIT procedure to determine the active contexts and connected terminations on the MG.	Mandatory
8	The MG may optionally inform the MGC of the state of its terminations via a MG TERMINATION AVAILABLE/MG TERMINATION UNAVAILABLE procedure.	MG TERMINATION AVAILABLE: Not used, MG TERMINATION UNAVAILABLE: Optional
9	The MGC may optionally Audit the state of its terminations if it cannot be assumed that the state is in-service or out-of-service via the AUDIT TERMINATION STATE procedure.	Not used
10	The MGC should not deblock associated circuits toward peer nodes before it has determined the true service state of the MG's circuits by one of the two procedures above.	Not used
NOTE: For this profile, physical terminations are not applicable.		

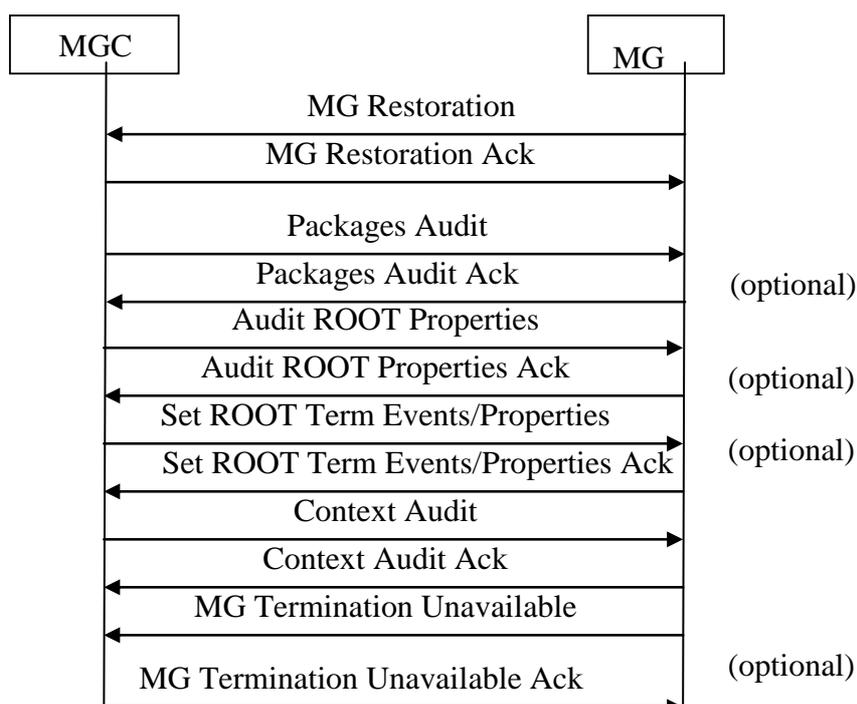

Figure 36: Enable MG (at MG) : MG Warm Boot

5.19.2 Enable MGC

This management primitive is applicable only to the MGC and results in a MGC being brought into service. The MGC will optionally have been provisioned with the identities H.248 Message IDentifier (MID) and possibly the IP addresses of transport address of the H.248 control association of its MGs.

Table 137: Enable MGC

Seq. Num.	Description	Support
1	The MGC may optionally check on the availability of its MGs via the CHECK MG AVAILABILITY procedure. This is only possible if the MGC is aware of the pre-provisioned IP address of the MG and UDP transport is used.	Optional
2	If the MG is available, the MGC may optionally request the MG to register via the MGC INITIATED SERVICE RESTORATION procedure which causes the MG to initiate the MG RE-REGISTRATION (RESTART) procedure.	Optional
3	If the MG is available, the MGC may optionally audit ROOT properties in the MG via the AUDIT ROOT PROPERTIES procedure.	Optional
4	If an MG is available, the MGC may optionally set properties and events in the MG on ROOT level via the SET ROOT TERMINATION EVENTS/PROPERTIES procedure.	Optional
5	If an MG is available, the MGC may optionally perform a CONTEXT AUDIT procedure to determine the active contexts and connected terminations on the MG.	Optional
6	If an MG is available, the MGC may optionally clean up hanging contexts/terminations via a WILDCARDED SUBTRACT.	Optional
7	If an MG is available, the MGC may optionally check on the service state of the physical terminations on the MG service via the AUDIT TERMINATION STATE procedure.	Not used
8	The MGC should not deblock associated circuits toward peer nodes before it has determined the true service state of the MG's circuits.	Not used

5.19.3 Disable MG (Graceful)

This primitive is applicable to both the MG and MGC and covers the use case of management action that results in a MG being taken out of service gracefully. It is recommended that the network management system performs a Disable MG (Graceful) command to the MGC. The one scenario where a Disable MG (Graceful) command to the MG makes sense is for an Access Gateway in order to inhibit new calls being initiated toward the MGC during the graceful period - and even in this case a MGC would be able to reject any originating calls appropriately. In addition, the management primitive typically has no equivalent of the H.248 ServiceChangeDelay - rather the acceptable period during which all affected calls/connections ought to be removed is determined by the operator. Therefore when mapping into H.248, a default value for the ServiceChangeDelay period would need to be applied.

5.19.3.1 Disable MG (Graceful) (at MGC)

Table 138: Disable MG (Graceful) (MGC)

Seq. Num.	Description	Support
1	The MGC inhibits any new calls/connections to the MG and allows existing calls/connections to expire naturally/normally.	Optional
2	In the event of new calls originating from the MG (e.g. an AGW), the MGC would handle them appropriately via call related procedures (e.g. reject the call attempt and connect a failure indication).	Not Used
3	When all calls have been released, the management system is informed. <i>In this profile the MGC INITIATED SERVICE CANCELLATION procedure is not supported.</i>	Optional

5.19.3.2 Disable MG (Graceful) (at MG)

Table 139: Disable MG (Graceful) (MG)

Seq. Num.	Description	Support
1	The MG informs the MGC via the MG SERVICE CANCELLATION (GRACEFUL) procedure. This procedure enables the MG to specify a timer (the ServiceChangeDelay) during which it is anticipated that all existing calls/connections on that MG will expire normally.	Mandatory
2	If applicable, the MG may prevent new originating calls being offered to the MGC.	Not Used
3	The MGC inhibits any new calls/connections to the MG and allows existing calls/connections to expire naturally/normally.	Mandatory
4	At the end of the ServiceChangeDelay period, any remaining connections are left hanging on the MG.	Mandatory
5	At the end of the ServiceChangeDelay period, the MGC force releases any remaining calls that have not expired naturally (but does not signal to the MG since the control association is now assumed to be down).	Optional

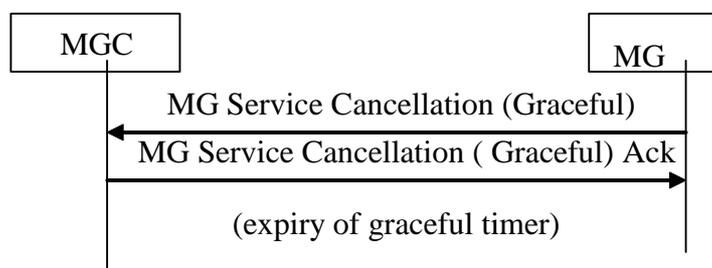

Figure 37: Disable MG (Graceful) (MG)

5.19.4 Disable MG (Immediate)

This primitive is applicable to both the MG and MGC and covers the use case of management action that results in a MG being taken out of service immediately.

5.19.4.1 Disable MG (Immediate) (at MGC)

Table 140: H.248 Procedures - Disable MG (Immediate) (MGC)

Seq. Num.	Description	Support
1	The MGC inhibits any new calls/connections to the MG and force releases existing calls/connections.	Mandatory
2	In the event of new calls originating from the MG (e.g. an AGW), the MGC would handle them appropriately via call related procedures (e.g. reject the call attempt and connect a failure indication).	Not Used
3	When all calls have been released, the management system is informed. <i>In this profile the MGC INITIATED SERVICE CANCELLATION procedure is not supported.</i>	Mandatory

5.19.4.2 Disable MG (Immediate) (at MG)

Table 141: H.248 Procedures - Disable MG (Immediate) (MG)

Seq. Num.	Description	Support
1	The MG informs the MGC via the MG SERVICE CANCELLATION (IMMEDIATE) procedure.	Mandatory
2	The MG responds to the management system. Note that existing connections are still hanging on the MG.	Mandatory
3	On receipt of the MG SERVICE CANCELLATION (IMMEDIATE) message, the MGC force releases any calls/connections associated with that MG. However, the connections cannot be removed on the MG due to the control association being down.	Mandatory

Since connections may be left hanging, it is recommended that the DISABLE MG (Immediate) primitive is applied firstly at the MGC and then at the MG.

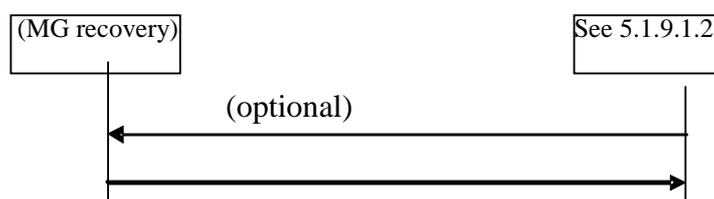

Figure 38: H.248 Procedures - Disable MG (Immediate) (at MG)

5.19.5 Disable MGC

This primitive is sent to a MGC and results in a MGC being taken out of service.

Table 142: H.248 Procedures - Disable MGC

Seq. Num.	Description	Support
1	Prior to the MGC being disabled, it is recommended that the MGC inform its dependent MGs to move their control associations to an alternative MGC via the MGC HANDOFF procedure (see clause 5.20.13) or that all dependent MGs are disabled prior to disabling the MGC (see clause 5.19.4).	Optional

5.19.6 Enable Termination

Void.

5.19.7 Disable Termination (Graceful)

Void.

5.19.8 Disable Termination (Immediate) (at MG)

This use case is triggered by management action that results in a MG termination being taken out of service immediately. The following H.248 procedures are performed.

Table 142b: H.248 Procedures - Disable Termination (Immediate) (at MG)

Seq. Num.	Description	Support
1	The MG informs the MGC via the MG TERMINATION UNAVAILABLE procedure.	Mandatory
2	The MGC acknowledges the message. The MGC will then proceed to force releases all affected calls/connections including subtracting appropriate terminations on the MG (see note).	Mandatory

NOTE: In this profile, this may be a wildcarded subtract at the interface level.

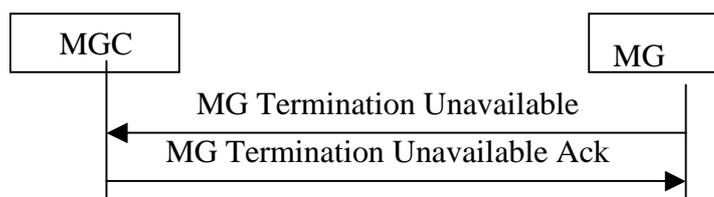
**Figure 38a: H.248 Procedures - Disable Termination (Immediate) (at MG)**

5.19.9 MG Failure and Recovery

This use case is triggered by a hardware/software failure on the MG.

Table 143: H.248 Procedures - MG Failure and Recovery

Seq. Num.	Description	Support Notes
1	If possible, the MG informs the MGC via the MG SERVICE CANCELLATION (IMMEDIATE) procedure. The MGC force releases all affected calls.	Optional
2	On recovering, the MG restarts and informs the MGC. The procedures of clause 5.19.1.2 are applicable.	Mandatory

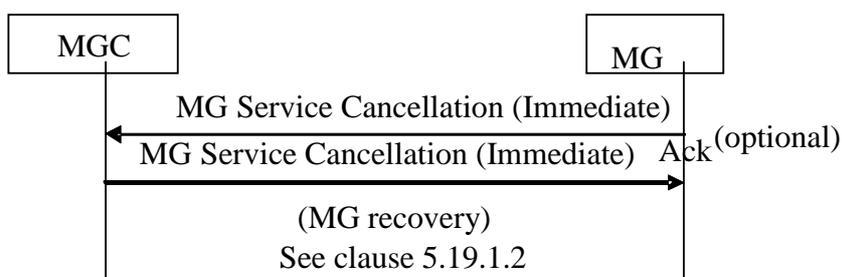
**Figure 39: H.248 Procedures - MG Failure and Recovery**

5.19.10 MG Termination Failure and Recovery

This use case is triggered by a hardware/software failure on the MG termination (e.g. loss of synchronization on an E1).

Table 144: H.248 Procedures - MG Termination Failure and Recovery

Seq. Num.	Description	Support
1	The MG informs the MGC via the MG TERMINATION UNAVAILABLE procedure. The MGC force releases any affected calls (and subtracts related terminations on the MG).	Mandatory
2	On the fault being cleared, the MG informs the MGC via the MG TERMINATION AVAILABLE procedure.	Not Used

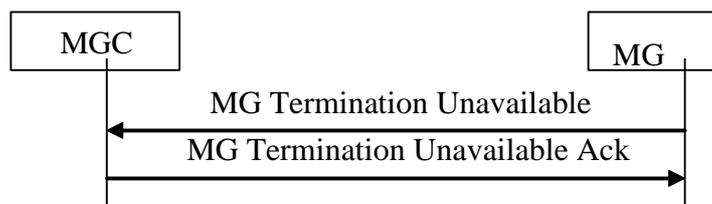

Figure 40: H.248 Procedures - MG Termination Failure and Recovery

5.19.11 MGC Failure and Recovery

This use case is triggered by a hardware/software failure on the MGC.

Table 145: H.248 Procedures - MG Termination Failure and Recovery

Seq. Num.	Description	Support Notes
1	During the outage, the procedures associated with the MG detecting the loss of the control link are applicable (see clause 5.19.13).	Mandatory
2	When the MGC recovers, the procedures of clause 5.19.2 are applicable.	Mandatory

5.19.12 User Plane Failure

This use case is triggered by the MG detecting loss of RTP on an ephemeral termination.

Table 146: H.248 Procedures - User Plane Failure

Seq. Num.	Description	Support
1	During the establishment of the connection, the MGC is assumed to have armed the MG to report an appropriate ObservedEvent which would be associated with user plane failure. There are a number of events that could be used for this purpose (e.g. nt/netfail, nt/qualert (see annex E.11 of ITU-T Recommendation H.248.1 [1]), g/cause (see annex E.1 of ITU-T Recommendation H.248.1 [1], etc.).	Mandatory
2	The MG detects loss of user plane data on one or more streams and notifies the MGC via the USER PLANE FAILURE procedure. The MG should avoid sending an avalanche of notifications where loss of user plane data is detected simultaneously across multiple ephemeral terminations.	Mandatory
3	On being informed of user plane failure, the MGC would typically remove the affected stream(s) and/or force release the affected call and subtract the related terminations.	Mandatory

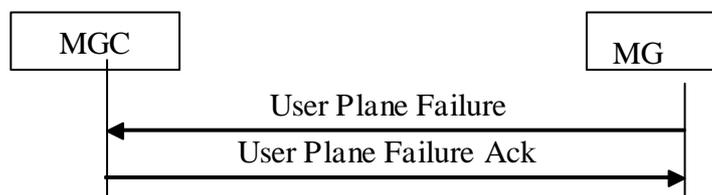

Figure 41: H.248 Procedures - User Plane Failure

5.19.13 MGC-MG Control Association Failure and Recovery

If UDP transport is used to convey the H.248 signalling, then the control association is monitored via the Inactivity Package (see ITU-T Recommendation H.248.14 [12]). In this case, it is assumed that the MGC has previously initiated the inactivity timer on the MG via the SET ROOT TERMINATION EVENTS/PROPERTIES procedure (see clause 5.19.1).

If SCTP transport is used, then the control association is monitored via SCTP procedures (which are out of scope of the present document) and the H.248 application layer is informed by the SCTP layer when the SCTP association goes down/comes up.

Table 147: H.248 Procedures - MGC-MG Control Association Failure and Recovery

Seq. Num.	Description	Support
1	For UDP transport, the MGC should endeavour to send at least one message to the MG during the period of the inactivity timer. If there are no call related messages, the MGC may use the CHECK MG AVAILABILITY procedure. If this procedure fails, the MGC shall periodically re-attempt the procedure to check if the control association is once more OK.	Optional
2	For UDP transport, on expiry of the inactivity timer, if the MG has received a message (including an acknowledgment) from the MGC during the inactivity timer period, then the MG resets the inactivity timer.	Optional
3	For UDP transport, on expiry of the inactivity timer, if the MG has not received a message (including an acknowledgment) from the MGC during the inactivity timer period, then the MG initiates the ROOT EVENT NOTIFICATION procedure to inform the MGC of the inactivity timer expiry.	Optional
4	For UDP transport, if the ROOT EVENT NOTIFICATION procedure is successfully completed, then the MG resets the inactivity timer.	Optional
5	For UDP transport, if no acknowledgement is received, then the control association is deemed to be down after normal H.248 retransmissions have occurred.	Optional
6	For UDP transport, the MG now attempts to re-establish the lost control link via the MG LOST COMMUNICATION (DISCONNECTED) procedure. If no acknowledgement is received (and normal H.248 retransmissions have occurred), then the MG attempts to establish an alternative control association via the MG LOST COMMUNICATION (FAILOVER) procedure.	Optional
7	For SCTP transport, on being informed by the SCTP layer that the SCTP association is now up, the MG re-establishes the H.248 control association via the MG LOST COMMUNICATION (DISCONNECTED) or MG LOST COMMUNICATION (FAILOVER) procedure dependent on whether the new SCTP association is to the same MGC as previous or not.	Optional
8	When the control association is re-established, the MGC may optionally re-synchronize its data with the MG via the AUDIT ROOT PROPERTIES, CONTEXT AUDIT and AUDIT TERMINATION STATE procedures.	Optional (see note 1)
9	When the control association is re-established, the MG shall inform the MGC of the state of its terminations via the MG TERMINATION AVAILABLE/MG TERMINATION UNAVAILABLE procedure if any changes occurred which it was unable to report during the control association outage.	Optional (see note 2)
10	When the control association is re-established, commands that were buffered during the outage period may be sent.	Optional
NOTE 1: The AUDIT TERMINATION STATE procedure shall not be used.		
NOTE 2: Only MG TERMINATION UNAVAILABLE is sent due to there being only ephemeral terminations.		

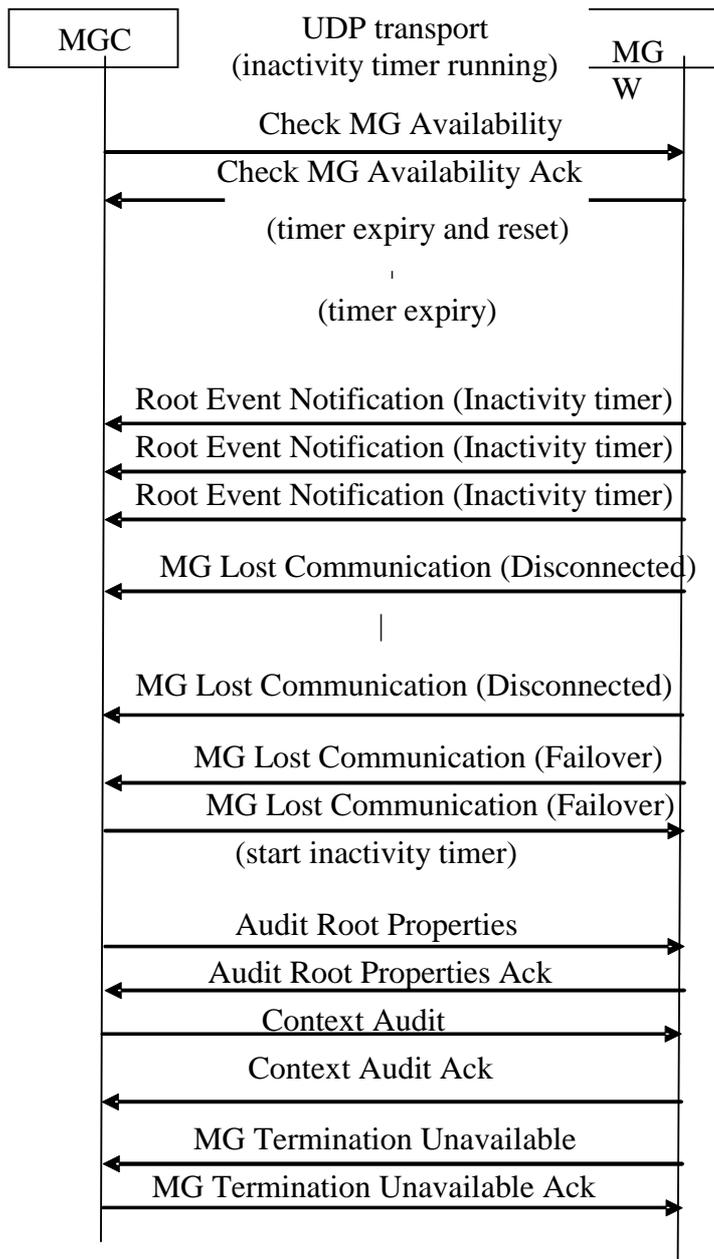

Figure 42a: H.248 Procedures - MGC-MG Control Association Failure and Recovery (UDP Transport)

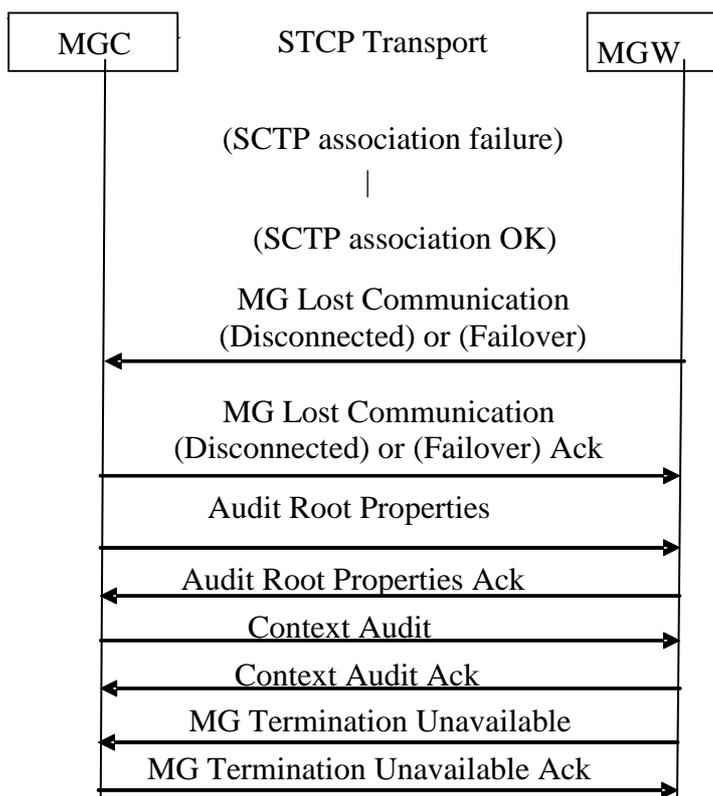

Figure 42b: H.248 Procedures - MGC-MG Control Association Failure and Recovery (SCTP Transport)

5.19.14 MG Overload

This use case is triggered by the MG entering an overloaded state. It is assumed that the MGC has previously armed the MG for notification of overload via the SET ROOT TERMINATION EVENTS/PROPERTIES procedure (see clause 5.19.1).

Table 148: H.248 Procedures - MG Overload Notification

Seq. Num.	Description	Support
1	The MG is pushed into overload by excessive session related activity. The MG informs the MGC of its overloaded condition via the ROOT EVENT NOTIFICATION (MG Overload) procedure. On receipt of the notification, the MGC takes appropriate action to reduce the offered load to the MG.	Optional

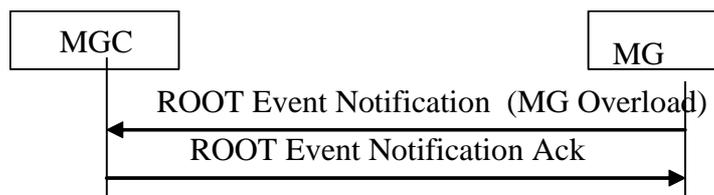

Figure 43: H.248 Procedures - MG Overload Notification Procedure

5.19.15 MGC Overload

Void.

5.19.16 MGC Hand-Off

This use case is triggered by management action that results in the MGC moving an existing control link association to an alternative MGC. This could be done as a load balancing exercise or as a pre-condition to taking a MGC out of service.

Table 149: H.248 Procedures - MGC Handoff after MG Registration

Seq. Num.	Description	Support
1	The MGC requests its MGs to move existing control associations to an alternative MGC via the MGC HANDOFF procedure. On receipt of this message, the MG then forms a new control association to the specified alternate MGC via the MG RE-REGISTRATION (HAND-OFF) procedure.	Optional

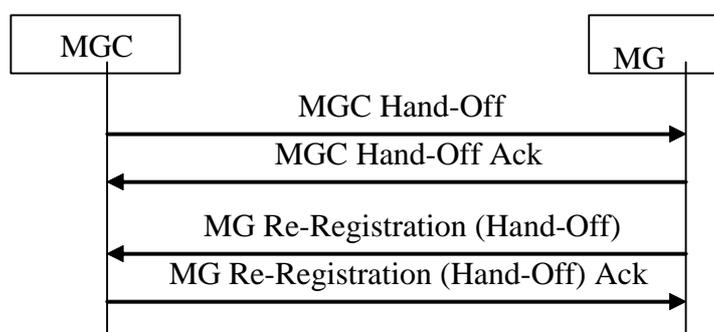

Figure 44: H.248 Procedures - MGC Handoff after MG Registration

5.19.17 MGC Re-Direct

This use case is triggered by an MGC rejecting a registration request from an MG and providing an alternative MGC address in the response. This could be done as a load balancing exercise. The following H.248 procedures are performed.

Table 150: H.248 Procedures - MGC Re-Direct

Seq. Num.	Description	Support
1	The MGC on receipt of a registration request, provide an alternative MGC identity/address in the registration response. This is shown in the REGISTRATION REDIRECT procedure. The MG subsequently repeats the original registration request to the alternate MGC.	Optional



Figure 45: H.248 Procedures - MGC Re-Direct

5.19.18 MG Failover

Void.

5.20 Session Independent Procedures (Command Level Details)

Table 151: Call Independent Procedures - References

Procedure	Support	Clause
MG Registration (Cold Boot) (see note)	Mandatory	5.20.1
MG Restoration (see note)	Mandatory	5.20.2
Packages Audit	Optional	5.20.3
Context Audit	Mandatory	5.20.4
MG Termination Available	Not Used	5.20.5
MG Termination Unavailable	Mandatory	5.20.6
Audit Termination State	Not Used	5.20.7
Set ROOT Termination Events/Properties	Optional	5.20.8
MGC Initiated Service Restoration	Optional	5.20.9
Check MG Availability	Optional	5.20.10
MG Service Cancellation (Graceful)	Optional	5.20.11
MG Service Cancellation (Immediate)	Mandatory	5.20.12
MGC Hand-Off	Optional	5.20.13
MG Re-Registration (Hand-Off) (see note)	Optional	5.20.14
MG Termination OOS Graceful	Not Used	5.20.15
MGC Overload Notification	Not Used	5.20.16
Registration Redirect	Optional	5.20.17
User Plane Failure	Mandatory	5.20.18
ROOT Event Notification	Optional	5.20.19
MG Lost Communication (Disconnected)	Mandatory	5.20.20
MG Lost Communication (Failover)	Optional	5.20.21
MG Redundant Takeover (Primary)	Not Used	5.20.22
Void	N/A	5.20.23
MG Re-Registration (Restart)	Optional	5.20.24
Wildcarded Subtract	Mandatory	5.20.25
MG Redundant Takeover (Secondary)	Not Used	5.20.26
MGC Initiated Service Cancellation	Not Used	5.20.27
Audit Service State	Not Used	5.20.28
Audit ROOT Properties	Optional	5.20.29
NOTE: These procedures are sent using H.248 version 1 and may be used to negotiate a higher protocol version. All other procedures are sent using the negotiated protocol version.		

5.20.1 MG Registration (Cold Boot)

Table 152: Message Contents - MG Registration (Cold Boot) and MG Registration (Cold Boot) Ack

Command/Response	Initiated	Information Element Name	Information Element Description	Information Element Required
MG Registration (Cold Boot)	MG	Context	This information element indicates the H.248 context for the command. Set to NULL.	Mandatory
		Command	This is the H.248 Command. Set to SERVICE CHANGE.	Mandatory
		Termination	This information element indicates the H.248 termination for the command. This is set to ROOT.	Mandatory
		Method	This information element indicates the method for service change. This is set to RESTART.	Mandatory
		Reason	This information element indicates the reason for service change. This is set to 901 - "Cold Boot".	Mandatory
		Service Change Profile	Indicates the name of a supported H.248 profile. <i>For this profile this is set to "ETSI_BGF/2".</i>	Optional
		Protocol Version	Indicates the highest H.248 version supported by the MG - if other than 1. <i>For this profile this is set to version 3.</i>	Optional
MG Registration (Cold Boot) Ack	MGC	Context	As received.	Mandatory
		Command	As received.	Mandatory
		Termination	As received.	Mandatory
		Protocol Version	If the highest protocol version supported by the MGC is lower than that proposed by the MG, this parameter must be included. If the protocol version proposed by the MG is supported by the MGC, this parameter may be included. Note that if the lowest protocol version supported by the MGC is greater than that proposed by the MG, the command is rejected with an error response 406 ("Version Not Supported"). <i>For this profile this is set to version 3.</i>	Optional
		Service Change Profile	This information element indicates the profile (name and version) supported by the MGC if different to that proposed by the MG. <i>For this profile this is set to "ETSI_BGF/2".</i>	Optional

An example message exchange would be:

- Transaction=1002{Context=- {ServiceChange=ROOT{Services{Method=Restart, Reason="901", Profile=ETSI_BGF/2, Version=3}}}}
- Reply=1002{Context=-{ServiceChange = ROOT}}

5.20.2 MG Restoration

Table 153: Message Contents - MG Restoration and MG Restoration Ack

Command/Response	Initiated	Information Element Name	Information Element Description	Information Element Required
MG Restoration	MG	Context	This information element indicates the H.248 context for the command. Set to NULL.	Mandatory
		Command	This is the H.248 Command. Set to SERVICE CHANGE.	Mandatory
		Termination	This information element indicates the H.248 termination for the command. This is set to ROOT.	Mandatory
		Method	This information element indicates the method for service change. This is set to RESTART.	Mandatory
		Reason	This information element indicates the reason for service change. This is set to 900 ("Service Restored") or 902 ("Warm Boot"). <i>For this profile the reason values 916 ("Packages Change"), 917 ("Capabilities Change") and 918 "Cancel Graceful" are not supported.</i>	Mandatory
		Service Change Profile	Indicates the name of a supported H.248 profile. <i>For this profile this is set to "ETSI_BGF/2".</i>	Optional
MG Restoration Ack	MGC	Context	As received.	Mandatory
		Command	As received.	Mandatory
		Termination	As received.	Mandatory
		Protocol Version	If the highest protocol version supported by the MGC is lower than that proposed by the MG, this parameter must be included. If the protocol version proposed by the MG is supported by the MGC, this parameter may be included. Note that if the lowest protocol version supported by the MGC is greater than that proposed by the MG, the command is rejected with an error response 406 ("Version Not Supported"). <i>For this profile this is set to version 3.</i>	Optional
		Service Change Profile	This information element indicates the profile (name and version) supported by the MGC if different from that proposed by the MG. <i>For this profile this is set to "ETSI_BGF/2".</i>	Optional

An example message exchange would be:

- Transaction=1002{Context=- {ServiceChange=ROOT{Services{Method=Restart, Reason="902", Profile=ETSI_BGF/2, Version=3}}}}
- Reply=1002{Context=-{ServiceChange = ROOT}}

5.20.3 Packages Audit

This procedure is typically performed against the ROOT termination, in which case the MG returns all supported packages. It is also possible for the MGC to request a packages audit against other than the ROOT termination (e.g. a circuit termination) in which case the MG returns the sub-set of the packages that are applicable to the termination type. However, it is recommended that a packages audit be performed on the ROOT termination since the MGC can be expected to know how the returned set of packages ought to be used in relation to its different termination types.

Table 154: Message Contents - Packages Audit and Packages Audit Ack procedures

Command/Response	Initiated	Information Element Name	Information Element Description	Information element required
Packages Audit	MGC	Context	This information element indicates the H.248 context for the command. Set to NULL.	M
		Command	This is the H.248 Command. Set to AUDIT VALUE.	M
		Termination	This information element indicates the H.248 termination for the command. This is set to ROOT.	M
		Audit packages	This is the Audit Descriptor requesting "Packages".	M
Packages Audit Ack	MG	Context	As received.	M
		Command	As received.	M
		Termination	As received.	M
		Package List	The list of supported packages.	M

An example message exchange would be:

- Transaction=1002{Context=- { AuditValue=ROOT{ Audit{Packages}}}}
- Reply=1002{Context=-{AuditValue = ROOT {Packages { g-2,root-2, nt-1,etc.}}}}

5.20.4 Context Audit

This procedure is invoked by the MGC to check/determine the list of active contexts and related terminations on the MG. There are a number of variations to this audit dependent on the amount of information available to the MGC prior to the audit (e.g. context identity known or termination naming scheme known, etc.). A MGC may choose to use one or a combination of these variations dependent on its specific audit requirements.

Table 155: Context Audit and Context Audit Ack procedure support

Command/Response	Support	Reference
Termination ID known	-	
Context known	-	
Termination ID partly known	M	Table 156
Context List	-	

Table 156: Message Contents - Context Audit and Context Audit Ack procedures (termination id partly known)

Command/Response	Initiated	Information Element Name	Information Element Description	Information element required
Context Audit	MGC	Context	This information element indicates the H.248 context for the command. Set to ALL or NULL.	Mandatory (see note)
		Command	This is the H.248 Command. Set to AUDIT VALUE.	Mandatory
		Termination	This information element indicates the H.248 termination for the command. This is set to a partially wildcarded termination, e.g. ip/0/*.	Mandatory (see note)
		Audit Information	This is the Audit Descriptor requesting the appropriate information to be returned.	Not Used
Context Audit Ack	MG	Context	One or more active contexts associated with the wildcarded termination identity.	Mandatory (see note)
		Command	As received.	Mandatory
		Termination(s)	For each returned context, one or two matching terminations.	Mandatory
		Audited Information	The information requested (per termination).	Not Used
NOTE: In the event of there a mismatch between the wildcarded termination and specified context, an error 431 would be returned.				

An example message exchange would be:

- Transaction=1002{Context=* {AuditValue=ip/15/*{ Audit{ } }}}
- Reply=1002{Context=12{ AuditValue = ip/15/1/204, AuditValue = ip/7/2/12}, Context=15{ AuditValue= ip/15/2/5, AuditValue = ip/203/1/6}, Context=23{ AuditValue= ip/15/1/17, AuditValue = ip/37/2/95}}

5.20.5 MG Termination Available

Void.

5.20.6 MG Termination Unavailable

Table 157: Message Contents - MG Termination Unavailable and MG Termination Unavailable Ack

Command/Response	Initiated	Information Element Name	Information Element Description	Information Element Required
MG Termination Unavailable	MG	Context	This information element indicates the H.248 context for the command. Set to specific or ALL. <i>For this profile Context=NULL is not supported.</i>	Mandatory
		Command	This is the H.248 Command. Set to SERVICE CHANGE.	Mandatory
		Termination	This information element indicates the H.248 termination for the command. This is set to a specific termination identity or a partially wildcarded identity (i.e. specifying the "interface" part of the termination ID and wildcarding the "group" and "Id" parts) or a wholly wildcarded identity (i.e. ip/*).	Mandatory
		Method	This information element indicates the method for service change. This is set to FORCED.	Mandatory
		Reason	This information element indicates the reason for service change. This is set to 904 ("Termination Malfunction") or 905 ("Termination Taken OOS") or 906 ("Loss of Lower Layer Connectivity"), or 907 ("Transmission Failure") or 910 ("Media Capability Failure") or 912 ("Mux Capability Failure") or 913 ("Signal Capability Failure") or 914 ("Event Capability Failure" or 915 ("State Loss").	Mandatory
MG Termination Unavailable Ack	MGC	Context	As received.	Mandatory
		Command	As received.	Mandatory
		Termination	As received.	Mandatory

An example message exchange would be:

- Transaction=1002{Context=- { ServiceChange=ip/15/1/204{ Services{Method=Forced, Reason="905"} }}}
- Reply=1002{Context=-{ServiceChange = ip/15/1/204}}

OR

- Transaction=1002{Context=* { W- ServiceChange=ip/*/1/*{ Services{Method=Forced, Reason="905"} }}}
- Reply=1002{Context=-{ServiceChange = ip/*/1/*}}

5.20.7 Audit Termination State

Not Used.

Background:

- This is related to MG *warm boot* (see clause 5.19.1.2.2) and MG restoration (see clause 5.20.2) respectively. Should a termination go out of service during the period the H.248 control association is down, then, after the H.248 control association is established again, this shall be reported according to use case (see clause 5.19.10) following the procedure according to clause 5.20.6.

5.20.8 Set ROOT Termination Events/Properties

Table 158: Message Contents - Set ROOT Termination Events/Properties and Set ROOT Termination Events/Properties Ack procedures

Command/Response	Initiated	Information Element Name	Information Element Description	Information Element Required
Set ROOT Termination Events/Properties	MGC	Context	This information element indicates the H.248 context for the command. Set to NULL.	Mandatory
		Command	This is the H.248 Command. Set to MODIFY.	Mandatory
		Termination	This information element indicates the H.248 termination for the command. This is set to ROOT.	Mandatory
		ROOT Properties	These are the ROOT level properties - e.g. "Normal MGC Execution Time".	Optional
		ROOT Events	These are the ROOT level events - e.g. notification of expiry of inactivity timer, notification of overload, etc.	Optional
Set ROOT Termination Events/Properties Ack	MG	Context	As received.	Mandatory
		Command	As received.	Mandatory
		Termination	As received.	Mandatory

An example message exchange would be:

- Transaction=1002{Context=- { Modify=ROOT{ Media {TerminationState { root/MGCProvisionalResponseTimerValue=700, root/MGCOriginatedPendingLimit=3, root/NormalMGExecutionTime = 3000, root/MGProvisionalResponseTimerValue=3000, root/MGOriginatedPendingLimit=3, seg/MGCMaxPDUSize=1000, seg/MGCSegmentationTimerValue=20}}, Events{ocp/mg_overload, it/ito{mit=3000}}}}}
- Reply=1002{Context=-{Modify = ROOT}}

5.20.9 MGC Initiated Service Restoration

Table 159: MGC Initiated Service Restoration and MGC Initiated Service Restoration Ack

Command/Response	Initiated	Information element name	Information element required	Information element description
MGC Initiated Service Restoration	MGC	Context	M	This information element indicates the H.248 context for the command. Set to NULL.
		Command	M	This is the H.248 Command. Set to SERVICE CHANGE.
		Termination	M	This information element indicates the H.248 termination for the command. This is set to ROOT.
		Method	M	This information element indicates the method for service change. This is set to RESTART.
		Reason	M	This information element indicates the reason for service change. This is set to 900 ("Service Restored") or 901 ("Cold Boot")
MGC Initiated Service Restoration Ack	MG	Context	M	As received.
		Command	M	As received
		Termination	M	As received..

An example message exchange would be:

- Transaction=1002{Context=- { ServiceChange=ROOT{ Services{Method=Restart, Reason="901" } }}}
- Reply=1002{Context=-{ServiceChange = ROOT} }

5.20.10 Check MG Availability

Table 160: Message Contents - Check MG Availability and Check MG Availability Ack procedures

Command/Response	Initiated	Information Element Name	Information Element Description	Information Element Required
Check MG Availability	MGC	Context	This information element indicates the H.248 context for the command. Set to NULL.	Mandatory
		Command	This is the H.248 Command. Set to AUDIT VALUE.	Mandatory
		Termination	This information element indicates the H.248 termination for the command. This is set to ROOT.	Mandatory
Check MG Availability Ack	MG	Context	As received.	Mandatory
		Command	As received.	Mandatory
		Termination	As received.	Mandatory

An example message exchange would be:

- Transaction=1002{Context=- { AuditValue=ROOT{ Audit{ } }}}
- Reply=1002{Context=-{AuditValue = ROOT} }

5.20.11 MG Service Cancellation (Graceful)

Table 161: Message Contents - MG Service Cancellation (Graceful) and MG Service Cancellation (Graceful) Ack

Command/Response	Initiated	Information Element Name	Information Element Description	Information Element Required
MG Service Cancellation (Graceful)	MG	Context	This information element indicates the H.248 context for the command. Set to NULL.	Mandatory
		Command	This is the H.248 Command. Set to SERVICE CHANGE.	Mandatory
		Termination	This information element indicates the H.248 termination for the command. This is set to ROOT.	Mandatory
		Method	This information element indicates the method for service change. This is set to GRACEFUL.	Mandatory
		Reason	This information element indicates the reason for service change. This is set to 908 - "MG Impending Failure". <i>For this profile reason value 905 "Termination OOS" is not supported.</i>	Mandatory
		Service Change Delay	Indicates the period before which the MG will go out of service.	Optional
MG Service Cancellation (Graceful) Ack	MGC	Context	As received.	Mandatory
		Command	As received.	Mandatory
		Termination	As received.	Mandatory

An example message exchange would be:

- Transaction=1002{Context=- { ServiceChange=ROOT{ Services{Method=Graceful, Reason="908", Delay=600}}}}
- Reply=1002{Context=-{ServiceChange = ROOT}}

5.20.12 MG Service Cancellation (Immediate)

Table 162: Message Contents - MG Service Cancellation (Immediate) and MG Service Cancellation (Immediate) Ack

Command/Response	Initiated	Information Element Name	Information Element Description	Information Element Required
MG Service Cancellation (Immediate)	MG	Context	This information element indicates the H.248 context for the command. Set to NULL.	Mandatory
		Command	This is the H.248 Command. Set to SERVICE CHANGE.	Mandatory
		Termination	This information element indicates the H.248 termination for the command. This is set to ROOT.	Mandatory
		Method	This information element indicates the method for service change. This is set to FORCED.	Mandatory
		Reason	This information element indicates the reason for service change. This is set to 905 - "Termination Taken OOS".	Mandatory
MG Service Cancellation (Immediate) Ack	MGC	Context	As received.	Mandatory
		Command	As received.	Mandatory
		Termination	As received.	Mandatory

An example message exchange would be:

- Transaction=1002{Context=- { ServiceChange=ROOT{ Services{Method=Forced, Reason="905"}}}}
- Reply=1002{Context=-{ServiceChange = ROOT}}

5.20.13 MGC Hand-Off

Table 163: Message Contents - MGC Hand-Off and MGC Hand-Off Ack

Command/Response	Initiated	Information Element Name	Information Element Description	Information Element Required
MGC Hand-Off	MGC	Context	This information element indicates the H.248 context for the command. Set to NULL.	Mandatory
		Command	This is the H.248 Command. Set to SERVICE CHANGE.	Mandatory
		Termination	This information element indicates the H.248 termination for the command. This is set to ROOT.	Mandatory
		Method	This information element indicates the method for service change. This is set to HANDOFF.	Mandatory
		Reason	This information element indicates the reason for service change. This is set to 903 - "MGC Directed Change".	Mandatory
		Alternate MGC Id	This is the alternate MGC Identity to which the control association should be moved.	Mandatory
MG Hand-Off Ack	MG	Context	As received.	Mandatory
		Command	As received.	Mandatory
		Termination	As received.	Mandatory

An example message exchange would be:

- Transaction=1002{Context=- { ServiceChange=ROOT{ Services{Method=Handoff, Reason="903", MgcIdToTry=1.2.3.4}}}}
- Reply=1002{Context=-{ServiceChange = ROOT}}

5.20.14 MG Re-Registration (Hand-Off)

Table 164: Message Contents - MG Re-Registration (Hand-Off) and MGC Re-Registration (Hand-Off) Ack

Command/Response	Initiated	Information Element Name	Information Element Description	Information Element Required
MG Re-Registration (Hand-Off)	MG	Context	This information element indicates the H.248 context for the command. Set to NULL.	Mandatory
		Command	This is the H.248 Command. Set to SERVICE CHANGE.	Mandatory
		Termination	This information element indicates the H.248 termination for the command. This is set to ROOT.	Mandatory
		Method	This information element indicates the method for service change. This is set to HANDOFF.	Mandatory
		Reason	This information element indicates the reason for service change. This is set to 903 - "MGC Directed Change".	Mandatory
		Service Change Profile	This information element indicates the profile (name and version) supported by the MGC if different from that proposed by the MG <i>For this profile this is "ETSI_BGF/2".</i>	Optional
		Protocol Version	Indicates the highest H.248 version supported by the MG - if other than 1. <i>For this profile this is version 3.</i>	Optional
MG Re-Registration (Hand-Off) Ack	MGC	Context	As received.	Mandatory
		Command	As received.	Mandatory
		Termination	As received.	Mandatory
		Service Change Profile	This information element indicates the profile supported by the MGC. <i>For this profile this is "ETSI_BGF/2".</i>	Optional
		Protocol Version	If the highest protocol version supported by the MGC is lower than that proposed by the MG, this parameter must be included. If the protocol version proposed by the MG is supported by the MGC, this parameter may be included. Note that if the lowest protocol version supported by the MGC is greater than that proposed by the MG, the command is rejected with an error response 406 ("Version Not Supported"). <i>For this profile this is version 3.</i>	Optional

An example message exchange would be:

- Transaction=1002{Context=- { ServiceChange=ROOT{ Services{Method=Handoff, Reason="903", Profile=ETSI_BGF/2, Version=3}}}}
- Reply=1002{Context=-{ServiceChange = ROOT {Services { Version=3}}}}

5.20.15 MG Termination OOS Graceful

Void.

5.20.16 MGC Overload Notification

Void.

5.20.17 Registration Redirect

Table 165: Message Contents - Registration Redirect

Command/Response	Initiated	Information Element Name	Information Element Description	Information Element Required
Registration	MG	Context	This information element indicates the H.248 context for the command. Set to NULL.	Mandatory
		Command	This is the H.248 Command. Set to SERVICE CHANGE.	Mandatory
		Termination	This information element indicates the H.248 termination for the command. This is set to ROOT.	Mandatory
		Method	This information element indicates the method for service change. This is set to any apart from FORCED/GRACEFUL.	Mandatory
		Reason	This information element indicates the reason for service change. This is set dependent on the METHOD.	Mandatory
		Service Change Profile	Indicates the name of a supported H.248 profile. <i>For this profile this is "ETSI_BGF/2".</i>	Optional
		Protocol Version	Indicates the highest H.248 version supported by the MG - if other than 1. <i>For this profile this is version 3.</i>	Optional
Registration Redirect	MGC	Context	As received.	Mandatory
		Command	As received.	Mandatory
		Termination	As received.	Mandatory
		Protocol Version	If the highest protocol version supported by the MGC is lower than that proposed by the MG, this parameter must be included. If the protocol version proposed by the MG is supported by the MGC, this parameter may be included. Note that if the lowest protocol version supported by the MGC is greater than that proposed by the MG, the command is rejected with an error response 406 ("Version Not Supported"). <i>For this profile this is version 3.</i>	Optional
		Service Change Profile	This information element indicates the profile (name and version) supported by the MGC if different to that proposed by the MG. <i>For this profile this is "ETSI_BGF/2".</i>	Optional
		Alternate MGC Id	This element enables the MGC to inform the MG that it should re-direct its Service Change to an alternative address. The MG will now repeat the MG Initial Registration procedure to this alternate address.	Mandatory

An example message exchange would be:

- Transaction=1002{Context=- { ServiceChange=ROOT{ Services{Method=Restart, Reason="901", Profile=ETSI_BGF/2, Version=3}}}}
- Reply=1002{Context=-{ServiceChange = ROOT {Services { Version=3, MGCIdToTry=1.2.3.4}}}}

5.20.18 User Plane Failure

Table 166: Message Contents User Plane Failure and User Plane Failure Ack

Command/Response	Initiated	Information Element Name	Information Element Description	Information Element Required
User Plane Failure	MG	Context	This information element indicates the H.248 context for the command. Set to a specific value.	Mandatory
		Command	This is the H.248 Command. Set to NOTIFY.	Mandatory
		Termination	This information element indicates the H.248 termination for the command. This is set to a specific ephemeral termination identity or a partially wildcarded identity (i.e. specifying the "interface" part of the termination ID and wildcarding the "group" and "Id" parts) or a wholly wildcarded identity (i.e. ip/*).	Mandatory
		User Plane Failure	This information element indicates that a failure in the user plane has been detected (e.g. nt/netfail, g/cause, adid/ipstop, etc.).	Mandatory
User Plane Failure Ack	MGC	Context	As received.	Mandatory
		Command	As received.	Mandatory
		Termination	As received.	Mandatory

An example message exchange would be:

- Transaction=1002{Context=1 { Notify=ip/15/3/2{ ObservedEvents{g/cause}}}}
- Reply=1002{Context=1 {Notify = ip/15/3/2}}

OR

- Transaction=1002{Context=* { W- Notify=ip/*/31/*{ ObservedEvents{g/cause}}}}
- Reply=1002{Context=1 {Notify = ip/*/31/*}}

• OR

- Transaction=1002{Context=1 { Notify=ip/15/3/2{ ObservedEvents{nt/netfail}}}}
- Reply=1002{Context=1 {Notify = ip/15/3/2}}

OR

- Transaction=1002{Context=* { W- Notify=ip/*/31/*{ ObservedEvents{nt/netfail}}}}
- Reply=1002{Context=1 {Notify = ip/*/31/*}}

OR

- Transaction=1002{Context=1 { Notify=ip/15/3/2{ ObservedEvents{adid/ipstop}}}}
- Reply=1002{Context=1 {Notify = ip/15/3/2}}

OR

- Transaction=1002{Context=* { W- Notify=ip/*/31/*{ ObservedEvents{adid/ipstop}}}}
- Reply=1002{Context=1 {Notify = ip/*/31/*}}

5.20.19 ROOT Event Notification

Table 167: Message Contents - ROOT Event Notification and ROOT Event Notification Ack

Command/Response	Initiated	Information Element Name	Information Element Description	Information Element Required
ROOT Event Notification	MG	Context	This information element indicates the H.248 context for the command. Set to NULL.	Mandatory
		Command	This is the H.248 Command. Set to NOTIFY.	Mandatory
		Termination	This information element indicates the H.248 termination for the command. This is set to ROOT.	Mandatory
		Notified ROOT Event	This information element indicates the detected ROOT event (e.g. inactivity timer expiry or MG Overload, etc.).	Mandatory
ROOT Event Notification Ack	MGC	Context	As received.	Mandatory
		Command	As received.	Mandatory
		Termination	As received.	Mandatory

An example message exchange would be:

- Transaction=1002{Context=- { Notify=ROOT{ ObservedEvents{it/ito} } } } OR
- Transaction=1002{Context=- { Notify=ROOT{ ObservedEvents{ocp/mg_overload} } } }
- Reply=1002{Context=-{Notify = ROOT } }

5.20.20 MG Lost Communication (Disconnected)

Table 168: Message Contents - MG Lost Communication (Disconnected) and MG Lost Communication (Disconnected) Ack

Command/Response	Initiated	Information Element Name	Information Element Description	Information Element Required
MG Lost Communication (Disconnected)	MG	Context	This information element indicates the H.248 context for the command. Set to NULL.	Mandatory
		Command	This is the H.248 Command. Set to SERVICE CHANGE.	Mandatory
		Termination	This information element indicates the H.248 termination for the command. This is set to ROOT.	Mandatory
		Method	This information element indicates the method for service change. This is set to DISCONNECTED.	Mandatory
		Reason	This information element indicates the reason for service change. This is set to 900 "Service Restored".	Mandatory
MG Lost Communication (Disconnected) Ack	MGC	Context	As received.	Mandatory
		Command	As received.	Mandatory
		Termination	As received.	Mandatory

An example message exchange would be:

- Transaction=1002{Context=- { ServiceChange=ROOT{ Services{Method=Disconnected, Reason="900"} } } }
- Reply=1002{Context=-{ServiceChange = ROOT } }

5.20.21 MG Lost Communication (Failover)

The MG attempts to establish a new control association using its list of pre-provisioned MGC identities. The MG cycles through its list until a successful response is received.

Table 169: Message Contents - MG Lost Communication (Failover) and MG Lost Communication (Failover) Ack

Command/Response	Initiated	Information Element Name	Information Element Description	Information Element Required
MG Lost Communication (Failover)	MG	Context	This information element indicates the H.248 context for the command. Set to NULL.	Mandatory
		Command	This is the H.248 Command. Set to SERVICE CHANGE.	Mandatory
		Termination	This information element indicates the H.248 termination for the command. This is set to ROOT.	Mandatory
		Method	This information element indicates the method for service change. This is set to FAILOVER.	Mandatory
		Reason	This information element indicates the reason for service change. This is set to 909 - "MGC Impending Failure".	Mandatory
		Service Change Profile	Indicates the name of a supported H.248 profile. <i>For this profile this is "ETSI_BGF/2".</i>	Optional
		Protocol Version	Indicates the highest H.248 version supported by the MG - if other than 1. <i>For this profile this is version 3.</i>	Optional
MG Lost Communication (Failover) Ack	MGC	Context	As received.	Mandatory
		Command	As received.	Mandatory
		Termination	As received.	Mandatory
		Service Change Profile	This information element indicates the profile (name and version) supported by the MGC if different to that proposed by the MG <i>For this profile this is "ETSI_BGF/2".</i>	Optional
		Protocol Version	If the highest protocol version supported by the MGC is lower than that proposed by the MG, this parameter must be included. If the protocol version proposed by the MG is supported by the MGC, this parameter may be included. Note that if the lowest protocol version supported by the MGC is greater than that proposed by the MG, the command is rejected with an error response 406 ("Version Not Supported"). <i>For this profile this is version 3.</i>	Optional

An example message exchange would be:

- Transaction=1002{Context=- { ServiceChange=ROOT{ Services{Method=Failover, Reason="909", Profile=ETSI_BGF/2, Version=3}}}}
- Reply=1002{Context=-{ServiceChange = ROOT {Services { Version=3}}}}

5.20.22 MG Redundant Takeover (Primary)

Void.

5.20.23 Void

5.20.24 MG Re-Registration (Restart)

Table 170: Message Contents - MG Re-Registration (Restart) and MG Re-Registration (Restart) Ack

Command/Response	Initiated	Information Element Name	Information Element Description	Information Element Required
MG Re-Registration (Restart)	MG	Context	This information element indicates the H.248 context for the command. Set to NULL.	Mandatory
		Command	This is the H.248 Command. Set to SERVICE CHANGE.	Mandatory
		Termination	This information element indicates the H.248 termination for the command. This is set to ROOT.	Mandatory
		Method	This information element indicates the method for service change. This is set to RESTART.	Mandatory
		Reason	This information element indicates the reason for service change. This is set to the value received from the MGC during the MGC ORDERED RE-REGISTER procedure - see clause 5.20.9.	Mandatory
MG Re-Registration (Restart) Ack	MGC	Context	As received.	Mandatory
		Command	As received.	Mandatory
		Termination	As received.	Mandatory

An example message exchange would be:

- Transaction=1002{Context=- { ServiceChange=ROOT{ Services{Method=Restart, Reason="901"} }}}
- Reply=1002{Context=-{ServiceChange = ROOT}}

5.20.25 Wildcarded Subtract

Table 171: Message Contents - Wildcarded Subtract and Wildcarded Subtract Ack

Command/Response	Initiated	Information Element Name	Information Element Description	Information Element Required
Wildcarded Subtract	MGC	Context	This information element indicates the H.248 context for the command. Set to ALL.	Mandatory
		Command	This is the H.248 Command. Set to SUBTRACT or W-SUBTRACT.	Mandatory
		Termination	This information element indicates the H.248 termination for the command. This is set to ALL or a partially wildcarded identity (e.g. ip/2/*).	Mandatory
Wildcarded Subtract Ack	MG	Context	As received (if W prefix used), else a list of specific context IDs.	Mandatory
		Command	As received.	Mandatory
		Termination	As received (if W prefix used), else a list of specific IDs.	Mandatory

An example message exchange would be:

- Transaction=1002{Context=* { W-Subtract=*{ Audit{ } }}}
- Reply=1002{Context=*{Subtract= *}}

An example with wildcarding at group level would be:

- Transaction=1002{Context=* { W-Subtract=ip/5/*{ Audit{}}}}
- Reply=1002{Context=*{Subtract= ip/5/*}}

An example with wildcarding at interface level would be:

- Transaction=1002{Context=* { W-Subtract=ip/*/5/*{ Audit{}}}}
- Reply=1002{Context=*{Subtract= ip/*/5/*}}

5.20.26 MG Redundant Takeover (Secondary)

Void.

5.20.27 MGC Initiated Service Cancellation

Void.

5.20.28 Audit Service State

Void.

5.20.29 Audit ROOT Properties

Table 172: Message Contents - Audit ROOT Properties and Audit ROOT Properties Ack

Command/Response	Initiated	Information Element Name	Information Element Description	Information Element Required
Audit ROOT Properties	MGC	Context	This information element indicates the H.248 context for the command. Set to NULL.	Mandatory
		Command	This is the H.248 Command. Set to AUDIT VALUE.	Mandatory
		Termination	This information element indicates the H.248 termination for the command. This is set to ROOT.	Mandatory
		Audit Properties	This is the list of ROOT properties required to be audited by the MGC.	Mandatory
Audit ROOT Properties ACK	MG	Context	As received	Mandatory
		Command	As received.	Mandatory
		Termination	As received	Mandatory
		Root Properties	The returned list of ROOT properties as requested by the MGC.	Mandatory

An example message exchange would be:

- Transaction=1002{Context=- { AuditValue=ROOT{ Audit{Media{TerminationState{root/*}, TerminationState{seg/*}}}}}}
- Reply=1002{Context=-{AuditValue = ROOT { Media{TerminationState {root/maxNumberOfContexts=1000, root/maxTerminationsPerContext=2, root/normalMGExecutionTime=2, root/normalMGCExecutionTime=2, root/MGProvisionalResponseTimerValue=5, root/MGCProvisionalResponseTimerValue=5, root/MGCOriGINatedPendingLimit=10, root/MGOriGINatedPendingLimit=10, seg/MGMaxPDUSize=1000, seg/MGSegmentationTimerValue=20}}}}

Annex A (informative): Illustration of Gate/Pinhole Concept

Purpose of this informative annex is the illustration of the H.248 Stream/Termination model by showing exemplary realizations of gates for uni- versus bidirectional media flows.

A.1 General

Only point-to-point sessions are in scope of this H.248 Profile (see clause 5.4). Interconnection of individual H.248 Streams is based on the basic principle described in clause 7.1.6/ITU-T Recommendation H.248.1 [1]. The H.248 Multiplex Descriptor is therefore not necessary (see clause 5.6.2). The H.248 Topology Descriptor definition includes individual H.248 Streams, but is also not necessary (see clause 5.7.8).

It has to be noted that all sessions have unicast media flows. Potential multicast applications are transparent for MG point of view.

A.2 Relationships between gates and H.248 Streams

The realization of a gate is illustrated in figure A.1. There is a unidirectional media flow in that example, and there is a single H.248 Stream per Termination. A **H.248 Stream** covers per definition a single **bidirectional** media flow (clause 7.1.6/ITU-T Recommendation H.248.1 [1]). Media flows are interconnected by using the same **StreamID** (here: StreamID equals to S1 for T1 and T2).

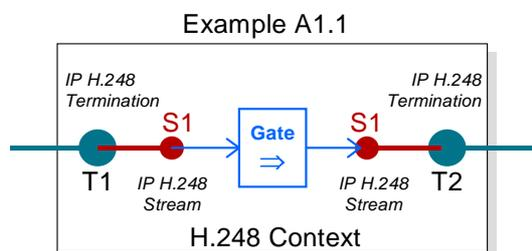

Figure A.1: H.248 Context - Illustration of Gate, Stream and Terminations

The uni- or bidirectional application of an H.248 Streams is controlled via usage of Local Descriptor (LD) and Remote Descriptor (RD). Figure A.2 shows a bidirectional session. There is again a single H.248 Stream per Termination. Gates are direction-dependent, there are consequently two gates in this example.

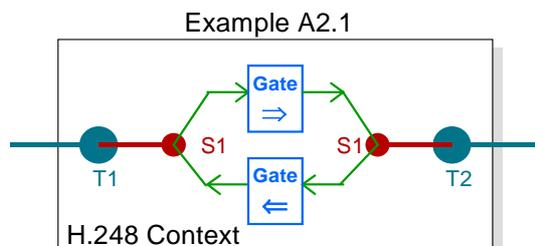

Figure A.2: H.248 Context Bidirectional Session using single H.248 Streams

Annex B (informative): Comparison between ES 283 018 V1.1.4 (Ia Profile Version 1) and TS 102 333 (GCP)

B.1 General

The H.248 Profile defined in ES 283 018 V1.1.4 [19] supports similar functionality than the Gate Control Profile defined in TS 102 333 [i.1]; however, it is important to note that the "H.248 Profile for the Ia Interface" is a new profile. This annex provides an overview of the main differences between them.

B.2 Differences between TS 102 333 (GCP) and ES 283 018 V1.1.4 (Ia Profile Version 1)

Table B.1 provides an overview of the differences between the Gate Control Protocol and the H.248 Profile Version 1 for the Ia Interface.

Table B.1: Difference between TS 102 333 [i.1] and ES 283 018 [19] (V1.1.4)

Topic	TS 102 333 [i.1](Gate Control Protocol)	ES 283 018 V1.1.4 [19] (Ia Profile Version 1)
Required H.248 Version	H.248 Version 2	H.248 Version 3
QoS monitoring	Supported	Not Supported
Supported with "latching" capability only	Hosted NAT traversal	Supported with "relatching" capabilities
Connection Model (see note)	A gate is represented by an ephemeral termination. Hence, a bidirectional active session requires two open gates (one at each side of the border gateway).	A gate is represented by a pair of ephemeral terminations (one at each side of the border gateway). A bidirectional active session requires two gates (one per direction) sharing the same pair of terminations.
Termination ID structure	ip/<interface>/<id>	ip/<group>/<interface>/<id>
Transport	mandates the support of SCTP, TCP or UDP	Recommends SCTP, UDP as optional
Encoding	Text and Binary	Text
SDP Usage (s=, t=)	Specifies how the s= and t= lines should be set	Provides no guidance on this
Security	IPSec as an option	Does not assume a security mechanism
TimeStamps in ServiceChange and Notify commands	Required	Not required
Transaction Timers	Shall be in a range between 100 ms and 5 s	No range specified
Packages		
Generic Package	Version 1	Version 2
Root Package	Version 1	Version 2
NAT traversal package	Supported	Not Supported
IP NAPT traversal package	Not Supported	Supported
Congestion Handling package	Supported	Not Supported
Quality Alert Ceasing	Optional	Not Supported
Overload Control	Optional	Not Supported
EMP Package	Optional	Not Supported
Gate Recovery Information	Supported	Not Supported
MGC Information Package	Not Supported	Optional
Segmentation Package	NA	Optional
NOTE: This difference in modelling does not have any impact on the external behaviour of the border gateway.		

Annex C (informative): Comparison with Ia Profile Version 1

C.1 General

The H.248 Profile defined in the present document is the upversioned Profile as defined in ES 283 018 V1.1.4 [19]. This annex provides an overview of the main differences between the two profile versions.

C.2 Differences between ES 283 018 V1.1.4 (Ia Profile Version 1) and ES 283 018 V2.7.1 (Ia Profile Version 2)

Table C.1 provides an overview of the differences between both profiles.

Table C.1: Difference between ES 283 018 [19] V1.1.4 (Ia Profile Version 1) and the present document (Ia Profile Version 2)

Topic	ES 283 018 [19] V1.1.4 (Ia Profile Version 1)	ES 283 018 V2.7.1 (Ia Profile Version 2)
QoS monitoring	Not Supported	Basic support via H.248 statistics (see clause 5.17.1.6).
TerminationID structure	ip/<group>/<interface>/<id>	ip/<group>/<interface>/<id> Field element "interface" is off-loaded from the semantic of "IP realm/domain" indication.
SDP Usage: "s=", "t=" and "o=" lines	Provides no guidance on this	Guidance provided in clause 5.16.
SDP Usage "b=" line	The bandwidth-value value defines the required <i>protocol layer 2</i> (e.g. Ethernet) bandwidth for the specific H.248 Stream.	The bandwidth-value value defines the <i>IP layer</i> bandwidth for the specific H.248 Stream.
Semantic for ignoring SDP information.	Usage of "ignore"	Replacement of "ignore" by text describing the handling of received SDP at the BGF for both media aware and media agnostic cases.
Packages		
RTP Package	Not Supported	Optional Version 1
IP Domain Connection Package	Not Supported	Version 1
Media Gateway Overload Control Package	Not Supported	Optional Version 1
Application Data Inactivity Package	Not Supported	Optional Version 1
Hanging Termination Package	Not Supported	Optional Version 1
Statistics Conditional Reporting	Not Supported	Optional Version 1
Procedures		
Session Independent Procedures (also known as <i>Call Independent Procedures</i> or <i>Non-Call Related Procedures</i>)	Implicit (see note 1) link to TS 183 025 [i.2].	Explicit link to TS 183 025 [i.2] by clause 5.17.2. Additional details in clause 5.19.
	Call-independent procedures for ES 283 018 [19] are defined in a separate document (TS 183 025 [i.2]), which is an overall description for all ETSI defined H.248 profile specifications, i.e. TS 183 025 [i.2] complements each profile specification. The set of profile-applicable call-independent procedures is primarily given by the supported H.248 Command API capabilities for AuditValue (see clause 5.8.5), AuditCapabilities (see clause 5.8.6) and ServiceChange (see clause 5.8.8), and supported packages (e.g. for overload control), by each profile.	

Topic	ES 283 018 [19] V1.1.4 (la Profile Version 1)	ES 283 018 V2.7.1 (la Profile Version 2)
IP Domain/Realm Indication	Via semantical overloading of the TerminationID (see note 2).	Explicit protocol element: via ipdc/realm property (ITU-T Recommendation H.248.41 [15]; see clause 5.17.1.10).
BGF Resource Reservation	One-stage mechanism	Additional support of a two-stage resource reservation (see clause 5.17.1.11)
RTCP Handling	High-level description in clause 5.17.1.1.	Additional information by clause 5.17.1.7.
NOTE 1: The TR was still in work when la profile version 1 was published.		
NOTE 2: ITU-T Recommendation H.248.41 [15] was still in work when la profile version 1 was published.		

Annex D (informative): Illustration of an IP processing model for an H.248 (IP, IP) Context

Purpose of this informative annex is the illustration of a possible IP flow processing model. Such a model may be helpful when considering aspects concerning:

- location of a particular function within the (BGF) processing pipeline; or
- possible interactions between functions (e.g. see clause D.2).

It has to be noted that the model is just an example, not exhaustive concerning all possible functions with regards to supported capabilities by this profile, and not related to any particular implementation.

D.1 Example model

Figure D.1 provides an example pipeline model, which is only indicating a single H.248 Stream of the (IP, IP) Context. A H.248 Stream is fundamentally bidirectional, i.e. relates to two unicast IP flows, one per traffic direction. This example is not considering aspects of RTP/RTCP mapping on a H.248 Stream.

The example model is considering optional and mandatory functions by this profile specification. The example is using modelling components for *filter* (F), *detector* (D), *address* processing (A) and *statistic* (S) entities. There might be further modelling components, e.g. for media-aware specific processing functions. The example model is assuming a pure serial processing pipeline, real implementations may of course benefit from parallelization.

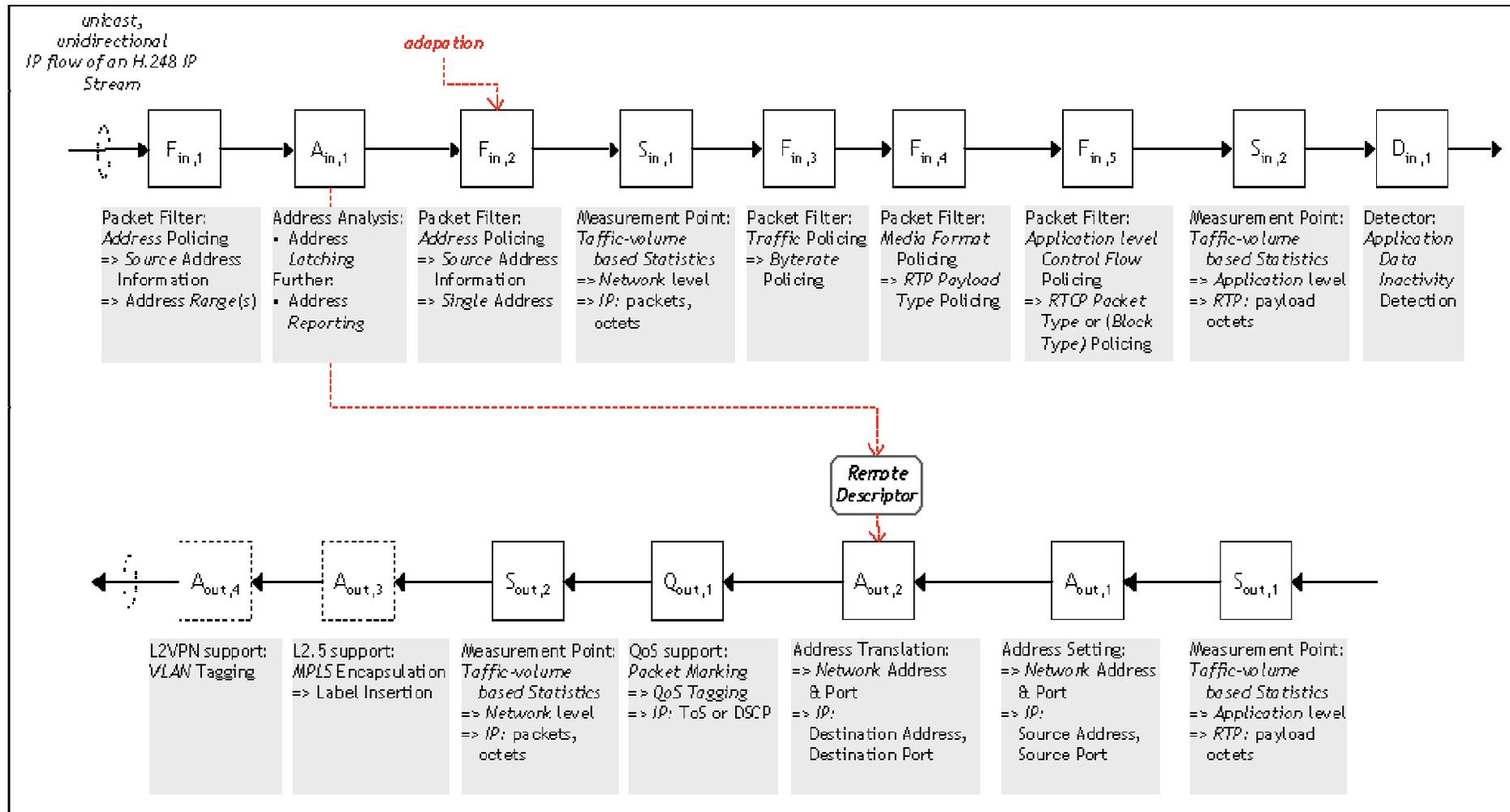

Figure D.1: H.248 Context - Illustration of IP flow processing - Example Overview

There might be dependencies between different processing stages, which impact the order of pipeline stages.

D.2 Aspects of filter interaction

Possible filter interactions are already indicated in several package specifications of the ITU-T Recommendation H.248.x-series of Recommendations. General solutions/recommendations are not yet provided by the package definitions themselves. This is therefore rather a subject for profile specifications, which using the correspondent packages.

D.2.1 Interaction between address latching and address policing

This profile version indicates two possible cases for filter interaction, either due to:

- enabled *latching* plus *address policing* per H.248 Stream, i.e. application of packages *ipnapt* v1 and *gm* v1; or
- the *correlation* of *SDP information* from the RD and *gm* v1 address policing (see clause 5.18.1.1.1).

Figure D.2 illustrates the possible interaction: the ingress filter stage $F_{in,1}$ provides explicit source address and port policing and is controlled via *gm* v1 properties (see clause 5.18.1.1.1). Source address and port policing may be applied for a single individual address/port, a single address/port range, multiple individual addresses/ports, multiple address/port ranges, or combinations thereof. Stage $F_{in,2}$ provides implicit source address/port policing and is controlled via the (re)latching process (and *not* controlled via *gm* v1 properties).

The function address latching/re-latching is provided by stage $A_{in,1}$.

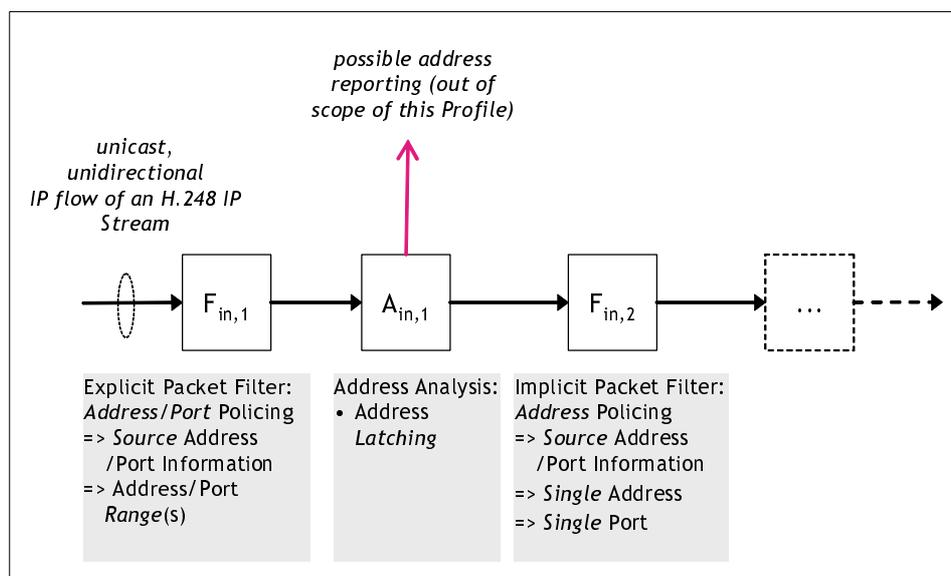

Figure D.2: H.248 Context - Illustration of IP flow processing - Interaction between address latching and address policing - Example model 1

Package *gm* v1 controlled filters are independent of the latching process. The latching process should lead to an adaptation of the implicit source address/port filter (according clause 5.18.1.1.1, and as indicated in figures D.2, D.3 or D.4).

The interaction and adaptation may affect different filter stages, dependent on the applied model. Figure D.3 illustrates another example: $F_{in,1}$ filters on some source address and port ranges.

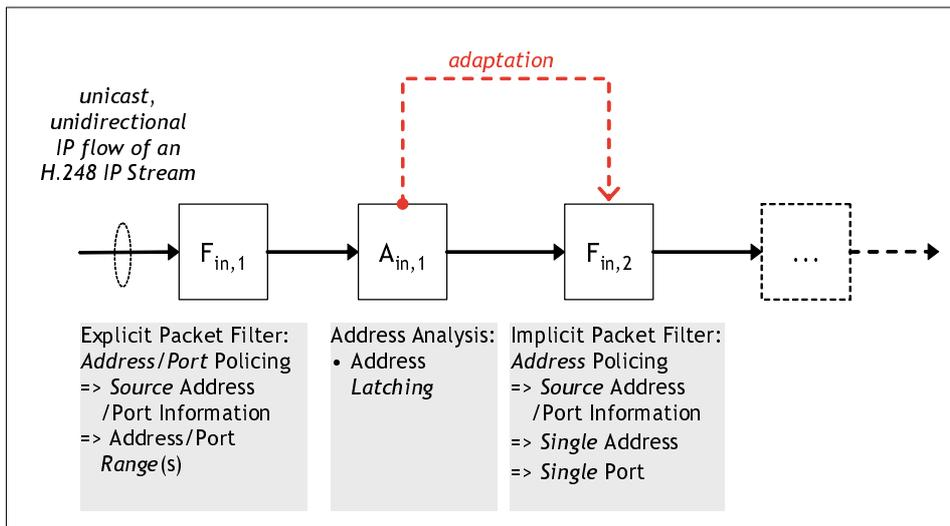

Figure D.3: H.248 Context - Illustration of IP flow processing - Interaction between address latching and address policing - Example model 2

Figure D.4 illustrates another example: stage $F_{in,1}$ filters on a specific source address/port range.

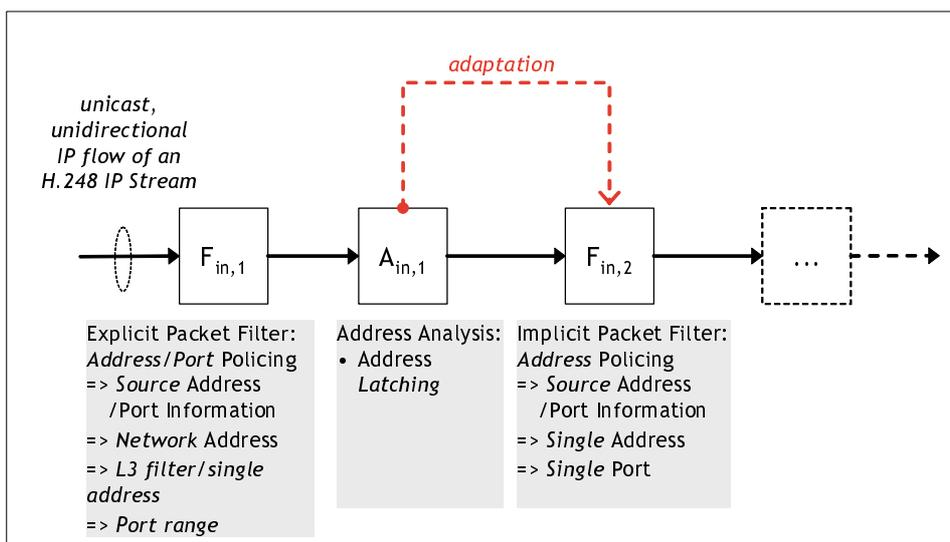

Figure D.4: H.248 Context - Illustration of IP flow processing - Interaction between address latching and address policing - Example model 3

Annex E (informative): Guidelines for Ia-to-Gq' mapping

Purpose of this informative annex is to provide mapping guidelines in the area of:

- session-independent procedures;
- bearer-specific events (e.g. due to failure detection); or
- unsuccessful session completions.

E.1 Guidelines for Ia-to-Gq' mapping with regards to session-independent procedures

E.1.1 Introduction

The procedures of the H.248 Ia profile are divided in *session-dependent* (see clause 5.17.1) and *session-independent* (see clause 5.17.2) procedures. Figure E.1 depicts the major difference between both procedure categories when looking at the vertical interfaces Gq' besides Ia.

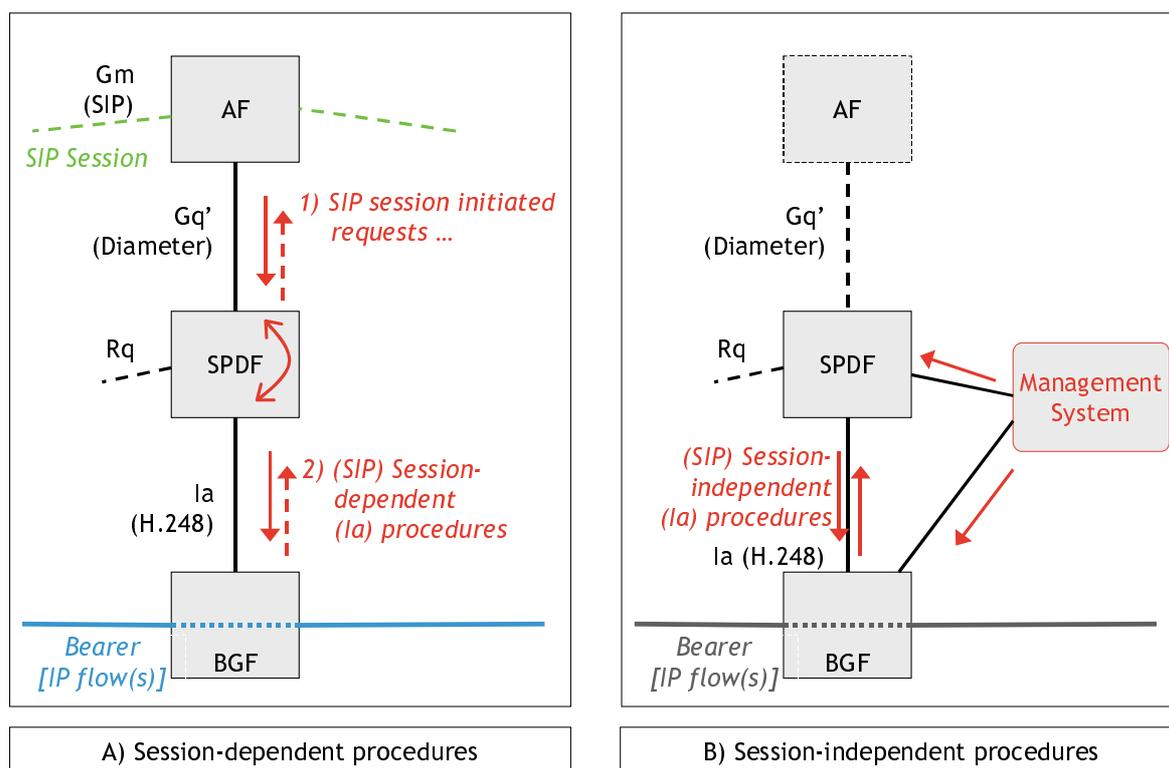

Figure E.1: RACS architecture - Session-dependent vs. Session-independent procedures from Ia point of view

E.1.2 Mapping guidelines

E.1.2.1 Session-dependent procedures

Mapping rules for Gq'-to-Ia for *session-dependent* procedures (see (A) in figure E.1) is in scope of TS 183 048 [i.13].

E.1.2.2 Session-independent procedures

The scope of *session-independent* procedures, as defined by this profile, is limited on Ia (see (B) in figure E.1). There are thus neither guidelines required nor provided for mappings from/towards Gq'.

E.2 Guidelines for Ia-to-Gq' mapping with regards to bearer-specific events

E.2.1 Introduction

H.248 provides a much wider set of protocol elements for support of bearer-related events as in comparison to other protocols like Diameter. This means for H.248-to-Diameter mappings, like for Ia-to-Gq' signalling direction, that often typically more than one H.248 procedure could be mapped on the same Diameter procedure.

The Ia-to-Gq' mapping function is therefore not bijective (at least as long as both protocols providing different capability sets). Mapping guidelines might be thus beneficial for implementers.

Figure E.2 illustrates the relevant part of RACS.

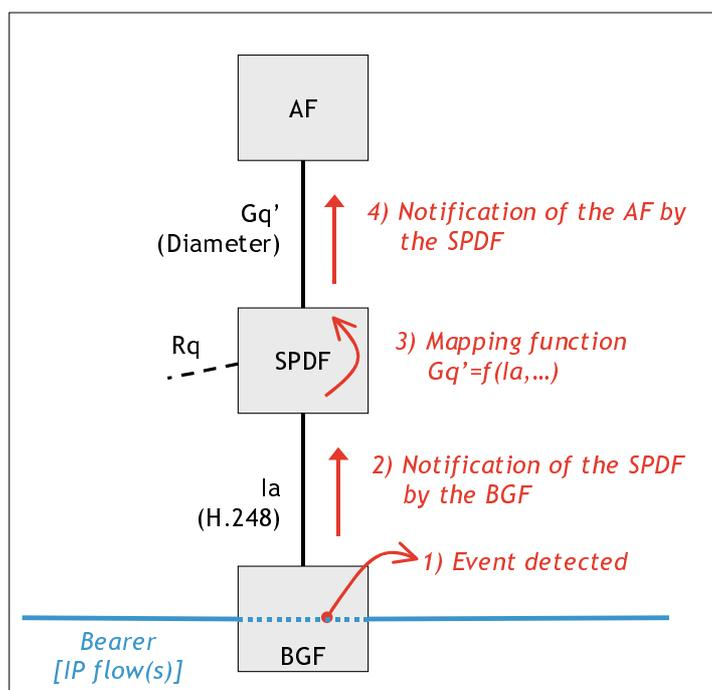

Figure E.2: RACS architecture - Vertical event notifications - Ia-to-Gq' mapping

E.2.2 Mapping guidelines

E.2.2.1 Guidelines for *Specific Action AVPs*

Table E.1: Guidelines for Attribute Value Pairs according clause 7.3.23/TS 183 017 [i.14]

Gq' (Diameter)	Ia (H.248)		
Specific action AVP Ref.: TS 183 017 [i.14], clause 7.3.23	Possible H.248 Protocol Elements	Possible H.248 Ia Profile Procedure	Recommended for Ia Version 2
INDICATION_OF_ LOSS_OF_BEARER (2)	H.248.1 Event: g/cause	User Plane Failure (5.19.12/5.20.18)	Yes
	H.248.1 Event: nt/netfail	ditto	Yes (but optional profile element)
	H.248.1 Event: nt/qualert	ditto	Yes (but optional profile element)
	H.248.40 Event: adid/ipstop	IP Media Stop (see clause 5.18.4.1)	(See note 7)
	H.248.36 Event: hangterm/thb Not applicable here	-	-
	H.248 ServiceChange: {Forced/Graceful, 904}	(See note 1)	No
	H.248 ServiceChange: {Forced/Graceful, 905}	(See note 2)	No
INDICATION_OF_ RECOVERY_OF_ BEARER (3)	H.248.13 Event: nt/qac/qualertcease	Not supported by this profile version.	(See note 6)
	H.248 ServiceChange: {Restart, 900}	(See note 4) Not supported by this profile version.	No
INDICATION_OF_ RELEASE_OF_ BEARER (4)	H.248 Subtract.reply command	Regular H.248 method (see note 5).	Yes
NOTE 1: Indication of " <i>termination malfunction</i> " for ephemeral termination.			
NOTE 2: Indication of " <i>termination taken Out-of-Service</i> " for ephemeral termination.			
NOTE 3: Indication of " <i>loss of lower layer connectivity</i> " for ephemeral termination.			
NOTE 4: Indication of " <i>service restore</i> " for ephemeral termination.			
NOTE 5: The H.248 Media Gateway is not allowed to autonomously "subtract a H.248 Stream/Termination", which would relate to a "release bearer" event. There is therefore also not any ServiceChange procedure defined.			
NOTE 6: This method might be as closest to the AVP (3) semantic, particularly when <i>nt/qualert</i> would be used for AVP (2).			
NOTE 7: This event may be overlaid with multiple applications. Thus, "No" in case that event is already used for other purposes (e.g. like latching deadlock detection), else "Yes".			

E.2.2.2 Other AVPs

The AVPs that are discussed in this Annex serve as a guideline and are not meant to be an exhaustive list of the AVPs that require mapping to/from Ia (H.248). There may well be further AVPs require mapping guidelines to/from Ia (H.248). Such further mapping is considered to be beyond the scope of this annex.

Annex F (informative): Bibliography

- ITU-T Recommendation H.248.4 (2000): "Gateway control protocol: Transport over Stream Control Transmission Protocol (SCTP)".

Annex G (informative): Change history

Change history							
Date	WG Doc.	CR	Rev	CAT	Title/Comment	Current Version	New Version
29-06-08	17bTD140r1				WI request for la v2 maintenance		
30-06-08	17bTD099r2	108		F	H.248 la Profile Version 2 Editorial issue in 5.17.1.6.2.2 RTP Case	2.3.0	2.3.2
01-07-08	18WTD65r2	109		F	Clarification of Ignore in SDP Tables	2.3.2	2.3.3
01-07-08	18WTD66r1	110		F	Missing description of a=rtcp attribute is added	2.3.2	2.3.3
01-07-08	18WTD110r1	111		F	Alignment with System Management TR v2.2.0.	2.3.2	2.3.3
01-07-08	18WTD271r1	112		D	Change to Signals descriptor in session related flow examples	2.3.2	2.3.3
01-07-08	18WTD214r1	113		F	Corrections to table 89	2.3.2	2.3.3
07-08					TB Approval of CRs 109 to 113	2.3.3	2.4.0
15-09-08					Correction of clause numbering and editing clean-up by ETSI Secretariat	2.4.0	2.4.1
24-09-08	18bTD144r2	114		F	Consistency of tman properties with la v3	2.4.1	2.4.2
24-09-08	18bTD145r2	115		F	Error in 5.20.7	2.4.1	2.4.2
24-09-08	18bTD147r2	116		F	Correction to reference list	2.4.1	2.4.2
24-09-08	18bTD151r2	117		F	Editorial IPDC Realm	2.4.1	2.4.2
24-09-08	18bTD166r1	118		F	WI-03176 H.248 la Profile Version 2 Revision of Annex D.2 'Aspects of filter interaction'	2.4.1	2.4.2
24-09-08	18bTD167r2	119		F	WI-03176 H.248 la Profile Version 2 Clause 5.14.2.4: Update of DiffServ Package version 1 specification	2.4.1	2.4.2
24-09-08	18bTD168r1	120		F	WI-03176 H.248 la Profile Version 2 Clause 5.14.2.9: Update of VLAN Package specification	2.4.1	2.4.2
24-09-08	19bTD231r1	121		C	Latching, relatching, and source filtering	2.4.1	2.4.2
13-11-08					CRs 114 to 121 TB approved and clean-up by ETSI Secretariat	2.4.2	2.5.0
24-11-08	19bTD064r1	122		F	Change to annex C.2 regarding SDP "ignore"	2.5.0	2.5.1
25-11-08	19bTD076r1	123		F	Alignment of meaning of Optional and Mandatory with H.248.1	2.5.0	2.5.1
24-11-08	19bTD077r1	124		F	Adding THF to la v2 Summary	2.5.0	2.5.1
21-01-09	19tTD103r1	125		F	Clarification of Table 89	2.5.1	2.5.2
21-01-09	19tTD104r1	126		F	Clarification of definition of nt/os and nt/or	2.5.1	2.5.2
21-01-09	19tTD139r1	127		D	Inconsistency of format of package heading titles	2.5.1	2.5.2
21-01-09	19tTD140r1	128		F	Error in Table 49	2.5.1	2.5.2
21-01-09	19tTD141r1	129		F	Change to table 62	2.5.1	2.5.2
21-01-09	19tTD142r1	130		D	Error in table 79	2.5.1	2.5.2
21-01-09	19tTD143r2	131		F	Error in table 80	2.5.1	2.5.2
21-01-09	19tTD138r1	132		D	Improvement to text in clause 5.17.1.7.1.3	2.5.1	2.5.2
24-02-09	20WTD99r1	133		F	Table 48 correction	2.5.2	2.5.3
24-02-09	20WTD100r1	134		F	Clarification to 5.19.2	2.5.2	2.5.3
24-02-09	20WTD101r2	135		F	Clarification to 5.19.13	2.5.2	2.5.3
24-02-09	20WTD159r1	136		F	Mid session update (addr/port)	2.5.2	2.5.3
24-02-09	20WTD103r1	137		F	Wildcard subtract corrections	2.5.2	2.5.3
24-02-09	20WTD107r1	138		F	Update to SysMan TS reference	2.5.2	2.5.3
24-02-09	20WTD138r1	139		F	Correction to H248 version in 5.18.5.X.	2.5.2	2.5.3
24-02-09	20WTD153r1	140		F	Clarification of latching to multiple streams	2.5.2	2.5.3
24-02-09	20WTD203r1	141		F	Table 5 corrections.	2.5.2	2.5.3
24-02-09	20WTD206r1	142		F	New clause 4.2	2.5.2	2.5.3
10-03-09					CRs 122 142 TB approved at TISPAN#20	2.5.3	2.6.0
18-03-09	20bTD047r1	143		F	Removing editor's notes from 5.6.1.1.1	2.6.0	2.6.1
18-03-09	20bTD048r1	144		F	Corrections to Thru' Connect Procedure.	2.6.0	2.6.1
18-03-09	20bTD049r1	145		F	Splitting table 47, new table 47a	2.6.0	2.6.1
18-03-09	20bTD050r1	146		F	Procedures for NA(P)T less mode	2.6.0	2.6.1
18-03-09	20bTD092r1	147		F	Corrections to 5.8.5.	2.6.0	2.6.1
18-03-09	20bTD093r1	148		F	Corrections to 5.8.8.	2.6.0	2.6.1
18-03-09	20bTD094r1	149		F	Typo in 5.17.1.6	2.6.0	2.6.1
18-03-09	20bTD095r2	150		F	Addition of SDP o,s,t lines and other corrections to session dependent procedures.	2.6.0	2.6.1
18-03-09	20bTD096r1	151		F	Errors in 5.19.4.2 and 5.19.9	2.6.0	2.6.1
18-03-09	20bTD097r1	152		F	H248 syntax error in 5.20.4	2.6.0	2.6.1
18-03-09	20bTD098r1	153		F	Changes due to packages being consented in ITU SG16.	2.6.0	2.6.1
18-03-09	20bTD099r1	154		F	Changes to table 49	2.6.0	2.6.1
18-03-09	20bTD100r1	155		F	Changes to table 142	2.6.0	2.6.1
18-03-09	20bTD261r2	156		F	Addition of procedure - Session Establishment (Delete Stream)	2.6.0	2.6.1
18-03-09	20bTD278r1	157		F	Correction to Bandwidth Change procedure.	2.6.0	2.6.1
					Editorial update of table numbering (89a -> 89c) applied by the Secretariat.	2.6.1	2.6.2
09-06-09	21WTD111r1	158		F	Error in table 5.	2.6.2	2.6.3
09-06-09	21WTD112r2	159		F	Addition of SDP o/s/t lines to tables in clause 5.18	2.6.2	2.6.3
09-06-09	21WTD113r1	160		F	Miscellaneous corrections. Typos corrected and changes applied to 5.18 and 5.20 to ensure that all package properties/events/signals/stats are cited.	2.6.2	2.6.3
09-06-09	21WTD114r1	161		F	Editorial change to add AF to abbreviations.	2.6.2	2.6.3
09-06-09	21WTD115r1	162		F	Audit related errors/omissions.	2.6.2	2.6.3
09-06-09	21WTD116r1	163		F	Error in H248 syntax in clause 5.18.1.4.1.	2.6.2	2.6.3
					Publication	2.6.3	2.7.1
					Re-publication after editorial correction of table 5 (correct implementation of CR 158)	2.7.1	2.7.2

History

Document history		
V2.3.0	May 2008	Publication
V2.3.1	June 2008	Publication
V2.7.1	September 2009	Publication
V2.7.2	January 2010	Publication