



ETSI Standard

**Access, Terminals, Transmission and Multiplexing (ATTM);
Energy management;
Global KPIs;
Operational infrastructures;
Part 2: Specific requirements;
Sub-part 1: Data centres**

Reference

RES/ATTM-0238

Keywords

performance, power

ETSI

650 Route des Lucioles
F-06921 Sophia Antipolis Cedex - FRANCE

Tel.: +33 4 92 94 42 00 Fax: +33 4 93 65 47 16

Siret N° 348 623 562 00017 - NAF 742 C
Association à but non lucratif enregistrée à la
Sous-Préfecture de Grasse (06) N° 7803/88

Important notice

Individual copies of the present document can be downloaded from:

<http://www.etsi.org>

The present document may be made available in more than one electronic version or in print. In any case of existing or perceived difference in contents between such versions, the reference version is the Portable Document Format (PDF). In case of dispute, the reference shall be the printing on ETSI printers of the PDF version kept on a specific network drive within ETSI Secretariat.

Users of the present document should be aware that the document may be subject to revision or change of status. Information on the current status of this and other ETSI documents is available at

<http://portal.etsi.org/tb/status/status.asp>

If you find errors in the present document, please send your comment to one of the following services:

http://portal.etsi.org/chaicor/ETSI_support.asp

Copyright Notification

No part may be reproduced except as authorized by written permission.
The copyright and the foregoing restriction extend to reproduction in all media.

© European Telecommunications Standards Institute 2014.
All rights reserved.

DECT™, PLUGTESTS™, UMTS™ and the ETSI logo are Trade Marks of ETSI registered for the benefit of its Members.
3GPP™ and LTE™ are Trade Marks of ETSI registered for the benefit of its Members and
of the 3GPP Organizational Partners.
GSM® and the GSM logo are Trade Marks registered and owned by the GSM Association.

Contents

Intellectual Property Rights	5
Foreword.....	5
Introduction	5
1 Scope	7
2 References	7
2.1 Normative references	7
2.2 Informative references.....	8
3 Definitions, symbols and abbreviations	8
3.1 Definitions	8
3.2 Symbols.....	9
3.3 Abbreviations	10
4 System definition and boundaries	10
5 Mapping to the objectives of ES 205 200-1	12
5.1 Energy consumption.....	12
5.2 Task efficiency	12
5.3 Energy re-use.....	12
5.4 Renewable energy	13
6 Global operational KPIs	13
6.1 Scale	13
6.2 Evolution	13
6.3 Formulae.....	14
6.3.1 KPI_{EM}	14
6.3.1.1 Formula	14
6.3.1.2 Definitions of terms.....	14
6.3.1.3 Measurement procedures	15
6.3.1.4 Criteria	15
6.3.2 KPI_{EC}	15
6.3.2.1 Formula	15
6.3.2.2 Definitions of terms.....	16
6.3.2.3 Energy sources	16
6.3.2.4 Measurement points	16
6.3.2.4.1 General	16
6.3.2.4.2 Dedicated energy sources	16
6.3.2.4.3 Shared supply systems.....	17
6.3.2.5 Measurement procedures	17
6.3.2.6 Criteria	18
6.3.3 KPI_{TE}	18
6.3.3.1 Formula	18
6.3.3.2 Definitions of terms.....	18
6.3.3.3 Measurement points	18
6.3.3.4 Measurement procedures	19
6.3.3.5 Criteria	19
6.3.4 KPI_{REUSE}	19
6.3.4.1 Formula	19
6.3.4.2 Definitions of terms.....	20
6.3.4.3 Measurement points	20
6.3.4.4 Measurement procedures	20
6.3.4.5 Criteria	20
6.3.5 KPI_{REN}	21
6.3.5.1 Formula	21
6.3.5.2 Definitions of terms.....	21
6.3.5.3 Measurement points	21

6.3.5.4	Measurement procedures	21
6.3.5.5	Criteria	21
6.4	Weighting factors	21
6.4.1	Energy re-use	21
6.4.1.1	W_{REUSE}	21
6.4.1.2	W_L	22
6.4.2	Renewable energy (W_{REN})	22
Annex A (informative): Concepts: Energy management, sustainability and Key Performance Indicators		23
A.1	Energy management and sustainability concepts	23
A.2	The status of Key Performance Indicators (KPIs)	24
A.2.1	Technical KPIs	24
A.2.2	Objective KPIs	24
A.2.3	Global KPIs	25
A.2.4	Summary	25
History	26

Intellectual Property Rights

IPRs essential or potentially essential to the present document may have been declared to ETSI. The information pertaining to these essential IPRs, if any, is publicly available for **ETSI members and non-members**, and can be found in ETSI SR 000 314: "*Intellectual Property Rights (IPRs); Essential, or potentially Essential, IPRs notified to ETSI in respect of ETSI standards*", which is available from the ETSI Secretariat. Latest updates are available on the ETSI Web server (<http://ipr.etsi.org>).

Pursuant to the ETSI IPR Policy, no investigation, including IPR searches, has been carried out by ETSI. No guarantee can be given as to the existence of other IPRs not referenced in ETSI SR 000 314 (or the updates on the ETSI Web server) which are, or may be, or may become, essential to the present document.

Foreword

This final draft ETSI Standard (ES) has been produced by ETSI Technical Committee Access, Terminals, Transmission and Multiplexing (ATTM), and is now submitted for the ETSI standards Membership Approval Procedure.

The present document is part 2, sub-part 1 of a multi-part deliverable covering operational energy management and sustainability of broadband deployment, as identified below:

Part 1: "General requirements ";

Part 2: "Specific requirements":

Sub-part 1: Data centres;

Sub-part 2: Fixed (excluding cable) access networks;

Sub-part 3: Mobile access networks;

Sub-part 4: Cable Access Networks;

Part 3: "Monitoring of sustainability".

NOTE 1: Additional documents are in development by ETSI Technical Committee Access, Terminals, Transmission and Multiplexing (ATTM) which include:

- 205 200-1-1: Energy management: Global KPIs: Operational infrastructures: Guidance (see NWIP DES/ATTM-02025)
- 205 200-2-2: Fixed (other than cable) access networks (see NWIP DES/ATTM-02026)
- 205 200-3: Monitoring of other environmental viability aspects of sustainability (see NWIP DES/ATTM-02027)

NOTE 2: A further document is under consideration ETSI Technical Committee CABLE to address "cable access networks".

Introduction

Energy costs continue to rise, a trend that will continue in the future, while broadband penetration is introducing new active equipment to the network architecture. In this context, and to reflect other environmental aspects of sustainability, it is vital that the main telecommunication actors implement effective general engineering of fixed and mobile broadband networks and sites provisioning, managing or using those networks (i.e. operator sites, operator data centres and customer data centres) in order to respond to critical issues of energy consumption while proposing essential solutions to true broadband deployment.

These issues are of particular importance in data centres - both of operators **and** customers. To guide this process, it is essential that metrics are defined, termed Global Key Performance Indicators (KPI_{EM}) that enable energy usage to be managed more efficiently.

This multi-part deliverable comprises:

- ES 205 200-1 [2]: a generic requirements document addressing Global KPIs for operational infrastructures;

NOTE: Global KPIs do not address design/operation of components or subsystems of broadband deployment networks.

- a sub-series ES 205 200-2 [i.10] that defines the Global KPIs, and drives energy management targets, for specific operational networks and sites and which describes how the Global KPIs are to be applied (which may be used to support future regulatory objectives);
 - ES 205 200-2-1: Data centres;
 - ES 205 200-2-3: Mobile access networks.

These documents do not define KPI limits or targets (which is outside the scope of this multi-part deliverable).

These documents will accelerate:

- availability of operational infrastructure architectures and network implementations that use energy more efficiently;
- the definition and attainment of sustainability objectives for operational broadband networks.

Within the present document:

- clause 4 explains the definition of a data centre in terms of the systems it comprises and the boundaries that apply and shows that the present document is equally applicable to operator data centres, operator sites and customers data centres;
- clause 5 describes how the Objective KPIs of the present document meet the requirements of ES 205 200-1 [2];
- clause 6 describes the specific requirements of the Global KPI and the supporting Objective KPIs for data centres;
- annex A discusses the roles of different types of Key Performance Indicators i.e. Technical, Objective and Global in relation to the overall energy management concepts of the present document.

The comparative costs and environmental impacts of different energy sources are not addressed in the present document.

1 Scope

The present document specifies Global Key Performance Indicators (KPI_{EE}) in relation to energy management for operator data centres (ODC), operator sites (OS) and customer data centres (CDC) and addresses the following objectives:

- energy consumption;
- task efficiency;
- energy re-use;
- renewable energy.

The definition of the Global KPIs (clause 6) are in accordance with requirements of ES 205 200-1 [2] (as described in clause 5) in relation to:

- infrastructure scalability;
- infrastructure evolution;
- formulae and definitions of terms;
- measurement points and procedures.

The present document also provides information on system definition and boundaries (clause 4).

The comparative costs and environmental impacts of different energy sources are outside the scope of the present document.

2 References

References are either specific (identified by date of publication and/or edition number or version number) or non-specific. For specific references, only the cited version applies. For non-specific references, the latest version of the reference document (including any amendments) applies.

Referenced documents which are not found to be publicly available in the expected location might be found at <http://docbox.etsi.org/Reference>.

NOTE: While any hyperlinks included in this clause were valid at the time of publication, ETSI cannot guarantee their long term validity.

2.1 Normative references

The following referenced documents are necessary for the application of the present document.

- [1] CENELEC EN 50600-2-2: "Information technology - Data centre facilities and infrastructures - Part 2-2: Power distribution".
- [2] ETSI ES 205 200-1: "Access, Terminals, Transmission and Multiplexing (ATTM); Energy management; Global KPIs; Operational infrastructures; Part 1: General requirements".
- [3] CEN EN 1434 series: "Heat Meters".

2.2 Informative references

The following referenced documents are not necessary for the application of the present document but they assist the user with regard to a particular subject area.

- [i.1] CENELEC EN 50600-1: "Information technology - Data centre facilities and infrastructures - Part 1: General requirements".
- [i.2] EC Mandate M/462; "Standardisation mandate addressed to CEN, CENELEC and ETSI in the field of Information and Communication Technologies".
- [i.3] ETSI TR 105 174-2-2: "Access, Terminals, Transmission and Multiplexing (ATTM); Broadband Deployment and Energy Management; Part 2: Network sites; Sub-part 2: Data centres".
- [i.4] European Commission DG JRC Code of Conduct for Data Centre Energy Efficiency.
- [i.5] Recommendation ITU-T L.1300: "Series L: Construction, installation and protection of cables and other elements of outside plant: Best practices for green data centers".
- [i.6] European Commission DG JRC Code of Conduct on Energy Consumption of Broadband Equipment.
- [i.7] ISO Guide 82: "Guide for addressing sustainability in standards".
- [i.8] ETSI TR 105 174-1: "Access, Terminals, Transmission and Multiplexing (ATTM); Broadband Deployment and Energy Management; Part 1: Overview, common and generic aspects".
- [i.9] ETSI ES 205 200 (all parts): "Access, Terminals, Transmission and Multiplexing (ATTM); Energy management; Global KPIs; Operational infrastructures".
- [i.10] ETSI ES 205 200-2 (all parts): "Access, Terminals, Transmission and Multiplexing (ATTM); Energy management; Global KPIs; Operational infrastructures; Part 2: Specific requirements".

3 Definitions, symbols and abbreviations

3.1 Definitions

For the purposes of the present document, the following terms and definitions apply:

core infrastructure (core network): functional elements (that is equipment and infrastructure) that enable communication between operator sites and/or operator data centres

NOTE: See TR 105 174-1 [i.8].

customer data centre: data centre that is not directly connected to the core network

data centre: structure, or group of structures, dedicated to the centralized accommodation, interconnection and operation of information technology and network telecommunications equipment providing data storage, processing and transport services together with all the facilities and infrastructures for power distribution and environmental control together with the necessary levels of resilience and security required to provide the desired service availability

energy consumption: total consumption of electrical energy by an operational infrastructure

energy management: combination of reduced energy consumption and increased task efficiency, re-use of energy and use of renewable energy

energy re-use: transfer or conversion of energy (typically in the form of heat) produced by the operational infrastructure to do other work

fixed access network: functional elements that enable wired (including optical fibre) communications to customer equipment

Information Technology Equipment (ITE): equipment providing data storage, processing and transport services for subsequent distribution by network telecommunications equipment

ITE and/or NTE load: total requirement for power by a set of information technology equipment (ITE) and/or network telecommunications equipment (NTE)

mobile access network: functional elements that enable wireless communications to customer equipment

Network Telecommunications Equipment (NTE): equipment dedicated to providing direct connection to core and/or access networks

objective KPI: KPI assessing one of the objectives of operational energy performance which is subsequently used to define a Global KPI for energy management (KPI_{EM})

operational infrastructure: combination of information technology equipment (ITE) and/or network telecommunications equipment (NTE) together with the power supply and environmental control systems necessary to ensure provision of service

operator data centre: data centre embedded within the core network

operator site: premises accommodating network telecommunications equipment providing direct connection to the core and access networks and which may also accommodate information technology equipment

primary distribution equipment: equipment which is required to manage, control and convert incoming power supplies (primary, secondary and, where appropriate, additional) in a form suitable for distribution by secondary distribution equipment

NOTE: See EN 50600-2-2 [1].

renewable energy: energy produced from dedicated generation systems using resources that are naturally replenished

secondary distribution equipment: equipment which is required to manage, control and distribute the power provided by the primary distribution equipment to the short-break and unprotected sockets within the data centre and to the tertiary distribution equipment

NOTE 1: See EN 50600-2-2 [1].

NOTE 2: The power supply may be single-phase AC, three-phase AC or DC. If there is a change from 3-phase to 1-phase supply, this is generally achieved at the secondary distribution equipment that is served directly from the primary distribution equipment.

task efficiency: measure of the work done (as a result of design and/or operational procedures) for a given amount of energy consumed

3.2 Symbols

For the purposes of the present document, the following symbols apply:

Δt	the maximum time variation between measurement points of the different Objective Key Performance Indicators within a given Global Key Performance Indicator
KPI_{EC}	Objective Key Performance Indicator of energy consumption
KPI_{EM}	Global Key Performance Indicator of energy management
KPI_{REN}	Objective Key Performance Indicator of renewable energy usage
KPI_{REUSE}	Objective Key Performance Indicator of energy re-use
KPI_{TE}	Objective Key Performance Indicator of task efficiency
T_{KPI}	period of time over which Objective KPIs are assessed
T_{REPEAT}	the minimum time between which the Objective KPIs can be assessed to determine relevant trend information
W_{EC}	weighting factor applied to KPI_{EC}
W_L	weighting factor within KPI_{REUSE}
W_{REN}	weighting factor applied to KPI_{REN}
W_{REUSE}	weighting factor applied to KPI_{REUSE}
W_{TE}	weighting factor applied to KPI_{TE}

3.3 Abbreviations

For the purposes of the present document, the following abbreviations apply:

CDC	Customer Data Centre
ffs	for further study
ITE	Information Technology Equipment
KPI	Key Performance Indicator
NTE	Network Telecommunications Equipment
ODC	Operator Data Centre
OS	Operator Site
PDU	Power Distribution Unit
UPS	Uninterruptible Power Supply

4 System definition and boundaries

Figure 1 shows the schematic of the operational infrastructures of broadband deployment as contained with the ESO response to the EC Mandate M/462 [i.2].

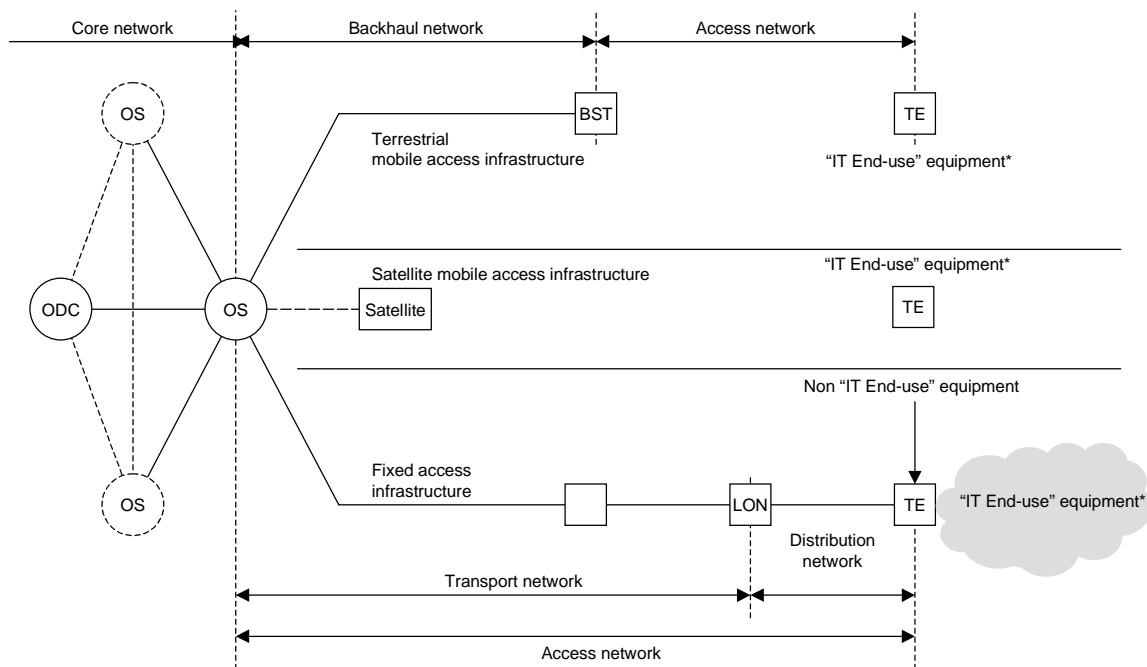

* out of scope of Mandate M/462

NOTE: Not all the terms and abbreviations of Figure 1 are included in clause 3 of the present document.

Figure 1: Schematic of core network together with fixed and mobile access infrastructures

With reference to Figure 1:

- an operator data centre (ODC) accommodates a mixture of information technology equipment (ITE) and network telecommunication equipment (NTE);
- an operator site (OS) will also accommodate a mixture of ITE and NTE - where the NTE may provide connections to connections to core, fixed access, terrestrial mobile access and satellite mobile access network infrastructures.

It is unlikely that either the ODC or OS of Figure 1 would allow separate assessment of energy consumption of the ITE and the various NTE for the disparate network infrastructures. As a result, the boundaries applied to ODC and OS in relation to the objective of Global KPIs for operational infrastructures have to be modified from that of Figure 1 to that shown in Figure 2.

Similarly, the principal difference between the ODC and the OS would be the relative proportion of ITE and NTE as is shown in Figure 3. Furthermore a customer data centre (CDC) would also contain NTE - although generally providing a connection to the access networks. For this reason, the present document considers its Global KPIs for operators data centres to also be applicable to OSs and CDCs.

The Global KPIs are therefore applicable to ODCs, OS and CDCs of all types, regardless of:

- their Availability Class as defined in CLC EN 50600-1 [i.1];
- the business model of the data centre (such as operator, enterprise, co-location service or co-host service);
- the type, quantity and relative proportions of ITE and NTE.

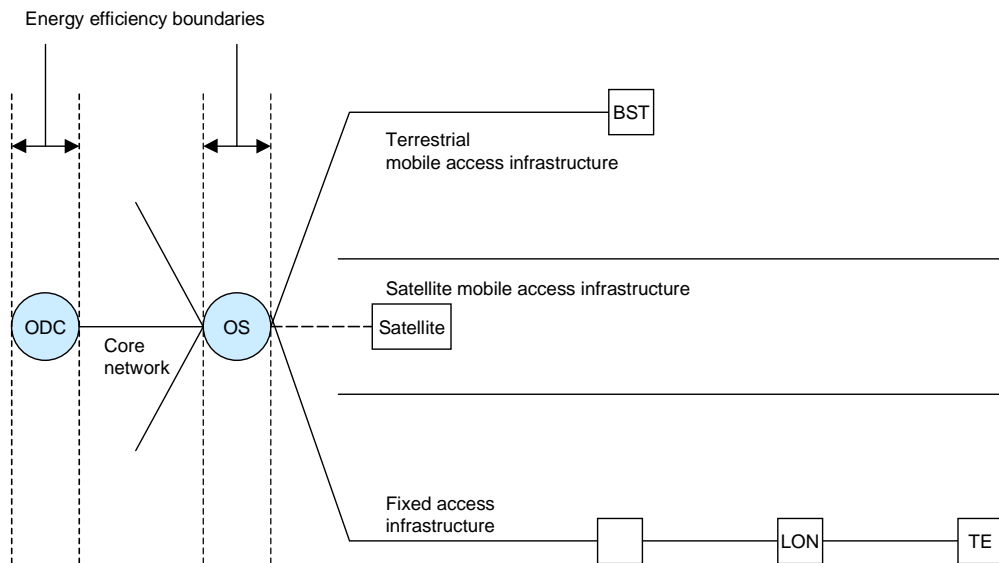

Figure 2: Schematic of energy efficiency boundaries of ODC and OS

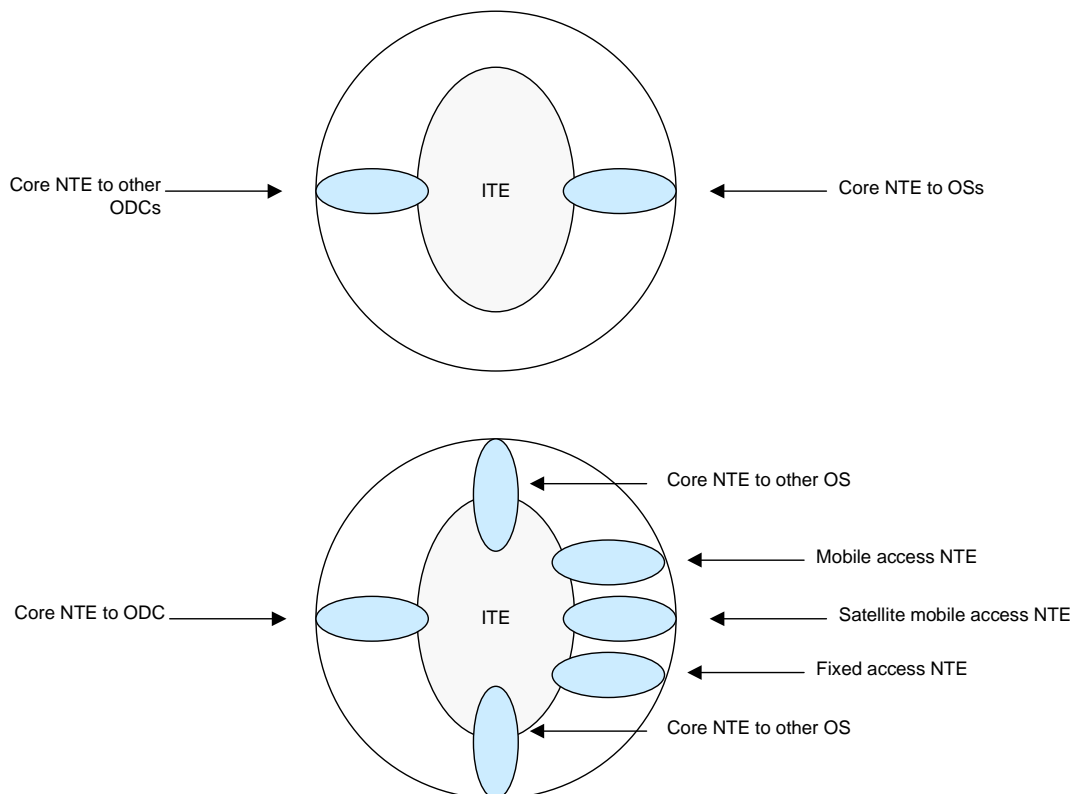

Figure 3: Schematic of generalized ODC and OS contents

5 Mapping to the objectives of ES 205 200-1

5.1 Energy consumption

A reduction in the energy consumption required to provide a given level of service is a primary objective of the present document.

The KPI for energy consumption (KPI_{EC}) may be applied to a single data centre or a group of data centres under common governance. If the KPI_{EC} is applied to a group of data centres under common governance then the KPIs of clauses 5.2, 5.3 and 5.4 shall apply to the same group.

The KPI_{EC} may be improved by local actions within individual data centres and/or global actions applied to the group under common governance.

Requirements or recommendations in relation to the improvement of the energy consumption of the ITE, NTE and support infrastructures are not within the scope of the present document. Best practices enabling reductions in energy consumption of operational data centres are described in a number of documents including:

- TR 105 174-2-2 [i.3];
- European Commission DG JRC Code of Conduct for Data Centre Energy Efficiency [i.4];
- Recommendation ITU-T L.1300 [i.5].

Objectives for energy consumption of NTE within OS are included in the European Commission DG JRC Code of Conduct on Energy Consumption of Broadband Equipment [i.6]. Similar equipment will also be found in ODCs and CDCs.

5.2 Task efficiency

An improvement in task efficiency is a primary objective of the present document.

In a data centre, an improvement of the KPI for task efficiency (KPI_{TE}) reflects a reduction of the overall energy consumption required to both power a given ITE and/or NTE load and to support (e.g. cool) the equipment associated with that load over a given period of time.

The KPI_{TE} may be applied to a single data centre or a group of data centres under common governance. If the KPI_{EC} of clause 5.1 is applied to a group of data centres under common governance then the KPI_{TE} and the KPIs of clauses 5.3 and 5.4 shall apply to the same group.

It should be noted that the work done by the load is not a basis for the KPI_{TE} due to the wide variety of operations performed by the ITE and NTE in data centres.

5.3 Energy re-use

The re-use of energy is a secondary objective of the present document subject to the following conditions:

- "non-use" is better than "re-use" and therefore the KPI_{REUSE} will reflect a preference for energy consumption reduction rather than re-use;
- any KPI_{REUSE} shall reflect a preference for re-use of energy in the form of heat generated by the ITE/NTE rather than from poorly designed facilities and infrastructures.

All energy input to a data centre is converted into heat.

The KPI for energy re-use (KPI_{REUSE}):

- provides the main incentive to the re-use of heat up to the quantity produced by cooling the ITE and/or NTE load;

- provides a lower incentive to the re-use of heat produced by the facilities and infrastructures of the data centre including, but not limited to, power distribution, environmental control, lighting security and safety systems.

The KPI_{REUSE} may be applied to a single data centre or a group of data centres under common governance. If the KPI_{EC} of clause 5.1 is applied to a group of data centres under common governance then the KPI_{REUSE} and the KPIs of clauses 5.2 and 5.4 shall apply to the same group.

KPI_{REUSE} can only be assessed and included in subsequent calculation and presentation of KPI_{EE} if the energy re-used is measurable in kWh at the intended point of delivery i.e. any losses in the delivery system shall not be included.

5.4 Renewable energy

The use of renewable energy is a secondary objective of the present document.

The energy provided to data centres comes from either utility (grid) or local sources (non-renewable or renewable).

A data centre is unlikely to meet all of its energy needs from local renewable sources on a continuous basis. However, the provision of energy to specific and non-critical functions can be switched from the utility supply when adequate renewable energy is available.

The scope of the KPI for renewable energy use (KPI_{REN}) only takes locally generated renewable energy into account.

NOTE: This does not, as yet, take into consideration any proportion of renewable electricity in the mix of production of utility supplies certified as "green" (e.g. based on the carbon footprint of the energy source) by electricity suppliers or in accordance with nationally recognized schemes.

The KPI_{REN} may be applied to a single data centre or a group of data centres with a common governance. If the KPI_{EC} of clause 5.1 is applied to a group of data centres under common governance then the KPI_{REN} and the KPIs of clauses 5.2 and 5.3 shall apply to the same group.

6 Global operational KPIs

6.1 Scale

KPI_{EM} is measured in kWh.

The dominant factor in the calculation of KPI_{EM} is the Objective KPI for energy consumption (KPI_{EC}). Large data centres that are fully utilized will naturally have higher values of KPI_{EC} .

The value of KPI_{EC} is mitigated by the weighted subtraction of any valid energy re-use (KPI_{REUSE}) and any energy contribution from locally generated renewable sources (KPI_{REN}).

This modified consumption value is multiplied by the Objective KPI for task efficiency (KPI_{TE}) which increases the value of the KPI_{EM} in direct proportion to the lack of task efficiency i.e. data centres with poor task efficiency will be adversely affected.

This approach allows:

- the energy impact of all scales of data centres to be assessed but not compared;
- regulatory objectives to be applied to groups of data centres which have the greatest individual energy impact.

6.2 Evolution

Since KPI_{EM} is measured in kWh, a given data centre is able to be assessed throughout its operational life.

KPI_{EM} is applicable from early stages, while KPI_{EC} is low and KPI_{TE} may be higher than the design objective (i.e. task efficiency may be poorer than that of a fully utilized data centre), to a more complete utilization stage when KPI_{TE} should match the design goals and KPI_{EC} is higher.

Where operational actions are taken to improve the task efficiency (i.e. reduce the value of KPI_{TE}), KPI_{EM} will reduce in all cases when the initial value of KPI_{TE} is lower than 2,0. However, for data centres with higher values of KPI_{TE} , KPI_{EM} will only reduce if reductions of ITE and/or NTE load are supported by reductions in non-"ITE and/or NTE load" consumption.

This approach encourages:

- the re-engineering of the supporting infrastructures (e.g. power distribution and environmental control systems) in older legacy data centres which tend to exhibit high KPI_{TE} values;
- the optimization of ITE and/or NTE loads by selection, configuration and utilization of equipment and management systems.

6.3 Formulae

6.3.1 KPI_{EM}

6.3.1.1 Formula

An assessment of KPI_{EM} requires that the energy supplied to the data centre provides all the primary functions of the data centre (i.e. ITE/NTE load, environmental control, etc.). If the supply of energy of any of the non-"ITE and or NTE loads" is provided by other supplies not included in KPI_{EC} then KPI_{EM} cannot be assessed.

KPI_{EM} is defined mathematically as:

$$KPI_{EM} = KPI_{EC} \times KPI_{TE} \times (1 - (KPI_{REN} \times W_{REN})) \times (1 - (KPI_{REUSE} \times W_{REUSE})),$$

subject to a minimum value of 0.

This is shown schematically in Figure 4.

Default weighting factors are detailed in clause 6.4.

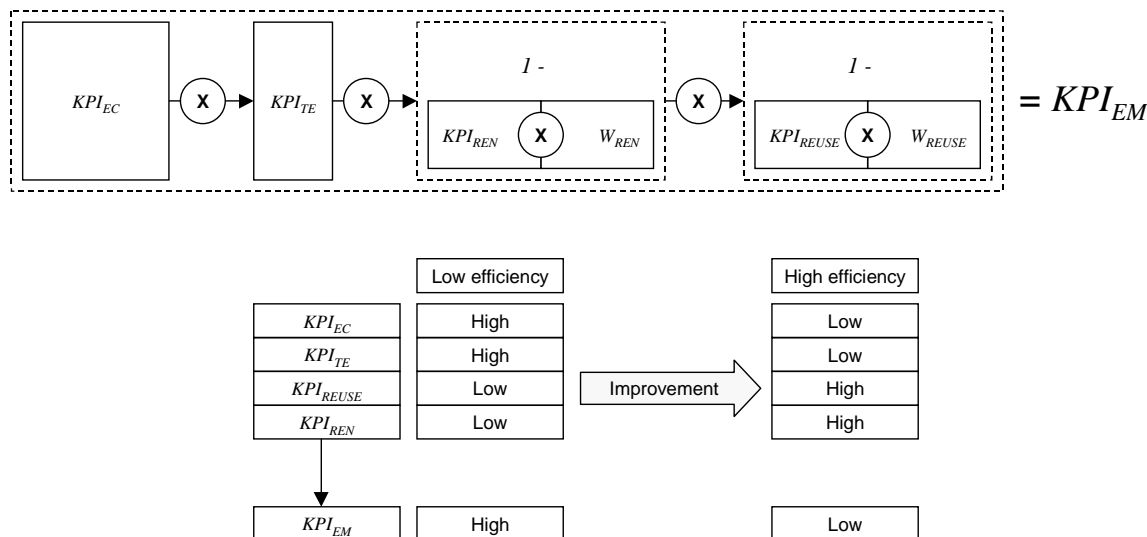

Figure 4: Schematic of data centre objective and global KPIs

6.3.1.2 Definitions of terms

See clause 3.2.

6.3.1.3 Measurement procedures

The objective KPIs shall be measured on a single data centre (or a common group of data centres) over the same period of time (T_{KPI}) subject to the allowed variation (Δt) as shown in Figure 5.

6.3.1.4 Criteria

The default value of T_{KPI} as shown in Figure 5 shall be 365 days (in order to take account of the climatic variations that will be experienced by the operational infrastructure). T_{REPEAT} shall be one calendar month.

The maximum time difference in the periods of assessment of the objective KPIs (Δt as shown in Figure 5) shall be 7 days.

In order to make effective comparisons between different periods of assessment, the weighting factors (W_{REN} , W_{REUSE}) employed shall be the same in each period.

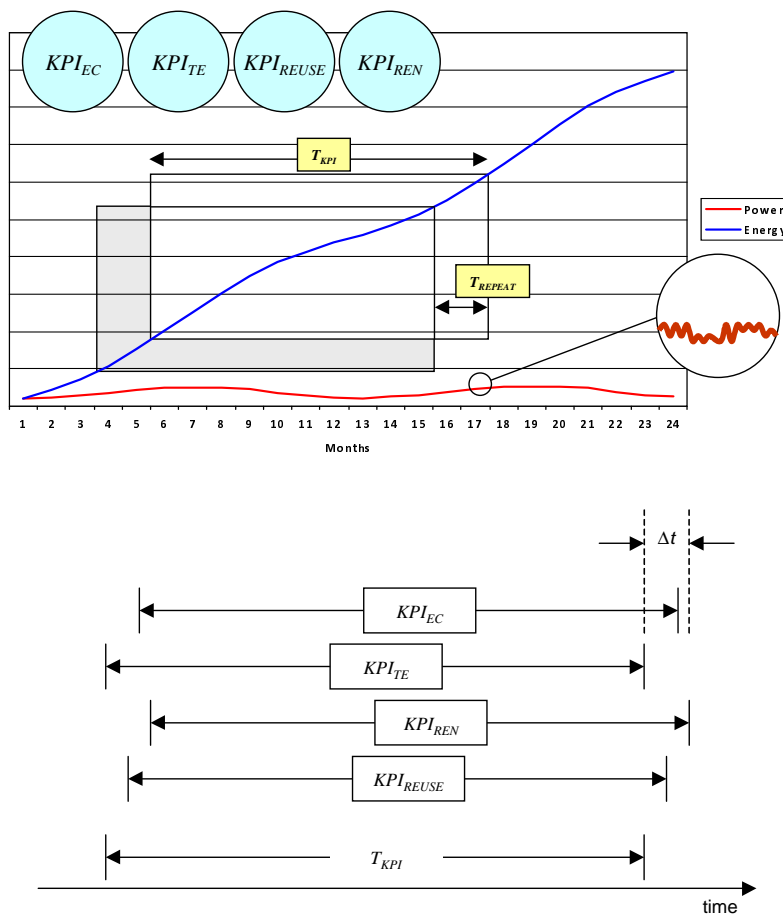

Figure 5: Schematic of KPI assessment periods

6.3.2 KPI_{EC}

6.3.2.1 Formula

KPI_{EC} for assessment period k is defined mathematically as:

$$KPI_{EC}(t_k^{(EC)}) = KPI_{EC}^{(k)} = \sum_{n=1}^N C_n^{(k)} \text{ for } k=1, 2, 3, \dots$$

where:

$$C_n^{(k)} = \sum_{n=1}^{S_n} (1 + MP_{s,n}^{(EC)}) \times C_{s,n}^{(k)}$$

6.3.2.2 Definitions of terms

$n =$	data centre number (if the assessment is applied to a common set of data centres)
$N =$	total number of data centres (if the assessment is applied to a common set of data centres)
$C_n^{(k)} =$	total energy consumption by data centre n during the KPI assessment interval t_{k-1}^{begin} to t_{k-1}^{end} as described in detail in ES 205 200-1 [2]
$C_{s,n}^{(k)} =$	total energy consumption for energy source s in the data centre n during the KPI assessment interval between t_{k-1}^{begin} and t_{k-1}^{end} as described in detail in ES 205 200-1 [2]
$s =$	energy source number
$S_n =$	total number of separate energy sources of the data centre n including those provided only during fault conditions
$MP_{s,n}^{(EC)} =$	measurement penalty for energy source s at data centre n which takes account of the means by which energy consumption measurement is obtained

6.3.2.3 Energy sources

The sources of energy consumed during the assessment period are assumed to be:

- utility (grid) supply;
- local sources of electricity based on fossil energy;
- local sources of electricity based on renewable sources;
- externally-provided thermal energy.

6.3.2.4 Measurement points

6.3.2.4.1 General

Requirements for the measurement of the energy consumption parameters for each data centre are specified in EN 50600-2-2 [1]. Figure 6 provides additional detail relevant to the present document.

6.3.2.4.2 Dedicated energy sources

Where the utility (grid) and/or the local source(s) are dedicated to the data centre then:

- the consumption $C_{s,n}^{(k)}$ from the utility (grid) supply(s) shall be measured at the input to the transformer (point A in Figure 6) in which case $MP_{s,n}^{(EC)} = 0$. Where this is not possible:
 - $C_{s,n}^{(k)}$ may be measured at the output of the transformer (point A¹ in Figure 6) and $MP_{s,n}^{(EC)} = 0,015$ (i.e. 1,5 % of additional penalty);
 - $C_{s,n}^{(k)}$ may be measured at the input to the switchgear in the primary distribution equipment or at the input to the supply transfer switch (if present) of the data centre (points B in Figure 6) and $MP_{s,n}^{(EC)} = 0,02$ (i.e. 2 % of additional penalty).

- the consumption $C_{s,n}^{(k)}$ from local sources (including those provided only during fault conditions) shall be measured at their output in which case $MP_{s,n}^{(EC)} = 0$. Where this is not possible, $C_{s,n}^{(k)}$ may be measured at the input to the supply transfer switch of the data centre (point B in Figure 6) and $MP_{s,n}^{(EC)} = 0,02$ (i.e. 2 % of additional penalty).

For externally-provided thermal energy, the consumption $C_{s,n}^{(k)}$ shall be determined as follows:

- measuring using a calorie counter/integrator according to EN 1434 series [3] where the distribution loop is considered a closed loop, at entry to the data centre and converting that measurement to a kWh value;
- calculating the electrical energy required to deliver that thermal energy by dividing that kWh value by a conversion factor of either:
 - a known and certified value which combines the energy efficiency ratio with the relevant distribution losses (and $MP_{s,n}^{(EC)} = 0,0$);
 - if a known and certified value is not available, then the conversion factor shall be 2,5 and $MP_{s,n}^{(EC)} = 0,08$ (i.e. 8 % of additional penalty).

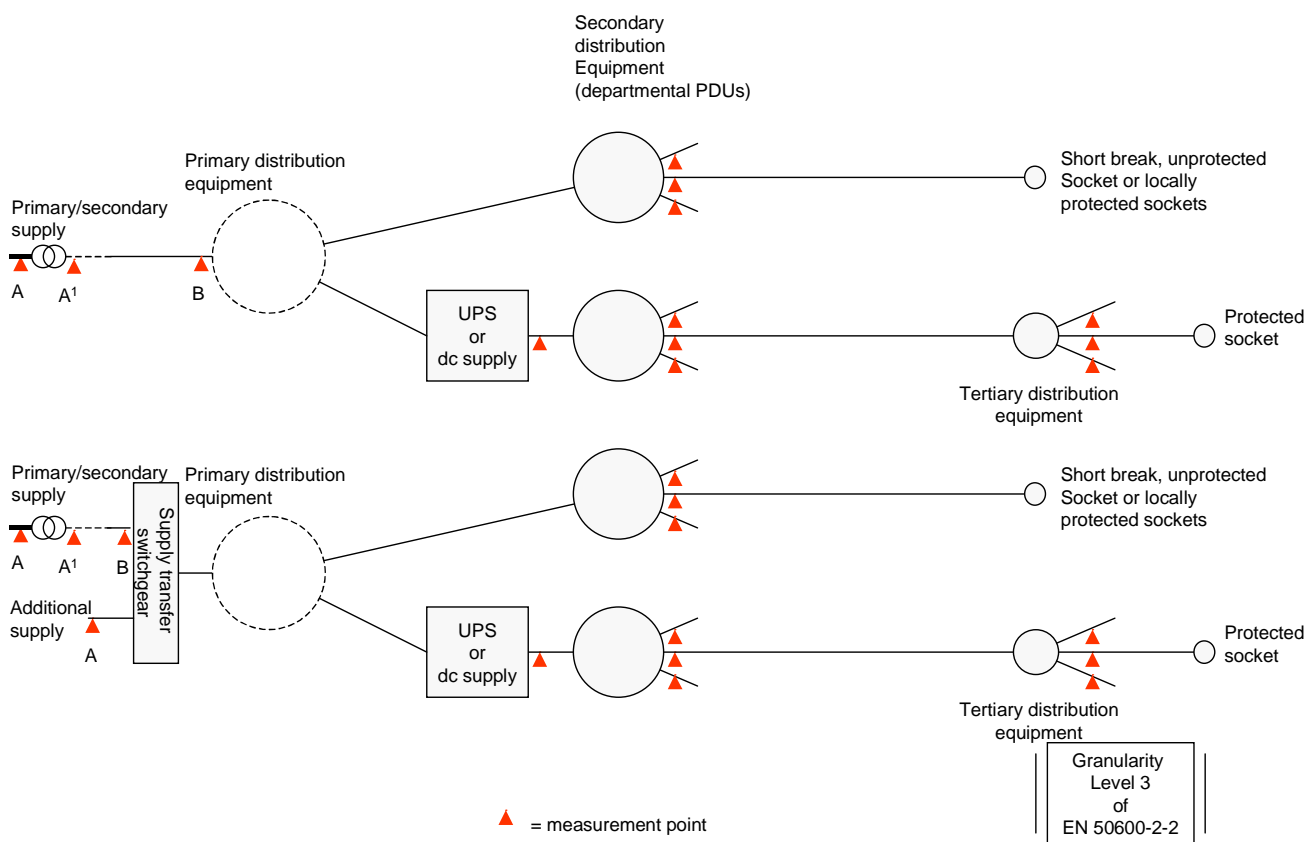

Figure 6: Measurement points for energy consumption

6.3.2.4.3 Shared supply systems

Where the utility (grid) and/or the local source(s) are shared with other infrastructures within the premises and separate measurements as detailed above is not possible then the relevant consumption of the data centre shall be measured at the input to the feed(s) dedicated to the data centre and $MP_{s,n}^{(EC)} = 0,05$ (i.e. 5 % of additional penalty).

6.3.2.5 Measurement procedures

$C_{s,n}^{(k)}$ for each data centre is defined as the energy consumption (kWh) recorded by all meters (utility (grid) and local sources) over the specified time period used to assess KPI_{EM} (i.e. T_{KPI} between t_{k-1}^{begin} and t_{k-1}^{end} subject to the allowed variation (Δt) as shown in Figure 5 and described in more detail in ES 205 200-1 [2]).

6.3.2.6 Criteria

The data centre shall operate at its design level of service availability during the period of assessment. This includes any circumstances during which fault conditions exist and alternative sources are used (e.g. testing, online standby duty).

All the energy required to maintain the data centre at its design level of service availability, such as cooling, power distribution, surveillance systems, access control, flood and fire detection, fire extinguishing system and lighting shall be included any measurements of $C_{s,n}^{(k)}$.

All other energy consumption within the boundaries of the data centre but not necessary to deliver the design level of service availability (such as office facilities) are out of the scope and shall not be included in any measurements of $C_{s,n}^{(k)}$.

6.3.3 KPI_{TE}

6.3.3.1 Formula

KPI_{TE} for assessment period k is defined mathematically as:

$$KPI_{TE}(t_k^{(TE)}) = KPI_{TE}^{(k)} = \sum_{n=1}^{n=N} \frac{C_n^{(k)}}{L_n^{(k)}} \text{ for } k=1, 2, 3, \dots$$

Where:

$$L_n^{(k)} = \sum_{j=1}^{J_n} [L_{j,n}^{(k)} \times (1 - MP_{j,n}^{(TE)})]$$

6.3.3.2 Definitions of terms

$n =$	data centre number (if the assessment is applied to a common set of data centres)
$N =$	total number of data centres (if the assessment is applied to a common set of data centres)
$C_n^{(k)} =$	total energy consumption of data centre n during the KPI assessment interval t_{k-1}^{begin} to t_{k-1}^{end} as described in detail in ES 205 200-1 [2]
$L_n^{(k)} =$	total energy consumed by ITE and/or NTE load in data centre n during the KPI assessment interval between t_{k-1}^{begin} and t_{k-1}^{end} as described in detail in ES 205 200-1 [2]
$j =$	ITE and/or NTE load measurement point number
$J_n =$	total number of measurement points of ITE and/or NTE load in data centre n
$L_{j,n}^{(k)} =$	energy consumed by ITE and/or NTE load at the measurement point j in data centre n
$MP_{j,n}^{(TE)} =$	measurement penalty for ITE and/or NTE load measurement point j in data centre n

6.3.3.3 Measurement points

Measurement points for $C_n^{(k)}$ are specified in clause 6.3.2.3.

Where practicable, $L_n^{(k)}$ shall be the total of all measurements of energy consumption (kWh) measured at the socket(s) directly feeding the ITE and/or NTE i.e. granularity Level 3 of EN 50600-2-2 [1] as shown in Figure 6 in which case $MP_{j,n}^{(TE)} = 0$.

Alternatively, $L_{j,n}^{(k)}$ may be measured at other points of measurement as follows:

- measurement may be made at the secondary distribution equipment shown in Figure 6 (also termed "departmental PDU" level) excluding (if any) feeds to non-ITE and/or NTE loads, provided that the feeds of ITE and/or NTE are separate from feeds to non ITE/NTE such as rack cooling systems;

- measurement may be made at the UPS output provided that all the ITE and/or NTE is fed by UPS and that the UPS only feeds such equipment.

The measurement of $L_n^{(k)}$ at the other points detailed above invokes a measurement penalty to reflect the additional waste heat in cabling between the measurement point and the ITE/NTE equipment as follows:

- for measurement at secondary distribution equipment shown in Figure 6: $MP_{j,n}^{(TE)} = 0,01$ (i.e. 1 % of additional penalty);
- for measurement at UPS output: $MP_{j,n}^{(TE)} = 0,02$ (i.e. 2 % of additional penalty).

6.3.3.4 Measurement procedures

Measurement procedures for $C_n^{(k)}$ are specified in clause 6.3.2.4.

$L_{j,n}^{(k)}$ for each data centre n and ITE and/or NTE load measurement point j is defined as the difference in energy consumption (kWh) recorded by all meters serving the ITE and/or NTE load over the specified time period used to assess KPI_{EM} (i.e. T_{KPI} between t_{k-1}^{begin} and t_{k-1}^{end} subject to the allowed variation (Δt) as shown in Figure 5 and described in more detail in ES 205 200-1 [2]).

It is recognized that the actual times of measurement of $C_n^{(k)}$ and $L_{j,n}^{(k)}$ may differ by the allowed variation (Δt). However, by ensuring that the maximum variation is maintained with the required value of 7 days whereas T_{KPI} is one year, the impact on the accuracy of the resulting KPI_{TE} will be minimal. If improved accuracy is required the actual value of Δt should be minimized.

6.3.3.5 Criteria

Measurement criteria for $C_n^{(k)}$ are specified in clause 6.3.2.5.

All the ITE and NTE equipment shall be taken into account in the measurement of $L_{j,n}^{(k)}$. The energy consumption of other equipment such as rack cooling systems, room air handling units and office utilities shall not be included in $L_{j,n}^{(k)}$.

6.3.4 KPI_{REUSE}

6.3.4.1 Formula

KPI_{REUSE} can only be assessed and included in subsequent calculation and presentation of KPI_{EE} if the energy re-used is measurable in kWh at the intended point of delivery i.e. any losses in the delivery system shall not be included.

KPI_{REUSE} for assessment period k is defined mathematically as:

$$KPI_{REUSE}(t_k^{(REUSE)}) = KPI_{REUSE}^{(k)} = \sum_{i=1}^N \frac{\{\min\{RU_n^{(k)}, L_n^{(k)}\} + W_L \times \max\{0, RU_i^{(k)} - L_n^{(k)}\}\}}{C_n^{(k)}} \text{ for } k=1, 2, 3, \dots$$

This is shown schematically in Figure 7.

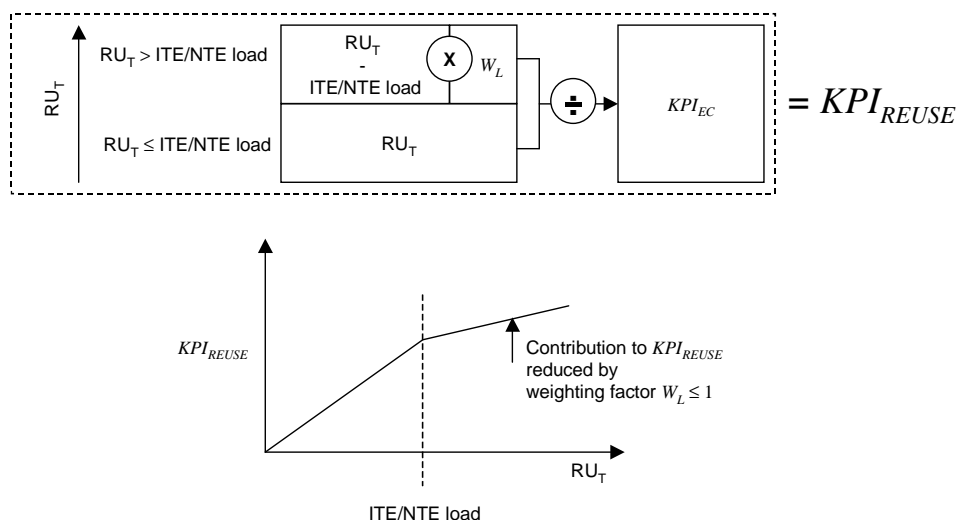

Figure 7: Schematic of energy re-use KPI

6.3.4.2 Definitions of terms

$n =$	data centre number (if the assessment is applied to a common set of data centres)
$N =$	total number of data centres (if the assessment is applied to a common set of data centres)
$L_n^{(k)} =$	total energy consumed by ITE and/or NTE load in data centre n during the KPI assessment interval between t_{k-1}^{begin} and t_{k-1}^{end} as described in detail in ES 205 200-1 [2] (see clause 6.3.2.2)
$RU_n^{(k)} =$	total energy re-used from data centre n during the KPI assessment interval between t_{k-1}^{begin} and t_{k-1}^{end} as described in detail in ES 205 200-1 [2] (see clause 6.3.2.2)
$W_L =$	ratio of re-used energy taken into account for the portion that is above the load energy, if any
$\min(x,y) =$	the smaller of x and y
$\max(x,y) =$	the larger of x and y
$C_n^{(k)} =$	total energy consumption by data centre n during the KPI assessment interval t_{k-1}^{begin} to t_{k-1}^{end} as described in detail in clause 6.3.2

6.3.4.3 Measurement points

Measurement points for $C_n^{(k)}$ are specified in clause 6.3.2.4.

Measurement points for $L_n^{(k)}$ are specified in clause 6.3.3.3.

Measurement points for $RU_n^{(k)}$ shall be at the intended point of delivery i.e. any losses in the delivery system shall not be included.

6.3.4.4 Measurement procedures

Measurement procedures for $C_n^{(k)}$ are specified in clause 6.3.2.5.

Measurement procedures for $L_n^{(k)}$ are specified in clause 6.3.3.4.

$RU_n^{(k)}$ shall be measured in kWh.

6.3.4.5 Criteria

Measurement criteria for $C_n^{(k)}$ are specified in clause 6.3.2.6.

Measurement criteria for $L_n^{(k)}$ are specified in clause 6.3.3.5.

In order to make effective comparisons between different periods of assessment, the weighting factor, W_i , employed shall be the same in each period.

6.3.5 KPI_{REN}

6.3.5.1 Formula

KPI_{REN} for assessment period k is defined mathematically as:

$$KPI_{REN}(t_k^{(REN)}) = KPI_{REN}^{(k)} = \sum_{n=1}^N \frac{REN_n^{(k)}}{C_n^{(k)}} \text{ for } k=1, 2, 3, \dots$$

6.3.5.2 Definitions of terms

$n =$	data centre number (if the assessment is applied to a common set of data centres)
$N =$	total number of data centres (if the assessment is applied to a common set of data centres)
$REN_n^{(k)} =$	energy input (kWh) from local, renewable, sources to data centre n during the KPI assessment interval between t_{k-1}^{begin} and t_{k-1}^{end} as described in detail in ES 205 200-1 [2] (see clause 6.3.2.2)
$C_n^{(k)} =$	total energy consumption by data centre n during the KPI assessment interval t_{k-1}^{begin} to t_{k-1}^{end} as described in detail in 6.3.2

6.3.5.3 Measurement points

Measurement points for $C_n^{(k)}$ are specified in clause 6.3.2.4.

Requirements for the measurement of $REN_n^{(k)}$ for each data centre are specified in EN 50600-2-2 [1] and as shown in Figure 6.

Where the renewable energy source(s) are dedicated to the data centre see clause 6.3.2.3.2.

Where the renewable energy source(s) are shared with other infrastructures within premises see clause 6.3.2.3.3.

6.3.5.4 Measurement procedures

Measurement procedures for $C_n^{(k)}$ are specified in clause 6.3.2.5.

$REN_n^{(k)}$ for each data centre is defined as the difference in energy consumption (kWh) of all renewable energy meters recorded over the specified time period used to assess KPI_{EE} (i.e. T_{KPI} between t_{k-1}^{begin} and t_{k-1}^{end} subject to the allowed variation (Δt) as shown in Figure 5 and described in more detail in ES 205 200-1 [2]).

6.3.5.5 Criteria

Measurement criteria for $C_n^{(k)}$ are specified in clause 6.3.2.6.

Only energy from renewable local sources shall be recorded. Utility (grid) energy, whether "green" or not, and energy from non-renewable local sources such as diesel engine generators shall not be taken into account.

6.4 Weighting factors

6.4.1 Energy re-use

6.4.1.1 W_{REUSE}

In accordance with clause 5.3, the contribution of energy re-use to the reduction of KPI_{EM} shall not undermine efforts to reduce energy consumption.

The general application of this weighting factor requires $0 \leq W_{REUSE} \leq 1$.

In order to conform to the present document, the value of W_{REUSE} employed shall be 1,0.

This value still encourages "non-use rather than re-use" as required in clause 5.3 as it is considered unlikely that all waste heat could be captured for re-use.

Organizations that wish to apply the requirements of the present document using a different value of W_{REUSE} in line with their short, medium or long term objectives do not conform to the present document but in any case would be subject to the criteria requirements of clause 6.3.1.4 in relation to the application of weighting factors.

6.4.1.2 W_L

In accordance with clause 5.3, the contribution of energy re-use to the reduction of KPI_{EE} shall not undermine efforts to reduce energy consumption.

W_L is applied to the re-use of waste heat from the supporting infrastructures such as power distribution and environmental control. Since it is the intention to improve task efficiency, by reducing this aspect of energy consumption for a given ITE and/or NTE load, the value of W_L should be lower than that for W_{REUSE} .

The general application of this weighting factor requires $0 \leq W_L \leq W_{REUSE}$.

In order to conform to the present document, the value of W_L employed shall be 0,5.

This value still encourages "non-use rather than re-use" as required in clause 5.3.

Organizations that wish to apply the requirements of the present document using a different value of W_L in line with their short, medium or long term objectives do not conform to the present document but in any case would be subject to the criteria requirements of clause 6.3.4.5 in relation to the application of weighting factors.

6.4.2 Renewable energy (W_{REN})

In accordance with ES 205 200-1 [2], the application of KPI_{REN} shall not undermine efforts to reduce energy consumption. If all energy was generated locally from renewable sources and $W_{REN} = 1,0$, KPI_{EM} would be zero - independent of total consumption or task efficiency. This situation, although obviously extreme, would be undesirable since if so much energy were available from locally generated renewable sources it should not be "wasted" by profligate energy consumption or poor task efficiency within the infrastructures of broadband deployment.

The general application of this weighting factor requires $0 \leq W_{REN}$.

In order to conform to the present document, the value of W_{REN} employed shall be 0,8.

Organizations that wish to apply the requirements of the present document using a different value of W_{REN} in line with their short, medium or long term objectives do not conform to the present document. This would allow the application of values of $W_{REN} > 1,0$ where specific emphasis on renewable energy sources is desired. In any case would be subject to the criteria requirements of clause 6.3.1.4 in relation to the application of weighting factors.

Annex A (informative): Concepts: Energy management, sustainability and Key Performance Indicators

A.1 Energy management and sustainability concepts

ISO Guide 82 [i.7], entitled "*Guide for addressing sustainability in standards*", defines sustainability as "state of the global system, which includes environmental, social and economic subsystems, in which the needs of the present are met without compromising the ability of future generations to meet their own needs".

The documents in this multi-part deliverable [i.9] do not specifically address any social and economic aspects of sustainability but do focus on the environmental issues in relation to the operational performance of infrastructures of deployed broadband.

The documents in this multi-part deliverable [i.9] adopt the position that the environmental viability aspects of sustainability comprise:

- those elements that relate directly to energy consumption and its outcomes within the locale of the broadband deployment infrastructures;
- other environmental elements relating to the wider impact of energy generation (e.g. greenhouse gas, carbon), consumption of other resources (e.g. water), and issues such as life cycle assessment.

It is common for equipment suppliers to define the energy efficiency of their products either in terms of the total energy consumed by a device or improvements in the performance of a specific task or outcome for a given energy input. Within this multi-part deliverable, these are considered, separately, as improvements in "energy consumption" and "task efficiency" respectively.

By comparison, operators and legislators are more interested in the performance of complete systems at an operational level taking into account global management aspects. As a result they apply a wider view of energy management that combines energy consumption and task efficiency with more general objectives such as the re-use of waste heat and the use of renewable energy.

For example both the EU Codes of Conduct on Data Centres Energy Efficiency [i.4] and Energy Consumption of Broadband Equipment [i.6] are actually targeted to reduce energy consumption by increasing task efficiency (i.e. not by reducing service levels) but includes re-use of waste heat as one of its best practices to achieve this goal.

While it is self-evident that if less energy is consumed by an operational infrastructure then the environmental impact of that infrastructure will be reduced, it is equally important to consider:

- the task efficiency of the operation for which that energy is consumed;
- while not wishing to encourage poor task efficiency, some benefit can be seen if waste energy, typically in the form of heat, is able to be re-used - substituting, to some degree, for other utility grid energy, the replacement of utility grid supplies by locally generated energy from renewable sources.

These four aspects: energy consumption, task efficiency, re-use of waste heat and the contribution of locally generated energy from renewable sources are considered to work in concert, albeit to different degrees for different infrastructures - and in this multi-part deliverable [i.9] are considered as key objectives for which Objective KPIs are specified and for from which a Global KPI is produced which reflects energy efficiency of operational systems -meeting the needs of operators and legislators alike.

The imperatives placed on the different elements may vary from time to time - regulators specifically encouraging local generation of energy from renewable sources but then shifting focus on to other areas.

A.2 The status of Key Performance Indicators (KPIs)

A.2.1 Technical KPIs

At the most basic level, individual components or sub-assemblies can be designed to have improved task efficiency, i.e. less energy is consumed for a given output or task. Such components or sub-assemblies may be inherently more efficient in the way in which they use energy under specific operating conditions but are essentially unable to manage that consumption. An example of such a product would be a power supply unit which may be more efficient under higher load conditions.

More complex products may contain hardware and/or software which automatically reduces energy consumption under specific operating conditions by putting certain functions into "idle" states if not required. This is distinctly different than that of a single task component or sub-assembly detailed above.

Technical KPIs can be applied to both of the above by assessing energy consumption for a number of specific operating conditions and also across a combination of such operating conditions. Assuming those operating conditions reflect the probable operating environment for the component, sub-assembly or product, a customer may make valued judgements in relation to the appropriateness of the Technical KPI.

For example, two products that have equal "combined" Technical KPIs, may be more efficient under very specific conditions. For example, a design of power supply that is more task efficient under high load conditions may be inappropriate for users who plan to predominantly operate under low load conditions (and vice versa).

A higher level of task efficiency management is also possible where groups of products are managed to reduce energy consumption by either allocating loads in such a way that the group is operating at maximum task efficiency and/or by putting individual products within the group into an "idle" mode. Examples of such managed solutions are seen in data centre software plug-ins (such as those developed under the Fit4Green and GAMES projects funded by the European Commission) and in documents developed by ETSI TC EE. Once again, the value of such approaches can be validated by the establishment of Technical KPIs which can be applied to both of the above by assessing energy consumption of a defined group of products for a number of specific operating conditions and also across a combination of such operating conditions.

Figure A.1 provides a schematic in relation to energy-related KPIs. The left-hand side of that schematic relates to the Technical KPIs of the design and engineering phase for components, sub-assemblies, products and systems.

A.2.2 Objective KPIs

The Objective KPIs described in the documents of the ES 205 200-2 series [i.10] relate to specific elements of energy management described in clause A.1 for operational infrastructures under the control of operators as follows:

- energy consumption: the total consumption of energy by an operational infrastructure;
- task efficiency: a measure of the work done (as a result of design and/or operational procedures) for a given amount of energy consumed;
- energy re-use: transfer or conversion of energy (typically in the form of heat) produced by the operational infrastructure to do other work;
- renewable energy: energy produced from dedicated generation systems using resources that are naturally replenished.

The procurement of products and systems based upon their Technical KPIs for energy consumption and/or task efficiency underpins the relevant Objective KPIs. However, the ES 205 200-2 series [i.10] documents define requirements for the measurement of those Objective KPIs for operational infrastructures, i.e. taking into account the real operating conditions over a defined period of time.

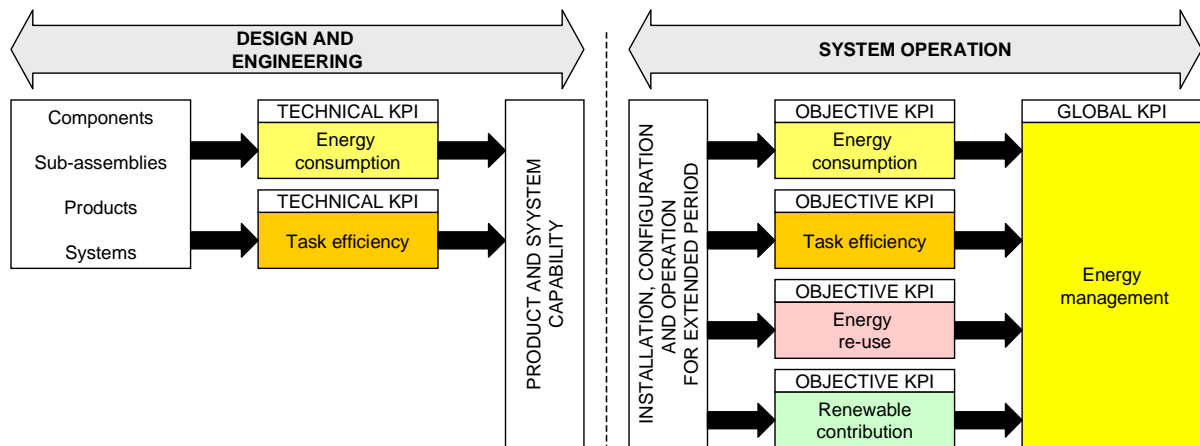

Figure A.1: The relationship of energy-related Technical, Objective and Global KPIs

The performance of products and systems, of proven Technical KPIs performance, may exhibit different energy consumption and task efficiency characteristics when subjected to actual operating conditions which lie outside those of the Technical KPIs applied to those products and systems at the design and engineering stages and, equally importantly, when subjected to user configuration and controls which may undermine the sophisticated systems available.

The right-hand side of the schematic in Figure A.1 relates to the Objective KPIs of complete infrastructures in the operational phase.

A.2.3 Global KPIs

The Objective KPIs, of which task efficiency is only one, are combined using a formula appropriate to the specific operational infrastructure to produce a Global operational KPI which reflects the overall performance of the operational infrastructures against wider energy management targets which may be self-imposed by the operators or externally applied by legislators.

Global KPIs provide a wider view of a users commitment to strategic energy management practices than the Objective KPIs. For example a user is not supporting overall energy goals by achieving class-leading provision of local renewable energy if their overall energy consumption is based upon equipment with very poor task efficiency.

A.2.4 Summary

Operational Global and Objective KPIs are fundamentally different to the Technical KPIs applied to products and systems at the design and engineering stages. The former are used to monitor and drive user behaviour whereas the latter are substantial indications of potential operational performance.

It is therefore important to support, but differentiate, the role of the Technical KPIs from the Objective and Global operational KPIs.

History

Document history		
V1.1.1	May 2013	Publication
V1.2.0	January 2014	Membership Approval Procedure MV 20140311: 2014-01-10 to 2014-03-11