

**Access and Terminals (AT);  
Public Switched Telephone Network (PSTN);  
Harmonized specification of physical and electrical  
characteristics of a 2-wire analogue interface  
for short line interface**

---



---

Reference

RES/AT-010131

---

Keywords

2-wire, access, analogue, interface, POTS, PSTN

**ETSI**

650 Route des Lucioles  
F-06921 Sophia Antipolis Cedex - FRANCE

Tel.: +33 4 92 94 42 00 Fax: +33 4 93 65 47 16

Siret N° 348 623 562 00017 - NAF 742 C  
Association à but non lucratif enregistrée à la  
Sous-Préfecture de Grasse (06) N° 7803/88

---

**Important notice**

Individual copies of the present document can be downloaded from:

<http://www.etsi.org>

The present document may be made available in more than one electronic version or in print. In any case of existing or perceived difference in contents between such versions, the reference version is the Portable Document Format (PDF). In case of dispute, the reference shall be the printing on ETSI printers of the PDF version kept on a specific network drive within ETSI Secretariat.

Users of the present document should be aware that the document may be subject to revision or change of status. Information on the current status of this and other ETSI documents is available at

<http://portal.etsi.org/tb/status/status.asp>

If you find errors in the present document, please send your comment to one of the following services:

[http://portal.etsi.org/chaicor/ETSI\\_support.asp](http://portal.etsi.org/chaicor/ETSI_support.asp)

---

**Copyright Notification**

No part may be reproduced except as authorized by written permission.  
The copyright and the foregoing restriction extend to reproduction in all media.

© European Telecommunications Standards Institute 2006.  
All rights reserved.

**DECT**<sup>TM</sup>, **PLUGTESTS**<sup>TM</sup> and **UMTS**<sup>TM</sup> are Trade Marks of ETSI registered for the benefit of its Members.  
**TIPHON**<sup>TM</sup> and the **TIPHON logo** are Trade Marks currently being registered by ETSI for the benefit of its Members.  
**3GPP**<sup>TM</sup> is a Trade Mark of ETSI registered for the benefit of its Members and of the 3GPP Organizational Partners.

# Contents

Intellectual Property Rights .....	5
Foreword.....	5
Introduction .....	5
1 Scope .....	6
2 References .....	6
3 Definitions, symbols and abbreviations .....	8
3.1 Definitions .....	8
3.2 Symbols.....	9
3.3 Abbreviations .....	9
4 General .....	9
5 Physical connections .....	10
5.1 Mechanical aspects.....	10
5.2 Support of more than one terminal .....	11
5.2.1 Wiring arrangement .....	11
5.2.2 Loading factors .....	11
6 DC feed conditions.....	11
6.1 Polarity .....	11
6.2 Quiescent state.....	11
6.2.1 Maximum voltage.....	11
6.2.2 Minimum voltage.....	11
6.2.3 Supply interruption .....	12
6.3 Loop current .....	12
6.3.1 Loop current range.....	12
6.3.2 Loop current interruptions caused by the terminal .....	12
7 Seize signal.....	12
7.1 Must not seize condition.....	12
7.2 Must seize condition.....	12
8 Clear signal.....	13
8.1 Clear signal generated by TE .....	13
8.2 Clear indication from the network.....	13
8.3 Seizing the line for a new call .....	13
9 Impedance .....	13
9.1 Impedance at the R interface .....	13
9.2 Balance about earth .....	14
10 Transmission .....	14
10.1 Relative level.....	14
10.2 Variation of gain with input level.....	15
10.3 Frequency response .....	16
10.4 Coding law .....	16
10.5 Noise .....	16
10.5.1 Weighted noise .....	16
10.5.2 Single frequency noise.....	17
10.6 Echo and stability .....	17
10.6.1 Echo.....	17
10.6.2 Stability.....	17
10.7 Crosstalk.....	17
10.8 Total distortion including quantizing distortion .....	18
11 DTMF Dialling.....	18

12	Ringling	18
12.1	Ringling drive capability	19
12.1.1	Ringling frequency	19
12.1.2	Ringling voltage	19
12.1.2.1	Ringling with DC	19
12.1.2.2	Ringling without DC	19
12.2	Ring cadence	20
12.3	Ring trip	21
12.4	False ring trip	21
13	Supervisory signals	21
13.1	Supervisory tones	21
13.2	Tone levels	21
13.3	Cadences and frequencies	22
14	Optional functions	22
14.1	Loop disconnect dialling	22
14.2	Register recall	22
14.3	Metering	22
14.4	Supplementary and other enhanced services	23
14.5	Polarity reversal	23
14.6	End of call signal ("K-break")	23
14.7	Payphones	23
<b>Annex A (informative): Test set-up for the change from DC to ringing voltage</b>		<b>24</b>
<b>Annex B (informative): Bibliography</b>		<b>25</b>
History		26

---

## Intellectual Property Rights

IPRs essential or potentially essential to the present document may have been declared to ETSI. The information pertaining to these essential IPRs, if any, is publicly available for **ETSI members and non-members**, and can be found in ETSI SR 000 314: "*Intellectual Property Rights (IPRs); Essential, or potentially Essential, IPRs notified to ETSI in respect of ETSI standards*", which is available from the ETSI Secretariat. Latest updates are available on the ETSI Web server (<http://webapp.etsi.org/IPR/home.asp>).

Pursuant to the ETSI IPR Policy, no investigation, including IPR searches, has been carried out by ETSI. No guarantee can be given as to the existence of other IPRs not referenced in ETSI SR 000 314 (or the updates on the ETSI Web server) which are, or may be, or may become, essential to the present document.

---

## Foreword

This ETSI Standard (ES) has been produced by ETSI Technical Committee Access and Terminals (AT), and is now submitted for the ETSI standards Membership Approval Procedure.

---

## Introduction

The present process of harmonization of the 2-wire analogue voice band switched interface (traditionally PSTN) has focussed on harmonization of the terminal equipment. Now that the terminal harmonization process is nearing completion, it becomes feasible to move towards harmonization of the network termination point (NTP) itself. This is particularly true for new local access delivery systems which tend to provide service via short local loops.

The present document specifies technical characteristics for an interface digital on the network side and analogue on the terminal side. The technology on the network side is unspecified.

---

# 1 Scope

The present document is applicable to an analogue presented interface intended to deliver 3,1 kHz voiceband services which terminates a Public Switched Telephone Network (PSTN) with 2-wire local loops. The signal is digitally encoded on the network side of the interface, but the technology is not specified.

The present document applies to interfaces where any terminal equipment (TE) connected to the interface is connected via a cable with a maximum loop resistance of 100  $\Omega$ .

NOTE: This is equivalent to approximately 500 metres of cable with 0,5 mm diameter copper conductors. See figure 1 for clarification.

The objective of the present document is to specify the physical and electrical characteristics at an analogue interface. The present document specifies characteristics of the interface to enable it to operate with most existing national PSTN TE, and especially with PSTN TE designed according to the European standards for analogue presented TEs.

The electrical conditions specified for the interface are sufficient to ensure satisfactory operation of the following functions of TE:

- a) call control;
- b) transmission;
- c) dialling;
- d) ringing.

---

# 2 References

The following documents contain provisions which, through reference in this text, constitute provisions of the present document.

- References are either specific (identified by date of publication and/or edition number or version number) or non-specific.
- For a specific reference, subsequent revisions do not apply.
- For a non-specific reference, the latest version applies.

Referenced documents which are not found to be publicly available in the expected location might be found at <http://docbox.etsi.org/Reference>.

- [1] ETSI TBR 021: "Terminal Equipment (TE); Attachment requirements for pan-European approval for connection to the analogue Public Switched Telephone Networks (PSTNs) of TE (excluding TE supporting the voice telephony service) in which network addressing, if provided, is by means of Dual Tone Multi Frequency (DTMF) signalling".
- [2] ETSI TR 101 768: "Public Switched Telephone Network (PSTN); Study on the generation of analogue ringing signals".
- [3] ETSI TBR 038: "Public Switched Telephone Network (PSTN); Attachment requirements for a terminal equipment incorporating an analogue handset function capable of supporting the justified case service when connected to the analogue interface of the PSTN in Europe".
- [4] ETSI EN 300 659-1: "Access and Terminals (AT); Analogue access to the Public Switched Telephone Network (PSTN); Subscriber line protocol over the local loop for display (and related) services; Part 1: On-hook data transmission".
- [5] ETSI EN 300 659-2: "Access and Terminals (AT); Analogue access to the Public Switched Telephone Network (PSTN); Subscriber line protocol over the local loop for display (and related) services; Part 2: Off-hook data transmission".

- [6] ETSI TR 101 183: "Public Switched Telephone Network (PSTN); Analogue ringing signals".
- [7] ETSI ES 201 235-1: "Specification of Dual Tone Multi-Frequency (DTMF) Transmitters and Receivers; Part 1: General".
- [8] ETSI ES 201 235-3: "Access and Terminals (AT); Specification of Dual-Tone Multi-Frequency (DTMF) Transmitters and Receivers; Part 3: Receivers".
- [9] ETSI ES 201 729: "Public Switched Telephone Network (PSTN); 2-wire analogue voice band switched interfaces; Timed break recall (register recall); Specific requirements for terminals".
- [10] ETSI TR 101 041-1: "Human Factors (HF); European harmonization of network generated tones; Part 1: A review and recommendations".
- [11] ETSI ETR 344: "Terminal Equipment (TE); The technical feasibility of a harmonized plug and socket standard for European Public Switched Telephone Network (PSTN) access".
- [12] ETSI ES 201 187: "2-wire analogue voice band interfaces; Loop Disconnect (LD) dialling specific requirements".
- [13] ETSI EG 201 120: "Public Switched Telephone Network (PSTN); Method of rating terminal equipment so that it can be connected in series and/or in parallel to a Network Termination Point (NTP)".
- [14] ETSI ES 201 071: "Public Switched Telephone Network (PSTN); Protocol over the local loop for display services; Server Display and Script Services (SDSS)".
- [15] ETSI ES 200 778-1: "Access and Terminals (AT); Analogue access to the Public Switched Telephone Network (PSTN); Protocol over the local loop for display and related services; Terminal Equipment requirements; Part 1: On-hook data transmission".
- [16] ETSI ES 200 778-2: "Access and Terminals (AT); Analogue access to the Public Switched Telephone Network (PSTN); Protocol over the local loop for display and related services; Terminal Equipment requirements; Part 2: Off-hook data transmission".
- [17] ETSI ES 201 912: "Access and Terminals (AT); Short Message Service (SMS) for PSTN/ISDN; Short Message Communication between a fixed network Short Message Terminal Equipment and a Short Message Service Centre".
- [18] ETSI TR 101 182: "Analogue Terminals and Access (ATA); Definitions, abbreviations and symbols".
- [19] ITU-T Recommendation G.711 (1988): "Pulse code modulation (PCM) of voice frequencies".
- [20] ITU-T Recommendation G.100.1 (2001): "The use of the decibel and of relative levels in speechband telecommunications".
- [21] ITU-T Recommendation Q.35 /E.180 (1998): "Technical characteristics of tones for the telephone service".
- NOTE: This Recommendation is published with the double number E.180 and Q.35. For more details see E.180.
- [22] ITU-T Recommendation Q.552 (2001): "Transmission characteristics at 2-wire analogue interfaces of digital exchanges".
- [23] ITU-T Recommendation G.117 (1996): "Transmission aspects of unbalance about earth".
- [24] ITU-T Recommendation V.92 (2000): "Enhancements to Recommendation V.90".
- [25] ITU-T Recommendation G.223 (1988): "Assumptions for the calculation of noise on hypothetical reference circuits for telephony".
- [26] ITU-T Recommendation G.712 (2001): "Transmission performance characteristics of pulse code modulation channels".
- [27] ITU-T Recommendation G.168 (2004): "Digital network echo cancellers".

- [28] ITU-T Recommendation G.131 (2003): "Talker echo and its control".
- [29] ITU-T Recommendation G.122: "Influence of national systems on stability and talker echo in international connections".
- [30] ITU-T Recommendation G.120: "Transmission characteristics of national networks".

## 3 Definitions, symbols and abbreviations

### 3.1 Definitions

For the purposes of the present document, the following terms and definitions apply:

**answer signal:** indication that a terminal is answering an incoming call

**called party answer signal:** signal which may be provided at the call originating NTP by the network to indicate that the called party has answered the call

**clear indication:** indication that the network is attempting to release a connection

**clear signal:** signal indicating that a terminal is attempting to release a connection

**end-of-call signal:** signal provided at the NTP by the network to indicate that the call has been released

**half-connection:** bidirectional path comprised of an input connection and an output connection

**input connection:** unidirectional path from an analogue TE connection point to an interface of a digital path

NOTE: See figure 4.

**longitudinal conversion loss:** measure of the degree of unbalance about earth

NOTE: More information is given in ITU-T Recommendation G.117 [23], clause 4.1.3.

**output connection:** unidirectional path from an interface of a digital path to the analogue TE connection point

NOTE: See figure 4.

**R interface:** analogue presented POTS/PSTN interface derived from digital terminating equipment

NOTE: This definition is consistent with the definition in ITU-T Recommendation I.411 (see bibliography), however other types of interfaces that also fit definition in ITU-T Recommendation I.411 are also possible (e.g. data interfaces).

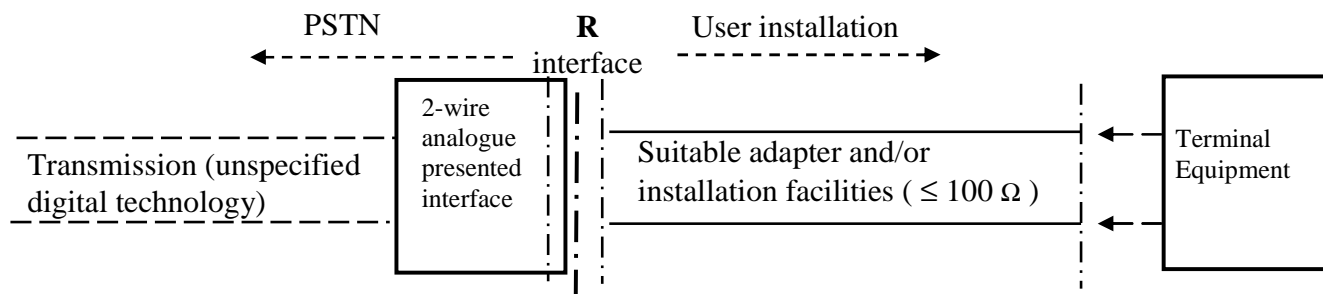

Figure 1: 2-wire analogue presented interface (R-interface)

**ringing state:** condition of the network where a ringing/alerting signal has been applied at the NTP

**ring trip:** removal of the ringing signal at the NTP in response to a valid answer signal applied to the NTP

**seize signal:** signal indicating that a terminal is attempting to establish a connection by means of applying a loop condition



**user installation:** any installation between the R-interface and the end users terminal equipment

## 3.2 Symbols

For the purposes of the present document, the following symbols apply:

dBV	absolute voltage level expressed as dB relative to 1 V
dBm0	absolute power level in dBm referred to a point of zero relative level (dBm is the absolute power level expressed as dB relative to 1 mVA)
dBmp	decibel psophometrically weighted
dBr	relative level of a signal in a transmission path referred to the level at a reference point on the path
mVrms	milliVolts root mean squared

NOTE: For more information on dB-related issues, see ITU-T Recommendation G.100.1 [20].

## 3.3 Abbreviations

For the purposes of the present document, the following abbreviations apply:

AC	Alternating Current
AGC	Automatic Gain Control
DC	Direct Current
DTMF	Dual Tone Multi Frequency
IDP	Inter-Digital Pause
LD	Loop Disconnect
LF	Loading Factor
LU	Loading Unit
NGN	New Generation Networks
NTP	Network Termination Point
PCM	Pulse Code Modulation
PSTN	Public Switched Telephone Network
RLR	Receiving Loudness Rating
SDSS	Server Display and Script Services protocol
SLR	Sending Loudness Rating
SMS	Short Message Service
TBRL	Terminal Balance Return Loss
TE	Terminal Equipment
UBS	User Based Solution
xDSL	x (A, H, V, S etc.) Digital Subscriber Line

---

## 4 General

The performance of interfaces according to the present document is intended to ensure that:

- the interface will interwork successfully with TE compliant with PSTN TE TBRs (TBR 021 [1]) and will support voice band services accessible across the interface (TBR 038 [3]);
- the network being presented at the interface will not suffer harm as a result of signals normally appearing at such an interface, when used under normal operating conditions, including when TE compliant with PSTN TBRs (TBR 021 [1] and TBR 038 [3]) are connected.

The following states and conditions described in TR 101 182 [18] are considered in the present document (see figure 2).

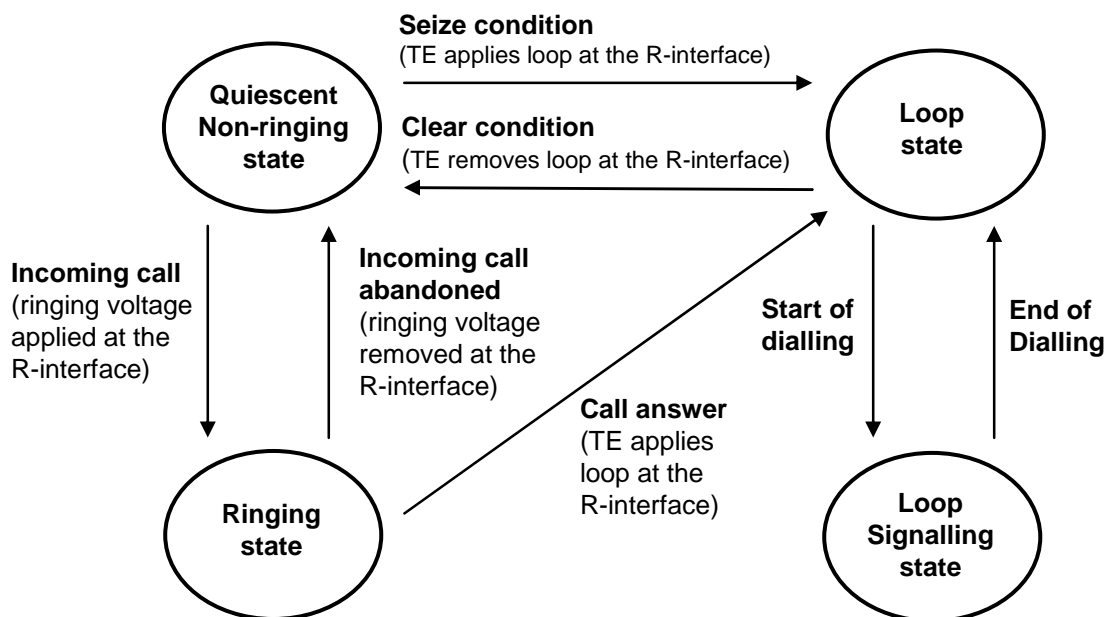

Figure 2: States and conditions

Where the present document refers directly to requirements of other publications, these requirements apply for the purpose of the present document irrespective of the scope of the referred publication.

## 5 Physical connections

### 5.1 Mechanical aspects

The physical presentation shall be specified in such a way that a terminal manufacturer can supply a suitable terminal connector. The connection arrangements should be:

Option 1) either be according to established national practice;

Option 2) or by the arrangement described below.

Recommended harmonized arrangement:

Where the R interface is presented as a socket it should be a socket capable of connecting with a miniature 6-position plug as specified in ANSI/TIA-968-A (see bibliography), clause (a) with contact assignments as specified in table 1. This connector is often referred to as RJ 11/12.

Table 1: Contact assignments

Contact number	Pin allocation
1	Unspecified
2	Unspecified
3/4	Pair (A- and B-wire)
5	Unspecified
6	Unspecified

NOTE 1: A selection of national arrangements are described in ETR 344 [11].

NOTE 2: In some cases the R interface is located outside of the user premises in which case the physical presentation may be realized as a set of connection contacts (e.g. a screw terminal block).

## 5.2 Support of more than one terminal

### 5.2.1 Wiring arrangement

The operator shall inform his customers of wiring arrangements for the connection of additional terminals. The instructions shall be expressed in a way that makes it straightforward for a customer to add additional points for connection of terminals.

### 5.2.2 Loading factors

The operator should inform the users about the maximum numbers of terminals that can be supported at the R interface. This information should be supplied in terms of a Loading Factor (LF), as defined in EG 201 120 [13], for the parameters given in table 2.

The LF specified by the operator should be the lowest of the LFs for the individual TE parameters of table 2, rounded down to the nearest whole number.

The R interface should be able to operate with an LF of at least 100 LU.

NOTE: In addition to the LF-value discussed above, the vendor is invited to also give the applicable LF-values of each individual parameter. This more detailed information would enable a skilled user to take full advantage of the available resources at the R interface.

**Table 2: Calculation of loading factors**

Operating state of TE	Terminal Parameter	Test method	Value for 100 LU	Formula for calculation of LF and unit for input data
Quiescent	Resistance to earth	TBR 021 [1], A.4.4.4	$R = 10 \text{ M}\Omega$	$1\ 000/R \text{ [M}\Omega]$
Quiescent	DC resistance	TBR 021 [1], A.4.4.1	$R = 1 \text{ M}\Omega$	$100/R \text{ [M}\Omega]$
Ringing	Impedance at 25 Hz	TBR 021 [1], A.4.4.2.1	$Z = 4 \text{ k}\Omega$	$400/Z \text{ [k}\Omega]$
Ringing	DC current during ringing	TBR 021 [1], A.4.4.2.3	$I = 0,6 \text{ mA}$	$100 \times I / 0,6 \text{ [mA]}$

---

## 6 DC feed conditions

NOTE: The present document gives recommendations about DC-feeding conditions, but is not concerned with reference to ground potential.

### 6.1 Polarity

The polarity of the DC voltage presented at the R interface is arbitrary with respect to the connected A- and B-wire terminals.

### 6.2 Quiescent state

#### 6.2.1 Maximum voltage

The maximum open circuit DC voltage presented between the A- and B- wires of the R interface shall not exceed 78 V.

#### 6.2.2 Minimum voltage

When a resistor with a value of  $100/LF \text{ M}\Omega$ , where LF is the stated LF arising from clause 5.2.2, is connected between the A- and B- wires of the R interface, the continuous DC voltage appearing at the R interface shall not be less than 38 V.

NOTE: The requirement assumes that individual LF-values are given as suggested by the note in clause 5.2.2 and that the LF is taken from table 2, "DC resistance in quiescent state".

### 6.2.3 Supply interruption

It is recommended that during the quiescent state the network feed voltage applied at the R interface should not be removed for periods longer than 10 s for maintenance or other purposes.

## 6.3 Loop current

### 6.3.1 Loop current range

When a resistor with a value in the range  $0\ \Omega$  to  $600\ \Omega$  is connected between the A- and B- wires at the R interface, a minimum DC current of 18 mA shall flow but shall not exceed 70 mA. It is recommended that the DC current is in the range of 25 mA to 40 mA.

NOTE: 18 mA is the minimum current required to match the TE access requirements for interworking with the network.

### 6.3.2 Loop current interruptions caused by the terminal

Short single loop current interruptions (where the current becomes less than 1,0 mA) of up to 20 ms between the A- and B- wires shall not cause any change in state or condition at the R interface.

---

## 7 Seize signal

### 7.1 Must not seize condition

When a resistor with a value such as to cause a loop current not greater than 3,0 mA DC to flow is connected at the A- and B- wires of the R interface, it shall not be recognized by the network as a seize signal.

The network shall not recognize a seize condition when the loop current changes from quiescent state to loop state levels for a period of less than 80 ms.

### 7.2 Must seize condition

When a resistor with a value such as to cause a loop current equal to or greater than 10,0 mA DC to flow is connected for a period of greater than 150 ms at the A- and B- wires of the R interface, it shall be correctly accepted by the network as a seize signal.

NOTE: Some designs of line interface, particularly those with constant current feed, use a high impedance monitoring facility with a reduced current drive capability to check for a seize condition before applying the normal loop current drive capability. For example, 50 V may be applied via a 10 k $\Omega$  resistor (i.e. a maximum current of 5 mA) with a seize-current threshold of 4 mA. Similarly, some designs of terminal equipment, particularly line powered TE using solid state hookswitches, may assume the instant availability of a minimum loop current of say 18 mA. Such designs of terminal may not achieve the loop state condition if only 5 mA is available due to insufficient current to fully operate the electronic hookswitch. While in this partial loop state condition, TE may present an equivalent resistance up to 5 k $\Omega$  instead of the normal loop state condition. Care needs to be taken to ensure that proper startup occurs when such terminals and line interfaces are interworking. This may best be achieved by meeting the following additional transient seize condition: It is recommended that during the transition from quiescent state to loop state, the R interface should be capable of supplying a minimum current of 4 mA into a load of 5 k $\Omega$  for a minimum period of 20 ms. This implies that for TE to correctly seize network interfaces providing a partial loop current, they should be developed so as to present an equivalent resistance not exceeding 5 k $\Omega$  with a loop current of 4 mA.

---

## 8 Clear signal

### 8.1 Clear signal generated by TE

In order to ensure satisfactory operation of the seize/clear function, hysteresis of the seize and clear currents shall be provided. The clear signal threshold current shall be at least 0,5 mA lower than the seize signal threshold current.

When the load applied at the A- and B- wires of the R interface is such as to reduce the loop current below the clear threshold current for a period:

- a) less than 250 ms, the network shall not accept this as a clear signal; and
- b) greater than 500 ms, the network shall accept this as a clear signal and release the loop condition at the R interface.

These time period values are valid for the calling party. For the called party, other values are possible (usually much longer times, e.g. to allow for the called party to change from one terminal to another), and could typically be greater than 60 s.

### 8.2 Clear indication from the network

Depending upon the network characteristics, a connection may be cleared:

- a) as a result of calling party TE providing a clear signal to the network; or
- b) as a result of either the calling party or the called party TE providing a clear signal to the network; or
- c) at the instigation of the network itself, independently of the state of the calling party or the called party.

A PSTN end-of-call signal shall be applied at the R interface when the connection is cleared and the interface is still in the loop state (e.g. when a call is cleared by the other party). This should be given as a release tone as specified in clause 13.3.

NOTE: In case other end-of-call signals are used in addition to the release tone, e.g. polarity reversal (see clause 14.5) or K-break (see clause 14.6), it needs to be specified by the operator.

### 8.3 Seizing the line for a new call

After the network has recognized the call clear signal from the TE, the R interface shall allow the TE to seize the line for a new call according to clause 7. In particular, an event indicating that a new seizure condition has been applied by the TE shall not be ignored whenever it occurs following recognition by the network of a call clear signal.

NOTE: This applies to both cases (clearing from calling and called party) mentioned in clause 8.1.

---

## 9 Impedance

### 9.1 Impedance at the R interface

The impedance presented by the network between the A- and B- wires of the R interface when in the loop state shall have a return loss not less than the values shown in table 3 (linear dB - logarithmic frequency scale) with respect to the reference impedance  $Z_R$  shown in figure 3. This requirement shall be met for any DC current that can be delivered at the R interface (i.e. between the 18 mA and the short circuit current).

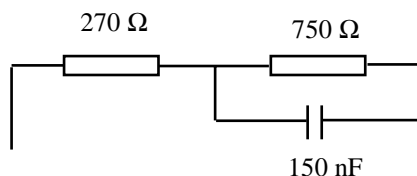

Figure 3: Reference impedance  $Z_R$

Table 3: Return loss requirements

Frequency (Hz)	Minimum value (dB)
200 to 300	12 to 14
300 to 500	14 to 18
500 to 2 000	18
2 000 to 3 800	18 to 14

## 9.2 Balance about earth

The balance about earth at the R interface, measured as Longitudinal Conversion Loss, see ITU-T Recommendation G.117 [23], shall not be less than the values given in table 4 (the higher value applies at the transition frequency):

Table 4: Balance about earth requirements

Frequency	Minimum value
50 Hz	40 dB
200 to 600 Hz	40 dB
600 to 3 800 Hz	46 dB

---

# 10 Transmission

These requirements are based on the ITU-T recommendations G.712 [26] and Q.552 [22].

## 10.1 Relative level

To enable full signal handling capacity, the nominal relative levels (at 1 020 Hz) at the R interface shall be:

Input relative level:  $L_i = +4$  dBr.

Output relative level:  $L_o = -11$  dBr.

NOTE 1: The concept of relative levels is described in ITU-T Recommendation G.100.1 [20].

NOTE 2: These relative levels are chosen to obtain optimum performance for a speech telephony terminal in accordance with TBR 038 [3] having nominal SLR = +3 dB and RLR = -8 dB. Due to the wide tolerances on SLR and RLR therein defined, the difference between the implemented relative levels and the nominal relative levels should be within  $\pm 0,5$  dB.

NOTE 3: Some types of line interfaces which provide constant DC current feeding will prevent the Automatic Gain Control (AGC) function of existing TEs from operating. Therefore it is recommended to use a loop current which makes the AGC function of existing TEs to adjust the SLR and RLR to proper values.

The digital testpoints are assumed to be ITU-R Recommendation G.711 [19], 0 dBr points. See figure 4.

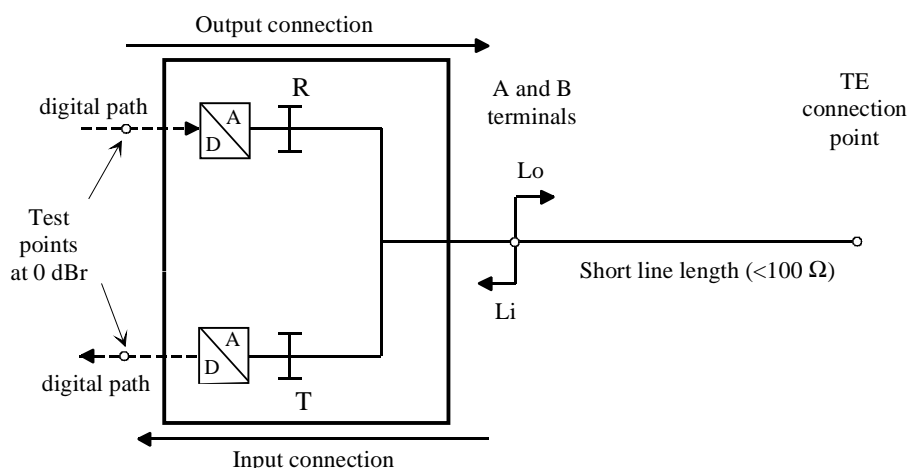

Figure 4: Relative levels

## 10.2 Variation of gain with input level

With a sine-wave test signal at the reference frequency 1 020 Hz and at a level between -55 dBm0 and level A, see figure 5, applied to the analogue interface input connection, or with a digitally simulated sine-wave signal of the same characteristic applied to the input test point of the output connection, the gain variation of that connection, relative to the gain at an input level of -10 dBm0, shall lie within the limits given in figure 5.

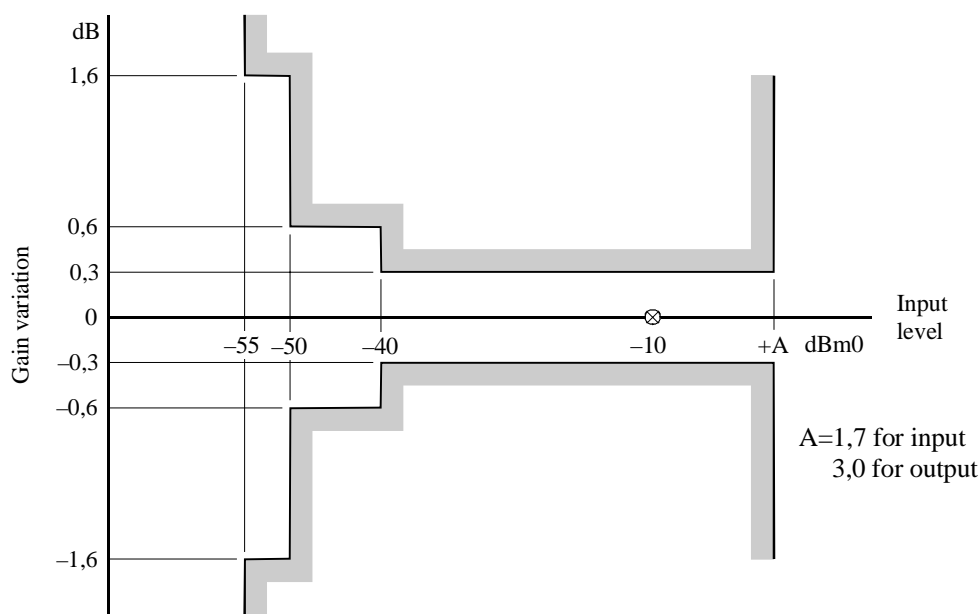

Figure 5: Variation of gain with input level

NOTE: The overload point in a PCM A-law coder is +3,14 dBm0. It is however not necessary that the input stage of a line card is able to handle higher signal levels than what is to be expected from a TE under normal conditions. TBR 021 [1] limits the value of instantaneous levels sent to the R interface from the TE to 5 V peak-to-peak. Assuming a sinewave signal, this corresponds to 1,77 Vrms which by ITU-T convention is equal to +5,7 dBm across  $Z_R$  (figure 3). With an input relative level of +4 dBr this corresponds to +1,77 dBm0.

## 10.3 Frequency response

The loss distortion with frequency of the input or output connection shall lie within the limits shown in the mask of figure 6. The preferred input level is -10 dBm0.

NOTE: Attention is drawn to the need to accommodate voice band data applications which require a greater bandwidth for optimum operation (e.g. ITU-T Recommendation V.92 [24] modems). It is recommended that the bandwidth available be as wide as is practicable in order to accommodate such applications.

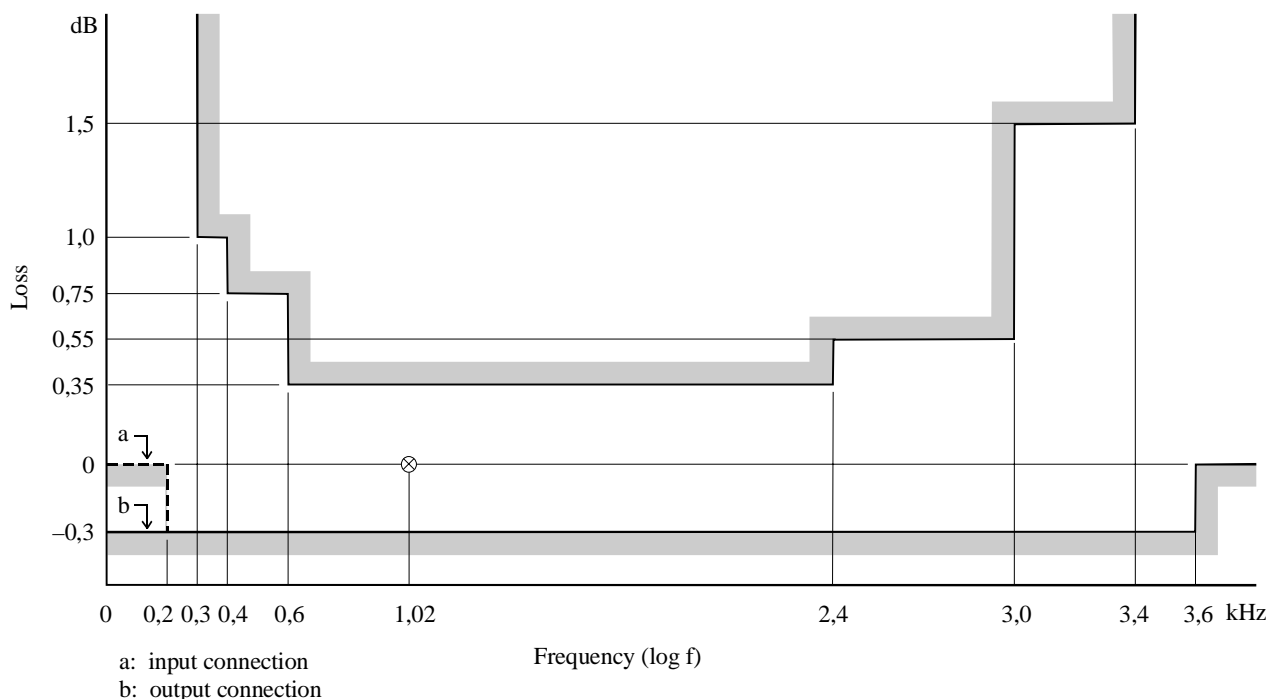

Figure 6: Loss distortion with frequency

## 10.4 Coding law

When the interface is (transparent) digitally connected with the PSTN the coding law should be A-law.

Where other than A-law conversion according to ITU-T Recommendation G.711 [19] is used, this should be stated.

NOTE 1: The distortion depends on technology used to provide the path to the R interface. Low bit rate coders are often used when the main part of the local loop is digital. These usually produce a different type of distortion than A-law, and their effect on voice band data transmission may be greater than their effect on speech signals, and in some cases totally preventing voice band data operation.

NOTE 2: Low bit rate coders may also be used in other parts of the network. Cascading of low bit rate coders may further degrade speech and voice band data quality.

## 10.5 Noise

### 10.5.1 Weighted noise

NOTE: For the calculation of these values, two components of noise should be considered: noise arising from the coding process and noise from the interface power supply and other analogue sources transmitted through signalling circuits. The first component is limited by clause 9 of ITU-T Recommendation G.712 [26] to -67 dBm0p for an input connection and to -70 dBm0p for an output connection. The other component is limited by clause 3 of ITU-T Recommendation G.120 [30] to -67 dBmp for each interface.



The maximum values for overall weighted noise at the outputs of a half connection shall be:

Input connection: -65 dBm0p;

Output connection: -67 dBmp.

## 10.5.2 Single frequency noise

The level of any unwanted single frequency (in particular the sampling frequency and its multiples), measured selectively with a bandwidth of 80 Hz in the frequency range from 4 kHz to 72 kHz at the interface shall not exceed -50 dBm0.

NOTE: In this case "unwanted" refers to self generated noise such as feed-through of sampling frequencies and not to tones used for signalling or for normal traffic.

## 10.6 Echo and stability

### 10.6.1 Echo

When terminating the 2-wire interface with the nominal value of the impedance given in figure 3, the Terminal Balance Return Loss (TBRL) shall be not less than the limits shown in figure 7.

NOTE: Where there is only a small amount of delay in the transmission medium including any associated voice compression techniques from the local exchange to the R-interface the values given in figure 7 and the additional echo attenuation achieved through the relative level given in clause 10.1 will provide good echo performance. If there is a considerable delay however additional echo control (preferably an echo canceller according to ITU-T Recommendation G.168 [27]) will be needed in order for the interface not to cause disturbing echo. Guidance on echo control is given in ITU-T Recommendation G.131 [28].

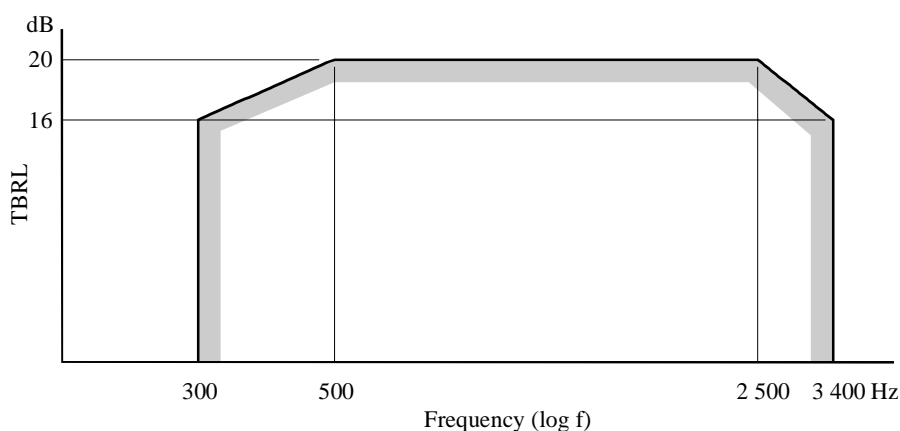

Figure 7: Limits for TBRL

### 10.6.2 Stability

Stability in the network shall be maintained for AC open and short circuit conditions applied at the R interface.

NOTE: The relative levels specified in clause 10.1 will ensure a sufficient stability margin even under worst case terminating conditions (normally simulated with an AC open and short circuit) to meet the ITU-T objective for terminating a 4-wire connection (6 dB, see ITU-T Recommendation G.122 [29]).

## 10.7 Crosstalk

The minimum crosstalk level within the voice bandwidth between two R-interfaces (intended to be connected to pairs in the local network), shall be less than -73 dBm0 when using a sending signal of 0 dBm0.

## 10.8 Total distortion including quantizing distortion

With a sine-wave test signal at the reference frequency of 1 020 Hz applied to the 2-wire interface of the input connection, or with a digitally simulated sine-wave signal of the same characteristic applied to the input test point of an output connection, the signal-to-total distortion ratio, measured at the corresponding outputs of the half connection with a proper noise weighting, specified in table 4 of ITU-T Recommendation G.223 [25], shall be not less than the limits for the input and output given in figure 8.

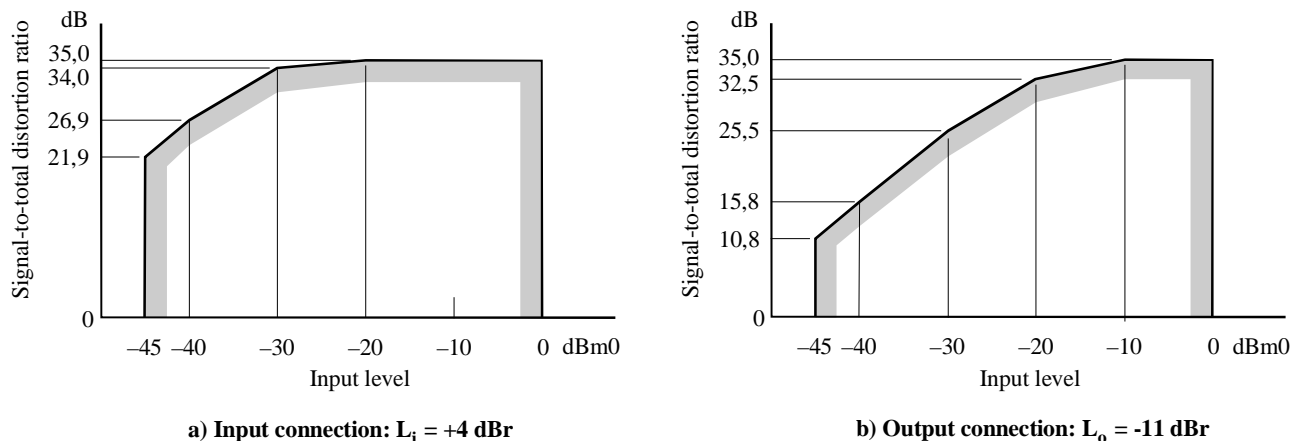

**Figure 8: Limits for signal-to-total distortion ratio as a function of input level including analogue noise**

---

## 11 DTMF Dialling

The R interface shall correctly interpret DTMF signals when received at the R interface with the following characteristics:

- a level within the range -5 dBV to -15 dBV (see note 1); and
- with a maximum difference in level between the high and low group tones of 6,0 dB; and
- with frequencies within  $\pm (1,5 \% + 2 \text{ Hz})$  of the nominal values; and
- pulse duration greater than 40 ms and an inter-digit pause of not less than 40 ms.

DTMF signals received at the R interface with a duration of less than 20 ms shall be ignored.

NOTE 1: Levels taken from the DTMF transmit level of TBR 021 [1] plus a small margin. The levels are not the same as in the DTMF receiver standard ES 201 235-3 [8], which specifies a reception range between -3 dBV to -28 dBV. The reason for this deviation is that the present document specifies requirements at the R interface where the line length to the terminal is very short ( $\leq 100 \Omega$ ). This means that the levels appearing at the R interface will be approximately the same as the levels transmitted from the terminal.

NOTE 2: See ES 201 235-1 [7] and ES 201 235-3 [8] for more information on DTMF receivers.

---

## 12 Ringing

NOTE: Guidance on generation of ringing signals may be found in TR 101 768 [2]. Guidance on ringing without DC may be found in TR 101 959 (see bibliography).

## 12.1 Ringing drive capability

### 12.1.1 Ringing frequency

The R interface shall provide a ringing supply with a nominal frequency of  $25 \text{ Hz} \pm 2 \text{ Hz}$  or  $50 \text{ Hz} \pm 2 \text{ Hz}$  and with a peak to rms voltage ratio in the range 1,2 to 1,6. The waveform shall be essentially symmetrical with a total harmonic content not exceeding 10 %.

NOTE 1: Some existing terminals in some networks are designed to operate only with 25 Hz or only with 50 Hz ringing signals, a fact which should be taken into account.

NOTE 2: The requirements provided in this clause reflect the state of the art of the current legacy POTS networks. It is however recognized that, due to the power constraints of terminating equipment of wide band networks, these requirements may need future revision in order to facilitate the implementation of POTS interfaces in NGN networks.

### 12.1.2 Ringing voltage

The open circuit AC voltage shall not exceed 100 V<sub>rms</sub> at the R interface.

The R interface shall provide sufficient ringing current so as to produce a voltage not less than 35 V<sub>rms</sub> across an AC load of  $400/LF \text{ k}\Omega$ , where LF is the stated LF arising from clause 5.2.2 (if individual LF-values are given as suggested by the note in clause 5.2.2, the LF is taken from table 2, "lowest impedance at 25 Hz").

NOTE 1: A single terminal equipment may present a load of  $4 \text{ k}\Omega$  at the R interface. However, terminals normally present a considerably higher impedance at the R interface.

It is recommended that the ringing signal be balanced with respect to earth.

Fault conditions on the interface (during ringing) shall not damage the interface or the wiring connected.

NOTE 2: Examples of fault conditions are short circuit or unintended connections to earth or unintended connections to the wires of other R-interfaces.

#### 12.1.2.1 Ringing with DC

If the AC ringing signal is superimposed on a DC voltage, the DC voltage shall be as specified in clause 6.2.

#### 12.1.2.2 Ringing without DC

If the AC ringing signal is not superimposed on a DC voltage, the following shall apply:

- a) The DC voltage shall be presented during the off (silent) parts of the ring cadence.
- b) Requirement of clause 12.1.2 (supply  $\geq 35 \text{ V}$  to a load of  $400/LF \text{ k}\Omega$ ) shall be tested with an AC load impedance with a modulus of  $400/LF \text{ k}\Omega$ , and a phase angle of -70 degrees to -1 degree.

For this test, a resistor with a value of  $100 \Omega$ , representing the maximum length on the TE side, shall be connected between the R interface and the load specified above.

NOTE 1: It is expected that the TE show a capacitive load at 25 Hz (in the on-hook state).

NOTE 2: There are no requirements in TBR 021 [1] concerning the behaviour of TEs with ringing signals without a DC superimposed voltage, or the off-hook impedance of TEs at 25 Hz. As a consequence, it cannot be assured that a TE complying with TBR 021 [1] will correctly interwork with networks delivering AC ringing signals without a DC superimposed voltage. Increasing the ringing voltage from 35 V<sub>rms</sub> to 55 V<sub>rms</sub> (on the loads specified in clause 12.1.2) may improve the probability of correct interworking of these TEs in the area of ring detection where ringing is not superimposed on a DC component.

NOTE 3: A requirement on change from DC to ringing voltage is. Until such a requirement has been finalized, the following guidance (taken from TR 101 959 (see bibliography)) is given to designers:

- The change from DC to ringing voltage shall be made in a smooth way. The best way to accomplish this is to start, and also to stop, with the ringing voltage when it has the same voltage level as the DC feeding voltage level (see figure 9), otherwise there could be transients due to loading and unloading of the TE's ringer capacitor at the beginning and the end of the ringing pulse. This transient has a steep slope and could disturb xDSL signals.
- Draft requirement:  
At the transition from DC line feed voltage to ringing voltage (and from ringing voltage to DC), the modulus of the change of the current to the load, measured in an infinite small time span ( $|dI/dt|$ ), shall be less than 300 A/s. During the test, the R interface is terminated with an AC load impedance of  $100 \Omega$  at higher frequencies. For this test load the following network is proposed:  $100 \Omega + 500 \text{ nF}$ .
- A test set-up can be found in annex A.

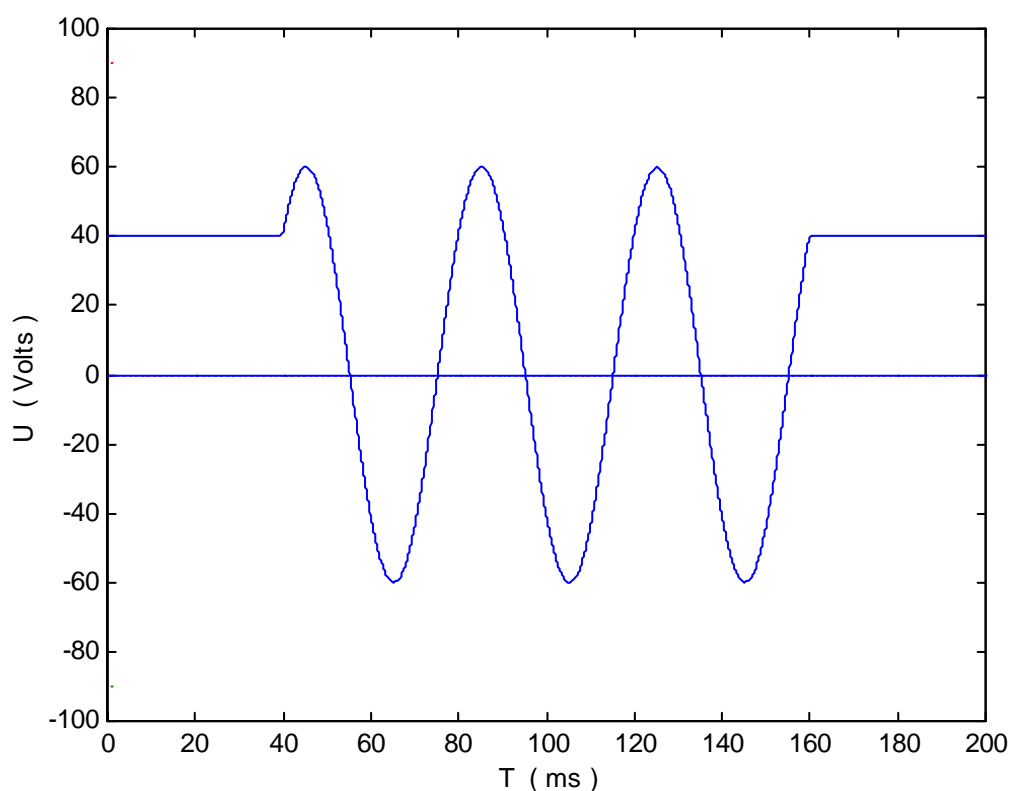

NOTE: To make the picture clearer, only 3 periods of the ringing voltage are shown.

**Figure 9: Example of the principle of switching the ringing voltage on and off at the right moment**

## 12.2 Ring cadence

The nominal ringing cadencing shall be 1 s on and 4 s off.

Other ringing cadences can be supplied as an option. Where provided, these shall be specified by the operator.

NOTE: Information of cadences frequently used in public networks is given in TR 101 183 [6].

## 12.3 Ring trip

Any ringing signal presented at the R interface shall be removed within 200 ms of an answer signal consisting of:

- a) a DC condition as defined in clause 7 being applied to the R interface; and
- b) for the case where the AC ringing signal is not superimposed on a DC voltage, an impedance not exceeding  $700\ \Omega$  at 25 Hz applied at the R interface. For this test load the following network is proposed: 6,8 uF in parallel with  $2800\ \Omega$ .

## 12.4 False ring trip

For "ringing without DC", the network shall not recognize the ringing current as an "off-hook" condition when an impedance exceeding  $1\ 500\ \Omega$  at 25 Hz is applied at the interface. This is tested with a test impedance having a modulus of  $1\ 500\ \Omega$  and a phase angle of -70 degrees. This test impedance is composed of a resistor having a value of  $513\ \Omega$  in series with a capacitor having a value of 4,52  $\mu\text{F}$ . Tolerances for the resistor and capacitor shall be  $\leq 2\ \%$ .

NOTE: If the R interface is capable of supplying a 50 Hz ringing signal in addition, the testing of that feature should be done with the capacitor having a value of 2,26  $\mu\text{F}$ .

---

# 13 Supervisory signals

Apart from the dial tone, other tones may be generated at locations other than the equipment delivering the R interface. Where tones are generated at the equipment delivering the R interface, the requirements of this clause apply.

NOTE 1: Further information on network generated tones may be found in TR 101 041-1 [10].

NOTE 2: The tones specified in this clause are in accordance with ITU-T Recommendation Q.35/E.180 [21].

## 13.1 Supervisory tones

The following types of supervisory tone shall be provided:

- a) dial tone;
- b) ringing tone;
- c) busy tone.

It is recommended that the following additional supervisory tones are also provided:

- d) release tone (if such a tone is used as specified in clause 8.2);
- e) special dial tone (often used to indicate the presence of messages waiting, or call forward activated);
- f) special information tone;
- g) call waiting tone;
- h) congestion tone.

## 13.2 Tone levels

The level of supervisory tones applied at the R interface into a reference impedance load  $Z_R$  as shown in figure 3, shall be within the range  $-18\ \text{dBV} \pm 6\ \text{dBV}$ .

## 13.3 Cadences and frequencies

Cadences and frequencies shall be in line with national supervisory signals or in line with the values in table 6:

**Table 5: Void**

**Table 6: Supervisory signals - Nominal cadences and frequencies**

Tone	Cadence	Frequency
Dial tone	Continuous	425 Hz
Ringing tone	1 s on, 4 s off	425 Hz
Busy tone	0,5 s on, 0,5 s off	425 Hz
Special dial tone	0,5 s on, 0,05 s off	425 Hz
Special information tone (see note 2)	3 × 0,33 s on, 1 s off	950 Hz, 1 400 Hz, 1 800 Hz
Release tone	0,25 s on, 0,25 s off	425 Hz
Call waiting tone	0,2 s on, 0,2 s off, 0,2 s on, 9 s off	425 Hz
Congestion tone	0,25 s on, 0,25 s off	425 Hz

NOTE 1: Tolerances for cadences are  $\pm 10\%$  and for frequencies  $\pm 1,5\%$ .  
 NOTE 2: The above specification is consistent with current practice in a number of European countries. For clarification, the special information tone consists of a repetition of three sequential tones followed by a pause (950 Hz for 0,33 s, 1 400 Hz for 0,33 s, 1 800 Hz for 0,33 s, silence for 1 s).

## 14 Optional functions

### 14.1 Loop disconnect dialling

The R interface shall correctly interpret Loop Disconnect (LD) signals applied within the following limits:

- pulsing rate: 8 to 12 pulses per second;
- make to break ratio: break = 50 % to 75 % of the total pulse period;
- make current: loop current not less than 18 mA;
- break current: loop current not exceeding 2,5 mA;
- inter-digital pause (IDP): 240 ms minimum (see note 1).

NOTE 1: Terminals with automatic LD signalling will normally generate pulse trains with a maximum IDP of 920 ms. It is possible for terminals with manual LD signalling to exceed this limit.

NOTE 2: Information on the requirements for TE with LD signalling capability may be found in ES 201 187 [12].

### 14.2 Register recall

Except during loop disconnect dialling, the network shall recognize breaks in the loop current within the range 50 ms to 130 ms applied at the R interface as a register recall signal. The break period is the time for which the loop current is below 2,5 mA.

NOTE: Information on the requirements for TE with Register Recall signalling capability may be found in ES 201 729 [9].

### 14.3 Metering

If meter pulses using 12 kHz or 16 kHz signals are used the level between the A- and B-wires at the R interface shall be at least 100 mVrms, with cadences 100 ms / 100 ms ( $\pm 30\%$  time values for a pulse packet and  $\pm 1,5\%$  for frequency values), when measured with a termination of 200  $\Omega$ .

## 14.4 Supplementary and other enhanced services

For the implementation of supplementary and other services, the requirements of EN 300 659, parts 1 [4] and 2 [5], shall be fulfilled.

It is recommended that in order to support the provision of ALASS services to the TE, the R interface should be capable of providing features selected from the list below, according to the implemented options:

- a) a single burst of ringing current with or without polarity reversal;
- b) provision of loop current up to 2,5 mA at a voltage greater than 32 V without it being treated as a seize signal;
- c) ignore on-line value DC current pulses not exceeding 25 ms duration, i.e. do not treat as a seize signal.

NOTE 1: More details may be found in EN 300 659-1 [4] for the R interface and ES 200 778-1 [15] and ES 200 778-2 [16] for the TE.

NOTE 2: ES 201 912 [17] standardizes the Short Message Service (SMS) for the User Based Solution (UBS), protocols for analogue TE of the PSTN/ISDN to communicate with the appropriate service centre. To implement such services no specific additional requirement is necessary in the present document, it is enough to fulfil the requirements of EN 300 659, parts 1 [4] and 2 [5].

NOTE 3: ES 201 071 [14] standardizes the Server Display and Script Services protocol (SDSS), which is also a protocol supporting enhanced services based on interfaces considered in the scope of the present document. To implement such services no specific additional requirement is necessary in the present document, it is enough to fulfil the requirements of EN 300 659, parts 1 [4] and 2 [5].

## 14.5 Polarity reversal

Where polarity reversal is provided, its purpose shall be specified.

NOTE 1: In order to ensure compatibility with the installed base of terminals in certain European networks it may be necessary to use polarity reversals to indicate start and end of ringing signal. In these cases, compatibility should be adequately ensured if the normal DC polarity is reversed when the first ringing voltage is applied. The polarity should revert to the normal polarity when the line is seized or cleared.

NOTE 2: Polarity reversal can be used to indicate called party answer and end-of-call.

NOTE 3: Polarity reversal can also be used for other signalling purposes (e.g. as given in EN 300 659, parts 1 [4] and 2 [5]).

## 14.6 End of call signal ("K-break")

An end-of-call signal consisting of a reduction in the PSTN loop current to below 1 mA for a certain period is referred to as K-break. Two times are suggested for the break:

- a) a range of 90 ms to 130 ms;
- b) a range of 250 ms to 300 ms. This is preferred for new equipment to avoid overlapping with the register recall signal (see clause 14.2).

## 14.7 Payphones

There may be a need to adapt certain parameters at the R interface in order to support a wide range of payphones available on the market.

---

## Annex A (informative): Test set-up for the change from DC to ringing voltage

In figure A.1 is a test set-up, to test the requirement for the change from DC to ringing voltage, as described in note 3 in clause 12.1.2.2.

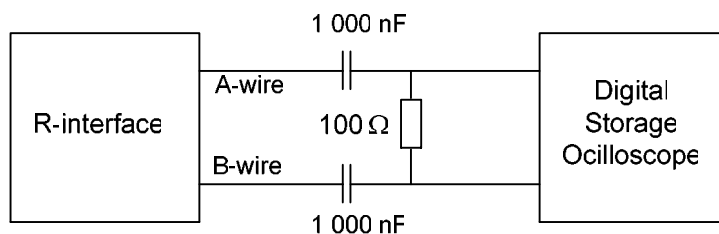

NOTE: The oscilloscope should have a balanced (differential) input, not to disturb the results.

**Figure A.1: Test set-up for the change from DC to ringing voltage**



---

## Annex B (informative): Bibliography

- ANSI/TIA-968: "Telecommunications - Telephone Terminal Equipment - Technical Requirements for Connection of Terminal Equipment to the Telephone Network".

NOTE: The above document can be obtained from:  
Telecommunications Industry Association 2500 Wilson Blvd., Suite 300 Arlington, VA 22201 USA  
phone: (703) 907-7700  
fax: (703) 907-7727.

- ETSI TR 101 959: "Access and Terminals (AT); Study on Ringing without DC (For TE and Terminal Support Interfaces)".
- ITU-T Recommendation I.411: "ISDN user-network interfaces - Reference configurations".

---

## History

<b>Document history</b>		
V1.1.1	May 2005	Publication as TS 102 971
V1.2.1	January 2006	Membership Approval Procedure    MV 20060310: 2006-01-10 to 2006-03-10