



**Methods for Testing and Specification (MTS);
The Testing and Test Control Notation version 3;
TTCN-3 Language Extensions:
Configuration and Deployment Support**

Reference

RES/MTS-202781ConfDeplv181

Keywords

protocol, testing, TTCN-3

ETSI

650 Route des Lucioles
F-06921 Sophia Antipolis Cedex - FRANCE

Tel.: +33 4 92 94 42 00 Fax: +33 4 93 65 47 16

Siret N° 348 623 562 00017 - APE 7112B
Association à but non lucratif enregistrée à la
Sous-Préfecture de Grasse (06) N° w061004871

Important notice

The present document can be downloaded from:

<http://www.etsi.org/standards-search>

The present document may be made available in electronic versions and/or in print. The content of any electronic and/or print versions of the present document shall not be modified without the prior written authorization of ETSI. In case of any existing or perceived difference in contents between such versions and/or in print, the prevailing version of an ETSI deliverable is the one made publicly available in PDF format at www.etsi.org/deliver.

Users of the present document should be aware that the document may be subject to revision or change of status.

Information on the current status of this and other ETSI documents is available at

<https://portal.etsi.org/TB/ETSIDeliverableStatus.aspx>

If you find errors in the present document, please send your comment to one of the following services:

<https://portal.etsi.org/People/CommitteeSupportStaff.aspx>

Notice of disclaimer & limitation of liability

The information provided in the present deliverable is directed solely to professionals who have the appropriate degree of experience to understand and interpret its content in accordance with generally accepted engineering or other professional standard and applicable regulations.

No recommendation as to products and services or vendors is made or should be implied.

No representation or warranty is made that this deliverable is technically accurate or sufficient or conforms to any law and/or governmental rule and/or regulation and further, no representation or warranty is made of merchantability or fitness for any particular purpose or against infringement of intellectual property rights.

In no event shall ETSI be held liable for loss of profits or any other incidental or consequential damages.

Any software contained in this deliverable is provided "AS IS" with no warranties, express or implied, including but not limited to, the warranties of merchantability, fitness for a particular purpose and non-infringement of intellectual property rights and ETSI shall not be held liable in any event for any damages whatsoever (including, without limitation, damages for loss of profits, business interruption, loss of information, or any other pecuniary loss) arising out of or related to the use of or inability to use the software.

Copyright Notification

No part may be reproduced or utilized in any form or by any means, electronic or mechanical, including photocopying and microfilm except as authorized by written permission of ETSI.

The content of the PDF version shall not be modified without the written authorization of ETSI.

The copyright and the foregoing restriction extend to reproduction in all media.

© ETSI 2021.

All rights reserved.

Contents

Intellectual Property Rights	6
Foreword.....	6
Modal verbs terminology.....	7
1 Scope	8
2 References	8
2.1 Normative references	8
2.2 Informative references.....	8
3 Definition of terms, symbols and abbreviations.....	9
3.1 Terms.....	9
3.2 Symbols.....	9
3.3 Abbreviations	9
4 Package conformance and compatibility.....	9
5 Package Concepts for the Core Language.....	10
5.0 General	10
5.1 Static configurations.....	11
5.1.1 The special configuration type: configuration	11
5.1.2 The configuration function	11
5.1.3 Starting a static test configuration.....	13
5.1.4 Destruction of static test configurations.....	13
5.1.5 Creation of static test components	14
5.1.6 Establishment of static connections and static mappings.....	15
5.1.7 Test case definitions for static test configuration.....	15
5.1.8 Executing test cases on static test configurations	16
5.1.9 Further restrictions	18
5.1.10 Logging the status of static configurations	18
5.2 Ports with translation capability	18
5.2.0 General.....	18
5.2.1 Translation capability in port type declaration.....	20
5.2.2 Mapping and connecting ports.....	21
5.2.3 Translation functions	21
5.2.4 Translation state	22
5.2.5 Sending	24
5.2.6 Receiving	24
5.2.7 Address	26
5.2.8 Clear, start, stop and halt operation	26
5.2.9 The outer port reference.....	27
5.3 Parallel Control Components	28
5.3.0 General.....	28
5.3.1 Component Operations	29
5.3.2 Port Operations	30
5.3.3 Alt and Interleave Statements	30
5.3.4 Test Case Execution.....	30
5.3.5 MTC Reference and Clause	30
5.3.6 Changes to the Test Control Interface TCI	30
6 Package Semantics	31
6.0 General	31
6.1 Replacement of short forms.....	33
6.2 Order of replacement steps	33
6.3 Flow graph representation of TTCN-3 behaviour	34
6.4 Flow graph construction procedure	34
6.5 Flow graph representation of configuration functions.....	35
6.6 Retrieval of start nodes of flow graphs.....	36
6.7 Module state	36

6.8	Accessing the module state	36
6.9	Configuration state	36
6.10	Accessing the configuration state	37
6.11	Entity states	37
6.12	Accessing entity states.....	39
6.13	Handling of connections among ports	40
6.14	Handling of port states	41
6.15	Void.....	42
6.16	Evaluation phases, general	42
6.17	Phase I: Initialization.....	42
6.18	Phase II: Update	43
6.19	Phase III: Selection.....	43
6.20	Phase IV: Execution	44
6.21	Global functions	44
6.22	Clear port operation.....	45
6.23	Configuration function call.....	45
6.24	Connect operation.....	46
6.25	Create operation	47
6.26	Flow graph segment <disconnect-all>.....	49
6.27	Flow graph segment <disconnect-comp>.....	50
6.28	Flow graph segment <disconnect-port>	51
6.29	Flow graph segment <disconnect-two-par-pairs>	51
6.30	Execute statement.....	52
6.31	Flow graph segment <execute-without-config>.....	53
6.32	Flow graph segment <execute-on-config>	53
6.33	Flow graph segment <execute-on-config-without-timeout>	53
6.34	Flow graph segment <execute-on-config-timeout>.....	54
6.35	Flow graph segment <statement-block>	56
6.36	Halt port operation.....	57
6.37	Kill component operation	58
6.38	Flow graph segment <kill-mtc>	60
6.39	Flow graph segment <kill-all-comp>	60
6.40	Kill execution statement.....	62
6.41	Kill configuration operation	63
6.42	Map operation	63
6.43	Start port operation.....	64
6.44	Stop component operation.....	65
6.45	Flow graph segment <stop-mtc>.....	67
6.46	Flow graph segment <stop-config>.....	68
6.47	Flow graph segment <stop-tc-config>.....	69
6.48	Stop port operation	70
6.49	Flow graph segment <unmap-all>.....	71
6.50	Flow graph segment <unmap-comp>.....	72
6.51	Flow graph segment <unmap-port>	73
7	TRI Extensions for the Package	73
7.1	Changes and extensions to clause 5.5.2 of ETSI ES 201 873-5 Connection handling operations.....	73
7.2	Extensions to clause 6 of ETSI ES 201 873-5 Java™ language mapping.....	75
7.3	Extensions to clause 7 of ETSI ES 201 873-5 ANSI C language mapping.....	75
7.4	Extensions to clause 8 of ETSI ES 201 873-5 C++ language mapping.....	75
7.5	Extensions to clause 9 of ETSI ES 201 873-5 C# language mapping.....	76
8	TCI Extensions for the Package	76
8.1	Extensions to clause 7.2.1.1 of ETSI ES 201 873-6 Management	76
8.2	Extensions to clause 7.3.1.1 of ETSI ES 201 873-6 TCI-TM required	76
8.3	Extensions to clause 7.3.1.2 of ETSI ES 201 873-6 TCI-TM provided	78
8.4	Extensions to clause 7.3.3.1 of ETSI ES 201 873-6 TCI-CH required	78
8.5	Extensions to clause 7.3.3.2 of ETSI ES 201 873-6 TCI CH provided.....	79
8.6	Extensions to clause 7.3.4 of ETSI ES 201 873-6 TCI-TL provided	81
8.7	Extensions to clause 8 of ETSI ES 201 873-6 Java™ language mapping.....	83
8.8	Extensions to clause 9 of ETSI ES 201 873-6 ANSI C language mapping.....	85
8.9	Extensions to clause 10 of ETSI ES 201 873-6 C++ language mapping.....	86

8.10	Extensions to clause 11 of ETSI ES 201 873-6 W3C XML mapping.....	88
8.11	Extensions to clause 12 of ETSI ES 201 873-6 C# language mapping	91
8.12	Extensions to Annex A (normative) of ETSI ES 201 873-6 IDL Specification of TCI	93
Annex A (normative): BNF and static semantics		94
A.1	Additional TTCN-3 terminals	94
A.2	Modified TTCN-3 syntax BNF productions	94
A.3	Additional TTCN-3 syntax BNF productions	95
Annex B (informative): Library of useful types		97
B.1	Limitations	97
B.2	Useful TTCN-3 types	97
B.2.1	Status values for port states	97
History		98

Intellectual Property Rights

Essential patents

IPRs essential or potentially essential to normative deliverables may have been declared to ETSI. The declarations pertaining to these essential IPRs, if any, are publicly available for **ETSI members and non-members**, and can be found in ETSI SR 000 314: "*Intellectual Property Rights (IPRs); Essential, or potentially Essential, IPRs notified to ETSI in respect of ETSI standards*", which is available from the ETSI Secretariat. Latest updates are available on the ETSI Web server (<https://ipr.etsi.org/>).

Pursuant to the ETSI Directives including the ETSI IPR Policy, no investigation regarding the essentiality of IPRs, including IPR searches, has been carried out by ETSI. No guarantee can be given as to the existence of other IPRs not referenced in ETSI SR 000 314 (or the updates on the ETSI Web server) which are, or may be, or may become, essential to the present document.

Trademarks

The present document may include trademarks and/or tradenames which are asserted and/or registered by their owners. ETSI claims no ownership of these except for any which are indicated as being the property of ETSI, and conveys no right to use or reproduce any trademark and/or tradename. Mention of those trademarks in the present document does not constitute an endorsement by ETSI of products, services or organizations associated with those trademarks.

DECT™, **PLUGTESTS™**, **UMTS™** and the ETSI logo are trademarks of ETSI registered for the benefit of its Members. **3GPP™** and **LTE™** are trademarks of ETSI registered for the benefit of its Members and of the 3GPP Organizational Partners. **oneM2M™** logo is a trademark of ETSI registered for the benefit of its Members and of the oneM2M Partners. **GSM®** and the GSM logo are trademarks registered and owned by the GSM Association.

Foreword

This final draft ETSI Standard (ES) has been produced by ETSI Technical Committee Methods for Testing and Specification (MTS), and is now submitted for the ETSI standards Membership Approval Procedure.

The use of underline (additional text) and strike through (deleted text) highlights the differences between base document and extended documents.

The present document relates to the multi-part series ETSI ES 201 873 covering the Testing and Test Control Notation version 3, as identified below:

- Part 1: "TTCN-3 Core Language";
- Part 4: "TTCN-3 Operational Semantics";
- Part 5: "TTCN-3 Runtime Interface (TRI)";
- Part 6: "TTCN-3 Control Interface (TCI)";
- Part 7: "Using ASN.1 with TTCN-3";
- Part 8: "The IDL to TTCN-3 Mapping";
- Part 9: "Using XML schema with TTCN-3";
- Part 10: "TTCN-3 Documentation Comment Specification";
- Part 11: "Using JSON with TTCN-3".

Modal verbs terminology

In the present document "**shall**", "**shall not**", "**should**", "**should not**", "**may**", "**need not**", "**will**", "**will not**", "**can**" and "**cannot**" are to be interpreted as described in clause 3.2 of the [ETSI Drafting Rules](#) (Verbal forms for the expression of provisions).

"**must**" and "**must not**" are **NOT** allowed in ETSI deliverables except when used in direct citation.

1 Scope

The present document defines the Configuration and Deployment Support package of TTCN-3. TTCN-3 can be used for the specification of all types of reactive system tests over a variety of communication ports. Typical areas of application are protocol testing (including mobile and Internet protocols), service testing (including supplementary services), module testing, testing of APIs, etc. TTCN-3 is not restricted to conformance testing and can be used for many other kinds of testing including interoperability, robustness, regression, system and integration testing. The specification of test suites for physical layer protocols is outside the scope of the present document.

TTCN-3 packages are intended to define additional TTCN-3 concepts, which are not mandatory as concepts in the TTCN-3 core language, but which are optional as part of a package which is suited for dedicated applications and/or usages of TTCN-3.

This package defines the TTCN-3 support for static test configurations.

While the design of TTCN-3 package has taken into account the consistency of a combined usage of the core language with a number of packages, the concrete usages of and guidelines for this package in combination with other packages is outside the scope of the present document.

2 References

2.1 Normative references

References are either specific (identified by date of publication and/or edition number or version number) or non-specific. For specific references, only the cited version applies. For non-specific references, the latest version of the referenced document (including any amendments) applies.

Referenced documents which are not found to be publicly available in the expected location might be found at <https://docbox.etsi.org/Reference/>.

NOTE: While any hyperlinks included in this clause were valid at the time of publication, ETSI cannot guarantee their long term validity.

The following referenced documents are necessary for the application of the present document.

- [1] ETSI ES 201 873-1: "Methods for Testing and Specification (MTS); The Testing and Test Control Notation version 3; Part 1: TTCN-3 Core Language".
- [2] ETSI ES 201 873-4: "Methods for Testing and Specification (MTS); The Testing and Test Control Notation version 3; Part 4: TTCN-3 Operational Semantics".
- [3] ETSI ES 201 873-5: "Methods for Testing and Specification (MTS); The Testing and Test Control Notation version 3; Part 5: TTCN-3 Runtime Interface (TRI)".
- [4] ETSI ES 201 873-6: "Methods for Testing and Specification (MTS); The Testing and Test Control Notation version 3; Part 6: TTCN-3 Control Interface (TCI)".
- [5] ISO/IEC 9646-1: "Information technology - Open Systems Interconnection - Conformance testing methodology and framework; Part 1: General concepts".

2.2 Informative references

References are either specific (identified by date of publication and/or edition number or version number) or non-specific. For specific references, only the cited version applies. For non-specific references, the latest version of the referenced document (including any amendments) applies.

NOTE: While any hyperlinks included in this clause were valid at the time of publication, ETSI cannot guarantee their long term validity.

The following referenced documents are not necessary for the application of the present document but they assist the user with regard to a particular subject area.

- [i.1] ETSI ES 201 873-7: "Methods for Testing and Specification (MTS); The Testing and Test Control Notation version 3; Part 7: Using ASN.1 with TTCN-3".
- [i.2] ETSI ES 201 873-8: "Methods for Testing and Specification (MTS); The Testing and Test Control Notation version 3; Part 8: The IDL to TTCN-3 Mapping".
- [i.3] ETSI ES 201 873-9: "Methods for Testing and Specification (MTS); The Testing and Test Control Notation version 3; Part 9: Using XML schema with TTCN-3".
- [i.4] ETSI ES 201 873-10: "Methods for Testing and Specification (MTS); The Testing and Test Control Notation version 3; Part 10: TTCN-3 Documentation Comment Specification".

3 Definition of terms, symbols and abbreviations

3.1 Terms

For the purposes of the present document, the terms given in ETSI ES 201 873-1 [1], ETSI ES 201 873-4 [2], ETSI ES 201 873-5 [3], ETSI ES 201 873-6 [4] and ISO/IEC 9646-1 [5] apply.

3.2 Symbols

Void.

3.3 Abbreviations

For the purposes of the present document, the abbreviations given in ETSI ES 201 873-1 [1], ETSI ES 201 873-4 [2], ETSI ES 201 873-5 [3], ETSI ES 201 873-6 [4], ISO/IEC 9646-1 [5] and the following apply:

MTC	Main Test Component
PTC	Parallel Test Component

4 Package conformance and compatibility

The package presented in the present document is identified by the package tag:

"TTCN-3:2009 Static Test Configurations" - to be used with modules complying with the present document.

For an implementation claiming to conform to this package version, all features specified in the present document shall be implemented consistently with the requirements given in the present document, in ETSI ES 201 873-1 [1] and in ETSI ES 201 873-4 [2].

The package presented in the present document is compatible to:

- ETSI ES 201 873-1 [1] version 4.9.1;
- ETSI ES 201 873-4 [2] version 4.6.1;
- ETSI ES 201 873-5 [3] version 4.8.1;
- ETSI ES 201 873-6 [4] version 4.9.1;
- ETSI ES 201 873-7 [i.1];
- ETSI ES 201 873-8 [i.2];

- ETSI ES 201 873-9 [i.3];
- ETSI ES 201 873-10 [i.4].

If later versions of those parts are available and should be used instead, the compatibility to the package presented in the present document has to be checked individually.

5 Package Concepts for the Core Language

5.0 General

This package defines the TTCN-3 means to define *static test configurations*. A static test configuration is a test configuration with a lifetime that is not bound to a single test case. The test components of a static test configuration may be used by several test cases. This package realizes the following concepts:

- A special *configuration function* is introduced which can only be called in the control part of a TTCN-3 module to create *static test configurations*. The configuration function returns a handle of the predefined type **configuration** to access an existing static test configuration.
- A static test configuration consists of *static test components*, a test system interface, *static connections* and *static mappings*. These constituents have the following semantics:
 - A *static test component* is a special kind of test component that can only be created during the creation of a static test configuration and can only be destroyed during the destruction of a static test configuration. By definition, the MTC of a static test configuration is a static test component.
 - The test system interface of a static test configuration plays the same role as the test system interface of a test configuration created by a test case.
 - A *static connection* is a connection between static test components. It can only be established during the creation of a static test configuration and only be destroyed during the destruction of a static test configuration.
 - A *static mapping* is a mapping of a port of a static test component to a port of the test system interface of a static test configuration. Such a mapping can only be established during the creation of a static test configuration and only be destroyed during the destruction of a static test configuration.
- A static test configuration can be used by several test cases. For this the test case is started on a previously created static test configuration. This means:
 - The body of the test case is executed on the MTC of the static test configuration.
 - The MTC may start behaviour on other static test components of the static test configuration.
 - Static test components may create, start, stop and kill normal and alive test components. The lifetime of these components is bound to the actual test case that is executed on the static test configuration. In case that a normal and alive test component is not destroyed explicitly by another test component, it is implicitly destroyed when the test case ends.
 - During test case execution non-static connections and non-static mappings may be established. The lifetime of non-static connections and non-static mappings is bound to the actual test case that is executed on the static test configuration. In case that a non-static connection or a non-static mapping is not destroyed explicitly by another test component, it is implicitly destroyed when the test case ends.
- Component timers and variables of static test components are not reset or reinitialized when a test case is started on a static test configuration. They remain in the same state as when they were left after the creation of the static test configuration or after the termination of a previous test case. This allows to transfer information from one test case to another.

- Ports of static test components are not emptied or restarted when a test case is started on a static test configuration. For example, this allows a delayed handling of SUT responses like e.g. repetitive status messages, during the test campaign. In addition, all port operations (i.e. **clear**, **start**, **stop** and **halt**) are disallowed for ports of static test components. All ports of a static test component remain started during the whole lifetime of a static test configuration.
- In contrast to component timers, variables and ports, the verdict and the default handling is reset. This means all activated defaults are deactivated, all local verdicts and the global verdict are set to **none**.

5.1 Static configurations

5.1.1 The special configuration type: configuration

The special configuration type **configuration** is a handle for static test configurations. The special value **null** is available to indicate an undefined configuration reference, e.g. for the initialization of variables to handle a static test configuration.

Values of type **configuration** shall be the result of configuration functions, they can be checked for equality, e.g. to check if two variables store the same value, and they can be used in **execute** statements for starting a test case on an existing static test configuration and in **kill** configuration statements to destroy an existing static test configuration.

Each successful execution of a configuration function results in a different configuration value which is only equal to itself.

Restrictions

The following restrictions apply to usages of the **configuration** type:

- The **configuration** type cannot be subtyped or constrained.
- The **configuration** type is not a data type, therefore, the **anytype** does not include the configuration type.
- Module parameters shall not be of type **configuration**.
- Signature parameters shall not be of type **configuration**.
- Templates shall not be of type **configuration**.
- Templates shall not be of a structured type that contains fields or elements of type **configuration** on any level of nesting.
- External functions are not allowed to contain parameters or return values of type **configuration**.

EXAMPLES:

```

var configuration myStaticConfig := null; // Declaration and initialization of a
                                         // configuration variable.

myStaticConfig := aStaticConfig();      // Assigns a value to the previously declared
                                         // configuration variable. It is assumed that
                                         // aStaticConfig() is a configuration function.

myStaticConfig.kill                     // Kills the static test configuration stored in
                                         // variable myStaticConfig.

```

5.1.2 The configuration function

A configuration function allows the start of a static test configuration.

Syntactical Structure

```

configuration ConfigurationIdentifier
"(" [ { ( FormalValuePar | FormalTemplatePar) [","] } ] ")"
runs on ComponentType

```

```
[ system ComponentType ]
StatementBlock
```

Semantic Description

A configuration function allows the start of a static test configuration. A configuration function has to be defined in the definitions part of a TTCN-3 module and shall only be invoked in the control part of a TTCN-3 module. By definition, a configuration function returns a value of type **configuration** if the start of the configuration was successful, or **null** if the start of the configuration was not successful.

The invocation of a configuration function causes the creation of the MTC and the test system interface of the static test configuration. The types of MTC and test system interface shall be referenced in a **runs on** and a **system** clause. The **system** clause is optional and can be omitted, if the test system has exactly the same ports as the MTC and these ports are mapped one to one to each other.

The behaviour in the body of a configuration function shall be executed on the newly created MTC. During the start of a test configuration only behaviour on the MTC shall be executed and only static test components, static connections and static mappings shall be created or established. Communication with the SUT or with static PTCs is not allowed.

NOTE: The configuration function only returns a reference to a test configuration and no verdict. However, communication with the SUT might have to be checked. For this purpose, initial communication, e.g. for registration or coordination purposes, could be defined in form of a test case.

A static test configuration is successfully started if the behaviour of the corresponding configuration function has been executed till its end or if a **return** statement in the corresponding configuration function is reached. In case of a successful start, a reference to the newly created configuration is returned. The usage of a **stop** or a **kill** statement allows to specify an unsuccessful start of a static test configuration. In case of an unsuccessful start, the value **null** is returned.

Restrictions

- a) The rules for formal parameter lists for the configuration function shall be followed as defined in clause 5.4 of ETSI ES 201 873-4 [2].
- b) Configuration functions shall only be invoked in the module control part.
- c) For the behaviour definition in the body of the configuration function and all functions directly or indirectly from the configuration function, the following restrictions shall hold:
 - Only static test components, static connections and static mappings shall be created or established. All created test components, connections and mappings during the execution of a configuration function are static.
 - Once created or established static test components, static connections and static mappings shall not be destroyed.
 - It is not allowed to start behaviour on newly created static test components.
 - Communication, timer and port operations are not allowed.

EXAMPLES:

```
// The following configuration function can be used to start a simple static test configuration
// which only consists of one MTC.
```

```
configuration simpleStaticConfig () runs on MyMTCtype{}
```

```
// The following configuration function starts a more complex static configuration.
// Configuration information is stored in MTC component variables. Further non-static
// connections and mappings may be established by the test cases that are executed
// on this configuration.
```

```
configuration aComplexStaticConfig (in integer NoOfPTCs) runs on MyMTCtype system MySystemType {
  var integer i;

  if (NoOfPTCs < 0) {
    log ("Negative number of PTCs");
```

```

    kill; // unsuccessful termination
}
else if (NoOfPTCs > MaxNoOfPTCs) { // MaxNoOfPTCs is a constant
    log ("Number of PTCs is too high");
    kill; // unsuccessful termination
}
else {
    for (i := 1, i <= NoOfPTCs, i := i + 1) {
        PTC[i] := PtcType.create static; // creation of static PTCs,
        // Array PTC[] is a component variable
        connect (mtc:SyncPort, PTC[i]:SyncPort) static; // static connection
    }
    map(mtc:PCO, system:PCO1) static; // static mapping of MTC.
    map(PTC[1]:PCO, system:PCO2); // some static mappings of PTCs,
    map(PTC[2]:PCO, system:PCO3); // further non-static mappings may be
    // established during test runs
}
return; // successful termination
}

```

5.1.3 Starting a static test configuration

A static test configuration is started by calling a configuration function in the control part of a TTCN-3 module. In case of a successful start, a reference to the newly created static test configuration is returned. In case of an unsuccessful start, the special value `null` is returned.

EXAMPLES:

```

control {
    var configuration myStaticConfig := null; // Declaration and initialization of a
    // configuration variable.

    myStaticConfig := aStaticConfig(); // Assigns a value to the previously declared
    // configuration variable. It is assumed that
    // aStaticConfig() is a configuration function.

    if (myStaticConfig == null) {
        stop; // Stop test campaign due to an unsuccessful start
    }
    else {
        execute(MyTestCase(), myStaticConfig) // Successful start, continuation of test campaign
        ...
    }
}

```

5.1.4 Destruction of static test configurations

A static test configuration can be destroyed by executing a **kill** configuration operation.

Syntactical Structure

ConfigurationReference.kill

Semantic Description

The execution of a **kill** configuration operation causes the destruction of a static test configuration. The destruction is similar to stopping a test case by killing the MTC. This means, resources of all static PTCs shall be released and the PTCs shall be removed. The only difference is that no test verdict is calculated and returned. After executing the **kill** configuration operation, it is not possible to execute a test case on the killed static test configuration.

Executing the kill configuration operation with the special value `null` shall have no effect, executing a kill configuration operation with a reference to a non-existing static test configuration shall cause a runtime error.

Restrictions

- a) The **kill** configuration operation shall only be executed in the control part of a TTCN-3 module.

EXAMPLES:

```

control {
  var configuration myStaticConfig := null; // Declaration and initialization of a
                                           // configuration variable.

  myStaticConfig := aStaticConfig();      // Assigns a value to the previously declared
                                           // configuration variable. It is assumed that
                                           // aStaticConfig() is a configuration function.

  myStaticConfig.kill                     // Destruction of the previously started static
                                           // test configuration.

```

5.1.5 Creation of static test components

All create operations invoked directly or indirectly from configuration functions create static test components. The creation of static test components can be indicated by the additional optional keyword **static** in the **create** operation. The extension of the **create** operation in clause 21.2.1 of ETSI ES 201 873-4 [2] required for the creation of static test components is described in this clause.

Syntactical Structure

```

ComponentType "." create [ "(" (Name | "-") [ "," HostId ] ")" ] [ alive | static ]

```

Semantic Description

The **create** operation in combination with the keyword **static** shall only be used to create static test components. Static test components can only be created by executing a configuration function and by functions directly or indirectly invoked by configuration functions. The keyword **static** in a **create** operation shall not be used in combination with the keyword **alive**.

NOTE 1: During the lifetime of a static test configuration, a static component behaves like an alive component.

Static test components are created in the same manner as normal test components that are not declared as alive components. Further details on this can be found in clause 21.2.1 of ETSI ES 201 873-4 [2].

NOTE 2: Static test components can only be created directly or indirectly by a configuration function. This may be checkable at runtime and therefore the keyword **static** may not be required, but for having an explicit specification of static test configurations and for keeping the feature of static test configurations extendible, the keyword **static** has been introduced.

Restrictions

- a) The **create** operation in combination with the keyword **static** shall only be invoked in configuration functions and in function that may be directly or indirectly called by such a configuration function.
- b) The keyword **static** in a **create** operation shall not be used in combination with the keyword **alive**.

EXAMPLES:

```

// This example declares variables of type MyComponentType, which are used to store the
// references of newly created static component instances of type MyComponentType.
// An associated name is allocated to some of the created component instances.
:
var MyComponentType MyNewComponent;
var MyComponentType MyNewestComponent;
:
MyNewComponent := MyComponentType.create static;
MyNewestComponent := MyComponentType.create("Newest") static;

```

5.1.6 Establishment of static connections and static mappings

The **map** and **connect** operations called directly or indirectly from configuration functions establish static connections and static mappings. This can be indicated by the additional optional keyword **static** in **connect** and the **map** operations. The extension of the **connect** and **map** operation in clause 21.1.1 of ETSI ES 201 873-4 [2] required for the establishment of static connections and mapping is described in this clause.

Syntactical Structure

```
connect "(" ComponentRef ":" Port "," ComponentRef ":" Port ")" [ static ]

map "(" ComponentRef ":" Port "," ComponentRef ":" Port ")"
  [ param "(" [ { ActualPar ["," ] }+ ] ")" ] [ static ]
```

Semantic Description

The **connect** and **map** the operation in combination with the keyword **static** shall only be used to establish static connections and static mappings. Static connections and static mappings can only be established by executing the creator function of a configuration type and by functions directly or indirectly invoked by the creator functions of configuration type.

Static connections and static mappings are established in the same manner as normal connections and mappings. Further details on this can be found in clause 21.1.1 of ETSI ES 201 873-4 [2].

NOTE: Static connections and mappings can only be established directly or indirectly by a creator function of a configuration type. This may be checkable at runtime and therefore the keyword **static** may not be required, but for having an explicit specification of static test configurations and for keeping the feature of static test configurations extendible, the keyword **static** has been introduced.

Restrictions

- a) The **connect** and **map** operation in combination with the keyword **static** shall only be used in configuration functions and in functions that may be directly or indirectly called by a configuration function.
- b) Static connections and static mappings shall only be established to connect ports of static test components and to map ports of a static component to the ports of the test system interface of a configuration type.

EXAMPLES:

```
// The following code fragment may be part of a creator function of a configuration type.
// It is assumed that the ports Port1, Port2, Port3 and PC01 are properly defined and declared
// in the corresponding port type and component type definitions
:
var MyComponentType MyNewPTC;
MyNewPTC := MyComponentType.create static;
:
connect(MyNewPTC:Port1, mtc:Port3) static;
map(MyNewPTC:Port2, system:PC01) static;
:
```

5.1.7 Test case definitions for static test configuration

Test cases that are executed on a static test configuration have to be defined in a special manner. Such test cases shall reference the configuration function that starts a static configuration on which the test case can be executed. The type of the MTC and the type of the test system interface are referenced in the configuration function and shall therefore not be specified in the test case header. The extension of the test case definition in clause 16.3 of ETSI ES 201 873-4 [2] required for the execution of a test case on a static test configuration is described in this clause.

Syntactical Structure

```
testcase TestcaseIdentifier
  "(" [ { ( FormalValuePar | FormalTemplatePar) ["," ] } ] ")"
  ( runs on ComponentType [ system ComponentType ] | execute on ConfigurationType )
  StatementBlock
```

Semantic Description

A test case definition that includes an **execute on** clause will be executed on previously created static test configuration of the given configuration type. The type of the MTC and the type of the test system interface is defined in the referenced configuration type. A test case definition that includes an **execute on** clause shall not have a **runs on** or a **system** clause.

Apart from the execute on clause, the definition of test cases to be executed on a static test configuration follows the same rules as described in clause 16.3 of ETSI ES 201 873-4 [2].

Restrictions

- a) A test case definition that includes an **execute on** clause shall not have a **runs on** or a **system** clause.

EXAMPLES:

```

configuration aConfiguration () runs on MyMTCtype system MySystemType {
    PeerComponent := MyPTCType.create static; // creation of a static PTC
                                           // PeerComponent is a component variable

    connect(mtc:syncPort, PeerComponent:syncPort); // static connection

    map (mtc:PC01, system:PC01) // static mapping of MTC
    map (PeerComponent:PC02, system:PC02); // static mapping of Peer Component

    return // successful start of test configuration
}

testcase MyTestCase () execute on aConfiguration {
    default := activate(UnexpectedReceptions()); // activate a default

    PeerComponent.start (PTCbehaviour()); // starting PTC behaviour
    SyncPort.send (Ready); // synchronization with PTC
    SyncPort.receive(Ready); // PTC ready

    PC01.send (stimulus); // test starts

    ... // test behaviour
}

```

5.1.8 Executing test cases on static test configurations

This clause only describes the syntax extensions of the **execute** statement to allow the execution of test cases with an **execute on** clause on static test configurations and the semantics for executing such test cases. The semantics of the **execute** statement for test cases without **execute on** clause remains unchanged.

Syntactical Structure

```

execute "(" TestcaseRef "(" [ { TemplateInstance [ "," ] } ] ")"
         [ "," (TimerValue | "-")
         [ "," (HostId | "-")
         [ "," ConfigurationRef ] ] ] ")"

```

Semantic Description

A test case definition that includes an **execute on** clause shall be executed on previously started static test configuration of a given configuration function. The reference of the previously started static test configuration shall be referenced in the **execute** statement.

Trying to execute a test case on a non-existing or unfitting static test configuration shall cause a run time error. Unfitting test configuration means that the referenced static test configuration has not been created by the configuration function referenced in the test case header.

If the execution of a test case on a static test configuration causes an **error** verdict, all following usages of this static test configuration in **execute** statements shall cause a runtime error.

NOTE: It is allowed to kill the possibly erroneous static test configuration and to start a new one by invoking the configuration function again.

A test case that shall be started on a fitting static test configuration can rely on the following things:

- All static test components, static connections and static mappings created or established by the referenced configuration function shall exist.
- No static test component is running.
- No non-static test components, non-static connections and non-static mappings shall exist.
- Component timers and variables of static test components shall not be reset or reinitialized when a test case is started on a static test configuration. They remain in the same state as when they were left after the creation of the static test configuration or after the termination of a previous test case, except for running timers which can change their state to timed out. This allows to transfer information from one test case to another. If a timer of a static component is running when a test case terminates, it can still time out even before the next test case starts. However, this can only be observed during the execution of a test case.
- Ports of static test components shall not be emptied or restarted when a test case is started on a static test configuration. For example, this allows a delayed handling of SUT responses like e.g. repetitive status messages, during the test campaign. Messages, calls, replies, exceptions and call-timeouts can still be enqueued at ports of static test components after the termination of a test case, but they can only be observed and processed during a following test case.
- In contrast to component timers, variables and ports, the verdict and the default handling shall be reset. This means all activated defaults are deactivated, all local verdicts and the global verdict are set to **none**.

Executing a test case on a static test configuration means that the body of the test case is executed on the MTC of the static test configuration. During test execution, all static PTCs behave like alive test components. This means, static PTCs may be stopped and started several times. During test case execution, non-static normal and alive components may be created, started, killed and stopped. In addition, non-static connections and mappings may be established and destroyed.

A test case that is executed on a static test configuration shall end when the behaviour of the MTC ends. In this case, the final test case verdict is returned. The final test case verdict shall be calculated based on the local verdicts of all static and non-static test components. Furthermore, all test components (static and non-static) shall be stopped, all non-static test components, non-static connections and all non-static mappings shall be discarded.

Restrictions

All restrictions mentioned in clause 26.1 of the core language document ETSI ES 201 873-1 [1] apply.

EXAMPLES:

```

var verdict MyVerdict // local variable

var configuration MyConfiguration := aConfiguration(); // starting a static test configuration

MyVerdict := execute(MyTestCase (),MyConfiguration); // execution of a test case on a static
// test configuration

if (MyVerdict == pass) {
    MyVerdict := execute MyTestCase (), 10.0, MyConfiguration); // executing the same test case
// with time guard
}

... // further test behaviour
stop;

```

5.1.9 Further restrictions

Static test components, static connections and static mappings have a special semantics. Therefore, situations shall cause a runtime error:

- Applying a **kill** test component operation to a static test component.
- Applying port operations (**clear**, **start**, **stop** and **halt**) to a port owned by a static test component.
- Applying a **disconnect** operation to a static connection.
- Applying **unmap** operation to a static mapping.

5.1.10 Logging the status of static configurations

The **log** statement can be used to log the status of static configurations. Table 1 "TTCN 3 language elements that can be logged" of ETSI ES 201 873-1 [1] is to be extended as follows:

Table 1: TTCN-3 language elements that can be logged

Used in a log statement	What is logged	Comment
...
configuration reference	actual state	Configurations states shall be logged according to note 9.
NOTE 10: Configuration states that can be logged are: Started and Killed.		

5.2 Ports with translation capability

5.2.0 General

This clause describes an extension of a message port type definition adding translation capability into it.

Translation feature is a set of rules that allows to convert messages and/or addresses of one type into messages and/or addresses of different type during sending or receiving.

It can be used e.g. in situations where the test behaviour is defined on one set of data types but the system under test (or connected component) actually communicates using a different set of data types, i.e. if the test system works on a different layer of the protocol stack than the system under test.

To allow flexible adaptation to the system under test, the user shall have the means to control this translation in the abstract test suite.

Syntactical Structure

```

type port PortTypeIdmessage
[ map to { OuterPortType [ "," ] }+ ]
[ connect to { OuterPortType [ "," ] }+ ] "{"
{
  ( in { InnerInType [ from { OuterInType with InFunction "(" ")" [ "," ] }+ ] [ "," ] }+ |
    out { InnerOutType [ to { OuterOutType with OutFunction "(" ")" [ "," ] }+ ] [ "," ] }+ |
    inout { InOutType [ "," ] }+ |
    address AddrType [ to { OuterAddrTypewith AddrOutFunction "(" ")" [ "," ] }+ ]
  [ from { OuterAddrTypewith AddrInFunction "(" ")" [ "," ] }+ ] |
  map param "(" { FormalValuePar [ "," ] }+ ")" |
  unmap param "(" { FormalValuePar [ "," ] }+ ")" |
  VarInstance ) ";"
}+
" }"

```

NOTE: Please note that the same *OuterInType* may appear in more than one **in** message specifications for different *InnerInType*-s. In each such clause the *InFunction* is different.

Semantic Description

PortTypeId is name of the type being defined.

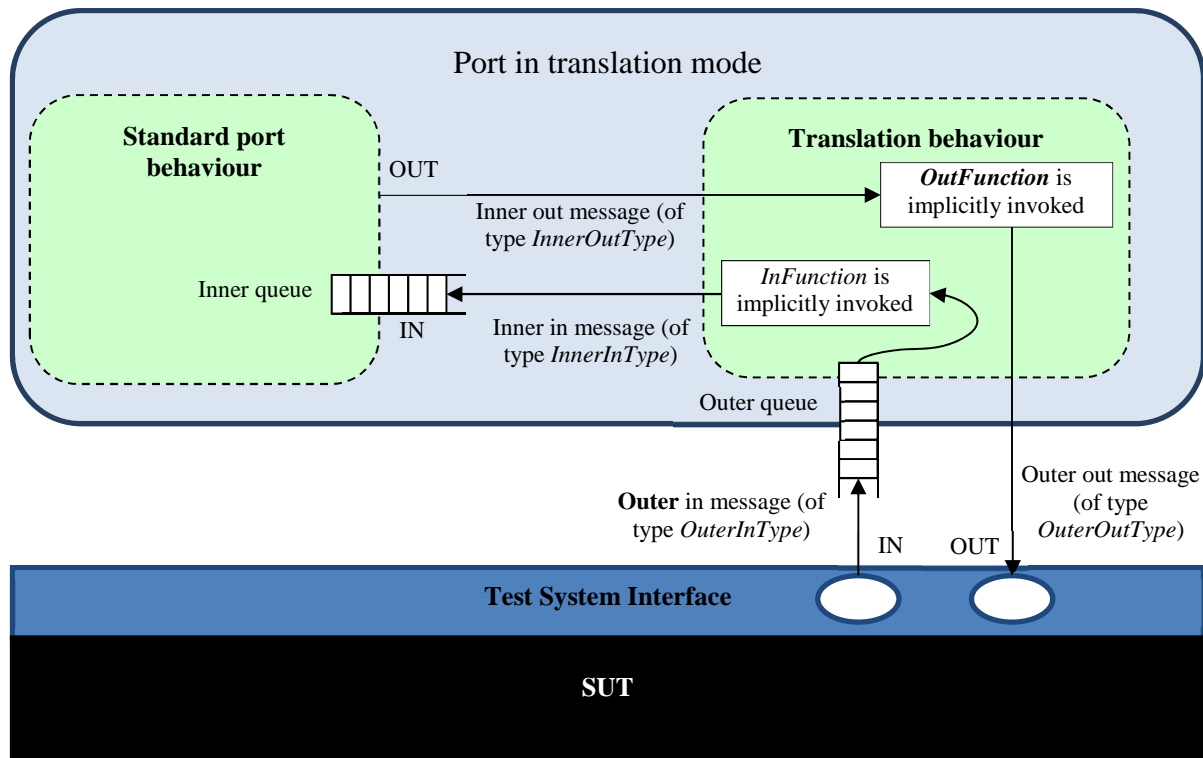

Figure 1: Illustration of ports with translation capability

- *OuterPortType* references the outer message port type this port is mapped to. If the referenced port is a mapped port, it shall not contain direct or indirect reference to the *PortTypeId* in the list of its *OuterPortTypes*.
- *InnerInType* references a type that can be received over such a port.
- *OuterInType* references a type that is actually received and which shall be translated to *InnerInType*.
- *InFunction* references a function which shall be used to translate *OuterInType* to *InnerInType*.
- *InnerOutType* references a type that can be sent over such a port.
- *OuterOutType* references a type that is actually sent which has been translated from *InnerOutType*.
- *OutFunction* references a function which shall be used to translate *InnerOutType* to *OuterOutType*.
- *InOutType* references a type that can be sent and received by the port.
- *AddrType* is the address type bound to the port type being defined.
- *OuterAddrType* is the address type into which the *AddrType* is translated.
- *AddrOutFunction* references a function which shall be used to translate the *AddrType* to the *OuterAddrType*.
- *AddrInFunction* references a function which shall be used to translate the *OuterAddrType* to the *AddrType*.
- *VarInstance* is a declaration of a port variable.

5.2.1 Translation capability in port type declaration

If a port type declaration includes translation capability, it shall always contain at least one map or connect clause. These clauses define one or more port types for which translation mechanism is defined.

If a port type is referenced in the map clause, the following applies:

- All types from the **in** message list of the *OuterPortType* shall be referenced either as *InnerInType*, *OuterInType* or *InOutType* in the port type with translation capability.
- All *InOutTypes* shall be present either in the **in** and **out** lists (at the same time) or in the **inout** message list of the *OuterPortType*.
- All *InnerOutTypes* shall be referenced in the out message list of the *OuterPortType* or if such a reference does not exist, the *OuterPortType* shall contain at least one reference to any of the *OuterOutTypes* associated with the *InnerOutType* in its **out** message list.

NOTE 1: If these conditions are met, it is always safe to map TSI ports of *OuterOutType* to instances of the port type with translation capability.

If a port type is referenced in the connect clause, the following applies:

- All types from the out message list of the *OuterPortType* shall be referenced either as *InnerInType*, *OuterInType* or *InOutType* in the port type with translation capability.
- All *InOutTypes* shall be present either in the **in** and **out** lists (at the same time) or in the **inout** message list of the *OuterPortType*.
- All *InnerOutTypes* shall be referenced in the **in** message list of the *OuterPortType* or if such a reference does not exist, the *OuterPortType* shall contain at least one reference to any of the *OuterOutTypes* associated with the *InnerOutType* in its **in** message list.

NOTE 2: If these conditions are met, it is always safe to connect ports with translation capability to ports of *OuterOutType*.

Port types with translation capability can contain variable declarations. These variables are created and initialized when a port instance is created and have the same lifetime as the port instance itself. Every port instance has its own copy of these variables. Port variables can be accessed only from *InFunctions* and *OutFunctions*. They are not visible outside of the translation procedure. The variables can be used e.g. for buffering data between individual calls of *InFunctions* and *OutFunctions* (e.g. in case of fragmented messages).

Restrictions

In addition to the general static rules of TTCN-3 restrictions specified in clause 6.2.9 of ETSI ES 201 873-1 [1], the following restrictions apply:

- a) If the *OuterPortType* is a port type with translation capability, it shall neither directly nor indirectly reference *PortTypeId* in its map or connect clause (i.e. port types with translation capability cannot reference each other).
- b) All *OuterAddrTypes* shall be used as an address type at least in one of the *OuterPortTypes*.
- c) All *InFunction*, *OutFunction* and *AddrFunction* identifiers shall be references to a translation function.

EXAMPLE:

```

type port TransportPort
{
    inout TransportMessage;
}

type port DataPort map to TransportPort
{
    in DataMessage from TransportMessage with transportToData();
    out DataMessage to TransportMessage with dataToTransport();
}

```

5.2.2 Mapping and connecting ports

Ports with translation capability can work in two different modes: normal and translation mode. In normal mode, the port behaves as a standard message port according to the rules specified in ETSI ES 201 873-1 [1]. In translation mode, the port uses rules described in the following clauses of the present document to convert messages and addresses when communicating with linked ports.

The translation mode is activated in these cases:

- A map operation is applied to a component port and TSI port and the component port type contains a reference to the TSI port type in its map clause.
- A port type of one operands of a connect operation contains a reference to the port type of the other operand in its connect clause.

In all other cases, normal mode is activated.

EXAMPLE:

```

type port TransportPort {
  ...
}

type port DataPort map to TransportPort {
  ...
}

type component SystemComponent{
  port DataPort dataPort;
  port TransportPort transportPort;
}

type component TestComponent{
  port DataPort dataPort;
}

testcase TC runs on TestComponent system SystemComponent
{
  if (PX_TRANSPORT_USED){
    // activate translation mode (TransportPort is implicitly referenced via transportPort
    // in the map operation)
    map(mtc:dataPort, system:transportPort);
  }
  else{
    // activate normal mode (TransportPort is not referenced in the map operation)
    map(mtc:dataPort, system:dataPort);
  }
}

```

5.2.3 Translation functions

Translation functions are used by ports working in translation mode for converting incoming and outgoing messages and addresses from one type to another.

Syntactical Structure

```

function FunctionIdentifier("in FormalValuePar ", "out FormalValuePar ")
[port PortTypeId]
StatementBlock

```

Semantic Description

Translation functions have always two parameters. The first one is always an **in** parameter and it is used to pass in a value that shall be translated by the function. The second one is always an **out** parameter and it shall be used to pass the result of the translation to the translation procedure (see clauses 5.2.5, 5.2.6 and 5.2.7) in case of successful translation.

Unlike standard functions described in clause 16.1 of ETSI ES 201 873-1 [1], translation functions can contain a **port** clause. If the port clause is present, all variables defined in the referenced port type become visible in the function body.

Restrictions

- a) Translation functions shall never return a value.

NOTE: The **setstate** operation is used to inform the test system about the success of translation.

- b) Translation functions shall not contain a runs on clause.
- c) Translation function containing a **port** clause can be referenced only in the port type referenced in this port clause.
- d) The type of the **in** parameter of a translation function referenced as an *InFunction* in an **in** clause shall be the *OuterInType* immediately preceding the *InFunction* reference and the type of its **out** parameter shall be the *InnerInType*.
- e) The type of the **in** parameter of a translation function referenced as an *OutFunction* in an **out** clause shall be the *InnerOutType* and the type of its **out** parameter shall be the *OuterOutType* immediately preceding the *OutFunction* reference.
- f) The type of the **in** parameter of a translation function referenced as an *AddrOutFunction* in a port **address** declaration shall be the *AddrType* and the type of its **out** parameter shall be the *OuterAddrType* that immediately precedes the *AddrFunction* reference.
- g) The type of the **in** parameter of a translation function referenced as an *AddrInFunction* in a port **address** declaration shall be the *OuterAddrType* that immediately precedes the *AddrFunction* reference and the type of its **out** parameter shall be the *AddrType*.
- h) Translation functions and any behaviour invoked directly or indirectly from the translation function shall not contain any blocking operations.
- i) Invoking a function with a **port** clause explicitly shall cause an error.
- j) Translation functions and any behaviour invoked directly or indirectly from the translation function shall not contain the following port operations: **start** (port), **stop** (port), **halt**, **connect**, **disconnect**, **map** and **unmap**.
- k) The rules for functions called from special places defined in clause 16.1.4 of ETSI ES 201 873-1 [1] are valid for receiving translation functions (i.e. the functions referenced in the *OutFunction* part of a translation port type definition). The only exception to this rule is the send operation which is allowed in receiving translation functions. When executing the send operation initiated from receiving translation function, the TE temporarily stores sent messages and places them on an outgoing message port after snapshot evaluation is finished.

EXAMPLE:

```

type port DataPort map to TransportPort
{
    in DataMessage from TransportMessage with transportToData();
    out DataMessage to TransportMessage with dataToTransport();
    var octetstring vp_remainings
}

function transportToData(inTransportMessage p_msg, outDataMessage p_res) port DataPort {
    ...
    port.setstate(0, "Translated");
}

function dataToTransport(inDataMessage p_msg, outTransportMessage p_res) port DataPort {
    ...
    port.setstate(0, "Translated");
}

```

5.2.4 Translation state

In addition to port state dimensions defined ETSI ES 201 873-1 [1], all ports working in translation mode have an additional port state dimension called translation state. The translation state always contains the result of the last executed translation function performed by the port.

There are five possible translation states:

- **unset** is the default state before invoking a translation error. If a translation function ends with this state, an error is generated;
- **not translated** means that the translation function has not been successful;
- **fragmented** indicates the translation function did not finish translation, because the input data did not contain a complete message (i.e. more fragments are needed to finish translation);
- **translated** means that the translation function successfully performed translation and there are no non-translated data left;
- **partially translated** is used when the translation function successfully performed translation, but there are additional data which has not been translated yet (i.e. the input data contained more than one message);
- **discarded** is used when the translation function finished successfully, by discarding the message.

Translation state is set implicitly to *unset* whenever a translation function is called to translate a sent or received message. The translation state can be changed by a **setstate** operation.

Syntactical Structure

```
port.setstate("SingleExpression { ", " ( FreeText | TemplateInstance ) } ")
```

Semantic Description

The **setstate** operation can be used only inside a function that is called during a translation procedure to translate a sent or received a message. It changes the translation state of the related port.

The optional parameters allow to provide information that explains the reasons for setting a port translation state. This information is composed to a string and might be used for logging purposes.

Restrictions

- a) The value passed to the **setstate** operation in the first parameter shall be of the **integer** type and shall have one of the following values:
 - 0 (meaning *translated*)
 - 1 (meaning *not translated*)
 - 2 (meaning *fragmented*)
 - 3 (meaning *partially translated*)
 - 4 (meaning *discarded*)

NOTE 1: Numeric parameter values 0, 1 and 2 are the same as results of the predefined **decvalue** function.

NOTE 2: Clause B.2.1 of the present document includes the type definition translation state and the constant definitions TRANSLATED, NOT_TRANSLATED, FRAGMENTED, PARTIALLY_TRANSLATED, DISCARDED.

- b) Calling the **setstate** operation with an **integer** not listed in a) in the first parameter shall lead to an error.
- c) Calling the **setstate** operation outside of a translation function or in a translation function translating an address shall cause a runtime error.
- d) For *FreeText* and *TemplateInstance*, the same rules and restrictions apply as for the parameters of the log statement. See clause 19.11 of ETSI ES 201 873-1 [1] for more details.

NOTE 3: The *unset* state cannot be set by the **setstate** operation, it is reserved for TE internal use only.

5.2.5 Sending

When a message is to be sent over a port, working in translation mode, the following shall apply:

- If no *OutFunction* is specified for the given *InnerOutType*, it is simply sent over the port transparently.
- If an *OutFunction* is specified for the *InnerOutType*, the translation procedure first sets the translation state to *Unset*. Then the *OutFunction* is automatically invoked to translate the *InnerOutType* to the *OuterOutType*. When the function execution is finished, then depending on the current translation state one of the following actions is taken:
 - The *unset* state shall cause an error (i.e. if there is no **setstate** operation is invoked in the translation function).
 - If the state is *not translated*, the translation procedure tries to translate the message using the next *OutFunction* specified for the given *InnerOutType*. *OutFunction*-s are tried according to their textual order in the port type definition. If there is no such a function, an error is generated.
 - If the state is *fragmented*, the translation procedure ends but no data is sent to the connected or mapped port (the port will wait for the next fragment to complete translation). The **to** clause of the following send operation shall be the same as the **to** clause of the current send operation or missing if the current send operation does not contain any to clause.
 - If the state is *translated*, the translation procedure sends the translated message (retrieved from the out parameter of the *OutFunction*) to the port it is mapped or connected to.
 - If the state is *partially translated*, the sent message of the *InnerOutType* contains several messages (or message fragments) of the *OuterOutType*. In this case, the translation procedure sends the translated message to the mapped or connected port. The translation function is then called again, with the same **in** parameter value, to enable sending of the remaining messages.
 - If the state is *discarded*, the translation procedure ends, with no data sent to the connected or mapped port (the message was intentionally discarded).

NOTE: In the *fragmented* case the non-translated part of *InnerOutType* has to be explicitly assigned to port variables.

5.2.6 Receiving

Unlike a port working in standard mode, ports working in translation mode maintain two different queues. The outer queue is used to keep not translated messages that are either enqueued or sent to the port working in translation mode. The inner message queue contains already translated messages. Receiving operations access this inner queue. In case of successful receiving (see clause 22.2.2 of ETSI ES 201 873-1 [1]), the successfully received message is removed from the inner queue. Messages stored in the outer queue can be removed from it only by the translation procedure as described below.

The TTCN-3 Executable (TE, see ETSI ES 201 873-6 [4]) shall control the translation process and the normal decoding algorithm (see note 1) in co-operation, as specified below. But yet, the normal decoding algorithm itself is not changed.

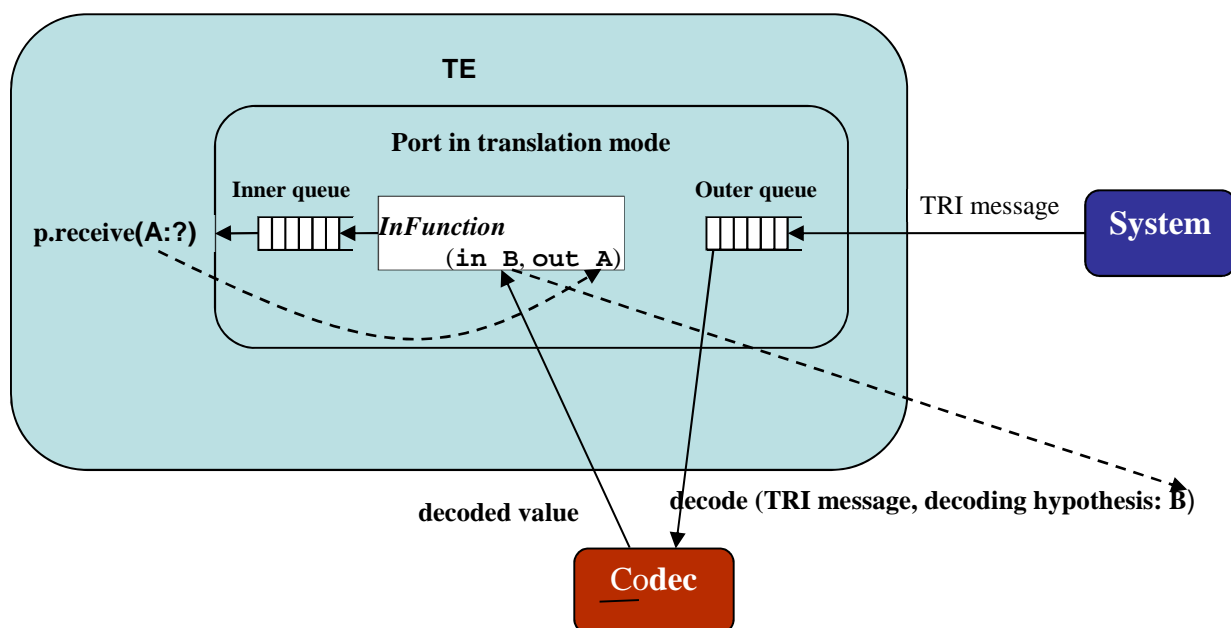

Figure 2: Illustration of the interworking of decoding and translation procedure during receiving

NOTE 1: In this clause the "normal decoding algorithm" refers to the process that the TE invokes decoding the received bitstring as specified in clauses 7.3.2 and C.5.4 of ETSI ES 201 873-6 [4].

The translation procedure for receiving operations is invoked by the snapshot mechanism. This procedure iterates through all **in** clauses (*InnerInType*-s) defined in the port type definition. The **in** clauses are iterated according to their textual order. During this iteration, the following shall apply:

- If no *InFunction* is specified for the given *InnerInType*, the translation procedure checks, if the top item of the outer queue is of *InnerInType* (i.e. invokes the normal decoding algorithm, and the check is successful if the decoding is successful). If the result of the check is positive, the message is moved from the outer queue into the inner queue (i.e. the port will relay the message from the outer port to the inner port transparently) and iteration ends.
- Otherwise (if the *InFunction* is present for the *InnerInType*), then the translation procedure checks if the top item of the outer queue is of the *OuterInType*, by invoking the normal decoding algorithm, as described above. If the check is successful, the translation procedure automatically executes the *InFunction*: first sets the translation state to *Unset* and passes the message of the *OuterInType* to it, in the first parameter. When the function execution is finished, the translation procedure checks the translation state of the port:
 - The *unset* state shall cause an error (i.e. if there is no **setstate** operation is invoked in the translation function).
 - If the state is *not translated*, the iteration shall continue with the next *InFunction* for the same *OuterInType*. If there is no more such *InFunction*, the translation procedure shall continue with the next *OuterInType*. If there is no more *OuterInType*-s for the given *InnerInType*, the iteration process shall continue with the next *InnerInType*. The order is determined by the textual order in the port type definition.
 - If the state is *fragmented*, the top item of the outer queue is removed and the iteration shall be restarted to process the next message in the outer queue. The next message shall have the same address as the current one (including a missing address). If there is no such message, the iteration shall continue with the next *InnerInType*.
 - If the state is *translated*, the top item of the outer queue is removed and the translated message (retrieved from the out parameter of the *InFunction*) is inserted into the inner queue. This ends the whole iteration.

- If the state is *partially translated*, the received message of the *OuterInType* contains several messages (or message fragments) of the *InnerInType*. In this case, the translated message (retrieved from the out parameter of the *InFunction*) is inserted into the inner queue. Unlike in the *translated* case, the top message is not removed from the outer queue. Instead, it is kept in its decoded form in the queue to enable translation of the remaining messages embedded in the outer message in subsequent receive calls.
- If the state is *discarded*, the top item of the outer queue is removed. No new message is inserted into the inner queue. The iteration shall be restarted to process the next message in the outer queue.

NOTE 2: In the *fragmented* case the non-translated part of *OuterInType* has to be explicitly assigned to port variables.

- If the iteration has processed all **in** clauses without any success (no transparently relayed message was successfully moved from the outer to inner queue and all *InFunction* calls ended with the *not translated* state), the iteration process returns.
- In case the iteration produces a successful result, the translation procedure might restart the iteration in order to translate the remaining messages in the outer queue (if there are any), or it might for performance consideration postpone this translation to the moment when the next snapshot is taken. For the same performance reasons, the snapshot mechanism is not required to start the translation procedure in case the inner queue already contains some messages.

5.2.7 Address

When an address type associated with a mapped port working in the translation mode contains a **to** or **from** clause and one of the *OuterAddrType*-s is the same as the address type of the mapped TSI port, the translation procedure is applied to all addresses used by sending or receiving calls of the port.

In case of sending a message, the translation procedure automatically invokes the *AddrOutFunction* passing the address value defined in the **to** clause to it, in its first parameter. In case of receiving a message, the translation procedure automatically invokes the *AddrInFunction* passing the received address value to it, in its first parameter. When the function execution is over, the translation procedure retrieves the translated address from the **out** parameter of the translation function and the control is returned to the calling sending or receiving procedure to finish the operation using the translated address value.

NOTE: Unlike translation functions used for translating sent or received messages, the translation functions for addresses do not use translation states.

EXAMPLE:

```

type port TransportPort
{
    ...
    address TransportAddress;
}

type port DataPort map to TransportPort
{
    ...
    address DataAddress to TransportAddress with toTransportAddress()
    from TransportAddress with fromTransportAddress;
}

function toTransportAddress(DataAddress p_addr, out TransportAddress p_translated) { ... }
function fromTransportAddress(TransportAddress p_addr, out DataAddress p_translated) { ... }

```

5.2.8 Clear, start, stop and halt operation

The **clear** and **start** operations clean messages both from inner and outer message queues. In addition to that, all port variables are reset in the following way: if a variable declaration contains an assignment, the assignment operation will be performed as a part of the clear or start operation restoring the initial value of the variable. Otherwise (if the variable declaration does not contain an assignment part), the value of the variable will be uninitialized after the clear or start operation.

The **halt** operation affects the outer queue only. The translation procedure can still insert translated messages into the inner queue of a halted port, provided that there are available messages in the outer queue.

Since the **stop** port operation requires all communication operations to cease before the port is stopped, all unfinished translation operations shall be completely performed before the working of the port is suspended.

5.2.9 The outer port reference

If the **port** clause of a translation function is present, it is possible to reference the mapped or connected outer port using the **port** keyword.

Semantic Description

The **port** keyword is used in expressions and port operations as a reference to the mapped or connected outer port.

Restrictions

- a) The outer port reference shall be present only in translation functions that contain a **port** clause.
- b) The port type referenced in the **port** clause of the translation function shall contain an *OuterPortType* reference.

NOTE: Translation functions can use only a limited set of port operations (see clause 5.2.3 for more details). These restrictions are valid for the outer port reference as well.

EXAMPLE:

```
// The example shows a way how to support service messages (in this case a simple handshake
// procedure) that are required for correct communication with the target, but not directly
// related to the translated content.

type record HelloMessage {...}
type record DataRequest {...}
type record HelloMessageReply {...}
type record DataReply {...}
type union TransportLayerReply {
  HelloMessageReply helloReply,
  DataReply dataReply
}
type port TransportLayerPort message {
  out HelloMessage, DataRequest;
  in TransportLayerReply;
}

type port DataLayerPort message map to TransportLayerPort {
  in charstring from TransportLayerReply with ft_replyToString();
  out charstring to DataRequest with ft_stringToRequest();
  var ETransportLayerStatus vp_status := handshakeNotStarted;
  var charstring vp_storedMsg;
}

type component MyComp {
  port DataLayerPort p;
}

type component System {
  port TransportLayerPort p;
}

type enumerated ETransportLayerStatus { handshakeNotStarted, handshakeStarted, handshakeDone }

function f_createDataRequest(charstring p_msg) return DataRequest {...}

function f_extractPayloadFromReply (DataReply p_msg) return charstring {...}

function ft_stringToRequest (in charstring p_input, out DataRequest p_output)
port DataLayerPort {
  if (vp_state == handshakeNotStarted) { // handshake required
    port.send(TransportLayerMessageHelloMessage:{...}); // send the handshake message
    vp_state := handshakeStarted; // change the translation port state
    vp_storedMsg := p_input;
    port.setstate(2); // notify the TE that translation hasn't been finished yet
  }
}
```

```

    } else if (vp_state == handshakeDone) {
        // handshake done, transform the input payload to a standard message
        p_output = f_createDataRequest(p_input);
        port.setstate(0);
    } else { // unexpected state: handshake not initialized yet
        port.setstate(1);
    }
}

function ft_replyToString (in TransportLayerReply v_input, out charstring v_output)
port DataLayerPort {
if (vp_state == handshakeStarted) { // handshake reply: finish handshake
    if (ischosen(v_input.helloReply) {
        vp_state := handshakeDone; // change the translation port state
        port.send(f_createDataRequest(vp_storedMsg)); // send the stored data request
        port.setstate(2); // notify the TE that the reply is not ready yet
    } else { // unexpected message
        port.setstate(1);
    }
} else if (vp_state == handshakeDone) { // handshake done; data reply expected
    if (ischosen(v_input.dataReply) {
        v_output := extractPayloadFromReply(v_input.dataReply);
        port.setstate(0); // notify the TE about successful translation
    } else { // unexpected message
        port.setstate(1);
    }
} else { // unexpected state: handshake not initialized yet
    port.setstate(1);
}
}

testcase TC_TEST_01() runs on MyComp system System {
    map(self:p, system:p);
    p.send("Test"); // starts the handshake procedure
    p.receive(charstring:?); // finishes the handshake procedure, then dispatches the request
        // and receives a reply
    p.send("Test"); // dispatches the request (handshake already done)
    p.receive(charstring:?); // receives the reply
}

```

5.3 Parallel Control Components

5.3.0 General

This clause describes an extension of capabilities of control behaviour definitions, allowing coordinated parallel execution of test cases.

The main control function is the control function or control block that is started from outside the test system.

Before the main control function is started, first a main control component (MCC) is implicitly instantiated which will execute the control function behaviour, similar to the MTC in a test case that is implicitly created when a test case is executed.

Inside the behaviour definition being executed by a control component it is allowed to dynamically create additional Parallel Control Components (PCCs) and start them with other control behaviour similar to how a test component inside test case behaviour is allowed to create and start PTCs. All restrictions applying to control behaviour in general apply also to control behaviour executed on PCCs.

PCCs are allowed to execute test cases independently and in parallel with test cases being executed on other PCCs and the MCC.

The restriction that in every configuration there shall be one (and only one) MTC is amended to that in every test case configuration shall be exactly one MTC and no MTC exists inside control behaviour. Additionally, a new restriction is added that in every test system configuration, there shall be exactly one MCC in case that the test system is started by executing a control function.

NOTE 1: The feature of PCCs has multiple possible applications from coordinated parallel execution of independent test cases to co-execution of a test case with its mirror test case simulating the system under test for test case validation.

NOTE 2: Since the test cases are running in parallel in the same test environment, the values for module parameters are the same for all test cases and cannot be configured per test case independently.

At any point in time, every component of the set of currently existing components inside the test system shall have a globally unique id. Each MTC and PTC has a test case local id. The globally unique id of the MTC or any PTC existing in the scope of a running test case are a pairing of the global id of the control component that is executing the test case and the test case local id of the component. So, in parallelly running test cases, a component in one test case might have the same local id as a component in the other test case. In test cases executed sequentially by the same control component, the test case local ids may be the same as in a previous test case executed by the same control component, since these do not exist at the same point in time.

EXAMPLE:

```
testcase T() runs on MtcType system SystemType { ... }
testcase TMirror() runs on MtcMirrorType system SystemMirrorType { ... }
function @control executeT(float maxTime) {
    execute(T(), maxTime);
}
function @control executeTMirror() {
    execute(TMirror());
}
control {
    var PccType mirror := PccType.create;
    var PccType tc := PccType.create;
    mirror.start(executeTMirror());
    tc.start(executeT(200.0));
    alt {
        [] tc.done { mirror.stop }
        [] mirror.done { tc.stop }
    }
}
```

5.3.1 Component Operations

The component operations **create**, **start**, **call**, **stop**, **kill**, **running**, **alive**, **done**, **killed** shall be allowed to be used also in control behaviour with the same semantics and the same restrictions as for test components inside test behaviour with the following differences.

When the MCC terminates, all running PCCs are killed implicitly which will in turn stop all currently executed test cases.

The usages of the **any component** and **all component** operations inside control behaviour reference only the created and started PCCs, not the PTCs that are running inside test cases started on these PCCs. Control behaviour has no way of referencing components created for an executed test case.

The usages of the **any component** and **all component** operations when used inside test case behaviour reference only the set of PTCs started by the behaviours associated with the test case behaviour that is using these operations. One test case cannot reference the components of another test case.

Restrictions

- a) The use of the operations **any component** and **all component** when used inside control behaviour are only allowed inside the control behaviour running on the MCC.

- b) The behaviour definitions used with the **start** or **call** operation when used inside control behaviour shall be control behaviour definitions.

5.3.2 Port Operations

The port operations **map**, **unmap**, **send**, **receive**, **trigger**, **call**, **getcall**, **reply**, **getreply**, **raise**, **catch**, **start**, **halt**, **clear** shall be allowed for the ports of control components with the same semantics and restrictions as for ports of test components.

NOTE: Control components are allowed to communicate with the SUT. This communication is intended to be used for setting up the testing environment and it is not a part of the actual tests.

5.3.3 Alt and Interleave Statements

alt statements and **interleave** statements used in control behaviour shall be allowed to use all port, timer and component operations allowed inside control behaviour. Default alternatives started during control behaviour shall also be allowed to use these operations. The semantics of **alt** statements and **interleave** statements as well as the **activate** and **deactivate** operations are the same as for behaviour executed on a test component.

5.3.4 Test Case Execution

Control components are allowed to use the **execute** operation to execute test cases. The **execute** operation inside PCC behaviour will also block (same as inside MCC behaviour) until either the executed test case has terminated or the given timeout has occurred and test execution has been stopped. Thus, there can still be only at most one test case executed per control component. If a PCC is stopped (explicitly by the MCC or implicitly when the MCC terminates) while executing a test case, test case execution will be stopped before the PCC terminates.

Restrictions

- a) The types of parameters of test cases executed by control behaviour shall be data types.

5.3.5 MTC Reference and Clause

The **mtc** operation inside control behaviour shall reference the MCC. Likewise, the type of the **mtc** clause of control behaviour definitions shall be the type of the MCC and thus mtc compatibility restrictions apply in reference to the MCC inside control behaviour.

5.3.6 Changes to the Test Control Interface TCI

In clause 7.1.1.2 of ETSI ES 201 873-6 [4], table 2 shall be replaced with the following table 2.

Table 2: Correlation between TTCN-3 test case, test component and port operations and TCI operation invocations

TTCN-3 Operation Name	TCI Operation Name	TCI Interface Name
create	tciCreateTestComponentReq	TCI-CH Provided
	tciCreateTestComponent	TCI-CH Required
start (a component)	tciStartTestComponentReq	TCI-CH Provided
	tciStartTestComponent	TCI-CH Required
stop (a component)	tciStopTestComponentReq	TCI-CH Provided
	tciStopTestComponent	TCI-CH Required
kill	tciKillTestComponentReq	TCI-CH Provided
	tciKillTestComponent	TCI-CH Required
connect	tciConnectReq	TCI-CH Provided
	tciConnect	TCI-CH Required
disconnect	tciDisconnectReq	TCI-CH Provided
	tciDisconnect	TCI-CH Required

TTCN-3 Operation Name	TCI Operation Name	TCI Interface Name
map	tciMapReq (see note 1)	TCI-CH Provided
	tciMapParamReq (see note 2)	
	tciMap (see note 1)	TCI-CH Required
	tciMapParam (see note 2)	
unmap	tciUnmapReq (see note 1)	TCI-CH Provided
	tciUnmapParamReq (see note 2)	
	tciUnmap (see note 1)	TCI-CH Required
	tciUnmapParam (see note 2)	
running	tciTestComponentRunningReq	TCI-CH Provided
	tciTestComponentRunning	TCI-CH Required
alive	tciTestComponentAliveReq	TCI-CH Provided
	tciTestComponentAlive	TCI-CH Required
done	tciTestComponentDoneReq	TCI-CH Provided
	tciTestComponentDone	TCI-CH Required
killed	tciTestComponentKilledReq	TCI-CH Provided
	tciTestComponentKilled	TCI-CH Required
mtc	tciGetMTCReq, tciGetParallelMTCReq	TCI-CH Provided
	tciGetMTC, tciGetParallelMTC	TCI-CH Required
execute	tciTestCaseExecuteReq	TCI-CH Provided
	tciTestCaseExecute	TCI-CH Required
NOTE 1: For statement without configuration parameter.		
NOTE 2: For statement with configuration parameter.		

6 Package Semantics

6.0 General

The complete semantics of the using the package in TTCN-3 is defined by copying the following clauses in the following manner into of ETSI ES 201 873-4 [2]: TTCN-3 Operational Semantics.

- Clause 6.1 replaces clause 7 in ETSI ES 201 873-4 [2].
- Clause 6.2 replaces clause 7.1 in ETSI ES 201 873-4 [2].
- Clause 6.3 replaces clause 8.2 in ETSI ES 201 873-4 [2].
- Clause 6.4 replaces clause 8.2.1 in ETSI ES 201 873-4 [2].
- Clause 6.5 is a new clause. It would become clause 8.2.6a in ETSI ES 201 873-4 [2].
- Clause 6.6 replaces clause 8.2.7 in ETSI ES 201 873-4 [2].
- Clause 6.7 replaces clause 8.3.1.0 in ETSI ES 201 873-4 [2].
- Clause 6.8 replaces clause 8.3.1.1 in ETSI ES 201 873-4 [2].
- Clause 6.9 replaces clause 8.3.1a.0 in ETSI ES 201 873-4 [2].
- Clause 6.10 replaces clause 8.3.1a.1 in ETSI ES 201 873-4 [2].
- Clause 6.11 replaces clause 8.3.2.0 in ETSI ES 201 873-4 [2].
- Clause 6.12 replaces clause 8.3.2.1 in ETSI ES 201 873-4 [2].
- Clause 6.13 replaces clause 8.3.3.1 in ETSI ES 201 873-4 [2].
- Clause 6.14 replaces clause 8.3.3.2 in ETSI ES 201 873-4 [2].
- Clause 6.16 replaces clause 8.6.1 in ETSI ES 201 873-4 [2].

- Clause 6.17 replaces clause 8.6.1.1 in ETSI ES 201 873-4 [2].
- Clause 6.18 replaces clause 8.6.1.2 in ETSI ES 201 873-4 [2].
- Clause 6.19 replaces clause 8.6.1.3 in ETSI ES 201 873-4 [2].
- Clause 6.20 replaces clause 8.6.1.4 in ETSI ES 201 873-4 [2].
- Clause 6.21 replaces clause 8.6.2 in ETSI ES 201 873-4 [2].
- Clause 6.22 replaces clause 9.9 in ETSI ES 201 873-4 [2].
- Clause 6.23 is a new clause. It would become clause 9.9a in ETSI ES 201 873-4 [2].
- Clause 6.24 replaces clause 9.10 in ETSI ES 201 873-4 [2].
- Clause 6.25 replaces clause 9.12 in ETSI ES 201 873-4 [2].
- Clause 6.26 replaces clause 9.14.2 in ETSI ES 201 873-4 [2].
- Clause 6.27 replaces clause 9.14.3 in ETSI ES 201 873-4 [2].
- Clause 6.28 replaces clause 9.14.4 in ETSI ES 201 873-4 [2].
- Clause 6.29 replaces clause 9.14.5 in ETSI ES 201 873-4 [2].
- Clause 6.30 replaces clause 9.17 in ETSI ES 201 873-4 [2].
- Clause 6.31 is a new clause. It would become clause 9.17.0 in ETSI ES 201 873-4 [2].
- Clause 6.32 is a new clause. It would become clause 9.17.3 in ETSI ES 201 873-4 [2].
- Clause 6.33 is a new clause. It would become clause 9.17.4 in ETSI ES 201 873-4 [2].
- Clause 6.34 is a new clause. It would become clause 9.17.5 in ETSI ES 201 873-4 [2].
- Clause 6.35 replaces clause 9.22 in ETSI ES 201 873-4 [2].
- Clause 6.36 replaces clause 9.28a in ETSI ES 201 873-4 [2].
- Clause 6.37 replaces clause 9.29a in ETSI ES 201 873-4 [2].
- Clause 6.38 replaces clause 9.29a.1 in ETSI ES 201 873-4 [2].
- Clause 6.39 replaces clause 9.29a.3 in ETSI ES 201 873-4 [2].
- Clause 6.40 replaces clause 9.29b in ETSI ES 201 873-4 [2].
- Clause 6.41 is a new clause. It would become clause 9.29c in ETSI ES 201 873-4 [2].
- Clause 6.42 replaces clause 9.32 in ETSI ES 201 873-4 [2].
- Clause 6.43 replaces clause 9.47 in ETSI ES 201 873-4 [2].
- Clause 6.44 replaces clause 9.49 in ETSI ES 201 873-4 [2].
- Clause 6.45 replaces clause 9.49.1 in ETSI ES 201 873-4 [2].
- Clause 6.46 is a new clause. It would become clause 9.49.4 in ETSI ES 201 873-4 [2].
- Clause 6.47 is a new clause. It would become clause 9.49.5 in ETSI ES 201 873-4 [2].
- Clause 6.48 replaces clause 9.51 in ETSI ES 201 873-4 [2].
- Clause 6.49 replaces clause 9.56.1 in ETSI ES 201 873-4 [2].
- Clause 6.50 replaces clause 9.56.2 in ETSI ES 201 873-4 [2].

- Clause 6.51 replaces clause 9.56.3 in ETSI ES 201 873-4 [2].

6.1 Replacement of short forms

Short forms have to be expanded by the corresponding complete definitions on a textual level before this operational semantics can be used for the explanation of TTCN-3 behaviour.

TTCN-3 short forms are:

- lists of module parameter, constant and variable declarations of the same type and lists of timer declarations;
- stand-alone receiving operations;
- stand-alone altsteps calls;
- **trigger** operations;
- missing **return** and **stop** statements at the end of function, configuration function and test case definitions;
- missing **stop** execution statements;
- **interleave** statements;
- **select-case** statements;
- **break** and **continue** statements;
- **disconnect** and **unmap** operations without parameters; and
- default values of missing actual parameters.

In addition to the handling of short forms, the operational semantics requires a special handling for module parameters, global constants, i.e. constants that are defined in the module definitions part, and pre-processing macros. All references to module parameters, global constants and pre-processing macros shall be replaced by concrete values. This means, it is assumed that the value of module parameters, global constants and pre-processing macros can be determined before the operational semantics becomes relevant.

NOTE 1: The handling of module parameters and global constants in the operational semantics will be different from their handling in a TTCN-3 compiler. The operational semantics describes the meaning of TTCN-3 behaviour and is not a guideline for the implementation of a TTCN-3 compiler.

NOTE 2: The operational semantics handles parameters of and local constants in test components, test cases, functions and module control like variables. The wrong usage of local constants or **in**, **out** and **inout** parameters has to be checked statically.

6.2 Order of replacement steps

The textual replacements of short forms, global constants and module parameters have to be done in the following order:

- 1) replacement of lists of module parameter, constant, variable and timer declarations with individual declarations;
- 2) replacement of global constants and module parameters by concrete values;
- 3) replacement of all **select-case** statements by equivalent nested **if-else** statements;
- 4) embedding stand-alone receiving operations into **alt** statements;
- 5) embedding stand-alone altstep calls into **alt** statements;
- 6) expansion of **interleave** statements;

- 7) replacement of all **trigger** operations by equivalent **receive** operations and **repeat** statements;
- 8) adding **return** at the end of function and configuration function definitions without **return** statement, adding **self.stop** operations at the end of test case definitions without a **stop** statement;
- 9) adding **stop** at the end a module control part without stop statement;
- 10) expansion of **break** statements;
- 11) expansion of **continue** statements;
- 12) adding default parameters to **disconnect** and **unmap** operations without parameters; and
- 13) adding default values of parameters.

NOTE: Without keeping this order of replacement steps, the result of the replacements would not represent the defined behaviour.

6.3 Flow graph representation of TTCN-3 behaviour

The operational semantics assumes that TTCN-3 behaviour descriptions are provided in form of a set of flow graphs, i.e. for each TTCN-3 behaviour description a separate flow graph has to be constructed.

The operational semantics interprets the following kinds of TTCN-3 definitions as behaviour descriptions:

- a) module control;
- b) test case definitions;
- c) function definitions;
- d) altstep definitions;
- e) component type definitions;
- f) configuration functions.

The module control specifies the test campaign, i.e. the execution order (possibly repetitious) of the actual test cases. Test case definitions define the behaviour of the MTC. Functions structure behaviour. They are executed by the module control or by the test components. Altsteps are used for the definition of default behaviour or in a function-like manner to structure behaviour. Component type definitions are assumed to be behaviour descriptions because they specify the creation, declaration and initialization of ports, constants, variables and timers during the creation of an instance of a component type. Configuration functions specify the creation of static test configurations.

6.4 Flow graph construction procedure

The flow graphs presented in the figures 18 to 22 of ETSI ES 201 873-4 [2] and the flow graph segments presented in clause 8 of ETSI ES 201 873-4 [2] are only templates. They include *placeholders* for information that have to be provided in order to produce a concrete flow graph or flow graph segment. The placeholders are marked with "<" and ">" parenthesis.

The construction of a flow graph representation of a TTCN-3 module is done in three steps:

- 1) For each TTCN-3 statement in module control, test cases, altsteps, functions and component type definitions a concrete flow graph segment is constructed.
- 2) For the module control and for each test case, altstep, function, component type and configuration function definition a concrete flow graph (with reference nodes) is constructed.
- 3) In a stepwise procedure all reference nodes in the concrete flow graphs are replaced by corresponding flow graph segment definitions until all flow graphs only include one start node, end nodes and basic flow graph nodes.

NOTE 1: Basic flow graph nodes describe basic indivisible execution units. The operational semantics for TTCN-3 behaviour is based on the interpretation of basic flow graph nodes. Clause 8.6 of ETSI ES 201 873-4 [2] presents execution methods for basic flow graph nodes only.

The replacement of a reference node by the corresponding flow graph segment definition may lead to unconnected parts in a flow graph, i.e. parts which cannot be reached from the start node by traversing through the flow graph along the flow lines. The operational semantics will ignore unconnected parts of a flow graph.

NOTE 2: An unconnected part of a flow graph is a result of the mechanical replacement procedure. For the construction of an optimal flow graph representation the different combinations of TTCN-3 statements also has to be taken into consideration. However, the goal of the present document is to provide a correct and complete semantics, not an optimal flow graph representation.

6.5 Flow graph representation of configuration functions

Schematically, the syntactical structure of a TTCN-3 test case definition is:

```
configuration <identifier> (<parameter>) <testcase-interface> <statement-block>
```

The <testcase-interface> above refers to the (mandatory) **runs on** and the (optional) **system** clauses in the configuration function definition. The flow graph description of a configuration function describes the behaviour of the MTC when establishing a new static configuration. Variables, timers and constants defined and declared in the component type definition are made visible to the MTC behaviour by the **runs on** clause in the <testcase-interface>. The **system** clause is not relevant for the MTC and is therefore not represented in the flow graph representation of a configuration function.

The scheme of the flow graph representation of a configuration function is shown in figure 22a of ETSI ES 201 873-4 [2]. The flow graph name <identifier> refers to the name of the represented configuration function. The nodes of the flow graph have associated comments describing the meaning of the different nodes. The reference node <return-with-value> covers the case where no explicit **return** operation for the MTC is specified, i.e. the operational semantics assumes that a **return** operation is implicitly added. After a successful termination, a configuration function always returns a handle to the newly created static test configuration.

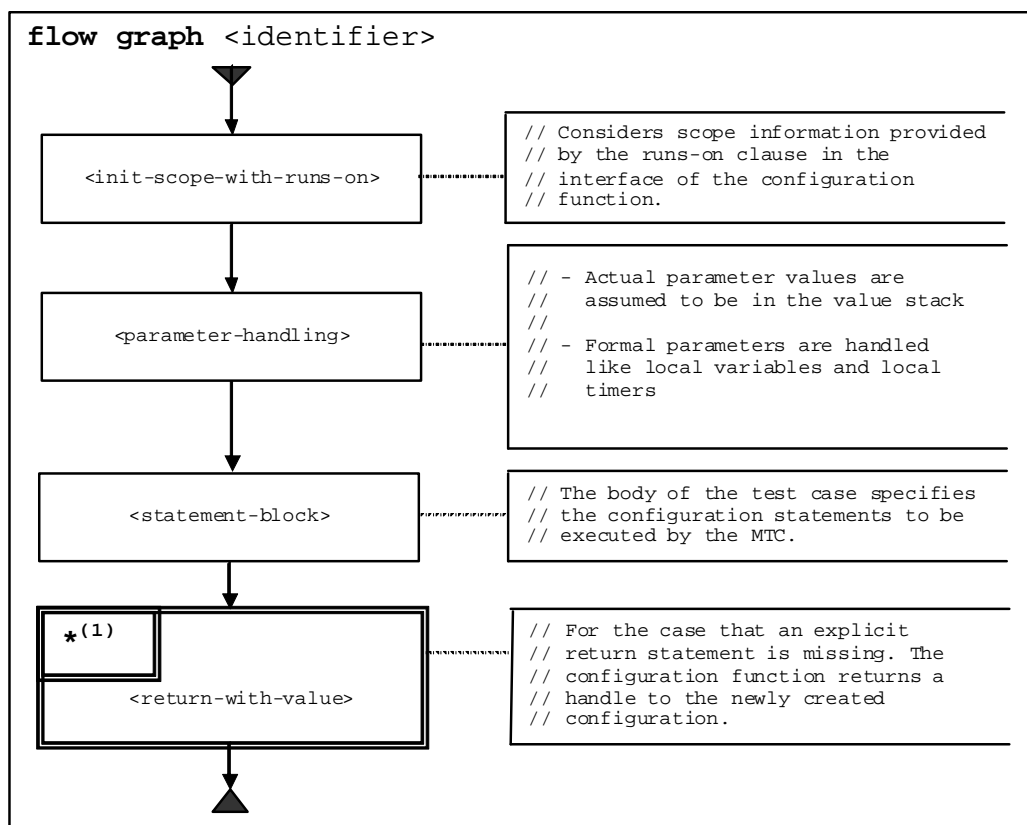

Figure 22a of ETSI ES 201 873-4 [2]: Flow graph representation of configuration functions

6.6 Retrieval of start nodes of flow graphs

For the retrieval of the start node reference of a flow graph the following function is required:

The `GET-FLOW-GRAPH` function: `GET-FLOW-GRAPH (flow-graph-identifier)`

The function returns a reference to the start node of a flow graph with the name *flow-graph-identifier*. The *flow-graph-identifier* refers to the module name for the control, to test case names, to function names, to altstep names to component type names and configuration function names.

6.7 Module state

As shown in figure 23 of ETSI ES 201 873-4 [2] a module state is structured into a CONTROL state and an ALL-CONFIGURATIONS state. The CONTROL state describes the state of the module control. Module control is handled like a test component, i.e. CONTROL is an entity state as defined in ETSI ES 201 873-4 [2], clause 8.3.2. ALL-CONFIGURATIONS is a list of configuration states representing test configurations that are instantiated during the execution of module control.

CONTROL	ALL-CONFIGURATIONS		
	CONFIG ₁	...	CONFIG _n

Figure 23 of ETSI ES 201 873-4 [2]: Structure of a module state

6.8 Accessing the module state

The CONTROL state and the ALL-CONFIGURATIONS state of the module state can be addressed by using their names, i.e. CONTROL and ALL-CONFIGURATIONS. Configurations can be accessed by using the dot notation, e.g. ALL-CONFIGURATIONS.CONFIG₁, or by using the list operations defined in clause 8.3.1.1a of ETSI ES 201 873-4 [2].

6.9 Configuration state

As shown in figure 23a of ETSI ES 201 873-4 [2] the configuration state is structured into ALL-ENTITY-STATES, ALL-PORT-STATES, TC-VERDICT, DONE and KILLED. ALL-ENTITY-STATES represents the states of all instantiated test components during the execution of a test case. The first element of ALL-ENTITY-STATES is the reference to the MTC of the configuration. ALL-PORT-STATES describes the states of the different ports. TC-VERDICT stores the actual global test verdict of a test case, DONE is a list of all currently stopped test components during test case execution and KILLED is a list of all terminated test components during test case execution.

NOTE 1: The number of updates of TC-VERDICT is identical to the number of test components that have terminated.

NOTE 2: An alive-type test component is put into the DONE list each time when it is stopped and removed from the DONE list each time when it is started. It is put into the KILL and the DONE list when it is killed.

NOTE 3: Port states may be considered to be part of the entity states. By **connect** and **map** ports are made visible for other components and therefore, this operational semantics handles ports on the top level of the configuration state.

ALL-ENTITY-STATES			ALL-PORT-STATES			TC-VERDICT	DONE	KILLED
MTC	ES ₁	... ES _n	P ₁	...	P _n			

Figure 23a of ETSI ES 201 873-4 [2]: Structure of a configuration state

6.10 Accessing the configuration state

The TC-VERDICT and the lists ALL-ENTITY-STATES, ALL-PORT-STATES, DONE and KILLED can be accessed like variables by their name and the dot notation, e.g. CONFIG.TC-VERDICT for accessing the test verdict of configuration CONFIG.

For the creation of a new configuration state the function NEW-CONFIGURATION is assumed to be available:

- NEW-CONFIGURATION();

creates a new configuration state and returns its reference. The components of the new configuration state have the following values:

- ALL-ENTITY-STATES is an empty list;
- ALL-PORT-STATES is an empty list;
- TC-VERDICT is set to none;
- DONE is an empty list;
- KILLED is an empty list.

For the handling of lists, e.g. ALL-ENTITY-STATES, ALL-PORT-STATES, DONE and KILLED in module states, the list operations add, append, delete, member, first, last, length, next, random and change can be used. They have the following meaning:

- myList.add(item) adds *item* as first element into the list *myList* and myList.add(sublist) adds the list *sublist* to list *myList*, i.e. add can be used to add single elements or lists to lists;
- myList.append(item) appends *item* as last element into the list *myList* and myList.append(sublist) appends the list *sublist* to list *myList*, i.e. append can be used to append single elements or lists to lists;
- myList.delete(item) deletes *item* from the list *myList*;
- myList.member(item) returns **true** if *item* is an element of the list *myList*, otherwise **false**;
- myList.first() returns the first element of *myList*;
- myList.last() returns the last element of *myList*;
- myList.length() returns the length of *myList*;
- myList.next(item) returns the element that follows *item* in *myList*, or **NULL** if *item* is the last element in *myList*;
- myList.random(<condition>) returns randomly an element of *myList*, which fulfils the Boolean condition *<condition>* or **NULL**, if no element of *myList* fulfils *<condition>*;
- myList.change(<operation>) allows to apply *<operation>* on all elements of *myList*.

NOTE: The operations random and change are not common list operations. They are introduced to explain the meaning of the keywords **all** and **any** in TTCN-3 operations.

Additionally, a general copy operation is available. The copy operation copies and returns an item instead of returning a reference to an item:

- copy(item) returns a copy of *item*.

6.11 Entity states

Entity states are used to describe the actual states of module control and test components. In the module state, CONTROL is an entity state and in the configuration state, the test component states are handled in the list ALL-ENTITY-STATES. The structure of an entity state is shown in figure 24 of ETSI ES 201 873-4 [2].

STATUS
CONTROL-STACK
DEFAULT-LIST
DEFAULT-POINTER
VALUE-STACK
E-VERDICT
TIMER-GUARD
DATA-STATE
TIMER-STATE
PORT-REF
SNAP-ALIVE
SNAP-DONE
SNAP-KILLED
KEEP-ALIVE
STATIC

Figure 24 of ETSI ES 201 873-4 [2]: Structure of an entity state

The *STATUS* describes whether the module control or a test component is **ACTIVE**, **BREAK**, **SNAPSHOT**, **REPEAT** or **BLOCKED**. Module control is blocked during the execution of a test case. Test components are blocked during the creation of other test components, i.e. when they call a **create** operation, and when they wait for being started. The status **SNAPSHOT** indicates that the component is active, but in the evaluation phase of a snapshot. The status **REPEAT** denotes that the component is active and in an **alt** statement that should be re-evaluated due to a **repeat** statement. The **BREAK** status is set when a **break** statement is executed for leaving altstep. In this case, the **alt** statement in which the altstep was directly or indirectly (i.e. by means of the default mechanism) called is immediately left.

The *CONTROL-STACK* is a stack of flow graph node references. The top element in *CONTROL-STACK* is the flow graph node that has to be interpreted next. The stack is required to model function calls in an adequate manner.

The *DEFAULT-LIST* is a list of activated defaults, i.e. it is a list of pointers that refer to the start nodes of activated defaults. The list is in the reverse order of activation, i.e. the default that has been activated first is the last element in the list.

During the execution of the default mechanism, the *DEFAULT-POINTER* refers to the next default that has to be evaluated if the actual default terminates unsuccessfully.

The *VALUE-STACK* is a stack of values of all possible types that allows an intermediate storage of final or intermediate results of operations, functions and statements. For example, the result of the evaluation of an expression or the result of the **mtc** operation will be pushed onto the *VALUE-STACK*. In addition to the values of all data types known in a module, the special value **MARK** to be part of the stack alphabet has been defined. When leaving a scope unit, the **MARK** is used to clean *VALUE-STACK*.

The *E-VERDICT* stores the actual local verdict of a test component. The *E-VERDICT* is ignored if an entity state represents the module control.

The *TIMER-GUARD* represents the special timer, which is necessary to guard the execution time of test cases and the duration of call operations. The *TIMER-GUARD* is modelled as a timer binding (see ETSI ES 201 873-4 [2], clause 8.3.2.4 and figure 28).

The *DATA-STATE* is considered to be a list of lists of variable bindings. The list of lists structure reflects nested scope units due to nested function and altstep calls. Each list in the list of lists of variable bindings describes the variables declared in a certain scope unit and their values. Entering or leaving a scope unit corresponds to adding or deleting a list of variable bindings from the *DATA-STATE*. A description of the *DATA-STATE* part of an entity state can be found in ETSI ES 201 873-4 [2], clause 8.3.2.2.

The TIMER-STATE is considered to be a list of lists of timer bindings. The list of lists structure reflects nested scope units due to nested function and altstep calls. Each list in the list of lists of timer bindings describes the known timers and their status in a certain scope unit. Entering or leaving a scope unit corresponds to adding or deleting a list of timer bindings from the TIMER-STATE. A description of the TIMER-STATE part of an entity state can be found in ETSI ES 201 873-4 [2], clause 8.3.2.4.

The PORT-REF is considered to be a list of lists of port bindings. The list of lists structure reflects nested scope units due to nested function and altstep calls. Nested scope units for ports are the result of port parameters in functions and altsteps. Each list in the list of lists of port bindings identifies the known ports in a certain scope unit. Entering or leaving a scope unit corresponds to adding or deleting a list of port bindings from the PORT-REF. A description of the PORT-REF part of an entity state can be found in ETSI ES 201 873-4 [2], clause 8.3.2.6.

NOTE: The TTCN-3 semantics administrates ports globally in the module state. Due to port parameterization, a test component may access a port by using different names in different scopes. The PORT-REF part of an entity state is used to identify port states uniquely in the module state.

The SNAP-ALIVE supports the snapshot semantics of test components. When a snapshot is taken, a copy of the ALL-ENTITY-STATES list of the module state will be assigned to SNAP-ALIVE, i.e. SNAP-ALIVE includes all entities (test components and test control) which are alive in the test system.

The SNAP-DONE supports the snapshot semantics of test components. When a snapshot is taken, a copy of the DONE list of the module state will be assigned to SNAP-DONE, i.e. SNAP-DONE is a list of component identifiers of stopped components.

The SNAP-KILLED supports the snapshot semantics of test components. When a snapshot is taken, a copy of the KILLED list of the module state will be assigned to SNAP-KILL, i.e. SNAP-DONE is a list of component identifiers of terminated components.

The KEEP-ALIVE field indicates whether the entity can be restarted after its termination or not. It is set to true if the entity can be restarted. Otherwise it is set to false.

The STATIC field indicates whether a test component is part of a static test configuration or not. It is set to **true** if the test component is created during the execution of configuration function. During the execution of a configuration function the STATIC field of the entity representing test control is also set to **true**. In all other cases, the STATIC field is set to **false**.

6.12 Accessing entity states

The STATUS, DEFAULT-POINTER, E-VERDICT and TIMER-GUARD parts of an entity state are handled like variables that are globally visible, i.e. the values of STATUS, DEFAULT-POINTER and E-VERDICT can be retrieved or changed by using the "dot" notation, e.g. *myEntity.STATUS*, *myEntity.DEFAULT-POINTER* and *myEntity.E-VERDICT*, where *myEntity* refers to an entity state.

NOTE: In the following, it is assumed that the "dot" notation by using references and unique identifiers can be used. For example, in *myEntity.STATUS*, *myEntityState* may be pointer to an entity state or be the value of the <identifier> field.

The CONTROL-STACK, DEFAULT-LIST and VALUE-STACK of an entity state *myEntity* can be addressed by using the "dot" notation *myEntity.CONTROL-STACK*, *myEntity.DEFAULT-LIST* and *myEntity.VALUE-STACK*.

CONTROL-STACK and VALUE-STACK can be accessed and manipulated by using the stack operations push, pop, top, clear and clear-until. The stack operations have the following meaning:

- *myStack.push(item)* pushes *item* onto *myStack*;
- *myStack.pop()* pops the top item from *myStack*;
- *myStack.top()* returns the top element of *myStack* or **NULL** if *myStack* is empty;
- *myStack.clear()* clears *myStack*, i.e. pops all items from *myStack*;
- *myStack.clear-until(item)* pops items from *myStack* until *item* is found or *myStack* is empty.

DEFAULT-LIST can be accessed and manipulated by using the list operations add, append, delete, member, first, length, next, random and change. The meaning of these list operations is defined in ETSI ES 201 873-4 [2], clause 8.3.1.1.

For the creation of a new entity state the function NEW-ENTITY is assumed to be available:

- NEW-ENTITY (*flow-graph-node-reference*, *keep-alive*, *static*)

creates a new entity state and returns its reference. The components of the new entity state have the following values:

- STATUS is set to **ACTIVE**;
- *flow-graph-node-reference* is the only (top) element in CONTROL-STACK;
- DEFAULT-LIST is an empty list;
- DEFAULT-POINTER has the value **NULL**;
- VALUE-STACK is an empty stack;
- E-VERDICT is set to **none**;
- TIMER-GUARD is a new timer binding with name **GUARD**, status **IDLE** and no default duration;
- DATA-STATE is an empty list;
- TIMER-STATE is an empty list;
- PORT-REF is an empty list;
- SNAP-ALIVE is an empty list;
- SNAP-DONE is an empty list;
- SNAP-KILLED is an empty list;
- KEEP-ALIVE is set to the value of the *keep-alive* parameter;
- STATIC is set to the value of the *static* parameter.

During the traversal of a flow graph the CONTROL-STACK changes its value often in the same manner: the top element is popped from and the successor node of the popped node is pushed onto CONTROL-STACK. This series of stack operations is encapsulated in the NEXT-CONTROL function:

```
myEntity.NEXT-CONTROL(myBool) {
  successorNode := myEntity.CONTROL-STACK.NEXT(myBool).top();
  myEntity.CONTROL-STACK.pop();
  myEntity.CONTROL-STACK.push(successorNode);
}
```

6.13 Handling of connections among ports

A connection between two test components is made by connecting two of their ports by means of a **connect** operation. Thus, a component can afterwards use its local port name to address the remote queue. As shown in figure 30 of ETSI ES 201 873-4 [2], *connection* is represented in the states of both connected queues by a pair of REMOTE-ENTITY and REMOTE-PORT-NAME. The REMOTE-ENTITY is the unique identifier of the test component that owns the remote port. The REMOTE-PORT-NAME refers to the port name that is used to declare the port in the component type definition of the test component REMOTE-ENTITY. STATIC is a Boolean which is true if connection is a static connection of a static test configuration. TTCN-3 supports one-to-many connections of ports and therefore all connections of a port are organized in a list.

NOTE 1: Connections made by **map** operations are also handled in the list of connections. The **map** operation: **map**(*PTCI:MyPort*, **system.PCOI**) leads to a new (non static) connection (**system**, *PCOI*, **false**) in the port state of *MyPort* owned by *PTCI*. The remote side to which *PCOI* is connected to, resides inside the SUT. Its behaviour is outside the scope of this semantics.

NOTE 2: The operational semantics handles the keyword **system** as a symbolic address. A connection (**system**, *myPort*, **false**) in the list of connections of a port it indicates that the port is mapped onto the port *myPort* in the test system interface. The **false** indicates that the mapping is not static.

REMOTE-ENTITY	REMOTE-PORT-NAME	STATIC
---------------	------------------	--------

Figure 30 of ETSI ES 201 873-4 [2]: Structure of a connection

6.14 Handling of port states

The queue of values in a port state can be accessed and manipulated by using the known queue operations *enqueue*, *dequeue*, *first* and *clear*. Using a *GET-PORT* or a *GET-REMOTE-PORT* function references the queue that shall be accessed.

NOTE 1: The queue operations *enqueue*, *dequeue*, *first* and *clear* have the following meaning:

- *myQueue.enqueue(item)* puts *item* as last item into *myQueue*;
- *myQueue.dequeue()* deletes the first item from *myQueue*;
- *myQueue.first()* returns the first item in *myQueue* or **NULL** if *myQueue* is empty;
- *myQueue.clear()* removes all elements from *myQueue*.

The handling of port states is supported by the following functions:

- a) The *NEW-PORT* function: *NEW-PORT* (*myEntity*, *myPort*)
creates a new port and returns its reference. The *OWNER* entry of the new port is set to *myEntity* and *COMP-PORT-NAME* has the value *myPort*. The status of the new port is **STARTED**. The *CONNECTIONS-LIST* and the *VALUE-QUEUE* are empty. The *SNAP-VALUE* has the value **NULL** (i.e. the input queue of the new port is empty).
 - b) The *GET-PORT* function: *GET-PORT* (*myEntity*, *myPort*)
returns a reference to the port identified by *OWNER myEntity* and *COMP-PORT-NAME myPort*.
 - c) The *GET-REMOTE-PORT* function: *GET-REMOTE-PORT* (*myEntity*, *myPort*, *myRemoteEntity*)
returns the reference to the port that is owned by test component *myRemoteEntity* and connected to a port identified by *OWNER myEntity* and *COMP-PORT-NAME myPort*. The symbolic address **SYSTEM** is returned, if the remote port is mapped onto a port in the test system interface.
- NOTE 2: *GET-REMOTE-PORT* returns **NULL** if there is no remote port or if the remote port cannot be identified uniquely. The special value **NONE** can be used as value for the *myRemoteEntity* parameter if the remote entity is not known or not required, i.e. there exists only a one-to-one connection for this port.
- d) The *STATUS* of a port is handled like a variable. It can be addressed by qualifying *STATUS* with a *GET-PORT* call
GET-PORT(myEntity, myPort).STATUS.
 - e) The *ADD-CON* function: *ADD-CON* (*myEntity*, *myPort*, *myRemoteEntity*, *myRemotePort*, *myStatic*)
adds a connection (*myRemoteEntity*, *myRemotePort*, *myStatic*) to the list of connections of the port identified by *OWNER myEntity* and *COMP-PORT-NAME myPort*.
 - f) The *DEL-CON* function: *DEL-CON* (*myEntity*, *myPort*, *myRemoteEntity*, *myRemotePort*)
removes a connection (*myRemoteEntity*, *myRemotePort*, ?) with any *STATIC* value from the list of connections of the port identified by *OWNER myEntity* and *COMP-PORT-NAME myPort*.

- g) The GET-CON function: GET-CON (myEntity, myPort, myRemoteEntity, myRemotePort)

retrieves a connection (*myRemoteEntity*, *myRemotePort*, ?) with any STATIC value from the list of connections of the port identified by OWNER *myEntity* and COMP-PORT-NAME *myPort*.

- h) The SNAP-PORTS function: SNAP-PORTS (myEntity)

updates SNAP-VALUE for all ports owned by *myEntity*, i.e.

```

SNAP-PORTS (myEntity) {
  for all ports p /* in the module state */ {
    if (p.OWNER == myEntity) {
      if (p.STATUS == STOPPED) {
        p.SNAP-VALUE := NULL;
      }
      else {
        if (p.STATUS == HALTED && p.first() == HALT-MARKER) {
          // Port is halted and halt marker is reached
          p.SNAP-VALUE := NULL;
          p.dequeue(); // Removal of halt marker
          p.STATUS := STOPPED;
        }
        else {
          p.SNAP-VALUE := p.first()
        }
      }
    }
  }
}

```

NOTE 3: The SNAP-PORTS function handles the **HALT-MARKER** that may be put by a **halt** port operation into the port queue. If such a marker is found, the marker is removed, the SNAP-VALUE of the port is set to **NULL** and the status of the port is changed to **STOPPED**.

6.15 Void

6.16 Evaluation phases, general

The evaluation procedure for a TTCN-3 module is structured into:

- 1) initialization phase;
- 2) update phase;
- 3) selection phase; and
- 4) execution phase.

The phases (2), (3) and (4) are repeated until module control terminates. The evaluation procedure is described by means of a mixture of informal text and pseudo-code.

6.17 Phase I: Initialization

The initialization phase includes the following actions:

- a) **Declaration and initialization of global variables:**

- INIT-FLOW-GRAPHS(); // Initialization of flow graph handling. INIT-FLOW-GRAPHS is // explained in ETSI ES 201 873-4 [2], clause 8.6.2.
- Entity := **NULL**; // Entity will be used to refer to an entity state. An entity state either // represents module control or a test component.
- MTC := **NULL**; // MTC will be used to refer to the entity state of the main test component of // a test case during test case execution.

NOTE 1: The global variable CONTROL form the control state of a module state during the interpretation of a TTCN-3 module (see ETSI ES 201 873-4 [2], clause 8.3.1).

- CONTROL := NULL; // CONTROL will be used to refer to the entity state of module control a;

NOTE 2: The global variable CONFIGURATION is used to store the reference to a configuration state in the Module state, i.e. a member of ALL-CONFIGURATIONS (see ETSI ES 201 873-4 [2], clause 8.3.1).

- CONFIGURATION := NULL;

NOTE 3: The following global variables ALL-ENTITY-STATES, ALL-PORT-STATES, TC-VERDICT, DONE, and KILLED are used to store references to a test configuration state of a module state during the interpretation of a TTCN-3 module (see ETSI ES 201 873-4 [2], clause 8.3.1).

- ALL-ENTITY-STATES := NULL;
- ALL-PORT-STATES := NULL;
- TC-VERDICT := none;
- DONE := NULL;
- KILLED := NULL.

b) **Creation and initialization of module control:**

- CONTROL := NEW-ENTITY (GET-FLOW-GRAPH (<moduleId>), **false**, **false**);
// A new entity state is created and initialized with the start node of
// the flow graph representing the behaviour of the control of the
// module with the name <moduleId>. The Boolean parameters
// indicate that module control cannot be restarted after it is
// stopped and that it is not a static component in a test configuration.
- CONTROL.INIT-VAR-SCOPE(); // New variable scope.
- CONTROL.VALUE-STACK.push(**MARK**); // A mark is pushed onto the value stack.

6.18 Phase II: Update

The update phase is related to all actions that are outside the scope of the operational semantics but influence the interpretation of a TTCN-3 module. The update phase comprises the following actions:

- a) **Time progress:** All running timers are updated, i.e. the TIME-LEFT values of running timers are (possibly) decreased, and if due to the update a timer expires, the corresponding timer bindings are updated, i.e. TIME-LEFT is set to 0.0 and STATUS is set to **TIMEOUT**.

NOTE 1: The update of timers includes the update of all running TIMER-GUARD timers in module states. TIMER-GUARD timers are used to guard the execution of test cases and call operations.

- b) **Behaviour of the SUT:** Messages, remote procedure calls, replies to remote procedure calls and exceptions (possibly) received from the SUT are put into the port queues at which the corresponding receptions shall take place.

NOTE 2: This operational semantics makes no assumptions about time progress and the behaviour of the SUT.

6.19 Phase III: Selection

The selection phase consists of the following two actions:

- a) **Selection:** Select a non-blocked entity, i.e. an entity that has not the STATUS value **BLOCKED**. The entity may be CONTROL, i.e. module control, or a test component in a test configuration that is executing a test case.

b) **Storage:**

- Store the identifier of the selected entity in the global variable *Entity*.
- If *Entity* is *CONTROL*, set *CONFIGURATION* to **NULL**.
- If *Entity* is not *CONTROL*, store the identifier of the configuration of which *Entity* is part of in the global variable *CONFIGURATION* and do the following assignments:
 - *ALL-ENTITY-STATES* := *CONFIGURATION.ALL-ENTITY-STATES*;
 - *MTC* := *CONFIGURATION.ALL-ENTITY-STATES.first()*;
 - *ALL-PORT-STATES* := *CONFIGURATION.ALL-PORT-STATES*;
 - *TC-VERDICT* := *CONFIGURATION.TC-VERDICT*;
 - *DONE* := *CONFIGURATION.DONE*;
 - *KILLED* := *CONFIGURATION.KILLED*.

6.20 Phase IV: Execution

The execution phase consists of the following three actions:

- a) **Execution step of the selected entity:** Execute the top flow graph node in the *CONTROL-STACK* of *Entity*.
- b) **Update of the module state:** This includes an update of the configuration state of the executed *Entity*.
- c) **Check termination criterion:** Stop execution if module control has terminated, i.e. *CONTROL* is **NULL**. Otherwise continue with Phase II.

6.21 Global functions

The evaluation procedure uses the global function *INIT-FLOW-GRAPHS*:

- a) *INIT-FLOW-GRAPHS* is assumed to be the function that initializes the flow graph handling. The handling may include the creation of the flow graphs and the handling of the pointers to the flow graphs and flow graph nodes.

The pseudo-code used in the present document to describe execution of flow graph nodes use the functions *CONTINUE-COMPONENT*, *RETURN*, *****DYNAMIC-ERROR*****:

- b) *CONTINUE-COMPONENT* the actual test component continues its execution with the node lying on top of the control stack, i.e. the control is not given back to the module evaluation procedure described in this clause.
- c) *RETURN* returns the control back to the module evaluation procedure described in this clause. The *RETURN* is the last action of the "*execution step of the selected entity*" of the *execution* phase.
- d) *****DYNAMIC-ERROR***** refers to the occurrence of a dynamic error. The error handling procedure itself is outside the scope of the operational semantics. If a dynamic error occurs all following behaviour of the test case is meant to be undefined. In this case resources allocated to the test case shall be cleared and the **error** verdict is assigned to the test case. Control is given to the statement in the control part following the execute statement in which the error occurred. This is modelled by the flow graph segment <dynamic-error> (see ETSI ES 201 873-4 [2], clause 9.18.5).

NOTE: The occurrence of a dynamic error is related to test behaviour. A dynamic error as specified by the operational semantics denotes a problem in the usage of TTCN-3, e.g. wrong usage or race condition.

- e) *APPLY-OPERATOR* used as generic function for describing the evaluation of operators (e.g. +, *, / or -) in expressions (see ETSI ES 201 873-4 [2], clause 9.18.4).

6.22 Clear port operation

The syntactical structure of the **clear** port operation is:

```
<portId>.clear
```

The flow graph segment <clear-port-op> in figure 59 of ETSI ES 201 873-4 [2] defines the execution of the **clear** port operation.

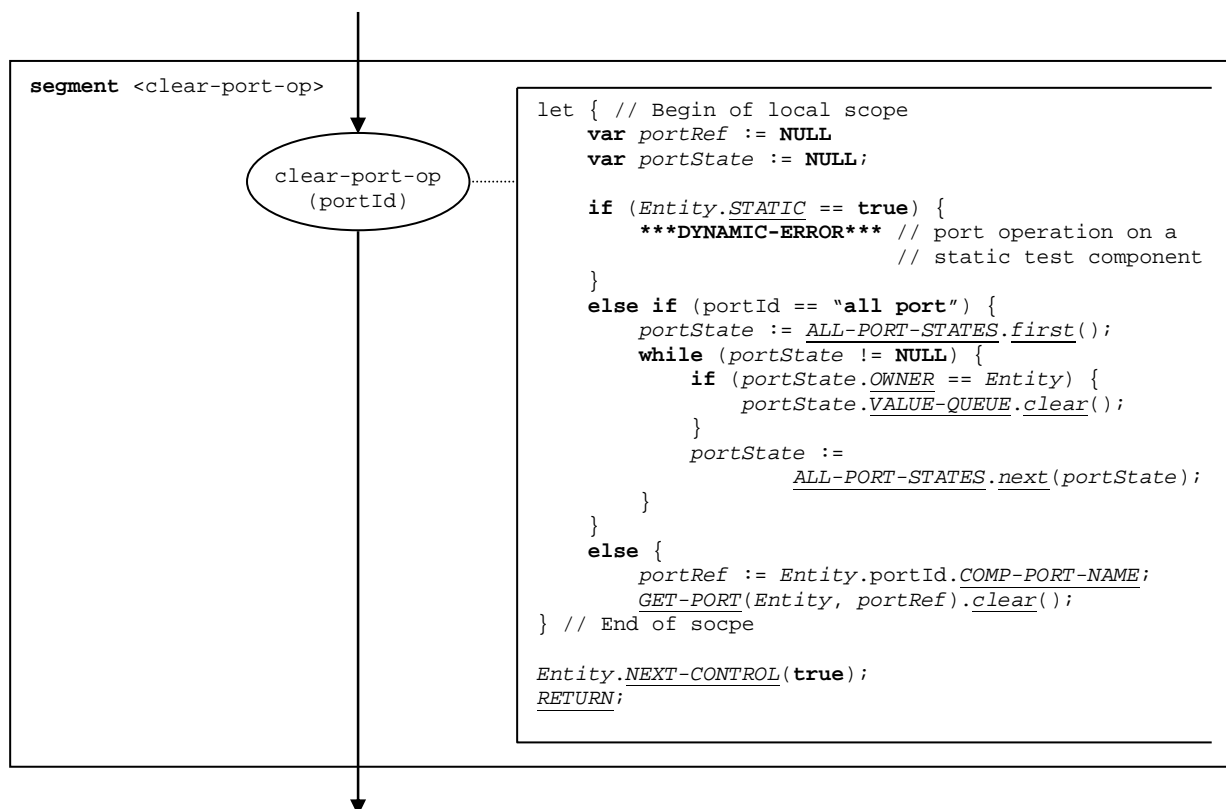

Figure 59 of ETSI ES 201 873-4 [2]: Flow graph segment <clear-port-op>

6.23 Configuration function call

The invocation of a configuration function starts with the creation of the MTC. In a static test configuration the MTC is modelled as a static alive component. Then the MTC is started with the behaviour defined in the configuration function. Afterwards, the module control waits until the configuration function terminates. The creation and the start of the MTC can be described by using **create** and **start** statements:

```
var mtcType MyMTC := mtcType.create alive static;
MyMTC.start(ConfigurationFunctionName(P1...Pn));
```

The flow graph segment <config-func-call> in figure 59a of ETSI ES 201 873-4 [2] defines the execution of a configuration function by using the flow graph segments of the operations **create** and the **start**.

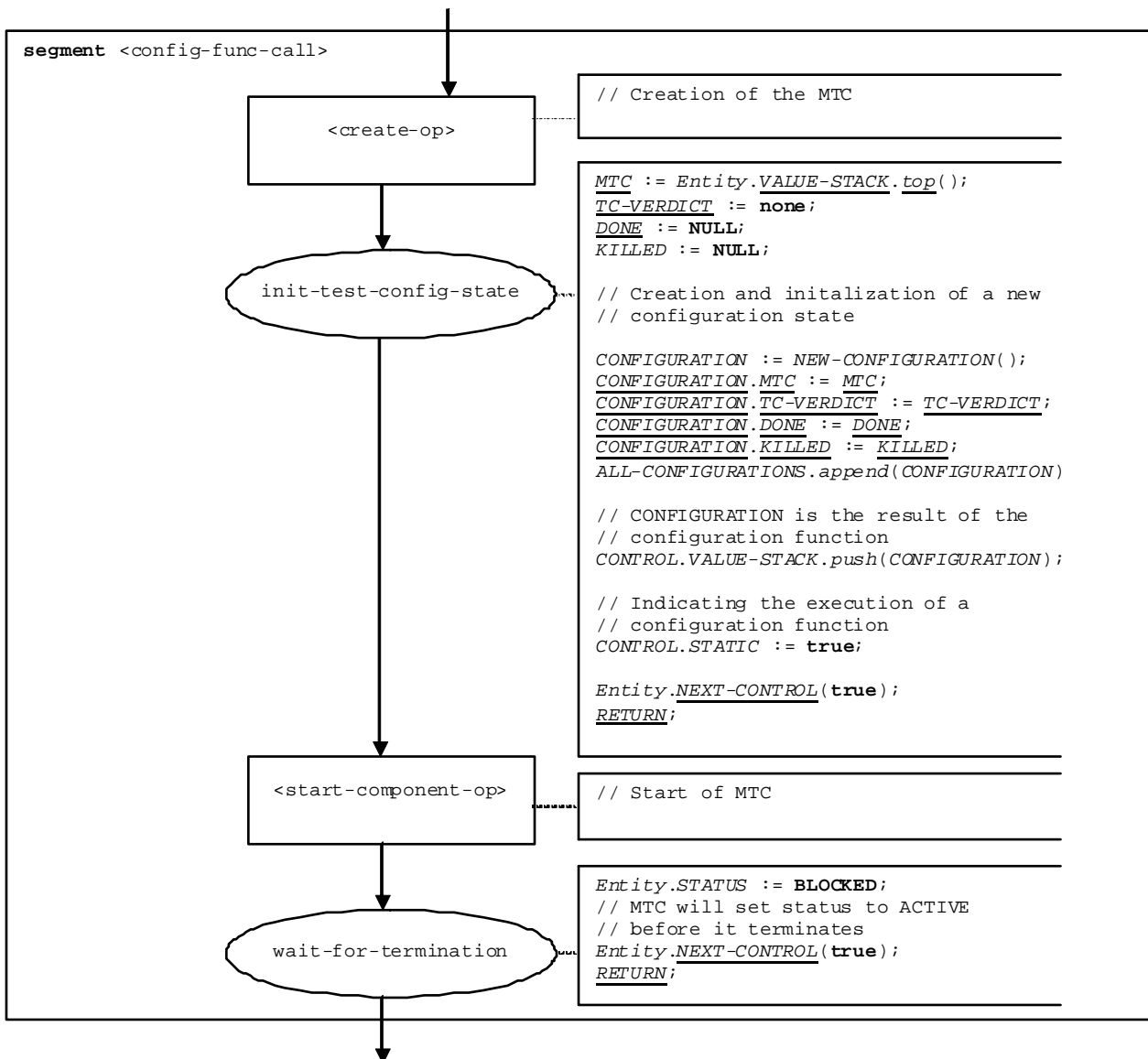

Figure 59a of ETSI ES 201 873-4 [2]: Flow graph segment <config-func-call>

6.24 Connect operation

The syntactical structure of the **connect** operation is:

```
connect(<component-expression1>:<portId1>, <component-expression2>:<portId2>) [static]
```

The identifiers <portId1> and <portId2> are considered to be port identifiers of the corresponding test components. The components to which the ports belong are referenced by means of the component references <component-expression₁> and <component-expression₂>. The references may be stored in variables or is returned by a function, i.e. are expressions, which evaluate to component references. The value stack is used for storing the component references.

A present **static** clause indicates that the new connection is static, i.e. established during the execution of a configuration function. Presence and absence of the **static** clause is handled as a Boolean flag in the operational semantics (see *static* parameter of the basic flow graph node *connect-op* in figure 60 of ETSI ES 201 873-4 [2]).

The execution of the **connect** operation is defined by the flow graph segment <connect-op> shown in figure 60 of ETSI ES 201 873-4 [2]. In the flow graph description the first expression to be evaluated refers to <component-expression₁> and the second expression to <component-expression₂>, i.e. the <component-expression₂> is on top of the value stack when the *connect-op* node is executed.

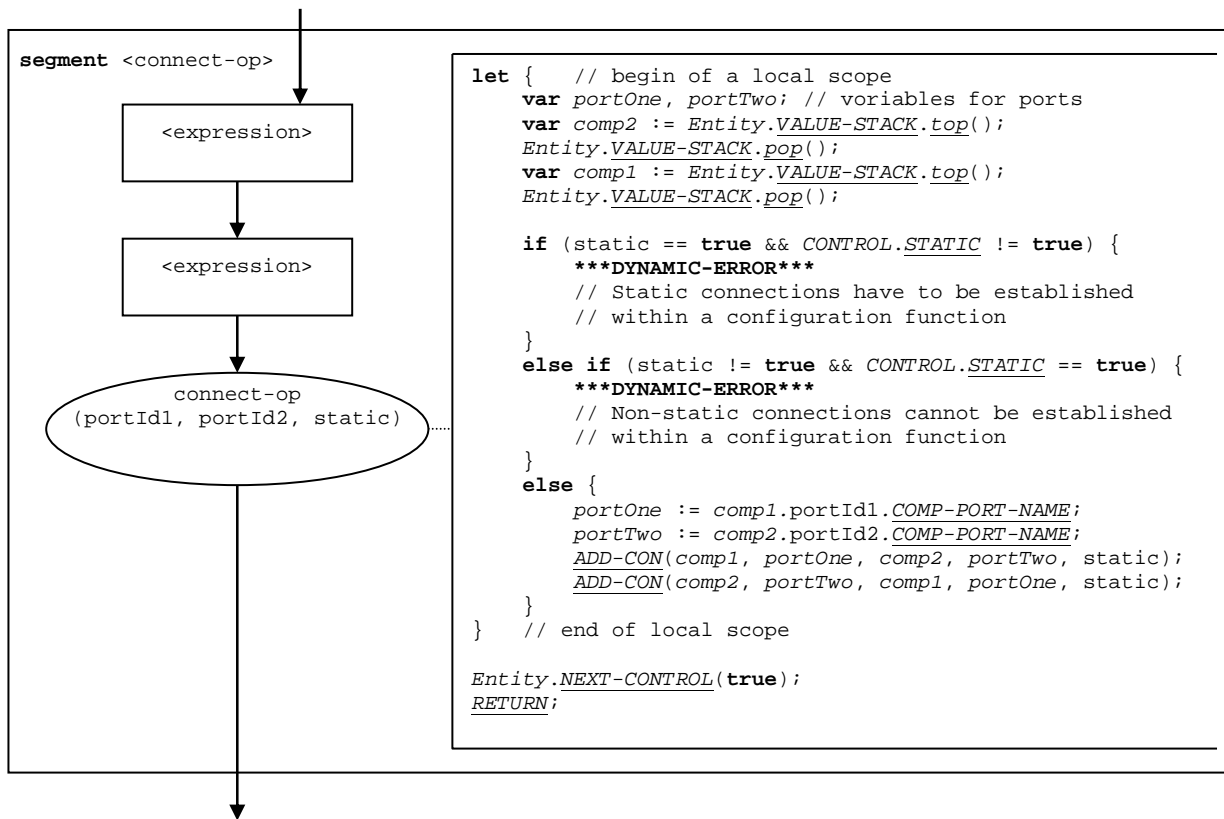

Figure 60 of ETSI ES 201 873-4 [2]: Flow graph segment <connect-op>

6.25 Create operation

The syntactical structure of the **create** operation is:

```
<componentTypeId>.create [alive] [static]
```

A present **alive** clause indicates that the created component can be restarted after it has been stopped. Presence and absence of the alive clause is handled as a Boolean flag in the operational semantics (see `alive` parameter of the basic flow graph node `create-op` in figure 62 of ETSI ES 201 873-4 [2]).

A present **static** clause indicates that the new component is static, i.e. part of a static test configuration and created during the execution of a configuration function. Presence and absence of the **static** clause is handled as a Boolean flag in the operational semantics (see `static` parameter of the basic flow graph node `create-op` in figure 62 of ETSI ES 201 873-4 [2]).

The flow graph segment <create-op> in figure 62 of ETSI ES 201 873-4 [2] defines the execution of the **create** operation.

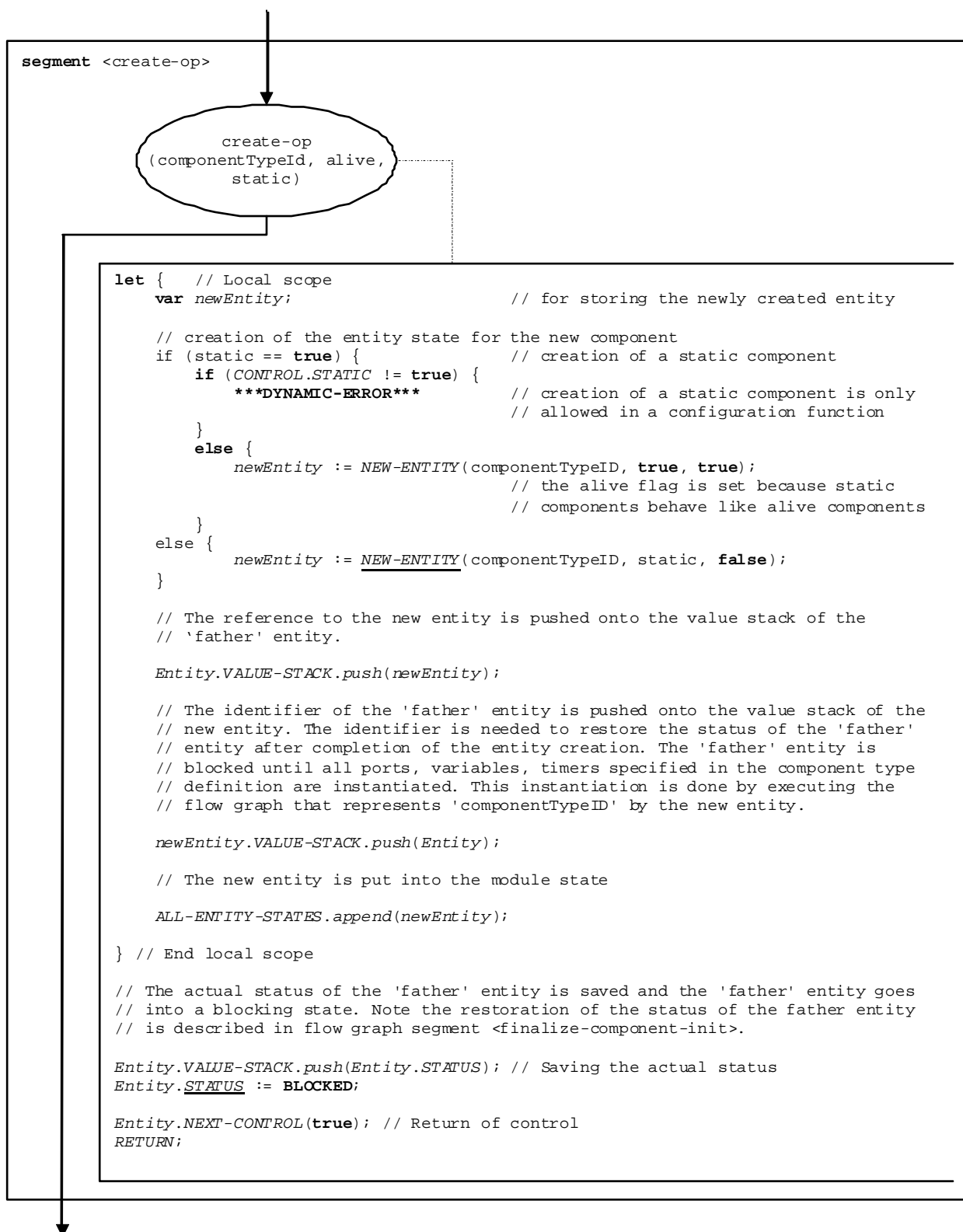

Figure 62 of ETSI ES 201 873-4 [2]: Flow graph segment <create-op>

6.26 Flow graph segment <disconnect-all>

The flow graph segment <disconnect-all> defines the disconnection of all components at all connected ports. Static connections will not be disconnected. Their lifetime is bound to the lifetime of the static test configuration.

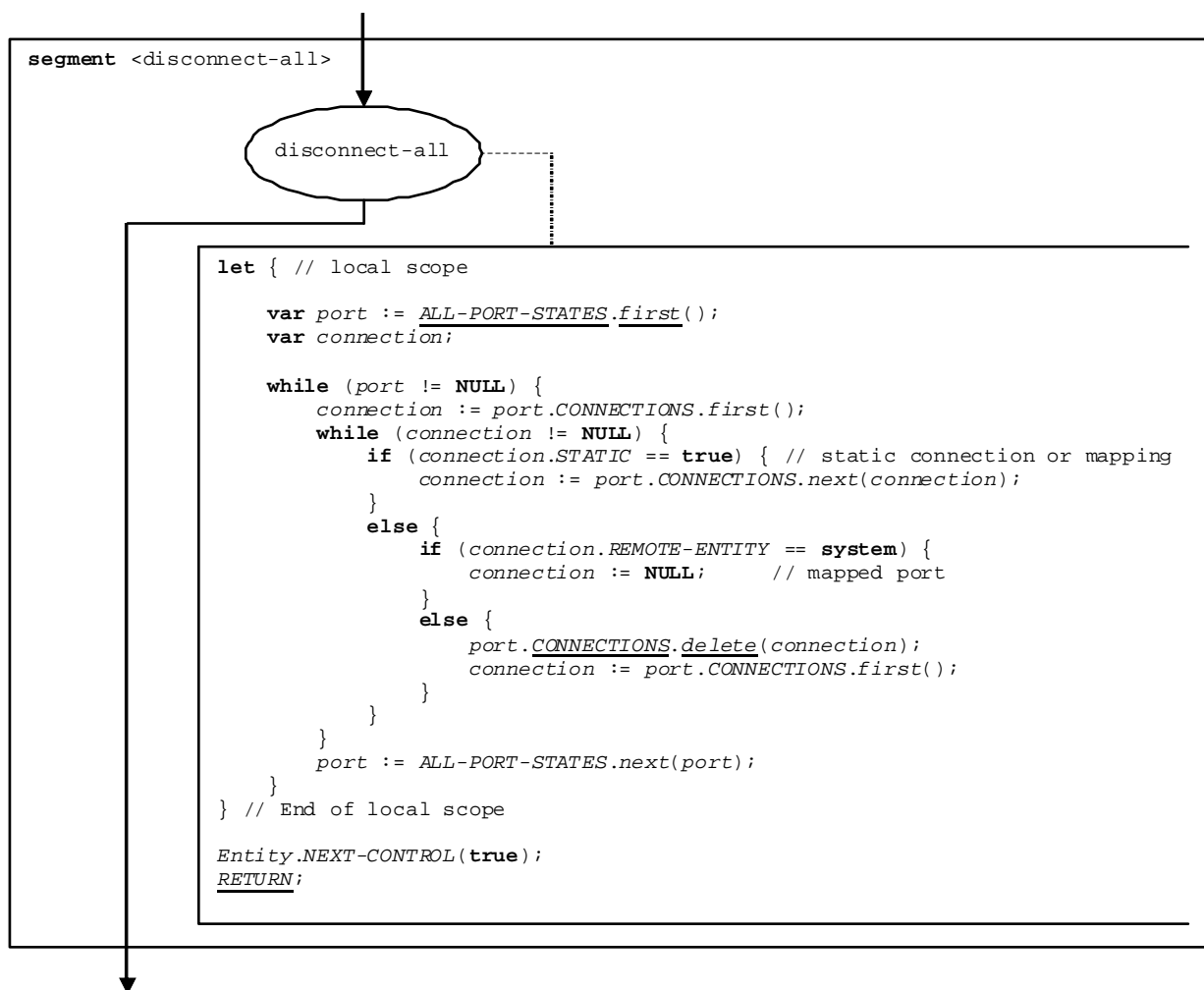

Figure 64b of ETSI ES 201 873-4 [2]: Flow graph segment <disconnect-all>

6.27 Flow graph segment <disconnect-comp>

The flow graph segment <disconnect-comp> defines the disconnection of all ports of a specified component. Static connections will not be disconnected. Their lifetime is bound to the lifetime of the static test configuration.

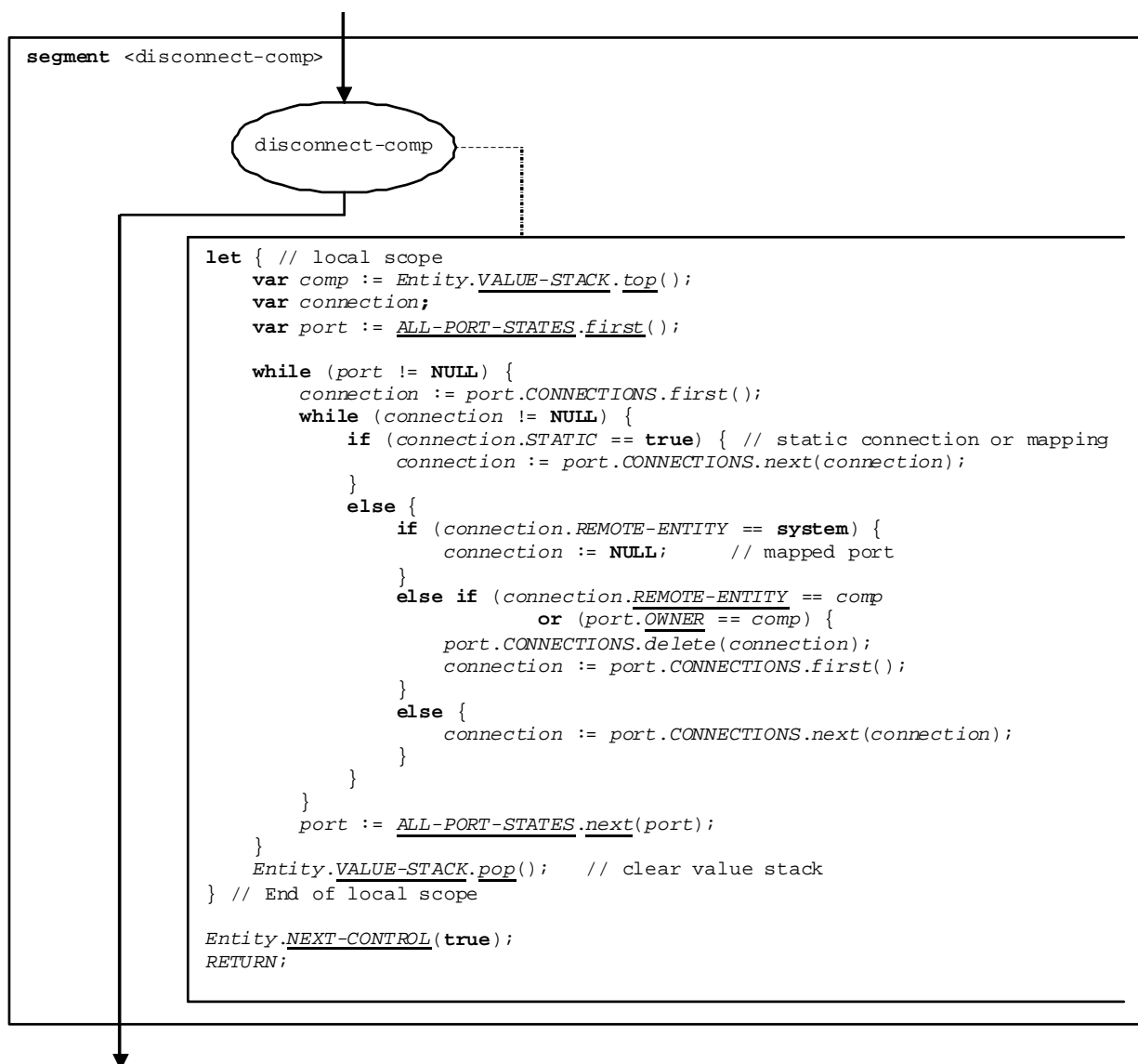

Figure 64c of ETSI ES 201 873-4 [2]: Flow graph segment <disconnect-comp>

6.28 Flow graph segment <disconnect-port>

The flow graph segment <disconnect-port> defines the disconnection of a specified port. Static connections will not be disconnected. Their lifetime is bound to the lifetime of the static test configuration.

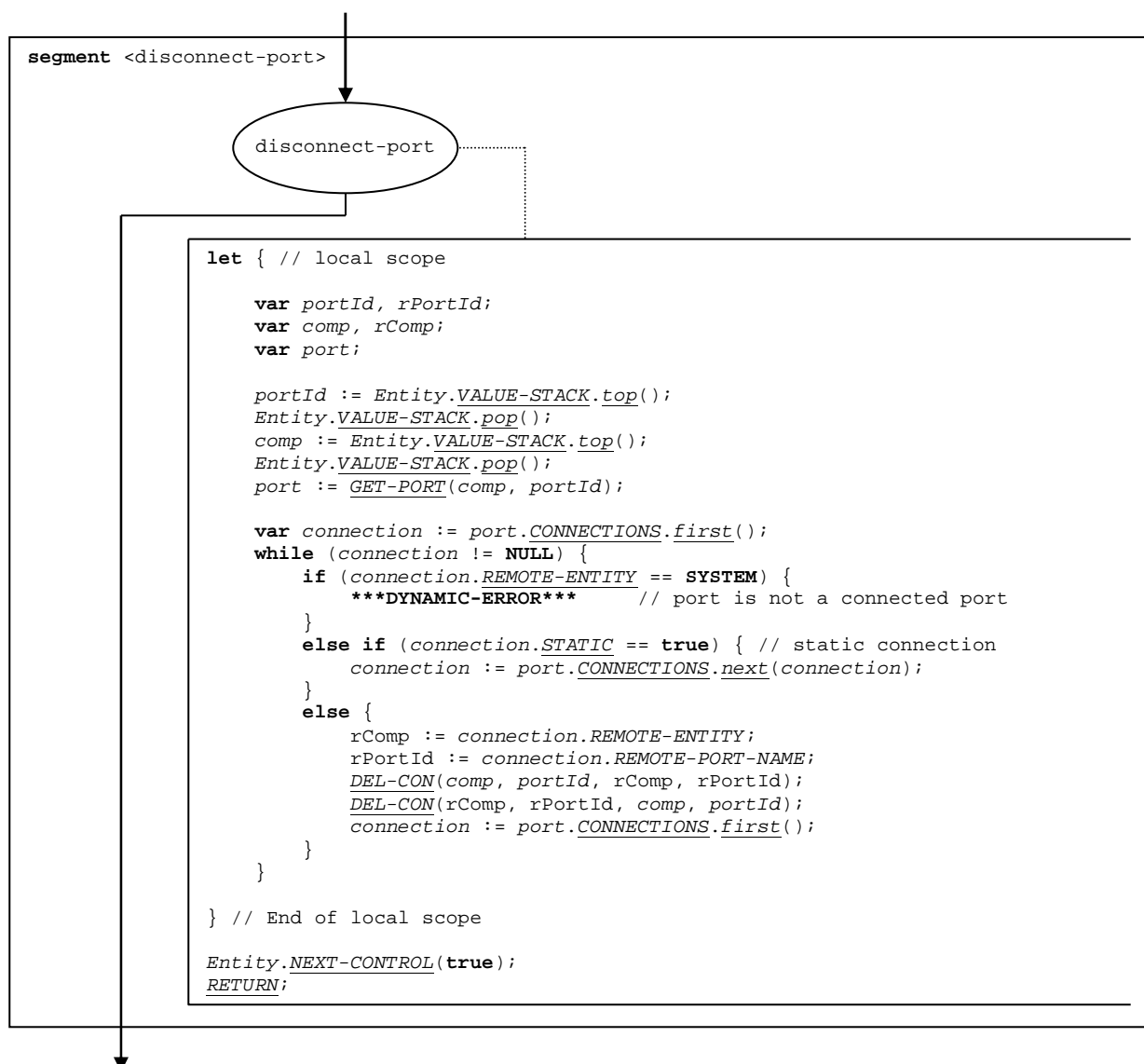

Figure 64d of ETSI ES 201 873-4 [2]: Flow graph segment <disconnect-port>

6.29 Flow graph segment <disconnect-two-par-pairs>

The flow graph segment <disconnect-two-par-pairs> shown in figure 64e of ETSI ES 201 873-4 [2] defines the execution of the **disconnect** operation with two parameter pairs which disconnects specific connections. In the flow graph segment the first expression to be evaluated refers to <component-expression₁> (see syntactical structure of the **disconnect** operation in ETSI ES 201 873-4 [2], clause 9.14) and the second expression to <component-expression₂>, i.e. the <component-expression₂> is on top of the value stack when the **disconnect-two** node is executed. Applying the **disconnect** operation to a static connection leads to a dynamic error.

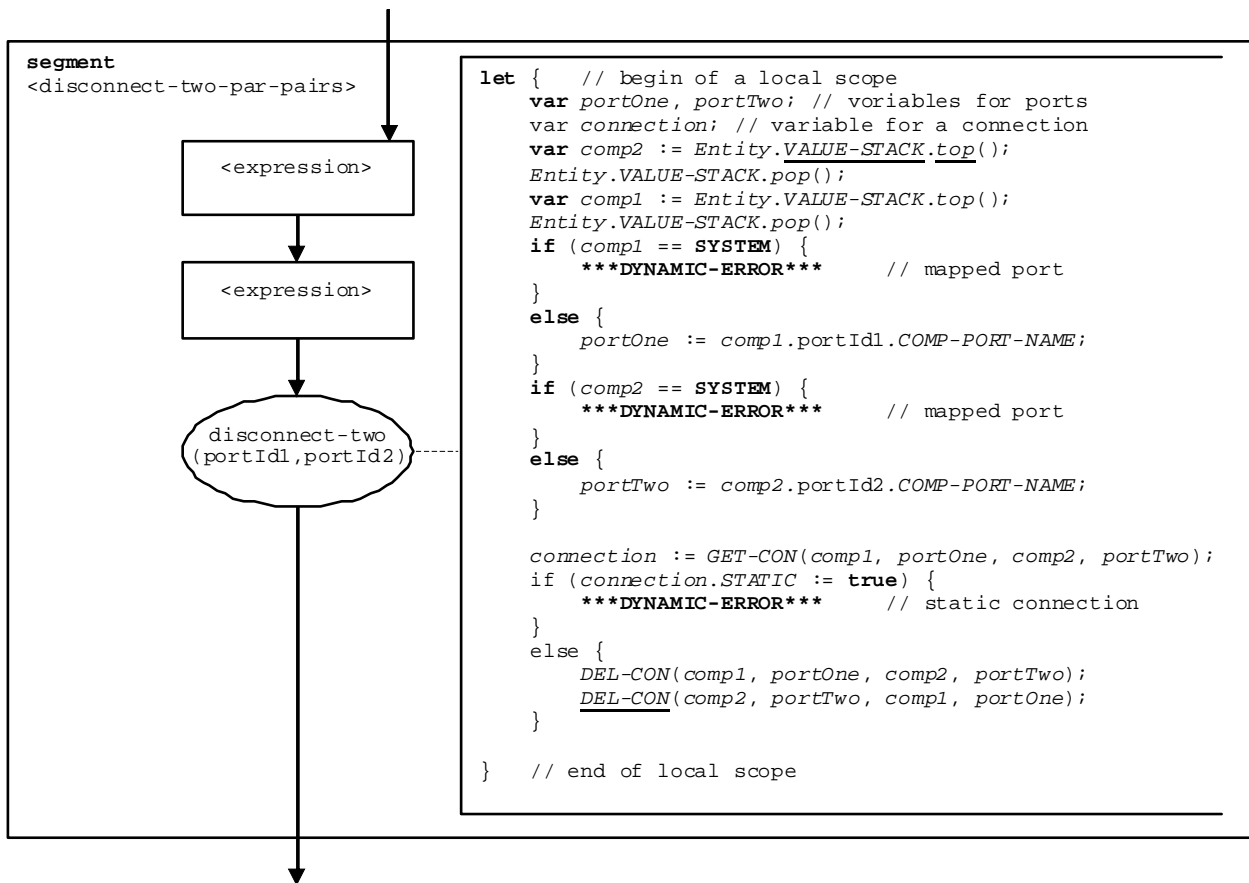

Figure 64e of ETSI ES 201 873-4 [2]: Flow graph segment <disconnect-two-par-pairs>

6.30 Execute statement

The syntactical structure of the **execute** statement is:

```
execute(<testCaseId>([<act-par1>, ... , <act-parn>])) [, <float-expression>] [, <config-expression>])
```

The **execute** statement describes the execution of a test case <testCaseId> with the (optional) actual parameters <act-par₁>, ... , <act-par_n>. Optionally the execute statement may be guarded by a duration provided in form of an expression that evaluates to a **float**. If within the specified duration the test case does not return a verdict, a timeout exception occurs, the test configuration is destroyed and an **error** verdict is returned.

If a test case is executed on an existing static test configuration, the configuration shall be provided in form on an expression that evaluates to a configuration reference.

If no timeout exception occurs, the MTC is created or started, the control instance (representing the control part of the TTCN-3 module) is blocked until the test case terminates, and for the further test case execution the flow of control is given to the MTC. The flow of control is given back to the control instance when the MTC stops its execution.

The flow graph segment <execute-stmt> in figure 67 of ETSI ES 201 873-4 [2] defines the execution of an **execute** statement. The operational semantics distinguishes the cases where a test case is executed on an existing static test configuration and where not.

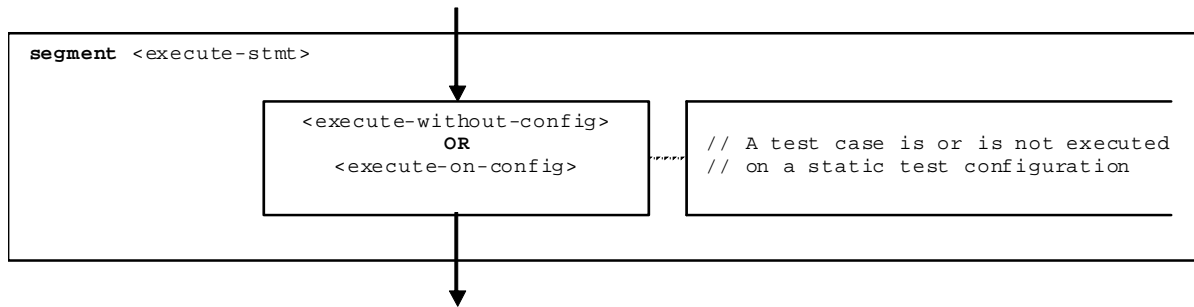

Figure 67 of ETSI ES 201 873-4 [2]: Flow graph segment `<execute-stmt>`

6.31 Flow graph segment `<execute-without-config>`

The flow graph segment `<execute-without-config>` in figure 67a of ETSI ES 201 873-4 [2] distinguishes between the case where the execution is guarded by a timeout and the case where the statement is not guarded.

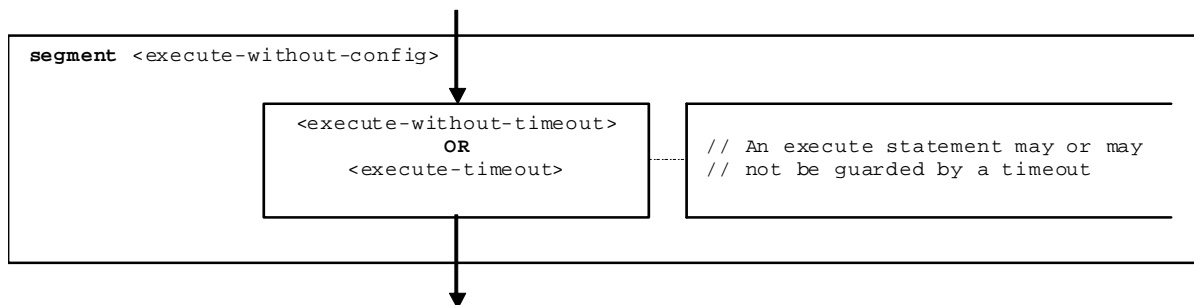

Figure 67a of ETSI ES 201 873-4 [2]: Flow graph segment `<execute-stmt>`

6.32 Flow graph segment `<execute-on-config>`

The flow graph segment `<execute-on-config>` in figure 69a of ETSI ES 201 873-4 [2] distinguishes between the case where the execution of a test case on a configuration is guarded by a timeout and the case where the execution is not guarded.

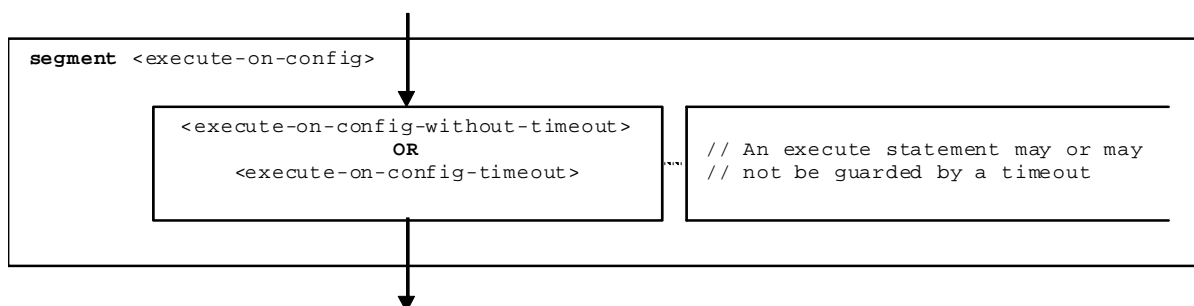

Figure 69a of ETSI ES 201 873-4 [2]: Flow graph segment `<execute-on-config>`

6.33 Flow graph segment `<execute-on-config-without-timeout>`

Executing a test case on a static configuration means to start the behaviour of the test case on the MTC of the test configuration, i.e. `MyMTC.start(TestCaseName(P1...Pn))`.

- In addition the following parts of the configuration state have to be reset to the following values:
 - the global test case verdict and all local component verdicts are set to **none**;
 - the local default lists of all components of the test configuration are emptied;

- the global lists DONE and KILLED are emptied. These lists are used for storing the test components that stopped their execution or have been killed during test execution.

The flow graph segment <execute-on-config-without-timeout> in figure 69b of ETSI ES 201 873-4 [2] specifies the execution of a test case on a static configuration where the execution is not guarded by a timer. It makes use of the **start** component operation.

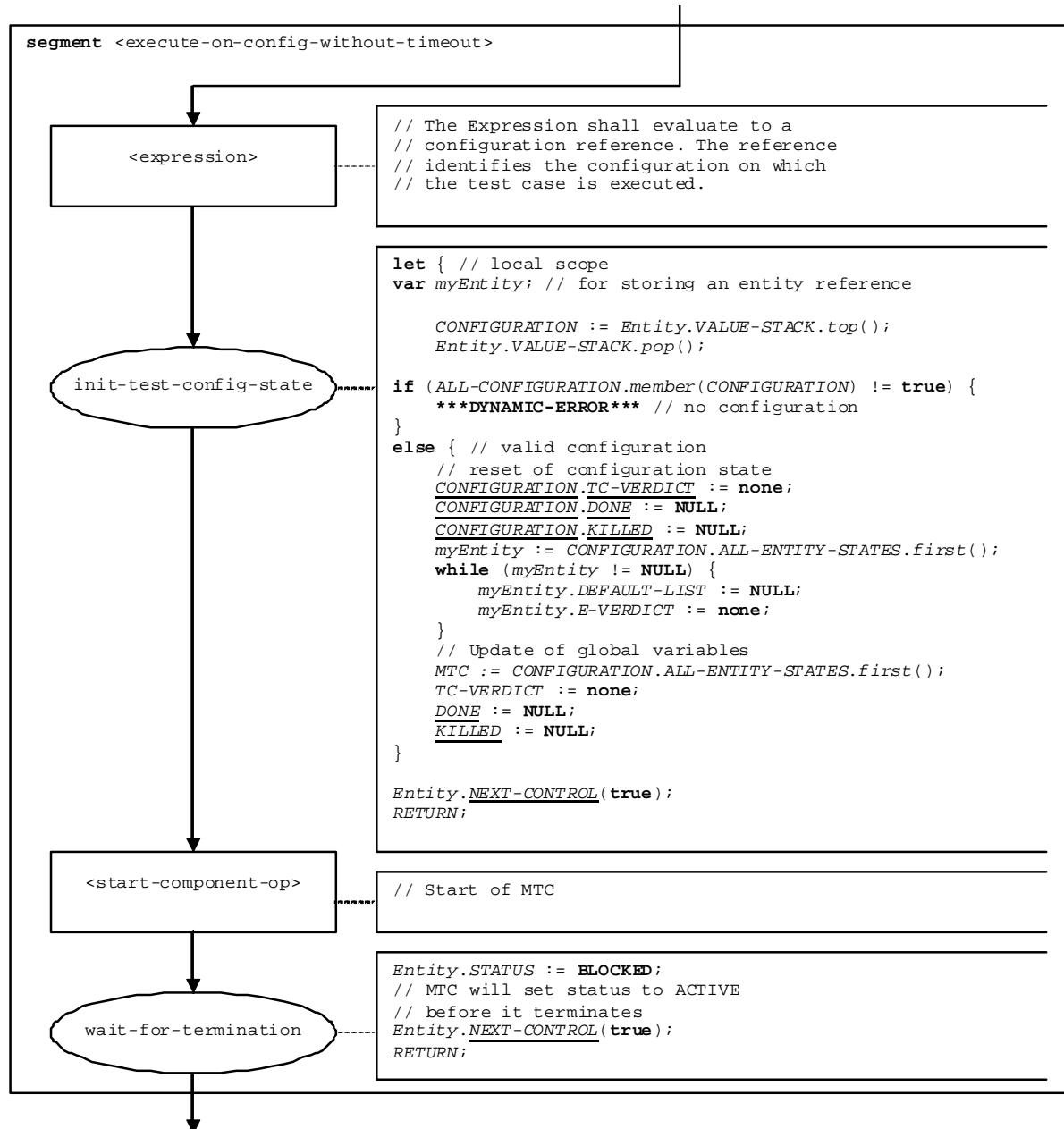

Figure 69b of ETSI ES 201 873-4 [2]: Flow graph segment <execute-on-config-without-timeout>

6.34 Flow graph segment <execute-on-config-timeout>

The flow graph segment <execute-on-config-timeout> in figure 69c of ETSI ES 201 873-4 [2] defines the execution of a test case on a configuration that is guarded by a timeout value. The flow graph segment also models the execution of the test case by starting the behaviour of the test case on the MTC on an existing static test configuration. In addition, TIMER-GUARD guards the termination.

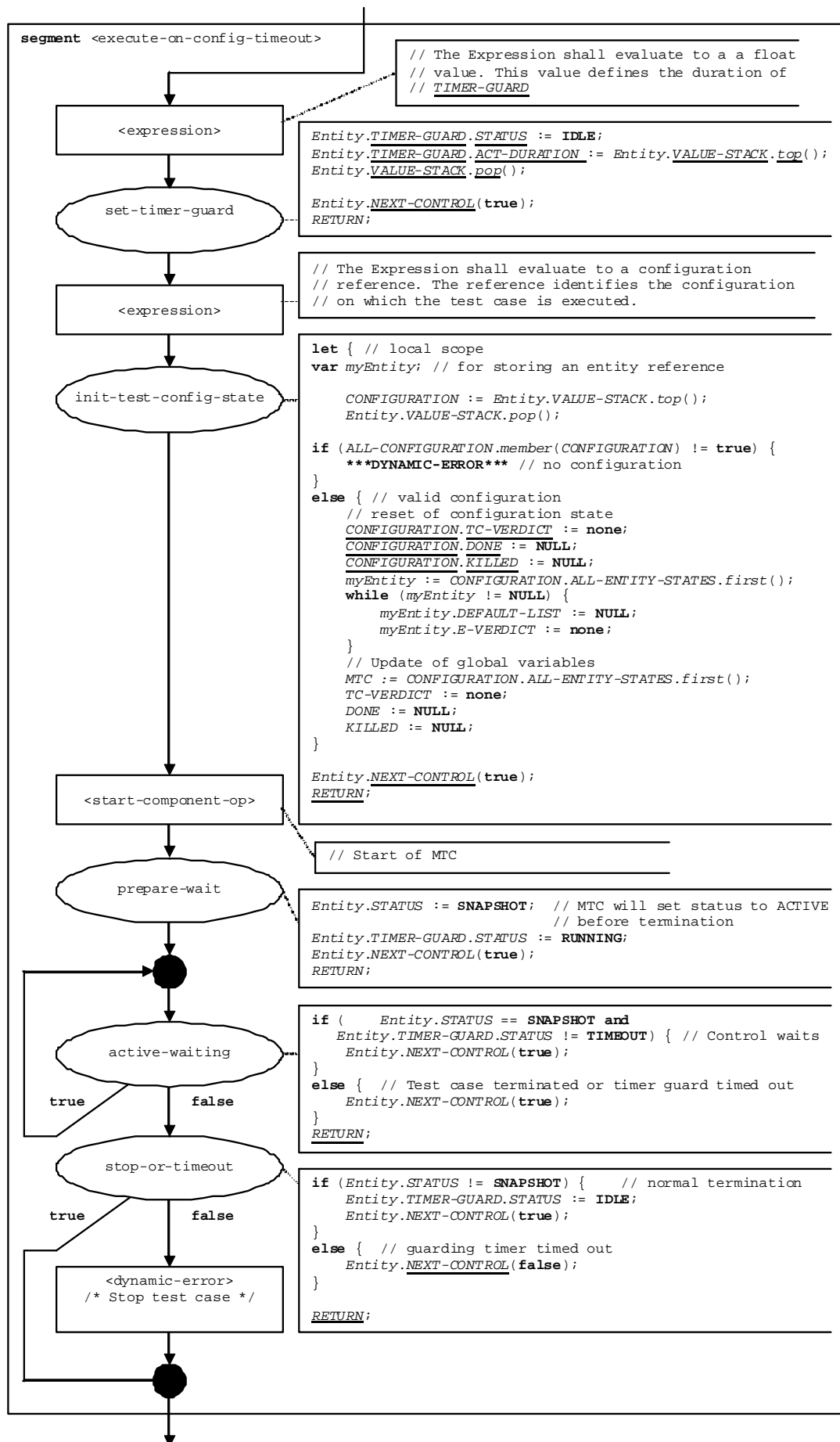

Figure 69c of ETSI ES 201 873-4 [2]: Flow graph segment <execute-on-config-timeout>

6.35 Flow graph segment <statement-block>

The syntactical structure of a statement block is:

```
{ <statement1>; ... ; <statementn> }
```

A statement block is a scope unit. When entering a scope unit, new scopes for variables, timers and the value stack have to be initialized. When leaving a scope unit, all variables, timers and stack values of this scope have to be destroyed.

NOTE 1: A Statement block can be embedded in another statement blocks or can occur as body of functions, altsteps, test cases and module control, and within compound statements, e.g. **alt**, **if-else** or **do-while**.

NOTE 2: Receiving operations and altstep calls cannot appear in statement blocks, they are embedded in **alt** statements or **call** operations.

NOTE 3: The operational semantics also handles operations and declarations like statements, i.e. they are allowed in statement blocks.

NOTE 4: Some TTCN-3 functions, like e.g. **system** or **self**, are considered to be expressions, which are not useful as stand-alone statements in statement blocks. Their flow graph representations are not listed in figure 78 of ETSI ES 201 873-4 [2].

The flow graph segment <statement-block> in figure 78 of ETSI ES 201 873-4 [2] defines the execution of a statement block.

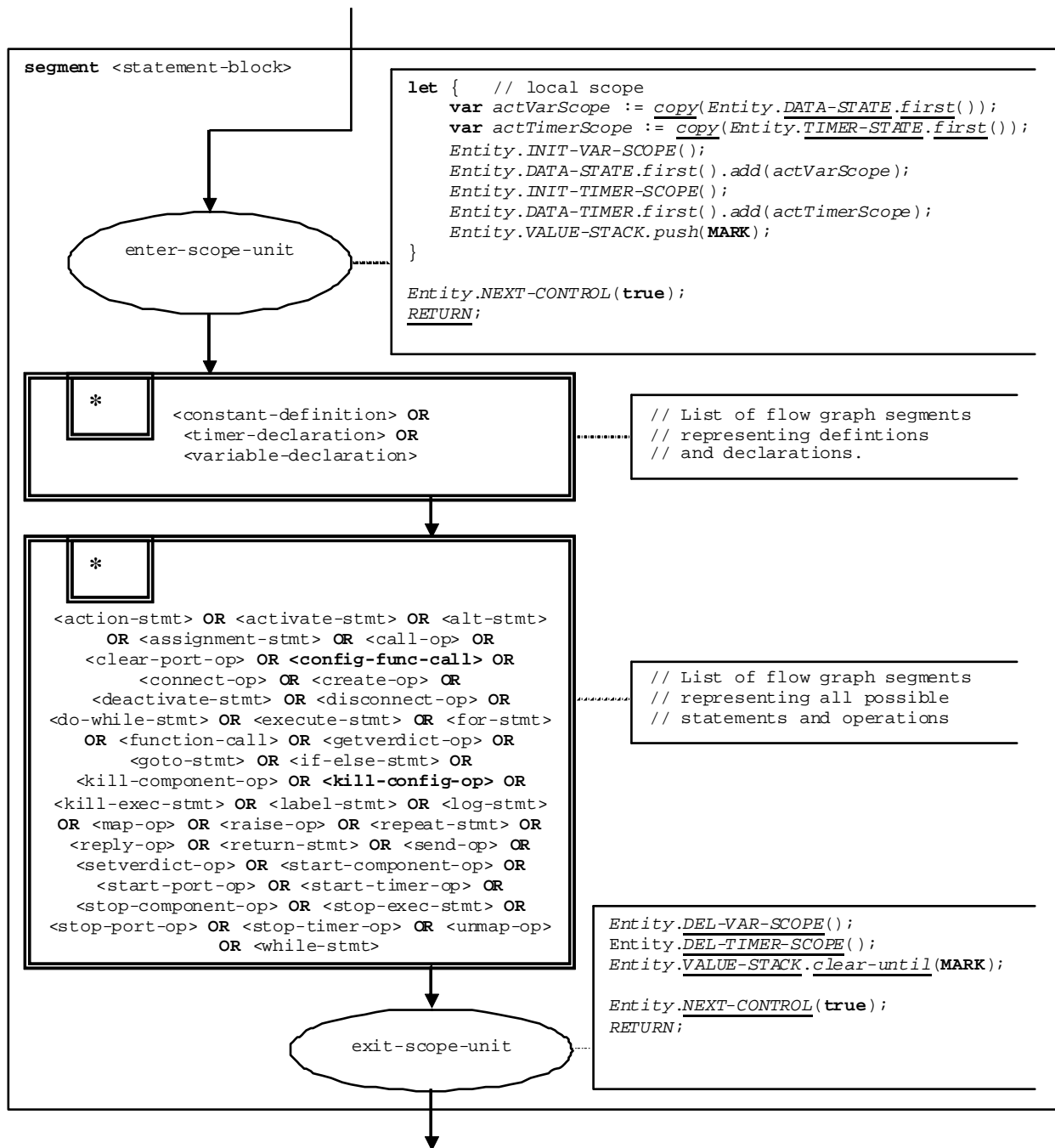

Figure 78 of ETSI ES 201 873-4 [2]: Flow graph segment <statement-block>

6.36 Halt port operation

The syntactical structure of the **halt** port operation is:

```
<portId>.halt
```

The flow graph segment <halt-port-op> in figure 89a of ETSI ES 201 873-4 [2] defines the execution of the **halt** port operation.

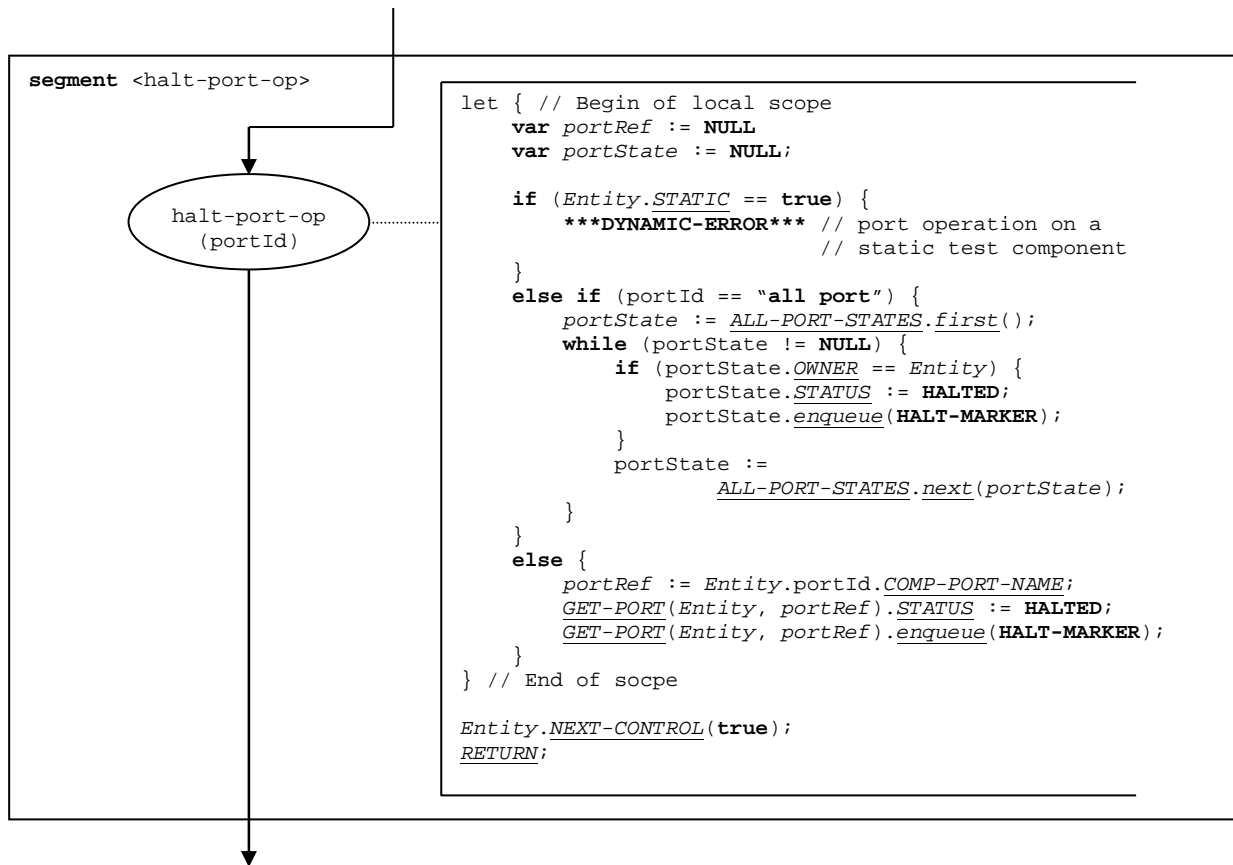

Figure 89a of ETSI ES 201 873-4 [2]: Flow graph segment <halt-port-op>

NOTE: The **HALT-MARKER** that is put by a **halt** operation into the port queue is removed by the SNAP-PORTS function (see ETSI ES 201 873-4 [2], clause 8.3.3.2) when the marker is reached, i.e. all messages preceding the marker have been processed. The SNAP-PORTS function is called when taking a snapshot.

6.37 Kill component operation

The syntactical structure of the **kill** component statement is:

```
<component-expression>.kill
```

The **kill** component operation stops the specified component and removes it from the test system. All test components will be stopped and removed from the test system, i.e. the test case terminates, if the MTC is killed (e.g. **mtc.kill**) or kills itself (e.g. **self.kill**). The MTC may kill all parallel test components by using the **all** keyword, i.e. **all component.kill**.

Special rules apply for using the **kill** component operation in static test configurations: Applying the **kill** component operation to a static component leads to a dynamic error. The lifetime of all static components (including the MTC) is bound to the lifetime of the test configuration. However, the MTC may kill all non-static parallel test components by using the **all** keyword, i.e. **all component.kill**.

A component to be killed is identified by a component reference provided as expression, e.g. a value or value returning function. For simplicity, the keyword "**all component**" is considered to be special values of `<component-expression>`. The operations **mtc** and **self** are evaluated according to ETSI ES 201 873-4 [2], clauses 9.33 and 9.43.

The flow graph segment `<kill-component-op>` in figure 90a of ETSI ES 201 873-4 [2] defines the execution of the **kill** component operation.

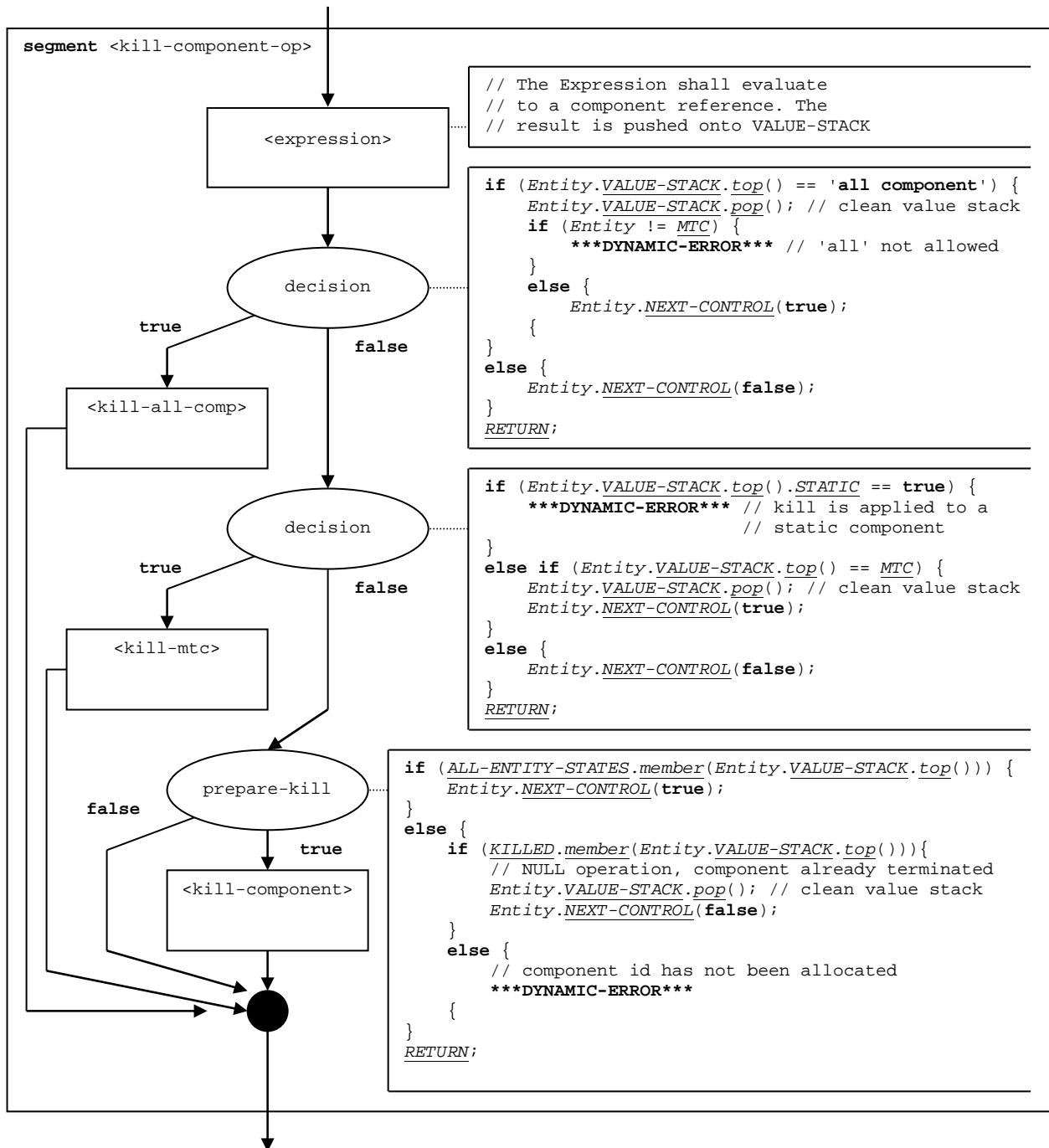

Figure 90a of ETSI ES 201 873-4 [2]: Flow graph segment <kill-component-op>

6.38 Flow graph segment <kill-mtc>

The <kill-mtc> flow graph segment in figure 90b of ETSI ES 201 873-4 [2] describes the killing of the MTC. The effect is that the test case terminates, i.e. the final verdict is calculated and pushed onto the value stack of module control. The release of all resources are released is modelled by deleting the test configuration from the ALL-CONFIGURATIONS list.

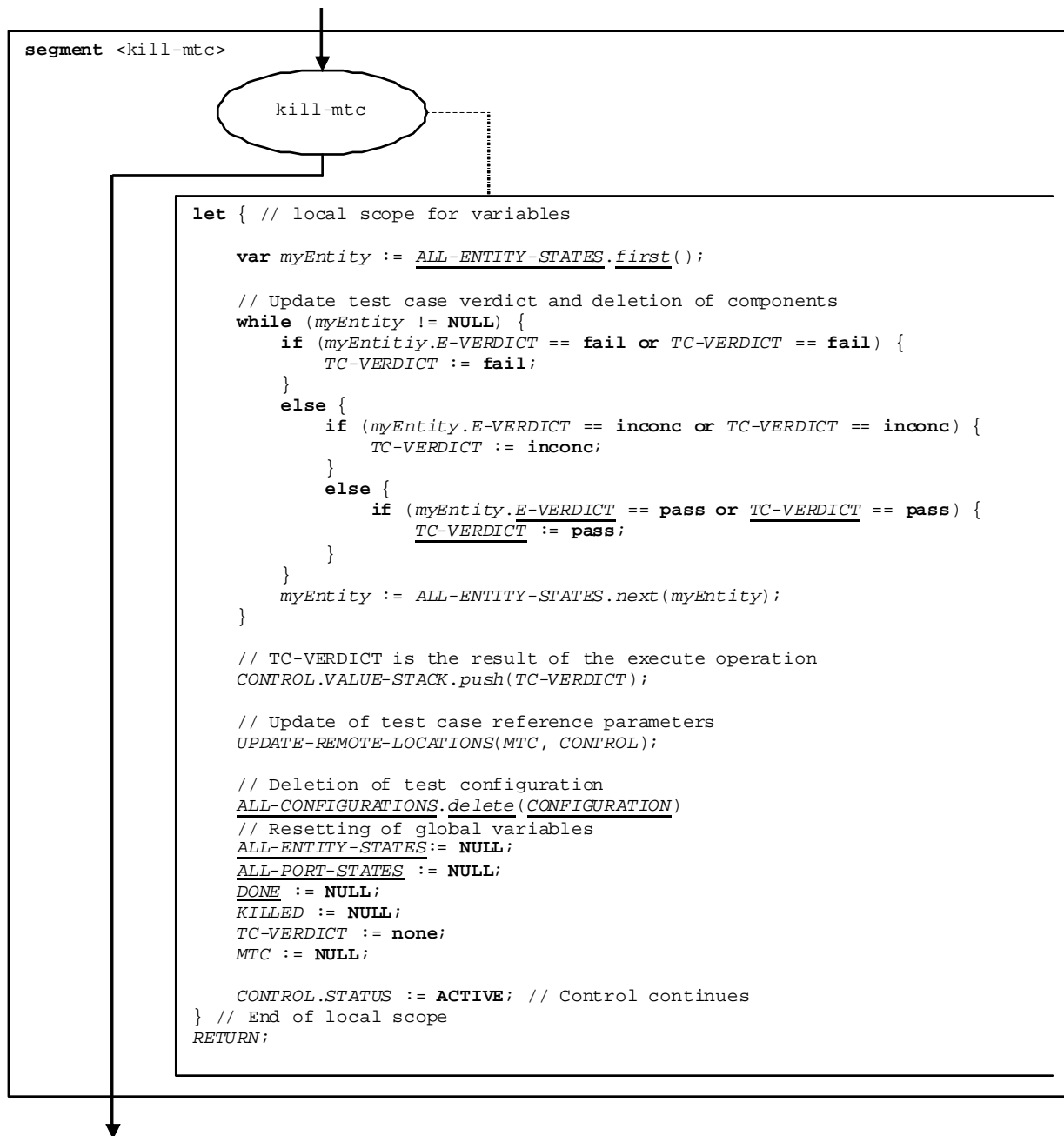

Figure 90b of ETSI ES 201 873-4 [2]: Flow graph segment <kill-mtc-op>

6.39 Flow graph segment <kill-all-comp>

The <kill-all-comp> flow graph segment in figure 90d of ETSI ES 201 873-4 [2] describes the termination of all parallel test components of a test case.



Figure 90d of ETSI ES 201 873-4 [2]: Flow graph segment <stop-all-comp>

6.40 Kill execution statement

The syntactical structure of the **kill** execution statement is:

```
kill
```

The effect of the **kill** execution statement depends on the entity that executes the **kill** execution statement:

- If **kill** is performed by the module control, the test campaign ends, i.e. all test components and the module control disappear from the module state.
- If the **kill** is executed by the MTC, all parallel test components and the MTC stop execution. The global test case verdict is updated and pushed onto the value stack of the module control. Finally, control is given back to the module control and the MTC terminates.
- If the **kill** is executed by a test component, the global test case verdict *TC-VERDICT* and the global *DONE* and *KILLED* lists are updated. Then the component disappears from the module.

The execution of the **kill** execution statement by any static test component (including the MTC of a static test configuration) is not allowed. It leads to a dynamic error.

The flow graph segment <kill-exec-stmt> in figure 90e of ETSI ES 201 873-4 [2] describes the execution of the kill statement.

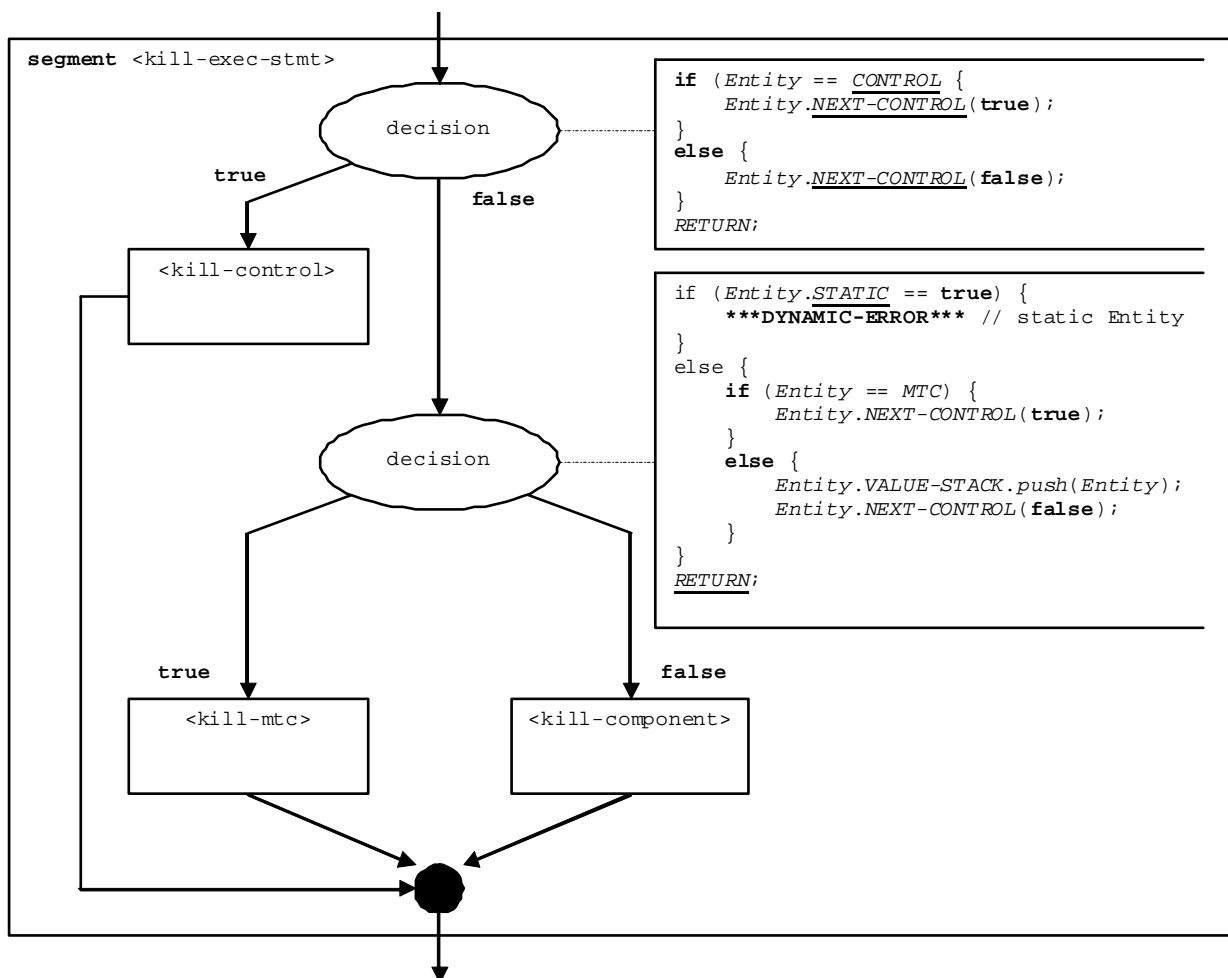

Figure 90e of ETSI ES 201 873-4 [2]: Flow graph segment <kill-exec-stmt>

6.41 Kill configuration operation

The syntactical structure of the **kill** configuration operation is:

```
<configuration-expression>.kill
```

The **kill** configuration operation destructs the specified test configuration and removes it from the test system. The kill configuration operation shall only be executed by module control. The configuration to be killed is identified by means of a <configuration-expression>., i.e. an expression that evaluates to a reference to a configuration.

The flow graph segment <kill-config-op> in figure 90f of ETSI ES 201 873-4 [2] defines the execution of the **kill** configuration operation.

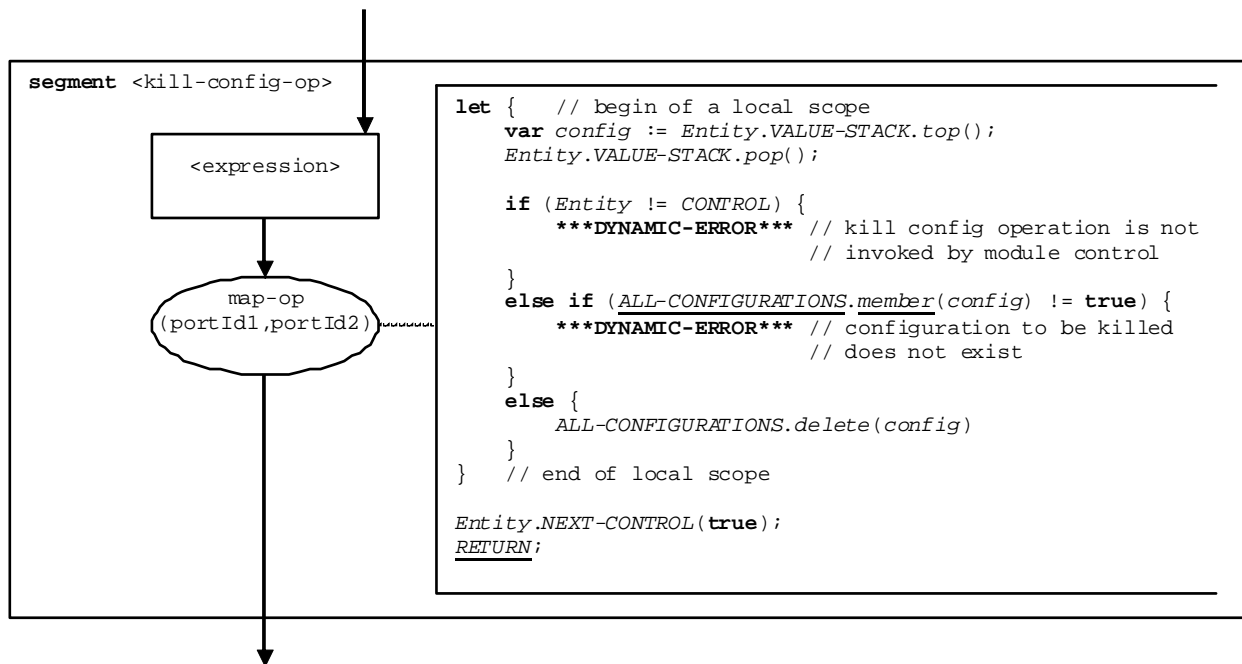

Figure 90f of ETSI ES 201 873-4 [2]: Flow graph segment <kill-config-op>

6.42 Map operation

The syntactical structure of the **map** operation is:

```
map(<component-expression>:<portId1>, system:<portId2>) [static]
```

The identifiers <portId1> and <portId2> are considered to be port identifiers of the corresponding test component and test system interface. The component to which the <portId1> belongs is referenced by means of the component reference <component-expression>. The reference may be stored in variables or is returned by a function, i.e. it is an expression, which evaluates to a component reference. The value stack is used for storing the component reference.

A present **static** clause indicates that the new mapping is static, i.e. established during the execution of a configuration function. Presence and absence of the **static** clause is handled as a Boolean flag in the operational semantics (see **static** parameter of the basic flow graph node map-op in figure 93 of ETSI ES 201 873-4 [2]).

NOTE: The **map** operation does not care whether the **system:<portId>** statement appears as first or as second parameter. For simplicity, it is assumed that it is always the second parameter.

The execution of the **map** operation is defined by the flow graph segment <map-op> shown in figure 93 of ETSI ES 201 873-4 [2].

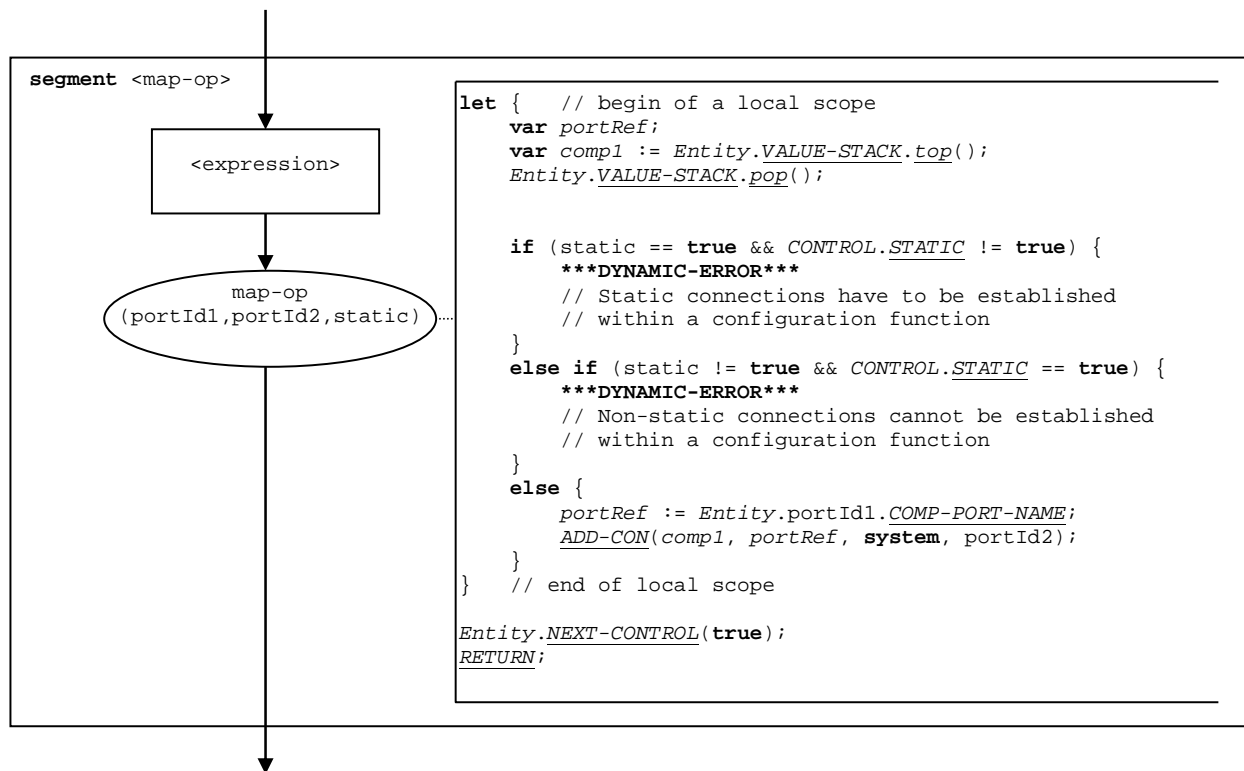

Figure 93 of ETSI ES 201 873-4 [2]: Flow graph segment <map-op>

6.43 Start port operation

The syntactical structure of the **start** port operation is:

```
<portId>.start
```

The flow graph segment <start-port-op> in figure 121 of ETSI ES 201 873-4 [2] defines the execution of the **start** port operation.

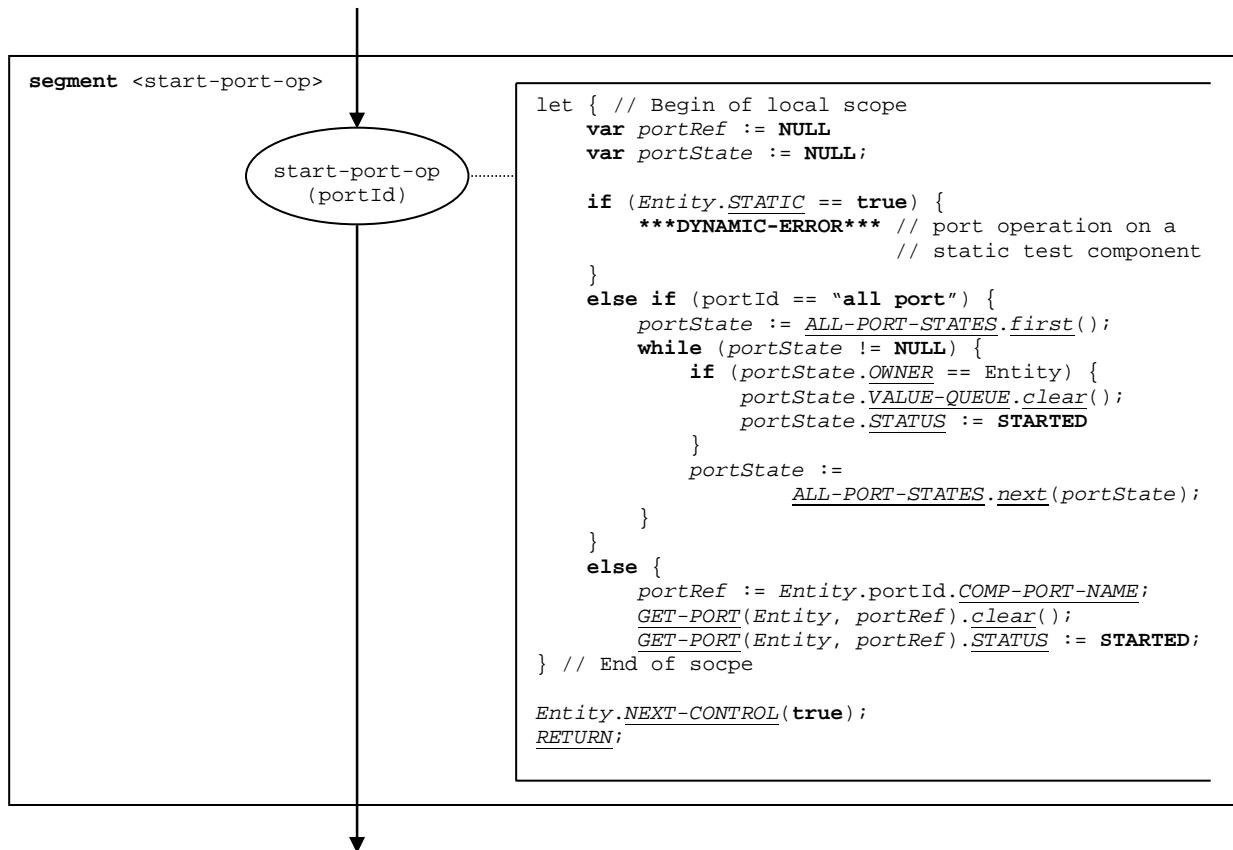

Figure 121 of ETSI ES 201 873-4 [2]: Flow graph segment `<start-port-op>`

6.44 Stop component operation

The syntactical structure of the **stop** component statement is:

```
<component-expression>.stop
```

The **stop** component operation stops the specified component. All test components will be stopped, i.e. the test case terminates, if the MTC is stopped (e.g. `mtc.stop`) or stops itself (e.g. `self.stop`). The MTC may stop all parallel test components by using the **all** keyword, i.e. `all component.stop`.

Stopped components created with an **alive** clause in the **create** operation are not removed from the test system. They can be restarted by using a **start** statement. Variables, ports, constants and timers owned by such a component, i.e. declared and defined in the corresponding component type definition, keep their status. A **stop** operation for a component created without an **alive** clause is semantically equivalent to a **kill** operation. The component is removed from the test system.

A component to be stopped is identified by a component reference provided as expression, e.g. a value or value returning function. For simplicity, the keyword "**all component**" is considered to be special values of `<component-expression>`. The operations **mtc** and **self** are evaluated according to ETSI ES 201 873-4 [2], clauses 9.33 and 9.43.

The flow graph segment `<stop-component-op>` in figure 125 of ETSI ES 201 873-4 [2] defines the execution of the **stop** component operation.

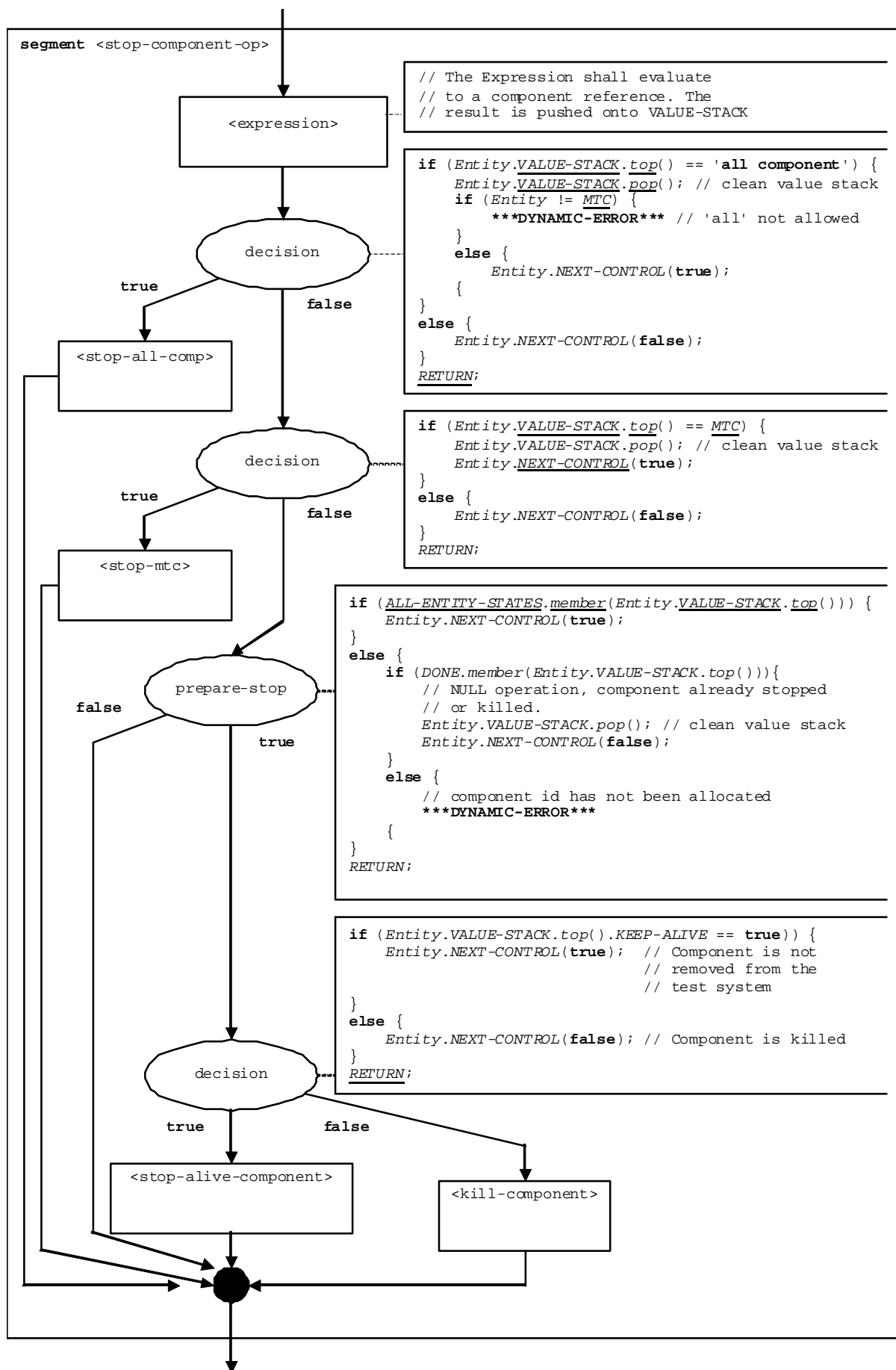

Figure 125 of ETSI ES 201 873-4 [2]: Flow graph segment <stop-component-op>

6.45 Flow graph segment <stop-mtc>

The flow graph segment <stop-mtc> in figure 125a of ETSI ES 201 873-4 [2] describes the stopping of an MTC. The effect of stopping an MTC is that a test case or a configuration function terminates. Depending on where and how an MTC has been executed, three cases have to be distinguished:

- 1) The MTC stops the behaviour of a test case that has not been executed on a static test configuration.
- 2) The MTC stops the behaviour of a test case that has been executed on a static test configuration.
- 3) The MTC stops the execution of a configuration function.

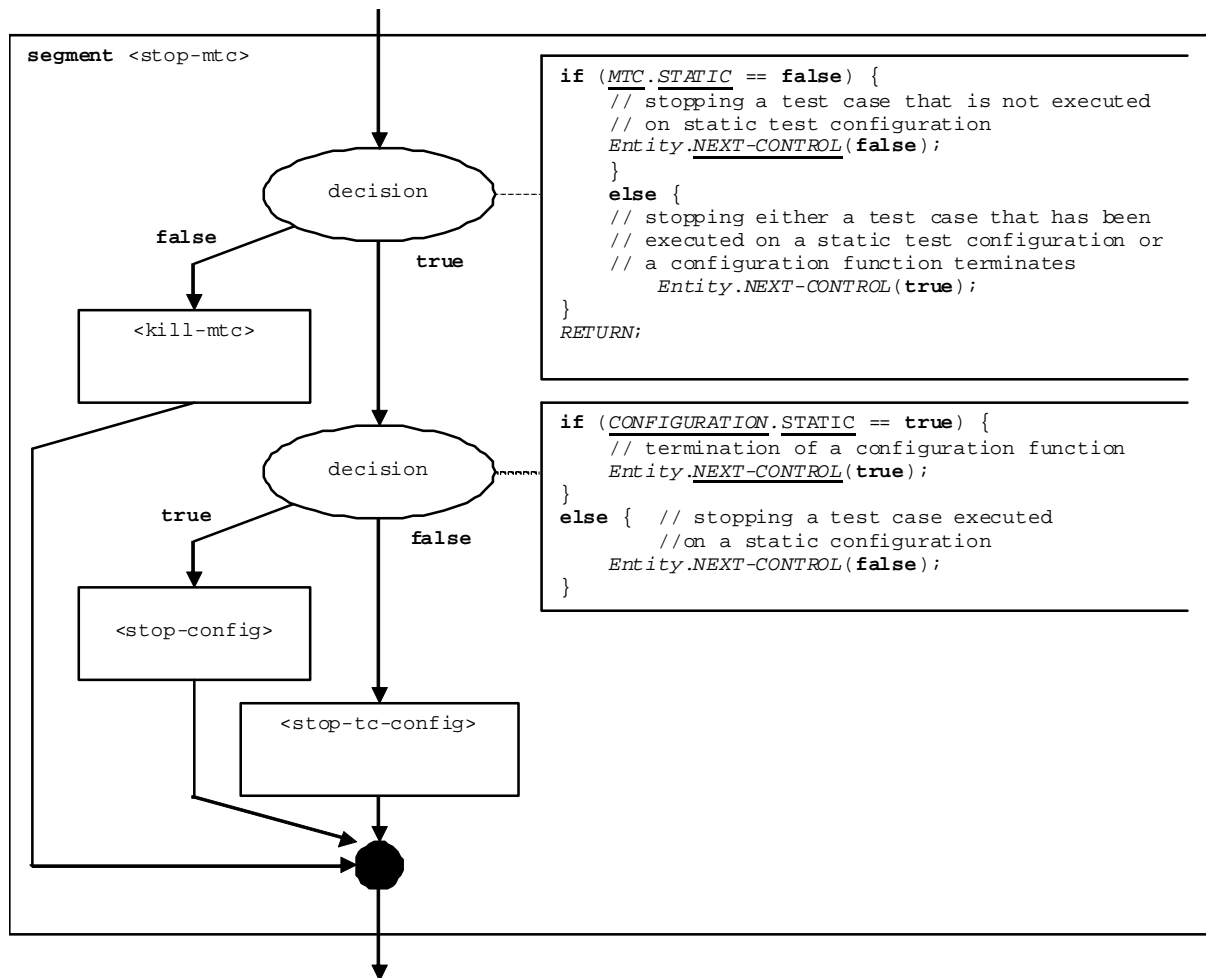

Figure 125a of ETSI ES 201 873-4 [2]: Flow graph segment <stop-mtc>

6.46 Flow graph segment <stop-config>

The <stop-config> flow graph segment in figure 127a of ETSI ES 201 873-4 [2] describes the stopping of an MTC that has executed a configuration function.

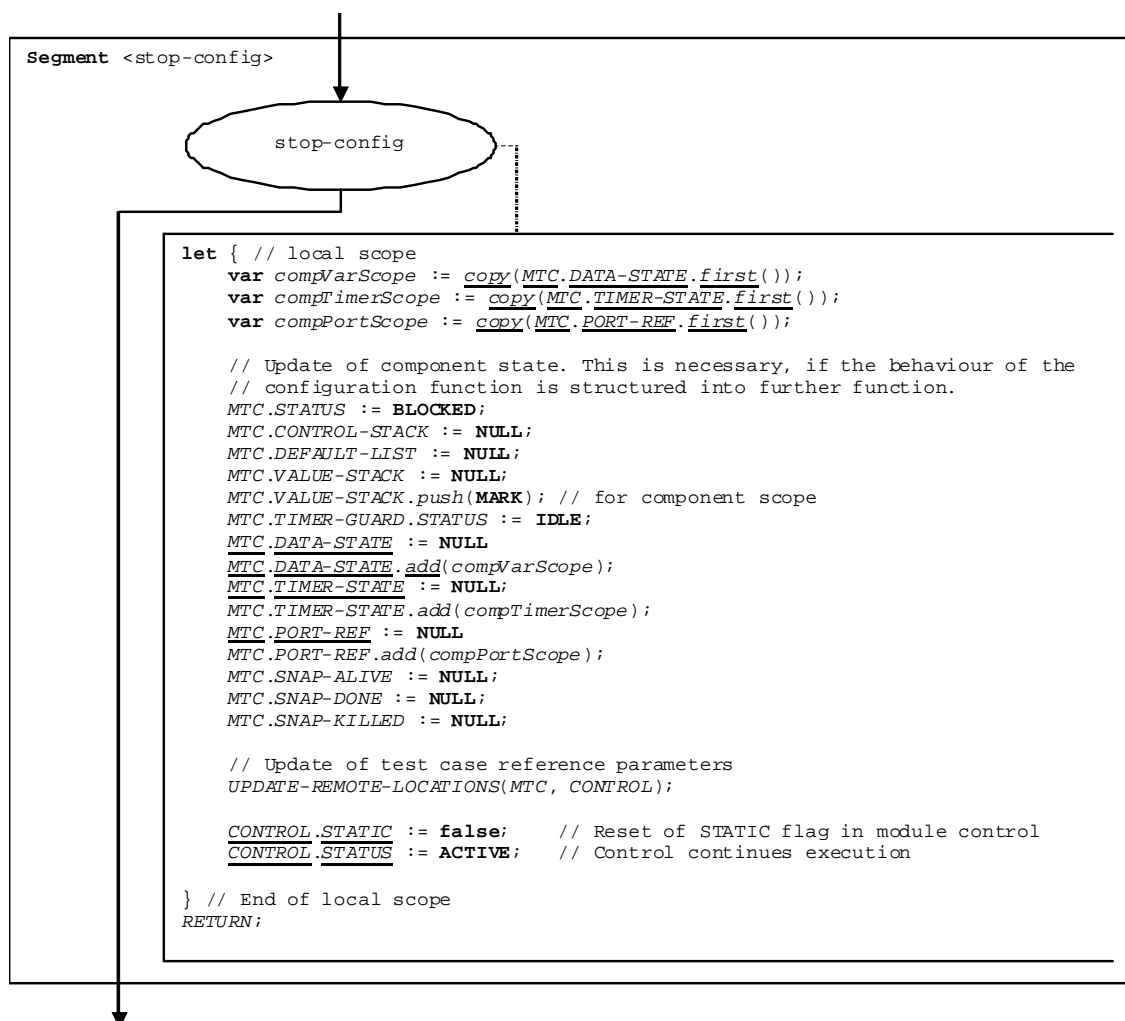

Figure 127a of ETSI ES 201 873-4 [2]: Flow graph segment <stop-config>

6.47 Flow graph segment <stop-tc-config>

The <stop-tc-config> flow graph segment in figure 127b of ETSI ES 201 873-4 [2] describes the termination of a test case that is executed on a static test configuration.

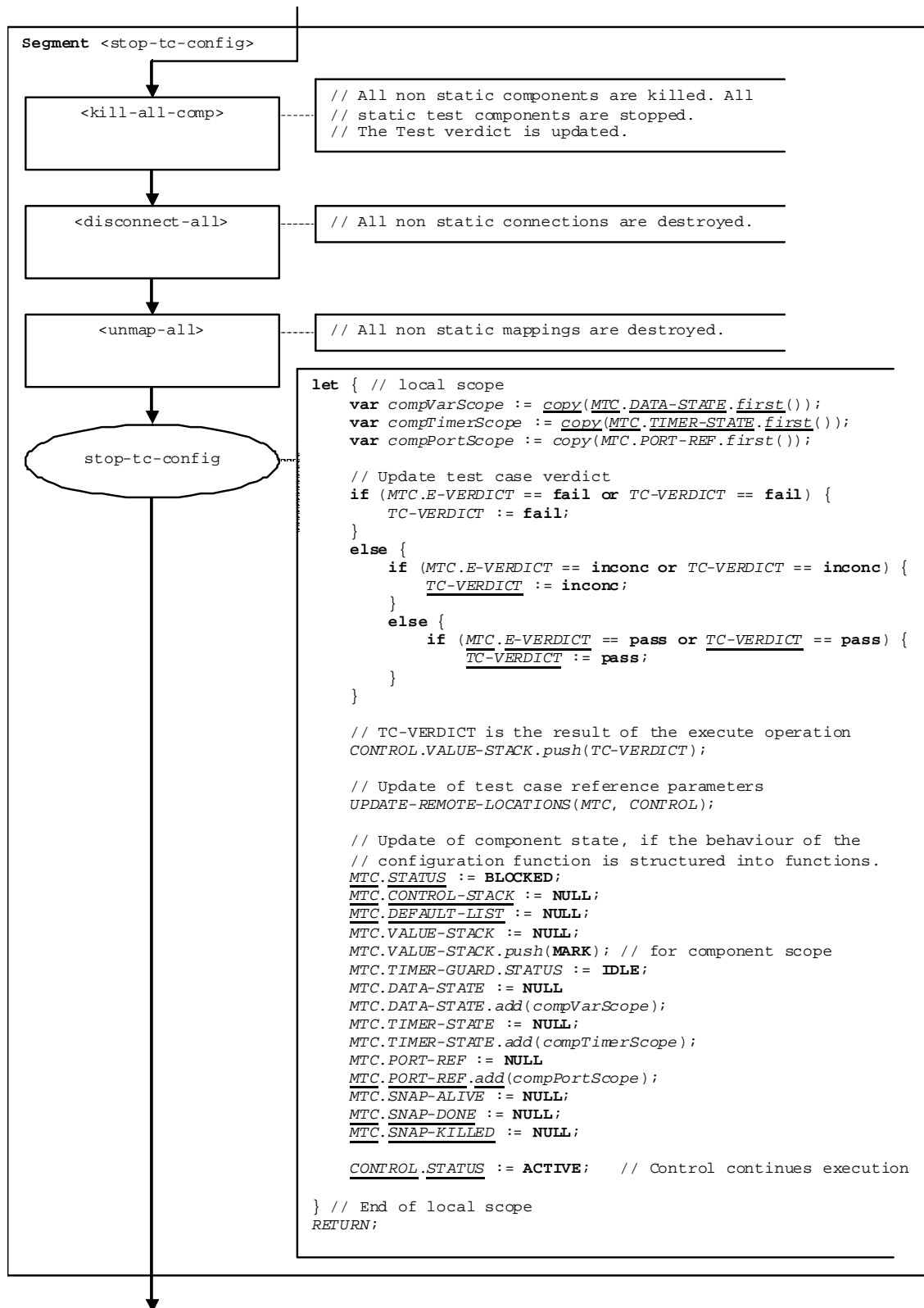

Figure 127b of ETSI ES 201 873-4 [2]: Flow graph segment <stop-tc-config>

6.48 Stop port operation

The syntactical structure of the **stop** port operation is:

```
<portId>.stop
```

The flow graph segment <stop-port-op> in figure 129 of ETSI ES 201 873-4 [2] defines the execution of the **stop** port operation.



Figure 129 of ETSI ES 201 873-4 [2]: Flow graph segment <stop-port-op>

6.49 Flow graph segment <unmap-all>

The flow graph segment <unmap-all> defines the unmapping of all components at all mapped ports. Static mappings will not be unmapped. Their lifetime is bound to the lifetime of the static test configuration.

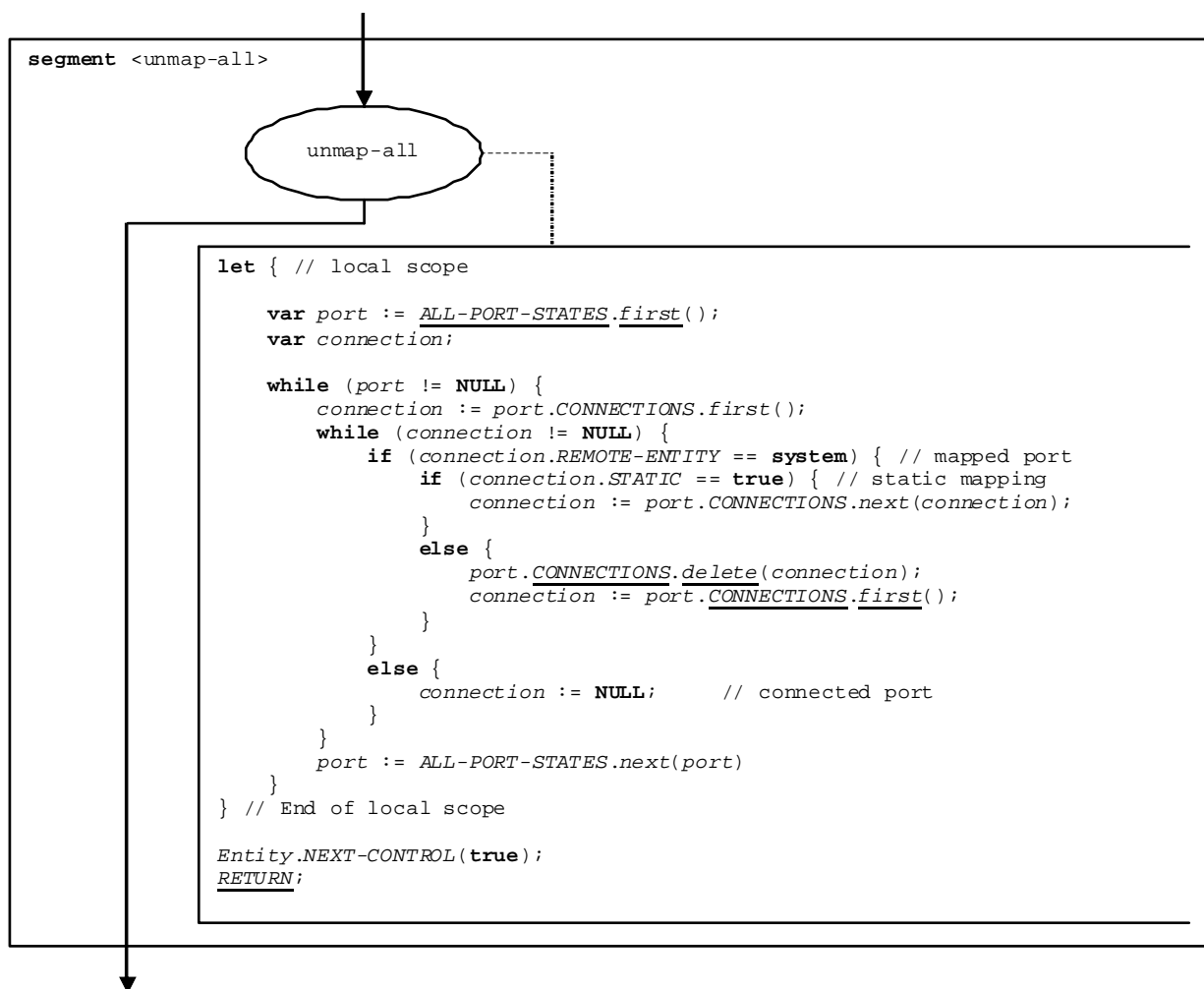

Figure 136a of ETSI ES 201 873-4 [2]: Flow graph segment <unmap-all>

6.50 Flow graph segment <unmap-comp>

The flow graph segment <unmap-comp> defines the unmapping of all mapped ports of a specified component. Static mappings will not be unmapped. Their lifetime is bound to the lifetime of the static test configuration.

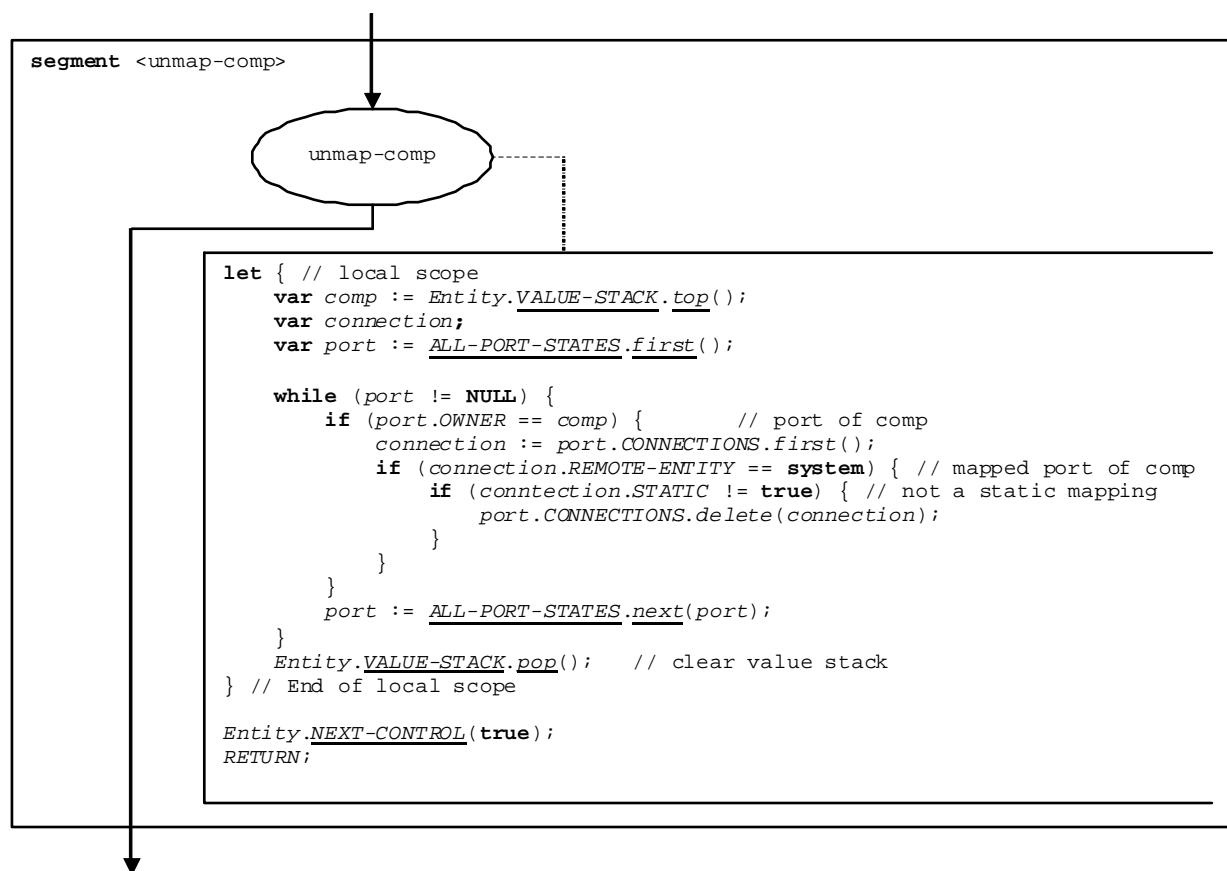

Figure 136b of ETSI ES 201 873-4 [2]: Flow graph segment <unmap-comp>

6.51 Flow graph segment <unmap-port>

The flow segment <unmap-port> defines the **unmap** operation for a specific mapped port.

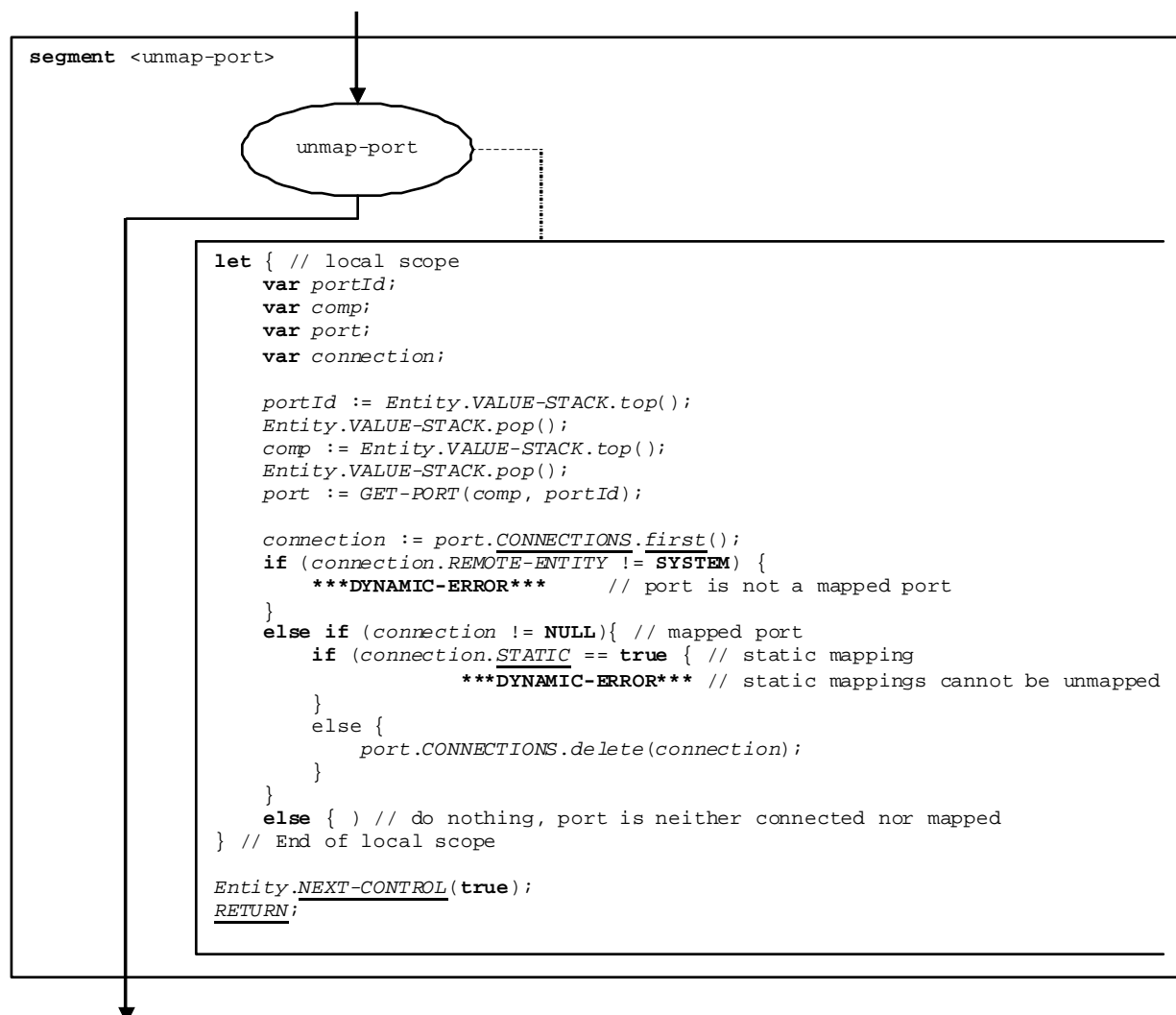

Figure 136c of ETSI ES 201 873-4 [2]: Flow graph segment <unmap-port>

7 TRI Extensions for the Package

7.1 Changes and extensions to clause 5.5.2 of ETSI ES 201 873-5 Connection handling operations

If this package is being used, the `TriExecuteTestCase` operation shall be used only for initialization purposes of the SA, but not for the establishment of static connections. In order to establish static connections, the `TriStaticMap` operation shall be used instead. The `TriUnmap` can be used for closing dynamic and static connections.

Clause 5.5.2.1 triExecuteTestCase (TE → SA)

This clause is changed as follows.

Signature	TriStatusType triExecuteTestCase(in TriTestCaseIdType testCaseId, in TriPortIdListType tsiPortList)
In Parameters	testCaseId identifier of the test case that is going to be executed tsiPortList a list of test system interface ports defined for the test system
Out Parameters	n.a.
Return Value	The return status of the triExecuteTestCase operation. The return status indicates the local success (TRI_OK) or failure (TRI_Error) of the operation.
Constraints	This operation is called by the TE immediately before the execution of any test case. The test case that is going to be executed is indicated by the testCaseId. tsiPortList contains all ports that have been declared in the definition of the system component for the test case, i.e. the TSI ports. If a system component has not been explicitly defined for the test case in the TTCN-3 ATS then the tsiPortList contains all communication ports of the MTC test component. The ports in tsiPortList are ordered as they appear in the respective TTCN-3 component declaration.
Effect	The SA can set up any static connections to the SUT and can initialize any communication means for TSI ports. The triExecuteTestCase operation returns TRI_OK in case the operation has been successfully performed, TRI_Error otherwise.

Clause 5.5.2.3 triUnmap (TE → SA)

This clause is changed as follows.

Signature	TriStatusType triUnmap(in TriPortIdType compPortId, in TriPortIdType tsiPortId)
In Parameters	compPortId identifier of the test component port to be unmapped tsiPortId identifier of the test system interface port to be unmapped
Out Parameters	n.a.
Return Value	The return status of the triUnmap operation. The return status indicates the local success (TRI_OK) or failure (TRI_Error) of the operation.
Constraints	This operation is called by the TE when it executes any TTCN-3 unmap operation.
Effect	The SA shall close a dynamic or static connection to the SUT for the referenced TSI port. The triUnmap operation returns TRI_Error in case a connection could not be closed successfully or no such connection has been established previously, TRI_OK otherwise. The operation should return TRI_OK in case no connections have to be closed by the test system.

Clause 5.5.2.3b triStaticMapParam (TE → SA)

This clause is to be added.

Signature	TriStatusType triStaticMapParam(in TriPortIdType compPortId, in TriPortIdType tsiPortId, in TriParameterListType paramList)
In Parameters	compPortId identifier of the test component port to be mapped tsiPortId identifier of the test system interface port to be mapped paramList configuration parameter list
Out Parameters	n.a.
Return Value	The return status of the triStaticMapParam operation. The return status indicates the local success (TRI_OK) or failure (TRI_Error) of the operation.
Constraints	This operation is called by the TE when it executes a TTCN-3 map operation including parameters.
Effect	The SA can establish a static connection to the SUT for the referenced TSI port. The triStaticMapParam operation returns TRI_Error in case a connection could not be established successfully, TRI_OK otherwise. The operation should return TRI_OK in case no static connection needs to be established by the test system. The configuration parameter paramList can be used for setting connection establishment specific parameters.

Clause 5.5.2.5 triStaticMap (TE → SA)

This clause is to be added.

Signature	TriStatusType triStaticMap(in TriPortIdType compPortId, in TriPortIdType tsiPortId)
In Parameters	compPortId identifier of the test component port to be mapped in a static connection tsiPortId identifier of the test system interface port to be mapped in a static connection
Out Parameters	n.a.
Return Value	The return status of the triStaticMap operation. The return status indicates the local success (TRI_OK) or failure (TRI_Error) of the operation.
Constraints	This operation is called by the TE when it executes a TTCN-3 static map operation.
Effect	The SA can establish a static connection to the SUT for the referenced TSI port. The triStaticMap operation returns TRI_Error in case a connection could not be established successfully, TRI_OK otherwise. The operation should return TRI_OK in case no static connection needs to be established by the test system.

7.2 Extensions to clause 6 of ETSI ES 201 873-5 Java™ language mapping

Clause 6.5.2.1 triCommunicationSA

The triCommunicationSA interface mapping is to be extended with the definition for TriStaticMap:

```
// TriCommunication
// TE -> SA
package org.etsi.ttcn.tri;
public interface TriCommunicationSA {
    :
    // Connection handling operations
    :
    // Ref: TRI-Definition 5.5.2.5
    public TriStatus triStaticMap(TriPortId compPortId, TriPortId tsiPortId);
    :
}
```

7.3 Extensions to clause 7 of ETSI ES 201 873-5 ANSI C language mapping

Clause 7.2.4 TRI operation mapping

The table is to be extended with the definition for TriStaticMap:

IDL Representation	ANSI C Representation
...	...
TriStatusType triStaticMap (in TriPortIdType compPortId, in TriPortIdType tsiPortId)	TriStatus triStatic Map (const TriPortId* compPortId, const TriPortId* tsiPortId)
...	...

7.4 Extensions to clause 8 of ETSI ES 201 873-5 C++ language mapping

Clause 8.6.1 TriCommunicationSA

The triCommunicationSA interface mapping is to be extended with the definition for TriStaticMap. In addition, the description of TriUnmap has to be changed to handle also the closing of static connections:

```
class TriCommunicationSA {
public:
    :
    //To establish a static connection between two ports.
    virtual TriStatus triStaticMap (const TriPortId *comPortId, const TriPortId *tsiPortId)=0;
```

```
//To close a dynamic or static connection to the SUT for the referenced TSI port.
virtual TriStatus triUnmap (const TriPortId *comPortId, const TriPortId *tsiPortId)=0;
:
```

7.5 Extensions to clause 9 of ETSI ES 201 873-5 C# language mapping

Clause 9.5.2.1 ITriCommunicationSA

The ITriCommunicationSA interface is to be extended with the definition for TriStaticMap. In addition, the description of TriUnmap has to be changed to handle also the closing of static connections:

```
public interface ITriCommunicationSA {
:
//To establish a static connection between two ports.
TriStatus TriStaticMap (ITriPortId comPortId, ITriPortId tsiPortId);
:
```

8 TCI Extensions for the Package

8.1 Extensions to clause 7.2.1.1 of ETSI ES 201 873-6 Management

The management type TciTestComponentKindType has to be extended with constants for static test components:

TciTestComponentKindType A value of type TciTestComponentKindType is a literal of the set of kinds of TTCN-3 test components, i.e. CONTROL, MTC, PTC, SYSTEM, PTC_ALIVE, MTC_STATIC, PTC_STATIC, and SYSTEM_STATIC. This abstract type is used for component handling.

8.2 Extensions to clause 7.3.1.1 of ETSI ES 201 873-6 TCI-TM required

In order to handle static configurations via TCI-TM, the operations tciStartConfig and tciKillConfig are defined as follows.

Clause 7.3.1.1.7 tciStartTestCase

This clause is to be extended.

Signature	void tciStartTestCase(in TciTestCaseIdType testCaseId, in TciParameterListType parameterList, in TciConfigurationIdType ref)	
In Parameters	testCaseId	A test case identifier as defined in the TTCN-3 module.
	parameterList	A list of Values where each value defines a parameter from the parameter list as defined in the TTCN-3 test case definition. The parameters in parameterList are ordered as they appear in the TTCN-3 signature of the test case. If no parameters have to be passed either the null value or an empty parameterList, i.e. a list of length zero shall be passed.
	ref	An optional reference to a static configuration for the test case, which is to be used if a static configuration has been defined for the test case.
Return Value	void	

Constraint	Shall be called only if a module has been selected before. Only <code>testCaseIds</code> for test cases that are declared in the currently selected TTCN-3 module shall be passed. Only if the test case requires a static configuration, a <code>ref</code> to a started static configuration that is of the configuration type in the test case definition shall be given. If no static configuration has been defined for the test case in the TTCN-3 ATS, the distinct value <code>null</code> shall be passed in for <code>ref</code> . Test cases that are imported in a referenced module cannot be started. To start imported test cases the referenced (imported) module shall be selected first using the <code>tcRootModule</code> operation.
Effect	<code>tcStartTestCase</code> starts a test case in the currently selected module with the given parameters. A <code>tcError</code> will be issued by the TE if no such test case exists or if the static configuration has not been started or has been killed but is required by the test case. All <i>in</i> and <i>inout</i> test case parameters in <code>parameterList</code> contain <code>Value</code> . All <i>out</i> test case parameters in <code>parameterList</code> shall contain the distinct value of <code>null</code> since they are only of relevance when the test case terminates.

Clause 7.3.1.11 `tcStartConfig`

This clause is to be added.

Signature	<code>TciConfigurationIdType tcStartConfig (in TciBehaviourIdType configId, in TciParameterListType parameterList)</code>	
In Parameters	<code>configId</code>	A configuration function identifier as defined in the TTCN-3 module.
	<code>parameterList</code>	A list of <code>Values</code> where each value defines a parameter from the parameter list as defined in the TTCN-3 configuration function definition. The parameters in <code>parameterList</code> are ordered as they appear in the TTCN-3 signature of the configuration function. If no parameters have to be passed either the <code>null</code> value or an empty <code>parameterList</code> , i.e. a list of length zero shall be passed.
Return Value	<code>TciConfigurationIdType</code>	
Constraint	Shall be called only if a module has been selected before. Only <code>configId</code> for test cases with static configurations that are declared in the currently selected TTCN-3 module shall be passed - see <code>tcStartTestCase</code> .	
Effect	Starts a static configuration of the selected module as described in the TTCN-3 configuration function and returns an identifier to this configuration. A static configuration started from TCI-TM will be used by test cases that reference the static configuration and are executed from TCI-TM.	

Clause 7.3.1.12 `tcKillConfig`

This clause is to be added.

Signature	<code>void tcKillConfig(in TciConfigurationIdType ref)</code>	
In Parameters	<code>ref</code>	The reference to the static configuration.
Return Value	<code>void</code>	
Constraint	Shall be called only if a module has been selected before.	
Effect	<code>tcKillConfig</code> causes the destruction of the static test configuration <code>ref</code> . If <code>ref</code> is currently not started, the operation will be ignored.	

Clause 7.3.3.1.18 `tcExecuteTestCase`

This clause is to be extended.

Signature	<code>void tcExecuteTestCase (in TciTestCaseIdType testCaseId, in TriPortIdListType tsiPortList, in TciConfigurationIdType ref)</code>	
In Parameters	<code>testCaseId</code>	A test case identifier as defined in the TTCN-3 module.
	<code>tsiPortList</code>	Contains all ports that have been declared in the definition of the system component for the test case or in the configuration type of the test case, i.e. the TSI ports. If a system component has not been explicitly defined for the test case, then the <code>tsiPortList</code> contains all communication ports of the MTC. The ports in <code>tsiPortList</code> are ordered as they appear in the TTCN-3 component type declaration or in the configuration type declaration respectively. If no ports have to be passed either the <code>null</code> value or an empty <code>tsiPortList</code> , i.e. a list of length zero shall be passed.
	<code>ref</code>	An optional reference to a static configuration for the test case, which is to be used if a static configuration has been defined for the test case.

Return Value	void
Constraint	This operation shall be called by the CH at the appropriate local TE when at a remote TE a <i>provided</i> <code>tciExecuteTestCaseReq</code> has been called. Only if the test case requires a static configuration, a <code>ref</code> to a started static configuration that is of the configuration type in the test case definition shall be given. If no static configuration has been defined for the test case in the TTCN-3 ATS, the distinct value <code>null</code> shall be passed in for <code>ref</code> .
Effect	The local TE determines whether static connections to the SUT and the initialization of communication means for TSI ports should be done. This is for example not the case if the static configuration has been started already.

8.3 Extensions to clause 7.3.1.2 of ETSI ES 201 873-6 TCI-TM provided

In order to enable the indication of static configuration start and destruction at TCI-TM, the operations `tciConfigStarted` and `tciConfigKilled` are defined as follows.

Clause 7.3.1.2.7 `tciConfigStarted`

This clause is to be added.

Signature	void <code>tciConfigStarted</code> (in <code>TciConfigurationIdType ref</code>)	
In Parameters	<code>ref</code>	The reference to the static configuration.
Return Value	<code>TciConfigurationIdType</code>	
Constraint	Shall only be called after the static configuration has been started either using the <i>required</i> operations <code>tciStartConfig</code> or internally by the TE.	
Effect	<code>tciConfigStarted</code> indicates to the TM that static configuration <code>ref</code> has been started. It will not be distinguished whether the static configuration has been started explicitly using the <i>required</i> operation <code>tciStartConfig</code> or implicitly while executing the control part.	

Clause 7.3.1.2.8 `tciConfigKilled`

This clause is to be added.

Signature	void <code>tciConfigKilled</code> (in <code>TciConfigurationIdType ref</code>)	
In Parameters	<code>ref</code>	The reference to the static configuration.
Return Value	<code>TciConfigurationIdType</code>	
Constraint	Shall only be called after the static configuration has been killed either using the <i>required</i> operations <code>tciKillConfig</code> or internally by the TE.	
Effect	<code>tciConfigKilled</code> indicates to the TM that static configuration <code>ref</code> has been destructed. It will not be distinguished whether the static configuration has been started explicitly using the <i>required</i> operation <code>tciKillConfig</code> or implicitly while executing the control part.	

8.4 Extensions to clause 7.3.3.1 of ETSI ES 201 873-6 TCI-CH required

In order to establish static connections, the `tciStaticConnect` and `tciStaticMap` operations shall be used at TCI-CH. The `tciDisconnect` and `TciUnmap` can be used for closing static connections.

Clause 7.3.3.1.21 tciStaticConnect to 7.3.3.1.8b

This clause is to be added.

Signature	void tciStaticConnect(in TriPortIdType fromPort, in TriPortIdType toPort)	
In Parameters	fromPort	Identifier of the test component port to be connected from.
	toPort	Identifier of the test component port to be connected to.
Return Value	void	
Constraint	This operation shall be called by the CH at the local TE when at a remote TE a <i>provided</i> tciStaticConnectReq has been called.	
Effect	The TE shall statically connect the indicated ports to one another.	

Clause 7.3.3.1.21 tciStaticMap to 7.3.3.1.10b

This clause is to be added.

Signature	void tciStaticMap(in TriPortIdType fromPort, in TriPortIdType toPort)	
In Parameters	fromPort	Identifier of the test component port to be mapped from.
	toPort	Identifier of the test component port to be mapped to.
Return Value	void	
Constraint	This operation shall be called by the CH at the local TE when at a remote TE a <i>provided</i> tciStaticMapReq has been called.	
Effect	The TE shall statically map the indicated ports to one another.	

Clause 7.3.3.1.25 tciGetParallelMTC to 7.3.3.1.17b

This clause is to be added.

Signature	TriComponentIdType tciGetParallelMTC(in TriComponentIdType component)	
In Parameters	component	Identifier of the control component executing the test case for which the MTC shall be determined.
Return Value	A TriComponentIdType value of the MTC associated with the given parallel control component if the MTC executes on the local TE, the distinct value null otherwise.	
Constraint	This operation can be called by the CH at the appropriate local TE when at a remote TE a <i>provided</i> tciGetParallelMTCReq has been called.	
Effect	The local TE determines whether the MTC of the given component is executing on the local TE. If the MTC executes on the local TE the component id of the MTC is being returned. If the MTC is not executed on the local TE the distinct value null will be returned. The operation will have no effect on the execution of the MTC. After the operation returns, the CH will communicate the value back to the remote TE.	

8.5 Extensions to clause 7.3.3.2 of ETSI ES 201 873-6 TCI CH provided

In order to establish static connections, the tciStaticConnectReq and tciStaticMapReq operations shall be used at TCI-CH. The tciDisconnectReq and TciUnmapReq can be used for closing static connections.

Clause 7.3.3.2.26 tciExecuteTestCaseReq

This clause is to be extended.

Signature	void tciExecuteTestCaseReq (in TciTestCaseIdType testCaseId, in TriPortIdListType tsiPortList, in TciConfigurationIdType ref)	
In Parameters	testCaseId	A test case identifier as defined in the TTCN-3 module.
	tsiPortList	tsiPortList contains all ports that have been declared in the definition of the system component for the test case or in the configuration type of the test case, i.e. the TSI ports. If a system component has not been explicitly defined for the test case, then the tsiPortList contains all communication ports of the MTC. The ports in tsiPortList are ordered as they appear in the TTCN-3 component type declaration or in the configuration type declaration respectively. If no ports have to be passed either the null value or an empty tsiPortList, i.e. a list of length zero shall be passed.
	ref	An optional reference to a static configuration for the test case, which is to be used if a static configuration has been defined for the test case.
Return Value	void	
Constraint	This operation can be called by the TE immediately before it starts the test case behaviour on the MTC (in course of a TTCN-3 execute operation). Only if the test case requires a static configuration, a ref to a started static configuration that is of the configuration type in the test case definition shall be given. If no static configuration has been defined for the test case in the TTCN-3 ATS, the distinct value null shall be passed in for ref.	
Effect	CH transmits the execute test case request to the remote TEs having system ports of the indicated test case. Static connections to the SUT and the initialization of communication means for TSI ports can be set up if needed. This is for example not the case if the static configuration has been started.	

Clause 7.3.3.2.29 tciStaticConnectReq to 7.3.3.2.16b

This clause is to be added.

Signature	void tciStaticConnectReq(in TriPortIdType fromPort, in TriPortIdType toPort)	
In Parameters	fromPort	Identifier of the test component port to be connected from.
	toPort	Identifier of the test component port to be connected to.
Return Value	void	
Constraint	This operation shall be called by the TE when it executes a TTCN-3 static connect operation.	
Effect	CH transmits the static connection request to the remote TE where it calls the tciStaticConnect operation to establish a logical static connection between the two indicated ports. Note that both ports can be on remote TEs. In this case, the operation returns only after calling the tciStaticConnect operation on both remote TEs.	

Clause 7.3.3.2.30 tciStaticMapReq to 7.3.3.2.18b

This clause is to be added.

Signature	void tciStaticMapReq(in TriPortIdType fromPort, in TriPortIdType toPort)	
In Parameters	fromPort	Identifier of the test component port to be mapped from.
	toPort	Identifier of the test component port to be mapped to.
Return Value	void	
Constraint	This operation shall be called by the TE when it executes a TTCN-3 static map operation.	
Effect	CH transmits the static map request to the remote TE where it calls the tciStaticMap operation to establish a logical static connection between the two indicated ports.	

Clause 7.3.3.2.33 tciGetParallelMTCReq to 7.3.3.2.25b

This clause is to be added.

Signature	TriComponentIdType tciGetParallelMTCReq(in TriComponentIdType component)	
In Parameters	component	Identifier of the control component executing the test case for which the MTC shall be determined.
Return Value	A TriComponentIdType value of the MTC.	
Constraint	This operation shall be called by the TE when it executes a TTCN-3 mtc operation.	
Effect	The CH determines the component id of the MTC.	

8.6 Extensions to clause 7.3.4 of ETSI ES 201 873-6 TCI-TL provided

In order to log the handling of static connections and of static components, the operations are tliCStaticCreate, tliPStaticConnect, and tliPStaticMap are defined. For the logging of the starting and destruction of static configurations, the operations tliConfigStarted and tliConfigKilled are defined.

Clause 7.3.4.1.106 tliCStaticCreate to 7.3.4.1.59b

This clause is to be added.

Signature	void tliCStaticCreate(in TString am, in TInteger ts, in TString src, in TInteger line, in TriComponentIdType c, in TriComponentIdType comp, in TString name)	
In Parameters	am	An additional message.
	ts	The time when the event is produced.
	src	The source file of the test specification.
	line	The line number where the request is performed.
	c	The component which produces this event.
	comp	The component which is created.
	name	The name of the component which is created.
Return Value	void	
Constraint	Shall be called by TE to log the create component operation. This event occurs after component creation.	
Effect	The TL presents all the information provided in the parameters of this operation to the user. The kind of the created component (see TciTestComponentKindType) can be logged in am. How this is done is not within the scope of the present document.	

Clause 7.3.4.1.107 tliPStaticConnect to 7.3.4.1.70b

This clause is to be added.

Signature	void tliPStaticConnect(in TString am, in TInteger ts, in TString src, in TInteger line, in TriComponentIdType c, in TriPortIdType port1, in TriPortIdType port2)	
In Parameters	am	An additional message.
	ts	The time when the event is produced.
	src	The source file of the test specification.
	line	The line number where the request is performed.
	c	The component which produces this event.
	port1	The first port to be connected.
	port2	The second port to be connected.
Return Value	void	
Constraint	Shall be called by CH or TE to log the connect operation. This event occurs after the connect operation.	
Effect	The TL presents all the information provided in the parameters of this operation to the user. The kind of the connection (i.e. dynamic or static) can be logged in am. How this is done is not within the scope of the present document.	

Clause 7.3.4.1.108 tliPStaticMap to 7.3.4.1.72b

This clause is to be added.

Signature	void tliPStaticMap(in TString am, in TInteger ts, in TString src, in TInteger line, in TriComponentIdType c, in TriPortIdType port1, in TriPortIdType port2)	
In Parameters	am	An additional message.
	ts	The time when the event is produced.
	src	The source file of the test specification.
	line	The line number where the request is performed.
	c	The component which produces this event.
	port1	The first port to be mapped.
	port2	The second port to be mapped.
Return Value	void	
Constraint	Shall be called by SA or TE to log the map operation. This event occurs after the map operation.	
Effect	The TL presents all the information provided in the parameters of this operation to the user. The kind of the connection (i.e. dynamic or static) can be logged in am. How this is done is not within the scope of the present document.	

Clause 7.3.4.1.109 tliConfigStarted to 7.3.4.1.6b

This clause is to be added.

Signature	void tliConfigStarted (in TString am, in TInteger ts, in TString src, in TInteger line, in TriComponentIdType c, in TciBehaviourIdType configId, in TciParameterListType tciPars, in TciConfigurationIdType ref)	
In Parameters	am	An additional message.
	ts	The time when the event is produced.
	src	The source file of the test specification.
	line	The line number where the request is performed.
	c	The component which produces this event.
	configId	The static configuration function being started.
	tciPars	The parameters of the started configuration function.
	ref	The resulting static configuration reference.
Return Value	void	
Constraint	Shall be called by TE to log the starting of a static test configuration. This event occurs after static configuration start.	
Effect	The TL presents all the information provided in the parameters of this operation to the user, how this is done is not within the scope of the present document.	

Clause 7.3.4.1.110 tliConfigKilled to 7.3.4.1.8b

This clause is to be added.

Signature	void tliConfigKilled (in TString am, in TInteger ts, in TString src, in TInteger line, in TriComponentIdType c, in TciConfigurationIdType ref)	
In Parameters	am	An additional message.
	ts	The time when the event is produced.
	src	The source file of the test specification.
	line	The line number where the request is performed.
	c	The component which produces this event.
	ref	The static configuration reference that has been destructed.
Return Value	void	
Constraint	Shall be called by TE to log the kill configuration operation. This event occurs after configuration kill.	
Effect	The TL presents all the information provided in the parameters of this operation to the user, how this is done is not within the scope of the present document.	

Clause 7.3.4.1.111 tliPSetState to 7.3.4.1.79b

This clause is to be added.

Signature	void tliPSetState (in TString am, in TInteger ts, in TString src, in TInteger line, in TriComponentIdType c, in TInteger state, in TString reason)	
In Parameters	am	An additional message.
	ts	The time when the event is produced.
	src	The source file of the test specification.
	line	The line number where the request is performed.
	c	The component which produces this event.
	state	The new translation state.
	reason	The optional reason of the port.setstate statement.
Return Value	void	
Constraint	Shall be called by TE to log the port.setstate operation. This event occurs after the port state is set.	
Effect	The TL presents all the information provided in the parameters of this operation to the user, how this is done is not within the scope of the present document.	

8.7 Extensions to clause 8 of ETSI ES 201 873-6 Java™ language mapping

Clause 8.2.2.5 TciTestComponentKindType

This clause is to be extended.

```
// TCI IDL TciTestComponentKindType
public interface TciTestComponentKind {
    :
    public final static int TCI_MTC_STATIC_COMP = 5;
    public final static int TCI_PTC_STATIC_COMP = 6;
    public final static int TCI_SYSTEM_STATIC_COMP = 7;
}
```

Clause 8.3.2.4 TciTypeClassType

This clause is to be extended.

```
public interface TciTypeClass {
    :
    public final static int CONFIGURATION = 25;
}
```

Clause 8.3.2.16 TciConfigurationIdType

This clause is to be added.

TciConfigurationIdType is mapped to the following interface:

```
// TCI IDL TciConfigurationIdType
package org.etsi.ttcn.tci;
public interface TciConfigurationId {
    public String getConfigurationId();
    public String getConfigurationName();
    public String getConfigurationTypeName();
    public boolean equals(TciConfigurationId conf);
}
```

Methods

- `getConfigurationId`
Returns a representation of this unique configuration identifier.
- `getConfigurationName`
Returns the configuration name as defined in the TTCN-3 specification. If no name is provided, an empty string is returned.

- `getConfigurationTypeName`
Returns the configuration type name as defined in the TTCN-3 specification.
- `equals`
Compares `conf` with this `TciConfigurationId` for equality. Returns `true` if and only if both configurations have the same representation of this unique configuration identifier, `false` otherwise.

Clause 8.5.1.1 TCI TM provided

This clause is to be extended.

```
// TCI-TM
// TE -> TM
package org.etsi.ttcn.tci;
public interface TciTMProvided {
    :
    public void tciConfigStarted(TciConfigurationId ref);
    public void tciConfigKilled(TciConfigurationId ref);
}
```

Clause 8.5.1.2 TCI TM required

This clause is to be extended.

```
// TCI-TM
// TM -> TE
package org.etsi.ttcn.tci;
public interface TciTMRequired {
    :
    public void tciStartTestCase
        (String testCaseId, TciParameterList parameterList, TciConfigurationId ref);
    :
    public TciConfigurationId tciStartConfig
        (TciBehaviourId configId, TciParameterList parameterList);
    public void tciKillConfig(TciConfigurationId ref);
}
```

Clause 8.5.3.1 TCI CH provided

This clause is to be extended.

```
// TciCHProvided
// TE -> CH
package org.etsi.ttcn.tci;
public interface TciCHProvided {
    :
    public void tciStaticConnectReq(TriPortId fromPort, TriPortId toPort);
    public void tciStaticMapReq(TriPortId fromPort, TriPortId toPort);
    public void tciGetParallelMTCReq(TriComponentId comp) ;
}
```

Clause 8.5.3.2 TCI CH required

This clause is to be extended.

```
// TciCHRequired
// CH -> TE
package org.etsi.ttcn.tci;
public interface TciCHRequired extends TciCDRequired {
    :
    public void tciStaticConnect(TriPortId fromPort, TriPortId toPort);
    public void tciStaticMap(TriPortId fromPort, TriPortId toPort);
    public void tciGetParallelMTC(TriComponentId comp) ;
}
```

Clause 8.5.4.1 TCI TL provided

This clause is to be extended.

```
// TCI-TL
// TE, TM,CH,CD, SA,PA -> TL
package org.etsi.ttcn.tci;
public interface TciTLProvided {
    :
    public void tliCStaticCreate(String am, int ts, String src, int line, TriComponentId c,
        TriComponentId comp, String name);
    public void tliPStaticConnect(String am, int ts, String src, int line, TriComponentId c,
        TriPortId port1, TriPortId port2);
    public void tliPStaticMap(String am, int ts, String src, int line, TriComponentId c,
        TriPortId port1, TriPortId port2);
    public void tliConfigStarted (String am, int ts, String src, int line, TriComponentId c,
        TciBehaviourId configId, TciParameterList tciPars, TciConfigurationId ref);
    public void tliConfigKilled (String am, int ts, String src, int line, TriComponentId c,
        TciConfigurationId ref);
    public void tliPSetState (String am, int ts, String src, int line, TriComponentId c,
        int state, String reason);
}
}
```

8.8 Extensions to clause 9 of ETSI ES 201 873-6 ANSI C language mapping

Clause 9.5 Data

The table is to be extended.

TCI IDL ADT	ANSI C representation (Type definition)	Notes and comments
:		
TciTypeClassType	typedef enum { : TCI_CONFIGURATION_TYPE = 25 } TciTypeClassType;	
TciTestComponentKindType	typedef enum { : TCI_MTC_STATIC_COMP, TCI_PTC_STATIC_COMP, TCI_SYSTEM_STATIC_COMP } TciTestComponentKindType;	
:		
TciConfigurationIdType	typedef struct TciConfigurationIdType { BinaryString confInst; String confName; QualifiedName confType; } TciConfigurationIdType;	

Clause 9.4.1.1 TCI TM provided

This clause is to be extended.

```
:
void tciConfigStarted(TciConfigurationId ref);
void tciConfigKilled(TciConfigurationId ref)
```

Clause 9.4.1.2 TCI TM required

This clause is to be extended.

```
:
void tciStartTestCase
    (TciTestCaseIdType testCaseId, TciParameterListType parameterlist,
     TciConfigurationIdType ref)
:
TciConfigurationId tciStartConfig
```

```
(TciBehaviourIdType configId, TciParameterListType parameterList)
void tciKillConfig(TciConfigurationId ref)
```

Clause 9.4.3.1 TCI CH provided

This clause is to be extended.

```
:
void tciExecuteTestCaseReq
    (TciTestCaseIdType testCaseId, TriPortIdList tsiPortList,
     TciConfigurationIdType ref)
:
void tciStaticConnectReq(TriPortId fromPort, TriPortId toPort);
void tciStaticMapReq(TriPortId fromPort, TriPortId toPort);
void tciGetParallelMTCReq(TriComponentId component)
```

Clause 9.4.3.2 TCI CH required

This clause is to be extended.

```
:
void tciExecuteTestCase
    (TciTestCaseIdType testCaseId, TriPortIdList tsiPortList,
     TciConfigurationIdType ref)
:
void tciStaticConnect(TriPortId fromPort, TriPortId toPort)
void tciStaticMap(TriPortId fromPort, TriPortId toPort)
void tciGetParallelMTC(TriComponentId component)
```

Clause 9.4.4.1 TCI TL provided

This clause is to be extended.

```
:
void tliCStaticCreate (String am, int ts, String src, int line, TriComponentId c,
                      TriComponentId comp, String name)
void tliPStaticConnect (String am, int ts, String src, int line, TriComponentId c,
                       TriPortId port1, TriPortId port2)
void tliPStaticMap (String am, int ts, String src, int line, TriComponentId c,
                   TriPortId port1, TriPortId port2)
void tliConfigStarted (String am, int ts, String src, int line, TriComponentId c,
                      TciBehaviourIdType configId, TciParameterListType tciPars, Value ref)
void tliConfigKilled (String am, int ts, String src, int line, TriComponentId c,
                     Value ref)
void tliPSetState (String am, int ts, String src, int line, TriComponentId c,
                  int state, String reason)
```

8.9 Extensions to clause 10 of ETSI ES 201 873-6 C++ language mapping

Clause 10.5.2.13 TciTestComponentKind

This clause is to be extended.

```
class TciTestComponentKind {
public:
    :
    static const TciTestComponentKind MTC_STATIC_COMP;
    static const TciTestComponentKind PTC_STATIC_COMP;
    static const TciTestComponentKind SYSTEM_STATIC_COMP;
    :
}
}
```

Clause 10.5.2.14 TciTypeClassType

This clause is to be extended.

```
typedef enum
{
    :
    TCI_CONFIGURATION = 25
} TciTypeClass;
```

Clause 10.5.2.16 TciConfigurationId

This clause is to be added.

Identifies a static configuration. It is mapped to the pure virtual class:

```
class TciConfigurationId {
public:
    virtual ~TciConfigurationId ();
    virtual const QualifiedName & getConfigurationTypeName () const =0;
    virtual void setConfigurationTypeName (const QualifiedName &tName)=0;
    virtual const Tstring & getConfigurationName () const =0;
    virtual void setConfigurationName (const Tstring &sName)=0;
    virtual const Tinteger & getConfigurationId () const =0;
    virtual void setConfigurationId (const Tinteger &id)=0;
    virtual Tboolean operator== (const TciConfigurationId &cmp) const =0;
    virtual TciComponentId * cloneConfigurationId () const =0;
    virtual Tboolean operator< (const TciConfigurationId &cmp) const =0;
}

```

Methods

- ~TciConfigurationId
Destructor.
- getConfigurationTypeName
Returns a const reference to the configuration type name.
- setConfigurationTypeName
Set the configuration type name.
- getConfigurationName
Gets the configuration name.
- setConfigurationName
Set the configuration name.
- getConfigurationId
Returns the configuration identifier.
- setConfigurationId
Set the configuration identifier.
- operator==
Returns true if both TciConfigurationId objects are equal.
- cloneConfigurationId
Returns a copy of the TciConfigurationId.
- operator<
Operator < overload.

Clause 10.6.1.1 TciTmRequired

This clause is to be extended.

```
:
virtual void tciStartTestCase
    (const TciTestCaseId *testCaseId, const TciParameterList *parameterList,
     const TciConfigurationId *ref)=0;
:
virtual const TciConfigurationId *tciStartConfig
    (const TciBehaviourId *configId, TciParameterList *parameterList)=0;
virtual void tciKillConfig(const TciConfigurationId *ref)=0;

```

Clause 10.6.1.2 TciTmProvided

This clause is to be extended.

```
:
//Indicates the start of a static configuration
virtual void tciConfigStarted(const TciConfigurationId *ref) =0;

```

```
virtual void tciConfigKilled(const TciConfigurationId *ref)=0;
```

Clause 10.6.3.1 TciChRequired

This clause is to be extended.

```
:
virtual void tciExecuteTestCase
    (const TciTestCaseId *testCaseId, const TriPortIdList *tsiPortList,
     const TciConfigurationId *ref)=0;
:
virtual void tciStaticConnect(const TriPortId *fromPort, const TriPortId *toPort)=0;
virtual void tciStaticMap(const TriPortId *fromPort, const TriPortId *toPort)=0;
//This operation can be called by the CH at the appropriate local TE when at a remote TE a
//provided tciGetParallelMTCReq has been called
virtual const TriComponentId * tciGetParallelMTC (const TriComponentId *component) const =0;
```

Clause 10.6.3.2 TciChProvided

This clause is to be extended.

```
:
virtual void tciExecuteTestCaseReq
    (const TciTestCaseId *testCaseId, const TriPortIdList *tsiPortList,
     const TciConfigurationId *ref)=0;
:
virtual void tciStaticConnectReq(const TriPortId *fromPort, const TriPortId *toPort)=0;
virtual void tciStaticMapReq(const TriPortId *fromPort, const TriPortId *toPort)=0;
//Called by the TE when it executes a TTCN-3 mtc on a parallel control component operation
virtual const TriComponentId * tciGetParallelMTCReq (const TriComponentId *component) const =0;
```

Clause 10.6.4.1 TciTIProvided

This clause is to be extended.

```
:
virtual void tlicStaticCreate (const Tstring &am, const timeval ts, const Tstring src,
const Tinteger line, const TriComponentId *c, const TriComponentId *comp,
const Tstring &name)=0;

virtual void tliPStaticConnect (const Tstring &am, const timeval ts, const Tstring src,
const Tinteger line, const TriComponentId *c, const TriPortId *port1, const TriPortId *port2)=0;

virtual void tliPStaticMap (const Tstring &am, const timeval ts, const Tstring src,
const Tinteger line, const TriComponentId *c, const TriPortId *port1, const TriPortId *port2)=0;

virtual void tliConfigStarted (const Tstring &am, const timeval ts, const Tstring src,
const Tinteger line, const TriComponentId *c, const TciBehaviourId *configId,
const TciParameterList *tciPars, const TciValue *ref)=0;

virtual void tliConfigKilled (const Tstring &am, const timeval ts, const Tstring src,
const Tinteger line, const TriComponentId *c, const TciValue *ref)=0;

virtual void tliPSetState (const Tstring &am, const timeval ts, const Tstring src,
const Tinteger line, const TriComponentId *c, const Tinteger status, const Tstring &reason)=0;
```

8.10 Extensions to clause 11 of ETSI ES 201 873-6 W3C XML mapping

Clause 11.3.2.21 TciConfigurationIdType

This clause is to be added.

TciConfigurationIdType is mapped to the following complex type:

```
<xsd:complexType name="TciConfigurationIdType">
  <xsd:sequence>
    <xsd:choice>
      <xsd:element name="null" type="Templates:null"/>
      <xsd:element name="id" type="Types:Id"/>
    </xsd:choice>
  </xsd:sequence>
</xsd:complexType>
```

Elements:

- `id` The identifier of the static configuration.
- `null` The null identifier. To be used if there is no static configuration identifier.

Attributes:

- none.

Clause 11.4.2.1 TCI TL provided

This clause is to be extended.

```

:
<xsd:complexType name="tliTcExecute">
  <xsd:complexContent mixed="true">
    <xsd:extension base="Events:Event">
      <xsd:sequence>
        <xsd:element name="tcId" type="Types:TciTestCaseIdType"/>
        <xsd:element name="tciPars" type="Types:TciParameterListType" minOccurs="0"/>
        <xsd:element name="dur" type="SimpleTypes:TriTimerDurationType" minOccurs="0"/>
        <xsd:element name="ref" type="Types:TciConfigurationIdType" minOccurs="0"/>
      </xsd:sequence>
    </xsd:extension>
  </xsd:complexContent>
</xsd:complexType>
:
<xsd:complexType name="tliTcStart">
  <xsd:complexContent mixed="true">
    <xsd:extension base="Events:Event">
      <xsd:sequence>
        <xsd:element name="tcId" type="Types:TciTestCaseIdType"/>
        <xsd:element name="tciPars" type="Types:TciParameterListType" minOccurs="0"/>
        <xsd:element name="dur" type="SimpleTypes:TriTimerDurationType" minOccurs="0"/>
        <xsd:element name="ref" type="Types:TciConfigurationIdType" minOccurs="0"/>
      </xsd:sequence>
    </xsd:extension>
  </xsd:complexContent>
</xsd:complexType>
:
<xsd:complexType name="tliTcStarted">
  <xsd:complexContent mixed="true">
    <xsd:extension base="Events:Event">
      <xsd:sequence>
        <xsd:element name="tcId" type="Types:TciTestCaseIdType"/>
        <xsd:element name="tciPars" type="Types:TciParameterListType" minOccurs="0"/>
        <xsd:element name="dur" type="SimpleTypes:TriTimerDurationType" minOccurs="0"/>
        <xsd:element name="ref" type="Types:TciConfigurationIdType" minOccurs="0"/>
      </xsd:sequence>
    </xsd:extension>
  </xsd:complexContent>
</xsd:complexType>
:
<xsd:complexType name="tliCStaticCreate">
  <xsd:complexContent mixed="true">
    <xsd:extension base="Events:Event">
      <xsd:sequence>
        <xsd:element name="comp" type="Types:TriComponentIdType"/>
        <xsd:element name="name" type="SimpleTypes:TString"/>
      </xsd:sequence>
    </xsd:extension>
  </xsd:complexContent>
</xsd:complexType>
:
<xsd:complexType name="tliPStaticConnect">
  <xsd:complexContent mixed="true">
    <xsd:extension base="Events:PortConfiguration"/>
  </xsd:complexContent>
</xsd:complexType>
:
<xsd:complexType name="tliPStaticMap">
  <xsd:complexContent mixed="true">
    <xsd:extension base="Events:PortConfiguration"/>
  </xsd:complexContent>

```

```

</xsd:complexType>

<xsd:complexType name="tliConfigStarted">
  <xsd:complexContent mixed="true">
    <xsd:extension base="Events:Event">
      <xsd:sequence>
        <xsd:element name="configId" type="Types:TciBehaviourIdType"/>
        <xsd:element name="tciPars" type="Types:TciParameterListType" minOccurs="0"/>
        <xsd:element name="ref" type="Types:TciConfigurationIdType"/>
      </xsd:sequence>
    </xsd:extension>
  </xsd:complexContent>
</xsd:complexType>

<xsd:complexType name="tliConfigKilled">
  <xsd:complexContent mixed="true">
    <xsd:extension base="Events:Event">
      <xsd:sequence>
        <xsd:element name="ref" type="Types:TciConfigurationIdType"/>
      </xsd:sequence>
    </xsd:extension>
  </xsd:complexContent>
</xsd:complexType>

<xsd:complexType name="tliPSetState">
  <xsd:complexContent mixed="true">
    <xsd:extension base="Events:Event">
      <xsd:sequence>
        <xsd:element name="state" type="SimpleTypes:TInteger"/>
        <xsd:element name="reason" type="SimpleTypes:TString" minOccurs="0"/>
      </xsd:sequence>
    </xsd:extension>
  </xsd:complexContent>
</xsd:complexType>

```

Clause B.5 TCI TL XML Schema for Events

Insert the following XML elements before the closing tag </xsd:schema>:

```

:
<xsd:complexType name="tliCStaticCreate">
  <xsd:complexContent mixed="true">
    <xsd:extension base="Events:Event">
      <xsd:sequence>
        <xsd:element name="comp" type="Types:TriComponentIdType"/>
        <xsd:element name="name" type="SimpleTypes:TString"/>
      </xsd:sequence>
    </xsd:extension>
  </xsd:complexContent>
</xsd:complexType>

<xsd:complexType name="tliPStaticConnect">
  <xsd:complexContent mixed="true">
    <xsd:extension base="Events:PortConfiguration"/>
  </xsd:complexContent>
</xsd:complexType>

<xsd:complexType name="tliPStaticMap">
  <xsd:complexContent mixed="true">
    <xsd:extension base="Events:PortConfiguration"/>
  </xsd:complexContent>
</xsd:complexType>

<xsd:complexType name="tliConfigStarted">
  <xsd:complexContent mixed="true">
    <xsd:extension base="Events:Event">
      <xsd:sequence>
        <xsd:element name="configId" type="Types:TciBehaviourIdType"/>
        <xsd:element name="tciPars" type="Types:TciParameterListType" minOccurs="0"/>
        <xsd:element name="ref" type="Types:TciConfigurationIdType"/>
      </xsd:sequence>
    </xsd:extension>
  </xsd:complexContent>
</xsd:complexType>

<xsd:complexType name="tliConfigKilled">
  <xsd:complexContent mixed="true">
    <xsd:extension base="Events:Event">

```

```

        <xsd:sequence>
            <xsd:element name="ref" type="Types:TciConfigurationIdType"/>
        </xsd:sequence>
    </xsd:extension>
</xsd:complexContent>
</xsd:complexType>

<xsd:complexType name="tliPSetState">
    <xsd:complexContent mixed="true">
        <xsd:extension base="Events:Event">
            <xsd:sequence>
                <xsd:element name="state" type="SimpleTypes:TInteger"/>
                <xsd:element name="reason" type="SimpleTypes:TString" minOccurs="0"/>
            </xsd:sequence>
        </xsd:extension>
    </xsd:complexContent>
</xsd:complexType>
:

```

Clause B.6 TCI TL XML Schema for a Log

```

:
<xsd:complexType name="Body">
    <xsd:choice maxOccurs="unbounded">
        :
        <!-- static configurations -->
        <xsd:element name="tliCStaticCreate" type="Events:tliCStaticCreate"/>
        <xsd:element name="tliPStaticConnect" type="Events:tliPStaticConnect"/>
        <xsd:element name="tliPStaticMap" type="Events:tliPStaticMap"/>
        <xsd:element name="tliConfigStarted" type="Events:tliConfigStarted"/>
        <xsd:element name="tliConfigKilled" type="Events:tliConfigKilled"/>
        <xsd:element name="tliPSetState" type="Events:tliPSetState"/>
        :
    </xsd:choice>
</xsd:complexType>
:

```

8.11 Extensions to clause 12 of ETSI ES 201 873-6 C# language mapping

Clause 12.4.2.5 TciTestComponentKindType

This clause is to be extended.

```

public enum TciTestComponentKind {
    :
    TciMtcStaticComp = 5;
    TciPtcStaticComp = 6;
    TciSystemComp = 7;
}

```

Clause 12.4.2.4 TciTypeClassType

This clause is to be extended.

```

public enum TciTypeClass {
    :
    Configuration = 25;
}

```

Clause 12.4.2.16 TciConfigurationIdType

This clause is to be added.

TciConfigurationIdType is mapped to the following interface:

```

public interface ITciConfigurationId {
    string ConfigurationId { get; }
    string ConfigurationName { get; }
    IQualifiedName ConfigurationTypeName { get; }
    bool Equals(ITciConfigurationId conf);
}

```

Methods

- `ConfigurationId`
Returns a representation of this unique configuration identifier.
- `ConfigurationName`
Returns the configuration name as defined in the TTCN-3 specification. If no name is provided, an empty string is returned.
- `ConfigurationTypeName`
Returns the configuration type name as defined in the TTCN-3 specification.
- `Equals`
Compares `conf` with this `TciConfigurationId` for equality. Returns `true` if and only if both configurations have the same representation of this unique configuration identifier, `false` otherwise.

Clause 12.5.1.1 TCI-TM provided

This clause is to be extended.

```
public interface ITciTMProvided {
    :
    void tciConfigStarted(ITciConfigurationId ref);
    void tciConfigKilled(ITciConfigurationId ref)
}
```

Clause 12.5.1.2 TCI-TM required

This clause is to be extended.

```
public interface ITciTMRequired {
    :
    void TciStartTestCase(ITciTestCaseId testCaseId,
        ITciParameterList parameterList, ITciConfigurationId ref);
    :
    ITciConfigurationId tciStartConfig
        (ITciBehaviourId configId, ITciParameterList parameterList)
    void tciKillConfig(ITciConfigurationId ref)
}
```

Clause 12.5.3.1 TCI-CH provided

This clause is to be extended.

Amend the following definition as shown below:

```
public interface ITciCHProvided {
    :
    void TciExecuteTestCaseReq(ITriComponentId component,
        ITriPortIdList tsiPortList, ITciConfigurationId ref);
}
```

Add the following definitions:

```
void tciStaticConnectReq(ITriPortId fromPort, ITriPortId toPort);
void tciStaticMapReq(ITriPortId fromPort, ITriPortId toPort);
ITriComponentId TciGetParallelMTC (ITriComponentId component);
}
```

Clause 12.5.3.2 TCI-CH required

This clause is to be extended.

```
public interface ITciCHRequired {
    :
    void TciExecuteTestCase (ITciTestCaseId testCaseId,
        ITriPortIdList tsiPortList, ITciConfigurationId ref);
    :
    void tciStaticConnect(ITriPortId fromPort, ITriPortId toPort);
    void tciStaticMap(ITriPortId fromPort, ITriPortId toPort);
    ITriComponentId TciGetParallelMtc(ITriComponentId comp);
}
```

Clause 12.5.4.1 TCI-TL provided

This clause is to be extended.

```
public interface ITciTLProvided {
    :
    void tliCStaticCreate(string am, System.DateTime ts, string src, int line,
        ITriComponentId c,
        ITriComponentId comp, sString name);
    void tliPStaticConnect(string am, System.DateTime ts, string src, int line,
        ITriComponentId c,
        ITriPortId port1, ITriPortId port2);
    void tliPStaticMap(string am, System.DateTime ts, string src, int line,
        ITriComponentId c,
        ITriPortId port1, ITriPortId port2);
    void tliConfigStarted (string am, System.DateTime ts, string src, int line,
        ITriComponentId c,
        ITciBehaviourId configId, ITciParameterList tciPars, ITciValue ref);
    void tliConfigKilled (string am, System.DateTime ts, string src, int line,
        ITriComponentId c,
        ITciValue ref);
    void tliPSetState (string am, System.DateTime ts, string src, int line,
        ITriComponentId c,
        int state, string reason);
}
```

8.12 Extensions to Annex A (normative) of ETSI ES 201 873-6 IDL Specification of TCI

The definition interface TCI_CH_Required : TCI_CD_Required is to be extended by:

```
TriComponentIdType tciGetParallelMTC (
    in TriComponentIdType comp
);
```

The definition interface TCI_CH_Provided is to be extended by:

```
TriComponentIdType tciGetParallelMTCReq (
    in TriComponentIdType comp
);
```

Annex A (normative): BNF and static semantics

A.1 Additional TTCN-3 terminals

Table A.1 presents all additional TTCN-3 terminals which are reserved words when using this package. Like the reserved words defined in the TTCN-3 core language, the TTCN-3 terminals listed in table A.1 shall not be used as identifiers in a TTCN-3 module. These terminals shall be written in all lowercase letters.

Table A.1: List of additional TTCN-3 terminals which are reserved words

<code>configuration</code>	<code>static</code>	<code>setstate</code>	
----------------------------	---------------------	-----------------------	--

A.2 Modified TTCN-3 syntax BNF productions

This clause includes all BNF productions that are modifications of BNF rules defined in the TTCN-3 core language document ETSI ES 201 873-1 [1]. When using this package the BNF rules below replace the corresponding BNF rules in the TTCN-3 core language document. The rule numbers define the correspondence of BNF rules.

```

7. ModuleDefinition ::= (([Visibility] (TypeDef |
                               ConstDef |
                               TemplateDef |
                               ModuleParDef |
                               FunctionDef |
                               SignatureDef |
                               TestcaseDef |
                               AltstepDef |
                               ImportDef |
                               ExtFunctionDef |
                               ExtConstDef |
                               ConfigurationDef
                               )) |
    ([ "public" ] GroupDef) |
    ([ "private" ] FriendModuleDef)
    ) [WithStatement]

51. PortDefAttribs ::= MessageAttribs |
    ProcedureAttribs |
    MixedAttribs |
    TranslationPortAttribs

186. TestcaseDef ::= TestcaseKeyword TestcaseIdentifier
    "(" [TestcaseFormalParList] ")" ConfigSpec | ExecuteOnSpec
    StatementBlock

192. TestcaseInstance ::= ExecuteKeyword "(" TestcaseRef "(" [ActualParList] ")"
    [ "," (Expression | Minus)
    [ "," (SingleExpression | Minus)
    [ "," ConfigurationReference]] ")"

205. ExceptElement ::= ExceptGroupSpec |
    ExceptTypeDefSpec |
    ExceptTemplateSpec |
    ExceptConstSpec |
    ExceptTestcaseSpec |
    ExceptAltstepSpec |
    ExceptFunctionSpec |
    ExceptSignatureSpec |
    ExceptModuleParSpec |
    ExceptConfigurationSpec

217. ImportElement ::= ImportGroupSpec |
    ImportTypeDefSpec |
    ImportTemplateSpec |
    ImportConstSpec |

```

```

    ImportTestcaseSpec |
    ImportAltstepSpec |
    ImportFunctionSpec |
    ImportSignatureSpec |
    ImportModuleParSpec |
    ImportImportSpec |
    ImportConfigurationSpec

251. ControlStatement ::= TimerStatements |
    BasicStatements |
    BehaviourStatements |
    SUTStatements |
    StopKeyword |
    KillConfigStatement

256 ValueRef ::= Identifier [ExtendedFieldReference] | PortOp

264. CreateOp ::= ComponentType Dot CreateKeyword
    ["(" (SingleExpression | Minus) ["," SingleExpression] ")"]
    [AliveKeyword | StaticKeyword]

279. ConnectStatement ::= ConnectKeyword SingleConnectionSpec [StaticKeyword]

289. MapStatement ::= MapKeyword SingleConnectionSpec [ParamClause] [StaticKeyword]

396. PredefinedType ::= BitStringKeyword |
    BooleanKeyword |
    CharStringKeyword |
    UniversalCharString |
    IntegerKeyword |
    OctetStringKeyword |
    HexStringKeyword |
    VerdictTypeKeyword |
    FloatKeyword |
    AddressKeyword |
    DefaultKeyword |
    AnyTypeKeyword |
    ConfigurationKeyword

540. OpCall ::= ConfigurationOps |
    GetLocalVerdict |
    VerdictOps |
    TimerOps |
    TestcaseInstance |
    FunctionInstance [ ExtendedFieldReference ] |
    TemplateOps [ ExtendedFieldReference ] |
    ActivateOp |
    ConfigurationInstance

```

A.3 Additional TTCN-3 syntax BNF productions

This clause includes all additional BNF productions that needed to define the syntax introduced by this package. All rules start with the digits "781". Additional BNF rules that have a relation to modified BNF rules defined in clause A.2, will have the rule number of the modified rule followed by a lower case letter, e.g. number of modified rule 316, number of related additional rule 781316a. The numbering of other new rules start with number 781001.

```
781186a. ExecuteOnSpec ::= ExecuteKeyword OnKeyword ConfigurationRef
```

```
781264a. StaticKeyword ::= "static"
```

```
781001. ConfigurationDef ::= ConfigurationKeyword ConfigurationIdentifier
    ("[" TemplateOrValueFormalParList ] ")" ConfigSpec
    StatementBlock
```

```
781002. ConfigurationKeyword ::= "configuration"
```

```
781003. ConfigurationIdentifier ::= Identifier
```

```
781004. ConfigurationInstance ::= ConfigurationRef "(" [ ActualParList ] ")"
```

```
781005. ConfigurationRef ::= [ ModuleId Dot ] ConfigurationIdentifier
```

```

781006. KillConfigStatement ::= ConfigurationReference Dot KillKeyword
781007. ConfigurationReference ::= VariableRef | FunctionInstance

781008. TranslationPortAttribs ::= MessageKeyword OuterPortTypeSpec "{" {
    ( TranslationAddrDecl | TranslationMessageList | ConfigParamDef )
    [SemiColon]}+
    "}"

781009. OuterPortTypeSpec ::= OuterPortTypeMapSpec | OuterPortTypeConnectSpec
781010. OuterPortTypeMapSpec ::= MapKeyword ToKeyword Type { "," Type } [ OuterPortTypeConnectSpec ]
781011. OuterPortTypeConnectSpec ::= ConnectKeyword ToKeyword Type { "," Type }

781012. TranslationAddrDecl ::= AddressKeyword Type [ TranslationAddrSpec { "," TranslationAddrSpec }
]
781013. TranslationAddrSpec ::= ( ToKeyword | FromKeyword ) Type WithKeyword FunctionRef "(" ")"

781014. TranslationMessageList ::= InParKeyword TranslationInTypeList |
    OutParKeyword TranslationOutTypeList |
    InOutParKeyword TypeList

781015. TranslationInTypeList ::= TranslationInType { "," TranslationInType }
781016. TranslationInType ::= Type [ TranslationInSpec { "," TranslationInSpec } ]
781017. TranslationInSpec ::= FromKeyword Type WithKeyword FunctionRef "(" ")"

781018. TranslationOutTypeList ::= TranslationOutType { "," TranslationOutType }
781019. TranslationOutType ::= Type [ TranslationOutSpec { "," TranslationOutSpec } ]
781020. TranslationOutSpec ::= ToKeyword Type WithKeyword FunctionRef "(" ")"

781021. FuncPortSpec ::= PortKeyword Identifier

781022. SetPortState ::= PortKeyword "." SetStateKeyword "(" SingleExpression { "," LogItem } ")"
781023. SetStateKeyword ::= "setstate"

781024. ExceptConfigurationSpec ::= ConfigurationKeyword IdentifierListOrAll
781025. ImportConfigurationSpec ::= ConfigurationKeyword AllKeyword
781026. PortOp ::= PortKeyword

```

Annex B (informative): Library of useful types

B.1 Limitations

The types and constants described in this annex use the same rule as specified in clause E.1 of ETSI ES 201 873-1 [1].

B.2 Useful TTCN-3 types

B.2.1 Status values for port states

Type and constants defined in this clause support the secure usage of the **setstate** port operation defined in clause 5.10.4 of ETSI ES 201 873-1 [1].

The type definition for this type is:

```
type integer translationState(0..4);
```

Useful constant definitions for working with object states are:

```
const translationState TRANSLATED := 0;  
const translationState NOT_TRANSLATED := 1;  
const translationState FRAGMENTED := 2;  
const translationState PARTIALLY_TRANSLATED :=3;  
const translationState DISCARDED := 4;
```

History

Document history		
V1.1.1	August 2010	Publication
V1.2.1	June 2013	Publication
V1.3.1	June 2014	Publication
V1.4.1	June 2015	Publication
V1.5.1	May 2017	Publication
V1.6.1	May 2018	Publication
V1.7.1	April 2019	Publication
V1.8.1	April 2021	Membership Approval Procedure MV 20210626: 2021-04-27 to 2021-06-28