

# ETSI ES 202 388-5 V1.1.1 (2005-03)

---

*ETSI Standard*

**Open Service Access (OSA);  
Application Programming Interface (API);  
Test Suite Structure and Test Purposes (TSS&TP);  
Part 5: User interaction SCF  
(Parlay 4)**

---



---

Reference

DES/TISPAN-06004-05-OSA

---

Keywords

API, OSA, TSS&TP

**ETSI**

650 Route des Lucioles  
F-06921 Sophia Antipolis Cedex - FRANCE

Tel.: +33 4 92 94 42 00 Fax: +33 4 93 65 47 16

Siret N° 348 623 562 00017 - NAF 742 C  
Association à but non lucratif enregistrée à la  
Sous-Préfecture de Grasse (06) N° 7803/88

---

**Important notice**

Individual copies of the present document can be downloaded from:

<http://www.etsi.org>

The present document may be made available in more than one electronic version or in print. In any case of existing or perceived difference in contents between such versions, the reference version is the Portable Document Format (PDF). In case of dispute, the reference shall be the printing on ETSI printers of the PDF version kept on a specific network drive within ETSI Secretariat.

Users of the present document should be aware that the document may be subject to revision or change of status. Information on the current status of this and other ETSI documents is available at

<http://portal.etsi.org/tb/status/status.asp>

If you find errors in the present document, please send your comment to one of the following services:

[http://portal.etsi.org/chaicor/ETSI\\_support.asp](http://portal.etsi.org/chaicor/ETSI_support.asp)

---

**Copyright Notification**

No part may be reproduced except as authorized by written permission.  
The copyright and the foregoing restriction extend to reproduction in all media.

© European Telecommunications Standards Institute 2005.  
All rights reserved.

**DECT**<sup>TM</sup>, **PLUGTESTS**<sup>TM</sup> and **UMTS**<sup>TM</sup> are Trade Marks of ETSI registered for the benefit of its Members.  
**TIPHON**<sup>TM</sup> and the **TIPHON logo** are Trade Marks currently being registered by ETSI for the benefit of its Members.  
**3GPP**<sup>TM</sup> is a Trade Mark of ETSI registered for the benefit of its Members and of the 3GPP Organizational Partners.

---

# Contents

Intellectual Property Rights .....	4
Foreword.....	4
1 Scope .....	5
2 References .....	5
3 Definitions and abbreviations.....	5
3.1 Definitions .....	5
3.2 Abbreviations .....	6
4 Test Suite Structure (TSS).....	6
5 Test Purposes (TP) .....	6
5.1 Introduction .....	6
5.1.1 TP naming convention .....	6
5.1.2 Source of TP definition.....	6
5.1.3 Test strategy.....	7
5.2 TPs for the User Interaction SCF .....	7
5.2.1 User Interaction, SCF side .....	7
5.2.1.1 IpUIManager interface .....	7
5.2.1.2 IpUI interface .....	17
5.2.1.3 IpUICall interface .....	30
5.2.2 User Interaction, application side .....	54
5.2.2.1 IpAppUIManager interface .....	55
5.2.2.2 IpAppUI interface .....	58
5.2.2.3 IpAppUICall interface.....	62
History .....	73

---

## Intellectual Property Rights

IPRs essential or potentially essential to the present document may have been declared to ETSI. The information pertaining to these essential IPRs, if any, is publicly available for **ETSI members and non-members**, and can be found in ETSI SR 000 314: "*Intellectual Property Rights (IPRs); Essential, or potentially Essential, IPRs notified to ETSI in respect of ETSI standards*", which is available from the ETSI Secretariat. Latest updates are available on the ETSI Web server (<http://webapp.etsi.org/IPR/home.asp>).

Pursuant to the ETSI IPR Policy, no investigation, including IPR searches, has been carried out by ETSI. No guarantee can be given as to the existence of other IPRs not referenced in ETSI SR 000 314 (or the updates on the ETSI Web server) which are, or may be, or may become, essential to the present document.

---

## Foreword

This ETSI Standard (ES) has been produced by ETSI Technical Committee Telecommunications and Internet converged Services and Protocols for Advanced Networking (TISPAN).

The present document is part 5 of a multi-part deliverable. Full details of the entire series can be found in part 1 [6].

To evaluate conformance of a particular implementation, it is necessary to have a set of test purposes to evaluate the dynamic behaviour of the Implementation Under Test (IUT). The specification containing those test purposes is called a Test Suite Structure and Test Purposes (TSS&TP) specification.

---

# 1 Scope

The present document provides the Test Suite Structure and Test Purposes (TSS&TP) specification for the User Interaction SCF of the Application Programming Interface (API) for Open Service Access (OSA) defined in ES 202 915-5 [1] in compliance with the relevant requirements, and in accordance with the relevant guidance given in ISO/IEC 9646-2 [4] and ETS 300 406 [5].

---

# 2 References

The following documents contain provisions which, through reference in this text, constitute provisions of the present document.

- References are either specific (identified by date of publication and/or edition number or version number) or non-specific.
- For a specific reference, subsequent revisions do not apply.
- For a non-specific reference, the latest version applies.

Referenced documents which are not found to be publicly available in the expected location might be found at <http://docbox.etsi.org/Reference>.

- [1] ETSI ES 202 915-5: "Open Service Access (OSA); Application Programming Interface (API); Part 5: User Interaction SCF (Parlay 4)".
- [2] ETSI ES 202 363: "Open Service Access (OSA); Application Programming Interface (API); Implementation Conformance Statement (ICS) proforma specification; (Parlay 4)".
- [3] ISO/IEC 9646-1: "Information technology - Open Systems Interconnection - Conformance testing methodology and framework - Part 1: General concepts".
- [4] ISO/IEC 9646-2: "Information technology - Open Systems Interconnection - Conformance testing methodology and framework - Part 2: Abstract Test Suite specification".
- [5] ETSI ETS 300 406: "Methods for Testing and Specification (MTS); Protocol and profile conformance testing specifications; Standardization methodology".
- [6] ETSI ES 202 388-1: "Open Service Access (OSA); Application Programming Interface (API); Test Suite Structure and Test Purposes (TSS&TP); Part 1: Overview (Parlay 4)".

---

# 3 Definitions and abbreviations

## 3.1 Definitions

For the purposes of the present document, the terms and definitions given in ES 202 915-5 [1], ISO/IEC 9646-1 [3], ISO/IEC 9646-2 [4] and the following apply:

**abstract test case:** Refer to ISO/IEC 9646-1 [3].

**Abstract Test Method (ATM):** Refer to ISO/IEC 9646-1 [3].

**Abstract Test Suite (ATS):** Refer to ISO/IEC 9646-1 [3].

**Implementation Under Test (IUT):** Refer to ISO/IEC 9646-1 [3].

**Lower Tester (LT):** Refer to ISO/IEC 9646-1 [3].

**Implementation Conformance Statement (ICS):** Refer to ISO/IEC 9646-1 [3].

**ICS proforma:** Refer to ISO/IEC 9646-1 [3].

**Implementation eXtra Information for Testing (IXIT):** Refer to ISO/IEC 9646-1 [3].

**IXIT proforma:** Refer to ISO/IEC 9646-1 [3].

**Test Purpose (TP):** Refer to ISO/IEC 9646-1 [3].

## 3.2 Abbreviations

For the purposes of the present document, the following abbreviations apply:

API	Application Programming Interface
ATM	Abstract Test Method
ATS	Abstract Test Suite
ICS	Implementation Conformance Statement
IUT	Implementation Under Test
IXIT	Implementation eXtra Information for Testing
LT	Lower Tester
OSA	Open Service Access
SCF	Service Capability Feature
TP	Test Purpose
TSS	Test Suite Structure

---

## 4 Test Suite Structure (TSS)

- User Interaction
  - IPUIManager interface
  - IPUI interface
  - IPUICall interface

---

## 5 Test Purposes (TP)

### 5.1 Introduction

For each test requirement a TP is defined.

#### 5.1.1 TP naming convention

Tps are numbered, starting at 01, within each group. Groups are organized according to the TSS. Additional references are added to identify the actual test suite (see table 1).

**Table 1: TP identifier naming convention scheme**

Identifier: <suite_id>_<nnn>	
<suite_id>	= SCG name: "UI" for <b>U</b> ser <b>I</b> nteraction part of User Interaction SCF 'UI_APP' for <b>U</b> ser <b>I</b> nteraction part of User interaction Application
<nn>	= sequential number: (01-99)

#### 5.1.2 Source of TP definition

The TPs are based on ES 202 915-5 [1].

### 5.1.3 Test strategy

As the base standard ES 202 915-5 [1] contains no explicit requirements for testing, the TPs were generated as a result of an analysis of the base standard and the PICS specification ES 202 363 [2].

The TPs are only based on conformance requirements related to the externally observable behaviour of the IUT and are limited to conceivable situations to which a real implementation is likely to be faced (see ETS 300 406 [5]).

## 5.2 TPs for the User Interaction SCF

All PICS items referred to in this clause are as specified in ES 202 363 [2] unless indicated otherwise by another numbered reference.

All parameters specified in method calls are valid unless specified.

The procedures to trigger the SCF to call methods in the application are dependant on the underlying network architecture and are out of the scope of the present document. Those method calls are preceded by the words "Triggered action".

### 5.2.1 User Interaction, SCF side

Pre-requisite:

- Registration of the IUT (User Interaction SCF) and the tester (application) to the framework. The tester must have obtained a reference to an instance of the IpUIManager interface through selecting that service and signing the required service agreement.

#### 5.2.1.1 IpUIManager interface

##### Test UI\_01

Summary: **IpUIManager**, createUI method, successful

Reference: ES 202 915-5 [1], clause 8.1

Selection: createUI method supported - PICS item: [2] UIM1

Test Sequence:

1. Method call **createUI()**  
Parameters: appUI, userAddress  
Check: valid value of TpUIIdentifier is returned

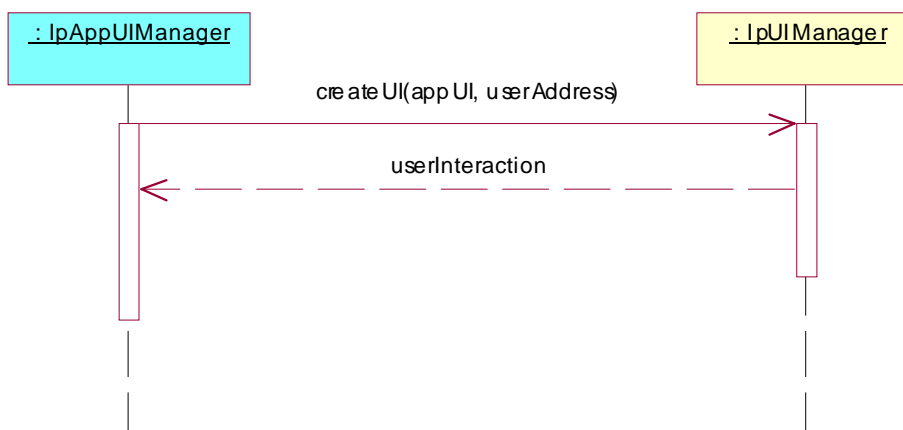

**Test UI\_02**

Summary: **IpUIManager**, createUI method, P\_INVALID\_NETWORK\_STATE

Reference: ES 202 915-5 [1], clause 8.1

Selection: createUI method supported - PICS item: [2] UIM1

Condition: the underlying protocol cannot support the method call.

Test Sequence:

1. Method call **createUI()**  
 Parameters: appUI, userAddress  
 Check: P\_INVALID\_NETWORK\_STATE is returned

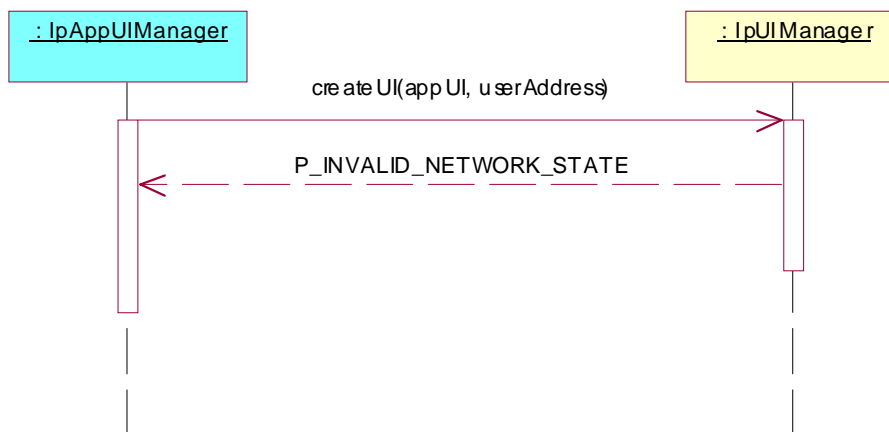
**Test UI\_03**

Summary: **IpUIManager**, createUI method, P\_INVALID\_INTERFACE\_TYPE

Reference: ES 202 915-5 [1], clause 8.1

Selection: createUI method supported - PICS item: [2] UIM1

Test Sequence:

1. Method call **createUI()**  
 Parameters: appUI including an invalid reference type, userAddress  
 Check: P\_INVALID\_INTERFACE\_TYPE is returned

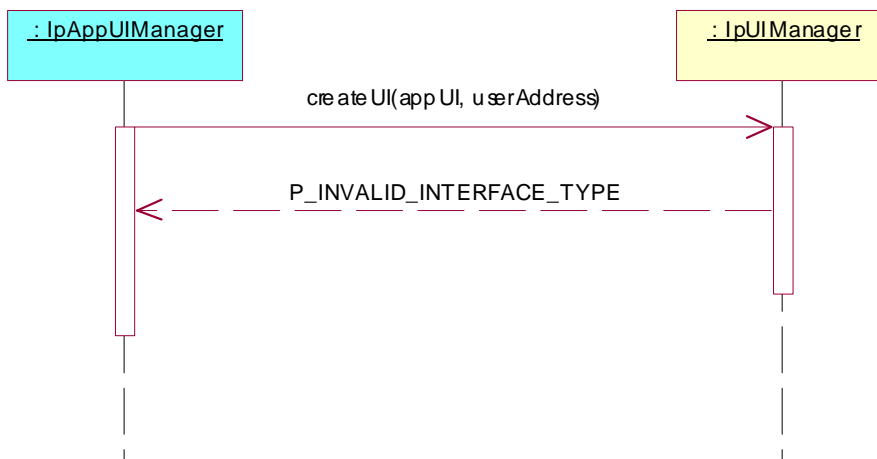



**Test UI\_04**

Summary: **IpUIManager**, createUICall method, successful

Reference: ES 202 915-5 [1], clause 8.1

Selection: createUICall method supported - PICS item: [2] UIM2

Test Sequence:

1. Method call **createUICall()**  
 Parameters: appUI, uiTargetObject  
 Check: valid value of TpUIIdentifier is returned

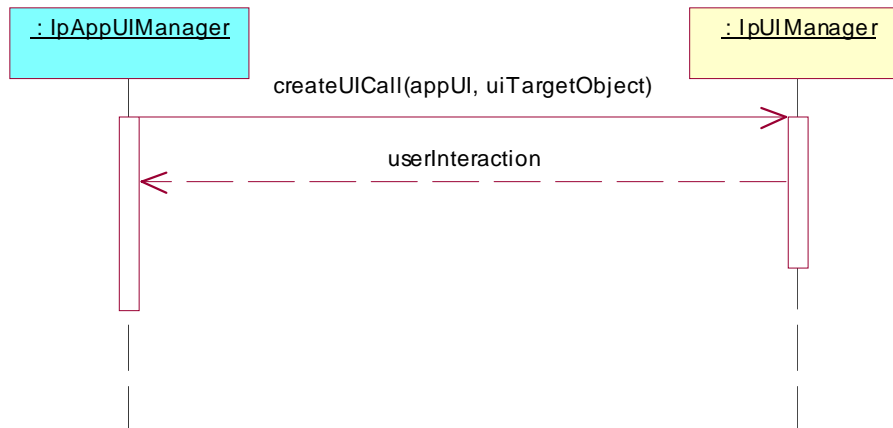
**Test UI\_05**

Summary: **IpUIManager**, createUICall method, P\_INVALID\_NETWORK\_STATE

Reference: ES 202 915-5 [1], clause 8.1

Selection: createUICall method supported - PICS item: [2] UIM2

Condition: the underlying protocol cannot support the method call.

Test Sequence:

1. Method call **createUICall()**  
 Parameters: appUI, userAddress  
 Check: P\_INVALID\_NETWORK\_STATE is returned

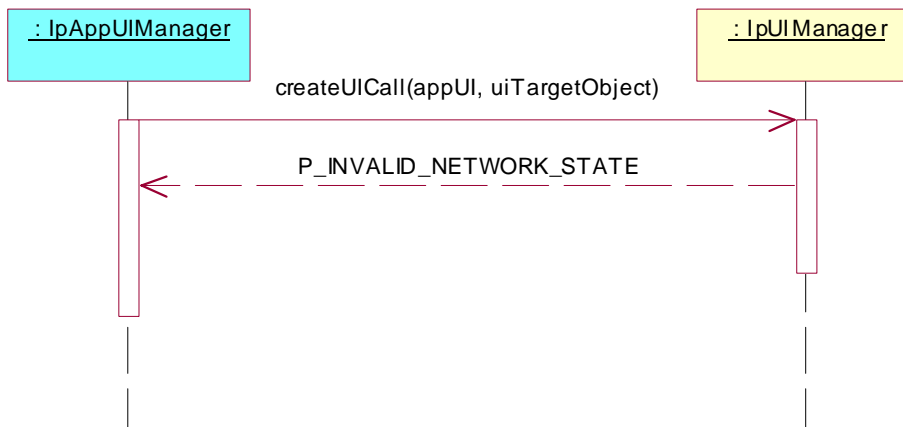

**Test UI\_06**

Summary: **IpUIManager**, createUICall method, P\_INVALID\_INTERFACE\_TYPE

Reference: ES 202 915-5 [1], clause 8.1

Selection: createUICall method supported - PICS item: [2] UIM2

Test Sequence:

1. Method call **createUICall()**

Parameters: appUI including an invalid reference type, uiTargetObject

Check: P\_INVALID\_INTERFACE\_TYPE is returned

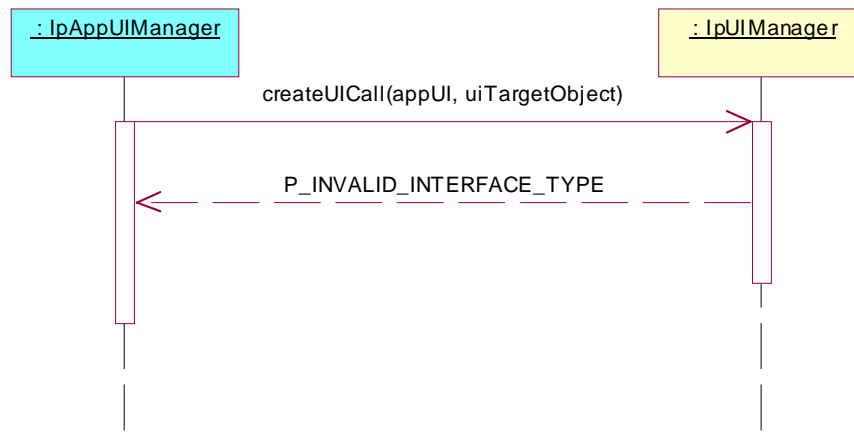
**Test UI\_07**

Summary: **IpUIManager**, all createNotification and destroyNotification methods, successful

Reference: ES 202 915-5 [1], clause 8.1

Selection: createNotification methods supported - PICS item: [2] UIM3

Test Sequence:

1. Method call **createNotification()**

Parameters: appUIManager, eventCriteria,

Check: valid value of TpAssignmentID is returned

2. Method call **destroyNotification()**

Parameters: assignmentID as returned in 1..

Check: no exception is returned.

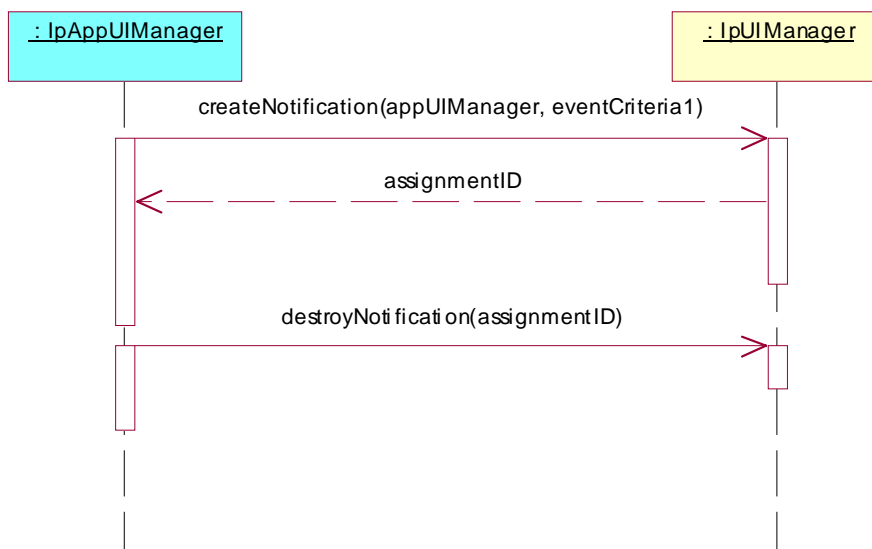
**Test UI\_08**

Summary: **IpUIManager**, receipt of reportEventNotification method, successful

Reference: ES 202 915-5 [1], clauses 8.1 and 8.2

Selection: createNotification methods supported - PICS item: [2] UIM3

Test Sequence:

1. Method call **createNotification()**  
 Parameters: appUIManager, eventCriteria,  
 Check: valid value of TpAssignmentID is returned
  
2. Triggered action: cause IUT to call **reportEventNotification()** method on the tester's (Application) **IpAppUIManager** interface.  
 Check: valid value of userInteraction, eventNotificationInfo and assignmentID given in 1. is transmitted,  
 Return: valid value of IpAppUIRef

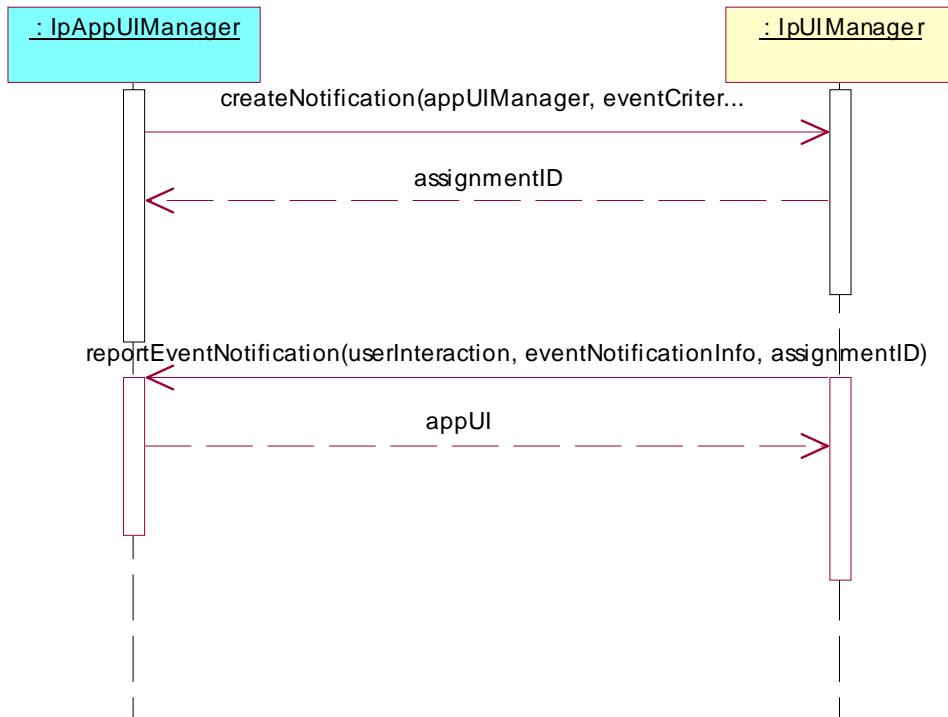
**Test UI\_09**

Summary: **IpUIManager**, createNotification method, P\_INVALID\_INTERFACE\_TYPE

Reference: ES 202 915-5 [1], clause 8.1

Selection: createNotification methods supported - PICS item: [2] UIM3

Test Sequence:

1. Method call **createNotification()**

Parameters: appUIManager including an invalid reference type, eventCriteria,

Check: P\_INVALID\_INTERFACE\_TYPE is returned

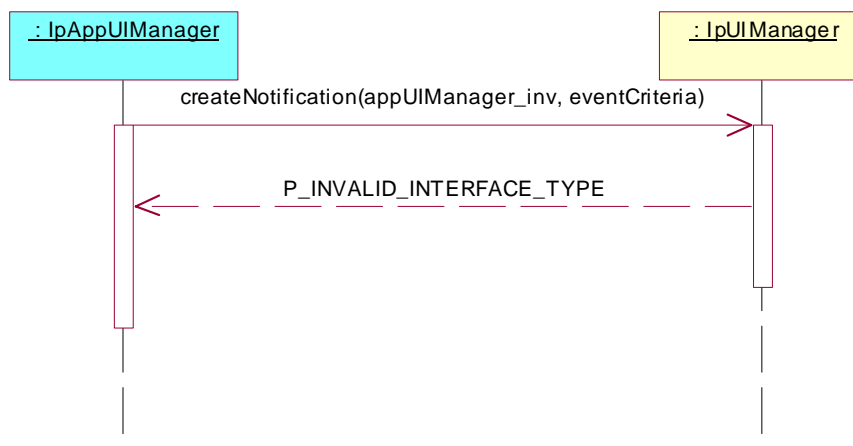

**Test UI\_10**

Summary: **IpUIManager**, createNotification method, P\_INVALID\_CRITERIA

Reference: ES 202 915-5 [1], clause 8.1

Selection: createNotification methods supported - PICS item: [2] UIM3

Test Sequence:

1. Method call **createNotification()**  
Parameters: appUIManager, eventCriteria containing an invalid criteria.  
Check: P\_INVALID\_CRITERIA is returned.

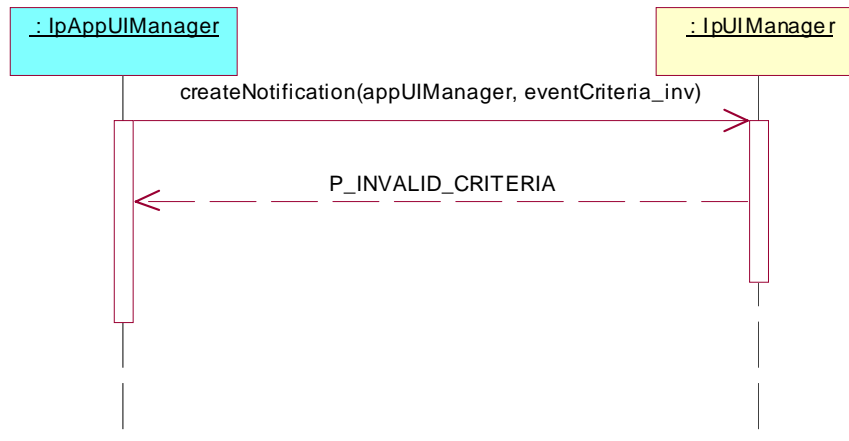
**Test UI\_11**

Summary: **IpUIManager**, createNotification and changeNotification methods, P\_INVALID\_ASSIGNMENT\_ID

Reference: ES 202 915-5 [1], clause 8.1

Selection: createNotification and changeNotification methods supported - PICS item: [2] UIM3 AND UIM5

Test Sequence:

1. Method call **createNotification()**  
Parameters: appUIManager, eventCriteria,  
Check: valid value of TpAssignmentID is returned
2. Method call **changeNotification()**  
Parameters: assignmentID different from returned in 1., eventCriteria.  
Check: P\_INVALID\_ASSIGNMENT\_ID is returned.

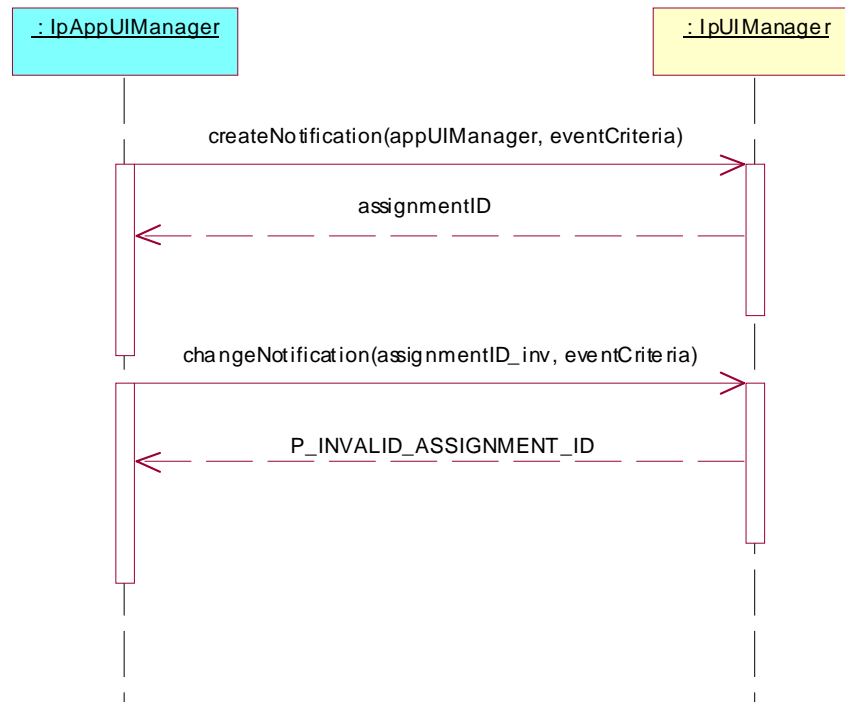

### Test UI\_12

Summary: **IpUIManager**, createNotification and changeNotification method, P\_INVALID\_CRITERIA

Reference: ES 202 915-5 [1], clause 8.1

Selection: createNotification and changeNotification methods supported - PICS item: [2] UIM3 AND UIM5

Test Sequence:

1. Method call **createNotification()**  
 Parameters: appUIManager, eventCriteria,  
 Check: valid value of TpAssignmentID is returned
2. Method call **changeNotification()**  
 Parameters: assignmentID as returned in 1., eventCriteria containing an invalid criteria..  
 Check: P\_INVALID\_CRITERIA is returned.

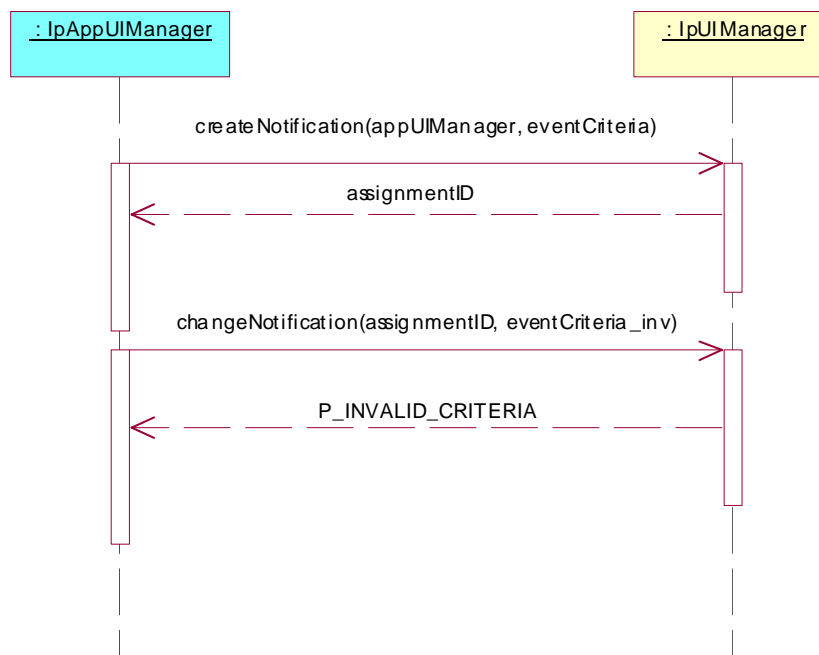

**Test UI\_13**

Summary: **IpUIManager**, destroyNotification method, P\_INVALID\_ASSIGNMENT\_ID

Reference: ES 202 915-5 [1], clause 8.1

Selection: createNotification method supported - PICS item: [2] UIM3

Test Sequence:

1. Method call **createNotification()**  
 Parameters: appUIManager, eventCriteria,  
 Check: valid value of TpAssignmentID is returned
2. Method call **destroyNotification()**  
 Parameters: assignmentID different from 1..  
 Check: P\_INVALID\_ASSIGNMENT\_ID is returned.

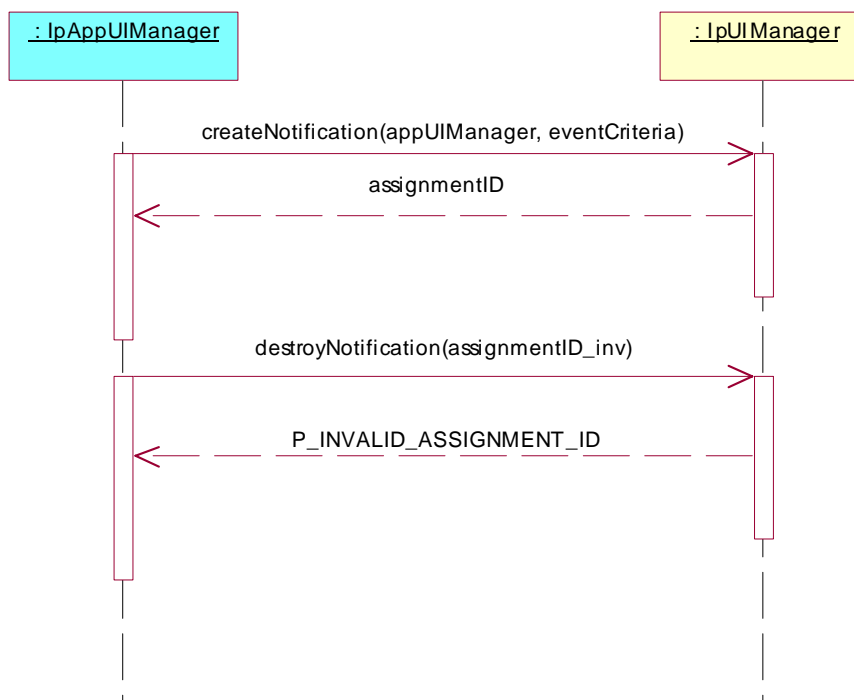

**Test UI\_52**

Summary: **IpUIManager**, all methods, successful

Reference: ES 202 915-5 [1], clause 8.1

Precondition: enableNotifications supported

Preamble: Registration of the IUT (User Interaction SCF) and the tester (application) to the framework. The tester must have obtained a reference to an instance of the IpUIManager interface through selecting that service and signing the required service agreement.

Test Sequence:

1. Method call **enableNotifications()**  
Parameters: appUIManager  
Check: valid value of TpAssignmentID is returned
2. Triggered action: cause IUT to call **reportEventNotification()** method on the tester's (Application) **IpAppAccountManager** interface.  
Parameters: userInteraction, eventNotificationInfo, assignmentID
3. Method call **disableNotifications()**  
Parameters: none  
Check: no exception is returned

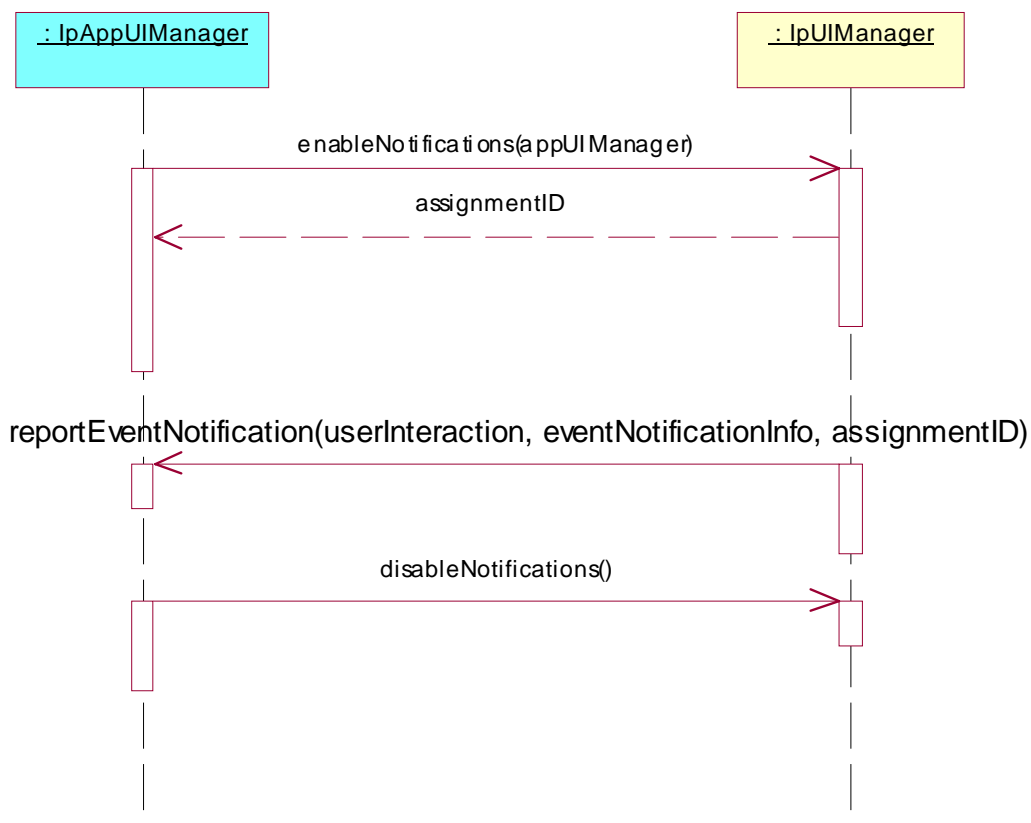



## 5.2.1.2 IpUI interface

### Test UI\_14

Summary: **IpUI**, sendInfoReq & sendInfoRes methods, successful

Reference: ES 202 915-5 [1], clauses 8.3 and 8.4

Preamble: A User Interaction object, created either with the createUI or the createUICall method on the IpUIManager interface or reported in a reportEventNotification method, exists. The given sessionID is used in the following methods to identify this User Interaction object.

Selection: sendInfoReq method supported - PICS item: [2] UI1

Test Sequence:

- Method call **sendInfoReq()**  
 Parameters: userInteractionSessionID given in preamble, info, language, variableInfo, repeatIndicator, responseRequested.  
 Check: valid value of TpAssignmentID is returned
- Triggered action: cause IUT to call **sendInfoRes()** method on the tester's (Application) **IpAppUI** interface.  
 Check: valid value of userInteractionSessionID (given in preamble), assignmentID (given in 1.) and response is transmitted,  
 Return: no parameter

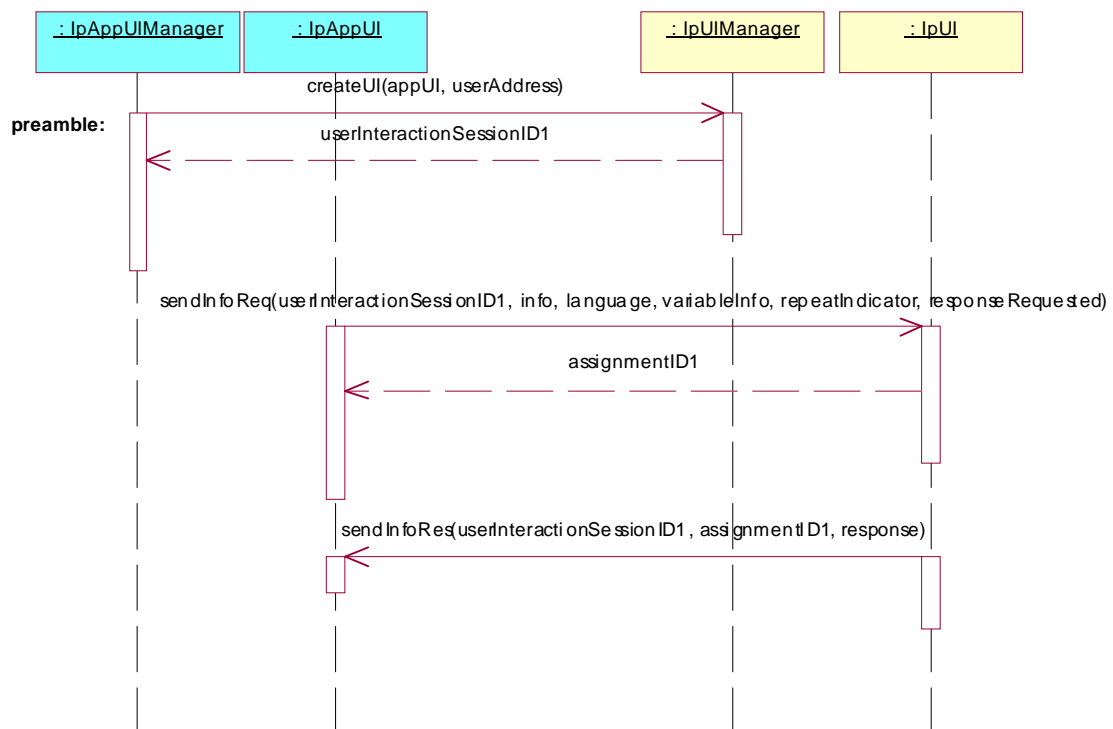

**Test UI\_15**

Summary: **IpUI**, sendInfoReq methods, P\_INVALID\_SESSION\_ID

Reference: ES 202 915-5 [1], clause 8.3

Preamble: A User Interaction object, created either with the createUI or the createUICall method on the IpUIManager interface or reported in a reportEventNotification method exists. The given sessionID is used in the following methods to identify this User Interaction object.

Selection: sendInfoReq method supported - PICS item: [2] UI1

Test Sequence:

1. Method call **sendInfoReq()**

Parameters: invalid userInteractionSessionID, info, language, variableInfo, repeatIndicator, responseRequested.

Check: P\_INVALID\_SESSION\_ID is returned

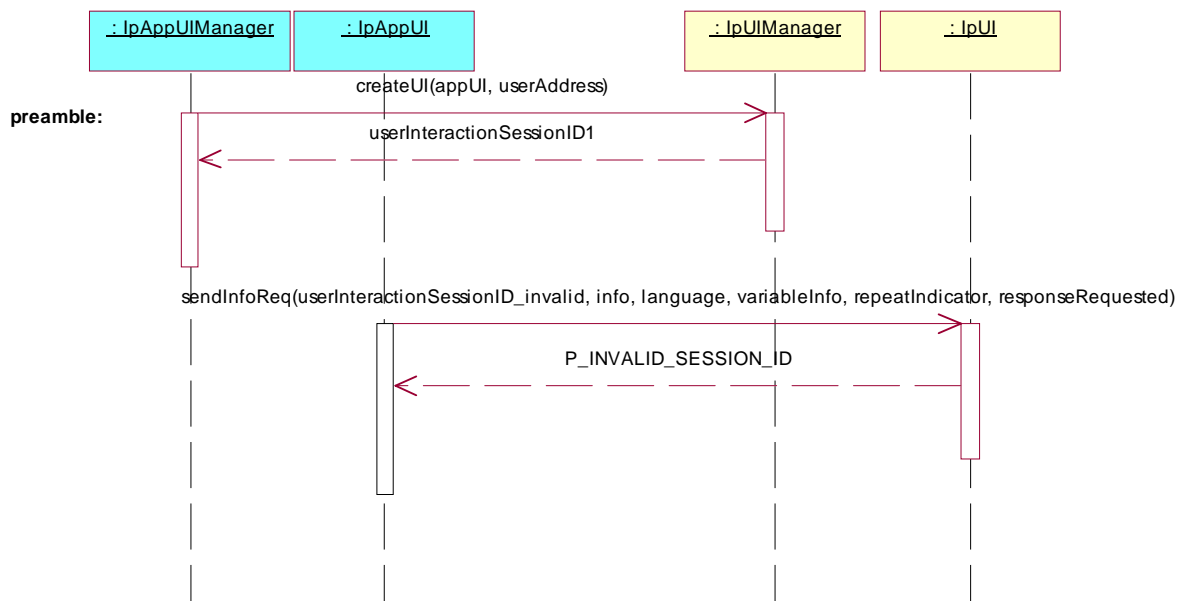

**Test UI\_16**

Summary: **IpUI**, sendInfoReq methods, P\_INVALID\_NETWORK\_STATE

Reference: ES 202 915-5 [1], clause 8.3

Preamble: A User Interaction object, created either with the createUI or the createUICall method on the IpUIManager interface or reported in a reportEventNotification method exists. The given sessionID is used in the following methods to identify this User Interaction object.

Condition: the underlying protocol cannot support the method call.

Selection: sendInfoReq method supported - PICS item: [2] UI1

Test Sequence:

1. Method call **sendInfoReq()**

Parameters: userInteractionSessionID given in preamble, info, language, variableInfo, repeatIndicator, responseRequested.

Check: P\_INVALID\_NETWORK\_STATE is returned

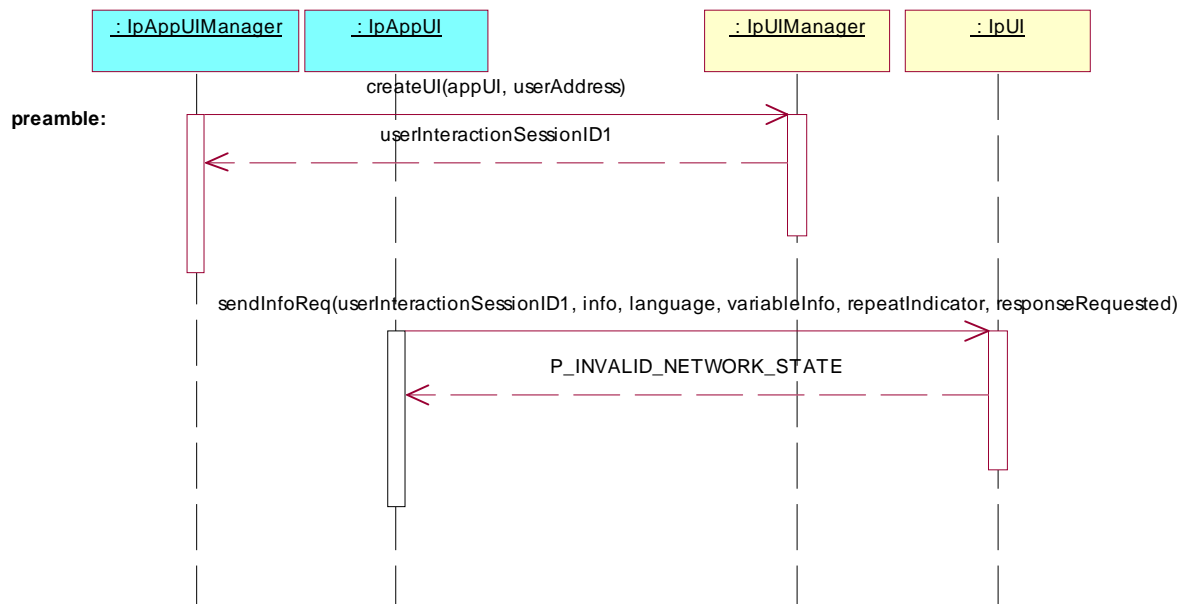

**Test UI\_17**

Summary: **IpUI**, sendInfoReq methods, P\_ILLEGAL\_ID

Reference: ES 202 915-5 [1], clause 8.3

Preamble: A User Interaction object, created either with the createUI or the createUICall method on the IpUIManager interface or reported in a reportEventNotification method exists. The given sessionID is used in the following methods to identify this User Interaction object.

Selection: sendInfoReq method supported - PICS item: [2] UI1

Test Sequence:

1. Method call **sendInfoReq()**

Parameters: userInteractionSessionID given in preamble, illegal info, language, variableInfo, repeatIndicator, responseRequested.

Check: P\_ILLEGAL\_ID or P\_ID\_NOT\_FOUND is returned

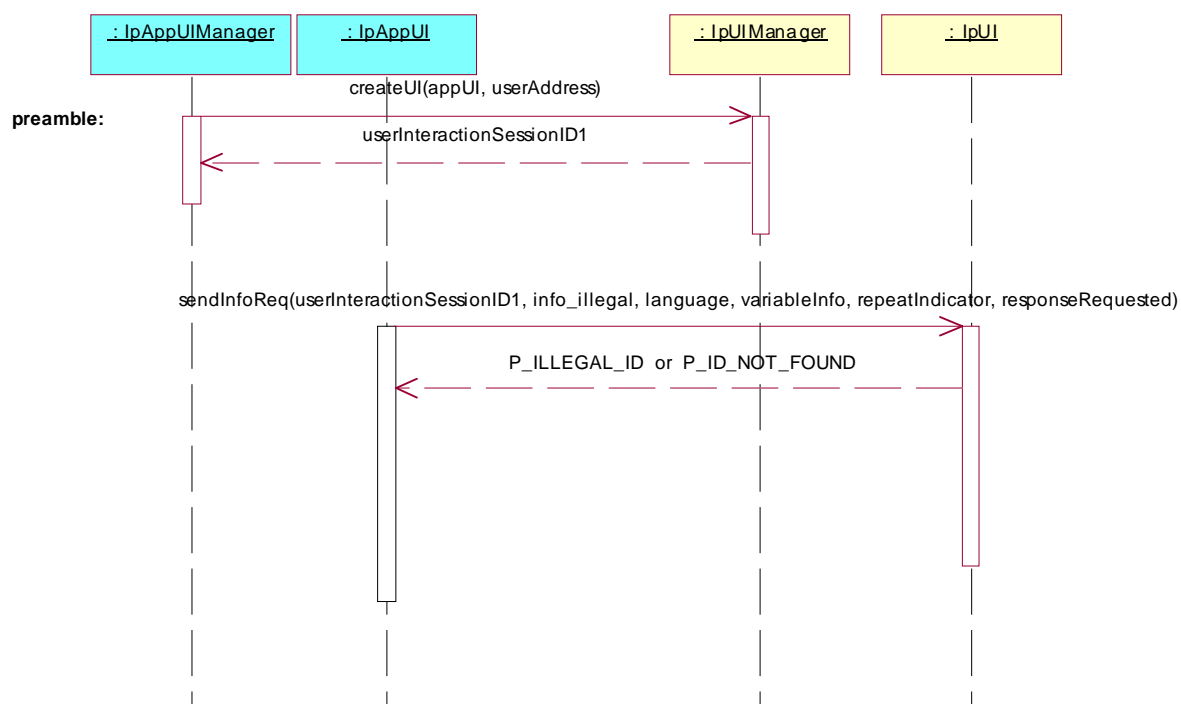

**Test UI\_18**

Summary: **IpUI**, sendInfoAndCollectReq & sendInfoAndCollectRes methods, successful

Reference: ES 202 915-5 [1], clauses 8.3 and 8.4

Preamble: A User Interaction object, created either with the createUI or the createUICall method on the IpUIManager interface or reported in a reportEventNotification method exists. The given sessionID is used in the following methods to identify this User Interaction object.

Selection: sendInfoAndCollectReq method supported - PICS item: [2] UI2

Test Sequence:

- Method call **sendInfoAndCollectReq()**  
 Parameters: userInteractionSessionID given in preamble, info, language, variableInfo, criteria, responseRequested.  
 Check: valid value of TpAssignmentID is returned
- Triggered action: cause IUT to call **sendInfoAndCollectRes()** method on the tester's (Application) **IpAppUI** interface.  
 Check: valid value of userInteractionSessionID (given in preamble), assignmentID (given in 1.), response and collectedInfo is transmitted,  
 Return: no parameter

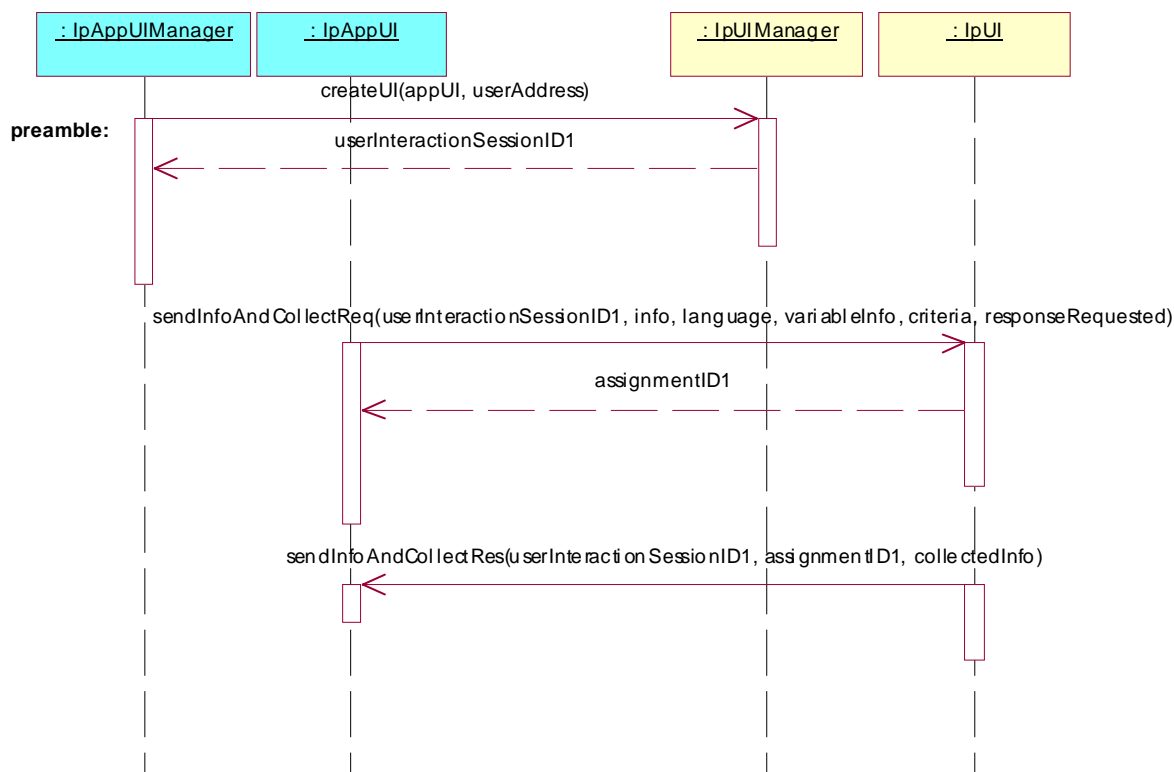

**Test UI\_19**

Summary: **IpUI**, **sendInfoAndCollectReq** methods, **P\_INVALID\_SESSION\_ID**

Reference: ES 202 915-5 [1], clause 8.3

Preamble: A User Interaction object, created either with the **createUI** or the **createUICall** method on the **IpUIManager** interface or reported in a **reportEventNotification** method exists. The given **sessionID** is used in the following methods to identify this User Interaction object.

Selection: **sendInfoAndCollectReq** method supported - PICS item: [2] UI2

Test Sequence:

1. Method call **sendInfoAndCollectReq()**

Parameters: invalid **userInteractionSessionID**, **info**, **language**, **variableInfo**, **criteria**, **responseRequested**.

Check: **P\_INVALID\_SESSION\_ID** is returned

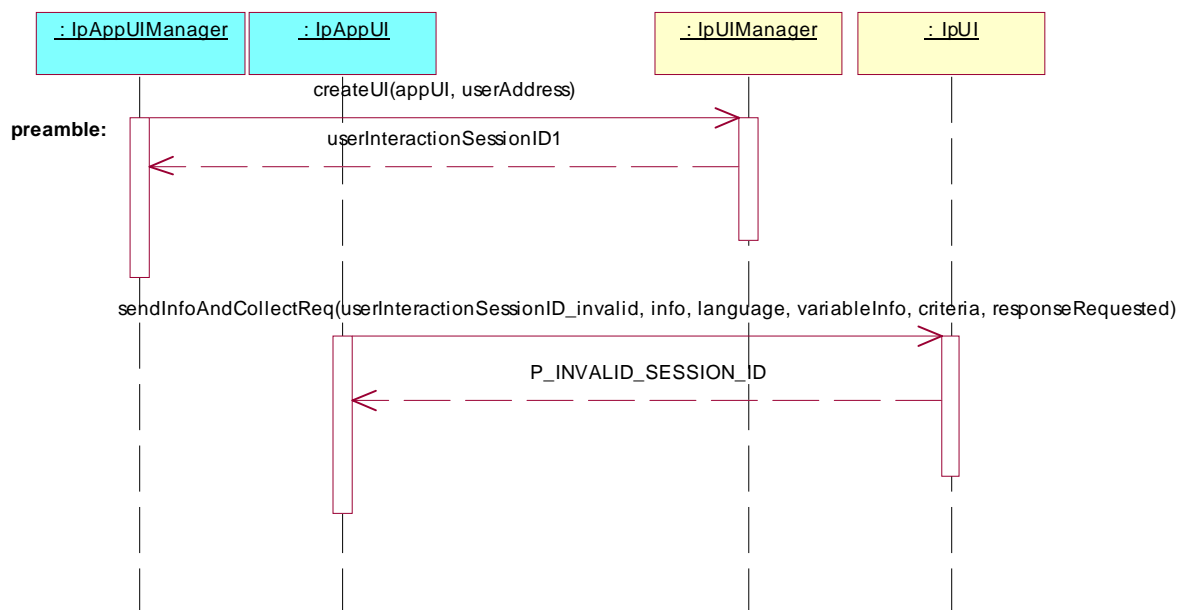

**Test UI\_20**

Summary: **IpUI**, **sendInfoAndCollectReq** methods, **P\_INVALID\_NETWORK\_STATE**

Reference: ES 202 915-5 [1], clause 8.3

Preamble: A User Interaction object, created either with the createUI or the createUICall method on the IpUIManager interface or reported in a reportEventNotification method exists. The given sessionID is used in the following methods to identify this User Interaction object.

Condition: the underlying protocol cannot support the method call.

Selection: sendInfoAndCollectReq method supported - PICS item: [2] UI2

Test Sequence:

1. Method call **sendInfoAndCollectReq()**  
 Parameters: userInteractionSessionID given in preamble, info, language, variableInfo, criteria, responseRequested.  
 Check: P\_INVALID\_NETWORK\_STATE is returned

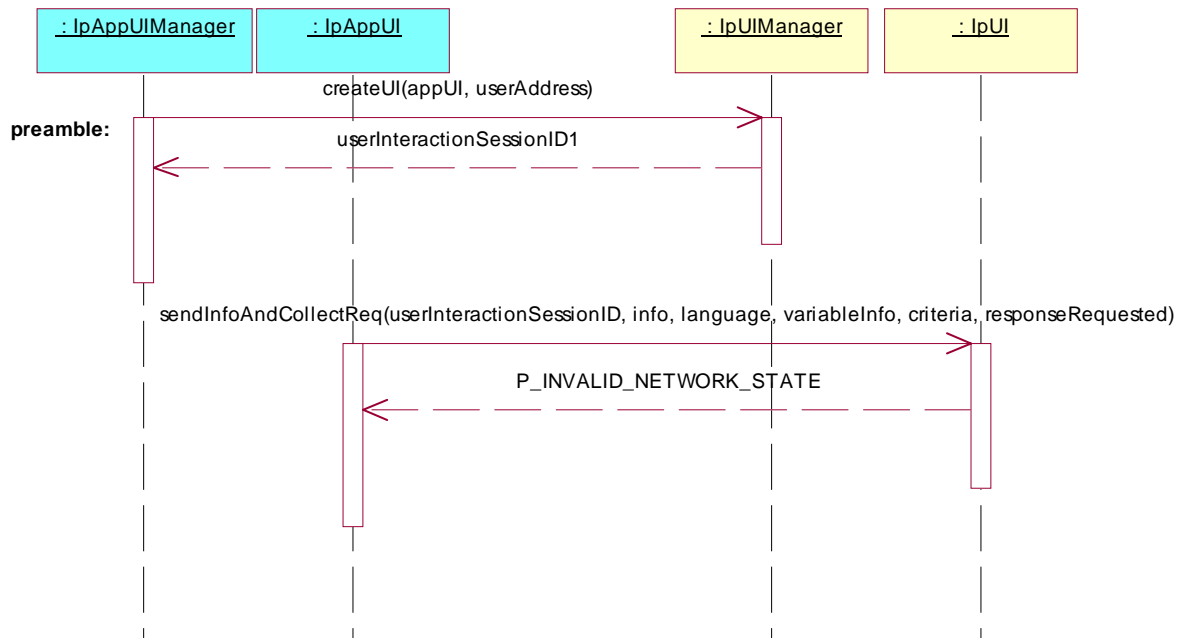

**Test UI\_21**

Summary: **IpUI**, sendInfoAndCollectReq methods, P\_ILLEGAL\_ID

Reference: ES 202 915-5 [1], clause 8.3

Preamble: A User Interaction object, created either with the createUI or the createUICall method on the IpUIManager interface or reported in a reportEventNotification method exists. The given sessionID is used in the following methods to identify this User Interaction object.

Selection: sendInfoAndCollectReq method supported - PICS item: [2] UI2

Test Sequence:

- Method call **sendInfoAndCollectReq()**  
 Parameters: userInteractionSessionID given in preamble, illegal info, language, variableInfo, criteria, responseRequested  
 Check: P\_ILLEGAL\_ID or P\_ID\_NOT\_FOUND is returned

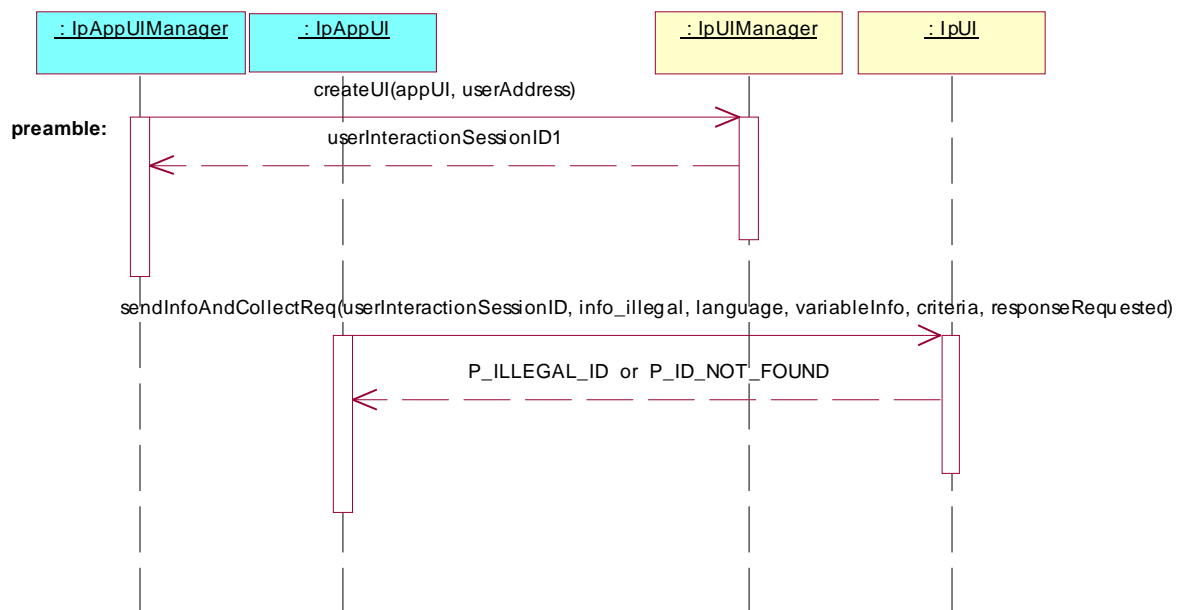



**Test UI\_22**

Summary: **IpUI**, `sendInfoAndCollectReq` methods, `P_ILLEGAL_RANGE`

Reference: ES 202 915-5 [1], clause 8.3

Preamble: A User Interaction object, created either with the `createUI` or the `createUICall` method on the `IpUIManager` interface or reported in a `reportEventNotification` method exists. The given `sessionID` is used in the following methods to identify this User Interaction object.

Selection: `sendInfoAndCollectReq` method supported - PICS item: [2] UI2

Test Sequence:

1. Method call **`sendInfoAndCollectReq()`**

Parameters: `userInteractionSessionID` given in preamble, `info`, `language`, `variableInfo`, `criteria` with collection length out of range, `responseRequested`.

Check: `P_ILLEGAL_RANGE` is returned

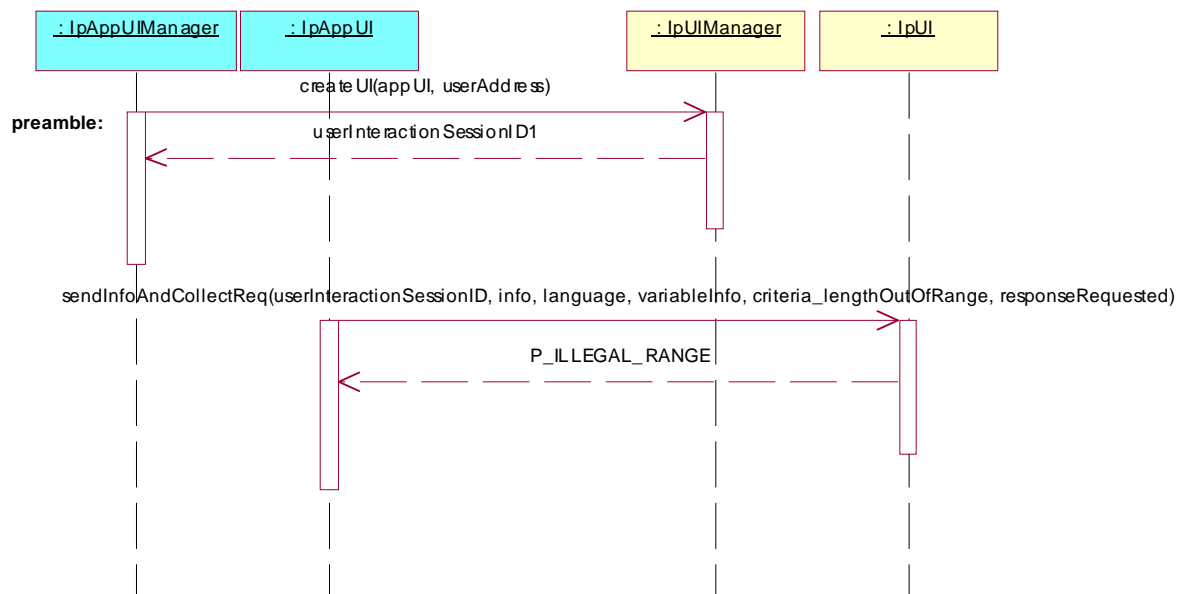

**Test UI\_23**

Summary: **IpUI**, sendInfoAndCollectReq methods, P\_INVALID\_COLLECTION\_CRITERIA

Reference: ES 202 915-5 [1], clause 8.3

Preamble: A User Interaction object, created either with the createUI or the createUICall method on the IpUIManager interface or reported in a reportEventNotification method exists. The given sessionID is used in the following methods to identify this User Interaction object.

Selection: sendInfoAndCollectReq method supported - PICS item: [2] UI2

Test Sequence:

1. Method call **sendInfoAndCollectReq()**

Parameters: userInteractionSessionID given in preamble, info, language, variableInfo, invalid collection criteria, responseRequested.

Check: P\_INVALID\_COLLECTION\_CRITERIA is returned

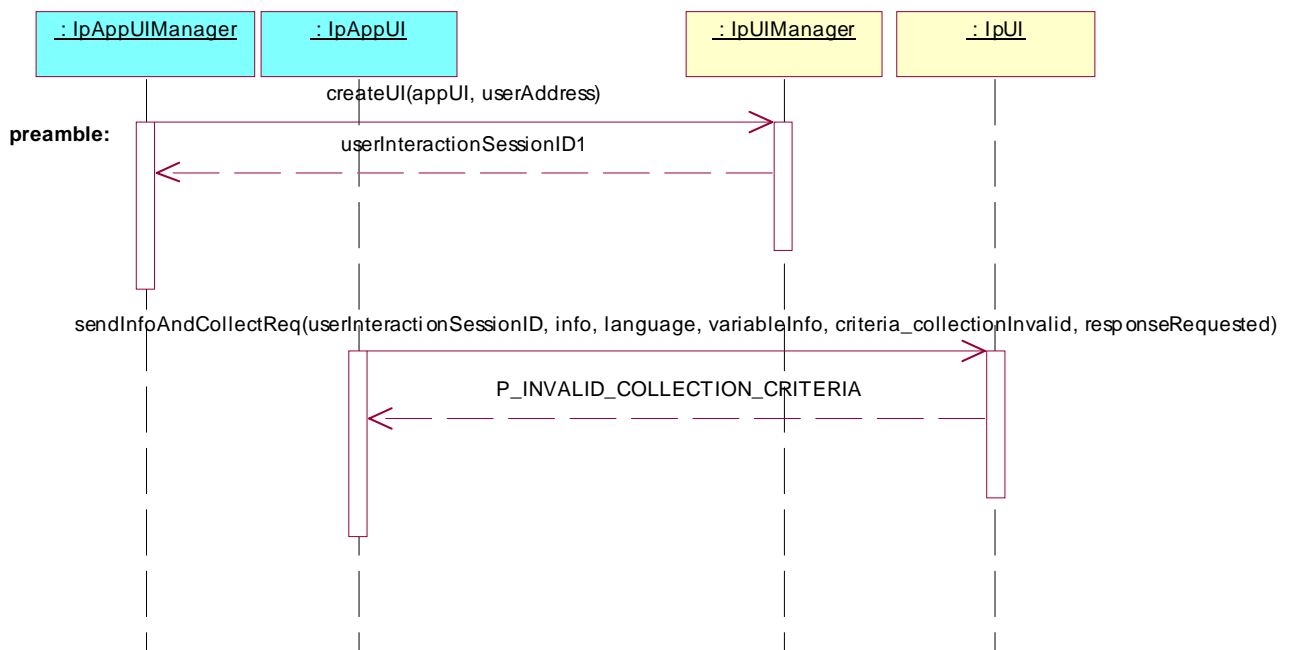

**Test UI\_24**

Summary: **IpUI**, release method, successful

Reference: ES 202 915-5 [1], clause 8.3

Preamble: A User Interaction object, created either with the createUI or the createUICall method on the IpUIManager interface, exists. The given sessionID is used in the following methods to identify this User Interaction object.

Test Sequence:

1. Method call **release()**

Parameters: userInteractionSessionID given in preamble.

Check: no exception is returned.

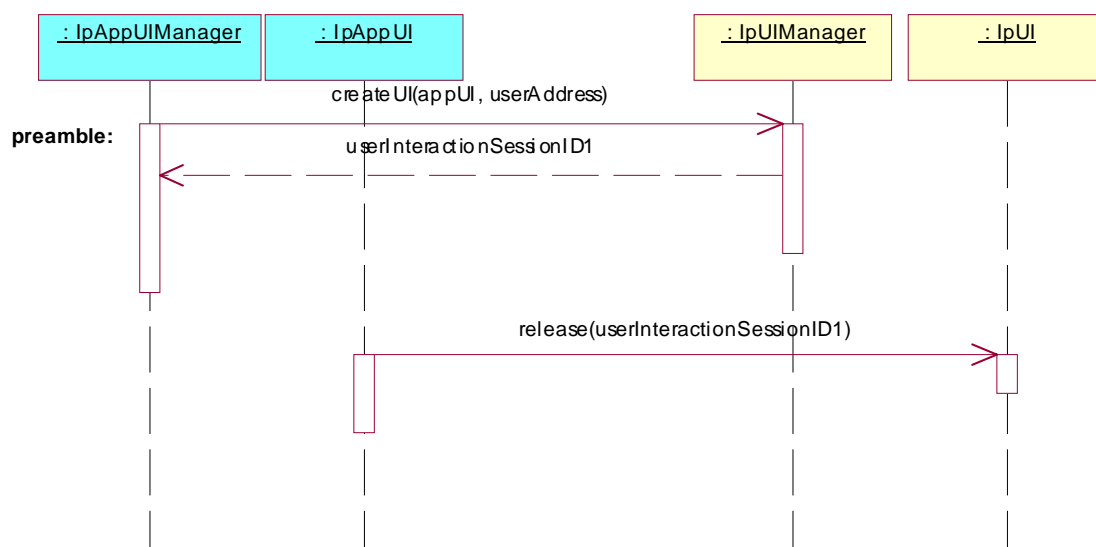

**Test UI\_25**

Summary: **IpUI**, release method, P\_INVALID\_SESSION\_ID

Reference: ES 202 915-5 [1], clause 8.3

Preamble: A User Interaction object, created either with the createUI or the createUICall method on the IpUIManager interface or reported in a reportEventNotification method exists. The given sessionID is used in the following methods to identify this User Interaction object.

Test Sequence:

1. Method call **release()**

Parameters: invalid userInteractionSessionID,

Check: P\_INVALID\_SESSION\_ID is returned.

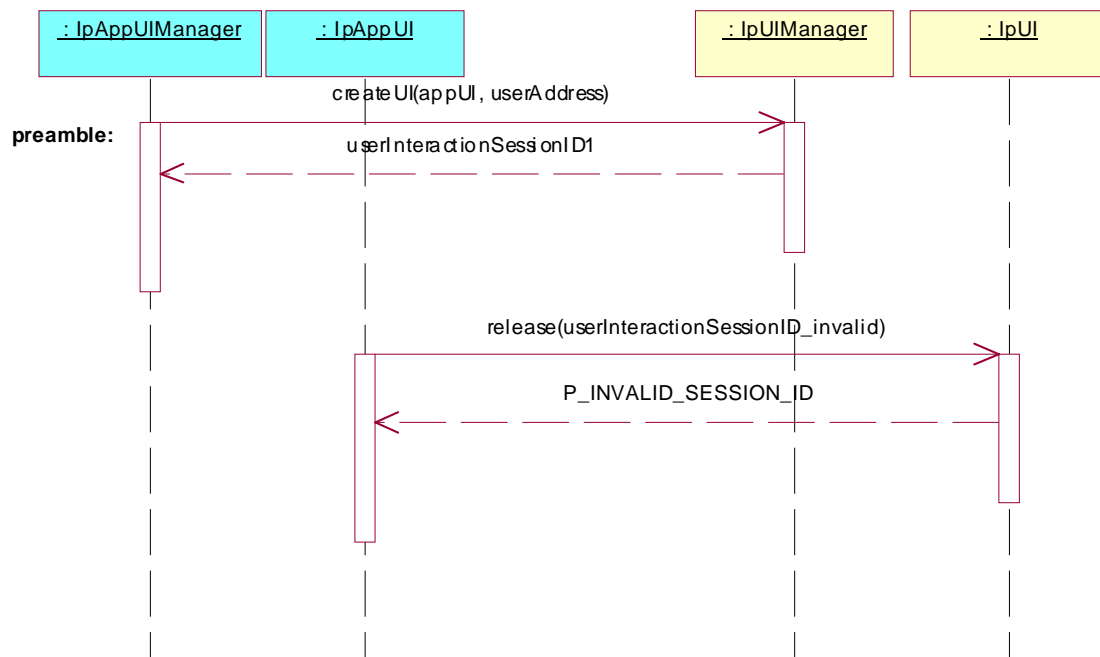

**Test UI\_53**

Summary: **IpUI**, all method, successful

Reference: ES 202 915-5 [1], clause 8.3

Preamble: A User Interaction object, created either with the createUI or the createUICall method on the IpUIManager interface or reported in a reportEventNotification method exists. The given sessionID is used in the following methods to identify this User Interaction object.

Test Sequence:

1. Method call **getOriginatingAddress ()**  
Parameters: userInteractionSessionID,  
Check: valid value of TpString is returned.
2. Method call **setOriginatingAddress ()**  
Parameters: userInteractionSessionID, origin with different value of returned in 1.,  
Check: valid value of TpAssignmentID is returned.
3. Method call **getOriginatingAddress ()**  
Parameters: userInteractionSessionID,  
Check: valid value of TpString is returned with value given in 2.

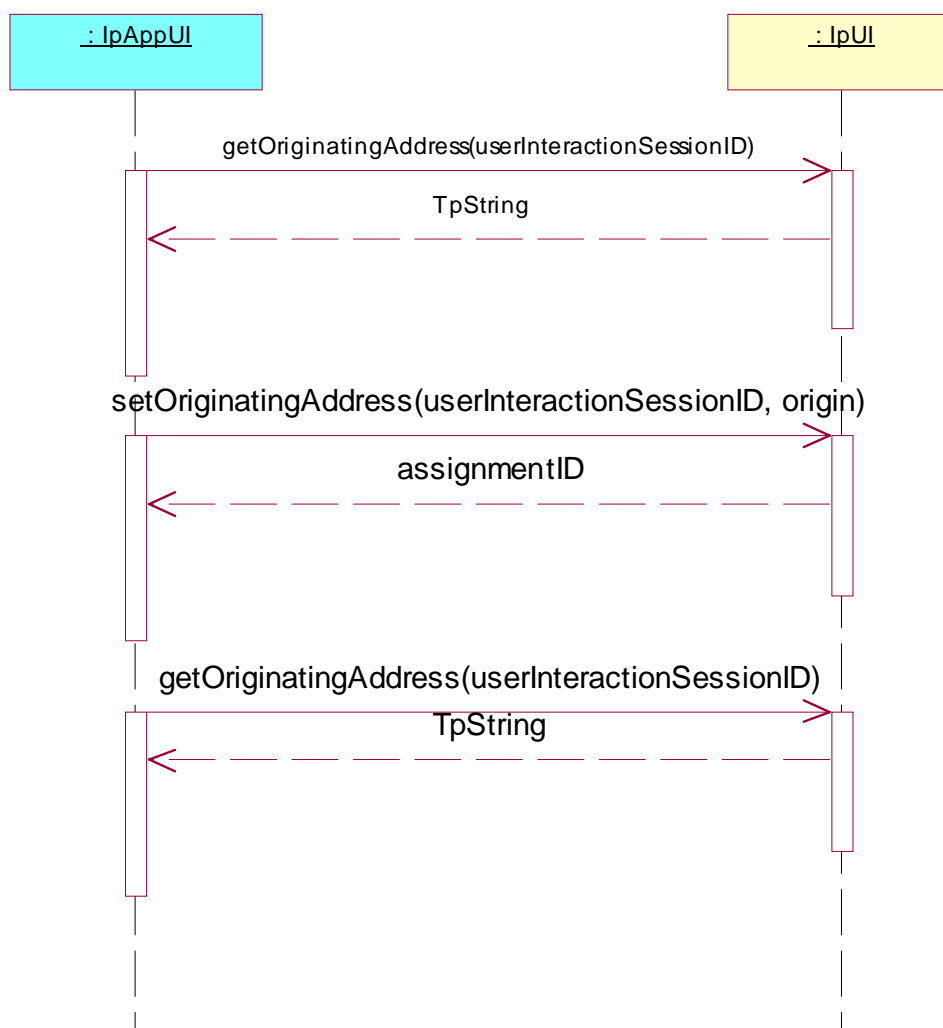

### 5.2.1.3 IpUICall interface

#### Test UI\_26

Summary: **IpUICall**, sendInfoReq & sendInfoRes methods, successful

Reference: ES 202 915-5 [1], clauses 8.5 and 8.6

Preamble: A User Interaction object, created either with the createUI or the createUICall method on the IpUIManager interface or reported in a reportEventNotification method, exists. The given sessionID is used in the following methods to identify this User Interaction object.

Selection: sendInfoReq method supported - PICS item: [2] UIC1

Test Sequence:

1. Method call **sendInfoReq()**  
 Parameters: userInteractionSessionID given in preamble, info, language, variableInfo, repeatIndicator, responseRequested.  
 Check: valid value of TpAssignmentID is returned
2. Triggered action: cause IUT to call **sendInfoRes()** method on the tester's (Application) **IpAppUICall** interface.  
 Check: valid value of userInteractionSessionID (given in preamble), assignmentID (given in 1.) and response is transmitted,  
 Return: no parameter

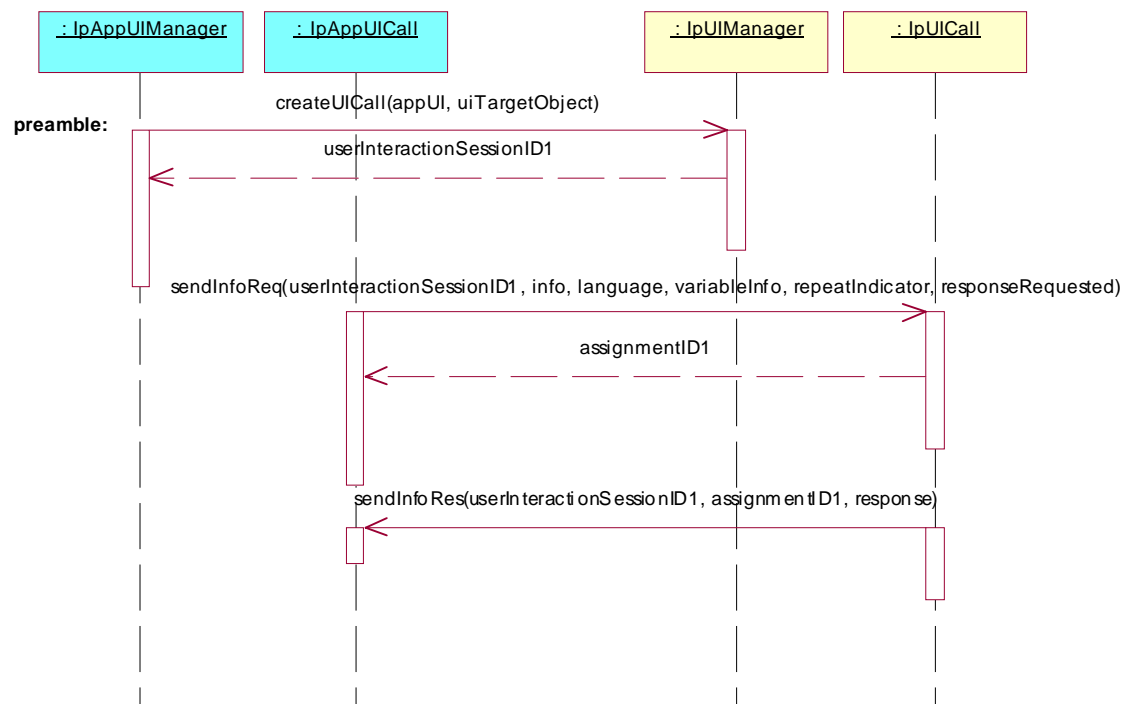

**Test UI\_27**

Summary: **IpUICall**, sendInfoAndCollectReq & sendInfoAndCollectRes methods, successful

Reference: ES 202 915-5 [1], clauses 8.5 and 8.6

Preamble: A User Interaction object, created either with the createUI or the createUICall method on the IpUIManager interface or reported in a reportEventNotification method exists. The given sessionID is used in the following methods to identify this User Interaction object.

Selection: sendInfoAndCollectReq method supported - PICS item: [2] UIC2

Test Sequence:

- Method call **sendInfoAndCollectReq()**  
 Parameters: userInteractionSessionID given in preamble, info, language, variableInfo, criteria, responseRequested.  
 Check: valid value of TpAssignmentID is returned
- Triggered action: cause IUT to call **sendInfoAndCollectRes()** method on the tester's (Application) **IpAppUICall** interface.  
 Check: valid value of userInteractionSessionID (given in preamble), assignmentID (given in 1.), response and collectedInfo is transmitted,  
 Return: no parameter

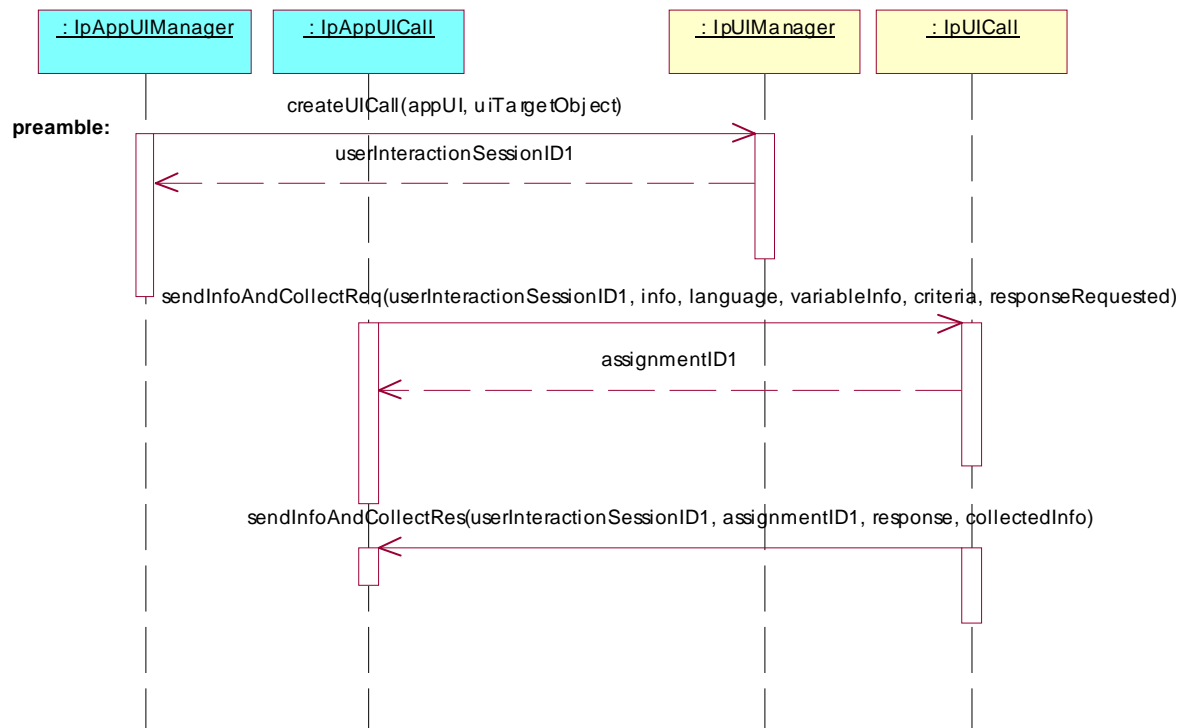

**Test UI\_28**

Summary: **IpUICall**, all methods, successful

Reference: ES 202 915-5 [1], clauses 8.5 and 8.6

Preamble: A User Interaction object, created either with the createUI or the createUICall method on the IpUIManager interface or reported in a reportEventNotification method exists. The given sessionID is used in the following methods to identify this User Interaction object.

Selection: recordMessageReq and deleteMessageReq methods supported - PICS item: [2] UIC4 AND UIC5

Test Sequence:

1. Method call **recordMessageReq()**  
Parameters: userInteractionSessionID given in preamble, info, criteria.  
Check: valid value of TpAssignmentID is returned
2. Triggered action: cause IUT to call **recordMessageRes()** method on the tester's (Application) **IpAppUICall** interface.  
Check: valid value of userInteractionSessionID (given in preamble), assignmentID (given in 1.), response and messageID is transmitted,  
Return: no parameter
3. Method call **deleteMessageReq()**  
Parameters: userInteractionSessionID given in preamble, messageID returned in 2.  
Check: valid value of TpAssignmentID is returned
4. Triggered action: cause IUT to call **deleteMessageRes()** method on the tester's (Application) **IpAppUICall** interface.  
Check: valid value of userInteractionSessionID (given in preamble), response and assignmentID (returned in 3.) is transmitted,  
Return: no parameter



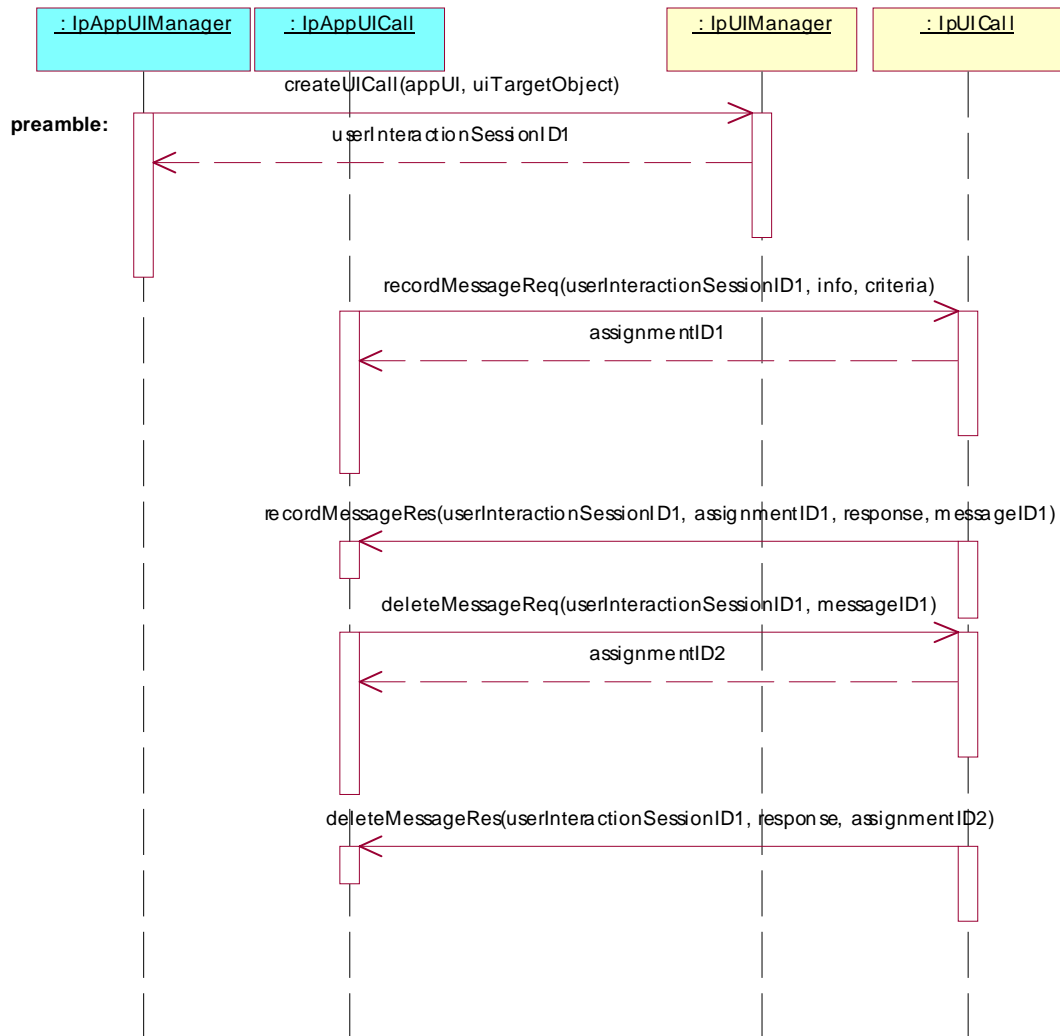

**Test UI\_29**

Summary: **IpUICall**, abortActionReq and abortActionRes methods, successful

Reference: ES 202 915-5 [1], clauses 8.5 and 8.6

Preamble: A User Interaction object, created either with the createUI or the createUICall method on the IpUIManager interface or reported in a reportEventNotification method exists. The given sessionID is used in the following methods to identify this User Interaction object.

Selection: sendInfoReq and abortActionReq methods supported - PICS item: [2] UIC1 AND UIC6

Test Sequence:

1. Method call **sendInfoReq()**  
 Parameters: userInteractionSessionID given in preamble, info, language, variableInfo, repeatIndicator, responseRequested.  
 Check: valid value of TpAssignmentID is returned
2. Method call **abortActionReq()**  
 Parameters: userInteractionSessionID given in preamble, assignmentID returned in 1.  
 Check: no exception is returned.
3. Triggered action: cause IUT to call **abortActionRes()** method on the tester's (Application) **IpAppUICall** interface.  
 Check: valid value of userInteractionSessionID (given in preamble) and assignmentID (returned in 1.) is transmitted,  
 Return: no parameter

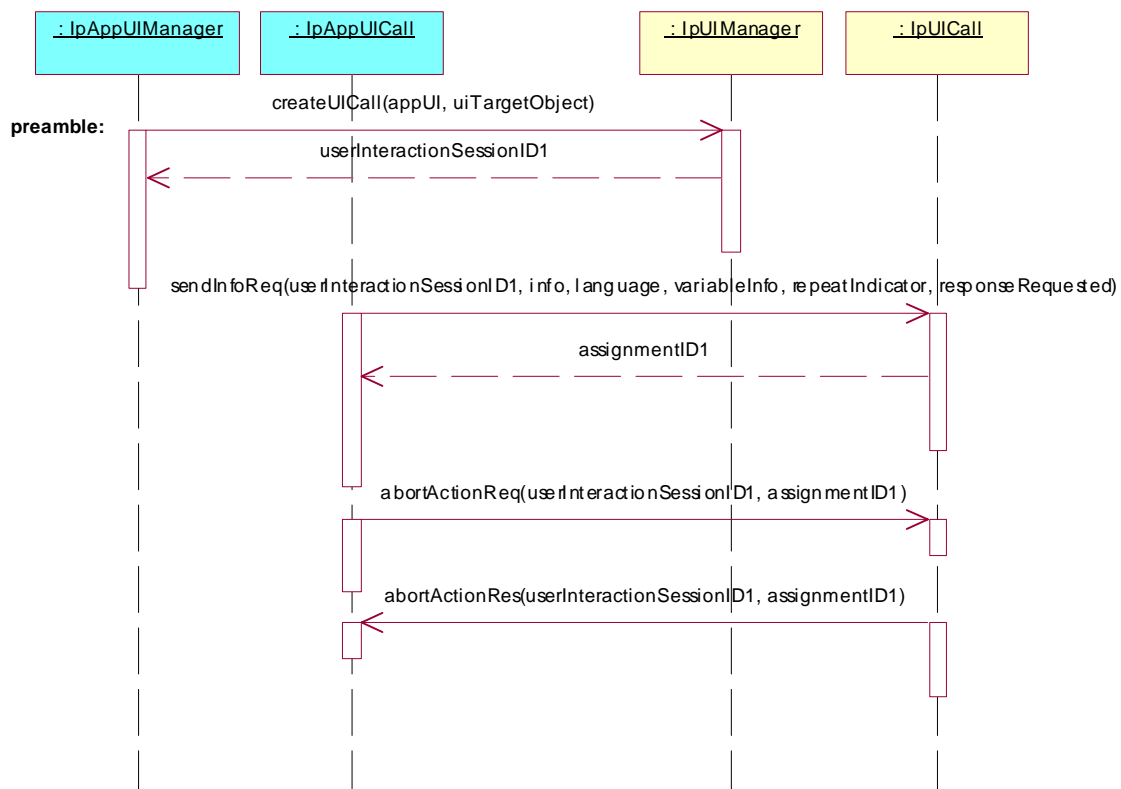

**Test UI\_30**

Summary: **IpUICall**, abortActionReq and abortActionRes methods, successful

Reference: ES 202 915-5 [1], clauses 8.5 and 8.6

Preamble: A User Interaction object, created either with the createUI or the createUICall method on the IpUIManager interface or reported in a reportEventNotification method exists. The given sessionID is used in the following methods to identify this User Interaction object.

Selection: sendInfoAndCollectReq and abortActionReq methods supported - PICS item: [2] UIC2 AND UIC6

Test Sequence:

1. Method call **sendInfoAndCollectReq()**  
 Parameters: userInteractionSessionID given in preamble, info, language, variableInfo, criteria, responseRequested.  
 Check: valid value of TpAssignmentID is returned
2. Method call **abortActionReq()**  
 Parameters: userInteractionSessionID given in preamble, assignmentID returned in 1.  
 Check: no exception is returned.
3. Triggered action: cause IUT to call **abortActionRes()** method on the tester's (Application) **IpAppUICall** interface.  
 Check: valid value of userInteractionSessionID (given in preamble) and assignmentID (returned in 1.) is transmitted,  
 Return: no parameter

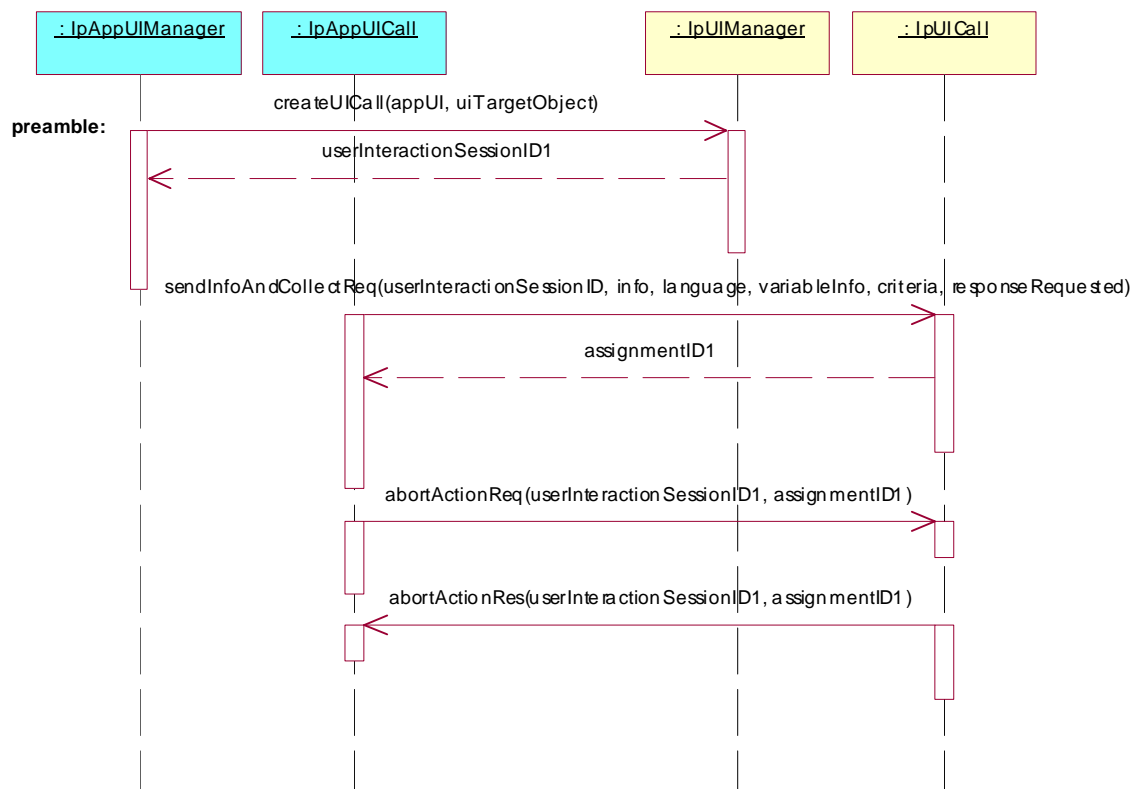

**Test UI\_31**

Summary: **IpUICall**, release method, successful

Reference: ES 202 915-5 [1], clause 8.5

Preamble: A User Interaction object, created either with the createUI or the createCallUIcreateUICall method on the IpUIManager interface, exists. The given sessionID is used in the following methods to identify this User Interaction object.

Test Sequence:

1. Method call **release()**

Parameters: userInteractionSessionID given in preamble.

Check: no exception is returned.

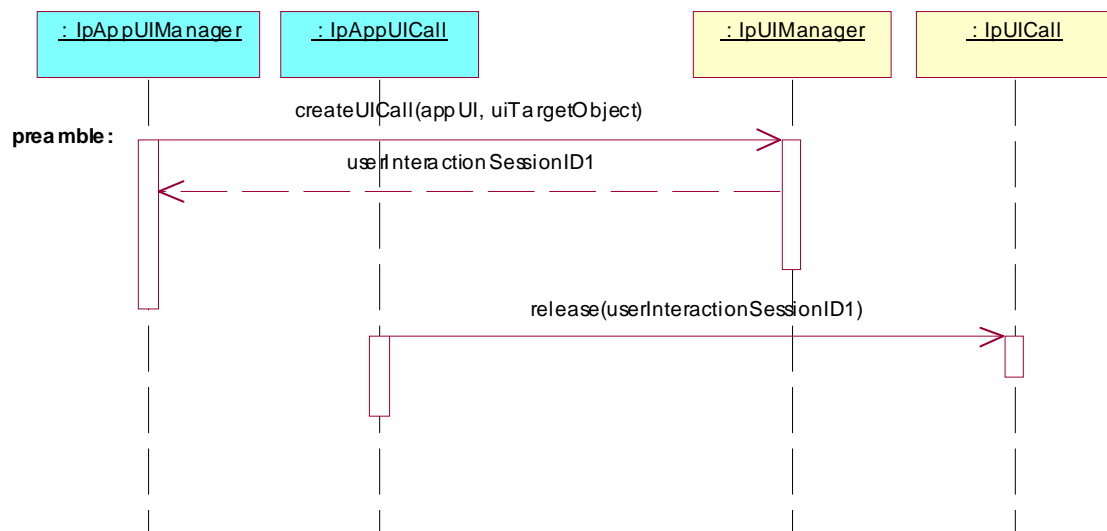

**Test UI\_32**

Summary: **IpUICall**, sendInfoReq methods, P\_INVALID\_SESSION\_ID

Reference: ES 202 915-5 [1], clause 8.5

Preamble: A User Interaction object, created either with the createUI or the createUICall method on the IpUIManager interface or reported in a reportEventNotification method exists. The given sessionID is used in the following methods to identify this User Interaction object.

Selection: sendInfoReq method supported - PICS item: [2] UIC1

Test Sequence:

1. Method call **sendInfoReq()**

Parameters: invalid userInteractionSessionID, info, language, variableInfo, repeatIndicator, responseRequested.

Check: P\_INVALID\_SESSION\_ID is returned

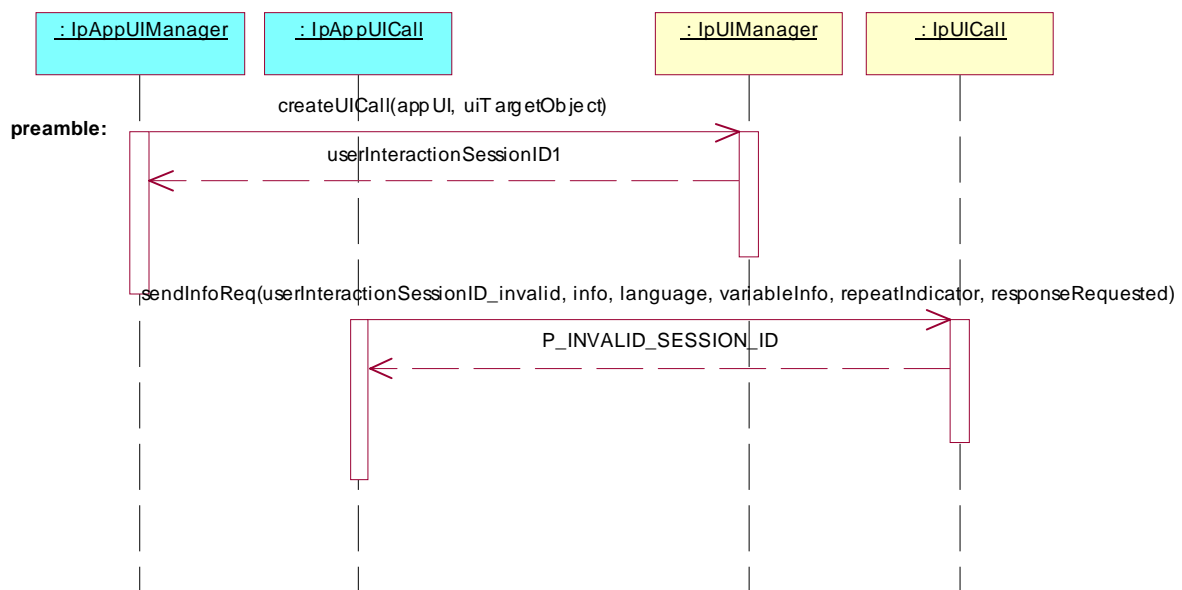

**Test UI\_33**

Summary: **IpUICall**, sendInfoReq methods, P\_INVALID\_NETWORK\_STATE

Reference: ES 202 915-5 [1], clause 8.5

Preamble: A User Interaction object, created either with the createUI or the createUICall method on the IpUIManager interface or reported in a reportEventNotification method exists. The given sessionID is used in the following methods to identify this User Interaction object.

Condition: the underlying protocol cannot support the method call.

Selection: sendInfoReq method supported - PICS item: [2] UIC1

Test Sequence:

1. Method call **sendInfoReq()**

Parameters: userInteractionSessionID given in preamble, info, language, variableInfo, repeatIndicator, responseRequested.

Check: P\_INVALID\_NETWORK\_STATE is returned

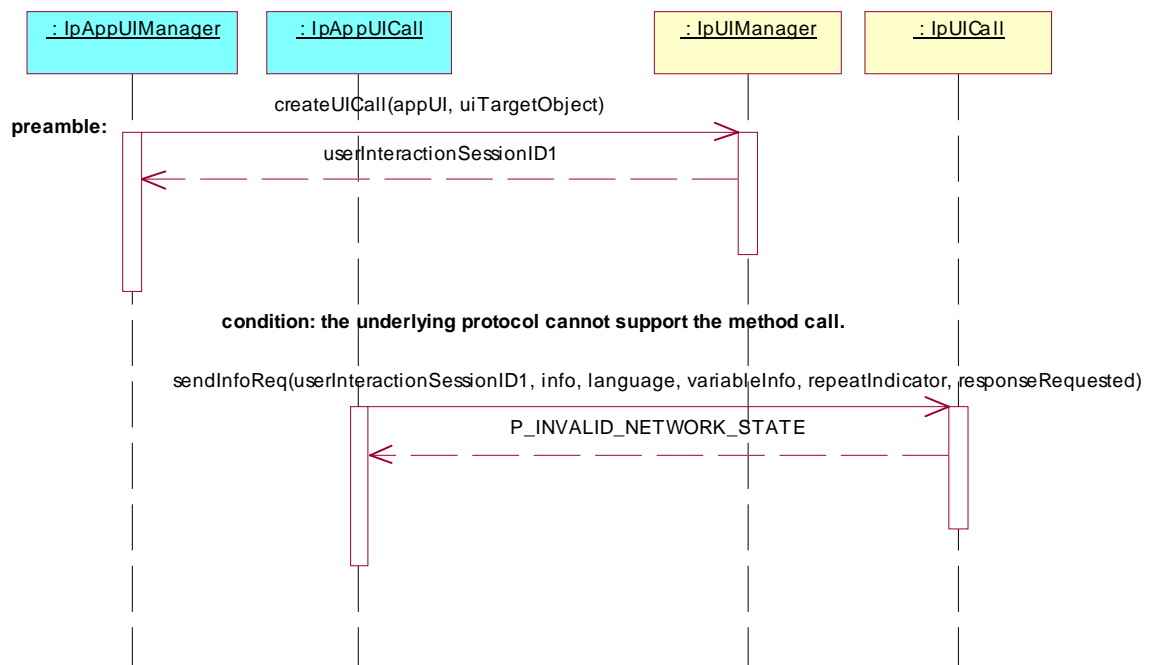

**Test UI\_34**

Summary: **IpUICall**, sendInfoReq methods, P\_ILLEGAL\_ID

Reference: ES 202 915-5 [1], clause 8.5

Preamble: A User Interaction object, created either with the createUI or the createUICall method on the IpUIManager interface or reported in a reportEventNotification method exists. The given sessionID is used in the following methods to identify this User Interaction object.

Selection: sendInfoReq method supported - PICS item: [2] UIC1

Test Sequence:

1. Method call **sendInfoReq()**

Parameters: userInteractionSessionID given in preamble, illegal info, language, variableInfo, repeatIndicator, responseRequested.

Check: P\_ILLEGAL\_ID or P\_ID\_NOT\_FOUND is returned

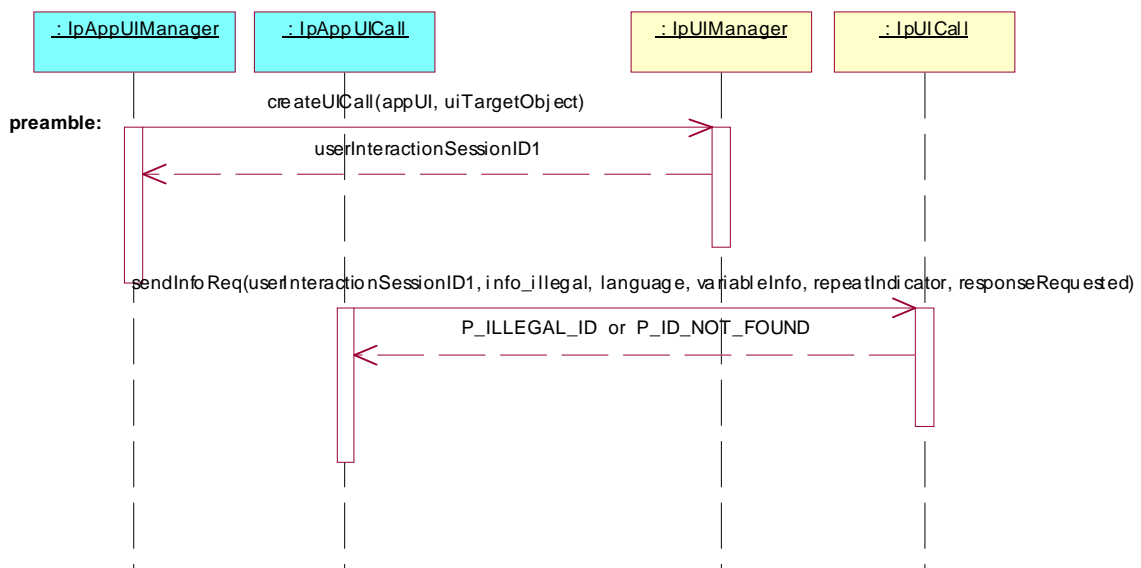

**Test UI\_35**

Summary: **IpUICall**, **sendInfoAndCollectReq** methods, **P\_INVALID\_SESSION\_ID**

Reference: ES 202 915-5 [1], clause 8.5

Preamble: A User Interaction object, created either with the **createUI** or the **createUICall** method on the **IpUIManager** interface or reported in a **reportEventNotification** method exists. The given **sessionID** is used in the following methods to identify this User Interaction object.

Selection: **sendInfoAndCollectReq** method supported - PICS item: [2] UIC2

Test Sequence:

1. Method call **sendInfoAndCollectReq()**

Parameters: **invalid userInteractionSessionID**, **info**, **language**, **variableInfo**, **criteria**, **responseRequested**.

Check: **P\_INVALID\_SESSION\_ID** is returned

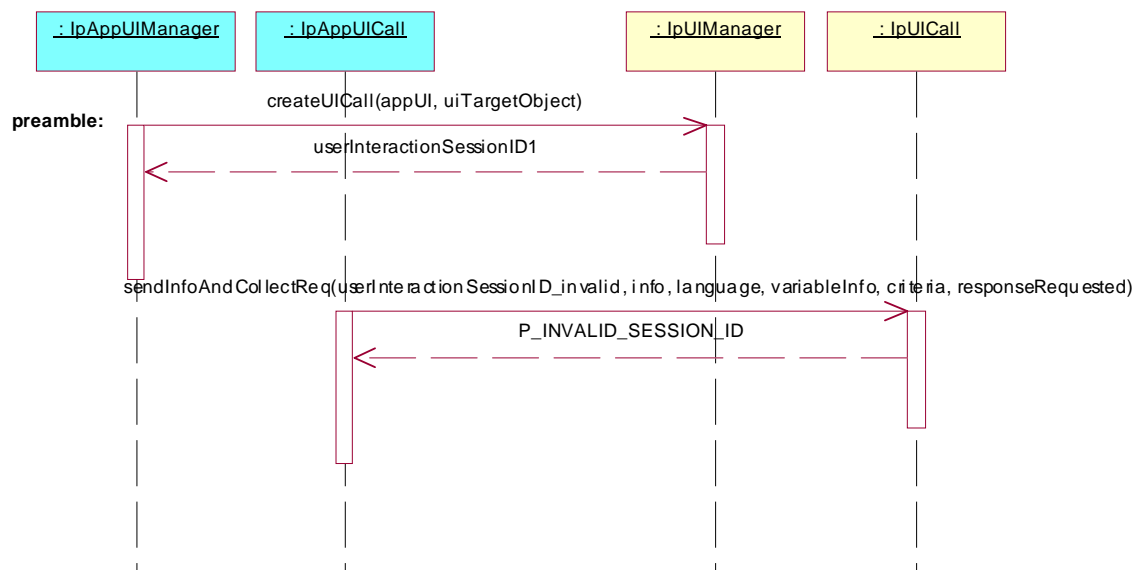



**Test UI\_36**

Summary: **IpUICall**, sendInfoAndCollectReq methods, P\_INVALID\_NETWORK\_STATE

Reference: ES 202 915-5 [1], clause 8.5

Preamble: A User Interaction object, created either with the createUI or the createUICall method on the IpUIManager interface or reported in a reportEventNotification method exists. The given sessionID is used in the following methods to identify this User Interaction object.

Condition: the underlying protocol cannot support the method call.

Selection: sendInfoAndCollectReq method supported - PICS item: [2] UIC2

Test Sequence:

1. Method call **sendInfoAndCollectReq()**

Parameters: userInteractionSessionID given in preamble, info, language, variableInfo, criteria, responseRequested.

Check: P\_INVALID\_NETWORK\_STATE is returned

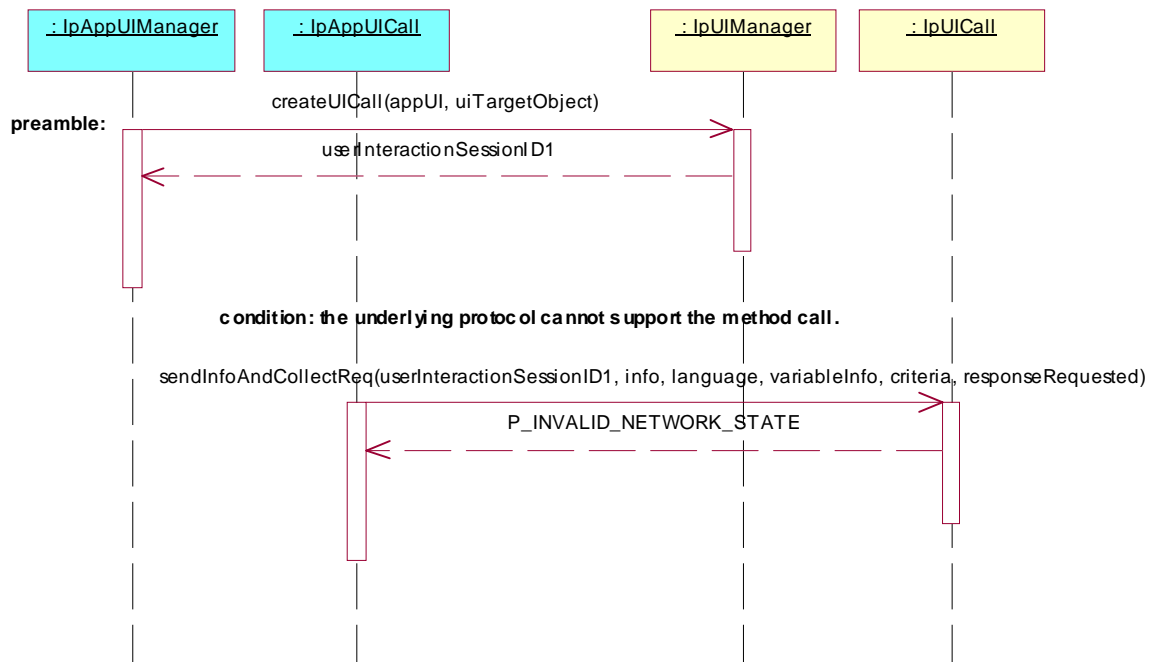

**Test UI\_37**

Summary: **IpUICall**, sendInfoAndCollectReq methods, P\_ILLEGAL\_ID

Reference: ES 202 915-5 [1], clause 8.5

Preamble: A User Interaction object, created either with the createUI or the createUICall method on the IpUIManager interface or reported in a reportEventNotification method exists. The given sessionID is used in the following methods to identify this User Interaction object.

Selection: sendInfoAndCollectReq method supported - PICS item: [2] UIC2

Test Sequence:

- Method call **sendInfoAndCollectReq()**  
 Parameters: userInteractionSessionID given in preamble, illegal info, language, variableInfo, criteria, responseRequested  
 Check: P\_ILLEGAL\_ID or P\_ID\_NOT\_FOUND is returned

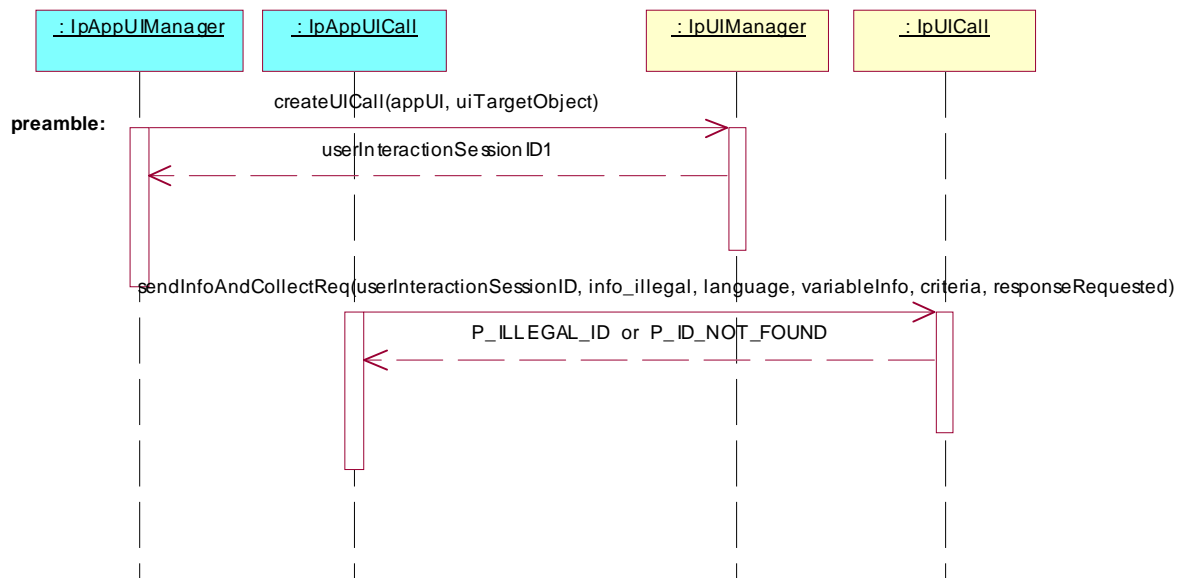

**Test UI\_38**

Summary: **IpUICall**, **sendInfoAndCollectReq** methods, **P\_ILLEGAL\_RANGE**

Reference: ES 202 915-5 [1], clause 8.5

Preamble: A User Interaction object, created either with the **createUI** or the **createUICall** method on the **IpUIManager** interface or reported in a **reportEventNotification** method exists. The given **sessionID** is used in the following methods to identify this User Interaction object.

Selection: **sendInfoAndCollectReq** method supported - PICS item: [2] UIC2

Test Sequence:

1. Method call **sendInfoAndCollectReq()**

Parameters: **userInteractionSessionID** given in preamble, **info**, **language**, **variableInfo**, **criteria** with collection length out of range, **responseRequested**.

Check: **P\_ILLEGAL\_RANGE** is returned

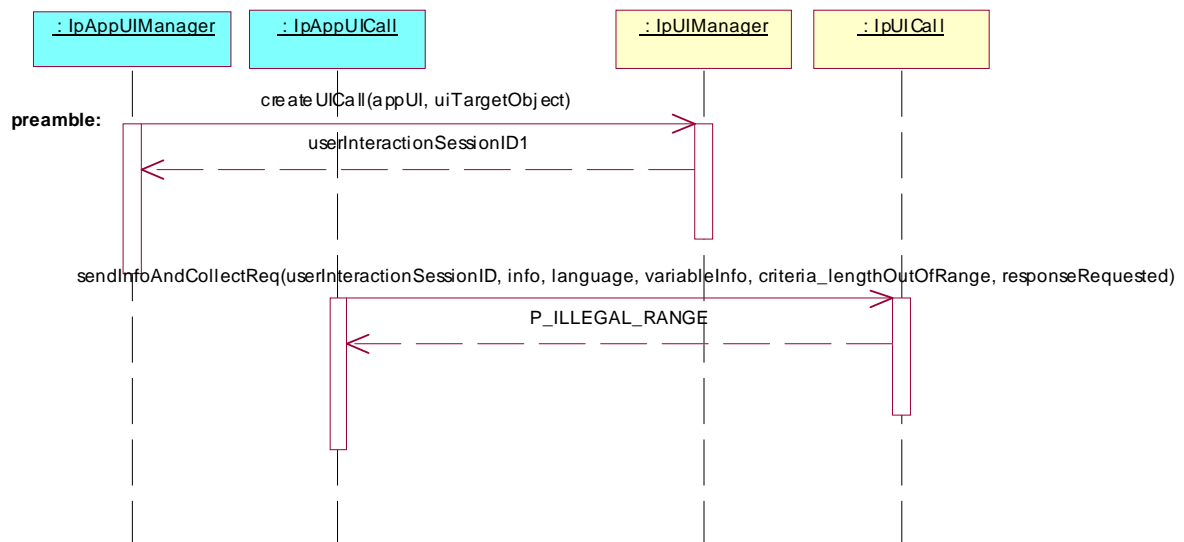

**Test UI\_39**

Summary: **IpUICall**, **sendInfoAndCollectReq** methods, **P\_INVALID\_COLLECTION\_CRITERIA**

Reference: ES 202 915-5 [1], clause 8.5

Preamble: A User Interaction object, created either with the **createUI** or the **createUICall** method on the **IpUIManager** interface or reported in a **reportEventNotification** method exists. The given **sessionID** is used in the following methods to identify this User Interaction object.

Selection: **sendInfoAndCollectReq** method supported - PICS item: [2] UIC2

Test Sequence:

1. Method call **sendInfoAndCollectReq()**

Parameters: **userInteractionSessionID** given in preamble, **info**, **language**, **variableInfo**, **invalid collection criteria**, **responseRequested**.

Check: **P\_INVALID\_COLLECTION\_CRITERIA** is returned

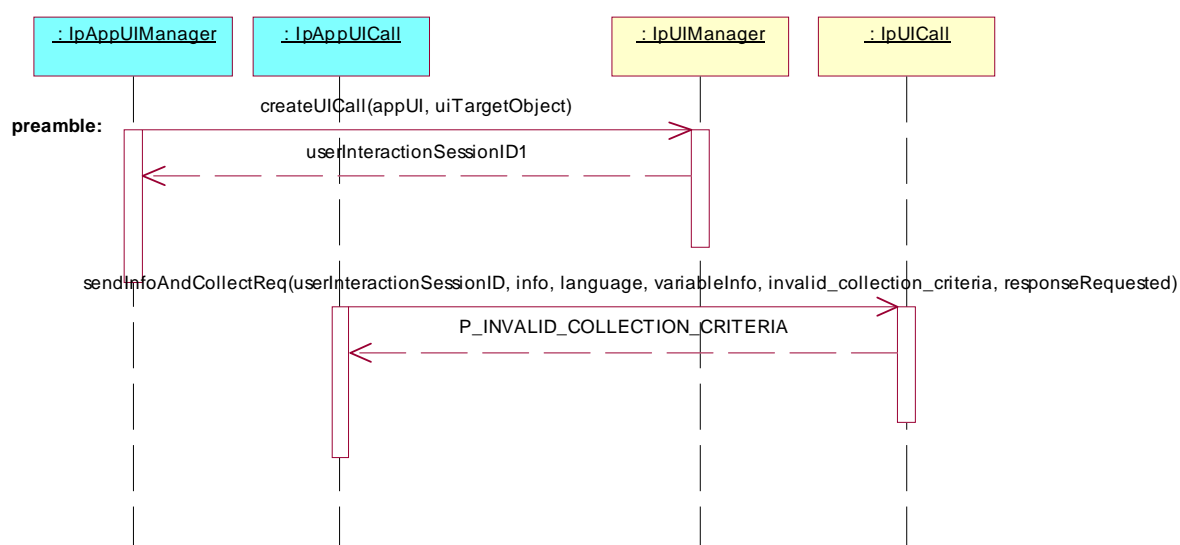

**Test UI\_40**

Summary: **IpUICall**, recordMessageReq methods, P\_INVALID\_SESSION\_ID

Reference: ES 202 915-5 [1], clause 8.5

Preamble: A User Interaction object, created either with the createUI or the createUICall method on the IpUIManager interface or reported in a reportEventNotification method exists. The given sessionID is used in the following methods to identify this User Interaction object.

Selection: recordMessageReq method supported - PICS item: [2] UIC4

Test Sequence:

- Method call **recordMessageReq()**  
 Parameters: invalid userInteractionSessionID, info, criteria,  
 Check: P\_INVALID\_SESSION\_ID is returned

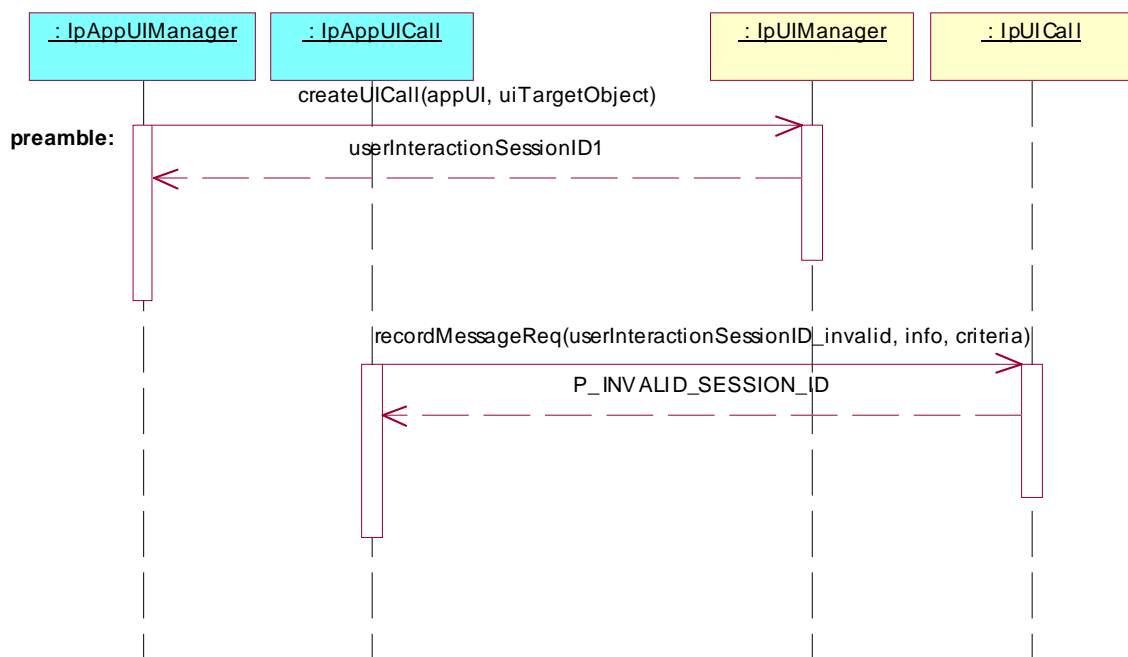

**Test UI\_41**

Summary: **IpUICall**, recordMessageReq methods, P\_INVALID\_NETWORK\_STATE

Reference: ES 202 915-5 [1], clause 8.5

Preamble: A User Interaction object, created either with the createUI or the createUICall method on the IpUIManager interface or reported in a reportEventNotification method exists. The given sessionID is used in the following methods to identify this User Interaction object.

Condition: the underlying protocol cannot support the method call (e.g. incompatible Call state)

Selection: recordMessageReq method supported - PICS item: [2] UIC4

Test Sequence:

1. Method call **recordMessageReq()**

Parameters: userInteractionSessionID given in preamble, info, criteria,

Check: P\_INVALID\_NETWORK\_STATE is returned

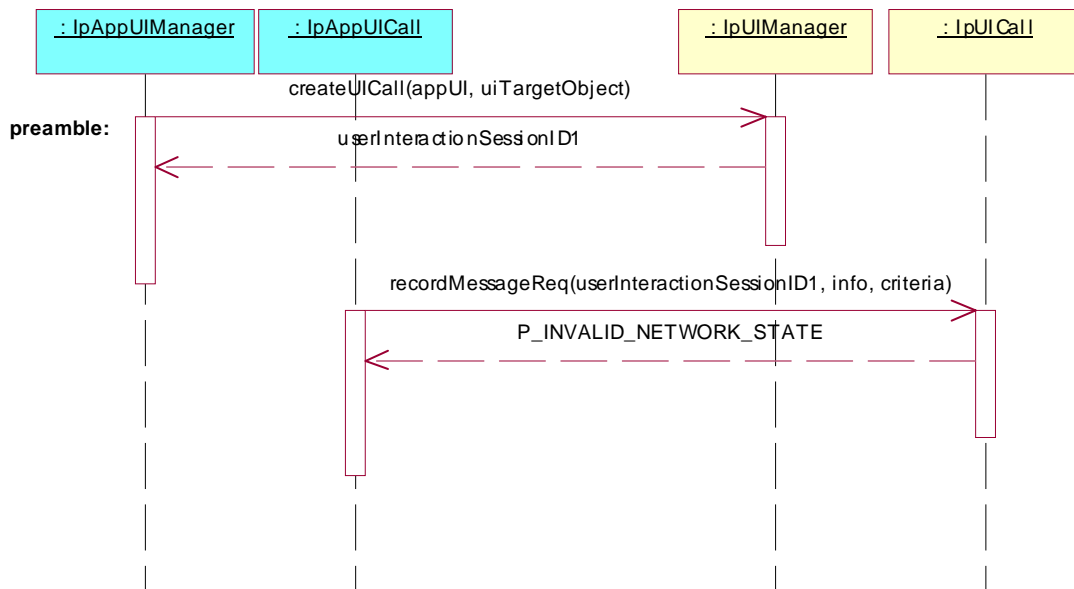

**Test UI\_42**

Summary: **IpUICall**, recordMessageReq methods, P\_ILLEGAL\_ID

Reference: ES 202 915-5 [1], clause 8.5

Preamble: A User Interaction object, created either with the createUI or the createUICall method on the IpUIManager interface or reported in a reportEventNotification method exists. The given sessionID is used in the following methods to identify this User Interaction object.

Selection: recordMessageReq method supported - PICS item: [2] UIC4

Test Sequence:

1. Method call **recordMessageReq()**

Parameters: userInteractionSessionID given in preamble, illegal info, criteria,

Check: P\_ILLEGAL\_ID or P\_ID\_NOT\_FOUND is returned

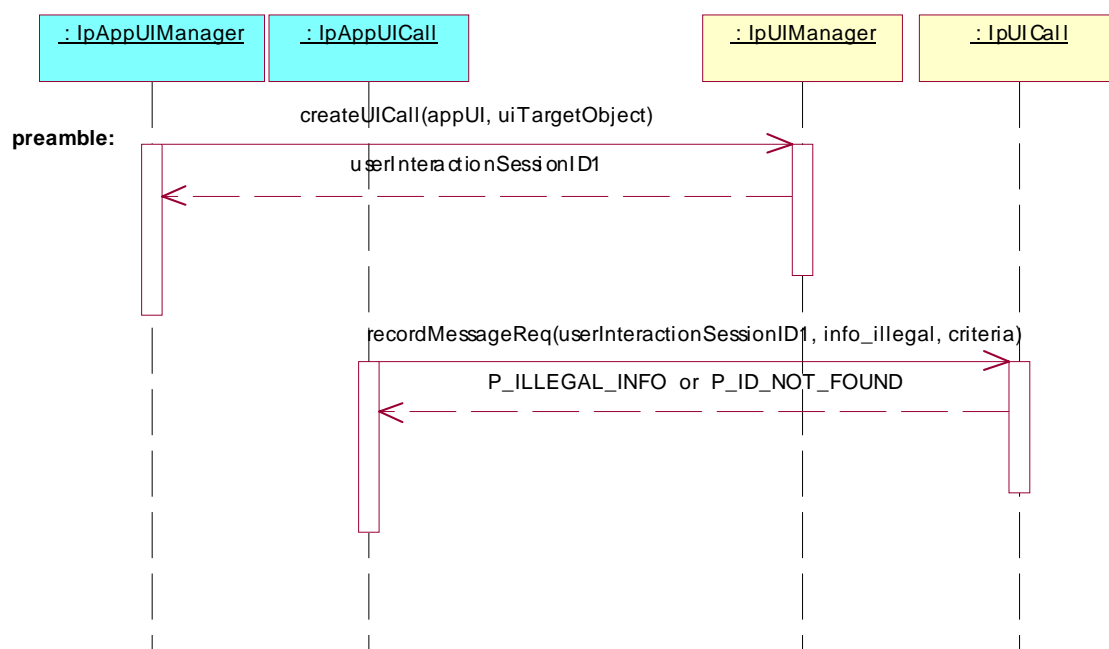

**Test UI\_43**

Summary: **IpUICall**, recordMessageReq methods, P\_INVALID\_CRITERIA

Reference: ES 202 915-5 [1], clause 8.5

Preamble: A User Interaction object, created either with the createUI or the createUICall method on the IpUIManager interface or reported in a reportEventNotification method exists. The given sessionID is used in the following methods to identify this User Interaction object.

Selection: recordMessageReq method supported - PICS item: [2] UIC4

Test Sequence:

1. Method call **recordMessageReq()**

Parameters: userInteractionSessionID given in preamble, info, invalid criteria,

Check: P\_INVALID\_CRITERIA is returned

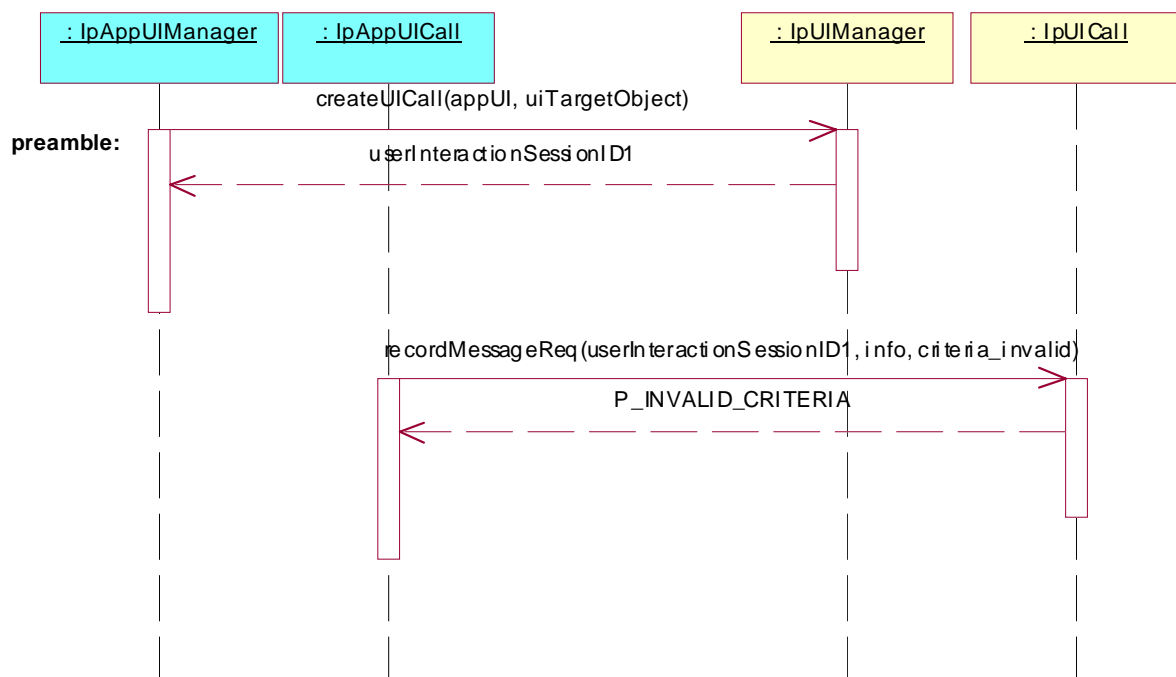



**Test UI\_44**

Summary: **IpUICall**, deleteMessageReq, P\_INVALID\_SESSION\_ID

Reference: ES 202 915-5 [1], clauses 8.5 and 8.6

Preamble: A User Interaction object, created either with the createUI or the createUICall method on the IpUIManager interface or reported in a reportEventNotification method exists. The given sessionID is used in the following methods to identify this User Interaction object.

Selection: recordMessageReq and deleteMessageReq methods supported - PICS item: [2] UIC4 AND UIC5

Test Sequence:

1. Method call **recordMessageReq()**  
 Parameters: userInteractionSessionID given in preamble, info, criteria.  
 Check: valid value of TpAssignmentID is returned
2. Triggered action: cause IUT to call **recordMessageRes()** method on the tester's (Application) **IpAppUICall** interface.  
 Check: valid value of userInteractionSessionID (given in preamble), assignmentID (given in 1.), response and messageID is transmitted,  
 Return: no parameter
3. Method call **deleteMessageReq()**  
 Parameters: invalid userInteractionSessionID, messageID returned in 2.  
 Check: P\_INVALID\_SESSION\_ID is returned

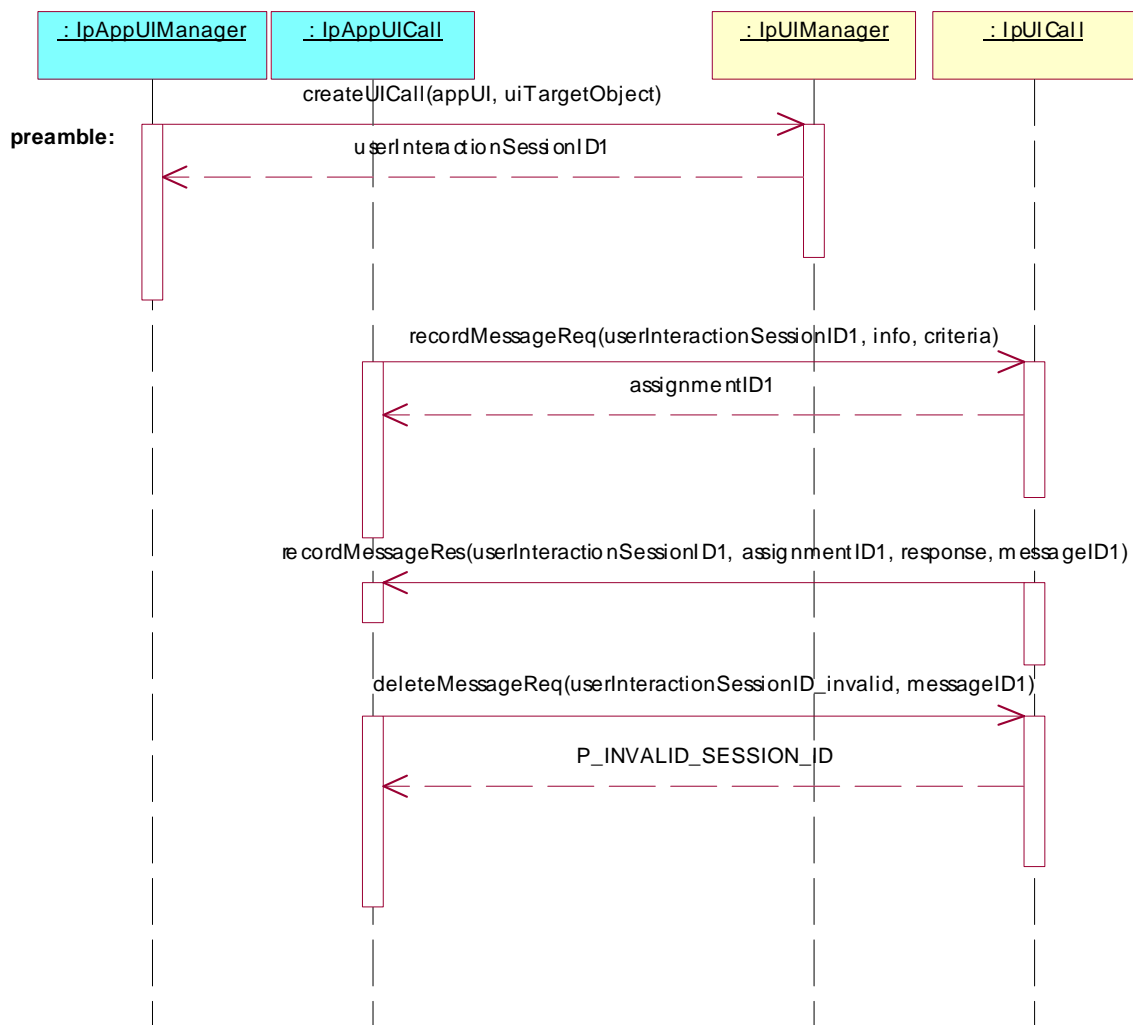

**Test UI\_45**

Summary: **IpUICall**, deleteMessageReq, P\_ILLEGAL\_ID

Reference: ES 202 915-5 [1], clauses 8.5 and 8.6

Preamble: A User Interaction object, created either with the createUI or the createUICall method on the IpUIManager interface or reported in a reportEventNotification method exists. The given sessionID is used in the following methods to identify this User Interaction object.

Selection: recordMessageReq and deleteMessageReq methods supported - PICS item: [2] UIC4 AND UIC5

Test Sequence:

1. Method call **recordMessageReq()**  
 Parameters: userInteractionSessionID given in preamble, info, criteria.  
 Check: valid value of TpAssignmentID is returned
2. Triggered action: cause IUT to call **recordMessageRes()** method on the tester's (Application) **IpAppUICall** interface.  
 Check: valid value of userInteractionSessionID (given in preamble), assignmentID (given in 1.), response and messageID is transmitted,  
 Return: no parameter
3. Method call **deleteMessageReq()**  
 Parameters: userInteractionSessionID given in preamble, illegal messageID.  
 Check: P\_ILLEGAL\_ID or P\_ID\_NOT\_FOUND is returned

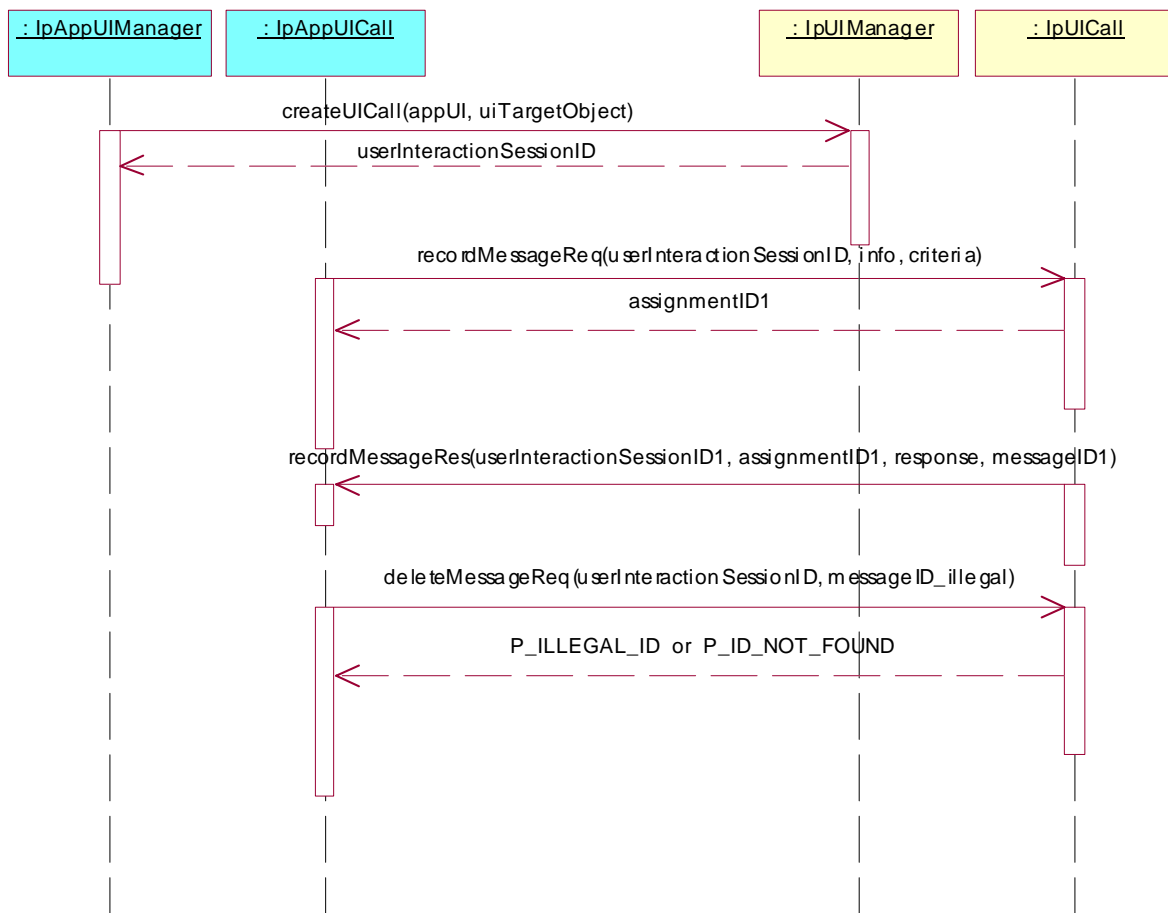

**Test UI\_46**

Summary: **IpUICall**, abortActionReq method, P\_INVALID\_SESSION\_ID

Reference: ES 202 915-5 [1], clause 8.5

Preamble: A User Interaction object, created either with the createUI or the createUICall method on the IpUIManager interface or reported in a reportEventNotification method exists. The given sessionID is used in the following methods to identify this User Interaction object.

Selection: sendInfoReq and abortActionReq methods supported - PICS item: [2] UIC1 AND UIC6

Test Sequence:

1. Method call **sendInfoReq()**  
 Parameters: userInteractionSessionID given in preamble, info, language, variableInfo, repeatIndicator, responseRequested.  
 Check: valid value of TpAssignmentID is returned
2. Method call **abortActionReq()**  
 Parameters: invalid userInteractionSessionID, assignmentID returned in 1.  
 Check: P\_INVALID\_SESSION\_ID is returned.

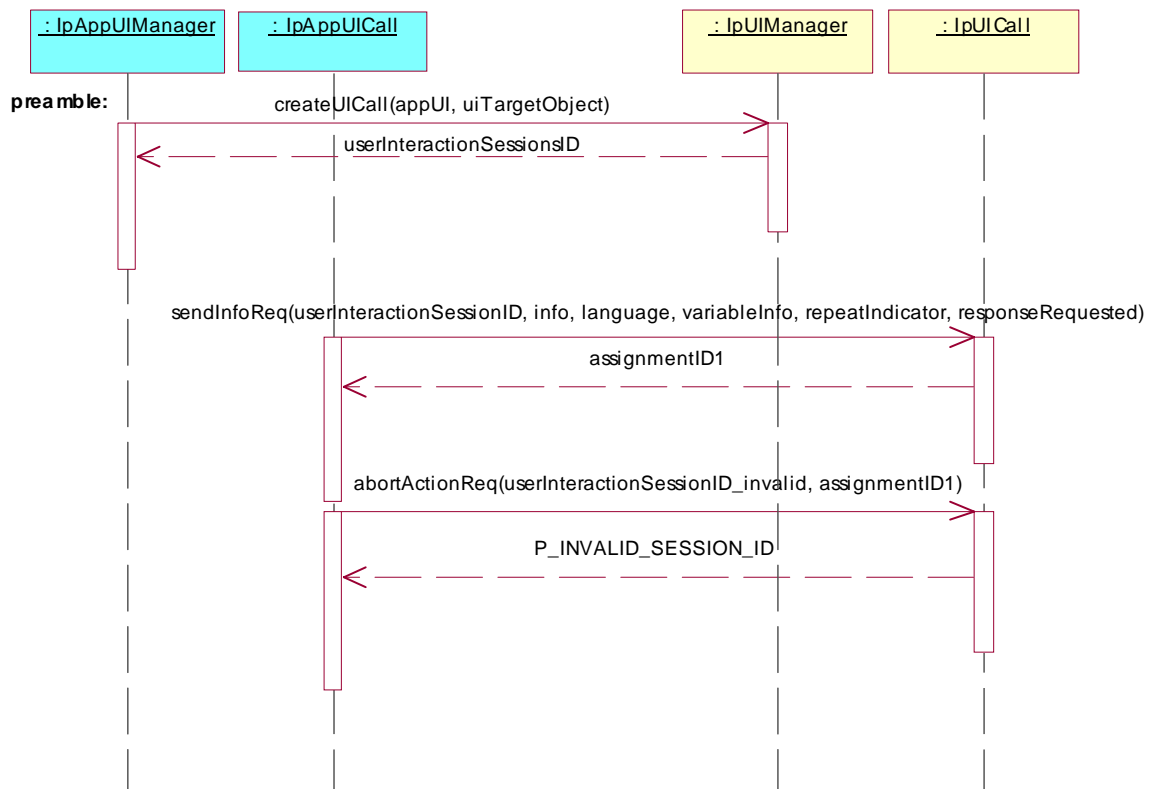

**Test UI\_47**

Summary: **IpUICall**, abortActionReq method, P\_INVALID\_ASSIGNMENT\_ID

Reference: ES 202 915-5 [1], clause 8.5

Preamble: A User Interaction object, created either with the createUI or the createUICall method on the IpUIManager interface or reported in a reportEventNotification method exists. The given sessionID is used in the following methods to identify this User Interaction object.

Selection: sendInfoReq and abortActionReq methods supported - PICS item: [2] UIC1 AND UIC6

Test Sequence:

1. Method call **sendInfoReq()**  
 Parameters: userInteractionSessionID given in preamble, info, language, variableInfo, repeatIndicator, responseRequested.  
 Check: valid value of TpAssignmentID is returned
2. Method call **abortActionReq()**  
 Parameters: userInteractionSessionID given in preamble, invalid assignmentID.  
 Check: P\_INVALID\_ASSIGNMENT\_ID is returned.

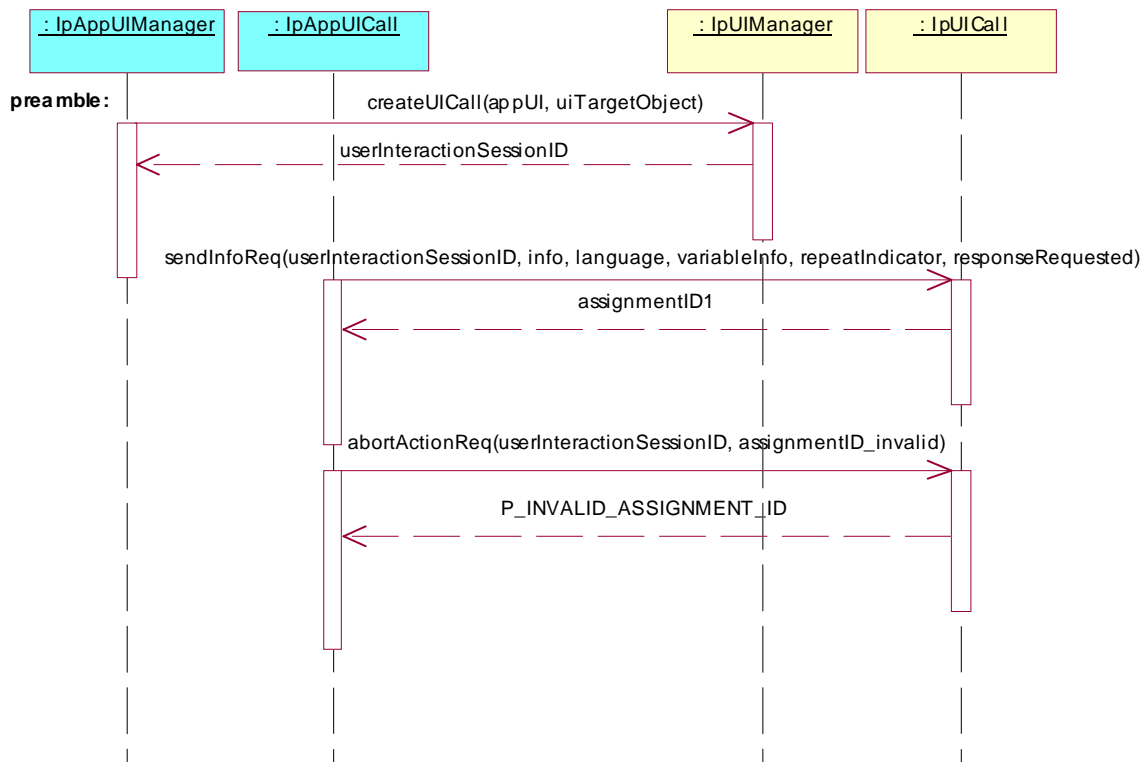

**Test UI\_48**

Summary: **IpUICall**, abortActionReq method, P\_INVALID\_SESSION\_ID

Reference: ES 202 915-5 [1], clause 8.5

Preamble: A User Interaction object, created either with the createUI or the createUICall method on the IpUIManager interface or reported in a reportEventNotification method exists. The given sessionID is used in the following methods to identify this User Interaction object.

Selection: sendInfoAndCollectReq and abortActionReq methods supported - PICS item: [2] UIC2 AND UIC6

Test Sequence:

1. Method call **sendInfoAndCollectReq()**  
 Parameters: userInteractionSessionID given in preamble, info, language, variableInfo, criteria, responseRequested.  
 Check: valid value of TpAssignmentID is returned
2. Method call **abortActionReq()**  
 Parameters: invalid userInteractionSessionID, assignmentID returned in 1.  
 Check: P\_INVALID\_SESSION\_ID is returned.

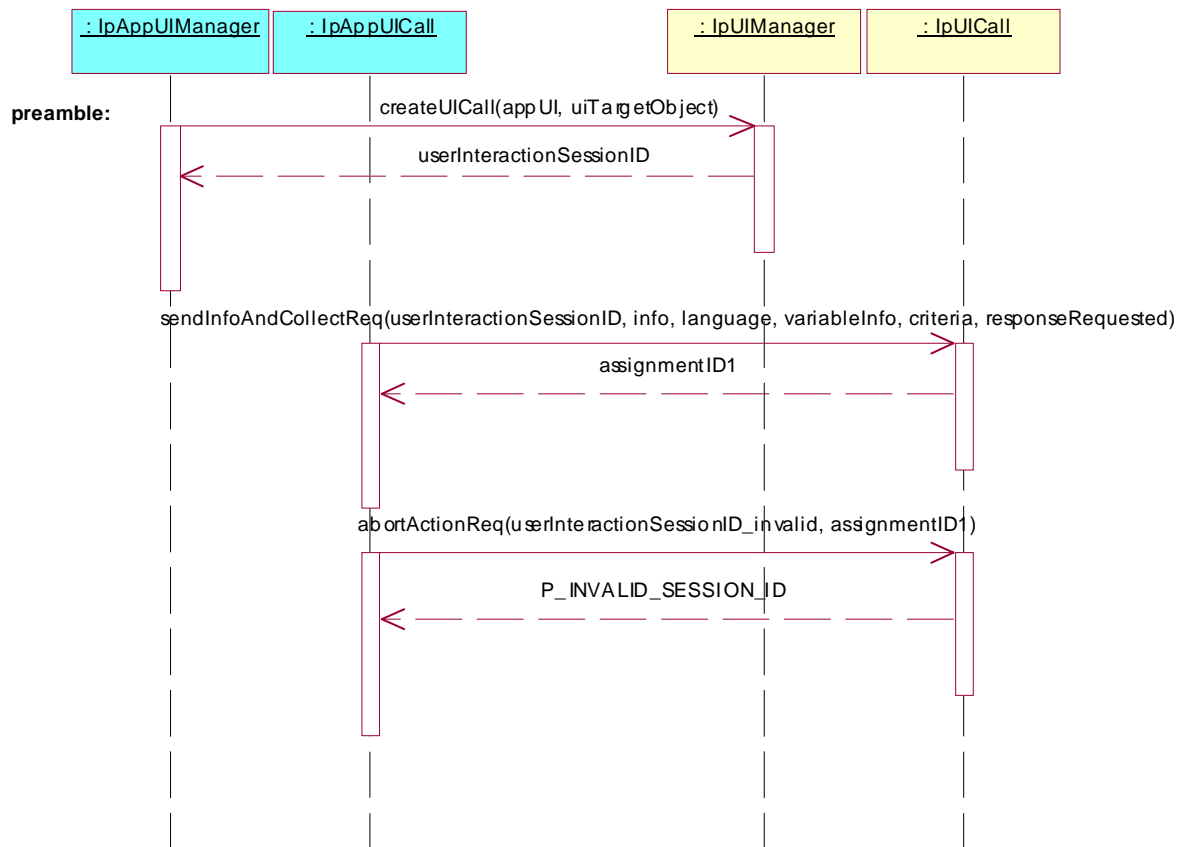

**Test UI\_49**

Summary: **IpUICall**, abortActionReq method, P\_INVALID\_ASSIGNMENT\_ID

Reference: ES 202 915-5 [1], clause 8.5

Preamble: A User Interaction object, created either with the createUI or the createUICall method on the IpUIManager interface or reported in a reportEventNotification method exists. The given sessionID is used in the following methods to identify this User Interaction object.

Selection: sendInfoAndCollectReq and abortActionReq methods supported - PICS item: [2] UIC2 AND UIC6

Test Sequence:

1. Method call **sendInfoAndCollectReq()**  
 Parameters: userInteractionSessionID given in preamble, info, language, variableInfo, criteria, responseRequested.  
 Check: valid value of TpAssignmentID is returned
2. Method call **abortActionReq()**  
 Parameters: userInteractionSessionID given in preamble, invalid assignmentID.  
 Check: P\_INVALID\_ASSIGNMENT\_ID is returned.

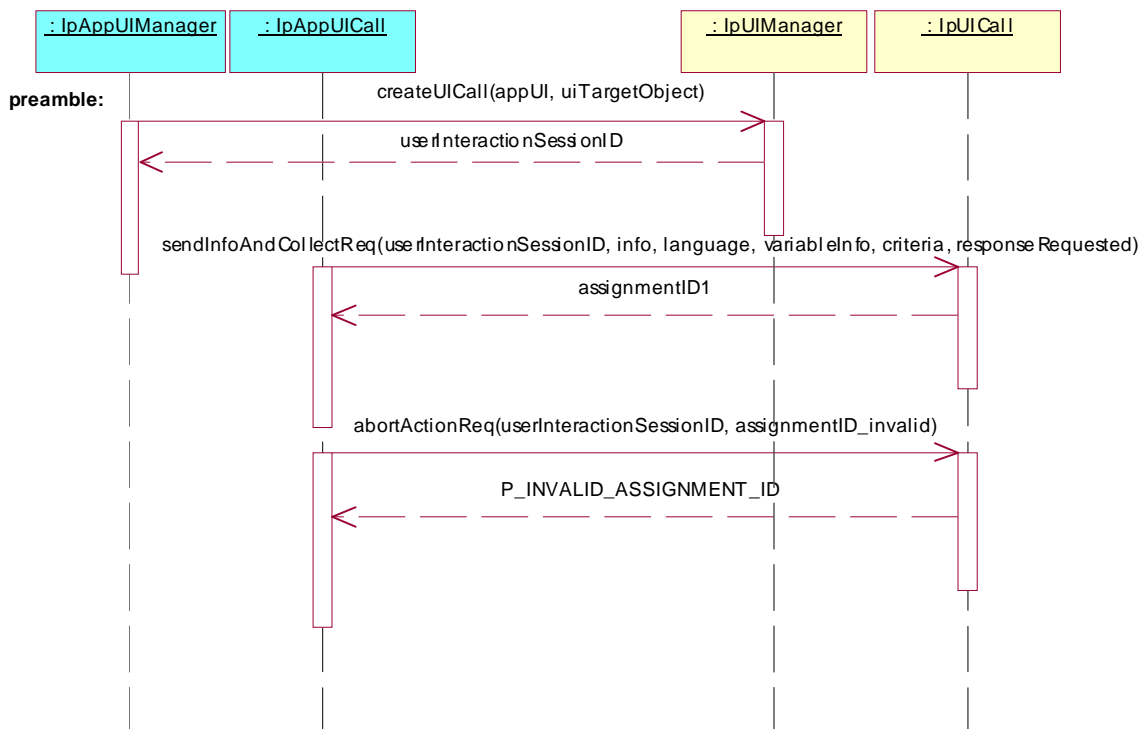

## 5.2.2 User Interaction, application side

In performing the tests for the application, it may be necessary to permit the application to perform any valid set of method exchanges with the tester in between the triggered actions or method calls indicated in the tests below. The tester shall respond to the application's method calls in conformance to the API specification and as required by the application. The requirements of the application should be made known to the tester's operator in advance.

### 5.2.2.1 IpAppUIManager interface

#### Test UI\_APP\_01

Summary: **IpAppUIManager**, userInteractionAborted

Reference: ES 202 915-5 [1], clause 8.2

Preamble: A User Interaction object, created either with the createUI or the createUICall method on the corresponding IpUIManager interface or reported in a reportEventNotification method, exists. The given sessionID is used in the following methods to identify this User Interaction object.

Selection: userInteractionAborted method supported - PICS item: [2] AUIM1

Test Sequence:

1. Method call **userInteractionAborted()**  
 Parameters: userInteractionSessionID as given in preamble.  
 Check: no exception is returned

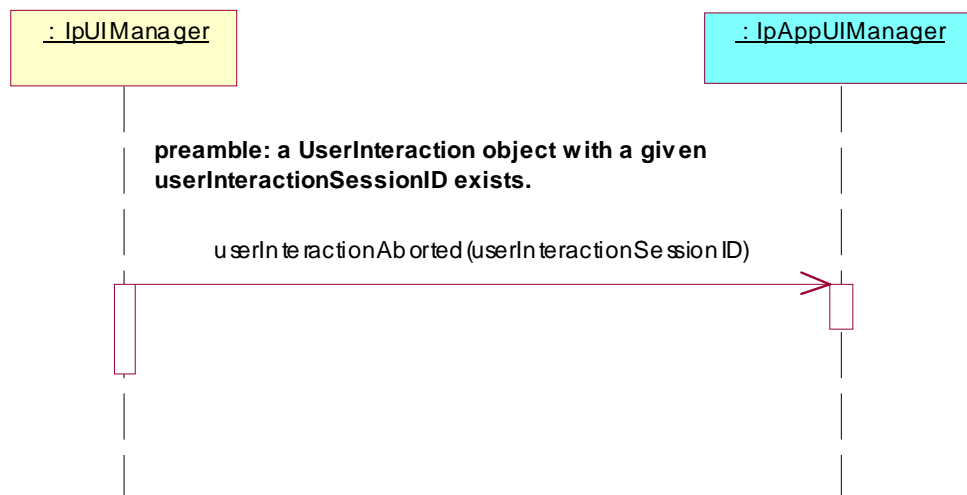

#### Test UI\_APP\_02

Summary: **IpAppUIManager**, userInteractionNotificationInterrupted

Reference: ES 202 915-5 [1], clause 8.2

Preamble: A User Interaction object, created either with the createUI or the createUICall method on the corresponding IpUIManager interface or reported in a reportEventNotification method, exists.

Selection: userInteractionNotificationInterrupted method supported - PICS item: [2] AUIM2

Test Sequence:

1. Method call **userInteractionNotificationInterrupted ()**  
 Parameters: none.  
 Check: no exception is returned

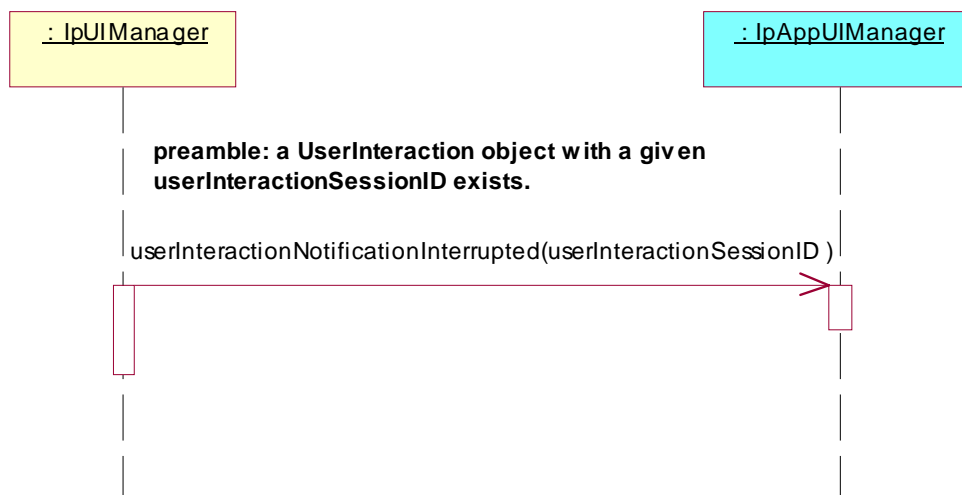
**Test UI\_APP\_03**

Summary: **IpAppUIManager**, `userInteractionNotificationContinued`

Reference: ES 202 915-5 [1], clause 8.2

Preamble: A User Interaction object, created either with the `createUI` or the `createUICall` method on the corresponding `IpUIManager` interface or reported in a `reportEventNotification` method, exists.

Selection: `userInteractionNotificationContinued` method supported - PICS item: [2] AUIM3

Test Sequence:

1. Method call **`userInteractionNotificationContinued ()`**  
Parameters: none.  
Check: no exception is returned

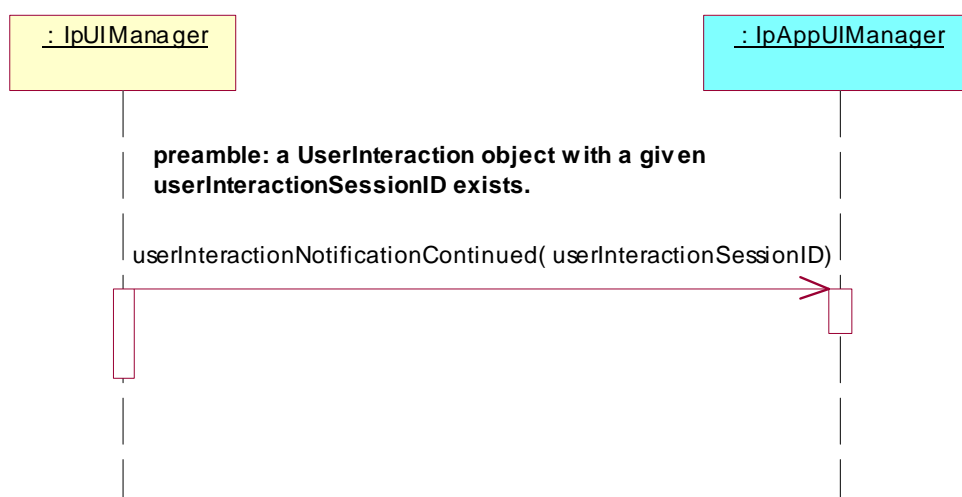



**Test AM\_APP\_20**

Summary: **IpAppUIManager** all methods, successful

Reference: ES 202 915-5 [1], clause 8.2

Precondition: reportEventNotification supported

Preamble: Registration of the IUT (application) and the tester (User Interaction SCF) to the framework. The tester must have obtained a reference to an instance of the IpAppAccountManager interface through selecting that service and signing the required service agreement.

Test Sequence:

1. Triggered action: cause IUT to call **enableNotifications ()** method on the tester's (SCF) **IpUIManager** interface.  
Parameters: appAccountManager
2. Method call **reportEventNotification ()**  
Parameters: userInteraction, eventNotificationInfo, assignmentID  
Check: no exception is returned
3. Triggered action: cause IUT to call **disableNotifications ()** method on the tester's (SCF) **IpUIManager** interface.  
Parameters: none

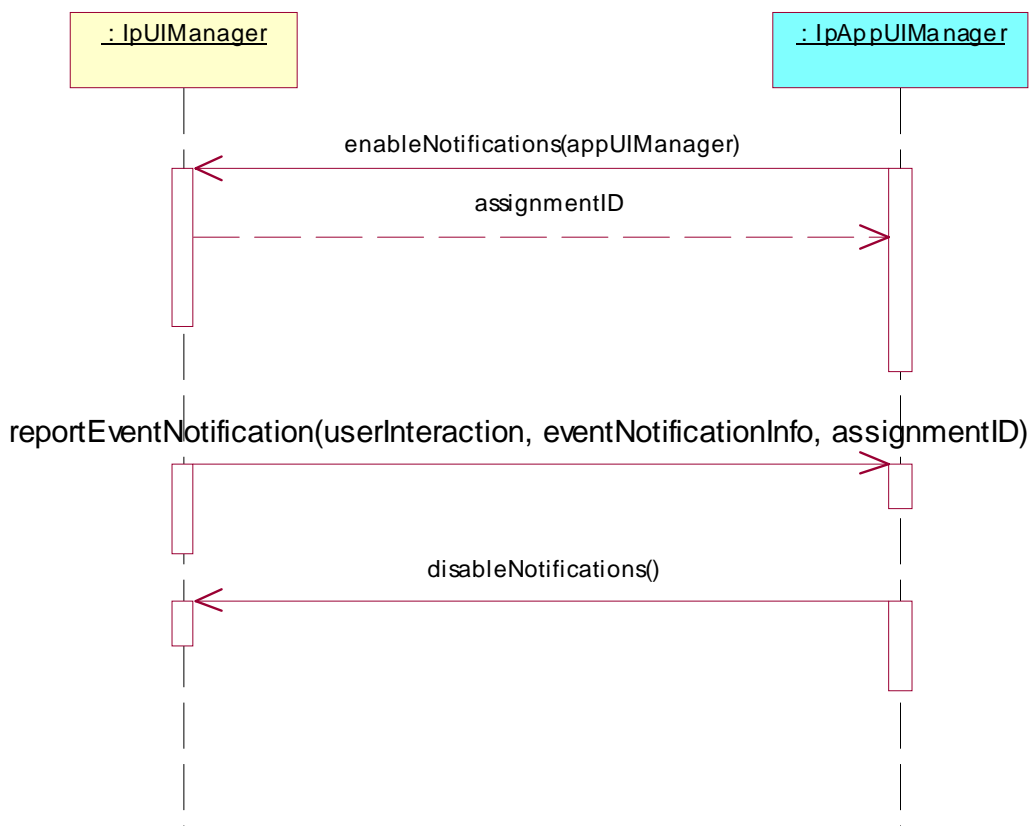

## 5.2.2.2 IpAppUI interface

### Test UI\_APP\_04

Summary: **IpAppUI**, sendInfoRes

Reference: ES 202 915-5 [1], clause 8.4

Preamble: A User Interaction object, created either with the createUI or the createUICall method on the corresponding IpUIManager interface or reported in a reportEventNotification method, exists. The given sessionID is used in the following methods to identify this User Interaction object.

Selection: sendInfoRes method supported - PICS item: [2] AUI1

Test Sequence:

1. Triggered action: cause IUT to call **sendInfoReq()** method on the tester's (SCF) **IpUI** interface.  
 Check: valid value of userInteraction, info, language, variableInfo, repeatIndicator and responseRequested is transmitted,  
 Return: valid value of TpAssignmentID is returned
2. Method call **sendInfoRes()**  
 Parameters: userInteractionSessionID as given in preamble, assignmentID as given in 1. and response is transmitted.  
 Check: no exception is returned

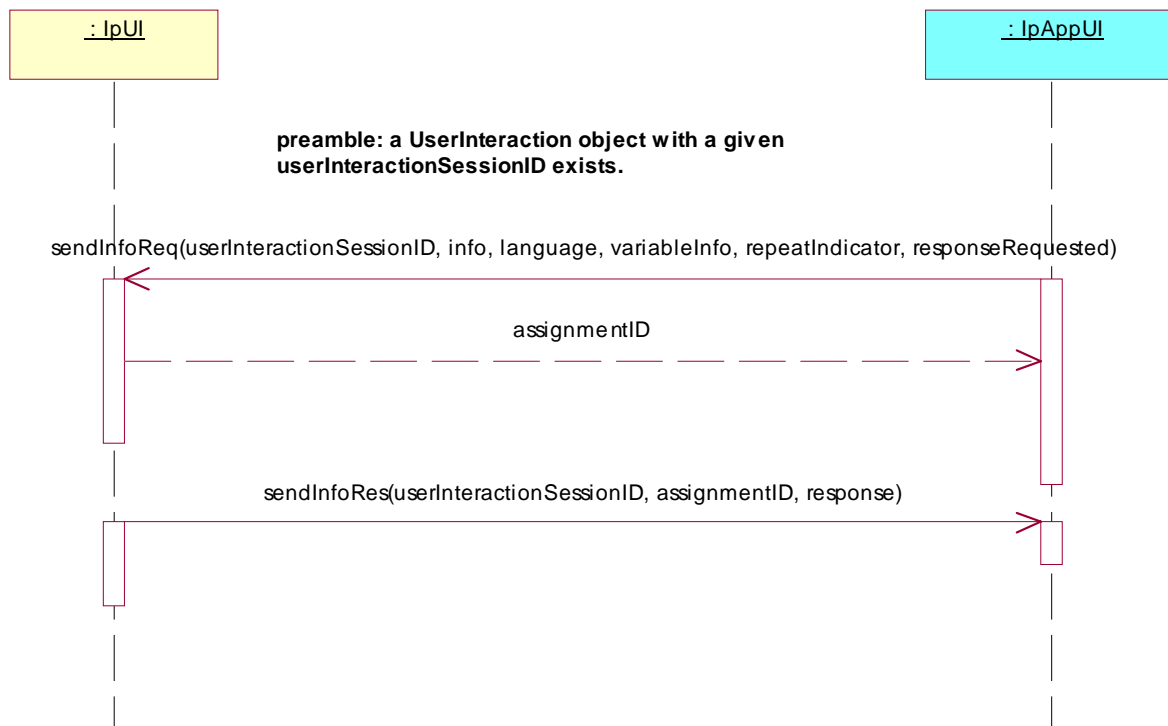

**Test UI\_APP\_05**

Summary: **IpAppUI**, sendInfoErr

Reference: ES 202 915-5 [1], clause 8.4

Preamble: A User Interaction object, created either with the createUI or the createUICall method on the corresponding IpUIManager interface or reported in a reportEventNotification method, exists. The given sessionId is used in the following methods to identify this User Interaction object.

Selection: sendInfoErr method supported - PICS item: [2] AUI2

Test Sequence:

1. Triggered action: cause IUT to call **sendInfoReq()** method on the tester's (SCF) **IpUI** interface.  
 Check: valid value of userInteraction, info, language, variableInfo, repeatIndicator and responseRequested is transmitted,  
 Return: valid value of TpAssignmentID is returned
2. Method call **sendInfoErr()**  
 Parameters: userInteractionSessionID as given in preamble, assignmentID as given in 1. and error is transmitted.  
 Check: no exception is returned

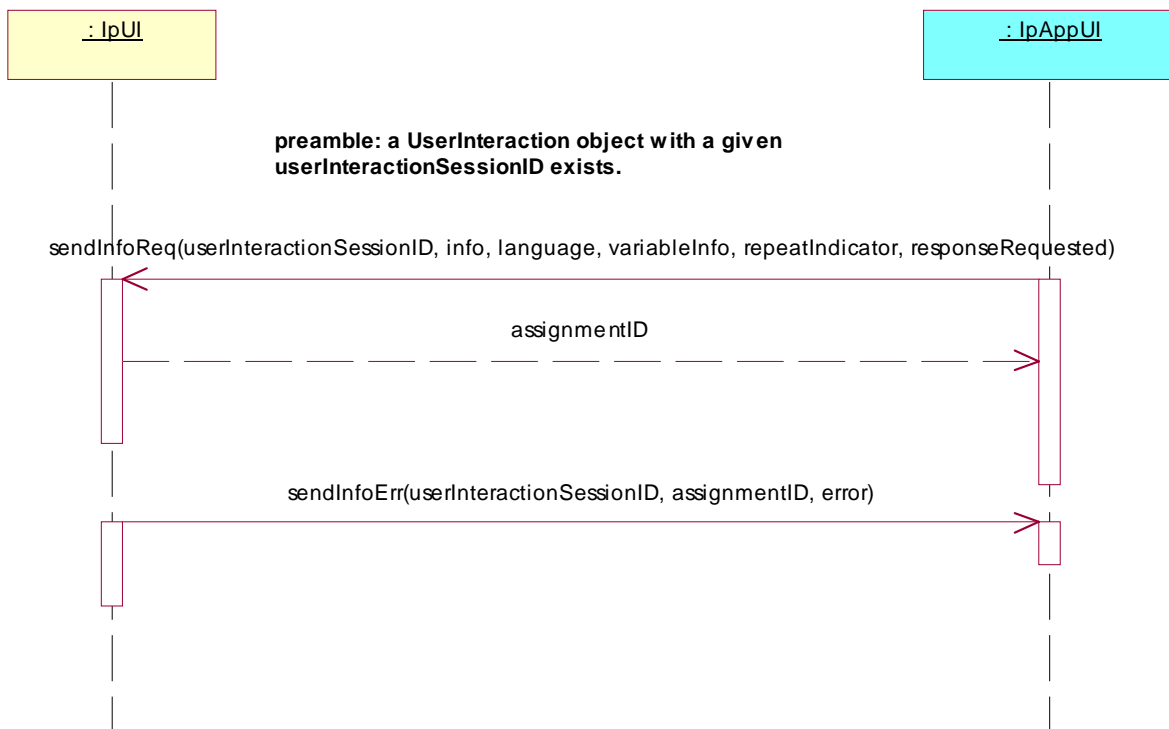

**Test UI\_APP\_06**

Summary: **IpAppUI**, sendInfoAndCollectRes

Reference: ES 202 915-5 [1], clause 8.4

Preamble: A User Interaction object, created either with the createUI or the createUICall method on the corresponding IpUIManager interface or reported in a reportEventNotification method, exists. The given sessionID is used in the following methods to identify this User Interaction object.

Selection: sendInfoAnd CollectRes method supported - PICS item: [2] AUI3

Test Sequence:

1. Triggered action: cause IUT to call **sendInfoAndCollectReq()** method on the tester's (SCF) **IpUI** interface.  
 Check: valid value of userInteraction, info, language, variableInfo, criteria and responseRequested is transmitted,  
 Return: valid value of TpAssignmentID is returned
2. Method call **sendInfoAndCollectRes()**  
 Parameters: userInteractionSessionID as given in preamble, assignmentID as given in 1. response and collectedInfo is transmitted.  
 Check: no exception is returned

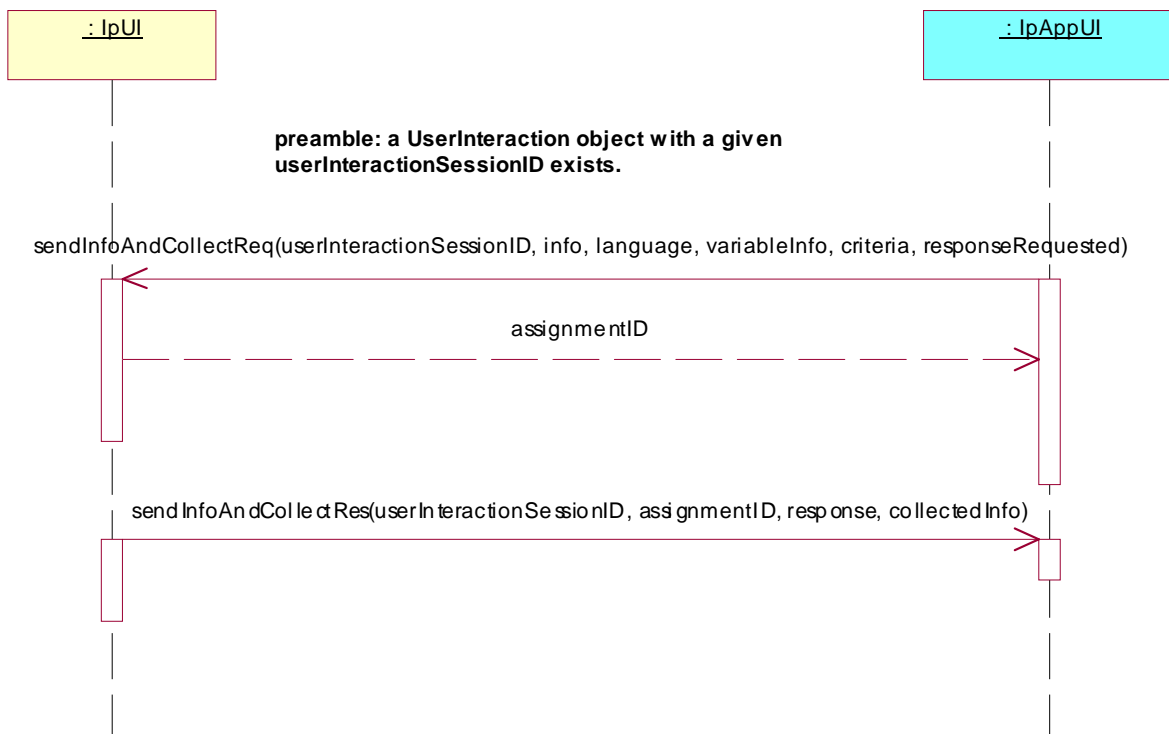

**Test UI\_APP\_07**

Summary: **IpAppUI**, sendInfoAndCollectErr

Reference: ES 202 915-5 [1], clause 8.4

Preamble: A User Interaction object, created either with the createUI or the createUICall method on the corresponding IpUIManager interface or reported in a reportEventNotification method, exists. The given sessionID is used in the following methods to identify this User Interaction object.

Selection: sendInfoAndCollectErr method supported - PICS item: [2] AUI4

Test Sequence:

1. Triggered action: cause IUT to call **sendInfoAndCollectReq()** method on the tester's (SCF) **IpUI** interface.  
 Check: valid value of userInteraction, info, language, variableInfo, criteria and responseRequested is transmitted,  
 Return: valid value of TpAssignmentID is returned
2. Method call **sendInfoAndCollectErr()**  
 Parameters: userInteractionSessionID as given in preamble, assignmentID as given in 1. error and collectedInfo is transmitted.  
 Check: no exception is returned

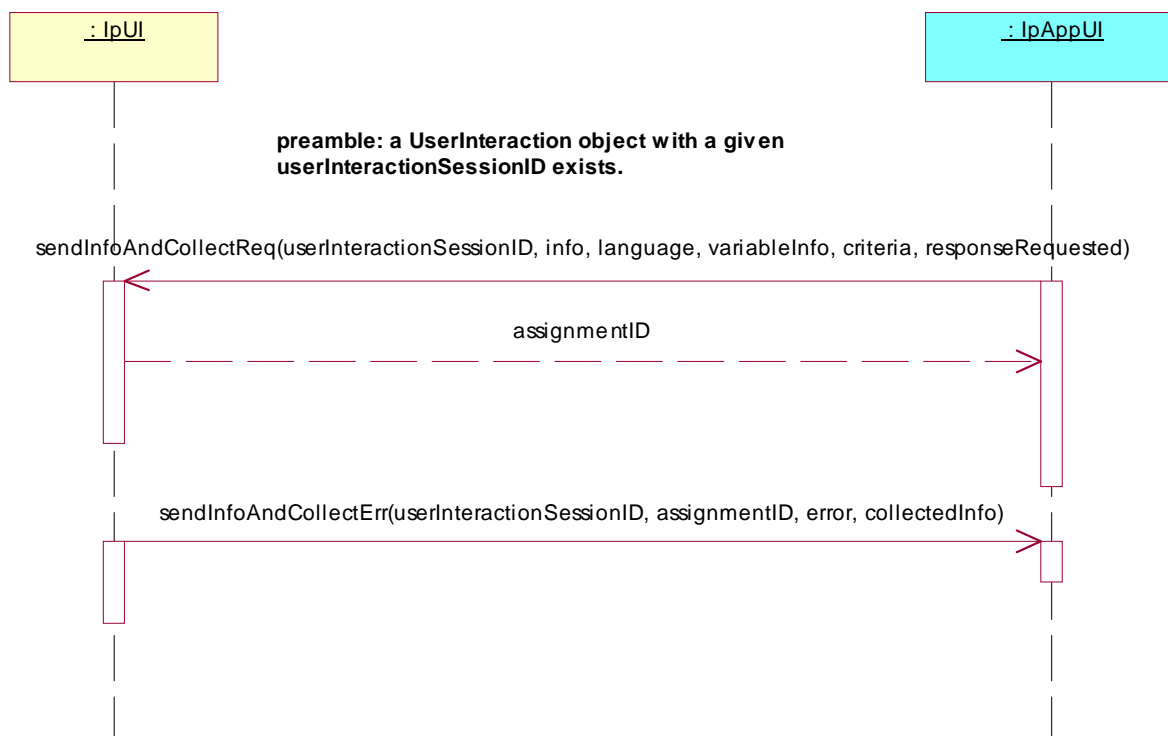

**Test UI\_APP\_08**

Summary: **IpAppUI**, userInteractionFaultDetected

Reference: ES 202 915-5 [1], clause 8.4

Preamble: A User Interaction object, created either with the createUI or the createUICall method on the corresponding IpUIManager interface or reported in a reportEventNotification method, exists. The given sessionID is used in the following methods to identify this User Interaction object.

Selection: userInteractionFaultDetected method supported - PICS item: [2] AUI5

Test Sequence:

1. Method call **userInteractionFaultDetected()**  
 Parameters: userInteractionSessionID as given in preamble and fault is transmitted.  
 Check: no exception is returned

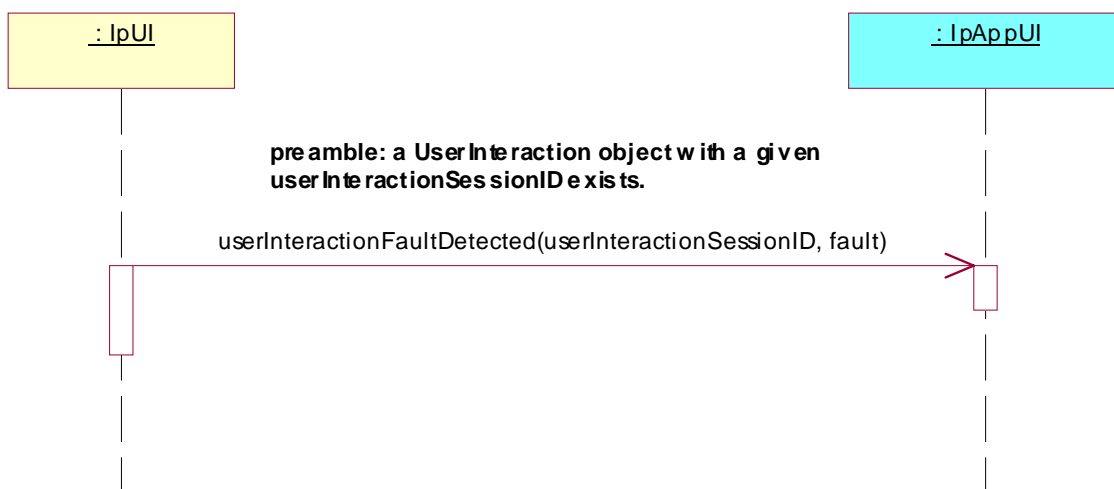
**5.2.2.3 IpAppUICall interface****Test UI\_APP\_09**

Summary: **IpAppUICall**, sendInfoRes

Reference: ES 202 915-5 [1], clause 8.6

Preamble: A User Interaction object, created either with the createUI or the createUICall method on the corresponding IpUIManager interface or reported in a reportEventNotification method, exists. The given sessionID is used in the following methods to identify this User Interaction object.

Selection: sendInfoRes method supported - PICS item: [2] AUI C1

Test Sequence:

1. Triggered action: cause IUT to call **sendInfoReq()** method on the tester's (SCF) **IpUICall** interface.  
 Check: valid value of userInteraction, info, language, variableInfo, repeatIndicator and responseRequested is transmitted,  
 Return: valid value of TpAssignmentID is returned
2. Method call **sendInfoRes()**  
 Parameters: userInteractionSessionID as given in preamble, assignmentID as given in 1. and response is transmitted.  
 Check: no exception is returned

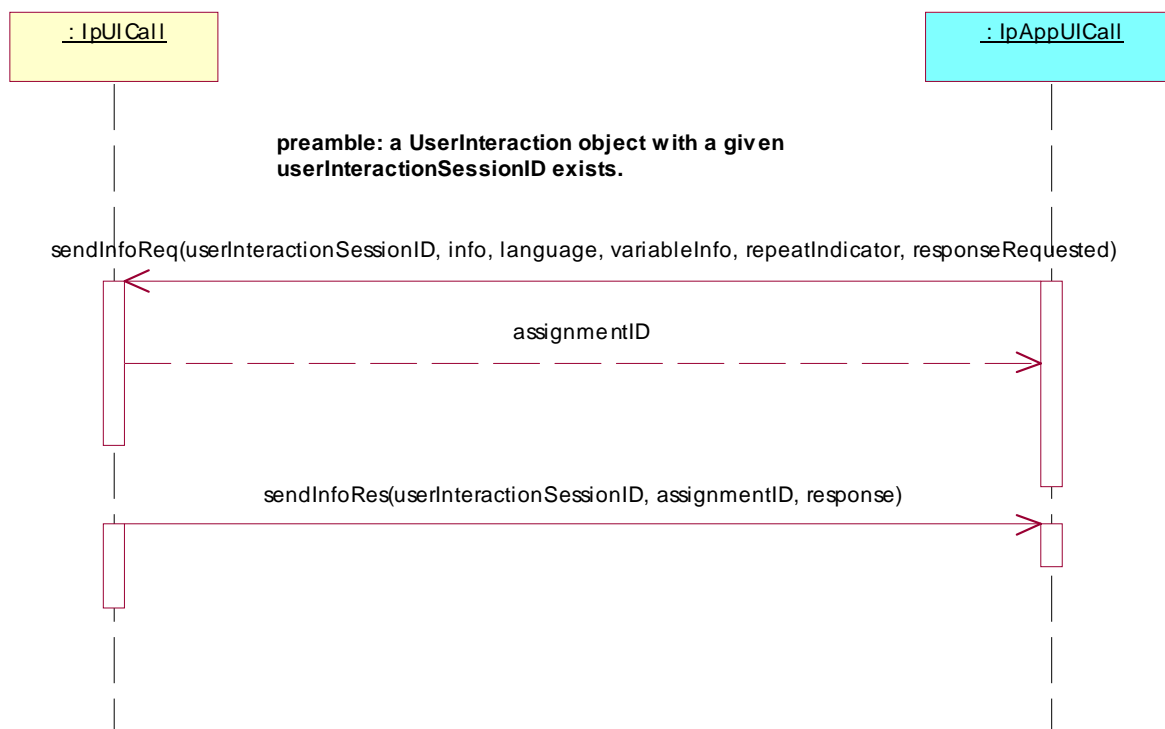

### Test UI\_APP\_10

Summary: **IpAppUICall**, sendInfoErr

Reference: ES 202 915-5 [1], clause 8.6

Preamble: A User Interaction object, created either with the createUI or the createUICall method on the corresponding IpUIManager interface or reported in a reportEventNotification method, exists. The given sessionID is used in the following methods to identify this User Interaction object.

Selection: sendInfoErr method supported - PICS item: [2] AUC2

Test Sequence:

1. Triggered action: cause IUT to call **sendInfoReq()** method on the tester's (SCF) **IpUICall** interface.  
 Check: valid value of userInteraction, info, language, variableInfo, repeatIndicator and responseRequested is transmitted,  
 Return: valid value of TpAssignmentID is returned
2. Method call **sendInfoErr()**  
 Parameters: userInteractionSessionID as given in preamble, assignmentID as given in 1. and error is transmitted.  
 Check: no exception is returned

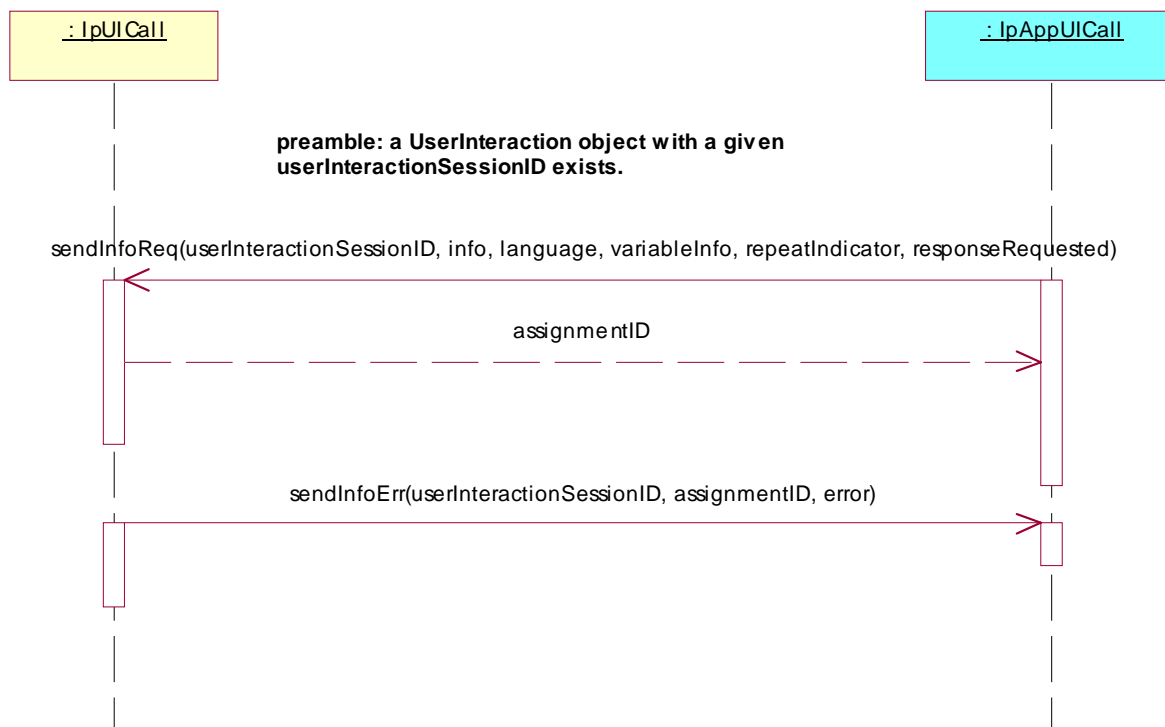

### Test UI\_APP\_11

Summary: **IpAppUICall**, sendInfoAndCollectRes

Reference: ES 202 915-5 [1], clause 8.6

Preamble: A User Interaction object, created either with the createUI or the createUICall method on the corresponding IpUIManager interface or reported in a reportEventNotification method, exists. The given sessionID is used in the following methods to identify this User Interaction object.

Selection: sendInfoAnd CollectRes method supported - PICS item: [2] AUC3

Test Sequence:

1. Triggered action: cause IUT to call **sendInfoAndCollectReq()** method on the tester's (SCF) **IpUICall** interface.  
 Check: valid value of userInteraction, info, language, variableInfo, criteria and responseRequested is transmitted,  
 Return: valid value of TpAssignmentID is returned
2. Method call **sendInfoAndCollectRes()**  
 Parameters: userInteractionSessionID as given in preamble, assignmentID as given in 1. response and collectedInfo is transmitted.  
 Check: no exception is returned



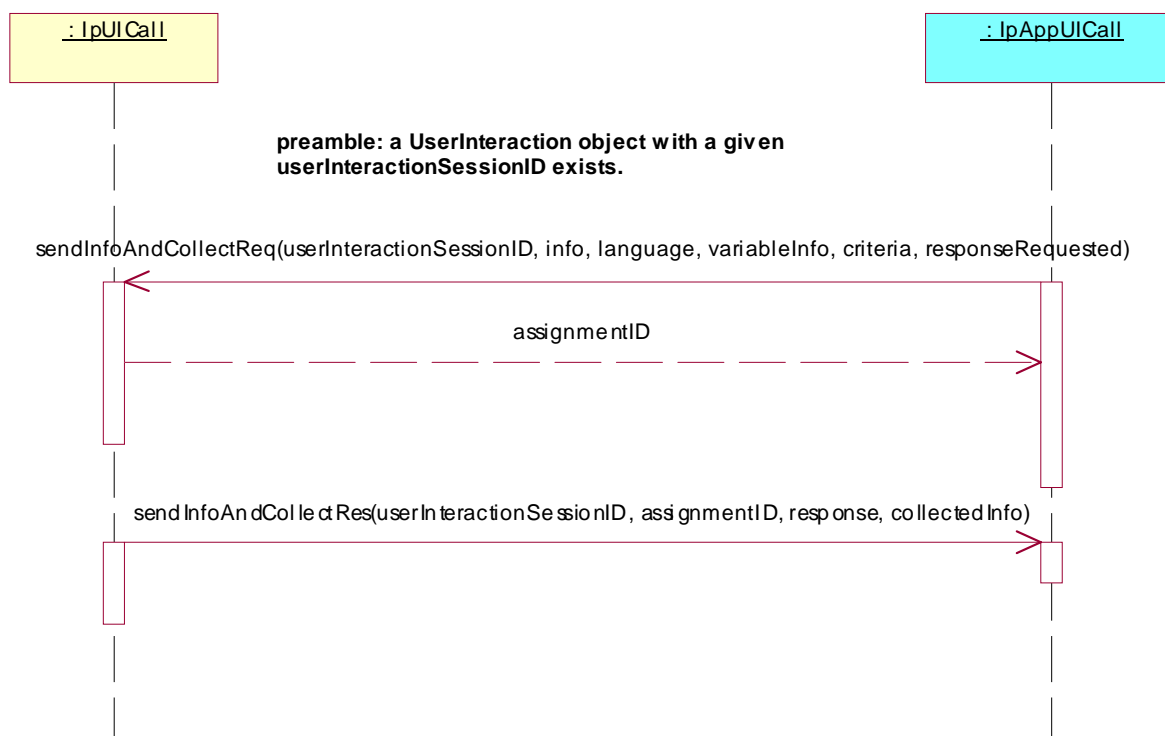

### Test UI\_APP\_12

Summary: **IpAppUICall**, **sendInfoAndCollectErr**

Reference: ES 202 915-5 [1], clause 8.6

Preamble: A User Interaction object, created either with the **createUI** or the **createUICall** method on the corresponding **IpUIManager** interface or reported in a **reportEventNotification** method, exists. The given **sessionID** is used in the following methods to identify this User Interaction object.

Selection: **sendInfoAndCollectErr** method supported - PICS item: [2] AUC4

Test Sequence:

1. Triggered action: cause IUT to call **sendInfoAndCollectReq()** method on the tester's (SCF) **IpUICall** interface.  
 Check: valid value of **userInteraction**, **info**, **language**, **variableInfo**, **criteria** and **responseRequested** is transmitted,  
 Return: valid value of **TpAssignmentID** is returned
2. Method call **sendInfoAndCollectErr()**  
 Parameters: **userInteractionSessionID** as given in preamble, **assignmentID** as given in 1. error and **collectedInfo** is transmitted.  
 Check: no exception is returned

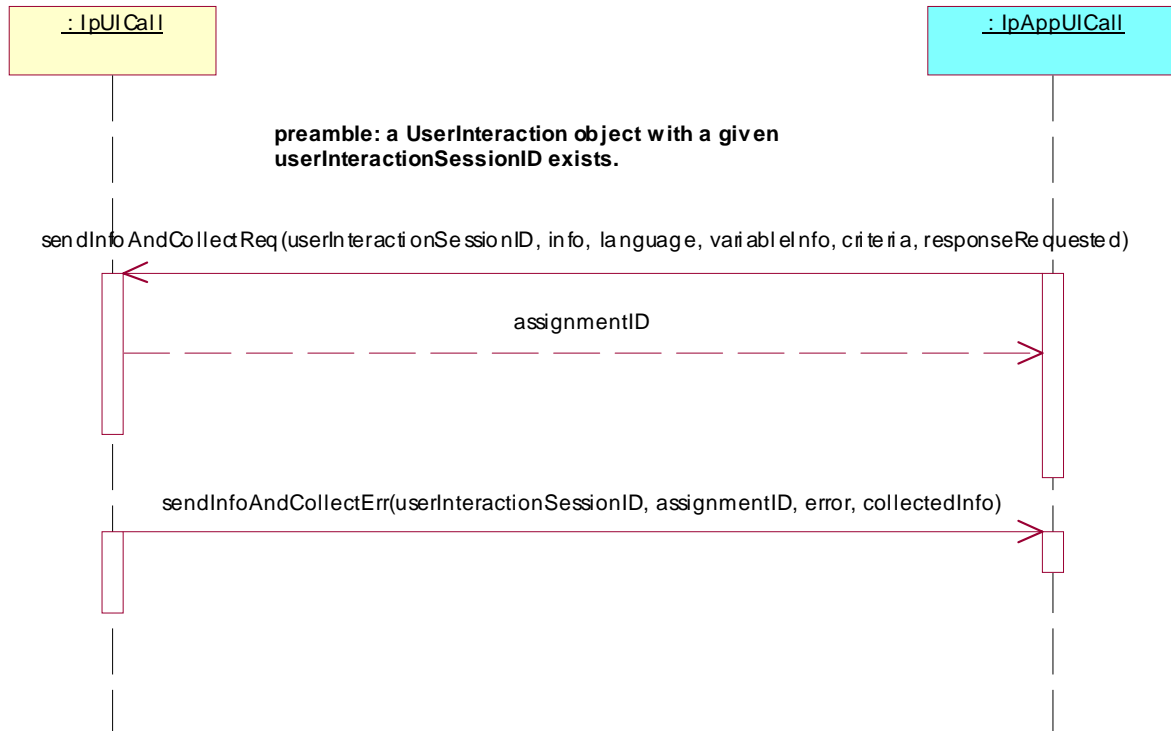

### Test UI\_APP\_13

Summary: **IpAppUICall**, userInteractionFaultDetected

Reference: ES 202 915-5 [1], clause 8.6

Preamble: A User Interaction object, created either with the createUI or the createUICall method on the corresponding IpUIManager interface or reported in a reportEventNotification method, exists. The given sessionID is used in the following methods to identify this User Interaction object.

Selection: userInteractionFaultDetected method supported - PICS item: [2] AUC5

Test Sequence:

1. Method call **userInteractionFaultDetected()**  
 Parameters: userInteractionSessionID as given in preamble and fault is transmitted.  
 Check: no exception is returned

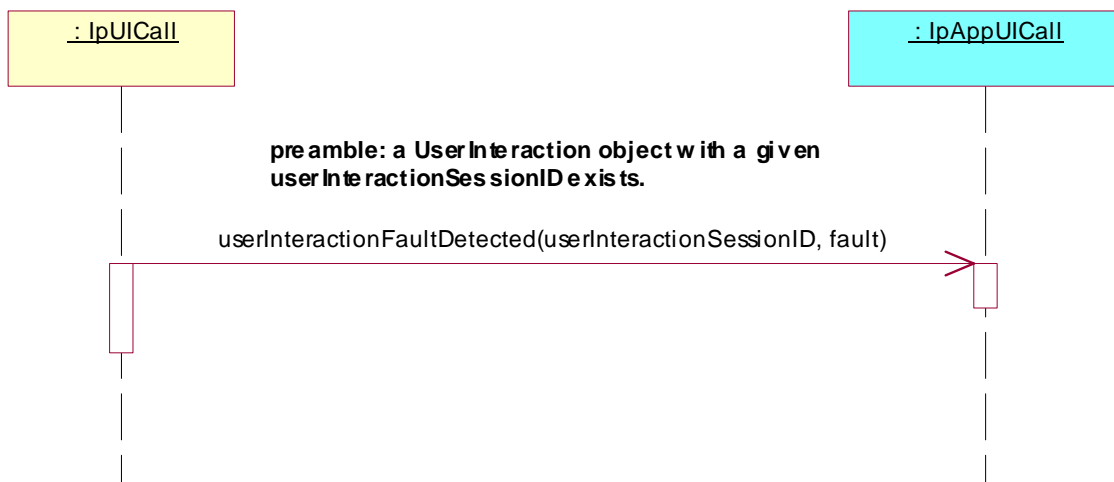

**Test UI\_APP\_14**

Summary: **IpAppUICall**, recordMessageRes

Reference: ES 202 915-5 [1], clause 8.6

Preamble: A User Interaction object, created either with the createUI or the createUICall method on the corresponding IpUIManager interface or reported in a reportEventNotification method, exists. The given sessionID is used in the following methods to identify this User Interaction object.

Selection: recordMessageRes method supported - PICS item: [2] AUIC6

Test Sequence:

1. Triggered action: cause IUT to call **recordMessageReq()** method on the tester's (SCF) **IpUICall** interface.  
 Check: valid value of userInteraction, info and criteria is transmitted,  
 Return: valid value of TpAssignmentID is returned
2. Method call **recordMessageRes()**  
 Parameters: userInteractionSessionID as given in preamble, assignmentID as given in 1, response and messageID is transmitted.  
 Check: no exception is returned

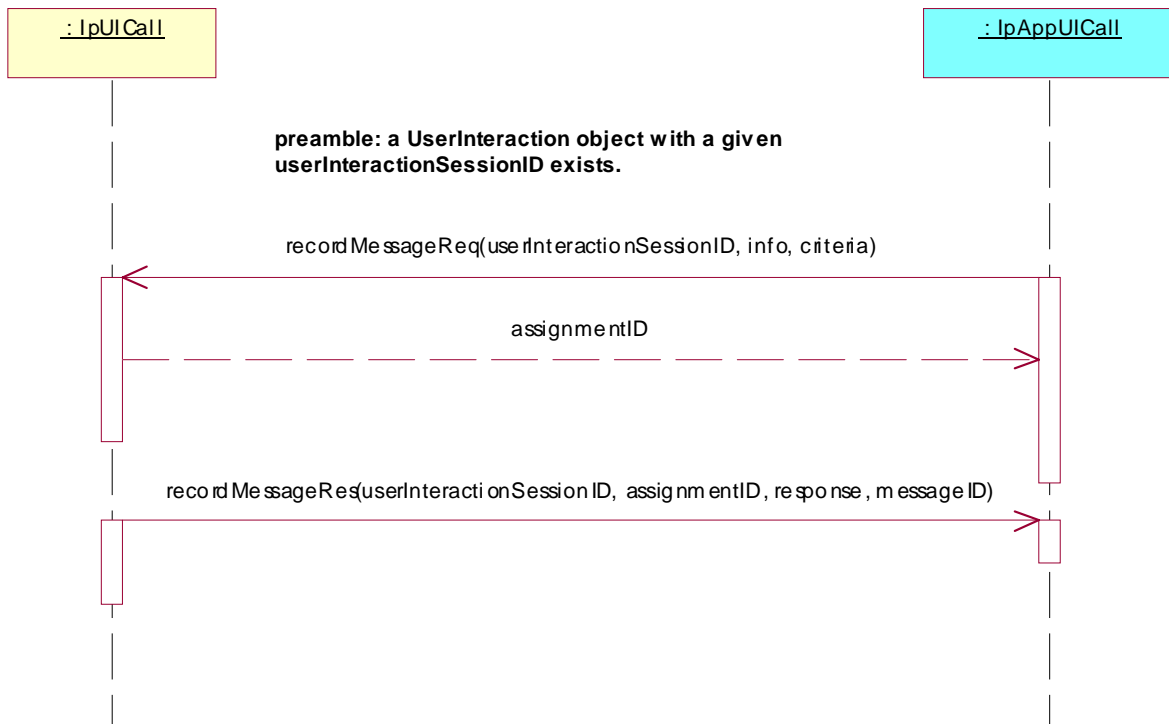

**Test UI\_APP\_15**

Summary: **IpAppUICall**, recordMessageErr

Reference: ES 202 915-5 [1], clause 8.6

Preamble: A User Interaction object, created either with the createUI or the createUICall method on the corresponding IpUIManager interface or reported in a reportEventNotification method, exists. The given sessionID is used in the following methods to identify this User Interaction object.

Selection: recordMessageErr method supported - PICS item: [2] AUIC7

Test Sequence:

1. Triggered action: cause IUT to call **recordMessageReq()** method on the tester's (SCF) **IpUICall** interface.  
 Check: valid value of userInteraction, info and criteria is transmitted,  
 Return: valid value of TpAssignmentID is returned
2. Method call **recordMessageErr()**  
 Parameters: userInteractionSessionID as given in preamble, assignmentID as given in 1, and error is transmitted.  
 Check: no exception is returned

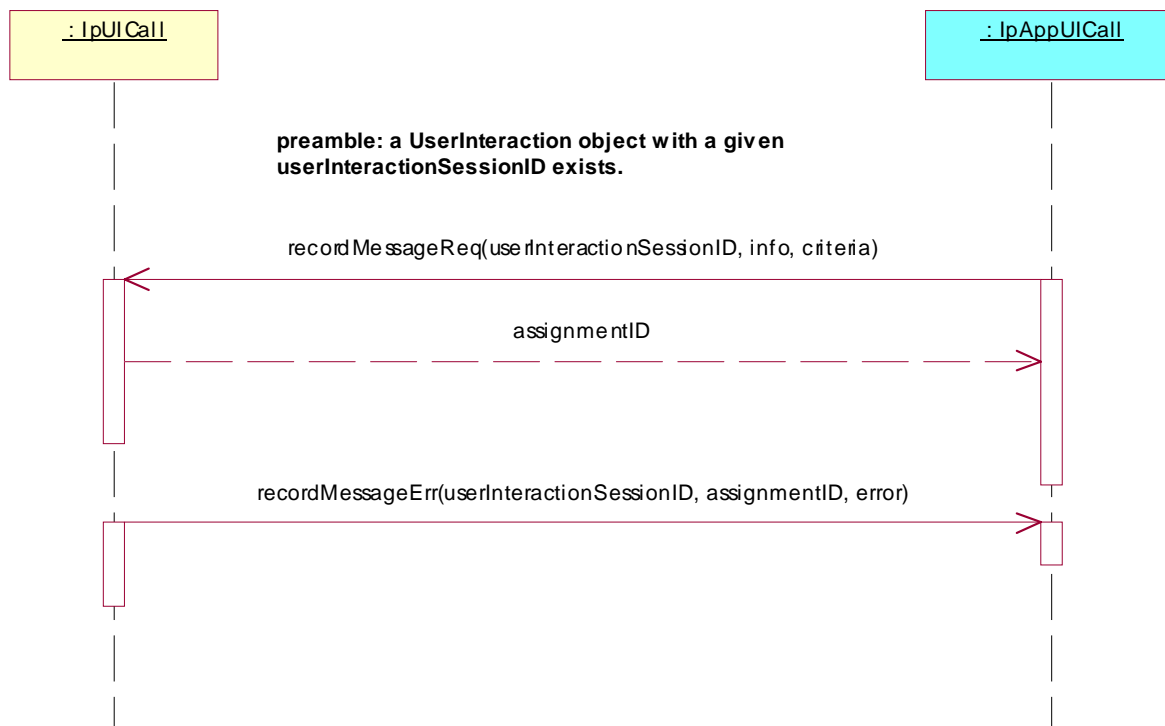

**Test UI\_APP\_16**

Summary: **IpAppUICall**, deleteMessageRes

Reference: ES 202 915-5 [1], clause 8.6

Preamble: A User Interaction object, created either with the createUI or the createUICall method on the corresponding IpUIManager interface or reported in a reportEventNotification method, exists. The given sessionID is used in the following methods to identify this User Interaction object.

Selection: deleteMessageRes method supported - PICS item: [2] AUC8

Test Sequence:

1. Triggered action: cause IUT to call **deleteMessageReq()** method on the tester's (SCF) **IpUICall** interface.  
 Check: valid value of userInteraction and messageID is transmitted,  
 Return: valid value of TpAssignmentID is returned
2. Method call **deleteMessageRes()**  
 Parameters: userInteractionSessionID as given in preamble, response and assignmentID as given in 1. is transmitted.  
 Check: no exception is returned

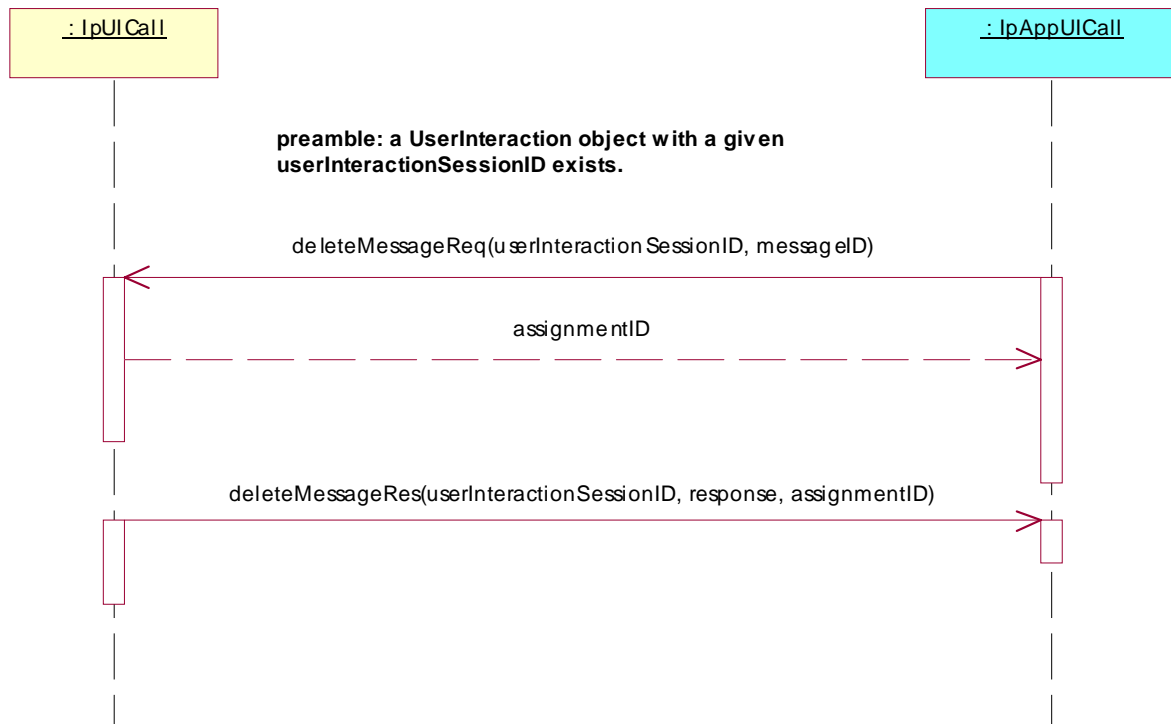

**Test UI\_APP\_17**

Summary: **IpAppUICall**, deleteMessageErr

Reference: ES 202 915-5 [1], clause 8.6

Preamble: A User Interaction object, created either with the createUI or the createUICall method on the corresponding IpUIManager interface or reported in a reportEventNotification method, exists. The given sessionID is used in the following methods to identify this User Interaction object.

Selection: deleteMessageErr method supported - PICS item: [2] AUC9

Test Sequence:

1. Triggered action: cause IUT to call **deleteMessageReq()** method on the tester's (SCF) **IpUICall** interface.  
 Check: valid value of userInteraction and messageID is transmitted,  
 Return: valid value of TpAssignmentID is returned
2. Method call **deleteMessageErr()**  
 Parameters: userInteractionSessionID as given in preamble, error and assignmentID as given in 1. is transmitted.  
 Check: no exception is returned

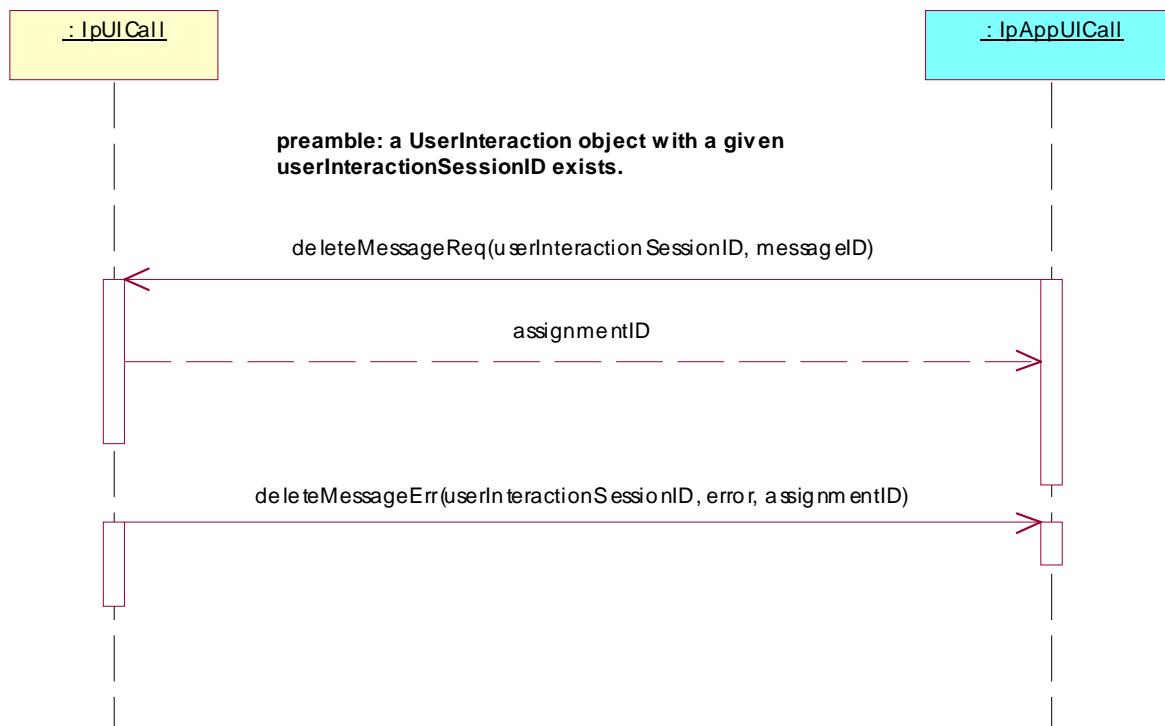

**Test UI\_APP\_18**

Summary: **IpAppUICall**, abortActionRes

Reference: ES 202 915-5 [1], clause 8.6

Preamble: A User Interaction object, created either with the createUI or the createUICall method on the corresponding IpUIManager interface or reported in a reportEventNotification method, exists. The given sessionID is used in the following methods to identify this User Interaction object.

Selection: abortActionRes method supported - PICS item: [2] AUC10

Test Sequence:

1. Triggered action: cause IUT to call **recordMessageReq()** method on the tester's (SCF) **IpUICall** interface.  
 Check: valid value of userInteraction, info and criteria is transmitted,  
 Return: valid value of TpAssignmentID is returned
2. Triggered action: cause IUT to call **abortActionReq()** method on the tester's (SCF) **IpUICall** interface.  
 Check: valid value of userInteraction, and assignmentID as given in 1. is transmitted,  
 Return: no exception is returned
3. Method call **abortActionRes()**  
 Parameters: userInteractionSessionID as given in preamble, and assignmentID as given in 1. is transmitted.  
 Check: no exception is returned

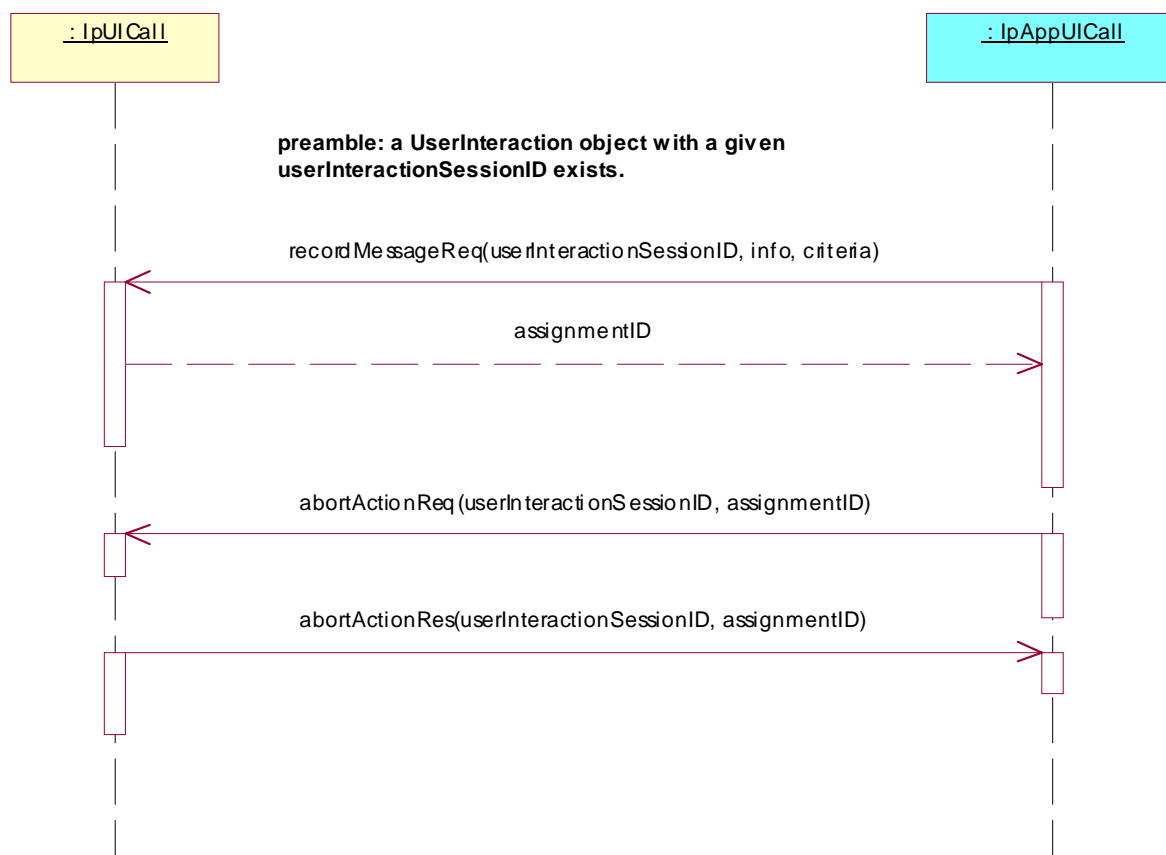

**Test UI\_APP\_19**

Summary: **IpAppUICall**, abortActionErr

Reference: ES 202 915-5 [1], clause 8.6

Preamble: A User Interaction object, created either with the createUI or the createUICall method on the corresponding IpUIManager interface or reported in a reportEventNotification method, exists. The given sessionID is used in the following methods to identify this User Interaction object.

Selection: abortActionErr method supported - PICS item: [2] AUIC10

Test Sequence:

1. Triggered action: cause IUT to call **recordMessageReq()** method on the tester's (SCF) **IpUICall** interface.  
 Check: valid value of userInteraction, info and criteria is transmitted,  
 Return: valid value of TpAssignmentID is returned
2. Triggered action: cause IUT to call **abortActionReq()** method on the tester's (SCF) **IpUICall** interface.  
 Check: valid value of userInteraction, and assignmentID as given in 1. is transmitted,  
 Return: no exception is returned
3. Method call **abortActionErr()**  
 Parameters: userInteractionSessionID as given in preamble, assignmentID as given in 1. and error is transmitted.  
 Check: no exception is returned

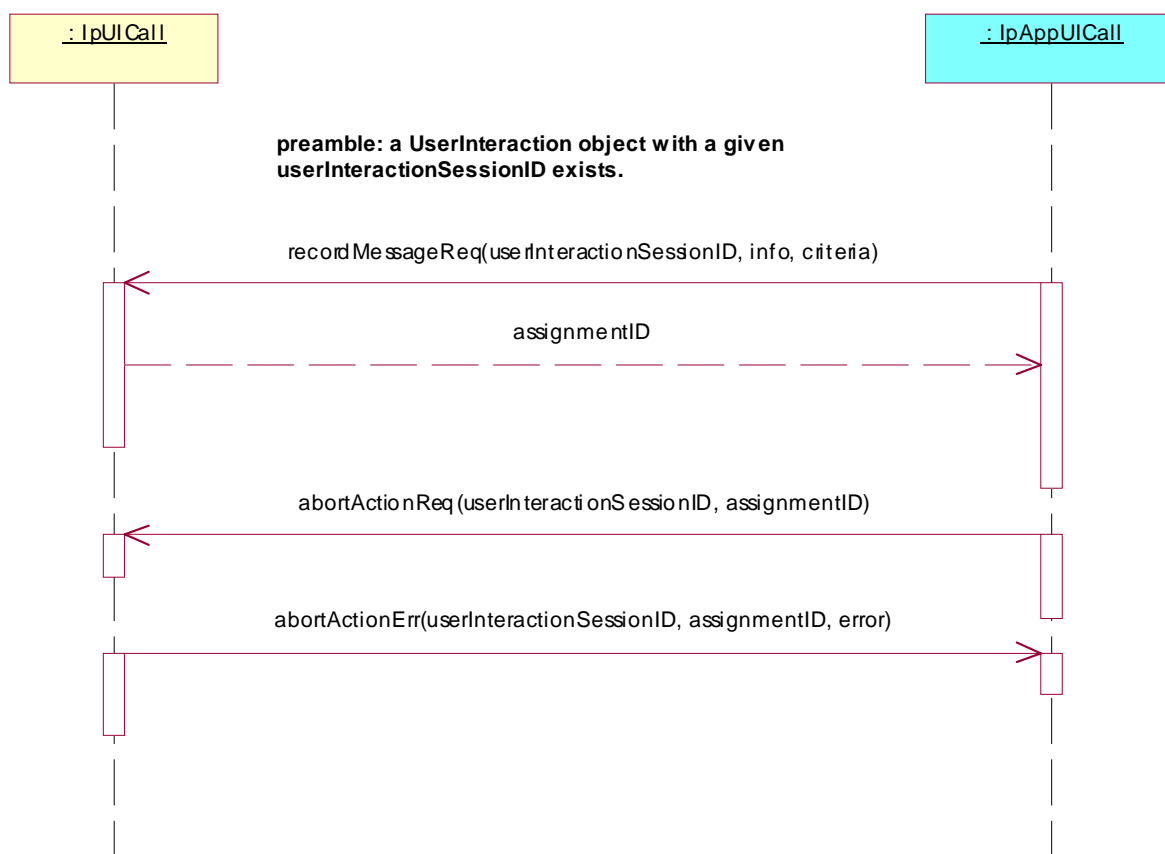



---

## History

<b>Document history</b>		
V1.1.1	January 2005	Membership Approval Procedure    MV 20050311: 2005-01-11 to 2005-03-11
V1.1.1	March 2005	Publication