

**Open Service Access (OSA);
Application Programming Interface (API);
Test Suite Structure and Test Purposes (TSS&TP);
Part 4: Call control SCF
(Parlay 3)**



Reference

RES/TISPAN-06005-04-OSA

Keywords

API, OSA, TSS&TP

ETSI

650 Route des Lucioles
F-06921 Sophia Antipolis Cedex - FRANCE

Tel.: +33 4 92 94 42 00 Fax: +33 4 93 65 47 16

Siret N° 348 623 562 00017 - NAF 742 C
Association à but non lucratif enregistrée à la
Sous-Préfecture de Grasse (06) N° 7803/88

Important notice

Individual copies of the present document can be downloaded from:

<http://www.etsi.org>

The present document may be made available in more than one electronic version or in print. In any case of existing or perceived difference in contents between such versions, the reference version is the Portable Document Format (PDF). In case of dispute, the reference shall be the printing on ETSI printers of the PDF version kept on a specific network drive within ETSI Secretariat.

Users of the present document should be aware that the document may be subject to revision or change of status. Information on the current status of this and other ETSI documents is available at

<http://portal.etsi.org/tb/status/status.asp>

If you find errors in the present document, please send your comment to one of the following services:

http://portal.etsi.org/chaicor/ETSI_support.asp

Copyright Notification

No part may be reproduced except as authorized by written permission.
The copyright and the foregoing restriction extend to reproduction in all media.

© European Telecommunications Standards Institute 2004.
All rights reserved.

DECT™, **PLUGTESTS™** and **UMTS™** are Trade Marks of ETSI registered for the benefit of its Members.
TIPHON™ and the **TIPHON logo** are Trade Marks currently being registered by ETSI for the benefit of its Members.
3GPP™ is a Trade Mark of ETSI registered for the benefit of its Members and of the 3GPP Organizational Partners.

Contents

Intellectual Property Rights	6
Foreword.....	6
1 Scope	7
2 References	7
3 Definitions and abbreviations.....	7
3.1 Definitions	7
3.2 Abbreviations	8
4 Test Suite Structure (TSS) - SCF	8
5 Test Purposes (TP) - SCF	8
5.1 Introduction	8
5.1.1 TP naming convention	8
5.1.2 Source of TP definition.....	9
5.1.3 Test strategy.....	9
5.2 TPs for the Call Control SCF	9
5.2.1 Generic Call Control.....	10
5.2.1.1 IpCallControlManager	10
5.2.1.1.1 Mandatory, valid behaviour.....	10
5.2.1.1.2 Mandatory, invalid behaviour.....	13
5.2.1.1.3 Optional, valid behaviour	15
5.2.1.1.4 Optional, invalid behaviour	21
5.2.1.2 IpCall.....	24
5.2.1.2.1 Mandatory, valid behaviour.....	24
5.2.1.2.2 Mandatory, invalid behaviour.....	25
5.2.1.2.3 Optional, valid behaviour	32
5.2.1.2.4 Optional, invalid behaviour	38
5.2.2 MultiParty Call Control Service (MPCC).....	44
5.2.2.1 IpMultiPartyCallControlManager	44
5.2.2.1.1 Mandatory, valid behaviour.....	44
5.2.2.1.2 Mandatory, invalid behaviour.....	46
5.2.2.1.3 Optional, valid behaviour	49
5.2.2.1.4 Optional, invalid behaviour	54
5.2.2.2 IpMultiPartyCall	57
5.2.2.2.1 Mandatory, valid behaviour.....	57
5.2.2.2.2 Mandatory, invalid behaviour.....	61
5.2.2.2.3 Optional, valid behaviour	66
5.2.2.2.4 Optional, invalid behaviour	69
5.2.2.3 IpCallLeg	73
5.2.2.3.1 Mandatory, valid behaviour.....	73
5.2.2.3.2 Mandatory, invalid behaviour.....	77
5.2.2.3.3 Optional, valid behaviour	83
5.2.2.3.4 Optional, invalid behaviour	90
5.2.3 MultiMedia Call Control Service (MMCC).....	98
5.2.3.1 IpMultiMediaCallControlManager	98
5.2.3.1.1 Mandatory, valid behaviour.....	98
5.2.3.1.2 Mandatory, invalid behaviour.....	102
5.2.3.1.3 Optional, valid behaviour	106
5.2.3.1.4 Optional, invalid behaviour	114
5.2.3.2 IpMultimediaCall	119
5.2.3.2.1 Mandatory, valid behaviour.....	119
5.2.3.2.2 Mandatory, invalid behaviour.....	124
5.2.3.2.3 Optional, valid behaviour	130
5.2.3.2.4 Optional, invalid behaviour	135
5.2.3.3 IpMultiMediaCallLeg	140

5.2.3.3.1	Mandatory, valid behaviour.....	140
5.2.3.3.2	Mandatory, invalid behaviour.....	143
5.2.3.3.3	Optional, valid behaviour	149
5.2.3.3.4	Optional, invalid behaviour	158
5.2.3.4	IpMultiMediaStream.....	166
5.2.3.4.1	Mandatory, valid behaviour.....	166
5.2.3.4.2	Mandatory, invalid behaviour.....	168
5.2.4	Conference Call Control Service (CCC).....	169
5.2.4.1	IpConfCallControlManager	169
5.2.4.1.1	Mandatory, valid behaviour.....	169
5.2.4.1.2	Mandatory, invalid behaviour.....	172
5.2.4.1.3	Optional, valid behaviour	172
5.2.4.1.4	Optional, invalid behaviour	173
5.2.4.2	IpConfCall.....	174
5.2.4.2.1	Mandatory, valid behaviour.....	174
5.2.4.2.2	Mandatory, invalid behaviour.....	176
5.2.4.2.3	Optional, valid behaviour	178
5.2.4.2.4	Optional, invalid behaviour	184
5.2.4.3	IpSubConfCall	190
5.2.4.3.1	Mandatory, valid behaviour.....	190
5.2.4.3.2	Mandatory, invalid behaviour.....	197
5.2.4.3.3	Optional, valid behaviour	207
5.2.4.3.4	Optional, invalid behaviour	214
5.2.4.4	IpMultiMediaCallLeg	223
5.2.4.4.1	Mandatory, valid behaviour.....	223
5.2.4.4.2	Mandatory, invalid behaviour.....	226
5.2.4.4.3	Optional, valid behaviour	234
5.2.4.4.4	Optional, invalid behaviour	243
5.2.4.5	IpMultiMediaStream.....	249
5.2.4.5.1	Mandatory, valid behaviour.....	249
5.2.4.5.2	Mandatory, invalid behaviour.....	251
6	Test Suite Structure (TSS) - Application.....	252
7	Test Purposes (TP) - Application	252
7.1	Introduction	252
7.1.1	TP naming convention	252
7.1.2	Source of TP definition.....	252
7.1.3	Test strategy.....	252
7.2	TPs for the application using the Call Control SCF	252
7.2.1	Generic Call Control.....	253
7.2.1.1	IpAppCallControlManager	253
7.2.1.2	IpAppCall.....	260
7.2.1.2.1	No Parties state.....	260
7.2.1.2.2	General tests, Active state	264
7.2.1.2.3	Active state, Routing to Destination(s) sub-state.....	270
7.2.1.2.4	Active state, 1 Party in Call sub-state.....	272
7.2.1.2.5	Active state, 2 Parties in Call sub-state	278
7.2.1.2.6	Network Released and Finished state	281
7.2.1.2.7	Application Released state.....	283
7.2.2	MultiParty Call Control Service (MPCC).....	284
7.2.2.1	IpAppMultiPartyCallControlManager	284
7.2.2.2	IpAppMultiPartyCall.....	292
7.2.2.2.1	Idle state	292
7.2.2.2.2	Active state	298
7.2.2.2.3	Released state	307
7.2.2.3	IpAppCallLeg.....	309
7.2.2.3.1	Originating Leg	309
7.2.2.3.2	Terminating Leg	346
7.2.3	MultiMedia Call Control Service (MMCC).....	376
7.2.3.1	IpAppMultiMediaCallControlManager.....	376
7.2.3.2	IpAppMultiMediaCall.....	387

7.2.3.2.1	Idle state	387
7.2.3.2.2	Active state	393
7.2.3.2.3	Released state	402
7.2.3.3	IpAppMultiMediaCallLeg.....	403
7.2.3.3.1	Originating Leg	404
7.2.3.3.2	Terminating Leg	440
7.2.3.4	IpMultiMediaStream	471
7.2.4	Conference Call Control Service (CCC).....	472
7.2.4.1	IpAppCallControlManager	472
7.2.4.2	IpAppConfCall	476
7.2.4.3	IpAppSubConfCall.....	485
7.2.4.4	IpAppMultiMediaCallLeg.....	496
7.2.4.5	IpMultiMediaStream	510
History		511

Intellectual Property Rights

IPRs essential or potentially essential to the present document may have been declared to ETSI. The information pertaining to these essential IPRs, if any, is publicly available for **ETSI members and non-members**, and can be found in ETSI SR 000 314: "*Intellectual Property Rights (IPRs); Essential, or potentially Essential, IPRs notified to ETSI in respect of ETSI standards*", which is available from the ETSI Secretariat. Latest updates are available on the ETSI Web server (<http://webapp.etsi.org/IPR/home.asp>).

Pursuant to the ETSI IPR Policy, no investigation, including IPR searches, has been carried out by ETSI. No guarantee can be given as to the existence of other IPRs not referenced in ETSI SR 000 314 (or the updates on the ETSI Web server) which are, or may be, or may become, essential to the present document.

Foreword

This ETSI Standard (ES) has been produced by ETSI Technical Committee Telecommunications and Internet converged Services and Protocols for Advanced Networking (TISPAN), and is now submitted for the ETSI standards Membership Approval Procedure.

The present document is part 4 of a multi-part deliverable covering Open Service Access (OSA); Application Programming Interface (API); Test Suite Structure and Test Purposes (TSS&TP) for Parlay 3, as identified below:

- Part 1: "Overview";
- Part 2: "Common data definitions";
- Part 3: "Framework";
- Part 4: "Call control SCF";**
- Part 5: "User interaction SCF";
- Part 6: "Mobility SCF";
- Part 7: "Terminal capabilities SCF";
- Part 8: "Data session control SCF";
- Part 9: "Generic messaging SCF";
- Part 10: "Connectivity manager SCF";
- Part 11: "Account management SCF";
- Part 12: "Charging SCF".

To evaluate conformance of a particular implementation, it is necessary to have a set of test purposes to evaluate the dynamic behaviour of the Implementation Under Test (IUT). The specification containing those test purposes is called a Test Suite Structure and Test Purposes (TSS&TP) specification.

1 Scope

The present document provides the Test Suite Structure and Test Purposes (TSS&TP) specification for the Call Control SCF of the Application Programming Interface (API) for Open Service Access (OSA) defined in ES 201 915-4 [1] in compliance with the relevant requirements, and in accordance with the relevant guidance given in ISO/IEC 9646-2 [4] and ETS 300 406 [5].

2 References

The following documents contain provisions which, through reference in this text, constitute provisions of the present document.

- References are either specific (identified by date of publication and/or edition number or version number) or non-specific.
- For a specific reference, subsequent revisions do not apply.
- For a non-specific reference, the latest version applies.

Referenced documents which are not found to be publicly available in the expected location might be found at <http://docbox.etsi.org/Reference>.

- [1] ETSI ES 201 915-4: "Open Service Access (OSA); Application Programming Interface (API); Part 4: Call Control SCF (Parlay 3)".
- [2] ETSI ES 202 170: "Open Service Access (OSA); Application Programming Interface (API); Implementation Conformance Statement (ICS) proforma specification (Parlay 3)".
- [3] ISO/IEC 9646-1: "Information technology - Open Systems Interconnection - Conformance testing methodology and framework - Part 1: General concepts".
- [4] ISO/IEC 9646-2: "Information technology - Open Systems Interconnection - Conformance testing methodology and framework - Part 2: Abstract Test Suite specification".
- [5] ETSI ETS 300 406: "Methods for Testing and Specification (MTS); Protocol and profile conformance testing specifications; Standardization methodology".

3 Definitions and abbreviations

3.1 Definitions

For the purposes of the present document, the terms and definitions given in ES 201 915-4 [1], ISO/IEC 9646-1 [3], ISO/IEC 9646-2 [4] and the following apply:

abstract test case: Refer to ISO/IEC 9646-1 [3].

Abstract Test Method (ATM): Refer to ISO/IEC 9646-1 [3].

Abstract Test Suite (ATS): Refer to ISO/IEC 9646-1 [3].

ICS proforma: Refer to ISO/IEC 9646-1 [3].

Implementation Conformance Statement (ICS): Refer to ISO/IEC 9646-1 [3].

Implementation eXtra Information for Testing (IXIT): Refer to ISO/IEC 9646-1 [3].

Implementation Under Test (IUT): Refer to ISO/IEC 9646-1 [3].

IXIT proforma: Refer to ISO/IEC 9646-1 [3].

Lower Tester (LT): Refer to ISO/IEC 9646-1 [3].

Test Purpose (TP): Refer to ISO/IEC 9646-1 [3].

3.2 Abbreviations

For the purposes of the present document, the following abbreviations apply:

API	Application Programming Interface
ATM	Abstract Test Method
ATS	Abstract Test Suite
CC	Call Control
CCC	Conference Call Control service
GCC	Generic Call Control service
ICS	Implementation Conformance Statement
IUT	Implementation Under Test
IXIT	Implementation eXtra Information for Testing
LT	Lower Tester
MMCC	MultiMedia Call Control service
MPCC	MultiParty Call Control service
OSA	Open Service Access
TP	Test Purpose
TSS	Test Suite Structure

4 Test Suite Structure (TSS) - SCF

Call Control (CC):

- Generic Call Control Service (GCC).
- MultiParty Call Control Service (MPCC).
- MultiMedia Call Control Service (MMCC).
- Conference Call Control Service (CCC).

5 Test Purposes (TP) - SCF

5.1 Introduction

For each test requirement a TP is defined.

5.1.1 TP naming convention

Tps are numbered, starting at 01, within each group. Groups are organized according to the TSS. Additional references are added to identify the actual test suite (see table 1).

Table 1: TP identifier naming convention scheme

Identifier:	<suite_id>_<group>_<nn>
<suite_id>	= SCG name: "CC" for C all C ontrol part of Call Control SCF
<group>	= group number: field representing the group reference according to TSS
<nn>	= sequential number: (01 to 99)

5.1.2 Source of TP definition

The TPs are based on ES 201 915-4 [1].

5.1.3 Test strategy

As the base standard ES 201 915-4 [1] contains no explicit requirements for testing, the TPs were generated as a result of an analysis of the base standard and the ICS specification ES 202 170 [2].

The TPs are only based on conformance requirements related to the externally observable behaviour of the IUT and are limited to conceivable situations to which a real implementation is likely to be faced (see ETS 300 406 [5]).

5.2 TPs for the Call Control SCF

All ICS items referred to in this clause are as specified in ES 202 170 [2] unless indicated otherwise by another numbered reference.

All parameters specified in method calls are valid unless specified.

The procedures to trigger the SCF to call methods in the application are dependant on the underlying network architecture and are out of the scope of this test specification. Those method calls are preceded by the words "Triggered action".

5.2.1 Generic Call Control

5.2.1.1 IpCallControlManager

5.2.1.1.1 Mandatory, valid behaviour

Test GCC_IPCALLCONTROLMANAGER_01

Summary: IpCallControlManager, all mandatory methods, successful

Reference: ES 201 915-4 [1], clause 6.3.1

Condition: createCall method is supported

Test Sequence:

1. Method call **setCallback()** on IpCallControlManager
Parameters: valid, not null, value of appInterface parameter
Check: no exception is returned
2. Method call **createCall()**
Parameters: valid appCall
Check: valid value of TpCallIdentifier is returned

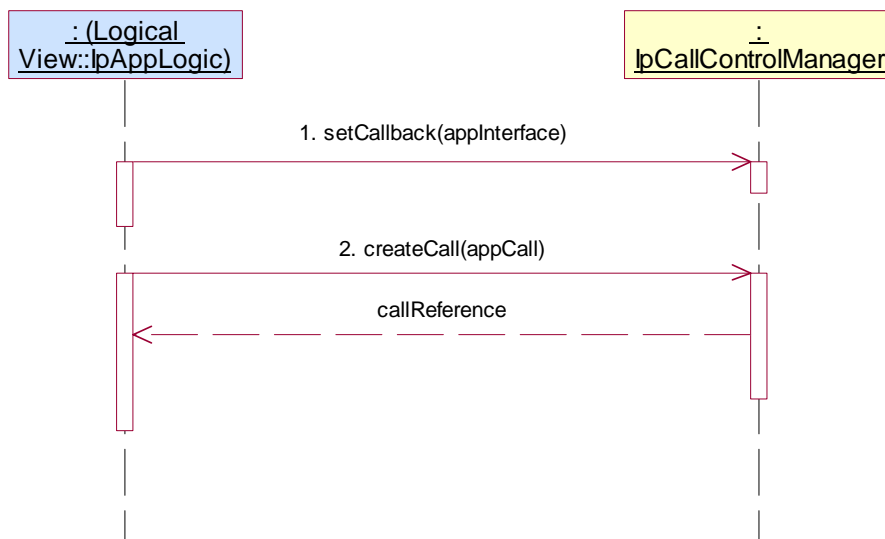

Test GCC_IPCALLCONTROLMANAGER_02

Summary: IpCallControlManager, all mandatory methods, successful

Reference: ES 201 915-4 [1], clause 6.3.1

Condition: enableCallNotification method is supported

Test Sequence:

1. Method call **enableCallNotification()**
 Parameters: appCallControlManager with valid, not null, value, valid eventCriteria
 Check: valid value of TpAssignmentID is returned
2. Triggered action: cause IUT to call **callEventNotify()** method on the tester's (Application) **IpAppCallControlManager** interface
 Parameters: valid callReference, valid eventInfo, assignmentID returned in 1.
3. Method call **disableCallNotification()**
 Parameters: assignmentID returned in 1
 Check: no exception is returned

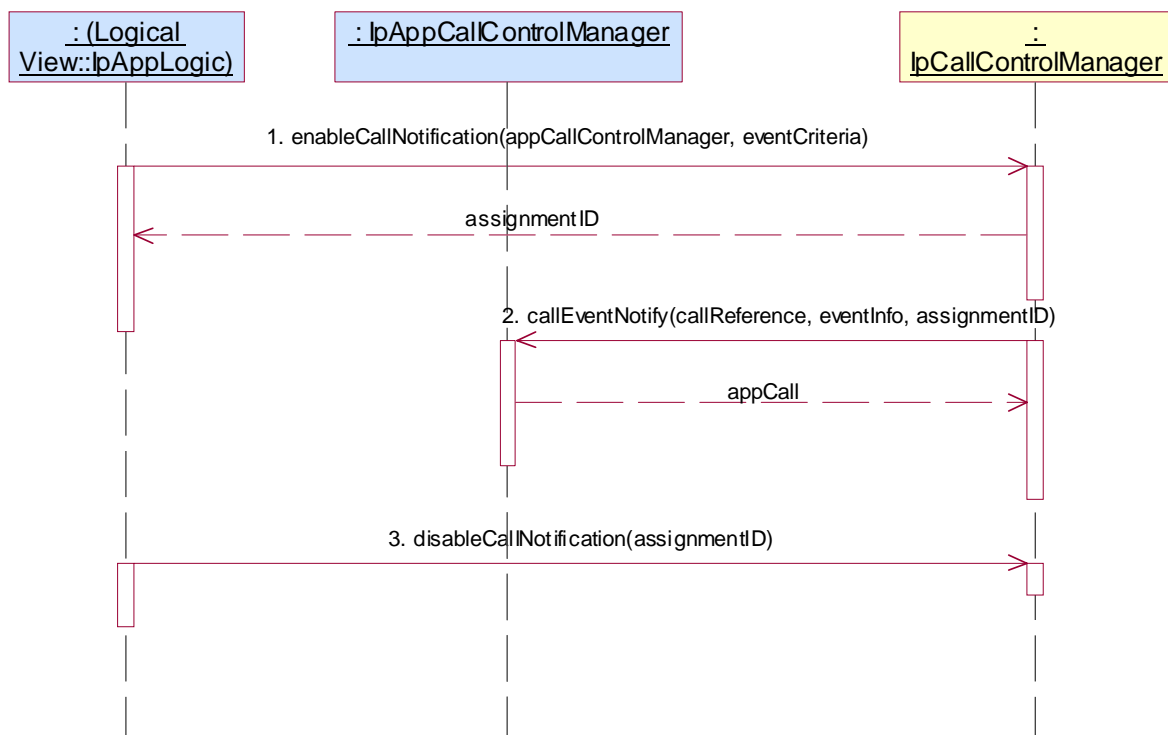

Test GCC_IPCALLCONTROLMANAGER_03

Summary: IpCallControlManager, all mandatory methods, successful

Reference: ES 201 915-4 [1], clause 6.3.1

Condition: enableCallNotification method is supported

Test Sequence:

1. Method call **setCallback()** on IpCallControlManager
Parameters: valid, non-null, value of appInterface parameter
Check: no exception is returned
2. Method call **enableCallNotification()**
Parameters: appCallControlManager with null, value, valid eventCriteria
Check: valid value of TpAssignmentID is returned
3. Triggered action: cause IUT to call **callEventNotify()** method on the tester's (Application) **IpAppCallControlManager** interface
Parameters: valid callReference, valid eventInfo, assignmentID returned in 2.
4. Method call **disableCallNotification()**
Parameters: assignmentID returned in 2.
Check: no exception is returned

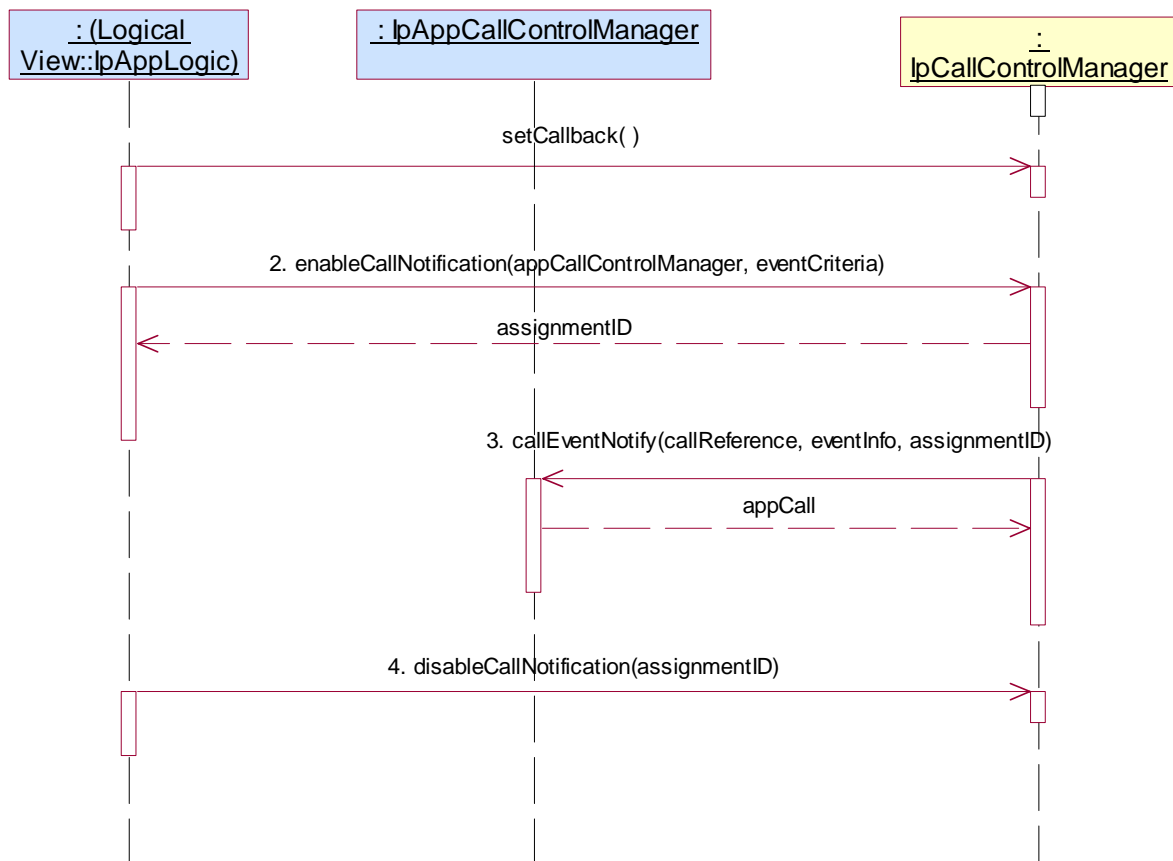

5.2.1.1.2 Mandatory, invalid behaviour

Test GCC_IPCALLCONTROLMANAGER_04

Summary: IpCallControlManager, enableCallNotification, P_INVALID_CRITERIA

Reference: ES 201 915-4 [1], clause 6.3.1

Condition: enableCallNotification method is supported

Test Sequence:

1. Method call **enableCallNotification()**
 Parameters: valid appCallControlManager, invalid eventCriteria but with a valid event type
 Check: P_INVALID_CRITERIA is returned

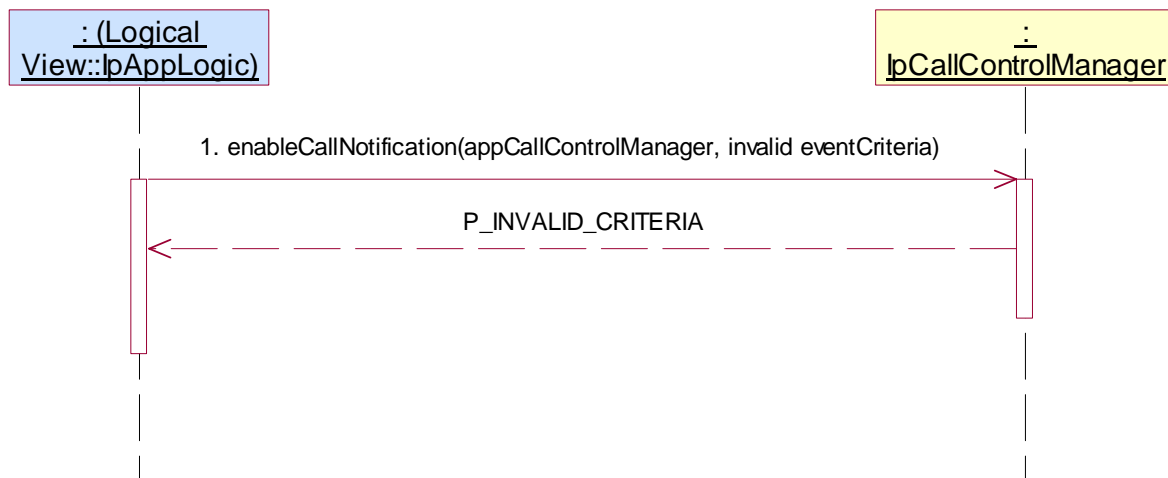
**Test GCC_IPCALLCONTROLMANAGER_05**

Summary: IpCallControlManager, enableCallNotification, P_INVALID_INTERFACE_TYPE

Reference: ES 201 915-4 [1], clause 6.3.1

Condition: enableCallNotification method is supported

Test Sequence:

1. Method call **enableCallNotification()**
 Parameters: invalid appCallControlManager, valid eventCriteria
 Check: P_INVALID_INTERFACE_TYPE is returned



Test GCC_IPCALLCONTROLMANAGER_06

Summary: IpCallControlManager, disableCallNotification, P_INVALID_ASSIGNMENT_ID

Reference: ES 201 915-4 [1], clause 6.3.1

Condition: disableCallNotification is supported

Test Sequence:

1. Method call **enableCallNotification()**
Parameters: appCallControlManager with valid, not null, value, valid eventCriteria
Check: valid value of TpAssignmentID is returned
2. Method call **disableCallNotification()**
Parameters: invalid assignmentID
Check: P_INVALID_ASSIGNMENT_ID is returned

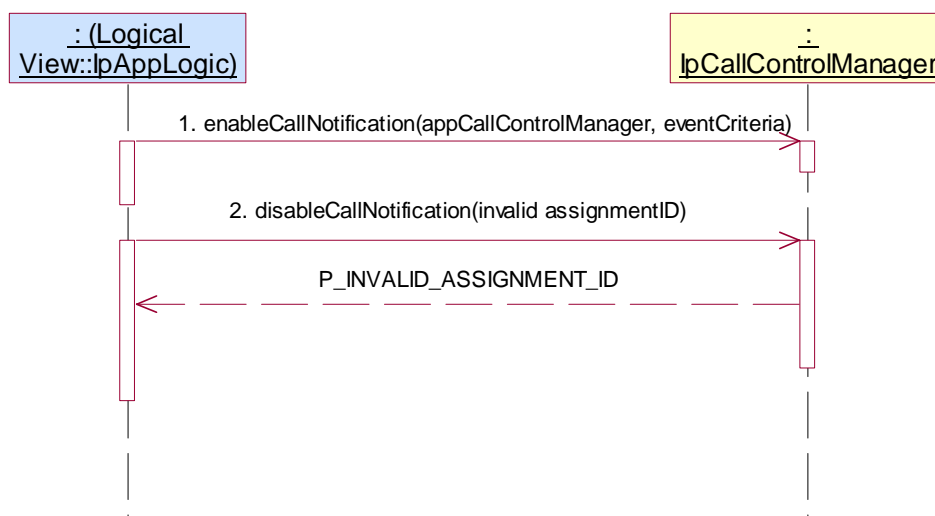
**Test GCC_IPCALLCONTROLMANAGER_07**

Summary: IpCallControlManager, createCall, P_INVALID_INTERFACE_TYPE

Reference: ES 201 915-4 [1], clause 6.3.1

Condition: createCall method is supported

Test Sequence:

1. Method call **createCall()**
Parameters: invalid value of appCall
Check: P_INVALID_INTERFACE_TYPE is returned

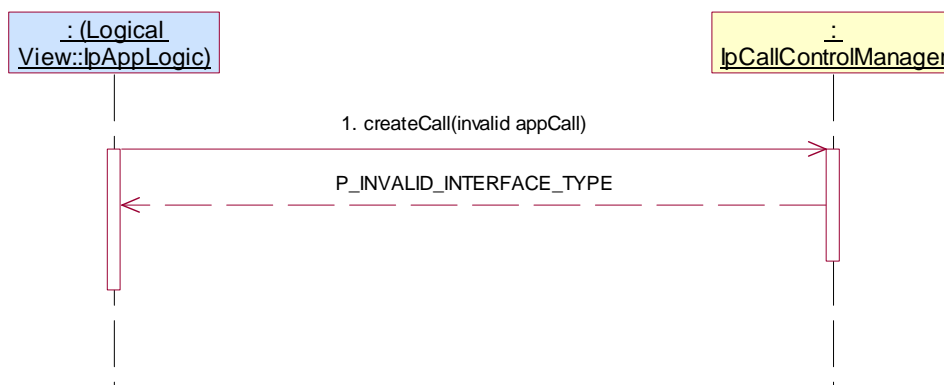

5.2.1.1.3 Optional, valid behaviour

Test GCC_IPCALLCONTROLMANAGER_08

Summary: IpCallControlManager, getCriteria, successful

Reference: ES 201 915-4 [1], clause 6.3.1

Condition: enableCallNotification and getCriteria methods are supported

Test Sequence:

1. Method call **setCallback()** on IpCallControlManager
Parameters: valid, non-null, value of appInterface parameter
Check: no exception is returned
2. Method call **enableCallNotification()**
Parameters: appCallControlManager with null value, valid eventCriteria
Check: valid value of TpAssignmentID is returned
3. Method call **getCriteria()**
Parameters: None
Check: valid value of TpCallEventCriteriaResultSet is returned where eventCriteria given in 1. is included as a value of this TpCallEventCriteriaResultSet
4. Method call **disableCallNotification()**
Parameters: assignmentID returned in 1.
Check: no exception is returned

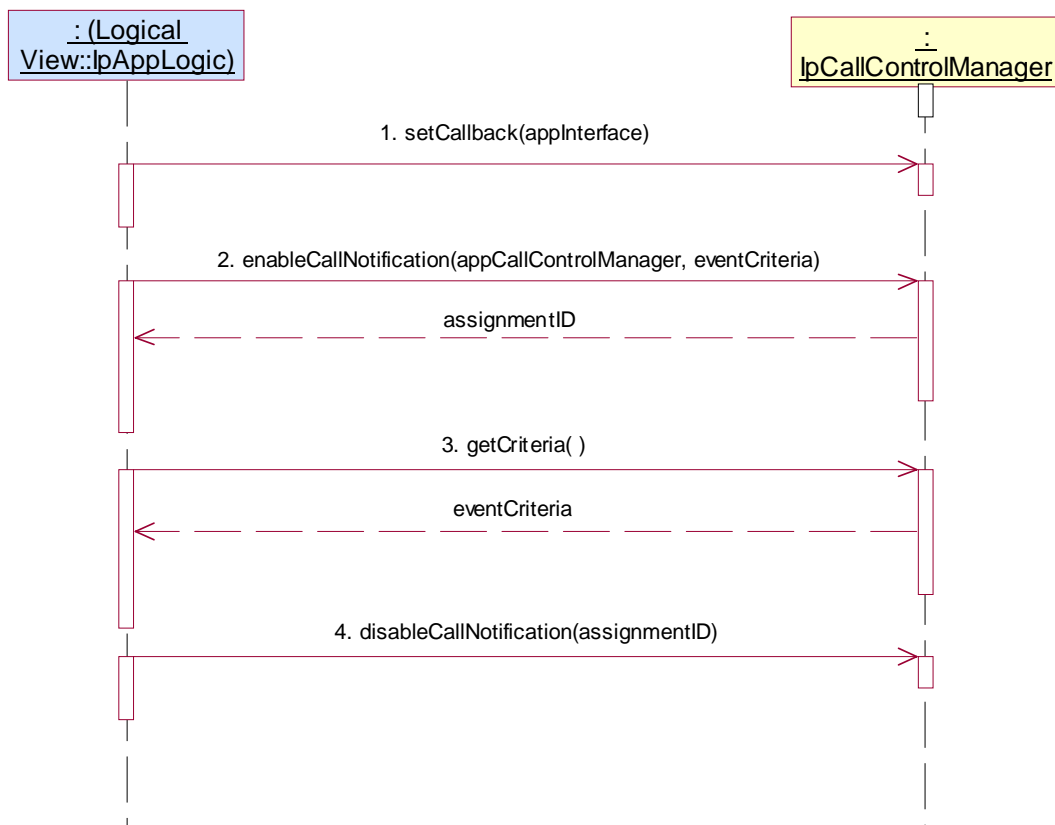

Test GCC_IPCALLCONTROLMANAGER_09

Summary: IpCallControlManager, changeCallNotification, successful

Reference: ES 201 915-4 [1], clause 6.3.1

Condition: enableCallNotification, getCriteria and changeCallNotification methods are supported

Preamble: Application has a reference interface used for callbacks

Test Sequence:

1. Method call **enableCallNotification()**
Parameters: appCallControlManager with valid, not null, value, valid eventCriteria
Check: valid value of TpAssignmentID is returned
2. Method call **getCriteria()**
Parameters: None
Check: valid value of TpCallEventCriteriaResultSet is returned where eventCriteria given in 1. is included as a value of this TpCallEventCriteriaResultSet
3. Method call **changeCallNotification()**
Parameters: assignmentID returned in 1., valid eventCriteria different from this given in 1.
Check: no exception is returned
4. Method call **getCriteria()**
Parameters: None
Check: valid value of TpCallEventCriteriaResultSet is returned where eventCriteria given in 3. is included as a value of this TpCallEventCriteriaResultSet
5. Triggered action: cause IUT to call **callEventNotify()** method on the tester's (Application) **IpAppCallControlManager** interface
Parameters: valid callReference, valid eventInfo, assignmentID returned in 1.
6. Method call **disableCallNotification()**
Parameters: assignmentID returned in 1.
Check: no exception is returned

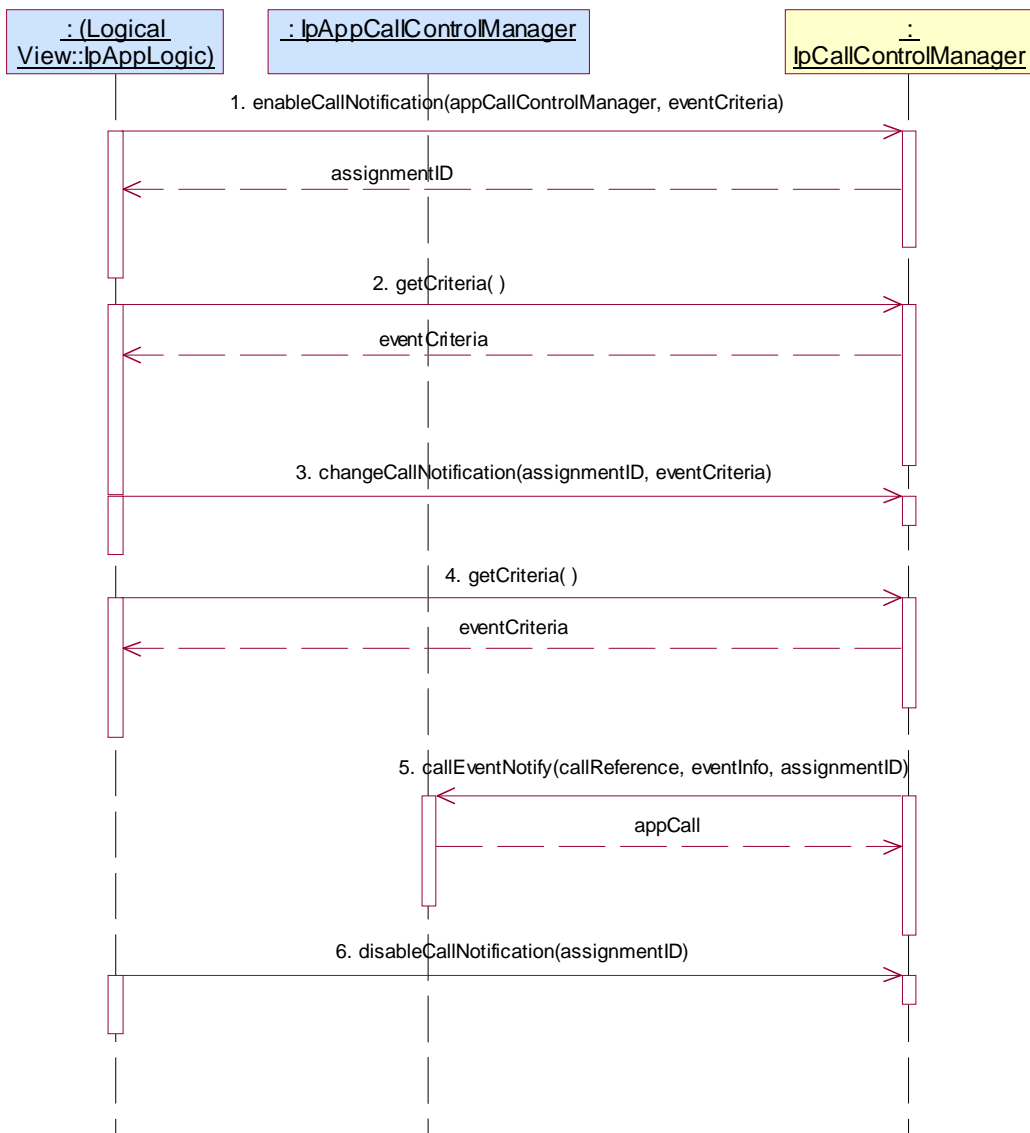

Test GCC_IPCALLCONTROLMANAGER_10

Summary: IpCallControlManager, all methods, successful

Reference: ES 201 915-4 [1], clause 6.3.1

Condition: enableCallNotification, setCallLoadControl, callOverLoadEncountered and callOverLoadCeased methods are supported

Test Sequence:

1. Method call **enableCallNotification()**
Parameters: appCallControlManager with valid, not null, value, valid eventCriteria
Check: valid value of TpAssignmentID is returned
2. Method call **setCallLoadControl()**
Parameters: valid duration, valid mechanism, valid treatment, valid addressRange
Check: valid value of TpAssignmentID is returned
3. Triggered action: cause IUT to call callEventNotify() numerous times during the following sequence, and attempt to provoke an overload condition and then remove it
4. Triggered action: cause IUT to call **callOverLoadEncountered()** method on the tester's (Application) **IpAppCallControlManager** interface
Parameters: valid assignmentID
5. Triggered action: cause IUT to call **callOverLoadCeased()** method on the tester's (Application) **IpAppCallControlManager** interface
Parameters: valid assignmentID

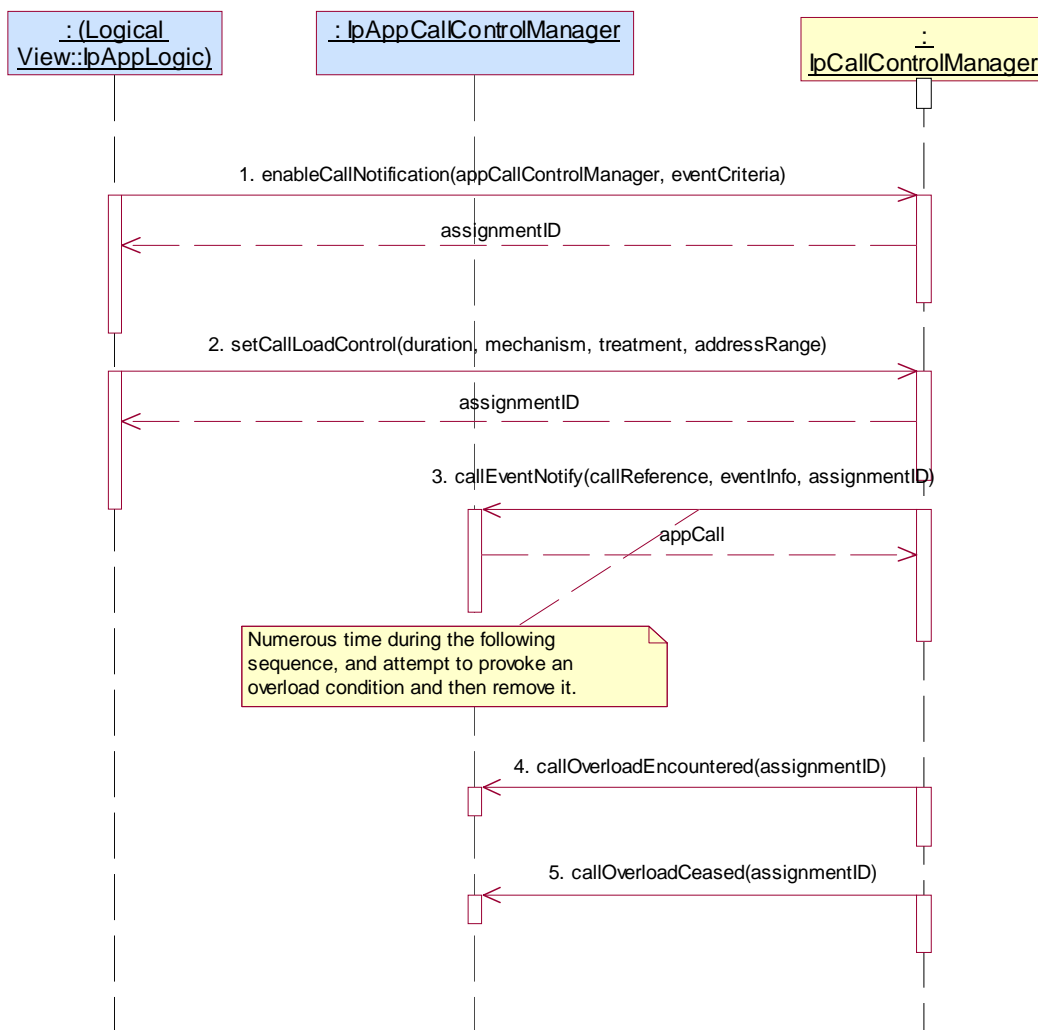

Test GCC_IPCALLCONTROLMANAGER_11

Summary: IpCallControlManager, all methods, successful

Reference: ES 201 915-4 [1], clause 6.3.1

Condition: enableCallNotification method is supported

Test Sequence:

1. Method call **enableCallNotification()**
Parameters: appCallControlManager with valid, not null, value, valid eventCriteria
Check: valid value of TpAssignmentID is returned
2. Triggered action: cause IUT to call **callEventNotify()** method on the tester's (Application) **IpAppCallControlManager** interface
3. Triggered action: cause IUT to call **callNotificationInterrupted()** method on the tester's (Application) **IpAppCallControlManager** interface
Parameters: None
4. Triggered action: cause IUT to call **callNotificationContinued()** method on the tester's (Application) **IpAppCallControlManager** interface
Parameters: None

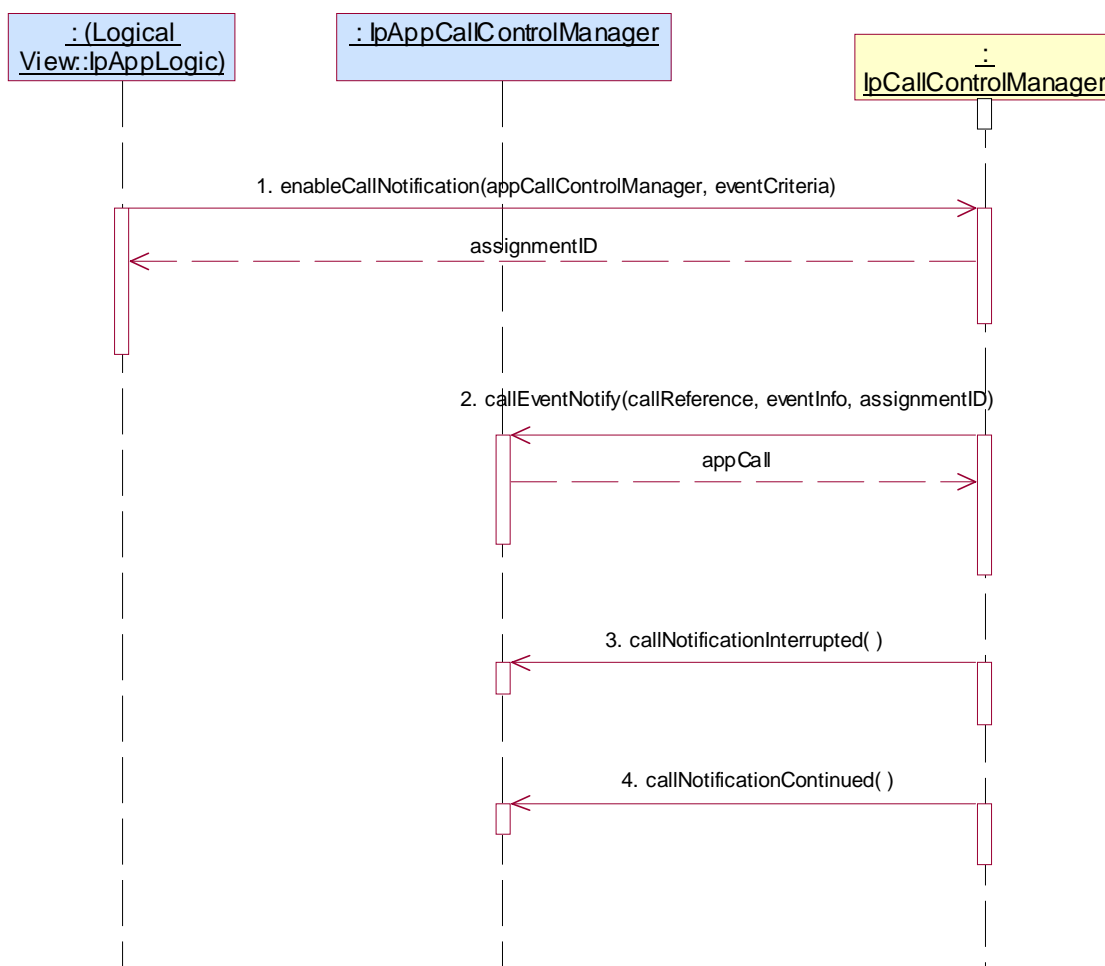

Test GCC_IPCALLCONTROLMANAGER_12

Summary: IpCallControlManager, all methods, successful

Reference: ES 201 915-4 [1], clause 6.3.1

Condition: enableCallNotification and callAborted methods are supported

Test Sequence:

1. Method call **enableCallNotification()**
Parameters: appCallControlManager with valid, not null, value, valid eventCriteria
Check: valid value of TpAssignmentID is returned
2. Triggered action: cause IUT to call **callEventNotify()** method on the tester's (Application) **IpAppCallControlManager** interface
3. Triggered action: cause IUT to call **callAborted()** method on the tester's (Application) **IpAppCallControlManager** interface
Parameters: valid callReference as reported in callEventNotify

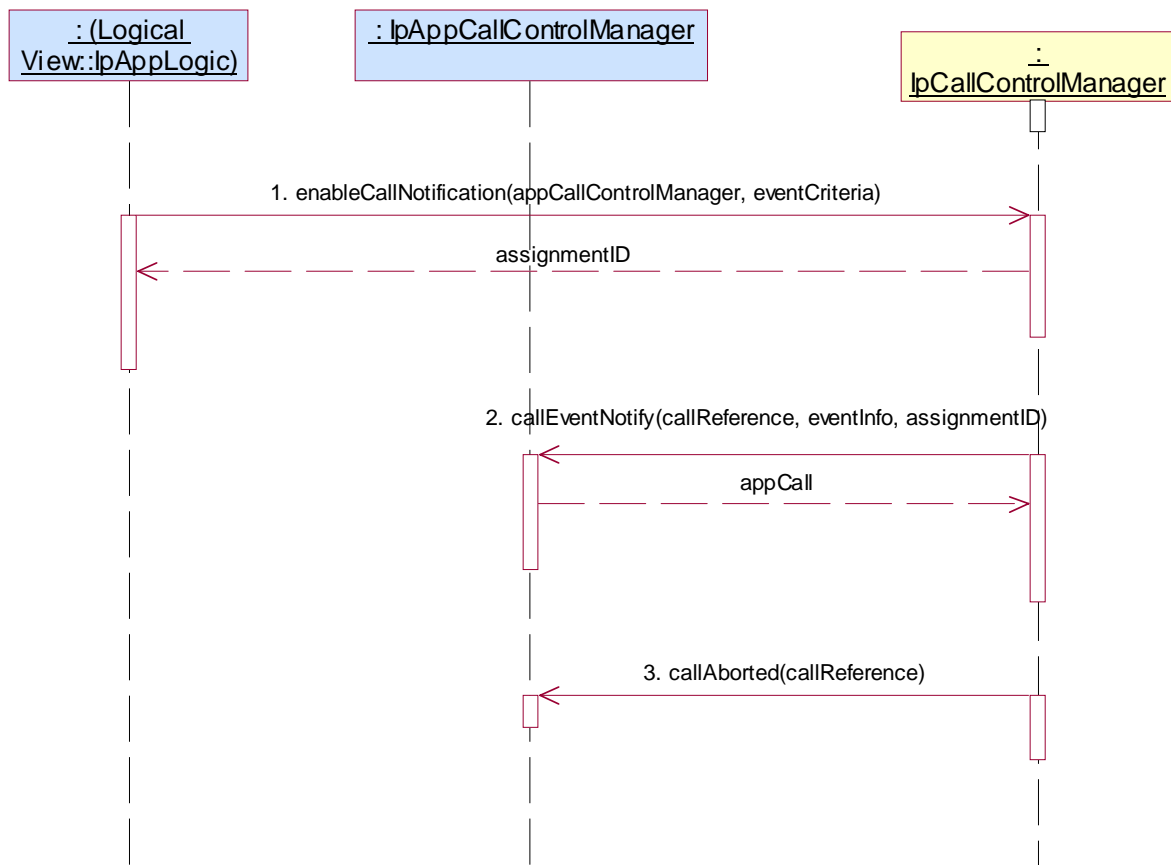

5.2.1.1.4 Optional, invalid behaviour

Test GCC_IPCALLCONTROLMANAGER_13

Summary: IpCallControlManager, changeCallNotification, P_INVALID_ASSIGNMENT_ID

Reference: ES 201 915-4 [1], clause 6.3.1

Condition: changeCallNotification is supported

Test Sequence:

1. Method call **enableCallNotification()**
 Parameters: appCallControlManager with valid, not null, value, valid eventCriteria
 Check: valid value of TpAssignmentID is returned
2. Method call **changeCallNotification()**
 Parameters: invalid assignmentID, valid eventCriteria
 Check: P_INVALID_ASSIGNMENT_ID is returned

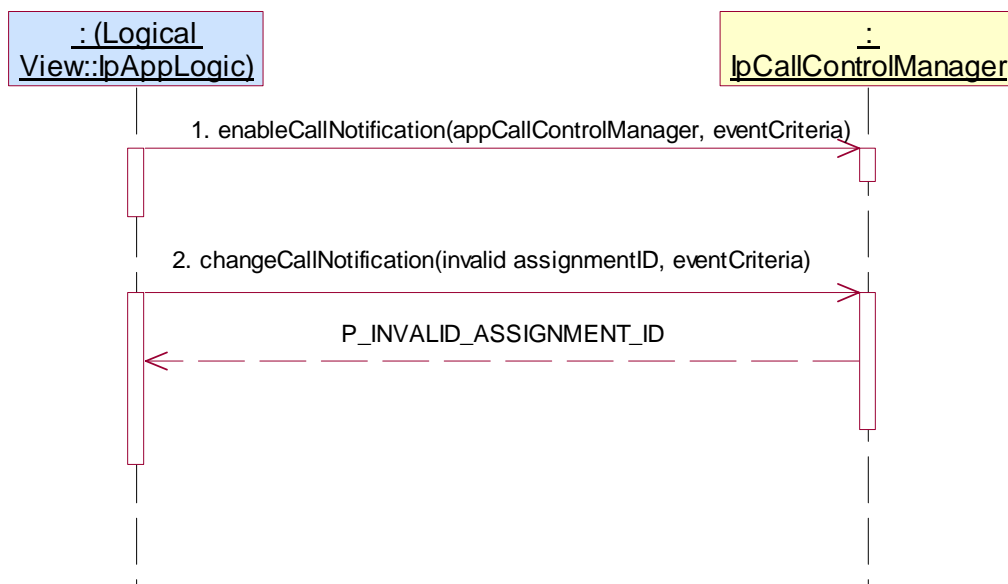

Test GCC_IPCALLCONTROLMANAGER_14

Summary: IpCallControlManager, changeCallNotification, P_INVALID_CRITERIA

Reference: ES 201 915-4 [1], clause 6.3.1

Condition: enableCallNotification and changeCallNotification methods are supported

Test Sequence:

1. Method call **enableCallNotification()**
 Parameters: appCallControlManager with null value, valid eventCriteria
 Check: valid value of TpAssignmentID is returned
2. Method call **changeCallNotification()**
 Parameters: assignmentID returned in 1., invalid eventCriteria but with valid event type
 Check: P_INVALID_CRITERIA is returned

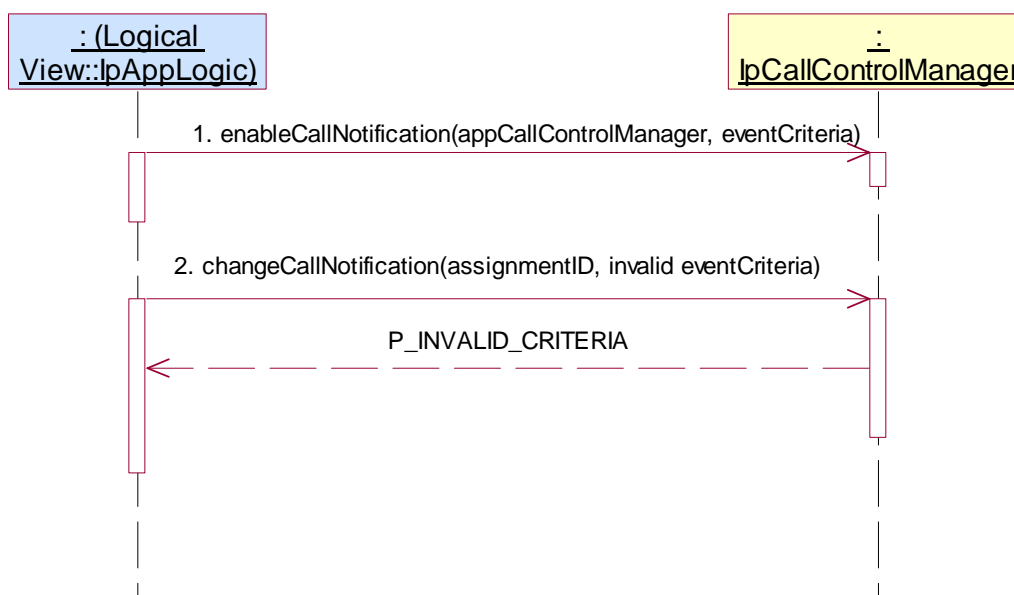

Test GCC_IPCALLCONTROLMANAGER_15

Summary: IpCallControlManager, setCallLoadControl, P_INVALID_ADDRESS

Reference: ES 201 915-4 [1], clause 6.3.1

Condition: enableCallNotification and setCallLoadControl method are supported

Test Sequence:

1. Method call **enableCallNotification()**
 Parameters: appCallControlManager with valid, not null, value, valid eventCriteria
 Check: valid value of TpAssignmentID is returned
2. Method call **setCallLoadControl()**
 Parameters: valid duration, valid mechanism, valid treatment, invalid addressRange
 Check: P_INVALID_ADDRESS, P_UNsupported_ADDRESS_PLAN or another suitable exception, is returned

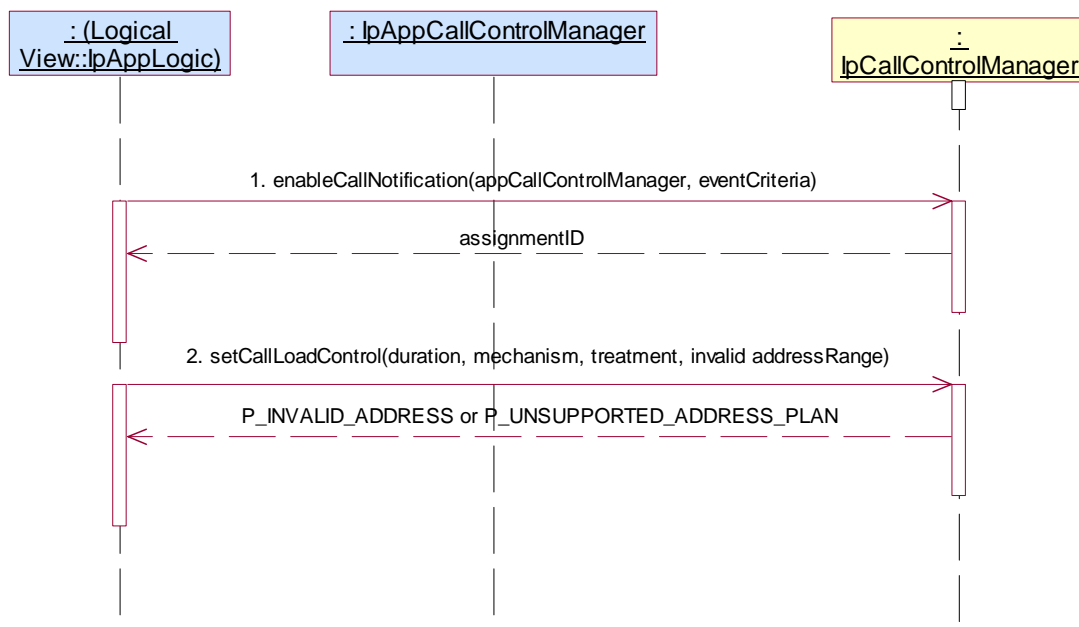

5.2.1.2 IpCall

5.2.1.2.1 Mandatory, valid behaviour

Test GCC_IPCALL_01

Summary: IpCall, all mandatory methods, successful

Reference: ES 201 915-4 [1], clauses 6.3.1 and 6.3.3

Preamble: Application has a valid callSessionID returned by one of the two following sequence:

1. Method call **setCallback()** on IpCallControlManager
Parameters: valid, non-null, value of appInterface parameter
Check: no exception is returned
2. Method call **createCall()**
Parameters: valid appCall
Check: valid value of TpCallIdentifier is returned

or

1. Method call **enableCallNotification()**
Parameters: appCallControlManager with valid, not null, value, valid eventCriteria
Check: valid value of TpAssignmentID is returned
2. Triggered action: cause IUT to call **callEventNotify()** method on the tester's (Application) **IpAppCallControlManager** interface
Parameters: valid callReference, valid eventInfo, assignmentID returned in 1.

Test Sequence:

1. Method call **routeReq()**
Parameters: valid callSessionID reported in preamble, valid responseRequested, valid targetAddress, valid originatingAddress, valid originalDestinationAddress, valid redirectingAddress, valid appInfo
Check: Valid value of TpSessionID is returned
2. Method call **deassignCall()**
Parameters: valid callSessionID reported in preamble
Check: no exception is returned

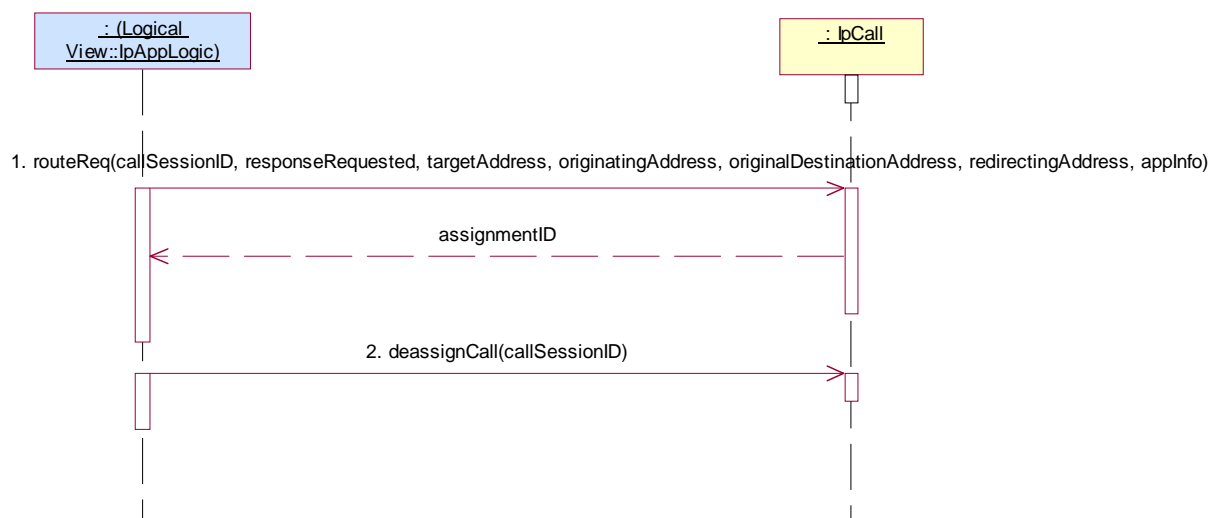

Test GCC_IPCALL_02

Summary: IpCall, all mandatory methods, successful

Reference: ES 201 915-4 [1], clauses 6.3.1 and 6.3.3

Preamble: Same as GCC_IPCALL_01

Test Sequence:

1. Method call **release()**
Parameters: valid callSessionID reported in preamble
Check: no exception is returned

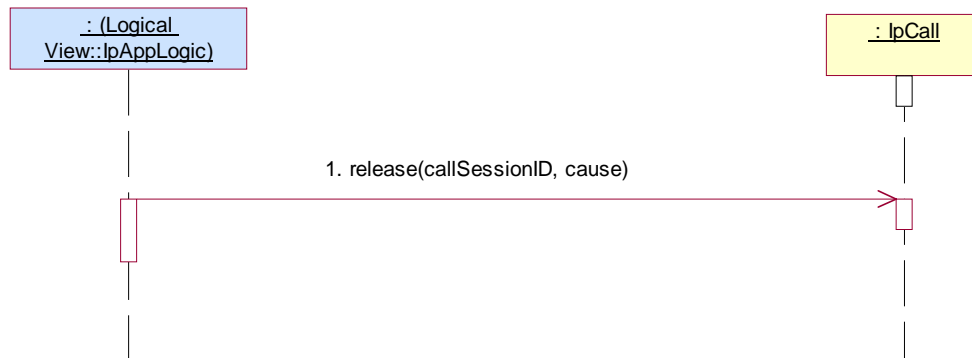
**5.2.1.2.2 Mandatory, invalid behaviour****Test GCC_IPCALL_03**

Summary: IpCall, routeReq, P_INVALID_SESSION_ID

Reference: ES 201 915-4 [1], clause 6.3.3

Preamble: Same as GCC_IPCALL_01

Test Sequence:

1. Method call **routeReq()**
Parameters: invalid callSessionID, valid responseRequested, valid targetAddress, valid originatingAddress, valid originalDestinationAddress, valid redirectingAddress, valid appInfo
Check: P_INVALID_SESSION_ID is returned
2. Method call **release()**
Parameters: valid callSessionID reported in preamble
Check: no exception is returned

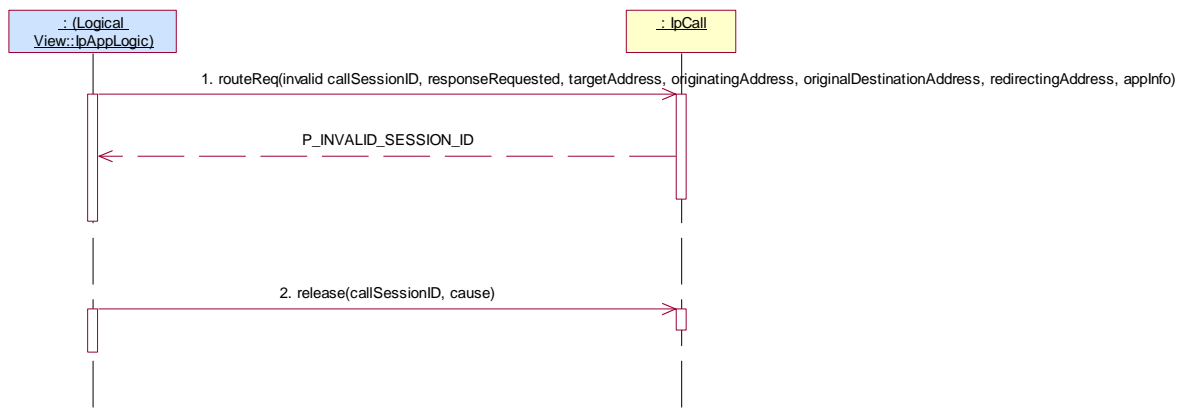

Test GCC_IPCALL_04

Summary: IpCall, routeReq, P_INVALID_ADDRESS

Reference: ES 201 915-4 [1], clauses 6.3.1 and 6.3.3

Preamble: Same as GCC_IPCALL_01

Test Sequence:

1. Method call **routeReq()**
 Parameters: valid callSessionID reported in preamble, valid responseRequested, invalid targetAddress, valid originatingAddress, valid originalDestinationAddress or null value, valid redirectingAddress or null value, valid appInfo
 Check: P_INVALID_ADDRESS is returned
2. Method call **release()**
 Parameters: valid callSessionID reported in preamble
 Check: no exception is returned

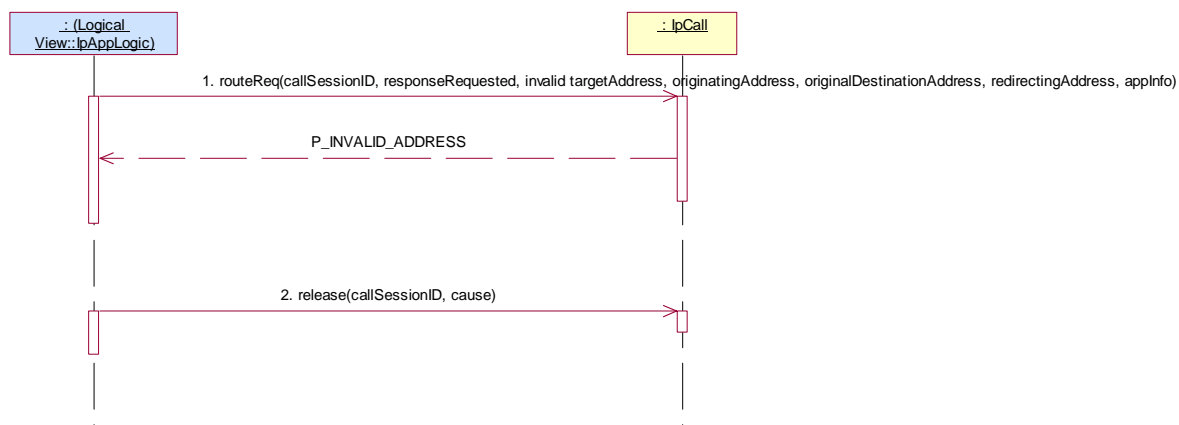

Test GCC_IPCALL_05

Summary: IpCall, routeReq, P_INVALID_ADDRESS

Reference: ES 201 915-4 [1], clauses 6.3.1 and 6.3.3

Preamble: Same as GCC_IPCALL_01

Test Sequence:

1. Method call **routeReq()**
 Parameters: valid callSessionID reported in preamble, valid responseRequested, valid targetAddress, invalid originatingAddress, valid originalDestinationAddress or null value, valid redirectingAddress or null value, valid appInfo
 Check: P_INVALID_ADDRESS is returned
2. Method call **release()**
 Parameters: valid callSessionID reported in preamble.
 Check: no exception is returned

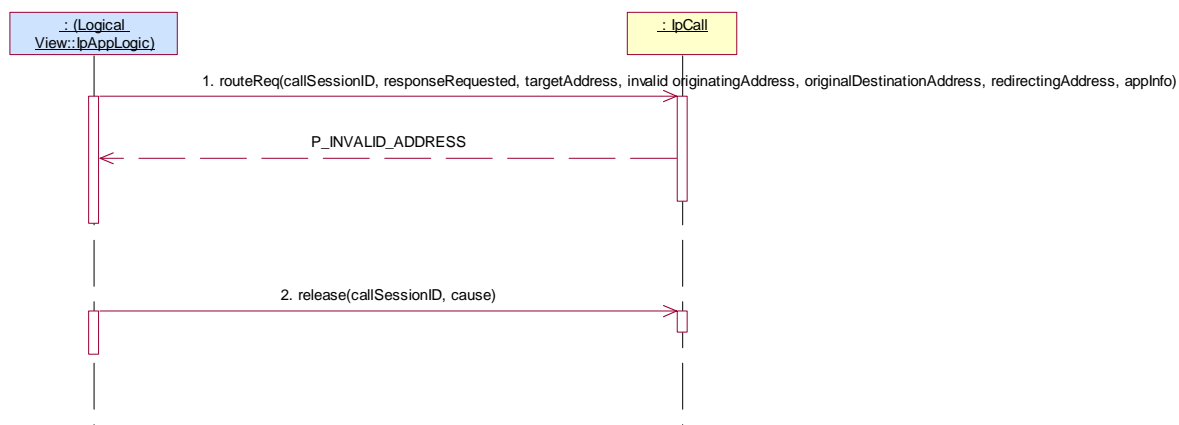

Test GCC_IPCALL_06

Summary: IpCall, routeReq, P_INVALID_ADDRESS

Reference: ES 201 915-4 [1], clauses 6.3.1 and 6.3.3

Preamble: Same as GCC_IPCALL_01

Test Sequence:

1. Method call **routeReq()**

Parameters: valid callSessionID reported in preamble, valid responseRequested, valid targetAddress, valid originatingAddress, invalid originalDestinationAddress, valid redirectingAddress, valid appInfo

Check: P_INVALID_ADDRESS is returned

2. Method call **release()**

Parameters: valid callSessionID reported in preamble

Check: no exception is returned

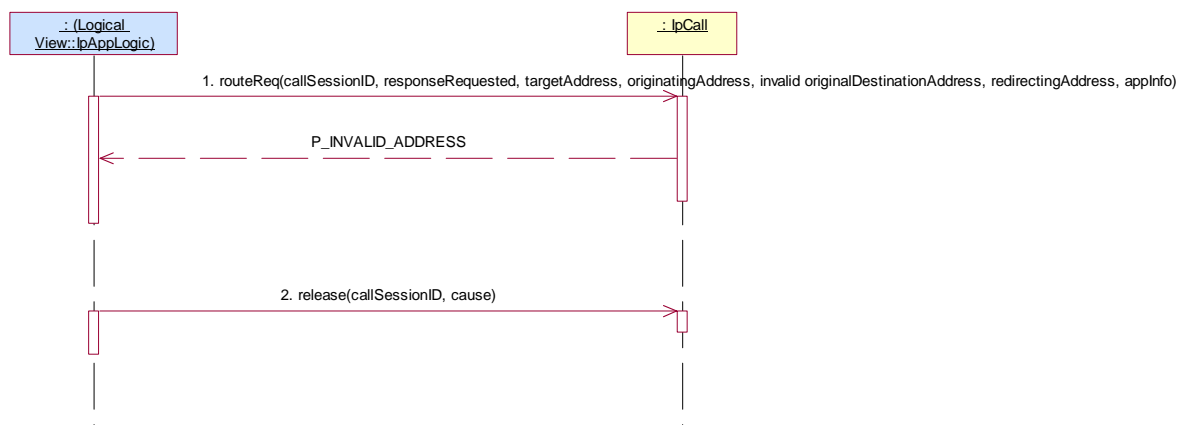

Test GCC_IPCALL_07

Summary: IpCall, routeReq, P_INVALID_ADDRESS

Reference: ES 201 915-4 [1], clauses 6.3.1 and 6.3.3

Preamble: Same as GCC_IPCALL_01

Test Sequence:

1. Method call **routeReq()**

Parameters: valid callSessionID reported in preamble, valid responseRequested, valid targetAddress, valid originatingAddress, valid originalDestinationAddress, invalid redirectingAddress, valid appInfo

Check: P_INVALID_ADDRESS is returned

2. Method call **release()**

Parameters: valid callSessionID reported in preamble

Check: no exception is returned

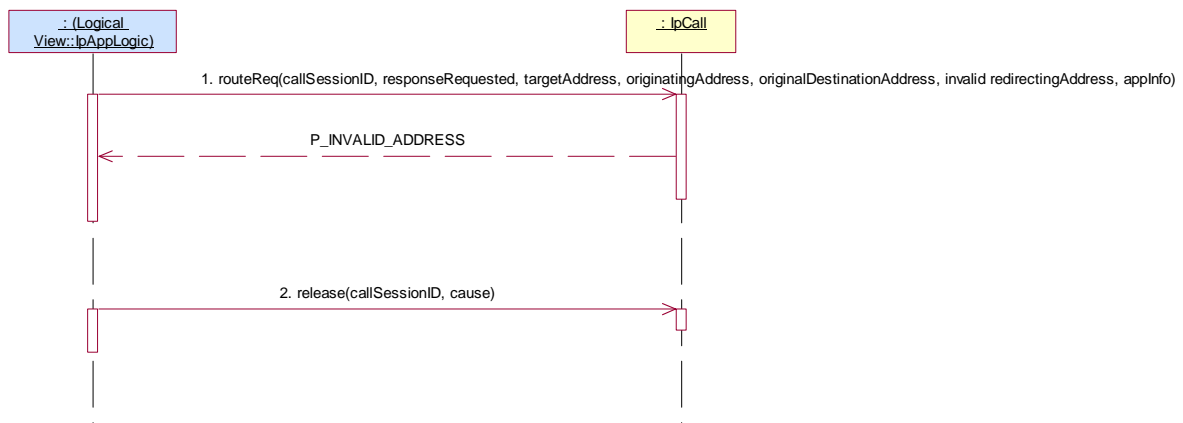

Test GCC_IPCALL_08

Summary: IpCall, deassignCall, P_INVALID_SESSION_ID

Reference: ES 201 915-4 [1], clause 6.3.3

Preamble: Same as GCC_IPCALL_01

Test Sequence:

1. Method call **deassignCall()**
Parameters: invalid callSessionID
Check: P_INVALID_SESSION_ID is returned
2. Method call **release()**
Parameters: valid callSessionID reported in preamble
Check: no exception is returned

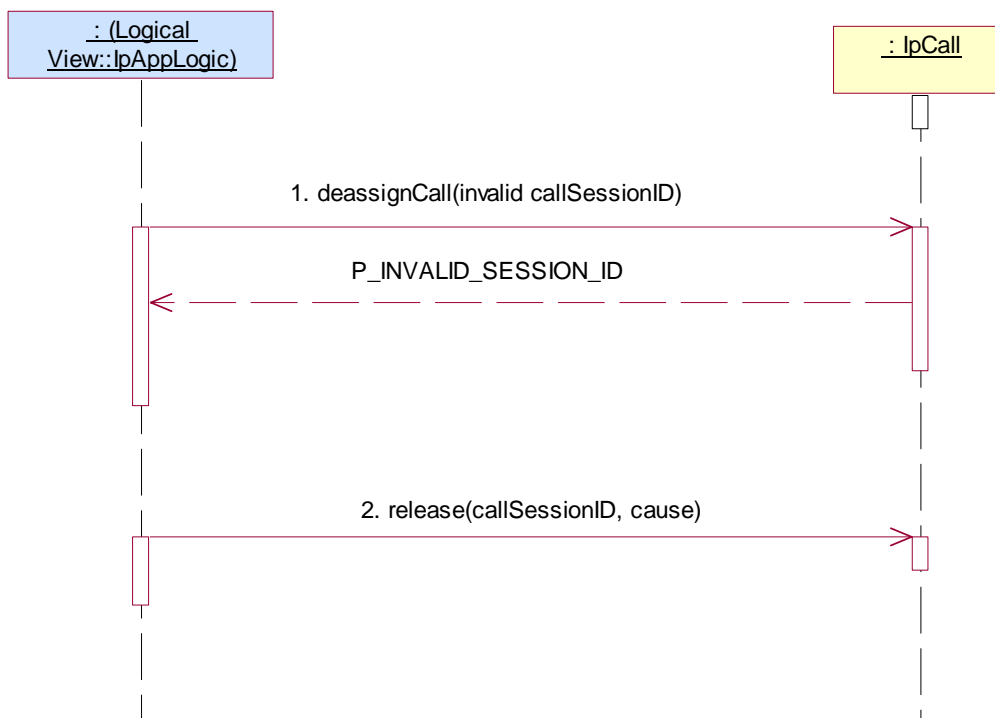

Test GCC_IPCALL_09

Summary: IpCall, release, P_INVALID_SESSION_ID

Reference: ES 201 915-4 [1], clause 6.3.3

Preamble: Same as GCC_IPCALL_01

Test Sequence:

1. Method call **release()**
Parameters: invalid callSessionID
Check: P_INVALID_SESSION_ID is returned
2. Method call **release()**
Parameters: valid callSessionID reported in preamble
Check: no exception is returned

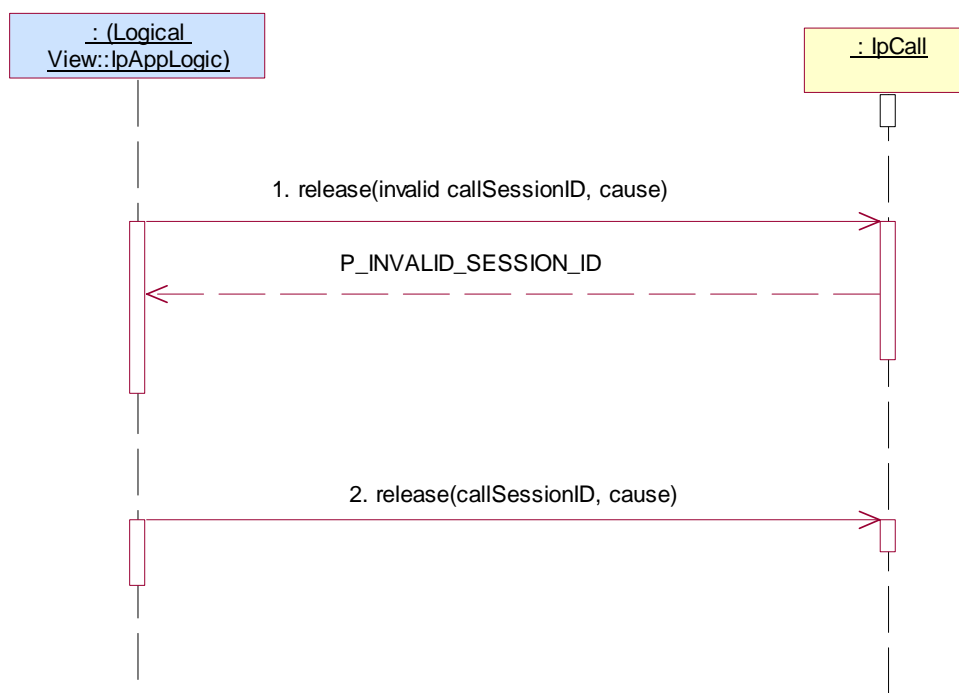

5.2.1.2.3 Optional, valid behaviour

Test GCC_IPCALL_10

Summary: IpCall, getCallInfoReq, successful

Reference: ES 201 915-4 [1], clauses 6.3.1 and 6.3.3

Preamble: Same as GCC_IPCALL_01

Condition: getCallInfoReq method is supported.

Test Sequence:

1. Method call **getCallInfoReq()**
Parameters: valid callSessionID reported in preamble, valid callInfoRequested
Check: no exception is returned
2. Method call **routeReq()**
Parameters: valid callSessionID reported in preamble, valid responseRequested, valid targetAddress, valid originatingAddress, valid originalDestinationAddress, valid redirectingAddress, valid appInfo
Check: Valid value of TpSessionID is returned
3. Triggered action: cause IUT to call **routeRes()** method on tester's (Application) **IpAppCall** interface
Parameters: callSessionID given in 1, valid eventReport, valid callLegSessionID
4. Method call **release()**
Parameters: valid callSessionID reported in preamble.
Check: no exception is returned
5. Triggered action: cause IUT to call **getCallInfoRes()** method on the tester's (Application) **IpAppCall** interface
Parameters: callSessionID given in preamble, valid callInfoReport

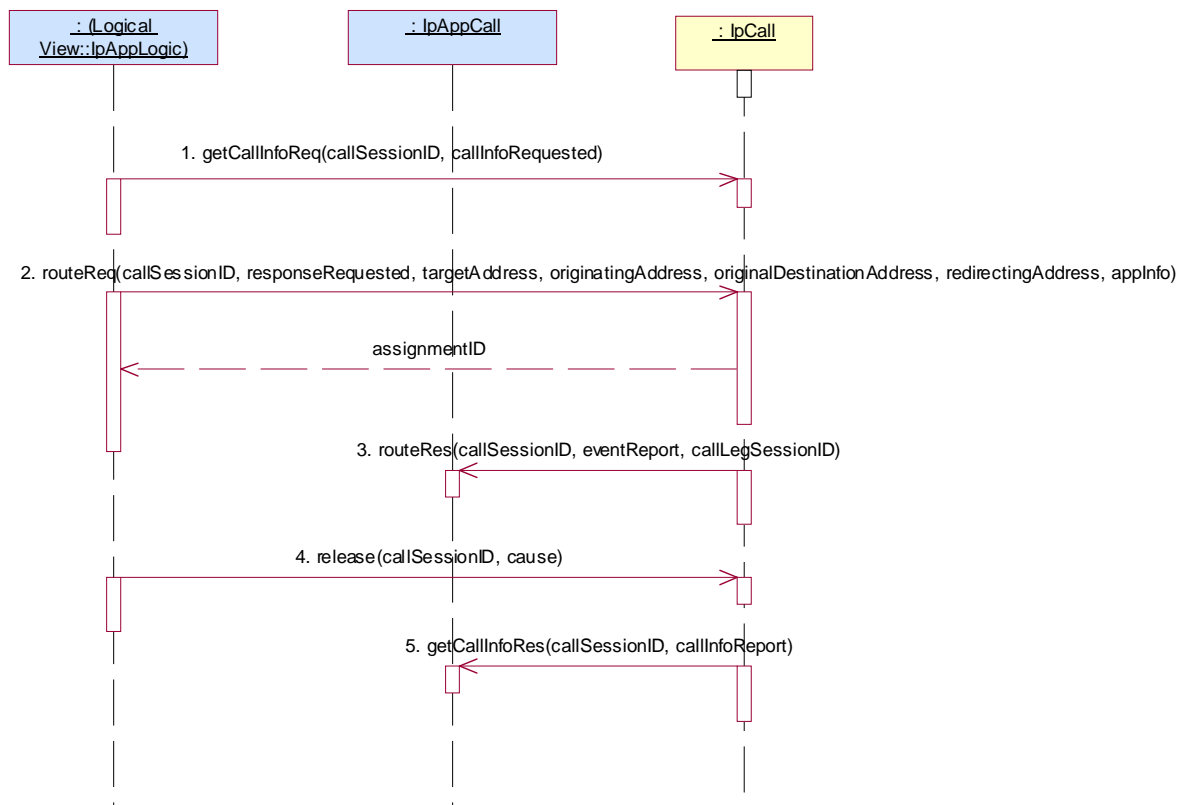

Test GCC_IPCALL_11

Summary: IpCall, setCallChargePlan, successful

Reference: ES 201 915-4 [1], clauses 6.3.1 and 6.3.3

Preamble: Same as GCC_IPCALL_01

Condition: setCallChargePlan method is supported

Test Sequence:

1. Method call **setCallChargePlan()**
Parameters: valid callSessionID reported in preamble, valid callChargePlan
Check: no exception is returned
2. Method call **release()**
Parameters: valid callSessionID reported in preamble
Check: no exception is returned

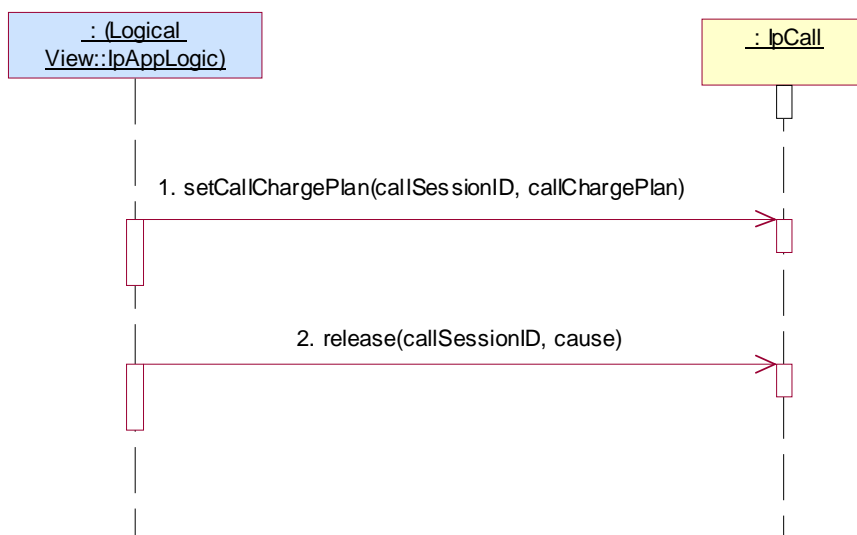

Test GCC_IPCALL_12

Summary: IpCall, setAdviceOfCharge, successful

Reference: ES 201 915-4 [1], clauses 6.3.1 and 6.3.3

Preamble: Same as GCC_IPCALL_01

Condition: setAdviceOfCharge method is supported

Test Sequence:

1. Method call **setAdviceOfCharge()**
Parameters: valid callSessionID reported in preamble, valid aOCInfo, valid tariffSwitch
Check: no exception is returned
2. Method call **release()**
Parameters: valid callSessionID reported in preamble
Check: no exception is returned

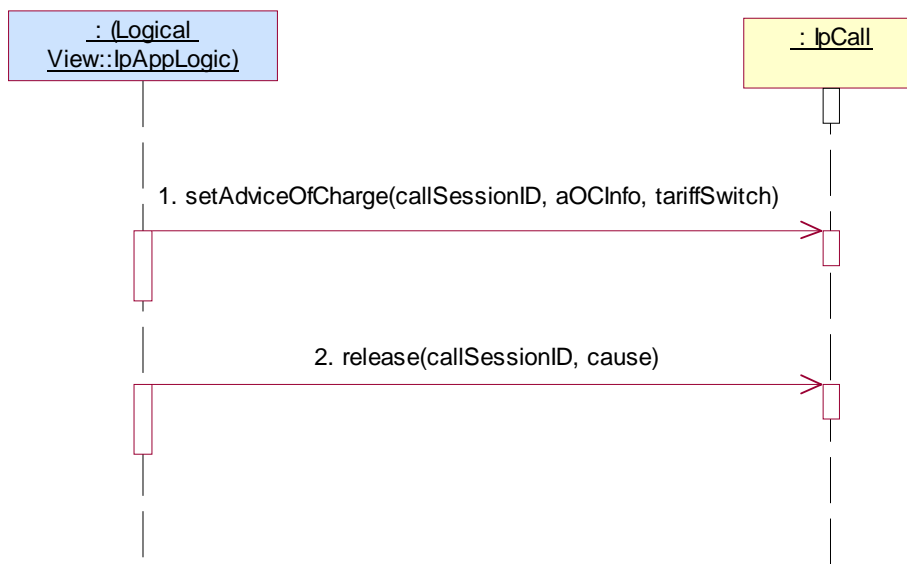

Test GCC_IPCALL_13

Summary: IpCall, getMoreDialledDigitsReq, successful

Reference: ES 201 915-4 [1], clauses 6.3.1 and 6.3.3

Condition: getMoreDialledDigitsReq method is supported

Test Sequence:

1. Method call **enableCallNotification()**
Parameters: appCallControlManager with valid, not null, value, valid eventCriteria requesting P_EVENT_GCCS_ADDRESS_COLLECTED_EVENT
Check: valid value of TpAssignmentID is returned
2. Triggered action: cause IUT to call **callEventNotify()** method on the tester's (Application) **IpAppCallControlManager** interface
Parameters: valid callReference, valid eventInfo, assignmentID returned in 1.
3. Method call **getMoreDialledDigitsReq()**
Parameters: valid callSessionID reported in 2., valid length
Check: no exception is returned
4. Triggered action: cause IUT to call **getMoreDialledDigitsRes()** method on the tester's (Application) **IpAppCall** interface
Parameters: callSessionID given in 2., valid digits
5. Method call **release()**
Parameters: valid callSessionID reported in 2.
Check: no exception is returned

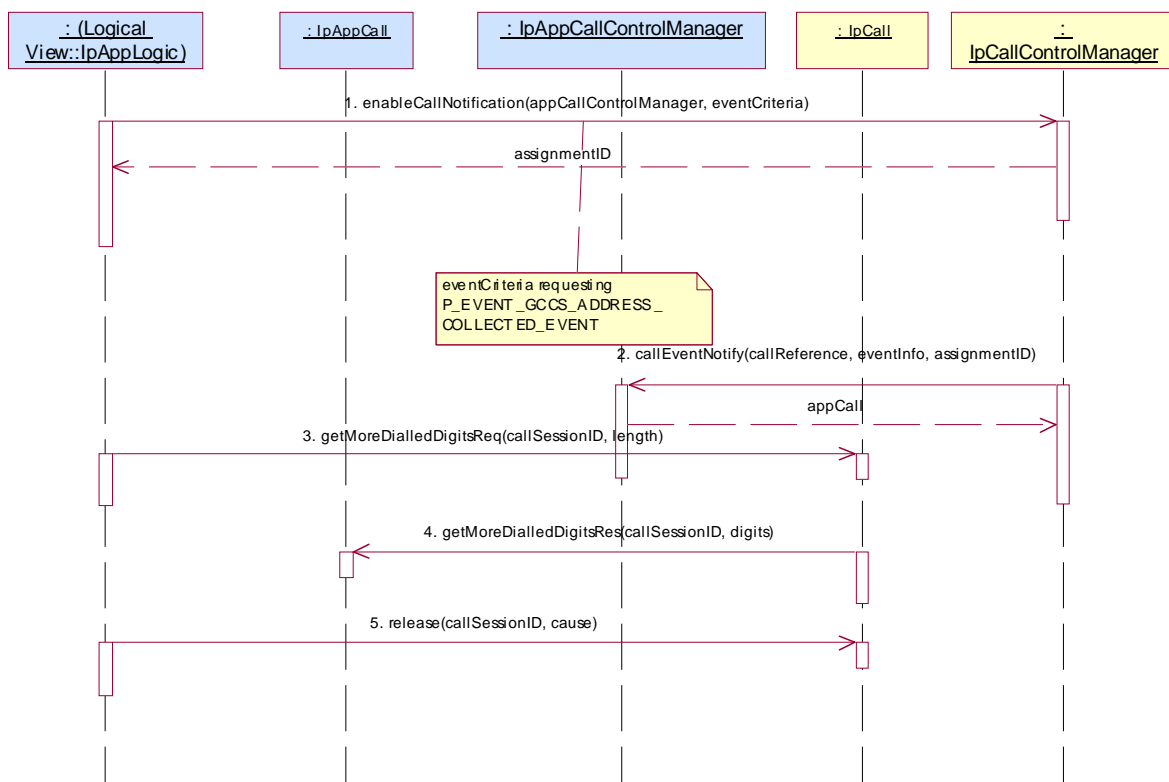

Test GCC_IPCALL_14

Summary: IpCall, superviseCallReq, successful

Reference: ES 201 915-4 [1], clauses 6.3.1 and 6.3.3

Preamble: Same as GCC_IPCALL_01

Condition: superviseCallReq method is supported

Test Sequence:

1. Method call **superviseCallReq()**
Parameters: valid callSessionID reported in preamble, valid time, valid treatment
Check: no exception is returned
2. Method call **routeReq()**
Parameters: valid callSessionID reported in preamble, valid responseRequested, valid targetAddress, valid originatingAddress, valid originalDestinationAddress, valid redirectingAddress, valid appInfo
Check: Valid value of TpSessionID is returned
3. Triggered action: cause IUT to call **superviseCallRes()** method on the tester's (Application) **IpAppCall** interface.
Parameters: callSessionID given in 1., valid report, valid usedTime
4. Method call **release()**
Parameters: valid callSessionID reported in preamble
Check: no exception is returned

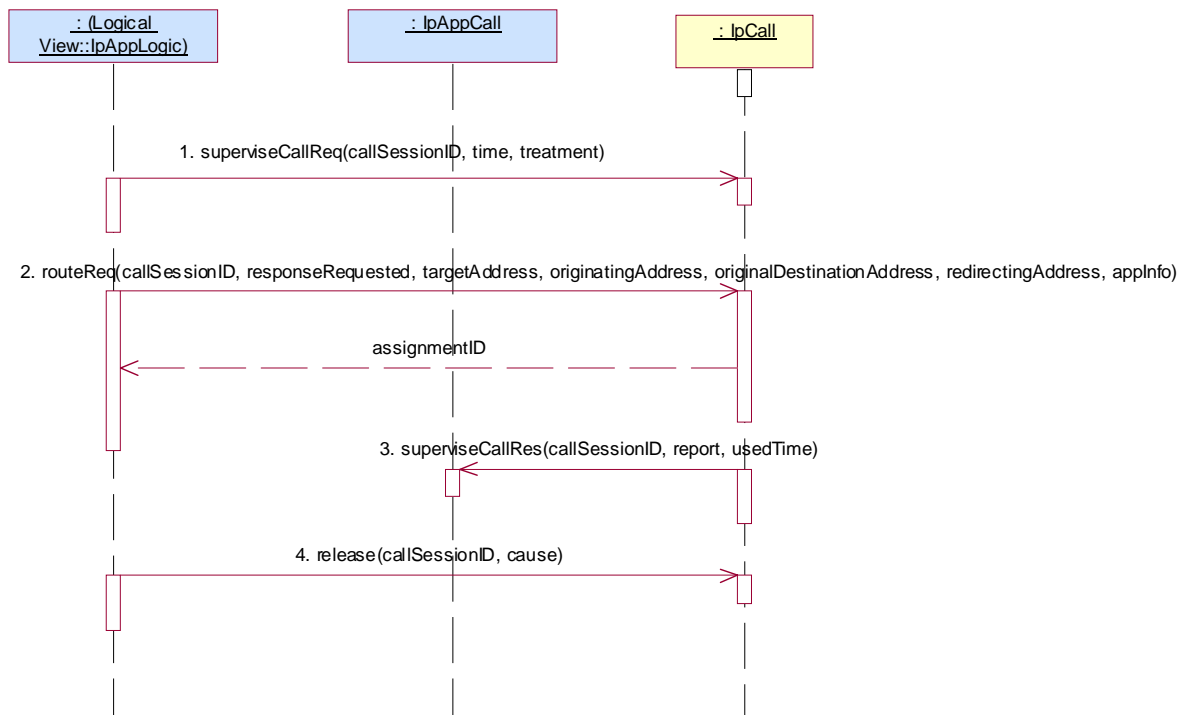

Test GCC_IPCALL_15

Summary: IpCall, continueProcessing, successful

Reference: ES 201 915-4 [1], clauses 6.3.1 and 6.3.3

Test Sequence:

1. Method call **enableCallNotification()**
 Parameters: appCallControlManager with valid, not null, value, valid eventCriteria
 eventCriteria.MonitorMode = P_CALL_MONITOR_MODE_INTERRUPT
 Check: valid value of TpAssignmentID is returned
2. Triggered action: cause IUT to call **callEventNotify()** method on the tester's (Application) **IpAppCallControlManager** interface
 Parameters: valid callReference, valid eventInfo, assignmentID returned in 1.
3. Method call **continueProcessing()**
 Parameters: callSessionID
 Check: no exception is returned

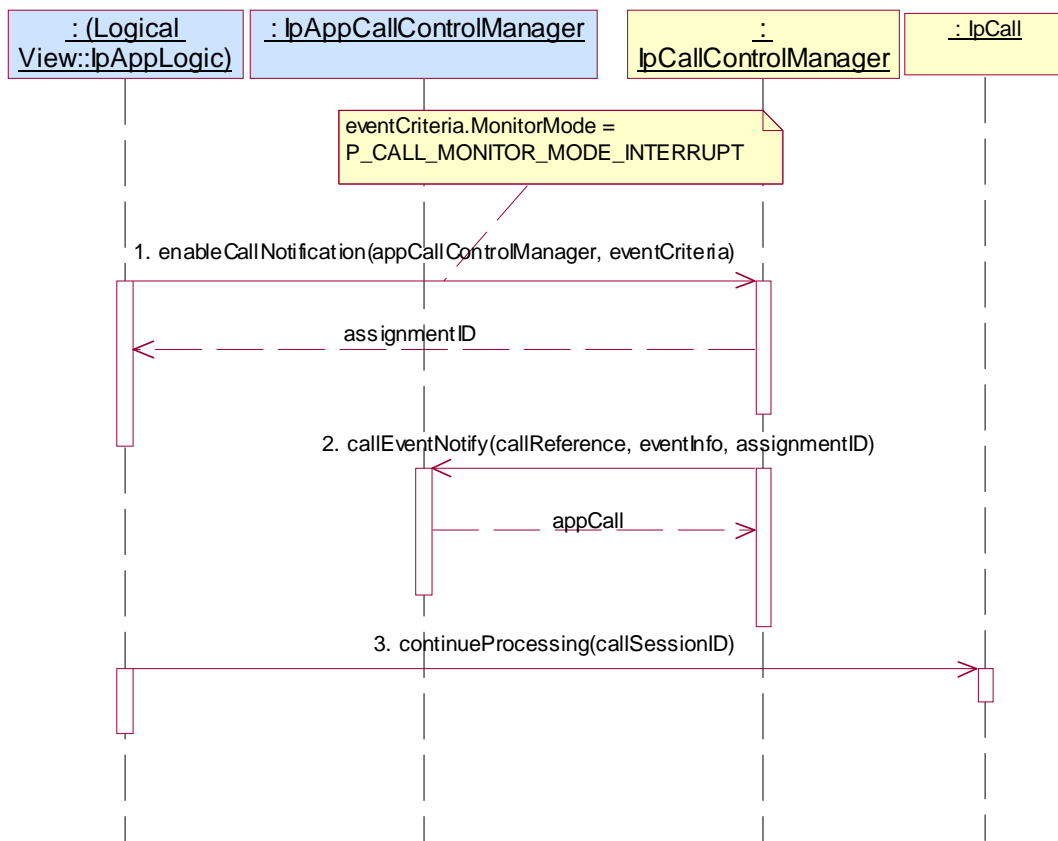

5.2.1.2.4 Optional, invalid behaviour

Test GCC_IPCALL_16

Summary: IpCall, getCallInfoReq, P_INVALID_SESSION_ID

Reference: ES 201 915-4 [1], clause 6.3.3

Preamble: Same as GCC_IPCALL_01

Condition: getCallInfoReq is supported

Test Sequence:

1. Method call **getCallInfoReq()**
 Parameters: invalid callSessionID, valid callInfoRequested
 Check: P_INVALID_SESSION_ID exception is returned
2. Method call **release()**
 Parameters: valid callSessionID reported in preamble
 Check: no exception is returned

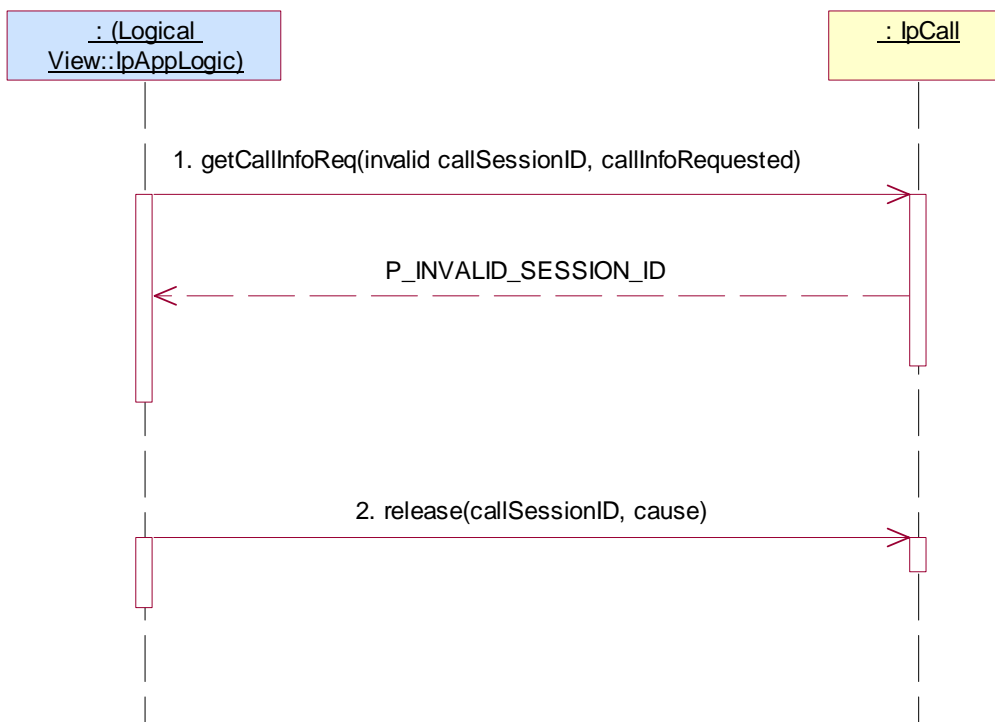

Test GCC_IPCALL_17

Summary: IpCall, setCallChargePlan, P_INVALID_SESSION_ID

Reference: ES 201 915-4 [1], clause 6.3.3

Preamble: Same as GCC_IPCALL_01

Condition: setCallChargePlan is supported

Test Sequence:

1. Method call **setCallChargePlan()**
 Parameters: invalid callSessionID, valid callChargePlan
 Check: P_INVALID_SESSION_ID exception is returned
2. Method call **release()**
 Parameters: valid callSessionID reported in preamble
 Check: no exception is returned

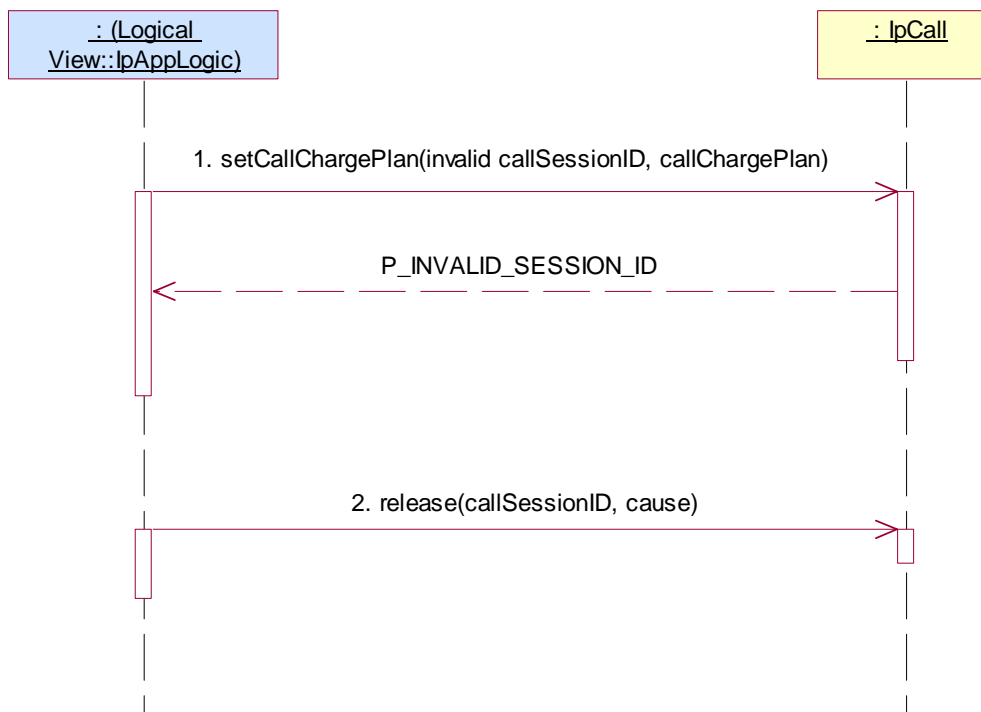

Test GCC_IPCALL_18

Summary: IpCall, setAdviceOfCharge, P_INVALID_SESSION_ID

Reference: ES 201 915-4 [1], clause 6.3.3

Preamble: Same as GCC_IPCALL_01

Condition: setAdviceOfCharge is supported

Test Sequence:

1. Method call **setAdviceOfCharge()**
 Parameters: invalid callSessionID, valid aOCInfo, valid tariffSwitch
 Check: P_INVALID_SESSION_ID is returned
2. Method call **release()**
 Parameters: valid callSessionID reported in preamble
 Check: no exception is returned

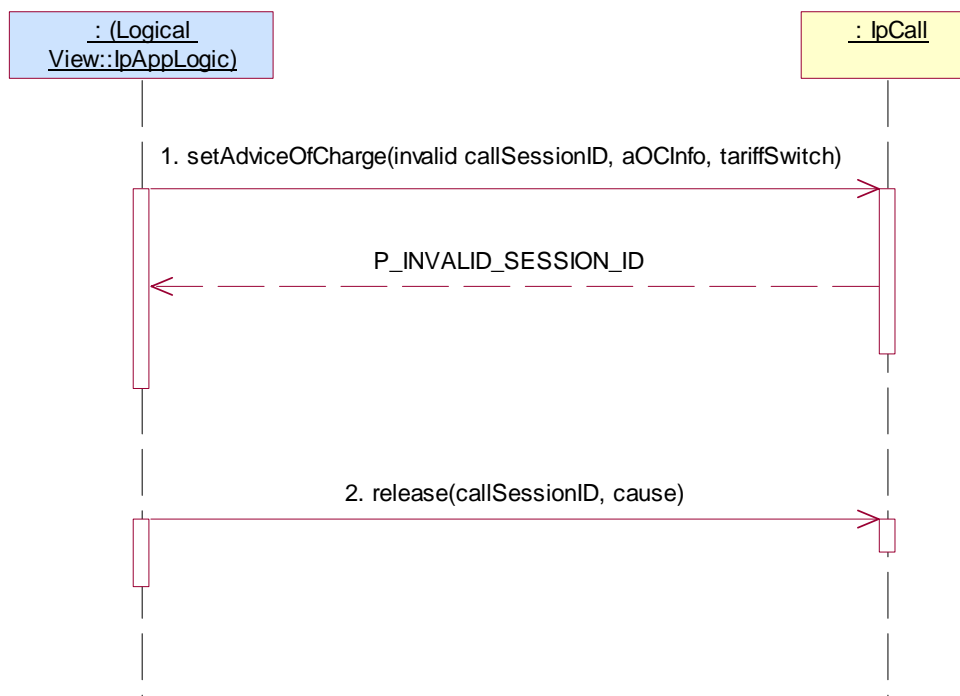

Test GCC_IPCALL_19

Summary: IpCall, getMoreDialledDigitsReq, P_INVALID_SESSION_ID

Reference: ES 201 915-4 [1], clause 6.3.3

Condition: getMoreDialledDigitsReq is supported

Test Sequence:

1. Method call **enableCallNotification()**
 Parameters: appCallControlManager with valid, not null, value, valid eventCriteria requesting P_EVENT_GCCS_ADDRESS_COLLECTED_EVENT
 Check: valid value of TpAssignmentID is returned
2. Triggered action: cause IUT to call **callEventNotify()** method on the tester's (Application) **IpAppCallControlManager** interface
 Parameters: valid callReference, valid eventInfo, assignmentID returned in 1.
3. Method call **getMoreDialledDigitsReq()**
 Parameters: invalid callSessionID, valid length
 Check: P_INVALID_SESSION_ID is returned
4. Method call **release()**
 Parameters: valid callSessionID reported in 2.
 Check: no exception is returned

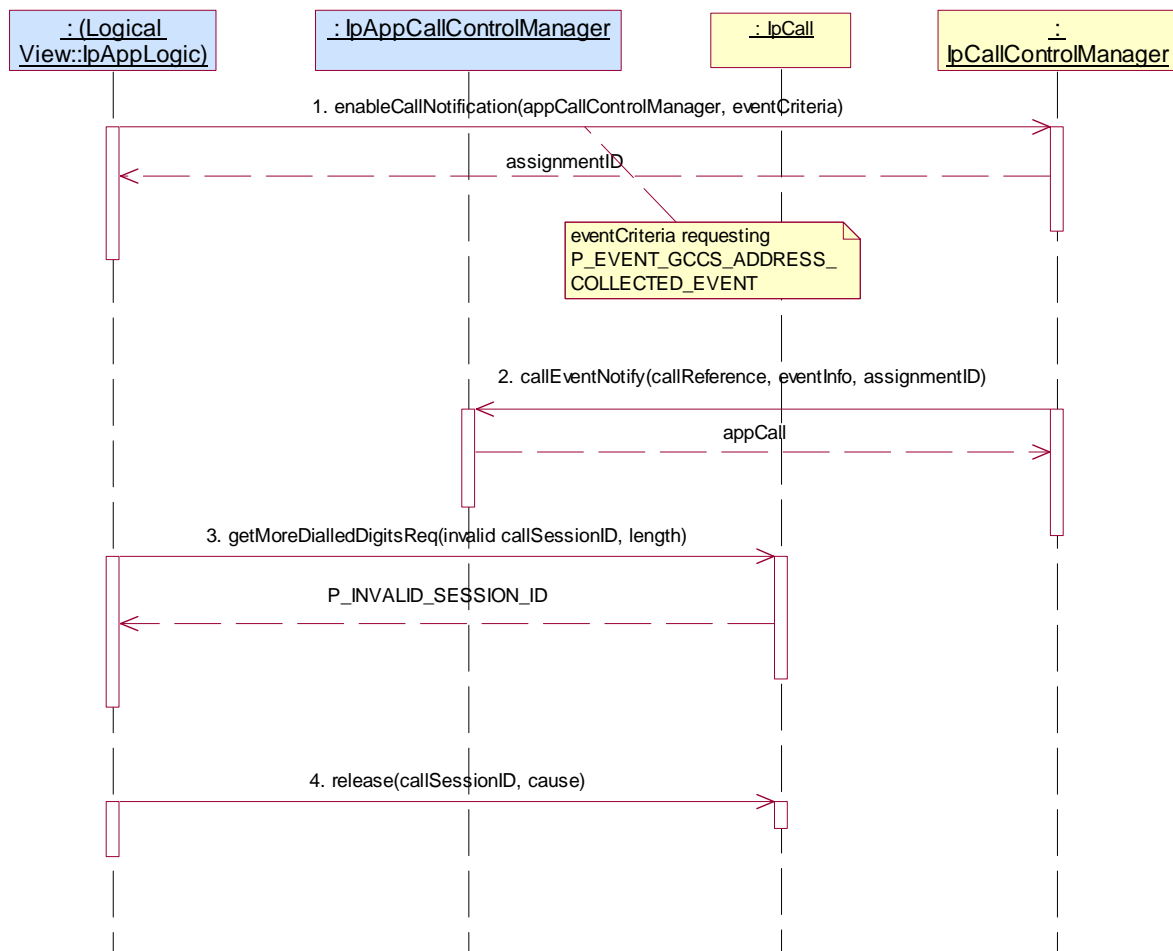

Test GCC_IPCALL_20

Summary: IpCall, superviseCallReq, P_INVALID_SESSION_ID

Reference: ES 201 915-4 [1], clause 6.3.3

Preamble: Same as GCC_IPCALL_01

Condition: superviseCallReq is supported

Test Sequence:

1. Method call **superviseCallReq()**
 Parameters: invalid callSessionID, valid time, valid treatment
 Check: P_INVALID_SESSION_ID is returned
2. Method call **release()**
 Parameters: valid callSessionID reported in preamble
 Check: no exception is returned

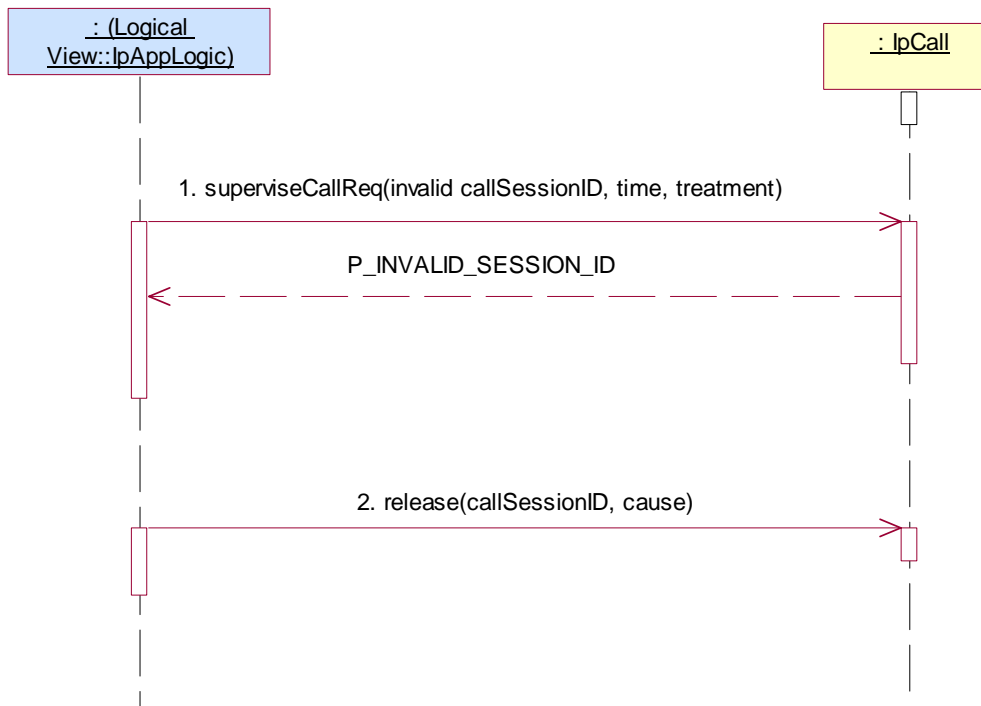

Test GCC_IPCALL_21

Summary: IpCall, continueProcessing, P_INVALID_SESSION_ID

Reference: ES 201 915-4 [1], clauses 6.3.1 and 6.3.3

Test Sequence:

1. Method call **enableCallNotification()**
 Parameters: appCallControlManager with valid, not null, value, valid eventCriteria
 eventCriteria.MonitorMode = P_CALL_MONITOR_MODE_INTERRUPT
 Check: valid value of TpAssignmentID is returned
2. Triggered action: cause IUT to call **callEventNotify()** method on the tester's (Application) **IpAppCallControlManager** interface
 Parameters: valid callReference, valid eventInfo, assignmentID returned in 1.
3. Method call **continueProcessing()**
 Parameters: invalid callSessionID
 Check: P_INVALID_SESSION_ID is returned

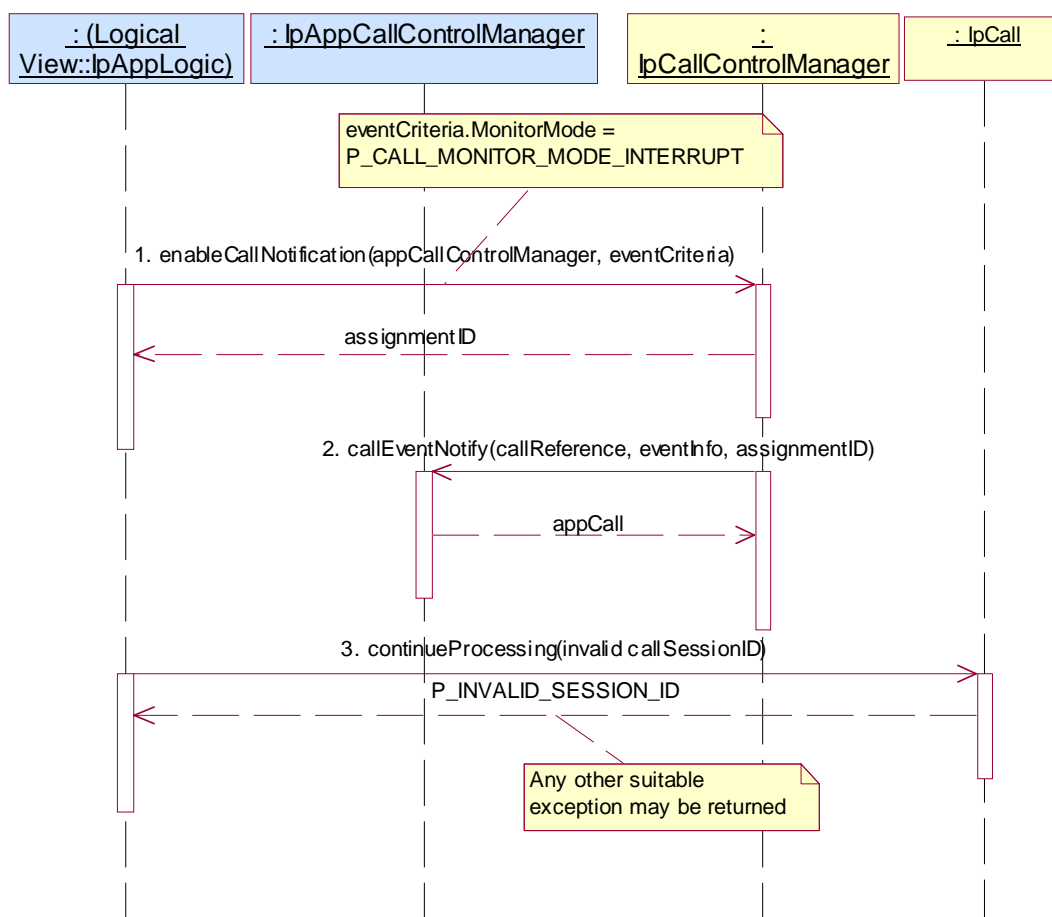

5.2.2 MultiParty Call Control Service (MPCC)

5.2.2.1 IpMultiPartyCallControlManager

5.2.2.1.1 Mandatory, valid behaviour

Test MPCC_IpMultiPartyCallControlManager_01

Summary: IpMultiPartyCallControlManager, all mandatory methods, successful

Reference: ES 201 915-4 [1], clause 7.3.1

Condition: createNotification method is supported

Test Sequence:

1. Method call **createNotification()**
 Parameters: appCallControlManager with valid, non-null, value, valid notificationRequest
 Check: valid value of TpAssignmentID is returned
2. Triggered action: cause IUT to call Method **reportNotification()** method on the tester's (application) **IpAppMultiPartyCallControlManager** interface
 Parameters: callReference, callLegReferenceSet, notificationInfo, assignmentID
3. Method call **destroyNotification()**
 Parameters: assignmentID returned in 1.
 Check: no exception is returned

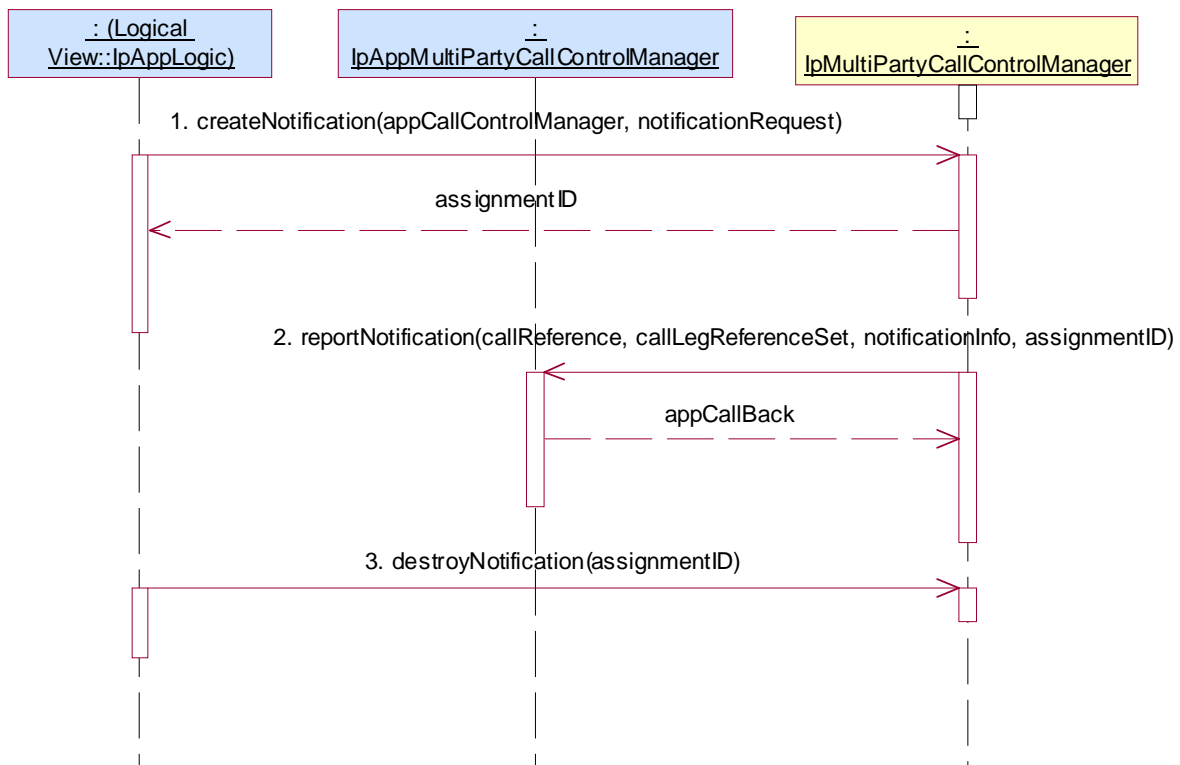

Test MPCC_IpMultiPartyCallControlManager_02

Summary: IpMultiPartyCallControlManager, all mandatory methods, successful

Reference: ES 201 915-4 [1], clause 7.3.1

Condition: createNotification method is supported

Test Sequence:

1. Method call **setCallback()** on IpMultiPartyCallControlManager
Parameters: valid, non-null, value of appInterface parameter
Check: no exception is returned
2. Method call **createNotification()**
Parameters: appCallControlManager with null, value, valid notificationRequest
Check: valid value of TpAssignmentID is returned
3. Triggered action: cause IUT to call Method **reportNotification()** method on the tester's (application) **IpAppMultiPartyCallControlManager** interface
Parameters: callReference, callLegReferenceSet, notificationInfo, assignmentID
4. Method call **destroyNotification()**
Parameters: assignmentID returned in 1.
Check: no exception is returned

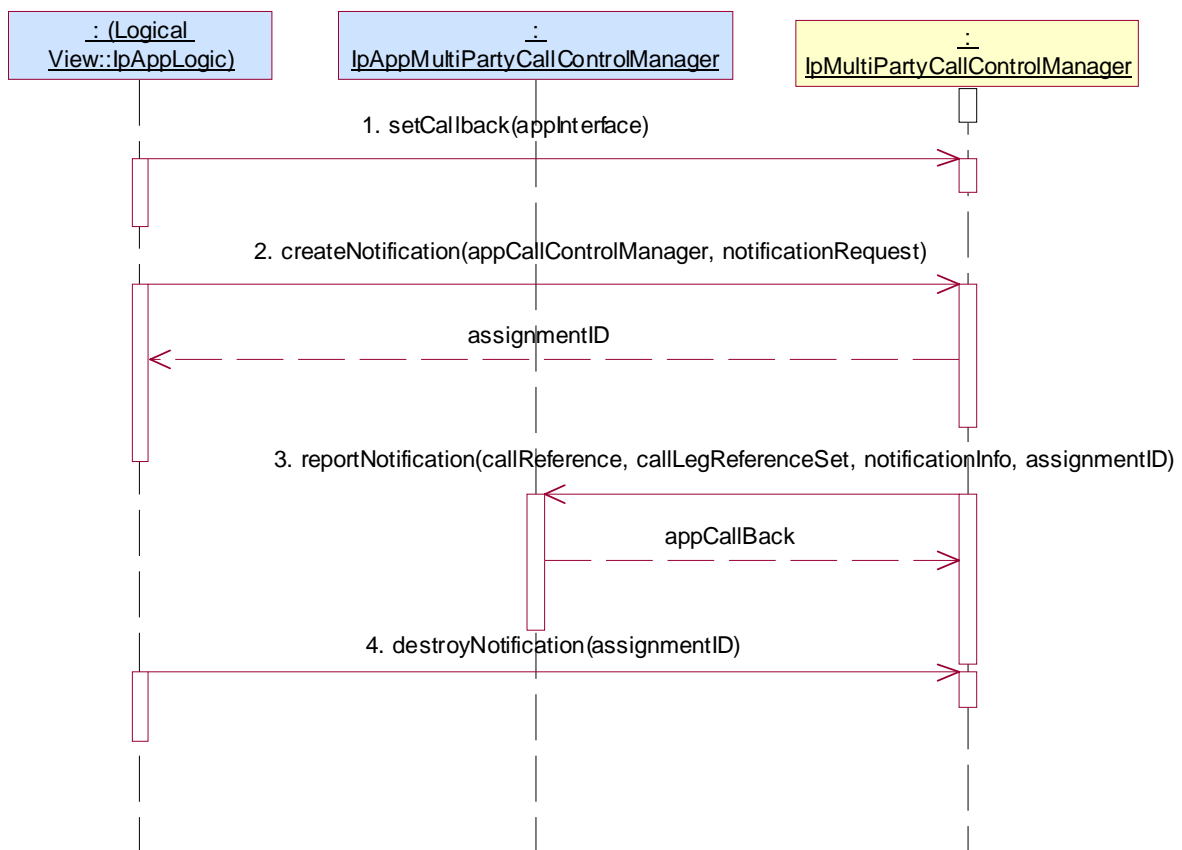

Test MPCC_IpMultiPartyCallControlManager_03

Summary: IpMultiPartyCallControlManager, all mandatory methods, successful

Reference: ES 201 915-4 [1], clause 7.3.1

Preamble: Application has a reference interface used for callbacks

Condition: createCall method is supported

Test Sequence:

1. Method call **setCallback()** on IpMultiPartyCallControlManager
Parameters: valid, non-null, value of appInterface parameter
Check: no exception is returned
2. Method call **createCall()**
Parameters: valid appCall
Check: valid value of TpMultiPartyCallIdentifier is returned

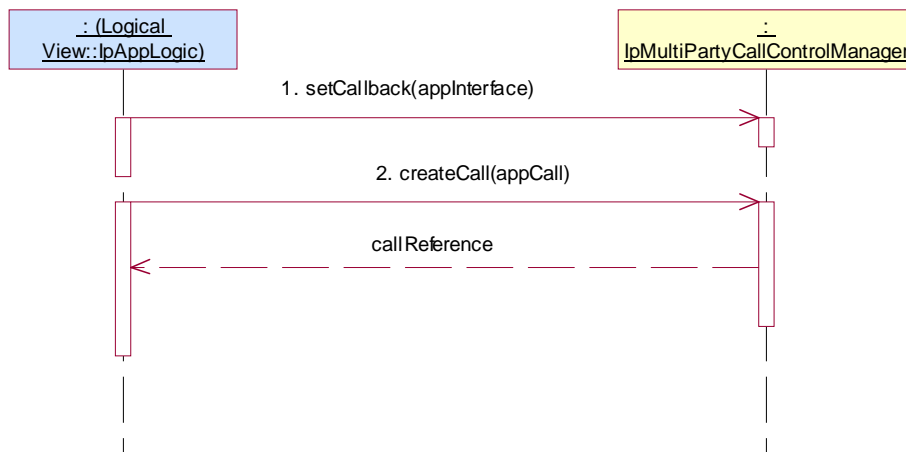

5.2.2.1.2 Mandatory, invalid behaviour

Test MPCC_IpMultiPartyCallControlManager_04

Summary: IpMultiPartyCallControlManager, createNotification, P_INVALID_CRITERIA

Reference: ES 201 915-4 [1], clause 7.3.1

Condition: createNotification method is supported

Test Sequence:

1. Method call **createNotification()**
Parameters: appCallControlManager with null value, invalid notificationRequest
Check: P_INVALID_CRITERIA is returned

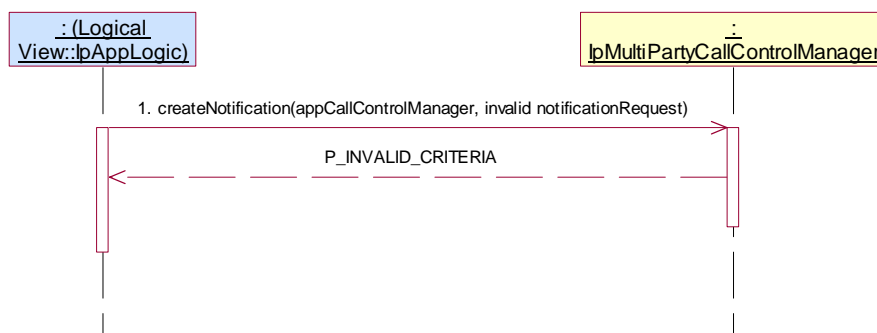

Test MPCC_IpMultiPartyCallControlManager_05

Summary: IpMultiPartyCallControlManager, destroyNotification, P_INVALID_ASSIGNMENT_ID

Reference: ES 201 915-4 [1], clause 7.3.1

Condition: createNotification and destroyNotification methods are supported

Test Sequence:

1. Method call **createNotification()**
 Parameters: appCallControlManager with null value, valid notificationRequest
 Check: valid value of TpAssignmentID is returned
2. Method call **destroyNotification()**
 Parameters: INVALID assignmentID
 Check: P_INVALID_ASSIGNMENT_ID is returned

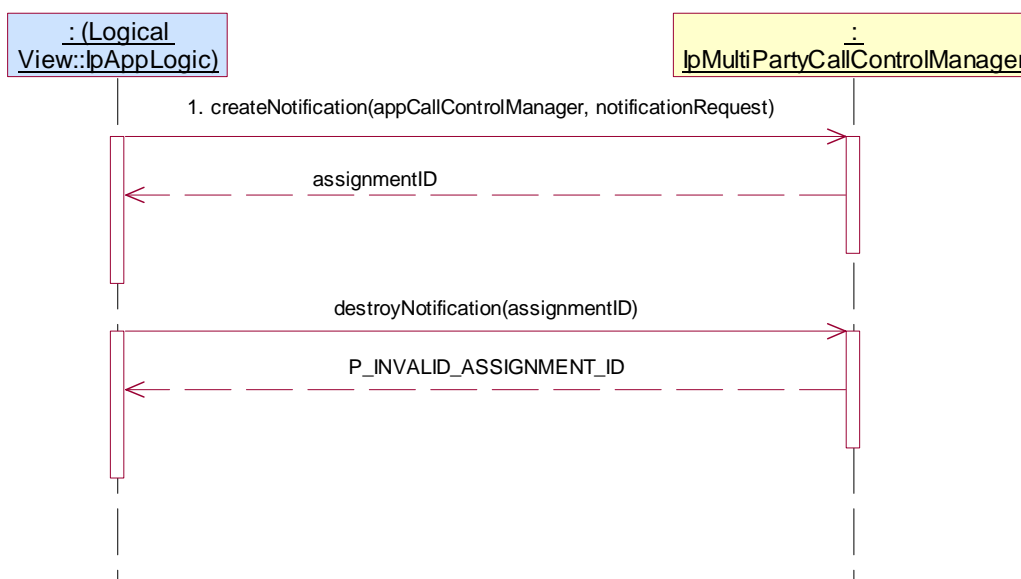

Test MPCC_IpMultiPartyCallControlManager_06

Summary: IpMultiPartyCallControlManager, createCall, P_INVALID_INTERFACE_TYPE

Reference: ES 201 915-4 [1], clause 7.3.1

Condition: createCall method is supported

Test Sequence:

1. Method call **createCall()**

Parameters: invalid (not Null) value of appCall

Check: P_INVALID_INTERFACE_TYPE is returned

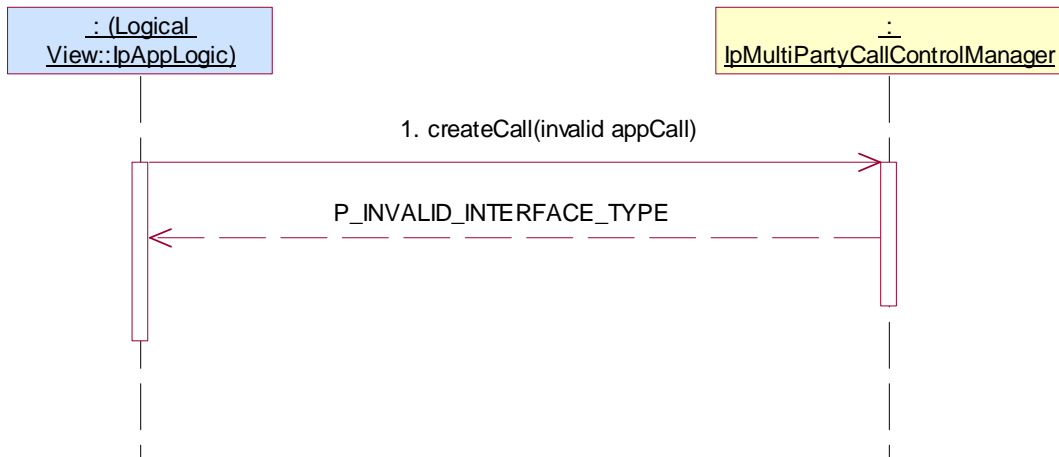

5.2.2.1.3 Optional, valid behaviour

Test MPCC_IpMultiPartyCallControlManager_07

Summary: IpMultiPartyCallControlManager, getNotification, successful

Reference: ES 201 915-4 [1], clause 7.3.1

Condition: getNotification method is supported

Test Sequence:

1. Method call **createNotification()**
 Parameters: appCallControlManager with valid, non-null, value, valid notificationRequest
 Check: valid value of TpAssignmentID is returned
2. Method call **getNotification()**
 Parameters: None
 Check: valid value of TpNotificationRequestedSet is returned where notificationRequest given in 1. is included as a value of this TpCallEventCriteriaResult

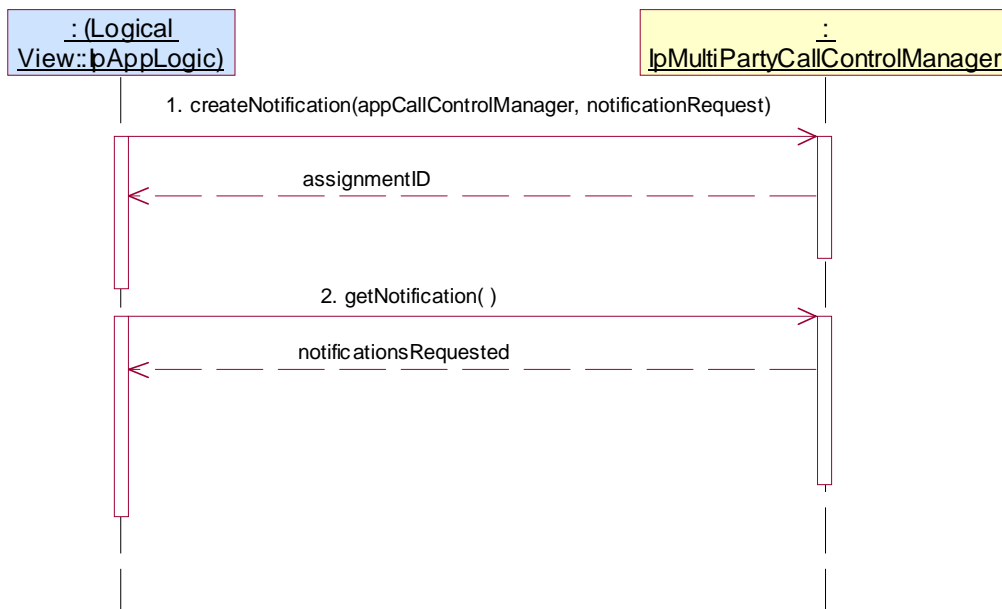

Test MPCC_IpMultiPartyCallControlManager_08

Summary: IpMultiPartyCallControlManager, changeNotification, successful

Reference: ES 201 915-4 [1], clause 7.3.1

Condition: createNotification, getNotification and changeNotification methods are supported

Test Sequence:

1. Method call **createNotification()**
Parameters: appCallControlManager with valid, non-null, value, valid notificationRequest
Check: valid value of TpAssignmentID is returned
2. Method call **getNotification()**
Parameters: None
Check: valid value of TpNotificationRequestedSet is returned where notificationRequest given in 1. is included as a value of this TpCallEventCriteriaResult
3. Method call **changeNotification()**
Parameters: assignmentID returned in 1., valid notificationRequest different from this given in 1.
Check: no exception is returned
4. Method call **getNotification()**
Parameters: None
Check: valid value of TpNotificationRequestedSet is returned where notificationRequest given in 3. is included as a value of this TpCallEventCriteriaResult
5. Method call **destroyNotification()**
Parameters: assignmentID returned in 1.
Check: no exception is returned

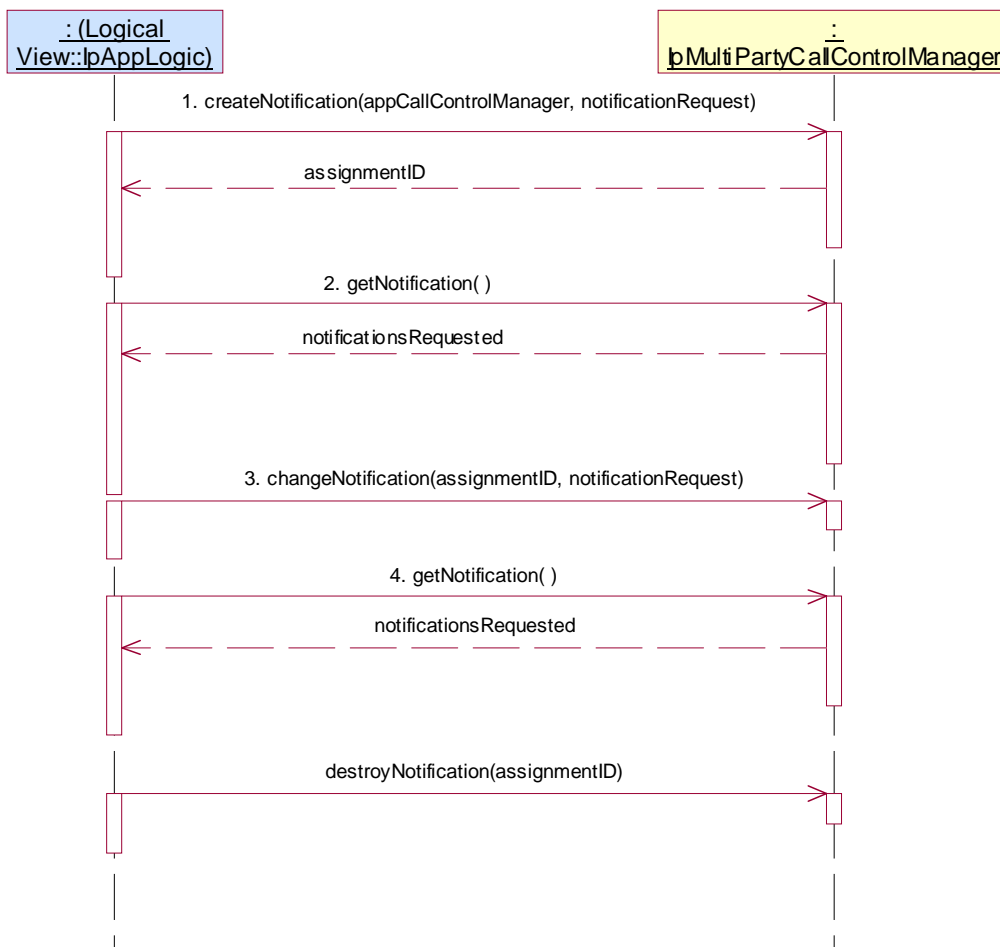

Test MPCC_IpMultiPartyCallControlManager_09

Summary: IpMultiPartyCallControlManager, all methods, successful

Reference: ES 201 915-4 [1], clause 7.3.1

Condition: createNotification, setCallLoadControl, callOverLoadEncountered and callOverLoadCeased methods are supported

Test Sequence:

1. Method call **createNotification()**
Parameters: appCallControlManager with valid, non-null, value, valid notificationReques
Check: valid value of TpAssignmentID is returned
2. Method call **setCallLoadControl()**
Parameters: valid duration, valid mechanism, valid treatment, valid addressRange
Check: valid value of TpAssignmentID is returned
3. Triggered action: cause IUT to call reportNotification() numerous times during the following sequence, and attempt to provoke an overload condition and then remove it
4. Triggered action: cause IUT to call **callOverLoadEncountered()** method on the tester's (Application) **IpAppMultiPartyCallControlManager** interface
Parameters: valid assignmentID
5. Triggered action: cause IUT to call **callOverLoadCeased()** method on the tester's (Application) **IpAppMultiPartyCallControlManager** interface
Parameters: valid assignmentID

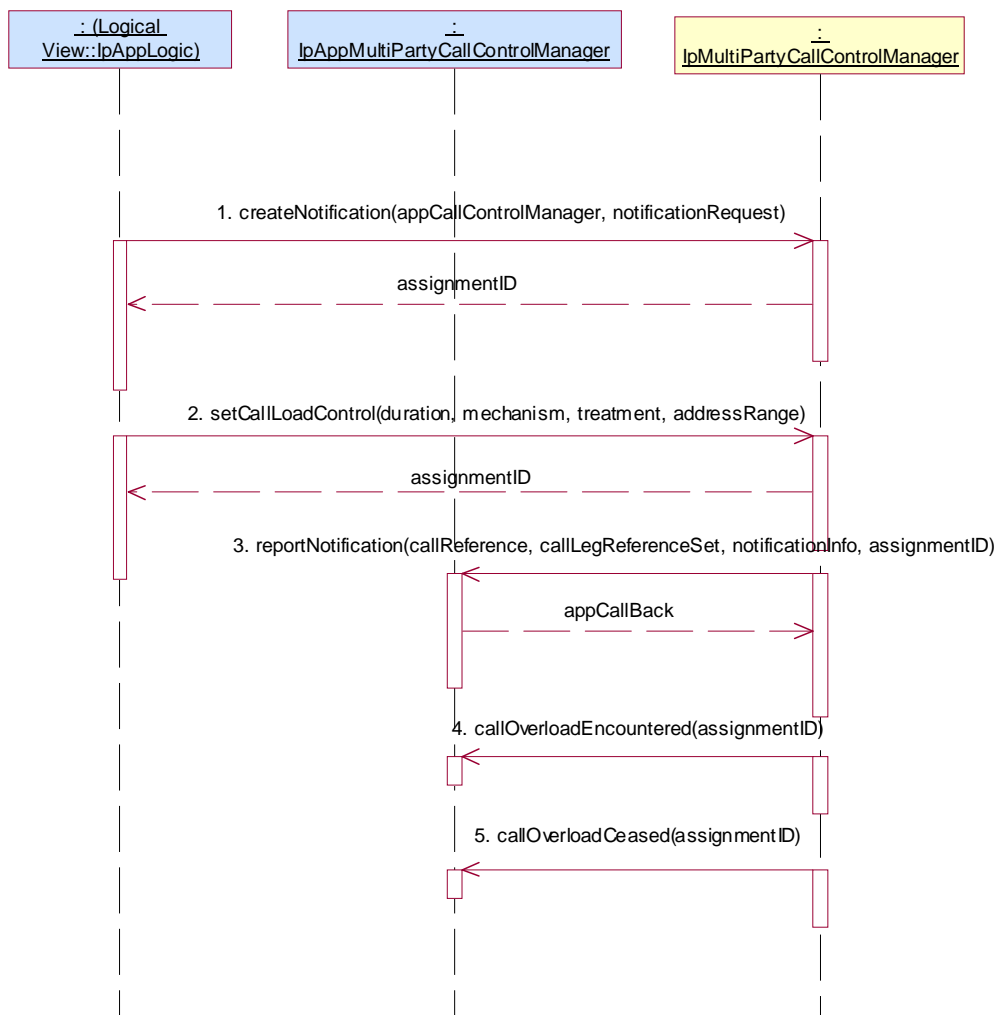

Test MPCC_IpMultiPartyCallControlManager_10

Summary: IpMultiPartyCallControlManager, all methods, successful

Reference: ES 201 915-4 [1], clause 7.3.1

Condition: createNotification, managerInterrupted methods are supported

Test Sequence:

1. Method call **createNotification()**
Parameters: appCallControlManager with valid, not null, value, valid eventCriteria
Check: valid value of TpAssignmentID is returned
2. Triggered action: cause IUT to call **reportNotification()** method on the tester's (Application) **IpAppMultiPartyCallControlManager** interface
3. Triggered action: cause IUT to call **managerInterrupted()** method on the tester's (Application) **IpAppMultiPartyCallControlManager** interface
Parameters: None
4. Triggered action: cause IUT to call **managerResumed()** method on the tester's (Application) **IpAppMultiPartyCallControlManager** interface
Parameters: None

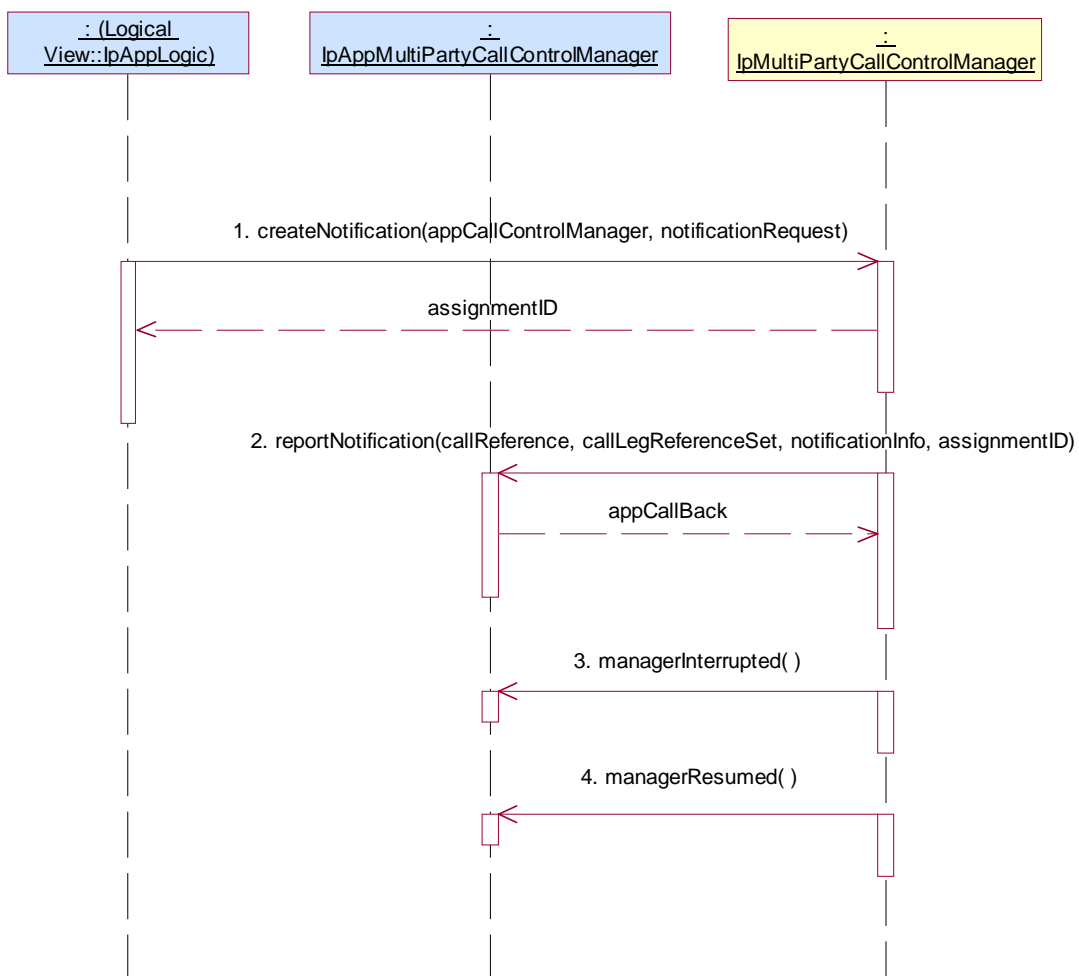

Test MPCC_IpMultiPartyCallControlManager_11

Summary: IpMultiPartyCallControlManager, all methods, successful

Reference: ES 201 915-4 [1], clause 7.3.1

Condition: createNotification and callAborted methods are supported

Test Sequence:

1. Method call **createNotification()**
Parameters: appCallControlManager with valid, not null, value, valid eventCriteria
Check: valid value of TpAssignmentID is returned
2. Triggered action: cause IUT to call **reportNotification()** method on the tester's (Application) **IpAppMultiPartyCallControlManager** interface
3. Triggered action: cause IUT to call **callAborted()** method on the tester's (Application) **IpAppMultiPartyCallControlManager** interface
Parameters: valid callReferences as reported in reportNotification

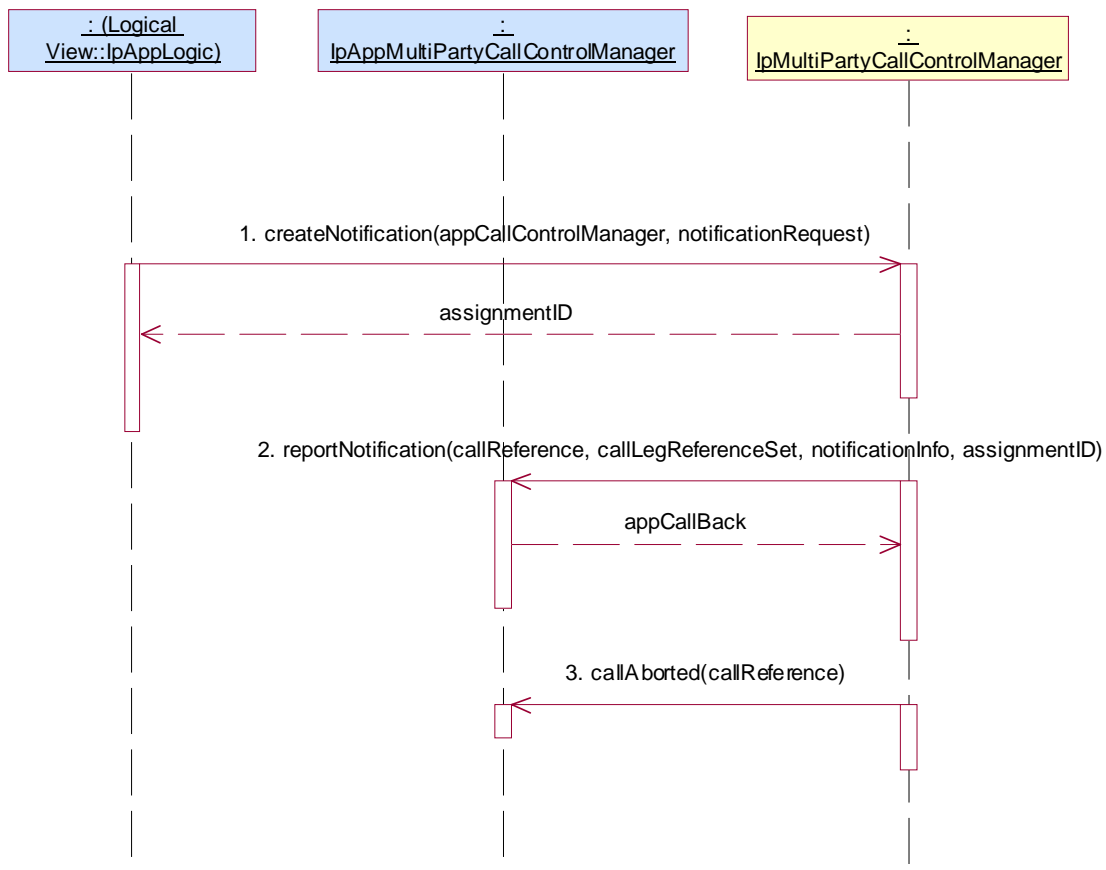

5.2.2.1.4 Optional, invalid behaviour

Test MPCC_IpMultiPartyCallControlManager_12

Summary: IpMultiPartyCallControlManager, changeNotification, P_INVALID_ASSIGNMENT_ID

Reference: ES 201 915-4 [1], clause 7.3.1

Condition: createNotification and changeNotification methods are supported

Test Sequence:

1. Method call **createNotification()**
 Parameters: appCallControlManager with valid, non-null, value, valid notificationRequest
 Check: valid value of TpAssignmentID is returned
2. Method call **changeNotification()**
 Parameters: invalid assignmentID, valid notificationRequest
 Check: P_INVALID_ASSIGNMENT_ID is returned

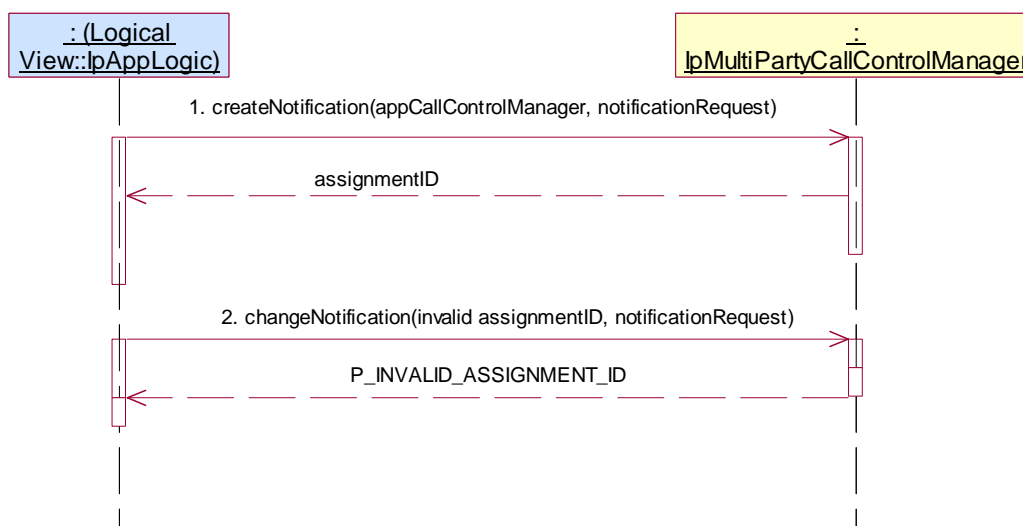

Test MPCC_IpMultiPartyCallControlManager_13

Summary: IpMultiPartyCallControlManager, changeNotification, P_INVALID_CRITERIA

Reference: ES 201 915-4 [1], clause 7.3.1

Preamble: Application has a reference interface used for callbacks

Condition: createNotification and changeNotification methods are supported

Test Sequence:

1. Method call **createNotification()**
 Parameters: appCallControlManager with null value, valid notificationRequest
 Check: valid value of TpAssignmentID is returned
2. Method call **changeNotification()**
 Parameters: assignmentID returned in 1., invalid notificationRequest
 Check: P_INVALID_CRITERIA is returned

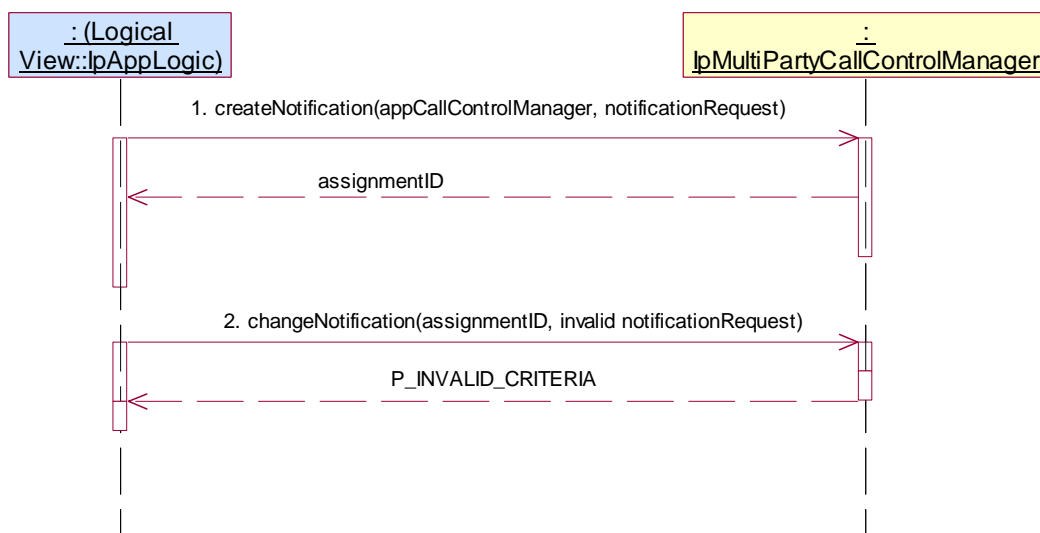

Test MPCC_IpMultiPartyCallControlManager_14

Summary: IpMultiPartyCallControlManager, setCallLoadControl, P_INVALID_ADDRESS

Reference: ES 201 915-4 [1], clause 7.3.1

Condition: createNotification and setCallLoadControl methods are supported

Test Sequence:

1. Method call **createNotification()**
 Parameters: appCallControlManager with valid, non-null, value, valid notificationRequest
 Check: valid value of TpAssignmentID is returned
2. Method call **setCallLoadControl()**
 Parameters: valid duration, valid mechanism, valid treatment, invalid addressRange
 Check: P_INVALID_ADDRESS is returned

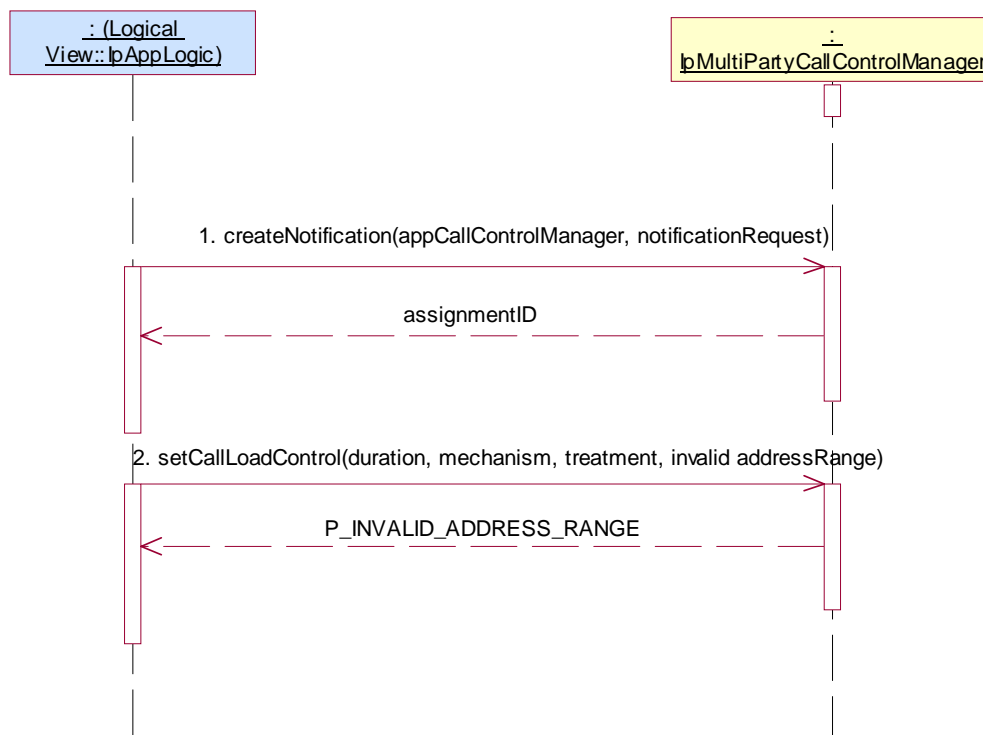

5.2.2.2 IpMultiPartyCall

5.2.2.2.1 Mandatory, valid behaviour

Test MPCC_IpMultiPartyCall_01

Summary: IpMultiPartyCall, all methods mandatory, successful

Reference: ES 201 915-4 [1], clauses 7.3.1 and 7.3.3

Condition: createCall and CreateCallLeg methods are supported

Test sequence:

1. Method call **setCallback()** on IpMultiPartyCallControlManager
Parameters: valid, non-null, value of appInterface parameter
Check: no exception is returned
2. Method call **createCall()**
Parameters: valid appCall
Check: valid value of TpMultiPartyCallIdentifier is returned
3. Method call **createCallLeg()**
Parameters: valid callSessionID returned in 1., valid appCallLeg
Check: valid value of TpCallLegIdentifier is returned

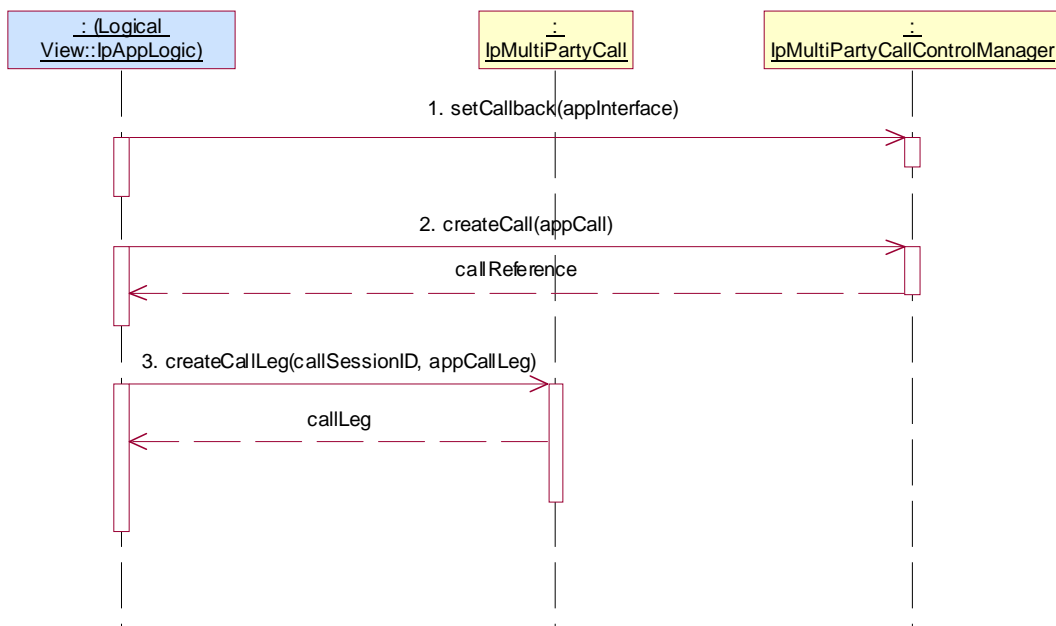

Test MPCC_IpMultiPartyCall_02

Summary: IpMultiPartyCall, all methods mandatory, successful

Reference: ES 201 915-4 [1], clauses 7.3.1 and 7.3.3

Condition: createCall and CreateAndRouteCallLeg methods are supported

Test sequence:

1. Method call **setCallback()** on IpMultiPartyCallControlManager
Parameters: valid, non-null, value of appInterface parameter
Check: no exception is returned
2. Method call **createCall()**
Parameters: valid appCall
Check: valid value of TpMultiPartyCallIdentifier is returned
3. Method call **createAndRouteCallLegReq()**
Parameters: valid callSessionID returned in 2., valid eventsRequested, valid targetAddress, valid originatingAddress, valid appInfo, valid appLegInterface
Check: valid value of TpCallLegIdentifier

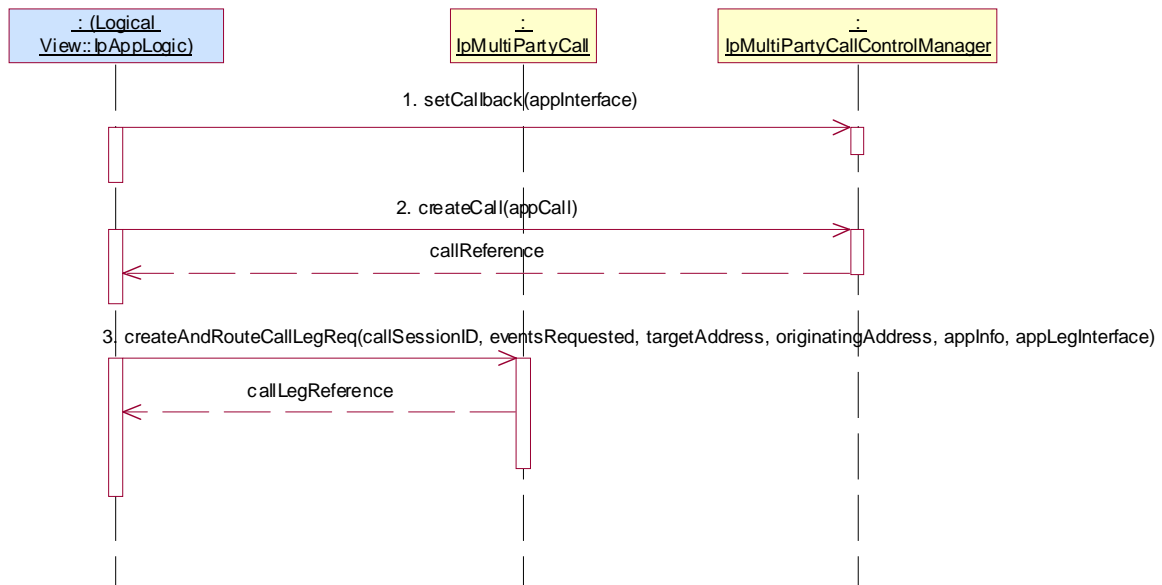

Test MPCC_IpMultiPartyCall_03

Summary: IpMultiPartyCall, all methods mandatory, successful

Reference: ES 201 915-4 [1], clauses 7.3.1 and 7.3.3

Preamble: Application has a valid callSessionID returned by one of the two following sequence:

1. Method call **setCallback()** on IpMultiPartyCallControlManager
Parameters: valid, non-null, value of appInterface parameter
Check: no exception is returned
2. Method call **createCall()**
Parameters: valid appCall
Check: valid value of TpMultiPartyCallIdentifier is returned

either

3. Method call **createCallLeg()**
Parameters: valid callSessionID returned in 2., valid appCallLeg
Check: valid value of TpCallLegIdentifier is returned
4. Method call **eventReportReq()**
Parameters: valid callLegSessionID returned in 1, valid eventsRequested with an Interrupt event
Check: no exception is returned
5. Method call **routeReq()**
Parameters: valid callLegSessionID returned in 3, valid targetAddress, valid originatingAddress, valid appInfo, valid connectionProperties
Check: no exception is returned

or

3. Method call **createAndRouteCallLegReq()**
Parameters: valid callSessionID returned in 2., valid eventsRequested with Interrupt event, valid targetAddress, valid originatingAddress, valid appInfo, valid appLegInterface
Check: valid value of TpCallLegIdentifier

or

1. Method call **createNotification()**
Parameters: appCallControlManager with valid, non-null, value, valid notificationRequest
Check: valid value of TpAssignmentID is returned
2. Triggered action: cause IUT to call Method **reportNotification()** method on the tester's (application) **IpAppMultiPartyCallControlManager** interface
Parameters: callReference, callLegReferenceSet, notificationInfo, assignmentID

either

3. Method call **createCallLeg()**
Parameters: valid callSessionID reported in 2., valid appCallLeg
Check: valid value of TpCallLegIdentifier is returned
4. Method call **eventReportReq()**
Parameters: valid callLegSessionID returned in 1, valid eventsRequested with an Interrupt event
Check: no exception is returned
5. Method call **routeReq()**
Parameters: valid callLegSessionID returned in 3, valid targetAddress, valid originatingAddress, valid appInfo, valid connectionProperties
Check: no exception is returned

or

3. Method call **createAndRouteCallLegReq()**

Parameters: valid callSessionID reported in 2., valid eventsRequested with Interrupt event, valid targetAddress, valid originatingAddress, valid appInfo, valid appLegInterface

Check: valid value of TpCallLegIdentifier

Test Sequence:

1. Method call **release()**

Parameters: valid callSessionID reported in preamble, valid cause

Check: no exception is returned

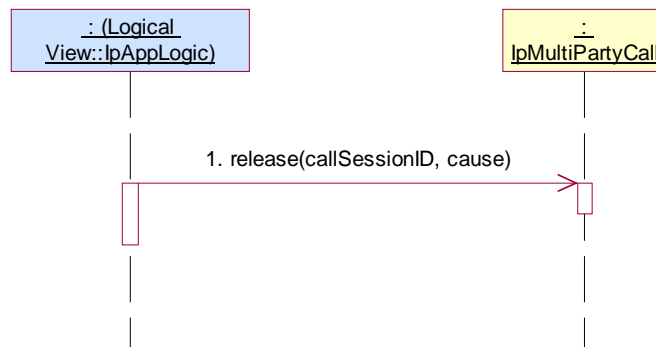
**Test MPCC_IpMultiPartyCall_04**

Summary: IpMultiPartyCall, all methods mandatory, successful

Reference: ES 201 915-4 [1], clauses 7.3.1 and 7.3.3

Preamble: Same as MPCC_IpMultiPartyCall_03

Test Sequence:

1. Method call **deassignCall()**

Parameters: valid callSessionID reported in preamble

Check: no exception is returned

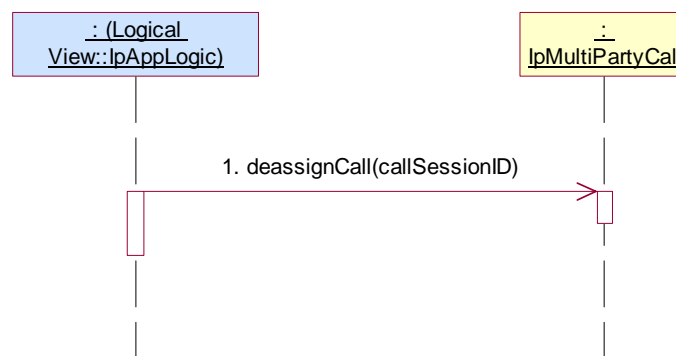

5.2.2.2.2 Mandatory, invalid behaviour

Test MPCC_IpMultiPartyCall_05

Summary: IpMultiPartyCall, deassignCall, P_INVALID_SESSION_ID

Reference: ES 201 915-4 [1], clause 7.3.3

Preamble: Same as MPCC_IpMultiPartyCall_03

Test Sequence:

1. Method call **deassignCall()**
Parameters: invalid callSessionID
Check: P_INVALID_SESSION_ID is returned

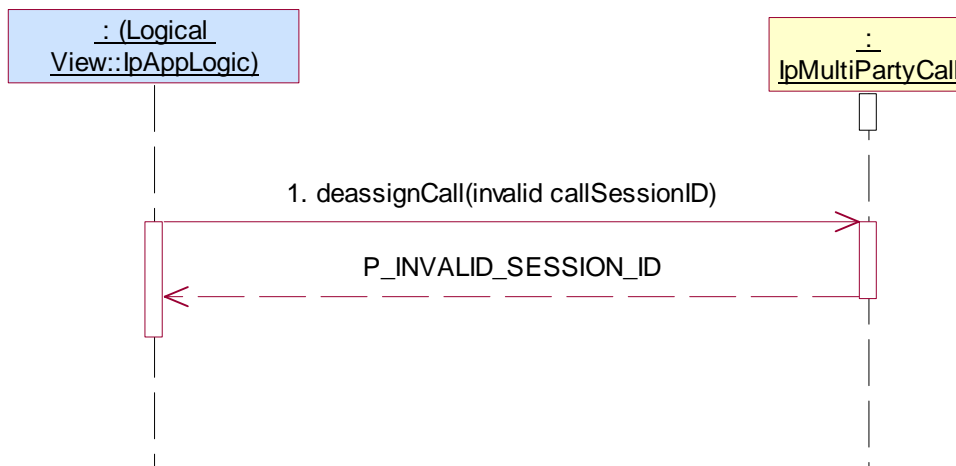

Test MPCC_IpMultiPartyCall_06

Summary: IpMultiPartyCall, release, P_INVALID_SESSION_ID

Reference: ES 201 915-4 [1], clause 7.3.3

Preamble: Same as MPCC_IpMultiPartyCall_03

Test Sequence:

1. Method call **release()**
Parameters: invalid callSessionID, valid cause
Check: P_INVALID_SESSION_ID is returned

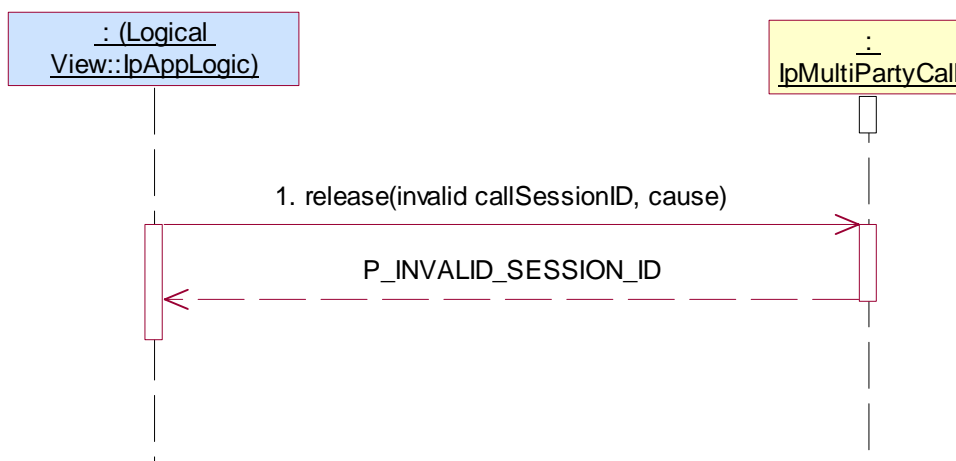

Test MPCC_IpMultiPartyCall_07

Summary: IpMultiPartyCall, createCallLeg, P_INVALID_SESSION_ID

Reference: ES 201 915-4 [1], clause 7.3.3

Preamble: Application has a valid callSessionID returned by one of the two following sequence:

1. Method call **setCallback()** on IpMultiPartyCallControlManager
Parameters: valid, non-null, value of appInterface parameter
Check: no exception is returned
2. Method call **createCall()**
Parameters: valid appCall
Check: valid value of TpMultiPartyCallIdentifier is returned

or

1. Method call **createNotification()**
Parameters: appCallControlManager with valid, non-null, value, valid notificationRequest
Check: valid value of TpAssignmentID is returned
2. Triggered action: cause IUT to call Method **reportNotification()** method on the tester's (application) **IpAppMultiPartyCallControlManager** interface
Parameters: callReference, callLegReferenceSet, notificationInfo, assignmentID

Condition: createCallLeg method is supported

Test Sequence:

1. Method call **createCallLeg()**
Parameters: invalid callSessionID, valid appCallLeg
Check: P_INVALID_SESSION_ID is returned



Test MPCC_IpMultiPartyCall_08

Summary: IpMultiPartyCall, createCallLeg, P_INVALID_INTERFACE_TYPE

Reference: ES 201 915-4 [1], clauses 7.3.1 and 7.3.3

Preamble: Same as MPCC_IpMultiPartyCall_07

Condition: createCallLeg method is supported

Test Sequence:

- Method call **createCallLeg()**
 Parameters: valid callSessionID reported in preamble, invalid (not Null) appCallLeg
 Check: P_INVALID_INTERFACE_TYPE is returned

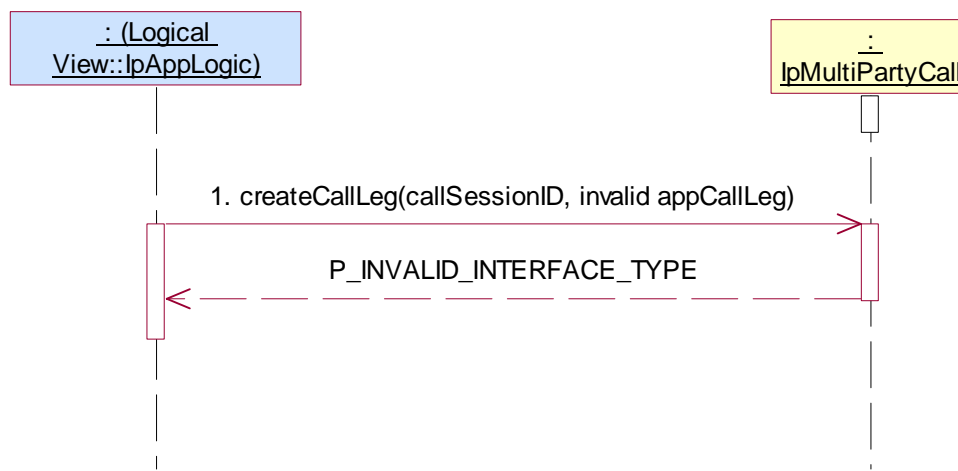
**Test MPCC_IpMultiPartyCall_09**

Summary: IpMultiPartyCall, createAndRouteCallLegReq, P_INVALID_SESSION_ID

Reference: ES 201 915-4 [1], clause 7.3.3

Preamble: Same as MPCC_IpMultiPartyCall_07

Condition: createAndRouteCallLegReq method is supported

Test Sequence:

- Method call **createAndRouteCallLegReq()**
 Parameters: invalid callSessionID, valid eventsRequested, valid targetAddress, valid originatingAddress, valid appInfo, valid appLegInterface
 Check: P_INVALID_SESSION_ID is returned



Test MPCC_IpMultiPartyCall_10

Summary: IpMultiPartyCall, createAndRouteCallLegReq, P_INVALID_INTERFACE_TYPE

Reference: ES 201 915-4 [1], clause 7.3.3

Preamble: Same as MPCC_IpMultiPartyCall_07

Condition: createAndRouteCallLegReq method is supported

Test Sequence:

- Method call **createAndRouteCallLegReq()**
 Parameters: valid callSessionID, valid eventsRequested, valid targetAddress, valid originatingAddress, valid appInfo, invalid (not Null) appLegInterface
 Check: P_INVALID_INTERFACE_TYPE is returned

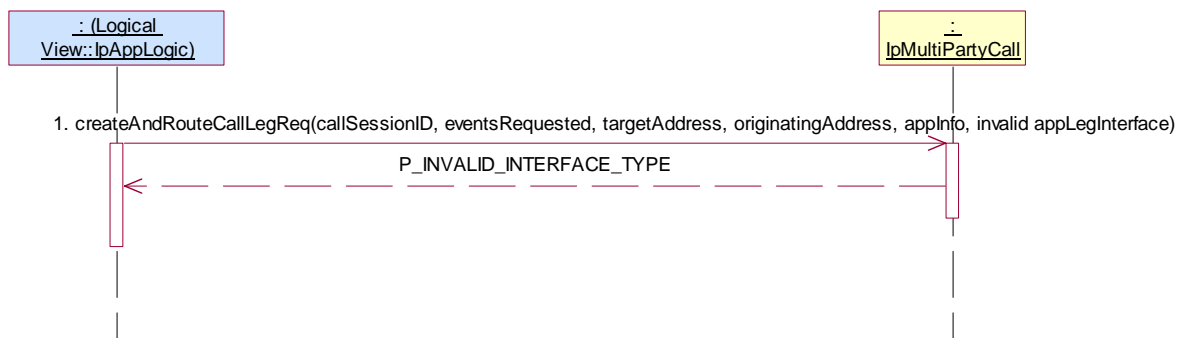
**Test MPCC_IpMultiPartyCall_11**

Summary: IpMultiPartyCall, createAndRouteCallLegReq, P_INVALID_ADDRESS

Reference: ES 201 915-4 [1], clause 7.3.3

Preamble: Same as MPCC_IpMultiPartyCall_07

Condition: createAndRouteCallLegReq method is supported

Test Sequence:

- Method call **createAndRouteCallLegReq()**
 Parameters: valid callSessionID, valid eventsRequested, invalid targetAddress, valid originatingAddress, valid appInfo, valid appLegInterface
 Check: P_INVALID_ADDRESS is returned



Test MPCC_IpMultiPartyCall_12

Summary: IpMultiPartyCall, createAndRouteCallLegReq, P_INVALID_ADDRESS

Reference: ES 201 915-4 [1], clause 7.3.3

Preamble: Same as MPCC_IpMultiPartyCall_07

Condition: createAndRouteCallLegReq method is supported

Test Sequence:

- Method call **createAndRouteCallLegReq()**
 Parameters: valid callSessionID, valid eventsRequested, valid targetAddress, invalid originatingAddress, valid appInfo, valid appLegInterface
 Check: P_INVALID_ADDRESS is returned

**Test MPCC_IpMultiPartyCall_13**

Summary: IpMultiPartyCall, createAndRouteCallLegReq, P_INVALID_CRITERIA

Reference: ES 201 915-4 [1], clause 7.3.3

Preamble: Same as MPCC_IpMultiPartyCall_07

Condition: createAndRouteCallLegReq method is supported

Test Sequence:

- Method call **createAndRouteCallLegReq()**
 Parameters: valid callSessionID, invalid eventsRequested but with valid event type, valid targetAddress, valid originatingAddress, valid appInfo, valid appLegInterface
 Check: P_INVALID_CRITERIA is returned

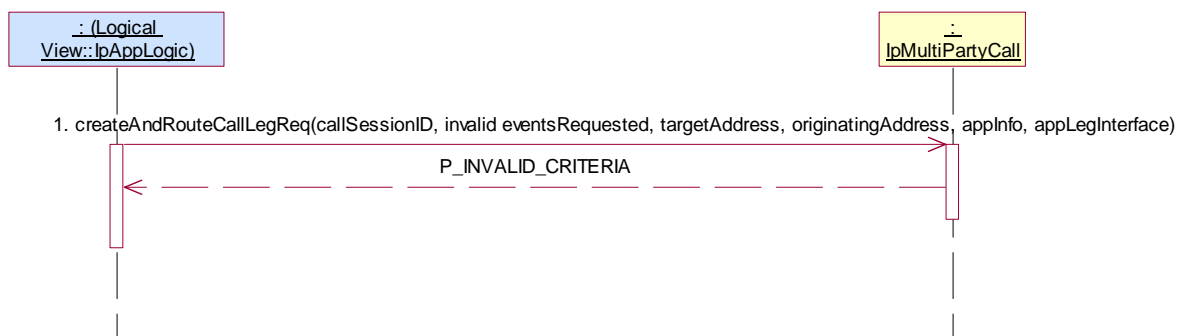

5.2.2.2.3 Optional, valid behaviour

Test MPCC_IpMultiPartyCall_14

Summary: IpMultiPartyCall, getInfoReq, successful

Reference: ES 201 915-4 [1], clauses 7.3.1 and 7.3.3

Preamble: Application has a valid callSessionID returned by one of the two following sequence:

1. Method call **setCallback()** on IpMultiPartyCallControlManager
Parameters: valid, non-null, value of appInterface parameter
Check: no exception is returned
2. Method call **createCall()**
Parameters: valid appCall
Check: valid value of TpMultiPartyCallIdentifier is returned
3. Method call **createCallLeg()**
Parameters: valid callSessionID returned in 2., valid appCallLeg
Check: valid value of TpCallLegIdentifier is returned

or

1. Method call **createNotification()**
Parameters: appCallControlManager with valid, non-null, value, valid notificationRequest
Check: valid value of TpAssignmentID is returned
2. Triggered action: cause IUT to call Method **reportNotification()** method on the tester's (application) **IpAppMultiPartyCallControlManager** interface
Parameters: callReference, callLegReferenceSet, notificationInfo, assignmentID
3. Method call **createCallLeg ()**
Parameters: valid callSessionID reported in 2., valid appCallLeg
Check: valid value of TpCallLegIdentifier is returned

Condition: createCallLeg and getInfoReq methods are supported

Test Sequence:

1. Method call **getInfoReq()**
Parameters: valid callSessionID reported in preamble, valid callInfoRequested
Check: no exception is returned
2. Triggered action: cause IUT to call **getInfoRes()** method on the tester's (Application) **IpAppMultiPartyCall** interface
Parameters: callSessionID given in 1., valid callInfoReport
Check: no exception is returned

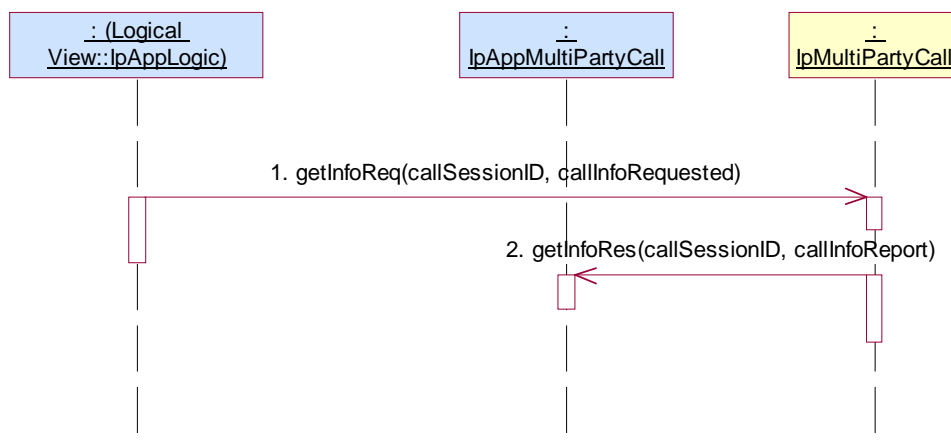

Test MPCC_IpMultiPartyCall_15

Summary: IpMultiPartyCall, setChargePlan, successful

Reference: ES 201 915-4 [1], clauses 7.3.1 and 7.3.3

Preamble: Same as MPCC_IpMultiPartyCall_14

Condition: createCallLeg and setChargePlan methods are supported

Test Sequence:

1. Method call **setChargePlan()**
 Parameters: valid callSessionID reported in preamble, valid callChargePlan
 Check: no exception is returned

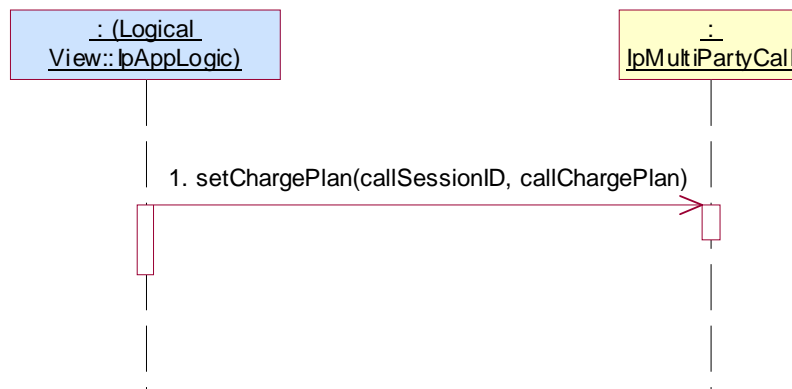
**Test MPCC_IpMultiPartyCall_16**

Summary: IpMultiPartyCall, setAdviceOfCharge, successful

Reference: ES 201 915-4 [1], clauses 7.3.1 and 7.3.3

Preamble: Same as MPCC_IpMultiPartyCall_14

Condition: createCallLeg and setAdviceOfCharge method are supported

Test Sequence:

1. Method call **setAdviceOfCharge()**
 Parameters: valid callSessionID reported in preamble, valid aOCInfo, valid tariffSwitch
 Check: no exception is returned

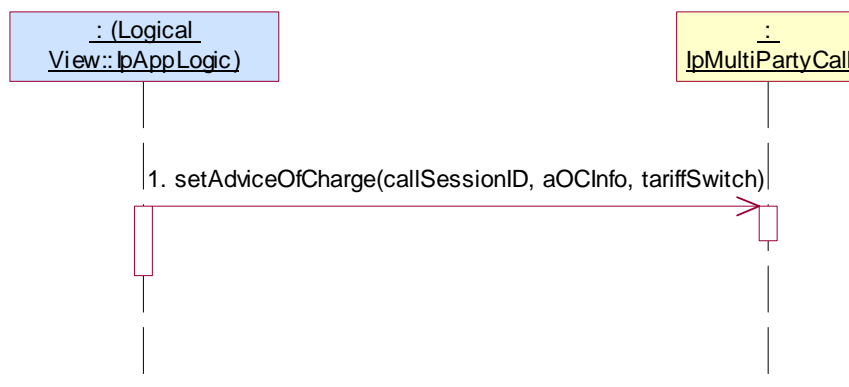

Test MPCC_IpMultiPartyCall _17

Summary: IpMultiPartyCall, superviseReq, successful

Reference: ES 201 915-4 [1], clauses 7.3.1 and 7.3.3

Preamble: Same as MPCC_IpMultiPartyCall _14

Condition: createCallLeg and superviseReq methods are supported

Test Sequence:

1. Method call **superviseReq()**
Parameters: valid callSessionID reported in preamble, valid time, valid treatment
Check: no exception is returned
2. Method call **routeReq()**
Parameters: valid callLegSessionID reported in preamble, valid targetAddress, valid originatingAddress, valid appInfo, valid connectionProperties
Check: no exception is returned
3. Triggered action: cause IUT to call **superviseRes()** method on the tester's (Application) **IpAppMultiPartyCall** interface
Parameters: callSessionID given in preamble, valid report, valid usedTime

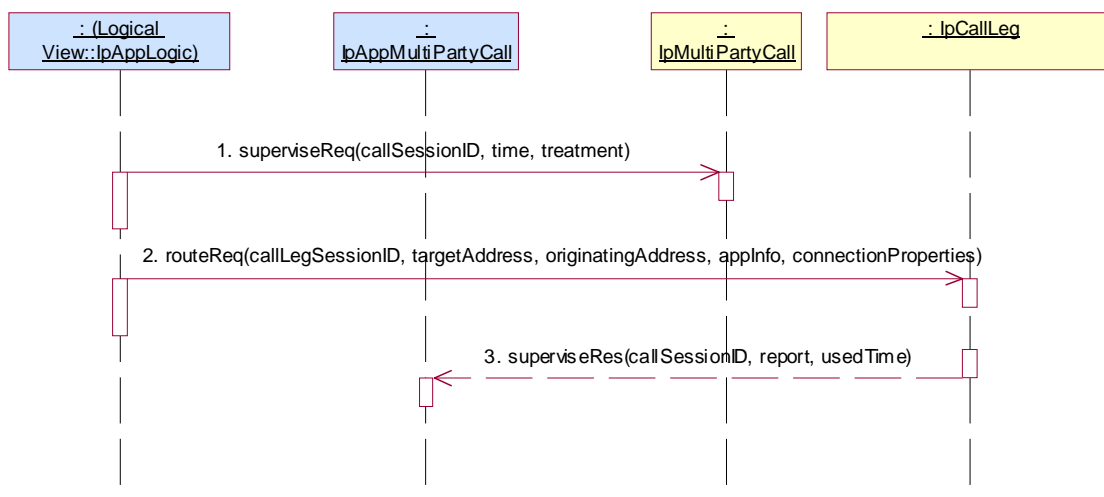

Test MPCC_IpMultiPartyCall_18

Summary: IpMultiPartyCall, getCallLegs, successful

Reference: ES 201 915-4 [1], clauses 7.3.1 and 7.3.3

Preamble: Same as MPCC_IpMultiPartyCall_03

Condition: getCallLegs method is supported

Test Sequence:

1. Method call **getCallLegs()**
 Parameters: valid callSessionID reported in preamble
 Check: valid value of TpCallLegIdentifierSet which contains CallLegIdentifier returned in preamble

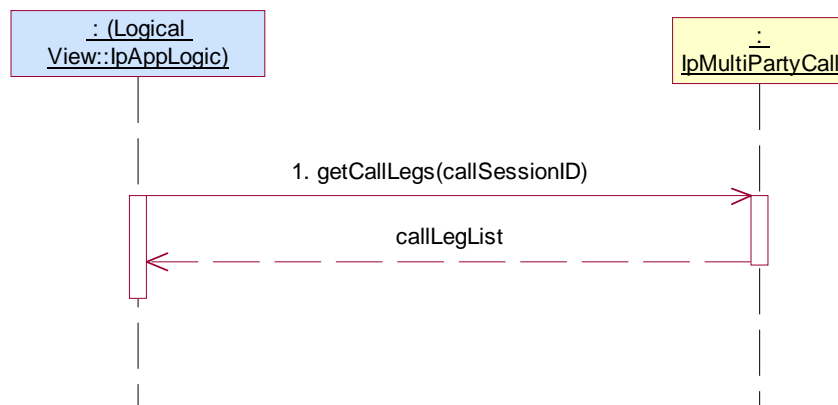
**5.2.2.2.4 Optional, invalid behaviour****Test MPCC_IpMultiPartyCall_19**

Summary: IpMultiPartyCall, getInfoReq, P_INVALID_SESSION_ID

Reference: ES 201 915-4 [1], clauses 7.3.1 and 7.3.3

Preamble: Same as MPCC_IpMultiPartyCall_14

Condition: createCallLeg and getInfoReq methods are supported

Test Sequence:

1. Method call **getInfoReq()**
 Parameters: invalid callSessionID, valid callInfoRequested
 Check: P_INVALID_SESSION_ID is returned



Test MPCC_IpMultiPartyCall_20

Summary: IpMultiPartyCall, setChargePlan, P_INVALID_SESSION_ID

Reference: ES 201 915-4 [1], clauses 7.3.1 and 7.3.3

Preamble: Same as MPCC_IpMultiPartyCall_14

Condition: createCallLeg and setChargePlan methods are supported

Test Sequence:

1. Method call **setChargePlan()**
 Parameters: invalid callSessionID., valid callChargePlan
 Check: P_INVALID_SESSION_ID is returned

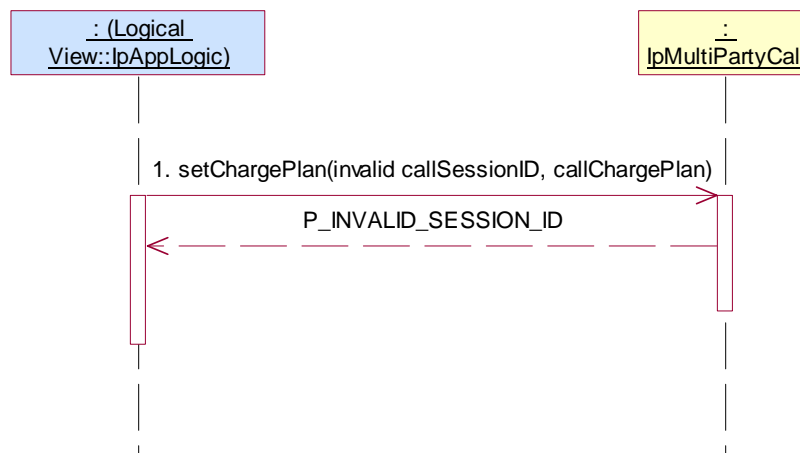
**Test MPCC_IpMultiPartyCall_21**

Summary: IpMultiPartyCall, setAdviceOfCharge, P_INVALID_SESSION_ID

Reference: ES 201 915-4 [1], clauses 7.3.1 and 7.3.3

Preamble: Same as MPCC_IpMultiPartyCall_14

Condition: createCallLeg and setAdviceOfCharge methods are supported

Test Sequence:

1. Method call **setAdviceOfCharge()**
 Parameters: invalid callSessionID, valid aOCInfo, valid tariffSwitch
 Check: P_INVALID_SESSION_ID is returned

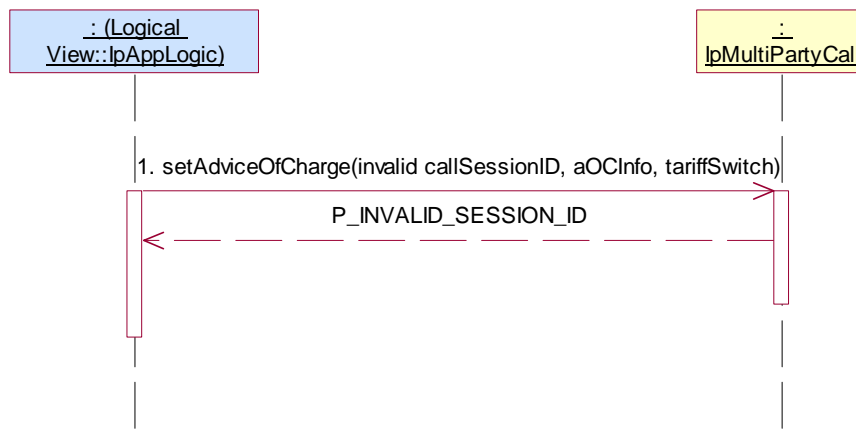

Test MPCC_IpMultiPartyCall_22

Summary: IpMultiPartyCall, setAdviceOfCharge, P_INVALID_CURRENCY

Reference: ES 201 915-4 [1], clauses 7.3.1 and 7.3.3

Preamble: Same as MPCC_IpMultiPartyCall_14

Condition: createCallLeg and setAdviceOfCharge methods are supported

Test Sequence:

- Method call **setAdviceOfCharge()**
 Parameters: valid callSessionID reported in preamble, aOCInfo with invalid currency, valid tariffSwitch
 Check: P_INVALID_CURRENCY is returned.

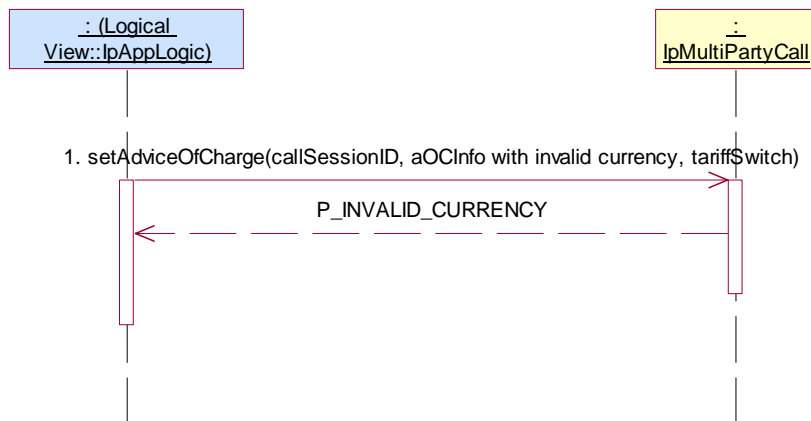
**Test MPCC_IpMultiPartyCall_23**

Summary: IpMultiPartyCall, setAdviceOfCharge, P_INVALID_AMOUNT

Reference: ES 201 915-4 [1], clauses 7.3.1 and 7.3.3

Preamble: Same as MPCC_IpMultiPartyCall_14

Condition: createCallLeg and setAdviceOfCharge methods are supported

Test Sequence:

- Method call **setAdviceOfCharge()**
 Parameters: valid callSessionID reported in preamble, aOCInfo, with invalid amount, valid tariffSwitch
 Check: P_INVALID_AMOUNT is returned

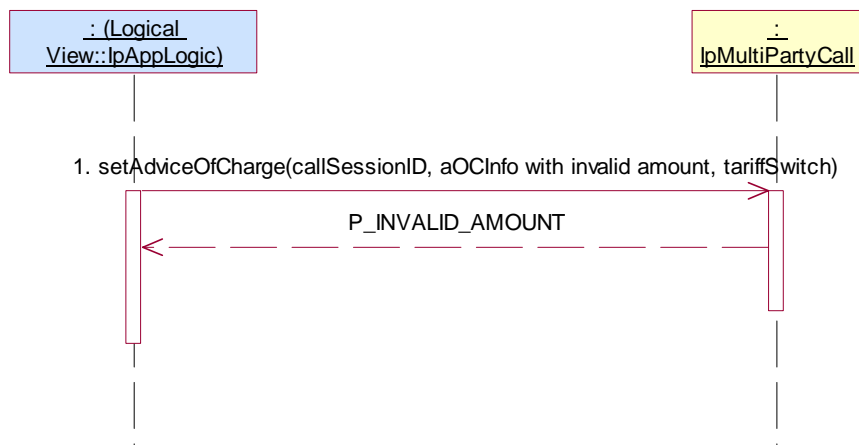

Test MPCC_IpMultiPartyCall_24

Summary: IpMultiPartyCall, superviseReq, P_INVALID_SESSION_ID

Reference: ES 201 915-4 [1], clause 7.3.3

Preamble: Same as MPCC_IpMultiPartyCall_14

Condition: createCallLeg and superviseReq methods are supported

Test Sequence:

1. Method call **superviseReq()**
 Parameters: invalid callSessionID, valid time, valid treatment
 Check: P_INVALID_SESSION_ID is returned

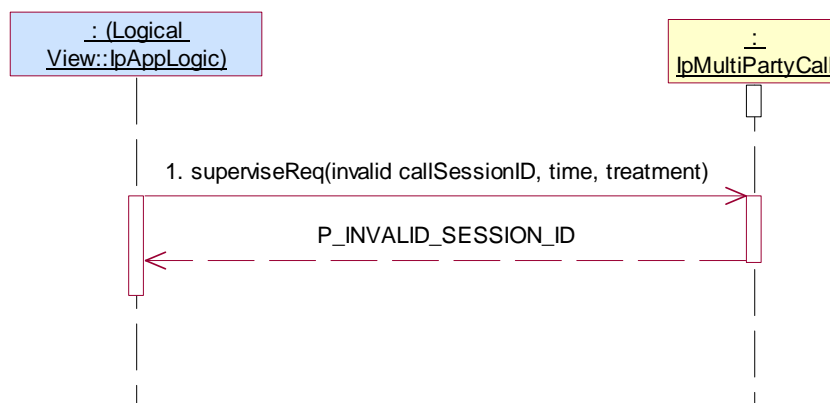
**Test MPCC_IpMultiPartyCall_25**

Summary: IpMultiPartyCall, getCallLegs, P_INVALID_SESSION_ID

Reference: ES 201 915-4 [1], clause 7.3.3

Preamble: Same as MPCC_IpMultiPartyCall_07

Condition: getCallLegs method is supported

Test Sequence:

1. Method call **getCallLegs()**
 Parameters: invalid callSessionID
 Check: P_INVALID_SESSION_ID is returned

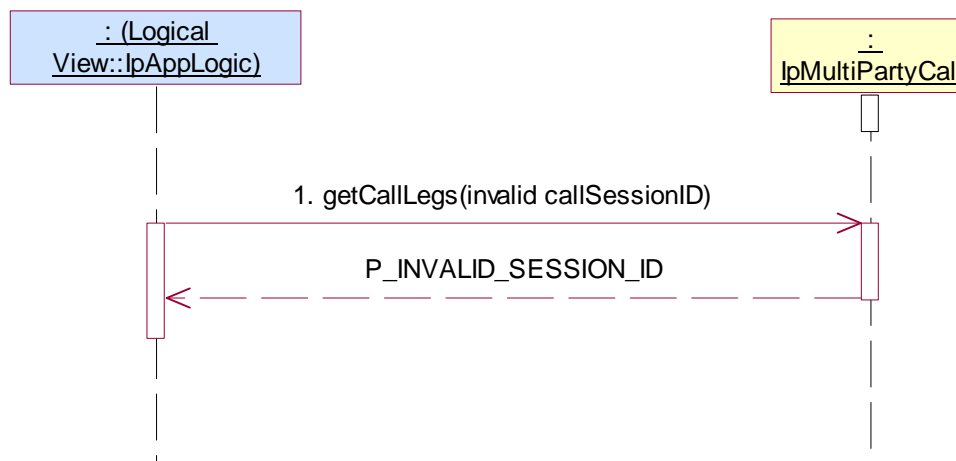

5.2.2.3 IpCallLeg

5.2.2.3.1 Mandatory, valid behaviour

Test MPCC_IpCallLeg_01

Summary: IpCallLeg, all mandatory methods, successful

Reference: ES 201 915-4 [1], clauses 7.3.1, 7.3.3 and 7.3.5

Preamble: Same as MPCC_IpMultiPartyCall_07

Condition: createCallLeg method is supported

Test Sequence:

1. Method call **createCallLeg()**
 Parameters: valid callSessionID reported in preamble, valid appCallLeg
 Check: valid value of TpCallLegIdentifier is returned
2. Method call **eventReportReq()**
 Parameters: valid callLegSessionID returned in 1, valid eventsRequested with an Interrupt event
 Check: no exception is returned
3. Method call **routeReq()**
 Parameters: valid callLegSessionID returned in 1, valid targetAddress, valid originatingAddress, valid appInfo, valid connectionProperties
 Check: no exception is returned
4. Triggered action: cause IUT to interrupted call leg processing with a notification or an event: cause IUT to call **eventReportRes()** method on the tester's (Application) **IpAppCallLeg** interface
 Parameters: callLegSessionID, eventInfo
5. Method call **continueProcessing()**
 Parameters: valid callLegSessionID returned in 1.
 Check: no exception is returned
6. Method call **release()**
 Parameters: valid callLegSessionID returned in 1, valid cause
 Check: no exception is returned

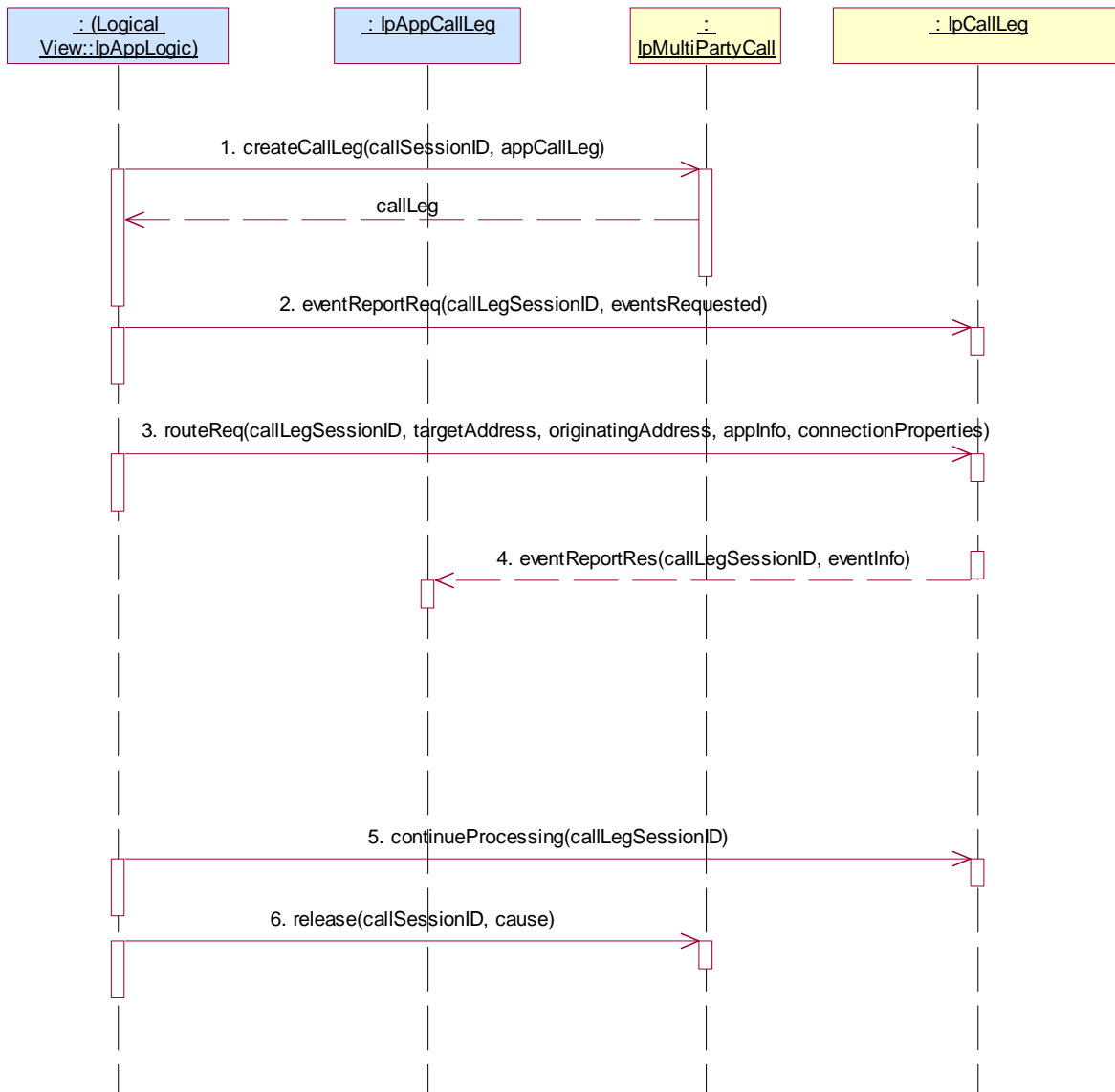

Test MPCC_IpCallLeg_02

Summary: IpCallLeg, all mandatory methods, successful

Reference: ES 201 915-4 [1], clauses 7.3.1, 7.3.3 and 7.3.5

Preamble: Same as MPCC_IpMultiPartyCall_07

Condition: createAndRouteCallLeg method is supported

Test Sequence:

1. Method call **createAndRouteCallLegReq()**
Parameters: valid callSessionID reported in preamble, valid eventsRequested with an Interrupt event, valid targetAddress, valid originatingAddress, valid appInfo, valid appLegInterface
Check: valid value of TpCallLegIdentifier returned
2. Triggered action: cause IUT to interrupt call leg processing with a notification or an event: cause IUT to call **eventReportRes()** method on the tester's (Application) **IpAppCallLeg** interface
Parameters: callLegSessionID, eventInfo
3. Method call **continueProcessing()**
Parameters: valid callLegSessionID returned in 1.
Check: no exception is returned
4. Method call **release()**
Parameters: valid callLegSessionID returned in 1, valid cause
Check: no exception is returned

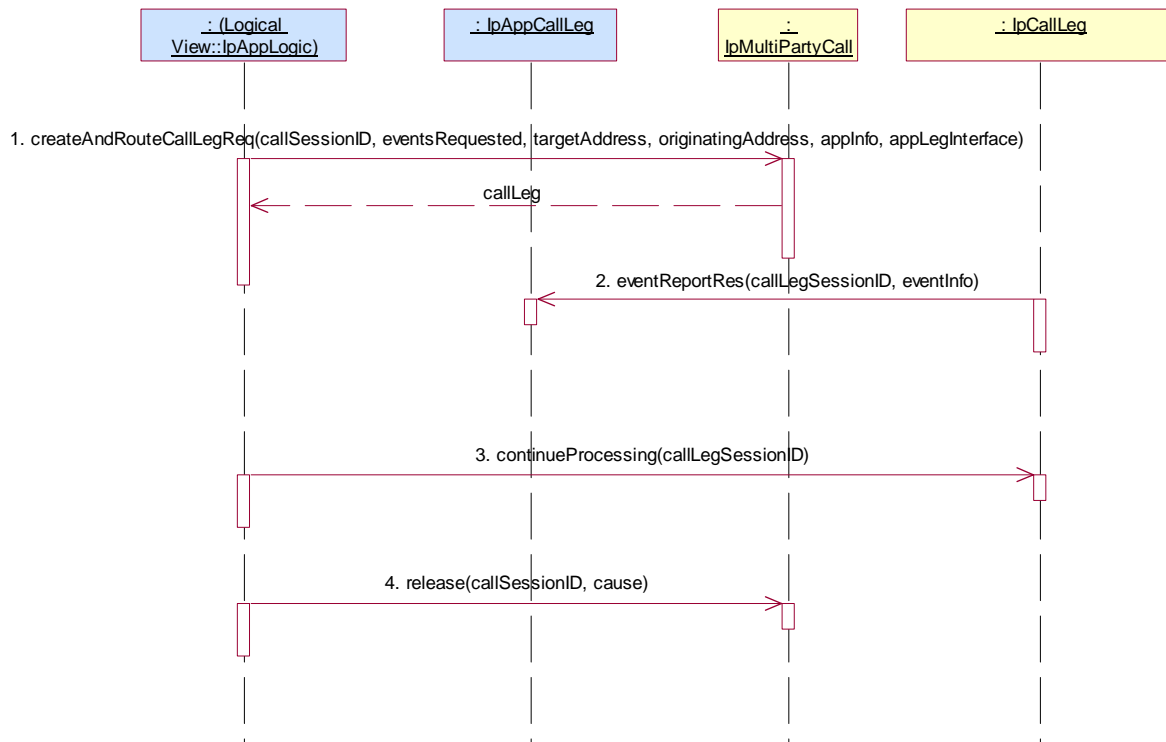

Test MPCC_ IpCallLeg _03

Summary: IpCallLeg, all mandatory methods, successful

Reference: ES 201 915-4 [1], clauses 7.3.1, 7.3.3 and 7.3.5

Preamble: Same as MPCC_ IpMultiPartyCall _03

Test Sequence:

1. Method call **deassign()**
Parameters: valid callLegSessionID returned in preamble
Check: no exception is returned



5.2.2.3.2 Mandatory, invalid behaviour

Test MPCC_IpCallLeg_04

Summary: IpCallLeg, continueProcessing, P_INVALID_SESSION_ID

Reference: ES 201 915-4 [1], clause 7.3.5

Preamble: Same as MPCC_IpMultiPartyCall_03

Test Sequence:

- 1 Triggered action: cause IUT to interrupted call leg processing with a notification or an event: cause IUT to call **eventReportRes()** method on the tester's (Application) **IpAppCallLeg** interface
Parameters: callLegSessionID, eventInfo
2. Method call **continueProcessing()**
Parameters: invalid callLegSessionID
Check: P_INVALID_SESSION_ID is returned

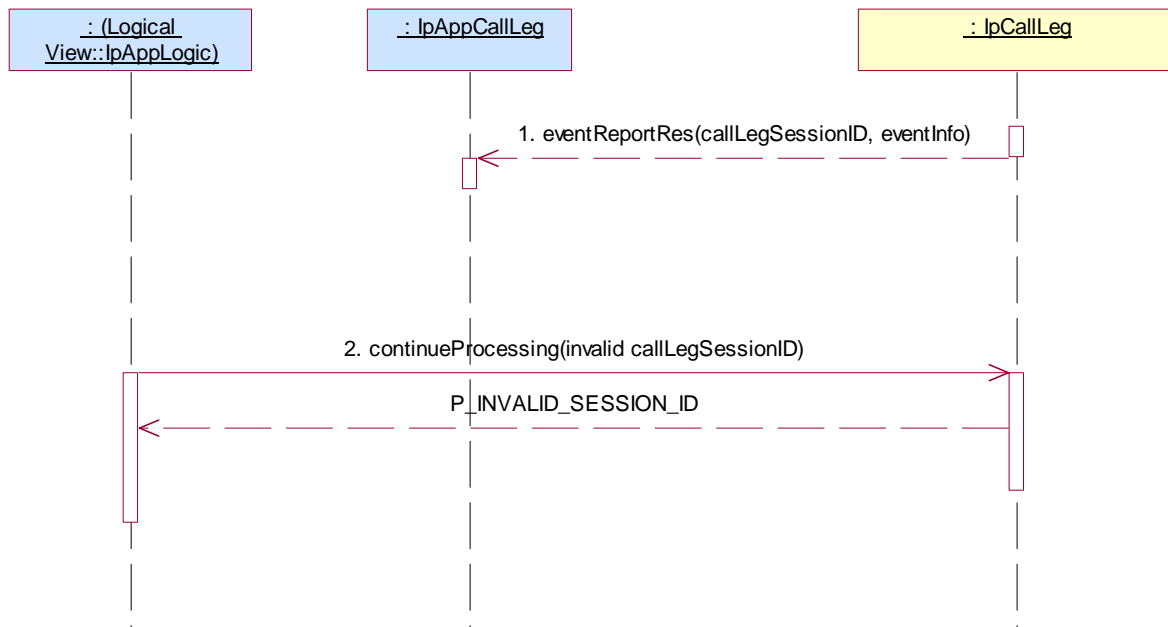

Test MPCC_IpCallLeg_05

Summary: IpCallLeg, routeReq, P_INVALID_SESSION_ID

Reference: ES 201 915-4 [1], clause 7.3.5

Preamble: Same as MPCC_IpMultiPartyCall_14

Condition: createCallLeg method is supported

Test Sequence:

1. Method call **routeReq()**

Parameters: invalid callLegSessionID, valid targetAddress, valid originatingAddress, valid appInfo, valid connectionProperties

Check: P_INVALID_SESSION_ID is returned

**Test MPCC_IpCallLeg_06**

Summary: IpCallLeg, routeReq, P_INVALID_ADDRESS

Reference: ES 201 915-4 [1], clauses 7.3.1, 7.3.3 and 7.3.5

Preamble: Same as MPCC_IpMultiPartyCall_14

Condition: createCallLeg method is supported

Test Sequence:

1. Method call **routeReq()**

Parameters: valid callLegSessionID returned in preamble, invalid targetAddress, valid originatingAddress, valid appInfo, valid connectionProperties

Check: P_INVALID_ADDRESS is returned



Test MPCC_IpCallLeg_07

Summary: IpCallLeg, routeReq, P_INVALID_ADDRESS

Reference: ES 201 915-4 [1], clauses 7.3.1, 7.3.3 and 7.3.5

Preamble: Same as MPCC_IpMultiPartyCall_14

Condition: createCallLeg method is supported.

Test Sequence:

1. Method call **routeReq()**

Parameters: valid callLegSessionID returned in preamble, valid targetAddress, invalid originatingAddress, valid appInfo, valid connectionProperties

Check: P_INVALID_ADDRESS is returned



Test MPCC_IpCallLeg_08

Summary: IpCallLeg, eventReportReq, P_INVALID_SESSION_ID

Reference: ES 201 915-4 [1], clause 7.3.5

Preamble: Same as MPCC_IpMultiPartyCall_07

Condition: createCallLeg and eventReportReq methods are supported

Test Sequence:

1. Method call **eventReportReq()**
Parameters: invalid callLegSessionID, valid eventsRequested
Check: P_INVALID_SESSION_ID is returned



Test MPCC_ IpCallLeg _09

Summary: IpCallLeg, eventReportReq, P_INVALID_CRITERIA

Reference: ES 201 915-4 [1], clauses 7.3.1, 7.3.3 and 7.3.5

Preamble: Same as MPCC_ IpMultiPartyCall _07

Condition: createCallLeg and eventReportReq methods are supported

Test Sequence:

1. Method call **eventReportReq()**
Parameters: valid callLegSessionID returned in preamble, invalid eventsRequested but with valid event type
Check: P_INVALID_CRITERIA is returned

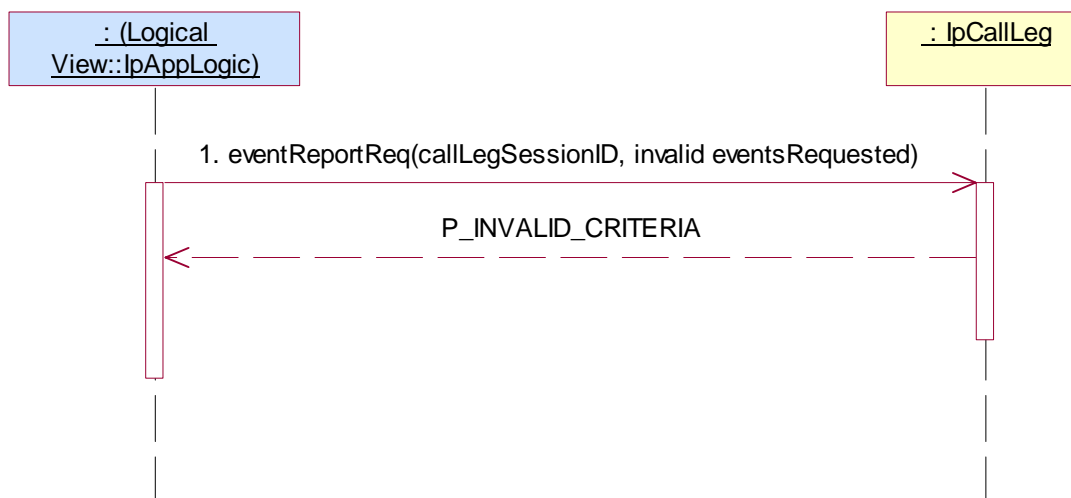

Test MPCC_IpCallLeg_10

Summary: IpCallLeg, release, P_INVALID_SESSION_ID

Reference: ES 201 915-4 [1], clause 7.3.5

Preamble: Same as MPCC_IpMultiPartyCall_03

Test Sequence:

1. Method call **release()**
 Parameters: invalid callLegSessionID, valid cause
 Check: P_INVALID_SESSION_ID is returned

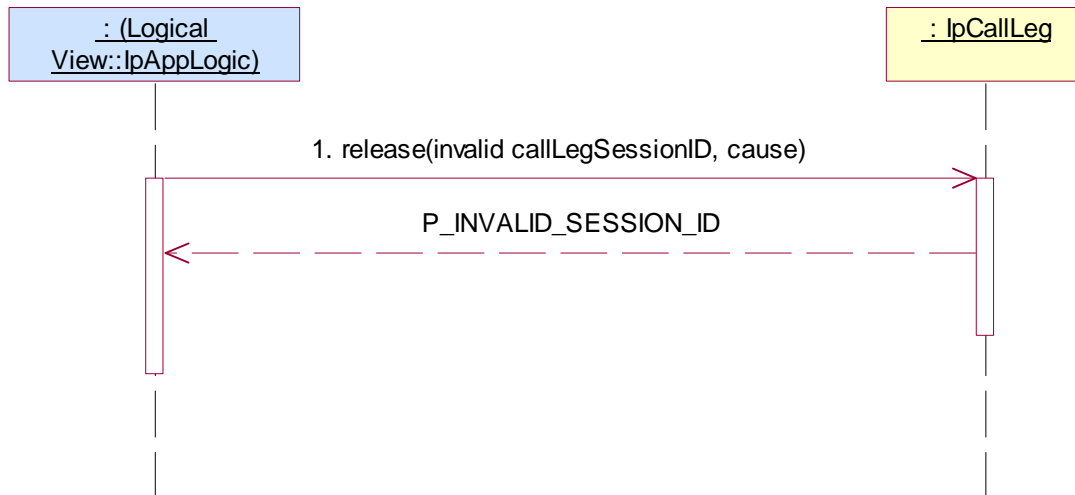
**Test MPCC_IpCallLeg_11**

Summary: IpCallLeg, deassign, P_INVALID_SESSION_ID

Reference: ES 201 915-4 [1], clause 7.3.5

Preamble: Same as MPCC_IpMultiPartyCall_03

Test Sequence:

1. Method call **deassign()**
 Parameters: invalid callLegSessionID
 Check: P_INVALID_SESSION_ID is returned.

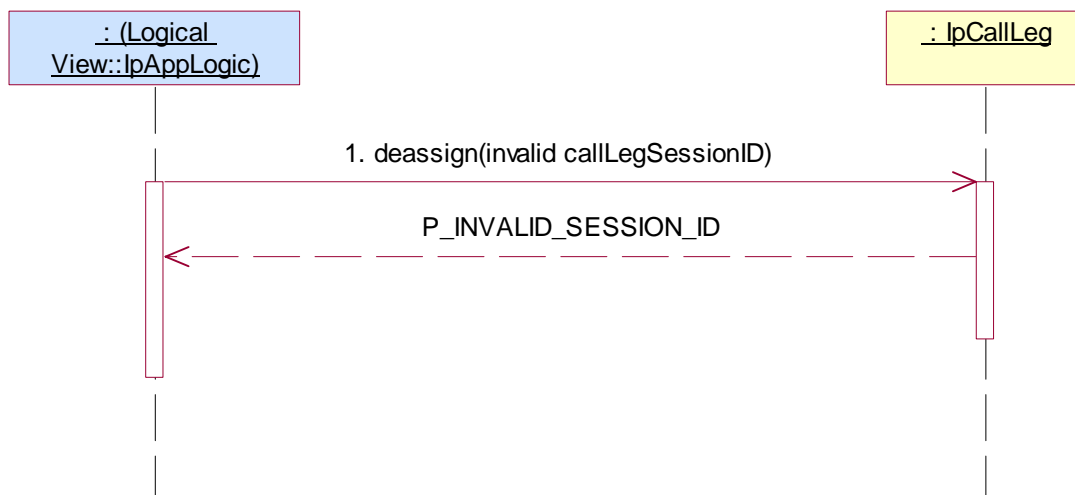

5.2.2.3.3 Optional, valid behaviour

Test MPCC_IpCallLeg_12

Summary: IpCallLeg, getInfoReq, successful

Reference: ES 201 915-4 [1], clauses 7.3.1, 7.3.3 and 7.3.5

Preamble: Same as MPCC_IpMultiPartyCall_14

Condition: createCallLeg and getInfoReq methods are supported

Test Sequence:

1. Method call **getInfoReq()**
Parameters: valid callLegSessionID returned in preamble, valid callLegInfoRequested
Check: no exception is returned
2. Method call **routeReq()**
Parameters: valid callLegSessionID returned in preamble, valid targetAddress, valid appInfo, valid connectionProperties
Check: no exception is returned
- 2 Triggered action: cause IUT to call **getInfoRes()** method on the tester's (Application) **IpAppCallLeg** interface.
Parameters: callLegSessionID given in 1., valid callLegInfoReport.
- 3 Triggered action: cause IUT to call **callLegEnded()** method on the tester's (Application) **IpAppCallLeg** interface.
Parameters: callLegSessionID given in 1, cause

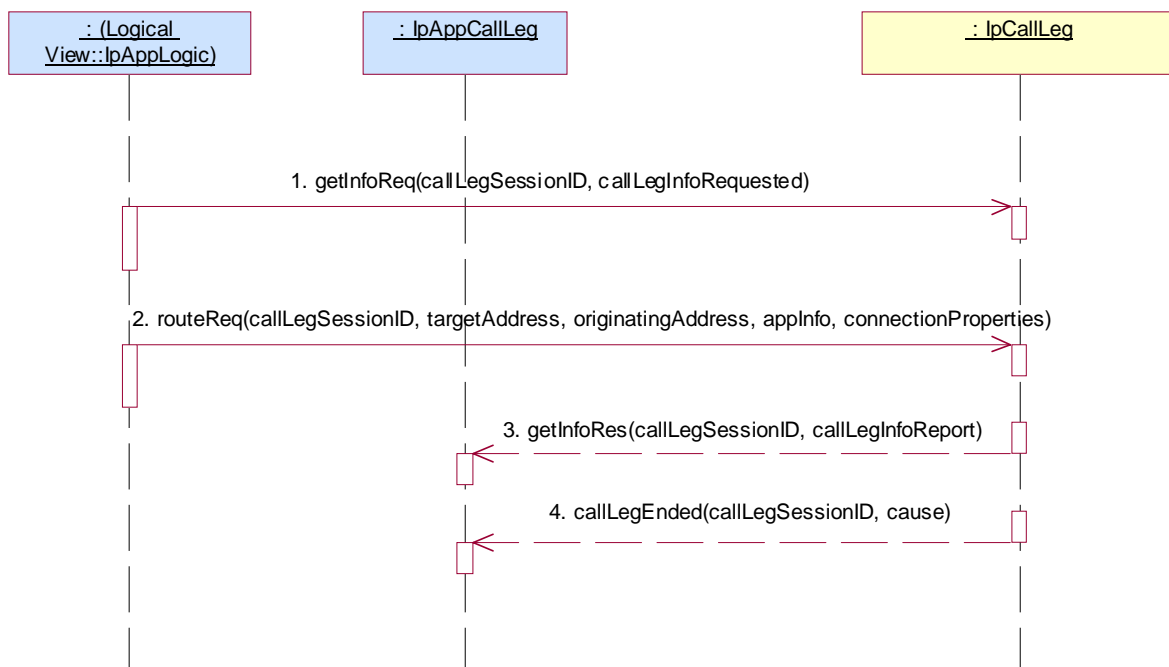

Test MPCC_IpCallLeg_13

Summary: IpCallLeg, attachMediaReq, successful

Reference: ES 201 915-4 [1], clauses 7.3.1, 7.3.3 and 7.3.5

Preamble: Same as MPCC_IpMultiPartyCall_07

Condition: createCallLeg and attachMediaReq methods are supported

Test Sequence:

1. Method call **createCallLeg()**
Parameters: valid callSessionID reported in preamble, valid appCallLeg
Check: valid value of TpCallLegIdentifier is returned
2. Method call **eventReportReq()**
Parameters: valid callLegSessionID returned in 1, valid eventsRequested
Check: no exception is returned
3. Method call **routeReq()**
Parameters: valid callLegSessionID returned in 1, valid targetAddress, valid originatingAddress, valid appInfo, valid connectionProperties set to have explicit media management
Check: no exception is returned
4. Method call **attachMediaReq()**
Parameters: valid callLegSessionID returned in 1.
Check: no exception is returned
5. Triggered action: cause IUT to call **attachMediaRes()** method on the tester's (Application) **IpAppCallLeg** interface.
Parameters: callLegSessionID

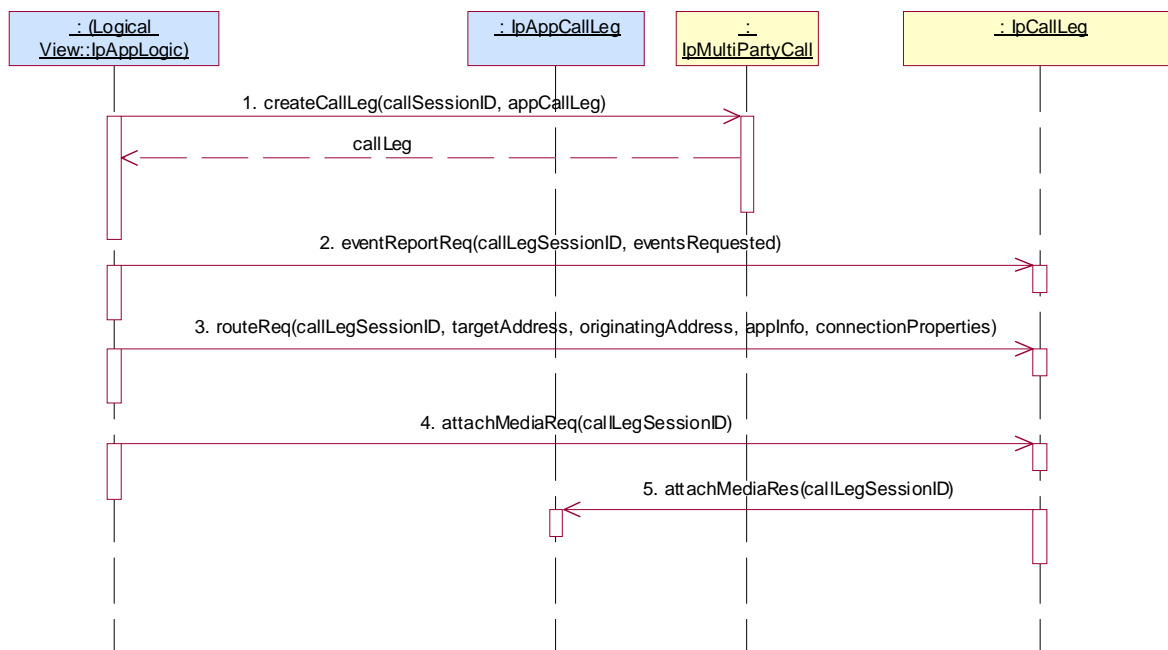

Test MPCC_IpCallLeg_14

Summary: IpCallLeg, detachMediaReq, successful

Reference: ES 201 915-4 [1], clauses 7.3.1, 7.3.3 and 7.3.5

Preamble: Same as MPCC_IpMultiPartyCall_07

Condition: createCallLeg, attachMediaReq and detachMediaReq methods are supported

Test Sequence:

1. Method call **createCallLeg()**
Parameters: valid callSessionID reported in preamble, valid appCallLeg
Check: valid value of TpCallLegIdentifier is returned
2. Method call **eventReportReq()**
Parameters: valid callLegSessionID returned in 1, valid eventsRequested
Check: no exception is returned
3. Method call **routeReq()**
Parameters: valid callLegSessionID returned in 1, valid targetAddress, valid originatingAddress, valid appInfo, valid connectionProperties set to have explicit media management
Check: no exception is returned
4. Method call **attachMediaReq()**
Parameters: valid callLegSessionID returned in 1.
Check: no exception is returned
5. Triggered action: cause IUT to call **attachMediaRes()** method on the tester's (Application) **IpAppCallLeg** interface.
Parameters: callLegSessionID
6. Method call **detachMediaReq()**
Parameters: valid callLegSessionID returned in 1.
Check: no exception is returned
7. Triggered action: cause IUT to call **detachMediaRes()** method on the tester's (Application) **IpAppCallLeg** interface.
Parameters: callLegSessionID

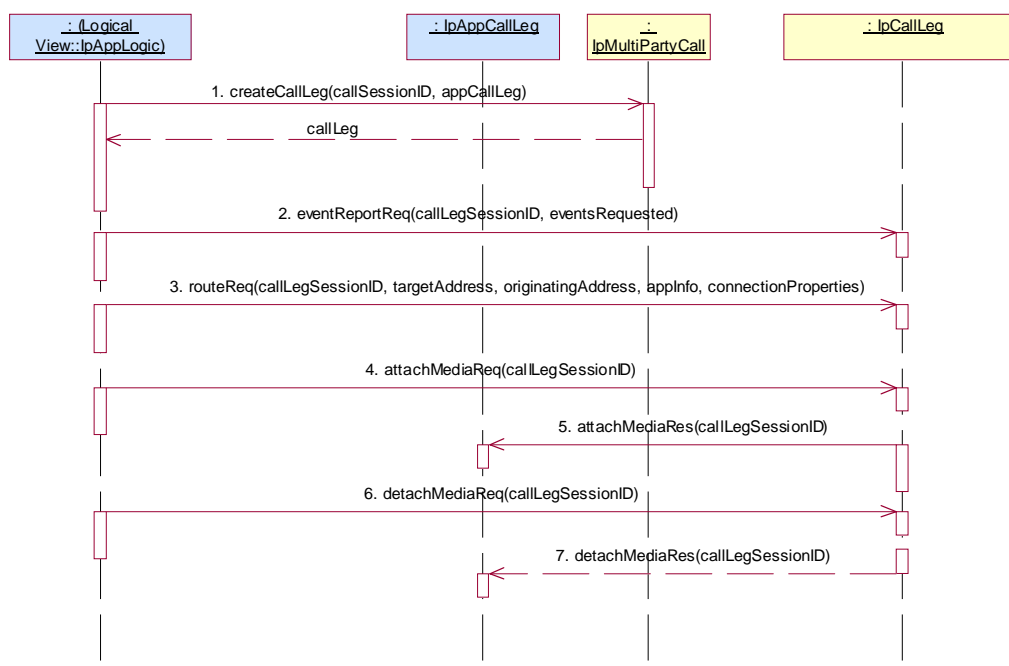

Test MPCC_IpCallLeg_15

Summary: IpCallLeg, getCurrentDestinationAddress, successful

Reference: ES 201 915-4 [1], clauses 7.3.1, 7.3.3 and 7.3.5

Preamble: Same as MPCC_IpMultiPartyCall_03

Condition: getCurrentDestinationAddress method is supported

Test Sequence:

1. Method call **getCurrentDestinationAddress()**
 Parameters: valid callLegSessionID returned in preamble
 Check: valid value of TpAddress is returned

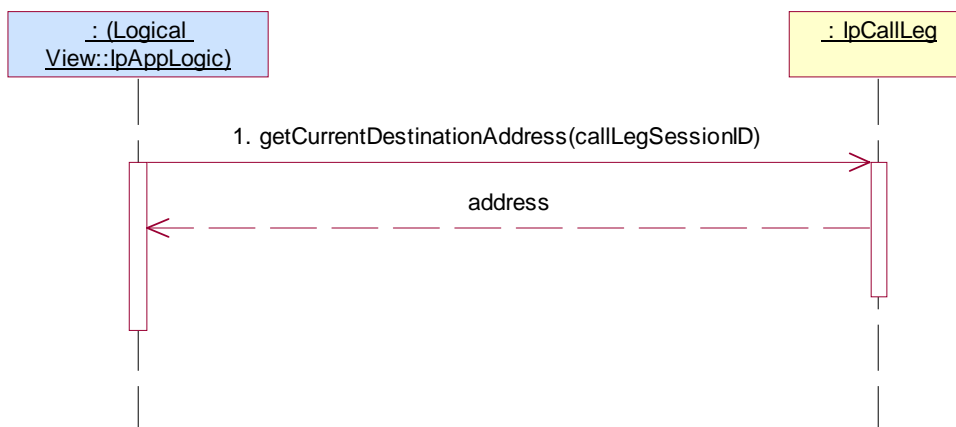
**Test MPCC_IpCallLeg_16**

Summary: IpCallLeg, setChargePlan, successful

Reference: ES 201 915-4 [1], clauses 7.3.1, 7.3.3 and 7.3.5

Preamble: Same as MPCC_IpMultiPartyCall_14

Condition: createCallLeg and setChargePlan methods are supported

Test Sequence:

1. Method call **setChargePlan()**
 Parameters: valid callLegSessionID returned in preamble, valid callChargePlan
 Check: no exception is returned

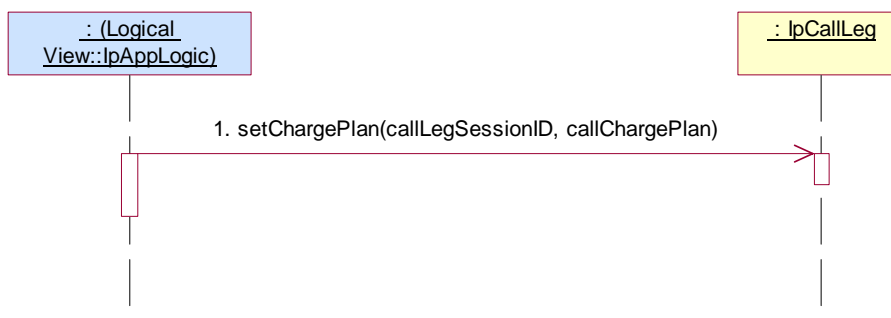

Test MPCC_IpCallLeg_17

Summary: IpCallLeg, setAdviceOfCharge, successful

Reference: ES 201 915-4 [1], clauses 7.3.1, 7.3.3 and 7.3.5

Preamble: Same as MPCC_IpMultiPartyCall_14

Condition: createCallLeg and setAdviceOfCharge methods are supported

Test Sequence:

1. Method call **setAdviceOfCharge()**

Parameters: valid callLegSessionID returned in preamble, valid aOCInfo, valid tariffSwitch

Check: no exception is returned

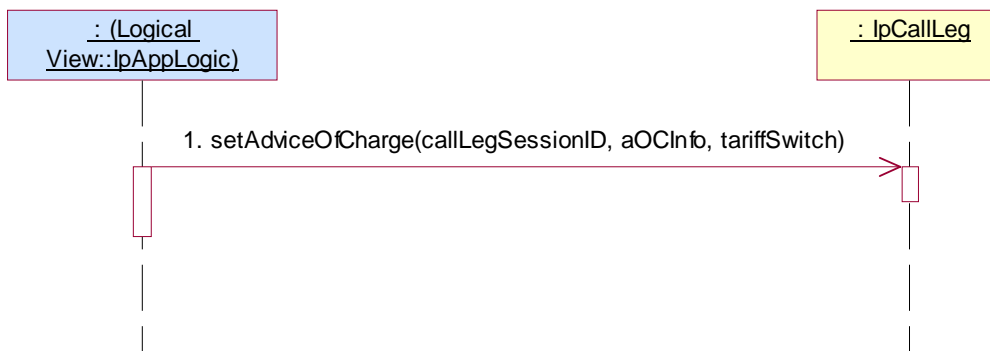

Test MPCC_IpCallLeg_18

Summary: IpCallLeg, superviseReq, successful

Reference: ES 201 915-4 [1], clauses 7.3.1, 7.3.3 and 7.3.5

Preamble: Same as MPCC_IpMultiPartyCall_14

Condition: createCallLeg and superviseReq methods are supported

Test Sequence:

1. Method call **superviseReq()**
 Parameters: valid callLegSessionID returned in preamble, valid time, valid treatment
 Check: no exception is returned
2. Method call **routeReq()**
 Parameters: valid callLegSessionID returned in preamble, valid targetAddress, valid originatingAddress, valid appInfo, valid connectionProperties
 Check: no exception is returned
3. Triggered action: cause IUT to call **superviseRes()** method on the tester's (Application) **IpAppCallLeg** interface.
 Parameters: callLegSessionID, report, usedTime

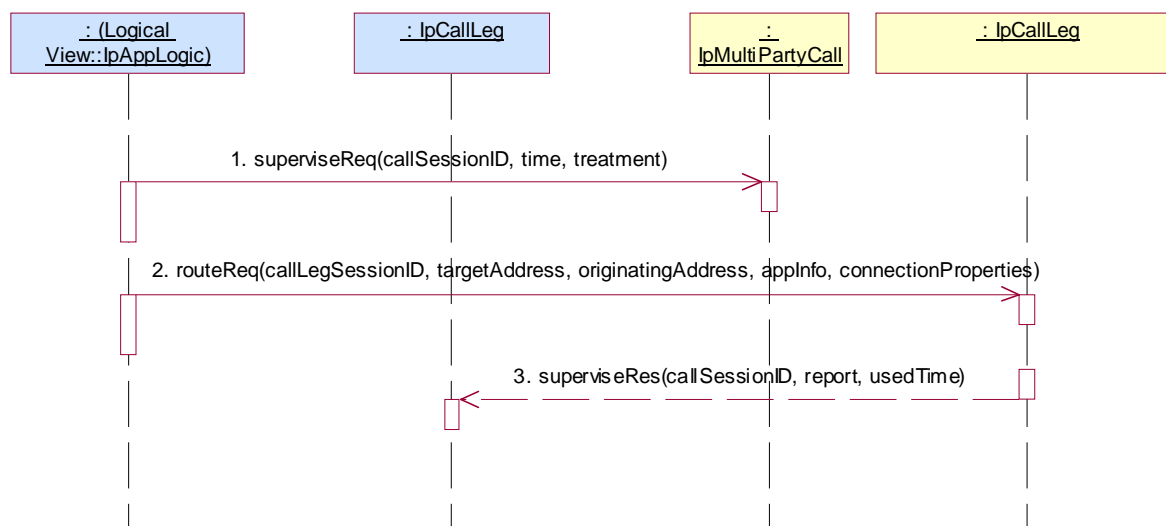

Test MPCC_IpCallLeg_19

Summary: IpCallLeg, getCall, successful

Reference: ES 201 915-4 [1], clauses 7.3.1, 7.3.3 and 7.3.5

Preamble: Same as MPCC_IpMultiPartyCall_03

Condition: getCall method is supported.

Test Sequence:

1. Method call **getCall()**
Parameters: valid callLegSessionID returned in preamble
Check: valid TpMultiPartyCallIdentifier is returned

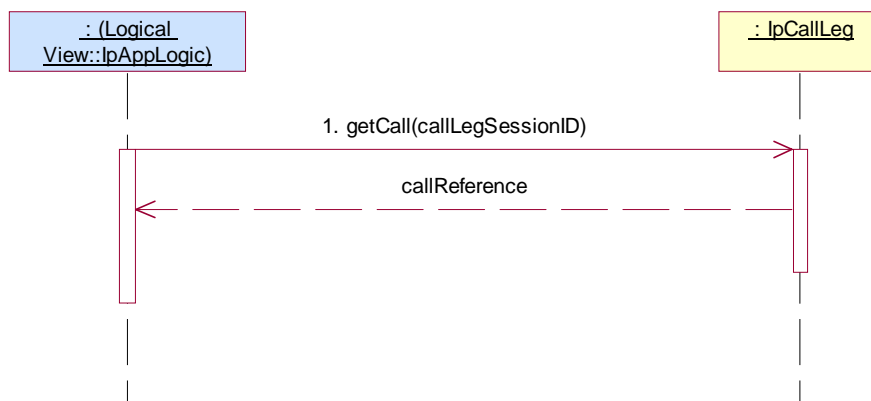

5.2.2.3.4 Optional, invalid behaviour

Test MPCC_IpCallLeg_20

Summary: IpCallLeg, getInfoReq, P_INVALID_SESSION_ID

Reference: ES 201 915-4 [1], clause 7.3.5

Preamble: Same as MPCC_IpMultiPartyCall_14

Condition: createCallLeg and getInfoReq methods are supported

Test Sequence:

1. Method call **getInfoReq()**
Parameters: invalid callLegSessionID, valid callLegInfoRequested
Check: P_INVALID_SESSION_ID is returned



Test MPCC_IpCallLeg_21

Summary: IpCallLeg, attachMediaReq, P_INVALID_SESSION_ID

Reference: ES 201 915-4 [1], clause 7.3.5

Preamble: Same as MPCC_IpMultiPartyCall_25

Condition: attachMediaReq method is supported

Test Sequence:

1. Method call **createCallLeg()**
Parameters: valid callSessionID reported in preamble, valid appCallLeg
Check: valid value of TpCallLegIdentifier is returned
2. Method call **eventReportReq()**
Parameters: valid callLegSessionID returned in 1, valid eventsRequested
Check: no exception is returned
3. Method call **routeReq()**
Parameters: valid callLegSessionID returned in 1, valid targetAddress, valid originatingAddress, valid appInfo, valid connectionProperties set to have explicit media management
Check: no exception is returned
4. Method call **attachMediaReq()**
Parameters: invalid callLegSessionID
Check: P_INVALID_SESSION_ID is returned

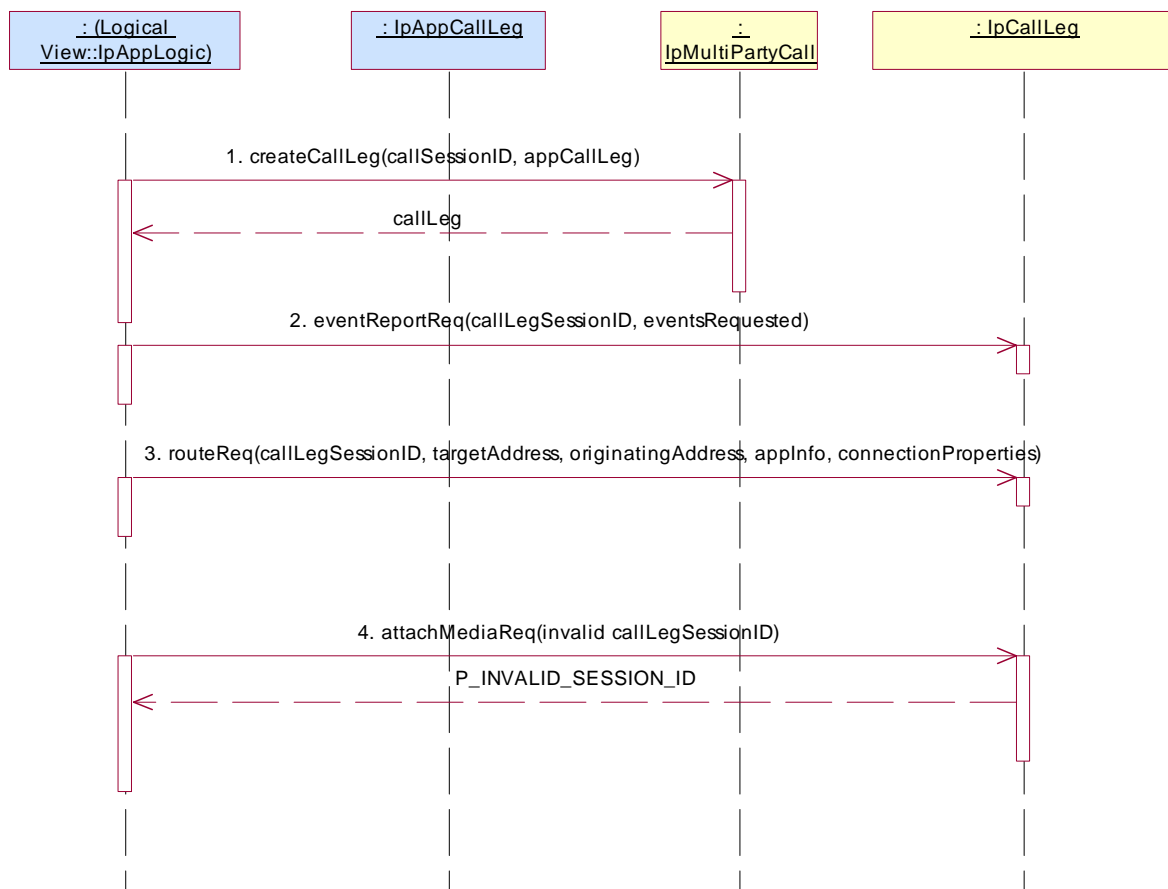

Test MPCC_ IpCallLeg _22

Summary: IpCallLeg, detachMediaReq, P_INVALID_SESSION_ID

Reference: ES 201 915-4 [1], clause 7.3.5

Preamble: Same as MPCC_ IpMultiPartyCall _25

Condition: attachMediaReq and detachMediaReq methods are supported

Test Sequence:

1. Method call **createCallLeg()**
Parameters: valid callSessionID reported in preamble, valid appCallLeg
Check: valid value of TpCallLegIdentifier is returned
2. Method call **eventReportReq()**
Parameters: valid callLegSessionID returned in 1., valid eventsRequested with Interrupt event
Check: no exception is returned
3. Method call **routeReq()**
Parameters: valid callLegSessionID returned in 1., valid targetAddress, valid originatingAddress, valid appInfo, valid connectionProperties set to have explicit media management
Check: no exception is returned
4. Method call **attachMediaReq()**
Parameters: valid callLegSessionID returned in 1.
Check: no exception is returned
5. Triggered action: cause IUT to call **attachMediaRes()** method on the tester's (Application) **IpAppCallLeg** interface
Parameters: callLegSessionID
6. Method call **detachMediaReq()**
Parameters: invalid callLegSessionID
Check: P_INVALID_SESSION_ID is returned

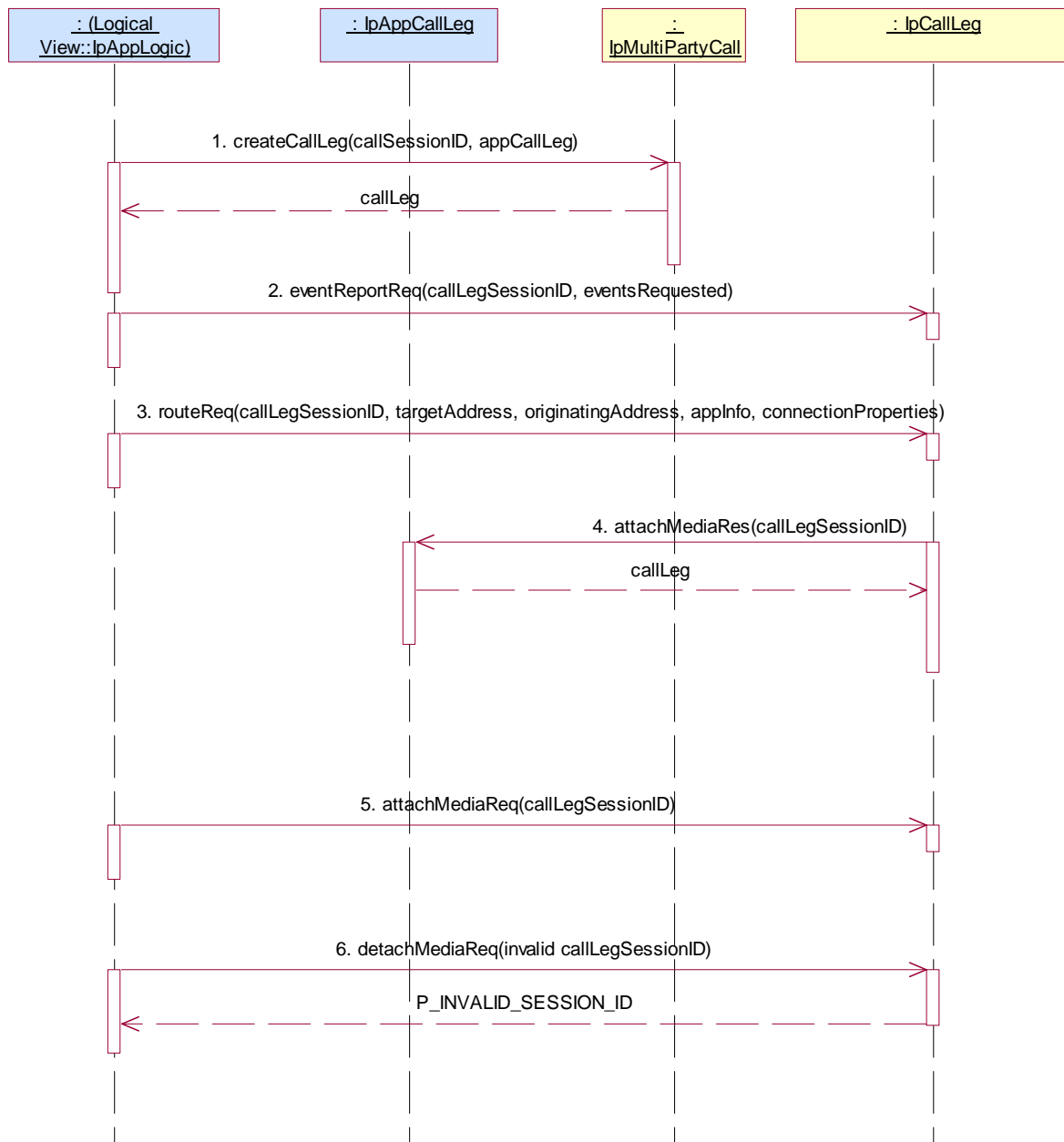

Test MPCC_IpCallLeg_23

Summary: IpCallLeg, getCurrentDestinationAddress, P_INVALID_SESSION_ID

Reference: ES 201 915-4 [1], clause 7.3.5

Preamble: Same as MPCC_IpMultiPartyCall_03

Condition: getCurrentDestinationAddress method is supported

Test Sequence:

- Method call **getCurrentDestinationAddress()**
 Parameters: invalid callLegSessionID
 Check: P_INVALID_SESSION_ID is returned

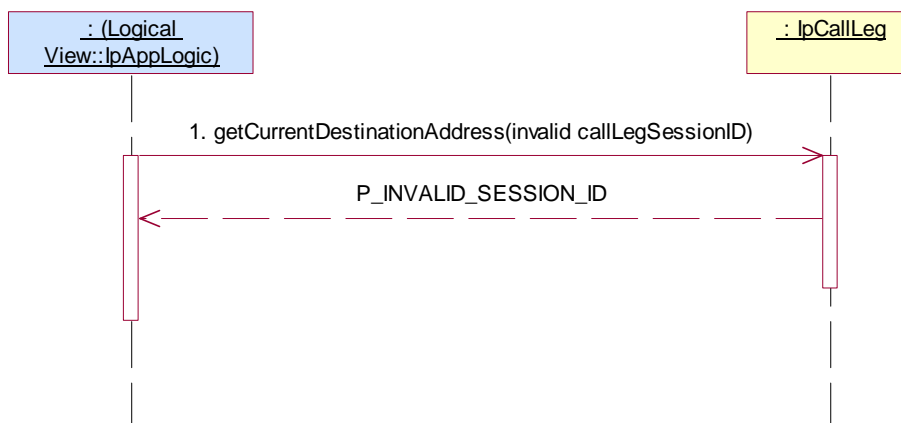
**Test MPCC_IpCallLeg_24**

Summary: IpCallLeg, setChargePlan, P_INVALID_SESSION_ID

Reference: ES 201 915-4 [1], clause 7.3.5

Preamble: Same as MPCC_IpMultiPartyCall_14

Condition: createCallLeg and setChargePlan methods are supported

Test Sequence:

- Method call **setChargePlan()**
 Parameters: invalid callLegSessionID, valid callChargePlan
 Check: P_INVALID_SESSION_ID is returned

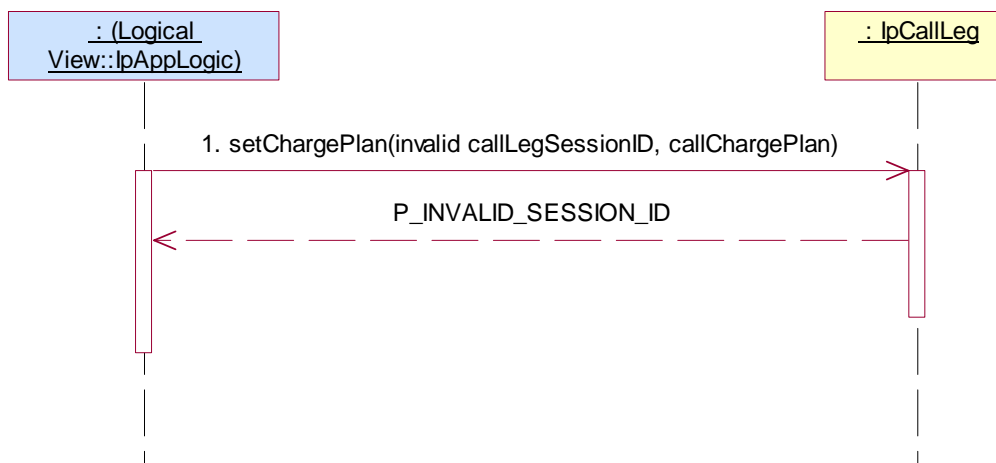

Test MPCC_IpCallLeg_25

Summary: IpCallLeg, setAdviceOfCharge, P_INVALID_SESSION_ID

Reference: ES 201 915-4 [1], clause 7.3.5

Preamble: Same as MPCC_IpMultiPartyCall_14

Condition: createCallLeg and setAdviceOfCharge methods are supported

Test Sequence:

1. Method call **setAdviceOfCharge()**
 Parameters: invalid callLegSessionID, valid aOCInfo, valid tariffSwitch
 Check: P_INVALID_SESSION_ID is returned

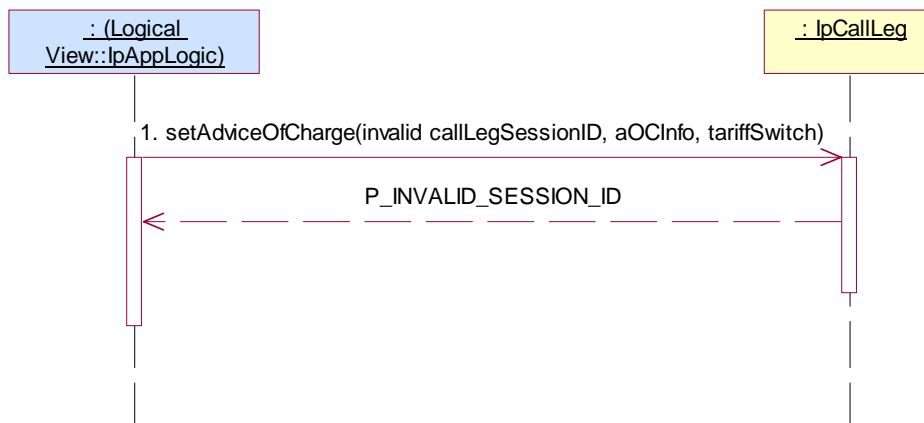
**Test MPCC_IpCallLeg_26**

Summary: IpCallLeg, setAdviceOfCharge, P_INVALID_CURRENCY

Reference: ES 201 915-4 [1], clauses 7.3.1, 7.3.3 and 7.3.5

Preamble: Same as MPCC_IpMultiPartyCall_14

Condition: createCallLeg and setAdviceOfCharge methods are supported

Test Sequence:

1. Method call **setAdviceOfCharge()**
 Parameters: valid callLegSessionID returned in preamble, aOCInfo with invalid currency, valid tariffSwitch
 Check: P_INVALID_CURRENCY is returned

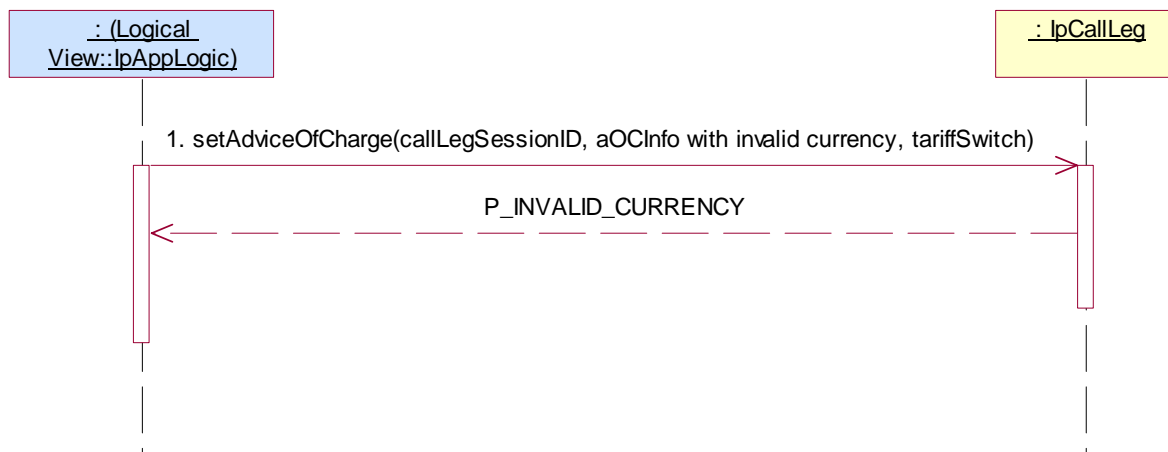

Test MPCC_IpCallLeg_27

Summary: IpCallLeg, setAdviceOfCharge, P_INVALID_AMOUNT

Reference: ES 201 915-4 [1], clauses 7.3.1, 7.3.3 and 7.3.5

Preamble: Same as MPCC_IpMultiPartyCall_14

Condition: createCallLeg and setAdviceOfCharge methods are supported

Test Sequence:

- Method call **setAdviceOfCharge()**
 Parameters: valid callLegSessionID returned in preamble, aOCInfo with invalid amount, valid tariffSwitch
 Check: P_INVALID_AMOUNT is returned

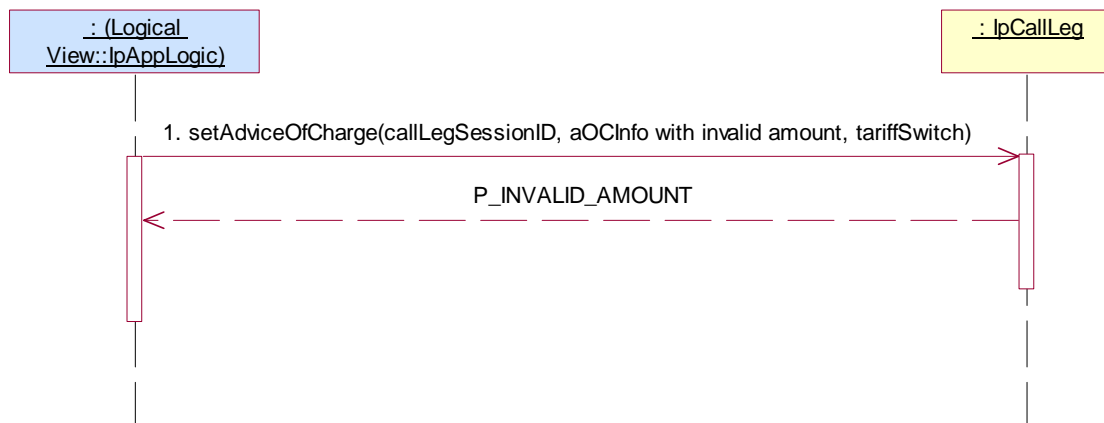
**Test MPCC_IpCallLeg_28**

Summary: IpCallLeg, superviseReq, P_INVALID_SESSION_ID

Reference: ES 201 915-4 [1], clause 7.3.5

Preamble: Same as MPCC_IpMultiPartyCall_14

Condition: createCallLeg and superviseReq methods are supported

Test Sequence:

- Method call **superviseReq()**
 Parameters: invalid callLegSessionID, valid time, valid treatment
 Check: P_INVALID_SESSION_ID is returned

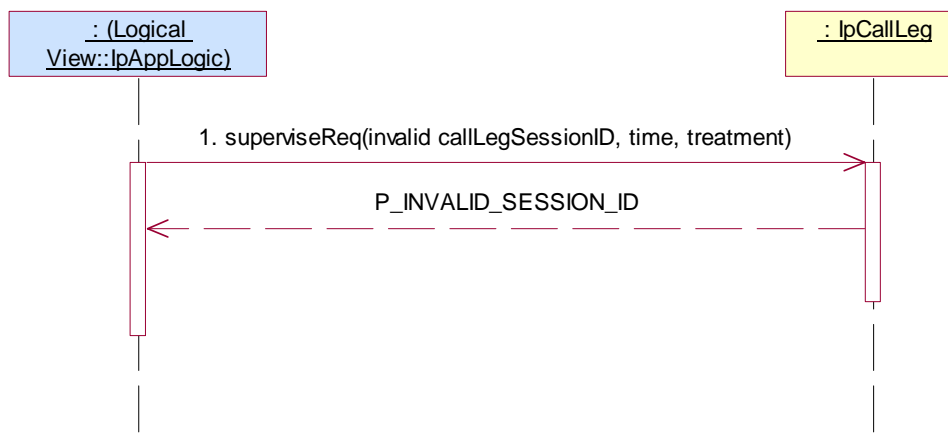

Test MPCC_IpCallLeg_29

Summary: IpCallLeg, getCall, P_INVALID_SESSION_ID

Reference: ES 201 915-4 [1], clause 7.3.5

Preamble: Same as MPCC_IpMultiPartyCall_03

Condition: getCall method is supported

Test Sequence:

1. Method call **getCall()**
Parameters: invalid callLegSessionID
Check: P_INVALID_SESSION_ID is returned

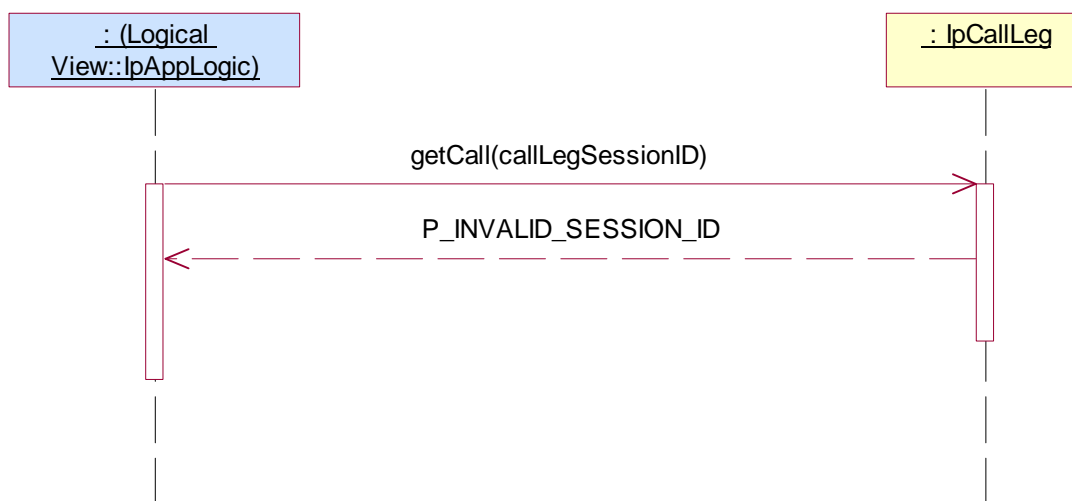

5.2.3 MultiMedia Call Control Service (MMCC)

5.2.3.1 IpMultiMediaCallControlManager

5.2.3.1.1 Mandatory, valid behaviour

Test MMCC_IpMultiMediaCallControlManager_01

Summary: IpMultiMediaCallControlManager, all mandatory methods, successful

Reference: ES 201 915-4 [1], clauses 7.3.1 and 8.3.1

Condition: createNotification method is supported

Test Sequence:

1. Method call **createNotification()**
Parameters: appCallControlManager with valid, non-null, value, valid notificationRequest
Check: valid value of TpAssignmentID is returned
2. Triggered action: cause IUT to call Method **reportNotification()** method on the tester's (application) **IpAppMultiMediaCallControlManager** interface
Parameters: callReference, callLegReferenceSet, notificationInfo, assignmentID
3. Method call **destroyNotification()**
Parameters: assignmentID returned in 1.
Check: no exception is returned

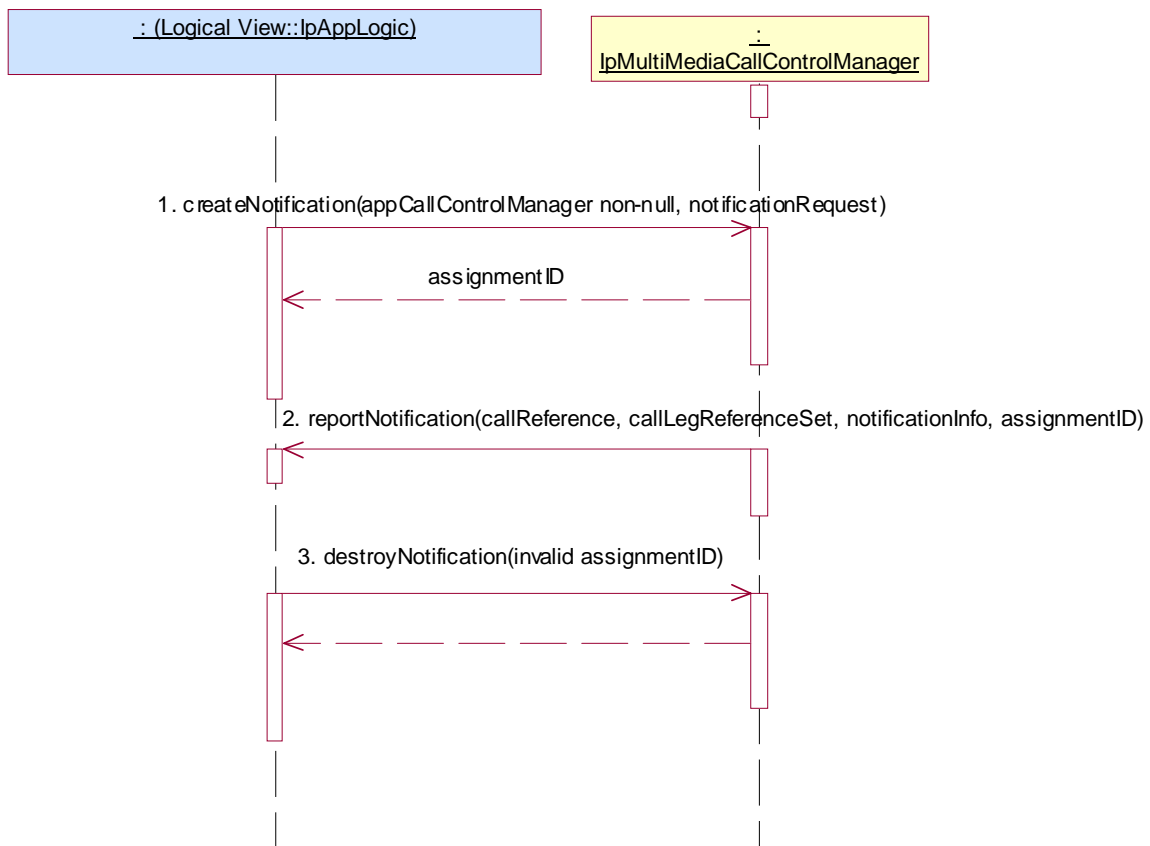

Test MMCC_ IpMultiMediaCallControlManager _02

Summary: IpMultiMediaCallControlManager, all mandatory methods, successful

Reference: ES 201 915-4 [1], clauses 7.3.1 and 8.3.1

Condition: createNotification method is supported

Test Sequence:

1. Method call **setCallback()** on IpMultiMediaCallControlManager
Parameters: valid, non-null, value of appInterface parameter
Check: no exception is returned
2. Method call **createNotification()**
Parameters: appCallControlManager with null, value, valid notificationRequest
Check: valid value of TpAssignmentID is returned
3. Triggered action: cause IUT to call Method **reportNotification()** method on the tester's (application) **IpAppMultiMediaCallControlManager** interface
Parameters: callReference, callLegReferenceSet, notificationInfo, assignmentID
4. Method call **destroyNotification()**
Parameters: assignmentID returned in 1.
Check: no exception is returned

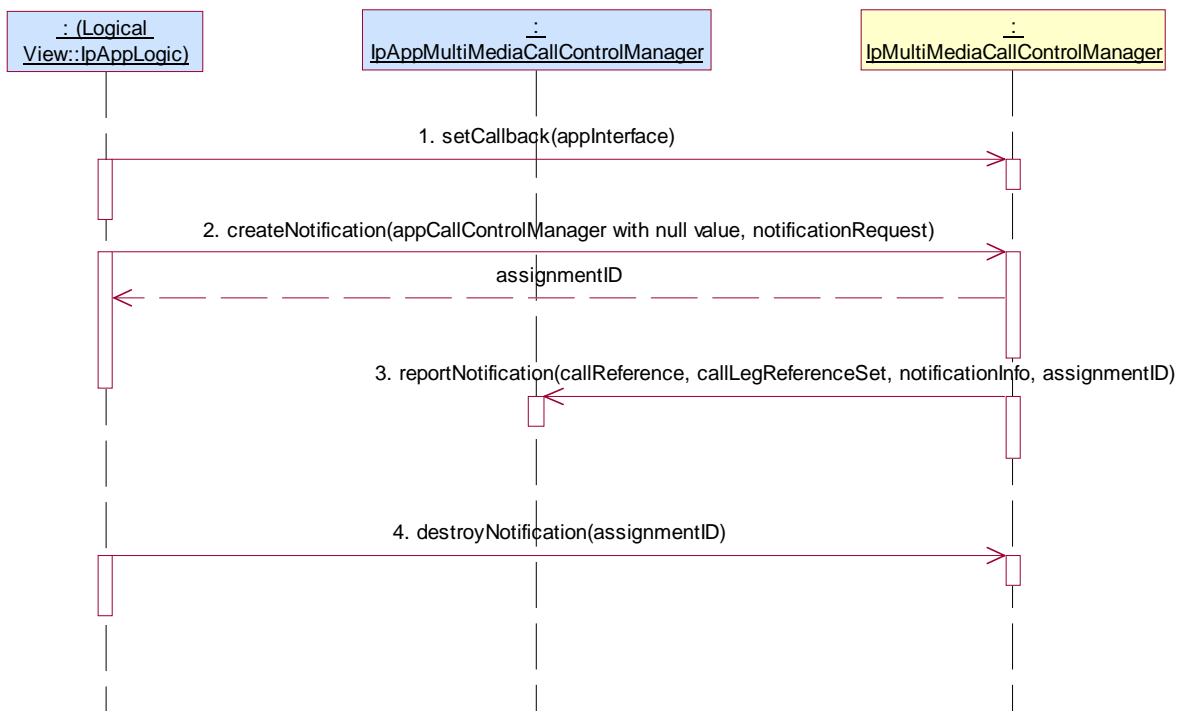

Test MMCC_IpMultiMediaCallControlManager_03

Summary: IpMultiMediaCallControlManager, all mandatory methods, successful

Reference: ES 201 915-4 [1], clauses 7.3.1 and 8.3.1

Preamble: Application has a reference interface used for callbacks

Condition: createCall method is supported

Test Sequence:

1. Method call **setCallback()** on IpMultiMediaCallControlManager
 Parameters: valid, non-null, value of appInterface parameter
 Check: no exception is returned
2. Method call **createCall()**
 Parameters: valid appCall
 Check: valid value of TpMultiMediaCallIdentifier is returned

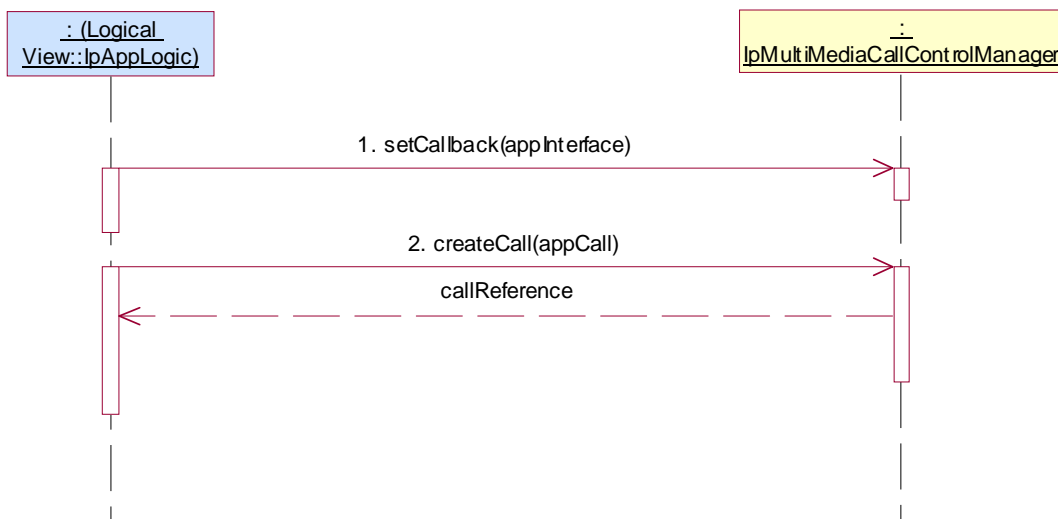

Test MMCC_IpMultiMediaCallControlManager_04

Summary: IpMultiMediaCallControlManager, all methods mandatory, successful

Reference: ES 201 915-4 [1], clause 8.3.1

Test Sequence:

1. Method call **createMediaNotification()**
Parameters: valid appInterface, valid notificationMediaRequest
Check: valid value of TpAssignmentID is returned
2. Triggered action: cause IUT to call Method **reportMediaNotification()** method on the tester's (application) **IpAppMultiMediaCallControlManager** interface
Parameters: callReference, callLegReferenceSet, notificationInfo, assignmentID
3. Method call **destroyMediaNotification()**
Parameters: valid assignmentID returned in 1.
Check: no exception is returned

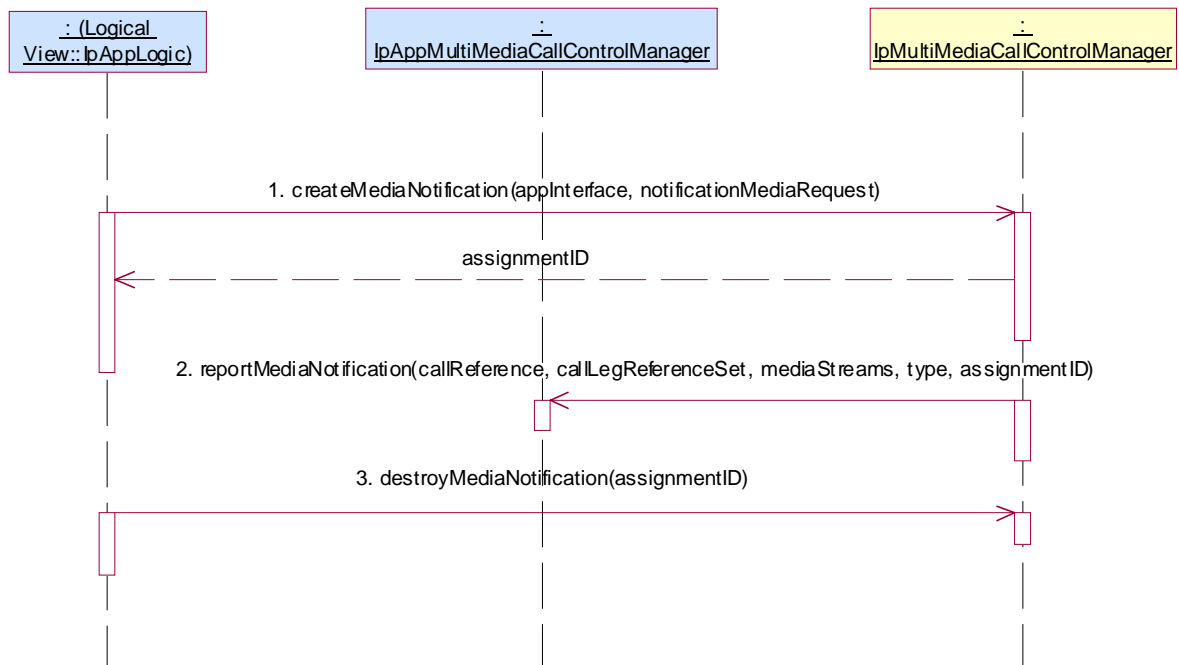

5.2.3.1.2 Mandatory, invalid behaviour

Test MMCC_IpMultiMediaCallControlManager_05

Summary: IpMultiMediaCallControlManager, createMediaNotification, P_INVALID_CRITERIA

Reference: ES 201 915-4 [1], clause 8.3.1

Preamble: Application has a reference interface used for callbacks

Test Sequence:

1. Method call **createMediaNotification()**
Parameters: valid appInterface, valid notificationMediaRequest with invalid criteria
Check: P_INVALID_CRITERIA is returned

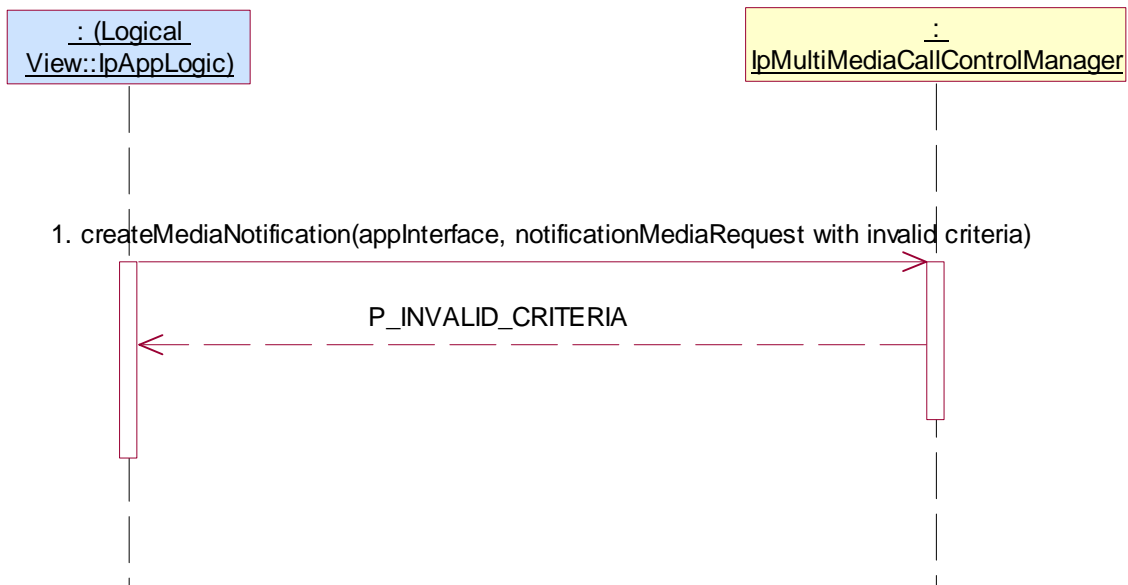

Test MMCC_IpMultiMediaCallControlManager_06

Summary: IpMultiMediaCallControlManager, createNotification, P_INVALID_CRITERIA

Reference: ES 201 915-4 [1], clause 7.3.1

Condition: createNotification method is supported

Test Sequence:

1. Method call **createNotification()**

Parameters: appCallControlManager with null value, invalid notificationRequest

Check: P_INVALID_CRITERIA is returned

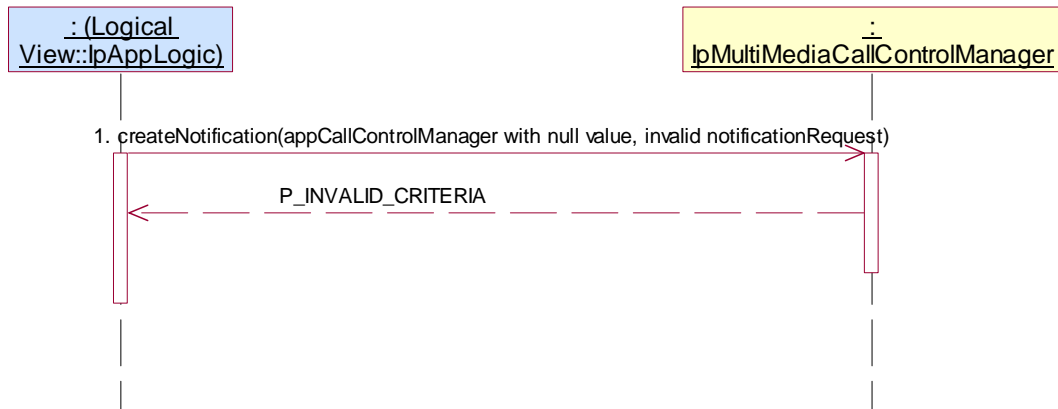

Test MMCC_IpMultiMediaCallControlManager_07

Summary: IpMultiMediaCallControlManager, destroyNotification, P_INVALID_ASSIGNMENT_ID

Reference: ES 201 915-4 [1], clause 7.3.1

Condition: createNotification, destroyNotification methods are supported

Test Sequence:

1. Method call **createNotification()**
 Parameters: appCallControlManager with valid, non-null, value, valid notificationRequest
 Check: valid value of TpAssignmentID is returned
2. Method call **destroyNotification()**
 Parameters: invalid assignmentID
 Check: P_INVALID_ASSIGNMENT_ID is returned

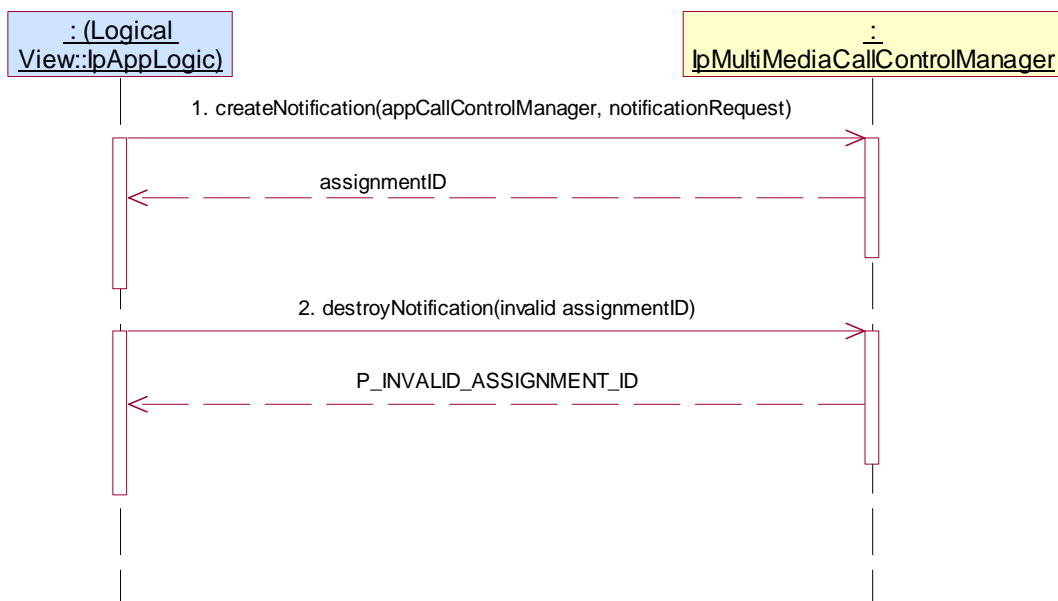

Test MMCC_IpMultiMediaCallControlManager_08

Summary: IpMultiMediaCallControlManager, createCall, P_INVALID_INTERFACE_TYPE

Reference: ES 201 915-4 [1], clause 7.3.1

Condition: createCall method is supported

Test Sequence:

1. Method call **createCall()**
Parameters: invalid value of appCall
Check: P_INVALID_INTERFACE_TYPE is returned

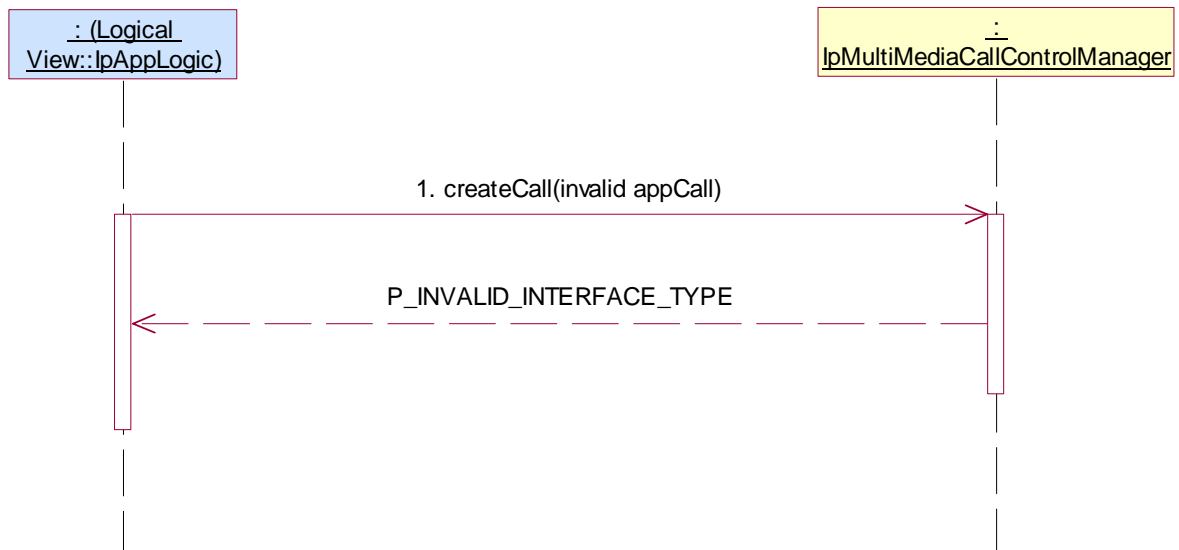

5.2.3.1.3 Optional, valid behaviour

Test MMCC_IpMultiMediaCallControlManager_09

Summary: IpMultiMediaCallControlManager, getNotification, successful

Reference: ES 201 915-4 [1], clause 7.3.1

Condition: createNotification and getNotification methods are supported

Test Sequence:

1. Method call **createNotification()**
 Parameters: appCallControlManager with valid, non-null, value, valid notificationRequest
 Check: valid value of TpAssignmentID is returned
2. Method call **getNotification()**
 Parameters: None
 Check: valid value of TpNotificationRequestedSet is returned where notificationRequest given in 1. is included as a value of this TpCallEventCriteriaResult

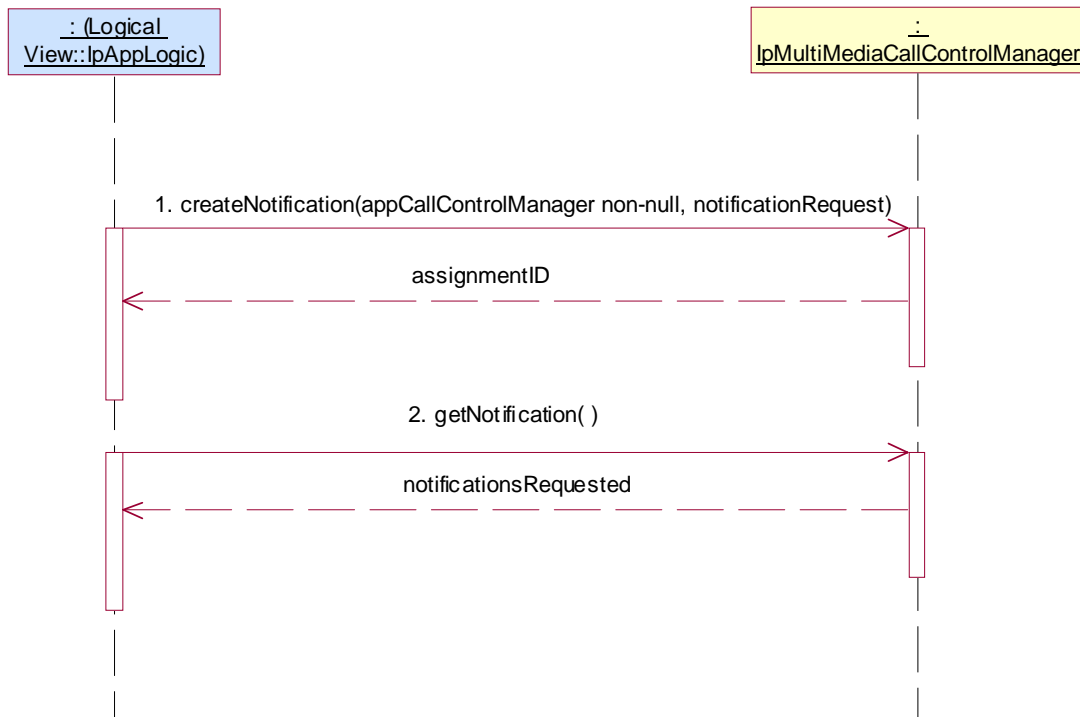

Test MMCC_IpMultiMediaCallControlManager_10

Summary: IpMultiMediaCallControlManager, getMediaNotification, successful

Reference: ES 201 915-4 [1], clause 8.3.1

Condition: getMediaNotification method is supported

Test Sequence:

1. Method call **createMediaNotification()**
Parameters: valid appInterface, valid notificationMediaRequest
Check: valid value of TpAssignmentID is returned
2. Method call **getMediaNotification()**
Parameters: None
Check: valid value of TpMediaNotificatioRequestedSet is returned with values of notificationMediaRequest given in 1.
3. Method call **destroyMediaNotification()**
Parameters: valid assignmentID returned in 1.
Check: no exception is returned

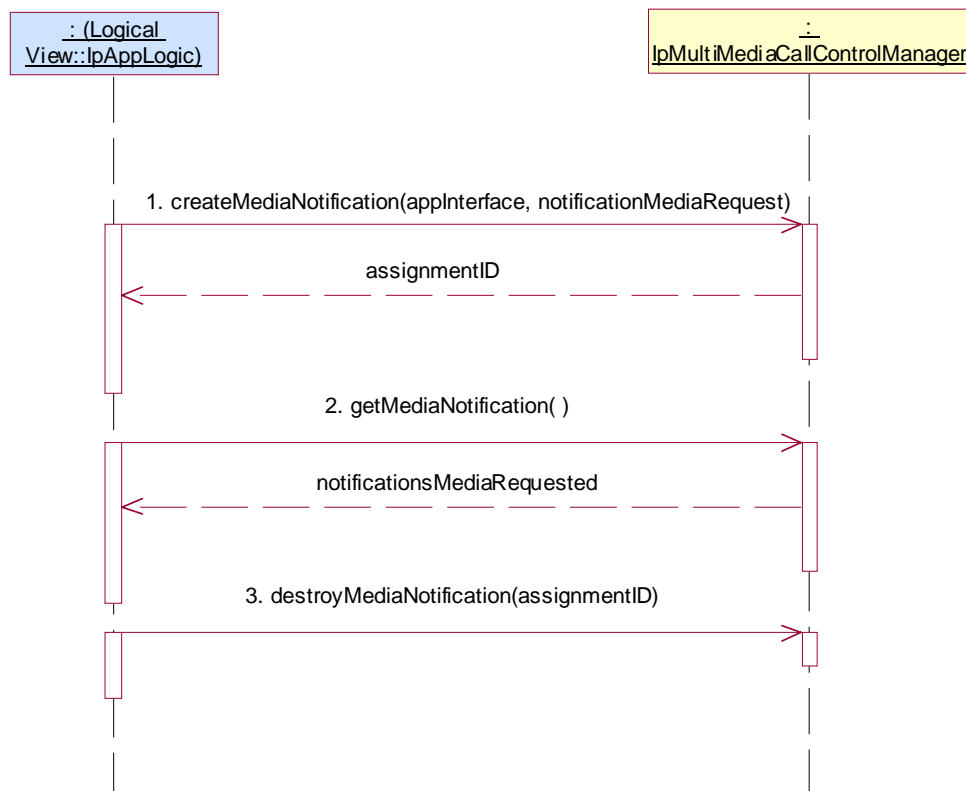

Test MMCC_IpMultiMediaCallControlManager_11

Summary: IpMultiMediaCallControlManager, changeMediaNotification, successful

Reference: ES 201 915-4 [1], clause 8.3.1

Condition: getMediaNotification and changeMediaNotification methods are supported

Test Sequence:

1. Method call **createMediaNotification()**
Parameters: valid appInterface, valid notificationMediaRequest
Check: valid value of TpAssignmentID is returned
2. Method call **getMediaNotification()**
Parameters: None
Check: valid value of TpMediaNotificatioRequestedSet is returned with values of notificationMediaRequest given in 1.
3. Method call **changeMediaNotification()**
Parameters: valid assignmentID returned in 1., valid notificationMediaRequest with different values from notificationMediaRequest given in 1.
Check: no exception is returned
4. Method call **getMediaNotification()**
Parameters: None
Check: valid value of TpMediaNotificatioRequestedSet is returned with values of notificationMediaRequest given in 3.
5. Method call **destroyMediaNotification()**
Parameters: valid assignmentID returned in 1.
Check: no exception is returned

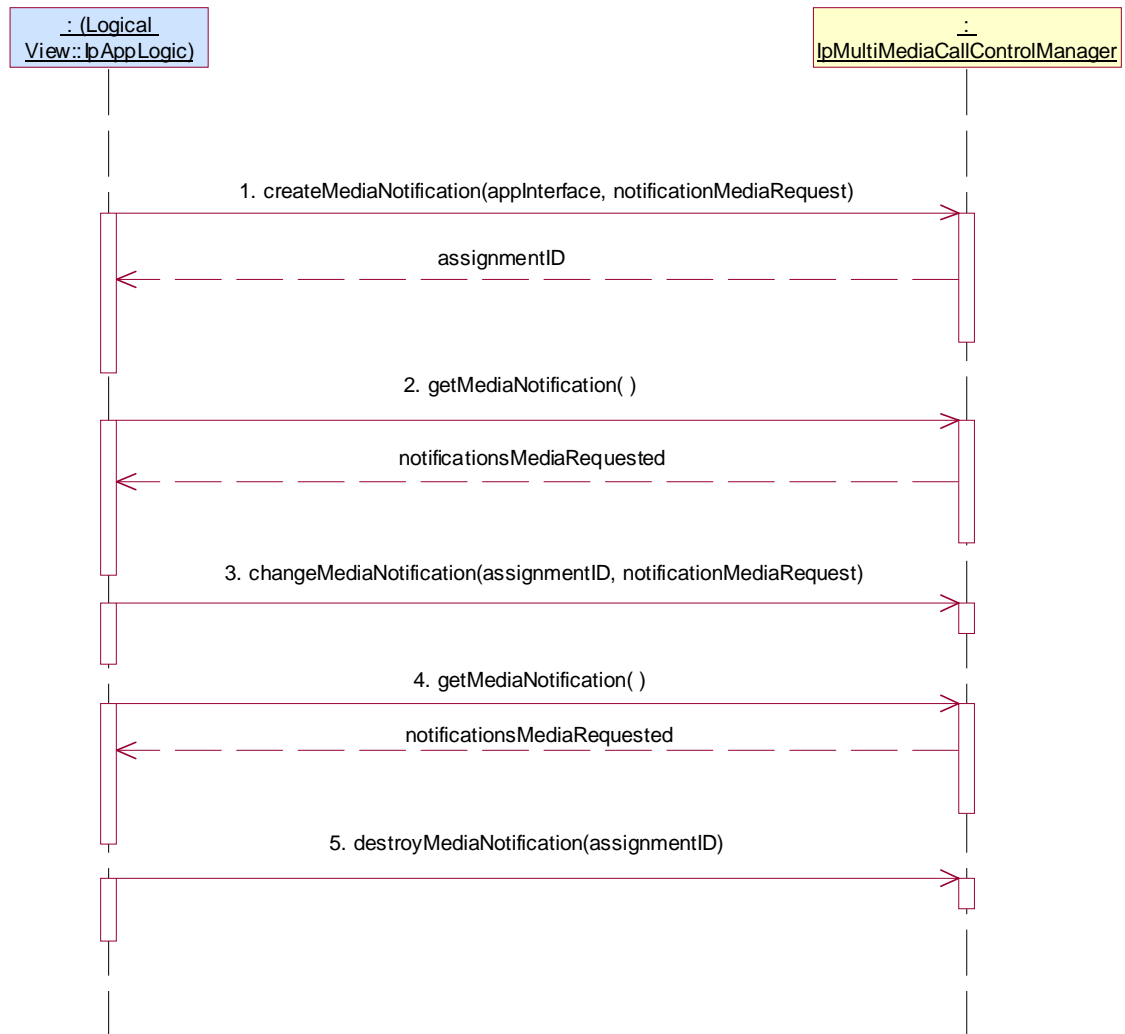

Test MMCC_IpMultiMediaCallControlManager_12

Summary: IpMultiMediaCallControlManager, changeNotification, successful

Reference: ES 201 915-4 [1], clause 7.3.1

Condition: createNotification, getNotification and changeNotification methods are supported

Test Sequence:

1. Method call **createNotification()**
Parameters: appCallControlManager with valid, non-null, value, valid notificationRequest
Check: valid value of TpAssignmentID is returned
2. Method call **getNotification()**
Parameters: None
Check: valid value of TpNotificationRequestedSet is returned where notificationRequest given in 1. is included as a value of this TpCallEventCriteriaResult
3. Method call **changeNotification()**
Parameters: assignmentID returned in 1., valid notificationRequest different from this given in 1.
Check: no exception is returned
4. Method call **getNotification()**
Parameters: None
Check: valid value of TpNotificationRequestedSet is returned where notificationRequest given in 3. is included as a value of this TpCallEventCriteriaResult
5. Method call **destroyNotification()**
Parameters: assignmentID returned in 1.
Check: no exception is returned

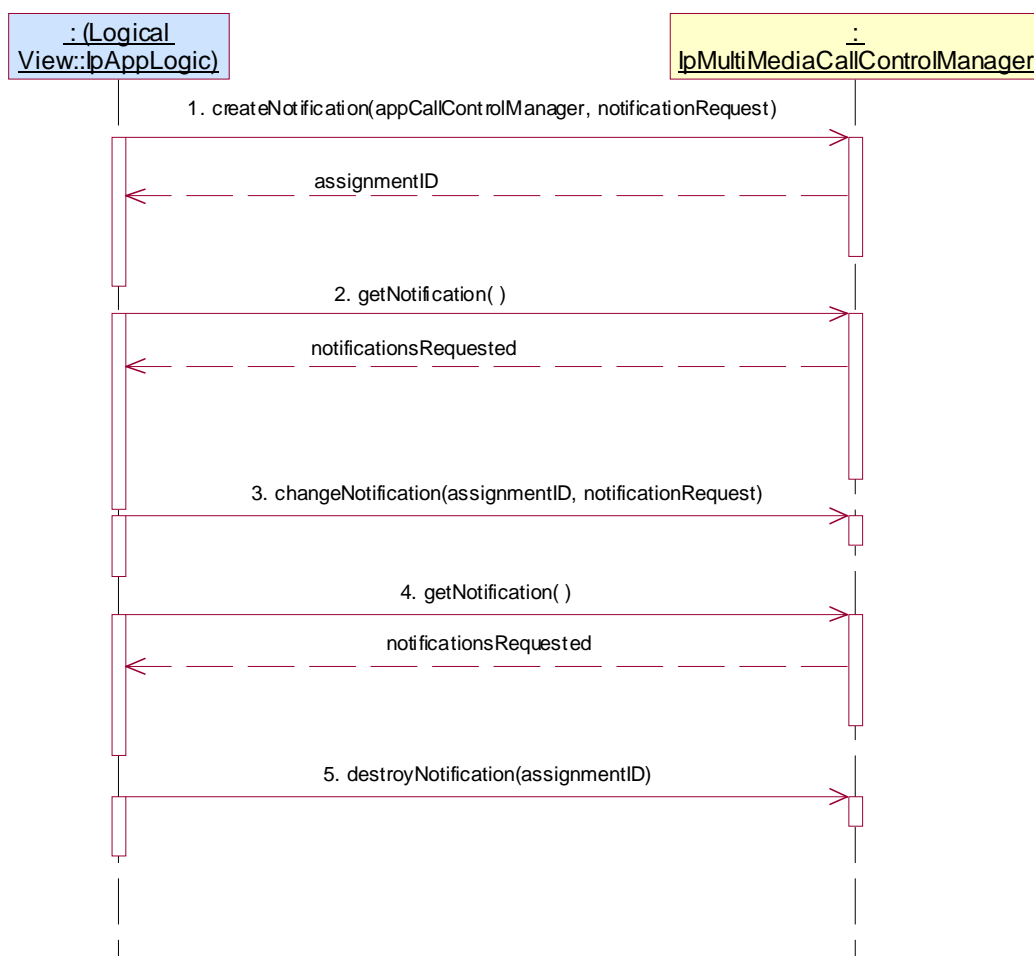

Test MMCC_IpMultiMediaCallControlManager_13

Summary: IpMultiMediaCallControlManager, all methods, successful

Reference: ES 201 915-4 [1], clauses 7.3.1 and 8.3.1

Condition: createNotification, callOverLoadEncountered and callOverLoadCeased methods are supported

Test Sequence:

1. Method call **createNotification()**
Parameters: appCallControlManager with valid, non-null, value, valid notificationRequest
Check: valid value of TpAssignmentID is returned
2. Method call **setCallLoadControl()**
Parameters: valid duration, valid mechanism, valid treatment, valid addressRange
Check: valid value of TpAssignmentID is returned
3. Triggered action: cause IUT to call **reportNotification()** numerous times during the following sequence, and attempt to provoke an overload condition and then remove it
4. Triggered action: cause IUT to call **callOverLoadEncountered()** method on the tester's (Application) IpAppMultiMediaCallControlManager interface
Parameters: valid assignmentID returned in 2.
5. Triggered action: cause IUT to call **callOverLoadCeased()** method on the tester's (Application) IpAppMultiMediaCallControlManager interface
Parameters: valid assignmentID returned in 2.

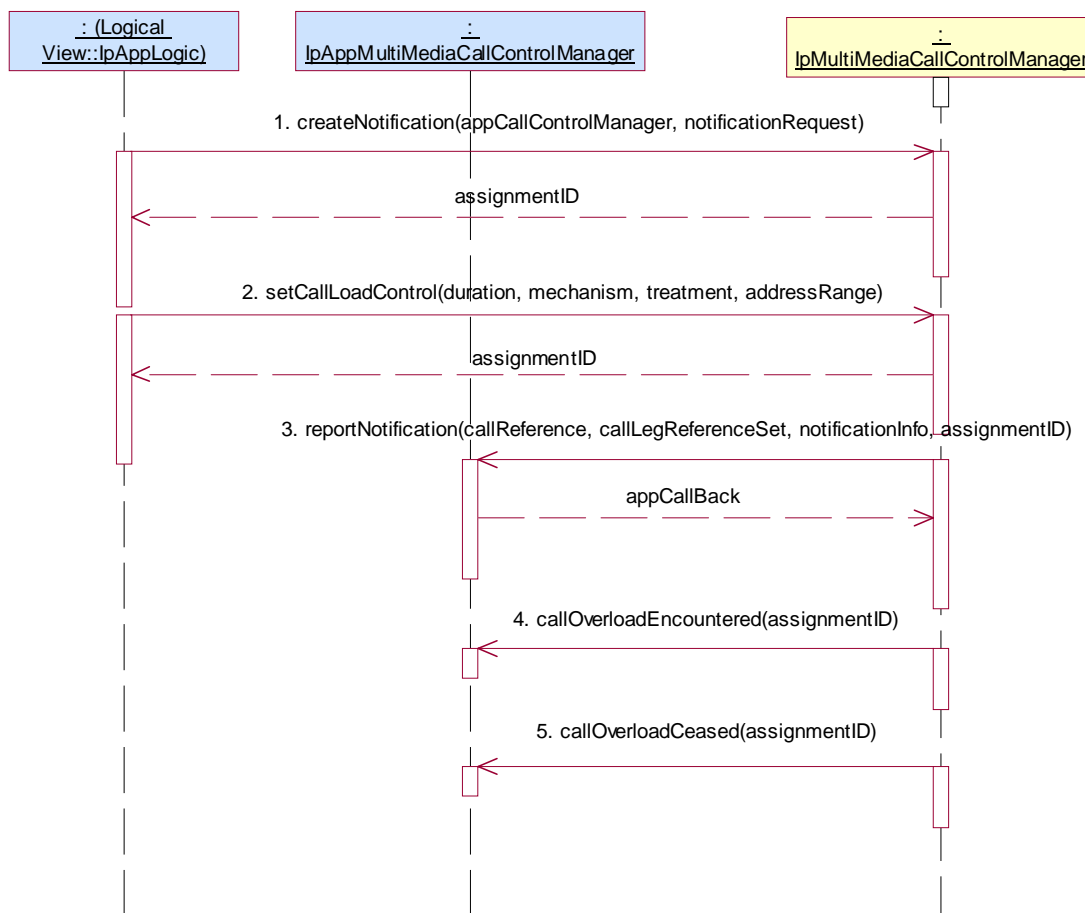

Test MMCC_IpMultiMediaCallControlManager_14

Summary: IpMultiMediaCallControlManager, all methods, successful

Reference: ES 201 915-4 [1], clause 7.3.1 and 8.3.1

Condition: createNotification, setCallLoadControl methods are supported

Test Sequence:

1. Method call **createNotification()**
Parameters: appCallControlManager with valid, not null, value, valid eventCriteria
Check: valid value of TpAssignmentID is returned
2. Method call **setCallLoadControl()**
Parameters: valid duration, valid mechanism, valid treatment, valid addressRange
Check: valid value of TpAssignmentID is returned
3. Triggered action: cause IUT to call **reportNotification()** method on the tester's (Application) **IpAppMultiMediaCallControlManager** interface
4. Triggered action: cause IUT to call **managerInterrupted()** method on the tester's (Application) **IpAppMultiMediaCallControlManager** interface
Parameters: None
5. Triggered action: cause IUT to call **managerResumed()** method on the tester's (Application) **IpAppMultiMediaCallControlManager** interface
Parameters: None

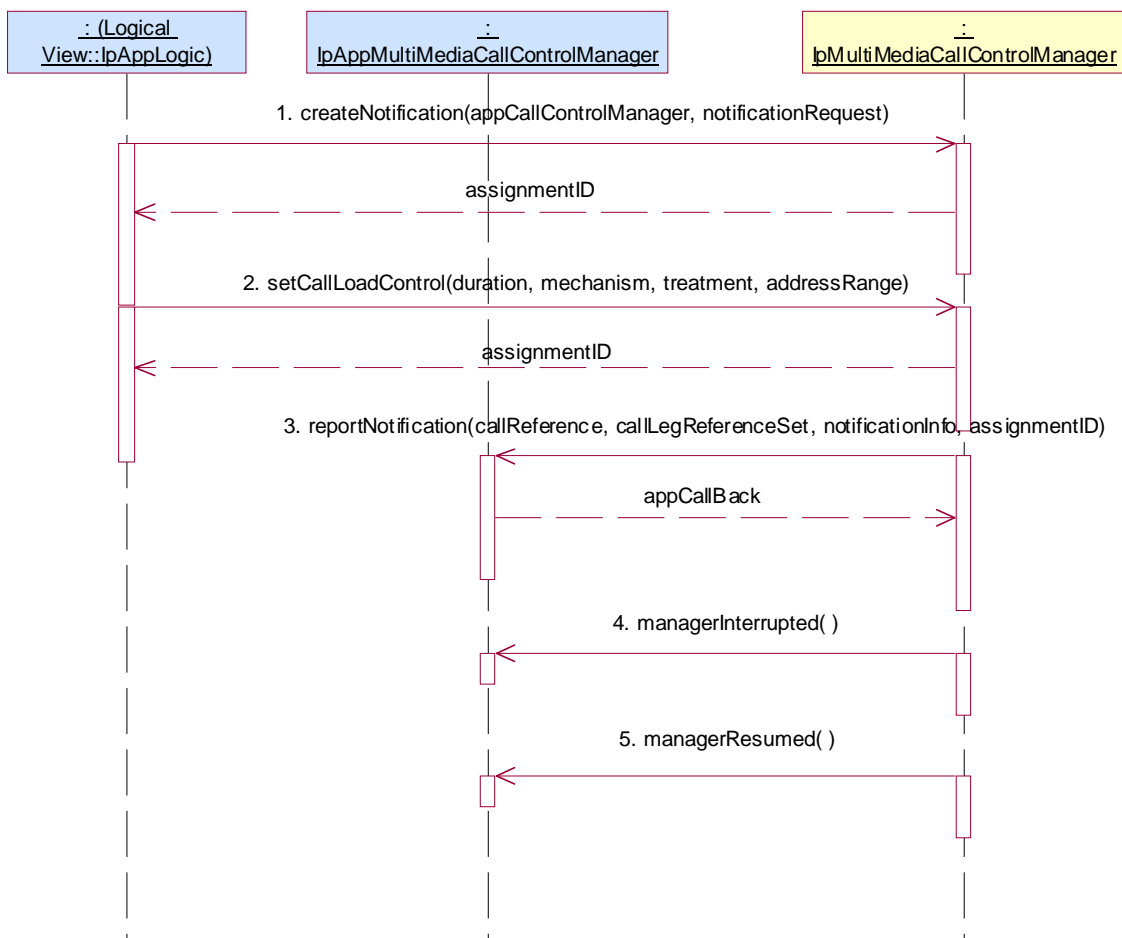

Test MMCC_IpMultiMediaCallControlManager_15

Summary: IpMultiMediaCallControlManager, all methods, successful

Reference: ES 201 915-4 [1], clauses 7.3.1 and 8.3.1

Condition: createNotification and callAborted methods are supported

Test Sequence:

1. Method call **createNotification()**
Parameters: appCallControlManager with valid, not null, value, valid eventCriteria
Check: valid value of TpAssignmentID is returned
2. Triggered action: cause IUT to call **reportNotification()** method on the tester's (Application) **IpAppMultiMediaCallControlManager** interface
3. Triggered action: cause IUT to call **callAborted()** method on the tester's (Application) **IpAppMultiMediaCallControlManager** interface
Parameters: valid callReference as reported in reportNotification

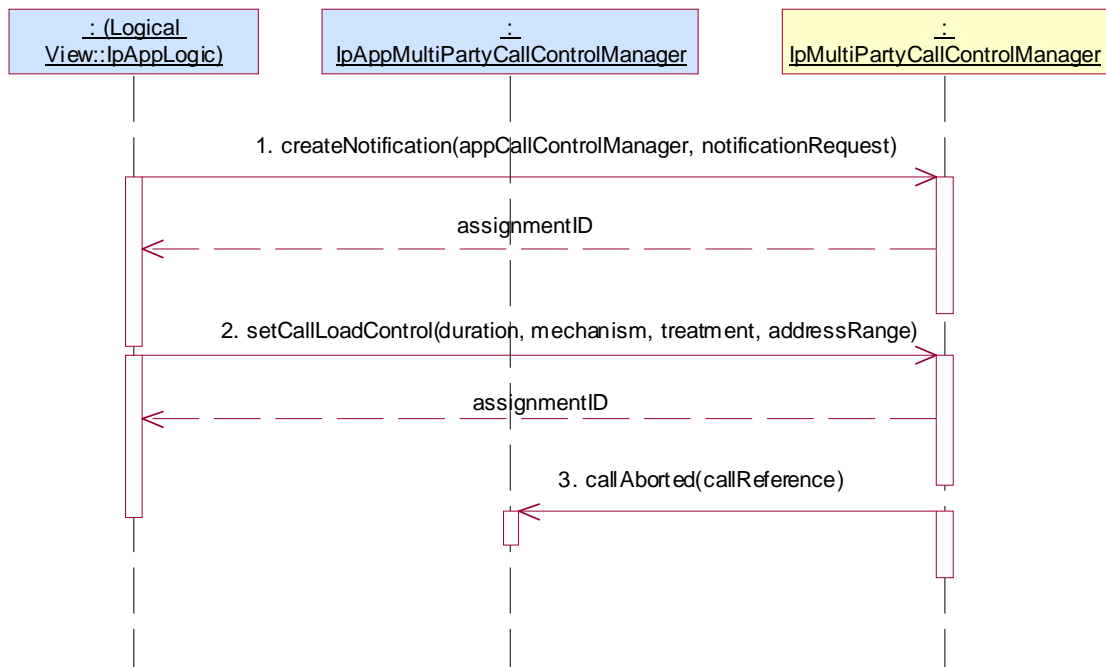

5.2.3.1.4 Optional, invalid behaviour

Test MMCC_IpMultiMediaCallControlManager_16

Summary: IpMultiMediaCallControlManager, changeMediaNotification, P_INVALID_CRITERIA

Reference: ES 201 915-4 [1], clause 8.3.1

Preamble: Application has a reference interface used for callbacks

Condition: changeMediaNotification method is supported

Test Sequence:

1. Method call **createMediaNotification()**
 Parameters: valid appInterface, valid notificationMediaRequest
 Check: valid value of TpAssignmentID is returned
2. Method call **changeMediaNotification()**
 Parameters: valid assignmentID returned in 1., valid notificationMediaRequest with invalid criteria
 Check: P_INVALID_CRITERIA is returned

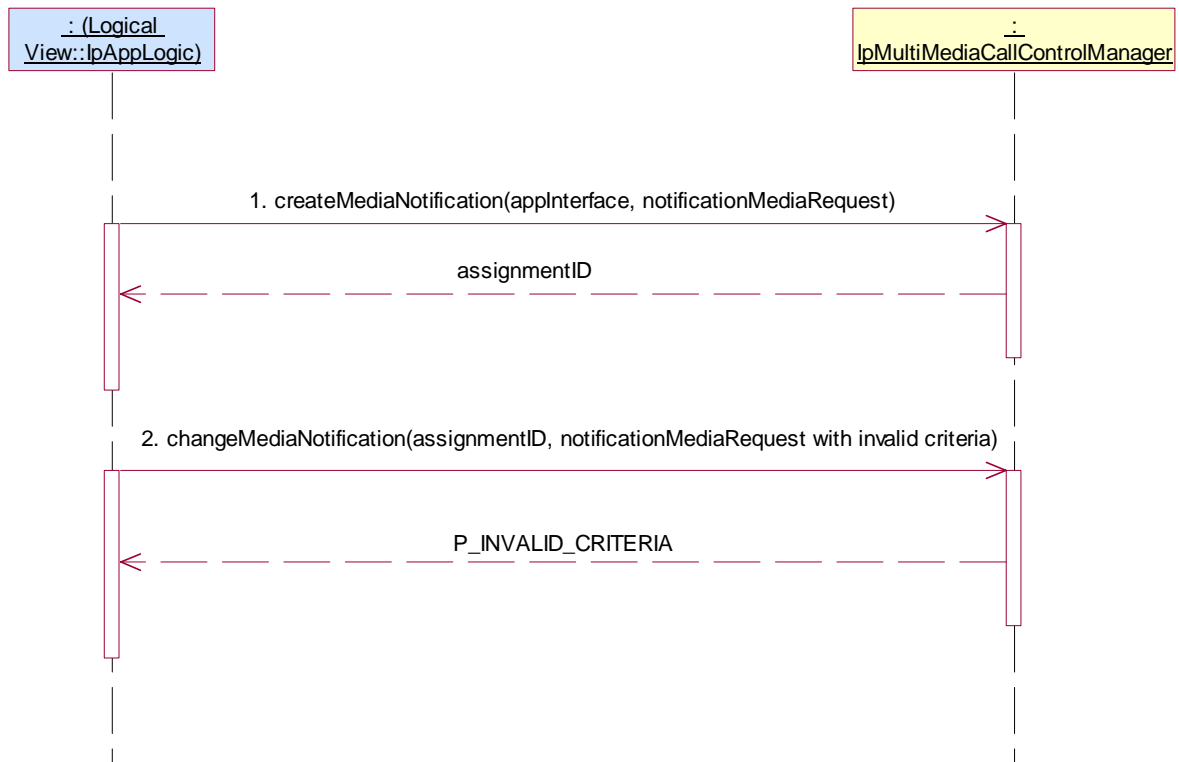

Test MMCC_IpMultiMediaCallControlManager_17

Summary: IpMultiMediaCallControlManager, changeMediaNotification, P_INVALID_ASSIGNMENT_ID

Reference: ES 201 915-4 [1], clause 8.3.1

Condition: createNotification, changeMediaNotification methods are supported

Test Sequence:

1. Method call **createNotification()**
 Parameters: appCallControlManager with valid, non-null, value, valid notificationRequest
 Check: valid value of TpAssignmentID is returned
2. Method call **changeMediaNotification()**
 Parameters: invalid assignmentID, valid notificationMediaRequest
 Check: P_INVALID_ASSIGNMENT_ID is returned

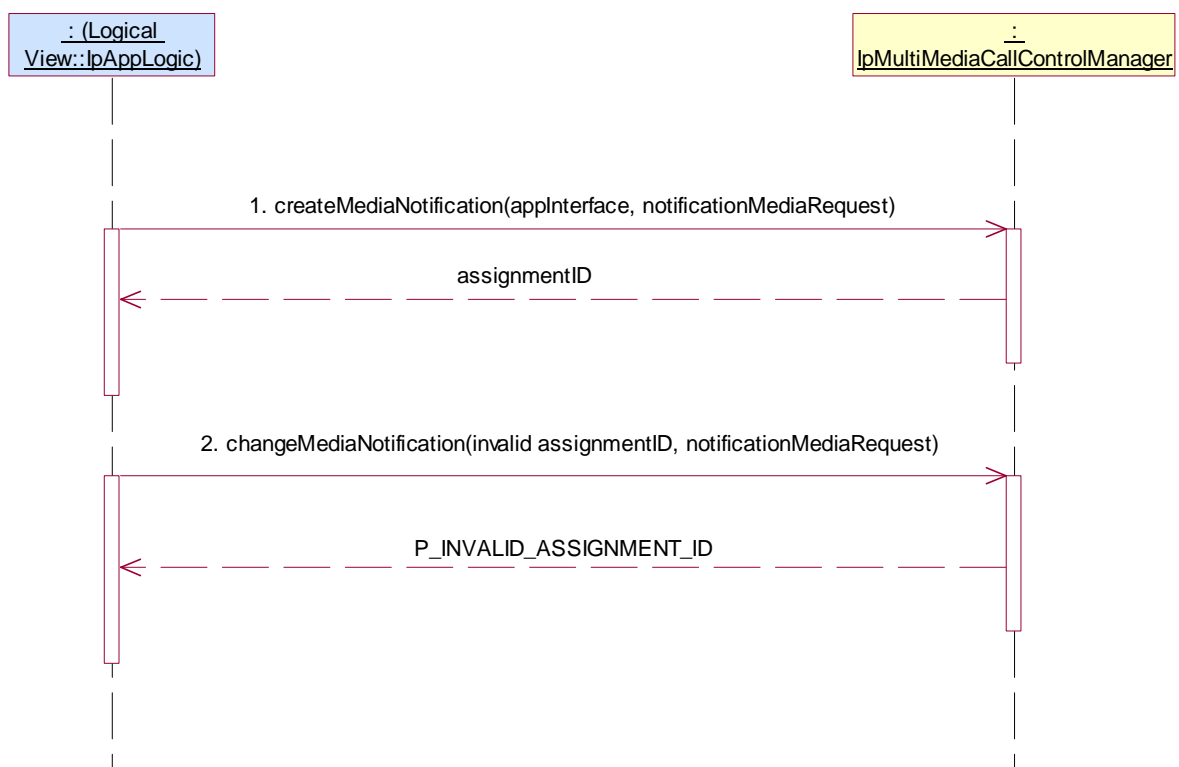

Test MMCC_IpMultiMediaCallControlManager_18

Summary: IpMultiMediaCallControlManager, changeNotification, P_INVALID_ASSIGNMENT_ID

Reference: ES 201 915-4 [1], clause 7.3.1

Condition: createNotification, changeNotification methods are supported

Test Sequence:

1. Method call **createNotification()**
 Parameters: appCallControlManager with valid, non-null, value, valid notificationRequest
 Check: valid value of TpAssignmentID is returned
2. Method call **changeNotification()**
 Parameters: invalid assignmentID, valid notificationRequest
 Check: P_INVALID_ASSIGNMENT_ID is returned

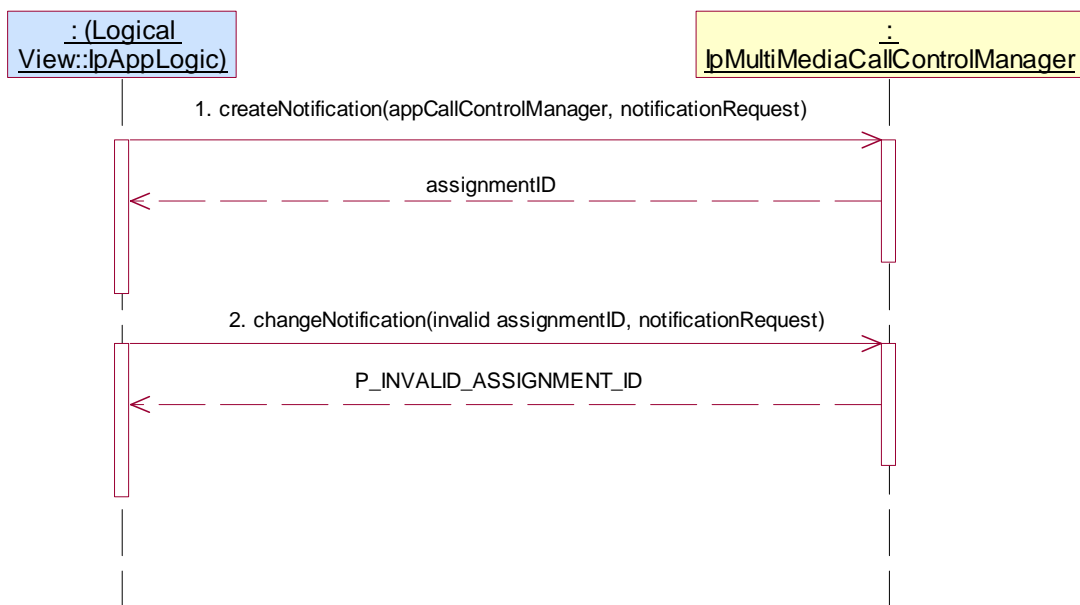

Test MMCC_IpMultiMediaCallControlManager_19

Summary: IpMultiMediaCallControlManager, changeNotification, P_INVALID_CRITERIA

Reference: ES 201 915-4 [1], clause 7.3.1

Preamble: Application has a reference interface used for callbacks

Condition: createNotification and changeNotification methods are supported

Test Sequence:

1. Method call **createNotification()**
 Parameters: appCallControlManager with null value, valid notificationRequest
 Check: valid value of TpAssignmentID is returned
2. Method call **changeNotification()**
 Parameters: assignmentID returned in 1., invalid notificationRequest
 Check: P_INVALID_CRITERIA is returned

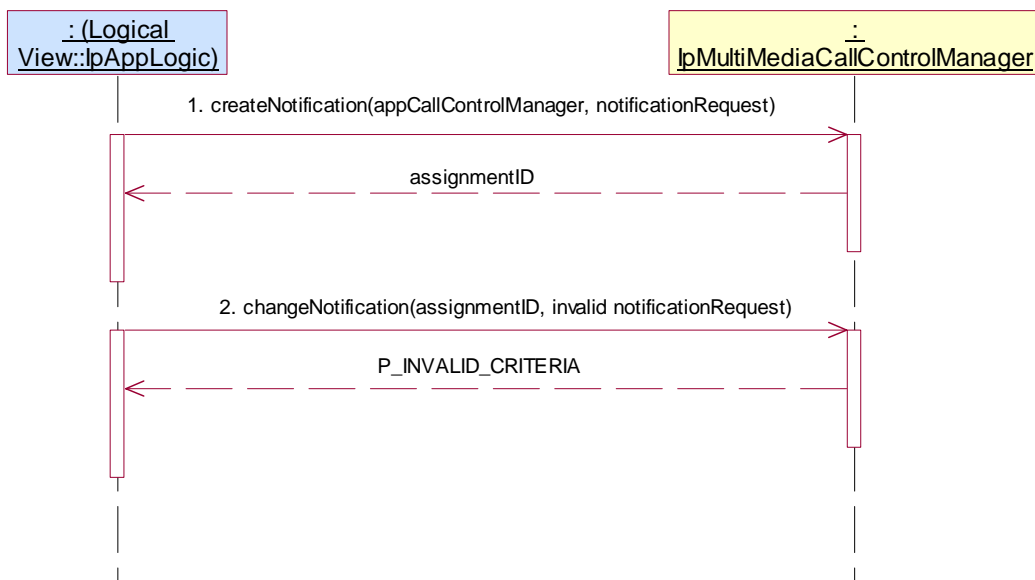

Test MMCC_IpMultiMediaCallControlManager_20

Summary: IpMultiMediaCallControlManager, setCallLoadControl, P_INVALID_ADDRESS

Reference: ES 201 915-4 [1], clause 7.3.1

Condition: createNotification and setCallLoadControl are supported

Test Sequence:

1. Method call **createNotification()**
 Parameters: appCallControlManager with valid, not null, value, valid eventCriteria
 Check: valid value of TpAssignmentID is returned
2. Method call **setCallLoadControl()**
 Parameters: valid duration, valid mechanism, valid treatment, invalid addressRange
 Check: P_INVALID_ADDRESS, P_UNSUPPORTED_ADDRESS_PLAN or another suitable exception, is returned

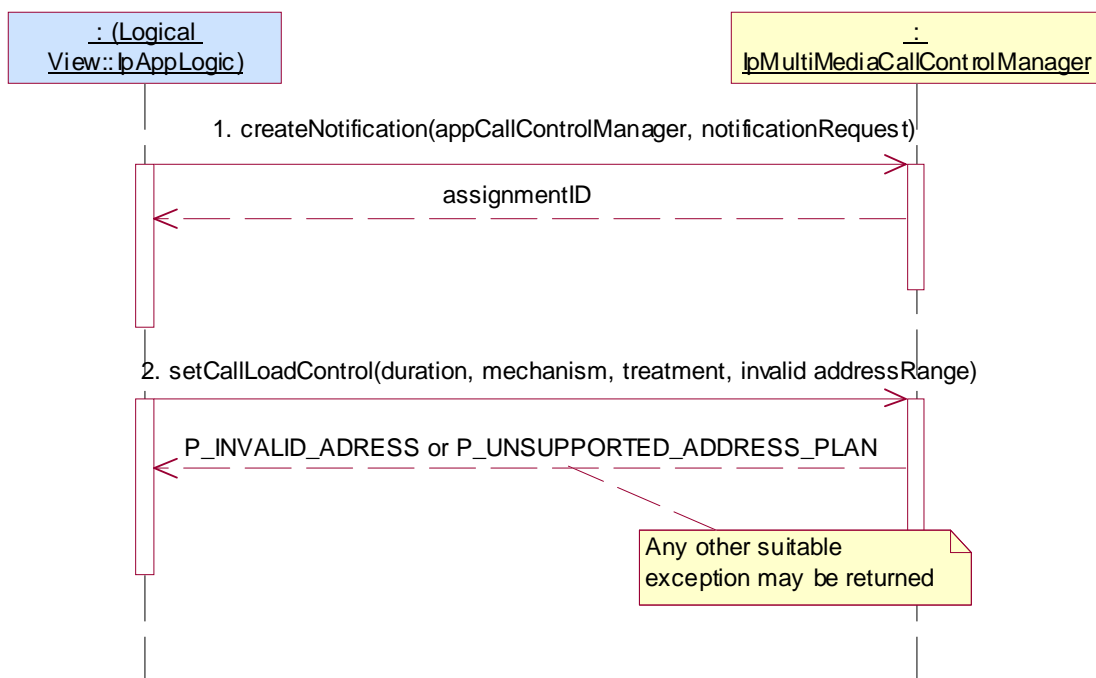

5.2.3.2 IpMultimediaCall

5.2.3.2.1 Mandatory, valid behaviour

According to the Call Control SCF specification, at least one of the two following test sequences is mandatory.

Test MMCC_IpMultiMediaCall_01

Summary: IpMultiMediaCall, all methods mandatory, successful

Reference: ES 201 915-4 [1], clause 7.3.1 and 7.3.3

Condition: createCall, createCallLeg methods are supported

Test Sequence:

1. Method call **setCallback()** on IpMultiMediaCallControlManager
Parameters: valid, non-null, value of appInterface parameter
Check: no exception is returned
2. Method call **createCall()**
Parameters: valid appCall
Check: valid value of TpMultiMediaCallIdentifier is returned
3. Method call **createCallLeg()** on IpMultiMediaCall
Parameters: valid callSessionID returned in 2., valid appCallLeg
Check: valid value of TpCallLegIdentifier is returned

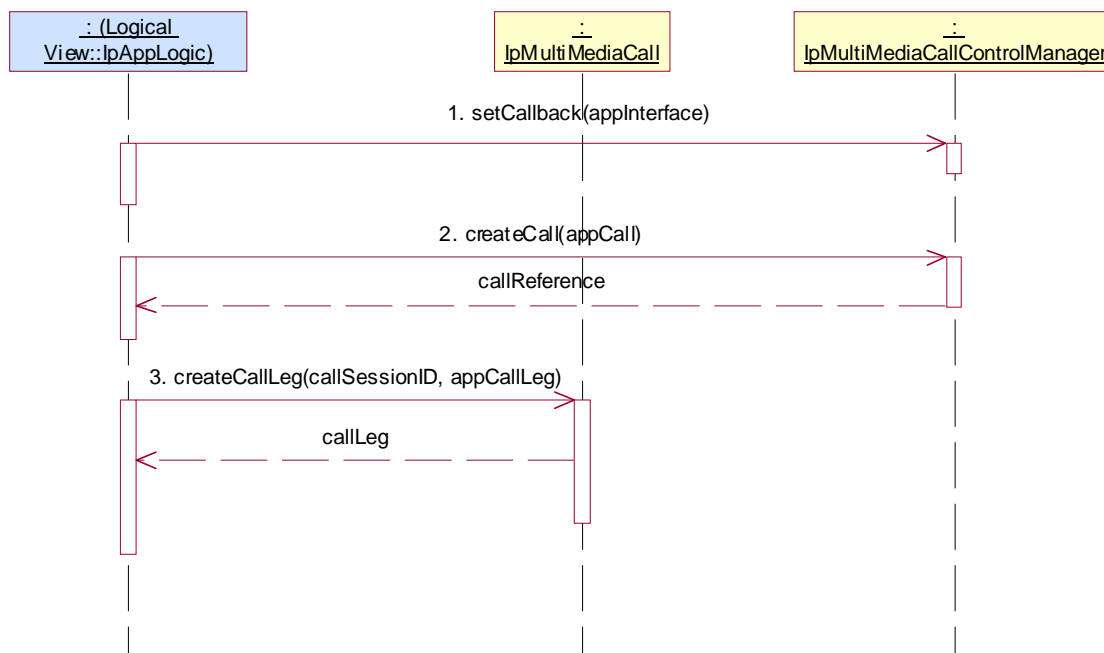

Test MMCC_IpMultiMediaCall_02

Summary: IpMultiMediaCall, all methods mandatory, successful

Reference: ES 201 915-4 [1], clauses 7.3.1 and 7.3.3

Condition: createCall, createAndRouteCallLeg method is supported

Test Sequence:

1. Method call **setCallback()** on IpMultiMediaCallControlManager
Parameters: valid, non-null, value of appInterface parameter
Check: no exception is returned
2. Method call **createCall()**
Parameters: valid appCall
Check: valid value of TpMultiMediaCallIdentifier is returned
3. Method call **createAndRouteCallLegReq()** on IpMultiMediaCall
Parameters: valid callSessionID returned in 2., valid eventsRequested, valid targetAddress, valid originatingAddress, valid appInfo, valid appLegInterface
Check: valid value of TpCallLegIdentifier

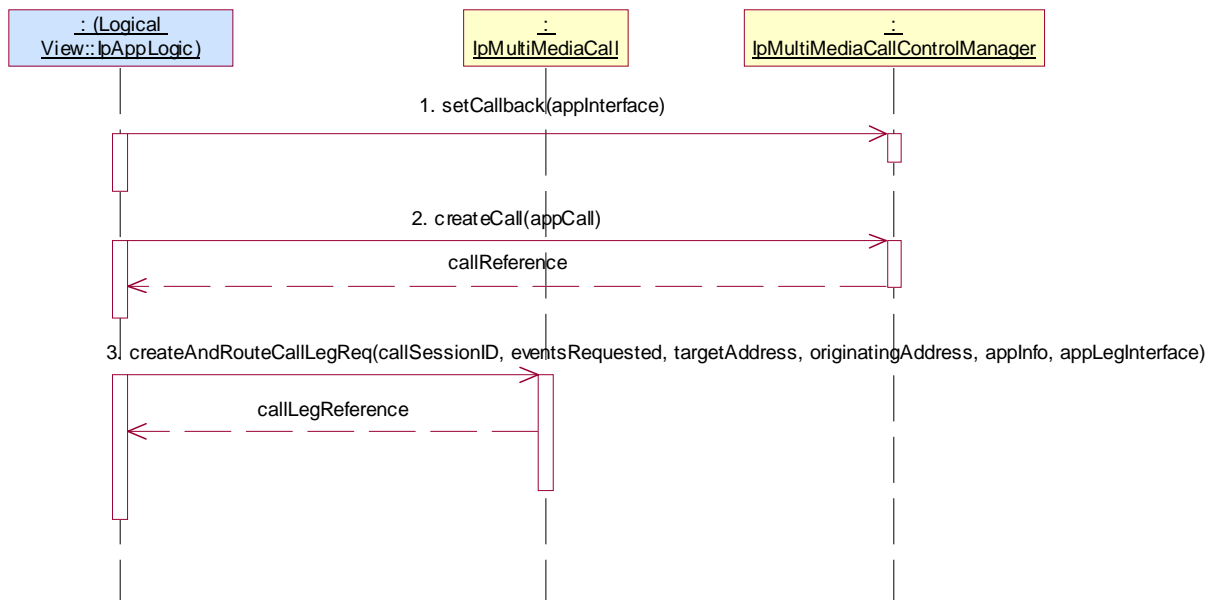

Test MMCC_IpMultiMediaCall_03

Summary: IpMultiMediaCall, all methods mandatory, successful

Reference: ES 201 915-4 [1], clauses 7.3.1 and 7.3.3

Preamble: Application has a valid callSessionID returned by one of the three following sequence:

1. Method call **setCallback()** on IpMultiMediaCallControlManager
Parameters: valid, non-null, value of appInterface parameter
Check: no exception is returned
2. Method call **createCall()**
Parameters: valid appCall
Check: valid value of TpMultiMediaCallIdentifier is returned

either

3. Method call **createCallLeg()** on IpMultiMediaCall
Parameters: valid callSessionID returned in 2., valid appCallLeg
Check: valid value of TpCallLegIdentifier is returned
4. Method call **eventReportReq()**
Parameters: valid callLegSessionID returned in 1, valid eventsRequested with an Interrupt event
Check: no exception is returned
5. Method call **routeReq()** on IpMultiMediaCallLeg
Parameters: valid callLegSessionID returned in 3., valid targetAddress, valid appInfo, valid connectionProperties
Check: no exception is returned

or

3. Method call **createAndRouteCallLegReq()** on IpMultiMediaCall
Parameters: valid callSessionID returned in 2., valid eventsRequested with Interrupt event, valid targetAddress, valid originatingAddress, valid appInfo, valid appLegInterface
Check: valid value of TpCallLegIdentifier

or

1. Method call **createNotification()**
Parameters: appCallControlManager with valid, non-null, value, valid notificationRequest
Check: valid value of TpAssignmentID is returned
2. Triggered action: cause IUT to call Method **reportNotification()** method on the tester's (application's) **IpMultiMediaCallControlManager** interface
Parameters: callReference, callLegReferenceSet, notificationInfo, assignmentID

either

3. Method call **createCallLeg()** on IpMultiMediaCall
Parameters: valid callSessionID reported in 2., valid appCallLeg
Check: valid value of TpCallLegIdentifier is returned
4. Method call **eventReportReq()**
Parameters: valid callLegSessionID returned in 1, valid eventsRequested with an Interrupt event
Check: no exception is returned
5. Method call **routeReq()** on IpMultiMediaCallLeg
Parameters: valid callLegSessionID returned in 3., valid targetAddress, valid appInfo, valid connectionProperties
Check: no exception is returned

or

3. Method call **createAndRouteCallLegReq()** on IpMultiMediaCall
 Parameters: valid callSessionID reported in 2., valid eventsRequested with Interrupt event, valid targetAddress, valid originatingAddress, valid appInfo, valid appLegInterface
 Check: valid value of TpCallLegIdentifier

or

1. Method call **createMediaNotification()**
 Parameters: valid appInterface, valid notificationMediaRequest
 Check: valid value of TpAssignmentID is returned
2. Triggered action: cause IUT to call Method **reportMediaNotification()** method on the tester's (application's) **IpMultiMediaCallControlManager** interface.
 Parameters: callReference, callLegReferenceSet, notificationInfo, assignmentID

either

3. Method call **createCallLeg()** on IpMultiMediaCall
 Parameters: valid callSessionID reported in 2., valid appCallLeg
 Check: valid value of TpCallLegIdentifier is returned
4. Method call **eventReportReq()**
 Parameters: valid callLegSessionID returned in 1, valid eventsRequested with an Interrupt event
 Check: no exception is returned
5. Method call **routeReq()** on IpMultiMediaCallLeg
 Parameters: valid callLegSessionID returned in 3., valid targetAddress, valid appInfo, valid connectionProperties
 Check: no exception is returned

or

3. Method call **createAndRouteCallLegReq()** on IpMultiMediaCall
 Parameters: valid callSessionID reported in 2., valid eventsRequested with Interrupt event, valid targetAddress, valid originatingAddress, valid appInfo, valid appLegInterface
 Check: valid value of TpCallLegIdentifier

Test Sequence:

1. Method call **release()** on IpMultiMediaCall
 Parameters: valid callSessionID returned in preamble, valid cause
 Check: no exception is returned

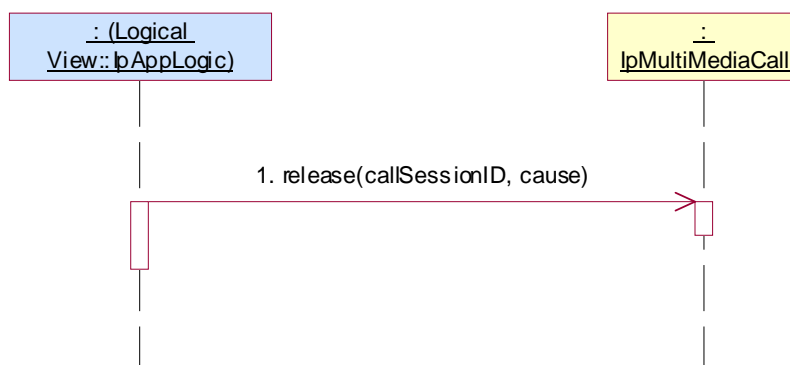

Test MMCC_ IpMultiMediaCall _04

Summary: IpMultiMediaCall, all methods mandatory, successful

Reference: ES 201 915-4 [1], clauses 7.3.1 and 7.3.3

Preamble: Same as MMCC_ IpMultiMediaCall _03

Test Sequence:

1. Method call **deassignCall()** on IpMultiMediaCall
Parameters: valid callSessionID returned in preamble
Check: no exception is returned

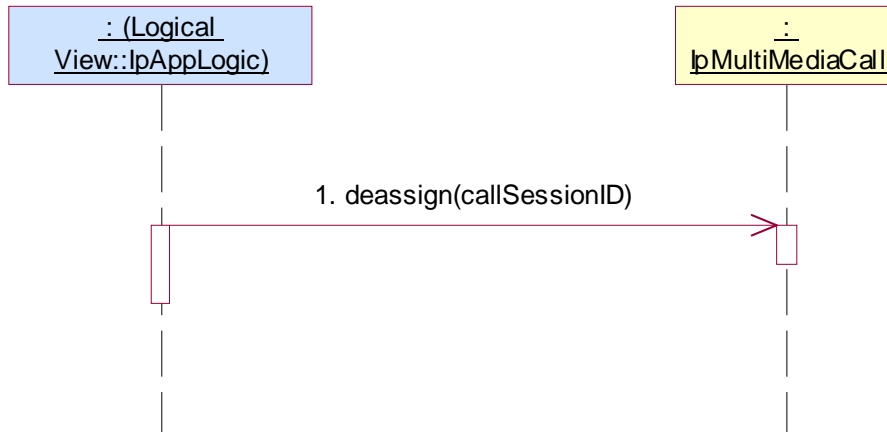

5.2.3.2.2 Mandatory, invalid behaviour

Test MMCC_IpMultiMediaCall_05

Summary: IpMultiMediaCall, deassignCall, P_INVALID_SESSION_ID

Reference: ES 201 915-4 [1], clause 7.3.3

Preamble: Same as MMCC_IpMultiMediaCall_03

Test Sequence:

1. Method call **deassignCall()** on IpMultiMediaCall
Parameters: invalid callSessionID
Check: P_INVALID_SESSION_ID is returned

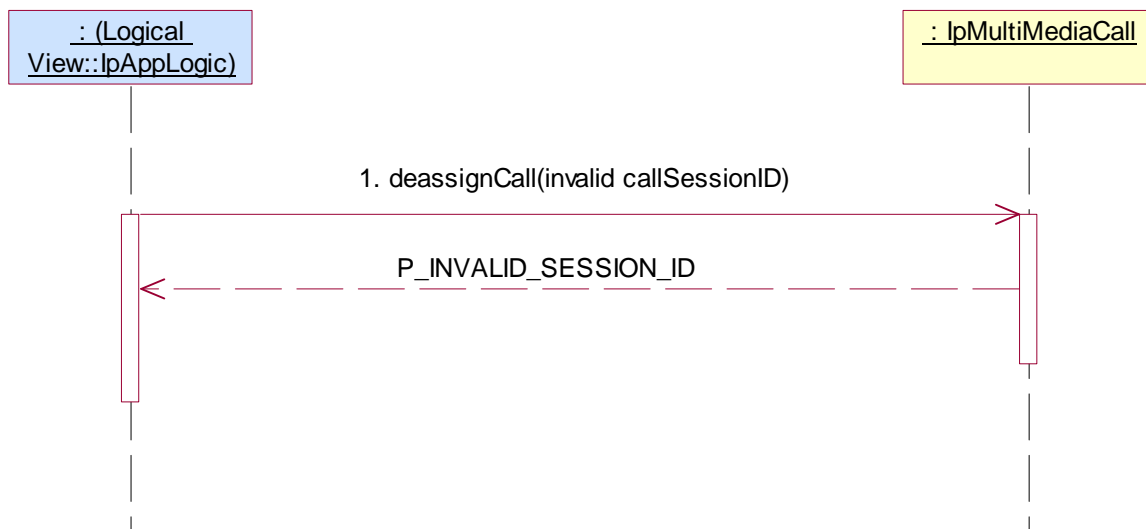

Test MMCC_IpMultiMediaCall_06

Summary: IpMultiMediaCall, release, P_INVALID_SESSION_ID

Reference: ES 201 915-4 [1], clause 7.3.3

Preamble: Same as MMCC_IpMultiMediaCall_03

Test Sequence:

1. Method call **release()** on IpMultiMediaCall
Parameters: invalid callSessionID, valid cause
Check: P_INVALID_SESSION_ID is returned

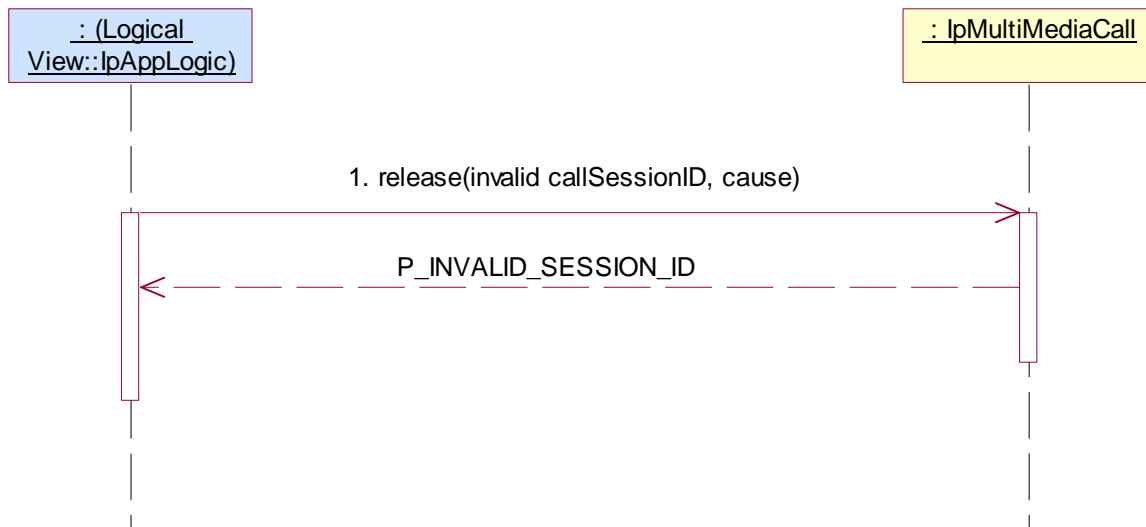

Test MMCC_IpMultiMediaCall_07

Summary: IpMultiMediaCall, createCallLeg, P_INVALID_SESSION_ID

Reference: ES 201 915-4 [1], clause 7.3.3

Preamble: Application has a valid callSessionID returned by one of the two following sequence:

1. Method call **setCallback()** on IpMultiMediaCallControlManager
Parameters: valid, non-null, value of appInterface parameter
Check: no exception is returned
2. Method call **createCall()**
Parameters: valid appCall
Check: valid value of TpMultiPartyCallIdentifier is returned

or

1. Method call **createNotification()**
Parameters: appCallControlManager with valid, non-null, value, valid notificationRequest
Check: valid value of TpAssignmentID is returned
2. Triggered action: cause IUT to call Method **reportNotification()** method on the tester's (application)
Parameters: callReference, callLegReferenceSet, notificationInfo, assignmentID

Condition: createCallLeg method is supported.

Test Sequence:

1. Method call **createCallLeg()** on IpMultiMediaCall
Parameters: invalid callSessionID, valid appCallLeg
Check: P_INVALID_SESSION_ID is returned

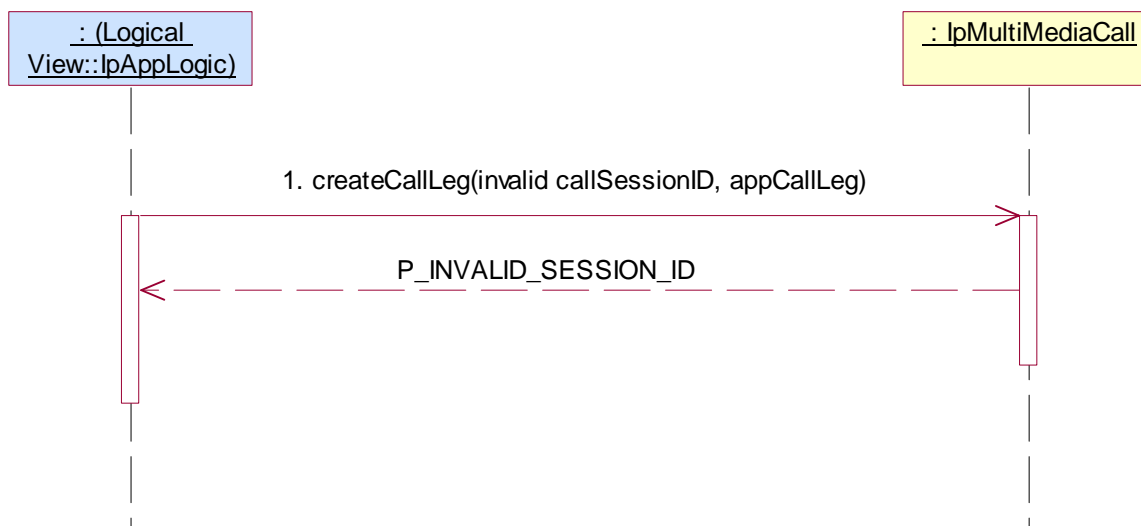

Test MMCC_IpMultiMediaCall_08

Summary: IpMultiMediaCall, createCallLeg, P_INVALID_INTERFACE_TYPE

Reference: ES 201 915-4 [1], clauses 7.3.1 and 7.3.3

Preamble: Same as MMCC_IpMultiMediaCall_07

Condition: CreateCallLeg method is supported.

Test Sequence:

1. Method call **createCallLeg()** on IpMultiMediaCall
Parameters: valid callSessionID returned in preamble, invalid appCallLeg
Check: P_INVALID_INTERFACE_TYPE is returned

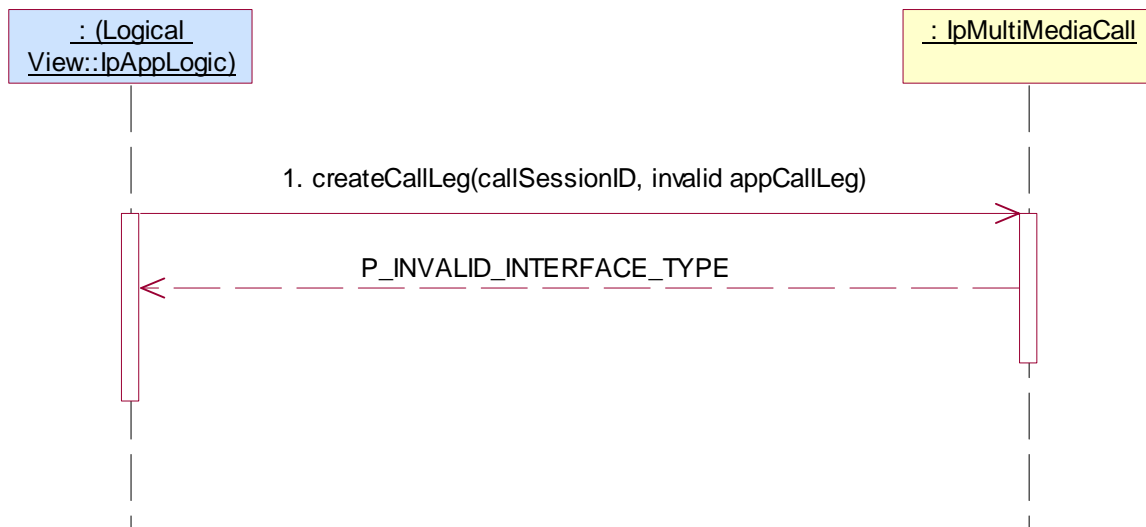

Test MMCC_IpMultiMediaCall_09

Summary: IpMultiMediaCall, createAndRouteCallLegReq, P_INVALID_SESSION_ID

Reference: ES 201 915-4 [1], clause 7.3.3

Preamble: Same as MMCC_IpMultiMediaCall_07

Condition: CreateAndRouteCallLeg method is supported

Test Sequence:

- Method call **createAndRouteCallLegReq()** on IpMultiMediaCall
 Parameters: invalid callSessionID, valid eventsRequested, valid targetAddress, valid originatingAddress, valid appInfo, valid appLegInterface
 Check: P_INVALID_SESSION_ID is returned

**Test MMCC_IpMultiMediaCall_10**

Summary: IpMultiMediaCall, createAndRouteCallLegReq, P_INVALID_INTERFACE_TYPE

Reference: ES 201 915-4 [1], clause 7.3.3

Preamble: Same as MMCC_IpMultiMediaCall_07

Condition: CreateAndRouteCallLeg method is supported

Test Sequence:

- Method call **createAndRouteCallLegReq()** on IpMultiMediaCall
 Parameters: valid callSessionID, valid eventsRequested, valid targetAddress, valid originatingAddress, valid appInfo, invalid appLegInterface
 Check: P_INVALID_INTERFACE_TYPE is returned

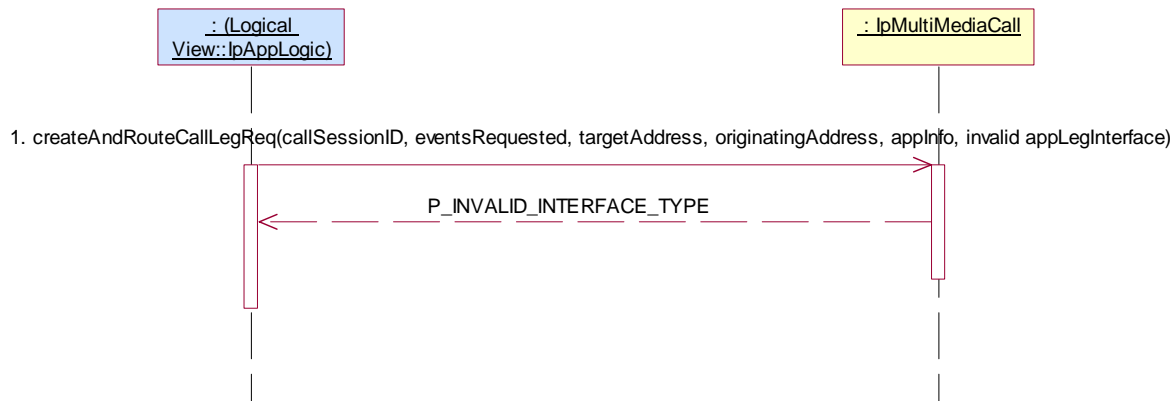

Test MMCC_IpMultiMediaCall_11

Summary: IpMultiMediaCall, createAndRouteCallLegReq, P_INVALID_ADDRESS

Reference: ES 201 915-4 [1], clause 7.3.3.

Preamble: Same as MMCC_IpMultiMediaCall_07

Condition: CreateAndRouteCallLeg method is supported.

Test Sequence:

- Method call **createAndRouteCallLegReq()** on IpMultiMediaCall
 Parameters: valid callSessionID, valid eventsRequested, invalid targetAddress, valid originatingAddress, valid appInfo, valid appLegInterface
 Check: P_INVALID_ADDRESS is returned

**Test MMCC_IpMultiMediaCall_12**

Summary: IpMultiMediaCall, createAndRouteCallLegReq, P_INVALID_ADDRESS

Reference: ES 201 915-4 [1], clause 7.3.3

Preamble: Same as MMCC_IpMultiMediaCall_07

Condition: CreateAndRouteCallLeg method is supported

Test Sequence:

- Method call **createAndRouteCallLegReq()** on IpMultiMediaCall
 Parameters: valid callSessionID, valid eventsRequested, valid targetAddress, invalid originatingAddress, valid appInfo, valid appLegInterface
 Check: P_INVALID_ADDRESS is returned



Test MMCC_IpMultiMediaCall_13

Summary: IpMultiMediaCall, createAndRouteCallLegReq, P_INVALID_CRITERIA

Reference: ES 201 915-4 [1], clause 7.3.3

Preamble: Same as MMCC_IpMultiMediaCall_07

Condition: CreateAndRouteCallLeg method is supported

Test Sequence:

1. Method call **createAndRouteCallLegReq()** on IpMultiMediaCall
 Parameters: valid callSessionID, invalid eventsRequested, valid targetAddress, valid originatingAddress, valid appInfo, valid appLegInterface
 Check: P_INVALID_CRITERIA is returned

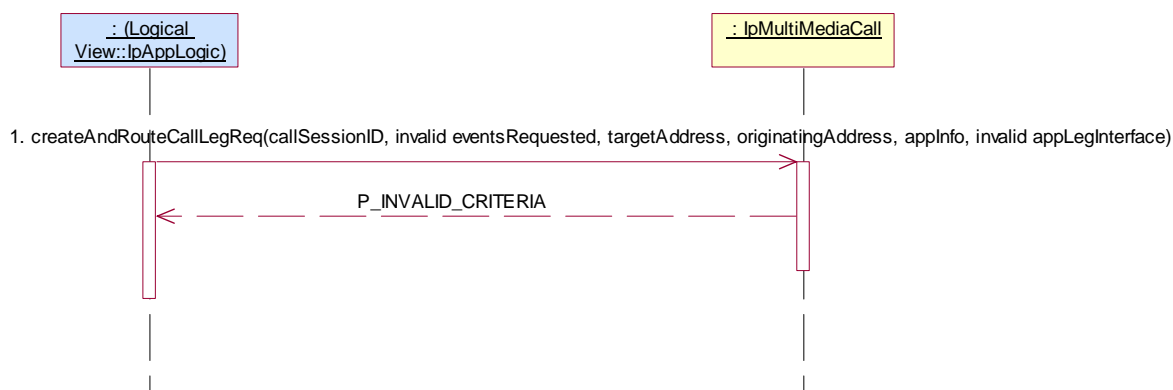
**5.2.3.2.3 Optional, valid behaviour****Test MMCC_IpMultiMediaCall_14**

Summary: IpMultiMediaCall, all methods, successful

Reference: ES 201 915-4 [1], clauses 7.3.1 and 8.3.1

Preamble: Application has a valid callSessionID returned by one of the two following sequence:

1. Method call **setCallback()** on IpMultiMediaCallControlManager
 Parameters: valid, non-null, value of appInterface parameter
 Check: no exception is returned
2. Method call **createCall()**
 Parameters: valid appCall
 Check: valid value of TpMultiPartyCallIdentifier is returned
3. Method call **createCallLeg()** on IpMultiMediaCall
 Parameters: valid callSessionID returned in 2., valid appCallLeg
 Check: valid value of TpCallLegIdentifier is returned

or

1. Method call **createNotification()**
 Parameters: appCallControlManager with valid, non-null, value, valid notificationRequest
 Check: valid value of TpAssignmentID is returned
2. Triggered action: cause IUT to call Method **reportNotification()** method on the tester's (application) **IpAppMultiMediaCallControlManager interface**
 Parameters: callReference, callLegReferenceSet, notificationInfo, assignmentID

3. Method call **createCallLeg()** on IpMultiMediaCall
 Parameters: valid callSessionID reported in 2., valid appCallLeg
 Check: valid value of TpCallLegIdentifier is returned

Condition: superviseVolumeReq method is supported.

Test Sequence:

1. Method call **superviseVolumeReq()** on IpMultiMediaCall
 Parameters: valid callSessionID returned in preamble, valid volume, valid treatment
 Check: no exception is returned
2. Method call **routeReq()** on IpMultiMediaCallLeg
 Parameters: valid callLegSessionID returned in preamble, valid targetAddress, valid appInfo, valid connectionProperties
 Check: no exception is returned
3. Triggered action: cause IUT to call Method **superviseVolumeRes()** method on the tester's (application) **IpMultiMediaCall** interface.
 Parameters: callSessionID, report, usedVolume

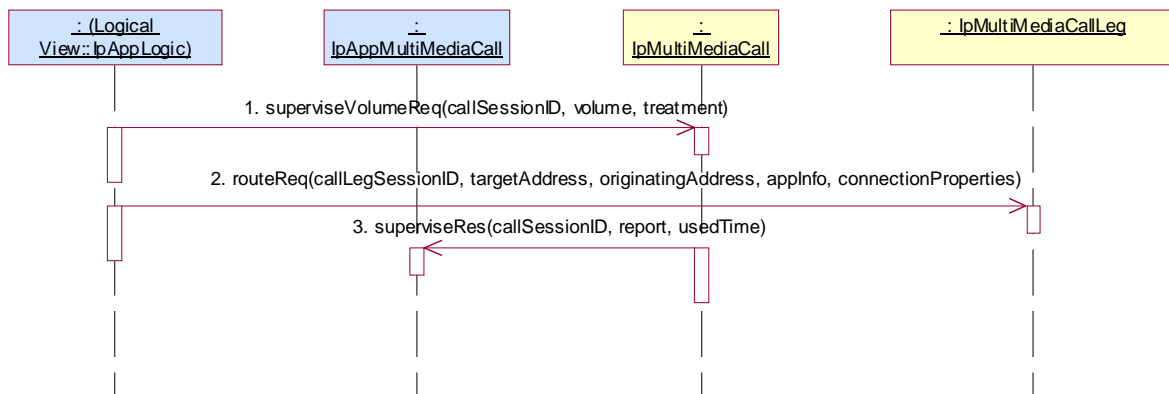

Test MMCC_ IpMultiMediaCall _15

Summary: IpMultiMediaCall, getInfoReq, successful

Reference: ES 201 915-4 [1], clauses 7.3.1 and 7.3.3

Preamble: Same as MMCC_ IpMultiMediaCall _14

Condition: createCallLeg and getInfoReq methods are supported

Test Sequence:

1. Method call **getInfoReq()** on IpMultiMediaCall
Parameters: valid callSessionID returned in preamble, valid callInfoRequested
Check: no exception is returned
2. Method call **routeReq()** on IpMultiMediaCallLeg
Parameters: valid callLegSessionID returned in preamble, valid targetAddress, valid appInfo, valid connectionProperties
Check: no exception is returned
3. Method call **release()** on IpMultiMediaCall
Parameters: valid callSessionID returned in preamble, valid cause
Check: no exception is returned
4. Triggered action: cause IUT to call **getInfoRes()** method on the tester's (Application) **IpAppMultiMediaCall** interface
Parameters: callSessionID given in 1., valid callInfoReport

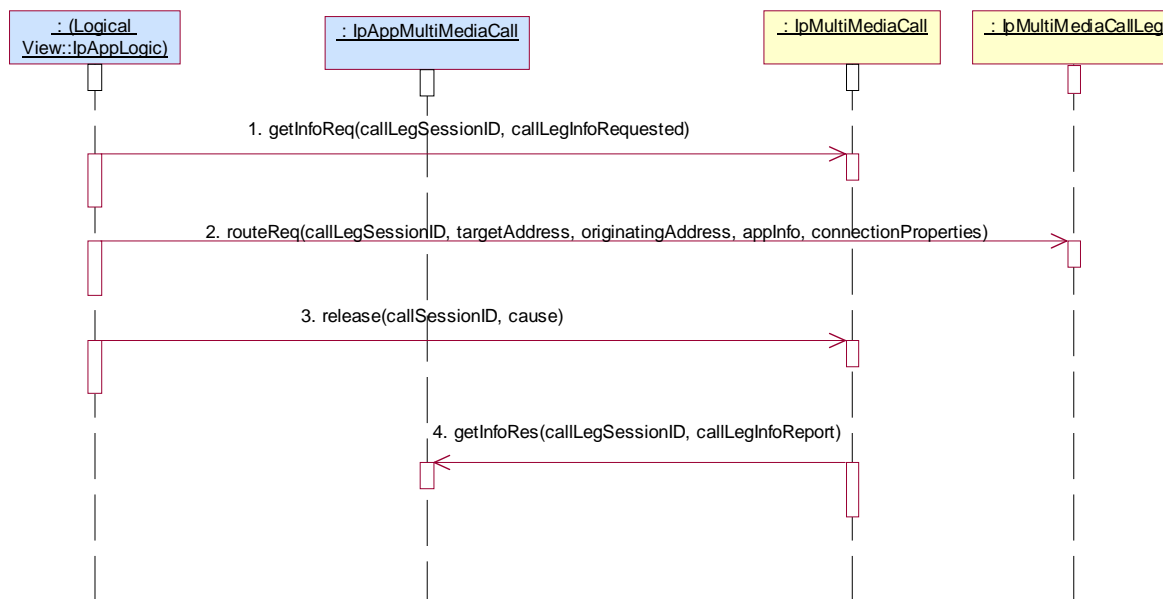

Test MMCC_IpMultiMediaCall_16

Summary: IpMultiMediaCall, setChargePlan, successful

Reference: ES 201 915-4 [1], clauses 7.3.1 and 7.3.3

Preamble: Same as MMCC_IpMultiMediaCall_14

Condition: createCallLeg and setChargePlan methods are supported

Test Sequence:

1. Method call **setChargePlan()** on IpMultiMediaCall
 Parameters: valid callSessionID returned in preamble, valid callChargePlan
 Check: no exception is returned

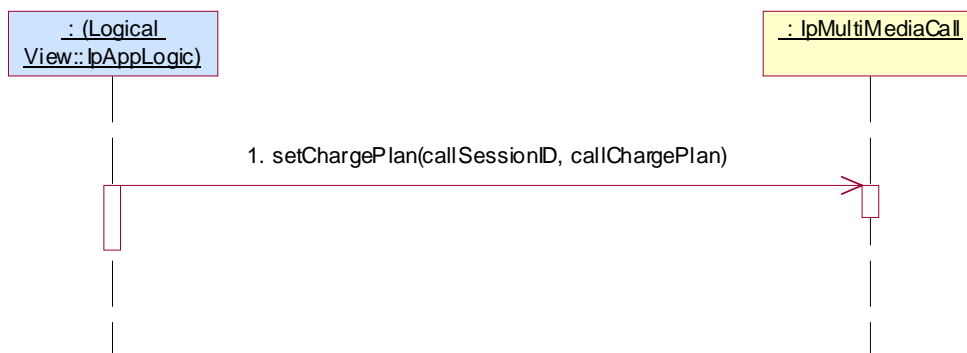
**Test MMCC_IpMultiMediaCall_17**

Summary: IpMultiMediaCall, setAdviceOfCharge, successful

Reference: ES 201 915-4 [1], clauses 7.3.1 and 7.3.3

Preamble: Same as MMCC_IpMultiMediaCall_14

Condition: createCallLeg and setAdviceOfCharge methods are supported

Test Sequence:

1. Method call **setAdviceOfCharge()** on IpMultiMediaCall
 Parameters: valid callSessionID returned in 1., valid aOCInfo, valid tariffSwitch
 Check: no exception is returned



Test MMCC_IpMultiMediaCall_18

Summary: IpMultiMediaCall, superviseReq, successful

Reference: ES 201 915-4 [1], clauses 7.3.1 and 7.3.3

Preamble: Same as MMCC_IpMultiMediaCall_14

Condition: createCallLeg and superviseReq methods are supported

Test Sequence:

1. Method call **superviseReq()** on IpMultiMediaCall
Parameters: valid callSessionID returned in preamble, valid time, valid treatment
Check: no exception is returned
2. Method call **routeReq()** on IpMultiMediaCallLeg
Parameters: valid callLegSessionID returned in preamble, valid targetAddress, valid appInfo, valid connectionProperties
Check: no exception is returned
3. Triggered action: cause IUT to call **superviseRes()** method on the tester's (Application) **IpAppMultiMediaCall** interface
Parameters: callSessionID given in 1., valid report, valid usedTime

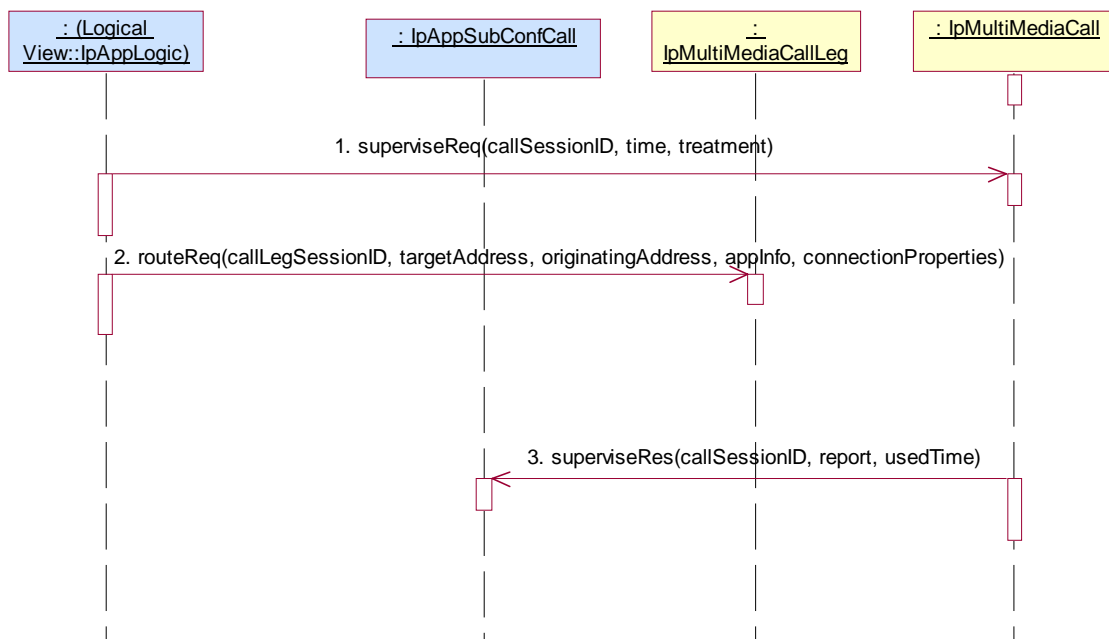

Test MMCC_IpMultiMediaCall_19

Summary: IpMultiMediaCall, all methods, successful

Reference: ES 201 915-4 [1], clauses 7.3.1 and 7.3.3

Preamble: Same as MMCC_IpMultiMediaCall_03

Condition: getCallLegs method is supported

Test Sequence:

- Method call **getCallLegs()** on IpMultiMediaCall
 Parameters: valid callSessionID returned in preamble
 Check: valid value of TpCallLegIdentifierSet which contains CallLegIdentifier returned in preamble

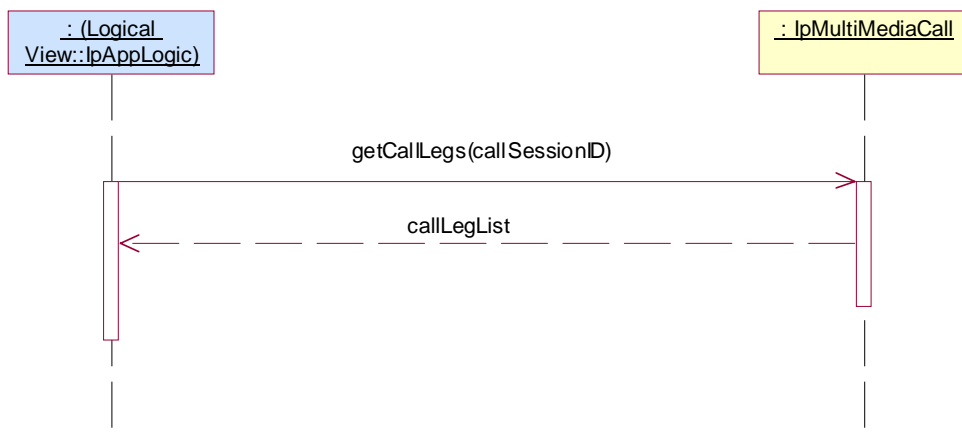

5.2.3.2.4 Optional, invalid behaviour

Test MMCC_IpMultiMediaCall_20

Summary: IpMultiMediaCall, superviseVolumeReq, P_INVALID_SESSION_ID

Reference: ES 201 915-4 [1], clause 8.3.1

Preamble: Same as MMCC_IpMultiMediaCall_14

Condition: superviseVolumeReq method is supported

Test Sequence:

- Method call **superviseVolumeReq()** on IpMultiMediaCall
 Parameters: invalid callSessionID, valid volume, valid treatment
 Check: P_INVALID_SESSION_ID is returned

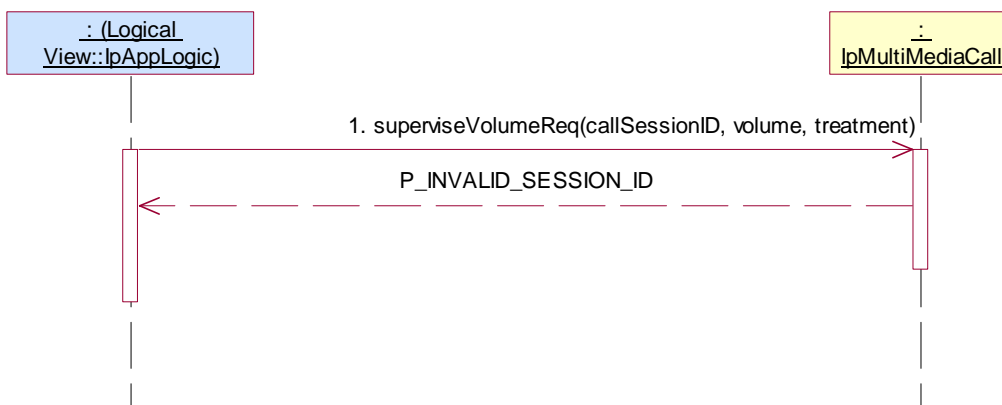

Test MMCC_IpMultiMediaCall_21

Summary: IpMultiMediaCall, getInfoReq, P_INVALID_SESSION_ID

Reference: ES 201 915-4 [1], clauses 7.3.1 and 7.3.3

Preamble: Same as MMCC_IpMultiMediaCall_14

Condition: createCallLeg and getInfoReq methods are supported

Test Sequence:

- Method call **getInfoReq()** on IpMultiMediaCall
 Parameters: invalid callSessionID, valid callInfoRequested
 Check: P_INVALID_SESSION_ID is returned

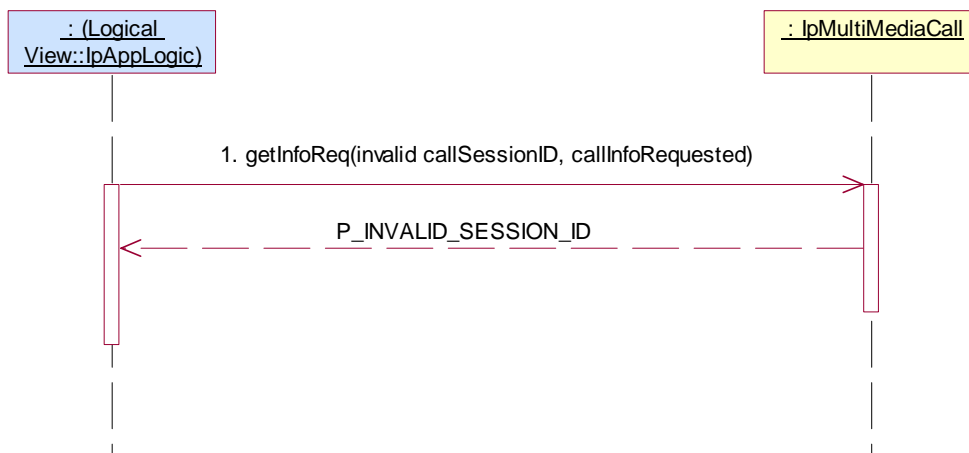

Test MMCC_IpMultiMediaCall_22

Summary: IpMultiMediaCall, setChargePlan, P_INVALID_SESSION_ID

Reference: ES 201 915-4 [1], clauses 7.3.1 and 7.3.3

Preamble: Same as MMCC_IpMultiMediaCall_14

Condition: createCallLeg and setChargePlan methods are supported

Test Sequence:

- Method call **setChargePlan()** on IpMultiMediaCall
 Parameters: invalid callSessionID, valid callChargePlan
 Check: P_INVALID_SESSION_ID is returned

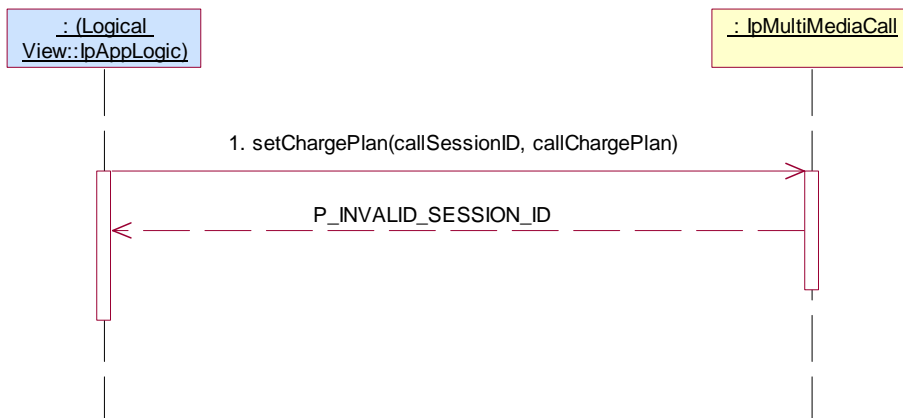

Test MMCC_IpMultiMediaCall_23

Summary: IpMultiMediaCall, setAdviceOfCharge, P_INVALID_SESSION_ID

Reference: ES 201 915-4 [1], clauses 7.3.1 and 7.3.3

Preamble: Same as MMCC_IpMultiMediaCall_14

Condition: createCallLeg and setAdviceOfCharge methods are supported

Test Sequence:

1. Method call **setAdviceOfCharge()** on IpMultiMediaCall
 Parameters: invalid callSessionID, valid aOCInfo, valid tariffSwitch
 Check: P_INVALID_SESSION_ID is returned

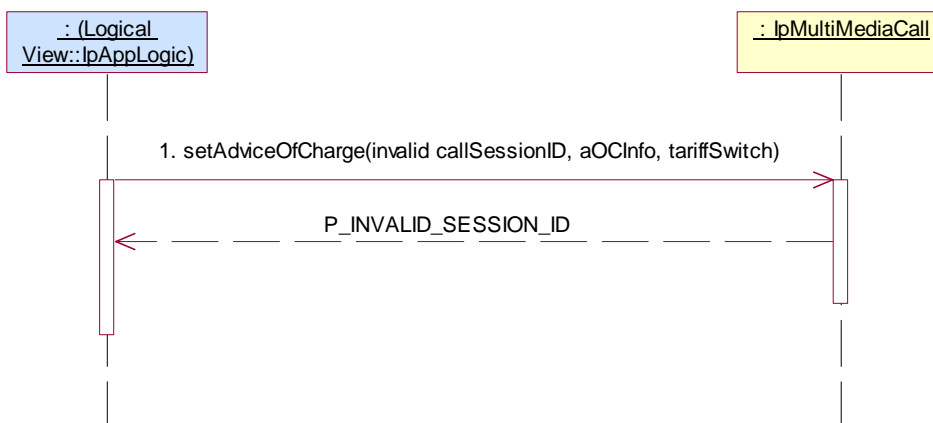
**Test MMCC_IpMultiMediaCall_24**

Summary: IpMultiMediaCall, setAdviceOfCharge, P_INVALID_CURRENCY

Reference: ES 201 915-4 [1], clauses 7.3.1 and 7.3.3

Preamble: Same as MMCC_IpMultiMediaCall_14

Condition: createCallLeg and setAdviceOfCharge methods are supported

Test Sequence:

1. Method call **setAdviceOfCharge()** on IpMultiMediaCall
 Parameters: valid callSessionID returned in 1., aOCInfo with invalid currency, valid tariffSwitch
 Check: P_INVALID_CURRENCY is returned

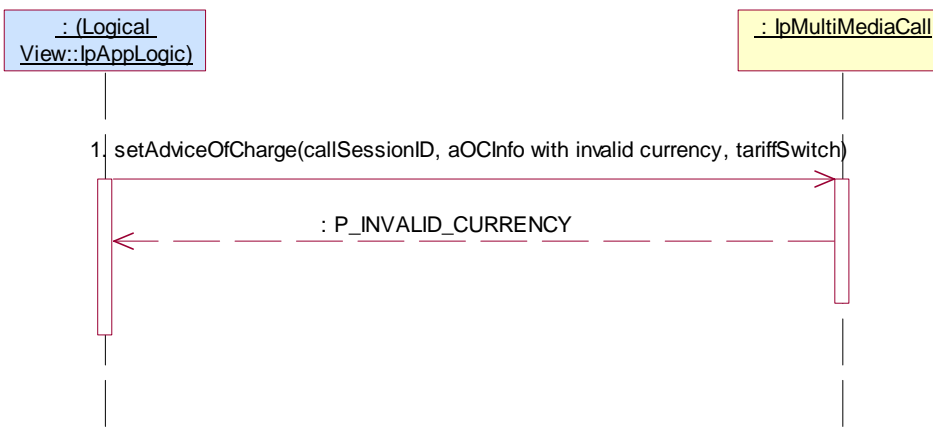

Test MMCC_IpMultiMediaCall_25

Summary: IpMultiMediaCall, setAdviceOfCharge, P_INVALID_AMOUNT

Reference: ES 201 915-4 [1], clauses 7.3.1 and 7.3.3

Preamble: Same as MMCC_IpMultiMediaCall_14

Condition: createCallLeg and setAdviceOfCharge methods are supported

Test Sequence:

1. Method call **setAdviceOfCharge()** on IpMultiMediaCall
 Parameters: valid callSessionID returned in 1., aOCInfo, with invalid amount, valid tariffSwitch
 Check: P_INVALID_AMOUNT is returned

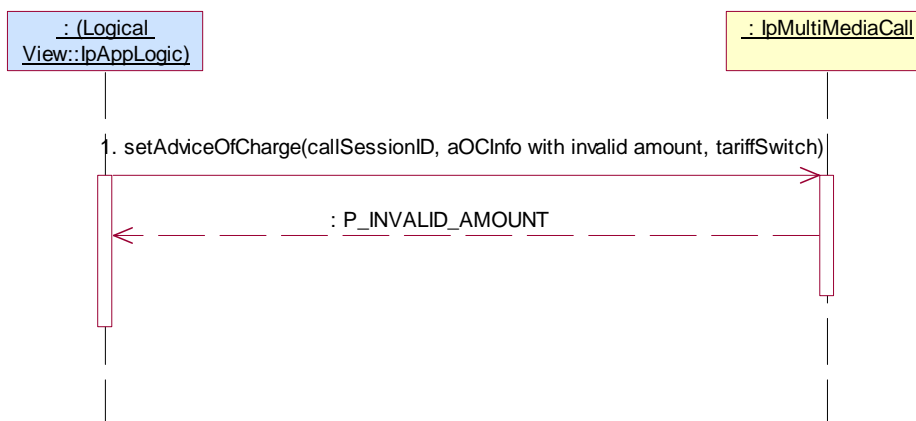
**Test MMCC_IpMultiMediaCall_26**

Summary: IpMultiMediaCall, superviseReq, P_INVALID_SESSION_ID

Reference: ES 201 915-4 [1], clause 7.3.3

Preamble: Same as MMCC_IpMultiMediaCall_14

Condition: createCallLeg and superviseReq methods are supported

Test Sequence:

1. Method call **superviseReq()** on IpMultiMediaCall
 Parameters: invalid callSessionID, valid time, valid treatment
 Check: P_INVALID_SESSION_ID is returned



Test MMCC_IpMultiMediaCall_27

Summary: IpMultiMediaCall, getCallLegs, P_INVALID_SESSION_ID

Reference: ES 201 915-4 [1], clause 7.3.3

Preamble: Same as MMCC_IpMultiMediaCall_03

Condition: CreateCallLeg method is supported

Test Sequence:

1. Method call **getCallLegs()** on IpMultiMediaCall
Parameters: invalid callSessionID
Check: P_INVALID_SESSION_ID is returned

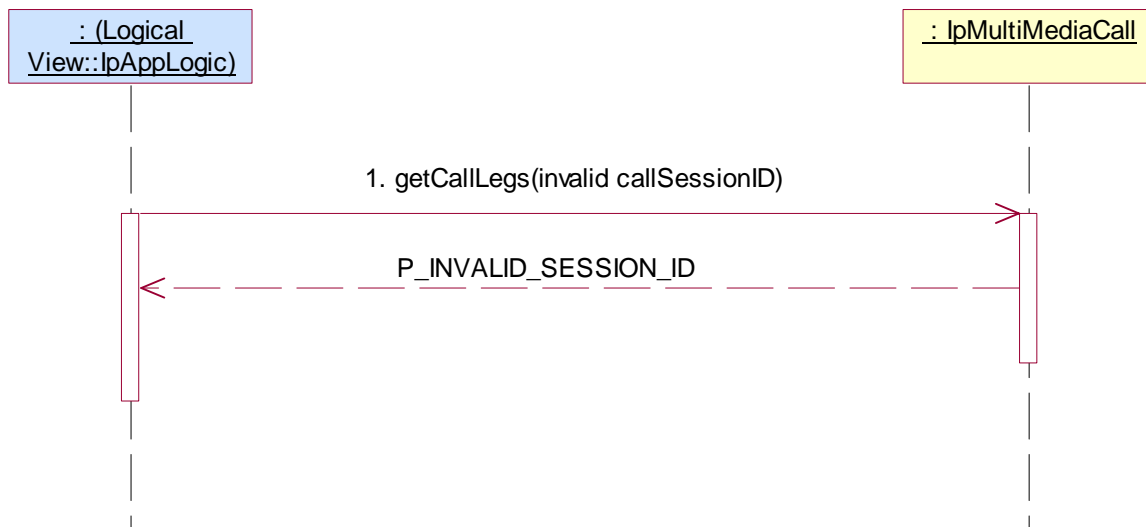

5.2.3.3 IpMultiMediaCallLeg

5.2.3.3.1 Mandatory, valid behaviour

Test MMCC_ IpMultiMediaCallLeg _01

Summary: IpMultiMediaCallLeg, all methods mandatory, successful

Reference: ES 201 915-4 [1], clauses 7.3.1, 7.3.3 and 8.3.5

Preamble: Same as MMCC_ IpMultiMediaCall _03

Test Sequence:

1. Method call **mediaStreamMonitorReq()** on IpMultiMediaCallLeg
Parameters: valid callLegSessionID returned in preamble, valid mediaStreamEventCriteria
Check: no exception is returned
2. Triggered action: cause IUT to call Method **mediaStreamMonitorRes()** method on the tester's (application)
Parameters: callLegSessionID, streams, type
3. Method call **mediaStreamAllow()** on IpMultiMediaCallLeg
Parameters: valid callLegSessionID returned in preamble, valid mediaStreamList
Check: no exception is returned

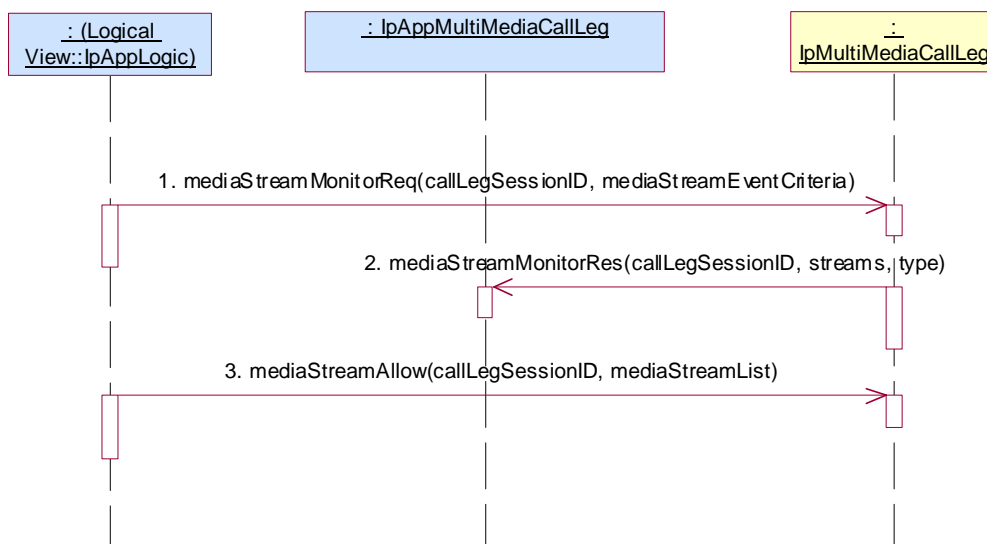

Test MMCC_ IpMultiMediaCallLeg _02

Summary: IpMultiMediaCallLeg, all mandatory methods, successful

Reference: ES 201 915-4 [1], clauses 7.3.1, 7.3.3 and 7.3.5

Preamble: Same as MMCC_ IpMultiMediaCall _07

Condition: createCallLeg method is supported

Test Sequence:

1. Method call **createCallLeg()** on IpMultiMediaCall
Parameters: valid callSessionID returned in preamble, valid appCallLeg
Check: valid value of TpCallLegIdentifier is returned
2. Method call **eventReportReq()** on IpMultiMediaCallLeg
Parameters: valid callLegSessionID returned in 1., valid eventsRequested with Interrupt event
Check: no exception is returned
3. Method call **routeReq()** on IpMultiMediaCallLeg
Parameters: valid callLegSessionID returned in 1., valid targetAddress, valid appInfo, valid connectionProperties
Check: no exception is returned
4. Triggered action: cause IUT to interrupt call leg processing with a notification or an event: cause IUT to call **eventReportRes()** method on the tester's (Application) **IpAppCallLeg** interface.
Parameters: callLegSessionID, eventInfo
5. Method call **continueProcessing()** on IpMultiMediaCallLeg
Parameters: valid callLegSessionID returned in 1.
Check: no exception is returned
6. Method call **release()** on IpMultiMediaCallLeg
Parameters: valid callLegSessionID returned in 1., valid cause
Check: no exception is returned

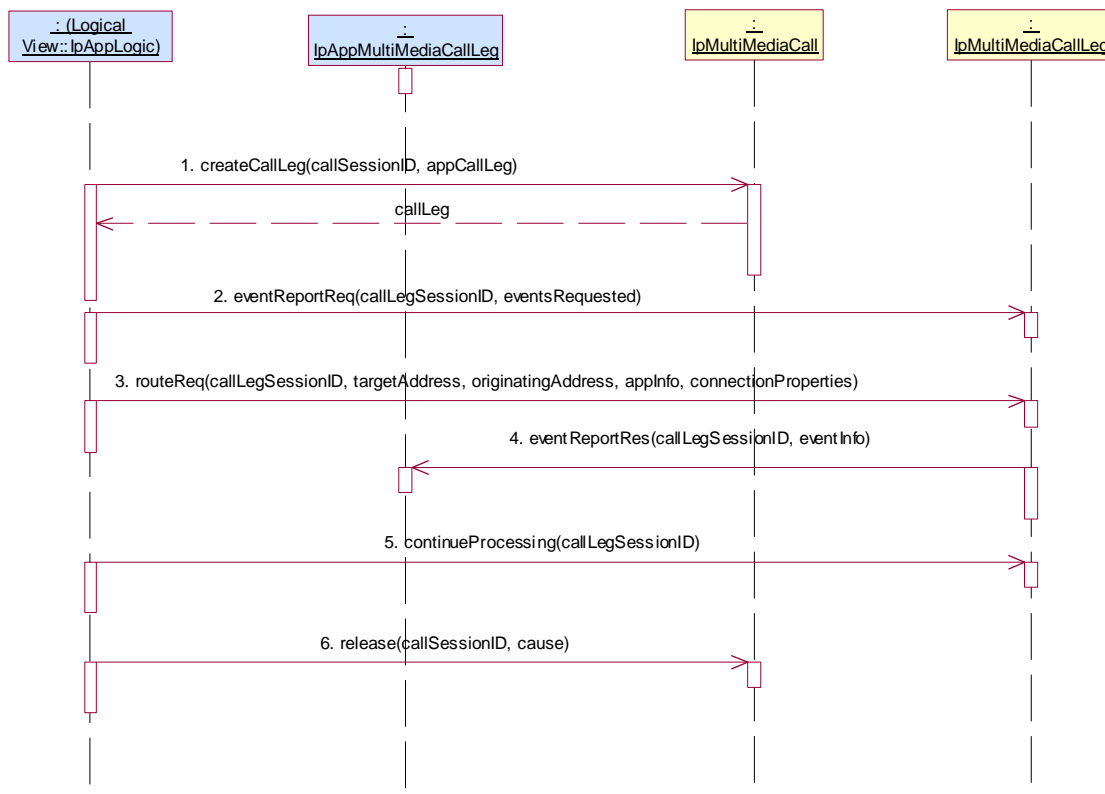

Test MMCC_IpMultiMediaCallLeg_03

Summary: IpMultiMediaCallLeg, all mandatory methods, successful

Reference: ES 201 915-4 [1], clauses 7.3.1, 7.3.3 and 7.3.5

Preamble: Same as MMCC_IpMultiMediaCall_07

Condition: createAndRouteCallLeg method is supported

Test Sequence:

1. Method call **createAndRouteCallLeg()** on IpMultiMediaCall
 Parameters: valid callSessionID returned in preamble, valid eventsRequested, valid targetAddress, valid originatingAddress, valid appInfo, valid appLegInterface
 Check: valid value of TpCallLegIdentifier is returned
2. Triggered action: cause IUT to interrupt call leg processing with a notification or an event: cause IUT to call **eventReportRes()** method on the tester's (Application) **IpAppCallLeg** interface
 Parameters: callLegSessionID returned in 1, eventInfo
3. Method call **continueProcessing()** on IpMultiMediaCallLeg
 Parameters: valid callLegSessionID returned in preamble
 Check: no exception is returned
4. Method call **release()** on IpMultiMediaCallLeg
 Parameters: valid callLegSessionID returned in preamble, valid cause
 Check: no exception is returned

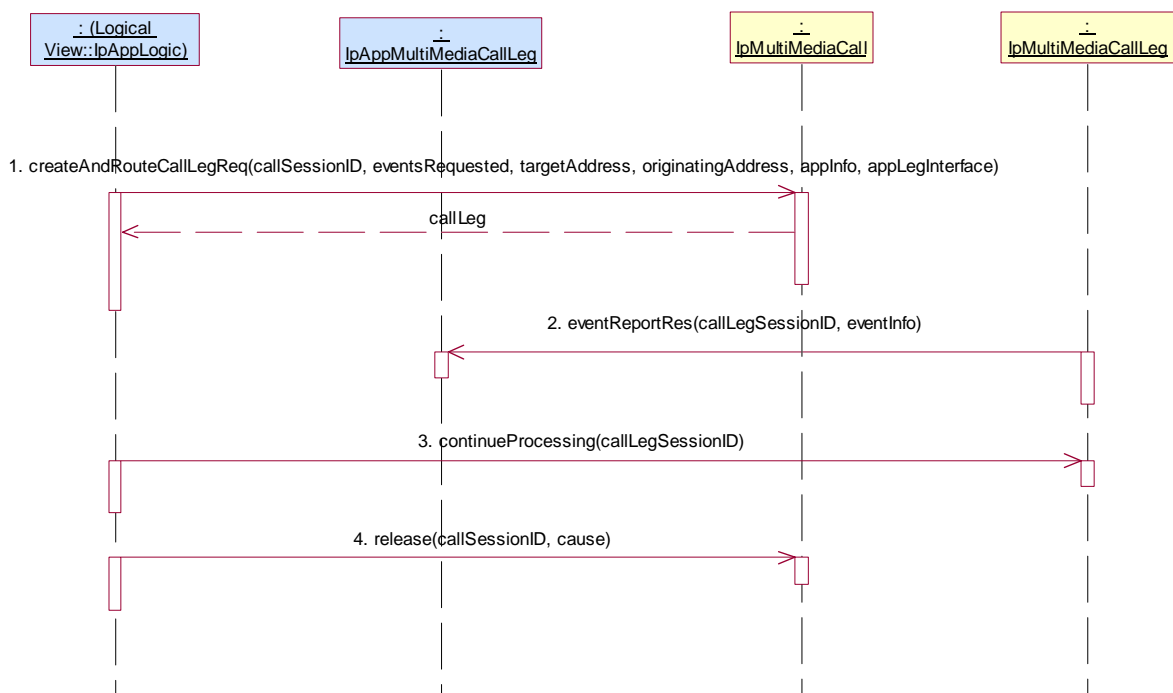

Test MMCC_IpMultiMediaCallLeg_04

Summary: IpMultiMediaCallLeg, all mandatory methods, successful

Reference: ES 201 915-4 [1], clauses 7.3.1, 7.3.3 and 7.3.5

Preamble: Same as MMCC_IpMultiMediaCall_03

Test Sequence:

1. Method call **deassign()** on IpMultiMediaCallLeg
Parameters: valid callLegSessionID returned in preamble
Check: no exception is returned

**5.2.3.3.2 Mandatory, invalid behaviour****Test MMCC_IpMultiMediaCallLeg_05**

Summary: IpMultiMediaCallLeg, continueProcessing, : P_INVALID_SESSION_ID

Reference: ES 201 915-4 [1], clause 7.3.5

Preamble: Same as MMCC_IpMultiMediaCall_07

Test Sequence:

1. Method call **createCallLeg()** on IpMultiMediaCall
Parameters: valid callSessionID returned in preamble, valid appCallLeg
Check: valid value of TpCallLegIdentifier is returned
2. Method call **eventReportReq()** on IpMultiMediaCallLeg
Parameters: valid callLegSessionID returned in 1., valid eventsRequested with Interrupt event
Check: no exception is returned
3. Method call **routeReq()** on IpMultiMediaCallLeg
Parameters: valid callLegSessionID returned in 1., valid targetAddress, valid appInfo, valid connectionProperties
Check: no exception is returned
4. Triggered action: cause IUT to interrupt call leg processing with a notification or an event: cause IUT to call **eventReportRes()** method on the tester's (Application) **IpAppCallLeg** interface
Parameters: callLegSessionID, eventInfo
5. Method call **continueProcessing()** on IpMultiMediaCallLeg
Parameters: invalid callLegSessionID
Check: P_INVALID_SESSION_ID is returned
6. Method call **release()** on IpMultiMediaCallLeg
Parameters: valid callLegSessionID returned in 1., valid cause
Check: no exception is returned



Test MMCC_IpMultiMediaCallLeg_06

Summary: IpMultiMediaCallLeg, release, P_INVALID_SESSION_ID

Reference: ES 201 915-4 [1], clause 7.3.5

Preamble: Same as MMCC_IpMultiMediaCall_03

Test Sequence:

1. Method call **release()** on IpMultiMediaCallLeg
 Parameters: invalid callLegSessionID, valid cause
 Check: P_INVALID_SESSION_ID is returned

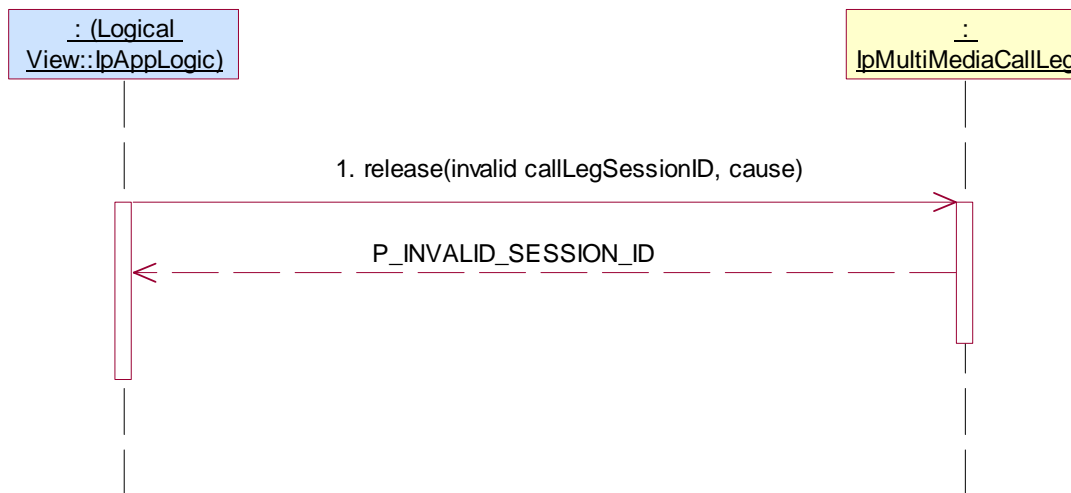

Test MMCC_IpMultiMediaCallLeg_07

Summary: IpMultiMediaCallLeg, deassign, P_INVALID_SESSION_ID

Reference: ES 201 915-4 [1], clause 7.3.5

Preamble: Same as MMCC_IpMultiMediaCall_03

Test Sequence:

1. Method call **deassign()** on IpMultiMediaCallLeg
Parameters: invalid callLegSessionID
Check: P_INVALID_SESSION_ID is returned



Test MMCC_ IpMultiMediaCallLeg _08

Summary: IpMultiMediaCallLeg, mediaStreamAllow, P_INVALID_SESSION_ID

Reference: ES 201 915-4 [1], clause 8.3.5

Preamble: Same as MMCC_ IpMultiMediaCall _03

Test Sequence:

1. Method call **mediaStreamMonitorReq()** on IpMultiMediaCallLeg
Parameters: valid callLegSessionID returned in preamble, valid mediaStreamEventCriteria
Check: no exception is returned
2. Triggered action: cause IUT to call Method **mediaStreamMonitorRes()** method on the tester's (application)
Parameters: callLegSessionID, streams, type
3. Method call **mediaStreamAllow()** on IpMultiMediaCallLeg
Parameters: invalid callLegSessionID, valid mediaStreamList
Check: P_INVALID_SESSION_ID is returned

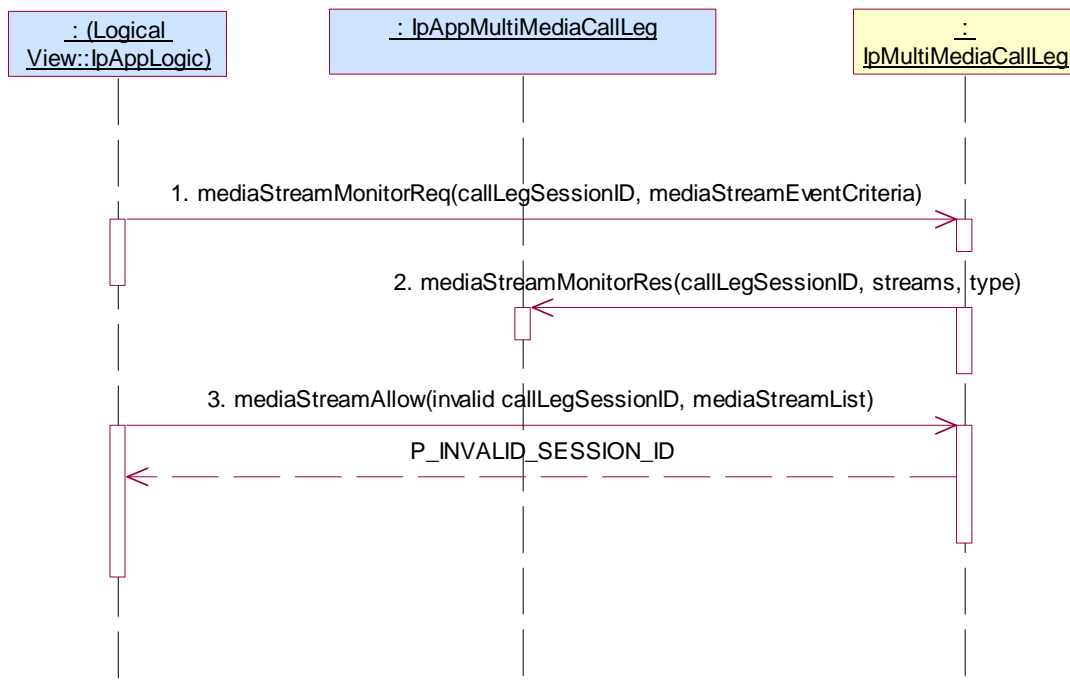

Test MMCC_IpMultiMediaCallLeg_09

Summary: IpMultiMediaCallLeg, mediaStreamMonitorReq, P_INVALID_SESSION_ID

Reference: ES 201 915-4 [1], clause 8.3.5

Preamble: Same as MMCC_IpMultiMediaCall_03

Test Sequence:

1. Method call **mediaStreamMonitorReq()** on IpMultiMediaCallLeg
Parameters: invalid callLegSessionID, valid mediaStreamEventCriteria
Check: P_INVALID_SESSION_ID is returned



Test MMCC_IpMultiMediaCallLeg_10

Summary: IpMultiMediaCallLeg, mediaStreamMonitorReq, P_INVALID_CRITERIA

Reference: ES 201 915-4 [1], clauses 7.3.1, 7.3.3 and 8.3.5

Preamble: Same as MMCC_IpMultiMediaCall_03

Test Sequence:

1. Method call **mediaStreamMonitorReq()** on IpMultiMediaCallLeg
Parameters: valid callLegSessionID returned in 2., valid mediaStreamEventCriteria with invalid criteria
Check: P_INVALID_CRITERIA is returned

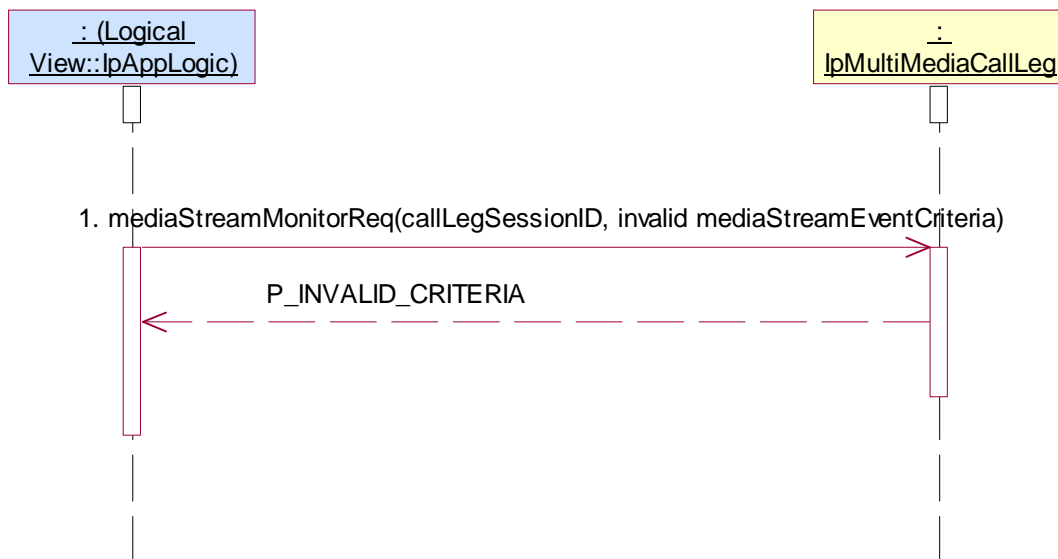

5.2.3.3.3 Optional, valid behaviour

Test MMCC_IpMultiMediaCallLeg_11

Summary: IpMultiMediaCallLeg, getInfoReq, successful

Reference: ES 201 915-4 [1], clauses 7.3.1, 7.3.3 and 7.3.5

Preamble: Same as MMCC_IpMultiMediaCall_14

Test Sequence:

1. Method call **getInfoReq()** on IpMultiMediaCallLeg
Parameters: valid callLegSessionID returned in preamble, valid callLegInfoRequested
Check: no exception is returned
2. Method call **routeReq()** on IpMultiMediaCallLeg
Parameters: valid callLegSessionID returned in preamble, valid targetAddress, valid appInfo, valid connectionProperties
Check: no exception is returned
3. Triggered action: cause IUT to call **getInfoRes()** method on the tester's (Application) **IpAppCallLeg** interface
Parameters: callLegSessionID given in 1., valid callLegInfoReport

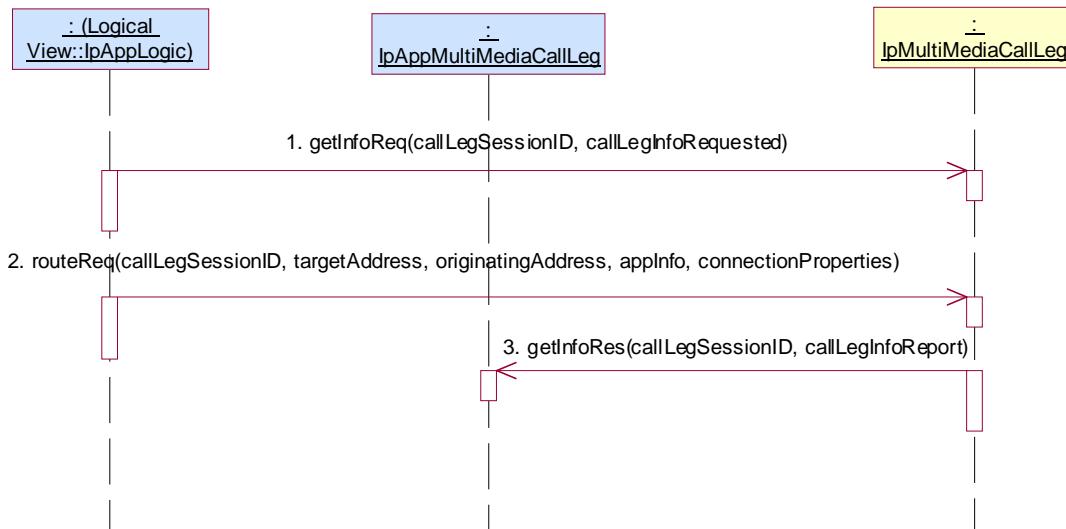

Test MMCC_IpMultiMediaCallLeg_12

Summary: IpMultiMediaCallLeg, attachMediaReq, successful

Reference: ES 201 915-4 [1], clauses 7.3.1, 7.3.3 and 7.3.5

Preamble: Application has a valid callSessionID returned by one of the three following sequence:

1. Method call **setCallback()** on IpMultiMediaCallControlManager
Parameters: valid, non-null, value of appInterface parameter
Check: no exception is returned
2. Method call **createCall()**
Parameters: valid appCall
Check: valid value of TpMultiMediaCallIdentifier is returned
3. Method call **createCallLeg()** on IpMultiMediaCall
Parameters: valid callSessionID returned in 2., valid appCallLeg
Check: valid value of TpCallLegIdentifier is returned
4. Method call **routeReq()** on IpMultiMediaCallLeg
Parameters: valid callLegSessionID returned in 3., valid targetAddress, valid appInfo, valid connectionProperties set to have explicit media management
Check: no exception is returned

or

1. Method call **createNotification()**
Parameters: appCallControlManager with valid, non-null, value, valid notificationRequest
Check: valid value of TpAssignmentID is returned
2. Triggered action: cause IUT to call Method **reportNotification()** method on the tester's (application's) **IpMultiMediaCallControlManager** interface
Parameters: callReference, callLegReferenceSet, notificationInfo, assignmentID
3. Method call **createCallLeg()** on IpMultiMediaCall
Parameters: valid callSessionID reported in 2., valid appCallLeg
Check: valid value of TpCallLegIdentifier is returned
4. Method call **routeReq()** on IpMultiMediaCallLeg
Parameters: valid callLegSessionID returned in 3., valid targetAddress, valid appInfo, valid connectionProperties set to have explicit media management
Check: no exception is returned

or

1. Method call **createMediaNotification()**
Parameters: valid appInterface, valid notificationMediaRequest
Check: valid value of TpAssignmentID is returned
2. Triggered action: cause IUT to call Method **reportMediaNotification()** method on the tester's (application's) **IpMultiMediaCallControlManager** interface.
Parameters: callReference, callLegReferenceSet, notificationInfo, assignmentID
3. Method call **createCallLeg()** on IpMultiMediaCall
Parameters: valid callSessionID reported in 2., valid appCallLeg
Check: valid value of TpCallLegIdentifier is returned
4. Method call **routeReq()** on IpMultiMediaCallLeg
Parameters: valid callLegSessionID returned in 3., valid targetAddress, valid appInfo, valid connectionProperties set to have explicit media management
Check: no exception is returned

Test Sequence:

1. Method call **attachMediaReq()** on IpMultiMediaCallLeg
Parameters: valid callLegSessionID returned in preamble
Check: no exception is returned
2. Triggered action: cause IUT to call **attachMediaRes()** method on the tester's (Application) **IpAppCallLeg** interface.
Parameters: callLegSessionID

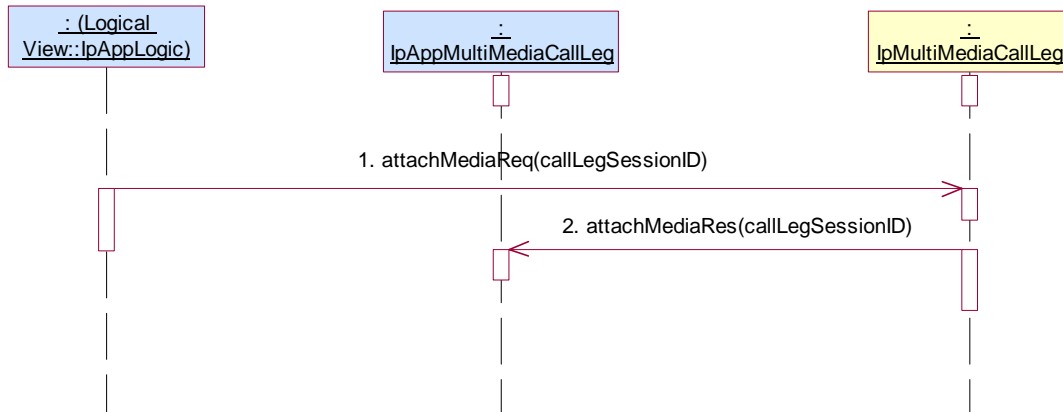

Test MMCC_ IpMultiMediaCallLeg _13

Summary: IpMultiMediaCallLeg, detachMediaReq, successful

Reference: ES 201 915-4 [1], clauses 7.3.1, 7.3.3 and 7.3.5

Preamble: Same as MMCC_ IpMultiMediaCallleg _12

Test Sequence:

1. Method call **attachMediaReq()** on IpMultiMediaCallLeg
Parameters: valid callLegSessionID returned in preamble
Check: no exception is returned
2. Triggered action: cause IUT to call **attachMediaRes()** method on the tester's (Application) **IpAppCallLeg** interface
Parameters: callLegSessionID
3. Method call **detachMediaReq()** on IpMultiMediaCallLeg
Parameters: valid callLegSessionID returned in preamble
Check: no exception is returned
4. Triggered action: cause IUT to call **detachMediaRes()** method on the tester's (Application) **IpAppCallLeg** interface
Parameters: callLegSessionID

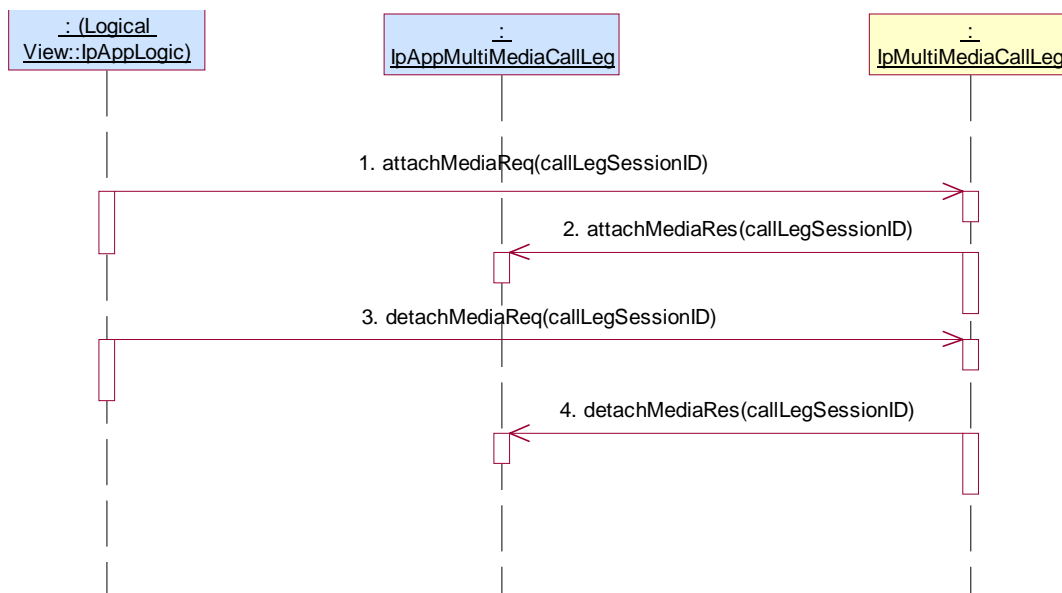

Test MMCC_IpMultiMediaCallLeg_14

Summary: IpMultiMediaCallLeg, getCurrentDestinationAddress, successful

Reference: ES 201 915-4 [1], clauses 7.3.1, 7.3.3 and 7.3.5

Preamble: Same as MMCC_IpMultiMediaCall_03

Test Sequence:

1. Method call **getCurrentDestinationAddress()** on IpMultiMediaCallLeg
 Parameters: valid callLegSessionID returned in preamble
 Check: valid value of TpAddress is returned

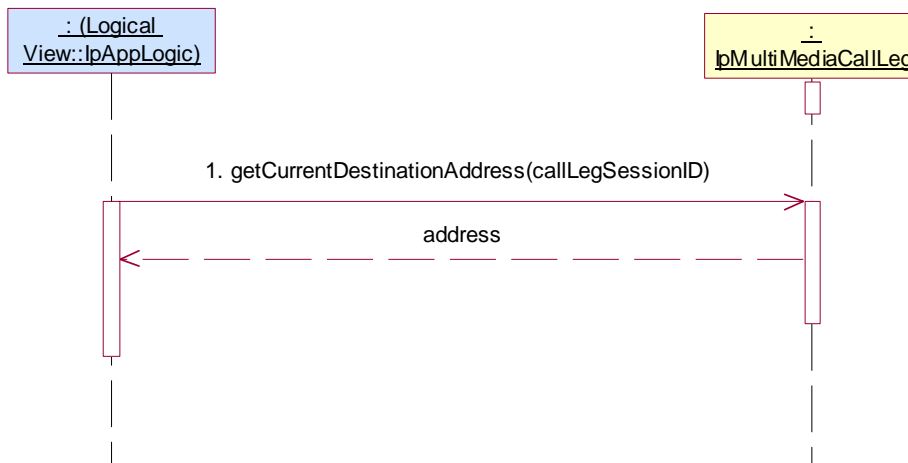
**Test MMCC_IpMultiMediaCallLeg_15**

Summary: IpMultiMediaCallLeg, setChargePlan, successful

Reference: ES 201 915-4 [1], clauses 7.3.1, 7.3.3 and 7.3.5

Preamble: Same as MMCC_IpMultiMediaCall_14

Test Sequence:

1. Method call **setChargePlan()** on IpMultiMediaCallLeg
 Parameters: valid callLegSessionID returned in preamble, valid callChargePlan
 Check: no exception is returned

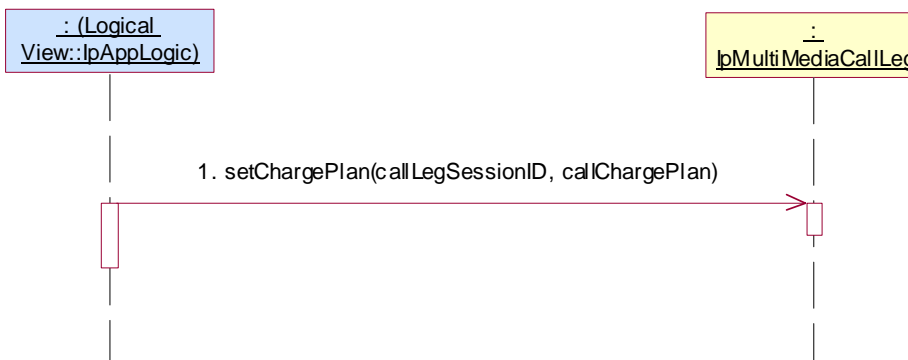

Test MMCC_ IpMultiMediaCallLeg _16

Summary: IpMultiMediaCallLeg, setAdviceOfCharge, successful

Reference: ES 201 915-4 [1], clauses 7.3.1, 7.3.3 and 7.3.5

Preamble: Same as MMCC_ IpMultiMediaCall _14

Test Sequence:

1. Method call **setAdviceOfCharge()** on IpMultiMediaCallLeg
Parameters: valid callLegSessionID returned in preamble, valid aOCInfo, valid tariffSwitch
Check: no exception is returned

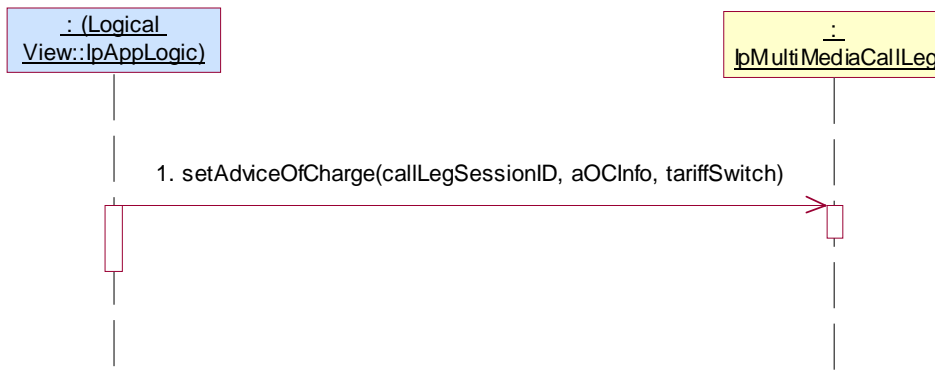

Test MMCC_IpMultiMediaCallLeg _17

Summary: IpMultiMediaCallLeg, superviseReq, successful

Reference: ES 201 915-4 [1], clauses 7.3.1, 7.3.3 and 7.3.5

Preamble: Same as MMCC_IpMultiMediaCall _14

Test Sequence:

1. Method call **superviseReq()** on IpMultiMediaCallLeg
Parameters: valid callLegSessionID returned in preamble, valid time, valid treatment
Check: no exception is returned
2. Method call **routeReq()** on IpMultiMediaCallLeg
Parameters: valid callLegSessionID returned in preamble, valid targetAddress, valid appInfo, valid connectionProperties
Check: no exception is returned
3. Triggered action: cause IUT to call **superviseRes()** method on the tester's (Application) **IpAppCallLeg** interface
Parameters: callLegSessionID, report, usedTime

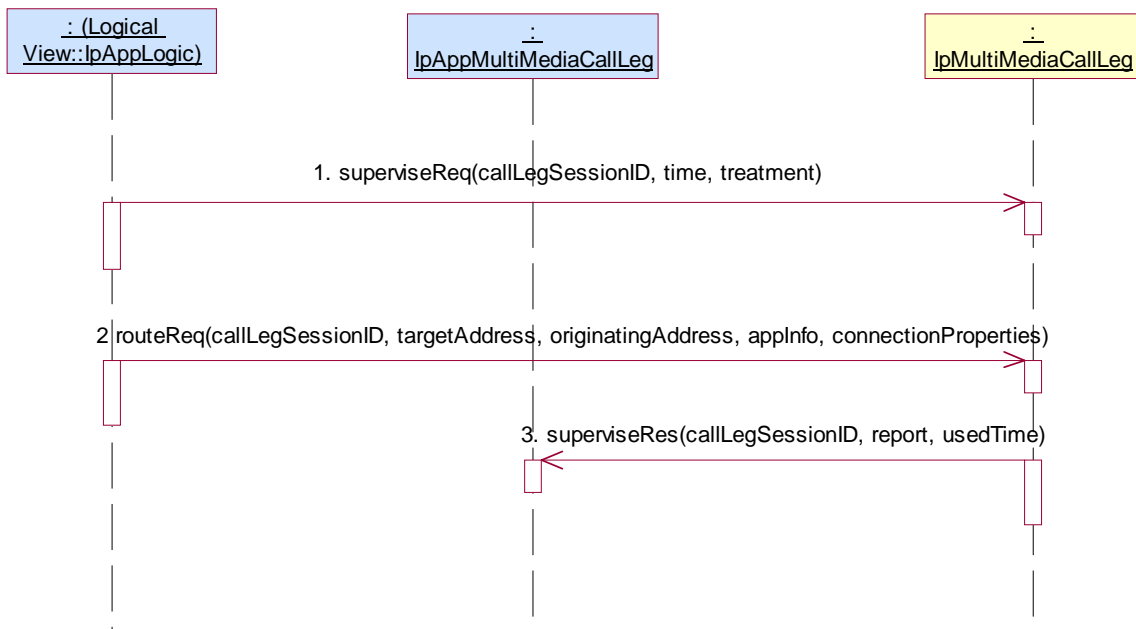

Test MMCC_ IpMultiMediaCallLeg _18

Summary: IpMultiMediaCallLeg, getCall, successful

Reference: ES 201 915-4 [1], clauses 7.3.1, 7.3.3 and 7.3.5

Preamble: Same as MMCC_ IpMultiMediaCall _14

Test Sequence:

1. Method call **getCall()** on IpMultiMediaCallLeg
Parameters: valid callLegSessionID returned in preamble
Check: valid TpMultiPartyCallIdentifier is returned



Test MMCC_IpMultiMediaCallLeg_19

Summary: IpMultiMediaCallLeg, CallLegEnded, successful

Reference: ES 201 915-4 [1], clauses 7.3.1, 7.3.3 and 7.3.5

Preamble: Same as MMCC_IpMultiMediaCall_14

Test Sequence:

1. Method call **getCall()** on IpMultiMediaCallLeg
 Parameters: valid callLegSessionID returned in preamble
 Check: valid TpMultiPartyCallIdentifier is returned
2. Method call **routeReq()** on IpMultiMediaCallLeg
 Parameters: valid callLegSessionID returned in preamble, valid targetAddress, valid appInfo, valid connectionProperties
 Check: no exception is returned
3. Triggered action: cause IUT to call **callLegEnded()** method on the tester's (Application) **IpAppCallLeg** interface
 Parameters: callLegSessionID, cause

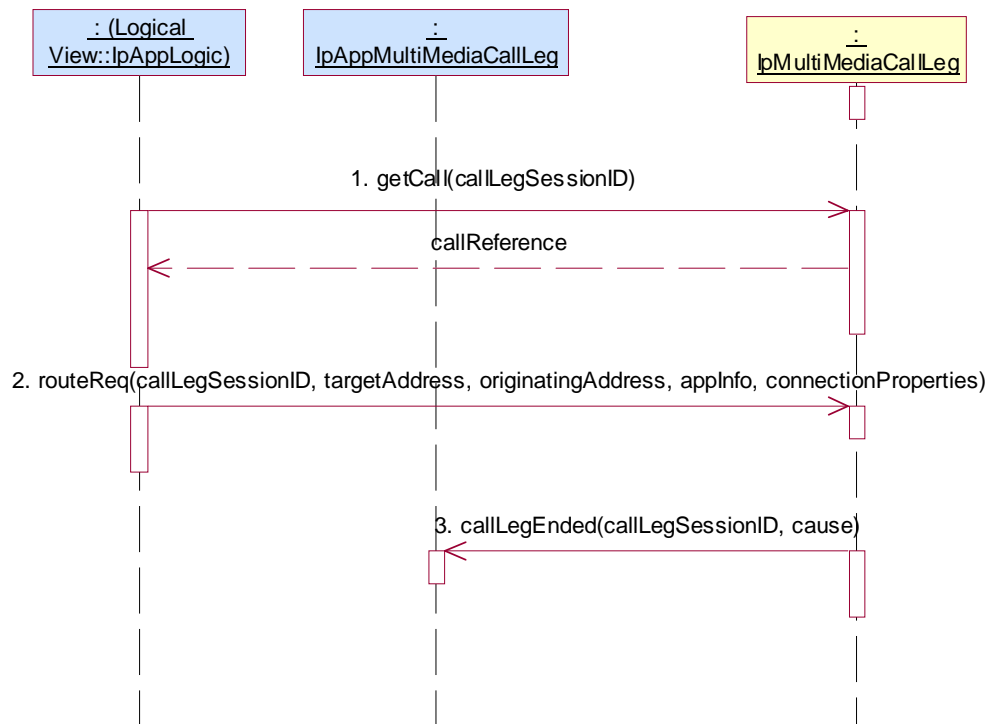

5.2.3.3.4 Optional, invalid behaviour

Test MMCC_IpMultiMediaCallLeg_20

Summary: IpMultiMediaCallLeg, getInfoReq, : P_INVALID_SESSION_ID

Reference: ES 201 915-4 [1], clause 7.3.5

Preamble: Same as MMCC_IpMultiMediaCall_14

Test Sequence:

1. Method call **getInfoReq()** on IpMultiMediaCallLeg
 Parameters: invalid callLegSessionID, valid callLegInfoRequested
 Check: P_INVALID_SESSION_ID is returned



Test MMCC_IpMultiMediaCallLeg_21

Summary: IpMultiMediaCallLeg, attachMediaReq: P_INVALID_SESSION_ID

Reference: ES 201 915-4 [1], clause 7.3.5

Preamble: Same as MMCC_IpMultiMediaCallLeg_12

Test Sequence:

1. Method call **attachMediaReq()** on IpMultiMediaCallLeg
 Parameters: invalid callLegSessionID
 Check: P_INVALID_SESSION_ID is returned



Test MMCC_IpMultiMediaCallLeg_22

Summary: IpMultiMediaCallLeg, detachMediaReq, : P_INVALID_SESSION_ID

Reference: ES 201 915-4 [1], clause 7.3.5

Preamble: Same as MMCC_IpMultiMediaCall_03

Test Sequence:

1. Method call **detachMediaReq()** on IpMultiMediaCallLeg
Parameters: invalid callLegSessionID
Check: P_INVALID_SESSION_ID is returned

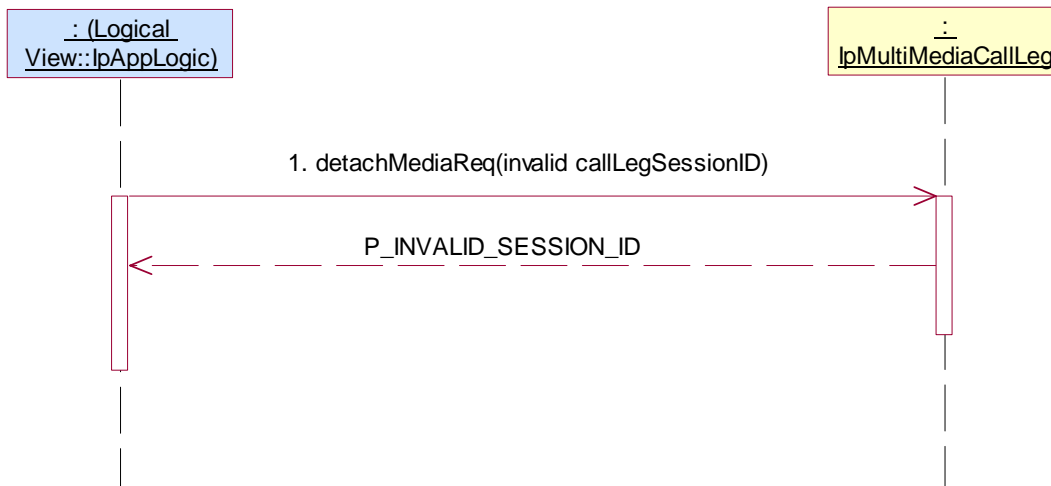
**Test MMCC_IpMultiMediaCallLeg_23**

Summary: IpMultiMediaCallLeg, getCurrentDestinationAddress, : P_INVALID_SESSION_ID

Reference: ES 201 915-4 [1], clause 7.3.5

Preamble: Same as MMCC_IpMultiMediaCall_03

Test Sequence:

1. Method call **getCurrentDestinationAddress()** on IpMultiMediaCallLeg
Parameters: invalid callLegSessionID
Check: P_INVALID_SESSION_ID is returned

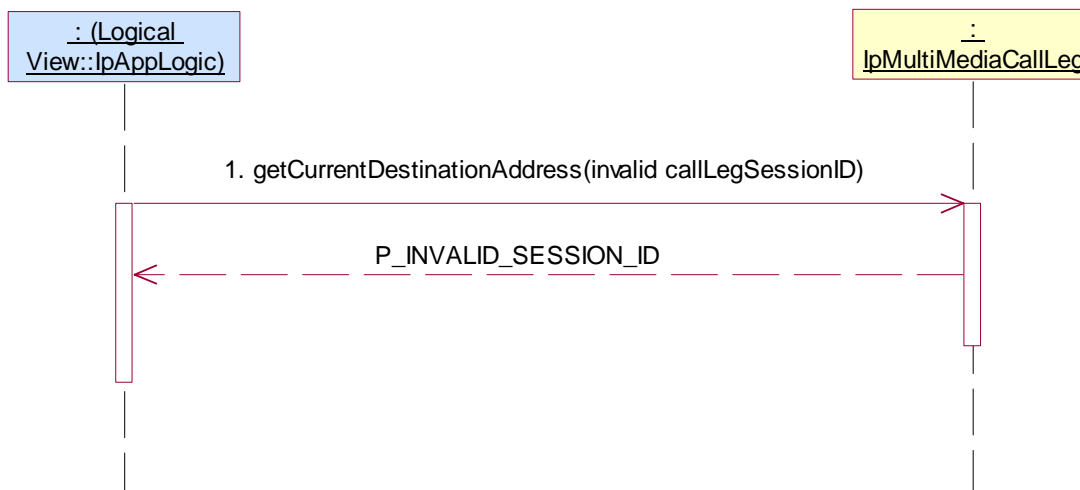

Test MMCC_IpMultiMediaCallLeg_24

Summary: IpMultiMediaCallLeg, setChargePlan: P_INVALID_SESSION_ID

Reference: ES 201 915-4 [1], clause 7.3.5

Preamble: Same as MMCC_IpMultiMediaCall_14

Test Sequence:

1. Method call **setChargePlan()** on IpMultiMediaCallLeg
Parameters: invalid callLegSessionID, valid callChargePlan
Check: P_INVALID_SESSION_ID is returned

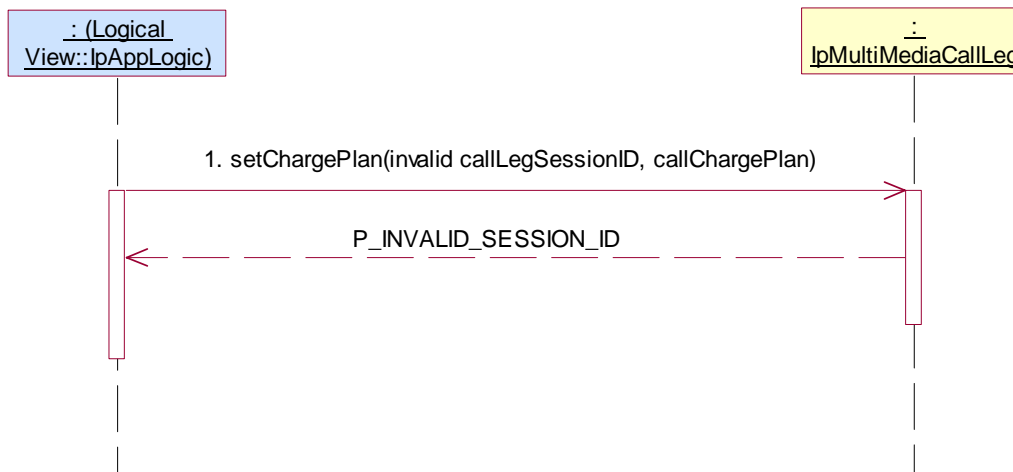
**Test MMCC_IpMultiMediaCallLeg_25**

Summary: IpMultiMediaCallLeg, setAdviceOfCharge, : P_INVALID_SESSION_ID

Reference: ES 201 915-4 [1], clause 7.3.5

Preamble: Same as MMCC_IpMultiMediaCall_14

Test Sequence:

1. Method call **setAdviceOfCharge()** on IpMultiMediaCallLeg
Parameters: invalid callLegSessionID, valid aOCInfo, valid tariffSwitch
Check: P_INVALID_SESSION_ID is returned

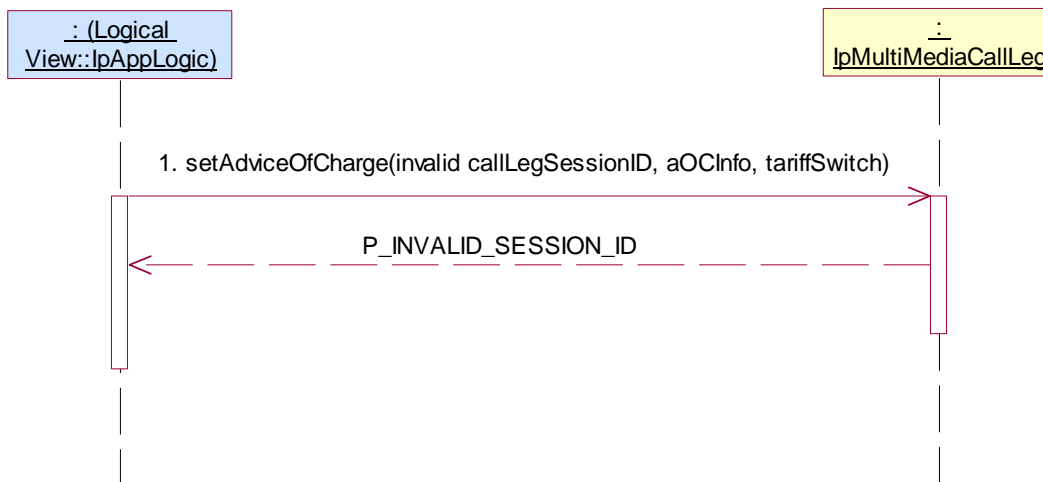

Test MMCC_IpMultiMediaCallLeg_26

Summary: IpMultiMediaCallLeg, setAdviceOfCharge, P_INVALID_CURRENCY

Reference: ES 201 915-4 [1], clauses 7.3.1, 7.3.3 and 7.3.5

Preamble: Same as MMCC_IpMultiMediaCall_14

Test Sequence:

1. Method call **setAdviceOfCharge()** on IpMultiMediaCallLeg
 Parameters: valid callLegSessionID returned in preamble, aOCInfo with invalid currency, valid tariffSwitch
 Check: P_INVALID_CURRENCY is returned

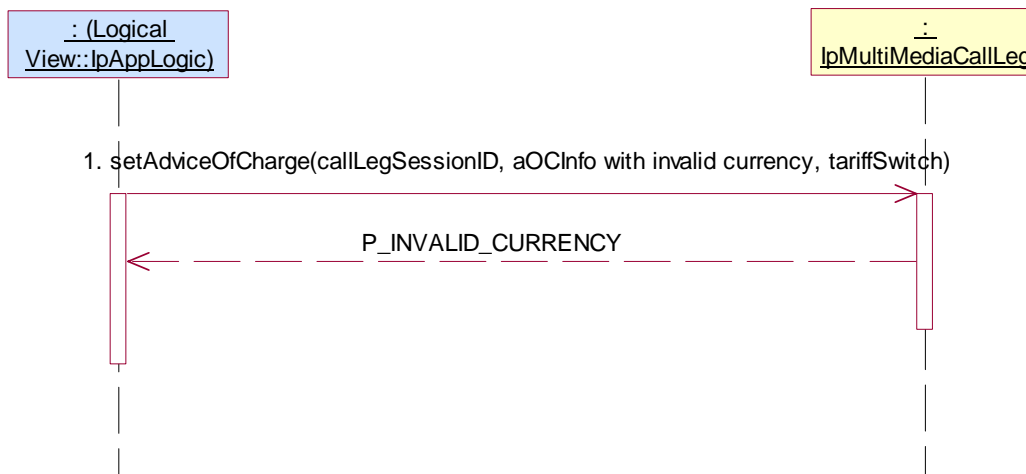
**Test MMCC_IpMultiMediaCallLeg_27**

Summary: IpMultiMediaCallLeg, setAdviceOfCharge, P_INVALID_AMOUNT

Reference: ES 201 915-4 [1], clauses 7.3.1, 7.3.3 and 7.3.5

Preamble: Same as MMCC_IpMultiMediaCall_14

Test Sequence:

1. Method call **setAdviceOfCharge()** on IpMultiMediaCallLeg
 Parameters: valid callLegSessionID returned in preamble, aOCInfo with invalid amount, valid tariffSwitch
 Check: P_INVALID_AMOUNT is returned

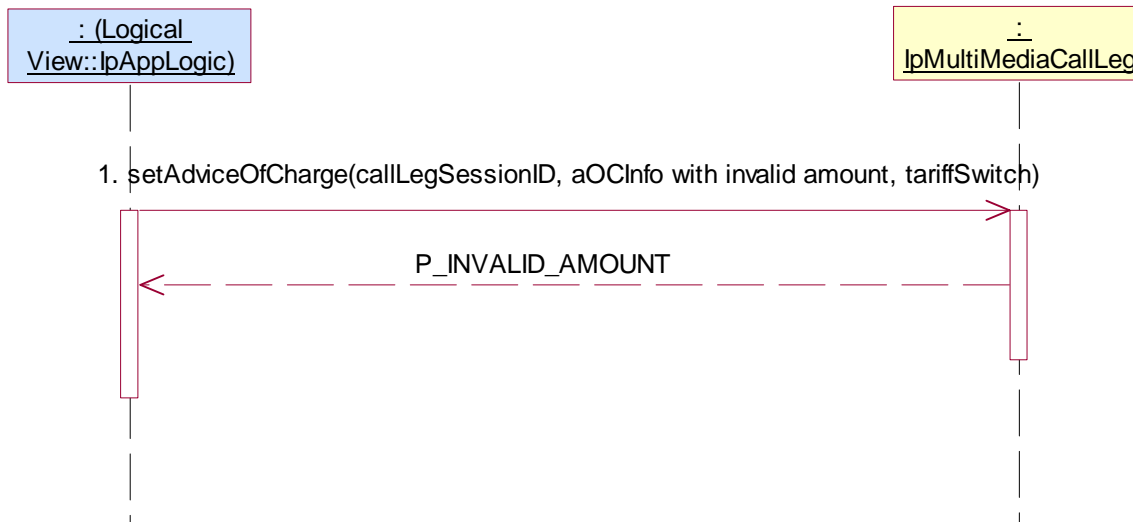

Test MMCC_IpMultiMediaCallLeg_28

Summary: IpMultiMediaCallLeg, superviseReq, : P_INVALID_SESSION_ID

Reference: ES 201 915-4 [1], clause 7.3.5

Preamble: Same as MMCC_IpMultiMediaCall_14

Test Sequence:

1. Method call **superviseReq()** on IpMultiMediaCallLeg
 Parameters: invalid callLegSessionID, valid time, valid treatment
 Check: P_INVALID_SESSION_ID is returned

**Test MMCC_IpMultiMediaCallLeg_29**

Summary: IpMultiMediaCallLeg, routeReq,: P_INVALID_SESSION_ID

Reference: ES 201 915-4 [1], clause 7.3.5

Preamble: Same as MMCC_IpMultiMediaCall_14

Test Sequence:

1. Method call **routeReq()** on IpMultiMediaCallLeg
 Parameters: invalid callLegSessionID, valid targetAddress, valid originatingAddress, valid appInfo, valid connectionProperties
 Check: P_INVALID_SESSION_ID is returned



Test MMCC_IpMultiMediaCallLeg_30

Summary: IpMultiMediaCallLeg, routeReq, P_INVALID_ADDRESS

Reference: ES 201 915-4 [1], clauses 7.3.1, 7.3.3 and 7.3.5

Preamble: Same as MMCC_IpMultiMediaCall_14

Test Sequence:

1. Method call **routeReq()** on IpMultiMediaCallLeg
 Parameters: valid callLegSessionID returned in preamble, invalid targetAddress, valid originatingAddress, valid appInfo, valid connectionProperties
 Check: P_INVALID_ADDRESS is returned

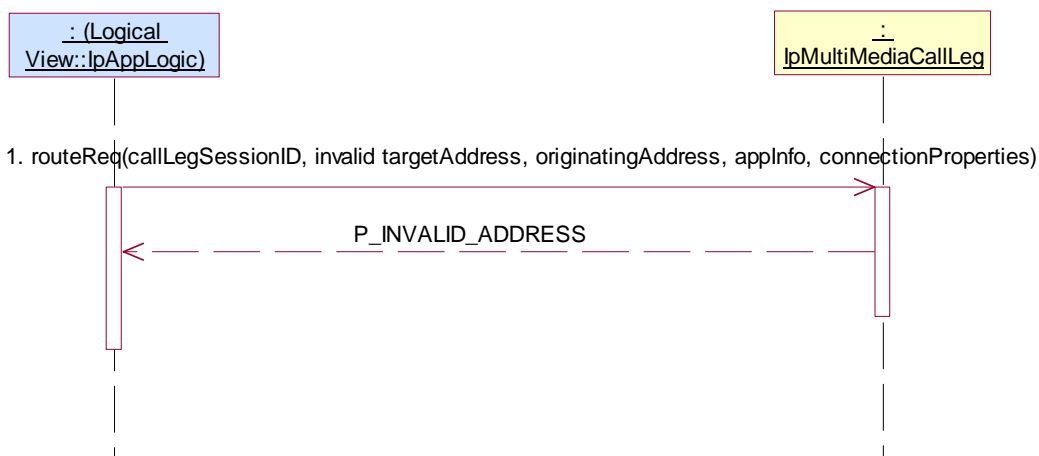
**Test MMCC_IpMultiMediaCallLeg_31**

Summary: IpMultiMediaCallLeg, routeReq, P_INVALID_ADDRESS

Reference: ES 201 915-4 [1], clauses 7.3.1, 7.3.3 and 7.3.5.

Preamble: Same as MMCC_IpMultiMediaCall_14

Test Sequence:

1. Method call **routeReq()** on IpMultiMediaCallLeg
 Parameters: valid callLegSessionID returned in preamble, valid targetAddress, invalid originatingAddress, valid appInfo, valid connectionProperties
 Check: P_INVALID_ADDRESS is returned

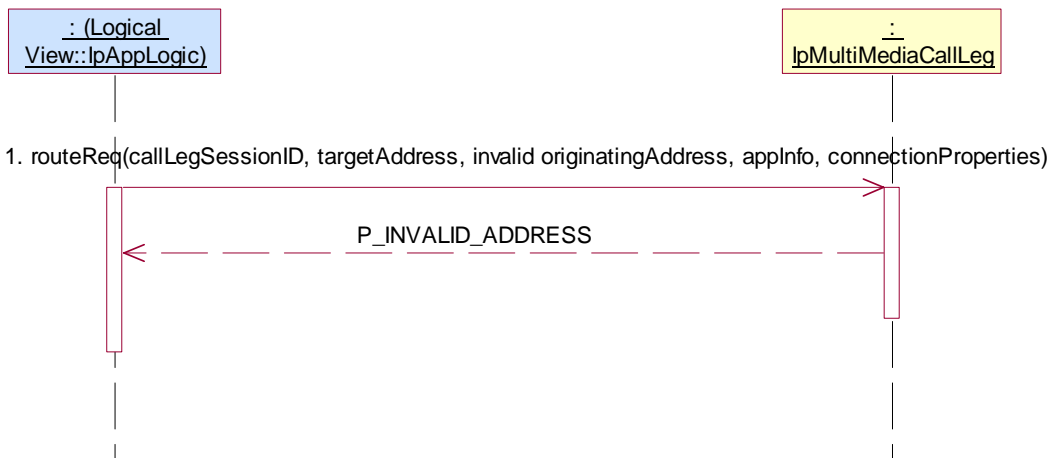

Test MMCC_IpMultiMediaCallLeg_32

Summary: IpMultiMediaCallLeg, eventReportReq, P_INVALID_SESSION_ID

Reference: ES 201 915-4 [1], clause 7.3.5

Preamble: Same as MMCC_IpMultiMediaCall_14

Test Sequence:

1. Method call **eventReportReq()** on IpMultiMediaCallLeg
 Parameters: invalid callLegSessionID, valid eventsRequested
 Check: P_INVALID_SESSION_ID is returned

**Test MMCC_IpMultiMediaCallLeg_33**

Summary: IpMultiMediaCallLeg, eventReportReq, P_INVALID_CRITERIA

Reference: ES 201 915-4 [1], clauses 7.3.1, 7.3.3 and 7.3.5

Preamble: Same as MMCC_IpMultiMediaCall_14

Test Sequence:

1. Method call **eventReportReq()** on IpMultiMediaCallLeg
 Parameters: valid callLegSessionID returned in preamble, invalid eventsRequested
 Check: P_INVALID_CRITERIA is returned



Test MMCC_IpMultiMediaCallLeg_34

Summary: IpMultiMediaCallLeg, getCall, P_INVALID_SESSION_ID

Preamble: Same as MMCC_IpMultiMediaCall_03

Reference: ES 201 915-4 [1], clause 7.3.5

1. Method call **getCall()** on IpMultiMediaCallLeg
 Parameters: invalid callLegSessionID
 Check: P_INVALID_SESSION_ID is returned

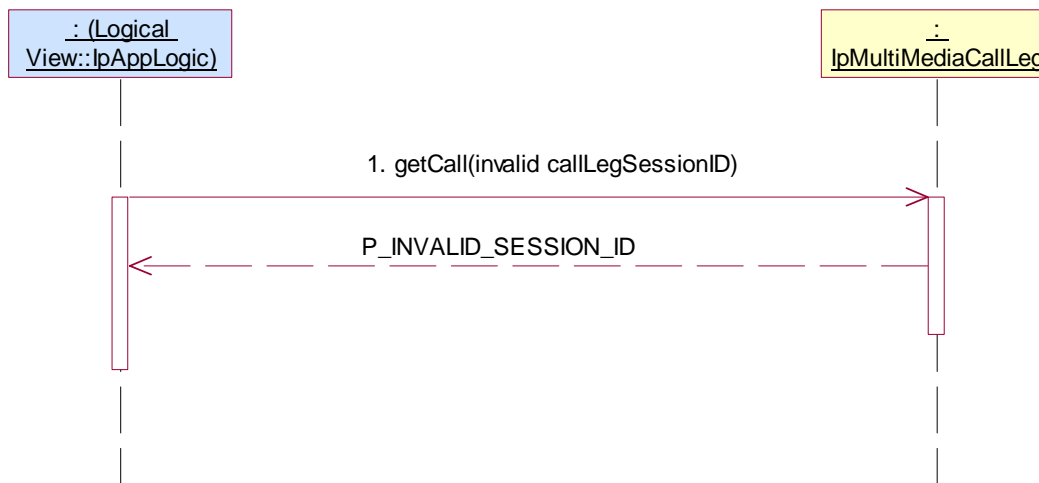
**Test MMCC_IpMultiMediaCallLeg_35**

Summary: IpMultiMediaCallLeg, getMediaStreams, P_INVALID_SESSION_ID

Reference: ES 201 915-4 [1], clause 8.3.5

Preamble: Same as MMCC_IpMultiMediaCall_03

Test Sequence:

1. Method call **getMediaStreams()** on IpMultiMediaCallLeg
 Parameters: invalid callLegSessionID
 Check: P_INVALID_SESSION_ID is returned

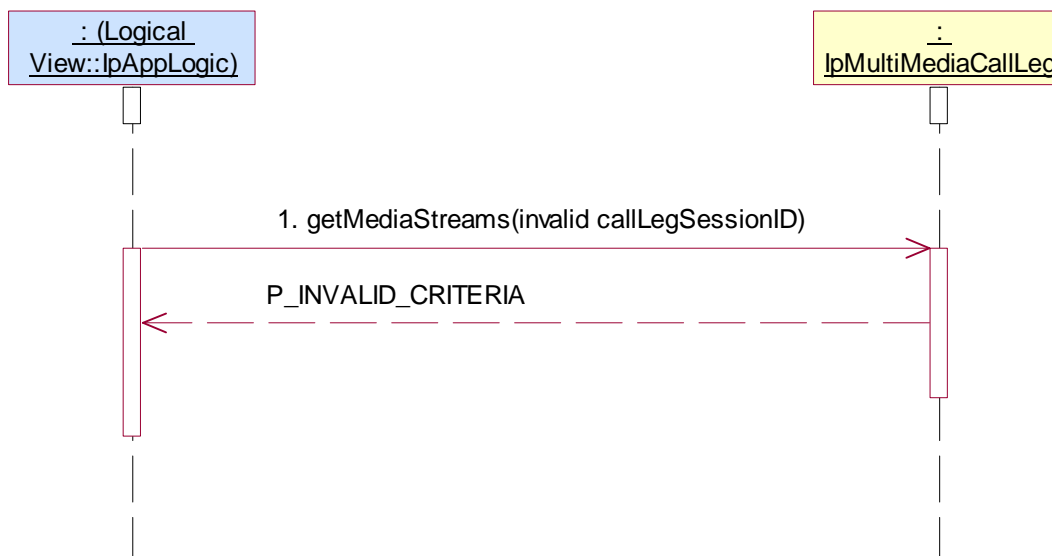

5.2.3.4 IpMultiMediaStream

5.2.3.4.1 Mandatory, valid behaviour

Test MMCC_ IpMultiMediaStream _01

Summary: IpMultiMediaStream, all methods mandatory, successful

Reference: ES 201 915-4 [1], clauses 7.3.1, 7.3.3, 8.3.5 and 8.3.7

Preamble: Application has a valid callSessionID returned by one of the three following sequence:

1. Method call **setCallback()** on IpMultiMediaCallControlManager
Parameters: valid, non-null, value of appInterface parameter
Check: no exception is returned
2. Method call **createCall()**
Parameters: valid appCall
Check: valid value of TpMultiMediaCallIdentifier is returned
3. Method call **createCallLeg()** on IpMultiMediaCall
Parameters: valid callSessionID returned in 2., valid appCallLeg
Check: valid value of TpCallLegIdentifier is returned
4. Method call **routeReq()** on IpMultiMediaCallLeg
Parameters: valid callLegSessionID returned in 2., valid targetAddress, valid appInfo, valid connectionProperties
Check: no exception is returned

or

3. Method call **createAndRouteCallLegReq()** on IpMultiMediaCall
Parameters: valid callSessionID returned in 2., valid eventsRequested, valid targetAddress, valid originatingAddress, valid appInfo, valid appLegInterface
Check: valid value of TpCallLegIdentifier
5. Method call **mediaStreamMonitorReq()** on IpMultiMediaCallLeg
Parameters: valid callLegSessionID returned in 3., valid mediaStreamEventCriteria
Check: no exception is returned
6. Triggered action: cause IUT to call Method **mediaStreamMonitorRes()** method on the tester's (application)
Parameters: callLegSessionID, streams, type
7. Method call **mediaStreamAllow()** on IpMultiMediaCallLeg
Parameters: valid callLegSessionID returned in 3., valid mediaStreamList
Check: no exception is returned

or

1. Method call **createNotification()**
Parameters: appCallControlManager with valid, non-null, value, valid notificationRequest
Check: valid value of TpAssignmentID is returned
2. Triggered action: cause IUT to call Method **reportNotification()** method on the tester's (application)
Parameters: callReference, callLegReferenceSet, notificationInfo, assignmentID
3. Method call **createCallLeg()** on IpMultiMediaCall
Parameters: valid callSessionID reported in 2., valid appCallLeg
Check: valid value of TpCallLegIdentifier is returned

4. Method call **routeReq()** on IpMultiMediaCallLeg
 Parameters: valid callLegSessionID returned in 2., valid targetAddress, valid appInfo, valid connectionProperties
 Check: no exception is returned

or

3. Method call **createAndRouteCallLegReq()** on IpMultiMediaCall
 Parameters: valid callSessionID returned in 2., valid eventsRequested, valid targetAddress, valid originatingAddress, valid appInfo, valid appLegInterface
 Check: valid value of TpCallLegIdentifier
5. Method call **mediaStreamMonitorReq()** on IpMultiMediaCallLeg
 Parameters: valid callLegSessionID returned in 3., valid mediaStreamEventCriteria
 Check: no exception is returned
6. Triggered action: cause IUT to call Method **mediaStreamMonitorRes()** method on the tester's (application)
 Parameters: callLegSessionID, streams, type
7. Method call **mediaStreamAllow()** on IpMultiMediaCallLeg
 Parameters: valid callLegSessionID returned in 3., valid mediaStreamList
 Check: no exception is returned

or

1. Method call **createMediaNotification()**
 Parameters: valid appInterface, valid notificationMediaRequest
 Check: valid value of TpAssignmentID is returned
2. Triggered action: cause IUT to call Method **reportMediaNotification()** method on the tester's (application)
 Parameters: callReference, callLegReferenceSet, notificationInfo, assignmentID
3. Method call **createCallLeg()** on IpMultiMediaCall
 Parameters: valid callSessionID reported in 2., valid appCallLeg
 Check: valid value of TpCallLegIdentifier is returned
4. Method call **routeReq()** on IpMultiMediaCallLeg
 Parameters: valid callLegSessionID returned in 2., valid targetAddress, valid appInfo, valid connectionProperties
 Check: no exception is returned

or

3. Method call **createAndRouteCallLegReq()** on IpMultiMediaCall
 Parameters: valid callSessionID returned in 2., valid eventsRequested, valid targetAddress, valid originatingAddress, valid appInfo, valid appLegInterface
 Check: valid value of TpCallLegIdentifier
5. Method call **mediaStreamMonitorReq()** on IpMultiMediaCallLeg
 Parameters: valid callLegSessionID returned in 3., valid mediaStreamEventCriteria
 Check: no exception is returned
6. Triggered action: cause IUT to call Method **mediaStreamMonitorRes()** method on the tester's (application)
 Parameters: callLegSessionID, streams, type
7. Method call **mediaStreamAllow()** on IpMultiMediaCallLeg
 Parameters: valid callLegSessionID returned in 3., valid mediaStreamList
 Check: no exception is returned

Test Sequence:

- Method call **subtract()** on IpMultiMediaStream
 Parameters: valid mediaStreamSessionID from TpMediaStreamSet returned in preamble.
 Check: no exception is returned

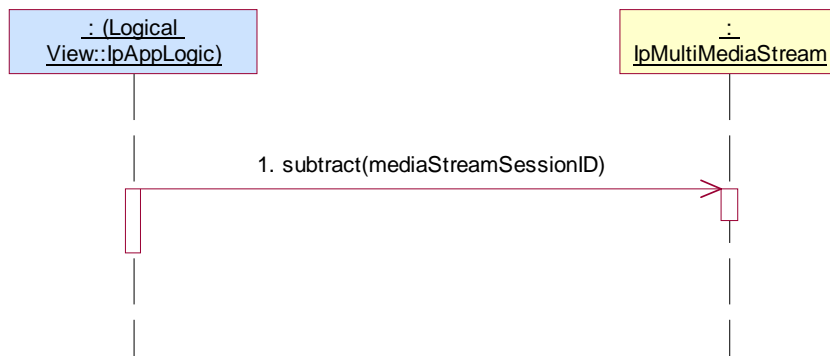

5.2.3.4.2 Mandatory, invalid behaviour

Test MMCC_ IpMultiMediaStream _02

Summary: IpMultiMediaStream, subtract, P_INVALID_SESSION_ID

Reference: ES 201 915-4 [1], clause 8.3.7

Preamble: Same as MMCC_ IpMultiMediaStream _01

Test Sequence:

- Method call **subtract()** on IpMultiMediaStream
 Parameters: invalid mediaStreamSessionID
 Check: P_INVALID_SESSION_ID is returned

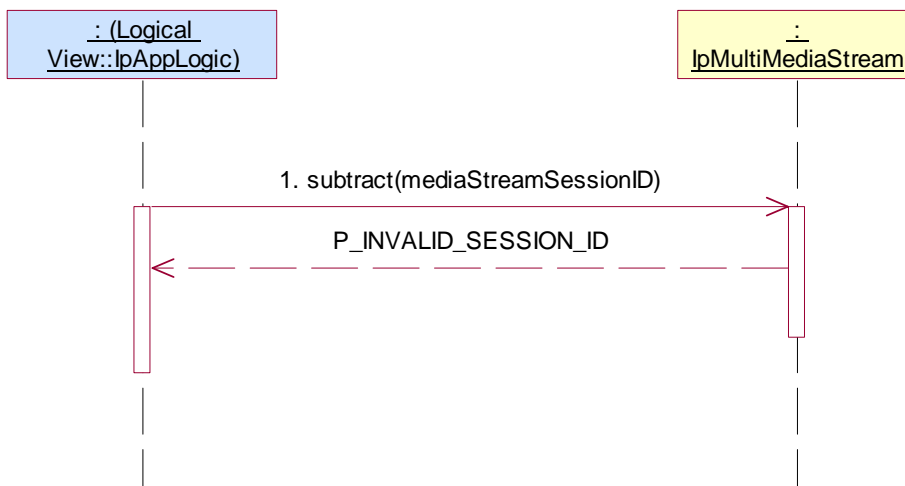

5.2.4 Conference Call Control Service (CCC)

5.2.4.1 IpConfCallControlManager

5.2.4.1.1 Mandatory, valid behaviour

According to the Call Control SCF specification, at least one of the two following test sequences is mandatory:

Test CCC _ IpConfCallControlManager _01

Summary: IpConfCallControlManager, all mandatory methods, successful

Reference: ES 201 915-4 [1], clause 9.3.1

Preamble: Application has a reference interface used for callbacks

Condition: createConference method is supported

Test Sequence:

- Method call **createConference()**
 Parameters: valid appConferenceCall, valid numberOfSubConferences, valid conferencePolicy, valid numberOfParticipants, valid duration
 Check: valid value of TpConfCallIdentifier is returned

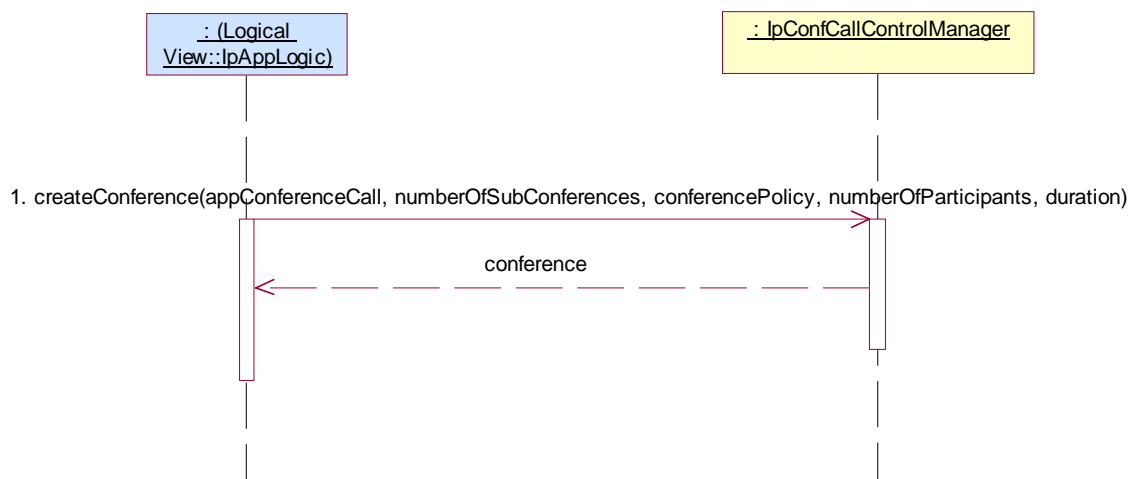

Test CCC _ IpConfCallControlManager _02

Summary: IpConfCallControlManager, all mandatory methods, successful

Reference: ES 201 915-4 [1], clause 9.3.1

Preamble: Application has a reference interface used for callbacks

Condition: reserveResources method is supported

Test Sequence:

1. Method call **reserveResources()**
 Parameters: valid appInterface, valid startTime, valid numberOfParticipants, valid duration, valid conferencePolicy
 Check: valid value of TpResourceReservation is returned
2. Method call **freeResources()**
 Parameters: valid resourceReservation returned in 1.
 Check: no exception is returned

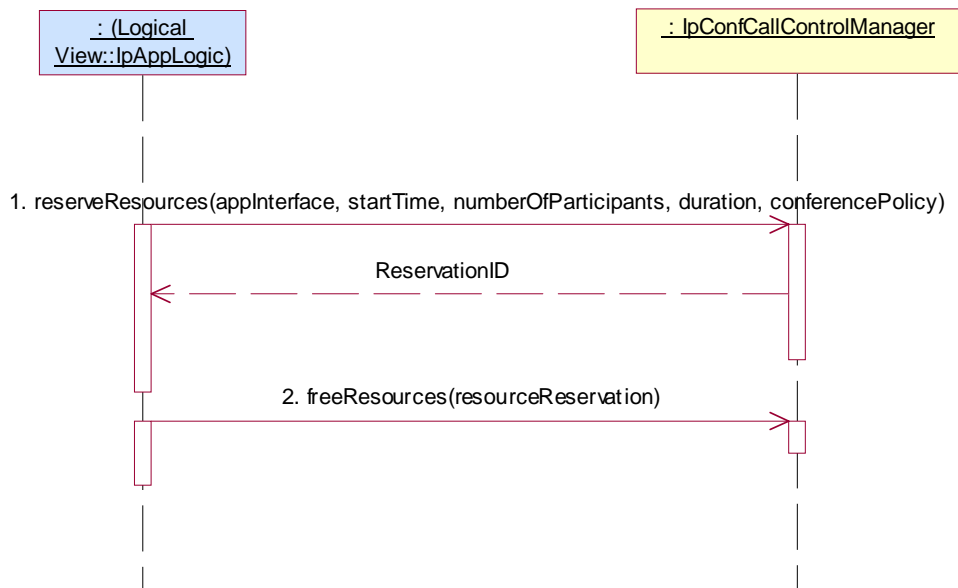

Test CCC _ IpConfCallControlManager _03

Summary: IpConfCallControlManager, all mandatory methods, successful

Reference: ES 201 915-4 [1], clause 9.3.1

Preamble: Application has a reference interface used for callbacks

Condition: reserveResources method is supported

Test Sequence:

1. Method call **reserveResources()**
 Parameters: valid appInterface, valid startTime, valid numberOfParticipants, valid duration, valid conferencePolicy
 Check: valid value of TpResourceReservation is returned
2. Trigger IUT to call **conferenceCreated()** on Tester's (application's) IpAppConfCallControlManager interface
 Parameters: valid conferenceCall

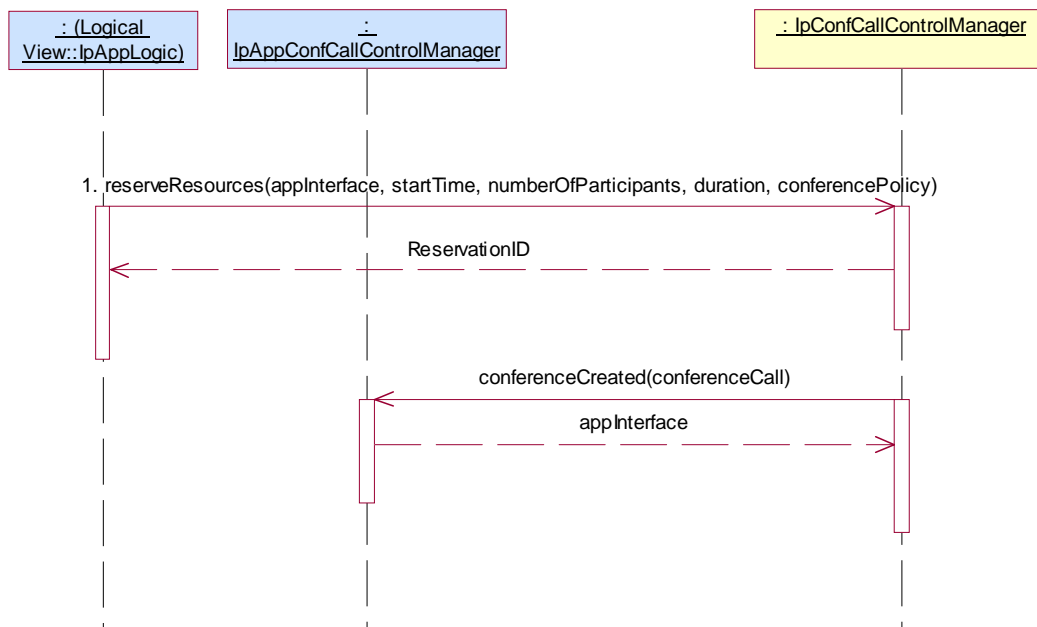

5.2.4.1.2 Mandatory, invalid behaviour

For further study.

5.2.4.1.3 Optional, valid behaviour

Test CCC _ IpConfCallControlManager _04

Summary: IpConfCallControlManager, checkResources, successful

Reference: ES 201 915-4 [1], clause 9.3.1

Condition: reserveResources, checkResources methods are supported

Preamble: Application has a reference interface used for callbacks

Test Sequence:

1. Method call **reserveResources()**
 Parameters: valid appInterface, valid startTime, valid numberOfParticipants, valid duration, valid conferencePolicy
 Check: valid value of TpResourceReservation is returned
2. Method call **checkResources()**
 Parameters: valid searchCriteria regarding reservation made in 1.
 Check: valid value of TpConfSearchResult is returned with values of reservation made in 1.
3. Method call **freeResources()**
 Parameters: valid resourceReservation returned in 2.
 Check: no exception is returned

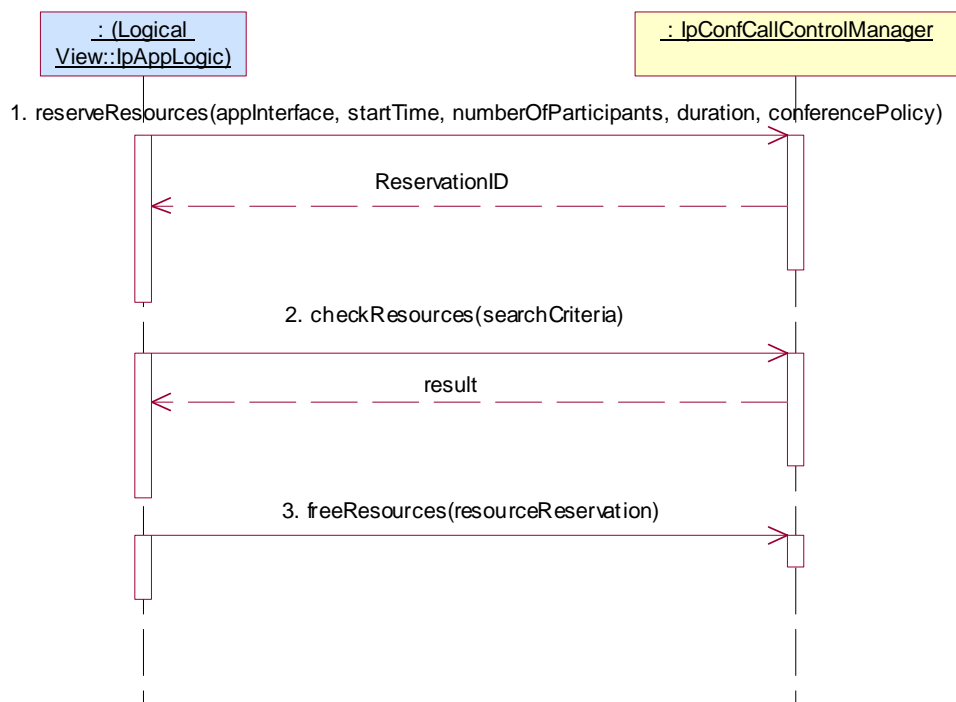

Test CCC _ IpConfCallControlManager _05

Summary: IpConfCallControlManager, all methods, successful

Reference: ES 201 915-4 [1], clauses 7.3.1 and 8.3.1

Condition: managerInterrupted, managerResumed methods are supported

Test Sequence:

1. Triggered action: cause IUT to call **managerInterrupted()** method on the tester's (Application) **IpAppConfCallControlManager** interface.
Parameters: None
2. Triggered action: cause IUT to call **managerResumed()** method on the tester's (Application) **IpAppConfCallControlManager** interface.
Parameters: None

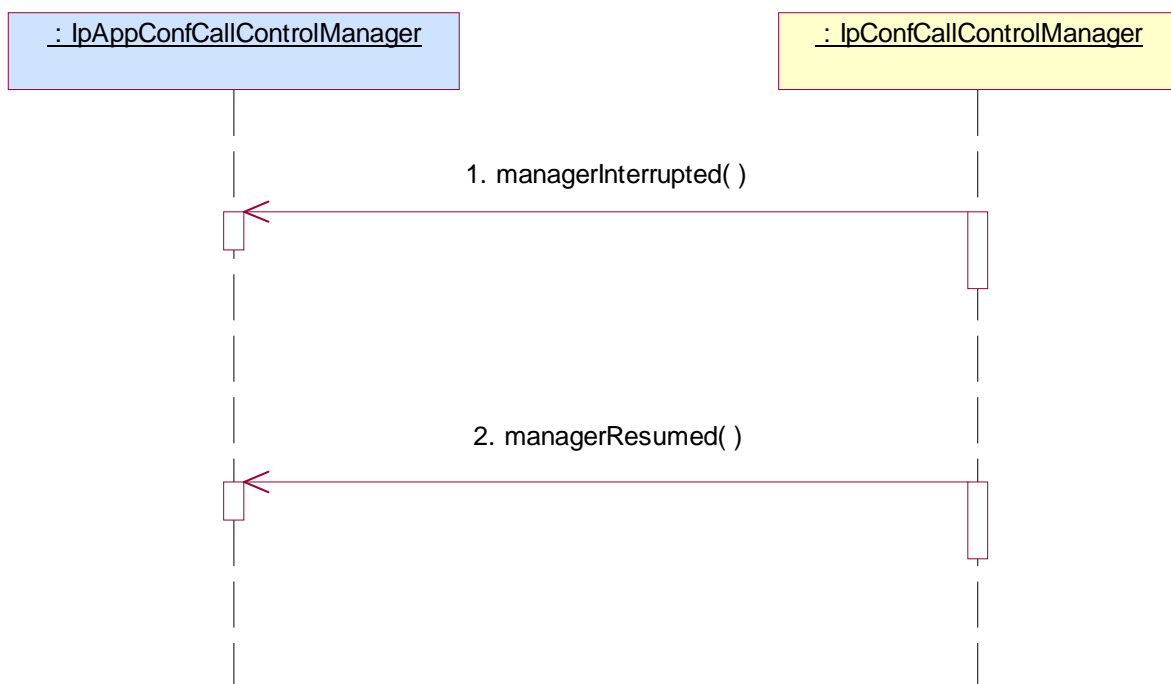

5.2.4.1.4 Optional, invalid behaviour

For further study.

5.2.4.2 IpConfCall

5.2.4.2.1 Mandatory, valid behaviour

Test CCC _ IpConfCall _01

Summary: IpConfCall, all methods mandatory, successful

Reference: ES 201 915-4 [1], clauses 9.3.1 and 9.3.3.

Preamble: Application has a reference interface used for callbacks.

Test Sequence:

1. Method call **createConference()** on IpConfCallControlManager
 Parameters: valid appConferenceCall, valid numberOfSubConferences, valid conferencePolicy, valid numberOfParticipants, valid duration
 Check: valid value of TpConfCallIdentifier is returned
2. Method call **createSubConference()** on IpConfCall
 Parameters: valid conferenceSessionID returned in 1., valid appSubConference, valid conferencePolicy
 Check: valid value of TpSubConfCallIdentifier is returned
3. Method call **getSubConferences()** on IpConfCall
 Parameters: valid conferenceSessionID returned in 1.
 Check: valid value of TpSubConfCallIdentifierSet is returned which contains TpSubConfCallIdentifier returned in 2.



Test CCC _ IpConfCall _02

Summary: IpConfCall, all methods mandatory, successful

Reference: ES 201 915-4 [1], clauses 7.3.1 and 7.3.3.

Preamble: Application has a valid callSessionID returned by one of the following sequences:

1. Method call **createConference()** on IpConfCallControlManager
Parameters: valid appConferenceCall, valid numberOfSubConferences, valid conferencePolicy, valid numberOfParticipants, valid duration
Check: valid value of TpConfCallIdentifier is returned
2. Method call **createSubConference()** on IpConfCall
Parameters: valid conferenceSessionID returned in 1., valid appSubConference, valid conferencePolicy
Check: valid value of TpSubConfCallIdentifier is returned
3. Method call **getSubConferences()** on IpConfCall
Parameters: valid conferenceSessionID returned in 1.
Check: valid value of TpSubConfCallIdentifierSet is returned which contains TpSubConfCallIdentifier returned in 2.

or

1. Method call **reserveResources()**
Parameters: valid appInterface, valid startTime, valid numberOfParticipants, valid duration, valid conferencePolicy
Check: valid value of TpResourceReservation is returned
2. Triggered action: cause IUT to call **conferenceCreated()** on Tester's (application's) IpAppConfCallControlManager interface
Parameters: valid conferenceCall.
3. Method call **getSubConferences()** on IpConfCall
Parameters: valid conferenceSessionID returned in 1.
Check: valid value of TpSubConfCallIdentifierSet is returned which contains TpSubConfCallIdentifier returned in 2.

Test Sequence:

1. Method call **release()** on IpConfCall
Parameters: valid callSessionID returned in preamble, valid cause
Check: no exception is returned

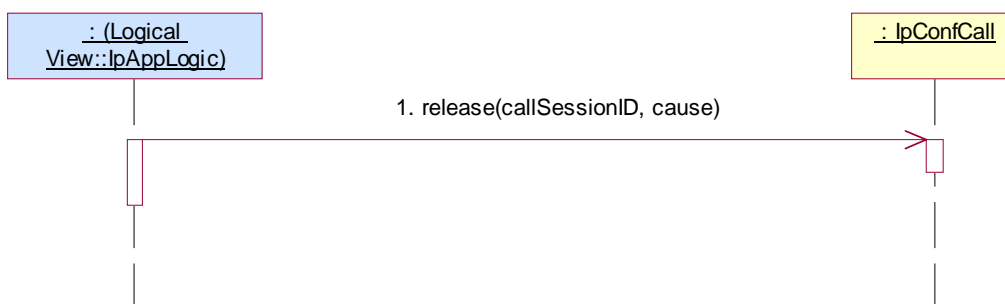

Test CCC _ IpConfCall _03

Summary: IpConfCall, all methods mandatory, successful

Reference: ES 201 915-4 [1], clauses 7.3.1 and 7.3.3.

Preamble: Same as CCC _ IpConfCall _02

Test Sequence:

1. Method call **deassignCall()** on IpConfCall
 Parameters: valid callSessionID returned in preamble.
 Check: no exception is returned

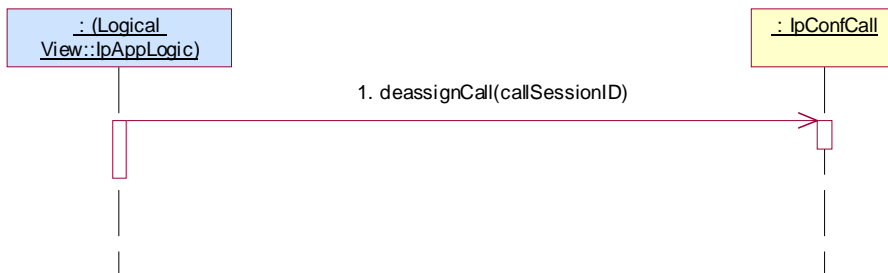

5.2.4.2.2 Mandatory, invalid behaviour

Test CCC _ IpConfCall _04

Summary: IpConfCall createSubConference, P_INVALID_SESSION_ID

Reference: ES 201 915-4 [1], clause 9.3.3

Preamble: Application has a reference interface used for callbacks

Test Sequence:

1. Method call **createConference()** on IpConfCallControlManager
 Parameters: valid appConferenceCall, valid numberOfSubConferences, valid conferencePolicy, valid numberOfParticipants, valid duration
 Check: valid value of TpConfCallIdentifier is returned
2. Method call **createSubConference()** on IpConfCall
 Parameters: invalid conferenceSessionID, valid appSubConference, valid conferencePolicy
 Check: P_INVALID_SESSION_ID is returned

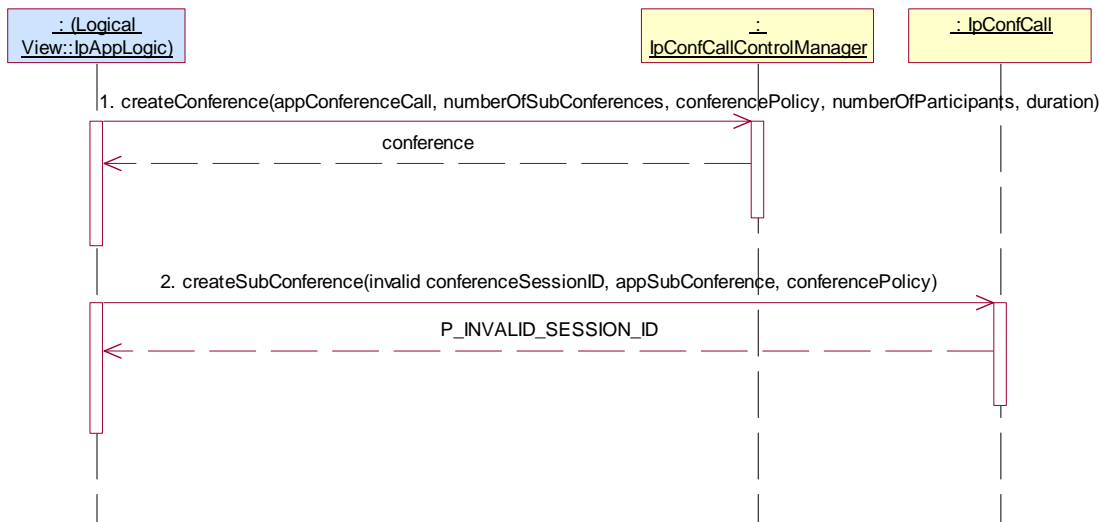

Test CCC _ IpConfCall _05

Summary: IpConfCall, deassignCall, P_INVALID_SESSION_ID

Reference: ES 201 915-4 [1], clause 7.3.3.

Preamble: Same as CCC _ IpConfCall _02

Test Sequence:

1. Method call **deassignCall()** on IpConfCall
Parameters: invalid callSessionID
Check: P_INVALID_SESSION_ID is returned

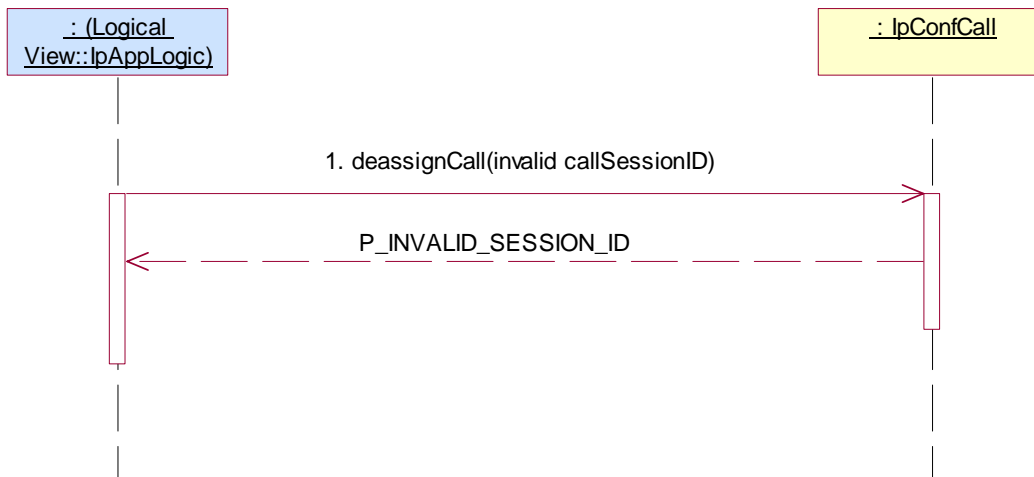
**Test CCC _ IpConfCall _06**

Summary: IpConfCall, release, P_INVALID_SESSION_ID

Reference: ES 201 915-4 [1], clause 7.3.3

Preamble: Same as CCC _ IpConfCall _02

Test Sequence:

1. Method call **release()** on IpConfCall
Parameters: invalid callSessionID, valid cause
Check: P_INVALID_SESSION_ID is returned

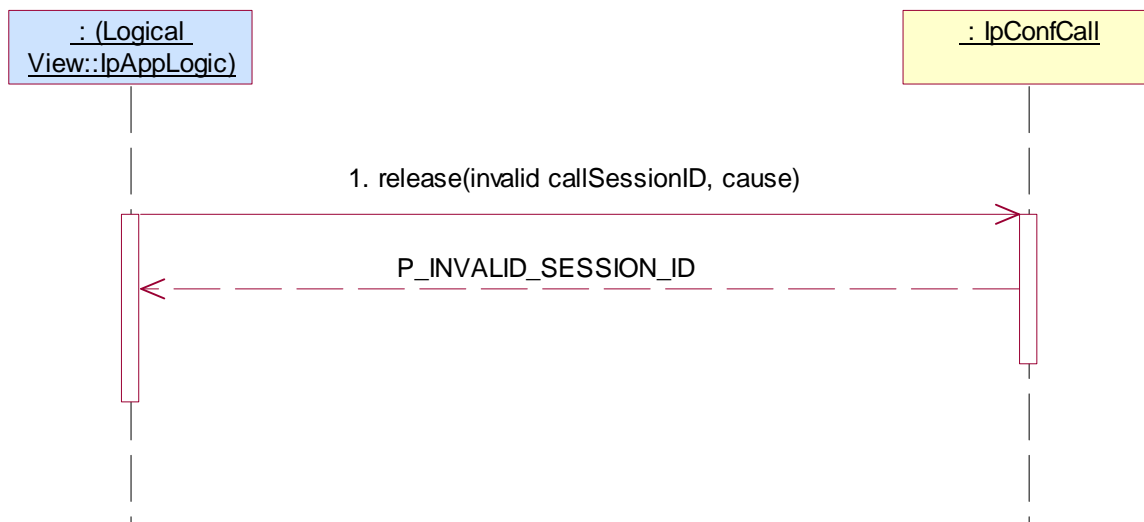

5.2.4.2.3 Optional, valid behaviour

Test CCC _ IpConfCall _07

Summary: IpConfCall, all methods, successful

Reference: ES 201 915-4 [1], clauses 9.3.1 and 9.3.3

Preamble: Application has a reference interface used for callbacks

Condition: leaveMonitorReq method is supported

Test Sequence:

1. Method call **createConference()** on IpConfCallControlManager
Parameters: valid appConferenceCall, valid numberOfSubConferences, valid conferencePolicy, valid numberOfParticipants, valid duration
Check: valid value of TpConfCallIdentifier is returned
2. Method call **createSubConference()** on IpConfCall
Parameters: valid conferenceSessionID returned in 1., valid appSubConference, valid conferencePolicy
Check: valid value of TpSubConfCallIdentifier is returned
3. Method call **getSubConferences()** on IpConfCall
Parameters: valid conferenceSessionID returned in 1.
Check: valid value of TpSubConfCallIdentifierSet is returned which contains TpSubConfCallIdentifier returned in 2.
4. Method call **leaveMonitorReq()** on IpConfCall
Parameters: valid conferenceSessionID returned in 1.
Check: no exception is returned

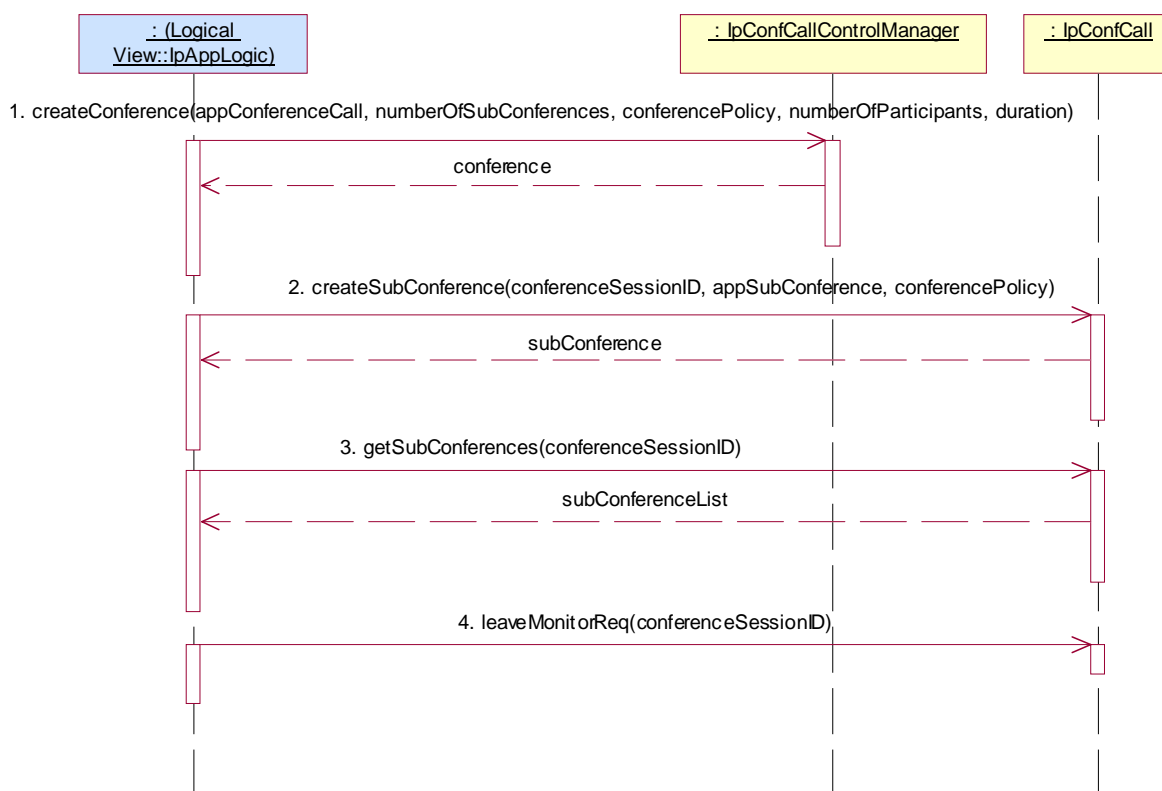

Test CCC _ IpConfCall _08

Summary: IpConfCall, all methods, successful

Reference: ES 201 915-4 [1], clauses 7.3.1 and 8.3.1

Preamble: Application has a valid callSessionID returned by one of the two following sequence:

1. Method call **createConference()** on IpConfCallControlManager
Parameters: valid appConferenceCall, valid numberOfSubConferences, valid conferencePolicy, valid numberOfParticipants, valid duration
Check: valid value of TpConfCallIdentifier is returned
2. Method call **createSubConference()** on IpConfCall
Parameters: valid conferenceSessionID returned in 1., valid appSubConference, valid conferencePolicy
Check: valid value of TpSubConfCallIdentifier is returned
3. Method call **getSubConferences()** on IpConfCall
Parameters: valid conferenceSessionID returned in 1.
Check: valid value of TpSubConfCallIdentifierSet is returned which contains TpSubConfCallIdentifier returned in 2.
4. Method call **createCallLeg()** on IpSubConfCall
Parameters: valid callSessionID returned in 2., valid appCallLeg
Check: valid value of TpCallLegIdentifier is returned

or

1. Method call **reserveResources()**
Parameters: valid appInterface, valid startTime, valid numberOfParticipants, valid duration, valid conferencePolicy
Check: valid value of TpResourceReservation is returned
2. Triggered action: cause IUT to call **conferenceCreated()** on Tester's (application's) IpAppConfCallControlManager interface
Parameters: valid conferenceCall.
3. Method call **getSubConferences()** on IpConfCall
Parameters: valid conferenceSessionID returned in 1.
Check: valid value of TpSubConfCallIdentifierSet is returned which contains TpSubConfCallIdentifier returned in 2.
4. Method call **createCallLeg()** on IpSubConfCall
Parameters: valid callSessionID reported in 2., valid appCallLeg
Check: valid value of TpCallLegIdentifier is returned

Condition: superviseVolumeReq method is supported.

Test Sequence:

1. Method call **superviseVolumeReq()** on IpConfCall
Parameters: valid callSessionID returned in preamble, valid volume, valid treatment
Check: no exception is returned
2. Method call **routeReq()** on IpMultiMediaCallLeg
Parameters: valid callLegSessionID returned in preamble, valid targetAddress, valid appInfo, valid connectionProperties
Check: no exception is returned
3. Triggered action: cause IUT to call Method **superviseVolumeRes()** method on the tester's (application) **IpConfCall** interface.
Parameters: callSessionID, report, usedVolume

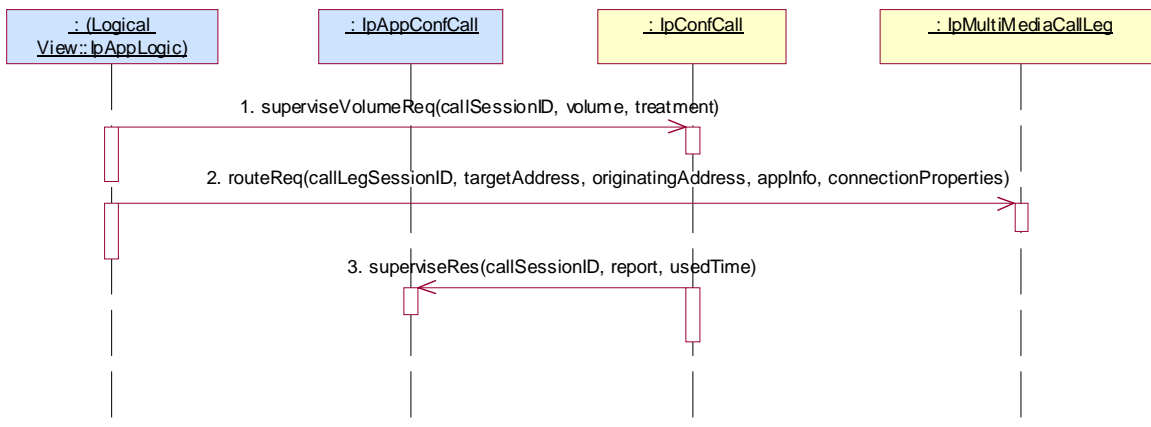

Test CCC _ IpConfCall _09

Summary: IpConfCall, getInfoReq, successful

Reference: ES 201 915-4 [1], clauses 7.3.1 and 7.3.3

Preamble: Same as CCC _ IpConfCall _08

Condition: createCallLeg and getInfoReq methods are supported

Test Sequence:

1. Method call **getInfoReq()** on IpConfCall
 Parameters: valid callSessionID returned in preamble, valid callInfoRequested
 Check: no exception is returned
2. Method call **routeReq()** on IpMultiMediaCallLeg
 Parameters: valid callLegSessionID returned in preamble, valid targetAddress, valid appInfo, valid connectionProperties
 Check: no exception is returned
3. Method call **release()** on IpConfCall
 Parameters: valid callSessionID returned in preamble, valid cause
 Check: no exception is returned
4. Triggered action: cause IUT to call **getInfoRes()** method on the tester's (Application) **IpAppConfCall** interface.
 Parameters: callSessionID given in 1., valid callInfoReport.

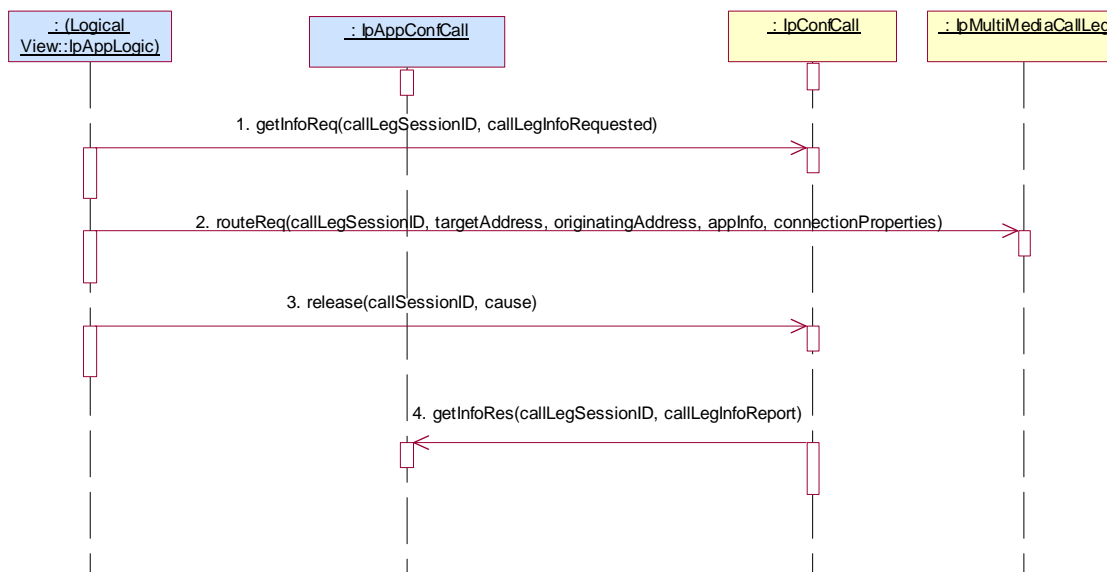

Test CCC _ IpConfCall _10

Summary: IpConfCall, setChargePlan, successful

Reference: ES 201 915-4 [1], clauses 7.3.1 and 7.3.3

Preamble: Same as CCC _ IpConfCall _02

Condition: createCallLeg and setChargePlan methods are supported

Test Sequence:

1. Method call **setChargePlan()** on IpConfCall
 Parameters: valid callSessionID returned in 1., valid callChargePlan
 Check: no exception is returned

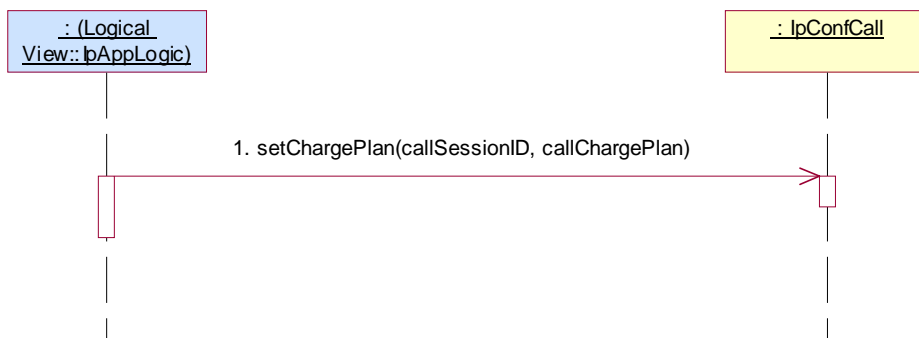
**Test CCC _ IpConfCall _11**

Summary: IpConfCall, setAdviceOfCharge, successful

Reference: ES 201 915-4 [1], clauses 7.3.1 and 7.3.3

Preamble: Same as CCC _ IpConfCall _02

Condition: createCallLeg and setAdviceOfCharge methods are supported

Test Sequence:

1. Method call **setAdviceOfCharge()** on IpConfCall
 Parameters: valid callSessionID returned in 1., valid aOCInfo, valid tariffSwitch
 Check: no exception is returned

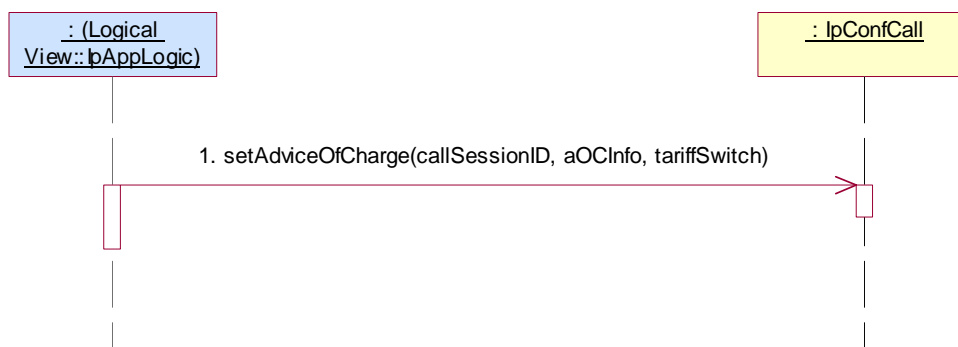

Test CCC _ IpConfCall _12

Summary: IpConfCall, superviseReq, successful

Reference: ES 201 915-4 [1], clauses 7.3.1 and 7.3.3

Preamble: Same as CCC _ IpConfCall _08

Condition: createCallLeg and superviseReq methods are supported

Test Sequence:

1. Method call **superviseReq()** on IpConfCall
Parameters: valid callSessionID returned in preamble, valid time, valid treatment
Check: no exception is returned
2. Method call **routeReq()** on IpMultiMediaCallLeg
Parameters: valid callLegSessionID returned in preamble, valid targetAddress, valid appInfo, valid connectionProperties
Check: no exception is returned
3. Triggered action: cause IUT to call **superviseRes()** method on the tester's (Application) **IpAppConfCall** interface.
Parameters: callSessionID given in 1., valid report, valid usedTime.

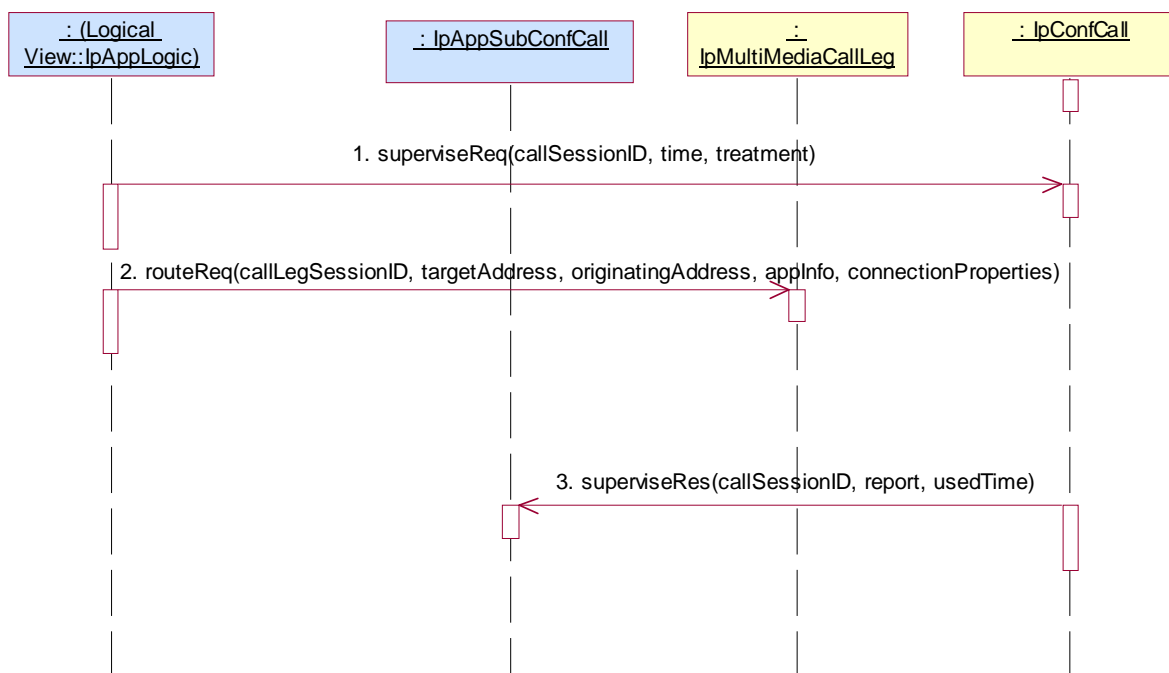

Test CCC _ IpConfCall _13

Summary: IpConfCall, all methods, successful

Reference: ES 201 915-4 [1], clauses 7.3.1 and 7.3.3

Preamble: Same as CCC _ IpConfCall _08

Condition: getCallLegs method is supported

Test Sequence:

1. Method call **getCallLegs()** on IpConfCall
Parameters: valid callSessionID returned in preamble.
Check: valid value of TpCallLegIdentifierSet which contains CallLegIdentifier returned in preamble.



5.2.4.2.4 Optional, invalid behaviour

Test CCC _ IpConfCall _14

Summary: IpConfCall, getSubConferences, P_INVALID_SESSION_ID

Reference: ES 201 915-4 [1], clause 9.3.3

Preamble: Application has a reference interface used for callbacks

Test Sequence:

1. Method call **createConference()** on IpConfCallControlManager
 Parameters: valid appConferenceCall, valid numberOfSubConferences, valid conferencePolicy, valid numberOfParticipants, valid duration
 Check: valid value of TpConfCallIdentifier is returned
2. Method call **createSubConference()** on IpConfCall
 Parameters: valid conferenceSessionID returned in 1., valid appSubConference, valid conferencePolicy
 Check: valid value of TpSubConfCallIdentifier is returned
3. Method call **getSubConferences()**
 Parameters: invalid conferenceSessionID
 Check: P_INVALID_SESSION_ID is returned

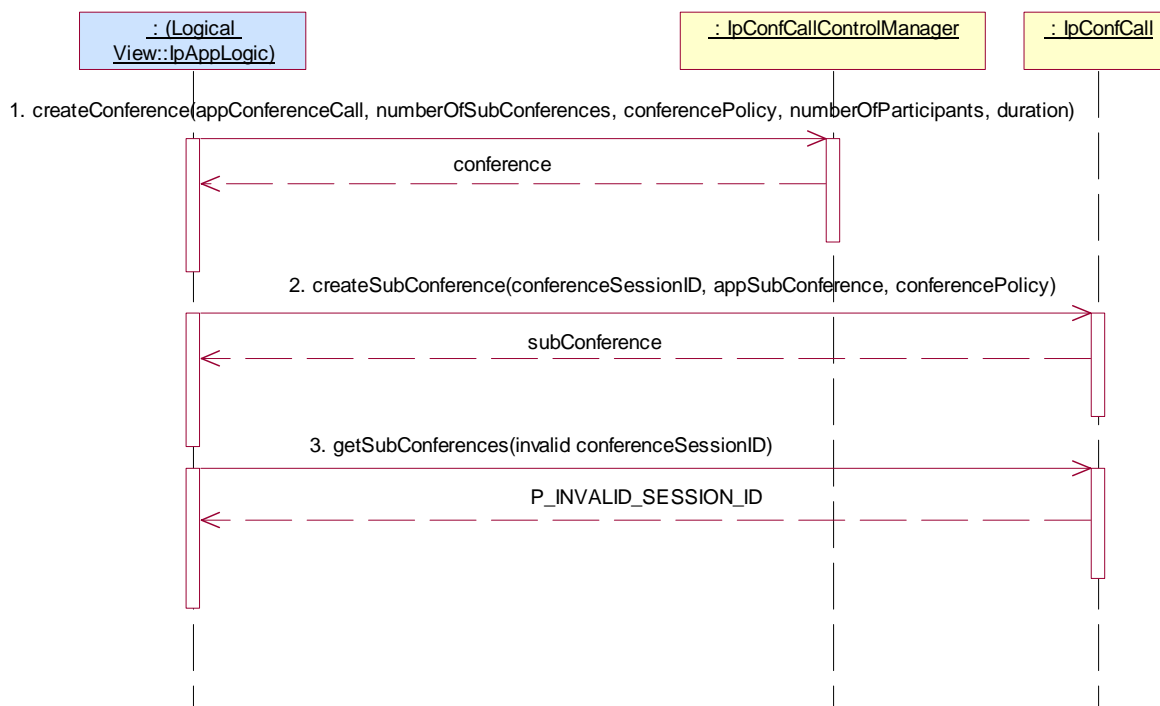

Test CCC _ IpConfCall _15

Summary: IpConfCall, leaveMonitorReq, P_INVALID_SESSION_ID

Reference: ES 201 915-4 [1], clause 9.3.3

Preamble: Application has a reference interface used for callbacks

Condition: leaveMonitorReq method is supported

Test Sequence:

1. Method call **createConference()** on IpConfCallControlManager

Parameters: valid appConferenceCall, valid numberOfSubConferences, valid conferencePolicy, valid numberOfParticipants, valid duration

Check: valid value of TpConfCallIdentifier is returned
2. Method call **leaveMonitorReq()**

Parameters: invalid conferenceSessionID

Check: P_INVALID_SESSION_ID is returned

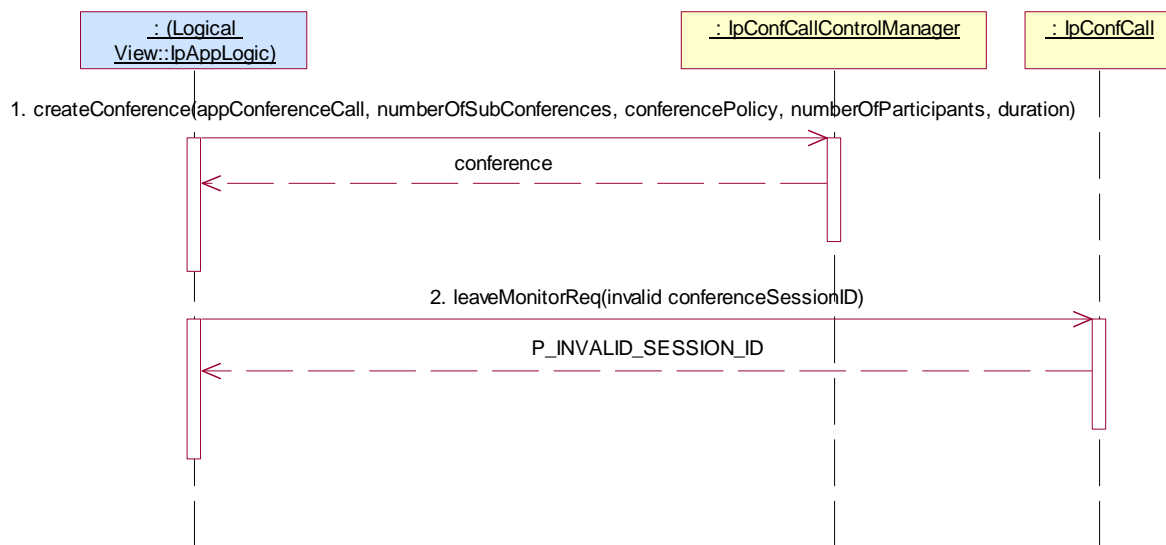

Test CCC _ IpConfCall _16

Summary: IpConfCall, superviseVolumeReq, P_INVALID_SESSION_ID

Reference: ES 201 915-4 [1], clause 8.3.1

Preamble: Same as CCC _ IpConfCall _02

Condition: superviseVolumeReq method is supported

Test Sequence:

1. Method call **superviseVolumeReq()** on IpConfCall
Parameters: invalid callSessionID, valid volume, valid treatment
Check: P_INVALID_SESSION_ID is returned

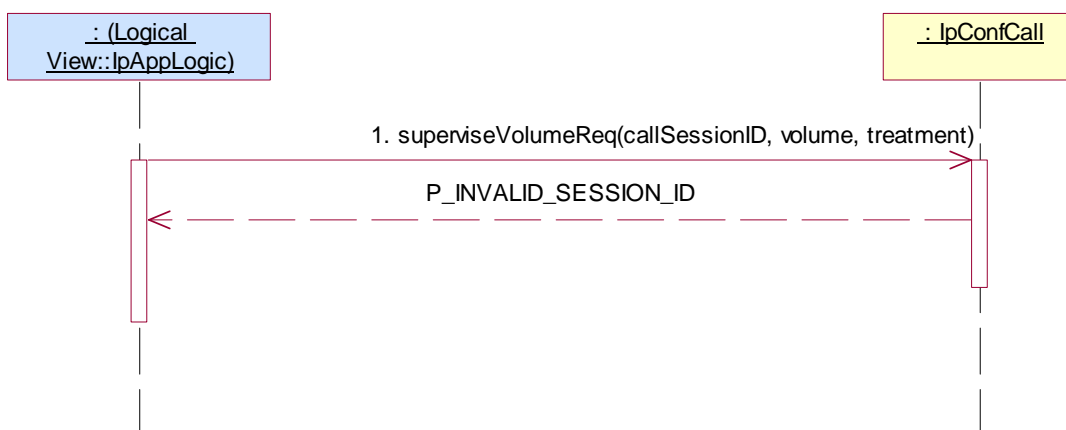
**Test CCC _ IpConfCall _17**

Summary: IpConfCall, getInfoReq, P_INVALID_SESSION_ID

Reference: ES 201 915-4 [1], clauses 7.3.1 and 7.3.3

Preamble: Same as CCC _ IpConfCall _08

Condition: getInfoReq method is supported

Test Sequence:

1. Method call **getInfoReq()** on IpConfCall
Parameters: invalid callSessionID, valid callInfoRequested
Check: P_INVALID_SESSION_ID is returned

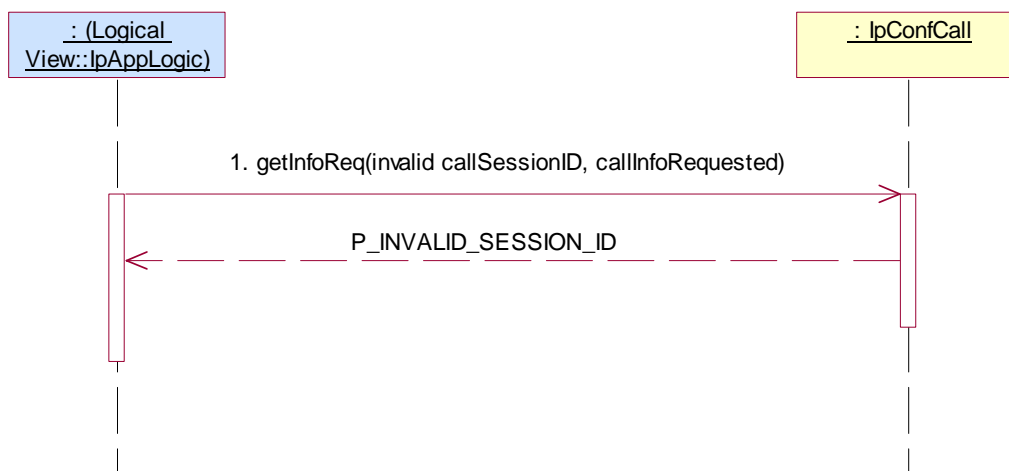

Test CCC _ IpConfCall _18

Summary: IpConfCall, setChargePlan, P_INVALID_SESSION_ID

Reference: ES 201 915-4 [1], clauses 7.3.1 and 7.3.3

Preamble: Same as CCC _ IpConfCall _02

Condition: setChargePlan method is supported

Test Sequence:

1. Method call **setChargePlan()** on IpConfCall
Parameters: invalid callSessionID, valid callChargePlan
Check: P_INVALID_SESSION_ID is returned

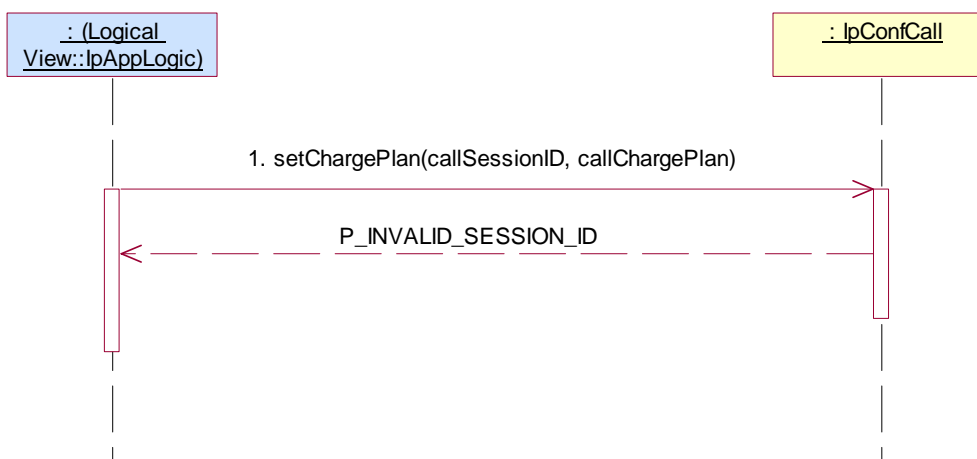
**Test CCC _ IpConfCall _19**

Summary: IpConfCall, setAdviceOfCharge, P_INVALID_SESSION_ID

Reference: ES 201 915-4 [1], clauses 7.3.1 and 7.3.3

Preamble: Same as CCC _ IpConfCall _02

Condition: setAdviceOfCharge method is supported

Test Sequence:

1. Method call **setAdviceOfCharge()** on IpConfCall
Parameters: invalid callSessionID, valid aOCInfo, valid tariffSwitch
Check: P_INVALID_SESSION_ID is returned

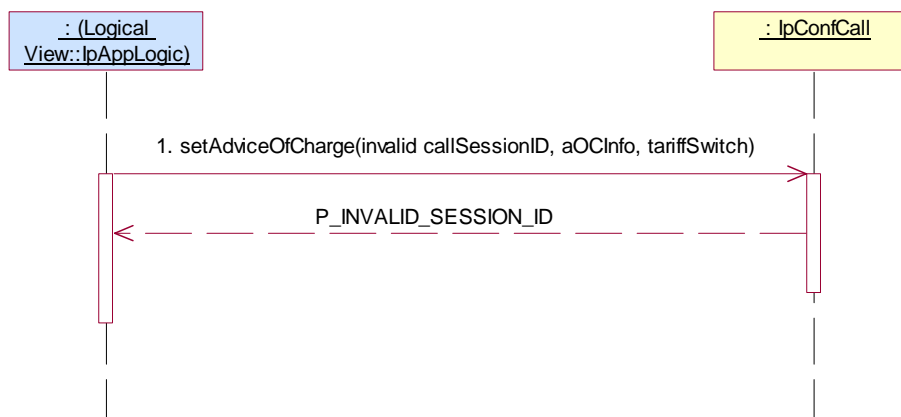

Test CCC _ IpConfCall _20

Summary: IpConfCall, setAdviceOfCharge, P_INVALID_CURRENCY

Reference: ES 201 915-4 [1], clauses 7.3.1 and 7.3.3

Preamble: Same as CCC _ IpConfCall _02

Condition: setAdviceOfCharge method is supported

Test Sequence:

1. Method call **setAdviceOfCharge()** on IpConfCall
 Parameters: valid callSessionID returned in preamble., aOCInfo with invalid currency, valid tariffSwitch
 Check: P_INVALID_CURRENCY is returned

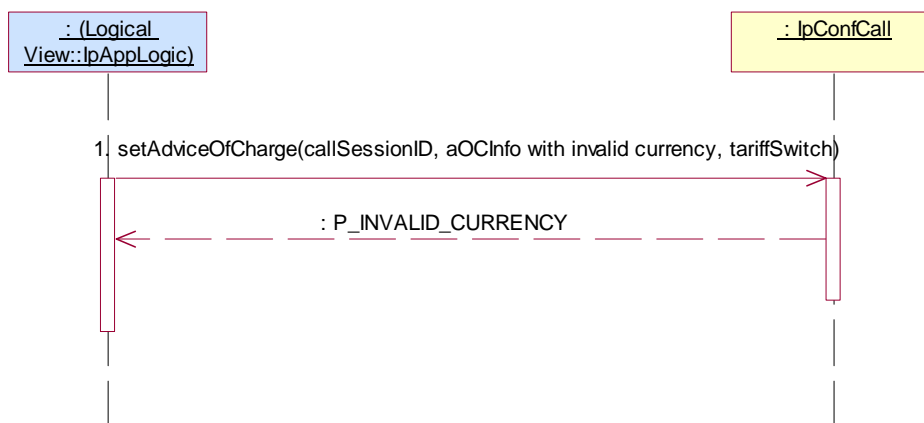
**Test CCC _ IpConfCall _21**

Summary: IpConfCall, setAdviceOfCharge, P_INVALID_AMOUNT

Reference: ES 201 915-4 [1], clauses 7.3.1 and 7.3.3

Preamble: Same as CCC _ IpConfCall _02

Condition: setAdviceOfCharge method is supported

Test Sequence:

1. Method call **setAdviceOfCharge()** on IpConfCall
 Parameters: valid callSessionID returned in preamble., aOCInfo, with invalid amount, valid tariffSwitch
 Check: P_INVALID_AMOUNT is returned

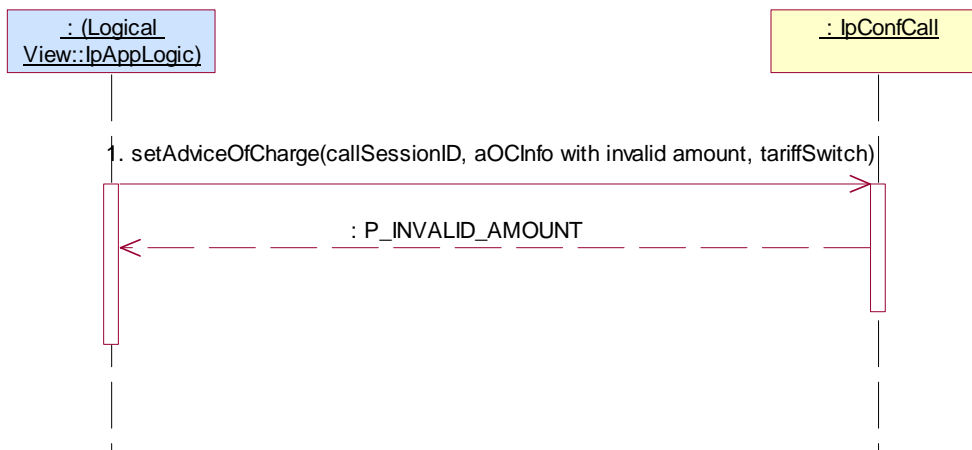

Test CCC _ IpConfCall _22

Summary: IpConfCall, superviseReq, P_INVALID_SESSION_ID

Reference: ES 201 915-4 [1], clause 7.3.3

Preamble: Same as CCC _ IpConfCall _02

Condition: superviseReq method is supported

Test Sequence:

1. Method call **superviseReq()** on IpConfCall
Parameters: invalid callSessionID, valid time, valid treatment
Check: P_INVALID_SESSION_ID is returned

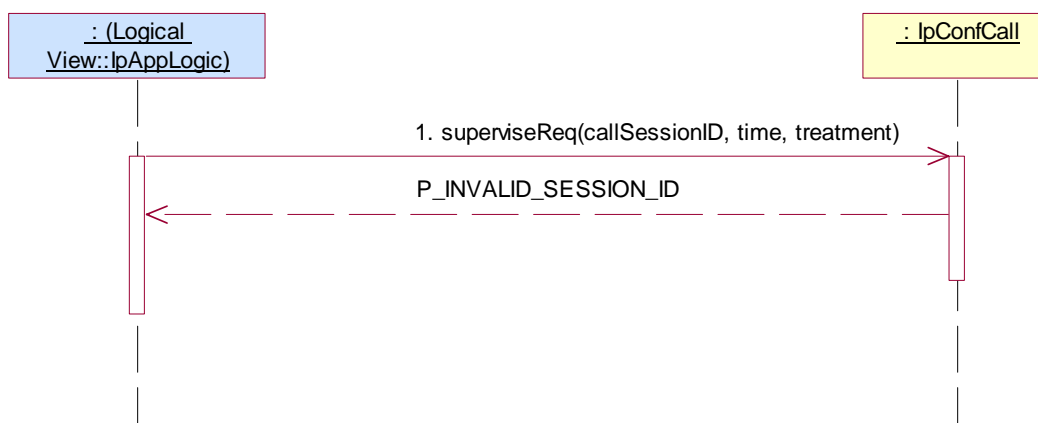
**Test CCC _ IpConfCall _23**

Summary: IpConfCall, getCallLegs, P_INVALID_SESSION_ID

Reference: ES 201 915-4 [1], clause 7.3.3

Preamble: Same as CCC _ IpConfCall _08

Condition: createCallLeg, getCallLegs methods are supported

Test Sequence:

1. Method call **getCallLegs()** on IpConfCall
Parameters: invalid callSessionID
Check: P_INVALID_SESSION_ID is returned

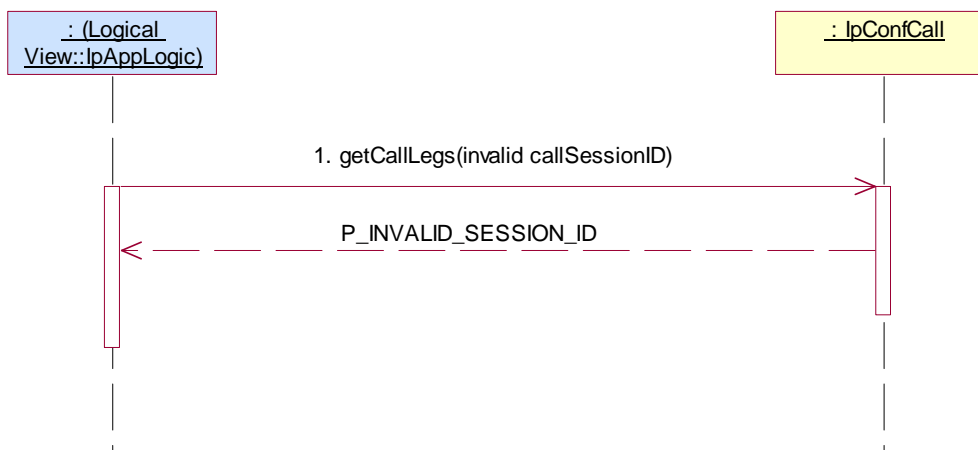

5.2.4.3 IpSubConfCall

5.2.4.3.1 Mandatory, valid behaviour

Test CCC _ IpSubConfCall _01

Summary: IpSubConfCall, all methods mandatory, successful

Reference: ES 201 915-4 [1], clauses 7.3.1 and 7.3.3

Preamble: Application has a valid callSessionID returned by one of the three following sequence:

1. Method call **createConference()** on IpConfCallControlManager
Parameters: valid appConferenceCall, valid numberOfSubConferences, valid conferencePolicy, valid numberOfParticipants, valid duration
Check: valid value of TpConfCallIdentifier is returned
2. Method call **createSubConference()** on IpConfCall
Parameters: valid conferenceSessionID returned in 1., valid appSubConference, valid conferencePolicy
Check: valid value of TpSubConfCallIdentifier is returned
3. Method call **getSubConferences()** on IpConfCall
Parameters: valid conferenceSessionID returned in 1.
Check: valid value of TpSubConfCallIdentifierSet is returned which contains TpSubConfCallIdentifier returned in 2.

either

4. Method call **createCallLeg()** on IpSubConfCall
Parameters: valid callSessionID returned in 2., valid appCallLeg
Check: valid value of TpCallLegIdentifier is returned
5. Method call **routeReq()** on IpMultiMediaCallLeg
Parameters: valid callLegSessionID returned in 3., valid targetAddress, valid appInfo, valid connectionProperties
Check: no exception is returned

or

4. Method call **createAndRouteCallLegReq()** on IpSubConfCall
Parameters: valid callSessionID returned in 2., valid eventsRequested, valid targetAddress, valid originatingAddress, valid appInfo, valid appLegInterface
Check: valid value of TpCallLegIdentifier

or

1. Method call **reserveResources()**
Parameters: valid appInterface, valid startTime, valid numberOfParticipants, valid duration, valid conferencePolicy
Check: valid value of TpResourceReservation is returned
2. Triggered action: cause IUT to call **conferenceCreated()** on Tester's (application's) IpAppConfCallControlManager interface
Parameters: valid conferenceCall.
3. Method call **getSubConferences()** on IpConfCall
Parameters: valid conferenceSessionID returned in 1.
Check: valid value of TpSubConfCallIdentifierSet is returned which contains TpSubConfCallIdentifier returned in 2.

either

4. Method call **createCallLeg()** on IpSubConfCall
Parameters: valid callSessionID reported in 2., valid appCallLeg
Check: valid value of TpCallLegIdentifier is returned
5. Method call **routeReq()** on IpMultiMediaCallLeg
Parameters: valid callLegSessionID returned in 3., valid targetAddress, valid appInfo, valid connectionProperties
Check: no exception is returned

or

4. Method call **createAndRouteCallLegReq()** on IpSubConfCall
Parameters: valid callSessionID reported in 2., valid eventsRequested, valid targetAddress, valid originatingAddress, valid appInfo, valid appLegInterface
Check: valid value of TpCallLegIdentifier

Test Sequence:

1. Method call **release()** on IpSubConfCall
Parameters: valid callSessionID returned in preamble, valid cause
Check: no exception is returned



Test CCC _ IpSubConfCall _02

Summary: IpSubConfCall, all methods mandatory, successful

Reference: ES 201 915-4 [1], clauses 7.3.1 and 7.3.3

Preamble: Same as CCC _ IpSubConfCall _01

Test Sequence:

1. Method call **deassignCall()** on IpSubConfCall
Parameters: valid callSessionID returned in preamble.
Check: no exception is returned

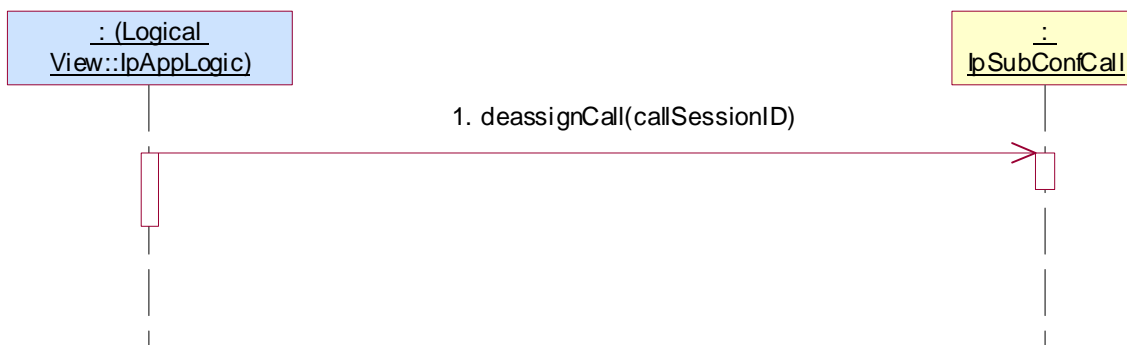

According Call Control SCF specification, at least one of the two following test sequence is mandatory

Test CCC _ IpSubConfCall _03

Summary: IpSubConfCall, all methods mandatory, successful

Reference: ES 201 915-4 [1], clauses 7.3.1 and 7.3.3

Condition: createCall, createCallLeg methods are supported

Preamble: Same as CCC_IpConfCall_02

Test Sequence:

1. Method call **createCallLeg()** on IpSubConfCall
Parameters: valid callSessionID returned in 2., valid appCallLeg
Check: valid value of TpCallLegIdentifier is returned

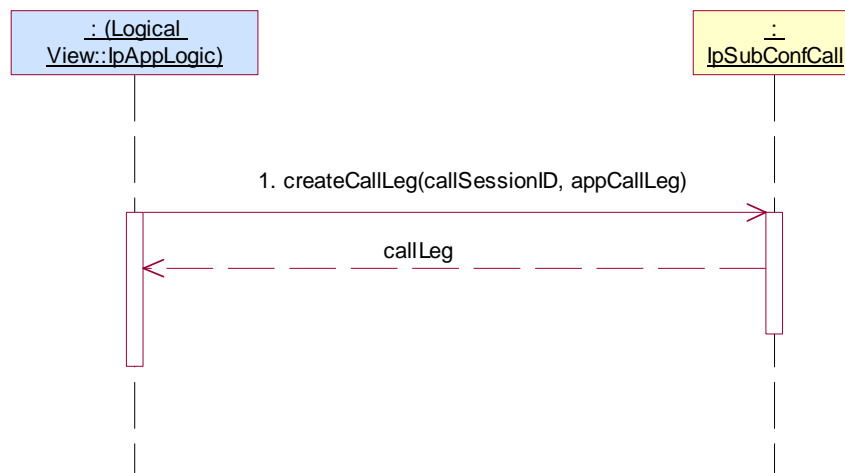

Test CCC _ IpSubConfCall _04

Summary: IpSubConfCall, all methods mandatory, successful

Reference: ES 201 915-4 [1], clauses 7.3.1 and 7.3.3

Condition: createCall, createAndRouteCallLeg method is supported

Preamble CCC_IpConfCall_02

- Method call **createAndRouteCallLegReq()** on IpSubConfCall
 Parameters: valid callSessionID returned in 2., valid eventsRequested, valid targetAddress, valid originatingAddress, valid appInfo, valid appLegInterface
 Check: valid value of TpCallLegIdentifier

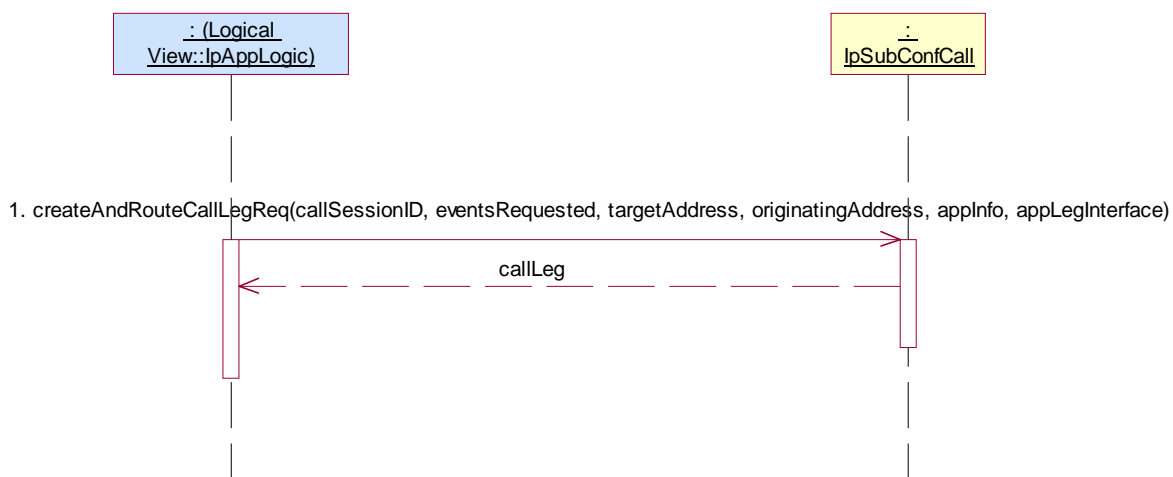

According Call Control SCF specification, at least one of the two following test sequence is mandatory

Test CCC _ IpSubConfCall _05

Summary: IpSubConfCall, all methods mandatory, successful

Reference: ES 201 915-4 [1], clauses 9.3.1 and 9.3.3

Preamble: Application has a valid subConferenceSessionID returned by one of the following sequence:

- Method call **createConference()** on IpConfCallControlManager
 Parameters: valid appConferenceCall, valid numberOfSubConferences equal to 1, valid conferencePolicy, valid numberOfParticipants, valid duration
 Check: valid value of TpConfCallIdentifier is returned
- Method call **getSubConferences()** on IpConfCall
 Parameters: valid conferenceSessionID returned in 1.
 Check: valid value of TpSubConfCallIdentifierSet is returned.

either

- Method call **createCallLeg()** on IpSubConfCall
 Parameters: valid callSessionID, valid appCallLeg
 Check: valid value of TpCallLegIdentifier is returned
- Method call **eventReportReq()** on IpMultiMediaCallLeg
 Parameters: valid callLegSessionID returned in 3, valid eventsRequested with Interrupt event
 Check: no exception is returned
- Method call **routeReq()** on IpMultiMediaCallLeg
 Parameters: valid callLegSessionID returned in 3, valid targetAddress, valid originatingAddress, valid appInfo, valid connectionProperties
 Check: no exception is returned

or

3. Method call **createAndRouteCallLegReq()** on IpSubConfCall
Parameters: valid callSessionID, valid eventsRequested with Interrupt event, valid targetAddress, valid originatingAddress, valid appInfo, valid appLegInterface
Check: valid value of TpCallLegIdentifier

and then, for both:

- 6/4 Triggered action: cause IUT to interrupted call leg processing with a notification or an event: cause IUT to call **eventReportRes()** method on the tester's (Application) **IpAppMultiMediaCallLeg** interface
Parameters: callLegSessionID, eventInfo

or

1. Method call **reserveResources()**
Parameters: valid appInterface, valid startTime, valid numberOfParticipants, valid duration, valid conferencePolicy
Check: valid value of TpResourceReservation is returned
2. Triggered action: cause IUT to call **conferenceCreated()** on Tester's (application's) IpAppConfCallControlManager interface
Parameters: valid conferenceCall
3. Method call **getSubConferences()** on IpConfCall
Parameters: valid conferenceSessionID returned in 1.
Check: valid value of TpSubConfCallIdentifierSet is returned which contains TpSubConfCallIdentifier returned in 2.

either

4. Method call **createCallLeg()** on IpSubConfCall
Parameters: valid callSessionID, valid appCallLeg
Check: valid value of TpCallLegIdentifier is returned
5. Method call **eventReportReq()** on IpMultiMediaCallLeg
Parameters: valid callLegSessionID returned in 3., valid eventsRequested with Interrupt event
Check: no exception is returned
6. Method call **routeReq()** on IpMultiMediaCallLeg
Parameters: valid callLegSessionID returned in 3., valid targetAddress, valid originatingAddress, valid appInfo, valid connectionProperties
Check: no exception is returned

or

4. Method call **createAndRouteCallLegReq()** on IpSubConfCall
Parameters: valid callSessionID, valid eventsRequested with Interrupt event, valid targetAddress, valid originatingAddress, valid appInfo, valid appLegInterface
Check: valid value of TpCallLegIdentifier

and then, for both:

- 7/5 Triggered action: cause IUT to interrupted call leg processing with a notification or an event: cause IUT to call **eventReportRes()** method on the tester's (Application) **IpAppMultiMediaCallLeg** interface
Parameters: callLegSessionID, eventInfo

Condition: splitSubConference method is supported.

Test Sequence:

1. Method call **splitSubConference()**
 Parameters: valid subConferenceSessionID returned in preamble, valid callLegList, valid appSubConferenceCall
 Check: valid value of TpSubConfCallIdentifierSet is returned
2. Method call **mergeSubConference()**
 Parameters: valid subConferenceSessionID returned in preamble, valid targetSubConferenceCall returned in 3.
 Check: no exception is returned
3. Method call **release() on IpSubConfCall**
 Parameters: valid callLegSessionID returned in preamble, valid cause
 Check: no exception is returned

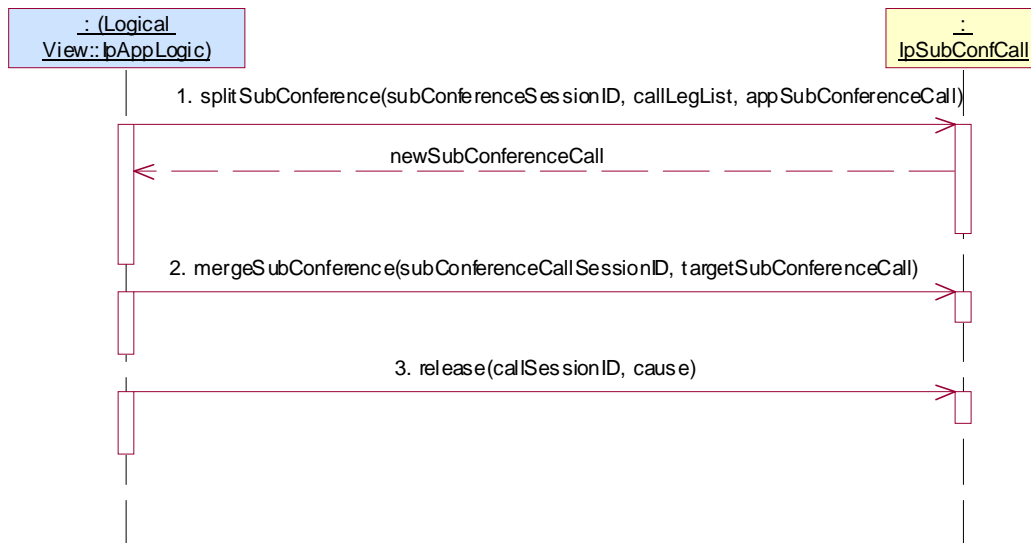

Test CCC _ IpSubConfCall _06

Summary: IpSubConfCall, all methods mandatory, successful

Reference: ES 201 915-4 [1], clauses 9.3.1 and 9.3.3

Preamble: Same as CCC _ IpSubConfCall _05

Test Sequence:

1. Method call **createSubConference()** on IpConfCall
 Parameters: valid conferenceSessionID returned in preamble, valid appSubConference, valid conferencePolicy
 Check: valid value of TpSubConfCallIdentifier is returned
2. Method call **moveCallLeg()**
 Parameters: valid subConferenceSessionID returned in preamble, valid targetSubConferenceCall returned in 1., valid callLeg
 Check: no exception is returned
3. Method call **release()** on IpConfCall
 Parameters: valid callSessionID returned in preamble, valid cause
 Check: no exception is returned

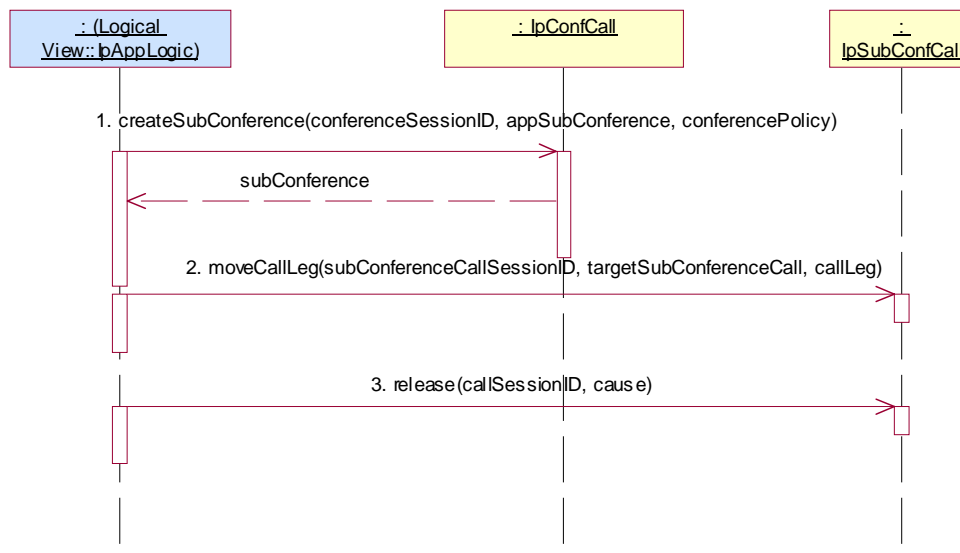

5.2.4.3.2 Mandatory, invalid behaviour

Test CCC _ IpSubConfCall _07

Summary: IpSubConfCall, splitSubConference, P_INVALID_SESSION_ID

Reference: ES 201 915-4 [1], clauses 9.3.1 and 9.3.3

Preamble: Same as CCC _ IpSubConfCall _05

Test Sequence:

1. Method call **splitSubConference()**
 Parameters: invalid subConferenceSessionID, valid callLegList, valid appSubConferenceCall
 Check: P_INVALID_SESSION_ID is returned



Test CCC _ IpSubConfCall _08

Summary: IpSubConfCall, mergeSubConference, P_INVALID_SESSION_ID

Reference: ES 201 915-4 [1], clauses 9.3.1 and 9.3.3

Preamble: Same as CCC _ IpSubConfCall _05

Test Sequence:

1. Method call **splitSubConference()**
 Parameters: valid subConferenceSessionID returned in preamble, valid callLegList, valid appSubConferenceCall
 Check: valid value of TpSubConfCallIdentifierSet is returned.
2. Method call **mergeSubConference()**
 Parameters: invalid subConferenceSessionID, valid targetSubConferenceCall
 Check: P_INVALID_SESSION_ID is returned.

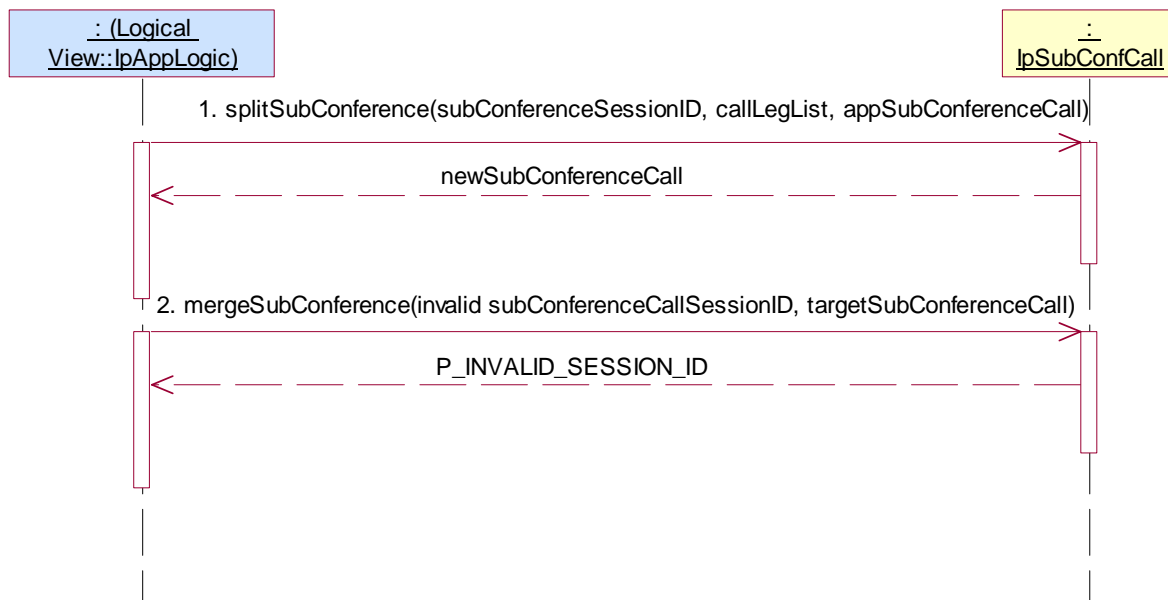

Test CCC _ IpSubConfCall _09

Summary: IpSubConfCall, mergeSubConference, P_INVALID_SESSION_ID

Reference: ES 201 915-4 [1], clauses 9.3.1 and 9.3.3

Preamble: Same as CCC _ IpSubConfCall _05

Test Sequence:

1. Method call **splitSubConference()**
 Parameters: valid subConferenceSessionID returned in preamble, valid callLegList, valid appSubConferenceCall
 Check: valid value of TpSubConfCallIdentifierSet is returned
2. Method call **mergeSubConference()**
 Parameters: valid subConferenceSessionID, invalid targetSubConferenceCall
 Check: P_INVALID_SESSION_ID is returned

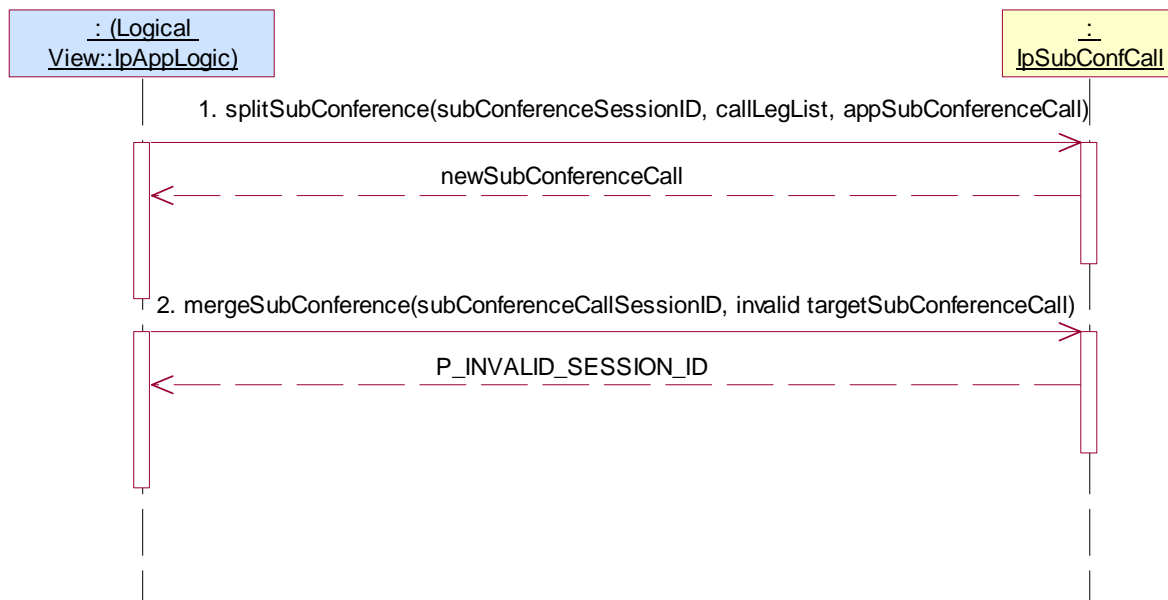

Test CCC _ IpSubConfCall _10

Summary: IpSubConfCall, moveCallLeg, P_INVALID_SESSION_ID

Reference: ES 201 915-4 [1], clauses 9.3.1 and 9.3.3

Preamble: Same as CCC _ IpSubConfCall _05

Test Sequence:

1. Method call **createSubConference()** on IpConfCall
 Parameters: valid conferenceSessionID returned in preamble, valid appSubConference, valid conferencePolicy
 Check: valid value of TpSubConfCallIdentifier is returned
2. Method call **moveCallLeg()**
 Parameters: invalid subConferenceSessionID, valid targetSubConferenceCall, valid callLeg
 Check: P_INVALID_SESSION_ID is returned

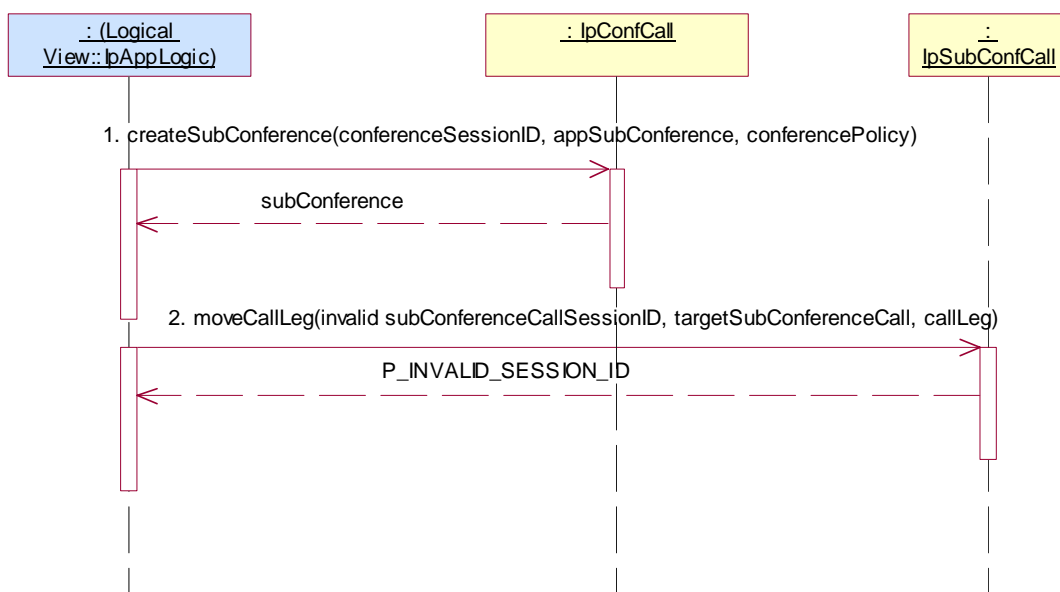

Test CCC _ IpSubConfCall _11

Summary: IpSubConfCall, moveCallLeg, P_INVALID_SESSION_ID

Reference: ES 201 915-4 [1], clauses 9.3.1 and 9.3.3

Preamble: Same as CCC _ IpSubConfCall _05

Test Sequence:

1. Method call **createSubConference()** on IpConfCall
 Parameters: valid conferenceSessionID returned in preamble, valid appSubConference, valid conferencePolicy
 Check: valid value of TpSubConfCallIdentifier is returned
2. Method call **moveCallLeg()**
 Parameters: valid subConferenceSessionID, invalid targetSubConferenceCall, valid callLeg
 Check: P_INVALID_SESSION_ID is returned

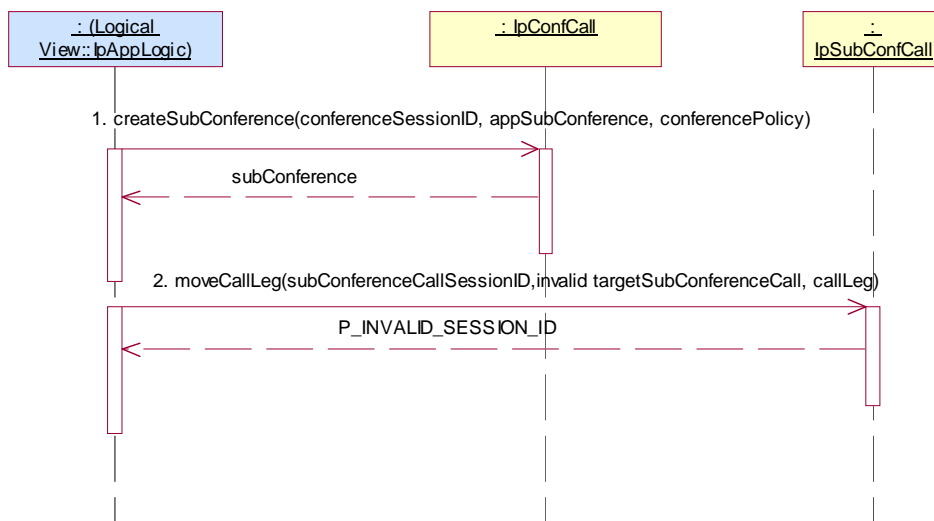

Test CCC _ IpSubConfCall _12

Summary: IpSubConfCall, deassignCall, P_INVALID_SESSION_ID

Reference: ES 201 915-4 [1], clause 7.3.3

Preamble: Same as CCC _ IpSubConfCall _01

Test Sequence:

1. Method call **deassignCall()** on IpSubConfCall
Parameters: invalid callSessionID
Check: P_INVALID_SESSION_ID is returned

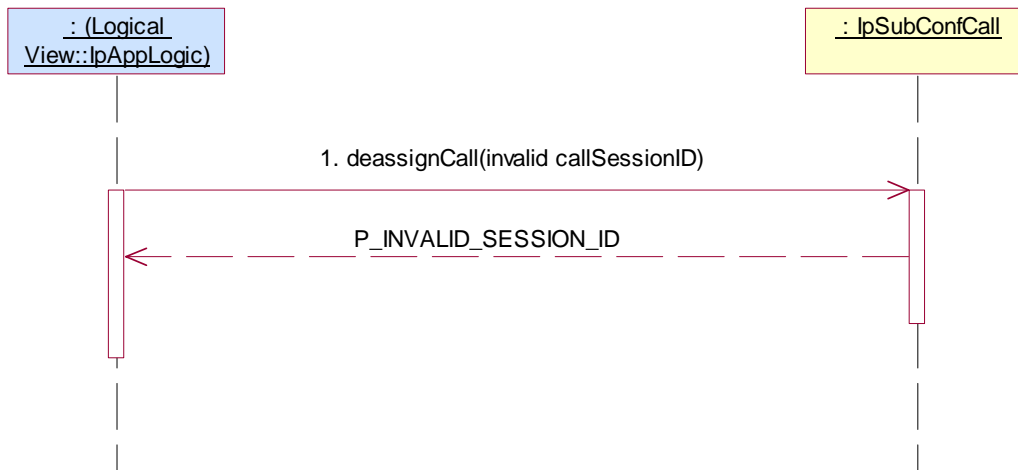
**Test CCC _ IpSubConfCall _13**

Summary: IpSubConfCall, release, P_INVALID_SESSION_ID

Reference: ES 201 915-4 [1], clause 7.3.3

Preamble: Same as CCC _ IpSubConfCall _01

Test Sequence:

1. Method call **release()** on IpSubConfCall
Parameters: invalid callSessionID, valid cause
Check: P_INVALID_SESSION_ID is returned

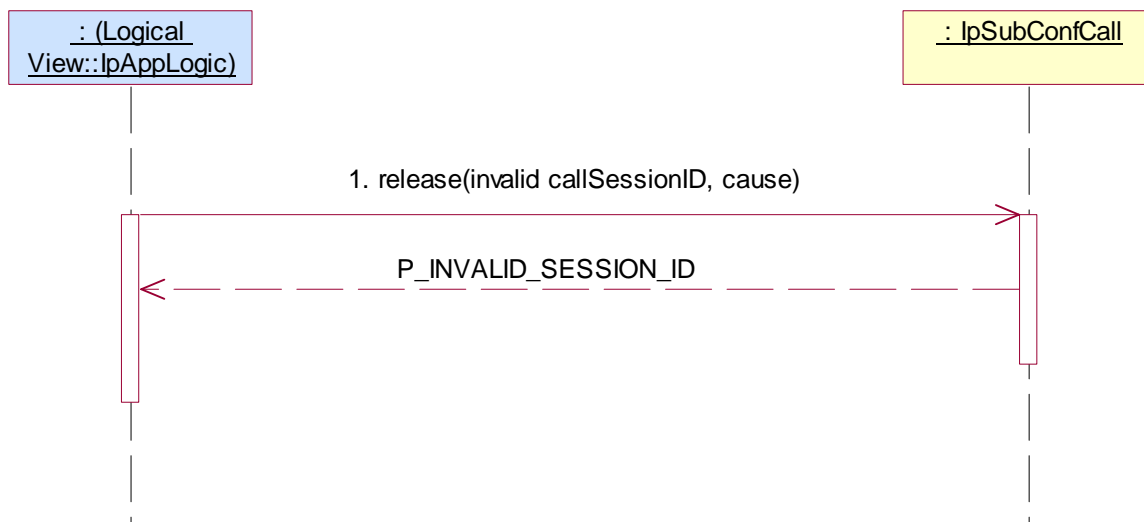

Test CCC_IpSubConfCall_14

Summary: IpSubConfCall, createCallLeg, P_INVALID_SESSION_ID

Reference: ES 201 915-4 [1], clause 7.3.3

Preamble: Same as CCC_IpConfCall_02

Condition: createCallLeg method is supported

Test Sequence:

1. Method call **createCallLeg()** on IpSubConfCall
 Parameters: invalid callSessionID, valid appCallLeg
 Check: P_INVALID_SESSION_ID is returned

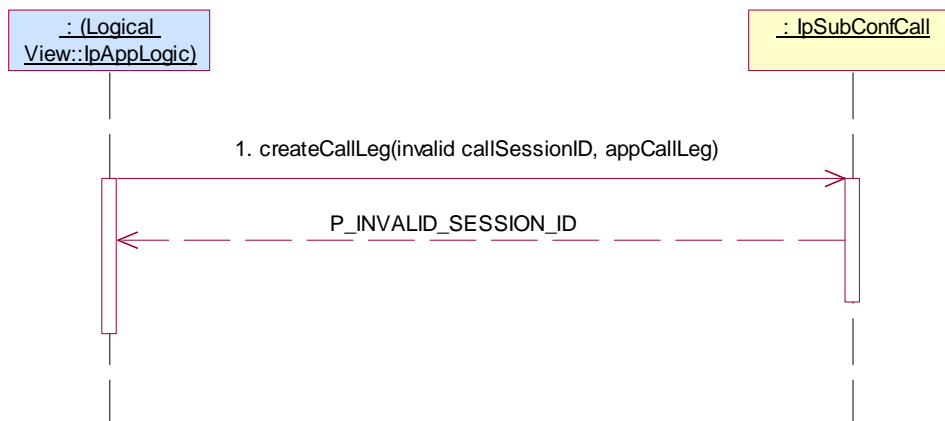
**Test CCC_IpSubConfCall_15**

Summary: IpSubConfCall, createCallLeg, P_INVALID_INTERFACE_TYPE

Reference: ES 201 915-4 [1], clause 7.3.1 and 7.3.3

Preamble: Same as CCC_IpConfCall_02

Condition: CreateCallLeg method is supported

Test Sequence:

1. Method call **createCallLeg()** on IpSubConfCall
 Parameters: valid callSessionID returned in preamble, invalid appCallLeg
 Check: P_INVALID_INTERFACE_TYPE is returned

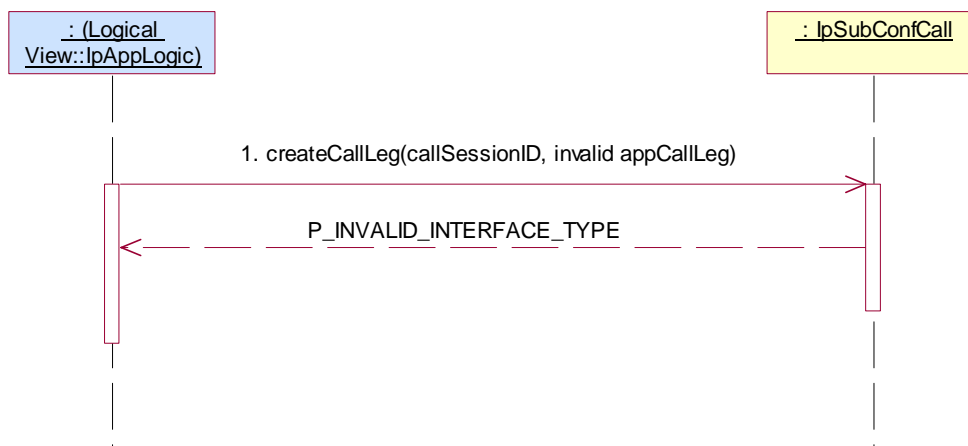

Test CCC _ IpSubConfCall _16

Summary: IpSubConfCall, createAndRouteCallLegReq, P_INVALID_SESSION_ID

Reference: ES 201 915-4 [1], clause 7.3.3

Preamble: Same as CCC_IpConfCall_02

Condition: CreateAndRouteCallLeg method is supported

Test Sequence:

- Method call **createAndRouteCallLegReq()** on IpSubConfCall
 Parameters: invalid callSessionID, valid eventsRequested, valid targetAddress, valid originatingAddress, valid appInfo, valid appLegInterface
 Check: P_INVALID_SESSION_ID is returned

**Test CCC _ IpSubConfCall _17**

Summary: IpSubConfCall, createAndRouteCallLegReq, P_INVALID_INTERFACE_TYPE

Reference: ES 201 915-4 [1], clause 7.3.3

Preamble: Same as CCC_IpConfCall_02

Condition: CreateAndRouteCallLeg method is supported

Test Sequence:

- Method call **createAndRouteCallLegReq()** on IpSubConfCall
 Parameters: valid callSessionID, valid eventsRequested, valid targetAddress, valid originatingAddress, valid appInfo, invalid appLegInterface
 Check: P_INVALID_INTERFACE_TYPE is returned

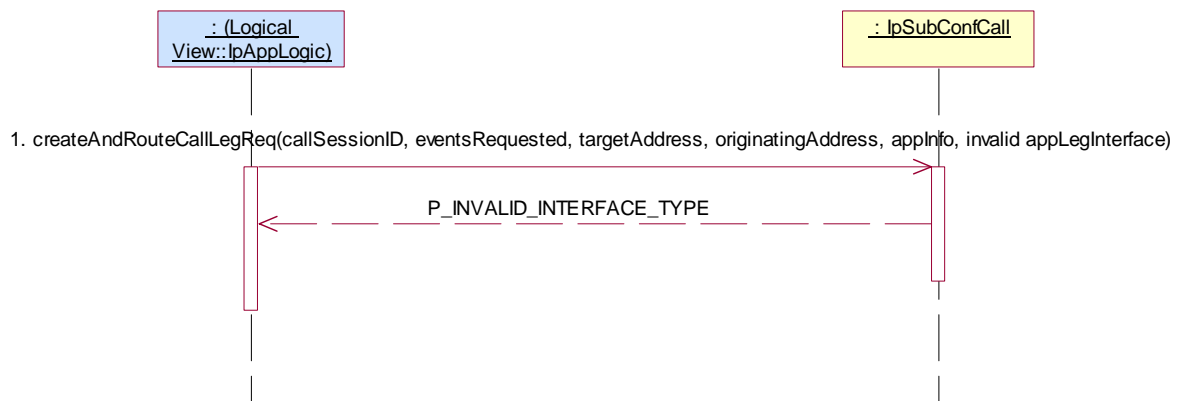

Test CCC _ IpSubConfCall _18

Summary: IpSubConfCall, createAndRouteCallLegReq, P_INVALID_ADDRESS

Reference: ES 201 915-4 [1], clause 7.3.3

Preamble: Same as CCC_IpConfCall_02

Condition: CreateAndRouteCallLeg method is supported

Test Sequence:

- Method call **createAndRouteCallLegReq()** on IpSubConfCall
 Parameters: valid callSessionID, valid eventsRequested, invalid targetAddress, valid originatingAddress, valid appInfo, valid appLegInterface
 Check: P_INVALID_ADDRESS is returned

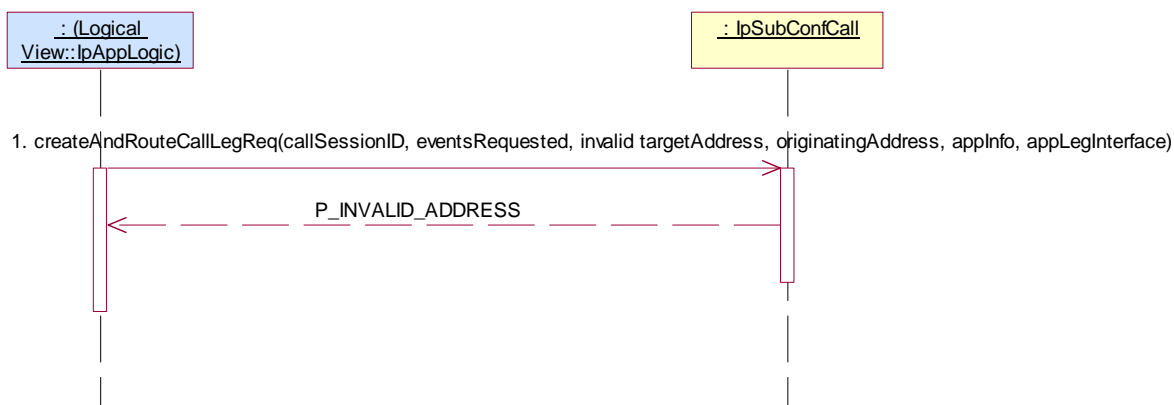
**Test CCC _ IpSubConfCall _19**

Summary: IpSubConfCall, createAndRouteCallLegReq, P_INVALID_ADDRESS

Reference: ES 201 915-4 [1], clause 7.3.3

Preamble: Same as CCC_IpConfCall_02

Condition: CreateAndRouteCallLeg method is supported

Test Sequence:

- Method call **createAndRouteCallLegReq()** on IpSubConfCall
 Parameters: valid callSessionID, valid eventsRequested, valid targetAddress, invalid originatingAddress, valid appInfo, valid appLegInterface
 Check: P_INVALID_ADDRESS is returned

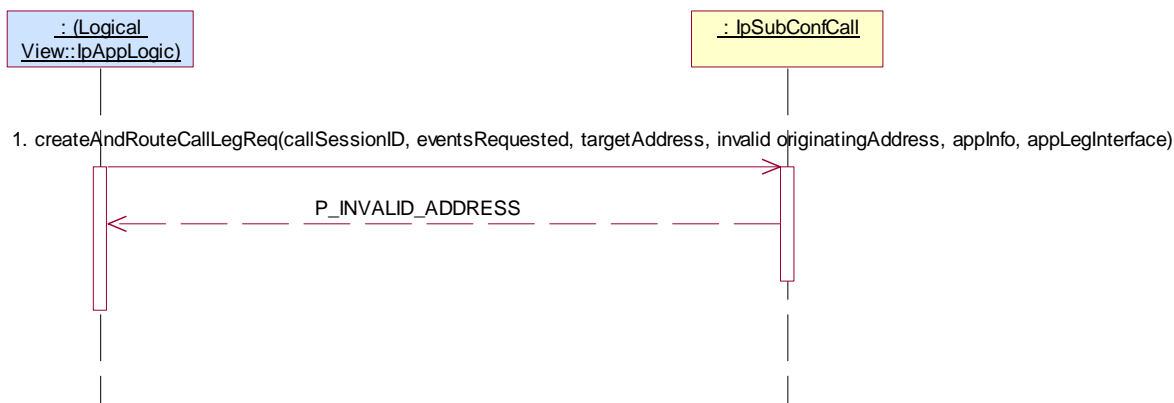

Test CCC _ IpSubConfCall _20

Summary: IpSubConfCall, createAndRouteCallLegReq, P_INVALID_CRITERIA

Reference: ES 201 915-4 [1], clause 7.3.3

Preamble: Same as CCC_IpConfCall_02

Condition: CreateAndRouteCallLeg method is supported

Test Sequence:

1. Method call **createAndRouteCallLegReq()** on IpSubConfCall
Parameters: valid callSessionID, invalid eventsRequested, valid targetAddress, valid originatingAddress, valid appInfo, valid appLegInterface
Check: P_INVALID_CRITERIA is returned

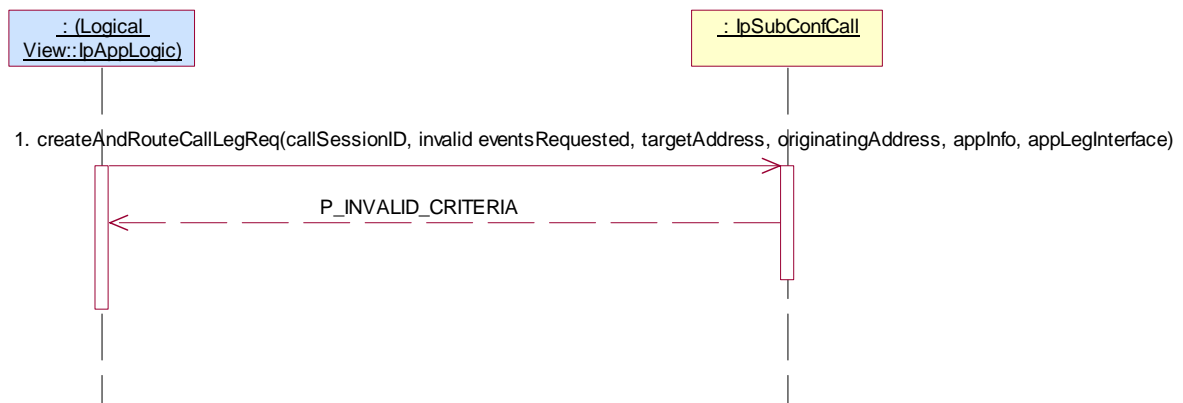

5.2.4.3.3 Optional, valid behaviour

Test CCC _ IpSubConfCall _21

Summary: IpSubConfCall, all methods, successful

Reference: ES 201 915-4 [1], clause 9.3.1 and 9.3.3

Preamble: Application has a reference interface used for callbacks

Test Sequence:

1. Method call **createConference()** on IpConfCallControlManager
 Parameters: valid appConferenceCall, valid numberOfSubConferences equal to 1, valid conferencePolicy, valid numberOfParticipants, valid duration
 Check: valid value of TpConfCallIdentifier is returned
2. Method call **getSubConferences()** on IpConfCall
 Parameters: valid conferenceSessionID returned in 1.
 Check: valid value of TpSubConfCallIdentifierSet is returned.

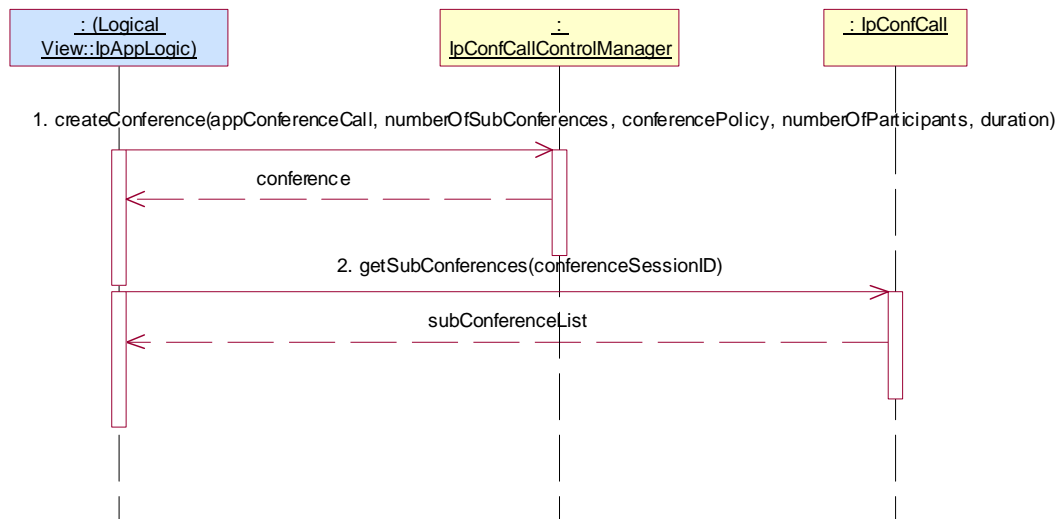

Test CCC _ IpSubConfCall _22

Summary: IpSubConfCall, all methods, successful

Reference: ES 201 915-4 [1], clauses 9.3.1 and 9.3.3

Preamble: Application has a reference interface used for callbacks

Test Sequence:

1. Method call **createConference()** on IpConfCallControlManager
 Parameters: valid appConferenceCall, valid numberOfSubConferences greater than 1., valid conferencePolicy, valid numberOfParticipants, valid duration
 Check: valid value of TpConfCallIdentifier is returned
2. Method call **getSubConferences()** on IpConfCall
 Parameters: valid conferenceSessionID returned in 1.
 Check: valid value of TpSubConfCallIdentifierSet is returned and verify numberOfSubConferences created.

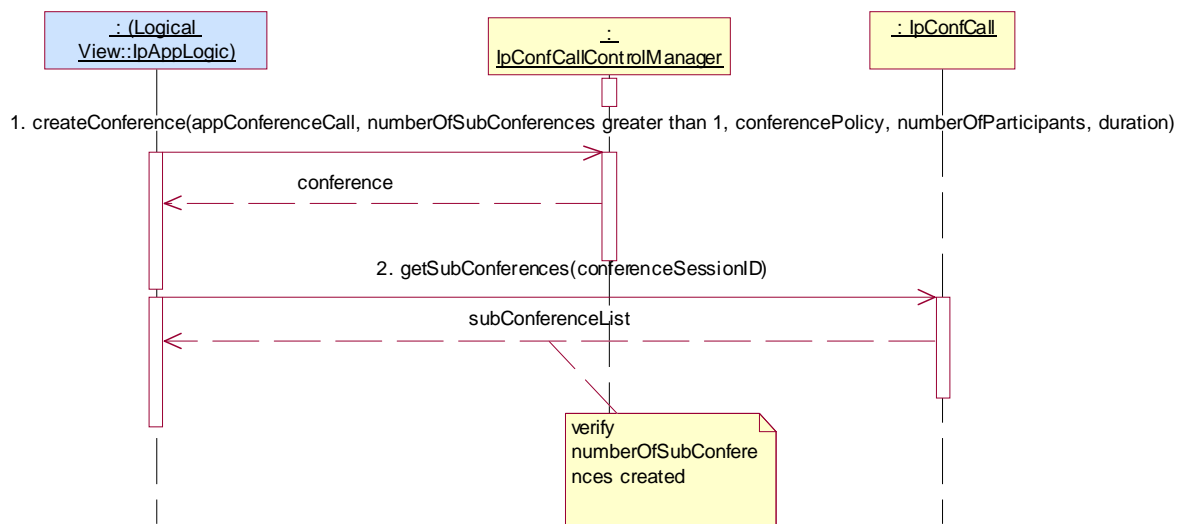

Test CCC _ IpSubConfCall _23

Summary: IpSubConfCall, all methods, successful

Reference: ES 201 915-4 [1], clauses 9.3.1 and 9.3.3

Preamble: Same as CCC _ IpSubConfCall _01

Test Sequence:

1. Method call **inspectVideo()**
Parameters: valid subConferenceSessionID returned in preamble, valid inspectedCallLeg
Check: no exception is returned
2. Method call **inspectVideoCancel()**
Parameters: valid subConferenceSessionID returned in preamble
Check: no exception is returned
3. Method call **release() on IpSubConfCall**
Parameters: valid callLegSessionID returned in preamble, valid cause
Check: no exception is returned



Test CCC _ IpSubConfCall _24

Summary: IpSubConfCall, all methods, successful

Reference: ES 201 915-4 [1], clauses 9.3.1 and 9.3.3

Preamble: Same as CCC _ IpSubConfCall _01

Test Sequence:

1. Method call **chairSelection()**
Parameters: valid subConferenceSessionID returned in preamble, valid chairCallLeg
Check: no exception is returned.
2. Method call **appointSpeaker()**
Parameters: valid subConferenceSessionID returned in preamble, valid speakerCallLeg
Check: no exception is returned
3. Method call **release() on IpSubConfCall**
Parameters: valid callLegSessionID returned in preamble, valid cause
Check: no exception is returned

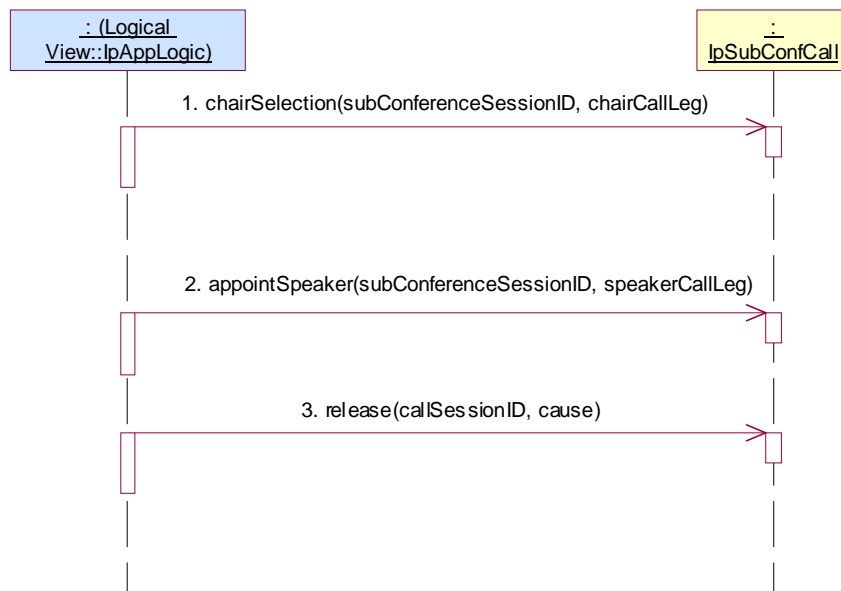

Test CCC _ IpSubConfCall _25

Summary: IpSubConfCall, all methods, successful

Reference: ES 201 915-4 [1], clauses 9.3.1 and 9.3.3

Preamble: Same as CCC _ IpSubConfCall _01

Test Sequence:

1. Method call **changeConferencePolicy()**
Parameters: valid subConferenceSessionID returned in preamble, valid conferencePolicy
Check: no exception is returned
2. Method call **release() on IpSubConfCall**
Parameters: valid callLegSessionID returned in preamble, valid cause
Check: no exception is returned

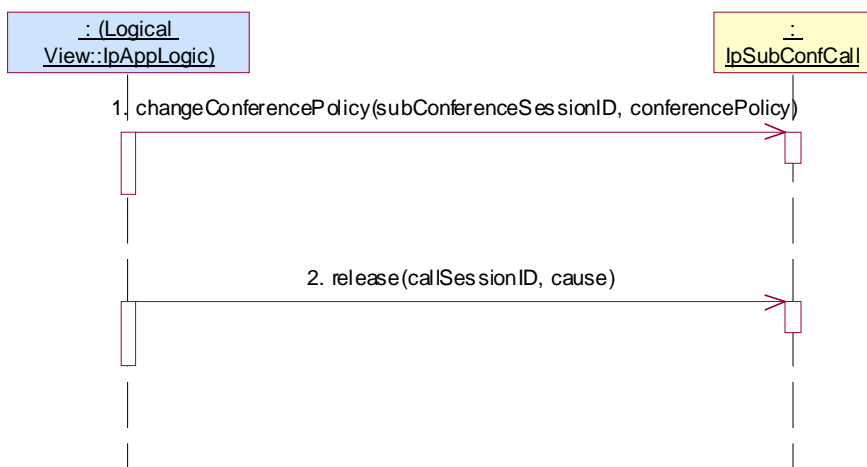

Test CCC _ IpSubConfCall _26

Summary: IpSubConfCall, getInfoReq, successful

Reference: ES 201 915-4 [1], clauses 7.3.1 and 7.3.3

Preamble: Same as CCC _ IpConfCall _08

Condition: createCallLeg and getInfoReq methods are supported

Test Sequence:

1. Method call **getInfoReq()** on IpSubConfCall
Parameters: valid callSessionID returned in preamble, valid callInfoRequested
Check: no exception is returned
2. Method call **routeReq()** on IpMultiMediaCallLeg
Parameters: valid callLegSessionID returned in preamble, valid targetAddress, valid appInfo, valid connectionProperties
Check: no exception is returned
3. Method call **release()** on IpSubConfCall
Parameters: valid callSessionID returned in preamble, valid cause
Check: no exception is returned
4. Triggered action: cause IUT to call **getInfoRes()** method on the tester's (Application) **IpAppSubConfCall** interface.
Parameters: callSessionID given in 1., valid callInfoReport

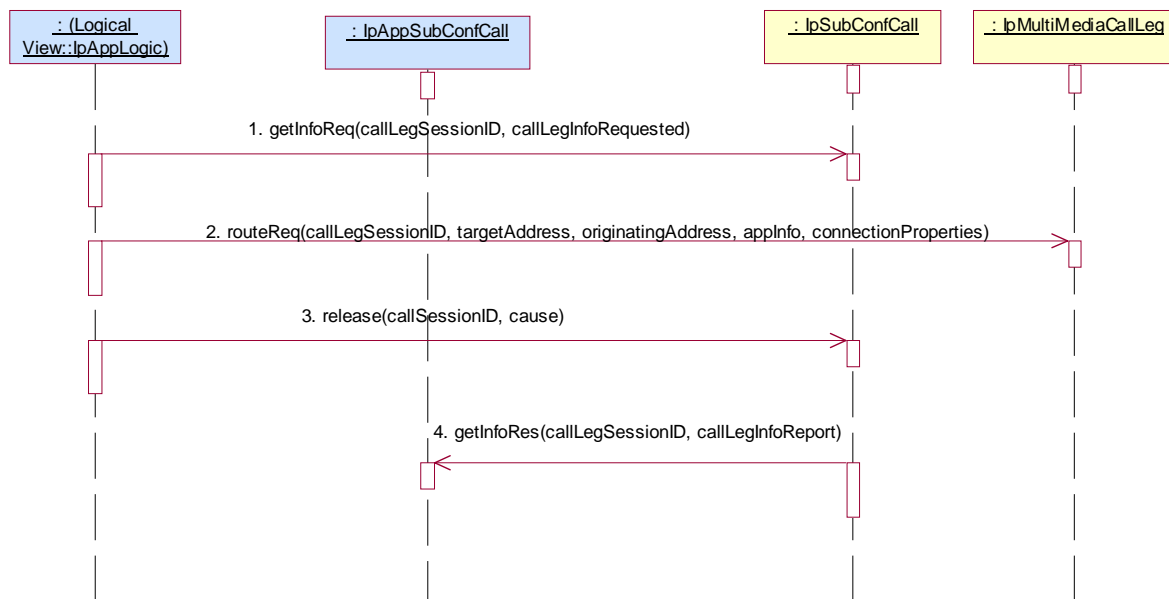

Test CCC _ IpSubConfCall _27

Summary: IpSubConfCall, setChargePlan, successful

Reference: ES 201 915-4 [1], clauses 7.3.1 and 7.3.3

Preamble: Same as CCC _ IpConfCall _08

Condition: createCallLeg and setChargePlan methods are supported

Test Sequence:

1. Method call **setChargePlan()** on IpSubConfCall
 Parameters: valid callSessionID returned in 1., valid callChargePlan
 Check: no exception is returned

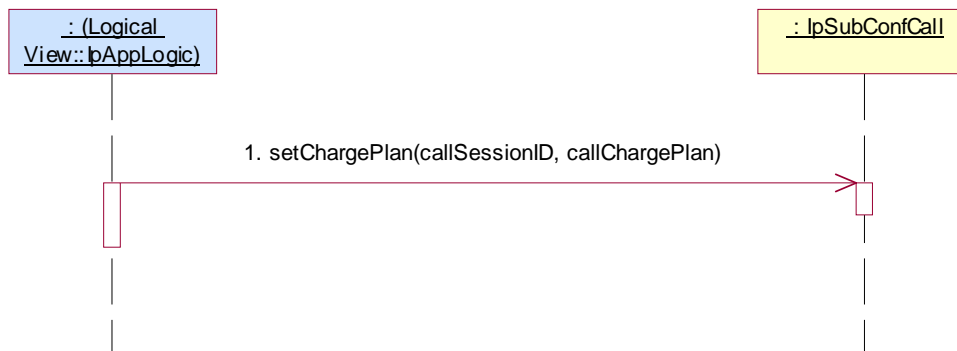
**Test CCC _ IpSubConfCall _28**

Summary: IpSubConfCall, setAdviceOfCharge, successful

Reference: ES 201 915-4 [1], clauses 7.3.1 and 7.3.3

Preamble: Same as CCC _ IpConfCall _08

Condition: createCallLeg and setAdviceOfCharge methods are supported

Test Sequence:

1. Method call **setAdviceOfCharge()** on IpSubConfCall
 Parameters: valid callSessionID returned in 1., valid aOCInfo, valid tariffSwitch
 Check: no exception is returned

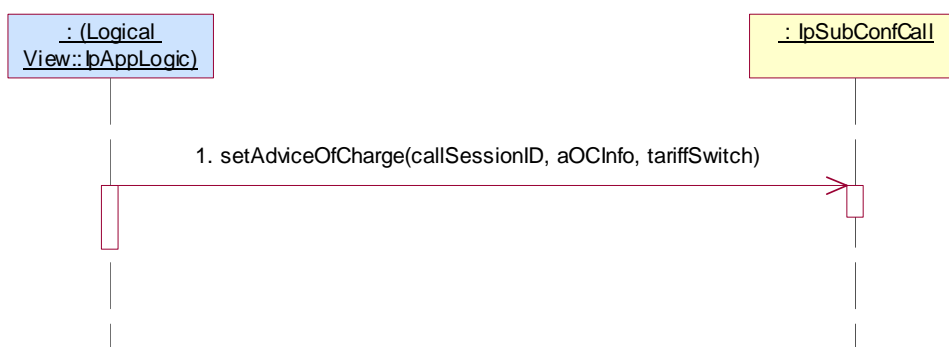

Test CCC _ IpSubConfCall _29

Summary: IpSubConfCall, all methods, successful

Reference: ES 201 915-4 [1], clauses 7.3.1 and 7.3.3

Preamble: Same as CCC _ IpSubConfCall _05

Condition: getCallLegs method is supported

Test Sequence:

- Method call **getCallLegs()** on IpSubConfCall
 Parameters: valid callSessionID returned in preamble
 Check: valid value of TpCallLegIdentifierSet which contains CallLegIdentifier returned in preamble



5.2.4.3.4 Optional, invalid behaviour

Test CCC _ IpSubConfCall _30

Summary: IpSubConfCall, inspectVideo, P_INVALID_SESSION_ID

Reference: ES 201 915-4 [1], clauses 9.3.1 and 9.3.3

Preamble: Same as CCC _ IpSubConfCall _01

Test Sequence:

- Method call **inspectVideo()**
 Parameters: invalid subConferenceSessionID, valid inspectedCallLeg
 Check: P_INVALID_SESSION_ID is returned



Test CCC _ IpSubConfCall _31

Summary: IpSubConfCall, inspectVideoCancel, P_INVALID_SESSION_ID

Reference: ES 201 915-4 [1], clauses 9.3.1 and 9.3.3

Preamble: Same as CCC _ IpSubConfCall _01

Test Sequence:

1. Method call **inspectVideo()**
 Parameters: valid subConferenceSessionID returned in preamble, valid inspectedCallLeg
 Check: no exception is returned
2. Method call **inspectVideoCancel()**
 Parameters: invalid subConferenceSessionID
 Check: P_INVALID_SESSION_ID is returned

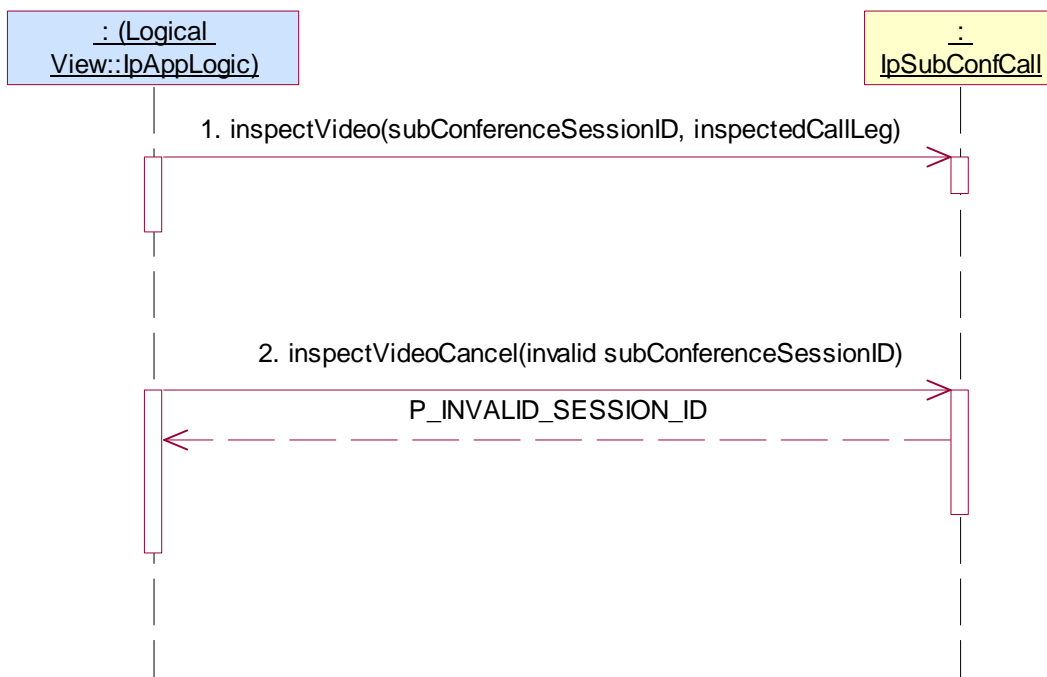

Test CCC _ IpSubConfCall _32

Summary: IpSubConfCall, appointSpeaker, P_INVALID_SESSION_ID

Reference: ES 201 915-4 [1], clauses 9.3.1 and 9.3.3

Preamble: Same as CCC _ IpSubConfCall _01

Test Sequence:

1. Method call **appointSpeaker()**
 Parameters: invalid subConferenceSessionID, valid speakerCallLeg
 Check: P_INVALID_SESSION_ID is returned

**Test CCC _ IpSubConfCall _33**

Summary: IpSubConfCall, chairSelection, P_INVALID_SESSION_ID

Reference: ES 201 915-4 [1], clauses 9.3.1 and 9.3.3

Preamble: Same as CCC _ IpSubConfCall _01

Test Sequence:

1. Method call **chairSelection()**
 Parameters: invalid subConferenceSessionID, valid chairCallLeg
 Check: P_INVALID_SESSION_ID is returned



Test CCC _ IpSubConfCall _34

Summary: IpSubConfCall, changeConferencePolicy, P_INVALID_SESSION_ID

Reference: ES 201 915-4 [1], clauses 9.3.1 and 9.3.3

Preamble: Same as CCC _ IpSubConfCall _01

Test Sequence:

1. Method call **changeConferencePolicy()**
 Parameters: invalid subConferenceSessionID, valid conferencePolicy
 Check: P_INVALID_SESSION_ID is returned

**Test CCC _ IpSubConfCall _35**

Summary: IpSubConfCall, getInfoReq, P_INVALID_SESSION_ID

Reference: ES 201 915-4 [1], clauses 7.3.1 and 7.3.3

Preamble: Same as CCC _ IpSubConfCall _01

Condition: createCallLeg and getInfoReq methods are supported

Test Sequence:

1. Method call **getInfoReq()** on IpSubConfCall
 Parameters: invalid callSessionID, valid callInfoRequested
 Check: P_INVALID_SESSION_ID is returned

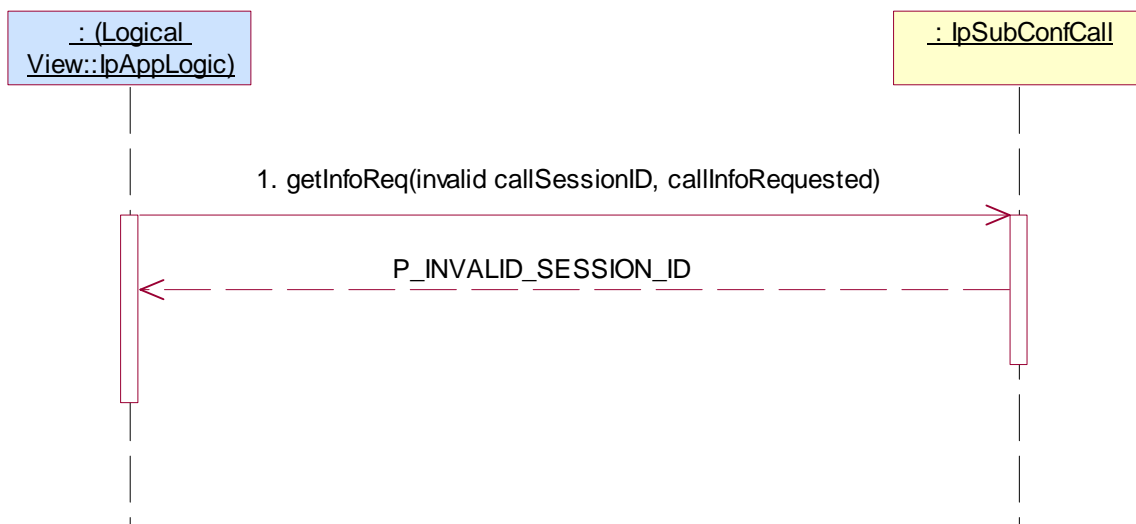

Test CCC _ IpSubConfCall _36

Summary: IpSubConfCall, setChargePlan, P_INVALID_SESSION_ID

Reference: ES 201 915-4 [1], clauses 7.3.1 and 7.3.3

Preamble Same as CCC_IpConfCall_02

Condition: createCallLeg and setChargePlan methods are supported

Test Sequence:

1. Method call **setChargePlan()** on IpSubConfCall
Parameters: invalid callSessionID, valid callChargePlan
Check: P_INVALID_SESSION_ID is returned

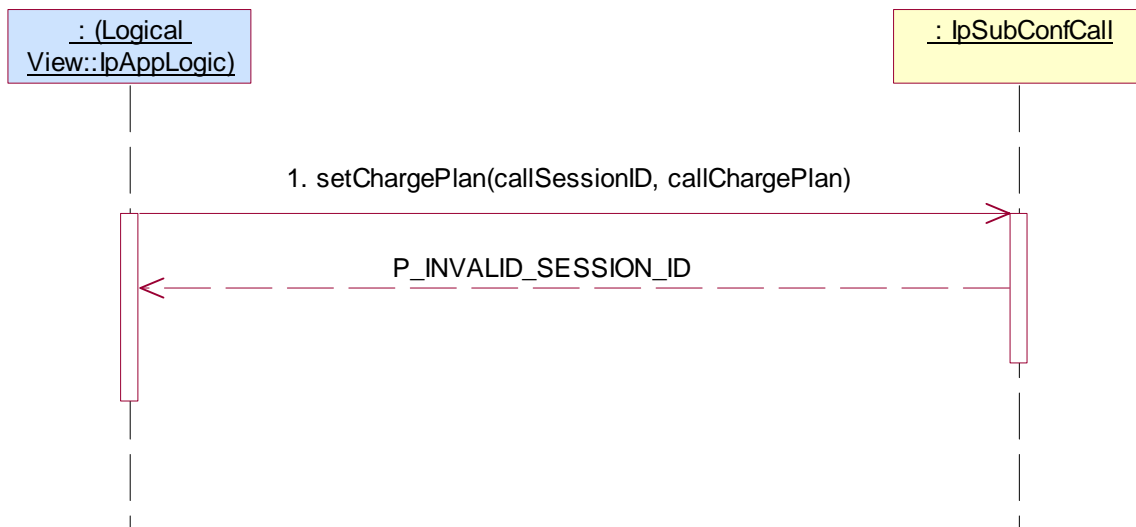

Test CCC _ IpSubConfCall _37

Summary: IpSubConfCall, setAdviceOfCharge, P_INVALID_SESSION_ID

Reference: ES 201 915-4 [1], clauses 7.3.1 and 7.3.3

Preamble Same as CCC_IpConfCall_02

Condition: createCallLeg and setAdviceOfCharge methods are supported

Test Sequence:

1. Method call **setAdviceOfCharge()** on IpSubConfCall
Parameters: invalid callSessionID, valid aOCInfo, valid tariffSwitch
Check: P_INVALID_SESSION_ID is returned

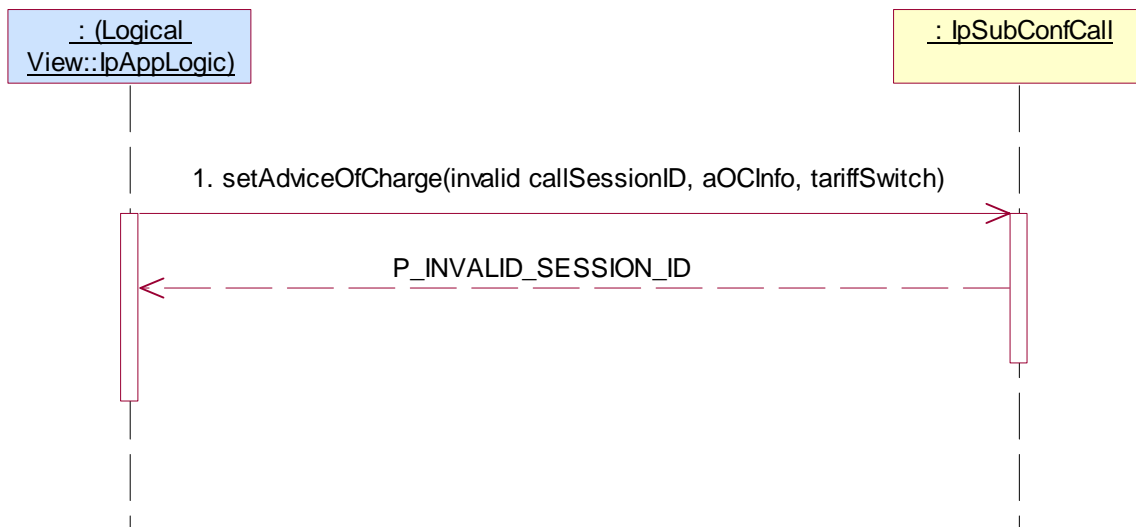

Test CCC _ IpSubConfCall _38

Summary: IpSubConfCall, setAdviceOfCharge, P_INVALID_CURRENCY

Reference: ES 201 915-4 [1], clauses 7.3.1 and 7.3.3

Preamble Same as CCC_IpConfCall_02

Condition: createCallLeg and setAdviceOfCharge methods are supported

Test Sequence:

1. Method call **setAdviceOfCharge()** on IpSubConfCall
Parameters: valid callSessionID returned in 1., aOCInfo with invalid currency, valid tariffSwitch
Check: P_INVALID_CURRENCY is returned

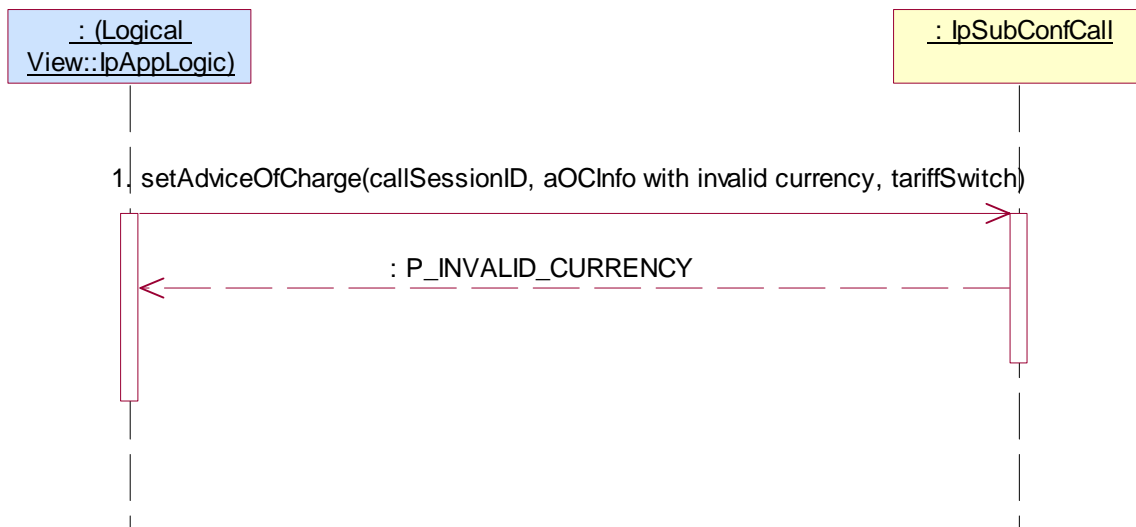

Test CCC _ IpSubConfCall _39

Summary: IpSubConfCall, setAdviceOfCharge, P_INVALID_AMOUNT

Reference: ES 201 915-4 [1], clauses 7.3.1 and 7.3.3

Preamble Same as CCC_IpConfCall_02

Condition: createCallLeg and setAdviceOfCharge methods are supported

Test Sequence:

1. Method call **setAdviceOfCharge()** on IpSubConfCall
Parameters: valid callSessionID returned in 1., aOCInfo, with invalid amount, valid tariffSwitch
Check: P_INVALID_AMOUNT is returned

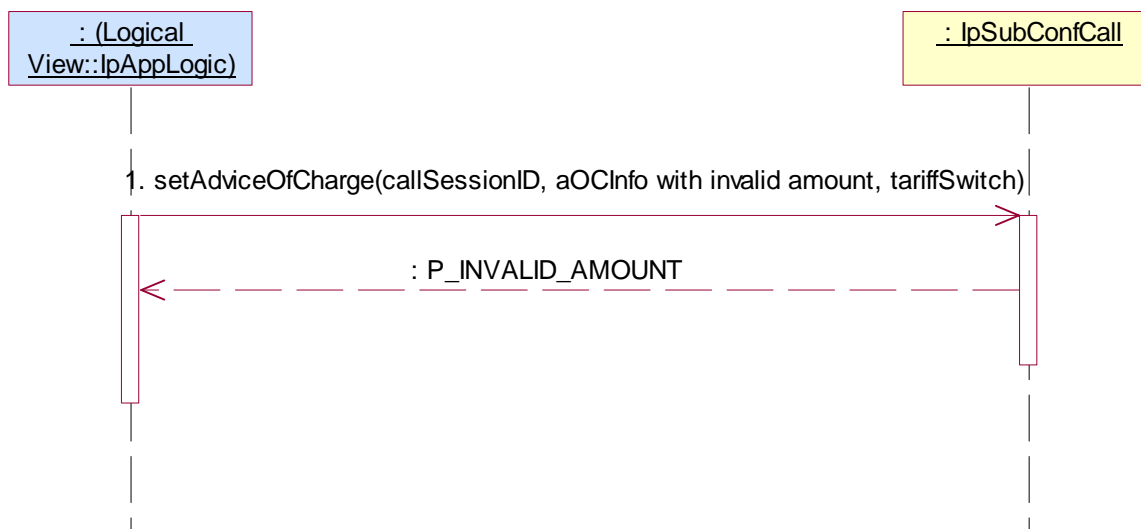

Test CCC_IpSubConfCall_40

Summary: IpSubConfCall, getCallLegs, P_INVALID_SESSION_ID

Reference: ES 201 915-4 [1], clause 7.3.3

Preamble Same as CCC_IpConfCall_02

Condition: CreateCallLeg method is supported

Test Sequence:

1. Method call **getCallLegs()** on IpSubConfCall
Parameters: invalid callSessionID
Check: P_INVALID_SESSION_ID is returned

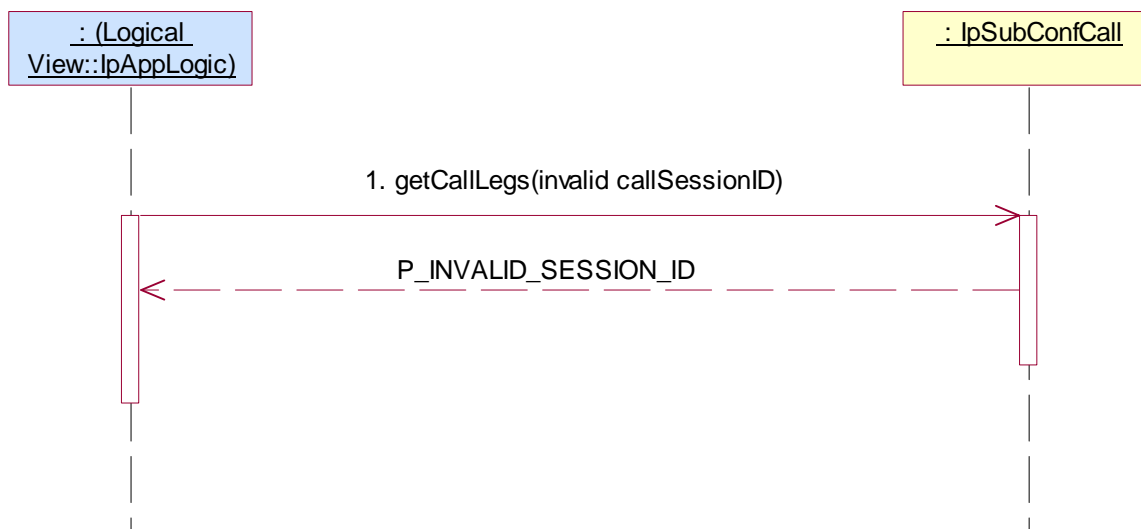

5.2.4.4 IpMultiMediaCallLeg

5.2.4.4.1 Mandatory, valid behaviour

Test CCC _ IpMultiMediaCallLeg _01

Summary: IpMultiMediaCallLeg, all methods mandatory, successful

Reference: ES 201 915-4 [1], clauses 7.3.1, 7.3.3 and 8.3.5

Preamble: Same as CCC _ IpSubConfCall_01

Test Sequence:

1. Method call **mediaStreamMonitorReq()** on IpMultiMediaCallLeg
Parameters: valid callLegSessionID returned in preamble, valid mediaStreamEventCriteria
Check: no exception is returned
2. Triggered action: cause IUT to call Method **mediaStreamMonitorRes()** method on the tester's (application)
Parameters: callLegSessionID, streams, type
3. Method call **mediaStreamAllow()** on IpMultiMediaCallLeg
Parameters: valid callLegSessionID returned in preamble, valid mediaStreamList
Check: no exception is returned

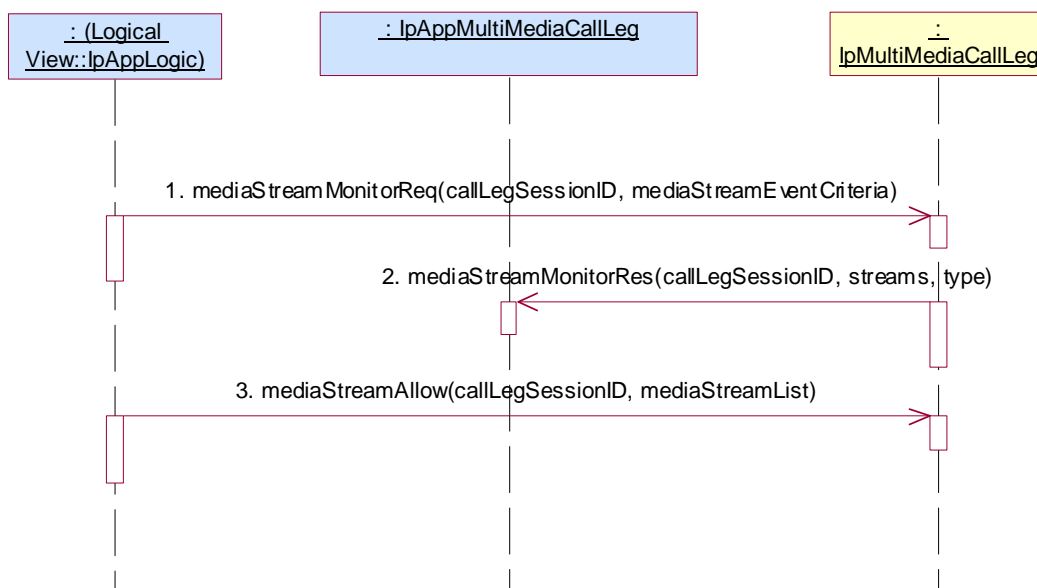

Test CCC _ IpMultiMediaCallLeg _02

Summary: IpMultiMediaCallLeg, all mandatory methods, successful

Reference: ES 201 915-4 [1], clauses 7.3.1, 7.3.3 and 7.3.5

Preamble: Same as CCC _ IpConfCall _08

Condition: createCallLeg method is supported

Test Sequence:

1. Method call **eventReportReq()** on IpMultiMediaCallLeg
Parameters: valid callLegSessionID returned in 1, valid eventsRequested with Interrupt event
Check: no exception is returned
2. Method call **routeReq()** on IpMultiMediaCallLeg
Parameters: valid callLegSessionID returned in 1., valid targetAddress, valid appInfo, valid connectionProperties
Check: no exception is returned
3. Triggered action: cause IUT to interrupt call leg processing with a notification or an event: cause IUT to call **eventReportRes()** method on the tester's (Application) **IpAppMultiMediaCallLeg** interface.
Parameters: callLegSessionID, eventInfo
4. Method call **continueProcessing()** on IpMultiMediaCallLeg
Parameters: valid callLegSessionID returned in 1.
Check: no exception is returned
5. Method call **release()** on IpMultiMediaCallLeg
Parameters: valid callLegSessionID returned in 1., valid cause
Check: no exception is returned

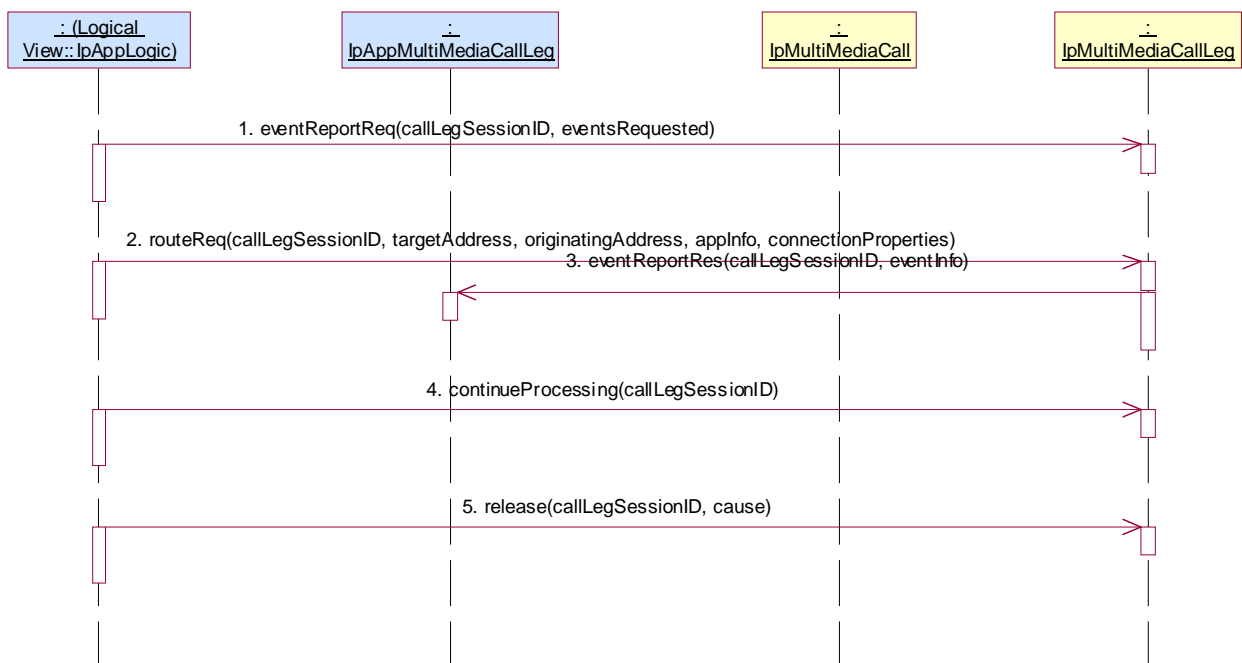

Test CCC _ IpMultiMediaCallLeg _03

Summary: IpMultiMediaCallLeg, all mandatory methods, successful

Reference: ES 201 915-4 [1], clauses 7.3.1, 7.3.3 and 7.3.5

Preamble: Same as CCC_IpConfCall_02

Condition: createAndRouteCallLeg method is supported

Test Sequence:

1. Method call **createAndRouteCallLeg()** on IpSubConfCall
Parameters: valid callSessionID returned in preamble, valid eventsRequested with Interrupt event, valid targetAddress, valid originatingAddress, valid appInfo, valid appLegInterface
Check: valid value of TpCallLegIdentifier is returned
2. Triggered action: cause IUT to interrupt call leg processing with a notification or an event: cause IUT to call **eventReportRes()** method on the tester's (Application) **IpAppMultiMediaCallLeg** interface
Parameters: callLegSessionID returned in 1, eventInfo
3. Method call **continueProcessing()** on IpMultiMediaCallLeg
Parameters: valid callLegSessionID returned in preamble
Check: no exception is returned
4. Method call **release()** on IpMultiMediaCallLeg
Parameters: valid callLegSessionID returned in preamble, valid cause
Check: no exception is returned

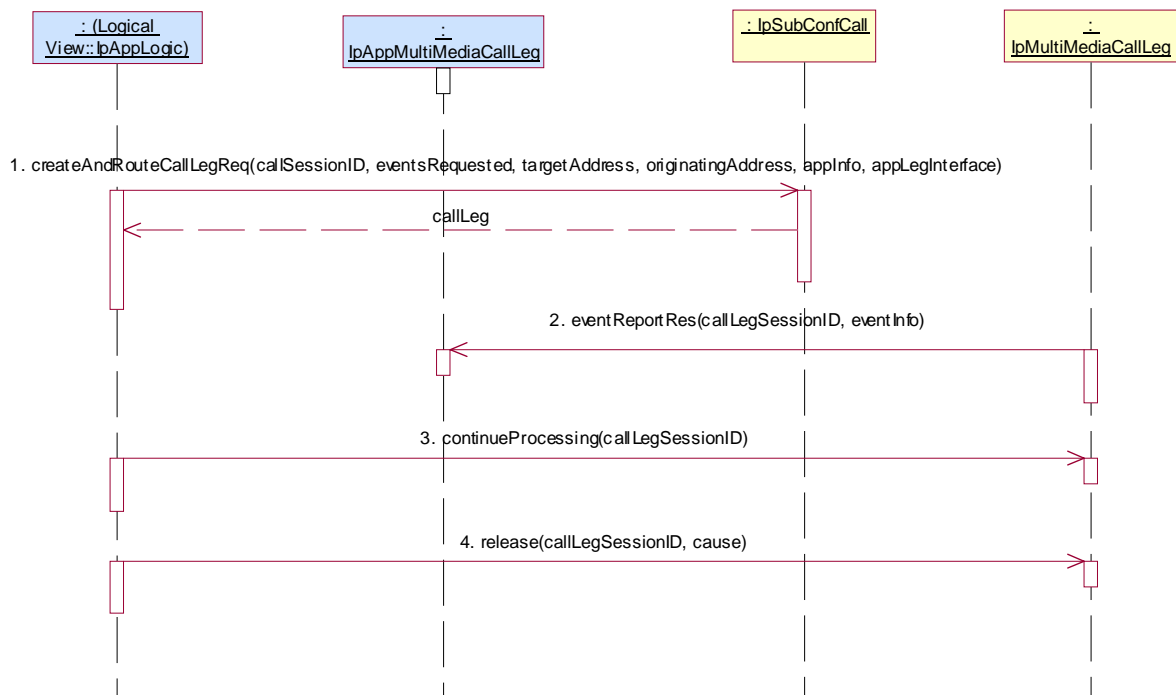

Test CCC _ IpMultiMediaCallLeg _04

Summary: IpMultiMediaCallLeg, all mandatory methods, successful

Reference: ES 201 915-4 [1], clauses 7.3.1, 7.3.3 and 7.3.5

Preamble: Same as CCC_IpSubConfCall _01

Test Sequence:

1. Method call **deassign()** on IpMultiMediaCallLeg
Parameters: valid callLegSessionID returned in preamble
Check: no exception is returned



5.2.4.4.2 Mandatory, invalid behaviour

Test CCC _ IpMultiMediaCallLeg _05

Summary: IpMultiMediaCallLeg, continueProcessing, : P_INVALID_SESSION_ID

Reference: ES 201 915-4 [1], clause 7.3.5

Preamble: Same as CCC_IpConfCall_02

Test Sequence:

1. Method call **createCallLeg()** on IpSubConfCall
Parameters: valid callSessionID returned in preamble, valid appCallLeg
Check: valid value of TpCallLegIdentifier is returned
2. Method call **eventReportReq()** on IpMultiMediaCallLeg
Parameters: valid callLegSessionID returned in 1., valid eventsRequested with Interrupt event
Check: no exception is returned
3. Method call **routeReq()** on IpMultiMediaCallLeg
Parameters: valid callLegSessionID returned in 1., valid targetAddress, valid appInfo, valid connectionProperties
Check: no exception is returned
4. Triggered action: cause IUT to interrupt call leg processing with a notification or an event: cause IUT to call **eventReportRes()** method on the tester's (Application) **IpAppCallLeg** interface.
Parameters: callLegSessionID, eventInfo
5. Method call **continueProcessing()** on IpMultiMediaCallLeg
Parameters: invalid callLegSessionID
Check: P_INVALID_SESSION_ID is returned
6. Method call **release()** on IpMultiMediaCallLeg
Parameters: valid callLegSessionID returned in 1., valid cause
Check: no exception is returned



Test CCC _ IpMultiMediaCallLeg _06

Summary: IpMultiMediaCallLeg, routeReq: P_INVALID_SESSION_ID

Reference: ES 201 915-4 [1], clause 7.3.5

Preamble: Same as CCC _ IpConfCall _08

Test Sequence:

1. Method call **routeReq()** on IpMultiMediaCallLeg
 Parameters: invalid callLegSessionID, valid targetAddress, valid originatingAddress, valid appInfo, valid connectionProperties
 Check: P_INVALID_SESSION_ID is returned

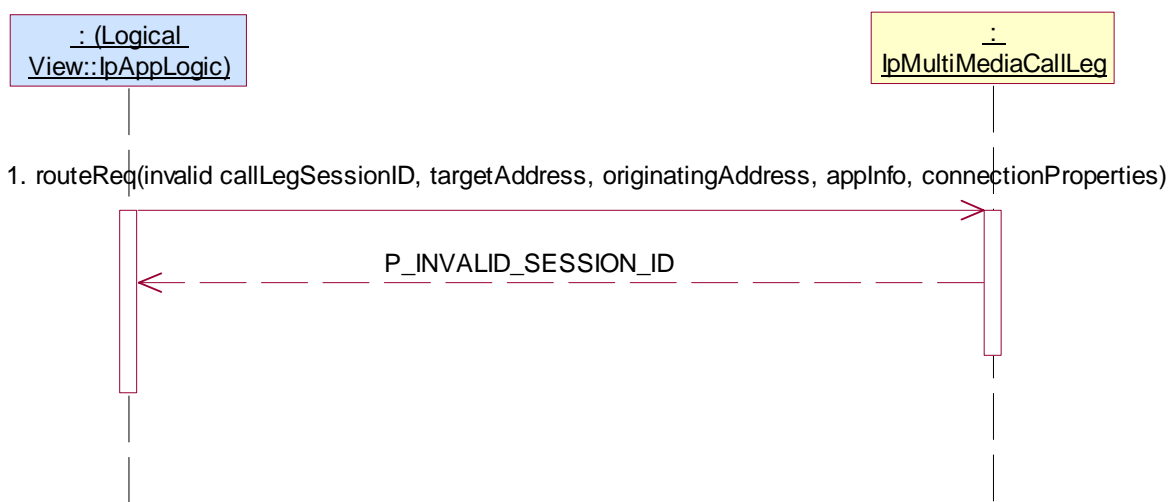

Test CCC _ IpMultiMediaCallLeg _07

Summary: IpMultiMediaCallLeg, routeReq, P_INVALID_ADDRESS

Reference: ES 201 915-4 [1], clauses 7.3.1, 7.3.3 and 7.3.5

Preamble: Same as CCC _ IpConfCall _08

Test Sequence:

1. Method call **routeReq()** on IpMultiMediaCallLeg
Parameters: valid callLegSessionID returned in preamble, invalid targetAddress, valid originatingAddress, valid appInfo, valid connectionProperties
Check: P_INVALID_ADDRESS is returned

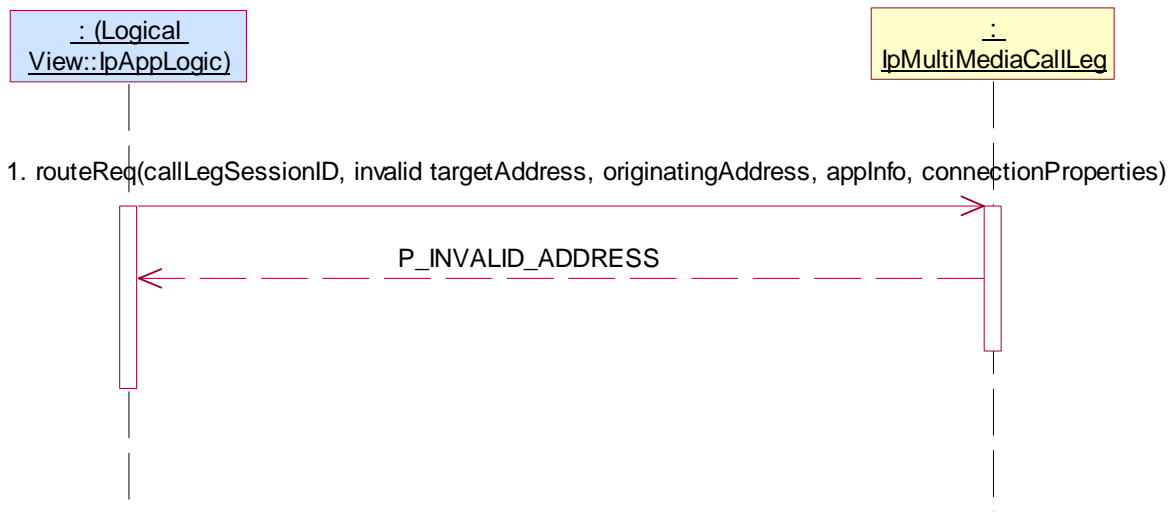

Test CCC _ IpMultiMediaCallLeg _08

Summary: IpMultiMediaCallLeg, routeReq, P_INVALID_ADDRESS

Reference: ES 201 915-4 [1], clauses 7.3.1, 7.3.3 and 7.3.5

Preamble: Same as CCC _ IpConfCall _08

Test Sequence:

1. Method call **routeReq()** on IpMultiMediaCallLeg
 Parameters: valid callLegSessionID returned in preamble, valid targetAddress, invalid originatingAddress, valid appInfo, valid connectionProperties
 Check: P_INVALID_ADDRESS is returned

**Test CCC _ IpMultiMediaCallLeg _09**

Summary: IpMultiMediaCallLeg, release, P_INVALID_SESSION_ID

Reference: ES 201 915-4 [1], clause 7.3.5

Preamble: Same as CCC _ IpSubConfCall_01

Test Sequence:

1. Method call **release()** on IpMultiMediaCallLeg
 Parameters: invalid callLegSessionID, valid cause
 Check: P_INVALID_SESSION_ID is returned

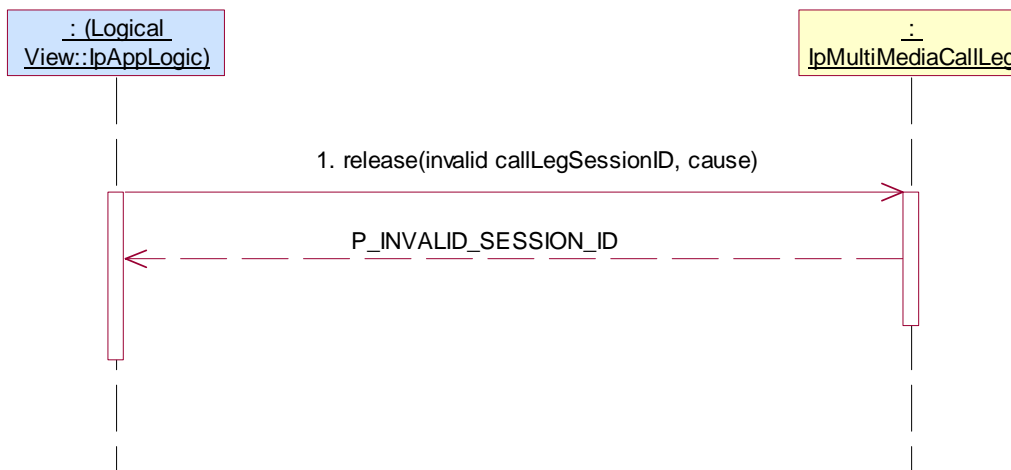

Test CCC _ IpMultiMediaCallLeg _10

Summary: IpMultiMediaCallLeg, deassign, P_INVALID_SESSION_ID

Reference: ES 201 915-4 [1], clause 7.3.5

Preamble: Same as CCC _ IpSubConfCall_01

Test Sequence:

1. Method call **deassign()** on IpMultiMediaCallLeg
Parameters: invalid callLegSessionID
Check: P_INVALID_SESSION_ID is returned

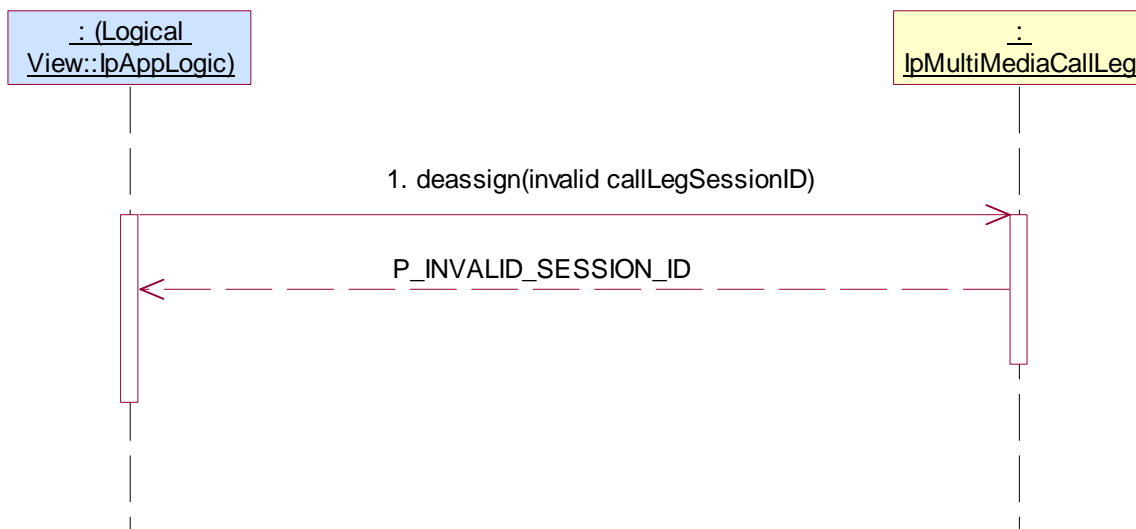

Test CCC _ IpMultiMediaCallLeg _11

Summary: IpMultiMediaCallLeg, mediaStreamAllow, P_INVALID_SESSION_ID

Reference: ES 201 915-4 [1], clause 8.3.5.

Preamble: Same as CCC _ IpSubConfCall_01

Test Sequence:

1. Method call **mediaStreamMonitorReq()** on IpMultiMediaCallLeg
Parameters: valid callLegSessionID returned in preamble, valid mediaStreamEventCriteria
Check: no exception is returned
2. Triggered action: cause IUT to call Method **mediaStreamMonitorRes()** method on the tester's (application)
Parameters: callLegSessionID, streams, type
3. Method call **mediaStreamAllow()** on IpMultiMediaCallLeg
Parameters: invalid callLegSessionID, valid mediaStreamList
Check: P_INVALID_SESSION_ID is returned

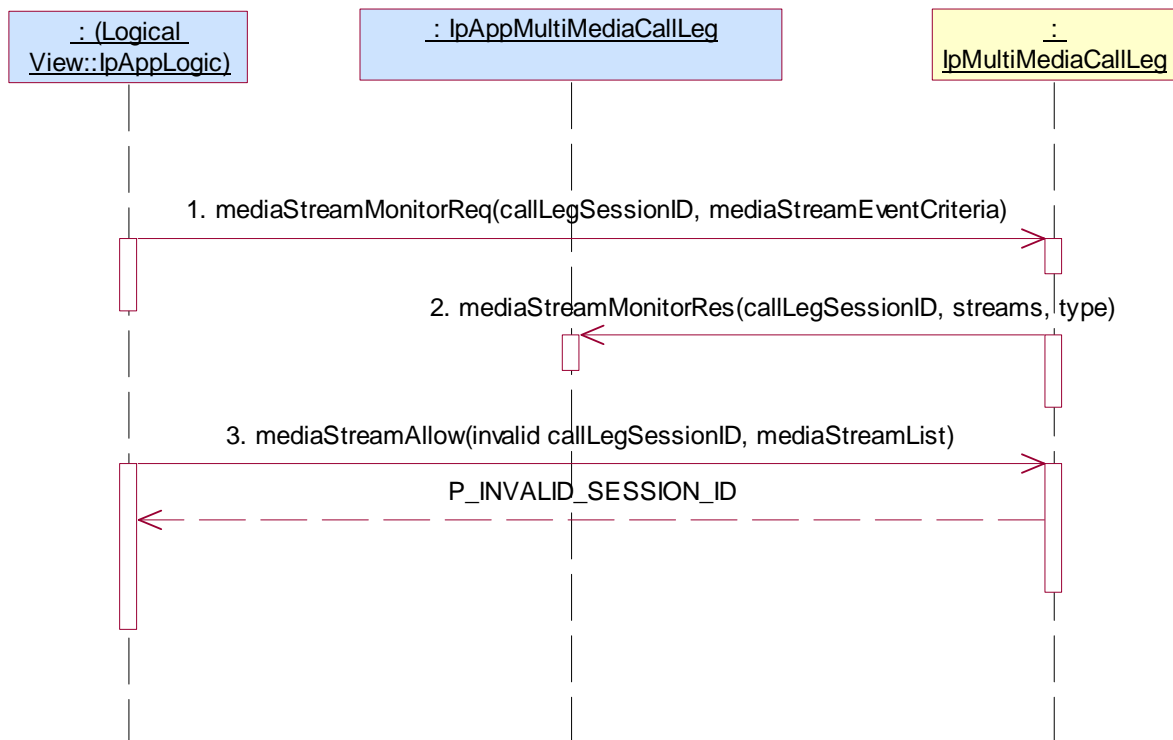

Test CCC _ IpMultiMediaCallLeg _12

Summary: IpMultiMediaCallLeg, mediaStreamMonitorReq, P_INVALID_SESSION_ID

Reference: ES 201 915-4 [1], clause 8.3.5

Preamble: Same as CCC _ IpSubConfCall_01

Test Sequence:

1. Method call **mediaStreamMonitorReq()** on IpMultiMediaCallLeg
Parameters: invalid callLegSessionID, valid mediaStreamEventCriteria
Check: P_INVALID_SESSION_ID is returned



Test CCC _ IpMultiMediaCallLeg _13

Summary: IpMultiMediaCallLeg, mediaStreamMonitorReq, P_INVALID_CRITERIA

Reference: ES 201 915-4 [1], clauses 7.3.1, 7.3.3 and 8.3.5

Preamble: Same as CCC _ IpSubConfCall_01

Test Sequence:

1. Method call **mediaStreamMonitorReq()** on IpMultiMediaCallLeg
Parameters: valid callLegSessionID returned in 2., valid mediaStreamEventCriteria with invalid criteria
Check: P_INVALID_CRITERIA is returned

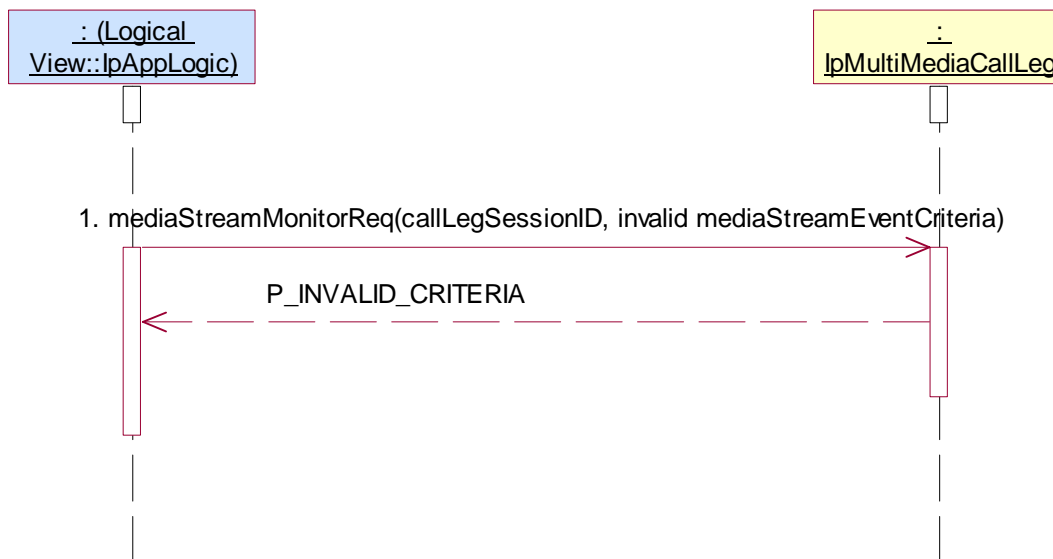

5.2.4.4.3 Optional, valid behaviour

Test CCC _ IpMultiMediaCallLeg _14

Summary: IpMultiMediaCallLeg, getInfoReq, successful

Reference: ES 201 915-4 [1], clauses 7.3.1, 7.3.3 and 7.3.5

Preamble: Same as CCC _ IpConfCall _08

Test Sequence:

1. Method call **getInfoReq()** on IpMultiMediaCallLeg
Parameters: valid callLegSessionID returned in preamble, valid callLegInfoRequested
Check: no exception is returned
2. Method call **routeReq()** on IpMultiMediaCallLeg
Parameters: valid callLegSessionID returned in preamble, valid targetAddress, valid appInfo, valid connectionProperties
Check: no exception is returned
3. Triggered action: cause IUT to call **getInfoRes()** method on the tester's (Application) **IpAppMultiMediaCallLeg** interface.
Parameters: callLegSessionID given in 1., valid callLegInfoReport.

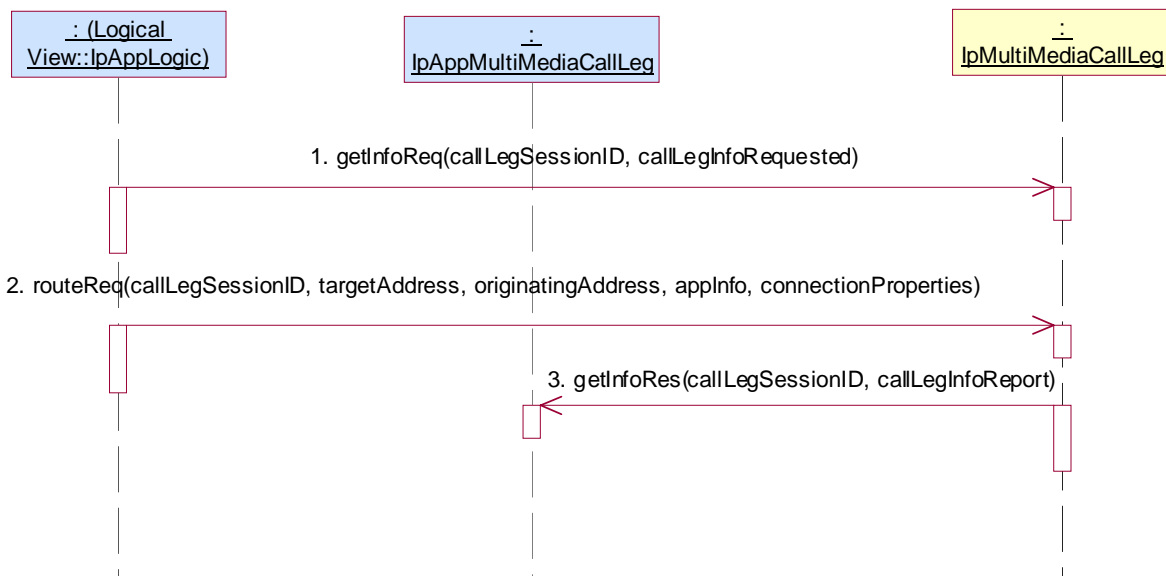

Test CCC _ IpMultiMediaCallLeg _15

Summary: IpMultiMediaCallLeg, attachMediaReq, successful

Reference: ES 201 915-4 [1], clauses 7.3.1, 7.3.3 and 7.3.5

Preamble: Application has a valid callSessionID returned by one of the three following sequence:

1. Method call **createConference()** on IpConfCallControlManager
 Parameters: valid appConferenceCall, valid numberOfSubConferences, valid conferencePolicy, valid numberOfParticipants, valid duration
 Check: valid value of TpConfCallIdentifier is returned
2. Method call **createSubConference()** on IpConfCall
 Parameters: valid conferenceSessionID returned in 1., valid appSubConference, valid conferencePolicy
 Check: valid value of TpSubConfCallIdentifier is returned
3. Method call **getSubConferences()** on IpConfCall
 Parameters: valid conferenceSessionID returned in 1.
 Check: valid value of TpSubConfCallIdentifierSet is returned which contains TpSubConfCallIdentifier returned in 2.
4. Method call **createCallLeg()** on IpSubConfCall
 Parameters: valid callSessionID returned in 2., valid appCallLeg
 Check: valid value of TpCallLegIdentifier is returned
5. Method call **routeReq()** on IpMultiMediaCallLeg
 Parameters: valid callLegSessionID returned in 3., valid targetAddress, valid appInfo, valid connectionProperties set to have explicit media management
 Check: no exception is returned

or

1. Method call **reserveResources()**
 Parameters: valid appInterface, valid startTime, valid numberOfParticipants, valid duration, valid conferencePolicy
 Check: valid value of TpResourceReservation is returned
2. Triggered action: cause IUT to call **conferenceCreated()** on Tester's (application's) IpAppConfCallControlManager interface
 Parameters: valid conferenceCall.
3. Method call **getSubConferences()** on IpConfCall
 Parameters: valid conferenceSessionID returned in 1.
 Check: valid value of TpSubConfCallIdentifierSet is returned which contains TpSubConfCallIdentifier returned in 2.
4. Method call **createCallLeg()** on IpSubConfCall
 Parameters: valid callSessionID reported in 2., valid appCallLeg
 Check: valid value of TpCallLegIdentifier is returned
5. Method call **routeReq()** on IpMultiMediaCallLeg
 Parameters: valid callLegSessionID returned in 3., valid targetAddress, valid appInfo, valid connectionProperties set to have explicit media management
 Check: no exception is returned

Test Sequence:

1. Method call **attachMediaReq()** on IpMultiMediaCallLeg
Parameters: valid callLegSessionID returned in preamble.
Check: no exception is returned
2. Triggered action: cause IUT to call **attachMediaRes()** method on the tester's (Application) **IpAppMultiMediaCallLeg** interface.
Parameters: callLegSessionID

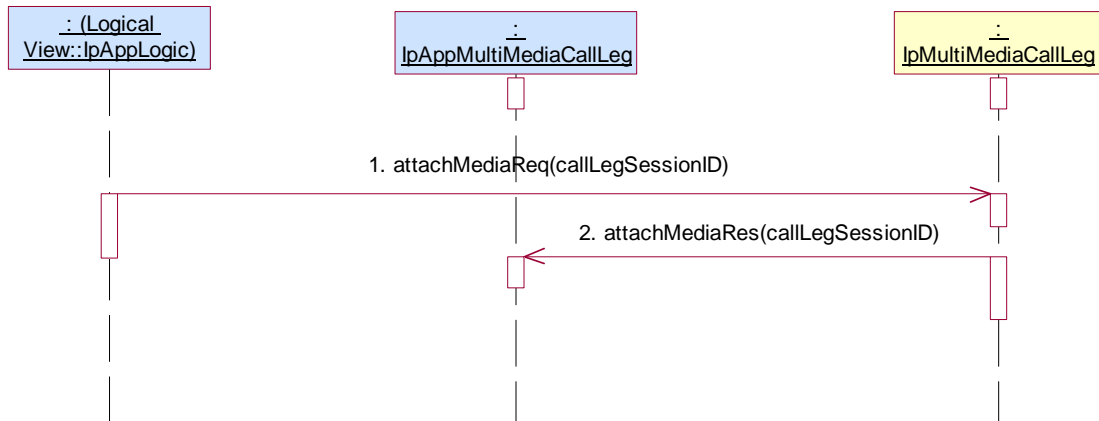

Test CCC _ IpMultiMediaCallLeg _16

Summary: IpMultiMediaCallLeg, detachMediaReq, successful

Reference: ES 201 915-4 [1], clauses 7.3.1, 7.3.3 and 7.3.5

Preamble: Same as CCC _ IpMultiMediaCallLeg_15

Test Sequence:

1. Method call **attachMediaReq()** on IpMultiMediaCallLeg
Parameters: valid callLegSessionID returned in preamble
Check: no exception is returned
2. Triggered action: cause IUT to call **attachMediaRes()** method on the tester's (Application) **IpAppMultiMediaCallLeg** interface
Parameters: callLegSessionID
3. Method call **detachMediaReq()** on IpMultiMediaCallLeg
Parameters: valid callLegSessionID returned in preamble
Check: no exception is returned
4. Triggered action: cause IUT to call **detachMediaRes()** method on the tester's (Application) **IpAppMultiMediaCallLeg** interface
Parameters: callLegSessionID

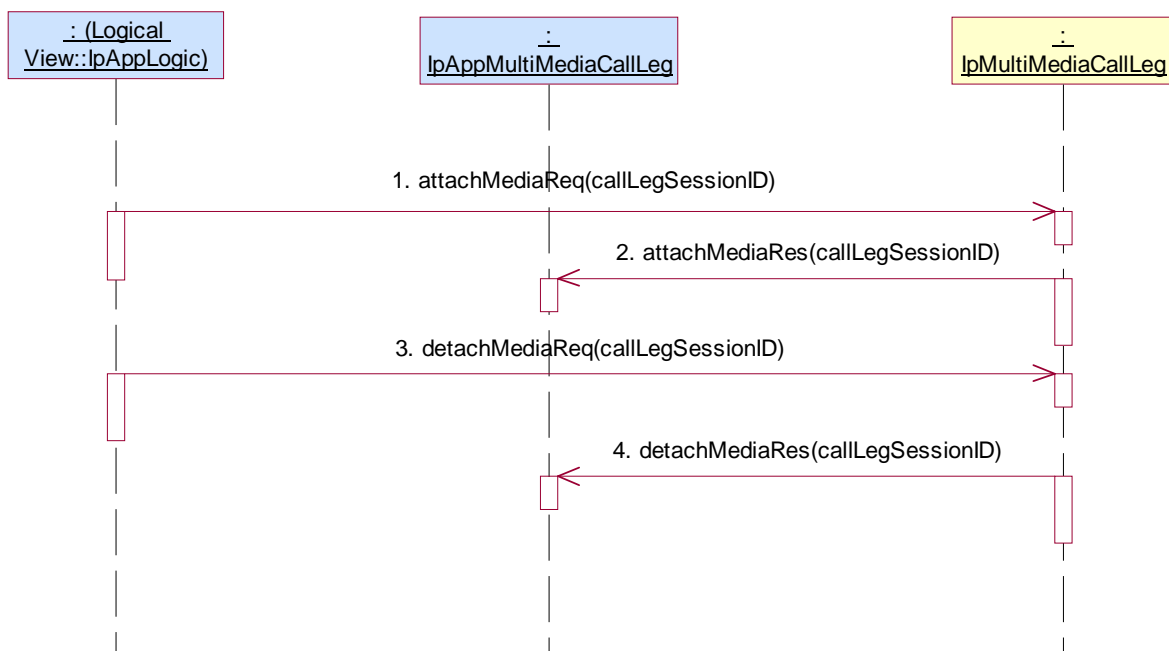

Test CCC _ IpMultiMediaCallLeg _17

Summary: IpMultiMediaCallLeg, getCurrentDestinationAddress, successful

Reference: ES 201 915-4 [1], clauses 7.3.1, 7.3.3 and 7.3.5

Preamble: Same as CCC _ IpSubConfCall_01

Test Sequence:

1. Method call **getCurrentDestinationAddress()** on IpMultiMediaCallLeg
 Parameters: valid callLegSessionID returned in preamble
 Check: valid value of TpAddress is returned

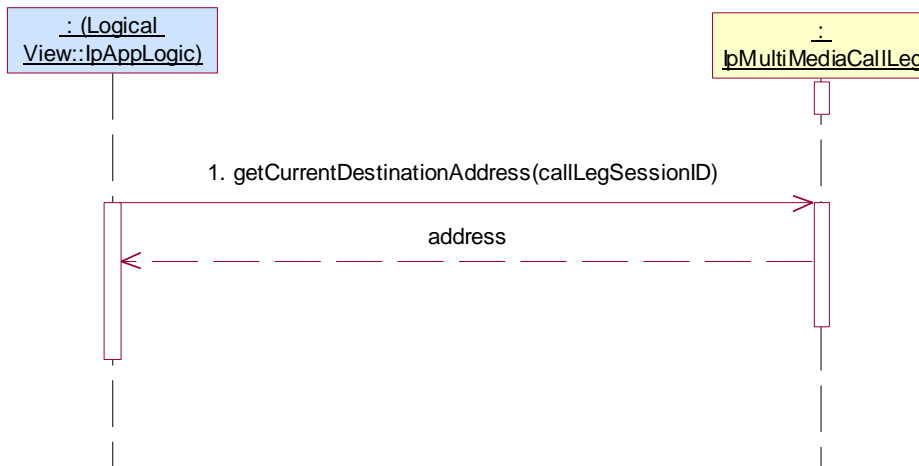
**Test CCC _ IpMultiMediaCallLeg _18**

Summary: IpMultiMediaCallLeg, setChargePlan, successful

Reference: ES 201 915-4 [1], clauses 7.3.1, 7.3.3 and 7.3.5

Preamble: Same as CCC _ IpConfCall _08

Test Sequence:

1. Method call **setChargePlan()** on IpMultiMediaCallLeg
 Parameters: valid callLegSessionID returned in preamble, valid callChargePlan
 Check: no exception is returned



Test CCC _ IpMultiMediaCallLeg _19

Summary: IpMultiMediaCallLeg, setAdviceOfCharge, successful

Reference: ES 201 915-4 [1], clauses 7.3.1, 7.3.3 and 7.3.5

Preamble: Same as CCC _ IpConfCall _08

Test Sequence:

1. Method call **setAdviceOfCharge()** on IpMultiMediaCallLeg
Parameters: valid callLegSessionID returned in preamble, valid aOCInfo, valid tariffSwitch
Check: no exception is returned

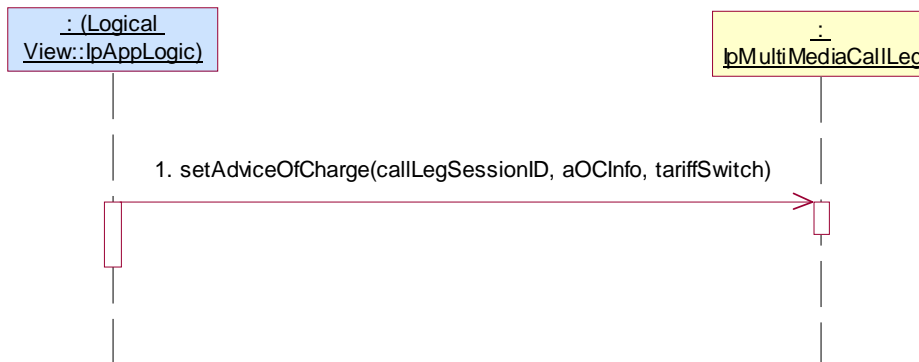

Test CCC _ IpMultiMediaCallLeg _20

Summary: IpMultiMediaCallLeg, superviseReq, successful

Reference: ES 201 915-4 [1], clauses 7.3.1, 7.3.3 and 7.3.5

Preamble: Same as CCC _ IpConfCall _08

Test Sequence:

1. Method call **superviseReq()** on IpMultiMediaCallLeg
Parameters: valid callLegSessionID returned in preamble, valid time, valid treatment
Check: no exception is returned
2. Method call **routeReq()** on IpMultiMediaCallLeg
Parameters: valid callLegSessionID returned in preamble, valid targetAddress, valid appInfo, valid connectionProperties
Check: no exception is returned
3. Triggered action: cause IUT to call **superviseRes()** method on the tester's (Application) **IpAppMultiMediaCallLeg** interface
Parameters: callLegSessionID, report, usedTime

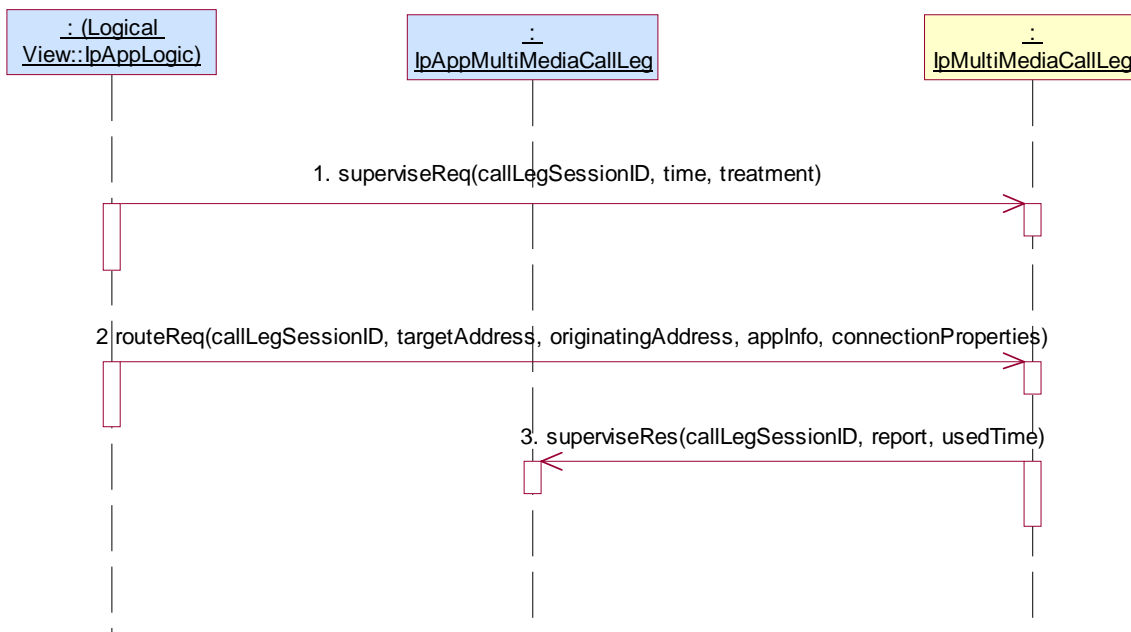

Test CCC _ IpMultiMediaCallLeg _21

Summary: IpMultiMediaCallLeg, getCall, successful

Reference: ES 201 915-4 [1], clauses 7.3.1, 7.3.3 and 7.3.5

Preamble: Same as CCC _ IpConfCall _08

Test Sequence:

1. Method call **getCall()** on IpMultiMediaCallLeg
Parameters: valid callLegSessionID returned in preamble
Check: valid TpMultiPartyCallIdentifier is returned

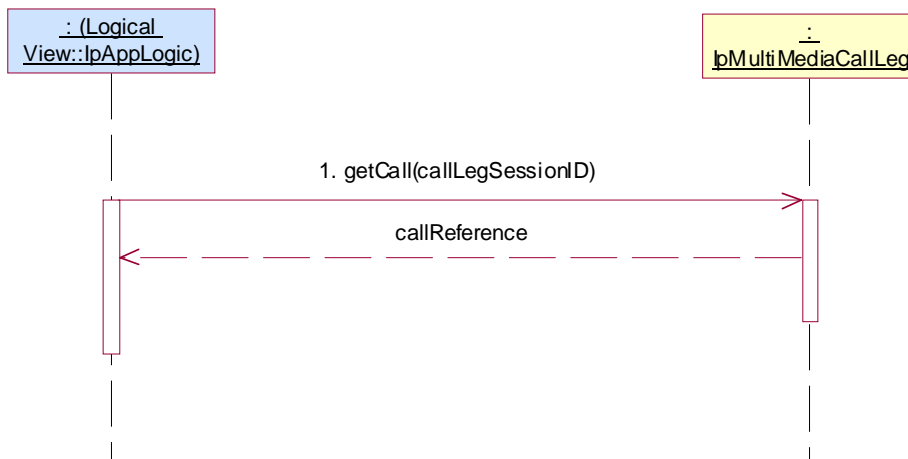

Test CCC _ IpMultiMediaCallLeg _22

Summary: IpMultiMediaCallLeg, getCall, successful

Reference: ES 201 915-4 [1], clauses 7.3.1, 7.3.3 and 7.3.5

Preamble: Same as CCC _ IpConfCall _08

Test Sequence:

1. Method call **getCall()** on IpMultiMediaCallLeg
 Parameters: valid callLegSessionID returned in preamble
 Check: valid TpMultiPartyCallIdentifier is returned
2. Method call **routeReq()** on IpMultiMediaCallLeg
 Parameters: valid callLegSessionID returned in preamble, valid targetAddress, valid appInfo, valid connectionProperties
 Check: no exception is returned
3. Triggered action: cause IUT to call **callLegEnded()** method on the tester's (Application) **IpAppMultiMediaCallLeg** interface
 Parameters: callLegSessionID, cause

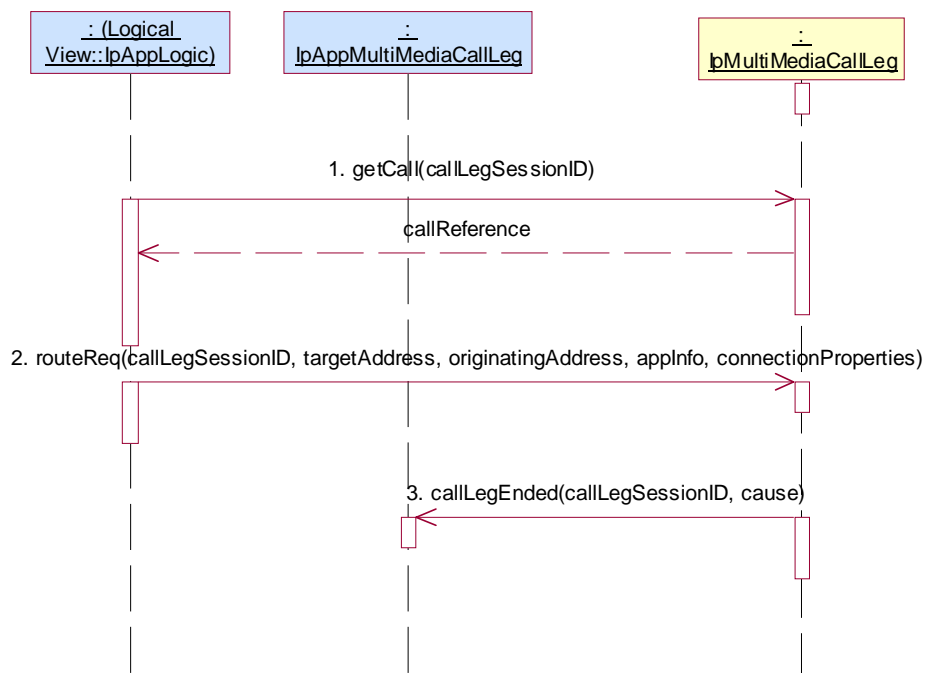

5.2.4.4.4 Optional, invalid behaviour

Test CCC _ IpMultiMediaCallLeg _23

Summary: IpMultiMediaCallLeg, getInfoReq, : P_INVALID_SESSION_ID

Reference: ES 201 915-4 [1], clause 7.3.5

Preamble: Same as CCC _ IpConfCall _08

Test Sequence:

1. Method call **getInfoReq()** on IpMultiMediaCallLeg
Parameters: invalid callLegSessionID, valid callLegInfoRequested
Check: P_INVALID_SESSION_ID is returned

**Test CCC _ IpMultiMediaCallLeg _24**

Summary: IpMultiMediaCallLeg, attachMediaReq, : P_INVALID_SESSION_ID

Reference: ES 201 915-4 [1], clause 7.3.5

Preamble: Same as CCC _ IpMultiMediaCallLeg_15

Test Sequence:

1. Method call **attachMediaReq()** on IpMultiMediaCallLeg
Parameters: invalid callLegSessionID
Check: P_INVALID_SESSION_ID is returned



Test CCC _ IpMultiMediaCallLeg _25

Summary: IpMultiMediaCallLeg, detachMediaReq, : P_INVALID_SESSION_ID

Reference: ES 201 915-4 [1], clause 7.3.5

Preamble: Same as CCC _ IpSubConfCall_01

Test Sequence:

1. Method call **detachMediaReq()** on IpMultiMediaCallLeg
Parameters: invalid callLegSessionID
Check: P_INVALID_SESSION_ID is returned

**Test CCC _ IpMultiMediaCallLeg _26**

Summary: IpMultiMediaCallLeg, getCurrentDestinationAddress, : P_INVALID_SESSION_ID

Reference: ES 201 915-4 [1], clause 7.3.5

Preamble: Same as CCC _ IpSubConfCall_01

Test Sequence:

1. Method call **getCurrentDestinationAddress()** on IpMultiMediaCallLeg
Parameters: invalid callLegSessionID
Check: P_INVALID_SESSION_ID is returned



Test CCC _ IpMultiMediaCallLeg _27

Summary: IpMultiMediaCallLeg, setChargePlan, : P_INVALID_SESSION_ID

Reference: ES 201 915-4 [1], clause 7.3.5

Preamble: Same as CCC _ IpConfCall _08

Test Sequence:

1. Method call **setChargePlan()** on IpMultiMediaCallLeg
Parameters: invalid callLegSessionID, valid callChargePlan
Check: P_INVALID_SESSION_ID is returned

**Test CCC _ IpMultiMediaCallLeg _28**

Summary: IpMultiMediaCallLeg, setAdviceOfCharge, : P_INVALID_SESSION_ID

Reference: ES 201 915-4 [1], clause 7.3.5

Preamble: Same as CCC _ IpConfCall _08

Test Sequence:

1. Method call **setAdviceOfCharge()** on IpMultiMediaCallLeg
Parameters: invalid callLegSessionID, valid aOCInfo, valid tariffSwitch
Check: P_INVALID_SESSION_ID is returned

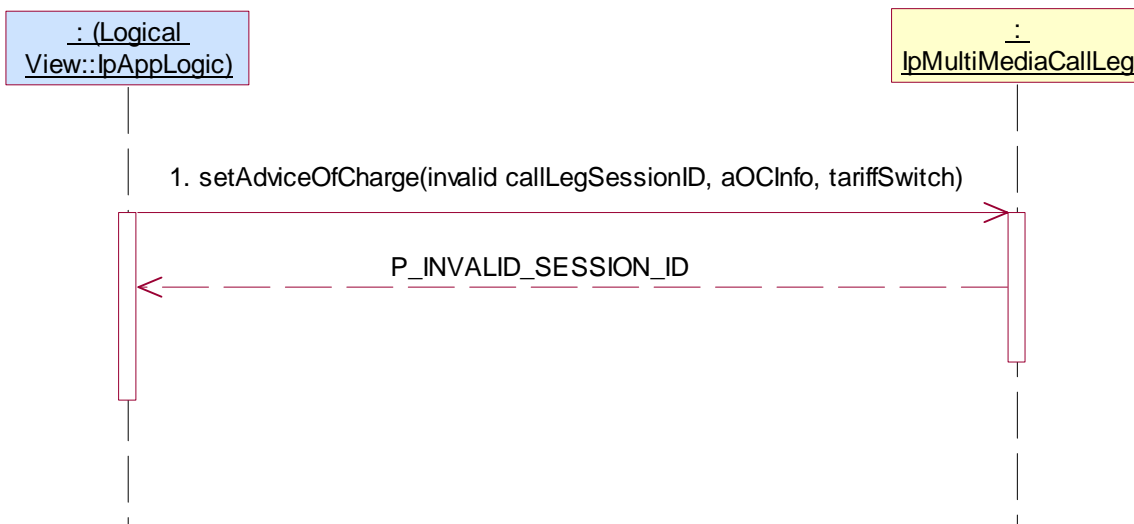

Test CCC _ IpMultiMediaCallLeg _29

Summary: IpMultiMediaCallLeg, setAdviceOfCharge, P_INVALID_CURRENCY

Reference: ES 201 915-4 [1], clauses 7.3.1, 7.3.3 and 7.3.5

Preamble: Same as CCC _ IpConfCall _08

Test Sequence:

1. Method call **setAdviceOfCharge()** on IpMultiMediaCallLeg
 Parameters: valid callLegSessionID returned in preamble, aOCInfo with invalid currency, valid tariffSwitch
 Check: P_INVALID_CURRENCY is returned

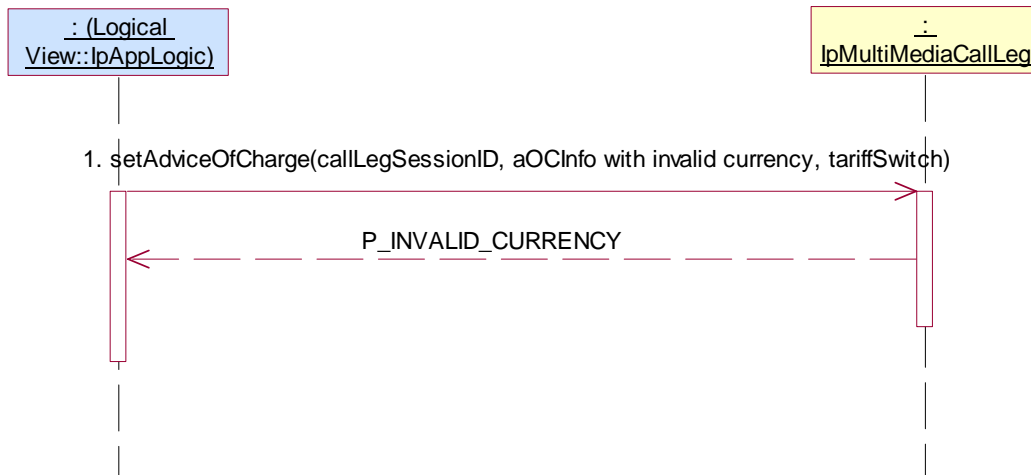
**Test CCC _ IpMultiMediaCallLeg _30**

Summary: IpMultiMediaCallLeg, setAdviceOfCharge, P_INVALID_AMOUNT

Reference: ES 201 915-4 [1], clause 7.3.1, 7.3.3 and 7.3.5

Preamble: Same as CCC _ IpConfCall _08

Test Sequence:

1. Method call **setAdviceOfCharge()** on IpMultiMediaCallLeg
 Parameters: valid callLegSessionID returned in preamble, aOCInfo with invalid amount, valid tariffSwitch
 Check: P_INVALID_AMOUNT is returned

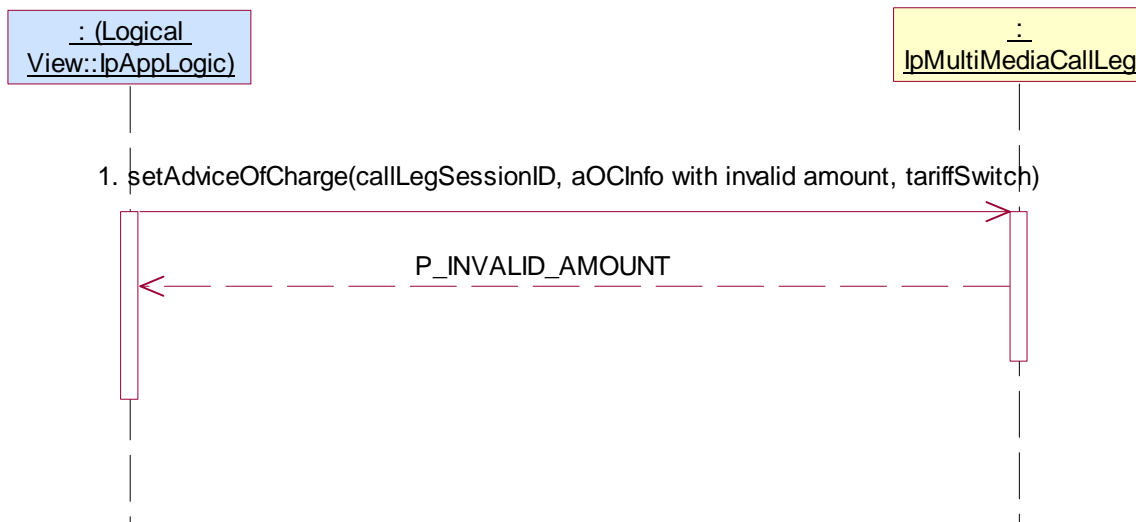

Test CCC _ IpMultiMediaCallLeg _31

Summary: IpMultiMediaCallLeg, superviseReq, : P_INVALID_SESSION_ID

Reference: ES 201 915-4 [1], clause 7.3.5

Preamble: Same as CCC _ IpConfCall _08

Test Sequence:

1. Method call **superviseReq()** on IpMultiMediaCallLeg
Parameters: invalid callLegSessionID, valid time, valid treatment
Check: P_INVALID_SESSION_ID is returned

**Test CCC _ IpMultiMediaCallLeg _32**

Summary: IpMultiMediaCallLeg, eventReportReq, P_INVALID_SESSION_ID

Reference: ES 201 915-4 [1], clause 7.3.5

Preamble: Same as CCC _ IpConfCall _08

Test Sequence:

1. Method call **eventReportReq()** on IpMultiMediaCallLeg
Parameters: invalid callLegSessionID, valid eventsRequested
Check: P_INVALID_SESSION_ID is returned



Test CCC _ IpMultiMediaCallLeg _33

Summary: IpMultiMediaCallLeg, eventReportReq, P_INVALID_CRITERIA

Reference: ES 201 915-4 [1], clause 7.3.1, 7.3.3 and 7.3.5

Preamble: Same as CCC _ IpConfCall _08

Test Sequence:

1. Method call **eventReportReq()** on IpMultiMediaCallLeg
 Parameters: valid callLegSessionID returned in preamble, invalid eventsRequested
 Check: P_INVALID_CRITERIA is returned

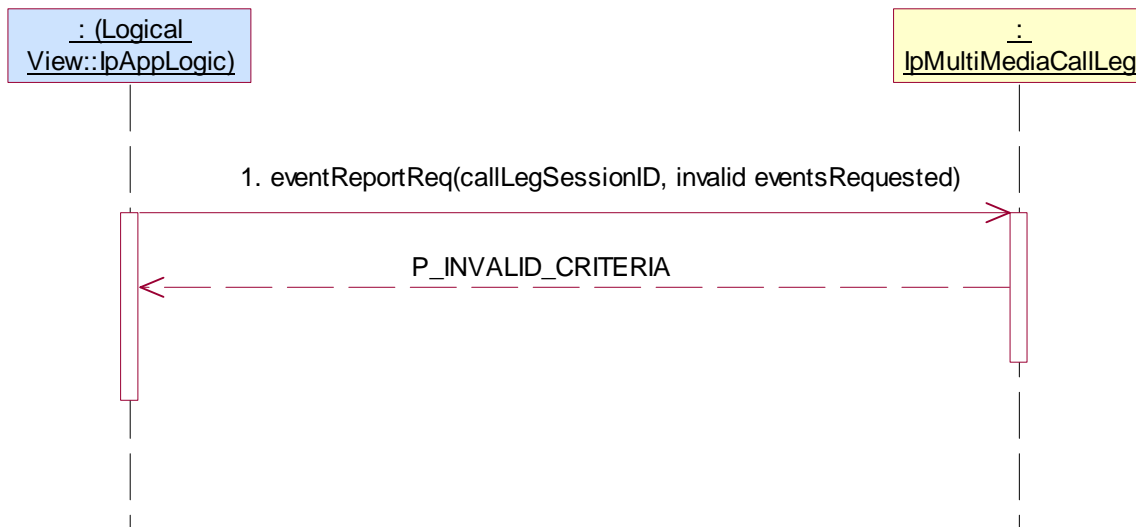
**Test CCC _ IpMultiMediaCallLeg _34**

Summary: IpMultiMediaCallLeg, getCall, P_INVALID_SESSION_ID

Reference: ES 201 915-4 [1], clause 7.3.5

Preamble: Same as CCC _ IpConfCall _08

1. Method call **getCall()** on IpMultiMediaCallLeg
 Parameters: invalid callLegSessionID
 Check: P_INVALID_SESSION_ID is returned



Test CCC _ IpMultiMediaCallLeg _35

Summary: IpMultiMediaCallLeg, getMediaStreams, P_INVALID_SESSION_ID

Reference: ES 201 915-4 [1], clause 8.3.5

Preamble: Same as CCC _ IpSubConfCall_01

Test Sequence:

1. Method call **getMediaStreams()** on IpMultiMediaCallLeg
Parameters: invalid callLegSessionID
Check: P_INVALID_SESSION_ID is returned

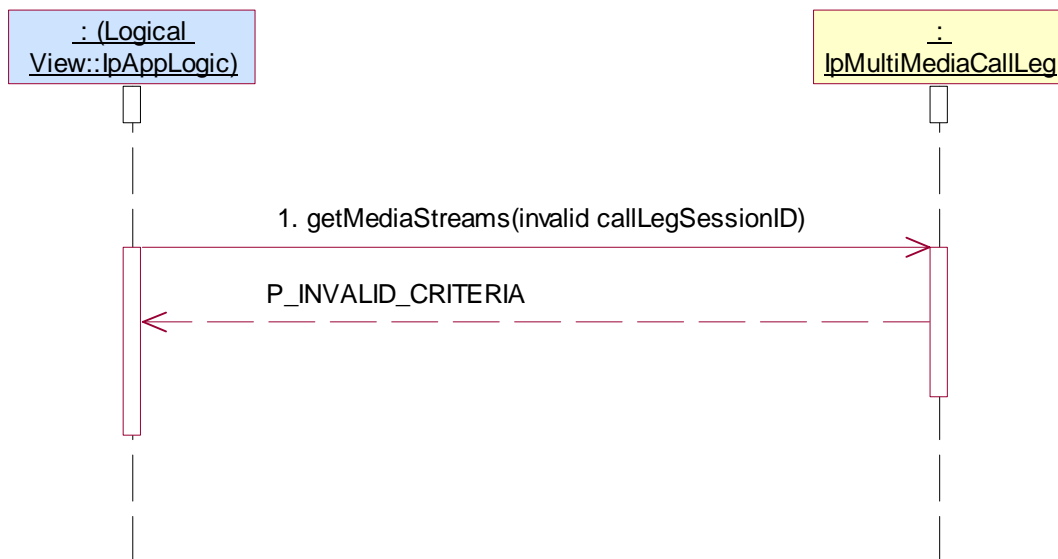
**5.2.4.5 IpMultiMediaStream****5.2.4.5.1 Mandatory, valid behaviour****Test CCC_ IpMultiMediaStream _01**

Summary: IpMultiMediaStream, all methods mandatory, successful

Reference: ES 201 915-4 [1], clauses 7.3.1, 7.3.3, 8.3.5 and 8.3.7

Preamble: Application has a valid callSessionID returned by one of the three following sequence:

1. Method call **createConference()** on IpConfCallControlManager
Parameters: valid appConferenceCall, valid numberOfSubConferences, valid conferencePolicy, valid numberOfParticipants, valid duration
Check: valid value of TpConfCallIdentifier is returned
2. Method call **getSubConferences()**
Parameters: valid conferenceSessionID
Check: valid value of TpSubConfCallIdentifierSet is returned
3. Method call **createCallLeg()** on IpSubConfCall
Parameters: valid callSessionID returned in 2., valid appCallLeg
Check: valid value of TpCallLegIdentifier is returned
4. Method call **routeReq()** on IpMultiMediaCallLeg
Parameters: valid callLegSessionID returned in 2., valid targetAddress, valid appInfo, valid connectionProperties
Check: no exception is returned

or

3. Method call **createAndRouteCallLegReq()** on IpSubConfCall
Parameters: valid callSessionID returned in 2., valid eventsRequested, valid targetAddress, valid originatingAddress, valid appInfo, valid appLegInterface
Check: valid value of TpCallLegIdentifier
4. Method call **mediaStreamMonitorReq()** on IpMultiMediaCallLeg
Parameters: valid callLegSessionID returned in 3., valid mediaStreamEventCriteria
Check: no exception is returned
5. Triggered action: cause IUT to call Method **mediaStreamMonitorRes()** method on the tester's (application)
Parameters: callLegSessionID, streams, type
6. Method call **mediaStreamAllow()** on IpMultiMediaCallLeg
Parameters: valid callLegSessionID returned in 3., valid mediaStreamList
Check: no exception is returned

or

1. Method call **reserveResources()**
Parameters: valid appInterface, valid startTime, valid numberOfParticipants, valid duration, valid conferencePolicy
Check: valid value of TpResourceReservation is returned
2. Triggered action: cause IUT to call **conferenceCreated()** on Tester's (application's) IpAppConfCallControlManager interface
Parameters: valid conferenceCall.
3. Method call **getSubConferences()**
Parameters: valid conferenceSessionID
Check: valid value of TpSubConfCallIdentifierSet is returned
4. Method call **createCallLeg()** on IpSubConfCall
Parameters: valid callSessionID reported in 2., valid appCallLeg
Check: valid value of TpCallLegIdentifier is returned
5. Method call **routeReq()** on IpMultiMediaCallLeg
Parameters: valid callLegSessionID returned in 2., valid targetAddress, valid appInfo, valid connectionProperties
Check: no exception is returned

or

4. Method call **createAndRouteCallLegReq()** on IpSubConfCall
Parameters: valid callSessionID returned in 2., valid eventsRequested, valid targetAddress, valid originatingAddress, valid appInfo, valid appLegInterface
Check: valid value of TpCallLegIdentifier
5. Method call **mediaStreamMonitorReq()** on IpMultiMediaCallLeg
Parameters: valid callLegSessionID returned in 3., valid mediaStreamEventCriteria
Check: no exception is returned
6. Triggered action: cause IUT to call Method **mediaStreamMonitorRes()** method on the tester's (application)
Parameters: callLegSessionID, streams, type
7. Method call **mediaStreamAllow()** on IpMultiMediaCallLeg
Parameters: valid callLegSessionID returned in 3., valid mediaStreamList
Check: no exception is returned

Test Sequence:

- Method call **subtract()** on IpMultiMediaStream
 Parameters: valid mediaStreamSessionID from TpMediaStreamSet returned in preamble.
 Check: no exception is returned

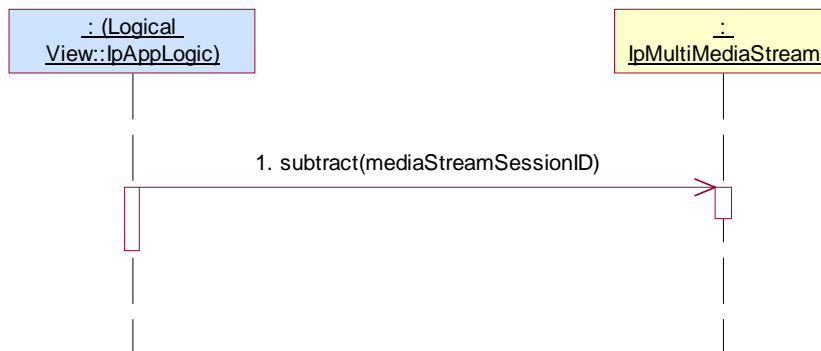

5.2.4.5.2 Mandatory, invalid behaviour

Test CCC_ IpMultiMediaStream _02

Summary: IpMultiMediaStream, subtract, P_INVALID_SESSION_ID

Reference: ES 201 915-4 [1], clause 8.3.7

Preamble: Same as Test CCC_ IpMultiMediaStream _01

Test Sequence:

- Method call **subtract()** on IpMultiMediaStream
 Parameters: invalid mediaStreamSessionID
 Check: P_INVALID_SESSION_ID is returned

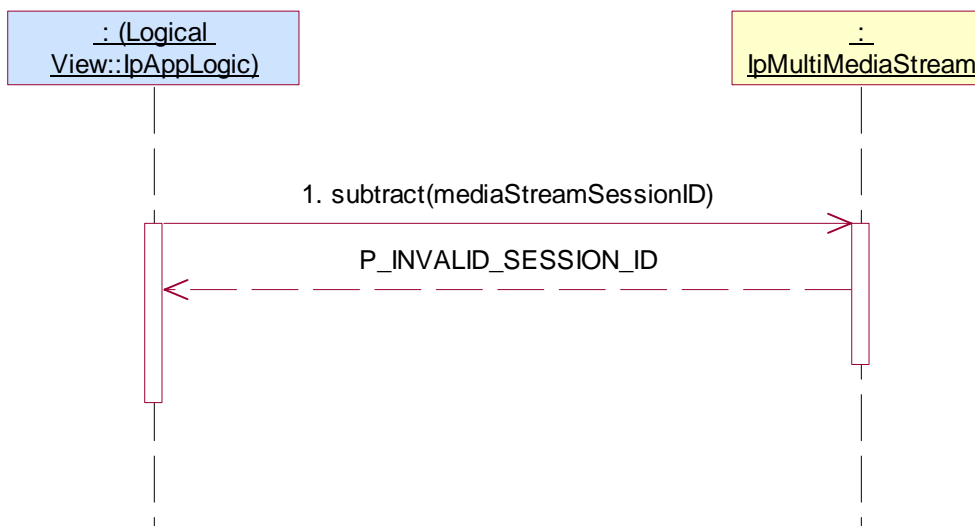

6 Test Suite Structure (TSS) - Application

Call Control (CC):

- Generic Call Control Service (GCC).
- MultiParty Call Control Service (MPCC).
- MultiMedia Call Control Service (MMCC).
- Conference Call Control Service (CCC).

7 Test Purposes (TP) - Application

7.1 Introduction

For each test requirement a TP is defined.

7.1.1 TP naming convention

TPs are numbered, starting at 01, within each group. Groups are organized according to the TSS. Additional references are added to identify the actual test suite (see table 1).

Table 1: TP identifier naming convention scheme

Identifier:	<suite_id>_<group>_<nnn>
<suite_id>	= SCG name: "CC" for Call Control part of Call Control SCF
<group>	= group number: field representing the group reference according to TSS
<nn>	= sequential number: (01 to 99)

7.1.2 Source of TP definition

The TPs are based on ES 201 915-4 [1].

7.1.3 Test strategy

As the base standard ES 201 915-4 [1] contains no explicit requirements for testing, the TPs were generated as a result of an analysis of the base standard and the ICS specification ES 202 170 [2].

The TPs are only based on conformance requirements related to the externally observable behaviour of the IUT and are limited to conceivable situations to which a real implementation is likely to be faced (see ETS 300 406 [5]).

7.2 TPs for the application using the Call Control SCF

All ICS items referred to in this clause are as specified in ES 202 170 [2] unless indicated otherwise by another numbered reference.

All parameters specified in method calls are valid unless specified.

The procedures to trigger the application to call methods in the SCF are dependant on the underlying network architecture and are out of the scope of this test specification. Those method calls are preceded by the words "Triggered action".

In performing the tests for the application, it may be necessary to permit the application to perform any valid set of method exchanges with the tester in between the triggered actions or method calls indicated in the tests below. The tester shall respond to the application's method calls in conformance to the API specification and as required by the application. The requirements of the application should be made known to the tester's operator in advance.

7.2.1 Generic Call Control

7.2.1.1 IpAppCallControlManager

Test GCC_IPAPPCALLCONTROLMANAGER_01

Summary: create call object

Reference: ES 201 915-4 [1], clause 6.3.1

Precondition: IUT capable of invoking **createCall()**

Preamble: Registration of the IUT (application) and the tester (Call Control SCF) to the framework. The IUT must have obtained a reference to an instance of the IpCallControlManager interface through selecting that service and signing the required service agreement.

The application is permitted to provide its IpAppCallControlManager interface reference in a setCallback() method which it calls prior to invoking further methods.

Test Sequence:

1. Triggered Action: cause IUT to call **createCall()** method on the tester's (SCF's) IpCallControlManager interface.
Parameters: appCall

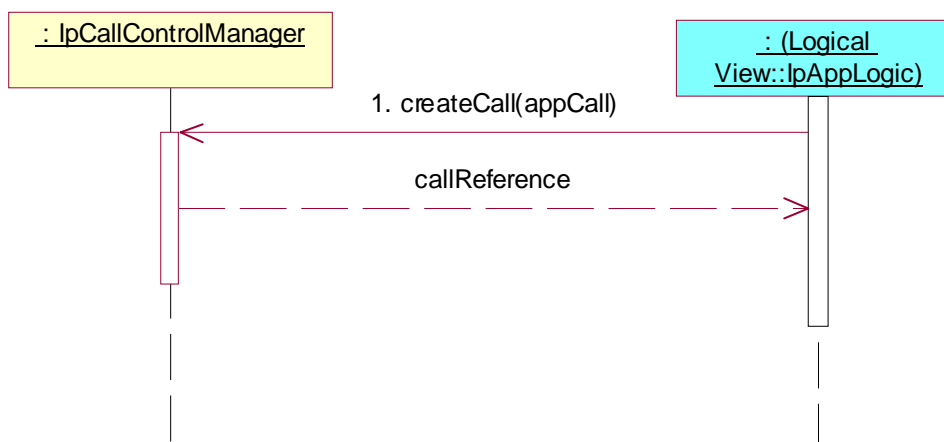

Test GCC_IPAPPCALLCONTROLMANAGER_02

Summary: create call object and accept abort

Reference: ES 201 915-4 [1], clauses 6.3.1 and 6.3.2

Precondition: IUT capable of invoking **createCall()**; **callAborted()** implemented

Preamble: Registration of the IUT (application) and the tester (Call Control SCF) to the framework. The IUT must have obtained a reference to an instance of the IpCallControlManager interface through selecting that service and signing the required service agreement.

Test Sequence:

1. Triggered Action: cause IUT to call **setCallback()** method on the tester's (SCF's) IpCallControlManager interface.
Parameters: valid, non NULL, value of appInterface
2. Triggered Action: cause IUT to call **createCall()** method on the tester's (SCF's) IpCallControlManager interface.
Parameters: appCall
3. Method call **callAborted()**
Parameters: callReference
Check: no exception is returned

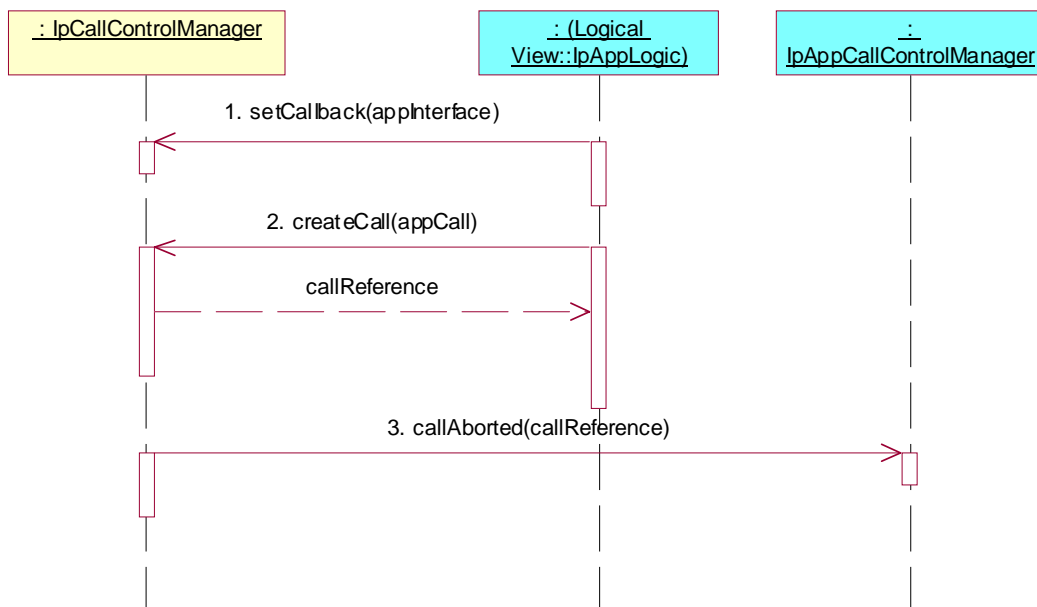
**Test GCC_IPAPPCALLCONTROLMANAGER_03**

Summary: enable and accept call notifications

Reference: ES 201 915-4 [1], clauses 6.3.1 and 6.3.2

Precondition: IUT capable of invoking **enableCallNotification()**, **callEventNotify()** implemented

Preamble: Registration of the IUT (application) and the tester (Call Control SCF) to the framework. The IUT must have obtained a reference to an instance of the IpCallControlManager interface through selecting that service and signing the required service agreement.

The application is permitted to provide its IpAppCallControlManager interface reference in a setCallback() method which it calls prior to invoking further methods.

Test Sequence:

1. Triggered Action: cause IUT to call **enableCallNotification()** method on the tester's (SCF's) IpCallControlManager interface.
Parameters: appCallControlManager, eventCriteria
2. Method call **callEventNotify()**
Parameters: callReference, eventInfo, assignmentID
Check: valid value of IpAppCallRef is returned

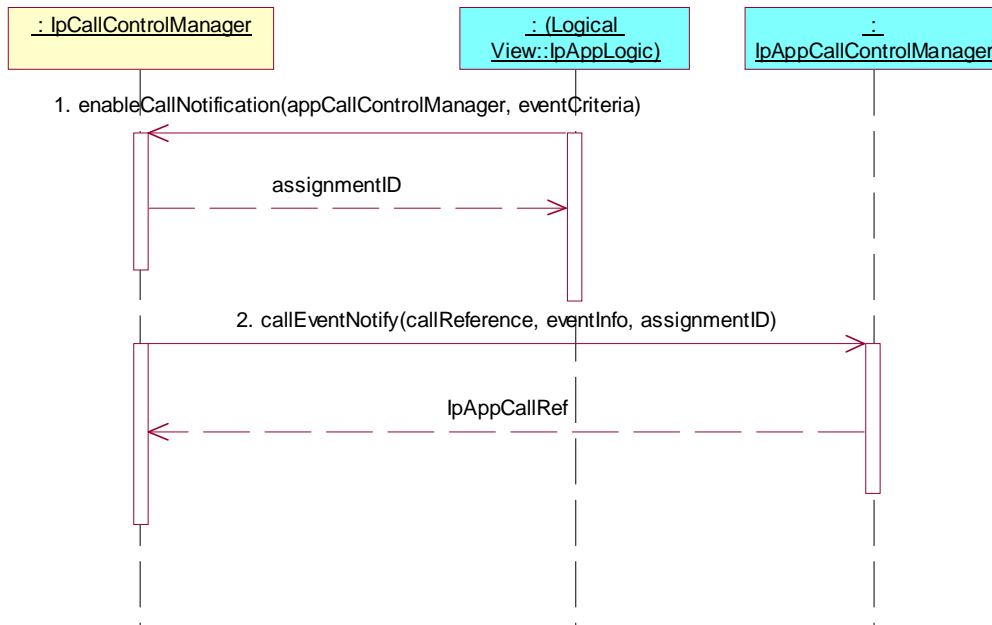

Test GCC_IPAPPCALLCONTROLMANAGER_04

Summary: interrupt and continue call notifications

Reference: ES 201 915-4 [1], clauses 6.3.1 and 6.3.2

Precondition: IUT capable of invoking **enableCallNotification()**, **callNotificationInterrupted()**, **callNotificationContinued()** and **callEventNotify()** implemented

Preamble: Registration of the IUT (application) and the tester (Call Control SCF) to the framework. The IUT must have obtained a reference to an instance of the IpCallControlManager interface through selecting that service and signing the required service agreement.

The application is permitted to provide its IpAppCallControlManager interface reference in a setCallback() method which it calls prior to invoking further methods.

Test Sequence:

1. Triggered Action: cause IUT to call **enableCallNotification()** method on the tester's (SCF's) IpCallControlManager interface.
Parameters: appCallControlManager, eventCriteria

Delay between enableCallNotification and callNotificationInterrupted

2. Method call **callNotificationInterrupted()**

Parameters: none

Check: no exception is returned

Delay between callNotificationInterrupted and callNotificationContinued

3. Method call **callNotificationContinued()**
Parameters: none
Check: no exception is returned
4. Method call **callEventNotify()**
Parameters: callReference, eventInfo, assignmentID
Check: valid value of IpAppCallRef is returned

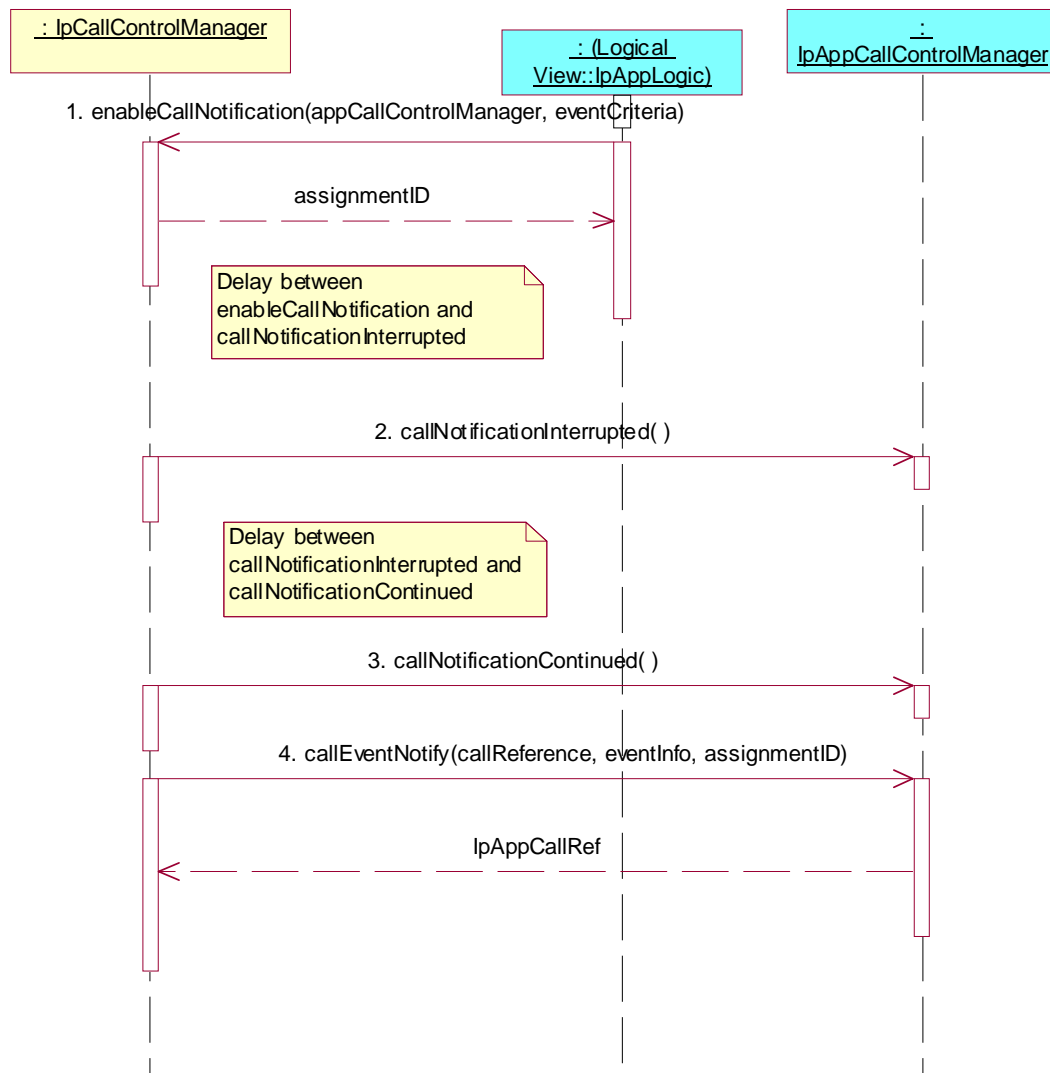

Test GCC_IPAPPCALLCONTROLMANAGER_05

Summary: enable and change call notifications

Reference: ES 201 915-4 [1], clauses 6.3.1 and 6.3.2

Precondition: IUT capable of invoking **enableCallNotification()** and **changeCallNotification()**, **callEventNotify()** implemented

Preamble: Registration of the IUT (application) and the tester (Call Control SCF) to the framework. The IUT must have obtained a reference to an instance of the IpCallControlManager interface through selecting that service and signing the required service agreement.

The application is permitted to provide its IpAppCallControlManager interface reference in a setCallback() method which it calls prior to invoking further methods.

Test Sequence:

1. Triggered Action: cause IUT to call **enableCallNotification()** method on the tester's (SCF's) IpCallControlManager interface.
Parameters: appCallControlManager, eventCriteria
2. Triggered Action: cause IUT to call **changeCallNotification()** method on the tester's (SCF's) IpCallControlManager interface.
Parameters: assignmentID, eventCriteria
3. Method call **callEventNotify()**
Parameters: callReference, eventInfo, assignmentID
Check: valid value of IpAppCallRef is returned



Test GCC_IPAPPCALLCONTROLMANAGER_06

Summary: enable and disable call notifications

Reference: ES 201 915-4 [1], clauses 6.3.1 and 6.3.2

Precondition: IUT capable of invoking **enableCallNotification()** and **disableCallNotification()**

Preamble: Registration of the IUT (application) and the tester (Call Control SCF) to the framework. The IUT must have obtained a reference to an instance of the IpCallControlManager interface through selecting that service and signing the required service agreement.

The application is permitted to provide its IpAppCallControlManager interface reference in a setCallback() method which it calls prior to invoking further methods.

Test Sequence:

1. Triggered Action: cause IUT to call **enableCallNotification()** method on the tester's (SCF's) IpCallControlManager interface.
Parameters: appCallControlManager, eventCriteria
2. Triggered Action: cause IUT to call **disableCallNotification()** method on the tester's (SCF's) IpCallControlManager interface.
Parameters: assignmentID

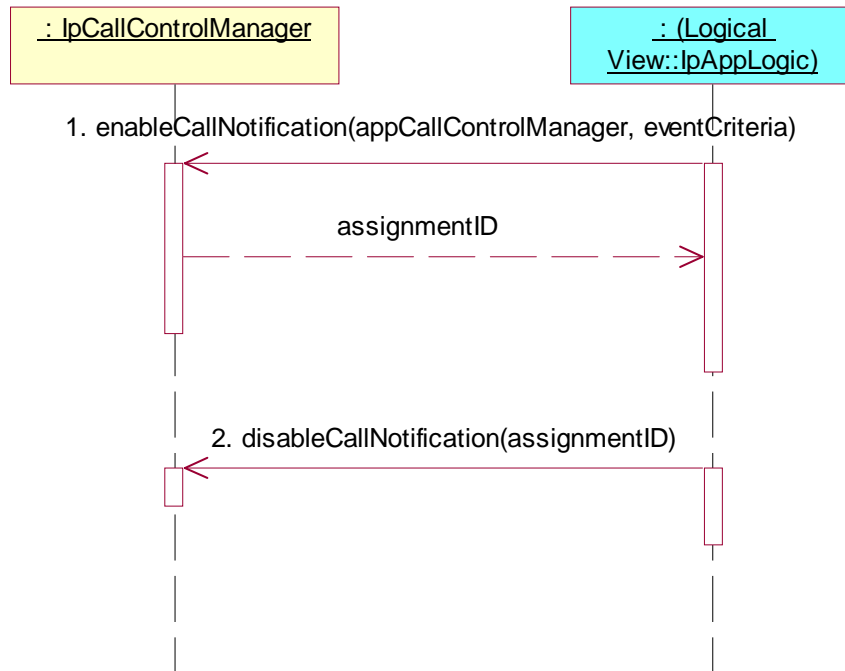

Test GCC_IPAPPCALLCONTROLMANAGER_07

Summary: enablecall notifications and get criteria

Reference: ES 201 915-4 [1], clauses 6.3.1 and 6.3.2

Precondition: IUT capable of invoking **enableCallNotification()** and **getCriteria()**

Preamble: Registration of the IUT (application) and the tester (Call Control SCF) to the framework. The IUT must have obtained a reference to an instance of the IpCallControlManager interface through selecting that service and signing the required service agreement.

The application is permitted to provide its IpAppCallControlManager interface reference in a setCallback() method which it calls prior to invoking further methods.

Test Sequence:

1. Triggered Action: cause IUT to call **enableCallNotification()** method on the tester's (SCF's) IpCallControlManager interface.
Parameters: appCallControlManager, eventCriteria
2. Triggered Action: cause IUT to call **getCriteria()** method on the tester's (SCF's) IpCallControlManager interface.
Parameters: None

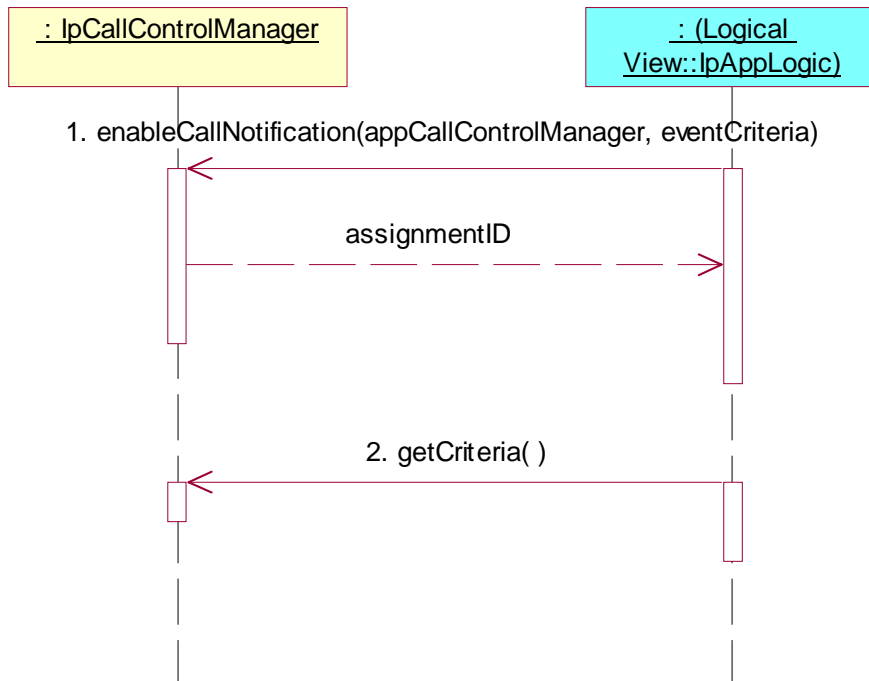

Test GCC_IPAPPCALLCONTROLMANAGER_08

Summary: enable load control and accept overload notifications

Reference: ES 201 915-4 [1], clauses 6.3.1 and 6.3.2

Precondition: IUT capable of invoking **setCallLoadControl()**, **callOverloadEncountered()** and **callOverloadCeased()** implemented

Preamble: Registration of the IUT (application) and the tester (Call Control SCF) to the framework. The IUT must have obtained a reference to an instance of the IpCallControlManager interface through selecting that service and signing the required service agreement.

The application is permitted to provide its IpAppCallControlManager interface reference in a setCallback() method which it calls prior to invoking further methods.

Test Sequence:

1. Triggered Action: cause IUT to call **setCallLoadControl()** method on the tester's (SCF's) IpCallControlManager interface.
Parameters: duration, mechanism, treatment, addressRange

NOTE 1: Delay between setCallLoadControl and callOverloadEncountered.

2. Method call **callOverloadEncountered()**
Parameters: assignmentID
Check: no exception is returned

NOTE 2: Delay between callOverloadEncountered and callOverloadCeased.

3. Method call **callOverloadCeased()**
Parameters: assignmentID
Check: no exception is returned

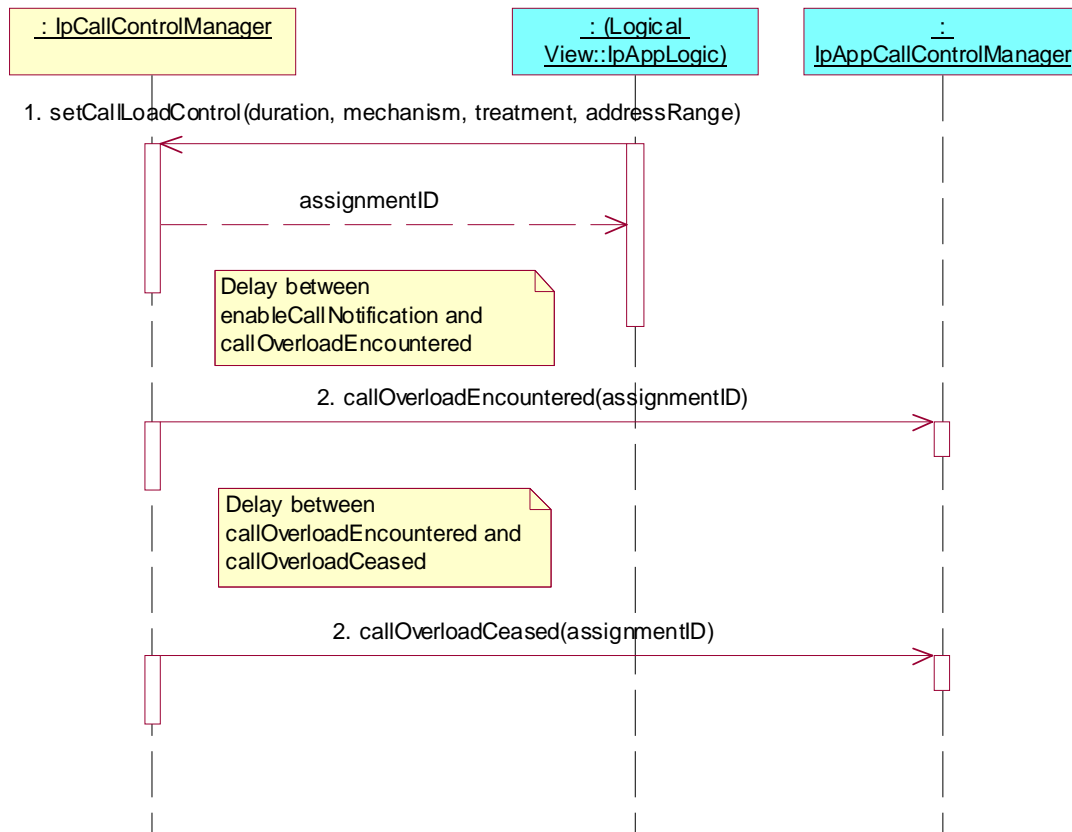

7.2.1.2 IpAppCall

Applications need not be capable of performing each of the sequences below, even if they support the methods indicated below.

Reference: ES 201 915-4 [1], clause 6.4.2

7.2.1.2.1 No Parties state

Precondition: IUT capable of invoking **createCall()**

Preamble GCC_IPAPPCALL_No_Parties

Reference: ES 201 915-4 [1], clause 6.4.2

Pre-preamble: Registration of the IUT (application) and the tester (Call Control SCF) to the framework. The IUT must have obtained a reference to an instance of the **IpCallControlManager** interface through selecting that service and signing the required service agreement.

The application is permitted to provide its **IpAppCallControlManager** interface reference in a **setCallback()** method which it calls prior to invoking further methods.

Preamble Sequence:

1. Triggered Action: cause IUT to call **createCall()** method on the tester's (SCF's) **IpCallControlManager** interface.
Parameters: **appCall**

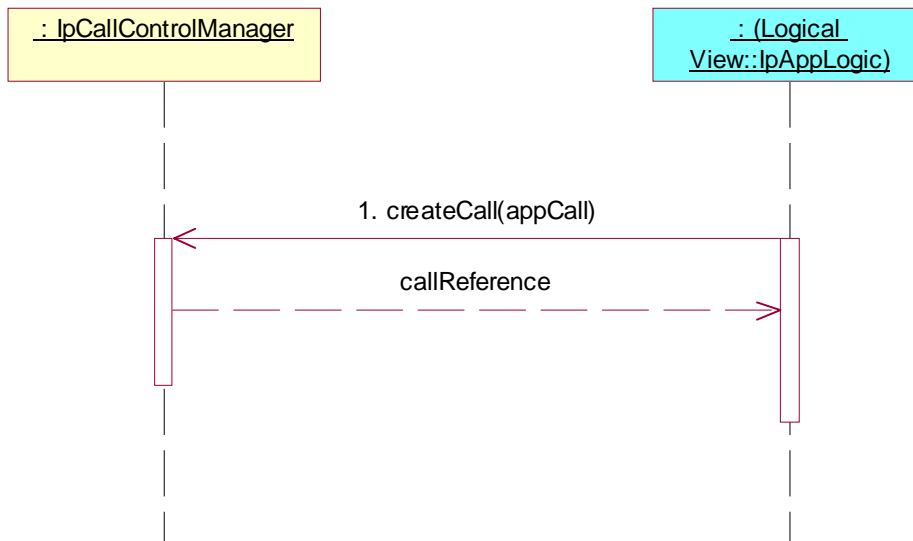

Test GCC_IPAPPCALL_01

Summary: application initiated call, request connection to 1st call leg

Reference: ES 201 915-4 [1], clauses 6.1.3, 6.3.3 and 6.3.4

Precondition: IUT capable of invoking **routeReq()**

Preamble: GCC_IPAPPCALL_No_Parties

Test Sequence:

1. Triggered Action: cause IUT to call **routeReq()** method on the tester's (SCF's) IpCall interface, i.e. connect to call leg to subscriber A.
 Parameters: callSessionID, responseRequested, targetAddress, originatingAddress, originalDestinationAddress, redirectingAddress, appInfo

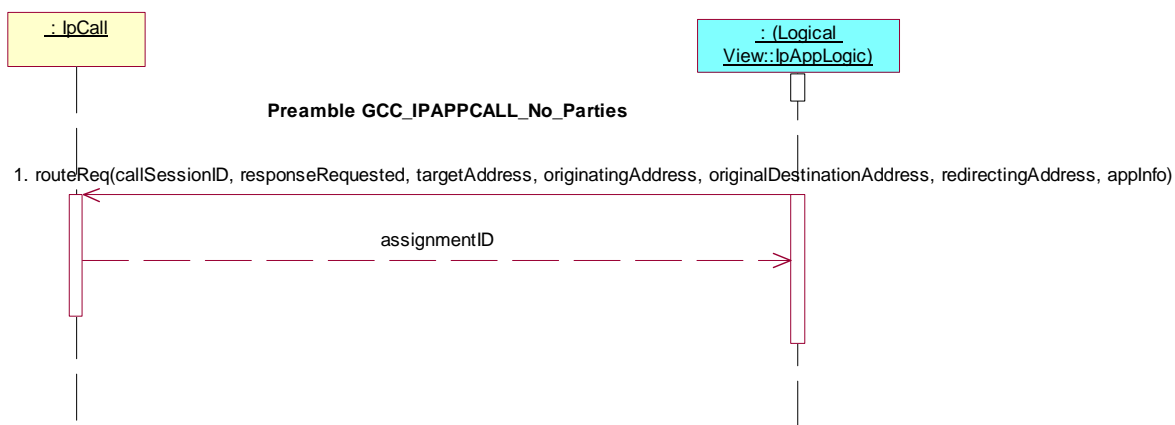

Test GCC_IPAPPCALL_02

Summary: set supervision of call

Reference: ES 201 915-4 [1], clause 6.3.3

Precondition: IUT capable of invoking **superviseCallReq()**

Preamble: GCC_IPAPPCALL_No_Parties

Test Sequence:

1. Triggered Action: cause IUT to call **superviseCallReq()** method on the tester's (SCF's) IpCall interface.
Parameters: callSessionID, time, treatment

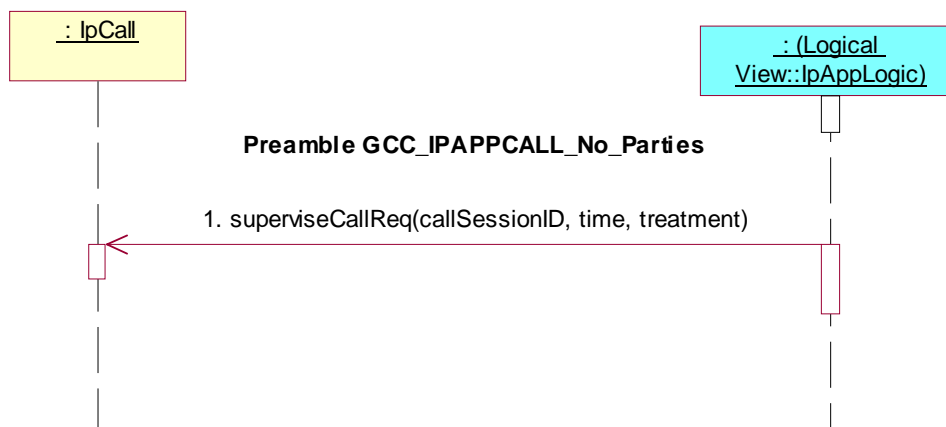
**Test GCC_IPAPPCALL_03**

Summary: request information about call

Reference: ES 201 915-4 [1], clause 6.3.3

Precondition: IUT capable of invoking **getCallInfoReq()**

Preamble: GCC_IPAPPCALL_No_Parties

Test Sequence:

1. Triggered Action: cause IUT to call **getCallInfoReq()** method on the tester's (SCF's) IpCall interface.
Parameters: callSessionID, callInfoRequested

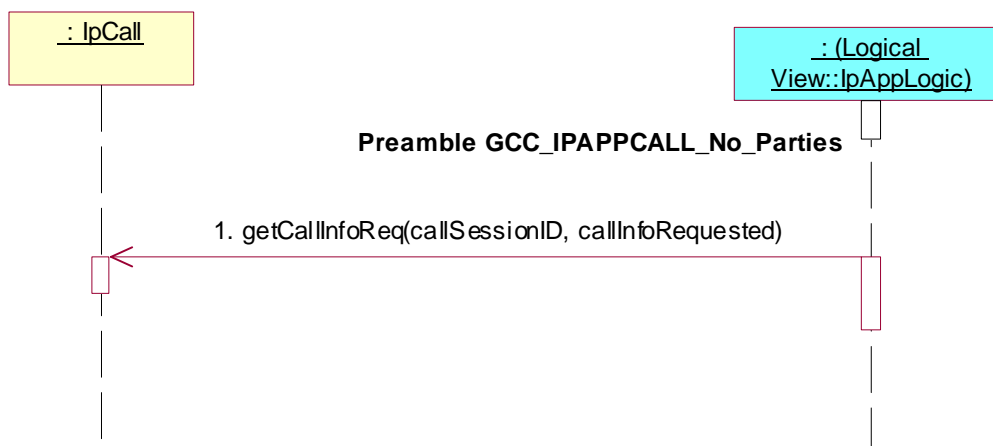

Test GCC_IPAPPCALL_04

Summary: specify charge plan for call

Reference: ES 201 915-4 [1], clause 6.3.3

Precondition: IUT capable of invoking **setCallChargePlan()**

Preamble: GCC_IPAPPCALL_No_Parties

Test Sequence:

1. Triggered Action: cause IUT to call **setCallChargePlan()** method on the tester's (SCF's) IpCall interface.
Parameters: callSessionID, callChargePlan

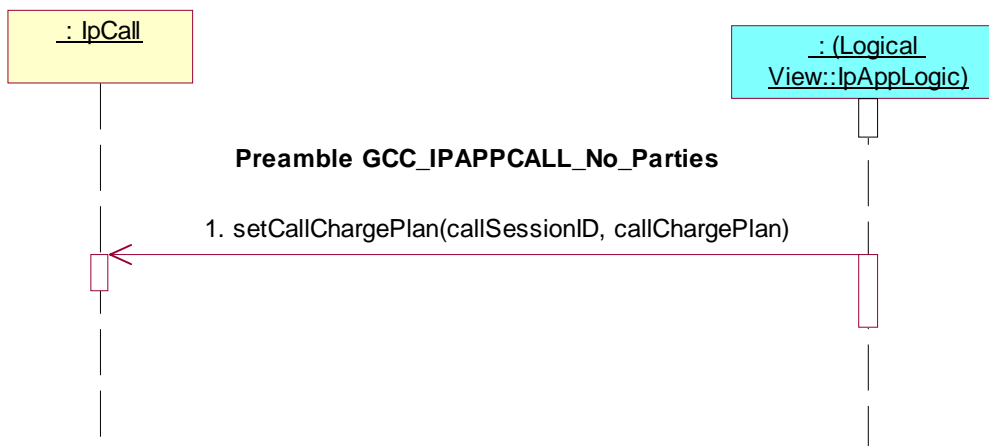
**Test GCC_IPAPPCALL_05**

Summary: allow advice of charge information for call

Reference: ES 201 915-4 [1], clause 6.3.3

Precondition: IUT capable of invoking **setAdviceOfCharge()**

Preamble: GCC_IPAPPCALL_No_Parties

Test Sequence:

1. Triggered Action: cause IUT to call **setAdviceOfCharge()** method on the tester's (SCF's) IpCall interface.
Parameters: callSessionID, aOCInfo, tariffSwitch

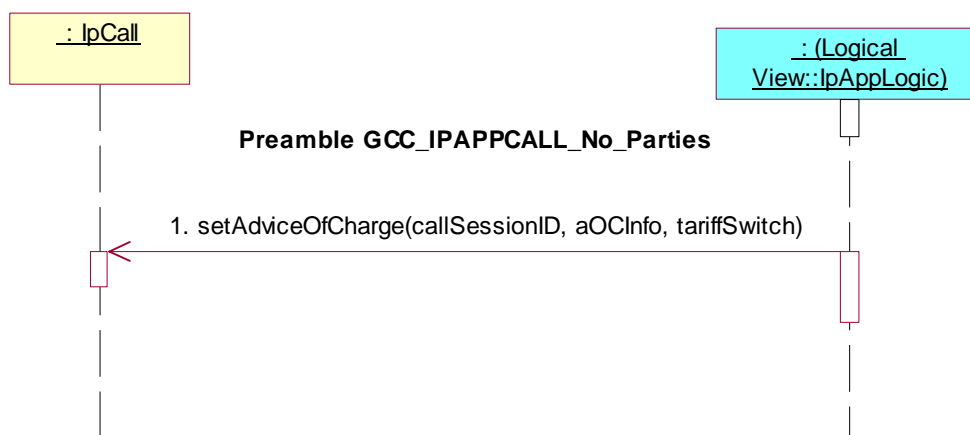

7.2.1.2.2 General tests, Active state

NOTE: Tests GCC_IPAPPCALL_06 to 13 do not specify the values of CallEventName field in the eventCriteria parameter of the enableCallNotification() method expected from the IUT. This has been done intentionally to keep these basic tests simple. Note that the tester has to answer with parameter values that make sense in relation to the parameter values received from the IUT.

Precondition: IUT capable of invoking **enableCallNotification()**

Preamble GCC_IPAPPCALL_Active

Reference: ES 201 915-4 [1], clause 6.4.2

Pre-preamble: Registration of the IUT (application) and the tester (Call Control SCF) to the framework. The IUT must have obtained a reference to an instance of the IpCallControlManager interface through selecting that service and signing the required service agreement.

The application is permitted to provide its IpAppCallControlManager interface reference in a setCallback() method which it calls prior to invoking further methods.

1. Triggered Action: cause IUT to call **enableCallNotification()** method on the tester's (SCF's) IpCallControlManager interface.
Parameters: appCallControlManager, eventCriteria
eventCriteria.MonitorMode = P_CALL_MONITOR_MODE_INTERRUPT
2. Method call **callEventNotify()**
Parameters: callReference, eventInfo, assignmentID
Check: valid value of IpAppCallRef is returned

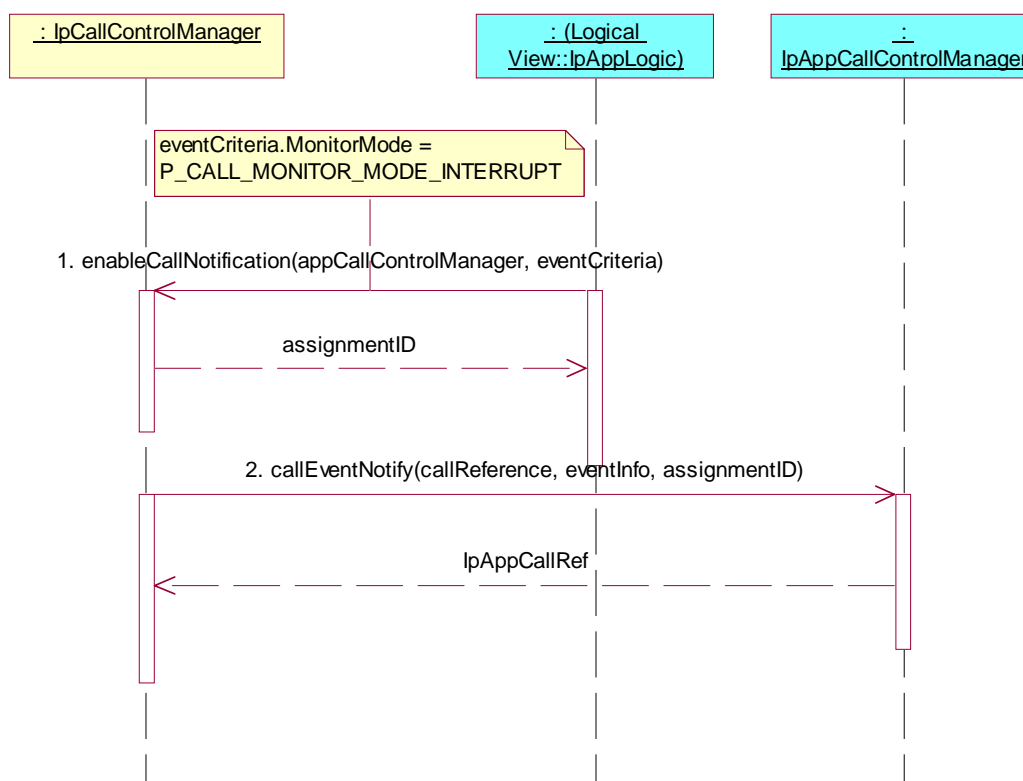

Test GCC_IPAPPCALL_06

Summary: set supervision of call, successful

Reference: ES 201 915-4 [1], clause 6.3.3

Precondition: IUT capable of invoking **superviseCallReq()**

Preamble: GCC_IPAPPCALL_Active

Test Sequence:

1. Triggered Action: cause IUT to call **superviseCallReq()** method on the tester's (SCF's) IpCall interface.
Parameters: callSessionID, time, treatment
2. Method call **superviseCallRes()**
Parameters: callSessionID, report, usedTime
Check: no exception is returned

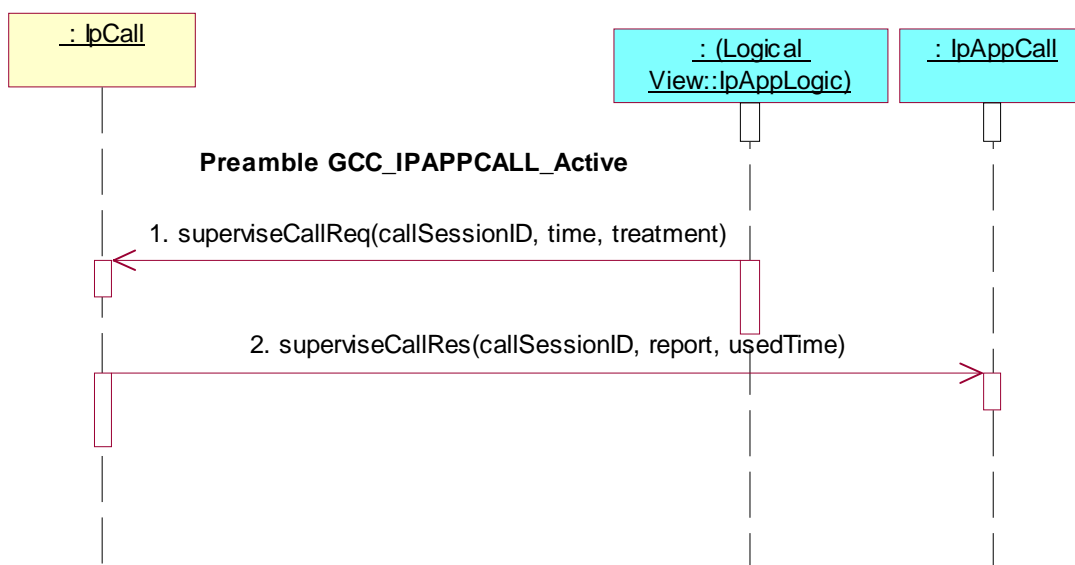

Test GCC_IPAPPCALL_07

Summary: set supervision of call, unsuccessful

Reference: ES 201 915-4 [1], clause 6.3.3

Precondition: IUT capable of invoking **superviseCallReq()**

Preamble: GCC_IPAPPCALL_Active

Test Sequence:

1. Triggered Action: cause IUT to call **superviseCallReq()** method on the tester's (SCF's) IpCall interface.
Parameters: callSessionID, time, treatment
2. Method call **superviseCallErr()**
Parameters: callSessionID, errorIndication
Check: no exception is returned

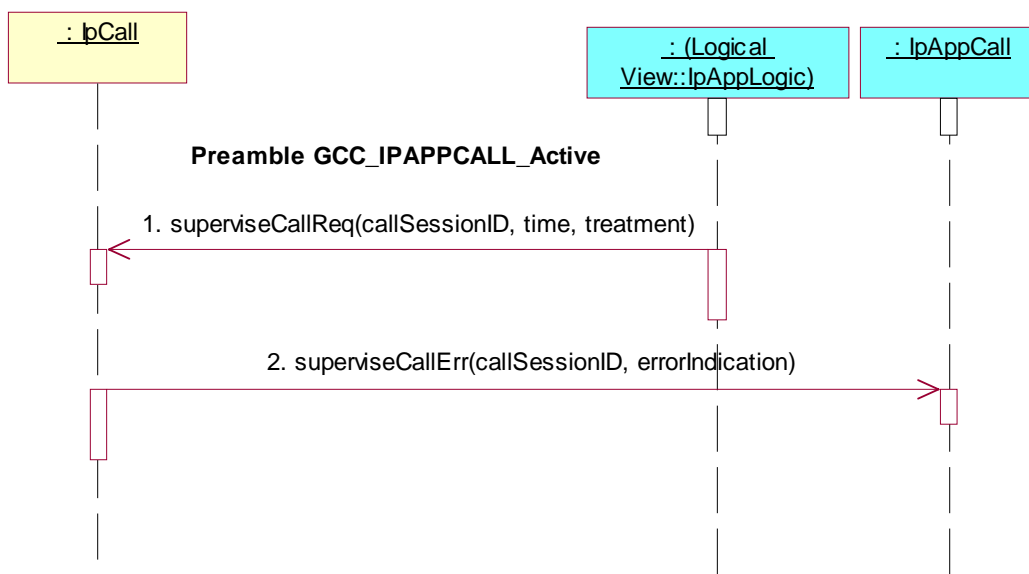

Test GCC_IPAPPCALL_08

Summary: specify charge plan for call

Reference: ES 201 915-4 [1], clause 6.3.3

Precondition: IUT capable of invoking **setCallChargePlan()**

Preamble: GCC_IPAPPCALL_Active

Test Sequence:

1. Triggered Action: cause IUT to call **setCallChargePlan()** method on the tester's (SCF's) IpCall interface.
Parameters: callSessionID, callChargePlan

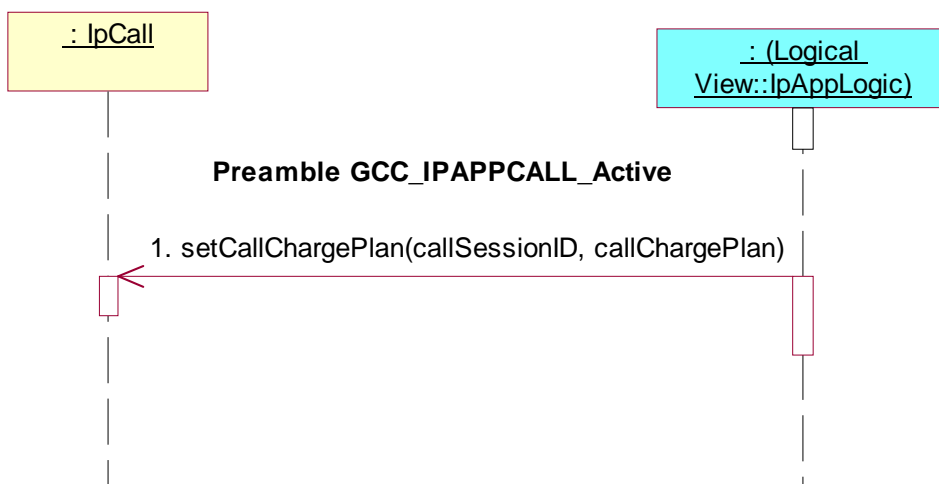

Test GCC_IPAPPCALL_09

Summary: allow advice of charge information for call

Reference: ES 201 915-4 [1], clause 6.3.3

Precondition: IUT capable of invoking **setAdviceOfCharge()**

Preamble: GCC_IPAPPCALL_Active

Test Sequence:

1. Triggered Action: cause IUT to call **setAdviceOfCharge()** method on the tester's (SCF's) IpCall interface.
Parameters: callSessionID, aOCInfo, tariffSwitch

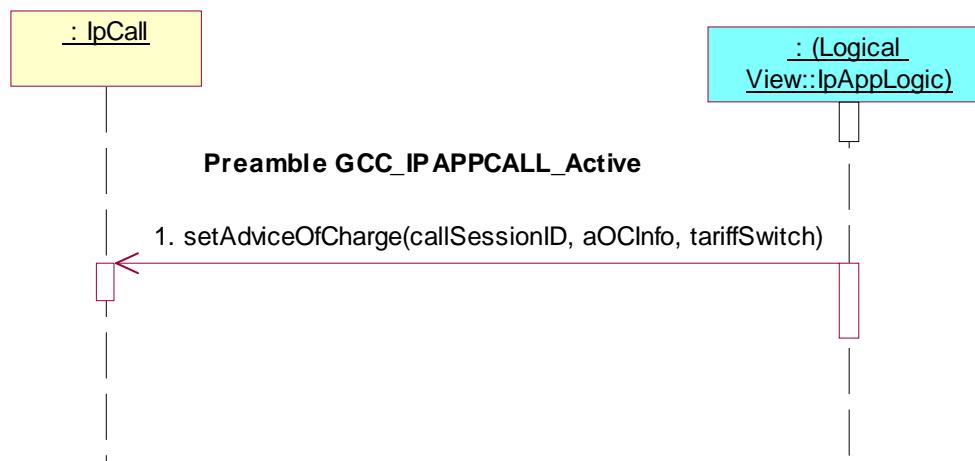
**Test GCC_IPAPPCALL_10**

Summary: release call

Reference: ES 201 915-4 [1], clause 6.3.3

Precondition: IUT capable of invoking **release()**

Preamble: GCC_IPAPPCALL_Active

Test Sequence:

1. Triggered Action: cause IUT to call **release()** method on the tester's (SCF's) IpCall interface.
Parameters: callSessionID, reason

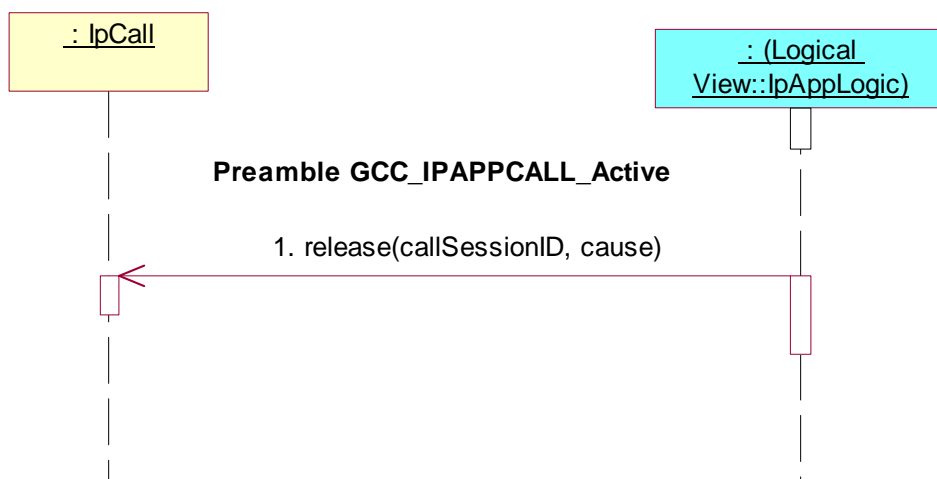

Test GCC_IPAPPCALL_11

Summary: indication of a call fault

Reference: ES 201 915-4 [1], clause 6.3.4

Precondition: **callFaultDetected()** implemented

Preamble: GCC_IPAPPCALL_Active

Test Sequence:

1. Method call **callFaultDetected()**
 Parameters: callSessionID, fault
 Check: no exception is returned

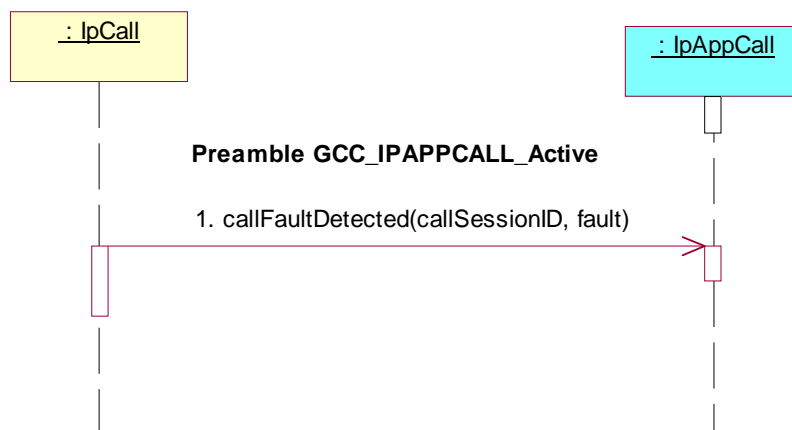
**Test GCC_IPAPPCALL_12**

Summary: indication of a call ended

Reference: ES 201 915-4 [1], clause 6.3.4

Precondition: **callEnded()** implemented

Preamble: GCC_IPAPPCALL_Active

Test Sequence:

1. Method call **callEnded()**
 Parameters: callSessionID, report
 Check: no exception is returned

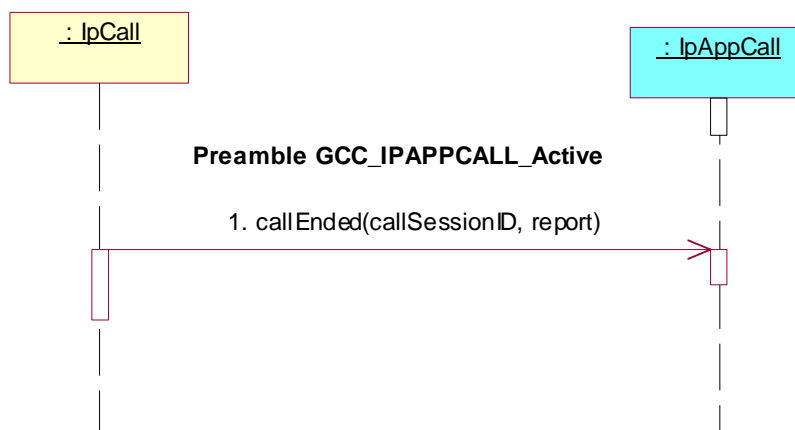

Test GCC_IPAPPCALL_13

Summary: continue processing for call

Reference: ES 201 915-4 [1], clause 6.3.3

Precondition: IUT capable of invoking **continueProcessing()**

Preamble: GCC_IPAPPCALL_Active

Test Sequence:

1. Triggered Action: cause IUT to call **continueProcessing()** method on the tester's (SCF's) IpCall interface.
Parameters: callSessionID

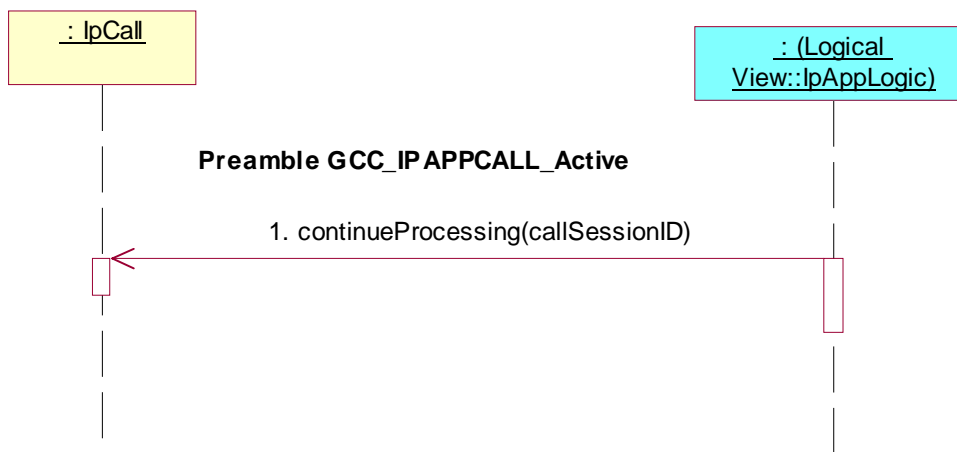
**7.2.1.2.3 Active state, Routing to Destination(s) sub-state**

Precondition: IUT capable of invoking **createCall()** and **routeReq()**

Preamble GCC_IPAPPCALL_Active_Routing_to_Destination(s)

Reference: ES 201 915-4 [1], clause 6.4.2

Pre-preamble: Registration of the IUT (application) and the tester (Call Control SCF) to the framework. The IUT must have obtained a reference to an instance of the IpCallControlManager interface through selecting that service and signing the required service agreement.

The application is permitted to provide its IpAppCallControlManager interface reference in a **setCallback()** method which it calls prior to invoking further methods.

1. Triggered Action: cause IUT to call **createCall()** method on the tester's (SCF's) IpCallControlManager interface.
Parameters: appCall
2. Triggered Action: cause IUT to call **routeReq()** method on the tester's (SCF's) IpCall interface, i.e. connect to call leg to subscriber A.
Parameters: callSessionID, responseRequested, targetAddress, originatingAddress, originalDestinationAddress, redirectingAddress, appInfo

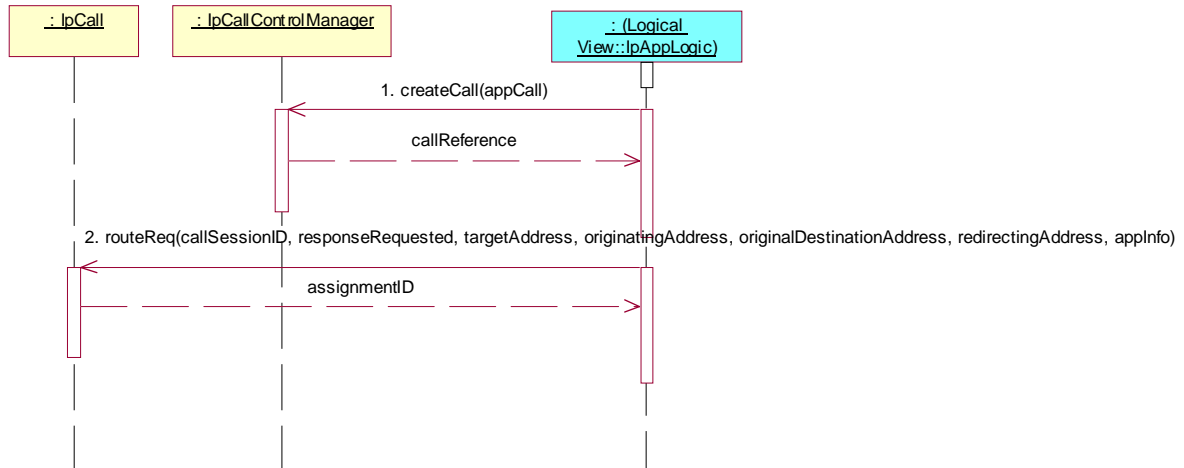

Test GCC_IPAPPCALL_14

Summary: application initiated call, 1st call leg, successful

Reference: ES 201 915-4 [1], clauses 6.1.3, 6.3.3 and 6.3.4

Preamble: GCC_IPAPPCALL_Active_Routing_to_Destination(s)

Test Sequence:

1. Method call **routeRes()**
 Parameters: callSessionId, eventReport, callLegSessionId
 Check: no exception is returned

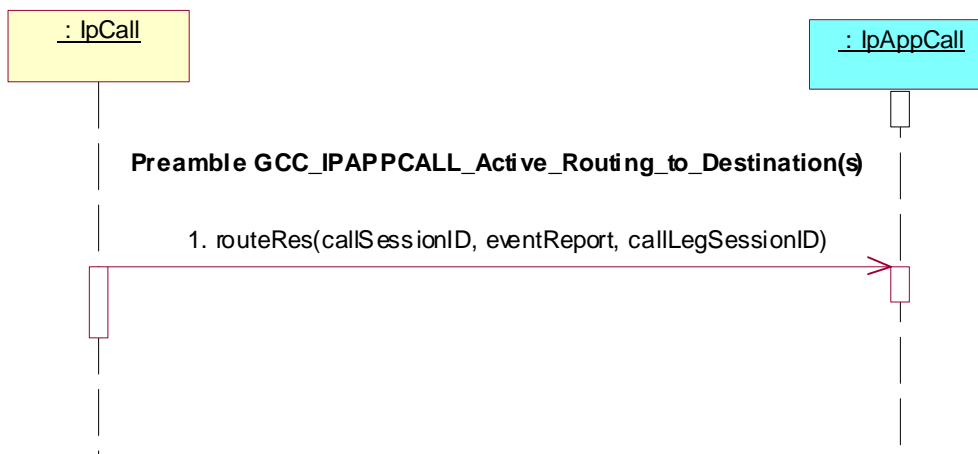

Test GCC_IPAPPCALL_15

Summary: application initiated call, 1st call leg, unsuccessful

Reference: ES 201 915-4 [1], clauses 6.1.3, 6.3.3 and 6.3.4

Preamble: GCC_IPAPPCALL_Active_Routing_to_Destination(s)

Test Sequence:

1. Method call **routeErr()**
Parameters: callSessionId, errorIndication, callLegSessionId
Check: no exception is returned

**7.2.1.2.4 Active state, 1 Party in Call sub-state**

Precondition: IUT capable of invoking **enableCallNotification()** or **createCall()** and **routeReq()**

Preamble GCC_IPAPPCALL_1_Party_in_Call

Reference: ES 201 915-4 [1], clause 6.4.2

Pre-preamble: Registration of the IUT (application) and the tester (Call Control SCF) to the framework. The IUT must have obtained a reference to an instance of the IpCallControlManager interface through selecting that service and signing the required service agreement.

The application is permitted to provide its IpAppCallControlManager interface reference in a setCallback() method which it calls prior to invoking further methods.

1. Triggered Action: cause IUT to call **enableCallNotification()** method on the tester's (SCF's) IpCallControlManager interface.
Parameters: appCallControlManager, eventCriteria
eventCriteria.MonitorMode = P_CALL_MONITOR_MODE_INTERRUPT
eventCriteria.CallEventName <> P_EVENT_GCCS_ANSWER_FROM_CALL_PARTY
2. Method call **callEventNotify()**
Parameters: callReference, eventInfo, assignmentID
Check: valid value of IpAppCallRef is returned

or

1. Triggered Action: cause IUT to call **createCall()** method on the tester's (SCF's) IpCallControlManager interface.
Parameters: appCall
2. Triggered Action: cause IUT to call **routeReq()** method on the tester's (SCF's) IpCall interface, i.e. connect to call leg to subscriber A.

Parameters: callSessionID, responseRequested, targetAddress, originatingAddress, originalDestinationAddress, redirectingAddress, appInfo

3. Method call **routeRes()**

Parameters: callSessionId, eventReport, callLegSessionId

Check: no exception is returned

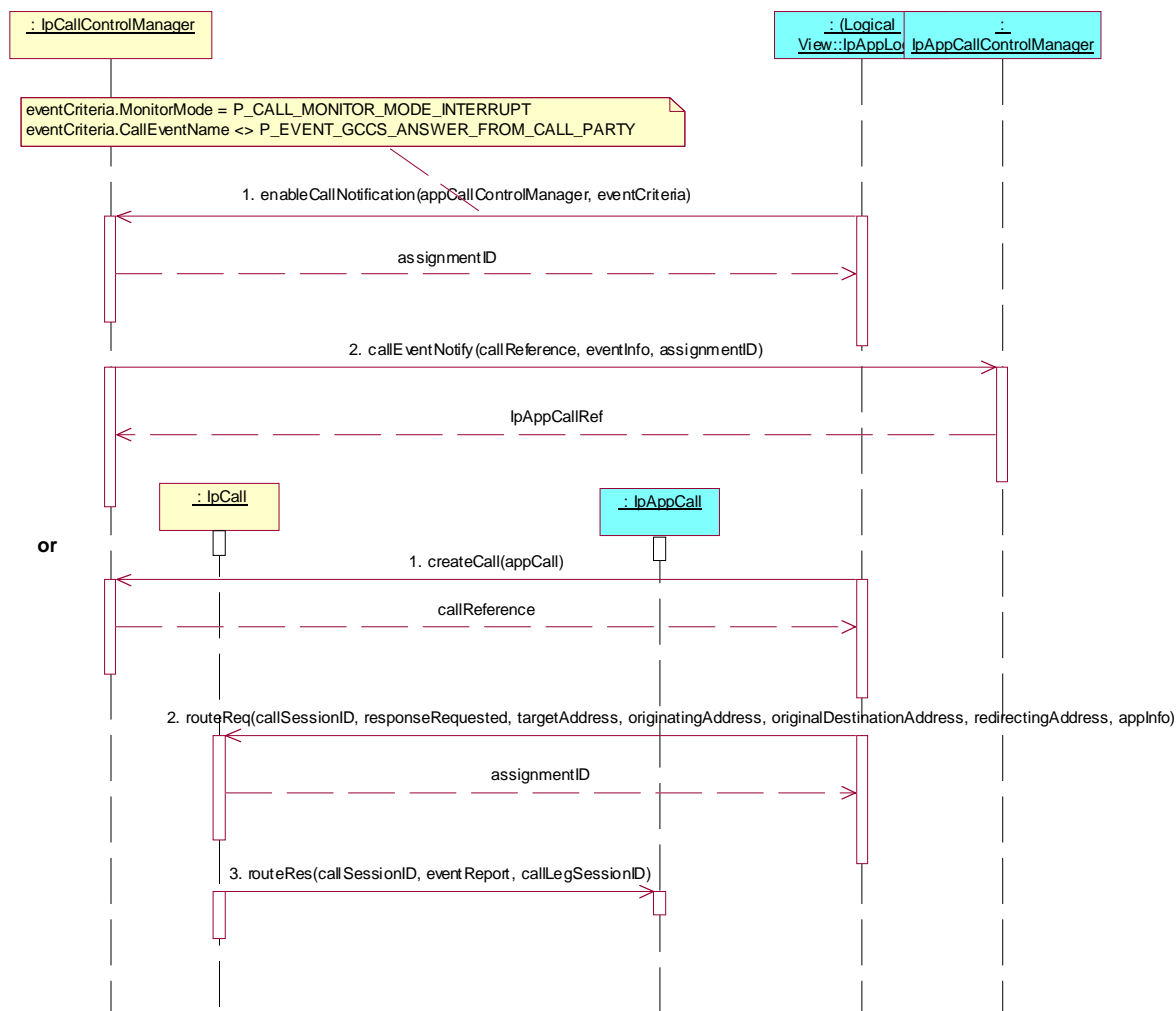

Test GCC_IPAPPCALL_16

Summary: connect to 2nd call leg, successful

Reference: ES 201 915-4 [1], clauses 6.3.3 and 6.3.4

Preamble: GCC_IPAPPCALL_1_Party_in_Call

Test Sequence:

1. Triggered Action: cause IUT to call **routeReq()** method on the tester's (SCF's) IpCall interface, i.e. connect to call leg to subscriber B.
Parameters: callSessionID, responseRequested, targetAddress, originatingAddress, originalDestinationAddress, redirectingAddress, appInfo
2. Method call **routeRes()**
Parameters: callSessionId, eventReport, callLegSessionId
Check: no exception is returned

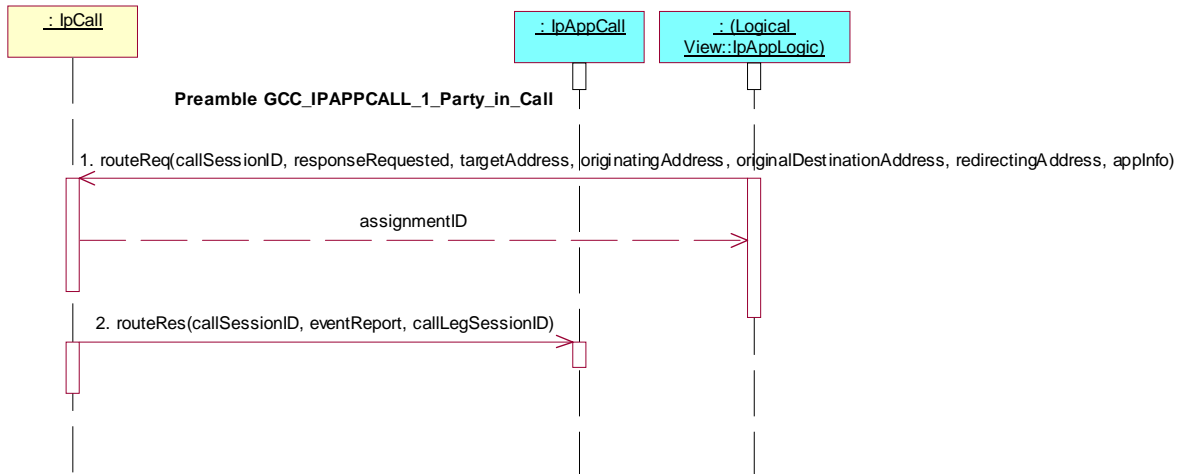

Test GCC_IPAPPCALL_17

Summary: connect to 2nd call leg, unsuccessful

Reference: ES 201 915-4 [1], clauses 6.3.3 and 6.3.4

Preamble: GCC_IPAPPCALL_1_Party_in_Call

Test Sequence:

1. Triggered Action: cause IUT to call **routeReq()** method on the tester's (SCF's) IpCall interface, i.e. connect to call leg to subscriber B.
Parameters: callSessionID, responseRequested, targetAddress, originatingAddress, originalDestinationAddress, redirectingAddress, appInfo
2. Method call **routeErr()**
Parameters: callSessionId, errorIndication, callLegSessionId
Check: no exception is returned

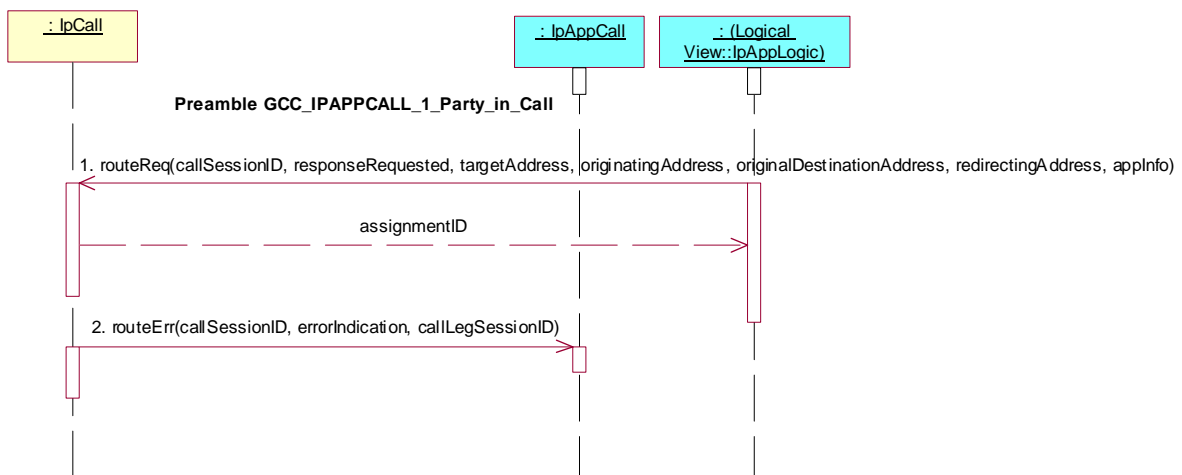

Test GCC_IPAPPCALL_18

Summary: request information about call

Reference: ES 201 915-4 [1], clause 6.3.3

Precondition: IUT capable of invoking **getCallInfoReq()**

Preamble: GCC_IPAPPCALL_1_Party_in_Call

Test Sequence:

1. Triggered Action: cause IUT to call **getCallInfoReq()** method on the tester's (SCF's) IpCall interface.
Parameters: callSessionID, callInfoRequested

**Test GCC_IPAPPCALL_19**

Summary: specify charge plan for call

Reference: ES 201 915-4 [1], clause 6.3.3

Precondition: IUT capable of invoking **setCallChargePlan()**

Preamble: GCC_IPAPPCALL_1_Party_in_Call

Test Sequence:

1. Triggered Action: cause IUT to call **setCallChargePlan()** method on the tester's (SCF's) IpCall interface.
Parameters: callSessionID, callChargePlan

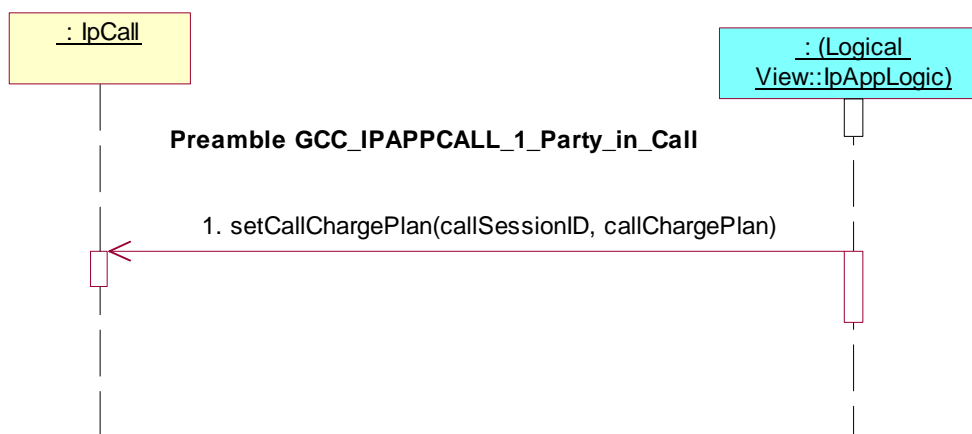

Test GCC_IPAPPCALL_20

Summary: request further digits for call, successful

Reference: ES 201 915-4 [1], clauses 6.3.3 and 6.3.4

Precondition: Call originated from the network, IUT capable of invoking **getMoreDialledDigitsReq()**

Preamble: Registration of the IUT (application) and the tester (Call Control SCF) to the framework. The IUT must have obtained a reference to an instance of the IpCallControlManager interface through selecting that service and signing the required service agreement.

The application is permitted to provide its IpAppCallControlManager interface reference in a setCallback() method which it calls prior to invoking further methods.

Test Sequence:

1. Triggered Action: cause IUT to call **enableCallNotification()** method on the tester's (SCF's) IpCallControlManager interface.
Parameters: appCallControlManager, eventCriteria
eventCriteria.MonitorMode = P_CALL_MONITOR_MODE_INTERRUPT
eventCriteria.CallEventName = P_EVENT_GCCS_ADDRESS_COLLECTED_EVENT
2. Method call **callEventNotify()**
Parameters: callReference, eventInfo, assignmentID
Check: valid value of IpAppCallRef is returned
3. Triggered Action: cause IUT to call **getMoreDialledDigitsReq()** method on the tester's (SCF's) IpCall interface.
Parameters: callSessionID, length
4. Method call **getMoreDialledDigitsRes()**
Parameters: callSessionId, digits
Check: no exception is returned

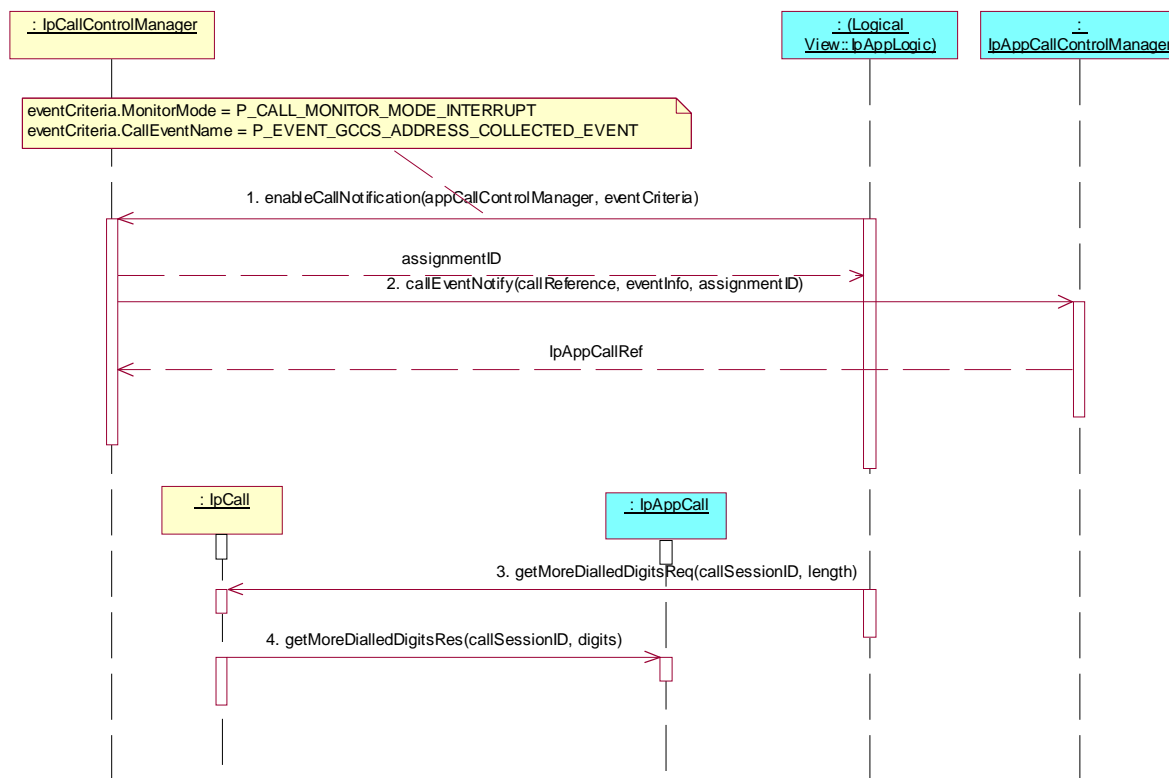

Test GCC_IPAPPCALL_21

Summary: request further digits for call, unsuccessful

Reference: ES 201 915-4 [1], clauses 6.3.3 and 6.3.4

Precondition: Call originated from the network, IUT capable of invoking **getMoreDialledDigitsReq()**

Preamble: Registration of the IUT (application) and the tester (Call Control SCF) to the framework. The IUT must have obtained a reference to an instance of the IpCallControlManager interface through selecting that service and signing the required service agreement.

The application is permitted to provide its IpAppCallControlManager interface reference in a setCallback() method which it calls prior to invoking further methods.

Test Sequence:

1. Triggered Action: cause IUT to call **enableCallNotification()** method on the tester's (SCF's) IpCallControlManager interface.
Parameters: appCallControlManager, eventCriteria
eventCriteria.MonitorMode = P_CALL_MONITOR_MODE_INTERRUPT
eventCriteria.CallEventName = P_EVENT_GCCS_ADDRESS_COLLECTED_EVENT
2. Method call **callEventNotify()**
Parameters: callReference, eventInfo, assignmentID
Check: valid value of IpAppCallRef is returned
3. Triggered Action: cause IUT to call **getMoreDialledDigitsReq()** method on the tester's (SCF's) IpCall interface.
Parameters: callSessionID, length
4. Method call **getMoreDialledDigitsErr()**
Parameters: callSessionId, errorIndication
Check: no exception is returned

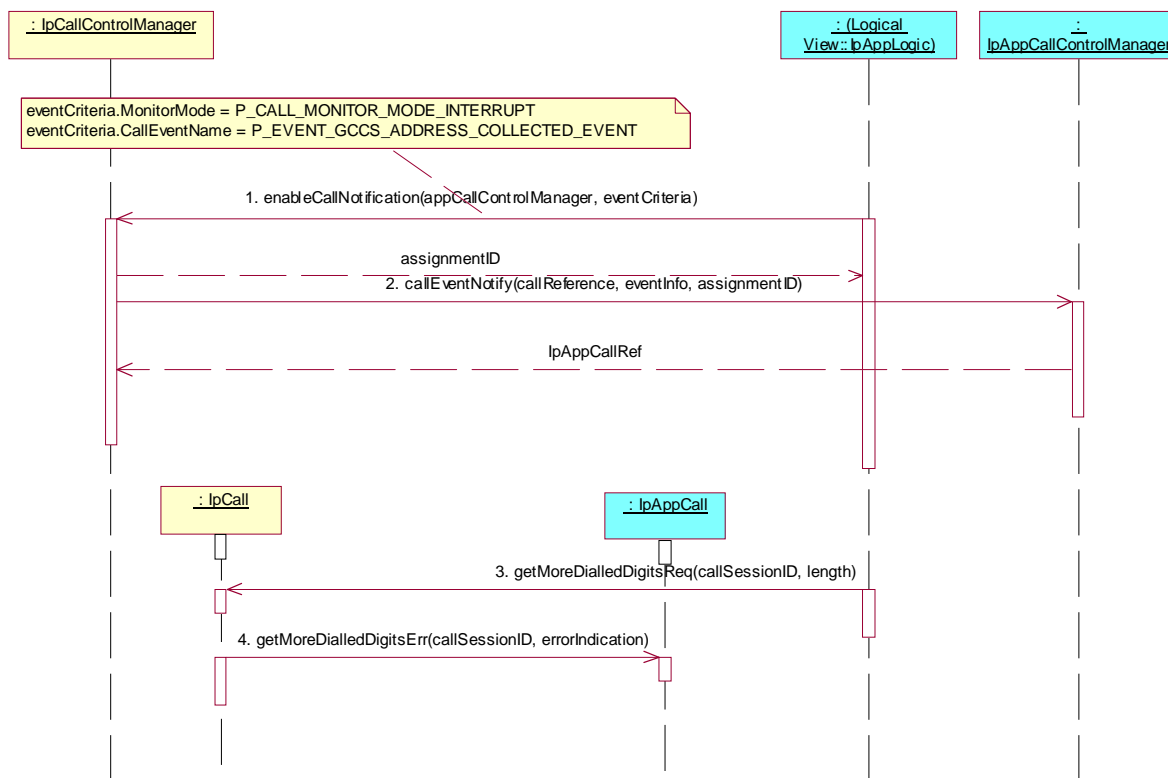

7.2.1.2.5 Active state, 2 Parties in Call sub-state

Precondition: IUT capable of invoking **enableCallNotification()** or **createCall()** and **routeReq()**

Preamble GCC_IPAPPCALL_2_Parties_in_Call

Reference: ES 201 915-4 [1], clause 6.4.2

Pre-preamble: Registration of the IUT (application) and the tester (Call Control SCF) to the framework. The IUT must have obtained a reference to an instance of the IpCallControlManager interface through selecting that service and signing the required service agreement.

The application is permitted to provide its IpAppCallControlManager interface reference in a setCallback() method which it calls prior to invoking further methods.

1. Triggered Action: cause IUT to call **enableCallNotification()** method on the tester's (SCF's) IpCallControlManager interface.
Parameters: appCallControlManager, eventCriteria
eventCriteria.MonitorMode = P_CALL_MONITOR_MODE_INTERRUPT
eventCriteria.CallEventName = P_EVENT_GCCS_ANSWER_FROM_CALL_PARTY
2. Method call **callEventNotify()**
Parameters: callReference, eventInfo, assignmentID
Check: valid value of IpAppCallRef is returned

or

1. Triggered Action: cause IUT to call **enableCallNotification()** method on the tester's (SCF's) IpCallControlManager interface.
Parameters: appCallControlManager, eventCriteria
eventCriteria.MonitorMode = P_CALL_MONITOR_MODE_INTERRUPT
eventCriteria.CallEventName <> P_EVENT_GCCS_ANSWER_FROM_CALL_PARTY

2. Method call **callEventNotify()**
 Parameters: callReference, eventInfo, assignmentID
 Check: valid value of IpAppCallRef is returned
3. Triggered Action: cause IUT to call **routeReq()** method on the tester's (SCF's) IpCall interface, i.e. connect to call leg to subscriber B.
 Parameters: callSessionID, responseRequested, targetAddress, originatingAddress, originalDestinationAddress, redirectingAddress, appInfo
 responseRequested.CallReportType = P_CALL_REPORT_ANSWER
4. Method call **routeRes()**
 Parameters: callSessionId, eventReport, callLegSessionId
 Check: no exception is returned

or

1. Triggered Action: cause IUT to call **createCall()** method on the tester's (SCF's) IpCallControlManager interface.
 Parameters: appCall
2. Triggered Action: cause IUT to call **routeReq()** method on the tester's (SCF's) IpCall interface, i.e. connect to call leg to subscriber A.
 Parameters: callSessionID, responseRequested, targetAddress, originatingAddress, originalDestinationAddress, redirectingAddress, appInfo
 responseRequested.CallReportType = P_CALL_REPORT_ANSWER
3. Method call **routeRes()**
 Parameters: callSessionId, eventReport, callLegSessionId
 Check: no exception is returned
4. Triggered Action: cause IUT to call **routeReq()** method on the tester's (SCF's) IpCall interface, i.e. connect to call leg to subscriber B.
 Parameters: callSessionID, responseRequested, targetAddress, originatingAddress, originalDestinationAddress, redirectingAddress, appInfo
 responseRequested.CallReportType = P_CALL_REPORT_ANSWER
5. Method call **routeRes()**
 Parameters: callSessionId, eventReport, callLegSessionId
 Check: no exception is returned

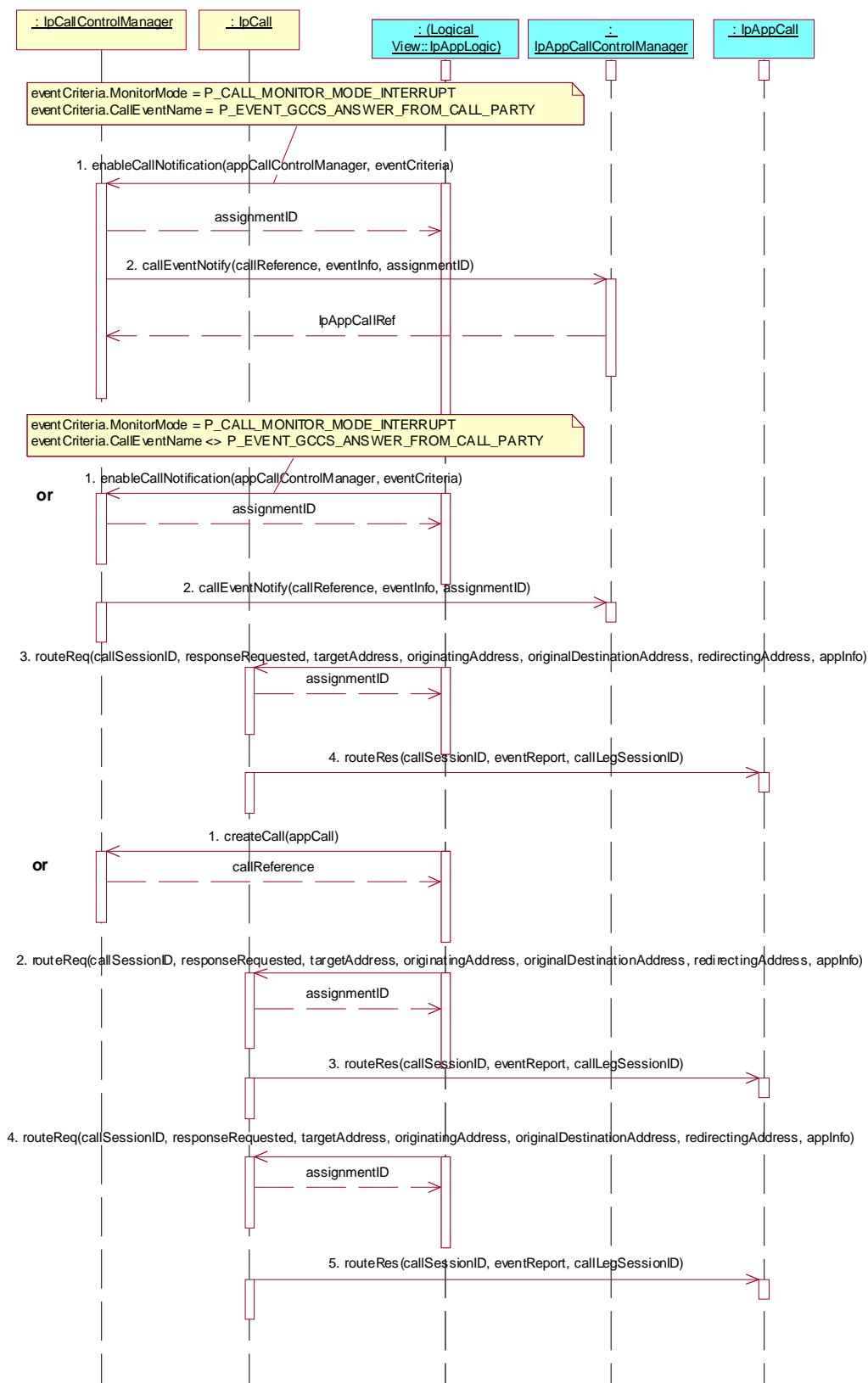

NOTE: No tests specific to this state have been defined.

7.2.1.2.6 Network Released and Finished state

NOTE: The following test is testing both the Network Released and the Finished state, as there is a direct state transition from the first to the latter state, when no supervision request has been sent by the application or when a sent supervision request is answered by the SCF.

Test GCC_IPAPPCALL_22

Summary: de-assign call that has been released by the network for reasons of fault

Reference: ES 201 915-4 [1], clauses 6.3.3 and 6.3.4

Precondition: IUT capable of invoking **deassignCall()**

Preamble: GCC_IPAPPCALL_Active

Test Sequence:

1. Method call **callFaultDetected()**
Parameters: callSessionID, fault
Check: no exception is returned
2. Triggered Action: cause IUT to call **deassignCall()** method on the tester's (SCF's) IpCall interface.
Parameters: callSessionID

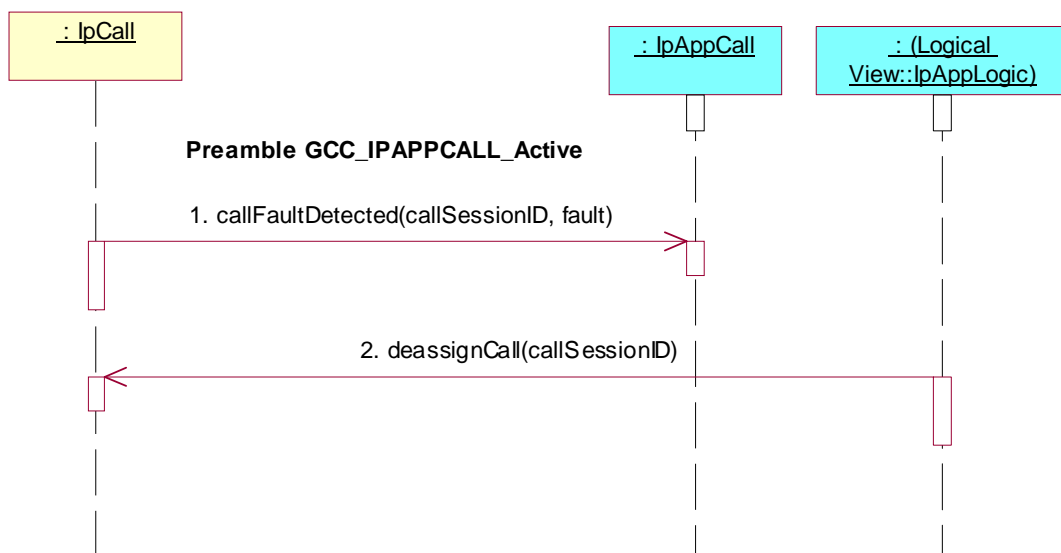

Test GCC_IPAPPCALL_23

Summary: de-assign network released call **after** receipt of supervision result

Reference: ES 201 915-4 [1], clauses 6.3.3 and 6.3.4

Precondition: IUT capable of invoking **superviseCallReq()** and **deassignCall()**

Preamble: GCC_IPAPPCALL_Active

Test Sequence:

1. Triggered Action: cause IUT to call **superviseCallReq()** method on the tester's (SCF's) IpCall interface.
Parameters: callSessionID, time, treatment
2. Method call **callFaultDetected()**
Parameters: callSessionID, fault
Check: no exception is returned
3. Method call **superviseCallRes()**
Parameters: callSessionID, report, usedTime
Check: no exception is returned
4. Triggered Action: cause IUT to call **deassignCall()** method on the tester's (SCF's) IpCall interface.
Parameters: callSessionID

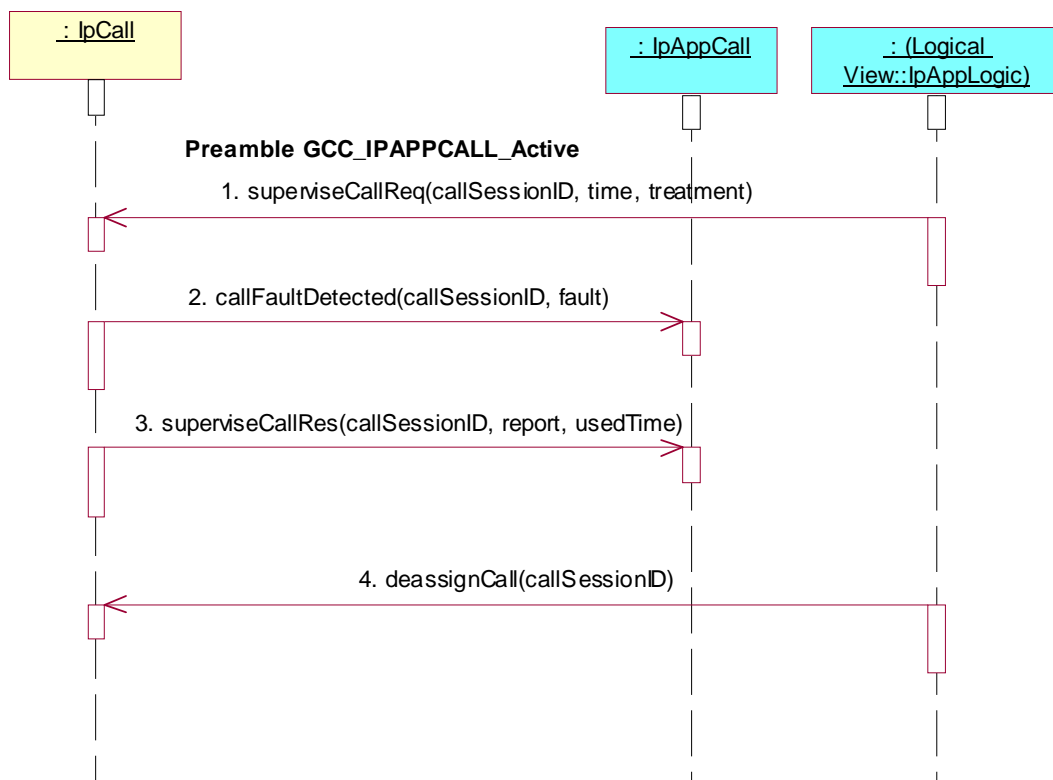

7.2.1.2.7 Application Released state

Test GCC_IPAPPCALL_24

Summary: accept receipt of supervision result **after** release of call by application

Reference: ES 201 915-4 [1], clauses 6.3.3 and 6.3.4

Precondition: IUT capable of invoking **superviseCallReq()** and **release()**

Preamble: GCC_IPAPPCALL_Active

Test Sequence:

1. Triggered Action: cause IUT to call **superviseCallReq()** method on the tester's (SCF's) IpCall interface.
Parameters: callSessionID, time, treatment
2. Triggered Action: cause IUT to call **release()** method on the tester's (SCF's) IpCall interface.
Parameters: callSessionID, cause
3. Method call **superviseCallRes()**
Parameters: callSessionID, report, usedTime
Check: no exception is returned

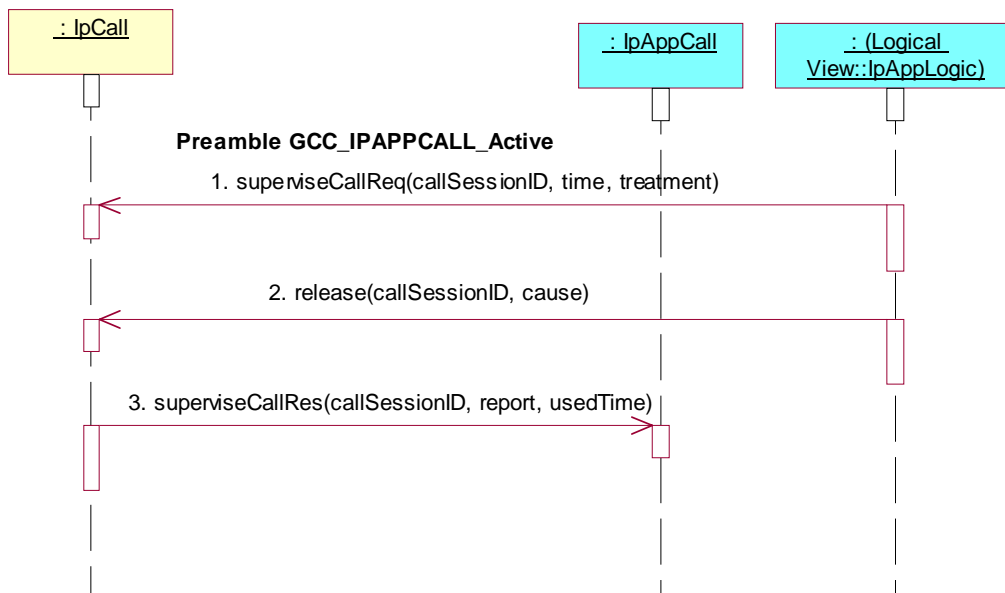

7.2.2 MultiParty Call Control Service (MPCC)

7.2.2.1 IpAppMultiPartyCallControlManager

Test MPCC_IpAppMultiPartyCallControlManager_01

Summary: create call object

Reference: ES 201 915-4 [1], clause 7.3.1

Precondition: IUT capable of invoking **createCall()**

Preamble: Registration of the IUT (application) and the tester (Call Control SCF) to the framework. The IUT must have obtained a reference to an instance of the IpMultiPartyCallControlManager interface through selecting that service and signing the required service agreement.

The application is permitted to provide its IpAppMultiPartyCallControlManager interface reference in a setCallback() method which it calls prior to invoking further methods.

Test Sequence:

1. Triggered Action: cause IUT to call **createCall()** method on the tester's (SCF's) IpMultiPartyCallControlManager interface.
Parameters: appCall

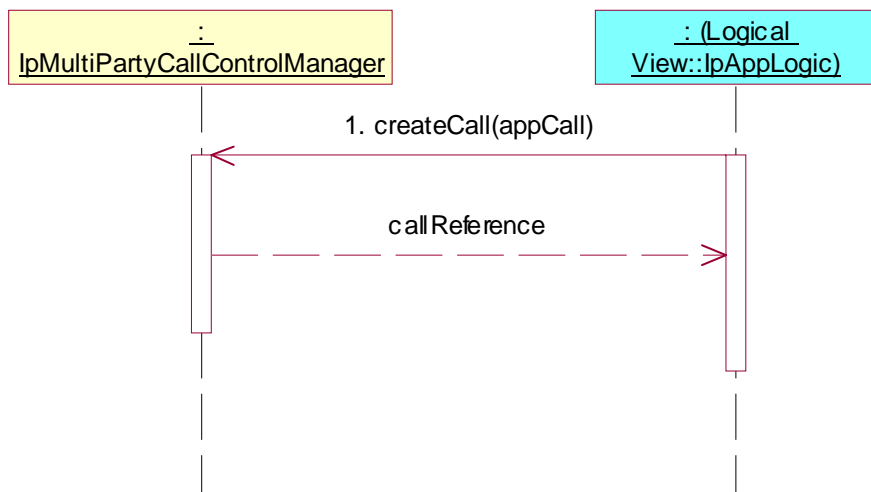

Test MPCC_IpAppMultiPartyCallControlManager_02

Summary: create call object and accept abort

Reference: ES 201 915-4 [1], clauses 7.3.1 and 7.3.2

Precondition: IUT capable of invoking **createCall()**; **callAborted()** implemented

Preamble: Registration of the IUT (application) and the tester (Call Control SCF) to the framework. The IUT must have obtained a reference to an instance of the IpMultiPartyCallControlManager interface through selecting that service and signing the required service agreement.

Test Sequence:

1. Triggered Action: cause IUT to call **setCallback()** method on the tester's (SCF's) IpMultiPartyCallControlManager interface.
Parameters: valid, non NULL, value of appInterface
2. Triggered Action: cause IUT to call **createCall()** method on the tester's (SCF's) IpMultiPartyCallControlManager interface.
Parameters: appCall
3. Method call **callAborted()**
Parameters: callReference
Check: no exception is returned

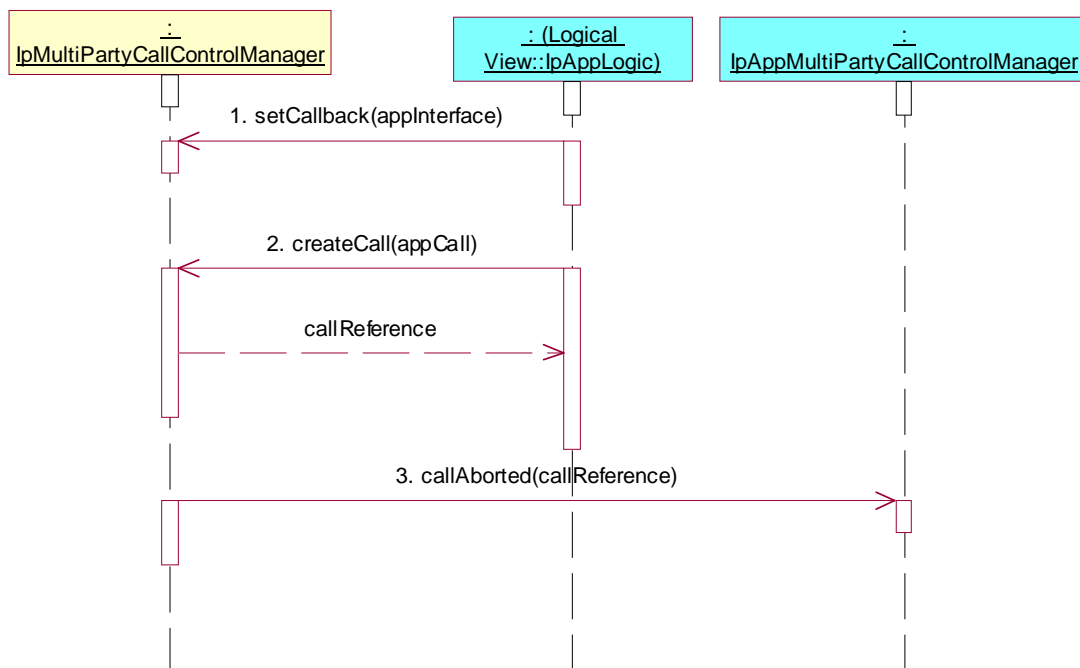

Test MPCC_IpAppMultiPartyCallControlManager_03

Summary: enable and accept call notifications

Reference: ES 201 915-4 [1], clauses 7.3.1 and 7.3.2

Precondition: IUT capable of invoking **createNotification()**, **reportNotification()** implemented

Preamble: Registration of the IUT (application) and the tester (Call Control SCF) to the framework. The IUT must have obtained a reference to an instance of the IpMultiPartyCallControlManager interface through selecting that service and signing the required service agreement.

The application is permitted to provide its IpAppMultiPartyCallControlManager interface reference in a setCallback() method which it calls prior to invoking further methods.

Test Sequence:

1. Triggered Action: cause IUT to call **createNotification()** method on the tester's (SCF's) IpMultiPartyCallControlManager interface.
Parameters: appCallControlManager, notificationRequest
2. Method call **reportNotification()**
Parameters: callReference, callLegReferenceSet, notificationInfo, assignmentID
Check: valid value of TpAppMultiPartyCallBack is returned

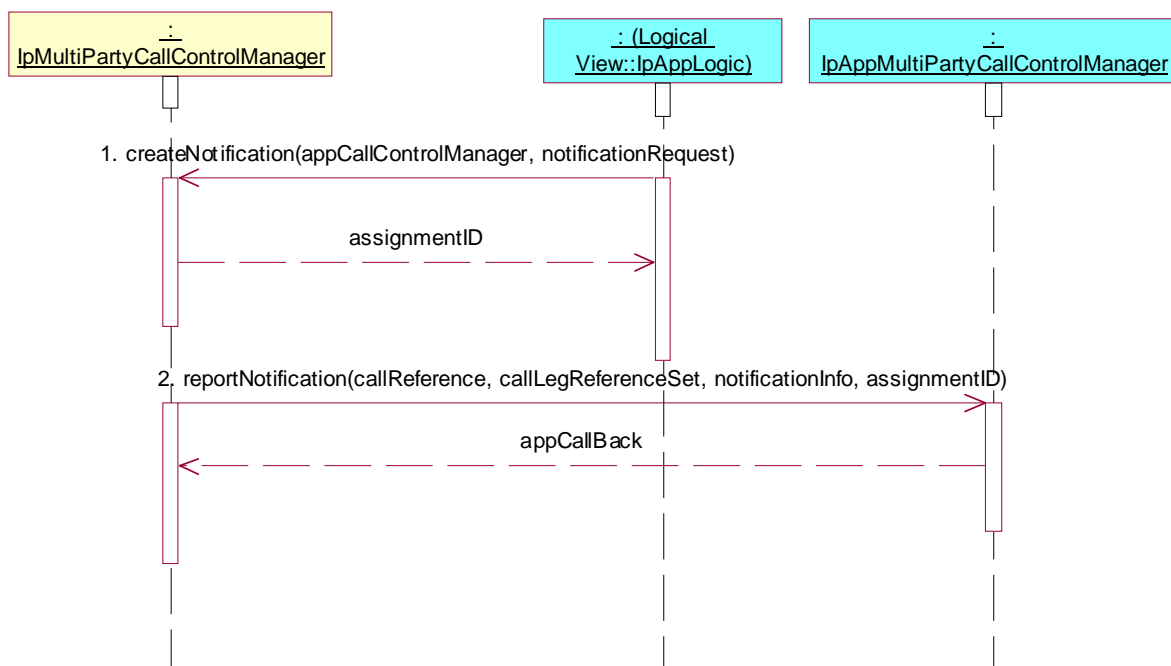

Test MPCC_IpAppMultiPartyCallControlManager_04

Summary: interrupt and continue call notifications

Reference: ES 201 915-4 [1], clauses 7.3.1 and 7.3.2

Precondition: IUT capable of invoking **createNotification()**, **managerInterrupted()**, **managerContinued()** and **reportNotification()** implemented

Preamble: Registration of the IUT (application) and the tester (Call Control SCF) to the framework. The IUT must have obtained a reference to an instance of the IpMultiPartyCallControlManager interface through selecting that service and signing the required service agreement.

The application is permitted to provide its IpAppMultiPartyCallControlManager interface reference in a setCallback() method which it calls prior to invoking further methods.

Test Sequence:

1. Triggered Action: cause IUT to call **createNotification()** method on the tester's (SCF's) IpMultiPartyCallControlManager interface.
Parameters: appCallControlManager, notificationRequest

Delay between createNotification and managerInterrupted

2. Method call **managerInterrupted()**
Parameters: none
Check: no exception is returned

Delay between managerInterrupted and managerContinued

3. Method call **managerContinued()**
Parameters: none
Check: no exception is returned

4. Method call **reportNotification()**
Parameters: callReference, callLegReferenceSet, notificationInfo, assignmentID
Check: valid value of TpAppMultiPartyCallBack is returned

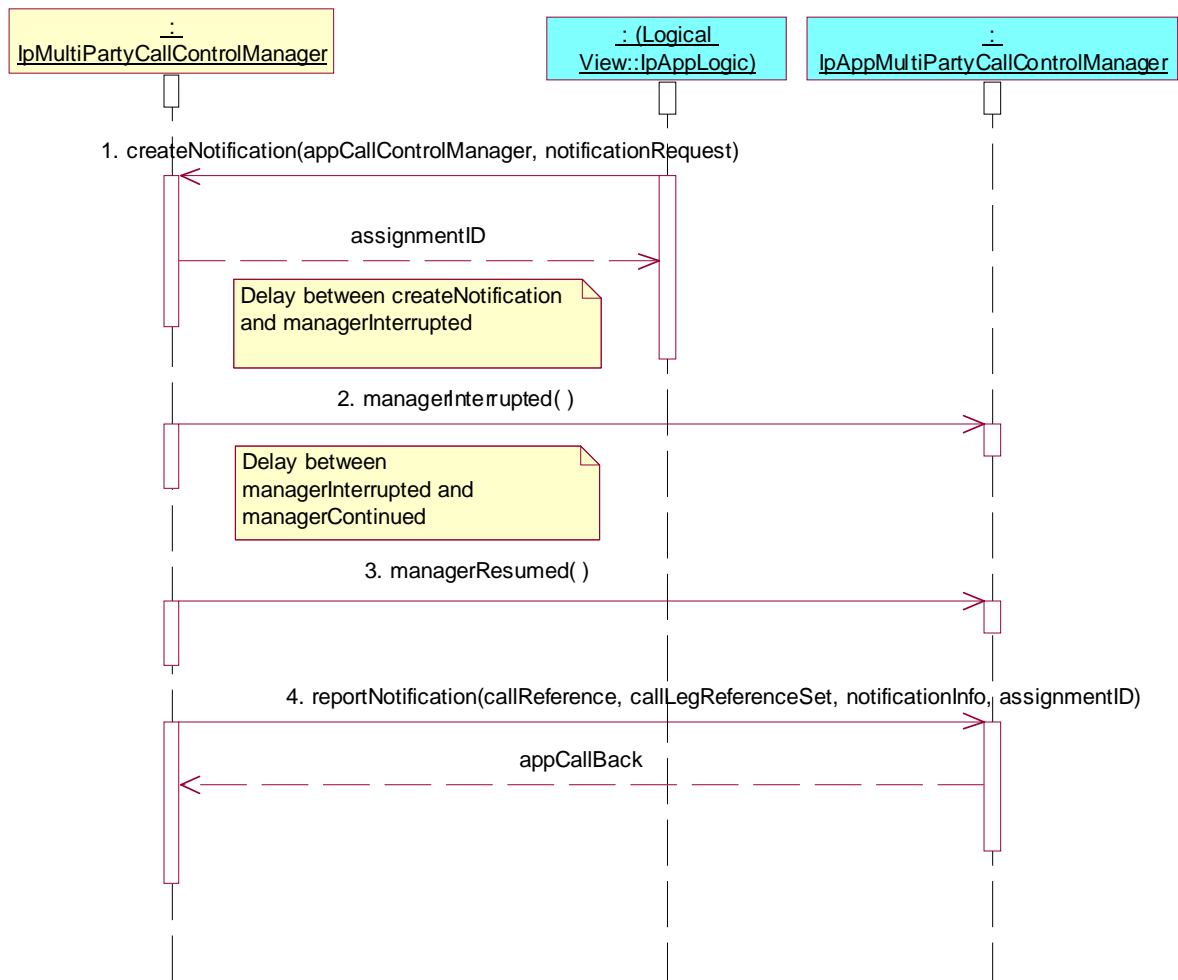

Test MPCC_IpAppMultiPartyCallControlManager_05

Summary: enable and change call notifications

Reference: ES 201 915-4 [1], clauses 7.3.1 and 7.3.2

Precondition: IUT capable of invoking **createNotification()** and **changeNotification()**, **reportNotification()** implemented

Preamble: Registration of the IUT (application) and the tester (Call Control SCF) to the framework. The IUT must have obtained a reference to an instance of the IpMultiPartyCallControlManager interface through selecting that service and signing the required service agreement.

The application is permitted to provide its IpAppMultiPartyCallControlManager interface reference in a setCallback() method which it calls prior to invoking further methods.

Test Sequence:

1. Triggered Action: cause IUT to call **createNotification()** method on the tester's (SCF's) IpMultiPartyCallControlManager interface.
Parameters: appCallControlManager, notificationRequest
2. Triggered Action: cause IUT to call **changeNotification()** method on the tester's (SCF's) IpMultiPartyCallControlManager interface.
Parameters: assignmentID, notificationRequest
3. Method call **reportNotification()**
Parameters: callReference, callLegReferenceSet, notificationInfo, assignmentID
Check: valid value of TpAppMultiPartyCallBack is returned

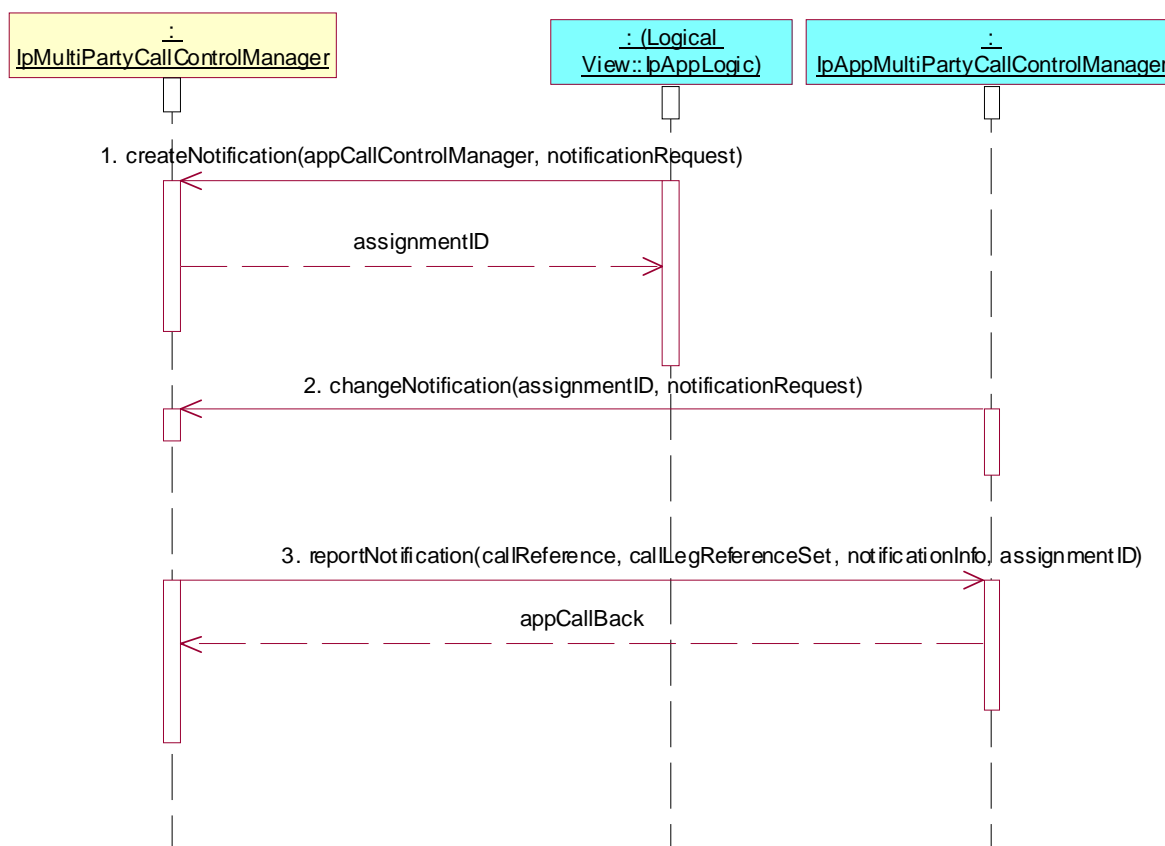

Test MPCC_IpAppMultiPartyCallControlManager_06

Summary: enable and destroy call notifications

Reference: ES 201 915-4 [1], clauses 7.3.1 and 7.3.2

Precondition: IUT capable of invoking **createNotification()** and **destroyNotification()**

Preamble: Registration of the IUT (application) and the tester (Call Control SCF) to the framework. The IUT must have obtained a reference to an instance of the IpMultiPartyCallControlManager interface through selecting that service and signing the required service agreement.

The application is permitted to provide its IpAppMultiPartyCallControlManager interface reference in a setCallback() method which it calls prior to invoking further methods.

Test Sequence:

1. Triggered Action: cause IUT to call **createNotification()** method on the tester's (SCF's) IpMultiPartyCallControlManager interface.
Parameters: appCallControlManager, notificationRequest
2. Triggered Action: cause IUT to call **destroyNotification()** method on the tester's (SCF's) IpMultiPartyCallControlManager interface.
Parameters: assignmentID

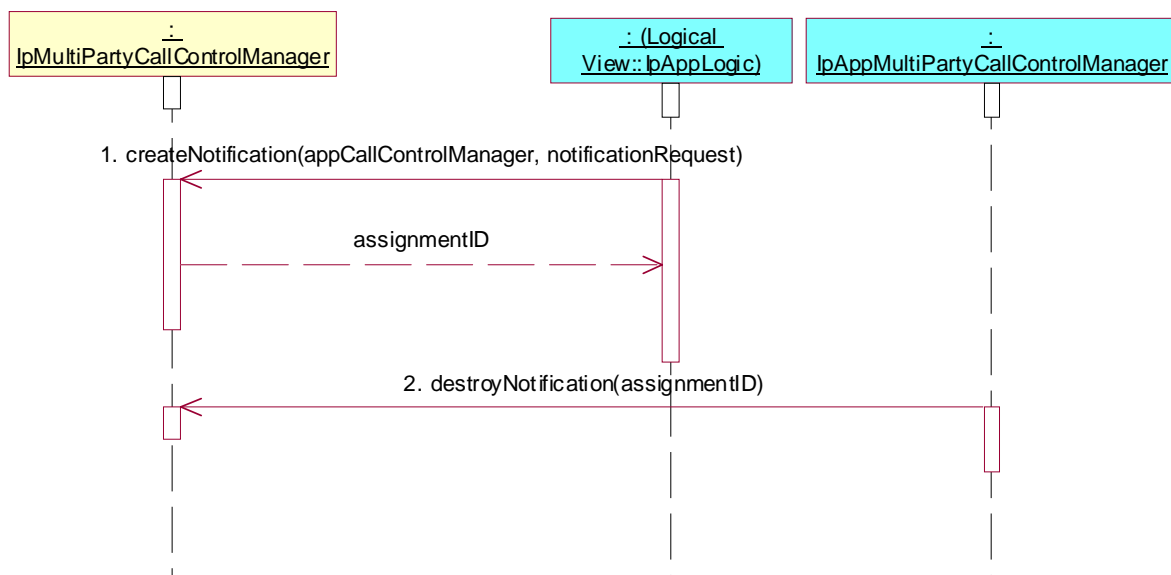

Test MPCC_IpAppMultiPartyCallControlManager_07

Summary: enable call notifications and get criteria

Reference: ES 201 915-4 [1], clauses 7.3.1 and 7.3.2

Precondition: IUT capable of invoking **createNotification()** and **getNotification()**

Preamble: Registration of the IUT (application) and the tester (Call Control SCF) to the framework. The IUT must have obtained a reference to an instance of the IpMultiPartyCallControlManager interface through selecting that service and signing the required service agreement.

The application is permitted to provide its IpAppMultiPartyCallControlManager interface reference in a setCallback() method which it calls prior to invoking further methods.

Test Sequence:

1. Triggered Action: cause IUT to call **createNotification()** method on the tester's (SCF's) IpMultiPartyCallControlManager interface.
Parameters: appCallControlManager, notificationRequest
2. Triggered Action: cause IUT to call **getNotification()** method on the tester's (SCF's) IpMultiPartyCallControlManager interface.
Parameters: none

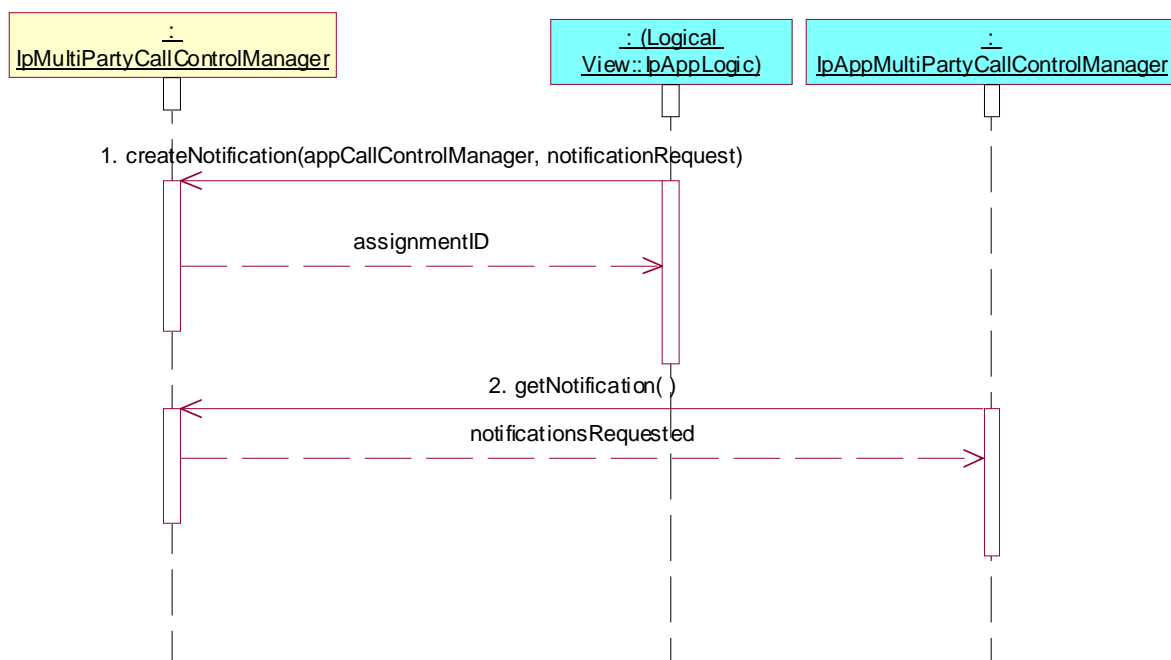

Test MPCC_IpAppMultiPartyCallControlManager_08

Summary: enable load control and accept overload notifications

Reference: ES 201 915-4 [1], clauses 7.3.1 and 7.3.2

Precondition: IUT capable of invoking **setCallLoadControl()**, **callOverloadEncountered()** and **callOverloadCeased()** implemented

Preamble: Registration of the IUT (application) and the tester (Call Control SCF) to the framework. The IUT must have obtained a reference to an instance of the IpMultiPartyCallControlManager interface through selecting that service and signing the required service agreement.

The application is permitted to provide its IpAppMultiPartyCallControlManager interface reference in a setCallback() method which it calls prior to invoking further methods.

Test Sequence:

1. Triggered Action: cause IUT to call **createNotification()** method on the tester's (SCF's) IpMultiPartyCallControlManager interface.
Parameters: appCallControlManager, notificationRequest
2. Triggered Action: cause IUT to call **setCallLoadControl()** method on the tester's (SCF's) IpMultiPartyCallControlManager interface.
Parameters: duration, mechanism, treatment, addressRange

Delay between setCallLoadControl and callOverloadEncountered

3. Method call **callOverloadEncountered()**
Parameters: assignmentID
Check: no exception is returned

Delay between callOverloadEncountered and callOverloadCeased

4. Method call **callOverloadCeased()**
Parameters: assignmentID
Check: no exception is returned

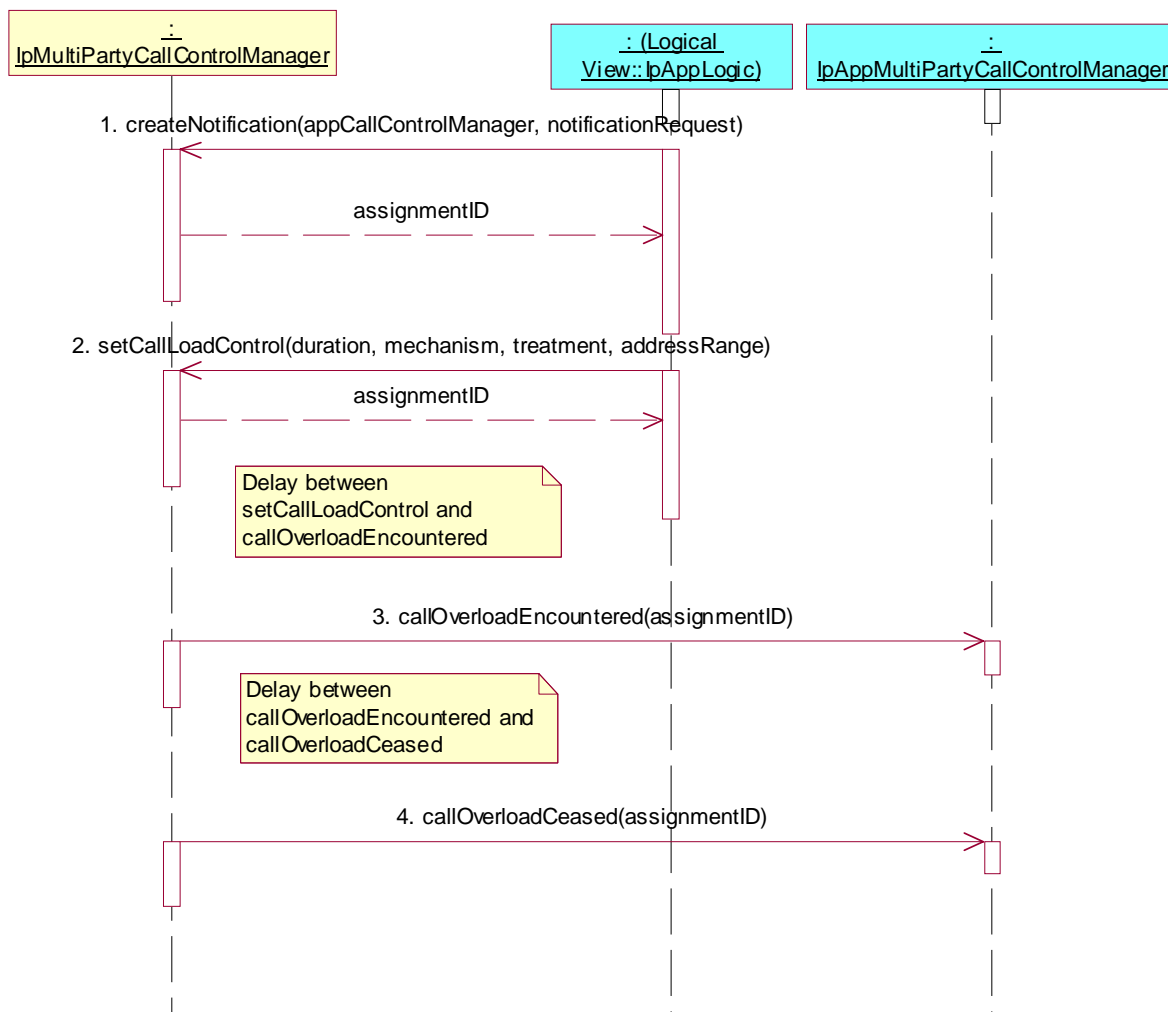

7.2.2.2 IpAppMultiPartyCall

Applications need not be capable of performing each of the sequences below, even if they support the methods indicated below.

Reference: ES 201 915-4 [1], clause 7.4.2

7.2.2.2.1 Idle state

Precondition: IUT capable of invoking `createCall()`

Preamble MPCC_IpAppMultiPartyCall_Idle

Reference: ES 201 915-4 [1], clause 7.4.2.1

Pre-preamble: Registration of the IUT (application) and the tester (Call Control SCF) to the framework. The IUT must have obtained a reference to an instance of the `IpMultiPartyCallControlManager` interface through selecting that service and signing the required service agreement.

The application is permitted to provide its `IpAppMultiPartyCallControlManager` interface reference in a `setCallback()` method which it calls prior to invoking further methods.

Preamble Sequence:

1. Triggered Action: cause IUT to call **createCall()** method on the tester's (SCF's) IpMultiPartyCallControlManager interface.
Parameters: appCall

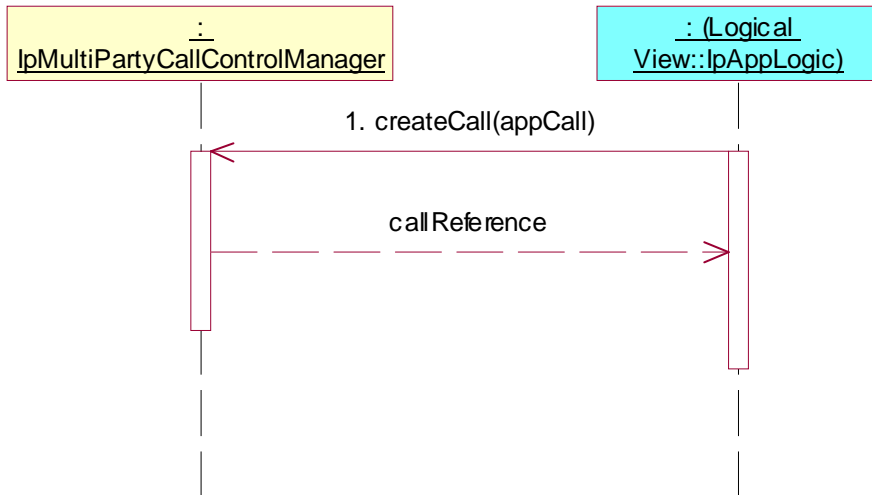

Test MPCC_IpAppMultiPartyCall_01

Summary: create call leg

Reference: ES 201 915-4 [1], clause 7.4.2.1

Precondition: IUT capable of invoking **createCallLeg()**

Preamble: **MPCC_IpAppMultiPartyCall_Idle**

Test Sequence:

1. Triggered Action: cause IUT to call **createCallLeg()** method on the tester's (SCF's) IpMultiPartyCall interface.
Parameters: callSessionID, appCallLeg

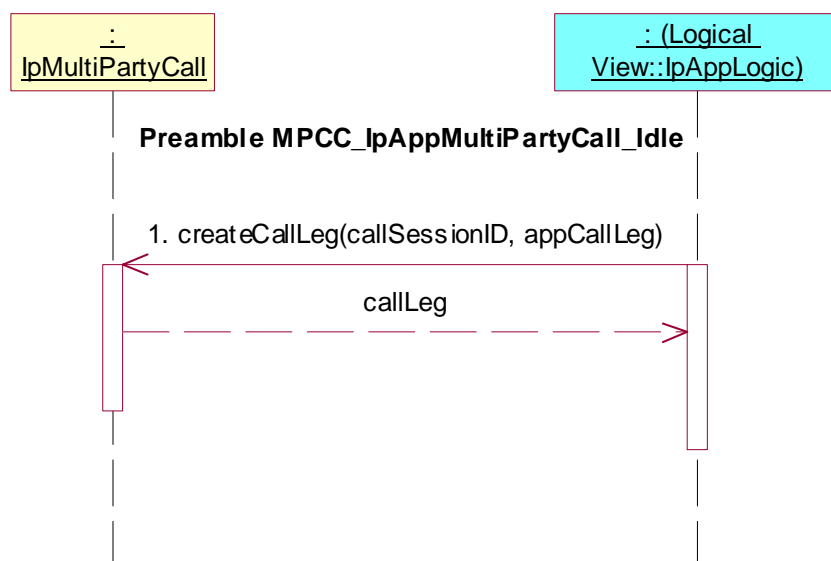

Test MPCC_IpAppMultiPartyCall_02

Summary: create and route call leg, unsuccessful

Reference: ES 201 915-4 [1], clause 7.4.2.1

Precondition: IUT capable of invoking **createAndRouteCallLegReq()**

Preamble: **MPCC_IpAppMultiPartyCall_Idle**

Test Sequence:

1. Triggered Action: cause IUT to call **createAndRouteCallLegReq()** method on the tester's (SCF's) IpMultiPartyCall interface.
Parameters: callSessionID, eventsRequested, targetAddress, originatingAddress, appInfo, appLegInterface
2. Method call **createAndRouteCallLegErr()**
Parameters: callSessionID, appCallLegReference, errorIndication
Check: no exception is returned

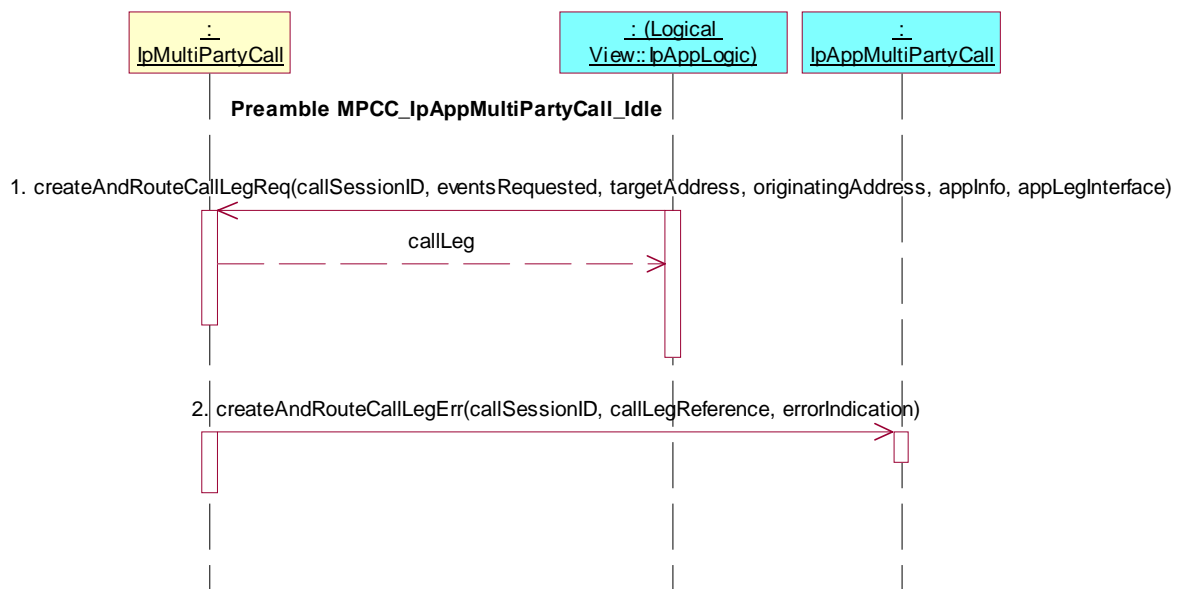

Test MPCC_IpAppMultiPartyCall_03

Summary: supervise call

Reference: ES 201 915-4 [1], clause 7.4.2.1

Precondition: IUT capable of invoking **superviseReq()**

Preamble: **MPCC_IpAppMultiPartyCall_Idle**

Test Sequence:

1. Triggered Action: cause IUT to call **superviseReq()** method on the tester's (SCF's) IpMultiPartyCall interface.
Parameters: callSessionID, time, treatment

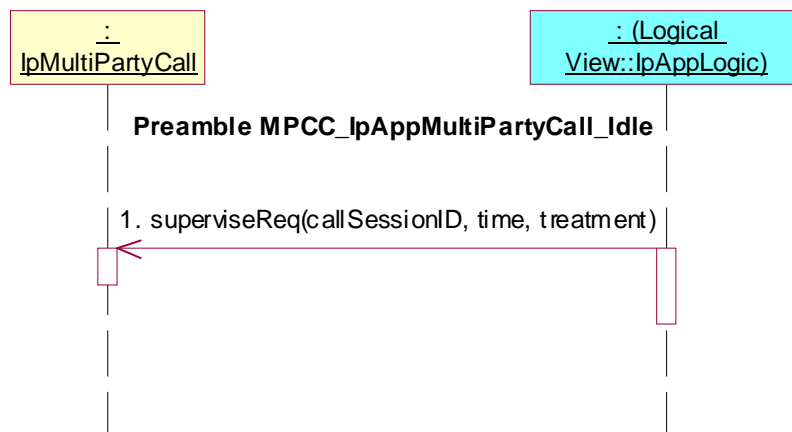
**Test MPCC_IpAppMultiPartyCall_04**

Summary: request call information

Reference: ES 201 915-4 [1], clause 7.4.2.1

Precondition: IUT capable of invoking **getInfoReq()**

Preamble: **MPCC_IpAppMultiPartyCall_Idle**

Test Sequence:

1. Triggered Action: cause IUT to call **getInfoReq()** method on the tester's (SCF's) IpMultiPartyCall interface.
Parameters: callSessionID, callInfoRequested

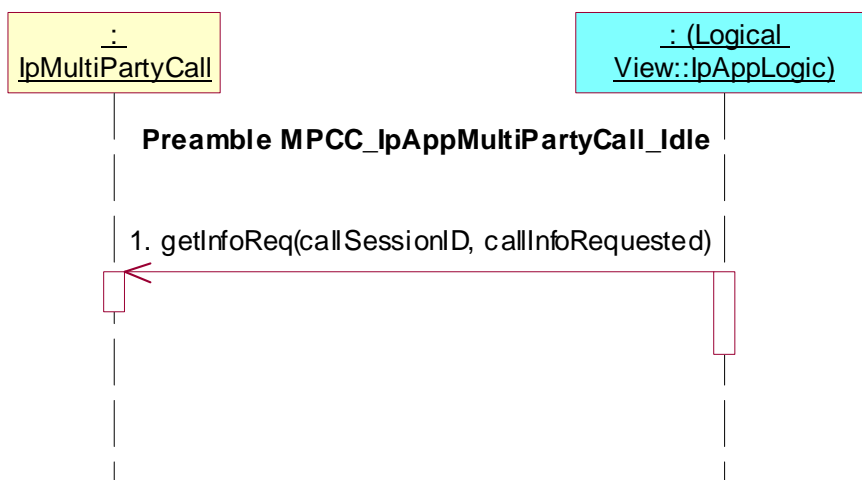

Test MPCC_IpAppMultiPartyCall_05

Summary: request call information, unsuccessful

Reference: ES 201 915-4 [1], clause 7.4.2.1

Precondition: IUT capable of invoking **getInfoReq()**

Preamble: **MPCC_IpAppMultiPartyCall_Idle**

Test Sequence:

1. Triggered Action: cause IUT to call **getInfoReq()** method on the tester's (SCF's) IpMultiPartyCall interface.
Parameters: callSessionID, callInfoRequested
2. Method call **getInfoErr()**
Parameters: callSessionID, errorIndication
Check: no exception is returned

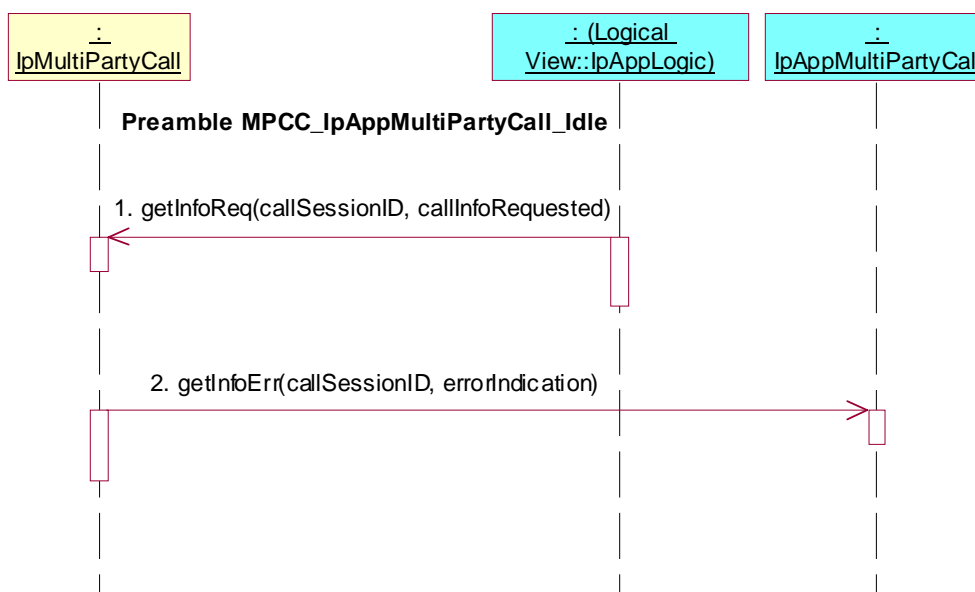

Test MPCC_IpAppMultiPartyCall_06

Summary: set charge plan for the call

Reference: ES 201 915-4 [1], clause 7.4.2.1

Precondition: IUT capable of invoking **setChargePlan()**

Preamble: **MPCC_IpAppMultiPartyCall_Idle**

Test Sequence:

1. Triggered Action: cause IUT to call **setChargePlan()** method on the tester's (SCF's) IpMultiPartyCall interface.
Parameters: callSessionID, callChargePlan

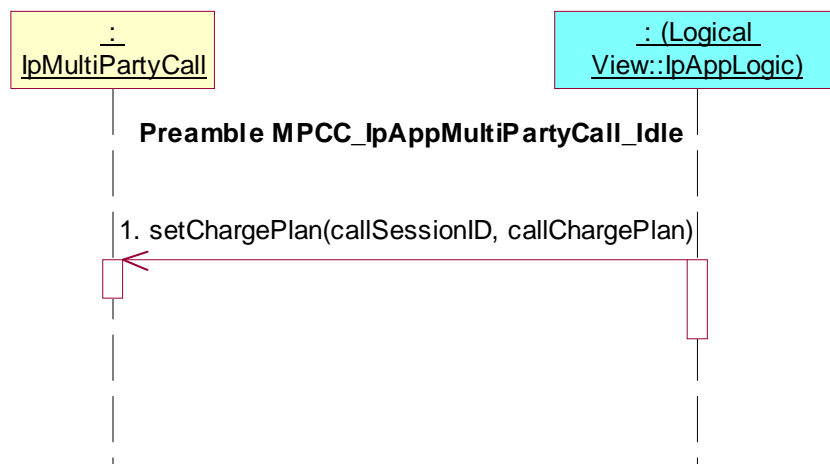
**Test MPCC_IpAppMultiPartyCall_07**

Summary: allow advice of charge information

Reference: ES 201 915-4 [1], clause 7.4.2.1

Precondition: IUT capable of invoking **setAdviceOfCharge()**

Preamble: **MPCC_IpAppMultiPartyCall_Idle**

Test Sequence:

1. Triggered Action: cause IUT to call **setAdviceOfCharge()** method on the tester's (SCF's) IpMultiPartyCall interface.
Parameters: callSessionID, aOCInfo, tariffSwitch

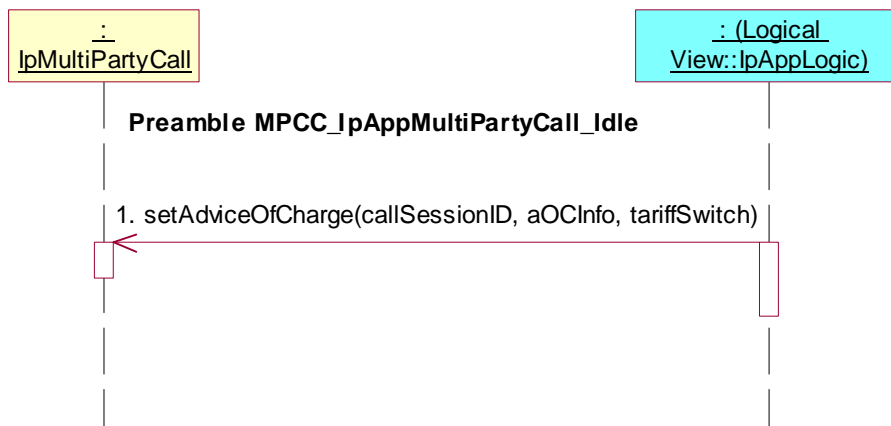

7.2.2.2.2 Active state

Precondition: IUT capable of invoking **createCall()** and **createCallLeg()**

or IUT capable of invoking **createCall()** and **createAndRouteCallLegReq()**

or IUT capable of invoking **createNotification()**

Preamble MPCC_IpAppMultiPartyCall_Active

Reference: ES 201 915-4 [1], clause 7.4.2.2

Pre-preamble: Registration of the IUT (application) and the tester (Call Control SCF) to the framework. The IUT must have obtained a reference to an instance of the IpMultiPartyCallControlManager interface through selecting that service and signing the required service agreement.

The application is permitted to provide its IpAppMultiPartyCallControlManager interface reference in a setCallback() method which it calls prior to invoking further methods.

Preamble Sequence:

1. Triggered Action: cause IUT to call **createCall()** method on the tester's (SCF's) IpMultiPartyCallControlManager interface.
Parameters: appCall
2. Triggered Action: cause IUT to call **createCallLeg()** method on the tester's (SCF's) IpMultiPartyCall interface.
Parameters: callSessionID, appCallLeg

or

1. Triggered Action: cause IUT to call **createCall()** method on the tester's (SCF's) IpMultiPartyCallControlManager interface.
Parameters: appCall
2. Triggered Action: cause IUT to call **createAndRouteCallLegReq()** method on the tester's (SCF's) IpMultiPartyCall interface.
Parameters: callSessionID, eventsRequested, targetAddress, originatingAddress, appInfo, appLegInterface

or

1. Triggered Action: cause IUT to call **createNotification()** method on the tester's (SCF's) IpMultiPartyCallControlManager interface.
Parameters: appCallControlManager, notificationRequest
notificationRequest.CallMonitorMode= P_CALL_MONITOR_MODE_INTERRUPT
2. Method call **reportNotification()**
Parameters: callReference, callLegReferenceSet, notificationInfo, assignmentID
Check: valid value of TpAppMultiPartyCallBack is returned

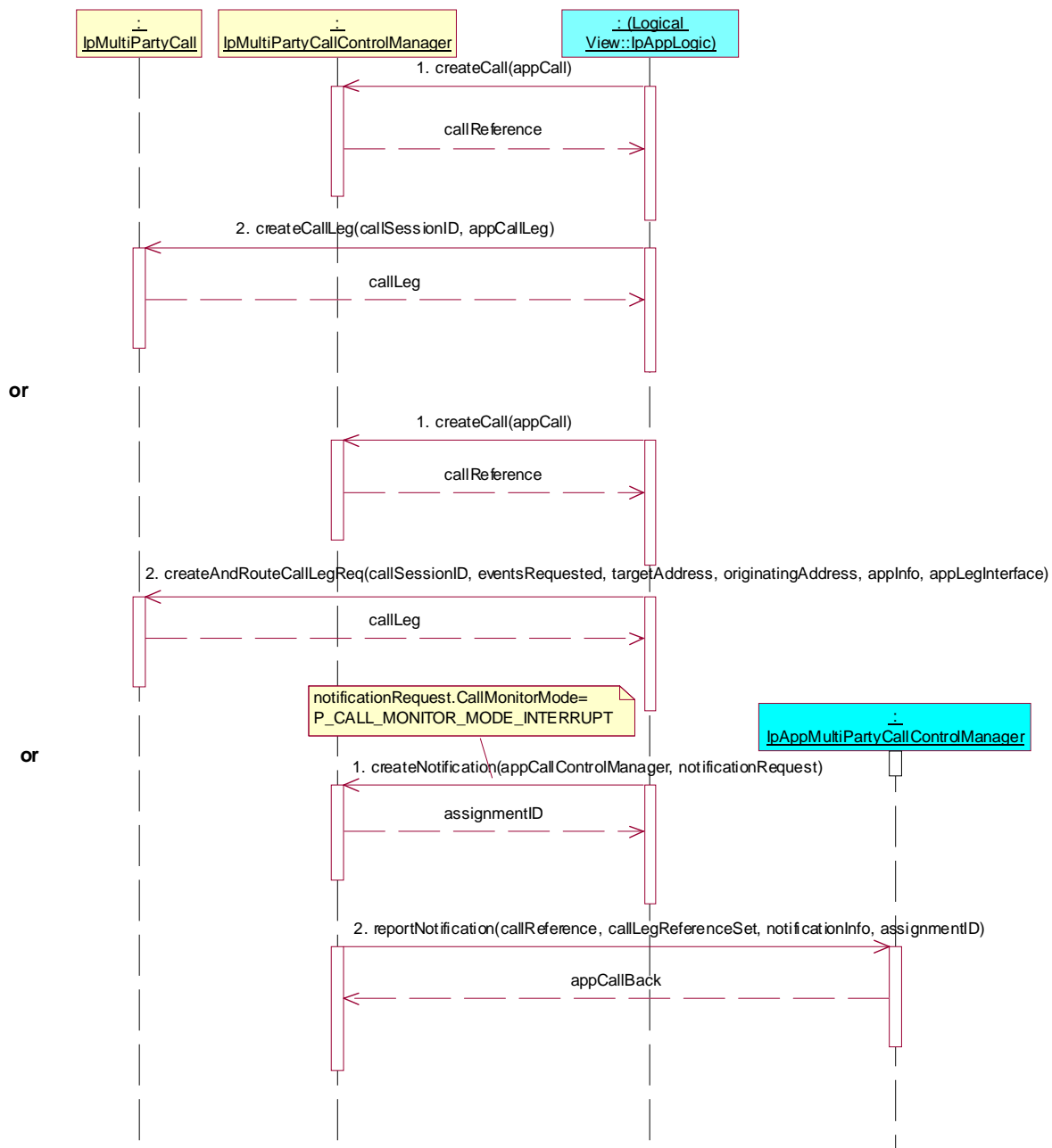

Test MPCC_IpAppMultiPartyCall_08

Summary: create call leg

Reference: ES 201 915-4 [1], clause 7.4.2.2

Precondition: IUT capable of invoking **createCallLeg()**

Preamble: **MPCC_IpAppMultiPartyCall_Active**

Test Sequence:

1. Triggered Action: cause IUT to call **createCallLeg()** method on the tester's (SCF's) IpMultiPartyCall interface.
Parameters: callSessionID, appCallLeg

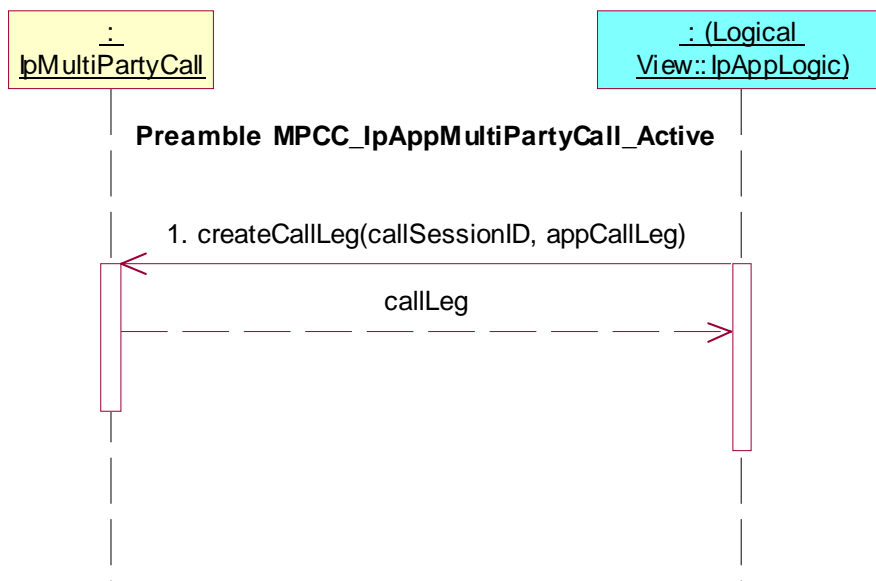

Test MPCC_IpAppMultiPartyCall_09

Summary: create and route call leg, unsuccessful

Reference: ES 201 915-4 [1], clause 7.4.2.2

Precondition: IUT capable of invoking **createAndRouteCallLegReq()**

Preamble: **MPCC_IpAppMultiPartyCall_Active**

Test Sequence:

1. Triggered Action: cause IUT to call **createAndRouteCallLegReq()** method on the tester's (SCF's) IpMultiPartyCall interface.
Parameters: callSessionID, eventsRequested, targetAddress, originatingAddress, appInfo, appLegInterface
2. Method call **createAndRouteCallLegErr()**
Parameters: callSessionID, appCallLegReference, errorIndication
Check: no exception is returned

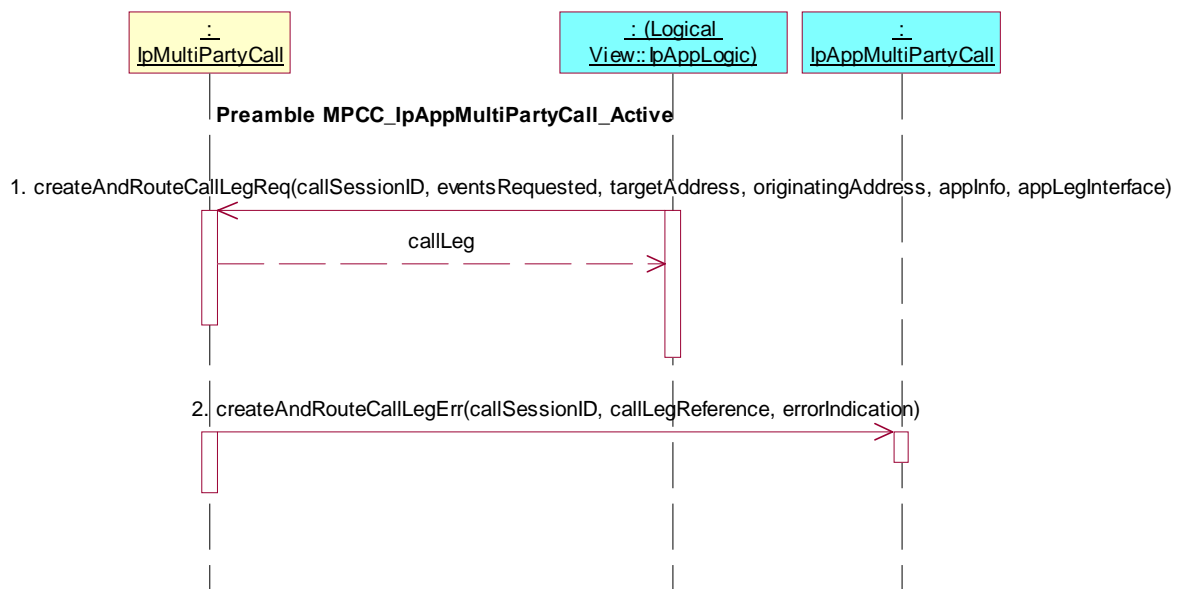

Test MPCC_IpAppMultiPartyCall_10

Summary: supervise call, successful

Reference: ES 201 915-4 [1], clause 7.4.2.2

Precondition: IUT capable of invoking **superviseReq()**

Preamble: **MPCC_IpAppMultiPartyCall_Active**

Test Sequence:

1. Triggered Action: cause IUT to call **superviseReq()** method on the tester's (SCF's) IpMultiPartyCall interface.
Parameters: callSessionID, time, treatment

NOTE: Between these two method sequences, the IUT may need to be triggered to complete establishment of the call to both parties, in order to justify the Tester's calling of a superviseRes() method.

2. Method call **superviseRes()**
Parameters: callSessionID, report, usedTime
Check: no exception is returned

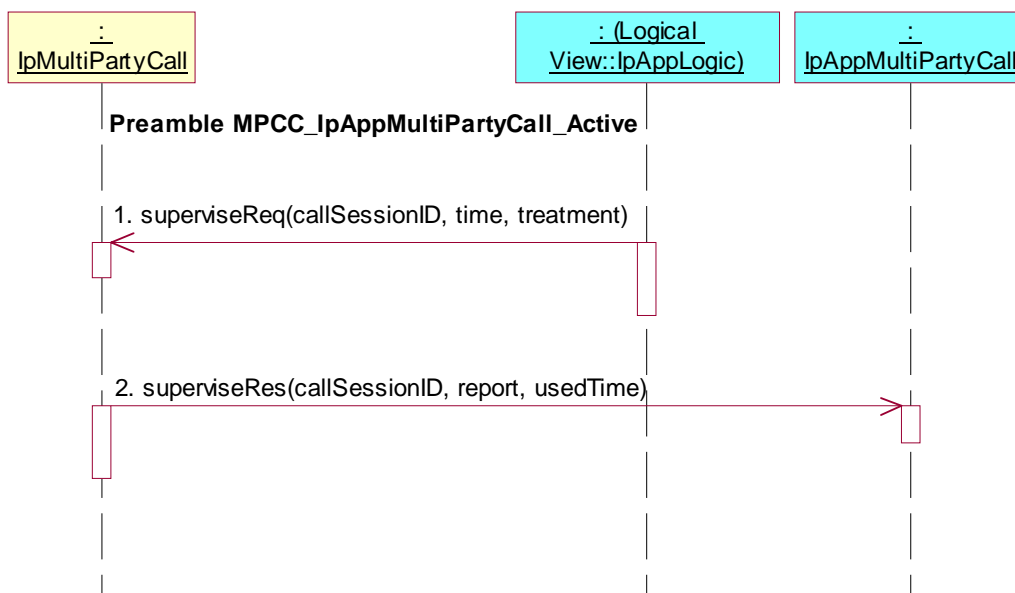

Test MPCC_IpAppMultiPartyCall_11

Summary: supervise call, unsuccessful

Reference: ES 201 915-4 [1], clause 7.4.2.2

Precondition: IUT capable of invoking **superviseReq()**

Preamble: **MPCC_IpAppMultiPartyCall_Active**

Test Sequence:

1. Triggered Action: cause IUT to call **superviseReq()** method on the tester's (SCF's) IpMultiPartyCall interface.
Parameters: callSessionID, time, treatment
2. Method call **superviseErr()**
Parameters: callSessionID, errorIndication
Check: no exception is returned

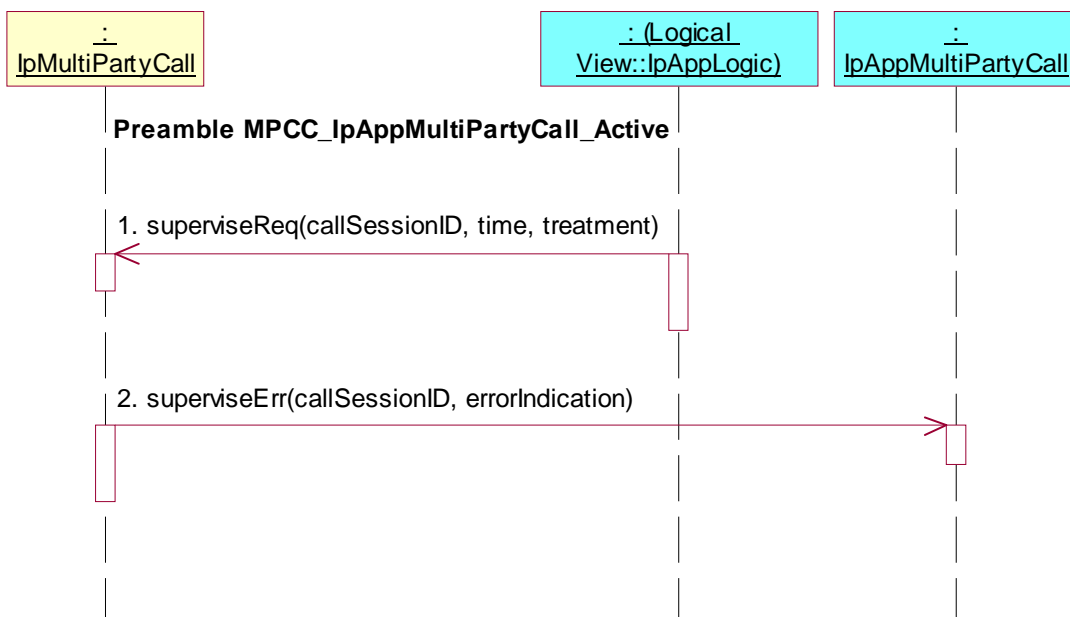

Test MPCC_IpAppMultiPartyCall_12

Summary: request call leg information

Reference: ES 201 915-4 [1], clause 7.4.2.2

Precondition: IUT capable of invoking **getCallLegs()**

Preamble: **MPCC_IpAppMultiPartyCall_Active**

Test Sequence:

1. Triggered Action: cause IUT to call **getCallLegs()** method on the tester's (SCF's) IpMultiPartyCall interface.
Parameters: callSessionID

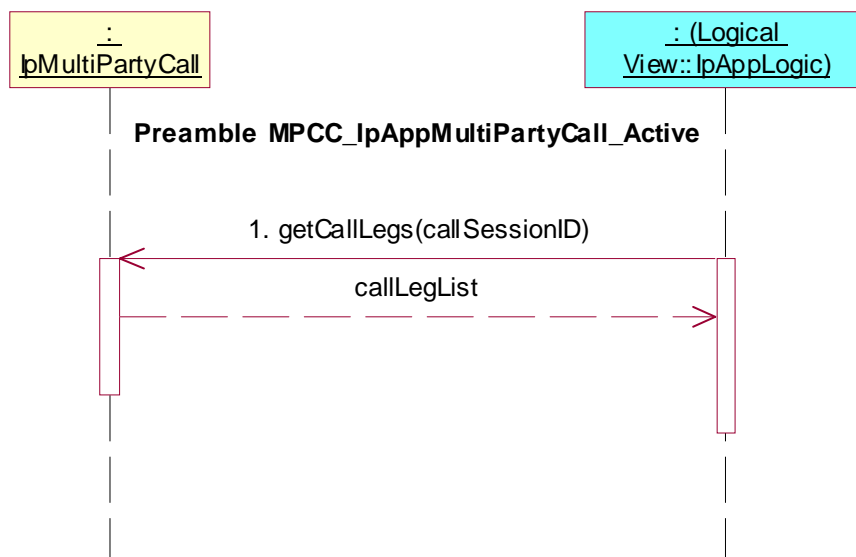

Test MPCC_IpAppMultiPartyCall_13

Summary: release call

Reference: ES 201 915-4 [1], clause 7.4.2.2

Precondition: IUT capable of invoking **release()**

Preamble: **MPCC_IpAppMultiPartyCall_Active**

Test Sequence:

1. Triggered Action: cause IUT to call **release()** method on the tester's (SCF's) IpMultiPartyCall interface.
Parameters: callSessionID, cause

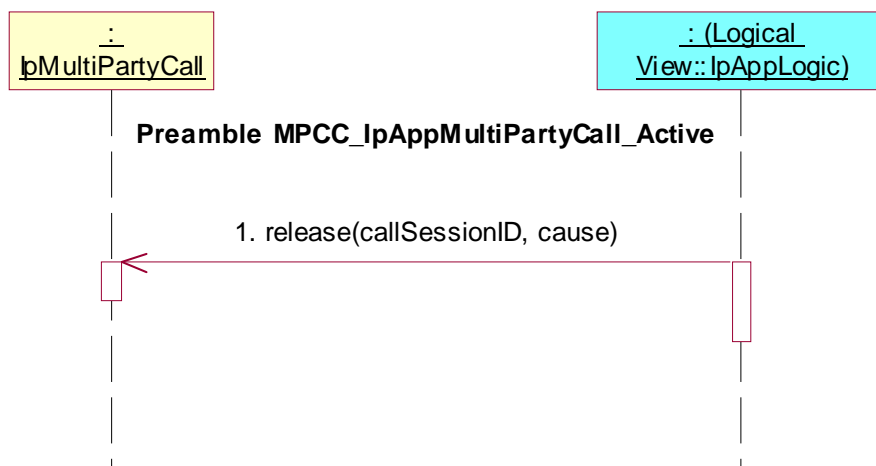
**Test MPCC_IpAppMultiPartyCall_14**

Summary: deassign call

Reference: ES 201 915-4 [1], clause 7.4.2.2

Precondition: IUT capable of invoking **deassignCall()**

Preamble: **MPCC_IpAppMultiPartyCall_Active**

Test Sequence:

1. Triggered Action: cause IUT to call **deassignCall()** method on the tester's (SCF's) IpMultiPartyCall interface.
Parameters: callSessionID

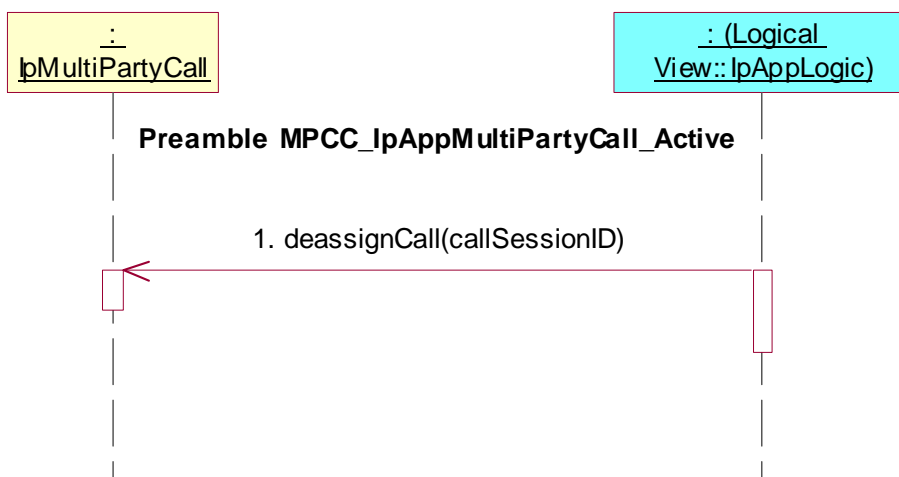

Test MPCC_IpAppMultiPartyCall_15

Summary: indication of termination of call

Reference: ES 201 915-4 [1], clause 7.4.2.2

Precondition: **callEnded()** implemented

Preamble: **MPCC_IpAppMultiPartyCall_Active**

Test Sequence:

1. Method call **callEnded()**
Parameters: callSessionID, report
Check: no exception is returned

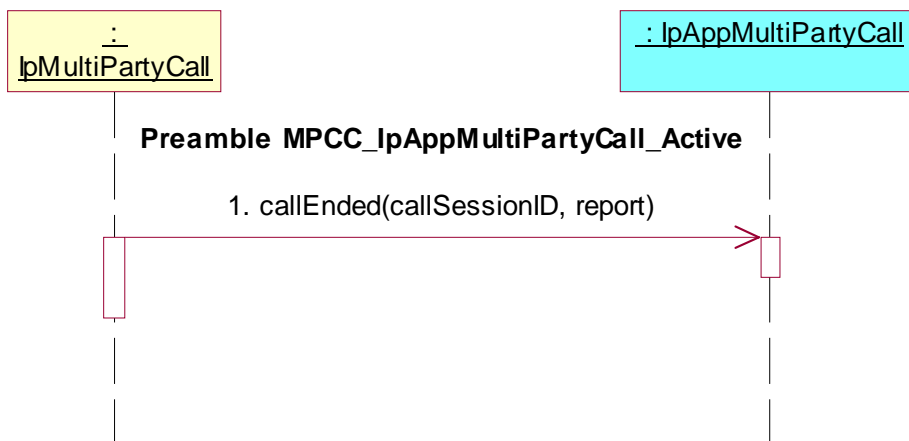

7.2.2.2.3 Released state

Precondition: IUT capable of invoking **createCall()** and **createCallLeg()**

or IUT capable of invoking **createCall()** and **createAndRouteCallLegReq()**

or IUT capable of invoking **createNotification()**

and IUT capable of invoking **release()**

Preamble MPCC_IpAppMultiPartyCall_Released

Reference: ES 201 915-4 [1], clause 7.4.2.3

Pre-preamble: **MPCC_IpAppMultiPartyCall_Active**

Preamble Sequence:

1. Triggered Action: cause IUT to call **release()** method on the tester's (SCF's) IpMultiPartyCall interface.
Parameters: callSessionID, cause

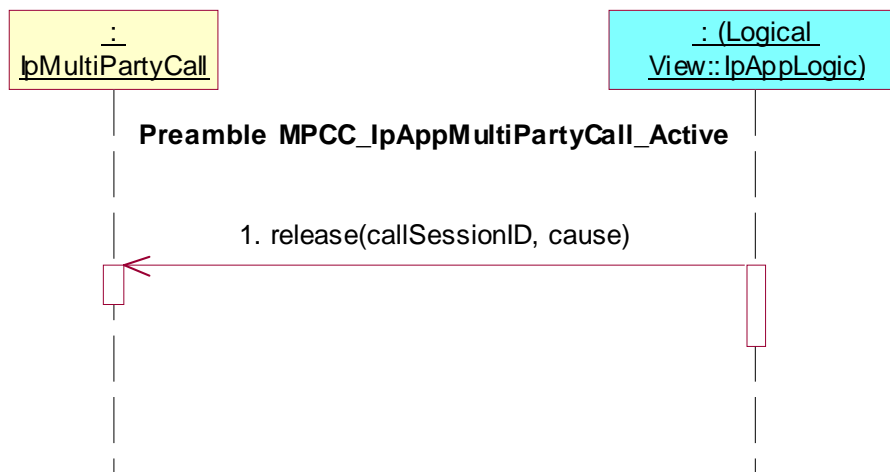

Test MPCC_IpAppMultiPartyCall_16

Summary: request call leg information

Reference: ES 201 915-4 [1], clause 7.4.2.3

Precondition: IUT capable of invoking **getCallLegs()**

Preamble: **MPCC_IpAppMultiPartyCall_Released**

Test Sequence:

1. Triggered Action: cause IUT to call **getCallLegs()** method on the tester's (SCF's) IpMultiPartyCall interface.
Parameters: callSessionID

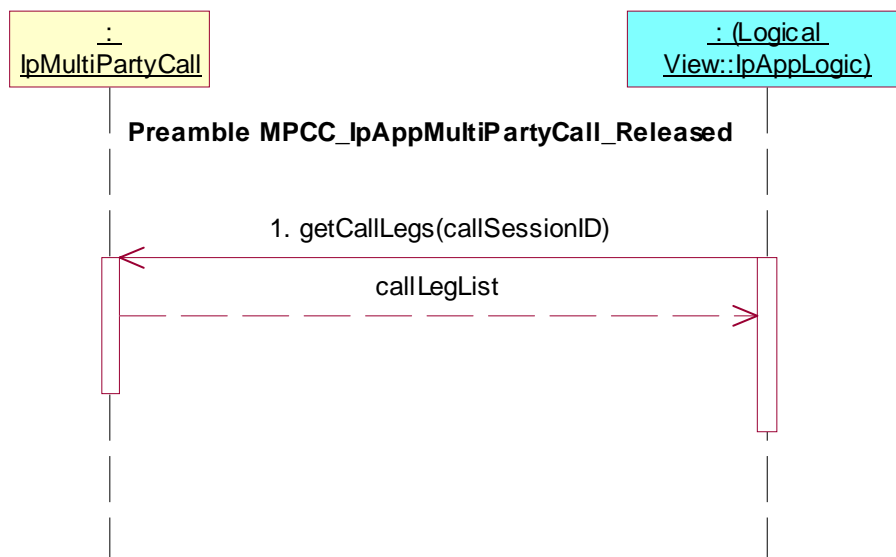

Test MPCC_IpAppMultiPartyCall_17

Summary: indication of termination of call

Reference: ES 201 915-4 [1], clause 7.4.2.3

Precondition: **callEnded()** implemented

Preamble: **MPCC_IpAppMultiPartyCall_Released**

Test Sequence:

1. Method call **callEnded()**
Parameters: callSessionID, report
Check: no exception is returned

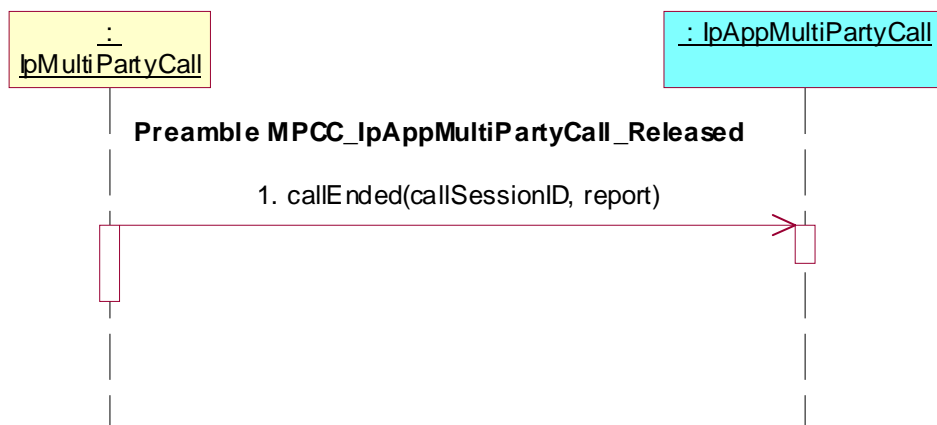
**7.2.2.3 IpAppCallLeg**

Applications need not be capable of performing each of the sequences below, even if they support the methods indicated below.

Reference: ES 201 915-4 [1], clause 7.4.3

7.2.2.3.1 Originating Leg

Reference: ES 201 915-4 [1], clause 7.4.3.1

Precondition: IUT capable of invoking **createNotification()**

7.2.2.3.1.1 Initiating state**Preamble MPCC_IpAppCallLeg_Initiating**

Reference: ES 201 915-4 [1], clause 7.4.3.1.1

Pre-preamble: Registration of the IUT (application) and the tester (Call Control SCF) to the framework. The IUT must have obtained a reference to an instance of the **IpMultiPartyCallControlManager** interface through selecting that service and signing the required service agreement.

The application is permitted to provide its **IpAppMultiPartyCallControlManager** interface reference in a **setCallback()** method which it calls prior to invoking further methods.

Preamble Sequence:

1. Triggered Action: cause IUT to call **createNotification()** method on the tester's (SCF's) IpMultiPartyCallControlManager interface.
 Parameters: appCallControlManager, notificationRequest
 notificationRequest.CallMonitorMode= P_CALL_MONITOR_MODE_INTERRUPT
 notificationRequest.CallEventType= P_CALL_EVENT_ORIGINATING_CALL_ATTEMPT
 or P_CALL_EVENT_ORIGINATING_CALL_ATTEMPT_AUTHORISED
2. Method call **reportNotification()**
 Parameters: callReference, callLegReferenceSet, notificationInfo, assignmentID
 Check: valid value of TpAppMultiPartyCallBack is returned

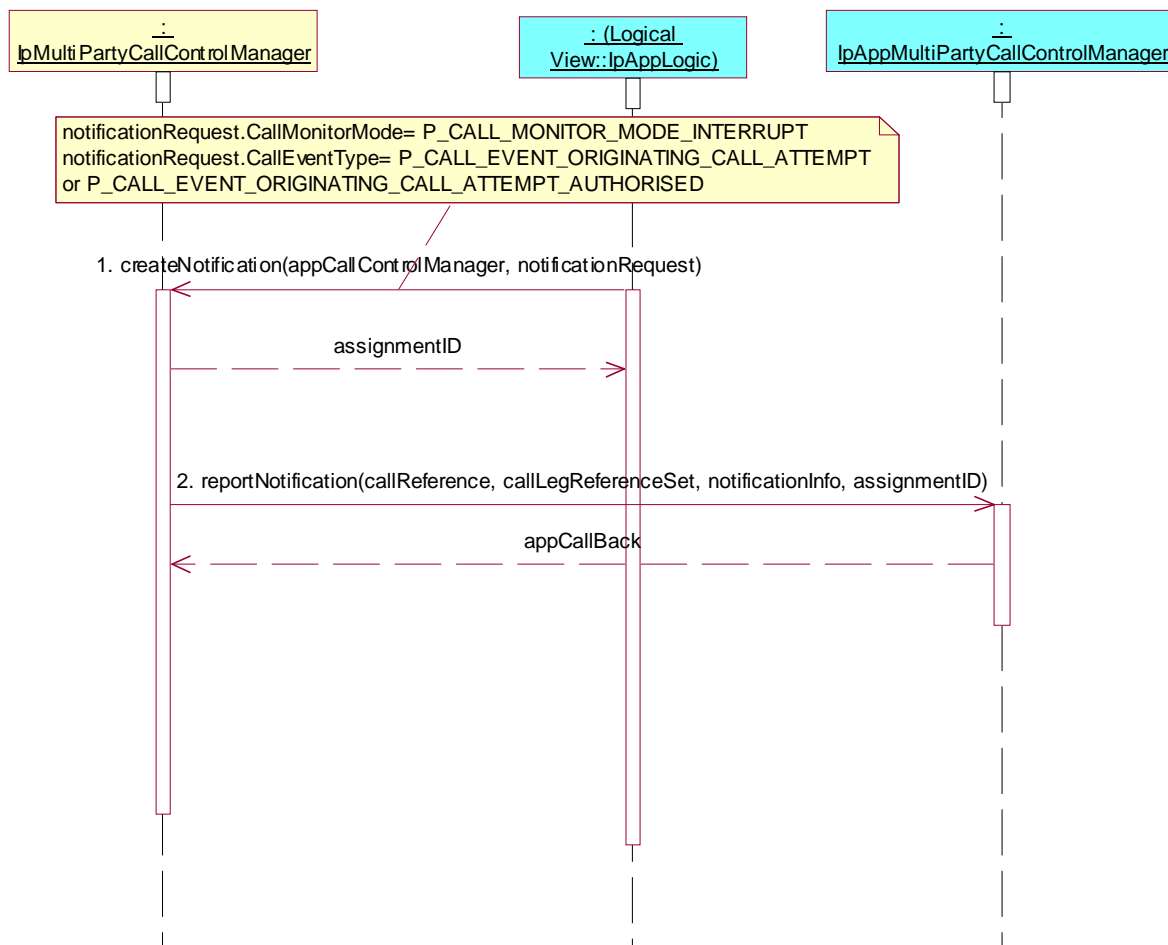

Test MPCC_IpAppCallLeg_01

Summary: request reference of call related to call leg

Reference: ES 201 915-4 [1], clause 7.4.3.1

Precondition: IUT capable of invoking **getCall()**

Preamble: **MPCC_IpAppCallLeg_Initiating**

Test Sequence:

1. Triggered Action: cause IUT to call **getCall()** method on the tester's (SCF's) IpCallLeg interface.
Parameters: callLegSessionID

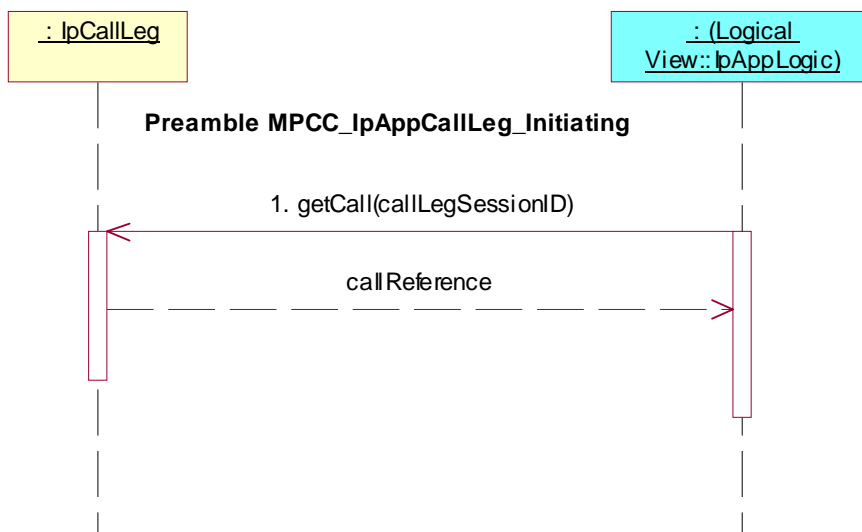
**Test MPCC_IpAppCallLeg_02**

Summary: continue processing of call leg

Reference: ES 201 915-4 [1], clause 7.4.3.1

Precondition: IUT capable of invoking **continueProcessing()**

Preamble: **MPCC_IpAppCallLeg_Initiating**

Test Sequence:

1. Triggered Action: cause IUT to call **continueProcessing()** method on the tester's (SCF's) IpCallLeg interface.
Parameters: callLegSessionID

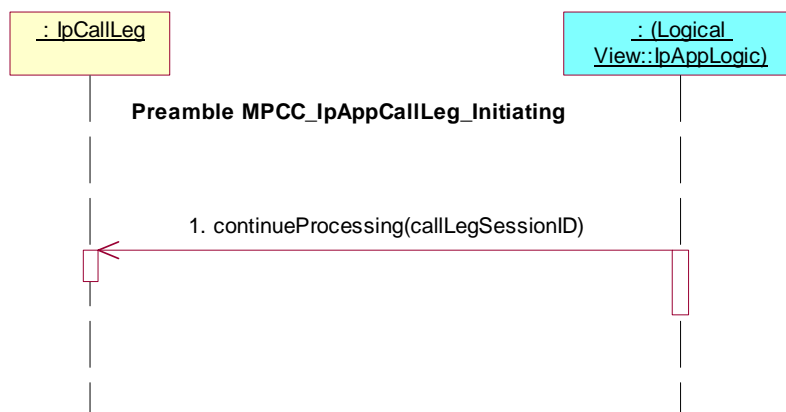

Test MPCC_IpAppCallLeg_03

Summary: release call leg

Reference: ES 201 915-4 [1], clause 7.4.3.1

Precondition: IUT capable of invoking **release()**

Preamble: **MPCC_IpAppCallLeg_Initiating**

Test Sequence:

1. Triggered Action: cause IUT to call **release()** method on the tester's (SCF's) IpCallLeg interface.
Parameters: callLegSessionID, cause

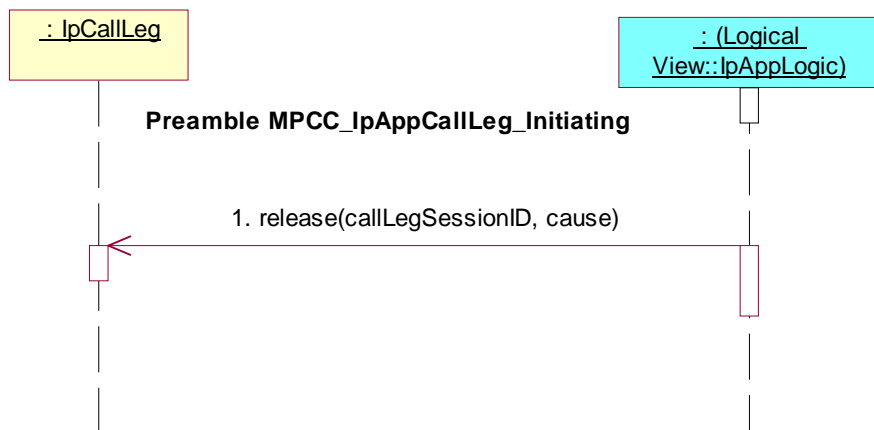
**Test MPCC_IpAppCallLeg_04**

Summary: de-assign call leg

Reference: ES 201 915-4 [1], clause 7.4.3.1

Precondition: IUT capable of invoking **deassign()**

Preamble: **MPCC_IpAppCallLeg_Initiating**

Test Sequence:

1. Triggered Action: cause IUT to call **deassign()** method on the tester's (SCF's) IpCallLeg interface.
Parameters: callLegSessionID

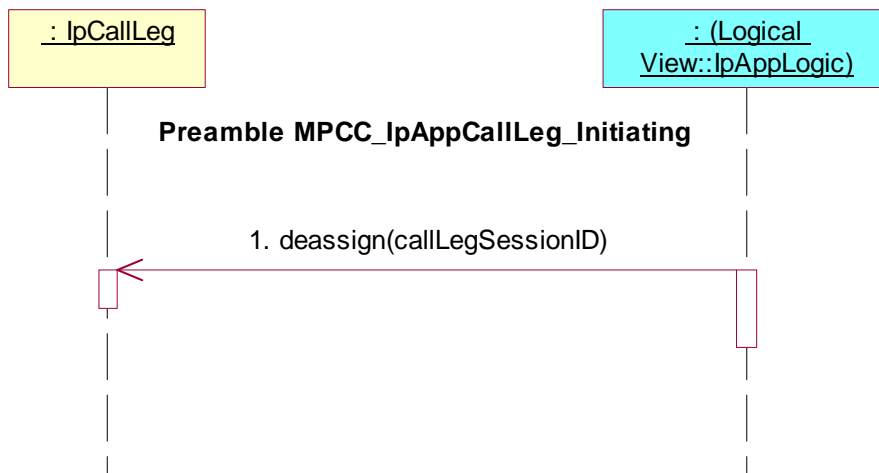

Test MPCC_IpAppCallLeg_05

Summary: change or clear event criteria

Reference: ES 201 915-4 [1], clause 7.4.3.1

Precondition: IUT capable of invoking **eventReportReq()**

Preamble: **MPCC_IpAppCallLeg_Initiating**

Test Sequence:

1. Triggered Action: cause IUT to call **eventReportReq()** method on the tester's (SCF's) IpCallLeg interface.
Parameters: callLegSessionID, eventsRequested

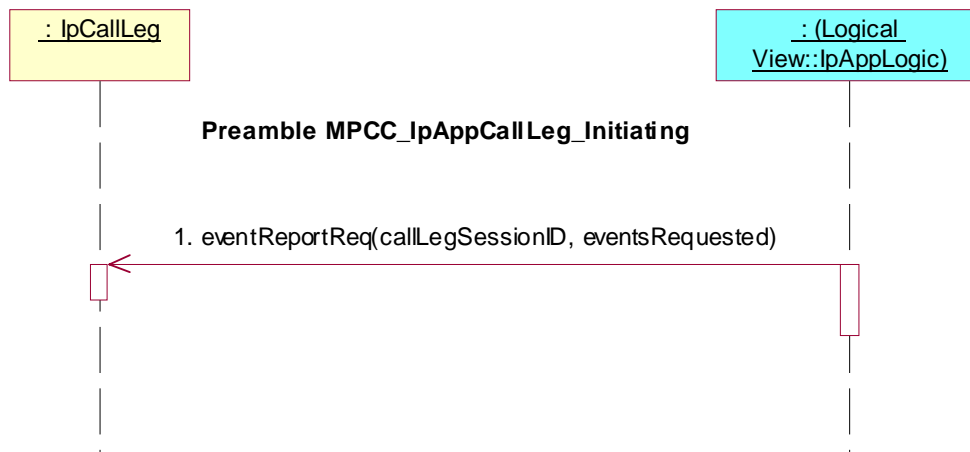

Test MPCC_IpAppCallLeg_06

Summary: change or clear event criteria, unsuccessful

Reference: ES 201 915-4 [1], clause 7.4.3.1

Precondition: IUT capable of invoking **eventReportReq()**

Preamble: **MPCC_IpAppCallLeg_Initiating**

Test Sequence:

1. Triggered Action: cause IUT to call **eventReportReq()** method on the tester's (SCF's) IpCallLeg interface.
Parameters: callLegSessionID, eventsRequested
2. Method call **eventReportErr()**
Parameters: callLegSessionID, errorIndication
Check: no exception is returned

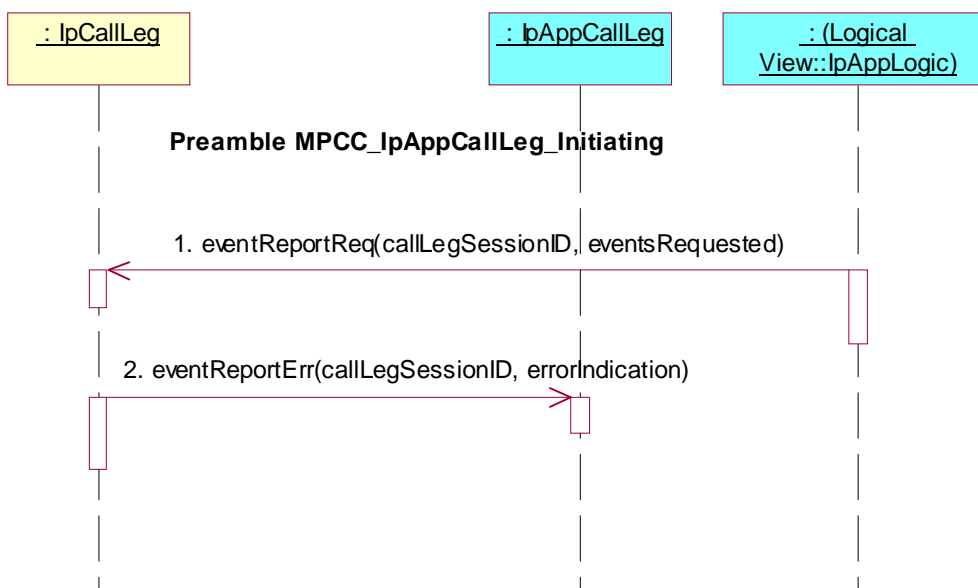

Test MPCC_IpAppCallLeg_07

Summary: get information about call leg

Reference: ES 201 915-4 [1], clause 7.4.3.1

Precondition: IUT capable of invoking **getInfoReq()**

Preamble: **MPCC_IpAppCallLeg_Initiating**

Test Sequence:

1. Triggered Action: cause IUT to call **getInfoReq()** method on the tester's (SCF's) IpCallLeg interface.
Parameters: callLegSessionID, callLegInfoRequested

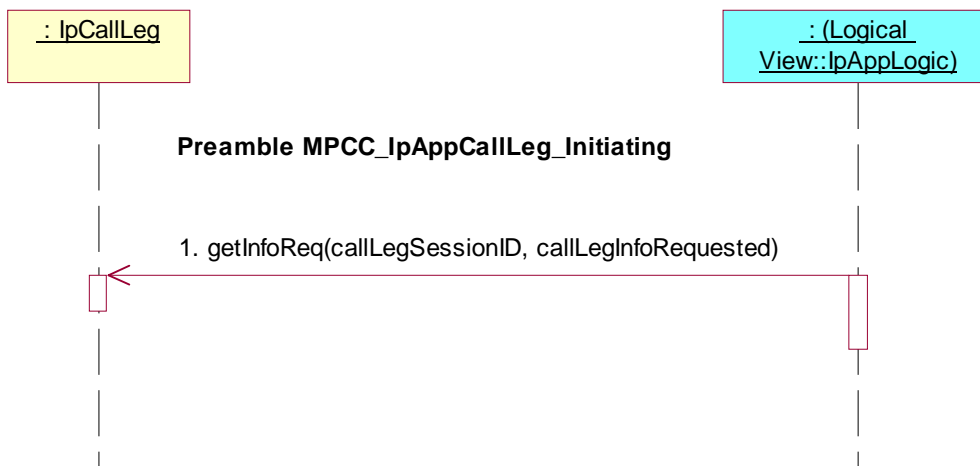

Test MPCC_IpAppCallLeg_08

Summary: get information about call leg, unsuccessful

Reference: ES 201 915-4 [1], clause 7.4.3.1

Precondition: IUT capable of invoking **getInfoReq()**

Preamble: **MPCC_IpAppCallLeg_Initiating**

Test Sequence:

1. Triggered Action: cause IUT to call **getInfoReq()** method on the tester's (SCF's) IpCallLeg interface.
Parameters: callLegSessionID, callLegInfoRequested
2. Method call **getInfoErr()**
Parameters: callLegSessionID, errorIndication
Check: no exception is returned

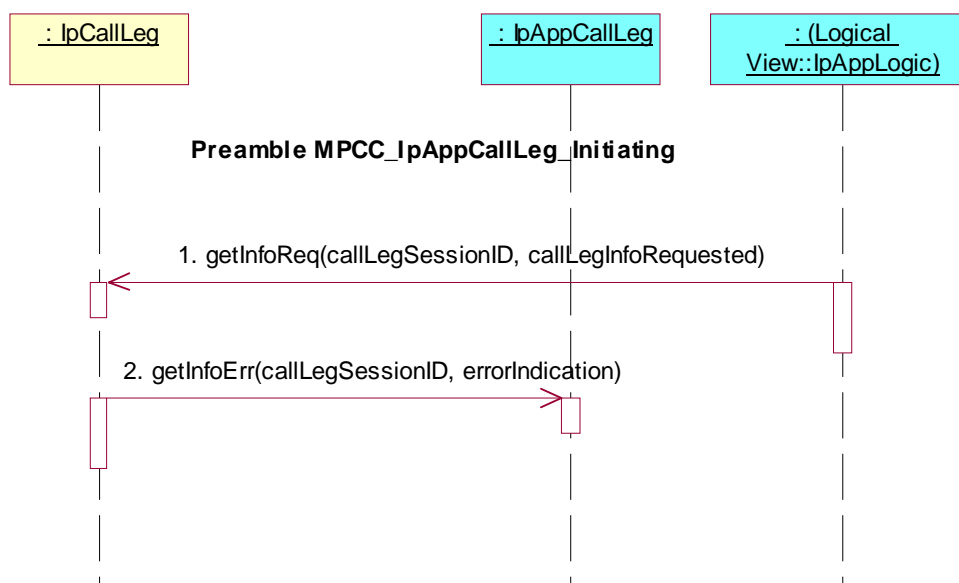

Test MPCC_IpAppCallLeg_09

Summary: set charge plan for call leg

Reference: ES 201 915-4 [1], clause 7.4.3.1

Precondition: IUT capable of invoking **setChargePlan()**

Preamble: **MPCC_IpAppCallLeg_Initiating**

Test Sequence:

1. Triggered Action: cause IUT to call **setChargePlan()** method on the tester's (SCF's) IpCallLeg interface.
Parameters: callLegSessionID, callChargePlan

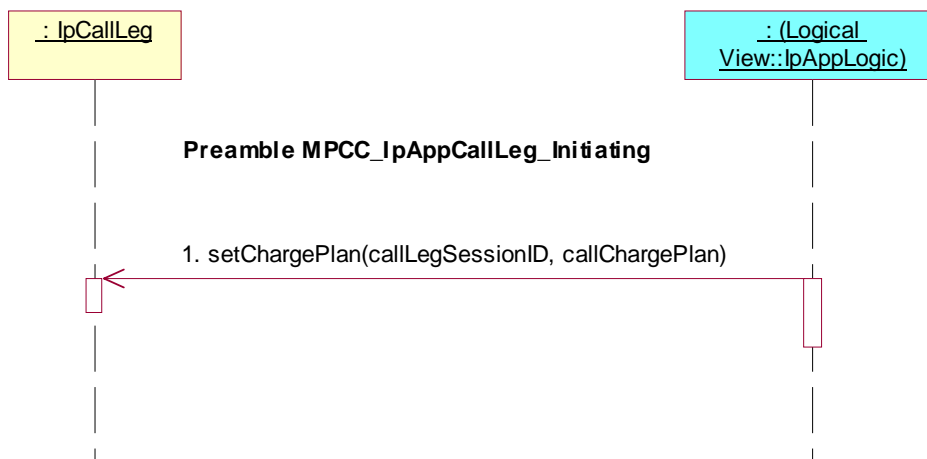
**Test MPCC_IpAppCallLeg_10**

Summary: allow advice of charge information

Reference: ES 201 915-4 [1], clause 7.4.3.1

Precondition: IUT capable of invoking **setAdviceOfCharge()**

Preamble: **MPCC_IpAppCallLeg_Initiating**

Test Sequence:

1. Triggered Action: cause IUT to call **setAdviceOfCharge()** method on the tester's (SCF's) IpCallLeg interface.
Parameters: callLegSessionID, aOCInfo, tariffSwitch

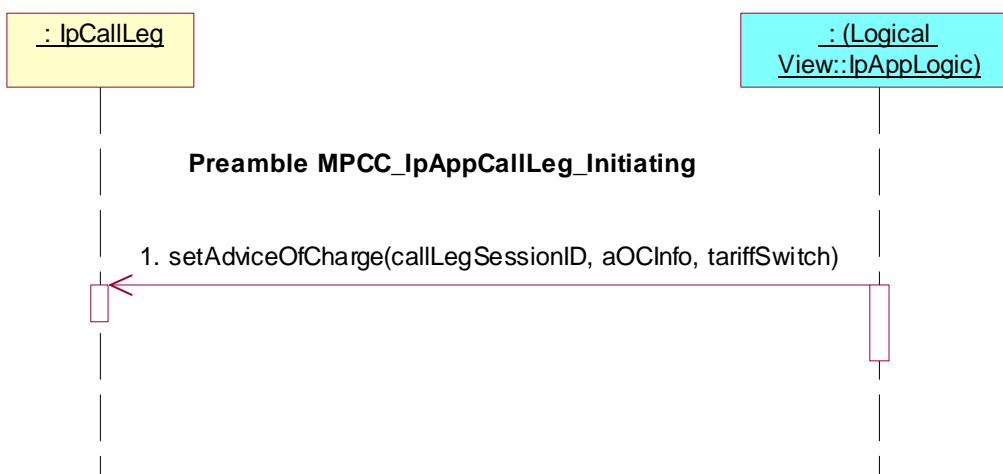

Test MPCC_IpAppCallLeg_11

Summary: supervise call leg

Reference: ES 201 915-4 [1], clause 7.4.3.1

Precondition: IUT capable of invoking **superviseReq()**

Preamble: **MPCC_IpAppCallLeg_Initiating**

Test Sequence:

1. Triggered Action: cause IUT to call **superviseReq()** method on the tester's (SCF's) IpCallLeg interface.
Parameters: callLegSessionID, time, treatment

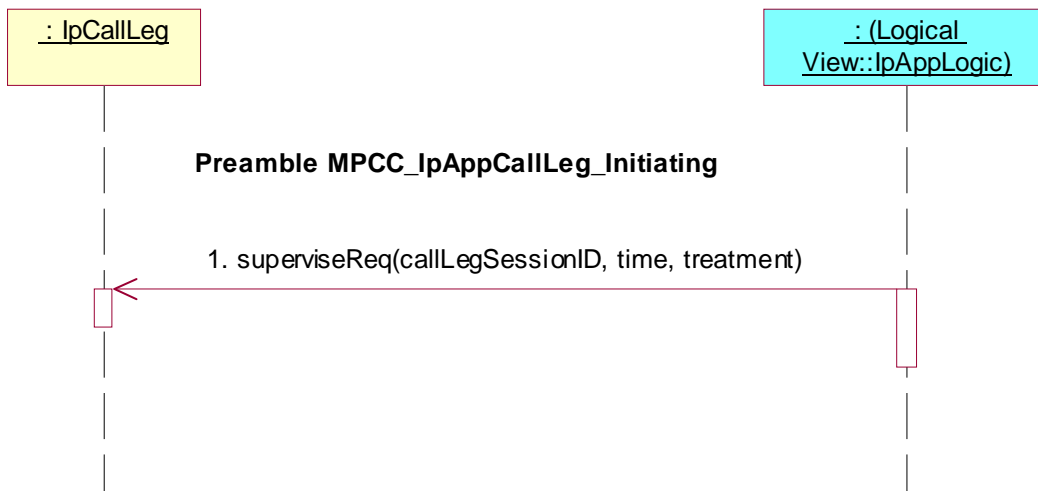

Test MPCC_IpAppCallLeg_12

Summary: supervise call leg, unsuccessful

Reference: ES 201 915-4 [1], clause 7.4.3.1

Precondition: IUT capable of invoking **superviseReq()**

Preamble: **MPCC_IpAppCallLeg_Initiating**

Test Sequence:

1. Triggered Action: cause IUT to call **superviseReq()** method on the tester's (SCF's) IpCallLeg interface.
Parameters: callLegSessionID, time, treatment
2. Method call **superviseErr()**
Parameters: callLegSessionID, errorIndication
Check: no exception is returned

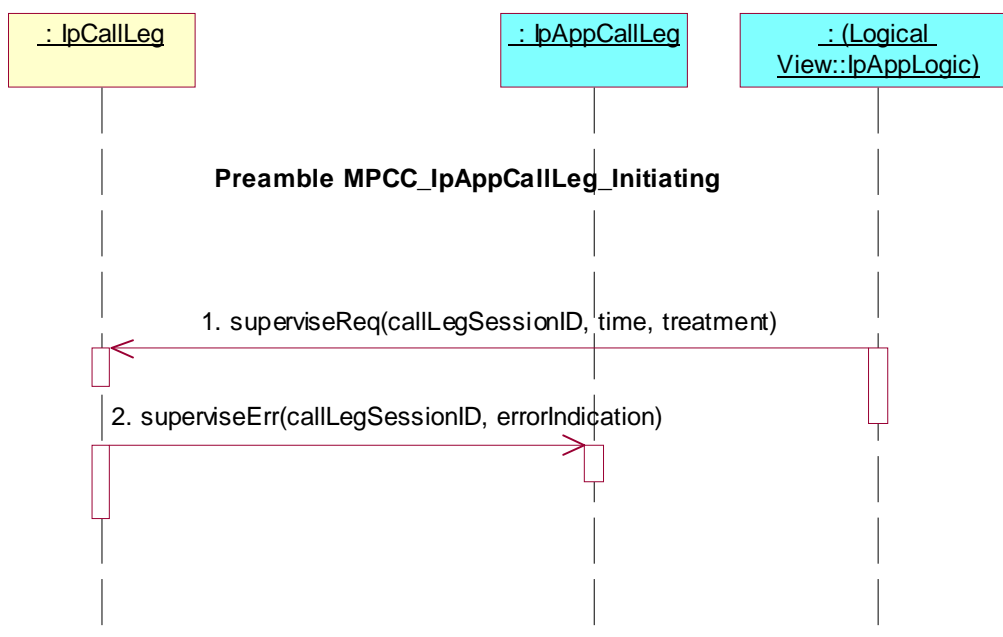

7.2.2.3.1.2 Analysing state

Preamble MPCC_IpAppCallLeg_Analysing

Reference: ES 201 915-4 [1], clause 7.4.3.1.2

Pre-preamble: Registration of the IUT (application) and the tester (Call Control SCF) to the framework. The IUT must have obtained a reference to an instance of the IpMultiPartyCallControlManager interface through selecting that service and signing the required service agreement.

The application is permitted to provide its IpAppMultiPartyCallControlManager interface reference in a setCallback() method which it calls prior to invoking further methods.

Preamble Sequence:

1. Triggered Action: cause IUT to call **createNotification()** method on the tester's (SCF's) IpMultiPartyCallControlManager interface.
Parameters: appCallControlManager, notificationRequest
notificationRequest.CallMonitorMode= P_CALL_MONITOR_MODE_INTERRUPT
notificationRequest.CallEventType= P_CALL_EVENT_ADDRESS_COLLECTED

2. Method call **reportNotification()**

Parameters: callReference, callLegReferenceSet, notificationInfo, assignmentID

Check: valid value of TpAppMultiPartyCallBack is returned

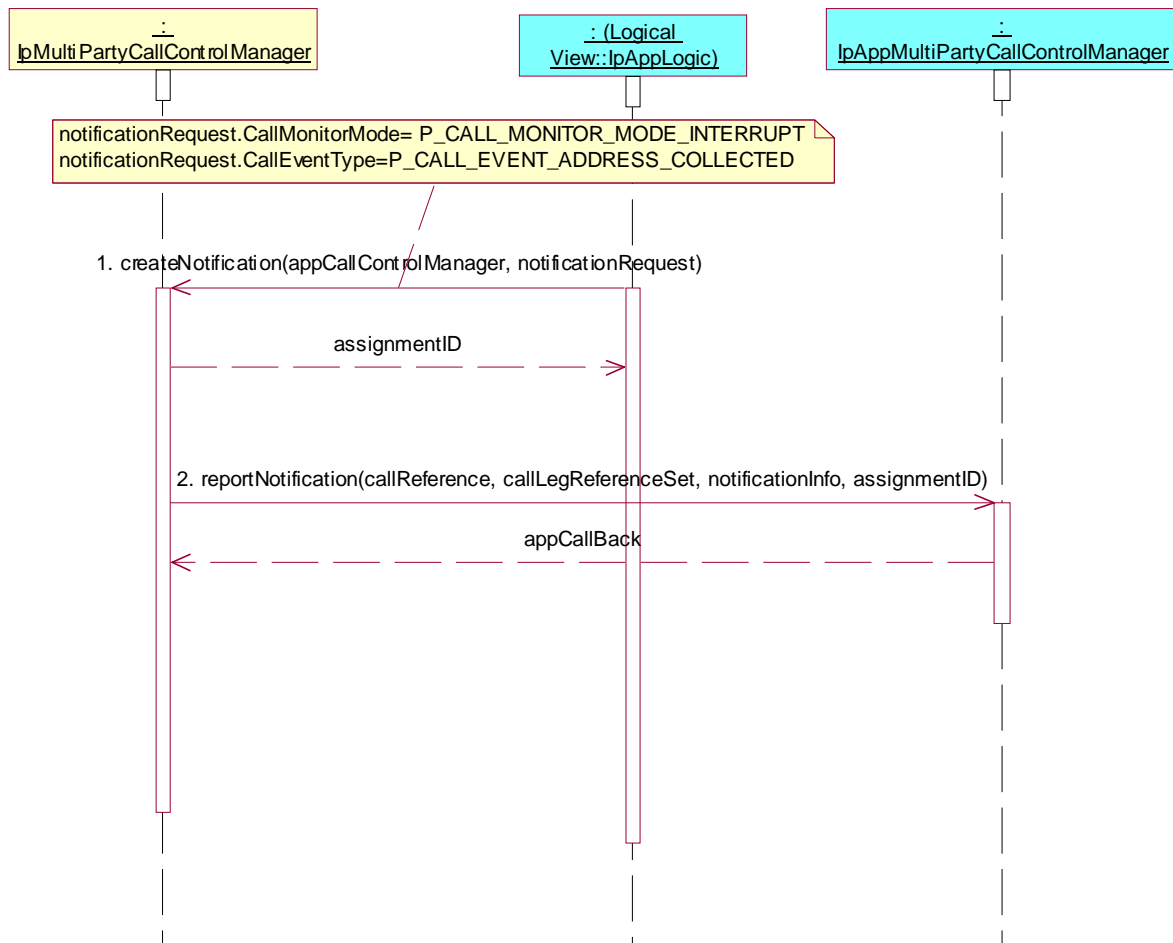
**Test MPCC_IpAppCallLeg_13**

Summary: attach media, successful

Reference: ES 201 915-4 [1], clause 7.4.3.1

Precondition: IUT capable of invoking **attachMediaReq()**Preamble: **MPCC_IpAppCallLeg_Analysing**

Test Sequence:

1. Triggered Action: cause IUT to call **attachMediaReq()** method on the tester's (SCF's) IpCallLeg interface.
Parameters: callLegSessionID
2. Method call **attachMediaRes()**
Parameters: callLegSessionID
Check: no exception is returned

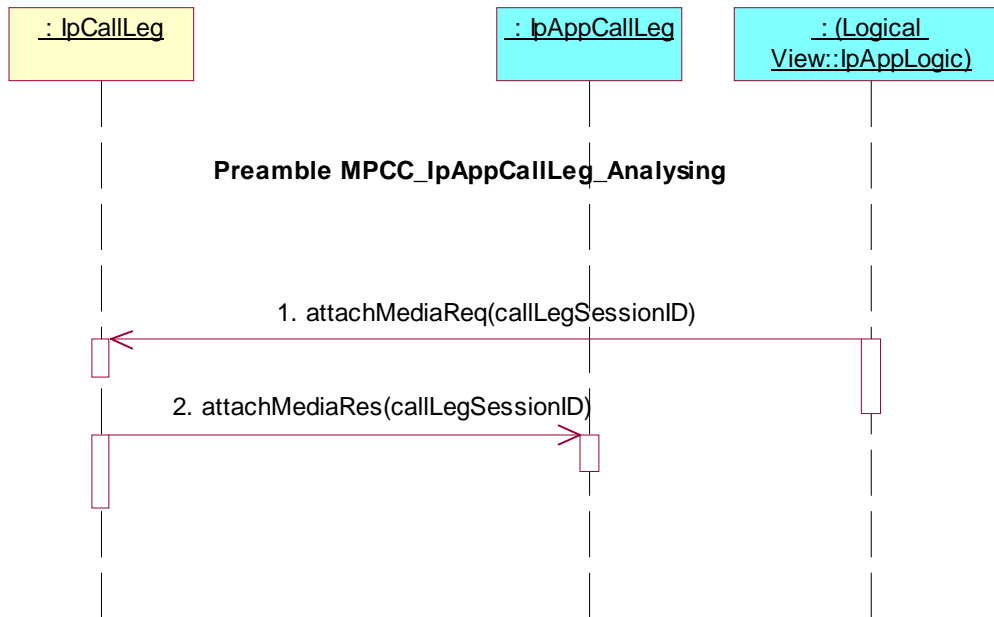

Test MPCC_IpAppCallLeg_14

Summary: attach media, unsuccessful

Reference: ES 201 915-4 [1], clause 7.4.3.1

Precondition: IUT capable of invoking **attachMediaReq()**

Preamble: **MPCC_IpAppCallLeg_Analysing**

Test Sequence:

1. Triggered Action: cause IUT to call **attachMediaReq()** method on the tester's (SCF's) IpCallLeg interface.
Parameters: callLegSessionID
2. Method call **attachMediaErr()**
Parameters: callLegSessionID, errorIndication
Check: no exception is returned

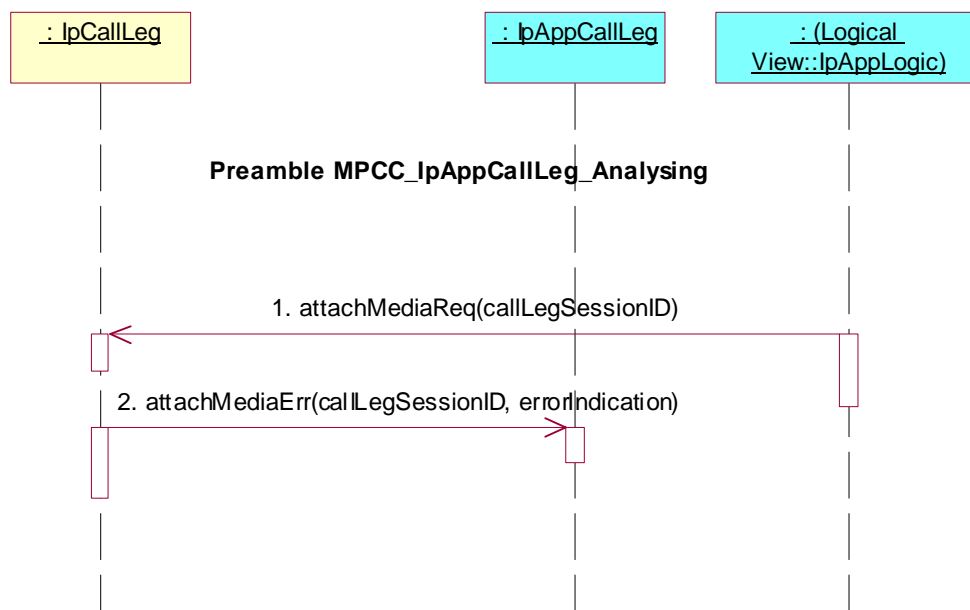

Test MPCC_IpAppCallLeg_15

Summary: detach media, successful

Reference: ES 201 915-4 [1], clause 7.4.3.1

Precondition: IUT capable of invoking **detachMediaReq()**

Preamble: **MPCC_IpAppCallLeg_Analysing**

Test Sequence:

1. Triggered Action: cause IUT to call **attachMediaReq()** method on the tester's (SCF's) IpCallLeg interface.
Parameters: callLegSessionID
2. Method call **attachMediaRes()**
Parameters: callLegSessionID
Check: no exception is returned
3. Triggered Action: cause IUT to call **detachMediaReq()** method on the tester's (SCF's) IpCallLeg interface.
Parameters: callLegSessionID
4. Method call **detachMediaRes()**
Parameters: callLegSessionID
Check: no exception is returned

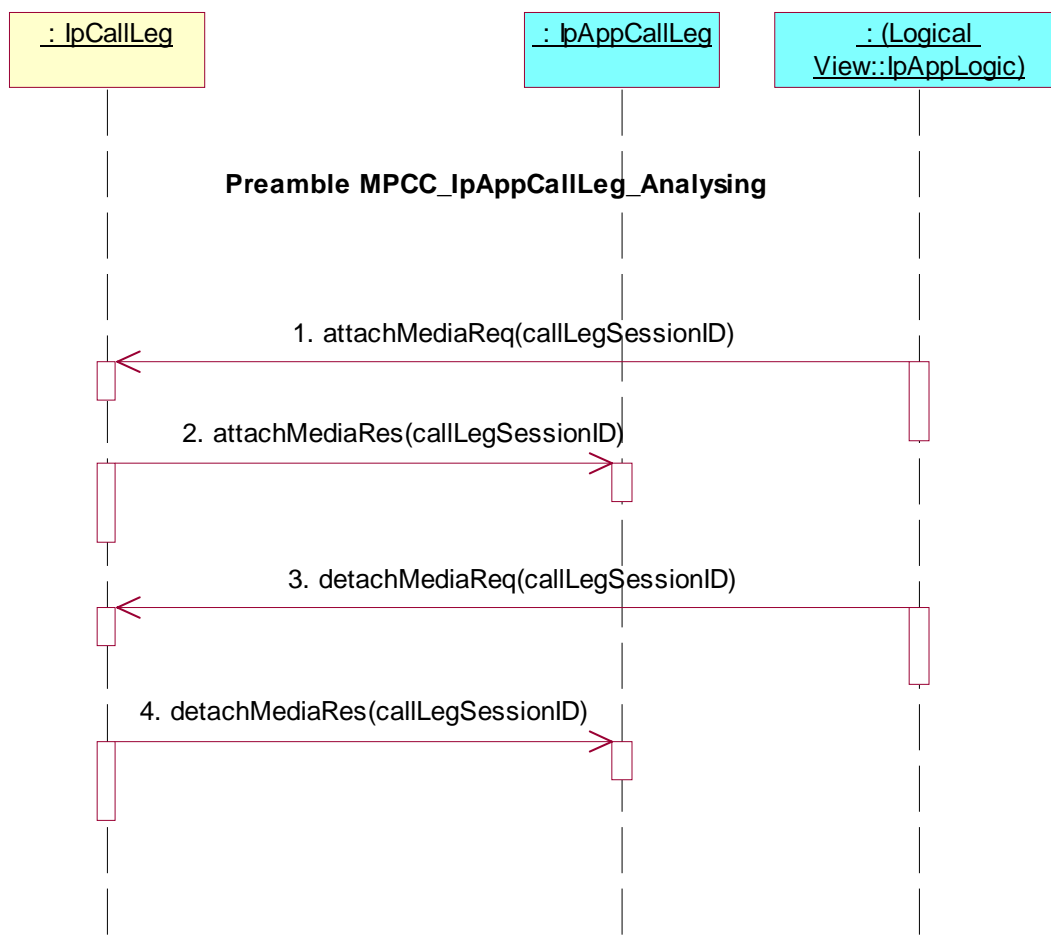

Test MPCC_IpAppCallLeg_16

Summary: detach media, unsuccessful

Reference: ES 201 915-4 [1], clause 7.4.3.1

Precondition: IUT capable of invoking **detachMediaReq()**

Preamble: **MPCC_IpAppCallLeg_Analysing**

Test Sequence:

1. Triggered Action: cause IUT to call **attachMediaReq()** method on the tester's (SCF's) IpCallLeg interface.
Parameters: callLegSessionID
2. Method call **attachMediaRes()**
Parameters: callLegSessionID
Check: no exception is returned
3. Triggered Action: cause IUT to call **detachMediaReq()** method on the tester's (SCF's) IpCallLeg interface.
Parameters: callLegSessionID
4. Method call **detachMediaErr()**
Parameters: callLegSessionID, errorIndication
Check: no exception is returned

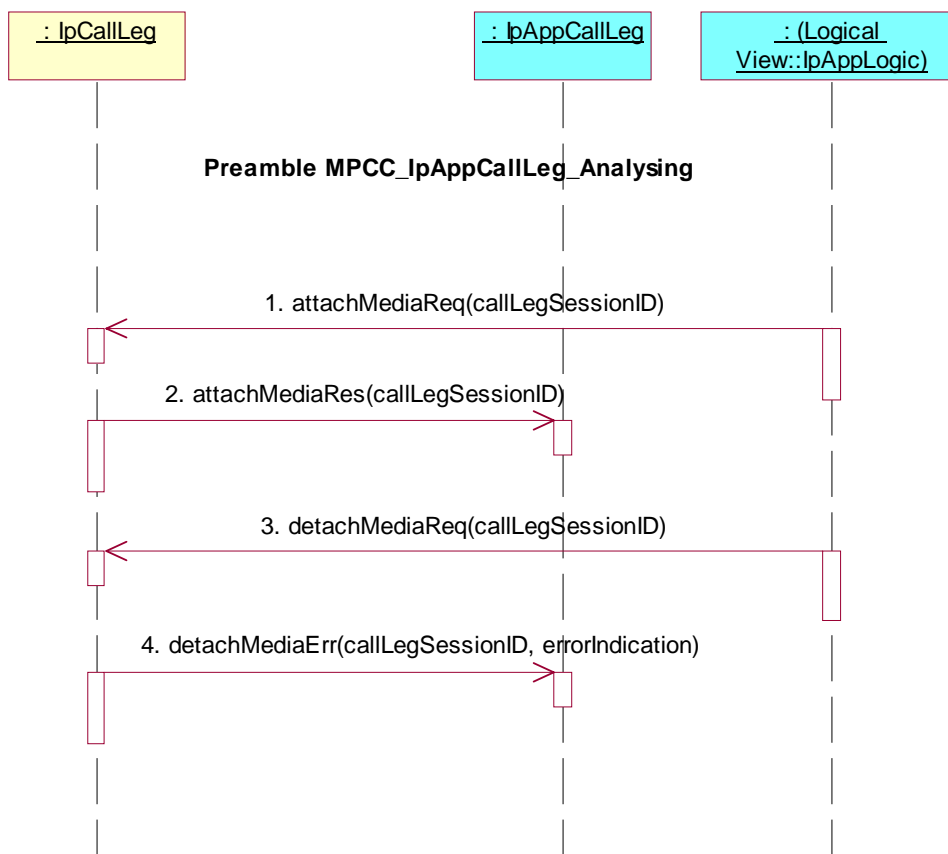

Test MPCC_IpAppCallLeg_17

Summary: request reference of call related to call leg

Reference: ES 201 915-4 [1], clause 7.4.3.1

Precondition: IUT capable of invoking **getCall()**

Preamble: **MPCC_IpAppCallLeg_Analysing**

Test Sequence:

1. Triggered Action: cause IUT to call **getCall()** method on the tester's (SCF's) IpCallLeg interface.
Parameters: callLegSessionID

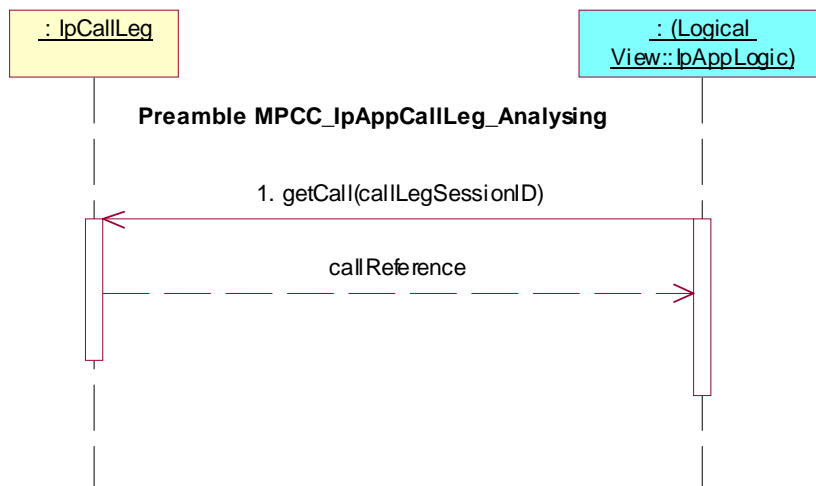
**Test MPCC_IpAppCallLeg_18**

Summary: continue processing of call leg

Reference: ES 201 915-4 [1], clause 7.4.3.1

Precondition: IUT capable of invoking **continueProcessing()**

Preamble: **MPCC_IpAppCallLeg_Analysing**

Test Sequence:

1. Triggered Action: cause IUT to call **continueProcessing()** method on the tester's (SCF's) IpCallLeg interface.
Parameters: callLegSessionID

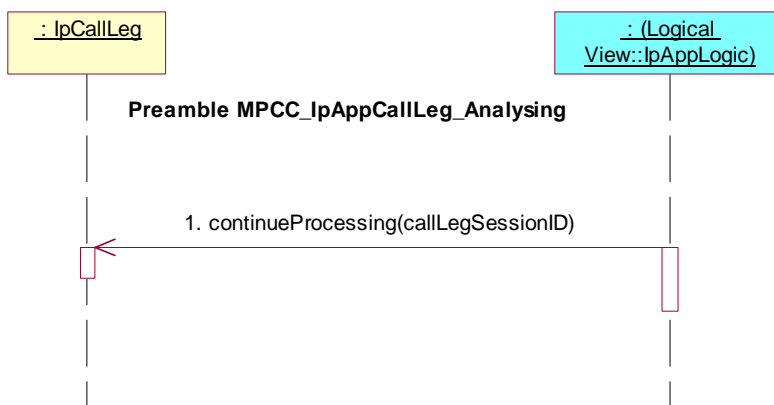

Test MPCC_IpAppCallLeg_19

Summary: release call leg

Reference: ES 201 915-4 [1], clause 7.4.3.1

Precondition: IUT capable of invoking **release()**

Preamble: **MPCC_IpAppCallLeg_Analysing**

Test Sequence:

1. Triggered Action: cause IUT to call **release()** method on the tester's (SCF's) IpCallLeg interface.
Parameters: callLegSessionID, cause

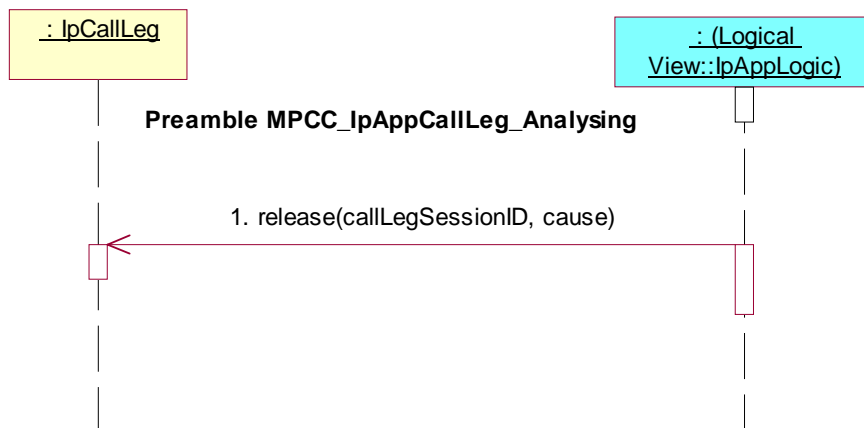
**Test MPCC_IpAppCallLeg_20**

Summary: de-assign call leg

Reference: ES 201 915-4 [1], clause 7.4.3.1

Precondition: IUT capable of invoking **deassign()**

Preamble: **MPCC_IpAppCallLeg_Analysing**

Test Sequence:

1. Triggered Action: cause IUT to call **deassign()** method on the tester's (SCF's) IpCallLeg interface.
Parameters: callLegSessionID

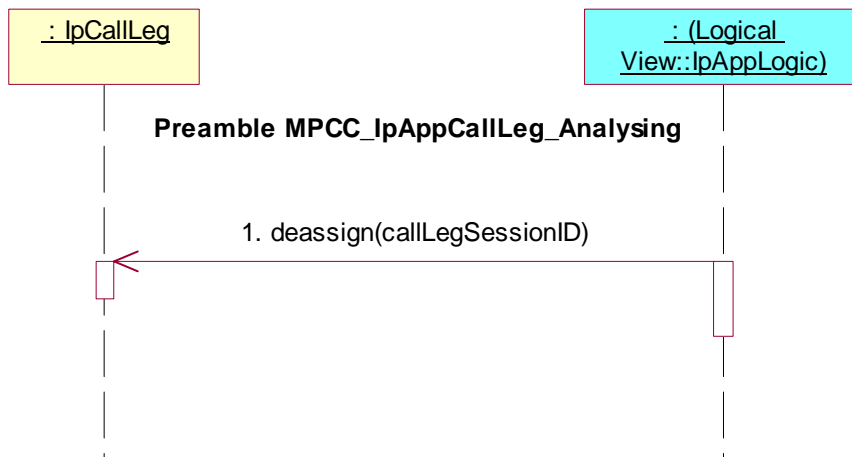

Test MPCC_IpAppCallLeg_21

Summary: change or clear event criteria

Reference: ES 201 915-4 [1], clause 7.4.3.1

Precondition: IUT capable of invoking **eventReportReq()**

Preamble: **MPCC_IpAppCallLeg_Analysing**

Test Sequence:

1. Triggered Action: cause IUT to call **eventReportReq()** method on the tester's (SCF's) IpCallLeg interface.
Parameters: callLegSessionID, eventsRequested

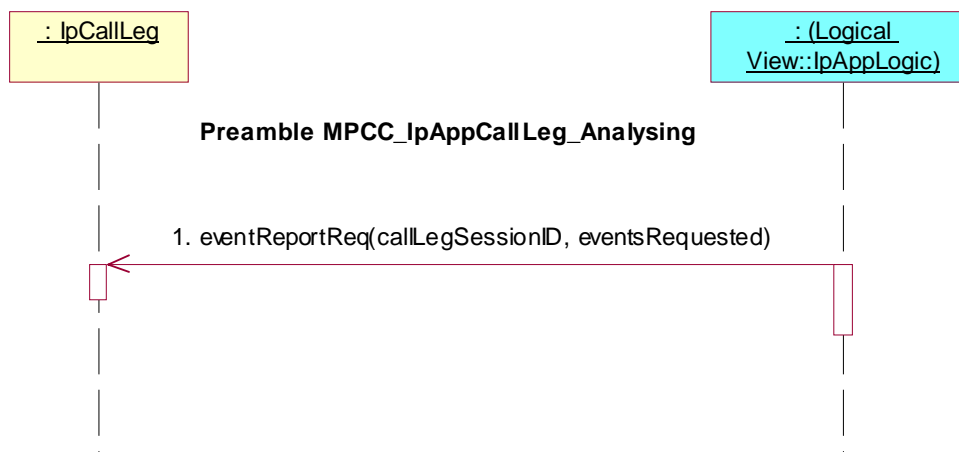
**Test MPCC_IpAppCallLeg_22**

Summary: change or clear event criteria, unsuccessful

Reference: ES 201 915-4 [1], clause 7.4.3.1

Precondition: IUT capable of invoking **eventReportReq()**

Preamble: **MPCC_IpAppCallLeg_Analysing**

Test Sequence:

1. Triggered Action: cause IUT to call **eventReportReq()** method on the tester's (SCF's) IpCallLeg interface.
Parameters: callLegSessionID, eventsRequested
2. Method call **eventReportErr()**
Parameters: callLegSessionID, errorIndication
Check: no exception is returned

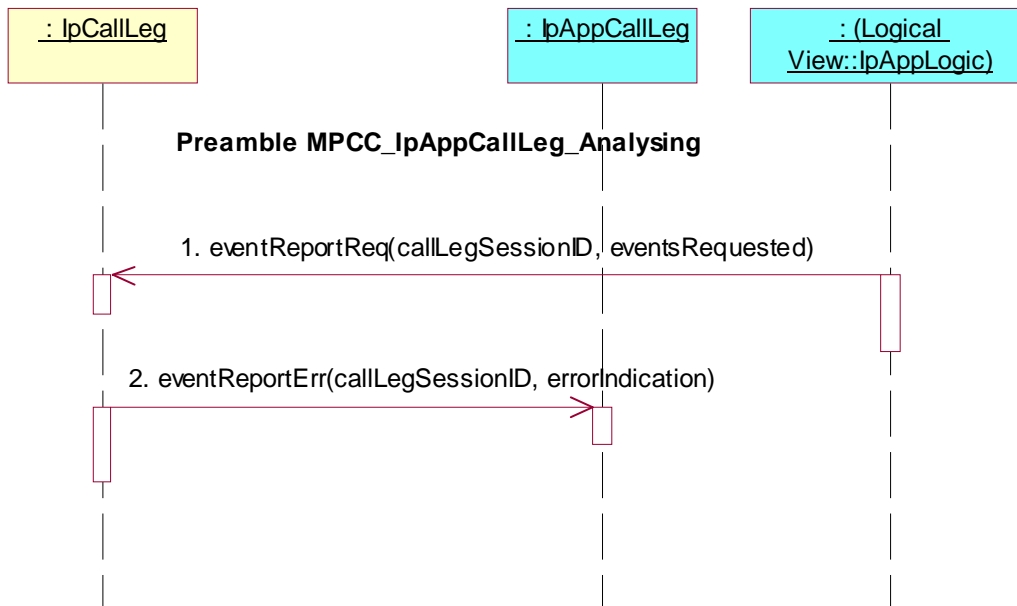

Test MPCC_IpAppCallLeg_23

Summary: get information about call leg

Reference: ES 201 915-4 [1], clause 7.4.3.1

Precondition: IUT capable of invoking **getInfoReq()**

Preamble: **MPCC_IpAppCallLeg_Analysing**

Test Sequence:

1. Triggered Action: cause IUT to call **getInfoReq()** method on the tester's (SCF's) IpCallLeg interface.
Parameters: callLegSessionID, callLegInfoRequested

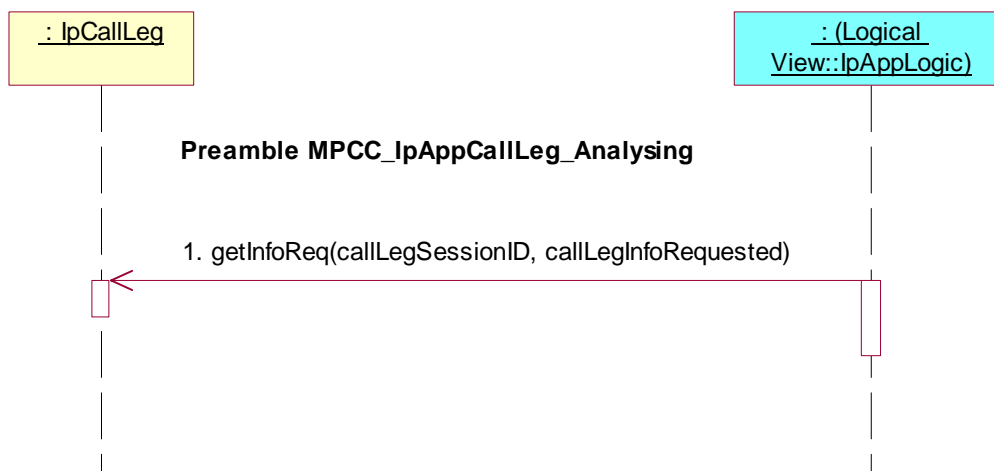

Test MPCC_IpAppCallLeg_24

Summary: get information about call leg, unsuccessful

Reference: ES 201 915-4 [1], clause 7.4.3.1

Precondition: IUT capable of invoking **getInfoReq()**

Preamble: **MPCC_IpAppCallLeg_Analysing**

Test Sequence:

1. Triggered Action: cause IUT to call **getInfoReq()** method on the tester's (SCF's) IpCallLeg interface.
Parameters: callLegSessionID, callLegInfoRequested
2. Method call **getInfoErr()**
Parameters: callLegSessionID, errorIndication
Check: no exception is returned

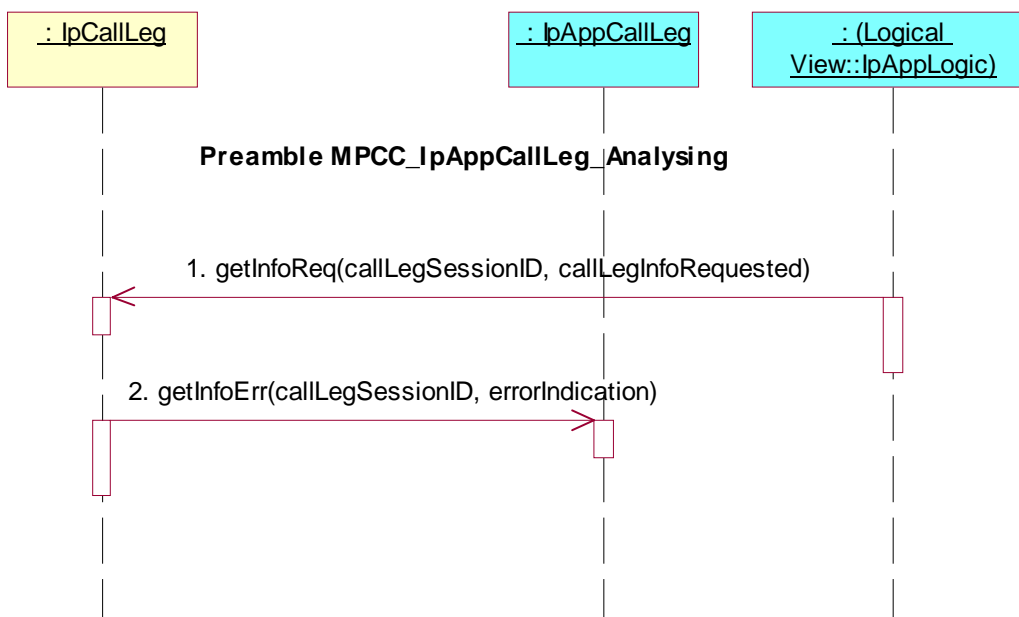
**Test MPCC_IpAppCallLeg_25**

Summary: set charge plan for call leg

Reference: ES 201 915-4 [1], clause 7.4.3.1

Precondition: IUT capable of invoking **setChargePlan()**

Preamble: **MPCC_IpAppCallLeg_Analysing**

Test Sequence:

1. Triggered Action: cause IUT to call **setChargePlan()** method on the tester's (SCF's) IpCallLeg interface.
Parameters: callLegSessionID, callChargePlan

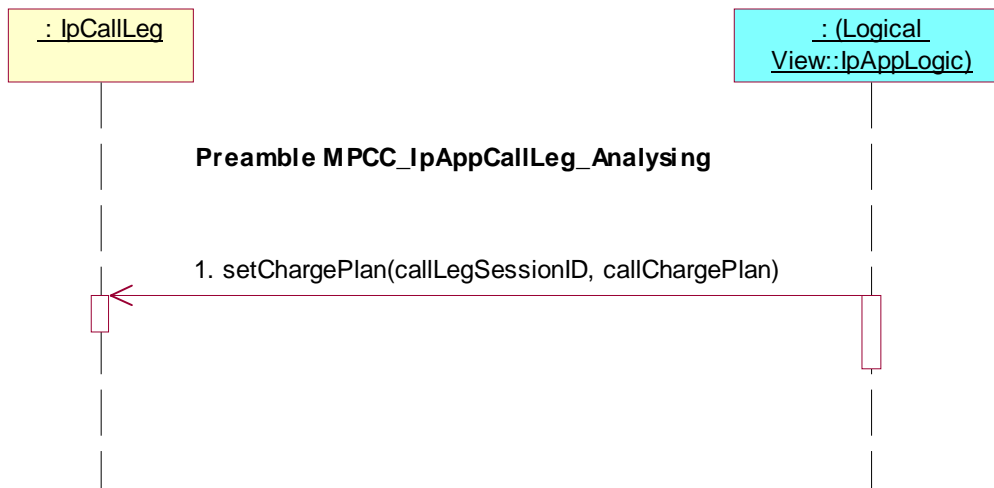

Test MPCC_IpAppCallLeg_26

Summary: allow advice of charge information

Reference: ES 201 915-4 [1], clause 7.4.3.1

Precondition: IUT capable of invoking **setAdviceOfCharge()**

Preamble: **MPCC_IpAppCallLeg_Analysing**

Test Sequence:

1. Triggered Action: cause IUT to call **setAdviceOfCharge()** method on the tester's (SCF's) IpCallLeg interface.
Parameters: callLegSessionID, aOCInfo, tariffSwitch

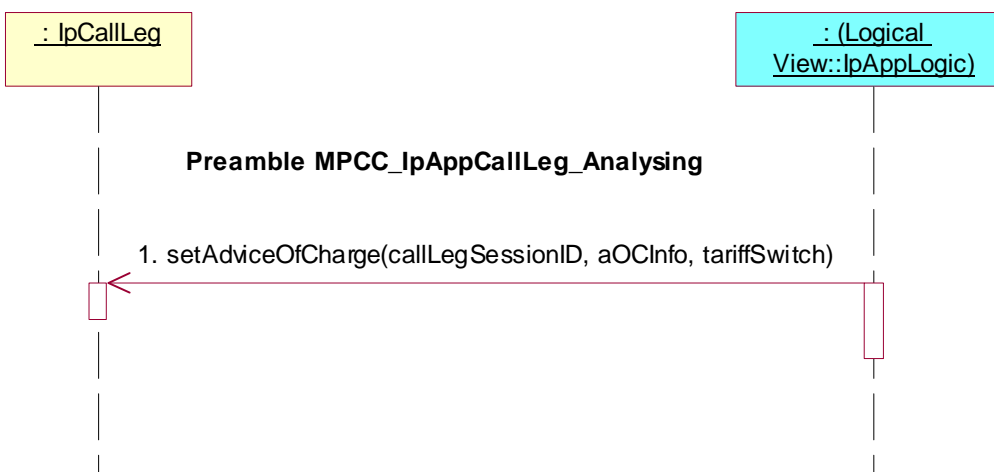

Test MPCC_IpAppCallLeg_27

Summary: supervise call leg

Reference: ES 201 915-4 [1], clause 7.4.3.1

Precondition: IUT capable of invoking **superviseReq()**

Preamble: **MPCC_IpAppCallLeg_Analysing**

Test Sequence:

1. Triggered Action: cause IUT to call **superviseReq()** method on the tester's (SCF's) IpCallLeg interface.
Parameters: callLegSessionID, time, treatment

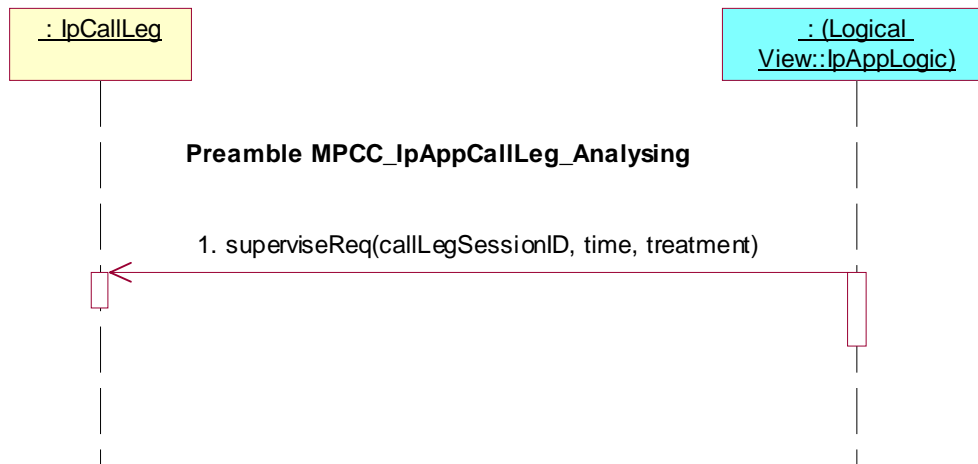

Test MPCC_IpAppCallLeg_28

Summary: supervise call leg, unsuccessful

Reference: ES 201 915-4 [1], clause 7.4.3.1

Precondition: IUT capable of invoking **superviseReq()**

Preamble: **MPCC_IpAppCallLeg_Analysing**

Test Sequence:

1. Triggered Action: cause IUT to call **superviseReq()** method on the tester's (SCF's) IpCallLeg interface.
Parameters: callLegSessionID, time, treatment
2. Method call **superviseErr()**
Parameters: callLegSessionID, errorIndication
Check: no exception is returned

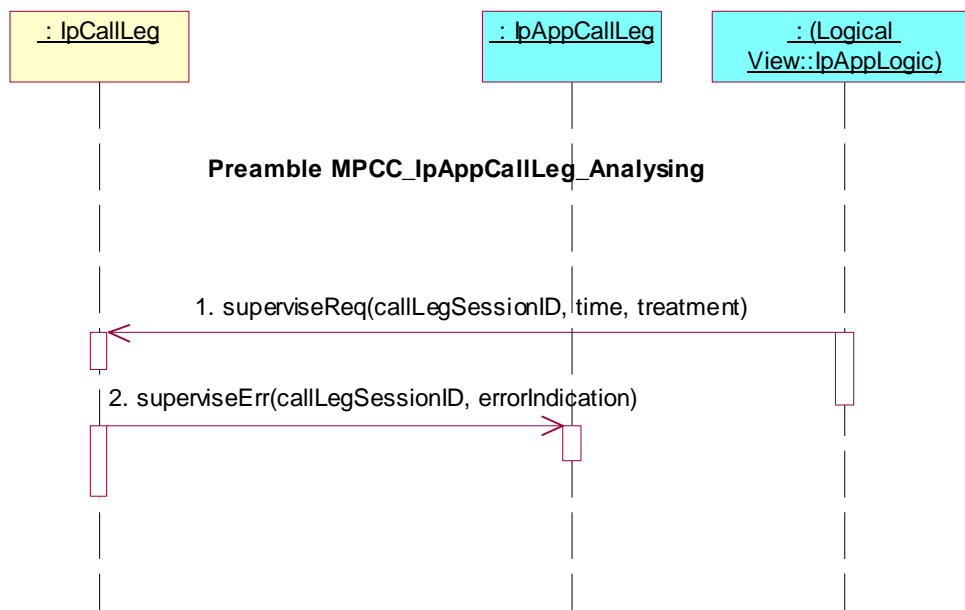

7.2.2.3.1.3 Active state

Preamble MPCC_IpAppCallLeg_Active

Reference: ES 201 915-4 [1], clause 7.4.3.1.3

Pre-preamble: Registration of the IUT (application) and the tester (Call Control SCF) to the framework. The IUT must have obtained a reference to an instance of the IpMultiPartyCallControlManager interface through selecting that service and signing the required service agreement.

The application is permitted to provide its IpAppMultiPartyCallControlManager interface reference in a setCallback() method which it calls prior to invoking further methods.

Preamble Sequence:

1. Triggered Action: cause IUT to call **createNotification()** method on the tester's (SCF's) IpMultiPartyCallControlManager interface.
 Parameters: appCallControlManager, notificationRequest
 notificationRequest.CallMonitorMode= P_CALL_MONITOR_MODE_INTERRUPT
 notificationRequest.CallEventType= P_CALL_EVENT_ADDRESS_ANALYSED or P_CALL_EVENT_ORIGINATING_SERVICE_CODE
2. Method call **reportNotification()**
 Parameters: callReference, callLegReferenceSet, notificationInfo, assignmentID
 Check: valid value of TpAppMultiPartyCallBack is returned

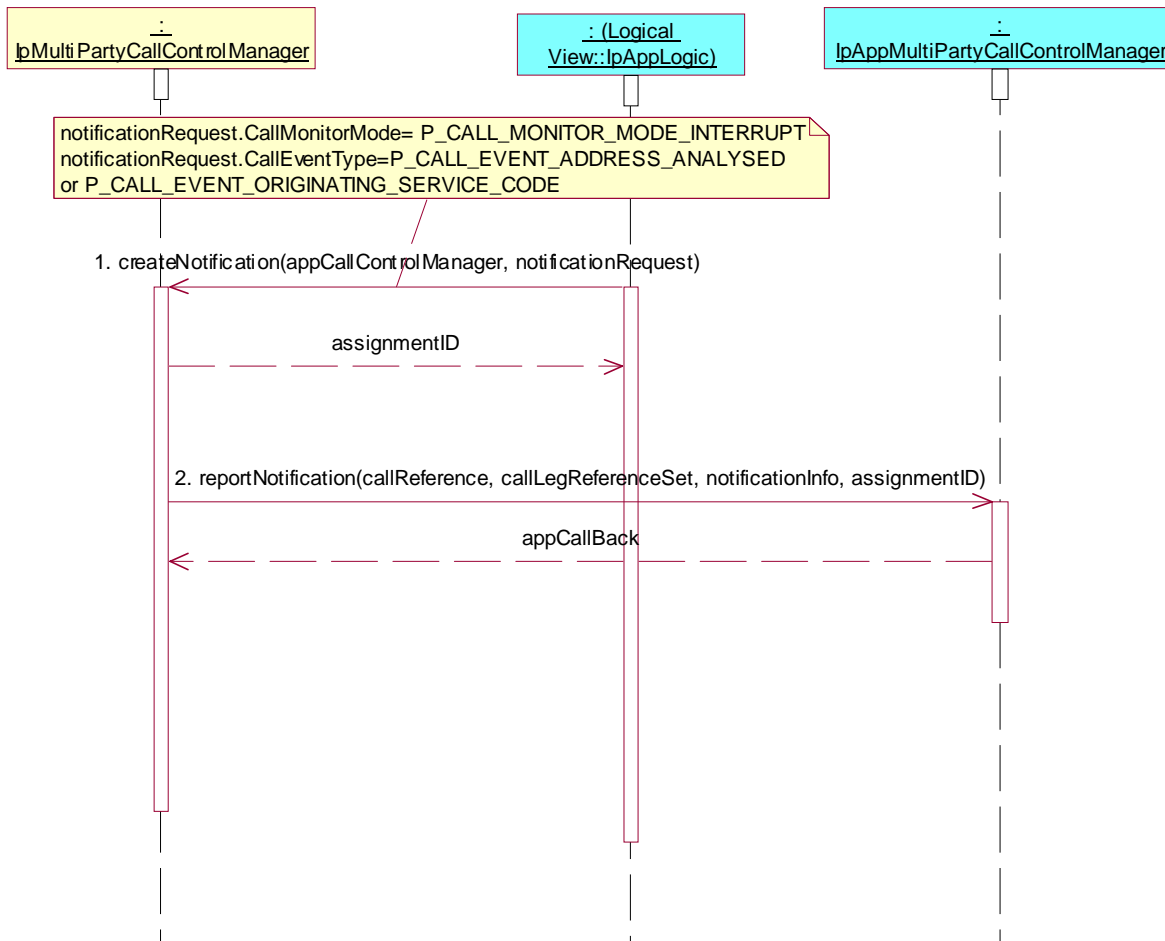

Test MPCC_IpAppCallLeg_29

Summary: attach media, successful

Reference: ES 201 915-4 [1], clause 7.4.3.1

Precondition: IUT capable of invoking **attachMediaReq()**

Preamble: **MPCC_IpAppCallLeg_Active**

Test Sequence:

1. Triggered Action: cause IUT to call **attachMediaReq()** method on the tester's (SCF's) IpCallLeg interface.
Parameters: callLegSessionID
2. Method call **attachMediaRes()**
Parameters: callLegSessionID
Check: no exception is returned

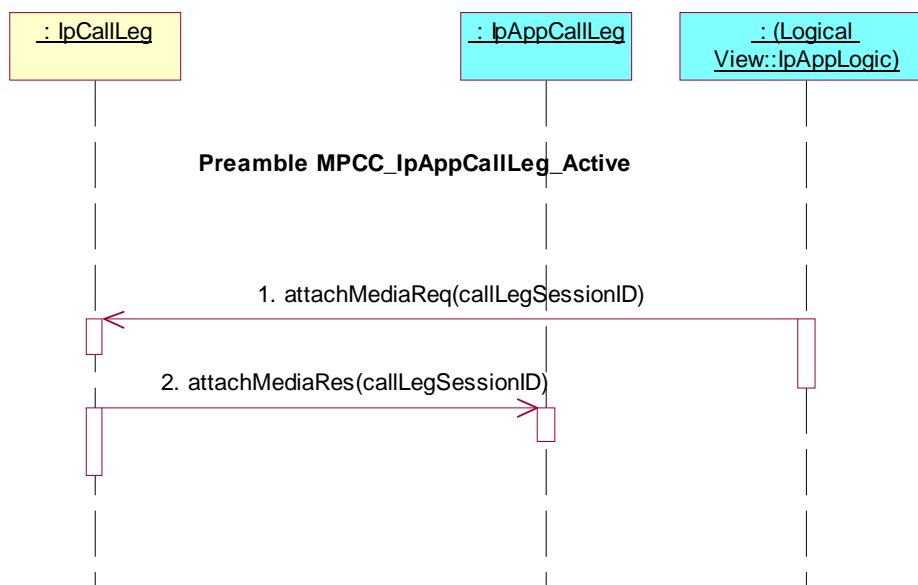
**Test MPCC_IpAppCallLeg_30**

Summary: attach media, unsuccessful

Reference: ES 201 915-4 [1], clause 7.4.3.1

Precondition: IUT capable of invoking **attachMediaReq()**

Preamble: **MPCC_IpAppCallLeg_Active**

Test Sequence:

1. Triggered Action: cause IUT to call **attachMediaReq()** method on the tester's (SCF's) IpCallLeg interface.
Parameters: callLegSessionID
2. Method call **attachMediaErr()**
Parameters: callLegSessionID, errorIndication
Check: no exception is returned

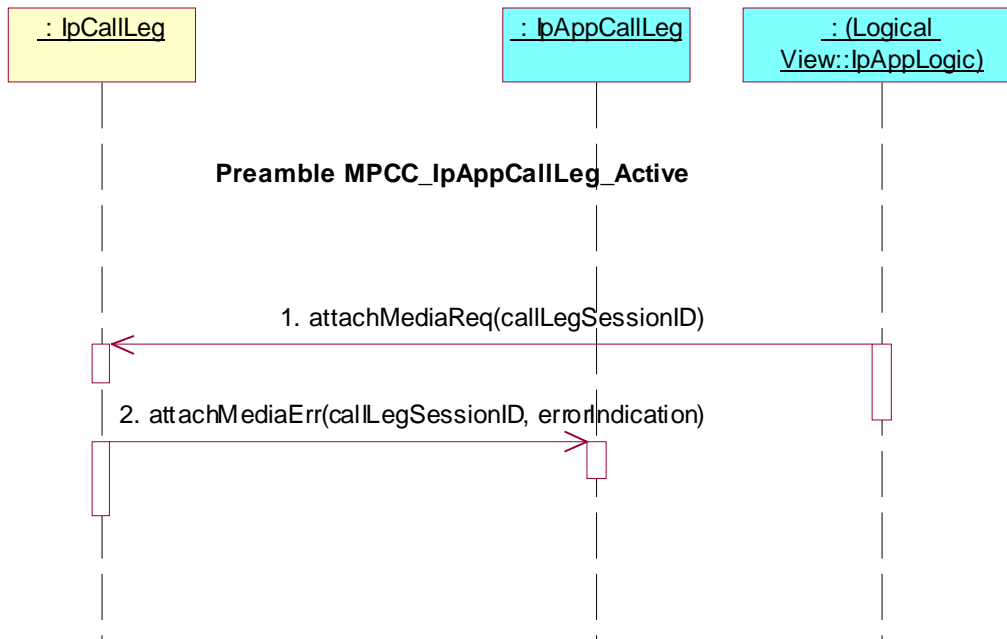

Test MPCC_IpAppCallLeg_31

Summary: detach media, successful

Reference: ES 201 915-4 [1], clause 7.4.3.1

Precondition: IUT capable of invoking **detachMediaReq()**

Preamble: **MPCC_IpAppCallLeg_Active**

Test Sequence:

1. Triggered Action: cause IUT to call **attachMediaReq()** method on the tester's (SCF's) IpCallLeg interface.
Parameters: callLegSessionID
2. Method call **attachMediaRes()**
Parameters: callLegSessionID
Check: no exception is returned
3. Triggered Action: cause IUT to call **detachMediaReq()** method on the tester's (SCF's) IpCallLeg interface.
Parameters: callLegSessionID
4. Method call **detachMediaRes()**
Parameters: callLegSessionID
Check: no exception is returned

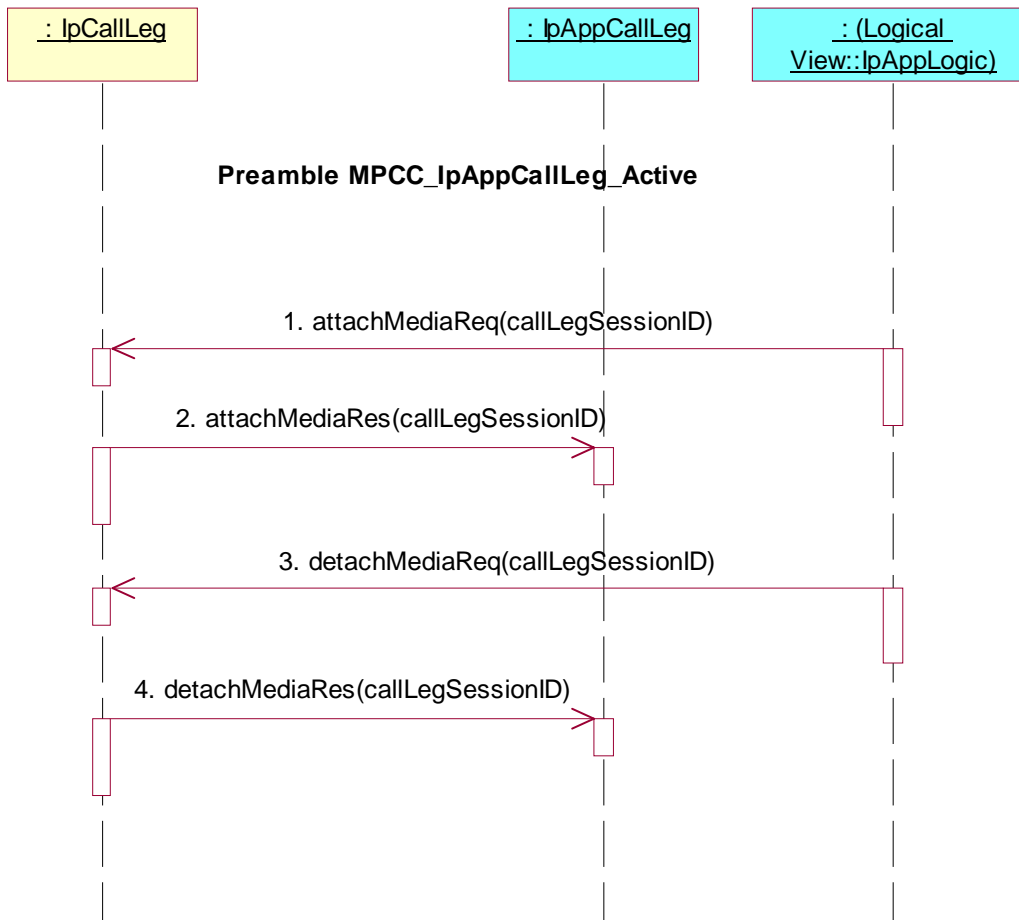

Test MPCC_IpAppCallLeg_32

Summary: detach media, unsuccessful

Reference: ES 201 915-4 [1], clause 7.4.3.1

Precondition: IUT capable of invoking **detachMediaReq()**

Preamble: **MPCC_IpAppCallLeg_Active**

Test Sequence:

1. Triggered Action: cause IUT to call **attachMediaReq()** method on the tester's (SCF's) IpCallLeg interface.
Parameters: callLegSessionID
2. Method call **attachMediaRes()**
Parameters: callLegSessionID
Check: no exception is returned
3. Triggered Action: cause IUT to call **detachMediaReq()** method on the tester's (SCF's) IpCallLeg interface.
Parameters: callLegSessionID
4. Method call **detachMediaErr()**
Parameters: callLegSessionID, errorIndication
Check: no exception is returned

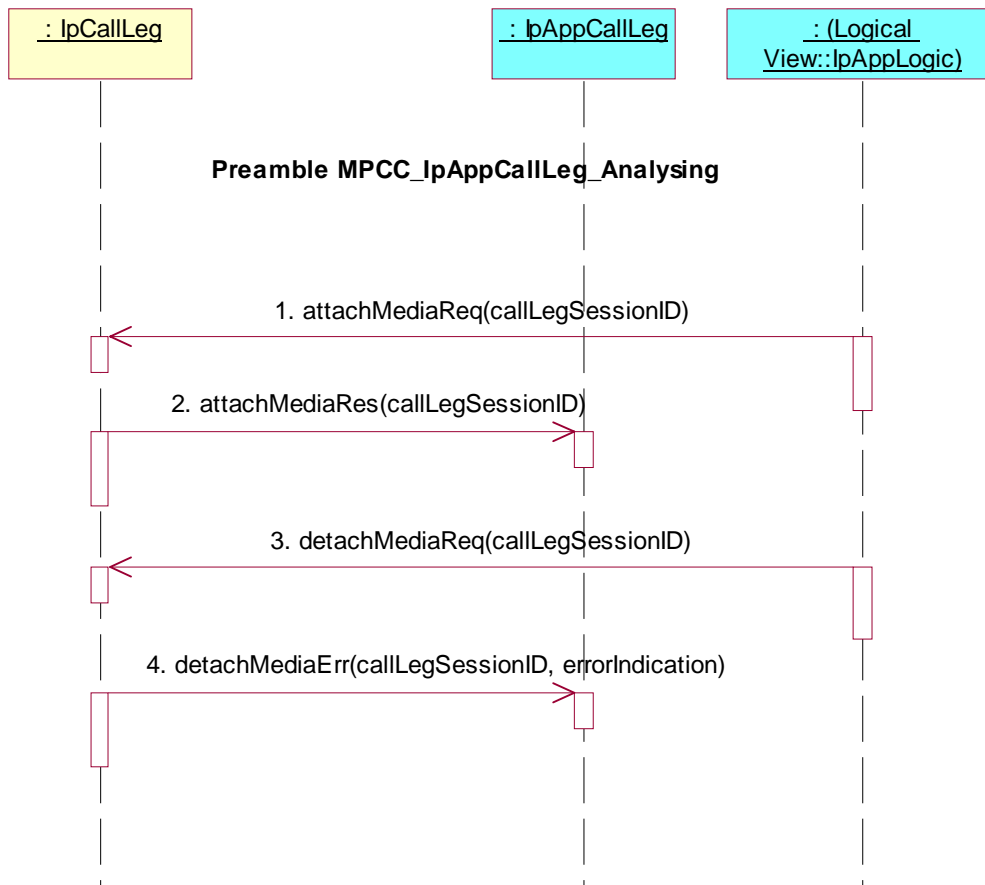

Test MPCC_IpAppCallLeg_33

Summary: request reference of call related to call leg

Reference: ES 201 915-4 [1], clause 7.4.3.1

Precondition: IUT capable of invoking **getCall()**

Preamble: **MPCC_IpAppCallLeg_Active**

Test Sequence:

1. Triggered Action: cause IUT to call **getCall()** method on the tester's (SCF's) IpCallLeg interface.
Parameters: callLegSessionID

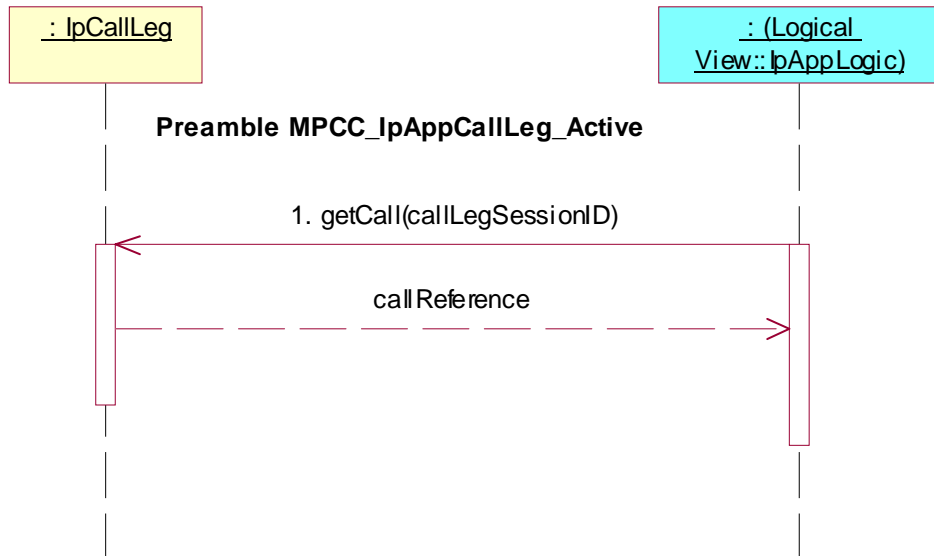

Test MPCC_IpAppCallLeg_34

Summary: continue processing of call leg

Reference: ES 201 915-4 [1], clause 7.4.3.1

Precondition: IUT capable of invoking **continueProcessing()**

Preamble: **MPCC_IpAppCallLeg_Active**

Test Sequence:

1. Triggered Action: cause IUT to call **continueProcessing()** method on the tester's (SCF's) IpCallLeg interface.
Parameters: callLegSessionID

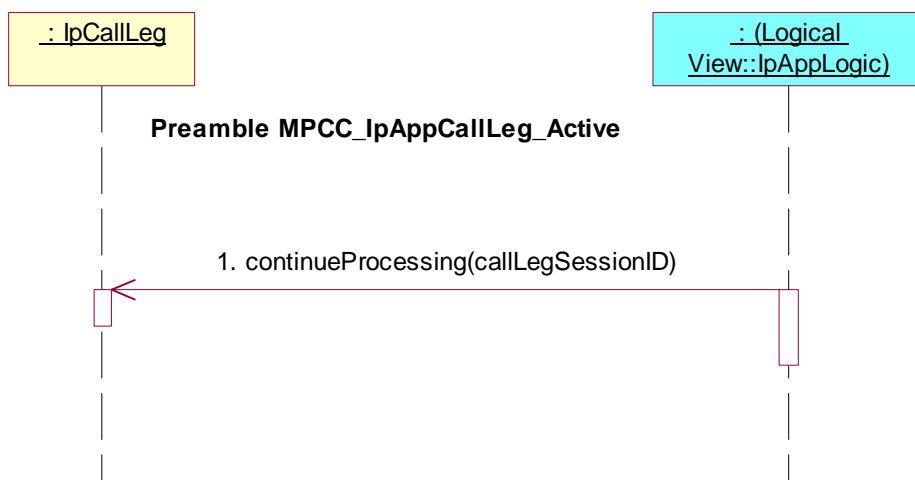

Test MPCC_IpAppCallLeg_35

Summary: release call leg

Reference: ES 201 915-4 [1], clause 7.4.3.1

Precondition: IUT capable of invoking **release()**

Preamble: **MPCC_IpAppCallLeg_Active**

Test Sequence:

1. Triggered Action: cause IUT to call **release()** method on the tester's (SCF's) IpCallLeg interface.
Parameters: callLegSessionID, cause

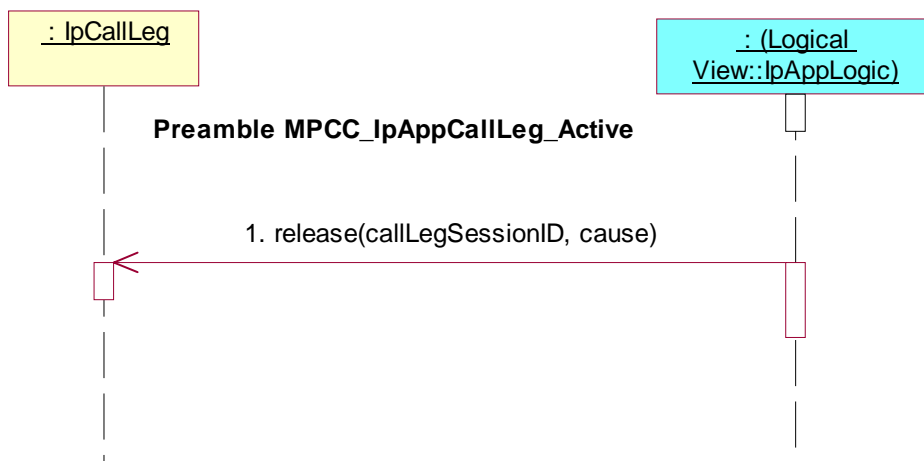
**Test MPCC_IpAppCallLeg_36**

Summary: de-assign call leg

Reference: ES 201 915-4 [1], clause 7.4.3.1

Precondition: IUT capable of invoking **deassign()**

Preamble: **MPCC_IpAppCallLeg_Active**

Test Sequence:

1. Triggered Action: cause IUT to call **deassign()** method on the tester's (SCF's) IpCallLeg interface.
Parameters: callLegSessionID

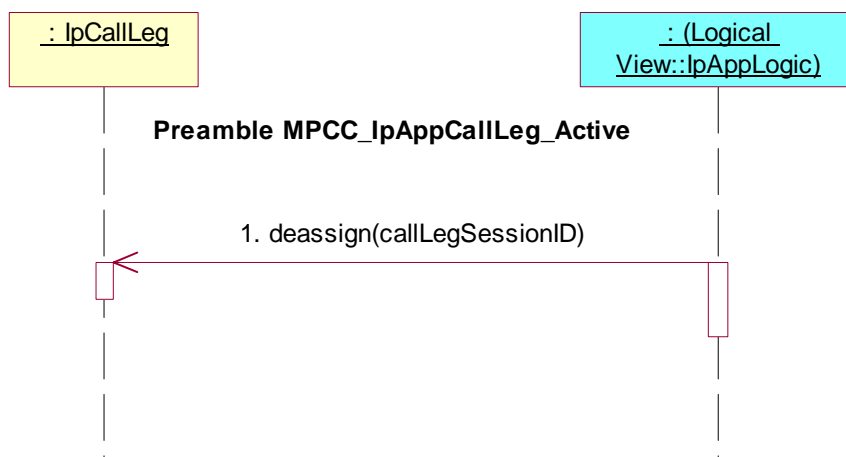

Test MPCC_IpAppCallLeg_37

Summary: change or clear event criteria

Reference: ES 201 915-4 [1], clause 7.4.3.1

Precondition: IUT capable of invoking **eventReportReq()**

Preamble: **MPCC_IpAppCallLeg_Active**

Test Sequence:

1. Triggered Action: cause IUT to call **eventReportReq()** method on the tester's (SCF's) IpCallLeg interface.
Parameters: callLegSessionID, eventsRequested

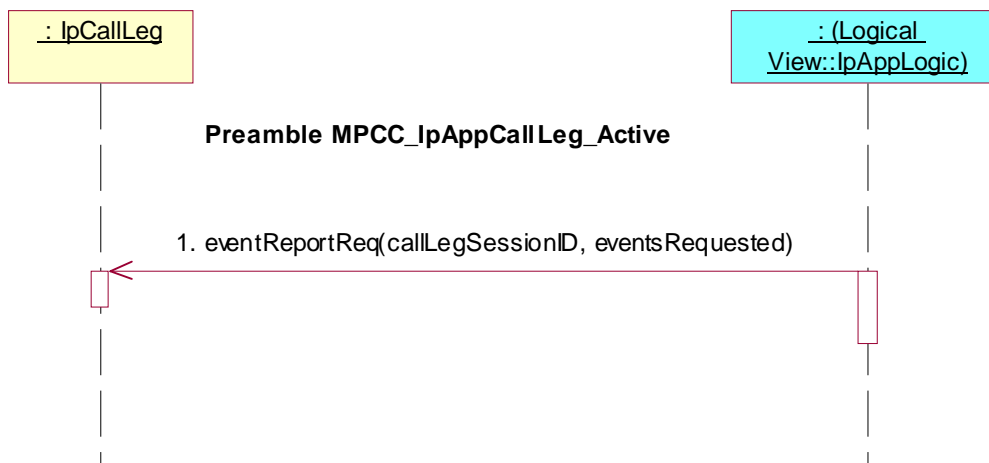
**Test MPCC_IpAppCallLeg_38**

Summary: change or clear event criteria, unsuccessful

Reference: ES 201 915-4 [1], clause 7.4.3.1

Precondition: IUT capable of invoking **eventReportReq()**

Preamble: **MPCC_IpAppCallLeg_Active**

Test Sequence:

1. Triggered Action: cause IUT to call **eventReportReq()** method on the tester's (SCF's) IpCallLeg interface.
Parameters: callLegSessionID, eventsRequested
2. Method call **eventReportErr()**
Parameters: callLegSessionID, errorIndication
Check: no exception is returned

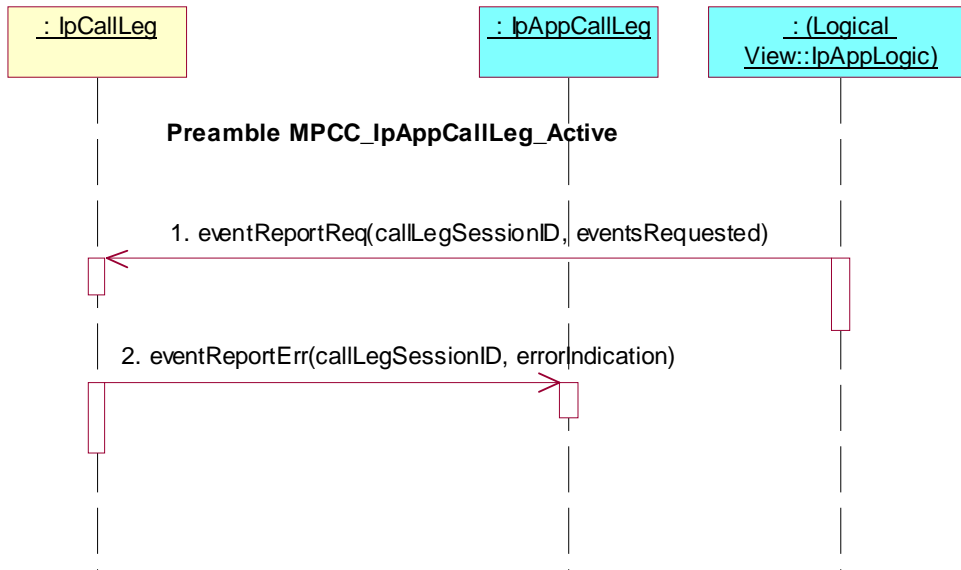

Test MPCC_IpAppCallLeg_39

Summary: get information about call leg

Reference: ES 201 915-4 [1], clause 7.4.3.1

Precondition: IUT capable of invoking **getInfoReq()**

Preamble: **MPCC_IpAppCallLeg_Active**

Test Sequence:

1. Triggered Action: cause IUT to call **getInfoReq()** method on the tester's (SCF's) IpCallLeg interface.
Parameters: callLegSessionID, callLegInfoRequested

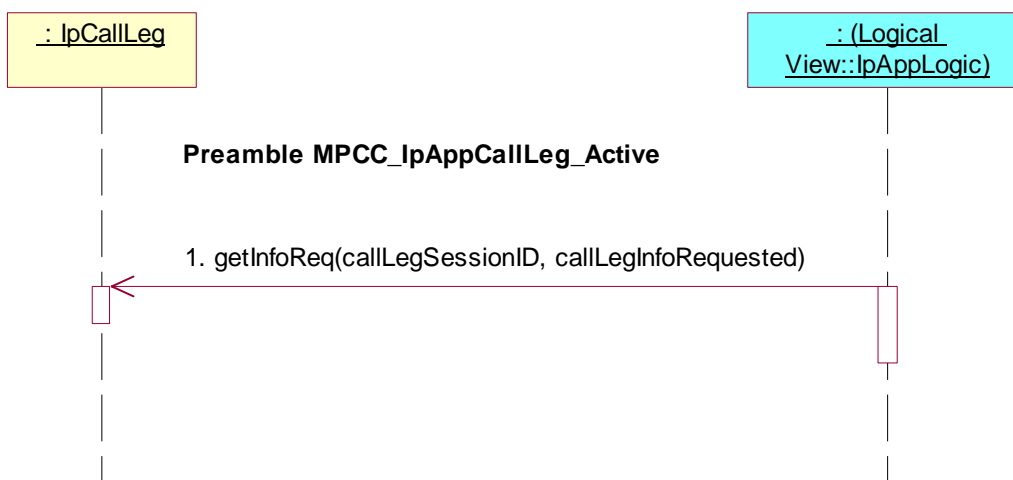

Test MPCC_IpAppCallLeg_40

Summary: get information about call leg, unsuccessful

Reference: ES 201 915-4 [1], clause 7.4.3.1

Precondition: IUT capable of invoking **getInfoReq()**

Preamble: **MPCC_IpAppCallLeg_Active**

Test Sequence:

1. Triggered Action: cause IUT to call **getInfoReq()** method on the tester's (SCF's) IpCallLeg interface.
Parameters: callLegSessionID, callLegInfoRequested
2. Method call **getInfoErr()**
Parameters: callLegSessionID, errorIndication
Check: no exception is returned

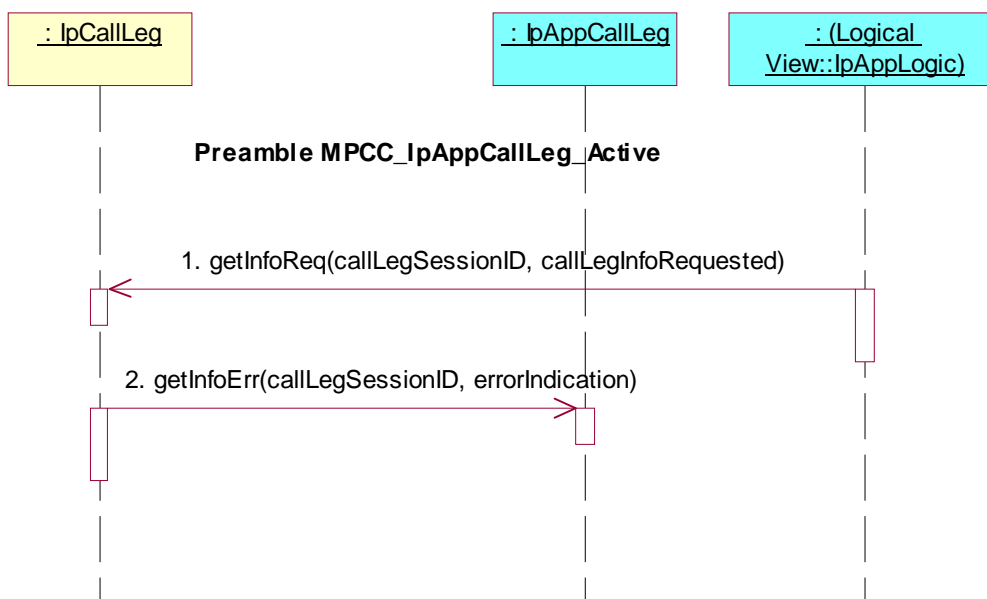
**Test MPCC_IpAppCallLeg_41**

Summary: set charge plan for call leg

Reference: ES 201 915-4 [1], clause 7.4.3.1

Precondition: IUT capable of invoking **setChargePlan()**

Preamble: **MPCC_IpAppCallLeg_Active**

Test Sequence:

1. Triggered Action: cause IUT to call **setChargePlan()** method on the tester's (SCF's) IpCallLeg interface.
Parameters: callLegSessionID, callChargePlan

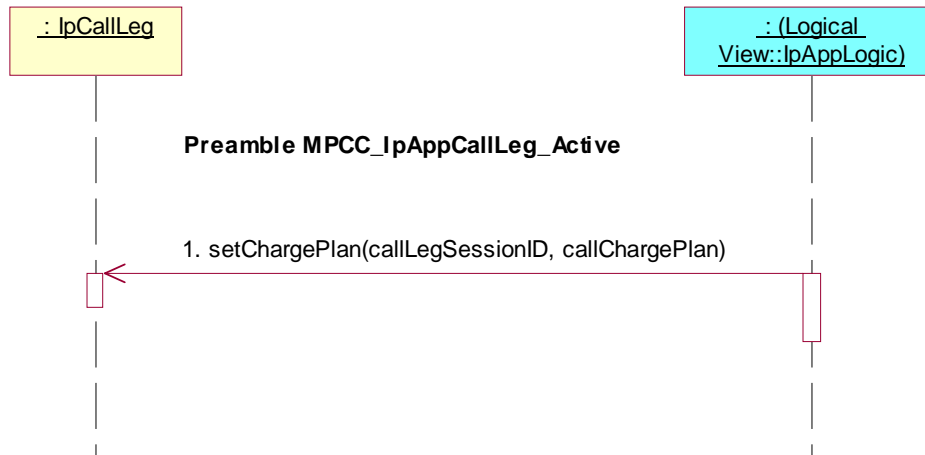

Test MPCC_IpAppCallLeg_42

Summary: allow advice of charge information

Reference: ES 201 915-4 [1], clause 7.4.3.1

Precondition: IUT capable of invoking **setAdviceOfCharge()**

Preamble: **MPCC_IpAppCallLeg_Active**

Test Sequence:

1. Triggered Action: cause IUT to call **setAdviceOfCharge()** method on the tester's (SCF's) IpCallLeg interface.
Parameters: callLegSessionID, aOCInfo, tariffSwitch

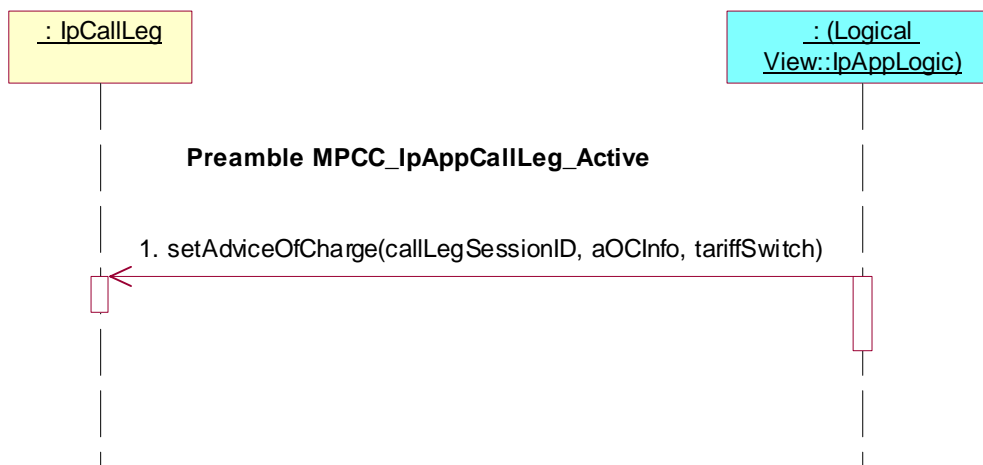

Test MPCC_IpAppCallLeg_43

Summary: supervise call leg,

Reference: ES 201 915-4 [1], clause 7.4.3.1

Precondition: IUT capable of invoking **superviseReq()**

Preamble: **MPCC_IpAppCallLeg_Active**

Test Sequence:

1. Triggered Action: cause IUT to call **superviseReq()** method on the tester's (SCF's) IpCallLeg interface.
Parameters: callLegSessionID, time, treatment

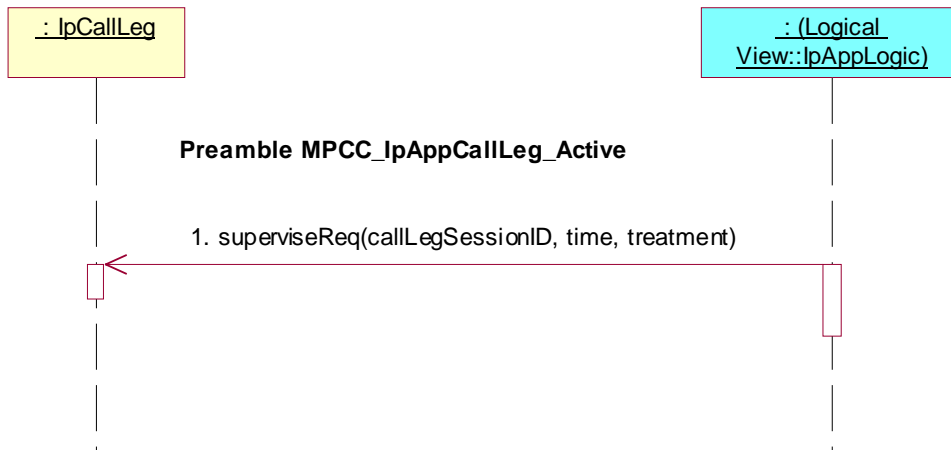

Test MPCC_IpAppCallLeg_44

Summary: supervise call leg, unsuccessful

Reference: ES 201 915-4 [1], clause 7.4.3.1

Precondition: IUT capable of invoking **superviseReq()**

Preamble: **MPCC_IpAppCallLeg_Active**

Test Sequence:

1. Triggered Action: cause IUT to call **superviseReq()** method on the tester's (SCF's) IpCallLeg interface.
Parameters: callLegSessionID, time, treatment
2. Method call **superviseErr()**
Parameters: callLegSessionID, errorIndication
Check: no exception is returned

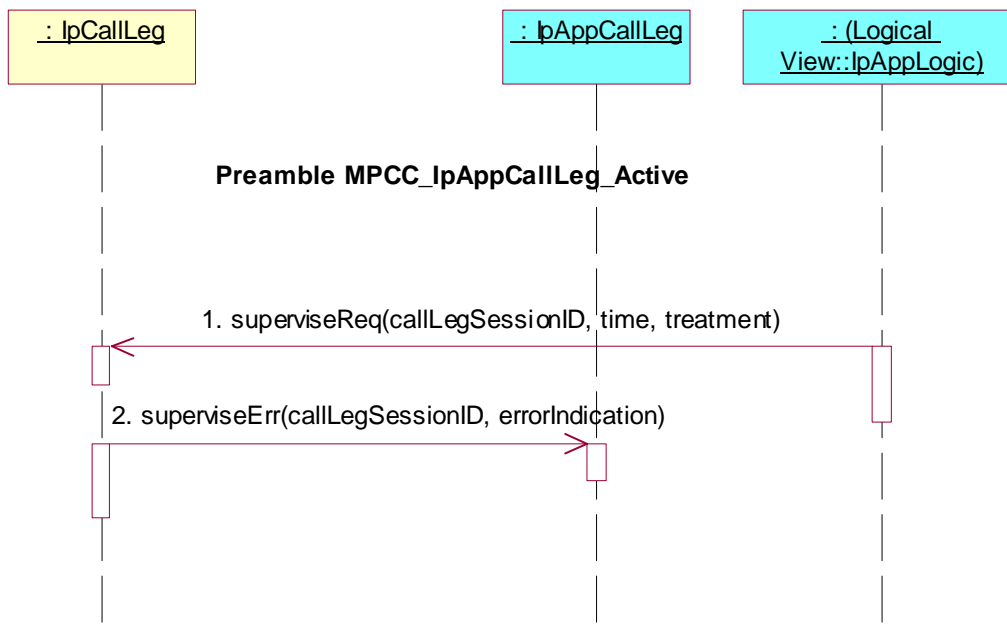

7.2.2.3.1.4 Releasing state

Preamble MPCC_IpAppCallLeg_Releasing

Reference: ES 201 915-4 [1], clause 7.4.3.1.4

Pre-preamble: Registration of the IUT (application) and the tester (Call Control SCF) to the framework. The IUT must have obtained a reference to an instance of the IpMultiPartyCallControlManager interface through selecting that service and signing the required service agreement.

The application is permitted to provide its IpAppMultiPartyCallControlManager interface reference in a setCallback() method which it calls prior to invoking further methods.

Preamble Sequence:

1. Triggered Action: cause IUT to call **createNotification()** method on the tester's (SCF's) IpMultiPartyCallControlManager interface.
 Parameters: appCallControlManager, notificationRequest
 notificationRequest.CallMonitorMode= P_CALL_MONITOR_MODE_INTERRUPT
 notificationRequest.CallEventType= P_CALL_EVENT_ORIGINATING_RELEASE
2. Method call **reportNotification()**
 Parameters: callReference, callLegReferenceSet, notificationInfo, assignmentID
 Check: valid value of TpAppMultiPartyCallBack is returned

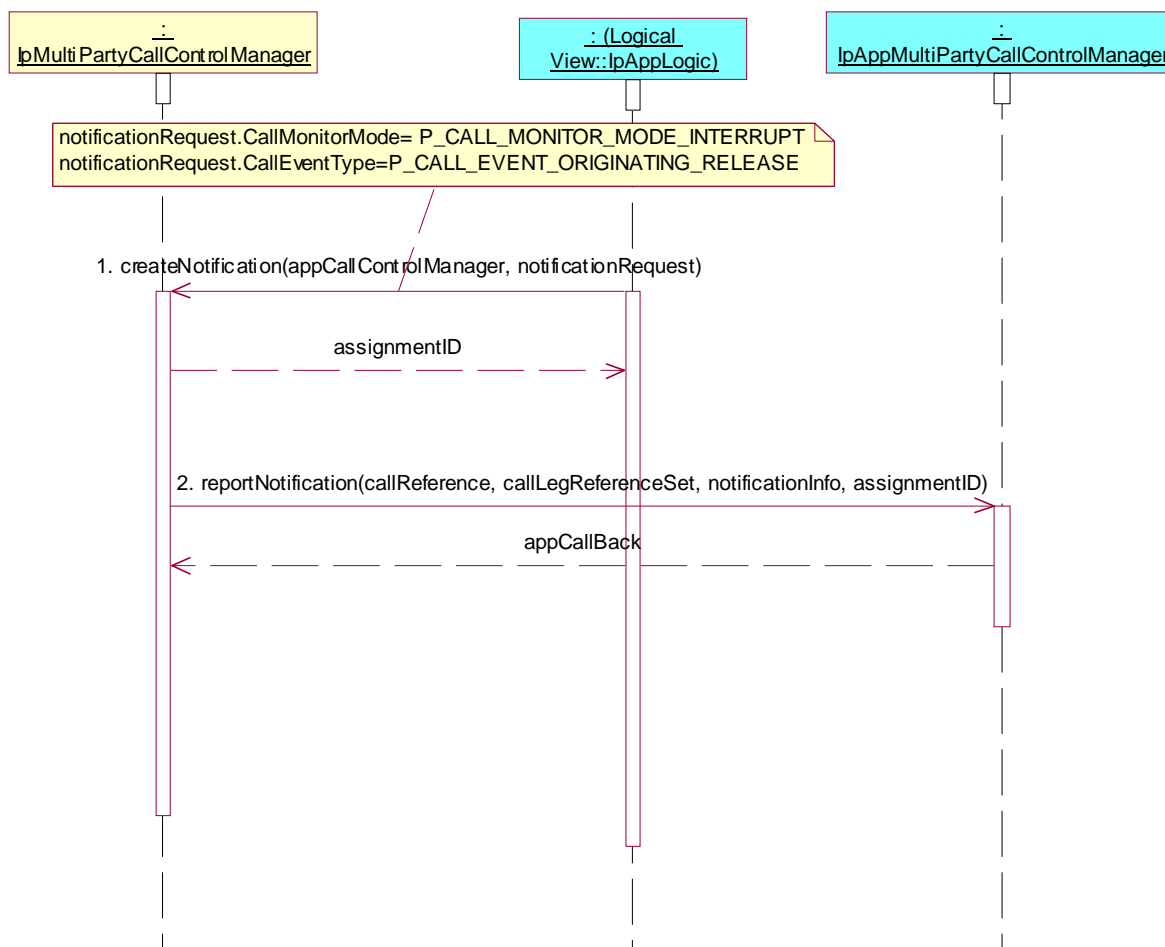

Test MPCC_IpAppCallLeg_45

Summary: request reference of call related to call leg

Reference: ES 201 915-4 [1], clause 7.4.3.1

Precondition: IUT capable of invoking **getCall()**

Preamble: **MPCC_IpAppCallLeg_Releasing**

Test Sequence:

1. Triggered Action: cause IUT to call **getCall()** method on the tester's (SCF's) IpCallLeg interface.
Parameters: callLegSessionID

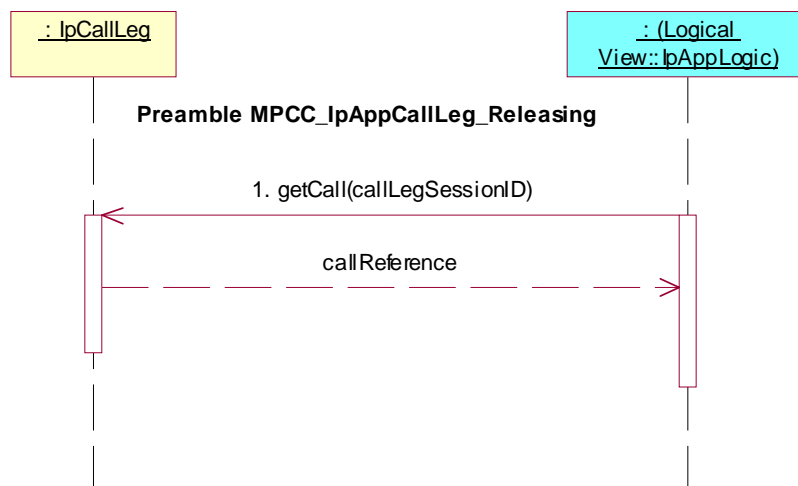
**Test MPCC_IpAppCallLeg_46**

Summary: continue processing of call leg

Reference: ES 201 915-4 [1], clause 7.4.3.1

Precondition: IUT capable of invoking **continueProcessing()**

Preamble: **MPCC_IpAppCallLeg_Releasing**

Test Sequence:

1. Triggered Action: cause IUT to call **continueProcessing()** method on the tester's (SCF's) IpCallLeg interface.
Parameters: callLegSessionID

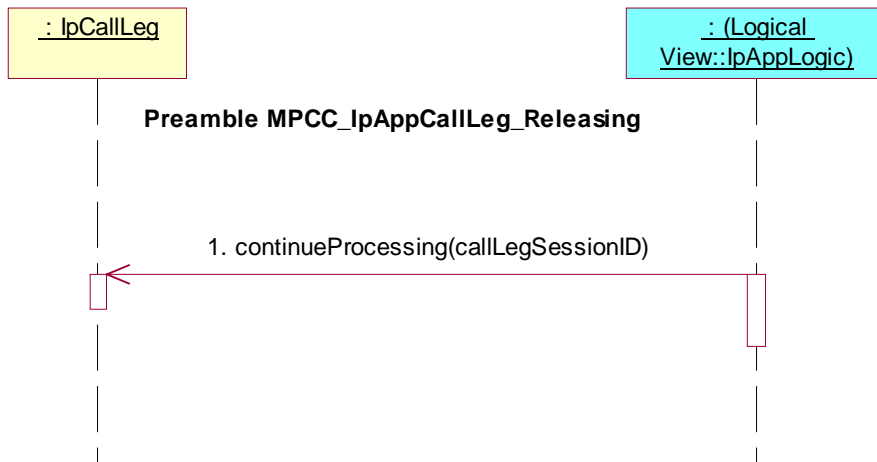

Test MPCC_IpAppCallLeg_47

Summary: de-assign call leg

Reference: ES 201 915-4 [1], clause 7.4.3.1

Precondition: IUT capable of invoking **deassign()**

Preamble: **MPCC_IpAppCallLeg_Releasing**

Test Sequence:

1. Triggered Action: cause IUT to call **deassign()** method on the tester's (SCF's) IpCallLeg interface.
Parameters: callLegSessionID

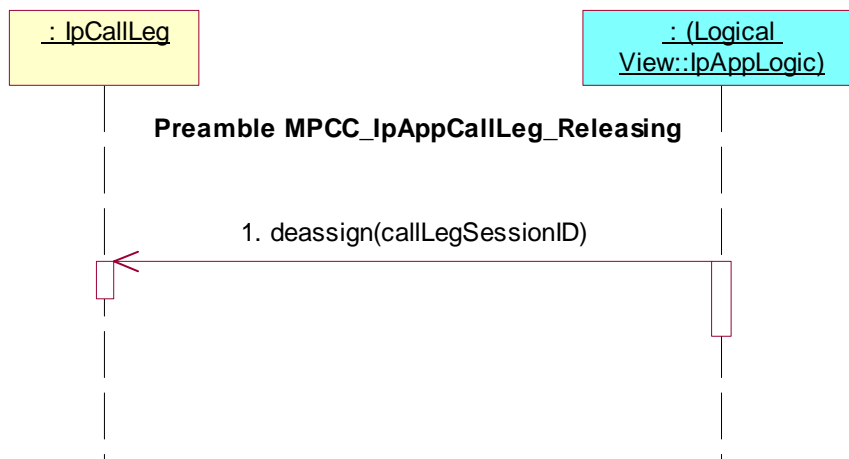

7.2.2.3.2 Terminating Leg

Reference: ES 201 915-4 [1], clauses 7.4.3.2

Precondition: IUT capable of invoking **createNotification()** and **createCallLeg()**

or IUT capable of invoking **createCall()**

7.2.2.3.2.1 Idle state

Preamble MPCC_IpAppCallLeg_Idle

Reference: ES 201 915-4 [1], clause 7.4.3.2.1

Pre-preamble: Registration of the IUT (application) and the tester (Call Control SCF) to the framework. The IUT must have obtained a reference to an instance of the IpMultiPartyCallControlManager interface through selecting that service and signing the required service agreement.

The application is permitted to provide its IpAppMultiPartyCallControlManager interface reference in a setCallback() method which it calls prior to invoking further methods.

Preamble Sequence:

1. Triggered Action: cause IUT to call **createNotification()** method on the tester's (SCF's) IpMultiPartyCallControlManager interface.
Parameters: appCallControlManager, notificationRequest
notificationRequest.CallMonitorMode= P_CALL_MONITOR_MODE_INTERRUPT
2. Method call **reportNotification()**
Parameters: callReference, callLegReferenceSet, notificationInfo, assignmentID
Check: valid value of TpAppMultiPartyCallBack is returned
3. Triggered Action: cause IUT to call **createCallLeg()** method on the tester's (SCF's) IpMultiPartyCall interface.
Parameters: callSessionID, appCallLeg

or

1. Triggered Action: cause IUT to call **createCall()** method on the tester's (SCF's) IpMultiPartyCallControlManager interface.
Parameters: appCall
2. Triggered Action: cause IUT to call **createCallLeg()** method on the tester's (SCF's) IpMultiPartyCall interface.
Parameters: callSessionID, appCallLeg

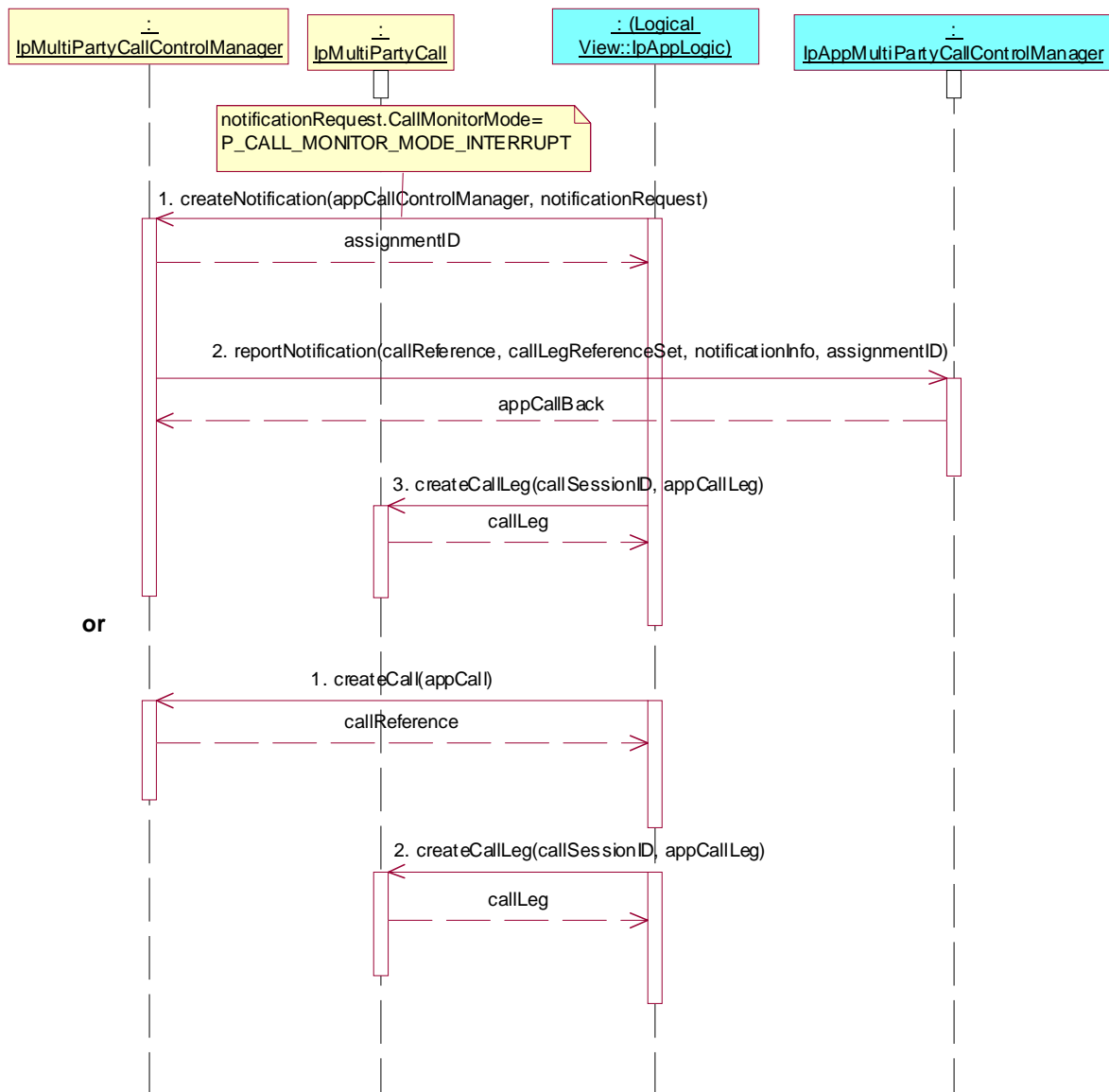

Test MPCC_IpAppCallLeg_48

Summary: route call leg, unsuccessful

Reference: ES 201 915-4 [1], clause 7.4.3.2

Precondition: IUT capable of invoking **routeReq()**

Preamble: **MPCC_IpAppCallLeg_Idle**

Test Sequence:

1. Triggered Action: cause IUT to call **routeReq()** method on the tester's (SCF's) terminating IpCallLeg interface.
Parameters: callLegSessionID, targetAddress, originatingAddress, appInfo, connectionProperties
2. Method call **routeErr()**
Parameters: callLegSessionID, errorIndication
Check: no exception is returned

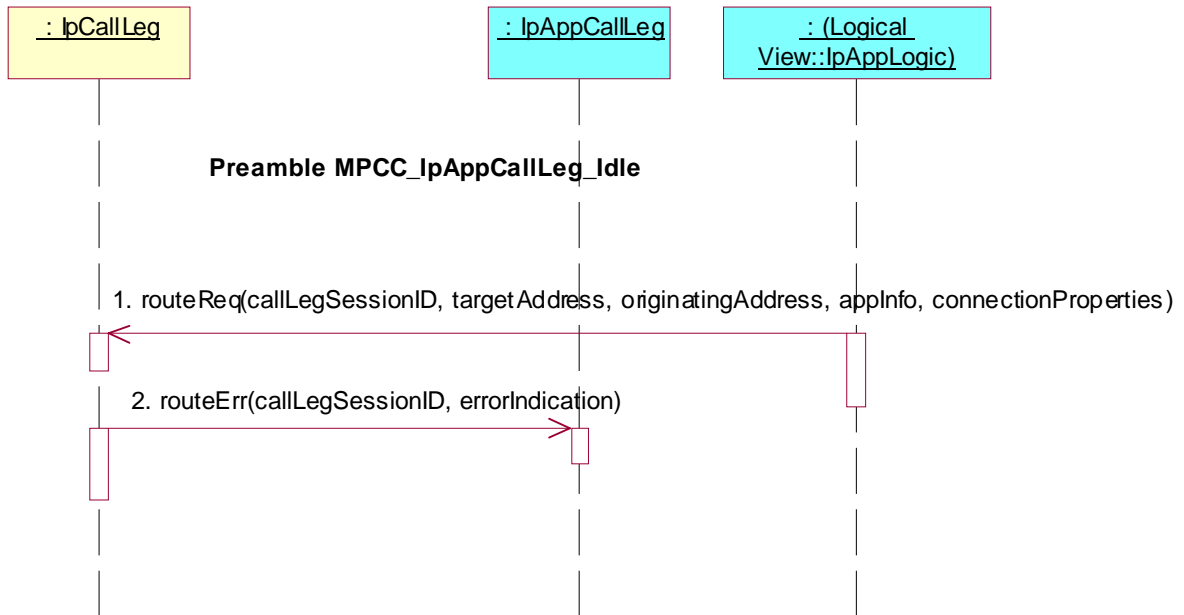

Test MPCC_IpAppCallLeg_49

Summary: request reference of call related to call leg

Reference: ES 201 915-4 [1], clause 7.4.3.2

Precondition: IUT capable of invoking **getCall()**

Preamble: **MPCC_IpAppCallLeg_Idle**

Test Sequence:

1. Triggered Action: cause IUT to call **getCall()** method on the tester's (SCF's) terminating IpCallLeg interface.
Parameters: callLegSessionID

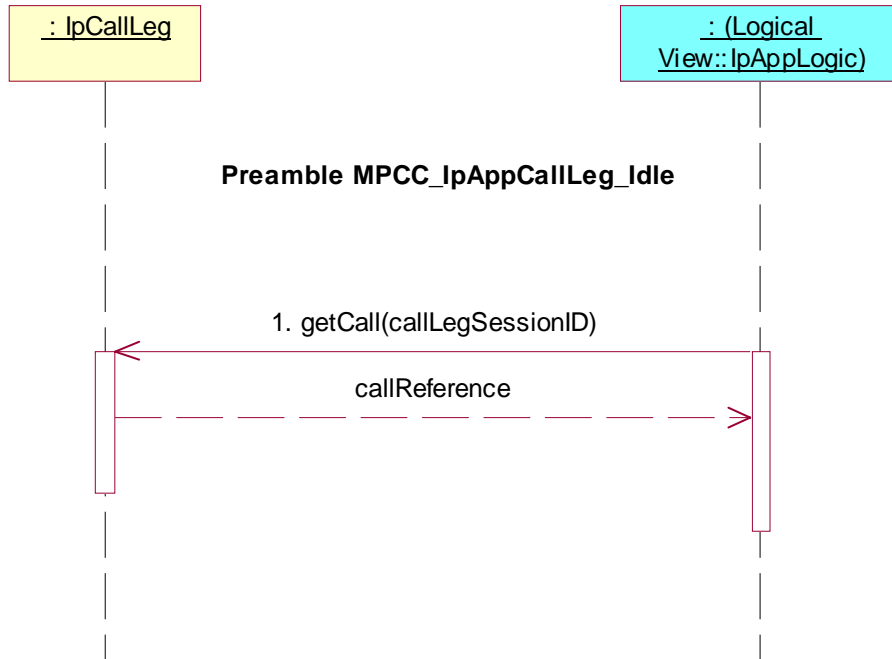

Test MPCC_IpAppCallLeg_50

Summary: release call leg

Reference: ES 201 915-4 [1], clause 7.4.3.2

Precondition: IUT capable of invoking **release()**

Preamble: **MPCC_IpAppCallLeg_Idle**

Test Sequence:

1. Triggered Action: cause IUT to call **release()** method on the tester's (SCF's) terminating IpCallLeg interface.
Parameters: callLegSessionID, cause

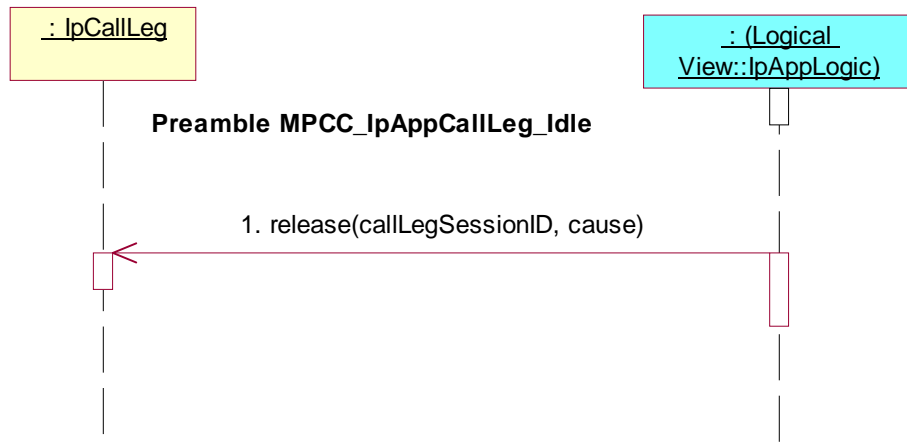

Test MPCC_IpAppCallLeg_51

Summary: change or clear event criteria

Reference: ES 201 915-4 [1], clause 7.4.3.2

Precondition: IUT capable of invoking **eventReportReq()**

Preamble: **MPCC_IpAppCallLeg_Idle**

Test Sequence:

1. Triggered Action: cause IUT to call **eventReportReq()** method on the tester's (SCF's) terminating IpCallLeg interface.
Parameters: callLegSessionID, eventsRequested

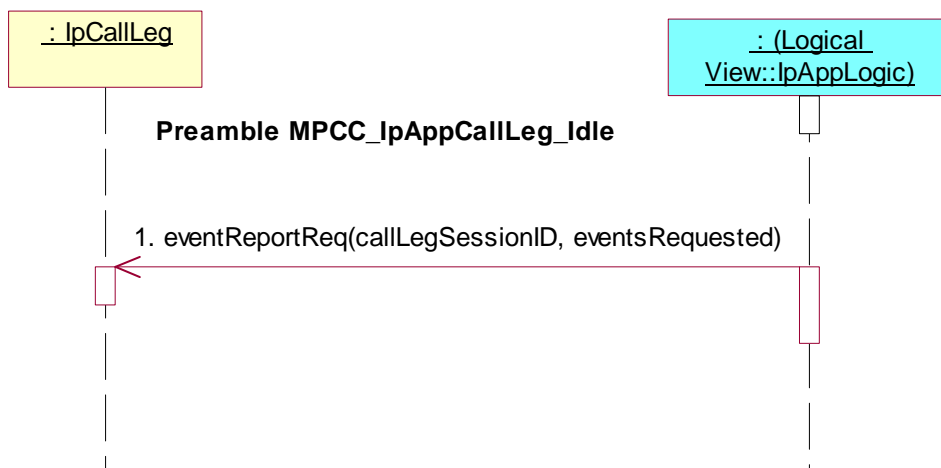

Test MPCC_IpAppCallLeg_52

Summary: change or clear event criteria, successful

Reference: ES 201 915-4 [1], clause 7.4.3.2

Precondition: IUT capable of invoking **eventReportReq()**, **routeReq()**

Preamble: **MPCC_IpAppCallLeg_Idle**

Test Sequence:

1. Triggered Action: cause IUT to call **eventReportReq()** method on the tester's (SCF's) terminating IpCallLeg interface.
Parameters: callLegSessionID, eventsRequested

2. Triggered Action: cause IUT to call **routeReq()** method on the tester's (SCF's) terminating IpCallLeg interface.
Parameters: callLegSessionID, targetAddress, originatingAddress, appInfo, connectionProperties
3. Method call **eventReportRes()**
Parameters: callLegSessionID, eventInfo
Check: no exception is returned

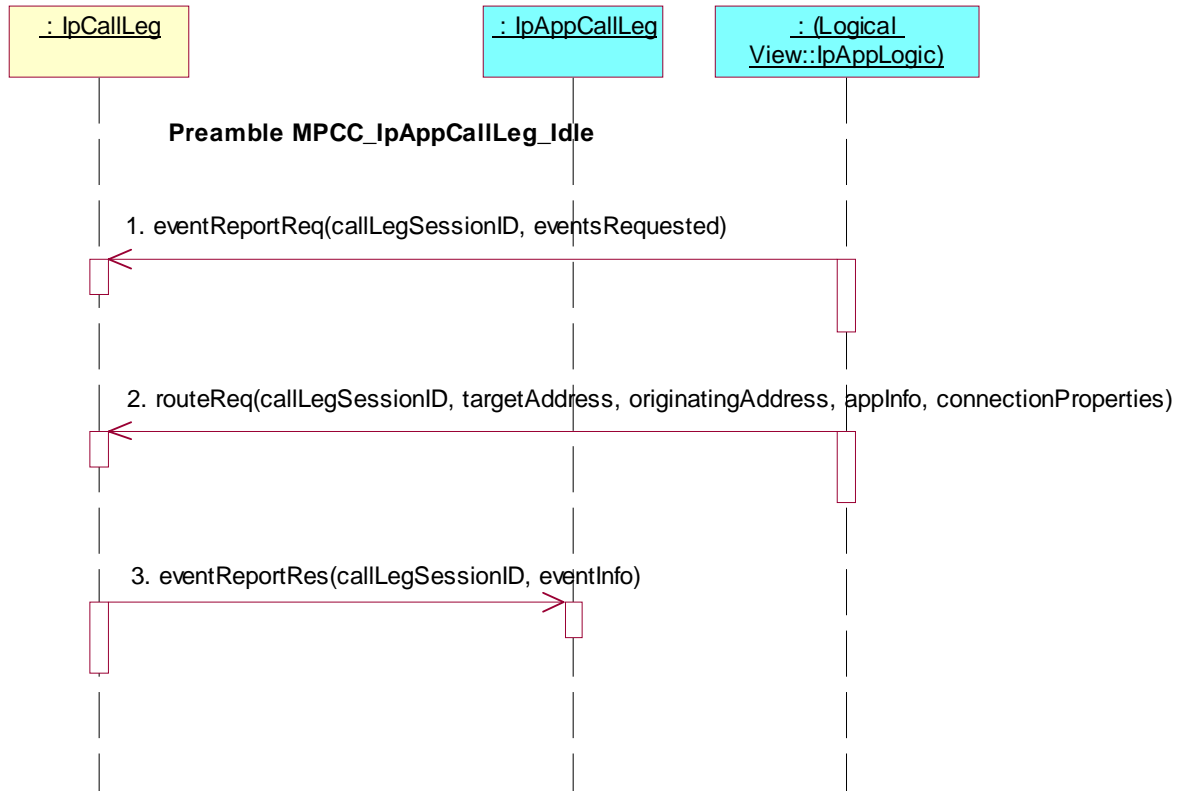

Test MPCC_IpAppCallLeg_53

Summary: change or clear event criteria, unsuccessful

Reference: ES 201 915-4 [1], clause 7.4.3.2

Precondition: IUT capable of invoking **eventReportReq()**

Preamble: **MPCC_IpAppCallLeg_Idle**

Test Sequence:

1. Triggered Action: cause IUT to call **eventReportReq()** method on the tester's (SCF's) terminating IpCallLeg interface.
Parameters: callLegSessionID, eventsRequested
2. Method call **eventReportErr()**
Parameters: callLegSessionID, errorIndication
Check: no exception is returned

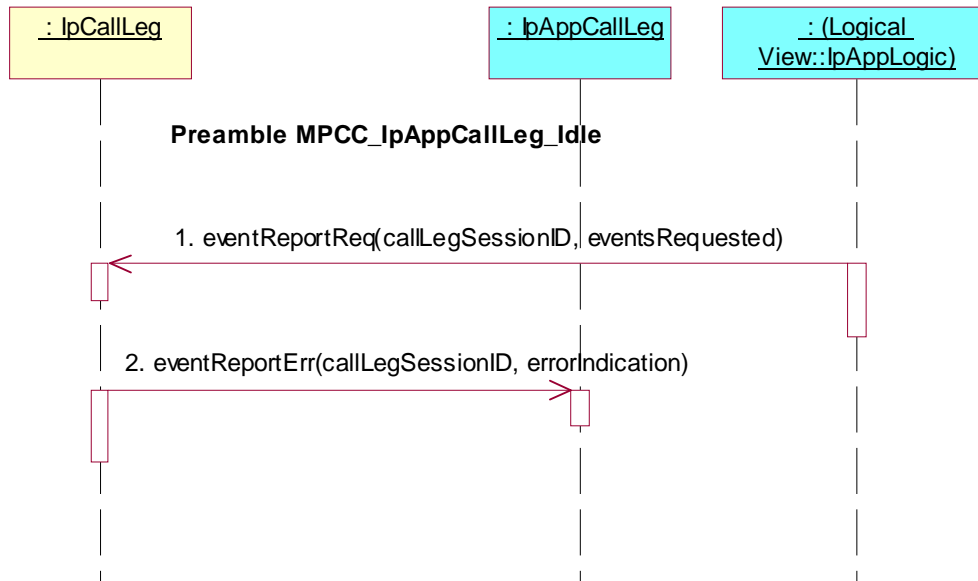

Test MPCC_IpAppCallLeg_54

Summary: get information about call leg

Reference: ES 201 915-4 [1], clause 7.4.3.2

Precondition: IUT capable of invoking **getInfoReq()**

Preamble: **MPCC_IpAppCallLeg_Idle**

Test Sequence:

1. Triggered Action: cause IUT to call **getInfoReq()** method on the tester's (SCF's) terminating IpCallLeg interface.
Parameters: callLegSessionID, callLegInfoRequested

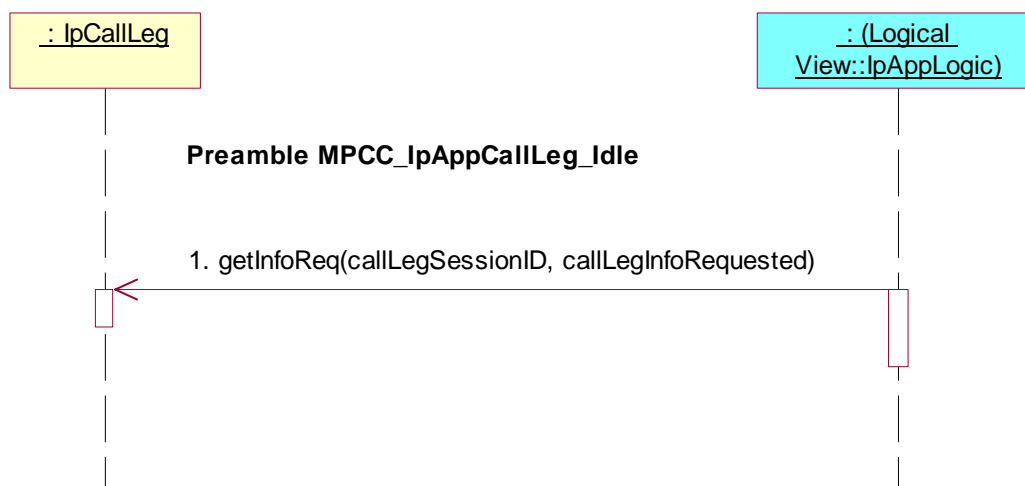

Test MPCC_IpAppCallLeg_55

Summary: get information about call leg, unsuccessful

Reference: ES 201 915-4 [1], clause 7.4.3.2

Precondition: IUT capable of invoking **getInfoReq()**

Preamble: **MPCC_IpAppCallLeg_Idle**

Test Sequence:

1. Triggered Action: cause IUT to call **getInfoReq()** method on the tester's (SCF's) terminating IpCallLeg interface.
Parameters: callLegSessionID, callLegInfoRequested
2. Method call **getInfoErr()**
Parameters: callLegSessionID, errorIndication
Check: no exception is returned

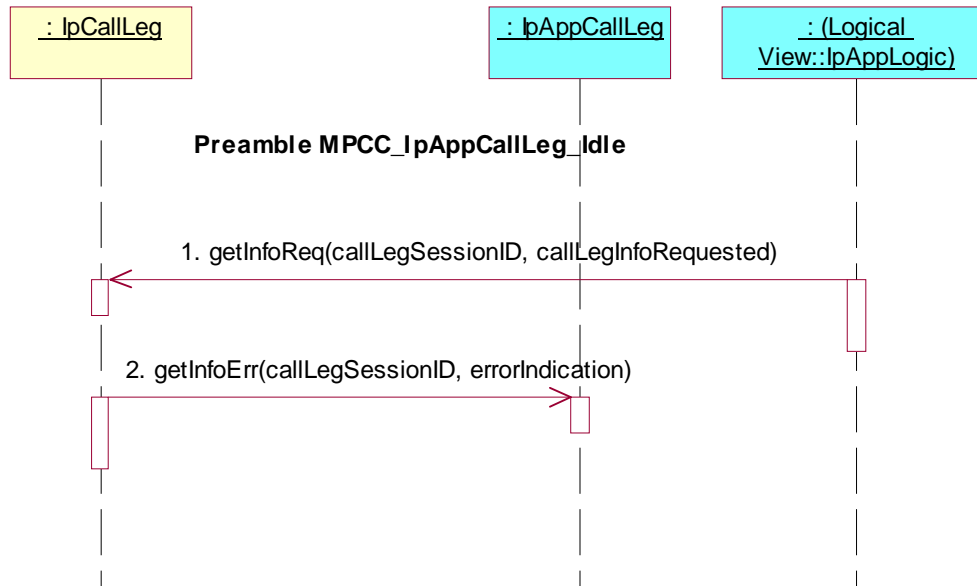

Test MPCC_IpAppCallLeg_56

Summary: set charge plan for call leg

Reference: ES 201 915-4 [1], clause 7.4.3.2

Precondition: IUT capable of invoking **setChargePlan()**

Preamble: **MPCC_IpAppCallLeg_Idle**

Test Sequence:

1. Triggered Action: cause IUT to call **setChargePlan()** method on the tester's (SCF's) terminating IpCallLeg interface.
Parameters: callLegSessionID, callChargePlan

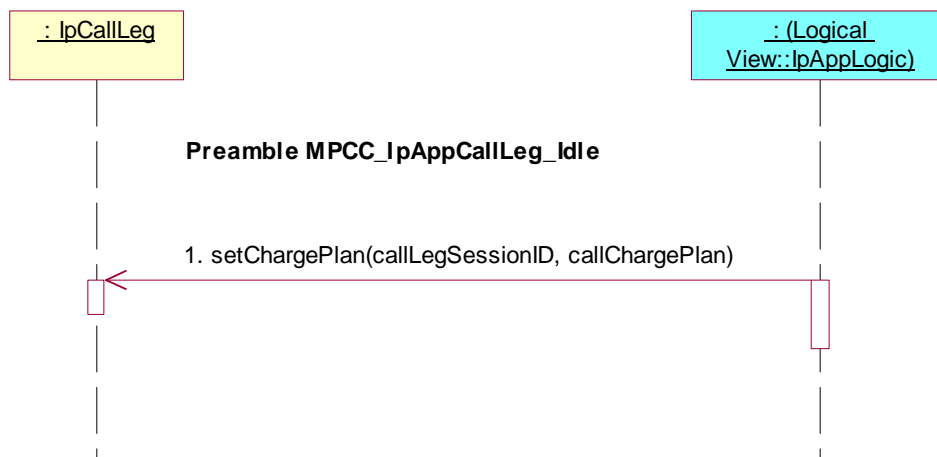

Test MPCC_IpAppCallLeg_57

Summary: allow advice of charge information

Reference: ES 201 915-4 [1], clause 7.4.3.2

Precondition: IUT capable of invoking **setAdviceOfCharge()**

Preamble: **MPCC_IpAppCallLeg_Idle**

Test Sequence:

1. Triggered Action: cause IUT to call **setAdviceOfCharge()** method on the tester's (SCF's) terminating IpCallLeg interface.
Parameters: callLegSessionID, aOCInfo, tariffSwitch

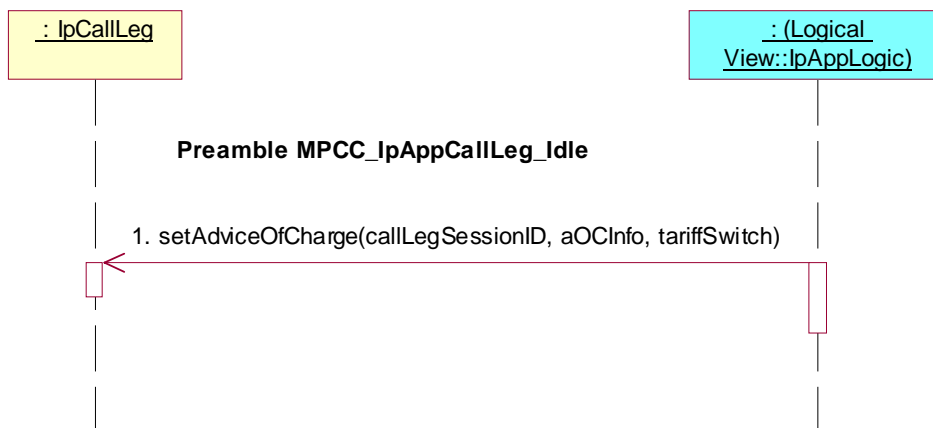
**Test MPCC_IpAppCallLeg_58**

Summary: supervise call leg

Reference: ES 201 915-4 [1], clause 7.4.3.2

Precondition: IUT capable of invoking **superviseReq()**

Preamble: **MPCC_IpAppCallLeg_Idle**

Test Sequence:

1. Triggered Action: cause IUT to call **superviseReq()** method on the tester's (SCF's) terminating IpCallLeg interface.
Parameters: callLegSessionID, time, treatment

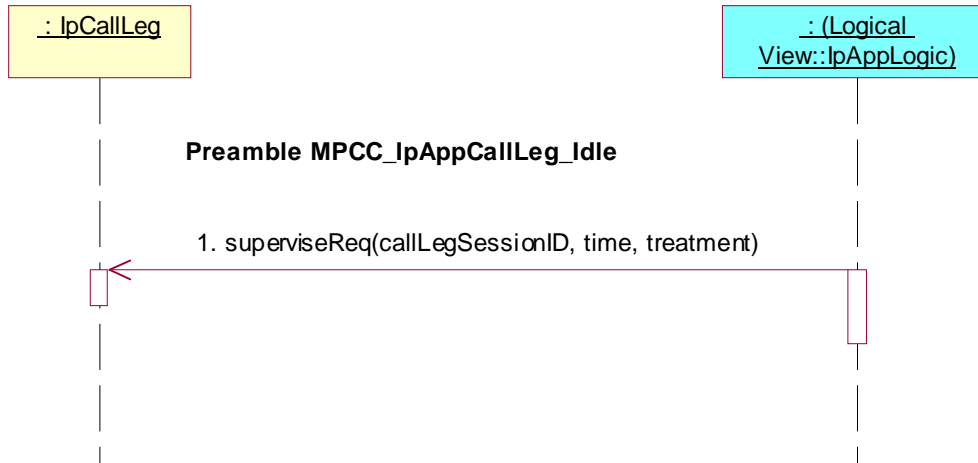

Test MPCC_IpAppCallLeg_59

Summary: supervise call leg, unsuccessful

Reference: ES 201 915-4 [1], clause 7.4.3.2

Precondition: IUT capable of invoking **superviseReq()**

Preamble: **MPCC_IpAppCallLeg_Idle**

Test Sequence:

1. Triggered Action: cause IUT to call **superviseReq()** method on the tester's (SCF's) terminating IpCallLeg interface.
Parameters: callLegSessionID, time, treatment
2. Method call **superviseErr()**
Parameters: callLegSessionID, errorIndication
Check: no exception is returned

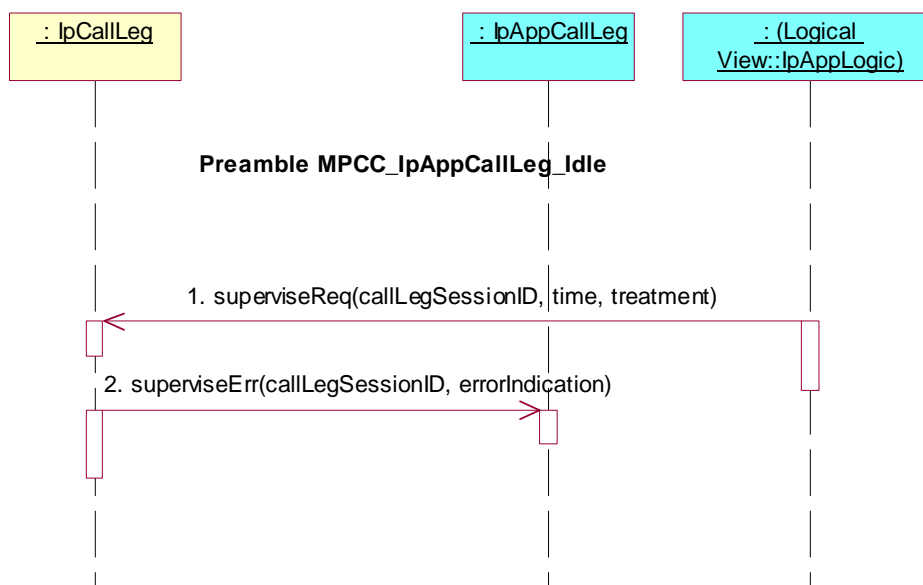

7.2.2.3.2.2 Active (Terminating) state

Precondition: IUT capable of invoking **eventReportReq()** and **routeReq()**

Preamble MPCC_IpAppCallLeg_Active_Terminating

Reference: ES 201 915-4 [1], clause 7.4.3.2.2

Pre-preamble: Registration of the IUT (application) and the tester (Call Control SCF) to the framework. The IUT must have obtained a reference to an instance of the IpMultiPartyCallControlManager interface through selecting that service and signing the required service agreement.

The application is permitted to provide its IpAppMultiPartyCallControlManager interface reference in a setCallback() method which it calls prior to invoking further methods.

Preamble Sequence:

1. Triggered Action: cause IUT to call **createNotification()** method on the tester's (SCF's) IpMultiPartyCallControlManager interface.
Parameters: appCallControlManager, notificationRequest
notificationRequest.CallMonitorMode= P_CALL_MONITOR_MODE_INTERRUPT
2. Method call **reportNotification()**
Parameters: callReference, callLegReferenceSet, notificationInfo, assignmentID
Check: valid value of TpAppMultiPartyCallBack is returned
3. Triggered Action: cause IUT to call **createCallLeg()** method on the tester's (SCF's) IpMultiPartyCall interface.
Parameters: callSessionID, appCallLeg
4. Triggered Action: cause IUT to call **eventReportReq()** method on the tester's (SCF's) terminating IpCallLeg interface.
Parameters: callLegSessionID, eventsRequested
5. Triggered Action: cause IUT to call **routeReq()** method on the tester's (SCF's) terminating IpCallLeg interface.
Parameters: callLegSessionID, targetAddress, originatingAddress, appInfo, connectionProperties
6. Method call **eventReportRes()**
Parameters: callLegSessionID, eventInfo
Check: no exception is returned

or

1. Triggered Action: cause IUT to call **createNotification()** method on the tester's (SCF's) IpMultiPartyCallControlManager interface.
Parameters: appCallControlManager, notificationRequest
notificationRequest.CallMonitorMode= P_CALL_MONITOR_MODE_INTERRUPT
notificationRequest.CallEventType= P_CALL_EVENT_TERMINATING_CALL_ATTEMPT
or P_CALL_EVENT_TERMINATING_CALL_ATTEMPT_AUTHORISED or
P_CALL_EVENT_ALERTING or P_CALL_EVENT_ANSWER or
P_CALL_EVENT_REDIRECTED or P_CALL_EVENT_QUEUED or
P_CALL_EVENT_TERMINATING_SERVICE_CODE
2. Method call **reportNotification()**
Parameters: callReference, callLegReferenceSet, notificationInfo, assignmentID
Check: valid value of TpAppMultiPartyCallBack is returned

or

1. Triggered Action: cause IUT to call **createCall()** method on the tester's (SCF's) IpMultiPartyCallControlManager interface.
Parameters: appCall

2. Triggered Action: cause IUT to call **createCallLeg()** method on the tester's (SCF's) IpMultiPartyCall interface.
Parameters: callSessionID, appCallLeg
3. Triggered Action: cause IUT to call **eventReportReq()** method on the tester's (SCF's) terminating IpCallLeg interface.
Parameters: callLegSessionID, eventsRequested
4. Triggered Action: cause IUT to call **routeReq()** method on the tester's (SCF's) terminating IpCallLeg interface.
Parameters: callLegSessionID, targetAddress, originatingAddress, appInfo, connectionProperties
5. Method call **eventReportRes()**
Parameters: callLegSessionID, eventInfo
Check: no exception is returned

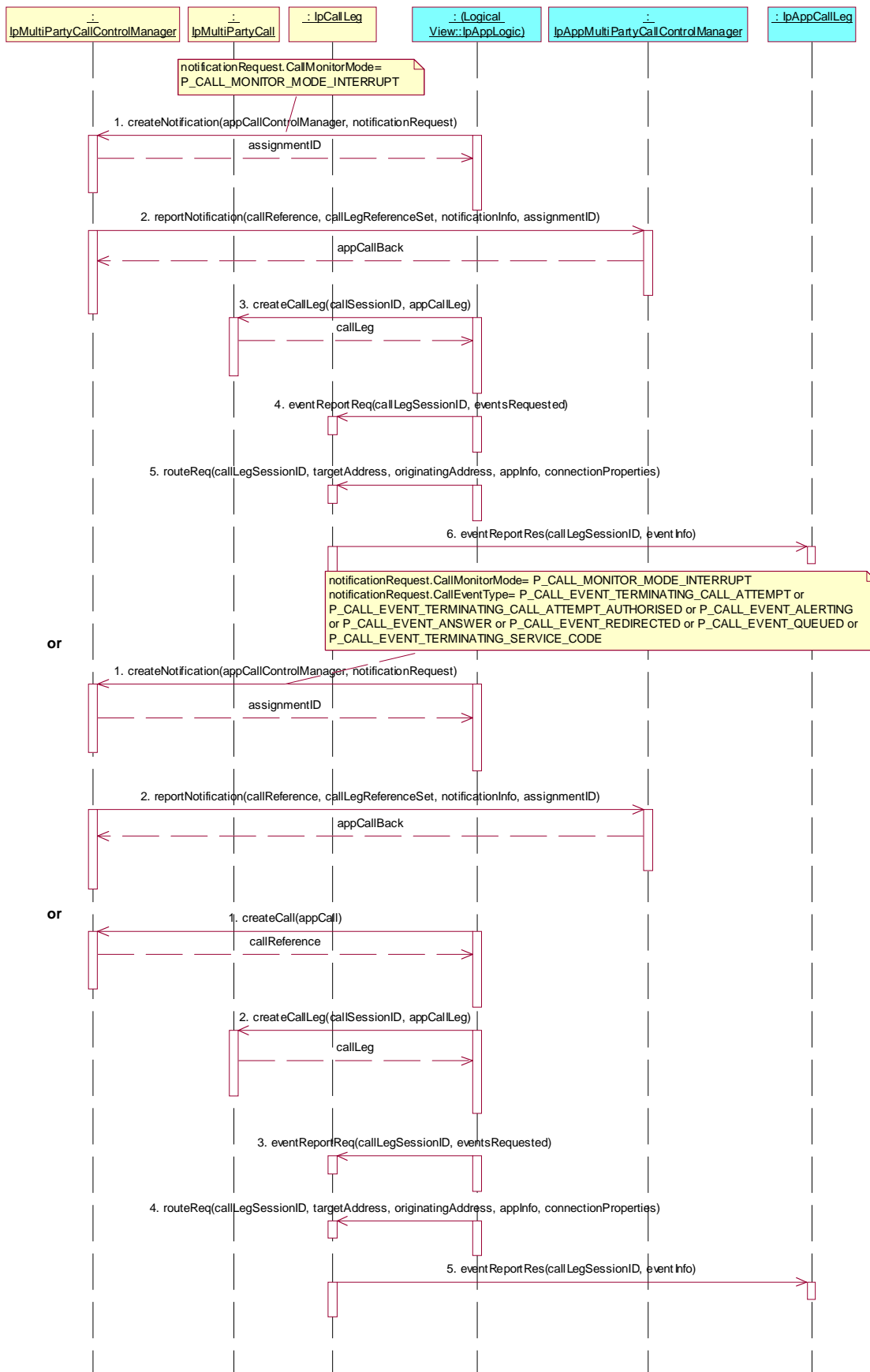

Test MPCC_IpAppCallLeg_60

Summary: attach media, successful

Reference: ES 201 915-4 [1], clause 7.4.3.2

Precondition: IUT capable of invoking **attachMediaReq()**

Preamble: **MPCC_IpAppCallLeg_Active_Terminating**

Test Sequence:

1. Triggered Action: cause IUT to call **attachMediaReq()** method on the tester's (SCF's) terminating IpCallLeg interface.
Parameters: callLegSessionID
2. Method call **attachMediaRes()**
Parameters: callLegSessionID
Check: no exception is returned

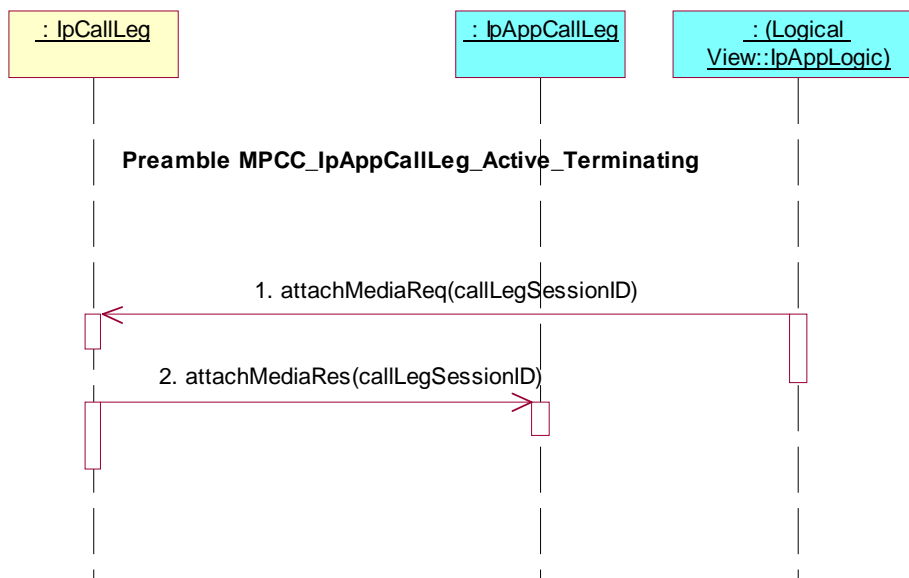
**Test MPCC_IpAppCallLeg_61**

Summary: attach media, unsuccessful

Reference: ES 201 915-4 [1], clause 7.4.3.2

Precondition: IUT capable of invoking **attachMediaReq()**

Preamble: **MPCC_IpAppCallLeg_Active_Terminating**

Test Sequence:

1. Triggered Action: cause IUT to call **attachMediaReq()** method on the tester's (SCF's) terminating IpCallLeg interface.
Parameters: callLegSessionID
2. Method call **attachMediaErr()**
Parameters: callLegSessionID, errorIndication
Check: no exception is returned

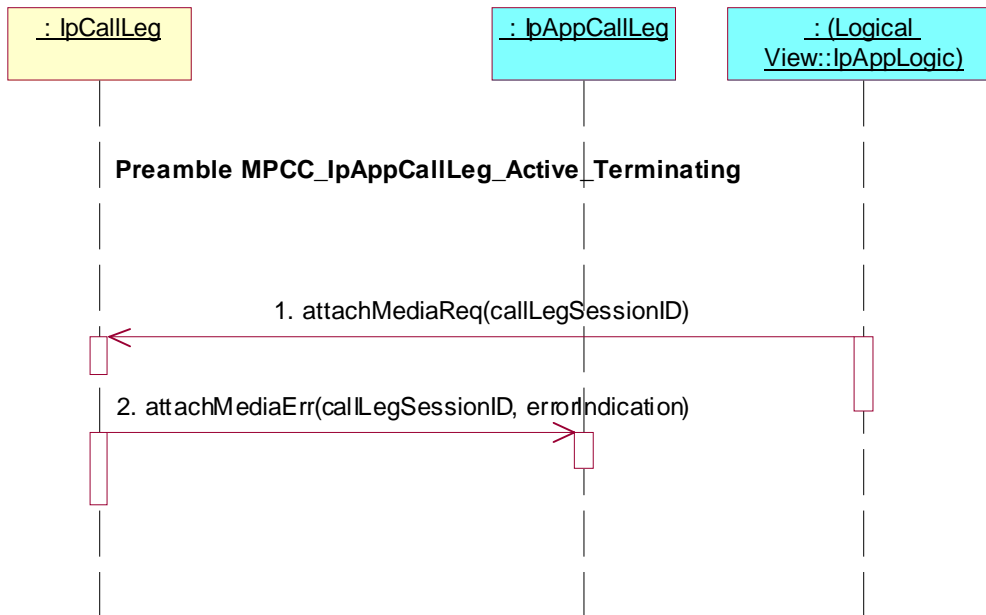

Test MPCC_IpAppCallLeg_62

Summary: detach media, successful

Reference: ES 201 915-4 [1], clause 7.4.3.2

Precondition: IUT capable of invoking **detachMediaReq()**

Preamble: **MPCC_IpAppCallLeg_Active_Terminating**

Test Sequence:

1. Triggered Action: cause IUT to call **attachMediaReq()** method on the tester's (SCF's) terminating IpCallLeg interface.
Parameters: callLegSessionID
2. Method call **attachMediaRes()**
Parameters: callLegSessionID
Check: no exception is returned
3. Triggered Action: cause IUT to call **detachMediaReq()** method on the tester's (SCF's) terminating IpCallLeg interface.
Parameters: callLegSessionID
4. Method call **detachMediaRes()**
Parameters: callLegSessionID
Check: no exception is returned

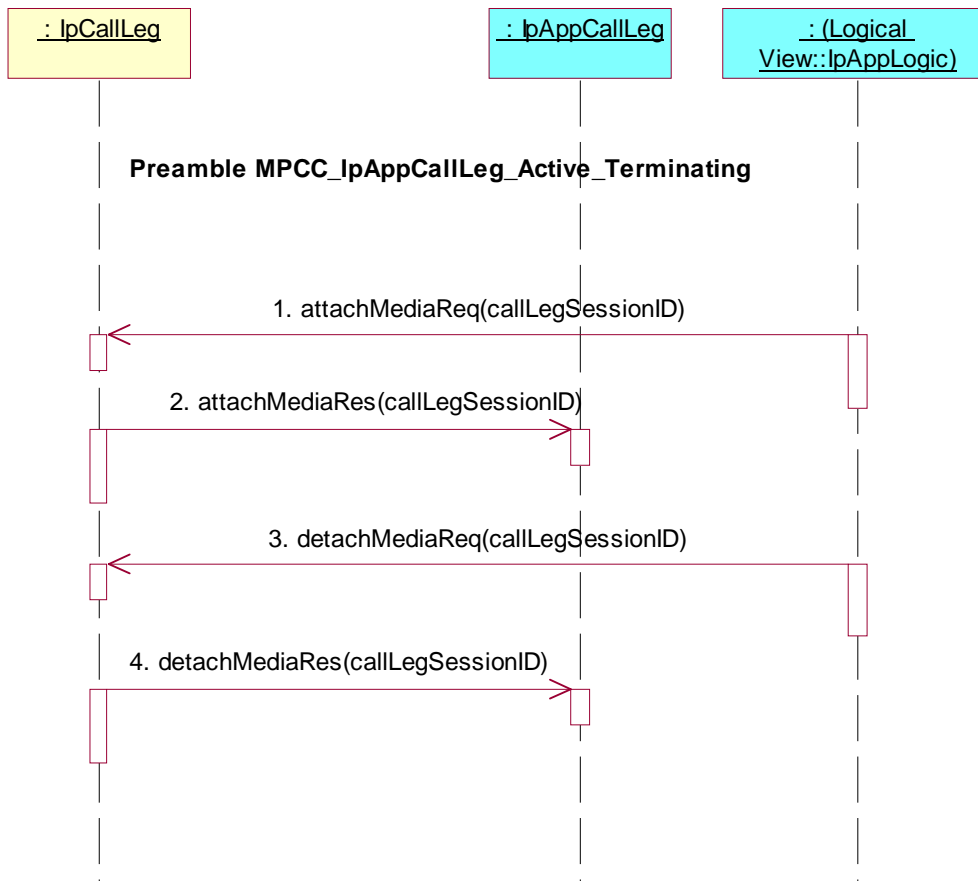

Test MPCC_IpAppCallLeg_63

Summary: detach media, unsuccessful

Reference: ES 201 915-4 [1], clause 7.4.3.2

Precondition: IUT capable of invoking **detachMediaReq()**

Preamble: **MPCC_IpAppCallLeg_Active_Terminating**

Test Sequence:

1. Triggered Action: cause IUT to call **attachMediaReq()** method on the tester's (SCF's) terminating IpCallLeg interface.
Parameters: callLegSessionID
2. Method call **attachMediaRes()**
Parameters: callLegSessionID
Check: no exception is returned
3. Triggered Action: cause IUT to call **detachMediaReq()** method on the tester's (SCF's) terminating IpCallLeg interface.
Parameters: callLegSessionID
4. Method call **detachMediaErr()**
Parameters: callLegSessionID, errorIndication
Check: no exception is returned

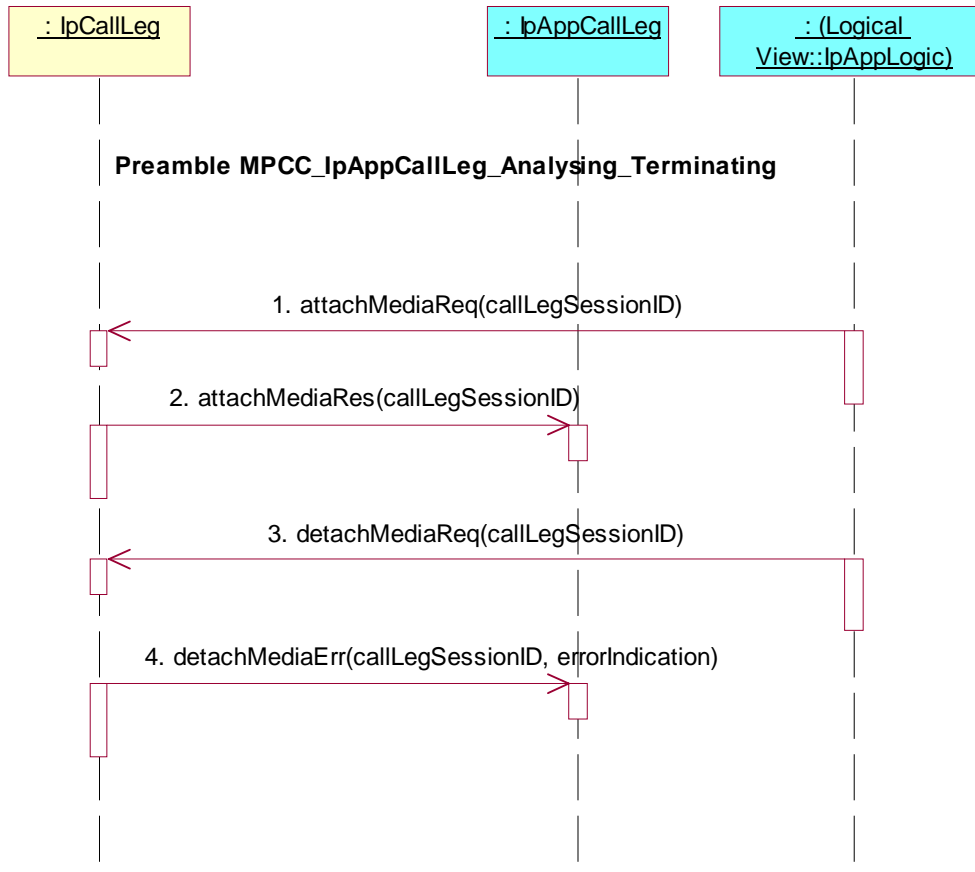

Test MPCC_IpAppCallLeg_64

Summary: request reference of call related to call leg

Reference: ES 201 915-4 [1], clause 7.4.3.2

Precondition: IUT capable of invoking **getCall()**

Preamble: **MPCC_IpAppCallLeg_Active_Terminating**

Test Sequence:

1. Triggered Action: cause IUT to call **getCall()** method on the tester's (SCF's) terminating IpCallLeg interface.
Parameters: callLegSessionID

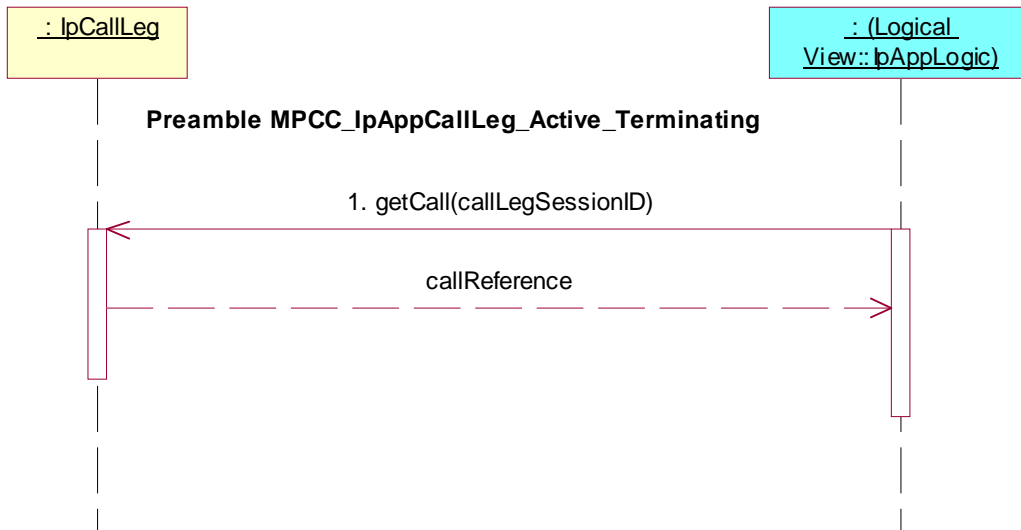

Test MPCC_IpAppCallLeg_65

Summary: request reference of call related to call leg

Reference: ES 201 915-4 [1], clause 7.4.3.2

Precondition: IUT capable of invoking **getCurrentDestinationAddress()**

Preamble: **MPCC_IpAppCallLeg_Active_Terminating**

Test Sequence:

1. Triggered Action: cause IUT to call **getCurrentDestinationAddress()** method on the tester's (SCF's) terminating IpCallLeg interface.
Parameters: callLegSessionID



Test MPCC_IpAppCallLeg_66

Summary: continue processing of call leg

Reference: ES 201 915-4 [1], clause 7.4.3.2

Precondition: IUT capable of invoking **continueProcessing()**

Preamble: **MPCC_IpAppCallLeg_Active_Terminating**

Test Sequence:

1. Triggered Action: cause IUT to call **continueProcessing()** method on the tester's (SCF's) terminating IpCallLeg interface.
Parameters: callLegSessionID

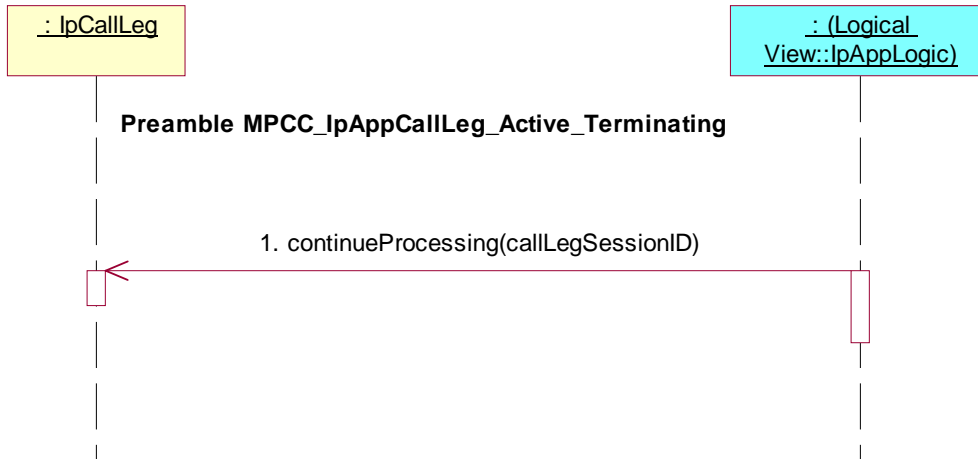

Test MPCC_IpAppCallLeg_67

Summary: release call leg

Reference: ES 201 915-4 [1], clause 7.4.3.2

Precondition: IUT capable of invoking **release()**

Preamble: **MPCC_IpAppCallLeg_Active_Terminating**

Test Sequence:

1. Triggered Action: cause IUT to call **release()** method on the tester's (SCF's) terminating IpCallLeg interface.
Parameters: callLegSessionID, cause

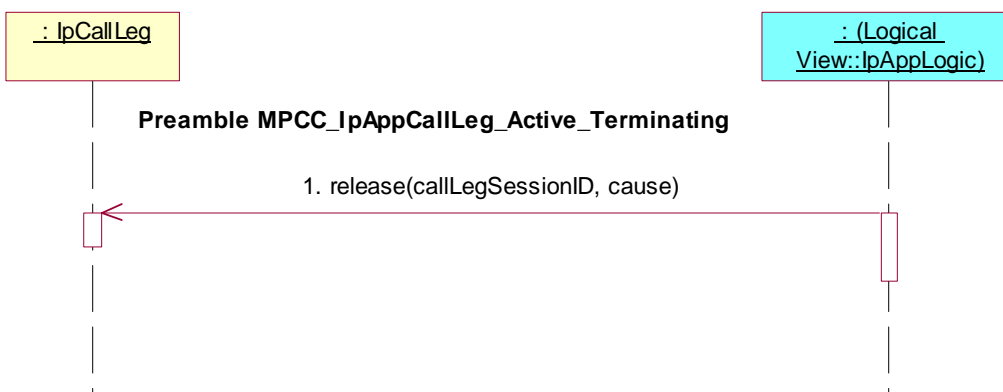

Test MPCC_IpAppCallLeg_68

Summary: de-assign call leg

Reference: ES 201 915-4 [1], clause 7.4.3.2

Precondition: IUT capable of invoking **deassign()**

Preamble: **MPCC_IpAppCallLeg_Active_Terminating**

Test Sequence:

1. Triggered Action: cause IUT to call **deassign()** method on the tester's (SCF's) terminating IpCallLeg interface.
Parameters: callLegSessionID

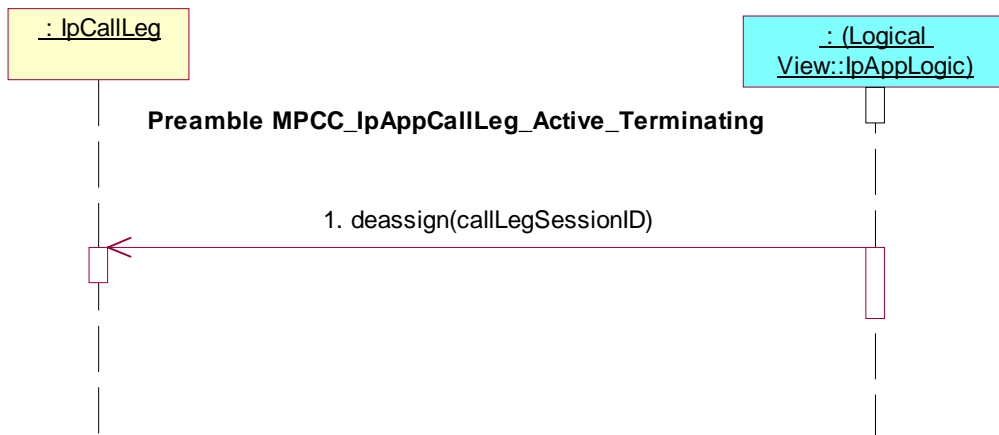

Test MPCC_IpAppCallLeg_69

Summary: get information about call leg

Reference: ES 201 915-4 [1], clause 7.4.3.2

Precondition: IUT capable of invoking **getInfoReq()**

Preamble: **MPCC_IpAppCallLeg_Active_Terminating**

Test Sequence:

1. Triggered Action: cause IUT to call **getInfoReq()** method on the tester's (SCF's) terminating IpCallLeg interface.
Parameters: callLegSessionID, callLegInfoRequested

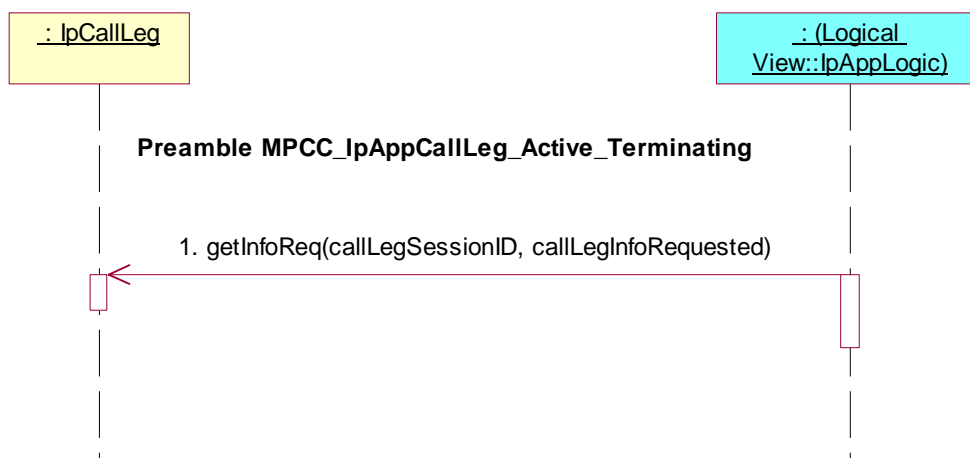

Test MPCC_IpAppCallLeg_70

Summary: get information about call leg, unsuccessful

Reference: ES 201 915-4 [1], clause 7.4.3.2

Precondition: IUT capable of invoking **getInfoReq()**

Preamble: **MPCC_IpAppCallLeg_Active_Terminating**

Test Sequence:

1. Triggered Action: cause IUT to call **getInfoReq()** method on the tester's (SCF's) terminating IpCallLeg interface.
Parameters: callLegSessionID, callLegInfoRequested
2. Method call **getInfoErr()**
Parameters: callLegSessionID, errorIndication
Check: no exception is returned

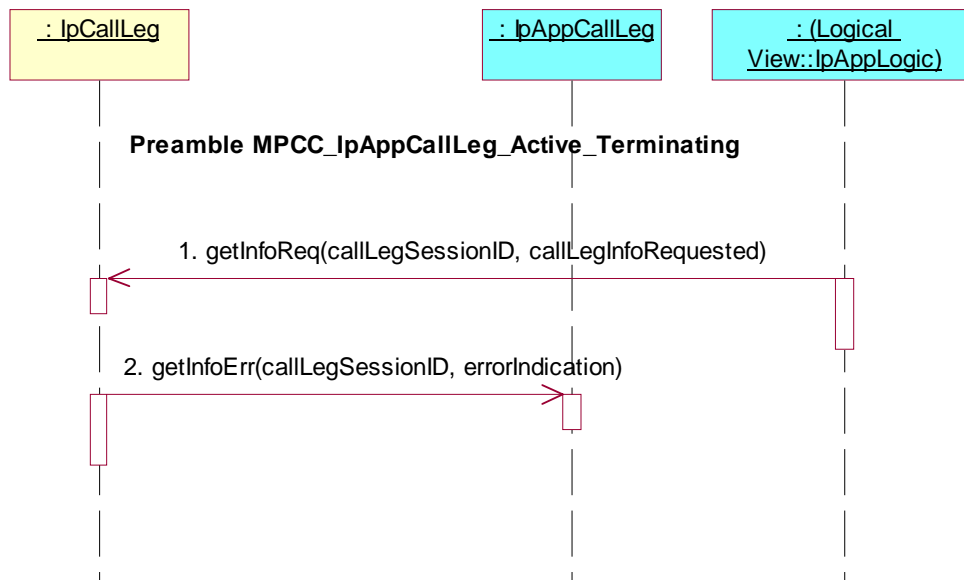

Test MPCC_IpAppCallLeg_71

Summary: supervise call leg

Reference: ES 201 915-4 [1], clause 7.4.3.2

Precondition: IUT capable of invoking **superviseReq()**

Preamble: **MPCC_IpAppCallLeg_Active_Terminating**

Test Sequence:

1. Triggered Action: cause IUT to call **superviseReq()** method on the tester's (SCF's) IpCallLeg interface.
Parameters: callLegSessionID, time, treatment

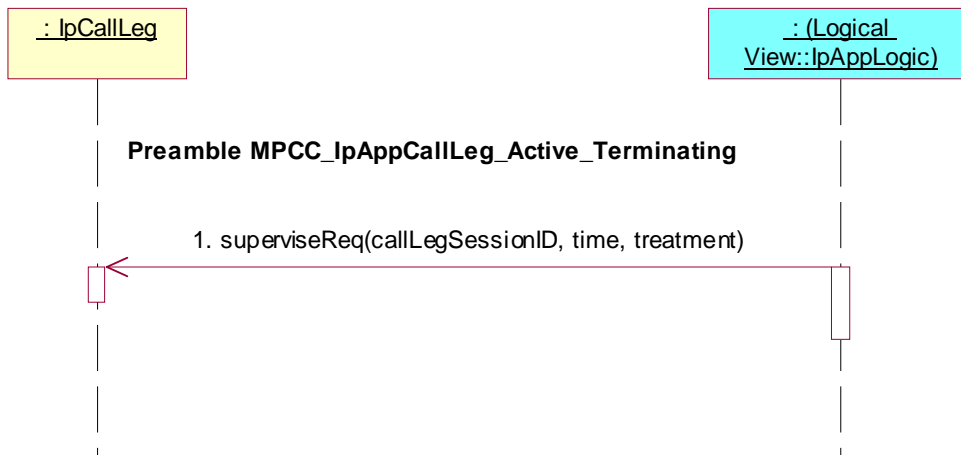

Test MPCC_IpAppCallLeg_72

Summary: supervise call leg, unsuccessful

Reference: ES 201 915-4 [1], clause 7.4.3.2

Precondition: IUT capable of invoking **superviseReq()**

Preamble: **MPCC_IpAppCallLeg_Active_Terminating**

Test Sequence:

1. Triggered Action: cause IUT to call **superviseReq()** method on the tester's (SCF's) IpCallLeg interface.
Parameters: callLegSessionID, time, treatment
2. Method call **superviseErr()**
Parameters: callLegSessionID, errorIndication
Check: no exception is returned

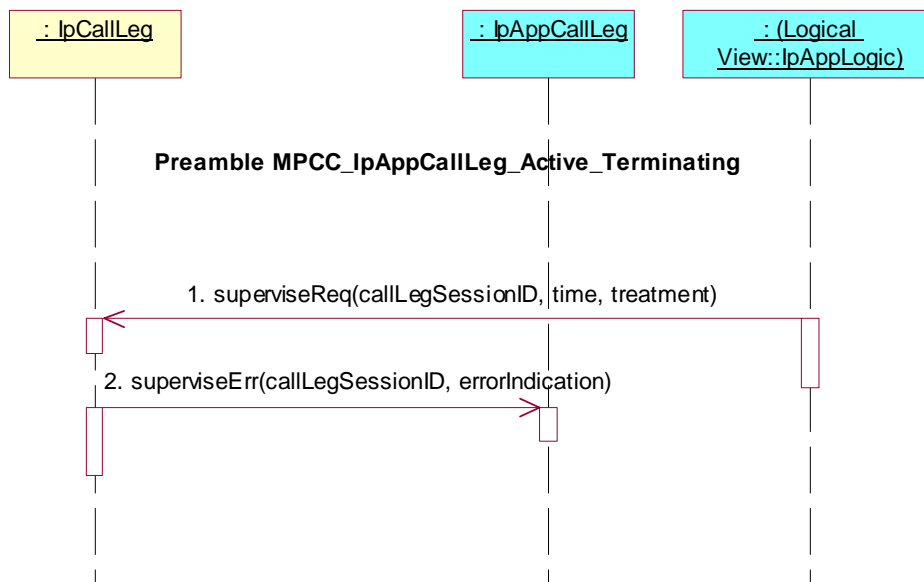

7.2.2.3.2.3 Releasing (Terminating) state

Precondition: IUT capable of invoking **eventReportReq()**, **routeReq()** and **release()**

Preamble MPCC_IpAppCallLeg_Releasing_Terminating

Reference: ES 201 915-4 [1], clause 7.4.3.2.3

Pre-preamble: Registration of the IUT (application) and the tester (Call Control SCF) to the framework. The IUT must have obtained a reference to an instance of the IpMultiPartyCallControlManager interface through selecting that service and signing the required service agreement.

The application is permitted to provide its IpAppMultiPartyCallControlManager interface reference in a setCallback() method which it calls prior to invoking further methods.

Preamble Sequence:

1. Triggered Action: cause IUT to call **createNotification()** method on the tester's (SCF's) IpMultiPartyCallControlManager interface.
Parameters: appCallControlManager, notificationRequest
notificationRequest.CallMonitorMode= P_CALL_MONITOR_MODE_INTERRUPT
2. Method call **reportNotification()**
Parameters: callReference, callLegReferenceSet, notificationInfo, assignmentID
Check: valid value of TpAppMultiPartyCallBack is returned
3. Triggered Action: cause IUT to call **createCallLeg()** method on the tester's (SCF's) IpMultiPartyCall interface.
Parameters: callSessionID, appCallLeg
4. Triggered Action: cause IUT to call **eventReportReq()** method on the tester's (SCF's) terminating IpCallLeg interface.
Parameters: callLegSessionID, eventsRequested
5. Triggered Action: cause IUT to call **routeReq()** method on the tester's (SCF's) terminating IpCallLeg interface.
Parameters: callLegSessionID, targetAddress, originatingAddress, appInfo, connectionProperties
6. Triggered Action: cause IUT to call **release()** method on the tester's (SCF's) terminating IpCallLeg interface.
Parameters: callLegSessionID, cause

or

1. Triggered Action: cause IUT to call **createNotification()** method on the tester's (SCF's) IpMultiPartyCallControlManager interface.
Parameters: appCallControlManager, notificationRequest
notificationRequest.CallMonitorMode= P_CALL_MONITOR_MODE_INTERRUPT
notificationRequest.CallEventType= P_CALL_EVENT_TERMINATING_RELEASE
2. Method call **reportNotification()**
Parameters: callReference, callLegReferenceSet, notificationInfo, assignmentID
Check: valid value of TpAppMultiPartyCallBack is returned

or

1. Triggered Action: cause IUT to call **createCall()** method on the tester's (SCF's) IpMultiPartyCallControlManager interface.
Parameters: appCall
2. Triggered Action: cause IUT to call **createCallLeg()** method on the tester's (SCF's) IpMultiParty interface.
Parameters: callSessionID, appCallLeg
3. Triggered Action: cause IUT to call **eventReportReq()** method on the tester's (SCF's) terminating IpCallLeg interface.
Parameters: callLegSessionID, eventsRequested

4. Triggered Action: cause IUT to call **routeReq()** method on the tester's (SCF's) terminating IpCallLeg interface.
Parameters: callLegSessionID, targetAddress, originatingAddress, appInfo, connectionProperties
5. Triggered Action: cause IUT to call **release()** method on the tester's (SCF's) terminating IpCallLeg interface.
Parameters: callLegSessionID, cause

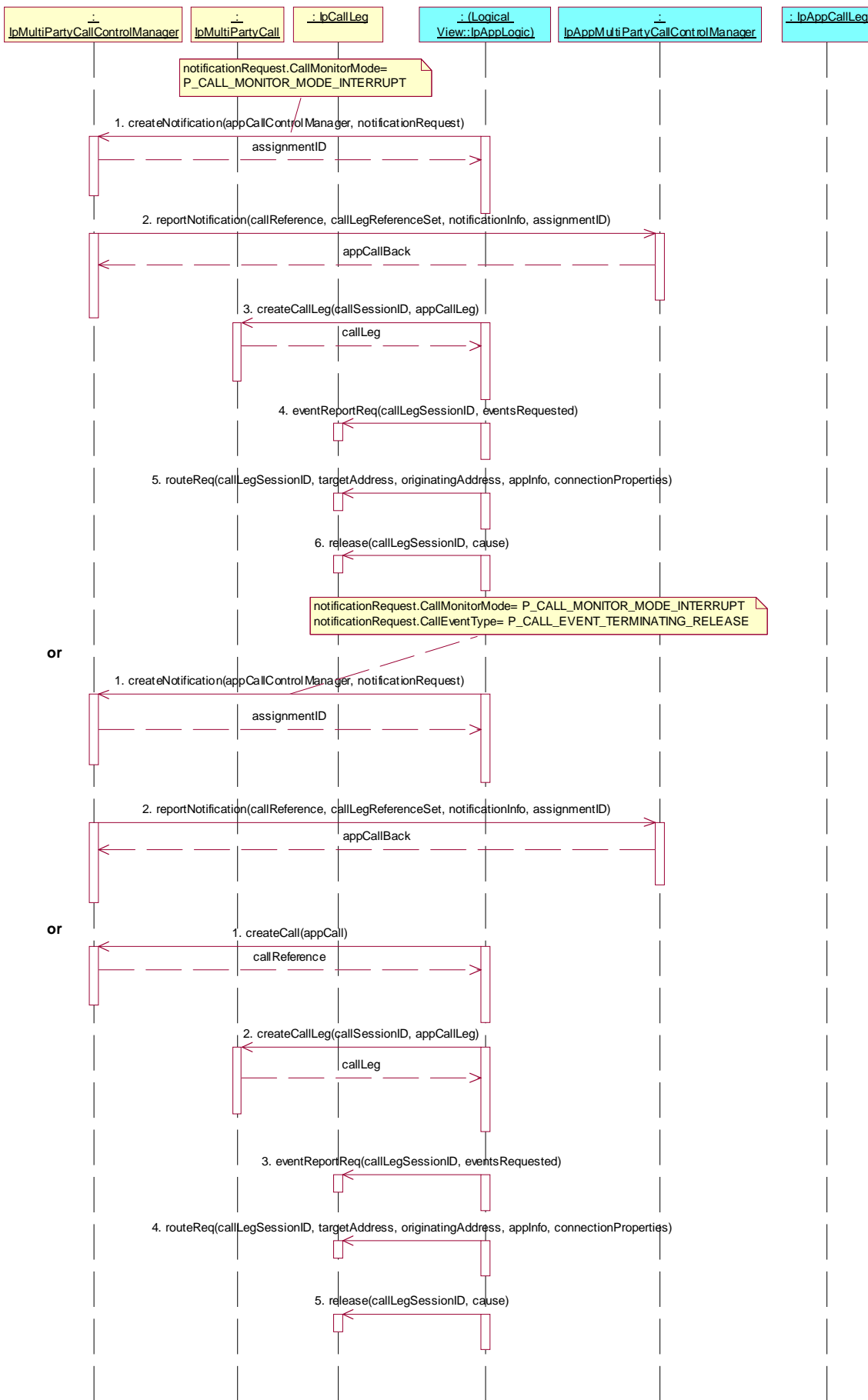

Test MPCC_IpAppCallLeg_73

Summary: request reference of call related to call leg

Reference: ES 201 915-4 [1], clause 7.4.3.2

Precondition: IUT capable of invoking **getCall()**

Preamble: **MPCC_IpAppCallLeg_Releasing_Terminating**

Test Sequence:

1. Triggered Action: cause IUT to call **getCall()** method on the tester's (SCF's) terminating IpCallLeg interface.
Parameters: callLegSessionID

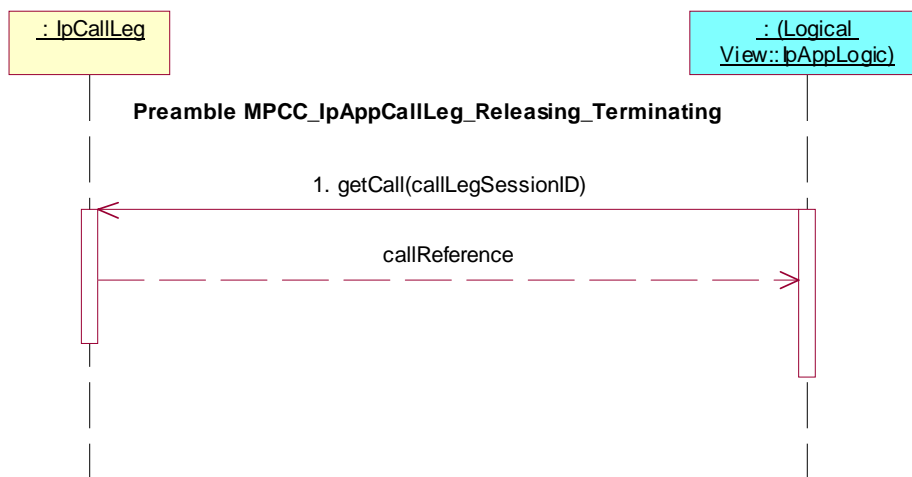
**Test MPCC_IpAppCallLeg_74**

Summary: request reference of call related to call leg

Reference: ES 201 915-4 [1], clause 7.4.3.2

Precondition: IUT capable of invoking **getCurrentDestinationAddress()**

Preamble: **MPCC_IpAppCallLeg_Releasing_Terminating**

Test Sequence:

1. Triggered Action: cause IUT to call **getCurrentDestinationAddress()** method on the tester's (SCF's) terminating IpCallLeg interface.
Parameters: callLegSessionID

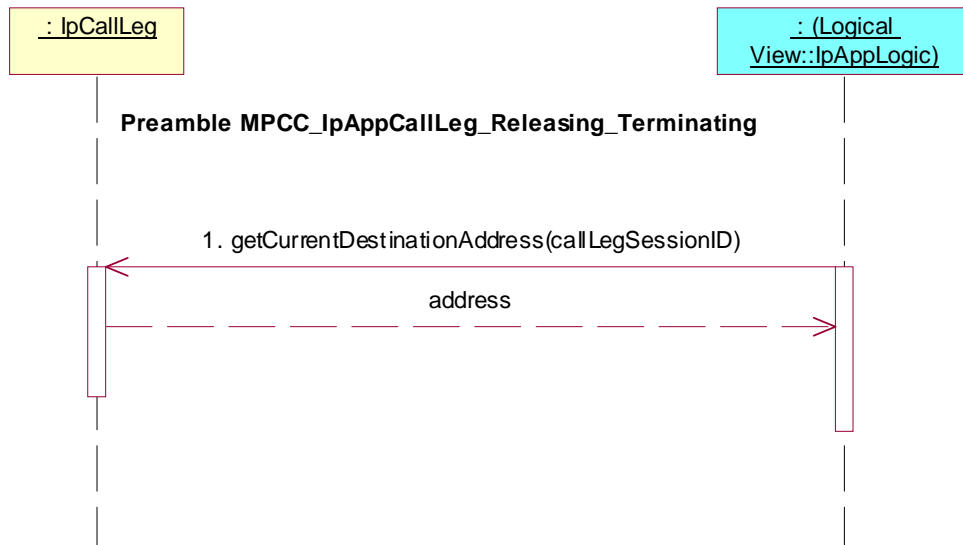

Test MPCC_IpAppCallLeg_75

Summary: continue processing of call leg

Reference: ES 201 915-4 [1], clause 7.4.3.2

Precondition: IUT capable of invoking **continueProcessing()**

Preamble: **MPCC_IpAppCallLeg_Releasing_Terminating**

Test Sequence:

1. Triggered Action: cause IUT to call **continueProcessing()** method on the tester's (SCF's) terminating IpCallLeg interface.
Parameters: callLegSessionID

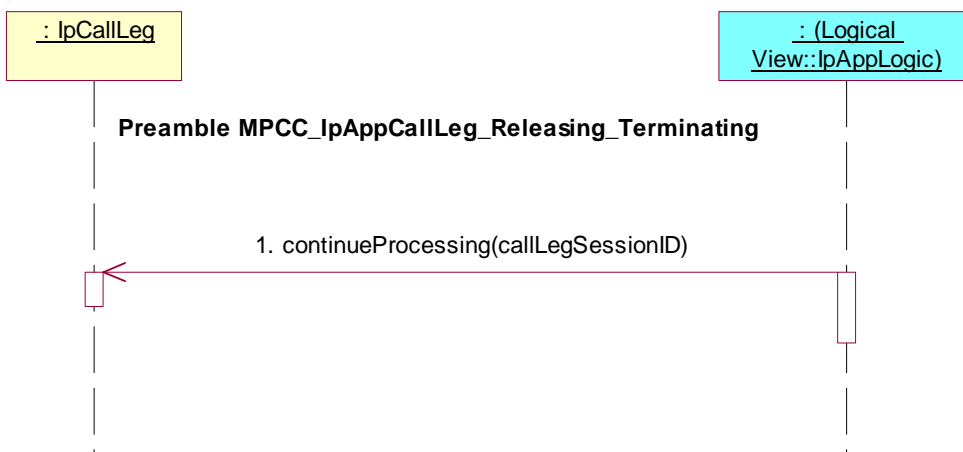

Test MPCC_IpAppCallLeg_76

Summary: continue processing of call leg

Reference: ES 201 915-4 [1], clause 7.4.3.2

Precondition: IUT capable of invoking **getInfoReq()**, **continueProcessing()** and **release()**

Preamble: **MPCC_IpAppCallLeg_Active_Terminating**

Test Sequence:

1. Triggered Action: cause IUT to call **getInfoReq()** method on the tester's (SCF's) terminating IpCallLeg interface.
Parameters: callLegSessionID, callLegInfoRequested
2. Triggered Action: cause IUT to call **continueProcessing()** method on the tester's (SCF's) terminating IpCallLeg interface.
Parameters: callLegSessionID
3. Triggered Action: cause IUT to call **release()** method on the tester's (SCF's) terminating IpCallLeg interface.
Parameters: callLegSessionID, cause
4. Method call **getInfoRes()**
Parameters: callLegSessionID, callLegInfoReport
Check: no exception is returned
5. Method call **callLegEnded()**
Parameters: callLegSessionID, cause
Check: no exception is returned

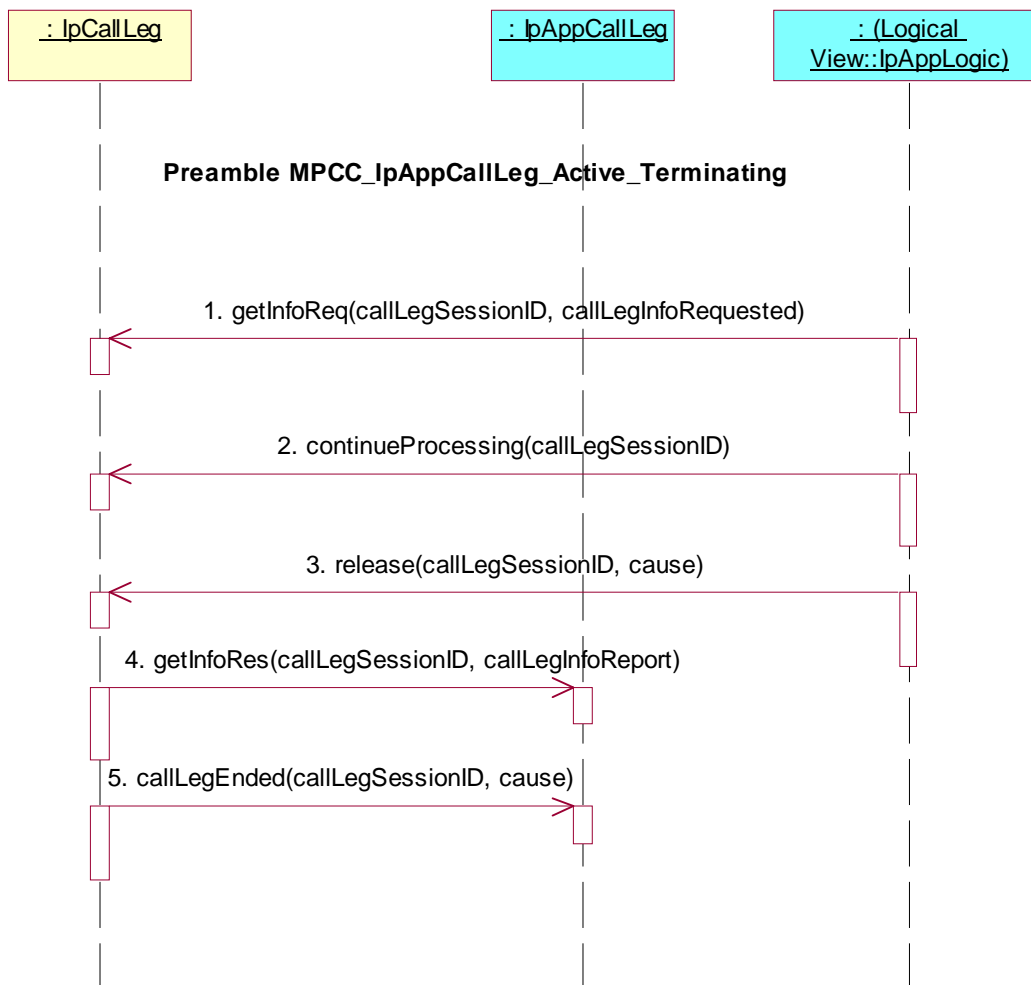

Test MPCC_IpAppCallLeg_77

Summary: continue processing of call leg

Reference: ES 201 915-4 [1], clause 7.4.3.2

Precondition: IUT capable of invoking **superviseReq()**, **continueProcessing()** and **release()**

Preamble: **MPCC_IpAppCallLeg_Active_Terminating**

Test Sequence:

1. Triggered Action: cause IUT to call **superviseReq()** method on the tester's (SCF's) terminating IpCallLeg interface.
Parameters: callLegSessionID, time, treatment
2. Triggered Action: cause IUT to call **continueProcessing()** method on the tester's (SCF's) terminating IpCallLeg interface.
Parameters: callLegSessionID
3. Triggered Action: cause IUT to call **release()** method on the tester's (SCF's) terminating IpCallLeg interface.
Parameters: callLegSessionID, cause
4. Method call **superviseRes()**
Parameters: callLegSessionID, report, usedTime
Check: no exception is returned

5. Method call **callLegEnded()**
 Parameters: callLegSessionID, cause
 Check: no exception is returned

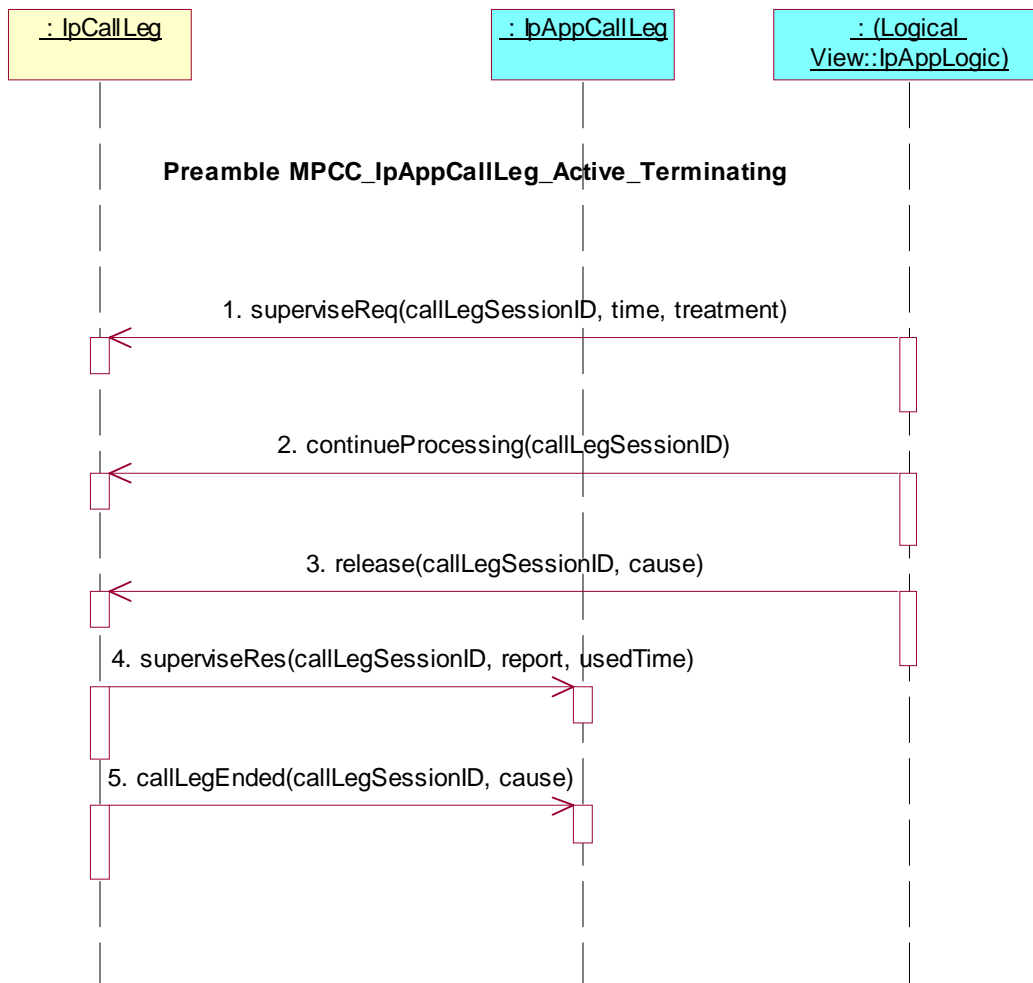

Test MPCC_IpAppCallLeg_78

Summary: de-assign call leg

Reference: ES 201 915-4 [1], clause 7.4.3.2

Precondition: IUT capable of invoking **deassign()**

Preamble: **MPCC_IpAppCallLeg_Releasing_Terminating**

Test Sequence:

1. Triggered Action: cause IUT to call **deassign()** method on the tester's (SCF's) terminating IpCallLeg interface.
 Parameters: callLegSessionID

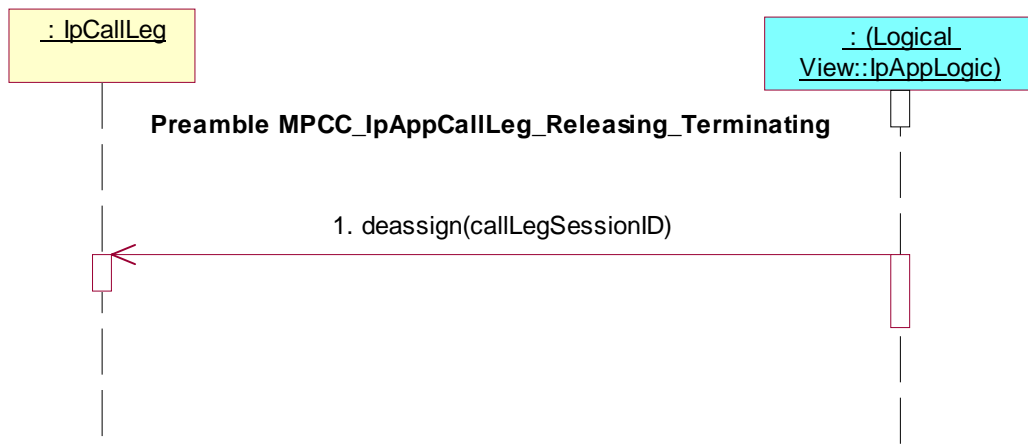

7.2.3 MultiMedia Call Control Service (MMCC)

7.2.3.1 IpAppMultiMediaCallControlManager

Test MMCC_IpAppMultiMediaCallControlManager_01

Summary: create call object

Reference: ES 201 915-4 [1], clause 7.3.1

Precondition: IUT capable of invoking **createCall()**

Preamble: Registration of the IUT (application) and the tester (Call Control SCF) to the framework. The IUT must have obtained a reference to an instance of the IpMultiMediaCallControlManager interface through selecting that service and signing the required service agreement.

The application is permitted to provide its IpAppMultiMediaCallControlManager interface reference in a setCallback() method which it calls prior to invoking further methods.

Test Sequence:

1. Triggered Action: cause IUT to call **createCall()** method on the tester's (SCF's) IpMultiMediaCallControlManager interface.
Parameters: appCall

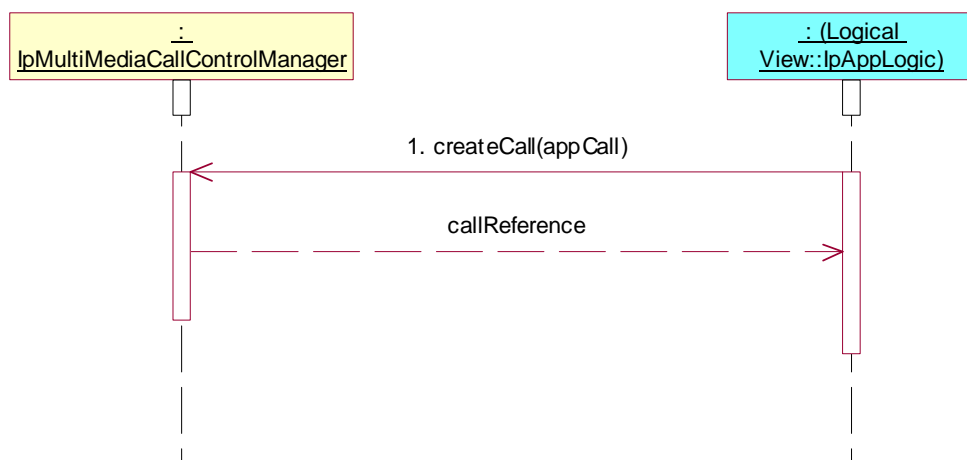

Test MMCC_IpAppMultiMediaCallControlManager_02

Summary: create call object and accept abort

Reference: ES 201 915-4 [1], clauses 7.3.1 and 7.3.2

Precondition: IUT capable of invoking **createCall()**; **callAborted()** implemented

Preamble: Registration of the IUT (application) and the tester (Call Control SCF) to the framework. The IUT must have obtained a reference to an instance of the IpMultiMediaCallControlManager interface through selecting that service and signing the required service agreement.

Test Sequence:

1. Triggered Action: cause IUT to call **setCallBack()** method on the tester's (SCF's) IpMultiMediaCallControlManager interface.
Parameters: valid, non NULL, value of appInterface
2. Triggered Action: cause IUT to call **createCall()** method on the tester's (SCF's) IpMultiMediaCallControlManager interface.
Parameters: appCall
3. Method call **callAborted()**
Parameters: callReference
Check: no exception is returned

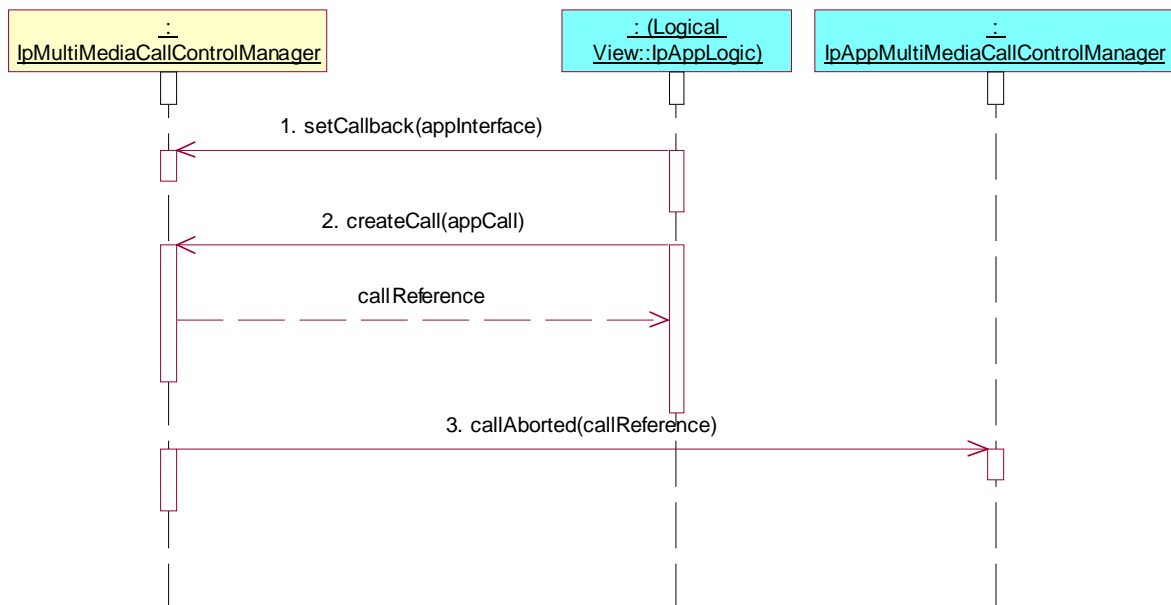

Test MMCC_IpAppMultiMediaCallControlManager_03

Summary: enable and accept call notifications

Reference: ES 201 915-4 [1], clauses 7.3.1 and 7.3.2

Precondition: IUT capable of invoking **createNotification()**, **reportNotification()** implemented

Preamble: Registration of the IUT (application) and the tester (Call Control SCF) to the framework. The IUT must have obtained a reference to an instance of the IpMultiMediaCallControlManager interface through selecting that service and signing the required service agreement.

The application is permitted to provide its IpAppMultiMediaCallControlManager interface reference in a setCallback() method which it calls prior to invoking further methods.

Test Sequence:

1. Triggered Action: cause IUT to call **createNotification()** method on the tester's (SCF's) IpMultiMediaCallControlManager interface.
Parameters: appCallControlManager, notificationRequest
2. Method call **reportNotification()**
Parameters: callReference, callLegReferenceSet, notificationInfo, assignmentID
Check: valid value of TpAppMultiMediaCallBack is returned

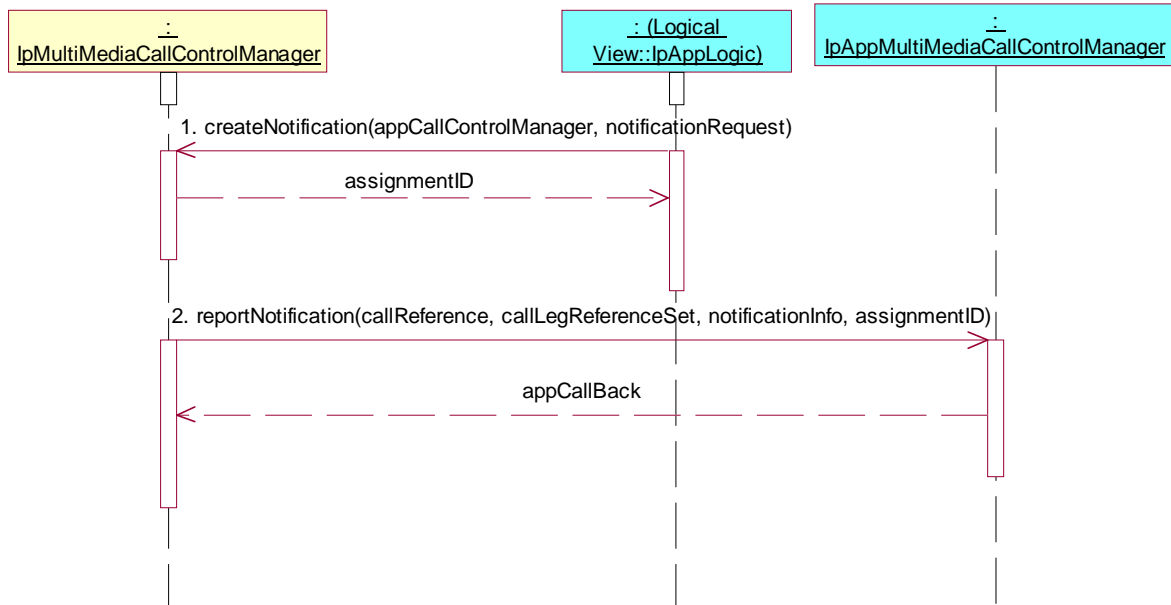

Test MMCC_IpAppMultiMediaCallControlManager_04

Summary: interrupt and continue call notifications

Reference: ES 201 915-4 [1], clauses 7.3.1 and 7.3.2

Precondition: IUT capable of invoking **createNotification()**, **managerInterrupted()**, **managerContinued()** and **reportNotification()** implemented

Preamble: Registration of the IUT (application) and the tester (Call Control SCF) to the framework. The IUT must have obtained a reference to an instance of the IpMultiMediaCallControlManager interface through selecting that service and signing the required service agreement.

The application is permitted to provide its IpAppMultiMediaCallControlManager interface reference in a setCallback() method which it calls prior to invoking further methods.

Test Sequence:

1. Triggered Action: cause IUT to call **createNotification()** method on the tester's (SCF's) IpMultiMediaCallControlManager interface.
Parameters: appCallControlManager, notificationRequest
- NOTE 1: Delay between createNotification and managerInterrupted.
2. Method call **managerInterrupted()**
Parameters: none
Check: no exception is returned

NOTE 2: Delay between managerInterrupted and managerContinued.

3. Method call **managerContinued()**
Parameters: none
Check: no exception is returned
4. Method call **reportNotification()**
Parameters: callReference, callLegReferenceSet, notificationInfo, assignmentID
Check: valid value of TpAppMultiMediaCallBack is returned

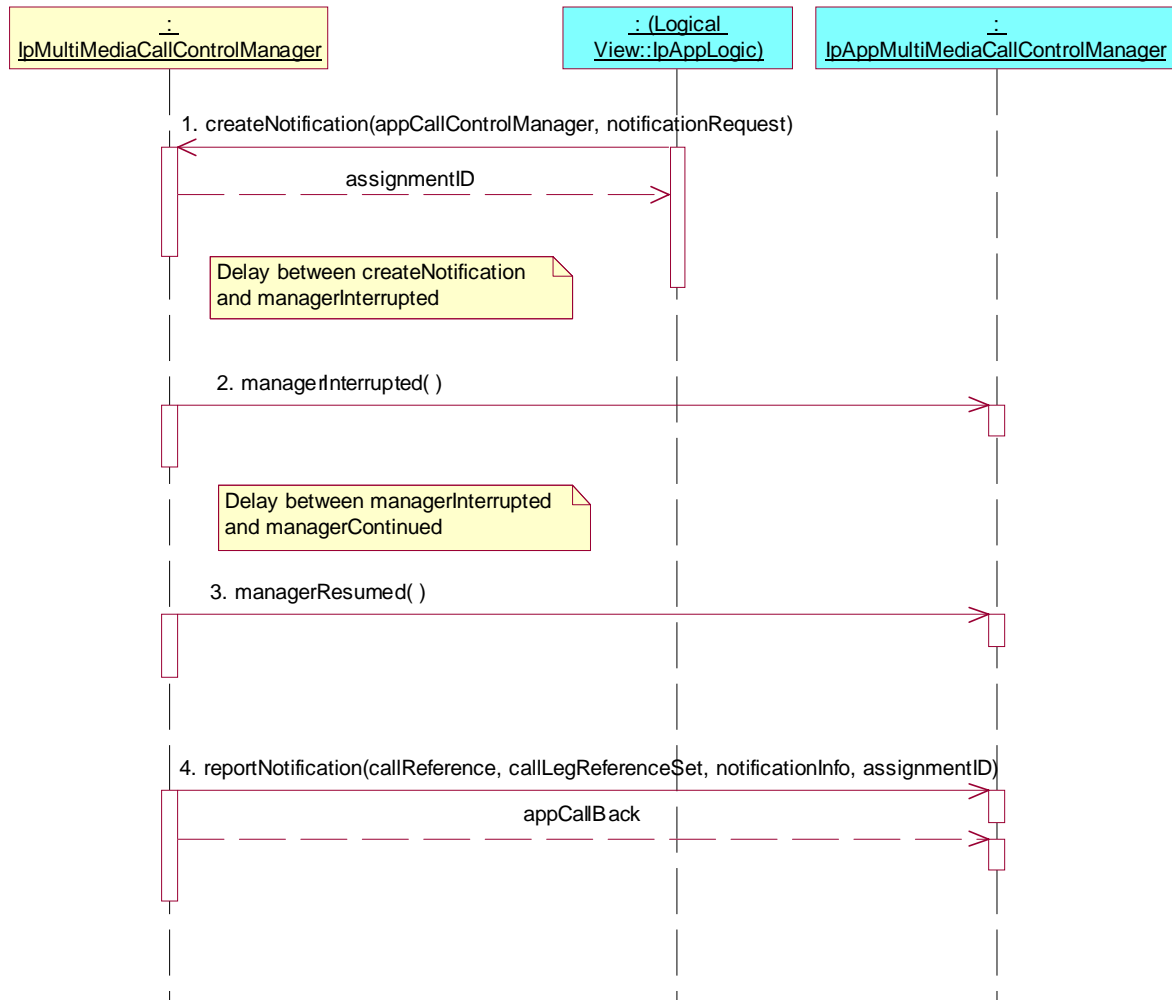

Test MMCC_IpAppMultiMediaCallControlManager_05

Summary: enable and change call notifications

Reference: ES 201 915-4 [1], clauses 7.3.1 and 7.3.2

Precondition: IUT capable of invoking **createNotification()** and **changeNotification()**, **reportNotification()** implemented

Preamble: Registration of the IUT (application) and the tester (Call Control SCF) to the framework. The IUT must have obtained a reference to an instance of the IpMultiMediaCallControlManager interface through selecting that service and signing the required service agreement.

The application is permitted to provide its IpAppMultiMediaCallControlManager interface reference in a setCallback() method which it calls prior to invoking further methods.

Test Sequence:

1. Triggered Action: cause IUT to call **createNotification()** method on the tester's (SCF's) IpMultiMediaCallControlManager interface.
Parameters: appCallControlManager, notificationRequest
2. Triggered Action: cause IUT to call **changeNotification()** method on the tester's (SCF's) IpMultiMediaCallControlManager interface.
Parameters: assignmentID, notificationRequest
3. Method call **reportNotification()**
Parameters: callReference, callLegReferenceSet, notificationInfo, assignmentID
Check: valid value of TpAppMultiMediaCallBack is returned

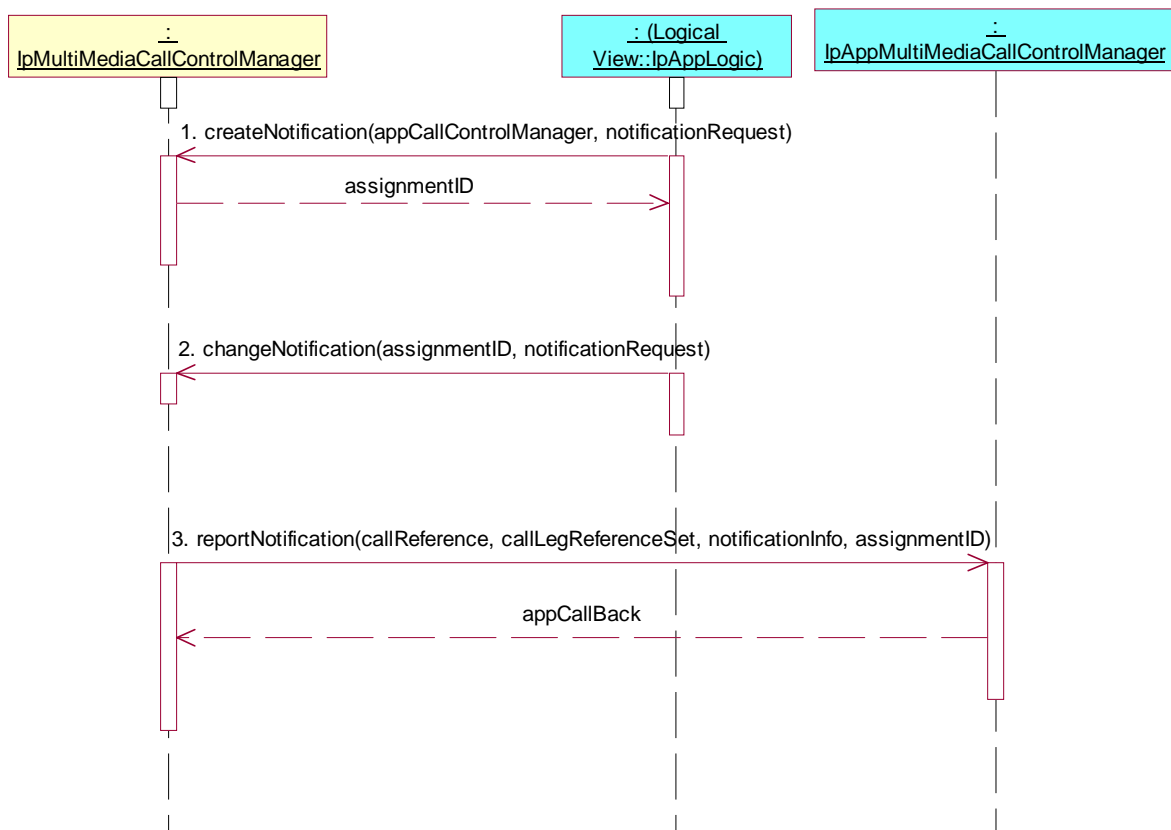

Test MMCC_IpAppMultiMediaCallControlManager_06

Summary: enable and destroy call notifications

Reference: ES 201 915-4 [1], clauses 7.3.1 and 7.3.2

Precondition: IUT capable of invoking **createNotification()** and **destroyNotification()**

Preamble: Registration of the IUT (application) and the tester (Call Control SCF) to the framework. The IUT must have obtained a reference to an instance of the IpMultiMediaCallControlManager interface through selecting that service and signing the required service agreement.

The application is permitted to provide its IpAppMultiMediaCallControlManager interface reference in a setCallback() method which it calls prior to invoking further methods.

Test Sequence:

1. Triggered Action: cause IUT to call **createNotification()** method on the tester's (SCF's) IpMultiMediaCallControlManager interface.
Parameters: appCallControlManager, notificationRequest

2. Triggered Action: cause IUT to call **destroyNotification()** method on the tester's (SCF's) IpMultiMediaCallControlManager interface.
Parameters: assignmentID

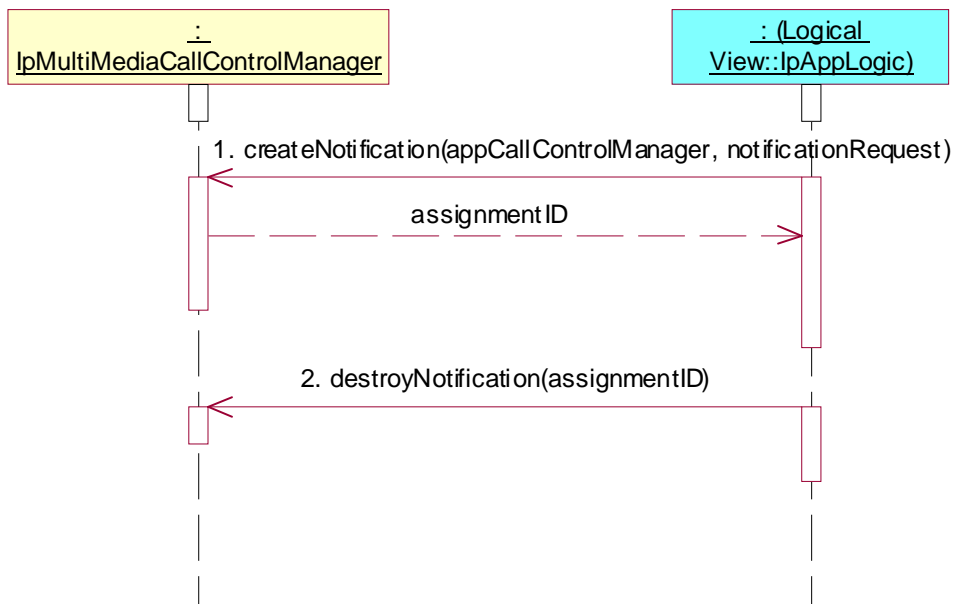

Test MMCC_IpAppMultiMediaCallControlManager_07

Summary: enable call notifications and get criteria

Reference: ES 201 915-4 [1], clauses 7.3.1 and 7.3.2

Precondition: IUT capable of invoking **createNotification()** and **getNotification()**

Preamble: Registration of the IUT (application) and the tester (Call Control SCF) to the framework. The IUT must have obtained a reference to an instance of the IpMultiMediaCallControlManager interface through selecting that service and signing the required service agreement.

The application is permitted to provide its IpAppMultiMediaCallControlManager interface reference in a setCallback() method which it calls prior to invoking further methods.

Test Sequence:

1. Triggered Action: cause IUT to call **createNotification()** method on the tester's (SCF's) IpMultiMediaCallControlManager interface.
Parameters: appCallControlManager, notificationRequest
2. Triggered Action: cause IUT to call **getNotification()** method on the tester's (SCF's) IpMultiMediaCallControlManager interface.
Parameters: none

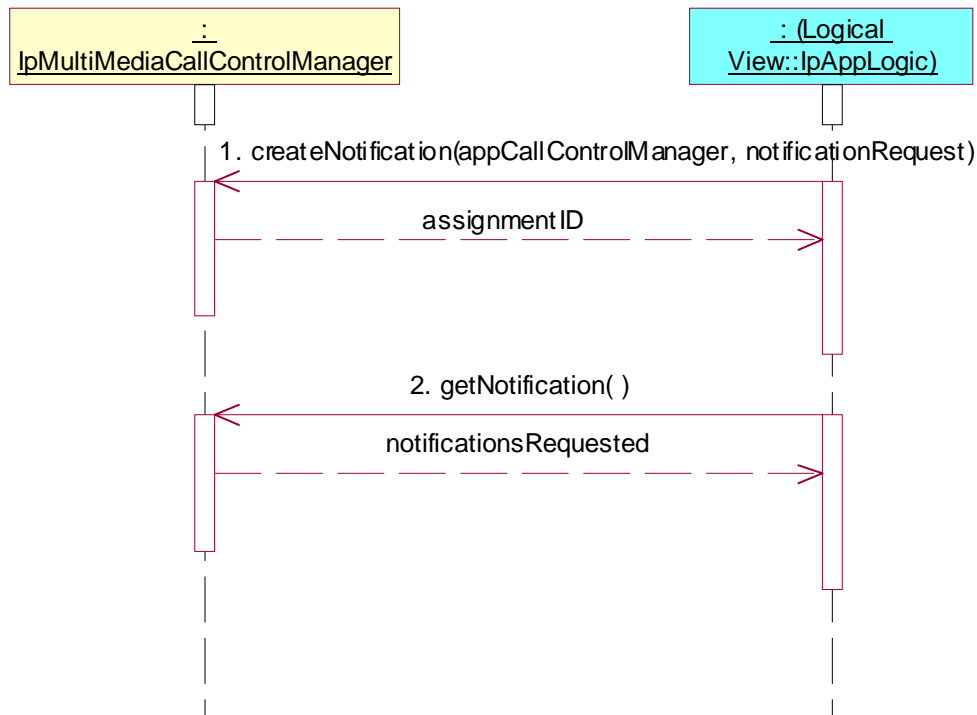

Test MMCC_IpAppMultiMediaCallControlManager_08

Summary: enable load control and accept overload notifications

Reference: ES 201 915-4 [1], clauses 7.3.1 and 7.3.2

Precondition: IUT capable of invoking **setCallLoadControl()**, **callOverloadEncountered()** and **callOverloadCeased()** implemented

Preamble: Registration of the IUT (application) and the tester (Call Control SCF) to the framework. The IUT must have obtained a reference to an instance of the IpMultiMediaCallControlManager interface through selecting that service and signing the required service agreement.

The application is permitted to provide its IpAppMultiMediaCallControlManager interface reference in a setCallback() method which it calls prior to invoking further methods.

Test Sequence:

1. Triggered Action: cause IUT to call **createNotification()** method on the tester's (SCF's) IpMultiMediaCallControlManager interface.
Parameters: appCallControlManager, notificationRequest
2. Triggered Action: cause IUT to call **setCallLoadControl()** method on the tester's (SCF's) IpMultiMediaCallControlManager interface.
Parameters: duration, mechanism, treatment, addressRange

NOTE 1: Delay between setCallLoadControl and callOverloadEncountered.

3. Method call **callOverloadEncountered()**
Parameters: assignmentID
Check: no exception is returned

NOTE 2: Delay between callOverloadEncountered and callOverloadCeased.

4. Method call **callOverloadCeased()**
Parameters: assignmentID
Check: no exception is returned

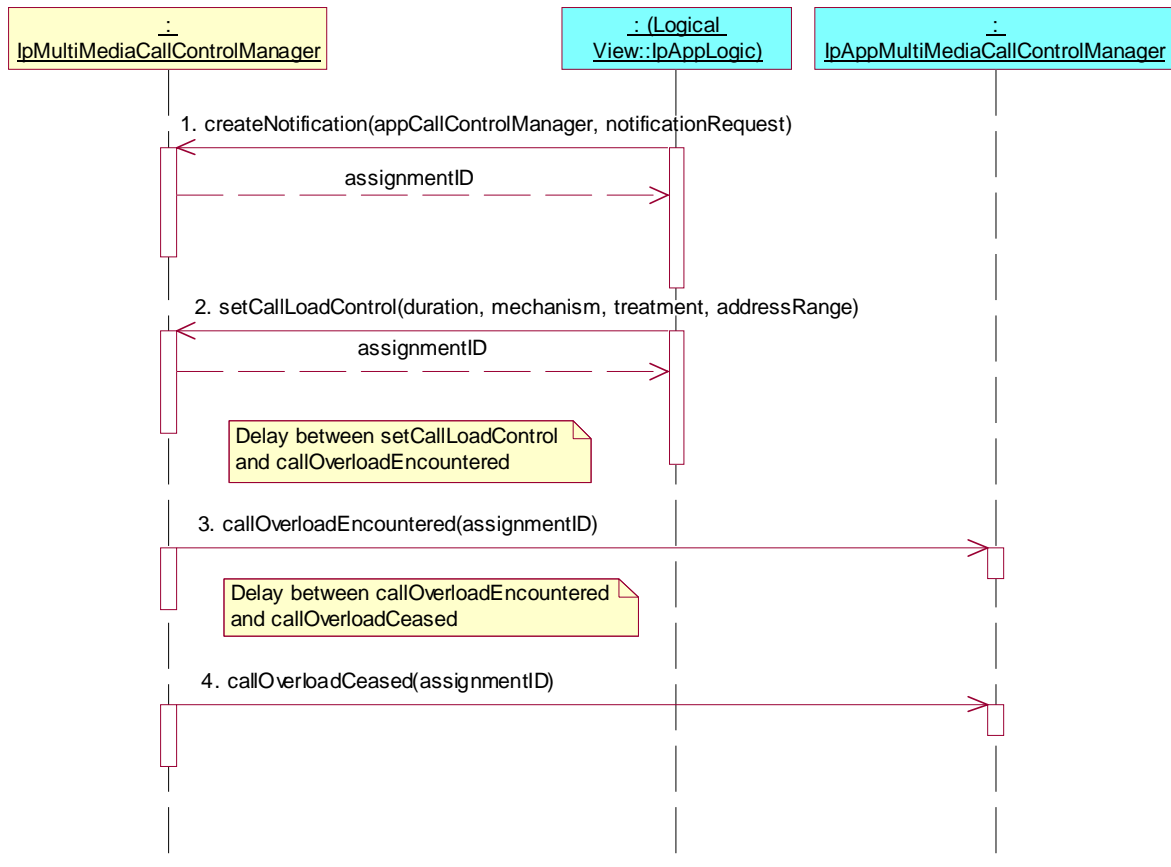

Test MMCC_IpAppMultiMediaCallControlManager_09

Summary: create media stream notifications and accept report

Reference: ES 201 915-4 [1], clauses 8.3.1 and 8.3.2

Precondition: IUT capable of invoking **createMediaNotification()**, **reportMediaNotification()** implemented

Preamble: Registration of the IUT (application) and the tester (Call Control SCF) to the framework. The IUT must have obtained a reference to an instance of the IpMultiMediaCallControlManager interface through selecting that service and signing the required service agreement.

The application is permitted to provide its IpAppMultiMediaCallControlManager interface reference in a setCallback() method which it calls prior to invoking further methods.

Test Sequence:

1. Triggered Action: cause IUT to call **createMediaNotification()** method on the tester's (SCF's) IpMultiMediaCallControlManager interface.
Parameters: appInterface, notificationMediaRequest
2. Method call **reportMediaNotification()**
Parameters: callReference, callLegReferenceSet, mediaStreams, type
Check: valid value of TpAppMultiMediaCallBack is returned

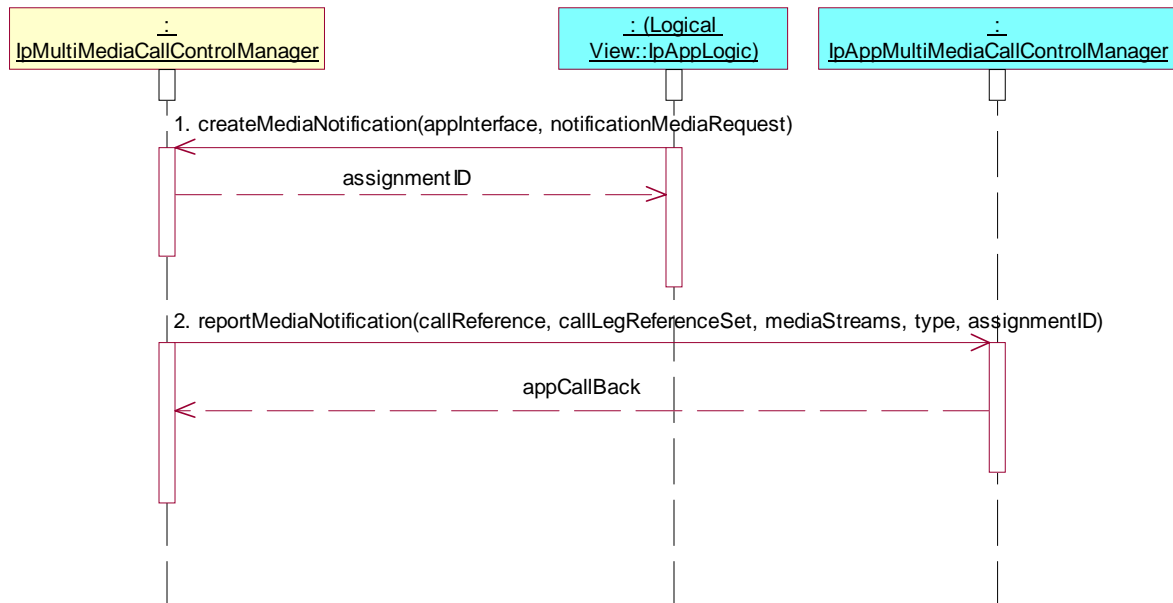

Test MMCC_IpAppMultiMediaCallControlManager_10

Summary: create and destroy media stream notifications

Reference: ES 201 915-4 [1], clauses 8.3.1 and 8.3.2

Precondition: IUT capable of invoking **createMediaNotification()** and **destroyMediaNotification()**

Preamble: Registration of the IUT (application) and the tester (Call Control SCF) to the framework. The IUT must have obtained a reference to an instance of the **IpMultiMediaCallControlManager** interface through selecting that service and signing the required service agreement.

The application is permitted to provide its **IpAppMultiMediaCallControlManager** interface reference in a **setCallback()** method which it calls prior to invoking further methods.

Test Sequence:

1. Triggered Action: cause IUT to call **createMediaNotification()** method on the tester's (SCF's) **IpMultiMediaCallControlManager** interface.
Parameters: **appInterface, notificationMediaRequest**
2. Triggered Action: cause IUT to call **destroyMediaNotification()** method on the tester's (SCF's) **IpMultiMediaCallControlManager** interface.
Parameters: **assignmentID**

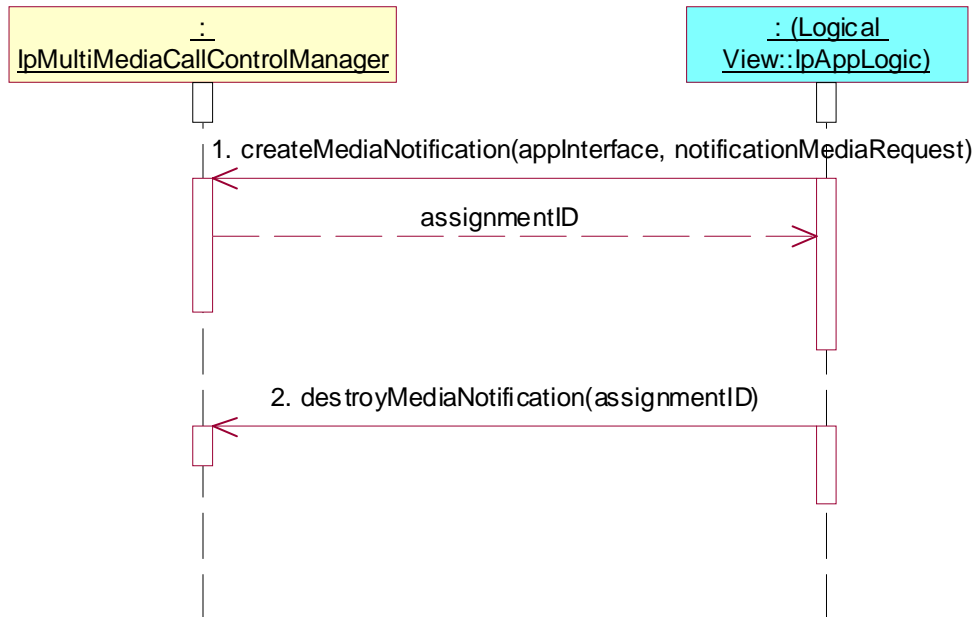

Test MMCC_IpAppMultiMediaCallControlManager_11

Summary: create and modify media stream notifications

Reference: ES 201 915-4 [1], clauses 8.3.1 and 8.3.2

Precondition: IUT capable of invoking **createMediaNotification()** and **changeMediaNotification()**, **reportMediaNotification()** implemented

Preamble: Registration of the IUT (application) and the tester (Call Control SCF) to the framework. The IUT must have obtained a reference to an instance of the IpMultiMediaCallControlManager interface through selecting that service and signing the required service agreement.

The application is permitted to provide its IpAppMultiMediaCallControlManager interface reference in a setCallback() method which it calls prior to invoking further methods.

Test Sequence:

1. Triggered Action: cause IUT to call **createMediaNotification()** method on the tester's (SCF's) IpMultiMediaCallControlManager interface.
Parameters: appInterface, notificationMediaRequest
2. Triggered Action: cause IUT to call **changeMediaNotification()** method on the tester's (SCF's) IpMultiMediaCallControlManager interface.
Parameters: assignmentID, notificationMediaRequest
3. Method call **reportMediaNotification()**
Parameters: callReference, callLegReferenceSet, mediaStreams, type
Check: valid value of TpAppMultiMediaCallBack is returned

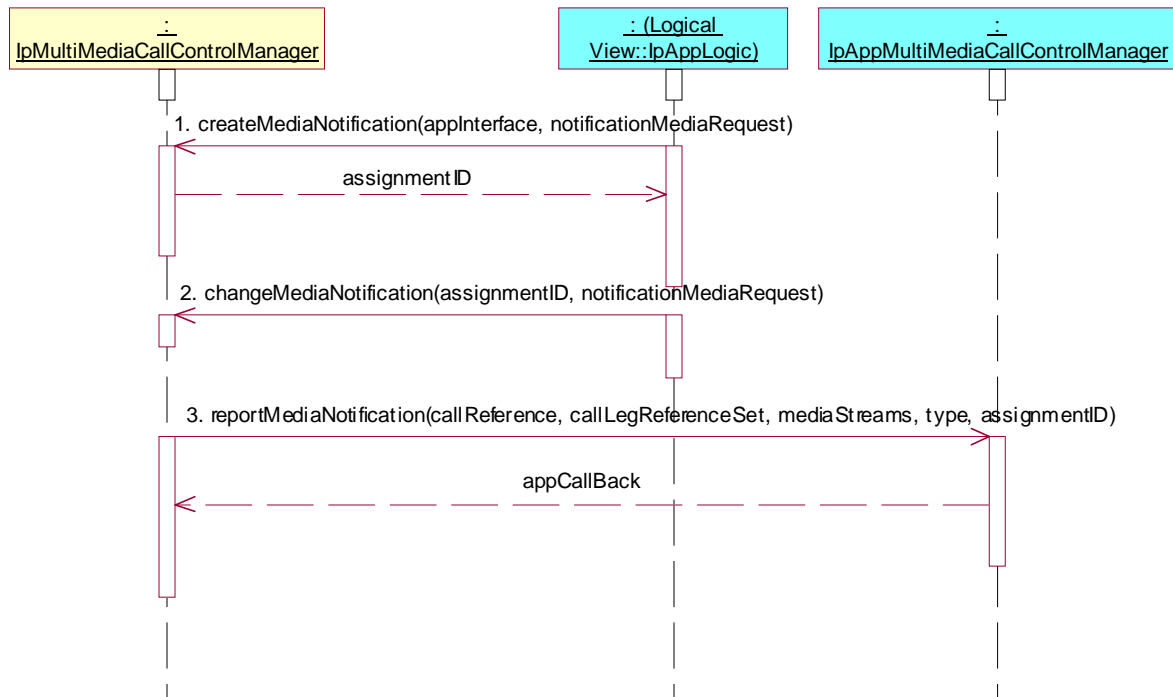

Test MMCC_IpAppMultiMediaCallControlManager_12

Summary: create and get media stream notifications

Reference: ES 201 915-4 [1], clauses 8.3.1 and 8.3.2

Precondition: IUT capable of invoking **createMediaNotification()** and **getMediaNotification()**

Preamble: Registration of the IUT (application) and the tester (Call Control SCF) to the framework. The IUT must have obtained a reference to an instance of the **IpMultiMediaCallControlManager** interface through selecting that service and signing the required service agreement.

The application is permitted to provide its **IpAppMultiMediaCallControlManager** interface reference in a `setCallback()` method which it calls prior to invoking further methods.

Test Sequence:

1. Triggered Action: cause IUT to call **createMediaNotification()** method on the tester's (SCF's) **IpMultiMediaCallControlManager** interface.
Parameters: `appInterface`, `notificationMediaRequest`
2. Triggered Action: cause IUT to call **getMediaNotification()** method on the tester's (SCF's) **IpMultiMediaCallControlManager** interface.
Parameters: none

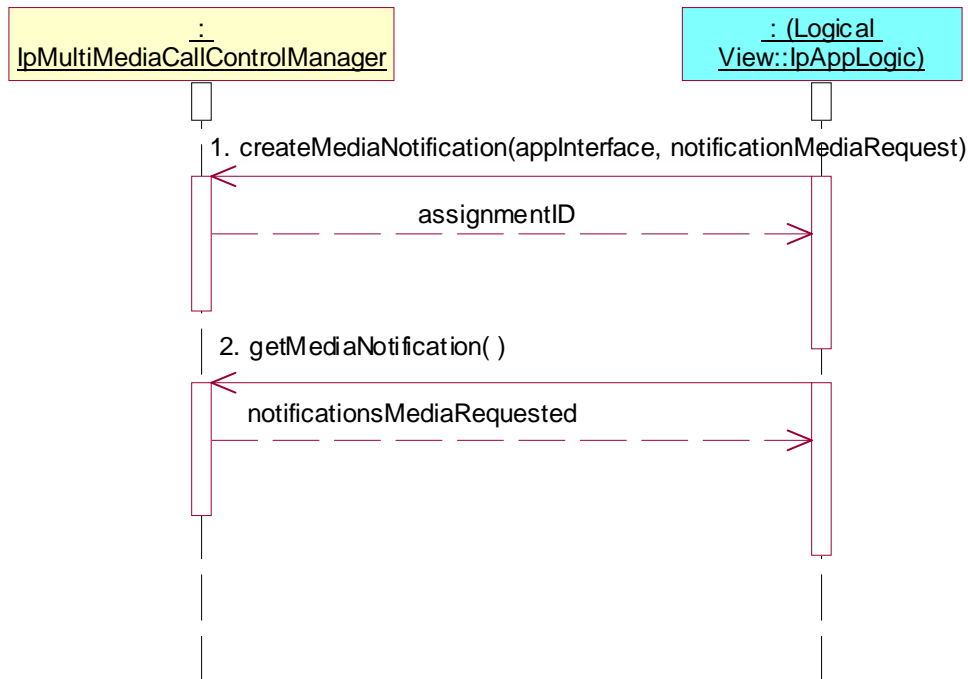

7.2.3.2 IpAppMultiMediaCall

Applications need not be capable of performing each of the sequences below, even if they support the methods indicated below.

Reference: ES 201 915-4 [1], clauses 7.4.2, 8.3.3 and 8.3.4

7.2.3.2.1 Idle state

Precondition: IUT capable of invoking **createCall()**

Preamble MMCC_IpAppMultiMediaCall_Idle

Reference: ES 201 915-4 [1], clause 7.4.2.1

Pre-preamble: Registration of the IUT (application) and the tester (Call Control SCF) to the framework. The IUT must have obtained a reference to an instance of the `IpMultiMediaCallControlManager` interface through selecting that service and signing the required service agreement.

The application is permitted to provide its `IpAppMultiMediaCallControlManager` interface reference in a `setCallback()` method which it calls prior to invoking further methods.

Preamble Sequence:

1. Triggered Action: cause IUT to call **createCall()** method on the tester's (SCF's) `IpMultiMediaCallControlManager` interface.
Parameters: `appCall`

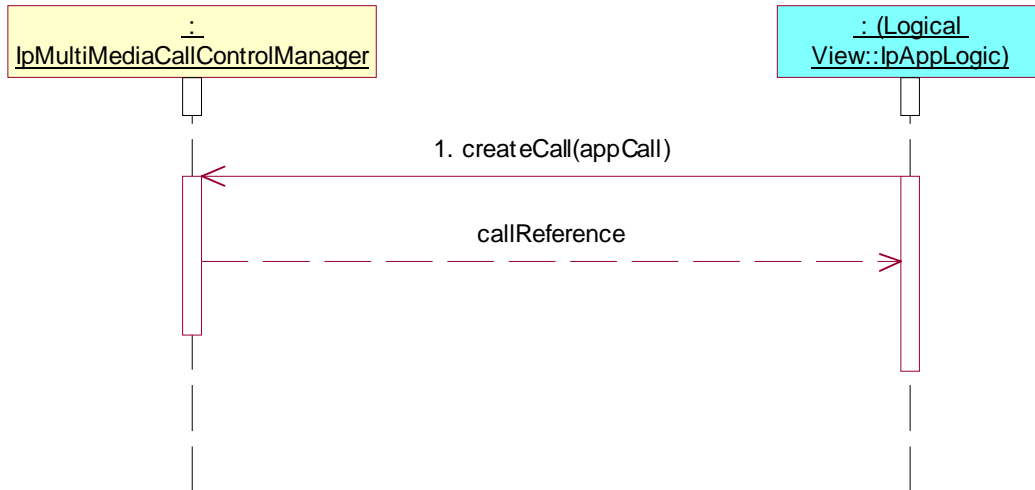

Test MMCC_IpAppMultiMediaCall_01

Summary: create call leg

Reference: ES 201 915-4 [1], clause 7.4.2.1

Precondition: IUT capable of invoking **createCallLeg()**

Preamble: **MMCC_IpAppMultiMediaCall_Idle**

Test Sequence:

1. Triggered Action: cause IUT to call **createCallLeg()** method on the tester's (SCF's) IpMultiMediaCall interface.
Parameters: callSessionID, appCallLeg

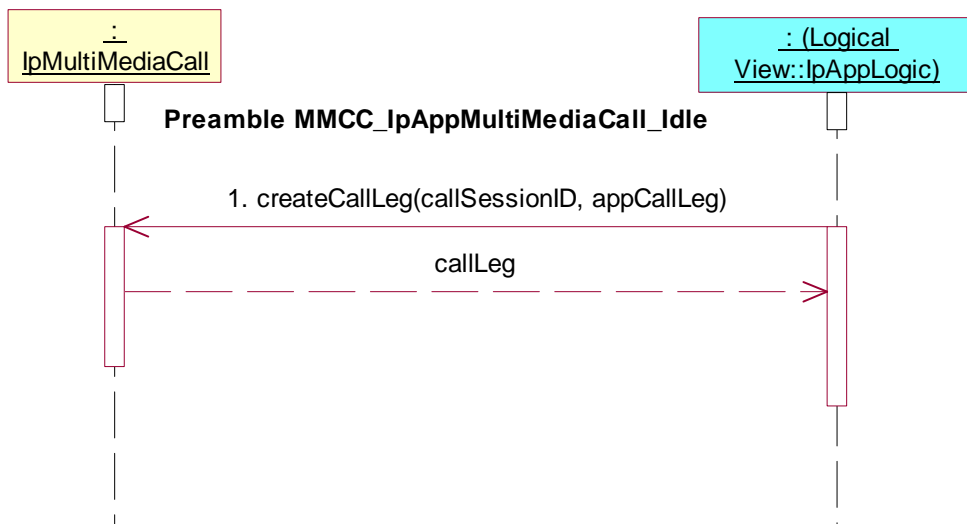

Test MMCC_IpAppMultiMediaCall_02

Summary: create and route call leg, unsuccessful

Reference: ES 201 915-4 [1], clause 7.4.2.1

Precondition: IUT capable of invoking **createAndRouteCallLegReq()**

Preamble: **MMCC_IpAppMultiMediaCall_Idle**

Test Sequence:

1. Triggered Action: cause IUT to call **createAndRouteCallLegReq()** method on the tester's (SCF's) IpMultiMediaCall interface.
Parameters: callSessionID, eventsRequested, targetAddress, originatingAddress, appInfo, appLegInterface
2. Method call **createAndRouteCallLegErr()**
Parameters: callSessionID, appCallLegReference, errorIndication
Check: no exception is returned

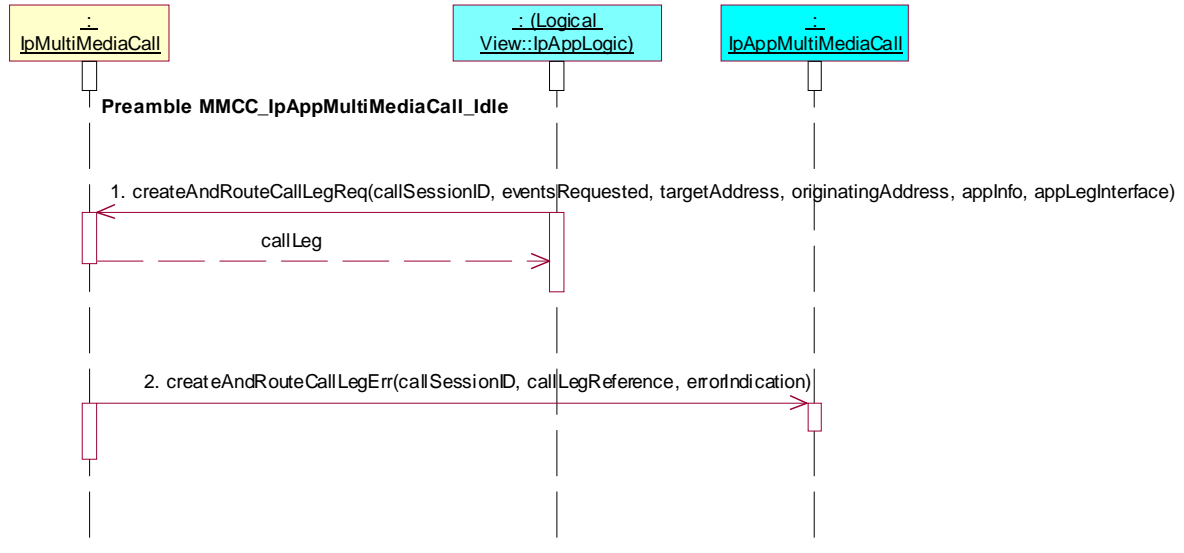

Test MMCC_IpAppMultiMediaCall_03

Summary: supervise call

Reference: ES 201 915-4 [1], clause 7.4.2.1

Precondition: IUT capable of invoking **superviseReq()**

Preamble: **MMCC_IpAppMultiMediaCall_Idle**

Test Sequence:

1. Triggered Action: cause IUT to call **superviseReq()** method on the tester's (SCF's) IpMultiMediaCall interface.
Parameters: callSessionID, time, treatment

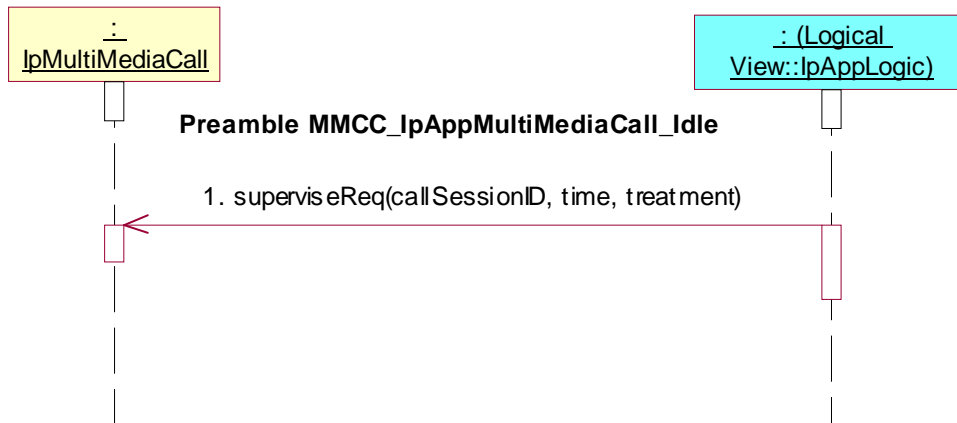

Test MMCC_IpAppMultiMediaCall_04

Summary: request call information

Reference: ES 201 915-4 [1], clause 7.4.2.1

Precondition: IUT capable of invoking **getInfoReq()**

Preamble: **MMCC_IpAppMultiMediaCall_Idle**

Test Sequence:

1. Triggered Action: cause IUT to call **getInfoReq()** method on the tester's (SCF's) IpMultiMediaCall interface.
Parameters: callSessionID, callInfoRequested

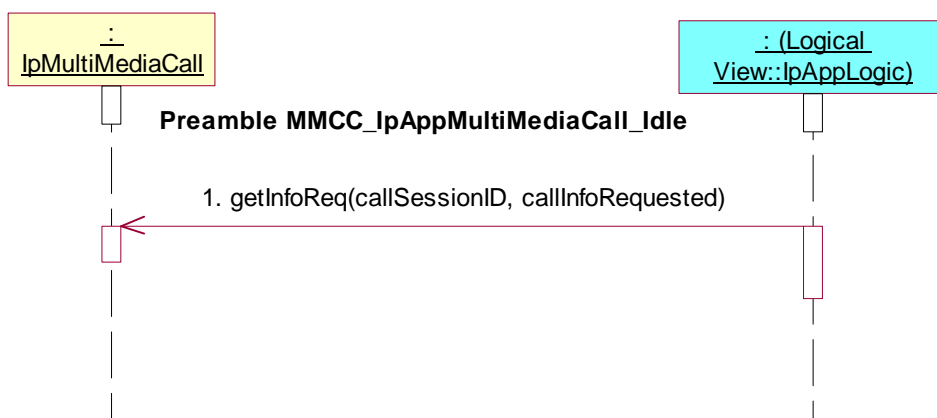

Test MMCC_IpAppMultiMediaCall_05

Summary: request call information, unsuccessful

Reference: ES 201 915-4 [1], clause 7.4.2.1

Precondition: IUT capable of invoking **getInfoReq()**

Preamble: **MMCC_IpAppMultiMediaCall_Idle**

Test Sequence:

1. Triggered Action: cause IUT to call **getInfoReq()** method on the tester's (SCF's) IpMultiMediaCall interface.
Parameters: callSessionID, callInfoRequested
2. Method call **getInfoErr()**
Parameters: callSessionID, errorIndication
Check: no exception is returned

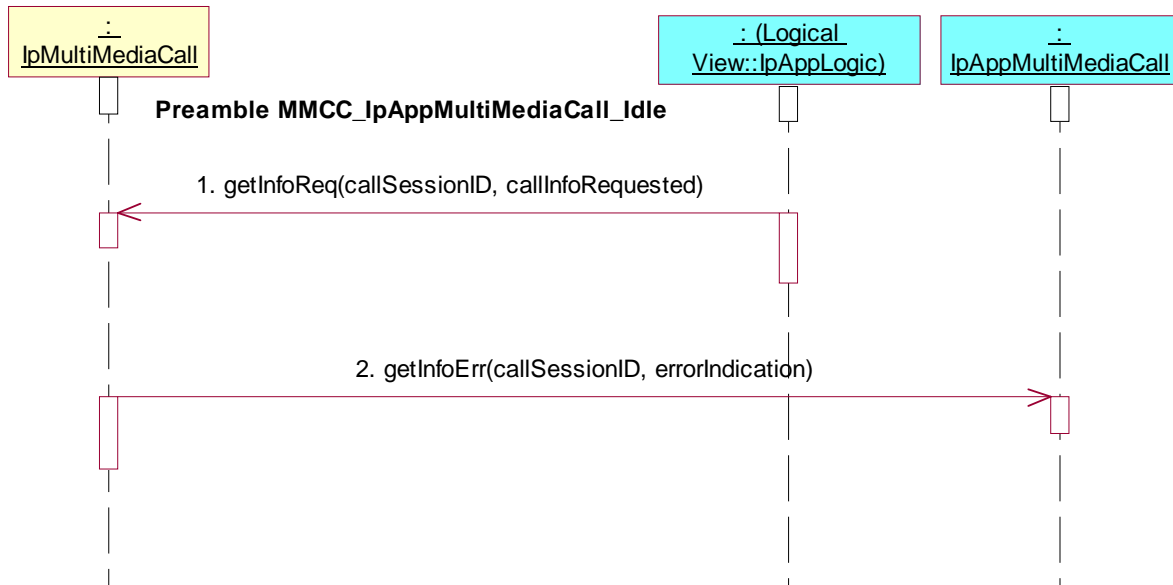

Test MMCC_IpAppMultiMediaCall_06

Summary: set charge plan for the call

Reference: ES 201 915-4 [1], clause 7.4.2.1

Precondition: IUT capable of invoking **setChargePlan()**

Preamble: **MMCC_IpAppMultiMediaCall_Idle**

Test Sequence:

1. Triggered Action: cause IUT to call **setChargePlan()** method on the tester's (SCF's) **IpMultiMediaCall** interface.
Parameters: **callSessionID, callChargePlan**

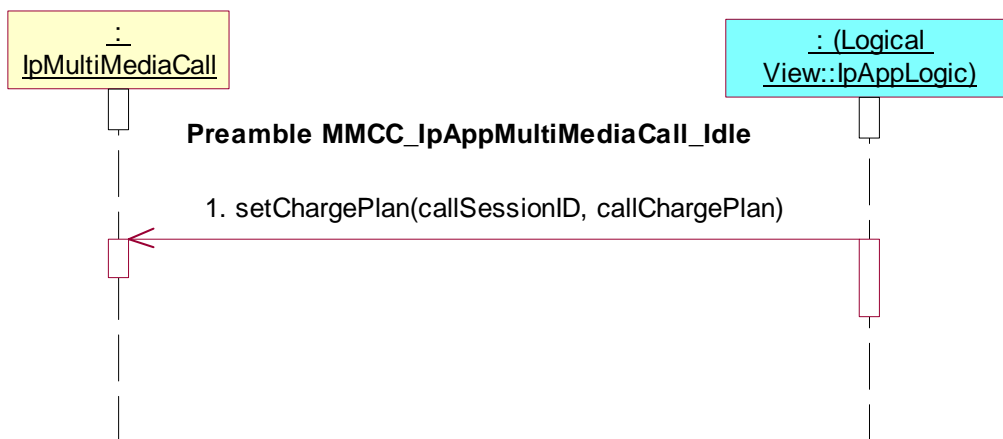

Test MMCC_IpAppMultiMediaCall_07

Summary: allow advice of charge information

Reference: ES 201 915-4 [1], clause 7.4.2.1

Precondition: IUT capable of invoking **setAdviceOfCharge()**

Preamble: **MMCC_IpAppMultiMediaCall_Idle**

Test Sequence:

1. Triggered Action: cause IUT to call **setAdviceOfCharge()** method on the tester's (SCF's) IpMultiMediaCall interface.
Parameters: callSessionID, aOCInfo, tariffSwitch

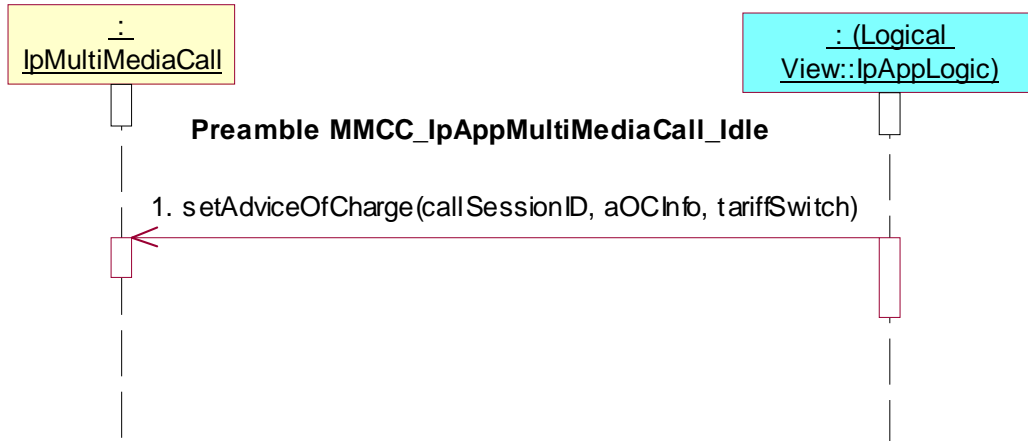

Test MMCC_IpAppMultiMediaCall_08

Summary: supervise call with granted volume

Reference: ES 201 915-4 [1], clause 8.3.3

Precondition: IUT capable of invoking **superviseVolumeReq()**

Preamble: **MMCC_IpAppMultiMediaCall_Idle**

Test Sequence:

1. Triggered Action: cause IUT to call **superviseVolumeReq()** method on the tester's (SCF's) IpMultiMediaCall interface.
Parameters: callSessionID, volume, treatment

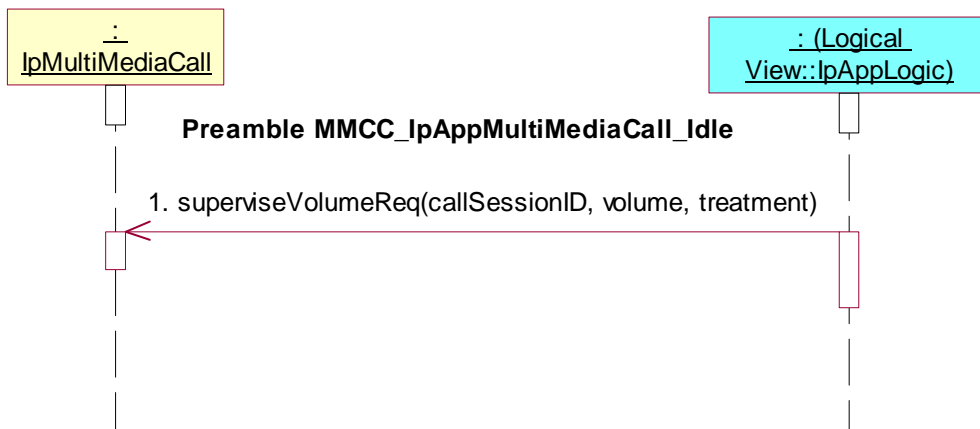

7.2.3.2.2 Active state

Precondition: IUT capable of invoking **createCall()** and **createCallLeg()**

or IUT capable of invoking **createCall()** and **createAndRouteCallLegReq()**

or IUT capable of invoking **createNotification()**

Preamble MMCC_IpAppMultiMediaCall_Active

Reference: ES 201 915-4 [1], clause 7.4.2.2

Pre-preamble: Registration of the IUT (application) and the tester (Call Control SCF) to the framework. The IUT must have obtained a reference to an instance of the IpMultiMediaCallControlManager interface through selecting that service and signing the required service agreement.

The application is permitted to provide its IpAppMultiMediaCallControlManager interface reference in a setCallback() method which it calls prior to invoking further methods.

Preamble Sequence:

1. Triggered Action: cause IUT to call **createCall()** method on the tester's (SCF's) IpMultiMediaCallControlManager interface.
Parameters: appCall
2. Triggered Action: cause IUT to call **createCallLeg()** method on the tester's (SCF's) IpMultiMediaCall interface.
Parameters: callSessionID, appCallLeg

or

1. Triggered Action: cause IUT to call **createCall()** method on the tester's (SCF's) IpMultiMediaCallControlManager interface.
Parameters: appCall
2. Triggered Action: cause IUT to call **createAndRouteCallLegReq()** method on the tester's (SCF's) IpMultiMediaCall interface.
Parameters: callSessionID, eventsRequested, targetAddress, originatingAddress, appInfo, appLegInterface

or

1. Triggered Action: cause IUT to call **createNotification()** method on the tester's (SCF's) IpMultiMediaCallControlManager interface.
Parameters: appCallControlManager, notificationRequest
notificationRequest.CallMonitorMode= P_CALL_MONITOR_MODE_INTERRUPT
2. Method call **reportNotification()**
Parameters: callReference, callLegReferenceSet, notificationInfo, assignmentID
Check: valid value of TpAppMultiMediaCallBack is returned

or

1. Triggered Action: cause IUT to call **createMediaNotification()** method on the tester's (SCF's) IpMultiMediaCallControlManager interface.
Parameters: appInterface, notificationMediaRequest
2. Method call **reportMediaNotification()**
Parameters: callReference, callLegReferenceSet, mediaStreams, type
Check: valid value of TpAppMultiMediaCallBack is returned

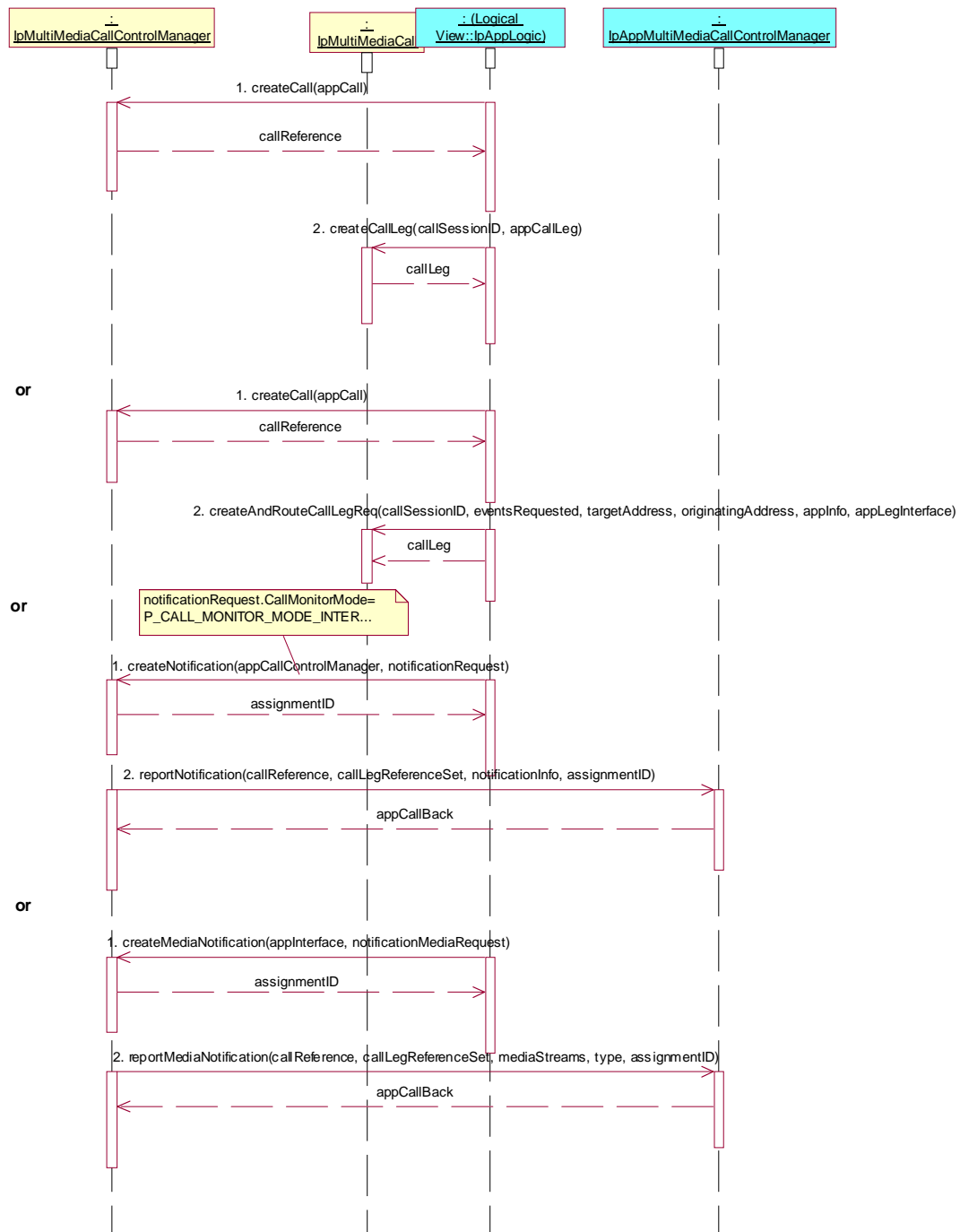

Test MMCC_IpAppMultiMediaCall_09

Summary: create call leg

Reference: ES 201 915-4 [1], clause 7.4.2.2

Precondition: IUT capable of invoking `createCallLeg()`

Preamble: `MMCC_IpAppMultiMediaCall_Active`

Test Sequence:

1. Triggered Action: cause IUT to call **createCallLeg()** method on the tester's (SCF's) IpMultiMediaCall interface.
Parameters: callSessionID, appCallLeg

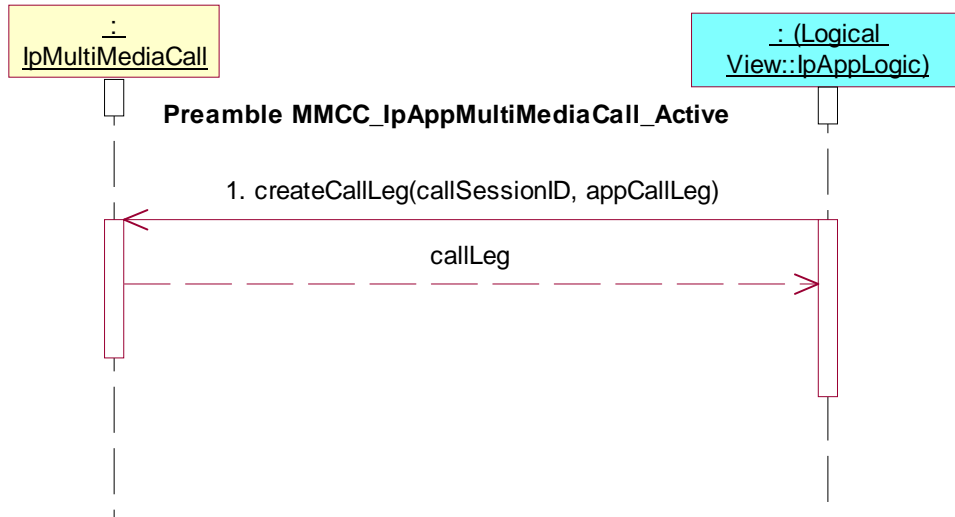

Test MMCC_IpAppMultiMediaCall_10

Summary: create and route call leg, unsuccessful

Reference: ES 201 915-4 [1], clause 7.4.2.2

Precondition: IUT capable of invoking **createAndRouteCallLegReq()**

Preamble: **MMCC_IpAppMultiMediaCall_Active**

Test Sequence:

1. Triggered Action: cause IUT to call **createAndRouteCallLegReq()** method on the tester's (SCF's) IpMultiMediaCall interface.
Parameters: callSessionID, eventsRequested, targetAddress, originatingAddress, appInfo, appLegInterface
2. Method call **createAndRouteCallLegErr()**
Parameters: callSessionID, appCallLegReference, errorIndication
Check: no exception is returned

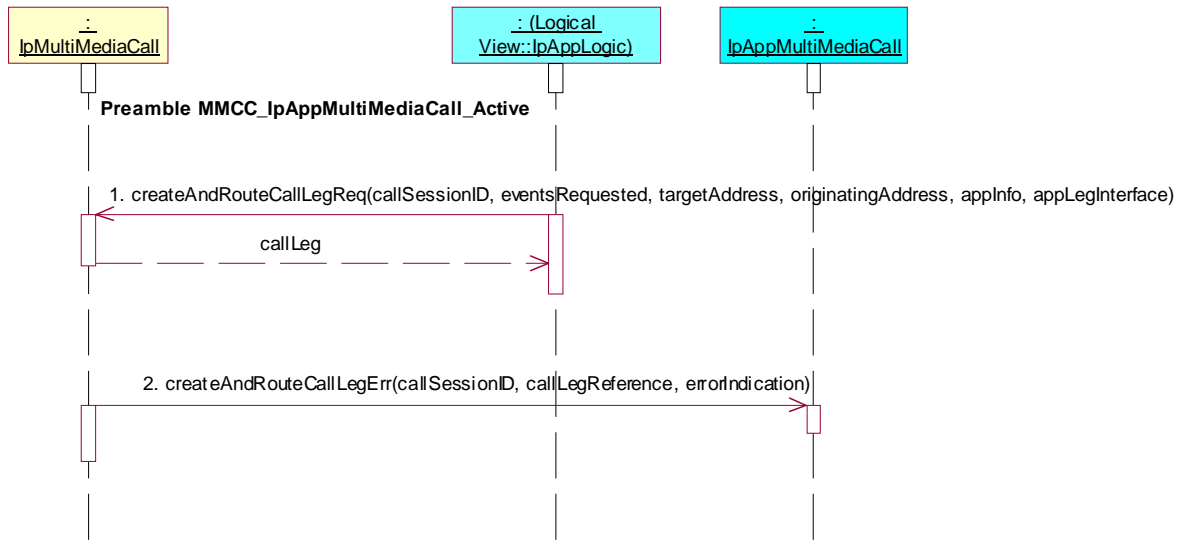

Test MMCC_IpAppMultiMediaCall_11

Summary: supervise call, successful

Reference: ES 201 915-4 [1], clause 7.4.2.2

Precondition: IUT capable of invoking **superviseReq()**

Preamble: **MMCC_IpAppMultiMediaCall_Active**

Test Sequence:

1. Triggered Action: cause IUT to call **superviseReq()** method on the tester's (SCF's) IpMultiMediaCall interface.
Parameters: callSessionID, time, treatment

Note: between these two method sequences, the IUT may need to be triggered to complete establishment of the call to both parties, in order to justify the Tester's calling of a superviseRes() method.

2. Method call **superviseRes()**
Parameters: callSessionID, report, usedTime
Check: no exception is returned

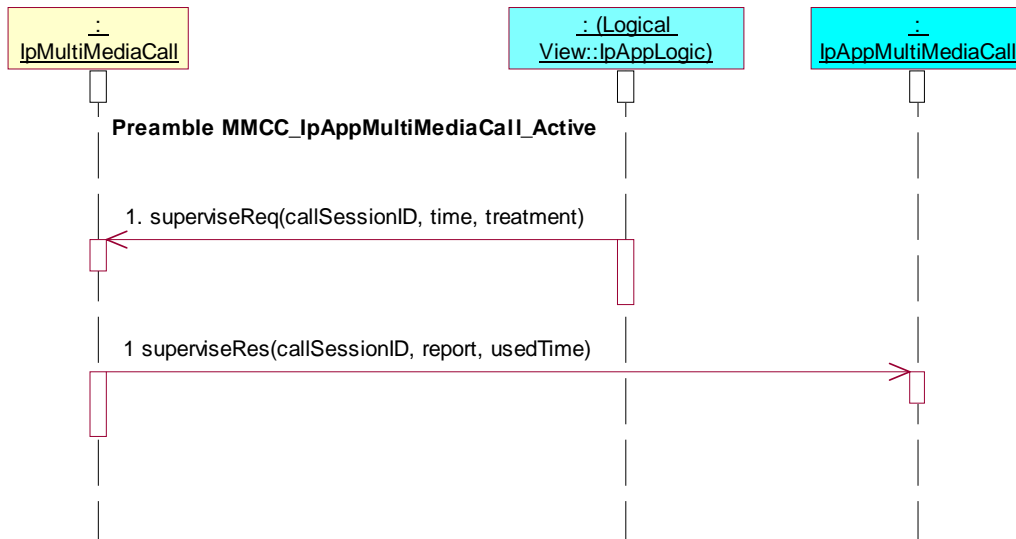

Test MMCC_IpAppMultiMediaCall_12

Summary: supervise call, unsuccessful

Reference: ES 201 915-4 [1], clause 7.4.2.2

Precondition: IUT capable of invoking **superviseReq()**

Preamble: **MMCC_IpAppMultiMediaCall_Active**

Test Sequence:

1. Triggered Action: cause IUT to call **superviseReq()** method on the tester's (SCF's) IpMultiMediaCall interface.
Parameters: callSessionID, time, treatment
2. Method call **superviseErr()**
Parameters: callSessionID, errorIndication
Check: no exception is returned

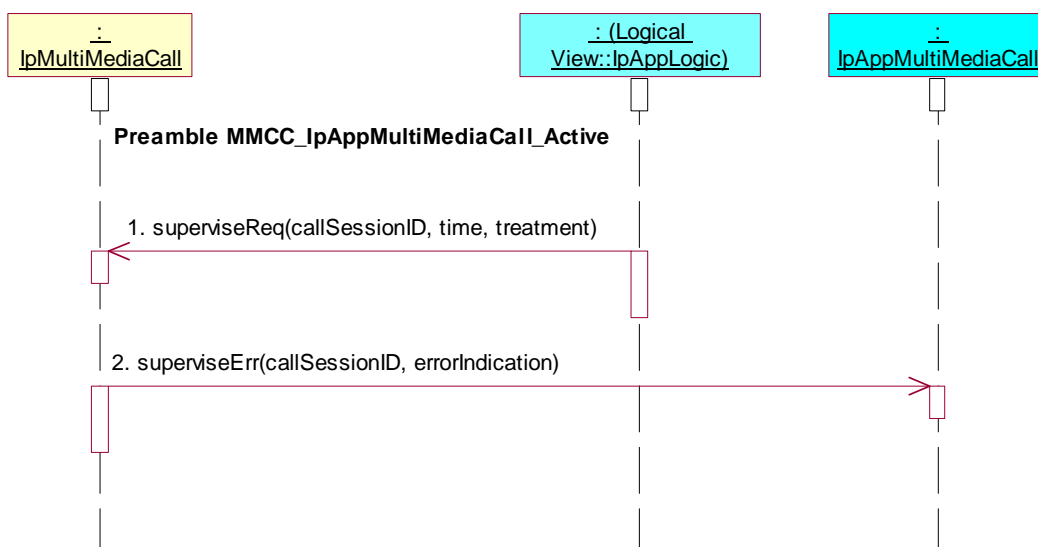

Test MMCC_IpAppMultiMediaCall_13

Summary: request call leg information

Reference: ES 201 915-4 [1], clause 7.4.2.2

Precondition: IUT capable of invoking **getCallLegs()**

Preamble: **MMCC_IpAppMultiMediaCall_Active**

Test Sequence:

1. Triggered Action: cause IUT to call **getCallLegs()** method on the tester's (SCF's) IpMultiMediaCall interface.
Parameters: callSessionID

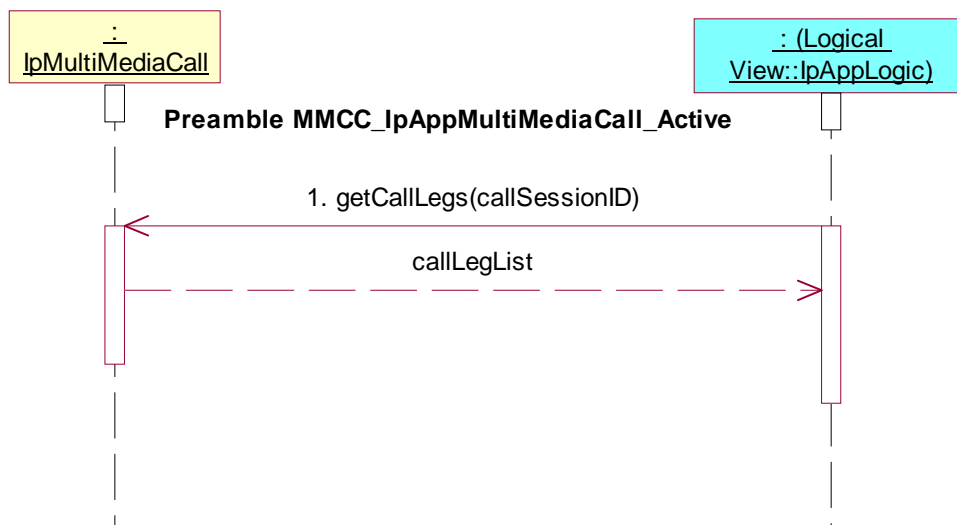
**Test MMCC_IpAppMultiMediaCall_14**

Summary: release call

Reference: ES 201 915-4 [1], clause 7.4.2.2

Precondition: IUT capable of invoking **release()**

Preamble: **MMCC_IpAppMultiMediaCall_Active**

Test Sequence:

1. Triggered Action: cause IUT to call **release()** method on the tester's (SCF's) IpMultiMediaCall interface.
Parameters: callSessionID, cause

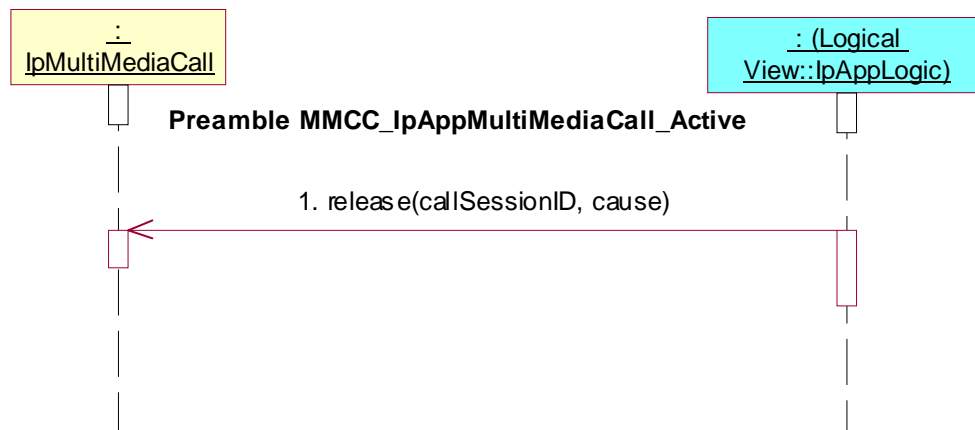

Test MMCC_IpAppMultiMediaCall_15

Summary: deassign call

Reference: ES 201 915-4 [1], clause 7.4.2.2

Precondition: IUT capable of invoking **deassignCall()**

Preamble: **MMCC_IpAppMultiMediaCall_Active**

Test Sequence:

1. Triggered Action: cause IUT to call **deassignCall()** method on the tester's (SCF's) IpMultiMediaCall interface.
Parameters: callSessionID

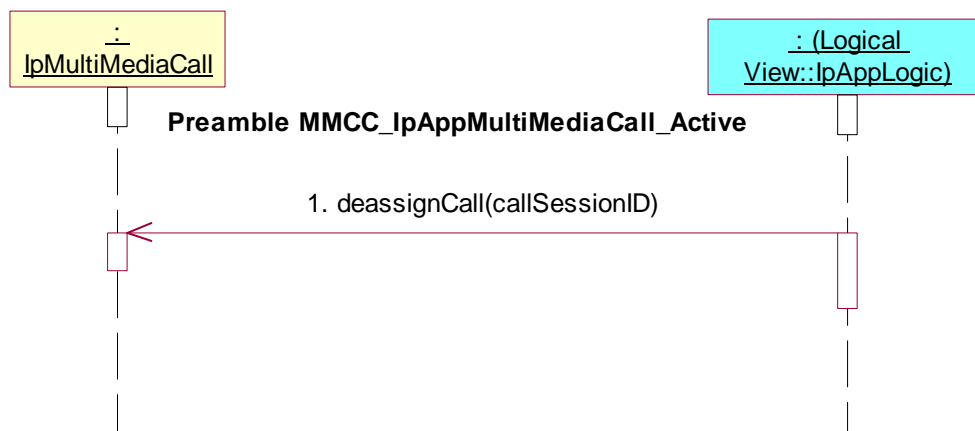

Test MMCC_IpAppMultiMediaCall_16

Summary: indication of termination of call

Reference: ES 201 915-4 [1], clause 7.4.2.2

Precondition: **callEnded()** implemented

Preamble: **MMCC_IpAppMultiMediaCall_Active**

Test Sequence:

1. Method call **callEnded()**
Parameters: callSessionID, report
Check: no exception is returned

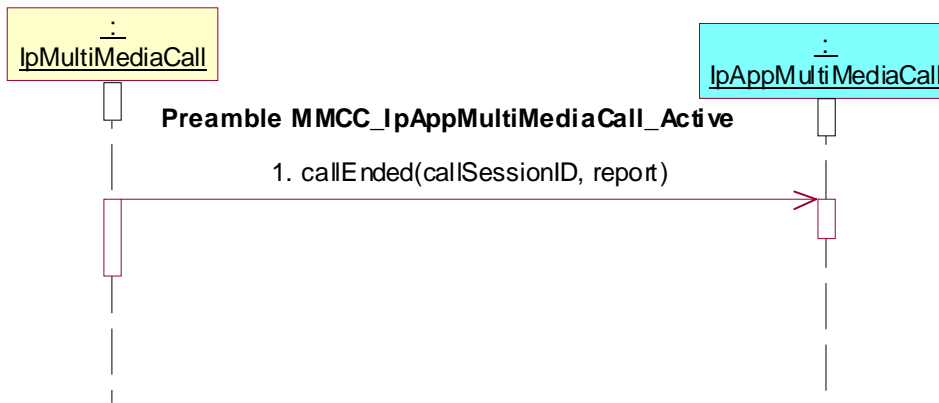

Test MMCC_IpAppMultiMediaCall_17

Summary: supervise call with granted volume, successful

Reference: ES 201 915-4 [1], clauses 8.3.3 and 8.3.4

Precondition: IUT capable of invoking **superviseVolumeReq()**

Preamble: **MMCC_IpAppMultiMediaCall_Active**

Test Sequence:

1. Triggered Action: cause IUT to call **superviseVolumeReq()** method on the tester's (SCF's) IpMultiMediaCall interface.
Parameters: callSessionID, volume, treatment

NOTE: Between these two method sequences, the IUT may need to be triggered to complete establishment of the call to both parties, in order to justify the Tester's calling of a superviseVolumeRes() method.

2. Method call **superviseVolumeRes()**
Parameters: callSessionID, report, usedVolume
Check: no exception is returned

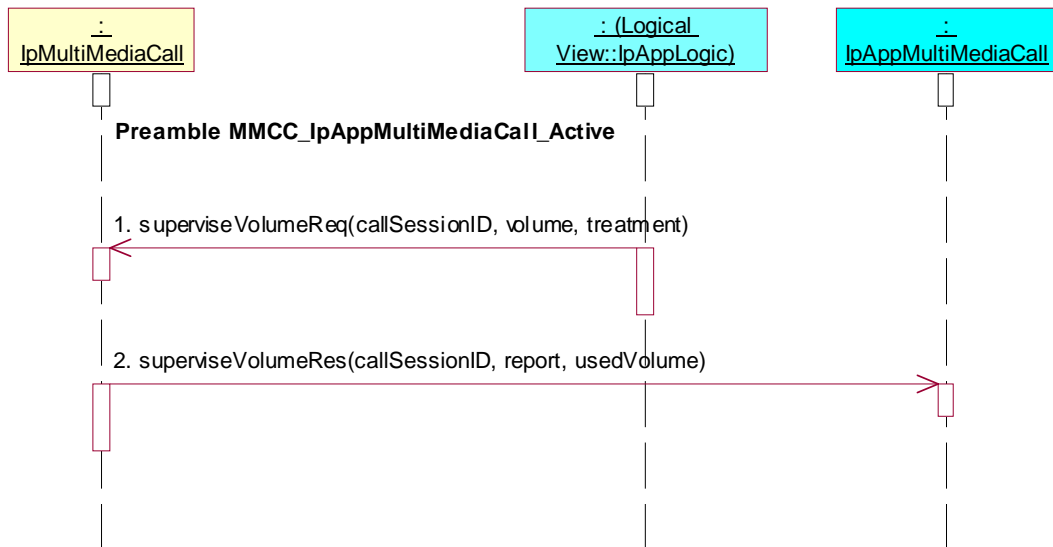

Test MMCC_IpAppMultiMediaCall_18

Summary: supervise call with granted volume, unsuccessful

Reference: ES 201 915-4 [1], clauses 8.3.3 and 8.3.4

Precondition: IUT capable of invoking **superviseVolumeReq()**

Preamble: **MMCC_IpAppMultiMediaCall_Active**

Test Sequence:

1. Triggered Action: cause IUT to call **superviseVolumeReq()** method on the tester's (SCF's) IpMultiMediaCall interface.
Parameters: callSessionID, volume, treatment
2. Method call **superviseVolumeErr()**
Parameters: callSessionID, errorIndication
Check: no exception is returned

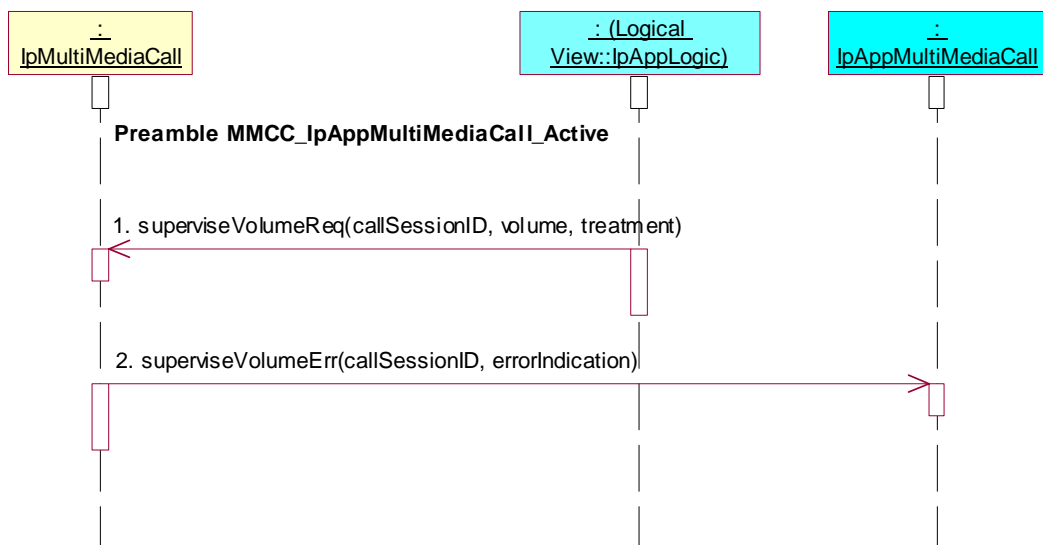

7.2.3.2.3 Released state

Precondition: IUT capable of invoking **createCall()** and **createCallLeg()**

or IUT capable of invoking **createCall()** and **createAndRouteCallLegReq()**

or IUT capable of invoking **createNotification()**

and IUT capable of invoking **release()**

Preamble MMCC_IpAppMultiMediaCall_Released

Reference: ES 201 915-4 [1], clause 7.4.2.3

Pre-preamble: **MMCC_IpAppMultiMediaCall_Active**

Preamble Sequence:

1. Triggered Action: cause IUT to call **release()** method on the tester's (SCF's) IpMultiMediaCall interface.
Parameters: callSessionID, cause

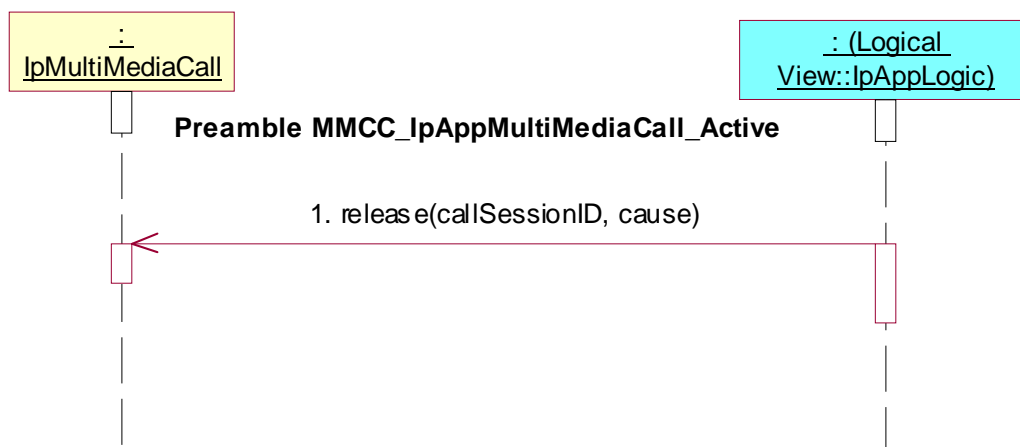

Test MMCC_IpAppMultiMediaCall_19

Summary: request call leg information

Reference: ES 201 915-4 [1], clause 7.4.2.3

Precondition: IUT capable of invoking **getCallLegs()**

Preamble: **MMCC_IpAppMultiMediaCall_Released**

Test Sequence:

1. Triggered Action: cause IUT to call **getCallLegs()** method on the tester's (SCF's) IpMultiMediaCall interface.
Parameters: callSessionID

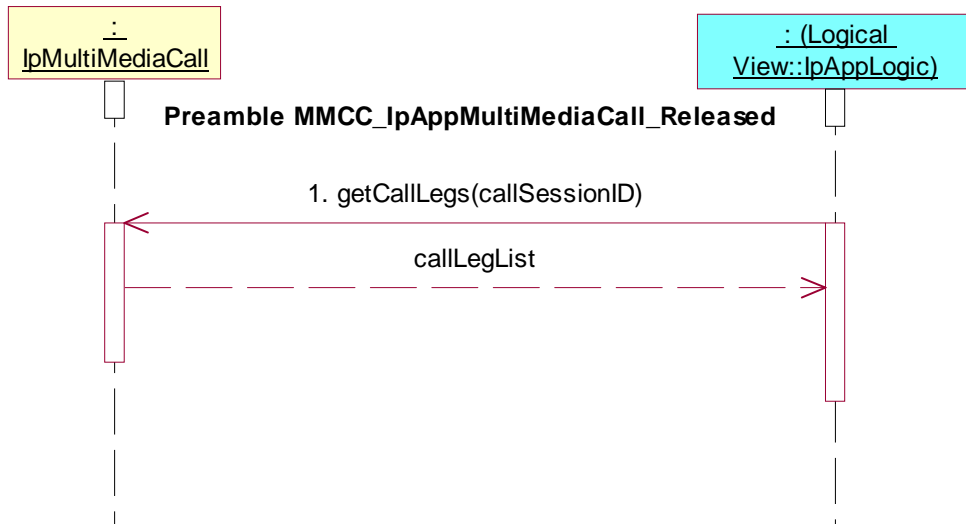

Test MMCC_IpAppMultiMediaCall_20

Summary: indication of termination of call

Reference: ES 201 915-4 [1], clause 7.4.2.3

Precondition: **callEnded()** implemented

Preamble: **MMCC_IpAppMultiMediaCall_Released**

Test Sequence:

1. Method call **callEnded()**
 Parameters: callSessionID, report
 Check: no exception is returned

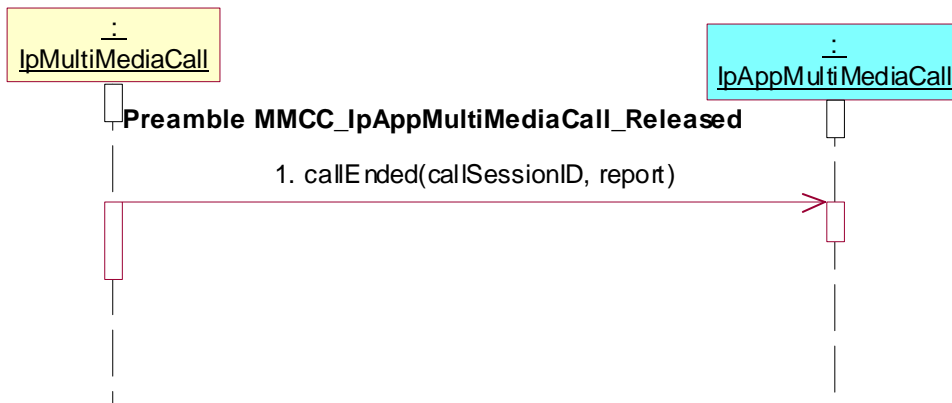

7.2.3.3 IpAppMultiMediaCallLeg

Applications need not be capable of performing each of the sequences below, even if they support the methods indicated below.

Reference: ES 201 915-4 [1], clauses 7.4.3, 8.3.5 and 8.3.6

7.2.3.3.1 Originating Leg

Reference: ES 201 915-4 [1], clauses 7.4.3.1

Precondition: IUT capable of invoking **createNotification()**

7.2.3.3.1.1 Initiating state

Preamble MMCC_IpAppMultiMediaCallLeg_Initiating

Reference: ES 201 915-4 [1], clause 7.4.3.1.1

Pre-preamble: Registration of the IUT (application) and the tester (Call Control SCF) to the framework. The IUT must have obtained a reference to an instance of the IpMultiMediaCallControlManager interface through selecting that service and signing the required service agreement.

The application is permitted to provide its IpAppMultiMediaCallControlManager interface reference in a setCallback() method which it calls prior to invoking further methods.

Preamble Sequence:

1. Triggered Action: cause IUT to call **createNotification()** method on the tester's (SCF's) IpMultiMediaCallControlManager interface.
Parameters: appCallControlManager, notificationRequest
notificationRequest.CallMonitorMode= P_CALL_MONITOR_MODE_INTERRUPT
notificationRequest.CallEventType= P_CALL_EVENT_ORIGINATING_CALL_ATTEMPT
or P_CALL_EVENT_ORIGINATING_CALL_ATTEMPT_AUTHORISED
2. Method call **reportNotification()**
Parameters: callReference, callLegReferenceSet, notificationInfo, assignmentID
Check: valid value of TpAppMultiPartyCallBack is returned

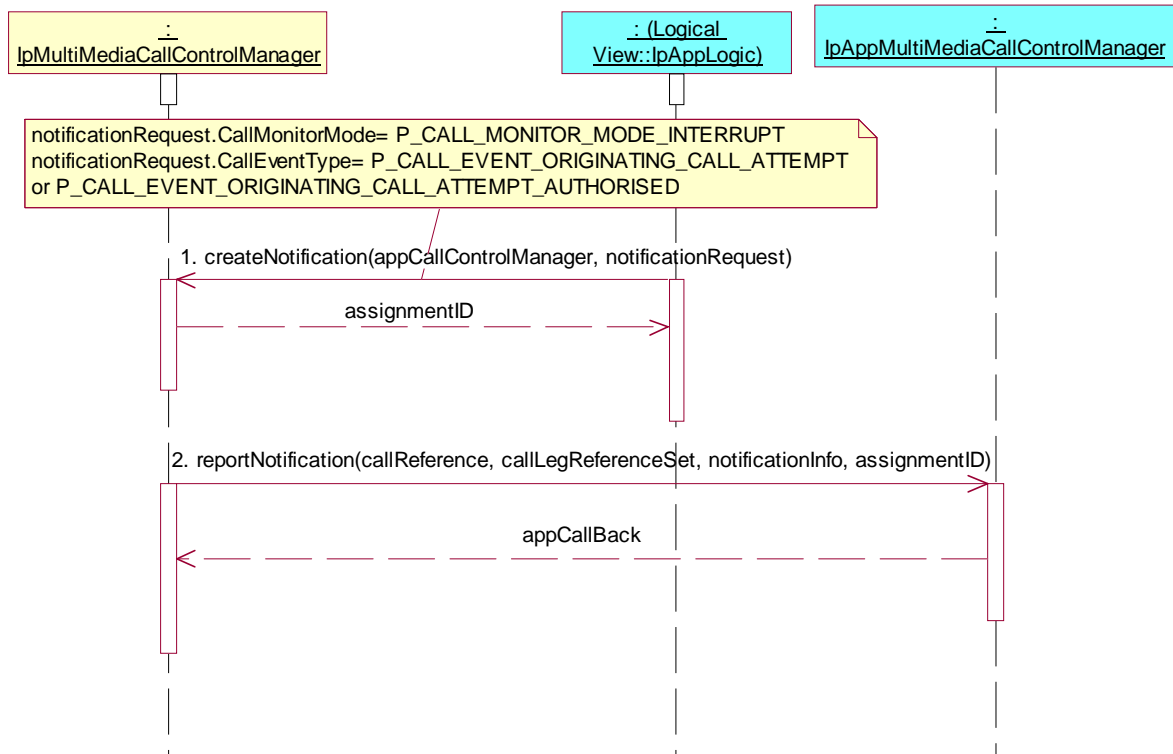

Test MMCC_IpAppMultiMediaCallLeg_01

Summary: request reference of call related to call leg

Reference: ES 201 915-4 [1], clause 7.4.3.1

Precondition: IUT capable of invoking `getCall()`

Preamble: **MMCC_IpAppMultiMediaCallLeg_Initiating**

Test Sequence:

1. Triggered Action: cause IUT to call `getCall()` method on the tester's (SCF's) `IpMultiMediaCallLeg` interface.
Parameters: `callLegSessionID`

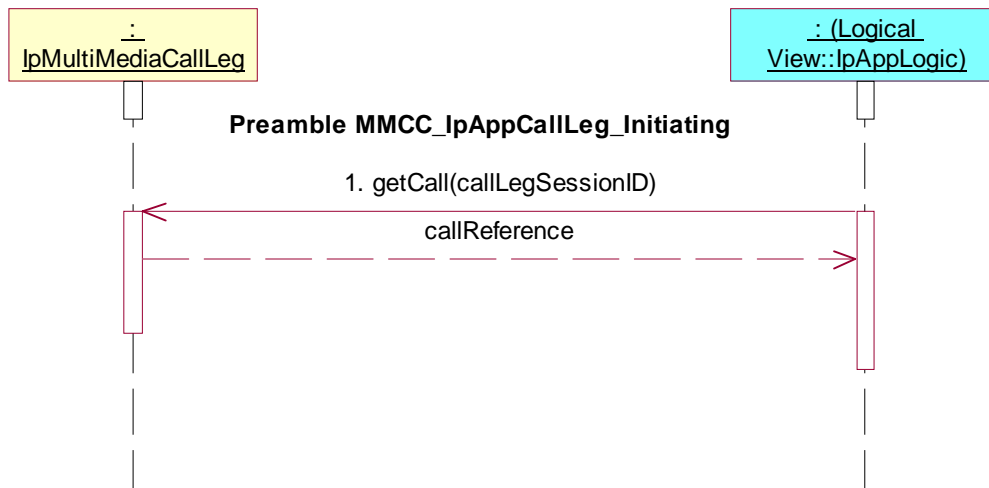

Test MMCC_IpAppMultiMediaCallLeg_02

Summary: continue processing of call leg

Reference: ES 201 915-4 [1], clause 7.4.3.1

Precondition: IUT capable of invoking **continueProcessing()**

Preamble: **MMCC_IpAppMultiMediaCallLeg_Initiating**

Test Sequence:

1. Triggered Action: cause IUT to call **continueProcessing()** method on the tester's (SCF's) IpMultiMediaCallLeg interface.
Parameters: callLegSessionID

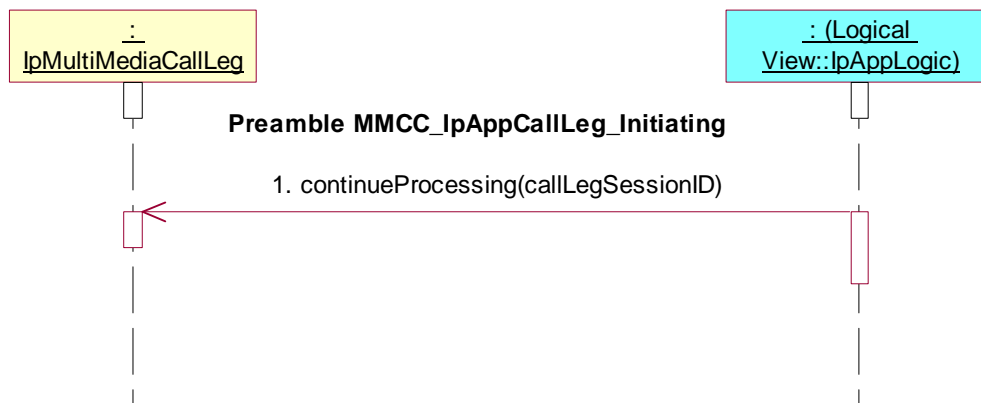

Test MMCC_IpAppMultiMediaCallLeg_03

Summary: release call leg

Reference: ES 201 915-4 [1], clause 7.4.3.1

Precondition: IUT capable of invoking **release()**

Preamble: **MMCC_IpAppMultiMediaCallLeg_Initiating**

Test Sequence:

1. Triggered Action: cause IUT to call **release()** method on the tester's (SCF's) IpMultiMediaCallLeg interface.
Parameters: callLegSessionID, cause

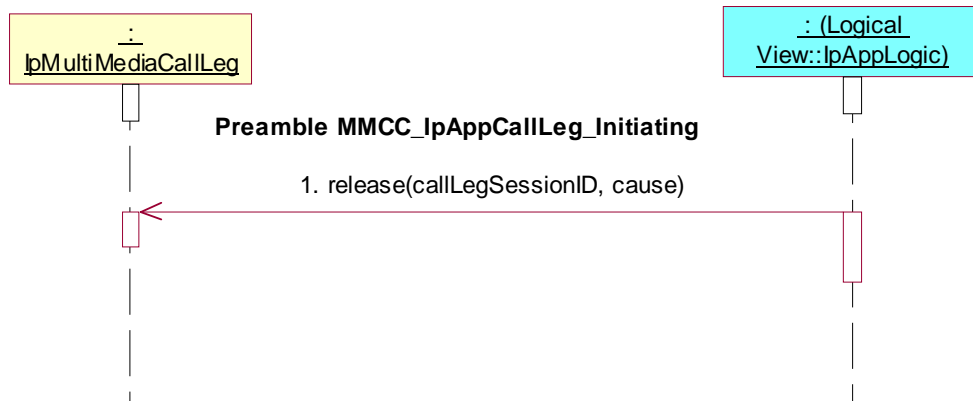

Test MMCC_IpAppMultiMediaCallLeg_04

Summary: de-assign call leg

Reference: ES 201 915-4 [1], clause 7.4.3.1

Precondition: IUT capable of invoking **deassign()**

Preamble: **MMCC_IpAppMultiMediaCallLeg_Initiating**

Test Sequence:

1. Triggered Action: cause IUT to call **deassign()** method on the tester's (SCF's) IpMultiMediaCallLeg interface.
Parameters: callLegSessionID

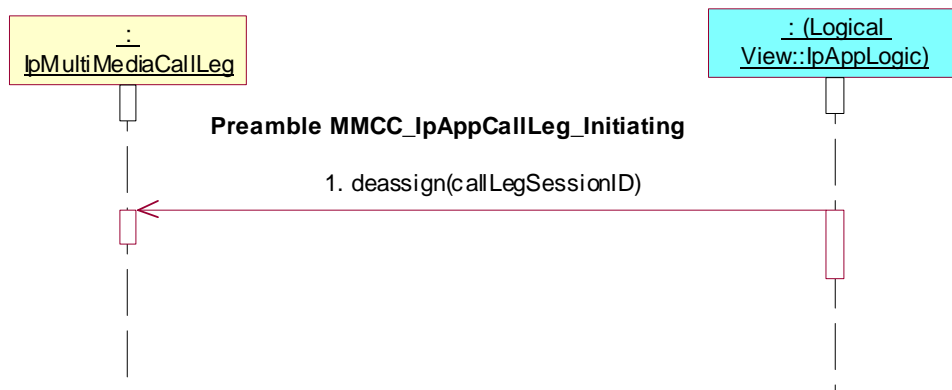

Test MMCC_IpAppMultiMediaCallLeg_05

Summary: change or clear event criteria

Reference: ES 201 915-4 [1], clause 7.4.3.1

Precondition: IUT capable of invoking **eventReportReq()**

Preamble: **MMCC_IpAppMultiMediaCallLeg_Initiating**

Test Sequence:

1. Triggered Action: cause IUT to call **eventReportReq()** method on the tester's (SCF's) IpMultiMediaCallLeg interface.
Parameters: callLegSessionID, eventsRequested

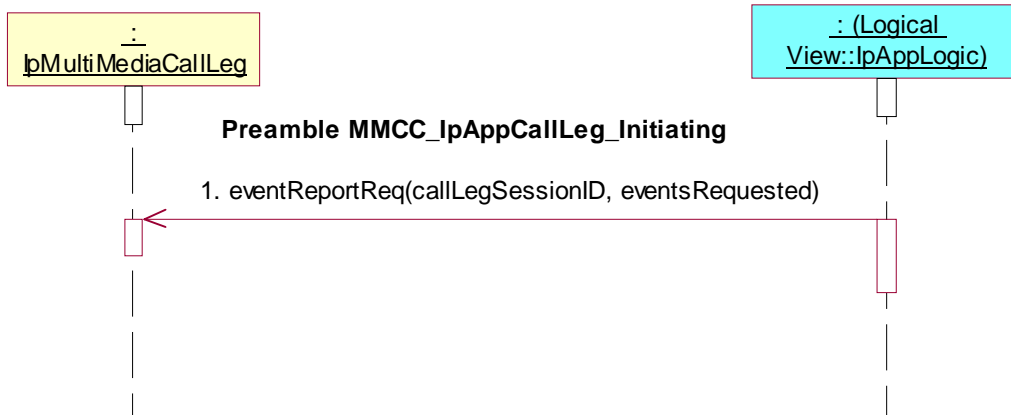

Test MMCC_IpAppMultiMediaCallLeg_06

Summary: change or clear event criteria, unsuccessful

Reference: ES 201 915-4 [1], clause 7.4.3.1

Precondition: IUT capable of invoking **eventReportReq()**

Preamble: **MMCC_IpAppMultiMediaCallLeg_Initiating**

Test Sequence:

1. Triggered Action: cause IUT to call **eventReportReq()** method on the tester's (SCF's) IpMultiMediaCallLeg interface.
Parameters: callLegSessionID, eventsRequested
2. Method call **eventReportErr()**
Parameters: callLegSessionID, errorIndication
Check: no exception is returned

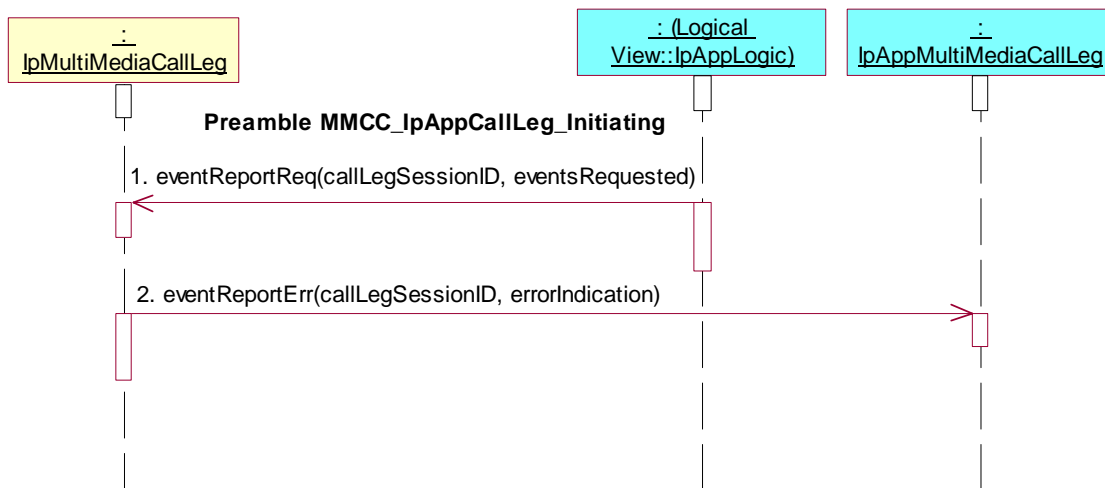

Test MMCC_IpAppMultiMediaCallLeg_07

Summary: get information about call leg

Reference: ES 201 915-4 [1], clause 7.4.3.1

Precondition: IUT capable of invoking **getInfoReq()**

Preamble: **MMCC_IpAppMultiMediaCallLeg_Initiating**

Test Sequence:

1. Triggered Action: cause IUT to call **getInfoReq()** method on the tester's (SCF's) IpMultiMediaCallLeg interface.
Parameters: callLegSessionID, callLegInfoRequested



Test MMCC_IpAppMultiMediaCallLeg_08

Summary: get information about call leg, unsuccessful

Reference: ES 201 915-4 [1], clause 7.4.3.1

Precondition: IUT capable of invoking **getInfoReq()**

Preamble: **MMCC_IpAppMultiMediaCallLeg_Initiating**

Test Sequence:

1. Triggered Action: cause IUT to call **getInfoReq()** method on the tester's (SCF's) IpMultiMediaCallLeg interface.
Parameters: callLegSessionID, callLegInfoRequested
2. Method call **getInfoErr()**
Parameters: callLegSessionID, errorIndication
Check: no exception is returned

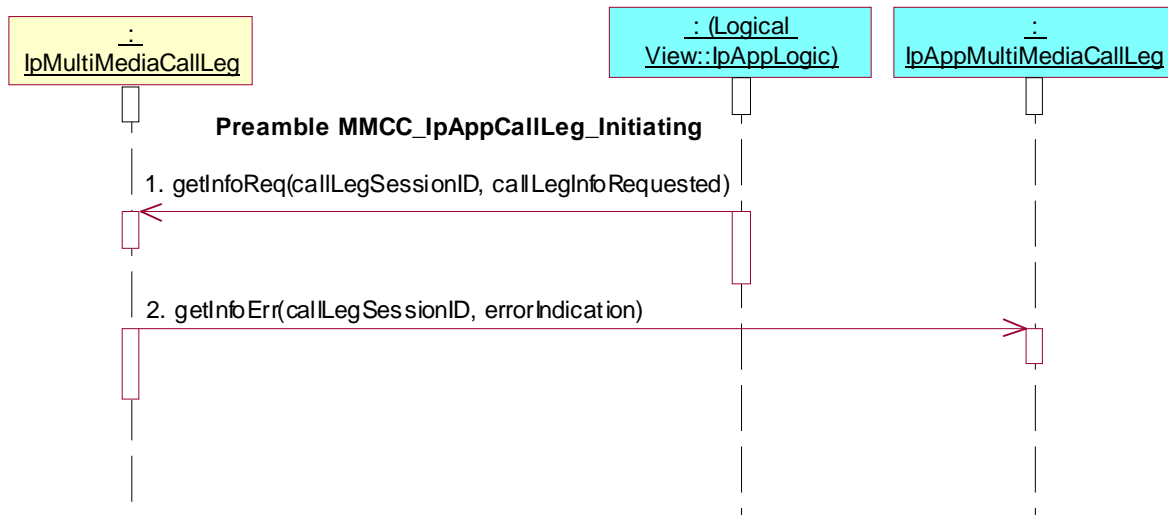

Test MMCC_IpAppMultiMediaCallLeg_09

Summary: set charge plan for call leg

Reference: ES 201 915-4 [1], clause 7.4.3.1

Precondition: IUT capable of invoking **setChargePlan()**

Preamble: **MMCC_IpAppMultiMediaCallLeg_Initiating**

Test Sequence:

1. Triggered Action: cause IUT to call **setChargePlan()** method on the tester's (SCF's) **IpMultiMediaCallLeg** interface.
Parameters: `callLegSessionID`, `callChargePlan`

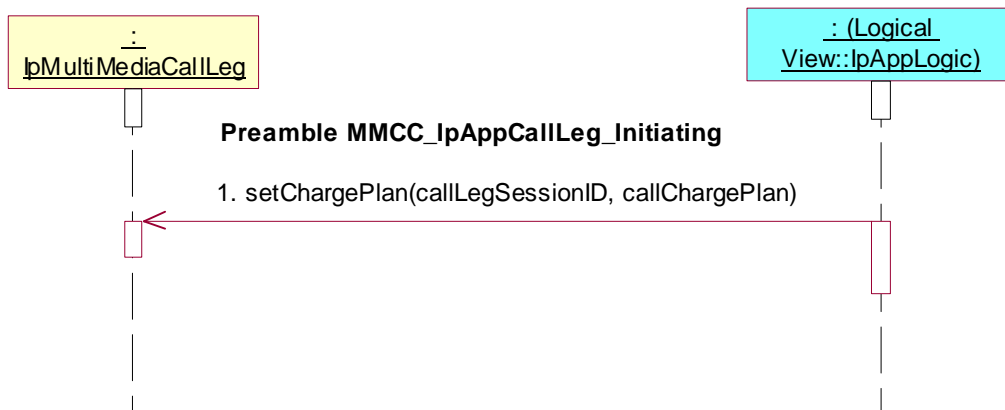

Test MMCC_IpAppMultiMediaCallLeg_10

Summary: allow advice of charge information

Reference: ES 201 915-4 [1], clause 7.4.3.1

Precondition: IUT capable of invoking **setAdviceOfCharge()**

Preamble: **MMCC_IpAppMultiMediaCallLeg_Initiating**

Test Sequence:

1. Triggered Action: cause IUT to call **setAdviceOfCharge()** method on the tester's (SCF's) IpMultiMediaCallLeg interface.
Parameters: callLegSessionID, aOCInfo, tariffSwitch

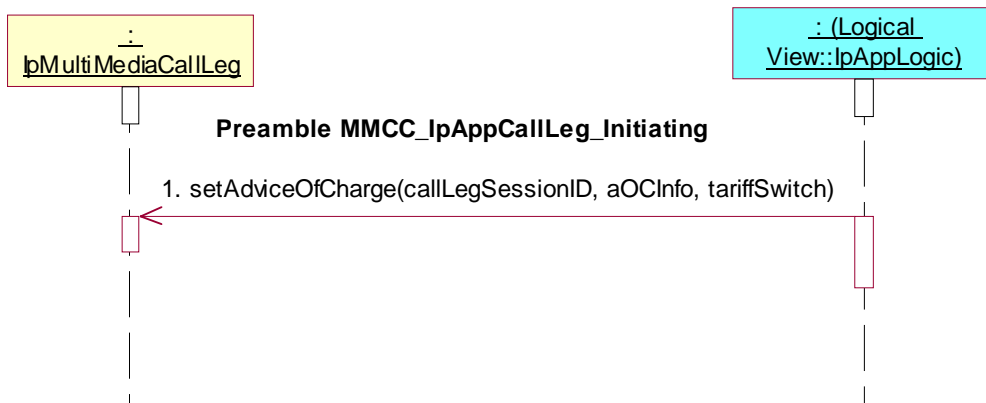

Test MMCC_IpAppMultiMediaCallLeg_11

Summary: supervise call leg

Reference: ES 201 915-4 [1], clause 7.4.3.1

Precondition: IUT capable of invoking **superviseReq()**

Preamble: **MMCC_IpAppMultiMediaCallLeg_Initiating**

Test Sequence:

1. Triggered Action: cause IUT to call **superviseReq()** method on the tester's (SCF's) IpMultiMediaCallLeg interface.
Parameters: callLegSessionID, time, treatment

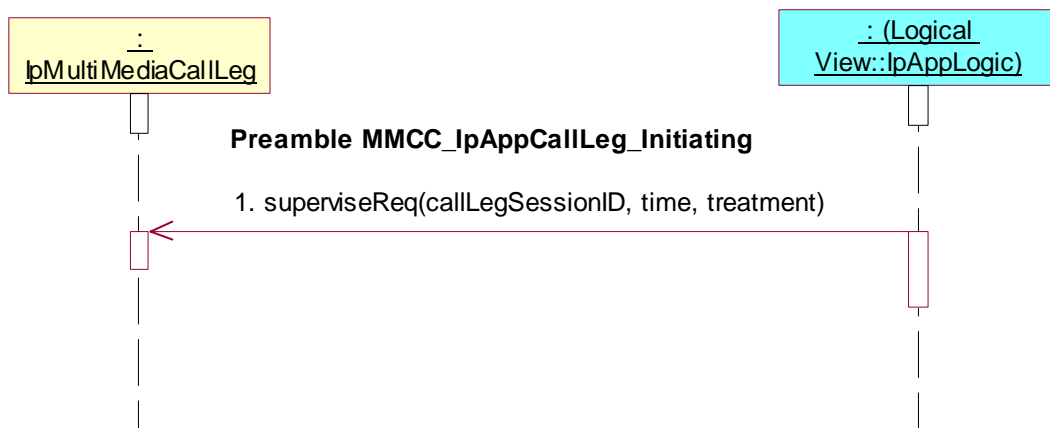

Test MMCC_IpAppMultiMediaCallLeg_12

Summary: supervise call leg, unsuccessful

Reference: ES 201 915-4 [1], clause 7.4.3.1

Precondition: IUT capable of invoking **superviseReq()**

Preamble: **MMCC_IpAppMultiMediaCallLeg_Initiating**

Test Sequence:

1. Triggered Action: cause IUT to call **superviseReq()** method on the tester's (SCF's) IpMultiMediaCallLeg interface.
Parameters: callLegSessionID, time, treatment
2. Method call **superviseErr()**
Parameters: callLegSessionID, errorIndication
Check: no exception is returned

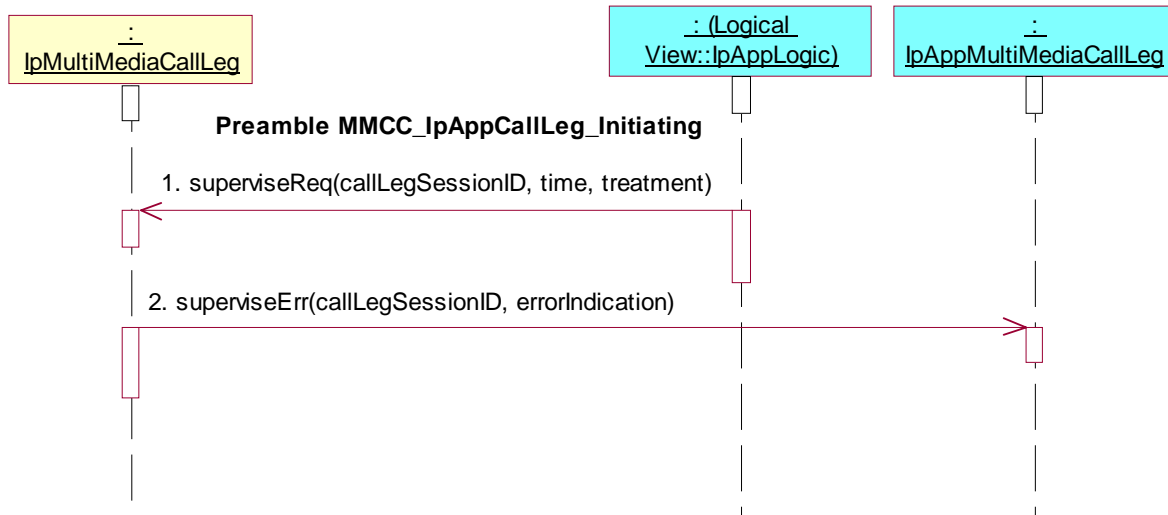

7.2.3.3.1.2 Analysing state

Preamble MMCC_IpAppMultiMediaCallLeg_Analysing

Reference: ES 201 915-4 [1], clause 7.4.3.1.2

Pre-preamble: Registration of the IUT (application) and the tester (Call Control SCF) to the framework. The IUT must have obtained a reference to an instance of the IpMultiMediaCallControlManager interface through selecting that service and signing the required service agreement.

The application is permitted to provide its IpAppMultiMediaCallControlManager interface reference in a setCallback() method which it calls prior to invoking further methods.

Preamble Sequence:

1. Triggered Action: cause IUT to call **createNotification()** method on the tester's (SCF's) IpMultiMediaCallControlManager interface.
Parameters: appCallControlManager, notificationRequest
notificationRequest.CallMonitorMode= P_CALL_MONITOR_MODE_INTERRUPT
notificationRequest.CallEventType= P_CALL_EVENT_ADDRESS_COLLECTED
2. Method call **reportNotification()**
Parameters: callReference, callLegReferenceSet, notificationInfo, assignmentID
Check: valid value of TpAppMultiPartyCallBack is returned

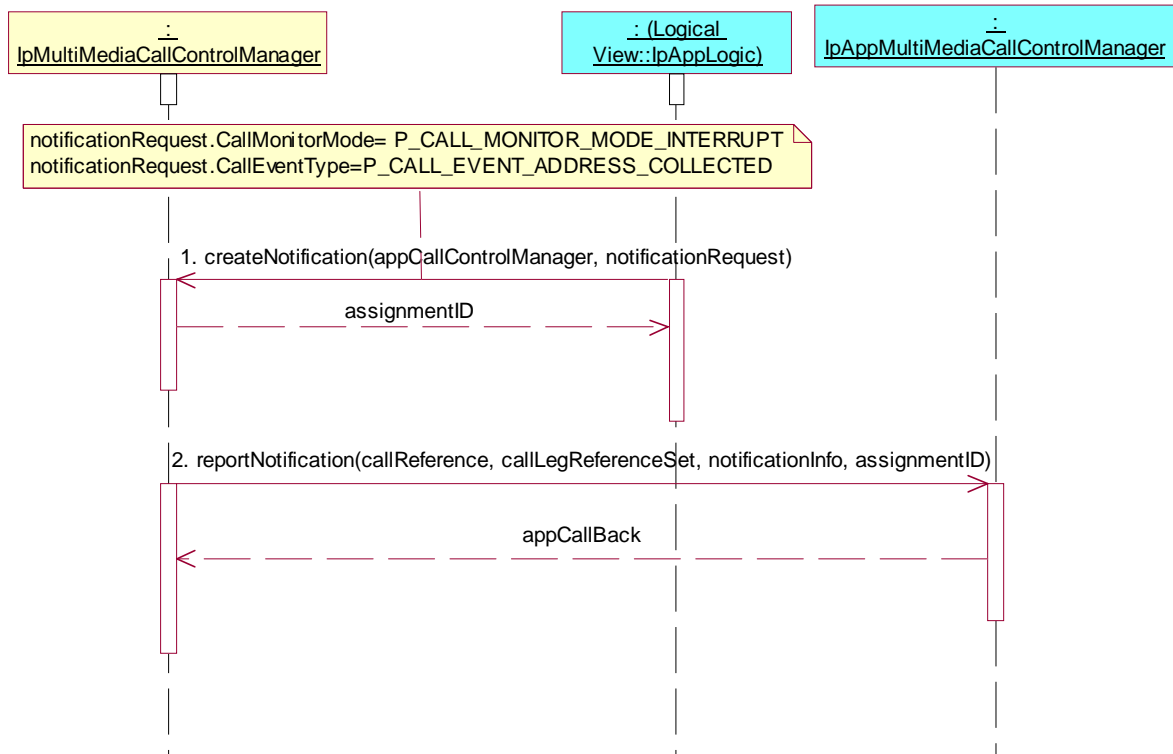

Test MMCC_IpAppMultiMediaCallLeg_13

Summary: attach media, successful

Reference: ES 201 915-4 [1], clause 7.4.3.1

Precondition: IUT capable of invoking **attachMediaReq()**

Preamble: **MMCC_IpAppMultiMediaCallLeg_Analysing**

Test Sequence:

1. Triggered Action: cause IUT to call **attachMediaReq()** method on the tester's (SCF's) IpMultiMediaCallLeg interface.
Parameters: callLegSessionID
2. Method call **attachMediaRes()**
Parameters: callLegSessionID
Check: no exception is returned

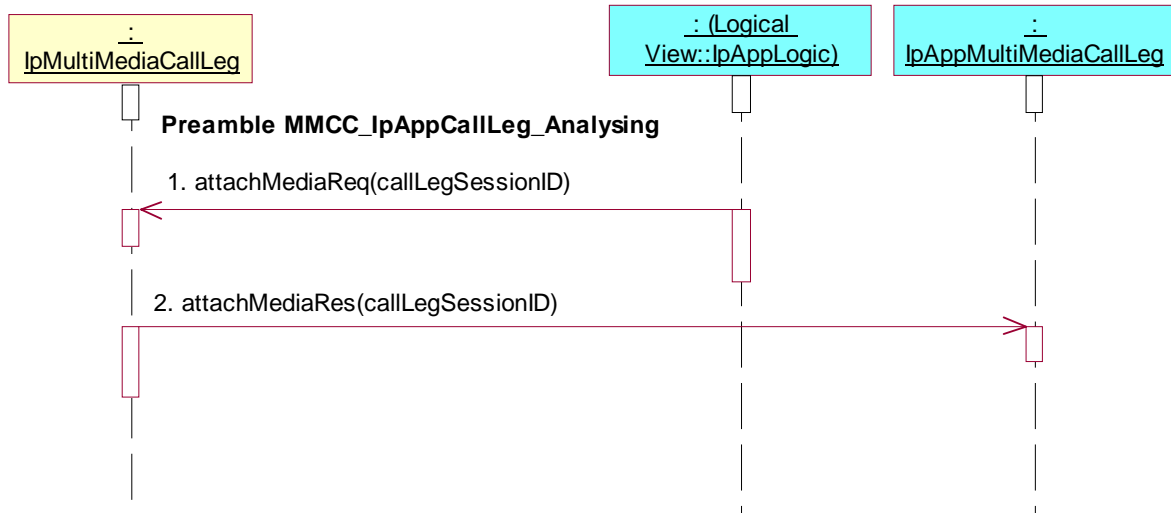

Test MMCC_IpAppMultiMediaCallLeg_14

Summary: attach media, unsuccessful

Reference: ES 201 915-4 [1], clause 7.4.3.1

Precondition: IUT capable of invoking **attachMediaReq()**

Preamble: **MMCC_IpAppMultiMediaCallLeg_Analysing**

Test Sequence:

1. Triggered Action: cause IUT to call **attachMediaReq()** method on the tester's (SCF's) IpMultiMediaCallLeg interface.
Parameters: callLegSessionID
2. Method call **attachMediaErr()**
Parameters: callLegSessionID, errorIndication
Check: no exception is returned

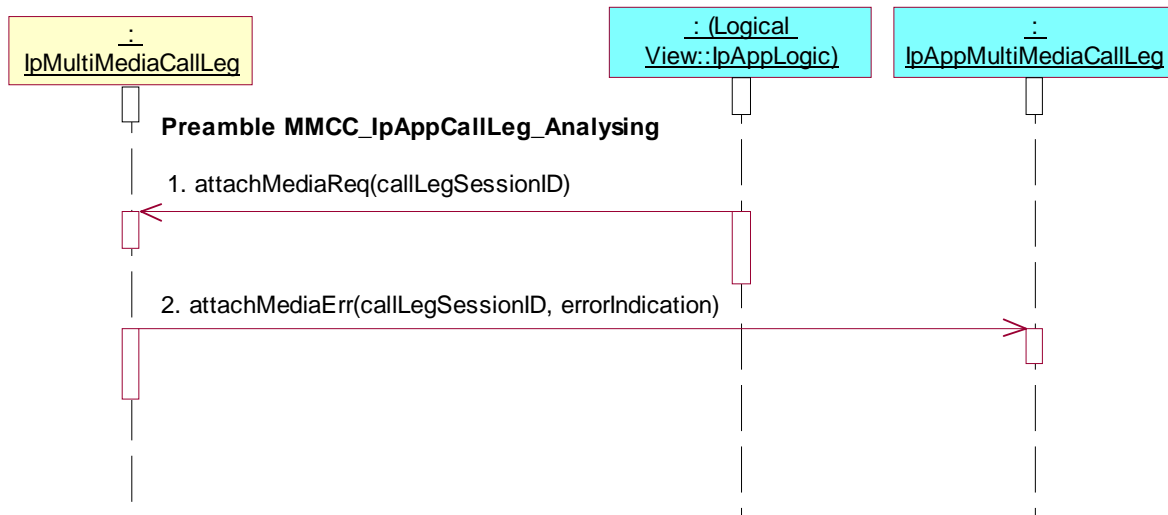

Test MMCC_IpAppMultiMediaCallLeg_15

Summary: detach media, successful

Reference: ES 201 915-4 [1], clause 7.4.3.1

Precondition: IUT capable of invoking **detachMediaReq()**

Preamble: **MMCC_IpAppMultiMediaCallLeg_Analysing**

Test Sequence:

1. Triggered Action: cause IUT to call **attachMediaReq()** method on the tester's (SCF's) IpMultiMediaCallLeg interface.
Parameters: callLegSessionID
2. Method call **attachMediaRes()**
Parameters: callLegSessionID
Check: no exception is returned
3. Triggered Action: cause IUT to call **detachMediaReq()** method on the tester's (SCF's) IpMultiMediaCallLeg interface.
Parameters: callLegSessionID
4. Method call **detachMediaRes()**
Parameters: callLegSessionID
Check: no exception is returned

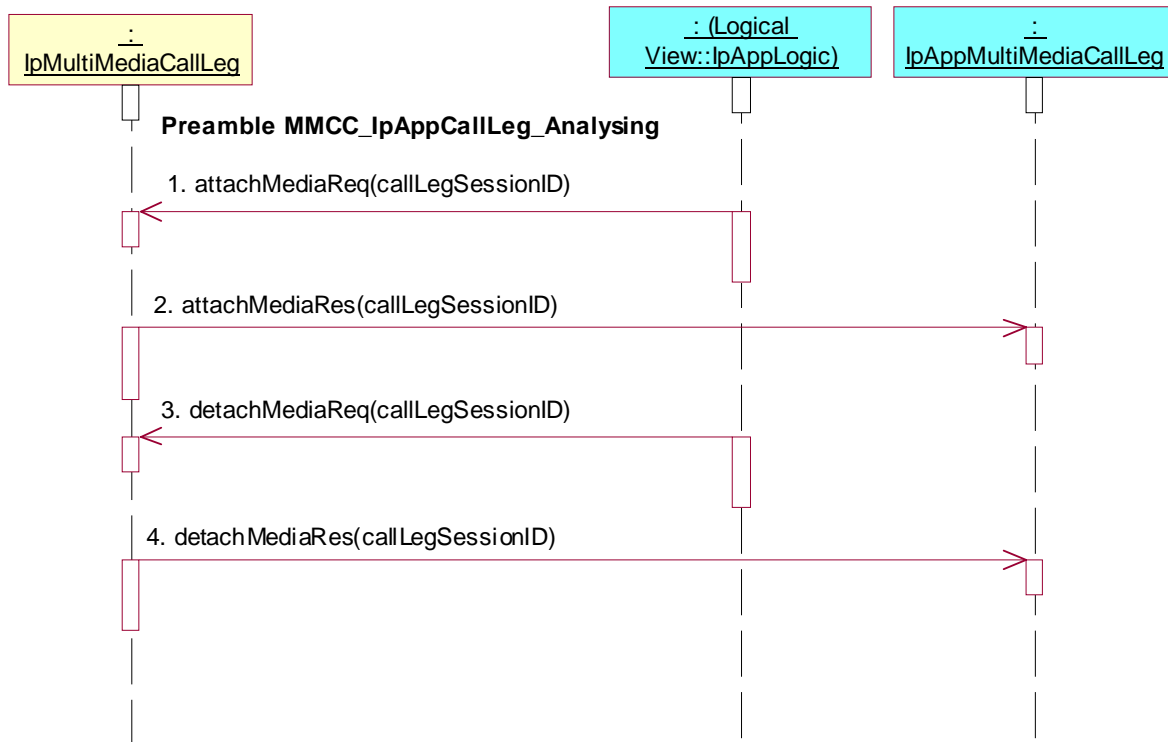

Test MMCC_IpAppMultiMediaCallLeg_16

Summary: detach media, unsuccessful

Reference: ES 201 915-4 [1], clause 7.4.3.1

Precondition: IUT capable of invoking **detachMediaReq()**

Preamble: **MMCC_IpAppMultiMediaCallLeg_Analysing**

Test Sequence:

1. Triggered Action: cause IUT to call **attachMediaReq()** method on the tester's (SCF's) IpMultiMediaCallLeg interface.
Parameters: callLegSessionID
2. Method call **attachMediaRes()**
Parameters: callLegSessionID
Check: no exception is returned
3. Triggered Action: cause IUT to call **detachMediaReq()** method on the tester's (SCF's) IpMultiMediaCallLeg interface.
Parameters: callLegSessionID
4. Method call **detachMediaErr()**
Parameters: callLegSessionID, errorIndication
Check: no exception is returned

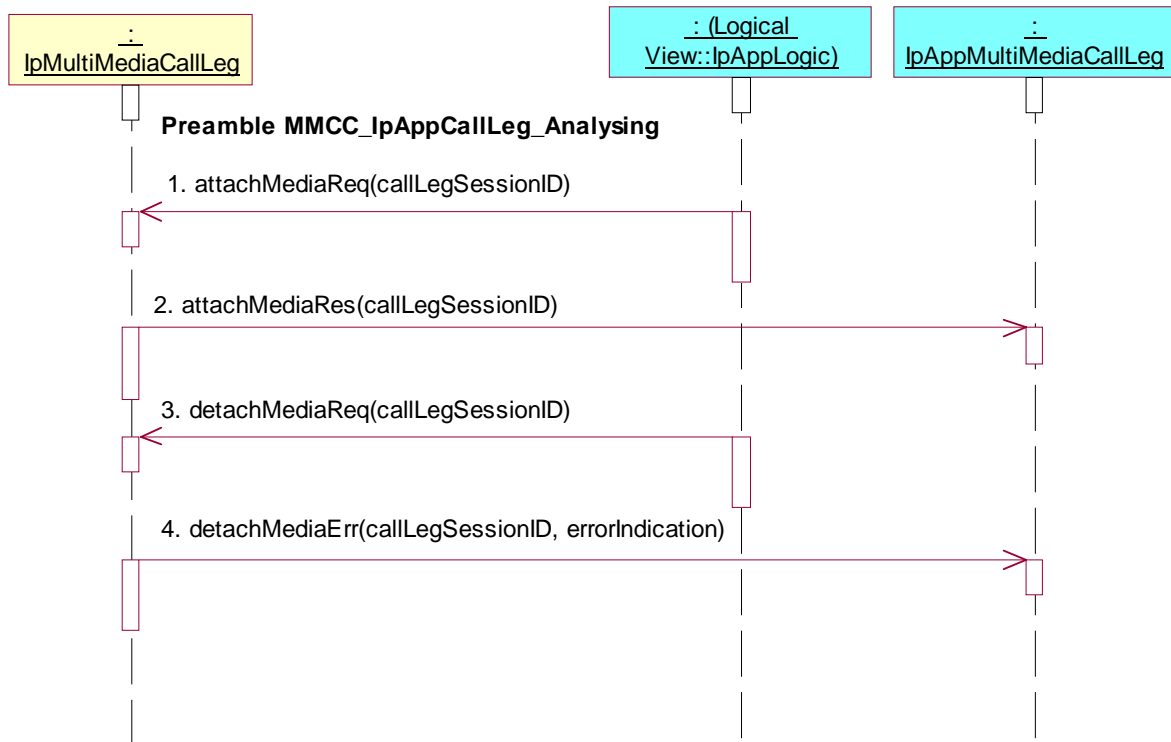

Test MMCC_IpAppMultiMediaCallLeg_17

Summary: request reference of call related to call leg

Reference: ES 201 915-4 [1], clause 7.4.3.1

Precondition: IUT capable of invoking **getCall()**

Preamble: **MMCC_IpAppMultiMediaCallLeg_Analysing**

Test Sequence:

1. Triggered Action: cause IUT to call **getCall()** method on the tester's (SCF's) **IpMultiMediaCallLeg** interface.
Parameters: **callLegSessionID**

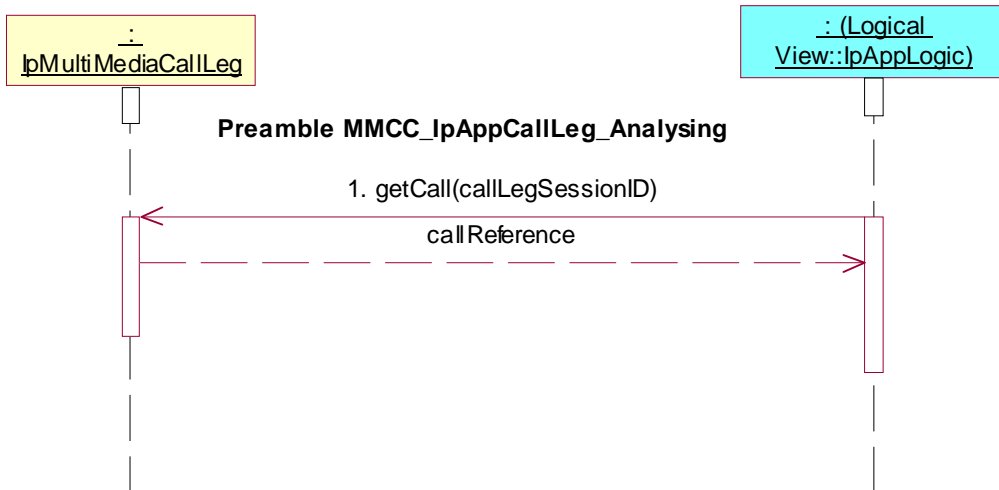

Test MMCC_IpAppMultiMediaCallLeg_18

Summary: continue processing of call leg

Reference: ES 201 915-4 [1], clause 7.4.3.1

Precondition: IUT capable of invoking **continueProcessing()**

Preamble: **MMCC_IpAppMultiMediaCallLeg_Analysing**

Test Sequence:

1. Triggered Action: cause IUT to call **continueProcessing()** method on the tester's (SCF's) IpMultiMediaCallLeg interface.
Parameters: callLegSessionID

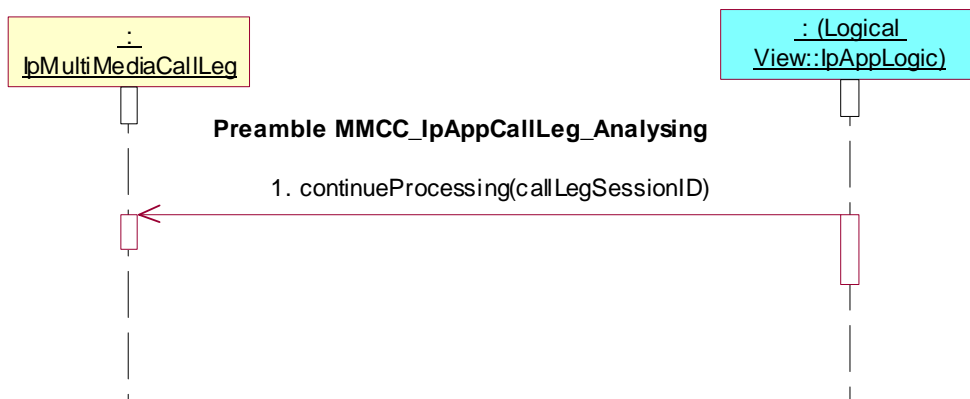

Test MMCC_IpAppMultiMediaCallLeg_19

Summary: release call leg

Reference: ES 201 915-4 [1], clause 7.4.3.1

Precondition: IUT capable of invoking **release()**

Preamble: **MMCC_IpAppMultiMediaCallLeg_Analysing**

Test Sequence:

1. Triggered Action: cause IUT to call **release()** method on the tester's (SCF's) IpMultiMediaCallLeg interface.
Parameters: callLegSessionID, cause

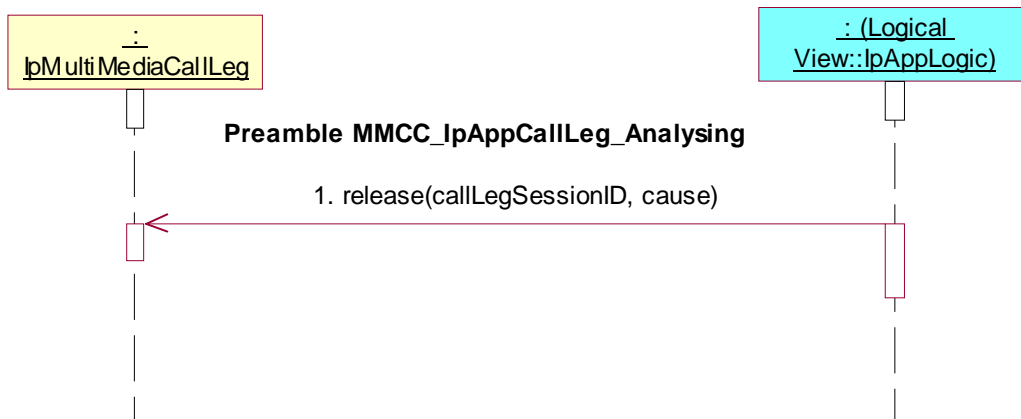

Test MMCC_IpAppMultiMediaCallLeg_20

Summary: de-assign call leg

Reference: ES 201 915-4 [1], clause 7.4.3.1

Precondition: IUT capable of invoking **deassign()**

Preamble: **MMCC_IpAppMultiMediaCallLeg_Analysing**

Test Sequence:

1. Triggered Action: cause IUT to call **deassign()** method on the tester's (SCF's) IpMultiMediaCallLeg interface.
Parameters: callLegSessionID

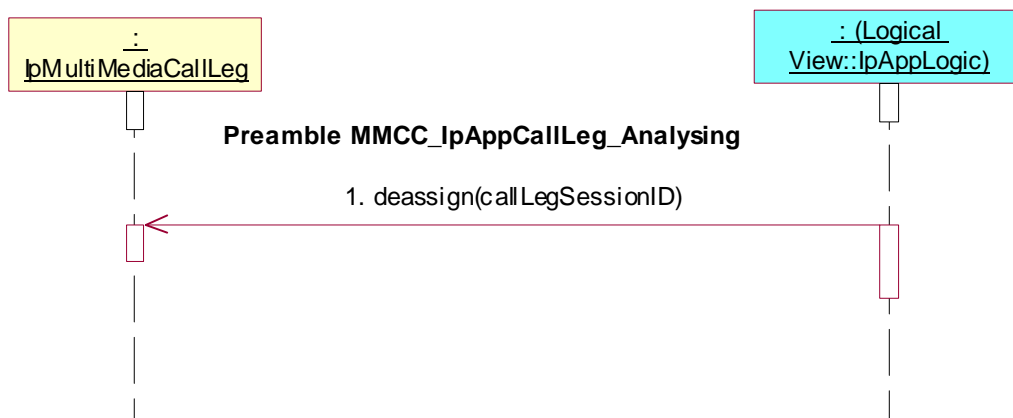

Test MMCC_IpAppMultiMediaCallLeg_21

Summary: change or clear event criteria

Reference: ES 201 915-4 [1], clause 7.4.3.1

Precondition: IUT capable of invoking **eventReportReq()**

Preamble: **MMCC_IpAppMultiMediaCallLeg_Analysing**

Test Sequence:

1. Triggered Action: cause IUT to call **eventReportReq()** method on the tester's (SCF's) IpMultiMediaCallLeg interface.
Parameters: callLegSessionID, eventsRequested

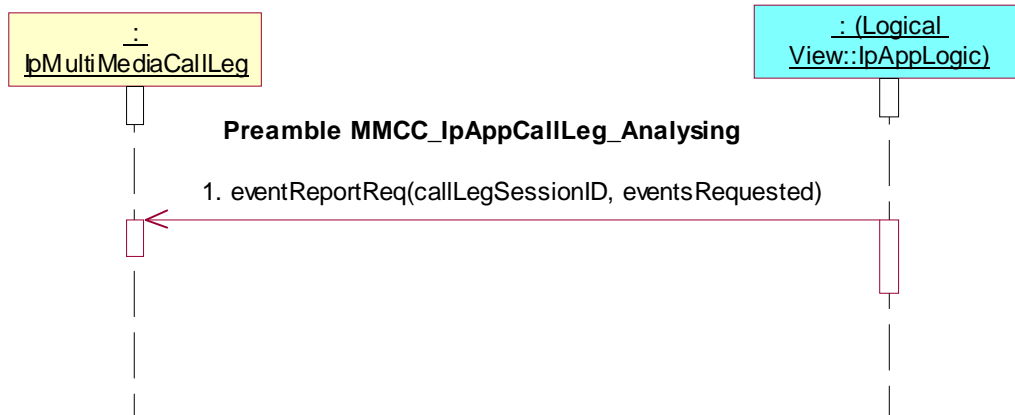

Test MMCC_IpAppMultiMediaCallLeg_22

Summary: change or clear event criteria, unsuccessful

Reference: ES 201 915-4 [1], clause 7.4.3.1

Precondition: IUT capable of invoking **eventReportReq()**

Preamble: **MMCC_IpAppMultiMediaCallLeg_Analysing**

Test Sequence:

1. Triggered Action: cause IUT to call **eventReportReq()** method on the tester's (SCF's) IpMultiMediaCallLeg interface.
Parameters: callLegSessionID, eventsRequested
2. Method call **eventReportErr()**
Parameters: callLegSessionID, errorIndication
Check: no exception is returned

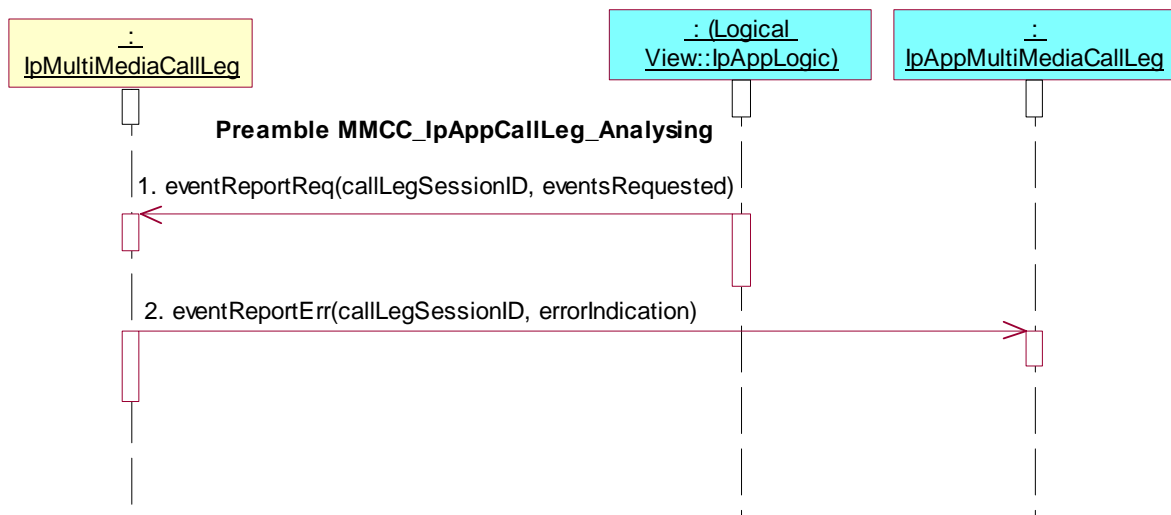

Test MMCC_IpAppMultiMediaCallLeg_23

Summary: get information about call leg

Reference: ES 201 915-4 [1], clause 7.4.3.1

Precondition: IUT capable of invoking **getInfoReq()**

Preamble: **MMCC_IpAppMultiMediaCallLeg_Analysing**

Test Sequence:

1. Triggered Action: cause IUT to call **getInfoReq()** method on the tester's (SCF's) IpMultiMediaCallLeg interface.
Parameters: callLegSessionID, callLegInfoRequested

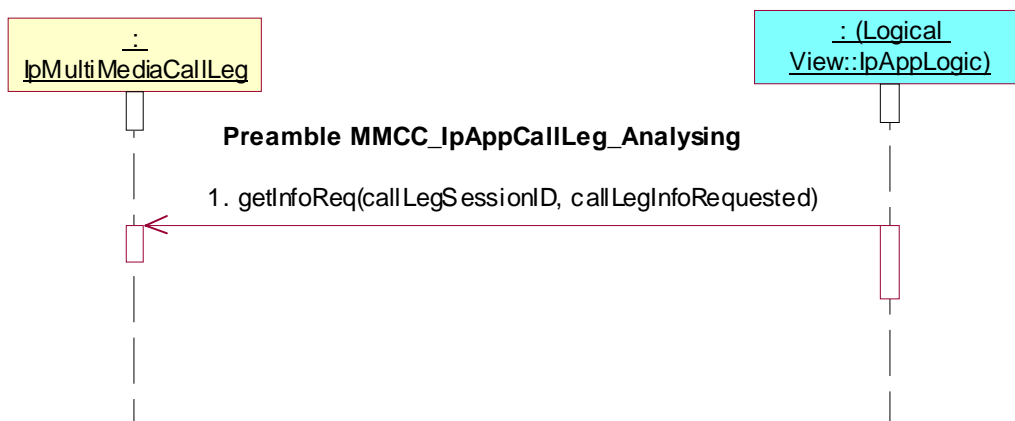
**Test MMCC_IpAppMultiMediaCallLeg_24**

Summary: get information about call leg, unsuccessful

Reference: ES 201 915-4 [1], clause 7.4.3.1

Precondition: IUT capable of invoking **getInfoReq()**

Preamble: **MMCC_IpAppMultiMediaCallLeg_Analysing**

Test Sequence:

1. Triggered Action: cause IUT to call **getInfoReq()** method on the tester's (SCF's) IpMultiMediaCallLeg interface.
Parameters: callLegSessionID, callLegInfoRequested
2. Method call **getInfoErr()**
Parameters: callLegSessionID, errorIndication
Check: no exception is returned

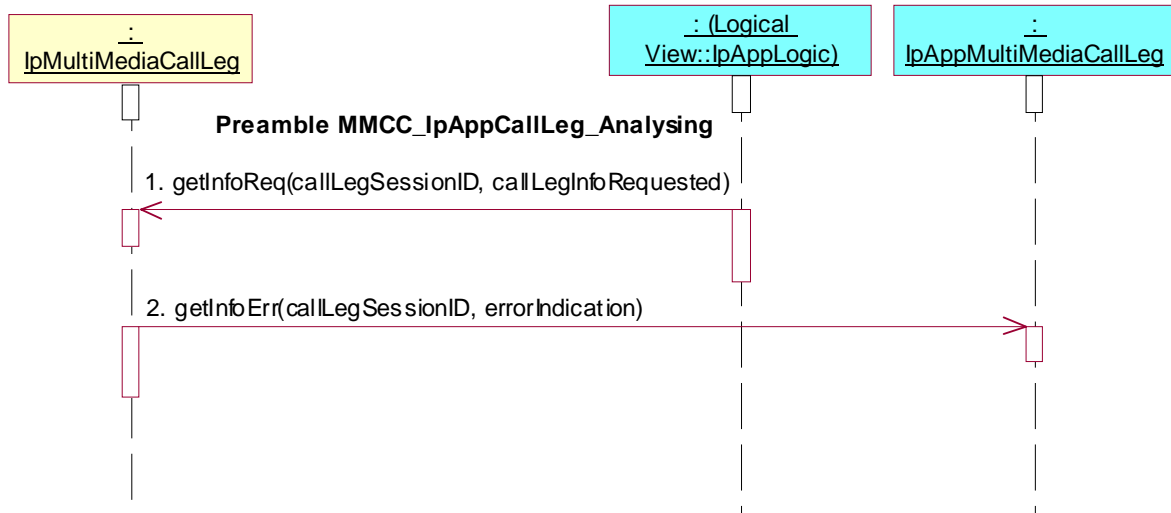

Test MMCC_IpAppMultiMediaCallLeg_25

Summary: set charge plan for call leg

Reference: ES 201 915-4 [1], clause 7.4.3.1

Precondition: IUT capable of invoking **setChargePlan()**

Preamble: **MMCC_IpAppMultiMediaCallLeg_Analysing**

Test Sequence:

1. Triggered Action: cause IUT to call **setChargePlan()** method on the tester's (SCF's) IpMultiMediaCallLeg interface.
Parameters: callLegSessionID, callChargePlan

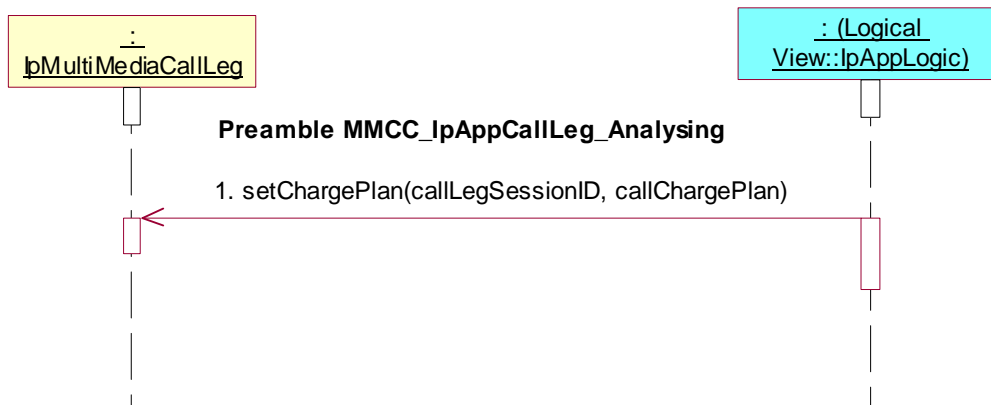

Test MMCC_IpAppMultiMediaCallLeg_26

Summary: allow advice of charge information

Reference: ES 201 915-4 [1], clause 7.4.3.1

Precondition: IUT capable of invoking **setAdviceOfCharge()**

Preamble: **MMCC_IpAppMultiMediaCallLeg_Analysing**

Test Sequence:

1. Triggered Action: cause IUT to call **setAdviceOfCharge()** method on the tester's (SCF's) IpMultiMediaCallLeg interface.
Parameters: callLegSessionID, aOCInfo, tariffSwitch

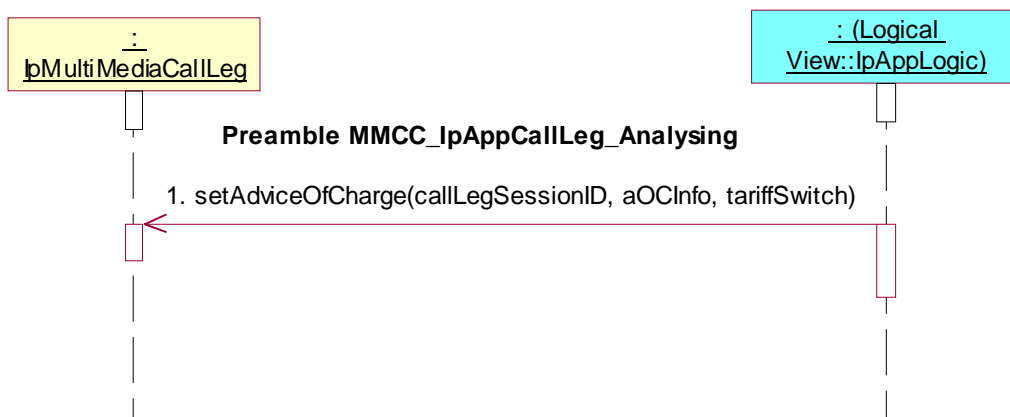
**Test MMCC_IpAppMultiMediaCallLeg_27**

Summary: supervise call leg

Reference: ES 201 915-4 [1], clause 7.4.3.1

Precondition: IUT capable of invoking **superviseReq()**

Preamble: **MMCC_IpAppMultiMediaCallLeg_Analysing**

Test Sequence:

1. Triggered Action: cause IUT to call **superviseReq()** method on the tester's (SCF's) IpMultiMediaCallLeg interface.
Parameters: callLegSessionID, time, treatment

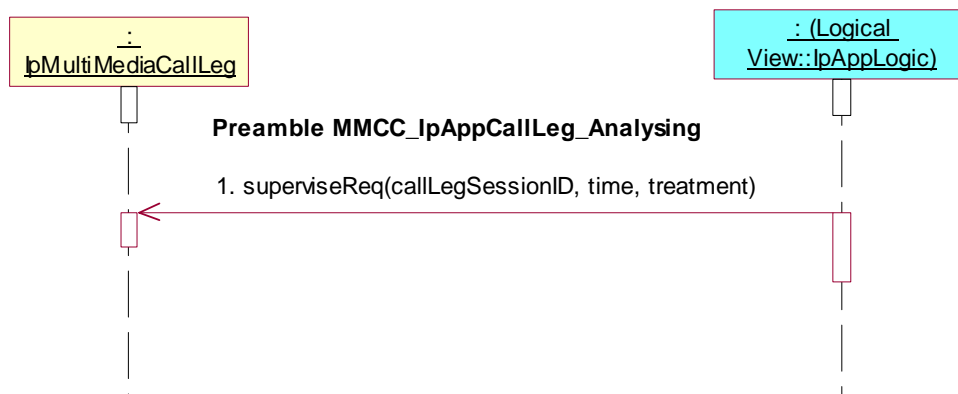

Test MMCC_IpAppMultiMediaCallLeg_28

Summary: supervise call leg, unsuccessful

Reference: ES 201 915-4 [1], clause 7.4.3.1

Precondition: IUT capable of invoking **superviseReq()**

Preamble: **MMCC_IpAppMultiMediaCallLeg_Analysing**

Test Sequence:

1. Triggered Action: cause IUT to call **superviseReq()** method on the tester's (SCF's) IpMultiMediaCallLeg interface.
Parameters: callLegSessionID, time, treatment
2. Method call **superviseErr()**
Parameters: callLegSessionID, errorIndication
Check: no exception is returned

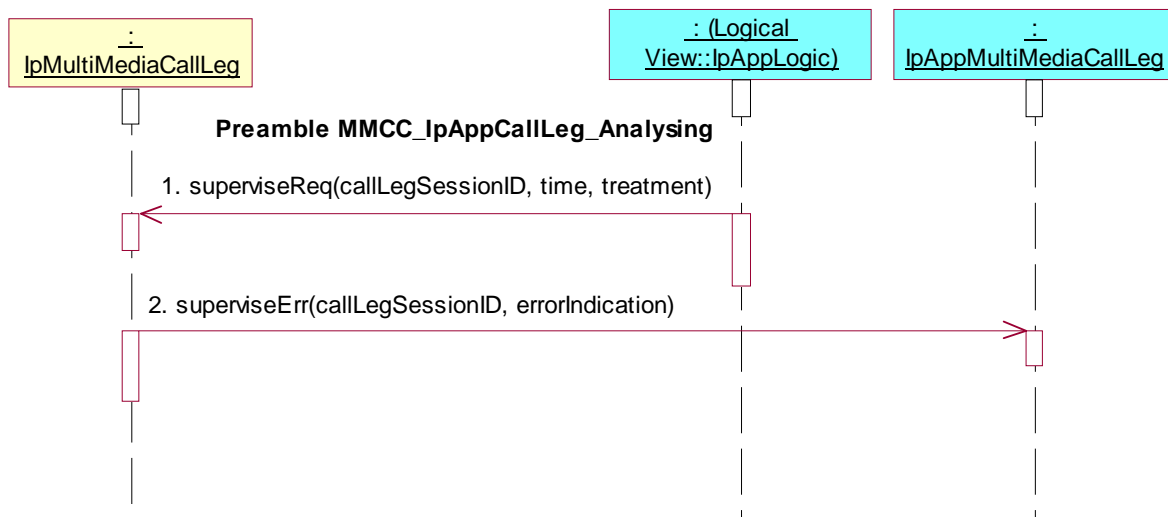

7.2.3.3.1.3 Active state

Preamble MMCC_IpAppMultiMediaCallLeg_Active

Reference: ES 201 915-4 [1], clause 7.4.3.1.3

Pre-preamble: Registration of the IUT (application) and the tester (Call Control SCF) to the framework. The IUT must have obtained a reference to an instance of the IpMultiMediaCallControlManager interface through selecting that service and signing the required service agreement.

The application is permitted to provide its IpAppMultiMediaCallControlManager interface reference in a setCallback() method which it calls prior to invoking further methods.

Preamble Sequence:

1. Triggered Action: cause IUT to call **createNotification()** method on the tester's (SCF's) IpMultiMediaCallControlManager interface.
Parameters: appCallControlManager, notificationRequest
notificationRequest.CallMonitorMode= P_CALL_MONITOR_MODE_INTERRUPT
notificationRequest.CallEventType= P_CALL_EVENT_ADDRESS_ANALYSED or P_CALL_EVENT_ORIGINATING_SERVICE_CODE
2. Method call **reportNotification()**
Parameters: callReference, callLegReferenceSet, notificationInfo, assignmentID
Check: valid value of TpAppMultiPartyCallBack is returned

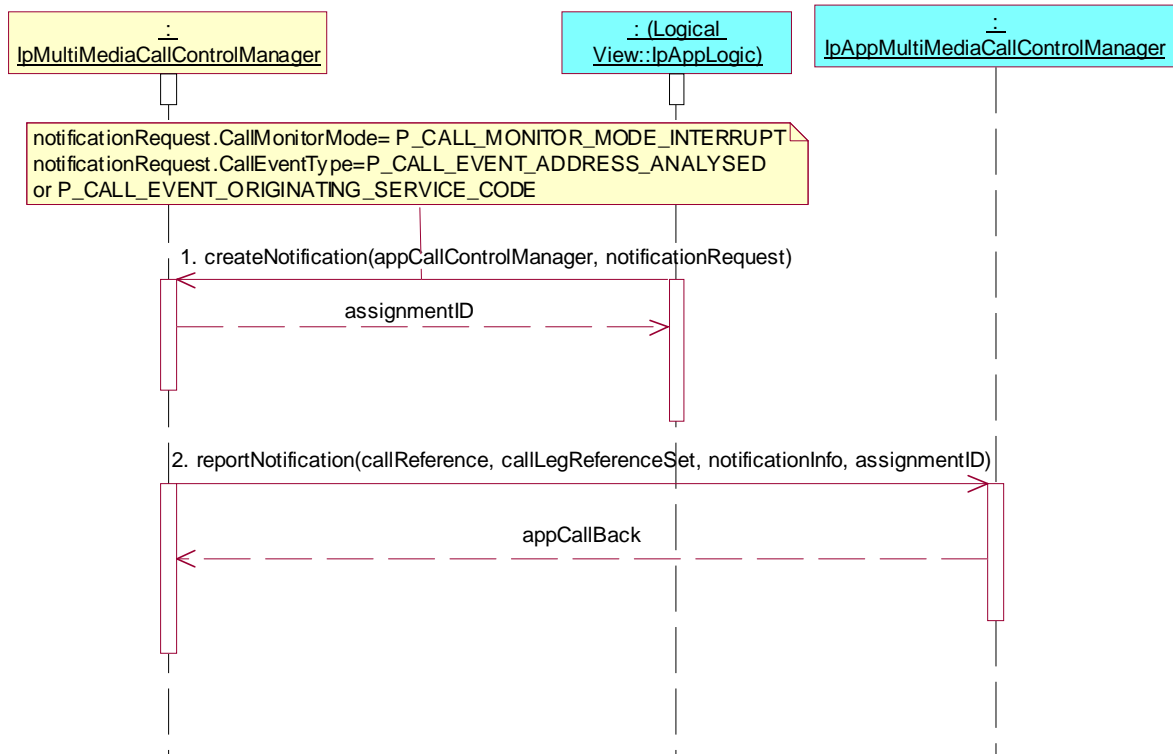

Test MMCC_IpAppMultiMediaCallLeg_29

Summary: attach media, successful

Reference: ES 201 915-4 [1], clause 7.4.3.1

Precondition: IUT capable of invoking **attachMediaReq()**

Preamble: **MMCC_IpAppMultiMediaCallLeg_Active**

Test Sequence:

1. Triggered Action: cause IUT to call **attachMediaReq()** method on the tester's (SCF's) **IpMultiMediaCallLeg** interface.
Parameters: `callLegSessionID`
2. Method call **attachMediaRes()**
Parameters: `callLegSessionID`
Check: no exception is returned

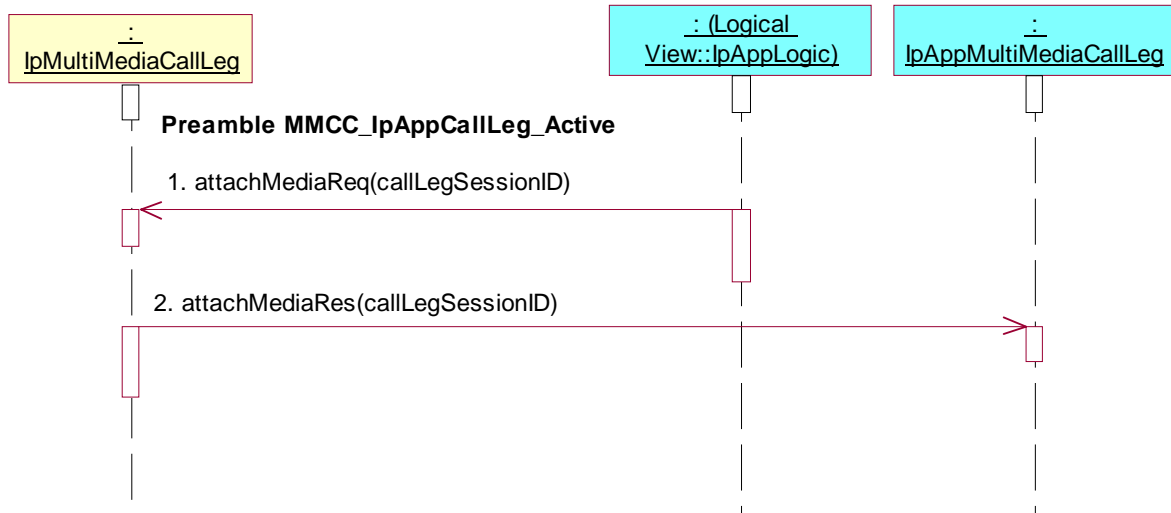

Test MMCC_IpAppMultiMediaCallLeg_30

Summary: attach media, unsuccessful

Reference: ES 201 915-4 [1], clause 7.4.3.1

Precondition: IUT capable of invoking **attachMediaReq()**

Preamble: **MMCC_IpAppMultiMediaCallLeg_Active**

Test Sequence:

1. Triggered Action: cause IUT to call **attachMediaReq()** method on the tester's (SCF's) IpMultiMediaCallLeg interface.
Parameters: callLegSessionID
2. Method call **attachMediaErr()**
Parameters: callLegSessionID, errorIndication
Check: no exception is returned

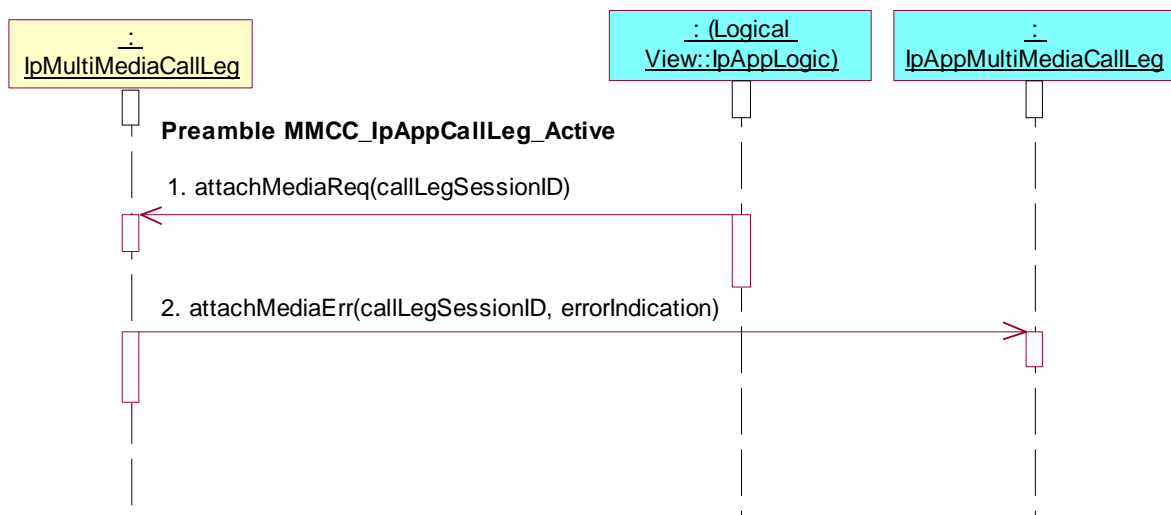

Test MMCC_IpAppMultiMediaCallLeg_31

Summary: detach media, successful

Reference: ES 201 915-4 [1], clause 7.4.3.1

Precondition: IUT capable of invoking **detachMediaReq()**

Preamble: **MMCC_IpAppMultiMediaCallLeg_Active**

Test Sequence:

1. Triggered Action: cause IUT to call **attachMediaReq()** method on the tester's (SCF's) IpMultiMediaCallLeg interface.
Parameters: callLegSessionID
2. Method call **attachMediaRes()**
Parameters: callLegSessionID
Check: no exception is returned
3. Triggered Action: cause IUT to call **detachMediaReq()** method on the tester's (SCF's) IpMultiMediaCallLeg interface.
Parameters: callLegSessionID
4. Method call **detachMediaRes()**
Parameters: callLegSessionID
Check: no exception is returned

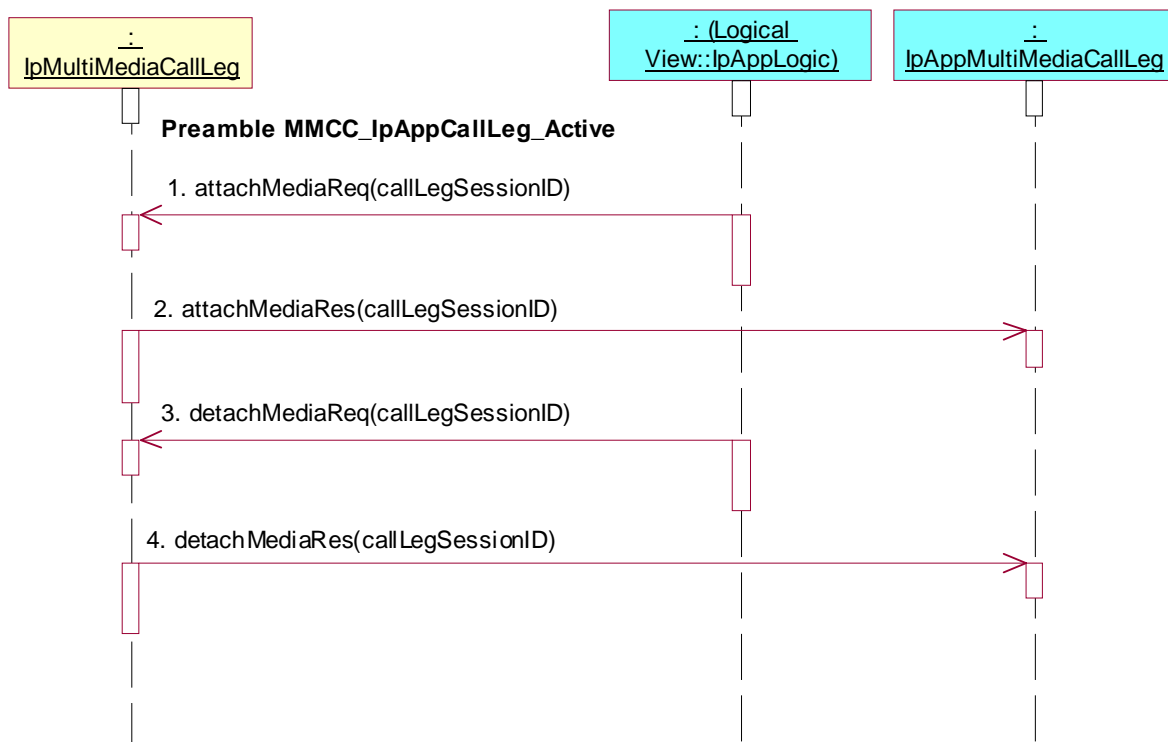
**Test MMCC_IpAppMultiMediaCallLeg_32**

Summary: detach media, unsuccessful

Reference: ES 201 915-4 [1], clause 7.4.3.1

Precondition: IUT capable of invoking **detachMediaReq()**

Preamble: **MMCC_IpAppMultiMediaCallLeg_Active**

Test Sequence:

1. Triggered Action: cause IUT to call **attachMediaReq()** method on the tester's (SCF's) IpMultiMediaCallLeg interface.
Parameters: callLegSessionID
2. Method call **attachMediaRes()**
Parameters: callLegSessionID
Check: no exception is returned
3. Triggered Action: cause IUT to call **detachMediaReq()** method on the tester's (SCF's) IpMultiMediaCallLeg interface.
Parameters: callLegSessionID
4. Method call **detachMediaErr()**
Parameters: callLegSessionID, errorIndication
Check: no exception is returned

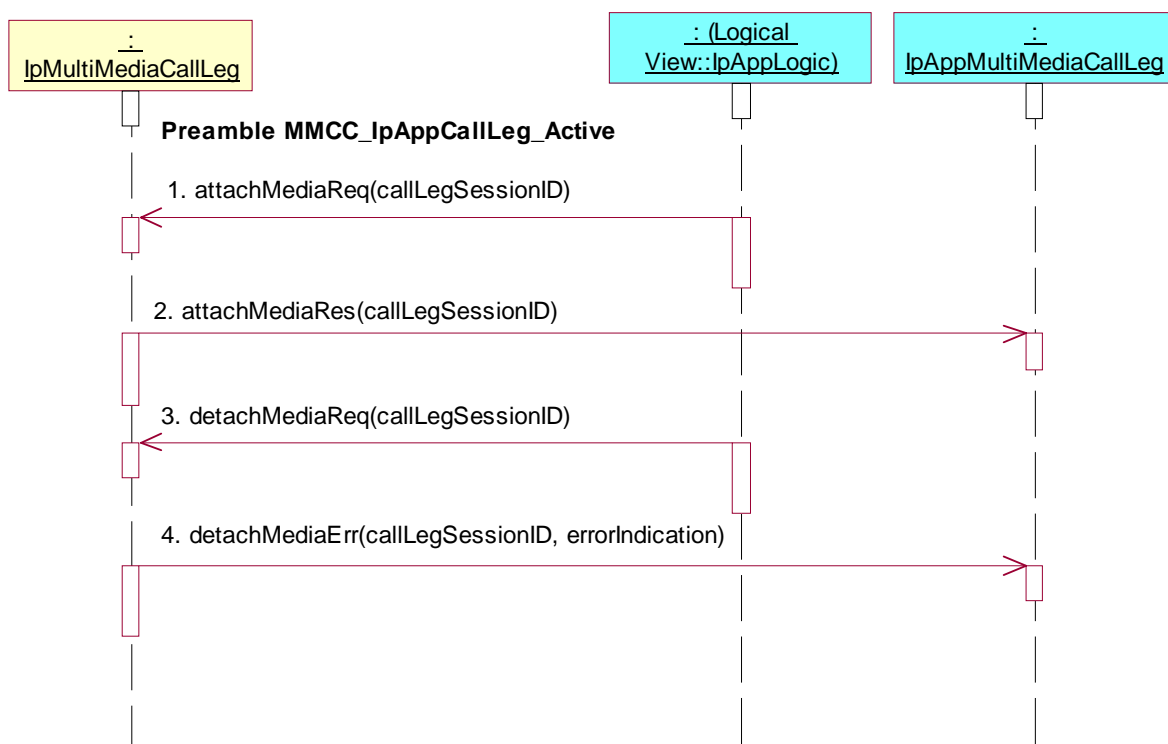

Test MMCC_IpAppMultiMediaCallLeg_33

Summary: request reference of call related to call leg

Reference: ES 201 915-4 [1], clause 7.4.3.1

Precondition: IUT capable of invoking **getCall()**

Preamble: **MMCC_IpAppMultiMediaCallLeg_Active**

Test Sequence:

1. Triggered Action: cause IUT to call **getCall()** method on the tester's (SCF's) IpMultiMediaCallLeg interface.
Parameters: callLegSessionID

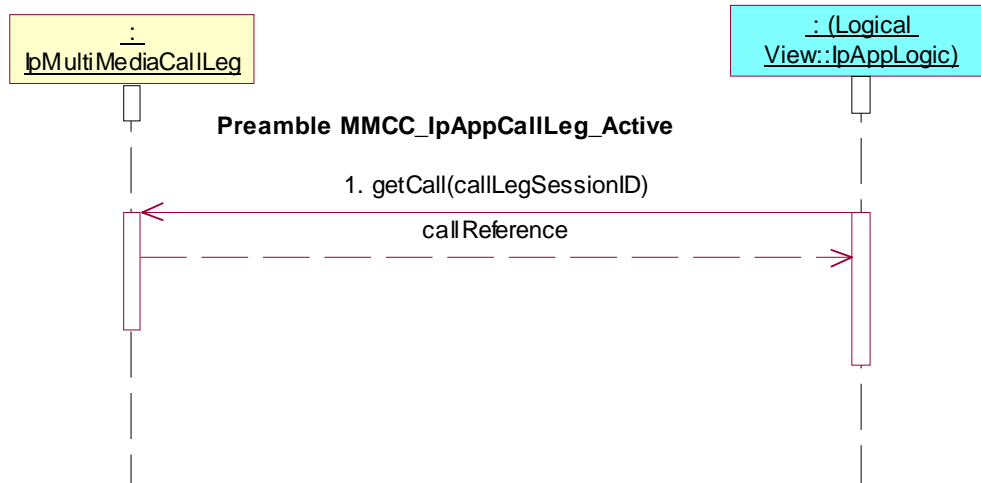

Test MMCC_IpAppMultiMediaCallLeg_34

Summary: continue processing of call leg

Reference: ES 201 915-4 [1], clause 7.4.3.1

Precondition: IUT capable of invoking **continueProcessing()**

Preamble: **MMCC_IpAppMultiMediaCallLeg_Active**

Test Sequence:

1. Triggered Action: cause IUT to call **continueProcessing()** method on the tester's (SCF's) IpMultiMediaCallLeg interface.
Parameters: callLegSessionID

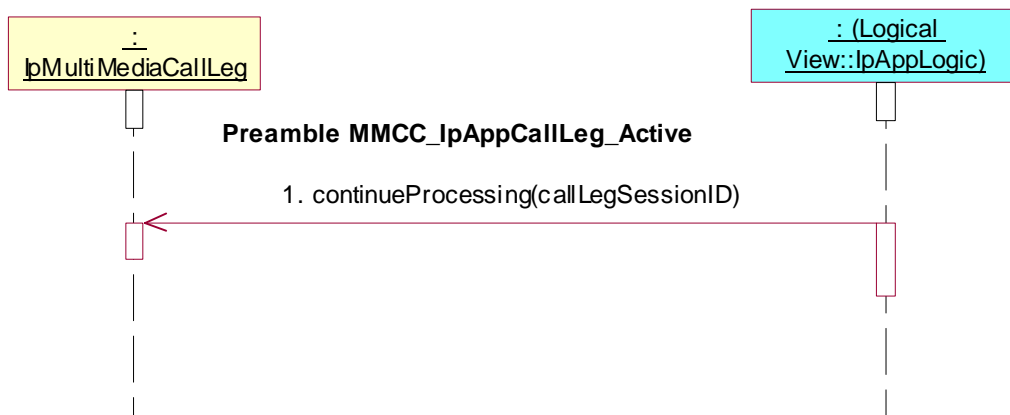

Test MMCC_IpAppMultiMediaCallLeg_35

Summary: release call leg

Reference: ES 201 915-4 [1], clause 7.4.3.1

Precondition: IUT capable of invoking **release()**

Preamble: **MMCC_IpAppMultiMediaCallLeg_Active**

Test Sequence:

1. Triggered Action: cause IUT to call **release()** method on the tester's (SCF's) IpMultiMediaCallLeg interface.
Parameters: callLegSessionID, cause

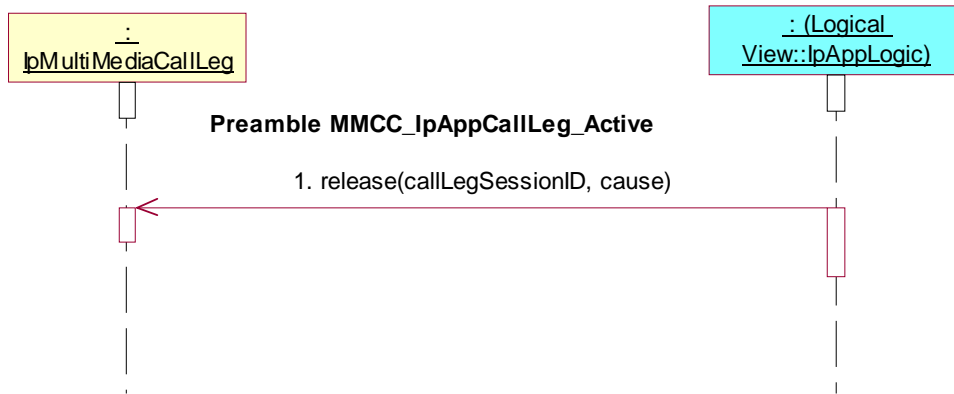

Test MMCC_IpAppMultiMediaCallLeg_36

Summary: de-assign call leg

Reference: ES 201 915-4 [1], clause 7.4.3.1

Precondition: IUT capable of invoking **deassign()**

Preamble: **MMCC_IpAppMultiMediaCallLeg_Active**

Test Sequence:

1. Triggered Action: cause IUT to call **deassign()** method on the tester's (SCF's) IpMultiMediaCallLeg interface.
Parameters: callLegSessionID



Test MMCC_IpAppMultiMediaCallLeg_37

Summary: change or clear event criteria

Reference: ES 201 915-4 [1], clause 7.4.3.1

Precondition: IUT capable of invoking **eventReportReq()**

Preamble: **MMCC_IpAppMultiMediaCallLeg_Active**

Test Sequence:

1. Triggered Action: cause IUT to call **eventReportReq()** method on the tester's (SCF's) IpMultiMediaCallLeg interface.
Parameters: callLegSessionID, eventsRequested

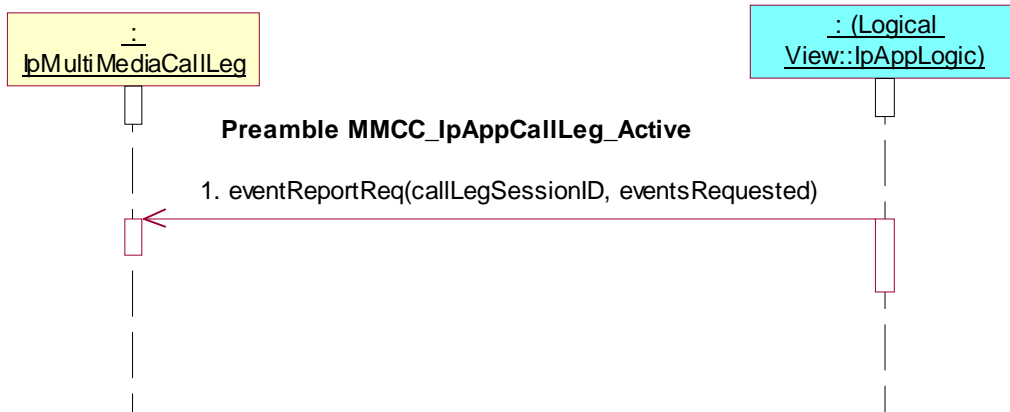

Test MMCC_IpAppMultiMediaCallLeg_38

Summary: change or clear event criteria, unsuccessful

Reference: ES 201 915-4 [1], clause 7.4.3.1

Precondition: IUT capable of invoking **eventReportReq()**

Preamble: **MMCC_IpAppMultiMediaCallLeg_Active**

Test Sequence:

1. Triggered Action: cause IUT to call **eventReportReq()** method on the tester's (SCF's) IpMultiMediaCallLeg interface.
Parameters: callLegSessionID, eventsRequested
2. Method call **eventReportErr()**
Parameters: callLegSessionID, errorIndication
Check: no exception is returned

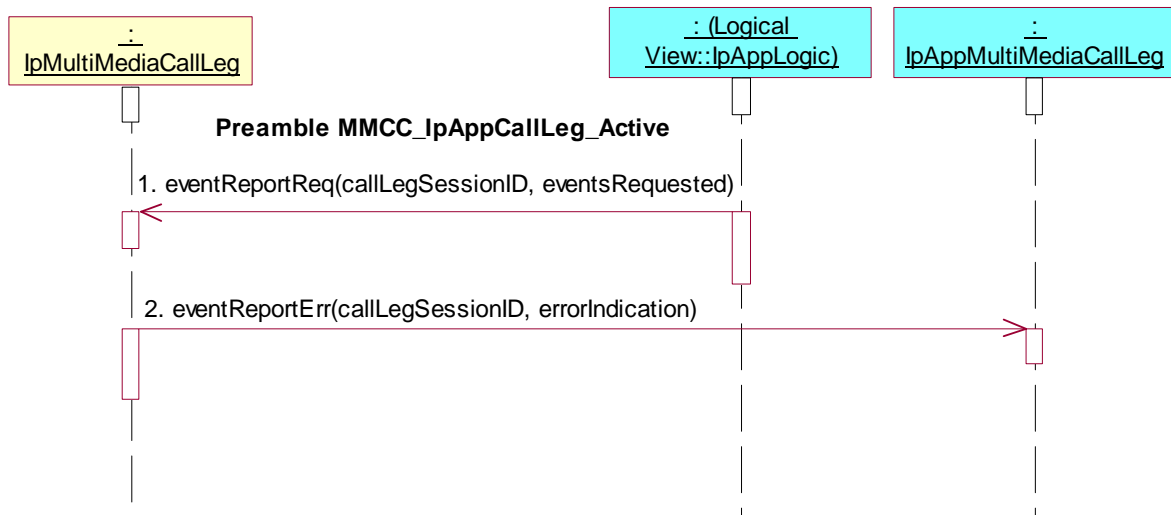

Test MMCC_IpAppMultiMediaCallLeg_39

Summary: get information about call leg

Reference: ES 201 915-4 [1], clause 7.4.3.1

Precondition: IUT capable of invoking **getInfoReq()**

Preamble: **MMCC_IpAppMultiMediaCallLeg_Active**

Test Sequence:

1. Triggered Action: cause IUT to call **getInfoReq()** method on the tester's (SCF's) IpMultiMediaCallLeg interface.
Parameters: callLegSessionID, callLegInfoRequested

**Test MMCC_IpAppMultiMediaCallLeg_40**

Summary: get information about call leg, unsuccessful

Reference: ES 201 915-4 [1], clause 7.4.3.1

Precondition: IUT capable of invoking **getInfoReq()**

Preamble: **MMCC_IpAppMultiMediaCallLeg_Active**

Test Sequence:

1. Triggered Action: cause IUT to call **getInfoReq()** method on the tester's (SCF's) IpMultiMediaCallLeg interface.
Parameters: callLegSessionID, callLegInfoRequested
2. Method call **getInfoErr()**
Parameters: callLegSessionID, errorIndication
Check: no exception is returned

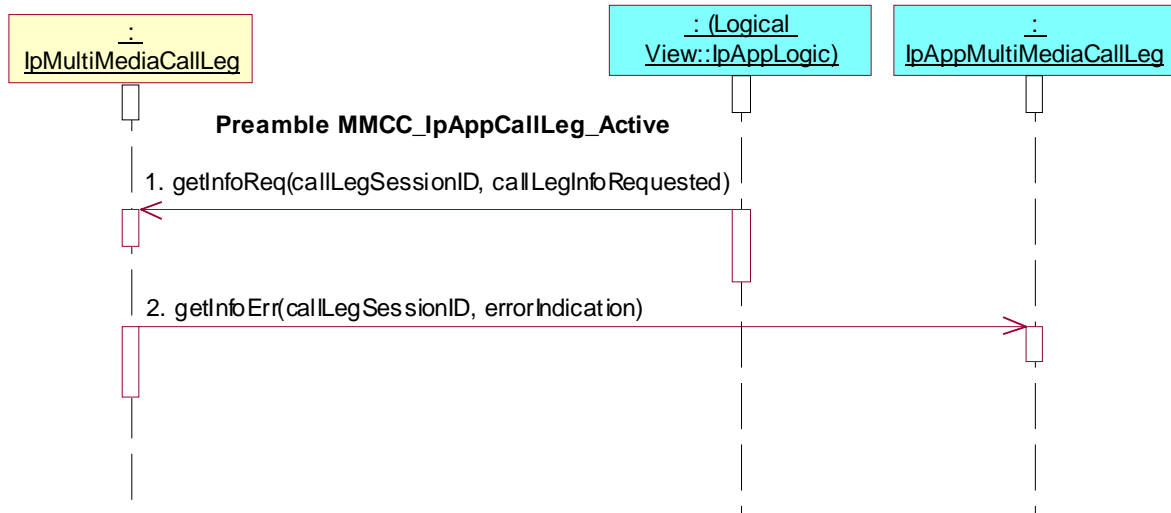

Test MMCC_IpAppMultiMediaCallLeg_41

Summary: set charge plan for call leg

Reference: ES 201 915-4 [1], clause 7.4.3.1

Precondition: IUT capable of invoking `setChargePlan()`

Preamble: **MMCC_IpAppMultiMediaCallLeg_Active**

Test Sequence:

1. Triggered Action: cause IUT to call `setChargePlan()` method on the tester's (SCF's) `IpMultiMediaCallLeg` interface.
Parameters: `callLegSessionID`, `callChargePlan`

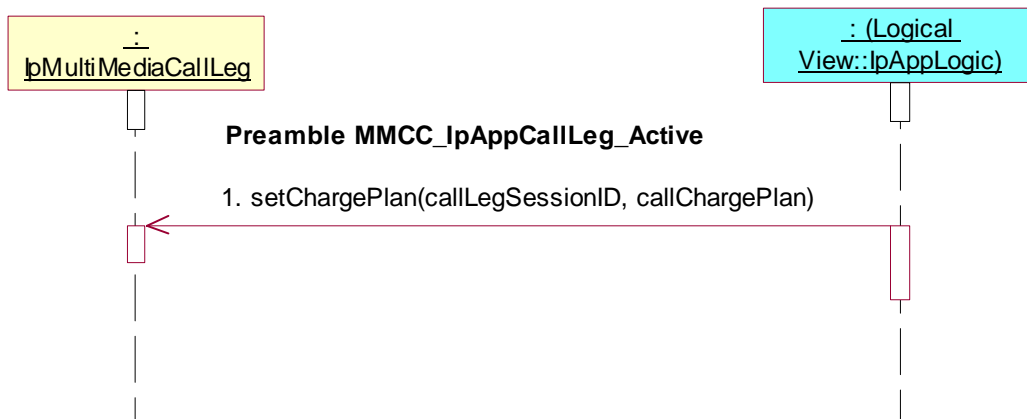

Test MMCC_IpAppMultiMediaCallLeg_42

Summary: allow advice of charge information

Reference: ES 201 915-4 [1], clause 7.4.3.1

Precondition: IUT capable of invoking `setAdviceOfCharge()`

Preamble: **MMCC_IpAppMultiMediaCallLeg_Active**

Test Sequence:

1. Triggered Action: cause IUT to call **setAdviceOfCharge()** method on the tester's (SCF's) IpMultiMediaCallLeg interface.
Parameters: callLegSessionID, aOCInfo, tariffSwitch

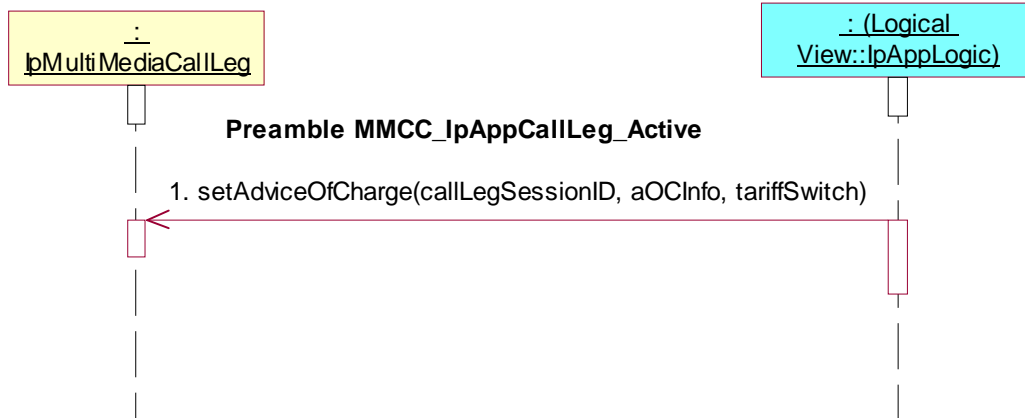

Test MMCC_IpAppMultiMediaCallLeg_43

Summary: supervise call leg

Reference: ES 201 915-4 [1], clause 7.4.3.1

Precondition: IUT capable of invoking **superviseReq()**

Preamble: **MMCC_IpAppMultiMediaCallLeg_Active**

Test Sequence:

1. Triggered Action: cause IUT to call **superviseReq()** method on the tester's (SCF's) IpMultiMediaCallLeg interface.
Parameters: callLegSessionID, time, treatment



Test MMCC_IpAppMultiMediaCallLeg_44

Summary: supervise call leg, unsuccessful

Reference: ES 201 915-4 [1], clause 7.4.3.1

Precondition: IUT capable of invoking **superviseReq()**

Preamble: **MMCC_IpAppMultiMediaCallLeg_Active**

Test Sequence:

1. Triggered Action: cause IUT to call **superviseReq()** method on the tester's (SCF's) IpMultiMediaCallLeg interface.
Parameters: callLegSessionID, time, treatment
2. Method call **superviseErr()**
Parameters: callLegSessionID, errorIndication
Check: no exception is returned

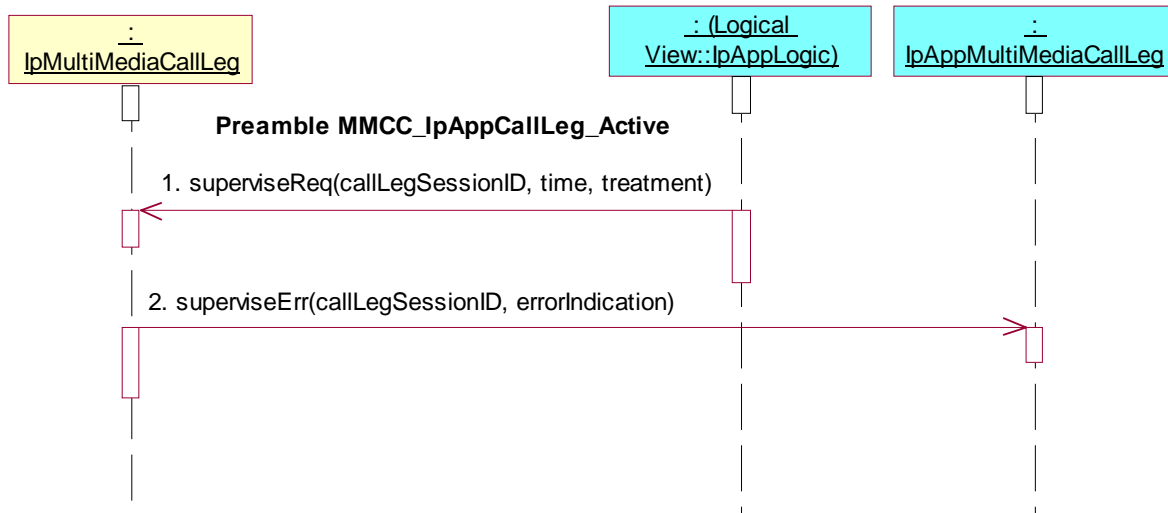

Test MMCC_IpAppMultiMediaCallLeg_45

Summary: set monitor on media streams

Reference: ES 201 915-4 [1], clauses 7.4.3.1, 8.3.5 and 8.3.6

Precondition: IUT capable of invoking **mediaStreamMonitorReq()**

Preamble: **MMCC_IpAppMultiMediaCallLeg_Active**

Test Sequence:

1. Triggered Action: cause IUT to call **mediaStreamMonitorReq()** method on the tester's (SCF's) IpMultiMediaCallLeg interface.
Parameters: callLegSessionID, mediaStreamEventCriteria
2. Method call **mediaStreamMonitorRes()**
Parameters: callLegSessionID, streams, type
Check: no exception is returned

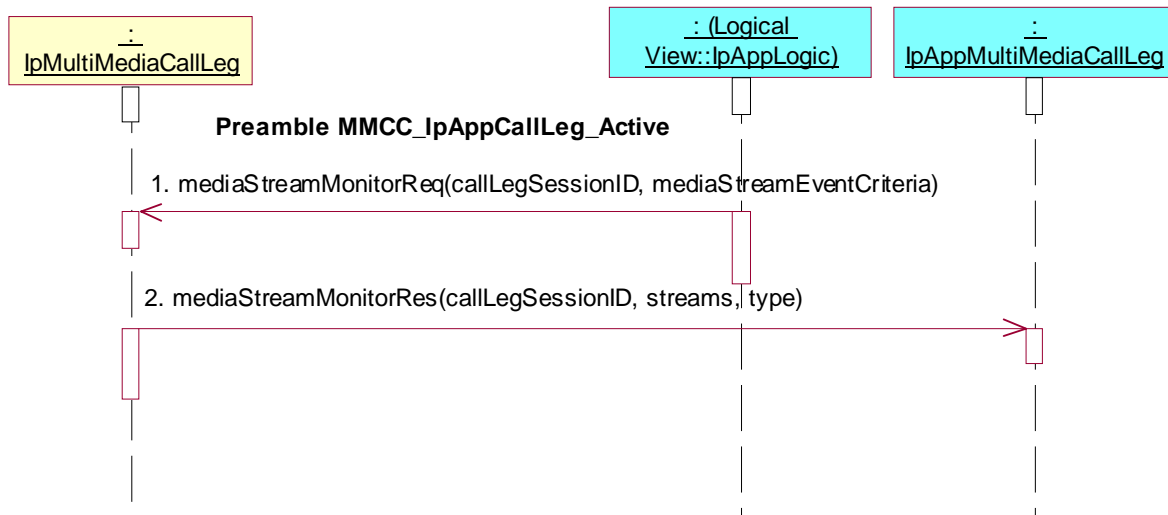

Test MMCC_IpAppMultiMediaCallLeg_46

Summary: set monitor on media streams and allow setup

Reference: ES 201 915-4 [1], clauses 7.4.3.1, 8.3.5 and 8.3.6

Precondition: IUT capable of invoking **mediaStreamMonitorReq()** and **mediaStreamAllow()**

Preamble: **MMCC_IpAppMultiMediaCallLeg_Active**

Test Sequence:

1. Triggered Action: cause IUT to call **mediaStreamMonitorReq()** method on the tester's (SCF's) IpMultiMediaCallLeg interface.
Parameters: callLegSessionID, mediaStreamEventCriteria
mediaStreamEventCriteria.CallMonitorMode= P_CALL_MONITOR_MODE_INTERRUPT
2. Method call **mediaStreamMonitorRes()**
Parameters: callLegSessionID, streams, type
Check: no exception is returned
3. Triggered Action: cause IUT to call **mediaStreamAllow()** method on the tester's (SCF's) IpMultiMediaCallLeg interface.
Parameters: callLegSessionID, mediaStreamList

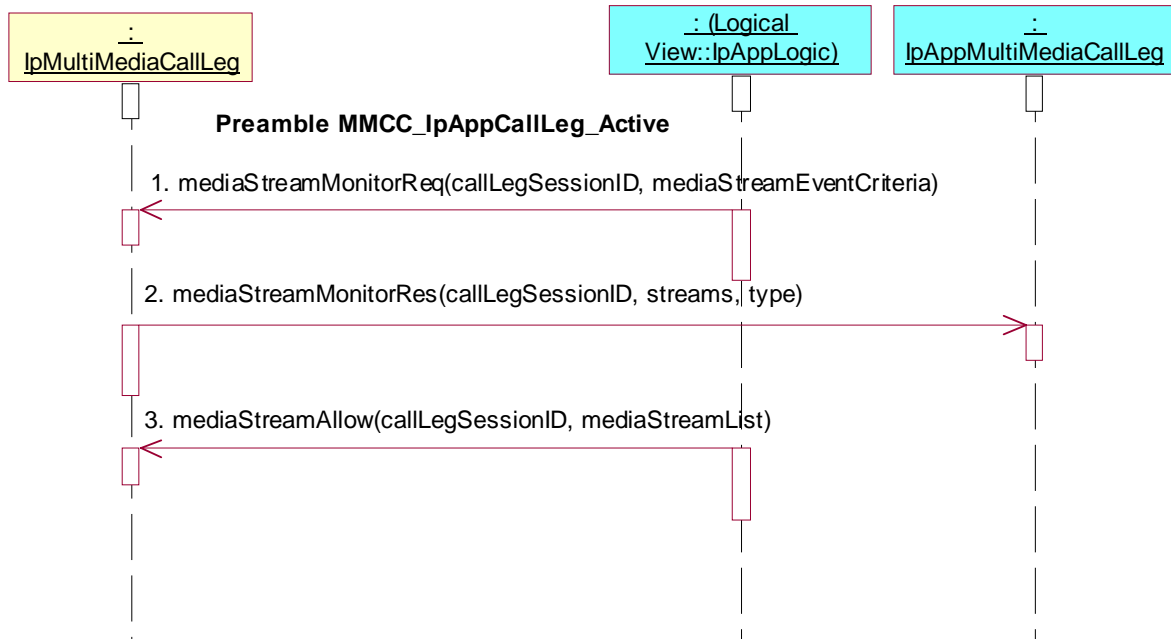

Test MMCC_IpAppMultiMediaCallLeg_47

Summary: get media streams

Reference: ES 201 915-4 [1], clauses 7.4.3.1, 8.3.5 and 8.3.6

Precondition: IUT capable of invoking **getMediaStreams()**

Preamble: **MMCC_IpAppMultiMediaCallLeg_Active**

Test Sequence:

1. Triggered Action: cause IUT to call **getMediaStreams()** method on the tester's (SCF's) IpMultiMediaCallLeg interface.
Parameters: callLegSessionID

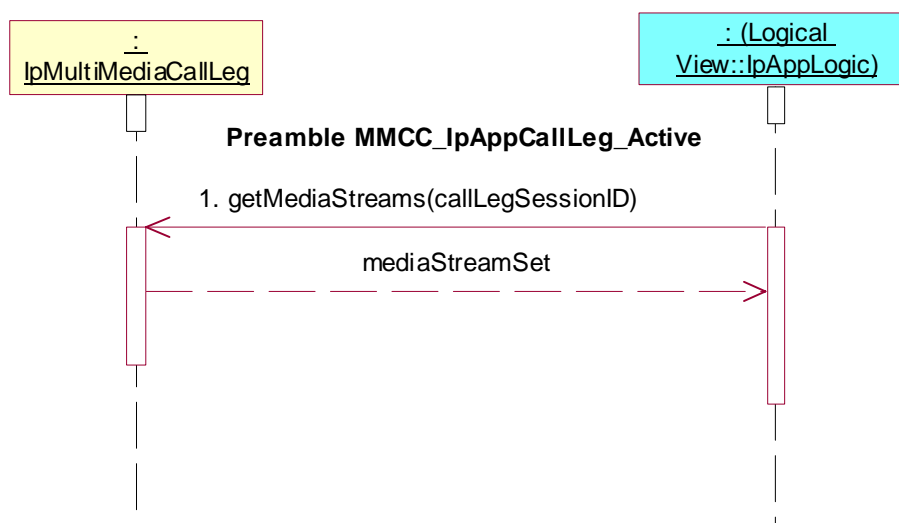

7.2.3.3.1.4 Releasing state

Preamble MMCC_IpAppMultiMediaCallLeg_Releasing

Reference: ES 201 915-4 [1], clause 7.4.3.1.4

Pre-preamble: Registration of the IUT (application) and the tester (Call Control SCF) to the framework. The IUT must have obtained a reference to an instance of the IpMultiMediaCallControlManager interface through selecting that service and signing the required service agreement.

The application is permitted to provide its IpAppMultiMediaCallControlManager interface reference in a setCallback() method which it calls prior to invoking further methods.

Preamble Sequence:

1. Triggered Action: cause IUT to call **createNotification()** method on the tester's (SCF's) IpMultiMediaCallControlManager interface.
Parameters: appCallControlManager, notificationRequest
notificationRequest.CallMonitorMode= P_CALL_MONITOR_MODE_INTERRUPT
notificationRequest.CallEventType= P_CALL_EVENT_ORIGINATING_RELEASE
2. Method call **reportNotification()**
Parameters: callReference, callLegReferenceSet, notificationInfo, assignmentID
Check: valid value of TpAppMultiPartyCallBack is returned

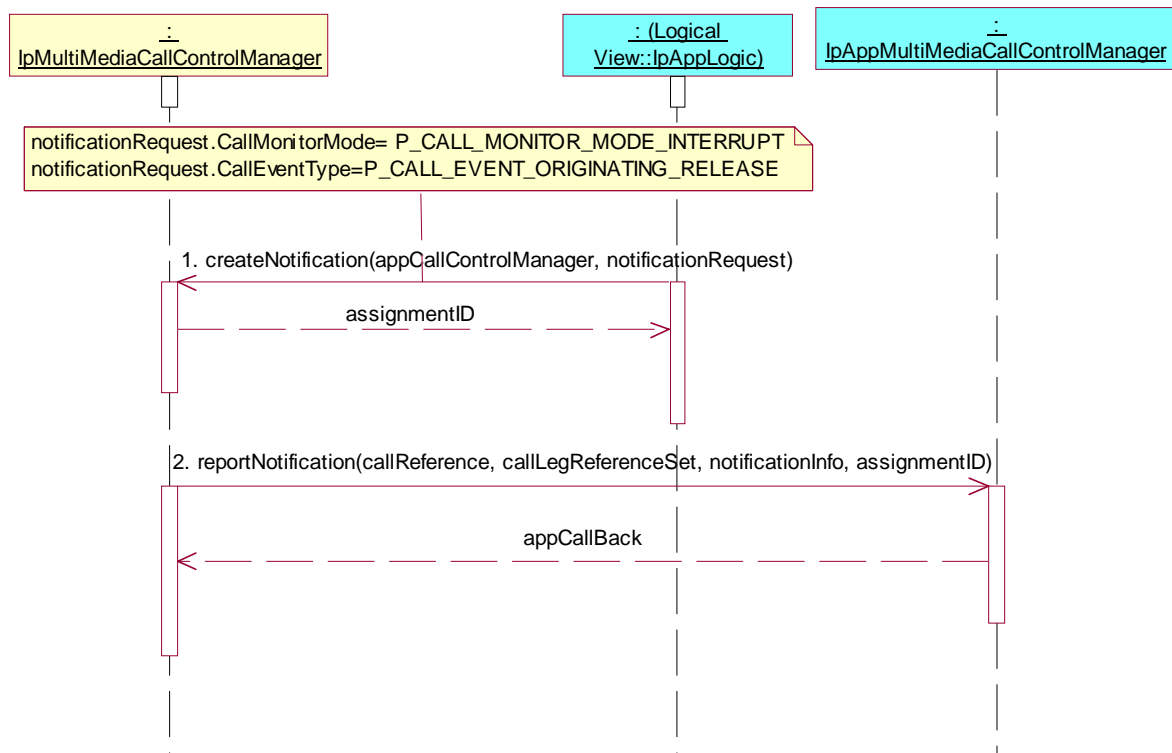
**Test MMCC_IpAppMultiMediaCallLeg_48**

Summary: request reference of call related to call leg

Reference: ES 201 915-4 [1], clause 7.4.3.1

Precondition: IUT capable of invoking **getCall()**

Preamble: **MMCC_IpAppMultiMediaCallLeg_Releasing**

Test Sequence:

1. Triggered Action: cause IUT to call **getCall()** method on the tester's (SCF's) IpMultiMediaCallLeg interface.
Parameters: callLegSessionID

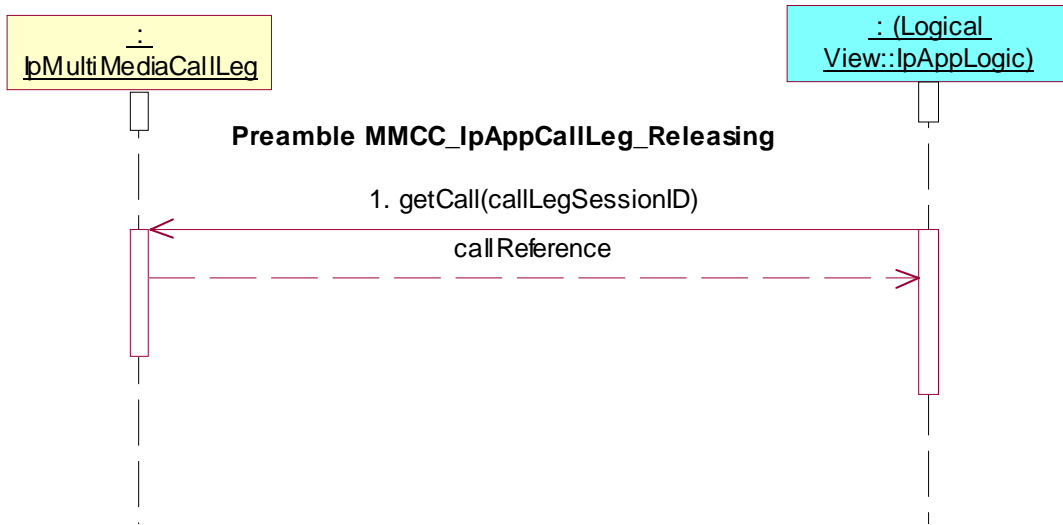

Test MMCC_IpAppMultiMediaCallLeg_49

Summary: continue processing of call leg

Reference: ES 201 915-4 [1], clause 7.4.3.1

Precondition: IUT capable of invoking **continueProcessing()**

Preamble: **MMCC_IpAppMultiMediaCallLeg_Releasing**

Test Sequence:

1. Triggered Action: cause IUT to call **continueProcessing()** method on the tester's (SCF's) IpMultiMediaCallLeg interface.
Parameters: callLegSessionID

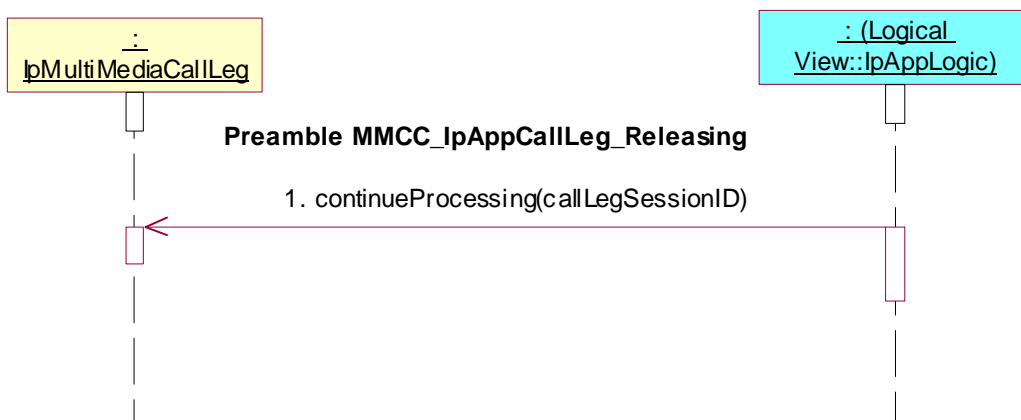

Test MMCC_IpAppMultiMediaCallLeg_50

Summary: de-assign call leg

Reference: ES 201 915-4 [1], clause 7.4.3.1

Precondition: IUT capable of invoking **deassign()**

Preamble: **MMCC_IpAppMultiMediaCallLeg_Releasing**

Test Sequence:

1. Triggered Action: cause IUT to call **deassign()** method on the tester's (SCF's) IpMultiMediaCallLeg interface.
Parameters: callLegSessionID

**7.2.3.3.2 Terminating Leg**

Reference: ES 201 915-4 [1], clauses 7.4.3.2

Precondition: IUT capable of invoking **createNotification()** and **createCallLeg()**

7.2.3.3.2.1 Idle state**Preamble MMCC_IpAppMultiMediaCallLeg_Idle**

Reference: ES 201 915-4 [1], clause 7.4.3.2.1

Pre-preamble: Registration of the IUT (application) and the tester (Call Control SCF) to the framework. The IUT must have obtained a reference to an instance of the IpMultiMediaCallControlManager interface through selecting that service and signing the required service agreement.

The application is permitted to provide its IpAppMultiMediaCallControlManager interface reference in a setCallback() method which it calls prior to invoking further methods.

Preamble Sequence:

1. Triggered Action: cause IUT to call **createNotification()** method on the tester's (SCF's) IpMultiMediaCallControlManager interface.
Parameters: appCallControlManager, notificationRequest
notificationRequest.CallMonitorMode= P_CALL_MONITOR_MODE_INTERRUPT
2. Method call **reportNotification()**
Parameters: callReference, callLegReferenceSet, notificationInfo, assignmentID
Check: valid value of TpAppMultiPartyCallBack is returned
3. Triggered Action: cause IUT to call **createCallLeg()** method on the tester's (SCF's) IpMultiMediaCall interface.
Parameters: callSessionID, AppMultiMediaCallLeg

or

1. Triggered Action: cause IUT to call **createCall()** method on the tester's (SCF's) IpMultiMediaCallControlManager interface.
Parameters: appCall
2. Triggered Action: cause IUT to call **createCallLeg()** method on the tester's (SCF's) IpMultiMediaCall interface.
Parameters: callSessionID, appCallLeg

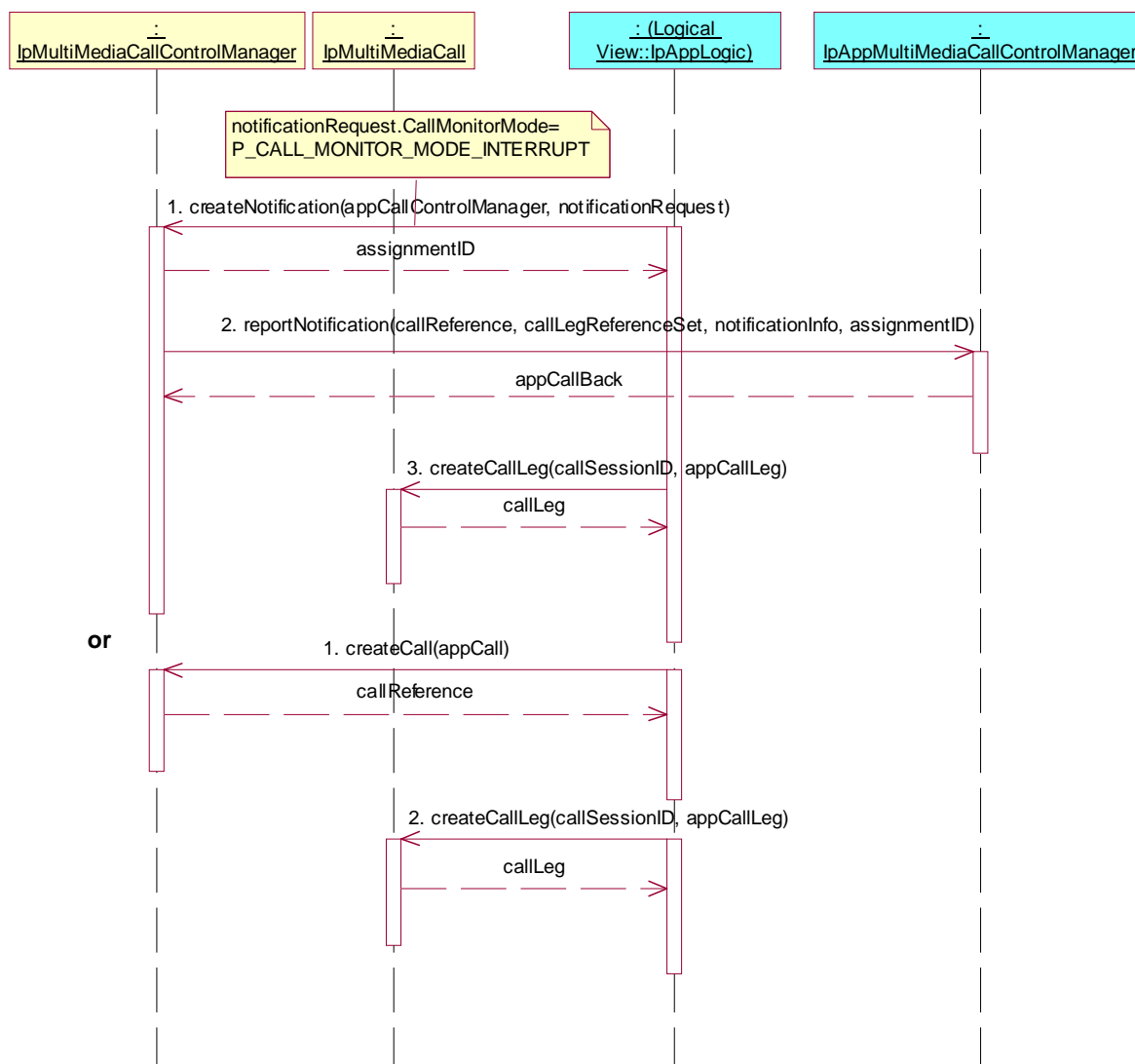

Test MMCC_IpAppMultiMediaCallLeg_51

Summary: route call leg, unsuccessful

Reference: ES 201 915-4 [1], clause 7.4.3.2

Precondition: IUT capable of invoking **routeReq()**

Preamble: **MMCC_IpAppMultiMediaCallLeg_Idle**

Test Sequence:

1. Triggered Action: cause IUT to call **routeReq()** method on the tester's (SCF's) terminating IpMultiMediaCallLeg interface.
Parameters: callLegSessionID, targetAddress, originatingAddress, appInfo, connectionProperties
2. Method call **routeErr()**
Parameters: callLegSessionID, errorIndication
Check: no exception is returned

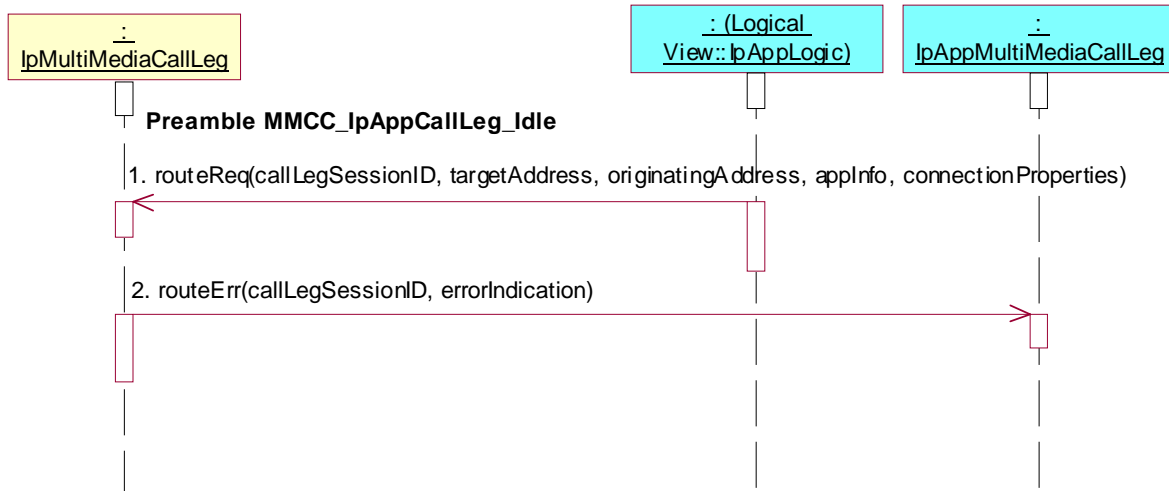

Test MMCC_IpAppMultiMediaCallLeg_52

Summary: request reference of call related to call leg

Reference: ES 201 915-4 [1], clause 7.4.3.2

Precondition: IUT capable of invoking **getCall()**

Preamble: **MMCC_IpAppMultiMediaCallLeg_Idle**

Test Sequence:

1. Triggered Action: cause IUT to call **getCall()** method on the tester's (SCF's) terminating IpMultiMediaCallLeg interface.
Parameters: callLegSessionID

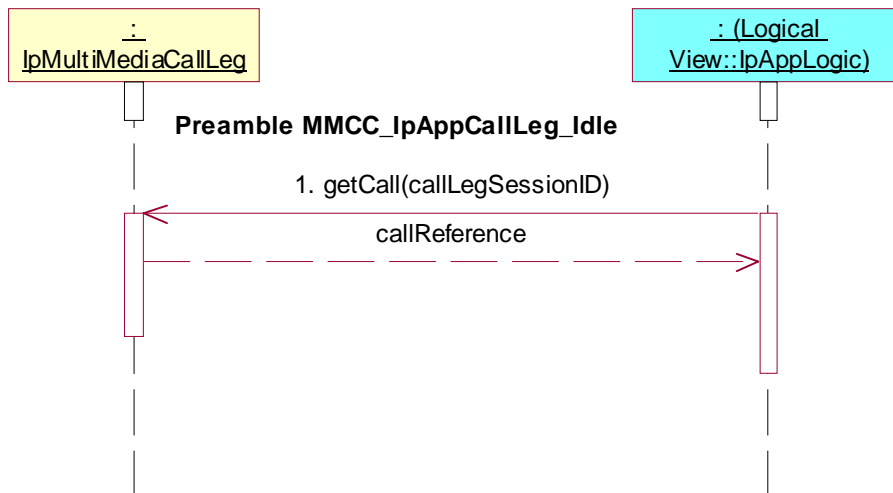

Test MMCC_IpAppMultiMediaCallLeg_53

Summary: release call leg

Reference: ES 201 915-4 [1], clause 7.4.3.2

Precondition: IUT capable of invoking **release()**

Preamble: **MMCC_IpAppMultiMediaCallLeg_Idle**

Test Sequence:

1. Triggered Action: cause IUT to call **release()** method on the tester's (SCF's) terminating IpMultiMediaCallLeg interface.
Parameters: callLegSessionID, cause

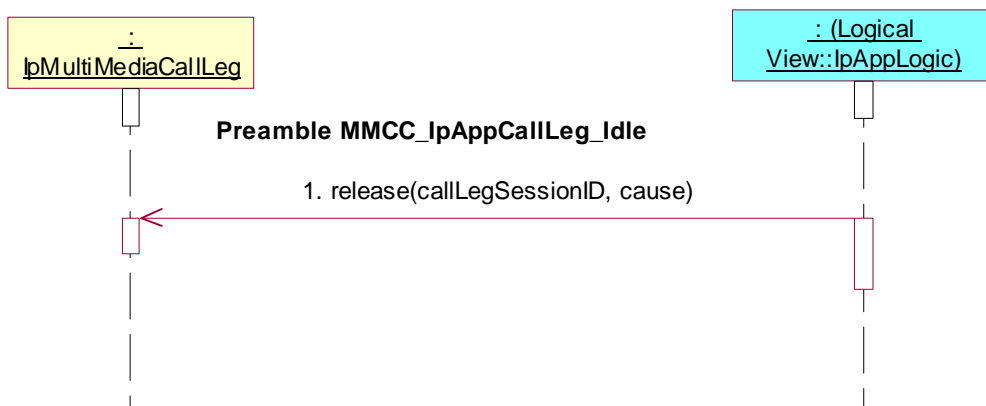

Test MMCC_IpAppMultiMediaCallLeg_54

Summary: change or clear event criteria

Reference: ES 201 915-4 [1], clause 7.4.3.2

Precondition: IUT capable of invoking **eventReportReq()**

Preamble: **MMCC_IpAppMultiMediaCallLeg_Idle**

Test Sequence:

1. Triggered Action: cause IUT to call **eventReportReq()** method on the tester's (SCF's) terminating IpMultiMediaCallLeg interface.
Parameters: callLegSessionID, eventsRequested

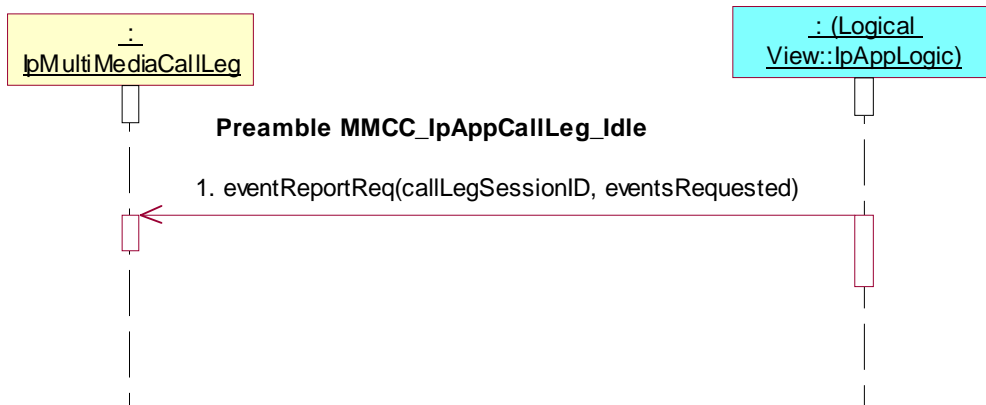

Test MMCC_IpAppMultiMediaCallLeg_55

Summary: change or clear event criteria, successful

Reference: ES 201 915-4 [1], clause 7.4.3.2

Precondition: IUT capable of invoking **eventReportReq()**, **routeReq()**

Preamble: **MMCC_IpAppCallLeg_Idle**

Test Sequence:

1. Triggered Action: cause IUT to call **eventReportReq()** method on the tester's (SCF's) terminating IpMultiMediaCallLeg interface.
Parameters: callLegSessionID, eventsRequested
2. Triggered Action: cause IUT to call **routeReq()** method on the tester's (SCF's) terminating IpMultiMediaCallLeg interface.
Parameters: callLegSessionID, targetAddress, originatingAddress, appInfo, connectionProperties
3. Method call **eventReportRes()**
Parameters: callLegSessionID, eventInfo
Check: no exception is returned

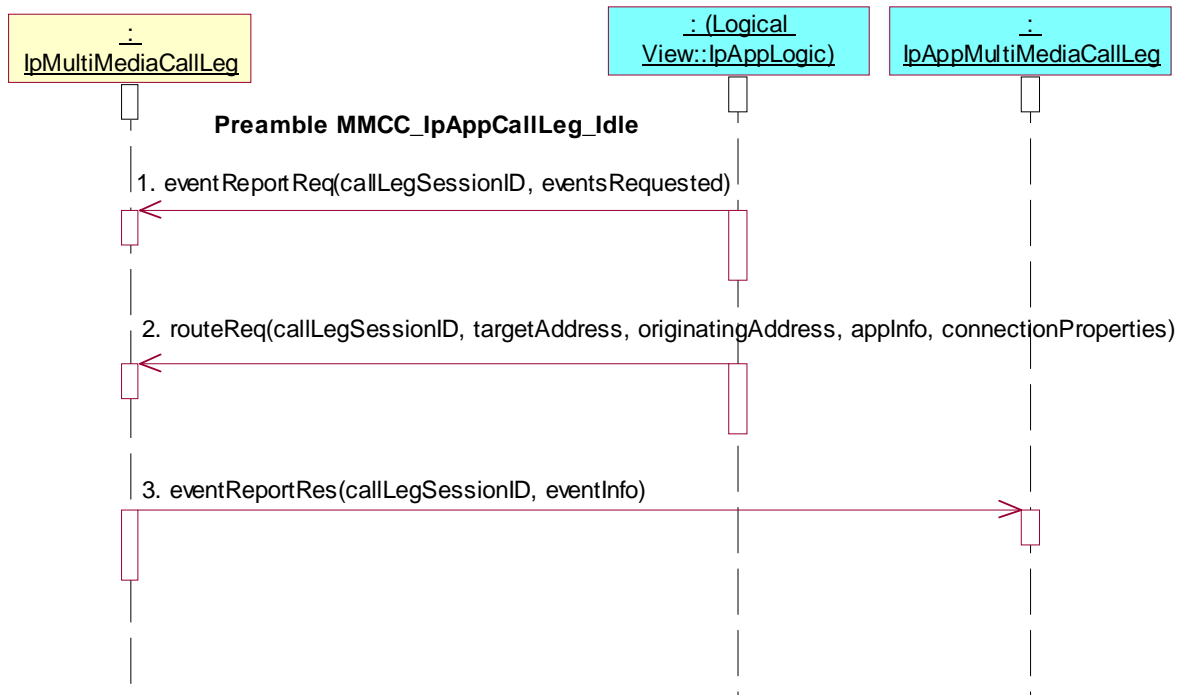

Test MMCC_IpAppMultiMediaCallLeg_56

Summary: change or clear event criteria, unsuccessful

Reference: ES 201 915-4 [1], clause 7.4.3.2

Precondition: IUT capable of invoking **eventReportReq()**

Preamble: **MMCC_IpAppMultiMediaCallLeg_Idle**

Test Sequence:

1. Triggered Action: cause IUT to call **eventReportReq()** method on the tester's (SCF's) terminating IpMultiMediaCallLeg interface.
Parameters: callLegSessionID, eventsRequested
2. Method call **eventReportErr()**
Parameters: callLegSessionID, errorIndication
Check: no exception is returned

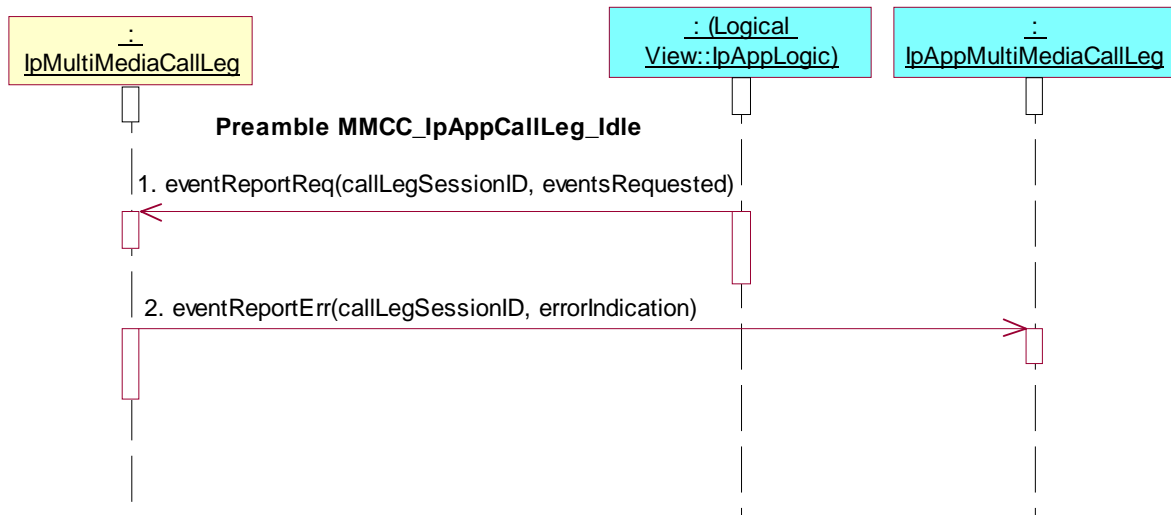

Test MMCC_IpAppMultiMediaCallLeg_57

Summary: get information about call leg

Reference: ES 201 915-4 [1], clause 7.4.3.2

Precondition: IUT capable of invoking **getInfoReq()**

Preamble: **MMCC_IpAppMultiMediaCallLeg_Idle**

Test Sequence:

1. Triggered Action: cause IUT to call **getInfoReq()** method on the tester's (SCF's) terminating IpMultiMediaCallLeg interface.
Parameters: callLegSessionID, callLegInfoRequested



Test MMCC_IpAppMultiMediaCallLeg_58

Summary: get information about call leg, unsuccessful

Reference: ES 201 915-4 [1], clause 7.4.3.2

Precondition: IUT capable of invoking **getInfoReq()**

Preamble: **MMCC_IpAppMultiMediaCallLeg_Idle**

Test Sequence:

1. Triggered Action: cause IUT to call **getInfoReq()** method on the tester's (SCF's) terminating IpMultiMediaCallLeg interface.
Parameters: callLegSessionID, callLegInfoRequested
2. Method call **getInfoErr()**
Parameters: callLegSessionID, errorIndication
Check: no exception is returned

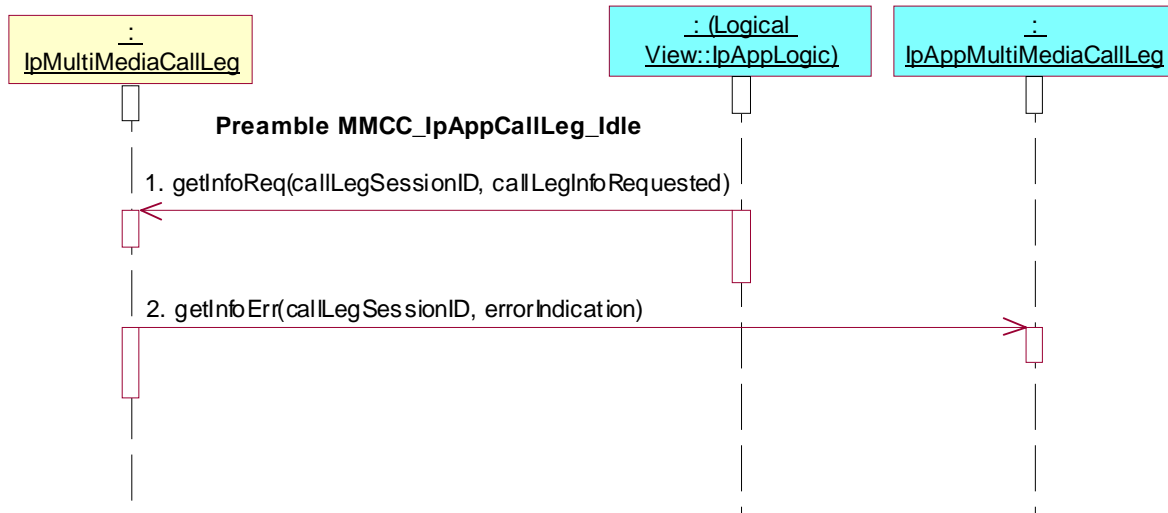

Test MMCC_IpAppMultiMediaCallLeg_59

Summary: set charge plan for call leg

Reference: ES 201 915-4 [1], clause 7.4.3.2

Precondition: IUT capable of invoking **setChargePlan()**

Preamble: **MMCC_IpAppMultiMediaCallLeg_Idle**

Test Sequence:

1. Triggered Action: cause IUT to call **setChargePlan()** method on the tester's (SCF's) terminating IpMultiMediaCallLeg interface.
Parameters: callLegSessionID, callChargePlan

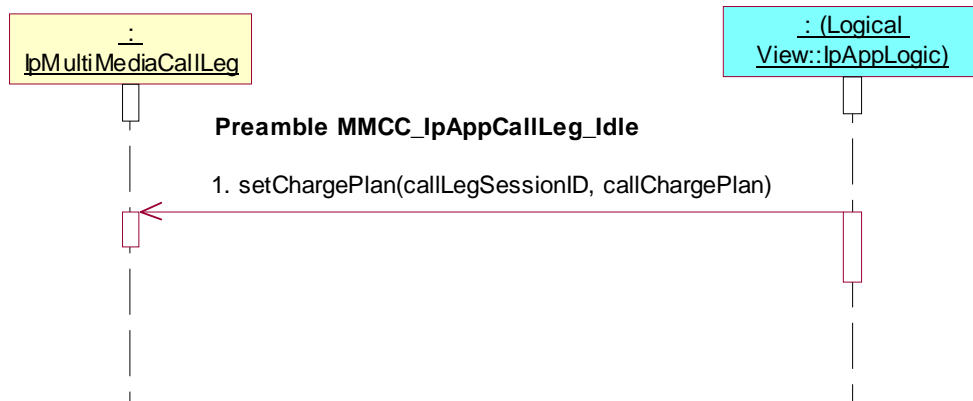

Test MMCC_IpAppMultiMediaCallLeg_60

Summary: allow advice of charge information

Reference: ES 201 915-4 [1], clause 7.4.3.2

Precondition: IUT capable of invoking **setAdviceOfCharge()**

Preamble: **MMCC_IpAppMultiMediaCallLeg_Idle**

Test Sequence:

1. Triggered Action: cause IUT to call **setAdviceOfCharge()** method on the tester's (SCF's terminating) IpMultiMediaCallLeg interface.
Parameters: callLegSessionID, aOCInfo, tariffSwitch

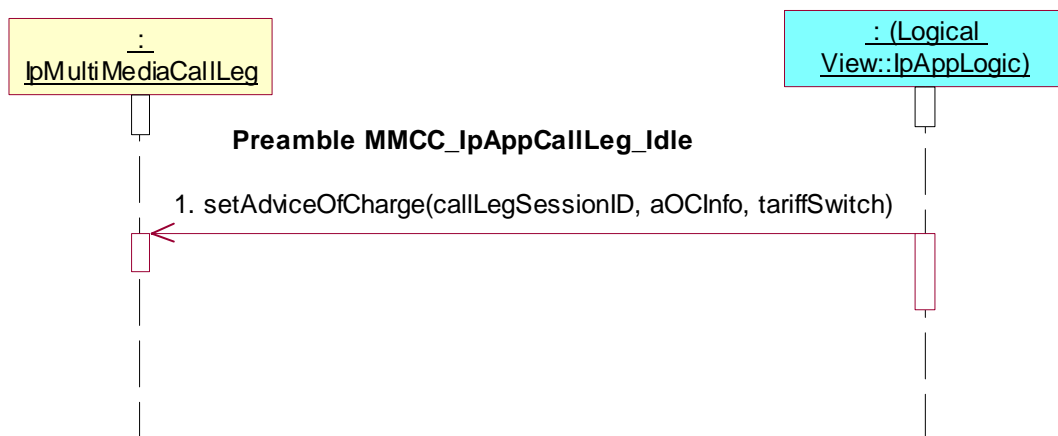

Test MMCC_IpAppMultiMediaCallLeg_61

Summary: supervise call leg

Reference: ES 201 915-4 [1], clause 7.4.3.2

Precondition: IUT capable of invoking **superviseReq()**

Preamble: **MMCC_IpAppMultiMediaCallLeg_Idle**

Test Sequence:

1. Triggered Action: cause IUT to call **superviseReq()** method on the tester's (SCF's) terminating IpMultiMediaCallLeg interface.
Parameters: callLegSessionID, time, treatment



Test MMCC_IpAppMultiMediaCallLeg_62

Summary: supervise call leg, unsuccessful

Reference: ES 201 915-4 [1], clause 7.4.3.2

Precondition: IUT capable of invoking **superviseReq()**

Preamble: **MMCC_IpAppMultiMediaCallLeg_Idle**

Test Sequence:

1. Triggered Action: cause IUT to call **superviseReq()** method on the tester's (SCF's) terminating IpMultiMediaCallLeg interface.
Parameters: callLegSessionID, time, treatment
2. Method call **superviseErr()**
Parameters: callLegSessionID, errorIndication
Check: no exception is returned

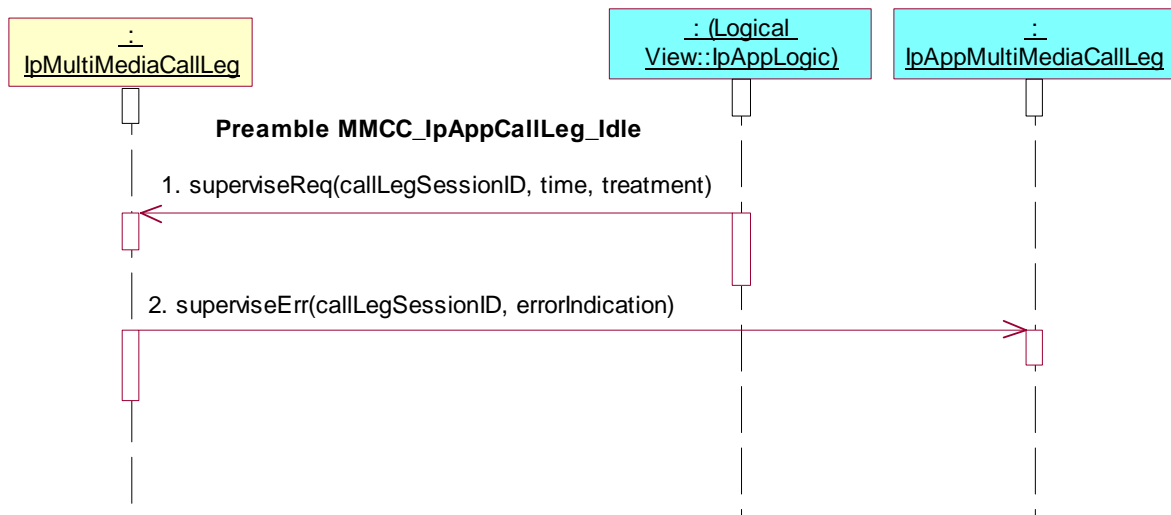

7.2.3.3.2.2 Active (Terminating) state

Precondition: IUT capable of invoking **eventReportReq()** and **routeReq()**

Preamble MMCC_IpAppMultiMediaCallLeg_Active_Terminating

Reference: ES 201 915-4 [1], clause 7.4.3.2.2

Pre-preamble: Registration of the IUT (application) and the tester (Call Control SCF) to the framework. The IUT must have obtained a reference to an instance of the IpMultiMediaCallControlManager interface through selecting that service and signing the required service agreement.

The application is permitted to provide its IpAppMultiMediaCallControlManager interface reference in a setCallback() method which it calls prior to invoking further methods.

Preamble Sequence:

1. Triggered Action: cause IUT to call **createNotification()** method on the tester's (SCF's) IpMultiMediaCallControlManager interface.
Parameters: appCallControlManager, notificationRequest
notificationRequest.CallMonitorMode= P_CALL_MONITOR_MODE_INTERRUPT
2. Method call **reportNotification()**
Parameters: callReference, callLegReferenceSet, notificationInfo, assignmentID
Check: valid value of TpAppMultiPartyCallBack is returned
3. Triggered Action: cause IUT to call **createCallLeg()** method on the tester's (SCF's) IpMultiMediaCall interface.
Parameters: callSessionID, AppMultiMediaCallLeg
4. Triggered Action: cause IUT to call **eventReportReq()** method on the tester's (SCF's) terminating IpMultiMediaCallLeg interface.
Parameters: callLegSessionID, eventsRequested
5. Triggered Action: cause IUT to call **routeReq()** method on the tester's (SCF's) terminating IpMultiMediaCallLeg interface.
Parameters: callLegSessionID, targetAddress, originatingAddress, appInfo, connectionProperties
6. Method call **eventReportRes()**
Parameters: callLegSessionID, eventInfo
Check: no exception is returned

or

1. Triggered Action: cause IUT to call **createNotification()** method on the tester's (SCF's) IpMultiMediaCallControlManager interface.
Parameters: appCallControlManager, notificationRequest
notificationRequest.CallMonitorMode= P_CALL_MONITOR_MODE_INTERRUPT
notificationRequest.CallEventType= P_CALL_EVENT_TERMINATING_CALL_ATTEMPT
or P_CALL_EVENT_TERMINATING_CALL_ATTEMPT_AUTHORISED or
P_CALL_EVENT_ALERTING or P_CALL_EVENT_ANSWER or
P_CALL_EVENT_REDIRECTED or P_CALL_EVENT_QUEUED or
P_CALL_EVENT_TERMINATING_SERVICE_CODE
2. Method call **reportNotification()**
Parameters: callReference, callLegReferenceSet, notificationInfo, assignmentID
Check: valid value of TpAppMultiPartyCallBack is returned

or

1. Triggered Action: cause IUT to call **createCall()** method on the tester's (SCF's) IpMultiPartyCallControlManager interface.
Parameters: appCall

2. Triggered Action: cause IUT to call **createCallLeg()** method on the tester's (SCF's) IpMultiMediaCall interface.
Parameters: callSessionID, AppMultiMediaCallLeg
3. Triggered Action: cause IUT to call **eventReportReq()** method on the tester's (SCF's) terminating IpMultiMediaCallLeg interface.
Parameters: callLegSessionID, eventsRequested
4. Triggered Action: cause IUT to call **routeReq()** method on the tester's (SCF's) terminating IpMultiMediaCallLeg interface.
Parameters: callLegSessionID, targetAddress, originatingAddress, appInfo, connectionProperties
5. Method call **eventReportRes()**
Parameters: callLegSessionID, eventInfo
Check: no exception is returned

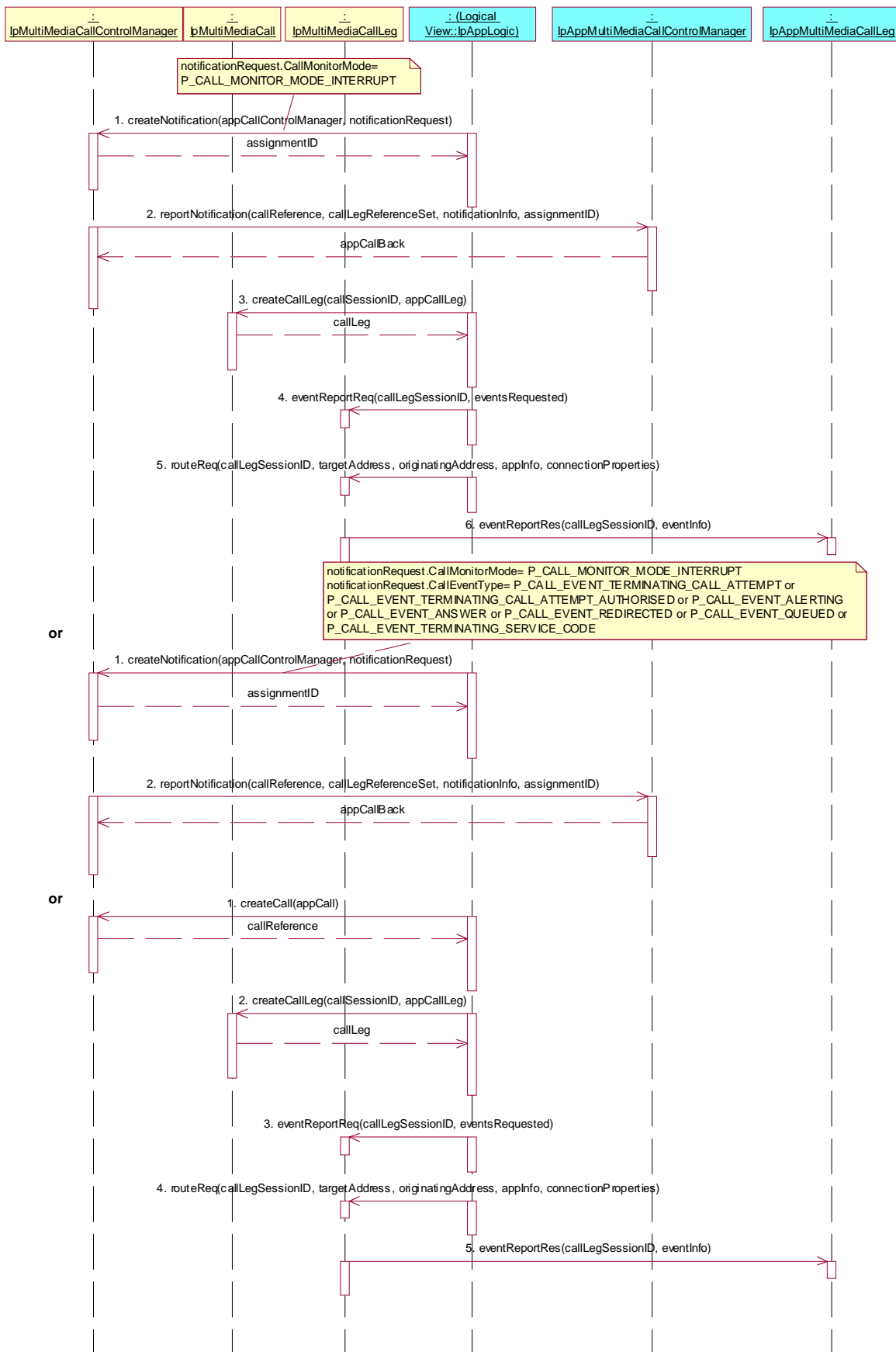

Test MMCC_IpAppMultiMediaCallLeg_63

Summary: attach media, successful

Reference: ES 201 915-4 [1], clause 7.4.3.2

Precondition: IUT capable of invoking **attachMediaReq()**

Preamble: **MMCC_IpAppMultiMediaCallLeg_Active_Terminating**

Test Sequence:

1. Triggered Action: cause IUT to call **attachMediaReq()** method on the tester's (SCF's) terminating IpMultiMediaCallLeg interface.
Parameters: callLegSessionID
2. Method call **attachMediaRes()**
Parameters: callLegSessionID
Check: no exception is returned

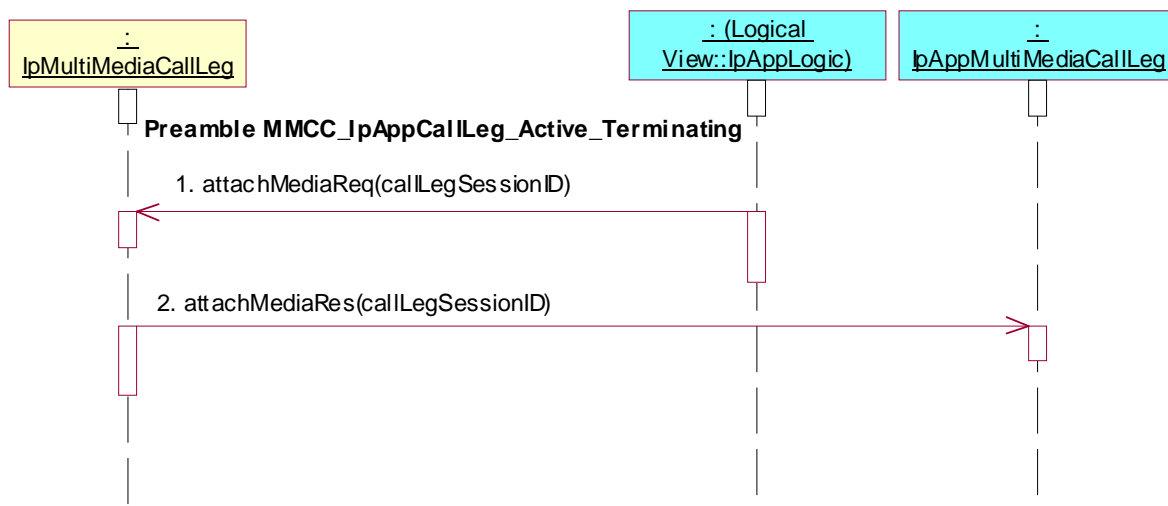
**Test MMCC_IpAppMultiMediaCallLeg_64**

Summary: attach media, unsuccessful

Reference: ES 201 915-4 [1], clause 7.4.3.2

Precondition: IUT capable of invoking **attachMediaReq()**

Preamble: **MMCC_IpAppMultiMediaCallLeg_Active_Terminating**

Test Sequence:

1. Triggered Action: cause IUT to call **attachMediaReq()** method on the tester's (SCF's) terminating IpMultiMediaCallLeg interface.
Parameters: callLegSessionID
2. Method call **attachMediaErr()**
Parameters: callLegSessionID, errorIndication
Check: no exception is returned

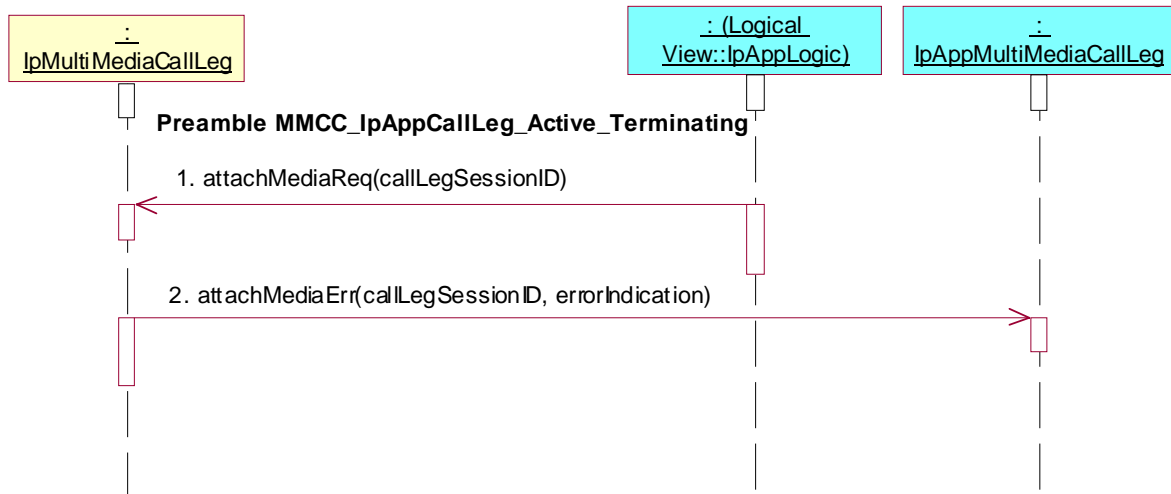

Test MMCC_IpAppMultiMediaCallLeg_65

Summary: detach media, successful

Reference: ES 201 915-4 [1], clause 7.4.3.2

Precondition: IUT capable of invoking **detachMediaReq()**

Preamble: **MMCC_IpAppMultiMediaCallLeg_Active_Terminating**

Test Sequence:

1. Triggered Action: cause IUT to call **attachMediaReq()** method on the tester's (SCF's) terminating IpMultiMediaCallLeg interface.
Parameters: callLegSessionID
2. Method call **attachMediaRes()**
Parameters: callLegSessionID
Check: no exception is returned
3. Triggered Action: cause IUT to call **detachMediaReq()** method on the tester's (SCF's) terminating IpMultiMediaCallLeg interface.
Parameters: callLegSessionID
4. Method call **detachMediaRes()**
Parameters: callLegSessionID
Check: no exception is returned

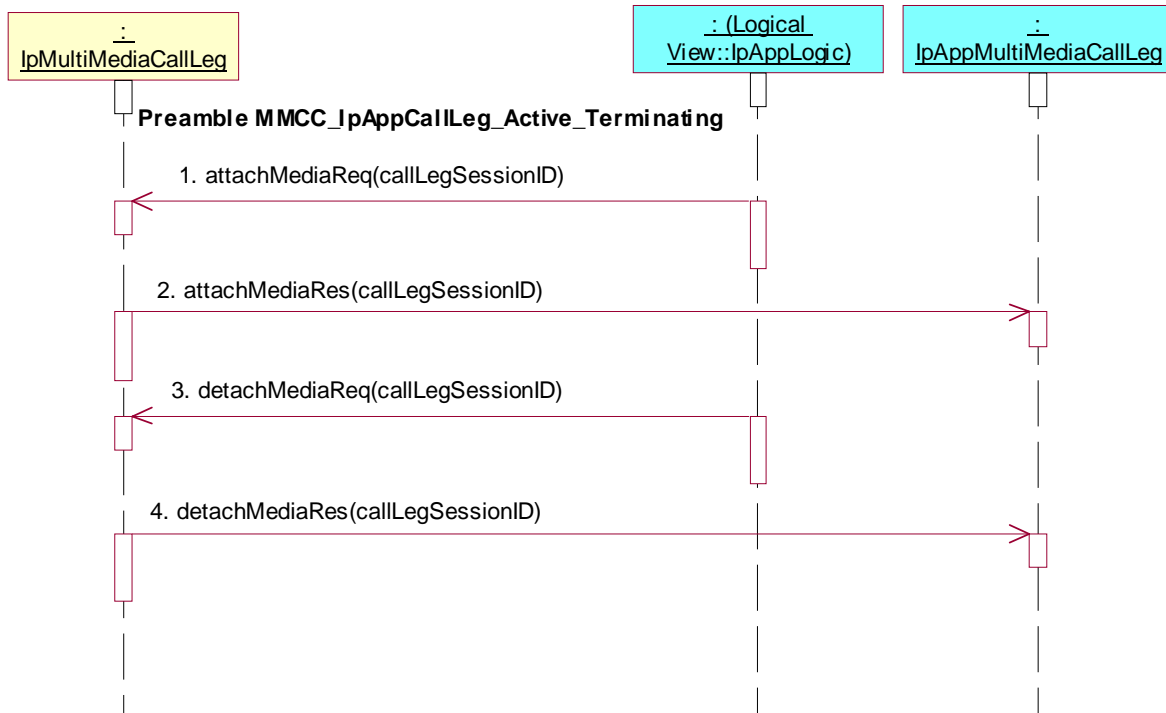

Test MMCC_IpAppMultiMediaCallLeg_66

Summary: detach media, unsuccessful

Reference: ES 201 915-4 [1], clause 7.4.3.2

Precondition: IUT capable of invoking **detachMediaReq()**

Preamble: **MMCC_IpAppMultiMediaCallLeg_Active_Terminating**

Test Sequence:

1. Triggered Action: cause IUT to call **attachMediaReq()** method on the tester's (SCF's) terminating IpMultiMediaCallLeg interface.
Parameters: callLegSessionID
2. Method call **attachMediaRes()**
Parameters: callLegSessionID
Check: no exception is returned
3. Triggered Action: cause IUT to call **detachMediaReq()** method on the tester's (SCF's) terminating IpMultiMediaCallLeg interface.
Parameters: callLegSessionID
4. Method call **detachMediaErr()**
Parameters: callLegSessionID, errorIndication
Check: no exception is returned

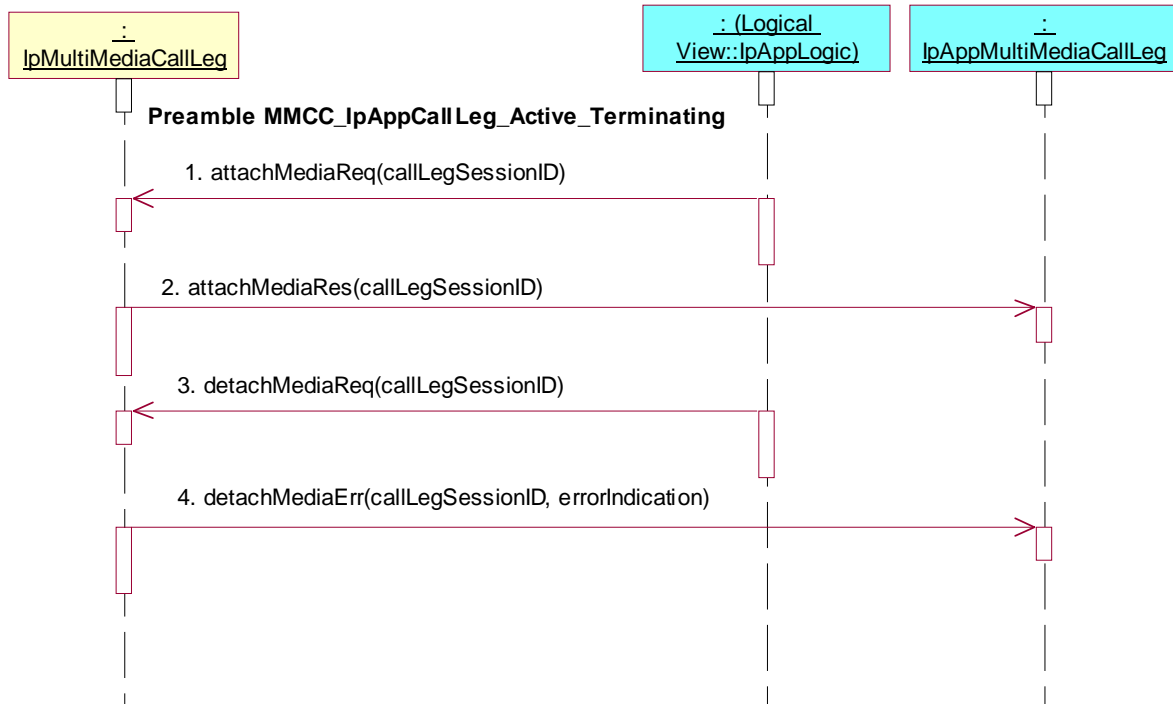

Test MMCC_IpAppMultiMediaCallLeg_67

Summary: request reference of call related to call leg

Reference: ES 201 915-4 [1], clause 7.4.3.2

Precondition: IUT capable of invoking **getCall()**

Preamble: **MMCC_IpAppMultiMediaCallLeg_Active_Terminating**

Test Sequence:

1. Triggered Action: cause IUT to call **getCall()** method on the tester's (SCF's) **IpMultiMediaCallLeg** terminating interface.
Parameters: **callLegSessionID**

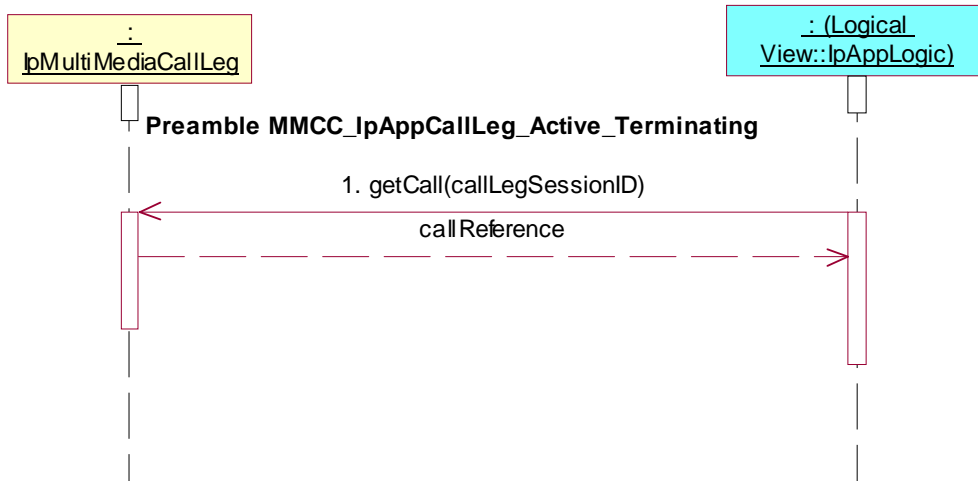

Test MMCC_IpAppMultiMediaCallLeg_68

Summary: request reference of call related to call leg

Reference: ES 201 915-4 [1], clause 7.4.3.2

Precondition: IUT capable of invoking `getCurrentDestinationAddress()`

Preamble: **MMCC_IpAppMultiMediaCallLeg_Active_Terminating**

Test Sequence:

1. Triggered Action: cause IUT to call `getCurrentDestinationAddress()` method on the tester's (SCF's) terminating `IpMultiMediaCallLeg` interface.
Parameters: `callLegSessionID`

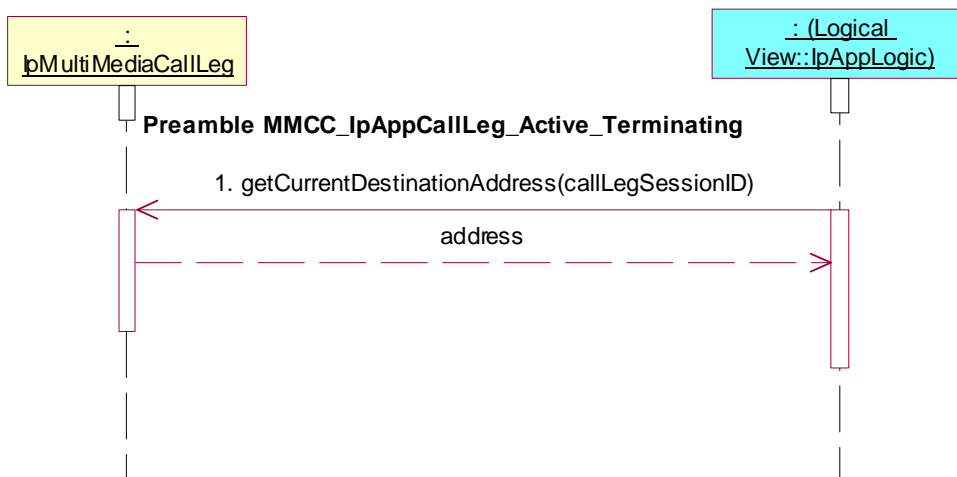

Test MMCC_IpAppMultiMediaCallLeg_69

Summary: continue processing of call leg

Reference: ES 201 915-4 [1], clause 7.4.3.2

Precondition: IUT capable of invoking `continueProcessing()`

Preamble: **MMCC_IpAppMultiMediaCallLeg_Active_Terminating**

Test Sequence:

1. Triggered Action: cause IUT to call **continueProcessing()** method on the tester's (SCF's) terminating IpMultiMediaCallLeg interface.
Parameters: callLegSessionID

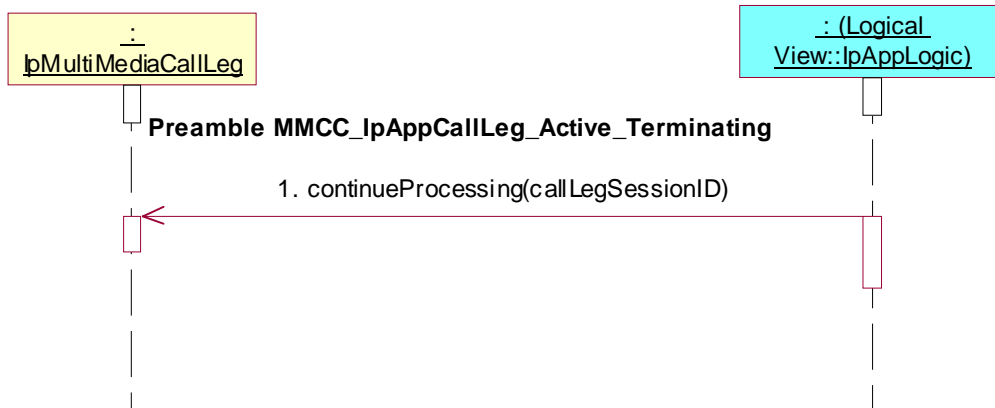

Test MMCC_IpAppMultiMediaCallLeg_70

Summary: release call leg

Reference: ES 201 915-4 [1], clause 7.4.3.2

Precondition: IUT capable of invoking **release()**

Preamble: **MMCC_IpAppMultiMediaCallLeg_Active_Terminating**

Test Sequence:

1. Triggered Action: cause IUT to call **release()** method on the tester's (SCF's) terminating IpMultiMediaCallLeg interface.
Parameters: callLegSessionID, cause

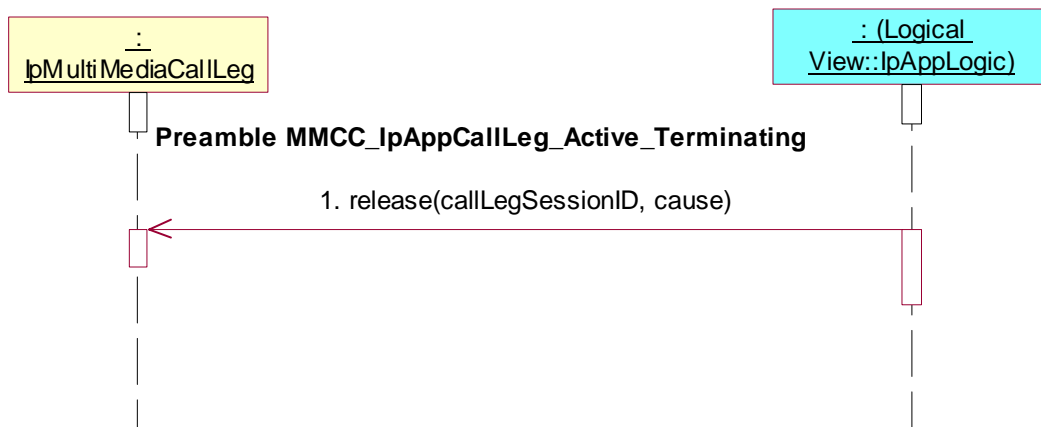

Test MMCC_IpAppMultiMediaCallLeg_71

Summary: de-assign call leg

Reference: ES 201 915-4 [1], clause 7.4.3.2

Precondition: IUT capable of invoking **deassign()**

Preamble: **MMCC_IpAppMultiMediaCallLeg_Active_Terminating**

Test Sequence:

1. Triggered Action: cause IUT to call **deassign()** method on the tester's (SCF's) terminating IpMultiMediaCallLeg interface.
Parameters: callLegSessionID



Test MMCC_IpAppMultiMediaCallLeg_72

Summary: get information about call leg

Reference: ES 201 915-4 [1], clause 7.4.3.2

Precondition: IUT capable of invoking **getInfoReq()**

Preamble: **MMCC_IpAppMultiMediaCallLeg_Active_Terminating**

Test Sequence:

1. Triggered Action: cause IUT to call **getInfoReq()** method on the tester's (SCF's) terminating IpMultiMediaCallLeg interface.
Parameters: callLegSessionID, callLegInfoRequested

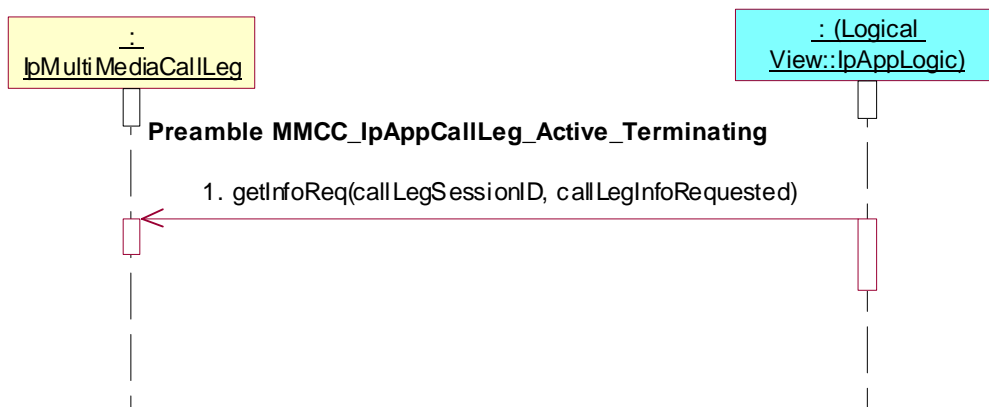

Test MMCC_IpAppMultiMediaCallLeg_73

Summary: get information about call leg, unsuccessful

Reference: ES 201 915-4 [1], clause 7.4.3.2

Precondition: IUT capable of invoking **getInfoReq()**

Preamble: **MMCC_IpAppMultiMediaCallLeg_Active_Terminating**

Test Sequence:

1. Triggered Action: cause IUT to call **getInfoReq()** method on the tester's (SCF's) terminating IpMultiMediaCallLeg interface.
Parameters: callLegSessionID, callLegInfoRequested
2. Method call **getInfoErr()**
Parameters: callLegSessionID, errorIndication
Check: no exception is returned

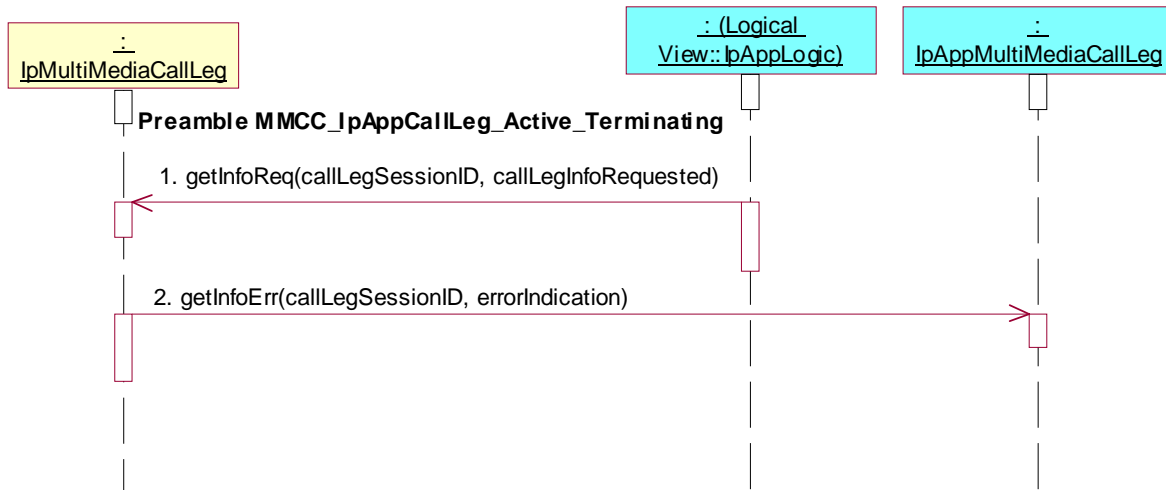

Test MMCC_IpAppMultiMediaCallLeg_74

Summary: supervise call leg

Reference: ES 201 915-4 [1], clause 7.4.3.2

Precondition: IUT capable of invoking **superviseReq()**

Preamble: **MMCC_IpAppMultiMediaCallLeg_Active_Terminating**

Test Sequence:

1. Triggered Action: cause IUT to call **superviseReq()** method on the tester's (SCF's) terminating IpMultiMediaCallLeg interface.
Parameters: callLegSessionID, time, treatment

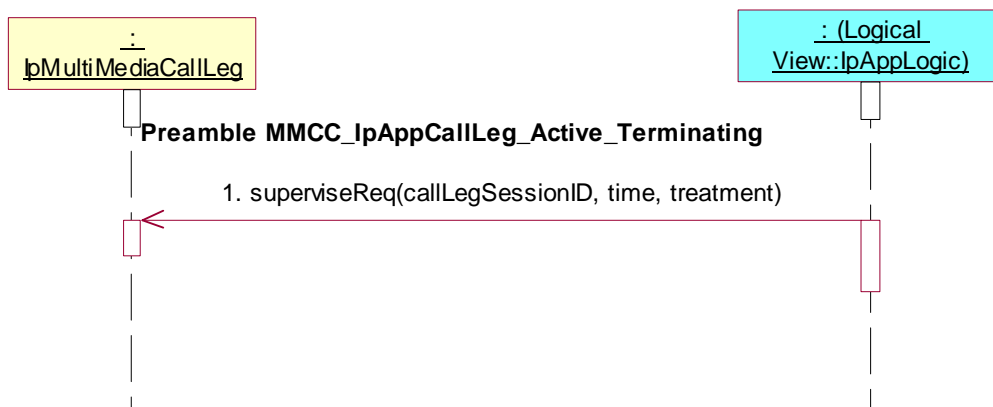

Test MMCC_IpAppMultiMediaCallLeg_75

Summary: supervise call leg, unsuccessful

Reference: ES 201 915-4 [1], clause 7.4.3.2

Precondition: IUT capable of invoking **superviseReq()**

Preamble: **MMCC_IpAppMultiMediaCallLeg_Active_Terminating**

Test Sequence:

1. Triggered Action: cause IUT to call **superviseReq()** method on the tester's (SCF's) terminating IpMultiMediaCallLeg interface.
Parameters: callLegSessionID, time, treatment
2. Method call **superviseErr()**
Parameters: callLegSessionID, errorIndication
Check: no exception is returned

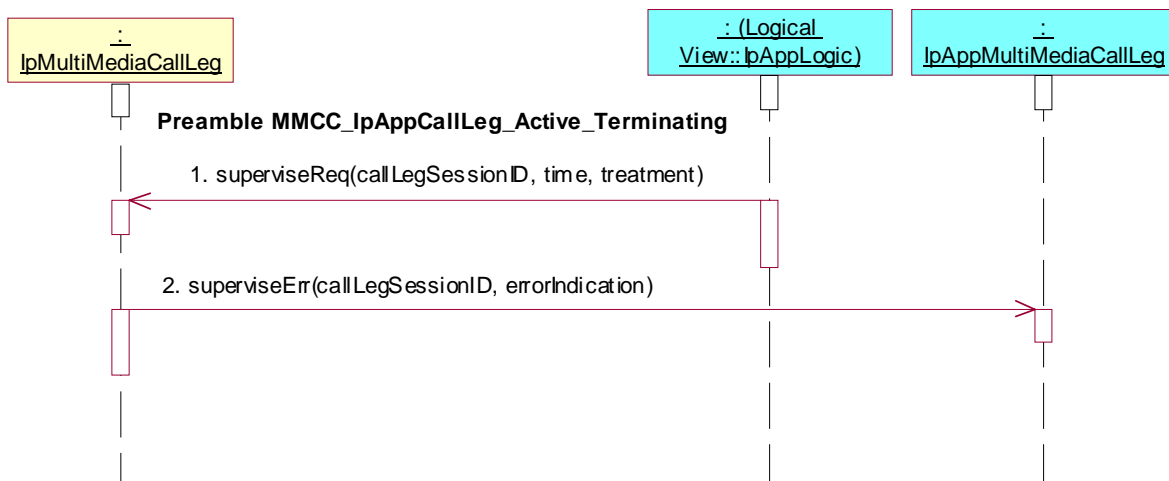
**Test MMCC_IpAppMultiMediaCallLeg_76**

Summary: set monitor on media streams

Reference: ES 201 915-4 [1], clauses 7.4.3.2, 8.3.5 and 8.3.6

Precondition: IUT capable of invoking **mediaStreamMonitorReq()**

Preamble: **MMCC_IpAppMultiMediaCallLeg_Active_Terminating**

Test Sequence:

1. Triggered Action: cause IUT to call **mediaStreamMonitorReq()** method on the tester's (SCF's) terminating IpMultiMediaCallLeg interface.
Parameters: callLegSessionID, mediaStreamEventCriteria
2. Method call **mediaStreamMonitorRes()**
Parameters: callLegSessionID, streams, type
Check: no exception is returned

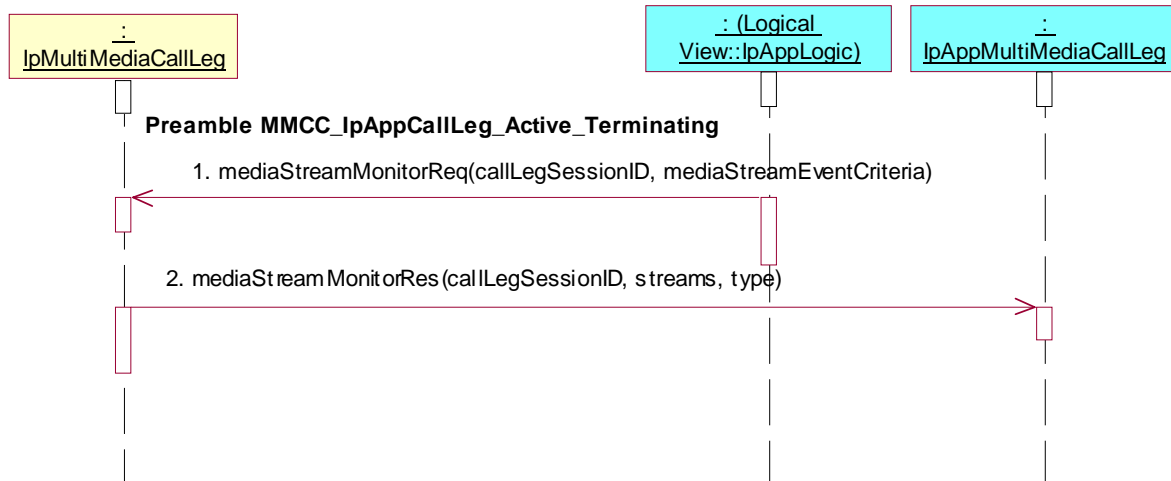

Test MMCC_IpAppMultiMediaCallLeg_77

Summary: set monitor on media streams and allow setup

Reference: ES 201 915-4 [1], clauses 7.4.3.2, 8.3.5 and 8.3.6

Precondition: IUT capable of invoking **mediaStreamMonitorReq()** and **mediaStreamAllow()**

Preamble: **MMCC_IpAppMultiMediaCallLeg_Active_Terminating**

Test Sequence:

1. Triggered Action: cause IUT to call **mediaStreamMonitorReq()** method on the tester's (SCF's) terminating IpMultiMediaCallLeg interface.
Parameters: callLegSessionID, mediaStreamEventCriteria
mediaStreamEventCriteria.CallMonitorMode= P_CALL_MONITOR_MODE_INTERRUPT
2. Method call **mediaStreamMonitorRes()**
Parameters: callLegSessionID, streams, type
Check: no exception is returned
3. Triggered Action: cause IUT to call **mediaStreamAllow()** method on the tester's (SCF's) terminating IpMultiMediaCallLeg interface.
Parameters: callLegSessionID, mediaStreamList

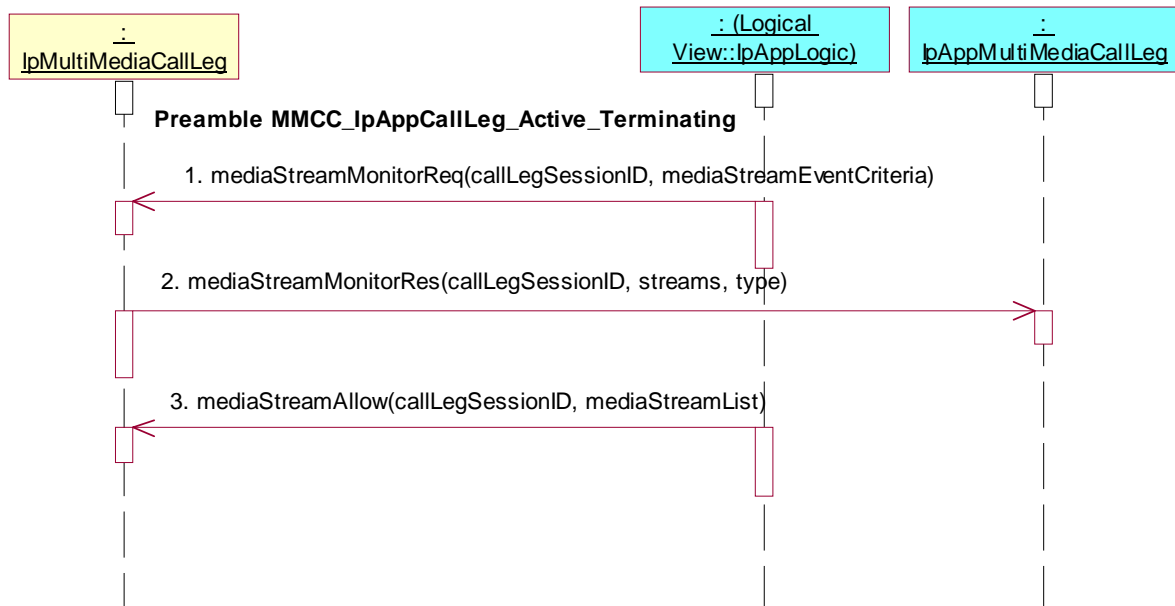

Test MMCC_IpAppMultiMediaCallLeg_78

Summary: get media streams

Reference: ES 201 915-4 [1], clauses 7.4.3.2, 8.3.5 and 8.3.6

Precondition: IUT capable of invoking **getMediaStreams()**

Preamble: **MMCC_IpAppMultiMediaCallLeg_Active_Terminating**

Test Sequence:

1. Triggered Action: cause IUT to call **getMediaStreams()** method on the tester's (SCF's) terminating IpMultiMediaCallLeg interface.
Parameters: callLegSessionID

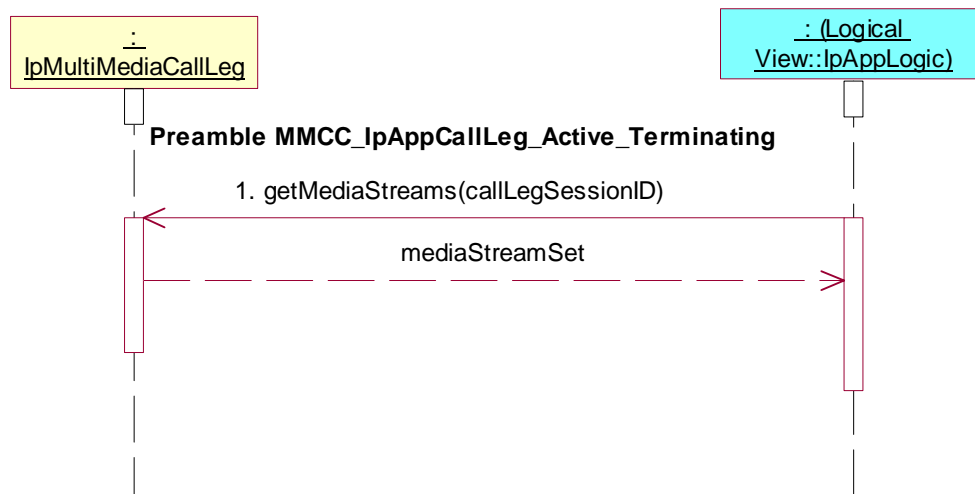

7.2.3.3.2.3 Releasing (Terminating) state

Precondition: IUT capable of invoking **eventReportReq()**, **routeReq()** and **release()**

Preamble MMCC_IpAppMultiMediaCallLeg_Releasing_Terminating

Reference: ES 201 915-4 [1], clause 7.4.3.2.3

Pre-preamble: Registration of the IUT (application) and the tester (Call Control SCF) to the framework. The IUT must have obtained a reference to an instance of the IpMultiMediaCallControlManager interface through selecting that service and signing the required service agreement.

The application is permitted to provide its IpAppMultiMediaCallControlManager interface reference in a setCallback() method which it calls prior to invoking further methods.

Preamble Sequence:

1. Triggered Action: cause IUT to call **createNotification()** method on the tester's (SCF's) IpMultiMediaCallControlManager interface.
Parameters: appCallControlManager, notificationRequest
notificationRequest.CallMonitorMode= P_CALL_MONITOR_MODE_INTERRUPT
2. Method call **reportNotification()**
Parameters: callReference, callLegReferenceSet, notificationInfo, assignmentID
Check: valid value of TpAppMultiPartyCallBack is returned
3. Triggered Action: cause IUT to call **createCallLeg()** method on the tester's (SCF's) IpMultiMediaCall interface.
Parameters: callSessionID, AppMultiMediaCallLeg
4. Triggered Action: cause IUT to call **eventReportReq()** method on the tester's (SCF's) terminating IpMultiMediaCallLeg interface.
Parameters: callLegSessionID, eventsRequested
5. Triggered Action: cause IUT to call **routeReq()** method on the tester's (SCF's) terminating IpMultiMediaCallLeg interface.
Parameters: callLegSessionID, targetAddress, originatingAddress, appInfo, connectionProperties
6. Triggered Action: cause IUT to call **release()** method on the tester's (SCF's) terminating IpMultiMediaCallLeg interface.
Parameters: callLegSessionID, cause

or

1. Triggered Action: cause IUT to call **createNotification()** method on the tester's (SCF's) IpMultiMediaCallControlManager interface.
Parameters: appCallControlManager, notificationRequest
notificationRequest.CallMonitorMode= P_CALL_MONITOR_MODE_INTERRUPT
notificationRequest.CallEventType= P_CALL_EVENT_TERMINATING_RELEASE
2. Method call **reportNotification()**
Parameters: callReference, callLegReferenceSet, notificationInfo, assignmentID
Check: valid value of TpAppMultiPartyCallBack is returned

or

1. Triggered Action: cause IUT to call **createCall()** method on the tester's (SCF's) IpMultiMediaCallControlManager interface.
Parameters: appCall
2. Triggered Action: cause IUT to call **createCallLeg()** method on the tester's (SCF's) IpMultiMediaCall interface.
Parameters: callSessionID, AppMultiMediaCallLeg

3. Triggered Action: cause IUT to call **eventReportReq()** method on the tester's (SCF's) terminating IpMultiMediaCallLeg interface.
Parameters: callLegSessionID, eventsRequested
4. Triggered Action: cause IUT to call **routeReq()** method on the tester's (SCF's) terminating IpMultiMediaCallLeg interface.
Parameters: callLegSessionID, targetAddress, originatingAddress, appInfo, connectionProperties
5. Triggered Action: cause IUT to call **release()** method on the tester's (SCF's) terminating IpMultiMediaCallLeg interface.
Parameters: callLegSessionID, cause

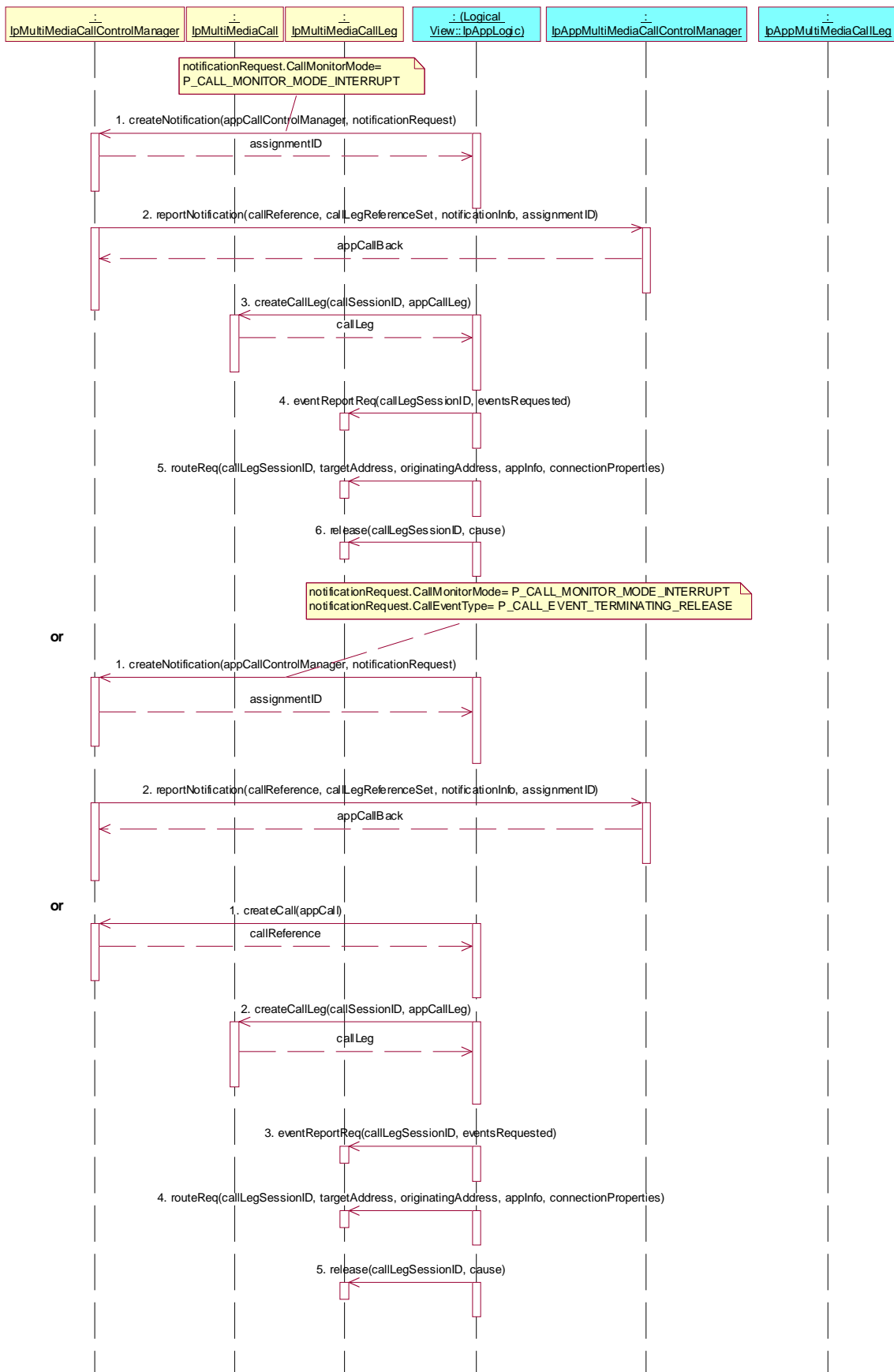

Test MMCC_IpAppMultiMediaCallLeg_79

Summary: request reference of call related to call leg

Reference: ES 201 915-4 [1], clause 7.4.3.2

Precondition: IUT capable of invoking **getCall()**

Preamble: **MMCC_IpAppMultiMediaCallLeg_Releasing_Terminating**

Test Sequence:

1. Triggered Action: cause IUT to call **getCall()** method on the tester's (SCF's) terminating IpMultiMediaCallLeg interface.
Parameters: callLegSessionID

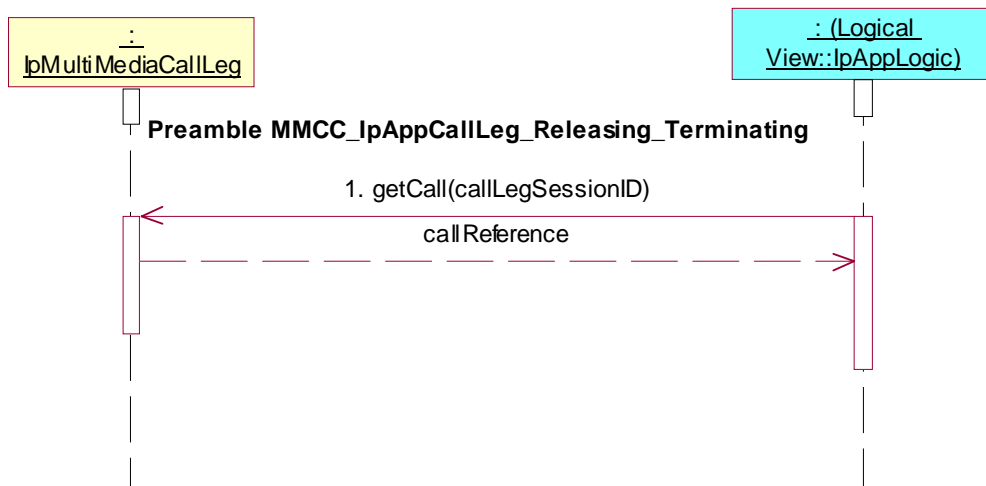
**Test MMCC_IpAppMultiMediaCallLeg_80**

Summary: request reference of call related to call leg

Reference: ES 201 915-4 [1], clause 7.4.3.2

Precondition: IUT capable of invoking **getCurrentDestinationAddress()**

Preamble: **MMCC_IpAppMultiMediaCallLeg_Releasing_Terminating**

Test Sequence:

1. Triggered Action: cause IUT to call **getCurrentDestinationAddress()** method on the tester's (SCF's) terminating IpMultiMediaCallLeg interface.
Parameters: callLegSessionID

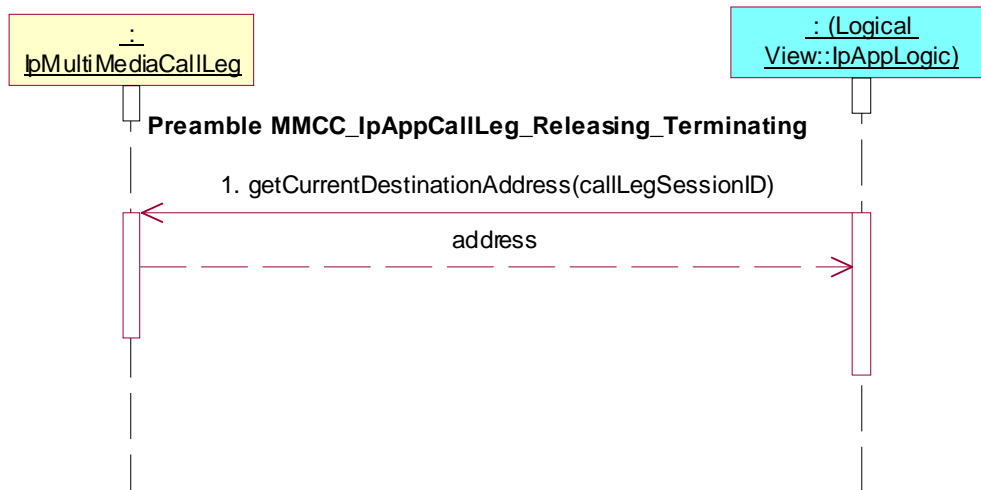

Test MMCC_IpAppMultiMediaCallLeg_81

Summary: continue processing of call leg

Reference: ES 201 915-4 [1], clause 7.4.3.2

Precondition: IUT capable of invoking **continueProcessing()**

Preamble: **MMCC_IpAppMultiMediaCallLeg_Releasing_Terminating**

Test Sequence:

1. Triggered Action: cause IUT to call **continueProcessing()** method on the tester's (SCF's) terminating IpMultiMediaCallLeg interface.
Parameters: callLegSessionID

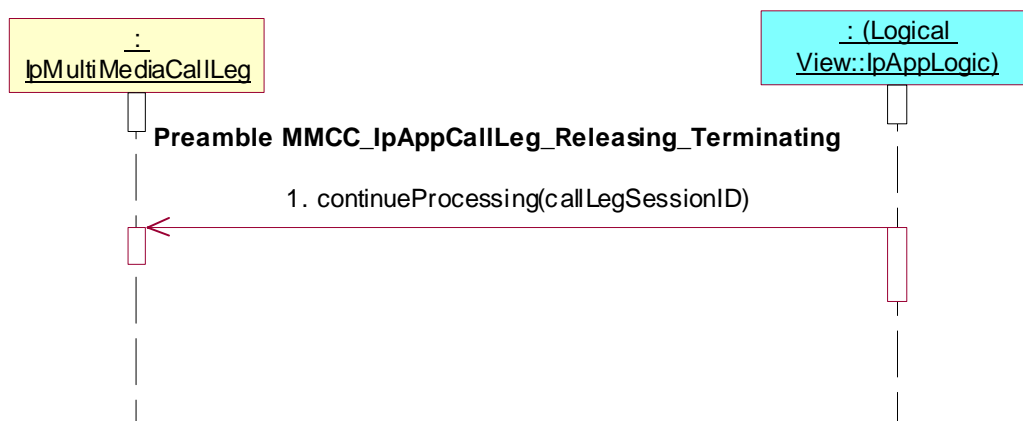

Test MMCC_IpAppMultiMediaCallLeg_82

Summary: continue processing of call leg

Reference: ES 201 915-4 [1], clause 7.4.3.2

Precondition: IUT capable of invoking **getInfoReq()**, **continueProcessing()** and **release()**

Preamble: **MMCC_IpAppCallLeg_Active_Terminating**

Test Sequence:

1. Triggered Action: cause IUT to call **getInfoReq()** method on the tester's (SCF's) terminating IpMultiMediaCallLeg interface.
Parameters: callLegSessionID, callLegInfoRequested

2. Triggered Action: cause IUT to call **continueProcessing()** method on the tester's (SCF's) terminating IpMultiMediaCallLeg interface.
Parameters: callLegSessionID
3. Triggered Action: cause IUT to call **release()** method on the tester's (SCF's) terminating IpMultiMediaCallLeg interface.
Parameters: callLegSessionID, cause
4. Method call **getInfoRes()**
Parameters: callLegSessionID, callLegInfoReport
Check: no exception is returned
5. Method call **callLegEnded()**
Parameters: callLegSessionID, cause
Check: no exception is returned

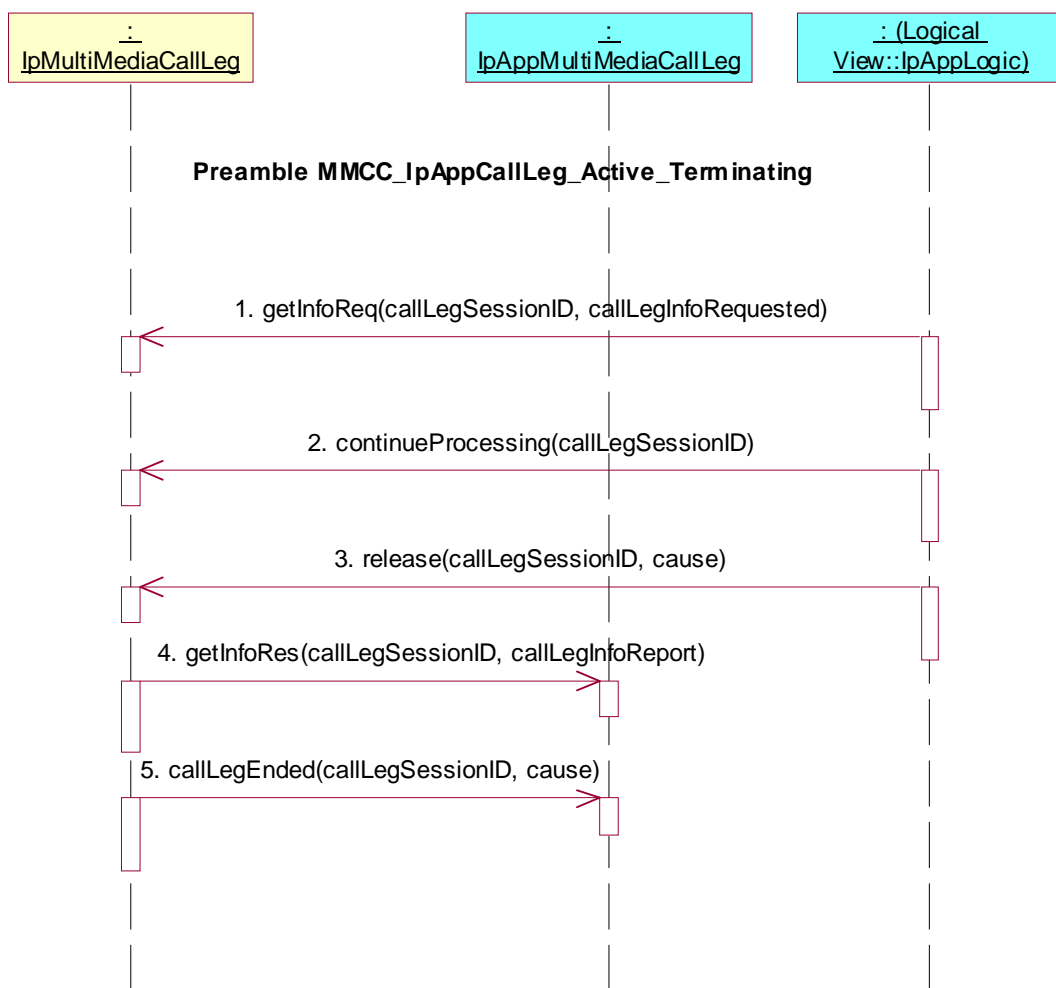

Test MMCC_IpAppMultiMediaCallLeg_83

Summary: continue processing of call leg

Reference: ES 201 915-4 [1], clause 7.4.3.2

Precondition: IUT capable of invoking **superviseReq()**, **continueProcessing()** and **release()**

Preamble: **MMCC_IpAppCallLeg_Active_Terminating**

Test Sequence:

1. Triggered Action: cause IUT to call **superviseReq()** method on the tester's (SCF's) terminating IpMultiMediaCallLeg interface.
Parameters: callLegSessionID, time, treatment
2. Triggered Action: cause IUT to call **continueProcessing()** method on the tester's (SCF's) terminating IpMultiMediaCallLeg interface.
Parameters: callLegSessionID
3. Triggered Action: cause IUT to call **release()** method on the tester's (SCF's) terminating IpMultiMediaCallLeg interface.
Parameters: callLegSessionID, cause
4. Method call **superviseRes()**
Parameters: callLegSessionID, report, usedTime
Check: no exception is returned
5. Method call **callLegEnded()**
Parameters: callLegSessionID, cause
Check: no exception is returned

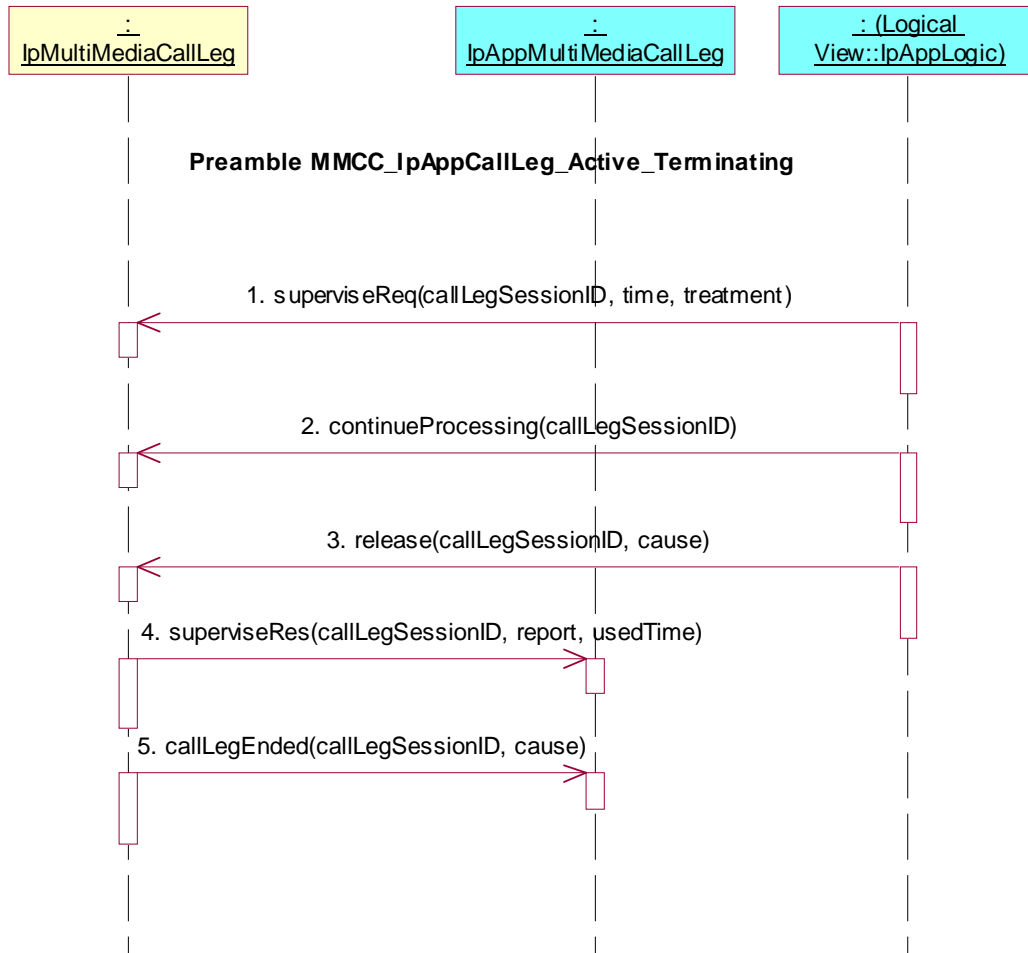

Test MMCC_IpAppMultiMediaCallLeg_84

Summary: de-assign call leg

Reference: ES 201 915-4 [1], clause 7.4.3.2

Precondition: IUT capable of invoking **deassign()**

Preamble: **MMCC_IpAppMultiMediaCallLeg_Releasing_Terminating**

Test Sequence:

1. Triggered Action: cause IUT to call **deassign()** method on the tester's (SCF's) terminating IpMultiMediaCallLeg interface.
Parameters: callLegSessionID

**7.2.3.4 IpMultiMediaStream****Test MMCC_IpAppMultiMediaStream_01**

Summary: substract media stream

Reference: ES 201 915-4 [1], clause 8.3.7

Precondition: IUT capable of invoking **mediaStreamMonitorReq()** and **substract()**

Preamble: **MMCC_IpAppMultiMediaCallLeg_Active** or
MMCC_IpAppMultiMediaCallLeg_Active_Terminating

Test Sequence:

1. Triggered Action: cause IUT to call **mediaStreamMonitorReq()** method on the tester's (SCF's) IpMultiMediaCallLeg interface.
Parameters: callLegSessionID, mediaStreamEventCriteria
2. Method call **mediaStreamMonitorRes()**
Parameters: callLegSessionID, streams, type
Check: no exception is returned
3. Triggered Action: cause IUT to call **substract()** method on the tester's (SCF's) IpMultiMediaStream interface.
Parameters: mediaStreamSessionID

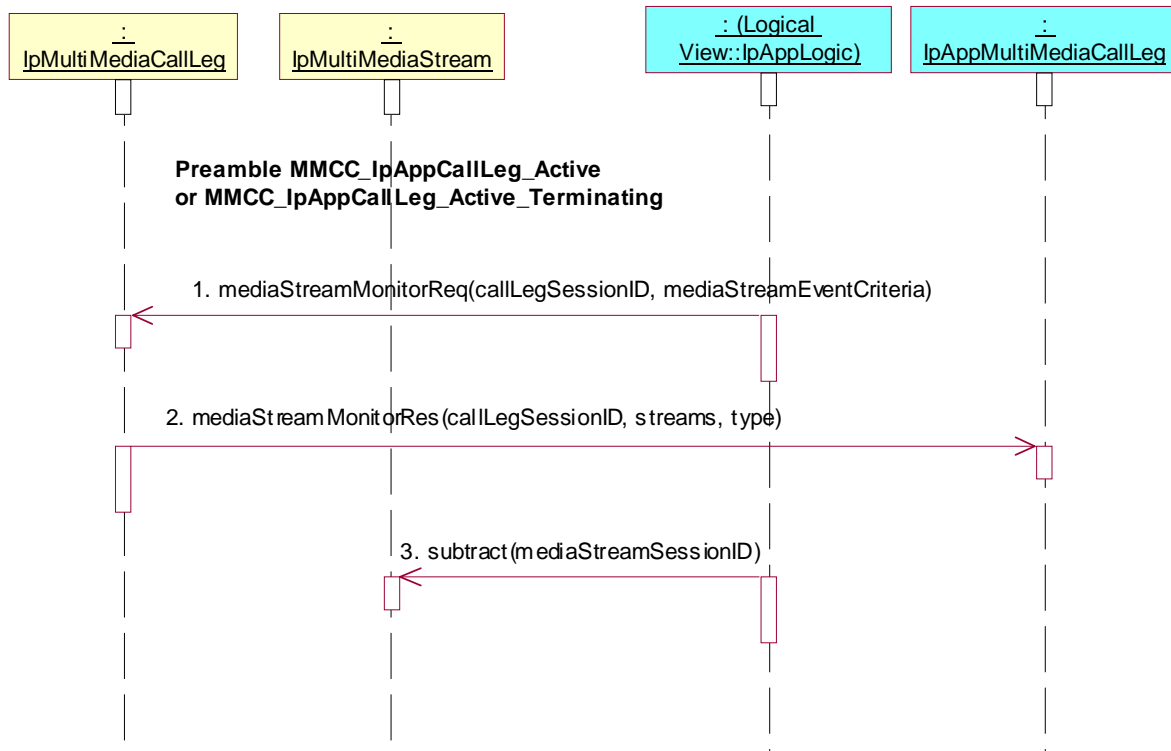

7.2.4 Conference Call Control Service (CCC)

7.2.4.1 IpAppCallControlManager

Test CCC_IpAppConfCallControlManager_01

Summary: create conference

Reference: ES 201 915-4 [1], clause 9.3.1

Precondition: IUT capable of invoking **createConference()**

Preamble: Registration of the IUT (application) and the tester (Call Control SCF) to the framework. The IUT must have obtained a reference to an instance of the IpConfCallControlManager interface through selecting that service and signing the required service agreement.

The application is permitted to provide its IpAppConferenceCallControlManager interface reference in a setCallback() method which it calls prior to invoking further methods.

Test Sequence:

1. Triggered Action: cause IUT to call **createConference()** method on the tester's (SCF's) IpConfCallControlManager interface.
Parameters: appConferenceCall, numberOfSubConferences, conferencePolicy, numberOfParticipants, duration

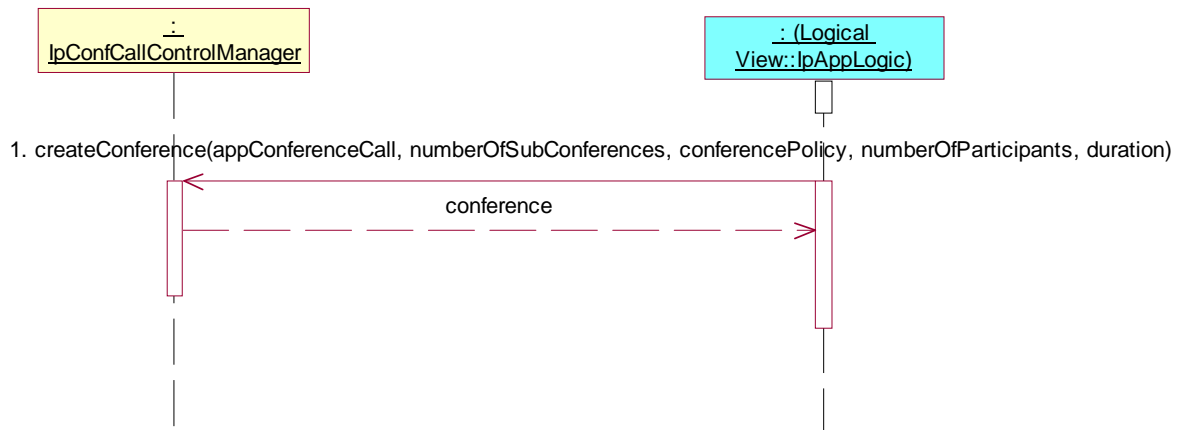

Test CCC_IpAppConfCallControlManager_02

Summary: reserve conference resources and accept create create notification

Reference: ES 201 915-4 [1], clauses 9.3.1 and 9.3.2

Precondition: IUT capable of invoking **reserveResources()**; **conferenceCreated()** implemented

Preamble: Registration of the IUT (application) and the tester (Call Control SCF) to the framework. The IUT must have obtained a reference to an instance of the IpConfCallControlManager interface through selecting that service and signing the required service agreement.

The application is permitted to provide its IpAppConferenceCallControlManager interface reference in a setCallback() method which it calls prior to invoking further methods.

Test Sequence:

1. Triggered Action: cause IUT to call **reserveResources()** method on the tester's (SCF's) IpConfCallControlManager interface.
Parameters: appInterface, startTime, numberOfParticipants, duration, conferencePolicy

2. Method call **conferenceCreated()**

Parameters: conferenceCall

Check: valid value of IpAppConfCallRef is returned

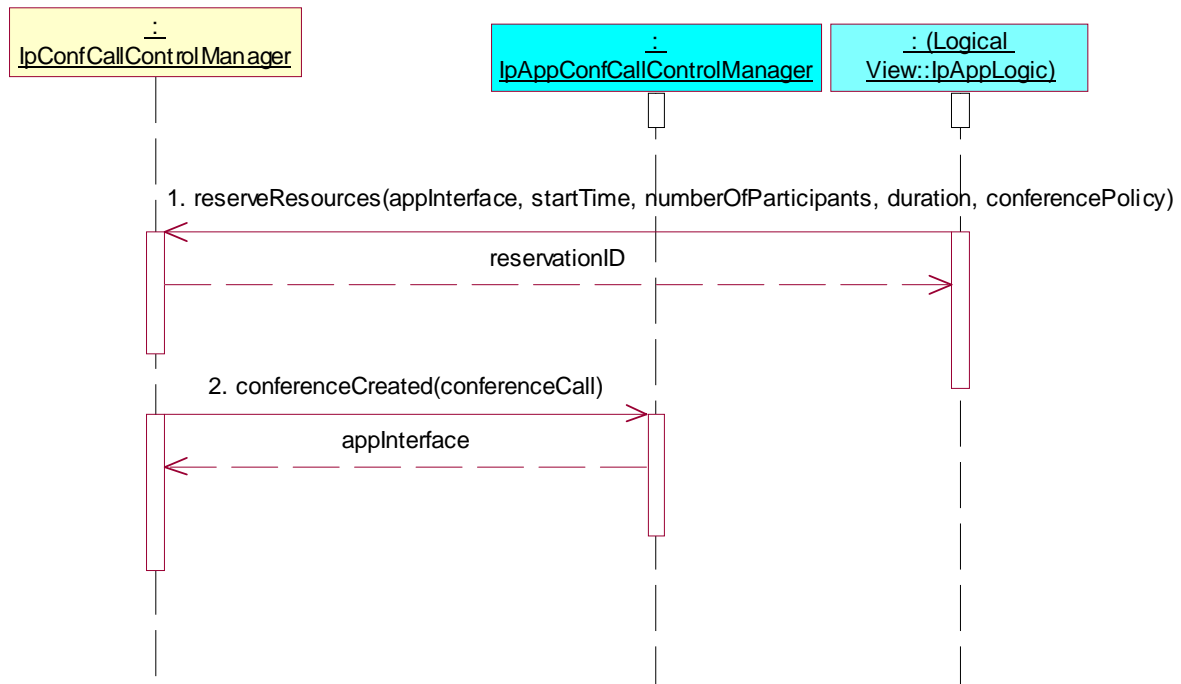
**Test CCC_IpAppConfCallControlManager_03**

Summary: reserve and free conference resources

Reference: ES 201 915-4 [1], clause 9.3.1

Precondition: IUT capable of invoking **reserveResources()** and **freeResources()**

Preamble: Registration of the IUT (application) and the tester (Call Control SCF) to the framework. The IUT must have obtained a reference to an instance of the IpConfCallControlManager interface through selecting that service and signing the required service agreement.

The application is permitted to provide its IpAppConferenceCallControlManager interface reference in a setCallback() method which it calls prior to invoking further methods.

Test Sequence:

1. Triggered Action: cause IUT to call **reserveResources()** method on the tester's (SCF's) IpConfCallControlManager interface.
Parameters: applInterface, startTime, numberOfParticipants, duration, conferencePolicy
2. Triggered Action: cause IUT to call **freeResources()** method on the tester's (SCF's) IpConfCallControlManager interface.
Parameters: resourceReservation

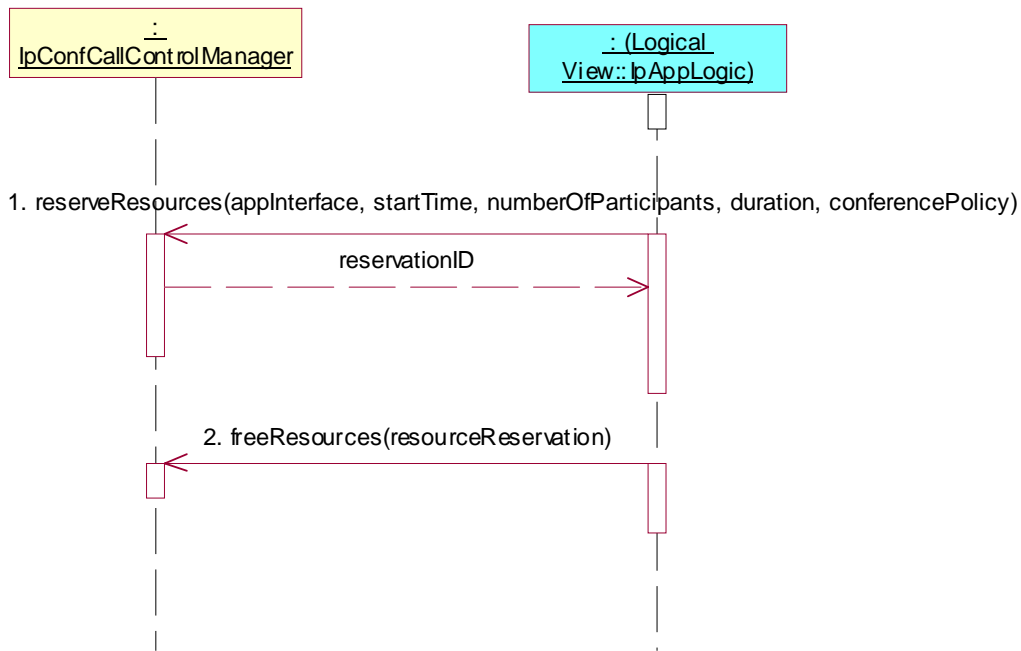

Test CCC_IpAppConfCallControlManager_04

Summary: check conference resources

Reference: ES 201 915-4 [1], clause 9.3.1

Precondition: IUT capable of invoking **checkResources()**

Preamble: Registration of the IUT (application) and the tester (Call Control SCF) to the framework. The IUT must have obtained a reference to an instance of the `IpConfCallControlManager` interface through selecting that service and signing the required service agreement.

The application is permitted to provide its `IpAppConferenceCallControlManager` interface reference in a `setCallback()` method which it calls prior to invoking further methods.

Test Sequence:

1. Triggered Action: cause IUT to call **reserveResources()** method on the tester's (SCF's) `IpConfCallControlManager` interface.
Parameters: `applInterface`, `startTime`, `numberOfParticipants`, `duration`, `conferencePolicy`
2. Triggered Action: cause IUT to call **checkResources()** method on the tester's (SCF's) `IpConfCallControlManager` interface.
Parameters: `searchCriteria`

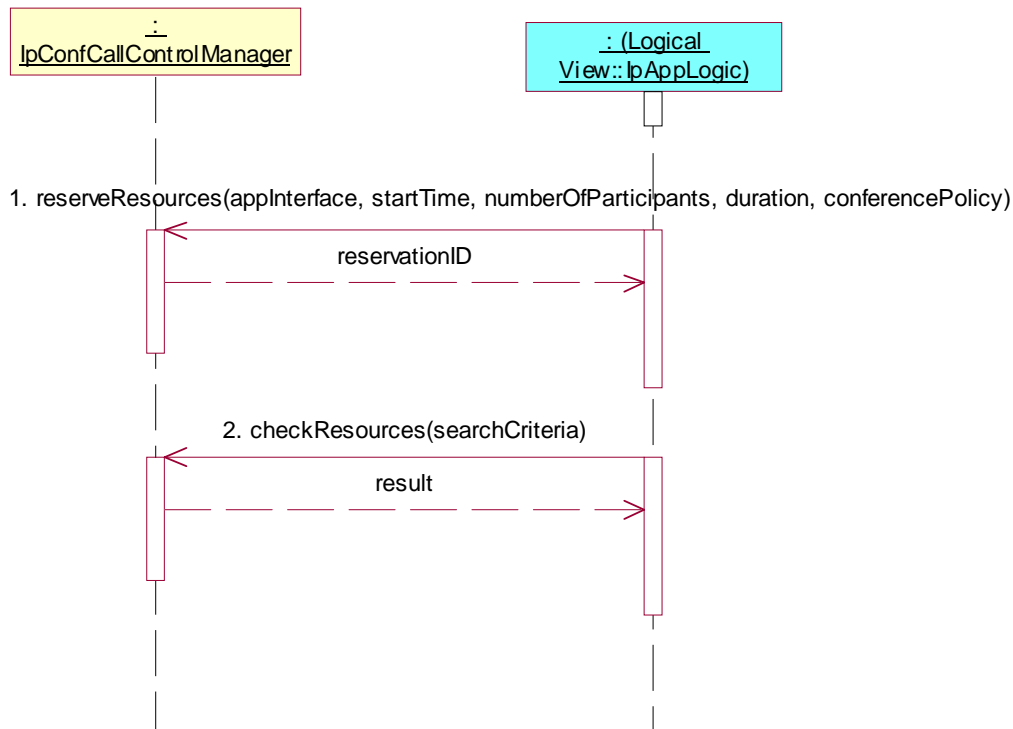

7.2.4.2 IpAppConfCall

Applications need not be capable of performing each of the sequences below, even if they support the methods indicated below.

Reference: ES 201 915-4 [1], clauses 9.3.3 and 9.3.4

Precondition: IUT capable of invoking **reserveResources()** or **createConference()**

Preamble CCC_IpAppConfCall_Conference_Active

Reference: ES 201 915-4 [1], clauses 9.3.1 and 9.3.2

Pre-preamble: Registration of the IUT (application) and the tester (Call Control SCF) to the framework. The IUT must have obtained a reference to an instance of the `IpConfCallControlManager` interface through selecting that service and signing the required service agreement.

The application is permitted to provide its `IpAppConferenceCallControlManager` interface reference in a `setCallback()` method which it calls prior to invoking further methods.

Preamble Sequence:

1. Triggered Action: cause IUT to call **reserveResources()** method on the tester's (SCF's) `IpConfCallControlManager` interface.
Parameters: `appInterface`, `startTime`, `numberOfParticipants`, `duration`, `conferencePolicy`
2. Method call **conferenceCreated()**
Parameters: `conferenceCall`
Check: valid value of `IpAppConfCallRef` is returned

or

1. Triggered Action: cause IUT to call **createConference()** method on the tester's (SCF's) `IpConfCallControlManager` interface.
Parameters: `appConferenceCall`, `numberOfSubConferences`, `conferencePolicy`, `numberOfParticipants`, `duration`

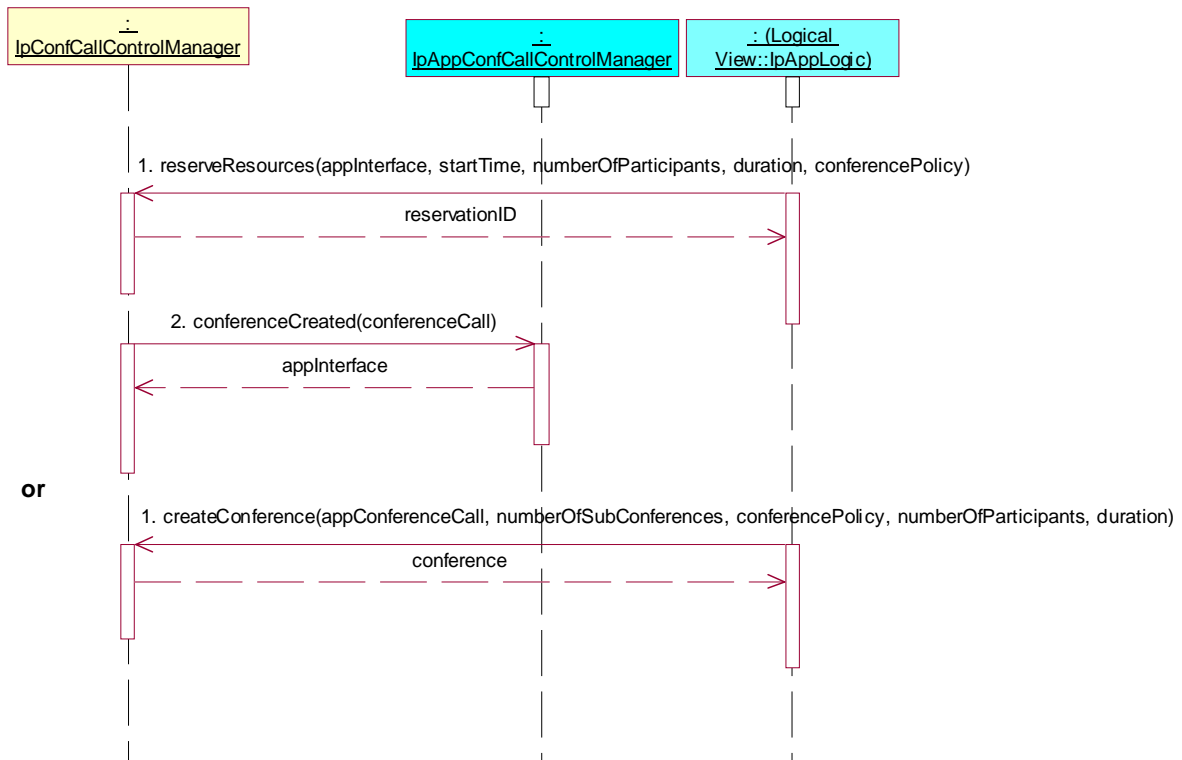

Test CCC_IpAppConfCall_01

Summary: get subconferences

Reference: ES 201 915-4 [1], clause 9.3.3

Precondition: IUT capable of invoking **getSubConferences()**

Preamble: **CCC_IpAppConfCall_Conference_Active**

Test Sequence:

1. Triggered Action: cause IUT to call **getSubConferences()** method on the tester's (SCF's) IpConfCall interface.
Parameters: conferenceSessionID

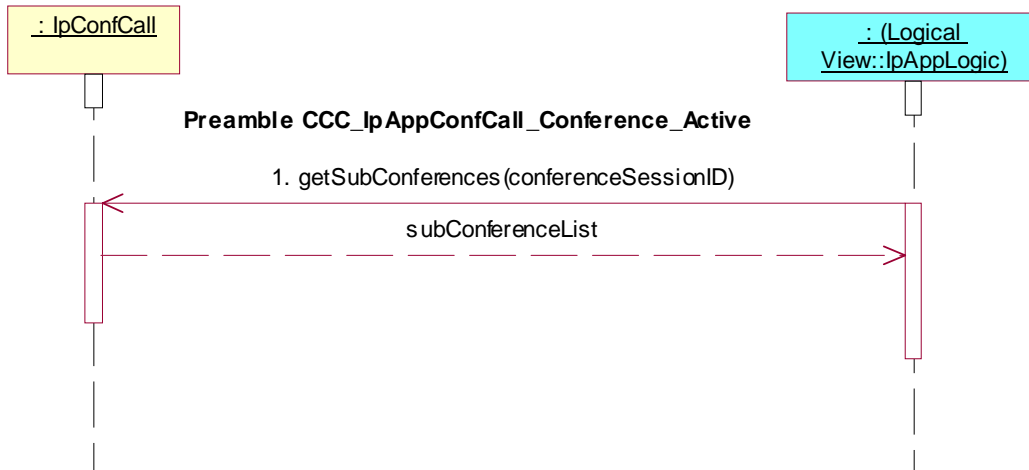

Test CCC_IpAppConfCall_02

Summary: create subconference

Reference: ES 201 915-4 [1], clause 9.3.3

Precondition: IUT capable of invoking **createSubConference()**

Preamble: **CCC_IpAppConfCall_Conference_Active**

Test Sequence:

1. Triggered Action: cause IUT to call **createSubConference()** method on the tester's (SCF's) IpConfCall interface.
Parameters: conferenceSessionID, appSubConference, conferencePolicy



Test CCC_IpAppConfCall_03

Summary: request and accept leave notifications

Reference: ES 201 915-4 [1], clauses 9.3.3 and 9.3.4

Precondition: IUT capable of invoking **leaveMonitorReq()**

Preamble: **CCC_IpAppConfCall_Conference_Active**

Test Sequence:

1. Triggered Action: cause IUT to call **leaveMonitorReq()** method on the tester's (SCF's) IpConfCall interface.
Parameters: conferenceSessionID
2. Method call **leaveMonitorRes()**
Parameters: conferenceSessionID, callLeg
Check: valid value of IpAppConfCallRef is returned

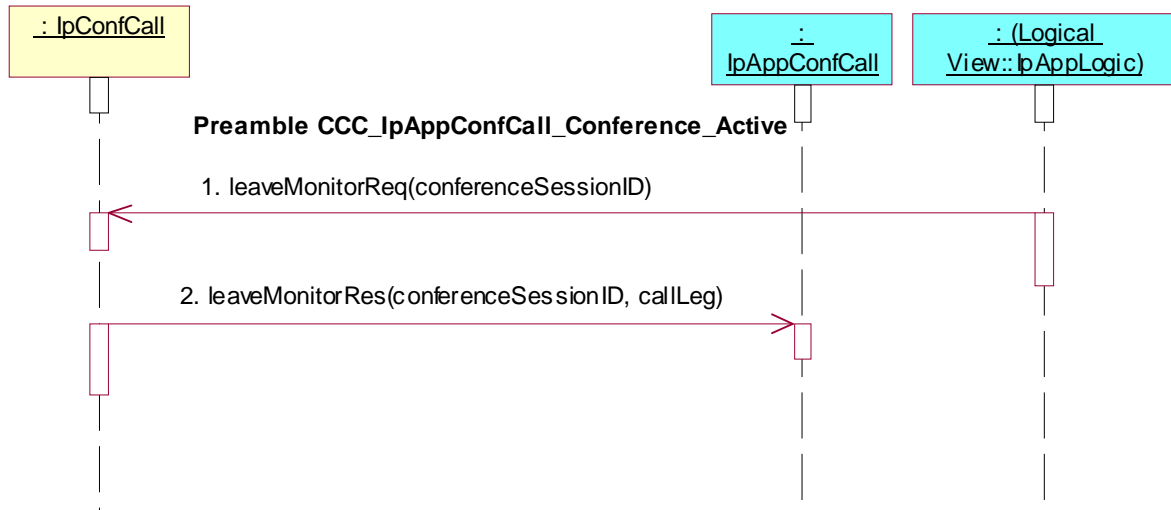

Test CCC_IpAppConfCall_04

Summary: accept new party indication

Reference: ES 201 915-4 [1], clause 9.3.4

Precondition: **partyJoined()** implemented

Preamble: **CCC_IpAppConfCall_Conference_Active** with **conferencePolicy.JoinAllowed = TRUE**

Test Sequence:

1. Method call **partyJoined()**
Parameters: conferenceSessionID, callLeg, eventInfo
Check: valid value of mpccs:IpAppCallLegRef is returned

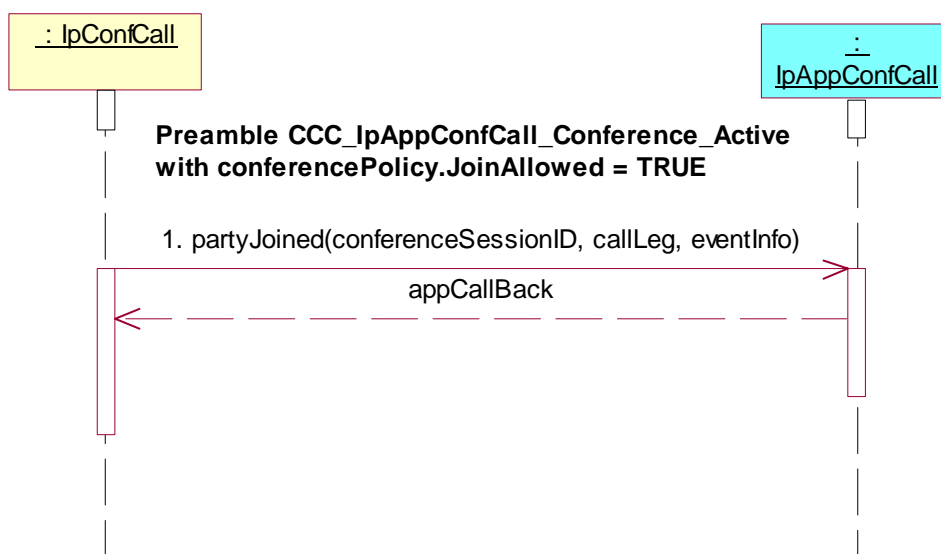

Test CCC_IpAppConfCall_05

Summary: release call

Reference: ES 201 915-4 [1], clauses 7.4.2.2 and 9.3.3

Precondition: IUT capable of invoking **release()**

Preamble: **CCC_IpAppConfCall_Conference_Active**

Test Sequence:

1. Triggered Action: cause IUT to call **release()** method on the tester's (SCF's) IpConfCall interface.
Parameters: callSessionID, cause

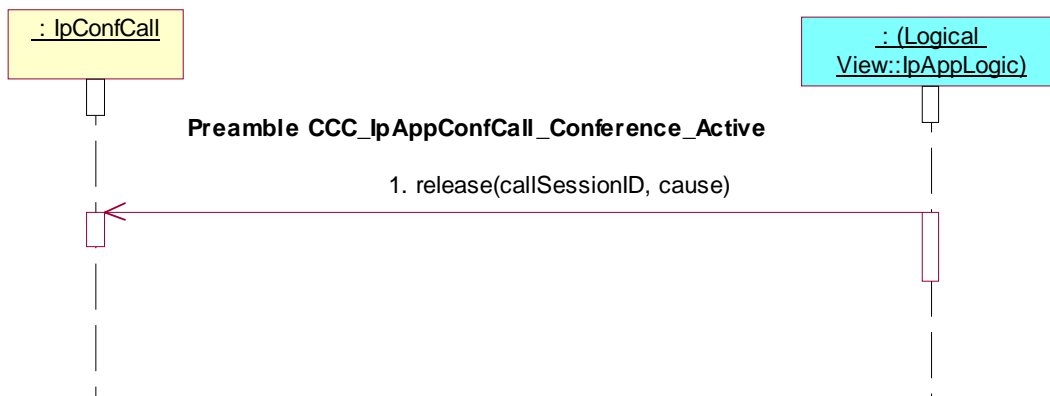
**Test CCC_IpAppConfCall_06**

Summary: deassign call

Reference: ES 201 915-4 [1], clauses 7.4.2.2 and 9.3.5

Precondition: IUT capable of invoking **deassignCall()**

Preamble: **CCC_IpAppConfCall_Conference_Active**

Test Sequence:

1. Triggered Action: cause IUT to call **deassignCall()** method on the tester's (SCF's) IpConfCall interface.
Parameters: callSessionID

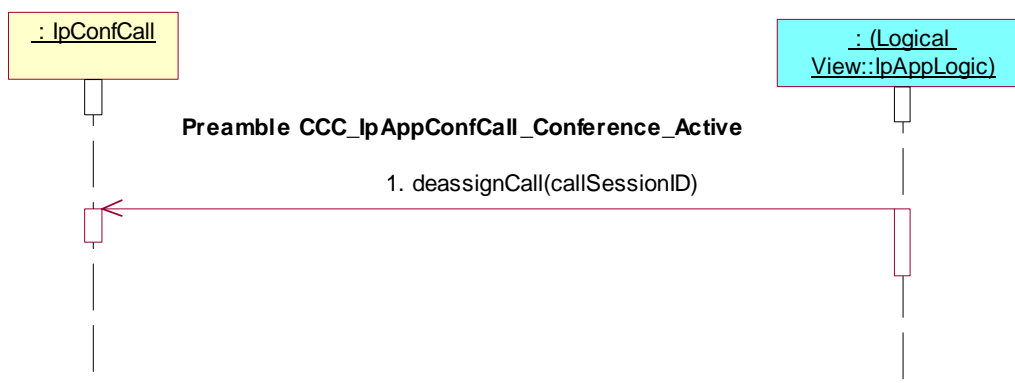

Test CCC_IpAppConfCall_07

Summary: supervise call

Reference: ES 201 915-4 [1], clauses 7.4.2.2 and 9.3.3

Precondition: IUT capable of invoking **superviseReq()**

Preamble: **CCC_IpAppConfCall_Conference_Active**

Test Sequence:

1. Triggered Action: cause IUT to call **superviseReq()** method on the tester's (SCF's) IpConfCall interface.
Parameters: callSessionID, time, treatment

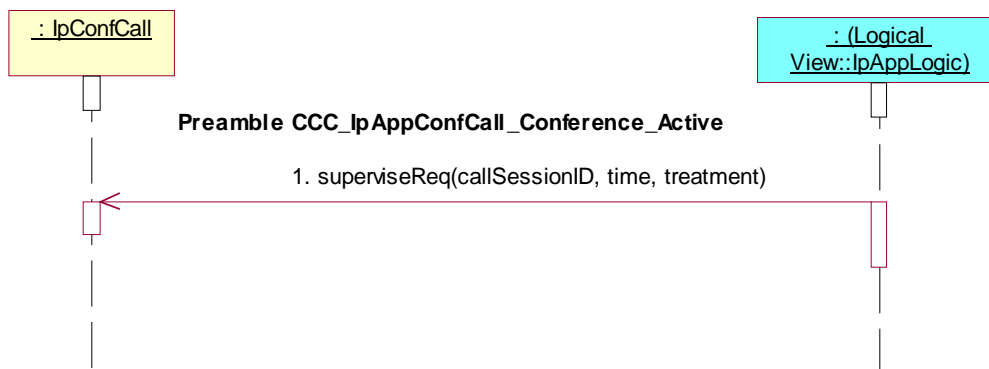
**Test CCC_IpAppConfCall_08**

Summary: supervise call, unsuccessful

Reference: ES 201 915-4 [1], clauses 7.4.2.2 and 9.3.3

Precondition: IUT capable of invoking **superviseReq()**

Preamble: **CCC_IpAppConfCall_Conference_Active**

Test Sequence:

1. Triggered Action: cause IUT to call **superviseReq()** method on the tester's (SCF's) IpConfCall interface.
Parameters: callSessionID, time, treatment
2. Method call **superviseErr()**
Parameters: callSessionID, errorIndication
Check: no exception is returned

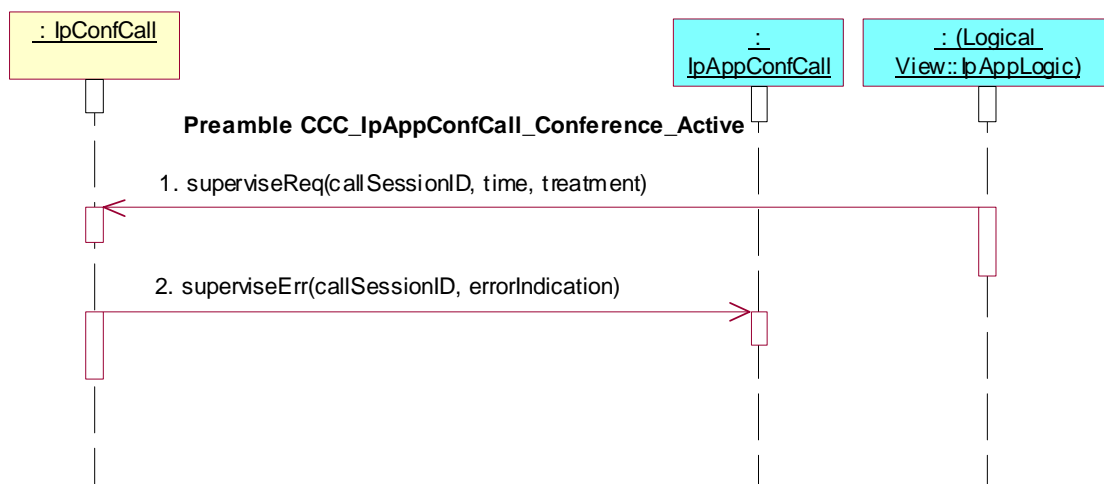

Test CCC_IpAppConfCall_09

Summary: supervise call with granted volume

Reference: ES 201 915-4 [1], clauses 8.3.3, 8.3.4 and 9.3.3

Precondition: IUT capable of invoking **superviseVolumeReq()**

Preamble: **CCC_IpAppConfCall_Conference_Active**

Test Sequence:

1. Triggered Action: cause IUT to call **superviseVolumeReq()** method on the tester's (SCF's) IpConfCall interface.
Parameters: callSessionID, volume, treatment

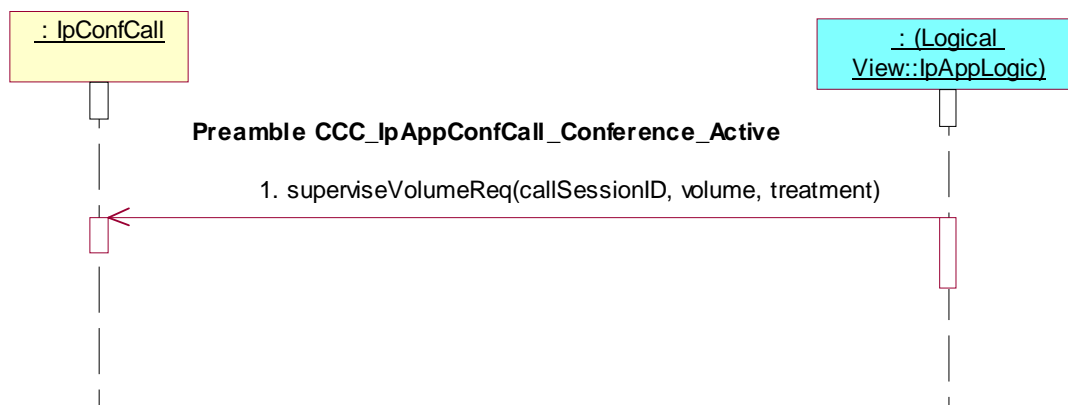
**Test CCC_IpAppConfCall_10**

Summary: supervise call with granted volume

Reference: ES 201 915-4 [1], clauses 8.3.3, 8.3.4 and 9.3.3

Precondition: IUT capable of invoking **superviseVolumeReq()**

Preamble: **CCC_IpAppConfCall_Conference_Active**

Test Sequence:

1. Triggered Action: cause IUT to call **superviseVolumeReq()** method on the tester's (SCF's) IpConfCall interface.
Parameters: callSessionID, volume, treatment
2. Method call **superviseVolumeErr()**
Parameters: callSessionID, errorIndication
Check: no exception is returned

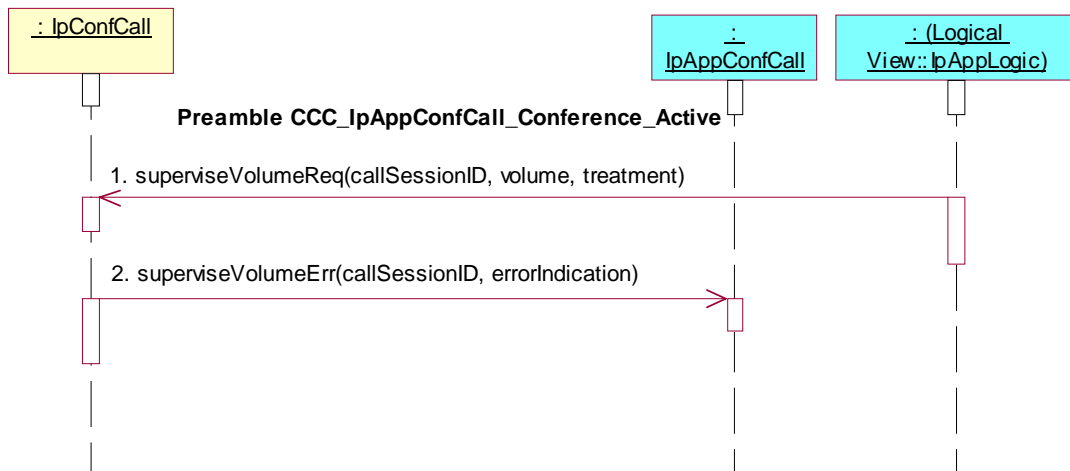

Test CCC_IpAppConfCall_11

Summary: request call information

Reference: ES 201 915-4 [1], clauses 7.4.2.2 and 9.3.3

Precondition: IUT capable of invoking **getInfoReq()**

Preamble: **CCC_IpAppConfCall_Conference_Active**

Test Sequence:

1. Triggered Action: cause IUT to call **getInfoReq()** method on the tester's (SCF's) IpConfCall interface.
Parameters: callSessionID, callInfoRequested



Test CCC_IpAppConfCall_12

Summary: request call information, unsuccessful

Reference: ES 201 915-4 [1], clauses 7.4.2.2 and 9.3.3

Precondition: IUT capable of invoking **getInfoReq()**

Preamble: **CCC_IpAppConfCall_Conference_Active**

Test Sequence:

1. Triggered Action: cause IUT to call **getInfoReq()** method on the tester's (SCF's) IpConfCall interface.
Parameters: callSessionID, callInfoRequested

2. Method call **getInfoErr()**
 Parameters: callSessionID, errorIndication
 Check: no exception is returned

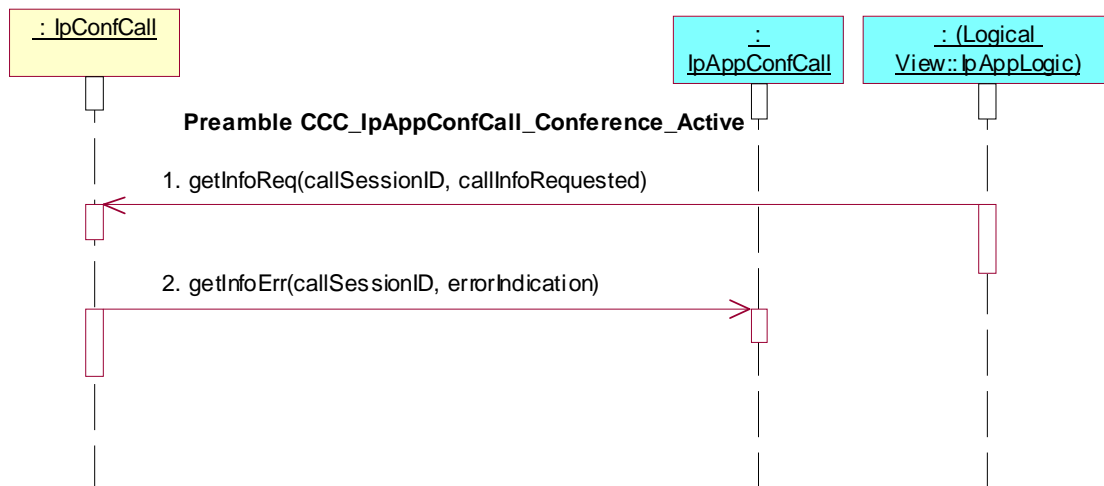

Test CCC_IpAppConfCall_13

Summary: set charge plan for the call

Reference: ES 201 915-4 [1], clauses 7.4.2.1 and 9.3.3

Precondition: IUT capable of invoking **setChargePlan()**

Preamble: **CCC_IpAppConfCall_Conference_Active**

Test Sequence:

1. Triggered Action: cause IUT to call **setChargePlan()** method on the tester's (SCF's) IpConfCall interface.
 Parameters: callSessionID, callChargePlan

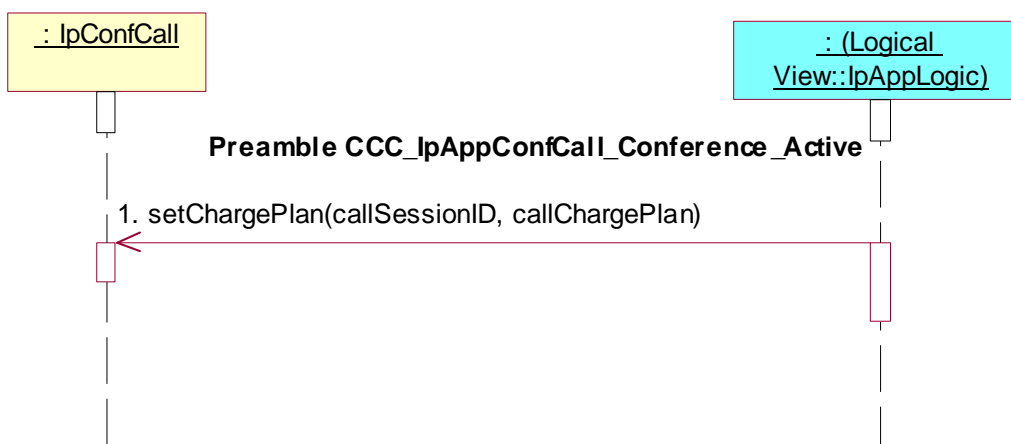

Test CCC_IpAppConfCall_14

Summary: allow advice of charge information

Reference: ES 201 915-4 [1], clauses 7.4.2.1 and 9.3.3

Precondition: IUT capable of invoking **setAdviceOfCharge()**

Preamble: **CCC_IpAppConfCall_Conference_Active**

Test Sequence:

1. Triggered Action: cause IUT to call **setAdviceOfCharge()** method on the tester's (SCF's) IpConfCall interface.
Parameters: callSessionID, aOCInfo, tariffSwitch

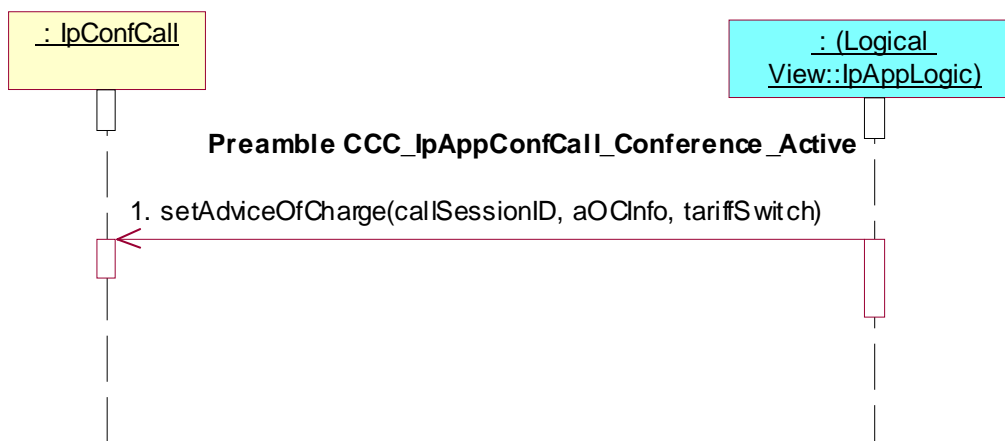
**7.2.4.3 IpAppSubConfCall**

Applications need not be capable of performing each of the sequences below, even if they support the methods indicated below.

Reference: ES 201 915-4 [1], clauses 9.3.5 and 9.3.6

Precondition: IUT capable of invoking **createSubConference()** and **reserveResources()** or **createConference()**

Preamble **CCC_IpAppSubConfCall_Conference_Active**

Reference: ES 201 915-4 [1], clauses 7.3.3, 7.3.5, 9.3.1, 9.3.2 and 9.3.3

Pre-preamble: Registration of the IUT (application) and the tester (Call Control SCF) to the framework. The IUT must have obtained a reference to an instance of the IpConfCallControlManager interface through selecting that service and signing the required service agreement.

The application is permitted to provide its IpAppConferenceCallControlManager interface reference in a setCallback() method which it calls prior to invoking further methods.

Preamble Sequence:

1. Triggered Action: cause IUT to call **reserveResources()** method on the tester's (SCF's) IpConfCallControlManager interface.
Parameters: appInterface, startTime, numberOfParticipants, duration, conferencePolicy

2. Method call **conferenceCreated()**
Parameters: conferenceCall
Check: valid value of IpAppConfCallRef is returned
3. Triggered Action: cause IUT to call **createSubConference()** method on the tester's (SCF's) IpConfCall interface.
Parameters: confrenceSessionID, appSubConference, conferencePolicy

and either

4. Triggered Action: cause IUT to call **createCallLeg()** method on the tester's (SCF's) IpSubConfCall interface.
Parameters: callSessionID, appCallLeg
5. Triggered Action: cause IUT to call **routeReq()** method on the tester's (SCF's) IpMultiMediaCallLeg interface.
Parameters: callSessionID, targetAddress, originatingAddress, appInfo, connectionProperties

or

4. Triggered Action: cause IUT to call **createAndRouteCallLeg()** method on the tester's (SCF's) IpSubConfCall interface.
Parameters: callSessionID, eventsRequested, targetAddress, originatingAddress, appInfo, appCallLegInterface

or

1. Triggered Action: cause IUT to call **createConference()** method on the tester's (SCF's) IpConfCallControlManager interface.
Parameters: appConferenceCall, numberOfSubConferences, conferencePolicy, numberOfParticipants, duration
2. Triggered Action: cause IUT to call **createSubConference()** method on the tester's (SCF's) IpConfCall interface.
Parameters: confrenceSessionID, appSubConference, conferencePolicy

and either

3. Triggered Action: cause IUT to call **createCallLeg()** method on the tester's (SCF's) IpSubConfCall interface.
Parameters: callSessionID, appCallLeg
4. Triggered Action: cause IUT to call **routeReq()** method on the tester's (SCF's) IpMultiMediaCallLeg interface.
Parameters: callSessionID, targetAddress, originatingAddress, appInfo, connectionProperties

or

3. Triggered Action: cause IUT to call **createAndRouteCallLeg()** method on the tester's (SCF's) IpSubConfCall interface.
Parameters: callSessionID, eventsRequested, targetAddress, originatingAddress, appInfo, appCallLegInterface

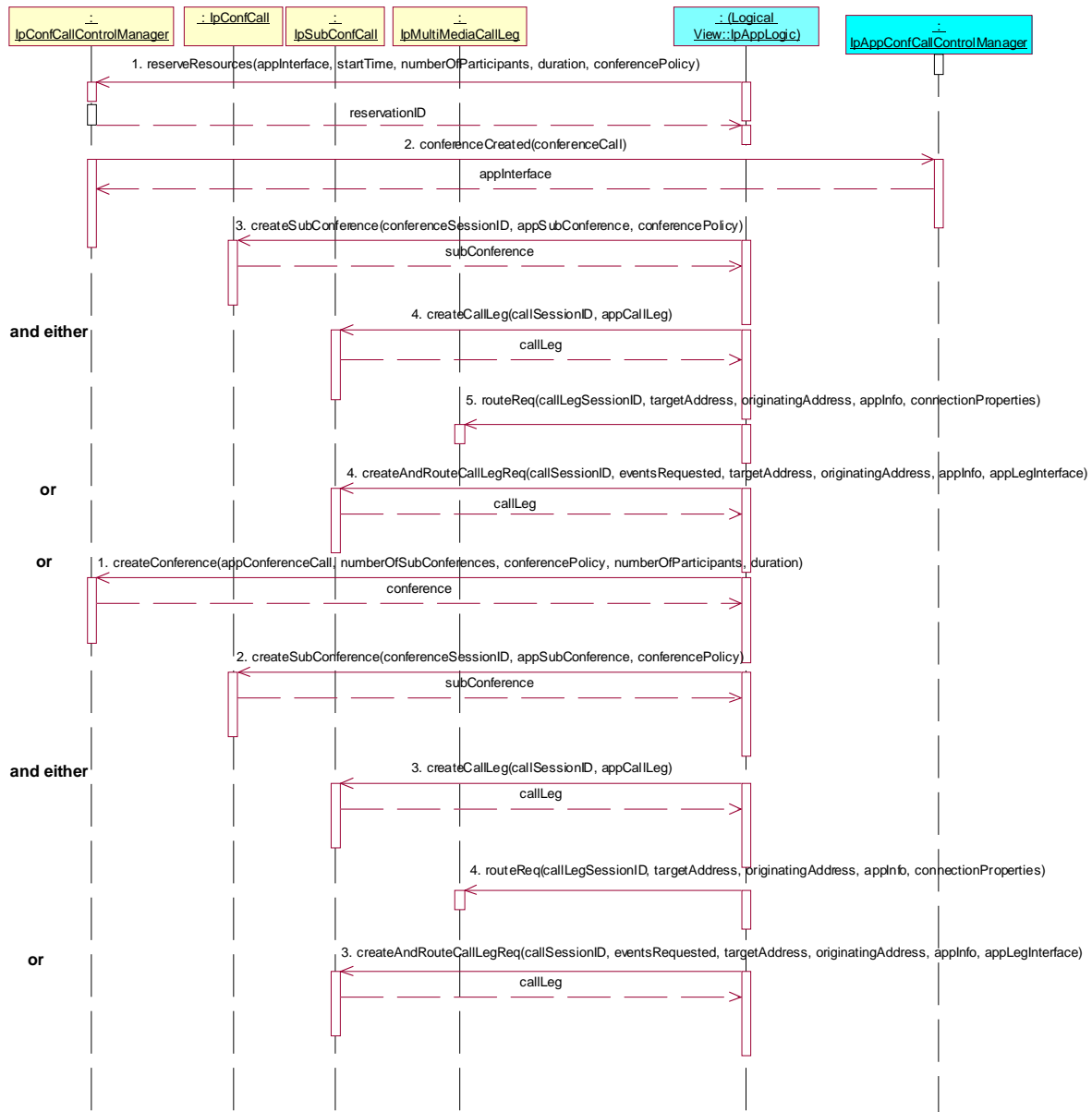

Test CCC_IpAppSubConfCall_01

Summary: split subconference

Reference: ES 201 915-4 [1], clause 9.3.5

Precondition: IUT capable of invoking **splitSubConference()**

Preamble CCC_IpAppSubConfCall_Conference_Active

Test Sequence:

1. Triggered Action: cause IUT to call **splitSubConference()** method on the tester's (SCF's) IpSubConfCall interface.
Parameters: subConferenceSessionID, CallLegList, appSubConferenceCall

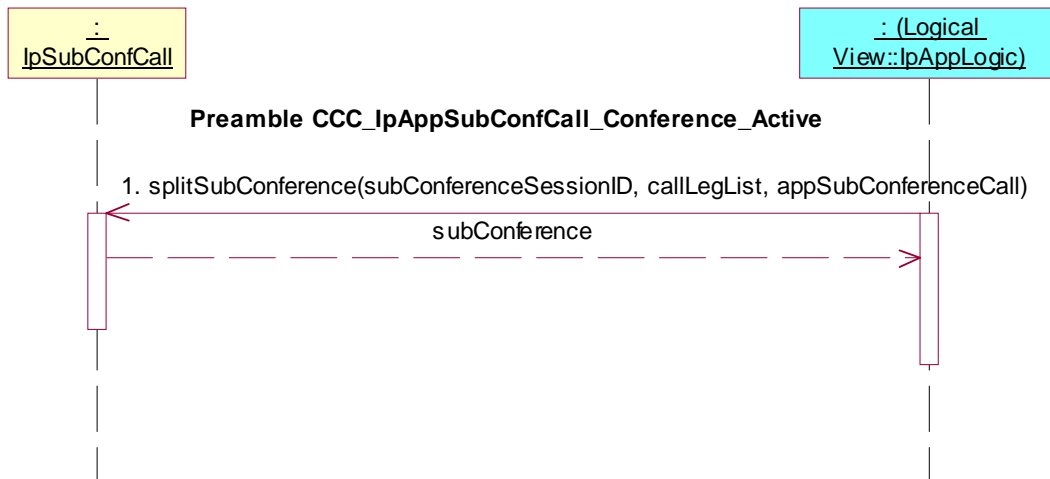

Test CCC_IpAppSubConfCall_02

Summary: merge subconferences

Reference: ES 201 915-4 [1], clause 9.3.5

Precondition: IUT capable of invoking **mergeSubConference()**

Preamble CCC_IpAppSubConfCall_Conference_Active

Test Sequence:

1. Triggered Action: cause IUT to call **mergeSubConference()** method on the tester's (SCF's) IpSubConfCall interface.
Parameters: subConferenceCallSessionID, targetSubConferenceCall

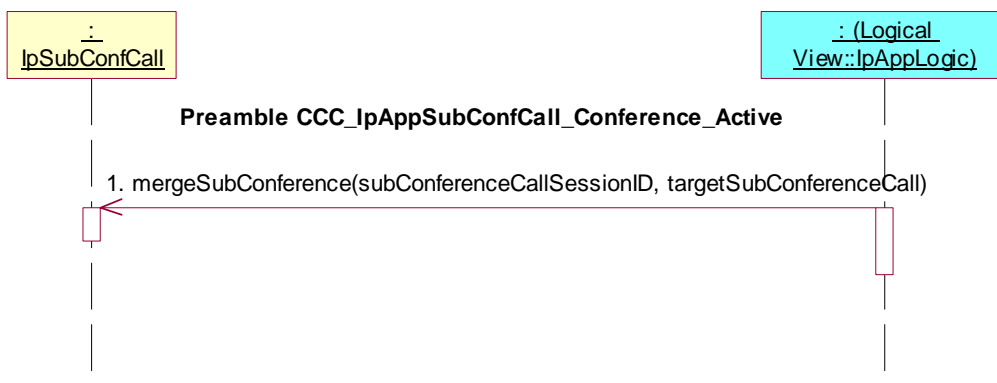

Test CCC_IpAppSubConfCall_03

Summary: move call leg between subconferences

Reference: ES 201 915-4 [1], clause 9.3.5

Precondition: IUT capable of invoking **moveCallLeg()**

Preamble CCC_IpAppSubConfCall_Conference_Active

Test Sequence:

1. Triggered Action: cause IUT to call **moveCallLeg()** method on the tester's (SCF's) IpSubConfCall interface.
Parameters: subConferenceCallSessionID, targetSubConferenceCall, callLeg

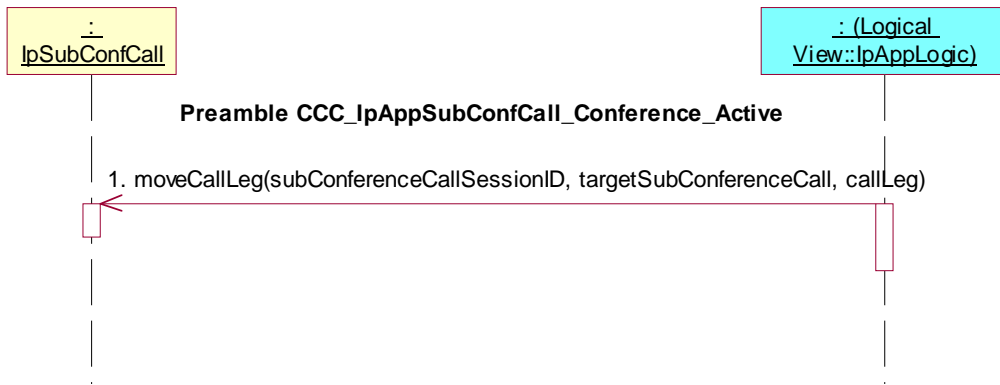

Test CCC_IpAppSubConfCall_04

Summary: change conferences policy

Reference: ES 201 915-4 [1], clause 9.3.5

Precondition: IUT capable of invoking **changeConferencePolicy()**

Preamble CCC_IpAppSubConfCall_Conference_Active

Test Sequence:

1. Triggered Action: cause IUT to call **changeConferencePolicy()** method on the tester's (SCF's) IpSubConfCall interface.
Parameters: subConferenceSessionID, conferencePolicy

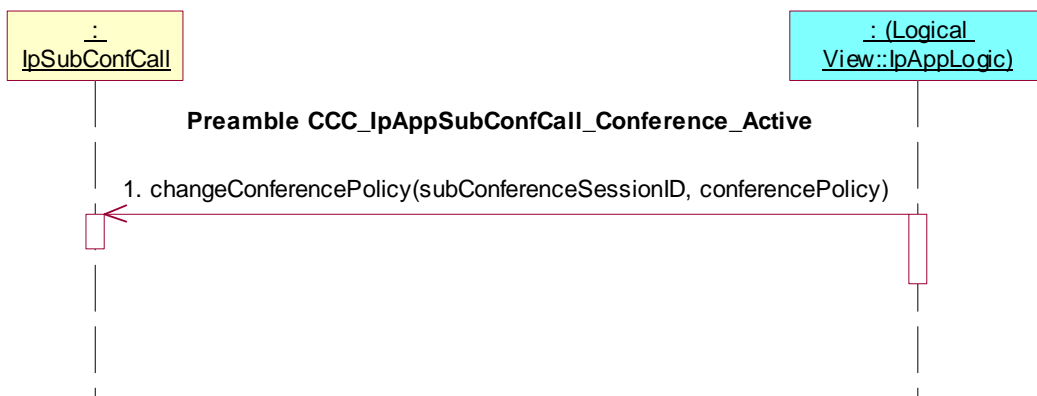

Test CCC_IpAppSubConfCall_05

Summary: appoint speaker on request

Reference: ES 201 915-4 [1], clauses 9.3.5 and 9.3.6

Precondition: IUT capable of invoking **appointSpeaker()**

Preamble CCC_IpAppSubConfCall_Conference_Active

Test Sequence:

1. Method call **floorRequest()**
Parameters: subConferenceSessionID, CallLegSessionID
Check: no exception is returned
2. Triggered Action: cause IUT to call **appointSpeaker()** method on the tester's (SCF's) IpSubConfCall interface.
Parameters: subConferenceSessionID, speakerCallLeg

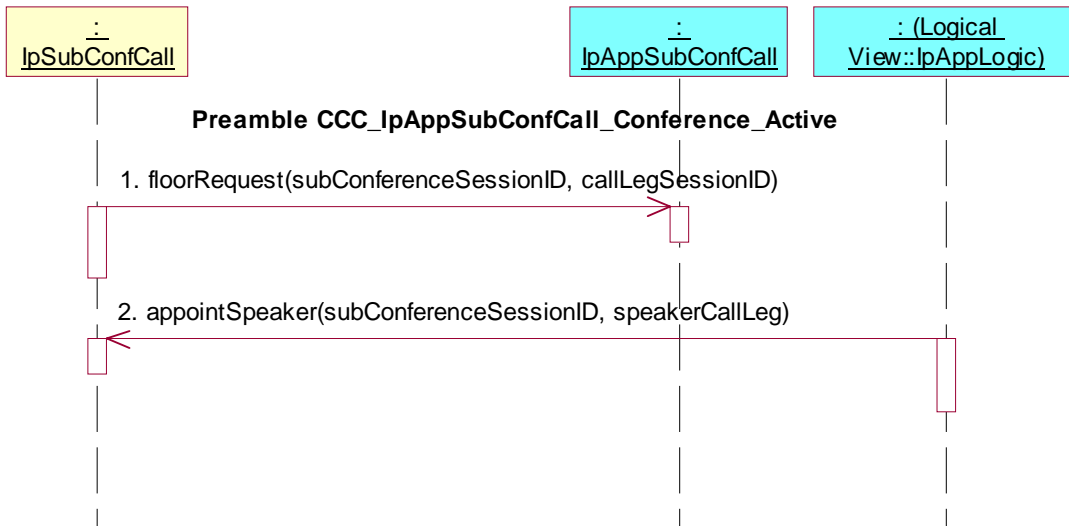

Test CCC_IpAppSubConfCall_06

Summary: select chair on request

Reference: ES 201 915-4 [1], clauses 9.3.5 and 9.3.6

Precondition: IUT capable of invoking **chairSelection()**

Preamble CCC_IpAppSubConfCall_Conference_Active with conferencePolicy = P_CONFERENCE_POLICY_MULTIMEDIA and conferencePolicy.Chaired = TRUE

Test Sequence:

1. Method call **chairSelection()**
 Parameters: subConferenceSessionID, CallLegSessionID
 Check: no exception is returned
2. Triggered Action: cause IUT to call **chairSelection()** method on the tester's (SCF's) IpSubConfCall interface.
 Parameters: subConferenceSessionID, chairCallLeg

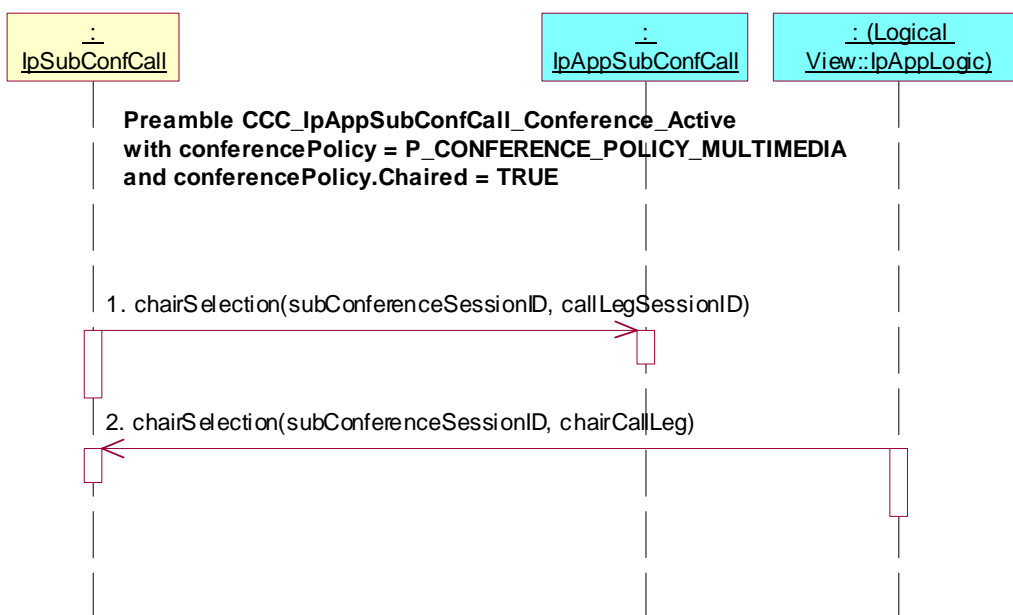

Test CCC_IpAppSubConfCall_07

Summary: select chair on request and inspect video

Reference: ES 201 915-4 [1], clauses 9.3.5 and 9.3.6

Precondition: IUT capable of invoking **chairSelection()**, **inspectVideo()** and **InspectVideoCancel()**

Preamble CCC_IpAppSubConfCall_Conference_Active with conferencePolicy = P_CONFERENCE_POLICY_MULTIMEDIA and conferencePolicy.Chaired = TRUE and conferencePolicy.MediaAllowed = Video

Test Sequence:

1. Method call **chairSelection()**
Parameters: subConferenceSessionID, CallLegSessionID
Check: no exception is returned
2. Triggered Action: cause IUT to call **chairSelection()** method on the tester's (SCF's) IpSubConfCall interface.
Parameters: subConferenceSessionID, chairCallLeg
3. Triggered Action: cause IUT to call **inspectVideo()** method on the tester's (SCF's) IpSubConfCall interface.
Parameters: subConferenceSessionID, inspectedCallLeg
4. Triggered Action: cause IUT to call **InspectVideoCancel()** method on the tester's (SCF's) IpSubConfCall interface.
Parameters: subConferenceSessionID

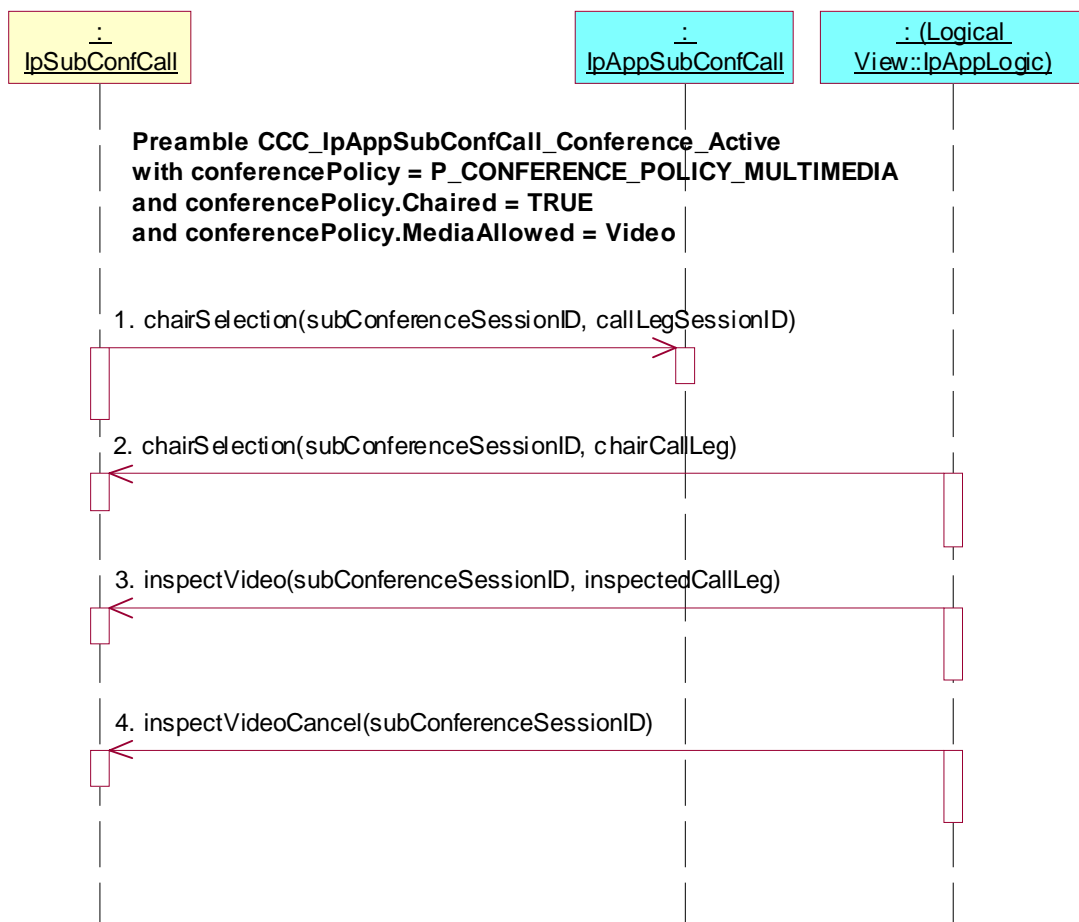

Test CCC_IpAppSubConfCall_08

Summary: release call

Reference: ES 201 915-4 [1], clauses 7.4.2.2 and 9.3.5

Precondition: IUT capable of invoking **release()**

Preamble: **CCC_IpAppSubConfCall_Conference_Active**

Test Sequence:

1. Triggered Action: cause IUT to call **release()** method on the tester's (SCF's) IpConfCall interface.
Parameters: callSessionID, cause

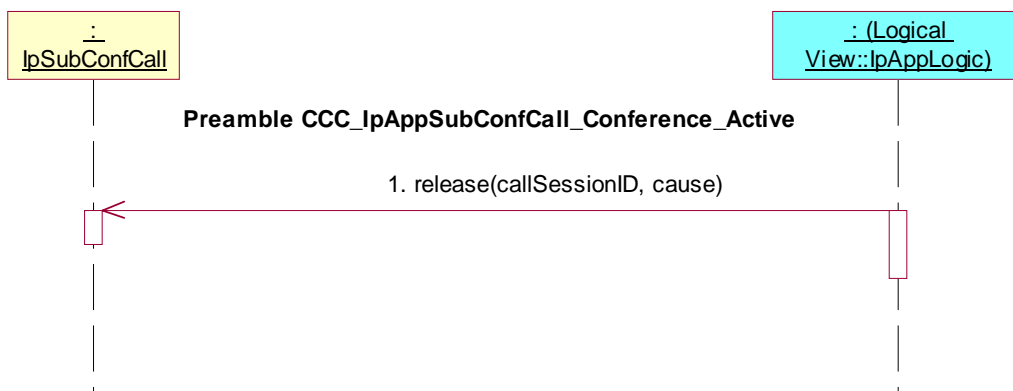
**Test CCC_IpAppSubConfCall_09**

Summary: deassign call

Reference: ES 201 915-4 [1], clauses 7.4.2.2 and 9.3.5

Precondition: IUT capable of invoking **deassignCall()**

Preamble: **CCC_IpAppSubConfCall_Conference_Active**

Test Sequence:

1. Triggered Action: cause IUT to call **deassignCall()** method on the tester's (SCF's) IpConfCall interface.
Parameters: callSessionID

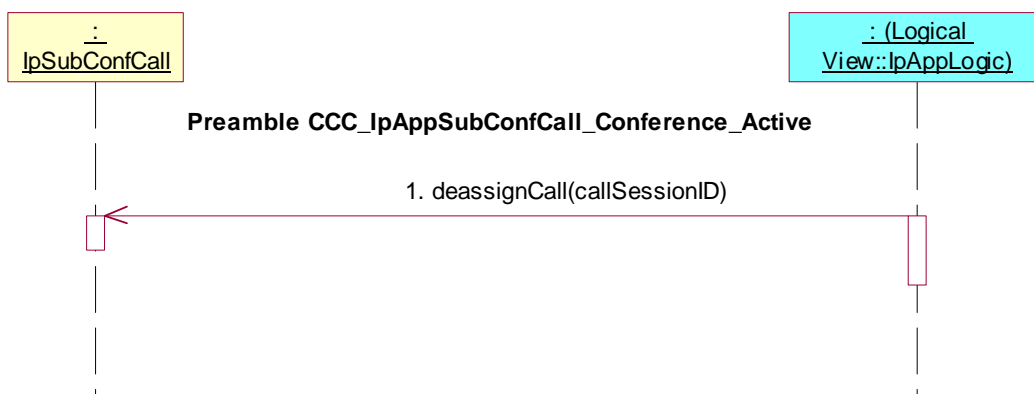

Test CCC_IpAppConfCall_10

Summary: create call leg

Reference: ES 201 915-4 [1], clauses 7.4.2.2 and 9.3.5

Precondition: IUT capable of invoking **createCallLeg()**

Preamble: **CCC_IpAppSubConfCall_Conference_Active**

Test Sequence:

1. Triggered Action: cause IUT to call **createCallLeg()** method on the tester's (SCF's) IpConfCall interface.
Parameters: callSessionID, appCallLeg

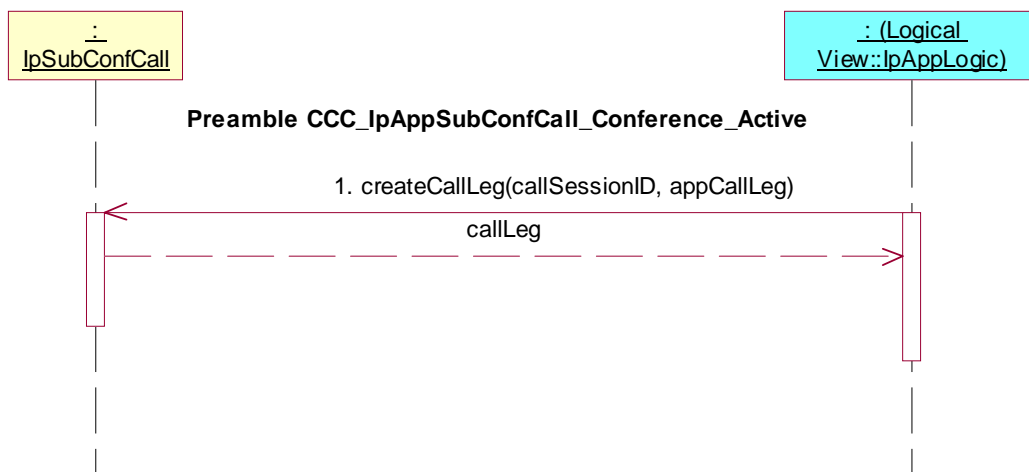
**Test CCC_IpAppSubConfCall_11**

Summary: create and route call

Reference: ES 201 915-4 [1], clauses 7.4.2.2 and 9.3.5

Precondition: IUT capable of invoking **createAndRouteCallLeg()**

Preamble: **CCC_IpAppSubConfCall_Conference_Active**

Test Sequence:

1. Triggered Action: cause IUT to call **createAndRouteCallLeg()** method on the tester's (SCF's) IpSubConfCall interface.
Parameters: callSessionID, eventsRequested, targetAddress, originatingAddress, appInfo, appCallLegInterface

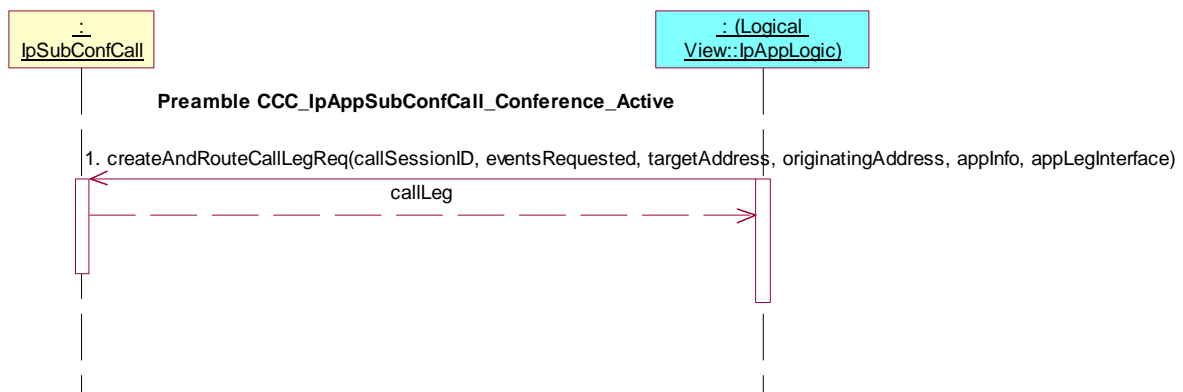

Test CCC_IpAppSubConfCall_12

Summary: request call leg information

Reference: ES 201 915-4 [1], clauses 7.4.2.2 and 9.3.5

Precondition: IUT capable of invoking **getCallLegs()**

Preamble: **CCC_IpAppSubConfCall_Conference_Active**

Test Sequence:

1. Triggered Action: cause IUT to call **getCallLegs()** method on the tester's (SCF's) IpConfCall interface.
Parameters: callSessionID

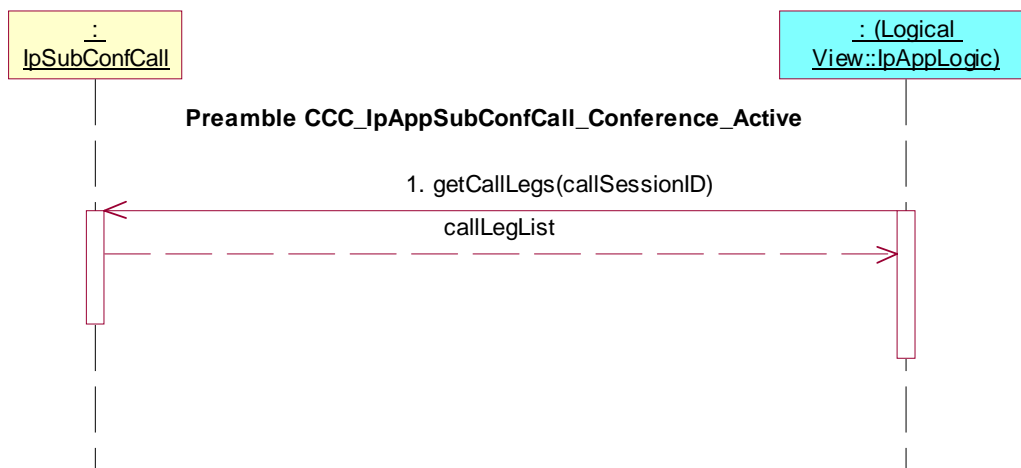
**Test CCC_IpAppSubConfCall_13**

Summary: request call information

Reference: ES 201 915-4 [1], clauses 7.4.2.2 and 9.3.5

Precondition: IUT capable of invoking **getInfoReq()**

Preamble: **CCC_IpAppSubConfCall_Conference_Active**

Test Sequence:

1. Triggered Action: cause IUT to call **getInfoReq()** method on the tester's (SCF's) IpConfCall interface.
Parameters: callSessionID, callInfoRequested

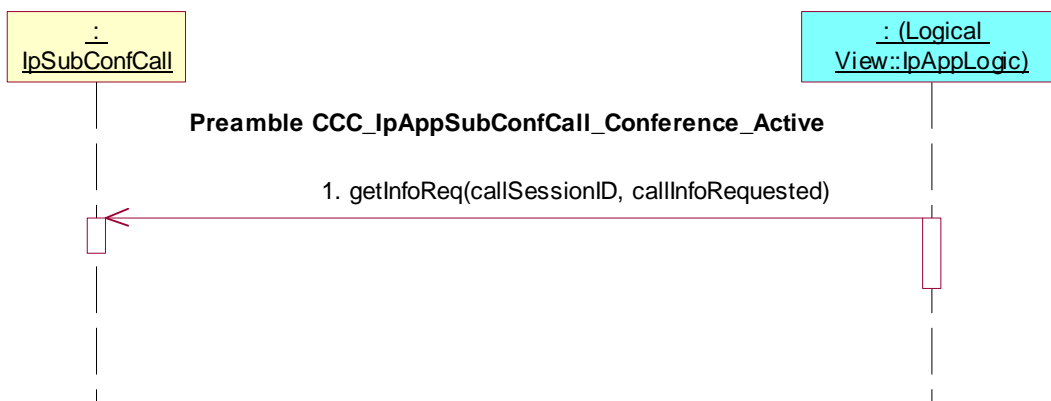

Test CCC_IpAppSubConfCall_14

Summary: request call information, unsuccessful

Reference: ES 201 915-4 [1], clauses 7.4.2.2 and 9.3.5

Precondition: IUT capable of invoking **getInfoReq()**

Preamble: **CCC_IpAppSubConfCall_Conference_Active**

Test Sequence:

1. Triggered Action: cause IUT to call **getInfoReq()** method on the tester's (SCF's) IpConfCall interface.
Parameters: callSessionID, callInfoRequested
2. Method call **getInfoErr()**
Parameters: callSessionID, errorIndication
Check: no exception is returned

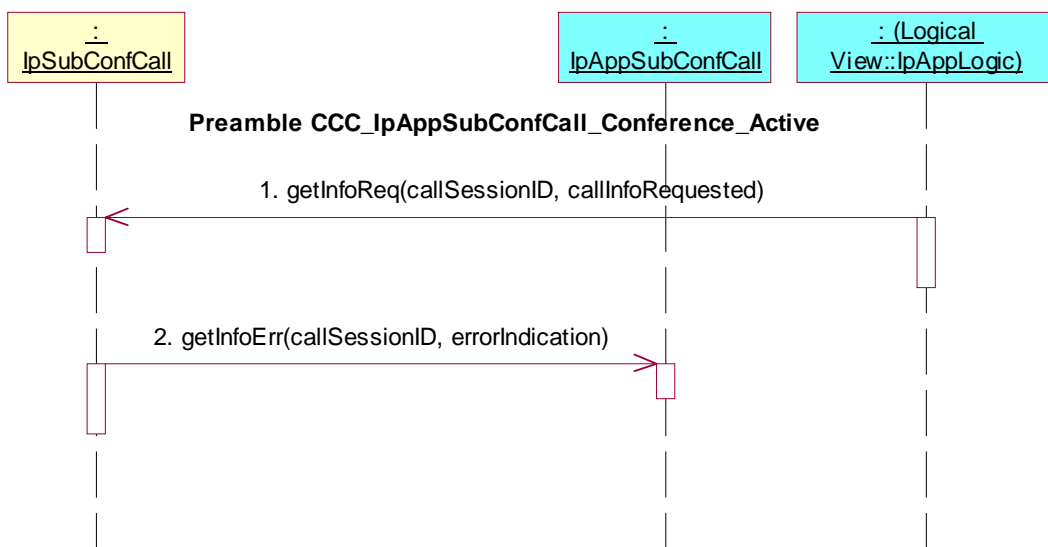
**Test CCC_IpAppSubConfCall_15**

Summary: allow advice of charge information

Reference: ES 201 915-4 [1], clauses 7.4.2.1 and 9.3.5

Precondition: IUT capable of invoking **setAdviceOfCharge()**

Preamble: **CCC_IpAppSubConfCall_Conference_Active**

Test Sequence:

1. Triggered Action: cause IUT to call **setAdviceOfCharge()** method on the tester's (SCF's) IpConfCall interface.
Parameters: callSessionID, aOCInfo, tariffSwitch

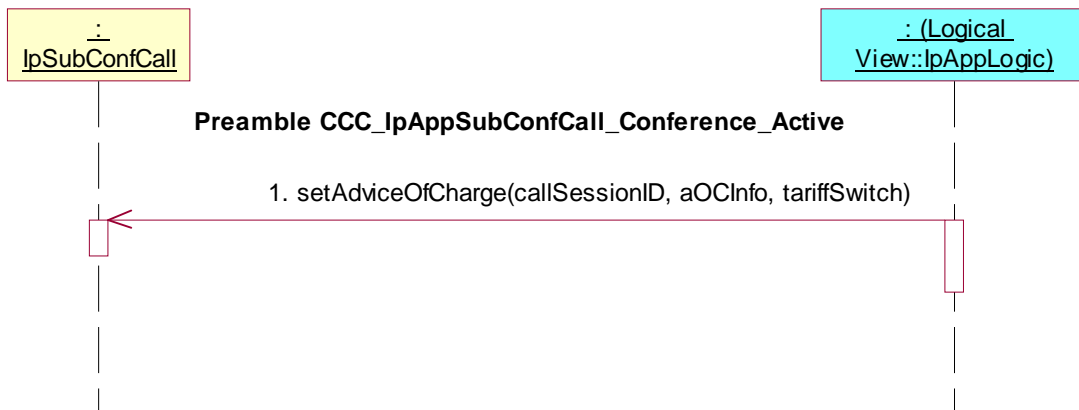

7.2.4.4 IpAppMultiMediaCallLeg

Applications need not be capable of performing each of the sequences below, even if they support the methods indicated below.

Reference: ES 201 915-4 [1], clauses 7.4.3, 8.3.5 and 8.3.6

Precondition: IUT capable of invoking **createSubConference()** and **reserveResources()** or **createConference()**

Test CCC_IpAppMultiMediaCallLeg_01

Summary: attach media, successful

Reference: ES 201 915-4 [1], clause 7.4.3.2

Precondition: IUT capable of invoking **attachMediaReq()**

Preamble: **CCC_IpAppSubConfCall_Conference_Active**

Test Sequence:

1. Triggered Action: cause IUT to call **attachMediaReq()** method on the tester's (SCF's) IpMultiMediaCallLeg interface.
Parameters: callLegSessionID
2. Method call **attachMediaRes()**
Parameters: callLegSessionID
Check: no exception is returned

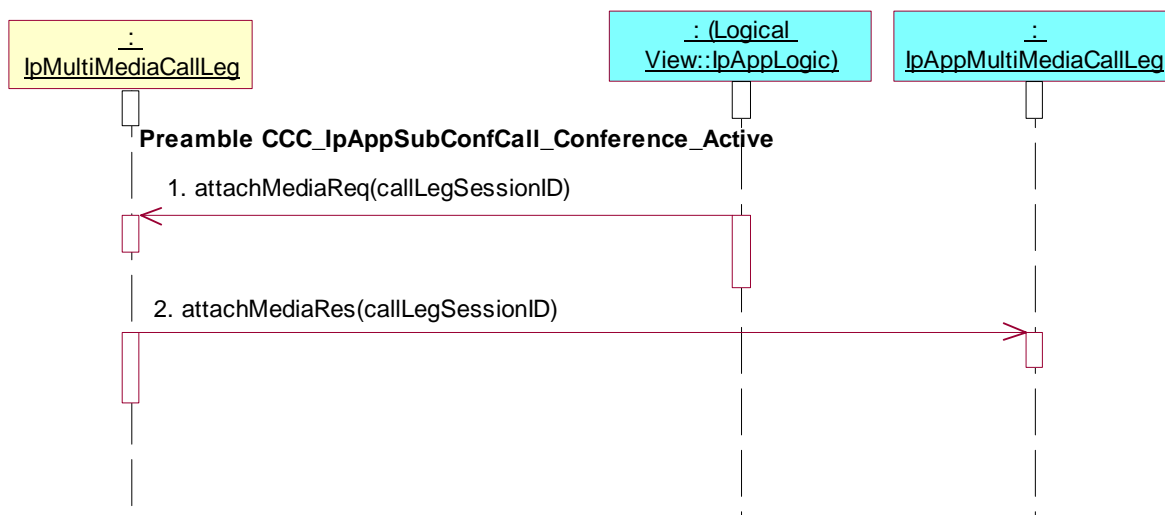

Test CCC_IpAppMultiMediaCallLeg_02

Summary: attach media, unsuccessful

Reference: ES 201 915-4 [1], clause 7.4.3.2

Precondition: IUT capable of invoking **attachMediaReq()**

Preamble: **CCC_IpAppSubConfCall_Conference_Active**

Test Sequence:

1. Triggered Action: cause IUT to call **attachMediaReq()** method on the tester's (SCF's) IpMultiMediaCallLeg interface.
Parameters: callLegSessionID
2. Method call **attachMediaErr()**
Parameters: callLegSessionID, errorIndication
Check: no exception is returned

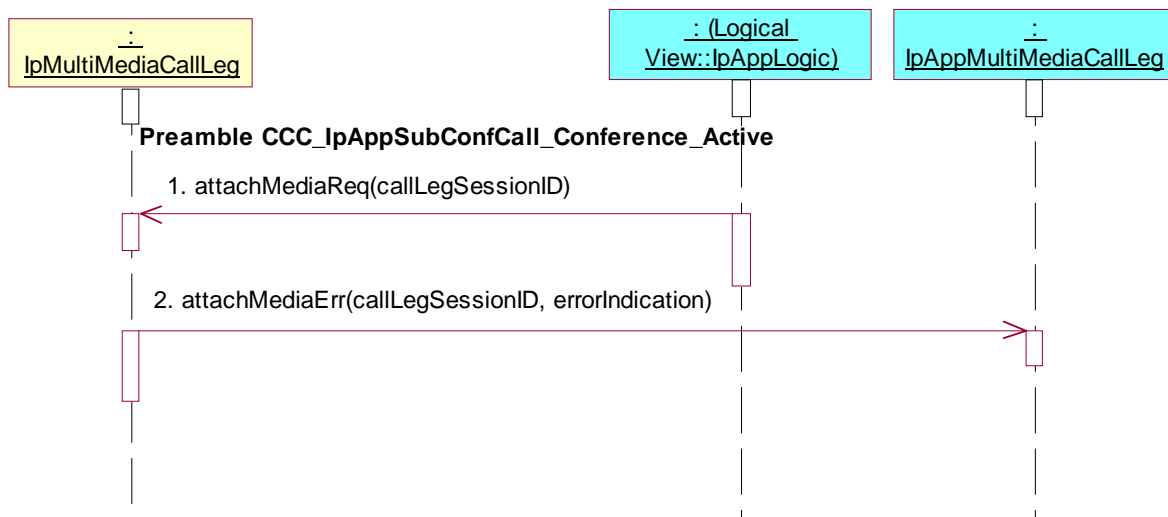
**Test CCC_IpAppMultiMediaCallLeg_03**

Summary: detach media, successful

Reference: ES 201 915-4 [1], clause 7.4.3.2

Precondition: IUT capable of invoking **detachMediaReq()**

Preamble: **CCC_IpAppSubConfCall_Conference_Active**

Test Sequence:

1. Triggered Action: cause IUT to call **attachMediaReq()** method on the tester's (SCF's) IpMultiMediaCallLeg interface.
Parameters: callLegSessionID
2. Method call **attachMediaRes()**
Parameters: callLegSessionID
Check: no exception is returned
3. Triggered Action: cause IUT to call **detachMediaReq()** method on the tester's (SCF's) IpMultiMediaCallLeg interface.
Parameters: callLegSessionID

4. Method call **detachMediaRes()**
 Parameters: callLegSessionID
 Check: no exception is returned

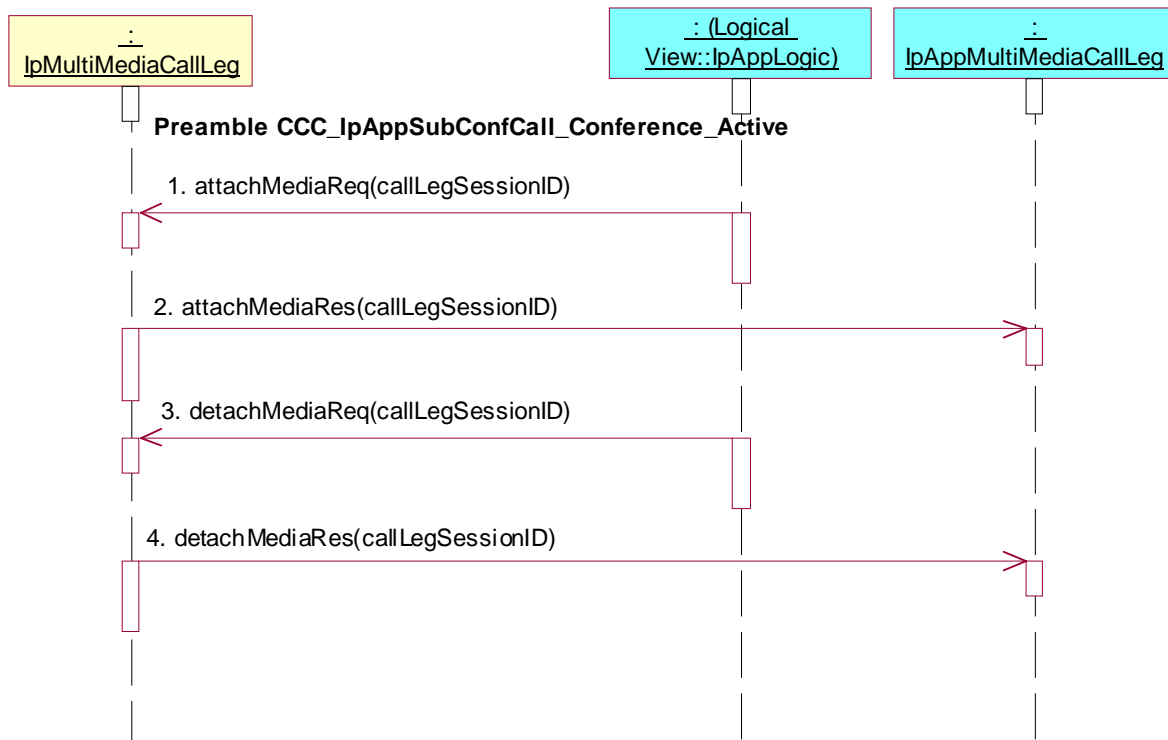

Test CCC_IpAppMultiMediaCallLeg_04

Summary: detach media, unsuccessful

Reference: ES 201 915-4 [1], clause 7.4.3.2

Precondition: IUT capable of invoking **detachMediaReq()**

Preamble: **CCC_IpAppSubConfCall_Conference_Active**

Test Sequence:

1. Triggered Action: cause IUT to call **attachMediaReq()** method on the tester's (SCF's) IpMultiMediaCallLeg interface.
 Parameters: callLegSessionID
2. Method call **attachMediaRes()**
 Parameters: callLegSessionID
 Check: no exception is returned
3. Triggered Action: cause IUT to call **detachMediaReq()** method on the tester's (SCF's) IpMultiMediaCallLeg interface.
 Parameters: callLegSessionID
4. Method call **detachMediaErr()**
 Parameters: callLegSessionID, errorIndication
 Check: no exception is returned

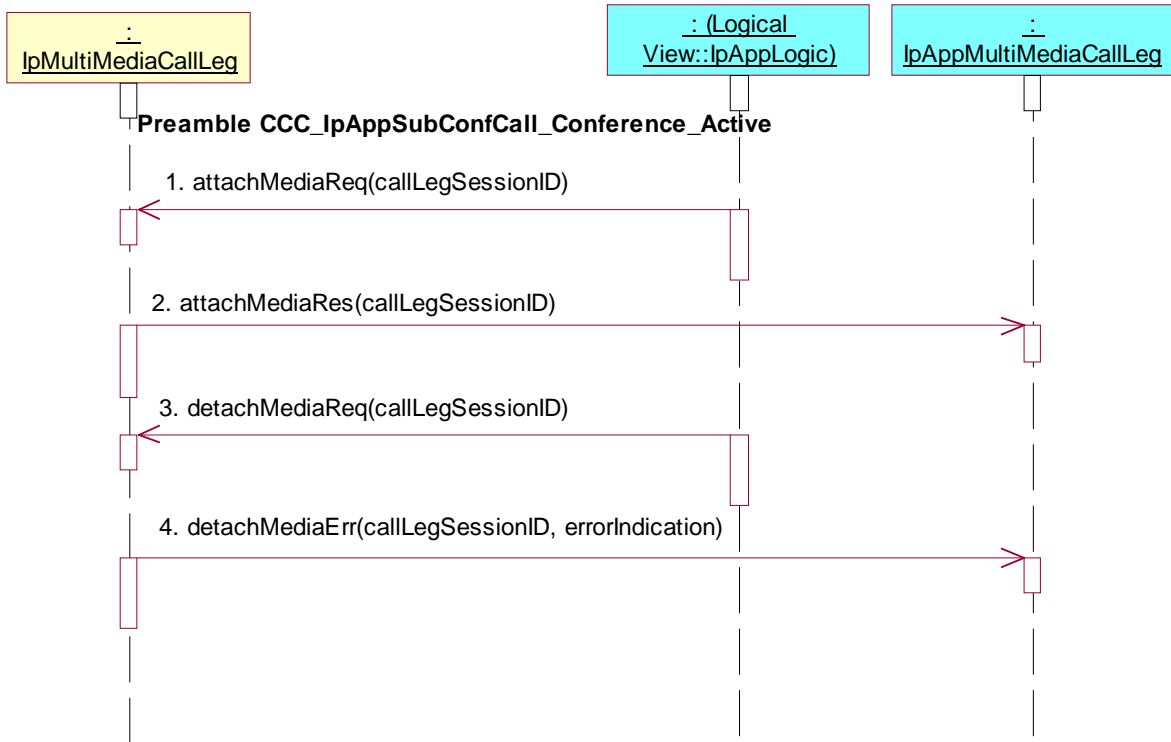

Test CCC_IpAppMultiMediaCallLeg_05

Summary: request reference of call related to call leg

Reference: ES 201 915-4 [1], clause 7.4.3.2

Precondition: IUT capable of invoking **getCall()**

Preamble: **CCC_IpAppSubConfCall_Conference_Active**

Test Sequence:

1. Triggered Action: cause IUT to call **getCall()** method on the tester's (SCF's) IpMultiMediaCallLeg interface.
Parameters: callLegSessionID

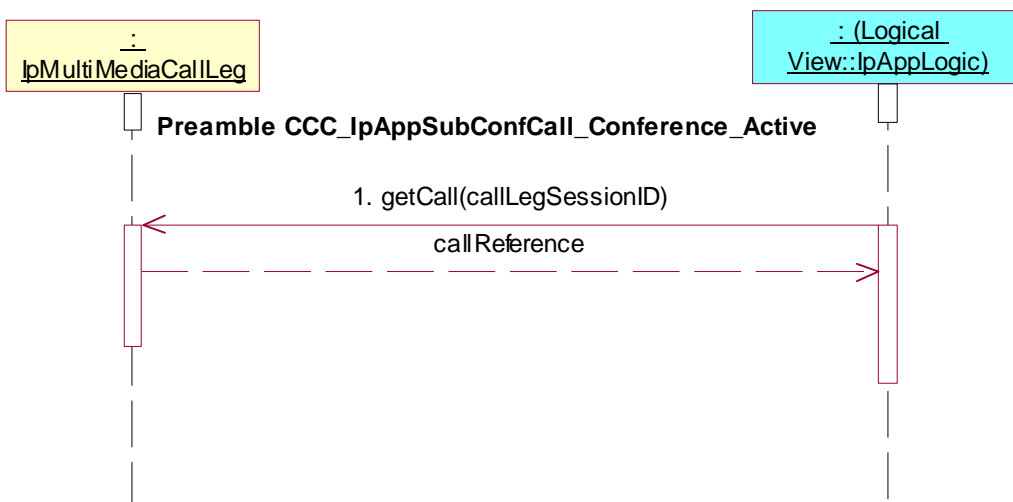

Test CCC_IpAppMultiMediaCallLeg_06

Summary: request reference of call related to call leg

Reference: ES 201 915-4 [1], clause 7.4.3.2

Precondition: IUT capable of invoking **getCurrentDestinationAddress()**

Preamble: **CCC_IpAppSubConfCall_Conference_Active**

Test Sequence:

1. Triggered Action: cause IUT to call **getCurrentDestinationAddress()** method on the tester's (SCF's) IpMultiMediaCallLeg interface.
Parameters: callLegSessionID

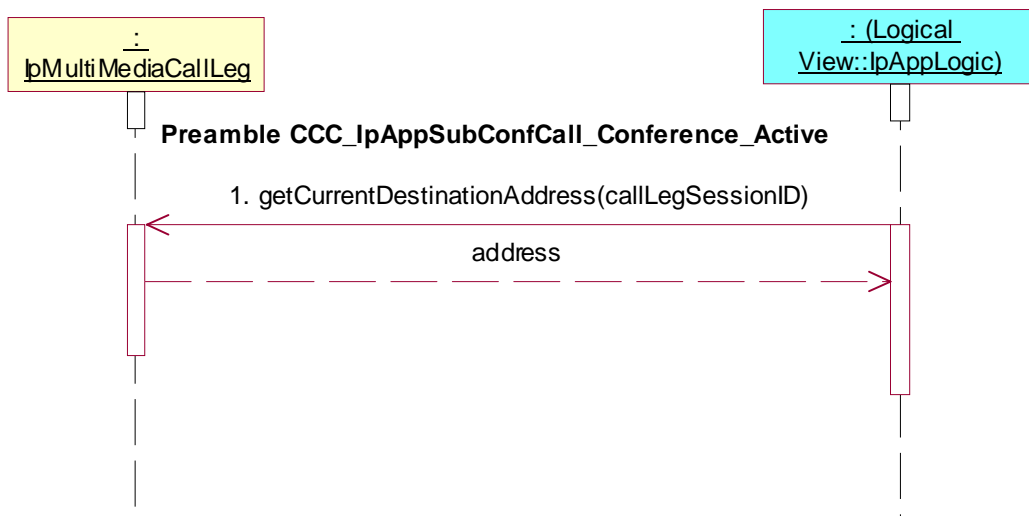
**Test CCC_IpAppMultiMediaCallLeg_07**

Summary: continue processing of call leg

Reference: ES 201 915-4 [1], clause 7.4.3.2

Precondition: IUT capable of invoking **continueProcessing()**

Preamble: **CCC_IpAppSubConfCall_Conference_Active**

Test Sequence:

1. Triggered Action: cause IUT to call **continueProcessing()** method on the tester's (SCF's) IpMultiMediaCallLeg interface.
Parameters: callLegSessionID

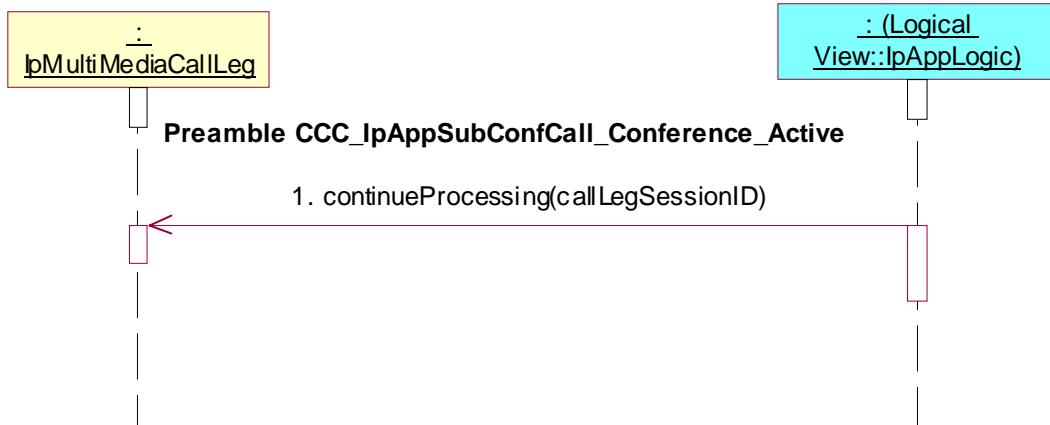

Test CCC_IpAppMultiMediaCallLeg_08

Summary: release call leg

Reference: ES 201 915-4 [1], clause 7.4.3.2

Precondition: IUT capable of invoking **release()**

Preamble: **CCC_IpAppSubConfCall_Conference_Active**

Test Sequence:

1. Triggered Action: cause IUT to call **release()** method on the tester's (SCF's) IpMultiMediaCallLeg interface.
Parameters: callLegSessionID, cause

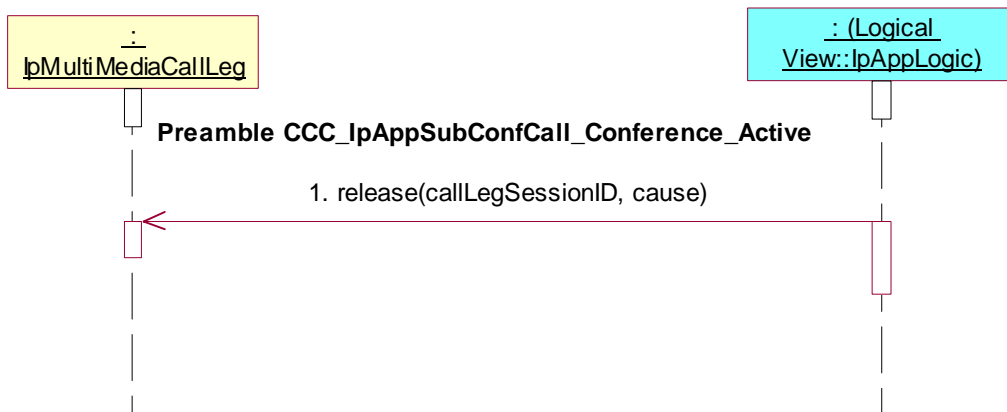

Test CCC_IpAppMultiMediaCallLeg_09

Summary: de-assign call leg

Reference: ES 201 915-4 [1], clause 7.4.3.2

Precondition: IUT capable of invoking **deassign()**

Preamble: **CCC_IpAppSubConfCall_Conference_Active**

Test Sequence:

1. Triggered Action: cause IUT to call **deassign()** method on the tester's (SCF's) IpMultiMediaCallLeg interface.
Parameters: callLegSessionID



Test CCC_IpAppMultiMediaCallLeg_10

Summary: change or clear event criteria, successful

Reference: ES 201 915-4 [1], clause 7.4.3.2

Precondition: IUT capable of invoking **eventReportReq()**

Preamble: **CCC_IpAppSubConfCall_Conference_Active**

Test Sequence:

1. Triggered Action: cause IUT to call **eventReportReq()** method on the tester's (SCF's) IpMultiMediaCallLeg interface.
Parameters: callLegSessionID, eventsRequested
2. Method call **eventReportRes()**
Parameters: callLegSessionID, eventInfo
Check: no exception is returned

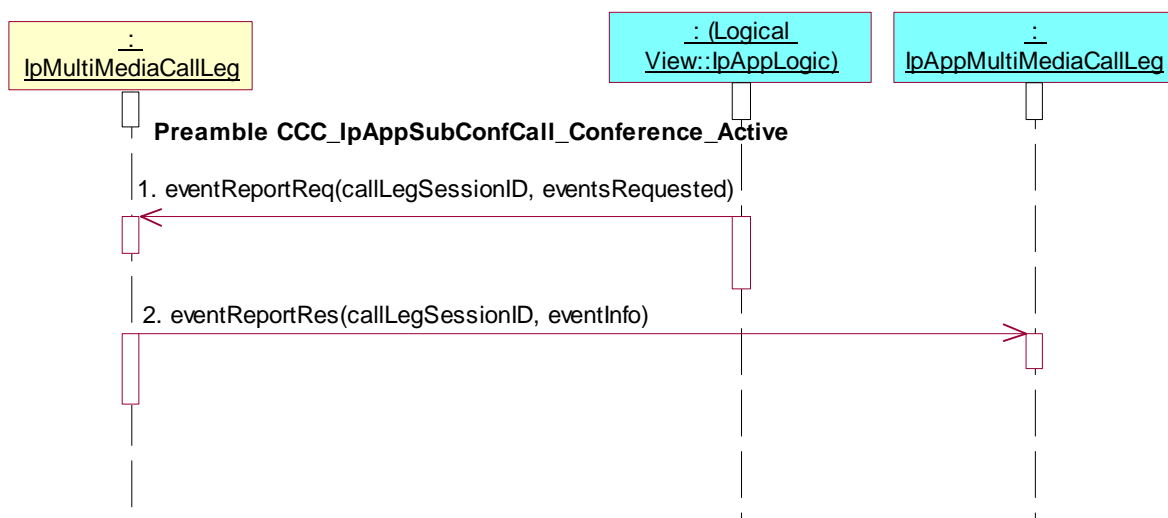

Test CCC_IpAppMultiMediaCallLeg_11

Summary: change or clear event criteria, unsuccessful

Reference: ES 201 915-4 [1], clause 7.4.3.2

Precondition: IUT capable of invoking **eventReportReq()**

Preamble: **CCC_IpAppSubConfCall_Conference_Active**

Test Sequence:

1. Triggered Action: cause IUT to call **eventReportReq()** method on the tester's (SCF's) IpMultiMediaCallLeg interface.
Parameters: callLegSessionID, eventsRequested
2. Method call **eventReportErr()**
Parameters: callLegSessionID, errorIndication
Check: no exception is returned

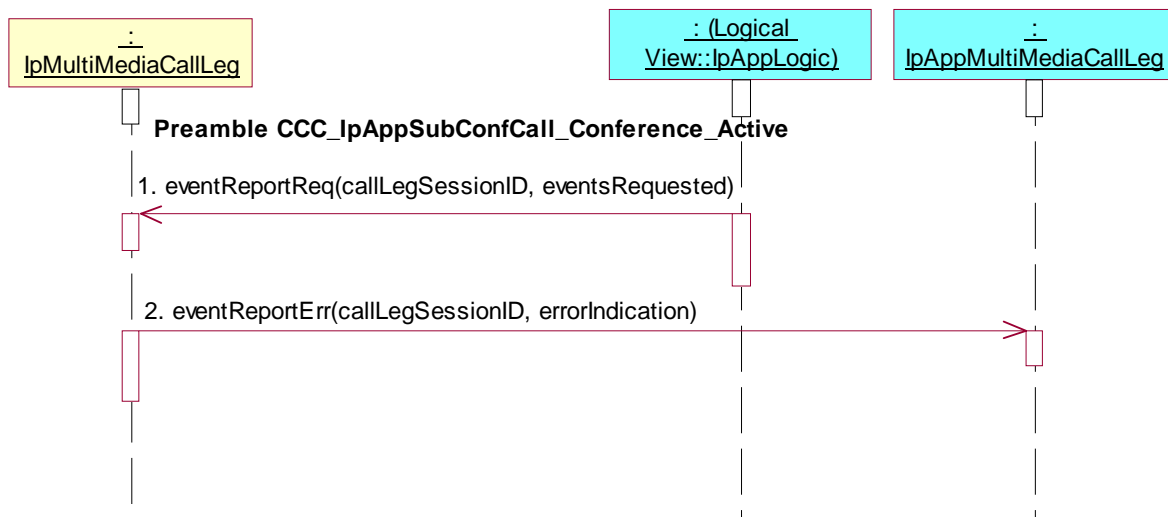
**Test CCC_IpAppMultiMediaCallLeg_12**

Summary: get information about call leg, successful

Reference: ES 201 915-4 [1], clause 7.4.3.2

Precondition: IUT capable of invoking **getInfoReq()**

Preamble: **CCC_IpAppSubConfCall_Conference_Active**

Test Sequence:

1. Triggered Action: cause IUT to call **getInfoReq()** method on the tester's (SCF's) IpMultiMediaCallLeg interface.
Parameters: callLegSessionID, callLegInfoRequested
2. Method call **getInfoRes()**
Parameters: callLegSessionID, callLegInfoReport
Check: no exception is returned

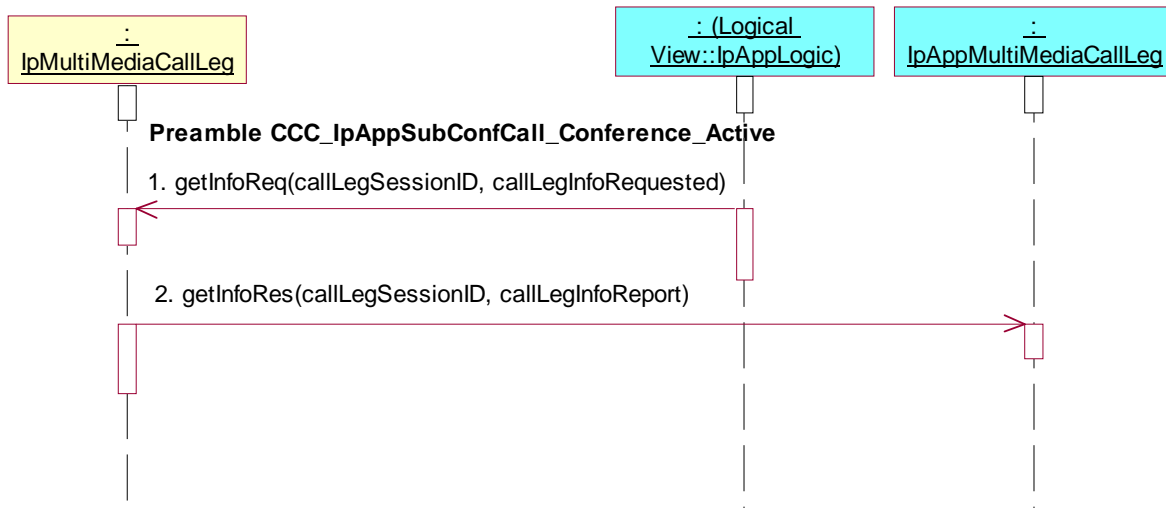

Test CCC_IpAppMultiMediaCallLeg_13

Summary: get information about call leg, unsuccessful

Reference: ES 201 915-4 [1], clause 7.4.3.2

Precondition: IUT capable of invoking **getInfoReq()**

Preamble: **CCC_IpAppSubConfCall_Conference_Active**

Test Sequence:

1. Triggered Action: cause IUT to call **getInfoReq()** method on the tester's (SCF's) IpMultiMediaCallLeg interface.
Parameters: callLegSessionID, callLegInfoRequested
2. Method call **getInfoErr()**
Parameters: callLegSessionID, errorIndication
Check: no exception is returned

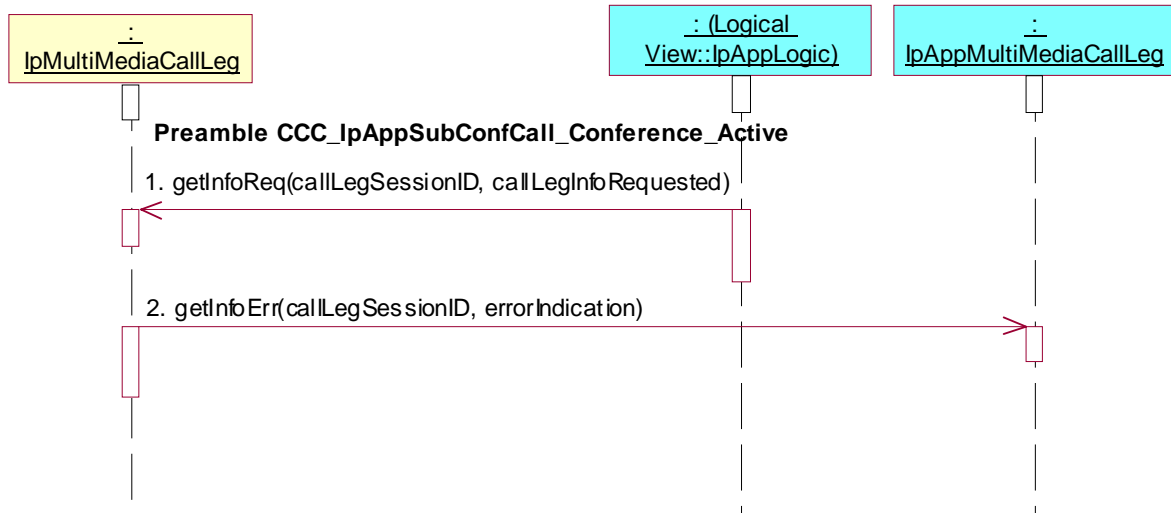

Test CCC_IpAppMultiMediaCallLeg_14

Summary: set charge plan for call leg

Reference: ES 201 915-4 [1], clause 7.4.3.2

Precondition: IUT capable of invoking **setChargePlan()**

Preamble: **CCC_IpAppSubConfCall_Conference_Active**

Test Sequence:

1. Triggered Action: cause IUT to call **setChargePlan()** method on the tester's (SCF's) IpMultiMediaCallLeg interface.
Parameters: callLegSessionID, callChargePlan

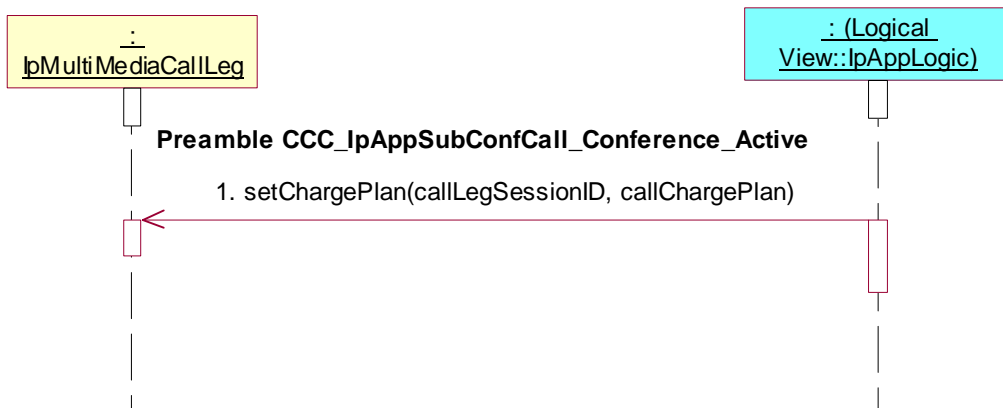

Test CCC_IpAppMultiMediaCallLeg_15

Summary: allow advice of charge information

Reference: ES 201 915-4 [1], clause 7.4.3.2

Precondition: IUT capable of invoking **setAdviceOfCharge()**

Preamble: **CCC_IpAppSubConfCall_Conference_Active**

Test Sequence:

1. Triggered Action: cause IUT to call **setAdviceOfCharge()** method on the tester's (SCF's) IpMultiMediaCallLeg interface.
Parameters: callLegSessionID, aOCInfo, tariffSwitch

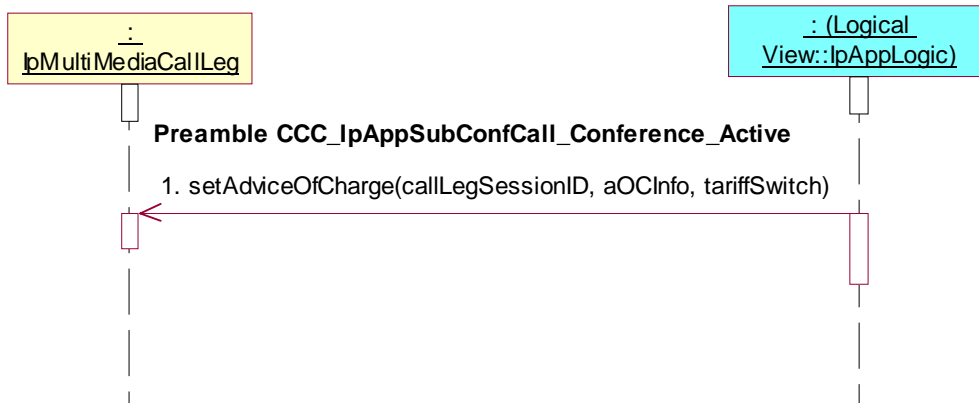

Test CCC_IpAppMultiMediaCallLeg_16

Summary: supervise call leg, successful

Reference: ES 201 915-4 [1], clause 7.4.3.2

Precondition: IUT capable of invoking **superviseReq()**

Preamble: **CCC_IpAppSubConfCall_Conference_Active**

Test Sequence:

1. Triggered Action: cause IUT to call **superviseReq()** method on the tester's (SCF's) IpMultiMediaCallLeg interface.
Parameters: callLegSessionID, time, treatment
2. Method call **superviseRes()**
Parameters: callLegSessionID, report, usedTime
Check: no exception is returned

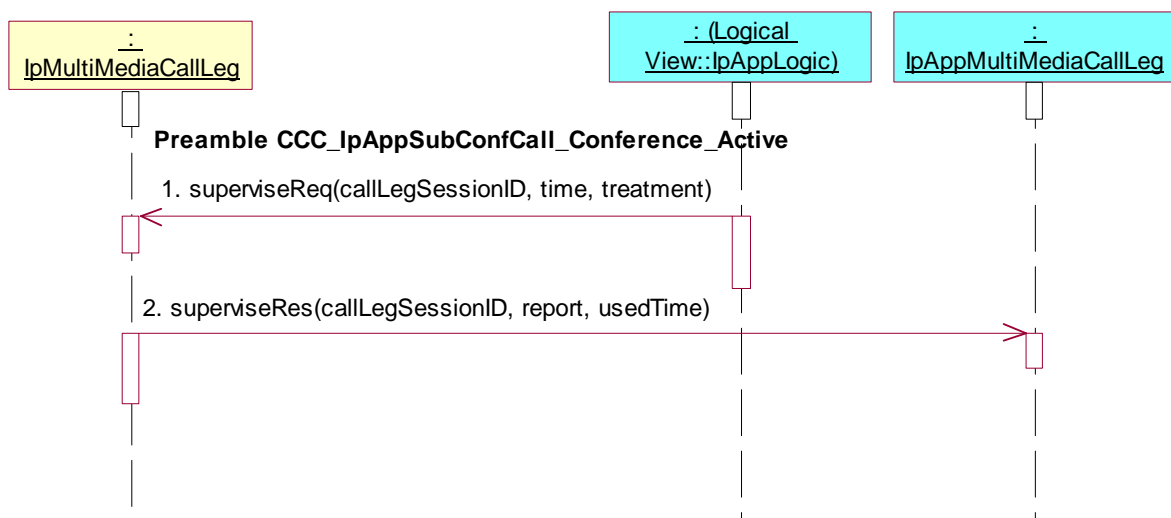

Test CCC_IpAppMultiMediaCallLeg_17

Summary: supervise call leg, unsuccessful

Reference: ES 201 915-4 [1], clause 7.4.3.2

Precondition: IUT capable of invoking **superviseReq()**

Preamble: **CCC_IpAppSubConfCall_Conference_Active**

Test Sequence:

1. Triggered Action: cause IUT to call **superviseReq()** method on the tester's (SCF's) IpMultiMediaCallLeg interface.
Parameters: callLegSessionID, time, treatment
2. Method call **superviseErr()**
Parameters: callLegSessionID, errorIndication
Check: no exception is returned

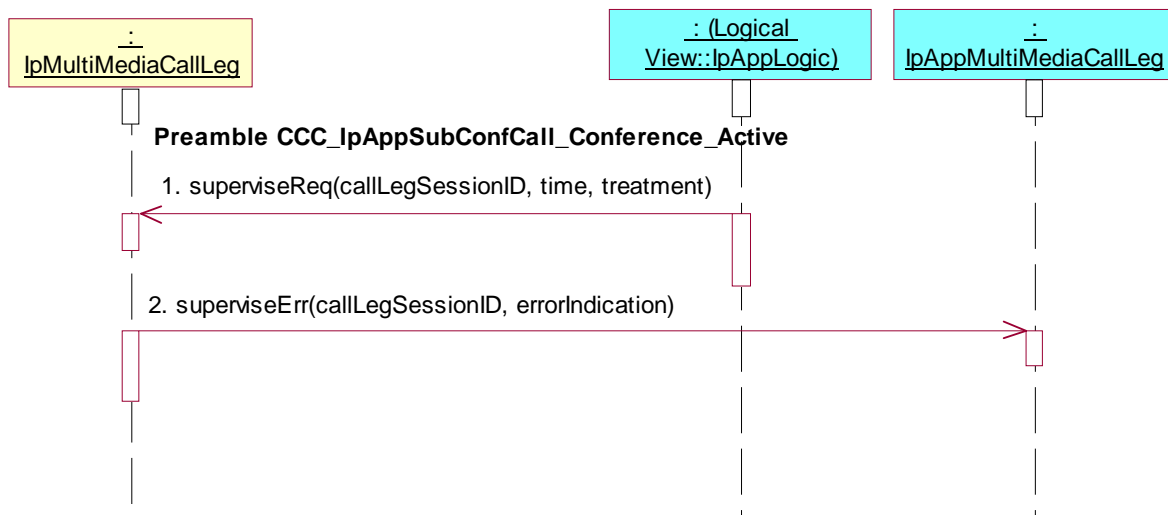
**Test CCC_IpAppMultiMediaCallLeg_18**

Summary: set monitor on media streams

Reference: ES 201 915-4 [1], clauses 7.4.3.2, 8.3.5 and 8.3.6

Precondition: IUT capable of invoking **mediaStreamMonitorReq()**

Preamble: **CCC_IpAppSubConfCall_Conference_Active**

Test Sequence:

1. Triggered Action: cause IUT to call **mediaStreamMonitorReq()** method on the tester's (SCF's) IpMultiMediaCallLeg interface.
Parameters: callLegSessionID, mediaStreamEventCriteria
2. Method call **mediaStreamMonitorRes()**
Parameters: callLegSessionID, streams, type
Check: no exception is returned

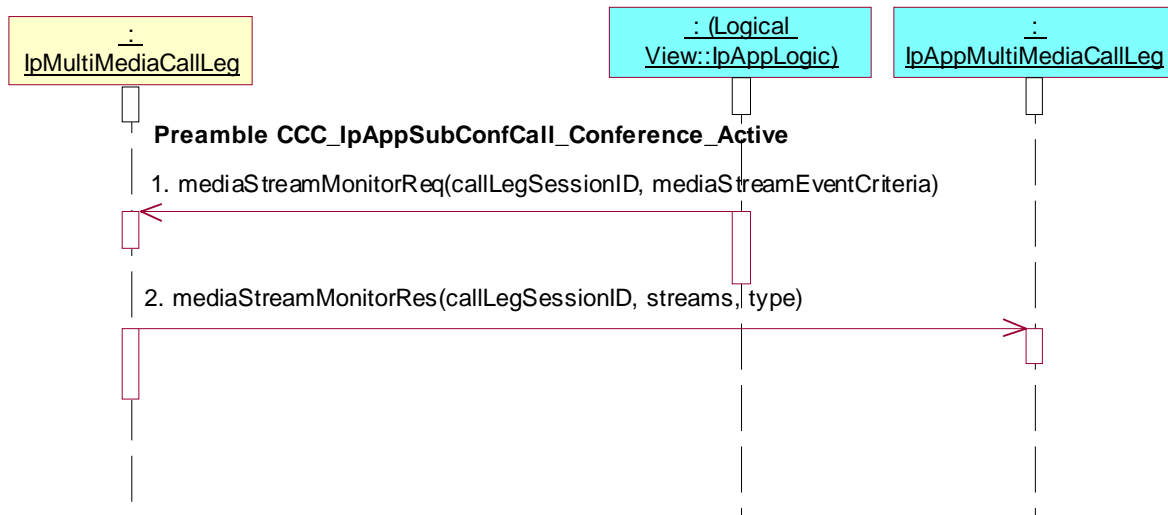

Test CCC_IpAppMultiMediaCallLeg_19

Summary: set monitor on media streams and allow setup

Reference: ES 201 915-4 [1], clauses 7.4.3.2, 8.3.5 and 8.3.6

Precondition: IUT capable of invoking **mediaStreamMonitorReq()** and **mediaStreamAllow()**

Preamble: **CCC_IpAppSubConfCall_Conference_Active**

Test Sequence:

1. Triggered Action: cause IUT to call **mediaStreamMonitorReq()** method on the tester's (SCF's) IpMultiMediaCallLeg interface.
Parameters: callLegSessionID, mediaStreamEventCriteria
mediaStreamEventCriteria.CallMonitorMode= P_CALL_MONITOR_MODE_INTERRUPT
2. Method call **mediaStreamMonitorRes()**
Parameters: callLegSessionID, streams, type
Check: no exception is returned
3. Triggered Action: cause IUT to call **mediaStreamAllow()** method on the tester's (SCF's) IpMultiMediaCallLeg interface.
Parameters: callLegSessionID, mediaStreamList

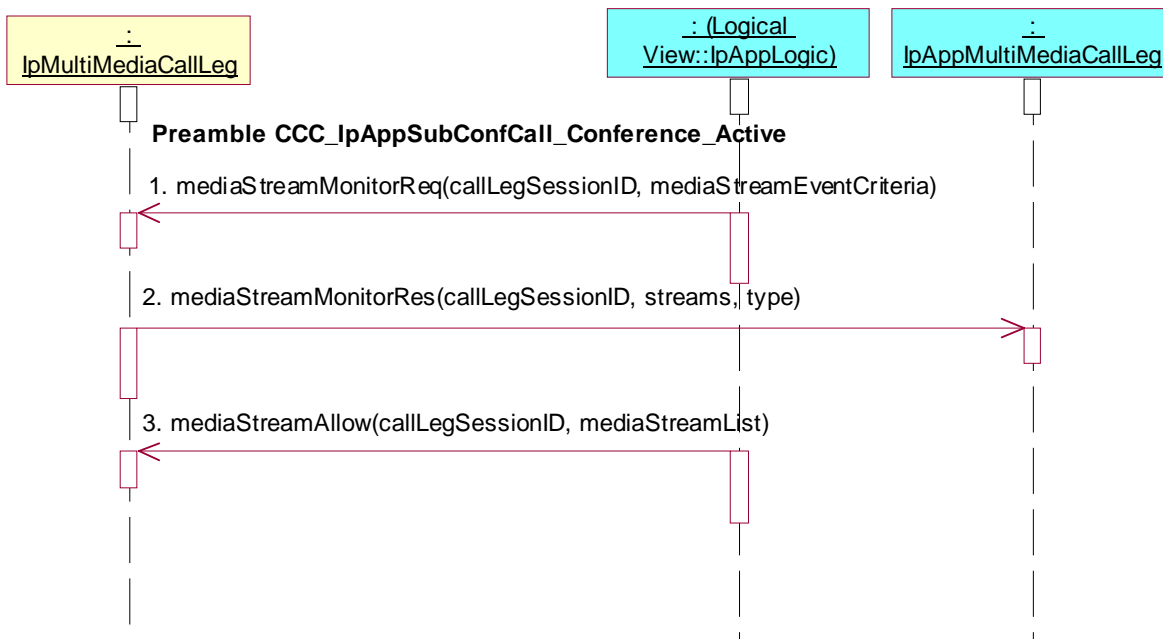

Test CCC_IpAppMultiMediaCallLeg_20

Summary: get media streams

Reference: ES 201 915-4 [1], clauses 7.4.3.2, 8.3.5 and 8.3.6

Precondition: IUT capable of invoking **getMediaStreams()**

Preamble: **CCC_IpAppSubConfCall_Conference_Active**

Test Sequence:

1. Triggered Action: cause IUT to call **getMediaStreams()** method on the tester's (SCF's) IpMultiMediaCallLeg interface.
Parameters: callLegSessionID

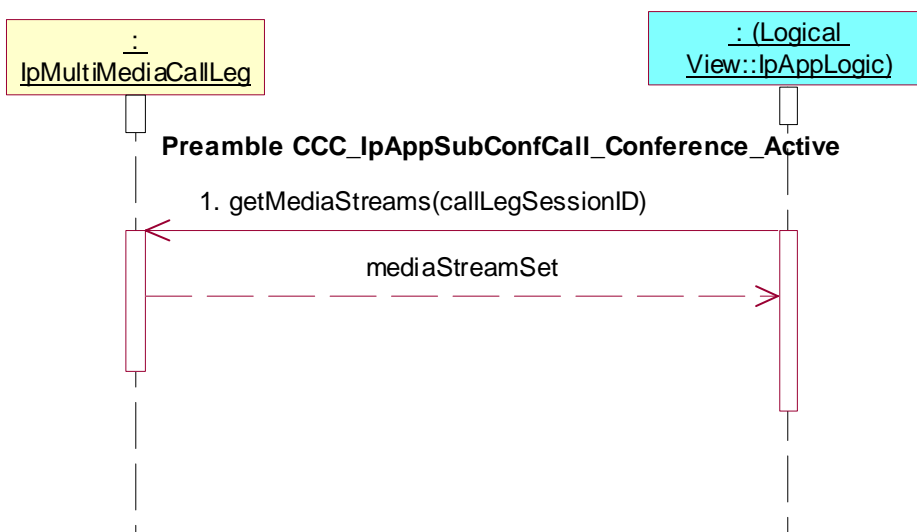

7.2.4.5 IpMultiMediaStream

Test CCC_IpAppMultiMediaStream_01

Summary: substract media stream

Reference: ES 201 915-4 [1], clause 8.3.7

Precondition: IUT capable of invoking **mediaStreamMonitorReq()** and **substract()**

Preamble: **CCC_IpAppSubConfCall_Conference_Active**

Test Sequence:

1. Triggered Action: cause IUT to call **mediaStreamMonitorReq()** method on the tester's (SCF's) IpMultiMediaCallLeg interface.
Parameters: callLegSessionID, mediaStreamEventCriteria
2. Method call **mediaStreamMonitorRes()**
Parameters: callLegSessionID, streams, type
Check: no exception is returned
3. Triggered Action: cause IUT to call **substract()** method on the tester's (SCF's) IpMultiMediaStream interface.
Parameters: mediaStreamSessionID

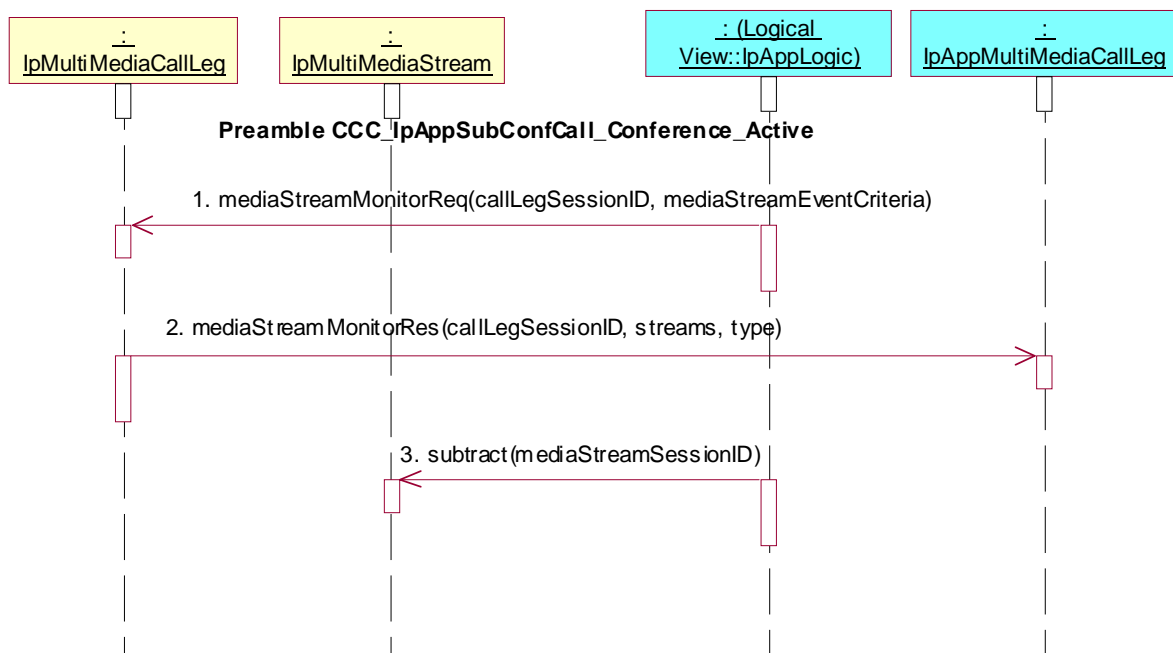

History

Document history		
V1.1.1	August 2003	Publication
V1.2.1	December 2004	Membership Approval Procedure MV 20050211: 2004-12-14 to 2005-02-11