



**Methods for Testing and Specification (MTS);
The Testing and Test Control Notation version 3;
Part 6: TTCN-3 Control Interface (TCI)**

Reference

RES/MTS-201873-6 T3TCI ed491

Keywords

control, interface, methodology, TCI, testing,
TTCN-3

ETSI

650 Route des Lucioles
F-06921 Sophia Antipolis Cedex - FRANCE

Tel.: +33 4 92 94 42 00 Fax: +33 4 93 65 47 16

Siret N° 348 623 562 00017 - NAF 742 C
Association à but non lucratif enregistrée à la
Sous-Préfecture de Grasse (06) N° 7803/88

Important notice

The present document can be downloaded from:
<http://www.etsi.org/standards-search>

The present document may be made available in electronic versions and/or in print. The content of any electronic and/or print versions of the present document shall not be modified without the prior written authorization of ETSI. In case of any existing or perceived difference in contents between such versions and/or in print, the only prevailing document is the print of the Portable Document Format (PDF) version kept on a specific network drive within ETSI Secretariat.

Users of the present document should be aware that the document may be subject to revision or change of status. Information on the current status of this and other ETSI documents is available at
<https://portal.etsi.org/TB/ETSIDeliverableStatus.aspx>

If you find errors in the present document, please send your comment to one of the following services:
<https://portal.etsi.org/People/CommiteeSupportStaff.aspx>

Copyright Notification

No part may be reproduced or utilized in any form or by any means, electronic or mechanical, including photocopying and microfilm except as authorized by written permission of ETSI.

The content of the PDF version shall not be modified without the written authorization of ETSI.
The copyright and the foregoing restriction extend to reproduction in all media.

© European Telecommunications Standards Institute 2017.
All rights reserved.

DECT™, **PLUGTESTS™**, **UMTS™** and the ETSI logo are Trade Marks of ETSI registered for the benefit of its Members.
3GPP™ and **LTE™** are Trade Marks of ETSI registered for the benefit of its Members and of the 3GPP Organizational Partners.
GSM® and the GSM logo are Trade Marks registered and owned by the GSM Association.

Contents

Intellectual Property Rights	16
Foreword.....	16
Modal verbs terminology.....	16
1 Scope	17
2 References	17
2.1 Normative references	17
2.2 Informative references.....	18
3 Definitions and abbreviations.....	18
3.1 Definitions.....	18
3.2 Abbreviations	19
4 Introduction	20
5 Compliance.....	20
6 General structure of a TTCN-3 test system.....	20
6.1 Entities in a TTCN-3 test system.....	20
6.1.0 Types of entities.....	20
6.1.1 Test Management and Control (TMC).....	22
6.1.1.0 Test Management and Control Entities	22
6.1.1.1 Test Management (TM)	22
6.1.1.2 Coding and Decoding (CD)	22
6.1.1.3 Component Handling (CH).....	22
6.1.1.4 Test Logging (TL).....	24
6.1.2 TTCN-3 Executable (TE)	24
6.1.3 SUT Adaptor (SA).....	24
6.1.4 Platform Adaptor (PA).....	24
6.2 Execution requirements for a TTCN-3 test system	24
7 TTCN-3 control interface and operations.....	24
7.1 Overview of the TCI.....	24
7.1.0 TCI role in a TTCN-3 test system.....	24
7.1.1 Correlation between TTCN-3 and TCI operation invocations	25
7.1.1.0 Mapping of TTCN-3 operations to TCI operations.....	25
7.1.1.1 TTCN-3 operations with TCI operation equivalent	25
7.1.1.2 TTCN-3 operations with TCI operation pair equivalent	26
7.1.1.3 TTCN-3 operations without direct TCI operation equivalent	27
7.1.1.3.0 Mapping of TTCN-3 operations to series of TCI operations.....	27
7.1.1.3.1 Test case stop operation.....	27
7.2 TCI data.....	27
7.2.0 Abstract data types.....	27
7.2.1 General abstract data types	27
7.2.1.0 Use of general abstract data types	27
7.2.1.1 Management.....	27
7.2.1.2 Communication	28
7.2.2 Abstract TTCN-3 data types and values	29
7.2.2.0 Definition and scope of use.....	29
7.2.2.1 Abstract TTCN-3 data types	29
7.2.2.2 Abstract TTCN-3 values	31
7.2.2.2.0 Basic rules	31
7.2.2.2.1 The abstract data type Value	32
7.2.2.2.2 The abstract data type IntegerValue	34
7.2.2.2.3 The abstract data type FloatValue	34
7.2.2.2.4 The abstract data type BooleanValue	35
7.2.2.2.5 The abstract data type CharstringValue	35
7.2.2.2.6 The abstract data type UniversalCharstringValue.....	35

7.2.2.2.7	The abstract data type BitstringValue.....	36
7.2.2.2.8	The abstract data type OctetstringValue.....	37
7.2.2.2.9	The abstract data type HexstringValue.....	38
7.2.2.2.10	The abstract data type RecordValue.....	39
7.2.2.2.11	The abstract data type RecordOfValue.....	39
7.2.2.2.12	The abstract data type UnionValue.....	41
7.2.2.2.13	The abstract data type EnumeratedValue.....	41
7.2.2.2.14	The abstract data type VerdictValue.....	41
7.2.2.2.15	The abstract data type AddressValue.....	42
7.2.2.3	Abstract TTCN-3 matching mechanisms.....	42
7.2.2.3.1	The abstract data type MatchingMechanism.....	42
7.2.2.3.2	The abstract data type MatchingList.....	42
7.2.2.3.3	The abstract data type ValueRange.....	43
7.2.2.3.4	The abstract data type CharacterPattern.....	43
7.2.2.3.5	The abstract data type MatchDecodedContent.....	44
7.2.2.4	Data types for complex TTCN-3 properties.....	44
7.2.2.4.0	Scope of use of TTCN-3 properties.....	44
7.2.2.4.1	The abstract data type LengthRestriction.....	44
7.2.2.4.2	The abstract data type Permutation.....	44
7.2.2.4.3	The abstract data type RangeBoundary.....	45
7.2.3	Abstract logging types.....	45
7.2.3.1	The abstract data type TciValueTemplate.....	45
7.2.3.2	The abstract data type TciNonValueTemplate.....	45
7.2.3.3	The Value List and Mismatch Types.....	46
7.2.3.4	The Status Types.....	46
7.3	TCI operations.....	47
7.3.0	The TCI interfaces.....	47
7.3.1	The TCI-TM interface.....	48
7.3.1.0	Scope of use.....	48
7.3.1.1	TCI-TM required.....	48
7.3.1.1.0	Scope of use.....	48
7.3.1.1.1	tciRootModule.....	48
7.3.1.1.2	tciGetImportedModules.....	49
7.3.1.1.3	tciGetModuleParameters.....	49
7.3.1.1.4	tciGetTestCases.....	49
7.3.1.1.5	tciGetTestCaseParameters.....	49
7.3.1.1.6	tciGetTestCaseTSI.....	49
7.3.1.1.7	tciStartTestCase.....	50
7.3.1.1.8	tciStopTestCase.....	50
7.3.1.1.9	tciStartControl.....	50
7.3.1.1.10	tciStopControl.....	50
7.3.1.2	TCI-TM provided.....	51
7.3.1.2.0	Scope of use.....	51
7.3.1.2.1	tciTestCaseStarted.....	51
7.3.1.2.2	tciTestCaseTerminated.....	51
7.3.1.2.3	tciControlTerminated.....	51
7.3.1.2.4	tciGetModulePar.....	51
7.3.1.2.5	tciLog.....	52
7.3.1.2.6	tciError.....	52
7.3.2	The TCI-CD interface.....	52
7.3.2.0	Scope of use.....	52
7.3.2.1	TCI-CD required.....	53
7.3.2.1.0	Scope of use.....	53
7.3.2.1.1	getTypeForName.....	53
7.3.2.1.2	getInteger.....	54
7.3.2.1.3	getFloat.....	54
7.3.2.1.4	getBoolean.....	54
7.3.2.1.5	Void.....	54
7.3.2.1.6	getCharstring.....	54
7.3.2.1.7	getUniversalCharstring.....	54

7.3.2.1.8	getHexstring	54
7.3.2.1.9	getBitstring	54
7.3.2.1.10	getOctetstring	55
7.3.2.1.11	getVerdict	55
7.3.2.1.12	tciErrorReq	55
7.3.2.2	TCI-CD provided	55
7.3.2.2.0	Scope of use	55
7.3.2.2.1	decode	55
7.3.2.2.2	encode	55
7.3.2.2.3	decodeValue	56
7.3.2.2.4	encodeValue	56
7.3.3	The TCI-CH interface	56
7.3.3.0	Scope of use	56
7.3.3.1	TCI-CH required	57
7.3.3.1.0	Scope of use	57
7.3.3.1.1	tciEnqueueMsgConnected	58
7.3.3.1.2	tciEnqueueCallConnected	58
7.3.3.1.3	tciEnqueueReplyConnected	58
7.3.3.1.4	tciEnqueueRaiseConnected	59
7.3.3.1.5	tciCreateTestComponent	59
7.3.3.1.6	tciStartTestComponent	59
7.3.3.1.7	tciStopTestComponent	60
7.3.3.1.8	tciConnect	60
7.3.3.1.9	tciDisconnect	60
7.3.3.1.10	tciMap	60
7.3.3.1.11	tciMapParam	60
7.3.3.1.12	tciUnmap	61
7.3.3.1.13	tciUnmapParam	61
7.3.3.1.14	tciTestComponentTerminated	61
7.3.3.1.15	tciTestComponentRunning	61
7.3.3.1.16	tciTestComponentDone	61
7.3.3.1.17	tciGetMTC	62
7.3.3.1.18	tciExecuteTestCase	62
7.3.3.1.19	tciReset	62
7.3.3.1.20	tciKillTestComponent	62
7.3.3.1.21	tciTestComponentAlive	63
7.3.3.1.22	tciTestComponentKilled	63
7.3.3.2	TCI-CH provided	63
7.3.3.2.0	Scope of use	63
7.3.3.2.1	tciSendConnected	63
7.3.3.2.2	tciSendConnectedBC	63
7.3.3.2.3	tciSendConnectedMC	64
7.3.3.2.4	tciCallConnected	64
7.3.3.2.5	tciCallConnectedBC	64
7.3.3.2.6	tciCallConnectedMC	65
7.3.3.2.7	tciReplyConnected	65
7.3.3.2.8	tciReplyConnectedBC	66
7.3.3.2.9	tciReplyConnectedMC	66
7.3.3.2.10	tciRaiseConnected	67
7.3.3.2.11	tciRaiseConnectedBC	67
7.3.3.2.12	tciRaiseConnectedMC	67
7.3.3.2.13	tciCreateTestComponentReq	68
7.3.3.2.14	tciStartTestComponentReq	68
7.3.3.2.15	tciStopTestComponentReq	68
7.3.3.2.16	tciConnectReq	68
7.3.3.2.17	tciDisconnectReq	69
7.3.3.2.18	tciMapReq	69
7.3.3.2.19	tciMapParamReq	69
7.3.3.2.20	tciUnmapReq	69
7.3.3.2.21	tciUnmapParamReq	70
7.3.3.2.22	tciTestComponentTerminatedReq	70
7.3.3.2.23	tciTestComponentRunningReq	70

7.3.3.2.24	tcitestComponentDoneReq.....	70
7.3.3.2.25	tcitestGetMTCReq.....	70
7.3.3.2.26	tcitestExecuteTestCaseReq.....	71
7.3.3.2.27	tcitestResetReq.....	71
7.3.3.2.28	tcitestKillTestComponentReq.....	71
7.3.3.2.29	tcitestTestComponentAliveReq.....	71
7.3.3.2.30	tcitestTestComponentKilledReq.....	71
7.3.4	The TCI-TL interface.....	72
7.3.4.0	Scope of use.....	72
7.3.4.1	TCI-TL provided.....	72
7.3.4.1.0	Scope of use.....	72
7.3.4.1.1	tliTcExecute.....	72
7.3.4.1.2	tliTcStart.....	73
7.3.4.1.3	tliTcStop.....	73
7.3.4.1.4	tliTcStarted.....	73
7.3.4.1.5	tliTcTerminated.....	74
7.3.4.1.6	tliCtrlStart.....	74
7.3.4.1.7	tliCtrlStop.....	74
7.3.4.1.8	tliCtrlTerminated.....	75
7.3.4.1.9	tliMSend_m.....	75
7.3.4.1.10	tliMSend_m_BC.....	76
7.3.4.1.11	tliMSend_m_MC.....	76
7.3.4.1.12	tliMSend_c.....	77
7.3.4.1.13	tliMSend_c_BC.....	77
7.3.4.1.14	tliMSend_c_MC.....	77
7.3.4.1.15	tliMDetected_m.....	78
7.3.4.1.16	tliMDetected_c.....	78
7.3.4.1.17	tliMMismatch_m.....	78
7.3.4.1.18	tliMMismatch_c.....	79
7.3.4.1.19	tliMReceive_m.....	79
7.3.4.1.20	tliMReceive_c.....	80
7.3.4.1.21	tliPrCall_m.....	80
7.3.4.1.22	tliPrCall_m_BC.....	81
7.3.4.1.23	tliPrCall_m_MC.....	81
7.3.4.1.24	tliPrCall_c.....	82
7.3.4.1.25	tliPrCall_c_BC.....	82
7.3.4.1.26	tliPrCall_c_MC.....	82
7.3.4.1.27	tliPrGetCallDetected_m.....	83
7.3.4.1.28	tliPrGetCallDetected_c.....	83
7.3.4.1.29	tliPrGetCallMismatch_m.....	84
7.3.4.1.30	tliPrGetCallMismatch_c.....	84
7.3.4.1.31	tliPrGetCall_m.....	85
7.3.4.1.32	tliPrGetCall_c.....	85
7.3.4.1.33	tliPrReply_m.....	86
7.3.4.1.34	tliPrReply_m_BC.....	86
7.3.4.1.35	tliPrReply_m_MC.....	87
7.3.4.1.36	tliPrReply_c.....	87
7.3.4.1.37	tliPrReply_c_BC.....	88
7.3.4.1.38	tliPrReply_c_MC.....	88
7.3.4.1.39	tliPrGetReplyDetected_m.....	89
7.3.4.1.40	tliPrGetReplyDetected_c.....	89
7.3.4.1.41	tliPrGetReplyMismatch_m.....	90
7.3.4.1.42	tliPrGetReplyMismatch_c.....	90
7.3.4.1.43	tliPrGetReply_m.....	91
7.3.4.1.44	tliPrGetReply_c.....	91
7.3.4.1.45	tliPrRaise_m.....	92
7.3.4.1.46	tliPrRaise_m_BC.....	92
7.3.4.1.47	tliPrRaise_m_MC.....	93
7.3.4.1.48	tliPrRaise_c.....	93
7.3.4.1.49	tliPrRaise_c_BC.....	94
7.3.4.1.50	tliPrRaise_c_MC.....	94
7.3.4.1.51	tliPrCatchDetected_m.....	95

7.3.4.1.52	tliPrCatchDetected_c	95
7.3.4.1.53	tliPrCatchMismatch_m	96
7.3.4.1.54	tliPrCatchMismatch_c	96
7.3.4.1.55	tliPrCatch_m	97
7.3.4.1.56	tliPrCatch_c	97
7.3.4.1.57	tliPrCatchTimeoutDetected	98
7.3.4.1.58	tliPrCatchTimeout	98
7.3.4.1.59	tliCCreate	98
7.3.4.1.60	tliCStart	99
7.3.4.1.61	tliCRunning	99
7.3.4.1.62	tliCAlive	99
7.3.4.1.63	tliCStop	100
7.3.4.1.64	tliCKill	100
7.3.4.1.65	tliCDoneMismatch	100
7.3.4.1.66	tliCDone	101
7.3.4.1.67	tliCKilledMismatch	101
7.3.4.1.68	tliCKilled	101
7.3.4.1.69	tliCTerminated	102
7.3.4.1.70	tliPConnect	102
7.3.4.1.71	tliPDisconnect	102
7.3.4.1.72	tliPMap	103
7.3.4.1.73	tliPMapParam	103
7.3.4.1.74	tliPUnmap	103
7.3.4.1.75	tliPUnmapParam	104
7.3.4.1.76	tliPClear	104
7.3.4.1.77	tliPStart	104
7.3.4.1.78	tliPStop	105
7.3.4.1.79	tliPHalt	105
7.3.4.1.80	tliEncode	105
7.3.4.1.81	tliDecode	106
7.3.4.1.82	tliTTimeoutDetected	106
7.3.4.1.83	tliTTimeoutMismatch	106
7.3.4.1.84	tliTTimeout	107
7.3.4.1.85	tliTStart	107
7.3.4.1.86	tliTStop	107
7.3.4.1.87	tliTRead	108
7.3.4.1.88	tliTRunning	108
7.3.4.1.89	tliSEnter	108
7.3.4.1.90	tliSLeave	109
7.3.4.1.91	tliVar	109
7.3.4.1.92	tliModulePar	109
7.3.4.1.93	tliGetVerdict	110
7.3.4.1.94	tliSetVerdict	110
7.3.4.1.95	tliLog	110
7.3.4.1.96	tliAEnter	111
7.3.4.1.97	tliALeave	111
7.3.4.1.98	tliANomatch	111
7.3.4.1.99	tliARepeat	111
7.3.4.1.100	tliADefaults	112
7.3.4.1.101	tliAActivate	112
7.3.4.1.102	tliADeactivate	112
7.3.4.1.103	tliAWait	113
7.3.4.1.104	tliAction	113
7.3.4.1.105	tliMatch	113
7.3.4.1.106	tliMatchMismatch	113
7.3.4.1.107	tliInfo	114
7.3.4.1.108	tliMChecked_m	114
7.3.4.1.109	tliMChecked_c	114
7.3.4.1.110	tliPrGetCallChecked_m	115
7.3.4.1.111	tliPrGetCallChecked_c	115
7.3.4.1.112	tliPrGetReplyChecked_m	116
7.3.4.1.113	tliPrGetReplyChecked_c	116

7.3.4.1.114	tliPrCatchChecked_m.....	117
7.3.4.1.115	tliPrCatchChecked_c	117
7.3.4.1.116	tliCheckedAny_m.....	118
7.3.4.1.117	tliCheckedAny_c	118
7.3.4.1.118	tliCheckAnyMismatch_m.....	118
7.3.4.1.119	tliCheckAnyMismatch_c	119
7.3.4.1.120	tliRnd	119
7.3.4.1.121	tliEvaluate.....	119
8	Java™ language mapping.....	120
8.1	Introduction	120
8.2	Names and scopes	120
8.2.1	Names	120
8.2.2	Scopes	120
8.3	Type mapping.....	120
8.3.1	Basic type mapping.....	120
8.3.2	Structured type mapping	121
8.3.2.0	General principles	121
8.3.2.1	TciParameterType	121
8.3.2.2	TciParameterPassingModeType.....	122
8.3.2.3	TciParameterListType	122
8.3.2.4	TciTypeClassType	122
8.3.2.5	TciTestComponentKindType.....	123
8.3.2.6	TciBehaviourIdType	123
8.3.2.7	TciTestCaseIdType	123
8.3.2.8	TciModuleIdType	123
8.3.2.9	TciModuleParameterIdType	123
8.3.2.10	TciModuleParameterListType	124
8.3.2.11	TciModuleParameterType.....	124
8.3.2.12	TciParameterTypeListType.....	124
8.3.2.13	TciParameterTypeType.....	125
8.3.2.14	TciModuleIdListType	125
8.3.2.15	TciTestCaseIdListType	125
8.3.2.16	TciDecodingResult.....	126
8.3.2.17	TciMatchingTypeType.....	126
8.3.2.18	LengthRestriction.....	126
8.3.2.19	Permutation	127
8.3.2.20	RangeBoundary.....	127
8.3.3	Abstract type mapping.....	128
8.3.3.0	General principles	128
8.3.3.1	Type	128
8.3.4	Abstract value mapping	129
8.3.4.0	General principles	129
8.3.4.1	Value	129
8.3.4.2	IntegerValue	130
8.3.4.3	FloatValue	131
8.3.4.4	BooleanValue	131
8.3.4.5	CharstringValue	131
8.3.4.6	BitstringValue	132
8.3.4.7	OctetstringValue	133
8.3.4.8	UniversalCharstringValue	134
8.3.4.9	HexstringValue	134
8.3.4.10	RecordValue.....	135
8.3.4.11	RecordOfValue	135
8.3.4.12	UnionValue	137
8.3.4.13	EnumeratedValue.....	137
8.3.4.14	VerdictValue	138
8.3.4.15	AddressValue	138
8.3.5	Abstract template mapping	138
8.3.5.0	General principles	138
8.3.5.1	MatchingMechanism.....	138
8.3.5.2	MatchingList	139

8.3.5.3	ValueRange	139
8.3.5.4	CharacterPattern	139
8.3.5.5	MatchDecodedContent	140
8.3.6	Abstract logging types mapping	140
8.3.6.0	General principles	140
8.3.6.1	TciValueTemplate	140
8.3.6.2	TciNonValueTemplate	140
8.3.6.3	TciValueList	141
8.3.6.4	TciValueDifference	141
8.3.6.5	TciValueDifferenceList	141
8.3.6.6	ComponentStatus	142
8.3.6.7	TimerStatus	142
8.3.6.8	TciStatus	142
8.4	Constants	142
8.5	Mapping of interfaces	144
8.5.0	Calling rules	144
8.5.1	The TCI-TM interface	144
8.5.1.1	TCI-TM provided	144
8.5.1.2	TCI-TM required	145
8.5.2	The TCI-CD interface	145
8.5.2.1	TCI-CD provided	145
8.5.2.2	TCI-CD required	145
8.5.3	The TCI-CH interface	145
8.5.3.1	TCI-CH provided	145
8.5.3.2	TCI-CH required	147
8.5.4	The TCI-TL interface	148
8.5.4.1	TCI-TL provided	148
8.6	Optional parameters	152
8.7	TCI initialization	152
8.8	Error handling	152
9	ANSI C language mapping	153
9.1	Introduction	153
9.2	Value interfaces	153
9.3	Logging interface	159
9.4	Operation interfaces	159
9.4.1	The TCI-TM interface	159
9.4.1.1	TCI-TM provided	159
9.4.1.2	TCI-TM required	160
9.4.2	The TCI-CD interface	160
9.4.2.1	TCI-CD provided	160
9.4.2.2	TCI-CD required	160
9.4.3	The TCI-CH interface	160
9.4.3.1	TCI-CH provided	160
9.4.3.2	TCI-CH required	161
9.4.4	The TCI-TL interface	162
9.4.4.1	TCI-TL provided	162
9.5	Data	167
9.6	Miscellaneous	168
9.7	Optional parameters	169
10	C++ language mapping	169
10.1	Introduction	169
10.2	Names and scopes	169
10.3	Memory management	170
10.4	Error handling	170
10.5	Type mapping	170
10.5.0	Basic concepts	170
10.5.1	Encapsulated C++ types	170
10.5.2	General abstract data types	170
10.5.2.1	TciBehaviourId	170
10.5.2.2	TciModuleId	171

10.5.2.3	TciModuleParameterId	171
10.5.2.4	TciTestCaseId	171
10.5.2.5	TciModuleIdList	172
10.5.2.6	TciModuleParameter	172
10.5.2.7	TciModuleParameterList	173
10.5.2.8	TciParameterPassingMode	173
10.5.2.9	TciParameter	174
10.5.2.10	TciParameterList	174
10.5.2.11	TciParameterType	175
10.5.2.12	TciParameterTypeList	175
10.5.2.13	TciTestComponentKind	176
10.5.2.14	TciTypeClass	176
10.5.2.15	TciTestCaseIdList	176
10.5.2.16	TciMatchingTypeType	177
10.5.2.17	LengthRestriction	177
10.5.2.18	Permutation	178
10.5.2.19	RangeBoundary	178
10.5.3	Abstract TTCN-3 data types and values	179
10.5.3.1	TciType	179
10.5.3.2	TciValue	180
10.5.3.3	IntegerValue	181
10.5.3.4	FloatValue	182
10.5.3.5	BooleanValue	182
10.5.3.6	CharstringValue	183
10.5.3.7	UniversalCharstringValue	183
10.5.3.8	BitstringValue	184
10.5.3.9	OctetstringValue	184
10.5.3.10	HexstringValue	185
10.5.3.11	RecordValue	186
10.5.3.12	RecordOfValue	186
10.5.3.13	UnionValue	187
10.5.3.14	EnumeratedValue	188
10.5.3.15	VerdictValue	188
10.5.3.16	VerdictValueEnum	189
10.5.3.17	AddressValue	189
10.5.3.18	MatchingMechanism	189
10.5.3.19	MatchingList	190
10.5.3.20	ValueRange	190
10.5.3.21	CharacterPattern	191
10.5.3.22	MatchDecodedContent	191
10.5.4	Abstract logging types	192
10.5.4.1	TciValueTemplate	192
10.5.4.2	TciNonValueTemplate	192
10.5.4.3	TciValueList	193
10.5.4.4	TciValueDifference	193
10.5.4.5	TciValueDifferenceList	194
10.5.4.6	ComponentStatus	194
10.5.4.7	TimerStatus	194
10.5.4.8	TciStatus	195
10.6	Operations mapping	195
10.6.1	TCI-TM	195
10.6.1.1	TciTmRequired	195
10.6.1.2	TciTmProvided	195
10.6.2	TCI-CD	196
10.6.2.1	TciCdRequired	196
10.6.2.2	TciCdProvided	196
10.6.3	TCI-CH	197
10.6.3.1	TciChRequired	197
10.6.3.2	TciChProvided	198
10.6.4	TCI-TL	200
10.6.4.1	TciTIProvided	200

11	W3C XML mapping.....	208
11.1	Introduction	208
11.2	Scopes	208
11.3	Type mapping.....	208
11.3.1	Mapping of simple types.....	208
11.3.1.1	TBoolean.....	208
11.3.1.2	TString	208
11.3.1.3	TInteger	209
11.3.1.4	TriTimerDurationType.....	209
11.3.1.5	TciParameterPassingModeType.....	209
11.3.1.6	TriStatusType.....	209
11.3.1.7	TciStatusType	209
11.3.1.8	ComponentStatusType	209
11.3.1.9	TimerStatusType	209
11.3.1.10	PortStatusType	209
11.3.2	Complex type mapping	209
11.3.2.1	TriPortIdType.....	209
11.3.2.2	TriComponentIdType.....	210
11.3.2.3	TriComponentIdListType	210
11.3.2.4	Port.....	210
11.3.2.5	Id	211
11.3.2.6	TriMessageType.....	211
11.3.2.7	TriParameterType	211
11.3.2.8	TriParameterListType	212
11.3.2.9	TriAddressType	212
11.3.2.10	TriAddressListType	212
11.3.2.11	TriExceptionType	213
11.3.2.12	TriSignatureIdType	213
11.3.2.13	TriTimerIdType	213
11.3.2.14	TriTimerDurationType.....	213
11.3.2.15	QualifiedName	214
11.3.2.16	TciBehaviourIdType	214
11.3.2.17	TciTestCaseIdType	214
11.3.2.18	TciParameterType.....	214
11.3.2.19	TciParameterListType.....	215
11.3.2.20	TriPortIdListType	215
11.3.3	Abstract value mapping	215
11.3.3.1	Value	215
11.3.3.2	IntegerValue	217
11.3.3.3	FloatValue	217
11.3.3.4	BooleanValue.....	218
11.3.3.5	Void.....	218
11.3.3.6	VerdictValue	218
11.3.3.7	BitstringValue	219
11.3.3.8	HexstringValue	219
11.3.3.9	OctetstringValue	220
11.3.3.10	CharstringValue	220
11.3.3.11	UniversalCharstringValue.....	220
11.3.3.12	RecordValue.....	221
11.3.3.13	RecordOfValue	222
11.3.3.14	ArrayValue.....	224
11.3.3.15	SetValue	225
11.3.3.16	SetOfValue.....	227
11.3.3.17	EnumeratedValue.....	228
11.3.3.18	UnionValue	229
11.3.3.19	AnytypeValue	230
11.3.3.20	AddressValue	231
11.3.3.21	ComponentValue	232
11.3.3.22	PortValue	233
11.3.3.23	DefaultValue	233
11.3.3.24	TimerValue	234
11.3.4	Abstract logging types mapping	234

11.3.4.1	TciValueTemplate.....	234
11.3.4.2	TciNonValueTemplate.....	235
11.3.4.3	TciValueList.....	236
11.3.4.4	TciValueDifference.....	236
11.3.4.5	TciValueDifferenceList.....	237
11.4	Mapping of the operations on the logging interface.....	237
11.4.0	Mapping rules.....	237
11.4.1	Event.....	237
11.4.2	The TCI-TL interface.....	238
11.4.2.1	TCI-TL provided.....	238
12	C# mapping.....	259
12.1	Introduction.....	259
12.2	Names and scopes.....	259
12.2.1	Names.....	259
12.2.2	Scopes.....	259
12.3	Null value mapping.....	259
12.4	Type mapping.....	259
12.4.1	Basic type mapping.....	259
12.4.1.0	Mapped types.....	259
12.4.1.1	TciVerdict.....	260
12.4.2	Structured type mapping.....	260
12.4.2.0	Mapping rules.....	260
12.4.2.1	TciParameterPassingModeType.....	260
12.4.2.2	TciParameterType.....	261
12.4.2.3	TciParameterListType.....	261
12.4.2.4	TciTypeClassType.....	261
12.4.2.5	TciTestComponentKindType.....	262
12.4.2.6	TciBehaviourIdType.....	262
12.4.2.7	TciTestCaseIdType.....	262
12.4.2.8	TciTestCaseIdListType.....	262
12.4.2.9	TciModuleIdType.....	263
12.4.2.10	TciModuleIdListType.....	263
12.4.2.11	TciModuleParameterIdType.....	263
12.4.2.12	TciModuleParameterType.....	263
12.4.2.13	TciModuleParameterListType.....	263
12.4.2.14	TciParameterTypeType.....	264
12.4.2.15	TciParameterTypeListType.....	264
12.4.2.16	TciMatchingTypeType.....	265
12.4.2.17	LengthRestriction.....	265
12.4.2.18	Permutation.....	265
12.4.2.19	RangeBoundary.....	265
12.4.3	Abstract type mapping.....	266
12.4.3.0	Mapping rules.....	266
12.4.3.1	Type.....	266
12.4.4	Abstract value mapping.....	267
12.4.4.0	Mapping rules.....	267
12.4.4.1	Value.....	267
12.4.4.2	IntegerValue.....	269
12.4.4.3	FloatValue.....	269
12.4.4.4	BooleanValue.....	269
12.4.4.5	CharstringValue.....	269
12.4.4.6	BitstringValue.....	270
12.4.4.7	OctetstringValue.....	271
12.4.4.8	UniversalCharstringValue.....	271
12.4.4.9	HexstringValue.....	272
12.4.4.10	RecordValue.....	272
12.4.4.11	RecordOfValue.....	273
12.4.4.12	UnionValue.....	274
12.4.4.13	EnumeratedValue.....	275
12.4.4.14	VerdictValue.....	275
12.4.4.15	AddressValue.....	275

12.4.5	Abstract template mapping	275
12.4.5.0	Mapping rules	275
12.4.5.1	MatchingMechanism.....	275
12.4.5.2	MatchingList	276
12.4.5.3	ValueRange	276
12.4.5.4	CharacterPattern.....	276
12.4.5.5	MatchDecodedContent.....	277
12.4.6	Abstract logging types mapping	277
12.4.6.0	Mapping rules	277
12.4.6.1	TciValueTemplate.....	277
12.4.6.2	TciNonValueTemplate.....	277
12.4.6.3	TciValueList.....	278
12.4.6.4	TciValueDifference.....	278
12.4.6.5	TciValueDifferenceList.....	278
12.4.6.6	TciStatusType	279
12.4.6.7	ComponentStatusType.....	279
12.4.6.8	TimerStatusType	279
12.5	Mapping of interfaces.....	279
12.5.0	Calling rules.....	279
12.5.1	TCI-TM interface.....	280
12.5.1.1	TCI-TM provided.....	280
12.5.1.2	TCI-TM required.....	280
12.5.2	TCI-CD interface	280
12.5.2.1	TCI-CD provided	280
12.5.2.2	TCI-CD required	281
12.5.3	TCI-CH interface	281
12.5.3.1	TCI-CH provided	281
12.5.3.2	TCI-CH required	282
12.5.4	TCI-TL interface.....	283
12.5.4.1	TCI-TL provided.....	283
12.6	Optional parameters	289
12.7	Error Handling.....	289
Annex A (normative):	IDL Specification of TCI.....	290
Annex B (normative):	XML Mapping for TCI TL Provided.....	308
B.0	Introduction	308
B.1	TCI-TL XML Schema for Simple Types	308
B.2	TCI-TL XML Schema for Types	309
B.3	TCI-TL XML Schema for Values	311
B.4	TCI-TL XML Schema for Templates	318
B.5	TCI-TL XML Schema for Events	325
B.6	TCI-TL XML Schema for a Log.....	347
Annex C (informative):	Use scenarios	351
C.0	Introduction	351
C.1	Initialization, collecting information, logging.....	351
C.1.1	Use scenario: initialization	351
C.1.1.0	Scenario description.....	351
C.1.1.1	Sequence diagram.....	352
C.1.1.2	TTCN-3 fragment	352
C.1.2	Use scenario: requesting module parameters	352
C.1.2.0	Scenario description.....	352
C.1.2.1	Sequence diagram.....	353
C.1.2.2	TTCN-3 fragment	353
C.1.3	Use scenario: logging	353

C.1.3.0	Scenario description.....	353
C.1.3.1	Sequence diagram.....	354
C.1.3.2	TTCN-3 fragment.....	354
C.2	Execution of test cases and control.....	354
C.2.1	Use scenario: execution of control.....	354
C.2.1.0	Scenario description.....	354
C.2.1.1	Sequence diagram.....	355
C.2.1.2	TTCN-3 fragment.....	355
C.2.2	Use scenario: test case execution within control.....	355
C.2.2.0	Scenario description.....	355
C.2.2.1	Sequence diagram.....	356
C.2.2.2	TTCN-3 fragment.....	356
C.2.3	Use scenario: direct test case execution.....	356
C.2.3.0	Scenario description.....	356
C.2.3.1	Sequence diagram.....	357
C.2.3.2	TTCN-3 fragment.....	357
C.2.4	Use scenario: execute test case to TRI.....	357
C.2.4.0	Scenario description.....	357
C.2.4.1	Sequence diagram.....	358
C.2.4.2	TTCN-3 fragment.....	358
C.3	Component handling.....	358
C.3.1	Use scenario: local control component creation.....	358
C.3.1.0	Scenario description.....	358
C.3.1.1	Sequence diagram.....	359
C.3.1.2	TTCN-3 fragment.....	359
C.3.2	Use scenario: remote control component creation.....	359
C.3.2.0	Scenario description.....	359
C.3.2.1	Sequence diagram.....	360
C.3.2.2	TTCN-3 fragment.....	360
C.3.3	Use scenario: local MTC creation.....	360
C.3.3.0	Scenario description.....	360
C.3.3.1	Sequence diagram.....	361
C.3.3.2	TTCN-3 fragment.....	361
C.3.4	Use scenario: remote MTC creation.....	361
C.3.4.0	Scenario description.....	361
C.3.4.1	Sequence diagram.....	362
C.3.4.2	TTCN-3 fragment.....	362
C.3.5	Use scenario: component handling for test case execution within control.....	362
C.3.5.0	Scenario description.....	362
C.3.5.1	Sequence diagram.....	363
C.3.5.2	TTCN-3 fragment.....	363
C.3.6	Use scenario: component handling for direct test case execution.....	364
C.3.6.0	Scenario description.....	364
C.3.6.1	Sequence diagram.....	364
C.3.6.2	TTCN-3 fragment.....	365
C.3.7	Use scenario: propagation of map/connect.....	365
C.3.7.0	Scenario description.....	365
C.3.7.1	Sequence diagram.....	365
C.3.7.2	TTCN-3 fragment.....	365
C.3.8	Use scenario: propagation of unmap/disconnect.....	366
C.3.8.0	Scenario description.....	366
C.3.8.1	Sequence diagram.....	366
C.3.8.2	TTCN-3 fragment.....	366
C.4	Termination of test cases and control.....	366
C.4.1	Use scenario: stop a test case.....	366
C.4.1.0	Scenario description.....	366
C.4.1.1	Sequence diagram.....	367
C.4.1.2	TTCN-3 fragment.....	367
C.4.2	Use scenario: stop control.....	367
C.4.2.0	Scenario description.....	367

C.4.2.1	Sequence diagram	368
C.4.2.2	TTCN-3 fragment	368
C.4.3	Use scenario: termination of control after error	368
C.4.3.0	Scenario description.....	368
C.4.3.1	Sequence diagram.....	369
C.4.3.2	TTCN-3 fragment	369
C.4.4	Use scenario: termination of a test case after error.....	369
C.4.4.0	Scenario description.....	369
C.4.4.1	Sequence diagram.....	370
C.4.4.2	TTCN-3 fragment	371
C.4.5	Use scenario: reset.....	371
C.4.5.0	Scenario description.....	371
C.4.5.1	Sequence diagram.....	371
C.4.5.2	TTCN-3 fragment	371
C.5	Communication	371
C.5.1	Use scenario: local intercomponent communication.....	371
C.5.1.0	Scenario description.....	371
C.5.1.1	Sequence diagram.....	372
C.5.1.2	TTCN-3 fragment	372
C.5.2	Use scenario: internode communication between test components.....	373
C.5.2.0	Scenario description.....	373
C.5.2.1	Sequence diagram.....	373
C.5.2.2	TTCN-3 fragment	373
C.5.3	Use scenario: encoding.....	374
C.5.3.0	Scenario description.....	374
C.5.3.1	Sequence diagram.....	374
C.5.3.2	TTCN-3 fragment	374
C.5.4	Use scenario: decoding.....	374
C.5.4.0	Scenario description.....	374
C.5.4.1	Sequence diagram.....	375
C.5.4.2	TTCN-3 fragment	375
Annex D (informative):	Bibliography.....	376
History		377

Intellectual Property Rights

IPRs essential or potentially essential to the present document may have been declared to ETSI. The information pertaining to these essential IPRs, if any, is publicly available for **ETSI members and non-members**, and can be found in ETSI SR 000 314: "*Intellectual Property Rights (IPRs); Essential, or potentially Essential, IPRs notified to ETSI in respect of ETSI standards*", which is available from the ETSI Secretariat. Latest updates are available on the ETSI Web server (<https://ipr.etsi.org>).

Pursuant to the ETSI IPR Policy, no investigation, including IPR searches, has been carried out by ETSI. No guarantee can be given as to the existence of other IPRs not referenced in ETSI SR 000 314 (or the updates on the ETSI Web server) which are, or may be, or may become, essential to the present document.

Foreword

This final draft ETSI Standard (ES) has been produced by ETSI Technical Committee Methods for Testing and Specification (MTS), and is now submitted for the ETSI standards Membership Approval Procedure.

The present document is part 6 of a multi-part deliverable. Full details of the entire series can be found in part 1 [1].

Modal verbs terminology

In the present document "**shall**", "**shall not**", "**should**", "**should not**", "**may**", "**need not**", "**will**", "**will not**", "**can**" and "**cannot**" are to be interpreted as described in clause 3.2 of the [ETSI Drafting Rules](#) (Verbal forms for the expression of provisions).

"**must**" and "**must not**" are **NOT** allowed in ETSI deliverables except when used in direct citation.

1 Scope

The present document specifies the control interfaces for TTCN-3 test system implementations. The TTCN-3 Control Interfaces provide a standardized adaptation for management, test component handling and encoding/decoding of a test system to a particular test platform. The present document defines the interfaces as a set of operations independent of a target language.

The interfaces are defined to be compatible with the TTCN-3 standard (see clause 2). The interface definition uses the CORBA Interface Definition Language (IDL) to specify the TCI completely. Clauses 8, 9, 10, 11 and 12 present language mappings for this abstract specification to the target languages Java™, ANSI C, C++, XML and C#. A summary of the IDL-based interface specification is provided in annex A.

NOTE: Java™ is the trade name of a programming language developed by Oracle Corporation. This information is given for the convenience of users of the present document and does not constitute an endorsement by ETSI of the programming language named. Equivalent programming languages may be used if they can be shown to lead to the same results.

2 References

2.1 Normative references

References are either specific (identified by date of publication and/or edition number or version number) or non-specific. For specific references, only the cited version applies. For non-specific references, the latest version of the referenced document (including any amendments) applies.

Referenced documents which are not found to be publicly available in the expected location might be found at <http://docbox.etsi.org/Reference>.

NOTE: While any hyperlinks included in this clause were valid at the time of publication ETSI cannot guarantee their long term validity.

The following referenced documents are necessary for the application of the present document.

- [1] ETSI ES 201 873-1: "Methods for Testing and Specification (MTS); The Testing and Test Control Notation version 3; Part 1: TTCN-3 Core Language".
- [2] ETSI ES 201 873-4: "Methods for Testing and Specification (MTS); The Testing and Test Control Notation version 3; Part 4: TTCN-3 Operational Semantics".
- [3] ETSI ES 201 873-5: "Methods for Testing and Specification (MTS); The Testing and Test Control Notation version 3; Part 5: TTCN-3 Runtime Interface (TRI)".
- [4] Recommendation ITU-T X.290: "OSI conformance testing methodology and framework for protocol Recommendations for ITU-T applications - General concepts".

NOTE: The corresponding ISO/IEC standard is ISO/IEC 9646-1: "Information technology - Open Systems Interconnection - Conformance testing methodology and framework; Part 1: General concepts".

- [5] ISO/IEC 10646: "Information technology -- Universal Coded Character Set (UCS)".
- [6] CORBA 3.0: "The Common Object Request Broker: Architecture and Specification", OMG Formal Document (specifies IDL).
- [7] Sun Microsystems: "Java™ Language Specification".

NOTE: See at http://java.sun.com/docs/books/jls/third_edition/html/j3TOC.html.

- [8] ISO/IEC 9899: "Information technology -- Programming languages -- C".
- [9] ISO/IEC 14882: "Information technology -- Programming languages -- C++".

[10] W3C Recommendation: "XML Schema Part 0: Primer".

NOTE: See at <http://www.w3.org/TR/xmlschema-0/>.

[11] W3C Recommendation: "XML Schema Part 1: Structures".

NOTE: See at <http://www.w3.org/TR/xmlschema-1/>.

[12] W3C Recommendation: "XML Schema Part 2: Datatypes".

NOTE: See at <http://www.w3.org/TR/xmlschema-2/>.

[13] ECMA-334: "C# Language Specification".

NOTE: See at <http://www.ecma-international.org/publications/standards/Ecma-334.htm>.

2.2 Informative references

References are either specific (identified by date of publication and/or edition number or version number) or non-specific. For specific references, only the cited version applies. For non-specific references, the latest version of the referenced document (including any amendments) applies.

NOTE: While any hyperlinks included in this clause were valid at the time of publication ETSI cannot guarantee their long term validity.

The following referenced documents are not necessary for the application of the present document but they assist the user with regard to a particular subject area.

Not applicable.

3 Definitions and abbreviations

3.1 Definitions

For the purposes of the present document, the terms and definitions given in Recommendation ITU-T X.290 [4] and the following apply:

Abstract Test Suite (ATS): test suite composed of abstract test cases, which are specified by TTCN-3 module(s)

codec: encoder/decoder entity used for encoding and decoding data to be transmitted and received, respectively

Coding/Decoding (CD): entity that administers the value and type handling incl. encoding and decoding in the TTCN-3 test system

communication port: abstract mechanism facilitating communication between test components

NOTE: A communication port is modelled as a FIFO queue in the receiving direction. Ports can be message-based, procedure-based or a mixture of the two.

Component Handling (CH): entity that administers the handling of test components in the TTCN-3 test system

control component: component that executes the behaviour of the control part of a TTCN-3 module

Executable Test Suite (ETS): Refer to Recommendation ITU-T X.290 [4].

Implementation eXtra Information for Testing (IXIT): Refer to Recommendation ITU-T X.290 [4].

Platform Adaptor (PA): entity that adapts the TTCN-3 Executable to a particular execution platform

NOTE: The Platform Adaptor creates a single notion of time for a TTCN-3 test system, and implements both, explicit and implicit, timers as well as external functions.

real test system interface: Refer to Recommendation ITU-T X.290 [4].

SUT Adaptor (SA): entity that adapts the TTCN-3 communication operations with the SUT based on an abstract test system interface

NOTE: It implements the real test system interface.

System Under Test (SUT): Refer to Recommendation ITU-T X.290 [4].

test case: Refer to Recommendation ITU-T X.290 [4].

test event: either sent or received test data (message or procedure call) on a communication port that is part of the test system interface as well as timeout events of timers

Test Logging (TL): entity which provides logging information about test execution (including also the information provided by the TTCN-3 log statement)

Test Management (TM): entity which provides a user interface to as well as the administration of the TTCN-3 test system

Test Management and Control (TMC): set of entities providing test management and control; consists of the Test Management (TM), the Component Handling (CH), the Test Logging (TL) and the Coding/Decoding (CD)

NOTE: The TMC is an implementation of TCI.

test system: Refer to Recommendation ITU-T X.290 [4].

Test System Interface (TSI): test component that provides a mapping of the ports available in the (abstract) TTCN-3 test system to those offered by a real test system

Testing and Test Control Notation (TTCN-3): Refer to Recommendation ITU-T X.290 [4].

TTCN-3 Control Interfaces (TCI): four interfaces that define the interaction of the TTCN-3 Executable with the test management, the coding and decoding, the test component handling and the logging in a test system

TTCN-3 Executable (TE): part of a test system that deals with interpretation or execution of a TTCN-3 ETS

TTCN-3 Runtime Interface (TRI): two interfaces that define the interaction of the TTCN-3 Executable between the SUT and the Platform Adaptor (PA) and the System Adaptor (SA) in a test system

3.2 Abbreviations

For the purposes of the present document, the following abbreviations apply:

ADT	Abstract Data Type
ANSI	American National Standards Institute
ASCII	American Standard Code for Information Interchange
ATS	Abstract Test Suite
CD	(External) Coding/Decoding
CH	Component Handler
CORBA	Common Object Request Broker Architecture
ETS	Executable Test Suite
FIFO	First In First Out
IDL	Interface Definition Language
IXIT	Implementation eXtra Information for Testing
MTC	Main Test Component
OMG	Object Management Group
PA	Platform Adaptor
PTC	Parallel Test Component
SA	SUT Adaptor
SUT	System Under Test
TCI	TTCN-3 Control Interfaces
TE	TTCN-3 Executable
TL	Test Logging

TLI	Test Logging Interface
TM	Test Management
TMC	Test Management and Control
TRI	TTCN-3 Runtime Interface
TSI	Test System Interface
TTCN-3	Testing and Test Control Notation Version 3
UML	Unified Modelling Language
W3C	World Wide Web Consortium
XML	Extensible Markup Language

4 Introduction

The present document consists of two distinct parts, the first part describing the structure of a TTCN-3 test system implementation and the second part presenting the TTCN-3 Control Interfaces specification.

The first part introduces the decomposition of a TTCN-3 test system into four main entities:

- Test Management and Control (TMC).
- TTCN-3 Executable (TE).
- SUT Adaptor (SA).
- Platform Adaptor (PA).

The TMC consists itself of three entities: Test Management (TM), Coder/Decoder (CD), and Test Component Handler (CH). In addition, the interaction between these entities, i.e. the corresponding interfaces, is defined.

The second part of the present document specifies the TTCN-3 Control Interfaces (TCI). The interfaces are defined in terms of operations implemented as part of one entity and called by other test system entities. For each operation, the interface specification defines associated data structures, the intended effect on the test system and any constraints on the usage of the operation. Note that these interface specifications only define interactions between the TE and TM, TE and CD, and TE and CH. For interactions between the TE and SA and the TE and PA please refer to the TTCN-3 Runtime Interface specification (ETSI ES 201 873-5 [3]).

5 Compliance

The minimum required for a TCI compliant TTCN-3 test system is to adhere to the interface specification stated in the present document. The TTCN-3 semantics in the test system shall adhere to the operational semantics defined in ETSI ES 201 873-4 [2]. In addition, one language mapping shall be supported. For example, if a vendor supports Java™, the TCI operation calls and implementations, which are part of the TTCN-3 executable, shall comply with the IDL to Java™ mapping specified in the present document. For the logging interface, the XML mapping can be used instead of the Java™ or the C mapping.

6 General structure of a TTCN-3 test system

6.1 Entities in a TTCN-3 test system

6.1.0 Types of entities

A TTCN-3 test system can be thought of conceptually as a set of interacting entities. Each entity implements specific test system functionality. These entities:

- manage test execution;
- interpret or execute compiled TTCN-3 code;

- realize proper communication with the SUT;
- administer types, values and test components;
- implement external functions; and
- handle timer operations.

The structure of a TTCN-3 test system implementation is illustrated in figure 1.

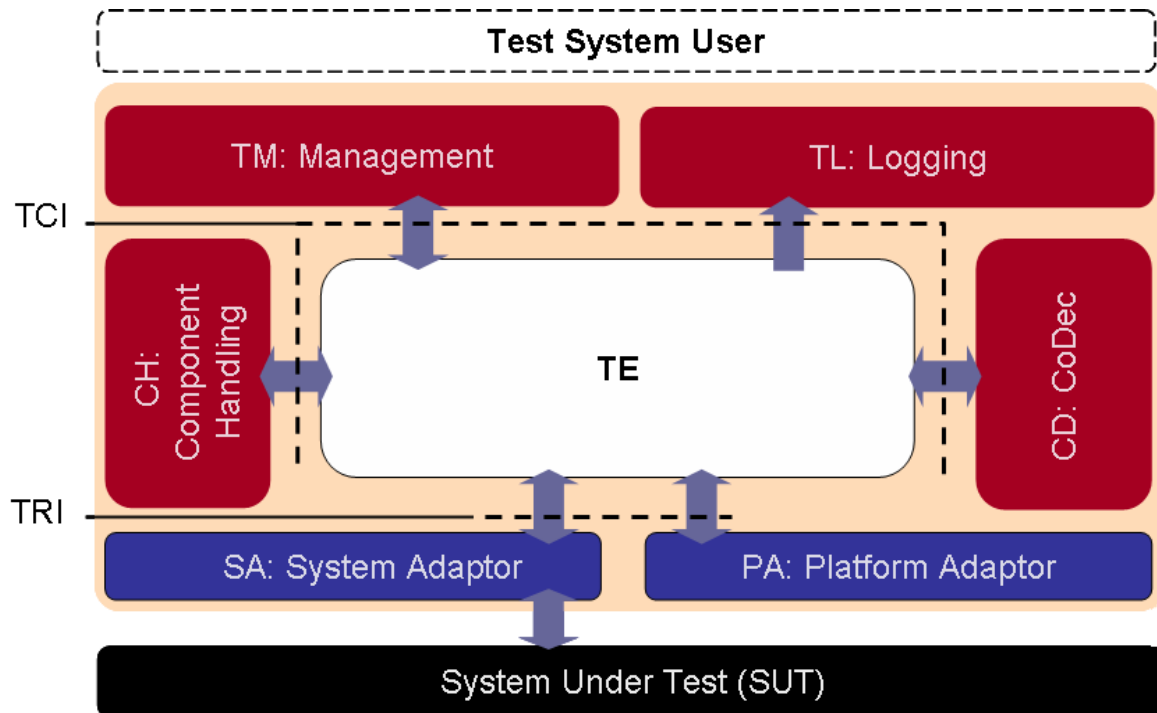

Figure 1: General structure of a TTCN-3 test system

As shown in figure 1, the TTCN-3 Executable (TE), also referred to as the Executable Test Suite (ETS), interprets and executes TTCN-3 modules. Various TE structural elements can be identified: control, behaviour, components, types, values and queues. The structural elements within the TE represent functionality that is defined within a TTCN-3 module or by the TTCN-3 standard (ETSI ES 201 873-1 [1]) itself. For example, the structural element "Control" represents the control part within a TTCN-3 module, while the structural element "Queues" represents the requirement on a TTCN-3 Executable that each port of a test component maintains its own port queue. While the first is specified within a TTCN-3 module, the latter is required by the TTCN-3 specification.

Refinement of the TE, as shown in figure 1, is provided as an aid in defining the TTCN-3 Control Interfaces. The TE would typically correspond in a test system implementation either to the executable code produced by a TTCN-3 compiler or by a TTCN-3 interpreter.

The TE may be executed in a centralized or in a distributed manner. That is, on a single test device or across several test devices respectively. Although the structural entities of the TE implement a complete TTCN-3 module, single structural entities might be distributed over several test devices.

The TE implements a TTCN-3 module on an abstract level. The other entities of a TTCN-3 test system make these abstract concepts concrete. For example, the abstract concept of sending a message or receiving a timeout cannot be implemented within the TE. The remaining part of the test system implements the encoding of the message and its sending over concrete physical means or measuring the time and determining when a timer has expired, respectively.

The SA and PA and their interaction with the TE are defined in ETSI ES 201 873-5 [3]. The TCI specification defines the interaction between the TE and the TMC.

The logging interface provides logging capabilities to all elements of the test system architecture, i.e. the TE, the TM, the CH, the CD, the SA and the PA are able to log information on the test execution via TL. Figure 2 represents a more detailed view on TL.

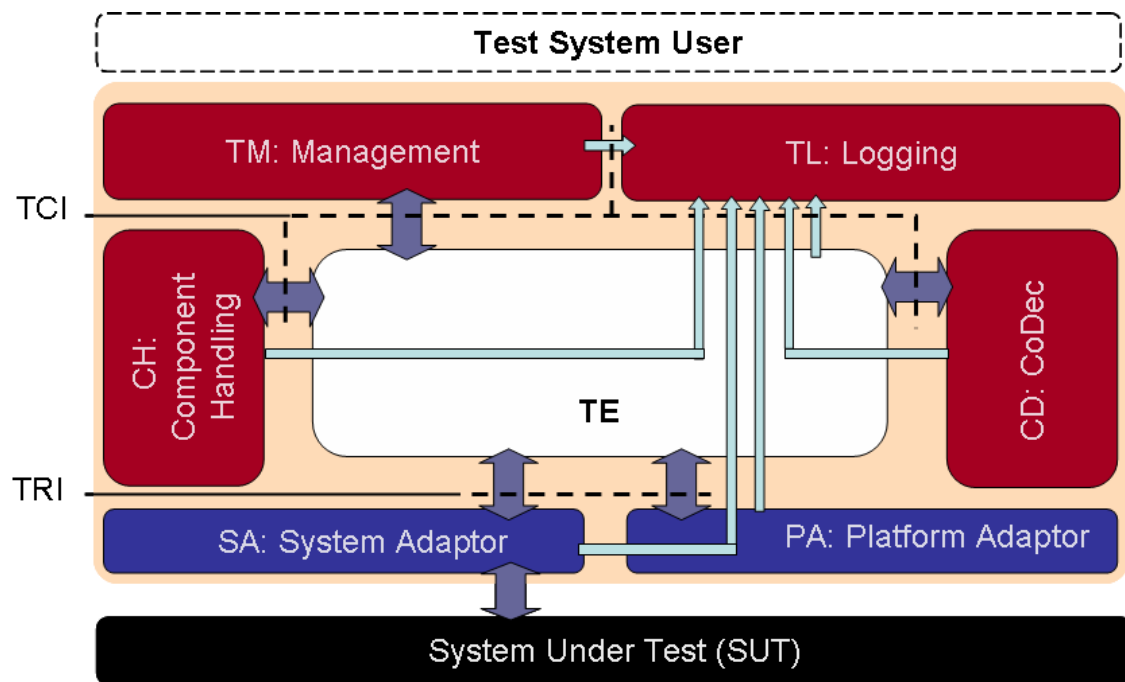

Figure 2: Detailed View on TL

6.1.1 Test Management and Control (TMC)

6.1.1.0 Test Management and Control Entities

The TMC entity includes functionality related to management of:

- test execution;
- components;
- encoding and decoding; and
- logging.

6.1.1.1 Test Management (TM)

The TM entity is responsible for the overall management of a test system. After the test system has been initialized, test execution starts within the TM entity. The entity is responsible for the proper invocation of TTCN-3 modules, i.e. propagating module parameters such as IXIT information to the TE if necessary. Typically, this entity would also implement a test system user interface.

6.1.1.2 Coding and Decoding (CD)

The CD entity is responsible for the external encoding and decoding of TTCN-3 values into bitstrings suitable to be sent to the System Under Tests (SUT). Whenever external codecs are used, the TE determines which codecs shall be used. It passes the TTCN-3 data to the appropriate encoder to obtain the encoded data. Received data is decoded in the CD entity by using the appropriate decoder, which translates the received data into TTCN-3 values.

6.1.1.3 Component Handling (CH)

The TE can be distributed among several test devices. The CH implements communication between distributed test system entities. The CH entity provides the means to synchronize test system entities which might be distributed onto several nodes.

NOTE 1: Nodes and test devices are used as synonyms.

The general structure of a test system distributed among several nodes is depicted in figure 3.

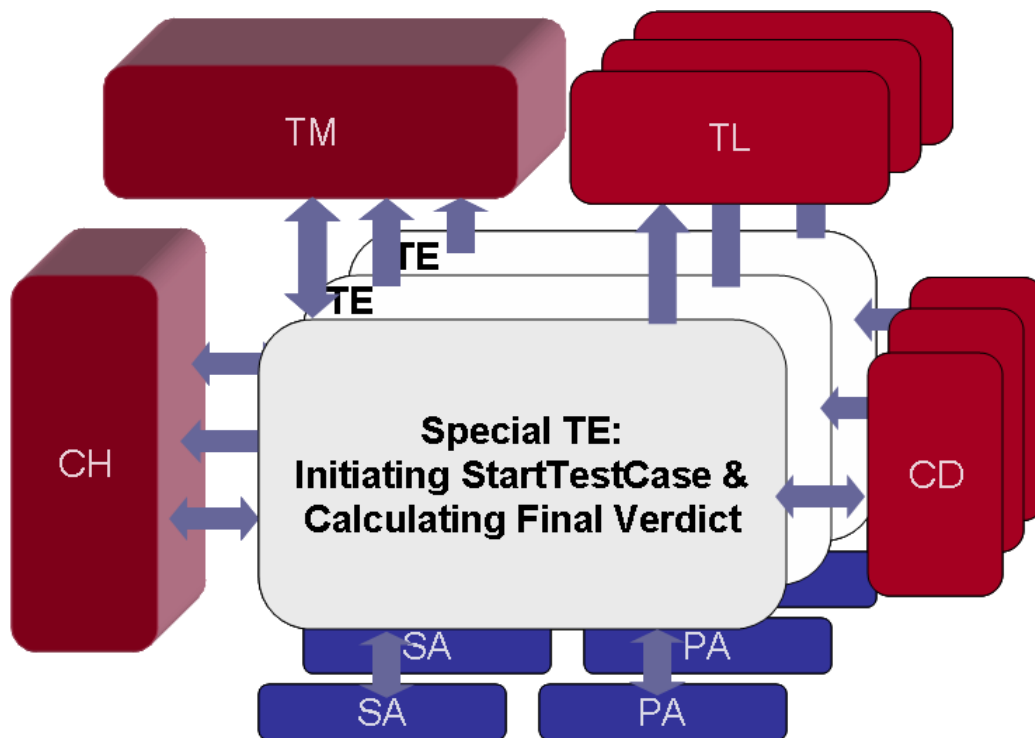

Figure 3: General structure of a distributed TTCN-3 test system

Each node within a test system includes the TE, SA, PA, CD and TL entities. The entities CH and TM mediate the test management and test component handling between the TEs on each node. The TE which starts a test case is a special TE. It shall calculate the final test case verdict. Besides this, all TEs are handled the same.

NOTE 2: As stated in ETSI ES 201 873-4 [2], a test system executes at most one test case at a given point in time, i.e. a TTCN-3 module cannot execute multiple test cases at the same time.

The creation of the MTC, PTCs and the control component in TEs is controlled by CH. Please note the special role of the system component, which exists only conceptually and not as a running test component in a TE. System ports, i.e. the ports of the system component, may be distributed among several nodes. Further, test components on different nodes may have access to the same physical port of the SUT, i.e. they may be mapped to the same port of the test system interface.

EXAMPLE: Access to remote real SUT ports can be realized by TEs via local proxies.

Communication between TTCN-3 components is either message or procedure based. Therefore, the CH adapts message and procedure based communication of TTCN-3 components to the particular execution platform of the test system. It is aware of connections between TTCN-3 test component communication ports. It propagates send request operations from one TTCN-3 component to another TTCN-3 component. The receiving component may reside in a different instance of the same TE located on a different node. It then notifies the TE of any received test events by enqueueing them in the port queues of the TE.

Procedure based communication operations between TTCN-3 components are also visible at the CH. The CH shall distinguish between the different kinds of procedure-based communication, i.e. call, reply, and exception, and shall propagate them in the appropriate manner to the TE where the target component resides. TTCN-3 procedure based communication semantics, i.e. the effect of such operation on TTCN-3 test component execution, are to be handled in the TE.

Additional communication is needed to implement the distribution of test components onto several nodes. Component management communication includes the indication of the creation of test components, the starting of execution of a test component, verdict distribution, as well as component termination indication. The CH does not implement the TTCN-3 component behaviour. Rather, it implements the communication between several components implemented by a TE.

6.1.1.4 Test Logging (TL)

The TL entity performs test event logging and presentation to the test system user. It provides the logging of information about the test execution such as which test components have been created, started and terminated, which data is sent to the SUT, received from the SUT and matched to TTCN-3 templates, which timers have been started, stopped or timed out, etc.

6.1.2 TTCN-3 Executable (TE)

The TE entity executes or interprets a TTCN-3 module. Conceptually, the TE can be decomposed into six interacting entities: a Control, Behaviour, Component, Type, Value and Queue entity. This structural decomposition of the TE is defined in ETSI ES 201 873-5 [3]. The terminology for TE defined in ETSI ES 201 873-5 [3] is used within the present document.

6.1.3 SUT Adaptor (SA)

The SA is the implementation of the System under Test Adaptor (SA) as defined in ETSI ES 201 873-5 [3]. The terminology for SA defined in ETSI ES 201 873-5 [3] is used within the present document.

6.1.4 Platform Adaptor (PA)

The PA is the implementation of the Platform Adaptor (PA) as defined in ETSI ES 201 873-5 [3]. The terminology for PA defined in ETSI ES 201 873-5 [3] is used within the present document.

6.2 Execution requirements for a TTCN-3 test system

Each TCI operation call shall be treated as an atomic operation in the calling entity. The called entity, which implements a TCI operation, shall return control to the calling entity as soon as its intended effect has been accomplished or if the operation cannot be completed successfully. The called entity shall not block in the implementation of procedure-based communication.

As stated before, no assumption is made as to whether the TTCN-3 test system or individual entities are implemented in a single executable or process or whether they are distributed among different processes or even test devices.

A TCI implementation shall fulfil the above mentioned requirements.

7 TTCN-3 control interface and operations

7.1 Overview of the TCI

7.1.0 TCI role in a TTCN-3 test system

The clause 7 defines a set of abstract data types used to represent data communicated between the TE and the TMC. In addition, it defines TCI operations in terms of their signatures, when they are to be used and what their effects on the TTCN-3 test system are.

This definition also includes a more detailed description of the input parameters required for each TCI operation call and its return value.

The TCI defines the interaction between the TTCN-3 Executable (TE), Component Handling (CH), the Test Management (TM), the Coding/Decoding (CD), the Test Logging (TL) entities within a TTCN-3 test system. It provides means for the TE to:

- manage test execution;
- distribute execution of test components among different test devices;

- encode and decode test data; and
- logging of information about test execution.

The TCI consists of four sub-interfaces:

- **TCI Test Management Interface (TCI-TM):** This interface includes all operations needed to manage test execution, provide module parameters and external constants and provide test event logging.
- **TCI Component Handling Interface (TCI-CH):** This interface consists of operations needed to implement the management of, and communication between TTCN-3 test components in a centralized or distributed test system. It includes operations to create, start and stop test components, establish connection between TTCN-3 components, manage test components and their verdicts, and handle message and procedure based communication between TTCN-3 components.
- **TCI Coding/Decoding Interface (TCI-CD):** This interface includes all operations needed to retrieve and access codecs, i.e. encoders or decoders, for encoding data to be sent, defined using the TTCN-3 encode attribute, and to decode received data.
- **TCI Test Logging Interface (TCI-TL):** This interface includes all operations needed to retrieve information about test execution and to control the level of detail of this information.

All interfaces are bi-directional so that calling and called parts reside in the TE and in the TMC of the test system. The provided interfaces (those operations which an interface offers to the TE) and the required operations (those operation which an interface needs to use from the TE) are combined into the respective provided and required subinterface for each interface, i.e. TCI-TM Provided/ TCI-TM Required, TCI-CH Provided/ TCI-CH Required, TCI-CD Provided/ TCI-CD Required, and TCI-TL Provided/TCI-TL Required.

7.1.1 Correlation between TTCN-3 and TCI operation invocations

7.1.1.0 Mapping of TTCN-3 operations to TCI operations

For some TTCN-3 operation invocations, there is a direct correlation to a TCI operation invocation, which is shown in table 1. Some of the TTCN-3 operations correlate to a pair of TCI operation request and TCI operation to implement the propagation of TTCN-3 operations through the test system. For the other TCI operation invocations there is an indirect correlation - they are needed to implement the TTCN-3 semantics of underlying concepts.

7.1.1.1 TTCN-3 operations with TCI operation equivalent

The correlation shown for TTCN-3 communication operations (i.e. `send`, `call`, `reply`, and `raise`) only holds if these operations are invoked on a test component port connected to another test component port. The correlation for communication operations that are invoked on test component ports that are mapped to test system interface ports is defined in ETSI ES 201 873-5 [3].

Table 1: Correlation between TTCN-3 communication operations and TCI operation invocations

TTCN-3 Operation Name	TCI Operation Name	TCI Interface Name
send	<code>tciSendConnected</code> (see note 1)	TCI-CH Provided
	<code>tciSendConnectedBC</code> (see note 2)	
	<code>tciSendConnectedMC</code> (see note 3)	
	<code>tciEnqueueMsgConnected</code>	TCI-CH Required
call	<code>tciCallConnected</code> (see note 1)	TCI-CH Provided
	<code>tciCallConnectedBC</code> (see note 2)	
	<code>tciCallConnectedMC</code> (see note 3)	
	<code>tciEnqueueCallConnected</code>	TCI-CH Required
reply	<code>tciReplyConnected</code> (see note 1)	TCI-CH Provided
	<code>tciReplyConnectedBC</code> (see note 2)	
	<code>tciReplyConnectedMC</code> (see note 3)	
	<code>tciEnqueueReplyConnected</code>	TCI-CH Required

TTCN-3 Operation Name	TCI Operation Name	TCI Interface Name
raise	tciRaiseConnected (see note 1)	TCI-CH Provided
	tciRaiseConnectedBC (see note 2)	
	tciRaiseConnectedMC (see note 3)	
	tciEnqueueRaiseConnected	TCI-CH Required
log	tliLog	TCI-TL Provided
NOTE 1: For unicast communication.		
NOTE 2: For broadcast communication.		
NOTE 3: For multicast communication.		

7.1.1.2 TTCN-3 operations with TCI operation pair equivalent

The correlation for TTCN-3 test case, test component and port operations is shown below. The initiating TE issues a TCI request operation to the TCI-CH, which propagates the respective TCI operation on the TE(s) which has (have) to perform it.

Table 2: Correlation between TTCN-3 test case, test component and port operations and TCI operation invocations

TTCN-3 Operation Name	TCI Operation Name	TCI Interface Name
create	tciCreateTestComponentReq	TCI-CH Provided
	tciCreateTestComponent	TCI-CH Required
start (a component)	tciStartTestComponentReq	TCI-CH Provided
	tciStartTestComponent	TCI-CH Required
stop (a component)	tciStopTestComponentReq	TCI-CH Provided
	tciStopTestComponent	TCI-CH Required
kill	tciKillTestComponentReq	TCI-CH Provided
	tciKillTestComponent	TCI-CH Required
connect	tciConnectReq	TCI-CH Provided
	tciConnect	TCI-CH Required
disconnect	tciDisconnectReq	TCI-CH Provided
	tciDisconnect	TCI-CH Required
map	tciMapReq (see note 1)	TCI-CH Provided
	tciMapParamReq (see note 2)	
	tciMap (see note 1)	TCI-CH Required
	tciMapParam (see note 2)	
unmap	tciUnmapReq (see note 1)	TCI-CH Provided
	tciUnmapParamReq (see note 2)	
	tciUnmap (see note 1)	TCI-CH Required
	tciUnmapParam (see note 2)	
running	tciTestComponentRunningReq	TCI-CH Provided
	tciTestComponentRunning	TCI-CH Required
alive	tciTestComponentAliveReq	TCI-CH Provided
	tciTestComponentAlive	TCI-CH Required
done	tciTestComponentDoneReq	TCI-CH Provided
	tciTestComponentDone	TCI-CH Required
killed	tciTestComponentKilledReq	TCI-CH Provided
	tciTestComponentKilled	TCI-CH Required
mtc	tciGetMTCReq	TCI-CH Provided
	tciGetMTC	TCI-CH Required
execute	tciTestCaseExecuteReq	TCI-CH Provided
	tciTestCaseExecute	TCI-CH Required
NOTE 1: For statement without configuration parameter.		
NOTE 2: For statement with configuration parameter.		

7.1.1.3 TTCN-3 operations without direct TCI operation equivalent

7.1.1.3.0 Mapping of TTCN-3 operations to series of TCI operations

For some TTCN-3 operation invocations, there is no direct correlation to TCI operation invocations as the ones shown in table 1. These TTCN-3 operation invocations are realized by a series of TCI operation invocations as described in this clause.

7.1.1.3.1 Test case stop operation

When the `testcase.stop` operation is invoked from the TE, the following actions need to be taken by the TE:

- the overall verdict should be set to `USER_ERROR` with the message given to the invocation of the `testcase.stop` operation as the verdict reason by invoking `tciSetVerdict()`;
- a reference to the `mtc` should be obtained by invoking `triGetMtcReq()` in the CH interface; and
- via TLI, `testcase.stop` shall be logged with `tliTcTerminated()` with verdict `USER_ERROR`;
- the `mtc` should be stopped by invoking `triStopTestComponentReq()` in the CH with the obtained reference to the `mtc`.

7.2 TCI data

7.2.0 Abstract data types

The TCI specification defines a set of abstract data types. These describe, at a very high level, which kind of data shall be passed from a calling to a called entity. The abstract data types are used to determine:

- how TTCN-3 data is passed from a TE to an encoder, to encode TTCN-3 value representations into a bitstring; and in the reverse case;
- how data passed from a decoder to the TE shall be decoded from a bitstring into its TTCN-3 value representation.

For these abstract data types a set of operations is defined to process the data by the coder/decoder.

The concrete representation of these abstract data types as well as the definition of basic data types like `string` and `boolean` are defined in the respective language mappings in clauses 8, 9, 10, 11 and 12.

Notice that the values for any identifier data type shall be unique in the test system implementation where uniqueness is defined as being globally distinct at any point in time. This guarantees that different objects, e.g. two timers, are identified by different identifiers and identifiers are not reused.

7.2.1 General abstract data types

7.2.1.0 Use of general abstract data types

The following abstract data types are defined and used for the definition of TCI operations.

7.2.1.1 Management

<code>TciModuleIdType</code>	A value of <code>TciModuleIdType</code> is the name of a TTCN-3 module as specified in the TTCN-3 ATS. This abstract type is used for module handling.
<code>TciModuleParameterIdType</code>	A value of <code>TciModuleParameterIdType</code> is the qualified name of a TTCN-3 module parameter as specified in the TTCN-3 ATS. This abstract type is used for module parameter handling.

<code>TciTestCaseIdType</code>	A value of <code>TciTestCaseIdType</code> is the qualified name of a TTCN-3 testcase as specified in the TTCN-3 ATS. This abstract type is used for testcase handling.
<code>TciTestCaseIdListType</code>	A value of <code>TciTestCaseIdListType</code> is a list of <code>TciTestCaseIdType</code> . This abstract type is used when retrieving the list of test cases in a TTCN-3 module.
<code>TciModuleIdListType</code>	A value of type <code>TciModuleIdListType</code> is a list of <code>TciModuleIdType</code> . This abstract type is used when retrieving the list of modules which are imported by a TTCN-3 module.
<code>TciModuleParameterType</code>	A value of type <code>TciModuleParameterType</code> is a structure of <code>TciModuleParameterIdType</code> and <code>Value</code> . This abstract type is used to represent the parameter name and the default value of a module parameter.
<code>TciModuleParameterListType</code>	A value of type <code>TciModuleParameterListType</code> is a list of <code>TciModuleParameterType</code> . This abstract type is used when retrieving the module parameters of a TTCN-3 module.
<code>TciParameterType</code>	A value of type <code>TciParameterType</code> includes a TTCN-3 <code>Value</code> , which can be absent, and a value of <code>TciParameterPassingModeType</code> to represent the name, the value and parameter passing mode specified for the parameter in the TTCN-3 ATS.
<code>TciParameterPassingModeType</code>	A value of type <code>TciParameterPassingModeType</code> is either <code>IN</code> , <code>INOUT</code> , or <code>OUT</code> . This abstract type is used when starting a test case or when the termination of a test case is indicated.
<code>TciParameterListType</code>	A value of type <code>TciParameterListType</code> is a list of <code>TciParameterType</code> . This abstract type is used when starting a test case or when the termination of a test case is indicated.
<code>TciParameterTypeType</code>	A value of type <code>TciParameterTypeType</code> is a structure of <code>Type</code> and <code>TciParameterPassingModeType</code> . This abstract type is used to represent the type, the name and the parameter passing mode of a test case parameter.
<code>TciParameterTypeListType</code>	A value of type <code>TciParameterTypeListType</code> is a list of <code>TciParameterTypeType</code> . This abstract type is used to represent the list of parameters of a test case.
<code>TciTestComponentKindType</code>	A value of type <code>TciTestComponentKindType</code> is a literal of the set of kinds of TTCN-3 test components, i.e. <code>CONTROL</code> , <code>MTC</code> , <code>PTC</code> , <code>SYSTEM</code> , and <code>PTC_ALIVE</code> . This abstract type is used for component handling.
<code>TciTypeClassType</code>	A value of type <code>TciTypeClassType</code> is a literal of the set of type classes in TTCN-3 such as <code>boolean</code> , <code>float</code> , <code>record</code> , etc. This abstract type is used for value handling.
<code>TciMatchingTypeType</code>	A value of type <code>TciMatchingTypeType</code> is a literal of the set of matching mechanism types in TTCN-3 such as <code>template list</code> , <code>range</code> , <code>AnyValue</code> etc. This abstract type is used for template handling.

7.2.1.2 Communication

<code>TciBehaviourIdType</code>	A value of type <code>TciBehaviourIdType</code> identifies a TTCN-3 behaviour functions.
---------------------------------	--

Additional abstract data types with the prefix `Tri` are taken from ETSI ES 201 873-5 [3]: `TriPortIdType`, `TriPortIdListType`, `TriComponentIdType`, `TriComponentIdListType`, `TriAddressType`, `TriAddressListType`, `TriTimerIdType` and `TriMessageType`.

7.2.2 Abstract TTCN-3 data types and values

7.2.2.0 Definition and scope of use

The clause 7.2.2 defines the set of abstract data types that build up the TTCN-3 type, value and template representation. Functionality of each data type is defined by an accompanying set of operations. Operations on or using this abstract data type return either a value of this abstract type or a basic type like `boolean`.

All operations have been defined using the Interface Description Language (IDL). Concrete language mappings for the operations on the abstract data types are given in clauses 8, 9, 10, 11 and 12. In certain languages, the application of an operation on an abstract data type is represented by passing (either by-value or by-reference, depending on the mapping) the concrete value as a parameter to the operation. Other languages might choose other referencing method to the concrete value, e.g. by considering the value as an object on which a method corresponding to the operation is invoked. To indicate the inability to perform a certain task or to indicate the absence of an optional parameter in the following, the distinct value `null` is used. It can be considered as being a reserved value indicating a special value. The language mappings will define a concrete representation of this distinct value `null`.

The abstract TTCN-3 type, value and template representation consists of the following parts:

- an abstract data type `Type` that represents all TTCN-3 types in a TTCN-3 module;
- different abstract data types that represent TTCN-3 values, i.e. TTCN-3 values of a given TTCN-3 type. This can be either values of TTCN-3 predefined types or of TTCN-3 user-defined types;
- different abstract data types that represent matching mechanisms that can occur in TTCN-3 templates;
- other abstract data types that represent complex value properties such a permutations or length restrictions.

For accessing, evaluating, and coding the TTCN-3 data the test system uses the abstract data type `Type` and the different abstract value data types. Therefore, these abstract data types define the abstraction level between the TTCN-3 Executable (TE) and the remaining test system using the TCI interfaces.

7.2.2.1 Abstract TTCN-3 data types

According to the present document TTCN-3 types, either predefined or user-defined, will be represented at the TCI interfaces using the abstract data type `Type`.

For the abstract data type `Type` a set of operations is defined to:

- reference predefined and user-defined TTCN-3 data types; and
- create and maintain TTCN-3 values and templates.

The following operations are defined for the abstract data type `Type`:

<code>TciModuleIdType</code>	<code>getDefiningModule()</code>	Returns the module identifier of the module in which type is defined. Returns the distinct value <code>null</code> if type is a TTCN-3 base type, e.g. <code>boolean</code> , <code>integer</code> , etc.).
<code>TString</code>	<code>getName()</code>	Returns the name of the type as defined in the TTCN-3 module. If the type is a nested type without explicit name, the TE has to create an additional unique identifier for this type which is consistently used in TRI/TCI.

NOTE 1: The creation of identifiers for nested types is tool dependent.

NOTE 2: The naming for a nested type without explicit name can follow the rules defined in clauses 6.2.1.1 and 6.2.3.2 of ETSI ES 201 873-1 [1], e.g. `TypeIdOrExpression.ElementId` and `TypeId[-]`, respectively.

`TciTypeClassType getTypeClass()` Returns the type class of the respective type. A value of `TciTypeClassType` can have one of the following constants: `ADDRESS`, `ANYTYPE`, `ARRAY`, `BITSTRING`, `BOOLEAN`, `CHARSTRING`, `COMPONENT`, `ENUMERATED`, `FLOAT`, `HEXSTRING`, `INTEGER`, `OCTETSTRING`, `RECORD`, `RECORD_OF`, `SET`, `SET_OF`, `UNION`, `UNIVERSAL_CHARSTRING`, `VERDICT`, `DEFAULT`, `PORT`, `TIMER`.

`Value newInstance()` Returns a freshly created value of the given type. This initial value of the created value is undefined.

NOTE 3: Newly created instances of empty record types are considered to be initialized.

`TString getTypeEncoding()` Returns the type encode attribute as defined in the TTCN-3 module. If no encode attribute is defined the distinct value `null` is returned. If the type has more than one encode attributes associated with it, all encode attributes are concatenated to a single string using LF (line feed char(0, 0, 0, 10)), CR (carriage return char(0, 0, 0, 13)) or their combination as a separator.

`TString getTypeEncodingVariant()` This operation returns the value encoding variant attribute as defined in the TTCN-3 module, if any. If no encoding variant attribute is defined the distinct value `null` is returned. If the type has more than one variant attributes associated with it, all variant attributes are concatenated to a single string using LF (line feed char(0, 0, 0, 10)), CR (carriage return char(0, 0, 0, 13)) or their combination as a separator. In case the type supports multiple encodings, the function returns variants for all encodings. Each variant is prefixed with the associated encode attribute and followed by a full stop character in this case.

`TStringSeq getEncodingAttributes()` Returns all encode attributes of the type as defined in the TTCN-3 module. If no encode attribute is defined the distinct value `null` is returned.

`TStringSeq getVariantAttributes(in TString encoding)` This operation returns all variant attributes of the type as defined in the TTCN-3 module. If no encode attribute is defined, the distinct value `null` is returned. The parameter is used to specify encoding the variant attributes are related to. It is required when the type has multiple encodings associated with it. If the type uses a single encoding, the parameter can be set to the special value `null`. The operation returns the special value `null`, if the parameter specifies a non-existent encoding or if it contains `null` and the type contains multiple encodings.

`TStringSeq getTypeExtension()` Returns the type extension attribute as defined in the TTCN-3 module.

`Value parseValue(in TString val)` This operation creates a new value of the given type from a string provided in the parameter. The input string shall use valid TTCN-3 syntax for values or templates of this type. The only references allowed in the input string are type references. If the input string contains an error, the distinct value `null` is returned. The operation is an optional part of the TCI and tool vendors are not required to support value parsing. If not supported, `parseValue` will always return the distinct value `null`.

NOTE 4: The `parseValue` operation can be used for defining matching symbols to enable the representation of templates in TCI.

`MatchingMechanism newTemplate(TciMatchingType matchingType)` Returns a freshly created matching mechanism of this type. The `matchingType` parameter determines what kind of matching mechanism will be created (see clause 7.2.2.3.1 for more details). If the created matching mechanism contains additional data properties, these properties are uninitialized in the created matching mechanism.

`RangeBoundary` `getLowerTypeBoundary()`

Returns the lower range boundary of the type if it has a range-restriction attached to it. Otherwise, the distinct value `null` is returned.

`RangeBoundary` `getUpperTypeBoundary()`

Returns the lower range boundary of the type if it has a range-restriction attached to it. Otherwise, the distinct value `null` is returned.

`LengthRestriction` `getTypeLengthRestriction()`

Returns the length restriction of the type if it has a length restriction attached to it. Otherwise, the distinct value `null` is returned.

`MatchingMechanism` `getTypeMatchingMechanism()`

Returns the matching mechanism of the type if it is restricted by a matching mechanism. Otherwise, the distinct value `null` is returned.

7.2.2.2 Abstract TTCN-3 values

7.2.2.2.0 Basic rules

According to the present document, TTCN-3 values are represented at the TCI interfaces via numerous abstract data types.

Figure 4 presents the hierarchy between the abstract data types for TTCN-3 values (short: abstract values).

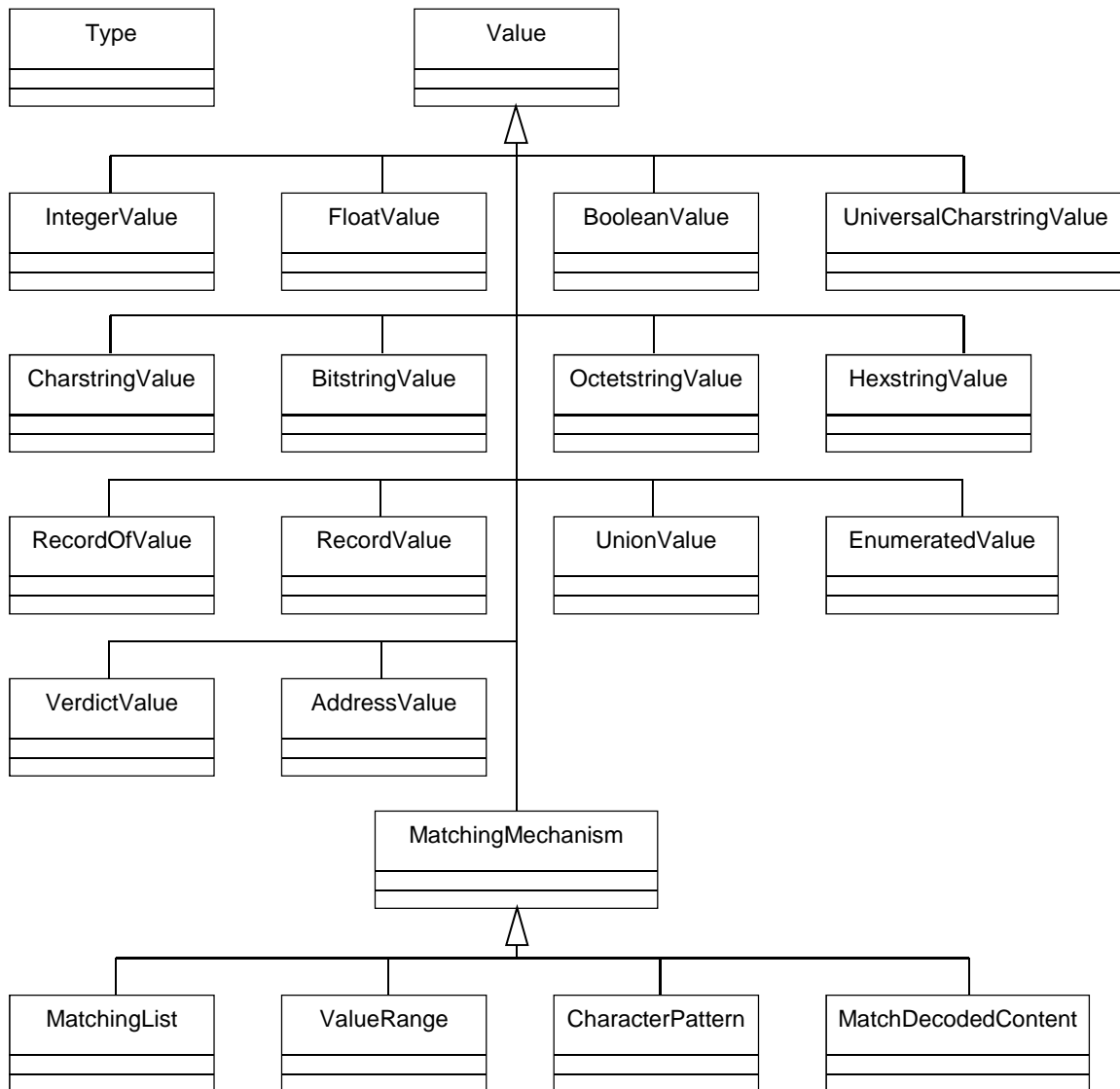

Figure 4: Hierarchy of abstract values

As shown in figure 4, all TTCN-3 abstract values share the same base abstract data type `Value`. All operations defined on this common base data type are implicitly defined also for the abstract value types derived from it.

In addition, `Value` can be used to represent matching mechanisms, which are used instead or inside values e.g. in template parameters or for template variables. Two additional operations: `isMatchingSymbol` (returns true for matching symbols) and `valueToString` (for printing value content in the same way as the log operation; can be used for displaying value content) are defined. These operations are not mandatory - it is up to a tool vendor to support them or not.

Values using `@lazy` and `@fuzzy` modifiers are represented by the `Value` data type too. However, it is not possible to use the `Value` data type to perform evaluation of these values; evaluation can be performed by the TE only. If a `@lazy` or `@fuzzy` value has been assigned, but it doesn't contain result of the evaluation, any data access operations shall result in an error.

7.2.2.2.1 The abstract data type `Value`

The following operations are defined on the base abstract data type `Value`. The concrete representations of these operations are defined in the respective language mapping sections:

`Type` `getType()`

Returns the type of the specified value.

<code>TBoolean notPresent()</code>	Returns <code>true</code> if the specified value is omit, <code>false</code> otherwise.
<code>TString getValueEncoding()</code>	Returns the value encode attribute as defined in the TTCN-3 module, if any. If no encoding attribute is defined the distinct value <code>null</code> is returned. If the value has more than one encode attributes associated with it, all encode attributes are concatenated to a single string using LF (line feed char(0, 0, 10)), CR (carriage return char(0, 0, 13)) or their combination as a separator.
<code>TString getValueEncodingVariant()</code>	Returns the value encoding variant attribute as defined in the TTCN-3 module, if any. If no encoding variant attribute is defined the distinct value <code>null</code> is returned. If the value has more than one variant attributes associated with it, all variant attributes are concatenated to a single string using LF (line feed char(0, 0, 10)), CR (carriage return char(0, 0, 13)) or their combination as a separator. In case the value supports multiple encodings, the function returns variants for all encodings. Each variant will be prefixed with the associated encode attribute and followed by a full stop character in this case.
<code>TStringSeq getEncodingAttributes()</code>	Returns all encode attributes of the value as defined in the TTCN-3 module. If no encode attribute is defined the distinct value <code>null</code> is returned.
<code>TStringSeq getVariantAttributes(in TString encoding)</code>	This operation returns all variant attributes of the value as defined in the TTCN-3 module. If no variant attribute is defined the distinct value <code>null</code> is returned. The parameter is used to specify encoding the variant attributes are related to. It is required when the value has multiple encodings associated with it. If the type uses a single encoding , the parameter can be set to the special value <code>null</code> . The operation returns the distinct value <code>null</code> , if the parameter specifies a non-existent encoding or if it contains <code>null</code> and the value contains multiple encodings.
<code>TBoolean isMatchingSymbol()</code>	Returns <code>true</code> if the instance is of the <code>MatchingMechanism</code> abstract data type (or any other abstract data type derived from the <code>MatchingMechanism</code> data type) and <code>false</code> in all other cases.
<p>NOTE: This method can be used for detecting the exact abstract data type of the instance. If the method returns <code>false</code>, it is safe to assume that the instance is one of the abstract value data types defined in clause 7.2.2.2. If the method returns <code>true</code>, the instance is one of the matching mechanism defined in clause 7.2.2.3.</p>	
<code>TString valueToString()</code>	Returns the same string as produced by the log operation (specified in clause 19.11 of ETSI ES 201 873-1 [1]) with the specified value as its parameter.
<code>TBoolean isFuzzy ()</code>	Returns <code>true</code> if the specified value has the <code>@fuzzy</code> modifier, <code>false</code> otherwise.
<code>TBoolean isLazy ()</code>	Returns <code>true</code> if the specified value has the <code>@lazy</code> modifier, <code>false</code> otherwise.
<code>TBoolean isEvaluated ()</code>	Returns <code>true</code> if the value has been evaluated and its data content is available, <code>false</code> otherwise. In case of uninitialized values, <code>false</code> is always returned. The method is typically used for <code>@lazy</code> values, and it returns <code>false</code> for values that have been assigned, but not evaluated yet and <code>true</code> if the value contains the evaluation result. The method returns <code>false</code> for <code>@fuzzy</code> values, as the result of evaluation is never stored by the TE. For all other values, the method returns <code>true</code> .
<code>LengthRestriction getLengthRestriction()</code>	Returns a length restriction matching attribute (specified in clause B.1.4.1 of ETSI ES 201 873-1 [1]) in case it is attached to the value or the distinct value <code>null</code> if no such matching attribute is present.

<code>void setLengthRestriction(LengthRestriction restriction)</code>	Adds a length restriction matching attribute (specified in clause B.1.4.1 of ETSI ES 201 873-1 [1]) to the value or modifies an existing one. The distinct value <code>null</code> can be used as a parameter to disable an existing length restriction.
<code>TBoolean isIfPresentEnabled()</code>	Returns <code>true</code> if the <code>ifpresent</code> indicator (specified in clause B.1.4.2 of ETSI ES 201 873-1 [1]) is attached to the value and <code>false</code> otherwise.
<code>void setIfPresentEnabled(TBoolean enabled)</code>	Sets the whether the <code>ifpresent</code> indicator (specified in clause B.1.4.2 of ETSI ES 201 873-1 [1]) is attached to the value or not.
<code>RangeBoundary getLowerTypeBoundary()</code>	Returns the lower range boundary of the value's type if it has a range-restriction attached to it. Otherwise, the distinct value <code>null</code> is returned. This is only applicable for values with types of typeclass <code>INTEGER</code> and <code>FLOAT</code> .
<code>RangeBoundary getUpperTypeBoundary()</code>	Returns the lower range boundary of the value's type if it has a range-restriction attached to it. Otherwise, the distinct value <code>null</code> is returned. This is only applicable for values with types of typeclass <code>INTEGER</code> or <code>FLOAT</code> .
<code>LengthRestriction getTypeLengthRestriction()</code>	Returns a length restriction matching attribute (specified in clause B.1.4.1 of ETSI ES 201 873-1 [1]) in case it is attached to the value's type or the distinct value <code>null</code> if no such matching attribute is present. This is only applicable for values with types of typeclass <code>CHARSTRING</code> , <code>UNIVERSAL_CHARSTRING</code> , <code>BITSTRING</code> , <code>HEXSTRING</code> , <code>OCTETSTRING</code> , <code>RECORD_OF</code> , <code>SET_OF</code> or <code>ARRAY</code> .
<code>MatchingMechanism getTypeMatchingMechanism()</code>	Returns the matching mechanism (see clause 7.2.2.3.1) of the value's type if it is restricted by a subtype specification attribute (specified in clauses 6.1.2 and 6.2.13 of ETSI ES 201 873-1 [1]). Otherwise, the distinct value <code>null</code> is returned.
<code>TBoolean isOptional()</code>	Returns <code>true</code> if and only if the value is either an optional field or a template without value or present template restriction.

When working with length restriction data using the `getLengthRestriction` and `setLengthRestriction`, methods, no assumption shall be made on how the data are stored in a value. An internal implementation might choose to use a reference to the data or copy the data. It is safe to assume that the data are copied. Therefore, it should be assumed that subsequent modifications of the length restriction data will not be considered in the value object.

7.2.2.2.2 The abstract data type `IntegerValue`

The abstract data type `IntegerValue` is based on the abstract data type `Value`. It represents TTCN-3 integer values.

The following operations are defined on the abstract data type `IntegerValue`:

<code>TInteger getInt()</code>	Returns the integer value of this TTCN-3 integer.
<code>void setInt(in TInteger value)</code>	Sets this <code>IntegerValue</code> to value.

7.2.2.2.3 The abstract data type `FloatValue`

The abstract data type `FloatValue` is based on the abstract data type `Value`. It represents TTCN-3 float values.

The following operations are defined on the abstract data type `FloatValue`:

`TFloat getFloat()` Returns the float value of this TTCN-3 float.
`void setFloat(in TFloat value)` Sets this `FloatValue` to value.

7.2.2.2.4 The abstract data type `BooleanValue`

The abstract data type `BooleanValue` is based on the abstract data type `Value`. It represents TTCN-3 boolean values.

The following operations are defined on the abstract data type `FloatValue`:

`TBoolean getBoolean ()` Returns the boolean value of the TTCN-3 boolean.
`void setBoolean(in TBoolean value)` Sets this boolean value to value.

7.2.2.2.5 The abstract data type `CharstringValue`

The abstract data type `CharstringValue` is based on the abstract data type `Value`. It represents TTCN-3 `charstring` values. `TChar` is a character within a `charstring` value.

The following operations are defined on the abstract data type `CharstringValue`:

`TString getString()` Returns the string value of the TTCN-3 `charstring`. The textual representation of the empty TTCN-3 `charstring` is "", while its length is zero.
`void setString(in TString value)` Sets this `CharstringValue` to value.
`TChar getChar(in TInteger position)` Returns the char value of the TTCN-3 `charstring` at `position`. Position 0 denotes the first char of the TTCN-3 `charstring`. Valid values for `position` are from 0 to `length - 1`.
`void setChar(in TInteger position, in TChar value)` Set the character at `position` to `value`. Valid values for `position` are from 0 to `length - 1`.
`TInteger getLength()` Returns the length of this `CharstringValue` in chars, zero if the value of this `CharstringValue` is omit.
`void setLength(in TInteger len)` `setLength` first resets this `CharstringValue` to its initial value and afterwards sets the length of this `CharstringValue` in chars to `len`.

7.2.2.2.6 The abstract data type `UniversalCharstringValue`

The abstract data type `UniversalCharstringValue` is based on the abstract data type `Value`. It represents TTCN-3 `universal charstring` values. `TUniversalChar` is a character within a `universal charstring` value.

The following operations are defined on the abstract data type `UniversalCharstringValue`:

`TString getString()` Returns the textual representation of this `UniversalCharstringValue`, as defined in TTCN-3.
`void setString(in TString value)` Sets the value of this `UniversalCharstringValue` according to the textual representation as defined by `value`.
`TUniversalChar getChar(in TInteger position)` Returns the universal char value of the TTCN-3 `universal charstring` at `position`. Position 0 denotes the first `TUniversalChar` of the TTCN-3 `universal charstring`. Valid values for `position` are from 0 to `length - 1`.

<code>void setChar(in TInteger position, in TUniversalChar value)</code>	Sets the universal char at position to value. Valid values for position are from 0 to length - 1.
<code>TInteger getLength()</code>	Returns the length of this universal charstring value in universal chars, zero if the value of this universal charstring value is omit.
<code>void setLength(in TInteger len)</code>	setLength first resets this UniversalCharstringValue to its initial value and afterwards sets the length of this UniversalCharstringValue in universal chars to len.

7.2.2.2.7 The abstract data type BitstringValue

The abstract data type `BitstringValue` is based on the abstract data type `Value`. It represents TTCN-3 `bitstring` values. This abstract data type uses a parameter `position` in some of its operations for addressing individual bits or embedded matching mechanisms. The following rules are valid in this case:

- Position 0 denotes the first bit or matching mechanism of the TTCN-3 bitstring
- Valid values for position are from 0 to length - 1, where length is the total number of bits and individual matching mechanisms in the value

Each individual matching mechanism takes exactly one position regardless of how many bits it can match.

The following operations are defined on the abstract data type `BitstringValue`.

<code>TString getString()</code>	Returns the textual representation of this <code>BitstringValue</code> , as defined in TTCN-3. E.g. the textual representation of 0101 is '0101'B. The textual representation of the empty TTCN-3 bitstring is ''B, while its length is zero.
<code>void setString(in TString value)</code>	Sets the value of this <code>BitstringValue</code> according to the textual representation as defined by value. E.g. the value of this <code>BitstringValue</code> is 0101 if the textual representation in value is '0101'B. The parameter may contain allowed matching symbols such as <code>AnyElement</code> or <code>AnyElementsOrNone</code> .
<code>TChar getBit(in TInteger position)</code>	Returns the value (0 1) at position of this TTCN-3 bitstring as a character. An error will occur when the specified position contains a matching mechanism.
<code>void setBit(in TInteger position, in TInteger value)</code>	Sets the bit at position to the value (0 1).
<code>TInteger getLength()</code>	Returns the length of this <code>BitstringValue</code> . The length is equal to the total number of bits and individual matching mechanisms in the value. If the value of this <code>BitstringValue</code> is omit, the length is equal to 0. Each individual matching mechanism is considered to have the length of one bit regardless of how many bits it can match.
<code>void setLength(in TInteger len)</code>	setLength first resets this <code>BitstringValue</code> to its initial value and afterwards sets the length of this <code>BitstringValue</code> in bits to len.
<code>TBoolean isMatchingAt(in TInteger position)</code>	Returns true if the item at position of this TTCN-3 bitstring is a matching mechanism inside a value (<code>AnyElement</code> , <code>AnyElementsOrNone</code>) and false otherwise.
<code>MatchingMechanism getMatchingAt(in TInteger position)</code>	If the position of this TTCN-3 bitstring contains a matching mechanism inside a value (<code>AnyElement</code> , <code>AnyElementsOrNone</code>), the method returns it. Otherwise the distinct value null is returned.

`void setMatching(in TInteger position, in MatchingMechanism template)`

Sets a matching mechanism at `position`. Only two matching mechanisms are allowed: `AnyElement` and `AnyElementsOrNone`.

7.2.2.2.8 The abstract data type `OctetstringValue`

The abstract data type `OctetstringValue` is based on the abstract data type `Value`. It represents TTCN-3 `octetstring` values. This abstract data type uses a parameter `position` in some of its operations for addressing individual octets or embedded matching mechanisms. The following rules are valid in this case:

- Position 0 denotes the first octet or matching mechanism of the TTCN-3 `octetstring`
- Valid values for position are from 0 to `length - 1`, where `length` is the total number of octets and individual matching mechanisms in the value
- Each individual matching mechanism takes exactly one position regardless of how many octets it can match

The following operations are defined on the abstract data type `OctetstringValue`:

`TString getString()`

Returns the textual representation of this `OctetstringValue`, as defined in TTCN-3. E.g. the textual representation of `0xCAFFEE` is `'CAFFEE'0`. The textual representation of the empty TTCN-3 `octetstring` is `'0`, while its length is zero.

`void setString(in TString value)`

Sets the value of this `OctetstringValue` according to the textual representation as defined by `value`. E.g. The value of this `OctetstringValue` is `0xCAFFEE` if the textual representation in `value` is `'CAFFEE'0`. The parameter may contain allowed matching symbols such as `AnyElement` or `AnyElementsOrNone`.

`TChar getOctet(in TInteger position)`

Returns the value (`0..255`) at `position` of this TTCN-3 `octetstring`. An error will occur when the specified position contains a matching mechanism.

`void setOctet(in TInteger position, in TInteger value)`

Sets the octet at `position` to value (`0..255`).

`TInteger getLength()`

Returns the length of this `OctetstringValue`. The length is equal to the total number of octets and individual matching mechanisms in the value. If the value of this `OctetstringValue` is `omit`, the length is equal to 0. Each individual matching mechanism is considered to have the length of one octet regardless of how many octets it can match.

`void setLength(in TInteger len)`

`setLength` first resets this `OctetstringValue` to its initial value and afterwards sets the length of this `OctetstringValue` in octets to `len`.

`TBoolean isMatchingAt(in TInteger position)`

Returns `true` if the item at `position` of this TTCN-3 `octetstring` is a matching mechanism inside a value (`AnyElement`, `AnyElementsOrNone`) and `false` otherwise.

`MatchingMechanism getMatchingAt(in TInteger position)`

If the `position` of this TTCN-3 `octetstring` contains a matching mechanism inside a value (`AnyElement`, `AnyElementsOrNone`), the method returns it. Otherwise the distinct value `null` is returned.

`void setMatching(in TInteger position, in MatchingMechanism template)`

Sets a matching mechanism at `position`. Only two matching mechanisms are allowed: `AnyElement` and `AnyElementsOrNone`.

7.2.2.2.9 The abstract data type `HexstringValue`

The abstract data type `HexstringValue` is based on the abstract data type `Value`. It represents TTCN-3 `hexstring` values. This abstract data type uses a parameter `position` in some of its operations for addressing individual hex digits or embedded matching mechanisms. The following rules are valid in this case:

- Position 0 denotes the first hex digit or matching mechanism of the TTCN-3 `hexstring`.
- Valid values for position are from 0 to `length - 1`, where `length` is the total number of hex digits and individual matching mechanisms in the value.

Each individual matching mechanism takes exactly one position regardless of how many hex digits it can match.

The following operations are defined on the abstract data type `HexstringValue`:

<code>TString getString()</code>	Returns the textual representation of this <code>HexstringValue</code> , as defined in TTCN-3. E.g. the textual representation of <code>0xAFFEE</code> is <code>'AFFEE'H</code> . The textual representation of the empty TTCN-3 <code>hexstring</code> is <code>'H</code> , while its length is zero.
<code>void setString(in TString value)</code>	Sets the value of this <code>HexstringValue</code> according to the textual representation as defined by <code>value</code> . E.g. The value of this <code>HexstringValue</code> is <code>0xAFFEE</code> if the textual representation in <code>value</code> is <code>'AFFEE'H</code> . The parameter may contain allowed matching symbols such as <code>AnyElement</code> or <code>AnyElementsOrNone</code> .
<code>TChar getHex(in TInteger position)</code>	Returns the value (0..15) at <code>position</code> of this TTCN-3 <code>hexstring</code> . An error will occur when the specified position contains a matching mechanism.
<code>void setHex(in TInteger position, in TInteger value)</code>	Sets the hex digit at <code>position</code> to <code>value</code> (0..15).
<code>TInteger getLength()</code>	Returns the length of this <code>HexstringValue</code> . The length is equal to the total number of hex digits and individual matching mechanisms in the value. If the value of this <code>HexstringValue</code> is <code>omit</code> , the length is equal to 0. Each individual matching mechanism is considered to have the length of one hex digit regardless of how many hex digits it can match.
<code>void setLength(in TInteger len)</code>	<code>setLength</code> first resets this <code>HexstringValue</code> to its initial value and afterwards sets the length of this <code>HexstringValue</code> in hex digits to <code>len</code> .
<code>TBoolean isMatchingAt(in TInteger position)</code>	Returns <code>true</code> if the item at <code>position</code> of this TTCN-3 <code>hexstring</code> is a matching mechanism inside a value (<code>AnyElement</code> , <code>AnyElementsOrNone</code>) and <code>false</code> otherwise.
<code>MatchingMechanism getMatchingAt(in TInteger position)</code>	If the <code>position</code> of this TTCN-3 <code>hexstring</code> contains a matching mechanism inside a value (<code>AnyElement</code> , <code>AnyElementsOrNone</code>) the method returns it. Otherwise the distinct value <code>null</code> is returned.
<code>void setMatching(in TInteger position, in MatchingMechanism template)</code>	Sets a matching mechanism at <code>position</code> . Only two matching mechanisms are allowed: <code>AnyElement</code> and <code>AnyElementsOrNone</code> .

7.2.2.2.10 The abstract data type `RecordValue`

The abstract data type `RecordValue` is based on the abstract data type `Value`. It specifies how to get and set the TTCN-3 record type.

NOTE: Newly created instances of empty record types are considered to be initialized.

The same abstract data type applies for values whose type class is `SET`. The distinction between `record` and `set` is only relevant at matching time.

The following operations are defined on the abstract data type `RecordValue`:

`Value getField(in TString fieldName)`

Returns the value of the field named `fieldName`. The return value is the common abstract base type `Value`, as a record field can have any type defined in TTCN-3. If the field cannot be obtained from the record the distinct value `null` is returned.

`void setField(in TString fieldName, in Value value)`

Sets the field named `fieldName` of the record to `value`. No assumption shall be made on how a field is stored in a record. An internal implementation might choose to store a reference to this value or to copy the value. It is safe to assume that the value is copied. Therefore it should be assumed that subsequent modifications of `value` will not be considered in the record. Using a `MatchingMechanism` of the `OMIT_TEMPLATE` type as the `value` parameter has the same effect as calling the `setFieldOmitted` with the `fieldName` as a parameter.

`TStringSeq getFieldNames()`

Returns a sequence of string of field names, the empty sequence, if the record has no fields.

`void setFieldOmitted(in TString fieldName)`

Mark the referenced field of the record as being omitted.

7.2.2.2.11 The abstract data type `RecordOfValue`

The abstract data type `RecordOfValue` is based on the abstract data type `Value`. It specifies how to get and set elements in TTCN-3 `record of` types. The same abstract data type applies for value whose type class is `ARRAY` or `SET_OF`. The distinction between `record of`, `set of`, and `array` is only relevant at matching time.

This abstract data type uses a parameter `position` in some of its operations for addressing individual elements or embedded matching mechanisms. The following rules are valid in this case:

- Position 0 denotes the first element or matching mechanism of the record of, set of or array value.
- Valid values for position are from 0 to `length - 1`, where `length` is the total number of elements and individual matching mechanisms in the record of, set of and or array value.
- In case of array, element indices start from 0, independent of the lower index bound.
- Each individual matching mechanism with exception permutations takes exactly one position regardless of how many elements it can match.
- Permutation takes exactly as many positions as many items it contains: each value or matching mechanism inside it takes exactly one position.

When working with instances received from the get methods (`getField`, `getPermutation`), and passed to the set methods (`setField`, `appendField`, `setPermutation`), no assumption shall be made on how the data are stored in a `record of`. An internal implementation might choose to use a reference to the data or to copy the data. It is safe to assume that the data are copied. Therefore, it should be assumed that subsequent modifications of the field or permutation data will not be considered in the `record of`.

The following operations are defined on the abstract data type RecordOfValue:

Value getField(in TInteger position)	Returns the value of the record of at position if position is between zero and length - 1, the distinct value null otherwise. The return value is the common abstract base type Value, as a record of can have fields of any type defined in TTCN-3.
void setField(in TInteger position, in Value value)	Sets the field at position to value. If position is greater than (length - 1) the record of is extended to have the length (position + 1). The record of elements between the original position at length and position - 1 is set to omit.
void appendField(in Value value)	Appends the value at the end of the record of, i.e. at position length.
Type getElementType()	Returns the Type of the elements of this record of.
TInteger getLength()	Returns the actual length of the record of value, zero if the record of value is omit.
void setLength(in TInteger len)	Sets the length of the record of to len. If len is greater than the original length, newly created elements have the value omit. If len is less or equal than the original length this operation is ignored.
TInteger getOffset()	Returns the lowest possible index. For a record of or set of value this is always 0. For an array value, this is the lower index bound used in the type definition.
TInteger getPermutationCount()	Returns the number of permutations in the record of or array value.
Permutation getPermutation(TInteger index)	Returns the permutation at the specified index. The allowed index range is from 0 to (getPermutationCount() - 1).
void definePermutation(Permutation permutation)	Creates permutation from existing elements of a record of value. The permutation parameter shall not include a direct or indirect reference to elements that are already a part of other existing permutations attached to the same record of. In particular, no element with and index greater or equal to permutation.getStartPostion() and less than permutation.getStartPosition() + permutation.getLength() may be a part of a different permutation. No elements are added to the record of by this operation.
void removePermutation(TInteger index)	Removes the permutation at the specified index. The allowed index range is from 0 to (getPermutationCount() - 1). No elements are removed from the record of by this operation. When the operation completes, the existing elements at positions specified by the removed permutation don't belong to any permutation.
void clearPermutations()	Removes all permutations from the value. The elements that belonged to the removed permutation are not removed.

7.2.2.2.12 The abstract data type `UnionValue`

The abstract data type `UnionValue` is based on the abstract data type `Value`. It specifies how to get and set variants in a TTCN-3 union type. The TTCN-3 anytype is represented by a `UnionValue` where the type class of the type obtained by `getType()` is ANYTYPE. For details on type classes see clause 7.2.2.1.

The following operations are defined on the abstract data type `UnionValue`:

<code>Value getVariant(in TString variantName)</code>	Returns the value of the TTCN-3 union <code>variantName</code> , if <code>variantName</code> equals the result of <code>getPresentVariantName</code> , the distinct value <code>null</code> otherwise. <code>variantName</code> denotes the name of the union variant as defined in the TTCN-3 module.
<code>void setVariant(in TString variantName, in Value value)</code>	Sets <code>variantName</code> of the union to <code>value</code> . If <code>variantName</code> is not defined for this union this operation is ignored. If another variant was selected the new variant is selected instead.
<code>TString getPresentVariantName()</code>	Returns a <code>String</code> representing the currently selected variant name in the given TTCN-3 union. The distinct value <code>null</code> is returned if no variant is selected.
<code>TStringSeq getVariantNames()</code>	Returns a sequence of string of variant names, the distinct value <code>null</code> , if the union has no fields. If the <code>UnionValue</code> represents the TTCN-3 anytype, i.e. the type class of the type obtained by <code>getType()</code> is ANYTYPE, all predefined and user-defined TTCN-3 types is returned.

7.2.2.2.13 The abstract data type `EnumeratedValue`

The abstract data type `EnumeratedValue` is based on the abstract data type `Value`. It specifies how TTCN-3 `enumerated` can be set and get.

The following operations are defined on the abstract data type `EnumeratedValue`:

<code>TString getEnum()</code>	Returns the string identifier of this <code>EnumeratedValue</code> . This identifier equals the identifier in the TTCN-3 specification.
<code>void setEnum(in TString enumValue)</code>	Sets the enum to <code>enumValue</code> . If <code>enumValue</code> is not an allowed value for this enumeration the operation is ignored.
<code>TInteger getInt()</code>	Returns the integer value of this <code>EnumeratedValue</code> . This integer equals the user-assigned integer value in the TTCN-3 specification or the automatically assigned integer value.
<code>setInt(in TInteger intValue)</code>	Sets the integer value of this <code>EnumeratedValue</code> . This integer should equal the user-assigned integer value in the TTCN-3 specification or the automatically assigned integer value. If <code>intValue</code> is not an allowed value for this enumeration the operation is ignored.

7.2.2.2.14 The abstract data type `VerdictValue`

The abstract data type `VerdictValue` is based on the abstract data type `Value`. It specifies how TTCN-3 `verdict` can be set and get.

The following operations are defined on the abstract data type `VerdictValue`:

<code>TInteger getVerdict()</code>	Returns the integer value for this <code>VerdictValue</code> . The integer is one of the following constants: <code>ERROR</code> , <code>FAIL</code> , <code>INCONC</code> , <code>NONE</code> , <code>PASS</code> , <code>USER_ERROR</code> .
------------------------------------	--

```
void setVerdict(in TInteger verdict)
```

Sets this `VerdictValue` to `verdict`. Note that a `VerdictValue` can be set to any of the above mentioned verdicts at any time. The `VerdictValue` does not perform any verdict calculations as defined in TTCN-3. For example, it is legal to set the `VerdictValue` first to `INCONC` and then to `PASS`.

7.2.2.2.15 The abstract data type `AddressValue`

The following operations are defined on the base abstract data type `AddressValue`. The concrete representations of these operations are defined in the respective language mapping sections:

```
Value getAddress()
```

Returns the address value, which will no longer be of type class `ADDRESS` but rather of the actual type used for address.

```
void setAddress(in Value value)
```

Sets this address value to `value`.

7.2.2.3 Abstract TTCN-3 matching mechanisms

7.2.2.3.1 The abstract data type `MatchingMechanism`

In case a template can occur in a TCI operation in the same place as a value (e.g. in a function call).

TTCN-3 matching mechanisms are represented at the TCI interfaces via numerous abstract data types. All matching mechanisms share the same abstract data type `MatchingMechanism`. This data type is based on the abstract data type `Value` and inherits all its operations. While simpler matching mechanisms that do not have any additional properties are represented by the `MatchingMechanism` data type, more complex ones have their own dedicated data types. These data types are derived from the `MatchingMechanism` data type implicitly inherit all its operations.

The abstract data type `MatchingMechanism` defines operations that are common for all TCI matching mechanisms. It is also used to represent simple matching mechanisms with no additional properties, in particular: `AnyValue`, `AnyValueOrNone`, `AnyElement`, `AnyElementsOrNone`, `omit`.

The following operations are defined on the base abstract data type `MatchingMechanism`. The concrete representations of these operations are defined in the respective language mapping sections:

```
TciMatchingTypeType getMatchingType()
```

Returns the matching mechanism type. A value of `TciMatchingTypeType` can have one of the following constants: `TEMPLATE_LIST`, `COMPLEMENTED_LIST`, `ANY_VALUE`, `ANY_VALUE_OR_NONE`, `VALUE_RANGE`, `SUBSET`, `SUPERSET`, `ANY_ELEMENT`, `ANY_ELEMENTS_OR_NONE`, `PATTERN`, `MATCH_DECODED_CONTENT`, `OMIT_TEMPLATE`.

NOTE: `OMIT_TEMPLATE` is used to represent an omit matching symbol assigned to a top-level template. Omitted fields of record templates are represented in a different way (see clause 7.2.2.2.10 for more details).

7.2.2.3.2 The abstract data type `MatchingList`

The abstract data type `MatchingList` is used to represent matching mechanisms that contain a list of items of the same type: template list, complemented template list, `SubSet` and `SuperSet`.

This abstract data type uses a parameter `position` in some of its operations for addressing individual values or templates inside this matching mechanism. The following rules are valid in this case:

- Position 0 denotes the first value or template in the TTCN-3 matching mechanism
- Valid values for position are from 0 to $(\text{size}() - 1)$

When working with instances received from the `get` method and passed to the set methods (`add`, `insert`), no assumption shall be made on how the data are stored in a matching mechanism. An internal implementation might choose to use a reference to the data or to copy the data. It is safe to assume that the data are copied. Therefore, it should be assumed that subsequent modifications of the data will not be considered in the matching mechanism.

The following operations are defined on the base abstract data type `MatchingList`:

<code>TInteger size()</code>	Returns the number of items in the matching mechanism.
<code>Value get(TInteger position)</code>	Returns the value or template at the specified <code>position</code> inside the matching mechanism.
<code>void add(Value item)</code>	Adds a new <code>item</code> to the end of the matching list, increasing its size.
<code>void remove(TInteger position)</code>	Removes the value or template at the specified <code>position</code> inside the matching mechanism.
<code>void clear()</code>	Removes all values and templates from the matching mechanism.

7.2.2.3.3 The abstract data type `ValueRange`

The abstract data type `ValueRange` is used to represent the value range matching mechanism.

When working with instances received from the get methods (`getLowerBoundary`, `getUpperBoundary`) and passed to the set methods (`setLowerBoundary`, `setUpperBoundary`), no assumption shall be made on how the data are stored in a matching mechanism. An internal implementation might choose to use a reference to the data or to copy the data. It is safe to assume that the data are copied. Therefore, it should be assumed that subsequent modifications of the data will not be considered in the `ValueRange` instance.

The following operations are defined on the base abstract data type `ValueRange`:

<code>RangeBoundary getLowerBoundary()</code>	Returns the lower boundary of the range.
<code>RangeBoundary getUpperBoundary()</code>	Returns the upper boundary of the range.
<code>void setLowerBoundary(RangeBoundary lowerBoundary)</code>	Sets the lower boundary of the range.
<code>void setUpperBoundary(RangeBoundary upperBoundary)</code>	Sets the upper boundary of the range.

7.2.2.3.4 The abstract data type `CharacterPattern`

The abstract data type `CharacterPattern` is used to represent the character pattern matching mechanism.

When working with instances received from the `getPatternString` method and passed to the `setPatternString` method, no assumption shall be made on how the data are stored in a matching mechanism. An internal implementation might choose to use a reference to the data or to copy the data. It is safe to assume that the data are copied. Therefore, it should be assumed that subsequent modifications of the data will not be considered in the `CharacterPattern` instance.

The following operations are defined on the base abstract data type `CharacterPattern`:

<code>Value getPatternString ()</code>	Returns the character pattern definition of this pattern (either a <code>CharstringValue</code> or <code>UniversalCharstringValue</code>).
<code>void setPatternString(Value characterPattern)</code>	Sets the character pattern definition of this pattern. The <code>characterPattern</code> parameter shall contain either a <code>CharstringValue</code> or <code>UniversalCharstringValue</code> .

7.2.2.3.5 The abstract data type `MatchDecodedContent`

The abstract data type `MatchDecodedContent` is used to represent the `decmatch` matching mechanism.

When working with instances received from the `getContent` method and passed to the `setContent` method, no assumption shall be made on how the data are stored in a matching mechanism. An internal implementation might choose to use a reference to the data or to copy the data. It is safe to assume that the data are copied. Therefore, it should be assumed that subsequent modifications of the data will not be considered in the `DecodedMatch` instance.

The following operations are defined on the base abstract data type `DecodedMatch`:

<code>Value getContent()</code>	Returns the value or matching mechanism used as an argument of the <code>decmatch</code> matching mechanism.
<code>void setContent(Value content)</code>	Sets the value or matching mechanism that is used as an argument of the <code>decmatch</code> matching mechanism.

7.2.2.4 Data types for complex TTCN-3 properties

7.2.2.4.0 Scope of use of TTCN-3 properties

The abstract data types described in the clause 7.2.2.4 are used to describe complex properties of TTCN-3 values and matching mechanisms.

7.2.2.4.1 The abstract data type `LengthRestriction`

The abstract data type `LengthRestriction` is used to represent the length restriction matching attribute.

The following operations are defined on the base abstract data type `LengthRestriction`:

<code>TInteger getLowerBoundary()</code>	Returns the lower boundary of the length restriction.
<code>TInteger getUpperBoundary()</code>	Returns the upper boundary of the length restriction.
<code>void setLowerBoundary(TInteger boundary)</code>	Sets the lower boundary value.
<code>void setUpperBoundary(TInteger boundary)</code>	Sets the upper boundary value.
<code>TBoolean isUpperBoundaryInfinity()</code>	Returns <code>true</code> if the upper boundary contains infinity and <code>false</code> otherwise.
<code>void setInfiniteUpperBoundary()</code>	Sets the upper boundary to infinity.

7.2.2.4.2 The abstract data type `Permutation`

The abstract data type `Permutation` is used to describe properties of a permutation matching mechanism embedded in a `RecordOfValue` instance.

The following operations are defined on the base abstract data type `Permutation`:

<code>TInteger getStartPosition()</code>	Returns the position of the first item of the permutation in the <code>RecordOfValue</code> .
<code>setStartPosition(TInteger position)</code>	Sets the position of the first item of the permutation in the <code>RecordOfValue</code> .
<code>TInteger getLength()</code>	Returns the number of elements or matching mechanisms of the <code>RecordOfValue</code> that are included in the permutation.

`void setLength(TInteger length)` Sets the number of elements or matching mechanisms of the `RecordOfValue` that are included in the permutation.

7.2.2.4.3 The abstract data type `RangeBoundary`

The abstract data type `RangeBoundary` is used to describe properties of lower and upper bound of `ValueRange` instances.

The following operations are defined on the base abstract data type `RangeBoundary`:

`Value getBoundary()` Returns the boundary value. Dependent on the type of the value range, the return value can be either an `IntegerValue`, `FloatValue`, `CharstringValue` or `UniversalCharstringValue`. If the boundary is undefined or it cannot be represented by a `Value` instance (infinity in case of integer values), the distinct value `null` is returned.

`TBoolean isInclusive()` Returns `true` if the boundary value is a part of the allowed range and `false` otherwise.

`void setBoundary(Value boundary, TBoolean inclusive)` Sets the boundary value. Dependent on the type of the value range, the boundary parameter can contain either an `IntegerValue`, `FloatValue`, `UniversalCharstringValue` or `CharstringValue`. The inclusive parameter determines whether the boundary value is a part of the range (`true`) or not (`false`).

`TBoolean isInfinity()` Returns `true` if the boundary is equal to infinity or `-infinity` and `false` otherwise. The infinity setting is context-dependent. If the `RangeBoundary` instance is used as a lower boundary, it will be interpreted as `-infinity` and if it is used as an upper boundary, it will be interpreted as `infinity`.

`void setToInfinity()` Sets the boundary to infinity.

7.2.3 Abstract logging types

7.2.3.1 The abstract data type `TciValueTemplate`

The following operations are defined on the abstract data type `TciValueTemplate`. The concrete representations of these operations are defined in the respective language mapping sections:

`TBoolean isOmit()` Returns `true` if the template is an omit template.

`TBoolean isAny()` Returns `true` if the template is an any template.

`TBoolean isAnyOrOmit()` Returns `true` if the template is an any or omit template.

`TString getTemplateDef()` Returns the definition of that template.

7.2.3.2 The abstract data type `TciNonValueTemplate`

The following operations are defined on the abstract data type `TciNonValueTemplate`. The concrete representations of these operations are defined in the respective language mapping sections:

`TBoolean isAny()` Returns `true` if the template is an any template.

`TBoolean isAll()` Returns `true` if the template is an all template.

`TString getTemplateDef()` Returns the definition of that template.

7.2.3.3 The Value List and Mismatch Types

The following abstract data types are defined and used for the logging of differences between values and templates:

<code>TciValueList</code>	A value of <code>TciValueList</code> is a list of values.
<code>TciValueDifference</code>	A value of <code>TciValueDifference</code> is a structure containing a value, a template, and a description for the reason of this difference.
<code>TciValueDifferenceList</code>	A value of <code>TciValueDifferenceList</code> is a sequence of value differences.

The following operations are defined on the abstract data type `TciValueList`. The concrete representations of these operations are defined in the respective language mapping sections:

<code>TInteger size()</code>	Returns the number of values in this list.
<code>TBoolean isEmpty()</code>	Returns <code>true</code> if this list contains no values.
<code>Value get(in TInteger index)</code>	Returns the value at the specified position.

The following operations are defined on the abstract data type `TciValueDifference`. The concrete representations of these operations are defined in the respective language mapping sections:

<code>Value getValue()</code>	Returns the value of the <code>TciValueDifference</code> .
<code>TciValueTemplate getTciValueTemplate()</code>	Returns the template of the <code>TciValueDifference</code> .
<code>String getDescription()</code>	Returns the description of the mismatch.

The following operations are defined on the abstract data type `TciValueDifferenceList`. The concrete representations of these operations are defined in the respective language mapping sections:

<code>TInteger size()</code>	Returns the number of values in the list.
<code>TBoolean isEmpty()</code>	Returns <code>true</code> if the list contains no values.
<code>TciValueDifference get(in TInteger index)</code>	Returns the <code>TciValueDifference</code> at the specified position.

7.2.3.4 The Status Types

The following abstract data types are defined and used for the logging of component and timer status:

<code>ComponentStatusType</code>	A value of <code>ComponentStatusType</code> is either "inactiveC", "runningC", "stoppedC", "killedC", or "nullC".
<code>TimerStatusType</code>	A value of <code>TimerStatusType</code> is either "runningT", "inactiveT", "expiredT", or "nullC".
<code>PortStatusType</code>	A value of <code>PortStatusType</code> is either "startedP", "haltedP", or "stoppedP".

7.3 TCI operations

7.3.0 The TCI interfaces

The clause 7.3 specifies the operations that a TTCN-3 Executable shall provide to a test system (*required operations*) and which functionality shall be provided by the test system to the TTCN-3 Executable (*provided operations*).

The terms "required" and "provided" reflect the fact that the present document defines the requirements on a TTCN-3 Executable from a user's point of view. The user "requires" from a TTCN-3 Executable certain functionality to build a complete TTCN-3-based test system. To fulfil its task the TTCN-3 Executable has to inform the user on certain events where the user has to "provide" this possibility to the TTCN-3 Executable.

All operation definitions in this clause are defined using the Interface Definition Language (IDL). Concrete language mappings are defined in clauses 8, 9, 10, 11 and 12. Annex B provides for the logging interface an alternative mapping to XML.

For every TCI operation call all *in*, *inout*, and *out* parameters listed in the particular operation definition are mandatory. The value of an *in* parameter is specified by the calling entity. Calling entity refers to the direction of the call. For operations on a *required* interface the calling entity is the test system while the called entity is the TTCN-3 Executable. For operations on a *provided* interface the calling entity is the TTCN-3 Executable while the test system is the called entity.

Similarly, the value of an *out* parameter is specified by the called entity. In the case of an *inout* parameter, a value is first specified by the calling entity but may be replaced with a new value by the called entity. Note that although TTCN-3 also uses *in*, *inout*, and *out* for signature definitions the denotations used in TCI IDL specification are not related to those in a TTCN-3 specification.

Operation calls should use a reserved value to indicate the absence of parameters. The reserved values for these types are defined in each language mapping and will be subsequently referred to as the `null` value.

In addition, the `null` value will also be used to indicate the inability to perform a certain task.

As this clause specifies interfaces only and does not suggest concrete implementations on how to perform the specified functionality the term entity will be used to identify the part of the test system implementation that implements this interface and performs the requested functionality. For example, the calling entity in the `tcISendConnected` operation is the TE, i.e. the part of test system implementation that provides the TE functionality.

All functions in the interface are described using the following template. Descriptions that are not applicable for certain operations are removed.

Signature	IDL Signature
In Parameters	Description of data passed as parameters to the operation from the calling entity to the called entity.
Out Parameters	Description of data passed as parameters to the operation from the called entity to the calling entity.
InOut Parameters	Description of data passed as parameters to the operation from the calling entity to the called entity and from the called entity back to the calling entity.
Return Value	Description of data returned from the operation to the calling entity.
Constraint	Description of any constraints when the operation can be called.
Effect	Behaviour required of the called entity before the operation may return.

7.3.1 The TCI-TM interface

7.3.1.0 Scope of use

The TCI Test Management Interface (TCI-TM) describes the operations a TTCN-3 Executable is required to implement and the operations a test management implementation shall provide to the TE (figure 5).

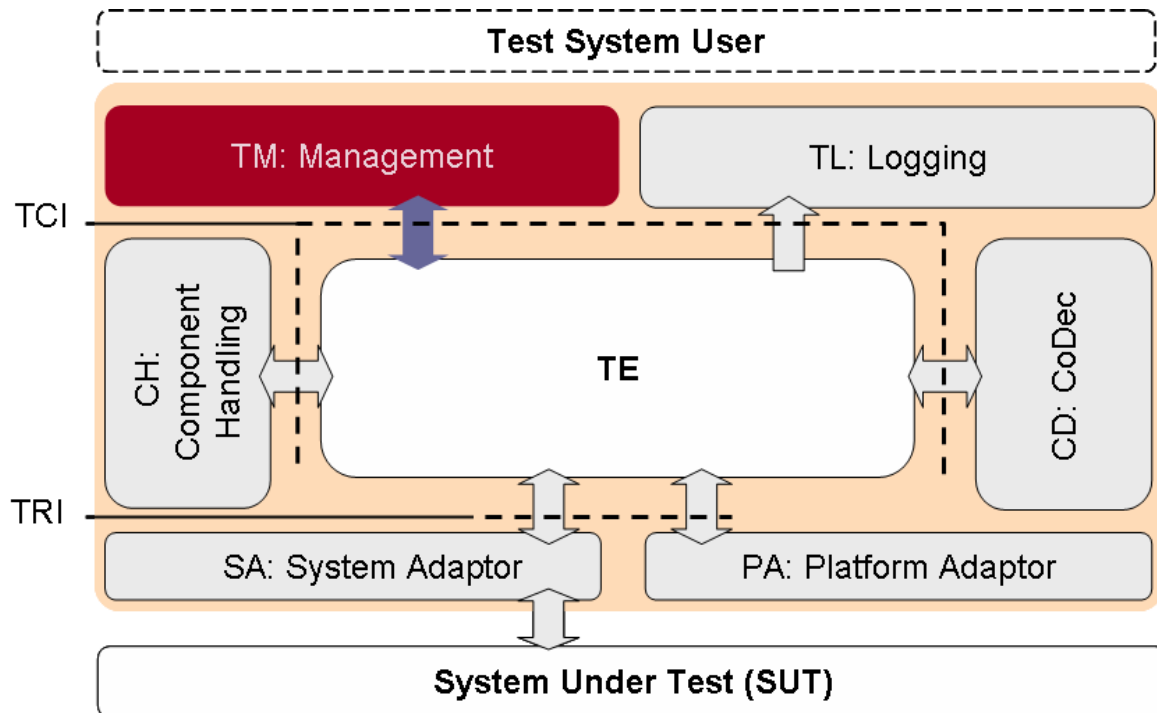

Figure 5: The TCI-TM interface

A test management implementation provides overall test management to the test system user. It requires from the TE the presence of operations to start and stop test execution of a TTCN-3 module or of certain test cases in a TTCN-3 module. In turn it provides operations to the TE for resolving module parameter at runtime and the indication of execution termination.

Annex C illustrates the usage and sequential ordering of operation calls by either the TE or the test management.

7.3.1.1 TCI-TM required

7.3.1.1.0 Scope of use

Clause 7.3.1.1 specifies the operations the TM requires from the TE. In addition to the operations specified in this clause, a test management requires the operations as required at the TCI-CD interface.

7.3.1.1.1 tciRootModule

Signature	void tciRootModule (in TciModuleIdType moduleName)	
In Parameters	moduleName	The moduleName denotes the module identifiers as defined in the TTCN-3 module.
Return Value	void	
Constraint	Shall be used only if neither the control part nor a test case is currently being executed.	
Effect	tciRootModule selects the indicated module for execution through a subsequent call using tciStartTestCase or tciStartControl. A tciError will be issued by the TE if no such module exists.	

7.3.1.1.2 tciGetImportedModules

Signature	TciModuleIdListType tciGetImportedModules()
Return Value	A list of all imported modules of the root module. The modules are ordered as they appear in the TTCN-3 module. If no imported modules exist, an empty module list is returned.
Constraint	Shall be used only if a root module has been set before.
Effect	The TE provides to the management a list of imported modules of the root module. If no imported module exists, an empty module list is returned. If the TE cannot provide a list, the distinct null value shall be returned.

7.3.1.1.3 tciGetModuleParameters

Signature	TciModuleParameterListType tciGetModuleParameters (in TciModuleIdType moduleName)
In Parameters	moduleName The moduleName denotes the module identifiers for which the module parameters should be retrieved.
Return Value	A list of all module parameters of the identified module. The parameters are ordered as they appear in the TTCN-3 module. If no parameters exist, an empty module parameter list is returned.
Constraint	Shall be used only if a root module has been set before.
Effect	The TE provides to the management a list of module parameters of the identified module. If no module parameters exist, an empty module parameter list is returned. If the TE cannot provide a list, the distinct null value shall be returned.

7.3.1.1.4 tciGetTestCases

Signature	TciTestCaseIdListType tciGetTestCases ()
Return Value	A list of all test cases that are either defined in or imported into the root module.
Constraint	Shall be used only if a root module has been set before.
Effect	The TE provides to the management a list of test cases. If no test cases exist, an empty test case list is returned. If the TE cannot provide a list, the distinct null value shall be returned.

7.3.1.1.5 tciGetTestCaseParameters

Signature	TciParameterTypeListType tciGetTestCaseParameters (in TciTestCaseIdType testCaseId)
In Parameters	testCaseId A test case identifier as defined in the TTCN-3 module.
Return Value	A list of all parameter types of the given test case. The parameter types are ordered as they appear in the TTCN-3 signature of the test case. If no parameters exist, an empty parameter type list is returned.
Constraint	Shall be used only if a root module has been set before.
Effect	The TE provides to the management a list of parameter types of the given test case. If no test case parameters exist, an empty parameter type list is returned. If the TE cannot provide a list, the distinct null value shall be returned.

7.3.1.1.6 tciGetTestCaseTSI

Signature	TriPortIdListType tciGetTestCaseTSI (in TciTestCaseIdType testCaseId)
In Parameters	testCaseId A test case identifier as defined in the TTCN-3 module.
Return Value	A list of all system ports of the given test case that have been declared in the definition of the system component for the test case, i.e. the TSI ports. If a system component has not been explicitly defined for the test case, then the list contains all communication ports of the MTC test component. The ports are ordered as they appear in the respective TTCN-3 component type declaration. If no system ports exist, an empty list, i.e. a list of length zero is returned.
Constraint	Shall be used only if a root module has been set before.
Effect	The TE provides to the management a list of system ports of the given test case. If no system ports exist, an empty port list is returned. If the TE cannot provide a list, the distinct null value shall be returned.

7.3.1.1.7 tciStartTestCase

Signature	void tciStartTestCase(in TciTestCaseIdType testCaseId, in TciParameterListType parameterList)	
In Parameters	testCaseId	A test case identifier as defined in the TTCN-3 module.
	parameterList	A list of Values where each value defines a parameter from the parameter list as defined in the TTCN-3 test case definition. The parameters in parameterList are ordered as they appear in the TTCN-3 signature of the test case. If no parameters have to be passed either the null value or an empty parameterList, i.e. a list of length zero shall be passed.
Return Value	void	
Constraint	Shall be called only if a module has been selected before. Only testCaseIds for test cases that are declared in the currently selected TTCN-3 module shall be passed. Test cases that are imported in a referenced module cannot be started. To start imported test cases the referenced (imported) module shall be selected first using the tciRootModule operation.	
Effect	tciStartTestCase starts a test case in the currently selected module with the given parameters. A tciError will be issued by the TE if no such test case exists. All in and inout test case parameters in parameterList contain Value. All out test case parameters in parameterList shall contain the distinct value of null since they are only of relevance when the test case terminates.	

7.3.1.1.8 tciStopTestCase

Signature	void tciStopTestCase()	
Return Value	void	
Constraint	Shall be called only if a module has been selected before.	
Effect	tciStopTestCase stops the test case currently being executed. If the TE is not executing a test case, the operation will be ignored. If the control part is being executed, tciStopTestCase will stop execution of the currently executed test case, i.e. the execution of the test case that has recently been indicated using the provided operation tciTestCaseStarted. A possible executing control part will continue execution as if the test case has stopped normally and returned with verdict ERROR.	

7.3.1.1.9 tciStartControl

Signature	TriComponentId tciStartControl()	
Return Value	A TriComponentId that represents the test component the module control part is executed on. If the TE cannot start control part of the selected module the distinct value null will be returned.	
Constraint	Shall be called only if a module has been selected before.	
Effect	Starts the control part of the selected module. The control part will start TTCN-3 test cases as described in TTCN-3. While executing the control part the TE will call the provided operation tciTestCaseStarted and tciTestCaseTerminated for every test case that has been started and that has terminated. After termination of the control part the TE will call the provided operation tciControlPartTerminated.	

7.3.1.1.10 tciStopControl

Signature	void tciStopControl()	
Return Value	void	
Constraint	Shall only be called if a module has been selected before.	
Effect	tciStopControl stops execution of the control part. If no control part is currently being executed the operation will be ignored. If a test case has been started directly this will stop execution of the current test case as if tciStopTestCase has been called.	

7.3.1.2 TCI-TM provided

7.3.1.2.0 Scope of use

The clause 7.3.1.2 specifies the operations the TM has to provide to the TE.

7.3.1.2.1 tciTestCaseStarted

Signature	void tciTestCaseStarted(in TciTestCaseIdType testCaseId, in TciParameterListType parameterList, in TFloat timer)	
In Parameters	testCaseId	A test case identifier as defined in the TTCN-3 module.
	parameterList	A list of values that are part of the test case signature. The parameters in parameterList are ordered as they appear in the TTCN-3 test case declaration.
	timer	A float value representing the duration of the test case timer.
Return Value	void	
Constraint	Shall only be called after either the control part of the module or a test case has been started using the <i>required</i> operations tciStartControl or tciStartTestCase.	
Effect	tciTestCaseStarted indicates to the TM that a test case with testCaseId has been started. It will not be distinguished whether the test case has been started explicitly using the <i>required</i> operation tciStartTestCase or implicitly while executing the control part.	

7.3.1.2.2 tciTestCaseTerminated

Signature	void tciTestCaseTerminated(in VerdictValue verdict, in TciParameterListType parameterList)	
In Parameters	verdict	The final verdict of the test case.
	parameterList	A list of values that are part of the test case signature. The parameters in parameterList are ordered as they appear in the TTCN-3 test case declaration.
Return Value	void	
Constraint	Shall only be called after either the control part of the module or a test case has been started using the <i>required</i> operations tciStartControl or tciStartTestCase.	
Effect	This operation will be called by the TE to indicate the test management that the test case that has been currently executed on the MTC has terminated and that the final verdict was verdict. On the invocation of a tciTestCaseTerminated operation all <i>out</i> and <i>inout</i> test case parameters contain Values. All in test case parameters contain the distinct value of null because they are only of relevance to the test case start but not in the reply to the call.	

7.3.1.2.3 tciControlTerminated

Signature	void tciControlTerminated ()
Return Value	void
Constraint	Shall only be called when the module execution has been started using the tciStartControl operation.
Effect	This operation will be called by the TE to indicate the test management that the control part of the selected module has just terminated execution.

7.3.1.2.4 tciGetModulePar

Signature	Value tciGetModulePar (in TciModuleParameterIdType parameterId)
In Parameters	parameterId The identifier of the module parameter as defined in the TTCN-3 module.
Return Value	A value.
Constraint	This operation shall be called whenever the TE needs to access the value of a module parameter. Every accessed module parameter will be resolved only once between a tciStartTestCase and tciTestCaseTerminated pair if a test case has been started explicitly or between a tciStartControl and tciControlTerminated pair if the control part of a module has been started.

Effect	The management provides to the TE a Value for the indicated <code>parameterId</code> . Every call of <code>tciGetModulePar()</code> will return the same value throughout the execution of an explicitly started test case or throughout the execution of a control part. If the management cannot provide a TTCN-3 value, the distinct <code>null</code> value shall be returned.
---------------	--

7.3.1.2.5 tciLog

Signature	<code>void tciLog (in TriComponentIdType testComponentId, in TString message)</code>	
In Parameters	<code>testComponentId</code>	Identifier of the component that logs the message.
	<code>message</code>	A string value, i.e. the message to be logged.
Return Value	<code>void</code>	
Constraint	Shall be called by the TE when the TTCN-3 statement log will be executed, either in the control part of a module or within the test case.	
Effect	The TM presents <code>testComponentId</code> and <code>message</code> to the user, how this done is not within the scope of the present document.	

7.3.1.2.6 tciError

Signature	<code>void tciError(in TString message)</code>	
In Parameters	<code>message</code>	A string value, i.e. the error message.
	<code>message</code>	A string value, i.e. the error message.
Return Value	<code>void</code>	
Constraint	Can be called at any time by the TE to indicate an unrecoverable error situation. This error situation could either be indicated by the CH or the CD or could occur within the TE.	
Effect	The TE indicates the occurrence of an unrecoverable error situation. <code>message</code> contains a reason phrase that might be communicated to the test system user. It is up to the test management to terminate execution of test cases or control parts if running. The test management has to take explicit measures to terminate test execution immediately.	

7.3.2 The TCI-CD interface

7.3.2.0 Scope of use

The TCI Codec Interface (TCI-CD) describes the operations a TTCN-3 Executable is required to implement and the operations a codec implementation for a certain encoding scheme shall provide to the TE (see figure 6).

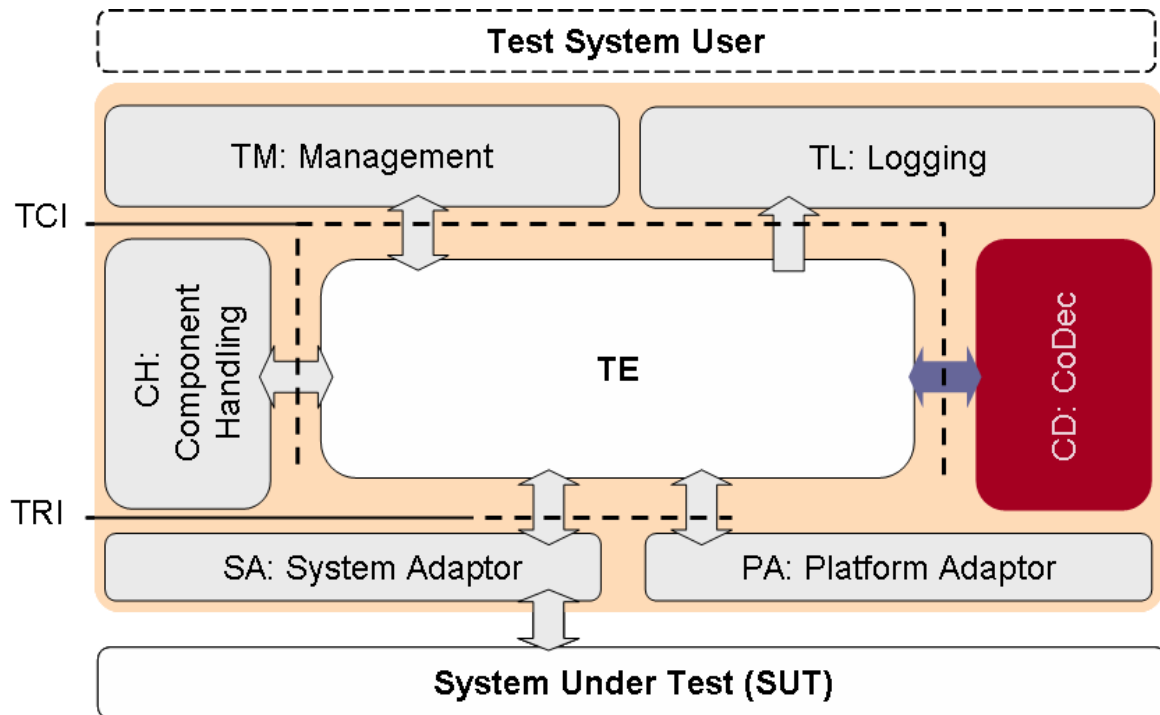

Figure 6: The TCI-CD interface

A codec implementation encodes TTCN-3 values according to the encoding attribute into a bitstring and decodes a bitstring according to decoding hypothesis. To be able to decode a bitstring into a TTCN-3 value the CD requires certain functionality from the TE. In turn the CD provides encoding and decoding functionality to the TTCN-3 Executable.

Annex C illustrates the usage and sequential ordering of operation calls by either the TE or the CD.

7.3.2.1 TCI-CD required

7.3.2.1.0 Scope of use

The clause 7.3.2.1 specifies the operations the CD requires from the TE. All operations specified in this clause are also required at the TCI-TM and TCI-CH interfaces.

7.3.2.1.1 getTypeForName

Signature	Type getTypeForName(in TString typeName)	
In Parameters	typeName	The TTCN-3 name of the type as defined in the TTCN-3 module. The following are reserved type names and will return a predefined type: "integer" "float" "bitstring" "hexstring" "octetstring" "charstring" "universal charstring" "boolean" "verdicttype" typeName has to be the fully qualified type name, i.e. module.typeName
Return Value	A type representing the requested TTCN-3 type.	
Constraint	---	

Effect	Returns a type representing a TTCN-3 type. Predefined TTCN-3 types can be retrieved from the TE by using the TTCN-3 keywords for the predefined types. In this case <code>typeName</code> denotes to the basic TTCN-3 type like "charstring", "bitstring", etc. Returns the distinct value <code>null</code> if the requested type cannot be returned. Note that the <code>anytype</code> and <code>address</code> cannot be obtained with module set to <code>null</code> . Although they are predefined types they might be distinct between modules. For example, <code>address</code> can either be the unmodified predefined type, or a user-defined type in a module. Other predefined types cannot be redefined.
---------------	--

7.3.2.1.2 `getInteger`

Signature	<code>Type getInteger()</code>
Return Value	An instance of <code>Type</code> representing a TTCN-3 integer type.
Effect	Constructs and returns a basic TTCN-3 integer type.

7.3.2.1.3 `getFloat`

Signature	<code>Type getFloat()</code>
Return Value	An instance of <code>Type</code> representing a TTCN-3 float type.
Effect	Constructs and returns a basic TTCN-3 float type.

7.3.2.1.4 `getBoolean`

Signature	<code>Type getBoolean()</code>
Return Value	An instance of <code>Type</code> representing a TTCN-3 boolean type.
Effect	Constructs and returns a basic TTCN-3 boolean type.

7.3.2.1.5 `Void`7.3.2.1.6 `getCharstring`

Signature	<code>Type getCharstring ()</code>
Return Value	An instance of <code>Type</code> representing a TTCN-3 charstring type.
Effect	Constructs and returns a basic TTCN-3 charstringtype.

7.3.2.1.7 `getUniversalCharstring`

Signature	<code>Type getUniversalCharstring ()</code>
Return Value	An instance of <code>Type</code> representing a TTCN-3 universal charstring type.
Effect	Constructs and returns a basic TTCN-3 universal charstring type.

7.3.2.1.8 `getHexstring`

Signature	<code>Type getHexstring ()</code>
Return Value	An instance of <code>Type</code> representing a TTCN-3 hexstring type.
Effect	Constructs and returns a basic TTCN-3 hexstring type.

7.3.2.1.9 `getBitstring`

Signature	<code>Type getBitstring()</code>
Return Value	An instance of <code>Type</code> representing a TTCN-3 bitstring type.
Effect	Constructs and returns a basic TTCN-3 bitstring type.

7.3.2.1.10 getOctetstring

Signature	Type getOctetstring ()
Return Value	An instance of Type representing a TTCN-3 octetstring type.
Effect	Constructs and returns a basic TTCN-3 octetstring type.

7.3.2.1.11 getVerdict

Signature	Type getVerdict()
Return Value	An instance of Type representing a TTCN-3 verdict type.
Effect	Constructs and returns a basic TTCN-3 verdict type.

7.3.2.1.12 tciErrorReq

Signature	void tciErrorReq(in TString message)	
In Parameters	Message	A string value, i.e. the error phrase describing the problem.
Return Value	void	
Constraint	Shall be called whenever an error situation has occurred.	
Effect	The TE will be notified about an unrecoverable error situation within the CD and forward the error indication to the test management.	

7.3.2.2 TCI-CD provided

7.3.2.2.0 Scope of use

Clause 7.3.2.2 specifies the operations the TM shall provide to the TE.

7.3.2.2.1 decode

Signature	Value decode(in TriMessageType message, in Type decodingHypothesis)	
In Parameters	message	The encoded message to be decoded.
	decodingHypothesis	The hypothesis the decoding can be based on.
Return Value	Returns the decoded value, if the value is of a compatible type as the decodingHypothesis, else the distinct value null.	
Constraint	This operation shall be called whenever the TE has to implicitly decode an encoded value (e.g. when performing a port operation such as receive, trigger, getcall, getreply, catch, check or calling an external function). The TE might decode immediately after reception of an encoded value, or might for performance considerations postpone the decoding until the actual access of the encoded value.	
Effect	This operation decodes message according to the encoding rules and returns a TTCN-3 value. The decodingHypothesis shall be used to determine whether the encoded value can be decoded. If an encoding rule is not self-sufficient, i.e. if the encoded message does not inherently contain its type decodingHypothesis shall be used. If the encoded value can be decoded without the decoding hypothesis, the distinct null value shall be returned if the type determined from the encoded message is not compatible with the decoding hypothesis.	

7.3.2.2.2 encode

Signature	TriMessageType encode(in Value value)	
In Parameters	value	The value to be encoded.
Return Value	Returns an encoded TriMessage for the specified encoding rule.	
Constraint	This operation shall be called whenever the TE has to implicitly encode a value (e.g. when performing a port operation such as send, call, reply and raise or calling an external function).	
Effect	Returns an encoded TriMessage according to the encoding rules.	

7.3.2.2.3 decodeValue

Signature	TInteger decodeValue(inout TriMessageType encodedValue, in Type decodingHypothesis, in TString encodingInfo, out Value decodedValue)	
In Parameters	message	The encoded message to be decoded.
	decodingHypothesis	The hypothesis the decoding can be based on.
	encodingInfo	Dynamic decoding parameters.
Out Parameters	decodedValue	The decoded value, if the value is of a compatible type as the decodingHypothesis, else the distinct value null.
Return Value	An integer value indicating success of the operation: 0 in case of success, 1 in case of an unspecified decoding error and 2 if decoding could not be completed because encodedValue didn't contain enough bits.	
Constraint	This operation shall be called whenever the TE invokes the predefined functions decvalue or decvalue_unichar.	
Effect	This operation decodes message according to the encoding rules and returns the result of the decoding operation. The decodingHypothesis shall be used to determine whether the encoded value can be decoded. If an encoding rule is not self-sufficient, i.e. if the encoded message does not inherently contain its type decodingHypothesis shall be used. In case of success, the used bits are removed from the encodedValue parameter and the decoded TTCN-3 value is passed to the caller in the decodedValue parameter. In case of a failure, the TE shall ignore the content of the encodedValue and decodedValue parameter and shall act as if the former one were unchanged and the latter one contained the distinct value null.	

7.3.2.2.4 encodeValue

Signature	TriMessageType encode(in Value value, in TString encodingInfo)	
In Parameters	value	The value to be encoded.
	encodingInfo	Dynamic encoding parameters.
Return Value	Returns an encoded TriMessage for the specified encoding rule.	
Constraint	This operation shall be called whenever the TE invokes the predefined functions encvalue or encvalue_unichar.	
Effect	Returns an encoded TriMessage according to the encoding rules.	

7.3.3 The TCI-CH interface

7.3.3.0 Scope of use

The TCI Component Handling Interface (TCI-CH) describes the operations a TTCN-3 Executable is required to implement and the operations a component handling implementation shall provide to the TE (figure 7).

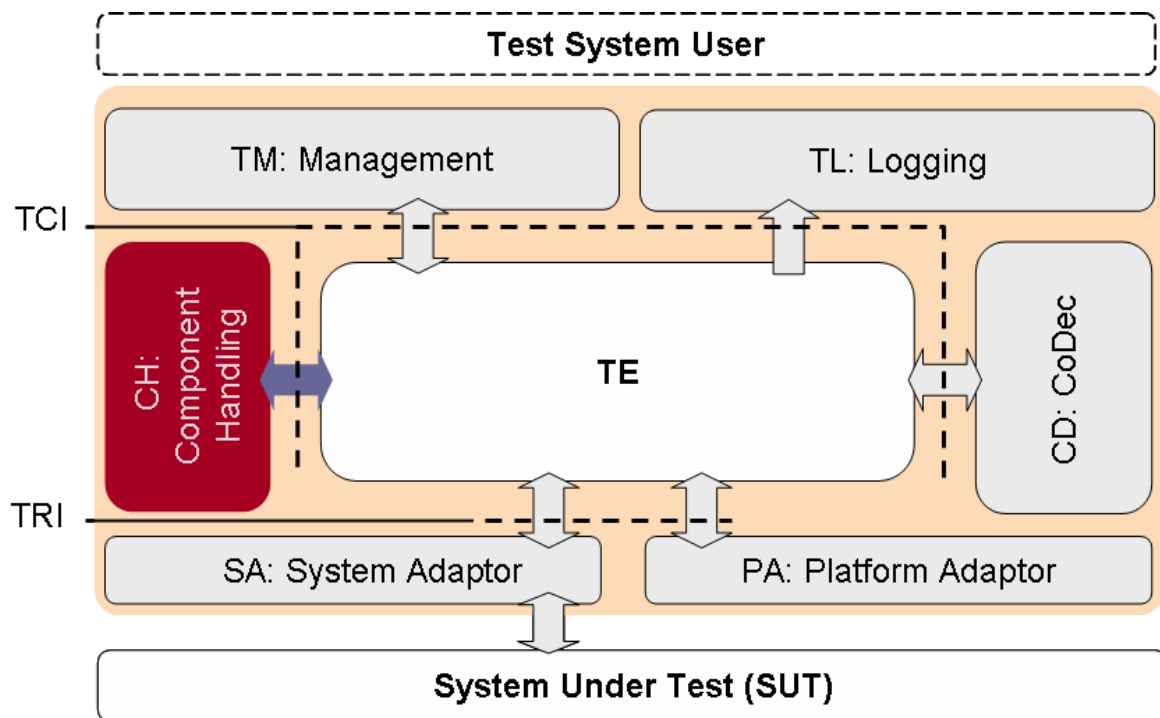

Figure 7: The TCI-CH interface

A component handling implementation distributes TTCN-3 configuration operations like create, connect and start and intercomponent communication like send on a connected port among one or more TTCN-3 Executables participating in a test session. Note that although multiple instances of a TE might participate in a test session this is not mandatory.

The basic principle is that TCI-CH is *not implementing* any kind of TTCN-3 functionality. Instead it will be informed by the TE that for example a test component shall be created. Based on Component Handling (CH) internal knowledge the request for creation of a test component will be transmitted to another (remote) participating TE. This second (remote) participating TE will create the TTCN-3 component and will provide a handle back to the requesting (local) TE. The requesting (local) TE can now operate on the created test component via this component handle.

Within the operation definitions the terms local TE and remote TE is used to highlight the fact that a test system implementation might be distributed over several test devices, each of them hosting a complete TE. The terms "local" and "remote" always refer to the interfaces currently being described. For convenience, the term "local" refers always to the TE being either the callee of an operation (for *required* operations) or the caller of an operation (for *provided* operations). While the TE is conceptually considered as being distributed, the CH is considered to be non-distributed. This can either be achieved using a centralized architecture or by using a middleware-platform that abstracts from distribution aspects. Although the TE might be distributed over different physical devices, there might be configurations where only one, non-distributed TE will participate in a test session. In this case the term "local" and "remote" refer to the same TE instance.

Annex C illustrates the usage and sequential ordering of operation calls by either the TE or the CH.

Although all TTCN-3 Executables participating in a test session are equal, there is a distinct TE*. This TE* is the TE where the explicit `tcIstartTestCase()` or `tcIstartControl()` has been processed. The reason for this distinction is, that TE* shall calculate the global verdict. TE* will notify the test management upon termination of test execution and shall provide then the global verdict of the test case.

7.3.3.1 TCI-CH required

7.3.3.1.0 Scope of use

Clause 7.3.3.1 specifies the operations the CH requires from the TE. In addition to the operations specified in this clause, all *required* operations of the TCI-CD interface are also required.

7.3.3.1.1 tciEnqueueMsgConnected

Signature	void tciEnqueueMsgConnected (in TriPortIdType sender, in TriComponentIdType receiver, in Value rcvdMessage)	
In Parameters	sender	Port identifier at the sending component via which the message is sent.
	receiver	Identifier of the receiving component.
	rcvdMessage	The value to be enqueued.
Return Value	void	
Constraint	This operation shall be called by the CH at the local TE when at remote TE a <i>provided</i> tciSendConnected has been called.	
Effect	The TE enqueues the received value into the local port queue of the indicated receiver component.	

7.3.3.1.2 tciEnqueueCallConnected

Signature	void tciEnqueueCallConnected (in TriPortIdType sender, in TriComponentIdType receiver, in TriSignatureIdType signature, in TciParameterListType parameterList)	
In Parameters	sender	Port identifier at the sending component via which the message is sent.
	receiver	Identifier of the receiving component.
	signature	Identifier of the signature of the procedure call.
	parameterList	A list of value parameters which are part of the indicated signature. The parameters in parameterList are ordered as they appear in the TTCN-3 signature declaration.
Return Value	void	
Constraint	This operation shall be called by the CH at the local TE when at a remote TE a <i>provided</i> tciCallConnected has been called. All <i>in</i> and <i>inout</i> procedure parameters contain values. All <i>out</i> procedure parameters shall contain the distinct value of null because they are only of relevance in a reply to the procedure call but not in the procedure call itself. The procedure parameters are the parameters specified in the TTCN-3 signature template.	
Effect	The TE enqueues the calls at the local port queue of the indicated receiver component.	

7.3.3.1.3 tciEnqueueReplyConnected

Signature	void tciEnqueueReplyConnected (in TriPortIdType sender, in TriComponentIdType receiver, in TriSignatureIdType signature, in TciParameterListType parameterList, in Value returnValue)	
In Parameters	sender	Identifier of the port sending the reply.
	receiver	Identifier of the component receiving the reply.
	signature	Identifier of the signature of the procedure call.
	parameterList	A list of value parameters which are part of the indicated signature. The parameters in parameterList are ordered as they appear in the TTCN-3 signature declaration.
	returnValue	(Optional) return value of the procedure call.
Return Value	void	
Constraint	This operation shall be called by the CH at the local TE when at a remote TE a <i>provided</i> tciReplyConnected has been called. All <i>out</i> and <i>inout</i> procedure parameters and the return value contain values. All <i>in</i> procedure parameters shall contain the distinct value of null since they are only of relevance to the procedure call but not in the reply to the call. The parameterList contains procedure call parameters. These parameters are the parameters specified in the TTCN-3 signature template. If no return type has been defined for the procedure signature in the TTCN-3 ATS, the distinct value null shall be passed for the returnValue.	
Effect	The TE enqueues the reply at the local port queue of the indicated receiver component.	

7.3.3.1.4 tciEnqueueRaiseConnected

Signature	void tciEnqueueRaiseConnected (in TriPortIdType sender, in TriComponentIdType receiver, in TriSignatureIdType signature, in Value exception)	
In Parameters	sender	Identifier of the port sending the reply.
	receiver	Identifier of the component receiving the reply.
	signature	Identifier of the signature of the procedure call.
	exception	The exception.
Return Value	void	
Constraint	This operation shall be called by the CH at the local TE when at a remote TE a <i>provided</i> tciRaiseConnected has been called.	
Effect	The TE enqueues the exception at the local port queue of the indicated receiver component.	

7.3.3.1.5 tciCreateTestComponent

Signature	TriComponentIdType tciCreateTestComponent (in TciTestComponentKindType kind, in Type componentType), in TString name)	
In Parameters	kind	The kind of component that shall be created (any kind except of SYSTEM).
	componentType	Identifier of the TTCN-3 component type that shall be created.
	name	Name of the component that shall be created.
Return Value	A TriComponentIdType value for the created component.	
Constraint	This operation shall be called by the CH at the local TE when at a remote TE a <i>provided</i> tciCreateTestComponentReq has been called. componentType shall be set to the distinct value null if a test component of kind control shall be created. name shall be set to the distinct value null if no name is given in the TTCN-3 create statement. If a non-null hostId is given, this hostId should be used to identify the remote TE in which to call tciCreateTestComponent.	
Effect	The TE creates a TTCN-3 test component of the componentType and passes a TriComponentIdType reference back to the CH. The CH communicates the reference back to the remote TE.	

7.3.3.1.6 tciStartTestComponent

Signature	void tciStartTestComponent(in TriComponentIdType component, in TciBehaviourIdType behaviour, in TciParameterListType parameterList)	
In Parameters	component	Identifier of the component to be started. Refers to an identifier previously created by a call of tciCreateTestComponent.
	behaviour	Identifier of the behaviour to be started on the component.
	parameterList	A list of Values where each value defines a parameter from the parameter list as defined in the TTCN-3 function declaration of the function being started. The parameters in parameterList are ordered as they appear in the TTCN-3 signature of the test case. If no parameters have to be passed either the null value or an empty parameterList, i.e. a list of length zero shall be passed.
Return Value	void	
Constraint	This operation shall be called by the CH at the local TE when at a remote TE a <i>provided</i> tciStartTestComponentReq has been called.	
Effect	The TE shall start the indicated behaviour on the indicated component.	

7.3.3.1.7 tciStopTestComponent

Signature	void tciStopTestComponent(in TriComponentIdType component)	
In Parameters	component	Identifier of the component to be stopped.
Return Value	void	
Constraint	This operation shall be called by the CH at the local TE when at a remote TE a <i>provided</i> tciStopTestComponentReq has been called.	
Effect	The TE shall stop the indicated behaviour on the indicated component.	

7.3.3.1.8 tciConnect

Signature	void tciConnect (in TriPortIdType fromPort, in TriPortIdType toPort)	
In Parameters	fromPort	Identifier of the test component port to be connected from.
	toPort	Identifier of the test component port to be connected to.
Return Value	void	
Constraint	This operation shall be called by the CH at the local TE when at a remote TE a <i>provided</i> tciConnectReq has been called.	
Effect	The TE shall connect the indicated ports to one another.	

7.3.3.1.9 tciDisconnect

Signature	void tciDisconnect (in TriPortIdType fromPort, in TriPortIdType toPort)	
In Parameters	fromPort	Identifier of the test component port to be disconnected.
	toPort	Identifier of the test component port to be disconnected.
Return Value	void	
Constraint	This operation shall be called by the CH at the local TE when at a remote TE a <i>provided</i> tciDisconnectReq has been called.	
Effect	The TE shall disconnect the indicated ports.	

7.3.3.1.10 tciMap

Signature	void tciMap (in TriPortIdType fromPort, in TriPortIdType toPort)	
In Parameters	fromPort	Identifier of the test component port to be mapped from.
	toPort	Identifier of the test component port to be mapped to.
Return Value	void	
Constraint	This operation shall be called by the CH at the local TE when at a remote TE a <i>provided</i> tciMapReq has been called.	
Effect	The TE shall map the indicated ports to one another.	

7.3.3.1.11 tciMapParam

Signature	void tciMapParam (in TriPortIdType fromPort, in TriPortIdType toPort in TriParamterListType paramList)	
In Parameters	fromPort	Identifier of the test component port to be mapped from.
	toPort	Identifier of the test component port to be mapped to.
	paramList	Configuration parameter list.
Return Value	void	
Constraint	This operation shall be called by the CH at the local TE when at a remote TE a <i>provided</i> tciMapParamReq has been called.	
Effect	The TE shall map the indicated ports to one another.	

7.3.3.1.12 tciUnmap

Signature	void tciUnmap (in TriPortIdType fromPort, in TriPortIdType toPort)	
In Parameters	fromPort	Identifier of the test component port to be unmapped.
	toPort	Identifier of the test component port to be unmapped.
Return Value	void	
Constraint	This operation shall be called by the CH at the local TE when at a remote TE a <i>provided</i> tciUnmapReq has been called.	
Effect	The TE shall unmap the indicated ports.	

7.3.3.1.13 tciUnmapParam

Signature	void tciUnmapParam (in TriPortIdType fromPort, in TriPortIdType toPort in TriParameterListType paramList)	
In Parameters	fromPort	Identifier of the test component port to be unmapped.
	toPort	Identifier of the test component port to be unmapped.
	paramList	Configuration parameter.
Return Value	void	
Constraint	This operation shall be called by the CH at the local TE when at a remote TE a <i>provided</i> tciUnmapParamReq has been called.	
Effect	The TE shall unmap the indicated ports.	

7.3.3.1.14 tciTestComponentTerminated

Signature	void tciTestComponentTerminated (in TriComponentIdType component, in VerdictValue verdict)	
In Parameters	component	Identifier of the component that has terminated.
	verdict	Verdict after termination of the component.
Return Value	void	
Constraint	This operation shall be called by the CH at the local TE when at a remote TE a <i>provided</i> tciTestComponentTerminatedReq has been called.	
Effect	The local TE is notified of the termination of the indicated test component on a remote TE. Because the out values of <i>inout</i> and <i>out</i> parameters of a function being executed on a test component have no effect on that test component (ETSI ES 201 873-1 [1]), the tciTestComponentTerminated operation does not have a parameterList parameter.	

7.3.3.1.15 tciTestComponentRunning

Signature	TBoolean tciTestComponentRunning (in TriComponentIdType component)	
In Parameters	component	Identifier of the component to be checked for running.
Return Value	true if the indicated component is still executing a behaviour, false otherwise.	
Constraint	This operation shall be called by the CH at the local TE when at a remote TE a <i>provided</i> tciTestComponentRunningReq has been called.	
Effect	The local TE determines whether the indicated component is executing a test behaviour. If the component is executing a behaviour true will be returned. In any other case, e.g. test component has finished execution, or test component has not been started, etc. false will be returned. After the operation returns, the CH will communicate the value back to the remote TE.	

7.3.3.1.16 tciTestComponentDone

Signature	TBoolean tciTestComponentDone (in TriComponentIdType comp, out TInteger verdict)	
In Parameters	comp	Identifier of the component to be checked for done.
Out Parameters	verdict	If the component has completed executing its behaviour, the parameter will contain numeric representation of the final component verdict (one of the following constants: ERROR, FAIL, INCONC, NONE, PASS, USER_ERROR). Otherwise, the parameter will contain the ERROR constant.

Return Value	<code>true</code> if the indicated component has completed executing its behaviour, <code>false</code> otherwise.
Constraint	This operation shall be called by the CH at the local TE when at a remote TE a <i>provided</i> <code>tciTestComponentDoneReq</code> has been called.
Effect	The local TE determines whether the indicated component has completed executing its test behaviour. If the component has completed its behaviour <code>true</code> will be returned. In any other case, e.g. test component has not been started, or test component is still executing, <code>false</code> will be returned. After the operation returns, the CH will communicate the value back to the remote TE.

7.3.3.1.17 tciGetMTC

Signature	<code>TriComponentIdType tciGetMTC()</code>
Return Value	A <code>TriComponentIdType</code> value of the MTC if the MTC executes on the local TE, the distinct value <code>null</code> otherwise.
Constraint	This operation can be called by the CH at the appropriate local TE when at a remote TE a <i>provided</i> <code>tciGetMTCReq</code> has been called.
Effect	The local TE determines whether the MTC is executing on the local TE. If the MTC executes on the local TE the component id of the MTC is being returned. If the MTC is not executed on the local TE the distinct value <code>null</code> will be returned. The operation will have no effect on the execution of the MTC. After the operation returns, the CH will communicate the value back to the remote TE.

7.3.3.1.18 tciExecuteTestCase

Signature	<code>void tciExecuteTestCase (in TciTestCaseIdType testCaseId, in TriPortIdListType tsiPortList)</code>				
In Parameters	<table border="1"> <tr> <td><code>testCaseId</code></td> <td>A test case identifier as defined in the TTCN-3 module.</td> </tr> <tr> <td><code>tsiPortList</code></td> <td>Contains all ports that have been declared in the definition of the system component for the test case, i.e. the TSI ports. If a system component has not been explicitly defined for the test case, then the <code>tsiPortList</code> contains all communication ports of the MTC. The ports in <code>tsiPortList</code> are ordered as they appear in the respective TTCN-3 component type declaration. If no ports have to be passed either the <code>null</code> value or an empty <code>tsiPortList</code>, i.e. a list of length zero shall be passed.</td> </tr> </table>	<code>testCaseId</code>	A test case identifier as defined in the TTCN-3 module.	<code>tsiPortList</code>	Contains all ports that have been declared in the definition of the system component for the test case, i.e. the TSI ports. If a system component has not been explicitly defined for the test case, then the <code>tsiPortList</code> contains all communication ports of the MTC. The ports in <code>tsiPortList</code> are ordered as they appear in the respective TTCN-3 component type declaration. If no ports have to be passed either the <code>null</code> value or an empty <code>tsiPortList</code> , i.e. a list of length zero shall be passed.
<code>testCaseId</code>	A test case identifier as defined in the TTCN-3 module.				
<code>tsiPortList</code>	Contains all ports that have been declared in the definition of the system component for the test case, i.e. the TSI ports. If a system component has not been explicitly defined for the test case, then the <code>tsiPortList</code> contains all communication ports of the MTC. The ports in <code>tsiPortList</code> are ordered as they appear in the respective TTCN-3 component type declaration. If no ports have to be passed either the <code>null</code> value or an empty <code>tsiPortList</code> , i.e. a list of length zero shall be passed.				
Return Value	<code>void</code>				
Constraint	This operation shall be called by the CH at the appropriate local TE when at a remote TE a <i>provided</i> <code>tciExecuteTestCaseReq</code> has been called.				
Effect	The local TE determines whether static connections to the SUT and the initialization of communication means for TSI ports should be done.				

7.3.3.1.19 tciReset

Signature	<code>void tciReset ()</code>
Return Value	<code>void</code>
Constraint	This operation shall be called by the CH at appropriate local TEs when at a remote TE a <i>provided</i> <code>tciResetReq</code> has been called.
Effect	The TE can decide to take any means to reset the test system locally.

7.3.3.1.20 tciKillTestComponent

Signature	<code>void tciKillTestComponent(in TriComponentIdType comp)</code>
In Parameters	<code>comp</code> Identifier of the component to be killed.
Return Value	<code>void</code>
Constraint	This operation shall be called by the CH at the local TE when at a remote TE a <i>provided</i> <code>tciKillTestComponentReq</code> has been called.
Effect	The TE stops the behaviour on the indicated component if necessary and transfers it into the killed state.

7.3.3.1.21 tciTestComponentAlive

Signature	TBoolean tciTestComponentAlive (in TriComponentIdType comp)	
In Parameters	comp	Identifier of the component to be checked for being alive.
Return Value	true if the indicated component is alive, false otherwise.	
Constraint	This operation shall be called by the CH at the local TE when at a remote TE a <i>provided</i> tciTestComponentAliveReq has been called.	
Effect	The local TE determines whether the indicated component is alive. After the operation returns, the CH will communicate the value back to the remote TE.	

7.3.3.1.22 tciTestComponentKilled

Signature	TBoolean tciTestComponentKilled (in TriComponentIdType comp, out TInteger verdict)	
In Parameters	comp	Identifier of the component to be checked for being killed.
Out Parameters	verdict	If the component has been killed, the parameter will contain numeric representation of the final component verdict (one of the following constants: ERROR, FAIL, INCONC, NONE, PASS, USER_ERROR). Otherwise, the parameter will contain the ERROR constant.
Return Value	true if the indicated component has been killed, false otherwise.	
Constraint	This operation shall be called by the CH at the local TE when at a remote TE a <i>provided</i> tciTestComponentKilledReq has been called.	
Effect	The local TE determines whether the indicated component is in the killed state. If it is, true will be returned. In any other case, false will be returned. After the operation returns, the CH will communicate the value back to the remote TE.	

7.3.3.2 TCI-CH provided

7.3.3.2.0 Scope of use

The clause 7.3.3.2 specifies the operations the CH shall provide to the TE.

7.3.3.2.1 tciSendConnected

Signature	void tciSendConnected (in TriPortIdType sender, in TriComponentIdType receiver, in Value sendMessage)	
In Parameters	sender	Port identifier at the sending component via which the message is sent.
	receiver	Identifier of the receiving component.
	sendMessage	The message to be sent.
Return Value	void	
Constraint	This operation shall be called by the TE when it executes a TTCN-3 unicast send operation on a component port, which has been connected to another component port.	
Effect	Sends an asynchronous transmission only to the given receiver component. CH transmits the message to the remote TE on which receiver is being executed and enqueues the data in the remote TE.	

7.3.3.2.2 tciSendConnectedBC

Signature	void tciSendConnectedBC (in TriPortIdType sender, in Value sendMessage)	
In Parameters	sender	Port identifier at the sending component via which the message is sent.
	sendMessage	The message to be sent.
Return Value	void	
Constraint	This operation shall be called by the TE when it executes a TTCN-3 broadcast send operation on a component port, which has been connected to other component ports.	
Effect	Sends an asynchronous transmission to all components being connected to this port. CH transmits the message to all remote TEs on which receivers are being executed and enqueues the data in the remote TEs.	

7.3.3.2.3 tciSendConnectedMC

Signature	void tciSendConnectedMC (in TriPortIdType sender, in TriComponentIdListType receivers, in Value sendMessage)	
In Parameters	sender	Port identifier at the sending component via which the message is sent.
	receivers	Identifiers of the receiving components.
	sendMessage	The message to be sent.
Return Value	void	
Constraint	This operation shall be called by the TE when it executes a TTCN-3 multicast send operation on a component port, which has been connected to other component ports.	
Effect	Sends an asynchronous transmission to all given receiver components. CH transmits the message to all remote TEs on which receivers are being executed and enqueues the data in the remote TEs.	

7.3.3.2.4 tciCallConnected

Signature	void tciCallConnected (in TriPortIdType sender, in TriComponentIdType receiver, in TriSignatureIdType signature, in TciParameterListType parameterList)	
In Parameters	sender	Port identifier at the sending component via which the message is sent.
	receiver	Identifier of the receiving component.
	signature	Identifier of the signature of the procedure call.
	parameterList	A list of value parameters which are part of the indicated signature. The parameters in parameterList are ordered as they appear in the TTCN-3 signature declaration.
Return Value	void	
Constraint	This operation shall be called by the TE when it executes a TTCN-3 unicast call operation on a component port, which has been connected to another component port. All <i>in</i> and <i>inout</i> procedure parameters contain values. All <i>out</i> procedure parameters shall contain the distinct value of null because they are only of relevance in a reply to the procedure call but not in the procedure call itself. The procedure parameters are the parameters specified in the TTCN-3 signature template.	
Effect	On invocation of this operation the TE can initiate the procedure call corresponding to the signature identifier signature at the called component receiver. The tciCallConnected operation shall return without waiting for the return of the issued procedure call. Note that an optional timeout value, which can be specified in the TTCN-3 ATS for a call operation, is not included in the tciCallConnected operation signature. The TE is responsible to address this issue by starting a timer for the TTCN-3 call operation in the PA with a separate TRI operation call, i.e. triStartTimer. CH transmits the call to the remote TE on which receiver is being executed and enqueues the call in the remote TE.	

7.3.3.2.5 tciCallConnectedBC

Signature	void tciCallConnectedBC (in TriPortIdType sender, in TriSignatureIdType signature, in TciParameterListType parameterList)	
In Parameters	sender	Port identifier at the sending component via which the message is sent.
	signature	Identifier of the signature of the procedure call.
	parameterList	A list of value parameters which are part of the indicated signature. The parameters in parameterList are ordered as they appear in the TTCN-3 signature declaration.
Return Value	void	
Constraint	This operation shall be called by the TE when it executes a TTCN-3 broadcast call operation on a component port, which has been connected to other component ports. All <i>in</i> and <i>inout</i> procedure parameters contain values. All <i>out</i> procedure parameters shall contain the distinct value of null because they are only of relevance in a reply to the procedure call but not in the procedure call itself. The procedure parameters are the parameters specified in the TTCN-3 signature template.	

Effect	On invocation of this operation the TE can initiate the procedure call corresponding to the signature identifier <i>signature</i> at the called component receiver. The <i>tciCallConnected</i> operation shall return without waiting for the return of the issued procedure call. Note that an optional timeout value, which can be specified in the TTCN-3 ATS for a call operation, is not included in the <i>tciCallConnected</i> operation signature. The TE is responsible to address this issue by starting a timer for the TTCN-3 call operation in the PA with a separate TRI operation call, i.e. <i>triStartTimer</i> . CH transmits the call to all remote TEs on which a receiver is being executed and enqueues the call in the remote TEs.
---------------	--

7.3.3.2.6 tciCallConnectedMC

Signature	void tciCallConnectedMC (in TriPortIdType sender, in TriComponentIdListType receivers, in TriSignatureIdType signature, in TciParameterListType parameterList)	
In Parameters	sender	Port identifier at the sending component via which the message is sent.
	receivers	Identifier of the receiving components.
	signature	Identifier of the signature of the procedure call.
	parameterList	A list of value parameters which are part of the indicated signature. The parameters in <i>parameterList</i> are ordered as they appear in the TTCN-3 signature declaration.
Return Value	void	
Constraint	This operation shall be called by the TE when it executes a TTCN-3 multicast call operation on a component port, which has been connected to other component ports. All <i>in</i> and <i>inout</i> procedure parameters contain values. All <i>out</i> procedure parameters shall contain the distinct value of <i>null</i> because they are only of relevance in a reply to the procedure call but not in the procedure call itself. The procedure parameters are the parameters specified in the TTCN-3 signature template.	
Effect	On invocation of this operation the TE can initiate the procedure call corresponding to the signature identifier <i>signature</i> at the called component receiver. The <i>tciCallConnected</i> operation shall return without waiting for the return of the issued procedure call. Note that an optional timeout value, which can be specified in the TTCN-3 ATS for a call operation, is not included in the <i>tciCallConnected</i> operation signature. The TE is responsible to address this issue by starting a timer for the TTCN-3 call operation in the PA with a separate TRI operation call, i.e. <i>triStartTimer</i> . CH transmits the call to all remote TEs on which a receiver is being executed and enqueues the call in the remote TEs.	

7.3.3.2.7 tciReplyConnected

Signature	void tciReplyConnected (in TriPortIdType sender, in TriComponentIdType receiver, in TriSignatureIdType signature, in TciParameterListType parameterList, in Value returnValue)	
In Parameters	sender	Identifier of the port sending the reply.
	receiver	Identifier of the component receiving the reply.
	signature	Identifier of the signature of the procedure call.
	parameterList	A list of encoded parameters which are part of the indicated signature. The parameters in <i>parameterList</i> are ordered as they appear in the TTCN-3 signature declaration.
	returnValue	(Optional) return value of the procedure call.
Return Value	void	
Constraint	This operation shall be called by the TE when it executes a TTCN-3 unicast reply operation on a component port which has been connected to another component port. All <i>out</i> and <i>inout</i> procedure parameters and the return value contain values. All <i>in</i> procedure parameters shall contain the distinct value of <i>null</i> since they are only of relevance to the procedure call but not in the reply to the call. The <i>parameterList</i> contains procedure call parameters. These parameters are the parameters specified in the TTCN-3 signature template. If no return type has been defined for the procedure signature in the TTCN-3 ATS, the distinct value <i>null</i> shall be passed for the return value.	
Effect	On invocation of this operation the CH can issue the reply to a procedure call corresponding to the signature identifier <i>signature</i> and component identifier <i>receiver</i> . CH transmits the reply to the remote TE on which <i>receiver</i> is being executed and enqueues the reply in the remote TE.	

7.3.3.2.8 tciReplyConnectedBC

Signature	void tciReplyConnectedBC (in TriPortIdType sender, in TriSignatureIdType signature, in TciParameterListType parameterList, in Value returnValue)	
In Parameters	sender	Identifier of the port sending the reply.
	signature	Identifier of the signature of the procedure call.
	parameterList	A list of encoded parameters which are part of the indicated signature. The parameters in parameterList are ordered as they appear in the TTCN-3 signature declaration.
	returnValue	(Optional) return value of the procedure call.
Return Value	void	
Constraint	This operation shall be called by the TE when it executes a TTCN-3 broadcast reply operation on a component port which has been connected to other component ports. All <i>out</i> and <i>inout</i> procedure parameters and the return value contain values. All <i>in</i> procedure parameters shall contain the distinct value of <code>null</code> since they are only of relevance to the procedure call but not in the reply to the call. The <code>parameterList</code> contains procedure call parameters. These parameters are the parameters specified in the TTCN-3 signature template. If no return type has been defined for the procedure signature in the TTCN-3 ATS, the distinct value <code>null</code> shall be passed for the return value.	
Effect	On invocation of this operation the CH can issue the reply to a procedure call corresponding to the signature identifier <code>signature</code> and all components connected to <code>sender</code> . CH transmits the exception to all remote TEs on which receivers are being executed and enqueues the exception in the remote TEs.	

7.3.3.2.9 tciReplyConnectedMC

Signature	void tciReplyConnectedMC (in TriPortIdType sender, in TriComponentIdListType receivers, in TriSignatureIdType signature, in TciParameterListType parameterList, in Value returnValue)	
In Parameters	sender	Identifier of the port sending the reply.
	receivers	Identifier of the components receiving the reply.
	signature	Identifier of the signature of the procedure call.
	parameterList	A list of encoded parameters which are part of the indicated signature. The parameters in parameterList are ordered as they appear in the TTCN-3 signature declaration.
	returnValue	(Optional) return value of the procedure call.
Return Value	void	
Constraint	This operation shall be called by the TE when it executes a TTCN-3 multicast reply operation on a component port which has been connected to other component ports. All <i>out</i> and <i>inout</i> procedure parameters and the return value contain values. All <i>in</i> procedure parameters shall contain the distinct value of <code>null</code> since they are only of relevance to the procedure call but not in the reply to the call. The <code>parameterList</code> contains procedure call parameters. These parameters are the parameters specified in the TTCN-3 signature template. If no return type has been defined for the procedure signature in the TTCN-3 ATS, the distinct value <code>null</code> shall be passed for the return value.	
Effect	On invocation of this operation the CH can issue the reply to a procedure call corresponding to the signature identifier <code>signature</code> and one of the component identifier in <code>receivers</code> . CH transmits the reply to the remote TEs on which <code>receivers</code> are being executed and enqueues the reply in the remote TEs.	

7.3.3.2.10 tciRaiseConnected

Signature	void tciRaiseConnected (in TriPortIdType sender, in TriComponentIdType receiver, in TriSignatureIdType signature, in Value exception)	
In Parameters	sender	Identifier of the port sending the reply.
	receiver	Identifier of the component receiving the reply.
	signature	Identifier of the signature of the procedure call.
	exception	The exception value.
Return Value	void	
Constraint	This operation shall be called by the TE when it executes a TTCN-3 unicast raise operation on a component port which has been connected to another component port.	
Effect	On invocation of this operation the CH can raise an exception to a procedure call corresponding to the signature identifier <i>signature</i> and component identifier <i>receiver</i> . CH transmits the exception to the remote TE on which <i>receiver</i> is being executed and enqueues the exception in the remote TE.	

7.3.3.2.11 tciRaiseConnectedBC

Signature	void tciRaiseConnectedBC (in TriPortIdType sender, in TriSignatureIdType signature, in Value exception)	
In Parameters	sender	Identifier of the port sending the reply.
	signature	Identifier of the signature of the procedure call.
	exception	The exception value.
Return Value	void	
Constraint	This operation shall be called by the TE when it executes a TTCN-3 broadcast raise operation on a component port which has been connected to other component ports.	
Effect	On invocation of this operation the CH can raise an exception to a procedure call corresponding to the signature identifier <i>signature</i> and all components connected to <i>sender</i> . CH transmits the exception to all remote TEs on which receivers are being executed and enqueues the exception in the remote TEs.	

7.3.3.2.12 tciRaiseConnectedMC

Signature	void tciRaiseConnectedMC (in TriPortIdType sender, in TriComponentIdListType receiver, in TriSignatureIdType signature, in Value exception)	
In Parameters	sender	Identifier of the port sending the reply.
	receivers	Identifiers of the component receiving the reply.
	signature	Identifier of the signature of the procedure call.
	exception	The exception value.
Return Value	void	
Constraint	This operation shall be called by the TE when it executes a TTCN-3 multicast raise operation on a component port which has been connected to another component port.	
Effect	On invocation of this operation the CH can raise an exception to a procedure call corresponding to the signature identifier <i>signature</i> and one of the component identifier <i>receivers</i> . CH transmits the exception to all remote TEs on which <i>receivers</i> are being executed and enqueues the exception in the remote TEs.	

7.3.3.2.13 tciCreateTestComponentReq

Signature	TriComponentIdType tciCreateTestComponentReq (in TciTestComponentKindType kind, in Type componentType, in TString name, in Value hostId)	
In Parameters	kind	The kind of component that shall be created (any kind except of SYSTEM).
	componentType	Identifier of the TTCN-3 component type that shall be created.
	hostId	Value identifying the remote TE where the component shall be deployed.
Return Value	A TriComponentIdType value for the created component.	
Constraint	This operation shall be called from the TE when a component has to be created, either explicitly when the TTCN-3 create operation is called or implicitly when the master test component (MTC) or a control component has to be created. name shall be set to the distinct value null if no name is given in the TTCN-3 create statement.	
Effect	CH transmits the component creation request to the remote TE and calls there the tciCreateTestComponent operation to obtain a component identifier for this component.	

7.3.3.2.14 tciStartTestComponentReq

Signature	void tciStartTestComponentReq(in TriComponentIdType component, in TciBehaviourIdType behaviour, in TciParameterListType parameterList)	
In Parameters	component	Identifier of the component to be started.
	behaviour	Identifier of the behaviour to be started on the component.
	parameterList	A list of Values where each value defines a parameter from the parameter list as defined in the TTCN-3 function declaration of the function being started. The parameters in parameterList are ordered as they appear in the TTCN-3 signature of the test case. If no parameters have to be passed either the null value or an empty parameterList, i.e. a list of length zero shall be passed.
Return Value	void	
Constraint	This operation shall be called by the TE when it executes the TTCN-3 start operation.	
Effect	CH transmits the start component request to the remote TE and calls there the tciStartTestComponent operation.	

7.3.3.2.15 tciStopTestComponentReq

Signature	void tciStopTestComponentReq(in TriComponentIdType component)	
In Parameters	component	Identifier of the component to be stopped.
Return Value	void	
Constraint	This operation shall be called by the TE when it executes the TTCN-3 stop operation.	
Effect	CH transmits the stop component request to the remote TE and calls there the tciStopTestComponent operation.	

7.3.3.2.16 tciConnectReq

Signature	void tciConnectReq (in TriPortIdType fromPort, in TriPortIdType toPort)	
In Parameters	fromPort	Identifier of the test component port to be connected from.
	toPort	Identifier of the test component port to be connected to.
Return Value	void	
Constraint	This operation shall be called by the TE when it executes a TTCN-3 connect operation.	
Effect	CH transmits the connection request to the remote TE where it calls the tciConnect operation to establish a logical connection between the two indicated ports. Note that both ports can be on remote TEs. In this case, the operation returns only after calling the tciConnect operation on both remote TEs.	

7.3.3.2.17 tciDisconnectReq

Signature	void tciDisconnectReq (in TriPortIdType fromPort, in TriPortIdType toPort)	
In Parameters	fromPort	Identifier of the test component port to be disconnected.
	toPort	Identifier of the test component port to be disconnected.
Return Value	void	
Constraint	This operation shall be called by the TE when it executes a TTCN-3 disconnect operation.	
Effect	CH transmits the disconnect request to the remote TE where it calls the tciDisconnect operation to tear down the logical connection between the two indicated ports. Note that both ports can be on remote TEs. In this case, the operation returns only after calling the tciDisconnect operation on both remote TEs.	

7.3.3.2.18 tciMapReq

Signature	void tciMapReq (in TriPortIdType fromPort, in TriPortIdType toPort)	
In Parameters	fromPort	Identifier of the test component port to be mapped from.
	toPort	Identifier of the test component port to be mapped to.
Return Value	void	
Constraint	This operation shall be called by the TE when it executes a TTCN-3 map operation.	
Effect	CH transmits the map request to the remote TE where it calls the tciMap operation to establish a logical connection between the two indicated ports.	

7.3.3.2.19 tciMapParamReq

Signature	void tciMapParamReq (in TriPortIdType fromPort, in TriPortIdType toPort, in TriParameterListType paramList)	
In Parameters	fromPort	Identifier of the test component port to be mapped from.
	toPort	Identifier of the test component port to be mapped to.
	paramList	Configuration parameter list.
Return Value	void	
Constraint	This operation shall be called by the TE when it executes a TTCN-3 map operation including parameters.	
Effect	CH transmits the map request to the remote TE where it calls the tciMapParam operation to establish a logical connection between the two indicated ports.	

7.3.3.2.20 tciUnmapReq

Signature	void tciUnmapReq (in TriPortIdType fromPort, in TriPortIdType toPort)	
In Parameters	fromPort	Identifier of the test component port to be unmapped.
	toPort	Identifier of the test component port to be unmapped.
Return Value	void	
Constraint	This operation shall be called by the TE when it executes a TTCN-3 unmap operation.	
Effect	CH transmits the unmap request to the remote TE where it calls the tciUnmap operation to tear down the logical connection between the two indicated ports.	

7.3.3.2.21 tciUnmapParamReq

Signature	void tciUnmapParamReq (in TriPortIdType fromPort, in TriPortIdType toPort, in TriParameterListType paramList)	
In Parameters	fromPort	Identifier of the test component port to be unmapped.
	toPort	Identifier of the test component port to be unmapped.
	paramList	Configuration parameter list.
Return Value	void	
Constraint	This operation shall be called by the TE when it executes a TTCN-3 unmap operation including parameters.	
Effect	CH transmits the unmap request to the remote TE where it calls the tciUnmapParam operation to teardown the connection between the two indicated ports.	

7.3.3.2.22 tciTestComponentTerminatedReq

Signature	void tciTestComponentTerminatedReq (in TriComponentIdType component, in VerdictValue verdict)	
In Parameters	component	Identifier of the component that has terminated.
	verdict	Verdict after termination of the component.
Return Value	void	
Constraint	This operation shall be called by the TE when a test component terminates execution, either explicitly with the TTCN-3 stop operation or implicitly, if it has reached the last statement.	
Effect	The CH is notified of the termination of the indicated test component. Because the out values of <i>inout</i> and <i>out</i> parameters of a function being executed on a test component have no effect on that test component (ETSI ES 201 873-1 [1]), the tciTestComponentTerminateReq operation does not have a parameterList parameter. CH communicates the termination of the indicated component to all participating TEs and to the special TE*, which keeps track of the overall verdict.	

7.3.3.2.23 tciTestComponentRunningReq

Signature	TBoolean tciTestComponentRunningReq (in TriComponentIdType component)	
In Parameters	component	Identifier of the component to be checked for running.
Return Value	true if the indicated component is still executing a behaviour, false otherwise.	
Constraint	This operation shall be called by the TE when it executes a TTCN-3 running operation.	
Effect	CH transmits the running request to the remote TE having the test component to be checked, where it calls the tciTestComponentRunning operation to check the execution status of the indicated test component.	

7.3.3.2.24 tciTestComponentDoneReq

Signature	TBoolean tciTestComponentDoneReq (in TriComponentIdType comp, out TInteger verdict)	
In Parameters	comp	Identifier of the component to be checked for done.
Out Parameters	verdict	If the component has completed executing its behaviour, the parameter will contain numeric representation of the final component verdict (one of the following constants: ERROR, FAIL, INCONC, NONE, PASS, USER_ERROR). Otherwise, the parameter will contain the ERROR constant.
Return Value	true if the indicated component has completed executing its behaviour, false otherwise.	
Constraint	This operation shall be called by the TE when it executes a TTCN-3 done operation.	
Effect	CH transmits the done request to the remote TE having the test component to be checked, where it calls the tciTestComponentDone operation to check the status of the indicated test component.	

7.3.3.2.25 tciGetMTCReq

Signature	TriComponentIdType tciGetMTCReq()	
Return Value	A TriComponentIdType value of the MTC.	
Constraint	This operation shall be called by the TE when it executes a TTCN-3 mtc operation.	
Effect	The CH determines the component id of the MTC.	

7.3.3.2.26 tciExecuteTestCaseReq

Signature	void tciExecuteTestCaseReq (in TciTestCaseIdType testCaseId, in TriPortIdListType tsiPortList)	
In Parameters	testCaseId	A test case identifier as defined in the TTCN-3 module.
	tsiPortList	tsiPortList contains all ports that have been declared in the definition of the system component for the test case, i.e. the TSI ports. If a system component has not been explicitly defined for the test case, then the tsiPortList contains all communication ports of the MTC. The ports in tsiPortList are ordered as they appear in the respective TTCN-3 component type declaration. If no ports have to be passed either the null value or an empty tsiPortList, i.e. a list of length zero shall be passed.
Return Value	void	
Constraint	This operation can be called by the TE immediately before it starts the test case behaviour on the MTC (in course of a TTCN-3 execute operation).	
Effect	CH transmits the execute test case request to the remote TEs having system ports of the indicated test case. Static connections to the SUT and the initialization of communication means for TSI ports can be set up.	

7.3.3.2.27 tciResetReq

Signature	void tciResetReq ()	
Return Value	void	
Constraint	This operation can be called by the TE at any time to reset the test system.	
Effect	CH transmits the reset request to all involved TEs.	

7.3.3.2.28 tciKillTestComponentReq

Signature	void tciKillTestComponentReq(in TriComponentIdType comp)	
In Parameters	comp	Identifier of the component to be killed.
Return Value	void	
Constraint	This operation shall be called by the TE when it executes the TTCN-3 kill operation.	
Effect	CH transmits the kill component request to the remote TE and calls there the tciKillTestComponent operation.	

7.3.3.2.29 tciTestComponentAliveReq

Signature	TBoolean tciTestComponentAliveReq (in TriComponentIdType comp)	
In Parameters	comp	Identifier of the component to be checked for being alive.
Return Value	true if the indicated component is alive, false otherwise.	
Constraint	This operation shall be called by the TE when it executes the TTCN-3 alive operation.	
Effect	CH transmits the request to the remote TE that created the test component in question, where it calls the tciTestComponentAlive operation to check the status of the indicated test component.	

7.3.3.2.30 tciTestComponentKilledReq

Signature	TBoolean tciTestComponentKilledReq (in TriComponentIdType comp, out TInteger verdict)	
In Parameters	comp	Identifier of the component to be checked for being killed.
Out Parameters	verdict	If the component has been killed, the parameter will contain numeric representation of the final component verdict (one of the following constants: ERROR, FAIL, INCONC, NONE, PASS, USER_ERROR). Otherwise, the parameter will contain the ERROR constant.
Return Value	true if the indicated component has been killed, false otherwise.	
Constraint	This operation shall be called by the TE when it executes the TTCN-3 killed operation.	
Effect	CH transmits the request to the remote TE that created the test component in question, where it calls the tciTestComponentKilled operation to check the status of the indicated test component.	

7.3.4 The TCI-TL interface

7.3.4.0 Scope of use

The TCI Test Logging Interface (TCI-TL) describes the operations a TTCN-3 Executable is required to implement and the operations a test logging implementation shall provide to the TE (figure 8).

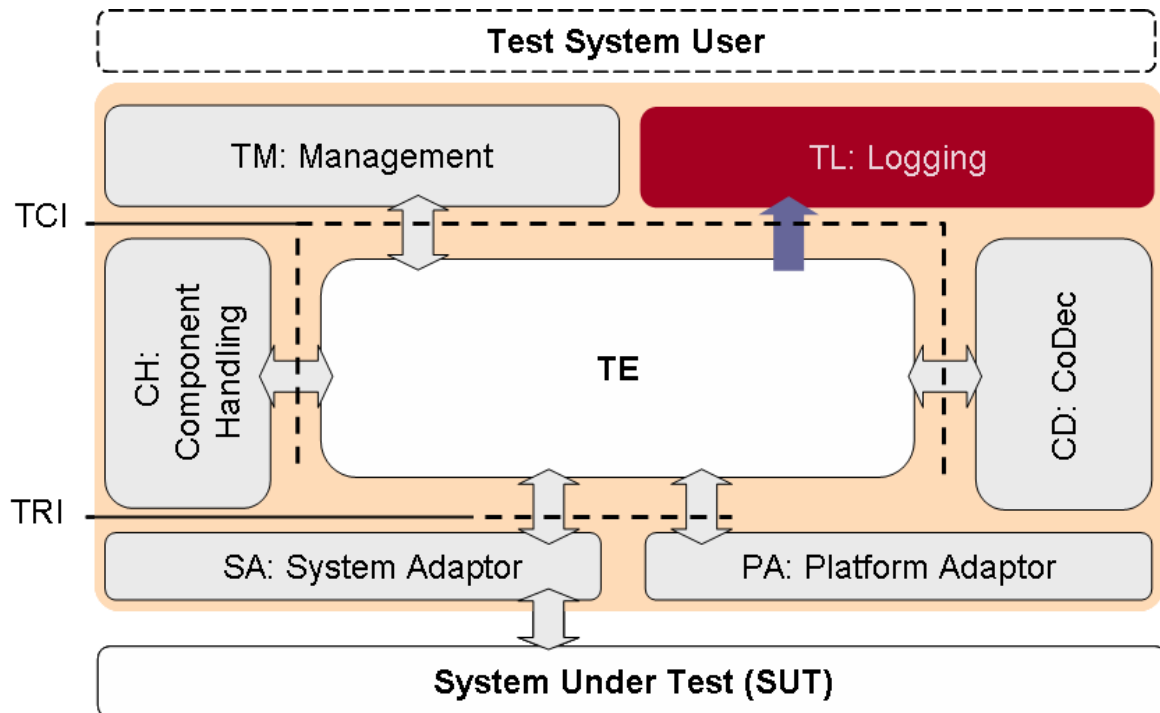

Figure 8: The TCI-TL interface

The logging provides for all TTCN-3 level operations an operation to log the respective event being performed by the TE, the SA, the PA, the CH or the CD to the user.

7.3.4.1 TCI-TL provided

7.3.4.1.0 Scope of use

Clause 7.3.4.1.0 specifies the operations the TL shall provide to the TE.

NOTE: A logging event is timestamped. The timestamps are specific to the language mapping and to the tool used. For example, C# mapping uses System.DateTime objects and C++ mapping uses the timeval structure. Java™, C and XML use integer instead, so that a tool has to choose its timestamp handling. For example, for Java™ System.currentTimeMillis() could be used or for C time() could be used.

7.3.4.1.1 tliTcExecute

Signature	void tliTcExecute(in TString am, in TInteger ts, in TString src, in TInteger line, in TriComponentIdType c, in TciTestCaseIdType tcId, in TciParameterListType tciPars, in TriTimerDurationType dur)	
In Parameters	am	An additional message.
	ts	The time when the event is produced.
	src	The source file of the test specification.
	line	The line number where the request is performed.
	c	The component which produces this event.
	tcId	The testcase to be executed.
	tciPars	The list of parameters required by the testcase.
	dur	Duration of the execution.

Return Value	void
Constraint	Shall be called by TE to log the execute test case request.
Effect	The TL presents all the information provided in the parameters of this operation to the user, how this is done is not within the scope of the present document.

7.3.4.1.2 tliTcStart

Signature	void tliTcStart(in TString am, in TInteger ts, in TString src, in TInteger line, in TriComponentIdType c, in TciTestCaseIdType tcId, in TciParameterListType tciPars, in TriTimerDurationType dur)	
In Parameters	am	An additional message.
	ts	The time when the event is produced.
	src	The source file of the test specification.
	line	The line number where the request is performed.
	c	The component which produces this event.
	tcId	The testcase to be executed.
	tciPars	The list of parameters required by the testcase.
dur	Duration of the execution.	
Return Value	void	
Constraint	Shall be called by TE to log the start of a testcase. This event occurs before the testcase is started.	
Effect	The TL presents all the information provided in the parameters of this operation to the user, how this is done is not within the scope of the present document.	

7.3.4.1.3 tliTcStop

Signature	void tliTcStop(in TString am, in TInteger ts, in TString src, in TInteger line, in TriComponentIdType c, in TString reason)	
In Parameters	Am	An additional message.
	Ts	The time when the event is produced.
	Src	The source file of the test specification.
	Line	The line number where the request is performed.
	C	The component which produces this event.
	reason	The optional reason of the setverdict statement.
Return Value	Void	
Constraint	Shall be called by TE to log the stop of a testcase.	
Effect	The TL presents all the information provided in the parameters of this operation to the user, how this is done is not within the scope of the present document.	

7.3.4.1.4 tliTcStarted

Signature	void tliTcStarted(in TString am, in TInteger ts, in TString src, in TInteger line, in TriComponentIdType c, in TciTestCaseIdType tcId, in TciParameterListType tciPars, in TriTimerDurationType dur)	
In Parameters	am	An additional message.
	ts	The time when the event is produced.
	src	The source file of the test specification.
	line	The line number where the request is performed.
	c	The component which produces this event.
	tcId	The testcase to be executed.
	tciPars	The list of parameters required by the testcase.
dur	Duration of the execution.	
Return Value	Void	
Constraint	Shall be called by TM or TE to log the start of a testcase. This event occurs after the testcase was started.	
Effect	The TL presents all the information provided in the parameters of this operation to the user, how this is done is not within the scope of the present document.	

7.3.4.1.5 tliTcTerminated

Signature	void tliTcTerminated(in TString am, in TInteger ts, in TString src, in TInteger line, in TriComponentIdType c, in TciTestCaseIdType tcId, in TciParameterListType tciPars, in VerdictValue verdict, in TString reason)	
In Parameters	am	An additional message.
	ts	The time when the event is produced.
	src	The source file of the test specification.
	line	The line number where the request is performed.
	c	The component which produces this event.
	tcId	The testcase to be executed.
	tciPars	The list of parameters required by the testcase.
	verdict	The verdict of the testcase.
reason	The optional reason of the setverdict statement.	
Return Value	void	
Constraint	Shall be called by TM or TE to log the termination of a testcase. This event occurs after the testcase terminated.	
Effect	The TL presents all the information provided in the parameters of this operation to the user, how this is done is not within the scope of the present document.	

7.3.4.1.6 tliCtrlStart

Signature	void tliCtrlStart(in TString am, in TInteger ts, in TString src, in TInteger line, in TriComponentIdType c)	
In Parameters	am	An additional message.
	ts	The time when the event is produced.
	src	The source file of the test specification.
	line	The line number where the request is performed.
	c	The component which produces this event.
Return Value	void	
Constraint	Shall be called by TE to log the start of the control part. This event occurs before the control is started. If the control is not represented by a TRI component, c is null.	
Effect	The TL presents all the information provided in the parameters of this operation to the user, how this is done is not within the scope of the present document.	

7.3.4.1.7 tliCtrlStop

Signature	void tliCtrlStop(in TString am, in TInteger ts, in TString src, in TInteger line, in TriComponentIdType c)	
In Parameters	am	An additional message.
	ts	The time when the event is produced.
	src	The source file of the test specification.
	line	The line number where the request is performed.
	c	The component which produces this event.
Return Value	void	
Constraint	Shall be called by TE to log the stop of the control part. This event occurs before the control is stopped. If the control is not represented by a TRI component, c is null.	
Effect	The TL presents all the information provided in the parameters of this operation to the user, how this is done is not within the scope of the present document.	

7.3.4.1.8 tliCtrlTerminated

Signature	void tliCtrlTerminated (in TString am, in TInteger ts, in TString src, in TInteger line, in TriComponentIdType c)	
In Parameters	am	An additional message.
	ts	The time when the event is produced.
	src	The source file of the test specification.
	line	The line number where the request is performed.
	c	The component which produces this event.
Return Value	void	
Constraint	Shall be called by TM or TE to log the termination of the control part. This event occurs after the control has terminated. If the control is not represented by a TRI component, c is null.	
Effect	The TL presents all the information provided in the parameters of this operation to the user, how this is done is not within the scope of the present document.	

7.3.4.1.9 tliMSend_m

Signature	void tliMSend_m(in TString am, in TInteger ts, in TString src, in TInteger line, in TriComponentIdType c, in TriPortIdType at, in TriPortIdType to, in Value msgValue, in Value addrValue, in TciStatusType encoderFailure, in TriMessageType msg, in TriAddressType address, in TriStatusType transmissionFailure)	
In Parameters	am	An additional message.
	ts	The time when the event is produced.
	src	The source file of the test specification.
	line	The line number where the request is performed.
	c	The component which produces this event.
	at	The port via which the message is sent.
	to	The port to which the message is sent.
	msgValue	The value to be encoded and sent.
	addrValue	The address value of the destination within the SUT.
	encoderFailure	The failure message which might occur at encoding.
	msg	The encoded message.
	address	The address of the destination within the SUT.
	transmissionFailure	The failure message which might occur at transmission.
Return Value	void	
Constraint	Shall be called by SA or TE to log a unicast send operation. This event occurs after sending. This event is used for logging the communication with the SUT.	
Effect	The TL presents all the information provided in the parameters of this operation to the user, how this is done is not within the scope of the present document.	

7.3.4.1.10 tliMSend_m_BC

Signature	<pre>void tliMSend_m_BC(in TString am, in TInteger ts, in TString src, in TInteger line, in TriComponentIdType c, in TriPortIdType at, in TriPortIdType to, in Value msgValue, in TciStatusType encoderFailure, in TriMessageType msg, in TriStatusType transmissionFailure)</pre>	
In Parameters	am	An additional message.
	ts	The time when the event is produced.
	src	The source file of the test specification.
	line	The line number where the request is performed.
	c	The component which produces this event.
	at	The port via which the message is sent.
	to	The port to which the message is sent.
	msgValue	The value to be encoded and sent.
	encoderFailure	The failure message which might occur at encoding.
	msg	The encoded message.
transmissionFailure	The failure message which might occur at transmission.	
Return Value	void	
Constraint	Shall be called by SA or TE to log a broadcast send operation. This event occurs after sending. This event is used for logging the communication with the SUT.	
Effect	The TL presents all the information provided in the parameters of this operation to the user, how this is done is not within the scope of the present document.	

7.3.4.1.11 tliMSend_m_MC

Signature	<pre>void tliMSend_m_MC(in TString am, in TInteger ts, in TString src, in TInteger line, in TriComponentIdType c, in TriPortIdType at, in TriPortIdType to, in Value msgValue, in TciValueList addrValues, in TciStatusType encoderFailure, in TriMessageType msg, in TriAddressListType addresses, in TriStatusType transmissionFailure)</pre>	
In Parameters	am	An additional message.
	ts	The time when the event is produced.
	src	The source file of the test specification.
	line	The line number where the request is performed.
	c	The component which produces this event.
	at	The port via which the message is sent.
	to	The port to which the message is sent.
	msgValue	The value to be encoded and sent.
	addrValues	The address values of the destinations within the SUT.
	encoderFailure	The failure message which might occur at encoding.
	msg	The encoded message.
	addresses	The addresses of the destinations within the SUT.
transmissionFailure	The failure message which might occur at transmission.	
Return Value	void	
Constraint	Shall be called by SA or TE to log a multicast send operation. This event occurs after sending. This event is used for logging the communication with the SUT.	
Effect	The TL presents all the information provided in the parameters of this operation to the user, how this is done is not within the scope of the present document.	

7.3.4.1.12 tliMSend_c

Signature	void tliMSend_c(in TString am, in TInteger ts, in TString src, in TInteger line, in TriComponentIdType c, in TriPortIdType at, in TriPortIdType to, in Value msgValue, in TriStatusType transmissionFailure)	
In Parameters	am	An additional message.
	ts	The time when the event is produced.
	src	The source file of the test specification.
	line	The line number where the request is performed.
	c	The component which produces this event.
	at	The port via which the message is sent.
	msgValue	The value to be encoded and sent.
	to	The component which will receive the message.
transmissionFailure	The failure message which might occur at transmission.	
Return Value	void	
Constraint	Shall be called by CH or TE to log a unicast send operation. This event occurs after sending. This event is used for logging the intercomponent communication.	
Effect	The TL presents all the information provided in the parameters of this operation to the user, how this is done is not within the scope of the present document.	

7.3.4.1.13 tliMSend_c_BC

Signature	void tliMSend_c_BC(in TString am, in TInteger ts, in TString src, in TInteger line, in TriComponentIdType c, in TriPortIdType at, in TriPortIdListType to, in Value msgValue, in TriStatusType transmissionFailure)	
In Parameters	am	An additional message.
	ts	The time when the event is produced.
	src	The source file of the test specification.
	line	The line number where the request is performed.
	c	The component which produces this event.
	at	The port via which the message is sent.
	to	The ports to which the message is sent.
	msgValue	The value to be encoded and sent.
transmissionFailure	The failure message which might occur at transmission.	
Return Value	void	
Constraint	Shall be called by CH or TE to log a broadcast send operation. This event occurs after sending. This event is used for logging the intercomponent communication.	
Effect	The TL presents all the information provided in the parameters of this operation to the user, how this is done is not within the scope of the present document.	

7.3.4.1.14 tliMSend_c_MC

Signature	void tliMSend_c_MC(in TString am, in TInteger ts, in TString src, in TInteger line, in TriComponentIdType c, in TriPortIdType at, in TriPortIdListType to, in Value msgValue, in TriStatusType transmissionFailure)	
In Parameters	am	An additional message.
	ts	The time when the event is produced.
	src	The source file of the test specification.
	line	The line number where the request is performed.
	c	The component which produces this event.
	at	The port via which the message is sent.
	to	The port to which the message is sent.
	msgValue	The value to be encoded and sent.
transmissionFailure	The failure message which might occur at transmission.	
Return Value	void	
Constraint	Shall be called by CH or TE to log a multicast send operation. This event occurs after sending. This event is used for logging the intercomponent communication.	
Effect	The TL presents all the information provided in the parameters of this operation to the user, how this is done is not within the scope of the present document.	

7.3.4.1.15 tliMDetected_m

Signature	void tliMDetected_m(in TString am, in TInteger ts, in TString src, in TInteger line, in TriComponentIdType c, in TriPortIdType at, in TriPortIdType from, in TriMessageType msg, in TriAddressType address)	
In Parameters	am	An additional message.
	ts	The time when the event is produced.
	src	The source file of the test specification.
	line	The line number where the request is performed.
	c	The component which produces this event.
	at	The port via which the message is received.
	from	The port from which the message has been sent.
	msg	The received encoded message.
address	The address of the source within the SUT.	
Return Value	Void	
Constraint	Shall be called by SA or TE to log the enqueueing of a message. This event occurs after the message is enqueued. This event is used for logging the communication with the SUT.	
Effect	The TL presents all the information provided in the parameters of this operation to the user, how this is done is not within the scope of the present document.	

7.3.4.1.16 tliMDetected_c

Signature	void tliMDetected_c(in TString am, in TInteger ts, in TString src, in TInteger line, in TriComponentIdType c, in TriPortIdType at, in TriPortIdType from, in Value msgValue)	
In Parameters	am	An additional message.
	ts	The time when the event is produced.
	src	The source file of the test specification.
	line	The line number where the request is performed.
	c	The component which produces this event.
	at	The port via which the message is received.
	from	The port from which the message has been sent.
	msgValue	The received message.
Return Value	Void	
Constraint	Shall be called by CH or TE to log the enqueueing of a message. This event occurs after the message is enqueued. This event is used for logging the intercomponent communication.	
Effect	The TL presents all the information provided in the parameters of this operation to the user, how this is done is not within the scope of the present document.	

7.3.4.1.17 tliMMismatch_m

Signature	void tliMMismatch_m(in TString am, in TInteger ts, in TString src, in TInteger line, in TriComponentIdType c, in TriPortIdType at, in Value msgValue, in TciValueTemplate msgTpl, in TciValueDifferenceList diffs, in Value addrValue, in TciValueTemplate addressTpl)	
In Parameters	am	An additional message.
	ts	The time when the event is produced.
	src	The source file of the test specification.
	line	The line number where the request is performed.
	c	The component which produces this event.
	at	The port via which the message is received.
	msgValue	The message which is checked against the template.
	msgTpl	The template used to check the message match.
	diffs	The difference/the mismatch between message and template.
	addrValue	The address value of the source within the SUT.
addressTpl	The expected address of the source within the SUT.	
Return Value	Void	

Constraint	Shall be called by TE to log the mismatch of a template. This event occurs after checking a template match. This event is used for logging the communication with the SUT.
Effect	The TL presents all the information provided in the parameters of this operation to the user, how this is done is not within the scope of the present document.

7.3.4.1.18 tliMMismatch_c

Signature	void tliMMismatch_c(in TString am, in TInteger ts, in TString src, in TInteger line, in TriComponentIdType c, in TriPortIdType at, in Value msgValue, in TciValueTemplate msgTpl, in TciValueDifferenceList diffs, in TriComponentIdType from, in TciNonValueTemplate fromTpl)	
In Parameters	am	An additional message.
	ts	The time when the event is produced.
	src	The source file of the test specification.
	line	The line number where the request is performed.
	c	The component which produces this event.
	at	The port via which the message is received.
	msgValue	The message which is checked against the template.
	msgTpl	The template used to check the message match.
	diffs	The difference/the mismatch between message and template.
	from	The component which sent the message.
fromTpl	The expected sender component.	
Return Value	Void	
Constraint	Shall be called by TE to log the mismatch of a template. This event occurs after checking a template match. This event is used for logging the intercomponent communication.	
Effect	The TL presents all the information provided in the parameters of this operation to the user, how this is done is not within the scope of the present document.	

7.3.4.1.19 tliMReceive_m

Signature	void tliMReceive_m(in TString am, in TInteger ts, in TString src, in TInteger line, in TriComponentIdType c, in TriPortIdType at, in Value msgValue, in TciValueTemplate msgTpl, in Value addrValue, in TciValueTemplate addressTpl)	
In Parameters	am	An additional message.
	ts	The time when the event is produced.
	src	The source file of the test specification.
	line	The line number where the request is performed.
	c	The component which produces this event.
	at	The port via which the message is received.
	msgValue	The message which is checked against the template.
	msgTpl	The template used to check the message match.
	addrValue	The address value of the source within the SUT.
addressTpl	The expected address of the source within the SUT.	
Return Value	Void	
Constraint	Shall be called by TE to log the receiving of a message. This event occurs after checking a template match. This event is used for logging the communication with SUT.	
Effect	The TL presents all the information provided in the parameters of this operation to the user, how this is done is not within the scope of the present document.	

7.3.4.1.20 tliMReceive_c

Signature	void tliMReceive_c(in TString am, in TInteger ts, in TString src, in TInteger line, in TriComponentIdType c, in TriPortIdType at, in Value msgValue, in TciValueTemplate msgTpl, in TriComponentIdType from, in TciNonValueTemplate fromTpl)	
In Parameters	am	An additional message.
	ts	The time when the event is produced.
	src	The source file of the test specification.
	line	The line number where the request is performed.
	c	The component which produces this event.
	at	The port via which the message is received.
	msgValue	The message which is checked against the template.
	msgTpl	The template used to check the message match.
	from	The component which sent the message.
fromTpl	The expected sender component.	
Return Value	Void	
Constraint	Shall be called by TE to log the receiving of a message. This event occurs after checking a template match. This event is used for logging the intercomponent communication.	
Effect	The TL presents all the information provided in the parameters of this operation to the user, how this is done is not within the scope of the present document.	

7.3.4.1.21 tliPrCall_m

Signature	void tliPrCall_m(in TString am, in TInteger ts, in TString src, in TInteger line, in TriComponentIdType c, in TriPortIdType at, in TriPortIdType to, in TriSignatureIdType signature, in TciParameterListType tciPars, in Value addrValue, in TciStatusType encoderFailure, in TriParameterListType triPars, in TriAddressType address, in TriStatusType transmissionFailure)	
In Parameters	am	An additional message.
	ts	The time when the event is produced.
	src	The source file of the test specification.
	line	The line number where the request is performed.
	c	The component which produces this event.
	at	The port via which the call is invoked.
	to	The port to which the call is sent.
	signature	The signature of the called operation.
	tciPars	The parameters of the called operation.
	addrValue	The address value of the destination within the SUT.
	encoderFailure	The failure message which might occur at encoding.
	triPars	The encoded parameters.
	address	The address of the destination within the SUT.
transmissionFailure	The failure message which might occur at transmission.	
Return Value	Void	
Constraint	Shall be called by SA or TE to log a unicast call operation. This event occurs after call execution. This event is used for logging the communication with the SUT.	
Effect	The TL presents all the information provided in the parameters of this operation to the user, how this is done is not within the scope of the present document.	

7.3.4.1.22 tliPrCall_m_BC

Signature	<pre>void tliPrCall_m_BC(in TString am, in TInteger ts, in TString src, in TInteger line, in TriComponentIdType c, in TriPortIdType at, in TriPortIdType to, in TriSignatureIdType signature, in TciParameterListType tciPars, in TciStatusType encoderFailure, in TriParameterListType triPars, in TriStatusType transmissionFailure)</pre>	
In Parameters	am	An additional message.
	ts	The time when the event is produced.
	src	The source file of the test specification.
	line	The line number where the request is performed.
	c	The component which produces this event.
	at	The port via which the call is invoked.
	to	The port to which the call is sent.
	signature	The signature of the called operation.
	tciPars	The parameters of the called operation.
	encoderFailure	The failure message which might occur at encoding.
	triPars	The encoded parameters.
	transmissionFailure	The failure message which might occur at transmission.
Return Value	Void	
Constraint	Shall be called by SA or TE to log a broadcast call operation. This event occurs after call execution. This event is used for logging the communication with the SUT.	
Effect	The TL presents all the information provided in the parameters of this operation to the user, how this is done is not within the scope of the present document.	

7.3.4.1.23 tliPrCall_m_MC

Signature	<pre>void tliPrCall_m_MC(in TString am, in TInteger ts, in TString src, in TInteger line, in TriComponentIdType c, in TriPortIdType at, in TriPortIdType to, in TriSignatureIdType signature, in TciParameterListType tciPars, in TciValueList addrValues, in TciStatusType encoderFailure, in TriParameterListType triPars, in TriAddressListType addresses, in TriStatusType transmissionFailure)</pre>	
In Parameters	am	An additional message.
	ts	The time when the event is produced.
	src	The source file of the test specification.
	line	The line number where the request is performed.
	c	The component which produces this event.
	at	The port via which the call is invoked.
	to	The port to which the call is sent.
	signature	The signature of the called operation.
	tciPars	The parameters of the called operation.
	addrValues	The address values of the destinations within the SUT.
	encoderFailure	The failure message which might occur at encoding.
	triPars	The encoded parameters.
	addresses	The addresses of the destinations within the SUT.
transmissionFailure	The failure message which might occur at transmission.	
Return Value	Void	
Constraint	Shall be called by SA or TE to log a multicast call operation. This event occurs after call execution. This event is used for logging the communication with the SUT.	
Effect	The TL presents all the information provided in the parameters of this operation to the user, how this is done is not within the scope of the present document.	

7.3.4.1.24 tliPrCall_c

Signature	void tliPrCall_c(in TString am, in TInteger ts, in TString src, in TInteger line, in TriComponentIdType c, in TriPortIdType at, in TriPortIdType to, in TriSignatureIdType signature, in TciParameterListType tciPars, in TriStatusType transmissionFailure)	
In Parameters	am	An additional message.
	ts	The time when the event is produced.
	src	The source file of the test specification.
	line	The line number where the request is performed.
	c	The component which produces this event.
	at	The port via which the call is invoked.
	to	The port to which the call is sent.
	signature	The signature of the called operation.
tciPars	The parameters of the called operation.	
transmissionFailure	The failure message which might occur at transmission.	
Return Value	Void	
Constraint	Shall be called by CH or TE to log a unicast call operation. This event occurs after call execution. This event is used for logging the intercomponent communication.	
Effect	The TL presents all the information provided in the parameters of this operation to the user, how this is done is not within the scope of the present document.	

7.3.4.1.25 tliPrCall_c_BC

Signature	void tliPrCall_c_BC(in TString am, in TInteger ts, in TString src, in TInteger line, in TriComponentIdType c, in TriPortIdType at, in TriPortIdListType to, in TriSignatureIdType signature, in TciParameterListType tciPars, in TriStatusType transmissionFailure)	
In Parameters	am	An additional message.
	ts	The time when the event is produced.
	src	The source file of the test specification.
	line	The line number where the request is performed.
	c	The component which produces this event.
	at	The port via which the call is invoked.
	to	The port list to which the call is sent.
	signature	The signature of the called operation.
tciPars	The parameters of the called operation.	
transmissionFailure	The failure message which might occur at transmission.	
Return Value	Void	
Constraint	Shall be called by CH or TE to log a broadcast call operation. This event occurs after call execution. This event is used for logging the intercomponent communication.	
Effect	The TL presents all the information provided in the parameters of this operation to the user, how this is done is not within the scope of the present document.	

7.3.4.1.26 tliPrCall_c_MC

Signature	void tliPrCall_c_MC(in TString am, in TInteger ts, in TString src, in TInteger line, in TriComponentIdType c, in TriPortIdType at, in TriPortIdListType to, in TriSignatureIdType signature, in TciParameterListType tciPars, in TriStatusType transmissionFailure)	
In Parameters	am	An additional message.
	ts	The time when the event is produced.
	src	The source file of the test specification.
	line	The line number where the request is performed.
	c	The component which produces this event.
	at	The port via which the call is invoked.
	to	The port list to which the call is sent.
	signature	The signature of the called operation.

	tciPars	The parameters of the called operation.
	transmissionFailure	The failure message which might occur at transmission.
Return Value	Void	
Constraint	Shall be called by CH or TE to log a multicast call operation. This event occurs after call execution. This event is used for logging the intercomponent communication.	
Effect	The TL presents all the information provided in the parameters of this operation to the user, how this is done is not within the scope of the present document.	

7.3.4.1.27 tliPrGetCallDetected_m

Signature	void tliPrGetCallDetected_m(in TString am, in TInteger ts, in TString src, in TInteger line, in TriComponentIdType c, in TriPortIdType at, in TriPortIdType from, in TriSignatureIdType signature, in TriParameterListType triPars, in TriAddressType address)	
In Parameters	am	An additional message.
	ts	The time when the event is produced.
	src	The source file of the test specification.
	line	The line number where the request is performed.
	c	The component which produces this event.
	at	The port via which the call is received.
	from	The port from which the call has been sent.
	signature	The signature of the detected call.
	triPars	The encoded parameters of detected call.
	address	The address of the destination within the SUT.
Return Value	Void	
Constraint	Shall be called by SA or TE to log the getcall enqueue operation. This event occurs after call is enqueued. This event is used for logging the communication with the SUT.	
Effect	The TL presents all the information provided in the parameters of this operation to the user, how this is done is not within the scope of the present document.	

7.3.4.1.28 tliPrGetCallDetected_c

Signature	void tliPrGetCallDetected_c(in TString am, in TInteger ts, in TString src, in TInteger line, in TriComponentIdType c, in TriPortIdType at, in TriPortIdType from, in TriSignatureIdType signature, in TciParameterListType tciPars)	
In Parameters	am	An additional message.
	ts	The time when the event is produced.
	src	The source file of the test specification.
	line	The line number where the request is performed.
	c	The component which produces this event.
	at	The port via which the call is received.
	from	The port from which the call has been sent.
	signature	The signature of the called operation.
	tciPars	The encoded parameters of detected call.
Return Value	Void	
Constraint	Shall be called by CH or TE to log the getcall enqueue operation. This event occurs after call is enqueued. This event is used for logging the intercomponent communication.	
Effect	The TL presents all the information provided in the parameters of this operation to the user, how this is done is not within the scope of the present document.	

7.3.4.1.29 tliPrGetCallMismatch_m

Signature	void tliPrGetCallMismatch_m(in TString am, in TInteger ts, in TString src, in TInteger line, in TriComponentIdType c, in TriPortIdType at, in TriSignatureIdType signature, in TciParameterListType tciPars, in TciValueTemplate parsTpl, in TciValueDifferenceList diffs, in Value addrValue, in TciValueTemplate addressTpl)	
In Parameters	am	An additional message.
	ts	The time when the event is produced.
	src	The source file of the test specification.
	line	The line number where the request is performed.
	c	The component which produces this event.
	at	The port via which the call is received.
	signature	The signature of the detected call.
	tciPars	The parameters of detected call.
	parsTpl	The template used to check the parameter match.
	diffs	The difference/the mismatch between call and template.
	addrValue	The address value of the source within the SUT.
	addressTpl	The expected address of the source within the SUT.
Return Value	Void	
Constraint	Shall be called by TE to log the mismatch of a getcall. This event occurs after getcall is checked against a template. This event is used for logging the communication with the SUT.	
Effect	The TL presents all the information provided in the parameters of this operation to the user, how this is done is not within the scope of the present document.	

7.3.4.1.30 tliPrGetCallMismatch_c

Signature	void tliPrGetCallMismatch_c(in TString am, in TInteger ts, in TString src, in TInteger line, in TriComponentIdType c, in TriPortIdType at, in TriSignatureIdType signature, in TciParameterListType tciPars, in TciValueTemplate parsTpl, in TciValueDifferenceList diffs, in TriComponentIdType from, in TciNonValueTemplate fromTpl)	
In Parameters	am	An additional message.
	ts	The time when the event is produced.
	src	The source file of the test specification.
	line	The line number where the request is performed.
	c	The component which produces this event.
	at	The port via which the call is received.
	signature	The signature of the detected call.
	tciPars	The parameters of detected call.
	parsTpl	The template used to check the parameter match.
	diffs	The difference/the mismatch between message and template.
	from	The component which called the operation.
	fromTpl	The expected calling component.
Return Value	Void	
Constraint	Shall be called by TE to log the mismatch of a getcall. This event occurs after getcall is checked against a template. This event is used for logging the intercomponent communication.	
Effect	The TL presents all the information provided in the parameters of this operation to the user, how this is done is not within the scope of the present document.	

7.3.4.1.31 tliPrGetCall_m

Signature	void tliPrGetCall_m(in TString am, in TInteger ts, in TString src, in TInteger line, in TriComponentIdType c, in TriPortIdType at, in TriSignatureIdType signature, in TciParameterListType tciPars, in TciValueTemplate parsTpl, in Value addrValue, in TciValueTemplate addressTpl)	
In Parameters	am	An additional message.
	ts	The time when the event is produced.
	src	The source file of the test specification.
	line	The line number where the request is performed.
	c	The component which produces this event.
	at	The port via which the call is received.
	signature	The signature of the detected call.
	tciPars	The parameters of detected call.
	parsTpl	The template used to check the parameter match.
	addrValue	The address value of the source within the SUT.
addressTpl	The expected address of the source within the SUT.	
Return Value	void	
Constraint	Shall be called by TE to log getting a call. This event occurs after getcall has matched against a template. This event is used for logging the communication with the SUT.	
Effect	The TL presents all the information provided in the parameters of this operation to the user, how this is done is not within the scope of the present document.	

7.3.4.1.32 tliPrGetCall_c

Signature	void tliPrGetCall_c(in TString am, in TInteger ts, in TString src, in TInteger line, in TriComponentIdType c, in TriPortIdType at, in TriSignatureIdType signature, in TciParameterListType tciPars, in TciValueTemplate parsTpl, in TriComponentIdType from, in TciNonValueTemplate fromTpl)	
In Parameters	am	An additional message.
	ts	The time when the event is produced.
	src	The source file of the test specification.
	line	The line number where the request is performed.
	c	The component which produces this event.
	at	The port via which the call is received.
	signature	The signature of the detected call.
	tciPars	The parameters of detected call.
	parsTpl	The template used to check the parameter match.
	from	The component which called the operation.
fromTpl	The expected calling component.	
Return Value	void	
Constraint	Shall be called by TE to log getting a call. This event occurs after getcall has matched against a template. This event is used for logging the intercomponent communication.	
Effect	The TL presents all the information provided in the parameters of this operation to the user, how this is done is not within the scope of the present document.	

7.3.4.1.33 tliPrReply_m

Signature	void tliPrReply_m(in TString am, in TInteger ts, in TString src, in TInteger line, in TriComponentIdType c, in TriPortIdType at, in TriPortIdType to, in TriSignatureIdType signature, in TciParameterListType tciPars, in Value replValue, in Value addrValue, in TciStatusType encoderFailure, in TriParameterListType triPars, in TriParameterType repl, in TriAddressType address, in TriStatusType transmissionFailure)	
In Parameters	am	An additional message.
	ts	The time when the event is produced.
	src	The source file of the test specification.
	line	The line number where the request is performed.
	c	The component which produces this event.
	at	The port via which the reply is sent.
	to	The port to which the reply is sent.
	signature	The signature relating to the reply.
	tciPars	The signature parameters relating to the reply.
	replValue	The reply to be sent.
	addrValue	The address value of the destination within the SUT.
	encoderFailure	The failure message which might occur at encoding.
	triPars	The encoded parameters.
	repl	The encoded reply.
address	The address of the destination within the SUT.	
transmissionFailure	The failure message which might occur at transmission.	
Return Value	void	
Constraint	Shall be called by SA or TE to log a unicast reply operation. This event occurs after reply execution. This event is used for logging the communication with the SUT.	
Effect	The TL presents all the information provided in the parameters of this operation to the user, how this is done is not within the scope of the present document.	

7.3.4.1.34 tliPrReply_m_BC

Signature	void tliPrReply_m_BC(in TString am, in TInteger ts, in TString src, in TInteger line, in TriComponentIdType c, in TriPortIdType at, in TriPortIdType to, in TriSignatureIdType signature, in TciParameterListType tciPars, in Value replValue, in TciStatusType encoderFailure, in TriParameterListType triPars, in TriParameterType repl, in TriStatusType transmissionFailure)	
In Parameters	am	An additional message.
	ts	The time when the event is produced.
	src	The source file of the test specification.
	line	The line number where the request is performed.
	c	The component which produces this event.
	at	The port via which the reply is sent.
	to	The port to which the reply is sent.
	signature	The signature relating to the reply.
	tciPars	The signature parameters relating to the reply.
	replValue	The reply to be sent.
	encoderFailure	The failure message which might occur at encoding.
	triPars	The encoded parameters.
	repl	The encoded reply.
	transmissionFailure	The failure message which might occur at transmission.
Return Value	void	
Constraint	Shall be called by SA or TE to log a broadcast reply operation. This event occurs after reply execution. This event is used for logging the communication with the SUT.	
Effect	The TL presents all the information provided in the parameters of this operation to the user, how this is done is not within the scope of the present document.	

7.3.4.1.35 tliPrReply_m_MC

Signature	void tliPrReply_m_MC(in TString am, in TInteger ts, in TString src, in TInteger line, in TriComponentIdType c, in TriPortIdType at, in TriPortIdType to, in TriSignatureIdType signature, in TciParameterListType tciPars, in Value replValue, in TciValueList addrValues, in TciStatusType encoderFailure, in TriParameterListType triPars, in TriParameterType repl, in TriAddressListType addresses, in TriStatusType transmissionFailure)	
In Parameters	am	An additional message.
	ts	The time when the event is produced.
	src	The source file of the test specification.
	line	The line number where the request is performed.
	c	The component which produces this event.
	at	The port via which the reply is sent.
	to	The port to which the reply is sent.
	signature	The signature relating to the reply.
	tciPars	The signature parameters relating to the reply.
	replValue	The reply to be sent.
	addrValues	The address values of the destinations within the SUT.
	encoderFailure	The failure message which might occur at encoding.
	triPars	The encoded parameters.
	repl	The encoded reply.
addresses	The addresses of the destinations within the SUT.	
transmissionFailure	The failure message which might occur at transmission.	
Return Value	void	
Constraint	Shall be called by SA or TE to log a multicast reply operation. This event occurs after reply execution. This event is used for logging the communication with the SUT.	
Effect	The TL presents all the information provided in the parameters of this operation to the user, how this is done is not within the scope of the present document.	

7.3.4.1.36 tliPrReply_c

Signature	void tliPrReply_c(in TString am, in TInteger ts, in TString src, in TInteger line, in TriComponentIdType c, in TriPortIdType at, in TriPortIdType to, in TriSignatureIdType signature, in Value parsValue, in Value replValue, in TriStatusType transmissionFailure)	
In Parameters	am	An additional message.
	ts	The time when the event is produced.
	src	The source file of the test specification.
	line	The line number where the request is performed.
	c	The component which produces this event.
	at	The port via which the reply is sent.
	to	The port to which the reply is sent.
	signature	The signature relating to the reply.
	parsValue	The signature parameters relating to the reply.
	replValue	The reply to be sent.
	transmissionFailure	The failure message which might occur at transmission.
Return Value	void	
Constraint	Shall be called by CH or TE to log a unicast reply operation. This event occurs after reply execution. This event is used for logging the intercomponent communication.	
Effect	The TL presents all the information provided in the parameters of this operation to the user, how this is done is not within the scope of the present document.	

7.3.4.1.37 tliPrReply_c_BC

Signature	void tliPrReply_c_BC(in TString am, in TInteger ts, in TString src, in TInteger line, in TriComponentIdType c, in TriPortIdType at, in TriPortIdListType to, in TriSignatureIdType signature, in Value parsValue, in Value replValue, in TriStatusType transmissionFailure)	
In Parameters	am	An additional message.
	ts	The time when the event is produced.
	src	The source file of the test specification.
	line	The line number where the request is performed.
	c	The component which produces this event.
	at	The port via which the reply is sent.
	to	The port list to which the reply is sent.
	signature	The signature relating to the reply.
	parsValue	The signature parameters relating to the reply.
	replValue	The reply to be sent.
	transmissionFailure	The failure message which might occur at transmission.
Return Value	void	
Constraint	Shall be called by CH or TE to log a broadcast reply operation. This event occurs after reply execution. This event is used for logging the intercomponent communication.	
Effect	The TL presents all the information provided in the parameters of this operation to the user, how this is done is not within the scope of the present document.	

7.3.4.1.38 tliPrReply_c_MC

Signature	void tliPrReply_c_MC(in TString am, in TInteger ts, in TString src, in TInteger line, in TriComponentIdType c, in TriPortIdType at, in TriPortIdListType to, in TriSignatureIdType signature, in Value parsValue, in Value replValue, in TriStatusType transmissionFailure)	
In Parameters	am	An additional message.
	ts	The time when the event is produced.
	src	The source file of the test specification.
	line	The line number where the request is performed.
	c	The component which produces this event.
	at	The port via which the reply is sent.
	to	The port list to which the reply is sent.
	signature	The signature relating to the reply.
	parsValue	The signature parameters relating to the reply.
	replValue	The reply to be sent.
	transmissionFailure	The failure message which might occur at transmission.
Return Value	void	
Constraint	Shall be called by CH or TE to log a multicast reply operation. This event occurs after reply execution. This event is used for logging the intercomponent communication.	
Effect	The TL presents all the information provided in the parameters of this operation to the user, how this is done is not within the scope of the present document.	

7.3.4.1.39 tliPrGetReplyDetected_m

Signature	void tliPrGetReplyDetected_m(in TString am, in TInteger ts, in TString src, in TInteger line, in TriComponentIdType c, in TriPortIdType at, in TriPortIdType from, in TriSignatureIdType signature, in TriParameterListType triPars, in TriParameterType repl, in TriAddressType address)	
In Parameters	am	An additional message.
	ts	The time when the event is produced.
	src	The source file of the test specification.
	line	The line number where the request is performed.
	c	The component which produces this event.
	at	The port via which the reply is received.
	from	The port from which the reply has been sent.
	signature	The signature relating to the reply.
	triPars	The encoded parameters of detected reply.
	repl	The received encoded reply.
address	The address of the source within the SUT.	
Return Value	void	
Constraint	Shall be called by SA or TE to log the getreply enqueue operation. This event occurs after getreply is enqueued. This event is used for logging the communication with the SUT.	
Effect	The TL presents all the information provided in the parameters of this operation to the user, how this is done is not within the scope of the present document.	

7.3.4.1.40 tliPrGetReplyDetected_c

Signature	void tliPrGetReplyDetected_c(in TString am, in TInteger ts, in TString src, in TInteger line, in TriComponentIdType c, in TriPortIdType at, in TriPortIdType from, in TriSignatureIdType signature, in TciParameterListType tciPars, in Value replValue)	
In Parameters	am	An additional message.
	ts	The time when the event is produced.
	src	The source file of the test specification.
	line	The line number where the request is performed.
	c	The component which produces this event.
	at	The port via which the reply is received.
	from	The port from which the reply has been sent.
	signature	The signature relating to the reply.
	tciPars	The encoded parameters of detected reply.
	replValue	The received reply.
Return Value	void	
Constraint	Shall be called by CH or TE to log the getreply enqueue operation. This event occurs after getreply is enqueued. This event is used for logging the intercomponent communication.	
Effect	The TL presents all the information provided in the parameters of this operation to the user, how this is done is not within the scope of the present document.	

7.3.4.1.41 tliPrGetReplyMismatch_m

Signature	<pre>void tliPrGetReplyMismatch_m(in TString am, in TInteger ts, in TString src, in TInteger line, in TriComponentIdType c, in TriPortIdType at, in TriSignatureIdType signature, in TciParameterListType tciPars, in TciValueTemplate parsTpl, in Value replValue, in TciValueTemplate replyTpl, in TciValueDifferenceList diffs, in Value addrValue, in TciValueTemplate addressTpl)</pre>	
In Parameters	am	An additional message.
	ts	The time when the event is produced.
	src	The source file of the test specification.
	line	The line number where the request is performed.
	c	The component which produces this event.
	at	The port via which the reply is received.
	signature	The signature relating to the reply.
	tciPars	The signature parameters relating to the reply.
	parsTpl	The template used to check the parameter match.
	replValue	The received reply.
	replyTpl	The template used to check the reply match.
	diffs	The difference/the mismatch between reply and template
	addrValue	The address value of the source within the SUT.
addressTpl	The expected address of the source within the SUT.	
Return Value	void	
Constraint	Shall be called by TE to log the mismatch of a getreply operation. This event occurs after getreply is checked against a template. This event is used for logging the communication with SUT.	
Effect	The TL presents all the information provided in the parameters of this operation to the user, how this is done is not within the scope of the present document.	

7.3.4.1.42 tliPrGetReplyMismatch_c

Signature	<pre>void tliPrGetReplyMismatch_c(in TString am, in TInteger ts, in TString src, in TInteger line, in TriComponentIdType c, in TriPortIdType at, in TriSignatureIdType signature, in TciParameterListType tciPars, in TciValueTemplate parsTpl, in Value replValue, in TciValueTemplate replyTpl, in TciValueDifferenceList diffs, in TriComponentIdType from, in TciNonValueTemplate fromTpl)</pre>	
In Parameters	am	An additional message.
	ts	The time when the event is produced.
	src	The source file of the test specification.
	line	The line number where the request is performed.
	c	The component which produces this event.
	at	The port via which the reply is received.
	signature	The signature relating to the reply.
	tciPars	The signature parameters relating to the reply.
	parsTpl	The template used to check the parameter match.
	repl	The received reply.
	replyTpl	The template used to check the reply match.
	diffs	The difference/the mismatch between reply and template.
	from	The component which sent the reply.
fromTpl	The expected replying component.	
Return Value	void	
Constraint	Shall be called by TE to log the mismatch of a getreply operation. This event occurs after getreply is checked against a template. This event is used for logging the intercomponent communication.	
Effect	The TL presents all the information provided in the parameters of this operation to the user, how this is done is not within the scope of the present document.	

7.3.4.1.43 tliPrGetReply_m

Signature	void tliPrGetReply_m(in TString am, in TInteger ts, in TString src, in TInteger line, in TriComponentIdType c, in TriPortIdType at, in TriSignatureIdType signature, in TciParameterListType tciPars, in TciValueTemplate parsTmpl, in Value replValue, in TciValueTemplate replyTmpl, in Value addrValue, in TciValueTemplate addressTmpl)	
In Parameters	am	An additional message.
	ts	The time when the event is produced.
	src	The source file of the test specification.
	line	The line number where the request is performed.
	c	The component which produces this event.
	at	The port via which the reply is received.
	signature	The signature relating to the reply.
	tciPars	The signature parameters relating to the reply.
	parsTmpl	The template used to check the parameter match.
	replValue	The received reply.
	replyTmpl	The template used to check the reply match.
	addrValue	The address value of the source within the SUT.
	addressTmpl	The expected address of the source within the SUT.
Return Value	void	
Constraint	Shall be called by TE to log getting a reply. This event occurs after getreply is checked against a template. This event is used for logging the communication with SUT.	
Effect	The TL presents all the information provided in the parameters of this operation to the user, how this is done is not within the scope of the present document.	

7.3.4.1.44 tliPrGetReply_c

Signature	void tliPrGetReply_c(in TString am, in TInteger ts, in TString src, in TInteger line, in TriComponentIdType c, in TriPortIdType at, in TriSignatureIdType signature, in TciParameterListType tciPars, in TciValueTemplate parsTmpl, in Value replValue, in TciValueTemplate replyTmpl, in TriComponentIdType from, in TciNonValueTemplate fromTmpl)	
In Parameters	am	An additional message.
	ts	The time when the event is produced.
	src	The source file of the test specification.
	line	The line number where the request is performed.
	c	The component which produces this event.
	at	The port via which the reply is received.
	signature	The signature relating to the reply.
	tciPars	The signature parameters relating to the reply.
	parsTmpl	The template used to check the parameter match.
	replValue	The received reply.
	replyTmpl	The template used to check the reply match.
	from	The component which sent the reply.
	fromTmpl	The expected replying component.
Return Value	void	
Constraint	Shall be called by TE to log getting a reply. This event occurs after getreply is checked against a template. This event is used for logging the intercomponent communication.	
Effect	The TL presents all the information provided in the parameters of this operation to the user, how this is done is not within the scope of the present document.	

7.3.4.1.45 tliPrRaise_m

Signature	void tliPrRaise_m(in TString am, in TInteger ts, in TString src, in TInteger line, in TriComponentIdType c, in TriPortIdType at, in TriPortIdType to, in TriSignatureIdType signature, in TciParameterListType tciPars, in Value excValue, in Value addrValue, in TciStatusType encoderFailure, in TriExceptionType exc, in TriAddressType address, in TriStatusType transmissionFailure)	
In Parameters	am	An additional message.
	ts	The time when the event is produced.
	src	The source file of the test specification.
	line	The line number where the request is performed.
	c	The component which produces this event.
	at	The port via which the exception is sent.
	to	The port to which the exception is sent.
	signature	The signature relating to the exception.
	tciPars	The signature parameters relating to the exception.
	excValue	The exception to be sent.
	addrValue	The address value of the destination within the SUT.
	encoderFailure	The failure message which might occur at encoding.
	exc	The encoded exception.
address	The address of the destination within the SUT.	
transmissionFailure	The failure message which might occur at transmission.	
Return Value	void	
Constraint	Shall be called by SA or TE to log a unicast raise operation. This event occurs after reply execution. This event is used for logging the communication with the SUT.	
Effect	The TL presents all the information provided in the parameters of this operation to the user, how this is done is not within the scope of the present document.	

7.3.4.1.46 tliPrRaise_m_BC

Signature	void tliPrRaise_m_BC(in TString am, in TInteger ts, in TString src, in TInteger line, in TriComponentIdType c, in TriPortIdType at, in TriPortIdType to, in TriSignatureIdType signature, in TciParameterListType tciPars, in Value excValue, in TciStatusType encoderFailure, in TriExceptionType exc, in TriStatusType transmissionFailure)	
In Parameters	am	An additional message.
	ts	The time when the event is produced.
	src	The source file of the test specification.
	line	The line number where the request is performed.
	c	The component which produces this event.
	at	The port via which the exception is sent.
	to	The port to which the exception is sent.
	signature	The signature relating to the exception.
	tciPars	The signature parameters relating to the exception.
	excValue	The exception to be sent.
	encoderFailure	The failure message which might occur at encoding.
	exc	The encoded exception.
	transmissionFailure	The failure message which might occur at transmission.
Return Value	void	
Constraint	Shall be called by SA or TE to log a broadcast raise operation. This event occurs after reply execution. This event is used for logging the communication with the SUT.	
Effect	The TL presents all the information provided in the parameters of this operation to the user, how this is done is not within the scope of the present document.	

7.3.4.1.47 tliPrRaise_m_MC

Signature	void tliPrRaise_m_MC(in TString am, in TInteger ts, in TString src, in TInteger line, in TriComponentIdType c, in TriPortIdType at, in TriPortIdType to, in TriSignatureIdType signature, in TciParameterListType tciPars, in Value excValue, in TciValueList addrValues, in TciStatusType encoderFailure, in TriExceptionType exc, in TriAddressListType addresses, in TriStatusType transmissionFailure)	
In Parameters	am	An additional message.
	ts	The time when the event is produced.
	src	The source file of the test specification.
	line	The line number where the request is performed.
	c	The component which produces this event.
	at	The port via which the exception is sent.
	to	The port to which the exception is sent.
	signature	The signature relating to the exception.
	tciPars	The signature parameters relating to the exception.
	excValue	The exception to be sent.
	addrValues	The address values of the destinations within the SUT.
	encoderFailure	The failure message which might occur at encoding.
	exc	The encoded exception.
addresses	The addresses of the destinations within the SUT.	
transmissionFailure	The failure message which might occur at transmission.	
Return Value	void	
Constraint	Shall be called by SA or TE to log a multicast raise operation. This event occurs after reply execution. This event is used for logging the communication with the SUT.	
Effect	The TL presents all the information provided in the parameters of this operation to the user, how this is done is not within the scope of the present document.	

7.3.4.1.48 tliPrRaise_c

Signature	void tliPrRaise_c(in TString am, in TInteger ts, in TString src, in TInteger line, in TriComponentIdType c, in TriPortIdType at, in TriPortIdType to, in TriSignatureIdType signature, in TciParameterListType tciPars, in Value excValue, in TriStatusType transmissionFailure)		
In Parameters	am	An additional message.	
	ts	The time when the event is produced.	
	src	The source file of the test specification.	
	line	The line number where the request is performed.	
	c	The component which produces this event.	
	at	The port via which the exception is sent.	
	to	The port to which the exception is sent.	
	signature	The signature relating to the exception.	
	tciPars	The signature parameters relating to the exception.	
	excValue	The exception to be sent.	
	transmissionFailure	The failure message which might occur at transmission.	
	Return Value	void	
	Constraint	Shall be called by CH or TE to log a unicast raise operation. This event occurs after reply execution. This event is used for logging the intercomponent communication.	
Effect	The TL presents all the information provided in the parameters of this operation to the user, how this is done is not within the scope of the present document.		

7.3.4.1.49 tliPrRaise_c_BC

Signature	void tliPrRaise_c_BC(in TString am, in TInteger ts, in TString src, in TInteger line, in TriComponentIdType c, in TriPortIdType at, in TriPortIdListType to, in TriSignatureIdType signature, in TciParameterListType tciPars, in Value excValue, in TriStatusType transmissionFailure)	
In Parameters	am	An additional message.
	ts	The time when the event is produced.
	src	The source file of the test specification.
	line	The line number where the request is performed.
	c	The component which produces this event.
	at	The port via which the exception is sent.
	to	The port list to which the exception is sent.
	signature	The signature relating to the exception.
	tciPars	The signature parameters relating to the exception.
	excValue	The exception to be sent.
	transmissionFailure	The failure message which might occur at transmission.
Return Value	void	
Constraint	Shall be called by CH or TE to log a broadcast raise operation. This event occurs after reply execution. This event is used for logging the intercomponent communication.	
Effect	The TL presents all the information provided in the parameters of this operation to the user, how this is done is not within the scope of the present document.	

7.3.4.1.50 tliPrRaise_c_MC

Signature	void tliPrRaise_c_MC(in TString am, in TInteger ts, in TString src, in TInteger line, in TriComponentIdType c, in TriPortIdType at, in TriPortIdListType to, in TriSignatureIdType signature, in TciParameterListType tciPars, in Value excValue, in TriStatusType transmissionFailure)	
In Parameters	am	An additional message.
	ts	The time when the event is produced.
	src	The source file of the test specification.
	line	The line number where the request is performed.
	c	The component which produces this event.
	at	The port via which the exception is sent.
	to	The port list to which the exception is sent.
	signature	The signature relating to the exception.
	tciPars	The signature parameters relating to the exception.
	excValue	The exception to be sent.
	transmissionFailure	The failure message which might occur at transmission.
Return Value	void	
Constraint	Shall be called by CH or TE to log a multicast raise operation. This event occurs after reply execution. This event is used for logging the intercomponent communication.	
Effect	The TL presents all the information provided in the parameters of this operation to the user, how this is done is not within the scope of the present document.	

7.3.4.1.51 tliPrCatchDetected_m

Signature	void tliPrCatchDetected_m(in TString am, in TInteger ts, in TString src, in TInteger line, in TriComponentIdType c, in TriPortIdType at, in TriPortIdType from, in TriSignatureIdType signature, in TriExceptionType exc, in TriAddressType address)	
In Parameters	am	An additional message.
	ts	The time when the event is produced.
	src	The source file of the test specification.
	line	The line number where the request is performed.
	c	The component which produces this event.
	at	The port via which the exception is received.
	from	The port from which the exception has been sent.
	signature	The signature relating to the exception.
	exc	The exception caught.
	address	The address of the source within the SUT.
Return Value	void	
Constraint	Shall be called by SA or TE to log the catch enqueue operation. This event occurs after catch is enqueued. This event is used for logging the communication with the SUT.	
Effect	The TL presents all the information provided in the parameters of this operation to the user, how this is done is not within the scope of the present document.	

7.3.4.1.52 tliPrCatchDetected_c

Signature	void tliPrCatchDetected_c(in TString am, in TInteger ts, in TString src, in TInteger line, in TriComponentIdType c, in TriPortIdType at, in TriPortIdType from, in TriSignatureIdType signature, in Value excValue)	
In Parameters	am	An additional message.
	ts	The time when the event is produced.
	src	The source file of the test specification.
	line	The line number where the request is performed.
	c	The component which produces this event.
	at	The port via which the exception is received.
	from	The port from which the exception has been sent.
	signature	The signature relating to the exception.
	excValue	The caught exception.
Return Value	void	
Constraint	Shall be called by CH or TE to log the catch enqueue operation. This event occurs after catch is enqueued. This event is used for logging the intercomponent communication.	
Effect	The TL presents all the information provided in the parameters of this operation to the user, how this is done is not within the scope of the present document.	

7.3.4.1.53 tliPrCatchMismatch_m

Signature	void tliPrCatchMismatch_m(in TString am, in TInteger ts, in TString src, in TInteger line, in TriComponentIdType c, in TriPortIdType at, in TriSignatureIdType signature, in Value excValue, in TciValueTemplate excTpl, in TciValueDifferenceList diffs, in Value addrValue, in TciValueTemplate addressTpl)	
In Parameters	am	An additional message.
	ts	The time when the event is produced.
	src	The source file of the test specification.
	line	The line number where the request is performed.
	c	The component which produces this event.
	at	The port via which the exception is received.
	signature	The signature relating to the exception.
	excValue	The received exception.
	excTpl	The template used to check the exception match.
	diffs	The difference/the mismatch between exception and template.
	addrValue	The address value of the source within the SUT.
	addressTpl	The expected address of the source within the SUT.
Return Value	void	
Constraint	Shall be called by TE to log the mismatch of a catch operation. This event occurs after catch is checked against a template. This event is used for logging the communication with SUT.	
Effect	The TL presents all the information provided in the parameters of this operation to the user, how this is done is not within the scope of the present document.	

7.3.4.1.54 tliPrCatchMismatch_c

Signature	void tliPrCatchMismatch_c(in TString am, in TInteger ts, in TString src, in TInteger line, in TriComponentIdType c, in TriPortIdType at, in TriSignatureIdType signature, in Value excValue, in TciValueTemplate excTpl, in TciValueDifferenceList diffs, in TriComponentIdType from, in TciNonValueTemplate fromTpl)	
In Parameters	Am	An additional message.
	Ts	The time when the event is produced.
	Src	The source file of the test specification.
	Line	The line number where the request is performed.
	C	The component which produces this event.
	At	The port via which the exception is received.
	Signature	The signature relating to the exception.
	excValue	The received exception.
	excTpl	The template used to check the exception match.
	Diffs	The difference/the mismatch between exception and template.
	From	The component which sent the reply.
	fromTpl	The expected replying component.
Return Value	Void	
Constraint	Shall be called by TE to log the mismatch of a catch operation. This event occurs after catch is checked against a template. This event is used for logging the intercomponent communication.	
Effect	The TL presents all the information provided in the parameters of this operation to the user, how this is done is not within the scope of the present document.	

7.3.4.1.55 tliPrCatch_m

Signature	void tliPrCatch_m(in TString am, in TInteger ts, in TString src, in TInteger line, in TriComponentIdType c, in TriPortIdType at, in TriSignatureIdType signature, in Value excValue, in TciValueTemplate excTpl, in Value addrValue, in TciValueTemplate addressTpl)	
In Parameters	Am	An additional message.
	Ts	The time when the event is produced.
	Src	The source file of the test specification.
	Line	The line number where the request is performed.
	C	The component which produces this event.
	At	The port via which the exception is received.
	Signature	The signature relating to the exception.
	excValue	The received exception.
	excTpl	The template used to check the exception match.
	addrValue	The address value of the source within the SUT.
	addressTpl	The expected address of the source within the SUT.
Return Value	Void	
Constraint	Shall be called by SA or TE to log catching an exception. This event occurs after catch is checked against a template. This event is used for logging the communication with SUT.	
Effect	The TL presents all the information provided in the parameters of this operation to the user, how this is done is not within the scope of the present document.	

7.3.4.1.56 tliPrCatch_c

Signature	void tliPrCatch_c(in TString am, in TInteger ts, in TString src, in TInteger line, in TriComponentIdType c, in TriPortIdType at, in TriSignatureIdType signature, in Value excValue, in TciValueTemplate excTpl, in TriComponentIdType from, in TciNonValueTemplate fromTpl)	
In Parameters	Am	An additional message.
	Ts	The time when the event is produced.
	Src	The source file of the test specification.
	Line	The line number where the request is performed.
	C	The component which produces this event.
	At	The port via which the exception is received.
	Signature	The signature relating to the exception.
	excValue	The received exception.
	excTpl	The template used to check the exception match.
	From	The component which sent the reply.
	fromTpl	The expected replying component.
Return Value	Void	
Constraint	Shall be called by CH or TE to log catching an exception. This event occurs after catch is checked against a template. This event is used for logging the intercomponent communication.	
Effect	The TL presents all the information provided in the parameters of this operation to the user, how this is done is not within the scope of the present document.	

7.3.4.1.57 tliPrCatchTimeoutDetected

Signature	void tliPrCatchTimeoutDetected (in TString am, in TInteger ts, in TString src, in TInteger line, in TriComponentIdType c, in TriPortIdType at, in TriSignatureIdType signature)	
In Parameters	Am	An additional message.
	Ts	The time when the event is produced.
	Src	The source file of the test specification.
	Line	The line number where the request is performed.
	C	The component which produces this event.
	At	The port via which the exception is received.
	Signature	The signature relating to the exception.
Return Value	Void	
Constraint	Shall be called by PA or TE to log the detection of a catch timeout. This event occurs after the timeout is enqueued.	
Effect	The TL presents all the information provided in the parameters of this operation to the user, how this is done is not within the scope of the present document.	

7.3.4.1.58 tliPrCatchTimeout

Signature	void tliPrCatchTimeout (in TString am, in TInteger ts, in TString src, in TInteger line, in TriComponentIdType c, in TriPortIdType at, in TriSignatureIdType signature)	
In Parameters	am	An additional message.
	ts	The time when the event is produced.
	src	The source file of the test specification.
	line	The line number where the request is performed.
	c	The component which produces this event.
	at	The port via which the exception is received.
	signature	The signature relating to the exception.
Return Value	void	
Constraint	Shall be called by TE to log catching a timeout. This event occurs after the catch timeout has been performed.	
Effect	The TL presents all the information provided in the parameters of this operation to the user, how this is done is not within the scope of the present document.	

7.3.4.1.59 tliCCreate

Signature	void tliCCreate(in TString am, in TInteger ts, in TString src, in TInteger line, in TriComponentIdType c, in TriComponentIdType comp, in TString name, in TBoolean alive)	
In Parameters	am	An additional message.
	ts	The time when the event is produced.
	src	The source file of the test specification.
	line	The line number where the request is performed.
	c	The component which produces this event.
	comp	The component which is created.
	name	The name of the component which is created.
	alive	If the component is an alive component.
Return Value	void	
Constraint	Shall be called by TE to log the create component operation. This event occurs after component creation.	
Effect	The TL presents all the information provided in the parameters of this operation to the user, how this is done is not within the scope of the present document.	

7.3.4.1.60 tliCStart

Signature	void tliCStart(in TString am, in TInteger ts, in TString src, in TInteger line, in TriComponentIdType c, in TriComponentIdType comp, in TciBehaviourIdType beh, in TciParameterListType tciPars)	
In Parameters	am	An additional message.
	ts	The time when the event is produced.
	src	The source file of the test specification.
	line	The line number where the request is performed.
	c	The component which produces this event.
	comp	The component which is started.
	beh	The behaviour being started on the component.
	tciPars	The parameters of the started behaviour.
Return Value	void	
Constraint	Shall be called by TE to log the start component operation. This event occurs after component start.	
Effect	The TL presents all the information provided in the parameters of this operation to the user, how this is done is not within the scope of the present document.	

7.3.4.1.61 tliCRunning

Signature	void tliCRunning(in TString am, in TInteger ts, in TString src, in TInteger line, in TriComponentIdType c, in TriComponentIdType comp, in ComponentStatusType status)	
In Parameters	am	An additional message.
	ts	The time when the event is produced.
	src	The source file of the test specification.
	line	The line number where the request is performed.
	c	The component which produces this event.
	comp	The component which is checked to be running.
	status	The status of this component.
Return Value	void	
Constraint	Shall be called by TE to log the running component operation. This event occurs after component running.	
Effect	The TL presents all the information provided in the parameters of this operation to the user, how this is done is not within the scope of the present document.	

7.3.4.1.62 tliCAlive

Signature	void tliCAlive(in TString am, in TInteger ts, in TString src, in TInteger line, in TriComponentIdType c, in TriComponentIdType comp, in ComponentStatusType status)	
In Parameters	am	An additional message.
	ts	The time when the event is produced.
	src	The source file of the test specification.
	line	The line number where the request is performed.
	c	The component which produces this event.
	comp	The component which is checked to be running.
	status	The status of this component.
Return Value	void	
Constraint	Shall be called by TE to log the alive component operation. This event occurs after component alive.	
Effect	The TL presents all the information provided in the parameters of this operation to the user, how this is done is not within the scope of the present document.	

7.3.4.1.63 tliCStop

Signature	void tliCStop(in TString am, in TInteger ts, in TString src, in TInteger line, in TriComponentIdType c, in TriComponentIdType comp)	
In Parameters	am	An additional message.
	ts	The time when the event is produced.
	src	The source file of the test specification.
	line	The line number where the request is performed.
	c	The component which produces this event.
	comp	The component which is stopped.
Return Value	void	
Constraint	Shall be called by TE to log the stop component operation. This event occurs after component stop.	
Effect	The TL presents all the information provided in the parameters of this operation to the user, how this is done is not within the scope of the present document.	

7.3.4.1.64 tliCKill

Signature	void tliCKill(in TString am, in TInteger ts, in TString src, in TInteger line, in TriComponentIdType c, in TriComponentIdType comp)	
In Parameters	am	An additional message.
	ts	The time when the event is produced.
	src	The source file of the test specification.
	line	The line number where the request is performed.
	c	The component which produces this event.
	comp	The component which is killed.
Return Value	void	
Constraint	Shall be called by TE to log the kill component operation. This event occurs after component kill.	
Effect	The TL presents all the information provided in the parameters of this operation to the user, how this is done is not within the scope of the present document.	

7.3.4.1.65 tliCDoneMismatch

Signature	void tliCDoneMismatch(in TString am, in TInteger ts, in TString src, in TInteger line, in TriComponentIdType c, in TriComponentIdType comp, in TciNonValueTemplate compTpl)	
In Parameters	am	An additional message.
	ts	The time when the event is produced.
	src	The source file of the test specification.
	line	The line number where the request is performed.
	c	The component which produces this event.
	comp	The first component that did not match.
	compTpl	The template used to check the done match.
Return Value	void	
Constraint	Shall be called by TE to log the mismatch of a done component operation. This event occurs after done is checked against a template.	
Effect	The TL presents all the information provided in the parameters of this operation to the user, how this is done is not within the scope of the present document.	

7.3.4.1.66 tliCDone

Signature	void tliCDone (in TString am, in TInteger ts, in TString src, in TInteger line, in TriComponentIdType c, in TciNonValueTemplate compTmpl, in VerdictValue verdict)	
In Parameters	am	An additional message.
	ts	The time when the event is produced.
	src	The source file of the test specification.
	line	The line number where the request is performed.
	c	The component which produces this event.
	compTmpl	The template used to check the done match.
	verdict	The final verdict of the component if the component is known or null otherwise.
Return Value	void	
Constraint	Shall be called by TE to log the done component operation. This event occurs after the done operation.	
Effect	The TL presents all the information provided in the parameters of this operation to the user, how this is done is not within the scope of the present document.	

7.3.4.1.67 tliCKilledMismatch

Signature	void tliCKilledMismatch(in TString am, in TInteger ts, in TString src, in TInteger line, in TriComponentIdType c, in TriComponentIdType comp, in TciNonValueTemplate compTmpl)	
In Parameters	am	An additional message.
	ts	The time when the event is produced.
	src	The source file of the test specification.
	line	The line number where the request is performed.
	c	The component which produces this event.
	comp	The first component that did not match.
	compTmpl	The template used to check the killed match.
Return Value	void	
Constraint	Shall be called by TE to log the mismatch of a killed component operation. This event occurs after killed is checked against a template.	
Effect	The TL presents all the information provided in the parameters of this operation to the user, how this is done is not within the scope of the present document.	

7.3.4.1.68 tliCKilled

Signature	void tliCKilled (in TString am, in TInteger ts, in TString src, in TInteger line, in TriComponentIdType c, in TciNonValueTemplate compTmpl, in VerdictValue verdict)	
In Parameters	am	An additional message.
	ts	The time when the event is produced.
	src	The source file of the test specification.
	line	The line number where the request is performed.
	c	The component which produces this event.
	compTmpl	The template used to check the killed match.
	verdict	The final verdict of the component if the component is known or null otherwise.
Return Value	void	
Constraint	Shall be called by TE to log the killed component operation. This event occurs after the killed operation.	
Effect	The TL presents all the information provided in the parameters of this operation to the user, how this is done is not within the scope of the present document.	

7.3.4.1.69 tliCTerminated

Signature	void tliCTerminated(in TString am, in TInteger ts, in TString src, in TInteger line, in TriComponentIdType c, in VerdictValue verdict, in TString reason)	
In Parameters	am	An additional message.
	ts	The time when the event is produced.
	src	The source file of the test specification.
	line	The line number where the request is performed.
	c	The component which produces this event.
	verdict	The verdict of the component.
	reason	The optional reason of the setverdict statement
Return Value	void	
Constraint	Shall be called by TE to log the termination of a component. This event occurs after the termination of the component.	
Effect	The TL presents all the information provided in the parameters of this operation to the user, how this is done is not within the scope of the present document.	

7.3.4.1.70 tliPConnect

Signature	void tliPConnect(in TString am, in TInteger ts, in TString src, in TInteger line, in TriComponentIdType c, in TriPortIdType port1, in TriPortIdType port2)	
In Parameters	am	An additional message.
	ts	The time when the event is produced.
	src	The source file of the test specification.
	line	The line number where the request is performed.
	c	The component which produces this event.
	port1	The first port to be connected.
	port2	The second port to be connected.
Return Value	void	
Constraint	Shall be called by CH or TE to log the connect operation. This event occurs after the connect operation.	
Effect	The TL presents all the information provided in the parameters of this operation to the user, how this is done is not within the scope of the present document.	

7.3.4.1.71 tliPDisconnect

Signature	void tliPDisconnect(in TString am, in TInteger ts, in TString src, in TInteger line, in TriComponentIdType c, in TriPortIdType port1, in TriPortIdType port2)	
In Parameters	am	An additional message.
	ts	The time when the event is produced.
	src	The source file of the test specification.
	line	The line number where the request is performed.
	c	The component which produces this event.
	port1	The first port to be disconnected.
	port2	The second port to be disconnected.
Return Value	void	
Constraint	Shall be called by CH or TE to log the disconnect operation. This event occurs after the disconnect operation.	
Effect	The TL presents all the information provided in the parameters of this operation to the user, how this is done is not within the scope of the present document.	

7.3.4.1.72 tliPMap

Signature	void tliPMap(in TString am, in TInteger ts, in TString src, in TInteger line, in TriComponentIdType c, in TriPortIdType port1, in TriPortIdType port2)	
In Parameters	am	An additional message.
	ts	The time when the event is produced.
	src	The source file of the test specification.
	line	The line number where the request is performed.
	c	The component which produces this event.
	port1	The first port to be mapped.
	port2	The second port to be mapped.
Return Value	void	
Constraint	Shall be called by SA or TE to log the map operation. This event occurs after the map operation.	
Effect	The TL presents all the information provided in the parameters of this operation to the user, how this is done is not within the scope of the present document.	

7.3.4.1.73 tliPMapParam

Signature	void tliPMapParam(in TString am, in TInteger ts, in TString src, in TInteger line, in TriComponentIdType c, in TriPortIdType port1, in TriPortIdType port2, in TciParameterListType tciPars, in TciStatusType encoderFailure, in TriParameterListType triPars)	
In Parameters	am	An additional message.
	ts	The time when the event is produced.
	src	The source file of the test specification.
	line	The line number where the request is performed.
	c	The component which produces this event.
	port1	The first port to be mapped.
	port2	The second port to be mapped.
	tciPars	The configuration parameter list.
	encoderFailure	The failure message which might occur at encoding.
	triPars	The encoded configuration parameter list.
Return Value	void	
Constraint	Shall be called by SA or TE to log the map operation. This event occurs after the map operation including parameters.	
Effect	The TL presents all the information provided in the parameters of this operation to the user, how this is done is not within the scope of the present document.	

7.3.4.1.74 tliPUnmap

Signature	void tliPUnmap(in TString am, in TInteger ts, in TString src, in TInteger line, in TriComponentIdType c, in TriPortIdType port1, in TriPortIdType port2)	
In Parameters	am	An additional message.
	ts	The time when the event is produced.
	src	The source file of the test specification.
	line	The line number where the request is performed.
	c	The component which produces this event.
	port1	The first port to be unmapped.
	port2	The second port to be unmapped.
Return Value	void	
Constraint	Shall be called by SA or TE to log the unmap operation. This event occurs after the unmap operation.	
Effect	The TL presents all the information provided in the parameters of this operation to the user, how this is done is not within the scope of the present document.	

7.3.4.1.75 tliPUnmapParam

Signature	void tliPUnmapParam(in TString am, in TInteger ts, in TString src, in TInteger line, in TriComponentIdType c, in TriPortIdType port1, in TriPortIdType port2, in TciParameterListType tciPars, in TciStatusType encoderFailure, in TriParameterListType triPars)	
In Parameters	am	An additional message.
	ts	The time when the event is produced.
	src	The source file of the test specification.
	line	The line number where the request is performed.
	c	The component which produces this event.
	port1	The first port to be unmapped.
	port2	The second port to be unmapped.
	tciPars	The configuration parameter list.
	encoderFailure	The failure message which might occur at encoding.
	triPars	The encoded configuration parameter list.
Return Value	void	
Constraint	Shall be called by SA or TE to log the unmap operation. This event occurs after the unmap operation including parameters.	
Effect	The TL presents all the information provided in the parameters of this operation to the user, how this is done is not within the scope of the present document.	

7.3.4.1.76 tliPClear

Signature	void tliPClear(in TString am, in TInteger ts, in TString src, in TInteger line, in TriComponentIdType c, in TriPortIdType port)	
In Parameters	am	An additional message.
	ts	The time when the event is produced.
	src	The source file of the test specification.
	line	The line number where the request is performed.
	c	The component which produces this event.
	port	The port to be cleared.
Return Value	void	
Constraint	Shall be called by TE to log the port clear operation. This event occurs after the port clear operation.	
Effect	The TL presents all the information provided in the parameters of this operation to the user, how this is done is not within the scope of the present document.	

7.3.4.1.77 tliPStart

Signature	void tliPStart(in TString am, in TInteger ts, in TString src, in TInteger line, in TriComponentIdType c, in TriPortIdType port)	
In Parameters	am	An additional message.
	ts	The time when the event is produced.
	src	The source file of the test specification.
	line	The line number where the request is performed.
	c	The component which produces this event.
	port	The port to be started.
Return Value	void	
Constraint	Shall be called by TE to log the port start operation. This event occurs after the port start operation.	
Effect	The TL presents all the information provided in the parameters of this operation to the user, how this is done is not within the scope of the present document.	

7.3.4.1.78 tliPStop

Signature	void tliPStop(in TString am, in TInteger ts, in TString src, in TInteger line, in TriComponentIdType c, in TriPortIdType port)	
In Parameters	am	An additional message.
	ts	The time when the event is produced.
	src	The source file of the test specification.
	line	The line number where the request is performed.
	c	The component which produces this event.
	port	The port to be stopped.
Return Value	void	
Constraint	Shall be called by TE to log the port stop operation. This event occurs after the port stop operation.	
Effect	The TL presents all the information provided in the parameters of this operation to the user, how this is done is not within the scope of the present document.	

7.3.4.1.79 tliPHalt

Signature	void tliPHalt(in TString am, in TInteger ts, in TString src, in TInteger line, in TriComponentIdType c, in TriPortIdType port)	
In Parameters	am	An additional message.
	ts	The time when the event is produced.
	src	The source file of the test specification.
	line	The line number where the request is performed.
	c	The component which produces this event.
	port	The port to be stopped.
Return Value	void	
Constraint	Shall be called by TE to log the port halt operation. This event occurs after the port halt operation.	
Effect	The TL presents all the information provided in the parameters of this operation to the user, how this is done is not within the scope of the present document.	

7.3.4.1.80 tliEncode

Signature	void tliEncode(in TString am, in TInteger ts, in TString src, in TInteger line, in TriComponentIdType c, in Value val, in TciStatusType encoderFailure, in TriMessageType msg, in TString codec)	
In Parameters	am	An additional message.
	ts	The time when the event is produced.
	src	The source file of the test specification.
	line	The line number where the request is performed.
	c	The component which produces this event.
	value	The value to be encoded.
	encoderFailure	The failure message which might occur at encoding.
	msg	The encoded value.
	codec	The used encoder.
Return Value	void	
Constraint	Shall be called by CD or TE to log the encode operation.	
Effect	The TL presents all the information provided in the parameters of this operation to the user, how this is done is not within the scope of the present document.	

7.3.4.1.81 tliDecode

Signature	void tliDecode(in TString am, in TInteger ts, in TString src, in TInteger line, in TriComponentIdType c, in TriMessageType msg, in TciStatusType decoderFailure, in Value val, in TString codec)	
In Parameters	am	An additional message.
	ts	The time when the event is produced.
	src	The source file of the test specification.
	line	The line number where the request is performed.
	c	The component which produces this event.
	msg	The value to be decoded.
	decoderFailure	The failure message which might occur at decoding.
	val	The decoded value.
Return Value	void	
Constraint	Shall be called by CD or TE to log the decode operation.	
Effect	The TL presents all the information provided in the parameters of this operation to the user, how this is done is not within the scope of the present document.	

7.3.4.1.82 tliTimeoutDetected

Signature	void tliTimeoutDetected(in TString am, in TInteger ts, in TString src, in TInteger line, in TriComponentIdType c, in TriTimerIdType timer)	
In Parameters	am	An additional message.
	ts	The time when the event is produced.
	src	The source file of the test specification.
	line	The line number where the request is performed.
	c	The component which produces this event.
	timer	The timer that timed out.
Return Value	void	
Constraint	Shall be called by PA or TE to log the detection of a timeout. This event occurs after timeout is enqueued.	
Effect	The TL presents all the information provided in the parameters of this operation to the user, how this is done is not within the scope of the present document.	

7.3.4.1.83 tliTimeoutMismatch

Signature	void tliTimeoutMismatch(in TString am, in TInteger ts, in TString src, in TInteger line, in TriComponentIdType c, in TriTimerIdType timer, in TciNonValueTemplate timerTpl)	
In Parameters	am	An additional message.
	ts	The time when the event is produced.
	src	The source file of the test specification.
	line	The line number where the request is performed.
	c	The component which produces this event.
	timer	The first timer that did not match.
	timerTpl	The timer template that did not match.
Return Value	void	
Constraint	Shall be called by TE to log a timeout mismatch. This event occurs after a timeout match failed.	
Effect	The TL presents all the information provided in the parameters of this operation to the user, how this is done is not within the scope of the present document.	

7.3.4.1.84 tliTTimeout

Signature	void tliTTimeout(in TString am, in TInteger ts, in TString src, in TInteger line, in TriComponentIdType c, in TriTimerIdType timer, in TciNonValueTemplate timerTpl)	
In Parameters	am	An additional message.
	ts	The time when the event is produced.
	src	The source file of the test specification.
	line	The line number where the request is performed.
	c	The component which produces this event.
	timer	The timer that matched.
	timerTpl	The timer template that matched.
Return Value	void	
Constraint	Shall be called by TE to log a timeout match. This event occurs after a timeout matched.	
Effect	The TL presents all the information provided in the parameters of this operation to the user, how this is done is not within the scope of the present document.	

7.3.4.1.85 tliTStart

Signature	void tliTStart(in TString am, in TInteger ts, in TString src, in TInteger line, in TriComponentIdType c, in TriTimerIdType timer, in TriTimerDurationType dur)	
In Parameters	am	An additional message.
	ts	The time when the event is produced.
	src	The source file of the test specification.
	line	The line number where the request is performed.
	c	The component which produces this event.
	timer	The timer that is started.
	dur	The timer duration.
Return Value	void	
Constraint	Shall be called by PA or TE to log the start of a timer. This event occurs after the start timer operation.	
Effect	The TL presents all the information provided in the parameters of this operation to the user, how this is done is not within the scope of the present document.	

7.3.4.1.86 tliTStop

Signature	void tliTStop(in TString am, in TInteger ts, in TString src, in TInteger line, in TriComponentIdType c, in TriTimerIdType timer, in TriTimerDurationType dur)	
In Parameters	am	An additional message.
	ts	The time when the event is produced.
	src	The source file of the test specification.
	line	The line number where the request is performed.
	c	The component which produces this event.
	timer	The timer that is stopped.
	dur	The duration of the timer when it was stopped.
Return Value	void	
Constraint	Shall be called by PA or TE to log the stop of a timer. This event occurs after the stop timer operation.	
Effect	The TL presents all the information provided in the parameters of this operation to the user, how this is done is not within the scope of the present document.	

7.3.4.1.87 tliTRead

Signature	void tliTRead(in TString am, in TInteger ts, in TString src, in TInteger line, in TriComponentIdType c, in TriTimerIdType timer, in TriTimerDurationType elapsed)	
In Parameters	am	An additional message.
	ts	The time when the event is produced.
	src	The source file of the test specification.
	line	The line number where the request is performed.
	c	The component which produces this event.
	timer	The timer that is started.
	elapsed	The elapsed time of the timer.
Return Value	void	
Constraint	Shall be called by PA or TE to log the reading of a timer. This event occurs after the read timer operation.	
Effect	The TL presents all the information provided in the parameters of this operation to the user, how this is done is not within the scope of the present document.	

7.3.4.1.88 tliTRunning

Signature	void tliTRunning(in TString am, in TInteger ts, in TString src, in TInteger line, in TriComponentIdType c, in TriTimerIdType timer, in TimerStatusType status)	
In Parameters	am	An additional message.
	ts	The time when the event is produced.
	src	The source file of the test specification.
	line	The line number where the request is performed.
	c	The component which produces this event.
	timer	The timer which is checked to be running.
	status	The status of this component.
Return Value	void	
Constraint	Shall be called by PA or TE to log the running timer operation. This event occurs after the running timer operation.	
Effect	The TL presents all the information provided in the parameters of this operation to the user, how this is done is not within the scope of the present document.	

7.3.4.1.89 tliSEnter

Signature	void tliSEnter(in TString am, in TInteger ts, in TString src, in TInteger line, in TriComponentIdType c, in QualifiedName name, in TciParameterListType tciPars, in TString kind)	
In Parameters	am	An additional message.
	ts	The time when the event is produced.
	src	The source file of the test specification.
	line	The line number where the request is performed.
	c	The component which produces this event.
	name	The name of the scope.
	tciPars	The parameters of the scope.
	kind	The kind of the scope. If the scope contains modifiers, they prefix the scope string.
Return Value	void	
Constraint	Shall be called by TE to log the entering of a scope. This event occurs after the scoped has been entered.	
Effect	The TL presents all the information provided in the parameters of this operation to the user, how this is done is not within the scope of the present document.	

7.3.4.1.90 tliSLeave

Signature	void tliSLeave(in TString am, in TInteger ts, in TString src, in TInteger line, in TriComponentIdType c, in QualifiedName name, in TciParameterListType tciPars, in Value returnValue, in TString kind)	
In Parameters	am	An additional message.
	ts	The time when the event is produced.
	src	The source file of the test specification.
	line	The line number where the request is performed.
	c	The component which produces this event.
	name	The name of the scope.
	tciPars	The parameters of the scope.
	returnValue	The return value of the scope.
	kind	The kind of the scope. If the scope contains modifiers, they prefix the scope string.
Return Value	void	
Constraint	Shall be called by TE to log the leaving of a scope. This event occurs after the scoped has been left.	
Effect	The TL presents all the information provided in the parameters of this operation to the user, how this is done is not within the scope of the present document.	

7.3.4.1.91 tliVar

Signature	void tliVar(in TString am, in TInteger ts, in TString src, in TInteger line, in TriComponentIdType c, in QualifiedName name, in Value varValue)	
In Parameters	am	An additional message.
	ts	The time when the event is produced.
	src	The source file of the test specification.
	line	The line number where the request is performed.
	c	The component which produces this event.
	name	The name of the variable.
	varValue	The new value of the variable.
	Return Value	void
Constraint	Shall be called by TE to log the modification of the value of a variable. This event occurs after the value has been changed. In case of @lazy variables, it is called also after performing evaluation as evaluation result is automatically assigned to the variable.	
Effect	The TL presents all the information provided in the parameters of this operation to the user, how this is done is not within the scope of the present document.	

7.3.4.1.92 tliModulePar

Signature	void tliModulePar(in TString am, in TInteger ts, in TString src, in TInteger line, in TriComponentIdType c, in QualifiedName name, in Value parValue)	
In Parameters	am	An additional message.
	ts	The time when the event is produced.
	src	The source file of the test specification.
	line	The line number where the request is performed.
	c	The component which produces this event.
	name	The name of the module parameter.
	parValue	The value of the module parameter.
	Return Value	void
Constraint	Shall be called by TE to log the value of a module parameter. This event occurs after the access to the value of a module parameter.	
Effect	The TL presents all the information provided in the parameters of this operation to the user, how this is done is not within the scope of the present document.	

7.3.4.1.93 tliGetVerdict

Signature	void tliGetVerdict(in TString am, in TInteger ts, in TString src, in TInteger line, in TriComponentIdType c, in VerdictValue verdict)	
In Parameters	am	An additional message.
	ts	The time when the event is produced.
	src	The source file of the test specification.
	line	The line number where the request is performed.
	c	The component which produces this event.
	verdict	The current value of the local verdict.
Return Value	void	
Constraint	Shall be called by TE to log the getverdict operation. This event occurs after the getverdict operation.	
Effect	The TL presents all the information provided in the parameters of this operation to the user, how this is done is not within the scope of the present document.	

7.3.4.1.94 tliSetVerdict

Signature	void tliSetVerdict(in TString am, in TInteger ts, in TString src, in TInteger line, in TriComponentIdType c, in VerdictValue verdict, in TString reason)	
In Parameters	am	An additional message.
	ts	The time when the event is produced.
	src	The source file of the test specification.
	line	The line number where the request is performed.
	c	The component which produces this event.
	verdict	The value to be set to the local verdict.
	reason	The optional reason of the setverdict statement.
Return Value	void	
Constraint	Shall be called by TE to log the setverdict operation or the occurrence of a runtime error. If used to log the setverdict operation, then this event occurs after the setverdict operation.	
Effect	The TL presents all the information provided in the parameters of this operation to the user, how this is done is not within the scope of the present document.	

7.3.4.1.95 tliLog

Signature	void tliLog (in TString am, in TInteger ts, in TString src, in TInteger line, in TriComponentIdType c, in TString log)	
In Parameters	am	An additional message.
	ts	The time when the event is produced.
	src	The source file of the test specification.
	line	The line number where the request is performed.
	c	The component which produces this event.
	log	The string to be logged.
Return Value	void	
Constraint	Shall be called by TM or TE to log the TTCN-3 statement log. This event occurs after the TTCN-3 log operation.	
Effect	The TL presents all the information provided in the parameters of this operation to the user, how this is done is not within the scope of the present document.	

7.3.4.1.96 tliAEnter

Signature	void tliAEnter(in TString am, in TInteger ts, in TString src, in TInteger line, in TriComponentIdType c)	
In Parameters	am	An additional message.
	ts	The time when the event is produced.
	src	The source file of the test specification.
	line	The line number where the request is performed.
	c	The component which produces this event.
Return Value	void	
Constraint	Shall be called by TE to log entering an alt. This event occurs after an alt has been entered.	
Effect	The TL presents all the information provided in the parameters of this operation to the user, how this is done is not within the scope of the present document.	

7.3.4.1.97 tliALeave

Signature	void tliALeave(in TString am, in TInteger ts, in TString src, in TInteger line, in TriComponentIdType c)	
In Parameters	am	An additional message.
	ts	The time when the event is produced.
	src	The source file of the test specification.
	line	The line number where the request is performed.
	c	The component which produces this event.
Return Value	void	
Constraint	Shall be called by TE to log leaving an alt. This event occurs after the alt has been leaved.	
Effect	The TL presents all the information provided in the parameters of this operation to the user, how this is done is not within the scope of the present document.	

7.3.4.1.98 tliANomatch

Signature	void tliANomatch (in TString am, in TInteger ts, in TString src, in TInteger line, in TriComponentIdType c)	
In Parameters	am	An additional message.
	ts	The time when the event is produced.
	src	The source file of the test specification.
	line	The line number where the request is performed.
	c	The component which produces this event.
Return Value	void	
Constraint	Shall be called by TE to log the nomatch of an alt. This event occurs after the alt has not matched.	
Effect	The TL presents all the information provided in the parameters of this operation to the user, how this is done is not within the scope of the present document.	

7.3.4.1.99 tliARepeat

Signature	void tliARepeat(in TString am, in TInteger ts, in TString src, in TInteger line, in TriComponentIdType c)	
In Parameters	am	An additional message.
	ts	The time when the event is produced.
	src	The source file of the test specification.
	line	The line number where the request is performed.
	c	The component which produces this event.
Return Value	void	
Constraint	Shall be called by TE to log repeating an alt. This event occurs when the alt has been repeated.	
Effect	The TL presents all the information provided in the parameters of this operation to the user, how this is done is not within the scope of the present document.	

7.3.4.1.100 tliADefaults

Signature	void tliADefaults(in TString am, in TInteger ts, in TString src, in TInteger line, in TriComponentIdType c)	
In Parameters	am	An additional message.
	ts	The time when the event is produced.
	src	The source file of the test specification.
	line	The line number where the request is performed.
	c	The component which produces this event.
Return Value	void	
Constraint	Shall be called by TE to log entering the default section. This event occurs after the default section has been entered.	
Effect	The TL presents all the information provided in the parameters of this operation to the user, how this is done is not within the scope of the present document.	

7.3.4.1.101 tliAActivate

Signature	void tliAActivate(in TString am, in TInteger ts, in TString src, in TInteger line, in TriComponentIdType c, in QualifiedName name, in TciParameterListType tciPars, in Value ref)	
In Parameters	am	An additional message.
	ts	The time when the event is produced.
	src	The source file of the test specification.
	line	The line number where the request is performed.
	c	The component which produces this event.
	name	The name of the default.
	tciPars	The parameter of the default.
	ref	The resulting default reference.
Return Value	void	
Constraint	Shall be called by TE to log the activation of a default. This event occurs after the default activation.	
Effect	The TL presents all the information provided in the parameters of this operation to the user, how this is done is not within the scope of the present document.	

7.3.4.1.102 tliADeactivate

Signature	void tliADeactivate(in TString am, in TInteger ts, in TString src, in TInteger line, in TriComponentIdType c, in Value ref)	
In Parameters	am	An additional message.
	ts	The time when the event is produced.
	src	The source file of the test specification.
	line	The line number where the request is performed.
	c	The component which produces this event.
	ref	The default reference.
Return Value	void	
Constraint	Shall be called by TE to log the deactivation of a default. This event occurs after the default deactivation.	
Effect	The TL presents all the information provided in the parameters of this operation to the user, how this is done is not within the scope of the present document.	

7.3.4.1.103 tliAwait

Signature	void tliAwait(in TString am, in TInteger ts, in TString src, in TInteger line, in TriComponentId c)	
In Parameters	am	An additional message.
	ts	The time when the event is produced.
	src	The source file of the test specification.
	line	The line number where the request is performed.
	c	The component which produces this event.
Return Value	void	
Constraint	Shall be called by TE to log that the component awaits events for a new snapshot.	
Effect	The TL presents all the information provided in the parameters of this operation to the user, how this is done is not within the scope of the present document.	

7.3.4.1.104 tliAction

Signature	void tliAction(in TString am, in TInteger ts, in TString src, in TInteger line, in TriComponentIdType c, in TString action)	
In Parameters	am	An additional message.
	ts	The time when the event is produced.
	src	The source file of the test specification.
	line	The line number where the request is performed.
	c	The component which produces this event.
	action	The action to be performed.
Return Value	void	
Constraint	Shall be called by TE to log that the component executed an SUT action.	
Effect	The TL presents all the information provided in the parameters of this operation to the user, how this is done is not within the scope of the present document.	

7.3.4.1.105 tliMatch

Signature	void tliMatch(in TString am, in TInteger ts, in TString src, in TInteger line, in TriComponentIdType c, in Value expr, in TciValueTemplate tpl)	
In Parameters	am	An additional message.
	ts	The time when the event is produced.
	src	The source file of the test specification.
	line	The line number where the request is performed.
	c	The component which produces this event.
	expr	The expression to be matched with tpl.
	tpl	The template to be matched with expr.
Return Value	void	
Constraint	Shall be called by TE to log that the component successfully executed a match operation.	
Effect	The TL presents all the information provided in the parameters of this operation to the user, how this is done is not within the scope of the present document.	

7.3.4.1.106 tliMatchMismatch

Signature	void tliMatchMismatch(in TString am, in TInteger ts, in TString src, in TInteger line, in TriComponentIdType c, in Value expr, in TciValueTemplate tpl, in TciValueDifferenceList diffs)	
In Parameters	am	An additional message.
	ts	The time when the event is produced.
	src	The source file of the test specification.
	line	The line number where the request is performed.
	c	The component which produces this event.
	expr	The expression to be matched with tpl.
	tpl	The template to be matched with expr.
	diffs	The difference/the mismatch between expr and tpl.
Return Value	void	
Constraint	Shall be called by TE to log that the component unsuccessfully executed a match operation - a mismatch occurred.	

Effect	The TL presents all the information provided in the parameters of this operation to the user, how this is done is not within the scope of the present document.
---------------	---

7.3.4.1.107 tliInfo

Signature	void tliInfo (in TString am, in TInteger ts, in TString src, in TInteger line, in TriComponentIdType c, in TInteger level, in TString info)	
In Parameters	am	An additional message.
	ts	The time when the event is produced.
	src	The source file of the test specification.
	line	The line number where the request is performed.
	c	The component which produces this event.
	level	The information level.
	info	The information.
Return Value	void	
Constraint	Can be called by TE to log additional information during test execution. The generation of this event is tool dependent as well as the usage of the parameters level and info.	
Effect	The TL presents all the information provided in the parameters of this operation to the user, how this is done is not within the scope of the present document.	

7.3.4.1.108 tliMChecked_m

Signature	void tliMChecked_m(in TString am, in TInteger ts, in TString src, in TInteger line, in TriComponentIdType c, in TriPortIdType at, in Value msgValue, in TciValueTemplate msgTpl, in Value addrValue, in TciValueTemplate addressTpl)	
In Parameters	am	An additional message.
	ts	The time when the event is produced.
	src	The source file of the test specification.
	line	The line number where the request is performed.
	c	The component which produces this event.
	at	The port via which the message is received.
	msgValue	The message which is checked against the template.
	msgTpl	The template used to check the message match.
	addrValue	The address value of the source within the SUT.
	addressTpl	The expected address of the source within the SUT.
Return Value	Void	
Constraint	Shall be called by SA or TE to log the checking of a message. This event occurs after the message is checked successfully. This event is used for logging the communication with the SUT.	
Effect	The TL presents all the information provided in the parameters of this operation to the user, how this is done is not within the scope of the present document.	

7.3.4.1.109 tliMChecked_c

Signature	void tliMChecked_c(in TString am, in TInteger ts, in TString src, in TInteger line, in TriComponentIdType c, in TriPortIdType at, in Value msgValue, in TciValueTemplate msgTpl, in TriComponentIdType from, in TciNonValueTemplate fromTpl)	
In Parameters	am	An additional message.
	ts	The time when the event is produced.
	src	The source file of the test specification.
	line	The line number where the request is performed.
	c	The component which produces this event.
	msgValue	The received message.
	msgTpl	The template used to check the message match.
	from	The component which sent the message.
	fromTpl	The expected sender component.

Return Value	Void
Constraint	Shall be called by CH or TE to log the checking of a message. This event occurs after the message is checked successfully. This event is used for logging the intercomponent communication.
Effect	The TL presents all the information provided in the parameters of this operation to the user, how this is done is not within the scope of the present document.

7.3.4.1.110 tliPrGetCallChecked_m

Signature	void tliPrGetCallChecked_m(in TString am, in TInteger ts, in TString src, in TInteger line, in TriComponentIdType c, in TriPortIdType at, in TriSignatureIdType signature, in TciParameterListType tciPars, in TciValueTemplate parsTpl, in Value addrValue, in TciValueTemplate addressTpl)	
In Parameters	am	An additional message.
	ts	The time when the event is produced.
	src	The source file of the test specification.
	line	The line number where the request is performed.
	c	The component which produces this event.
	at	The port via which the call is received.
	signature	The signature of the checked call.
	tciPars	The parameters of detected call.
	parsTpl	The template used to check the parameter match.
	addrValue	The address value of the source within the SUT.
addressTpl	The expected address of the source within the SUT.	
Return Value	Void	
Constraint	Shall be called by SA or TE to log the getcall check operation. This event occurs after call is checked successfully. This event is used for logging the communication with the SUT.	
Effect	The TL presents all the information provided in the parameters of this operation to the user, how this is done is not within the scope of the present document.	

7.3.4.1.111 tliPrGetCallChecked_c

Signature	void tliPrGetCallChecked_c(in TString am, in TInteger ts, in TString src, in TInteger line, in TriComponentIdType c, in TriPortIdType at, in TriSignatureIdType signature, in TciParameterListType tciPars, in TciValueTemplate parsTpl, in TriComponentIdType from, in TciNonValueTemplate fromTpl)	
In Parameters	am	An additional message.
	ts	The time when the event is produced.
	src	The source file of the test specification.
	line	The line number where the request is performed.
	c	The component which produces this event.
	at	The port via which the call is received.
	signature	The signature of the called operation.
	tciPars	The encoded parameters of checked call.
	parsTpl	The template used to check the parameter match.
	from	The component which called the operation.
fromTpl	The expected calling component.	
Return Value	Void	
Constraint	Shall be called by CH or TE to log the getcall check operation. This event occurs after call is checked successfully. This event is used for logging the intercomponent communication.	
Effect	The TL presents all the information provided in the parameters of this operation to the user, how this is done is not within the scope of the present document.	

7.3.4.1.112 tliPrGetReplyChecked_m

Signature	void tliPrGetReplyChecked_m(in TString am, in TInteger ts, in TString src, in TInteger line, in TriComponentIdType c, in TriPortIdType at, in TriSignatureIdType signature, in TciParameterListType tciPars, in TciValueTemplate parsTpl, in Value replValue, in TciValueTemplate replyTpl, in Value addrValue, in TciValueTemplate addressTpl)	
In Parameters	am	An additional message.
	ts	The time when the event is produced.
	src	The source file of the test specification.
	line	The line number where the request is performed.
	c	The component which produces this event.
	at	The port via which the reply is received.
	signature	The signature relating to the reply.
	tciPars	The signature parameters relating to the reply.
	parsTpl	The template used to check the parameter match.
	replValue	The received reply.
	replyTpl	The template used to check the reply match.
	addrValue	The address value of the source within the SUT.
addressTpl	The expected address of the source within the SUT.	
Return Value	Void	
Constraint	Shall be called by SA or TE to log the getreply check operation. This event occurs after getreply is checked successfully. This event is used for logging the communication with the SUT.	
Effect	The TL presents all the information provided in the parameters of this operation to the user, how this is done is not within the scope of the present document.	

7.3.4.1.113 tliPrGetReplyChecked_c

Signature	void tliPrGetReplyChecked_c(in TString am, in TInteger ts, in TString src, in TInteger line, in TriComponentIdType c, in TriPortIdType at, in TriSignatureIdType signature, in TciParameterListType tciPars, in TciValueTemplate parsTpl, in Value replValue, in TciValueTemplate replyTpl, in TriComponentIdType from, in TciNonValueTemplate fromTpl)	
In Parameters	am	An additional message.
	ts	The time when the event is produced.
	src	The source file of the test specification.
	line	The line number where the request is performed.
	c	The component which produces this event.
	at	The port via which the reply is received.
	signature	The signature relating to the reply.
	tciPars	The encoded parameters of checked reply.
	parsTpl	The template used to check the parameter match.
	replValue	The received reply.
	replyTpl	The template used to check the reply match.
	from	The component which sent the reply.
fromTpl	The expected replying component.	
Return Value	Void	
Constraint	Shall be called by CH or TE to log the getreply check operation. This event occurs after getreply is checked successfully. This event is used for logging the intercomponent communication.	
Effect	The TL presents all the information provided in the parameters of this operation to the user, how this is done is not within the scope of the present document.	

7.3.4.1.114 tliPrCatchChecked_m

Signature	void tliPrCatchChecked_m(in TString am, in TInteger ts, in TString src, in TInteger line, in TriComponentIdType c, in TriPortIdType at, in TriSignatureIdType signature, in Value excValue, in TciValueTemplate excTpl, in Value addrValue, in TciValueTemplate addressTpl)	
In Parameters	am	An additional message.
	ts	The time when the event is produced.
	src	The source file of the test specification.
	line	The line number where the request is performed.
	c	The component which produces this event.
	at	The port via which the exception is received.
	signature	The signature relating to the exception.
	excValue	The received exception.
	excTpl	The template used to check the exception match.
	addrValue	The address value of the source within the SUT.
	addressTpl	The expected address of the source within the SUT.
Return Value	Void	
Constraint	Shall be called by SA or TE to log the catch check operation. This event occurs after catch is checked successfully. This event is used for logging the communication with the SUT.	
Effect	The TL presents all the information provided in the parameters of this operation to the user, how this is done is not within the scope of the present document.	

7.3.4.1.115 tliPrCatchChecked_c

Signature	void tliPrCatchChecked_c(in TString am, in TInteger ts, in TString src, in TInteger line, in TriComponentIdType c, in TriPortIdType at, in TriSignatureIdType signature, in Value excValue, in TciValueTemplate excTpl, in TriComponentIdType from, in TciNonValueTemplate fromTpl)	
In Parameters	am	An additional message.
	ts	The time when the event is produced.
	src	The source file of the test specification.
	line	The line number where the request is performed.
	c	The component which produces this event.
	at	The port via which the exception is received.
	signature	The signature relating to the exception.
	excValue	The caught exception.
	excTpl	The template used to check the exception match.
	from	The component which sent the reply.
	fromTpl	The expected replying component.
Return Value	Void	
Constraint	Shall be called by CH or TE to log the catch check operation. This event occurs after catch is checked successfully. This event is used for logging the intercomponent communication.	
Effect	The TL presents all the information provided in the parameters of this operation to the user, how this is done is not within the scope of the present document.	

7.3.4.1.116 tliCheckedAny_m

Signature	void tliCheckedAny_m(in TString am, in TInteger ts, in TString src, in TInteger line, in TriComponentIdType c, in TriPortIdType at, in Value addrValue, in TciValueTemplate addressTpl)	
In Parameters	am	An additional message.
	ts	The time when the event is produced.
	src	The source file of the test specification.
	line	The line number where the request is performed.
	c	The component which produces this event.
	at	The port via which the message is received.
	addrValue	The address value of the source within the SUT.
	addressTpl	The expected address of the source within the SUT.
Return Value	Void	
Constraint	Shall be called by SA or TE to log a check any operation. This event occurs after the check is successfully performed. This event is used for logging the communication with the SUT.	
Effect	The TL presents all the information provided in the parameters of this operation to the user, how this is done is not within the scope of the present document.	

7.3.4.1.117 tliCheckedAny_c

Signature	void tliCheckedAny_c(in TString am, in TInteger ts, in TString src, in TInteger line, in TriComponentIdType c, in TriPortIdType at, in TriComponentIdType from, in TciNonValueTemplate fromTpl)	
In Parameters	am	An additional message.
	ts	The time when the event is produced.
	src	The source file of the test specification.
	line	The line number where the request is performed.
	c	The component which produces this event.
	at	The port via which the message is received.
	from	The component which sent the message.
	fromTpl	The expected sender component.
Return Value	Void	
Constraint	Shall be called by CH or TE to log a check any operation. This event occurs after the check is successfully performed. This event is used for logging the intercomponent communication.	
Effect	The TL presents all the information provided in the parameters of this operation to the user, how this is done is not within the scope of the present document.	

7.3.4.1.118 tliCheckAnyMismatch_m

Signature	void tliCheckAnyMismatch_m(in TString am, in TInteger ts, in TString src, in TInteger line, in TriComponentIdType c, in TriPortIdType at, in Value addrValue, in TciValueTemplate addressTpl)	
In Parameters	am	An additional message.
	ts	The time when the event is produced.
	src	The source file of the test specification.
	line	The line number where the request is performed.
	c	The component which produces this event.
	at	The port via which the message is received.
	addrValue	The address value of the source within the SUT.
	addressTpl	The expected address of the source within the SUT.
Return Value	Void	
Constraint	Shall be called by TE to log a mismatch that occurred during a check any operation. This event occurs after checking an address match. This event is used for logging the communication with the SUT.	
Effect	The TL presents all the information provided in the parameters of this operation to the user, how this is done is not within the scope of the present document.	

7.3.4.1.119 tliCheckAnyMismatch_c

Signature	void tliCheckAnyMismatch_c(in TString am, in TInteger ts, in TString src, in TInteger line, in TriComponentIdType c, in TriPortIdType at, in TriComponentIdType from, in TciNonValueTemplate fromTpl)	
In Parameters	am	An additional message.
	ts	The time when the event is produced.
	src	The source file of the test specification.
	line	The line number where the request is performed.
	c	The component which produces this event.
	at	The port via which the message is received.
	from	The component which sent the message.
	fromTpl	The expected sender component.
Return Value	Void	
Constraint	Shall be called by TE to log a mismatch that occurred during a check any operation. This event occurs after checking a component match. This event is used for logging the intercomponent communication.	
Effect	The TL presents all the information provided in the parameters of this operation to the user, how this is done is not within the scope of the present document.	

7.3.4.1.120 tliRnd

Signature	void tliRnd(in TString am, in TInteger ts, in TString src, in TInteger line, in TriComponentIdType c, in FloatValue val, in FloatValue seed)	
In Parameters	am	An additional message.
	ts	The time when the event is produced.
	src	The source file of the test specification.
	line	The line number where the request is performed.
	c	The component which produces this event.
	val	The value returned by the random number generator.
	seed	The value used by the random number generator as seed.
Return Value	Void	
Constraint	Shall be called by TE to log a call to the random number generator function rnd. This event occurs after the random number has been generated.	
Effect	The TL presents all the information provided in the parameters of this operation to the user, how this is done is not within the scope of the present document.	

7.3.4.1.121 tliEvaluate

Signature	void tliEvaluate (in TString am, in TInteger ts, in TString src, in TInteger line, in TriComponentIdType c, in QualifiedName name, in Value evalResult)	
In Parameters	am	An additional message.
	ts	The time when the event is produced.
	src	The source file of the test specification.
	line	The line number where the request is performed.
	c	The component which produces this event.
	name	The name of the template or variable.
	evalResult	The result of evaluation.
Return Value	void	
Constraint	Shall be called by TE to log the result of evaluation of a @lazy or @fuzzy template or variable. This event occurs after the template or variable has been evaluated.	
Effect	The TL presents all the information provided in the parameters of this operation to the user, how this is done is not within the scope of the present document.	

8 Java™ language mapping

8.1 Introduction

This clause introduces the TCI Java™ language mapping. For efficiency reasons a dedicated language mapping is introduced instead of using the OMG IDL [6] to Java™ language [7].

The Java™ language mapping for the TTCN-3 Control Interface defines how the IDL definitions described in clause 7 are mapped to the Java™ language. The language mapping is independent of the used Java™ version as only basic Java™ language constructs are used.

8.2 Names and scopes

8.2.1 Names

Although there are no conflicts between identifiers used in the IDL definition and the Java™ language some naming translation rules are applied to the IDL identifiers.

Java™ interfaces or class identifiers are omitting the trailing `Type` used in the IDL definition.

EXAMPLE: The IDL type `TciTestCaseIdType` maps to `TciTestCaseId` in Java™.

The resulting mapping conforms to the standard Java™ coding conventions.

8.2.2 Scopes

The IDL module `tciInterface` is mapped to the Java™ package `org.etsi.ttcn3.tci`. All IDL type declarations within this module are mapped to Java™ classes or interface declarations within this package.

8.3 Type mapping

8.3.1 Basic type mapping

Table 3 gives an overview on how the native types `TBoolean`, `TFloat`, `TInteger`, `TString`, and `TStringSeq` are mapped to the Java™ types.

Table 3: Basic type mappings

IDL Type	Java™ Type
<code>Tboolean</code>	<code>boolean</code>
<code>Tfloat</code>	<code>float</code>
<code>Tinteger</code>	<code>int</code>
<code>Tstring</code>	<code>java.lang.String</code>
<code>TstringSeq</code>	<code>java.lang.String[]</code>

`boolean`

The IDL `TBoolean` type is mapped to the java basic type `boolean`.

`float`

The IDL `TFloat` type is mapped to the java basic type `float`.

`char`

The IDL `TChar` type is mapped to the java basic type `char`.

int

The IDL **TInteger** type is mapped to the java basic type `int`.

String

The IDL **TString** type is mapped to the `java.lang.String` class without range checking or bounds for characters in the string. All possible strings defined in TTCN-3 can be converted to `java.lang.String`.

String[]

The IDL **TStringSeq** type is mapped to an array of the `java.lang.String` class.

Universal Char

The IDL **TUniversalChar** type is mapped to a java basic type `int`. The integer uses the canonical form as defined in ISO/IEC 10646 [5], clause 6.2.

8.3.2 Structured type mapping

8.3.2.0 General principles

The TCI IDL description defines user defined types as native types. In the Java™ language mapping these types are mapped to Java™ interfaces. The interfaces define methods and attributes being available for objects implementing this interface.

8.3.2.1 TciParameterType

TciParameterType is mapped to the following interface:

```
// TCI IDL TciParameterType
package org.etsi.ttcn.tci;
public interface TciParameter {
    public String    getParameterName();
    public void      setParameterName(String name);
    public int       getParameterPassingMode();
    public void      setParameterPassingMode(TciParameterPassingMode mode);
    public Value     getParameter();
    public void      setParameter(Value parameter);
}
```

Methods:

- `getParameterName` Returns the parameter name as defined in the TTCN-3 specification.
- `setParameterName` Sets the name of this `TciParameter` parameter to `name`.
- `getParameterPassingMode` Returns the parameter passing mode of this parameter.
- `setParameterPassingMode` Sets the parameter mode of this `TriParameter` parameter to `mode`.
- `getParameter` Returns the `Value` parameter of this `TciParameter`, or the `null` object if the parameter contains the distinct value `null`.
- `setParameter` Sets the `Value` parameter of this `TciParameter` to `parameter`. If the distinct value `null` shall be set to indicate that this parameter holds no value, the Java `null` shall be passed as parameter.

8.3.2.2 TciParameterPassingModeType

TciParameterPassingModeType is mapped to the following interface:

```
// TCI IDL TciParameterPassingModeType
package org.etsi.ttcn.tci;
public interface TciParameterPassingMode {
    public final static int TCI_IN      = 0;
    public final static int TCI_INOUT   = 1;
    public final static int TCI_OUT     = 2;
}
```

Constants:

- TCI_IN Will be used to indicate that a TciParameter is an in parameter.
- TCI_INOUT Will be used to indicate that a TciParameter is an inout parameter.
- TCI_OUT Will be used to indicate that a TciParameter is an out parameter.

8.3.2.3 TciParameterListType

TciParameterListType is mapped to the following interface:

```
// TCI IDL TciParameterListType
package org.etsi.ttcn.tci;
public interface TciParameterList {
    public int                            size() ;
    public boolean                        isEmpty() ;
    public java.util.Enumeration        getParameters() ;
    public TciParameter                 get(int index) ;
    public void                           clear() ;
    public void                           add(TciParameter parameter) ;
    public void                           setParameters(TciParameter[] parameters) ;
}
```

Methods:

- size Returns the number of parameters in this list.
- isEmpty Returns true if this list contains no parameters.
- getParameters Returns an Enumeration over the parameters in the list. The enumeration provides the parameters in the same order as they appear in the list.
- get Returns the TciParameter at the specified position.
- clear Removes all parameters from this TciParameterList.
- add Adds parameter to the end of this TciParameterList.
- setParameter Fills this TciParameterList with parameters.

8.3.2.4 TciTypeClassType

TciTypeClassType is mapped to the following interface:

```
// TCI IDL TciTypeClassType
package org.etsi.ttcn.tci;
public interface TciTypeClass {
    public final static int ADDRESS        = 0 ;
    public final static int ANYTYPE        = 1 ;
    public final static int BITSTRING      = 2 ;
    public final static int BOOLEAN        = 3 ;
    public final static int CHARSTRING     = 5 ;
    public final static int COMPONENT      = 6 ;
    public final static int ENUMERATED     = 7 ;
    public final static int FLOAT          = 8 ;
    public final static int HEXSTRING      = 9 ;
}
```

```

public final static int INTEGER           = 10 ;
public final static int OCTETSTRING      = 12 ;
public final static int RECORD           = 13 ;
public final static int RECORD_OF        = 14 ;
public final static int ARRAY            = 15 ;
public final static int SET              = 16 ;
public final static int SET_OF           = 17 ;
public final static int UNION            = 18 ;
public final static int UNIVERSAL_CHARSTRING = 20 ;
public final static int VERDICT          = 21 ;
public final static int DEFAULT          = 22 ;
public final static int PORT             = 23 ;
public final static int TIMER            = 24 ;
}

```

8.3.2.5 TciTestComponentKindType

TciTestComponentKindType is mapped to the following interface:

```

// TCI IDL TciTestComponentKindType
public interface TciTestComponentKind {
    public final static int TCI_CTRL_COMP      = 0;
    public final static int TCI_MTC_COMP      = 1;
    public final static int TCI_PTC_COMP      = 2;
    public final static int TCI_SYSTEM_COMP = 3;
    public final static int TCI_ALIVE_COMP    = 4;
}

```

8.3.2.6 TciBehaviourIdType

TciBehaviourIdType is mapped to the following interface:

```

// TCI IDL TciBehaviourIdType
package org.etsi.ttcn.tci;
public interface TciBehaviourId extends QualifiedName {
}

```

8.3.2.7 TciTestCaseIdType

TciTestCaseIdType is mapped to the following interface:

```

// TCI IDL TciTestCaseIdType
package org.etsi.ttcn.tci;
public interface TciTestCaseId extends QualifiedName {
}

```

8.3.2.8 TciModuleIdType

TciModuleIdType is mapped to the following interface:

```

// TCI IDL TciModuleIdType
package org.etsi.ttcn.tci;
public interface TciModuleId extends QualifiedName {
}

```

8.3.2.9 TciModuleParameterIdType

TciModuleParameterIdType is mapped to the following interface:

```

// TCI IDL TciModuleParameterIdType
package org.etsi.ttcn.tci;
public interface TciModuleParameterId extends QualifiedName {
}

```

8.3.2.10 TciModuleParameterListType

TciModuleParameterListType is mapped to the following interface:

```
// TCI IDL TciModuleParameterListType
package org.etsi.ttcn.tci;
public interface TciModuleParameterList {
    public int size() ;
    public boolean isEmpty() ;
    public java.util.Enumeration getModuleParameters() ;
    public TciModuleParameter get(int index) ;
}
```

Methods:

- `size` Returns the number of module parameters in this list.
- `isEmpty` Returns `true` if this list contains no module parameters.
- `getModuleParameters` Returns an `Enumeration` over the module parameters in the list. The enumeration provides the module parameters in the same order as they appear in the list.
- `get` Returns the `TciModuleParameter` at the specified position.

8.3.2.11 TciModuleParameterType

TciModuleParameterType is mapped to the following interface:

```
// TCI IDL TciModuleParameterType
package org.etsi.ttcn.tci;
public interface TciModuleParameter {
    public TciModuleParameterId getModuleParameterName();
    public Value getDefaultValue();
}
```

Methods:

- `getModuleParameterName` Returns the module parameter name as defined in the TTCN-3 specification.
- `getDefaultValue` Returns the default `Value` module parameter of this `TciModuleParameter`, or the `null` object if the module parameter contains the distinct value `null`.

8.3.2.12 TciParameterTypeListType

TciParameterTypeListType is mapped to the following interface:

```
// TCI IDL TciParameterTypeListType
package org.etsi.ttcn.tci;
public interface TciParameterTypeList {
    public int size() ;
    public boolean isEmpty() ;
    public java.util.Enumeration getParameterTypes() ;
    public TciParameterType get(int index) ;
}
```

Methods:

- `size` Returns the number of parameter types in this list.
- `isEmpty` Returns `true` if this list contains no parameter types.
- `getParameterTypes` Returns an `Enumeration` over the parameter types in the list. The enumeration provides the parameter types in the same order as they appear in the list.
- `get` Returns the `TciParameterType` at the specified position.

8.3.2.13 TciParameterTypeType

TciParameterTypeType is mapped to the following interface:

```
// TCI IDL TciParameterTypeType
package org.etsi.ttcn.tci;
public interface TciParameterType {
    public String    getParameterName();
    public Type      getParameterType();
    public int       getParameterPassingMode();
}
```

Methods:

- `getParameterName` Returns the parameter name as defined in the TTCN-3 specification.
- `getParameterType` Returns the `Type` of the parameter.
- `getParameterPassingMode` Returns the parameter passing mode of this parameter.

8.3.2.14 TciModuleIdListType

TciModuleIdListType is mapped to the following interface:

```
// TCI IDL TciModuleIdListType
package org.etsi.ttcn.tci;
public interface TciModuleIdList {
    public int          size();
    public boolean      isEmpty();
    public java.util.Enumeration tciGetImportedModules();
    public TciModuleId  get(int index);
}
```

Methods:

- `size` Returns the number of modules in this list.
- `isEmpty` Returns `true` if this list contains no modules.
- `tciGetImportedModules` Returns an `Enumeration` over the modules in the list. The enumeration provides the modules in the same order as they appear in the list.
- `get` Returns the `TciModuleId` at the specified position.

8.3.2.15 TciTestCaseIdListType

TciTestCaseIdType is mapped to the following interface:

```
// TCI IDL TciTestCaseIdListType
package org.etsi.ttcn.tci;
public interface TciTestCaseIdList {
    public int          size();
    public boolean      isEmpty();
    public java.util.Enumeration tciGetTestCases();
    public TciTestCaseId  get(int index);
}
```

Methods:

- `size` Returns the number of test cases in this list.
- `isEmpty` Returns `true` if this list contains no test cases.
- `tciGetTestCases` Returns an `Enumeration` over the test cases in the list. The enumeration provides the test cases in the same order as they appear in the list.
- `get` Returns the `TciTestCaseId` at the specified position.

8.3.2.16 TciDecodingResult

TciDecodingResult is used as a return type of the `TciCDPprovided.decodeValue` operation and it is defined as follows:

```
package org.etsi.ttcn.tci;
public interface TciDecodingResult {
    public int getResult ();
    public Value getDecodedValue ();
}
```

Methods:

- `getResult` Returns the numeric result of the `TciCDPprovided.decodeValue` operation.
- `getDecodedValue` Returns the decoded value or the distinct value `null`.

8.3.2.17 TciMatchingTypeType

TciMatchingTypeType is mapped to the following interface:

```
// TCI IDL TciTypeClassType
package org.etsi.ttcn.tci;
public interface TciMatchingType {
    public final static int TEMPLATE_LIST = 0 ;
    public final static int COMPLEMENTED_LIST = 1 ;
    public final static int ANY_VALUE = 2 ;
    public final static int ANY_VALUE_OR_NONE = 3 ;
    public final static int VALUE_RANGE = 4 ;
    public final static int SUBSET = 5 ;
    public final static int SUPERSET = 6 ;
    public final static int ANY_ELEMENT = 7 ;
    public final static int ANY_ELEMENTS_OR_NONE = 8 ;
    public final static int PATTERN = 9 ;
    public final static int MATCH_DECODED_CONTENT = 10 ;
    public final static int OMIT_TEMPLATE = 11 ;
}
```

8.3.2.18 LengthRestriction

LengthRestriction is mapped to the following interface:

```
// TCI IDL LengthRestriction
package org.etsi.ttcn.tci;
public interface LengthRestriction {
    public int getLowerBoundary ();
    public int getUpperBoundary ();
    public void setLowerBoundary (int boundary);
    public void setUpperBoundary (int boundary);
    public boolean isUpperBoundaryInfinity ();
    public void setInfiniteUpperBoundary ();
}
```

Methods:

- `getLowerBoundary` Returns the lower boundary of the length restriction.
- `getUpperBoundary` Returns the upper boundary of the length restriction.
- `setLowerBoundary` Sets the lower boundary value.
- `setUpperBoundary` Sets the upper boundary value.
- `isUpperBoundaryInfinity` Returns `true` if the upper boundary contains infinity and `false` otherwise.
- `setInfiniteUpperBoundary` Sets the upper boundary to infinity.

8.3.2.19 Permutation

Permutation is mapped to the following interface:

```
// TCI IDL Permutation
package org.etsi.ttcn.tci;
public interface Permutation {
    public int getStartPosition ();
    public void setStartPosition (int position);
    public int getLength ();
    public void setLength (int length);
}
```

Methods:

- `getStartPosition` Returns the position of the first item of the permutation in the `RecordOfValue`.
- `setStartPosition` Sets the position of the first item of the permutation in the `RecordOfValue`.
- `getLength` Returns the number of elements or matching mechanisms of the `RecordOfValue` that are included in the permutation.
- `setLength` Sets the number of elements or matching mechanisms of the `RecordOfValue` that are included in the permutation.

8.3.2.20 RangeBoundary

RangeBoundary is mapped to the following interface:

```
// TCI IDL RangeBoundary
package org.etsi.ttcn.tci;
public interface RangeBoundary {
    public Value getBoundary ();
    public boolean isInclusive ();
    public void setBoundary (Value boundary, boolean isInclusive);
    public boolean isInfinity ();
    public void setToInfinity ();
}
```

Methods:

- `getBoundary` Returns the boundary value. Dependent on the type of the value range, the return value can be either an `IntegerValue`, `FloatValue`, `CharstringValue` or `UniversalCharstringValue`. If the boundary is undefined or it cannot be represented by a `Value` instance (infinity in case of integer values), the distinct value `null` is returned.
- `isInclusive` Returns `true` if the boundary value is a part of the allowed range and `false` otherwise.
- `setBoundary` Sets the boundary value. Dependent on the type of the value range, the boundary parameter can contain either an `IntegerValue`, `FloatValue`, `UniversalCharstringValue` or `CharstringValue`. The inclusive parameter determines whether the boundary value is a part of the range (`true`) or not (`false`).
- `isInfinity` Returns `true` if the boundary is equal to infinity and `false` otherwise.
- `setToInfinity` Sets the boundary to infinity (if the instance is used for the upper range boundary) or `-infinity` (if the instance is used for the lower range boundary).

8.3.3 Abstract type mapping

8.3.3.0 General principles

The TTCN-3 data types are modelled in Java™ using the abstract type mapping as defined in the clause 8.3.3. The `Type` interface defines only operations used to retrieve in TTCN-3 defined types. No TTCN-3 types can be constructed using the `Type` interface. Types are modelled using the single interface `Type`, that provides methods to identify types and to retrieve values of a given type.

8.3.3.1 Type

Type is mapped to the following interface:

```
// TCI IDL Type
package org.etsi.ttcn.tci;
public interface Type {
    public TciModuleId getDefiningModule ();
    public String      getName ();
    public int         getTypeClass ();
    public Value       newInstance ();
    public String      getTypeEncoding ();
    public String      getTypeEncodingVariant();
    public String[]    getEncodeAttributes();
    public String[]    getVariantAttributes(String encoding);
    public String[]    getTypeExtension();
    public Value       parseValue (String val);
    public MatchingMechanism newTemplate (int matchingType);
    public RangeBoundary getLowerTypeBoundary();
    public RangeBoundary getUpperTypeBoundary();
    public LengthRestriction getTypeLengthRestriction();
    public MatchingMechanism getTypeMatchingMechanism();
}
```

Methods:

- `getDefiningModule` Returns the module identifier of the module the type has been defined in. If the type represents a TTCN-3 base type the distinct value `null` will be returned.
- `getName` Returns name of the type as defined in the TTCN-3 module.
- `getTypeClass` Returns the type class of the respective type. A value of `TciTypeClassType` can have on of the following constants: `ADDRESS`, `ANYTYPE`, `BITSTRING`, `BOOLEAN`, `CHARSTRING`, `COMPONENT`, `ENUMERATED`, `FLOAT`, `HEXSTRING`, `INTEGER`, `OCTETSTRING`, `RECORD`, `RECORD_OF`, `ARRAY`, `SET`, `SET_OF`, `UNION`, `UNIVERSAL_CHARSTRING`, `VERDICT`, `DEFAULT`, `PORT`, `TIMER`.
- `newInstance` Returns a freshly created value of the given type. This initial value of the created value is undefined.
- `getTypeEncoding` Returns the type encoding attribute as defined in the TTCN-3 module.
- `getTypeEncodingVariant` This operation returns the value encoding variant attribute as defined in the TTCN-3 module, if any. If no encoding variant attribute has been defined the distinct value `null` will be returned.
- `getEncodeAttributes` Returns all encode attributes of the type.
- `getVariantAttributes` Returns all variant attributes of the type for the specified encoding.
- `getTypeExtension` Returns the type extension attribute as defined in the TTCN-3 module.
- `parseValue` Parses the value provided in the parameter and in case of successful parsing returns a `Value` object representing the parsed value. In case of an error or if value parsing is not supported by the tool, the method returns `null`.

- `newTemplate` Returns a freshly created matching mechanism of this type. The `matchingType` parameter determines what kind of matching mechanism will be created and it shall be one of the following constants: `TEMPLATE_LIST`, `COMPLEMENTED_LIST`, `ANY_VALUE`, `ANY_VALUE_OR_NONE`, `VALUE_RANGE`, `SUBSET`, `SUPERSET`, `ANY_ELEMENT`, `ANY_ELEMENTS_OR_NONE`, `PATTERN`, `DECODED_MATCH`. If the created matching mechanism contains additional data properties, these properties are uninitialized in the created matching mechanism.
- `getLowerTypeBoundary` Return the lower boundary of the type restriction or `null`.
- `getUpperTypeBoundary` Return the upper boundary of the type restriction or `null`.
- `getTypeLengthRestriction` Return the length restriction of the type or `null`.
- `getTypeMatchingMechanism` Return the matching mechanism restriction of the type or `null`.

8.3.4 Abstract value mapping

8.3.4.0 General principles

TTCN-3 values can be retrieved from the TE and constructed using the Value interface. The value mapping interface is constructed hierarchically with Value as the basic interface. Specialized interfaces for different types of values have been defined.

8.3.4.1 Value

Value is mapped to the following interface:

```
// TCI IDL Value
package org.etsi.ttcn.tci;
public interface Value {
    public Type      getType();
    public boolean   notPresent();
    public String    getValueEncoding();
    public String    getValueEncodingVariant();
    public String[]  getEncodeAttributes();
    public String[]  getVariantAttributes(String encoding);
    public boolean   isMatchingSymbol();
    public String    valueToString ();
    public boolean   isLazy();
    public boolean   isFuzzy();
    public boolean   isEvaluated();
    public LengthRestriction getLengthRestriction ();
    public LengthRestriction newLengthRestriction ();
    public void      setLengthRestriction (LengthRestriction restriction);
    public boolean   isIfPresentEnabled ();
    public void      setIfPresentEnabled (boolean enabled);
    public RangeBoundary getLowerTypeBoundary();
    public RangeBoundary getUpperTypeBoundary();
    public LengthRestriction getTypeLengthRestriction();
    public MatchingMechanism getTypeMatchingMechanism();
    public boolean   isOptional();
}
public LengthRestriction getTypeLengthRestriction();
```

Methods:

- `getType` Returns the type of the specified value.
- `notPresent` Returns `true` if the specified value is omit, `false` otherwise.

- `getValueEncoding` This operation returns the value encoding attribute as defined in the TTCN-3 module, if any. If no encoding attribute has been defined the distinct value `null` will be returned.
- `getValueEncodingVariant` This operation returns the value encoding variant attribute as defined in TTCN-3, if any. If no encoding variant attribute has been defined the distinct value `null` will be returned.
- `getEncodeAttributes` Returns all encode attributes of the value.
- `getVariantAttributes` Returns all variant attributes of the value for the specified encoding.
- `isMatchingSymbol` Returns `true` if the specified value is a matching symbol (see clause 7.2.2.2.1 for more details), `false` otherwise.
- `valueToString` Returns the same string as produced by the `log` operation with the specified value as its parameter.
- `isLazy` Returns `true` if the specified value is `@lazy`, `false` otherwise.
- `isFuzzy` Returns `true` if the specified value is `@fuzzy`, `false` otherwise.
- `isEvaluated` Returns `true` if the specified value contains an evaluation result, `false` otherwise (see clause 7.2.2.2.1 for more details).
- `getLengthRestriction` Returns a length restriction matching attribute in case it is attached to the value or the distinct value `null` if no such matching attribute is present.
- `newLengthRestriction` Creates a new instance of the `LengthRestriction` interface.
- `setLengthRestriction` Adds a length restriction matching to the value or modifies an existing one. The distinct value `null` can be used as a parameter to disable an existing length restriction.
- `isIfPresentEnabled` Returns `true` if the `ifpresent` is attached to the value and `false` otherwise.
- `setIfPresentEnabled` Sets the whether the `ifpresent` indicator is attached to the value or not.
- `getLowerTypeBoundary` Return the lower boundary of the value's type restriction or `null`.
- `getUpperTypeBoundary` Return the upper boundary of the value's type restriction or `null`.
- `getTypeLengthRestriction` Return the value's type length restriction or `null`.
- `getTypeMatchingMechanism` Return the value's type restriction.
- `isOptional` Returns `true` if and only if the value is either an optional field or a template without value or `present` template restriction.

8.3.4.2 IntegerValue

IntegerValue type is mapped to the following interface:

```
// IntegerValue
package org.etsi.ttcn.tci;
public interface IntegerValue {
    public void    setInteger(int value);
    public int     getInteger();
}
```

Methods:

- `setInteger` Sets this `IntegerValue` to the int value `value`.
- `getInteger` Returns the int value represented by this `IntegerValue`.

8.3.4.3 FloatValue

FloatValue type is mapped to the following interface:

```
// FloatValue
package org.etsi.ttcn.tci;
public interface FloatValue {
    public void    setFloat(float value);
    public float   getFloat();
    public void    setDouble(double value);
    public double  getDouble();
    public void    setBigDecimal(java.math.BigDecimal value);
    public java.math.BigDecimal getBigDecimal();
}
```

Methods:

- `setFloat` Sets this `FloatValue` to the float value `value`.
- `getFloat` Returns the float value represented by this `FloatValue`.
- `setDouble` Sets this `FloatValue` to the float value with double precision.
- `getDouble` Returns the float value represented by this `FloatValue` with double precision.
- `setBigDecimal` Sets this `FloatValue` to the float value with user-defined precision. If loss of precision is probable when using float or double, this method should be used.
- `getBigDecimal` Returns the float value represented by this `FloatValue` with user-defined precision. If loss of precision is probable when using float or double, this method should be used.

8.3.4.4 BooleanValue

BooleanValue type is mapped to the following interface:

```
// BooleanValue
package org.etsi.ttcn.tci;
public interface BooleanValue {
    public void    setBoolean(boolean value);
    public boolean getBoolean();
}
```

Methods:

- `setBoolean` Sets this `BooleanValue` to the boolean value `value`.
- `getBoolean` Returns the boolean value represented by this `BooleanValue`.

8.3.4.5 CharstringValue

CharstringValue is mapped to the following interface:

```
// TCI IDL CharstringValue
package org.etsi.ttcn.tci;
public interface CharstringValue {
    String getString ();
    void    setString (String value);
    char    getChar (int position);
}
```

```

void    setChar (int position, char value);
int     getLength ();
void    setLength (int len);
}

```

Methods:

- `getString` Returns the string of the TTCN-3 charstring. The textual representation of the empty TTCN-3 charstring is "", while its length is zero.
- `setString` Sets this CharstringValue to value.
- `getChar` Returns the char value of the TTCN-3 charstring at position. position 0 denotes the first char of the TTCN-3 charstring. Valid values for position are 0 to length - 1.
- `setChar` Set the char at position to value. Valid values for position are 0 to length - 1.
- `getLength` Returns the length of this CharstringValue in chars, zero if the value of this CharstringValue is omit.
- `setLength` Sets the length of this CharstringValue in chars to len.

8.3.4.6 BitstringValue

BitstringValue is mapped to the following interface:

```

// TCI IDL BitstringValue
package org.etsi.ttcn.tci;
public interface BitstringValue {
    String getString ();
    void    setString (String value);
    int     getBit (int position);
    void    setBit (int position, int value);
    int     getLength ();
    void    setLength (int len);
    boolean isMatchingAt (int position);
    MatchingMechanism getMatchingAt (int position);
    void    setMatchingAt (int position, MatchingMechanism template);
}

```

Methods:

- `getString` Returns the textual representation of this BitstringValue, as defined in TTCN-3. E.g. the textual representation of 0101 is '0101'B. The textual representation of the empty TTCN-3 bitstring is ''B, while its length is zero.
- `setString` Sets the value of this BitstringValue according to the textual representation as defined by value. E.g. The value of this BitstringValue will be 0101 if the textual representation in value is '0101'B.
- `getBit` Returns the value (0 | 1) at position of this TTCN-3 bitstring. position 0 denotes the first bit of the TTCN-3 bitstring. Valid values for position are 0 to length - 1.
- `setBit` Set the bit at position to value (0 | 1). position 0 denotes the first bit in this BitstringValue. Valid values for position are 0 to length - 1.
- `getLength` Returns the length of this BitstringValue in bits, zero if the value of this BitstringValue is omit.
- `setLength` Sets the length of this BitstringValue in bits to len.

- `isMatchingAt` Returns `true` if the item at `position` of this TTCN-3 bitstring is a matching mechanism inside a value (`AnyElement`, `AnyElementsOrNone`) and `false` otherwise.
- `getMatchingAt` If the `position` of this TTCN-3 bitstring contains a matching mechanism inside a value (`AnyElement`, `AnyElementsOrNone`), the method returns it. Otherwise the distinct value `null` is returned.
- `setMatching` Sets a matching mechanism at `position`. Only two matching mechanisms are allowed: `AnyElement` and `AnyElementsOrNone`.

8.3.4.7 OctetstringValue

OctetstringValue is mapped to the following interface:

```
// TCI IDL OctetstringValue
package org.etsi.ttcn.tci;
public interface OctetstringValue {
    String getString ();
    void setString (String value);
    int getOctet (int position);
    void setOctet (int position, int value);
    int getLength ();
    void setLength (int len);
    boolean isMatchingAt (int position);
    MatchingMechanism getMatchingAt (int position);
    void setMatchingAt (int position, MatchingMechanism template);
}
```

Methods:

- `getString` Returns the textual representation of this `OctetstringValue`, as defined in TTCN-3. E.g. the textual representation of `0xCAFFEE` is `'CAFFEE'0`. The textual representation of the empty TTCN-3 octetstring is `'0`, while its length is zero.
- `setString` Sets the value of this `OctetstringValue` according to the textual representation as defined by `value`. E.g. the value of this `OctetstringValue` will be `0xCAFFEE` if the textual representation in `value` is `'CAFFEE'0`.
- `getOctet` Returns the value (0..255) at `position` of this TTCN-3 octetstring. `position 0` denotes the first octet of the TTCN-3 octetstring. Valid values for `position` are `0` to `length - 1`.
- `setOctet` Set the octet at `position` to `value` (0..255). `position 0` denotes the first octet in the octetstring. Valid values for `position` are `0` to `length - 1`.
- `getLength` Returns the length of this `OctetstringValue` in octets, zero if the value of this `OctetstringValue` is `omit`.
- `setLength` Sets the length of this `OctetstringValue` in octets to `len`.
- `isMatchingAt` Returns `true` if the item at `position` of this TTCN-3 octetstring is a matching mechanism inside a value (`AnyElement`, `AnyElementsOrNone`) and `false` otherwise.
- `getMatchingAt` If the `position` of this TTCN-3 octetstring contains a matching mechanism inside a value (`AnyElement`, `AnyElementsOrNone`), the method returns it. Otherwise the distinct value `null` is returned.
- `setMatching` Sets a matching mechanism at `position`. Only two matching mechanisms are allowed: `AnyElement` and `AnyElementsOrNone`.

8.3.4.8 UniversalCharstringValue

UniversalCharstringValue is mapped to the following interface:

```
// TCI IDL UniversalCharstringValue
package org.etsi.ttcn.tci;
public interface UniversalCharstringValue {
    String getString ();
    void    setString (String value);
    int     getChar (int position);
    void    setChar (int position, int value);
    int     getLength ();
    void    setLength (int len);
}
```

Methods:

- `getString` Returns the textual representation of this `UniversalCharstringValue`, as defined in TTCN-3.
- `setString` Sets the value of this `UniversalCharstringValue` according to the textual representation as defined by value.
- `getChar` Returns the `UniversalChar` value of the TTCN-3 universal charstring at position. position 0 denotes the first `UniversalChar` of the TTCN-3 universal charstring. Valid values for position are 0 to length - 1.
- `setChar` Set the `UniversalChar` at position to value. Valid values for position are 0 to length - 1.
- `getLength` Returns the length of this `UniversalCharstringValue` in `UniversalChars`, zero if the value of this `UniversalCharstringValue` is omit.
- `setLength` Sets the length of this `UniversalCharstringValue` in `UniversalChars` to len.

8.3.4.9 HexstringValue

HexstringValue is mapped to the following interface:

```
// TCI IDL HexstringValue
package org.etsi.ttcn.tci;
public interface HexstringValue {
    String getString ();
    void    setString (String value);
    int     getHex (int position);
    void    setHex (int position, int value);
    int     getLength ();
    void    setLength (int len);
    boolean isMatchingAt (int position);
    MatchingMechanism getMatchingAt (int position);
    void    setMatchingAt (int position, MatchingMechanism template);
}
```

Methods:

- `getString` Returns the textual representation of this `HexstringValue`, as defined in TTCN-3. E.g. the textual representation of `0xAFFEE` is `'AFFEE'H`. The textual representation of the empty TTCN-3 hexstring is `'H`, while its length is zero.
- `setString` Sets the value of this `HexstringValue` according to the textual representation as defined by value. E.g. the value of this `HexstringValue` will be `0xAFFEE` if the textual representation in value is `'AFFEE'H`.

- `getHex` Returns the value (0...15) at `position` of this TTCN-3 hexstring. `position` 0 denotes the first hex digits of the TTCN-3 hexstring. Valid values for `position` are 0 to `length - 1`.
- `setHex` Set the hex digit at `position` to value (0...16). `position` 0 denotes the first octet in the hexstring. Valid values for `position` are 0 to `length - 1`.
- `getLength` Returns the length of this `HexstringValue` in octets, zero if the value of this `HexstringValue` is `omit`.
- `setLength` Sets the length of this `HexstringValue` in hex digits to `len`.
- `isMatchingAt` Returns `true` if the item at `position` of this TTCN-3 hexstring is a matching mechanism inside a value (`AnyElement`, `AnyElementsOrNone`) and `false` otherwise.
- `getMatchingAt` If the `position` of this TTCN-3 hexstring contains a matching mechanism inside a value (`AnyElement`, `AnyElementsOrNone`), the method returns it. Otherwise the distinct value `null` is returned.
- `setMatching` Sets a matching mechanism at `position`. Only two matching mechanisms are allowed: `AnyElement` and `AnyElementsOrNone`.

8.3.4.10 RecordValue

RecordValue is mapped to the following interface:

```
// TCI IDL RecordValue
package org.etsi.ttcn.tci;
public interface RecordValue {
    public Value    getField(String fieldName) ;
    public void    setField(String fieldName, Value value) ;
    public String[] getFieldNames() ;
    public void    setFieldOmitted(String fieldName);
}
```

Methods:

- `getField` Returns the value of the field named `fieldName`. The return value is the common abstract base type `Value`, as a record field can have any type defined in TTCN-3. If the field cannot be obtained from the record the distinct value `null` will be returned.
- `setField` Set the field named `fieldName` of the record to `value`. No assumption shall be made on how a field is stored in a record. An internal implementation might choose to store a reference to this value or to copy the value. It is safe to assume that the value will be copied. Therefore it should be assumed that subsequent modifications of `value` will not be considered in the record.
- `getFieldNames` Returns an array of `String` of field names, the empty sequence, if the record has no fields.
- `setFieldOmitted` Set the field named `fieldName` of the record to `omit`.

8.3.4.11 RecordOfValue

RecordOfValue is mapped to the following interface:

```
// TCI IDL RecordOfValue
package org.etsi.ttcn.tci;
public interface RecordOfValue {
    public Value    getField(String fieldName) ;
    public void    setField(int position, Value value) ;
    public void    appendField(Value value) ;
    public Type    getElementType() ;
}
```

```

public int      getLength() ;
public void     setLength(int len) ;
public int      getOffset() ;
public int      getPermutationCount () ;
public Permutation getPermutation (int index);
public Permutation newPermutation ();
public void     definePermutation (Permutation permutation);
public void     removePermutation (int index);
public void     clearPermutations ();
}

```

Methods:

- `getField` Returns the value of the record of at position if position is between zero and length - 1, the distinct value null otherwise. The return value is the common abstract base type Value, as a record of can have fields of any type defined in TTCN-3.
- `setField` Sets the field at position to value. If position is greater than (length - 1) the record of will be extended to have the length (position + 1). The record of elements between the original position at length and position - 1 will be set to OMIT. No assumption shall be made on how a field is stored in a record of. An internal implementation might choose to store a reference to this value or to copy the value. It is safe to assume that the value will be copied. Therefore it should be assumed that subsequent modifications of value will not be considered in the record of.
- `appendField` Appends the value at the end of the record of, i.e. at position length. No assumption shall be made on how a field is stored in a record of. An internal implementation might choose to store a reference to this value or to copy the value. It is safe to assume that the value will be copied. Therefore it should be assumed that subsequent modifications of value will not be considered in the record of.
- `getElementType` This operation will return the Type of the elements of this record of.
- `getLength` Returns the actual length of the record of value, zero if the record of value is OMIT.
- `setLength` Set the length of the record of to len. If len is greater than the original length, newly created elements have the value OMIT. If len is less or equal than the original length this operation will be ignored.
- `getOffset` Returns the lowest possible index. For a record of or set of value this is always 0. For an array value, this is the lower index bound used in the type definition.
- `getPermutationCount` Returns the number of permutations in the record of or array value.
- `getPermutation` Returns the permutation at the specified index. The allowed index range is from 0 to (getPermutationCount() - 1).
- `newPermutation` Creates a new instance of the Permutation interface.
- `definePermutation` Creates permutation from existing elements of a record of value. The permutation parameter shall not include elements that are already a part of other existing permutations attached to the same record of. No elements are added to the record of by this operation.
- `removePermutation` Removes the permutation at the specified index. The allowed index range is from 0 to (getPermutationCount() - 1). No elements are removed from the record of by this operation. When the operation completes, the existing elements at positions specified by the removed permutation don't belong to any permutation.

- `clearPermutations` Removes all permutations from the value. The elements that belonged to the removed permutation are not removed.

8.3.4.12 UnionValue

UnionValue is mapped to the following interface:

```
// TCI IDL UnionValue
package org.etsi.ttcn.tci;
public interface UnionValue {
    Value      getVariant (String variantName);
    void       setVariant (String variantName, Value value);
    String     getPresentVariantName ();
    String[]   getVariantNames ();
}
```

Methods:

- `getVariant` Returns the value of the TTCN-3 union `variantName`, if `variantName` equals the result of `getPresentVariantName`, the distinct value `null` otherwise. `variantName` denotes the name of the union variant as defined in the TTCN-3 module.
- `setVariant` Sets `variantName` of the union to `value`. If `variantName` is not defined for this union this operation will be ignored. If another variant was selected the new variant will be selected instead.
- `getPresentVariantName` Returns the variant name that has a value in this union set as a `String`. The distinct value `null` will be returned if no variant is selected.
- `getVariantNames` Returns an array of `String` of variant names, the empty sequence, if the union has no fields. If the `UnionValue` represents the TTCN-3 anytype, i.e. the type class of the type obtained by `getType()` is `ANYTYPE`, all predefined and user-defined TTCN-3 types will be returned.

8.3.4.13 EnumeratedValue

EnumeratedValue is mapped to the following interface:

```
// TCI IDL EnumeratedValue
package org.etsi.ttcn.tci;
public interface EnumeratedValue {
    String  getEnum ();
    void    setEnum (String enumValue);
    int     getInt();
    void    setInt(int intValue);
}
```

Methods:

- `getEnum` Returns the string identifier of this `EnumeratedValue`. This identifier equals the identifier in the TTCN-3 specification.
- `setEnum` Set the enum to `enumValue`. If `enumValue` is not an allowed value for this enumeration the operation will be ignored.
- `getInt` Returns the integer value of this `EnumeratedValue`. This integer equals the user-assigned integer value in the TTCN-3 specification or the automatically assigned integer value.
- `setInt` Sets the integer value of this `EnumeratedValue`. This integer should equal the user-assigned integer value in the TTCN-3 specification or the automatically assigned integer value. If `intValue` is not an allowed value for this enumeration the operation is ignored.

8.3.4.14 VerdictValue

VerdictValue is mapped to the following interface:

```
// TCI IDL VerdictValue
package org.etsi.ttcn.tci;
public interface VerdictValue {
    public static final int NONE      = 0;
    public static final int PASS     = 1;
    public static final int INCONC   = 2;
    public static final int FAIL     = 3;
    public static final int ERROR    = 4;

    public int      getVerdict() ;
    public void     setVerdict(int verdict) ;
}
```

Methods:

- `getVerdict` Returns the integer value for this `VerdictValue`. The integer is one of the following constants: `ERROR`, `FAIL`, `INCONC`, `NONE`, `PASS`, `USER_ERROR`.
- `setVerdict` Sets this `VerdictValue` to `verdict`. Note that a `VerdictValue` can be set to any of the above mentioned verdicts at any time. The `VerdictValue` does not perform any verdict calculations as defined in TTCN-3. For example, it is legal to set the `VerdictValue` first to `INCONC` and then to `PASS`.

8.3.4.15 AddressValue

AddressValue is mapped to the following interface:

```
// TCI IDL Address_Value
package org.etsi.ttcn.tci;
public interface AddressValue {
    public int getAddress() ;
    public void setAddress(Value value) ;
}
```

Methods:

- `getAddress` Returns the value represented by this `AddressValue`.
- `setAddress` Sets this `AddressValue` to the value `value`.

8.3.5 Abstract template mapping

8.3.5.0 General principles

TTCN-3 matching mechanisms can be retrieved from the TE and constructed using the `MatchingMechanism` interface. The template mapping interface is constructed hierarchically with `MatchingMechanism` as the basic interface. Specialized interfaces for different types of matching mechanisms have been defined.

8.3.5.1 MatchingMechanism

MatchingMechanism is mapped to the following interface:

```
// TCI IDL MatchingMechanism
package org.etsi.ttcn.tci;
public interface MatchingMechanism {
    public TciMatchingType getMatchingType ();
}
```

Methods:

- `getMatchingType` Returns the matching mechanism type.

8.3.5.2 MatchingList

MatchingList is mapped to the following interface:

```
// TCI IDL MatchingList
package org.etsi.ttcn.tci;
public interface MatchingList {
    public int    size ();
    public Value  get (int position);
    public void   add (Value item);
    public void   remove (int position);
    public void   clear ();
}
```

Methods:

- `size` Returns the number of items in the matching mechanism.
- `get` Returns a value or template at the specified position.
- `add` Adds a value or template to the matching mechanism.
- `remove` Removes a value or template from the specified position.
- `clear` Removes all values and templates from the matching mechanism.

8.3.5.3 ValueRange

ValueRange is mapped to the following interface:

```
// TCI IDL ValueRange
package org.etsi.ttcn.tci;
public interface ValueRange {
    public RangeBoundary getLowerBoundary ();
    public RangeBoundary getUpperBoundary ();
    public void setLowerBoundary (RangeBoundary boundary);
    public void setUpperBoundary (RangeBoundary boundary);
}
```

Methods:

- `getLowerBoundary` Returns the lower boundary of the range.
- `getUpperBoundary` Returns the upper boundary of the range.
- `setLowerBoundary` Sets the lower boundary of the range.
- `setUpperBoundary` Sets the upper boundary of the range.

8.3.5.4 CharacterPattern

CharacterPattern is mapped to the following interface:

```
// TCI IDL CharacterPattern
package org.etsi.ttcn.tci;
public interface CharacterPattern {
    public Value getPatternString ();
    public void setPatternString (Value pattern);
}
```

Methods:

- `getPatternString` Returns the character pattern definition of this pattern (either a `CharstringValue` or `UniversalCharstringValue`).
- `setPatternString` Sets the character pattern definition of this pattern. The `CharacterPattern` parameter shall contain either a `CharstringValue` or `UniversalCharstringValue`.

8.3.5.5 MatchDecodedContent

MatchDecodedContent is mapped to the following interface:

```
// TCI IDL MatchDecodedContent
package org.etsi.ttcn.tci;
public interface MatchDecodedContent {
    public Value getContent ();
    public void setContent (Value pattern);
}
```

Methods:

- `getContent` Returns the value or matching mechanism used as an argument of the `decmatch` matching mechanism.
- `setContent` Sets the value or matching mechanism that is used as an argument of the `decmatch` matching mechanism.

8.3.6 Abstract logging types mapping

8.3.6.0 General principles

Additional types are defined to ease the logging of matches between values and templates.

8.3.6.1 TciValueTemplate

TciValueTemplate is mapped to the following interface:

```
// TCI IDL TciValueTemplate
package org.etsi.ttcn.tci;
public interface TciValueTemplate {
    public boolean isOmit();
    public boolean isAny();
    public boolean isAnyOrOmit();
    public String getTemplateDef();
}
```

Methods:

- `isOmit` Returns `true` if the template is omit, `false` otherwise.
- `isAny` Returns `true` if the template is any, `false` otherwise.
- `isAnyOrOmit` Returns `true` if the template is anyoromit, `false` otherwise.
- `getTemplateDef` This operation returns the template definition.

8.3.6.2 TciNonValueTemplate

TciNonValueTemplate is mapped to the following interface:

```
// TCI IDL TciNonValueTemplate
package org.etsi.ttcn.tci;
public interface TciNonValueTemplate {
    public boolean isAny();
    public boolean isAll();
    public String getTemplateDef();
}
```

Methods:

- `isAny` Returns `true` if the template is any, `false` otherwise.
- `isAll` Returns `true` if the template is all, `false` otherwise.

- `getTemplateDef` This operation returns the template definition.

8.3.6.3 TciValueList

TciValueList is mapped to the following interface:

```
// TCI IDL TciValueList
package org.etsi.ttcn.tci;
public interface TciValueList{
    public int          size() ;
    public boolean      isEmpty() ;
    public Value        get(int index) ;
}
```

Methods:

- `size` Returns the number of values in this list.
- `isEmpty` Returns `true` if this list contains no values.
- `get` Returns the `Value` at the specified position.

8.3.6.4 TciValueDifference

TciValueDifference is mapped to the following interface:

```
// TCI IDL TciValueDifference
package org.etsi.ttcn.tci;
public interface TciValueDifference {
    public Value    getValue();
    public TciValueTemplate getTciValueTemplate();
    public String   getDescription();
}
```

Methods:

- `getValue` Returns the value of this `TciValueDifference`.
- `getTciValueTemplate` Returns the template of this `TciValueDifference`.
- `getDescription` Returns the description of the mismatch.

8.3.6.5 TciValueDifferenceList

TciValueDifferenceList is mapped to the following interface:

```
// TCI IDL TciValueDifferenceList
package org.etsi.ttcn.tci;
public interface TciValueDifferenceList{
    public int          size() ;
    public boolean      isEmpty() ;
    public TciValueDifference get(int index) ;
}
```

Methods:

- `size` Returns the number of differences in this list.
- `isEmpty` Returns `true` if this list contains no differences.
- `get` Returns the `TciValueDifference` at the specified position.

8.3.6.6 ComponentStatus

ComponentStatus is mapped to the following interface:

```
// TCI IDL ComponentStatus
package org.etsi.ttcn.tci;
public interface ComponentStatus {
    public static final int INACTIVE_C = 0;
    public static final int RUNNING_C = 1;
    public static final int STOPPED_C = 2;
    public static final int KILLED_C = 3;
    public static final int NULL_C = 4;

    public int      getComponentStatus() ;
    public void     setComponentStatus (int componentStatus) ;
}

```

8.3.6.7 TimerStatus

TimerStatus is mapped to the following interface:

```
// TCI IDL TimerStatus
package org.etsi.ttcn.tci;
public interface TimerStatus {
    public static final int RUNNING_T = 0;
    public static final int INACTIVE_T = 1;
    public static final int EXPIRED_T = 2;
    public static final int NULL_T = 3;

    public int      getTimerStatus() ;
    public void     setTimerStatus (int timerStatus) ;
}

```

8.3.6.8 TciStatus

TciStatus is mapped to the following interface:

```
// TCI IDL TciStatus
package org.etsi.ttcn.tci;
public interface TciStatus {
    public static final int TCI_OK = 0;
    public static final int TCI_ERROR = -1;

    public int      getTciStatus() ;
    public void     setTciStatus (int tciStatus) ;
}

```

8.4 Constants

Within this Java™ language mapping constants have been specified. All constants are defined `public final static` and are accessible from every object from every package. The constants defined within this clause are not defined with the IDL clause. Instead they result from the specification of the TCI IDL types marked as native.

The following constants can be used to determine the parameter passing mode of TTCN-3 parameters (see also clause 8.3.2.3).

- `org.etsi.ttcn.tci.TciParameterPassingMode.TCI_IN;`
- `org.etsi.ttcn.tci.TciParameterPassingMode.TCI_INOUT;`
- `org.etsi.ttcn.tri.TciParameterPassingMode.TCI_OUT.`

For the distinct parameter value `null`, the encoded parameter value shall be set to Java `null`.

The following constants shall be used for value handling (see also clause 8.3.2.4).

- `org.etsi.ttcn.tci.TciTypeClass.ADDRESS;`
- `org.etsi.ttcn.tci.TciTypeClass.ANYTYPE;`

- `org.etsi.ttcn.tci.TciTypeClass.BITSTRING;`
- `org.etsi.ttcn.tci.TciTypeClass.BOOLEAN;`
- `org.etsi.ttcn.tci.TciTypeClass.CHARSTRING;`
- `org.etsi.ttcn.tci.TciTypeClass.COMPONENT;`
- `org.etsi.ttcn.tci.TciTypeClass.ENUMERATED;`
- `org.etsi.ttcn.tci.TciTypeClass.FLOAT;`
- `org.etsi.ttcn.tci.TciTypeClass.HEXSTRING;`
- `org.etsi.ttcn.tci.TciTypeClass.INTEGER;`
- `org.etsi.ttcn.tci.TciTypeClass.OCTETSTRING;`
- `org.etsi.ttcn.tci.TciTypeClass.RECORD;`
- `org.etsi.ttcn.tci.TciTypeClass.RECORD_OF;`
- `org.etsi.ttcn.tci.TciTypeClass.SET;`
- `org.etsi.ttcn.tci.TciTypeClass.SET_OF;`
- `org.etsi.ttcn.tci.TciTypeClass.ARRAY;`
- `org.etsi.ttcn.tci.TciTypeClass.UNION;`
- `org.etsi.ttcn.tci.TciTypeClass.UNIVERSAL_CHARSTRING;`
- `org.etsi.ttcn.tci.TciTypeClass.VERDICT.`

The following constants shall be used for component handling (see also clause 8.3.2.5).

- `org.etsi.ttcn.tci.TciTestComponentKind.TCI_CTRL_COMP;`
- `org.etsi.ttcn.tci.TciTestComponentKind.TCI_MTC_COMP;`
- `org.etsi.ttcn.tci.TciTestComponentKind.TCI_PTC_COMP;`
- `org.etsi.ttcn.tci.TciTestComponentKind.TCI_SYSTEM_COMP;`
- `org.etsi.ttcn.tci.TciTestComponentKind.TCI_ALIVE_COMP.`

The following constants shall be used for component status (see also clause 8.3.6.6).

- `org.etsi.ttcn.tci.ComponentStatus.INACTIVE_C;`
- `org.etsi.ttcn.tci.ComponentStatus.RUNNING_C;`
- `org.etsi.ttcn.tci.ComponentStatus.STOPPED_C;`
- `org.etsi.ttcn.tci.ComponentStatus.KILLED_C;`
- `org.etsi.ttcn.tci.ComponentStatus.NULL_C.`

The following constants shall be used for timer status (see also clause 8.3.6.7).

- `org.etsi.ttcn.tci.TimerStatus.RUNNING_T;`
- `org.etsi.ttcn.tci.TimerStatus.INACTIVE_T;`
- `org.etsi.ttcn.tci.TimerStatus.EXPIRED_T;`
- `org.etsi.ttcn.tci.TimerStatus.NULL_T.`

The following constants shall be used for TCI status (see also clause 8.3.6.8).

- `org.etsi.ttcn.tci.TciStatus.TCI_OK;`

- `org.etsi.ttcn.tci.TciStatus.TCI_ERROR`.

8.5 Mapping of interfaces

8.5.0 Calling rules

The TCI IDL definition defines four interfaces, the **TCI-TM**, the **TCI-CH**, the **TCI-CD**, and the **TCI-TL** interface. The operations are defined for different directions within this interface, i.e. some operations can only be called by the TTCN-3 Executable (TE), the System Adaptor (SA) or the Platform Adaptor (PA) on the Test Management and Control (TMC) while others can only be called by the TMC on the TE. This is reflected by dividing the TCI IDL interfaces in two sub interfaces, each suffixed by `Required` or `Provided`.

Table 4: Sub interfaces

Calling/Called	TE	TM	CD	CH	SA	PA	TL
TE	-	TCI-TM Provided	TCI-CD Provided	TCI-CH Provided	See ETSI ES 201 873-5 [3]	See ETSI ES 201 873-5 [3]	TCI-TL Provided
TM	TCI-TM Required	-	-	-	-	-	TCI-TL Provided
CD	TCI-CD Required	-	-	-	-	-	TCI-TL Provided
CH	TCI-CH Required	-	-	-	-	-	TCI-TL Provided
SA	See ETSI ES 201 873-5 [3]	-	-	-	-	-	TCI-TL Provided
PA	See ETSI ES 201 873-5 [3]	-	-	-	-	-	TCI-TL Provided
TL	-	-	-	-	-	-	-

All methods defined in these interfaces should behave as defined in clause 7.

8.5.1 The TCI-TM interface

8.5.1.1 TCI-TM provided

The `TCI-TM Provided` interface is mapped to the following interface:

```
// TCI-TM
// TE -> TM
package org.etsi.ttcn.tci;
public interface TciTMProvided {
    public void tciTestCaseStarted (TciTestCaseId testCaseId, TciParameterList parameterList, Float
timer);
    public void tciTestCaseTerminated (VerdictValue verdict, TciParameterList parameterList);
    public void tciControlTerminated ();
    public Value tciGetModulePar (TciModuleParameterId parameterId);
    public void tciLog (TriComponentId testComponentId, String message);
    public void tciError (String message);
}
```

8.5.1.2 TCI-TM required

The TCI-TM Required interface is mapped to the following interface:

```
// TCI-TM
// TM -> TE
package org.etsi.ttcn.tci;
public interface TciTMRequired {
    public void                tciRootModule (TciModuleId moduleName);
    public TciModuleIdList     tciGetImportedModules ();
    public TciModuleParameterList tciGetModuleParameters (TciModuleId moduleId);
    public TciTestCaseIdList   tciGetTestCases ();
    public TciParameterTypeList tciGetTestCaseParameters (TciTestCaseId testCaseId);
    public TriPortIdList       tciGetTestCaseTSI (TciTestCaseId testCaseId);
    public void                tciStartTestCase
        (String testCaseId, TciParameterList parameterList ) ;
    public void                tciStopTestCase ();
    public TriComponentId      tciStartControl ();
    public void                tciStopControl ();
}
```

8.5.2 The TCI-CD interface

8.5.2.1 TCI-CD provided

The TCI-CD Provided interface is mapped to the following interface:

```
// TCI-CD
// TE -> CD
package org.etsi.ttcn.tci;
public interface TciCDProvided {
    public Value                decode (TriMessage message, Type decodingHypothesis );
    public TriMessage           encode (Value value);
    public TciDecodingResult    decodeValue (TriMessage message, Type decodingHypothesis,
        String decodingInfo );
    public TriMessage           encodeValue (Value value, String encodingInfo);
}
```

8.5.2.2 TCI-CD required

The TCI-CD Required interface is mapped to the following interface:

```
// TCI-CD
// CD -> TE
package org.etsi.ttcn.tci;
public interface TciCDRequired {
    public Type                getTypeForName (String typeName);
    public Type                getInteger ();
    public Type                getFloat ();
    public Type                getBoolean ();
    public Type                getCharstring ();
    public Type                getUniversalCharstring ();
    public Type                getHexstring ();
    public Type                getBitstring ();
    public Type                getOctetstring ();
    public Type                getVerdict ();
    public void                tciErrorReq (String message);
}
```

8.5.3 The TCI-CH interface

8.5.3.1 TCI-CH provided

The TCI-CH Provided interface is mapped to the following interface:

```
// TciCHProvided
// TE -> CH
package org.etsi.ttcn.tci;
public interface TciCHProvided {
```

```

public void tciSendConnected (TriPortId sender, TriComponentId receiver, Value sendMessage);
public void tciSendConnectedBC (TriPortId sender, Value sendMessage);
public void tciSendConnectedMC (TriPortId sender, TriComponentIdList receivers,
Value sendMessage);

public void tciCallConnected(TriPortId sender,
TriComponentId receiver,
TriSignatureId signature,
TciParameterList parameterList) ;
public void tciCallConnectedBC(TriPortId sender,
TriSignatureId signature,
TciParameterList parameterList) ;
public void tciCallConnectedMC(TriPortId sender,
TriComponentIdList receivers,
TriSignatureId signature,
TciParameterList parameterList) ;

public void tciReplyConnected(TriPortId sender,
TriComponentId receiver,
TriSignatureId signature,
TciParameterList parameterList,
Value returnValue) ;
public void tciReplyConnectedBC(TriPortId sender,
TriSignatureId signature,
TciParameterList parameterList,
Value returnValue) ;
public void tciReplyConnectedMC(TriPortId sender,
TriComponentIdList receivers,
TriSignatureId signature,
TciParameterList parameterList,
Value returnValue) ;

public void tciRaiseConnected(TriPortId sender,
TriComponentId receiver,
TriSignatureId signature,
Value except) ;
public void tciRaiseConnectedBC(TriPortId sender,
TriSignatureId signature,
Value except) ;
public void tciRaiseConnectedMC(TriPortId sender,
TriComponentIdList receivers,
TriSignatureId signature,
Value except) ;

public TriComponentId tciCreateTestComponentReq(int kind,
Type componentType,
String name,
Value hostId) ;

public void tciStartTestComponentReq(TriComponentId comp,
TciBehaviourId behaviour,
TciParameterList parameterList) ;

public void tciStopTestComponentReq(TriComponentId comp) ;

public void tciConnectReq(TriPortId fromPort, TriPortId toPort) ;

public void tciDisconnectReq(TriPortId fromPort, TriPortId toPort) ;

public void tciTestComponentTerminatedReq(TriComponentId comp, VerdictValue verdict) ;

public boolean tciTestComponentRunningReq(TriComponentId comp) ;

public TriComponentId tciGetMTCReq() ;

public void tciMapReq(TriPortId fromPort, TriPortId toPort);
public void tciMapParamReq(TriPortId fromPort, TriPortId toPort,
TciParameterList parameterList);
public void tciUnmapReq(TriPortId fromPort, TriPortId toPort);
public void tciUnmapParamReq(TriPortId fromPort, TriPortId toPort,
TciParameterList parameterList);
public void tciExecuteTestCaseReq(TriComponentId testComponentId,
TriPortIdList tsiPortList);

```

```

public void    tciResetReq() ;

public boolean tciTestComponentDoneReq(TriComponentId testComponentId, VerdictValue verdict) ;

public void    tciKillTestComponentReq(TriComponentId component);

public boolean tciTestComponentAliveReq (TriComponentId component);

public boolean tciTestComponentKilledReq (TriComponentId component, VerdictValue verdict);
}

```

8.5.3.2 TCI-CH required

The TCI-CH Required interface is mapped to the following interface:

```

// TciCHRequired
// CH -> TE
package org.etsi.ttcn.tci;
public interface TciCHRequired extends TciCDRequired {
    public void    tciEnqueueMsgConnected(TriPortId sender,
                                          TriComponentId receiver,
                                          Value receivedMessage) ;

    public void    tciEnqueueCallConnected(TriPortId sender,
                                          TriComponentId receiver,
                                          TriSignatureId signature,
                                          TciParameterList parameterList) ;

    public void    tciEnqueueReplyConnected(TriPortId sender,
                                          TriComponentId receiver,
                                          TriSignatureId signature,
                                          TciParameterList parameterList,
                                          Value returnValue) ;

    public void    tciEnqueueRaiseConnected(TriPortId sender,
                                          TriComponentId receiver,
                                          TriSignatureId signature,
                                          Value except) ;

    public TriComponentId    tciCreateTestComponent(int kind, Type componentType, String name) ;

    public void    tciStartTestComponent(TriComponentId comp,
                                          TciBehaviourId behaviour,
                                          TciParameterList parameterList) ;

    public void    tciStopTestComponent(TriComponentId comp) ;

    public void    tciConnect(TriPortId fromPort, TriPortId toPort) ;

    public void    tciDisconnect(TriPortId fromPort, TriPortId toPort) ;

    public void    tciTestComponentTerminated(TriComponentId comp, VerdictValue verdict);

    public boolean tciTestComponentRunning(TriComponentId comp);

    public boolean tciTestComponentDone(TriComponentId comp, VerdictValue verdict);

    public TriComponentId    tciGetMTC ();

    public void    tciExecuteTestCase (TciTestCaseId TestCaseId, TriPortIdList tsiPortList);

    public void    tciReset ();

    public void    tciMap (TriPortId fromPort, TriPortId toPort);

    public void    tciMapParam (TriPortId fromPort, TriPortId toPort,
                                TciParameterList parameterList);

    public void    tciUnmap (TriPortId fromPort, TriPortId toPort);

    public void    tciUnmapParam (TriPortId fromPort, TriPortId toPort,
                                TciParameterList parameterList);

    public void    tciKillTestComponent(TriComponentId component);

    public boolean tciTestComponentAlive (TriComponentId component);
}

```

```

    public boolean tciTestComponentKilled (TriComponentId component, VerdictValue verdict);
}

```

8.5.4 The TCI-TL interface

8.5.4.1 TCI-TL provided

The TCI-TL Provided interface is mapped to the following interface:

```

// TCI-TL
// TE, TM,CH,CD, SA,PA -> TL
package org.etsi.ttcn.tci;
public interface TciTLProvided {
    public void tliTcExecute(String am, int ts, String src, int line, TriComponentId c,
        TciTestCaseId tcId, TciParameterList tciPars, TriTimerDuration dur);
    public void tliTcStart(String am, int ts, String src, int line, TriComponentId c,
        TciTestCaseId tcId, TciParameterList tciPars, TriTimerDuration dur);
    public void tliTcStop(String am, int ts, String src, int line, TriComponentId c, String reason);
    public void tliTcStarted(String am, int ts, String src, int line, TriComponentId c,
        TciTestCaseId tcId, TciParameterList tciPars, TriTimerDuration dur);
    public void tliTcTerminated(String am, int ts, String src, int line, TriComponentId c,
        TciTestCaseId tcId, TciParameterList tciPars, VerdictValue verdict, String reason);
    public void tliCtrlStart(String am, int ts, String src, int line, TriComponentId c);
    public void tliCtrlStop(String am, int ts, String src, int line, TriComponentId c);
    public void tliCtrlTerminated(String am, int ts, String src, int line, TriComponentId c);
    public void tliMSend_m(String am, int ts, String src, int line, TriComponentId c,
        TriPortId at, TriPortId to, Value msgValue, Value addrValue,
        TciStatus encoderFailure, TriMessage msg, TriAddress address,
        TriStatus transmissionFailure);
    public void tliMSend_m_BC(String am, int ts, String src, int line, TriComponentId c,
        TriPortId at, TriPortId to, Value msgValue,
        TciStatus encoderFailure, TriMessage msg, TriStatus transmissionFailure) ;
    public void tliMSend_m_MC(String am, int ts, String src, int line, TriComponentId c,
        TriPortId at, TriPortId to, Value msgValue, TciValueList addrValues,
        TciStatus encoderFailure, TriMessage msg, TriAddressList addresses,
        TriStatus transmissionFailure);
    public void tliMSend_c(String am, int ts, String src, int line, TriComponentId c,
        TriPortId at, TriPortId to, Value msgValue, TriStatus transmissionFailure);
    public void tliMSend_c_BC(String am, int ts, String src, int line, TriComponentId c,
        TriPortId at, TriPortIdList to, Value msgValue, TriStatus transmissionFailure);
    public void tliMSend_c_MC(String am, int ts, String src, int line, TriComponentId c,
        TriPortId at, TriPortIdList to, Value msgValue, TriStatus transmissionFailure);
    public void tliMDetected_m(String am, int ts, String src, int line, TriComponentId c,
        TriPortId at, TriPortId from, TriMessage msg, TriAddress address);
    public void tliMDetected_c(String am, int ts, String src, int line, TriComponentId c,
        TriPortId at, TriPortId from, Value msgValue );
    public void tliMMismatch_m(String am, int ts, String src, int line, TriComponentId c,
        TriPortId at, Value msgValue, TciValueTemplate msgTpl, TciValueDifferenceList diffs,
        Value addrValue, TciValueTemplate addressTpl);
    public void tliMMismatch_c(String am, int ts, String src, int line, TriComponentId c,
        TriPortId at, Value msgValue, TciValueTemplate msgTpl, TciValueDifferenceList diffs,
        TriComponentId from, TciNonValueTemplate fromTpl);
    public void tliMReceive_m(String am, int ts, String src, int line, TriComponentId c,
        TriPortId at, Value msgValue, TciValueTemplate msgTpl,
        Value addrValue, TciValueTemplate addressTpl);
    public void tliMReceive_c(String am, int ts, String src, int line, TriComponentId c,
        TriPortId at, Value msgValue, TciValueTemplate msgTpl,
        TriComponentId from, TciNonValueTemplate fromTpl);
    public void tliPrCall_m(String am, int ts, String src, int line, TriComponentId c,
        TriPortId at, TriPortId to, TriSignatureId signature, TciParameterList tciPars,
        Value addrValue, TciStatus encoderFailure, TriParameterList triPars,
        TriAddress address, TriStatus transmissionFailure);
    public void tliPrCall_m_BC(String am, int ts, String src, int line, TriComponentId c,
        TriPortId at, TriPortId to, TriSignatureId signature, TciParameterList tciPars,
        TciStatus encoderFailure, TriParameterList triPars,
        TriStatus transmissionFailure);
    public void tliPrCall_m_MC(String am, int ts, String src, int line, TriComponentId c,
        TriPortId at, TriPortId to, TriSignatureId signature, TciParameterList tciPars,
        TciValueList addrValues, TciStatus encoderFailure, TriParameterList triPars,
        TriAddressList addresses, TriStatus transmissionFailure);
    public void tliPrCall_c(String am, int ts, String src, int line, TriComponentId c,
        TriPortId at, TriPortId to, TriSignatureId signature, TciParameterList tciPars,
        TriStatus transmissionFailure);
}

```

```

public void tliPrCall_c_BC(String am, int ts, String src, int line, TriComponentId c,
    TriPortId at, TriPortIdList to, TriSignatureId signature, TciParameterList tciPars,
    TriStatus transmissionFailure);
public void tliPrCall_c_MC(String am, int ts, String src, int line, TriComponentId c,
    TriPortId at, TriPortIdList to, TriSignatureId signature, TciParameterList tciPars,
    TriStatus transmissionFailure);
public void tliPrGetCallDetected_m(String am, int ts, String src, int line, TriComponentId c,
    TriPortId at, TriPortId from, TriSignatureId signature, TriParameterList triPars,
    TriAddress address);
public void tliPrGetCallDetected_c(String am, int ts, String src, int line, TriComponentId c,
    TriPortId at, TriPortId from, TriSignatureId signature, TciParameterList tciPars );
public void tliPrGetCallMismatch_m(String am, int ts, String src, int line, TriComponentId c,
    TriPortId at, TriSignatureId signature,
    TciParameterList tciPars, TciValueTemplate parsTmpl, TciValueDifferenceList diffs,
    Value addrValue, TciValueTemplate addressTmpl);
public void tliPrGetCallMismatch_c(String am, int ts, String src, int line, TriComponentId c,
    TriPortId at, TriSignatureId signature,
    TciParameterList tciPars, TciValueTemplate parsTmpl, TciValueDifferenceList diffs,
    TriComponentId from, TciNonValueTemplate fromTmpl);
public void tliPrGetCall_m(String am, int ts, String src, int line, TriComponentId c,
    TriPortId at, TriSignatureId signature,
    TciParameterList tciPars, TciValueTemplate parsTmpl,
    Value addrValue, TciValueTemplate addressTmpl);
public void tliPrGetCall_c(String am, int ts, String src, int line, TriComponentId c,
    TriPortId at, TriSignatureId signature,
    TciParameterList tciPars, TciValueTemplate parsTmpl,
    TriComponentId from, TciNonValueTemplate fromTmpl);
public void tliPrReply_m(String am, int ts, String src, int line, TriComponentId c,
    TriPortId at, TriPortId to, TriSignatureId signature, TciParameterList tciPars,
    Value replValue, Value addrValue,
    TriStatus encoderFailure, TriParameterList triPars,
    TriParameter repl, TriAddress address, TriStatus transmissionFailure);
public void tliPrReply_m_BC(String am, int ts, String src, int line, TriComponentId c,
    TriPortId at, TriPortId to, TriSignatureId signature, TciParameterList tciPars,
    Value replValue, TriStatus encoderFailure,
    TriParameterList triPars, TriParameter repl, TriStatus transmissionFailure);
public void tliPrReply_m_MC(String am, int ts, String src, int line, TriComponentId c,
    TriPortId at, TriPortId to, TriSignatureId signature, TciParameterList tciPars,
    Value replValue, TciValueList addrValues,
    TriStatus encoderFailure, TriParameterList triPars,
    TriParameter repl, TriAddressList addresses, TriStatus transmissionFailure);
public void tliPrReply_c(String am, int ts, String src, int line, TriComponentId c,
    TriPortId at, TriPortId to, TriSignatureId signature,
    TciParameterList tciPars, Value replValue,
    TriStatus transmissionFailure);
public void tliPrReply_c_BC(String am, int ts, String src, int line, TriComponentId c,
    TriPortId at, TriPortIdList to, TriSignatureId signature, TciParameterList tciPars,
    Value replValue, TriStatus transmissionFailure);
public void tliPrReply_c_MC(String am, int ts, String src, int line, TriComponentId c,
    TriPortId at, TriPortIdList to, TriSignatureId signature, TciParameterList tciPars,
    Value replValue, TriStatus transmissionFailure);
public void tliPrGetReplyDetected_m(String am, int ts, String src, int line, TriComponentId c,
    TriPortId at, TriPortId from, TriSignatureId signature, TriParameterListType triPars,
    TriParameter repl, TriAddress address);
public void tliPrGetReplyDetected_c(String am, int ts, String src, int line, TriComponentId c,
    TriPortId at, TriPortId from, TriSignatureId signature, TciParameterList tciPars,
    Value replValue);
public void tliPrGetReplyMismatch_m(String am, int ts, String src, int line, TriComponentId c,
    TriPortId at, TriSignatureId signature,
    TciParameterList tciPars, TciValueTemplate parsTmpl,
    Value replValue, TciValueTemplate replyTmpl, TciValueDifferenceList diffs,
    Value addrValue, TciValueTemplate addressTmpl);
public void tliPrGetReplyMismatch_c(String am, int ts, String src, int line, TriComponentId c,
    TriPortId at, TriSignatureId signature,
    TciParameterList tciPars, TciValueTemplate parsTmpl,
    Value replValue, TciValueTemplate replyTmpl, TciValueDifferenceList diffs,
    TriComponentId from, TciNonValueTemplate fromTmpl);
public void tliPrGetReply_m(String am, int ts, String src, int line, TriComponentId c,
    TriPortId at, TriSignatureId signature,
    TciParameterList tciPars, TciValueTemplate parsTmpl,
    Value replValue, TciValueTemplate replyTmpl,
    Value addrValue, TciValueTemplate addressTmpl);
public void tliPrGetReply_c(String am, int ts, String src, int line, TriComponentId c,
    TriPortId at, TriSignatureId signature,
    TciParameterList tciPars, TciValueTemplate parsTmpl,
    Value replValue, TciValueTemplate replyTmpl,
    TriComponentId from, TciNonValueTemplate fromTmpl);

```

```

public void tliPrRaise_m(String am, int ts, String src, int line, TriComponentId c,
    TriPortId at, TriPortId to,
    TriSignatureId signature, TciParameterList tciPars, Value excValue,
    Value addrValue, TciStatus encoderFailure, TriException exc,
    TriAddress address, TriStatus transmissionFailure);
public void tliPrRaise_m_BC(String am, int ts, String src, int line, TriComponentId c,
    TriPortId at, TriPortId to,
    TriSignatureId signature, TciParameterList tciPars, Value excValue,
    TciStatus encoderFailure, TriException exc, TriStatus transmissionFailure) ;
public void tliPrRaise_m_MC(String am, int ts, String src, int line, TriComponentId c,
    TriPortId at, TriPortId to,
    TriSignatureId signature, TciParameterList tciPars, Value excValue,
    TciValueList addrValues, TciStatus encoderFailure, TriException exc,
    TriAddressList addresses, TriStatus transmissionFailure);
public void tliPrRaise_c(String am, int ts, String src, int line, TriComponentId c,
    TriPortId at, TriPortId to, TriSignatureId signature,
    TciParameterList tciPars, Value excValue, TriStatus transmissionFailure);
public void tliPrRaise_c_BC(String am, int ts, String src, int line, TriComponentId c,
    TriPortId at, TriPortIdList to, TriSignatureId signature, TciParameterList tciPars,
    Value excValue, TriStatus transmissionFailure);
public void tliPrRaise_c_MC(String am, int ts, String src, int line, TriComponentId c,
    TriPortId at, TriPortIdList to, TriSignatureId signature, TciParameterList tciPars,
    Value excValue, TriStatus transmissionFailure);
public void tliPrCatchDetected_m(String am, int ts, String src, int line, TriComponentId c,
    TriPortId at, TriPortId from, TriSignatureId signature,
    TriException exc, TriAddress address);
public void tliPrCatchDetected_c(String am, int ts, String src, int line, TriComponentId c,
    TriPortId at, TriPortId from, TriSignatureId signature,
    Value excValue);
public void tliPrCatchMismatch_m(String am, int ts, String src, int line, TriComponentId c,
    TriPortId at, TriSignatureId signature,
    Value excValue, TciValueTemplate excTmpl, TciValueDifferenceList diffs,
    Value addrValue, TciValueTemplate addressTmpl);
public void tliPrCatchMismatch_c(String am, int ts, String src, int line, TriComponentId c,
    TriPortId at, TriSignatureId signature,
    Value excValue, TciValueTemplate excTmpl, TciValueDifferenceList diffs,
    TriComponentId from, TciNonValueTemplate fromTmpl);
public void tliPrCatch_m(String am, int ts, String src, int line, TriComponentId c,
    TriPortId at, TriSignatureId signature,
    Value excValue, TciValueTemplate excTmpl,
    Value addrValue, TciValueTemplate addressTmpl);
public void tliPrCatch_c(String am, int ts, String src, int line, TriComponentId c,
    TriPortId at, TriSignatureId signature,
    Value excValue, TciValueTemplate excTmpl,
    TriComponentId from, TciNonValueTemplate fromTmpl);
public void tliPrCatchTimeoutDetected(String am, int ts, String src, int line, TriComponentId c,
    TriPortId at, TriSignatureId signature);
public void tliPrCatchTimeout(String am, int ts, String src, int line, TriComponentId c,
    TriPortId at, TriSignatureId signature);
public void tliCCreate(String am, int ts, String src, int line, TriComponentId c,
    TriComponentId comp, String name, Boolean alive);
public void tliCStart(String am, int ts, String src, int line, TriComponentId c,
    TriComponentId comp, TciBehaviourId name, TciParameterList tciPars);
public void tliCRunning(String am, int ts, String src, int line, TriComponentId c,
    TriComponentId comp, ComponentStatus status);
public void tliCAlive(String am, int ts, String src, int line, TriComponentId c,
    TriComponentId comp, ComponentStatus status);
public void tliCStop(String am, int ts, String src, int line, TriComponentId c,
    TriComponentId comp);
public void tliCKill(String am, int ts, String src, int line, TriComponentId c,
    TriComponentId comp);
public void tliCDoneMismatch(String am, int ts, String src, int line, TriComponentId c,
    TriComponentId comp, TciNonValueTemplate compTmpl);
public void tliCDone(String am, int ts, String src, int line, TriComponentId c,
    TciNonValueTemplate compTmpl, VerdictValue verdict);
public void tliCKilledMismatch(String am, int ts, String src, int line, TriComponentId c,
    TriComponentId comp, TciNonValueTemplate compTmpl);
public void tliCKilled(String am, int ts, String src, int line, TriComponentId c,
    TciNonValueTemplate compTmpl, VerdictValue verdict);
public void tliCTerminated(String am, int ts, String src, int line, TriComponentId c,
    VerdictValue verdict, String reason);
public void tliPConnect(String am, int ts, String src, int line, TriComponentId c,
    TriPortId port1, TriPortId port2);
public void tliPDisconnect(String am, int ts, String src, int line, TriComponentId c,
    TriPortId port1, TriPortId port2);
public void tliPMap(String am, int ts, String src, int line, TriComponentId c,
    TriPortId port1, TriPortId port2);

```

```

public void tliPMapParam(String am, int ts, String src, int line, TriComponentId c,
    TriPortId port1, TriPortId port2, TciParameterList tciPars,
    TciStatus encoderFailure, TriParameterList triPars);
public void tliPUnmap(String am, int ts, String src, int line, TriComponentId c,
    TriPortId port1, TriPortId port2);
public void tliPUnmapParam(String am, int ts, String src, int line, TriComponentId c,
    TriPortId port1, TriPortId port2, TciParameterList tciPars,
    TciStatus encoderFailure, TriParameterList triPars);
public void tliPClear(String am, int ts, String src, int line, TriComponentId c,
    TriPortId port);
public void tliPStart(String am, int ts, String src, int line, TriComponentId c,
    TriPortId port);
public void tliPStop(String am, int ts, String src, int line, TriComponentId c,
    TriPortId port);
public void tliPHalt(String am, int ts, String src, int line, TriComponentId c,
    TriPortId port);
public void tliEncode(String am, int ts, String src, int line, TriComponentId c,
    Value val, TciStatus encoderFailure, TriMessage msg, String codec);
public void tliDecode(String am, int ts, String src, int line, TriComponentId c,
    TriMessage msg, TciStatus decoderFailure, Value val, String codec);
public void tliTimeoutDetected(String am, int ts, String src, int line, TriComponentId c,
    TriTimerId timer);
public void tliTimeoutMismatch(String am, int ts, String src, int line, TriComponentId c,
    TriTimerId timer, TciNonValueTemplate timerTpl);
public void tliTimeout(String am, int ts, String src, int line, TriComponentId c,
    TriTimerId timer, TciNonValueTemplate timerTpl);
public void tliTStart(String am, int ts, String src, int line, TriComponentId c,
    TriTimerId timer, TriTimerDuration dur);
public void tliTStop(String am, int ts, String src, int line, TriComponentId c,
    TriTimerId timer, TriTimerDuration dur);
public void tliTRead(String am, int ts, String src, int line, TriComponentId c,
    TriTimerId timer, TriTimerDuration elapsed);
public void tliTRunning(String am, int ts, String src, int line, TriComponentId c,
    TriTimerId timer, TimerStatus status);
public void tliSEnter(String am, int ts, String src, int line, TriComponentId c,
    QualifiedName name, TciParameterList tciPars, String kind);
public void tliSLeave(String am, int ts, String src, int line, TriComponentId c,
    QualifiedName name, TciParameterList tciPars, Value returnValue, String kind);
public void tliVVar(String am, int ts, String src, int line, TriComponentId c,
    QualifiedName name, Value varValue);
public void tliModulePar(String am, int ts, String src, int line, TriComponentId c,
    QualifiedName name, Value parValue);
public void tliGetVerdict(String am, int ts, String src, int line, TriComponentId c,
    VerdictValue verdict);
public void tliSetVerdict(String am, int ts, String src, int line, TriComponentId c,
    VerdictValue verdict, String reason);
public void tliLog(String am, int ts, String src, int line, TriComponentId c,
    String log);
public void tliAEnter(String am, int ts, String src, int line, TriComponentId c);
public void tliALeave(String am, int ts, String src, int line, TriComponentId c);
public void tliADefaults(String am, int ts, String src, int line, TriComponentId c);
public void tliAActivate(String am, int ts, String src, int line, TriComponentId c,
    QualifiedName name, TciParameterList tciPars, Value ref);
public void tliADeactivate(String am, int ts, String src, int line, TriComponentId c,
    Value ref);
public void tliANomatch(String am, int ts, String src, int line, TriComponentId c);
public void tliARepeat(String am, int ts, String src, int line, TriComponentId c);
public void tliAwait(String am, int ts, String src, int line, TriComponentId c);
public void tliAction(String am, int ts, String src, int line, TriComponentId c, String action);
public void tliMatch(String am, int ts, String src, int line, TriComponentId c, Value expr,
    TciValueTemplate tpl);
public void tliMatchMismatch(String am, int ts, String src, int line, TriComponentId c,
    Value expr, TciValueTemplate tpl, TciValueDifferenceList diffs);
public void tliInfo (String am, int ts, String src, int line, TriComponentId c,
    int level, String info)
public void tliMChecked_m(String am, int ts, String src, int line, TriComponentId c,
    TriPortId at, Value msgValue, TciValueTemplate msgTpl,
    Value addrValue, TciValueTemplate addressTpl);
public void tliMChecked_c(String am, int ts, String src, int line, TriComponentId c,
    TriPortId at, Value msgValue, TciValueTemplate msgTpl,
    TriComponentId from, TciNonValueTemplate fromTpl);
public void tliPrGetCallChecked_m(String am, int ts, String src, int line, TriComponentId c,
    TriPortId at, TriSignatureId signature, TciParameterList tciPars,
    TciValueTemplate parsTpl, Value addrValue, TciValueTemplate addressTpl);
public void tliPrGetCallChecked_c(String am, int ts, String src, int line, TriComponentId c,
    TriPortId at, TriSignatureId signature, TciParameterList tciPars,
    TciValueTemplate parsTpl, TriComponentId from, TciNonValueTemplate fromTpl);

```

```

public void tliPrGetReplyChecked_m(String am, int ts, String src, int line, TriComponentId c,
    TriPortId at, TriSignatureId signature,
    TciParameterList tciPars, TciValueTemplate parsTmpl,
    Value replValue, TciValueTemplate replyTmpl,
    Value addrValue, TciValueTemplate addressTmpl);
public void tliPrGetReplyChecked_c(String am, int ts, String src, int line, TriComponentId c,
    TriPortId at, TriSignatureId signature,
    TciParameterList tciPars, TciValueTemplate parsTmpl,
    Value replValue, TciValueTemplate replyTmpl,
    TriComponentId from, TciNonValueTemplate fromTmpl);
public void tliPrCatchChecked_m(String am, int ts, String src, int line, TriComponentId c,
    TriPortId at, TriSignatureId signature,
    Value excValue, TciValueTemplate excTmpl,
    Value addrValue, TciValueTemplate addressTmpl);
public void tliPrCatchChecked_c(String am, int ts, String src, int line, TriComponentId c,
    TriPortId at, TriPortId from, TriSignatureId signature,
    Value excValue, TciValueTemplate excTmpl,
    TriComponentId from, TciNonValueTemplate fromTmpl);
public void tliCheckedAny_m(String am, int ts, String src, int line, TriComponentId c,
    TriPortId at, Value addrValue, TciValueTemplate addressTmpl);
public void tliCheckedAny_c(String am, int ts, String src, int line, TriComponentId c,
    TriPortId at, TriComponentId from, TciNonValueTemplate fromTmpl);
public void tliCheckAnyMismatch_m(String am, int ts, String src, int line,
    TriComponentId c, TriPortId at, Value addrValue, TciValueTemplate addressTmpl);
public void tliCheckAnyMismatch_c(String am, int ts, String src, int line,
    TriComponentId c, TriPortId at, TriComponentId from, TciNonValueTemplate fromTmpl);
public void tliRnd(String am, int ts, String src, int line,
    TriComponentId c, FloatValue val, FloatValue seed);
public void tliEvaluate(String am, int ts, String src, int line, TriComponentId c,
    QualifiedName name, Value evalResult);
}

```

8.6 Optional parameters

Clause 7.2.2 defines that a reserved value shall be used to indicate the absence of an optional parameter. For the Java™ language mapping the Java null value shall be used to indicate the absence of an optional value. For example, if in the `tciReplyConnected` operation the value parameter shall be omitted the operation invocation shall be `tciReplyConnected (sender, receiver, signature, parameterList, null)`.

8.7 TCI initialization

All methods are non-static, i.e. operations can only be called on objects. As the present document does not define concrete implementation strategies of TE, TM, CD and CH the mechanism how the TE, the TM, the CD or the CH get to know the handles on the respective objects is out of scope of the present document.

Tool vendors shall provide methods to the developers of TM, CD and CH to register the TE, TM, CD and CH to their respective communication partner.

8.8 Error handling

All operations called from the TM, CH or CD that return have succeeded. If an erroneous situation has been identified by the TE a test case error will be communicated to the user using the procedures as defined in clause 7.3.1.2.6 (`tciError`). If an operation called by the TE in the TM, CH, CD, or TL produces an error, this erroneous situation should be communicated to the TE using the procedures as defined in clause 7.3.2.1.12 (`tciErrorReq`).

Beside this error handling no additional error handling is defined with this Java™ language mapping. In particular, no exception handling mechanisms are defined.

9 ANSI C language mapping

9.1 Introduction

This clause defines the TCI ANSI-C [8] language mapping for the TCI data specified in clause 7.2 and for the TCI operations specified in clause 7.3.

9.2 Value interfaces

Table 5

TCI IDL Interface	ANSI C representation	Notes and comments
Type		
TciModuleIdType getDefiningModule()	TciModuleIdType tciGetDefiningModule(Type inst)	
Tstring getName()	String tciGetName(Type inst)	String type reused from IDL (OMG recommendation).
TciTypeClassType getTypeClass()	TciTypeClassType tciGetTypeClass (Type inst)	
Value newInstance()	Value tciNewInstance(Type inst)	
Value newTemplate (TciMatchingType matchingType)	Value tciNewTemplate(Type inst, TciMatchingType matchingType)	
TString getTypeEncoding()	String tciGetTypeEncoding(Type inst)	
TStringSeq getTypeExtension()	String* tciGetTypeExtension(Type inst)	Returns null pointer or a null-pointer terminated array
TString getTypeEncodingVariant()	String tciGetTypeEncodingVariant(Type inst)	
TString getEncodeAttributes ()	String* tciGetTypeEncodeAttributes(Type inst)	Returns null pointer or a null-pointer terminated array
TString getVariantAttributes (TString encoding)	String* tciGetTypeVariantAttributes(Type inst, String encoding)	Returns null pointer or a null-pointer terminated array
Value parseValue(TString val)	Value tciParseValue(Type inst, String val)	
LengthRestriction getTypeLengthRestriction()	int tciGetTypeLengthRestriction (Type inst, TciLengthRestriction * restriction)	Returns 0 for no restriction and -1 for restriction. The restriction is returned in the second parameter.
RangeBoundary getLowerTypeBoundary()	int tciGetLowerTypeBoundary (Type inst, TciRangeBoundary * boundary)	Returns 0 for no boundary and -1 if boundary is present. The boundary is returned in the second parameter.
RangeBoundary geUpperTypeBoundary()	int tciGetUpperTypeBoundary (Type inst, TciRangeBoundary * boundary)	
MatchingMechanism getTypeMatchingMechanism()	Value tciGetTypeMatchingMechanism (Type inst)	Get the restriction of type of value

TCI IDL Interface	ANSI C representation	Notes and comments
Value		
TString getValueEncoding()	String tciGetValueEncoding(Value inst)	
TString getValueEncodingVariant()	String tciGetValueEncodingVariant(Value inst)	
TString getEncodeAttributes ()	String* tciGetValueEncodeAttributes(Type inst)	Returns null pointer or a null-pointer terminated array
TString getVariantAttributes (TString encoding)	String* tciGetValueVariantAttributes(Type inst, String encoding)	Returns null pointer or a null-pointer terminated array
Type getType()	Type tciGetType(Value inst)	
Tboolean notPresent()	Boolean tciNotPresent(Value inst)	Boolean type reused from IDL (OMG recommendation).
	void tciSetNull(Value inst)	For optional parameters of operations, see clause 9.7.
	Boolean tciIsNull(Value inst)	For optional parameters of operations, see clause 9.7. Boolean type reused from IDL (OMG recommendation).
Tboolean isMatchingSymbol()	Boolean tciIsMatchingSymbol(Value inst)	
TString valueToString()	String tciValueToString(Value inst)	
Tboolean isLazy ()	Boolean tciIsLazy(Value inst)	
Tboolean isFuzzy ()	Boolean tciIsFuzzy(Value inst)	
Tboolean isEvaluated()	Boolean tciIsEvaluated(Value inst)	
	Boolean tciHasLengthRestriction(Value inst)	Returns true if length restriction is present, false otherwise.
LengthRestriction getLengthRestriction()	TciLengthRestriction tciGetLengthRestriction(Value inst)	
	void tciRemoveLengthRestriction(Value inst)	Removes length restriction.
void setLengthRestriction (LengthRestriction restriction)	void tciSetLengthRestriction(Value inst, TciLengthRestriction restriction)	
TBoolean isIfPresentEnabled()	Boolean tciIsIfPresentEnabled(Value inst)	
void setIfPresentEnabled(TBoolean enabled)	void tciSetIfPresentEnabled(Value inst, Boolean enabled)	
LengthRestriction getTypeLengthRestriction()	int tciGetValueLengthRestriction (Value inst, TciLengthRestriction * restriction)	Returns 0 for no restriction and -1 for restriction. The restriction is returned in the second parameter.
RangeBoundary getLowerTypeBoundary()	int tciGetLowerValueBoundary (Value inst, TciRangeBoundary * boundary)	Returns 0 for no boundary and -1 if boundary is present.
RangeBoundary geUpperTypeBoundary()	int tciGetUpperValueBoundary (Value inst, TciRangeBoundary * boundary)	The boundary is returned in the second parameter.
MatchingMechanism getTypeMatchingMechanism()	Value tciGetValueMatchingMechanism (Value inst)	Get the restriction of type of value
Tboolean isOptional()	Boolean tciIsOptional(Value inst)	

TCI IDL Interface	ANSI C representation	Notes and comments
IntegerValue		
Tinteger getInt()	String tciGetIntAbs(Value inst)	Returns the (10-base) integer absolute value as an ASCII string.
	unsigned long int tciGetIntNumberOfDigits (Value inst)	Returns the number of digits in an integer value.
	Boolean tciGetIntSign(Value inst)	Returns true if the number is positive, false otherwise.
	char tciGetIntDigit (Value inst, unsigned long int position)	Returns the value of the digit at position 'position', where position 0 is the least significant digit.
	long long tciGetInt(Value inst)	Alternative getInt realization for integers not exceeding the boundaries of signed 64-bit.
void setInt(in Tinteger value)	void tciSetIntAbs(Value inst, String value)	Sets the (10-base) absolute value of the integer via an ASCII string. The first digit shall not be 0 unless the value is 0.
	Void tciSetIntNumberOfDigits (Value inst, unsigned long int dig_num)	Sets the number of digits in an integer value.
	void tciSetIntSign (Value inst, Boolean sign)	Sets the sign to + (true) or - (false).
	void tciSetIntDigit (Value inst, unsigned long int position, char digit)	Sets the value of the digit at position 'position', where position 0 is the least significant digit.
	void tciSetInt(Value inst, long long value)	Alternative setInt realization for integers not exceeding the boundaries of signed 64-bit.
FloatValue		
Tfloat getFloat()	double tciGetFloatValue(Value inst)	
void setFloat(in Tfloat value)	void tciSetFloatValue(Value inst, double value)	
BooleanValue		
Tboolean getBoolean()	Boolean tciGetBooleanValue(Value inst)	
void setBoolean (in Tboolean value)	void tciSetBooleanValue (Value inst, Boolean value)	
CharstringValue		
Tstring getString()	TciCharStringValue tciGetCStringValue(Value inst)	
void setString(in Tstring value)	void tciSetCStringValue (Value inst, TciCharStringValue value)	
Tchar getChar (in Tinteger position)	char tciGetCStringCharValue (Value inst, long int position)	
void setChar (in Tinteger position, in Tchar value)	void tciSetCStringCharValue (Value inst, long int position, char value)	
Tinteger getLength()	unsigned long int tciGetCStringLength (Value inst)	
void setLength(in Tinteger len)	void tciSetCStringLength (Value inst, unsigned long int len)	

TCI IDL Interface	ANSI C representation	Notes and comments
UniversalCharstringValue		
Tstring getString()	TciUCStringValue tciGetUCStringValue(Value inst)	
void setString(in Tstring value)	void tciSetUCStringValue (Value inst, TciUCStringValue value)	
TuniversalChar getChar (in Tinteger position)	void tciGetUCStringCharValue (Value inst, unsigned long int position, TciUCValue result)	
void setChar (in Tinteger position, in TuniversalChar value)	void tciSetUCStringCharValue (Value inst, unsigned long int position, TciUCValue value)	
Tinteger getLength()	unsigned long int tciGetUCStringLength(Value inst)	
void setLength(in Tinteger len)	void tciSetUCStringLength (Value inst, unsigned long int len)	
BitstringValue		
Tstring getString()	String tciGetBStringValue(Value inst)	
void setString(in Tstring value)	void tciSetBStringValue (Value inst, String value)	
Tchar getBit (in integer position)	int tciGetBStringBitValue (Value inst, long int position)	
void setBit (in Tinteger position, in Tinteger value)	void tciSetBStringBitValue (Value inst, unsigned long int position, int value)	
Tinteger getLength()	unsigned long int tciGetBStringLength(Value inst)	
void setLength(in Tinteger len)	void tciSetBStringLength (Value inst, long int len)	
TBoolean isMatchingAt(in Tinteger position)	Boolean tciIsBStringMatchingAt(Value inst, unsigned long int position)	
MatchingMechanism getMatchingAt(in Tinteger position)	Value tciGetBStringMatchingAt(Value inst, unsigned long int position)	
void setMatching(in Tinteger position, in MatchingMechanism template)	void tciSetBStringMatchingAt(Value inst, unsigned long int position, Value template)	
HexstringValue		
Tstring getString()	String tciGetHStringValue(Value inst)	
void setString(in Tstring value)	void tciSetHStringValue (Value inst, String value)	
Tchar getHex (in Tinteger position)	int tciGetHStringHexValue (Value inst, unsigned long int position)	
void setBit (in Tinteger position, in Tinteger value)	void tciSetHStringHexValue (Value inst, unsigned long int position, int value)	
Tinteger getLength()	long int tciGetHStringLength(Value inst)	
void setLength(in Tinteger len)	void tciSetHStringLength (Value inst, unsigned long int len)	
TBoolean isMatchingAt(in Tinteger position)	Boolean tciIsHStringMatchingAt(Value inst, unsigned long int position)	
MatchingMechanism getMatchingAt(in Tinteger position)	Value tciGetHStringMatchingAt(Value inst, unsigned long int position)	
void setMatching(in Tinteger position, in MatchingMechanism template)	void tciSetHStringMatchingAt(Value inst, unsigned long int position, Value template)	

TCI IDL Interface	ANSI C representation	Notes and comments
OctetstringValue		
Tstring getString()	String tciGetOStringValue(Value inst)	
void setString(in Tstring value)	void tciSetOStringValue (Value inst, String value)	
Tchar getOctet(in Tinteger position)	int tciGetOStringOctetValue (Value inst, unsigned long int position)	
void setOctet (in Tinteger position, in Tinteger value)	void tciSetOStringOctetValue (Value inst, unsigned long int position, int value)	
Tinteger getLength()	unsigned long int tciGetOStringLength(Value inst)	
void setLength(in Tinteger len)	void tciSetOStringLength (Value inst, unsigned long int len)	
TBoolean isMatchingAt(in Tinteger position)	Boolean tciIsOStringMatchingAt(Value inst, unsigned long int position)	
MatchingMechanism getMatchingAt(in Tinteger position)	Value tciGetOStringMatchingAt(Value inst, unsigned long int position)	
void setMatching(in Tinteger position, in MatchingMechanism template)	void tciSetOStringMatchingAt(Value inst, unsigned long int position, Value template)	
RecordValue		
Value getField(in Tstring fieldName int)	Value tciGetRecFieldValue (Value inst, String fieldName int)	
void setField (in Tstring fieldName int, in Value value)	void tciSetRecFieldValue (Value inst, String fieldName int, Value value)	
Tstring[] getFieldNames()	char** tciGetRecFieldNames(Value inst)	Returns a NULL-terminated array of the field names.
void setFieldOmitted (in Tstring fieldName int)	void setFieldOmitted (Value inst, String fieldName int)	
RecordOfValue		
Value getField(in Tinteger position)	Value tciGetRecOfFieldValue (Value inst, unsigned long int position)	
void setField (in Tinteger position, in Value value)	void tciSetRecOfFieldValue (Value inst, unsigned long int position, Value value)	
void appendField(in Value value)	void tciAppendRecOfFieldValue (Value inst, Value value)	
Type getElementType()	Type tciGetRecOfElementType(Value inst)	
Tinteger getLength()	unsigned long int tciGetRecOfLength(Value inst)	
void setLength(in Tinteger len)	void tciSetRecOfLength (Value inst, unsigned long int len)	
Tinteger getOffset()	unsigned long int tciGetOffset(Value inst)	
Tinteger getPermutationCount()	unsigned long int tciGetPermutationCount(Value inst)	
Permutation getPermutation(Tinteger index)	TciPermutation tciGetPermutation(Value inst, unsigned long int index)	
void definePermutation(Permutation permutation)	void tciDefinePermutation(Value inst, TciPermutation permutation)	
void removePermutation(Tinteger index)	void tciRemovePermutation(Value inst, unsigned long int index)	
void clearPermutations()	void tciClearPermutations(Value inst)	

TCI IDL Interface	ANSI C representation	Notes and comments
UnionValue		
Value getVariant (in Tstring variantName)	Value tciGetUnionVariant (Value inst, String variantName)	
void setVariant (in Tstring variantName, in Value value)	void tciSetUnionVariant (Value inst, String variantName, Value value)	
Tstring getPresentVariantName()	String tciGetUnionPresentVariantName (Value inst)	
Tstring[] getVariantNames()	char** tciGetUnionVariantNames(Value inst)	Returns a NULL-terminated array of the field names.
EnumeratedValue		
Tstring getEnum()	String tciGetEnumValue(Value inst)	
void setEnum(in Tstring enumValue)	void tciSetEnumValue (Value inst, String enumValue)	
Tinteger getInt()	long tciGetEnumInt(Value inst);	
setInt(in Tinteger intValue)	void tciSetEnumInt(Value inst, long intValue);	
VerdictValue		
Tinteger getVerdict()	int tciGetVerdictValue(Value inst)	
void setVerdict(in Tinteger verdict)	void tciSetVerdictValue(Value inst, int verdict)	
AddressValue		
Value getAddress()	Value tciGetAddressValue(Value inst)	
void setAddress(in Value value)	void tciSetAddressValue(Value inst, Value value)	
MatchingMechanism		
TciMatchingTypeType getMatchingType()	TciMatchingTypeType tciGetMatchingType(Value inst)	
MatchingList		
Tinteger size()	unsigned long int tciGetMatchingListSize(Value inst)	
Value get(TInteger position)	Value tciGetMatchingListItem(Value inst, unsigned long int position)	
void add(Value item)	void tciAddMatchingListItem(Value inst, Value item)	
void remove(TInteger position)	void tciRemoveMatchingListItem(Value inst, unsigned long int position)	
void clear()	void tciClearMatchingList(Value inst)	
ValueRange		
RangeBoundary getLowerBoundary()	TciRangeBoundary tciGetLowerRangeBoundary(Value inst)	
RangeBoundary getUpperBoundary()	TciRangeBoundary tciGetUpperRangeBoundary(Value inst)	
void setLowerBoundary (RangeBoundary lowerBoundary)	void tciSetLowerRangeBoundary(Value inst, TciRangeBoundary lowerBoundary)	
void setUpperBoundary (RangeBoundary upperBoundary)	void tciSetUpperRangeBoundary(Value inst, TciRangeBoundary upperBoundary)	
CharacterPattern		
Value getPatternString ()	Value tciGetPatternString(Value inst)	
void setPatternString(Value characterPattern)	void tciSetPatternString(Value inst, Value characterPattern)	
MatchDecodedContent		
Value getContent()	Value tciGetDecodedMatchContent(Value inst)	
void setContent(Value content)	void tciSetDecodedMatchContent(Value inst, Value content)	

9.3 Logging interface

Table 6

TCI IDL Interface	ANSI C representation	Notes and comments
TciValueTemplate		
Tboolean isOmit()	Boolean tciIsOmit(TciValueTemplate inst)	Boolean type reused from IDL (OMG recommendation)
Tboolean isAny()	Boolean tciIsAny(TciValueTemplate inst)	Boolean type reused from IDL (OMG recommendation)
Tboolean isAnyOrOmit()	Boolean tciIsAnyOrOmit(TciValueTemplate inst)	Boolean type reused from IDL (OMG recommendation)
Tstring getTemplateDef()	String tciGetTemplateDef(TciValueTemplate inst)	String type reused from IDL (OMG recommendation)
TciNonValueTemplate		
Tboolean isAny()	Boolean tciIsAnyNonValue (TciNonValueTemplate inst)	Boolean type reused from IDL (OMG recommendation)
Tboolean isAll()	Boolean tciIsAllNonValue (TciNonValueTemplate inst)	Boolean type reused from IDL (OMG recommendation)
Tstring getTemplateDef()	String tciGetTemplateDefNonValue (TciNonValueTemplate inst)	String type reused from IDL (OMG recommendation)
TciValueList		
Tinteger size()	int size(TciValueList inst)	
Tboolean isEmpty()	Boolean isEmpty(TciValueList inst)	Boolean type reused from IDL (OMG recommendation)
Value get(Tinteger index)	Value get(TciValueList inst, int index)	
TciValueDifference		
Value getValue()	Value getValue(TciValueDifference inst)	
TciValueTemplate getTciValueTemplate()	TciValueTemplate getTciValueTemplate(TciValueDifference inst)	
Tstring getDescription()	String getDescription(TciValueDifference inst)	String type reused from IDL (OMG recommendation)
TciValueDifferenceList		
Tinteger size()	int size(TciValueDifferenceList inst)	
Tboolean isEmpty()	Boolean isEmpty(TciValueDifferenceList inst)	Boolean type reused from IDL (OMG recommendation)
TciValueDifference get(Tinteger index)	TciValueDifference get(TciValueDifferenceList inst, int index)	

9.4 Operation interfaces

9.4.1 The TCI-TM interface

9.4.1.1 TCI-TM provided

The TCI-TM Provided interface is mapped to the following interface:

```
void tciTestCaseStarted
    (TciTestCaseIdType testCaseId, TciParameterListType parameterList, double timer)
void tciTestCaseTerminated (VerdictValue verdict, TciParameterListType parameterlist)
void tciControlTerminated()
Value tciGetModulePar (TciModuleParameterIdType parameterId)
void tciLog(String message)
```

```
void tciError(String message)
```

9.4.1.2 TCI-TM required

The TCI-TM Required interface is mapped to the following interface:

```
void tciRootModule(String moduleId)
TciModuleIdListType tciGetImportedModules()
TciModuleParameterListType tciGetModuleParameters(TciModuleIdType moduleName)
TciTestCaseIdListType tciGetTestCases()
TciParameterTypeListType tciGetTestCaseParameters (TciTestCaseIdType testCaseId)
TriPortIdList tciGetTestCaseTSI (TciTestCaseIdType testCaseId)
void tciStartTestCase (TciTestCaseIdType testCaseId, TciParameterListType parameterlist)
void tciStopTestCase()
TriComponentId tciStartControl()
void tciStopControl()
```

9.4.2 The TCI-CD interface

9.4.2.1 TCI-CD provided

The TCI-CD Provided interface is mapped to the following interface:

```
Value tciDecode (BinaryString message, Type decHypothesis)
BinaryString tciEncode(Value value)
int tciDecodeValue (BinaryString * message, Type decHypothesis, String decodingInfo, Value *
    decodedValue)
BinaryString tciEncodeValue(Value value, string encodingInfo)
```

NOTE: BinaryString type reused from TRI.

9.4.2.2 TCI-CD required

The TCI-CD Required interface is mapped to the following interface:

```
Type tciGetTypeForName(String typeName)
Type tciGetIntegerType()
Type tciGetFloatType()
Type tciGetBooleanType()
Type tciGetCharType()
Type tciGetUniversalCharType()
Type tciGetTciCharstringType()
Type tciGetUniversalCharstringType()
Type tciGetHexstringType()
Type tciGetBitstringType()
Type tciGetOctetstringType()
Type tciGetVerdictType()
void tciErrorReq(String message)
```

9.4.3 The TCI-CH interface

9.4.3.1 TCI-CH provided

The TCI-CH Provided interface is mapped to the following interface:

```
void tciSendConnected(TriPortId sender, TriComponentId receiver, Value sendMessage)
void tciSendConnectedBC(TriPortId sender, Value sendMessage)
void tciSendConnectedMC
    (TriPortId sender, TriComponentIdList receivers, Value sendMessage)
void tciCallConnected
    (TriPortId sender, TriComponentId receiver, TriSignatureId signature,
    TciParameterListType parameterList)
void tciCallConnectedBC
    (TriPortId sender, TriSignatureId signature, TciParameterListType parameterList)
void tciCallConnectedMC
    (TriPortId sender, TriComponentIdList receivers, TriSignatureId signature,
    TciParameterListType parameterList)
void tciReplyConnected
```



```

(TriPortId sender, TriComponentId receiver, TriSignatureId signature,
 TciParameterListType parameterList, Value returnValue)
void          tciReplyConnectedBC
(TriPortId sender, TriSignatureId signature, TciParameterListType parameterList,
 Value returnValue)
void          tciReplyConnectedMC
(TriPortId sender, TriComponentIdList receivers, TriSignatureId signature,
 TciParameterListType parameterList, Value returnValue)
void          tciRaiseConnected
(TriPortId sender, TriComponentId receiver, TriSignatureId signature, Value exception)
void          tciRaiseConnectedBC
(TriPortId sender, TriSignatureId signature, Value exception)
void          tciRaiseConnectedMC
(TriPortId sender, TriComponentIdList receivers, TriSignatureId signature, Value exception)
TriComponentId tciCreateTestComponentReq
(TciTestComponentKindType kind, Type componentType, String name, Value hostId)
void          tciStartTestComponentReq
(TriComponentId component, TciBehaviourIdType behaviour, TciParameterListType parameterList)
void          tciStopTestComponentReq (TriComponentId component)
void          tciConnectReq(TriPortId fromPort, TriPortId toPort)
void          tciDisconnectReq(TriPortId fromPort, TriPortId toPort)
void          tciMapReq(TriPortId fromPort, TriPortId toPort)
void          tciMapParamReq
(TriPortId fromPort, TriPortId toPort, TciParameterListType parameterList)
void          tciUnmapReq(TriPortId fromPort, TriPortId toPort)
void          tciUnmapParamReq
(TriPortId fromPort, TriPortId toPort, TciParameterListType parameterList)
void          tciTestComponentTerminatedReq(TriComponentId component, VerdictValue verdict)
Boolean      tciTestComponentRunningReq(TriComponentId component)
Boolean      tciTestComponentDoneReq(TriComponentId component, int * verdict)
TriComponentId tciGetMTCReq()
void          tciExecuteTestCaseReq(TciTestCaseIdType testCaseId, TriPortIdList tsiPortList)
void          tciResetReq()
void          tciKillTestComponentReq(TriComponentId component)
Boolean      tciTestComponentAliveReq (TriComponentId component)
Boolean      tciTestComponentKilledReq (TriComponentId component, int * verdict)

```

9.4.3.2 TCI-CH required

The TCI-CH Required interface is mapped to the following interface:

```

void          tciEnqueueMsgConnected
(TriPortId sender, TriComponentId receiver, Value rcvdMessage)
void          tciEnqueueCallConnected
(TriPortId sender, TriComponentId receiver, TriSignatureId signature,
 TciParameterListType parameterList)
void          tciEnqueueReplyConnected
(TriPortId sender, TriComponentId receiver, TriSignatureId signature,
 TciParameterListType parameterList, Value returnValue)
void          tciEnqueueRaiseConnected
(TriPortId sender, TriComponentId receiver, TriSignatureId signature, Value exception)
TriComponentId tciCreateTestComponent
(TciTestComponentKindType kind, Type componentType, String name)
void          tciStartTestComponent
(TriComponentId component, TciBehaviourIdType behaviour, TciParameterListType parameterList)
void          tciStopTestComponent(TriComponentId component)
void          tciConnect(TriPortId fromPort, TriPortId toPort)
void          tciDisconnect(TriPortId fromPort, TriPortId toPort)
void          tciMap (TriPortId fromPort, TriPortId toPort)
void          tciMapParam
(TriPortId fromPort, TriPortId toPort, TciParameterListType parameterList)
void          tciUnmap(TriPortId fromPort, TriPortId toPort)
void          tciUnmapParam
(TriPortId fromPort, TriPortId toPort, TciParameterListType parameterList)
void          tciTestComponentTerminated(TriComponentId component, VerdictValue verdict)
Boolean      tciTestComponentRunning(TriComponentId component)
Boolean      tciTestComponentDone(TriComponentId component, int * verdict)
TriComponentId tciGetMTC()
void          tciExecuteTestCase(TciTestCaseIdType testCaseId, TriPortIdList tsiPortList)
void          tciReset()
void          tciKillTestComponent(TriComponentId component)
Boolean      tciTestComponentAlive(TriComponentId component)
Boolean      tciTestComponentKilled(TriComponentId component, int * verdict)

```

9.4.4 The TCI-TL interface

9.4.4.1 TCI-TL provided

The TCI-TL Provided interface is mapped to the following interface:

```

void tliTcExecute
  (String am, int ts, String src, int line, TriComponentId c, TciTestCaseIdType tcId,
   TciParameterListType tciPars, TriTimerDuration dur)
void tliTcStart
  (String am, int ts, String src, int line, TriComponentId c, TciTestCaseIdType tcId,
   TciParameterListType tciPars, TriTimerDuration dur)
void tliTcStop
  (String am, int ts, String src, int line, TriComponentId c, String reason)
void tliTcStarted
  (String am, int ts, String src, int line, TriComponentId c, TciTestCaseIdType tcId,
   TciParameterListType tciPars, TriTimerDuration dur)
void tliTcTerminated
  (String am, int ts, String src, int line, TriComponentId c, TciTestCaseIdType tcId,
   TciParameterListType tciPars, VerdictValue verdict, String reason)

void tliCtrlStart(String am, int ts, String src, int line, TriComponentId c)
void tliCtrlStop(String am, int ts, String src, int line, TriComponentId c)
void tliCtrlTerminated(String am, int ts, String src, int line, TriComponentId c)

void tliMSend_m
  (String am, int ts, String src, int line, TriComponentId c, TriPortId at, TriPortId to,
   Value msgValue, Value addrValue, TciStatus encoderFailure, TriMessage msg,
   TriAddress address, TriStatus transmissionFailure)
void tliMSend_m_BC
  (String am, int ts, String src, int line, TriComponentId c, TriPortId at, TriPortId to,
   Value msgValue, TciStatus encoderFailure, TriMessage msg, TriStatus transmissionFailure)
void tliMSend_m_MC
  (String am, int ts, String src, int line, TriComponentId c, TriPortId at, TriPortId to,
   Value msgValue, TciValueList addrValues, TciStatus encoderFailure, TriMessage msg,
   TriAddressList addresses, TriStatus transmissionFailure)
void tliMSend_c
  (String am, int ts, String src, int line, TriComponentId c, TriPortId at, TriPortId to,
   Value msgValue, TriStatus transmissionFailure)
void tliMSend_c_BC
  (String am, int ts, String src, int line, TriComponentId c, TriPortId at, TriPortIdList to,
   Value msgValue, TriStatus transmissionFailure)
void tliMSend_c_MC
  (String am, int ts, String src, int line, TriComponentId c, TriPortId at, TriPortIdList to,
   Value msgValue, TriStatus transmissionFailure)
void tliMDetected_m
  (String am, int ts, String src, int line, TriComponentId c, TriPortId at, TriPortId from,
   TriMessage msg, TriAddress address)
void tliMDetected_c
  (String am, int ts, String src, int line, TriComponentId c, TriPortId at, TriPortId from,
   Value msgValue)
void tliMMismatch_m
  (String am, int ts, String src, int line, TriComponentId c, TriPortId at, Value msgValue,
   TciValueTemplate msgTmpl, TciValueDifferenceList diffs, Value addrValue,
   TciValueTemplate addressTmpl)
void tliMMismatch_c
  (String am, int ts, String src, int line, TriComponentId c, TriPortId at, Value msgValue,
   TciValueTemplate msgTmpl, TciValueDifferenceList diffs, TriComponentId from,
   TciNonValueTemplate fromTmpl)
void tliMReceive_m
  (String am, int ts, String src, int line, TriComponentId c, TriPortId at, Value msgValue,
   TciValueTemplate msgTmpl, Value addrValue, TciValueTemplate addressTmpl)
void tliMReceive_c
  (String am, int ts, String src, int line, TriComponentId c, TriPortId at, Value msgValue,
   TciValueTemplate msgTmpl, TriComponentId from, TciNonValueTemplate fromTmpl)

void tliPrCall_m
  (String am, int ts, String src, int line, TriComponentId c, TriPortId at,
   TriPortId to, TriSignatureId signature,
   TciParameterListType tciPars, Value addrValue, TciStatus encoderFailure,
   TriParameterList triPars, TriAddress address, TriStatus transmissionFailure)
void tliPrCall_m_BC
  (String am, int ts, String src, int line, TriComponentId c, TriPortId at, TriPortId to,
   TriSignatureId signature, TciParameterListType tciPars, TciStatus encoderFailure,
   TriParameterList triPars, TriStatus transmissionFailure)

```

```

void tliPrCall_m_MC
  (String am, int ts, String src, int line, TriComponentId c, TriPortId at, TriPortId to,
   TriSignatureId signature, TciParameterListType tciPars, TciValueList addrValues,
   TciStatus encoderFailure, TriParameterList triPars, TriAddressList addresses,
   TriStatus transmissionFailure)
void tliPrCall_c
  (String am, int ts, String src, int line, TriComponentId c, TriPortId at,
   TriPortId to, TriSignatureId signature,
   TciParameterListType tciPars, TriStatus transmissionFailure)
void tliPrCall_c_BC
  (String am, int ts, String src, int line, TriComponentId c, TriPortId at, TriPortIdList to,
   TriSignatureId signature, TciParameterListType tciPars, TriStatus transmissionFailure)
void tliPrCall_c_MC
  (String am, int ts, String src, int line, TriComponentId c, TriPortId at, TriPortIdList to,
   TriSignatureId signature, TciParameterListType tciPars, TriStatus transmissionFailure)
void tliPrGetCallDetected_m
  (String am, int ts, String src, int line, TriComponentId c, TriPortId at, TriPortId from,
   TriSignatureId signature, TriParameterList triPars, TriAddress address)
void tliPrGetCallDetected_c
  (String am, int ts, String src, int line, TriComponentId c, TriPortId at, TriPortId from,
   TriSignatureId signature, TciParameterListType tciPars)
void tliPrGetCallMismatch_m
  (String am, int ts, String src, int line, TriComponentId c, TriPortId at, TriSignatureId signature,
   TciParameterListType tciPars, TciValueTemplate parsTmpl, TciValueDifferenceList diffs,
   Value addrValue, TciValueTemplate addressTmpl)
void tliPrGetCallMismatch_c
  (String am, int ts, String src, int line, TriComponentId c, TriPortId at, TriSignatureId signature,
   TciParameterListType tciPars, TciValueTemplate parsTmpl, TciValueDifferenceList diffs,
   TriComponentId from, TciNonValueTemplate fromTmpl)
void tliPrGetCall_m
  (String am, int ts, String src, int line, TriComponentId c, TriPortId at, TriSignatureId signature,
   TciParameterListType tciPars, TciValueTemplate parsTmpl, Value addrValue,
   TciValueTemplate addressTmpl)
void tliPrGetCall_c
  (String am, int ts, String src, int line, TriComponentId c, TriPortId at, TriSignatureId signature,
   TciParameterListType tciPars, TciValueTemplate parsTmpl, TriComponentId from,
   TciNonValueTemplate fromTmpl)
void tliPrReply_m
  (String am, int ts, String src, int line, TriComponentId c, TriPortId at, TriPortId to,
   TriSignatureId signature, TciParameterListType tciPars, Value replValue,
   Value addrValue, TciStatus encoderFailure, TriParameterList triPars,
   TriParameter repl, TriAddress address, TriStatus transmissionFailure)
void tliPrReply_m_BC
  (String am, int ts, String src, int line, TriComponentId c, TriPortId at, TriPortId to,
   TriSignatureId signature, TciParameterListType tciPars, Value replValue,
   TciStatus encoderFailure, TriParameterList triPars, TriParameter repl,
   TriStatus transmissionFailure)
void tliPrReply_m_MC
  (String am, int ts, String src, int line, TriComponentId c, TriPortId at, TriPortId to,
   TriSignatureId signature, TciParameterListType tciPars, Value replValue,
   TciValueList addrValues, TriStatus encoderFailure, TriParameterList triPars,
   TriParameter repl, TriAddressList addresses, TciStatus transmissionFailure)
void tliPrReply_c
  (String am, int ts, String src, int line, TriComponentId c, TriPortId at, TriPortId to,
   TriSignatureId signature, TciParameterListType tciPars, Value replValue,
   TriStatus transmissionFailure)
void tliPrReply_c_BC
  (String am, int ts, String src, int line, TriComponentId c, TriPortId at, TriPortIdList to,
   TriSignatureId signature, TciParameterListType tciPars, Value replValue,
   TriStatus transmissionFailure)
void tliPrReply_c_MC
  (String am, int ts, String src, int line, TriComponentId c, TriPortId at, TriPortIdList to,
   TriSignatureId signature, TciParameterListType tciPars, Value replValue,
   TriStatus transmissionFailure)
void tliPrGetReplyDetected_m
  (String am, int ts, String src, int line, TriComponentId c, TriPortId at, TriPortId from,
   TriSignatureId signature, TriParameterList triPars, TriParameter repl, TriAddress address)
void tliPrGetReplyDetected_c
  (String am, int ts, String src, int line, TriComponentId c, TriPortId at, TriPortId from,
   TriSignatureId signature, TciParameterListType tciPars, Value replValue)
void tliPrGetReplyMismatch_m
  (String am, int ts, String src, int line, TriComponentId c, TriPortId at, TriSignatureId signature,
   TciParameterListType tciPars, TciValueTemplate parsTmpl, Value replValue,
   TciValueTemplate replyTmpl, TciValueDifferenceList diffs, Value addrValue,
   TciValueTemplate addressTmpl)

```

```

void tliPrGetReplyMismatch_c
  (String am, int ts, String src, int line, TriComponentId c, TriPortId at, TriSignatureId signature,
   TciParameterListType tciPars, TciValueTemplate parsTpl, Value replValue,
   TciValueTemplate replyTpl, TciValueDifferenceList diffs, TriComponentId from,
   TciNonValueTemplate fromTpl)
void tliPrGetReply_m
  (String am, int ts, String src, int line, TriComponentId c, TriPortId at, TriSignatureId signature,
   TciParameterListType tciPars, TciValueTemplate parsTpl, Value replValue,
   TciValueTemplate replyTpl, Value addrValue, TciValueTemplate addressTpl)
void tliPrGetReply_c
  (String am, int ts, String src, int line, TriComponentId c, TriPortId at, TriSignatureId signature,
   TciParameterListType tciPars, TciValueTemplate parsTpl, Value replValue,
   TciValueTemplate replyTpl, TriComponentId from, TciNonValueTemplate fromTpl)
void tliPrRaise_m
  (String am, int ts, String src, int line, TriComponentId c, TriPortId at, TriPortId to,
   TriSignatureId signature, TciParameterListType tciPars, Value excValue, Value addrValue,
   TciStatus encoderFailure, TriException exc, TriAddress address, TriStatus transmissionFailure)
void tliPrRaise_m_BC
  (String am, int ts, String src, int line, TriComponentId c, TriPortId at, TriPortId to,
   TriSignatureId signature, TciParameterListType tciPars, Value excValue,
   TciStatus encoderFailure, TriException exc, TriStatus transmissionFailure)
void tliPrRaise_m_MC
  (String am, int ts, String src, int line, TriComponentId c, TriPortId at, TriPortId to,
   TriSignatureId signature, TciParameterListType tciPars, Value excValue,
   TciValueList addrValues, TciStatus encoderFailure, TriException exc,
   TriAddressList addresses, TriStatus transmissionFailure)
void tliPrRaise_c
  (String am, int ts, String src, int line, TriComponentId c, TriPortId at, TriPortId to,
   TriSignatureId signature, TciParameterListType tciPars, Value excValue,
   TriStatus transmissionFailure)
void tliPrRaise_c_BC
  (String am, int ts, String src, int line, TriComponentId c, TriPortId at, TriPortIdList to,
   TriSignatureId signature, TciParameterListType tciPars, Value excValue,
   TriStatus transmissionFailure)
void tliPrRaise_c_MC
  (String am, int ts, String src, int line, TriComponentId c, TriPortId at, TriPortIdList to,
   TriSignatureId signature, TciParameterListType tciPars, Value excValue,
   TriStatus transmissionFailure)
void tliPrCatchDetected_m
  (String am, int ts, String src, int line, TriComponentId c, TriPortId at, TriPortId from,
   TriSignatureId signature, TriException exc, TriAddress address)
void tliPrCatchDetected_c
  (String am, int ts, String src, int line, TriComponentId c, TriPortId at, TriPortId from,
   TriSignatureId signature, Value excValue)
void tliPrCatchMismatch_m
  (String am, int ts, String src, int line, TriComponentId c, TriPortId at, TriSignatureId signature,
   Value excValue, TciValueTemplate excTpl, TciValueDifferenceList diffs, Value addrValue,
   TciValueTemplate addressTpl)
void tliPrCatchMismatch_c
  (String am, int ts, String src, int line, TriComponentId c, TriPortId at, TriSignatureId signature,
   Value excValue, TciValueTemplate excTpl, TciValueDifferenceList diffs, TriComponentId from,
   TciNonValueTemplate fromTpl)
void tliPrCatch_m
  (String am, int ts, String src, int line, TriComponentId c, TriPortId at, TriSignatureId signature,
   Value excValue, TciValueTemplate excTpl, Value addrValue, TciValueTemplate addressTpl)
void tliPrCatch_c
  (String am, int ts, String src, int line, TriComponentId c, TriPortId at, TriSignatureId signature,
   Value excValue, TciValueTemplate excTpl, TriComponentId from, TciNonValueTemplate fromTpl)
void tliPrCatchTimeoutDetected
  (String am, int ts, String src, int line, TriComponentId c, TriPortId at, TriSignatureId signature)
void tliPrCatchTimeout
  (String am, int ts, String src, int line, TriComponentId c, TriPortId at, TriSignatureId signature)

void tliCCreate
  (String am, int ts, String src, int line, TriComponentId c, TriComponentId comp, String name,
   Boolean alive)
void tliCStart
  (String am, int ts, String src, int line, TriComponentId c, TriComponentId comp,
   TciBehaviourIdType name, TciParameterListType tciPars)
void tliCRunning
  (String am, int ts, String src, int line, TriComponentId c, TriComponentId comp,
   ComponentStatus status)
void tliCAlive
  (String am, int ts, String src, int line, TriComponentId c, TriComponentId comp,
   ComponentStatus status)
void tliCStop
  (String am, int ts, String src, int line, TriComponentId c, TriComponentId comp)

```

```

void tliCKill
  (String am, int ts, String src, int line, TriComponentId c, TriComponentId comp)
void tliCDoneMismatch
  (String am, int ts, String src, int line, TriComponentId c, TriComponentId comp,
   TciNonValueTemplate compTpl)
void tliCDone
  (String am, int ts, String src, int line, TriComponentId c, TciNonValueTemplate compTpl,
   VerdictValue verdict)
void tliCTerminated
  (String am, int ts, String src, int line, TriComponentId c, VerdictValue verdict, String reason)
void tliCKilledMismatch
  (String am, int ts, String src, int line, TriComponentId c, TriComponentId comp,
   TciNonValueTemplate compTpl)
void tliCKilled
  (String am, int ts, String src, int line, TriComponentId c, TciNonValueTemplate compTpl,
   VerdictValue verdict)

void tliPConnect
  (String am, int ts, String src, int line, TriComponentId c, TriPortId port1, TriPortId port2)
void tliPDisconnect
  (String am, int ts, String src, int line, TriComponentId c, TriPortId port1,
   TriPortId port2)
void tliPMap
  (String am, int ts, String src, int line, TriComponentId c, TriPortId port1, TriPortId port2)
void tliPMapParam
  (String am, int ts, String src, int line, TriComponentId c, TriPortId port1, TriPortId port2,
   TciParameterListType tciPars, TciStatus encoderFailure, TriParameterList triPars)
void tliPUnmap
  (String am, int ts, String src, int line, TriComponentId c, TriPortId port1,
   TriPortId port2)
void tliPUnmapParam
  (String am, int ts, String src, int line, TriComponentId c, TriPortId port1,
   TriPortId port2, TciParameterListType tciPars, TciStatus encoderFailure, TriParameterList triPars)
void tliPClear
  (String am, int ts, String src, int line, TriComponentId c, TriPortId port)
void tliPStart
  (String am, int ts, String src, int line, TriComponentId c, TriPortId port)
void tliPStop
  (String am, int ts, String src, int line, TriComponentId c, TriPortId port)
void tliPHalt
  (String am, int ts, String src, int line, TriComponentId c, TriPortId port)

void tliEncode
  (String am, int ts, String src, int line, TriComponentId c, Value val, TciStatus encoderFailure,
   TriMessage msg, String codec)
void tliDecode
  (String am, int ts, String src, int line, TriComponentId c, TriMessage msg,
   TciStatus decoderFailure, Value val, String codec)

void tliTimeoutDetected
  (String am, int ts, String src, int line, TriComponentId c, TriTimerId timer)
void tliTimeoutMismatch
  (String am, int ts, String src, int line, TriComponentId c, TriTimerId timer,
   TciNonValueTemplate timerTpl)
void tliTimeout
  (String am, int ts, String src, int line, TriComponentId c, TriTimerId timer,
   TciNonValueTemplate timerTpl)
void tliTStart
  (String am, int ts, String src, int line, TriComponentId c, TriTimerId timer, TriTimerDuration dur)
void tliTStop
  (String am, int ts, String src, int line, TriComponentId c, TriTimerId timer, TriTimerDuration dur)
void tliTRead
  (String am, int ts, String src, int line, TriComponentId c, TriTimerId timer,
   TriTimerDuration elapsed)
void tliTRunning
  (String am, int ts, String src, int line, TriComponentId c, TriTimerId timer, TimerStatus status)

void tliSEnter
  (String am, int ts, String src, int line, TriComponentId c, QualifiedName name,
   TciParameterListType tciPars, String kind)
void tliSLeave
  (String am, int ts, String src, int line, TriComponentId c, QualifiedName name,
   TciParameterListType tciPars, Value returnValue, String kind)

```

```

void tliVar
  (String am, int ts, String src, int line, TriComponentId c, QualifiedName name, Value varValue)
void tliModulePar
  (String am, int ts, String src, int line, TriComponentId c, QualifiedName name, Value parValue)

void tliGetVerdict(String am, int ts, String src, int line, TriComponentId c, VerdictValue verdict)
void tliSetVerdict
  (String am, int ts, String src, int line, TriComponentId c, VerdictValue verdict, String reason)

void tliLog(String am, int ts, String src, int line, TriComponentId c, String log)

void tliAEnter(String am, int ts, String src, int line, TriComponentId c)
void tliALeave(String am, int ts, String src, int line, TriComponentId c)
void tliADefaults(String am, int ts, String src, int line, TriComponentId c)
void tliAActivate
  (String am, int ts, String src, int line, TriComponentId c, QualifiedName name,
   TciParameterListType tciPars, Value ref)
void tliAdeactivate(String am, int ts, String src, int line, TriComponentId c, Value ref)
void tliANomatch(String am, int ts, String src, int line, TriComponentId c)
void tliARepet(String am, int ts, String src, int line, TriComponentId c)
void tliAWait(String am, int ts, String src, int line, TriComponentId c)

void tliAction(String am, int ts, String src, int line, TriComponentId c, String action)

void tliMatch
  (String am, int ts, String src, int line, TriComponentId c, Value expr, TciValueTemplate tmpl)
void tliMatchMismatch
  (String am, int ts, String src, int line, TriComponentId c, Value expr, TciValueTemplate tmpl,
   TciValueDifferenceList diffs);

void tliInfo
  (String am, int ts, String src, int line, TriComponentId c, int level, String info)

void tliMChecked_m
  (String am, int ts, String src, int line, TriComponentId c, TriPortId at, Value msgValue,
   TciValueTemplate msgTmpl, Value addrValue, TciValueTemplate addressTmpl)
void tliMChecked_c
  (String am, int ts, String src, int line, TriComponentId c, TriPortId at, Value msgValue,
   TciValueTemplate msgTmpl, TriComponentId from, TciNonValueTemplate fromTmpl)
void tliPrGetCallChecked_m
  (String am, int ts, String src, int line, TriComponentId c, TriPortId at, TriSignatureId signature,
   TciParameterListType tciPars, TciValueTemplate parsTmpl,
   Value addrValue, TciValueTemplate addressTmpl)
void tliPrGetCallChecked_c
  (String am, int ts, String src, int line, TriComponentId c, TriPortId at, TriSignatureId signature,
   TciParameterListType tciPars, TciValueTemplate parsTmpl,
   TriComponentId from, TciNonValueTemplate fromTmpl)
void tliPrGetReplyChecked_m
  (String am, int ts, String src, int line, TriComponentId c, TriPortId at, TriSignatureId signature,
   TciParameterListType tciPars, TciValueTemplate parsTmpl,
   Value replValue, TciValueTemplate replyTmpl, Value addrValue, TciValueTemplate addressTmpl)
void tliPrGetReplyChecked_c
  (String am, int ts, String src, int line, TriComponentId c, TriPortId at, TriSignatureId signature,
   TciParameterListType tciPars, TciValueTemplate parsTmpl,
   Value replValue, TciValueTemplate replyTmpl, TriComponentId from, TciNonValueTemplate fromTmpl)
void tliPrCatchChecked_m
  (String am, int ts, String src, int line, TriComponentId c, TriPortId at, TriSignatureId signature,
   Value excValue, TciValueTemplate excTmpl, Value addrValue, TciValueTemplate addressTmpl)
void tliPrCatchChecked_c
  (String am, int ts, String src, int line, TriComponentId c, TriPortId at, TriSignatureId signature,
   Value excValue, TciValueTemplate excTmpl, TriComponentId from, TciNonValueTemplate fromTmpl)
void tliCheckedAny_m
  (String am, int ts, String src, int line, TriComponentId c, TriPortId at,
   Value addrValue, TciValueTemplate addressTmpl)
void tliCheckedAny_c
  (String am, int ts, String src, int line, TriComponentId c, TriPortId at,
   TriComponentId from, TciNonValueTemplate fromTmpl)
void tliCheckAnyMismatch_m
  (String am, int ts, String src, int line, TriComponentId c, TriPortId at,
   Value addrValue, TciValueTemplate addressTmpl)
void tliCheckAnyMismatch_c
  (String am, int ts, String src, int line, TriComponentId c, TriPortId at,
   TriComponentId from, TciNonValueTemplate fromTmpl)
void tliRnd
  (String am, int ts, String src, int line, TriComponentId c, TFloat val, TFloat seed)
void tliEvaluate
  (String am, int ts, String src, int line, TriComponentId c, QualifiedName name, Value evalResult)

```

9.5 Data

Table 7

TCI IDL ADT	ANSI C representation (Type definition)	Notes and comments
TciModuleIdType	QualifiedName	
TciModuleParameterType	typedef struct TciModuleParameterType { QualifiedName parName; Value defaultValue; } TciModuleParameterType;	
TciModuleParameterListType	typedef struct TciModuleParameterListType { long int length; TciModuleParameterType *modParList; } TciModuleParameterListType;	
TciParameterType	typedef struct TciParameterType { String parName; TciParameterPassingModeType parPassMode; Value parValue; } TciParameterType;	
TciParameterPassingModeType	typedef enum { TCI_IN_PAR = 0, TCI_INOUT_PAR = 1, TCI_OUT_PAR = 2 } TciParameterPassingModeType;	
TciParameterListType	typedef struct TciParameterListType { long int length; TciParameterType *parList; } TciParameterListType;	length 0 shall be interpreted as "empty list".
TciParameterTypeListType	typedef struct TciParameterTypeListType { long int length; TciParameterTypeType *parList; } TciParameterTypeListType;	length 0 shall be interpreted as "empty list".
TciParameterTypeType	typedef struct TciParameterTypeType { String parName; Type parameterType; TciParameterPassingModeType mode; } TciParameterTypeType;	
TciTestCaseIdListType	typedef struct TciTestCaseIdListType { long int length; QualifiedName *idList; } TciTestCaseIdListType;	length 0 shall be interpreted as "empty list".
TciTypeClassType	typedef enum { TCI_ADDRESS_TYPE = 0, TCI_ANYTYPE_TYPE = 1, TCI_BITSTRING_TYPE = 2, TCI_BOOLEAN_TYPE = 3, TCI_CHARSTRING_TYPE = 5, TCI_COMPONENT_TYPE = 6, TCI_ENUMERATED_TYPE = 7, TCI_FLOAT_TYPE = 8, TCI_HEXSTRING_TYPE = 9, TCI_INTEGER_TYPE = 10, TCI_OCTETSTRING_TYPE = 12, TCI_RECORD_TYPE = 13, TCI_RECORD_OF_TYPE = 14, TCI_ARRAY_TYPE = 15, TCI_SET_TYPE = 16, TCI_SET_OF_TYPE = 17, TCI_UNION_TYPE = 18, TCI_UNIVERSAL_CHARSTRING_TYPE = 20, TCI_VERDICT_TYPE = 21, TCI_DEFAULT_TYPE = 22, TCI_PORT_TYPE = 23, TCI_TIMER_TYPE = 24 } TciTypeClassType;	

TCI IDL ADT	ANSI C representation (Type definition)	Notes and comments
TciTestComponentKindType	<pre>typedef enum { TCI_CTRL_COMP, TCI_MTC_COMP, TCI_PTC_COMP, TCI_SYS_COMP, TCI_ALIVE_COMP } TciTestComponentKindType;</pre>	
TciBehaviourIdType	QualifiedName	
TciValueDifference	<pre>typedef struct TciValueDifference { Value val; TciValueTemplate tmpl; String desc; } TciValueDifference;</pre>	
TciValueDifferenceList	<pre>typedef struct TciValueDifferenceList { long int length; TciValueDifference* diffList; } TciValueDifferenceList;</pre>	length 0 shall be interpreted as "empty list".
TciMatchingTypeType	<pre>typedef enum { TCI_TEMPLATE_LIST = 0, TCI_COMPLEMENTED_LIST = 1, TCI_ANY_VALUE = 2, TCI_ANY_VALUE_OR_NONE = 3, TCI_VALUE_RANGE = 4, TCI_SUBSET = 5, TCI_SUPERSET = 6, TCI_ANY_ELEMENT = 7, TCI_ANY_ELEMENTS_OR_NONE = 8, TCI_PATTERN = 9, TCI_MATCH_DECODED_CONTENT = 10, TCI_OMIT_TEMPLATE = 11 } TciMatchingTypeType;</pre>	
LengthRestriction	<pre>typedef struct TciLengthRestriction { unsigned long int lowerBoundary; unsigned long int upperBoundary; Boolean isUpperBoundaryInfinity; } TciLengthRestriction;</pre>	
Permutation	<pre>typedef struct TciPermutation { unsigned long int startPosition; unsigned long int length; } TciPermutation;</pre>	
RangeBoundary	<pre>typedef struct TciRangeBoundary { Value boundary; Boolean isInclusive; Boolean isInfinity; } TciRangeBoundary;</pre>	

9.6 Miscellaneous

Table 8

TCI concept	ANSI C representation	Notes and comments
Verdict representation		
NONE	const int TCI_VERDICT_NONE = 0	Since the VerdictValue interface is defined in terms of integers, consensus shall be established on which value defines which verdict.
PASS	const int TCI_VERDICT_PASS = 1	
INCONC	const int TCI_VERDICT_INCONC = 2	
FAIL	const int TCI_VERDICT_FAIL = 3	
ERROR	const int TCI_VERDICT_ERROR = 4	
USER_ERROR	const int TCI_VERDICT_USER_ERROR = 5	

TCI concept	ANSI C representation	Notes and comments
ComponentStatus		
INACTIVE_C	const int TCI_INACTIVE_C = 0	
RUNNING_C	const int TCI_RUNNING_C = 1	
STOPPED_C	const int TCI_STOPPED_C = 2	
KILLED_C	const int TCI_KILLED_C = 3	
NULL_C	const int TCI_NULL_C = 4	
TimerStatus		
RUNNING_T	const int TCI_RUNNING_T = 0	
INACTIVE_T	const int TCI_INACTIVE_T = 1	
EXPIRED_T	const int TCI_EXPIRED_T = 2	
NULL_T	const int TCI_NULL_T = 3	
TciStatus		
TCI_OK	const int TCI_OK = 0	
TCI_ERROR	const int TCI_ERROR = -1	
CharstringValue representation		
TciCharString	typedef struct TciCharStringValue { unsigned long int length; char* string; } TciCharStringValue	
Universal Character[string] representation		
Universal Char	typedef unsigned char TciUCValue[4]	
Universal Charstring	typedef struct TciUCStringValue { unsigned long int length; TciUCValue *string; } TciUCStringValue;	

9.7 Optional parameters

Clause 7.2.2 defines that a reserved value shall be used to indicate the absence of an optional parameter. For the C language mapping an explicit null shall be used. The function `tciSetNull` can be used to set a value to null and `tciIsNull` can be used to check whether a value represents null. `tciIsNull` returns true if the value is null, false otherwise.

For example, if in the `tciReplyConnected` operation the value parameter shall be omitted, then a value `reply` shall be created and set to null; the operation invocation shall be:

```
tciSetNull(reply);
tciReplyConnected (sender, receiver, signature, parameterList, reply).
```

10 C++ language mapping

10.1 Introduction

This clause introduces the TCI C++ language [9] mapping for the definitions given in clause 7.

10.2 Names and scopes

The namespace `ORG_ETSI_TTCN3_TCI` has been defined for the TCI C++ mapping, in order to avoid conflicts with the different names used, for example, in the C mapping.

C++ class identifiers are omitting the trailing "Type" at the end of the abstract definitions, e.g. the type `TciModuleIdType` is mapped to `TciModuleId` in C++.

10.3 Memory management

A general policy for memory management is not defined in this mapping. However, parameters are passed as pointers (or references) where possible, and a clone method has been added to the definition of every interface. The clone method can be used by the receiving entity to make a local copy where needed.

10.4 Error handling

No additional error handling has been defined for this mapping.

10.5 Type mapping

10.5.0 Basic concepts

This clause introduces the TRI C++ language mapping for the abstract types defined in clause 7.2. The following concepts have been used:

- Pure virtual classes have been used following the concept of an interface.
- C++ types have been encapsulated under abstract definitions like Tfloat or Tinteger.

10.5.1 Encapsulated C++ types

The following types have been defined in order to keep the definitions of data types and operations as general as possible:

Boolean type definition:	<code>typedef bool Tboolean</code>
Integer type definition:	<code>typedef long int Tinteger</code>
Size type definition:	<code>typedef unsigned long int Tsize</code>
Index type definition:	<code>typedef unsigned long int Tindex</code>
Float type definition:	<code>typedef double Tfloat</code>
String type definition:	<code>typedef std::string Tstring</code>
Universal string type definition:	<code>typedef std::wstring TuniversalString</code>
Bit type definition:	<code>typedef unsigned char Tbit</code>
Char type definition:	<code>typedef unsigned char Tchar</code>

10.5.2 General abstract data types

10.5.2.1 TciBehaviourId

Identifies a TTCN-3 behaviour functions. It is mapped to the following pure virtual class:

```
class TciBehaviourId: public ORG_ETSI_TTCN3_TRI::QualifiedName {
public:
    virtual ~TciBehaviourId ();
    virtual Tboolean operator== (const TciBehaviourId &bid) const =0;
    virtual TciBehaviourId * clone () const =0;
    virtual Tboolean operator< (const TciBehaviourId &bid) const =0;
}
```

Methods:

<code>~TciBehaviourId</code>	Destructor
<code>operator==</code>	Returns true if both objects are equal
<code>clone</code>	Return a copy of the TciBehaviourId
<code>operator<</code>	Operator < overload

10.5.2.2 TciModuleId

A value of TciModuleId specifies the name of a TTCN-3 module. It is mapped to the following pure virtual class:

```
class TciModuleId {
public:
    virtual ~TciModuleId ()
    virtual const Tstring & getObject_name() const = 0;
    virtual void setObject_name (const Tstring &p_name)=0;
    virtual Tboolean operator== (const TciModuleId &mid) const =0;
    virtual TciModuleId * clone () const =0;
    virtual Tboolean operator< (const TciModuleId &mid) const =0;
}
```

Methods:

~TciModuleId	Destructor
getObject_name	Get the moduleId name
setObject_name	Set the moduleId name
operator==	Returns true if both objects are equal
clone	Return a copy of the TciModuleId
operator<	Operator < overload

10.5.2.3 TciModuleParameterId

A value of TciModuleParameterId specifies the name of a TTCN-3 module parameter as defined in the TTCN-3 module. It is mapped to the following pure virtual class:

```
class TciModuleParameterId : public ORG_ETSI_TTCN3_TRI::QualifiedName {
public:
    virtual ~TciModuleParameterId ();
    virtual Tboolean operator== (const TciModuleParameterId &mparId) const =0;
    virtual TciModuleParameterId * clone () const =0;
    virtual Tboolean operator< (const TciModuleParameterId &mparId) const =0;
}
```

Methods:

~TciModuleParameterId	Destructor
operator==	Returns true if both objects are equal
clone	Return a copy of the TciModuleParameterId
operator<	Operator < overload

10.5.2.4 TciTestCaseId

A value of TciModuleParameterId specifies the name of a TTCN-3 testcase as defined in the TTCN-3 module. It is mapped to the following pure virtual class:

```
class TciTestCaseId : public TciBehaviourId {
public:
    virtual ~TciTestCaseId();
    virtual Tboolean operator== (const TciTestCaseId &tcid) const =0;
    virtual TciTestCaseId * clone () const =0;
    virtual Tboolean operator< (const TciTestCaseId &tcid) const =0;
}
```

Methods:

~TciTestCaseId	Destructor
operator==	Returns true if both objects are equal
clone	Return a copy of the TciTestCaseId
operator<	Operator < overload

10.5.2.5 TciModuleIdList

A value of TciModuleIdList defines a list of TciModuleId elements. It is mapped to the following pure virtual class:

```
class TciModuleIdList {
public:
    virtual ~TciModuleIdList();
    virtual Tsize size () const =0;
    virtual Tboolean empty () const =0;
    virtual const TciModuleId *get (Tsize p_index) const =0;
    virtual void clear ()=0;
    virtual void push_back (const TciModuleId &comp)=0;
    virtual Tboolean operator== (const TciModuleIdList &midList) const =0;
    virtual TciModuleIdList * clone () const =0;
    virtual Tboolean operator< (const TciModuleIdList &midList) const =0;
}

```

Methods:

~TciModuleIdList	Destructor
size	Return the size of the list
empty	Return true if the list is empty
get	Return the requested element
clear	Remove all the components from this list
push_back	Add a component to the end of this list
operator==	Returns true if both objects are equal
clone	Return a copy of the TciModuleId
operator<	Operator < overload

10.5.2.6 TciModuleParameter

This abstract type is used to represent the parameter name and the default value of a module parameter. It is mapped to the following pure virtual class:

```
class TciModuleParameter {
public:
    virtual ~TciModuleParameter ();
    virtual const TciValue &getDefaultValue () const =0;
    virtual const Tstring &getModuleParameterName () const =0;
    virtual const TciModuleParameterId &getTciModuleParameterId () const =0;
    virtual Tboolean operator== (const TciModuleParameter &mpar) const =0;
    virtual TciModuleParameter * clone () const =0;
    virtual Tboolean operator< (const TciModuleParameter &mpar) const =0;
}

```

Methods:

```

~TciModuleParameter
    Destructor
getDefaultValue
    Return default value of the parameter
getModuleParameterName
    Return parameter name
getTciModuleParameterId
    Get the name of the module parameter as defined in the TTCN-3 module
operator==
    Returns true if both objects are equal
clone
    Return a copy of the TciModuleParameter
operator<
    Operator < overload

```

10.5.2.7 TciModuleParameterList

A value of TciModuleParameterList is a list of TciModuleParameter elements. It is mapped to the following pure virtual class:

```

class TciModuleParameterList {
public:
    virtual ~TciModuleParameterList ();
    virtual Tsize size () const =0;
    virtual Tboolean empty () const =0;
    virtual const TciModuleParameter *get (Tindex p_index) const =0;
    virtual void clear ()=0;
    virtual void push_back (const TciModuleParameter &comp)=0;
    virtual Tboolean operator== (const TciModuleParameterList &mparList) const =0;
    virtual TciModuleParameterList * clone () const =0;
    virtual Tboolean operator< (const TciModuleParameterList &mparList) const =0;
}

```

Methods:

```

~TciModuleParameterList
    Destructor
size
    Return the size of the list
empty
    Return true if the list is empty
get
    Retrieve the specified element
clear
    Remove all components from this list
push_back
    Add a component to the end of this list
operator==
    Returns true if both objects are equal
clone
    Return a copy of the TciModuleParameterList
operator<
    Operator < overload

```

10.5.2.8 TciParameterPassingMode

Defines the parameter passing mode. It is mapped to an enumeration:

```

typedef enum
{
    IN = 0,
    OUT = 1,
    INOUT = 2
} TciParameterPassingMode;

```

10.5.2.9 TciParameter

Includes a TTCN-3 Value and a TciParameterPassingMode. It is mapped to the following pure virtual class:

```
class TciParameter {
public:
    virtual ~TciParameter ();
    virtual TciValue & getValue ()=0;
    virtual void setValue (TciValue &value)=0;
    virtual const TciParameterPassingMode &getParameterPassingMode () const =0;
    virtual void setParameterPassingMode (const TciParameterPassingMode &mode)=0;
    virtual const Tstring & getParameterName () const =0;
    virtual void setParameterName (const Tstring &name)=0;
    virtual Tboolean operator== (const TciParameter &param) const =0;
    virtual TciParameter * clone () const =0;
    virtual Tboolean operator< (const TciParameter &param) const =0;
}
```

Methods:

```
~TciParameter
    Destructor
getValue
    Retrieve the TTCN-3 value
setValue
    Set the TTCN-3 value
getParameterPassingMode
    Return the parameter passing mode
setParameterPassingMode
    Set the parameter passing mode
getParameterName
    Return the name of the parameter
setParameterName
    Set the name of the parameter
operator==
    Returns true if both objects are equal
clone
    Return a copy of the TciParameter
operator<
    Operator < overload
```

10.5.2.10 TciParameterList

Defines a list of TciParameter elements. It is mapped to the following pure virtual class:

```
class TciParameterList {
public:
    virtual ~TciParameterList ();
    virtual Tsize size () const =0;
    virtual Tboolean empty () const =0;
    virtual TciParameter *get (Tindex p_index) =0;
    virtual void clear ()=0;
    virtual void push_back (const TciParameter &comp)=0;
    virtual Tboolean operator== (const TciParameterList &param) const =0;
    virtual TciParameterList * clone () const =0;
    virtual Tboolean operator< (const TciParameterList &param) const =0;
}
```

Methods:

```
~TciParameterList
    Destructor
size
    Return the size of the list
empty
    Return true if the list is empty
get
    Get the specified element
clear
    Remove all the components from this list
push_back
```

Add a component to the end of this list
operator==
Returns true if both objects are equal
clone
Return a copy of the TciParameterList
operator<
Operator < overload

10.5.2.11 TciParameterType

Includes a TTCN-3 type, parameter name and a TciParameterPassingMode. It is mapped to the following pure virtual class:

```
class TciParameterType {
public:
    virtual ~TciParameterType ();
    virtual const Tstring & getParameterName () const =0;
    virtual const TciType & getType () const =0;
    virtual const TciParameterPassingMode & getParameterPassingMode () const =0;
    virtual Tboolean operator== (const TciParameterType &parType) const =0;
    virtual TciParameterType * clone () const =0;
    virtual Tboolean operator< (const TciParameterType &parType) const =0;
}
```

Methods:

~TciParameterType
Destructor
getType
Return the TTCN-3 Type
getParameterName
Return the name of the parameter
getParameterPassingMode
Get the parameter passing mode
operator==
Returns true if both objects are equal
clone
Return a copy of the TciParameterType
operator<
Operator < overload

10.5.2.12 TciParameterTypeList

Specifies a list of TciParameterType elements. It is mapped to the following pure virtual class:

```
class TciParameterTypeList {
public:
    virtual ~TciParameterTypeList ();
    virtual Tsize size () const =0;
    virtual Tboolean empty () const =0;
    virtual const TciParameterType *get (Tindex p_position) const =0;
    virtual void clear ()=0;
    virtual void push_back (const TciParameterType &comp)=0;
    virtual Tboolean operator== (const TciParameterTypeList &ptypeList) const =0;
    virtual TciParameterTypeList * clone () const =0;
    virtual Tboolean operator< (const TciParameterTypeList &ptypeList) const =0;
}
```

Methods:

~TciParameterTypeList
Destructor
size
Return the size of the list
empty
Returns true if the list is empty
get
Return the requested element
clear
Remove all the components from this list

```

push_back
    Add a component to the end of this list
operator==
    Returns true if both objects are equal
clone ()
    Returns a copy of the TciParameterTypeList
operator< (const TciParameterTypeList &ptypeList)
    Operator < overload

```

10.5.2.13 TciTestComponentKind

Defines the test component kind. It is mapped to an enumeration:

```

typedef enum
{
    SYSTEM_COMP = 0,
    PTC_COMP = 1,
    PTC_ALIVE_COMP = 2,
    MTC_COMP = 3,
    CTRL_COMP = 4
} TciTestComponentKind;

```

10.5.2.14 TciTypeClass

Defines the type class. It is mapped to an enumeration:

```

typedef enum
{
    TCI_ADDRESS = 0,
    TCI_ANYTYPE = 1,
    TCI_BITSTRING = 2,
    TCI_BOOLEAN = 3,
    TCI_CHARSTRING = 5,
    TCI_COMPONENT = 6,
    TCI_ENUMERATED = 7,
    TCI_FLOAT = 8,
    TCI_HEXSTRING = 9,
    TCI_INTEGER = 10,
    TCI_OCTETSTRING = 12,
    TCI_RECORD = 13,
    TCI_RECORD_OF = 14,
    TCI_ARRAY = 15,
    TCI_SET = 16,
    TCI_SET_OF = 17,
    TCI_UNION = 18,
    TCI_UNIVERSAL_CHARSTRING = 20,
    TCI_VERDICT = 21,
    TCI_DEFAULT = 22,
    TCI_PORT = 23,
    TCI_TIMER = 24
} TciTypeClass;

```

10.5.2.15 TciTestCaseIdList

Specifies a list of TciTestCaseId elements. It is mapped to the following pure virtual class:

```

class TciTestCaseIdList {
public:
    virtual ~TciTestCaseIdList ();
    virtual Tsize size () const =0;
    virtual Tboolean empty () const =0;
    virtual const TciTestCaseId *get (Tindex p_position) const =0;
    virtual void clear ()=0;
    virtual void push_back (const TciTestCaseId &comp)=0;
    virtual Tboolean operator== (const TciTestCaseIdList &ptypeList) const =0;
    virtual TciTestCaseIdList * clone () const =0;
    virtual Tboolean operator< (const TciTestCaseIdList &ptypeList) const =0;
}

```

Methods:

```

~TciTestCaseIdList
    Destructor
size
    Return the size of the list
empty
    Returns true if the list is empty
get
    Return the requested element
clear
    Remove all the components from this list
push_back
    Add a component to the end of this list
operator==
    Returns true if both objects are equal
clone ()
    Returns a copy of the TciTestCaseIdList
operator< (const TciTestCaseIdList &ptypeList)
    Operator < overload

```

10.5.2.16 TciMatchingType

Defines the matching template type. It is mapped to an enumeration:

```

typedef enum
{
    TCI_TEMPLATE_LIST = 0,
    TCI_COMPLEMENTED_LIST = 1,
    TCI_ANY_VALUE = 2,
    TCI_ANY_VALUE_OR_NONE = 3,
    TCI_VALUE_RANGE = 4,
    TCI_SUBSET = 5,
    TCI_SUPERSET = 6,
    TCI_ANY_ELEMENT = 7,
    TCI_ANY_ELEMENTS_OR_NONE = 8,
    TCI_PATTERN = 9,
    TCI_MATCH_DECODED_CONTENT = 10,
    TCI_OMIT_TEMPLATE = 11
} TciMatchingType;

```

10.5.2.17 LengthRestriction

Specifies a length restriction. It is mapped to the following pure virtual class:

```

class LengthRestriction {
public:
    virtual ~LengthRestriction ();
    virtual Tinteger getLowerBoundary () const =0;
    virtual Tinteger getUpperBoundary () const =0;
    virtual void setLowerBoundary (Tinteger p_boundary) =0;
    virtual void setUpperBoundary (Tinteger p_boundary) =0;
    virtual Tboolean isUpperBoundaryInfinity () const =0;
    virtual void setInfiniteUpperBoundary () =0;
    virtual Tboolean operator== (const LengthRestriction &p_lenRestriction) const =0;
    virtual LengthRestriction * clone () const =0;
    virtual Tboolean operator< (const LengthRestriction &p_lenRestriction) const =0;
}

```

Methods:

```

~LengthRestriction
    Destructor
getLowerBoundary
    Returns the lower boundary of the length restriction
getUpperBoundary
    Returns the upper boundary of the length restriction
setLowerBoundary
    Sets the lower boundary value
setUpperBoundary
    Sets the upper boundary value

```

isUpperBoundaryInfinity
 Returns true if the upper boundary contains infinity and false otherwise

setInfiniteUpperBoundary
 Sets the upper boundary to infinity

operator==
 Returns true if both objects are equal

clone ()
 Returns a copy of the LengthRestriction

operator<
 Operator < overload

10.5.2.18 Permutation

Specifies a permutation. It is mapped to the following pure virtual class:

```
class Permutation {
public:
    virtual ~Permutation ();
    virtual Tindex getStartPosition () const =0;
    virtual void setStartPosition (Tindex p_position) =0;
    virtual Tsize getLength () const =0;
    virtual void setLength (Tsize p_length) =0;
    virtual Tboolean operator== (const Permutation &p_permutation) const =0;
    virtual Permutation * clone () const =0;
    virtual Tboolean operator< (const Permutation &p_permutation) const =0;
}
```

Methods:

~Permutation
 Destructor

getStartPosition
 Returns the position of the first item of the permutation in the RecordOfValue

setStartPosition
 Sets the position of the first item of the permutation in the RecordOfValue

getLength
 Returns the number of elements or matching mechanisms of the RecordOfValue that are included in the permutation

setLength
 Sets the number of elements or matching mechanisms of the RecordOfValue that are included in the permutation

operator==
 Returns true if both objects are equal

clone ()
 Returns a copy of the Permutation

operator<
 Operator < overload

10.5.2.19 RangeBoundary

Specifies a lower or upper boundary of a ValueRange. It is mapped to the following pure virtual class:

```
class RangeBoundary {
public:
    virtual ~RangeBoundary ();
    virtual TciValue& getBoundary () const =0;
    virtual Tboolean isInclusive () const =0;
    virtual void setBoundary (TciValue &p_value, Tboolean p_isInclusive) =0;
    virtual Tboolean isInfinity () const =0;
    virtual void setToInfinity () =0;
    virtual Tboolean operator== (const RangeBoundary &p_boundary) const =0;
    virtual RangeBoundary * clone () const =0;
    virtual Tboolean operator< (const RangeBoundary &p_boundary) const =0;
}
```

Methods:

~RangeBoundary
 Destructor

getBoundary
 Returns the boundary value

isInclusive
 Returns true if the boundary value is a part of the allowed range and false otherwise
setBoundary
 Sets the boundary value
isInfinity
 Returns true if the boundary is equal to infinity or -infinity and false otherwise
setToInfinity
 Sets the boundary to infinity
operator==
 Returns true if both objects are equal
clone ()
 Returns a copy of the LengthRestriction
operator<
 Operator < overload

10.5.3 Abstract TTCN-3 data types and values

10.5.3.1 TciType

A value of TciType represents one of the TTCN-3 types in a TTCN-3 module. It is mapped to the following pure virtual class:

```

class TciType {
public:
    virtual ~TciType ();
    virtual const TciModuleId & getDefiningModule () const =0;
    virtual const Tstring & getName () const =0;
    virtual const TciTypeClass & getTypeClass () const =0;
    virtual const Tstring & getTypeEncoding () const =0;
    virtual const Tstring & getTypeEncodingVariant () const =0;
    virtual const std::vector<Tstring*> & getEncodeAttributes () const =0;
    virtual const std::vector<Tstring*> & getVariantAttributes (const Tstring * encoding) const =0;
    virtual const std::vector<Tstring*> & getTypeExtension() const =0;
    virtual TciValue * newInstance () const =0;
    virtual MatchingMechanism * newTemplate (TciMatchingType matchingType) const =0;
    virtual TciValue * parseValue (const Tstring & val) const =0;
    virtual const RangeBoundary * getLowerTypeBoundary() const = 0;
    virtual const RangeBoundary * getUpperTypeBoundary() const = 0;
    virtual const LengthRestriction * getTypeLengthRestriction() const = 0;
    virtual const MatchingMechanism * getTypeMatchingMechanism() const = 0;
    virtual Tboolean operator== (const TciType &typ) const =0;
    virtual TciType * clone () const =0;
    virtual Tboolean operator< (const TciType &typ) const =0;
}
  
```

Methods:

~TciType
 Destructor
getDefiningModule
 Returns the defining module as defined in the TTCN-3 module
getName
 Returns type name as defined in the TTCN-3 module
getTypeClass
 Returns this type class
getTypeEncoding
 Returns type encoding as defined in the TTCN-3 module
getTypeEncodingVariant
 Returns encoding variant as defined in the TTCN-3 module
getEncodeAttributes
 Returns all encode attributes of the type as defined in the TTCN-3 module. The distinct value null is mapped to an empty vector.
getVariantAttributes
 Returns all variant attributes of the type as defined in the TTCN-3 module. The distinct value null is mapped to an empty vector.
getTypeExtension
 Returns type extension as defined in the TTCN-3 module
newInstance
 Returns a new Value instance of this type

`newTemplate`
Returns a freshly created matching mechanism of this type. The `matchingType` parameter determines what kind of matching mechanism will be created. If the created matching mechanism contains additional data properties, these properties are uninitialized in the created matching mechanism.

`parseValue`
Returns a new `TciValue` instance in case of successful parsing or null pointer in case of parsing error or if value parsing is not supported by the tool

`getLowerTypeBoundary`
Returns the lower boundary of the type restriction or `null`.

`getUpperTypeBoundary`
Returns the upper boundary of the type restriction or `null`.

`getTypeLengthRestriction`
Returns the type length restriction or `null`.

`getTypeMatchingMechanism`
Returns the matching mechanism restriction of the type or `null`.

`operator==`
Returns true if the types are equal

`clone`
Returns a copy of the `TciType`

`operator<`
Operator < overload

10.5.3.2 TciValue

A value of `TciValue` represents TTCN-3 values for a given type. It is mapped to the following pure virtual class:

```
class TciValue {
public:
    virtual ~TciValue ();
    virtual const TciType & getType () const =0;
    virtual const Tstring & getValueEncoding () const =0;
    virtual const Tstring & getValueEncodingVariant () const =0;
    virtual const std::vector<Tstring*> & getEncodeAttributes () const =0;
    virtual const std::vector<Tstring*> & getVariantAttributes (const Tstring * encoding) const =0;
    virtual Tboolean notPresent () const =0;
    virtual Tboolean isMatchingSymbol () const =0;
    virtual const Tstring & valueToString () const =0;
    virtual Tboolean isLazy () const =0;
    virtual Tboolean isFuzzy () const =0;
    virtual Tboolean isEvaluated () const =0;
    virtual LengthRestriction * getLengthRestriction () const = 0;
    virtual LengthRestriction * newLengthRestriction () const = 0;
    virtual void setLengthRestriction (const LengthRestriction * p_restriction) =0;
    virtual Tboolean isIfPresentEnabled () const =0;
    virtual void setIfPresentEnabled (Tboolean p_enabled) =0;
    virtual Tboolean isOptional () const =0;
    virtual RangeBoundary * getLowerTypeBoundary() const = 0;
    virtual RangeBoundary * getUpperTypeBoundary() const = 0;
    virtual LengthRestriction * getTypeLengthRestriction() const = 0;
    virtual MatchingMechanism * getTypeMatchingMechanism() const = 0;
    virtual Tboolean operator== (const TciValue &p_val) const =0;
    virtual TciValue * clone () const =0;
    virtual Tboolean operator< (const TciValue &p_val) const =0;
}

```

Methods:

`~TciValue`
Destructor

`getType`
Returns the type of the specified value

`getValueEncoding`
Returns the value encoding attribute as defined in the TTCN-3 module

`getValueEncodingVariant`
Returns the value encoding variant attribute as defined in the TTCN-3 module

`getEncodeAttributes`
Returns all encode attributes of the value as defined in the TTCN-3 module. The distinct value `null` is mapped to an empty vector.

`getVariantAttributes`
Returns all variant attributes of the value as defined in the TTCN-3 module. The distinct value `null` is mapped to an empty vector.

`notPresent`
 Returns true if the specified value is omit

`isMatchingSymbol`
 Returns true if the specified value is a matching symbol (see clause 7.2.2.2.1 for more details), false otherwise

`valueToString`
 Returns the same string as produced by the log operation

`isLazy`
 Returns true if the specified value is @lazy, false otherwise

`isFuzzy`
 Returns true if the specified value is @fuzzy, false otherwise

`isEvaluated`
 Returns true if the specified value contains an evaluation result, false otherwise (see clause 7.2.2.2.1 for more details)

`getLengthRestriction`
 Returns a length restriction matching attribute or null if no restriction is present

`newLengthRestriction`
 Creates a new instance of the `LengthRestriction` class

`setLengthRestriction`
 Adds a length restriction matching to the value or modifies an existing one. Null pointer can be used to remove an existing length restriction

`isIfPresentEnabled`
 Returns true if the `ifpresent` matching attribute is attached to the value and false otherwise

`setIfPresentEnabled`
 Sets the whether the `ifpresent` matching attribute is attached to the value or not

`isOptional`
 Returns whether the value is an optional field or a template without the present or value restriction.

`getLowerTypeBoundary`
 Returns the lower boundary of the value's type restriction or null.

`getUpperTypeBoundary`
 Returns the upper boundary of the value's type restriction or null.

`getTypeLengthRestriction`
 Returns the value's type length restriction or null.

`getTypeMatchingMechanism`
 Returns the matching mechanism type restriction of the value's type or null.

`operator==`
 Returns true if both objects are equal

`clone`
 Return a copy of the `TciValue`

`operator<`
 Operator < overload

10.5.3.3 IntegerValue

TTCN-3 integer value support. It is mapped to the following pure virtual class:

```

class IntegerValue : public virtual TciValue {
public:
    virtual ~IntegerValue ();
    virtual Tinteger getInt () const =0;
    virtual void setInt (Tinteger p_value)=0;
    virtual Tboolean operator== (const IntegerValue &p_intVal) const =0;
    virtual IntegerValue * clone () const =0;
    virtual Tboolean operator< (const IntegerValue & p_intVal) const =0;
}
  
```

Methods:

`~IntegerValue`
 Destructor

`getInt`
 Return integer value

`setInt`
 Set integer value

`operator==`
 Returns true if both objects are equal

`clone`
 Return a copy of the `IntegerValue`

```
operator<
    Operator < overload
```

10.5.3.4 FloatValue

TTCN-3 float value support. It is mapped to the following pure virtual class:

```
class FloatValue : public virtual TciValue {
public:
    virtual ~FloatValue ();
    virtual Tfloat getFloat () const =0;
    virtual void setFloat (Tfloat p_floatValue)=0;
    virtual Tboolean operator== (const FloatValue & p_floatVal) const =0;
    virtual FloatValue * clone () const =0;
    virtual Tboolean operator< (const FloatValue & p_floatVal) const =0;
}
```

Methods:

```
~FloatValue
    Destructor
getFloat
    Return the float value
setFloat
    Set float value
operator==
    Returns true if both objects are equal
clone
    Return a copy of the FloatValue
operator<
    Operator < overload
```

10.5.3.5 BooleanValue

TTCN-3 boolean values support. It is mapped to the following pure virtual class:

```
class BooleanValue : public virtual TciValue {
public:
    virtual ~BooleanValue ();
    virtual Tboolean getBoolean () const =0;
    virtual void setBoolean (Tboolean p_booleanValue)=0;
    virtual Tboolean operator== (const BooleanValue & p_booleanVal) const =0;
    virtual BooleanValue * clone () const =0;
    virtual Tboolean operator< (const BooleanValue & p_booleanVal) const =0;
}
```

Methods:

```
~BooleanValue
    Destructor
getBoolean
    Return the boolean value
setBoolean
    Set the variable to booleanValue
operator==
    Returns true if both objects are equal
clone
    Return a copy of the BooleanValue
operator<
    Operator < overload
```

10.5.3.6 CharstringValue

TTCN-3 charstring value support. It is mapped to the following pure virtual class:

```
class CharstringValue : public virtual TciValue {
public:
    virtual ~CharstringValue ();
    virtual char getChar (Tindex p_position) const =0;
    virtual Tsize getLength () const =0;
    virtual const Tstring & getString () const =0;
    virtual void setChar (Tsize p_position, char p_char)=0;
    virtual void setLength (Tsize p_length)=0;
    virtual void setString (const Tstring &p_charValue)=0;
    virtual Tboolean operator== (const CharstringValue & p_charStr) const =0;
    virtual CharstringValue * clone () const =0;
    virtual Tboolean operator< (const CharstringValue & p_charStr) const =0;
}
```

Methods:

```
~CharstringValue
    Destructor
getChar
    Return the char at the specified position
getLength
    Return length of the string
getString
    Return the value of the string
setChar
    Set the char at the specified position
setLength
    Set length of the string
setString
    Set the value of the string
operator==
    Returns true if both objects are equal
clone
    Return a copy of the CharstringValue
operator<
    Operator < overload
```

10.5.3.7 UniversalCharstringValue

TTCN-3 universal charstring value support. It is mapped to the following pure virtual class:

```
class UniversalCharstringValue : public virtual TciValue {
public:
    virtual ~UniversalCharstringValue ();
    virtual wchar_t getChar (Tindex p_position) const =0;
    virtual Tsize getLength () const =0;
    virtual const TuniversalString & getString () const =0;
    virtual void setChar (Tindex p_position, const wchar_t p_ucValue)=0;
    virtual void setLength (Tsize p_length)=0;
    virtual void setString (const TuniversalString &p_ucsValue)=0;
    virtual Tboolean operator== (const UniversalCharstringValue & p_uniCharstr) const =0;
    virtual UniversalCharstringValue * clone () const =0;
    virtual Tboolean operator< (const UniversalCharstringValue & p_uniCharstr) const =0;
}
```

Methods:

```
~UniversalCharstringValue
    Destructor
getChar
    Return the requested element
getLength
    Return the length of the universal charstring
getString
    Return the textual representation of the string
setChar
    Set the char at the specified position
```

setLength
 Set the length of the string
 setString
 Set the value of the string
 operator==
 Returns true if both objects are equal
 clone
 Return a copy of the UniversalCharstringValue
 operator<
 Operator < overload

10.5.3.8 BitstringValue

TTCN-3 bitstring value support. It is mapped to the following pure virtual class:

```

class BitstringValue : public virtual TciValue {
public:
    virtual ~BitstringValue ();
    virtual Tbit getBit (Tindex p_position) const =0;
    virtual Tsize getLength () const =0;
    virtual const Tstring & getString () const =0;
    virtual void setBit (Tindex p_position, Tbit p_bsValue)=0;
    virtual void setLength (Tindex p_new_length)=0;
    virtual void setString (const Tstring &p_bsValue)=0;
    virtual Tboolean isMatchingAt (Tindex p_position) const =0;
    virtual MatchingMechanism & getMatchingAt (Tindex p_position) const =0;
    virtual void setMatchingAt (Tindex p_position, MatchingMechanism &p_template) = 0;
    virtual Tboolean operator== (const BitstringValue &p_bitStr) const =0;
    virtual BitstringValue * clone () const =0;
    virtual Tboolean operator< (const BitstringValue &p_bitStr) const =0;
}
  
```

Methods:

~BitstringValue
 Destructor
 getBit
 Returns the bit at the specified position
 getLength
 Returns the length of the string
 getString
 Set the value of the string
 setBit
 Set the bit value at the specified position
 setLength
 Set the length of the string
 setString
 Set the string value
 isMatchingAt
 Returns true if the item at the specified position is a matching mechanism inside a value
 getMatchingAt
 Returns a matching mechanism at the specified position
 setMatchingAt
 Sets the matching mechanism at the specified position
 operator==
 Returns true if both objects are equal
 clone
 Return a copy of the BitstringValue
 operator<
 Operator < overload

10.5.3.9 OctetstringValue

TTCN-3 octetstring value support. It is mapped to the following pure virtual class:

```

class OctetstringValue : public virtual TciValue {
public:
    virtual ~OctetstringValue ();
    virtual Tsize getLength () const =0;
    virtual const Tchar getOctet (Tindex p_position) const =0;
}
  
```



```

virtual const Tstring & getString () const =0;
virtual void setLength (Tsize p_length)=0;
virtual void setOctet (Tindex p_position, Tchar p_ochar)=0;
virtual void setString (const Tstring &p_osValue)=0;
virtual Tboolean isMatchingAt (Tindex p_position) const =0;
virtual MatchingMechanism & getMatchingAt (Tindex p_position) const =0;
virtual void setMatchingAt (Tindex p_position, MatchingMechanism &p_template) = 0;
virtual Tboolean operator== (const OctetstringValue & p_octStr) const =0;
virtual OctetstringValue * clone () const =0;
virtual Tboolean operator< (const OctetstringValue & p_octStr) const =0;
}

```

Methods:

```

~OctetstringValue
    Destructor
getLength
    Return the length of the string
getOctet
    Return the textual representation of the octetchar at the specified position
getString
    Set the string value
setLength
    Set the length of the string
setOctet
    Set the char at specified position
setString
    Set the value of the string
isMatchingAt
    Returns true if the item at the specified position is a matching mechanism inside a value
getMatchingAt
    Returns a matching mechanism at the specified position
setMatchingAt
    Sets the matching mechanism at the specified position
operator==
    Returns true if both objects are equal
clone
    Return a copy of the OctetstringValue
operator<
    Operator < overload

```

10.5.3.10 HexstringValue

TTCN-3 hexstring value support. It is mapped to the following pure virtual class:

```

class HexstringValue : public virtual TciValue {
public:
    virtual ~HexstringValue ();
    virtual Tchar getHex (Tindex p_position) const =0;
    virtual Tsize getLength () const =0;
    virtual const Tstring & getString () const =0;
    virtual void setHex (Tindex p_position, Tchar p_hcValue)=0;
    virtual void setLength (Tsize p_length)=0;
    virtual void setString (const Tstring &p_hsValue)=0;
    virtual Tboolean isMatchingAt (Tindex p_position) const =0;
    virtual MatchingMechanism & getMatchingAt (Tindex p_position) const =0;
    virtual void setMatchingAt (Tindex p_position, MatchingMechanism &p_template) = 0;
    virtual Tboolean operator== (const HexstringValue & p_hexStr) const =0;
    virtual HexstringValue * clone () const =0;
    virtual Tboolean operator< (const HexstringValue & p_hexStr) const =0;
}

```

Methods:

```

~HexstringValue
    Destructor
getHex
    Return the element at the specified position
getLength
    Return the length of the string
getString
    Return the string value

```

setHex
 Set the hex value at the specified position
 setLength
 Set the length of the string
 setString
 Set the value of the string
 isMatchingAt
 Returns true if the item at the specified position is a matching mechanism inside a value
 getMatchingAt
 Returns a matching mechanism at the specified position
 setMatchingAt
 Sets the matching mechanism at the specified position
 operator==
 Returns true if both objects are equal
 clone
 Return a copy of the HexstringValue
 operator<
 Operator < overload

10.5.3.11 RecordValue

TTCN-3 record value support. It is mapped to the following pure virtual class:

```

class RecordValue : public virtual TciValue {
public:
    virtual ~RecordValue ();
    virtual TciValue &getField (const Tstring &p_field_name) =0;
    virtual void setField (const Tstring &p_field_name,const TciValue &p_new_value)=0;
    virtual const std::vector< Tstring *> &getFieldNames () const =0;
    virtual void setFieldOmitted (const Tstring &p_fieldName)=0;
    virtual Tboolean operator== (const RecordValue &p_rec) const =0;
    virtual RecordValue * clone () const =0;
    virtual Tboolean operator< (const RecordValue &p_rec) const =0;
}
  
```

Methods:

~RecordValue
 Destructor
 getField
 Return a reference to the field name
 setField
 Set the value of a field
 getFieldNames
 Return a list which containing the names of all the fields
 setFieldOmitted
 Set omit in one field
 operator==
 Returns true if both objects are equal
 clone
 Return a copy of the RecordValue
 operator<
 Operator < overload

10.5.3.12 RecordOfValue

TTCN-3 record of value support. It is mapped to the following pure virtual class:

```

class RecordOfValue : public virtual TciValue {
public:
    virtual ~RecordOfValue ();
    virtual TciValue &getField (Tindex p_position)=0;
    virtual void setField (Tindex p_position, const TciValue &p_value)=0;
    virtual void appendField (const TciValue &p_value)=0;
    virtual const TciType &getElementType () const =0;
    virtual Tsize getLength () const =0;
    virtual void setLength (Tsize p_length)=0;
    virtual Tindex getOffset() const =0;
    virtual Tsize getPermutationCount () const =0;
    virtual Permutation &getPermutation (Tindex p_position) const =0;
    virtual Permutation * newPermutation () =0;
}
  
```

```

virtual void definePermutation (const Permutation & permutation) =0;
virtual void removePermutation (Tindex p_position) =0;
virtual void clearPermutations () =0;
virtual Tboolean operator== (const RecordOfValue &p_recOf) const =0;
virtual RecordOfValue * clone () const =0;
virtual Tboolean operator< (const RecordOfValue &p_recOf) const =0;
}

```

Methods:

```

~RecordOfValue
    Destructor
getField
    Return the field at the specified position
setField
    Set the value at the specified position
appendField
    Add a value at the end of the record of
getElementType
    Return the type of the elements of this record of
getLength
    Return the length of the object
setLength
    Set length of the record of
getOffset
    For arrays, return the lower index bound used in the type definition of arrays. Return 0 for record of    and set
    of
getPermutationCount
    Returns the number of permutations in the record of or array value
getPermutation
    Returns the permutation at the specified index
getPermutation
    Creates a new Permutation class instance
definePermutation
    Creates permutation from existing elements of a record of value
removePermutation
    Removes the permutation at the specified index
clearPermutations
    Removes all permutaions from the value
operator==
    Returns true if both objects are equal
clone
    Return a copy of the RecordOfValue
operator<
    Operator < overload

```

10.5.3.13 UnionValue

TTCN-3 union value support. It is mapped to the following pure virtual class:

```

class UnionValue : public virtual TciValue {
public:
    virtual ~UnionValue ()
    virtual void setVariant (const Tstring &p_variantName, const TciValue &p_value)=0;
    virtual TciValue & getVariant (const Tstring &p_variantName) =0;
    virtual const Tstring & getPresentVariantName () const =0;
    virtual const std::set< Tstring *> & getVariantNames () const =0;
    virtual Tboolean operator== (const UnionValue & p_unionVal) const =0;
    virtual UnionValue * clone () const =0;
    virtual Tboolean operator< (const UnionValue & p_unionVal) const =0;
}

```

Methods:

```

~UnionValue
    Destructor
setVariant
    Set the variant name to a value
getVariant
    Return the value of the variant if exists

```

```

getPresentVariantName
    Return the name of the current variant value. null if no initialized
getVariantNames
    Return a list which contains the variant names as defined in the TTCN-3 module
operator==
    Returns true if both objects are equal
clone
    Return a copy of the UnionValue
operator<
    Operator < overload

```

10.5.3.14 EnumeratedValue

TTCN-3 enumerated value support. It is mapped to the following pure virtual class:

```

class EnumeratedValue : public virtual TciValue {
public:
    virtual ~EnumeratedValue ();
    virtual const Tstring & getEnum () const =0;
    virtual void setEnum (const Tstring &p_value)=0;
    virtual Tinteger getInt() const =0;
    virtual void setInt(Tinteger p_int);
    virtual Tboolean operator== (const EnumeratedValue & p_enumVal) const =0;
    virtual EnumeratedValue * clone () const =0;
    virtual Tboolean operator< (const EnumeratedValue & p_enumVal) const =0;
}

```

Methods:

```

~EnumeratedValue
    Destructor
getEnum
    Return current value
setEnum
    Set the enumeration value
getInt
    Return current integer value
setInt
    Set the integer value
operator==
    Returns true if both objects are equal
clone
    Return a copy of the EnumeratedValue
operator<
    Operator < overload

```

10.5.3.15 VerdictValue

TTCN-3 verdict value support. It is mapped to the following pure virtual class:

```

class VerdictValue : public virtual TciValue {
public:
    virtual ~VerdictValue ();
    virtual const VerdictValueEnum & getVerdict () const =0;
    virtual void setVerdict (const VerdictValueEnum & p_enum)=0;
    virtual Tboolean operator== (const VerdictValue & p_verdictVal) const =0;
    virtual VerdictValue * clone () const =0;
    virtual Tboolean operator< (const VerdictValue & p_verdictVal) const =0;
}

```

Methods:

```

~VerdictValue
    Destructor
getVerdict
    Return the value of the verdict
setVerdict
    Set the value of the verdict
operator==
    Returns true if both objects are equal

```

```
clone
    Return a copy of the VerdictValue
operator<
    Operator < overload
```

10.5.3.16 VerdictValueEnum

Defines verdict values as an enumeration:

```
typedef enum
{
    NONE = 0,
    PASS = 1,
    FAIL = 2,
    INCONC = 3,
    ERROR = 4,
    USER_ERROR = 5
} VerdictValueEnum;
```

10.5.3.17 AddressValue

TTCN-3 address value support. It is mapped to the following pure virtual class:

```
class AddressValue {
public:
    virtual ~AddressValue ();
    virtual TciValue & getAddress ()=0;
    virtual void setAddress ( const TciValue& T)=0;
    virtual Tboolean operator== (const AddressValue & p_addr) const =0;
    virtual AddressValue * cloneAddressValue () const =0;
    virtual Tboolean operator< (const AddressValue & p_addr) const =0;
}
```

Methods:

```
~AddressValue
    Destructor
getAddress
    Return the value of the address
setAddress
    Set the value of the address
operator==
    Returns true if both objects are equal
clone
    Return a copy of the AddressValue
operator<
    Operator < overload
```

10.5.3.18 MatchingMechanism

Represents a TTCN-3 matching mechanism. It is mapped to the following pure virtual class:

```
class MatchingMechanism : public virtual TciValue {
public:
    virtual ~MatchingMechanism ();
    virtual TciMatchingType getMatchingType () const =0;
    virtual Tboolean operator== (const MatchingMechanism &p_template) const =0;
    virtual MatchingMechanism * clone () const =0;
    virtual Tboolean operator< (const MatchingMechanism &p_template) const =0;
}
```

Methods:

```
~MatchingMechanism
    Destructor
getMatchingType
    Returns the matching mechanism type
operator==
    Returns true if both objects are equal
```

clone
Return a copy of the MatchingMechanism
operator<
Operator < overload

10.5.3.19 MatchingList

Represents the following TTCN-3 matching mechanisms: template list, complemented template list, subset, superset. It is mapped to the following pure virtual class:

```
class MatchingList : public virtual MatchingMechanism {
public:
    virtual ~MatchingList ();
    virtual Tsize size () const =0;
    virtual TciValue& get (Tindex p_position) const =0;
    virtual void add (TciValue& p_val) =0;
    virtual void remove (Tindex p_position) =0;
    virtual void clear () =0;
    virtual Tboolean operator== (const MatchingList &p_list) const =0;
    virtual MatchingList * clone () const =0;
    virtual Tboolean operator< (const MatchingList &p_list) const =0;
}
```

Methods:

~MatchingList
Destructor
size
Returns the number of items in the matching list
get
Returns the value or template at the specified position inside the matching list
add
Adds a new item to the end of the matching list, increasing its size
remove
Removes the value or template at the specified position inside the matching list
clear
Removes all values and templates from the matching list
operator==
Returns true if both objects are equal
clone
Return a copy of the MatchingList
operator<
Operator < overload

10.5.3.20 ValueRange

TTCN-3 value range support. It is mapped to the following pure virtual class:

```
class ValueRange : public virtual MatchingMechanism {
public:
    virtual ~ValueRange ();
    virtual RangeBoundary & getLowerBoundary () =0;
    virtual RangeBoundary & getUpperBoundary () =0;
    virtual void setLowerBoundary (const RangeBoundary & p_boundary) =0;
    virtual void setUpperBoundary (const RangeBoundary & p_boundary) =0;
    virtual Tboolean operator== (const ValueRange &p_range) const =0;
    virtual ValueRange * clone () const =0;
    virtual Tboolean operator< (const ValueRange &p_range) const =0;
}
```

Methods:

~ValueRange
Destructor
getLowerBoundary
Returns the lower boundary of the range
getUpperBoundary
Returns the upper boundary of the range
setLowerBoundary
Sets the lower boundary of the range

setUpperBoundary
 Sets the upper boundary of the range
 operator==
 Returns true if both objects are equal
 clone
 Return a copy of the ValueRange
 operator<
 Operator < overload

10.5.3.21 CharacterPattern

TTCN-3 pattern support. It is mapped to the following pure virtual class:

```

class CharacterPattern : public virtual MatchingMechanism {
public:
    virtual ~CharacterPattern ();
    virtual TciValue & getPatternString () =0;
    virtual void setPatternString (const TciValue & p_string) =0;
    virtual Tboolean operator== (const CharacterPattern &p_pattern) const =0;
    virtual CharacterPattern * clone () const =0;
    virtual Tboolean operator< (const CharacterPattern &p_pattern) const =0;
}
  
```

Methods:

~CharacterPattern
 Destructor
 getPatternString
 Returns the character pattern definition of this pattern
 setPatternString
 Sets the character pattern definition of this pattern
 operator==
 Returns true if both objects are equal
 clone
 Return a copy of the CharacterPattern
 operator<
 Operator < overload

10.5.3.22 MatchDecodedContent

TTCN-3 MatchDecodedContent support. It is mapped to the following pure virtual class:

```

class MatchDecodedContent : public virtual MatchingMechanism {
public:
    virtual ~MatchDecodedContent ();
    virtual TciValue & getContent () =0;
    virtual void setContent (const TciValue & p_content) =0;
    virtual Tboolean operator== (const MatchDecodedContent &p_content) const =0;
    virtual MatchDecodedContent * clone () const =0;
    virtual Tboolean operator< (const MatchDecodedContent &p_content) const =0;
}
  
```

Methods:

~MatchDecodedContent
 Destructor
 getContent
 Returns the value or matching mechanism used as an argument of the decmatch matching mechanism
 setContent
 Sets the value or matching mechanism used as an argument of the decmatch matching mechanism
 operator==
 Returns true if both objects are equal
 clone
 Return a copy of the MatchDecodedContent template
 operator<
 Operator < overload

10.5.4 Abstract logging types

10.5.4.1 TciValueTemplate

Interface that defines the concrete operations of the TTCN-3 template. It is mapped to the following pure virtual class:

```
class TciValueTemplate {
public:
    virtual ~TciValueTemplate ();
    virtual Tboolean isOmit () const =0;
    virtual Tboolean isAny () const =0;
    virtual Tboolean isAnyOrOmit () const =0;
    virtual const Tstring & getTemplateDef () const =0;
    virtual Tboolean operator== (const TciValueTemplate &vtempl) const =0;
    virtual TciValueTemplate * clone () const =0;
    virtual Tboolean operator< (const TciValueTemplate &vtempl) const =0;
}
```

Methods:

```
~TciValueTemplate ()
    Destructor
isOmit ()
    Return true if value of template is omit
isAny ()
    Return true if value of template is any
isAnyOrOmit ()
    Return true value of template if any or omit
getTemplateDef ()
    Return the template definition as defined in the TTCN-3 module
operator== (const TciValueTemplate &vtempl)
    Returns true if both objects are equal
clone ()
    Return a copy of the TciValueTemplate
operator< (const TciValueTemplate &vtempl)
    Operator < overload
```

10.5.4.2 TciNonValueTemplate

Support *all* and *any* matching mechanisms over TTCN-3 components and timers. It is mapped to the following pure virtual class:

```
class TciNonValueTemplate {
public:
    virtual ~TciNonValueTemplate ();
    virtual Tboolean isAny () const =0;
    virtual Tboolean isAll () const =0;
    virtual const Tstring & getTemplateDef () const =0;
    virtual Tboolean operator== (const TciNonValueTemplate &nvtempl) const =0;
    virtual TciNonValueTemplate * clone () const =0;
    virtual Tboolean operator< (const TciNonValueTemplate &nvtempl) const =0;
}
```

Methods:

```
~TciNonValueTemplate ()
    Destructor
isAny ()
    Return true if value is any
isAll ()
    Return true if is value all
getTemplateDef ()
    Return template definition as defined in the TTCN-3 module
operator== (const TciNonValueTemplate &nvtempl)
    Returns true if both objects are equal
clone ()
    Return a copy of the TciNonValueTemplate
operator< (const TciNonValueTemplate &nvtempl)
    Operator < overload
```

10.5.4.3 TciValueList

A list of TciValues. It is mapped to the following pure virtual class:

```
class TciValueList {
public:
    virtual ~TciValueList (void);
    virtual Tsize size () const =0;
    virtual Tboolean empty () const =0;
    virtual const TciValue *get (Tindex index) const =0;
    virtual void clear ()=0;
    virtual void add (const TciValue &comp)=0;
    virtual Tboolean operator== (const TciValueList &valList) const =0;
    virtual TciValueList * clone () const =0;
    virtual Tboolean operator< (const TciValueList &valList) const =0;
}

```

Methods:

```
~TciValueList ()
    Destructor
size ()
    Return the size of the list
empty ()
    Return true if the list is empty
get (Tindex index)
    Return the value at the specified position
clear ()
    Remove all the elements from this list
add (const TciValue &comp)
    Add an element to the end of this list
operator== (const TciValueList &valList)
    Returns true if both objects are equal
clone ()
    Return a copy of the TciValueList
operator< (const TciValueList &valList)
    Operator < overload

```

10.5.4.4 TciValueDifference

Represents the differences during a match operation. It is mapped to the following pure virtual class:

```
class TciValueDifference {
public:
    virtual ~TciValueDifference ();
    virtual const TciValue & getValue () const =0;
    virtual void setValue (TciValue &val)=0;
    virtual const TciValueTemplate & getTciValueTemplate () const =0;
    virtual void setTciValueTemplate (TciValueTemplate &valT)=0;
    virtual const Tstring & getDescription () const =0;
    virtual void setDescription (const Tstring &descr)=0;
    virtual Tboolean operator== (const TciValueDifference &vdiff) const =0;
    virtual TciValueDifference * clone () const =0;
    virtual Tboolean operator< (const TciValueDifference &vdiff) const =0;
}

```

Methods:

```
~TciValueDifference ()
    Destructor
getValue ()
    Return the value definition
setValue (TciValue &val)
    Set the value definition
getTciValueTemplate ()
    Return the template definition
setTciValueTemplate (TciValueTemplate &valT)
    Set the template definition
getDescription ()
    Return a string which describes the difference

```

```

setDescription (const Tstring &descr)
    Set description
operator== (const TciValueDifference &vdiff)
    Returns true if both objects are equal
clone ()
    Return a copy of the TciValueDifference
operator< (const TciValueDifference &vdiff)
    Operator < overload

```

10.5.4.5 TciValueDifferenceList

Collection of TciValueDifferences. It is mapped to the following pure virtual class:

```

class TciValueDifferenceList {
public:
    virtual ~TciValueDifferenceList ();
    virtual Tsize size () const =0;
    virtual Tboolean empty () const =0;
    virtual const TciValueDifference *get (Tindex p_position) const =0;
    virtual void clear ()=0;
    virtual void add (const TciValueDifference &comp)=0;
    virtual Tboolean operator== (const TciValueDifferenceList &vdList) const =0;
    virtual TciValueDifferenceList * clone () const =0;
    virtual Tboolean operator< (const TciValueDifferenceList &vdList) const =0;
}

```

Methods:

```

~TciValueDifferenceList ()
    Destructor
size ()
    Return the size of the list
empty ()
    Return true if this list contains no elements
get (Tindex p_position)
    Return the requested difference
clear ()
    Remove all the components from this list
add (const TciValueDifference &comp)
    Add a component to the end of the list
operator== (const TciValueDifferenceList &vdList)
    Returns true if both objects are equal
clone ()
    Return a copy of the TciValueDifferenceList
operator< (const TciValueDifferenceList &vdList)
    Operator < overload

```

10.5.4.6 ComponentStatus

Defines component status as an enumeration:

```

typedef enum
{
    INACTIVE_C = 0,
    RUNNING_C = 1,
    STOPPED_C = 2,
    KILLED_C = 3
    NULL_C = 4
} ComponentStatus;

```

10.5.4.7 TimerStatus

Defines timer status as an enumeration:

```

typedef enum
{
    RUNNING_T = 0,
    INACTIVE_T = 1,
    EXPIRED_T = 2
    NULL_T = 3
}

```

```
} TimerStatus;
```

10.5.4.8 TciStatus

Defines TCI status as an enumeration:

```
typedef enum
{
    TCI_OK = 0,
    TCI_ERROR = -1
} TciStatus;
```

10.6 Operations mapping

10.6.1 TCI-TM

10.6.1.1 TciTmRequired

Specifies the operations the TM requires from TE. It is mapped to the following interface:

```
//Destructor
virtual ~TciTmRequired ();

//Selects the indicated module for execution
virtual void tciRootModule (const TciModuleId *moduleName)=0;

//The TE provides to the management a list of imported modules of the root module
virtual const TciModuleIdList * getImportedModules () const =0;

//The TE provides to the management a list of module parameters of the identified module
virtual const TciModuleParameterList * tciGetModuleParameters (const TciModuleId *moduleName)=0;

//The TE provides to the management a list of test cases
virtual const TciTestCaseIdList * tciGetTestCases () const =0;

//The TE provides to the management a list of parameter types of the given test case
virtual const TciParameterTypeList * tciGetTestCaseParameters (const TciTestCaseId *testCaseId)
const =0;

//The TE provides to the management a list of system ports of the given test case
virtual const TriPortIdList * tciGetTestCaseTSI (const TciTestCaseId &testCaseId) const =0;

//Starts a testcase in the currently selected module with the given parameters
virtual void tciStartTestCase (const TciTestCaseId *testCaseId, const TciParameterList
*parameterList)=0;

//Stops the testcase currently being executed
virtual void tciStopTestCase ()=0;

//Starts the control part of the selected module
virtual const TriComponentId * tciStartControl ()=0;

//Stops execution of the control part
virtual void tciStopControl ()=0;
```

10.6.1.2 TciTmProvided

Specifies the operation the TM has to provide to the TE. It is mapped to the following interface:

```
//Destructor
virtual ~TciTmProvided ();

//Indicates to the TM that a test case with testCaseId has been started
virtual void tciTestCaseStarted (const TciTestCaseId &testCaseId, const TciParameterList
&parameterList, const Tfloat &timer)=0;

//Called to indicate that the test case has terminated execution
virtual void tciTestCaseTerminated (const VerdictValue &verdict, const TciParameterList
&parameterList)=0;
```

```

//Called to indicate that the control part of the selected module has just terminated execution
virtual void tciControlTerminated ()=0;

//The management provides to the TE a Value for the indicated parameterId
virtual TciValue * tciGetModulePar (const TciModuleParameterId &parameterId)=0;

//Indicates the occurrence of an unrecoverable error situation
virtual void tciError (const Tstring &message)=0;

//The TE indicates a message of a test component
virtual void tciLog (const TriComponentId &testComponentId, const Tstring &message)=0;

```

10.6.2 TCI-CD

10.6.2.1 TciCdRequired

This class defines the TCI_CD required interface. It is mapped to the following interface:

```

//Destructor
virtual ~TciCdRequired ();

//Returns a type representing a ttcn type
virtual const TciType * getTypeForName (const Tstring typeName) const =0;

//Constructs and returns a basic TTCN-3 integer type
virtual const TciType & getInteger () const =0;

//Constructs and returns a basic TTCN-3 float type
virtual const TciType & getFloat () const =0;

//Constructs and returns a basic TTCN-3 boolean type
virtual const TciType & getBoolean () const =0;

//Constructs and returns a basic TTCN-3 charstring type
virtual const TciType & getCharstring () const =0;

//Constructs and returns a basic TTCN-3 universal charstring type
virtual const TciType & getUniversalCharstring () const =0;

//Constructs and returns a basic TTCN-3 hexstring type
virtual const TciType & getHexstring () const =0;

//Constructs and returns a basic TTCN-3 bitstring type
virtual const TciType & getBitstring () const =0;

//Constructs and returns a basic TTCN-3 octetstring type
virtual const TciType & getOctetstring () const =0;

//Constructs and returns a basic TTCN-3 verdict type
virtual const TciType & getVerdict () const =0;

//The TE will be notified about an unrecoverable error situation within the CD
virtual void tciErrorReq (const Tstring message)=0;

```

10.6.2.2 TciCdProvided

This class defines the TCI_CD provided interface. It is mapped to the following interface:

```

//Destructor
virtual ~TciCdProvided ();

//This operation is called whenever the TE has to implicitly decode a value
virtual TciValue * decode (const TriMessage *p_message, const TciType *p_decodingHypothesis)=0;

//This operation is called whenever the TE has to implicitly encode a value
virtual TriMessage * encode (const TciValue *p_value)=0;

//This operation is called whenever the TE invokes decvalue
virtual Tinteger decodeValue (TriMessage *p_message, const TciType *p_decodingHypothesis,
    const TuniversalString & decodingInfo, TciValue ** decodedValue )=0;

//This operation is called whenever the TE invokes encvalue
virtual TriMessage * encodeValue (const TciValue *p_value, const TuniversalString & encodingInfo)=0;

```

10.6.3 TCI-CH

10.6.3.1 TciChRequired

This class defines the TCI_CH required interface. It is mapped to the following interface:

```
//Default destructor
virtual ~TciChRequired ();

//This operation is called by the CH at the local TE when at a remote TE a provided
//tciSendConnected has been called
virtual void tciEnqueueMsgConnected (const TriPortId *sender, const TriComponentId *receiver,
const TciValue *rcvdMessage)=0;

//This operation is called by the CH at the local TE when at a remote TE a provided
//tciCallConnected has been called
virtual void tciEnqueueCallConnected (const TriPortId *sender, const TriComponentId *receiver,
const TriSignatureId *signature, const TciParameterList *parameterList)=0;

//This operation is called by the CH at the local TE when at a remote TE a provided
//tciReplyConnected has been called
virtual void tciEnqueueReplyConnected (const TriPortId *sender, const TriComponentId *receiver,
const TriSignatureId *signature, const TciParameterList *parameterList,
const TciValue *returnValue)=0;

//This operation is called by the CH at the local TE when at a remote TE a provided
//tciRaiseConnected has been called
virtual void tciEnqueueRaiseConnected (const TriPortId *sender, const TriComponentId *receiver,
const TriSignatureId *signature, const TciValue *exception)=0;

//This operation is called by the CH at the local TE when at a remote TE a provided
//tciCreateTestComponentReq has been called
virtual const TriComponentId * tciCreateTestComponent (const TciTestComponentKind *kind,
const TciType *componentType, const Tstring *name)=0;

//This operation is called by the CH at the local TE when at a remote TE a provided
//tciStartTestComponentReq has been called
virtual void tciStartTestComponent (const TriComponentId *component,
const TciBehaviourId *behaviour, const TciParameterList *parameterList)=0;

//This operation is called by the CH at the local TE when at a remote TE a provided
//tciStopTestComponentReq has been called
virtual void tciStopTestComponent (const TriComponentId *component)=0;

//This operation is called by the CH at the local TE when at a remote TE a provided tciConnect
//has been called
virtual void tciConnect (const TriPortId *fromPort, const TriPortId *toPort)

//This operation is called by the CH at the local TE when at a remote TE a provided
//tciDisconnect has been called
virtual void tciDisconnect (const TriPortId *fromPort, const TriPortId *toPort)=0;

//This operation is called by the CH at the local TE when at a remote TE a provided tciMapReq
//has been called
virtual void tciMap (const TriPortId *fromPort, const TriPortId *toPort)=0;

//This operation is called by the CH at the local TE when at a remote TE a provided
//tciMapParamReq has been called
virtual void tciMapParam (const TriPortId *fromPort, const TriPortId *toPort,
const TciParameterList *parameterList)=0;

//This operation is called by the CH at the local TE when at a remote TE a provided tciUnmapReq
//has been called
virtual void tciUnmap (const TriPortId *fromPort, const TriPortId *toPort)=0;

//This operation is called by the CH at the local TE when at a remote TE a provided
//tciUnmapParamReq has been called
virtual void tciUnmapParam (const TriPortId *fromPort, const TriPortId *toPort,
const TciParameterList *parameterList)=0;

//This operation is called by the CH at the local TE when at a remote TE a provided tciUnmapReq
//has been called
virtual void tciTestComponentTerminated (const TriComponentId *component,
const VerdictValue *verdict) const =0;
```

```

//This operation is called by the CH at the local TE when at a remote TE a provided
//tciTestComponentRunningReq has been called
virtual Tboolean tciTestComponentRunning (const TriComponentId *component) const =0;

//This operation is called by the CH at the local TE when at a remote TE a provided
//tciTestComponentDoneReq has been called
virtual Tboolean tciTestComponentDone (const TriComponentId *comp, VerdictValueEnum * verdict)
const =0;

//This operation can be called by the CH at the appropriate local TE when at a remote TE a
//provided tciGetMTCReq has been called
virtual const TriComponentId * tciGetMTC () const =0;

//This operation is called by the CH at the appropriate local TE when at a remote TE a provided
//tciExecuteTestCaseReq has been called
virtual void tciExecuteTestCase (const TciTestCaseId *testCaseId,
const TriPortIdList *tsiPortList)=0;

//This operation is called by the CH at appropriate local TEs when at a remote TE a provided
//tciResetReq has been called
virtual void tciReset ()=0;

//This operation is called by the CH at the local TE when at a remote TE a provided
//tciKillTestComponentReq has been called
virtual void tciKillTestComponent (const TriComponentId *comp, VerdictValueEnum * verdict)=0;

//This operation is called by the CH at the local TE when at a remote TE a provided
//tciTestComponentAliveReq has been called
virtual Tboolean tciTestComponentAlive (const TriComponentId *comp) const =0;

//This operation is called by the CH at the local TE when at a remote TE a provided
//tciTestComponentKilledReq has been called
virtual Tboolean tciTestComponentKilled (const TriComponentId *comp) const =0;

```

10.6.3.2 TciChProvided

This class defines the TCL_CH provided interface. It is mapped to the following interface:

```

//Destructor
virtual ~TciChProvided ();

//Called by the TE when it executes a TTCN-3 unicast send operation on a component port
virtual void tciSendConnected (const TriPortId *sender, const TriComponentId *receiver,
const TciValue *sendMessage)=0;

//Called by the TE when it executes a TTCN-3 broadcast send operation on a component port
virtual void tciSendConnectedBC (const TriPortId *sender, const TciValue *sendMessage)=0;

//Called by the TE when it executes a TTCN-3 multicast send operation on a component port
virtual void tciSendConnectedMC (const TriPortId *sender, const TriComponentIdList *receivers,
const TciValue *sendMessage)=0;

//Called by the TE when it executes a TTCN-3 unicast call operation on a component port
virtual void tciCallConnected (const TriPortId *sender, const TriComponentId *receiver,
const TriSignatureId *signature, const TciParameterList *parameterList)=0;

//Called by the TE when it executes a TTCN-3 broadcast call operation on a component port
virtual void tciCallConnectedBC (const TriPortId *sender, const TriSignatureId *signature,
const TciParameterList *parameterList)=0;

//Called by the TE when it executes a TTCN-3 multicast call operation on a component port
virtual void tciCallConnectedMC (const TriPortId *sender, const TriComponentIdList *receivers,
const TriSignatureId *signature, const TciParameterList *parameterList)=0;

//Called by the TE when it executes a TTCN-3 unicast reply operation on a component port
virtual void tciReplyConnected (const TriPortId *sender, const TriComponentId *receiver,
const TriSignatureId *signature, const TciParameterList *parameterList,
const TciValue *returnValue)=0;

//Called by the TE when it executes a TTCN-3 broadcast reply operation on a component port
virtual void tciReplyConnectedBC (const TriPortId *sender, const TriSignatureId *signature,
const TciParameterList *parameterList, const TciValue *returnValue)=0;

```

```

//Called by the TE when it executes a TTCN-3 multicast reply operation on a component
virtual void tciReplyConnectedMC (const TriPortId *sender, const TriComponentIdList *receivers,
const TriSignatureId *signature, const TciParameterList *parameterList,
const TciValue *returnValue)=0;

//Called by the TE when it executes a TTCN-3 unicast raise operation on a component port
virtual void tciRaiseConnected (const TriPortId *sender, const TriComponentId *receiver,
const TriSignatureId *signature, const TciValue *exception)=0;

//Called by the TE when it executes a TTCN-3 broadcast raise operation on a component portvirtual
void tciRaiseConnectedBC (const TriPortId *sender, const TriSignatureId *signature,
const TciValue *exception)=0;

//Called by the TE when it executes a TTCN-3 multicast raise operation on a component
virtual void tciRaiseConnectedMC (const TriPortId *sender, const TriComponentIdList *receiver,
const TriSignatureId *signature, const TciValue *exception)=0;

//Called from the TE when a component has to be created
virtual const TriComponentId * tciCreateTestComponentReq (const TciTestComponentKind *kind,
const QualifiedName *componentType, const Tstring &name, const TciValue *hostId)=0;

//Called by the TE when it executes the TTCN-3 start operation
virtual void tciStartTestComponentReq (const TriComponentId *component,
const TciBehaviourId *behaviour, const TciParameterList *parameterList)=0;

//Called by the TE when it executes the TTCN-3 stop operation
virtual void tciStopTestComponentReq (const TriComponentId *component)=0;

//Called by the TE when it executes a TTCN-3 connect operation
virtual void tciConnectReq (const TriPortId *fromPort, const TriPortId *toPort)=0;

//Called by the TE when it executes a TTCN-3 disconnect operation
virtual void tciDisconnectReq (const TriPortId *fromPort, const TriPortId *toPort)=0;

//Called by the TE when it executes a TTCN-3 map operation
virtual void tciMapReq (const TriPortId *fromPort, const TriPortId *toPort)=0;

//Called by the TE when it executes a TTCN-3 map operation including parameters
virtual void tciMapParamReq (const TriPortId *fromPort, const TriPortId *toPort,
const TciParameterList *parameterList)=0;

//Called by the TE when it executes a TTCN-3 unmap operation
virtual void tciUnmapReq (const TriPortId *fromPort, const TriPortId *toPort)=0;

//Called by the TE when it executes a TTCN-3 unmap operation including parameters
virtual void tciUnmapParamReq (const TriPortId *fromPort, const TriPortId *toPort,
const TciParameterList *parameterList)=0;

//Called by the TE when a test component terminates execution
virtual void tciTestComponentTerminatedReq (const TriComponentId *component,
const VerdictValue *verdict)=0;

//Called by the TE when it executes a TTCN-3 running operation
virtual Tboolean tciTestComponentRunningReq (const TriComponentId *component) const =0;

//Called by the TE when it executes a TTCN-3 done operation
virtual Tboolean tciTestComponentDoneReq (const TriComponentId *comp, VerdictValueEnum * verdict)
const =0;

//Called by the TE when it executes a TTCN-3 mtc operation
virtual const TriComponentId * tciGetMTCReq () const =0;

//Called by the TE immediately before it starts the test case behaviour on the MTC
virtual void tciExecuteTestCaseReq (const TciTestCaseId *testCaseId,
const TriPortIdList *tsiPortList)=0;

//Called by the TE at any time to reset the test system
virtual void tciResetReq ()=0;

//Called by the TE when it executes the TTCN-3 kill operation
virtual void tciKillTestComponentReq (const TriComponentId *comp)=0;

//Called by the TE when it executes the TTCN-3 alive operation
virtual Tboolean tciTestComponentAliveReq (const TriComponentId *comp) const =0;

//Called by the TE when it executes the TTCN-3 killed operation
virtual Tboolean tciTestComponentKilledReq (const TriComponentId *comp, VerdictValueEnum * verdict)
const =0;

```

10.6.4 TCI-TL

10.6.4.1 TciTlProvided

This class defines the TCI_TL provided Tinterface:

```
//Default constructor
TciTlProvided ();

// Destructor
virtual ~TciTlProvided ();

//Called by TE to log the execute test case request
virtual void tliTcExecute (const Tstring &am, const timeval ts, const Tstring src, const Tinteger
line, const TriComponentId *c, const TciTestCaseId *tcId, const TciParameterList *tciPars, const
TriTimerDuration *dur)=0;

//Called by TE to log the start of a testcase. This event occurs before the testcase is started
virtual void tliTcStart (const Tstring &am, const timeval ts, const Tstring &src, const Tinteger
line, const TriComponentId *c, const TciTestCaseId *tcId, const TciParameterList *tciPars, const
TriTimerDuration *dur)=0;

//Called by TE to log the stop of a testcase
virtual void tliTcStop (const Tstring &am, const timeval ts, const Tstring &src, const Tinteger
line, const TriComponentId *c, const Tstring &reason)=0;

//Called by TE to log the start of a testcase
virtual void tliTcStarted (const Tstring &am, const timeval ts, const Tstring &src, const Tinteger
line, const TriComponentId *c, const TciTestCaseId *tcId, const TciParameterList *tciPars, const
TriTimerDuration *dur)=0;

//Called by TE to log the termination of a testcase
virtual void tliTcTerminated (const Tstring &am, const timeval ts, const Tstring &src, const
Tinteger line, const TriComponentId *c, const TciTestCaseId *tcId, const TciParameterList *tciPars,
const VerdictValue *verdict, const Tstring &reason)=0;

//Called by TE to log the start of the control part
virtual void tliCtrlStart (const Tstring &am, const timeval ts, const Tstring &src, const Tinteger
line, const TriComponentId *c)=0;

//Called by TE to log the stop of the control part. This event occurs after the control has
//stopped. If the control is not represented by TRI component, c is null
virtual void tliCtrlStop (const Tstring &am, const timeval ts, const Tstring &src, const Tinteger
line, const TriComponentId *c)=0;

//Called by TE to log the termination of the control part
virtual void tliCtrlTerminated (const Tstring &am, const timeval ts, const Tstring &src, const
Tinteger line, const TriComponentId *c)=0;

//Called by TE to log a unicast send operation
virtual void tliMSend_m (const Tstring &am, const timeval ts, const Tstring &src, const Tinteger
line, const TriComponentId *c, const TriPortId *at, const TriPortId *to, const TciValue *msgValue,
const TriAddress *address, const TciStatus *encoderFailure, const TriMessage *msg, const TriStatus
*transmissionFailure)=0;

//Called by TE to log a broadcast send operation
virtual void tliMSend_m_BC (const Tstring &am, const timeval ts, const Tstring &src, const Tinteger
line, const TriComponentId *c, const TriPortId *at, const TriPortId *to, const TciValue *msgValue,
const TciStatus *encoderFailure, const TriMessage *msg, const TriStatus *transmissionFailure)=0;

//Called by TE to log a multicast send operation
virtual void tliMSend_m_MC (const Tstring &am, const timeval ts, const Tstring &src, const Tinteger
line, const TriComponentId *c, const TriPortId *at, const TriPortId *to, const TciValue *msgValue,
const TriAddressList *addresses, const TciStatus *encoderFailure, const TriMessage *msg, const
TriStatus *transmissionFailure)=0;

//Called by TE to log a unicast send operation
virtual void tliMSend_c (const Tstring &am, const timeval ts, const Tstring src, const Tinteger
line, const TriComponentId *c, const TriPortId *at, const TriPortId *to, const TciValue *msgValue,
const TriStatus *transmissionFailure)=0;

//Called by TE to log a broadcast send operation
virtual void tliMSend_c_BC (const Tstring &am, const timeval ts, const Tstring src, const Tinteger
line, const TriComponentId *c, const TriPortId *at, const TriPortIdList *to, const TciValue
*msgValue, const TriStatus *transmissionFailure)=0;
```



```

//Called by TE to log a multicast send operation
virtual void tliMSend_c_MC (const Tstring &am, const timeval ts, const Tstring src, const Tinteger
line, const TriComponentId *c, const TriPortId *at, const TriPortIdList *to, const TciValue
*msgValue, const TriStatus *transmissionFailure)=0;

//Called by TE to log the enqueueing of a message
virtual void tliMDetected_m (const Tstring &am, const timeval ts, const Tstring &src, const Tinteger
line, const TriComponentId *c, const TriPortId *at, const TriPortId *from, const TriMessage *msg,
const TriAddress *address)=0;

//Called by CH to log the enqueueing of a message
virtual void tliMDetected_c (const Tstring &am, const timeval ts, const Tstring src, const Tinteger
line, const TriComponentId *c, const TriPortId *at, const TriPortId *from, const TciValue
*msgValue)=0;

//Called by TE to log the mismatch of a template
virtual void tliMMismatch_m (const Tstring &am, const timeval ts, const Tstring &src, const Tinteger
line, const TriComponentId *c, const TriPortId *at, const TciValue *msgValue, const TciValueTemplate
*msgTpl, const TciValueDifferenceList *diffs, const TciValue *addrValue, const TciValueTemplate
*addressTpl)=0;

//Called by TE to log the mismatch of a template
virtual void tliMMismatch_c (const Tstring &am, const timeval ts, const Tstring &src, const Tinteger
line, const TriComponentId *c, const TriPortId *at, const TciValue *msgValue, const TciValueTemplate
*msgTpl, const TciValueDifferenceList *diffs, const TriComponentId *from, const TciNonValueTemplate
*fromTpl)=0;

// Called by TE to log the receiving of a message
virtual void tliMReceive_m (const Tstring &am, const timeval ts, const Tstring &src, const Tinteger
line, const TriComponentId *c, const TriPortId *at, const TciValue *msgValue, const TciValueTemplate
*msgTpl, const TciValue *addrValue, const TciValueTemplate *addressTpl)=0;

//Called by TE to log the mismatch of a template
virtual void tliMReceive_c (const Tstring &am, const timeval ts, const Tstring &src, const Tinteger
line, const TriComponentId *c, const TriPortId *at, const TciValue *msgValue, const TciValueTemplate
*msgTpl, const TriComponentId *fromComp, const TciNonValueTemplate *fromTpl)=0;

//Called by TE to log a unicast call operation
virtual void tliPrCall_m (const Tstring &am, const timeval ts, const Tstring src, const Tinteger
line, const TriComponentId *c, const TriPortId *at, const TriPortId *to, const TriSignatureId
*signature, const TciParameterList *tciPars, const TriAddress *address, const TciStatus
*encoderFailure, const TriParameterList *triPars, const TriStatus *transmissionFailure)=0;

//Called by TE to log a broadcast call operation
virtual void tliPrCall_m_BC (const Tstring &am, const timeval ts, const Tstring src, const Tinteger
line, const TriComponentId *c, const TriPortId *at, const TriPortId *to, const TriSignatureId
*signature, const TciParameterList *tciPars, const TciStatus *encoderFailure, const TriParameterList
*triPars, const TriStatus *transmissionFailure)=0;

//Called by TE to log a multicast call operation
virtual void tliPrCall_m_MC (const Tstring &am, const timeval ts, const Tstring src, const Tinteger
line, const TriComponentId *c, const TriPortId *at, const TriPortId *to, const TriSignatureId
*signature, const TciParameterList *tciPars, const TriAddressList *addresses, const TciStatus
*encoderFailure, const TriParameterList *triPars, const TriStatus *transmissionFailure)=0;

//Called by TE to log a unicast call operation
virtual void tliPrCall_c (const Tstring &am, const timeval ts, const Tstring src, const Tinteger
line, const TriComponentId *c, const TriPortId *at, const TriPortId *to, const TriSignatureId
*signature, const TciParameterList *tciPars, const TriStatus *transmissionFailure)=0;

//Called by TE to log a broadcast call operation
virtual void tliPrCall_c_BC (const Tstring &am, const timeval ts, const Tstring src, const Tinteger
line, const TriComponentId *c, const TriPortId *at, const TriPortIdList *to, const TriSignatureId
*signature, const TciParameterList *tciPars, const TriStatus *transmissionFailure)=0;

//Called by TE to log a multicast call operation
virtual void tliPrCall_c_MC (const Tstring &am, const timeval ts, const Tstring src, const Tinteger
line, const TriComponentId *c, const TriPortId *at, const TriPortIdList *to, const TriSignatureId
*signature, const TciParameterList *tciPars, const TriStatus *transmissionFailure)=0;

//Called by TE to log the getcall enqueue operation
virtual void tliPrGetCallDetected_m (const Tstring &am, const timeval ts, const Tstring src, const
Tinteger line, const TriComponentId *c, const TriPortId *at, const TriPortId *from, const
TriSignatureId *signature, const TriParameterList *triPars, const TriAddress *address)=0;

```

```

//Called by TE to log the getcall enqueue operation
virtual void tliPrGetCallDetected_c (const Tstring &am, const timeval ts, const Tstring src, const
Tinteger line, const TriComponentId *c, const TriPortId *at, const TriPortId *from, const
TriSignatureId *signature, const TciParameterList *tciPars)=0;

//Called by TE to log the mismatch of a getcall
virtual void tliPrGetCallMismatch_m (const Tstring &am, const timeval ts, const Tstring src, const
Tinteger line, const TriComponentId *c, const TriPortId *at, const TriSignatureId *signature, const
TciParameterList *tciPars, const TciValueTemplate *parsTmpl, const TciValueDifferenceList *diffs,
const TciValue *addrValue, const TciValueTemplate *addressTmpl)=0;

//Called by TE to log the mismatch of a getcall
virtual void tliPrGetCallMismatch_c (const Tstring &am, const timeval ts, const Tstring src, const
Tinteger line, const TriComponentId *c, const TriPortId *at, const TriSignatureId *signature, const
TciParameterList *tciPars, const TciValueTemplate *parsTmpl, const TciValueDifferenceList *diffs,
const TriComponentId *from, const TciValueTemplate *fromTmpl)=0;

//Called by TE to log getting a call
virtual void tliPrGetCall_m (const Tstring &am, const timeval ts, const Tstring src, const Tinteger
line, const TriComponentId *c, const TriPortId *at, const TriSignatureId *signature, const
TciParameterList *tciPars, const TciValueTemplate *parsTmpl, const TciValue *addrValue, const
TciValueTemplate *addressTmpl)=0;

//Called by TE to log getting a call
virtual void tliPrGetCall_c (const Tstring &am, const timeval ts, const Tstring src, const Tinteger
line, const TriComponentId *c, const TriPortId *at, const TriSignatureId *signature, const
TciParameterList *tciPars, const TciValueTemplate *parsTmpl, const TriComponentId *from, const
TciNonValueTemplate *fromTmpl)=0;

//Called by TE to log a unicast reply operation
virtual void tliPrReply_m (const Tstring &am, const timeval ts, const Tstring src, const Tinteger
line, const TriComponentId *c, const TriPortId *at, const TriPortId *to, const TriSignatureId
*signature, const TciParameterList *tciPars, const TciValue *replValue, const TriAddress *address,
const TciStatus *encoderFailure, const TriParameterList *triPars, const TriParameter *repl, const
TriStatus *transmissionFailure)=0;

//Called by TE to log a broadcast reply operation
virtual void tliPrReply_m_BC (const Tstring &am, const timeval ts, const Tstring src, const Tinteger
line, const TriComponentId *c, const TriPortId *at, const TriPortId *to, const TriSignatureId
*signature, const TciParameterList *tciPars, const TciValue *replValue, const TciStatus
*encoderFailure, const TriParameterList *triPars, const TriParameter *repl, const TriStatus
*transmissionFailure)=0;

//Called by TE to log a multicast reply operation
virtual void tliPrReply_m_MC (const Tstring &am, const timeval ts, const Tstring src, const Tinteger
line, const TriComponentId *c, const TriPortId *at, const TriPortId *to, const TriSignatureId
*signature, const TciParameterList *tciPars, const TciValue *replValue, const TriAddressList
*addresses, const TciStatus *encoderFailure, const TriParameterList *triPars, const TriParameter
*repl, const TriStatus *transmissionFailure)=0;

//Called by TE to log a unicast reply operation
virtual void tliPrReply_c (const Tstring &am, const timeval ts, const Tstring src, const Tinteger
line, const TriComponentId *c, const TriPortId *at, const TriPortId *to, const TriSignatureId
*signature, const TciValue *parsValue, const TciValue *replValue, const TriStatus
*transmissionFailure)=0;

//Called by TE to log a broadcast reply operation
virtual void tliPrReply_c_BC (const Tstring &am, const timeval ts, const Tstring src, const Tinteger
line, const TriComponentId *c, const TriPortId *at, const TriPortIdList *to, const TriSignatureId
*signature, const TciValue *parsValue, const TciValue *replValue, const TriStatus
*transmissionFailure)=0;

//Called by TE to log og a multicast reply operation
virtual void tliPrReply_c_MC (const Tstring &am, const timeval ts, const Tstring src, const Tinteger
line, const TriComponentId *c, const TriPortId *at, const TriPortIdList *to, const TriSignatureId
*signature, const TciValue *parsValue, const TciValue *replValue, const TriStatus
*transmissionFailure)=0;

//Called by TE to log the getreply enqueue operation
virtual void tliPrGetReplyDetected_m (const Tstring &am, const timeval ts, const Tstring src, const
Tinteger line, const TriComponentId *c, const TriPortId *at, const TriPortId *from, const
TriSignatureId *signature, const TriParameterList *triPars, const TriParameter *repl, const
TriAddress *address)=0;

```

```

//Called by CH to log the getreply enqueue operation
virtual void tliPrGetReplyDetected_c (const Tstring &am, const timeval ts, const Tstring src, const
Tinteger line, const TriComponentId *c, const TriPortId *at, const TriPortId *from, const
TriSignatureId *signature, const TciParameterList *tciPars, const TciValue *replValue)=0;

//Called by TE to log the mismatch of a getreply operation
virtual void tliPrGetReplyMismatch_m (const Tstring &am, const timeval ts, const Tstring src, const
Tinteger line, const TriComponentId *c, const TriPortId *at, const TriSignatureId *signature, const
TciParameterList *tciPars, const TciValueTemplate *parsTmpl, const TciValue *replValue, const
TciValueTemplate *replyTmpl, const TciValueDifferenceList *diffs, const TciValue *addrValue, const
TciValueTemplate *addressTmpl)=0;

//Called by TE to log the mismatch of a getreply operation
virtual void tliPrGetReplyMismatch_c (const Tstring &am, const timeval ts, const Tstring src, const
Tinteger line, const TriComponentId *c, const TriPortId *at, const TriSignatureId *signature, const
TciParameterList *tciPars, const TciValueTemplate *parsTmpl, const TciValue *replValue, const
TciValueTemplate *replyTmpl, const TciValueDifferenceList *diffs, const TriComponentId *from, const
TciNonValueTemplate *fromTmpl)=0;

//Called by TE to log getting a reply
virtual void tliPrGetReply_m (const Tstring &am, const timeval ts, const Tstring src, const Tinteger
line, const TriComponentId *c, const TriPortId *at, const TriSignatureId *signature, const
TciParameterList *tciPars, const TciValueTemplate *parsTmpl, const TciValue *replValue, const
TciValueTemplate *replyTmpl, const TciValue *addrValue, const TciValueTemplate *addressTmpl)=0;

//Called by TE to log getting a reply
virtual void tliPrGetReply_c (const Tstring &am, const timeval ts, const Tstring src, const Tinteger
line, const TriComponentId *c, const TriPortId *at, const TriSignatureId *signature, const
TciParameterList *tciPars, const TciValueTemplate *parsTmpl, const TciValue *replValue, const
TciValueTemplate *replyTmpl, const TriComponentId *from, const TciNonValueTemplate *fromTmpl)=0;

//Called by TE to log a unicast raise operation
virtual void tliPrRaise_m (const Tstring &am, const timeval ts, const Tstring src, const Tinteger
line, const TriComponentId *c, const TriPortId *at, const TriPortId *to, const TriSignatureId
*signature, const TciParameterList *tciPars, const TciValue *excValue, const TriAddress *address,
const TriStatus *encoderFailure, const TriException *exc, const TriStatus *transmissionFailure)=0;

//Called by TE to log a broadcast raise operation
virtual void tliPrRaise_m_BC (const Tstring &am, const timeval ts, const Tstring src, const Tinteger
line, const TriComponentId *c, const TriPortId *at, const TriPortId *to, const TriSignatureId
*signature, const TciParameterList *tciPars, const TciValue *excValue, const TriStatus
*encoderFailure, const TriException *exc, const TriStatus *transmissionFailure)=0;

//Called by TE to log a multicast raise operation
virtual void tliPrRaise_m_MC (const Tstring &am, const timeval ts, const Tstring src, const Tinteger
line, const TriComponentId *c, const TriPortId *at, const TriPortId *to, const TriSignatureId
*signature, const TciParameterList *tciPars, const TciValue *excValue, const TriAddressList
*addresses, const TriStatus *encoderFailure, const TriException *exc, const TriStatus
*transmissionFailure)=0;

//Called by TE to log a unicast raise operation
virtual void tliPrRaise_c (const Tstring &am, const timeval ts, const Tstring src, const Tinteger
line, const TriComponentId *c, const TriPortId *at, const TriPortId *to, const TriSignatureId
*signature, const TciParameterList *tciPars, const TciValue *excValue, const TriStatus
*transmissionFailure)=0;

//Called by TE to log a broadcast raise operation
virtual void tliPrRaise_c_BC (const Tstring &am, const timeval ts, const Tstring src, const Tinteger
line, const TriComponentId *c, const TriPortId *at, const TriPortIdList *to, const TriSignatureId
*signature, const TciParameterList *tciPars, const TciValue *excValue, const TriStatus
*transmissionFailure)=0;

//Called by TE to log a multicast raise operation
virtual void tliPrRaise_c_MC (const Tstring &am, const timeval ts, const Tstring src, const Tinteger
line, const TriComponentId *c, const TriPortId *at, const TriPortIdList *to, const TriSignatureId
*signature, const TciParameterList *tciPars, const TciValue *excValue, const TriStatus
*transmissionFailure)=0;

//Called by TE to log the catch enqueue operation
virtual void tliPrCatchDetected_m (const Tstring &am, const timeval ts, const Tstring src, const
Tinteger line, const TriComponentId *c, const TriPortId *at, const TriPortId *from, const
TriSignatureId *signature, const TriException *exc, const TriAddress *address)=0;

//Called by TE to log the catch enqueue operation
virtual void tliPrCatchDetected_c (const Tstring &am, const timeval ts, const Tstring src, const
Tinteger line, const TriComponentId *c, const TriPortId *at, const TriPortId *from, const
TriSignatureId *signature, const TciValue *excValue)=0;

```

```
//Called by TE to log the mismatch of a catch operation
virtual void tliPrCatchMismatch_m (const Tstring &am, const timeval ts, const Tstring src, const
Tinteger line, const TriComponentId *c, const TriPortId *at, const TriSignatureId *signature, const
TciValue *excValue, const TciValueTemplate *excTmpl, const TciValueDifferenceList *diffs, const
TciValue *addrValue, const TciValueTemplate *addressTmpl)=0;

//Called by TE to log the mismatch of a catch operation
virtual void tliPrCatchMismatch_c (const Tstring &am, const timeval ts, const Tstring src, const
Tinteger line, const TriComponentId *c, const TriPortId *at, const TriSignatureId *signature, const
TciValue *excValue, const TciValueTemplate *excTmpl, const TciValueDifferenceList *diffs, const
TriComponentId *from, const TciNonValueTemplate *fromTmpl)=0;

//Called by TE to log catching an exception
virtual void tliPrCatch_m (const Tstring &am, const timeval ts, const Tstring src, const Tinteger
line, const TriComponentId *c, const TriPortId *at, const TriSignatureId *signature, const TciValue
*excValue, const TciValueTemplate *excTmpl, const TciValue *addrValue, const TciValueTemplate
*addressTmpl)=0;

//Called by TE to log catching an exception
virtual void tliPrCatch_c (const Tstring &am, const timeval ts, const Tstring src, const Tinteger
line, const TriComponentId *c, const TriPortId *at, const TriSignatureId *signature, const TciValue
*excValue, const TciValueTemplate *excTmpl, const TriComponentId *from, const TciNonValueTemplate
*fromTmpl)=0;

//Called by TE to log the detection of a catch timeout
virtual void tliPrCatchTimeoutDetected (const Tstring &am, const timeval ts, const Tstring src,
const Tinteger line, const TriComponentId *c, const TriPortId *at, const TriSignatureId
*signature)=0;

//Called by TE to log catching a timeout
virtual void tliPrCatchTimeout (const Tstring &am, const timeval ts, const Tstring src, const
Tinteger line, const TriComponentId *c, const TriPortId *at, const TriSignatureId *signature)=0;

//Called by TE to log the create component operation
virtual void tliCCreate (const Tstring &am, const timeval ts, const Tstring src, const Tinteger
line, const TriComponentId *c, const TriComponentId *comp, const Tstring &name, const Tboolean
alive)=0;

//Called by TE to log the start component operation
virtual void tliCStart (const Tstring &am, const timeval ts, const Tstring &src, const Tinteger
line, const TriComponentId *c, const TriComponentId *comp, const TciBehaviourId *beh, const
TciParameterList *tciPars)=0;

//Called by TE to log the running component operation
virtual void tliCRunning (const Tstring &am, const timeval ts, const Tstring &src, const Tinteger
line, const TriComponentId *c, const TriComponentId *comp, const ComponentStatus status)=0;

//Called by TE to log the alive component operation
virtual void tliCAlive (const Tstring &am, const timeval ts, const Tstring &src, const Tinteger
line, const TriComponentId *c, const TriComponentId *comp, const ComponentStatus status)=0;

//Called by TE to log the stop component operation
virtual void tliCStop (const Tstring &am, const timeval ts, const Tstring &src, const Tinteger line,
const TriComponentId *c, const TriComponentId *comp)=0;

//Called by TE to log the kill component operation
virtual void tliCKill (const Tstring &am, const timeval ts, const Tstring &src, const Tinteger line,
const TriComponentId *c, const TriComponentId *comp)=0;

//Called by TE to log the mismatch of a done component operation
virtual void tliCDoneMismatch (const Tstring &am, const timeval ts, const Tstring &src, const
Tinteger line, const TriComponentId *c, const TriComponentId *comp, const TciNonValueTemplate
*compTmpl)=0;

//Called by TE to log the done component operation
virtual void tliCDone (const Tstring &am, const timeval ts, const Tstring &src, const Tinteger line,
const TriComponentId *c, const TciNonValueTemplate *compTmpl, const VerdictValue * verdict)=0;

//Called by TE to log the mismatch of a killed component operation
virtual void tliCKilledMismatch (const Tstring &am, const timeval ts, const Tstring &src, const
Tinteger line, const TriComponentId *c, const TciNonValueTemplate *compTmpl)=0;

//Called by TE to log the killed component operation
virtual void tliCKilled (const Tstring &am, const timeval ts, const Tstring &src, const Tinteger
line, const TriComponentId *c, const TciNonValueTemplate *compTmpl, const VerdictValue * verdict)=0;
```

```

//Called by TE to log the termination of a component
virtual void tliCTerminated (const TString &am, const timeval ts, const TString &src, const TInteger
line, const TriComponentId *c, const VerdictValue *verdict, const TString &reason)=0;

//Called by TE to log the connect operation
virtual void tliPConnect (const TString &am, const timeval ts, const TString src, const TInteger
line, const TriComponentId *c, const TriPortId *port1, const TriPortId *port2)=0;

//Called by TE to log the connect operation
virtual void tliPDisconnect (const TString &am, const timeval ts, const TString src, const TInteger
line, const TriComponentId *c, const TriPortId *port1, const TriPortId *port2)=0;

//Called by TE to log the map operation
virtual void tliPMap (const TString &am, const timeval ts, const TString &src, const TInteger line,
const TriComponentId *c, const TriPortId *port1, const TriPortId *port2)=0;

//Called by TE to log the map operation including param
virtual void tliPMapParam (const TString &am, const timeval ts, const TString &src, const TInteger
line, const TriComponentId *c, const TriPortId *port1, const TriPortId *port2, const
TciParameterList *tciPars, const TriStatus *encoderFailure,
const TriParameterList *triPars)=0;

//Called by TE to log the unmap operation
virtual void tliPUnmap (const TString &am, const timeval ts, const TString &src, const TInteger
line, const TriComponentId *c, const TriPortId *port1, const TriPortId *port2)=0;

//Called by TE to log the unmap operation including param
virtual void tliPUnmapParam (const TString &am, const timeval ts, const TString &src, const TInteger
line, const TriComponentId *c, const TriPortId *port1, const TriPortId *port2, const
TciParameterList *tciPars, const TriStatus *encoderFailure,
const TriParameterList *triPars)=0;

//Called by TE to log the port clear operation
virtual void tliPClear (const TString &am, const timeval ts, const TString &src, const TInteger
line, const TriComponentId *c, const TriPortId *port)=0;

//Called by TE to log the port start operation
virtual void tliPStart (const TString &am, const timeval ts, const TString &src, const TInteger
line, const TriComponentId *c, const TriPortId *port)=0;

//Called by TE to log the port stop operation
virtual void tliPStop (const TString &am, const timeval ts, const TString &src, const TInteger line,
const TriComponentId *c, const TriPortId *port)=0;

//Called by TE to log the port stop operation
virtual void tliPHalt (const TString &am, const timeval ts, const TString &src, const TInteger line,
const TriComponentId *c, const TriPortId *port)=0;

//Called by TE to log the encode operation
virtual void tliEncode (const TString &am, const timeval ts, const TString &src, const TInteger
line, const TriComponentId *c, const TciValue *val, const TciStatus *encoderFailure, const
TriMessage *msg, const TString &codec)=0;

//Called by TE to log the decode operation
virtual void tliDecode (const TString &am, const timeval ts, const TString &src, const TInteger
line, const TriComponentId *c, const TriMessage *msg, const TciStatus *decoderFailure, const
TciValue *val, const TString &codec)=0;

//Called by TE to log the detection of a timeout
virtual void tliTTimeoutDetected (const TString &am, const timeval ts, const TString &src, const
TInteger line, const TriComponentId *c, const TriTimerId *timer)=0;

//Called by TE to log a timeout mismatch
virtual void tliTTimeoutMismatch (const TString &am, const timeval ts, const TString &src, const
TInteger line, const TriComponentId *c, const TriTimerId *timer, const TciNonValueTemplate
*timerTpl)=0;

//Called by TE to log a timeout match
virtual void tliTTimeout (const TString &am, const timeval ts, const TString &src, const TInteger
line, const TriComponentId *c, const TriTimerId *timer, const TciNonValueTemplate *timerTpl)=0;

//Called by TE to log the start of a timer
virtual void tliTStart (const TString &am, const timeval ts, const TString &src, const TInteger
line, const TriComponentId *c, const TriTimerId *timer, const TriTimerDuration *dur)=0;

```

```
//Called by TE to log the stop of a timer
virtual void tliTStop (const Tstring &am, const timeval ts, const Tstring &src, const Tinteger line,
const TriComponentId *c, const TriTimerId *timer, const TriTimerDuration *dur)=0;

//Called by TE to log the reading of a timer
virtual void tliTRead (const Tstring &am, const timeval ts, const Tstring &src, const Tinteger line,
const TriComponentId *c, const TriTimerId *timer, const TriTimerDuration *elapsed)=0;

//Called by TE to log the running timer operation
virtual void tliTRunning (const Tstring &am, const timeval ts, const Tstring &src, const Tinteger
line, const TriComponentId *c, const TriTimerId *timer, const TimerStatus status)=0;

//Called by TE to log the entering of a scope
virtual void tliSEnter (const Tstring &am, const timeval ts, const Tstring &src, const Tinteger
line, const TriComponentId *c, const QualifiedName &name, const TciParameterList *tciPars, const
Tstring &kind)=0;

//Called by TE to log the leaving of a scope
virtual void tliSLeave (const Tstring &am, const timeval ts, const Tstring &src, const Tinteger
line, const TriComponentId *c, const QualifiedName &name, const TciParameterList *tciPars, const
TciValue *returnValue, const Tstring &kind)=0;

//Called by TE to log the modification of the value of a variable
virtual void tliVVar (const Tstring &am, const timeval ts, const Tstring &src, const Tinteger line,
const TriComponentId *c, const QualifiedName &name, const TciValue *varValue)=0;

//Called by TE to log the value of a module parameter
virtual void tliModulePar (const Tstring &am, const timeval ts, const Tstring &src, const Tinteger
line, const TriComponentId *c, const QualifiedName &name, const TciValue *parValue)=0;

//Called by TE to log the value of a module parameter
virtual void tliGetVerdict (const Tstring &am, const timeval ts, const Tstring &src, const Tinteger
line, const TriComponentId *c, const VerdictValue *verdict)=0;

//Called by TE to log the setverdict operation
virtual void tliSetVerdict (const Tstring &am, const timeval ts, const Tstring &src, const Tinteger
line, const TriComponentId *c, const VerdictValue *verdict, const TString &reason)=0;

//Called by TE to log the TTCN-3 statement log
virtual void tliLog (const Tstring &am, const timeval ts, const Tstring &src, const Tinteger line,
const TriComponentId *c, const Tstring *log)=0;

//Called by TE to log entering an alt
virtual void tliAEnter (const Tstring &am, const timeval ts, const Tstring &src, const Tinteger
line, const TriComponentId *c)=0;

//Called by TE to log leaving an alt
virtual void tliALeave (const Tstring &am, const timeval ts, const Tstring &src, const Tinteger
line, const TriComponentId *c)=0;

//Called by TE to log the nomatch of an alt
virtual void tliANomatch (const Tstring &am, const timeval ts, const Tstring &src, const Tinteger
line, const TriComponentId *c)=0;

//Called by TE to log repeating an alt
virtual void tliARepeat (const Tstring &am, const timeval ts, const Tstring &src, const Tinteger
line, const TriComponentId *c)=0;

//Called by TE to log entering the default section
virtual void tliADefaults (const Tstring &am, const timeval ts, const Tstring &src, const Tinteger
line, const TriComponentId *c)=0;

//Called by TE to log the activation of a default
virtual void tliAActivate (const Tstring &am, const timeval ts, const Tstring &src, const Tinteger
line, const TriComponentId *c, const QualifiedName &name, const TciParameterList *tciPars, const
TciValue *ref)=0;

//Called by TE to log the deactivation of a default
virtual void tliADeactivate (const Tstring &am, const timeval ts, const Tstring &src, const Tinteger
line, const TriComponentId *c, const TciValue *ref)=0;

//Called by TE to log entering an alt
virtual void tliAWait (const Tstring &am, const timeval ts, const Tstring &src, const Tinteger line,
const TriComponentId *c)=0;
```

```

//Called by TE to log that the component executed an SUT action
virtual void tliAction (const Tstring &am, const timeval ts, const Tstring &src, const Tinteger
line, const TriComponentId *c, const Tstring &action)=0;

//Called by TE to log that the component successfully executed a match operation
virtual void tliMatch (const Tstring &am, const timeval ts, const Tstring &src, const Tinteger line,
const TriComponentId *c, const TciValue &expr, const TciValueTemplate &ttempl)=0;

//Called by TE to log that the component executed a match operation, and a mismatch occurred
virtual void tliMatchMismatch (const Tstring &am, const timeval ts, const Tstring &src, const
Tinteger line, const TriComponentId *c, const TciValue &expr, const TciValueTemplate &ttempl, const
TciValueDifferenceList &diffs)=0;

//Can be called by the TE to log additional information during test execution
virtual void tliInfo (const Tstring &am, const timeval ts, const Tstring &src, const Tinteger line,
const TriComponentId *c, const Tinteger level, const Tstring &info)=0;

//Called by TE to log the checking of a message
virtual void tliMChecked_m (const Tstring &am, const timeval ts, const Tstring &src,
const Tinteger line, const TriComponentId *c, const TriPortId *at,
const TciValue *msgValue, const TciValueTemplate *msgTmpl,
const TriAddress *address, const TciValueTemplate *addressTmpl)=0;

//Called by CH to log the checking of a message
virtual void tliMChecked_c (const Tstring &am, const timeval ts, const Tstring src,
const Tinteger line, const TriComponentId *c, const TriPortId *at,
const TciValue *msgValue, const TciValueTemplate *msgTmpl,
const TriComponentId *from, const TciNonValueTemplate *fromTmpl)=0;

//Called by TE to log checking of the getcall operation
virtual void tliPrGetCallChecked_m (const Tstring &am, const timeval ts, const Tstring src,
const Tinteger line, const TriComponentId *c, const TriPortId *at, const TriSignatureId *signature,
const TciParameterList *tciPars, const TciValueTemplate *parsTmpl,
const TriAddress *address, const TciValueTemplate *addressTmpl)=0;

//Called by TE to log checking of the getcall operation
virtual void tliPrGetCallChecked_c (const Tstring &am, const timeval ts, const Tstring src,
const Tinteger line, const TriComponentId *c, const TriPortId *at, const TriSignatureId *signature,
const TciParameterList *tciPars, const TciValueTemplate *parsTmpl,
const TriComponentId *from, const TciNonValueTemplate *fromTmpl)=0;

//Called by TE to log checking of the getreply operation
virtual void tliPrGetReplyChecked_m (const Tstring &am, const timeval ts, const Tstring src,
const Tinteger line, const TriComponentId *c, const TriPortId *at, const TriSignatureId *signature,
const TciParameterList *tciPars, const TciValueTemplate *parsTmpl,
const TciValue *replValue, const TciValueTemplate *replyTmpl,
const TriAddress *address, const TciValueTemplate *addressTmpl)=0;

//Called by CH to log checking of the getreply operation
virtual void tliPrGetReplyChecked_c (const Tstring &am, const timeval ts, const Tstring src,
const Tinteger line, const TriComponentId *c, const TriPortId *at, const TriSignatureId *signature,
const TciParameterList *tciPars, const TciValueTemplate *parsTmpl,
const TciValue *replValue, const TciValueTemplate *replyTmpl,
const TriComponentId *from, const TciNonValueTemplate *fromTmpl)=0;

//Called by TE to log checking of the catch operation
virtual void tliPrCatchChecked_m (const Tstring &am, const timeval ts, const Tstring src,
const Tinteger line, const TriComponentId *c, const TriPortId *at, const TriSignatureId *signature,
const TciValue *excValue, const TciValueTemplate *excTmpl,
const TriAddress *address, const TciValueTemplate *addressTmpl)=0;

//Called by TE to log checking of the catch operation
virtual void tliPrCatchChecked_c (const Tstring &am, const timeval ts, const Tstring src,
const Tinteger line, const TriComponentId *c, const TriPortId *at, const TriSignatureId *signature,
const TciValue *excValue, const TciValueTemplate *excTmpl,
const TriComponentId *from, const TciNonValueTemplate *fromTmpl)=0;

//Called by TE to log the check any operation
virtual void tliCheckedAny_m (const Tstring &am, const timeval ts, const Tstring &src,
const Tinteger line, const TriComponentId *c, const TriPortId *at,
const TriAddress *address, const TciValueTemplate *addressTmpl)=0;

//Called by CH to log the check any operation
virtual void tliCheckedAny_c (const Tstring &am, const timeval ts, const Tstring src,
const Tinteger line, const TriComponentId *c, const TriPortId *at,
const TriComponentId *from, const TciNonValueTemplate *fromTmpl)=0;

```

```

//Called by TE to log the mismatch in a check any operation
virtual void tliCheckAnyMismatch_m (const Tstring &am, const timeval ts, const Tstring &src,
const Tinteger line, const TriComponentId *c, const TriPortId *at,
const TciValue *addrValue, const TciValueTemplate *addressTpl)=0;

//Called by CH to log the mismatch in a check any operation
virtual void tliCheckAnyMismatch_c (const Tstring &am, const timeval ts, const Tstring src,
const Tinteger line, const TriComponentId *c, const TriPortId *at,
const TriComponentId *from, const TciNonValueTemplate *fromTpl)=0;

//Called by TE to log the generation of a random number
virtual void tliRnd (const Tstring &am, const timeval ts, const Tstring src, const Tinteger line,
const TriComponentId *c, const FloatValue *val, const FloatValue *seed)=0;

//Called by TE to log evaluation of a @fuzzy or @lazy template or variable
virtual void tliEvaluate (const Tstring &am, const timeval ts, const Tstring &src, const Tinteger
line, const TriComponentId *c, const QualifiedName &name, const TciValue *evalResult)=0;

```

11 W3C XML mapping

11.1 Introduction

This clause introduces the TCI XML mapping [10], [11] and [12] for the logging interface of TCI. The XML mapping for the logging interface defines how the IDL definitions for TCI-TL described in clause 7 are mapped to XML. The complete schema definitions for this mapping are given in annex B.

11.2 Scopes

The IDL module **tciInterface** is mapped to an XML schema with the name space http://uri.etsi.org/ttcn-3/tci/TLI_v4_6_1.xsd.

This schema uses further schemas:

- http://uri.etsi.org/ttcn-3/tci/SimpleTypes_v4_6_1.xsd
for the mapping of simple types to XML.
- http://uri.etsi.org/ttcn-3/tci/Types_v4_6_1.xsd
for the mapping of structured types to XML.
- http://uri.etsi.org/ttcn-3/tci/Values_v4_6_1.xsd
for the mapping of values to XML.
- http://uri.etsi.org/ttcn-3/tci/Templates_v4_6_1.xsd
for the mapping of templates to XML.
- http://uri.etsi.org/ttcn-3/tci/Events_v4_6_1.xsd
for the mapping of logging events to XML.

11.3 Type mapping

11.3.1 Mapping of simple types

11.3.1.1 TBoolean

The IDL **TBoolean** type is mapped to the xsd basic type `boolean`.

11.3.1.2 TString

The IDL **TString** type is mapped to the xsd basic type `string`.

11.3.1.3 TInteger

The IDL **TInteger** type is mapped to the xsd basic type `integer`.

11.3.1.4 TriTimerDurationType

The IDL **TriTimerDurationType** type is mapped to the xsd basic type `float`.

11.3.1.5 TciParameterPassingModeType

The IDL **TciParameterPassingModeType** type is mapped to the xsd basic type `string` with enumeration values "in", "out" and "inout".

11.3.1.6 TriStatusType

The IDL **TriStatusType** type is mapped to the xsd basic type `string` with enumeration values "TRI_Ok" and "TRI_Error".

11.3.1.7 TciStatusType

The IDL **TriStatusType** type is mapped to the xsd basic type `string` with enumeration values "TCI_Ok" and "TCI_Error".

11.3.1.8 ComponentStatusType

The IDL **ComponentStatusType** type is mapped to the xsd basic type `string` with enumeration values "inactiveC", "runningC", "stoppedC", "killedC" and "nullC".

11.3.1.9 TimerStatusType

The IDL **TimerStatusType** type is mapped to the xsd basic type `string` with enumeration values "runningT", "inactiveT", "expiredT", and "nullT".

11.3.1.10 PortStatusType

The IDL **PortStatusType** type is mapped to the xsd basic type `string` with enumeration values "startedP", "haltedP" and "stoppedP".

11.3.2 Complex type mapping

11.3.2.1 TriPortIdType

TriPortIdType is mapped to the following complex type:

```
<xsd:complexType name="TriPortIdType">
  <xsd:sequence>
    <xsd:element name="comp" type="Types:TriComponentIdType" />
    <xsd:element name="port" type="Types:Port" />
  </xsd:sequence>
</xsd:complexType>
```

Elements:

- `comp` The TRI component identifier.
- `port` The identification of the port.

Attributes:

- none.

11.3.2.2 TriComponentIdType

TriComponentIdType is mapped to the following complex type:

```
<xsd:complexType name="TriComponentIdType">
  <xsd:sequence>
    <xsd:choice>
      <xsd:element name="null" type="Templates:null"/>
      <xsd:element name="id" type="Types:Id"/>
    </xsd:choice>
  </xsd:sequence>
</xsd:complexType>
```

Elements:

- `id` The identifier of the TRI component.
- `null` The null identifier. To be used if there is no TRI component identifier.

Attributes:

- none.

11.3.2.3 TriComponentIdListType

TriComponentIdListType is mapped to the following complex type:

```
<xsd:complexType name="TriComponentIdListType">
  <xsd:sequence>
    <xsd:element name="comp" type="Types:TriComponentIdType" minOccurs="0"
      maxOccurs="unbounded"/>
  </xsd:sequence>
</xsd:complexType>
```

Elements:

- `comp` The identifiers of TRI components in that list.

Attributes:

- none.

11.3.2.4 Port

Port is mapped to the following complex type:

```
<xsd:complexType name="Port">
  <xsd:sequence>
    <xsd:element name="id" type="Types:Id"/>
    <xsd:element name="index" type="xsd:int"/>
  </xsd:sequence>
</xsd:complexType>
```

Elements:

- `id` The port identifier.
- `port` The port index.

Attributes:

- none.

11.3.2.5 Id

Id is used as identification for components, ports and timers and is mapped to the following complex type:

```
<xsd:complexType name="Id">
  <xsd:sequence>
    <xsd:element name="name" type="SimpleTypes:TString"/>
    <xsd:element name="id" type="SimpleTypes:TString" minOccurs="0"/>
    <xsd:element name="type" type="SimpleTypes:TString" minOccurs="0"/>
  </xsd:sequence>
</xsd:complexType>
```

Elements:

- **name** The name of the component, port or timer.
- **id** The internal representation of the component, port or timer.
- **type** The type of the component, port or timer.

Attributes:

- none.

11.3.2.6 TriMessageType

TriMessageType is mapped to the following complex type:

```
<xsd:complexType name="TriMessageType">
  <xsd:attribute name="val" type="xsd:hexBinary"/>
  <xsd:attribute name="paddingBits" type="xsd:integer" use="optional" default="0"/>
</xsd:complexType>
```

NOTE: `paddingBits` is optional with a default value of 0 and should only take values between 0 and 7.
 The relation between `paddingBits` and `numberOfBits` is:
 $numberOfBits == (\text{length}(\text{val-attribute})/2) * 8 - \text{paddingBits}$
 In the byte-aligned case which is the typical one, the `paddingBits` attribute can be left out.

Elements:

- none.

Attributes:

- **val** The encoded message.
- **paddingBits** The padding bits of the encoded message.

11.3.2.7 TriParameterType

TriParameterType is mapped to the following complex type:

```
<xsd:complexType name="TriParameterType">
  <xsd:attribute name="val" type="xsd:hexBinary"/>
  <xsd:attribute name="paddingBits" type="xsd:integer" use="optional" default="0"/>
  <xsd:attribute name="name" type="SimpleTypes:TString"/>
  <xsd:attribute name="mode" type="SimpleTypes:TciParameterPassingModeType"/>
</xsd:complexType>
```

NOTE: `paddingBits` is optional with a default value of 0 and should only take values between 0 and 7.
 The relation between `paddingBits` and `numberOfBits` is:
 $numberOfBits == (\text{length}(\text{val-attribute})/2) * 8 - \text{paddingBits}$
 In the byte-aligned case which is the typical one, the `paddingBits` attribute can be left out.

Elements:

- none.

Attributes:

- `val` The encoded parameter.
- `paddingBits` The padding bits of the encoded parameter.
- `name` The parameter name.
- `mode` The parameter passing mode.

11.3.2.8 TriParameterListType

TriParameterListType is mapped to the following complex type:

```
<xsd:complexType name="TriParameterListType">
  <xsd:sequence>
    <xsd:element name="par" type="Types:TriParameterType" minOccurs="0"
      maxOccurs="unbounded"/>
  </xsd:sequence>
</xsd:complexType>
```

Sequence of Elements:

- `par` The parameters in that list.

Attributes:

- none.

11.3.2.9 TriAddressType

TriAddressType is mapped to the following complex type:

```
<xsd:complexType name="TriAddressType">
  <xsd:attribute name="val" type="xsd:hexBinary"/>
  <xsd:attribute name="paddingBits" type="xsd:integer" use="optional" default="0"/>
</xsd:complexType>
```

NOTE: `paddingBits` is optional with a default value of 0 and should only take values between 0 and 7.
 The relation between `paddingBits` and `numberOfBits` is:
 $numberOfBits == (\text{length}(\text{val-attribute})/2) * 8 - \text{paddingBits}$
 In the byte-aligned case which is the typical one, the `paddingBits` attribute can be left out.

Elements:

- none.

Attributes:

- `val` The address value.
- `paddingBits` The padding bits of the encoded address.

11.3.2.10 TriAddressListType

TriAddressListType is mapped to the following complex type:

```
<xsd:complexType name="TriAddressListType">
  <xsd:sequence>
    <xsd:element name="addr" type="Types:TriAddressType" minOccurs="0"
      maxOccurs="unbounded"/>
  </xsd:sequence>
</xsd:complexType>
```

Elements:

- `addr` The addresses in that list.

Attributes:

- none.

11.3.2.11 TriExceptionType

TriExceptionType is mapped to the following complex type:

```
<xsd:complexType name="TriExceptionType">
  <xsd:attribute name="val" type="xsd:hexBinary"/>
  <xsd:attribute name="paddingBits" type="xsd:integer" use="optional" default="0"/>
</xsd:complexType>
```

NOTE: paddingBits is optional with a default value of 0 and should only take values between 0 and 7.

The relation between paddingBits and numberOfBits is:

numberOfBits == (length(val-attribute)/2)*8-paddingBits

In the byte-aligned case which is the typical one, the paddingBits attribute can be left out.

Elements:

- val The exception.

Attributes:

- none.

11.3.2.12 TriSignatureIdType

TriSignatureIdType is mapped to the following complex type:

```
<xsd:complexType name="TriSignatureIdType">
  <xsd:attribute name="val" type="SimpleTypes:TString" use="required"/>
</xsd:complexType>
```

Elements:

- val The signature.

Attributes:

- none.

11.3.2.13 TriTimerIdType

TriTimerIdType is mapped to the following complex type:

```
<xsd:complexType name="TriTimerIdType">
  <xsd:sequence>
    <xsd:element name="id" type="Types:Id"/>
  </xsd:sequence>
</xsd:complexType>
```

Elements:

- id The identification of the timer.

Attributes:

- none.

11.3.2.14 TriTimerDurationType

TriTimerDurationType is mapped to the following simple type:

```
<xsd:simpleType name="TriTimerDurationType">
  <xsd:restriction base="xsd:float"/>
</xsd:simpleType>
```

11.3.2.15 QualifiedName

QualifiedName is used to fully qualify module parameters, variables, etc and is mapped to the following complex type:

```
<xsd:complexType name="QualifiedName">
  <xsd:attribute name="moduleName" type="SimpleTypes:TString" use="required"/>
  <xsd:attribute name="baseName" type="SimpleTypes:TString" use="required"/>
</xsd:complexType>
```

Elements:

- `moduleName` The module name of the TTCN-3 module.
- `baseName` The name of the object that is fully qualified.

Attributes:

- none.

11.3.2.16 TciBehaviourIdType

TciBehaviourIdType is mapped to the following complex type:

```
<xsd:complexType name="TciBehaviourIdType">
  <xsd:sequence>
    <xsd:element name="name" type="Types:QualifiedName"/>
  </xsd:sequence>
</xsd:complexType>
```

Elements:

- `name` The qualified name of the behaviour.

Attributes:

- none.

11.3.2.17 TciTestCaseIdType

TciTestCaseIdType is mapped to the following complex type:

```
<xsd:complexType name="TciTestCaseIdType">
  <xsd:sequence>
    <xsd:element name="name" type="Types:QualifiedName"/>
  </xsd:sequence>
</xsd:complexType>
```

Elements:

- `name` The qualified name of the test case.

Attributes:

- none.

11.3.2.18 TciParameterType

TciParameterType is mapped to the following complex type:

```
<xsd:complexType name="TciParameterType">
  <xsd:sequence>
    <xsd:element name="val" type="Values:Value"/>
  </xsd:sequence>
  <xsd:attribute name="name" type="SimpleTypes:TString"/>
</xsd:complexType>
```

```
<xsd:attribute name="mode" type="SimpleTypes:TciParameterPassingModeType"/>
</xsd:complexType>
```

Elements:

- `val` The encoded parameter.

Attributes:

- `name` The parameter name.
- `mode` The parameter passing mode.

11.3.2.19 TciParameterListType

TciParameterListType is mapped to the following complex type:

```
<xsd:complexType name="TciParameterListType">
  <xsd:sequence>
    <xsd:element name="par" type="Types:TciParameterType"
      minOccurs="0" maxOccurs="unbounded"/>
  </xsd:sequence>
</xsd:complexType>
```

Sequence of Elements:

- `par` The parameters in that list.

Attributes:

- none.

11.3.2.20 TriPortIdListType

TriPortIdListType is mapped to the following complex type:

```
<xsd:complexType name="TriPortIdListType">
  <xsd:sequence>
    <xsd:element name="port" type="Types:TriPortIdType" minOccurs="0"
      maxOccurs="unbounded"/>
  </xsd:sequence>
</xsd:complexType>
```

Elements:

- `port` The identifiers of TRI ports in that list.

Attributes:

- none.

11.3.3 Abstract value mapping

11.3.3.1 Value

Value is mapped to the following complex type:

```
<xsd:complexType name="Value" mixed="true">
  <xsd:choice>
    <xsd:element name="integer" type="Values:IntegerValue"/>
    <xsd:element name="float" type="Values:FloatValue"/>
    <xsd:element name="boolean" type="Values:BooleanValue"/>
    <xsd:element name="verdicttype" type="Values:VerdictValue"/>
    <xsd:element name="bitstring" type="Values:BitstringValue"/>
    <xsd:element name="hexstring" type="Values:HexstringValue"/>
    <xsd:element name="octetstring" type="Values:OctetstringValue"/>
    <xsd:element name="charstring" type="Values:CharstringValue"/>
    <xsd:element name="universal_charstring" type="Values:UniversalCharstringValue"/>
  </xsd:choice>
</xsd:complexType>
```

```

<xsd:element name="record" type="Values:RecordValue"/>
<xsd:element name="record_of" type="Values:RecordOfValue"/>
<xsd:element name="array" type="Values:ArrayValue"/>
<xsd:element name="set" type="Values:SetValue"/>
<xsd:element name="set_of" type="Values:SetOfValue"/>
<xsd:element name="enumerated" type="Values:EnumeratedValue"/>
<xsd:element name="union" type="Values:UnionValue"/>
<xsd:element name="anytype" type="Values:AnytypeValue"/>
<xsd:element name="address" type="Values:AddressValue"/>
<xsd:element name="component" type="Values:ComponentValue"/>
<xsd:element name="port" type="Values:PortValue"/>
<xsd:element name="default" type="Values:DefaultValue"/>
<xsd:element name="timer" type="Values:TimerValue"/>
</xsd:choice>
<xsd:attributeGroup ref="Values:ValueAtts"/>
</xsd:complexType>

<xsd:simpleType name="ValueModifier">
  <xs:restriction base="SimpleTypes:TString">
    <xs:enumeration value="lazy"/>
    <xs:enumeration value="fuzzy"/>
  </xs:restriction>
</xsd:simpleType>

<xsd:attributeGroup name="ValueAtts">
  <xsd:attribute name="name" type="SimpleTypes:TString" use="optional"/>
  <xsd:attribute name="type" type="SimpleTypes:TString" use="optional"/>
  <xsd:attribute name="module" type="SimpleTypes:TString" use="optional"/>
  <xsd:attribute name="modifier" type="Values:ValueModifier" use="optional"/>
  <xsd:attribute name="annotation" type="SimpleTypes:TString" use="optional"/>
</xsd:attributeGroup>

```

Choice of Elements:

- integer An integer value.
- float A float value.
- boolean A boolean value.
- verdicttype A verdicttype value.
- bitstring A bitstring value.
- hexstring A hexstring value.
- octetstring An octetstring value.
- charstring A charstring value.
- universal_charstring A universal charstring value.
- record A record value.
- record_of A record of value.
- array An array value.
- set A set value.
- set_of A set of value.
- enumerated An enumerated value.
- union A union value.
- anytype An anytype value.
- address An address value.
- component A component value.

- port A port value.
- default A default value.
- timer A timer value.

Attributes:

- name The name of the value, if known.
- type The type of the value, if known.
- module The module of the value, if known.
- modifier The value modifier, if used: either lazy or fuzzy.
- annotation A helper attribute to provide additional matching/mismatching information, etc.

11.3.3.2 IntegerValue

IntegerValue is mapped to the following complex type:

```
<xsd:complexType name="IntegerValue">
  <xsd:choice >
    <xsd:element name="value" type="SimpleTypes:TString"/>
    <xsd:element name="null" type="Templates:null"/>
    <xsd:element name="omit" type="Templates:omit"/>
    <xsd:element name="matching_symbol" type="Templates:MatchingSymbol"/>
    <xsd:element name="not_evaluated" type="Values:NotEvaluated"/>
  </xsd:choice>
  <xsd:attributeGroup ref="Values:ValueAtts"/>
</xsd:complexType>
```

Choice of Elements:

- value The integer value as string.
- null If no value is given.
- omit If the value is omitted.
- matching_symbol If the value contains matching symbols.
- not_evaluated Used if a @lazy or @fuzzy value contains not evaluated content.

Attributes:

- The same attributes as those of Value.

11.3.3.3 FloatValue

FloatValue is mapped to the following complex type:

```
<xsd:complexType name="FloatValue">
  <xsd:choice >
    <xsd:element name="value" type="SimpleTypes:TString"/>
    <xsd:element name="null" type="Templates:null"/>
    <xsd:element name="omit" type="Templates:omit"/>
    <xsd:element name="matching_symbol" type="Templates:MatchingSymbol"/>
    <xsd:element name="not_evaluated" type="Values:NotEvaluated"/>
  </xsd:choice>
  <xsd:attributeGroup ref="Values:ValueAtts"/>
</xsd:complexType>
```

Choice of Elements:

- value The float value as string.

- `null` If no value is given.
- `omit` If the value is omitted.
- `matching_symbol` If the value contains matching symbols.
- `not_evaluated` Used if a `@lazy` or `@fuzzy` value contains not evaluated content.

Attributes:

- The same attributes as those of `Value`.

11.3.3.4 BooleanValue

BooleanValue is mapped to the following complex type:

```
<xsd:complexType name="BooleanValue">
  <xsd:choice >
    <xsd:element name="value" type="SimpleTypes:TString"/>
    <xsd:element name="null" type="Templates:null"/>
    <xsd:element name="omit" type="Templates:omit"/>
    <xsd:element name="matching_symbol" type="Templates:MatchingSymbol"/>
    <xsd:element name="not_evaluated" type="Values:NotEvaluated"/>
  </xsd:choice>
  <xsd:attributeGroup ref="Values:ValueAtts"/>
</xsd:complexType>
```

Choice of Elements:

- `value` The boolean value as string.
- `null` If no value is given.
- `omit` If the value is omitted.
- `matching_symbol` If the value contains matching symbols.
- `not_evaluated` Used if a `@lazy` or `@fuzzy` value contains not evaluated content.

Attributes:

- The same attributes as those of `Value`.

11.3.3.5 Void**11.3.3.6 VerdictValue**

VerdictValue is mapped to the following complex type:

```
<xsd:complexType name="VerdictValue">
  <xsd:choice >
    <xsd:element name="value" type="SimpleTypes:TString"/>
    <xsd:element name="null" type="Templates:null"/>
    <xsd:element name="omit" type="Templates:omit"/>
    <xsd:element name="matching_symbol" type="Templates:MatchingSymbol"/>
    <xsd:element name="not_evaluated" type="Values:NotEvaluated"/>
  </xsd:choice>
  <xsd:attributeGroup ref="Values:ValueAtts"/>
</xsd:complexType>
```

Choice of Elements:

- `value` The verdict value as string.
- `null` If no value is given.
- `omit` If the value is omitted.

- `matching_symbol` If the value contains matching symbols.
- `not_evaluated` Used if a `@lazy` or `@fuzzy` value contains not evaluated content.

Attributes:

- The same attributes as those of `Value`.

11.3.3.7 BitstringValue

BitstringValue is mapped to the following complex type:

```
<xsd:complexType name="BitstringValue">
  <xsd:choice >
    <xsd:element name="value" type="SimpleTypes:TString"/>
    <xsd:element name="null" type="Templates:null"/>
    <xsd:element name="omit" type="Templates:omit"/>
    <xsd:element name="matching_symbol" type="Templates:MatchingSymbol"/>
    <xsd:element name="not_evaluated" type="Values:NotEvaluated"/>
  </xsd:choice>
</xsd:complexType>
```

Choice of Elements:

- `value` The bitstring value as string.
- `null` If no value is given.
- `omit` If the value is omitted.
- `matching_symbol` If the value contains matching symbols.
- `not_evaluated` Used if a `@lazy` or `@fuzzy` value contains not evaluated content.

Attributes:

- The same attributes as those of `Value`.

11.3.3.8 HexstringValue

HexstringValue is mapped to the following complex type:

```
<xsd:complexType name="HexstringValue">
  <xsd:choice >
    <xsd:element name="value" type="SimpleTypes:TString"/>
    <xsd:element name="null" type="Templates:null"/>
    <xsd:element name="omit" type="Templates:omit"/>
    <xsd:element name="matching_symbol" type="Templates:MatchingSymbol"/>
    <xsd:element name="not_evaluated" type="Values:NotEvaluated"/>
  </xsd:choice>
  <xsd:attributeGroup ref="Values:ValueAtts"/>
</xsd:complexType>
```

Choice of Elements:

- `value` The hexstring value as string.
- `null` If no value is given.
- `omit` If the value is omitted.
- `matching_symbol` If the value contains matching symbols.
- `not_evaluated` Used if a `@lazy` or `@fuzzy` value contains not evaluated content.

Attributes:

- The same attributes as those of `Value`.

11.3.3.9 OctetstringValue

OctetstringValue is mapped to the following complex type:

```
<xsd:complexType name="OctetstringValue">
  <xsd:choice >
    <xsd:element name="value" type="SimpleTypes:TString"/>
    <xsd:element name="null" type="Templates:null"/>
    <xsd:element name="omit" type="Templates:omit"/>
    <xsd:element name="matching_symbol" type="Templates:MatchingSymbol"/>
    <xsd:element name="not_evaluated" type="Values:NotEvaluated"/>
  </xsd:choice>
  <xsd:attributeGroup ref="Values:ValueAtts"/>
</xsd:complexType>
```

Choice of Elements:

- value The octetstring value as string.
- null If no value is given.
- omit If the value is omitted.
- matching_symbol If the value contains matching symbols.
- not_evaluated Used if a @lazy or @fuzzy value contains not evaluated content.

Attributes:

- The same attributes as those of Value.

11.3.3.10 CharstringValue

CharstringValue is mapped to the following complex type:

```
<xsd:complexType name="CharstringValue">
  <xsd:choice>
    <xsd:element name="value" type="SimpleTypes:TString"/>
    <xsd:element name="null" type="Templates:null"/>
    <xsd:element name="omit" type="Templates:omit"/>
    <xsd:element name="matching_symbol" type="Templates:MatchingSymbol"/>
    <xsd:element name="not_evaluated" type="Values:NotEvaluated"/>
  </xsd:choice>
  <xsd:attributeGroup ref="Values:ValueAtts"/>
</xsd:complexType>
```

Choice of Elements:

- value The charstring value as string.
- null If no value is given.
- omit If the value is omitted.
- matching_symbol If the value contains matching symbols.
- not_evaluated Used if a @lazy or @fuzzy value contains not evaluated content.

Attributes:

- The same attributes as those of Value.

11.3.3.11 UniversalCharstringValue

UniversalCharstringValue is mapped to the following complex type:

```
<xsd:complexType name="UniversalCharstringValue">
  <xsd:choice>
    <xsd:element name="value" type="SimpleTypes:TString"/>
  </xsd:choice>
</xsd:complexType>
```

```

    <xsd:element name="null" type="Templates:null"/>
    <xsd:element name="omit" type="Templates:omit"/>
    <xsd:element name="matching_symbol" type="Templates:MatchingSymbol"/>
    <xsd:element name="not_evaluated" type="Values:NotEvaluated"/>
  </xsd:choice>
  <xsd:attributeGroup ref="Values:ValueAtts"/>
</xsd:complexType>

```

Choice of Elements:

- value The universal charstring value as string.
- null If no value is given.
- omit If the value is omitted.
- matching_symbol If the value contains matching symbols.
- not_evaluated Used if a @lazy or @fuzzy value contains not evaluated content.

Attributes:

- The same attributes as those of Value.

11.3.3.12 RecordValue

RecordValue is mapped to the following complex type:

```

<xsd:complexType name="RecordValue">
  <xsd:choice>
    <xsd:choice minOccurs="0" maxOccurs="unbounded">
      <xsd:element name="integer" type="Values:IntegerValue"/>
      <xsd:element name="float" type="Values:FloatValue"/>
      <xsd:element name="boolean" type="Values:BooleanValue"/>
      <xsd:element name="verdicttype" type="Values:VerdictValue"/>
      <xsd:element name="bitstring" type="Values:BitstringValue"/>
      <xsd:element name="hexstring" type="Values:HexstringValue"/>
      <xsd:element name="octetstring" type="Values:OctetstringValue"/>
      <xsd:element name="charstring" type="Values:CharstringValue"/>
      <xsd:element name="universal_charstring"
        type="Values:UniversalCharstringValue"/>
      <xsd:element name="record" type="Values:RecordValue"/>
      <xsd:element name="record_of" type="Values:RecordOfValue"/>
      <xsd:element name="array" type="Values:ArrayValue"/>
      <xsd:element name="set" type="Values:SetValue"/>
      <xsd:element name="set_of" type="Values:SetOfValue"/>
      <xsd:element name="enumerated" type="Values:EnumeratedValue"/>
      <xsd:element name="union" type="Values:UnionValue"/>
      <xsd:element name="anytype" type="Values:AnytypeValue"/>
      <xsd:element name="address" type="Values:AddressValue"/>
      <xsd:element name="component" type="Values:ComponentValue"/>
      <xsd:element name="default" type="Values:DefaultValue"/>
    </xsd:choice>
    <xsd:element name="null" type="Templates:null"/>
    <xsd:element name="omit" type="Templates:omit"/>
    <xsd:element name="matching_symbol" type="Templates:MatchingSymbol"/>
    <xsd:element name="not_evaluated" type="Values:NotEvaluated"/>
  </xsd:choice>
  <xsd:attributeGroup ref="Values:ValueAtts"/>
</xsd:complexType>

```

Sequence of Elements:

- integer An integer value.
- float A float value.
- boolean A boolean value.
- verdicttype A verdicttype value.
- bitstring A bitstring value.

- `hexstring` A hexstring value.
- `octetstring` An octetstring value.
- `charstring` A charstring value.
- `universal_charstring` A universal charstring value.
- `record` A record value.
- `record_of` A record of value.
- `array` An array value.
- `set` A set value.
- `set_of` A set of value.
- `enumerated` An enumerated value.
- `union` A union value.
- `anytype` An anytype value.
- `address` An address value.
- `component` A component value.
- `default` A default value.
- `null` If no field is given.
- `omit` If the field is omitted.
- `matching_symbol` If the value contains matching symbols.
- `not_evaluated` Used if a `@lazy` or `@fuzzy` value contains not evaluated content.

Attributes:

- The same attributes as those of `Value`.

11.3.3.13 RecordOfValue

RecordOfValue is mapped to the following complex type:

```
<xsd:complexType name="RecordOfValue">
  <xsd:choice>
    <xsd:element name="integer" type="Values:IntegerValue" minOccurs="0"
      maxOccurs="unbounded"/>
    <xsd:element name="float" type="Values:FloatValue" minOccurs="0"
      maxOccurs="unbounded"/>
    <xsd:element name="boolean" type="Values:BooleanValue" minOccurs="0"
      maxOccurs="unbounded"/>
    <xsd:element name="verdicttype" type="Values:VerdictValue" minOccurs="0"
      maxOccurs="unbounded"/>
    <xsd:element name="bitstring" type="Values:BitstringValue"
      minOccurs="0" maxOccurs="unbounded"/>
    <xsd:element name="hexstring" type="Values:HexstringValue"
      minOccurs="0" maxOccurs="unbounded"/>
    <xsd:element name="octetstring" type="Values:OctetstringValue"
      minOccurs="0" maxOccurs="unbounded"/>
    <xsd:element name="charstring" type="Values:CharstringValue"
      minOccurs="0" maxOccurs="unbounded"/>
    <xsd:element name="universal_charstring"
      type="Values:UniversalCharstringValue" minOccurs="0"
      maxOccurs="unbounded"/>
    <xsd:element name="record" type="Values:RecordValue" minOccurs="0"
      maxOccurs="unbounded"/>
  </xsd:choice>
</xsd:complexType>
```

```

<xsd:element name="record_of" type="Values:RecordOfValue"
  minOccurs="0" maxOccurs="unbounded"/>
<xsd:element name="array" type="Values:ArrayValue"
  minOccurs="0" maxOccurs="unbounded"/>
<xsd:element name="set" type="Values:SetValue" minOccurs="0"
  maxOccurs="unbounded"/>
<xsd:element name="set_of" type="Values:SetOfValue"
  minOccurs="0" maxOccurs="unbounded"/>
<xsd:element name="enumerated" type="Values:EnumeratedValue"
  minOccurs="0" maxOccurs="unbounded"/>
<xsd:element name="union" type="Values:UnionValue" minOccurs="0"
  maxOccurs="unbounded"/>
<xsd:element name="anytype" type="Values:AnytypeValue" minOccurs="0"
  maxOccurs="unbounded"/>
  <xsd:element name="address" type="Values:AddressValue" minOccurs="0"
    maxOccurs="unbounded"/>
<xsd:element name="component" type="Values:ComponentValue" minOccurs="0"
  maxOccurs="unbounded"/>
<xsd:element name="default" type="Values:DefaultValue" minOccurs="0"
  maxOccurs="unbounded"/>
<xsd:element name="null" type="Templates:null"/>
<xsd:element name="omit" type="Templates:omit"/>
<xsd:element name="matching_symbol" type="Templates:MatchingSymbol"/>
<xsd:element name="not_evaluated" type="Values:NotEvaluated"/>
</xsd:choice>
<xsd:attributeGroup ref="Values:ValueAtts"/>
</xsd:complexType>

```

Choice of Sequence of Elements:

- integer An integer value.
- float A float value.
- boolean A boolean value.
- verdicttype A verdicttype value.
- bitstring A bitstring value.
- hexstring A hexstring value.
- octetstring An octetstring value.
- charstring A charstring value.
- universal_charstring A universal charstring value.
- record A record value.
- record_of A record of value.
- array An array value.
- set A set value.
- set_of A set of value.
- enumerated An enumerated value.
- union A union value.
- anytype An anytype value.
- address An address value.
- component A component value.
- default A default value.

- `null` If no field is given.
- `omit` If the field is omitted.
- `matching_symbol` If the value contains matching symbols.
- `not_evaluated` Used if a `@lazy` or `@fuzzy` value contains not evaluated content.

Attributes:

- The same attributes as those of `Value`.

11.3.3.14 ArrayValue

ArrayValue is mapped to the following complex type:

```

<xsd:complexType name="ArrayValue">
  <xsd:choice>
    <xsd:element name="integer" type="Values:IntegerValue" minOccurs="0"
      maxOccurs="unbounded"/>
    <xsd:element name="float" type="Values:FloatValue" minOccurs="0"
      maxOccurs="unbounded"/>
    <xsd:element name="boolean" type="Values:BooleanValue" minOccurs="0"
      maxOccurs="unbounded"/>
    <xsd:element name="verdicttype" type="Values:VerdictValue" minOccurs="0"
      maxOccurs="unbounded"/>
    <xsd:element name="bitstring" type="Values:BitstringValue"
      minOccurs="0" maxOccurs="unbounded"/>
    <xsd:element name="hexstring" type="Values:HexstringValue"
      minOccurs="0" maxOccurs="unbounded"/>
    <xsd:element name="octetstring" type="Values:OctetstringValue"
      minOccurs="0" maxOccurs="unbounded"/>
    <xsd:element name="charstring" type="Values:CharstringValue"
      minOccurs="0" maxOccurs="unbounded"/>
    <xsd:element name="universal_charstring"
      type="Values:UniversalCharstringValue" minOccurs="0"
      maxOccurs="unbounded"/>
    <xsd:element name="record" type="Values:RecordValue" minOccurs="0"
      maxOccurs="unbounded"/>
    <xsd:element name="record_of" type="Values:RecordOfValue"
      minOccurs="0" maxOccurs="unbounded"/>
    <xsd:element name="array" type="Values:ArrayValue"
      minOccurs="0" maxOccurs="unbounded"/>
    <xsd:element name="set" type="Values:SetValue" minOccurs="0"
      maxOccurs="unbounded"/>
    <xsd:element name="set_of" type="Values:SetOfValue"
      minOccurs="0" maxOccurs="unbounded"/>
    <xsd:element name="enumerated" type="Values:EnumeratedValue"
      minOccurs="0" maxOccurs="unbounded"/>
    <xsd:element name="union" type="Values:UnionValue" minOccurs="0"
      maxOccurs="unbounded"/>
    <xsd:element name="anytype" type="Values:AnytypeValue" minOccurs="0"
      maxOccurs="unbounded"/>
    <xsd:element name="address" type="Values:AddressValue" minOccurs="0"
      maxOccurs="unbounded"/>
    <xsd:element name="component" type="Values:ComponentValue" minOccurs="0"
      maxOccurs="unbounded"/>
    <xsd:element name="port" type="Values:PortValue" minOccurs="0"
      maxOccurs="unbounded"/>
    <xsd:element name="default" type="Values:DefaultValue" minOccurs="0"
      maxOccurs="unbounded"/>
    <xsd:element name="timer" type="Values:TimerValue" minOccurs="0"
      maxOccurs="unbounded"/>
    <xsd:element name="null" type="Templates:null"/>
    <xsd:element name="omit" type="Templates:omit"/>
    <xsd:element name="matching_symbol" type="Templates:MatchingSymbol"/>
    <xsd:element name="not_evaluated" type="Values:NotEvaluated"/>
  </xsd:choice>
  <xsd:attributeGroup ref="Values:ValueAtts"/>
</xsd:complexType>

```

Choice of Sequence of Elements:

- `integer` An integer value.
- `float` A float value.
- `boolean` A boolean value.
- `verdicttype` A verdicttype value.
- `bitstring` A bitstring value.
- `hexstring` A hexstring value.
- `octetstring` An octetstring value.
- `charstring` A charstring value.
- `universal_charstring` A universal charstring value.
- `record` A record value.
- `record_of` A record of value.
- `array` An array value.
- `set` A set value.
- `set_of` A set of value.
- `enumerated` An enumerated value.
- `union` A union value.
- `anytype` An anytype value.
- `address` An address value.
- `component` A component value.
- `port` A port value.
- `default` A default value.
- `timer` A timer value.
- `null` If no field is given.
- `omit` If the field is omitted.
- `matching_symbol` If the value contains matching symbols.
- `not_evaluated` Used if a `@lazy` or `@fuzzy` value contains not evaluated content.

Attributes:

- The same attributes as those of `Value`.

11.3.3.15 SetValue

SetValue is mapped to the following complex type:

```
<xsd:complexType name="SetValue">
  <xsd:choice>
    <xsd:choice minOccurs="0" maxOccurs="unbounded">
      <xsd:element name="integer" type="Values:IntegerValue"/>
    </xsd:choice>
  </xsd:choice>
</xsd:complexType>
```

```

<xsd:element name="float" type="Values:FloatValue"/>
<xsd:element name="boolean" type="Values:BooleanValue"/>
<xsd:element name="verdicttype" type="Values:VerdictValue"/>
<xsd:element name="bitstring" type="Values:BitstringValue"/>
<xsd:element name="hexstring" type="Values:HexstringValue"/>
<xsd:element name="octetstring" type="Values:OctetstringValue"/>
<xsd:element name="charstring" type="Values:CharstringValue"/>
<xsd:element name="universal_charstring"
  type="Values:UniversalCharstringValue"/>
<xsd:element name="record" type="Values:RecordValue"/>
<xsd:element name="record_of" type="Values:RecordOfValue"/>
<xsd:element name="array" type="Values:ArrayValue"/>
<xsd:element name="set" type="Values:SetValue"/>
<xsd:element name="set_of" type="Values:SetOfValue"/>
<xsd:element name="enumerated" type="Values:EnumeratedValue"/>
<xsd:element name="union" type="Values:UnionValue"/>
<xsd:element name="anytype" type="Values:AnytypeValue"/>
<xsd:element name="address" type="Values:AddressValue"/>
<xsd:element name="component" type="Values:ComponentValue"/>
<xsd:element name="default" type="Values:DefaultValue"/>
</xsd:choice>
<xsd:element name="null" type="Templates:null"/>
<xsd:element name="omit" type="Templates:omit"/>
<xsd:element name="matching_symbol" type="Templates:MatchingSymbol"/>
<xsd:element name="not_evaluated" type="Values:NotEvaluated"/>
</xsd:choice>
  <xsd:attributeGroup ref="Values:ValueAtts"/>
</xsd:complexType>

```

Sequence of Elements:

- integer An integer value.
- float A float value.
- boolean A boolean value.
- verdicttype A verdicttype value.
- bitstring A bitstring value.
- hexstring A hexstring value.
- octetstring An octetstring value.
- charstring A charstring value.
- universal_charstring A universal charstring value.
- record A record value.
- record_of A record of value.
- array An array value.
- set A set value.
- set_of A set of value.
- enumerated An enumerated value.
- union A union value.
- anytype An anytype value.
- address An address value.
- component A component value.
- default A default value.

- `null` If no field is given.
- `omit` If the field is omitted.
- `matching_symbol` If the value contains matching symbols.
- `not_evaluated` Used if a `@lazy` or `@fuzzy` value contains not evaluated content.

Attributes:

- The same attributes as those of `Value`.

11.3.3.16 SetOfValue

`SetOfValue` is mapped to the following complex type:

```
<xsd:complexType name="SetOfValue">
  <xsd:choice>
    <xsd:element name="integer" type="Values:IntegerValue" minOccurs="0"
      maxOccurs="unbounded" />
    <xsd:element name="float" type="Values:FloatValue" minOccurs="0"
      maxOccurs="unbounded" />
    <xsd:element name="boolean" type="Values:BooleanValue" minOccurs="0"
      maxOccurs="unbounded" />
    <xsd:element name="verdicttype" type="Values:VerdictValue" minOccurs="0"
      maxOccurs="unbounded" />
    <xsd:element name="bitstring" type="Values:BitstringValue"
      minOccurs="0" maxOccurs="unbounded" />
    <xsd:element name="hexstring" type="Values:HexstringValue"
      minOccurs="0" maxOccurs="unbounded" />
    <xsd:element name="octetstring" type="Values:OctetstringValue"
      minOccurs="0" maxOccurs="unbounded" />
    <xsd:element name="charstring" type="Values:CharstringValue"
      minOccurs="0" maxOccurs="unbounded" />
    <xsd:element name="universal_charstring"
      type="Values:UniversalCharstringValue" minOccurs="0"
      maxOccurs="unbounded" />
    <xsd:element name="record" type="Values:RecordValue" minOccurs="0"
      maxOccurs="unbounded" />
    <xsd:element name="record_of" type="Values:RecordOfValue"
      minOccurs="0" maxOccurs="unbounded" />
    <xsd:element name="array" type="Values:ArrayValue"
      minOccurs="0" maxOccurs="unbounded" />
    <xsd:element name="set" type="Values:SetValue" minOccurs="0"
      maxOccurs="unbounded" />
    <xsd:element name="set_of" type="Values:SetOfValue"
      minOccurs="0" maxOccurs="unbounded" />
    <xsd:element name="enumerated" type="Values:EnumeratedValue"
      minOccurs="0" maxOccurs="unbounded" />
    <xsd:element name="union" type="Values:UnionValue" minOccurs="0"
      maxOccurs="unbounded" />
    <xsd:element name="anytype" type="Values:AnytypeValue" minOccurs="0"
      maxOccurs="unbounded" />
    <xsd:element name="address" type="Values:AddressValue" minOccurs="0"
      maxOccurs="unbounded" />
    <xsd:element name="component" type="Values:ComponentValue" minOccurs="0"
      maxOccurs="unbounded" />
    <xsd:element name="default" type="Values:DefaultValue" minOccurs="0"
      maxOccurs="unbounded" />
    <xsd:element name="null" type="Templates:null" />
    <xsd:element name="omit" type="Templates:omit" />
    <xsd:element name="matching_symbol" type="Templates:MatchingSymbol" />
    <xsd:element name="not_evaluated" type="Values:NotEvaluated" />
  </xsd:choice>
  <xsd:attributeGroup ref="Values:ValueAtts" />
</xsd:complexType>
```

Choice of Sequence of Elements:

- `integer` An integer value.
- `float` A float value.

- `boolean` A boolean value.
- `verdicttype` A verdicttype value.
- `bitstring` A bitstring value.
- `hexstring` A hexstring value.
- `octetstring` An octetstring value.
- `charstring` A charstring value.
- `universal_charstring` A universal charstring value.
- `record` A record value.
- `record_of` A record of value.
- `array` An array value.
- `set` A set value.
- `set_of` A set of value.
- `enumerated` An enumerated value.
- `union` A union value.
- `anytype` An anytype value.
- `address` An address value.
- `component` A component value.
- `default` A default value.
- `null` If no field is given.
- `omit` If the field is omitted.
- `matching_symbol` If the value contains matching symbols.
- `not_evaluated` Used if a `@lazy` or `@fuzzy` value contains not evaluated content.

Attributes:

- The same attributes as those of Value.

11.3.3.17 EnumeratedValue

EnumeratedValue is mapped to the following complex type:

```
<xsd:complexType name="EnumeratedValue">
  <xsd:choice>
    <xsd:element name="value" type="SimpleTypes:TString"/>
    <xsd:element name="intValue" type="SimpleTypes:TInteger" minOccurs="0"/>
    <xsd:element name="null" type="Templates:null"/>
    <xsd:element name="omit" type="Templates:omit"/>
    <xsd:element name="matching_symbol" type="Templates:MatchingSymbol"/>
    <xsd:element name="not_evaluated" type="Values:NotEvaluated"/>
  </xsd:choice>
</xsd:sequence>
  <xsd:attributeGroup ref="Values:ValueAtts"/>
</xsd:complexType>
```

Sequence of Elements:

- value The enumeration value.
- intValue The integer value.
- null If no value is given.
- omit If the value is omitted.
- matching_symbol If the value contains matching symbols.
- not_evaluated Used if a @lazy or @fuzzy value contains not evaluated content.

Attributes:

- The same attributes as those of Value.

11.3.3.18 UnionValue

UnionValue is mapped to the following complex type:

```
<xsd:complexType name="UnionValue">
  <xsd:choice>
    <xsd:element name="integer" type="Values:IntegerValue"/>
    <xsd:element name="float" type="Values:FloatValue"/>
    <xsd:element name="boolean" type="Values:BooleanValue"/>
    <xsd:element name="verdicttype" type="Values:VerdictValue"/>
    <xsd:element name="bitstring" type="Values:BitstringValue"/>
    <xsd:element name="hexstring" type="Values:HexstringValue"/>
    <xsd:element name="octetstring" type="Values:OctetstringValue"/>
    <xsd:element name="charstring" type="Values:CharstringValue"/>
    <xsd:element name="universal_charstring"
      type="Values:UniversalCharstringValue"/>
    <xsd:element name="record" type="Values:RecordValue"/>
    <xsd:element name="record_of" type="Values:RecordOfValue"/>
    <xsd:element name="array" type="Values:ArrayValue"/>
    <xsd:element name="set" type="Values:SetValue"/>
    <xsd:element name="set_of" type="Values:SetOfValue"/>
    <xsd:element name="enumerated" type="Values:EnumeratedValue"/>
    <xsd:element name="union" type="Values:UnionValue"/>
    <xsd:element name="anytype" type="Values:AnytypeValue"/>
    <xsd:element name="address" type="Values:AddressValue"/>
    <xsd:element name="component" type="Values:ComponentValue"/>
    <xsd:element name="default" type="Values:DefaultValue"/>
    <xsd:element name="null" type="Templates:null"/>
    <xsd:element name="omit" type="Templates:omit"/>
    <xsd:element name="matching_symbol" type="Templates:MatchingSymbol"/>
    <xsd:element name="not_evaluated" type="Values:NotEvaluated"/>
  </xsd:choice>
  <xsd:attributeGroup ref="Values:ValueAtts"/>
</xsd:complexType>
```

Choice of Elements:

- integer An integer value.
- float A float value.
- boolean A boolean value.
- verdicttype A verdicttype value.
- bitstring A bitstring value.
- hexstring A hexstring value.
- octetstring An octetstring value.
- charstring A charstring value.

- `universal_charstring` A universal charstring value.
- `record` A record value.
- `record_of` A record of value.
- `array` An array value.
- `set` A set value.
- `set_of` A set of value.
- `enumerated` An enumerated value.
- `union` A union value.
- `anytype` An anytype value.
- `address` An address value.
- `component` A component value.
- `default` A default value.
- `null` If no field is given.
- `omit` If the field is omitted.
- `matching_symbol` If the value contains matching symbols.
- `not_evaluated` Used if a `@lazy` or `@fuzzy` value contains not evaluated content.

Attributes:

- The same attributes as those of `Value`.

11.3.3.19 AnytypeValue

AnytypeValue is mapped to the following complex type:

```
<xsd:complexType name="AnytypeValue">
  <xsd:choice>
    <xsd:element name="integer" type="Values:IntegerValue"/>
    <xsd:element name="float" type="Values:FloatValue"/>
    <xsd:element name="boolean" type="Values:BooleanValue"/>
    <xsd:element name="verdicttype" type="Values:VerdictValue"/>
    <xsd:element name="bitstring" type="Values:BitstringValue"/>
    <xsd:element name="hexstring" type="Values:HexstringValue"/>
    <xsd:element name="octetstring" type="Values:OctetstringValue"/>
    <xsd:element name="charstring" type="Values:OctetstringValue"/>
    <xsd:element name="universal_charstring"
      type="Values:UniversalCharstringValue"/>
    <xsd:element name="record" type="Values:RecordValue"/>
    <xsd:element name="record_of" type="Values:RecordOfValue"/>
    <xsd:element name="array" type="Values:ArrayValue"/>
    <xsd:element name="set" type="Values:SetValue"/>
    <xsd:element name="set_of" type="Values:SetOfValue"/>
    <xsd:element name="enumerated" type="Values:EnumeratedValue"/>
    <xsd:element name="union" type="Values:UnionValue"/>
    <xsd:element name="address" type="Values:AddressValue"/>
    <xsd:element name="null" type="Templates:null"/>
    <xsd:element name="omit" type="Templates:omit"/>
    <xsd:element name="matching_symbol" type="Templates:MatchingSymbol"/>
    <xsd:element name="not_evaluated" type="Values:NotEvaluated"/>
  </xsd:choice>
  <xsd:attributeGroup ref="Values:ValueAtts"/>
</xsd:complexType>
```

Choice of Elements:

- integer An integer value.
- float A float value.
- boolean A boolean value.
- verdicttype A verdicttype value.
- bitstring A bitstring value.
- hexstring A hexstring value.
- octetstring An octetstring value.
- charstring A charstring value.
- universal_charstring A universal charstring value.
- record A record value.
- record_of A record of value.
- array An array value.
- set A set value.
- set_of A set of value.
- enumerated An enumerated value.
- union A union value.
- address An address value.
- null If no field is given.
- omit If the field is omitted.
- matching_symbol If the value contains matching symbols.
- not_evaluated Used if a @lazy or @fuzzy value contains not evaluated content.

Attributes:

- The same attributes as those of Value.

11.3.3.20 AddressValue

AddressValue is mapped to the following complex type:

```
<xsd:complexType name="AddressValue">
  <xsd:choice>
    <xsd:element name="integer" type="Values:IntegerValue"/>
    <xsd:element name="float" type="Values:FloatValue"/>
    <xsd:element name="boolean" type="Values:BooleanValue"/>
    <xsd:element name="verdicttype" type="Values:VerdictValue"/>
    <xsd:element name="bitstring" type="Values:BitstringValue"/>
    <xsd:element name="hexstring" type="Values:HexstringValue"/>
    <xsd:element name="octetstring" type="Values:OctetstringValue"/>
    <xsd:element name="charstring" type="Values:OctetstringValue"/>
    <xsd:element name="universal_charstring"
      type="Values:UniversalCharstringValue"/>
    <xsd:element name="record" type="Values:RecordValue"/>
    <xsd:element name="record_of" type="Values:RecordOfValue"/>
    <xsd:element name="array" type="Values:ArrayValue"/>
    <xsd:element name="set" type="Values:SetValue"/>
  </xsd:choice>
</xsd:complexType>
```

```

<xsd:element name="set_of" type="Values:SetOfValue"/>
<xsd:element name="enumerated" type="Values:EnumeratedValue"/>
<xsd:element name="union" type="Values:UnionValue"/>
<xsd:element name="anytype" type="Values:AnytypeValue"/>
<xsd:element name="null" type="Templates:null"/>
<xsd:element name="omit" type="Templates:omit"/>
<xsd:element name="matching_symbol" type="Templates:MatchingSymbol"/>
<xsd:element name="not_evaluated" type="Values:NotEvaluated"/>
</xsd:choice>
<xsd:attributeGroup ref="Values:ValueAtts"/>
</xsd:complexType>

```

Choice of Elements:

- integer An integer value.
- float A float value.
- boolean A boolean value.
- verdicttype A verdicttype value.
- bitstring A bitstring value.
- hexstring A hexstring value.
- octetstring An octetstring value.
- charstring A charstring value.
- universal_charstring A universal charstring value.
- record A record value.
- record_of A record of value.
- array An array of value.
- set A set value.
- set_of A set of value.
- enumerated An enumerated value.
- union A union value.
- anytype An anytype value.
- null If no field is given.
- omit If the field is omitted.
- matching_symbol If the value contains matching symbols.
- not_evaluated Used if a @lazy or @fuzzy value contains not evaluated content.

Attributes:

- The same attributes as those of Value.

11.3.3.21 ComponentValue

Value type used for component instances is mapped to the complex type specified below. The content of the XML elements based on the ComponentValue type shall be equal to the string produced by the valueToString operation (described in clause 7.2.2.2.1):

```

<xsd:complexType name="ComponentValue">
  <xsd:choice>

```



```

<xsd:element name="value" type="SimpleTypes:TString"/>
<xsd:element name="null" type="Templates:null"/>
<xsd:element name="omit" type="Templates:omit"/>
<xsd:element name="matching_symbol" type="Templates:MatchingSymbol"/>
<xsd:element name="not_evaluated" type="Values:NotEvaluated"/>
</xsd:choice>
<xsd:attributeGroup ref="Values:ValueAtts"/>
</xsd:complexType>

```

Choice of Elements:

- value The universal charstring value as string.
- null If no value is given.
- omit If the value is omitted.
- matching_symbol If the value contains matching symbols.
- not_evaluated Used if a @lazy or @fuzzy value contains not evaluated content.

Attributes:

- The same attributes as those of Value.

11.3.3.22 PortValue

Value type used for port instances is mapped to the complex type specified below. The content of the XML elements based on the PortValue type shall be equal to the string produced by the valueToString operation (described in clause 7.2.2.2.1):

```

<xsd:complexType name="PortValue">
  <xsd:choice>
    <xsd:element name="value" type="SimpleTypes:TString"/>
    <xsd:element name="null" type="Templates:null"/>
    <xsd:element name="omit" type="Templates:omit"/>
  </xsd:choice>
  <xsd:attributeGroup ref="Values:ValueAtts"/>
</xsd:complexType>

```

Choice of Elements:

- value The universal charstring value as string.
- null If no value is given.
- omit If the value is omitted.

Attributes:

- The same attributes as those of Value.

11.3.3.23 DefaultValue

Value type used for default instances is mapped to the complex type specified below. The content of the XML elements based on the DefaultValue type shall be equal to the string produced by the valueToString operation (described in clause 7.2.2.2.1):

```

<xsd:complexType name="DefaultValue">
  <xsd:choice>
    <xsd:element name="value" type="SimpleTypes:TString"/>
    <xsd:element name="null" type="Templates:null"/>
    <xsd:element name="omit" type="Templates:omit"/>
    <xsd:element name="not_evaluated" type="Values:NotEvaluated"/>
  </xsd:choice>
  <xsd:attributeGroup ref="Values:ValueAtts"/>
</xsd:complexType>

```

Choice of Elements:

- value The universal charstring value as string.
- null If no value is given.
- omit If the value is omitted.
- not_evaluated Used if a @lazy or @fuzzy value contains not evaluated content.

Attributes:

- The same attributes as those of Value.

11.3.3.24 TimerValue

Value type used for timer instances is mapped to the complex type specified below. The content of the XML elements based on the TimerValue type shall be equal to the string produced by the valueToString operation (described in clause 7.2.2.2.1):

```
<xsd:complexType name="TimerValue">
  <xsd:choice>
    <xsd:element name="value" type="SimpleTypes:TString"/>
    <xsd:element name="null" type="Templates:null"/>
    <xsd:element name="omit" type="Templates:omit"/>
  </xsd:choice>
  <xsd:attributeGroup ref="Values:ValueAtts"/>
</xsd:complexType>
```

Choice of Elements:

- value The universal charstring value as string.
- null If no value is given.
- omit If the value is omitted.

Attributes:

- The same attributes as those of Value.

11.3.4 Abstract logging types mapping**11.3.4.1 TciValueTemplate**

TciValueTemplate is mapped to the following complex type:

```
<xsd:complexType name="TciValueTemplate">
  <xsd:complexContent mixed="true">
    <xsd:extension base="Values:Value">
      <xsd:choice minOccurs="0">
        <xsd:element name="integer" type="Templates:IntegerTemplate"/>
        <xsd:element name="float" type="Templates:FloatTemplate"/>
        <xsd:element name="boolean" type="Templates:BooleanTemplate"/>
        <xsd:element name="verdicttype" type="Templates:VerdictTemplate"/>
        <xsd:element name="bitstring" type="Templates:BitstringTemplate"/>
        <xsd:element name="hexstring" type="Templates:HexstringTemplate"/>
        <xsd:element name="octetstring" type="Templates:OctetstringTemplate"/>
        <xsd:element name="charstring" type="Templates:CharstringTemplate"/>
        <xsd:element name="universal_charstring"
          type="Templates:UniversalCharstringTemplate"/>
        <xsd:element name="record" type="Templates:RecordTemplate"/>
        <xsd:element name="record_of" type="Templates:RecordOfTemplate"/>
        <xsd:element name="array" type="Templates:ArrayTemplate"/>
        <xsd:element name="set" type="Templates:SetTemplate"/>
        <xsd:element name="set_of" type="Templates:SetOfTemplate"/>
        <xsd:element name="enumerated" type="Templates:EnumeratedTemplate"/>
        <xsd:element name="union" type="Templates:UnionTemplate"/>
        <xsd:element name="anytype" type="Templates:AnytypeTemplate"/>
      </xsd:choice>
    </xsd:extension>
  </xsd:complexContent>
</xsd:complexType>
```

```

    <xsd:element name="address" type="Templates:AddressTemplate"/>
    <xsd:element name="omit" type="Templates:omit"/>
    <xsd:element name="any" type="Templates:any"/>
    <xsd:element name="anyoromit" type="Templates:anyoromit"/>
    <xsd:element name="templateDef" type="SimpleTypes:TString"/>
  </xsd:choice>
</xsd:extension>
</xsd:complexContent>
</xsd:complexType>

```

Choice of Elements:

- integer An integer template.
- float A float template.
- boolean A boolean template.
- verdicttype A verdicttype template.
- bitstring A bitstring template.
- hexstring A hexstring template.
- octetstring An octetstring template.
- charstring A charstring template.
- universal_charstring A universal charstring template.
- record A record template.
- record_of A record of template.
- array An array template.
- set A set template.
- set_of A set of template.
- enumerated An enumerated template.
- union A union template.
- anytype An anytype template.
- address An address template.
- omit An omit template.
- any An any template.
- anyoromit An anyoromit template.
- templateDef A complex template definition.

Attributes:

- none.

11.3.4.2 TciNonValueTemplate

TciNonValueTemplate is mapped to the following complex type:

```

<xsd:complexType name="TciNonValueTemplate">
  <xsd:sequence>
    <xsd:choice>
      <xsd:element name="any" type="Templates:any"/>
    </xsd:choice>
  </xsd:sequence>
</xsd:complexType>

```

```

    <xsd:element name="all" type="Templates:all"/>
    <xsd:element name="templateDef" type="SimpleTypes:TString"/>
    <xsd:element name="null" type="Templates:null"/>
  </xsd:choice>
</xsd:sequence>
</xsd:complexType>

```

Choice of Elements:

- any An any template.
- all An all template.
- templateDef A complex template definition.
- null No template is given.

Attributes:

- none.

11.3.4.3 TciValueList

TciValueList is mapped to the following complex type:

```

<xsd:complexType name="TciValueListType">
  <xsd:sequence>
    <xsd:element name="val" type="Values:Value"
      maxOccurs="unbounded"/>
  </xsd:sequence>
</xsd:complexType>

```

Sequence of Elements:

- val The values in the value list.

Attributes:

- none.

11.3.4.4 TciValueDifference

TciValueDifference is mapped to the following complex type:

```

<xsd:complexType name="TciValueDifference">
  <xsd:sequence>
    <xsd:element name="val" type="SimpleTypes:xpath"/>
    <xsd:element name="tpl"
type="SimpleTypes:xpath"/>
  </xsd:sequence>
  <xsd:attributeGroup ref="Values:ValueAtts"/>
  <xsd:attribute name="desc" type="SimpleTypes:TString"
use="optional"/>
</xsd:complexType>

```

Sequence of Elements:

- val A reference to the mismatching value.
- tpl A reference to the template.

Attributes:

- The same attributes as those of Value.
- desc The reason of the mismatch.

11.3.4.5 TciValueDifferenceList

TciValueDifferenceList is mapped to the following complex type:

```
<xsd:complexType name="TciValueDifferenceList">
  <xsd:sequence>
    <xsd:element name="diff" type="Templates:TciValueDifference"
      maxOccurs="unbounded"/>
  </xsd:sequence>
</xsd:complexType>
```

Sequence of Elements:

- **diff** The value/template differences in the value difference list.

Attributes:

- none.

11.4 Mapping of the operations on the logging interface

11.4.0 Mapping rules

Every operation provided at the logging interface has a corresponding complex type definition in XML. These complex type definitions are extensions of Event.

11.4.1 Event

Event is mapped to the following complex type:

```
<!-- common definition for all events -->
<xsd:complexType name="Event" mixed="true">
  <xsd:sequence>
    <xsd:element name="am" type="SimpleTypes:TString"/>
  </xsd:sequence>
  <xsd:attribute name="ts" type="xsd:long" use="required"/>
  <xsd:attribute name="src" type="SimpleTypes:TString" use="optional"/>
  <xsd:attribute name="line" type="SimpleTypes:TInteger" use="optional"/>

  <!-- general identifier structure for test components, ports and timer -->
  <xsd:attribute name="name" type="SimpleTypes:TString" use="required"/>
  <xsd:attribute name="id" type="SimpleTypes:TString" use="required"/>
  <xsd:attribute name="type" type="SimpleTypes:TString" use="required"/>
</xsd:complexType>
```

Elements:

- **am** A message, to be used for further information in the log.

Attributes:

- **ts** The time when the event is produced.
- **src** The source file of the test specification.
- **line** The line number where the request is performed.
- **name** The name of the component which produces this event.
- **id** The id of the component which produces this event.
- **type** The type of the component which produces this event.

11.4.2 The TCI-TL interface

11.4.2.1 TCI-TL provided

The TCI-TL Provided interface is mapped to the following interface:

```

<!-- testcases -->
<xsd:complexType name="tliTcExecute">
  <xsd:complexContent mixed="true">
    <xsd:extension base="Events:Event">
      <xsd:sequence>
        <xsd:element name="tcId" type="Types:TciTestCaseIdType"/>
        <xsd:element name="tciPars" type="Types:TciParameterListType" minOccurs="0"/>
        <xsd:element name="dur" type="SimpleTypes:TriTimerDurationType" minOccurs="0"/>
      </xsd:sequence>
    </xsd:extension>
  </xsd:complexContent>
</xsd:complexType>

<xsd:complexType name="tliTcStart">
  <xsd:complexContent mixed="true">
    <xsd:extension base="Events:Event">
      <xsd:sequence>
        <xsd:element name="tcId" type="Types:TciTestCaseIdType"/>
        <xsd:element name="tciPars" type="Types:TciParameterListType" minOccurs="0"/>
        <xsd:element name="dur" type="SimpleTypes:TriTimerDurationType" minOccurs="0"/>
      </xsd:sequence>
    </xsd:extension>
  </xsd:complexContent>
</xsd:complexType>

<xsd:complexType name="tliTcStop">
  <xsd:complexContent mixed="true">
    <xsd:extension base="Events:Event"/>
    <xsd:sequence>
      <xsd:element name="reason" type="SimpleTypes:TString" minOccurs="0"/>
    </xsd:sequence>
  </xsd:complexContent>
</xsd:complexType>

<xsd:complexType name="tliTcStarted">
  <xsd:complexContent mixed="true">
    <xsd:extension base="Events:Event">
      <xsd:sequence>
        <xsd:element name="tcId" type="Types:TciTestCaseIdType"/>
        <xsd:element name="tciPars" type="Types:TciParameterListType" minOccurs="0"/>
        <xsd:element name="dur" type="SimpleTypes:TriTimerDurationType" minOccurs="0"/>
      </xsd:sequence>
    </xsd:extension>
  </xsd:complexContent>
</xsd:complexType>

<xsd:complexType name="tliTcTerminated">
  <xsd:complexContent mixed="true">
    <xsd:extension base="Events:Event">
      <xsd:sequence>
        <xsd:element name="tcId" type="Types:TciTestCaseIdType"/>
        <xsd:element name="tciPars" type="Types:TciParameterListType" minOccurs="0"/>
        <xsd:element name="verdict" type="Values:VerdictValue"/>
        <xsd:element name="reason" type="SimpleTypes:TString" minOccurs="0"/>
      </xsd:sequence>
    </xsd:extension>
  </xsd:complexContent>
</xsd:complexType>

<!-- control -->
<xsd:complexType name="tliCtrlStart">
  <xsd:complexContent>
    <xsd:extension base="Events:Event"/>
  </xsd:complexContent>
</xsd:complexType>

<xsd:complexType name="tliCtrlStop">
  <xsd:complexContent>
    <xsd:extension base="Events:Event"/>
  </xsd:complexContent>

```

```

</xsd:complexType>

<xsd:complexType name="tliCtrlTerminated">
  <xsd:complexContent>
    <xsd:extension base="Events:Event" />
  </xsd:complexContent>
</xsd:complexType>

<!-- asynchronous communication -->
<xsd:complexType name="tliMSend_m">
  <xsd:complexContent mixed="true">
    <xsd:extension base="Events:Event">
      <xsd:sequence>
        <xsd:element name="at" type="Types:TriPortIdType" />
        <xsd:element name="to" type="Types:TriPortIdType" minOccurs="0" />
        <xsd:element name="msgValue" type="Values:Value" />
        <xsd:element name="addrValue" type="Values:Value" minOccurs="0" />
        <xsd:choice>
          <xsd:element name="encoder-failure" type="SimpleTypes:TciStatusType"
minOccurs="0" />
          <xsd:sequence>
            <xsd:element name="msg" type="Types:TriMessageType" minOccurs="0" />
            <xsd:element name="address" type="Types:TriAddressType" minOccurs="0" />
            <xsd:element name="transmission-failure"
type="SimpleTypes:TriStatusType" minOccurs="0" />
          </xsd:sequence>
        </xsd:choice>
      </xsd:sequence>
    </xsd:extension>
  </xsd:complexContent>
</xsd:complexType>

<xsd:complexType name="tliMSend_m_BC">
  <xsd:complexContent mixed="true">
    <xsd:extension base="Events:Event">
      <xsd:sequence>
        <xsd:element name="at" type="Types:TriPortIdType" />
        <xsd:element name="to" type="Types:TriPortIdType" minOccurs="0" />
        <xsd:element name="msgValue" type="Values:Value" />
        <xsd:choice>
          <xsd:element name="encoder-failure" type="SimpleTypes:TciStatusType"
minOccurs="0" />
          <xsd:sequence>
            <xsd:element name="msg" type="Types:TriMessageType" minOccurs="0" />
            <xsd:element name="transmission-failure"
type="SimpleTypes:TriStatusType" minOccurs="0" />
          </xsd:sequence>
        </xsd:choice>
      </xsd:sequence>
    </xsd:extension>
  </xsd:complexContent>
</xsd:complexType>

<xsd:complexType name="tliMSend_m_MC">
  <xsd:complexContent mixed="true">
    <xsd:extension base="Events:Event">
      <xsd:sequence>
        <xsd:element name="at" type="Types:TriPortIdType" />
        <xsd:element name="to" type="Types:TriPortIdType" minOccurs="0" />
        <xsd:element name="msgValue" type="Values:Value" />
        <xsd:element name="addrValues" type="Types:TciValueListType" minOccurs="0" />
        <xsd:choice>
          <xsd:element name="encoder-failure" type="SimpleTypes:TciStatusType"
minOccurs="0" />
          <xsd:sequence>
            <xsd:element name="msg" type="Types:TriMessageType" minOccurs="0" />
            <xsd:element name="addresses" type="Types:TriAddressListType"
minOccurs="0" />
            <xsd:element name="transmission-failure"
type="SimpleTypes:TriStatusType" minOccurs="0" />
          </xsd:sequence>
        </xsd:choice>
      </xsd:sequence>
    </xsd:extension>
  </xsd:complexContent>
</xsd:complexType>

```

```

<xsd:complexType name="tliMSend_c">
  <xsd:complexContent mixed="true">
    <xsd:extension base="Events:Event">
      <xsd:sequence>
        <xsd:element name="at" type="Types:TriPortIdType"/>
        <xsd:element name="to" type="Types:TriPortIdType" minOccurs="0"/>
        <xsd:element name="msgValue" type="Values:Value"/>
        <xsd:element name="transmission-failure" type="SimpleTypes:TriStatusType"
minOccurs="0"/>
      </xsd:sequence>
    </xsd:extension>
  </xsd:complexContent>
</xsd:complexType>

<xsd:complexType name="tliMSend_c_BC">
  <xsd:complexContent mixed="true">
    <xsd:extension base="Events:Event">
      <xsd:sequence>
        <xsd:element name="at" type="Types:TriPortIdType"/>
        <xsd:element name="to" type="Types:TriPortIdListType" minOccurs="0"/>
        <xsd:element name="msgValue" type="Values:Value"/>
        <xsd:element name="transmission-failure" type="SimpleTypes:TriStatusType"
minOccurs="0"/>
      </xsd:sequence>
    </xsd:extension>
  </xsd:complexContent>
</xsd:complexType>

<xsd:complexType name="tliMSend_c_MC">
  <xsd:complexContent mixed="true">
    <xsd:extension base="Events:Event">
      <xsd:sequence>
        <xsd:element name="at" type="Types:TriPortIdType"/>
        <xsd:element name="to" type="Types:TriPortIdListType" minOccurs="0"/>
        <xsd:element name="msgValue" type="Values:Value"/>
        <xsd:element name="transmission-failure" type="SimpleTypes:TriStatusType"
minOccurs="0"/>
      </xsd:sequence>
    </xsd:extension>
  </xsd:complexContent>
</xsd:complexType>

<xsd:complexType name="tliMDetected_m">
  <xsd:complexContent mixed="true">
    <xsd:extension base="Events:Event">
      <xsd:sequence>
        <xsd:element name="at" type="Types:TriPortIdType"/>
        <xsd:element name="from" type="Types:TriPortIdType" minOccurs="0"/>
        <xsd:element name="msgValue" type="Types:TriMessageType"/>
        <xsd:element name="address" type="Types:TriAddressType" minOccurs="0"/>
      </xsd:sequence>
    </xsd:extension>
  </xsd:complexContent>
</xsd:complexType>

<xsd:complexType name="tliMDetected_c">
  <xsd:complexContent mixed="true">
    <xsd:extension base="Events:Event">
      <xsd:sequence>
        <xsd:element name="at" type="Types:TriPortIdType"/>
        <xsd:element name="from" type="Types:TriPortIdType" minOccurs="0"/>
        <xsd:element name="msgValue" type="Values:Value"/>
      </xsd:sequence>
    </xsd:extension>
  </xsd:complexContent>
</xsd:complexType>

<xsd:complexType name="tliMMismatch_m">
  <xsd:complexContent mixed="true">
    <xsd:extension base="Events:Event">
      <xsd:sequence>
        <xsd:element name="at" type="Types:TriPortIdType"/>
        <xsd:element name="msgValue" type="Values:Value"/>
        <xsd:element name="msgTpl" type="Templates:TciValueTemplate"/>
        <xsd:element name="diffs" type="Templates:TciValueDifferenceList"/>
        <xsd:element name="addrValue" type="Values:Value" minOccurs="0"/>
        <xsd:element name="addressTpl" type="Templates:TciValueTemplate"

```



```

minOccurs="0"/>
    </xsd:sequence>
  </xsd:extension>
</xsd:complexContent>
</xsd:complexType>

<xsd:complexType name="tliMMismatch_c">
  <xsd:complexContent mixed="true">
    <xsd:extension base="Events:Event">
      <xsd:sequence>
        <xsd:element name="at" type="Types:TriPortIdType"/>
        <xsd:element name="msgValue" type="Values:Value"/>
        <xsd:element name="msgTmpl" type="Templates:TciValueTemplate"/>
        <xsd:element name="diffs" type="Templates:TciValueDifferenceList"/>
        <xsd:element name="from" type="Types:TriComponentIdType" minOccurs="0"/>
        <xsd:element name="fromTmpl" type="Templates:TciNonValueTemplate"
minOccurs="0"/>
      </xsd:sequence>
    </xsd:extension>
  </xsd:complexContent>
</xsd:complexType>

<xsd:complexType name="tliMReceive_m">
  <xsd:complexContent mixed="true">
    <xsd:extension base="Events:Event">
      <xsd:sequence>
        <xsd:element name="at" type="Types:TriPortIdType"/>
        <xsd:element name="msgValue" type="Values:Value" minOccurs="0"/>
        <xsd:element name="msgTmpl" type="Templates:TciValueTemplate"
minOccurs="0"/>
      <xsd:element name="addrValue" type="Values:Value" minOccurs="0"/>
      <xsd:element name="addressTmpl" type="Templates:TciValueTemplate"
minOccurs="0"/>
    </xsd:sequence>
  </xsd:extension>
</xsd:complexContent>
</xsd:complexType>

<xsd:complexType name="tliMReceive_c">
  <xsd:complexContent mixed="true">
    <xsd:extension base="Events:Event">
      <xsd:sequence>
        <xsd:element name="at" type="Types:TriPortIdType"/>
        <xsd:element name="msgValue" type="Values:Value" minOccurs="0"/>
        <xsd:element name="msgTmpl" type="Templates:TciValueTemplate"
minOccurs="0"/>
      <xsd:element name="from" type="Types:TriComponentIdType" minOccurs="0"/>
      <xsd:element name="fromTmpl" type="Templates:TciNonValueTemplate"
minOccurs="0"/>
    </xsd:sequence>
  </xsd:extension>
</xsd:complexContent>
</xsd:complexType>

<!-- synchronous communication -->
<xsd:complexType name="tliPrCall_m">
  <xsd:complexContent mixed="true">
    <xsd:extension base="Events:Event">
      <xsd:sequence>
        <xsd:element name="at" type="Types:TriPortIdType"/>
        <xsd:element name="to" type="Types:TriPortIdType" minOccurs="0"/>
        <xsd:element name="signature" type="Types:TriSignatureIdType"/>
        <xsd:element name="tciPars" type="Types:TciParameterListType" minOccurs="0"/>
        <xsd:element name="addrValue" type="Values:Value" minOccurs="0"/>
        <xsd:choice>
          <xsd:element name="encoder-failure" type="SimpleTypes:TciStatusType"
minOccurs="0"/>
          <xsd:sequence>
            <xsd:element name="triPars" type="Types:TriParameterListType"
minOccurs="0"/>
            <xsd:element name="address" type="Types:TriAddressType" minOccurs="0"/>
            <xsd:element name="transmission-failure"
type="SimpleTypes:TriStatusType" minOccurs="0"/>
          </xsd:sequence>
        </xsd:choice>
      </xsd:sequence>
    </xsd:extension>
  </xsd:complexContent>

```

```

</xsd:complexType>

<xsd:complexType name="tliPrCall_m_BC">
  <xsd:complexContent mixed="true">
    <xsd:extension base="Events:Event">
      <xsd:sequence>
        <xsd:element name="at" type="Types:TriPortIdType"/>
        <xsd:element name="to" type="Types:TriPortIdType" minOccurs="0"/>
        <xsd:element name="signature" type="Types:TriSignatureIdType"/>
        <xsd:element name="tciPars" type="Types:TciParameterListType" minOccurs="0"/>
        <xsd:choice>
          <xsd:element name="encoder-failure" type="SimpleTypes:TciStatusType"
minOccurs="0"/>
          <xsd:sequence>
            <xsd:element name="triPars" type="Types:TriParameterListType"
minOccurs="0"/>
            <xsd:element name="transmission-failure"
type="SimpleTypes:TriStatusType" minOccurs="0"/>
          </xsd:sequence>
        </xsd:choice>
      </xsd:sequence>
    </xsd:extension>
  </xsd:complexContent>
</xsd:complexType>

<xsd:complexType name="tliPrCall_m_MC">
  <xsd:complexContent mixed="true">
    <xsd:extension base="Events:Event">
      <xsd:sequence>
        <xsd:element name="at" type="Types:TriPortIdType"/>
        <xsd:element name="to" type="Types:TriPortIdType" minOccurs="0"/>
        <xsd:element name="signature" type="Types:TriSignatureIdType"/>
        <xsd:element name="tciPars" type="Types:TciParameterListType" minOccurs="0"/>
        <xsd:element name="addrValues" type="Types:TciValueListType" minOccurs="0"/>
        <xsd:choice>
          <xsd:element name="encoder-failure" type="SimpleTypes:TciStatusType"
minOccurs="0"/>
          <xsd:sequence>
            <xsd:element name="triPars" type="Types:TriParameterListType"
minOccurs="0"/>
            <xsd:element name="addresses" type="Types:TriAddressListType"
minOccurs="0"/>
            <xsd:element name="transmission-failure"
type="SimpleTypes:TriStatusType" minOccurs="0"/>
          </xsd:sequence>
        </xsd:choice>
      </xsd:sequence>
    </xsd:extension>
  </xsd:complexContent>
</xsd:complexType>

<xsd:complexType name="tliPrCall_c">
  <xsd:complexContent mixed="true">
    <xsd:extension base="Events:Event">
      <xsd:sequence>
        <xsd:element name="at" type="Types:TriPortIdType"/>
        <xsd:element name="to" type="Types:TriPortIdType" minOccurs="0"/>
        <xsd:element name="signature" type="Types:TriSignatureIdType"/>
        <xsd:element name="tciPars" type="Types:TciParameterListType" minOccurs="0"/>
        <xsd:element name="transmission-failure" type="SimpleTypes:TriStatusType"
minOccurs="0"/>
      </xsd:sequence>
    </xsd:extension>
  </xsd:complexContent>
</xsd:complexType>

<xsd:complexType name="tliPrCall_c_BC">
  <xsd:complexContent mixed="true">
    <xsd:extension base="Events:Event">
      <xsd:sequence>
        <xsd:element name="at" type="Types:TriPortIdType"/>
        <xsd:element name="to" type="Types:TriPortIdListType" minOccurs="0"/>
        <xsd:element name="signature" type="Types:TriSignatureIdType"/>
        <xsd:element name="tciPars" type="Types:TciParameterListType" minOccurs="0"/>
        <xsd:element name="transmission-failure" type="SimpleTypes:TriStatusType"
minOccurs="0"/>
      </xsd:sequence>
    </xsd:extension>
  </xsd:complexContent>
</xsd:complexType>

```

```

    </xsd:complexContent>
  </xsd:complexType>

  <xsd:complexType name="tliPrCall_c_MC">
    <xsd:complexContent mixed="true">
      <xsd:extension base="Events:Event">
        <xsd:sequence>
          <xsd:element name="at" type="Types:TriPortIdType"/>
          <xsd:element name="to" type="Types:TriPortIdListType" minOccurs="0"/>
          <xsd:element name="signature" type="Types:TriSignatureIdType"/>
          <xsd:element name="tciPars" type="Types:TciParameterListType" minOccurs="0"/>
          <xsd:element name="transmission-failure" type="SimpleTypes:TriStatusType"
minOccurs="0"/>
        </xsd:sequence>
      </xsd:extension>
    </xsd:complexContent>
  </xsd:complexType>

  <xsd:complexType name="tliPrGetCallDetected_m">
    <xsd:complexContent mixed="true">
      <xsd:extension base="Events:Event">
        <xsd:sequence>
          <xsd:element name="at" type="Types:TriPortIdType"/>
          <xsd:element name="from" type="Types:TriPortIdType" minOccurs="0"/>
          <xsd:element name="signature" type="Types:TriSignatureIdType"/>
          <xsd:element name="triPars" type="Types:TriParameterListType" minOccurs="0"/>
          <xsd:element name="address" type="Types:TriAddressType" minOccurs="0"/>
        </xsd:sequence>
      </xsd:extension>
    </xsd:complexContent>
  </xsd:complexType>

  <xsd:complexType name="tliPrGetCallDetected_c">
    <xsd:complexContent mixed="true">
      <xsd:extension base="Events:Event">
        <xsd:sequence>
          <xsd:element name="at" type="Types:TriPortIdType"/>
          <xsd:element name="from" type="Types:TriPortIdType" minOccurs="0"/>
          <xsd:element name="signature" type="Types:TriSignatureIdType"/>
          <xsd:element name="tciPars" type="Types:TciParameterListType" minOccurs="0"/>
        </xsd:sequence>
      </xsd:extension>
    </xsd:complexContent>
  </xsd:complexType>

  <xsd:complexType name="tliPrGetCallMismatch_m">
    <xsd:complexContent mixed="true">
      <xsd:extension base="Events:Event">
        <xsd:sequence>
          <xsd:element name="at" type="Types:TriPortIdType"/>
          <xsd:element name="signature" type="Types:TriSignatureIdType"/>
          <xsd:element name="tciPars" type="Types:TciParameterListType" minOccurs="0"/>
          <xsd:element name="parsTpl" type="Templates:TciValueTemplate" minOccurs="0"/>
          <xsd:element name="diffs" type="Templates:TciValueDifferenceList"/>
          <xsd:element name="addrValue" type="Values:Value" minOccurs="0"/>
          <xsd:element name="addressTpl" type="Templates:TciValueTemplate"
minOccurs="0"/>
        </xsd:sequence>
      </xsd:extension>
    </xsd:complexContent>
  </xsd:complexType>

  <xsd:complexType name="tliPrGetCallMismatch_c">
    <xsd:complexContent mixed="true">
      <xsd:extension base="Events:Event">
        <xsd:sequence>
          <xsd:element name="at" type="Types:TriPortIdType"/>
          <xsd:element name="signature" type="Types:TriSignatureIdType"/>
          <xsd:element name="tciPars" type="Types:TciParameterListType" minOccurs="0"/>
          <xsd:element name="parsTpl" type="Templates:TciValueTemplate" minOccurs="0"/>
          <xsd:element name="diffs" type="Templates:TciValueDifferenceList"/>
          <xsd:element name="from" type="Types:TriComponentIdType" minOccurs="0"/>
          <xsd:element name="fromTpl" type="Templates:TciValueTemplate" minOccurs="0"/>
        </xsd:sequence>
      </xsd:extension>
    </xsd:complexContent>
  </xsd:complexType>

```

```

<xsd:complexType name="tliPrGetCall_m">
  <xsd:complexContent mixed="true">
    <xsd:extension base="Events:Event">
      <xsd:sequence>
        <xsd:element name="at" type="Types:TriPortIdType"/>
        <xsd:element name="signature" type="Types:TriSignatureIdType"/>
        <xsd:element name="tciPars" type="Types:TciParameterListType" minOccurs="0"/>
        <xsd:element name="parsTmpl" type="Templates:TciValueTemplate" minOccurs="0"/>
        <xsd:element name="addrValue" type="Values:Value" minOccurs="0"/>
        <xsd:element name="addressTmpl" type="Templates:TciValueTemplate"
minOccurs="0"/>
      </xsd:sequence>
    </xsd:extension>
  </xsd:complexContent>
</xsd:complexType>

<xsd:complexType name="tliPrGetCall_c">
  <xsd:complexContent mixed="true">
    <xsd:extension base="Events:Event">
      <xsd:sequence>
        <xsd:element name="at" type="Types:TriPortIdType"/>
        <xsd:element name="signature" type="Types:TriSignatureIdType"/>
        <xsd:element name="tciPars" type="Types:TciParameterListType" minOccurs="0"/>
        <xsd:element name="parsTmpl" type="Templates:TciValueTemplate" minOccurs="0"/>
        <xsd:element name="from" type="Types:TriComponentIdType" minOccurs="0"/>
        <xsd:element name="fromTmpl" type="Templates:TciNonValueTemplate"
minOccurs="0"/>
      </xsd:sequence>
    </xsd:extension>
  </xsd:complexContent>
</xsd:complexType>

<xsd:complexType name="tliPrReply_m">
  <xsd:complexContent mixed="true">
    <xsd:extension base="Events:Event">
      <xsd:sequence>
        <xsd:element name="at" type="Types:TriPortIdType"/>
        <xsd:element name="to" type="Types:TriPortIdType" minOccurs="0"/>
        <xsd:element name="signature" type="Types:TriSignatureIdType"/>
        <xsd:element name="tciPars" type="Types:TciParameterListType" minOccurs="0"/>
        <xsd:element name="replValue" type="Values:Value" minOccurs="0"/>
        <xsd:element name="addrValue" type="Values:Value" minOccurs="0"/>
        <xsd:choice>
          <xsd:element name="encoder-failure" type="SimpleTypes:TciStatusType"
minOccurs="0"/>
          <xsd:sequence>
            <xsd:element name="triPars" type="Types:TriParameterListType"
minOccurs="0"/>
            <xsd:element name="repl" type="Types:TriParameterType" minOccurs="0"/>
            <xsd:element name="address" type="Types:TriAddressType" minOccurs="0"/>
            <xsd:element name="transmission-failure"
              type="SimpleTypes:TciStatusType" minOccurs="0"/>
          </xsd:sequence>
        </xsd:choice>
      </xsd:sequence>
    </xsd:extension>
  </xsd:complexContent>
</xsd:complexType>

<xsd:complexType name="tliPrReply_m_BC">
  <xsd:complexContent mixed="true">
    <xsd:extension base="Events:Event">
      <xsd:sequence>
        <xsd:element name="at" type="Types:TriPortIdType"/>
        <xsd:element name="to" type="Types:TriPortIdType" minOccurs="0"/>
        <xsd:element name="signature" type="Types:TriSignatureIdType"/>
        <xsd:element name="tciPars" type="Types:TciParameterListType" minOccurs="0"/>
        <xsd:element name="replValue" type="Values:Value" minOccurs="0"/>
        <xsd:choice>
          <xsd:element name="encoder-failure" type="SimpleTypes:TciStatusType"
minOccurs="0"/>
          <xsd:sequence>
            <xsd:element name="triPars" type="Types:TriParameterListType"
minOccurs="0"/>
            <xsd:element name="repl" type="Types:TriParameterType" minOccurs="0"/>
            <xsd:element name="transmission-failure"
              type="SimpleTypes:TciStatusType" minOccurs="0"/>
          </xsd:sequence>
        </xsd:choice>
      </xsd:sequence>
    </xsd:extension>
  </xsd:complexContent>
</xsd:complexType>

```

```

        </xsd:choice>
      </xsd:sequence>
    </xsd:extension>
  </xsd:complexContent>
</xsd:complexType>

<xsd:complexType name="tliPrReply_m_MC">
  <xsd:complexContent mixed="true">
    <xsd:extension base="Events:Event">
      <xsd:sequence>
        <xsd:element name="at" type="Types:TriPortIdType"/>
        <xsd:element name="to" type="Types:TriPortIdType" minOccurs="0"/>
        <xsd:element name="signature" type="Types:TriSignatureIdType"/>
        <xsd:element name="tciPars" type="Types:TciParameterListType" minOccurs="0"/>
        <xsd:element name="replValue" type="Values:Value" minOccurs="0"/>
        <xsd:element name="addrValues" type="Types:TciValueListType" minOccurs="0"/>
        <xsd:choice>
          <xsd:element name="encoder-failure" type="SimpleTypes:TciStatusType"
            minOccurs="0"/>
          <xsd:sequence>
            <xsd:element name="triPars" type="Types:TriParameterListType"
minOccurs="0"/>
            <xsd:element name="repl" type="Types:TriParameterType" minOccurs="0"/>
            <xsd:element name="addresses" type="Types:TriAddressListType"
minOccurs="0"/>
            <xsd:element name="transmission-failure"
              type="SimpleTypes:TciStatusType" minOccurs="0"/>
          </xsd:sequence>
        </xsd:choice>
      </xsd:sequence>
    </xsd:extension>
  </xsd:complexContent>
</xsd:complexType>

<xsd:complexType name="tliPrReply_c">
  <xsd:complexContent mixed="true">
    <xsd:extension base="Events:Event">
      <xsd:sequence>
        <xsd:element name="at" type="Types:TriPortIdType"/>
        <xsd:element name="to" type="Types:TriPortIdType" minOccurs="0"/>
        <xsd:element name="signature" type="Types:TriSignatureIdType"/>
        <xsd:element name="tciPars" type="Types:TciParameterListType" minOccurs="0"/>
        <xsd:element name="replValue" type="Values:Value" minOccurs="0"/>
        <xsd:element name="transmission-failure" type="SimpleTypes:TciStatusType"
minOccurs="0"/>
      </xsd:sequence>
    </xsd:extension>
  </xsd:complexContent>
</xsd:complexType>

<xsd:complexType name="tliPrReply_c_BC">
  <xsd:complexContent mixed="true">
    <xsd:extension base="Events:Event">
      <xsd:sequence>
        <xsd:element name="at" type="Types:TriPortIdType"/>
        <xsd:element name="to" type="Types:TriPortIdListType" minOccurs="0"/>
        <xsd:element name="signature" type="Types:TriSignatureIdType"/>
        <xsd:element name="tciPars" type="Types:TciParameterListType" minOccurs="0"/>
        <xsd:element name="replValue" type="Values:Value" minOccurs="0"/>
        <xsd:element name="transmission-failure" type="SimpleTypes:TciStatusType"
minOccurs="0"/>
      </xsd:sequence>
    </xsd:extension>
  </xsd:complexContent>
</xsd:complexType>

<xsd:complexType name="tliPrReply_c_MC">
  <xsd:complexContent mixed="true">
    <xsd:extension base="Events:Event">
      <xsd:sequence>
        <xsd:element name="at" type="Types:TriPortIdType"/>
        <xsd:element name="to" type="Types:TriPortIdListType" minOccurs="0"/>
        <xsd:element name="signature" type="Types:TriSignatureIdType"/>
        <xsd:element name="tciPars" type="Types:TciParameterListType" minOccurs="0"/>
        <xsd:element name="replValue" type="Values:Value" minOccurs="0"/>
        <xsd:element name="transmission-failure" type="SimpleTypes:TciStatusType"
minOccurs="0"/>
      </xsd:sequence>
    </xsd:extension>
  </xsd:complexContent>
</xsd:complexType>

```

```

    </xsd:extension>
  </xsd:complexContent>
</xsd:complexType>

<xsd:complexType name="tliPrGetReplyDetected_m">
  <xsd:complexContent mixed="true">
    <xsd:extension base="Events:Event">
      <xsd:sequence>
        <xsd:element name="at" type="Types:TriPortIdType"/>
        <xsd:element name="from" type="Types:TriPortIdType" minOccurs="0"/>
        <xsd:element name="signature" type="Types:TriSignatureIdType"/>
        <xsd:element name="triPars" type="Types:TriParameterListType" minOccurs="0"/>
        <xsd:element name="repl" type="Types:TriParameterType" minOccurs="0"/>
        <xsd:element name="address" type="Types:TriAddressType" minOccurs="0"/>
      </xsd:sequence>
    </xsd:extension>
  </xsd:complexContent>
</xsd:complexType>

<xsd:complexType name="tliPrGetReplyDetected_c">
  <xsd:complexContent mixed="true">
    <xsd:extension base="Events:Event">
      <xsd:sequence>
        <xsd:element name="at" type="Types:TriPortIdType"/>
        <xsd:element name="from" type="Types:TriPortIdType" minOccurs="0"/>
        <xsd:element name="signature" type="Types:TriSignatureIdType"/>
        <xsd:element name="tciPars" type="Types:TciParameterListType" minOccurs="0"/>
        <xsd:element name="replValue" type="Values:Value" minOccurs="0"/>
      </xsd:sequence>
    </xsd:extension>
  </xsd:complexContent>
</xsd:complexType>

<xsd:complexType name="tliPrGetReplyMismatch_m">
  <xsd:complexContent mixed="true">
    <xsd:extension base="Events:Event">
      <xsd:sequence>
        <xsd:element name="at" type="Types:TriPortIdType"/>
        <xsd:element name="signature" type="Types:TriSignatureIdType"/>
        <xsd:element name="tciPars" type="Types:TciParameterListType" minOccurs="0"/>
        <xsd:element name="parsTpl" type="Templates:TciValueTemplate" minOccurs="0"/>
        <xsd:element name="replValue" type="Values:Value" minOccurs="0"/>
        <xsd:element name="replTpl" type="Templates:TciValueTemplate" minOccurs="0"/>
        <xsd:element name="diffs" type="Templates:TciValueDifferenceList"/>
        <xsd:element name="addrValue" type="Values:Value" minOccurs="0"/>
        <xsd:element name="addressTpl" type="Templates:TciValueTemplate"
minOccurs="0"/>
      </xsd:sequence>
    </xsd:extension>
  </xsd:complexContent>
</xsd:complexType>

<xsd:complexType name="tliPrGetReplyMismatch_c">
  <xsd:complexContent mixed="true">
    <xsd:extension base="Events:Event">
      <xsd:sequence>
        <xsd:element name="at" type="Types:TriPortIdType"/>
        <xsd:element name="signature" type="Types:TriSignatureIdType"/>
        <xsd:element name="tciPars" type="Types:TciParameterListType" minOccurs="0"/>
        <xsd:element name="parsTpl" type="Templates:TciValueTemplate" minOccurs="0"/>
        <xsd:element name="replValue" type="Values:Value" minOccurs="0"/>
        <xsd:element name="replTpl" type="Templates:TciValueTemplate" minOccurs="0"/>
        <xsd:element name="diffs" type="Templates:TciValueDifferenceList"/>
        <xsd:element name="from" type="Types:TriComponentIdType" minOccurs="0"/>
        <xsd:element name="fromTpl" type="Templates:TciNonValueTemplate"
minOccurs="0"/>
      </xsd:sequence>
    </xsd:extension>
  </xsd:complexContent>
</xsd:complexType>

<xsd:complexType name="tliPrGetReply_m">
  <xsd:complexContent mixed="true">
    <xsd:extension base="Events:Event">
      <xsd:sequence>
        <xsd:element name="at" type="Types:TriPortIdType"/>
        <xsd:element name="signature" type="Types:TriSignatureIdType"/>
        <xsd:element name="tciPars" type="Types:TciParameterListType" minOccurs="0"/>

```

```

        <xsd:element name="parsTmpl" type="Templates:TciValueTemplate" minOccurs="0"/>
        <xsd:element name="replValue" type="Values:Value" minOccurs="0"/>
        <xsd:element name="replTmpl" type="Templates:TciValueTemplate" minOccurs="0"/>
        <xsd:element name="addrValue" type="Values:Value" minOccurs="0"/>
        <xsd:element name="addressTmpl" type="Templates:TciValueTemplate"
minOccurs="0"/>
    </xsd:sequence>
</xsd:extension>
</xsd:complexContent>
</xsd:complexType>

<xsd:complexType name="tliPrGetReply_c">
    <xsd:complexContent mixed="true">
        <xsd:extension base="Events:Event">
            <xsd:sequence>
                <xsd:element name="at" type="Types:TriPortIdType"/>
                <xsd:element name="signature" type="Types:TriSignatureIdType"/>
                <xsd:element name="tciPars" type="Types:TciParameterListType" minOccurs="0"/>
                <xsd:element name="parsTmpl" type="Templates:TciValueTemplate" minOccurs="0"/>
                <xsd:element name="replValue" type="Values:Value" minOccurs="0"/>
                <xsd:element name="replTmpl" type="Templates:TciValueTemplate" minOccurs="0"/>
                <xsd:element name="from" type="Types:TriComponentIdType" minOccurs="0"/>
                <xsd:element name="fromTmpl" type="Templates:TciNonValueTemplate"
minOccurs="0"/>
            </xsd:sequence>
</xsd:extension>
</xsd:complexContent>
</xsd:complexType>

<xsd:complexType name="tliPrRaise_m">
    <xsd:complexContent mixed="true">
        <xsd:extension base="Events:Event">
            <xsd:sequence>
                <xsd:element name="at" type="Types:TriPortIdType"/>
                <xsd:element name="to" type="Types:TriPortIdType" minOccurs="0"/>
                <xsd:element name="signature" type="Types:TriSignatureIdType"/>
                <xsd:element name="tciPars" type="Types:TciParameterListType" minOccurs="0"/>
                <xsd:element name="excValue" type="Values:Value" minOccurs="0"/>
                <xsd:element name="addrValue" type="Values:Value" minOccurs="0"/>
                <xsd:choice>
                    <xsd:element name="encoder-failure" type="SimpleTypes:TciStatusType"
minOccurs="0"/>
                </xsd:choice>
            </xsd:sequence>
            <xsd:sequence>
                <xsd:element name="exc" type="Types:TriExceptionType" minOccurs="0"/>
                <xsd:element name="address" type="Types:TriAddressType" minOccurs="0"/>
                <xsd:element name="transmission-failure"
type="SimpleTypes:TriStatusType" minOccurs="0"/>
            </xsd:sequence>
        </xsd:choice>
    </xsd:extension>
</xsd:complexContent>
</xsd:complexType>

<xsd:complexType name="tliPrRaise_m_BC">
    <xsd:complexContent mixed="true">
        <xsd:extension base="Events:Event">
            <xsd:sequence>
                <xsd:element name="at" type="Types:TriPortIdType"/>
                <xsd:element name="to" type="Types:TriPortIdType" minOccurs="0"/>
                <xsd:element name="signature" type="Types:TriSignatureIdType"/>
                <xsd:element name="tciPars" type="Types:TciParameterListType" minOccurs="0"/>
                <xsd:element name="excValue" type="Values:Value" minOccurs="0"/>
                <xsd:choice>
                    <xsd:element name="encoder-failure" type="SimpleTypes:TciStatusType"
minOccurs="0"/>
                </xsd:choice>
            </xsd:sequence>
            <xsd:sequence>
                <xsd:element name="exc" type="Types:TriExceptionType" minOccurs="0"/>
                <xsd:element name="transmission-failure"
type="SimpleTypes:TriStatusType" minOccurs="0"/>
            </xsd:sequence>
        </xsd:choice>
    </xsd:extension>
</xsd:complexContent>
</xsd:complexType>

<xsd:complexType name="tliPrRaise_m_MC">

```

```

<xsd:complexContent mixed="true">
  <xsd:extension base="Events:Event">
    <xsd:sequence>
      <xsd:element name="at" type="Types:TriPortIdType"/>
      <xsd:element name="to" type="Types:TriPortIdType" minOccurs="0"/>
      <xsd:element name="signature" type="Types:TriSignatureIdType"/>
      <xsd:element name="tciPars" type="Types:TciParameterListType" minOccurs="0"/>
      <xsd:element name="excValue" type="Values:Value" minOccurs="0"/>
      <xsd:element name="addrValues" type="Types:TciValueListType" minOccurs="0"/>
      <xsd:choice>
        <xsd:element name="encoder-failure" type="SimpleTypes:TciStatusType"
minOccurs="0"/>
        <xsd:sequence>
          <xsd:element name="exc" type="Types:TriExceptionType" minOccurs="0"/>
          <xsd:element name="addresses" type="Types:TriAddressListType"
minOccurs="0"/>
          <xsd:element name="transmission-failure"
type="SimpleTypes:TriStatusType" minOccurs="0"/>
        </xsd:sequence>
      </xsd:choice>
    </xsd:sequence>
  </xsd:extension>
</xsd:complexContent>
</xsd:complexType>

<xsd:complexType name="tliPrRaise_c">
  <xsd:complexContent mixed="true">
    <xsd:extension base="Events:Event">
      <xsd:sequence>
        <xsd:element name="at" type="Types:TriPortIdType"/>
        <xsd:element name="to" type="Types:TriPortIdType" minOccurs="0"/>
        <xsd:element name="signature" type="Types:TriSignatureIdType"/>
        <xsd:element name="tciPars" type="Types:TciParameterListType" minOccurs="0"/>
        <xsd:element name="excValue" type="Values:Value" minOccurs="0"/>
        <xsd:element name="transmission-failure" type="SimpleTypes:TriStatusType"
minOccurs="0"/>
      </xsd:sequence>
    </xsd:extension>
  </xsd:complexContent>
</xsd:complexType>

<xsd:complexType name="tliPrRaise_c_BC">
  <xsd:complexContent mixed="true">
    <xsd:extension base="Events:Event">
      <xsd:sequence>
        <xsd:element name="at" type="Types:TriPortIdType"/>
        <xsd:element name="to" type="Types:TriPortIdListType" minOccurs="0"/>
        <xsd:element name="signature" type="Types:TriSignatureIdType"/>
        <xsd:element name="tciPars" type="Types:TciParameterListType" minOccurs="0"/>
        <xsd:element name="excValue" type="Values:Value" minOccurs="0"/>
        <xsd:element name="transmission-failure" type="SimpleTypes:TriStatusType"
minOccurs="0"/>
      </xsd:sequence>
    </xsd:extension>
  </xsd:complexContent>
</xsd:complexType>

<xsd:complexType name="tliPrRaise_c_MC">
  <xsd:complexContent mixed="true">
    <xsd:extension base="Events:Event">
      <xsd:sequence>
        <xsd:element name="at" type="Types:TriPortIdType"/>
        <xsd:element name="to" type="Types:TriPortIdListType" minOccurs="0"/>
        <xsd:element name="signature" type="Types:TriSignatureIdType"/>
        <xsd:element name="tciPars" type="Types:TciParameterListType" minOccurs="0"/>
        <xsd:element name="excValue" type="Values:Value" minOccurs="0"/>
        <xsd:element name="transmission-failure" type="SimpleTypes:TriStatusType"
minOccurs="0"/>
      </xsd:sequence>
    </xsd:extension>
  </xsd:complexContent>
</xsd:complexType>

<xsd:complexType name="tliPrCatchDetected_m">
  <xsd:complexContent mixed="true">
    <xsd:extension base="Events:Event">
      <xsd:sequence>
        <xsd:element name="at" type="Types:TriPortIdType"/>

```



```

        <xsd:element name="from" type="Types:TriPortIdType" minOccurs="0"/>
        <xsd:element name="signature" type="Types:TriSignatureIdType"/>
        <xsd:element name="exc" type="Types:TriExceptionType" minOccurs="0"/>
        <xsd:element name="address" type="Types:TriAddressType" minOccurs="0"/>
    </xsd:sequence>
</xsd:extension>
</xsd:complexContent>
</xsd:complexType>

<xsd:complexType name="tliPrCatchDetected_c">
    <xsd:complexContent mixed="true">
        <xsd:extension base="Events:Event">
            <xsd:sequence>
                <xsd:element name="at" type="Types:TriPortIdType"/>
                <xsd:element name="from" type="Types:TriPortIdType" minOccurs="0"/>
                <xsd:element name="signature" type="Types:TriSignatureIdType"/>
                <xsd:element name="excValue" type="Values:Value" minOccurs="0"/>
            </xsd:sequence>
        </xsd:extension>
    </xsd:complexContent>
</xsd:complexType>

<xsd:complexType name="tliPrCatchMismatch_m">
    <xsd:complexContent mixed="true">
        <xsd:extension base="Events:Event">
            <xsd:sequence>
                <xsd:element name="at" type="Types:TriPortIdType"/>
                <xsd:element name="signature" type="Types:TriSignatureIdType"/>
                <xsd:element name="excValue" type="Values:Value" minOccurs="0"/>
                <xsd:element name="excTpl" type="Templates:TciValueTemplate" minOccurs="0"/>
                <xsd:element name="diffs" type="Templates:TciValueDifferenceList"/>
                <xsd:element name="addrValue" type="Values:Value" minOccurs="0"/>
                <xsd:element name="addressTpl" type="Templates:TciValueTemplate"
minOccurs="0"/>
            </xsd:sequence>
        </xsd:extension>
    </xsd:complexContent>
</xsd:complexType>

<xsd:complexType name="tliPrCatchMismatch_c">
    <xsd:complexContent mixed="true">
        <xsd:extension base="Events:Event">
            <xsd:sequence>
                <xsd:element name="at" type="Types:TriPortIdType"/>
                <xsd:element name="signature" type="Types:TriSignatureIdType"/>
                <xsd:element name="excValue" type="Values:Value" minOccurs="0"/>
                <xsd:element name="excTpl" type="Templates:TciValueTemplate" minOccurs="0"/>
                <xsd:element name="diffs" type="Templates:TciValueDifferenceList"/>
                <xsd:element name="from" type="Types:TriComponentIdType" minOccurs="0"/>
                <xsd:element name="fromTpl" type="Templates:TciNonValueTemplate"
minOccurs="0"/>
            </xsd:sequence>
        </xsd:extension>
    </xsd:complexContent>
</xsd:complexType>

<xsd:complexType name="tliPrCatch_m">
    <xsd:complexContent mixed="true">
        <xsd:extension base="Events:Event">
            <xsd:sequence>
                <xsd:element name="at" type="Types:TriPortIdType"/>
                <xsd:element name="signature" type="Types:TriSignatureIdType"/>
                <xsd:element name="excValue" type="Values:Value"/>
                <xsd:element name="excTpl" type="Templates:TciValueTemplate"/>
                <xsd:element name="addrValue" type="Values:Value" minOccurs="0"/>
                <xsd:element name="addressTpl" type="Templates:TciValueTemplate"
minOccurs="0"/>
            </xsd:sequence>
        </xsd:extension>
    </xsd:complexContent>
</xsd:complexType>

<xsd:complexType name="tliPrCatch_c">
    <xsd:complexContent mixed="true">
        <xsd:extension base="Events:Event">
            <xsd:sequence>
                <xsd:element name="at" type="Types:TriPortIdType"/>
                <xsd:element name="signature" type="Types:TriSignatureIdType"/>
            </xsd:sequence>
        </xsd:extension>
    </xsd:complexContent>
</xsd:complexType>

```

```

        <xsd:element name="excValue" type="Values:Value" minOccurs="0"/>
        <xsd:element name="excTmpl" type="Templates:TciValueTemplate" minOccurs="0"/>
        <xsd:element name="from" type="Types:TriComponentIdType" minOccurs="0"/>
        <xsd:element name="fromTmpl" type="Templates:TciNonValueTemplate"
minOccurs="0"/>
    </xsd:sequence>
</xsd:extension>
</xsd:complexContent>
</xsd:complexType>

<xsd:complexType name="tliPrCatchTimeoutDetected">
    <xsd:complexContent mixed="true">
        <xsd:extension base="Events:Event">
            <xsd:sequence>
                <xsd:element name="at" type="Types:TriPortIdType"/>
                <xsd:element name="signature" type="Types:TriSignatureIdType"/>
            </xsd:sequence>
        </xsd:extension>
    </xsd:complexContent>
</xsd:complexType>

<xsd:complexType name="tliPrCatchTimeout">
    <xsd:complexContent mixed="true">
        <xsd:extension base="Events:Event">
            <xsd:sequence>
                <xsd:element name="at" type="Types:TriPortIdType"/>
                <xsd:element name="signature" type="Types:TriSignatureIdType"/>
            </xsd:sequence>
        </xsd:extension>
    </xsd:complexContent>
</xsd:complexType>

<!-- components -->
<xsd:complexType name="tliCCreate">
    <xsd:complexContent mixed="true">
        <xsd:extension base="Events:Event">
            <xsd:sequence>
                <xsd:element name="comp" type="Types:TriComponentIdType"/>
                <xsd:element name="name" type="SimpleTypes:TString"/>
                <xsd:element name="hostId" type="Values:Value" minOccurs="0"/>
                <xsd:element name="alive" type="SimpleTypes:TBoolean"/>
            </xsd:sequence>
        </xsd:extension>
    </xsd:complexContent>
</xsd:complexType>

<xsd:complexType name="tliCStart">
    <xsd:complexContent mixed="true">
        <xsd:extension base="Events:Event">
            <xsd:sequence>
                <xsd:element name="comp" type="Types:TriComponentIdType"/>
                <xsd:element name="name" type="Types:TciBehaviourIdType"/>
                <xsd:element name="tciPars" type="Types:TciParameterListType" minOccurs="0"/>
            </xsd:sequence>
        </xsd:extension>
    </xsd:complexContent>
</xsd:complexType>

<xsd:complexType name="tliCRunning">
    <xsd:complexContent mixed="true">
        <xsd:extension base="Events:Event">
            <xsd:sequence>
                <xsd:element name="comp" type="Types:TriComponentIdType"/>
                <xsd:element name="status" type="SimpleTypes:ComponentStatusType"/>
            </xsd:sequence>
        </xsd:extension>
    </xsd:complexContent>
</xsd:complexType>

<xsd:complexType name="tliCAlive">
    <xsd:complexContent mixed="true">
        <xsd:extension base="Events:Event">
            <xsd:sequence>
                <xsd:element name="comp" type="Types:TriComponentIdType"/>
                <xsd:element name="status" type="SimpleTypes:ComponentStatusType"/>
            </xsd:sequence>
        </xsd:extension>
    </xsd:complexContent>
</xsd:complexType>

```

```

    </xsd:complexContent>
  </xsd:complexType>

  <xsd:complexType name="tlicStop">
    <xsd:complexContent mixed="true">
      <xsd:extension base="Events:Event">
        <xsd:sequence>
          <xsd:element name="comp" type="Types:TriComponentIdType" />
        </xsd:sequence>
      </xsd:extension>
    </xsd:complexContent>
  </xsd:complexType>

  <xsd:complexType name="tlicKill">
    <xsd:complexContent mixed="true">
      <xsd:extension base="Events:Event">
        <xsd:sequence>
          <xsd:element name="comp" type="Types:TriComponentIdType" />
        </xsd:sequence>
      </xsd:extension>
    </xsd:complexContent>
  </xsd:complexType>

  <xsd:complexType name="tlicDoneMismatch">
    <xsd:complexContent mixed="true">
      <xsd:extension base="Events:Event">
        <xsd:sequence>
          <xsd:element name="comp" type="Types:TriComponentIdType" />
          <xsd:element name="compTpl" type="Templates:TciNonValueTemplate" />
        </xsd:sequence>
      </xsd:extension>
    </xsd:complexContent>
  </xsd:complexType>

  <xsd:complexType name="tlicKilledMismatch">
    <xsd:complexContent mixed="true">
      <xsd:extension base="Events:Event">
        <xsd:sequence>
          <xsd:element name="comp" type="Types:TriComponentIdType" />
          <xsd:element name="compTpl" type="Templates:TciNonValueTemplate" />
        </xsd:sequence>
      </xsd:extension>
    </xsd:complexContent>
  </xsd:complexType>

  <xsd:complexType name="tlicDone">
    <xsd:complexContent mixed="true">
      <xsd:extension base="Events:Event">
        <xsd:sequence>
          <xsd:element name="compTpl" type="Templates:TciNonValueTemplate" />
          <xsd:element name="verdict" type="Values:VerdictValue" minOccurs="0" />
        </xsd:sequence>
      </xsd:extension>
    </xsd:complexContent>
  </xsd:complexType>

  <xsd:complexType name="tlicKilled">
    <xsd:complexContent mixed="true">
      <xsd:extension base="Events:Event">
        <xsd:sequence>
          <xsd:element name="compTpl" type="Templates:TciNonValueTemplate" />
          <xsd:element name="verdict" type="Values:VerdictValue" minOccurs="0" />
        </xsd:sequence>
      </xsd:extension>
    </xsd:complexContent>
  </xsd:complexType>

  <xsd:complexType name="tlicTerminated">
    <xsd:complexContent mixed="true">
      <xsd:extension base="Events:Event">
        <xsd:sequence>
          <xsd:element name="verdict" type="Values:VerdictValue" />
          <xsd:element name="reason" type="SimpleTypes:TString" minOccurs="0" />
        </xsd:sequence>
      </xsd:extension>
    </xsd:complexContent>
  </xsd:complexType>

```

```

<!-- ports -->
<xsd:complexType name="tliPConnect">
  <xsd:complexContent mixed="true">
    <xsd:extension base="Events:PortConfiguration"/>
  </xsd:complexContent>
</xsd:complexType>

<xsd:complexType name="tliPDisconnect">
  <xsd:complexContent mixed="true">
    <xsd:extension base="Events:PortConfiguration"/>
  </xsd:complexContent>
</xsd:complexType>

<xsd:complexType name="tliPMap">
  <xsd:complexContent mixed="true">
    <xsd:extension base="Events:PortConfiguration"/>
  </xsd:complexContent>
</xsd:complexType>

<xsd:complexType name="tliPMapParam">
  <xsd:complexContent mixed="true">
    <xsd:extension base="Events:tliPMap">
      <xsd:sequence>
        <xsd:element name="tciPars" type="Types:TciParameterListType" />
        <xsd:choice>
          <xsd:element name="encoder-failure" type="SimpleTypes:TciStatusType"
minOccurs="0"/>
          <xsd:element name="triPars" type="Types:TriParameterListType" />
        </xsd:choice>
      </xsd:sequence>
    </xsd:extension>
  </xsd:complexContent>
</xsd:complexType>

<xsd:complexType name="tliPUnmap">
  <xsd:complexContent mixed="true">
    <xsd:extension base="Events:PortConfiguration"/>
  </xsd:complexContent>
</xsd:complexType>

<xsd:complexType name="tliPUnmapParam">
  <xsd:complexContent mixed="true">
    <xsd:extension base="Events:tliPUnmap">
      <xsd:sequence>
        <xsd:element name="tciPars" type="Types:TciParameterListType" />
        <xsd:choice>
          <xsd:element name="encoder-failure" type="SimpleTypes:TciStatusType"
minOccurs="0"/>
          <xsd:element name="triPars" type="Types:TriParameterListType"/>
        </xsd:choice>
      </xsd:sequence>
    </xsd:extension>
  </xsd:complexContent>
</xsd:complexType>

<xsd:complexType name="tliPClear">
  <xsd:complexContent mixed="true">
    <xsd:extension base="Events:PortStatus"/>
  </xsd:complexContent>
</xsd:complexType>

<xsd:complexType name="tliPStart">
  <xsd:complexContent mixed="true">
    <xsd:extension base="Events:PortStatus"/>
  </xsd:complexContent>
</xsd:complexType>

<xsd:complexType name="tliPStop">
  <xsd:complexContent mixed="true">
    <xsd:extension base="Events:PortStatus"/>
  </xsd:complexContent>
</xsd:complexType>

<xsd:complexType name="tliPHalt">
  <xsd:complexContent mixed="true">
    <xsd:extension base="Events:PortStatus"/>
  </xsd:complexContent>

```

```

</xsd:complexType>

<!-- codec -->
<xsd:complexType name="tliEncode">
  <xsd:complexContent mixed="true">
    <xsd:extension base="Events:Event">
      <xsd:sequence>
        <xsd:element name="val" type="Values:Value"/>
        <xsd:choice>
          <xsd:element name="msg" type="Types:TriMessageType"/>
          <xsd:element name="encoder-failure" type="SimpleTypes:TciStatusType"
minOccurs="0"/>
        </xsd:choice>
        <xsd:element name="codec" type="SimpleTypes:TString"
          minOccurs="0"/>
      </xsd:sequence>
    </xsd:extension>
  </xsd:complexContent>
</xsd:complexType>

<xsd:complexType name="tliDecode" mixed="true">
  <xsd:complexContent mixed="true">
    <xsd:extension base="Events:Event">
      <xsd:sequence>
        <xsd:element name="msg" type="Types:TriMessageType"/>
        <xsd:choice>
          <xsd:element name="decoder-failure" type="SimpleTypes:TciStatusType"
minOccurs="0"/>
          <xsd:element name="val" type="Values:Value"/>
        </xsd:choice>
        <xsd:element name="codec" type="SimpleTypes:TString"
          minOccurs="0"/>
      </xsd:sequence>
    </xsd:extension>
  </xsd:complexContent>
</xsd:complexType>

<!-- timers -->
<xsd:complexType name="tliTimeoutDetected">
  <xsd:complexContent mixed="true">
    <xsd:extension base="Events:Event">
      <xsd:sequence>
        <xsd:element name="timer" type="Types:TriTimerIdType" />
      </xsd:sequence>
    </xsd:extension>
  </xsd:complexContent>
</xsd:complexType>

<xsd:complexType name="tliTimeoutMismatch">
  <xsd:complexContent mixed="true">
    <xsd:extension base="Events:Event">
      <xsd:sequence>
        <xsd:element name="timer" type="Types:TriTimerIdType" />
        <xsd:element name="timerTpl" type="Templates:TciNonValueTemplate" />
      </xsd:sequence>
    </xsd:extension>
  </xsd:complexContent>
</xsd:complexType>

<xsd:complexType name="tliTimeout">
  <xsd:complexContent mixed="true">
    <xsd:extension base="Events:Event">
      <xsd:sequence>
        <xsd:element name="timer" type="Types:TriTimerIdType" />
        <xsd:element name="timerTpl" type="Templates:TciNonValueTemplate" />
      </xsd:sequence>
    </xsd:extension>
  </xsd:complexContent>
</xsd:complexType>

<xsd:complexType name="tliTStart">
  <xsd:complexContent mixed="true">
    <xsd:extension base="Events:Event">
      <xsd:sequence>
        <xsd:element name="timer" type="Types:TriTimerIdType"/>
        <xsd:element name="dur" type="SimpleTypes:TriTimerDurationType"/>
      </xsd:sequence>
    </xsd:extension>
  </xsd:complexContent>

```

```

    </xsd:complexContent>
</xsd:complexType>

<xsd:complexType name="tliTStop">
  <xsd:complexContent mixed="true">
    <xsd:extension base="Events:Event">
      <xsd:sequence>
        <xsd:element name="timer" type="Types:TriTimerIdType"/>
        <xsd:element name="dur" type="SimpleTypes:TriTimerDurationType"/>
      </xsd:sequence>
    </xsd:extension>
  </xsd:complexContent>
</xsd:complexType>

<xsd:complexType name="tliTRead">
  <xsd:complexContent mixed="true">
    <xsd:extension base="Events:Event">
      <xsd:sequence>
        <xsd:element name="timer" type="Types:TriTimerIdType"/>
        <xsd:element name="elapsed" type="SimpleTypes:TriTimerDurationType"/>
      </xsd:sequence>
    </xsd:extension>
  </xsd:complexContent>
</xsd:complexType>

<xsd:complexType name="tliTRunning">
  <xsd:complexContent mixed="true">
    <xsd:extension base="Events:Event">
      <xsd:sequence>
        <xsd:element name="timer" type="Types:TriTimerIdType"/>
        <xsd:element name="status" type="SimpleTypes:TimerStatusType"/>
      </xsd:sequence>
    </xsd:extension>
  </xsd:complexContent>
</xsd:complexType>

<!-- scope -->
<xsd:complexType name="tliSEnter">
  <xsd:complexContent mixed="true">
    <xsd:extension base="Events:Event">
      <xsd:sequence>
        <xsd:element name="name" type="Types:QualifiedName" />
        <xsd:element name="tciPars" type="Types:TciParameterListType" minOccurs="0"/>
        <xsd:element name="kind" type="SimpleTypes:TString"/>
      </xsd:sequence>
    </xsd:extension>
  </xsd:complexContent>
</xsd:complexType>

<xsd:complexType name="tliSLeave">
  <xsd:complexContent mixed="true">
    <xsd:extension base="Events:Event">
      <xsd:sequence>
        <xsd:element name="name" type="Types:QualifiedName" />
        <xsd:element name="tciPars" type="Types:TciParameterListType" minOccurs="0"/>
        <xsd:element name="returnValue" type="Values:Value" minOccurs="0"/>
        <xsd:element name="kind" type="SimpleTypes:TString"/>
      </xsd:sequence>
    </xsd:extension>
  </xsd:complexContent>
</xsd:complexType>

<!-- variables and module parameter -->
<xsd:complexType name="tliVar">
  <xsd:complexContent mixed="true">
    <xsd:extension base="Events:Event">
      <xsd:sequence>
        <xsd:element name="name" type="Types:QualifiedName" />
        <xsd:element name="val" type="Values:Value" minOccurs="0"/>
      </xsd:sequence>
    </xsd:extension>
  </xsd:complexContent>
</xsd:complexType>

<xsd:complexType name="tliModulePar">
  <xsd:complexContent mixed="true">
    <xsd:extension base="Events:Event">
      <xsd:sequence>

```

```

        <xsd:element name="name" type="Types:QualifiedName" />
        <xsd:element name="val" type="Values:Value" minOccurs="0"/>
    </xsd:sequence>
</xsd:extension>
</xsd:complexContent>
</xsd:complexType>

<!-- verdicts -->
<xsd:complexType name="tliGetVerdict">
    <xsd:complexContent mixed="true">
        <xsd:extension base="Events:Event">
            <xsd:sequence>
                <xsd:element name="verdict" type="Values:VerdictValue"/>
            </xsd:sequence>
        </xsd:extension>
    </xsd:complexContent>
</xsd:complexType>

<xsd:complexType name="tliSetVerdict">
    <xsd:complexContent mixed="true">
        <xsd:extension base="Events:Event">
            <xsd:sequence>
                <xsd:element name="verdict" type="Values:VerdictValue"/>
                <xsd:element name="reason" type="SimpleTypes:TString" minOccurs="0"/>
            </xsd:sequence>
        </xsd:extension>
    </xsd:complexContent>
</xsd:complexType>

<!-- log -->
<xsd:complexType name="tliLog">
    <xsd:complexContent mixed="true">
        <xsd:extension base="Events:Event">
            <xsd:sequence>
                <xsd:element name="log" type="SimpleTypes:TString"/>
            </xsd:sequence>
        </xsd:extension>
    </xsd:complexContent>
</xsd:complexType>

<!-- alt -->
<xsd:complexType name="tliAEnter">
    <xsd:complexContent>
        <xsd:extension base="Events:Event"/>
    </xsd:complexContent>
</xsd:complexType>

<xsd:complexType name="tliALeave">
    <xsd:complexContent>
        <xsd:extension base="Events:Event"/>
    </xsd:complexContent>
</xsd:complexType>

<xsd:complexType name="tliADefaults">
    <xsd:complexContent>
        <xsd:extension base="Events:Event"/>
    </xsd:complexContent>
</xsd:complexType>

<xsd:complexType name="tliAActivate">
    <xsd:complexContent mixed="true">
        <xsd:extension base="Events:Event">
            <xsd:sequence>
                <xsd:element name="name" type="Types:QualifiedName" />
                <xsd:element name="tciPars" type="Types:TciParameterListType" minOccurs="0"/>
                <xsd:element name="ref" type="Values:Value"/>
            </xsd:sequence>
        </xsd:extension>
    </xsd:complexContent>
</xsd:complexType>

<xsd:complexType name="tliADeactivate">
    <xsd:complexContent mixed="true">
        <xsd:extension base="Events:Event">
            <xsd:sequence>
                <xsd:element name="ref" type="Values:Value"/>
            </xsd:sequence>
        </xsd:extension>
    </xsd:complexContent>
</xsd:complexType>

```

```

    </xsd:complexContent>
  </xsd:complexType>

  <xsd:complexType name="tliANomatch">
    <xsd:complexContent mixed="true">
      <xsd:extension base="Events:Event" />
    </xsd:complexContent>
  </xsd:complexType>

  <xsd:complexType name="tliARepeat">
    <xsd:complexContent>
      <xsd:extension base="Events:Event" />
    </xsd:complexContent>
  </xsd:complexType>

  <xsd:complexType name="tliAwait">
    <xsd:complexContent>
      <xsd:extension base="Events:Event" />
    </xsd:complexContent>
  </xsd:complexType>

  <xsd:complexType name="tliAction">
    <xsd:complexContent mixed="true">
      <xsd:extension base="Events:Event">
        <xsd:sequence>
          <xsd:element name="action" type="SimpleTypes:TString" />
        </xsd:sequence>
      </xsd:extension>
    </xsd:complexContent>
  </xsd:complexType>

  <xsd:complexType name="tliMatch">
    <xsd:complexContent mixed="true">
      <xsd:extension base="Events:Event">
        <xsd:sequence>
          <xsd:element name="expr" type="Values:Value" />
          <xsd:element name="tmpl" type="Templates:TciValueTemplate" />
        </xsd:sequence>
      </xsd:extension>
    </xsd:complexContent>
  </xsd:complexType>

  <xsd:complexType name="tliMatchMismatch">
    <xsd:complexContent mixed="true">
      <xsd:extension base="Events:Event">
        <xsd:sequence>
          <xsd:element name="expr" type="Values:Value" />
          <xsd:element name="tmpl" type="Templates:TciValueTemplate" />
          <xsd:element name="diffs" type="Templates:TciValueDifferenceList" />
        </xsd:sequence>
      </xsd:extension>
    </xsd:complexContent>
  </xsd:complexType>

  <xsd:complexType name="tliInfo">
    <xsd:complexContent mixed="true">
      <xsd:extension base="Events:Event">
        <xsd:sequence>
          <xsd:element name="level" type="SimpleTypes:TInteger" />
          <xsd:element name="info" type="SimpleTypes:TString" />
        </xsd:sequence>
      </xsd:extension>
    </xsd:complexContent>
  </xsd:complexType>

  <xsd:complexType name="tliMChecked_m">
    <xsd:complexContent mixed="true">
      <xsd:extension base="Events:Event">
        <xsd:sequence>
          <xsd:element name="at" type="Types:TriPortIdType" />
          <xsd:element name="from" type="Types:TriPortIdType" minOccurs="0" />
          <xsd:element name="msgValue" type="Types:TriMessageType" />
          <xsd:element name="address" type="Types:TriAddressType" minOccurs="0" />
        </xsd:sequence>
      </xsd:extension>
    </xsd:complexContent>
  </xsd:complexType>

```



```

<xsd:complexType name="tliMChecked_c">
  <xsd:complexContent mixed="true">
    <xsd:extension base="Events:Event">
      <xsd:sequence>
        <xsd:element name="at" type="Types:TriPortIdType"/>
        <xsd:element name="from" type="Types:TriPortIdType" minOccurs="0"/>
        <xsd:element name="msgValue" type="Values:Value"/>
      </xsd:sequence>
    </xsd:extension>
  </xsd:complexContent>
</xsd:complexType>

<xsd:complexType name="tliPrGetCallChecked_m">
  <xsd:complexContent mixed="true">
    <xsd:extension base="Events:Event">
      <xsd:sequence>
        <xsd:element name="at" type="Types:TriPortIdType"/>
        <xsd:element name="from" type="Types:TriPortIdType" minOccurs="0"/>
        <xsd:element name="signature" type="Types:TriSignatureIdType"/>
        <xsd:element name="triPars" type="Types:TriParameterListType" minOccurs="0"/>
        <xsd:element name="address" type="Types:TriAddressType" minOccurs="0"/>
      </xsd:sequence>
    </xsd:extension>
  </xsd:complexContent>
</xsd:complexType>

<xsd:complexType name="tliPrGetCallChecked_c">
  <xsd:complexContent mixed="true">
    <xsd:extension base="Events:Event">
      <xsd:sequence>
        <xsd:element name="at" type="Types:TriPortIdType"/>
        <xsd:element name="from" type="Types:TriPortIdType" minOccurs="0"/>
        <xsd:element name="signature" type="Types:TriSignatureIdType"/>
        <xsd:element name="tciPars" type="Types:TciParameterListType" minOccurs="0"/>
      </xsd:sequence>
    </xsd:extension>
  </xsd:complexContent>
</xsd:complexType>

<xsd:complexType name="tliPrGetReplyChecked_m">
  <xsd:complexContent mixed="true">
    <xsd:extension base="Events:Event">
      <xsd:sequence>
        <xsd:element name="at" type="Types:TriPortIdType"/>
        <xsd:element name="from" type="Types:TriPortIdType" minOccurs="0"/>
        <xsd:element name="signature" type="Types:TriSignatureIdType"/>
        <xsd:element name="triPars" type="Types:TriParameterListType" minOccurs="0"/>
        <xsd:element name="repl" type="Types:TriParameterType" minOccurs="0"/>
        <xsd:element name="address" type="Types:TriAddressType" minOccurs="0"/>
      </xsd:sequence>
    </xsd:extension>
  </xsd:complexContent>
</xsd:complexType>

<xsd:complexType name="tliPrGetReplyChecked_c">
  <xsd:complexContent mixed="true">
    <xsd:extension base="Events:Event">
      <xsd:sequence>
        <xsd:element name="at" type="Types:TriPortIdType"/>
        <xsd:element name="from" type="Types:TriPortIdType" minOccurs="0"/>
        <xsd:element name="signature" type="Types:TriSignatureIdType"/>
        <xsd:element name="tciPars" type="Types:TciParameterListType" minOccurs="0"/>
        <xsd:element name="replValue" type="Values:Value" minOccurs="0"/>
      </xsd:sequence>
    </xsd:extension>
  </xsd:complexContent>
</xsd:complexType>

<xsd:complexType name="tliPrCatchChecked_m">
  <xsd:complexContent mixed="true">
    <xsd:extension base="Events:Event">
      <xsd:sequence>
        <xsd:element name="at" type="Types:TriPortIdType"/>
        <xsd:element name="from" type="Types:TriPortIdType" minOccurs="0"/>
        <xsd:element name="signature" type="Types:TriSignatureIdType"/>
        <xsd:element name="exc" type="Types:TriExceptionType" minOccurs="0"/>
        <xsd:element name="address" type="Types:TriAddressType" minOccurs="0"/>
      </xsd:sequence>
    </xsd:extension>
  </xsd:complexContent>
</xsd:complexType>

```

```

    </xsd:extension>
  </xsd:complexContent>
</xsd:complexType>

<xsd:complexType name="tliPrCatchChecked_c">
  <xsd:complexContent mixed="true">
    <xsd:extension base="Events:Event">
      <xsd:sequence>
        <xsd:element name="at" type="Types:TriPortIdType"/>
        <xsd:element name="from" type="Types:TriPortIdType" minOccurs="0"/>
        <xsd:element name="signature" type="Types:TriSignatureIdType"/>
        <xsd:element name="excValue" type="Values:Value" minOccurs="0"/>
      </xsd:sequence>
    </xsd:extension>
  </xsd:complexContent>
</xsd:complexType>

<xsd:complexType name="tliCheckedAny_m">
  <xsd:complexContent mixed="true">
    <xsd:extension base="Events:Event">
      <xsd:sequence>
        <xsd:element name="at" type="Types:TriPortIdType"/>
        <xsd:element name="from" type="Types:TriPortIdType" minOccurs="0"/>
        <xsd:element name="address" type="Types:TriAddressType" minOccurs="0"/>
      </xsd:sequence>
    </xsd:extension>
  </xsd:complexContent>
</xsd:complexType>

<xsd:complexType name="tliCheckedAny_c">
  <xsd:complexContent mixed="true">
    <xsd:extension base="Events:Event">
      <xsd:sequence>
        <xsd:element name="at" type="Types:TriPortIdType"/>
        <xsd:element name="from" type="Types:TriPortIdType" minOccurs="0"/>
      </xsd:sequence>
    </xsd:extension>
  </xsd:complexContent>
</xsd:complexType>

<xsd:complexType name="tliCheckMismatch_m">
  <xsd:complexContent mixed="true">
    <xsd:extension base="Events:Event">
      <xsd:sequence>
        <xsd:element name="at" type="Types:TriPortIdType"/>
        <xsd:element name="addrValue" type="Values:Value" minOccurs="0"/>
        <xsd:element name="addressTpl" type="Templates:TciValueTemplate"
          minOccurs="0"/>
      </xsd:sequence>
    </xsd:extension>
  </xsd:complexContent>
</xsd:complexType>

<xsd:complexType name="tliCheckMismatch_c">
  <xsd:complexContent mixed="true">
    <xsd:extension base="Events:Event">
      <xsd:sequence>
        <xsd:element name="at" type="Types:TriPortIdType"/>
        <xsd:element name="from" type="Types:TriComponentIdType"
          minOccurs="0"/>
        <xsd:element name="fromTpl" type="Templates:TciNonValueTemplate"
          minOccurs="0"/>
      </xsd:sequence>
    </xsd:extension>
  </xsd:complexContent>
</xsd:complexType>

<xsd:complexType name="tliRnd">
  <xsd:complexContent mixed="true">
    <xsd:extension base="Events:Event">
      <xsd:sequence>
        <xsd:element name="val" type="Values:FloatValue"/>
        <xsd:element name="seed" type="Values:FloatValue"/>
      </xsd:sequence>
    </xsd:extension>
  </xsd:complexContent>
</xsd:complexType>

```

```
<xsd:complexType name="tliEvaluate">
  <xsd:complexContent mixed="true">
    <xsd:extension base="Events:Event">
      <xsd:sequence>
        <xsd:element name="name" type="Types:QualifiedName" />
        <xsd:element name="evalResult" type="Values:Value" minOccurs="0"/>
      </xsd:sequence>
    </xsd:extension>
  </xsd:complexContent>
</xsd:complexType>
```

12 C# mapping

12.1 Introduction

The C# mapping for the TTCN-3 Control Interface defines how the IDL [6] definitions described in clause 7 are mapped to the .Net language C# [13].

12.2 Names and scopes

12.2.1 Names

Although there are almost no conflicts between identifiers used in the IDL definition and C#, some naming translation rules are applied to the IDL identifiers.

C# interfaces are omitting the trailing Type used in the IDL definition. In addition to that, the capital letter "I" is added to the beginning of interface names.

EXAMPLE 1: The IDL type **TciTestCaseIdType** maps to **ITciTestCaseId** in C#.

C# names of enumerated items start with a capital letter and the remaining letters are low-case letters. If the enumerated item name is composed of several words, each word starts with a capital letter.

EXAMPLE 2: The identifier for boolean type defined in **TciTypeClassType** enumeration is **BooleanType** in C#.

The resulting mapping conforms to the standard C# coding conventions.

12.2.2 Scopes

The TCI interfaces are mapped to the namespace **Etsi.Ttcn3.Tci**. All IDL type declarations are mapped to C# interface declarations within this namespace. The associated assembly file is **Etsi.Ttcn3.Tci.dll**.

12.3 Null value mapping

The distinct value **null** specified in the IDL definition is equal to **null** in C#.

12.4 Type mapping

12.4.1 Basic type mapping

12.4.1.0 Mapped types

Table 9 gives an overview on how the used basic IDL types are mapped to the .Net types.

Table 9: Basic type mapping

IDL Type	C# Type/Interface
TBoolean	bool
TChar	char
TFloat	double
TInteger	int / TciVerdict
TString	string
TStringSeq	string[]
TUniversalChar	uint

TBoolean

The IDL TBoolean type is mapped to the C# type `bool`.

TFloat

The IDL TFloat type is mapped to the C# type `double`.

TChar

The IDL TChar type is mapped to the C# type `char`.

TInteger

The IDL TInteger type is usually mapped to the C# type `int`. Only in case of operations defined for the IDL type `TciVerdictValue`, the IDL TInteger type is mapped to `Etsi.Ttcn3.Tci.TciVerdict` enumeration.

TString

The IDL TString type is mapped to the C# class `string` without range checking or bounds for characters in the string. All possible strings defined in TTCN-3 can be converted to C# string class.

TStringSeq

The IDL TStringSeq type is mapped to a string array.

TUniversalChar

The IDL TUniversalChar type is mapped to the C# type `uint`. The integer uses the canonical form as defined in ISO/IEC 10646 [5], clause 6.2.

12.4.1.1 TciVerdict

In case of verdict operations, the IDL TInteger type is mapped to the **TciVerdict** enumeration. This enumeration is defined as follows:

```
public enum TciVerdict {
    None = 0,
    Pass = 1,
    Inconc = 2,
    Fail = 3,
    Error = 4
    User_Error = 5
}
```

12.4.2 Structured type mapping**12.4.2.0 Mapping rules**

The TCI IDL description defines user-defined types as native types. In the C# mapping, these types are mapped to C# interfaces. The interfaces define methods and properties being available for classes implementing this interface.

12.4.2.1 TciParameterPassingModeType

TciParameterPassingModeType is mapped to the following enumeration:

```
public enum TciParameterPassingMode {
    TciIn = 0,
    TciInOut = 1,
}
```

```

    TciOut = 2
}

```

12.4.2.2 TciParameterType

TciParameterType is mapped to the following interface:

```

public interface ITciParameter {
    string ParameterName { get; set; }
    TciParameterPassingMode ParameterPassingMode { get; set; }
    ITciValue Parameter { get; set; }
}

```

Members:

- **ParameterName**
Gets or sets the parameter name.
- **ParameterPassingMode**
Gets or sets the parameter passing mode of this parameter.
- **Parameter**
Used for getting or setting value of the parameter. The parameter can be an instance of `ITciValue` or the distinct value `null`.

12.4.2.3 TciParameterListType

TciParameterListType is mapped to the following interface:

```

public interface ITciParameterList: System.Collections.IEnumerable {
    int Size { get; }
    bool IsEmpty { get; }
    ITciParameter this[int index] { get; }
    void Clear();
    void Add(ITciParameter comp);
}

```

Members:

- **Size**
Returns the number of parameters in this list.
- **IsEmpty**
Returns `true` if this list contains no parameters.
- **GetEnumerator**
Inherited from `IEnumerable`. Returns an enumerator for this object and allows to use the list in a `foreach` loop.
- **operator**
Returns a `ITciParameter` instance at the specified position. `IndexOutOfRangeException` is thrown if the index is less than zero or greater or equal to the list size.
- **Clear**
Removes all parameters from the list.
- **Add**
Adds a parameter to the end of the list.

12.4.2.4 TciTypeClassType

TciTypeClassType is mapped to the following enumeration:

```

public enum TciTypeClass {
    Address = 0,
    Anytype = 1,
}

```

```

    Bitstring = 2,
    BooleanType = 3,
    Charstring = 5,
    Component = 6,
    Enumerated = 7,
    Float = 8,
    Hexstring = 9,
    IntegerType = 10,
    Octetstring = 12,
    Record = 13,
    RecordOf = 14,
    Array = 15
    Set = 16,
    SetOf = 17,
    Union = 18,
    UniversalCharstring = 20,
    Verdict = 21
}

```

12.4.2.5 TciTestComponentKindType

TciTestComponentKindType is mapped to the following enumeration:

```

public enum TciTestComponentKind {
    TciCtrlComp = 0,
    TciMtcComp = 1,
    TciPtcComp = 2,
    TciSystemComp = 3,
    TciAliveComp = 4
}

```

12.4.2.6 TciBehaviourIdType

TciBehaviourIdType C# mapping is derived from the `IQualifiedName` interface:

```

public interface ITciBehaviourId : IQualifiedName {}

```

12.4.2.7 TciTestCaseIdType

TciTestCaseIdType C# mapping is derived from the `IQualifiedName` interface:

```

public interface ITciTestCaseId : IQualifiedName {}

```

12.4.2.8 TciTestCaseIdListType

TciTestCaseIdListType is mapped to the following interface:

```

public interface ITciTestCaseIdList : System.Collections.IEnumerable {
    int Size { get; }
    bool IsEmpty { get; }
    ITciTestCaseId this[int index] { get; }
}

```

Members:

- `Size`
Returns the number of test case identifiers in this list.
- `IsEmpty`
Returns `true` if this list contains no parameters.
- `GetEnumerator`
Inherited from `IEnumerable`. Returns an enumerator for this object and allows to use the list in a `foreach` loop.
- `operator`
Returns a `ITciTestCaseId` instance at the specified position. `IndexOutOfRangeException` is thrown if the index is less than zero or greater or equal to the list size.

12.4.2.9 TciModuleIdType

TciModuleIdType C# mapping is derived from the `IQualifiedName` interface:

```
public interface ITciModuleId : IQualifiedName {
}
```

12.4.2.10 TciModuleIdListType

TciModuleIdListType is mapped to the following interface:

```
public interface ITciModuleIdList: System.Collections.IEnumerable {
    int Size { get; }
    bool IsEmpty { get; }
    ITciModuleId this[int index] { get; }
}
```

Members:

- `Size`
Returns the number of module identifiers in this list.
- `IsEmpty`
Returns `true` if this list contains no parameters.
- `GetEnumerator`
Inherited from `IEnumerable`. Returns an enumerator for this object and allows to use the list in a `foreach` loop.
- `operator`
Returns a `ITciModuleId` instance at the specified position. `IndexOutOfRangeException` is thrown if the index is less than zero or greater or equal to the list size.

12.4.2.11 TciModuleParameterIdType

TciModuleIdType C# mapping is derived from the `IQualifiedName` interface:

```
public interface ITciModuleParameterId : IQualifiedName {
}
```

12.4.2.12 TciModuleParameterType

TciModuleParameterType is mapped to the following interface:

```
public interface ITciModuleParameter {
    ITciModuleParameterId ModuleParameterName { get; }
    ITciValue DefaultValue { get; }
}
```

Members:

- `ModuleParameterName`
Returns the qualified module parameter name as defined in the TTCN-3 specification.
- `DefaultValue`
Returns the default value of this `TciModuleParameter` or the distinct value `null` if the default value is not specified.

12.4.2.13 TciModuleParameterListType

TciModuleParameterListType is mapped to the following interface:

```
public interface ITciModuleParameterList: System.Collections.IEnumerable {
    int Size { get; }
    bool IsEmpty { get; }
    ITciModuleParameter this[int index] { get; }
}
```

```
}

```

Members:

- `Size`
Returns the number of module identifiers in this list.
- `IsEmpty`
Returns `true` if this list contains no parameters.
- `GetEnumerator()`
Inherited from `IEnumerable`. Returns an enumerator for this object and allows to use the list in a `foreach` loop.
- `Indexing operator`
Returns a `ITciModuleId` instance at the specified position. `IndexOutOfRangeException` is thrown if the index is less than zero or greater or equal to the list size.

12.4.2.14 TciParameterType

TciParameterType is mapped to the following interface:

```
public interface ITciParameterType {
    string ParameterName { get; }
    ITciType ParameterType { get; }
    TciParameterPassingMode ParameterPassingMode { get; }
}

```

Members:

- `ParameterName`
Returns the name of the parameter.
- `ParameterType`
Returns the type of the parameter.
- `ParameterPassingMode`
Returns the passing mode of this parameter.

12.4.2.15 TciParameterTypeList

TciParameterList is mapped to the following interface:

```
public interface ITciParameterTypeList: System.Collections.IEnumerable {
    int Size { get; }
    bool IsEmpty { get; }
    ITciParameterType this[int index] { get; }
}

```

Members:

- `Size`
Returns the number of parameters in this list.
- `IsEmpty`
Returns `true` if this list contains no parameters.
- `GetEnumerator`
Inherited from `IEnumerable`. Returns an enumerator for this object and allows to use the list in a `foreach` loop.
- `Indexing operator`
Returns a `ITciParameter` instance at the specified position. `IndexOutOfRangeException` is thrown if the index is less than zero or greater or equal to the list size.

- **Clear**
Removes all parameters from the list.
- **Add**
Adds a parameter to the end of the list.

12.4.2.16 TciMatchingTypeType

TciMatchingTypeType is mapped to the following enumeration:

```
public enum TciMatchingType
{
    TemplateList = 0,
    ComplementedList = 1,
    AnyValue = 2,
    AnyValueOrNone = 3,
    ValueRange = 4,
    Subset = 5,
    Superset = 6,
    AnyElement = 7,
    AnyElementsOrNone = 8,
    Pattern = 9,
    MatchDecodedContent = 10,
    OmitTemplate = 11
}
```

12.4.2.17 LengthRestriction

LengthRestriction is mapped to the following interface:

```
public interface ITciLengthRestriction
{
    long LowerBoundary { get; set; }
    long UpperBoundary { get; set; }
    bool IsUpperBoundaryInfinity { get; set; }
}
```

Methods:

- **LowerBoundary** Gets or sets the lower boundary of the length restriction.
- **UpperBoundary** Gets or sets the upper boundary of the length restriction.
- **IsUpperBoundaryInfinity** Gets or sets the upper boundary infinity setting.

12.4.2.18 Permutation

Permutation is mapped to the following interface:

```
public interface ITciPermutation
{
    long StartPosition { get; set; }
    long Length { get; set; }
}
```

Methods:

- **StartPosition** Gets or sets the position of the first item of the permutation in the `RecordOfValue`.
- **Length** Gets or sets the number of elements or matching mechanisms of the `RecordOfValue` that are included in the permutation.

12.4.2.19 RangeBoundary

RangeBoundary is mapped to the following interface:

```
public interface ITciRangeBoundary
```

```

{
  ITciValue Boundary { get; set; }
  bool IsInclusive { get; set; }
  bool IsInfinity { get; set; }
}

```

Methods:

- `Boundary` Gets or sets the boundary value.
- `IsInclusive` Gets or sets whether the boundary value is a part of the allowed range or not.
- `IsInfinity` Gets or sets whether the boundary is infinity.

12.4.3 Abstract type mapping

12.4.3.0 Mapping rules

The TTCN-3 data types are modelled in C# using the abstract type mapping as defined in this clause. The `ITciType` interface defines only operations used to retrieve in TTCN-3 defined types. No TTCN-3 types can be constructed using the `ITciType` interface. Types are modelled using the single interface `ITciType`, that provides methods to identify types and to retrieve values of a given type.

12.4.3.1 Type

The IDL type **Type** is mapped to the following interface:

```

public interface ITciType {
  ITciModuleId DefiningModule { get; }
  string Name { get; }
  TciTypeClass TypeClass { get; }
  ITciValue NewInstance();
  ITciMatchingMechanism NewTemplate(TciMatchingType matchingType);
  string TypeEncoding { get; }
  string TypeEncodingVariant { get; }
  string[] EncodeAttributes { get; }
  string[] GetVariantAttributes(string encoding);
  string[] TypeExtension { get; }
  ITciValue ParseValue (string val);
  ITciRangeBoundary LowerTypeBoundary { get; }
  ITciRangeBoundary UpperTypeBoundary { get; }
  ITciLengthRestriction TypeLengthRestriction { get; }
  ITciMatchingMechanism TypeMatchingMechanism { get; }
}

```

Members:

- `DefiningModule`
Returns the module identifier of the module the type has been defined in. If the type represents a TTCN-3 base type the distinct value null will be returned.
- `Name`
Returns name of the type as defined in the TTCN-3 module.
- `TypeClass`
Returns the type class of the respective type.
- `NewInstance`
Returns a freshly created value of the given type. This initial value of the created value is undefined.
- `NewTemplate`
Returns a freshly created matching mechanism of this type. The `matchingType` parameter determines what kind of matching mechanism will be created. If the created matching mechanism contains additional data properties, these properties are uninitialized in the created matching mechanism.

- `TypeEncoding`
Returns the type encoding attribute as defined in the TTCN-3 module, if any. If no encoding attribute has been defined, the distinct value `null` will be returned.
- `TypeEncodingVariant`
This property returns the type encoding variant attribute as defined in TTCN-3, if any. If no encoding variant attribute has been defined, the distinct value `null` will be returned.
- `EncodeAttributes`
Returns all encode attributes of the type as defined in the TTCN-3 module. If no encode attribute has been defined, the distinct value `null` is returned.
- `GetVariantAttributes`
Returns all variant attributes of the type as defined in the TTCN-3 module. If no encoding attribute has been defined, the distinct value `null` is returned.
- `TypeExtension`
Returns the type extension attributes as defined in the TTCN-3 module. If no extension attributes have been defined, the distinct value `null` will be returned.
- `ParseValue`
Parses the value provided in the parameter and in case of successful parsing returns a `Value` object representing the parsed value. In case of an error or if value parsing is not supported by the tool, the method returns `null`.
- `LowerTypeBoundary`
Gets the lower range boundary of the type or `null`.
- `UpperTypeBoundary`
Gets the upper range boundary of the type or `null`.
- `TypeLengthRestriction`
Gets the length restriction of the type or `null`.
- `TypeMatchingMechanism`
Gets the matching mechanism restricting the type or `null`.

12.4.4 Abstract value mapping

12.4.4.0 Mapping rules

TTCN-3 values can be retrieved from the TE and constructed using the `ITciValue` interface. The value mapping interface is constructed hierarchically with `ITciValue` as the basic interface. Specialized interfaces for different types of values have been defined.

12.4.4.1 Value

The IDL type `Value` is mapped to the following interface:

```
public interface ITciValue {
    ITciType Type { get; }
    bool NotPresent { get; }
    string ValueEncoding { get; }
    string ValueEncodingVariant { get; }
    string[] EncodeAttributes { get; }
    string[] GetVariantAttributes(string encoding);
    bool IsMatchingSymbol { get; }
    string ValueToString();
    bool IsLazy { get; }
    bool IsFuzzy { get; }
    bool IsEvaluated { get; }
    ITciLengthRestriction LengthRestriction { get; set; }
    ITciLengthRestriction NewLengthRestriction ();
    bool IsIfPresentEnabled { get; set; }
}
```

```

ITciRangeBoundary LowerTypeBoundary { get; }
ITciRangeBoundary UpperTypeBoundary { get; }
ITciLengthRestriction TypeLengthRestriction { get; }
ITciMatchingMechanism TypeMatchingMechanism { get; }
bool IsOptional { get; }
}

```

Members:

- `Type`
Returns the type of the specified value.
- `NotPresent`
Returns `true` if the specified value is omit, `false` otherwise.
- `ValueEncoding`
This property returns the value encoding attribute as defined in TTCN-3, if any. If no encoding attribute has been defined the distinct value `null` will be returned.
- `ValueEncodingVariant`
This property returns the value encoding variant attribute as defined in TTCN-3, if any. If no encoding variant attribute has been defined the distinct value `null` will be returned.
- `EncodeAttributes`
Returns all encode attributes of the value as defined in the TTCN-3 module. If no encode attribute has been defined, the distinct value `null` is returned.
- `GetVariantAttributes`
Returns all variant attributes of the value as defined in the TTCN-3 module. If no encoding attribute has been defined, the distinct value `null` is returned.
- `NotPresent`
Returns `true` if the specified value is a matching symbol (see clause 7.2.2.2.1 for more details), `false` otherwise.
- `ValueToString`
Returns the same string as produced by the log operation with the specified value as its parameter.
- `IsLazy`
Returns `true` if the specified value is `@lazy`, `false` otherwise.
- `IsFuzzy`
Returns `true` if the specified value is `@fuzzy`, `false` otherwise.
- `IsEvaluated`
Returns `true` if the specified value contains an evaluation result, `false` otherwise (see clause 7.2.2.2.1 for more details).
- `LengthRestriction`
Gets or sets a length restriction matching attribute attached to the value.
- `NewLengthRestriction`
Creates a new instance of the `LengthRestriction` interface.
- `IfPresentEnabled`
Gets or sets whether the the `ifpresent` matching attribute is attached to the value or not.
- `LowerTypeBoundary`
Gets the value's type's lower range boundary or null.
- `UpperTypeBoundary`
Gets the value's type's upper range boundary or null.
- `TypeLengthRestriction`
Gets the value's type's length restriction or null.

- `TypeMatchingMechanism`
Gets the values's type restriction matching mechanism.
- `IsOptional`
Returns whether the value is either an optional field or a template without the `present` or `value` restriction.

12.4.4.2 IntegerValue

IntegerValue is mapped to the following interface:

```
public interface ITciIntegerValue : ITciValue {
    long IntegerValue { get; set; }
    string StringValue { get; set; }
}
```

Members:

- `IntegerValue`
Gets or sets the numeric value of the object. In case the numeric value exceeds the allowed value range of the `long` type, `long.MaxValue` or `long.MinValue` is returned.
- `StringValue`
Get or sets the value of the object. The string assigned to the property shall have the same format as TTCN-3 integer literals. The integer literal can be optionally preceded by a sign character ('+' or '-').

12.4.4.3 FloatValue

FloatValue is mapped to the following interface:

```
public interface ITciFloatValue : ITciValue {
    double FloatValue { get; set; }
    string StringValue { get; set; }
}
```

Members:

- `FloatValue`
Gets or sets the numeric value of the object. In case the numeric value exceeds the allowed value range of the `double` type, `double.MaxValue` or `double.MinValue` is returned.
- `StringValue`
Get or sets the value of the object. The string assigned to the property shall have the same format as TTCN-3 float literals. The float literal can be optionally preceded by a sign character ('+' or '-').

12.4.4.4 BooleanValue

BooleanValue is mapped to the following interface:

```
public interface ITciBooleanValue : ITciValue {
    bool BooleanValue { get; set; }
}
```

Members:

- `BooleanValue`
Gets or sets the boolean value of the object.

12.4.4.5 CharstringValue

CharstringValue is mapped to the following interface:

```
public interface ITciCharstringValue : ITciValue {
    string StringValue { get; set; }
    char this[int position] { get; set; }
    int Length { get; set; }
}
```

Members:

- `StringValue`
Gets or sets the string value of the TTCN-3 charstring. Strings assigned to this property shall contain only characters allowed in TTCN-3 charstring type.
- `Indexing operator`
Get or sets the character value of the TTCN-3 charstring at the specified position. `IndexOutOfRangeException` is thrown if the position is less than zero or greater or equal to the string length.
- `Length`
Gets or sets the length of this `ITciCharstringValue` in characters. The property returns zero if the value of this object is `omit`. In case the new length is greater than the length of the current string, characters with ordinal value 0 are added to the end of the string. If the new length is less than the length of the current string, the current string is truncated.

12.4.4.6 BitstringValue

BitstringValue is mapped to the following interface:

```
public interface ITciBitstringValue : ITciValue {
    string StringValue { get; set; }
    byte this[int position] { get; set; }
    int Length { get; set; }
    bool IsMatchingAt (int position);
    ITciMatchingMechanism GetMatchingAt (int position);
    void SetMatchingAt (int position, ITciMatchingMechanism template);
}
```

Members:

- `StringValue`
Gets or sets the string value of the TTCN-3 bitstring. The only allowed characters in the string passed to this property are '0' and '1'. The string returned by the property contains a sequence of '0' and '1' digits.
- `Indexing operator`
Get or sets the value of the bit at the specified position. All non-zero values shall be interpreted as if the bit was present. `IndexOutOfRangeException` is thrown if the position is less than zero or greater or equal to the string length.
- `Length`
Gets or sets the length of this `ITciBitstringValue` in bits. The property returns zero if the value of this object is `omit`. In case the new length is greater than the length of the current bitstring, the bitstring is padded with empty bits. If the new length is less than the length of the current bitstring, the current bitstring is truncated.
- `IsMatchingAt`
Returns `true` if the item at `position` of this TTCN-3 bitstring is a matching mechanism inside a value (`AnyElement`, `AnyElementsOrNone`) and `false` otherwise.
- `GetMatchingAt`
If the `position` of this TTCN-3 bitstring contains a matching mechanism inside a value (`AnyElement`, `AnyElementsOrNone`), the method returns it. Otherwise the distinct value `null` is returned.
- `SetMatchingAt`
Sets a matching mechanism at `position`. Only two matching mechanisms are allowed: `AnyElement` and `AnyElementsOrNone`.

12.4.4.7 OctetstringValue

OctetstringValue is mapped to the following interface:

```
public interface ITciOctetstringValue : ITciValue {
    string StringValue { get; set; }
    byte this[int position] { get; set; }
    int Length { get; set; }
    bool IsMatchingAt (int position);
    ITciMatchingMechanism GetMatchingAt (int position);
    void SetMatchingAt (int position, ITciMatchingMechanism template);
}
```

Members:

- **StringValue**
Gets or sets the string value of the TTCN-3 octetstring. The only allowed characters in the string passed to this property are hexadecimal digits. The length of the string passed to this property shall be even. The string returned by this property is a sequence of pairs of hexadecimal digits.
- **Indexing operator**
Get or sets the value of the octet at the specified position. `IndexOutOfRangeException` is thrown if the position is less than zero or greater or equal to the string length.
- **Length**
Gets or sets the length of this `ITciOctetstringValue` in octets. The property returns zero if the value of this object is `omit`. In case the new length is greater than the length of the current octetstring, the octetstring is padded with empty octets. If the new length is less than the length of the current octetstring, the current octetstring is truncated.
- **IsMatchingAt**
Returns `true` if the item at `position` of this TTCN-3 octetstring is a matching mechanism inside a value (`AnyElement`, `AnyElementsOrNone`) and `false` otherwise.
- **GetMatchingAt**
If the `position` of this TTCN-3 octetstring contains a matching mechanism inside a value (`AnyElement`, `AnyElementsOrNone`), the method returns it. Otherwise the distinct value `null` is returned.
- **SetMatchingAt**
Sets a matching mechanism at `position`. Only two matching mechanisms are allowed: `AnyElement` and `AnyElementsOrNone`.

12.4.4.8 UniversalCharstringValue

UniversalCharstringValue is mapped to the following interface:

```
public interface ITciUniversalCharstringValue : ITciValue {
    string StringValue { get; set; }
    uint this[int position] { get; set; }
    int Length { get; set; }
}
```

Members:

- **StringValue**
Gets or sets the string value of the TTCN-3 universal charstring. If the TTCN-3 universal charstring value contains characters that have higher ordinal value than `char.MaxValue`, these characters will be represented by a character `0xFFFFD` (the Unicode replacement character) in the string returned by this property.
- **Indexing operator**
Get or sets the character value of the TTCN-3 universal charstring at the specified position. The unsigned number used by this property is character ordinal value. `IndexOutOfRangeException` is thrown if the position is less than zero or greater or equal to the string length.

- `Length`
Gets or sets the length of this `ITciUniversalCharstringValue` in characters. The property returns zero if the value of this object is `omit`. In case the new length is greater than the length of the current string, characters with ordinal value 0 are added to the end of the string. If the new length is less than the length of the current string, the current string is truncated.

12.4.4.9 HexstringValue

HexstringValue is mapped to the following interface:

```
public interface ITciHexstringValue : ITciValue {
    string StringValue { get; set; }
    byte this[int position] { get; set; }
    int Length { get; set; }
    bool IsMatchingAt (int position);
    ITciMatchingMechanism GetMatchingAt (int position);
    void SetMatchingAt (int position, ITciMatchingMechanism template);
}
```

Members:

- `StringValue`
Gets or sets the string value of the TTCN-3 hexstring. The only allowed characters in the string passed to this property are hexadecimal digits. The string returned by this property is a sequence of hexadecimal digits.
- `Indexing operator`
Get or sets the hex digit at the specified position. Only the lower four bits of the passed value are used in this assignment. The upper four bits are ignored. `IndexOutOfRangeException` is thrown if the position is less than zero or greater or equal to the string length.
- `Length`
Gets or sets the length of this `ITciHexstringValue` in hex digits. The property returns zero if the value of this object is `omit`. In case the new length is greater than the length of the current hexstring, the hexstring is padded with zeroes. If the new length is less than the length of the current hexstring, the current hexstring is truncated.
- `IsMatchingAt`
Returns `true` if the item at `position` of this TTCN-3 hexstring is a matching mechanism inside a value (`AnyElement`, `AnyElementsOrNone`) and `false` otherwise.
- `GetMatchingAt`
If the `position` of this TTCN-3 hexstring contains a matching mechanism inside a value (`AnyElement`, `AnyElementsOrNone`), the method returns it. Otherwise the distinct value `null` is returned.
- `SetMatchingAt`
Sets a matching mechanism at `position`. Only two matching mechanisms are allowed: `AnyElement` and `AnyElementsOrNone`.

12.4.4.10 RecordValue

RecordValue is mapped to the following interface:

```
public interface ITciRecordValue : ITciValue {
    ITciValue GetField(string fieldName);
    void SetField(string fieldName, ITciValue value);
    string[] GetFieldNames();
    void SetFieldOmitted(string fieldName);
}
```

Members:

- `GetField`
Returns the value of the field named `fieldName`. The return value is the common abstract base type `ITciValue`, as a record field can have any type defined in TTCN-3. If the field cannot be obtained from the record the distinct value `null` will be returned.

- `SetField`
Sets the field named `fieldName` of the record to value. No assumption shall be made on how a field is stored in a record. An internal implementation might choose to store a reference to this value or to copy the value. It is safe to assume that the value will be copied. Therefore it should be assumed that subsequent modifications of value will not be considered in the record.
- `GetFieldNames`
Returns an array of String of field names, the empty sequence, if the record has no fields.
- `SetFieldOmitted`
Sets the field named `fieldName` of the record to omit.

12.4.4.11 RecordOfValue

RecordOfValue is mapped to the following interface:

```
public interface ITciRecordOfValue : ITciValue, System.Collections.IEnumerable {
    ITciValue this[int position] { get; set; }
    void AppendField(ITciValue value);
    ITciType ElementType { get; }
    int Length { get; set; }
    int Offset { get; }
    int PermutationCount { get; }
    ITciPermutation GetPermutation (int index);
    ITciPermutation NewPermutation ();
    void DefinePermutation (ITciPermutation permutation);
    void RemovePermutation (int index);
    void ClearPermutations ();
}
```

Members:

- `Indexing operator`
Returns or sets the value of the record of at the specified position. The class of this property is the common abstract base interface `ITciValue`, as a `record of` can have fields of any type defined in TTCN-3. When getting the value an `ITciValue` instance is returned only if `position` is between zero and $(length - 1)$. The distinct value `null` is returned otherwise. When setting the value, if `position` is greater than the current length, the record of will be extended to have the length $(position + 1)$. The record of elements between the original position at `length` and $(position - 1)$ will be set to omit. No assumption shall be made on how a field is stored in a `record of`. An internal implementation might choose to store a reference to this value or to copy the value. It is safe to assume that the value will be copied. Therefore it should be assumed that subsequent modifications of value will not be considered in the `record of`.
- `GetEnumerator`
Inherited from `IEnumerable`. Returns an enumerator for this object and allows to use the object in a `foreach` loop.
- `appendField`
Appends the value at the end of the `record of`, i.e. at position `length`. No assumption shall be made on how a field is stored in a `record of`. An internal implementation might choose to store a reference to this value or to copy the value. It is safe to assume that the value will be copied. Therefore it should be assumed that subsequent modifications of value will not be considered in the `record of`.
- `ElementType`
Returns the type of the elements of this `record of`.
- `Length`
Gets or sets the actual length of the `record of` value. When getting the length, zero is returned if the `record of` value is omit. When setting the length, if the new length is greater than the original length, newly created elements have the value omit. If the new length is less or equal than the original length, this operation will be ignored.

- `Offset`
Returns the lowest possible index. For a record of or set of value this is always 0. For an array value, this is the lower index bound used in the type definition.
- `PermutationCount`
Returns the number of permutations in the `record of` or array value.
- `GetPermutation`
Returns the permutation at the specified index. The allowed index range is from 0 to `(getPermutationCount() - 1)`.
- `NewPermutation`
Creates a new instance of the `Permutation` interface.
- `DefinePermutation`
Creates permutation from existing elements of a `record of` value. The `permutation` parameter shall not include elements that are already a part of other existing permutations attached to the same `record of`. No elements are added to the `record of` by this operation.
- `RemovePermutation`
Removes the permutation at the specified index. The allowed index range is from 0 to `(getPermutationCount() - 1)`. No elements are removed from the `record of` by this operation. When the operation completes, the existing elements at positions specified by the removed permutation don't belong to any permutation.
- `ClearPermutations`
Removes all permutations from the value. The elements that belonged to the removed permutation are not removed.

12.4.4.12 UnionValue

UnionValue is mapped to the following interface:

```
public interface ITciUnionValue : ITciValue {
    ITciValue GetVariant(string variantName);
    void SetVariant(string variantName, ITciValue value);
    string PresentVariantName { get; }
    string[] GetVariantNames();
}
```

Members:

- `GetVariant`
Returns the value of the TTCN-3 union variant, if `variantName` equals the result of `GetPresentVariantName`. The distinct value `null` is returned otherwise. `variantName` denotes the name of the union variant as defined in TTCN-3.
- `SetVariant`
Sets `variantName` of the union to `value`. If `variantName` is not defined for this union this operation will be ignored. If another variant was selected the new variant will be selected instead.
- `GetPresentVariantName`
Returns the variant name that has a value in this union set as a `string`. The distinct value `null` will be returned if no variant is selected.
- `GetVariantNames`
Returns an array of `string` of variant names, the empty sequence, if the union has no fields. If the `UnionValue` represents the TTCN-3 `anytype`, i.e. the value of the `Type` property is `TciTypeClass.Anytype`, all predefined and user-defined TTCN-3 types will be returned.

12.4.4.13 EnumeratedValue

EnumeratedValue is mapped to the following interface:

```
public interface ITciEnumeratedValue : ITciValue {
    string EnumValue { get; set; }
    int IntValue { get; set; }
}
```

Members:

- **EnumValue**
Returns or sets the enumerated value. The value of the property is equal to the identifier in the TTCN-3 specification. If the value assigned to the property is not an allowed value for this enumeration, the assignment will be ignored.
- **IntValue**
Returns or sets the integer value. This integer should equal the user-assigned integer value in the TTCN-3 specification or the automatically assigned integer value. If the integer assigned to the property is not allowed for this enumeration, the assignment will be ignored.

12.4.4.14 VerdictValue

VerdictValue is mapped to the following interface:

```
public interface ITciVerdictValue : ITciValue {
    TciVerdict Verdict { get; set; }
}
```

Members:

- **Verdict**
Returns the value of this **VerdictValue**. Note that a **VerdictValue** can be set to any of the verdicts defined in the **TciVerdict** enumeration at any time. The **VerdictValue** does not perform any verdict calculations as defined in TTCN-3. For example, it is legal to set the **VerdictValue** first to **TciVerdict.ErrorVerdict** and then to **TciVerdict.Pass**.

12.4.4.15 AddressValue

AddressValue is mapped to the following interface:

```
public interface ITciAddressValue : ITciValue {
    ITciValue Address { get; set; }
}
```

Members:

- **Address**
Gets or sets the value represented by this **AddressValue**.

12.4.5 Abstract template mapping

12.4.5.0 Mapping rules

TTCN-3 matching mechanisms can be retrieved from the TE and constructed using the **ITciMatchingMechanism** interface. The template mapping interface is constructed hierarchically with **ITciMatchingMechanism** as the basic interface. Specialized interfaces for different types of matching mechanisms have been defined.

12.4.5.1 MatchingMechanism

The IDL type **MatchingMechanism** is mapped to the following interface:

```
public interface ITciMatchingMechanism : ITciValue
{
```

```
TciMatchingType MatchingType { get; }
}
```

Members:

- MatchingType
Returns the matching mechanism type.

12.4.5.2 MatchingList

The IDL type **MatchingList** is mapped to the following interface:

```
public interface ITciMatchingList : ITciMatchingMechanism
{
    int Size { get; }
    ITciValue this[int position] { get; }
    void Add (ITciValue item);
    void Remove (int position);
    void Clear ();
}
```

Methods:

- Size
Returns the number of items in the matching mechanism.
- Indexing operator
Returns a value or template at the specified position.
- Add
Adds a value or template to the matching mechanism.
- Remove
Removes a value or template from the specified position.
- Clear
Removes all values and templates from the matching mechanism.

12.4.5.3 ValueRange

The IDL type **ValueRange** is mapped to the following interface:

```
public interface ITciValueRange : ITciMatchingMechanism
{
    ITciRangeBoundary LowerBoundary { get; set; }
    ITciRangeBoundary UpperBoundary { get; set; }
}
```

Methods:

- LowerBoundary
Gets or sets the lower boundary of the range.
- UpperBoundary
Gets or sets the upper boundary of the range.

12.4.5.4 CharacterPattern

The IDL type **CharacterPattern** is mapped to the following interface:

```
public interface ITciCharacterPattern : ITciMatchingMechanism
{
    ITciValue PatternString { get; set; }
}
```

Methods:

- `PatternString` Gets or sets the character pattern definition of this pattern (either a `ITciCharstringValue` or `ITciUniversalCharstringValue`).

12.4.5.5 MatchDecodedContent

The IDL type **MatchDecodedContent** is mapped to the following interface:

```
public interface ITciMatchDecodedContent : ITciMatchingMechanism
{
    ITciValue Content { get; set; }
}
```

Methods:

- `Content` Gets or sets the value or matching mechanism used as an argument of the `decmatch` matching mechanism.

12.4.6 Abstract logging types mapping

12.4.6.0 Mapping rules

Additional types are defined to ease the logging of object states and matches between values and templates.

12.4.6.1 TciValueTemplate

TciValueTemplate is mapped to the following interface:

```
public interface ITciValueTemplate {
    bool IsOmit { get; }
    bool IsAny { get; }
    bool IsAnyOrOmit { get; }
    string TemplateDef { get; }
}
```

Members:

- `IsOmit`
Returns `true` if the template is omit, `false` otherwise.
- `IsAny`
Returns `true` if the template is any, `false` otherwise.
- `IsAnyOrOmit`
Returns `true` if the template is `AnyValueOrNone`, `false` otherwise.
- `TemplateDef`
This property returns the template definition.

12.4.6.2 TciNonValueTemplate

TciNonValueTemplate is mapped to the following interface:

```
public interface ITciNonValueTemplate {
    bool IsAny { get; }
    bool IsAll { get; }
    string TemplateDef { get; }
}
```

Members:

- `IsAny`
Returns `true` if the template is any, `false` otherwise.

- `IsAll`
Returns `true` if the template is all, `false` otherwise.
- `TemplateDef`
This operation returns the template definition.

12.4.6.3 TciValueList

TciValueList is mapped to the following interface:

```
public interface ITciValueList: IEnumerable {
    int Size { get; }
    bool IsEmpty { get; }
    ITciValue this[int index] { get; }
}
```

Members:

- `Size`
Returns the number of values in this list.
- `IsEmpty`
Returns `true` if this list contains no values.
- `GetEnumerator`
Inherited from `IEnumerable`. Returns an enumerator for this object and allows to use the list in a `foreach` loop.
- `Indexing operator`
Returns a `ITciValue` instance at the specified position. `IndexOutOfRangeException` is thrown if the index is less than zero or greater or equal to the list size.

12.4.6.4 TciValueDifference

TciValueDifference is mapped to the following interface:

```
public interface ITciValueDifference {
    ITciValue Value { get; }
    ITciValueTemplate ValueTemplate { get; }
    string Description { get; }
}
```

Members:

- `Value`
Returns the value of this `ITciValueDifference`.
- `Template`
Returns the template of this `ITciValueDifference`.
- `Description`
Returns the description of the mismatch.

12.4.6.5 TciValueDifferenceList

TciValueDifferenceList is mapped to the following interface:

```
public interface ITciValueDifferenceList : IEnumerable {
    int Size { get; }
    bool IsEmpty { get; }
    ITciValueDifference this[int index] { get; }
}
```

Members:

- `Size`
Returns the number of differences in this list.
- `IsEmpty`
Returns `true` if this list contains no parameters.
- `GetEnumerator`
Inherited from `IEnumerable`. Returns an enumerator for this object and allows to use the list in a `foreach` loop.
- Indexing operator
Returns a `ITciValueDifference` instance at the specified position. `IndexOutOfRangeException` is thrown if the index is less than zero or greater or equal to the list size.

12.4.6.6 TciStatusType

TciStatusType is mapped to the following enumeration:

```
public enum TciStatus {
    TciOk = 0,
    TciError = -1
}
```

12.4.6.7 ComponentStatusType

ComponentStatusType is mapped to the following enumeration:

```
public enum TciComponentStatus {
    InactiveC = 0,
    RunningC = 1,
    StoppedC = 2,
    KilledC = 3,
    NullC = 4
}
```

12.4.6.8 TimerStatusType

TimerStatusType is mapped to the following enumeration:

```
public enum TciTimerStatus {
    RunningT = 0,
    InactiveT = 1,
    ExpiredT = 2,
    NullT = 3
}
```

12.5 Mapping of interfaces**12.5.0 Calling rules**

The TCI IDL definition defines four interfaces, the TCI-TM, the TCI-CH, the TCI-CD, and the TCI-TL interface. The operations are defined for different directions within this interface, i.e. some operations can only be called by the TTCN-3 Executable (TE), the System Adaptor (SA) or the Platform Adaptor (PA) on the Test Management and Control (TMC) while others can only be called by the TMC on the TE. This is reflected by dividing the TCI IDL interfaces in two sub interfaces, each suffixed by Required or Provided.

Table 10: TCI sub-interfaces

Calling	Called	Interface
TE	TMC	ITciTMProvided
TMC	TE	ITciTMRequired
TE	CD	ITciCDProvided
CD	TE	ITciCDRequired
TE	CH	ITciCHProvided
CH	TE	ITciCHRequired
TE, TMC, CD, CH, SA, PA	TL	ITciTLProvided

For better readability, references to types and interfaces defined in the Etsi.Ttcn3.Tci namespace and Etsi.Ttcn3.Tri namespace (described in [3]) that appear in the following interface definitions use a simple identifier form instead of a fully qualified one. Names of these types and interfaces start with a prefix that can be used for identification of its origin.

12.5.1 TCI-TM interface

12.5.1.1 TCI-TM provided

The **TCI-TM provided** interface is mapped to the following interface:

```
public interface ITciTMProvided {
    void TciTestCaseStarted(ITciTestCaseId testCaseId,
        ITciParameterList parameterList, double timer);
    void TciTestCaseTerminated(ITciVerdictValue verdict,
        ITciParameterList parameterList);
    void TciControlTerminated();
    ITciValue TciGetModulePar(ITciModuleParameterId parameterId);
    void TciLog(ITriComponentId testComponentId,
        string message);
    void TciError(string message);
}
```

12.5.1.2 TCI-TM required

The **TCI-TM required** interface is mapped to the following interface:

```
public interface ITciTMRequired {
    void TciRootModule(ITciModuleId moduleId);
    ITciModuleIdList TciGetImportedModules();
    ITciModuleParameterList TciGetModuleParameters(ITciModuleId moduleId);
    ITciTestCaseIdList TciGetTestCases();
    ITciParameterTypeList TciGetTestCaseParameters(ITciTestCaseId TestCaseId);
    ITriPortIdList TciGetTestCaseTsi(
        ITciTestCaseId testCaseId);
    void TciStartTestCase(ITciTestCaseId testCaseId,
        ITciParameterList parameterList);
    void TciStopTestCase();
    ITriComponentId TciStartControl();
    void TciStopControl();
}
```

12.5.2 TCI-CD interface

12.5.2.1 TCI-CD provided

The **TCI-CD provided** interface is mapped to the following interface:

```
public interface ITciCDProvided {
    ITciValue Decode(ITriMessage message,
        ITciType decodingHypothesis);
    ITriMessage Encode(ITciValue value);
    int DecodeValue(ITriMessage message,
        ITciType decodingHypothesis,
        string decodingInfo,
        out ITciValue decodedValue);
}
```



```

    ITriMessage EncodeValue(ITciValue value,
        string encodingInfo);
}

```

12.5.2.2 TCI-CD required

The **TCI-CD required** interface is mapped to the following interface:

```

public interface ITciCDRequired {
    ITciType GetTypeForName(string typeName);
    ITciType GetInteger();
    ITciType GetFloat();
    ITciType GetBoolean();
    ITciType GetCharstring();
    ITciType GetUniversalCharstring();
    ITciType GetHexstring();
    ITciType GetBitstring();
    ITciType GetOctetstring();
    ITciType GetVerdict();
    void TciErrorReq(string message);
}

```

12.5.3 TCI-CH interface

12.5.3.1 TCI-CH provided

The **TCI-CH provided** interface is mapped to the following interface:

```

public interface ITciCHProvided {
    void TciSendConnected(ITriPortId sender,
        ITriComponentId receiver, ITciValue sendMessage);
    void TciSendConnectedBC(ITriPortId sender,
        ITciValue sendMessage);
    void TciSendConnectedMC(ITriPortId sender,
        ITriComponentIdList receivers,
        ITciValue sendMessage);
    void TciCallConnected(ITriPortId sender,
        ITriComponentId receiver,
        ITriSignatureId signature,
        ITciParameterList parameterList);
    void TciCallConnectedBC(ITriPortId sender,
        ITriSignatureId signature,
        ITciParameterList parameterList);
    void TciCallConnectedMC(ITriPortId sender,
        ITriComponentIdList receivers,
        ITriSignatureId signature,
        ITciParameterList parameterList);
    void TciReplyConnected(ITriPortId sender,
        ITriComponentId receiver,
        ITriSignatureId signature,
        ITciParameterList parameterList, ITciValue returnValue);
    void TciReplyConnectedBC(ITriPortId sender,
        ITriSignatureId signature,
        ITciParameterList parameterList, ITciValue returnValue);
    void TciReplyConnectedMC(ITriPortId sender,
        ITriComponentIdList receivers,
        ITriSignatureId signature,
        ITciParameterList parameterList, ITciValue returnValue);
    void TciRaiseConnected(ITriPortId sender,
        ITriComponentId receiver,
        ITriSignatureId signature, ITciValue except);
    void TciRaiseConnectedBC(ITriPortId sender,
        ITriSignatureId signature, ITciValue except);
    void TciRaiseConnectedMC(ITriPortId sender,
        ITriComponentIdList receivers,
        ITriSignatureId signature, ITciValue except);
    ITriComponentId TciCreateTestComponentReq(int kind,
        ITciType componentType, string name, ITciValue hostId);
    void TciStartTestComponentReq(ITriComponentId comp,
        ITciBehaviourId behavior, ITciParameterList parameterList);
    void TciStopTestComponentReq(ITriComponentId comp);
    void TciConnectReq(ITriPortId fromPort,
        ITriPortId toPort);
    void TciDisconnectReq(ITriPortId fromPort,

```

```

    ITriPortId toPort);
void TciTestComponentTerminatedReq(ITriComponentId comp,
    ITciVerdictValue verdict);
bool TciTestComponentRunningReq(ITriComponentId comp);
ITriComponentId TciGetMmcReq();
void TciMapReq(ITriPortId fromPort,
    ITriPortId toPort);
void TciMapParamReq(ITriPortId fromPort,
    ITriPortId toPort, Etsi.Ttcn3.Tci.ITciParameterList parameterList);
void TciUnmapReq(ITriPortId fromPort,
    ITriPortId toPort);
void TciUnmapParamReq(ITriPortId fromPort,
    ITriPortId toPort, Etsi.Ttcn3.Tci.ITciParameterList parameterList);
void TciExecuteTestCaseReq(ITriComponentId component,
    ITriPortIdList tsiPortList);
void TciResetReq();
bool TciTestComponentDoneReq(ITriComponentId component, out TciVerdict verdict);
void TciKillTestComponentReq(ITriComponentId component);
bool TciTestComponentAliveReq(ITriComponentId component);
bool TciTestComponentKilledReq(ITriComponentId component, out TciVerdict verdict);
}

```

12.5.3.2 TCI-CH required

The **TCI-CH required** interface is mapped to the following interface:

```

public interface ITciCHRequired {
    void TciEnqueueMsgConnected(ITriPortId sender,
        ITriComponentId receiver,
        ITciValue receivedMessage);
    void TciEnqueueCallConnected(ITriPortId sender,
        ITriComponentId receiver,
        ITriSignatureId signature,
        ITciParameterList parameterList);
    void TciEnqueueReplyConnected(ITriPortId sender,
        ITriComponentId receiver,
        ITriSignatureId signature,
        ITciParameterList parameterList, ITciValue returnValue);
    void TciEnqueueRaiseConnected(ITriPortId sender,
        ITriComponentId receiver,
        ITriSignatureId signature, ITciValue except);
    ITriComponentId TciCreateTestComponent(int kind,
        ITciType componentType, string name);
    void TciStartTestComponent(ITriComponentId comp,
        ITciBehaviourId behavior, ITciParameterList parameterList);
    void TciStopTestComponent(ITriComponentId comp);
    void TciConnect(ITriPortId fromPort,
        ITriPortId toPort);
    void TciDisconnect(ITriPortId fromPort,
        ITriPortId toPort);
    void TciTestComponentTerminated(ITriComponentId comp,
        ITciVerdictValue verdict);
    bool TciTestComponentRunning(ITriComponentId comp);
    bool TciTestComponentDone(ITriComponentId comp, out TciVerdict verdict);
    ITriComponentId TciGetMtc();
    void TciExecuteTestCase (ITciTestId testCaseId,
        ITriPortIdList tsiPortList);
    void TciReset();
    void TciMap(ITriPortId fromPort,
        ITriPortId toPort);
    void TciMapParam(ITriPortId fromPort,
        ITriPortId toPort, Etsi.Ttcn3.Tci.ITciParameterList parameterList);
    void TciUnmap(ITriPortId fromPort,
        ITriPortId toPort);
    void TciUnmapParam(ITriPortId fromPort,
        ITriPortId toPort, Etsi.Ttcn3.Tci.ITciParameterList parameterList);
    void TciKillTestComponent(ITriComponentId component);
    bool TciTestComponentAlive (ITriComponentId component);
    bool TciTestComponentKilled(ITriComponentId component, out TciVerdict verdict);
}

```

12.5.4 TCI-TL interface

12.5.4.1 TCI-TL provided

The **TCI-TL provided** interface is mapped to the following interface:

```
public interface ITciTLProvided {
    void TliTcExecute(string am, System.DateTime ts, string src, int line,
        ITriComponentId c, ITciTestCaseId tcId,
        ITciParameterList tciPars, ITriTimerDuration dur);
    void TliTcStart(string am, System.DateTime ts, string src, int line,
        ITriComponentId c, ITciTestCaseId tcId,
        ITciParameterList tciPars, ITriTimerDuration dur);
    void TliTcStop(string am, System.DateTime ts, string src, int line,
        ITriComponentId c, string reason);
    void TliTcStarted(string am, System.DateTime ts, string src, int line,
        ITriComponentId c, ITciTestCaseId tcId,
        ITciParameterList tciPars, ITriTimerDuration dur);
    void TliTcTerminated(string am, System.DateTime ts, string src, int line,
        ITriComponentId c, ITciTestCaseId tcId,
        ITciParameterList tciPars, ITciVerdictValue verdict,
        string reason);
    void TliCtrlStart(string am, System.DateTime ts, string src, int line,
        ITriComponentId c);
    void TliCtrlStop(string am, System.DateTime ts, string src, int line,
        ITriComponentId c);
    void TliCtrlTerminated(string am, System.DateTime ts, string src, int
        line, ITriComponentId c);
    void TliMSend_m(string am, System.DateTime ts, string src, int line,
        ITriComponentId c, ITriPortId at,
        ITriPortId to, ITciValue msgValue,
        ITciValue addrValue, TciStatus encoderFailure,
        ITriMessage msg, ITriAddress address,
        TriStatus transmissionFailure);
    void TliMSend_m_BC(string am, System.DateTime ts, string src, int line,
        ITriComponentId c, ITriPortId at,
        ITriPortId to, ITciValue msgValue,
        TciStatus encoderFailure, ITriMessage msg,
        TriStatus transmissionFailure);
    void TliMSend_m_MC(string am, System.DateTime ts, string src, int line,
        ITriComponentId c, ITriPortId at,
        ITriPortId to, ITciValue msgValue,
        ITciValueList addrValues, TciStatus encoderFailure,
        ITriMessage msg,
        ITriAddressList addresses,
        TriStatus transmissionFailure);
    void TliMSend_c(string am, System.DateTime ts, string src, int line,
        ITriComponentId c, ITriPortId at,
        ITriPortId to, ITciValue msgValue,
        TriStatus transmissionFailure);
    void TliMSend_c_BC(string am, System.DateTime ts, string src, int line,
        ITriComponentId c, ITriPortId at,
        ITriPortIdList to, ITciValue msgValue,
        TriStatus transmissionFailure);
    void TliMSend_c_MC(string am, System.DateTime ts, string src, int line,
        ITriComponentId c, ITriPortId at,
        ITriPortIdList to, ITciValue msgValue,
        TriStatus transmissionFailure);
    void TliMDetected_m(string am, System.DateTime ts, string src, int line,
        ITriComponentId c, ITriPortId at,
        ITriPortId from, ITriMessage msg,
        ITriAddress address);
    void TliMDetected_c(string am, System.DateTime ts, string src, int line,
        ITriComponentId c, ITriPortId at,
        ITriPortId from, ITciValue msgValue);
    void TliMMismatch_m(string am, System.DateTime ts, string src, int line,
        ITriComponentId c, ITriPortId at,
        ITciValue msgValue, ITciValueTemplate msgTpl,
        ITciValueDifferenceList diffs, ITciValue address,
        ITciValueTemplate addressTpl);
    void TliMMismatch_c(string am, System.DateTime ts, string src, int line,
        ITriComponentId c, ITriPortId at,
        ITciValue msgValue, ITciValueTemplate msgTpl,
        ITciValueDifferenceList diffs, ITriComponentId from,
        ITciNonValueTemplate fromTpl);
    void TliMReceive_m(string am, System.DateTime ts, string src, int line,
```

```

    ITricomponentId c, ITricomponentId at,
    ITciValue msgValue, ITciValueTemplate msgTmpl, ITciValue address,
    ITciValueTemplate addressTmpl);
void TliMReceive_c(string am, System.DateTime ts, string src, int line,
    ITricomponentId c, ITricomponentId at,
    ITciValue msgValue, ITciValueTemplate msgTmpl,
    ITricomponentId fromComp,
    ITciNonValueTemplate fromTmpl);
void TliPrCall_m(string am, System.DateTime ts, string src, int line,
    ITricomponentId c, ITricomponentId at,
    ITricomponentId to,
    ITrisignatureId signature,
    ITciParameterList tciPars, ITciValue addrValue,
    TciStatus encoderFailure, ITricomponentId triPars,
    ITricomponentId address,
    TriStatus transmissionFailure);
void TliPrCall_m_BC(string am, System.DateTime ts, string src, int line,
    ITricomponentId c, ITricomponentId at,
    ITricomponentId to,
    ITrisignatureId signature, ITciParameterList tciPars,
    TciStatus encoderFailure, ITricomponentId triPars,
    TriStatus transmissionFailure);
void TliPrCall_m_MC(string am, System.DateTime ts, string src, int line,
    ITricomponentId c, ITricomponentId at,
    ITricomponentId to,
    ITrisignatureId signature, ITciParameterList tciPars,
    ITciValueList addrValues, TciStatus encoderFailure,
    ITricomponentId triPars,
    ITricomponentIdList addresses,
    TriStatus transmissionFailure);
void TliPrCall_c(string am, System.DateTime ts, string src, int line,
    ITricomponentId c, ITricomponentId at,
    ITricomponentId to,
    ITrisignatureId signature,
    ITciParameterList tciPars,
    TriStatus transmissionFailure);
void TliPrCall_c_BC(string am, System.DateTime ts, string src, int line,
    ITricomponentId c, ITricomponentId at,
    ITricomponentIdList to,
    ITrisignatureId signature, ITciParameterList tciPars,
    TriStatus transmissionFailure);
void TliPrCall_c_MC(string am, System.DateTime ts, string src, int line,
    ITricomponentId c, ITricomponentId at,
    ITricomponentIdList to,
    ITrisignatureId signature, ITciParameterList tciPars,
    TriStatus transmissionFailure);
void TliPrGetCallDetected_m(string am, System.DateTime ts, string src,
    int line, ITricomponentId c,
    ITricomponentId at, ITricomponentId from,
    ITrisignatureId signature,
    ITricomponentId triPars,
    ITricomponentId address);
void TliPrGetCallDetected_c(string am, System.DateTime ts, string src,
    int line, ITricomponentId c,
    ITricomponentId at, ITricomponentId from,
    ITrisignatureId signature,
    ITciParameterList tciPars);
void TliPrGetCallMismatch_m(string am, System.DateTime ts, string src,
    int line, ITricomponentId c,
    ITricomponentId at,
    ITrisignatureId signature, ITciParameterList tciPars,
    ITciValueTemplate parsTmpl, ITciValueDifferenceList diffs,
    ITciValue address, ITciValueTemplate addressTmpl);
void TliPrGetCallMismatch_c(string am, System.DateTime ts, string src,
    int line, ITricomponentId c,
    ITricomponentId at,
    ITrisignatureId signature,
    ITciParameterList tciPars, ITciValueTemplate parsTmpl,
    ITciValueDifferenceList diffs, ITricomponentId from,
    ITciNonValueTemplate fromTmpl);
void TliPrGetCall_m(string am, System.DateTime ts, string src, int line,
    ITricomponentId c, ITricomponentId at,
    ITrisignatureId signature,
    ITciParameterList tciPars, ITciValueTemplate parsTmpl,
    ITciValue address, ITciValueTemplate addressTmpl);
void TliPrGetCall_c(string am, System.DateTime ts, string src, int line,
    ITricomponentId c, ITricomponentId at,
    ITrisignatureId signature,

```

```

    ITciParameterList tciPars, ITciValueTemplate parsTpl,
    ITriComponentId from, ITciNonValueTemplate fromTpl);
void TliPrReply_m(string am, System.DateTime ts, string src, int line,
    ITriComponentId c, ITriPortId at,
    ITriPortId to,
    ITriSignatureId signature, ITciParameterList tciPars,
    ITciValue replValue, ITciValue addrValue, TciStatus encoderFailure,
    ITriParameterList triPars,
    ITriParameter repl,
    ITriAddress address,
    TriStatus transmissionFailure);
void TliPrReply_m_BC(string am, System.DateTime ts, string src, int line,
    ITriComponentId c, ITriPortId at,
    ITriPortId to,
    ITriSignatureId signature, ITciParameterList tciPars,
    ITciValue replValue, TciStatus encoderFailure,
    ITriParameterList triPars,
    ITriParameter repl,
    TriStatus transmissionFailure);
void TliPrReply_m_MC(string am, System.DateTime ts, string src, int line,
    ITriComponentId c, ITriPortId at,
    ITriPortId to,
    ITriSignatureId signature, ITciParameterList tciPars,
    ITciValue replValue, ITciValueList addrValues,
    TciStatus encoderFailure, ITriParameterList triPars,
    ITriParameter repl,
    ITriAddressList addresses,
    TriStatus transmissionFailure);
void TliPrReply_c(string am, System.DateTime ts, string src, int line,
    ITriComponentId c, ITriPortId at,
    ITriPortId to,
    ITriSignatureId signature, ITciParameterList tciPars,
    ITciValue replValue, TriStatus transmissionFailure);
void TliPrReply_c_BC(string am, System.DateTime ts, string src, int line,
    ITriComponentId c, ITriPortId at,
    ITriPortIdList to,
    ITriSignatureId signature, ITciParameterList tciPars,
    ITciValue replValue, TriStatus transmissionFailure);
void TliPrReply_c_MC(string am, System.DateTime ts, string src, int line,
    ITriComponentId c, ITriPortId at,
    ITriPortIdList to,
    ITriSignatureId signature, ITciParameterList tciPars,
    ITciValue replValue, TriStatus transmissionFailure);
void TliPrGetReplyDetected_m(string am, System.DateTime ts, string src,
    int line, ITriComponentId c,
    ITriPortId at, ITriPortId from,
    ITriSignatureId signature,
    ITriParameterList triPars,
    ITriParameter repl,
    ITriAddress address);
void TliPrGetReplyDetected_c(string am, System.DateTime ts, string src,
    int line, ITriComponentId c,
    ITriPortId at, ITriPortId from,
    ITriSignatureId signature, ITciParameterList tciPars,
    ITciValue replValue);
void TliPrGetReplyMismatch_m(string am, System.DateTime ts, string src,
    int line, ITriComponentId c,
    ITriPortId at,
    ITriSignatureId signature, ITciParameterList tciPars,
    ITciValueTemplate parsTpl, ITciValue replValue,
    ITciValueTemplate replyTpl, ITciValueDifferenceList diffs,
    ITciValue address, ITciValueTemplate addressTpl);
void TliPrGetReplyMismatch_c(string am, System.DateTime ts, string src,
    int line, ITriComponentId c,
    ITriPortId at,
    ITriSignatureId signature, ITciParameterList tciPars,
    ITciValueTemplate parsTpl, ITciValue replValue,
    ITciValueTemplate replyTpl, ITciValueDifferenceList diffs,
    ITriComponentId from, ITciNonValueTemplate fromTpl);
void TliPrGetReply_m(string am, System.DateTime ts, string src, int line,
    ITriComponentId c, ITriPortId at,
    ITriSignatureId signature, ITciParameterList tciPars,
    ITciValueTemplate parsTpl, ITciValue replValue,
    ITciValueTemplate replyTpl, ITciValue address,
    ITciValueTemplate addressTpl);
void TliPrGetReply_c(string am, System.DateTime ts, string src, int line,
    ITriComponentId c, ITriPortId at,
    ITriSignatureId signature,

```

```

ITciParameterList tciPars, ITciValueTemplate parsTpl,
ITciValue replValue, ITciValueTemplate replyTpl,
ITriComponentId from, ITciNonValueTemplate fromTpl);
void TliPrRaise_m(string am, System.DateTime ts, string src, int line,
ITriComponentId c, ITriPortId at,
ITriPortId to,
ITriSignatureId signature, ITciParameterList tciPars,
ITciValue excValue, ITciValue addrValue, TciStatus encoderFailure,
ITriException exc,
ITriAddress address,
TriStatus transmissionFailure);
void TliPrRaise_m_BC(string am, System.DateTime ts, string src, int line,
ITriComponentId c, ITriPortId at,
ITriPortId to,
ITriSignatureId signature, ITciParameterList tciPars,
ITciValue excValue, TciStatus encoderFailure,
ITriException exc,
TriStatus transmissionFailure);
void TliPrRaise_m_MC(string am, System.DateTime ts, string src, int line,
ITriComponentId c, ITriPortId at,
ITriPortId to,
ITriSignatureId signature, ITciParameterList tciPars,
ITciValue excValue, ITciValueList addrValues,
TciStatus encoderFailure, ITriException exc,
ITriAddressList addresses,
TriStatus transmissionFailure);
void TliPrRaise_c(string am, System.DateTime ts, string src, int line,
ITriComponentId c, ITriPortId at,
ITriPortId to,
ITriSignatureId signature, ITciParameterList tciPars,
ITciValue excValue, TriStatus transmissionFailure);
void TliPrRaise_c_BC(string am, System.DateTime ts, string src, int line,
ITriComponentId c, ITriPortId at,
ITriPortIdList to,
ITriSignatureId signature,
ITciParameterList tciPars, ITciValue excValue,
TriStatus transmissionFailure);
void TliPrRaise_c_MC(string am, System.DateTime ts, string src, int line,
ITriComponentId c, ITriPortId at,
ITriPortIdList to,
ITriSignatureId signature, ITciParameterList tciPars,
ITciValue excValue, TriStatus transmissionFailure);
void TliPrCatchDetected_m(string am, System.DateTime ts, string src,
int line, ITriComponentId c,
ITriPortId at, ITriPortId from,
ITriSignatureId signature,
ITriException exc,
ITriAddress address);
void TliPrCatchDetected_c(string am, System.DateTime ts, string src,
int line, ITriComponentId c,
ITriPortId at, ITriPortId from,
ITriSignatureId signature, ITciValue excValue);
void TliPrCatchMismatch_m(string am, System.DateTime ts, string src,
int line, ITriComponentId c,
ITriPortId at,
ITriSignatureId signature, ITciValue excValue,
ITciValueTemplate excTpl, ITciValueDifferenceList diffs,
ITciValue address, ITciValueTemplate addressTpl);
void TliPrCatchMismatch_c(string am, System.DateTime ts, string src,
int line, ITriComponentId c,
ITriPortId at,
ITriSignatureId signature,
ITciValue excValue, ITciValueTemplate excTpl,
ITciValueDifferenceList diffs, ITriComponentId from,
ITciNonValueTemplate fromTpl);
void TliPrCatch_m(string am, System.DateTime ts, string src, int line,
ITriComponentId c, ITriPortId at,
ITriSignatureId signature,
ITciValue excValue, ITciValueTemplate excTpl, ITciValue address,
ITciValueTemplate addressTpl);
void TliPrCatch_c(string am, System.DateTime ts, string src, int line,
ITriComponentId c, ITriPortId at,
ITriSignatureId signature,
ITciValue excValue, ITciValueTemplate excTpl,
ITriComponentId from, ITciNonValueTemplate fromTpl);
void TliPrCatchTimeoutDetected(string am, System.DateTime ts, string src,
int line, ITriComponentId c,
ITriPortId at,

```

```

    ITriSignatureId signature);
void TliPrCatchTimeout(string am, System.DateTime ts, string src,
    int line, ITriComponentId c,
    ITriPortId at,
    ITriSignatureId signature);
void TliCCreate(string am, System.DateTime ts, string src, int line,
    ITriComponentId c,
    ITriComponentId comp, string name, bool alive);
void TliCStart(string am, System.DateTime ts, string src, int line,
    ITriComponentId c,
    ITriComponentId comp, ITciBehaviourId name,
    ITciParameterList tciPars);
void TliCRunning(string am, System.DateTime ts, string src, int line,
    ITriComponentId c,
    ITriComponentId comp, TciComponentStatus status);
void TliCAlive(string am, System.DateTime ts, string src, int line,
    ITriComponentId c,
    ITriComponentId comp, TciComponentStatus status);
void TliCStop(string am, System.DateTime ts, string src, int line,
    ITriComponentId c,
    ITriComponentId comp);
void TliCKill(string am, System.DateTime ts, string src, int line,
    ITriComponentId c,
    ITriComponentId comp);
void TliCDoneMismatch(string am, System.DateTime ts, string src, int line,
    ITriComponentId c,
    ITriComponentId comp, ITciNonValueTemplate compTpl);
void TliCDone(string am, System.DateTime ts, string src, int line,
    ITriComponentId c, ITciNonValueTemplate compTpl, ITciVerdictValue verdict);
void TliCKilledMismatch(string am, System.DateTime ts, string src,
    int line, ITriComponentId c,
    ITriComponentId comp, ITciNonValueTemplate compTpl);
void TliCKilled(string am, System.DateTime ts, string src, int line,
    ITriComponentId c, ITciNonValueTemplate compTpl, ITciVerdictValue verdict);
void TliCTerminated(string am, System.DateTime ts, string src, int line,
    ITriComponentId c, ITciVerdictValue verdict,
    string reason);
void TliPConnect(string am, System.DateTime ts, string src, int line,
    ITriComponentId c, ITriPortId port1,
    ITriPortId port2);
void TliPDisconnect(string am, System.DateTime ts, string src, int line,
    ITriComponentId c, ITriPortId port1,
    ITriPortId port2);
void TliPMap(string am, System.DateTime ts, string src, int line,
    ITriComponentId c, ITriPortId port1,
    ITriPortId port2);
void TliPUnmap(string am, System.DateTime ts, string src, int line,
    ITriComponentId c, ITriPortId port1,
    ITriPortId port2);
void TliPClear(string am, System.DateTime ts, string src, int line,
    ITriComponentId c, ITriPortId port);
void TliPStart(string am, System.DateTime ts, string src, int line,
    ITriComponentId c, ITriPortId port);
void TliPStop(string am, System.DateTime ts, string src, int line,
    ITriComponentId c, ITriPortId port);
void TliPHalt(string am, System.DateTime ts, string src, int line,
    ITriComponentId c, ITriPortId port);
void TliEncode(string am, System.DateTime ts, string src, int line,
    ITriComponentId c, ITciValue val,
    TciStatus encoderFailure, ITriMessage msg,
    string codec);
void TliDecode(string am, System.DateTime ts, string src, int line,
    ITriComponentId c, ITriMessage msg,
    TciStatus decoderFailure, ITciValue val, string codec);
void TliTTimeoutDetected(string am, System.DateTime ts, string src,
    int line, ITriComponentId c,
    ITriTimerId timer);
void TliTTimeoutMismatch(string am, System.DateTime ts, string src,
    int line, ITriComponentId c,
    ITriTimerId timer, ITciNonValueTemplate timerTpl);
void TliTTimeout(string am, System.DateTime ts, string src, int line,
    ITriComponentId c, ITriTimerId timer,
    ITciNonValueTemplate timerTpl);
void TliTStart(string am, System.DateTime ts, string src, int line,
    ITriComponentId c, ITriTimerId timer,
    ITriTimerDuration dur);
void TliTStop(string am, System.DateTime ts, string src, int line,
    ITriComponentId c, ITriTimerId timer,

```

```

    ITriTimerDuration dur);
void TliTRead(string am, System.DateTime ts, string src, int line,
    ITriComponentId c, ITriTimerId timer,
    ITriTimerDuration elapsed);
void TliTRunning(string am, System.DateTime ts, string src, int line,
    ITriComponentId c, ITriTimerId timer,
    TciTimerStatus status);
void TliSEnter(string am, System.DateTime ts, string src, int line,
    ITriComponentId c,
    IQualifiedName name, ITciParameterList tciPars,
    string kind);
void TliSLeave(string am, System.DateTime ts, string src, int line,
    ITriComponentId c,
    IQualifiedName name, ITciParameterList tciPars,
    ITciValue returnValue, string kind);
void TliVar(string am, System.DateTime ts, string src, int line,
    ITriComponentId c,
    IQualifiedName name, ITciValue varValue);
void TliModulePar(string am, System.DateTime ts, string src, int line,
    ITriComponentId c,
    IQualifiedName name, ITciValue parValue);
void TliGetVerdict(string am, System.DateTime ts, string src, int line,
    ITriComponentId c, ITciVerdictValue verdict);
void TliSetVerdict(string am, System.DateTime ts, string src, int line,
    ITriComponentId c, ITciVerdictValue verdict,
    string reason);
void TliLog(string am, System.DateTime ts, string src, int line,
    ITriComponentId c, string log);
void TliAEnter(string am, System.DateTime ts, string src, int line,
    ITriComponentId c);
void TliALeave(string am, System.DateTime ts, string src, int line,
    ITriComponentId c);
void TliADefaults(string am, System.DateTime ts, string src, int line,
    ITriComponentId c);
void TliAActivate(string am, System.DateTime ts, string src, int line,
    ITriComponentId c,
    IQualifiedName name, ITciParameterList tciPars,
    ITciValue expr);
void TliADeactivate(string am, System.DateTime ts, string src, int line,
    ITriComponentId c, ITciValue expr);
void TliANomatch(string am, System.DateTime ts, string src, int line,
    ITriComponentId c);
void TliARepeat(string am, System.DateTime ts, string src, int line,
    ITriComponentId c);
void TliAwait(string am, System.DateTime ts, string src, int line,
    ITriComponentId c);
void TliAction(string am, System.DateTime ts, string src, int line,
    ITriComponentId c, string action);
void TliMatch(string am, System.DateTime ts, string src, int line,
    ITriComponentId c, ITciValue expr,
    ITciValueTemplate tpl);
void TliMatchMismatch(string am, System.DateTime ts, string src, int line,
    ITriComponentId c, ITciValue expr,
    ITciValueTemplate tpl, ITciValueDifferenceList diffs);
void TliInfo (string am, System.DateTime ts, string src, int line,
    ITriComponentId c, int level, string info);
void TliMChecked_m(string am, System.DateTime ts, string src, int line,
    ITriComponentId c, ITriPortId at,
    ITciValue msgValue, ITciValueTemplate msgTpl,
    ITciValue address, ITciValueTemplate addressTpl);
void TliMChecked_c(string am, System.DateTime ts, string src, int line,
    ITriComponentId c, ITriPortId at,
    ITciValue msgValue, ITciValueTemplate msgTpl,
    ITriComponentId fromComp, ITciNonValueTemplate fromTpl);
void TliPrGetCallChecked_m(string am, System.DateTime ts, string src,
    int line, ITriComponentId c,
    ITriPortId at, ITriSignatureId signature,
    ITciParameterList tciPars, ITciValueTemplate parsTpl,
    ITciValue address, ITciValueTemplate addressTpl);
void TliPrGetCallChecked_c(string am, System.DateTime ts, string src,
    int line, ITriComponentId c,
    ITriPortId at, ITriSignatureId signature,
    ITciParameterList tciPars, ITciValueTemplate parsTpl,
    ITriComponentId from, ITciNonValueTemplate fromTpl);
void TliPrGetReplyChecked_m(string am, System.DateTime ts, string src,
    int line, ITriComponentId c,
    ITriPortId at, ITriSignatureId signature,
    ITciParameterList tciPars, ITciValueTemplate parsTpl,

```



```

    ITciValue replValue, ITciValueTemplate replyTmpl,
    ITciValue address, ITciValueTemplate addressTmpl);
void TliPrGetReplyChecked_c(string am, System.DateTime ts, string src,
    int line, ITricomponentId c,
    ITricomponentId at, ITrisignatureId signature,
    ITciparameterList tciPars, ITciValueTemplate parsTmpl,
    ITciValue replValue, ITciValueTemplate replyTmpl,
    ITricomponentId from, ITcinonvalueTemplate fromTmpl);
void TliPrCatchChecked_m(string am, System.DateTime ts, string src,
    int line, ITricomponentId c,
    ITricomponentId at, ITrisignatureId signature,
    ITciValue excValue, ITciValueTemplate excTmpl,
    ITciValue address, ITciValueTemplate addressTmpl);
void TliPrCatchChecked_c(string am, System.DateTime ts, string src,
    int line, ITricomponentId c,
    ITricomponentId at, ITrisignatureId signature,
    ITciValue excValue, ITciValueTemplate excTmpl,
    ITricomponentId from, ITcinonvalueTemplate fromTmpl);
void TliCheckedAny_m(string am, System.DateTime ts, string src, int line,
    ITricomponentId c, ITricomponentId at,
    ITciValue address, ITciValueTemplate addressTmpl);
void TliCheckedAny_c(string am, System.DateTime ts, string src, int line,
    ITricomponentId c, ITricomponentId at,
    ITricomponentId from, ITcinonvalueTemplate fromTmpl);
void TliCheckAnyMismatch_m(string am, System.DateTime ts, string src, int line,
    ITricomponentId c, ITricomponentId at,
    ITciValue address, ITciValueTemplate addressTmpl);
void TliCheckAnyMismatch_c(string am, System.DateTime ts, string src, int line,
    ITricomponentId c, ITricomponentId at,
    ITricomponentId from, ITcinonvalueTemplate fromTmpl);
void TliRnd(string am, System.DateTime ts, string src, int line,
    ITricomponentId c, FloatValue val, FloatValue seed);
void TliEvaluate (string am, System.DateTime ts, string src, int line,
    ITricomponentId c, IqualifiedName name, ITciValue evalResult);
}

```

12.6 Optional parameters

Clause 7.3 in [1] defines that a reserved value shall be used to indicate the absence of an optional parameter. For the C# language mapping the distinct value `null` shall be used to indicate the absence of an optional value. For example, if in the `TciReplyConnected` operation the value parameter shall be omitted the operation invocation shall be `TciReplyConnected (sender, receiver, signature, parameterList, null)`.

12.7 Error Handling

All operations called from the TM, CH or CD that return have succeeded. If an erroneous situation has been identified by the TE a test case error will be communicated to the user using the procedures as defined in clause 7.3.1.2.6 (`TciError`). If an operation called by the TE in the TM, CH, CD, or TL produces an error, this erroneous situation should be communicated to the TE using the procedures as defined in clause 7.3.2.1.12 (`TciErrorReq`).

Beside this error handling and exceptions specified for indexing operators no additional error handling is defined in the C# mapping.

Annex A (normative): IDL Specification of TCI

This annex defines the TTCN-3 Control Interfaces using the Interface Definition Language (IDL).

```
// *****
// * Interface definitions for the TTCN-3 Control Interfaces
// *****

module tciInterface {

    /* Forward declaration */
    interface Value;
    interface Type;

    // *****
    // * Data types taken from the TRI definitions
    // *****

    // Connection
    native TriPortIdType ;
    native TriPortIdListType;
    native TriComponentIdType ;
    native TriComponentIdListType;

    // Communications
    native TriMessageType;
    native TriParameterType;
    native TriParameterListType;
    native TriAddressType;
    native TriAddressListType;
    native TriExceptionType;
    native TriSignatureIdType;

    // Miscellaneous
    native TriStatusType;
    native TriTimerIdType;
    native TriTimerDurationType;

    native TciStatusType;

    // *****
    // * General Abstract Data Types
    // *****

    // Basic definitions
    native TBoolean;
    native TFloat;
    native TChar;
    native TInteger;
    native TString;
    native TUniversalChar;
    typedef sequence <TString> TStringSeq;

    struct QualifiedName {
        TString moduleName;
        TString baseName;
    };

    // General TCI abstract data types
    typedef QualifiedName TciBehaviourIdType;
    typedef QualifiedName TciModuleIdType;
    typedef QualifiedName TciModuleParameterIdType;
    typedef QualifiedName TciTestCaseIdType;

    enum TciParameterPassingModeType {
        IN_MODE,
        OUT_MODE,
        INOUT_MODE
    };

    struct TciParameterType {
        TciModuleParameterIdType parameterName;
        Value parameterValue;
        TciParameterPassingModeType mode;
    };
};
```

```

};

typedef sequence <TciParameterType> TciParameterListType;

struct TciParameterTypeType {
    Type parameterType;
    TciParameterPassingModeType mode;
};

typedef sequence <TciParameterTypeType> TciParameterTypeListType;

struct TciModuleParameterType {
    TciModuleParameterIdType parameterName;
    Value defaultValue;
};

typedef sequence <TciModuleIdType> TciModuleIdListType ;

typedef sequence <TciModuleParameterType> TciModuleParameterListType;

typedef sequence <TciTestCaseIdType> TciTestCaseIdListType;

enum TciTestComponentKindType {
    CONTROL,
    MTC,
    PTC,
    SYSTEM,
    PTC_ALIVE
};

enum ComponentStatusType{
    inactiveC,
    runningC,
    stoppedC,
    killedC,
    nullC
};

enum TimerStatusType{
    runningT,
    inactiveT,
    expiredT,
    nullT
};

enum PortStatusType{
    startedP,
    haltedP,
    stoppedP
};

enum TciTypeClassType {
    ADDRESS_CLASS,
    ANYTYPE_CLASS,
    BITSTRING_CLASS,
    BOOLEAN_CLASS,
    CHARSTRING_CLASS,
    COMPONENT_CLASS,
    ENUMERATED_CLASS,
    FLOAT_CLASS,
    HEXSTRING_CLASS,
    INTEGER_CLASS,
    OCTETSTRING_CLASS,
    RECORD_CLASS,
    RECORDOF_CLASS,
    ARRAY_CLASS,
    SET_CLASS,
    SETOF_CLASS,
    UNION_CLASS,
    UNIVERSALCHARSTRING_CLASS,
    VERDICT_CLASS,
    DEFAULT_CLASS,
    PORT_CLASS,
    TIMER_CLASS
};
};

```

```

// *****
// * Abstract TTCN-3 Data Types And Values
// *****

// Abstract data type "Type"
interface Type {
  TciModuleIdType  getDefiningModule ();
  TString          getName ();
  TciTypeClassType getTypeClass ();
  Value           newInstance ();
  TString         getTypeEncoding ();
  TString         getTypeEncodingVariant ();
  TStringSeq      getTypeextension ();
  Value           parseValue(in TString val);
};

// Abstract TTCN-3 Values
interface Value {
  TString  getValueEncoding ();
  TString  getValueEncodingVariant ();
  Type     getType ();
  TBoolean notPresent ();
  TBoolean isMatchingSymbol ();
  TString  valueToString ();
};

interface RecordOfValue : Value {
  Value  getField (in TInteger position);
  void   setField (
    in TInteger position,
    in Value value
  );
  void   appendField (in Value value);
  Type   getElementType ();
  TInteger getLength ();
  void   setLength (in TInteger len);
  TInteger getOffset ();
};

interface RecordValue : Value {
  Value  getField (in TString fieldName);
  void   setField (
    in TString fieldName,
    in Value value
  );
  TStringSeq getFieldNames ();
  void   setFieldOmitted (in TString fieldName);
};

interface VerdictValue : Value {
  TInteger getVerdict ();
  void   setVerdict (in TInteger verdict);
};

interface BitstringValue : Value {
  TString  getString ();
  void   setString (in TString value);
  TInteger getBit (in TInteger position);
  void   setBit (
    in TInteger position,
    in TInteger value
  );
  TInteger getLength ();
  void   setLength (in TInteger len);
};

interface OctetstringValue : Value {
  TString  getString ();
  void   setString (in TString value);
  TInteger getOctet (in TInteger position);
  void   setOctet (
    in TInteger position,
    in TInteger value
  );
  TInteger getLength ();
  void   setLength (in TInteger len);
};

```

```

interface FloatValue : Value {
    TFloat getFloat ();
    void setFloat (in TFloat value);
};

interface HexstringValue : Value {
    TString getString ();
    void setString (in TString value);
    TInteger getHex (in TInteger position);
    void setHex (
        in TInteger position,
        in TInteger value
    );
    TInteger getLength ();
    void setLength (in TInteger len);
};

interface EnumeratedValue : Value {
    void setEnum (in TString enumValue);
    TString getEnum ();
};

interface IntegerValue : Value {
    TInteger getInt ();
    void setInt (in TInteger value);
};

interface CharValue : Value {
    TChar getChar ();
    void setChar (in TChar value);
};

interface CharstringValue : Value {
    TString getString ();
    void setString (in TString value);
    TChar getChar (in TInteger position);
    void setChar (
        in TInteger position,
        in TChar value
    );
    TInteger getLength ();
    void setLength (in TInteger len);
};

interface BooleanValue : Value {
    TBoolean getBoolean ();
    void setBoolean (in TBoolean value);
};

interface UniversalCharValue : Value {
    TUniversalChar getUniversalChar ();
    void setUniversalChar (in TUniversalChar value);
};

interface UniversalCharstringValue : Value {
    TString getString ();
    void setString (in TString value);
    TUniversalChar getChar (in TInteger position);
    void setChar (
        in TInteger position,
        in TUniversalChar value
    );
    TInteger getLength ();
    void setLength (in TInteger len);
};

interface UnionValue : Value {
    Value getVariant (in TString variantName);
    void setVariant (
        in TString variantName,
        in Value value
    );
    TString getPresentVariantName ();
    TStringSeq getVariantNames ();
};

```

```

// *****
// * Abstract Logging Types
// *****

interface TciValueTemplate : Value {
    TBoolean isOmit ();
    TBoolean isAny();
    TBoolean isAnyOrOmit();
    TString getTemplateDef();
};

interface TciNonValueTemplate {
    TBoolean isAny();
    TBoolean isAll();
    TString getTemplateDef();
};

typedef sequence <Value> TciValueListType;

struct TciValueDifferenceType
{
    TString desc;
    Value val;
    TciValueTemplate tmpl;
};

typedef sequence <TciValueDifferenceType> TciValueDifferenceListType;

interface TciValueList {
    attribute TciValueListType inst;
    TInteger size();
    TBoolean isEmpty();
    Value get(in TInteger index);
};

interface TciValueDifference {
    attribute TciValueDifferenceType inst;
    Value getValue();
    TciValueTemplate getTciValueTemplate();
    TString getDescription();
};

interface TciValueDifferenceList {
    attribute TciValueDifferenceListType inst;
    TInteger size();
    TBoolean isEmpty();
    TciValueDifference get(in TInteger index);
};

// *****
// Coding Decoding Interface
// - Required
// *****

interface TCI_CD_Required {
    Type getTypeForName (in TString typeName);
    Type getInteger ();
    Type getFloat ();
    Type getBoolean ();
    Type getChar ();
    Type getUniversalChar ();
    Type getCharstring ();
    Type getUniversalCharstring ();
    Type getHexstring ();
    Type getBitstring ();
    Type getOctetstring ();
    Type getVerdict ();
    void tciErrorReq (in TString message);
};

```

```

// *****
// Coding Decoding interface
// - Provided
// *****

interface TCI_CD_Provided {
    Value decode (
        in TriMessageType message,
        in Type decodingHypothesis
    );
    TriMessageType encode (in Value value);
};

// *****
// Test Management Interface
// - Required
// *****

interface TCI_TM_Required : TCI_CD_Required {
    void tciRootModule (in TciModuleIdType moduleName);
    TciModuleIdListType tciGetImportedModules();
    TciModuleParameterListType tciGetModuleParameters (in TciModuleIdType moduleName);
    TciTestCaseIdListType tciGetTestCases ();
    TciParameterTypeListType tciGetTestCaseParameters (
        in TciTestCaseIdType testCaseId
    );
    TriPortIdListType tciGetTestCaseTSI (
        in TciTestCaseIdType testCaseId
    );
    void tciStartTestCase (
        in TciTestCaseIdType testCaseId,
        in TciParameterListType parameterList
    );
    void tciStopTestCase ();
    TriComponentIdType tciStartControl ();
    void tciStopControl ();
};

// *****
// Test Management Interface
// - Provided
// *****

interface TCI_TM_Provided {
    void tciTestCaseStarted (
        in TciTestCaseIdType testCaseId,
        in TciParameterListType parameterList,
        in TFloat timer
    );
    void tciTestCaseTerminated (
        in VerdictValue verdict,
        in TciParameterListType parameterList
    );
    void tciControlTerminated ();
    Value tciGetModulePar (
        in TciModuleParameterIdType parameterId
    );
    void tciLog (
        in TriComponentIdType testComponentId,
        in TString message
    );
    void tciError (in TString message);
};

// *****
// Component Handling Interface
// - Required
// *****

interface TCI_CH_Required : TCI_CD_Required {
    void tciEnqueueMsgConnected (
        in TriPortIdType sender,
        in TriComponentIdType receiver,
        in Value receivedMessage
    );
};

```

```

void tciEnqueueCallConnected (
    in TriPortIdType sender,
    in TriComponentIdType receiver,
    in TriSignatureIdType signature,
    in TciParameterListType parameterList
);
void tciEnqueueReplyConnected (
    in TriPortIdType sender,
    in TriComponentIdType receiver,
    in TriSignatureIdType signature,
    in TciParameterListType parameterList,
    in Value returnValue
);
void tciEnqueueRaiseConnected (
    in TriPortIdType sender,
    in TriComponentIdType receiver,
    in TriSignatureIdType signature,
    in Value except
);
TriComponentIdType tciCreateTestComponent (
    in TciTestComponentKindType kind,
    in Type componentType,
    in TString name
);
void tciStartTestComponent (
    in TriComponentIdType comp,
    in TciBehaviourIdType behavior,
    in TciParameterListType parameterList
);
void tciStopTestComponent (
    in TriComponentIdType comp
);
void tciConnect (
    in TriPortIdType fromPort,
    in TriPortIdType toPort
);
void tciDisconnect (
    in TriPortIdType fromPort,
    in TriPortIdType toPort
);
void tciTestComponentTerminated (
    in TriComponentIdType comp,
    in VerdictValue verdict
);
TBoolean tciTestComponentRunning (
    in TriComponentIdType comp
);
TriComponentIdType tciGetMTC ();
void tciMap (
    in TriPortIdType fromPort,
    in TriPortIdType toPort
);
void tciUnmap (
    in TriPortIdType fromPort,
    in TriPortIdType toPort
);
void tciExecuteTestCase (
    in TciTestCaseIdType testCaseId,
    in TriPortIdListType tsiPortList
);
TBoolean tciTestComponentDone (
    in TriComponentIdType comp
);
void tciReset ();
};

// *****
// Component Handling Interface
// - Provided
// *****

interface TCI_CH_Provided {
    void tciSendConnected (
        in TriPortIdType sender,
        in TriComponentIdType receiver,
        in Value sendMessage
    );
};

```



```

void tciSendConnectedBC (
    in TriPortIdType sender,
    in Value sendMessage
);
void tciSendConnectedMC (
    in TriPortIdType sender,
    in TriComponentIdListType receivers,
    in Value sendMessage
);

void tciCallConnected (
    in TriPortIdType sender,
    in TriComponentIdType receiver,
    in TriSignatureIdType signature,
    in TciParameterListType parameterList
);
void tciCallConnectedBC (
    in TriPortIdType sender,
    in TriSignatureIdType signature,
    in TciParameterListType parameterList
);
void tciCallConnectedMC (
    in TriPortIdType sender,
    in TriComponentIdListType receivers,
    in TriSignatureIdType signature,
    in TciParameterListType parameterList
);

void tciReplyConnected (
    in TriPortIdType sender,
    in TriComponentIdType receiver,
    in TriSignatureIdType signature,
    in TciParameterListType parameterList,
    in Value returnValue
);
void tciReplyConnectedBC (
    in TriPortIdType sender,
    in TriSignatureIdType signature,
    in TciParameterListType parameterList,
    in Value returnValue
);
void tciReplyConnectedMC (
    in TriPortIdType sender,
    in TriComponentIdListType receivers,
    in TriSignatureIdType signature,
    in TciParameterListType parameterList,
    in Value returnValue
);

void tciRaiseConnected (
    in TriPortIdType sender,
    in TriComponentIdType receiver,
    in TriSignatureIdType signature,
    in Value except
);
void tciRaiseConnectedBC (
    in TriPortIdType sender,
    in TriSignatureIdType signature,
    in Value except
);
void tciRaiseConnectedMC (
    in TriPortIdType sender,
    in TriComponentIdListType receivers,
    in TriSignatureIdType signature,
    in Value except
);

TriComponentIdType tciCreateTestComponentReq (
    in TciTestComponentKindType kind,
    in Type componentType,
    in TString name,
    in Value hostId
);
void tciStartTestComponentReq (
    in TriComponentIdType comp,
    in TciBehaviourIdType behavior,
    in TciParameterListType parameterList
);

```

```

void tciStopTestComponentReq (
    in TriComponentIdType comp
);
void tciConnectReq (
    in TriPortIdType fromPort,
    in TriPortIdType toPort
);
void tciDisconnectReq (
    in TriPortIdType fromPort,
    in TriPortIdType toPort
);
void tciTestComponentTerminatedReq (
    in TriComponentIdType comp,
    in VerdictValue verdict
);
TBoolean tciTestComponentRunningReq (
    in TriComponentIdType comp
);
TriComponentIdType tciGetMTCReq ();
void tciMapReq (
    in TriPortIdType fromPort,
    in TriPortIdType toPort
);
void tciUnmapReq (
    in TriPortIdType fromPort,
    in TriPortIdType toPort
);
void tciExecuteTestCaseReq (
    in TciTestCaseIdType testCaseId,
    in TriPortIdListType tsiPortList
);
void tciResetReq ();
TBoolean tciTestComponentDoneReq (
    in TriComponentIdType comp
);
};

// *****
// Test Logging Interface
// - Provided
// *****

interface TCI_TL_Provided {
    void tliTcExecute(
        in TString am, in TInteger ts, in TString src, in TInteger line,
        in TriComponentIdType c, in TciTestCaseIdType tcId,
        in TciParameterListType tciPars, in TriTimerDurationType dur
    );
    void tliTcStart(
        in TString am, in TInteger ts, in TString src, in TInteger line,
        in TriComponentIdType c, in TciTestCaseIdType tcId,
        in TciParameterListType tciPars, in TriTimerDurationType dur
    );
    void tliTcStop(
        in TString am, in TInteger ts, in TString src, in TInteger line,
        in TriComponentIdType c, in TString reason
    );
    void tliTcStarted(
        in TString am, in TInteger ts, in TString src, in TInteger line,
        in TriComponentIdType c, in TciTestCaseIdType tcId,
        in TciParameterListType tciPars, in TriTimerDurationType dur
    );
    void tliTcTerminated(
        in TString am, in TInteger ts, in TString src, in TInteger line,
        in TriComponentIdType c, in TciTestCaseIdType tcId,
        in TciParameterListType tciPars, in VerdictValue verdict, in TString reason);
    void tliCtrlStart(
        in TString am, in TInteger ts, in TString src, in TInteger line,
        in TriComponentIdType c
    );
    void tliCtrlStop(
        in TString am, in TInteger ts, in TString src, in TInteger line,
        in TriComponentIdType c
    );
};

```

```

void tliCtrlTerminated(
    in TString am, in TInteger ts, in TString src, in TInteger line,
    in TriComponentIdType c);

void tliMSend_m(
    in TString am, in TInteger ts, in TString src, in TInteger line,
    in TriComponentIdType c, in TriPortIdType at, in TriPortIdType to, in Value msgValue,
    in Value addrValue, in TciStatusType encoderFailure,
    in TriMessageType msg, in TriAddressType address, in TriStatusType transmissionFailure
);
void tliMSend_m_BC(
    in TString am, in TInteger ts, in TString src, in TInteger line,
    in TriComponentIdType c, in TriPortIdType at, in TriPortIdType to, in Value msgValue,
    in TciStatusType encoderFailure, in TriMessageType msg,
    in TriStatusType transmissionFailure
);
void tliMSend_m_MC(
    in TString am, in TInteger ts, in TString src, in TInteger line,
    in TriComponentIdType c, in TriPortIdType at, in TriPortIdType to, in Value msgValue,
    in TciValueList addrValues, in TciStatusType encoderFailure,
    in TriMessageType msg, in TriAddressListType addresses,
    in TriStatusType transmissionFailure
);

void tliMSend_c(
    in TString am, in TInteger ts, in TString src, in TInteger line,
    in TriComponentIdType c, in TriPortIdType at, in TriPortIdType to, in Value msgValue,
    in TriStatusType transmissionFailure
);
void tliMSend_c_BC(
    in TString am, in TInteger ts, in TString src, in TInteger line,
    in TriComponentIdType c, in TriPortIdType at, in TriPortIdListType to, in Value msgValue,
    in TriStatusType transmissionFailure
);
void tliMSend_c_MC(
    in TString am, in TInteger ts, in TString src, in TInteger line,
    in TriComponentIdType c, in TriPortIdType at, in TriPortIdListType to, in Value msgValue,
    in TriStatusType transmissionFailure);

void tliMDetected_m(
    in TString am, in TInteger ts, in TString src, in TInteger line,
    in TriComponentIdType c, in TriPortIdType at, in TriPortIdType from,
    in TriMessageType msg,
    in TriAddressType address
);
void tliMDetected_c(
    in TString am, in TInteger ts, in TString src, in TInteger line,
    in TriComponentIdType c, in TriPortIdType at, in TriPortIdType from, in Value msgValue
);
void tliMMismatch_m(
    in TString am, in TInteger ts, in TString src, in TInteger line,
    in TriComponentIdType c, in TriPortIdType at, in Value msgValue,
    in TciValueTemplate msgTpl, in TciValueDifferenceList diffs,
    in Value addrValue, in TciValueTemplate addressTpl
);
void tliMMismatch_c(
    in TString am, in TInteger ts, in TString src, in TInteger line,
    in TriComponentIdType c, in TriPortIdType at, in Value msgValue,
    in TciValueTemplate msgTpl, in TciValueDifferenceList diffs,
    in TriComponentIdType from, in TciNonValueTemplate fromTpl
);
void tliMReceive_m(
    in TString am, in TInteger ts, in TString src, in TInteger line,
    in TriComponentIdType c, in TriPortIdType at, in Value msgValue,
    in TciValueTemplate msgTpl, in Value addrValue,
    in TciValueTemplate addressTpl
);
void tliMReceive_c(
    in TString am, in TInteger ts, in TString src, in TInteger line,
    in TriComponentIdType c, in TriPortIdType at, in Value msgValue,
    in TciValueTemplate msgTpl, in TriComponentIdType from,
    in TciNonValueTemplate fromTpl
);

void tliPrCall_m(
    in TString am, in TInteger ts, in TString src, in TInteger line,
    in TriComponentIdType c, in TriPortIdType at, in TriPortIdType to,
    in TriSignatureIdType signature, in TciParameterListType tciPars,

```

```

    in Value addrValue, in TciStatusType encoderFailure,
    in TriParameterListType triPars, in TriAddressType address,
    in TriStatusType transmissionFailure
    );
void tliPrCall_m_BC(
    in TString am, in TInteger ts, in TString src, in TInteger line,
    in TriComponentIdType c, in TriPortIdType at, in TriPortIdType to,
    in TriSignatureIdType signature, in TciParameterListType tciPars,
    in TciStatusType encoderFailure, in TriParameterListType triPars,
    in TriStatusType transmissionFailure
    );
void tliPrCall_m_MC(
    in TString am, in TInteger ts, in TString src, in TInteger line,
    in TriComponentIdType c, in TriPortIdType at, in TriPortIdType to,
    in TriSignatureIdType signature, in TciParameterListType tciPars,
    in TciValueList addrValues, in TciStatusType encoderFailure,
    in TriParameterListType triPars, in TriAddressListType addresses,
    in TriStatusType transmissionFailure
    );

void tliPrCall_c(
    in TString am, in TInteger ts, in TString src, in TInteger line,
    in TriComponentIdType c, in TriPortIdType at, in TriPortIdType to,
    in TriSignatureIdType signature, in TciParameterListType tciPars,
    in TriStatusType transmissionFailure
    );
void tliPrCall_c_BC(
    in TString am, in TInteger ts, in TString src, in TInteger line,
    in TriComponentIdType c, in TriPortIdType at, in TriPortIdListType to,
    in TriSignatureIdType signature, in TciParameterListType tciPars,
    in TriStatusType transmissionFailure
    );
void tliPrCall_c_MC(
    in TString am, in TInteger ts, in TString src, in TInteger line,
    in TriComponentIdType c, in TriPortIdType at, in TriPortIdListType to,
    in TriSignatureIdType signature, in TciParameterListType tciPars,
    in TriStatusType transmissionFailure
    );

void tliPrGetCallDetected_m(
    in TString am, in TInteger ts, in TString src, in TInteger line,
    in TriComponentIdType c, in TriPortIdType at, in TriPortIdType from,
    in TriSignatureIdType signature, in TriParameterListType triPars,
    in TriAddressType address
    );
void tliPrGetCallDetected_c(
    in TString am, in TInteger ts, in TString src, in TInteger line,
    in TriComponentIdType c, in TriPortIdType at, in TriPortIdType from,
    in TriSignatureIdType signature, in TciParameterListType tciPars
    );
void tliPrGetCallMismatch_m(
    in TString am, in TInteger ts, in TString src, in TInteger line,
    in TriComponentIdType c, in TriPortIdType at,
    in TriSignatureIdType signature, in TciParameterListType tciPars,
    in TciValueTemplate parsTpl, in TciValueDifferenceList diffs,
    in Value addrValue, in TciValueTemplate addressTpl
    );
void tliPrGetCallMismatch_c(
    in TString am, in TInteger ts, in TString src, in TInteger line,
    in TriComponentIdType c, in TriPortIdType at,
    in TriSignatureIdType signature, in TciParameterListType tciPars,
    in TciValueTemplate parsTpl, in TciValueDifferenceList diffs,
    in TriComponentIdType from, in TciNonValueTemplate fromTpl
    );
void tliPrGetCall_m(
    in TString am, in TInteger ts, in TString src, in TInteger line,
    in TriComponentIdType c, in TriPortIdType at,
    in TriSignatureIdType signature, in TciParameterListType tciPars,
    in TciValueTemplate parsTpl, in Value addrValue,
    in TciValueTemplate addressTpl
    );
void tliPrGetCall_c(
    in TString am, in TInteger ts, in TString src, in TInteger line,
    in TriComponentIdType c, in TriPortIdType at,
    in TriSignatureIdType signature, in TciParameterListType tciPars,

```

```

    in TciValueTemplate parsTpl, in TriComponentIdType from,
    in TciNonValueTemplate fromTpl
    );

void tliPrReply_m(
    in TString am, in TInteger ts, in TString src, in TInteger line,
    in TriComponentIdType c, in TriPortIdType at, in TriPortIdType to,
    in TriSignatureIdType signature, in TciParameterListType tciPars,
    in Value replValue, in Value addrValue,
    in TciStatusType encoderFailure, in TriParameterListType triPars,
    in TriParameterType repl, in TriAddressType address, in TriStatusType transmissionFailure
    );

void tliPrReply_m_BC(
    in TString am, in TInteger ts, in TString src, in TInteger line,
    in TriComponentIdType c, in TriPortIdType at, in TriPortIdType to,
    in TriSignatureIdType signature, in TciParameterListType tciPars, in Value replValue,
    in TciStatusType encoderFailure, in TriParameterListType triPars,
    in TriParameterType repl, in TriStatusType transmissionFailure
    );

void tliPrReply_m_MC(
    in TString am, in TInteger ts, in TString src, in TInteger line,
    in TriComponentIdType c, in TriPortIdType at, in TriPortIdType to,
    in TriSignatureIdType signature, in TciParameterListType tciPars, in Value replValue,
    in TciValueListType addrValues, in TciStatusType encoderFailure,
    in TriParameterListType triPars, in TriParameterType repl,
    in TriAddressListType addresses, in TriStatusType transmissionFailure
    );

void tliPrReply_c(
    in TString am, in TInteger ts, in TString src, in TInteger line,
    in TriComponentIdType c, in TriPortIdType at, in TriPortIdType to,
    in TriSignatureIdType signature, in TciParameterListType tciPars,
    in Value replValue, in TriStatusType transmissionFailure
    );

void tliPrReply_c_BC(
    in TString am, in TInteger ts, in TString src, in TInteger line,
    in TriComponentIdType c, in TriPortIdType at, in TriPortIdListType to,
    in TriSignatureIdType signature, in Value parsValue, in Value replValue,
    in TriStatusType transmissionFailure
    );

void tliPrReply_c_MC(
    in TString am, in TInteger ts, in TString src, in TInteger line,
    in TriComponentIdType c, in TriPortIdType at, in TriPortIdListType to,
    in TriSignatureIdType signature, in Value parsValue, in Value replValue,
    in TriStatusType transmissionFailure
    );

void tliPrGetReplyDetected_m(
    in TString am, in TInteger ts, in TString src, in TInteger line,
    in TriComponentIdType c, in TriPortIdType at, in TriPortIdType from,
    in TriSignatureIdType signature, in TriParameterListType triPars,
    in TriParameterType repl, in TriAddressType address
    );

void tliPrGetReplyDetected_c(
    in TString am, in TInteger ts, in TString src, in TInteger line,
    in TriComponentIdType c, in TriPortIdType at, in TriPortIdType from,
    in TriSignatureIdType signature, in TciParameterListType tciPars,
    in Value replValue
    );

void tliPrGetReplyMismatch_m(
    in TString am, in TInteger ts, in TString src, in TInteger line,
    in TriComponentIdType c, in TriPortIdType at,
    in TriSignatureIdType signature,
    in TciParameterListType tciPars, in TciValueTemplate parsTpl,
    in Value replValue, in TciValueTemplate replyTpl,
    in TciValueDifferenceList diffs, in Value addrValue,
    in TciValueTemplate addressTpl
    );

void tliPrGetReplyMismatch_c(
    in TString am, in TInteger ts, in TString src, in TInteger line,
    in TriComponentIdType c, in TriPortIdType at,
    in TriSignatureIdType signature,
    in TciParameterListType tciPars, in TciValueTemplate parsTpl,
    in Value replValue, in TciValueTemplate replyTpl,
    in TciValueDifferenceList diffs, in TriComponentIdType from,
    in TciNonValueTemplate fromTpl
    );

```

```

void tliPrGetReply_m(
    in TString am, in TInteger ts, in TString src, in TInteger line,
    in TriComponentIdType c, in TriPortIdType at,
    in TriSignatureIdType signature,
    in TciParameterListType tciPars, in TciValueTemplate parsTmpl,
    in Value replValue, in TciValueTemplate replyTmpl,
    in Value addrValue, in TciValueTemplate addressTmpl
);

void tliPrGetReply_c(
    in TString am, in TInteger ts, in TString src, in TInteger line,
    in TriComponentIdType c, in TriPortIdType at,
    in TriSignatureIdType signature,
    in TciParameterListType tciPars, in TciValueTemplate parsTmpl,
    in Value replValue, in TciValueTemplate replyTmpl,
    in TriComponentIdType from, in TciNonValueTemplate fromTmpl
);

void tliPrRaise_m(
    in TString am, in TInteger ts, in TString src, in TInteger line,
    in TriComponentIdType c, in TriPortIdType at, in TriPortIdType to,
    in TriSignatureIdType signature, in TciParameterListType tciPars,
    in Value excValue, in Value addrValue, in TciStatusType encoderFailure,
    in TriExceptionType exc, in TriAddressType address, in TriStatusType transmissionFailure
);

void tliPrRaise_m_BC(
    in TString am, in TInteger ts, in TString src, in TInteger line,
    in TriComponentIdType c, in TriPortIdType at, in TriPortIdType to,
    in TriSignatureIdType signature, in TciParameterListType tciPars,
    in Value excValue, in TciStatusType encoderFailure, in TriExceptionType exc,
    in TriStatusType transmissionFailure
);

void tliPrRaise_m_MC(
    in TString am, in TInteger ts, in TString src, in TInteger line,
    in TriComponentIdType c, in TriPortIdType at, in TriPortIdType to,
    in TriSignatureIdType signature, in TciParameterListType tciPars,
    in Value excValue, in TciValueListType addrValues,
    in TciStatusType encoderFailure, in TriExceptionType exc,
    in TriAddressListType addresses, in TriStatusType transmissionFailure
);

void tliPrRaise_c(
    in TString am, in TInteger ts, in TString src, in TInteger line,
    in TriComponentIdType c, in TriPortIdType at, in TriPortIdType to,
    in TriSignatureIdType signature, in TciParameterListType tciPars,
    in Value excValue, in TriStatusType transmissionFailure
);

void tliPrRaise_c_BC(
    in TString am, in TInteger ts, in TString src, in TInteger line,
    in TriComponentIdType c, in TriPortIdType at, in TriPortIdListType to,
    in TriSignatureIdType signature, in TciParameterListType tciPars,
    in Value excValue, in TriStatusType transmissionFailure
);

void tliPrRaise_c_MC(
    in TString am, in TInteger ts, in TString src, in TInteger line,
    in TriComponentIdType c, in TriPortIdType at, in TriPortIdListType to,
    in TriSignatureIdType signature, in TciParameterListType tciPars,
    in Value excValue, in TriStatusType transmissionFailure
);

void tliPrCatchDetected_m(
    in TString am, in TInteger ts, in TString src, in TInteger line,
    in TriComponentIdType c, in TriPortIdType at, in TriPortIdType from,
    in TriSignatureIdType signature,
    in TriExceptionType exc, in TriAddressType address
);

void tliPrCatchDetected_c(
    in TString am, in TInteger ts, in TString src, in TInteger line,
    in TriComponentIdType c, in TriPortIdType at, in TriPortIdType from,
    in TriSignatureIdType signature, in Value excValue
);

void tliPrCatchMismatch_m(
    in TString am, in TInteger ts, in TString src, in TInteger line,
    in TriComponentIdType c, in TriPortIdType at,
    in TriSignatureIdType signature,
    in Value excValue, in TciValueTemplate excTmpl,
    in TciValueDifferenceList diffs, in Value addrValue,
    in TciValueTemplate addressTmpl
);

```

```

void tliPrCatchMismatch_c(
    in TString am, in TInteger ts, in TString src, in TInteger line,
    in TriComponentIdType c, in TriPortIdType at,
    in TriSignatureIdType signature,
    in Value excValue, in TciValueTemplate excTmpl,
    in TciValueDifferenceList diffs, in TriComponentIdType from,
    in TciNonValueTemplate fromTmpl
);
void tliPrCatch_m(
    in TString am, in TInteger ts, in TString src, in TInteger line,
    in TriComponentIdType c, in TriPortIdType at,
    in TriSignatureIdType signature,
    in Value excValue, in TciValueTemplate excTmpl,
    in Value addrValue, in TciValueTemplate addressTmpl
);
void tliPrCatch_c(
    in TString am, in TInteger ts, in TString src, in TInteger line,
    in TriComponentIdType c, in TriPortIdType at,
    in TriSignatureIdType signature,
    in Value excValue, in TciValueTemplate excTmpl,
    in TriComponentIdType from, in TciNonValueTemplate fromTmpl
);
void tliPrCatchTimeoutDetected(
    in TString am, in TInteger ts, in TString src, in TInteger line,
    in TriComponentIdType c, in TriPortIdType at,
    in TriSignatureIdType signature
);
void tliPrCatchTimeout(
    in TString am, in TInteger ts, in TString src, in TInteger line,
    in TriComponentIdType c, in TriPortIdType at,
    in TriSignatureIdType signature
);
void tlicCreate(
    in TString am, in TInteger ts, in TString src, in TInteger line,
    in TriComponentIdType c, in TriComponentIdType comp,
    in TString name, in TBoolean alive
);
void tlicStart(
    in TString am, in TInteger ts, in TString src, in TInteger line,
    in TriComponentIdType c, in TriComponentIdType comp,
    in TciBehaviourIdType name, in TciParameterListType tciPars
);
void tlicRunning(
    in TString am, in TInteger ts, in TString src, in TInteger line,
    in TriComponentIdType c, in TriComponentIdType comp, in ComponentStatusType status
);
void tlicAlive(
    in TString am, in TInteger ts, in TString src, in TInteger line,
    in TriComponentIdType c,
    in TriComponentIdType comp, in ComponentStatusType status
);
void tlicStop(
    in TString am, in TInteger ts, in TString src, in TInteger line,
    in TriComponentIdType c, in TriComponentIdType comp
);
void tlicKill(
    in TString am, in TInteger ts, in TString src, in TInteger line,
    in TriComponentIdType c, in TriComponentIdType comp
);
void tlicDoneMismatch(
    in TString am, in TInteger ts, in TString src, in TInteger line,
    in TriComponentIdType c, in TriComponentIdType comp, in TciNonValueTemplate compTmpl
);
void tlicKilledMismatch(
    in TString am, in TInteger ts, in TString src, in TInteger line,
    in TriComponentIdType c, in TriComponentIdType comp, in TciNonValueTemplate compTmpl
);
void tlicDone(in TString am, in TInteger ts, in TString src, in TInteger line,
    in TriComponentIdType c, in TciNonValueTemplate compTmpl
);
void tlicKilled(
    in TString am, in TInteger ts, in TString src, in TInteger line,
    in TriComponentIdType c, in TciNonValueTemplate compTmpl
);
void tlicTerminated(
    in TString am, in TInteger ts, in TString src, in TInteger line,
    in TriComponentIdType c, in VerdictValue verdict, in TString reason
);

```

```

void tliPConnect(
    in TString am, in TInteger ts, in TString src, in TInteger line,
    in TriComponentIdType c, in TriPortIdType port1, in TriPortIdType port2
);
void tliPDisconnect(
    in TString am, in TInteger ts, in TString src, in TInteger line,
    in TriComponentIdType c, in TriPortIdType port1,
    in TriPortIdType port2
);
void tliPMap(
    in TString am, in TInteger ts, in TString src, in TInteger line,
    in TriComponentIdType c, in TriPortIdType port1, in TriPortIdType port2
);
void tliPUnmap(
    in TString am, in TInteger ts, in TString src, in TInteger line,
    in TriComponentIdType c, in TriPortIdType port1,
    in TriPortIdType port2
);
void tliPClear(
    in TString am, in TInteger ts, in TString src, in TInteger line,
    in TriComponentIdType c, in TriPortIdType port
);
void tliPStart(
    in TString am, in TInteger ts, in TString src, in TInteger line,
    in TriComponentIdType c, in TriPortIdType port
);
void tliPStop(
    in TString am, in TInteger ts, in TString src, in TInteger line,
    in TriComponentIdType c, in TriPortIdType port
);
void tliPHalt(
    in TString am, in TInteger ts, in TString src, in TInteger line,
    in TriComponentIdType c, in TriPortIdType port
);
void tliEncode(
    in TString am, in TInteger ts, in TString src, in TInteger line,
    in TriComponentIdType c, in Value val, in TciStatusType encoderFailure,
    in TriMessageType msg, in TString codec
);
void tliDecode(
    in TString am, in TInteger ts, in TString src, in TInteger line,
    in TriComponentIdType c, in TriMessageType msg,
    in TciStatusType decoderFailure, in Value val, in TString codec
);
void tliTimeoutDetected(
    in TString am, in TInteger ts, in TString src, in TInteger line,
    in TriComponentIdType c, in TriTimerIdType timer
);
void tliTimeoutMismatch(
    in TString am, in TInteger ts, in TString src, in TInteger line,
    in TriComponentIdType c, in TriTimerIdType timer, in TciNonValueTemplate timerTpl
);
void tliTimeout(
    in TString am, in TInteger ts, in TString src, in TInteger line,
    in TriComponentIdType c, in TriTimerIdType timer, in TciNonValueTemplate timerTpl
);
void tliTStart(
    in TString am, in TInteger ts, in TString src, in TInteger line,
    in TriComponentIdType c, in TriTimerIdType timer,
    in TriTimerDurationType dur
);
void tliTStop(
    in TString am, in TInteger ts, in TString src, in TInteger line,
    in TriComponentIdType c, in TriTimerIdType timer, in TriTimerDurationType dur
);
void tliTRead(
    in TString am, in TInteger ts, in TString src, in TInteger line,
    in TriComponentIdType c, in TriTimerIdType timer,
    in TriTimerDurationType elapsed
);
void tliTRunning(
    in TString am, in TInteger ts, in TString src, in TInteger line,
    in TriComponentIdType c, in TriTimerIdType timer, in TimerStatusType status
);

```



```

void tliSEnter(
    in TString am, in TInteger ts, in TString src, in TInteger line,
    in TriComponentIdType c, in QualifiedName name, in TciParameterListType tciPars,
    in TString kind
);
void tliSLeave(
    in TString am, in TInteger ts, in TString src, in TInteger line,
    in TriComponentIdType c, in QualifiedName name, in TciParameterListType tciPars,
    in Value returnValue, in TString kind
);
void tliVAr(
    in TString am, in TInteger ts, in TString src, in TInteger line,
    in TriComponentIdType c, in QualifiedName name, in Value varValue
);
void tliModulePar(
    in TString am, in TInteger ts, in TString src, in TInteger line,
    in TriComponentIdType c, in QualifiedName name, in Value parValue
);
void tliGetVerdict(
    in TString am, in TInteger ts, in TString src, in TInteger line,
    in TriComponentIdType c, in VerdictValue verdict
);
void tliSetVerdict(
    in TString am, in TInteger ts, in TString src, in TInteger line,
    in TriComponentIdType c, in VerdictValue verdict, in TString reason
);
void tliLog(
    in TString am, in TInteger ts, in TString src, in TInteger line,
    in TriComponentIdType c, in TString log
);
void tliAEnter(
    in TString am, in TInteger ts, in TString src, in TInteger line,
    in TriComponentIdType c
);
void tliALeave(
    in TString am, in TInteger ts, in TString src, in TInteger line,
    in TriComponentIdType c
);
void tliADefaults(
    in TString am, in TInteger ts, in TString src, in TInteger line,
    in TriComponentIdType c
);
void tliAActivate(
    in TString am, in TInteger ts, in TString src, in TInteger line,
    in TriComponentIdType c, in QualifiedName name, in TciParameterListType tciPars,
    in Value ref
);
void tliADeactivate(
    in TString am, in TInteger ts, in TString src, in TInteger line,
    in TriComponentIdType c, in Value ref
);
void tliANomatch(
    in TString am, in TInteger ts, in TString src, in TInteger line,
    in TriComponentIdType c
);
void tliARepet(
    in TString am, in TInteger ts, in TString src, in TInteger line,
    in TriComponentIdType c
);
void tliAWait(
    in TString am, in TInteger ts, in TString src, in TInteger line,
    in TriComponentIdType c
);
void tliAction(
    in TString am, in TInteger ts, in TString src, in TInteger line,
    in TriComponentIdType c, in TString action
);
void tliMatch(
    in TString am, in TInteger ts, in TString src, in TInteger line,
    in TriComponentIdType c, in Value expr, in TciValueTemplate tml
);
void tliMatchMismatch(
    in TString am, in TInteger ts, in TString src,
    in TInteger line, in TriComponentIdType c, in Value expr,
    in TciValueTemplate tml, in TciValueDifferenceList diffs
);

```

```

void tliInfo(
    in TString am, in TInteger ts, in TString src,
    in TInteger line, in TriComponentIdType c,
    in TInteger level, in TString info
);
void tliMChecked_m(
    in TString am, in TInteger ts,
    in TString src, in TInteger line, in TriComponentIdType c,
    in TriPortIdType at,
    in Value msgValue, in TciValueTemplate msgTpl,
    in Value addrValue, in TciValueTemplate addressTpl
);
void tliMChecked_c(
    in TString am, in TInteger ts,
    in TString src, in TInteger line, in TriComponentIdType c,
    in TriPortIdType at,
    in Value msgValue in TciValueTemplate msgTpl,
    in TriComponentIdType from, in TciNonValueTemplate fromTpl
);
void tliPrGetCallChecked_m(
    in TString am, in TInteger ts,
    in TString src,
    in TInteger line, in TriComponentIdType c,
    in TriPortIdType at,
    in TriSignatureIdType signature,
    in TciParameterListType tciPars, in TciValueTemplate parsTpl,
    in Value addrValue, in TciValueTemplate addressTpl
);
void tliPrGetCallChecked_c(
    in TString am, in TInteger ts,
    in TString src,
    in TInteger line, in TriComponentIdType c,
    in TriPortIdType at,
    in TriSignatureIdType signature,
    in TciParameterListType tciPars, in TciValueTemplate parsTpl,
    in TriComponentIdType from, in TciNonValueTemplate fromTpl
);
void tliPrGetReplyChecked_m(
    in TString am, in TInteger ts,
    in TString src,
    in TInteger line, in TriComponentIdType c,
    in TriPortIdType at,
    in TriSignatureIdType signature,
    in TciParameterListType tciPars, in TciValueTemplate parsTpl,
    in Value replValue, in TciValueTemplate replyTpl,
    in Value addrValue, in TciValueTemplate addressTpl
);
void tliPrGetReplyChecked_c(
    in TString am, in TInteger ts,
    in TString src,
    in TInteger line, in TriComponentIdType c,
    in TriPortIdType at,
    in TriSignatureIdType signature,
    in TciParameterListType tciPars, in TciValueTemplate parsTpl,
    in Value replValue, in TciValueTemplate replyTpl,
    in TriComponentIdType from, in TciNonValueTemplate fromTpl
);
void tliPrCatchChecked_m(
    in TString am, in TInteger ts,
    in TString src,
    in TInteger line, in TriComponentIdType c,
    in TriPortIdType at,
    in TriSignatureIdType signature,
    in Value excValue, in TciValueTemplate excTpl,
    in Value addrValue, in TciValueTemplate addressTpl
);
void tliPrCatchChecked_c(
    in TString am, in TInteger ts,
    in TString src,
    in TInteger line, in TriComponentIdType c,
    in TriPortIdType at,
    in TriSignatureIdType signature,
    in Value excValue, in TciValueTemplate excTpl,
    in TriComponentIdType from, in TciNonValueTemplate fromTpl
);
void tliCheckedAny_m(
    in TString am, in TInteger ts,
    in TString src, in TInteger line, in TriComponentIdType c,

```

```
        in TriPortIdType at,  
        in Value addrValue,  
        in TciValueTemplate addressTpl  
    );  
void tliCheckedAny_c(  
    in TString am, in TInteger ts,  
    in TString src, in TInteger line, in TriComponentIdType c,  
    in TriPortIdType at,  
    in TriComponentIdType from,  
    in TciNonValueTemplate fromTpl  
);  
void tliCheckAnyMismatch_m(  
    in TString am, in TInteger ts,  
    in TString src, in TInteger line, in TriComponentIdType c,  
    in TriPortIdType at,  
    in Value addrValue,  
    in TciValueTemplate addressTpl  
);  
void tliCheckAnyMismatch_c(  
    in TString am, in TInteger ts,  
    in TString src, in TInteger line, in TriComponentIdType c,  
    in TriPortIdType at,  
    in TriComponentIdType from,  
    in TciNonValueTemplate fromTpl  
);  
void tliRnd(  
    in TString am, in TInteger ts,  
    in TString src, in TInteger line, in TriComponentIdType c,  
    in FloatValue val, in FloatValue seed  
);  
};  
};
```

Annex B (normative): XML Mapping for TCI TL Provided

B.0 Introduction

This annex defines a mapping for the logging interface of TCI using eXtended Markup Language (XML) schema definitions.

B.1 TCI-TL XML Schema for Simple Types

```
<?xml version="1.0" encoding="UTF-8"?>
<xsd:schema xmlns:xsd="http://www.w3.org/2001/XMLSchema"
  targetNamespace="http://uri.etsi.org/ttcn-3/tci/SimpleTypes_v4_6_1.xsd"
  xmlns:SimpleTypes="http://uri.etsi.org/ttcn-3/tci/SimpleTypes_v4_6_1.xsd"
  elementFormDefault="qualified">

  <!-- Basic definitions -->
  <xsd:simpleType name="xpath">
    <!-- this string should be XPATH compliant -->
    <xsd:restriction base="xsd:string"/>
  </xsd:simpleType>

  <xsd:simpleType name="TBoolean">
    <xsd:restriction base="xsd:boolean"/>
  </xsd:simpleType>

  <xsd:simpleType name="TString">
    <xsd:restriction base="xsd:string"/>
  </xsd:simpleType>

  <xsd:simpleType name="TInteger">
    <xsd:restriction base="xsd:integer"/>
  </xsd:simpleType>

  <!-- Miscellaneous -->
  <xsd:simpleType name="TriTimerDurationType">
    <xsd:restriction base="xsd:float"/>
  </xsd:simpleType>

  <xsd:simpleType name="TciParameterPassingModeType">
    <xsd:restriction base="xsd:string">
      <xsd:enumeration value="in"/>
      <xsd:enumeration value="inout"/>
      <xsd:enumeration value="out"/>
    </xsd:restriction>
  </xsd:simpleType>

  <xsd:simpleType name="TriStatusType">
    <xsd:restriction base="xsd:string">
      <xsd:enumeration value="TRI_Ok"/>
      <xsd:enumeration value="TRI_Error"/>
    </xsd:restriction>
  </xsd:simpleType>

  <xsd:simpleType name="TciStatusType">
    <xsd:restriction base="xsd:string">
      <xsd:enumeration value="TCI_Ok"/>
      <xsd:enumeration value="TCI_Error"/>
    </xsd:restriction>
  </xsd:simpleType>

  <xsd:simpleType name="ComponentStatusType">
    <xsd:restriction base="xsd:string">
      <xsd:enumeration value="inactiveC"/>
      <xsd:enumeration value="runningC"/>
      <xsd:enumeration value="stoppedC"/>
      <xsd:enumeration value="killedC"/>
      <xsd:enumeration value="nullC"/>
    </xsd:restriction>
  </xsd:simpleType>
</xsd:schema>
```

```

</xsd:simpleType>

<xsd:simpleType name="TimerStatusType">
  <xsd:restriction base="xsd:string">
    <xsd:enumeration value="runningT"/>
    <xsd:enumeration value="inactiveT"/>
    <xsd:enumeration value="expiredT"/>
    <xsd:enumeration value="nullT"/>
  </xsd:restriction>
</xsd:simpleType>

<xsd:simpleType name="PortStatusType">
  <xsd:restriction base="xsd:string">
    <xsd:enumeration value="startedP"/>
    <xsd:enumeration value="haltedP"/>
    <xsd:enumeration value="stoppedP"/>
  </xsd:restriction>
</xsd:simpleType>
</xsd:schema>

```

B.2 TCI-TL XML Schema for Types

```

<?xml version="1.0" encoding="UTF-8"?>
<xsd:schema xmlns:xsd="http://www.w3.org/2001/XMLSchema"
  targetNamespace="http://uri.etsi.org/ttcn-3/tci/Types_v4_6_1.xsd"
  xmlns:Types="http://uri.etsi.org/ttcn-3/tci/Types_v4_6_1.xsd"
  xmlns:SimpleTypes="http://uri.etsi.org/ttcn-3/tci/SimpleTypes_v4_6_1.xsd"
  xmlns:Values="http://uri.etsi.org/ttcn-3/tci/Values_v4_6_1.xsd"
  xmlns:Templates="http://uri.etsi.org/ttcn-3/tci/Templates_v4_6_1.xsd"
  elementFormDefault="qualified">

  <xsd:import namespace="http://uri.etsi.org/ttcn-3/tci/Values_v4_6_1.xsd"
    schemaLocation="Values_v4_4_.xsd"/>
  <xsd:import namespace="http://uri.etsi.org/ttcn-3/tci/SimpleTypes_v4_6_1.xsd"
    schemaLocation="SimpleTypes_v4_6_1.xsd"/>
  <xsd:import namespace="http://uri.etsi.org/ttcn-3/tci/Templates_v4_6_1.xsd"
    schemaLocation="Templates_v4_6_1.xsd"/>

  <!-- Connection -->
  <xsd:complexType name="TriPortIdType">
    <xsd:sequence>
      <xsd:element name="comp" type="Types:TriComponentIdType" />
      <xsd:element name="port" type="Types:Port" />
    </xsd:sequence>
  </xsd:complexType>

  <xsd:complexType name="TriPortIdListType">
    <xsd:sequence>
      <xsd:element name="port" type="Types:TriPortIdType" minOccurs="0"
        maxOccurs="unbounded"/>
    </xsd:sequence>
  </xsd:complexType>

  <xsd:complexType name="Port">
    <xsd:sequence>
      <xsd:element name="id" type="Types:Id" />
      <xsd:element name="index" type="xsd:int" minOccurs="0" />
    </xsd:sequence>
  </xsd:complexType>

  <xsd:complexType name="TriComponentIdType">
    <xsd:sequence>
      <xsd:choice>
        <xsd:element name="null" type="Templates:null"/>
        <xsd:element name="id" type="Types:Id" />
      </xsd:choice>
    </xsd:sequence>
  </xsd:complexType>

```

```

<xsd:complexType name="TriComponentIdListType">
  <xsd:sequence>
    <xsd:element name="comp" type="Types:TriComponentIdType" minOccurs="0"
      maxOccurs="unbounded"/>
  </xsd:sequence>
</xsd:complexType>

<!-- Communication -->
<xsd:complexType name="TriMessageType">
  <xsd:attribute name="val" type="xsd:hexBinary"/>
  <xsd:attribute name="paddingBits" type="xsd:integer" use="optional" default="0"/>
</xsd:complexType>

<xsd:complexType name="TriParameterType">
  <xsd:attribute name="val" type="xsd:hexBinary" />
  <xsd:attribute name="paddingBits" type="xsd:integer" use="optional" default="0"/>
  <xsd:attribute name="name" type="SimpleTypes:TString"/>
  <xsd:attribute name="mode" type="SimpleTypes:TciParameterPassingModeType"/>
</xsd:complexType>

<xsd:complexType name="TriParameterListType">
  <xsd:sequence>
    <xsd:element name="par" type="Types:TriParameterType" minOccurs="0"
maxOccurs="unbounded"/>
  </xsd:sequence>
</xsd:complexType>

<xsd:complexType name="TriExceptionType">
  <xsd:attribute name="val" type="xsd:hexBinary"/>
</xsd:complexType>

<xsd:complexType name="TciValueListType">
  <xsd:complexContent>
    <xsd:extension base="Values:RecordValue"/>
  </xsd:complexContent>
</xsd:complexType>

<xsd:complexType name="TriSignatureIdType">
  <xsd:attribute name="val" type="SimpleTypes:TString" use="required"/>
</xsd:complexType>

<xsd:complexType name="TriAddressType">
  <xsd:attribute name="val" type="xsd:hexBinary"/>
  <xsd:attribute name="paddingBits" type="xsd:integer" use="optional" default="0"/>
</xsd:complexType>

<xsd:complexType name="TriAddressListType">
  <xsd:sequence>
    <xsd:element name="addr" type="Types:TriAddressType" minOccurs="0"
      maxOccurs="unbounded"/>
  </xsd:sequence>
</xsd:complexType>

<!-- Miscellaneous -->
<xsd:complexType name="TriTimerIdType">
  <xsd:sequence>
    <xsd:element name="id" type="Types:Id" />
  </xsd:sequence>
</xsd:complexType>

<!-- Basic definitions -->
<xsd:complexType name="QualifiedName">
  <xsd:attribute name="moduleName" type="SimpleTypes:TString" use="required"/>
  <xsd:attribute name="baseName" type="SimpleTypes:TString" use="required"/>
</xsd:complexType>

<!-- general TCI abstract data types -->
<xsd:complexType name="TciBehaviourIdType">
  <xsd:sequence>
    <xsd:element name="name" type="Types:QualifiedName" />
  </xsd:sequence>
</xsd:complexType>

<xsd:complexType name="TciTestCaseIdType">
  <xsd:sequence>
    <xsd:element name="name" type="Types:QualifiedName" />
  </xsd:sequence>

```

```

</xsd:complexType>

<xsd:complexType name="TciParameterType">
  <xsd:sequence>
    <xsd:element name="val" type="Values:Value" />
  </xsd:sequence>
  <xsd:attribute name="name" type="SimpleTypes:TString"/>
  <xsd:attribute name="mode" type="SimpleTypes:TciParameterPassingModeType"/>
</xsd:complexType>

<xsd:complexType name="TciParameterListType">
  <xsd:sequence>
    <xsd:element name="par" type="Types:TciParameterType" minOccurs="0"
maxOccurs="unbounded"/>
  </xsd:sequence>
</xsd:complexType>

<!-- general identifier structure for test components, ports and timer -->
<xsd:complexType name="Id">
  <xsd:sequence>
    <xsd:element name="name" type="SimpleTypes:TString" />
    <xsd:element name="id" type="SimpleTypes:TString" minOccurs="0"/>
    <xsd:element name="type" type="SimpleTypes:TString" minOccurs="0"/>
  </xsd:sequence>
</xsd:complexType>

</xsd:schema>

```

B.3 TCI-TL XML Schema for Values

```

<?xml version="1.0" encoding="UTF-8"?>
<xsd:schema xmlns:xsd="http://www.w3.org/2001/XMLSchema"
  targetNamespace="http://uri.etsi.org/ttcn-3/tci/Values_v4_6_1.xsd"
  xmlns:Values="http://uri.etsi.org/ttcn-3/tci/Values_v4_6_1.xsd"
  xmlns:Templates="http://uri.etsi.org/ttcn-3/tci/Templates_v4_6_1.xsd"
  xmlns:SimpleTypes="http://uri.etsi.org/ttcn-3/tci/SimpleTypes_v4_6_1.xsd"
  elementFormDefault="qualified">

  <xsd:import namespace="http://uri.etsi.org/ttcn-3/tci/Templates_v4_6_1.xsd"
    schemaLocation="Templates_v4_6_1.xsd"/>
  <xsd:import namespace="http://uri.etsi.org/ttcn-3/tci/SimpleTypes_v4_6_1.xsd"
    schemaLocation="SimpleTypes_v4_6_1.xsd"/>

  <xsd:simpleType name="ValueModifier">
    <xs:restriction base="SimpleTypes:TString">
      <xs:enumeration value="lazy"/>
      <xs:enumeration value="fuzzy"/>
    </xs:restriction>
  </xsd:simpleType>

  <xsd:attributeGroup name="ValueAtts">
    <xsd:attribute name="name" type="SimpleTypes:TString" use="optional"/>
    <xsd:attribute name="type" type="SimpleTypes:TString" use="optional"/>
    <xsd:attribute name="module" type="SimpleTypes:TString" use="optional"/>
    <xsd:attribute name="modifier" type="Values:ValueModifier" use="optional"/>
    <xsd:attribute name="annotation" type="SimpleTypes:TString" use="optional"/>
  </xsd:attributeGroup>

  <xsd:complexType name="Value" mixed="true">
    <xsd:choice>
      <xsd:element name="integer" type="Values:IntegerValue"/>
      <xsd:element name="float" type="Values:FloatValue"/>
      <xsd:element name="boolean" type="Values:BooleanValue"/>
      <xsd:element name="verdictttype" type="Values:VerdictValue"/>
      <xsd:element name="bitstring" type="Values:BitstringValue"/>
      <xsd:element name="hexstring" type="Values:HexstringValue"/>
      <xsd:element name="octetstring" type="Values:OctetstringValue"/>
      <xsd:element name="charstring" type="Values:CharstringValue"/>
      <xsd:element name="universal_charstring" type="Values:UniversalCharstringValue"/>
      <xsd:element name="record" type="Values:RecordValue"/>
      <xsd:element name="record_of" type="Values:RecordOfValue"/>
      <xsd:element name="array" type="Values:ArrayValue"/>
      <xsd:element name="set" type="Values:SetValue"/>
      <xsd:element name="set_of" type="Values:SetOfValue"/>
      <xsd:element name="enumerated" type="Values:EnumeratedValue"/>
    </xsd:choice>
  </xsd:complexType>

```

```

    <xsd:element name="union" type="Values:UnionValue"/>
    <xsd:element name="anytype" type="Values:AnytypeValue"/>
    <xsd:element name="address" type="Values:AddressValue"/>
    <xsd:element name="component" type="Values:ComponentValue"/>
    <xsd:element name="port" type="Values:PortValue"/>
    <xsd:element name="default" type="Values:DefaultValue"/>
    <xsd:element name="timer" type="Values:TimerValue"/>
</xsd:choice>
  <xsd:attributeGroup ref="Values:ValueAtts"/>
</xsd:complexType>

<xsd:complexType name="NotEvaluated">
  <xsd:attributeGroup ref="Values:ValueAtts"/>
</xsd:complexType>

<!-- general event elements -->
<xsd:complexType name="IntegerValue">
  <xsd:choice>
    <xsd:element name="value" type="SimpleTypes:TString"/>
    <xsd:element name="null" type="Templates:null"/>
    <xsd:element name="omit" type="Templates:omit"/>
    <xsd:element name="matching_symbol" type="Templates:MatchingSymbol"/>
    <xsd:element name="not_evaluated" type="Values:NotEvaluated"/>
  </xsd:choice>
  <xsd:attributeGroup ref="Values:ValueAtts"/>
</xsd:complexType>

<xsd:complexType name="FloatValue">
  <xsd:choice>
    <xsd:element name="value" type="SimpleTypes:TString"/>
    <xsd:element name="null" type="Templates:null"/>
    <xsd:element name="omit" type="Templates:omit"/>
    <xsd:element name="matching_symbol" type="Templates:MatchingSymbol"/>
    <xsd:element name="not_evaluated" type="Values:NotEvaluated"/>
  </xsd:choice>
  <xsd:attributeGroup ref="Values:ValueAtts"/>
</xsd:complexType>

<xsd:complexType name="BooleanValue">
  <xsd:choice>
    <xsd:element name="value" type="SimpleTypes:TString"/>
    <xsd:element name="null" type="Templates:null"/>
    <xsd:element name="omit" type="Templates:omit"/>
    <xsd:element name="matching_symbol" type="Templates:MatchingSymbol"/>
    <xsd:element name="not_evaluated" type="Values:NotEvaluated"/>
  </xsd:choice>
  <xsd:attributeGroup ref="Values:ValueAtts"/>
</xsd:complexType>

<xsd:complexType name="VerdictValue">
  <xsd:choice>
    <xsd:element name="value" type="SimpleTypes:TString"/>
    <xsd:element name="null" type="Templates:null"/>
    <xsd:element name="omit" type="Templates:omit"/>
    <xsd:element name="matching_symbol" type="Templates:MatchingSymbol"/>
    <xsd:element name="not_evaluated" type="Values:NotEvaluated"/>
  </xsd:choice>
  <xsd:attributeGroup ref="Values:ValueAtts"/>
</xsd:complexType>

<xsd:complexType name="BitstringValue">
  <xsd:choice>
    <xsd:element name="value" type="SimpleTypes:TString"/>
    <xsd:element name="null" type="Templates:null"/>
    <xsd:element name="omit" type="Templates:omit"/>
    <xsd:element name="matching_symbol" type="Templates:MatchingSymbol"/>
    <xsd:element name="not_evaluated" type="Values:NotEvaluated"/>
  </xsd:choice>
  <xsd:attributeGroup ref="Values:ValueAtts"/>
</xsd:complexType>

<xsd:complexType name="HexstringValue">
  <xsd:choice>
    <xsd:element name="value" type="SimpleTypes:TString"/>
    <xsd:element name="null" type="Templates:null"/>
    <xsd:element name="omit" type="Templates:omit"/>
    <xsd:element name="matching_symbol" type="Templates:MatchingSymbol"/>
    <xsd:element name="not_evaluated" type="Values:NotEvaluated"/>
  </xsd:choice>

```



```

    </xsd:choice>
    <xsd:attributeGroup ref="Values:ValueAtts"/>
</xsd:complexType>

<xsd:complexType name="OctetstringValue">
  <xsd:choice>
    <xsd:element name="value" type="SimpleTypes:TString"/>
    <xsd:element name="null" type="Templates:null"/>
    <xsd:element name="omit" type="Templates:omit"/>
    <xsd:element name="matching_symbol" type="Templates:MatchingSymbol"/>
    <xsd:element name="not_evaluated" type="Values:NotEvaluated"/>
  </xsd:choice>
  <xsd:attributeGroup ref="Values:ValueAtts"/>
</xsd:complexType>

<xsd:complexType name="CharstringValue">
  <xsd:choice>
    <xsd:element name="value" type="SimpleTypes:TString"/>
    <xsd:element name="null" type="Templates:null"/>
    <xsd:element name="omit" type="Templates:omit"/>
    <xsd:element name="matching_symbol" type="Templates:MatchingSymbol"/>
    <xsd:element name="not_evaluated" type="Values:NotEvaluated"/>
  </xsd:choice>
  <xsd:attributeGroup ref="Values:ValueAtts"/>
</xsd:complexType>

<xsd:complexType name="UniversalCharstringValue">
  <xsd:choice>
    <xsd:element name="value" type="SimpleTypes:TString"/>
    <xsd:element name="null" type="Templates:null"/>
    <xsd:element name="omit" type="Templates:omit"/>
    <xsd:element name="matching_symbol" type="Templates:MatchingSymbol"/>
    <xsd:element name="not_evaluated" type="Values:NotEvaluated"/>
  </xsd:choice>
  <xsd:attributeGroup ref="Values:ValueAtts"/>
</xsd:complexType>

<xsd:complexType name="RecordValue">
  <xsd:choice>
    <xsd:choice minOccurs="0" maxOccurs="unbounded">
      <xsd:element name="integer" type="Values:IntegerValue"/>
      <xsd:element name="float" type="Values:FloatValue"/>
      <xsd:element name="boolean" type="Values:BooleanValue"/>
      <xsd:element name="verdicttype" type="Values:VerdictValue"/>
      <xsd:element name="bitstring" type="Values:BitstringValue"/>
      <xsd:element name="hexstring" type="Values:HexstringValue"/>
      <xsd:element name="octetstring" type="Values:OctetstringValue"/>
      <xsd:element name="charstring" type="Values:CharstringValue"/>
      <xsd:element name="universal_charstring"
        type="Values:UniversalCharstringValue"/>
      <xsd:element name="record" type="Values:RecordValue"/>
      <xsd:element name="record_of" type="Values:RecordOfValue"/>
      <xsd:element name="array" type="Values:ArrayValue"/>
      <xsd:element name="set" type="Values:SetValue"/>
      <xsd:element name="set_of" type="Values:SetOfValue"/>
      <xsd:element name="enumerated" type="Values:EnumeratedValue"/>
      <xsd:element name="union" type="Values:UnionValue"/>
      <xsd:element name="anytype" type="Values:AnytypeValue"/>
      <xsd:element name="address" type="Values:AddressValue"/>
      <xsd:element name="component" type="Values:ComponentValue"/>
      <xsd:element name="default" type="Values:DefaultValue"/>
    </xsd:choice>
    <xsd:element name="null" type="Templates:null"/>
    <xsd:element name="omit" type="Templates:omit"/>
    <xsd:element name="matching_symbol" type="Templates:MatchingSymbol"/>
    <xsd:element name="not_evaluated" type="Values:NotEvaluated"/>
  </xsd:choice>
  <xsd:attributeGroup ref="Values:ValueAtts"/>
</xsd:complexType>

<xsd:complexType name="RecordOfValue">
  <xsd:choice>
    <xsd:element name="integer" type="Values:IntegerValue" minOccurs="0"
      maxOccurs="unbounded"/>
    <xsd:element name="float" type="Values:FloatValue" minOccurs="0"
      maxOccurs="unbounded"/>
    <xsd:element name="boolean" type="Values:BooleanValue" minOccurs="0"
      maxOccurs="unbounded"/>
  </xsd:choice>

```

```

<xsd:element name="verdicttype" type="Values:VerdictValue" minOccurs="0"
  maxOccurs="unbounded" />
<xsd:element name="bitstring" type="Values:BitstringValue"
  minOccurs="0" maxOccurs="unbounded" />
<xsd:element name="hexstring" type="Values:HexstringValue"
  minOccurs="0" maxOccurs="unbounded" />
<xsd:element name="octetstring" type="Values:OctetstringValue"
  minOccurs="0" maxOccurs="unbounded" />
<xsd:element name="charstring" type="Values:CharstringValue"
  minOccurs="0" maxOccurs="unbounded" />
<xsd:element name="universal_charstring"
  type="Values:UniversalCharstringValue" minOccurs="0"
  maxOccurs="unbounded" />
<xsd:element name="record" type="Values:RecordValue" minOccurs="0"
  maxOccurs="unbounded" />
<xsd:element name="record_of" type="Values:RecordOfValue"
  minOccurs="0" maxOccurs="unbounded" />
<xsd:element name="array" type="Values:ArrayValue"
  minOccurs="0" maxOccurs="unbounded" />
<xsd:element name="set" type="Values:SetValue" minOccurs="0"
  maxOccurs="unbounded" />
<xsd:element name="set_of" type="Values:SetOfValue"
  minOccurs="0" maxOccurs="unbounded" />
<xsd:element name="enumerated" type="Values:EnumeratedValue"
  minOccurs="0" maxOccurs="unbounded" />
<xsd:element name="union" type="Values:UnionValue" minOccurs="0"
  maxOccurs="unbounded" />
<xsd:element name="anytype" type="Values:AnytypeValue" minOccurs="0"
  maxOccurs="unbounded" />
<xsd:element name="address" type="Values:AddressValue" minOccurs="0"
  maxOccurs="unbounded" />
<xsd:element name="component" type="Values:ComponentValue" minOccurs="0"
  maxOccurs="unbounded" />
<xsd:element name="default" type="Values:DefaultValue" minOccurs="0"
  maxOccurs="unbounded" />
<xsd:element name="null" type="Templates:null" />
<xsd:element name="omit" type="Templates:omit" />
<xsd:element name="matching_symbol" type="Templates:MatchingSymbol" />
<xsd:element name="not_evaluated" type="Values:NotEvaluated" />
</xsd:choice>
<xsd:attributeGroup ref="Values:ValueAtts" />
</xsd:complexType>

```

```

<xsd:complexType name="ArrayValue">
  <xsd:choice>
    <xsd:element name="integer" type="Values:IntegerValue" minOccurs="0"
      maxOccurs="unbounded" />
    <xsd:element name="float" type="Values:FloatValue" minOccurs="0"
      maxOccurs="unbounded" />
    <xsd:element name="boolean" type="Values:BooleanValue" minOccurs="0"
      maxOccurs="unbounded" />
    <xsd:element name="verdicttype" type="Values:VerdictValue" minOccurs="0"
      maxOccurs="unbounded" />
    <xsd:element name="bitstring" type="Values:BitstringValue"
      minOccurs="0" maxOccurs="unbounded" />
    <xsd:element name="hexstring" type="Values:HexstringValue"
      minOccurs="0" maxOccurs="unbounded" />
    <xsd:element name="octetstring" type="Values:OctetstringValue"
      minOccurs="0" maxOccurs="unbounded" />
    <xsd:element name="charstring" type="Values:CharstringValue"
      minOccurs="0" maxOccurs="unbounded" />
    <xsd:element name="universal_charstring"
      type="Values:UniversalCharstringValue" minOccurs="0"
      maxOccurs="unbounded" />
    <xsd:element name="record" type="Values:RecordValue" minOccurs="0"
      maxOccurs="unbounded" />
    <xsd:element name="record_of" type="Values:RecordOfValue"
      minOccurs="0" maxOccurs="unbounded" />
    <xsd:element name="array" type="Values:ArrayValue"
      minOccurs="0" maxOccurs="unbounded" />
    <xsd:element name="set" type="Values:SetValue" minOccurs="0"
      maxOccurs="unbounded" />
    <xsd:element name="set_of" type="Values:SetOfValue"
      minOccurs="0" maxOccurs="unbounded" />
    <xsd:element name="enumerated" type="Values:EnumeratedValue"
      minOccurs="0" maxOccurs="unbounded" />
    <xsd:element name="union" type="Values:UnionValue" minOccurs="0"

```

```

        maxOccurs="unbounded" />
<xsd:element name="anytype" type="Values:AnytypeValue" minOccurs="0"
maxOccurs="unbounded" />
<xsd:element name="address" type="Values:AddressValue" minOccurs="0"
maxOccurs="unbounded" />
<xsd:element name="component" type="Values:ComponentValue" minOccurs="0"
maxOccurs="unbounded" />
<xsd:element name="port" type="Values:PortValue" minOccurs="0"
maxOccurs="unbounded" />
<xsd:element name="default" type="Values:DefaultValue" minOccurs="0"
maxOccurs="unbounded" />
<xsd:element name="timer" type="Values:TimerValue" minOccurs="0"
maxOccurs="unbounded" />
<xsd:element name="null" type="Templates:null" />
<xsd:element name="omit" type="Templates:omit" />
<xsd:element name="matching_symbol" type="Templates:MatchingSymbol" />
<xsd:element name="not_evaluated" type="Values:NotEvaluated" />
</xsd:choice>
<xsd:attributeGroup ref="Values:ValueAtts" />
</xsd:complexType>

<xsd:complexType name="SetValue">
<xsd:choice>
<xsd:choice minOccurs="0" maxOccurs="unbounded">
<xsd:element name="integer" type="Values:IntegerValue" />
<xsd:element name="float" type="Values:FloatValue" />
<xsd:element name="boolean" type="Values:BooleanValue" />
<xsd:element name="verdicttype" type="Values:VerdictValue" />
<xsd:element name="bitstring" type="Values:BitstringValue" />
<xsd:element name="hexstring" type="Values:HexstringValue" />
<xsd:element name="octetstring" type="Values:OctetstringValue" />
<xsd:element name="charstring" type="Values:CharstringValue" />
<xsd:element name="universal_charstring"
type="Values:UniversalCharstringValue" />
<xsd:element name="record" type="Values:RecordValue" />
<xsd:element name="record_of" type="Values:RecordOfValue" />
<xsd:element name="array" type="Values:ArrayValue" />
<xsd:element name="set" type="Values:SetValue" />
<xsd:element name="set_of" type="Values:SetOfValue" />
<xsd:element name="enumerated" type="Values:EnumeratedValue" />
<xsd:element name="union" type="Values:UnionValue" />
<xsd:element name="anytype" type="Values:AnytypeValue" />
<xsd:element name="address" type="Values:AddressValue" />
<xsd:element name="component" type="Values:ComponentValue" />
<xsd:element name="default" type="Values:DefaultValue" />
</xsd:choice>
<xsd:element name="null" type="Templates:null" />
<xsd:element name="omit" type="Templates:omit" />
<xsd:element name="matching_symbol" type="Templates:MatchingSymbol" />
<xsd:element name="not_evaluated" type="Values:NotEvaluated" />
</xsd:choice>
<xsd:attributeGroup ref="Values:ValueAtts" />
</xsd:complexType>

<xsd:complexType name="SetOfValue">
<xsd:choice>
<xsd:element name="integer" type="Values:IntegerValue" minOccurs="0"
maxOccurs="unbounded" />
<xsd:element name="float" type="Values:FloatValue" minOccurs="0"
maxOccurs="unbounded" />
<xsd:element name="boolean" type="Values:BooleanValue" minOccurs="0"
maxOccurs="unbounded" />
<xsd:element name="verdicttype" type="Values:VerdictValue" minOccurs="0"
maxOccurs="unbounded" />
<xsd:element name="bitstring" type="Values:BitstringValue"
minOccurs="0" maxOccurs="unbounded" />
<xsd:element name="hexstring" type="Values:HexstringValue"
minOccurs="0" maxOccurs="unbounded" />
<xsd:element name="octetstring" type="Values:OctetstringValue"
minOccurs="0" maxOccurs="unbounded" />
<xsd:element name="charstring" type="Values:CharstringValue"
minOccurs="0" maxOccurs="unbounded" />
<xsd:element name="universal_charstring"
type="Values:UniversalCharstringValue" minOccurs="0"
maxOccurs="unbounded" />
<xsd:element name="record" type="Values:RecordValue" minOccurs="0"
maxOccurs="unbounded" />
<xsd:element name="record_of" type="Values:RecordOfValue"

```

```

        minOccurs="0" maxOccurs="unbounded"/>
<xsd:element name="array" type="Values:ArrayValue"
    minOccurs="0" maxOccurs="unbounded"/>
<xsd:element name="set" type="Values:SetValue" minOccurs="0"
    maxOccurs="unbounded"/>
<xsd:element name="set_of" type="Values:SetOfValue"
    minOccurs="0" maxOccurs="unbounded"/>
<xsd:element name="enumerated" type="Values:EnumeratedValue"
    minOccurs="0" maxOccurs="unbounded"/>
<xsd:element name="union" type="Values:UnionValue" minOccurs="0"
    maxOccurs="unbounded"/>
<xsd:element name="anytype" type="Values:AnytypeValue" minOccurs="0"
    maxOccurs="unbounded"/>
<xsd:element name="address" type="Values:AddressValue" minOccurs="0"
    maxOccurs="unbounded"/>
<xsd:element name="component" type="Values:ComponentValue" minOccurs="0"
    maxOccurs="unbounded"/>
<xsd:element name="default" type="Values:DefaultValue" minOccurs="0"
    maxOccurs="unbounded"/>
<xsd:element name="null" type="Templates:null"/>
<xsd:element name="omit" type="Templates:omit"/>
<xsd:element name="matching_symbol" type="Templates:MatchingSymbol"/>
<xsd:element name="not_evaluated" type="Values:NotEvaluated"/>
</xsd:choice>
<xsd:attributeGroup ref="Values:ValueAtts"/>
</xsd:complexType>

<xsd:complexType name="EnumeratedValue">
    <xsd:choice>
        <xsd:element name="value" type="SimpleTypes:TString"/>
        <xsd:element name="intValue" type="SimpleTypes:TInteger" minOccurs="0"/>
        <xsd:element name="null" type="Templates:null"/>
        <xsd:element name="omit" type="Templates:omit"/>
        <xsd:element name="matching_symbol" type="Templates:MatchingSymbol"/>
        <xsd:element name="not_evaluated" type="Values:NotEvaluated"/>
    </xsd:choice>
    <xsd:attributeGroup ref="Values:ValueAtts"/>
</xsd:complexType>

<xsd:complexType name="UnionValue">
    <xsd:choice>
        <xsd:element name="integer" type="Values:IntegerValue"/>
        <xsd:element name="float" type="Values:FloatValue"/>
        <xsd:element name="boolean" type="Values:BooleanValue"/>
        <xsd:element name="verdicttype" type="Values:VerdictValue"/>
        <xsd:element name="bitstring" type="Values:BitstringValue"/>
        <xsd:element name="hexstring" type="Values:HexstringValue"/>
        <xsd:element name="octetstring" type="Values:OctetstringValue"/>
        <xsd:element name="charstring" type="Values:CharstringValue"/>
        <xsd:element name="universal_charstring"
            type="Values:UniversalCharstringValue"/>
        <xsd:element name="record" type="Values:RecordValue"/>
        <xsd:element name="record_of" type="Values:RecordOfValue"/>
        <xsd:element name="array" type="Values:ArrayValue"/>
        <xsd:element name="set" type="Values:SetValue"/>
        <xsd:element name="set_of" type="Values:SetOfValue"/>
        <xsd:element name="enumerated" type="Values:EnumeratedValue"/>
        <xsd:element name="union" type="Values:UnionValue"/>
        <xsd:element name="anytype" type="Values:AnytypeValue"/>
        <xsd:element name="address" type="Values:AddressValue"/>
        <xsd:element name="component" type="Values:ComponentValue"/>
        <xsd:element name="default" type="Values:DefaultValue"/>
        <xsd:element name="null" type="Templates:null"/>
        <xsd:element name="omit" type="Templates:omit"/>
        <xsd:element name="matching_symbol" type="Templates:MatchingSymbol"/>
        <xsd:element name="not_evaluated" type="Values:NotEvaluated"/>
    </xsd:choice>
    <xsd:attributeGroup ref="Values:ValueAtts"/>
</xsd:complexType>

<xsd:complexType name="AnytypeValue">
    <xsd:choice>
        <xsd:element name="integer" type="Values:IntegerValue"/>
        <xsd:element name="float" type="Values:FloatValue"/>
        <xsd:element name="boolean" type="Values:BooleanValue"/>
        <xsd:element name="verdicttype" type="Values:VerdictValue"/>
        <xsd:element name="bitstring" type="Values:BitstringValue"/>
        <xsd:element name="hexstring" type="Values:HexstringValue"/>

```

```

<xsd:element name="octetstring" type="Values:OctetstringValue"/>
<xsd:element name="charstring" type="Values:OctetstringValue"/>
<xsd:element name="universal_charstring"
  type="Values:UniversalCharstringValue"/>
<xsd:element name="record" type="Values:RecordValue"/>
<xsd:element name="record_of" type="Values:RecordOfValue"/>
<xsd:element name="array" type="Values:ArrayValue"/>
<xsd:element name="set" type="Values:SetValue"/>
<xsd:element name="set_of" type="Values:SetOfValue"/>
<xsd:element name="enumerated" type="Values:EnumeratedValue"/>
<xsd:element name="union" type="Values:UnionValue"/>
<xsd:element name="address" type="Values:AddressValue"/>
<xsd:element name="null" type="Templates:null"/>
<xsd:element name="omit" type="Templates:omit"/>
<xsd:element name="matching_symbol" type="Templates:MatchingSymbol"/>
<xsd:element name="not_evaluated" type="Values:NotEvaluated"/>
</xsd:choice>
<xsd:attributeGroup ref="Values:ValueAtts"/>
</xsd:complexType>

<xsd:complexType name="AddressValue">
  <xsd:choice>
    <xsd:element name="integer" type="Values:IntegerValue"/>
    <xsd:element name="float" type="Values:FloatValue"/>
    <xsd:element name="boolean" type="Values:BooleanValue"/>
    <xsd:element name="verdicttype" type="Values:VerdictValue"/>
    <xsd:element name="bitstring" type="Values:BitstringValue"/>
    <xsd:element name="hexstring" type="Values:HexstringValue"/>
    <xsd:element name="octetstring" type="Values:OctetstringValue"/>
    <xsd:element name="charstring" type="Values:OctetstringValue"/>
    <xsd:element name="universal_charstring"
      type="Values:UniversalCharstringValue"/>
    <xsd:element name="record" type="Values:RecordValue"/>
    <xsd:element name="record_of" type="Values:RecordOfValue"/>
    <xsd:element name="array" type="Values:ArrayValue"/>
    <xsd:element name="set" type="Values:SetValue"/>
    <xsd:element name="set_of" type="Values:SetOfValue"/>
    <xsd:element name="enumerated" type="Values:EnumeratedValue"/>
    <xsd:element name="union" type="Values:UnionValue"/>
    <xsd:element name="anytype" type="Values:AnytypeValue"/>
    <xsd:element name="null" type="Templates:null"/>
    <xsd:element name="omit" type="Templates:omit"/>
    <xsd:element name="matching_symbol" type="Templates:MatchingSymbol"/>
    <xsd:element name="not_evaluated" type="Values:NotEvaluated"/>
  </xsd:choice>
  <xsd:attributeGroup ref="Values:ValueAtts"/>
</xsd:complexType>

<xsd:complexType name="ComponentValue">
  <xsd:choice>
    <xsd:element name="value" type="SimpleTypes:TString"/>
    <xsd:element name="null" type="Templates:null"/>
    <xsd:element name="omit" type="Templates:omit"/>
    <xsd:element name="matching_symbol" type="Templates:MatchingSymbol"/>
    <xsd:element name="not_evaluated" type="Values:NotEvaluated"/>
  </xsd:choice>
  <xsd:attributeGroup ref="Values:ValueAtts"/>
</xsd:complexType>

<xsd:complexType name="PortValue">
  <xsd:choice>
    <xsd:element name="value" type="SimpleTypes:TString"/>
    <xsd:element name="null" type="Templates:null"/>
    <xsd:element name="omit" type="Templates:omit"/>
  </xsd:choice>
  <xsd:attributeGroup ref="Values:ValueAtts"/>
</xsd:complexType>

<xsd:complexType name="DefaultValue">
  <xsd:choice>
    <xsd:element name="value" type="SimpleTypes:TString"/>
    <xsd:element name="null" type="Templates:null"/>
    <xsd:element name="omit" type="Templates:omit"/>
    <xsd:element name="not_evaluated" type="Values:NotEvaluated"/>
  </xsd:choice>
  <xsd:attributeGroup ref="Values:ValueAtts"/>
</xsd:complexType>

```

```

<xsd:complexType name="TimerValue">
  <xsd:choice>
    <xsd:element name="value" type="SimpleTypes:TString"/>
    <xsd:element name="null" type="Templates:null"/>
    <xsd:element name="omit" type="Templates:omit"/>
  </xsd:choice>
  <xsd:attributeGroup ref="Values:ValueAtts"/>
</xsd:complexType>
</xsd:schema>

```

B.4 TCI-TL XML Schema for Templates

```

<?xml version="1.0" encoding="UTF-8"?>
<xsd:schema xmlns:xsd="http://www.w3.org/2001/XMLSchema"
  targetNamespace="http://uri.etsi.org/ttcn-3/tci/Templates_v4_6_1.xsd"
  xmlns:Templates="http://uri.etsi.org/ttcn-3/tci/Templates_v4_6_1.xsd"
  xmlns:Values="http://uri.etsi.org/ttcn-3/tci/Values_v4_6_1.xsd"
  xmlns:SimpleTypes="http://uri.etsi.org/ttcn-3/tci/SimpleTypes_v4_6_1.xsd"
  elementFormDefault="qualified">

  <xsd:import namespace="http://uri.etsi.org/ttcn-3/tci/Values_v4_6_1.xsd"
    schemaLocation="Values_v4_6_1.xsd"/>
  <xsd:import namespace="http://uri.etsi.org/ttcn-3/tci/SimpleTypes_v4_6_1.xsd"
    schemaLocation="SimpleTypes_v4_6_1.xsd"/>

  <xsd:complexType name="TciValueTemplate">
    <xsd:complexContent mixed="true">
      <xsd:extension base="Values:Value">
        <xsd:choice>
          <xsd:element name="integer" type="Templates:IntegerTemplate"/>
          <xsd:element name="float" type="Templates:FloatTemplate"/>
          <xsd:element name="boolean" type="Templates:BooleanTemplate"/>
          <xsd:element name="verdicttype" type="Templates:VerdictTemplate"/>
          <xsd:element name="bitstring" type="Templates:BitstringTemplate"/>
          <xsd:element name="hexstring" type="Templates:HexstringTemplate"/>
          <xsd:element name="octetstring" type="Templates:OctetstringTemplate"/>
          <xsd:element name="charstring" type="Templates:CharstringTemplate"/>
          <xsd:element name="universal_charstring"
            type="Templates:UniversalCharstringTemplate"/>
          <xsd:element name="record" type="Templates:RecordTemplate"/>
          <xsd:element name="record_of" type="Templates:RecordOfTemplate"/>
          <xsd:element name="array" type="Values:ArrayValue"/>
          <xsd:element name="set" type="Templates:SetTemplate"/>
          <xsd:element name="set_of" type="Templates:SetOfTemplate"/>
          <xsd:element name="enumerated" type="Templates:EnumeratedTemplate"/>
          <xsd:element name="union" type="Templates:UnionTemplate"/>
          <xsd:element name="anytype" type="Templates:AnytypeTemplate"/>
          <xsd:element name="address" type="Templates:AddressTemplate"/>
          <xsd:element name="omit" type="Templates:omit"/>
          <xsd:element name="any" type="Templates:any"/>
          <xsd:element name="anyoromit" type="Templates:anyoromit"/>
          <xsd:element name="templateDef" type="SimpleTypes:TString"/>
        </xsd:choice>
      </xsd:extension>
    </xsd:complexContent>
  </xsd:complexType>

  <xsd:complexType name="omit">
    <xsd:attributeGroup ref="Values:ValueAtts"/>
  </xsd:complexType>

  <xsd:complexType name="any">
    <xsd:attributeGroup ref="Values:ValueAtts"/>
  </xsd:complexType>

  <xsd:complexType name="anyoromit">
    <xsd:attributeGroup ref="Values:ValueAtts"/>
  </xsd:complexType>

  <xsd:complexType name="MatchingSymbol">
    <xsd:simpleContent>
      <xsd:extension base="SimpleTypes:TString">
        <xsd:attributeGroup ref="Values:ValueAtts"/>
      </xsd:extension>
    </xsd:simpleContent>
  </xsd:complexType>

```

```

</xsd:complexType>

<xsd:complexType name="TciNonValueTemplate">
  <xsd:sequence>
    <xsd:choice>
      <xsd:element name="any" type="Templates:any"/>
      <xsd:element name="all" type="Templates:all"/>
      <xsd:element name="templateDef" type="SimpleTypes:TString"/>
      <xsd:element name="null" type="Templates:null"/>
    </xsd:choice>
  </xsd:sequence>
</xsd:complexType>

<xsd:complexType name="all">
  <xsd:attributeGroup ref="Values:ValueAtts"/>
</xsd:complexType>

<xsd:complexType name="null">
  <xsd:attributeGroup ref="Values:ValueAtts"/>
</xsd:complexType>

<xsd:complexType name="TciValueDifference">
  <xsd:sequence>
    <xsd:element name="val" type="SimpleTypes:xpath"/>
    <xsd:element name="tmpl" type="SimpleTypes:xpath"/>
  </xsd:sequence>
  <xsd:attributeGroup ref="Values:ValueAtts"/>
  <xsd:attribute name="desc" type="SimpleTypes:TString" use="optional"/>
</xsd:complexType>

<xsd:complexType name="TciValueDifferenceList">
  <xsd:sequence>
    <xsd:element name="diff" type="Templates:TciValueDifference"
maxOccurs="unbounded"/>
  </xsd:sequence>
</xsd:complexType>

<xsd:complexType name="IntegerTemplate">
  <xsd:choice>
    <xsd:element name="value" type="SimpleTypes:TString"/>
    <xsd:element name="templateDef" type="SimpleTypes:TString"/>
    <xsd:element name="omit" type="Templates:omit"/>
    <xsd:element name="any" type="Templates:any"/>
    <xsd:element name="anyoromit" type="Templates:anyoromit"/>
    <xsd:element name="null" type="Templates:null"/>
  </xsd:choice>
  <xsd:attributeGroup ref="Values:ValueAtts"/>
</xsd:complexType>

<xsd:complexType name="FloatTemplate">
  <xsd:choice>
    <xsd:element name="value" type="SimpleTypes:TString"/>
    <xsd:element name="templateDef" type="SimpleTypes:TString"/>
    <xsd:element name="omit" type="Templates:omit"/>
    <xsd:element name="any" type="Templates:any"/>
    <xsd:element name="anyoromit" type="Templates:anyoromit"/>
    <xsd:element name="null" type="Templates:null"/>
  </xsd:choice>
  <xsd:attributeGroup ref="Values:ValueAtts"/>
</xsd:complexType>

<xsd:complexType name="BooleanTemplate">
  <xsd:choice>
    <xsd:element name="value" type="SimpleTypes:TString"/>
    <xsd:element name="templateDef" type="SimpleTypes:TString"/>
    <xsd:element name="omit" type="Templates:omit"/>
    <xsd:element name="any" type="Templates:any"/>
    <xsd:element name="anyoromit" type="Templates:anyoromit"/>
    <xsd:element name="null" type="Templates:null"/>
  </xsd:choice>
  <xsd:attributeGroup ref="Values:ValueAtts"/>
</xsd:complexType>

<xsd:complexType name="BitstringTemplate">
  <xsd:choice>
    <xsd:element name="value" type="SimpleTypes:TString"/>
    <xsd:element name="templateDef" type="SimpleTypes:TString"/>
    <xsd:element name="omit" type="Templates:omit"/>
  </xsd:choice>
</xsd:complexType>

```

```

        <xsd:element name="any" type="Templates:any" />
        <xsd:element name="anyoromit" type="Templates:anyoromit" />
        <xsd:element name="null" type="Templates:null" />
    </xsd:choice>
    <xsd:attributeGroup ref="Values:ValueAtts" />
</xsd:complexType>

<xsd:complexType name="HexstringTemplate">
    <xsd:choice>
        <xsd:element name="value" type="SimpleTypes:TString" />
        <xsd:element name="templateDef" type="SimpleTypes:TString" />
        <xsd:element name="omit" type="Templates:omit" />
        <xsd:element name="any" type="Templates:any" />
        <xsd:element name="anyoromit" type="Templates:anyoromit" />
        <xsd:element name="null" type="Templates:null" />
    </xsd:choice>
    <xsd:attributeGroup ref="Values:ValueAtts" />
</xsd:complexType>

<xsd:complexType name="OctetstringTemplate">
    <xsd:choice>
        <xsd:element name="value" type="SimpleTypes:TString" />
        <xsd:element name="templateDef" type="SimpleTypes:TString" />
        <xsd:element name="omit" type="Templates:omit" />
        <xsd:element name="any" type="Templates:any" />
        <xsd:element name="anyoromit" type="Templates:anyoromit" />
        <xsd:element name="null" type="Templates:null" />
    </xsd:choice>
    <xsd:attributeGroup ref="Values:ValueAtts" />
</xsd:complexType>

<xsd:complexType name="CharstringTemplate">
    <xsd:choice>
        <xsd:element name="value" type="SimpleTypes:TString" />
        <xsd:element name="templateDef" type="SimpleTypes:TString" />
        <xsd:element name="omit" type="Templates:omit" />
        <xsd:element name="any" type="Templates:any" />
        <xsd:element name="anyoromit" type="Templates:anyoromit" />
        <xsd:element name="null" type="Templates:null" />
    </xsd:choice>
    <xsd:attributeGroup ref="Values:ValueAtts" />
</xsd:complexType>

<xsd:complexType name="UniversalCharstringTemplate">
    <xsd:choice>
        <xsd:element name="value" type="SimpleTypes:TString" />
        <xsd:element name="templateDef" type="SimpleTypes:TString" />
        <xsd:element name="omit" type="Templates:omit" />
        <xsd:element name="any" type="Templates:any" />
        <xsd:element name="anyoromit" type="Templates:anyoromit" />
        <xsd:element name="null" type="Templates:null" />
    </xsd:choice>
    <xsd:attributeGroup ref="Values:ValueAtts" />
</xsd:complexType>

<xsd:complexType name="VerdictTemplate">
    <xsd:choice>
        <xsd:element name="value" type="SimpleTypes:TString" />
        <xsd:element name="templateDef" type="SimpleTypes:TString" />
        <xsd:element name="omit" type="Templates:omit" />
        <xsd:element name="any" type="Templates:any" />
        <xsd:element name="anyoromit" type="Templates:anyoromit" />
        <xsd:element name="null" type="Templates:null" />
    </xsd:choice>
    <xsd:attributeGroup ref="Values:ValueAtts" />
</xsd:complexType>

<xsd:complexType name="RecordTemplate">
    <xsd:complexContent>
        <xsd:extension base="Values:RecordValue">
            <xsd:choice>
                <xsd:choice minOccurs="0">
                    <xsd:element name="integer" type="Templates:IntegerTemplate" />
                    <xsd:element name="float" type="Templates:FloatTemplate" />
                    <xsd:element name="boolean" type="Templates:BooleanTemplate" />
                    <xsd:element name="verdicttype" type="Templates:VerdictTemplate" />
                    <xsd:element name="bitstring" type="Templates:BitstringTemplate" />
                    <xsd:element name="hexstring" type="Templates:HexstringTemplate" />
                </xsd:choice>
            </xsd:choice>
        </xsd:extension>
    </xsd:complexContent>
</xsd:complexType>

```



```

<xsd:element name="octetstring" type="Templates:OctetstringTemplate"/>
<xsd:element name="charstring" type="Templates:CharstringTemplate"/>
<xsd:element name="universal_charstring"
  type="Templates:UniversalCharstringTemplate"/>
<xsd:element name="record" type="Templates:RecordTemplate"/>
<xsd:element name="record_of" type="Templates:RecordOfTemplate"/>
<xsd:element name="array" type="Values:ArrayValue"/>
<xsd:element name="set" type="Templates:SetTemplate"/>
<xsd:element name="set_of" type="Templates:SetOfTemplate"/>
<xsd:element name="enumerated" type="Templates:EnumeratedTemplate"/>
<xsd:element name="union" type="Templates:UnionTemplate"/>
<xsd:element name="anytype" type="Templates:AnytypeTemplate"/>
<xsd:element name="address" type="Templates:AddressTemplate"/>
</xsd:choice>
<xsd:element name="omit" type="Templates:omit"/>
<xsd:element name="any" type="Templates:any"/>
<xsd:element name="anyoromit" type="Templates:anyoromit"/>
<xsd:element name="templateDef" type="SimpleTypes:TString"/>
<xsd:element name="null" type="Templates:null"/>
</xsd:choice>
</xsd:extension>
</xsd:complexContent>
</xsd:complexType>

<xsd:complexType name="RecordOfTemplate">
  <xsd:complexContent>
    <xsd:extension base="Values:RecordOfValue">
      <xsd:choice minOccurs="0" maxOccurs="unbounded">
        <xsd:element name="integer" type="Templates:IntegerTemplate" minOccurs="0"
          maxOccurs="unbounded"/>
        <xsd:element name="float" type="Templates:FloatTemplate" minOccurs="0"
          maxOccurs="unbounded"/>
        <xsd:element name="boolean" type="Templates:BooleanTemplate" minOccurs="0"
          maxOccurs="unbounded"/>
        <xsd:element name="verdicttype" type="Templates:VerdictTemplate" minOccurs="0"
          maxOccurs="unbounded"/>
        <xsd:element name="bitstring" type="Templates:BitstringTemplate"
          minOccurs="0" maxOccurs="unbounded"/>
        <xsd:element name="hexstring" type="Templates:HexstringTemplate"
          minOccurs="0" maxOccurs="unbounded"/>
        <xsd:element name="octetstring" type="Templates:OctetstringTemplate"
          minOccurs="0" maxOccurs="unbounded"/>
        <xsd:element name="charstring" type="Templates:CharstringTemplate"
          minOccurs="0" maxOccurs="unbounded"/>
        <xsd:element name="universal_charstring"
          type="Templates:UniversalCharstringTemplate" minOccurs="0"
          maxOccurs="unbounded"/>
        <xsd:element name="record" type="Templates:RecordTemplate" minOccurs="0"
          maxOccurs="unbounded"/>
        <xsd:element name="record_of" type="Templates:RecordOfTemplate"
          minOccurs="0" maxOccurs="unbounded"/>
        <xsd:element name="array" type="Templates:ArrayTemplate" minOccurs="0"
          maxOccurs="unbounded"/>
        <xsd:element name="set" type="Templates:SetTemplate" minOccurs="0"
          maxOccurs="unbounded"/>
        <xsd:element name="set_of" type="Templates:SetOfTemplate"
          minOccurs="0" maxOccurs="unbounded"/>
        <xsd:element name="enumerated" type="Templates:EnumeratedTemplate"
          minOccurs="0" maxOccurs="unbounded"/>
        <xsd:element name="union" type="Templates:UnionTemplate" minOccurs="0"
          maxOccurs="unbounded"/>
        <xsd:element name="anytype" type="Templates:AnytypeTemplate" minOccurs="0"
          maxOccurs="unbounded"/>
        <xsd:element name="address" type="Templates:AddressTemplate" minOccurs="0"
          maxOccurs="unbounded"/>
        <xsd:element name="omit" type="Templates:omit"/>
        <xsd:element name="any" type="Templates:any"/>
        <xsd:element name="anyoromit" type="Templates:anyoromit"/>
        <xsd:element name="templateDef" type="SimpleTypes:TString"/>
        <xsd:element name="null" type="Templates:null"/>
      </xsd:choice>
    </xsd:extension>
  </xsd:complexContent>
</xsd:complexType>

<xsd:complexType name="ArrayTemplate">
  <xsd:complexContent>
    <xsd:extension base="Values:ArrayValue">

```

```

<xsd:choice minOccurs="0" maxOccurs="unbounded">
  <xsd:element name="integer" type="Templates:IntegerTemplate" minOccurs="0"
    maxOccurs="unbounded"/>
  <xsd:element name="float" type="Templates:FloatTemplate" minOccurs="0"
    maxOccurs="unbounded"/>
  <xsd:element name="boolean" type="Templates:BooleanTemplate" minOccurs="0"
    maxOccurs="unbounded"/>
  <xsd:element name="verdicttype" type="Templates:VerdictTemplate" minOccurs="0"
    maxOccurs="unbounded"/>
  <xsd:element name="bitstring" type="Templates:BitstringTemplate"
    minOccurs="0" maxOccurs="unbounded"/>
  <xsd:element name="hexstring" type="Templates:HexstringTemplate"
    minOccurs="0" maxOccurs="unbounded"/>
  <xsd:element name="octetstring" type="Templates:OctetstringTemplate"
    minOccurs="0" maxOccurs="unbounded"/>
  <xsd:element name="charstring" type="Templates:CharstringTemplate"
    minOccurs="0" maxOccurs="unbounded"/>
  <xsd:element name="universal_charstring"
    type="Templates:UniversalCharstringTemplate" minOccurs="0"
    maxOccurs="unbounded"/>
  <xsd:element name="record" type="Templates:RecordTemplate" minOccurs="0"
    maxOccurs="unbounded"/>
  <xsd:element name="record_of" type="Templates:RecordOfTemplate"
    minOccurs="0" maxOccurs="unbounded"/>
  <xsd:element name="array" type="Templates:ArrayTemplate" minOccurs="0"
    maxOccurs="unbounded"/>
  <xsd:element name="set" type="Templates:SetTemplate" minOccurs="0"
    maxOccurs="unbounded"/>
  <xsd:element name="set_of" type="Templates:SetOfTemplate"
    minOccurs="0" maxOccurs="unbounded"/>
  <xsd:element name="enumerated" type="Templates:EnumeratedTemplate"
    minOccurs="0" maxOccurs="unbounded"/>
  <xsd:element name="union" type="Templates:UnionTemplate" minOccurs="0"
    maxOccurs="unbounded"/>
  <xsd:element name="anytype" type="Templates:AnytypeTemplate" minOccurs="0"
    maxOccurs="unbounded"/>
  <xsd:element name="address" type="Templates:AddressTemplate" minOccurs="0"
    maxOccurs="unbounded"/>
  <xsd:element name="omit" type="Templates:omit"/>
  <xsd:element name="any" type="Templates:any"/>
  <xsd:element name="anyoromit" type="Templates:anyoromit"/>
  <xsd:element name="templateDef" type="SimpleTypes:TString"/>
  <xsd:element name="null" type="Templates:null"/>
</xsd:choice>
</xsd:extension>
</xsd:complexContent>
</xsd:complexType>

<xsd:complexType name="SetTemplate">
  <xsd:complexContent>
    <xsd:extension base="Values:SetValue">
      <xsd:choice>
        <xsd:choice minOccurs="0">
          <xsd:element name="integer" type="Templates:IntegerTemplate"/>
          <xsd:element name="float" type="Templates:FloatTemplate"/>
          <xsd:element name="boolean" type="Templates:BooleanTemplate"/>
          <xsd:element name="verdicttype" type="Templates:VerdictTemplate"/>
          <xsd:element name="bitstring" type="Templates:BitstringTemplate"/>
          <xsd:element name="hexstring" type="Templates:HexstringTemplate"/>
          <xsd:element name="octetstring" type="Templates:OctetstringTemplate"/>
          <xsd:element name="charstring" type="Templates:CharstringTemplate"/>
          <xsd:element name="universal_charstring"
            type="Templates:UniversalCharstringTemplate"/>
          <xsd:element name="record" type="Templates:RecordTemplate"/>
          <xsd:element name="record_of" type="Templates:RecordOfTemplate"/>
          <xsd:element name="array" type="Templates:ArrayTemplate"/>
          <xsd:element name="set" type="Templates:SetTemplate"/>
          <xsd:element name="set_of" type="Templates:SetOfTemplate"/>
          <xsd:element name="enumerated" type="Templates:EnumeratedTemplate"/>
          <xsd:element name="union" type="Templates:UnionTemplate"/>
          <xsd:element name="anytype" type="Templates:AnytypeTemplate"/>
          <xsd:element name="address" type="Templates:AddressTemplate"/>
        </xsd:choice>
        <xsd:element name="omit" type="Templates:omit"/>
        <xsd:element name="any" type="Templates:any"/>
        <xsd:element name="anyoromit" type="Templates:anyoromit"/>
        <xsd:element name="templateDef" type="SimpleTypes:TString"/>
        <xsd:element name="null" type="Templates:null"/>
      </xsd:choice>
    </xsd:extension>
  </xsd:complexContent>
</xsd:complexType>

```

```

        </xsd:choice>
    </xsd:extension>
</xsd:complexContent>
</xsd:complexType>

<xsd:complexType name="SetOfTemplate">
    <xsd:complexContent>
        <xsd:extension base="Values:SetOfValue">
            <xsd:choice minOccurs="0" maxOccurs="unbounded">
                <xsd:element name="integer" type="Templates:IntegerTemplate" minOccurs="0"
                    maxOccurs="unbounded"/>
                <xsd:element name="float" type="Templates:FloatTemplate" minOccurs="0"
                    maxOccurs="unbounded"/>
                <xsd:element name="boolean" type="Templates:BooleanTemplate" minOccurs="0"
                    maxOccurs="unbounded"/>
                <xsd:element name="verdicttype" type="Templates:VerdictTemplate" minOccurs="0"
                    maxOccurs="unbounded"/>
                <xsd:element name="bitstring" type="Templates:BitstringTemplate"
                    minOccurs="0" maxOccurs="unbounded"/>
                <xsd:element name="hexstring" type="Templates:HexstringTemplate"
                    minOccurs="0" maxOccurs="unbounded"/>
                <xsd:element name="octetstring" type="Templates:OctetstringTemplate"
                    minOccurs="0" maxOccurs="unbounded"/>
                <xsd:element name="charstring" type="Templates:CharstringTemplate"
                    minOccurs="0" maxOccurs="unbounded"/>
                <xsd:element name="universal_charstring"
                    type="Templates:UniversalCharstringTemplate" minOccurs="0"
                    maxOccurs="unbounded"/>
                <xsd:element name="record" type="Templates:RecordTemplate" minOccurs="0"
                    maxOccurs="unbounded"/>
                <xsd:element name="record_of" type="Templates:RecordOfTemplate"
                    minOccurs="0" maxOccurs="unbounded"/>
                <xsd:element name="array" type="Templates:ArrayTemplate" minOccurs="0"
                    maxOccurs="unbounded"/>
                <xsd:element name="set" type="Templates:SetTemplate" minOccurs="0"
                    maxOccurs="unbounded"/>
                <xsd:element name="set_of" type="Templates:SetOfTemplate"
                    minOccurs="0" maxOccurs="unbounded"/>
                <xsd:element name="enumerated" type="Templates:EnumeratedTemplate"
                    minOccurs="0" maxOccurs="unbounded"/>
                <xsd:element name="union" type="Templates:UnionTemplate" minOccurs="0"
                    maxOccurs="unbounded"/>
                <xsd:element name="anytype" type="Templates:AnytypeTemplate" minOccurs="0"
                    maxOccurs="unbounded"/>
                <xsd:element name="address" type="Templates:AddressTemplate" minOccurs="0"
                    maxOccurs="unbounded"/>
                <xsd:element name="omit" type="Templates:omit"/>
                <xsd:element name="any" type="Templates:any"/>
                <xsd:element name="anyoromit" type="Templates:anyoromit"/>
                <xsd:element name="templateDef" type="SimpleTypes:TString"/>
                <xsd:element name="null" type="Templates:null"/>
            </xsd:choice>
        </xsd:extension>
    </xsd:complexContent>
</xsd:complexType>

<xsd:complexType name="EnumeratedTemplate">
    <xsd:complexContent>
        <xsd:extension base="Values:EnumeratedValue">
            <xsd:choice minOccurs="0">
                <xsd:element name="value" type="SimpleTypes:TString"/>
                <xsd:element name="templateDef" type="SimpleTypes:TString"/>
                <xsd:element name="omit" type="Templates:omit"/>
                <xsd:element name="any" type="Templates:any"/>
                <xsd:element name="anyoromit" type="Templates:anyoromit"/>
                <xsd:element name="null" type="Templates:null"/>
            </xsd:choice>
        </xsd:extension>
    </xsd:complexContent>
</xsd:complexType>

<xsd:complexType name="UnionTemplate">
    <xsd:complexContent>
        <xsd:extension base="Values:UnionValue">
            <xsd:choice minOccurs="0">
                <xsd:element name="integer" type="Templates:IntegerTemplate"/>
                <xsd:element name="float" type="Templates:FloatTemplate"/>
                <xsd:element name="boolean" type="Templates:BooleanTemplate"/>
            </xsd:choice>
        </xsd:extension>
    </xsd:complexContent>
</xsd:complexType>

```

```

<xsd:element name="verdicttype" type="Templates:VerdictTemplate"/>
<xsd:element name="bitstring" type="Templates:BitstringTemplate"/>
<xsd:element name="hexstring" type="Templates:HexstringTemplate"/>
<xsd:element name="octetstring" type="Templates:OctetstringTemplate"/>
<xsd:element name="charstring" type="Templates:CharstringTemplate"/>
<xsd:element name="universal_charstring"
  type="Templates:UniversalCharstringTemplate"/>
<xsd:element name="record" type="Templates:RecordTemplate"/>
<xsd:element name="record_of" type="Templates:RecordOfTemplate"/>
<xsd:element name="array" type="Templates:ArrayTemplate"/>
<xsd:element name="set" type="Templates:SetTemplate"/>
<xsd:element name="set_of" type="Templates:SetOfTemplate"/>
<xsd:element name="enumerated" type="Templates:EnumeratedTemplate"/>
<xsd:element name="union" type="Templates:UnionTemplate"/>
<xsd:element name="anytype" type="Templates:AnytypeTemplate"/>
<xsd:element name="address" type="Templates:AddressTemplate"/>
<xsd:element name="omit" type="Templates:omit"/>
<xsd:element name="any" type="Templates:any"/>
<xsd:element name="anyoromit" type="Templates:anyoromit"/>
<xsd:element name="templateDef" type="SimpleTypes:TString"/>
<xsd:element name="null" type="Templates:null"/>
</xsd:choice>
</xsd:extension>
</xsd:complexContent>
</xsd:complexType>

<xsd:complexType name="AnytypeTemplate">
  <xsd:complexContent>
    <xsd:extension base="Values:AnytypeValue">
      <xsd:choice minOccurs="0">
        <xsd:element name="integer" type="Templates:IntegerTemplate"/>
        <xsd:element name="float" type="Templates:FloatTemplate"/>
        <xsd:element name="boolean" type="Templates:BooleanTemplate"/>
        <xsd:element name="verdicttype" type="Templates:VerdictTemplate"/>
        <xsd:element name="bitstring" type="Templates:BitstringTemplate"/>
        <xsd:element name="hexstring" type="Templates:HexstringTemplate"/>
        <xsd:element name="octetstring" type="Templates:OctetstringTemplate"/>
        <xsd:element name="charstring" type="Templates:CharstringTemplate"/>
        <xsd:element name="universal_charstring"
          type="Templates:UniversalCharstringTemplate"/>
        <xsd:element name="record" type="Templates:RecordTemplate"/>
        <xsd:element name="record_of" type="Templates:RecordOfTemplate"/>
        <xsd:element name="array" type="Templates:ArrayTemplate"/>
        <xsd:element name="set" type="Templates:SetTemplate"/>
        <xsd:element name="set_of" type="Templates:SetOfTemplate"/>
        <xsd:element name="enumerated" type="Templates:EnumeratedTemplate"/>
        <xsd:element name="union" type="Templates:UnionTemplate"/>
        <xsd:element name="address" type="Templates:AddressTemplate"/>
        <xsd:element name="omit" type="Templates:omit"/>
        <xsd:element name="any" type="Templates:any"/>
        <xsd:element name="anyoromit" type="Templates:anyoromit"/>
        <xsd:element name="templateDef" type="SimpleTypes:TString"/>
        <xsd:element name="null" type="Templates:null"/>
      </xsd:choice>
    </xsd:extension>
  </xsd:complexContent>
</xsd:complexType>

<xsd:complexType name="AddressTemplate">
  <xsd:complexContent>
    <xsd:extension base="Values:AnytypeValue">
      <xsd:choice minOccurs="0">
        <xsd:element name="integer" type="Templates:IntegerTemplate"/>
        <xsd:element name="float" type="Templates:FloatTemplate"/>
        <xsd:element name="boolean" type="Templates:BooleanTemplate"/>
        <xsd:element name="bitstring" type="Templates:BitstringTemplate"/>
        <xsd:element name="hexstring" type="Templates:HexstringTemplate"/>
        <xsd:element name="octetstring" type="Templates:OctetstringTemplate"/>
        <xsd:element name="charstring" type="Templates:CharstringTemplate"/>
        <xsd:element name="universal_charstring"
          type="Templates:UniversalCharstringTemplate"/>
        <xsd:element name="record" type="Templates:RecordTemplate"/>
        <xsd:element name="record_of" type="Templates:RecordOfTemplate"/>
        <xsd:element name="array" type="Templates:ArrayTemplate"/>
        <xsd:element name="set" type="Templates:SetTemplate"/>
        <xsd:element name="set_of" type="Templates:SetOfTemplate"/>
        <xsd:element name="enumerated" type="Templates:EnumeratedTemplate"/>
        <xsd:element name="union" type="Templates:UnionTemplate"/>
      </xsd:choice>
    </xsd:extension>
  </xsd:complexContent>
</xsd:complexType>

```

```

        <xsd:element name="anytype" type="Templates:AnytypeTemplate"/>
        <xsd:element name="omit" type="Templates:omit"/>
        <xsd:element name="any" type="Templates:any"/>
        <xsd:element name="anyoromit" type="Templates:anyoromit"/>
        <xsd:element name="templateDef" type="SimpleTypes:TString"/>
        <xsd:element name="null" type="Templates:null"/>
    </xsd:choice>
</xsd:extension>
</xsd:complexContent>
</xsd:complexType>
</xsd:schema>

```

B.5 TCI-TL XML Schema for Events

```

<?xml version="1.0" encoding="UTF-8"?>
<xsd:schema xmlns:xsd="http://www.w3.org/2001/XMLSchema"
  targetNamespace="http://uri.etsi.org/ttcn-3/tci/Events_v4_6_1.xsd"
  xmlns:Events="http://uri.etsi.org/ttcn-3/tci/Events_v4_6_1.xsd"
  xmlns:Types="http://uri.etsi.org/ttcn-3/tci/Types_v4_6_1.xsd"
  xmlns:Templates="http://uri.etsi.org/ttcn-3/tci/Templates_v4_6_1.xsd"
  xmlns:SimpleTypes="http://uri.etsi.org/ttcn-3/tci/SimpleTypes_v4_6_1.xsd"
  xmlns:Values="http://uri.etsi.org/ttcn-3/tci/Values_v4_6_1.xsd"
  elementFormDefault="qualified">

  <xsd:import namespace="http://uri.etsi.org/ttcn-3/tci/SimpleTypes_v4_6_1.xsd"
    schemaLocation="SimpleTypes_v4_6_1.xsd"/>
  <xsd:import namespace="http://uri.etsi.org/ttcn-3/tci/Types_v4_6_1.xsd"
    schemaLocation="Types_v4_6_1.xsd"/>
  <xsd:import namespace="http://uri.etsi.org/ttcn-3/tci/Values_v4_6_1.xsd"
    schemaLocation="Values_v4_6_1.xsd"/>
  <xsd:import namespace="http://uri.etsi.org/ttcn-3/tci/Templates_v4_6_1.xsd"
    schemaLocation="Templates_v4_6_1.xsd"/>

  <!-- common definition for all events -->
  <xsd:complexType name="Event" mixed="true">
    <xsd:sequence>
      <xsd:element name="am" type="SimpleTypes:TString"/>
    </xsd:sequence>
    <xsd:attribute name="ts" type="xsd:long" use="required"/>
    <xsd:attribute name="src" type="SimpleTypes:TString" use="optional"/>
    <xsd:attribute name="line" type="SimpleTypes:TInteger" use="optional"/>

    <!-- general identifier structure for test components, ports and timer -->
    <xsd:attribute name="name" type="SimpleTypes:TString" use="required"/>
    <xsd:attribute name="id" type="SimpleTypes:TString" use="required"/>
    <xsd:attribute name="type" type="SimpleTypes:TString" use="required"/>
  </xsd:complexType>

  <!-- this event is extended by all port configuration events -->
  <xsd:complexType name="PortConfiguration">
    <xsd:complexContent mixed="true">
      <xsd:extension base="Events:Event">
        <xsd:sequence>
          <xsd:element name="port1" type="Types:TriPortIdType" />
          <xsd:element name="port2" type="Types:TriPortIdType" />
        </xsd:sequence>
      </xsd:extension>
    </xsd:complexContent>
  </xsd:complexType>

  <!-- this event is extended by all port status events -->
  <xsd:complexType name="PortStatus">
    <xsd:complexContent mixed="true">
      <xsd:extension base="Events:Event">
        <xsd:sequence>
          <xsd:element name="port" type="Types:TriPortIdType"/>
          <xsd:element name="stat" type="SimpleTypes:PortStatusType" minOccurs="0"/>
        </xsd:sequence>
      </xsd:extension>
    </xsd:complexContent>
  </xsd:complexType>

  <!-- testcases -->
  <xsd:complexType name="tliTcExecute">
    <xsd:complexContent mixed="true">

```

```

    <xsd:extension base="Events:Event">
      <xsd:sequence>
        <xsd:element name="tcId" type="Types:TciTestCaseIdType"/>
        <xsd:element name="tciPars" type="Types:TciParameterListType" minOccurs="0"/>
        <xsd:element name="dur" type="SimpleTypes:TriTimerDurationType" minOccurs="0"/>
      </xsd:sequence>
    </xsd:extension>
  </xsd:complexContent>
</xsd:complexType>

<xsd:complexType name="tliTcStart">
  <xsd:complexContent mixed="true">
    <xsd:extension base="Events:Event">
      <xsd:sequence>
        <xsd:element name="tcId" type="Types:TciTestCaseIdType"/>
        <xsd:element name="tciPars" type="Types:TciParameterListType" minOccurs="0"/>
        <xsd:element name="dur" type="SimpleTypes:TriTimerDurationType" minOccurs="0"/>
      </xsd:sequence>
    </xsd:extension>
  </xsd:complexContent>
</xsd:complexType>

<xsd:complexType name="tliTcStop">
  <xsd:complexContent mixed="true">
    <xsd:extension base="Events:Event"/>
    <xsd:sequence>
      <xsd:element name="reason" type="SimpleTypes:TString" minOccurs="0"/>
    </xsd:sequence>
  </xsd:complexContent>
</xsd:complexType>

<xsd:complexType name="tliTcStarted">
  <xsd:complexContent mixed="true">
    <xsd:extension base="Events:Event">
      <xsd:sequence>
        <xsd:element name="tcId" type="Types:TciTestCaseIdType"/>
        <xsd:element name="tciPars" type="Types:TciParameterListType" minOccurs="0"/>
        <xsd:element name="dur" type="SimpleTypes:TriTimerDurationType" minOccurs="0"/>
      </xsd:sequence>
    </xsd:extension>
  </xsd:complexContent>
</xsd:complexType>

<xsd:complexType name="tliTcTerminated">
  <xsd:complexContent mixed="true">
    <xsd:extension base="Events:Event">
      <xsd:sequence>
        <xsd:element name="tcId" type="Types:TciTestCaseIdType"/>
        <xsd:element name="tciPars" type="Types:TciParameterListType" minOccurs="0"/>
        <xsd:element name="verdict" type="Values:VerdictValue"/>
        <xsd:element name="reason" type="SimpleTypes:TString" minOccurs="0"/>
      </xsd:sequence>
    </xsd:extension>
  </xsd:complexContent>
</xsd:complexType>

<!-- control -->
<xsd:complexType name="tliCtrlStart">
  <xsd:complexContent>
    <xsd:extension base="Events:Event"/>
  </xsd:complexContent>
</xsd:complexType>

<xsd:complexType name="tliCtrlStop">
  <xsd:complexContent>
    <xsd:extension base="Events:Event"/>
  </xsd:complexContent>
</xsd:complexType>

<xsd:complexType name="tliCtrlTerminated">
  <xsd:complexContent>
    <xsd:extension base="Events:Event"/>
  </xsd:complexContent>
</xsd:complexType>

<!-- asynchronous communication -->
<xsd:complexType name="tliMsend_m">
  <xsd:complexContent mixed="true">

```

```

    <xsd:extension base="Events:Event">
      <xsd:sequence>
        <xsd:element name="at" type="Types:TriPortIdType"/>
        <xsd:element name="to" type="Types:TriPortIdType" minOccurs="0"/>
        <xsd:element name="msgValue" type="Values:Value"/>
        <xsd:element name="addrValue" type="Values:Value" minOccurs="0"/>
        <xsd:choice>
          <xsd:element name="encoder-failure" type="SimpleTypes:TciStatusType"
minOccurs="0"/>
          <xsd:sequence>
            <xsd:element name="msg" type="Types:TriMessageType" minOccurs="0"/>
            <xsd:element name="address" type="Types:TriAddressType" minOccurs="0"/>
            <xsd:element name="transmission-failure"
type="SimpleTypes:TriStatusType" minOccurs="0"/>
          </xsd:sequence>
        </xsd:choice>
      </xsd:sequence>
    </xsd:extension>
  </xsd:complexContent>
</xsd:complexType>

<xsd:complexType name="tliMSend_m_BC">
  <xsd:complexContent mixed="true">
    <xsd:extension base="Events:Event">
      <xsd:sequence>
        <xsd:element name="at" type="Types:TriPortIdType"/>
        <xsd:element name="to" type="Types:TriPortIdType" minOccurs="0"/>
        <xsd:element name="msgValue" type="Values:Value"/>
        <xsd:choice>
          <xsd:element name="encoder-failure" type="SimpleTypes:TciStatusType"
minOccurs="0"/>
          <xsd:sequence>
            <xsd:element name="msg" type="Types:TriMessageType" minOccurs="0"/>
            <xsd:element name="transmission-failure"
type="SimpleTypes:TriStatusType" minOccurs="0"/>
          </xsd:sequence>
        </xsd:choice>
      </xsd:sequence>
    </xsd:extension>
  </xsd:complexContent>
</xsd:complexType>

<xsd:complexType name="tliMSend_m_MC">
  <xsd:complexContent mixed="true">
    <xsd:extension base="Events:Event">
      <xsd:sequence>
        <xsd:element name="at" type="Types:TriPortIdType"/>
        <xsd:element name="to" type="Types:TriPortIdType" minOccurs="0"/>
        <xsd:element name="msgValue" type="Values:Value"/>
        <xsd:element name="addrValues" type="Types:TciValueListType" minOccurs="0"/>
        <xsd:choice>
          <xsd:element name="encoder-failure" type="SimpleTypes:TciStatusType"
minOccurs="0"/>
          <xsd:sequence>
            <xsd:element name="msg" type="Types:TriMessageType" minOccurs="0"/>
            <xsd:element name="addresses" type="Types:TriAddressListType"
minOccurs="0"/>
            <xsd:element name="transmission-failure"
type="SimpleTypes:TriStatusType" minOccurs="0"/>
          </xsd:sequence>
        </xsd:choice>
      </xsd:sequence>
    </xsd:extension>
  </xsd:complexContent>
</xsd:complexType>

<xsd:complexType name="tliMSend_c">
  <xsd:complexContent mixed="true">
    <xsd:extension base="Events:Event">
      <xsd:sequence>
        <xsd:element name="at" type="Types:TriPortIdType"/>
        <xsd:element name="to" type="Types:TriPortIdType" minOccurs="0"/>
        <xsd:element name="msgValue" type="Values:Value"/>
        <xsd:element name="transmission-failure" type="SimpleTypes:TriStatusType"
minOccurs="0"/>
      </xsd:sequence>
    </xsd:extension>
  </xsd:complexContent>
</xsd:complexType>

```

```

</xsd:complexType>

<xsd:complexType name="tliMSend_c_BC">
  <xsd:complexContent mixed="true">
    <xsd:extension base="Events:Event">
      <xsd:sequence>
        <xsd:element name="at" type="Types:TriPortIdType"/>
        <xsd:element name="to" type="Types:TriPortIdListType" minOccurs="0"/>
        <xsd:element name="msgValue" type="Values:Value"/>
        <xsd:element name="transmission-failure" type="SimpleTypes:TriStatusType"
minOccurs="0"/>
      </xsd:sequence>
    </xsd:extension>
  </xsd:complexContent>
</xsd:complexType>

<xsd:complexType name="tliMSend_c_MC">
  <xsd:complexContent mixed="true">
    <xsd:extension base="Events:Event">
      <xsd:sequence>
        <xsd:element name="at" type="Types:TriPortIdType"/>
        <xsd:element name="to" type="Types:TriPortIdListType" minOccurs="0"/>
        <xsd:element name="msgValue" type="Values:Value"/>
        <xsd:element name="transmission-failure" type="SimpleTypes:TriStatusType"
minOccurs="0"/>
      </xsd:sequence>
    </xsd:extension>
  </xsd:complexContent>
</xsd:complexType>

<xsd:complexType name="tliMDetected_m">
  <xsd:complexContent mixed="true">
    <xsd:extension base="Events:Event">
      <xsd:sequence>
        <xsd:element name="at" type="Types:TriPortIdType"/>
        <xsd:element name="from" type="Types:TriPortIdType" minOccurs="0"/>
        <xsd:element name="msgValue" type="Types:TriMessageType"/>
        <xsd:element name="address" type="Types:TriAddressType" minOccurs="0"/>
      </xsd:sequence>
    </xsd:extension>
  </xsd:complexContent>
</xsd:complexType>

<xsd:complexType name="tliMDetected_c">
  <xsd:complexContent mixed="true">
    <xsd:extension base="Events:Event">
      <xsd:sequence>
        <xsd:element name="at" type="Types:TriPortIdType"/>
        <xsd:element name="from" type="Types:TriPortIdType" minOccurs="0"/>
        <xsd:element name="msgValue" type="Values:Value"/>
      </xsd:sequence>
    </xsd:extension>
  </xsd:complexContent>
</xsd:complexType>

<xsd:complexType name="tliMMismatch_m">
  <xsd:complexContent mixed="true">
    <xsd:extension base="Events:Event">
      <xsd:sequence>
        <xsd:element name="at" type="Types:TriPortIdType"/>
        <xsd:element name="msgValue" type="Values:Value"/>
        <xsd:element name="msgTpl" type="Templates:TciValueTemplate"/>
        <xsd:element name="diffs" type="Templates:TciValueDifferenceList"/>
        <xsd:element name="addrValue" type="Values:Value" minOccurs="0"/>
        <xsd:element name="addressTpl" type="Templates:TciValueTemplate"
minOccurs="0"/>
      </xsd:sequence>
    </xsd:extension>
  </xsd:complexContent>
</xsd:complexType>

<xsd:complexType name="tliMMismatch_c">
  <xsd:complexContent mixed="true">
    <xsd:extension base="Events:Event">
      <xsd:sequence>
        <xsd:element name="at" type="Types:TriPortIdType"/>
        <xsd:element name="msgValue" type="Values:Value"/>
        <xsd:element name="msgTpl" type="Templates:TciValueTemplate"/>

```



```

        <xsd:element name="diffs" type="Templates:TciValueDifferenceList" />
        <xsd:element name="from" type="Types:TriComponentIdType" minOccurs="0" />
        <xsd:element name="fromTmpl" type="Templates:TciNonValueTemplate"
minOccurs="0" />
    </xsd:sequence>
</xsd:extension>
</xsd:complexContent>
</xsd:complexType>

<xsd:complexType name="tliMReceive_m">
    <xsd:complexContent mixed="true">
        <xsd:extension base="Events:Event">
            <xsd:sequence>
                <xsd:element name="at" type="Types:TriPortIdType" />
                <xsd:element name="msgValue" type="Values:Value" minOccurs="0" />
                <xsd:element name="msgTmpl" type="Templates:TciValueTemplate"
minOccurs="0" />
                <xsd:element name="addrValue" type="Values:Value" minOccurs="0" />
                <xsd:element name="addressTmpl" type="Templates:TciValueTemplate"
minOccurs="0" />
            </xsd:sequence>
        </xsd:extension>
    </xsd:complexContent>
</xsd:complexType>

<xsd:complexType name="tliMReceive_c">
    <xsd:complexContent mixed="true">
        <xsd:extension base="Events:Event">
            <xsd:sequence>
                <xsd:element name="at" type="Types:TriPortIdType" />
                <xsd:element name="msgValue" type="Values:Value" minOccurs="0" />
                <xsd:element name="msgTmpl" type="Templates:TciValueTemplate"
minOccurs="0" />
                <xsd:element name="from" type="Types:TriComponentIdType" minOccurs="0" />
                <xsd:element name="fromTmpl" type="Templates:TciNonValueTemplate"
minOccurs="0" />
            </xsd:sequence>
        </xsd:extension>
    </xsd:complexContent>
</xsd:complexType>

<!-- synchronous communication -->
<xsd:complexType name="tliPrCall_m">
    <xsd:complexContent mixed="true">
        <xsd:extension base="Events:Event">
            <xsd:sequence>
                <xsd:element name="at" type="Types:TriPortIdType" />
                <xsd:element name="to" type="Types:TriPortIdType" minOccurs="0" />
                <xsd:element name="signature" type="Types:TriSignatureIdType" />
                <xsd:element name="tciPars" type="Types:TciParameterListType" minOccurs="0" />
                <xsd:element name="addrValue" type="Values:Value" minOccurs="0" />
                <xsd:choice>
                    <xsd:element name="encoder-failure" type="SimpleTypes:TciStatusType"
minOccurs="0" />
                    <xsd:sequence>
                        <xsd:element name="triPars" type="Types:TriParameterListType"
minOccurs="0" />
                        <xsd:element name="address" type="Types:TriAddressType" minOccurs="0" />
                        <xsd:element name="transmission-failure"
type="SimpleTypes:TriStatusType" minOccurs="0" />
                    </xsd:sequence>
                </xsd:choice>
            </xsd:sequence>
        </xsd:extension>
    </xsd:complexContent>
</xsd:complexType>

<xsd:complexType name="tliPrCall_m_BC">
    <xsd:complexContent mixed="true">
        <xsd:extension base="Events:Event">
            <xsd:sequence>
                <xsd:element name="at" type="Types:TriPortIdType" />
                <xsd:element name="to" type="Types:TriPortIdType" minOccurs="0" />
                <xsd:element name="signature" type="Types:TriSignatureIdType" />
                <xsd:element name="tciPars" type="Types:TciParameterListType" minOccurs="0" />
                <xsd:choice>
                    <xsd:element name="encoder-failure" type="SimpleTypes:TciStatusType"

```

```

minOccurs="0"/>
        <xsd:sequence>
            <xsd:element name="triPars" type="Types:TriParameterListType"
minOccurs="0"/>
                <xsd:element name="transmission-failure"
type="SimpleTypes:TriStatusType" minOccurs="0"/>
            </xsd:sequence>
        </xsd:choice>
    </xsd:sequence>
</xsd:extension>
</xsd:complexContent>
</xsd:complexType>

<xsd:complexType name="tliPrCall_m_MC">
    <xsd:complexContent mixed="true">
        <xsd:extension base="Events:Event">
            <xsd:sequence>
                <xsd:element name="at" type="Types:TriPortIdType"/>
                <xsd:element name="to" type="Types:TriPortIdType" minOccurs="0"/>
                <xsd:element name="signature" type="Types:TriSignatureIdType"/>
                <xsd:element name="tciPars" type="Types:TciParameterListType" minOccurs="0"/>
                <xsd:element name="addrValues" type="Types:TciValueListType" minOccurs="0"/>
                <xsd:choice>
                    <xsd:element name="encoder-failure" type="SimpleTypes:TciStatusType"
minOccurs="0"/>
                </xsd:choice>
            </xsd:sequence>
        </xsd:extension>
    </xsd:complexContent>
</xsd:complexType>

<xsd:complexType name="tliPrCall_c">
    <xsd:complexContent mixed="true">
        <xsd:extension base="Events:Event">
            <xsd:sequence>
                <xsd:element name="triPars" type="Types:TriParameterListType"
minOccurs="0"/>
                <xsd:element name="addresses" type="Types:TriAddressListType"
minOccurs="0"/>
                <xsd:element name="transmission-failure"
type="SimpleTypes:TriStatusType" minOccurs="0"/>
            </xsd:sequence>
        </xsd:choice>
    </xsd:sequence>
</xsd:extension>
</xsd:complexContent>
</xsd:complexType>

<xsd:complexType name="tliPrCall_c">
    <xsd:complexContent mixed="true">
        <xsd:extension base="Events:Event">
            <xsd:sequence>
                <xsd:element name="at" type="Types:TriPortIdType"/>
                <xsd:element name="to" type="Types:TriPortIdType" minOccurs="0"/>
                <xsd:element name="signature" type="Types:TriSignatureIdType"/>
                <xsd:element name="tciPars" type="Types:TciParameterListType" minOccurs="0"/>
                <xsd:element name="transmission-failure" type="SimpleTypes:TriStatusType"
minOccurs="0"/>
            </xsd:sequence>
        </xsd:extension>
    </xsd:complexContent>
</xsd:complexType>

<xsd:complexType name="tliPrCall_c_BC">
    <xsd:complexContent mixed="true">
        <xsd:extension base="Events:Event">
            <xsd:sequence>
                <xsd:element name="at" type="Types:TriPortIdType"/>
                <xsd:element name="to" type="Types:TriPortIdListType" minOccurs="0"/>
                <xsd:element name="signature" type="Types:TriSignatureIdType"/>
                <xsd:element name="tciPars" type="Types:TciParameterListType" minOccurs="0"/>
                <xsd:element name="transmission-failure" type="SimpleTypes:TriStatusType"
minOccurs="0"/>
            </xsd:sequence>
        </xsd:extension>
    </xsd:complexContent>
</xsd:complexType>

<xsd:complexType name="tliPrCall_c_MC">
    <xsd:complexContent mixed="true">
        <xsd:extension base="Events:Event">
            <xsd:sequence>
                <xsd:element name="at" type="Types:TriPortIdType"/>
                <xsd:element name="to" type="Types:TriPortIdListType" minOccurs="0"/>
                <xsd:element name="signature" type="Types:TriSignatureIdType"/>
                <xsd:element name="tciPars" type="Types:TciParameterListType" minOccurs="0"/>
                <xsd:element name="transmission-failure" type="SimpleTypes:TriStatusType"

```

```

minOccurs="0"/>
  </xsd:sequence>
</xsd:extension>
</xsd:complexContent>
</xsd:complexType>

<xsd:complexType name="tliPrGetCallDetected_m">
  <xsd:complexContent mixed="true">
    <xsd:extension base="Events:Event">
      <xsd:sequence>
        <xsd:element name="at" type="Types:TriPortIdType"/>
        <xsd:element name="from" type="Types:TriPortIdType" minOccurs="0"/>
        <xsd:element name="signature" type="Types:TriSignatureIdType"/>
        <xsd:element name="triPars" type="Types:TriParameterListType" minOccurs="0"/>
        <xsd:element name="address" type="Types:TriAddressType" minOccurs="0"/>
      </xsd:sequence>
    </xsd:extension>
  </xsd:complexContent>
</xsd:complexType>

<xsd:complexType name="tliPrGetCallDetected_c">
  <xsd:complexContent mixed="true">
    <xsd:extension base="Events:Event">
      <xsd:sequence>
        <xsd:element name="at" type="Types:TriPortIdType"/>
        <xsd:element name="from" type="Types:TriPortIdType" minOccurs="0"/>
        <xsd:element name="signature" type="Types:TriSignatureIdType"/>
        <xsd:element name="tciPars" type="Types:TciParameterListType" minOccurs="0"/>
      </xsd:sequence>
    </xsd:extension>
  </xsd:complexContent>
</xsd:complexType>

<xsd:complexType name="tliPrGetCallMismatch_m">
  <xsd:complexContent mixed="true">
    <xsd:extension base="Events:Event">
      <xsd:sequence>
        <xsd:element name="at" type="Types:TriPortIdType"/>
        <xsd:element name="signature" type="Types:TriSignatureIdType"/>
        <xsd:element name="tciPars" type="Types:TciParameterListType" minOccurs="0"/>
        <xsd:element name="parsTmpl" type="Templates:TciValueTemplate" minOccurs="0"/>
        <xsd:element name="diffs" type="Templates:TciValueDifferenceList"/>
        <xsd:element name="addrValue" type="Values:Value" minOccurs="0"/>
        <xsd:element name="addressTmpl" type="Templates:TciValueTemplate"
minOccurs="0"/>
      </xsd:sequence>
    </xsd:extension>
  </xsd:complexContent>
</xsd:complexType>

<xsd:complexType name="tliPrGetCallMismatch_c">
  <xsd:complexContent mixed="true">
    <xsd:extension base="Events:Event">
      <xsd:sequence>
        <xsd:element name="at" type="Types:TriPortIdType"/>
        <xsd:element name="signature" type="Types:TriSignatureIdType"/>
        <xsd:element name="tciPars" type="Types:TciParameterListType" minOccurs="0"/>
        <xsd:element name="parsTmpl" type="Templates:TciValueTemplate" minOccurs="0"/>
        <xsd:element name="diffs" type="Templates:TciValueDifferenceList"/>
        <xsd:element name="from" type="Types:TriComponentIdType" minOccurs="0"/>
        <xsd:element name="fromTmpl" type="Templates:TciValueTemplate" minOccurs="0"/>
      </xsd:sequence>
    </xsd:extension>
  </xsd:complexContent>
</xsd:complexType>

<xsd:complexType name="tliPrGetCall_m">
  <xsd:complexContent mixed="true">
    <xsd:extension base="Events:Event">
      <xsd:sequence>
        <xsd:element name="at" type="Types:TriPortIdType"/>
        <xsd:element name="signature" type="Types:TriSignatureIdType"/>
        <xsd:element name="tciPars" type="Types:TciParameterListType" minOccurs="0"/>
        <xsd:element name="parsTmpl" type="Templates:TciValueTemplate" minOccurs="0"/>
        <xsd:element name="addrValue" type="Values:Value" minOccurs="0"/>
        <xsd:element name="addressTmpl" type="Templates:TciValueTemplate"
minOccurs="0"/>
      </xsd:sequence>

```

```

    </xsd:extension>
  </xsd:complexContent>
</xsd:complexType>

<xsd:complexType name="tliPrGetCall_c">
  <xsd:complexContent mixed="true">
    <xsd:extension base="Events:Event">
      <xsd:sequence>
        <xsd:element name="at" type="Types:TriPortIdType"/>
        <xsd:element name="signature" type="Types:TriSignatureIdType"/>
        <xsd:element name="tciPars" type="Types:TciParameterListType" minOccurs="0"/>
        <xsd:element name="parsTmpl" type="Templates:TciValueTemplate" minOccurs="0"/>
        <xsd:element name="from" type="Types:TriComponentIdType" minOccurs="0"/>
        <xsd:element name="fromTmpl" type="Templates:TciNonValueTemplate"
minOccurs="0"/>
      </xsd:sequence>
    </xsd:extension>
  </xsd:complexContent>
</xsd:complexType>

<xsd:complexType name="tliPrReply_m">
  <xsd:complexContent mixed="true">
    <xsd:extension base="Events:Event">
      <xsd:sequence>
        <xsd:element name="at" type="Types:TriPortIdType"/>
        <xsd:element name="to" type="Types:TriPortIdType" minOccurs="0"/>
        <xsd:element name="signature" type="Types:TriSignatureIdType"/>
        <xsd:element name="tciPars" type="Types:TciParameterListType" minOccurs="0"/>
        <xsd:element name="replValue" type="Values:Value" minOccurs="0"/>
        <xsd:element name="addrValue" type="Values:Value" minOccurs="0"/>
        <xsd:choice>
          <xsd:element name="encoder-failure" type="SimpleTypes:TciStatusType"
minOccurs="0"/>
          <xsd:sequence>
            <xsd:element name="triPars" type="Types:TriParameterListType"
minOccurs="0"/>
            <xsd:element name="repl" type="Types:TriParameterType" minOccurs="0"/>
            <xsd:element name="address" type="Types:TriAddressType" minOccurs="0"/>
            <xsd:element name="transmission-failure"
              type="SimpleTypes:TciStatusType" minOccurs="0"/>
          </xsd:sequence>
        </xsd:choice>
      </xsd:sequence>
    </xsd:extension>
  </xsd:complexContent>
</xsd:complexType>

<xsd:complexType name="tliPrReply_m_BC">
  <xsd:complexContent mixed="true">
    <xsd:extension base="Events:Event">
      <xsd:sequence>
        <xsd:element name="at" type="Types:TriPortIdType"/>
        <xsd:element name="to" type="Types:TriPortIdType" minOccurs="0"/>
        <xsd:element name="signature" type="Types:TriSignatureIdType"/>
        <xsd:element name="tciPars" type="Types:TciParameterListType" minOccurs="0"/>
        <xsd:element name="replValue" type="Values:Value" minOccurs="0"/>
        <xsd:choice>
          <xsd:element name="encoder-failure" type="SimpleTypes:TciStatusType"
minOccurs="0"/>
          <xsd:sequence>
            <xsd:element name="triPars" type="Types:TriParameterListType"
minOccurs="0"/>
            <xsd:element name="repl" type="Types:TriParameterType" minOccurs="0"/>
            <xsd:element name="transmission-failure"
              type="SimpleTypes:TciStatusType" minOccurs="0"/>
          </xsd:sequence>
        </xsd:choice>
      </xsd:sequence>
    </xsd:extension>
  </xsd:complexContent>
</xsd:complexType>

<xsd:complexType name="tliPrReply_m_MC">
  <xsd:complexContent mixed="true">
    <xsd:extension base="Events:Event">
      <xsd:sequence>
        <xsd:element name="at" type="Types:TriPortIdType"/>
        <xsd:element name="to" type="Types:TriPortIdType" minOccurs="0"/>

```

```

<xsd:element name="signature" type="Types:TriSignatureIdType"/>
<xsd:element name="tciPars" type="Types:TciParameterListType" minOccurs="0"/>
<xsd:element name="replValue" type="Values:Value" minOccurs="0"/>
<xsd:element name="addrValues" type="Types:TciValueListType" minOccurs="0"/>
<xsd:choice>
  <xsd:element name="encoder-failure" type="SimpleTypes:TciStatusType"
    minOccurs="0"/>
  <xsd:sequence>
    <xsd:element name="triPars" type="Types:TriParameterListType"
minOccurs="0"/>
    <xsd:element name="repl" type="Types:TriParameterType" minOccurs="0"/>
    <xsd:element name="addresses" type="Types:TriAddressListType"
minOccurs="0"/>
    <xsd:element name="transmission-failure"
      type="SimpleTypes:TciStatusType" minOccurs="0"/>
  </xsd:sequence>
</xsd:choice>
</xsd:sequence>
</xsd:extension>
</xsd:complexContent>
</xsd:complexType>

<xsd:complexType name="tliPrReply_c">
  <xsd:complexContent mixed="true">
    <xsd:extension base="Events:Event">
      <xsd:sequence>
        <xsd:element name="at" type="Types:TriPortIdType"/>
        <xsd:element name="to" type="Types:TriPortIdType" minOccurs="0"/>
        <xsd:element name="signature" type="Types:TriSignatureIdType"/>
        <xsd:element name="tciPars" type="Types:TciParameterListType" minOccurs="0"/>
        <xsd:element name="replValue" type="Values:Value" minOccurs="0"/>
        <xsd:element name="transmission-failure" type="SimpleTypes:TciStatusType"
minOccurs="0"/>
      </xsd:sequence>
    </xsd:extension>
  </xsd:complexContent>
</xsd:complexType>

<xsd:complexType name="tliPrReply_c_BC">
  <xsd:complexContent mixed="true">
    <xsd:extension base="Events:Event">
      <xsd:sequence>
        <xsd:element name="at" type="Types:TriPortIdType"/>
        <xsd:element name="to" type="Types:TriPortIdListType" minOccurs="0"/>
        <xsd:element name="signature" type="Types:TriSignatureIdType"/>
        <xsd:element name="tciPars" type="Types:TciParameterListType" minOccurs="0"/>
        <xsd:element name="replValue" type="Values:Value" minOccurs="0"/>
        <xsd:element name="transmission-failure" type="SimpleTypes:TciStatusType"
minOccurs="0"/>
      </xsd:sequence>
    </xsd:extension>
  </xsd:complexContent>
</xsd:complexType>

<xsd:complexType name="tliPrReply_c_MC">
  <xsd:complexContent mixed="true">
    <xsd:extension base="Events:Event">
      <xsd:sequence>
        <xsd:element name="at" type="Types:TriPortIdType"/>
        <xsd:element name="to" type="Types:TriPortIdListType" minOccurs="0"/>
        <xsd:element name="signature" type="Types:TriSignatureIdType"/>
        <xsd:element name="tciPars" type="Types:TciParameterListType" minOccurs="0"/>
        <xsd:element name="replValue" type="Values:Value" minOccurs="0"/>
        <xsd:element name="transmission-failure" type="SimpleTypes:TciStatusType"
minOccurs="0"/>
      </xsd:sequence>
    </xsd:extension>
  </xsd:complexContent>
</xsd:complexType>

<xsd:complexType name="tliPrGetReplyDetected_m">
  <xsd:complexContent mixed="true">
    <xsd:extension base="Events:Event">
      <xsd:sequence>
        <xsd:element name="at" type="Types:TriPortIdType"/>
        <xsd:element name="from" type="Types:TriPortIdType" minOccurs="0"/>
        <xsd:element name="signature" type="Types:TriSignatureIdType"/>
        <xsd:element name="triPars" type="Types:TriParameterListType" minOccurs="0"/>

```

```

        <xsd:element name="repl" type="Types:TriParameterType" minOccurs="0"/>
        <xsd:element name="address" type="Types:TriAddressType" minOccurs="0"/>
    </xsd:sequence>
</xsd:extension>
</xsd:complexContent>
</xsd:complexType>

<xsd:complexType name="tliPrGetReplyDetected_c">
    <xsd:complexContent mixed="true">
        <xsd:extension base="Events:Event">
            <xsd:sequence>
                <xsd:element name="at" type="Types:TriPortIdType"/>
                <xsd:element name="from" type="Types:TriPortIdType" minOccurs="0"/>
                <xsd:element name="signature" type="Types:TriSignatureIdType"/>
                <xsd:element name="tciPars" type="Types:TciParameterListType" minOccurs="0"/>
                <xsd:element name="replValue" type="Values:Value" minOccurs="0"/>
            </xsd:sequence>
        </xsd:extension>
    </xsd:complexContent>
</xsd:complexType>

<xsd:complexType name="tliPrGetReplyMismatch_m">
    <xsd:complexContent mixed="true">
        <xsd:extension base="Events:Event">
            <xsd:sequence>
                <xsd:element name="at" type="Types:TriPortIdType"/>
                <xsd:element name="signature" type="Types:TriSignatureIdType"/>
                <xsd:element name="tciPars" type="Types:TciParameterListType" minOccurs="0"/>
                <xsd:element name="parsTmpl" type="Templates:TciValueTemplate" minOccurs="0"/>
                <xsd:element name="replValue" type="Values:Value" minOccurs="0"/>
                <xsd:element name="replTmpl" type="Templates:TciValueTemplate" minOccurs="0"/>
                <xsd:element name="diffs" type="Templates:TciValueDifferenceList"/>
                <xsd:element name="addrValue" type="Values:Value" minOccurs="0"/>
                <xsd:element name="addressTmpl" type="Templates:TciValueTemplate"
minOccurs="0"/>
            </xsd:sequence>
        </xsd:extension>
    </xsd:complexContent>
</xsd:complexType>

<xsd:complexType name="tliPrGetReplyMismatch_c">
    <xsd:complexContent mixed="true">
        <xsd:extension base="Events:Event">
            <xsd:sequence>
                <xsd:element name="at" type="Types:TriPortIdType"/>
                <xsd:element name="signature" type="Types:TriSignatureIdType"/>
                <xsd:element name="tciPars" type="Types:TciParameterListType" minOccurs="0"/>
                <xsd:element name="parsTmpl" type="Templates:TciValueTemplate" minOccurs="0"/>
                <xsd:element name="replValue" type="Values:Value" minOccurs="0"/>
                <xsd:element name="replTmpl" type="Templates:TciValueTemplate" minOccurs="0"/>
                <xsd:element name="diffs" type="Templates:TciValueDifferenceList"/>
                <xsd:element name="from" type="Types:TriComponentIdType" minOccurs="0"/>
                <xsd:element name="fromTmpl" type="Templates:TciNonValueTemplate"
minOccurs="0"/>
            </xsd:sequence>
        </xsd:extension>
    </xsd:complexContent>
</xsd:complexType>

<xsd:complexType name="tliPrGetReply_m">
    <xsd:complexContent mixed="true">
        <xsd:extension base="Events:Event">
            <xsd:sequence>
                <xsd:element name="at" type="Types:TriPortIdType"/>
                <xsd:element name="signature" type="Types:TriSignatureIdType"/>
                <xsd:element name="tciPars" type="Types:TciParameterListType" minOccurs="0"/>
                <xsd:element name="parsTmpl" type="Templates:TciValueTemplate" minOccurs="0"/>
                <xsd:element name="replValue" type="Values:Value" minOccurs="0"/>
                <xsd:element name="replTmpl" type="Templates:TciValueTemplate" minOccurs="0"/>
                <xsd:element name="addrValue" type="Values:Value" minOccurs="0"/>
                <xsd:element name="addressTmpl" type="Templates:TciValueTemplate"
minOccurs="0"/>
            </xsd:sequence>
        </xsd:extension>
    </xsd:complexContent>
</xsd:complexType>

<xsd:complexType name="tliPrGetReply_c">

```

```

<xsd:complexContent mixed="true">
  <xsd:extension base="Events:Event">
    <xsd:sequence>
      <xsd:element name="at" type="Types:TriPortIdType"/>
      <xsd:element name="signature" type="Types:TriSignatureIdType"/>
      <xsd:element name="tciPars" type="Types:TciParameterListType" minOccurs="0"/>
      <xsd:element name="parsTmpl" type="Templates:TciValueTemplate" minOccurs="0"/>
      <xsd:element name="replValue" type="Values:Value" minOccurs="0"/>
      <xsd:element name="replTmpl" type="Templates:TciValueTemplate" minOccurs="0"/>
      <xsd:element name="from" type="Types:TriComponentIdType" minOccurs="0"/>
      <xsd:element name="fromTmpl" type="Templates:TciNonValueTemplate"
minOccurs="0"/>
    </xsd:sequence>
  </xsd:extension>
</xsd:complexContent>
</xsd:complexType>

<xsd:complexType name="tliPrRaise_m">
  <xsd:complexContent mixed="true">
    <xsd:extension base="Events:Event">
      <xsd:sequence>
        <xsd:element name="at" type="Types:TriPortIdType"/>
        <xsd:element name="to" type="Types:TriPortIdType" minOccurs="0"/>
        <xsd:element name="signature" type="Types:TriSignatureIdType"/>
        <xsd:element name="tciPars" type="Types:TciParameterListType" minOccurs="0"/>
        <xsd:element name="excValue" type="Values:Value" minOccurs="0"/>
        <xsd:element name="addrValue" type="Values:Value" minOccurs="0"/>
        <xsd:choice>
          <xsd:element name="encoder-failure" type="SimpleTypes:TciStatusType"
minOccurs="0"/>
          <xsd:sequence>
            <xsd:element name="exc" type="Types:TriExceptionType" minOccurs="0"/>
            <xsd:element name="address" type="Types:TriAddressType" minOccurs="0"/>
            <xsd:element name="transmission-failure"
type="SimpleTypes:TriStatusType" minOccurs="0"/>
          </xsd:sequence>
        </xsd:choice>
      </xsd:sequence>
    </xsd:extension>
  </xsd:complexContent>
</xsd:complexType>

<xsd:complexType name="tliPrRaise_m_BC">
  <xsd:complexContent mixed="true">
    <xsd:extension base="Events:Event">
      <xsd:sequence>
        <xsd:element name="at" type="Types:TriPortIdType"/>
        <xsd:element name="to" type="Types:TriPortIdType" minOccurs="0"/>
        <xsd:element name="signature" type="Types:TriSignatureIdType"/>
        <xsd:element name="tciPars" type="Types:TciParameterListType" minOccurs="0"/>
        <xsd:element name="excValue" type="Values:Value" minOccurs="0"/>
        <xsd:choice>
          <xsd:element name="encoder-failure" type="SimpleTypes:TciStatusType"
minOccurs="0"/>
          <xsd:sequence>
            <xsd:element name="exc" type="Types:TriExceptionType" minOccurs="0"/>
            <xsd:element name="transmission-failure"
type="SimpleTypes:TriStatusType" minOccurs="0"/>
          </xsd:sequence>
        </xsd:choice>
      </xsd:sequence>
    </xsd:extension>
  </xsd:complexContent>
</xsd:complexType>

<xsd:complexType name="tliPrRaise_m_MC">
  <xsd:complexContent mixed="true">
    <xsd:extension base="Events:Event">
      <xsd:sequence>
        <xsd:element name="at" type="Types:TriPortIdType"/>
        <xsd:element name="to" type="Types:TriPortIdType" minOccurs="0"/>
        <xsd:element name="signature" type="Types:TriSignatureIdType"/>
        <xsd:element name="tciPars" type="Types:TciParameterListType" minOccurs="0"/>
        <xsd:element name="excValue" type="Values:Value" minOccurs="0"/>
        <xsd:element name="addrValues" type="Types:TciValueListType" minOccurs="0"/>
        <xsd:choice>
          <xsd:element name="encoder-failure" type="SimpleTypes:TciStatusType"

```

```

minOccurs="0"/>
    <xsd:sequence>
      <xsd:element name="exc" type="Types:TriExceptionType" minOccurs="0"/>
      <xsd:element name="addresses" type="Types:TriAddressListType"
minOccurs="0"/>
    <xsd:element name="transmission-failure"
type="SimpleTypes:TriStatusType" minOccurs="0"/>
    </xsd:sequence>
  </xsd:choice>
</xsd:sequence>
</xsd:extension>
</xsd:complexContent>
</xsd:complexType>

<xsd:complexType name="tliPrRaise_c">
  <xsd:complexContent mixed="true">
    <xsd:extension base="Events:Event">
      <xsd:sequence>
        <xsd:element name="at" type="Types:TriPortIdType"/>
        <xsd:element name="to" type="Types:TriPortIdType" minOccurs="0"/>
        <xsd:element name="signature" type="Types:TriSignatureIdType"/>
        <xsd:element name="tciPars" type="Types:TciParameterListType" minOccurs="0"/>
        <xsd:element name="excValue" type="Values:Value" minOccurs="0"/>
        <xsd:element name="transmission-failure" type="SimpleTypes:TriStatusType"
minOccurs="0"/>
      </xsd:sequence>
    </xsd:extension>
  </xsd:complexContent>
</xsd:complexType>

<xsd:complexType name="tliPrRaise_c_BC">
  <xsd:complexContent mixed="true">
    <xsd:extension base="Events:Event">
      <xsd:sequence>
        <xsd:element name="at" type="Types:TriPortIdType"/>
        <xsd:element name="to" type="Types:TriPortIdListType" minOccurs="0"/>
        <xsd:element name="signature" type="Types:TriSignatureIdType"/>
        <xsd:element name="tciPars" type="Types:TciParameterListType" minOccurs="0"/>
        <xsd:element name="excValue" type="Values:Value" minOccurs="0"/>
        <xsd:element name="transmission-failure" type="SimpleTypes:TriStatusType"
minOccurs="0"/>
      </xsd:sequence>
    </xsd:extension>
  </xsd:complexContent>
</xsd:complexType>

<xsd:complexType name="tliPrRaise_c_MC">
  <xsd:complexContent mixed="true">
    <xsd:extension base="Events:Event">
      <xsd:sequence>
        <xsd:element name="at" type="Types:TriPortIdType"/>
        <xsd:element name="to" type="Types:TriPortIdListType" minOccurs="0"/>
        <xsd:element name="signature" type="Types:TriSignatureIdType"/>
        <xsd:element name="tciPars" type="Types:TciParameterListType" minOccurs="0"/>
        <xsd:element name="excValue" type="Values:Value" minOccurs="0"/>
        <xsd:element name="transmission-failure" type="SimpleTypes:TriStatusType"
minOccurs="0"/>
      </xsd:sequence>
    </xsd:extension>
  </xsd:complexContent>
</xsd:complexType>

<xsd:complexType name="tliPrCatchDetected_m">
  <xsd:complexContent mixed="true">
    <xsd:extension base="Events:Event">
      <xsd:sequence>
        <xsd:element name="at" type="Types:TriPortIdType"/>
        <xsd:element name="from" type="Types:TriPortIdType" minOccurs="0"/>
        <xsd:element name="signature" type="Types:TriSignatureIdType"/>
        <xsd:element name="exc" type="Types:TriExceptionType" minOccurs="0"/>
        <xsd:element name="address" type="Types:TriAddressType" minOccurs="0"/>
      </xsd:sequence>
    </xsd:extension>
  </xsd:complexContent>
</xsd:complexType>

<xsd:complexType name="tliPrCatchDetected_c">
  <xsd:complexContent mixed="true">

```



```

    <xsd:extension base="Events:Event">
      <xsd:sequence>
        <xsd:element name="at" type="Types:TriPortIdType"/>
        <xsd:element name="from" type="Types:TriPortIdType" minOccurs="0"/>
        <xsd:element name="signature" type="Types:TriSignatureIdType"/>
        <xsd:element name="excValue" type="Values:Value" minOccurs="0"/>
      </xsd:sequence>
    </xsd:extension>
  </xsd:complexContent>
</xsd:complexType>

<xsd:complexType name="tliPrCatchMismatch_m">
  <xsd:complexContent mixed="true">
    <xsd:extension base="Events:Event">
      <xsd:sequence>
        <xsd:element name="at" type="Types:TriPortIdType"/>
        <xsd:element name="signature" type="Types:TriSignatureIdType"/>
        <xsd:element name="excValue" type="Values:Value" minOccurs="0"/>
        <xsd:element name="excTmpl" type="Templates:TciValueTemplate" minOccurs="0"/>
        <xsd:element name="diffs" type="Templates:TciValueDifferenceList"/>
        <xsd:element name="addrValue" type="Values:Value" minOccurs="0"/>
        <xsd:element name="addressTmpl" type="Templates:TciValueTemplate"
minOccurs="0"/>
      </xsd:sequence>
    </xsd:extension>
  </xsd:complexContent>
</xsd:complexType>

<xsd:complexType name="tliPrCatchMismatch_c">
  <xsd:complexContent mixed="true">
    <xsd:extension base="Events:Event">
      <xsd:sequence>
        <xsd:element name="at" type="Types:TriPortIdType"/>
        <xsd:element name="signature" type="Types:TriSignatureIdType"/>
        <xsd:element name="excValue" type="Values:Value" minOccurs="0"/>
        <xsd:element name="excTmpl" type="Templates:TciValueTemplate" minOccurs="0"/>
        <xsd:element name="diffs" type="Templates:TciValueDifferenceList"/>
        <xsd:element name="from" type="Types:TriComponentIdType" minOccurs="0"/>
        <xsd:element name="fromTmpl" type="Templates:TciNonValueTemplate"
minOccurs="0"/>
      </xsd:sequence>
    </xsd:extension>
  </xsd:complexContent>
</xsd:complexType>

<xsd:complexType name="tliPrCatch_m">
  <xsd:complexContent mixed="true">
    <xsd:extension base="Events:Event">
      <xsd:sequence>
        <xsd:element name="at" type="Types:TriPortIdType"/>
        <xsd:element name="signature" type="Types:TriSignatureIdType"/>
        <xsd:element name="excValue" type="Values:Value"/>
        <xsd:element name="excTmpl" type="Templates:TciValueTemplate"/>
        <xsd:element name="addrValue" type="Values:Value" minOccurs="0"/>
        <xsd:element name="addressTmpl" type="Templates:TciValueTemplate"
minOccurs="0"/>
      </xsd:sequence>
    </xsd:extension>
  </xsd:complexContent>
</xsd:complexType>

<xsd:complexType name="tliPrCatch_c">
  <xsd:complexContent mixed="true">
    <xsd:extension base="Events:Event">
      <xsd:sequence>
        <xsd:element name="at" type="Types:TriPortIdType"/>
        <xsd:element name="signature" type="Types:TriSignatureIdType"/>
        <xsd:element name="excValue" type="Values:Value" minOccurs="0"/>
        <xsd:element name="excTmpl" type="Templates:TciValueTemplate" minOccurs="0"/>
        <xsd:element name="from" type="Types:TriComponentIdType" minOccurs="0"/>
        <xsd:element name="fromTmpl" type="Templates:TciNonValueTemplate"
minOccurs="0"/>
      </xsd:sequence>
    </xsd:extension>
  </xsd:complexContent>
</xsd:complexType>

<xsd:complexType name="tliPrCatchTimeoutDetected">

```

```

<xsd:complexContent mixed="true">
  <xsd:extension base="Events:Event">
    <xsd:sequence>
      <xsd:element name="at" type="Types:TriPortIdType"/>
      <xsd:element name="signature" type="Types:TriSignatureIdType"/>
    </xsd:sequence>
  </xsd:extension>
</xsd:complexContent>
</xsd:complexType>

<xsd:complexType name="tliPrCatchTimeout">
  <xsd:complexContent mixed="true">
    <xsd:extension base="Events:Event">
      <xsd:sequence>
        <xsd:element name="at" type="Types:TriPortIdType"/>
        <xsd:element name="signature" type="Types:TriSignatureIdType"/>
      </xsd:sequence>
    </xsd:extension>
  </xsd:complexContent>
</xsd:complexType>

<!-- components -->
<xsd:complexType name="tliCCreate">
  <xsd:complexContent mixed="true">
    <xsd:extension base="Events:Event">
      <xsd:sequence>
        <xsd:element name="comp" type="Types:TriComponentIdType"/>
        <xsd:element name="name" type="SimpleTypes:TString"/>
        <xsd:element name="hostId" type="Values:Value" minOccurs="0"/>
        <xsd:element name="alive" type="SimpleTypes:TBoolean"/>
      </xsd:sequence>
    </xsd:extension>
  </xsd:complexContent>
</xsd:complexType>

<xsd:complexType name="tliCStart">
  <xsd:complexContent mixed="true">
    <xsd:extension base="Events:Event">
      <xsd:sequence>
        <xsd:element name="comp" type="Types:TriComponentIdType"/>
        <xsd:element name="name" type="Types:TciBehaviourIdType"/>
        <xsd:element name="tciPars" type="Types:TciParameterListType" minOccurs="0"/>
      </xsd:sequence>
    </xsd:extension>
  </xsd:complexContent>
</xsd:complexType>

<xsd:complexType name="tliCRunning">
  <xsd:complexContent mixed="true">
    <xsd:extension base="Events:Event">
      <xsd:sequence>
        <xsd:element name="comp" type="Types:TriComponentIdType"/>
        <xsd:element name="status" type="SimpleTypes:ComponentStatusType"/>
      </xsd:sequence>
    </xsd:extension>
  </xsd:complexContent>
</xsd:complexType>

<xsd:complexType name="tliCAlive">
  <xsd:complexContent mixed="true">
    <xsd:extension base="Events:Event">
      <xsd:sequence>
        <xsd:element name="comp" type="Types:TriComponentIdType"/>
        <xsd:element name="status" type="SimpleTypes:ComponentStatusType"/>
      </xsd:sequence>
    </xsd:extension>
  </xsd:complexContent>
</xsd:complexType>

<xsd:complexType name="tliCStop">
  <xsd:complexContent mixed="true">
    <xsd:extension base="Events:Event">
      <xsd:sequence>
        <xsd:element name="comp" type="Types:TriComponentIdType"/>
      </xsd:sequence>
    </xsd:extension>
  </xsd:complexContent>
</xsd:complexType>

```

```

</xsd:complexType>

<xsd:complexType name="tliCKill">
  <xsd:complexContent mixed="true">
    <xsd:extension base="Events:Event">
      <xsd:sequence>
        <xsd:element name="comp" type="Types:TriComponentIdType"/>
      </xsd:sequence>
    </xsd:extension>
  </xsd:complexContent>
</xsd:complexType>

<xsd:complexType name="tliCDoneMismatch">
  <xsd:complexContent mixed="true">
    <xsd:extension base="Events:Event">
      <xsd:sequence>
        <xsd:element name="comp" type="Types:TriComponentIdType"/>
        <xsd:element name="compTpl" type="Templates:TciNonValueTemplate"/>
      </xsd:sequence>
    </xsd:extension>
  </xsd:complexContent>
</xsd:complexType>

<xsd:complexType name="tliCKilledMismatch">
  <xsd:complexContent mixed="true">
    <xsd:extension base="Events:Event">
      <xsd:sequence>
        <xsd:element name="comp" type="Types:TriComponentIdType"/>
        <xsd:element name="compTpl" type="Templates:TciNonValueTemplate"/>
      </xsd:sequence>
    </xsd:extension>
  </xsd:complexContent>
</xsd:complexType>

<xsd:complexType name="tliCDone">
  <xsd:complexContent mixed="true">
    <xsd:extension base="Events:Event">
      <xsd:sequence>
        <xsd:element name="compTpl" type="Templates:TciNonValueTemplate"/>
      </xsd:sequence>
    </xsd:extension>
  </xsd:complexContent>
</xsd:complexType>

<xsd:complexType name="tliCKilled">
  <xsd:complexContent mixed="true">
    <xsd:extension base="Events:Event">
      <xsd:sequence>
        <xsd:element name="compTpl" type="Templates:TciNonValueTemplate"/>
      </xsd:sequence>
    </xsd:extension>
  </xsd:complexContent>
</xsd:complexType>

<xsd:complexType name="tliCTerminated">
  <xsd:complexContent mixed="true">
    <xsd:extension base="Events:Event">
      <xsd:sequence>
        <xsd:element name="verdict" type="Values:VerdictValue" />
        <xsd:element name="reason" type="SimpleTypes:TString" minOccurs="0"/>
      </xsd:sequence>
    </xsd:extension>
  </xsd:complexContent>
</xsd:complexType>

<!-- ports -->
<xsd:complexType name="tliPConnect">
  <xsd:complexContent mixed="true">
    <xsd:extension base="Events:PortConfiguration"/>
  </xsd:complexContent>
</xsd:complexType>

<xsd:complexType name="tliPDisconnect">
  <xsd:complexContent mixed="true">
    <xsd:extension base="Events:PortConfiguration"/>
  </xsd:complexContent>
</xsd:complexType>

```

```

<xsd:complexType name="tliPMap">
  <xsd:complexContent mixed="true">
    <xsd:extension base="Events:PortConfiguration"/>
  </xsd:complexContent>
</xsd:complexType>

<xsd:complexType name="tliPMapParam">
  <xsd:complexContent mixed="true">
    <xsd:extension base="Events:tliPMap">
      <xsd:sequence>
        <xsd:element name="tciPars" type="Types:TciParameterListType" />
        <xsd:choice>
          <xsd:element name="encoder-failure" type="SimpleTypes:TciStatusType"
minOccurs="0"/>
          <xsd:element name="triPars" type="Types:TriParameterListType" />
        </xsd:choice>
      </xsd:sequence>
    </xsd:extension>
  </xsd:complexContent>
</xsd:complexType>

<xsd:complexType name="tliPUnmap">
  <xsd:complexContent mixed="true">
    <xsd:extension base="Events:PortConfiguration"/>
  </xsd:complexContent>
</xsd:complexType>

<xsd:complexType name="tliPUnmapParam">
  <xsd:complexContent mixed="true">
    <xsd:extension base="Events:tliPUnmap">
      <xsd:sequence>
        <xsd:element name="tciPars" type="Types:TciParameterListType" />
        <xsd:choice>
          <xsd:element name="encoder-failure" type="SimpleTypes:TciStatusType"
minOccurs="0"/>
          <xsd:element name="triPars" type="Types:TriParameterListType"/>
        </xsd:choice>
      </xsd:sequence>
    </xsd:extension>
  </xsd:complexContent>
</xsd:complexType>

<xsd:complexType name="tliPClear">
  <xsd:complexContent mixed="true">
    <xsd:extension base="Events:PortStatus"/>
  </xsd:complexContent>
</xsd:complexType>

<xsd:complexType name="tliPStart">
  <xsd:complexContent mixed="true">
    <xsd:extension base="Events:PortStatus"/>
  </xsd:complexContent>
</xsd:complexType>

<xsd:complexType name="tliPStop">
  <xsd:complexContent mixed="true">
    <xsd:extension base="Events:PortStatus"/>
  </xsd:complexContent>
</xsd:complexType>

<xsd:complexType name="tliPHalt">
  <xsd:complexContent mixed="true">
    <xsd:extension base="Events:PortStatus"/>
  </xsd:complexContent>
</xsd:complexType>

<!-- codec -->
<xsd:complexType name="tliEncode">
  <xsd:complexContent mixed="true">
    <xsd:extension base="Events:Event">
      <xsd:sequence>
        <xsd:element name="val" type="Values:Value"/>
        <xsd:choice>
          <xsd:element name="msg" type="Types:TriMessageType"/>
          <xsd:element name="encoder-failure" type="SimpleTypes:TciStatusType"
minOccurs="0"/>
        </xsd:choice>
        <xsd:element name="codec" type="SimpleTypes:TString"

```

```

        minOccurs="0"/>
      </xsd:sequence>
    </xsd:extension>
  </xsd:complexContent>
</xsd:complexType>

<xsd:complexType name="tliDecode" mixed="true">
  <xsd:complexContent mixed="true">
    <xsd:extension base="Events:Event">
      <xsd:sequence>
        <xsd:element name="msg" type="Types:TriMessageType"/>
        <xsd:choice>
          <xsd:element name="decoder-failure" type="SimpleTypes:TciStatusType"
minOccurs="0"/>
          <xsd:element name="val" type="Values:Value"/>
        </xsd:choice>
        <xsd:element name="codec" type="SimpleTypes:TString"
          minOccurs="0"/>
      </xsd:sequence>
    </xsd:extension>
  </xsd:complexContent>
</xsd:complexType>

<!-- timers -->
<xsd:complexType name="tliTimeoutDetected">
  <xsd:complexContent mixed="true">
    <xsd:extension base="Events:Event">
      <xsd:sequence>
        <xsd:element name="timer" type="Types:TriTimerIdType" />
      </xsd:sequence>
    </xsd:extension>
  </xsd:complexContent>
</xsd:complexType>

<xsd:complexType name="tliTimeoutMismatch">
  <xsd:complexContent mixed="true">
    <xsd:extension base="Events:Event">
      <xsd:sequence>
        <xsd:element name="timer" type="Types:TriTimerIdType" />
        <xsd:element name="timerTpl" type="Templates:TciNonValueTemplate" />
      </xsd:sequence>
    </xsd:extension>
  </xsd:complexContent>
</xsd:complexType>

<xsd:complexType name="tliTimeout">
  <xsd:complexContent mixed="true">
    <xsd:extension base="Events:Event">
      <xsd:sequence>
        <xsd:element name="timer" type="Types:TriTimerIdType" />
        <xsd:element name="timerTpl" type="Templates:TciNonValueTemplate" />
      </xsd:sequence>
    </xsd:extension>
  </xsd:complexContent>
</xsd:complexType>

<xsd:complexType name="tliTStart">
  <xsd:complexContent mixed="true">
    <xsd:extension base="Events:Event">
      <xsd:sequence>
        <xsd:element name="timer" type="Types:TriTimerIdType"/>
        <xsd:element name="dur" type="SimpleTypes:TriTimerDurationType"/>
      </xsd:sequence>
    </xsd:extension>
  </xsd:complexContent>
</xsd:complexType>

<xsd:complexType name="tliTStop">
  <xsd:complexContent mixed="true">
    <xsd:extension base="Events:Event">
      <xsd:sequence>
        <xsd:element name="timer" type="Types:TriTimerIdType"/>
        <xsd:element name="dur" type="SimpleTypes:TriTimerDurationType"/>
      </xsd:sequence>
    </xsd:extension>
  </xsd:complexContent>
</xsd:complexType>

```

```

<xsd:complexType name="tliTRead">
  <xsd:complexContent mixed="true">
    <xsd:extension base="Events:Event">
      <xsd:sequence>
        <xsd:element name="timer" type="Types:TriTimerIdType"/>
        <xsd:element name="elapsed" type="SimpleTypes:TriTimerDurationType"/>
      </xsd:sequence>
    </xsd:extension>
  </xsd:complexContent>
</xsd:complexType>

<xsd:complexType name="tliTRunning">
  <xsd:complexContent mixed="true">
    <xsd:extension base="Events:Event">
      <xsd:sequence>
        <xsd:element name="timer" type="Types:TriTimerIdType"/>
        <xsd:element name="status" type="SimpleTypes:TimerStatusType"/>
      </xsd:sequence>
    </xsd:extension>
  </xsd:complexContent>
</xsd:complexType>

<!-- scope -->
<xsd:complexType name="tliSEnter">
  <xsd:complexContent mixed="true">
    <xsd:extension base="Events:Event">
      <xsd:sequence>
        <xsd:element name="name" type="Types:QualifiedName" />
        <xsd:element name="tciPars" type="Types:TciParameterListType" minOccurs="0"/>
        <xsd:element name="kind" type="SimpleTypes:TString"/>
      </xsd:sequence>
    </xsd:extension>
  </xsd:complexContent>
</xsd:complexType>

<xsd:complexType name="tliSLeave">
  <xsd:complexContent mixed="true">
    <xsd:extension base="Events:Event">
      <xsd:sequence>
        <xsd:element name="name" type="Types:QualifiedName" />
        <xsd:element name="tciPars" type="Types:TciParameterListType" minOccurs="0"/>
        <xsd:element name="returnValue" type="Values:Value" minOccurs="0"/>
        <xsd:element name="kind" type="SimpleTypes:TString"/>
      </xsd:sequence>
    </xsd:extension>
  </xsd:complexContent>
</xsd:complexType>

<!-- variables and module parameter -->
<xsd:complexType name="tliVar">
  <xsd:complexContent mixed="true">
    <xsd:extension base="Events:Event">
      <xsd:sequence>
        <xsd:element name="name" type="Types:QualifiedName" />
        <xsd:element name="val" type="Values:Value" minOccurs="0"/>
      </xsd:sequence>
    </xsd:extension>
  </xsd:complexContent>
</xsd:complexType>

<xsd:complexType name="tliModulePar">
  <xsd:complexContent mixed="true">
    <xsd:extension base="Events:Event">
      <xsd:sequence>
        <xsd:element name="name" type="Types:QualifiedName" />
        <xsd:element name="val" type="Values:Value" minOccurs="0"/>
      </xsd:sequence>
    </xsd:extension>
  </xsd:complexContent>
</xsd:complexType>

<!-- verdicts -->
<xsd:complexType name="tliGetVerdict">
  <xsd:complexContent mixed="true">
    <xsd:extension base="Events:Event">
      <xsd:sequence>
        <xsd:element name="verdict" type="Values:VerdictValue"/>
      </xsd:sequence>
    </xsd:extension>
  </xsd:complexContent>
</xsd:complexType>

```

```

        </xsd:extension>
      </xsd:complexContent>
    </xsd:complexType>

    <xsd:complexType name="tliSetVerdict">
      <xsd:complexContent mixed="true">
        <xsd:extension base="Events:Event">
          <xsd:sequence>
            <xsd:element name="verdict" type="Values:VerdictValue"/>
            <xsd:element name="reason" type="SimpleTypes:TString" minOccurs="0"/>
          </xsd:sequence>
        </xsd:extension>
      </xsd:complexContent>
    </xsd:complexType>

    <!-- log -->
    <xsd:complexType name="tliLog">
      <xsd:complexContent mixed="true">
        <xsd:extension base="Events:Event">
          <xsd:sequence>
            <xsd:element name="log" type="SimpleTypes:TString"/>
          </xsd:sequence>
        </xsd:extension>
      </xsd:complexContent>
    </xsd:complexType>

    <!-- alt -->
    <xsd:complexType name="tliAEnter">
      <xsd:complexContent>
        <xsd:extension base="Events:Event"/>
      </xsd:complexContent>
    </xsd:complexType>

    <xsd:complexType name="tliALeave">
      <xsd:complexContent>
        <xsd:extension base="Events:Event"/>
      </xsd:complexContent>
    </xsd:complexType>

    <xsd:complexType name="tliADefaults">
      <xsd:complexContent>
        <xsd:extension base="Events:Event"/>
      </xsd:complexContent>
    </xsd:complexType>

    <xsd:complexType name="tliAActivate">
      <xsd:complexContent mixed="true">
        <xsd:extension base="Events:Event">
          <xsd:sequence>
            <xsd:element name="name" type="Types:QualifiedName" />
            <xsd:element name="tciPars" type="Types:TciParameterListType" minOccurs="0"/>
            <xsd:element name="ref" type="Values:Value"/>
          </xsd:sequence>
        </xsd:extension>
      </xsd:complexContent>
    </xsd:complexType>

    <xsd:complexType name="tliADeactivate">
      <xsd:complexContent mixed="true">
        <xsd:extension base="Events:Event">
          <xsd:sequence>
            <xsd:element name="ref" type="Values:Value"/>
          </xsd:sequence>
        </xsd:extension>
      </xsd:complexContent>
    </xsd:complexType>

    <xsd:complexType name="tliANomatch">
      <xsd:complexContent mixed="true">
        <xsd:extension base="Events:Event"/>
      </xsd:complexContent>
    </xsd:complexType>

    <xsd:complexType name="tliARepeat">
      <xsd:complexContent>
        <xsd:extension base="Events:Event"/>
      </xsd:complexContent>
    </xsd:complexType>

```

```

    </xsd:complexContent>
  </xsd:complexType>

  <xsd:complexType name="tliAwait">
    <xsd:complexContent>
      <xsd:extension base="Events:Event" />
    </xsd:complexContent>
  </xsd:complexType>

  <xsd:complexType name="tliAction">
    <xsd:complexContent mixed="true">
      <xsd:extension base="Events:Event">
        <xsd:sequence>
          <xsd:element name="action" type="SimpleTypes:TString" />
        </xsd:sequence>
      </xsd:extension>
    </xsd:complexContent>
  </xsd:complexType>

  <xsd:complexType name="tliMatch">
    <xsd:complexContent mixed="true">
      <xsd:extension base="Events:Event">
        <xsd:sequence>
          <xsd:element name="expr" type="Values:Value" />
          <xsd:element name="tpl" type="Templates:TciValueTemplate" />
        </xsd:sequence>
      </xsd:extension>
    </xsd:complexContent>
  </xsd:complexType>

  <xsd:complexType name="tliMatchMismatch">
    <xsd:complexContent mixed="true">
      <xsd:extension base="Events:Event">
        <xsd:sequence>
          <xsd:element name="expr" type="Values:Value" />
          <xsd:element name="tpl" type="Templates:TciValueTemplate" />
          <xsd:element name="diffs" type="Templates:TciValueDifferenceList" />
        </xsd:sequence>
      </xsd:extension>
    </xsd:complexContent>
  </xsd:complexType>

  <xsd:complexType name="tliInfo">
    <xsd:complexContent mixed="true">
      <xsd:extension base="Events:Event">
        <xsd:sequence>
          <xsd:element name="level" type="SimpleTypes:TInteger" />
          <xsd:element name="info" type="SimpleTypes:TString" />
        </xsd:sequence>
      </xsd:extension>
    </xsd:complexContent>
  </xsd:complexType>

  <xsd:complexType name="tliMChecked_m">
    <xsd:complexContent mixed="true">
      <xsd:extension base="Events:Event">
        <xsd:sequence>
          <xsd:element name="at" type="Types:TriPortIdType" />
          <xsd:element name="msgValue" type="Values:Value" minOccurs="0" />
          <xsd:element name="msgTpl" type="Templates:TciValueTemplate" minOccurs="0" />
          <xsd:element name="addrValue" type="Values:Value" minOccurs="0" />
          <xsd:element name="addressTpl" type="Templates:TciValueTemplate"
minOccurs="0" />
        </xsd:sequence>
      </xsd:extension>
    </xsd:complexContent>
  </xsd:complexType>

  <xsd:complexType name="tliMChecked_c">
    <xsd:complexContent mixed="true">
      <xsd:extension base="Events:Event">
        <xsd:sequence>
          <xsd:element name="at" type="Types:TriPortIdType" />
          <xsd:element name="msgValue" type="Values:Value" minOccurs="0" />
          <xsd:element name="msgTpl" type="Templates:TciValueTemplate"
minOccurs="0" />
          <xsd:element name="from" type="Types:TriComponentIdType" minOccurs="0" />

```



```

                <xsd:element name="fromTmpl" type="Templates:TciNonValueTemplate"
minOccurs="0"/>
            </xsd:sequence>
        </xsd:extension>
    </xsd:complexContent>
</xsd:complexType>

    <xsd:complexType name="tliPrGetCallChecked_m">
        <xsd:complexContent mixed="true">
            <xsd:extension base="Events:Event">
                <xsd:sequence>
                    <xsd:element name="at" type="Types:TriPortIdType"/>
                    <xsd:element name="signature" type="Types:TriSignatureIdType"/>
                    <xsd:element name="tciPars" type="Types:TciParameterListType" minOccurs="0"/>
                    <xsd:element name="parsTmpl" type="Templates:TciValueTemplate" minOccurs="0"/>
                    <xsd:element name="addrValue" type="Values:Value" minOccurs="0"/>
                    <xsd:element name="addressTmpl" type="Templates:TciValueTemplate"
minOccurs="0"/>
                </xsd:sequence>
            </xsd:extension>
        </xsd:complexContent>
    </xsd:complexType>

    <xsd:complexType name="tliPrGetCallChecked_c">
        <xsd:complexContent mixed="true">
            <xsd:extension base="Events:Event">
                <xsd:sequence>
                    <xsd:element name="at" type="Types:TriPortIdType"/>
                    <xsd:element name="signature" type="Types:TriSignatureIdType"/>
                    <xsd:element name="tciPars" type="Types:TciParameterListType" minOccurs="0"/>
                    <xsd:element name="parsTmpl" type="Templates:TciValueTemplate" minOccurs="0"/>
                    <xsd:element name="from" type="Types:TriComponentIdType" minOccurs="0"/>
                    <xsd:element name="fromTmpl" type="Templates:TciNonValueTemplate"
minOccurs="0"/>
                </xsd:sequence>
            </xsd:extension>
        </xsd:complexContent>
    </xsd:complexType>

    <xsd:complexType name="tliPrGetReplyChecked_m">
        <xsd:complexContent mixed="true">
            <xsd:extension base="Events:Event">
                <xsd:sequence>
                    <xsd:element name="at" type="Types:TriPortIdType"/>
                    <xsd:element name="signature" type="Types:TriSignatureIdType"/>
                    <xsd:element name="tciPars" type="Types:TciParameterListType" minOccurs="0"/>
                    <xsd:element name="parsTmpl" type="Templates:TciValueTemplate" minOccurs="0"/>
                    <xsd:element name="replValue" type="Values:Value"
minOccurs="0"/>
                </xsd:sequence>
            </xsd:extension>
        </xsd:complexContent>
    </xsd:complexType>

    <xsd:complexType name="tliPrGetReplyChecked_c">
        <xsd:complexContent mixed="true">
            <xsd:extension base="Events:Event">
                <xsd:sequence>
                    <xsd:element name="replTmpl" type="Templates:TciValueTemplate" minOccurs="0"/>
                    <xsd:element name="addrValue" type="Values:Value" minOccurs="0"/>
                    <xsd:element name="addressTmpl" type="Templates:TciValueTemplate"
minOccurs="0"/>
                </xsd:sequence>
            </xsd:extension>
        </xsd:complexContent>
    </xsd:complexType>

    <xsd:complexType name="tliPrGetReplyChecked_c">
        <xsd:complexContent mixed="true">
            <xsd:extension base="Events:Event">
                <xsd:sequence>
                    <xsd:element name="at" type="Types:TriPortIdType"/>
                    <xsd:element name="signature" type="Types:TriSignatureIdType"/>
                    <xsd:element name="tciPars" type="Types:TciParameterListType" minOccurs="0"/>
                    <xsd:element name="parsTmpl" type="Templates:TciValueTemplate" minOccurs="0"/>
                    <xsd:element name="replValue" type="Values:Value"
minOccurs="0"/>
                </xsd:sequence>
            </xsd:extension>
        </xsd:complexContent>
    </xsd:complexType>

    <xsd:complexType name="tliPrGetReplyChecked_c">
        <xsd:complexContent mixed="true">
            <xsd:extension base="Events:Event">
                <xsd:sequence>
                    <xsd:element name="replTmpl" type="Templates:TciValueTemplate" minOccurs="0"/>
                    <xsd:element name="from" type="Types:TriComponentIdType" minOccurs="0"/>
                    <xsd:element name="fromTmpl" type="Templates:TciNonValueTemplate"
minOccurs="0"/>
                </xsd:sequence>
            </xsd:extension>
        </xsd:complexContent>
    </xsd:complexType>

    <xsd:complexType name="tliPrCatchChecked_m">

```

```

    <xsd:complexContent mixed="true">
      <xsd:extension base="Events:Event">
        <xsd:sequence>
          <xsd:element name="at" type="Types:TriPortIdType"/>
          <xsd:element name="signature" type="Types:TriSignatureIdType"/>
          <xsd:element name="excValue" type="Values:Value"/>
          <xsd:element name="excTmpl" type="Templates:TciValueTemplate"/>
          <xsd:element name="addrValue" type="Values:Value" minOccurs="0"/>
          <xsd:element name="addressTmpl" type="Templates:TciValueTemplate"
minOccurs="0"/>
        </xsd:sequence>
      </xsd:extension>
    </xsd:complexContent>
  </xsd:complexType>

  <xsd:complexType name="tliPrCatchChecked_c">
    <xsd:complexContent mixed="true">
      <xsd:extension base="Events:Event">
        <xsd:sequence>
          <xsd:element name="at" type="Types:TriPortIdType"/>
          <xsd:element name="signature" type="Types:TriSignatureIdType"/>
          <xsd:element name="excValue" type="Values:Value" minOccurs="0"/>
          <xsd:element name="excTmpl" type="Templates:TciValueTemplate" minOccurs="0"/>
          <xsd:element name="from" type="Types:TriComponentIdType" minOccurs="0"/>
          <xsd:element name="fromTmpl" type="Templates:TciNonValueTemplate"
minOccurs="0"/>
        </xsd:sequence>
      </xsd:extension>
    </xsd:complexContent>
  </xsd:complexType>

  <xsd:complexType name="tliCheckedAny_m">
    <xsd:complexContent mixed="true">
      <xsd:extension base="Events:Event">
        <xsd:sequence>
          <xsd:element name="at" type="Types:TriPortIdType"/>
          <xsd:element name="addrValue" type="Values:Value" minOccurs="0"/>
          <xsd:element name="addressTmpl" type="Templates:TciValueTemplate"
minOccurs="0"/>
        </xsd:sequence>
      </xsd:extension>
    </xsd:complexContent>
  </xsd:complexType>

  <xsd:complexType name="tliCheckedAny_c">
    <xsd:complexContent mixed="true">
      <xsd:extension base="Events:Event">
        <xsd:sequence>
          <xsd:element name="at" type="Types:TriPortIdType"/>
          <xsd:element name="from" type="Types:TriComponentIdType"
minOccurs="0"/>
          <xsd:element name="fromTmpl" type="Templates:TciNonValueTemplate"
minOccurs="0"/>
        </xsd:sequence>
      </xsd:extension>
    </xsd:complexContent>
  </xsd:complexType>

  <xsd:complexType name="tliCheckMismatch_m">
    <xsd:complexContent mixed="true">
      <xsd:extension base="Events:Event">
        <xsd:sequence>
          <xsd:element name="at" type="Types:TriPortIdType"/>
          <xsd:element name="addrValue" type="Values:Value" minOccurs="0"/>
          <xsd:element name="addressTmpl" type="Templates:TciValueTemplate"
minOccurs="0"/>
        </xsd:sequence>
      </xsd:extension>
    </xsd:complexContent>
  </xsd:complexType>

  <xsd:complexType name="tliCheckMismatch_c">
    <xsd:complexContent mixed="true">
      <xsd:extension base="Events:Event">
        <xsd:sequence>
          <xsd:element name="at" type="Types:TriPortIdType"/>
          <xsd:element name="from" type="Types:TriComponentIdType"

```

```

        minOccurs="0" />
        <xsd:element name="fromTpl1" type="Templates:TciNonValueTemplate"
        minOccurs="0" />
    </xsd:sequence>
</xsd:extension>
</xsd:complexType>
</xsd:complexType>

<xsd:complexType name="tliRnd">
    <xsd:complexContent mixed="true">
        <xsd:extension base="Events:Event">
            <xsd:sequence>
                <xsd:element name="val" type="Values:FloatValue" />
                <xsd:element name="from" type="Values:FloatValue" />
            </xsd:sequence>
        </xsd:extension>
    </xsd:complexContent>
</xsd:complexType>

<xsd:complexType name="tliEvaluate">
    <xsd:complexContent mixed="true">
        <xsd:extension base="Events:Event">
            <xsd:sequence>
                <xsd:element name="name" type="Types:QualifiedName" />
                <xsd:element name="evalResult" type="Values:Value" minOccurs="0" />
            </xsd:sequence>
        </xsd:extension>
    </xsd:complexContent>
</xsd:complexType>
</xsd:schema>

```

B.6 TCI-TL XML Schema for a Log

```

<?xml version="1.0" encoding="UTF-8"?>
<xsd:schema xmlns:xsd="http://www.w3.org/2001/XMLSchema"
    targetNamespace="http://uri.etsi.org/ttcn-3/tci/TLI_v4_6_1.xsd"
    xmlns:TLI="http://uri.etsi.org/ttcn-3/tci/TLI_v4_6_1.xsd"
    xmlns:Events="http://uri.etsi.org/ttcn-3/tci/Events_v4_6_1.xsd"
    elementFormDefault="qualified">

    <xsd:import namespace="http://uri.etsi.org/ttcn-3/tci/Events_v4_6_1.xsd"
        schemaLocation="Events_v4_6_1.xsd" />

    <xsd:element name="logfile" type="TLI:LogModule" />
    <xsd:complexType name="LogModule">
        <xsd:sequence>
            <xsd:element name="header" type="TLI:Header" />
            <xsd:element name="body" type="TLI:Body" />
            <xsd:element name="trailer" type="TLI:Trailer" minOccurs="0" />
        </xsd:sequence>
    </xsd:complexType>
    <xsd:complexType name="Header">
        <xsd:sequence>
            <!-- logging version -->
            <xsd:element name="version" type="xsd:string" />
            <!-- begin of the log -->
            <xsd:element name="ts" type="xsd:long" />
        </xsd:sequence>
    </xsd:complexType>
    <xsd:complexType name="Trailer">
        <xsd:choice>
            <xsd:any namespace="##any" processContents="skip" minOccurs="0" maxOccurs="unbounded" />
        </xsd:choice>
    </xsd:complexType>

    <xsd:complexType name="Body">
        <xsd:choice maxOccurs="unbounded">

            <!-- test cases operations -->
            <xsd:element name="tliTcExecute" type="Events:tliTcExecute" />
            <xsd:element name="tliTcStart" type="Events:tliTcStart" />
            <xsd:element name="tliTcStop" type="Events:tliTcStop" />
            <xsd:element name="tliTcStarted" type="Events:tliTcStarted" />

```

```

<xsd:element name="tliTcTerminated" type="Events:tliTcTerminated"/>

<!-- control operations -->
<xsd:element name="tliCtrlStart" type="Events:tliCtrlStart"/>
<xsd:element name="tliCtrlStop" type="Events:tliCtrlStop"/>
<xsd:element name="tliCtrlTerminated" type="Events:tliCtrlTerminated"/>

<!-- asynchronous communication -->
<xsd:element name="tliMSend_m" type="Events:tliMSend_m"/>
<xsd:element name="tliMSend_c" type="Events:tliMSend_c"/>
<xsd:element name="tliMSend_m_BC" type="Events:tliMSend_m_BC"/>
<xsd:element name="tliMSend_c_BC" type="Events:tliMSend_c_BC"/>
<xsd:element name="tliMSend_m_MC" type="Events:tliMSend_m_MC"/>
<xsd:element name="tliMSend_c_MC" type="Events:tliMSend_c_MC"/>
<xsd:element name="tliMDetected_m" type="Events:tliMDetected_m"/>
<xsd:element name="tliMDetected_c" type="Events:tliMDetected_c"/>
<xsd:element name="tliMMismatch_m" type="Events:tliMMismatch_m"/>
<xsd:element name="tliMMismatch_c" type="Events:tliMMismatch_c"/>
<xsd:element name="tliMReceive_m" type="Events:tliMReceive_m"/>
<xsd:element name="tliMReceive_c" type="Events:tliMReceive_c"/>

<!-- synchronous communication -->
<xsd:element name="tliPrCall_m" type="Events:tliPrCall_m"/>
<xsd:element name="tliPrCall_c" type="Events:tliPrCall_c"/>
<xsd:element name="tliPrCall_m_BC" type="Events:tliPrCall_m_BC"/>
<xsd:element name="tliPrCall_c_BC" type="Events:tliPrCall_c_BC"/>
<xsd:element name="tliPrCall_m_MC" type="Events:tliPrCall_m_MC"/>
<xsd:element name="tliPrCall_c_MC" type="Events:tliPrCall_c_MC"/>

<xsd:element name="tliPrGetCallDetected_m" type="Events:tliPrGetCallDetected_m"/>
<xsd:element name="tliPrGetCallDetected_c" type="Events:tliPrGetCallDetected_c"/>
<xsd:element name="tliPrGetCallMismatch_m" type="Events:tliPrGetCallMismatch_m"/>
<xsd:element name="tliPrGetCallMismatch_c" type="Events:tliPrGetCallMismatch_c"/>
<xsd:element name="tliPrGetCall_m" type="Events:tliPrGetCall_m"/>
<xsd:element name="tliPrGetCall_c" type="Events:tliPrGetCall_c"/>

<xsd:element name="tliPrReply_m" type="Events:tliPrReply_m"/>
<xsd:element name="tliPrReply_c" type="Events:tliPrReply_c"/>
<xsd:element name="tliPrReply_m_BC" type="Events:tliPrReply_m_BC"/>
<xsd:element name="tliPrReply_c_BC" type="Events:tliPrReply_c_BC"/>
<xsd:element name="tliPrReply_m_MC" type="Events:tliPrReply_m_MC"/>
<xsd:element name="tliPrReply_c_MC" type="Events:tliPrReply_c_MC"/>

<xsd:element name="tliPrGetReplyDetected_m" type="Events:tliPrGetReplyDetected_m"/>
<xsd:element name="tliPrGetReplyDetected_c" type="Events:tliPrGetReplyDetected_c"/>
<xsd:element name="tliPrGetReplyMismatch_m" type="Events:tliPrGetReplyMismatch_m"/>
<xsd:element name="tliPrGetReplyMismatch_c" type="Events:tliPrGetReplyMismatch_c"/>
<xsd:element name="tliPrGetReply_m" type="Events:tliPrGetReply_m"/>
<xsd:element name="tliPrGetReply_c" type="Events:tliPrGetReply_c"/>

<xsd:element name="tliPrRaise_m" type="Events:tliPrRaise_m"/>
<xsd:element name="tliPrRaise_c" type="Events:tliPrRaise_c"/>
<xsd:element name="tliPrRaise_m_BC" type="Events:tliPrRaise_m_BC"/>
<xsd:element name="tliPrRaise_c_BC" type="Events:tliPrRaise_c_BC"/>
<xsd:element name="tliPrRaise_m_MC" type="Events:tliPrRaise_m_MC"/>
<xsd:element name="tliPrRaise_c_MC" type="Events:tliPrRaise_c_MC"/>

<xsd:element name="tliPrCatchDetected_m" type="Events:tliPrCatchDetected_m"/>
<xsd:element name="tliPrCatchDetected_c" type="Events:tliPrCatchDetected_c"/>
<xsd:element name="tliPrCatchMismatch_m" type="Events:tliPrCatchMismatch_m"/>
<xsd:element name="tliPrCatchMismatch_c" type="Events:tliPrCatchMismatch_c"/>
<xsd:element name="tliPrCatch_m" type="Events:tliPrCatch_m"/>
<xsd:element name="tliPrCatch_c" type="Events:tliPrCatch_c"/>

<xsd:element name="tliPrCatchTimeoutDetected"
                type="Events:tliPrCatchTimeoutDetected"/>
<xsd:element name="tliPrCatchTimeout" type="Events:tliPrCatchTimeout"/>

<!-- components -->
<xsd:element name="tliCCreate" type="Events:tliCCreate"/>
<xsd:element name="tliCStart" type="Events:tliCStart"/>
<xsd:element name="tliCRunning" type="Events:tliCRunning"/>
<xsd:element name="tliCAlive" type="Events:tliCAlive"/>
<xsd:element name="tliCStop" type="Events:tliCStop"/>
<xsd:element name="tliCKill" type="Events:tliCKill"/>
<xsd:element name="tliCDoneMismatch" type="Events:tliCDoneMismatch"/>
<xsd:element name="tliCDone" type="Events:tliCDone"/>
<xsd:element name="tliCKilledMismatch" type="Events:tliCKilledMismatch"/>

```

```

<xsd:element name="tliCKilled" type="Events:tliCKilled"/>
<xsd:element name="tliCTerminated" type="Events:tliCTerminated"/>

<!-- ports -->
<xsd:element name="tliPConnect" type="Events:tliPConnect"/>
<xsd:element name="tliPDisconnect" type="Events:tliPDisconnect"/>
<xsd:element name="tliPMap" type="Events:tliPMap"/>
<xsd:element name="tliPMapParam" type="Events:tliPMapParam"/>
<xsd:element name="tliPUnmap" type="Events:tliPUnmap"/>
<xsd:element name="tliPUnmapParam" type="Events:tliPUnmapParam"/>
<xsd:element name="tliPClear" type="Events:tliPClear"/>
<xsd:element name="tliPStart" type="Events:tliPStart"/>
<xsd:element name="tliPStop" type="Events:tliPStop"/>
<xsd:element name="tliPHalt" type="Events:tliPHalt"/>

<!-- codec -->
<xsd:element name="tliDecode" type="Events:tliDecode"/>
<xsd:element name="tliEncode" type="Events:tliEncode"/>

<!-- timers -->
<xsd:element name="tliTTimeoutDetected" type="Events:tliTTimeoutDetected"/>
<xsd:element name="tliTTimeoutMismatch" type="Events:tliTTimeoutMismatch"/>
<xsd:element name="tliTTimeout" type="Events:tliTTimeout"/>
<xsd:element name="tliTStart" type="Events:tliTStart"/>
<xsd:element name="tliTStop" type="Events:tliTStop"/>
<xsd:element name="tliTRead" type="Events:tliTRead"/>
<xsd:element name="tliTRunning" type="Events:tliTRunning"/>

<!-- scopes -->
<xsd:element name="tliSEnter" type="Events:tliSEnter"/>
<xsd:element name="tliSLeave" type="Events:tliSLeave"/>

<!-- statements -->
<xsd:element name="tliVar" type="Events:tliVar"/>
<xsd:element name="tliModulePar" type="Events:tliModulePar"/>
<xsd:element name="tliGetVerdict" type="Events:tliGetVerdict"/>
<xsd:element name="tliSetVerdict" type="Events:tliSetVerdict"/>
<xsd:element name="tliLog" type="Events:tliLog"/>

<!-- alt -->
<xsd:element name="tliAEnter" type="Events:tliAEnter"/>
<xsd:element name="tliALeave" type="Events:tliALeave"/>
<xsd:element name="tliADefaults" type="Events:tliADefaults"/>
<xsd:element name="tliAActivate" type="Events:tliAActivate"/>
<xsd:element name="tliADeactivate" type="Events:tliADeactivate"/>
<xsd:element name="tliANomatch" type="Events:tliANomatch"/>
<xsd:element name="tliARepet" type="Events:tliARepet"/>
<xsd:element name="tliAWait" type="Events:tliAWait"/>

<!-- action -->
<xsd:element name="tliAction" type="Events:tliAction"/>

<!-- match -->
<xsd:element name="tliMatch" type="Events:tliMatch"/>
<xsd:element name="tliMatchMismatch" type="Events:tliMatchMismatch"/>

<!-- info -->
<xsd:element name="tliInfo" type="Events:tliInfo"/>

<!-- check -->
<xsd:element name="tliMChecked_m" type="Events:tliMChecked_m"/>
<xsd:element name="tliMChecked_c" type="Events:tliMChecked_c"/>
<xsd:element name="tliPrGetCallChecked_m" type="Events:tliPrGetCallChecked_m"/>
<xsd:element name="tliPrGetCallChecked_c" type="Events:tliPrGetCallChecked_c"/>
<xsd:element name="tliPrGetReplyChecked_m" type="Events:tliPrGetReplyChecked_m"/>
<xsd:element name="tliPrGetReplyChecked_c" type="Events:tliPrGetReplyChecked_c"/>
<xsd:element name="tliPrCatchChecked_m" type="Events:tliPrCatchChecked_m"/>
<xsd:element name="tliPrCatchChecked_c" type="Events:tliPrCatchChecked_c"/>
<xsd:element name="tliCheckedAny_m" type="Events:tliCheckedAny_m"/>
<xsd:element name="tliCheckedAny_c" type="Events:tliCheckedAny_c"/>
<xsd:element name="tliCheckAnyMismatch_m" type="Events:tliCheckAnyMismatch_m"/>
<xsd:element name="tliCheckAnyMismatch_c" type="Events:tliCheckAnyMismatch_c"/>

<!-- rnd -->
<xsd:element name="tliRnd" type="Events:tliRnd"/>

<!-- evaluation of @lazy and @fuzzy variables -->
<xsd:element name="tliEvaluate" type="Events:tliEvaluate"/>

```

```
</xsd:choice>  
</xsd:complexType>  
</xsd:schema>
```

Annex C (informative): Use scenarios

C.0 Introduction

This annex contains use scenarios that should help users of the TCI and tool vendors providing the TCI understand the semantics of the operations defined within the present document.

The scenarios are defined in terms of UML sequence diagrams. The sequence diagram shows the interactions between the TCI entities. The scenarios are explained and where applicable underpinned with a TTCN-3 fragment corresponding to the scenario.

C.1 Initialization, collecting information, logging

C.1.1 Use scenario: initialization

C.1.1.0 Scenario description

The scenario in figure C.1 shows the initialization phase for a test system when a TTCN-3 module is to be selected for execution. At first, a root module has to be set with `tciRootModule`. The module parameters of the root module can be obtained with `tciGetModuleParameters`. Module parameter information can be used to ask the test system user for concrete values for each module parameter. The list of test cases available in the root module can be retrieved with `tciGetTestCases`. These test cases can be directly executed from the test management. Their parameters and their test system interface can be obtained with `tciGetTestCaseParameters` and `tciGetTestCaseTSI`, respectively.

C.1.1.1 Sequence diagram

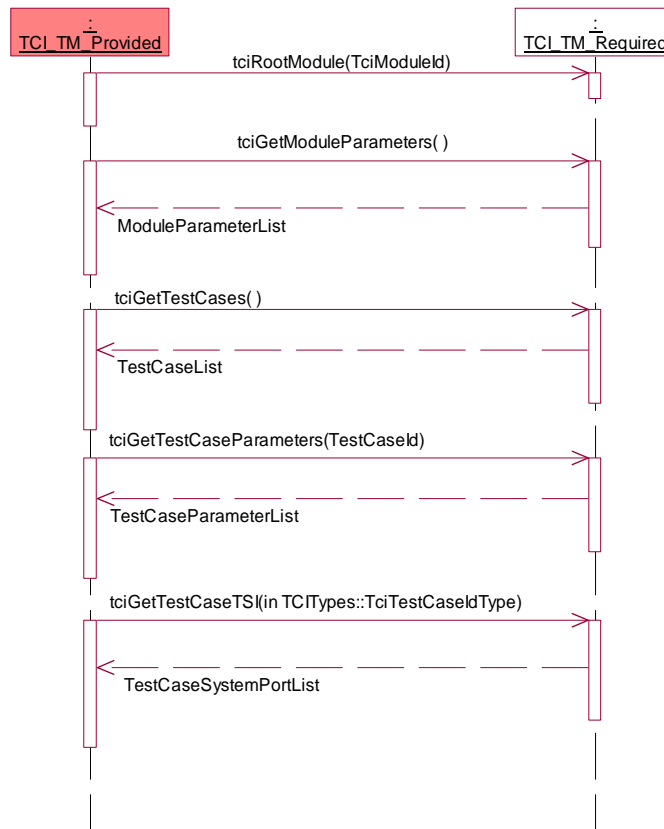

Figure C.1: Use scenario - initialization

C.1.1.2 TTCN-3 fragment

The initialization is outside the scope of TTCN-3.

C.1.2 Use scenario: requesting module parameters

C.1.2.0 Scenario description

The scenario in figure C.2 shows how a test component requests the actual value of a module parameter needed for the execution of its test behaviour. At first, the type of a module parameter is requested, then the value can be constructed by the TM and given to the TE.

C.1.2.1 Sequence diagram

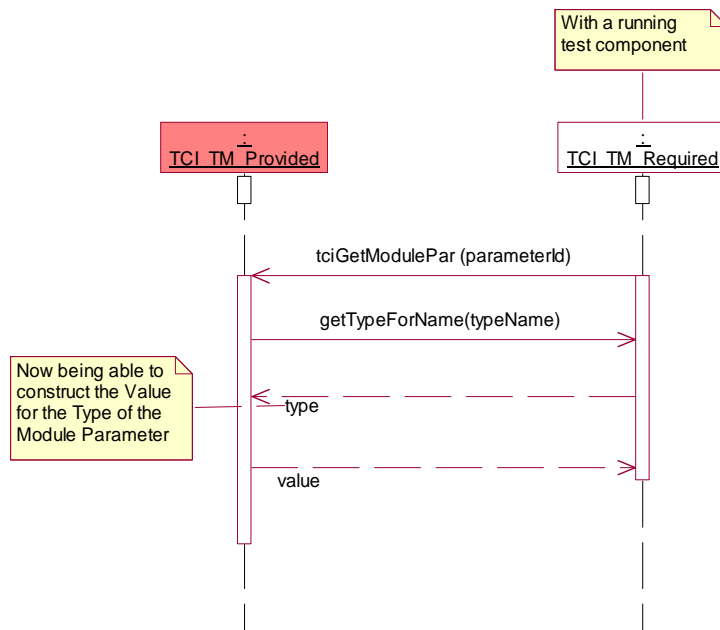

Figure C.2: Use scenario - requesting module Pars

C.1.2.2 TTCN-3 fragment

```

module AModule {
  ...
  modulepar {
    integer AModulePar
  }
  ...
  function AFunction (...) ... {
    integer x;
    ...
    x:= 2+AModulePar; // an expression with a module parameter
    ...
  }
  ...
}

```

C.1.3 Use scenario: logging

C.1.3.0 Scenario description

The scenario in figure C.3 shows logging of information during the execution of a test behaviour by a test component. The message to be logged is propagated to the test logging.

C.1.3.1 Sequence diagram

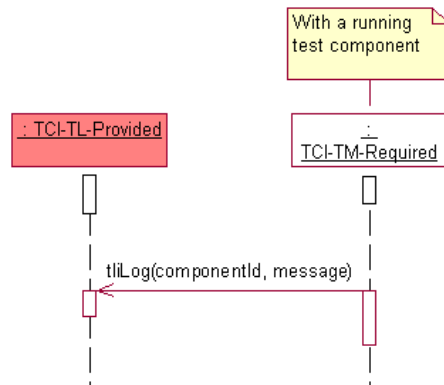

Figure C.3: Use scenario - logging

C.1.3.2 TTCN-3 fragment

```

module AModule {
  ...
  function AFunction (...) ... {
    ...
    log("AMessage");
    ...
  }
  ...
}

```

C.2 Execution of test cases and control

C.2.1 Use scenario: execution of control

C.2.1.0 Scenario description

The scenario in figure C.4 shows the sequence of operations to execute the control part of a TTCN-3 module. The module containing the control part is selected first, then the control is started, then it is executed until the execution is terminated by TE.

C.2.1.1 Sequence diagram

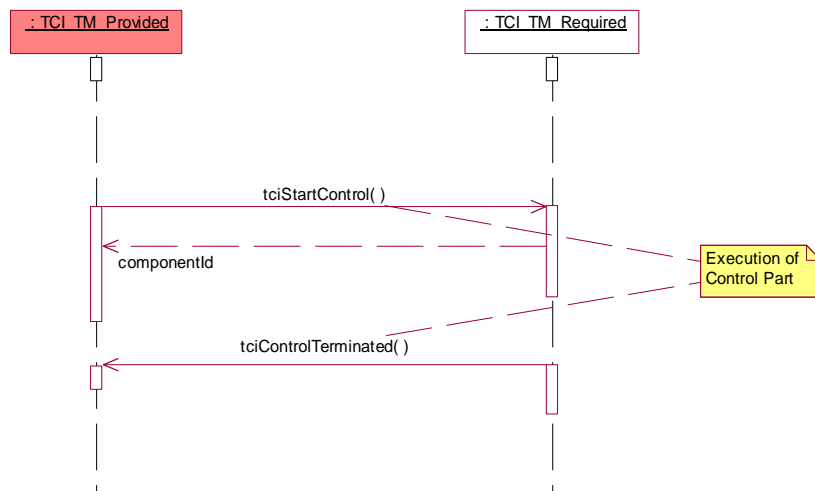

Figure C.4: Use scenario - execution of control

C.2.1.2 TTCN-3 fragment

```

module AModule {
  ...
  control {
    ...
  }
  ...
}
  
```

C.2.2 Use scenario: test case execution within control

C.2.2.0 Scenario description

The scenario in figure C.5 shows how a test case is executed within the control part.

C.2.2.1 Sequence diagram

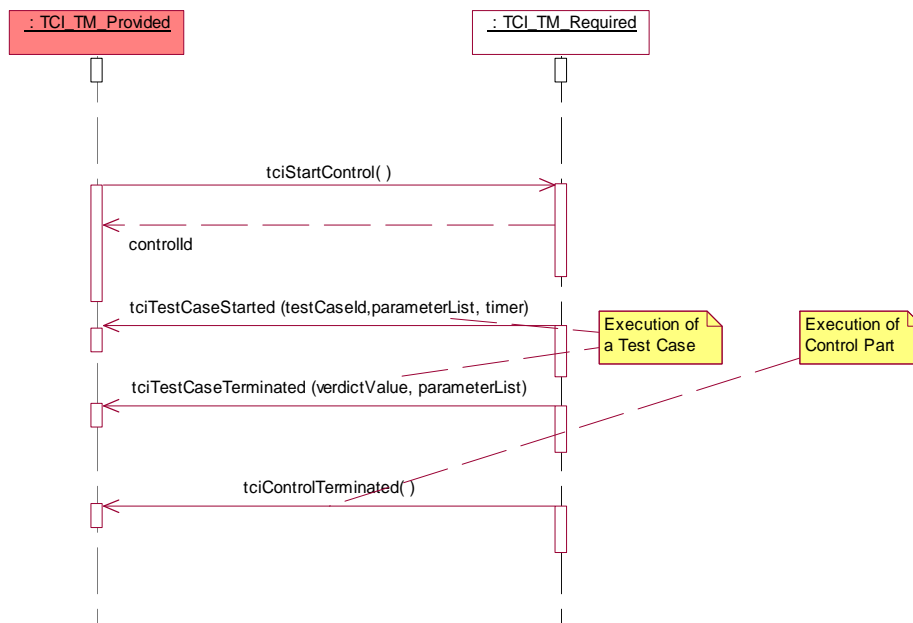

Figure C.5: Use scenario - test case execution within control

C.2.2.2 TTCN-3 fragment

```

module AModule {
  ...
  testcase ATestCase(...)... {
    ... //the test case behaviour
  }
  ...
  control {
    ...
    execute(ATestCase(...));
    ...
  }
  ...
}

```

C.2.3 Use scenario: direct test case execution

C.2.3.0 Scenario description

The scenario in figure C.6 shows how a test case can be directly executed from the test management outside the control part. After selecting the TTCN-3 module containing the test case to be executed, the start of the test case is requested. When the test case completes its execution, the test management is informed by the TE of the test case termination.

C.2.3.1 Sequence diagram

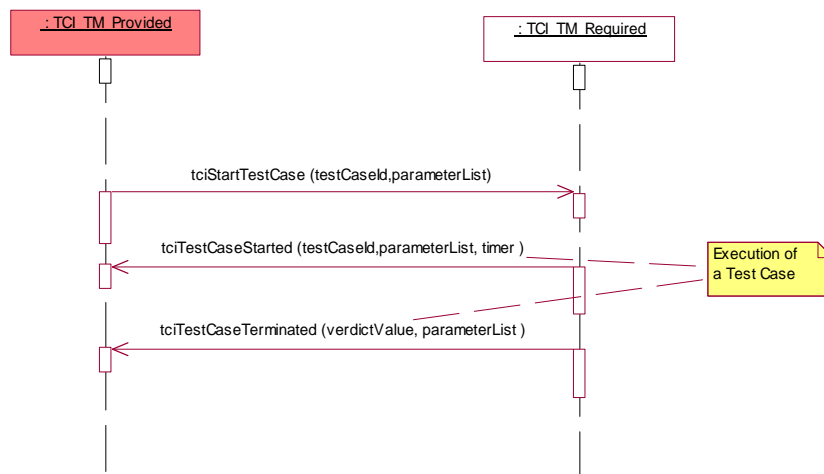

Figure C.6: Use scenario - direct test case execution

C.2.3.2 TTCN-3 fragment

The direct execution of a test case is outside the scope of TTCN-3.

C.2.4 Use scenario: execute test case to TRI

C.2.4.0 Scenario description

The scenario in figure C.7 shows how the TRI is informed about the execution of a test case so that it can set up and initialize system ports when needed. The execute test case request has to be issued before the test behaviour on the MTC of the current test case is started.

C.2.4.1 Sequence diagram

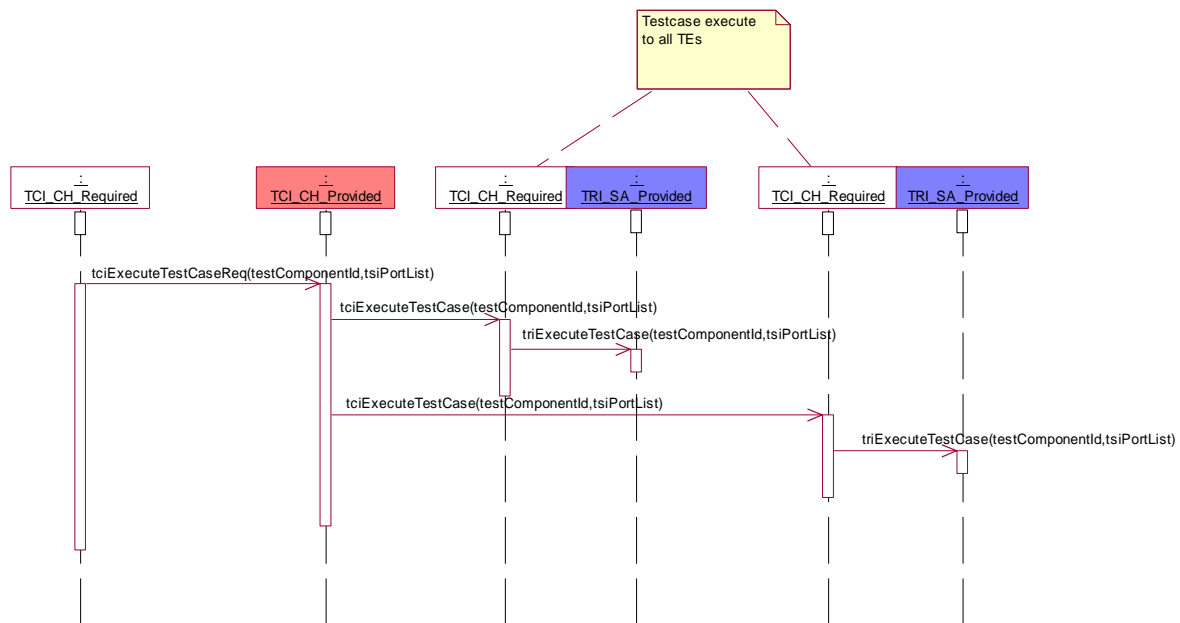

Figure C.7: Use scenario - execute test case to TRI

C.2.4.2 TTCN-3 fragment

```

module AModule {
  ...
  testcase ATestCase(...)... {
    ... //the test case behaviour
  }
  ...
  control {
    ...
    execute(ATestCase(...));
    ...
  }
  ...
}

```

C.3 Component handling

C.3.1 Use scenario: local control component creation

C.3.1.0 Scenario description

The scenario in figure C.8 demonstrates the creation of the control component on the same node where the user interface to the test management TCI-TM resides. A control component is created whenever the control part of a TTCN-3 module is executed. Whenever the test management TCI-TM issues the start of the control part, a create test component request is sent to the TCI-CH, which propagates it to the TE where the control component should be created. In this case it is the TE on the same node. The identifier for the control component is returned and given to the TCI-TM. The identifier is then used to start the behaviour of the control part on the control component.

C.3.1.1 Sequence diagram

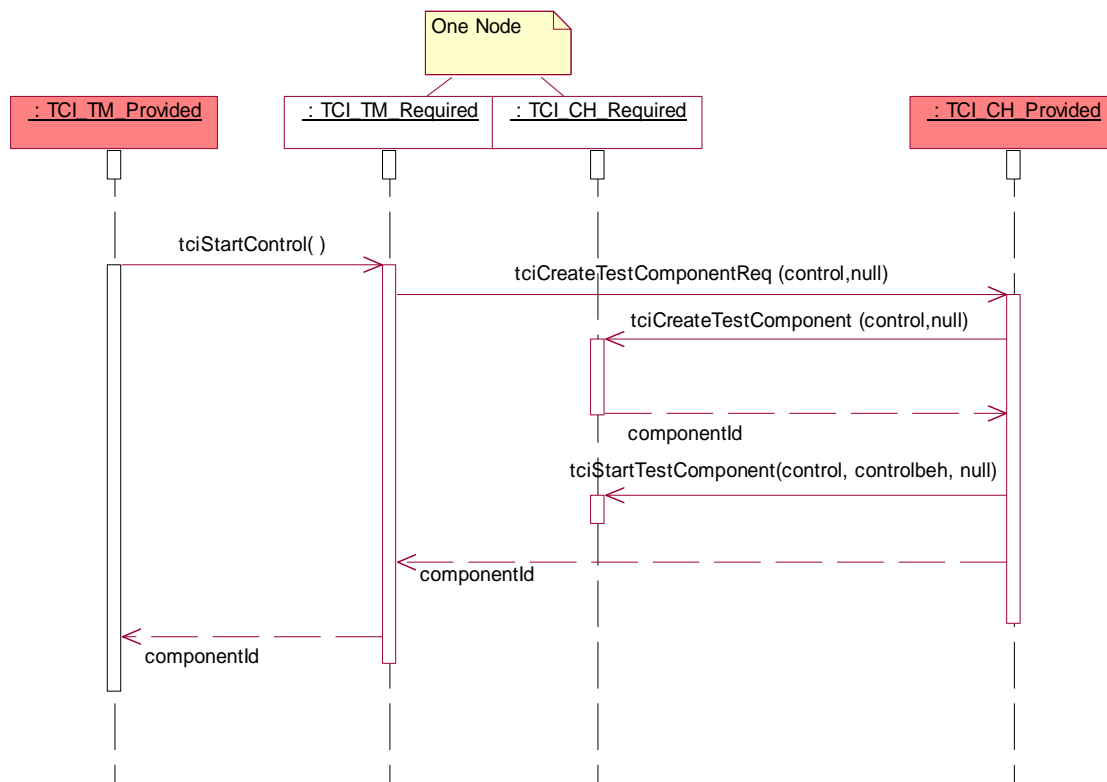

Figure C.8: Use scenario - local control component creation

C.3.1.2 TTCN-3 fragment

```

module AModule {
  ...
  control {
    ...
  }
  ...
}
  
```

C.3.2 Use scenario: remote control component creation

C.3.2.0 Scenario description

The scenario in figure C.9 demonstrates the creation of the control component on another node than where the user interface to the test management TCI-TM resides. A control component is created whenever the control part of a TTCN-3 module is executed. Whenever the test management TCI-TM issues the start of the control part, a create test component request is sent to the TCI-CH, which propagates it to the TE where the control component should be created. In this case it is the TE on another remote node. The identifier for the control component is returned and given to the TCI-TM. The identifier is then used to start the behaviour of the control part on the control component.

C.3.2.1 Sequence diagram

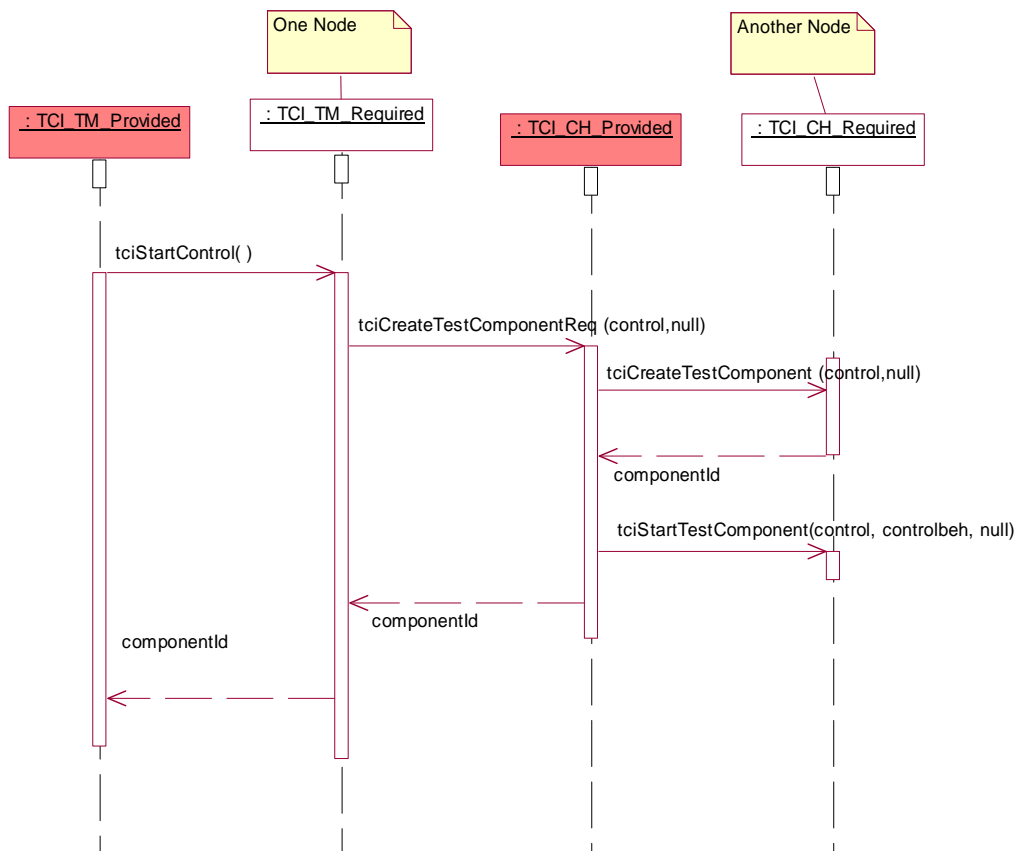

Figure C.9: Use scenario - remote control component creation

C.3.2.2 TTCN-3 fragment

```

module AModule {
  ...
  control {
    ...
  }
  ...
}

```

C.3.3 Use scenario: local MTC creation

C.3.3.0 Scenario description

The scenario in figure C.10 demonstrates the local creation of the main test component. Local is meant for two cases:

- 1) on the same node where the user interface to the test management TCI-TM resides (when a test case is started directly); or
- 2) on the same node where the control component resides (when a test case is executed from a control part).

A main test component is created whenever a test case is executed: a create test component request is sent to the TCI-CH, which propagates it to the TE where the main test component should be created. In this case it is the TE on the same node. The identifier for the main test component is returned and given to the TCI-TM. The identifier is then used to start the test case behaviour on the main test component (this is not shown here, but handled the same way as in the scenarios described in clauses C.2.2 and C.2.3).

C.3.3.1 Sequence diagram

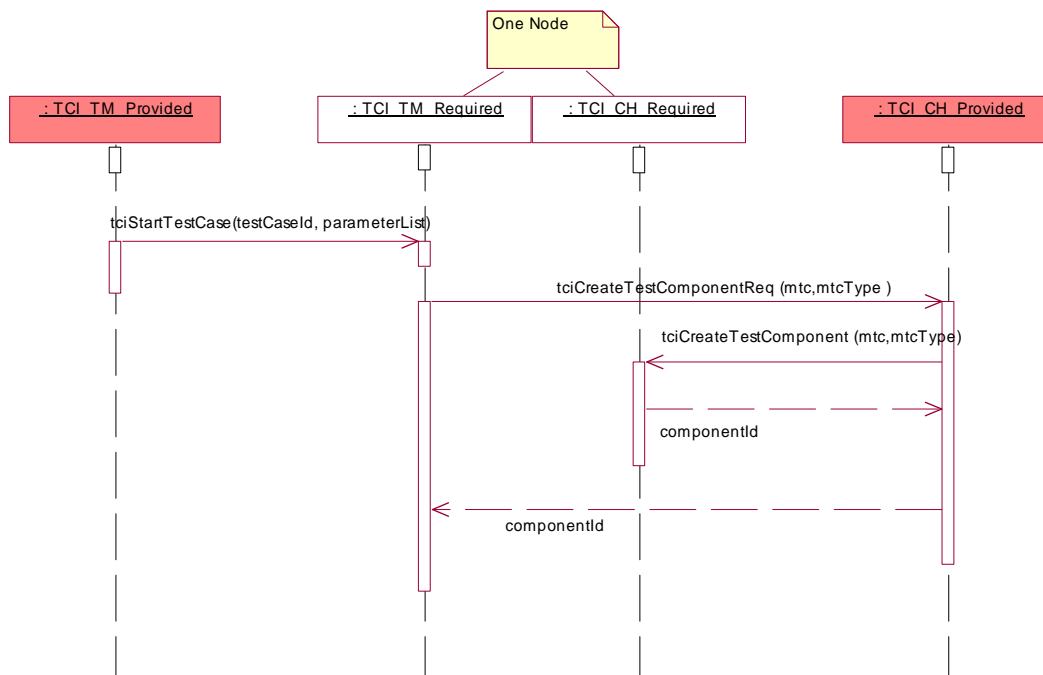

Figure C.10: Use scenario - local MTC creation

C.3.3.2 TTCN-3 fragment

```

module AModule {
  ...
  testcase ATestCase (...)runs on MTCType... {
    ... //the test case behaviour
  }
  ...
}
  
```

C.3.4 Use scenario: remote MTC creation

C.3.4.0 Scenario description

The scenario in figure C.11 demonstrates the remote creation of the main test component. Remote is meant for two cases:

- 1) on another node than where the user interface to the test management TCI-TM resides (when a test case is started directly); or
- 2) on another node than where the control component resides (when a test case is executed from a control part).

A main test component is created whenever a test case is executed: a create test component request is sent to the TCI-CH, which propagates it to the TE where the main test component should be created. In this case it is the TE on another node. The identifier for the main test component is returned and given to the TCI-TM. The identifier is then used to start the test case behaviour on the main test component (this is not shown here, but handled the same way as in the scenarios described in clauses C.2.2 and C.2.3).

C.3.4.1 Sequence diagram

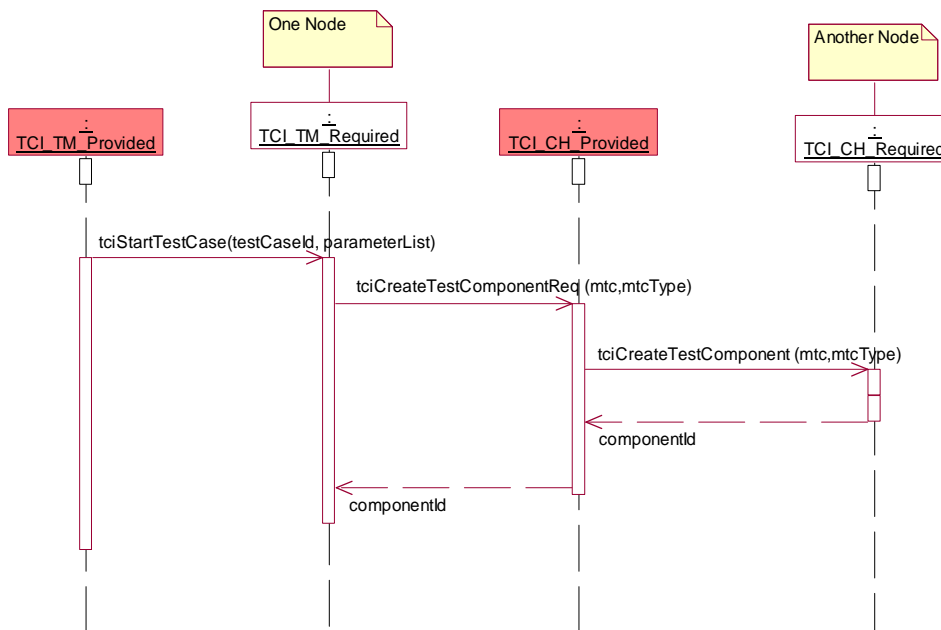

Figure C.11: Use scenario - remote MTC creation

C.3.4.2 TTCN-3 fragment

```

module AModule {
  ...
  testcase ATestCase(...)runs on MTCType ... {
    ... //the test case behaviour
  }
  ...
}

```

C.3.5 Use scenario: component handling for test case execution within control

C.3.5.0 Scenario description

The scenario in figure C.12 demonstrates the handling of components for the test case execution within a control part. When the control part is started, a control component is created and its component identifier returned to the test management. For each test case to be executed within the control part, a main test component is created and the component identifier returned to the control component. Afterwards, the test case behaviour is started on the main test component and the test management is informed about the start of the test case. When the main test component terminates, a request for the main test component termination together with the local verdict of the main test component is propagated to enable the derivation of the global test verdict and to enable the information about the test case termination.

C.3.5.1 Sequence diagram

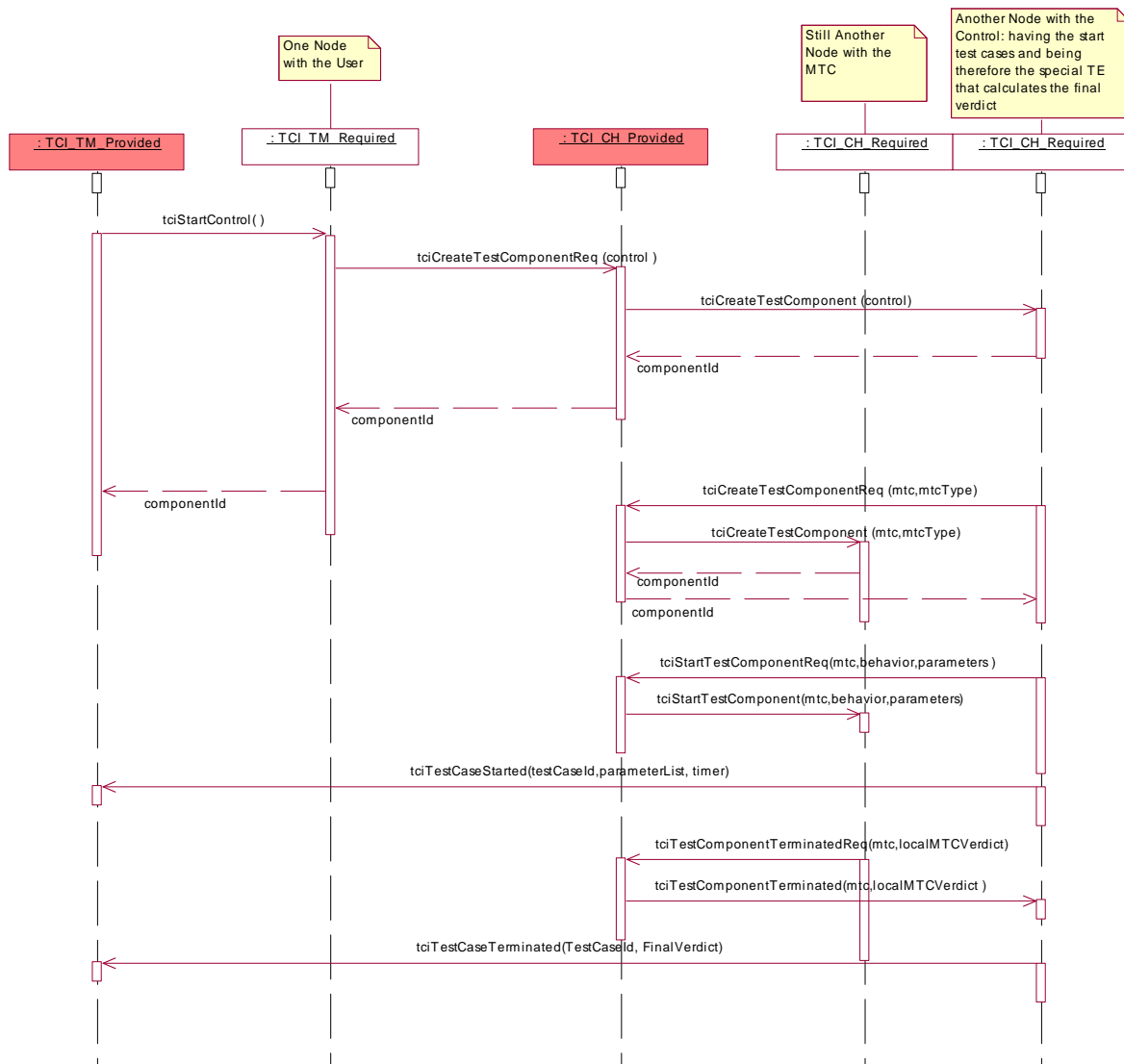

Figure C.12: Use scenario: component handling for test case execution within control

C.3.5.2 TTCN-3 fragment

```

module AModule {
  ...
  testcase ATestCase(...)... {
    ... //the test case behaviour
  }
  ...
  control {
    ...
    execute(ATestCase(...));
    ...
  }
  ...
}

```

C.3.6 Use scenario: component handling for direct test case execution

C.3.6.0 Scenario description

The scenario in figure C.13 shows how test components are handled when a test case is executed directly, i.e. outside a control part. When a test case is started, the main test component is created and the test case behaviour started on this main test component at first. Whenever a parallel test component is used within a test case, it is handled the same: the parallel test component is started first: giving a test component create request to the TCI-CH entity, which propagates the test component create to the TE in which the parallel test component is to be created. The identifier for the created parallel test component is returned. The identifier is then used to start the PTC behaviour for the start operation. When the PTC terminates its execution, a test component terminate request together with the local test verdict is issued to inform TCI-CH about this termination. The same is done when the main test component terminates. In addition, the termination of the main test component leads to the overall termination of the test case.

C.3.6.1 Sequence diagram

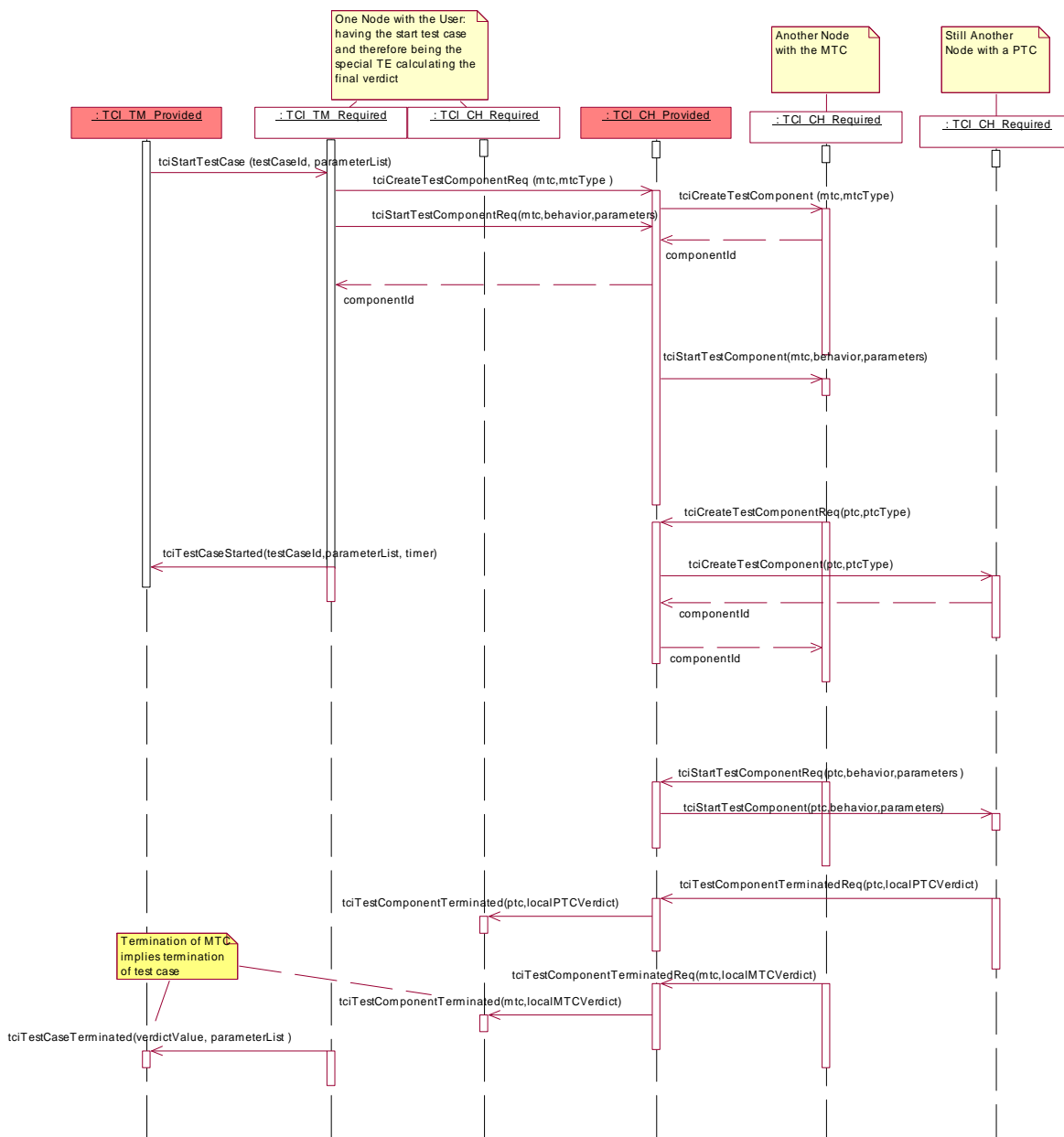

Figure C.13: Use scenario: component handling for direct test case execution

C.3.6.2 TTCN-3 fragment

```

module AModule {
  ...
  function APTCBehaviour(...) runs on APTCType {
    ... //the PTC behaviour
  }
  ...
  testcase ATestCase(...)... {
    ... //the test case behaviour
    var APTCType PTC:= APTCType.create;
    ...
    PTC.start(APTCBehaviour(...));
    ...
  }
  ...
}

```

C.3.7 Use scenario: propagation of map/connect

C.3.7.0 Scenario description

The scenario in figure C.14 shows how ports are mapped. The request to map a port is propagated to the TE where the map is finally performed. The propagation of connect requests works analogously.

C.3.7.1 Sequence diagram

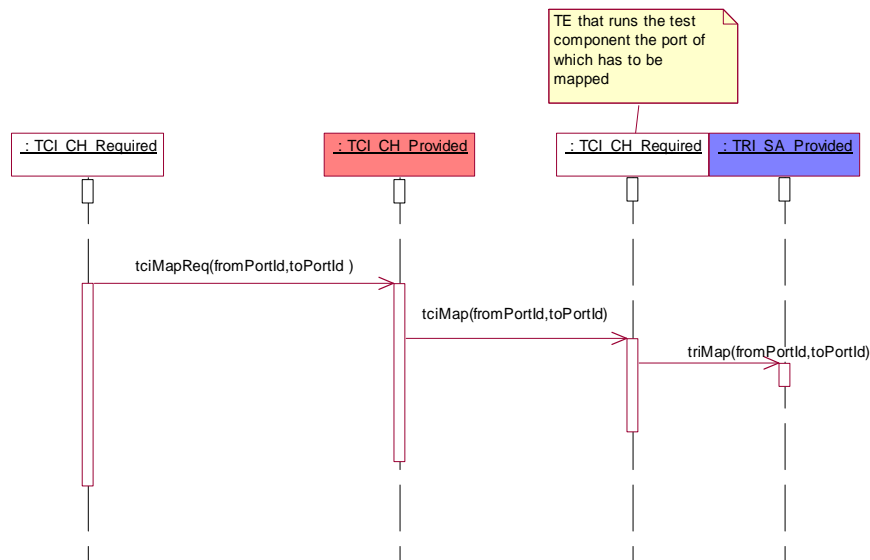

Figure C.14: Use scenario: propagation of map

C.3.7.2 TTCN-3 fragment

```

module AModule {
  ...
  type port A { ... }
  type component CA { port A a }
  type component CB { port A a }
  ...
  testcase ATestCase(...)runs on CA system CB {
    var CA ptc := CA.create;
    ... //the test case behaviour
    map(ptc:a, System:a);
    ...
  }
  ...
}

```

C.3.8 Use scenario: propagation of unmap/disconnect

C.3.8.0 Scenario description

The scenario in figure C.15 shows how ports are unmapped. The request to unmap a port is propagated to the TE where the unmap is finally performed. The propagation of disconnect requests works analogously.

C.3.8.1 Sequence diagram

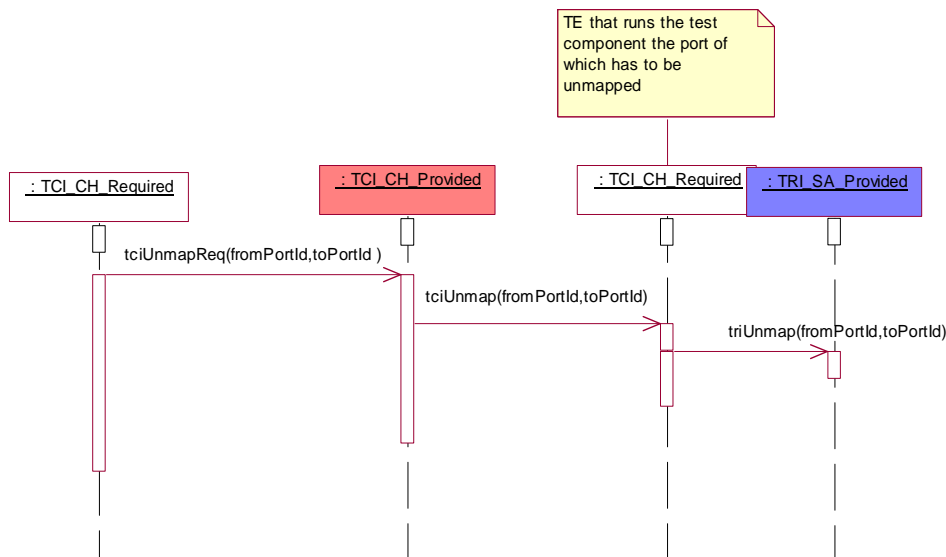

Figure C.15: Use scenario - propagation of map

C.3.8.2 TTCN-3 fragment

```

module AModule {
  ...
  type port A { ... }
  type component CA { port A a }
  type component CB { port A a }
  ...
  testcase ATestCase(...)runs on CA system CB {
    var CA ptc := CA.create;
    ... //the test case behaviour
    unmap(ptc:a,system:a);
    ...
  }
  ...
}

```

C.4 Termination of test cases and control

C.4.1 Use scenario: stop a test case

C.4.1.0 Scenario description

The scenario in figure C.16 shows how a test case is stopped from the test management during test case execution. Once the TM has received information about a started test case, a stop test case can be requested up until receiving the information that the test case has been terminated. Upon stopping a test case, all parallel test components will be stopped and the test system will be reset.

C.4.1.1 Sequence diagram

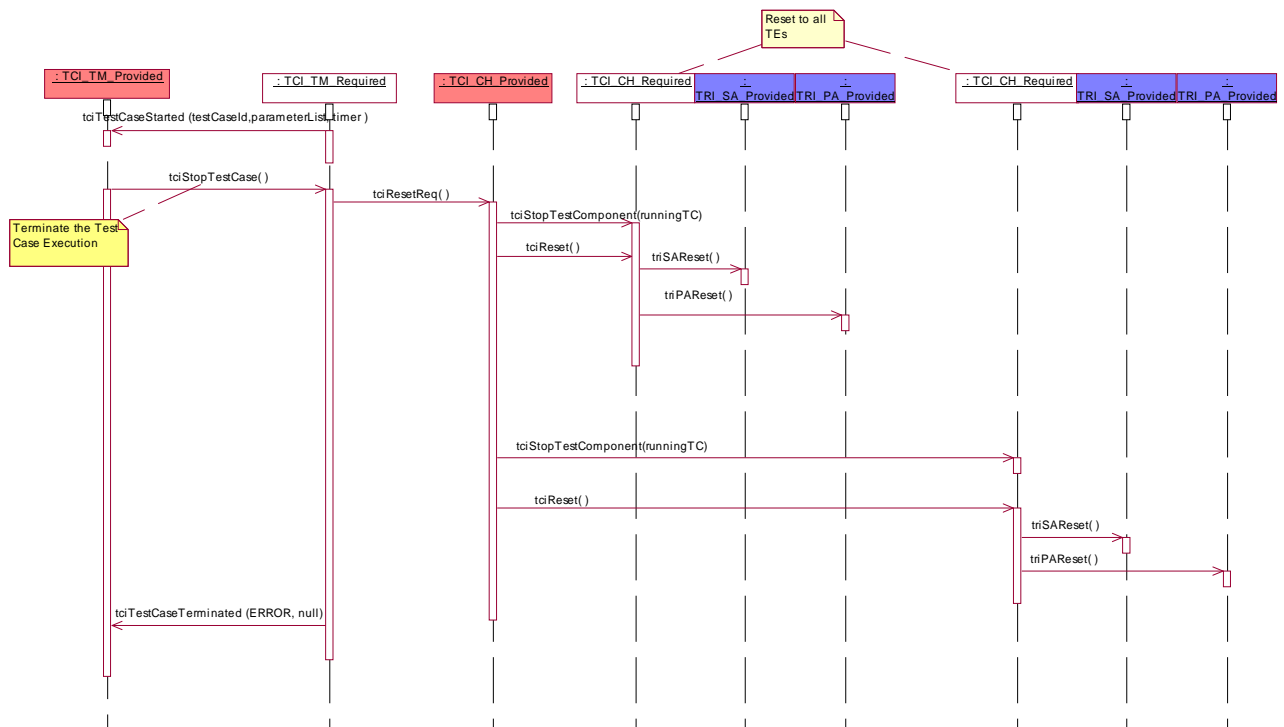

Figure C.16: Use scenario: stop a test case

C.4.1.2 TTCN-3 fragment

There is no TTCN-3 code related to how the TM chooses to implement test case termination. This is outside the scope of TTCN-3.

C.4.2 Use scenario: stop control

C.4.2.0 Scenario description

The scenario in figure C.17 shows how a control part is stopped from the test management during control part execution. A control part can be stopped in between starting the control and its termination. If the control part receives a stop test case request while a test case is executing, the executing test case is to be stopped. Furthermore, the test system is to be reset as described in figure C.16.

C.4.2.1 Sequence diagram

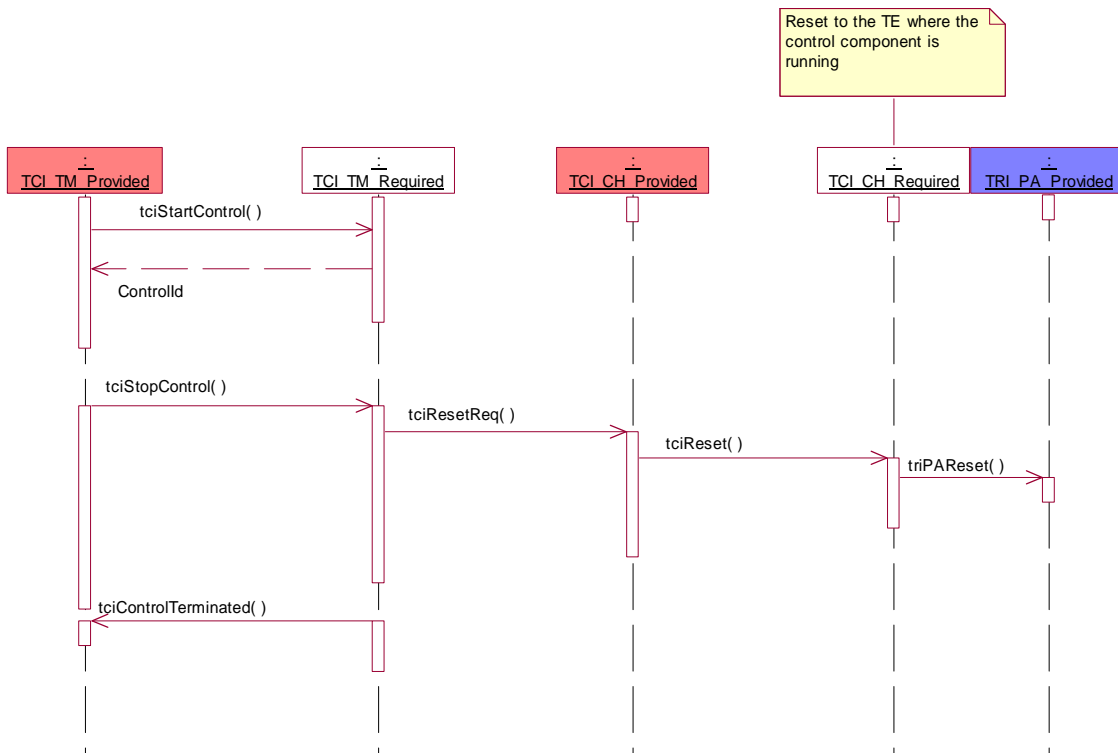

Figure C.17: Use scenario - stop control

C.4.2.2 TTCN-3 fragment

Stopping a control part from the test management is outside the scope of TTCN-3 so that no TTCN-3 fragment exists.

C.4.3 Use scenario: termination of control after error

C.4.3.0 Scenario description

The scenario in figure C.18 shows the handling of error situations during the execution of a control part when no test case is being executed. The test management is informed about the error situation and has then to terminate the execution of the control part explicitly. Upon termination of the control part, the test system will be reset.

C.4.3.1 Sequence diagram

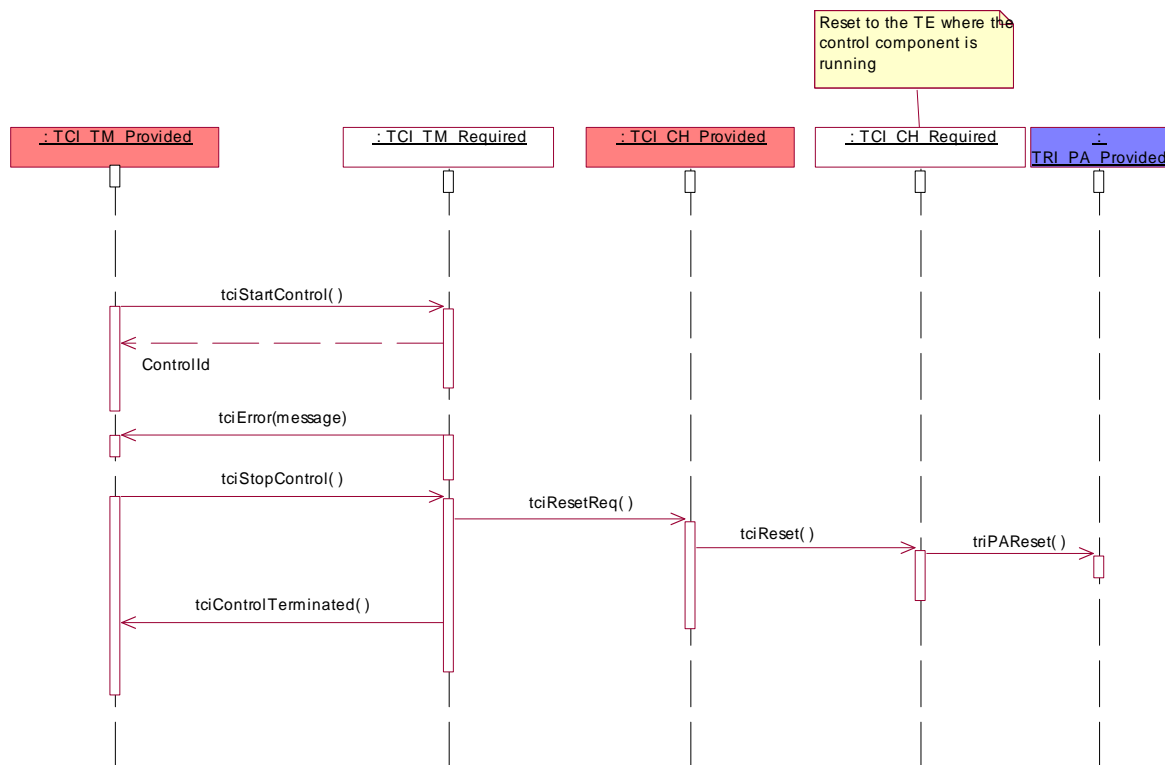

Figure C.18: Use scenario - termination of control after error

C.4.3.2 TTCN-3 fragment

There is no TTCN-3 fragment for this scenario since error situations are exceptional cases in a test system and not a TTCN-3 concept as such. Rather, the TTCN-3 semantics describes various potential error situations in a test system.

C.4.4 Use scenario: termination of a test case after error

C.4.4.0 Scenario description

The scenario in figure C.19 shows the handling of error situations during the direct execution of a test case. The test management is informed about the error situation. The TM has then to explicitly terminate test case execution. Upon stopping a test case, the parallel test components will be stopped and the test system is to be reset.

C.4.4.1 Sequence diagram

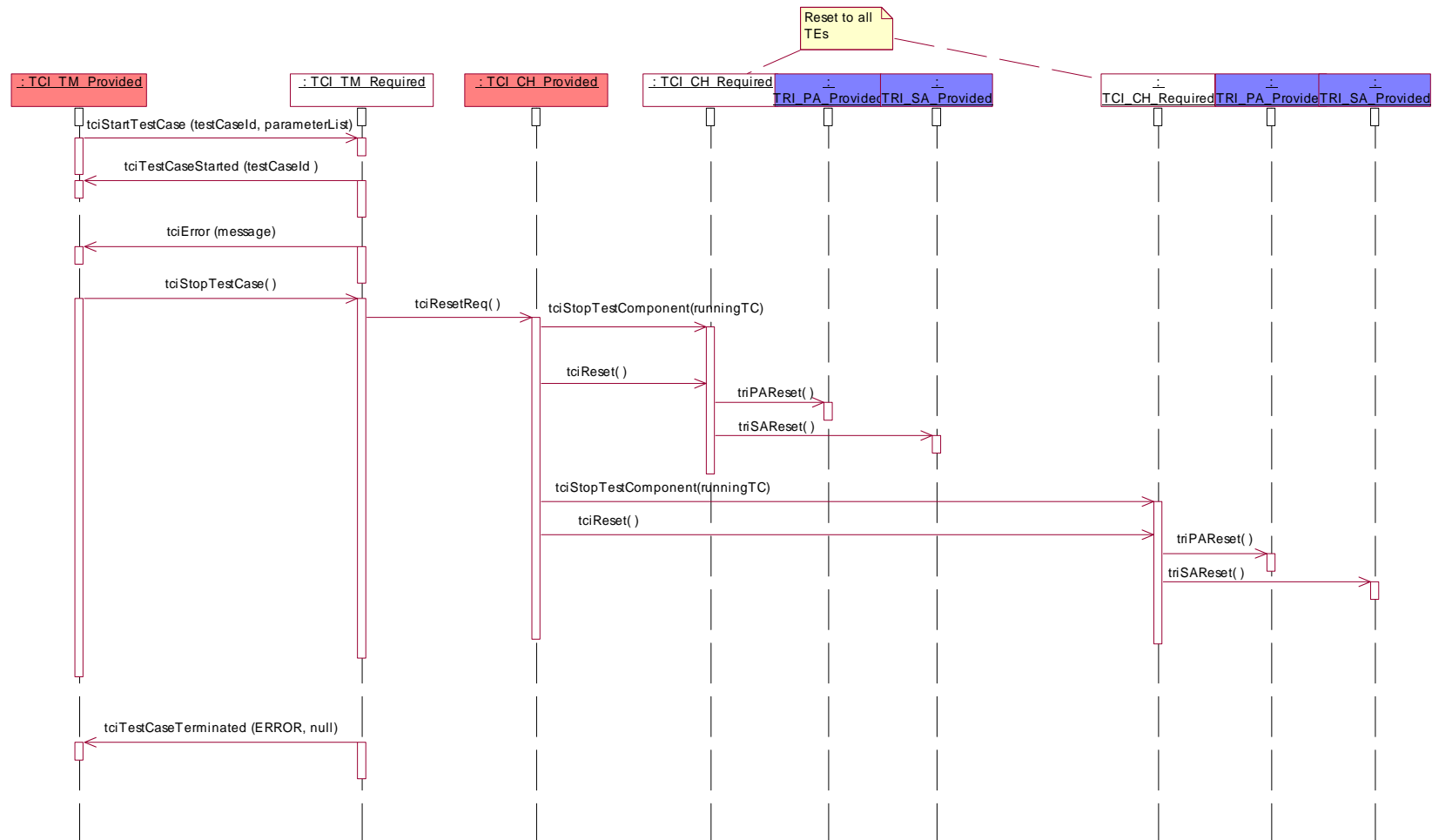

Figure C.19: Use scenario - termination of a test case after error

C.4.4.2 TTCN-3 fragment

There is no TTCN-3 fragment for this scenario since error situations are exceptional cases in a test system and not a TTCN-3 concept as such. Rather, the TTCN-3 semantics describes various potential error situations in a test system.

C.4.5 Use scenario: reset

C.4.5.0 Scenario description

The scenario in figure C.20 shows the reset of the test system. In that case all involved TEs together with their TRI System Adaptors (SA) and Platform Adaptors (PA) are reset.

C.4.5.1 Sequence diagram

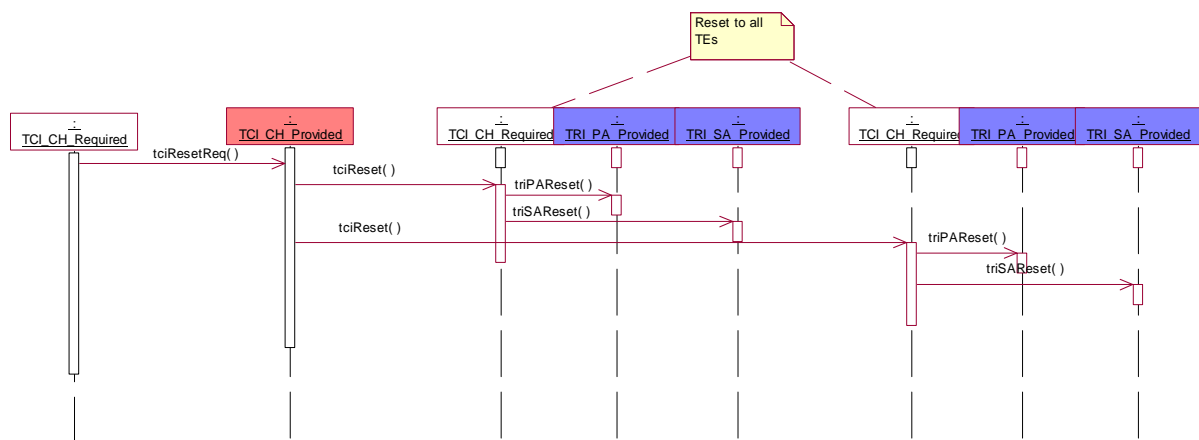

Figure C.20: Use scenario - reset

C.4.5.2 TTCN-3 fragment

There is no TTCN-3 fragment for this scenario since reset as required after error situations are exceptional cases in a test system and not a TTCN-3 concept as such.

C.5 Communication

C.5.1 Use scenario: local intercomponent communication

C.5.1.0 Scenario description

The scenario in figure C.21 shows the communication between test components (main test component or parallel test components), which reside on the same node. A communication request is given to the TCI-CH, which then decide where to enqueue this communication template. In this case, the communication is done locally via the TE on the same node. The scenario shows a message-based communication using the send operation - the scenario is the same for call, reply, and raise operations.

C.5.1.1 Sequence diagram

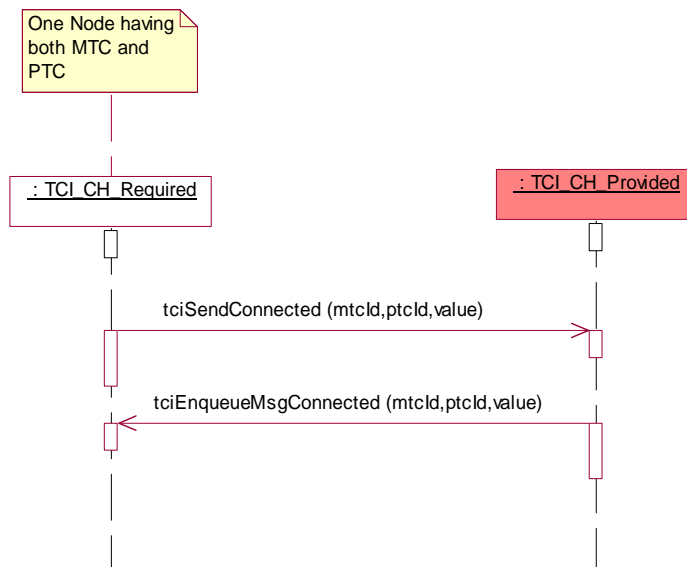

Figure C.21: Use scenario - local intercomponent communication

C.5.1.2 TTCN-3 fragment

```

module AModule {
  ...
  type port APortType message { ... }
  ...
  type component ATCType {
    ...
    APortType APort;
    ...
  }
  ...
  template AType AMessageTemplate { ... }
  ...
  function APTCBehaviour(...) runs on APTCType {
    ... //the PTC behaviour
  }
  ...
  testcase ATestCase(...) runs on ATCType... {
    ... //the test case behaviour
    var ATCType PTC1:= ATCType.create;
    connect(PTC1:APort,mtc:APort);
    ...
    PTC1.start(APTCBehaviour(...));
    APort.send(AMessageTemplate); //sending data to a test component
    ...
  }
  ...
}
  
```

C.5.2 Use scenario: internode communication between test components

C.5.2.0 Scenario description

The scenario in figure C.22 shows the communication between test components (main test component or parallel test components), which reside on different nodes. A communication request is given to the TCI-CH, which then decides where to enqueue this communication template. In this case, the communication is done remotely via the TE on another node. The scenario shows a message based communication using the send operation - the scenario is the same for call, reply, and raise operations.

C.5.2.1 Sequence diagram

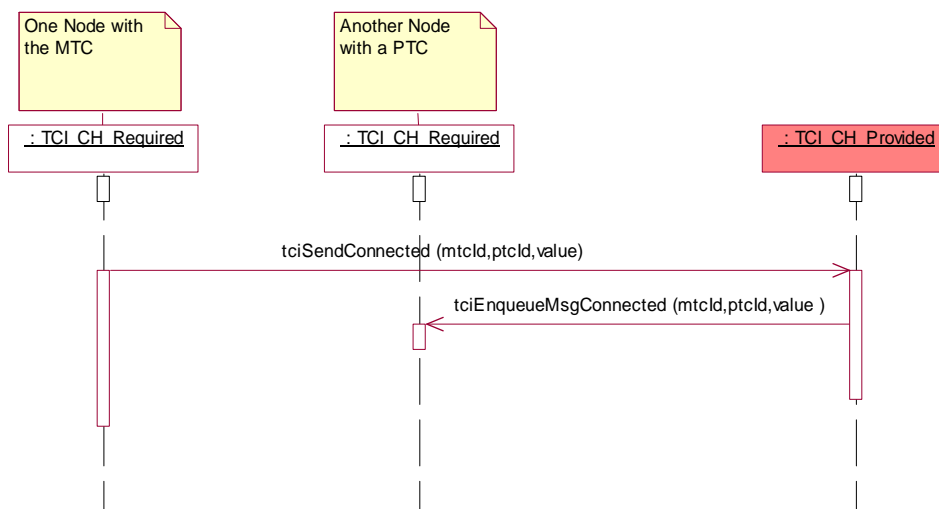

Figure C.22: Use scenario - internode communication between test components

C.5.2.2 TTCN-3 fragment

```

module AModule {
  ...
  type port APortType message { ... }
  ...
  type component ATCType {
    ...
    APortType APort;
    ...
  }
  ...
  template AType AMessageTemplate { ... }
  ...
  function APTCBehaviour(...) runs on APTCType {
    ... //the PTC behaviour
  }
  ...
  testcase ATestCase(...) runs on ATCType... {
    ... //the test case behaviour
    var ATCType PTC1:= ATCType.create;
    connect(PTC1:APort,mtc:APort);
    ...
    PTC1.start(APTCBehaviour(...));
    APort.send(AMessageTemplate); //sending data to a test component
  }
  ...
}

```

C.5.3 Use scenario: encoding

C.5.3.0 Scenario description

The scenario in figure C.23 shows the encoding of data, which is sent to the SUT. The encoded data is received from the coding/decoding entity via the TCI-CD. The encoded value is sent to the SUT via the TRI-SA. The scenario is the same for the call, the reply, and the raise operations.

C.5.3.1 Sequence diagram

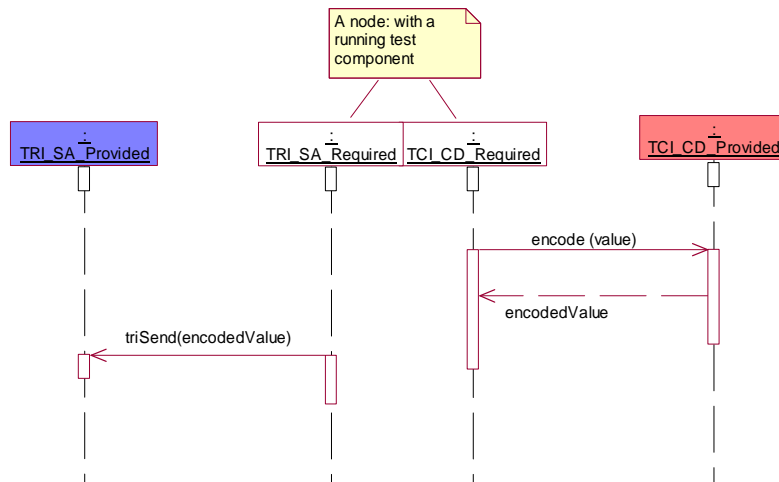

Figure C.23: Use scenario - encoding

C.5.3.2 TTCN-3 fragment

```

module AModule {
  ...
  type port APortType message { ... }
  ...
  type component APTCType {
    ...
    APortType APort;
    ...
  }
  ...
  template AType AMessageTemplate { ... }
  ...
  testcase ATestCase(...) runs on APTCType system APTCType {
    ... //the test case behaviour
    map(mtc:APort,system:APort);
    ...
    APort.send(AMessageTemplate); //sending data to the SUT
    ...
  }
  ...
} with { encoding "..."}
  
```

C.5.4 Use scenario: decoding

C.5.4.0 Scenario description

The scenario in figure C.24 shows the decoding of data, which is received from the SUT via the TRI-SA. The decoded data is received from the coding/decoding entity via the TCI-CD. The scenario is the same for the receive, the getcall, the getreply, the catch, and the check operations.

C.5.4.1 Sequence diagram

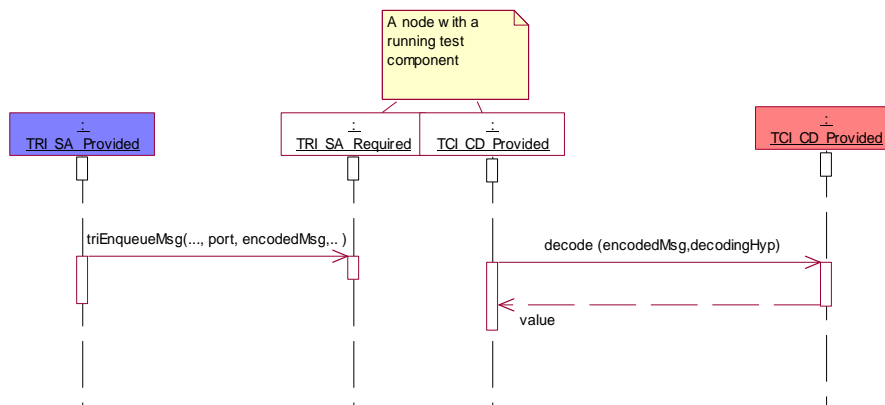

Figure C.24: Use scenario - decoding

C.5.4.2 TTCN-3 fragment

```

module AModule {
  ...
  type port APortType message { ... }
  ...
  type component APTCType {
    ...
    APortType APort;
    ...
  }
  ...
  template AType AMessageTemplate { ... }
  ...
  testcase ATestCase(...) runs on APTCType system APTCType {
    ... //the test case behaviour
    map(mtc:APort,system:APort);
    ...
    APort.receive(AMessageTemplate); //receiving data from the SUT
    ...
  }
  ...
} with { encoding "..."}

```

Annex D (informative): Bibliography

- INTOOL CGI/NPL038 (V2.2): "Generic Compiler/Interpreter interface; GCI Interface Specification" Infrastructural Tools, December 1996.
- ISO/IEC 9646-3 (1998): "Information technology - Open Systems Interconnection - Conformance testing methodology and framework - Part 3: The Tree and Tabular combined Notation (TTCN)".

History

Document history		
V1.1.1	July 2003	Publication
V3.1.1	June 2005	Publication
V3.2.1	February 2007	Publication
V3.3.1	April 2008	Publication
V3.4.1	September 2008	Publication
V4.1.1	June 2009	Publication
V4.2.1	July 2010	Publication
V4.3.1	June 2011	Publication
V4.4.1	April 2012	Publication
V4.5.1	April 2013	Publication
V4.6.1	June 2014	Publication
V4.7.1	June 2015	Publication
V4.8.1	July 2016	Publication
V4.9.1	February 2017	Membership Approval Procedure MV 20170428: 2017-02-27 to 2017-04-28