

ETSI ES 201 873-6 V4.4.1 (2012-04)



ETSI Standard

**Methods for Testing and Specification (MTS);
The Testing and Test Control Notation version 3;
Part 6: TTCN-3 Control Interface (TCI)**

Reference

RES/MTS-136-6 T3 ed441 TCI

Keywords

control, interface, MTS, TCI, testing, TTCN

ETSI

650 Route des Lucioles
F-06921 Sophia Antipolis Cedex - FRANCE

Tel.: +33 4 92 94 42 00 Fax: +33 4 93 65 47 16

Siret N° 348 623 562 00017 - NAF 742 C
Association à but non lucratif enregistrée à la
Sous-Préfecture de Grasse (06) N° 7803/88

Important notice

Individual copies of the present document can be downloaded from:

<http://www.etsi.org>

The present document may be made available in more than one electronic version or in print. In any case of existing or perceived difference in contents between such versions, the reference version is the Portable Document Format (PDF). In case of dispute, the reference shall be the printing on ETSI printers of the PDF version kept on a specific network drive within ETSI Secretariat.

Users of the present document should be aware that the document may be subject to revision or change of status. Information on the current status of this and other ETSI documents is available at

<http://portal.etsi.org/tb/status/status.asp>

If you find errors in the present document, please send your comment to one of the following services:

http://portal.etsi.org/chaicor/ETSI_support.asp

Copyright Notification

No part may be reproduced except as authorized by written permission.
The copyright and the foregoing restriction extend to reproduction in all media.

© European Telecommunications Standards Institute 2012.
All rights reserved.

DECT™, PLUGTESTS™, UMTS™ and the ETSI logo are Trade Marks of ETSI registered for the benefit of its Members.
3GPP™ and LTE™ are Trade Marks of ETSI registered for the benefit of its Members and
of the 3GPP Organizational Partners.
GSM® and the GSM logo are Trade Marks registered and owned by the GSM Association.

Contents

Intellectual Property Rights	15
Foreword.....	15
1 Scope	16
2 References	16
2.1 Normative references	16
2.2 Informative references.....	17
3 Definitions and abbreviations.....	17
3.1 Definitions.....	17
3.2 Abbreviations	18
4 Introduction	19
5 Compliance.....	19
6 General structure of a TTCN-3 test system.....	19
6.1 Entities in a TTCN-3 test system.....	20
6.1.1 Test Management and Control (TMC).....	21
6.1.1.1 Test Management (TM)	21
6.1.1.2 Coding and Decoding (CD)	21
6.1.1.3 Component Handling (CH)	21
6.1.1.4 Test Logging (TL).....	23
6.1.2 TTCN-3 Executable (TE)	23
6.1.3 SUT Adaptor (SA).....	23
6.1.4 Platform Adaptor (PA).....	23
6.2 Execution requirements for a TTCN-3 test system	23
7 TTCN-3 control interface and operations.....	23
7.1 Overview of the TCI.....	23
7.1.1 Correlation between TTCN-3 and TCI operation invocations.....	24
7.1.1.1 TTCN 3 operations with TCI operation equivalent.....	24
7.1.1.2 TTCN 3 operations with TCI operation pair equivalent.....	25
7.1.1.3 TTCN 3 operations without direct TCI operation equivalent.....	25
7.1.1.3.1 Test case stop operation.....	25
7.2 TCI data.....	26
7.2.1 General abstract data types	26
7.2.1.1 Management.....	26
7.2.1.2 Communication	27
7.2.2 Abstract TTCN-3 data types and values	27
7.2.2.1 Abstract TTCN-3 data types	28
7.2.2.2 Abstract TTCN-3 values	29
7.2.2.2.1 The abstract data type Value	29
7.2.2.2.2 The abstract data type IntegerValue	30
7.2.2.2.3 The abstract data type FloatValue	30
7.2.2.2.4 The abstract data type BooleanValue	30
7.2.2.2.5 The abstract data type CharstringValue	30
7.2.2.2.6 The abstract data type UniversalCharstringValue.....	31
7.2.2.2.7 The abstract data type BitstringValue.....	31
7.2.2.2.8 The abstract data type OctetstringValue.....	32
7.2.2.2.9 The abstract data type HexstringValue.....	32
7.2.2.2.10 The abstract data type RecordValue.....	33
7.2.2.2.11 The abstract data type RecordOfValue	33
7.2.2.2.12 The abstract data type UnionValue	34
7.2.2.2.13 The abstract data type EnumeratedValue	34
7.2.2.2.14 The abstract data type VerdictValue	35
7.2.2.2.15 The abstract data type AddressValue	35

7.2.3	Abstract logging types	35
7.2.3.1	The abstract data type TciValueTemplate	35
7.2.3.2	The abstract data type TciNonValueTemplate	35
7.2.3.3	The Value List and Mismatch Types	36
7.2.3.4	The Status Types	36
7.3	TCI operations	36
7.3.1	The TCI-TM interface	38
7.3.1.1	TCI-TM required	38
7.3.1.1.1	tciRootModule	38
7.3.1.1.2	tciGetImportedModules	39
7.3.1.1.3	tciGetModuleParameters	39
7.3.1.1.4	tciGetTestCases	39
7.3.1.1.5	tciGetTestCaseParameters	39
7.3.1.1.6	tciGetTestCaseTSI	39
7.3.1.1.7	tciStartTestCase	40
7.3.1.1.8	tciStopTestCase	40
7.3.1.1.9	tciStartControl	40
7.3.1.1.10	tciStopControl	40
7.3.1.2	TCI-TM provided	40
7.3.1.2.1	tciTestCaseStarted	41
7.3.1.2.2	tciTestCaseTerminated	41
7.3.1.2.3	tciControlTerminated	41
7.3.1.2.4	tciGetModulePar	41
7.3.1.2.5	tciLog	42
7.3.1.2.6	tciError	42
7.3.2	The TCI-CD interface	42
7.3.2.1	TCI-CD required	43
7.3.2.1.1	getTypeForName	43
7.3.2.1.2	getInteger	43
7.3.2.1.3	getFloat	43
7.3.2.1.4	getBoolean	43
7.3.2.1.5	Void	43
7.3.2.1.6	getCharstring	43
7.3.2.1.7	getUniversalCharstring	44
7.3.2.1.8	getHexstring	44
7.3.2.1.9	getBitstring	44
7.3.2.1.10	getOctetstring	44
7.3.2.1.11	getVerdict	44
7.3.2.1.12	tciErrorReq	44
7.3.2.2	TCI-CD provided	44
7.3.2.2.1	decode	45
7.3.2.2.2	encode	45
7.3.3	The TCI-CH interface	45
7.3.3.1	TCI-CH required	46
7.3.3.1.1	tciEnqueueMsgConnected	46
7.3.3.1.2	tciEnqueueCallConnected	46
7.3.3.1.3	tciEnqueueReplyConnected	47
7.3.3.1.4	tciEnqueueRaiseConnected	47
7.3.3.1.5	tciCreateTestComponent	47
7.3.3.1.6	tciStartTestComponent	48
7.3.3.1.7	tciStopTestComponent	48
7.3.3.1.8	tciConnect	48
7.3.3.1.9	tciDisconnect	48
7.3.3.1.10	tciMap	49
7.3.3.1.11	tciMapParam	49
7.3.3.1.12	tciUnmap	49
7.3.3.1.13	tciUnmapParam	49
7.3.3.1.14	tciTestComponentTerminated	50
7.3.3.1.15	tciTestComponentRunning	50
7.3.3.1.16	tciTestComponentDone	50
7.3.3.1.17	tciGetMTC	50
7.3.3.1.18	tciExecuteTestCase	51

7.3.3.1.19	tciParamReset	51
7.3.3.1.20	tciParamKillTestComponent	51
7.3.3.1.21	tciParamTestComponentAlive	51
7.3.3.1.22	tciParamTestComponentKilled	51
7.3.3.2	TCI-CH provided	52
7.3.3.2.1	tciParamSendConnected	52
7.3.3.2.2	tciParamSendConnectedBC	52
7.3.3.2.3	tciParamSendConnectedMC	52
7.3.3.2.4	tciParamCallConnected	53
7.3.3.2.5	tciParamCallConnectedBC	53
7.3.3.2.6	tciParamCallConnectedMC	54
7.3.3.2.7	tciParamReplyConnected	54
7.3.3.2.8	tciParamReplyConnectedBC	55
7.3.3.2.9	tciParamReplyConnectedMC	55
7.3.3.2.10	tciParamRaiseConnected	56
7.3.3.2.11	tciParamRaiseConnectedBC	56
7.3.3.2.12	tciParamRaiseConnectedMC	56
7.3.3.2.13	tciParamCreateTestComponentReq	57
7.3.3.2.14	tciParamStartTestComponentReq	57
7.3.3.2.15	tciParamStopTestComponentReq	57
7.3.3.2.16	tciParamConnectReq	57
7.3.3.2.17	tciParamDisconnectReq	58
7.3.3.2.18	tciParamMapReq	58
7.3.3.2.19	tciParamMapParamReq	58
7.3.3.2.20	tciParamUnmapReq	58
7.3.3.2.21	tciParamUnmapParamReq	59
7.3.3.2.22	tciParamTestComponentTerminatedReq	59
7.3.3.2.23	tciParamTestComponentRunningReq	59
7.3.3.2.24	tciParamTestComponentDoneReq	59
7.3.3.2.25	tciParamGetMTCReq	59
7.3.3.2.26	tciParamExecuteTestCaseReq	60
7.3.3.2.27	tciParamResetReq	60
7.3.3.2.28	tciParamKillTestComponentReq	60
7.3.3.2.29	tciParamTestComponentAliveReq	60
7.3.3.2.30	tciParamTestComponentKilledReq	60
7.3.4	The TCI-TL interface	61
7.3.4.1	TCI-TL provided	61
7.3.4.1.1	tliMExecute	61
7.3.4.1.2	tliMStart	62
7.3.4.1.3	tliMStop	62
7.3.4.1.4	tliMStarted	62
7.3.4.1.5	tliMTerminated	63
7.3.4.1.6	tliMCtrlStart	63
7.3.4.1.7	tliMCtrlStop	63
7.3.4.1.8	tliMCtrlTerminated	64
7.3.4.1.9	tliMSend_m	64
7.3.4.1.10	tliMSend_m_BC	65
7.3.4.1.11	tliMSend_m_MC	65
7.3.4.1.12	tliMSend_c	66
7.3.4.1.13	tliMSend_c_BC	66
7.3.4.1.14	tliMSend_c_MC	66
7.3.4.1.15	tliMDetected_m	67
7.3.4.1.16	tliMDetected_c	67
7.3.4.1.17	tliMMismatch_m	68
7.3.4.1.18	tliMMismatch_c	68
7.3.4.1.19	tliMReceive_m	69
7.3.4.1.20	tliMReceive_c	69
7.3.4.1.21	tliMPrCall_m	70
7.3.4.1.22	tliMPrCall_m_BC	70
7.3.4.1.23	tliMPrCall_m_MC	71
7.3.4.1.24	tliMPrCall_c	71
7.3.4.1.25	tliMPrCall_c_BC	72

7.3.4.1.26	tliPrCall_c_MC.....	72
7.3.4.1.27	tliPrGetCallDetected_m.....	73
7.3.4.1.28	tliPrGetCallDetected_c.....	73
7.3.4.1.29	tliPrGetCallMismatch_m.....	74
7.3.4.1.30	tliPrGetCallMismatch_c.....	74
7.3.4.1.31	tliPrGetCall_m.....	75
7.3.4.1.32	tliPrGetCall_c.....	75
7.3.4.1.33	tliPrReply_m.....	76
7.3.4.1.34	tliPrReply_m_BC.....	76
7.3.4.1.35	tliPrReply_m_MC.....	77
7.3.4.1.36	tliPrReply_c.....	77
7.3.4.1.37	tliPrReply_c_BC.....	78
7.3.4.1.38	tliPrReply_c_MC.....	78
7.3.4.1.39	tliPrGetReplyDetected_m.....	79
7.3.4.1.40	tliPrGetReplyDetected_c.....	79
7.3.4.1.41	tliPrGetReplyMismatch_m.....	80
7.3.4.1.42	tliPrGetReplyMismatch_c.....	80
7.3.4.1.43	tliPrGetReply_m.....	81
7.3.4.1.44	tliPrGetReply_c.....	81
7.3.4.1.45	tliPrRaise_m.....	82
7.3.4.1.46	tliPrRaise_m_BC.....	82
7.3.4.1.47	tliPrRaise_m_MC.....	83
7.3.4.1.48	tliPrRaise_c.....	83
7.3.4.1.49	tliPrRaise_c_BC.....	84
7.3.4.1.50	tliPrRaise_c_MC.....	84
7.3.4.1.51	tliPrCatchDetected_m.....	85
7.3.4.1.52	tliPrCatchDetected_c.....	85
7.3.4.1.53	tliPrCatchMismatch_m.....	86
7.3.4.1.54	tliPrCatchMismatch_c.....	86
7.3.4.1.55	tliPrCatch m.....	87
7.3.4.1.56	tliPrCatch c.....	87
7.3.4.1.57	tliPrCatchTimeoutDetected.....	88
7.3.4.1.58	tliPrCatchTimeout.....	88
7.3.4.1.59	tliCCreate.....	88
7.3.4.1.60	tliCStart.....	89
7.3.4.1.61	tliCRunning.....	89
7.3.4.1.62	tliCALive.....	89
7.3.4.1.63	tliCStop.....	90
7.3.4.1.64	tliCKill.....	90
7.3.4.1.65	tliCDoneMismatch.....	90
7.3.4.1.66	tliCDone.....	91
7.3.4.1.67	tliCKilledMismatch.....	91
7.3.4.1.68	tliCKilled.....	91
7.3.4.1.69	tliCTerminated.....	92
7.3.4.1.70	tliPConnect.....	92
7.3.4.1.71	tliPDisconnect.....	92
7.3.4.1.72	tliPMap.....	93
7.3.4.1.73	tliPMapParam.....	93
7.3.4.1.74	tliPUnmap.....	93
7.3.4.1.75	tliPUnmapParam.....	94
7.3.4.1.76	tliPClear.....	94
7.3.4.1.77	tliPStart.....	94
7.3.4.1.78	tliPStop.....	95
7.3.4.1.79	tliPHalt.....	95
7.3.4.1.80	tliEncode.....	95
7.3.4.1.81	tliDecode.....	96
7.3.4.1.82	tliTTimeoutDetected.....	96
7.3.4.1.83	tliTTimeoutMismatch.....	96
7.3.4.1.84	tliTTimeout.....	97
7.3.4.1.85	tliTStart.....	97
7.3.4.1.86	tliTStop.....	97
7.3.4.1.87	tliTRead.....	98

7.3.4.1.88	tliTRunning	98
7.3.4.1.89	tliSEnter	98
7.3.4.1.90	tliSLeave	99
7.3.4.1.91	tliVar	99
7.3.4.1.92	tliModulePar	99
7.3.4.1.93	tliGetVerdict	100
7.3.4.1.94	tliSetVerdict	100
7.3.4.1.95	tliLog	100
7.3.4.1.96	tliAEnter	100
7.3.4.1.97	tliALeave	101
7.3.4.1.98	tliANomatch	101
7.3.4.1.99	tliARepeat	101
7.3.4.1.100	tliADefaults	101
7.3.4.1.101	tliAActivate	102
7.3.4.1.102	tliADeactivate	102
7.3.4.1.103	tliAWait	102
7.3.4.1.104	tliAction	102
7.3.4.1.105	tliMatch	103
7.3.4.1.106	tliMatchMismatch	103
7.3.4.1.107	tliInfo	103
8	Java language mapping	104
8.1	Introduction	104
8.2	Names and scopes	104
8.2.1	Names	104
8.2.2	Scopes	104
8.3	Type mapping	104
8.3.1	Basic type mapping	104
8.3.2	Structured type mapping	105
8.3.2.1	TciParameterType	105
8.3.2.2	TciParameterPassingModeType	105
8.3.2.3	TciParameterListType	106
8.3.2.4	TciTypeClassType	106
8.3.2.5	TciTestComponentKindType	107
8.3.2.6	TciBehaviourIdType	107
8.3.2.7	TciTestCaseIdType	107
8.3.2.8	TciModuleIdType	107
8.3.2.9	TciModuleParameterIdType	107
8.3.2.10	TciModuleParameterListType	107
8.3.2.11	TciModuleParameterType	108
8.3.2.12	TciParameterTypeListType	108
8.3.2.13	TciParameterTypeType	108
8.3.2.14	TciModuleIdListType	109
8.3.2.15	TciTestCaseIdListType	109
8.3.3	Abstract type mapping	109
8.3.3.1	Type	110
8.3.4	Abstract value mapping	110
8.3.4.1	Value	110
8.3.4.2	IntegerValue	111
8.3.4.3	FloatValue	111
8.3.4.4	BooleanValue	111
8.3.4.5	CharstringValue	111
8.3.4.6	BitstringValue	112
8.3.4.7	OctetstringValue	113
8.3.4.8	UniversalCharstringValue	113
8.3.4.9	HexstringValue	114
8.3.4.10	RecordValue	114
8.3.4.11	RecordOfValue	115
8.3.4.12	UnionValue	116
8.3.4.13	EnumeratedValue	116
8.3.4.14	VerdictValue	117
8.3.4.15	AddressValue	117

8.3.5	Abstract logging types mapping	117
8.3.5.1	TciValueTemplate	117
8.3.5.2	TciNonValueTemplate	118
8.3.5.3	TciValueList	118
8.3.5.4	TciValueDifference	118
8.3.5.5	TciValueDifferenceList	119
8.3.5.6	ComponentStatus	119
8.3.5.7	TimerStatus	119
8.3.5.8	TciStatus	119
8.4	Constants	120
8.5	Mapping of interfaces	121
8.5.1	The TCI-TM interface	121
8.5.1.1	TCI-TM provided	121
8.5.1.2	TCI-TM required	122
8.5.2	The TCI-CD interface	122
8.5.2.1	TCI-CD provided	122
8.5.2.2	TCI-CD required	122
8.5.3	The TCI-CH interface	123
8.5.3.1	TCI-CH provided	123
8.5.3.2	TCI-CH required	124
8.5.4	The TCI-TL interface	125
8.5.4.1	TCI-TL provided	125
8.6	Optional parameters	129
8.7	TCI initialization	129
8.8	Error handling	129
9	ANSI C language mapping	129
9.1	Introduction	129
9.2	Value interfaces	129
9.3	Logging interface	132
9.4	Operation interfaces	133
9.4.1	The TCI-TM interface	133
9.4.1.1	TCI-TM provided	133
9.4.1.2	TCI-TM required	133
9.4.2	The TCI-CD interface	134
9.4.2.1	TCI-CD provided	134
9.4.2.2	TCI-CD required	134
9.4.3	The TCI-CH interface	134
9.4.3.1	TCI-CH provided	134
9.4.3.2	TCI-CH required	135
9.4.4	The TCI-TL interface	135
9.4.4.1	TCI-TL provided	135
9.5	Data	140
9.6	Miscellaneous	141
9.7	Optional parameters	142
10	C++ language mapping	142
10.1	Introduction	142
10.2	Names and scopes	142
10.3	Memory management	142
10.4	Error handling	142
10.5	Type mapping	142
10.5.1	Encapsulated C++ types	142
10.5.2	General abstract data types	143
10.5.2.1	TciBehaviourId	143
10.5.2.1.1	Methods	143
10.5.2.2	TciModuleId	143
10.5.2.2.1	Methods	143
10.5.2.3	TciModuleParameterId	144
10.5.2.3.1	Methods	144
10.5.2.4	TciTestCaseId	144
10.5.2.4.1	Methods	144

10.5.2.5	TciModuleIdList	144
10.5.2.5.1	Methods	145
10.5.2.6	TciModuleParameter	145
10.5.2.6.1	Methods	145
10.5.2.7	TciModuleParameterList	145
10.5.2.7.1	Methods	146
10.5.2.8	TciParameterPassingMode	146
10.5.2.9	TciParameter	146
10.5.2.9.1	Methods	146
10.5.2.10	TciParameterList	147
10.5.2.10.1	Methods	147
10.5.2.11	TciParameterType	147
10.5.2.11.1	Methods	147
10.5.2.12	TciParameterTypeList	148
10.5.2.12.1	Methods	148
10.5.2.13	TciTestComponentKind	148
10.5.2.14	TciTypeClass	148
10.5.2.15	TciTestCaseIdList	149
10.5.2.15.1	Methods	149
10.5.3	Abstract TTCN-3 data types and values	149
10.5.3.1	TciType	149
10.5.3.1.1	Methods	150
10.5.3.2	TciValue	150
10.5.3.2.1	Methods	150
10.5.3.3	IntegerValue	151
10.5.3.3.1	Methods	151
10.5.3.4	FloatValue	151
10.5.3.4.1	Methods	151
10.5.3.5	BooleanValue	151
10.5.3.5.1	Methods	152
10.5.3.6	CharstringValue	152
10.5.3.6.1	Methods	152
10.5.3.7	UniversalCharstringValue	152
10.5.3.7.1	Methods	153
10.5.3.8	BitstringValue	153
10.5.3.8.1	Methods	153
10.5.3.9	OctetstringValue	154
10.5.3.9.1	Methods	154
10.5.3.10	HexstringValue	154
10.5.3.10.1	Methods	154
10.5.3.11	RecordValue	155
10.5.3.11.1	Methods	155
10.5.3.12	RecordOfValue	155
10.5.3.12.1	Methods	156
10.5.3.13	UnionValue	156
10.5.3.13.1	Methods	156
10.5.3.14	EnumeratedValue	156
10.5.3.14.1	Methods	157
10.5.3.15	VerdictValue	157
10.5.3.15.1	Methods	157
10.5.3.16	VerdictValueEnum	157
10.5.3.17	AddressValue	158
10.5.3.17.1	Methods	158
10.5.4	Abstract logging types	158
10.5.4.1	TciValueTemplate	158
10.5.4.1.1	Methods	158
10.5.4.2	TciNonValueTemplate	159
10.5.4.2.1	Methods	159
10.5.4.3	TciValueList	159
10.5.4.3.1	Methods	159
10.5.4.4	TciValueDifference	160
10.5.4.4.1	Methods	160

10.5.4.5	TciValueDifferenceList.....	160
10.5.4.5.1	Methods.....	160
10.5.4.6	ComponentStatus.....	161
10.5.4.7	TimerStatus.....	161
10.5.4.8	TciStatus.....	161
10.6	Operations mapping.....	161
10.6.1	TCI-TM.....	161
10.6.1.1	TciTmRequired.....	161
10.6.1.2	TciTmProvided.....	162
10.6.2	TCI-CD.....	162
10.6.2.1	TciCdRequired.....	162
10.6.2.2	TciCdProvided.....	163
10.6.3	TCI-CH.....	163
10.6.3.1	TciChRequired.....	163
10.6.3.2	TciChProvided.....	164
10.6.4	TCI-TL.....	166
10.6.4.1	TciTlProvided.....	166
11	W3C XML mapping.....	173
11.1	Introduction.....	173
11.2	Scopes.....	173
11.3	Type mapping.....	174
11.3.1	Mapping of simple types.....	174
11.3.1.1	TBoolean.....	174
11.3.1.2	TString.....	174
11.3.1.3	TInteger.....	174
11.3.1.4	TriTimerDurationType.....	174
11.3.1.5	TciParameterPassingModeType.....	174
11.3.1.6	TriStatusType.....	174
11.3.1.7	TciStatusType.....	174
11.3.1.8	ComponentStatusType.....	174
11.3.1.9	TimerStatusType.....	174
11.3.1.10	PortStatusType.....	175
11.3.2	Complex type mapping.....	175
11.3.2.1	TriPortIdType.....	175
11.3.2.2	TriComponentIdType.....	175
11.3.2.3	TriComponentIdListType.....	175
11.3.2.4	Port.....	176
11.3.2.5	Id.....	176
11.3.2.6	TriMessageType.....	176
11.3.2.7	TriParameterType.....	177
11.3.2.8	TriParameterListType.....	177
11.3.2.9	TriAddressType.....	177
11.3.2.10	TriAddressListType.....	178
11.3.2.11	TriExceptionType.....	178
11.3.2.12	TriSignatureIdType.....	178
11.3.2.13	TriTimerIdType.....	178
11.3.2.14	TriTimerDurationType.....	179
11.3.2.15	QualifiedName.....	179
11.3.2.16	TciBehaviourIdType.....	179
11.3.2.17	TciTestCaseIdType.....	179
11.3.2.18	TciParameterType.....	180
11.3.2.19	TciParameterListType.....	180
11.3.3	Abstract value mapping.....	180
11.3.3.1	Value.....	180
11.3.3.2	IntegerValue.....	182
11.3.3.3	FloatValue.....	182
11.3.3.4	BooleanValue.....	182
11.3.3.5	Void.....	183
11.3.3.6	VerdictValue.....	183
11.3.3.7	BitstringValue.....	183
11.3.3.8	HexstringValue.....	183

11.3.3.9	OctetstringValue	184
11.3.3.10	CharstringValue	184
11.3.3.11	UniversalCharstringValue	184
11.3.3.12	RecordValue.....	185
11.3.3.13	RecordOfValue	186
11.3.3.14	ArrayValue.....	187
11.3.3.15	SetValue	189
11.3.3.16	SetOfValue.....	190
11.3.3.17	EnumeratedValue.....	191
11.3.3.18	UnionValue	192
11.3.3.19	AnytypeValue	193
11.3.3.20	AddressValue	194
11.3.4	Abstract logging types mapping	195
11.3.4.1	TciValueTemplate.....	195
11.3.4.2	TciNonValueTemplate	196
11.3.4.3	TciValueList.....	196
11.3.4.4	TciValueDifference.....	197
11.3.4.5	TciValueDifferenceList.....	197
11.4	Mapping of the operations on the logging interface.....	197
11.4.1	Event.....	197
11.4.2	The TCI-TL interface.....	198
11.4.2.1	TCI-TL provided.....	198
12	C# mapping	217
12.1	Introduction	217
12.2	Names and scopes	217
12.2.1	Names	217
12.2.2	Scopes.....	217
12.3	Null value mapping	217
12.4	Type mapping.....	218
12.4.1	Basic type mapping.....	218
12.4.1.1	TciVerdict	218
12.4.2	Structured type mapping	218
12.4.2.1	TciParameterPassingModeType.....	219
12.4.2.2	TciParameterType	219
12.4.2.3	TciParameterListType.....	219
12.4.2.4	TciTypeClassType	220
12.4.2.5	TciTestComponentKindType.....	220
12.4.2.6	TciBehaviourIdType	220
12.4.2.7	TciTestCaseIdType	220
12.4.2.8	TciTestCaseIdListType	220
12.4.2.9	TciModuleIdType	221
12.4.2.10	TciModuleIdListType	221
12.4.2.11	TciModuleParameterIdType	221
12.4.2.12	TciModuleParameterType.....	221
12.4.2.13	TciModuleParameterListType	222
12.4.2.14	TciParameterTypeType.....	222
12.4.2.15	TciParameterTypeListType.....	222
12.4.3	Abstract type mapping	223
12.4.3.1	Type	223
12.4.4	Abstract value mapping	223
12.4.4.1	Value	224
12.4.4.2	IntegerValue.....	224
12.4.4.3	FloatValue	224
12.4.4.4	BooleanValue	225
12.4.4.5	CharstringValue	225
12.4.4.6	BitstringValue	225
12.4.4.7	OctetstringValue	226
12.4.4.8	UniversalCharstringValue.....	226
12.4.4.9	HexstringValue	227
12.4.4.10	RecordValue.....	227
12.4.4.11	RecordOfValue	227

12.4.4.12	UnionValue	228
12.4.4.13	EnumeratedValue	229
12.4.4.14	VerdictValue	229
12.4.4.15	AddressValue	229
12.4.5	Abstract logging types mapping	229
12.4.5.1	TciValueTemplate	230
12.4.5.2	TciNonValueTemplate	230
12.4.5.3	TciValueList	230
12.4.5.4	TciValueDifference	231
12.4.5.5	TciValueDifferenceList	231
12.4.5.6	TciStatusType	231
12.4.5.7	ComponentStatusType	232
12.4.5.8	TimerStatusType	232
12.5	Mapping of interfaces	232
12.5.1	TCI-TM interface	232
12.5.1.1	TCI-TM provided	232
12.5.1.2	TCI-TM provided	233
12.5.2	TCI-CD interface	233
12.5.2.1	TCI-CD provided	233
12.5.2.2	TCI-CD required	233
12.5.3	TCI-CH interface	233
12.5.3.1	TCI-CH provided	233
12.5.3.2	TCI-CH required	235
12.5.4	TCI-TL interface	235
12.5.4.1	TCI-TL provided	235
12.6	Optional parameters	241
12.7	Error Handling	241
Annex A (normative):	IDL Specification of TCI	242
Annex B (normative):	XML Mapping for TCI TL Provided	258
B.1	TCI-TL XML Schema for Simple Types	258
B.2	TCI-TL XML Schema for Types	259
B.3	TCI-TL XML Schema for Values	261
B.4	TCI-TL XML Schema for Templates	266
B.5	TCI-TL XML Schema for Events	273
B.6	TCI-TL XML Schema for a Log	293
Annex C (informative):	Use scenarios	296
C.1	Initialization, collecting information, logging	296
C.1.1	Use scenario: initialization	296
C.1.1.1	Sequence diagram	296
C.1.1.2	TTCN-3 fragment	297
C.1.2	Use scenario: requesting module parameters	297
C.1.2.1	Sequence diagram	297
C.1.2.2	TTCN-3 fragment	297
C.1.3	Use scenario: logging	297
C.1.3.1	Sequence diagram	298
C.1.3.2	TTCN-3 fragment	298
C.2	Execution of test cases and control	298
C.2.1	Use scenario: execution of control	298
C.2.1.1	Sequence diagram	298
C.2.1.2	TTCN-3 fragment	299
C.2.2	Use scenario: test case execution within control	299
C.2.2.1	Sequence diagram	299
C.2.2.2	TTCN-3 fragment	299
C.2.3	Use scenario: direct test case execution	299

C.2.3.1	Sequence diagram	300
C.2.3.2	TTCN-3 fragment	300
C.2.4	Use scenario: execute test case to TRI	300
C.2.4.1	Sequence diagram	300
C.2.4.2	TTCN-3 fragment	301
C.3	Component handling	301
C.3.1	Use scenario: local control component creation	301
C.3.1.1	Sequence diagram	301
C.3.1.2	TTCN-3 fragment	302
C.3.2	Use scenario: remote control component creation	302
C.3.2.1	Sequence diagram	302
C.3.2.2	TTCN-3 fragment	302
C.3.3	Use scenario: local MTC creation	303
C.3.3.1	Sequence diagram	303
C.3.3.2	TTCN-3 fragment	303
C.3.4	Use scenario: remote MTC creation	304
C.3.4.1	Sequence diagram	304
C.3.4.2	TTCN-3 fragment	304
C.3.5	Use scenario: component handling for test case execution within control	305
C.3.5.1	Sequence diagram	305
C.3.5.2	TTCN-3 fragment	306
C.3.6	Use scenario: component handling for direct test case execution	306
C.3.6.1	Sequence diagram	307
C.3.6.2	TTCN-3 fragment	307
C.3.7	Use scenario: propagation of map/connect	308
C.3.7.1	Sequence diagram	308
C.3.7.2	TTCN-3 fragment	308
C.3.8	Use scenario: propagation of unmap/disconnect	308
C.3.8.1	Sequence diagram	309
C.3.8.2	TTCN-3 fragment	309
C.4	Termination of test cases and control	309
C.4.1	Use scenario: stop a test case	309
C.4.1.1	Sequence diagram	310
C.4.1.2	TTCN-3 fragment	310
C.4.2	Use scenario: stop control	310
C.4.2.1	Sequence diagram	311
C.4.2.2	TTCN-3 fragment	311
C.4.3	Use scenario: termination of control after error	311
C.4.3.1	Sequence diagram	312
C.4.3.2	TTCN-3 fragment	312
C.4.4	Use scenario: termination of a test case after error	312
C.4.4.1	Sequence diagram	313
C.4.4.2	TTCN-3 fragment	314
C.4.5	Use scenario: reset	314
C.4.5.1	Sequence diagram	314
C.4.5.2	TTCN-3 fragment	314
C.5	Communication	314
C.5.1	Use scenario: local intercomponent communication	314
C.5.1.1	Sequence diagram	315
C.5.1.2	TTCN-3 fragment	315
C.5.2	Use scenario: internode communication between test components	315
C.5.2.1	Sequence diagram	316
C.5.2.2	TTCN-3 fragment	316
C.5.3	Use scenario: encoding	316
C.5.3.1	Sequence diagram	317
C.5.3.2	TTCN-3 fragment	317
C.5.4	Use scenario: decoding	317
C.5.4.1	Sequence diagram	318
C.5.4.2	TTCN-3 fragment	318

Annex D (informative):	Bibliography.....	319
History		320

Intellectual Property Rights

IPRs essential or potentially essential to the present document may have been declared to ETSI. The information pertaining to these essential IPRs, if any, is publicly available for **ETSI members and non-members**, and can be found in ETSI SR 000 314: "*Intellectual Property Rights (IPRs); Essential, or potentially Essential, IPRs notified to ETSI in respect of ETSI standards*", which is available from the ETSI Secretariat. Latest updates are available on the ETSI Web server (<http://ipr.etsi.org>).

Pursuant to the ETSI IPR Policy, no investigation, including IPR searches, has been carried out by ETSI. No guarantee can be given as to the existence of other IPRs not referenced in ETSI SR 000 314 (or the updates on the ETSI Web server) which are, or may be, or may become, essential to the present document.

Foreword

This ETSI Standard (ES) has been produced by ETSI Technical Committee Methods for Testing and Specification (MTS).

The present document is part 6 of a multi-part deliverable. Full details of the entire series can be found in part 1 [1].

1 Scope

The present document specifies the control interfaces for TTCN-3 test system implementations. The TTCN-3 Control Interfaces provide a standardized adaptation for management, test component handling and encoding/decoding of a test system to a particular test platform. The present document defines the interfaces as a set of operations independent of a target language.

The interfaces are defined to be compatible with the TTCN-3 standard (see clause 2). The interface definition uses the CORBA Interface Definition Language (IDL) to specify the TCI completely. Clauses 8, 9, and 9.7 present language mappings for this abstract specification to the target languages Java, ANSI C, and C++. A summary of the IDL-based interface specification is provided in annex A.

2 References

References are either specific (identified by date of publication and/or edition number or version number) or non-specific. For specific references, only the cited version applies. For non-specific references, the latest version of the reference document (including any amendments) applies.

Referenced documents which are not found to be publicly available in the expected location might be found at <http://docbox.etsi.org/Reference>.

NOTE: While any hyperlinks included in this clause were valid at the time of publication ETSI cannot guarantee their long term validity.

2.1 Normative references

The following referenced documents are necessary for the application of the present document.

- [1] ETSI ES 201 873-1: "Methods for Testing and Specification (MTS); The Testing and Test Control Notation version 3; Part 1: TTCN-3 Core Language".
- [2] ETSI ES 201 873-4: "Methods for Testing and Specification (MTS); The Testing and Test Control Notation version 3; Part 4: TTCN-3 Operational Semantics".
- [3] ETSI ES 201 873-5: "Methods for Testing and Specification (MTS); The Testing and Test Control Notation version 3; Part 5: TTCN-3 Runtime Interface (TRI)".
- [4] ITU-T Recommendation X.290: "OSI conformance testing methodology and framework for protocol Recommendations for ITU-T applications - General concepts".

NOTE: The corresponding ISO/IEC standard is ISO/IEC 9646-1: "Information technology - Open Systems Interconnection - Conformance testing methodology and framework; Part 1: General concepts".

- [5] ISO/IEC 10646: "Information technology - Universal Coded Character Set (UCS)".
- [6] CORBA 3.0: "The Common Object Request Broker - Architecture and Specification", OMG Formal Document (specifies IDL).
- [7] Sun Microsystems: "Java Language Specification".

NOTE: See at http://java.sun.com/docs/books/jls/third_edition/html/j3TOC.html.

- [8] ISO/IEC 9899: "Information technology - Programming languages - C".
- [9] ISO/IEC 14882: "Information technology - Programming languages - C++".
- [10] W3C Recommendation: "XML Schema Part 0: Primer".

NOTE: See at <http://www.w3.org/TR/xmlschema-0/>.

[11] W3C Recommendation: "XML Schema Part 1: Structures".

NOTE: See at <http://www.w3.org/TR/xmlschema-1/>.

[12] W3C Recommendation: "XML Schema Part 2: Datatypes".

NOTE: See at <http://www.w3.org/TR/xmlschema-2/>.

[13] ECMA-334: "C# Language Specification".

NOTE: See at <http://www.ecma-international.org/publications/standards/Ecma-334.htm>.

2.2 Informative references

The following referenced documents are not necessary for the application of the present document but they assist the user with regard to a particular subject area.

Not applicable.

3 Definitions and abbreviations

3.1 Definitions

For the purposes of the present document, the terms and definitions given in ITU-T Recommendation X.290 [4] and the following apply:

Abstract Test Suite (ATS): test suite composed of abstract test cases, which are specified by TTCN-3 module(s)

codec: encoder/decoder entity used for encoding and decoding data to be transmitted and received, respectively

Coding/Decoding (CD): entity that administers the value and type handling incl. encoding and decoding in the TTCN-3 test system

Component Handling (CH): entity that administers the handling of test components in the TTCN-3 test system

communication port: abstract mechanism facilitating communication between test components

NOTE: A communication port is modelled as a FIFO queue in the receiving direction. Ports can be message-based, procedure-based or a mixture of the two.

control component: component that executes the behaviour of the control part of a TTCN-3 module

Executable Test Suite (ETS): Refer to ITU-T Recommendation X.290 [4].

Implementation eXtra Information for Testing (IXIT): Refer to ITU-T Recommendation X.290 [4].

Platform Adaptor (PA): entity that adapts the TTCN-3 Executable to a particular execution platform

NOTE: The Platform Adaptor creates a single notion of time for a TTCN-3 test system, and implements both, explicit and implicit, timers as well as external functions.

real test system interface: Refer to ITU-T Recommendation X.290 [4].

System Under Test (SUT): Refer to ITU-T Recommendation X.290 [4].

SUT Adaptor (SA): entity that adapts the TTCN-3 communication operations with the SUT based on an abstract test system interface

NOTE: It implements the real test system interface.

Testing and Test Control Notation (TTCN-3): Refer to ITU-T Recommendation X.290 [4].

test case: Refer to ITU-T Recommendation X.290 [4].

test event: either sent or received test data (message or procedure call) on a communication port that is part of the test system interface as well as timeout events of timers

Test Logging (TL): entity which provides logging information about test execution (including also the information provided by the TTCN-3 log statement)

Test Management (TM): entity which provides a user interface to as well as the administration of the TTCN-3 test system

Test Management and Control (TMC): set of entities providing test management and control; consists of the Test Management (TM), the Component Handling (CH), the Test Logging (TL) and the Coding/Decoding (CD)

NOTE: The TMC is an implementation of TCI.

test system: Refer to ITU-T Recommendation X.290 [4].

Test System Interface (TSI): test component that provides a mapping of the ports available in the (abstract) TTCN-3 test system to those offered by a real test system

TTCN-3 Executable (TE): part of a test system that deals with interpretation or execution of a TTCN-3 ETS

TTCN-3 Control Interfaces (TCI): four interfaces that define the interaction of the TTCN-3 Executable with the test management, the coding and decoding, the test component handling and the logging in a test system

TTCN-3 Runtime Interface (TRI): two interfaces that define the interaction of the TTCN-3 Executable between the SUT and the Platform Adapter (PA) and the System Adapter (SA) in a test system

3.2 Abbreviations

For the purposes of the present document, the following abbreviations apply:

ANSI	American National Standards Institute
ASCII	American Standard Code for Information Interchange
ATS	Abstract Test Suite
CD	(External) Coding/Decoding
CH	Component Handler
CORBA	Common Object Request Broker Architecture
ETS	Executable Test Suite
FIFO	First In First Out?
IDL	Interface Definition Language
IXIT	Implementation eXtra Information for Testing
MTC	Main Test Component
OMG	Object Management Group
PA	Platform Adaptor
PTC	Parallel Test Component
SA	SUT Adaptor
SUT	System Under Test
TCI	TTCN-3 Control Interfaces
TE	TTCN-3 Executable
TL	Test Logging
TM	Test Management
TMC	Test Management and Control
TRI	TTCN-3 Runtime Interface
TSI	Test System Interface
TTCN-3	Testing and Test Control Notation Version 3
UML	Unified Modelling Language
W3C	World Wide Web Consortium
XML	Extensible Markup Language

4 Introduction

The present document consists of two distinct parts, the first part describing the structure of a TTCN-3 test system implementation and the second part presenting the TTCN-3 Control Interfaces specification.

The first part introduces the decomposition of a TTCN-3 test system into four main entities:

- Test Management and Control (TMC).
- TTCN-3 Executable (TE).
- SUT Adaptor (SA).
- Platform Adaptor (PA).

The TMC consists itself of three entities: Test Management (TM), Coder/Decoder (CD), and Test Component Handler (CH). In addition, the interaction between these entities, i.e. the corresponding interfaces, is defined.

The second part of the present document specifies the TTCN-3 Control Interfaces (TCI). The interfaces are defined in terms of operations implemented as part of one entity and called by other test system entities. For each operation, the interface specification defines associated data structures, the intended effect on the test system and any constraints on the usage of the operation. Note that these interface specifications only define interactions between the TE and TM, TE and CD, and TE and CH. For interactions between the TE and SA and the TE and PA please refer to the TTCN-3 Runtime Interface specification (ES 201 873-5 [3]).

5 Compliance

The minimum required for a TCI compliant TTCN-3 test system is to adhere to the interface specification stated in the present document. The TTCN-3 semantics in the test system must adhere to the operational semantics defined in ES 201 873-4 [2]. In addition, one language mapping must be supported. For example, if a vendor supports Java, the TCI operation calls and implementations, which are part of the TTCN-3 executable, must comply with the IDL to Java mapping specified in the present document. For the logging interface, the XML mapping can be used instead of the Java or the C mapping.

6 General structure of a TTCN-3 test system

A TTCN-3 test system can be thought of conceptually as a set of interacting entities. Each entity implements specific test system functionality. These entities:

- manage test execution;
- interpret or execute compiled TTCN-3 code;
- realize proper communication with the SUT;
- administer types, values and test components;
- implement external functions; and
- handle timer operations.

6.1 Entities in a TTCN-3 test system

The structure of a TTCN-3 test system implementation is illustrated in figure 1.

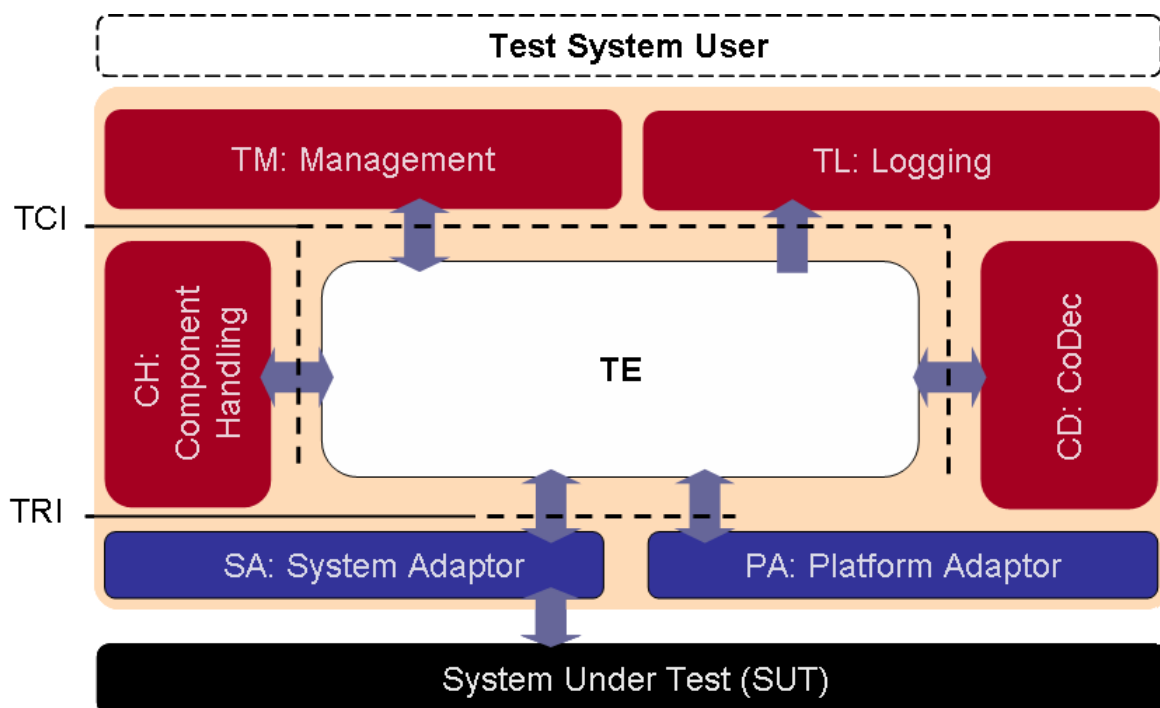

Figure 1: General structure of a TTCN-3 test system

As shown in figure 1, the TTCN-3 Executable (TE), also referred to as the Executable Test Suite (ETS), interprets and executes TTCN-3 modules. Various TE structural elements can be identified: control, behaviour, components, types, values and queues. The structural elements within the TE represent functionality that is defined within a TTCN-3 module or by the TTCN-3 standard (ES 201 873-1 [1]) itself. For example, the structural element "Control" represents the control part within a TTCN-3 module, while the structural element "Queues" represents the requirement on a TTCN-3 Executable that each port of a test component maintains its own port queue. While the first is specified within a TTCN-3 module, the latter is required by the TTCN-3 specification.

Refinement of the TE, as shown in figure 1, is provided as an aid in defining the TTCN-3 Control Interfaces. The TE would typically correspond in a test system implementation either to the executable code produced by a TTCN-3 compiler or by a TTCN-3 interpreter.

The TE may be executed in a centralized or in a distributed manner. That is, on a single test device or across several test devices respectively. Although the structural entities of the TE implement a complete TTCN-3 module, single structural entities might be distributed over several test devices.

The TE implements a TTCN-3 module on an abstract level. The other entities of a TTCN-3 test system make these abstract concepts concrete. For example, the abstract concept of sending a message or receiving a timeout cannot be implemented within the TE. The remaining part of the test system implements the encoding of the message and its sending over concrete physical means or measuring the time and determining when a timer has expired, respectively.

The SA and PA and their interaction with the TE are defined in ES 201 873-5 [3]. The TCI specification defines the interaction between the TE and the TMC.

The logging interface provides logging capabilities to all elements of the test system architecture, i.e. the TE, the TM, the CH, the CD, the SA and the PA are able to log information on the test execution via TL. Figure 2 represents a more detailed view on TL.

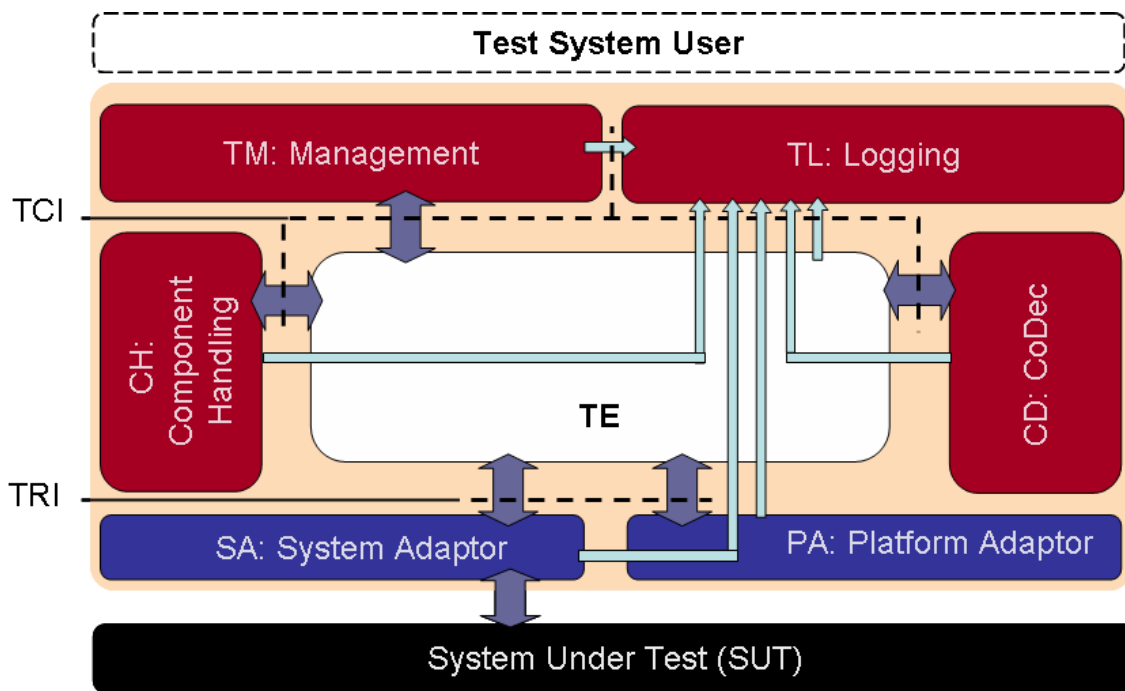

Figure 2: Detailed View on TL

6.1.1 Test Management and Control (TMC)

The TMC entity includes functionality related to management of:

- test execution;
- components;
- encoding and decoding; and
- logging.

6.1.1.1 Test Management (TM)

The TM entity is responsible for the overall management of a test system. After the test system has been initialized, test execution starts within the TM entity. The entity is responsible for the proper invocation of TTCN-3 modules, i.e. propagating module parameters such as IXIT information to the TE if necessary. Typically, this entity would also implement a test system user interface.

6.1.1.2 Coding and Decoding (CD)

The CD entity is responsible for the external encoding and decoding of TTCN-3 values into bitstrings suitable to be sent to the System Under Tests (SUT). Whenever external codecs are used, the TE determines which codecs shall be used. It passes the TTCN-3 data to the appropriate encoder to obtain the encoded data. Received data is decoded in the CD entity by using the appropriate decoder, which translates the received data into TTCN-3 values.

6.1.1.3 Component Handling (CH)

The TE can be distributed among several test devices. The CH implements communication between distributed test system entities. The CH entity provides the means to synchronize test system entities which might be distributed onto several nodes.

NOTE 1: Nodes and test devices are used as synonyms.

The general structure of a test system distributed among several nodes is depicted in figure 3.

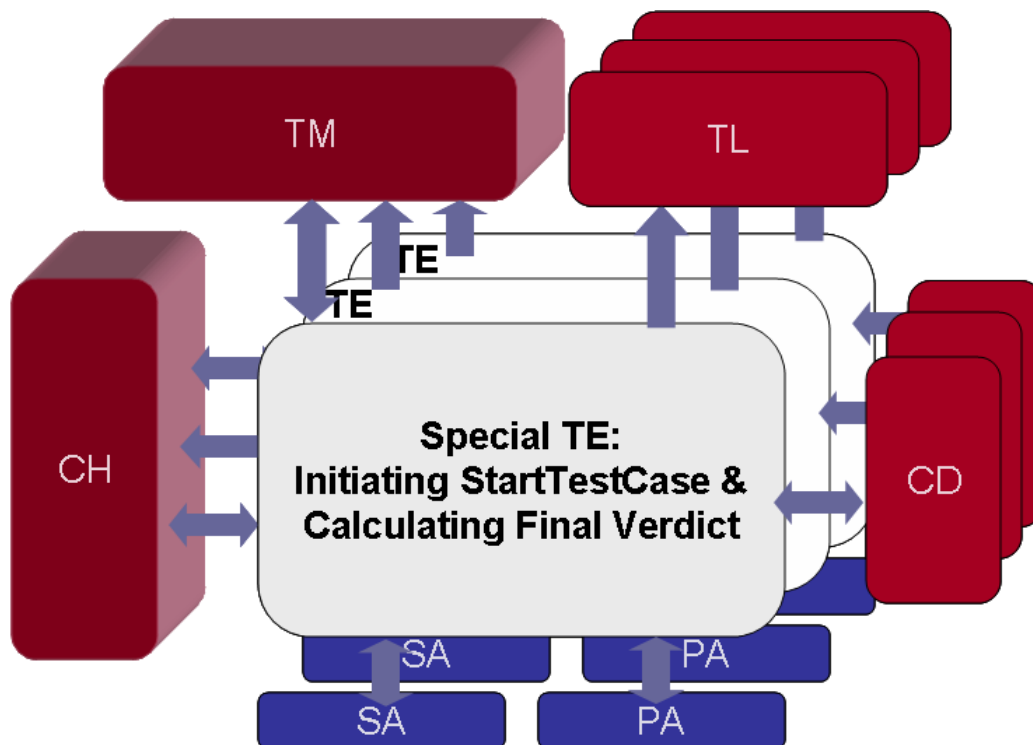

Figure 3: General structure of a distributed TTCN-3 test system

Each node within a test system includes the TE, SA, PA, CD and TL entities. The entities CH and TM mediate the test management and test component handling between the TEs on each node. The TE which starts a test case is a special TE. It shall calculate the final test case verdict. Besides this, all TEs are handled the same.

NOTE 2: As stated in ES 201 873-4 [2], a test system executes at most one test case at a given point in time, i.e. a TTCN-3 module cannot execute multiple test cases at the same time.

The creation of the MTC, PTCs and the control component in TEs is controlled by CH. Please note the special role of the system component, which exists only conceptually and not as a running test component in a TE. System ports, i.e. the ports of the system component, may be distributed among several nodes. Further, test components on different nodes may have access to the same physical port of the SUT, i.e. they may be mapped to the same port of the test system interface.

EXAMPLE: Access to remote real SUT ports can be realized by TEs via local proxies.

Communication between TTCN-3 components is either message or procedure based. Therefore, the CH adapts message and procedure based communication of TTCN-3 components to the particular execution platform of the test system. It is aware of connections between TTCN-3 test component communication ports. It propagates send request operations from one TTCN-3 component to another TTCN-3 component. The receiving component may reside in a different instance of the same TE located on a different node. It then notifies the TE of any received test events by enqueueing them in the port queues of the TE.

Procedure based communication operations between TTCN-3 components are also visible at the CH. The CH shall distinguish between the different kinds of procedure-based communication, i.e. call, reply, and exception, and shall propagate them in the appropriate manner to the TE where the target component resides. TTCN-3 procedure based communication semantics, i.e. the effect of such operation on TTCN-3 test component execution, are to be handled in the TE.

Additional communication is needed to implement the distribution of test components onto several nodes. Component management communication includes the indication of the creation of test components, the starting of execution of a test component, verdict distribution, as well as component termination indication. The CH does not implement the TTCN-3 component behaviour. Rather, it implements the communication between several components implemented by a TE.

6.1.1.4 Test Logging (TL)

The TL entity performs test event logging and presentation to the test system user. It provides the logging of information about the test execution such as which test components have been created, started and terminated, which data is sent to the SUT, received from the SUT and matched to TTCN-3 templates, which timers have been started, stopped or timed out, etc.

6.1.2 TTCN-3 Executable (TE)

The TE entity executes or interprets a TTCN-3 module. Conceptually, the TE can be decomposed into six interacting entities: a Control, Behaviour, Component, Type, Value and Queue entity. This structural decomposition of the TE is defined in ES 201 873-5 [3]. The terminology for TE defined in ES 201 873-5 [3] is used within the present document.

6.1.3 SUT Adaptor (SA)

The SA is the implementation of the System under Test Adaptor (SA) as defined in ES 201 873-5 [3]. The terminology for SA defined in ES 201 873-5 [3] is used within the present document.

6.1.4 Platform Adaptor (PA)

The PA is the implementation of the Platform Adaptor (PA) as defined in ES 201 873-5 [3]. The terminology for PA defined in ES 201 873-5 [3] is used within the present document.

6.2 Execution requirements for a TTCN-3 test system

Each TCI operation call shall be treated as an atomic operation in the calling entity. The called entity, which implements a TCI operation, shall return control to the calling entity as soon as its intended effect has been accomplished or if the operation cannot be completed successfully. The called entity shall not block in the implementation of procedure-based communication.

As stated before, no assumption is made as to whether the TTCN-3 test system or individual entities are implemented in a single executable or process or whether they are distributed among different processes or even test devices.

A TCI implementation shall fulfil the above mentioned requirements.

7 TTCN-3 control interface and operations

This clause defines a set of abstract data types used to represent data communicated between the TE and the TMC. In addition, it defines TCI operations in terms of their signatures, when they are to be used and what their effects on the TTCN-3 test system are.

This definition also includes a more detailed description of the input parameters required for each TCI operation call and its return value.

7.1 Overview of the TCI

The TCI defines the interaction between the TTCN-3 Executable (TE), Component Handling (CH), the Test Management (TM), the Coding/Decoding (CD), the Test Logging (TL) entities within a TTCN-3 test system. It provides means for the TE to:

- manage test execution;
- distribute execution of test components among different test devices;
- encode and decode test data; and
- logging of information about test execution.

The TCI consists of four sub-interfaces:

- **TCI Test Management Interface (TCI-TM):** This interface includes all operations needed to manage test execution, provide module parameters and external constants and provide test event logging.
- **TCI Component Handling Interface (TCI-CH):** This interface consists of operations needed to implement the management of, and communication between TTCN-3 test components in a centralized or distributed test system. It includes operations to create, start and stop test components, establish connection between TTCN-3 components, manage test components and their verdicts, and handle message and procedure based communication between TTCN-3 components.
- **TCI Coding/Decoding Interface (TCI-CD):** This interface includes all operations needed to retrieve and access codecs, i.e. encoders or decoders, for encoding data to be sent, defined using the TTCN-3 encode attribute, and to decode received data.
- **TCI Test Logging Interface (TCI-TL):** This interface includes all operations needed to retrieve information about test execution and to control the level of detail of this information.

All interfaces are bi-directional so that calling and called parts reside in the TE and in the TMC of the test system. The provided interfaces (those operations which an interface offers to the TE) and the required operations (those operation which an interface needs to use from the TE) are combined into the respective provided and required subinterface for each interface, i.e. TCI-TM Provided/ TCI-TM Required, TCI-CH Provided/ TCI-CH Required, TCI-CD Provided/ TCI-CD Required, and TCI-TL Provided/TCI-TL Required.

7.1.1 Correlation between TTCN-3 and TCI operation invocations

For some TTCN-3 operation invocations, there is a direct correlation to a TCI operation invocation, which is shown in table 1. Some of the TTCN-3 operations correlate to a pair of TCI operation request and TCI operation to implement the propagation of TTCN-3 operations through the test system. For the other TCI operation invocations there is an indirect correlation - they are needed to implement the TTCN-3 semantics of underlying concepts.

7.1.1.1 TTCN 3 operations with TCI operation equivalent

The correlation shown for TTCN-3 communication operations (i.e. `send`, `call`, `reply`, and `raise`) only holds if these operations are invoked on a test component port connected to another test component port. The correlation for communication operations that are invoked on test component ports that are mapped to test system interface ports is defined in ES 201 873-5 [3].

Table 1: Correlation between TTCN-3 communication operations and TCI operation invocations

TTCN-3 Operation Name	TCI Operation Name	TCI Interface Name
send	<code>tciSendConnected</code> (see note 1)	TCI-CH Provided
	<code>tciSendConnectedBC</code> (see note 2)	
	<code>tciSendConnectedMC</code> (see note 3)	
	<code>tciEnqueueMsgConnected</code>	
call	<code>tciCallConnected</code> (see note 1)	TCI-CH Provided
	<code>tciCallConnectedBC</code> (see note 2)	
	<code>tciCallConnectedMC</code> (see note 3)	
	<code>tciEnqueueCallConnected</code>	
reply	<code>tciReplyConnected</code> (see note 1)	TCI-CH Provided
	<code>tciReplyConnectedBC</code> (see note 2)	
	<code>tciReplyConnectedMC</code> (see note 3)	
	<code>tciEnqueueReplyConnected</code>	
raise	<code>tciRaiseConnected</code> (see note 1)	TCI-CH Provided
	<code>tciRaiseConnectedBC</code> (see note 2)	
	<code>tciRaiseConnectedMC</code> (see note 3)	
	<code>tciEnqueueRaiseConnected</code>	
log	<code>tliLog</code>	TCI-TL Provided
NOTE 1: For unicast communication.		
NOTE 2: For broadcast communication.		
NOTE 3: For multicast communication.		

7.1.1.2 TTCN 3 operations with TCI operation pair equivalent

The correlation for TTCN-3 test case, test component and port operations is shown below. The initiating TE issues a TCI request operation to the TCI-CH, which propagates the respective TCI operation on the TE(s) which has (have) to perform it.

Table 2: Correlation between TTCN-3 test case, test component and port operations and TCI operation invocations

TTCN-3 Operation Name	TCI Operation Name	TCI Interface Name
create	tciCreateTestComponentReq	TCI-CH Provided
	tciCreateTestComponent	TCI-CH Required
start (a component)	tciStartTestComponentReq	TCI-CH Provided
	tciStartTestComponent	TCI-CH Required
stop (a component)	tciStopTestComponentReq	TCI-CH Provided
	tciStopTestComponent	TCI-CH Required
kill	tciKillTestComponentReq	TCI-CH Provided
	tciKillTestComponent	TCI-CH Required
connect	tciConnectReq	TCI-CH Provided
	tciConnect	TCI-CH Required
disconnect	tciDisconnectReq	TCI-CH Provided
	tciDisconnect	TCI-CH Required
map	tciMapReq (see note 1)	TCI-CH Provided
	tciMapParamReq (see note 2)	
	tciMap (see note 1)	TCI-CH Required
	tciMapParam (see note 2)	
unmap	tciUnmapReq (see note 1)	TCI-CH Provided
	tciUnmapParamReq (see note 2)	
	tciUnmap (see note 1)	TCI-CH Required
	tciUnmapParam (see note 2)	
running	tciTestComponentRunningReq	TCI-CH Provided
	tciTestComponentRunning	TCI-CH Required
alive	tciTestComponentAliveReq	TCI-CH Provided
	tciTestComponentAlive	TCI-CH Required
done	tciTestComponentDoneReq	TCI-CH Provided
	tciTestComponentDone	TCI-CH Required
killed	tciTestComponentKilledReq	TCI-CH Provided
	tciTestComponentKilled	TCI-CH Required
mtc	tciGetMTCReq	TCI-CH Provided
	tciGetMTC	TCI-CH Required
execute	tciTestCaseExecuteReq	TCI-CH Provided
	tciTestCaseExecute	TCI-CH Required
NOTE 1: For statement without configuration parameter.		
NOTE 2: For statement with configuration parameter.		

7.1.1.3 TTCN 3 operations without direct TCI operation equivalent

For some TTCN-3 operation invocations, there is no direct correlation to TCI operation invocations as the ones shown in table 1. These TTCN-3 operation invocations are realized by a series of TCI operation invocations as described in this clause.

7.1.1.3.1 Test case stop operation

When the testcase.stop operation is invoked from the TE, the following actions need to be taken by the TE:

- the overall verdict should be set to USER_ERROR with the message given to the invocation of the testcase stop operation as the verdict reason by invoking tciSetVerdict();
- a reference to the mtc should be obtained by invoking triGetMtcReq() in the CH interface; and
- via TLI, testcase.stop shall be logged with tliTcTerminated() with verdict USER_ERROR;

- the mtc should be stopped by invoking `triStopTestComponentReq()` in the CH with the obtained reference to the mtc.

7.2 TCI data

The TCI specification defines a set of abstract data types. These describe, at a very high level, which kind of data shall be passed from a calling to a called entity. The abstract data types are used to determine:

- how TTCN-3 data is passed from a TE to an encoder, to encode TTCN-3 value representations into a bitstring; and in the reverse case;
- how data passed from a decoder to the TE shall be decoded from a bitstring into its TTCN-3 value representation.

For these abstract data types a set of operations is defined to process the data by the coder/decoder.

The concrete representation of these abstract data types as well as the definition of basic data types like `string` and `boolean` are defined in the respective language mappings in clauses 8, 9 and 9.7.

Notice that the values for any identifier data type shall be unique in the test system implementation where uniqueness is defined as being globally distinct at any point in time. This guarantees that different objects, e.g. two timers, are identified by different identifiers and identifiers are not reused.

7.2.1 General abstract data types

The following abstract data types are defined and used for the definition of TCI operations.

7.2.1.1 Management

<code>TciModuleIdType</code>	A value of <code>TciModuleIdType</code> is the name of a TTCN-3 module as specified in the TTCN-3 ATS. This abstract type is used for module handling.
<code>TciModuleParameterIdType</code>	A value of <code>TciModuleParameterIdType</code> is the qualified name of a TTCN-3 module parameter as specified in the TTCN-3 ATS. This abstract type is used for module parameter handling.
<code>TciTestCaseIdType</code>	A value of <code>TciTestCaseIdType</code> is the qualified name of a TTCN-3 testcase as specified in the TTCN-3 ATS. This abstract type is used for testcase handling.
<code>TciTestCaseIdListType</code>	A value of <code>TciTestCaseIdListType</code> is a list of <code>TciTestCaseIdListType</code> . This abstract type is used when retrieving the list of test cases in a TTCN-3 module.
<code>TciModuleIdListType</code>	A value of type <code>TciModuleIdListType</code> is a list of <code>TciModuleIdType</code> . This abstract type is used when retrieving the list of modules which are imported by a TTCN-3 module.
<code>TciModuleParameterType</code>	A value of type <code>TciModuleParameterType</code> is a structure of <code>TciModuleParameterIdType</code> and <code>Value</code> . This abstract type is used to represent the parameter name and the default value of a module parameter.
<code>TciModuleParameterListType</code>	A value of type <code>TciModuleParameterListType</code> is a list of <code>TciModuleParameterType</code> . This abstract type is used when retrieving the module parameters of a TTCN-3 module.
<code>TciParameterType</code>	A value of type <code>TciParameterType</code> includes a TTCN-3 <code>Value</code> , which can be absent, and a value of <code>TciParameterPassingModeType</code> to represent the parameter passing mode specified for the parameter in the TTCN-3 ATS.

<code>TciParameterPassingModeType</code>	A value of type <code>TciParameterPassingModeType</code> is either IN, INOUT, or OUT. This abstract type is used when starting a test case or when the termination of a test case is indicated.
<code>TciParameterListType</code>	A value of type <code>TciParameterListType</code> is a list of <code>TciParameterType</code> . This abstract type is used when starting a test case or when the termination of a test case is indicated.
<code>TciParameterTypeType</code>	A value of type <code>TciParameterTypeType</code> is a structure of <code>Type</code> and <code>TciParameterPassingModeType</code> . This abstract type is used to represent the type and the parameter passing mode of a test case parameter.
<code>TciParameterTypeListType</code>	A value of type <code>TciParameterTypeListType</code> is a list of <code>TciParameterTypeType</code> . This abstract type is used to represent the list of parameters of a test case.
<code>TciTestComponentKindType</code>	A value of type <code>TciTestComponentKindType</code> is a literal of the set of kinds of TTCN-3 test components, i.e. CONTROL, MTC, PTC, SYSTEM, and PTC_ALIVE. This abstract type is used for component handling.
<code>TciTypeClassType</code>	A value of type <code>TciTypeClassType</code> is a literal of the set of type classes in TTCN-3 such as boolean, float, record, etc. This abstract type is used for value handling.

7.2.1.2 Communication

<code>TciBehaviourIdType</code>	A value of type <code>TciBehaviourIdType</code> identifies a TTCN-3 behaviour functions.
---------------------------------	--

Additional abstract data types with the prefix `Tri` are taken from ES 201 873-5 [3]: `TriPortIdType`, `TriPortIdListType`, `TriComponentIdType`, `TriComponentIdListType`, `TriAddressType`, `TriAddressListType`, and `TriMessageType`.

7.2.2 Abstract TTCN-3 data types and values

This clause defines the set of abstract data types that build up the TTCN-3 type and value representation. Functionality of each data type is defined by an accompanying set of operations. Operations on or using this abstract data type return either a value of this abstract type or a basic type like `boolean`.

All operations have been defined using the Interface Description Language (IDL). Concrete language mappings for the operations on the abstract data types are given in clauses 8, 9 and 9.7. In certain languages, the application of an operation on an abstract data type is represented by passing (either by-value or by-reference, depending on the mapping) the concrete value as a parameter to the operation. Other languages might choose other referencing method to the concrete value, e.g. by considering the value as an object on which a method corresponding to the operation is invoked. To indicate the inability to perform a certain task or to indicate the absence of an optional parameter in the following, the distinct value `null` is used. It can be considered as being a reserved value indicating a special value. The language mappings will define a concrete representation of this distinct value `null`.

The abstract TTCN-3 type and value representation consists of two parts:

- an abstract data type `Type` that represents all TTCN-3 types in a TTCN-3 module;
- different abstract data types that represent TTCN-3 values, i.e. TTCN-3 values of a given TTCN-3 type. This can be either values of TTCN-3 predefined types or of TTCN-3 user-defined types.

For accessing, evaluating, and coding the TTCN-3 data the test system uses the abstract data type `Type` and the different abstract value data types. Therefore, these abstract data types define the abstraction level between the TTCN-3 Executable (TE) and the remaining test system using the TCI interfaces.

7.2.2.1 Abstract TTCN-3 data types

According to the present document TTCN-3 types, either predefined or user-defined, will be represented at the TCI interfaces using the abstract data type `Type`.

For the abstract data type `Type` a set of operations is defined to:

- reference predefined and user-defined TTCN-3 data types; and
- create and maintain TTCN-3 values.

The following operations are defined for the abstract data type `Type`:

`TciModuleIdType getDefiningModule()` Returns the module identifier of the module in which type is defined. Returns the distinct value `null` if type is a TTCN-3 base type, e.g. `boolean`, `integer`, etc.).

`TString getName()` Returns the name of the type as defined in the TTCN-3 module. If the type is a nested type without explicit name, the TE has to create an additional unique identifier for this type which is consistently used in TRI/TCI.

NOTE 1: The creation of identifiers for nested types is tool dependent.

NOTE 2: The naming for a nested type without explicit name can follow the rules defined in clauses 6.2.1.1 and 6.2.3.2 of ES 201 873-1 [1], e.g. `TypeIdOrExpression.ElementId` and `TypeId[-]`, respectively.

`TciTypeClassType getTypeClass()` Returns the type class of the respective type. A value of `TciTypeClassType` can have one of the following constants: `ADDRESS`, `ANYTYPE`, `ARRAY`, `BITSTRING`, `BOOLEAN`, `CHARSTRING`, `COMPONENT`, `ENUMERATED`, `FLOAT`, `HEXSTRING`, `INTEGER`, `OCTETSTRING`, `RECORD`, `RECORD_OF`, `SET`, `SET_OF`, `UNION`, `UNIVERSAL_CHARSTRING`, `VERDICT`.

`Value newInstance()` Returns a freshly created value of the given type. This initial value of the created value is undefined.

NOTE 3: Newly created instances of empty record types are considered to be initialized.

`TString getTypeEncoding()` Returns the type encoding attribute as defined in the TTCN-3 module.

`TString getTypeEncodingVariant()` This operation returns the value encoding variant attribute as defined in the TTCN-3 module, if any. If no encoding variant attribute is defined the distinct value `null` is returned.

`TStringseq getTypeExtension()` Returns the type extension attribute as defined in the TTCN-3 module.

7.2.2.2 Abstract TTCN-3 values

According to the present document, TTCN-3 values are represented at the TCI interfaces via numerous abstract data types.

Figure 4 presents the hierarchy between the abstract data types for TTCN-3 values (short: abstract values).

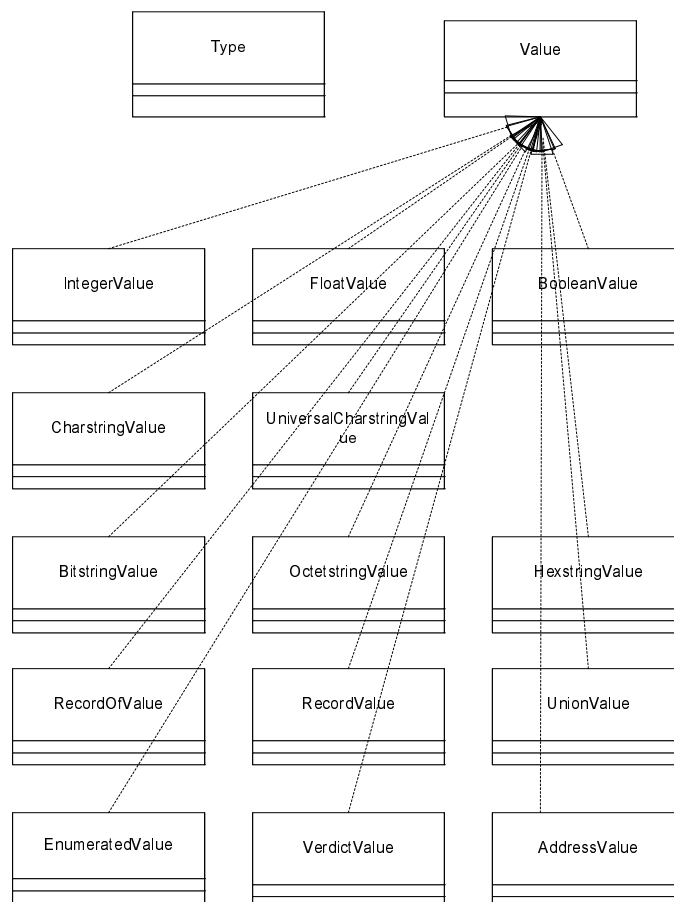

Figure 4: Hierarchy of abstract values

As shown in figure 4, all TTCN-3 abstract values share the same base abstract data type `Value`. All operations defined on this common base data type are implicitly defined also for the abstract value types derived from it.

7.2.2.2.1 The abstract data type `Value`

The following operations are defined on the base abstract data type `Value`. The concrete representations of these operations are defined in the respective language mapping sections:

<code>Type getType()</code>	Returns the type of the specified value.
<code>TBoolean notPresent()</code>	Returns <code>true</code> if the specified value is omit, <code>false</code> otherwise.
<code>TString getValueEncoding()</code>	Returns the value encoding attribute as defined in the TTCN-3 module, if any. If no encoding attribute is defined the distinct value <code>null</code> is returned.
<code>TString getValueEncodingVariant()</code>	Returns the value encoding variant attribute as defined in the TTCN-3 module, if any. If no encoding variant attribute is defined the distinct value <code>null</code> is returned.

7.2.2.2.2 The abstract data type IntegerValue

The abstract data type `IntegerValue` is based on the abstract data type `Value`. It represents TTCN-3 integer values.

The following operations are defined on the abstract data type `IntegerValue`:

`TInteger getInt()` Returns the integer value of this TTCN-3 integer.
`void setInt(in TInteger value)` Sets this `IntegerValue` to value.

7.2.2.2.3 The abstract data type FloatValue

The abstract data type `FloatValue` is based on the abstract data type `Value`. It represents TTCN-3 float values.

The following operations are defined on the abstract data type `FloatValue`:

`TFloat getFloat()` Returns the float value of this TTCN-3 float.
`void setFloat(in TFloat value)` Sets this `FloatValue` to value.

7.2.2.2.4 The abstract data type BooleanValue

The abstract data type `BooleanValue` is based on the abstract data type `Value`. It represents TTCN-3 boolean values.

The following operations are defined on the abstract data type `BooleanValue`:

`TBoolean getBoolean()` Returns the boolean value of the TTCN-3 boolean.
`void setBoolean(in TBoolean value)` Sets this boolean value to value.

7.2.2.2.5 The abstract data type CharstringValue

The abstract data type `CharstringValue` is based on the abstract data type `Value`. It represents TTCN-3 `charstring` values. `TChar` is a character within a `charstring` value.

The following operations are defined on the abstract data type `CharstringValue`:

`TString getString()` Returns the string value of the TTCN-3 `charstring`. The textual representation of the empty TTCN-3 `charstring` is "", while its length is zero.
`void setString(in TString value)` Sets this `CharstringValue` to value.
`TChar getChar(in TInteger position)` Returns the char value of the TTCN-3 `charstring` at `position`. Position 0 denotes the first char of the TTCN-3 `charstring`. Valid values for `position` are from 0 to `length - 1`.
`void setChar(in TInteger position, in TChar value)` Set the character at `position` to `value`. Valid values for `position` are from 0 to `length - 1`.
`TInteger getLength()` Returns the length of this `CharstringValue` in chars, zero if the value of this `CharstringValue` is omit.
`void setLength(in TInteger len)` `setLength` first resets this `CharstringValue` to its initial value and afterwards sets the length of this `CharstringValue` in chars to `len`.

7.2.2.2.6 The abstract data type `UniversalCharstringValue`

The abstract data type `UniversalCharstringValue` is based on the abstract data type `Value`. It represents TTCN-3 universal charstring values. `TUniversalChar` is a character within a universal charstring value.

The following operations are defined on the abstract data type `UniversalCharstringValue`:

<code>TString getString()</code>	Returns the textual representation of this <code>UniversalCharstringValue</code> , as defined in TTCN-3.
<code>void setString(in TString value)</code>	Sets the value of this <code>UniversalCharstringValue</code> according to the textual representation as defined by <code>value</code> .
<code>TUniversalChar getChar(in TInteger position)</code>	Returns the universal char value of the TTCN-3 universal charstring at position. Position 0 denotes the first <code>TUniversalChar</code> of the TTCN-3 universal charstring. Valid values for <code>position</code> are from 0 to <code>length - 1</code> .
<code>void setChar(in TInteger position, in TUniversalChar value)</code>	Sets the universal char at position to <code>value</code> . Valid values for <code>position</code> are from 0 to <code>length - 1</code> .
<code>TInteger getLength()</code>	Returns the length of this universal charstring value in universal chars, zero if the value of this universal charstring value is omit.
<code>void setLength(in TInteger len)</code>	<code>setLength</code> first resets this <code>UniversalCharstringValue</code> to its initial value and afterwards sets the length of this <code>UniversalCharstringValue</code> in universal chars to <code>len</code> .

7.2.2.2.7 The abstract data type `BitstringValue`

The abstract data type `BitstringValue` is based on the abstract data type `Value`. It represents TTCN-3 bitstring values:

The following operations are defined on the abstract data type `BitstringValue`.

<code>TString getString()</code>	Returns the textual representation of this <code>BitstringValue</code> , as defined in TTCN-3. E.g. the textual representation of 0101 is '0101'B. The textual representation of the empty TTCN-3 bitstring is ''B, while its length is zero.
<code>void setString(in TString value)</code>	Sets the value of this <code>BitstringValue</code> according to the textual representation as defined by <code>value</code> . E.g. the value of this <code>BitstringValue</code> is 0101 if the textual representation in <code>value</code> is '0101'B.
<code>TChar getBit(in TInteger position)</code>	Returns the value (0 1) at position of this TTCN-3 bitstring as a character. Position 0 denotes the first bit of the TTCN-3 bitstring. Valid values for <code>position</code> are from 0 to <code>length - 1</code> .
<code>void setBit(in TInteger position, in TInteger value)</code>	Sets the bit at position to the value (0 1). Position 0 denotes the first bit in this <code>BitstringValue</code> . Valid values for <code>position</code> are from 0 to <code>length - 1</code> .
<code>TInteger getLength()</code>	Returns the length of this <code>BitstringValue</code> in bits, zero if the value of this <code>BitstringValue</code> is omit.
<code>void setLength(in TInteger len)</code>	<code>setLength</code> first resets this <code>BitstringValue</code> to its initial value and afterwards sets the length of this <code>BitstringValue</code> in bits to <code>len</code> .

7.2.2.2.8 The abstract data type `OctetstringValue`

The abstract data type `OctetstringValue` is based on the abstract data type `Value`. It represents TTCN-3 `octetstring` values.

The following operations are defined on the abstract data type `OctetstringValue`:

<code>TString getString()</code>	Returns the textual representation of this <code>OctetstringValue</code> , as defined in TTCN-3. E.g. the textual representation of <code>0xCAFFEE</code> is <code>'CAFFEE'</code> . The textual representation of the empty TTCN-3 <code>octetstring</code> is <code>''</code> , while its length is zero.
<code>void setString(in TString value)</code>	Sets the value of this <code>OctetstringValue</code> according to the textual representation as defined by <code>value</code> . E.g. The value of this <code>OctetstringValue</code> is <code>0xCAFFEE</code> if the textual representation in <code>value</code> is <code>'CAFFEE'</code> .
<code>TChar getOctet(in TInteger position)</code>	Returns the value (0..255) at position of this TTCN-3 <code>octetstring</code> . Position 0 denotes the first octet of the TTCN-3 <code>octetstring</code> . Valid values for position are from 0 to <code>length - 1</code> .
<code>void setOctet(in TInteger position, in TInteger value)</code>	Sets the octet at position to value (0..255). Position 0 denotes the first octet in the <code>octetstring</code> . Valid values for position are from 0 to <code>length - 1</code> .
<code>TInteger getLength()</code>	Returns the length of this <code>OctetstringValue</code> in octets, zero if the value of this <code>OctetstringValue</code> is <code>omit</code> .
<code>void setLength(in TInteger len)</code>	<code>setLength</code> first resets this <code>OctetstringValue</code> to its initial value and afterwards sets the length of this <code>OctetstringValue</code> in octets to <code>len</code> .

7.2.2.2.9 The abstract data type `HexstringValue`

The abstract data type `HexstringValue` is based on the abstract data type `Value`. It represents TTCN-3 `hexstring` values.

The following operations are defined on the abstract data type `HexstringValue`:

<code>TString getString()</code>	Returns the textual representation of this <code>HexstringValue</code> , as defined in TTCN-3. E.g. the textual representation of <code>0xAFFEE</code> is <code>'AFFEE'</code> . The textual representation of the empty TTCN-3 <code>hexstring</code> is <code>''</code> , while its length is zero.
<code>void setString(in TString value)</code>	Sets the value of this <code>HexstringValue</code> according to the textual representation as defined by <code>value</code> . E.g. The value of this <code>HexstringValue</code> is <code>0xAFFEE</code> if the textual representation in <code>value</code> is <code>'AFFEE'</code> .
<code>TChar getHex(in TInteger position)</code>	Returns the value (0..15) at position of this TTCN-3 <code>hexstring</code> . Position 0 denotes the first hex digits of the TTCN-3 <code>hexstring</code> . Valid values for position are from 0 to <code>length - 1</code> .
<code>void setHex(in TInteger position, in TInteger value)</code>	Sets the hex digit at position to value (0..15). Position 0 denotes the first octet in the <code>hexstring</code> . Valid values for position are from 0 to <code>length - 1</code> .
<code>TInteger getLength()</code>	Returns the length of this <code>HexstringValue</code> in octets, zero if the value of this <code>HexstringValue</code> is <code>omit</code> .

`void setLength(in TInteger len)` `setLength` first resets this `HexstringValue` to its initial value and afterwards sets the length of this `HexstringValue` in hex digits to `len`.

7.2.2.2.10 The abstract data type `RecordValue`

The abstract data type `RecordValue` is based on the abstract data type `Value`. It specifies how to get and set the TTCN-3 record type.

NOTE: Newly created instances of empty record types are considered to be initialized.

The same abstract data type applies for values whose type class is `SET`. The distinction between `record` and `set` is only relevant at matching time.

The following operations are defined on the abstract data type `RecordValue`:

`Value getField(in TString fieldName)` Returns the value of the field named `fieldName`. The return value is the common abstract base type `Value`, as a record field can have any type defined in TTCN-3. If the field cannot be obtained from the record the distinct value `null` is returned.

`void setField(in TString fieldName, in Value value)`
Sets the field named `fieldName` of the record to `value`. No assumption shall be made on how a field is stored in a record. An internal implementation might choose to store a reference to this value or to copy the value. It is safe to assume that the value is copied. Therefore it should be assumed that subsequent modifications of `value` will not be considered in the record.

`TStringSeq getFieldNames()` Returns a sequence of string of field names, the empty sequence, if the record has no fields.

`void setFieldOmitted(in TString fieldName)`
Mark the referenced field of the record as being omitted.

7.2.2.2.11 The abstract data type `RecordOfValue`

The abstract data type `RecordOfValue` is based on the abstract data type `Value`. It specifies how to get and set elements in TTCN-3 record of types. The same abstract data type applies for value whose type class is `ARRAY` or `SET_OF`. The distinction between `record of`, `set of`, and `array` is only relevant at matching time.

The following operations are defined on the abstract data type `RecordOfValue`:

`Value getField(in TInteger position)` Returns the value of the record of at `position` if `position` is between zero and `length - 1`, the distinct value `null` otherwise. Also for array values indices start from 0, independent of the lower index bound. The return value is the common abstract base type `Value`, as a `record of` can have fields of any type defined in TTCN-3.

`void setField(in TInteger position, in Value value)`
Sets the field at `position` to `value`. If `position` is greater than `(length - 1)` the record of is extended to have the length `(position + 1)`. The record of elements between the original position at `length` and `position - 1` is set to omit. No assumption shall be made on how a field is stored in a `record of`. An internal implementation might choose to store a reference to this value or to copy the value. It is safe to assume that the value is copied. Therefore, it should be assumed that subsequent modifications of `value` will not be considered in the `record of`. Also for array values indices start from 0, independent of the lower index bound.

<code>void appendField(in Value value)</code>	Appends the value at the end of the record of, i.e. at position length. No assumption shall be made on how a field is stored in a record of. An internal implementation might choose to store a reference to this value or to copy the value. It is safe to assume that the value is copied. Therefore, it should be assumed that subsequent modifications of value will not be considered in the record of.
<code>Type getElementType()</code>	Returns the Type of the elements of this record of.
<code>TInteger getLength()</code>	Returns the actual length of the record of value, zero if the record of value is omit.
<code>void setLength(in TInteger len)</code>	Sets the length of the record of to len. If len is greater than the original length, newly created elements have the value omit. If len is less or equal than the original length this operation is ignored.
<code>TInteger getOffset()</code>	Returns the lowest possible index. For a record of or set of value this is always 0. For an array value, this is the lower index bound used in the type definition.

7.2.2.2.12 The abstract data type UnionValue

The abstract data type `UnionValue` is based on the abstract data type `Value`. It specifies how to get and set variants in a TTCN-3 union type. The TTCN-3 anytype is represented by a `UnionValue` where the type class of the type obtained by `getType()` is ANYTYPE. For details on type classes see clause 7.2.2.1.

The following operations are defined on the abstract data type `UnionValue`:

<code>Value getVariant(in TString variantName)</code>	Returns the value of the TTCN-3 union variantName, if variantName equals the result of <code>getPresentVariantName</code> , the distinct value null otherwise. variantName denotes the name of the union variant as defined in the TTCN-3 module.
<code>void setVariant(in TString variantName, in Value value)</code>	Sets variantName of the union to value. If variantName is not defined for this union this operation is ignored. If another variant was selected the new variant is selected instead.
<code>TString getPresentVariantName()</code>	Returns a String representing the currently selected variant name in the given TTCN-3 union. The distinct value null is returned if no variant is selected.
<code>TStringSeq getVariantNames()</code>	Returns a sequence of string of variant names, the distinct value null, if the union has no fields. If the <code>UnionValue</code> represents the TTCN-3 anytype, i.e. the type class of the type obtained by <code>getType()</code> is ANYTYPE, all predefined and user-defined TTCN-3 types is returned.

7.2.2.2.13 The abstract data type EnumeratedValue

The abstract data type `EnumeratedValue` is based on the abstract data type `Value`. It specifies how TTCN-3 enumerated can be set and get.

The following operations are defined on the abstract data type `EnumeratedValue`:

<code>TString getEnum()</code>	Returns the string identifier of this <code>EnumeratedValue</code> . This identifier equals the identifier in the TTCN-3 specification.
<code>void setEnum(in TString enumValue)</code>	Sets the enum to enumValue. If enumValue is not an allowed value for this enumeration the operation is ignored.

<code>TInteger getInt()</code>	Returns the integer value of this <code>EnumeratedValue</code> . This integer equals the user-assigned integer value in the TTCN-3 specification or the automatically assigned integer value.
<code>setInt(in TInteger intValue)</code>	Sets the integer value of this <code>EnumeratedValue</code> . This integer should equal the user-assigned integer value in the TTCN-3 specification or the automatically assigned integer value. If <code>intValue</code> is not an allowed value for this enumeration the operation is ignored.

7.2.2.2.14 The abstract data type `VerdictValue`

The abstract data type `VerdictValue` is based on the abstract data type `Value`. It specifies how TTCN-3 `verdict` can be set and get.

The following operations are defined on the abstract data type `VerdictValue`:

<code>TInteger getVerdict()</code>	Returns the integer value for this <code>VerdictValue</code> . The integer is one of the following constants: <code>ERROR</code> , <code>FAIL</code> , <code>INCONC</code> , <code>NONE</code> , <code>PASS</code> , <code>USER_ERROR</code> .
<code>void setVerdict(in TInteger verdict)</code>	Sets this <code>VerdictValue</code> to <code>verdict</code> . Note that a <code>VerdictValue</code> can be set to any of the above mentioned verdicts at any time. The <code>VerdictValue</code> does not perform any verdict calculations as defined in TTCN-3. For example, it is legal to set the <code>VerdictValue</code> first to <code>INCONC</code> and then to <code>PASS</code> .

7.2.2.2.15 The abstract data type `AddressValue`

The following operations are defined on the base abstract data type `AddressValue`. The concrete representations of these operations are defined in the respective language mapping sections:

<code>Value getAddress()</code>	Returns the address value, which will no longer be of type class <code>ADDRESS</code> but rather of the actual type used for address.
<code>void setAddress(in Value value)</code>	Sets this address value to <code>value</code> .

7.2.3 Abstract logging types

7.2.3.1 The abstract data type `TciValueTemplate`

The following operations are defined on the abstract data type `TciValueTemplate`. The concrete representations of these operations are defined in the respective language mapping sections:

<code>TBoolean isOmit()</code>	Returns <code>true</code> if the template is an omit template.
<code>TBoolean isAny()</code>	Returns <code>true</code> if the template is an any template.
<code>TBoolean isAnyOrOmit()</code>	Returns <code>true</code> if the template is an any or omit template.
<code>TString getTemplateDef()</code>	Returns the definition of that template.

7.2.3.2 The abstract data type `TciNonValueTemplate`

The following operations are defined on the abstract data type `TciNonValueTemplate`. The concrete representations of these operations are defined in the respective language mapping sections:

<code>TBoolean isAny()</code>	Returns <code>true</code> if the template is an any template.
<code>TBoolean isAll()</code>	Returns <code>true</code> if the template is an all template.
<code>TString getTemplateDef()</code>	Returns the definition of that template.

7.2.3.3 The Value List and Mismatch Types

The following abstract data types are defined and used for the logging of differences between values and templates:

<code>TciValueList</code>	A value of <code>TciValueList</code> is a list of values.
<code>TciValueDifference</code>	A value of <code>TciValueDifference</code> is a structure containing a value, a template, and a description for the reason of this difference.
<code>TciValueDifferenceList</code>	A value of <code>TciValueDifferenceList</code> is a sequence of value differences.

The following operations are defined on the abstract data type `TciValueList`. The concrete representations of these operations are defined in the respective language mapping sections:

<code>TInteger size()</code>	Returns the number of values in this list.
<code>TBoolean isEmpty()</code>	Returns <code>true</code> if this list contains no values.
<code>Value get(in TInteger index)</code>	Returns the value at the specified position.

The following operations are defined on the abstract data type `TciValueDifference`. The concrete representations of these operations are defined in the respective language mapping sections:

<code>Value getValue()</code>	Returns the value of the <code>TciValueDifference</code> .
<code>TciValueTemplate getTciValueTemplate()</code>	Returns the template of the <code>TciValueDifference</code> .
<code>String getDescription()</code>	Returns the description of the mismatch.

The following operations are defined on the abstract data type `TciValueDifferenceList`. The concrete representations of these operations are defined in the respective language mapping sections:

<code>TInteger size()</code>	Returns the number of values in the list.
<code>TBoolean isEmpty()</code>	Returns <code>true</code> if the list contains no values.
<code>TciValueDifference get(in TInteger index)</code>	Returns the <code>TciValueDifference</code> at the specified position.

7.2.3.4 The Status Types

The following abstract data types are defined and used for the logging of component and timer status:

<code>ComponentStatusType</code>	A value of <code>ComponentStatusType</code> is either "inactiveC", "runningC", "stoppedC", "killedC", or "nullC".
<code>TimerStatusType</code>	A value of <code>TimerStatusType</code> is either "runningT", "inactiveT", "expiredT", or "nullC".
<code>PortStatusType</code>	A value of <code>PortStatusType</code> is either "startedP", "haltedP", or "stoppedP".

7.3 TCI operations

This clause specifies the operations that a TTCN-3 Executable shall provide to a test system (*required operations*) and which functionality shall be provided by the test system to the TTCN-3 Executable (*provided operations*).

The terms "required" and "provided" reflect the fact that the present document defines the requirements on a TTCN-3 Executable from a user's point of view. The user "requires" from a TTCN-3 Executable certain functionality to build a complete TTCN-3-based test system. To fulfil its task the TTCN-3 Executable has to inform the user on certain events where the user has to "provide" this possibility to the TTCN-3 Executable.

All operation definitions in this clause are defined using the Interface Definition Language (IDL). Concrete language mappings are defined in clauses 8, 9 and 9.7. Annex B provides for the logging interface an alternative mapping to XML.

For every TCI operation call all *in*, *inout*, and *out* parameters listed in the particular operation definition are mandatory. The value of an *in* parameter is specified by the calling entity. Calling entity refers to the direction of the call. For operations on a *required* interface the calling entity is the test system while the called entity is the TTCN-3 Executable. For operations on a *provided* interface the calling entity is the TTCN-3 Executable while the test system is the called entity.

Similarly, the value of an *out* parameter is specified by the called entity. In the case of an *inout* parameter, a value is first specified by the calling entity but may be replaced with a new value by the called entity. Note that although TTCN-3 also uses *in*, *inout*, and *out* for signature definitions the denotations used in TCI IDL specification are not related to those in a TTCN-3 specification.

Operation calls should use a reserved value to indicate the absence of parameters. The reserved values for these types are defined in each language mapping and will be subsequently referred to as the `null` value.

In addition, the `null` value will also be used to indicate the inability to perform a certain task.

As this clause specifies interfaces only and does not suggest concrete implementations on how to perform the specified functionality the term entity will be used to identify the part of the test system implementation that implements this interface and performs the requested functionality. For example, the calling entity in the `tcISendConnected` operation is the TE, i.e. the part of test system implementation that provides the TE functionality.

All functions in the interface are described using the following template. Descriptions that are not applicable for certain operations are removed.

Signature	IDL Signature
In Parameters	Description of data passed as parameters to the operation from the calling entity to the called entity.
Out Parameters	Description of data passed as parameters to the operation from the called entity to the calling entity.
InOut Parameters	Description of data passed as parameters to the operation from the calling entity to the called entity and from the called entity back to the calling entity.
Return Value	Description of data returned from the operation to the calling entity.
Constraint	Description of any constraints when the operation can be called.
Effect	Behaviour required of the called entity before the operation may return.

7.3.1 The TCI-TM interface

The TCI Test Management Interface (TCI-TM) describes the operations a TTCN-3 Executable is required to implement and the operations a test management implementation shall provide to the TE (figure 5).

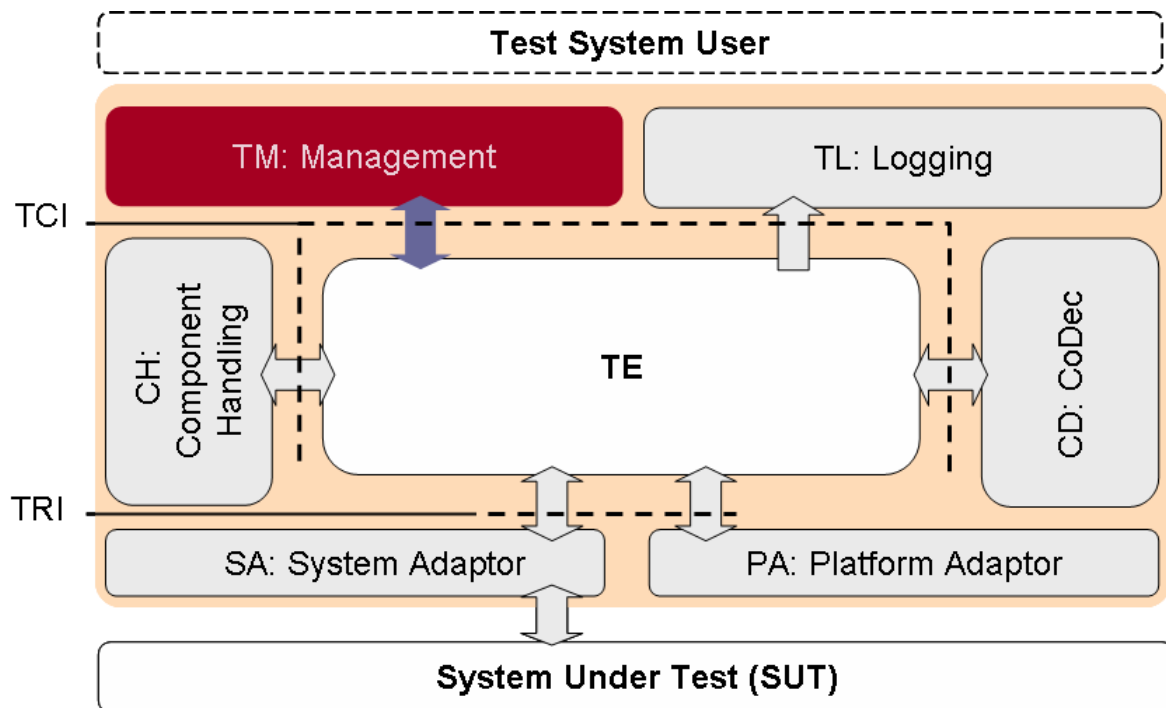

Figure 5: The TCI-TM interface

A test management implementation provides overall test management to the test system user. It requires from the TE the presence of operations to start and stop test execution of a TTCN-3 module or of certain test cases in a TTCN-3 module. In turn it provides operations to the TE for resolving module parameter at runtime and the indication of execution termination.

Annex C illustrates the usage and sequential ordering of operation calls by either the TE or the test management.

7.3.1.1 TCI-TM required

This clause specifies the operations the TM requires from the TE. In addition to the operations specified in this clause, a test management requires the operations as required at the TCI-CD interface.

7.3.1.1.1 tciRootModule

Signature	void tciRootModule (in TciModuleIdType moduleName)	
In Parameters	moduleName	The moduleName denotes the module identifiers as defined in the TTCN-3 module.
Return Value	void	
Constraint	Shall be used only if neither the control part nor a test case is currently being executed.	
Effect	tciRootModule selects the indicated module for execution through a subsequent call using tciStartTestCase or tciStartControl. A tciError will be issued by the TE if no such module exists.	

7.3.1.1.2 tciGetImportedModules

Signature	TciModuleIdListType tciGetImportedModules()
Return Value	A list of all imported modules of the root module. The modules are ordered as they appear in the TTCN-3 module. If no imported modules exist, an empty module list is returned.
Constraint	Shall be used only if a root module has been set before.
Effect	The TE provides to the management a list of imported modules of the root module. If no imported module exists, an empty module list is returned. If the TE cannot provide a list, the distinct null value shall be returned.

7.3.1.1.3 tciGetModuleParameters

Signature	TciModuleParameterListType tciGetModuleParameters (in TciModuleIdType moduleName)
In Parameters	moduleName The moduleName denotes the module identifiers for which the module parameters should be retrieved.
Return Value	A list of all module parameters of the identified module. The parameters are ordered as they appear in the TTCN-3 module. If no parameters exist, an empty module parameter list is returned.
Constraint	Shall be used only if a root module has been set before.
Effect	The TE provides to the management a list of module parameters of the identified module. If no module parameters exist, an empty module parameter list is returned. If the TE cannot provide a list, the distinct null value shall be returned.

7.3.1.1.4 tciGetTestCases

Signature	TciTestCaseIdListType tciGetTestCases ()
Return Value	A list of all test cases that are either defined in or imported into the root module.
Constraint	Shall be used only if a root module has been set before.
Effect	The TE provides to the management a list of test cases. If no test cases exist, an empty test case list is returned. If the TE cannot provide a list, the distinct null value shall be returned.

7.3.1.1.5 tciGetTestCaseParameters

Signature	TciParameterTypeListType tciGetTestCaseParameters (in TciTestCaseIdType testCaseId)
In Parameters	testCaseId A test case identifier as defined in the TTCN-3 module.
Return Value	A list of all parameter types of the given test case. The parameter types are ordered as they appear in the TTCN-3 signature of the test case. If no parameters exist, an empty parameter type list is returned.
Constraint	Shall be used only if a root module has been set before.
Effect	The TE provides to the management a list of parameter types of the given test case. If no test case parameters exist, an empty parameter type list is returned. If the TE cannot provide a list, the distinct null value shall be returned.

7.3.1.1.6 tciGetTestCaseTSI

Signature	TriPortIdListType tciGetTestCaseTSI (in TciTestCaseIdType testCaseId)
In Parameters	testCaseId A test case identifier as defined in the TTCN-3 module.
Return Value	A list of all system ports of the given test case that have been declared in the definition of the system component for the test case, i.e. the TSI ports. If a system component has not been explicitly defined for the test case, then the list contains all communication ports of the MTC test component. The ports are ordered as they appear in the respective TTCN-3 component type declaration. If no system ports exist, an empty list, i.e. a list of length zero is returned.
Constraint	Shall be used only if a root module has been set before.
Effect	The TE provides to the management a list of system ports of the given test case. If no system ports exist, an empty port list is returned. If the TE cannot provide a list, the distinct null value shall be returned.

7.3.1.1.7 tciStartTestCase

Signature	void tciStartTestCase(in TciTestCaseIdType testCaseId, in TciParameterListType parameterList)	
In Parameters	testCaseId	A test case identifier as defined in the TTCN-3 module.
	parameterList	A list of Values where each value defines a parameter from the parameter list as defined in the TTCN-3 test case definition. The parameters in parameterList are ordered as they appear in the TTCN-3 signature of the test case. If no parameters have to be passed either the null value or an empty parameterList, i.e. a list of length zero shall be passed.
Return Value	void	
Constraint	Shall be called only if a module has been selected before. Only testCaseIds for test cases that are declared in the currently selected TTCN-3 module shall be passed. Test cases that are imported in a referenced module cannot be started. To start imported test cases the referenced (imported) module must be selected first using the tciRootModule operation.	
Effect	tciStartTestCase starts a test case in the currently selected module with the given parameters. A tciError will be issued by the TE if no such test case exists. All in and inout test case parameters in parameterList contain Value. All out test case parameters in parameterList shall contain the distinct value of null since they are only of relevance when the test case terminates.	

7.3.1.1.8 tciStopTestCase

Signature	void tciStopTestCase()	
Return Value	void	
Constraint	Shall be called only if a module has been selected before.	
Effect	tciStopTestCase stops the test case currently being executed. If the TE is not executing a test case, the operation will be ignored. If the control part is being executed, tciStopTestCase will stop execution of the currently executed test case, i.e. the execution of the test case that has recently been indicated using the provided operation tciTestCaseStarted. A possible executing control part will continue execution as if the test case has stopped normally and returned with verdict ERROR.	

7.3.1.1.9 tciStartControl

Signature	TriComponentId tciStartControl()	
Return Value	A TriComponentId that represents the test component the module control part is executed on. If the TE cannot start control part of the selected module the distinct value null will be returned.	
Constraint	Shall be called only if a module has been selected before.	
Effect	Starts the control part of the selected module. The control part will start TTCN-3 test cases as described in TTCN-3. While executing the control part the TE will call the provided operation tciTestCaseStarted and tciTestCaseTerminated for every test case that has been started and that has terminated. After termination of the control part the TE will call the provided operation tciControlPartTerminated.	

7.3.1.1.10 tciStopControl

Signature	void tciStopControl()	
Return Value	void	
Constraint	Shall only be called if a module has been selected before.	
Effect	tciStopControl stops execution of the control part. If no control part is currently being executed the operation will be ignored. If a test case has been started directly this will stop execution of the current test case as if tciStopTestCase has been called.	

7.3.1.2 TCI-TM provided

This clause specifies the operations the TM has to provide to the TE.

7.3.1.2.1 tciTestCaseStarted

Signature	void tciTestCaseStarted(in TciTestCaseIdType testCaseId, in TciParameterListType parameterList, in TFloat timer)	
In Parameters	testCaseId	A test case identifier as defined in the TTCN-3 module.
	parameterList	A list of values that are part of the test case signature. The parameters in parameterList are ordered as they appear in the TTCN-3 test case declaration.
	timer	A float value representing the duration of the test case timer.
Return Value	void	
Constraint	Shall only be called after either the control part of the module or a test case has been started using the <i>required</i> operations tciStartControl or tciStartTestCase.	
Effect	tciTestCaseStarted indicates to the TM that a test case with testCaseId has been started. It will not be distinguished whether the test case has been started explicitly using the <i>required</i> operation tciStartTestCase or implicitly while executing the control part.	

7.3.1.2.2 tciTestCaseTerminated

Signature	void tciTestCaseTerminated(in VerdictValue verdict, in TciParameterListType parameterList)	
In Parameters	verdict	The final verdict of the test case.
	parameterList	A list of values that are part of the test case signature. The parameters in parameterList are ordered as they appear in the TTCN-3 test case declaration.
Return Value	void	
Constraint	Shall only be called after either the control part of the module or a test case has been started using the <i>required</i> operations tciStartControl or tciStartTestCase.	
Effect	This operation will be called by the TE to indicate the test management that the test case that has been currently executed on the MTC has terminated and that the final verdict was verdict. On the invocation of a tciTestCaseTerminated operation all <i>out</i> and <i>inout</i> test case parameters contain Values. All in test case parameters contain the distinct value of null because they are only of relevance to the test case start but not in the reply to the call.	

7.3.1.2.3 tciControlTerminated

Signature	void tciControlTerminated ()	
Return Value	void	
Constraint	Shall only be called when the module execution has been started using the tciStartControl operation.	
Effect	This operation will be called by the TE to indicate the test management that the control part of the selected module has just terminated execution.	

7.3.1.2.4 tciGetModulePar

Signature	Value tciGetModulePar (in TciModuleParameterIdType parameterId)	
In Parameters	parameterId	The identifier of the module parameter as defined in the TTCN-3 module.
Return Value	A value.	
Constraint	This operation shall be called whenever the TE needs to access the value of a module parameter. Every accessed module parameter will be resolved only once between a tciStartTestCase and tciTestCaseTerminated pair if a test case has been started explicitly or between a tciStartControl and tciControlTerminated pair if the control part of a module has been started.	
Effect	The management provides to the TE a Value for the indicated parameterId. Every call of tciGetModulePar() will return the same value throughout the execution of an explicitly started test case or throughout the execution of a control part. If the management cannot provide a TTCN-3 value, the distinct null value shall be returned.	

7.3.1.2.5 tciLog

Signature	void tciLog (in TriComponentIdType testComponentId, in TString message)	
In Parameters	testComponentId	Identifier of the component that logs the message.
	message	A string value, i.e. the message to be logged.
Return Value	void	
Constraint	Shall be called by the TE when the TTCN-3 statement log will be executed, either in the control part of a module or within the test case.	
Effect	The TM presents testComponentId and message to the user, how this done is not within the scope of the present document.	

7.3.1.2.6 tciError

Signature	void tciError(in TString message)	
In Parameters	message	A string value, i.e. the error message.
Return Value	void	
Constraint	Can be called at any time by the TE to indicate an unrecoverable error situation. This error situation could either be indicated by the CH or the CD or could occur within the TE.	
Effect	The TE indicates the occurrence of an unrecoverable error situation. message contains a reason phrase that might be communicated to the test system user. It is up to the test management to terminate execution of test cases or control parts if running. The test management has to take explicit measures to terminate test execution immediately.	

7.3.2 The TCI-CD interface

The TCI Codec Interface (TCI-CD) describes the operations a TTCN-3 Executable is required to implement and the operations a codec implementation for a certain encoding scheme shall provide to the TE (see figure 6).

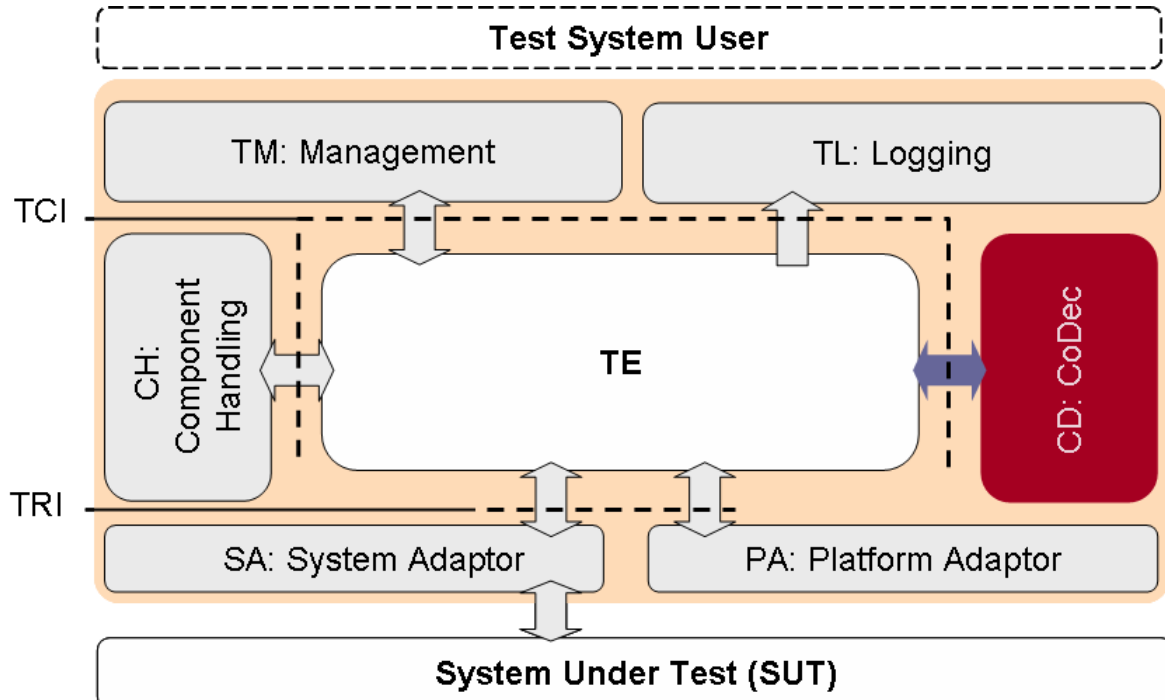

Figure 6: The TCI-CD interface

A codec implementation encodes TTCN-3 values according to the encoding attribute into a bitstring and decodes a bitstring according to decoding hypothesis. To be able to decode a bitstring into a TTCN-3 value the CD requires certain functionality from the TE. In turn the CD provides encoding and decoding functionality to the TTCN-3 Executable.

Annex C illustrates the usage and sequential ordering of operation calls by either the TE or the CD.

7.3.2.1 TCI-CD required

This clause specifies the operations the CD requires from the TE. All operations specified in this clause are also required at the TCI-TM and TCI-CH interfaces.

7.3.2.1.1 getTypeForName

Signature	Type getTypeForName(in TString typeName)	
In Parameters	typeName	The TTCN-3 name of the type as defined in the TTCN-3 module. The following are reserved type names and will return a predefined type: "integer" "float" "bitstring" "hexstring" "octetstring" "charstring" "universal charstring" "boolean" "verdicttype" typeName has to be the fully qualified type name, i.e. module.typeName
Return Value	A type representing the requested TTCN-3 type.	
Constraint	---	
Effect	Returns a type representing a TTCN-3 type. Predefined TTCN-3 types can be retrieved from the TE by using the TTCN-3 keywords for the predefined types. In this case typeName denotes to the basic TTCN-3 type like "charstring", "bitstring", etc. Returns the distinct value null if the requested type cannot be returned. Note that the anytype and address cannot be obtained with module set to null. Although they are predefined types they might be distinct between modules. For example, address can either be the unmodified predefined type, or a user-defined type in a module. Other predefined types cannot be redefined.	

7.3.2.1.2 getInteger

Signature	Type getInteger()
Return Value	An instance of Type representing a TTCN-3 integer type.
Effect	Constructs and returns a basic TTCN-3 integer type.

7.3.2.1.3 getFloat

Signature	Type getFloat()
Return Value	An instance of Type representing a TTCN-3 float type.
Effect	Constructs and returns a basic TTCN-3 float type.

7.3.2.1.4 getBoolean

Signature	Type getBoolean()
Return Value	An instance of Type representing a TTCN-3 boolean type.
Effect	Constructs and returns a basic TTCN-3 boolean type.

7.3.2.1.5 Void

7.3.2.1.6 getCharstring

Signature	Type getCharstring ()
Return Value	An instance of Type representing a TTCN-3 charstring type.
Effect	Constructs and returns a basic TTCN-3 charstringtype.

7.3.2.1.7 getUniversalCharstring

Signature	Type getUniversalCharstring ()
Return Value	An instance of Type representing a TTCN-3 universal charstring type.
Effect	Constructs and returns a basic TTCN-3 universal charstring type.

7.3.2.1.8 getHexstring

Signature	Type getHexstring ()
Return Value	An instance of Type representing a TTCN-3 hexstring type.
Effect	Constructs and returns a basic TTCN-3 hexstring type.

7.3.2.1.9 getBitstring

Signature	Type getBitstring()
Return Value	An instance of Type representing a TTCN-3 bitstring type.
Effect	Constructs and returns a basic TTCN-3 bitstring type.

7.3.2.1.10 getOctetstring

Signature	Type getOctetstring ()
Return Value	An instance of Type representing a TTCN-3 octetstring type.
Effect	Constructs and returns a basic TTCN-3 octetstring type.

7.3.2.1.11 getVerdict

Signature	Type getVerdict()
Return Value	An instance of Type representing a TTCN-3 verdict type.
Effect	Constructs and returns a basic TTCN-3 verdict type.

7.3.2.1.12 tciErrorReq

Signature	void tciErrorReq(in TString message)	
In Parameters	Message	A string value, i.e. the error phrase describing the problem.
Return Value	void	
Constraint	Shall be called whenever an error situation has occurred.	
Effect	The TE will be notified about an unrecoverable error situation within the CD and forward the error indication to the test management.	

7.3.2.2 TCI-CD provided

This clause specifies the operations the TM shall provide to the TE.

7.3.2.2.1 decode

Signature	Value decode(in TriMessageType message, in Type decodingHypothesis)	
In Parameters	message	The encoded message to be decoded.
	decodingHypothesis	The hypothesis the decoding can be based on.
Return Value	Returns the decoded value, if the value is of a compatible type as the decodingHypothesis, else the distinct value null.	
Constraint	This operation shall be called whenever the TE has to decode an encoded value. The TE might decode immediately after reception of an encoded value, or might for performance considerations postpone the decoding until the actual access of the encoded value.	
Effect	This operation decodes message according to the encoding rules and returns a TTCN-3 value. The decodingHypothesis shall be used to determine whether the encoded value can be decoded. If an encoding rule is not self-sufficient, i.e. if the encoded message does not inherently contain its type decodingHypothesis shall be used. If the encoded value can be decoded without the decoding hypothesis, the distinct null value shall be returned if the type determined from the encoded message is not compatible with the decoding hypothesis.	

7.3.2.2.2 encode

Signature	TriMessageType encode(in Value value)	
In Parameters	value	The value to be encoded.
Return Value	Returns an encoded TriMessage for the specified encoding rule.	
Constraint	This operation shall be called whenever the TE has to encode a Value.	
Effect	Returns an encoded TriMessage according to the encoding rules.	

7.3.3 The TCI-CH interface

The TCI Component Handling Interface (TCI-CH) describes the operations a TTCN-3 Executable is required to implement and the operations a component handling implementation shall provide to the TE (figure 7).

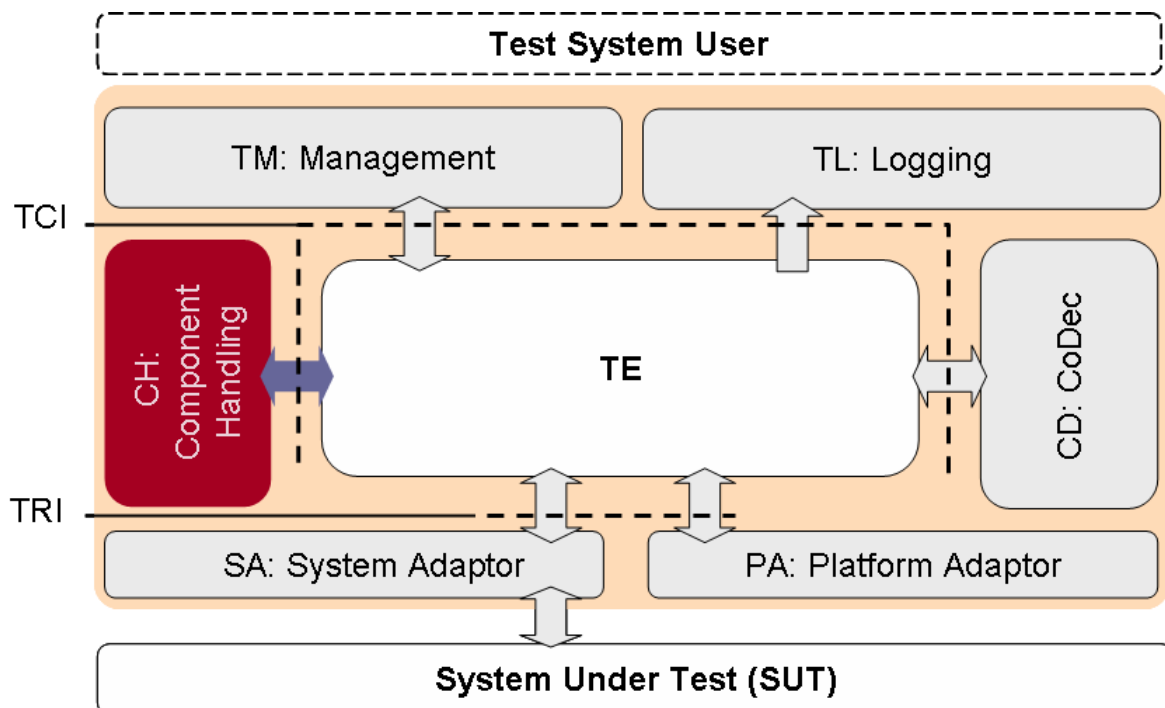

Figure 7: The TCI-CH interface

A component handling implementation distributes TTCN-3 configuration operations like create, connect and start and intercomponent communication like send on a connected port among one or more TTCN-3 Executables participating in a test session. Note that although multiple instances of a TE might participate in a test session this is not mandatory.

The basic principle is that TCI-CH is not *implementing* any kind of TTCN-3 functionality. Instead it will be informed by the TE that for example a test component shall be created. Based on Component Handling (CH) internal knowledge the request for creation of a test component will be transmitted to another (remote) participating TE. This second (remote) participating TE will create the TTCN-3 component and will provide a handle back to the requesting (local) TE. The requesting (local) TE can now operate on the created test component via this component handle.

Within the operation definitions the terms local TE and remote TE is used to highlight the fact that a test system implementation might be distributed over several test devices, each of them hosting a complete TE. The terms "local" and "remote" always refer to the interfaces currently being described. For convenience, the term "local" refers always to the TE being either the callee of an operation (for *required* operations) or the caller of an operation (for *provided* operations). While the TE is conceptually considered as being distributed, the CH is considered to be non-distributed. This can either be achieved using a centralized architecture or by using a middleware-platform that abstracts from distribution aspects. Although the TE might be distributed over different physical devices, there might be configurations where only one, non-distributed TE will participate in a test session. In this case the term "local" and "remote" refer to the same TE instance.

Annex C illustrates the usage and sequential ordering of operation calls by either the TE or the CH.

Although all TTCN-3 Executables participating in a test session are equal, there is a distinct TE*. This TE* is the TE where the explicit `tciStartTestCase()` or `tciStartControl()` has been processed. The reason for this distinction is, that TE* shall calculate the global verdict. TE* will notify the test management upon termination of test execution and shall provide then the global verdict of the test case.

7.3.3.1 TCI-CH required

This clause specifies the operations the CH requires from the TE. In addition to the operations specified in this clause, all *required* operations of the TCI-CD interface are also required.

7.3.3.1.1 tciEnqueueMsgConnected

Signature	void tciEnqueueMsgConnected (in TriPortIdType sender, in TriComponentIdType receiver, in Value rcvdMessage)	
In Parameters	sender	Port identifier at the sending component via which the message is sent.
	receiver	Identifier of the receiving component.
	rcvdMessage	The value to be enqueued.
Return Value	void	
Constraint	This operation shall be called by the CH at the local TE when at remote TE a <i>provided</i> <code>tciSendConnected</code> has been called.	
Effect	The TE enqueues the received value into the local port queue of the indicated receiver component.	

7.3.3.1.2 tciEnqueueCallConnected

Signature	void tciEnqueueCallConnected (in TriPortIdType sender, in TriComponentIdType receiver, in TriSignatureIdType signature, in TciParameterListType parameterList)	
In Parameters	sender	Port identifier at the sending component via which the message is sent.
	receiver	Identifier of the receiving component.
	signature	Identifier of the signature of the procedure call.
	parameterList	A list of value parameters which are part of the indicated signature. The parameters in <code>parameterList</code> are ordered as they appear in the TTCN-3 signature declaration.
Return Value	void	
Constraint	This operation shall be called by the CH at the local TE when at a remote TE a <i>provided</i> <code>tciCallConnected</code> has been called. All <i>in</i> and <i>inout</i> procedure parameters contain values. All <i>out</i> procedure parameters shall contain the distinct value of <code>null</code> because they are only of relevance in a reply to the procedure call but not in the procedure call itself. The procedure parameters are the parameters specified in the TTCN-3 signature template.	
Effect	The TE enqueues the calls at the local port queue of the indicated receiver component.	

7.3.3.1.3 tciEnqueueReplyConnected

Signature	void tciEnqueueReplyConnected (in TriPortIdType sender, in TriComponentIdType receiver, in TriSignatureIdType signature, in TciParameterListType parameterList, in Value returnValue)	
In Parameters	sender	Identifier of the port sending the reply.
	receiver	Identifier of the component receiving the reply.
	signature	Identifier of the signature of the procedure call.
	parameterList	A list of value parameters which are part of the indicated signature. The parameters in parameterList are ordered as they appear in the TTCN-3 signature declaration.
	returnValue	(Optional) return value of the procedure call.
Return Value	void	
Constraint	This operation shall be called by the CH at the local TE when at a remote TE a <i>provided</i> tciReplyConnected has been called. All <i>out</i> and <i>inout</i> procedure parameters and the return value contain values. All <i>in</i> procedure parameters shall contain the distinct value of null since they are only of relevance to the procedure call but not in the reply to the call. The parameterList contains procedure call parameters. These parameters are the parameters specified in the TTCN-3 signature template. If no return type has been defined for the procedure signature in the TTCN-3 ATS, the distinct value null shall be passed for the returnValue.	
Effect	The TE enqueues the reply at the local port queue of the indicated receiver component.	

7.3.3.1.4 tciEnqueueRaiseConnected

Signature	void tciEnqueueRaiseConnected (in TriPortIdType sender, in TriComponentIdType receiver, in TriSignatureIdType signature, in Value exception)	
In Parameters	sender	Identifier of the port sending the reply.
	receiver	Identifier of the component receiving the reply.
	signature	Identifier of the signature of the procedure call.
	exception	The exception.
Return Value	void	
Constraint	This operation shall be called by the CH at the local TE when at a remote TE a <i>provided</i> tciRaiseConnected has been called.	
Effect	The TE enqueues the exception at the local port queue of the indicated receiver component.	

7.3.3.1.5 tciCreateTestComponent

Signature	TriComponentIdType tciCreateTestComponent (in TciTestComponentKindType kind, in Type componentType), in TString name, in Value hostId)	
In Parameters	kind	The kind of component that shall be created (any kind except of SYSTEM).
	componentType	Identifier of the TTCN-3 component type that shall be created.
	name	Name of the component that shall be created.
	hostId	Value identifying the remote TE where the component shall be deployed.
Return Value	A TriComponentIdType value for the created component.	
Constraint	This operation shall be called by the CH at the local TE when at a remote TE a <i>provided</i> tciCreateTestComponentReq has been called. componentType shall be set to the distinct value null if a test component of kind control shall be created. name shall be set to the distinct value null if no name is given in the TTCN-3 create statement. If a non-null hostId is given, this hostId should be used to identify the remote TE in which to call tciCreateTestComponent.	
Effect	The TE creates a TTCN-3 test component of the componentType and passes a TriComponentIdType reference back to the CH. The CH communicates the reference back to the remote TE.	

7.3.3.1.6 tciStartTestComponent

Signature	void tciStartTestComponent (in TriComponentIdType component, in TciBehaviourIdType behaviour, in TciParameterListType parameterList)	
In Parameters	component	Identifier of the component to be started. Refers to an identifier previously created by a call of tciCreateTestComponent.
	behaviour	Identifier of the behaviour to be started on the component.
	parameterList	A list of Values where each value defines a parameter from the parameter list as defined in the TTCN-3 function declaration of the function being started. The parameters in parameterList are ordered as they appear in the TTCN-3 signature of the test case. If no parameters have to be passed either the null value or an empty parameterList, i.e. a list of length zero shall be passed.
Return Value	void	
Constraint	This operation shall be called by the CH at the local TE when at a remote TE a <i>provided</i> tciStartTestComponentReq has been called.	
Effect	The TE shall start the indicated behaviour on the indicated component.	

7.3.3.1.7 tciStopTestComponent

Signature	void tciStopTestComponent (in TriComponentIdType component)	
In Parameters	component	Identifier of the component to be stopped.
Return Value	void	
Constraint	This operation shall be called by the CH at the local TE when at a remote TE a <i>provided</i> tciStopTestComponentReq has been called.	
Effect	The TE shall stop the indicated behaviour on the indicated component.	

7.3.3.1.8 tciConnect

Signature	void tciConnect (in TriPortIdType fromPort, in TriPortIdType toPort)	
In Parameters	fromPort	Identifier of the test component port to be connected from.
	toPort	Identifier of the test component port to be connected to.
Return Value	void	
Constraint	This operation shall be called by the CH at the local TE when at a remote TE a <i>provided</i> tciConnectReq has been called.	
Effect	The TE shall connect the indicated ports to one another.	

7.3.3.1.9 tciDisconnect

Signature	void tciDisconnect (in TriPortIdType fromPort, in TriPortIdType toPort)	
In Parameters	fromPort	Identifier of the test component port to be disconnected.
	toPort	Identifier of the test component port to be disconnected.
Return Value	void	
Constraint	This operation shall be called by the CH at the local TE when at a remote TE a <i>provided</i> tciDisconnectReq has been called.	
Effect	The TE shall disconnect the indicated ports.	

7.3.3.1.10 tciMap

Signature	void tciMap (in TriPortIdType fromPort, in TriPortIdType toPort)	
In Parameters	fromPort	Identifier of the test component port to be mapped from.
	toPort	Identifier of the test component port to be mapped to.
Return Value	void	
Constraint	This operation shall be called by the CH at the local TE when at a remote TE a <i>provided</i> tciMapReq has been called.	
Effect	The TE shall map the indicated ports to one another.	

7.3.3.1.11 tciMapParam

Signature	void tciMapParam (in TriPortIdType fromPort, in TriPortIdType toPort in TriParameterListType paramList)	
In Parameters	fromPort	Identifier of the test component port to be mapped from.
	toPort	Identifier of the test component port to be mapped to.
	paramList	Configuration parameter list.
Return Value	void	
Constraint	This operation shall be called by the CH at the local TE when at a remote TE a <i>provided</i> tciMapParamReq has been called.	
Effect	The TE shall map the indicated ports to one another.	

7.3.3.1.12 tciUnmap

Signature	void tciUnmap (in TriPortIdType fromPort, in TriPortIdType toPort)	
In Parameters	fromPort	Identifier of the test component port to be unmapped.
	toPort	Identifier of the test component port to be unmapped.
Return Value	void	
Constraint	This operation shall be called by the CH at the local TE when at a remote TE a <i>provided</i> tciUnmapReq has been called.	
Effect	The TE shall unmap the indicated ports.	

7.3.3.1.13 tciUnmapParam

Signature	void tciUnmapParam (in TriPortIdType fromPort, in TriPortIdType toPort in TriParameterListType paramList)	
In Parameters	fromPort	Identifier of the test component port to be unmapped.
	toPort	Identifier of the test component port to be unmapped.
	paramList	Configuration parameter.
Return Value	void	
Constraint	This operation shall be called by the CH at the local TE when at a remote TE a <i>provided</i> tciUnmapParamReq has been called.	
Effect	The TE shall unmap the indicated ports.	

7.3.3.1.14 tciTestComponentTerminated

Signature	void tciTestComponentTerminated (in TriComponentIdType component, in VerdictValue verdict)	
In Parameters	component	Identifier of the component that has terminated.
	verdict	Verdict after termination of the component.
Return Value	void	
Constraint	This operation shall be called by the CH at the local TE when at a remote TE a <i>provided</i> tciTestComponentTerminatedReq has been called.	
Effect	The local TE is notified of the termination of the indicated test component on a remote TE. Because the out values of <i>inout</i> and <i>out</i> parameters of a function being executed on a test component have no effect on that test component (ES 201 873-1 [1]), the tciTestComponentTerminated operation does not have a parameterList parameter.	

7.3.3.1.15 tciTestComponentRunning

Signature	TBoolean tciTestComponentRunning (in TriComponentIdType component)	
In Parameters	component	Identifier of the component to be checked for running.
Return Value	true if the indicated component is still executing a behaviour, false otherwise.	
Constraint	This operation shall be called by the CH at the local TE when at a remote TE a <i>provided</i> tciTestComponentRunningReq has been called.	
Effect	The local TE determines whether the indicated component is executing a test behaviour. If the component is executing a behaviour true will be returned. In any other case, e.g. test component has finished execution, or test component has not been started, etc. false will be returned. After the operation returns, the CH will communicate the value back to the remote TE.	

7.3.3.1.16 tciTestComponentDone

Signature	TBoolean tciTestComponentDone (in TriComponentIdType comp)	
In Parameters	comp	Identifier of the component to be checked for done.
Return Value	true if the indicated component has completed executing its behaviour, false otherwise.	
Constraint	This operation shall be called by the CH at the local TE when at a remote TE a <i>provided</i> tciTestComponentDoneReq has been called.	
Effect	The local TE determines whether the indicated component has completed executing its test behaviour. If the component has completed its behaviour true will be returned. In any other case, e.g. test component has not been started, or test component is still executing, false will be returned. After the operation returns, the CH will communicate the value back to the remote TE.	

7.3.3.1.17 tciGetMTC

Signature	TriComponentIdType tciGetMTC ()	
Return Value	A TriComponentIdType value of the MTC if the MTC executes on the local TE, the distinct value null otherwise.	
Constraint	This operation can be called by the CH at the appropriate local TE when at a remote TE a <i>provided</i> tciGetMTCReq has been called.	
Effect	The local TE determines whether the MTC is executing on the local TE. If the MTC executes on the local TE the component id of the MTC is being returned. If the MTC is not executed on the local TE the distinct value null will be returned. The operation will have no effect on the execution of the MTC. After the operation returns, the CH will communicate the value back to the remote TE.	

7.3.3.1.18 tciExecuteTestCase

Signature	void tciExecuteTestCase (in TciTestCaseIdType testCaseId, in TriPortIdListType tsiPortList)	
In Parameters	testCaseId	A test case identifier as defined in the TTCN-3 module.
	tsiPortList	Contains all ports that have been declared in the definition of the system component for the test case, i.e. the TSI ports. If a system component has not been explicitly defined for the test case, then the tsiPortList contains all communication ports of the MTC. The ports in tsiPortList are ordered as they appear in the respective TTCN-3 component type declaration. If no ports have to be passed either the null value or an empty tsiPortList, i.e. a list of length zero shall be passed.
Return Value	void	
Constraint	This operation shall be called by the CH at the appropriate local TE when at a remote TE a <i>provided</i> tciExecuteTestCaseReq has been called.	
Effect	The local TE determines whether static connections to the SUT and the initialization of communication means for TSI ports should be done.	

7.3.3.1.19 tciReset

Signature	void tciReset ()	
Return Value	void	
Constraint	This operation shall be called by the CH at appropriate local TEs when at a remote TE a <i>provided</i> tciResetReq has been called.	
Effect	The TE can decide to take any means to reset the test system locally.	

7.3.3.1.20 tciKillTestComponent

Signature	void tciKillTestComponent (in TriComponentIdType comp)	
In Parameters	comp	Identifier of the component to be killed.
Return Value	void	
Constraint	This operation shall be called by the CH at the local TE when at a remote TE a <i>provided</i> tciKillTestComponentReq has been called.	
Effect	The TE stops the behaviour on the indicated component if necessary and transfers it into the killed state.	

7.3.3.1.21 tciTestComponentAlive

Signature	TBoolean tciTestComponentAlive (in TriComponentIdType comp)	
In Parameters	comp	Identifier of the component to be checked for being alive.
Return Value	true if the indicated component is alive, false otherwise.	
Constraint	This operation shall be called by the CH at the local TE when at a remote TE a <i>provided</i> tciTestComponentAliveReq has been called.	
Effect	The local TE determines whether the indicated component is alive. After the operation returns, the CH will communicate the value back to the remote TE.	

7.3.3.1.22 tciTestComponentKilled

Signature	TBoolean tciTestComponentKilled (in TriComponentIdType comp)	
In Parameters	comp	Identifier of the component to be checked for being killed.
Return Value	true if the indicated component has been killed, false otherwise.	
Constraint	This operation shall be called by the CH at the local TE when at a remote TE a <i>provided</i> tciTestComponentKilledReq has been called.	
Effect	The local TE determines whether the indicated component is in the killed state. If it is, true will be returned. In any other case, false will be returned. After the operation returns, the CH will communicate the value back to the remote TE.	

7.3.3.2 TCI-CH provided

This clause specifies the operations the CH shall provide to the TE.

7.3.3.2.1 tciSendConnected

Signature	void tciSendConnected (in TriPortIdType sender, in TriComponentIdType receiver, in Value sendMessage)	
In Parameters	sender	Port identifier at the sending component via which the message is sent.
	receiver	Identifier of the receiving component.
	sendMessage	The message to be sent.
Return Value	void	
Constraint	This operation shall be called by the TE when it executes a TTCN-3 unicast send operation on a component port, which has been connected to another component port.	
Effect	Sends an asynchronous transmission only to the given receiver component. CH transmits the message to the remote TE on which receiver is being executed and enqueues the data in the remote TE.	

7.3.3.2.2 tciSendConnectedBC

Signature	void tciSendConnectedBC (in TriPortIdType sender, in Value sendMessage)	
In Parameters	sender	Port identifier at the sending component via which the message is sent.
	sendMessage	The message to be sent.
Return Value	void	
Constraint	This operation shall be called by the TE when it executes a TTCN-3 broadcast send operation on a component port, which has been connected to other component ports.	
Effect	Sends an asynchronous transmission to all components being connected to this port. CH transmits the message to all remote TEs on which receivers are being executed and enqueues the data in the remote TEs.	

7.3.3.2.3 tciSendConnectedMC

Signature	void tciSendConnectedMC (in TriPortIdType sender, in TriComponentIdListType receivers, in Value sendMessage)	
In Parameters	sender	Port identifier at the sending component via which the message is sent.
	receivers	Identifiers of the receiving components.
	sendMessage	The message to be sent.
Return Value	void	
Constraint	This operation shall be called by the TE when it executes a TTCN-3 multicast send operation on a component port, which has been connected to other component ports.	
Effect	Sends an asynchronous transmission to all given receiver components. CH transmits the message to all remote TEs on which receivers are being executed and enqueues the data in the remote TEs.	

7.3.3.2.4 tciCallConnected

Signature	void tciCallConnected (in TriPortIdType sender, in TriComponentIdType receiver, in TriSignatureIdType signature, in TciParameterListType parameterList)	
In Parameters	sender	Port identifier at the sending component via which the message is sent.
	receiver	Identifier of the receiving component.
	signature	Identifier of the signature of the procedure call.
	parameterList	A list of value parameters which are part of the indicated signature. The parameters in parameterList are ordered as they appear in the TTCN-3 signature declaration.
Return Value	void	
Constraint	This operation shall be called by the TE when it executes a TTCN-3 unicast call operation on a component port, which has been connected to another component port. All <i>in</i> and <i>inout</i> procedure parameters contain values. All <i>out</i> procedure parameters shall contain the distinct value of null because they are only of relevance in a reply to the procedure call but not in the procedure call itself. The procedure parameters are the parameters specified in the TTCN-3 signature template.	
Effect	On invocation of this operation the TE can initiate the procedure call corresponding to the signature identifier signature at the called component receiver. The tciCallConnected operation shall return without waiting for the return of the issued procedure call. Note that an optional timeout value, which can be specified in the TTCN-3 ATS for a call operation, is not included in the tciCallConnected operation signature. The TE is responsible to address this issue by starting a timer for the TTCN-3 call operation in the PA with a separate TRI operation call, i.e. triStartTimer. CH transmits the call to the remote TE on which receiver is being executed and enqueues the call in the remote TE.	

7.3.3.2.5 tciCallConnectedBC

Signature	void tciCallConnectedBC (in TriPortIdType sender, in TriSignatureIdType signature, in TciParameterListType parameterList)	
In Parameters	sender	Port identifier at the sending component via which the message is sent.
	signature	Identifier of the signature of the procedure call.
	parameterList	A list of value parameters which are part of the indicated signature. The parameters in parameterList are ordered as they appear in the TTCN-3 signature declaration.
Return Value	void	
Constraint	This operation shall be called by the TE when it executes a TTCN-3 broadcast call operation on a component port, which has been connected to other component ports. All <i>in</i> and <i>inout</i> procedure parameters contain values. All <i>out</i> procedure parameters shall contain the distinct value of null because they are only of relevance in a reply to the procedure call but not in the procedure call itself. The procedure parameters are the parameters specified in the TTCN-3 signature template.	
Effect	On invocation of this operation the TE can initiate the procedure call corresponding to the signature identifier signature at the called component receiver. The tciCallConnected operation shall return without waiting for the return of the issued procedure call. Note that an optional timeout value, which can be specified in the TTCN-3 ATS for a call operation, is not included in the tciCallConnected operation signature. The TE is responsible to address this issue by starting a timer for the TTCN-3 call operation in the PA with a separate TRI operation call, i.e. triStartTimer. CH transmits the call to all remote TEs on which a receiver is being executed and enqueues the call in the remote TEs.	

7.3.3.2.6 tciCallConnectedMC

Signature	void tciCallConnectedMC (in TriPortIdType sender, in TriComponentIdListType receivers, in TriSignatureIdType signature, in TciParameterListType parameterList)	
In Parameters	sender	Port identifier at the sending component via which the message is sent.
	receivers	Identifier of the receiving components.
	signature	Identifier of the signature of the procedure call.
	parameterList	A list of value parameters which are part of the indicated signature. The parameters in parameterList are ordered as they appear in the TTCN-3 signature declaration.
Return Value	void	
Constraint	This operation shall be called by the TE when it executes a TTCN-3 multicast call operation on a component port, which has been connected to other component ports. All <i>in</i> and <i>inout</i> procedure parameters contain values. All <i>out</i> procedure parameters shall contain the distinct value of null because they are only of relevance in a reply to the procedure call but not in the procedure call itself. The procedure parameters are the parameters specified in the TTCN-3 signature template.	
Effect	On invocation of this operation the TE can initiate the procedure call corresponding to the signature identifier signature at the called component receiver. The tciCallConnected operation shall return without waiting for the return of the issued procedure call. Note that an optional timeout value, which can be specified in the TTCN-3 ATS for a call operation, is not included in the tciCallConnected operation signature. The TE is responsible to address this issue by starting a timer for the TTCN-3 call operation in the PA with a separate TRI operation call, i.e. triStartTimer. CH transmits the call to all remote TEs on which a receiver is being executed and enqueues the call in the remote TEs.	

7.3.3.2.7 tciReplyConnected

Signature	void tciReplyConnected (in TriPortIdType sender, in TriComponentIdType receiver, in TriSignatureIdType signature, in TciParameterListType parameterList, in Value returnValue)	
In Parameters	sender	Identifier of the port sending the reply.
	receiver	Identifier of the component receiving the reply.
	signature	Identifier of the signature of the procedure call.
	parameterList	A list of encoded parameters which are part of the indicated signature. The parameters in parameterList are ordered as they appear in the TTCN-3 signature declaration.
	returnValue	(Optional) return value of the procedure call.
Return Value	void	
Constraint	This operation shall be called by the TE when it executes a TTCN-3 unicast reply operation on a component port which has been connected to another component port. All <i>out</i> and <i>inout</i> procedure parameters and the return value contain values. All <i>in</i> procedure parameters shall contain the distinct value of null since they are only of relevance to the procedure call but not in the reply to the call. The parameterList contains procedure call parameters. These parameters are the parameters specified in the TTCN-3 signature template. If no return type has been defined for the procedure signature in the TTCN-3 ATS, the distinct value null shall be passed for the return value.	
Effect	On invocation of this operation the CH can issue the reply to a procedure call corresponding to the signature identifier signature and component identifier receiver. CH transmits the reply to the remote TE on which receiver is being executed and enqueues the reply in the remote TE.	

7.3.3.2.8 tciReplyConnectedBC

Signature	void tciReplyConnectedBC (in TriPortIdType sender, in TriSignatureIdType signature, in TciParameterListType parameterList, in Value returnValue)	
In Parameters	sender	Identifier of the port sending the reply.
	signature	Identifier of the signature of the procedure call.
	parameterList	A list of encoded parameters which are part of the indicated signature. The parameters in parameterList are ordered as they appear in the TTCN-3 signature declaration.
	returnValue	(Optional) return value of the procedure call.
Return Value	void	
Constraint	This operation shall be called by the TE when it executes a TTCN-3 broadcast reply operation on a component port which has been connected to other component ports. All <i>out</i> and <i>inout</i> procedure parameters and the return value contain values. All <i>in</i> procedure parameters shall contain the distinct value of <code>null</code> since they are only of relevance to the procedure call but not in the reply to the call. The <code>parameterList</code> contains procedure call parameters. These parameters are the parameters specified in the TTCN-3 signature template. If no return type has been defined for the procedure signature in the TTCN-3 ATS, the distinct value <code>null</code> shall be passed for the return value.	
Effect	On invocation of this operation the CH can issue the reply to a procedure call corresponding to the signature identifier <code>signature</code> and all components connected to <code>sender</code> . CH transmits the exception to all remote TEs on which receivers are being executed and enqueues the exception in the remote TEs.	

7.3.3.2.9 tciReplyConnectedMC

Signature	void tciReplyConnectedMC (in TriPortIdType sender, in TriComponentIdListType receivers, in TriSignatureIdType signature, in TciParameterListType parameterList, in Value returnValue)	
In Parameters	sender	Identifier of the port sending the reply.
	receivers	Identifier of the components receiving the reply.
	signature	Identifier of the signature of the procedure call.
	parameterList	A list of encoded parameters which are part of the indicated signature. The parameters in parameterList are ordered as they appear in the TTCN-3 signature declaration.
	returnValue	(Optional) return value of the procedure call.
Return Value	void	
Constraint	This operation shall be called by the TE when it executes a TTCN-3 multicast reply operation on a component port which has been connected to other component ports. All <i>out</i> and <i>inout</i> procedure parameters and the return value contain values. All <i>in</i> procedure parameters shall contain the distinct value of <code>null</code> since they are only of relevance to the procedure call but not in the reply to the call. The <code>parameterList</code> contains procedure call parameters. These parameters are the parameters specified in the TTCN-3 signature template. If no return type has been defined for the procedure signature in the TTCN-3 ATS, the distinct value <code>null</code> shall be passed for the return value.	
Effect	On invocation of this operation the CH can issue the reply to a procedure call corresponding to the signature identifier <code>signature</code> and one of the component identifier in <code>receivers</code> . CH transmits the reply to the remote TEs on which <code>receivers</code> are being executed and enqueues the reply in the remote TEs.	

7.3.3.2.10 tciRaiseConnected

Signature	void tciRaiseConnected (in TriPortIdType sender, in TriComponentIdType receiver, in TriSignatureIdType signature, in Value exception)	
In Parameters	sender	Identifier of the port sending the reply.
	receiver	Identifier of the component receiving the reply.
	signature	Identifier of the signature of the procedure call.
	exception	The exception value.
Return Value	void	
Constraint	This operation shall be called by the TE when it executes a TTCN-3 unicast raise operation on a component port which has been connected to another component port.	
Effect	On invocation of this operation the CH can raise an exception to a procedure call corresponding to the signature identifier <i>signature</i> and component identifier <i>receiver</i> . CH transmits the exception to the remote TE on which <i>receiver</i> is being executed and enqueues the exception in the remote TE.	

7.3.3.2.11 tciRaiseConnectedBC

Signature	void tciRaiseConnectedBC (in TriPortIdType sender, in TriSignatureIdType signature, in Value exception)	
In Parameters	sender	Identifier of the port sending the reply.
	signature	Identifier of the signature of the procedure call.
	exception	The exception value.
Return Value	void	
Constraint	This operation shall be called by the TE when it executes a TTCN-3 broadcast raise operation on a component port which has been connected to other component ports.	
Effect	On invocation of this operation the CH can raise an exception to a procedure call corresponding to the signature identifier <i>signature</i> and all components connected to <i>sender</i> . CH transmits the exception to all remote TEs on which receivers are being executed and enqueues the exception in the remote TEs.	

7.3.3.2.12 tciRaiseConnectedMC

Signature	void tciRaiseConnectedMC (in TriPortIdType sender, in TriComponentIdListType receiver, in TriSignatureIdType signature, in Value exception)	
In Parameters	sender	Identifier of the port sending the reply.
	receivers	Identifiers of the component receiving the reply.
	signature	Identifier of the signature of the procedure call.
	exception	The exception value.
Return Value	void	
Constraint	This operation shall be called by the TE when it executes a TTCN-3 multicast raise operation on a component port which has been connected to another component port.	
Effect	On invocation of this operation the CH can raise an exception to a procedure call corresponding to the signature identifier <i>signature</i> and one of the component identifier <i>receivers</i> . CH transmits the exception to all remote TEs on which <i>receivers</i> are being executed and enqueues the exception in the remote TEs.	

7.3.3.2.13 tciCreateTestComponentReq

Signature	TriComponentIdType tciCreateTestComponentReq (in TciTestComponentKindType kind, in Type componentType, in TString name)	
In Parameters	kind	The kind of component that shall be created (any kind except of SYSTEM).
	componentType	Identifier of the TTCN-3 component type that shall be created.
Return Value	A TriComponentIdType value for the created component.	
Constraint	This operation shall be called from the TE when a component has to be created, either explicitly when the TTCN-3 create operation is called or implicitly when the master test component (MTC) or a control component has to be created. name shall be set to the distinct value null if no name is given in the TTCN-3 create statement.	
Effect	CH transmits the component creation request to the remote TE and calls there the tciCreateTestComponent operation to obtain a component identifier for this component.	

7.3.3.2.14 tciStartTestComponentReq

Signature	void tciStartTestComponentReq(in TriComponentIdType component, in TciBehaviourIdType behaviour, in TciParameterListType parameterList)	
In Parameters	component	Identifier of the component to be started.
	behaviour	Identifier of the behaviour to be started on the component.
	parameterList	A list of Values where each value defines a parameter from the parameter list as defined in the TTCN-3 function declaration of the function being started. The parameters in parameterList are ordered as they appear in the TTCN-3 signature of the test case. If no parameters have to be passed either the null value or an empty parameterList, i.e. a list of length zero shall be passed.
Return Value	void	
Constraint	This operation shall be called by the TE when it executes the TTCN-3 start operation.	
Effect	CH transmits the start component request to the remote TE and calls there the tciStartTestComponent operation.	

7.3.3.2.15 tciStopTestComponentReq

Signature	void tciStopTestComponentReq(in TriComponentIdType component)	
In Parameters	component	Identifier of the component to be stopped.
Return Value	void	
Constraint	This operation shall be called by the TE when it executes the TTCN-3 stop operation.	
Effect	CH transmits the stop component request to the remote TE and calls there the tciStopTestComponent operation.	

7.3.3.2.16 tciConnectReq

Signature	void tciConnectReq (in TriPortIdType fromPort, in TriPortIdType toPort)	
In Parameters	fromPort	Identifier of the test component port to be connected from.
	toPort	Identifier of the test component port to be connected to.
Return Value	void	
Constraint	This operation shall be called by the TE when it executes a TTCN-3 connect operation.	
Effect	CH transmits the connection request to the remote TE where it calls the tciConnect operation to establish a logical connection between the two indicated ports. Note that both ports can be on remote TEs. In this case, the operation returns only after calling the tciConnect operation on both remote TEs.	

7.3.3.2.17 tciDisconnectReq

Signature	void tciDisconnectReq (in TriPortIdType fromPort, in TriPortIdType toPort)	
In Parameters	fromPort	Identifier of the test component port to be disconnected.
	toPort	Identifier of the test component port to be disconnected.
Return Value	void	
Constraint	This operation shall be called by the TE when it executes a TTCN-3 disconnect operation.	
Effect	CH transmits the disconnect request to the remote TE where it calls the tciDisconnect operation to tear down the logical connection between the two indicated ports. Note that both ports can be on remote TEs. In this case, the operation returns only after calling the tciDisconnect operation on both remote TEs.	

7.3.3.2.18 tciMapReq

Signature	void tciMapReq (in TriPortIdType fromPort, in TriPortIdType toPort)	
In Parameters	fromPort	Identifier of the test component port to be mapped from.
	toPort	Identifier of the test component port to be mapped to.
Return Value	void	
Constraint	This operation shall be called by the TE when it executes a TTCN-3 map operation.	
Effect	CH transmits the map request to the remote TE where it calls the tciMap operation to establish a logical connection between the two indicated ports.	

7.3.3.2.19 tciMapParamReq

Signature	void tciMapParamReq (in TriPortIdType fromPort, in TriPortIdType toPort, in TriParameterListType paramList)	
In Parameters	fromPort	Identifier of the test component port to be mapped from.
	toPort	Identifier of the test component port to be mapped to.
	paramList	Configuration parameter list.
Return Value	void	
Constraint	This operation shall be called by the TE when it executes a TTCN-3 map operation including parameters.	
Effect	CH transmits the map request to the remote TE where it calls the tciMapParam operation to establish a logical connection between the two indicated ports.	

7.3.3.2.20 tciUnmapReq

Signature	void tciUnmapReq (in TriPortIdType fromPort, in TriPortIdType toPort)	
In Parameters	fromPort	Identifier of the test component port to be unmapped.
	toPort	Identifier of the test component port to be unmapped.
Return Value	void	
Constraint	This operation shall be called by the TE when it executes a TTCN-3 unmap operation.	
Effect	CH transmits the unmap request to the remote TE where it calls the tciUnmap operation to tear down the logical connection between the two indicated ports.	

7.3.3.2.21 tciUnmapParamReq

Signature	void tciUnmapParamReq (in TriPortIdType fromPort, in TriPortIdType toPort, in TriParameterListType paramList)	
In Parameters	fromPort	Identifier of the test component port to be unmapped.
	toPort	Identifier of the test component port to be unmapped.
	paramList	Configuration parameter list.
Return Value	void	
Constraint	This operation shall be called by the TE when it executes a TTCN-3 unmap operation including parameters.	
Effect	CH transmits the unmap request to the remote TE where it calls the tciUnmapParam operation to teardown the connection between the two indicated ports.	

7.3.3.2.22 tciTestComponentTerminatedReq

Signature	void tciTestComponentTerminatedReq (in TriComponentIdType component, in VerdictValue verdict)	
In Parameters	component	Identifier of the component that has terminated.
	verdict	Verdict after termination of the component.
Return Value	void	
Constraint	This operation shall be called by the TE when a test component terminates execution, either explicitly with the TTCN-3 stop operation or implicitly, if it has reached the last statement.	
Effect	The CH is notified of the termination of the indicated test component. Because the out values of <i>inout</i> and <i>out</i> parameters of a function being executed on a test component have no effect on that test component (ES 201 873-1 [1]), the tciTestComponentTerminateReq operation does not have a parameterList parameter. CH communicates the termination of the indicated component to all participating TEs and to the special TE*, which keeps track of the overall verdict.	

7.3.3.2.23 tciTestComponentRunningReq

Signature	TBoolean tciTestComponentRunningReq (in TriComponentIdType component)	
In Parameters	component	Identifier of the component to be checked for running.
Return Value	true if the indicated component is still executing a behaviour, false otherwise.	
Constraint	This operation shall be called by the TE when it executes a TTCN-3 running operation.	
Effect	CH transmits the running request to the remote TE having the test component to be checked, where it calls the tciTestComponentRunning operation to check the execution status of the indicated test component.	

7.3.3.2.24 tciTestComponentDoneReq

Signature	TBoolean tciTestComponentDoneReq (in TriComponentIdType comp)	
In Parameters	comp	Identifier of the component to be checked for done.
Return Value	true if the indicated component has completed executing its behaviour, false otherwise.	
Constraint	This operation shall be called by the TE when it executes a TTCN-3 done operation.	
Effect	CH transmits the done request to the remote TE having the test component to be checked, where it calls the tciTestComponentDone operation to check the status of the indicated test component.	

7.3.3.2.25 tciGetMTCReq

Signature	TriComponentIdType tciGetMTCReq()	
Return Value	A TriComponentIdType value of the MTC.	
Constraint	This operation shall be called by the TE when it executes a TTCN-3 mtc operation.	
Effect	The CH determines the component id of the MTC.	

7.3.3.2.26 tciExecuteTestCaseReq

Signature	void tciExecuteTestCaseReq (in TciTestCaseIdType testCaseId, in TriPortIdListType tsiPortList)	
In Parameters	testCaseId	A test case identifier as defined in the TTCN-3 module.
	tsiPortList	tsiPortList contains all ports that have been declared in the definition of the system component for the test case, i.e. the TSI ports. If a system component has not been explicitly defined for the test case, then the tsiPortList contains all communication ports of the MTC. The ports in tsiPortList are ordered as they appear in the respective TTCN-3 component type declaration. If no ports have to be passed either the null value or an empty tsiPortList, i.e. a list of length zero shall be passed.
Return Value	void	
Constraint	This operation can be called by the TE immediately before it starts the test case behaviour on the MTC (in course of a TTCN-3 execute operation).	
Effect	CH transmits the execute test case request to the remote TEs having system ports of the indicated test case. Static connections to the SUT and the initialization of communication means for TSI ports can be set up.	

7.3.3.2.27 tciResetReq

Signature	void tciResetReq ()
Return Value	void
Constraint	This operation can be called by the TE at any time to reset the test system.
Effect	CH transmits the reset request to all involved TEs.

7.3.3.2.28 tciKillTestComponentReq

Signature	void tciKillTestComponentReq (in TriComponentIdType comp)	
In Parameters	comp	Identifier of the component to be killed.
Return Value	void	
Constraint	This operation shall be called by the TE when it executes the TTCN-3 kill operation.	
Effect	CH transmits the kill component request to the remote TE and calls there the tciKillTestComponent operation.	

7.3.3.2.29 tciTestComponentAliveReq

Signature	TBoolean tciTestComponentAliveReq (in TriComponentIdType comp)	
In Parameters	comp	Identifier of the component to be checked for being alive.
Return Value	true if the indicated component is alive, false otherwise.	
Constraint	This operation shall be called by the TE when it executes the TTCN-3 alive operation.	
Effect	CH transmits the request to the remote TE that created the test component in question, where it calls the tciTestComponentAlive operation to check the status of the indicated test component.	

7.3.3.2.30 tciTestComponentKilledReq

Signature	TBoolean tciTestComponentKilledReq (in TriComponentIdType comp)	
In Parameters	comp	Identifier of the component to be checked for being killed.
Return Value	true if the indicated component has been killed, false otherwise.	
Constraint	This operation shall be called by the TE when it executes the TTCN-3 killed operation.	
Effect	CH transmits the request to the remote TE that created the test component in question, where it calls the tciTestComponentKilled operation to check the status of the indicated test component.	

7.3.4 The TCI-TL interface

The TCI Test Logging Interface (TCI-TL) describes the operations a TTCN-3 Executable is required to implement and the operations a test logging implementation shall provide to the TE (figure 8).

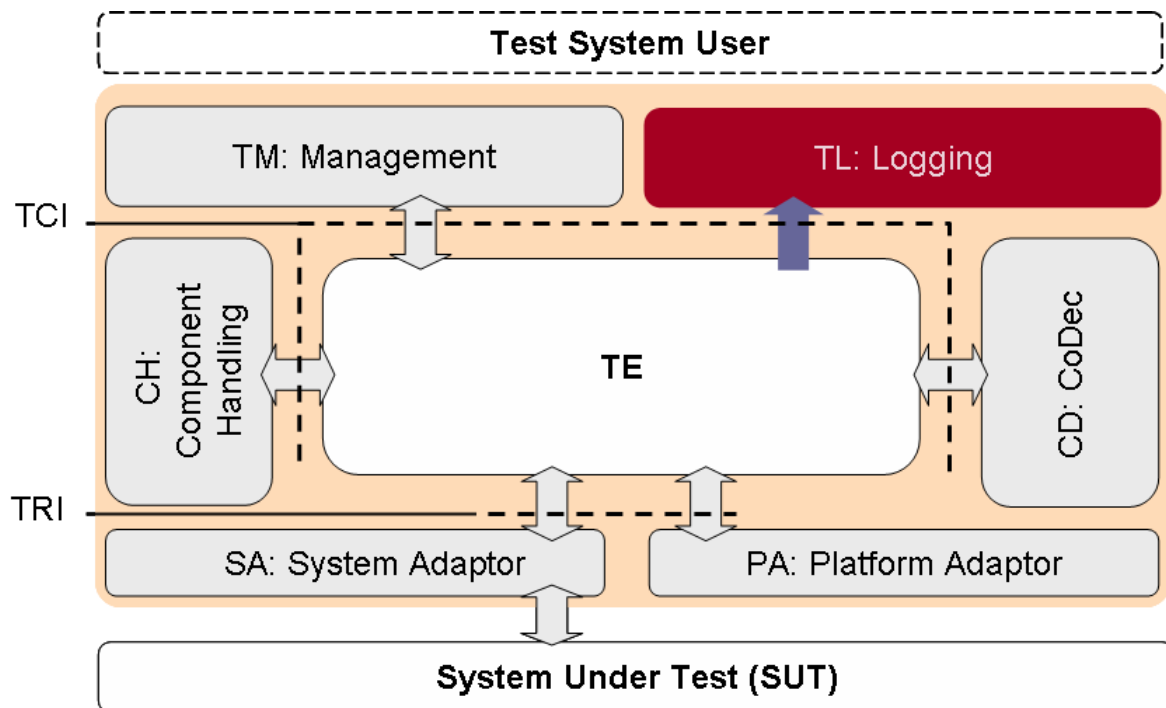

Figure 8: The TCI-TL interface

The logging provides for all TTCN-3 level operations an operation to log the respective event being performed by the TE, the SA, the PA, the CH or the CD to the user.

7.3.4.1 TCI-TL provided

This clause specifies the operations the TL shall provide to the TE.

7.3.4.1.1 tliTcExecute

Signature	void tliTcExecute(in TString am, in TInteger ts, in TString src, in TInteger line, in TriComponentIdType c, in TciTestCaseIdType tcId, in TciParameterListType triPars, in TriTimerDurationType dur)	
In Parameters	am	An additional message.
	ts	The time when the event is produced.
	src	The source file of the test specification.
	line	The line number where the request is performed.
	c	The component which produces this event.
	tcId	The testcase to be executed.
	triPars	The list of parameters required by the testcase.
Return Value	void	
Constraint	Shall be called by TE to log the execute test case request.	
Effect	The TL presents all the information provided in the parameters of this operation to the user, how this is done is not within the scope of the present document.	

7.3.4.1.2 tliTcStart

Signature	void tliTcStart(in TString am, in TInteger ts, in TString src, in TInteger line, in TriComponentIdType c, in TciTestCaseIdType tcId, in TciParameterListType tciPars, in TriTimerDurationType dur)	
In Parameters	am	An additional message.
	ts	The time when the event is produced.
	src	The source file of the test specification.
	line	The line number where the request is performed.
	c	The component which produces this event.
	tcId	The testcase to be executed.
	tciPars	The list of parameters required by the testcase.
dur	Duration of the execution.	
Return Value	void	
Constraint	Shall be called by TE to log the start of a testcase. This event occurs before the testcase is started.	
Effect	The TL presents all the information provided in the parameters of this operation to the user, how this is done is not within the scope of the present document.	

7.3.4.1.3 tliTcStop

Signature	void tliTcStop(in TString am, in TInteger ts, in TString src, in TInteger line, in TriComponentIdType c, in TString reason)	
In Parameters	Am	An additional message.
	Ts	The time when the event is produced.
	Src	The source file of the test specification.
	Line	The line number where the request is performed.
	C	The component which produces this event.
	reason	The optional reason of the setverdict statement
Return Value	Void	
Constraint	Shall be called by TE to log the stop of a testcase.	
Effect	The TL presents all the information provided in the parameters of this operation to the user, how this is done is not within the scope of the present document.	

7.3.4.1.4 tliTcStarted

Signature	void tliTcStarted(in TString am, in TInteger ts, in TString src, in TInteger line, in TriComponentIdType c, in TciTestCaseIdType tcId, in TciParameterListType tciPars, in TriTimerDurationType dur)	
In Parameters	am	An additional message.
	ts	The time when the event is produced.
	src	The source file of the test specification.
	line	The line number where the request is performed.
	c	The component which produces this event.
	tcId	The testcase to be executed.
	tciPars	The list of parameters required by the testcase.
dur	Duration of the execution.	
Return Value	Void	
Constraint	Shall be called by TM or TE to log the start of a testcase. This event occurs after the testcase was started.	
Effect	The TL presents all the information provided in the parameters of this operation to the user, how this is done is not within the scope of the present document.	

7.3.4.1.5 tliTcTerminated

Signature	void tliTcTerminated(in TString am, in TInteger ts, in TString src, in TInteger line, in TriComponentIdType c, in TciTestCaseIdType tcId, in TciParameterListType tciPars, in VerdictValue verdict, in TString reason)	
In Parameters	am	An additional message.
	ts	The time when the event is produced.
	src	The source file of the test specification.
	line	The line number where the request is performed.
	c	The component which produces this event.
	tcId	The testcase to be executed.
	tciPars	The list of parameters required by the testcase.
	verdict	The verdict of the testcase.
	reason	The optional reason of the setverdict statement
Return Value	void	
Constraint	Shall be called by TM or TE to log the termination of a testcase. This event occurs after the testcase terminated.	
Effect	The TL presents all the information provided in the parameters of this operation to the user, how this is done is not within the scope of the present document.	

7.3.4.1.6 tliCtrlStart

Signature	void tliCtrlStart(in TString am, in TInteger ts, in TString src, in TInteger line, in TriComponentIdType c)	
In Parameters	am	An additional message.
	ts	The time when the event is produced.
	src	The source file of the test specification.
	line	The line number where the request is performed.
	c	The component which produces this event.
Return Value	void	
Constraint	Shall be called by TE to log the start of the control part. This event occurs before the control is started. If the control is not represented by a TRI component, c is null.	
Effect	The TL presents all the information provided in the parameters of this operation to the user, how this is done is not within the scope of the present document.	

7.3.4.1.7 tliCtrlStop

Signature	void tliCtrlStop(in TString am, in TInteger ts, in TString src, in TInteger line, in TriComponentIdType c)	
In Parameters	am	An additional message.
	ts	The time when the event is produced.
	src	The source file of the test specification.
	line	The line number where the request is performed.
	c	The component which produces this event.
Return Value	void	
Constraint	Shall be called by TE to log the stop of the control part. This event occurs before the control is stopped. If the control is not represented by a TRI component, c is null.	
Effect	The TL presents all the information provided in the parameters of this operation to the user, how this is done is not within the scope of the present document.	

7.3.4.1.8 tliCtrlTerminated

Signature	void tliCtrlTerminated (in TString am, in TInteger ts, in TString src, in TInteger line, in TriComponentIdType c)	
In Parameters	am	An additional message.
	ts	The time when the event is produced.
	src	The source file of the test specification.
	line	The line number where the request is performed.
	c	The component which produces this event.
Return Value	void	
Constraint	Shall be called by TM or TE to log the termination of the control part. This event occurs after the control has terminated. If the control is not represented by a TRI component, c is null.	
Effect	The TL presents all the information provided in the parameters of this operation to the user, how this is done is not within the scope of the present document.	

7.3.4.1.9 tliMSend_m

Signature	void tliMSend_m(in TString am, in TInteger ts, in TString src, in TInteger line, in TriComponentIdType c, in TriPortIdType at, in TriPortIdType to, in Value msgValue, in Value addrValue, in TciStatusType encoderFailure, in TriMessageType msg, in TriAddressType address, in TriStatusType transmissionFailure)	
In Parameters	am	An additional message.
	ts	The time when the event is produced.
	src	The source file of the test specification.
	line	The line number where the request is performed.
	c	The component which produces this event.
	at	The port via which the message is sent.
	to	The port to which the message is sent.
	msgValue	The value to be encoded and sent.
	addrValue	The address value of the destination within the SUT.
	encoderFailure	The failure message which might occur at encoding.
	msg	The encoded message.
	address	The address of the destination within the SUT.
	transmissionFailure	The failure message which might occur at transmission.
Return Value	void	
Constraint	Shall be called by SA or TE to log a unicast send operation. This event occurs after sending. This event is used for logging the communication with the SUT.	
Effect	The TL presents all the information provided in the parameters of this operation to the user, how this is done is not within the scope of the present document.	

7.3.4.1.10 tliMSend_m_BC

Signature	void tliMSend_m_BC(in TString am, in TInteger ts, in TString src, in TInteger line, in TriComponentIdType c, in TriPortIdType at, in TriPortIdType to, in Value msgValue, in TciStatusType encoderFailure, in TriMessageType msg, in TriStatusType transmissionFailure)	
In Parameters	am	An additional message.
	ts	The time when the event is produced.
	src	The source file of the test specification.
	line	The line number where the request is performed.
	c	The component which produces this event.
	at	The port via which the message is sent.
	to	The port to which the message is sent.
	msgValue	The value to be encoded and sent.
	encoderFailure	The failure message which might occur at encoding.
	msg	The encoded message.
transmissionFailure	The failure message which might occur at transmission.	
Return Value	void	
Constraint	Shall be called by SA or TE to log a broadcast send operation. This event occurs after sending. This event is used for logging the communication with the SUT.	
Effect	The TL presents all the information provided in the parameters of this operation to the user, how this is done is not within the scope of the present document.	

7.3.4.1.11 tliMSend_m_MC

Signature	void tliMSend_m_MC(in TString am, in TInteger ts, in TString src, in TInteger line, in TriComponentIdType c, in TriPortIdType at, in TriPortIdType to, in Value msgValue, in TciValueList addrValues, in TciStatusType encoderFailure, in TriMessageType msg, in TriAddressListType addresses, in TriStatusType transmissionFailure)	
In Parameters	am	An additional message.
	ts	The time when the event is produced.
	src	The source file of the test specification.
	line	The line number where the request is performed.
	c	The component which produces this event.
	at	The port via which the message is sent.
	to	The port to which the message is sent.
	msgValue	The value to be encoded and sent.
	addrValues	The address values of the destinations within the SUT.
	encoderFailure	The failure message which might occur at encoding.
	msg	The encoded message.
	addresses	The addresses of the destinations within the SUT.
	transmissionFailure	The failure message which might occur at transmission.
Return Value	void	
Constraint	Shall be called by SA or TE to log a multicast send operation. This event occurs after sending. This event is used for logging the communication with the SUT.	
Effect	The TL presents all the information provided in the parameters of this operation to the user, how this is done is not within the scope of the present document.	

7.3.4.1.12 tliMSend_c

Signature	void tliMSend_c(in TString am, in TInteger ts, in TString src, in TInteger line, in TriComponentIdType c, in TriPortIdType at, in TriPortIdType to, in Value msgValue, in TriStatusType transmissionFailure)	
In Parameters	am	An additional message.
	ts	The time when the event is produced.
	src	The source file of the test specification.
	line	The line number where the request is performed.
	c	The component which produces this event.
	at	The port via which the message is sent.
	msgValue	The value to be encoded and sent.
	to	The component which will receive the message.
transmissionFailure	The failure message which might occur at transmission.	
Return Value	void	
Constraint	Shall be called by CH or TE to log a unicast send operation. This event occurs after sending. This event is used for logging the intercomponent communication.	
Effect	The TL presents all the information provided in the parameters of this operation to the user, how this is done is not within the scope of the present document.	

7.3.4.1.13 tliMSend_c_BC

Signature	void tliMSend_c_BC(in TString am, in TInteger ts, in TString src, in TInteger line, in TriComponentIdType c, in TriPortIdType at, in TriPortIdListType to, in Value msgValue, in TriStatusType transmissionFailure)	
In Parameters	am	An additional message.
	ts	The time when the event is produced.
	src	The source file of the test specification.
	line	The line number where the request is performed.
	c	The component which produces this event.
	at	The port via which the message is sent.
	to	The ports to which the message is sent.
	msgValue	The value to be encoded and sent.
transmissionFailure	The failure message which might occur at transmission.	
Return Value	void	
Constraint	Shall be called by CH or TE to log a broadcast send operation. This event occurs after sending. This event is used for logging the intercomponent communication.	
Effect	The TL presents all the information provided in the parameters of this operation to the user, how this is done is not within the scope of the present document.	

7.3.4.1.14 tliMSend_c_MC

Signature	void tliMSend_c_MC(in TString am, in TInteger ts, in TString src, in TInteger line, in TriComponentIdType c, in TriPortIdType at, in TriPortIdListType to, in Value msgValue, in TriStatusType transmissionFailure)	
In Parameters	am	An additional message.
	ts	The time when the event is produced.
	src	The source file of the test specification.
	line	The line number where the request is performed.
	c	The component which produces this event.
	at	The port via which the message is sent.
	to	The port to which the message is sent.
	msgValue	The value to be encoded and sent.
transmissionFailure	The failure message which might occur at transmission.	
Return Value	void	
Constraint	Shall be called by CH or TE to log a multicast send operation. This event occurs after sending. This event is used for logging the intercomponent communication.	
Effect	The TL presents all the information provided in the parameters of this operation to the user, how this is done is not within the scope of the present document.	

7.3.4.1.15 tliMDetected_m

Signature	void tliMDetected_m(in TString am, in TInteger ts, in TString src, in TInteger line, in TriComponentIdType c, in TriPortIdType at, in TriPortIdType from, in TriMessageType msg, in TriAddressType address)	
In Parameters	am	An additional message.
	ts	The time when the event is produced.
	src	The source file of the test specification.
	line	The line number where the request is performed.
	c	The component which produces this event.
	at	The port via which the message is received.
	from	The port from which the message has been sent.
	msg	The received encoded message.
address	The address of the source within the SUT.	
Return Value	Void	
Constraint	Shall be called by SA or TE to log the enqueueing of a message. This event occurs after the message is enqueued. This event is used for logging the communication with the SUT.	
Effect	The TL presents all the information provided in the parameters of this operation to the user, how this is done is not within the scope of the present document.	

7.3.4.1.16 tliMDetected_c

Signature	void tliMDetected_c(in TString am, in TInteger ts, in TString src, in TInteger line, in TriComponentIdType c, in TriPortIdType at, in TriPortIdType from, in Value msgValue)	
In Parameters	am	An additional message.
	ts	The time when the event is produced.
	src	The source file of the test specification.
	line	The line number where the request is performed.
	c	The component which produces this event.
	at	The port via which the message is received.
	from	The port from which the message has been sent.
	msgValue	The received message.
Return Value	Void	
Constraint	Shall be called by CH or TE to log the enqueueing of a message. This event occurs after the message is enqueued. This event is used for logging the intercomponent communication.	
Effect	The TL presents all the information provided in the parameters of this operation to the user, how this is done is not within the scope of the present document.	

7.3.4.1.17 tliMMismatch_m

Signature	void tliMMismatch_m(in TString am, in TInteger ts, in TString src, in TInteger line, in TriComponentIdType c, in TriPortIdType at, in Value msgValue, in TciValueTemplate msgTpl, in TciValueDifferenceList diffs, in Value addrValue, in TciValueTemplate addressTpl)	
In Parameters	am	An additional message.
	ts	The time when the event is produced.
	src	The source file of the test specification.
	line	The line number where the request is performed.
	c	The component which produces this event.
	at	The port via which the message is received.
	msgValue	The message which is checked against the template.
	msgTpl	The template used to check the message match.
	diffs	The difference/the mismatch between message and template
	addrValue	The address value of the source within the SUT.
addressTpl	The expected address of the source within the SUT.	
Return Value	Void	
Constraint	Shall be called by TE to log the mismatch of a template. This event occurs after checking a template match. This event is used for logging the communication with the SUT.	
Effect	The TL presents all the information provided in the parameters of this operation to the user, how this is done is not within the scope of the present document.	

7.3.4.1.18 tliMMismatch_c

Signature	void tliMMismatch_c(in TString am, in TInteger ts, in TString src, in TInteger line, in TriComponentIdType c, in TriPortIdType at, in Value msgValue, in TciValueTemplate msgTpl, in TciValueDifferenceList diffs, in TriComponentIdType from, in TciNonValueTemplate fromTpl)	
In Parameters	am	An additional message.
	ts	The time when the event is produced.
	src	The source file of the test specification.
	line	The line number where the request is performed.
	c	The component which produces this event.
	at	The port via which the message is received.
	msgValue	The message which is checked against the template.
	msgTpl	The template used to check the message match.
	diffs	The difference/the mismatch between message and template
	from	The component which sent the message.
fromTpl	The expected sender component.	
Return Value	Void	
Constraint	Shall be called by TE to log the mismatch of a template. This event occurs after checking a template match. This event is used for logging the intercomponent communication.	
Effect	The TL presents all the information provided in the parameters of this operation to the user, how this is done is not within the scope of the present document.	

7.3.4.1.19 tliMReceive_m

Signature	void tliMReceive_m(in TString am, in TInteger ts, in TString src, in TInteger line, in TriComponentIdType c, in TriPortIdType at, in Value msgValue, in TciValueTemplate msgTpl, in Value addrValue, in TciValueTemplate addressTpl)	
In Parameters	am	An additional message.
	ts	The time when the event is produced.
	src	The source file of the test specification.
	line	The line number where the request is performed.
	c	The component which produces this event.
	at	The port via which the message is received.
	msgValue	The message which is checked against the template.
	msgTpl	The template used to check the message match.
	addrValue	The address value of the source within the SUT.
	addressTpl	The expected address of the source within the SUT.
Return Value	Void	
Constraint	Shall be called by TE to log the receiving of a message. This event occurs after checking a template match. This event is used for logging the communication with SUT.	
Effect	The TL presents all the information provided in the parameters of this operation to the user, how this is done is not within the scope of the present document.	

7.3.4.1.20 tliMReceive_c

Signature	void tliMReceive_c(in TString am, in TInteger ts, in TString src, in TInteger line, in TriComponentIdType c, in TriPortIdType at, in Value msgValue, in TciValueTemplate msgTpl, in TriComponentIdType from, in TciNonValueTemplate fromTpl)	
In Parameters	am	An additional message.
	ts	The time when the event is produced.
	src	The source file of the test specification.
	line	The line number where the request is performed.
	c	The component which produces this event.
	at	The port via which the message is received.
	msg	The message which is checked against the template.
	msgTpl	The template used to check the message match.
	from	The component which sent the message.
	fromTpl	The expected sender component.
Return Value	Void	
Constraint	Shall be called by TE to log the receive of a message. This event occurs after checking a template match. This event is used for logging the intercomponent communication.	
Effect	The TL presents all the information provided in the parameters of this operation to the user, how this is done is not within the scope of the present document.	

7.3.4.1.21 tliPrCall_m

Signature	void tliPrCall_m(in TString am, in TInteger ts, in TString src, in TInteger line, in TriComponentIdType c, in TriPortIdType at, in TriPortIdType to, in TriSignatureIdType signature, in TciParameterListType tciPars, in Value addrValue, in TciStatusType encoderFailure, in TriParameterListType triPars, in TriAddressType address, in TriStatusType transmissionFailure)	
In Parameters	am	An additional message.
	ts	The time when the event is produced.
	src	The source file of the test specification.
	line	The line number where the request is performed.
	c	The component which produces this event.
	at	The port via which the call is invoked.
	to	The port to which the call is sent.
	signature	The signature of the called operation.
	tciPars	The parameters of the called operation.
	addrValue	The address value of the destination within the SUT.
	encoderFailure	The failure message which might occur at encoding.
	triPars	The encoded parameters.
	address	The address of the destination within the SUT.
transmissionFailure	The failure message which might occur at transmission.	
Return Value	Void	
Constraint	Shall be called by SA or TE to log a unicast call operation. This event occurs after call execution. This event is used for logging the communication with the SUT.	
Effect	The TL presents all the information provided in the parameters of this operation to the user, how this is done is not within the scope of the present document.	

7.3.4.1.22 tliPrCall_m_BC

Signature	void tliPrCall_m_BC(in TString am, in TInteger ts, in TString src, in TInteger line, in TriComponentIdType c, in TriPortIdType at, in TriPortIdType to, in TriSignatureIdType signature, in TciParameterListType tciPars, in TciStatusType encoderFailure, in TriParameterListType triPars, in TriStatusType transmissionFailure)	
In Parameters	am	An additional message.
	ts	The time when the event is produced.
	src	The source file of the test specification.
	line	The line number where the request is performed.
	c	The component which produces this event.
	at	The port via which the call is invoked.
	to	The port to which the call is sent.
	signature	The signature of the called operation.
	tciPars	The parameters of the called operation.
	encoderFailure	The failure message which might occur at encoding.
	triPars	The encoded parameters.
	transmissionFailure	The failure message which might occur at transmission.
	Return Value	Void
Constraint	Shall be called by SA or TE to log a broadcast call operation. This event occurs after call execution. This event is used for logging the communication with the SUT.	
Effect	The TL presents all the information provided in the parameters of this operation to the user, how this is done is not within the scope of the present document.	

7.3.4.1.23 tliPrCall_m_MC

Signature	void tliPrCall_m_MC(in TString am, in TInteger ts, in TString src, in TInteger line, in TriComponentIdType c, in TriPortIdType at, in TriPortIdType to, in TriSignatureIdType signature, in TciParameterListType tciPars, in TciValueList addrValues, in TciStatusType encoderFailure, in TriParameterListType triPars, in TriAddressListType addresses, in TriStatusType transmissionFailure)	
In Parameters	am	An additional message.
	ts	The time when the event is produced.
	src	The source file of the test specification.
	line	The line number where the request is performed.
	c	The component which produces this event.
	at	The port via which the call is invoked.
	to	The port to which the call is sent.
	signature	The signature of the called operation.
	tciPars	The parameters of the called operation.
	addrValues	The address values of the destinations within the SUT.
	encoderFailure	The failure message which might occur at encoding.
	triPars	The encoded parameters.
	addresses	The addresses of the destinations within the SUT.
transmissionFailure	The failure message which might occur at transmission.	
Return Value	Void	
Constraint	Shall be called by SA or TE to log a multicast call operation. This event occurs after call execution. This event is used for logging the communication with the SUT.	
Effect	The TL presents all the information provided in the parameters of this operation to the user, how this is done is not within the scope of the present document.	

7.3.4.1.24 tliPrCall_c

Signature	void tliPrCall_c(in TString am, in TInteger ts, in TString src, in TInteger line, in TriComponentIdType c, in TriPortIdType at, in TriPortIdType to, in TriSignatureIdType signature, in TciParameterListType tciPars, in TriStatusType transmissionFailure)	
In Parameters	am	An additional message.
	ts	The time when the event is produced.
	src	The source file of the test specification.
	line	The line number where the request is performed.
	c	The component which produces this event.
	at	The port via which the call is invoked.
	to	The port to which the call is sent.
	signature	The signature of the called operation.
	tciPars	The parameters of the called operation.
	transmissionFailure	The failure message which might occur at transmission.
Return Value	Void	
Constraint	Shall be called by CH or TE to log a unicast call operation. This event occurs after call execution. This event is used for logging the intercomponent communication.	
Effect	The TL presents all the information provided in the parameters of this operation to the user, how this is done is not within the scope of the present document.	

7.3.4.1.25 tliPrCall_c_BC

Signature	void tliPrCall_c_BC(in TString am, in TInteger ts, in TString src, in TInteger line, in TriComponentIdType c, in TriPortIdType at, in TriPortIdListType to, in TriSignatureIdType signature, in TciParameterListType tciPars, in TriStatusType transmissionFailure)	
In Parameters	am	An additional message.
	ts	The time when the event is produced.
	src	The source file of the test specification.
	line	The line number where the request is performed.
	c	The component which produces this event.
	at	The port via which the call is invoked.
	to	The port list to which the call is sent.
	signature	The signature of the called operation.
	tciPars	The parameters of the called operation.
	transmissionFailure	The failure message which might occur at transmission.
Return Value	Void	
Constraint	Shall be called by CH or TE to log a broadcast call operation. This event occurs after call execution. This event is used for logging the intercomponent communication.	
Effect	The TL presents all the information provided in the parameters of this operation to the user, how this is done is not within the scope of the present document.	

7.3.4.1.26 tliPrCall_c_MC

Signature	void tliPrCall_c_MC(in TString am, in TInteger ts, in TString src, in TInteger line, in TriComponentIdType c, in TriPortIdType at, in TriPortIdListType to, in TriSignatureIdType signature, in TciParameterListType tciPars, in TriStatusType transmissionFailure)	
In Parameters	am	An additional message.
	ts	The time when the event is produced.
	src	The source file of the test specification.
	line	The line number where the request is performed.
	c	The component which produces this event.
	at	The port via which the call is invoked.
	to	The port list to which the call is sent.
	signature	The signature of the called operation.
	tciPars	The parameters of the called operation.
	transmissionFailure	The failure message which might occur at transmission.
Return Value	Void	
Constraint	Shall be called by CH or TE to log a multicast call operation. This event occurs after call execution. This event is used for logging the intercomponent communication.	
Effect	The TL presents all the information provided in the parameters of this operation to the user, how this is done is not within the scope of the present document.	

7.3.4.1.27 tliPrGetCallDetected_m

Signature	void tliPrGetCallDetected_m(in TString am, in TInteger ts, in TString src, in TInteger line, in TriComponentIdType c, in TriPortIdType at, in TriPortIdType from, in TriSignatureIdType signature, in TriParameterListType triPars, in TriAddressType address)	
In Parameters	am	An additional message.
	ts	The time when the event is produced.
	src	The source file of the test specification.
	line	The line number where the request is performed.
	c	The component which produces this event.
	at	The port via which the call is received.
	from	The port from which the call has been sent.
	signature	The signature of the detected call.
	triPars	The encoded parameters of detected call.
address	The address of the destination within the SUT.	
Return Value	Void	
Constraint	Shall be called by SA or TE to log the getcall enqueue operation. This event occurs after call is enqueued. This event is used for logging the communication with the SUT.	
Effect	The TL presents all the information provided in the parameters of this operation to the user, how this is done is not within the scope of the present document.	

7.3.4.1.28 tliPrGetCallDetected_c

Signature	void tliPrGetCallDetected_c(in TString am, in TInteger ts, in TString src, in TInteger line, in TriComponentIdType c, in TriPortIdType at, in TriPortIdType from, in TriSignatureIdType signature, in TciParameterListType tciPars)	
In Parameters	am	An additional message.
	ts	The time when the event is produced.
	src	The source file of the test specification.
	line	The line number where the request is performed.
	c	The component which produces this event.
	at	The port via which the call is received.
	from	The port from which the call has been sent.
	signature	The signature of the called operation.
	tciPars	The encoded parameters of detected call.
Return Value	Void	
Constraint	Shall be called by CH or TE to log the getcall enqueue operation. This event occurs after call is enqueued. This event is used for logging the intercomponent communication.	
Effect	The TL presents all the information provided in the parameters of this operation to the user, how this is done is not within the scope of the present document.	

7.3.4.1.29 tliPrGetCallMismatch_m

Signature	void tliPrGetCallMismatch_m(in TString am, in TInteger ts, in TString src, in TInteger line, in TriComponentIdType c, in TriPortIdType at, in TriSignatureIdType signature, in TciParameterListType tciPars, in TciValueTemplate parsTpl, in TciValueDifferenceList diffs, in Value addrValue, in TciValueTemplate addressTpl)	
In Parameters	am	An additional message.
	ts	The time when the event is produced.
	src	The source file of the test specification.
	line	The line number where the request is performed.
	c	The component which produces this event.
	at	The port via which the call is received.
	signature	The signature of the detected call.
	tciPars	The parameters of detected call.
	parsTpl	The template used to check the parameter match.
	diffs	The difference/the mismatch between call and template
	addrValue	The address value of the source within the SUT.
	addressTpl	The expected address of the source within the SUT.
Return Value	Void	
Constraint	Shall be called by TE to log the mismatch of a getcall. This event occurs after getcall is checked against a template. This event is used for logging the communication with the SUT.	
Effect	The TL presents all the information provided in the parameters of this operation to the user, how this is done is not within the scope of the present document.	

7.3.4.1.30 tliPrGetCallMismatch_c

Signature	void tliPrGetCallMismatch_c(in TString am, in TInteger ts, in TString src, in TInteger line, in TriComponentIdType c, in TriPortIdType at, in TriSignatureIdType signature, in TciParameterListType tciPars, in TciValueTemplate parsTpl, in TciValueDifferenceList diffs, in TriComponentIdType from, in TciNonValueTemplate fromTpl)	
In Parameters	am	An additional message.
	ts	The time when the event is produced.
	src	The source file of the test specification.
	line	The line number where the request is performed.
	c	The component which produces this event.
	at	The port via which the call is received.
	signature	The signature of the detected call.
	tciPars	The parameters of detected call.
	parsTpl	The template used to check the parameter match.
	diffs	The difference/the mismatch between message and template
	from	The component which called the operation.
	fromTpl	The expected calling component.
Return Value	Void	
Constraint	Shall be called by TE to log the mismatch of a getcall. This event occurs after getcall is checked against a template. This event is used for logging the intercomponent communication.	
Effect	The TL presents all the information provided in the parameters of this operation to the user, how this is done is not within the scope of the present document.	

7.3.4.1.31 tliPrGetCall_m

Signature	void tliPrGetCall_m(in TString am, in TInteger ts, in TString src, in TInteger line, in TriComponentIdType c, in TriPortIdType at, in TriSignatureIdType signature, in TciParameterListType tciPars, in TciValueTemplate parsTpl, in Value addrValue, in TciValueTemplate addressTpl)	
In Parameters	am	An additional message.
	ts	The time when the event is produced.
	src	The source file of the test specification.
	line	The line number where the request is performed.
	c	The component which produces this event.
	at	The port via which the call is received.
	signature	The signature of the detected call.
	tciPars	The parameters of detected call.
	parsTpl	The template used to check the parameter match.
	addrValue	The address value of the source within the SUT.
addressTpl	The expected address of the source within the SUT.	
Return Value	void	
Constraint	Shall be called by TE to log getting a call. This event occurs after getcall has matched against a template. This event is used for logging the communication with the SUT.	
Effect	The TL presents all the information provided in the parameters of this operation to the user, how this is done is not within the scope of the present document.	

7.3.4.1.32 tliPrGetCall_c

Signature	void tliPrGetCall_c(in TString am, in TInteger ts, in TString src, in TInteger line, in TriComponentIdType c, in TriPortIdType at, in TriSignatureIdType signature, in TciParameterListType tciPars, in TciValueTemplate parsTpl, in TriComponentIdType from, in TciNonValueTemplate fromTpl)	
In Parameters	am	An additional message.
	ts	The time when the event is produced.
	src	The source file of the test specification.
	line	The line number where the request is performed.
	c	The component which produces this event.
	at	The port via which the call is received.
	signature	The signature of the detected call.
	tciPars	The parameters of detected call.
	parsTpl	The template used to check the parameter match.
	from	The component which called the operation.
fromTpl	The expected calling component.	
Return Value	void	
Constraint	Shall be called by TE to log getting a call. This event occurs after getcall has matched against a template. This event is used for logging the intercomponent communication.	
Effect	The TL presents all the information provided in the parameters of this operation to the user, how this is done is not within the scope of the present document.	

7.3.4.1.33 tliPrReply_m

Signature	<pre>void tliPrReply_m(in TString am, in TInteger ts, in TString src, in TInteger line, in TriComponentIdType c, in TriPortIdType at, in TriPortIdType to, in TriSignatureIdType signature, in TciParameterListType tciPars, in Value replValue, in Value addrValue, in TciStatusType encoderFailure, in TriParameterListType triPars, in TriParameterType repl, in TriAddressType address, in TriStatusType transmissionFailure)</pre>	
In Parameters	am	An additional message.
	ts	The time when the event is produced.
	src	The source file of the test specification.
	line	The line number where the request is performed.
	c	The component which produces this event.
	at	The port via which the reply is sent.
	to	The port to which the reply is sent.
	signature	The signature relating to the reply.
	tciPars	The signature parameters relating to the reply.
	replValue	The reply to be sent.
	addrValue	The address value of the destination within the SUT.
	encoderFailure	The failure message which might occur at encoding.
	triPars	The encoded parameters.
	repl	The encoded reply.
address	The address of the destination within the SUT.	
transmissionFailure	The failure message which might occur at transmission.	
Return Value	void	
Constraint	Shall be called by SA or TE to log a unicast reply operation. This event occurs after reply execution. This event is used for logging the communication with the SUT.	
Effect	The TL presents all the information provided in the parameters of this operation to the user, how this is done is not within the scope of the present document.	

7.3.4.1.34 tliPrReply_m_BC

Signature	<pre>void tliPrReply_m_BC(in TString am, in TInteger ts, in TString src, in TInteger line, in TriComponentIdType c, in TriPortIdType at, in TriPortIdType to, in TriSignatureIdType signature, in TciParameterListType tciPars, in Value replValue, in TciStatusType encoderFailure, in TriParameterListType triPars, in TriParameterType repl, in TriStatusType transmissionFailure)</pre>	
In Parameters	am	An additional message.
	ts	The time when the event is produced.
	src	The source file of the test specification.
	line	The line number where the request is performed.
	c	The component which produces this event.
	at	The port via which the reply is sent.
	to	The port to which the reply is sent.
	signature	The signature relating to the reply.
	tciPars	The signature parameters relating to the reply.
	replValue	The reply to be sent.
	encoderFailure	The failure message which might occur at encoding.
	triPars	The encoded parameters.
	repl	The encoded reply.
	transmissionFailure	The failure message which might occur at transmission.
Return Value	void	
Constraint	Shall be called by SA or TE to log a broadcast reply operation. This event occurs after reply execution. This event is used for logging the communication with the SUT.	
Effect	The TL presents all the information provided in the parameters of this operation to the user, how this is done is not within the scope of the present document.	

7.3.4.1.35 tliPrReply_m_MC

Signature	<pre>void tliPrReply_m_MC(in TString am, in TInteger ts, in TString src, in TInteger line, in TriComponentIdType c, in TriPortIdType at, in TriPortIdType to, in TriSignatureIdType signature, in TciParameterListType tciPars, in Value replValue, in TciValueList addrValues, in TciStatusType encoderFailure, in TriParameterListType triPars, in TriParameterType repl, in TriAddressListType addresses, in TriStatusType transmissionFailure)</pre>	
In Parameters	am	An additional message.
	ts	The time when the event is produced.
	src	The source file of the test specification.
	line	The line number where the request is performed.
	c	The component which produces this event.
	at	The port via which the reply is sent.
	to	The port to which the reply is sent.
	signature	The signature relating to the reply.
	tciPars	The signature parameters relating to the reply.
	replValue	The reply to be sent.
	addrValues	The address values of the destinations within the SUT.
	encoderFailure	The failure message which might occur at encoding.
	triPars	The encoded parameters.
	repl	The encoded reply.
addresses	The addresses of the destinations within the SUT.	
transmissionFailure	The failure message which might occur at transmission.	
Return Value	void	
Constraint	Shall be called by SA or TE to log a multicast reply operation. This event occurs after reply execution. This event is used for logging the communication with the SUT.	
Effect	The TL presents all the information provided in the parameters of this operation to the user, how this is done is not within the scope of the present document.	

7.3.4.1.36 tliPrReply_c

Signature	<pre>void tliPrReply_c(in TString am, in TInteger ts, in TString src, in TInteger line, in TriComponentIdType c, in TriPortIdType at, in TriPortIdType to, in TriSignatureIdType signature, in Value parsValue, in Value replValue, in TriStatusType transmissionFailure)</pre>	
In Parameters	am	An additional message.
	ts	The time when the event is produced.
	src	The source file of the test specification.
	line	The line number where the request is performed.
	c	The component which produces this event.
	at	The port via which the reply is sent.
	to	The port to which the reply is sent.
	signature	The signature relating to the reply.
	parsValue	The signature parameters relating to the reply.
	replValue	The reply to be sent.
transmissionFailure	The failure message which might occur at transmission.	
Return Value	void	
Constraint	Shall be called by CH or TE to log a unicast reply operation. This event occurs after reply execution. This event is used for logging the intercomponent communication.	
Effect	The TL presents all the information provided in the parameters of this operation to the user, how this is done is not within the scope of the present document.	

7.3.4.1.37 tliPrReply_c_BC

Signature	void tliPrReply_c_BC(in TString am, in TInteger ts, in TString src, in TInteger line, in TriComponentIdType c, in TriPortIdType at, in TriPortIdListType to, in TriSignatureIdType signature, in Value parsValue, in Value replValue, in TriStatusType transmissionFailure)	
In Parameters	am	An additional message.
	ts	The time when the event is produced.
	src	The source file of the test specification.
	line	The line number where the request is performed.
	c	The component which produces this event.
	at	The port via which the reply is sent.
	to	The port list to which the reply is sent.
	signature	The signature relating to the reply.
	parsValue	The signature parameters relating to the reply.
	replValue	The reply to be sent.
	transmissionFailure	The failure message which might occur at transmission.
Return Value	void	
Constraint	Shall be called by CH or TE to log a broadcast reply operation. This event occurs after reply execution. This event is used for logging the intercomponent communication.	
Effect	The TL presents all the information provided in the parameters of this operation to the user, how this is done is not within the scope of the present document.	

7.3.4.1.38 tliPrReply_c_MC

Signature	void tliPrReply_c_MC(in TString am, in TInteger ts, in TString src, in TInteger line, in TriComponentIdType c, in TriPortIdType at, in TriPortIdListType to, in TriSignatureIdType signature, in Value parsValue, in Value replValue, in TriStatusType transmissionFailure)	
In Parameters	am	An additional message.
	ts	The time when the event is produced.
	src	The source file of the test specification.
	line	The line number where the request is performed.
	c	The component which produces this event.
	at	The port via which the reply is sent.
	to	The port list to which the reply is sent.
	signature	The signature relating to the reply.
	parsValue	The signature parameters relating to the reply.
	replValue	The reply to be sent.
	transmissionFailure	The failure message which might occur at transmission.
Return Value	void	
Constraint	Shall be called by CH or TE to log a multicast reply operation. This event occurs after reply execution. This event is used for logging the intercomponent communication.	
Effect	The TL presents all the information provided in the parameters of this operation to the user, how this is done is not within the scope of the present document.	

7.3.4.1.39 tliPrGetReplyDetected_m

Signature	void tliPrGetReplyDetected_m(in TString am, in TInteger ts, in TString src, in TInteger line, in TriComponentIdType c, in TriPortIdType at, in TriPortIdType from, in TriSignatureIdType signature, in TriParameterListType triPars, in TriParameterType repl, in TriAddressType address)	
In Parameters	am	An additional message.
	ts	The time when the event is produced.
	src	The source file of the test specification.
	line	The line number where the request is performed.
	c	The component which produces this event.
	at	The port via which the reply is received.
	from	The port from which the reply has been sent.
	signature	The signature relating to the reply.
	triPars	The encoded parameters of detected reply.
	repl	The received encoded reply.
address	The address of the source within the SUT.	
Return Value	void	
Constraint	Shall be called by SA or TE to log the getreply enqueue operation. This event occurs after getreply is enqueued. This event is used for logging the communication with the SUT.	
Effect	The TL presents all the information provided in the parameters of this operation to the user, how this is done is not within the scope of the present document.	

7.3.4.1.40 tliPrGetReplyDetected_c

Signature	void tliPrGetReplyDetected_c(in TString am, in TInteger ts, in TString src, in TInteger line, in TriComponentIdType c, in TriPortIdType at, in TriPortIdType from, in TriSignatureIdType signature, in TciParameterListType tciPars, in Value replValue)	
In Parameters	am	An additional message.
	ts	The time when the event is produced.
	src	The source file of the test specification.
	line	The line number where the request is performed.
	c	The component which produces this event.
	at	The port via which the reply is received.
	from	The port from which the reply has been sent.
	signature	The signature relating to the reply.
	tciPars	The encoded parameters of detected reply.
	replValue	The received reply.
Return Value	void	
Constraint	Shall be called by CH or TE to log the getreply enqueue operation. This event occurs after getreply is enqueued. This event is used for logging the intercomponent communication.	
Effect	The TL presents all the information provided in the parameters of this operation to the user, how this is done is not within the scope of the present document.	

7.3.4.1.41 tliPrGetReplyMismatch_m

Signature	void tliPrGetReplyMismatch_m(in TString am, in TInteger ts, in TString src, in TInteger line, in TriComponentIdType c, in TriPortIdType at, in TriSignatureIdType signature, in TciParameterListType tciPars, in TciValueTemplate parsTpl, in Value replValue, in TciValueTemplate replyTpl, in TciValueDifferenceList diffs, in Value addrValue, in TciValueTemplate addressTpl)	
In Parameters	am	An additional message.
	ts	The time when the event is produced.
	src	The source file of the test specification.
	line	The line number where the request is performed.
	c	The component which produces this event.
	at	The port via which the reply is received.
	signature	The signature relating to the reply.
	tciPars	The signature parameters relating to the reply.
	parsTpl	The template used to check the parameter match.
	replValue	The received reply.
	replyTpl	The template used to check the reply match.
	diffs	The difference/the mismatch between reply and template
	addrValue	The address value of the source within the SUT.
addressTpl	The expected address of the source within the SUT.	
Return Value	void	
Constraint	Shall be called by TE to log the mismatch of a getreply operation. This event occurs after getreply is checked against a template. This event is used for logging the communication with SUT.	
Effect	The TL presents all the information provided in the parameters of this operation to the user, how this is done is not within the scope of the present document.	

7.3.4.1.42 tliPrGetReplyMismatch_c

Signature	void tliPrGetReplyMismatch_c(in TString am, in TInteger ts, in TString src, in TInteger line, in TriComponentIdType c, in TriPortIdType at, in TriSignatureIdType signature, in TciParameterListType tciPars, in TciValueTemplate parsTpl, in Value replValue, in TciValueTemplate replyTpl, in TciValueDifferenceList diffs, in TriComponentIdType from, in TciNonValueTemplate fromTpl)	
In Parameters	am	An additional message.
	ts	The time when the event is produced.
	src	The source file of the test specification.
	line	The line number where the request is performed.
	c	The component which produces this event.
	at	The port via which the reply is received.
	signature	The signature relating to the reply.
	tciPars	The signature parameters relating to the reply.
	parsTpl	The template used to check the parameter match.
	repl	The received reply.
	replyTpl	The template used to check the reply match.
	diffs	The difference/the mismatch between reply and template
	from	The component which sent the reply.
fromTpl	The expected replying component.	
Return Value	void	
Constraint	Shall be called by TE to log the mismatch of a getreply operation. This event occurs after getreply is checked against a template. This event is used for logging the intercomponent communication.	
Effect	The TL presents all the information provided in the parameters of this operation to the user, how this is done is not within the scope of the present document.	

7.3.4.1.43 tliPrGetReply_m

Signature	void tliPrGetReply_m(in TString am, in TInteger ts, in TString src, in TInteger line, in TriComponentIdType c, in TriPortIdType at, in TriSignatureIdType signature, in TciParameterListType tciPars, in TciValueTemplate parsTmpl, in Value replValue, in TciValueTemplate replyTmpl, in Value addrValue, in TciValueTemplate addressTmpl)	
In Parameters	am	An additional message.
	ts	The time when the event is produced.
	src	The source file of the test specification.
	line	The line number where the request is performed.
	c	The component which produces this event.
	at	The port via which the reply is received.
	signature	The signature relating to the reply.
	tciPars	The signature parameters relating to the reply.
	parsTmpl	The template used to check the parameter match.
	replValue	The received reply.
	replyTmpl	The template used to check the reply match.
	addrValue	The address value of the source within the SUT.
addressTmpl	The expected address of the source within the SUT.	
Return Value	void	
Constraint	Shall be called by TE to log getting a reply. This event occurs after getreply is checked against a template. This event is used for logging the communication with SUT.	
Effect	The TL presents all the information provided in the parameters of this operation to the user, how this is done is not within the scope of the present document.	

7.3.4.1.44 tliPrGetReply_c

Signature	void tliPrGetReply_c(in TString am, in TInteger ts, in TString src, in TInteger line, in TriComponentIdType c, in TriPortIdType at, in TriSignatureIdType signature, in TciParameterListType tciPars, in TciValueTemplate parsTmpl, in Value replValue, in TciValueTemplate replyTmpl, in TriComponentIdType from, in TciNonValueTemplate fromTmpl)	
In Parameters	am	An additional message.
	ts	The time when the event is produced.
	src	The source file of the test specification.
	line	The line number where the request is performed.
	c	The component which produces this event.
	at	The port via which the reply is received.
	signature	The signature relating to the reply.
	tciPars	The signature parameters relating to the reply.
	parsTmpl	The template used to check the parameter match.
	replValue	The received reply.
	replyTmpl	The template used to check the reply match.
	from	The component which sent the reply.
fromTmpl	The expected replying component.	
Return Value	void	
Constraint	Shall be called by TE to log getting a reply. This event occurs after getreply is checked against a template. This event is used for logging the intercomponent communication.	
Effect	The TL presents all the information provided in the parameters of this operation to the user, how this is done is not within the scope of the present document.	

7.3.4.1.45 tliPrRaise_m

Signature	void tliPrRaise_m(in TString am, in TInteger ts, in TString src, in TInteger line, in TriComponentIdType c, in TriPortIdType at, in TriPortIdType to, in TriSignatureIdType signature, in TciParameterListType tciPars, in Value excValue, in Value addrValue, in TciStatusType encoderFailure, in TriExceptionType exc, in TriAddressType address, in TriStatusType transmissionFailure)	
In Parameters	am	An additional message.
	ts	The time when the event is produced.
	src	The source file of the test specification.
	line	The line number where the request is performed.
	c	The component which produces this event.
	at	The port via which the exception is sent.
	to	The port to which the exception is sent.
	signature	The signature relating to the exception.
	tciPars	The signature parameters relating to the exception.
	excValue	The exception to be sent.
	addrValue	The address value of the destination within the SUT.
	encoderFailure	The failure message which might occur at encoding.
	exc	The encoded exception.
address	The address of the destination within the SUT.	
transmissionFailure	The failure message which might occur at transmission.	
Return Value	void	
Constraint	Shall be called by SA or TE to log a unicast raise operation. This event occurs after reply execution. This event is used for logging the communication with the SUT.	
Effect	The TL presents all the information provided in the parameters of this operation to the user, how this is done is not within the scope of the present document.	

7.3.4.1.46 tliPrRaise_m_BC

Signature	void tliPrRaise_m_BC(in TString am, in TInteger ts, in TString src, in TInteger line, in TriComponentIdType c, in TriPortIdType at, in TriPortIdType to, in TriSignatureIdType signature, in TciParameterListType tciPars, in Value excValue, in TciStatusType encoderFailure, in TriExceptionType exc, in TriStatusType transmissionFailure)	
In Parameters	am	An additional message.
	ts	The time when the event is produced.
	src	The source file of the test specification.
	line	The line number where the request is performed.
	c	The component which produces this event.
	at	The port via which the exception is sent.
	to	The port to which the exception is sent.
	signature	The signature relating to the exception.
	tciPars	The signature parameters relating to the exception.
	excValue	The exception to be sent.
	encoderFailure	The failure message which might occur at encoding.
	exc	The encoded exception.
	transmissionFailure	The failure message which might occur at transmission.
Return Value	void	
Constraint	Shall be called by SA or TE to log a broadcast raise operation. This event occurs after reply execution. This event is used for logging the communication with the SUT.	
Effect	The TL presents all the information provided in the parameters of this operation to the user, how this is done is not within the scope of the present document.	

7.3.4.1.47 tliPrRaise_m_MC

Signature	void tliPrRaise_m_MC(in TString am, in TInteger ts, in TString src, in TInteger line, in TriComponentIdType c, in TriPortIdType at, in TriPortIdType to, in TriSignatureIdType signature, in TciParameterListType tciPars, in Value excValue, in TciValueList addrValues, in TciStatusType encoderFailure, in TriExceptionType exc, in TriAddressListType addresses, in TriStatusType transmissionFailure)	
In Parameters	am	An additional message.
	ts	The time when the event is produced.
	src	The source file of the test specification.
	line	The line number where the request is performed.
	c	The component which produces this event.
	at	The port via which the exception is sent.
	to	The port to which the exception is sent.
	signature	The signature relating to the exception.
	tciPars	The signature parameters relating to the exception.
	excValue	The exception to be sent.
	addrValues	The address values of the destinations within the SUT.
	encoderFailure	The failure message which might occur at encoding.
	exc	The encoded exception.
	addresses	The addresses of the destinations within the SUT.
transmissionFailure	The failure message which might occur at transmission.	
Return Value	void	
Constraint	Shall be called by SA or TE to log a multicast raise operation. This event occurs after reply execution. This event is used for logging the communication with the SUT.	
Effect	The TL presents all the information provided in the parameters of this operation to the user, how this is done is not within the scope of the present document.	

7.3.4.1.48 tliPrRaise_c

Signature	void tliPrRaise_c(in TString am, in TInteger ts, in TString src, in TInteger line, in TriComponentIdType c, in TriPortIdType at, in TriPortIdType to, in TriSignatureIdType signature, in TciParameterListType tciPars, in Value excValue, in TriStatusType transmissionFailure)		
In Parameters	am	An additional message.	
	ts	The time when the event is produced.	
	src	The source file of the test specification.	
	line	The line number where the request is performed.	
	c	The component which produces this event.	
	at	The port via which the exception is sent.	
	to	The port to which the exception is sent.	
	signature	The signature relating to the exception.	
	tciPars	The signature parameters relating to the exception.	
	excValue	The exception to be sent.	
	transmissionFailure	The failure message which might occur at transmission.	
	Return Value	void	
	Constraint	Shall be called by CH or TE to log a unicast raise operation. This event occurs after reply execution. This event is used for logging the intercomponent communication.	
	Effect	The TL presents all the information provided in the parameters of this operation to the user, how this is done is not within the scope of the present document.	

7.3.4.1.49 tliPrRaise_c_BC

Signature	void tliPrRaise_c_BC(in TString am, in TInteger ts, in TString src, in TInteger line, in TriComponentIdType c, in TriPortIdType at, in TriPortIdListType to, in TriSignatureIdType signature, in TciParameterListType tciPars, in Value excValue, in TriStatusType transmissionFailure)	
In Parameters	am	An additional message.
	ts	The time when the event is produced.
	src	The source file of the test specification.
	line	The line number where the request is performed.
	c	The component which produces this event.
	at	The port via which the exception is sent.
	to	The port list to which the exception is sent.
	signature	The signature relating to the exception.
	tciPars	The signature parameters relating to the exception.
	excValue	The exception to be sent.
Return Value	void	
Constraint	Shall be called by CH or TE to log a broadcast raise operation. This event occurs after reply execution. This event is used for logging the intercomponent communication.	
Effect	The TL presents all the information provided in the parameters of this operation to the user, how this is done is not within the scope of the present document.	

7.3.4.1.50 tliPrRaise_c_MC

Signature	void tliPrRaise_c_MC(in TString am, in TInteger ts, in TString src, in TInteger line, in TriComponentIdType c, in TriPortIdType at, in TriPortIdListType to, in TriSignatureIdType signature, in TciParameterListType tciPars, in Value excValue, in TriStatusType transmissionFailure)	
In Parameters	am	An additional message.
	ts	The time when the event is produced.
	src	The source file of the test specification.
	line	The line number where the request is performed.
	c	The component which produces this event.
	at	The port via which the exception is sent.
	to	The port list to which the exception is sent.
	signature	The signature relating to the exception.
	tciPars	The signature parameters relating to the exception.
	excValue	The exception to be sent.
Return Value	void	
Constraint	Shall be called by CH or TE to log a multicast raise operation. This event occurs after reply execution. This event is used for logging the intercomponent communication.	
Effect	The TL presents all the information provided in the parameters of this operation to the user, how this is done is not within the scope of the present document.	

7.3.4.1.51 tliPrCatchDetected_m

Signature	void tliPrCatchDetected_m(in TString am, in TInteger ts, in TString src, in TInteger line, in TriComponentIdType c, in TriPortIdType at, in TriPortIdType from, in TriSignatureIdType signature, in TriExceptionType exc, in TriAddressType address)	
In Parameters	am	An additional message.
	ts	The time when the event is produced.
	src	The source file of the test specification.
	line	The line number where the request is performed.
	c	The component which produces this event.
	at	The port via which the exception is received.
	from	The port from which the exception has been sent.
	signature	The signature relating to the exception.
	exc	The exception caught.
Return Value	void	
Constraint	Shall be called by SA or TE to log the catch enqueue operation. This event occurs after catch is enqueued. This event is used for logging the communication with the SUT.	
Effect	The TL presents all the information provided in the parameters of this operation to the user, how this is done is not within the scope of the present document.	

7.3.4.1.52 tliPrCatchDetected_c

Signature	void tliPrCatchDetected_c(in TString am, in TInteger ts, in TString src, in TInteger line, in TriComponentIdType c, in TriPortIdType at, in TriPortIdType from, in TriSignatureIdType signature, in Value excValue)	
In Parameters	am	An additional message.
	ts	The time when the event is produced.
	src	The source file of the test specification.
	line	The line number where the request is performed.
	c	The component which produces this event.
	at	The port via which the exception is received.
	from	The port from which the exception has been sent.
	signature	The signature relating to the exception.
	excValue	The caught exception.
Return Value	void	
Constraint	Shall be called by CH or TE to log the catch enqueue operation. This event occurs after catch is enqueued. This event is used for logging the intercomponent communication.	
Effect	The TL presents all the information provided in the parameters of this operation to the user, how this is done is not within the scope of the present document.	

7.3.4.1.53 tliPrCatchMismatch_m

Signature	void tliPrCatchMismatch_m(in TString am, in TInteger ts, in TString src, in TInteger line, in TriComponentIdType c, in TriPortIdType at, in TriSignatureIdType signature, in Value excValue, in TciValueTemplate excTpl, in TciValueDifferenceList diffs, in Value addrValue, in TciValueTemplate addressTpl)	
In Parameters	am	An additional message.
	ts	The time when the event is produced.
	src	The source file of the test specification.
	line	The line number where the request is performed.
	c	The component which produces this event.
	at	The port via which the exception is received.
	signature	The signature relating to the exception.
	excValue	The received exception.
	excTpl	The template used to check the exception match.
	diffs	The difference/the mismatch between exception and template
	addrValue	The address value of the source within the SUT.
	addressTpl	The expected address of the source within the SUT.
	Return Value	void
Constraint	Shall be called by TE to log the mismatch of a catch operation. This event occurs after catch is checked against a template. This event is used for logging the communication with SUT.	
Effect	The TL presents all the information provided in the parameters of this operation to the user, how this is done is not within the scope of the present document.	

7.3.4.1.54 tliPrCatchMismatch_c

Signature	void tliPrCatchMismatch_c(in TString am, in TInteger ts, in TString src, in TInteger line, in TriComponentIdType c, in TriPortIdType at, in TriSignatureIdType signature, in Value excValue, in TciValueTemplate excTpl, in TciValueDifferenceList diffs, in TriComponentIdType from, in TciNonValueTemplate fromTpl)	
In Parameters	am	An additional message.
	ts	The time when the event is produced.
	src	The source file of the test specification.
	line	The line number where the request is performed.
	c	The component which produces this event.
	at	The port via which the exception is received.
	signature	The signature relating to the exception.
	excValue	The received exception.
	excTpl	The template used to check the exception match.
	diffs	The difference/the mismatch between exception and template
	from	The component which sent the reply.
	fromTpl	The expected replying component.
	Return Value	void
Constraint	Shall be called by TE to log the mismatch of a catch operation. This event occurs after catch is checked against a template. This event is used for logging the intercomponent communication.	
Effect	The TL presents all the information provided in the parameters of this operation to the user, how this is done is not within the scope of the present document.	

7.3.4.1.55 tliPrCatch m

Signature	void tliPrCatch_m(in TString am, in TInteger ts, in TString src, in TInteger line, in TriComponentIdType c, in TriPortIdType at, in TriSignatureIdType signature, in Value excValue, in TciValueTemplate excTpl, in Value addrValue, in TciValueTemplate addressTpl)	
In Parameters	am	An additional message.
	ts	The time when the event is produced.
	src	The source file of the test specification.
	line	The line number where the request is performed.
	c	The component which produces this event.
	at	The port via which the exception is received.
	signature	The signature relating to the exception.
	excValue	The received exception.
	excTpl	The template used to check the exception match.
	addrValue	The address value of the source within the SUT.
	addressTpl	The expected address of the source within the SUT.
Return Value	void	
Constraint	Shall be called by SA or TE to log catching an exception. This event occurs after catch is checked against a template. This event is used for logging the communication with SUT.	
Effect	The TL presents all the information provided in the parameters of this operation to the user, how this is done is not within the scope of the present document.	

7.3.4.1.56 tliPrCatch c

Signature	void tliPrCatch_c(in TString am, in TInteger ts, in TString src, in TInteger line, in TriComponentIdType c, in TriPortIdType at, in TriSignatureIdType signature, in Value excValue, in TciValueTemplate excTpl, in TriComponentIdType from, in TciNonValueTemplate fromTpl)	
In Parameters	am	An additional message.
	ts	The time when the event is produced.
	src	The source file of the test specification.
	line	The line number where the request is performed.
	c	The component which produces this event.
	at	The port via which the exception is received.
	signature	The signature relating to the exception.
	excValue	The received exception.
	excTpl	The template used to check the exception match.
		from
	fromTpl	The expected replying component.
Return Value	void	
Constraint	Shall be called by CH or TE to log catching an exception. This event occurs after catch is checked against a template. This event is used for logging the intercomponent communication.	
Effect	The TL presents all the information provided in the parameters of this operation to the user, how this is done is not within the scope of the present document.	

7.3.4.1.57 tliPrCatchTimeoutDetected

Signature	void tliPrCatchTimeoutDetected(in TString am, in TInteger ts, in TString src, in TInteger line, in TriComponentIdType c, in TriPortIdType at, in TriSignatureIdType signature)	
In Parameters	am	An additional message.
	ts	The time when the event is produced.
	src	The source file of the test specification.
	line	The line number where the request is performed.
	c	The component which produces this event.
	at	The port via which the exception is received.
	signature	The signature relating to the exception.
Return Value	void	
Constraint	Shall be called by PA or TE to log the detection of a catch timeout. This event occurs after the timeout is enqueued.	
Effect	The TL presents all the information provided in the parameters of this operation to the user, how this is done is not within the scope of the present document.	

7.3.4.1.58 tliPrCatchTimeout

Signature	void tliPrCatchTimeout (in TString am, in TInteger ts, in TString src, in TInteger line, in TriComponentIdType c, in TriPortIdType at, in TriSignatureIdType signature)	
In Parameters	am	An additional message.
	ts	The time when the event is produced.
	src	The source file of the test specification.
	line	The line number where the request is performed.
	c	The component which produces this event.
	at	The port via which the exception is received.
	signature	The signature relating to the exception.
Return Value	void	
Constraint	Shall be called by TE to log catching a timeout. This event occurs after the catch timeout has been performed.	
Effect	The TL presents all the information provided in the parameters of this operation to the user, how this is done is not within the scope of the present document.	

7.3.4.1.59 tliCCreate

Signature	void tliCCreate(in TString am, in TInteger ts, in TString src, in TInteger line, in TriComponentIdType c, in TriComponentIdType comp, in TString name, in TBoolean alive)	
In Parameters	am	An additional message.
	ts	The time when the event is produced.
	src	The source file of the test specification.
	line	The line number where the request is performed.
	c	The component which produces this event.
	comp	The component which is created.
	name	The name of the component which is created.
	alive	If the component is an alive component.
Return Value	void	
Constraint	Shall be called by TE to log the create component operation. This event occurs after component creation.	
Effect	The TL presents all the information provided in the parameters of this operation to the user, how this is done is not within the scope of the present document.	

7.3.4.1.60 tliCStart

Signature	void tliCStart(in TString am, in TInteger ts, in TString src, in TInteger line, in TriComponentIdType c, in TriComponentIdType comp, in TciBehaviourIdType beh, in TciParameterListType tciPars)	
In Parameters	am	An additional message.
	ts	The time when the event is produced.
	src	The source file of the test specification.
	line	The line number where the request is performed.
	c	The component which produces this event.
	comp	The component which is started.
	beh	The behaviour being started on the component.
	tciPars	The parameters of the started behaviour.
Return Value	void	
Constraint	Shall be called by TE to log the start component operation. This event occurs after component start.	
Effect	The TL presents all the information provided in the parameters of this operation to the user, how this is done is not within the scope of the present document.	

7.3.4.1.61 tliCRunning

Signature	void tliCRunning(in TString am, in TInteger ts, in TString src, in TInteger line, in TriComponentIdType c, in TriComponentIdType comp, in ComponentStatusType status)	
In Parameters	am	An additional message.
	ts	The time when the event is produced.
	src	The source file of the test specification.
	line	The line number where the request is performed.
	c	The component which produces this event.
	comp	The component which is checked to be running.
	status	The status of this component.
Return Value	void	
Constraint	Shall be called by TE to log the running component operation. This event occurs after component running.	
Effect	The TL presents all the information provided in the parameters of this operation to the user, how this is done is not within the scope of the present document.	

7.3.4.1.62 tliCAlive

Signature	void tliCAlive(in TString am, in TInteger ts, in TString src, in TInteger line, in TriComponentIdType c, in TriComponentIdType comp, in ComponentStatusType status)	
In Parameters	am	An additional message.
	ts	The time when the event is produced.
	src	The source file of the test specification.
	line	The line number where the request is performed.
	c	The component which produces this event.
	comp	The component which is checked to be running.
	status	The status of this component.
Return Value	void	
Constraint	Shall be called by TE to log the alive component operation. This event occurs after component alive.	
Effect	The TL presents all the information provided in the parameters of this operation to the user, how this is done is not within the scope of the present document.	

7.3.4.1.63 tliCStop

Signature	void tliCStop(in TString am, in TInteger ts, in TString src, in TInteger line, in TriComponentIdType c, in TriComponentIdType comp)	
In Parameters	am	An additional message.
	ts	The time when the event is produced.
	src	The source file of the test specification.
	line	The line number where the request is performed.
	c	The component which produces this event.
	comp	The component which is stopped.
Return Value	void	
Constraint	Shall be called by TE to log the stop component operation. This event occurs after component stop.	
Effect	The TL presents all the information provided in the parameters of this operation to the user, how this is done is not within the scope of the present document.	

7.3.4.1.64 tliCKill

Signature	void tliCKill(in TString am, in TInteger ts, in TString src, in TInteger line, in TriComponentIdType c, in TriComponentIdType comp)	
In Parameters	am	An additional message.
	ts	The time when the event is produced.
	src	The source file of the test specification.
	line	The line number where the request is performed.
	c	The component which produces this event.
	comp	The component which is killed.
Return Value	void	
Constraint	Shall be called by TE to log the kill component operation. This event occurs after component kill.	
Effect	The TL presents all the information provided in the parameters of this operation to the user, how this is done is not within the scope of the present document.	

7.3.4.1.65 tliCDoneMismatch

Signature	void tliCDoneMismatch(in TString am, in TInteger ts, in TString src, in TInteger line, in TriComponentIdType c, in TriComponentIdType comp, in TciNonValueTemplate compTpl)	
In Parameters	am	An additional message.
	ts	The time when the event is produced.
	src	The source file of the test specification.
	line	The line number where the request is performed.
	c	The component which produces this event.
	comp	The first component that did not match.
	compTpl	The template used to check the done match.
Return Value	void	
Constraint	Shall be called by TE to log the mismatch of a done component operation. This event occurs after done is checked against a template.	
Effect	The TL presents all the information provided in the parameters of this operation to the user, how this is done is not within the scope of the present document.	

7.3.4.1.66 tliCDone

Signature	void tliCDone (in TString am, in TInteger ts, in TString src, in TInteger line, in TriComponentIdType c, in TciNonValueTemplate compTpl)	
In Parameters	am	An additional message.
	ts	The time when the event is produced.
	src	The source file of the test specification.
	line	The line number where the request is performed.
	c	The component which produces this event.
	compTpl	The template used to check the done match.
Return Value	void	
Constraint	Shall be called by TE to log the done component operation. This event occurs after the done operation.	
Effect	The TL presents all the information provided in the parameters of this operation to the user, how this is done is not within the scope of the present document.	

7.3.4.1.67 tliCKilledMismatch

Signature	void tliCKilledMismatch(in TString am, in TInteger ts, in TString src, in TInteger line, in TriComponentIdType c, in TriComponentIdType comp, in TciNonValueTemplate compTpl)	
In Parameters	am	An additional message.
	ts	The time when the event is produced.
	src	The source file of the test specification.
	line	The line number where the request is performed.
	c	The component which produces this event.
	comp	The first component that did not match.
	compTpl	The template used to check the killed match.
Return Value	void	
Constraint	Shall be called by TE to log the mismatch of a killed component operation. This event occurs after killed is checked against a template.	
Effect	The TL presents all the information provided in the parameters of this operation to the user, how this is done is not within the scope of the present document.	

7.3.4.1.68 tliCKilled

Signature	void tliCKilled (in TString am, in TInteger ts, in TString src, in TInteger line, in TriComponentIdType c, in TciNonValueTemplate compTpl)	
In Parameters	am	An additional message.
	ts	The time when the event is produced.
	src	The source file of the test specification.
	line	The line number where the request is performed.
	c	The component which produces this event.
	compTpl	The template used to check the killed match.
Return Value	void	
Constraint	Shall be called by TE to log the killed component operation. This event occurs after the killed operation.	
Effect	The TL presents all the information provided in the parameters of this operation to the user, how this is done is not within the scope of the present document.	

7.3.4.1.69 tliCTerminated

Signature	void tliCTerminated(in TString am, in TInteger ts, in TString src, in TInteger line, in TriComponentIdType c, in VerdictValue verdict, in TString reason)	
In Parameters	am	An additional message.
	ts	The time when the event is produced.
	src	The source file of the test specification.
	line	The line number where the request is performed.
	c	The component which produces this event.
	verdict	The verdict of the component.
	reason	The optional reason of the setverdict statement
Return Value	void	
Constraint	Shall be called by TE to log the termination of a component. This event occurs after the termination of the component.	
Effect	The TL presents all the information provided in the parameters of this operation to the user, how this is done is not within the scope of the present document.	

7.3.4.1.70 tliPConnect

Signature	void tliPConnect(in TString am, in TInteger ts, in TString src, in TInteger line, in TriComponentIdType c, in TriPortIdType port1, in TriPortIdType port2)	
In Parameters	am	An additional message.
	ts	The time when the event is produced.
	src	The source file of the test specification.
	line	The line number where the request is performed.
	c	The component which produces this event.
	port1	The first port to be connected.
	port2	The second port to be connected.
Return Value	void	
Constraint	Shall be called by CH or TE to log the connect operation. This event occurs after the connect operation.	
Effect	The TL presents all the information provided in the parameters of this operation to the user, how this is done is not within the scope of the present document.	

7.3.4.1.71 tliPDisconnect

Signature	void tliPDisconnect(in TString am, in TInteger ts, in TString src, in TInteger line, in TriComponentIdType c, in TriPortIdType port1, in TriPortIdType port2)	
In Parameters	am	An additional message.
	ts	The time when the event is produced.
	src	The source file of the test specification.
	line	The line number where the request is performed.
	c	The component which produces this event.
	port1	The first port to be disconnected.
	port2	The second port to be disconnected.
Return Value	void	
Constraint	Shall be called by CH or TE to log the disconnect operation. This event occurs after the disconnect operation.	
Effect	The TL presents all the information provided in the parameters of this operation to the user, how this is done is not within the scope of the present document.	

7.3.4.1.72 tliPMap

Signature	void tliPMap(in TString am, in TInteger ts, in TString src, in TInteger line, in TriComponentIdType c, in TriPortIdType port1, in TriPortIdType port2)	
In Parameters	am	An additional message.
	ts	The time when the event is produced.
	src	The source file of the test specification.
	line	The line number where the request is performed.
	c	The component which produces this event.
	port1	The first port to be mapped.
	port2	The second port to be mapped.
Return Value	void	
Constraint	Shall be called by SA or TE to log the map operation. This event occurs after the map operation.	
Effect	The TL presents all the information provided in the parameters of this operation to the user, how this is done is not within the scope of the present document.	

7.3.4.1.73 tliPMapParam

Signature	void tliPMapParam(in TString am, in TInteger ts, in TString src, in TInteger line, in TriComponentIdType c, in TriPortIdType port1, in TriPortIdType port2, in TciParameterListType tciPars, in TciStatusType encoderFailure, in TriParameterListType triPars)	
In Parameters	am	An additional message.
	ts	The time when the event is produced.
	src	The source file of the test specification.
	line	The line number where the request is performed.
	c	The component which produces this event.
	port1	The first port to be mapped.
	port2	The second port to be mapped.
	tciPars	The configuration parameter list.
	encoderFailure	The failure message which might occur at encoding.
	triPars	The encoded configuration parameter list.
Return Value	void	
Constraint	Shall be called by SA or TE to log the map operation. This event occurs after the map operation including parameters.	
Effect	The TL presents all the information provided in the parameters of this operation to the user, how this is done is not within the scope of the present document.	

7.3.4.1.74 tliPUnmap

Signature	void tliPUnmap(in TString am, in TInteger ts, in TString src, in TInteger line, in TriComponentIdType c, in TriPortIdType port1, in TriPortIdType port2)	
In Parameters	am	An additional message.
	ts	The time when the event is produced.
	src	The source file of the test specification.
	line	The line number where the request is performed.
	c	The component which produces this event.
	port1	The first port to be unmapped.
	port2	The second port to be unmapped.
Return Value	void	
Constraint	Shall be called by SA or TE to log the unmap operation. This event occurs after the unmap operation.	
Effect	The TL presents all the information provided in the parameters of this operation to the user, how this is done is not within the scope of the present document.	

7.3.4.1.75 tliPUnmapParam

Signature	void tliPUnmapParam(in TString am, in TInteger ts, in TString src, in TInteger line, in TriComponentIdType c, in TriPortIdType port1, in TriPortIdType port2, in TciParameterListType tciPars, in TciStatusType encoderFailure, in TriParameterListType triPars)	
In Parameters	am	An additional message.
	ts	The time when the event is produced.
	src	The source file of the test specification.
	line	The line number where the request is performed.
	c	The component which produces this event.
	port1	The first port to be unmapped.
	port2	The second port to be unmapped.
	tciPars	The configuration parameter list.
	encoderFailure	The failure message which might occur at encoding.
	triPars	The encoded configuration parameter list.
Return Value	void	
Constraint	Shall be called by SA or TE to log the unmap operation. This event occurs after the unmap operation including parameters.	
Effect	The TL presents all the information provided in the parameters of this operation to the user, how this is done is not within the scope of the present document.	

7.3.4.1.76 tliPClear

Signature	void tliPClear(in TString am, in TInteger ts, in TString src, in TInteger line, in TriComponentIdType c, in TriPortIdType port)	
In Parameters	am	An additional message.
	ts	The time when the event is produced.
	src	The source file of the test specification.
	line	The line number where the request is performed.
	c	The component which produces this event.
	port	The port to be cleared.
Return Value	void	
Constraint	Shall be called by TE to log the port clear operation. This event occurs after the port clear operation.	
Effect	The TL presents all the information provided in the parameters of this operation to the user, how this is done is not within the scope of the present document.	

7.3.4.1.77 tliPStart

Signature	void tliPStart(in TString am, in TInteger ts, in TString src, in TInteger line, in TriComponentIdType c, in TriPortIdType port)	
In Parameters	am	An additional message.
	ts	The time when the event is produced.
	src	The source file of the test specification.
	line	The line number where the request is performed.
	c	The component which produces this event.
	port	The port to be started.
Return Value	void	
Constraint	Shall be called by TE to log the port start operation. This event occurs after the port start operation.	
Effect	The TL presents all the information provided in the parameters of this operation to the user, how this is done is not within the scope of the present document.	

7.3.4.1.78 tliPStop

Signature	void tliPStop(in TString am, in TInteger ts, in TString src, in TInteger line, in TriComponentIdType c, in TriPortIdType port)	
In Parameters	am	An additional message.
	ts	The time when the event is produced.
	src	The source file of the test specification.
	line	The line number where the request is performed.
	c	The component which produces this event.
	port	The port to be stopped.
Return Value	void	
Constraint	Shall be called by TE to log the port stop operation. This event occurs after the port stop operation.	
Effect	The TL presents all the information provided in the parameters of this operation to the user, how this is done is not within the scope of the present document.	

7.3.4.1.79 tliPHalt

Signature	void tliPHalt(in TString am, in TInteger ts, in TString src, in TInteger line, in TriComponentIdType c, in TriPortIdType port)	
In Parameters	am	An additional message.
	ts	The time when the event is produced.
	src	The source file of the test specification.
	line	The line number where the request is performed.
	c	The component which produces this event.
	port	The port to be stopped.
Return Value	void	
Constraint	Shall be called by TE to log the port halt operation. This event occurs after the port halt operation.	
Effect	The TL presents all the information provided in the parameters of this operation to the user, how this is done is not within the scope of the present document.	

7.3.4.1.80 tliEncode

Signature	void tliEncode(in TString am, in TInteger ts, in TString src, in TInteger line, in TriComponentIdType c, in Value val, in TciStatusType encoderFailure, in TriMessageType msg, in TString codec)	
In Parameters	am	An additional message.
	ts	The time when the event is produced.
	src	The source file of the test specification.
	line	The line number where the request is performed.
	c	The component which produces this event.
	value	The value to be encoded.
	encoderFailure	The failure message which might occur at encoding.
	msg	The encoded value.
	codec	The used encoder.
Return Value	void	
Constraint	Shall be called by CD or TE to log the encode operation.	
Effect	The TL presents all the information provided in the parameters of this operation to the user, how this is done is not within the scope of the present document.	

7.3.4.1.81 tliDecode

Signature	void tliDecode(in TString am, in TInteger ts, in TString src, in TInteger line, in TriComponentIdType c, in TriMessageType msg, in TciStatusType decoderFailure, in Value val, in TString codec)	
In Parameters	am	An additional message.
	ts	The time when the event is produced.
	src	The source file of the test specification.
	line	The line number where the request is performed.
	c	The component which produces this event.
	msg	The value to be decoded.
	decoderFailure	The failure message which might occur at decoding.
	val	The decoded value.
Return Value	void	
Constraint	Shall be called by CD or TE to log the decode operation.	
Effect	The TL presents all the information provided in the parameters of this operation to the user, how this is done is not within the scope of the present document.	

7.3.4.1.82 tliTimeoutDetected

Signature	void tliTimeoutDetected(in TString am, in TInteger ts, in TString src, in TInteger line, in TriComponentIdType c, in TriTimerIdType timer)	
In Parameters	am	An additional message.
	ts	The time when the event is produced.
	src	The source file of the test specification.
	line	The line number where the request is performed.
	c	The component which produces this event.
	timer	The timer that timed out.
Return Value	void	
Constraint	Shall be called by PA or TE to log the detection of a timeout. This event occurs after timeout is enqueued.	
Effect	The TL presents all the information provided in the parameters of this operation to the user, how this is done is not within the scope of the present document.	

7.3.4.1.83 tliTimeoutMismatch

Signature	void tliTimeoutMismatch(in TString am, in TInteger ts, in TString src, in TInteger line, in TriComponentIdType c, in TriTimerIdType timer, in TciNonValueTemplate timerTpl)	
In Parameters	am	An additional message.
	ts	The time when the event is produced.
	src	The source file of the test specification.
	line	The line number where the request is performed.
	c	The component which produces this event.
	timer	The first timer that did not match.
	timerTpl	The timer template that did not match.
Return Value	void	
Constraint	Shall be called by TE to log a timeout mismatch. This event occurs after a timeout match failed.	
Effect	The TL presents all the information provided in the parameters of this operation to the user, how this is done is not within the scope of the present document.	

7.3.4.1.84 tliTTimeout

Signature	void tliTTimeout(in TString am, in TInteger ts, in TString src, in TInteger line, in TriComponentIdType c, in TriTimerIdType timer, in TciNonValueTemplate timerTpl)	
In Parameters	am	An additional message.
	ts	The time when the event is produced.
	src	The source file of the test specification.
	line	The line number where the request is performed.
	c	The component which produces this event.
	timer	The timer that matched.
	timerTpl	The timer template that matched.
Return Value	void	
Constraint	Shall be called by TE to log a timeout match. This event occurs after a timeout matched.	
Effect	The TL presents all the information provided in the parameters of this operation to the user, how this is done is not within the scope of the present document.	

7.3.4.1.85 tliTStart

Signature	void tliTStart(in TString am, in TInteger ts, in TString src, in TInteger line, in TriComponentIdType c, in TriTimerIdType timer, in TriTimerDurationType dur)	
In Parameters	am	An additional message.
	ts	The time when the event is produced.
	src	The source file of the test specification.
	line	The line number where the request is performed.
	c	The component which produces this event.
	timer	The timer that is started.
	dur	The timer duration.
Return Value	void	
Constraint	Shall be called by PA or TE to log the start of a timer. This event occurs after the start timer operation.	
Effect	The TL presents all the information provided in the parameters of this operation to the user, how this is done is not within the scope of the present document.	

7.3.4.1.86 tliTStop

Signature	void tliTStop(in TString am, in TInteger ts, in TString src, in TInteger line, in TriComponentIdType c, in TriTimerIdType timer, in TriTimerDurationType dur)	
In Parameters	am	An additional message.
	ts	The time when the event is produced.
	src	The source file of the test specification.
	line	The line number where the request is performed.
	c	The component which produces this event.
	timer	The timer that is stopped.
	dur	The duration of the timer when it was stopped.
Return Value	void	
Constraint	Shall be called by PA or TE to log the stop of a timer. This event occurs after the stop timer operation.	
Effect	The TL presents all the information provided in the parameters of this operation to the user, how this is done is not within the scope of the present document.	

7.3.4.1.87 tliTRead

Signature	void tliTRead(in TString am, in TInteger ts, in TString src, in TInteger line, in TriComponentIdType c, in TriTimerIdType timer, in TriTimerDurationType elapsed)	
In Parameters	am	An additional message.
	ts	The time when the event is produced.
	src	The source file of the test specification.
	line	The line number where the request is performed.
	c	The component which produces this event.
	timer	The timer that is started.
	elapsed	The elapsed time of the timer.
Return Value	void	
Constraint	Shall be called by PA or TE to log the reading of a timer. This event occurs after the read timer operation.	
Effect	The TL presents all the information provided in the parameters of this operation to the user, how this is done is not within the scope of the present document.	

7.3.4.1.88 tliTRunning

Signature	void tliTRunning(in TString am, in TInteger ts, in TString src, in TInteger line, in TriComponentIdType c, in TriTimerIdType timer, in TimerStatusType status)	
In Parameters	am	An additional message.
	ts	The time when the event is produced.
	src	The source file of the test specification.
	line	The line number where the request is performed.
	c	The component which produces this event.
	timer	The timer which is checked to be running.
	status	The status of this component.
Return Value	void	
Constraint	Shall be called by PA or TE to log the running timer operation. This event occurs after the running timer operation.	
Effect	The TL presents all the information provided in the parameters of this operation to the user, how this is done is not within the scope of the present document.	

7.3.4.1.89 tliSEnter

Signature	void tliSEnter(in TString am, in TInteger ts, in TString src, in TInteger line, in TriComponentIdType c, in QualifiedName name, in TciParameterListType tciPars, in TString kind)	
In Parameters	am	An additional message.
	ts	The time when the event is produced.
	src	The source file of the test specification.
	line	The line number where the request is performed.
	c	The component which produces this event.
	name	The name of the scope.
	tciPars	The parameters of the scope.
	kind	The kind of the scope.
Return Value	void	
Constraint	Shall be called by TE to log the entering of a scope. This event occurs after the scoped has been entered.	
Effect	The TL presents all the information provided in the parameters of this operation to the user, how this is done is not within the scope of the present document.	

7.3.4.1.90 tliSLeave

Signature	void tliSLeave(in TString am, in TInteger ts, in TString src, in TInteger line, in TriComponentIdType c, in QualifiedName name, in TciParameterListType tciPars, in Value returnValue, in TString kind)	
In Parameters	am	An additional message.
	ts	The time when the event is produced.
	src	The source file of the test specification.
	line	The line number where the request is performed.
	c	The component which produces this event.
	name	The name of the scope.
	tciPars	The parameters of the scope.
	returnValue	The return value of the scope.
Return Value	void	
Constraint	Shall be called by TE to log the leaving of a scope. This event occurs after the scoped has been left.	
Effect	The TL presents all the information provided in the parameters of this operation to the user, how this is done is not within the scope of the present document.	

7.3.4.1.91 tliVar

Signature	void tliVar(in TString am, in TInteger ts, in TString src, in TInteger line, in TriComponentIdType c, in QualifiedName name, in Value varValue)	
In Parameters	am	An additional message.
	ts	The time when the event is produced.
	src	The source file of the test specification.
	line	The line number where the request is performed.
	c	The component which produces this event.
	name	The name of the variable.
	varValue	The new value of the variable.
Return Value	void	
Constraint	Shall be called by TE to log the modification of the value of a variable. This event occurs after the value has been changed.	
Effect	The TL presents all the information provided in the parameters of this operation to the user, how this is done is not within the scope of the present document.	

7.3.4.1.92 tliModulePar

Signature	void tliModulePar(in TString am, in TInteger ts, in TString src, in TInteger line, in TriComponentIdType c, in QualifiedName name, in Value parValue)	
In Parameters	am	An additional message.
	ts	The time when the event is produced.
	src	The source file of the test specification.
	line	The line number where the request is performed.
	c	The component which produces this event.
	name	The name of the module parameter.
	parValue	The value of the module parameter.
Return Value	void	
Constraint	Shall be called by TE to log the value of a module parameter. This event occurs after the access to the value of a module parameter.	
Effect	The TL presents all the information provided in the parameters of this operation to the user, how this is done is not within the scope of the present document.	

7.3.4.1.93 tliGetVerdict

Signature	void tliGetVerdict(in TString am, in TInteger ts, in TString src, in TInteger line, in TriComponentIdType c, in VerdictValue verdict)	
In Parameters	am	An additional message.
	ts	The time when the event is produced.
	src	The source file of the test specification.
	line	The line number where the request is performed.
	c	The component which produces this event.
	verdict	The current value of the local verdict.
Return Value	void	
Constraint	Shall be called by TE to log the getverdict operation. This event occurs after the getverdict operation.	
Effect	The TL presents all the information provided in the parameters of this operation to the user, how this is done is not within the scope of the present document.	

7.3.4.1.94 tliSetVerdict

Signature	void tliSetVerdict(in TString am, in TInteger ts, in TString src, in TInteger line, in TriComponentIdType c, in VerdictValue verdict, in TString reason)	
In Parameters	am	An additional message.
	ts	The time when the event is produced.
	src	The source file of the test specification.
	line	The line number where the request is performed.
	c	The component which produces this event.
	verdict	The value to be set to the local verdict.
	reason	The optional reason of the setverdict statement.
Return Value	void	
Constraint	Shall be called by TE to log the setverdict operation or the occurrence of a runtime error. If used to log the setverdict operation, then this event occurs after the setverdict operation.	
Effect	The TL presents all the information provided in the parameters of this operation to the user, how this is done is not within the scope of the present document.	

7.3.4.1.95 tliLog

Signature	void tliLog (in TString am, in TInteger ts, in TString src, in TInteger line, in TriComponentIdType c, in TString log)	
In Parameters	am	An additional message.
	ts	The time when the event is produced.
	src	The source file of the test specification.
	line	The line number where the request is performed.
	c	The component which produces this event.
	log	The string to be logged.
Return Value	void	
Constraint	Shall be called by TM or TE to log the TTCN-3 statement log. This event occurs after the TTCN-3 log operation.	
Effect	The TL presents all the information provided in the parameters of this operation to the user, how this is done is not within the scope of the present document.	

7.3.4.1.96 tliAEnter

Signature	void tliAEnter(in TString am, in TInteger ts, in TString src, in TInteger line, in TriComponentIdType c)	
In Parameters	am	An additional message.
	ts	The time when the event is produced.
	src	The source file of the test specification.
	line	The line number where the request is performed.
	c	The component which produces this event.
Return Value	void	

Constraint	Shall be called by TE to log entering an alt. This event occurs after an alt has been entered.
Effect	The TL presents all the information provided in the parameters of this operation to the user, how this is done is not within the scope of the present document.

7.3.4.1.97 tliALeave

Signature	void tliALeave(in TString am, in TInteger ts, in TString src, in TInteger line, in TriComponentIdType c)	
In Parameters	am	An additional message.
	ts	The time when the event is produced.
	src	The source file of the test specification.
	line	The line number where the request is performed.
	c	The component which produces this event.
Return Value	void	
Constraint	Shall be called by TE to log leaving an alt. This event occurs after the alt has been left.	
Effect	The TL presents all the information provided in the parameters of this operation to the user, how this is done is not within the scope of the present document.	

7.3.4.1.98 tliANomatch

Signature	void tliANomatch (in TString am, in TInteger ts, in TString src, in TInteger line, in TriComponentIdType c)	
In Parameters	am	An additional message.
	ts	The time when the event is produced.
	src	The source file of the test specification.
	line	The line number where the request is performed.
	c	The component which produces this event.
Return Value	void	
Constraint	Shall be called by TE to log the nomatch of an alt. This event occurs after the alt has not matched.	
Effect	The TL presents all the information provided in the parameters of this operation to the user, how this is done is not within the scope of the present document.	

7.3.4.1.99 tliARepeat

Signature	void tliARepeat(in TString am, in TInteger ts, in TString src, in TInteger line, in TriComponentIdType c)	
In Parameters	am	An additional message.
	ts	The time when the event is produced.
	src	The source file of the test specification.
	line	The line number where the request is performed.
	c	The component which produces this event.
Return Value	void	
Constraint	Shall be called by TE to log repeating an alt. This event occurs when the alt has been repeated.	
Effect	The TL presents all the information provided in the parameters of this operation to the user, how this is done is not within the scope of the present document.	

7.3.4.1.100 tliADefaults

Signature	void tliADefaults(in TString am, in TInteger ts, in TString src, in TInteger line, in TriComponentIdType c)	
In Parameters	am	An additional message.
	ts	The time when the event is produced.
	src	The source file of the test specification.
	line	The line number where the request is performed.
	c	The component which produces this event.
Return Value	void	
Constraint	Shall be called by TE to log entering the default section. This event occurs after the default section has been entered.	
Effect	The TL presents all the information provided in the parameters of this operation to the user, how this is done is not within the scope of the present document.	

7.3.4.1.101 tliAActivate

Signature	void tliAActivate(in TString am, in TInteger ts, in TString src, in TInteger line, in TriComponentIdType c, in QualifiedName name, in TciParameterListType tciPars, in Value ref)	
In Parameters	am	An additional message.
	ts	The time when the event is produced.
	src	The source file of the test specification.
	line	The line number where the request is performed.
	c	The component which produces this event.
	name	The name of the default.
	tciPars	The parameter of the default.
	ref	The resulting default reference.
Return Value	void	
Constraint	Shall be called by TE to log the activation of a default. This event occurs after the default activation.	
Effect	The TL presents all the information provided in the parameters of this operation to the user, how this is done is not within the scope of the present document.	

7.3.4.1.102 tliADeactivate

Signature	void tliADeactivate(in TString am, in TInteger ts, in TString src, in TInteger line, in TriComponentIdType c, in Value ref)	
In Parameters	am	An additional message.
	ts	The time when the event is produced.
	src	The source file of the test specification.
	line	The line number where the request is performed.
	c	The component which produces this event.
	ref	The default reference.
Return Value	void	
Constraint	Shall be called by TE to log the deactivation of a default. This event occurs after the default deactivation.	
Effect	The TL presents all the information provided in the parameters of this operation to the user, how this is done is not within the scope of the present document.	

7.3.4.1.103 tliAWait

Signature	void tliAWait(in TString am, in TInteger ts, in TString src, in TInteger line, in TriComponentId c)	
In Parameters	am	An additional message.
	ts	The time when the event is produced.
	src	The source file of the test specification.
	line	The line number where the request is performed.
	c	The component which produces this event.
Return Value	void	
Constraint	Shall be called by TE to log that the component awaits events for a new snapshot.	
Effect	The TL presents all the information provided in the parameters of this operation to the user, how this is done is not within the scope of the present document.	

7.3.4.1.104 tliAction

Signature	void tliAction(in TString am, in TInteger ts, in TString src, in TInteger line, in TriComponentIdType c, in TString action)	
In Parameters	am	An additional message.
	ts	The time when the event is produced.
	src	The source file of the test specification.
	line	The line number where the request is performed.
	c	The component which produces this event.

	action	The action to be performed.
Return Value	void	
Constraint	Shall be called by TE to log that the component executed an SUT action.	
Effect	The TL presents all the information provided in the parameters of this operation to the user, how this is done is not within the scope of the present document.	

7.3.4.1.105 tliMatch

Signature	void tliMatch(in TString am, in TInteger ts, in TString src, in TInteger line, in TriComponentIdType c, in Value expr, in TciValueTemplate tpl)	
In Parameters	am	An additional message.
	ts	The time when the event is produced.
	src	The source file of the test specification.
	line	The line number where the request is performed.
	c	The component which produces this event.
	expr	The expression to be matched with tpl.
	tpl	The template to be matched with expr.
Return Value	void	
Constraint	Shall be called by TE to log that the component successfully executed a match operation.	
Effect	The TL presents all the information provided in the parameters of this operation to the user, how this is done is not within the scope of the present document.	

7.3.4.1.106 tliMatchMismatch

Signature	void tliMatchMismatch(in TString am, in TInteger ts, in TString src, in TInteger line, in TriComponentIdType c, in Value expr, in TciValueTemplate tpl, in TciValueDifferenceList diffs)	
In Parameters	am	An additional message.
	ts	The time when the event is produced.
	src	The source file of the test specification.
	line	The line number where the request is performed.
	c	The component which produces this event.
	expr	The expression to be matched with tpl.
	tpl	The template to be matched with expr.
	diffs	The difference/the mismatch between expr and tpl.
Return Value	void	
Constraint	Shall be called by TE to log that the component unsuccessfully executed a match operation - a mismatch occurred.	
Effect	The TL presents all the information provided in the parameters of this operation to the user, how this is done is not within the scope of the present document.	

7.3.4.1.107 tliInfo

Signature	void tliInfo (in TString am, in TInteger ts, in TString src, in TInteger line, in TriComponentIdType c, in TInteger level, in TString info)	
In Parameters	am	An additional message.
	ts	The time when the event is produced.
	src	The source file of the test specification.
	line	The line number where the request is performed.
	c	The component which produces this event.
	level	The information level.
	info	The information.
Return Value	void	
Constraint	Can be called by TE to log additional information during test execution. The generation of this event is tool dependent as well as the usage of the parameters level and info.	
Effect	The TL presents all the information provided in the parameters of this operation to the user, how this is done is not within the scope of the present document.	

8 Java language mapping

8.1 Introduction

This clause introduces the TCI Java language mapping. For efficiency reasons a dedicated language mapping is introduced instead of using the OMG IDL [6] to Java language [7].

The Java language mapping for the TTCN-3 Control Interface defines how the IDL definitions described in clause 7 are mapped to the Java language. The language mapping is independent of the used Java version as only basic Java language constructs are used.

8.2 Names and scopes

8.2.1 Names

Although there are no conflicts between identifiers used in the IDL definition and the Java language some naming translation rules are applied to the IDL identifiers.

Java interfaces or class identifiers are omitting the trailing `Type` used in the IDL definition.

EXAMPLE: The IDL type `TciTestCaseIdType` maps to `TciTestCaseId` in Java.

The resulting mapping conforms to the standard Java coding conventions.

8.2.2 Scopes

The IDL module `tciInterface` is mapped to the Java package `org.etsi.ttcn3.tci`. All IDL type declarations within this module are mapped to Java classes or interface declarations within this package.

8.3 Type mapping

8.3.1 Basic type mapping

Table 3 gives an overview on how the native types `TBoolean`, `TFloat`, `TInteger`, `TString`, and `TStringSeq` are mapped to the Java types.

Table 3: Basic type mappings

IDL Type	Java Type
<code>TBoolean</code>	<code>boolean</code>
<code>TFloat</code>	<code>float</code>
<code>TInteger</code>	<code>int</code>
<code>TString</code>	<code>java.lang.String</code>
<code>TStringSeq</code>	<code>java.lang.String[]</code>

`boolean`

The IDL `TBoolean` type is mapped to the java basic type `boolean`.

`float`

The IDL `TFloat` type is mapped to the java basic type `float`.

`char`

The IDL `TChar` type is mapped to the java basic type `char`.

int

The IDL **TInteger** type is mapped to the java basic type `int`.

String

The IDL **TString** type is mapped to the `java.lang.String` class without range checking or bounds for characters in the string. All possible strings defined in TTCN-3 can be converted to `java.lang.String`.

String[]

The IDL **TStringSeq** type is mapped to an array of the `java.lang.String` class.

Universal Char

The IDL **TUniversalChar** type is mapped to a java basic type `int`. The integer uses the canonical form as defined in ISO/IEC 10646 [5], clause 6.2.

8.3.2 Structured type mapping

The TCI IDL description defines user defined types as native types. In the Java language mapping these types are mapped to Java interfaces. The interfaces define methods and attributes being available for objects implementing this interface.

8.3.2.1 TciParameterType

TciParameterType is mapped to the following interface:

```
// TCI IDL TciParameterType
package org.etsi.ttcn.tci;
public interface TciParameter {
    public String    getParameterName();
    public void     setParameterName(String name);
    public int      getParameterPassingMode();
    public void     setParameterPassingMode(TciParameterPassingMode mode);
    public Value    getParameter();
    public void     setParameter(Value parameter);
}
```

Methods:

- `getParameterName` Returns the parameter name as defined in the TTCN-3 specification.
- `setParameterName` Sets the name of this `TciParameter` parameter to `name`.
- `getParameterPassingMode` Returns the parameter passing mode of this parameter.
- `setParameterPassingMode` Sets the parameter mode of this `TciParameter` parameter to `mode`.
- `getParameter` Returns the `Value` parameter of this `TciParameter`, or the `null` object if the parameter contains the distinct value `null`.
- `setParameter` Sets the `Value` parameter of this `TciParameter` to `parameter`. If the distinct value `null` shall be set to indicate that this parameter holds no value, the Java `null` shall be passed as `parameter`.

8.3.2.2 TciParameterPassingModeType

TciParameterPassingModeType is mapped to the following interface:

```
// TCI IDL TciParameterPassingModeType
package org.etsi.ttcn.tci;
public interface TciParameterPassingMode {
    public final static int TCI_IN = 0;
```

```

    public final static int TCI_INOUT    = 1;
    public final static int TCI_OUT      = 2;
}

```

Constants:

- TCI_IN Will be used to indicate that a `TciParameter` is an in parameter.
- TCI_INOUT Will be used to indicate that a `TciParameter` is an inout parameter.
- TCI_OUT Will be used to indicate that a `TciParameter` is an out parameter.

8.3.2.3 TciParameterListType

TciParameterListType is mapped to the following interface:

```

// TCI IDL TciParameterListType
package org.etsi.ttcn.tci;
public interface TciParameterList {
    public int          size() ;
    public boolean     isEmpty() ;
    public java.util.Enumeration getParameters() ;
    public TciParameter get(int index) ;
    public void        clear() ;
    public void        add(TciParameter parameter) ;
    public void        setParameters(TciParameter[] parameters) ;
}

```

Methods:

- `size` Returns the number of parameters in this list.
- `isEmpty` Returns `true` if this list contains no parameters.
- `getParameters` Returns an `Enumeration` over the parameters in the list. The enumeration provides the parameters in the same order as they appear in the list.
- `get` Returns the `TciParameter` at the specified position.
- `clear` Removes all parameters from this `TciParameterList`.
- `add` Adds `parameter` to the end of this `TciParameterList`.
- `setParameter` Fills this `TciParameterList` with `parameters`.

8.3.2.4 TciTypeClassType

TciTypeClassType is mapped to the following interface:

```

// TCI IDL TciTypeClassType
package org.etsi.ttcn.tci;
public interface TciTypeClass {
    public final static int ADDRESS          = 0 ;
    public final static int ANYTYPE         = 1 ;
    public final static int BITSTRING       = 2 ;
    public final static int BOOLEAN         = 3 ;
    public final static int CHARSTRING      = 5 ;
    public final static int COMPONENT       = 6 ;
    public final static int ENUMERATED      = 7 ;
    public final static int FLOAT           = 8 ;
    public final static int HEXSTRING       = 9 ;
    public final static int INTEGER         = 10 ;
    public final static int OCTETSTRING     = 12 ;
    public final static int RECORD          = 13 ;
    public final static int RECORD_OF       = 14 ;
    public final static int ARRAY           = 15 ;
    public final static int SET             = 16 ;
    public final static int SET_OF          = 17 ;
    public final static int UNION           = 18 ;
    public final static int UNIVERSAL_CHARSTRING = 20 ;
}

```

```

    public final static int VERDICT                = 21 ;
}

```

8.3.2.5 TciTestComponentKindType

TciTestComponentKindType is mapped to the following interface:

```

// TCI IDL TciTestComponentKindType
public interface TciTestComponentKind {
    public final static int TCI_CTRL_COMP        = 0;
    public final static int TCI_MTC_COMP        = 1;
    public final static int TCI_PTC_COMP        = 2;
    public final static int TCI_SYSTEM_COMP     = 3;
    public final static int TCI_ALIVE_COMP      = 4;
}

```

8.3.2.6 TciBehaviourIdType

TciBehaviourIdType is mapped to the following interface:

```

// TCI IDL TciBehaviourIdType
package org.etsi.ttcn.tci;
public interface TciBehaviourId extends QualifiedName {
}

```

8.3.2.7 TciTestCaseIdType

TciTestCaseIdType is mapped to the following interface:

```

// TCI IDL TciTestCaseIdType
package org.etsi.ttcn.tci;
public interface TciTestCaseId extends QualifiedName {
}

```

8.3.2.8 TciModuleIdType

TciModuleIdType is mapped to the following interface:

```

// TCI IDL TciModuleIdType
package org.etsi.ttcn.tci;
public interface TciModuleId extends QualifiedName {
}

```

8.3.2.9 TciModuleParameterIdType

TciModuleParameterIdType is mapped to the following interface:

```

// TCI IDL TciModuleParameterIdType
package org.etsi.ttcn.tci;
public interface TciModuleParameterId extends QualifiedName {
}

```

8.3.2.10 TciModuleParameterListType

TciModuleParameterListType is mapped to the following interface:

```

// TCI IDL TciModuleParameterListType
package org.etsi.ttcn.tci;
public interface TciModuleParameterList {
    public int                size() ;
    public boolean            isEmpty() ;
    public java.util.Enumeration getModuleParameters() ;
    public TciModuleParameter get(int index) ;
}

```

Methods:

- `size` Returns the number of module parameters in this list.
- `isEmpty` Returns `true` if this list contains no module parameters.
- `getModuleParameters` Returns an `Enumeration` over the module parameters in the list. The enumeration provides the module parameters in the same order as they appear in the list.
- `get` Returns the `TciModuleParameter` at the specified position.

8.3.2.11 TciModuleParameterType

TciModuleParameterType is mapped to the following interface:

```
// TCI IDL TciModuleParameterType
package org.etsi.ttcn.tci;
public interface TciModuleParameter {
    public String      getModuleParameterName();
    public Value       getDefaultValue();
}
```

Methods:

- `getModuleParameterName` Returns the module parameter name as defined in the TTCN-3 specification.
- `getDefaultValue` Returns the default `Value` module parameter of this `TciModuleParameter`, or the `null` object if the module parameter contains the distinct value `null`.

8.3.2.12 TciParameterTypeListType

TciParameterTypeListType is mapped to the following interface:

```
// TCI IDL TciParameterTypeListType
package org.etsi.ttcn.tci;
public interface TciParameterTypeList {
    public int          size();
    public boolean      isEmpty();
    public java.util.Enumeration getParameterTypes();
    public TciParameterType get(int index);
}
```

Methods:

- `size` Returns the number of parameter types in this list.
- `isEmpty` Returns `true` if this list contains no parameter types.
- `getParameterTypes` Returns an `Enumeration` over the parameter types in the list. The enumeration provides the parameter types in the same order as they appear in the list.
- `get` Returns the `TciParameterType` at the specified position.

8.3.2.13 TciParameterTypeType

TciParameterTypeType is mapped to the following interface:

```
// TCI IDL TciParameterTypeType
package org.etsi.ttcn.tci;
public interface TciParameterTypeType {
    public Type         getParameterType();
    public int          getParameterPassingMode();
}
```

Methods:

- `getParameterType` Returns the `Type` of the parameter.
- `getParameterPassingMode` Returns the parameter passing mode of this parameter.

8.3.2.14 TciModuleIdListType

TciModuleIdListType is mapped to the following interface:

```
// TCI IDL TciModuleIdListType
package org.etsi.ttcn.tci;
public interface TciModuleIdList {
    public int                size() ;
    public boolean            isEmpty() ;
    public java.util.Enumeration tciGetImportedModules() ;
    public TciModuleId        get(int index) ;
}
```

Methods:

- `size` Returns the number of modules in this list.
- `isEmpty` Returns `true` if this list contains no modules.
- `tciGetImportedModules` Returns an `Enumeration` over the modules in the list. The enumeration provides the modules in the same order as they appear in the list.
- `get` Returns the `TciModuleId` at the specified position.

8.3.2.15 TciTestCaseIdListType

TciTestCaseIdType is mapped to the following interface:

```
// TCI IDL TciTestCaseIdListType
package org.etsi.ttcn.tci;
public interface TciTestCaseIdList {
    public int                size() ;
    public boolean            isEmpty() ;
    public java.util.Enumeration tciGetTestCases() ;
    public TciTestCaseId        get(int index) ;
}
```

Methods:

- `size` Returns the number of test cases in this list.
- `isEmpty` Returns `true` if this list contains no test cases.
- `tciGetTestCases` Returns an `Enumeration` over the test cases in the list. The enumeration provides the test cases in the same order as they appear in the list.
- `get` Returns the `TciTestCaseId` at the specified position.

8.3.3 Abstract type mapping

The TTCN-3 data types are modelled in Java using the abstract type mapping as defined in this clause. The `Type` interface defines only operations used to retrieve in TTCN-3 defined types. No TTCN-3 types can be constructed using the `Type` interface. Types are modelled using the single interface `Type`, that provides methods to identify types and to retrieve values of a given type.

8.3.3.1 Type

Type is mapped to the following interface:

```
// TCI IDL Type
package org.etsi.ttcn.tci;
public interface Type {
    public TciModuleId  getDefiningModule ();
    public String       getName ();
    public int          getTypeClass ();
    public Value        newInstance ();
    public String       getTypeEncoding ();
    public String       getTypeEncodingVariant ();
    public String[]     getTypeExtension ();
}
```

Methods:

- `getDefiningModule` Returns the module identifier of the module the type has been defined in. If the type represents a TTCN-3 base type the distinct value `null` will be returned.
- `getName` Returns name of the type as defined in the TTCN-3 module.
- `getTypeClass` Returns the type class of the respective type. A value of `TciTypeClassType` can have one of the following constants: `ADDRESS`, `ANYTYPE`, `BITSTRING`, `BOOLEAN`, `CHARSTRING`, `COMPONENT`, `ENUMERATED`, `FLOAT`, `HEXSTRING`, `INTEGER`, `OCTETSTRING`, `RECORD`, `RECORD_OF`, `ARRAY`, `SET`, `SET_OF`, `UNION`, `UNIVERSAL_CHARSTRING`, `VERDICT`.
- `newInstance` Returns a freshly created value of the given type. This initial value of the created value is undefined.
- `getTypeEncoding` Returns the type encoding attribute as defined in the TTCN-3 module.
- `getTypeEncodingVariant` This operation returns the value encoding variant attribute as defined in the TTCN-3 module, if any. If no encoding variant attribute has been defined the distinct value `null` will be returned.
- `getTypeExtension` Returns the type extension attribute as defined in the TTCN-3 module.

8.3.4 Abstract value mapping

TTCN-3 values can be retrieved from the TE and constructed using the Value interface. The value mapping interface is constructed hierarchically with Value as the basic interface. Specialized interfaces for different types of values have been defined.

8.3.4.1 Value

Value is mapped to the following interface:

```
// TCI IDL Value
package org.etsi.ttcn.tci;
public interface Value {
    public Type        getType();
    public boolean     notPresent();
    public String      getValueEncoding();
    public String      getValueEncodingVariant();
}
```

Methods:

- `getType` Returns the type of the specified value.
- `notPresent` Returns `true` if the specified value is omit, `false` otherwise.

- `getValueEncoding` This operation returns the value encoding attribute as defined in the TTCN-3 module, if any. If no encoding attribute has been defined the distinct value `null` will be returned.
- `getValueEncodingVariant` This operation returns the value encoding variant attribute as defined in TTCN-3, if any. If no encoding variant attribute has been defined the distinct value `null` will be returned.

8.3.4.2 IntegerValue

IntegerValue type is mapped to the following interface:

```
// IntegerValue
package org.etsi.ttcn.tci;
public interface IntegerValue {
    public void    setInteger(int value);
    public int     getInteger();
}
```

Methods:

- `setInteger` Sets this `IntegerValue` to the int value `value`.
- `getInteger` Returns the int value represented by this `IntegerValue`.

8.3.4.3 FloatValue

FloatValue type is mapped to the following interface:

```
// FloatValue
package org.etsi.ttcn.tci;
public interface FloatValue {
    public void    setFloat(float value);
    public float   getFloat();
}
```

Methods:

- `setFloat` Sets this `FloatValue` to the float value `value`.
- `getFloat` Returns the float value represented by this `FloatValue`.

8.3.4.4 BooleanValue

BooleanValue type is mapped to the following interface:

```
// BooleanValue
package org.etsi.ttcn.tci;
public interface BooleanValue {
    public void    setBoolean(boolean value);
    public boolean getBoolean();
}
```

Methods:

- `setBoolean` Sets this `BooleanValue` to the boolean value `value`.
- `getBoolean` Returns the boolean value represented by this `BooleanValue`.

8.3.4.5 CharstringValue

CharstringValue is mapped to the following interface:

```
// TCI IDL CharstringValue
package org.etsi.ttcn.tci;
public interface CharstringValue {
    String getString ();
}
```

```

void    setString (String value);
char    getChar (int position);
void    setChar (int position, char value);
int     getLength ();
void    setLength (int len);
}

```

Methods:

- `getString` Returns the string of the TTCN-3 charstring. The textual representation of the empty TTCN-3 charstring is "", while its length is zero.
- `setString` Sets this CharstringValue to value.
- `getChar` Returns the char value of the TTCN-3 charstring at position. position 0 denotes the first char of the TTCN-3 charstring. Valid values for position are 0 to length - 1.
- `setChar` Set the char at position to value. Valid values for position are 0 to length - 1.
- `getLength` Returns the length of this CharstringValue in chars, zero if the value of this CharstringValue is omit.
- `setLength` Sets the length of this CharstringValue in chars to len.

8.3.4.6 BitstringValue

BitstringValue is mapped to the following interface:

```

// TCI IDL BitstringValue
package org.etsi.ttcn.tci;
public interface BitstringValue {
    String getString ();
    void    setString (String value);
    int     getBit (int position);
    void    setBit (int position, int value);
    int     getLength ();
    void    setLength (int len);
}

```

Methods:

- `getString` Returns the textual representation of this BitstringValue, as defined in TTCN-3. E.g. the textual representation of 0101 is '0101'B. The textual representation of the empty TTCN-3 bitstring is ' 'B, while its length is zero.
- `setString` Sets the value of this BitstringValue according to the textual representation as defined by value. E.g. The value of this BitstringValue will be 0101 if the textual representation in value is '0101'B.
- `getBit` Returns the value (0 | 1) at position of this TTCN-3 bitstring. position 0 denotes the first bit of the TTCN-3 bitstring. Valid values for position are 0 to length - 1.
- `setBit` Set the bit at position to value (0 | 1). position 0 denotes the first bit in this BitstringValue. Valid values for position are 0 to length - 1.
- `getLength` Returns the length of this BitstringValue in bits, zero if the value of this BitstringValue is omit.
- `setLength` Sets the length of this BitstringValue in bits to len.

8.3.4.7 OctetstringValue

OctetstringValue is mapped to the following interface:

```
// TCI IDL OctetstringValue
package org.etsi.ttcn.tci;
public interface OctetstringValue {
    String getString ();
    void setString (String value);
    int getOctet (int position);
    void setOctet (int position, int value);
    int getLength ();
    void setLength (int len);
}
```

Methods:

- **getString** Returns the textual representation of this `OctetstringValue`, as defined in TTCN-3. E.g. the textual representation of `0xCAFFEE` is `'CAFFEE'0`. The textual representation of the empty TTCN-3 octetstring is `'0`, while its length is zero.
- **setString** Sets the value of this `OctetstringValue` according to the textual representation as defined by value. E.g. the value of this `OctetstringValue` will be `0xCAFFEE` if the textual representation in value is `'CAFFEE'0`.
- **getOctet** Returns the value (0..255) at position of this TTCN-3 octetstring. position 0 denotes the first octet of the TTCN-3 octetstring. Valid values for position are 0 to length - 1.
- **setOctet** Set the octet at position to value (0..255). position 0 denotes the first octet in the octetstring. Valid values for position are 0 to length - 1.
- **getLength** Returns the length of this `OctetstringValue` in octets, zero if the value of this `OctetstringValue` is omit.
- **setLength** Sets the length of this `OctetstringValue` in octets to len.

8.3.4.8 UniversalCharstringValue

UniversalCharstringValue is mapped to the following interface:

```
// TCI IDL UniversalCharstringValue
package org.etsi.ttcn.tci;
public interface UniversalCharstringValue {
    String getString ();
    void setString (String value);
    int getChar (int position);
    void setChar (int position, int value);
    int getLength ();
    void setLength (int len);
}
```

Methods:

- **getString** Returns the textual representation of this `UniversalCharstringValue`, as defined in TTCN-3.
- **setString** Sets the value of this `UniversalCharstringValue` according to the textual representation as defined by value.
- **getChar** Returns the `UniversalChar` value of the TTCN-3 universal charstring at position. position 0 denotes the first `UniversalChar` of the TTCN-3 universal charstring. Valid values for position are 0 to length - 1.

- `setChar` Set the `UniversalChar` at `position` to value. Valid values for `position` are 0 to `length - 1`.
- `getLength` Returns the length of this `UniversalCharstringValue` in `UniversalChars`, zero if the value of this `UniversalCharstringValue` is omit.
- `setLength` Sets the length of this `UniversalCharstringValue` in `UniversalChars` to `len`.

8.3.4.9 HexstringValue

HexstringValue is mapped to the following interface:

```
// TCI IDL HexstringValue
package org.etsi.ttcn.tci;
public interface HexstringValue {
    String getString ();
    void setString (String value);
    int getHex (int position);
    void setHex (int position, int value);
    int getLength ();
    void setLength (int len);
}
```

Methods:

- `getString` Returns the textual representation of this `HexstringValue`, as defined in TTCN-3. E.g. the textual representation of `0xAFFEE` is `'AFFEE'H`. The textual representation of the empty TTCN-3 hexstring is `'H`, while its length is zero.
- `setString` Sets the value of this `HexstringValue` according to the textual representation as defined by `value`. E.g. the value of this `HexstringValue` will be `0xAFFEE` if the textual representation in `value` is `'AFFEE'H`.
- `getHex` Returns the value (0...15) at `position` of this TTCN-3 hexstring. `position` 0 denotes the first hex digits of the TTCN-3 hexstring. Valid values for `position` are 0 to `length - 1`.
- `setHex` Set the hex digit at `position` to value (0...16). `position` 0 denotes the first octet in the hexstring. Valid values for `position` are 0 to `length - 1`.
- `getLength` Returns the length of this `HexstringValue` in octets, zero if the value of this `HexstringValue` is omit.
- `setLength` Sets the length of this `HexstringValue` in hex digits to `len`.

8.3.4.10 RecordValue

RecordValue is mapped to the following interface:

```
// TCI IDL RecordValue
package org.etsi.ttcn.tci;
public interface RecordValue {
    public Value    getField(String fieldName) ;
    public void    setField(String fieldName, Value value) ;
    public String[] getFieldNames() ;
    public void    setFieldOmitted(String fieldName)
}
}
```

Methods:

- `getField` Returns the value of the field named `fieldName`. The return value is the common abstract base type `Value`, as a record field can have any type defined in TTCN-3. If the field cannot be obtained from the record the distinct value `null` will be returned.
- `setField` Set the field named `fieldName` of the record to `value`. No assumption shall be made on how a field is stored in a record. An internal implementation might choose to store a reference to this value or to copy the value. It is safe to assume that the value will be copied. Therefore it should be assumed that subsequent modifications of `value` will not be considered in the record.
- `getFieldNames` Returns an array of `String` of field names, the empty sequence, if the record has no fields.
- `setFieldOmitted` Set the field named `fieldName` of the record to `omit`.

8.3.4.11 RecordOfValue

RecordOfValue is mapped to the following interface:

```
// TCI IDL RecordOfValue
package org.etsi.ttcn.tci;
public interface RecordOfValue {
    public Value    getField(String fieldName) ;
    public void    setField(int position, Value value) ;
    public void    appendField(Value value) ;
    public Type    getElementType() ;
    public int     getLength() ;
    public void    setLength(int len) ;
    public int     getOffset() ;
}
```

Methods:

- `getField` Returns the value of the record `of` at `position` if `position` is between zero and `length - 1`, the distinct value `null` otherwise. The return value is the common abstract base type `Value`, as a record `of` can have fields of any type defined in TTCN-3.
- `setField` Sets the field at `position` to `value`. If `position` is greater than (`length - 1`) the record `of` will be extended to have the length (`position + 1`). The record `of` elements between the original position at `length` and `position - 1` will be set to `OMIT`. No assumption shall be made on how a field is stored in a record `of`. An internal implementation might choose to store a reference to this value or to copy the value. It is safe to assume that the value will be copied. Therefore it should be assumed that subsequent modifications of `value` will not be considered in the record `of`.
- `appendField` Appends the value at the end of the record `of`, i.e. at position `length`. No assumption shall be made on how a field is stored in a record `of`. An internal implementation might choose to store a reference to this value or to copy the value. It is safe to assume that the value will be copied. Therefore it should be assumed that subsequent modifications of `value` will not be considered in the record `of`.
- `getElementType` This operation will return the `Type` of the elements of this record `of`.
- `getLength` Returns the actual length of the record `of` value, zero if the record `of` value is `OMIT`.

- `setLength` Set the length of the record of to `len`. If `len` is greater than the original length, newly created elements have the value `OMIT`. If `len` is less or equal than the original length this operation will be ignored.
- `getOffset` Returns the lowest possible index. For a record of or set of value this is always 0. For an array value, this is the lower index bound used in the type definition.

8.3.4.12 UnionValue

UnionValue is mapped to the following interface:

```
// TCI IDL UnionValue
package org.etsi.ttcn.tci;
public interface UnionValue {
    Value      getVariant (String variantName);
    void       setVariant (String variantName, Value value);
    String     getPresentVariantName ();
    String[]   getVariantNames ();
}
```

Methods:

- `getVariant` Returns the value of the TTCN-3 union `variantName`, if `variantName` equals the result of `getPresentVariantName`, the distinct value `null` otherwise. `variantName` denotes the name of the union variant as defined in the TTCN-3 module.
- `setVariant` Sets `variantName` of the union to `value`. If `variantName` is not defined for this union this operation will be ignored. If another variant was selected the new variant will be selected instead.
- `getPresentVariantName` Returns the variant name that has a value in this union set as a `String`. The distinct value `null` will be returned if no variant is selected.
- `getVariantNames` Returns an array of `String` of variant names, the empty sequence, if the union has no fields. If the `UnionValue` represents the TTCN-3 anytype, i.e. the type class of the type obtained by `getType()` is `ANYTYPE`, all predefined and user-defined TTCN-3 types will be returned.

8.3.4.13 EnumeratedValue

EnumeratedValue is mapped to the following interface:

```
// TCI IDL EnumeratedValue
package org.etsi.ttcn.tci;
public interface EnumeratedValue {
    String  getEnum ();
    void    setEnum (String enumValue);
    int     getInt ();
    void    setInt (int intValue);
}
```

Methods:

- `getEnum` Returns the string identifier of this `EnumeratedValue`. This identifier equals the identifier in the TTCN-3 specification.
- `setEnum` Set the enum to `enumValue`. If `enumValue` is not an allowed value for this enumeration the operation will be ignored.
- `getInt` Returns the integer value of this `EnumeratedValue`. This integer equals the user-assigned integer value in the TTCN-3 specification or the automatically assigned integer value.

- `setInt` Sets the integer value of this `EnumeratedValue`. This integer should equal the user-assigned integer value in the TTCN-3 specification or the automatically assigned integer value. If `intValue` is not an allowed value for this enumeration the operation is ignored.

8.3.4.14 VerdictValue

VerdictValue is mapped to the following interface:

```
// TCI IDL VerdictValue
package org.etsi.ttcn.tci;
public interface VerdictValue {
    public static final int NONE      = 0;
    public static final int PASS      = 1;
    public static final int INCONC    = 2;
    public static final int FAIL      = 3;
    public static final int ERROR     = 4;

    public int      getVerdict() ;
    public void     setVerdict(int verdict) ;
}
```

Methods:

- `getVerdict` Returns the integer value for this `VerdictValue`. The integer is one of the following constants: `ERROR`, `FAIL`, `INCONC`, `NONE`, `PASS`, `USER_ERROR`.
- `setVerdict` Sets this `VerdictValue` to `verdict`. Note that a `VerdictValue` can be set to any of the above mentioned verdicts at any time. The `VerdictValue` does not perform any verdict calculations as defined in TTCN-3. For example, it is legal to set the `VerdictValue` first to `INCONC` and then to `PASS`.

8.3.4.15 AddressValue

AddressValue is mapped to the following interface:

```
// TCI IDL Address_Value
> package org.etsi.ttcn.tci;
> public interface AddressValue {
> public int getAddress() ;
> public void setAddress(Value value) ;
> }
>
```

Methods:

- `getAddress` Returns the value represented by this `AddressValue`.
- `setAddress` Sets this `AddressValue` to the value `value`.

8.3.5 Abstract logging types mapping

Additional types are defined to ease the logging of matches between values and templates.

8.3.5.1 TciValueTemplate

TciValueTemplate is mapped to the following interface:

```
// TCI IDL TciValueTemplate
package org.etsi.ttcn.tci;
public interface TciValueTemplate {
    public boolean isOmit();
    public boolean isAny();
    public boolean isAnyOrOmit();
    public String getTemplateDef();
}
```

Methods:

- `isOmit` Returns `true` if the template is omit, `false` otherwise.
- `isAny` Returns `true` if the template is any, `false` otherwise.
- `isAnyOrOmit` Returns `true` if the template is anyoromit, `false` otherwise.
- `getTemplateDef` This operation returns the template definition.

8.3.5.2 TciNonValueTemplate

TciNonValueTemplate is mapped to the following interface:

```
// TCI IDL TciNonValueTemplate
package org.etsi.ttcn.tci;
public interface TciNonValueTemplate {
    public boolean isAny();
    public boolean isAll();
    public String getTemplateDef();
}
```

Methods:

- `isAny` Returns `true` if the template is any, `false` otherwise.
- `isAll` Returns `true` if the template is all, `false` otherwise.
- `getTemplateDef` This operation returns the template definition.

8.3.5.3 TciValueList

TciValueList is mapped to the following interface:

```
// TCI IDL TciValueList
package org.etsi.ttcn.tci;
public interface TciValueList{
    public int size() ;
    public boolean isEmpty() ;
    public Value get(int index) ;
}
```

Methods:

- `size` Returns the number of values in this list.
- `isEmpty` Returns `true` if this list contains no values.
- `get` Returns the `Value` at the specified position.

8.3.5.4 TciValueDifference

TciValueDifference is mapped to the following interface:

```
// TCI IDL TciValueDifference
package org.etsi.ttcn.tci;
public interface TciValueDifference {
    public Value getValue();
    public TciValueTemplate getTciValueTemplate();
    public String getDescription()
}
```

Methods:

- `getValue` Returns the value of this `TciValueDifference`.
- `getTciValueTemplate` Returns the template of this `TciValueDifference`.

- `getDescription` Returns the description of the mismatch.

8.3.5.5 TciValueDifferenceList

TciValueDifferenceList is mapped to the following interface:

```
// TCI IDL TciValueDifferenceList
package org.etsi.ttcn.tci;
public interface TciValueDifferenceList{
    public int size() ;
    public boolean isEmpty() ;
    public TciValueDifference get(int index) ;
}
```

Methods:

- `size` Returns the number of differences in this list.
- `isEmpty` Returns `true` if this list contains no differences.
- `get` Returns the `TciValueDifference` at the specified position.

8.3.5.6 ComponentStatus

ComponentStatus is mapped to the following interface:

```
// TCI IDL ComponentStatus
package org.etsi.ttcn.tci;
public interface ComponentStatus {
    public static final int INACTIVE_C = 0;
    public static final int RUNNING_C = 1;
    public static final int STOPPED_C = 2;
    public static final int KILLED_C = 3;
    public static final int NULL_C = 4;

    public int getComponentStatus() ;
    public void setComponentStatus (int componentStatus) ;
}
```

8.3.5.7 TimerStatus

TimerStatus is mapped to the following interface:

```
// TCI IDL TimerStatus
package org.etsi.ttcn.tci;
public interface TimerStatus {
    public static final int RUNNING_T = 0;
    public static final int INACTIVE_T = 1;
    public static final int EXPIRED_T = 2;
    public static final int NULL_T = 3;

    public int getTimerStatus() ;
    public void setTimerStatus (int timerStatus) ;
}
```

8.3.5.8 TciStatus

TciStatus is mapped to the following interface:

```
// TCI IDL TciStatus
package org.etsi.ttcn.tci;
public interface TciStatus {
    public static final int TCI_OK = 0;
    public static final int TCI_ERROR = -1;

    public int getTciStatus() ;
    public void setTciStatus (int tciStatus) ;
}
```

8.4 Constants

Within this Java language mapping constants have been specified. All constants are defined `public final static` and are accessible from every object from every package. The constants defined within this clause are not defined with the IDL clause. Instead they result from the specification of the TCI IDL types marked as native.

The following constants can be used to determine the parameter passing mode of TTCN-3 parameters (see also clause 8.3.2.3).

- `org.etsi.ttcn.tci.TciParameterPassingMode.TCI_IN;`
- `org.etsi.ttcn.tci.TciParameterPassingMode.TCI_INOUT;`
- `org.etsi.ttcn.tci.TciParameterPassingMode.TCI_OUT.`

For the distinct parameter value `null`, the encoded parameter value shall be set to Java `null`.

The following constants shall be used for value handling (see also clause 8.3.2.4).

- `org.etsi.ttcn.tci.TciTypeClass.ADDRESS;`
- `org.etsi.ttcn.tci.TciTypeClass.ANYTYPE;`
- `org.etsi.ttcn.tci.TciTypeClass.BITSTRING;`
- `org.etsi.ttcn.tci.TciTypeClass.BOOLEAN;`
- `org.etsi.ttcn.tci.TciTypeClass.CHARSTRING;`
- `org.etsi.ttcn.tci.TciTypeClass.COMPONENT;`
- `org.etsi.ttcn.tci.TciTypeClass.ENUMERATED;`
- `org.etsi.ttcn.tci.TciTypeClass.FLOAT;`
- `org.etsi.ttcn.tci.TciTypeClass.HEXSTRING;`
- `org.etsi.ttcn.tci.TciTypeClass.INTEGER;`
- `org.etsi.ttcn.tci.TciTypeClass.OCTETSTRING;`
- `org.etsi.ttcn.tci.TciTypeClass.RECORD;`
- `org.etsi.ttcn.tci.TciTypeClass.RECORD_OF;`
- `org.etsi.ttcn.tci.TciTypeClass.SET;`
- `org.etsi.ttcn.tci.TciTypeClass.SET_OF;`
- `org.etsi.ttcn.tci.TciTypeClass.ARRAY;`
- `org.etsi.ttcn.tci.TciTypeClass.UNION;`
- `org.etsi.ttcn.tci.TciTypeClass.UNIVERSAL_CHARSTRING;`
- `org.etsi.ttcn.tci.TciTypeClass.VERDICT.`

The following constants shall be used for component handling (see also clause 8.3.2.5).

- `org.etsi.ttcn.tci.TciTestComponentKind.TCI_CTRL_COMP;`
- `org.etsi.ttcn.tci.TciTestComponentKind.TCI_MTC_COMP;`
- `org.etsi.ttcn.tci.TciTestComponentKind.TCI_PTC_COMP;`
- `org.etsi.ttcn.tci.TciTestComponentKind.TCI_SYSTEM_COMP;`
- `org.etsi.ttcn.tci.TciTestComponentKind.TCI_ALIVE_COMP.`

The following constants shall be used for component status (see also clause 8.3.5.6).

- `org.etsi.ttcn.tci.ComponentStatus.INACTIVE_C;`
- `org.etsi.ttcn.tci.ComponentStatus.RUNNING_C;`
- `org.etsi.ttcn.tci.ComponentStatus.STOPPED_C;`
- `org.etsi.ttcn.tci.ComponentStatus.KILLED_C;`
- `org.etsi.ttcn.tci.ComponentStatus.NULL_C.`

The following constants shall be used for timer status (see also clause 8.3.5.7).

- `org.etsi.ttcn.tci.TimerStatus.RUNNING_T;`
- `org.etsi.ttcn.tci.TimerStatus.INACTIVE_T;`
- `org.etsi.ttcn.tci.TimerStatus.EXPIRED_T;`
- `org.etsi.ttcn.tci.TimerStatus.NULL_T.`

The following constants shall be used for TCI status (see also clause 8.3.5.8).

- `org.etsi.ttcn.tci.TciStatus.TCI_OK;`
- `org.etsi.ttcn.tci.TciStatus.TCI_ERROR.`

8.5 Mapping of interfaces

The TCI IDL definition defines four interfaces, the **TCI-TM**, the **TCI-CH**, the **TCI-CD**, and the **TCI-TL** interface. The operations are defined for different directions within this interface, i.e. some operations can only be called by the TTCN-3 Executable (TE), the System Adaptor (SA) or the Platform Adaptor (PA) on the Test Management and Control (TMC) while others can only be called by the TMC on the TE. This is reflected by dividing the TCI IDL interfaces in two sub interfaces, each suffixed by *Required* or *Provided*.

Table 4: Sub interfaces

Calling/Called	TE	TM	CD	CH	SA	PA	TL
TE	-	TCI-TM Provided	TCI-CD Provided	TCI-CH Provided	See ES 201 873-5 [3]	See ES 201 873-5 [3]	TCI-TL Provided
TM	TCI-TM Required	-	-	-	-	-	TCI-TL Provided
CD	TCI-CD Required	-	-	-	-	-	TCI-TL Provided
CH	TCI-CH Required	-	-	-	-	-	TCI-TL Provided
SA	See ES 201 873-5 [3]	-	-	-	-	-	TCI-TL Provided
PA	See ES 201 873-5 [3]	-	-	-	-	-	TCI-TL Provided
TL	-	-	-	-	-	-	-

All methods defined in these interfaces should behave as defined in clause 7.

8.5.1 The TCI-TM interface

8.5.1.1 TCI-TM provided

The **TCI-TM Provided** interface is mapped to the following interface:

```
// TCI-TM
// TE -> TM
package org.etsi.ttcn.tci;
public interface TciTMProvided {
```

```

    public void tciTestCaseStarted (TciTestCaseId testCaseId, TciParameterList parameterList, Float
timer);
    public void      tciTestCaseTerminated (VerdictValue verdict, TciParameterList parameterList);
    public void      tciControlTerminated ();
    public Value     tciGetModulePar (TciModuleParameterId parameterId);
    public void      tciLog (TriComponentId testComponentId, String message);
    public void      tciError (String message);
}

```

8.5.1.2 TCI-TM required

The TCI-TM Required interface is mapped to the following interface:

```

// TCI-TM
// TM -> TE
package org.etsi.ttcn.tci;
public interface TciTMRequired {
    public void      tciRootModule (TciModuleId moduleName) ;
    public TciModuleIdList tciGetImportedModules ();
    public TciModuleParameterList tciGetModuleParameters (TciModuleId moduleId);
    public TciTestCaseIdList tciGetTestCases ();
    public TciParameterTypeList tciGetTestCaseParameters (TciTestCaseId testCaseId);
    public TriPortIdList tciGetTestCaseTSI (TciTestCaseId testCaseId);
    public void      tciStartTestCase
        (String testCaseId, TciParameterList parameterList ) ;
    public void      tciStopTestCase ();
    public TriComponentId tciStartControl ();
    public void      tciStopControl ();
}

```

8.5.2 The TCI-CD interface

8.5.2.1 TCI-CD provided

The TCI-CD Provided interface is mapped to the following interface:

```

// TCI-CD
// TE -> CD
package org.etsi.ttcn.tci;
public interface TciCDProvided {
    public Value      decode (TriMessage message, Type decodingHypothesis );
    public TriMessage encode (Value value);
}

```

8.5.2.2 TCI-CD required

The TCI-CD Required interface is mapped to the following interface:

```

// TCI-CD
// CD -> TE
package org.etsi.ttcn.tci;
public interface TciCDRequired {
    public Type      getTypeForName (String typeName);
    public Type      getInteger ();
    public Type      getFloat ();
    public Type      getBoolean ();
    public Type      getCharstring ();
    public Type      getUniversalCharstring ();
    public Type      getHexstring ();
    public Type      getBitstring ();
    public Type      getOctetstring ();
    public Type      getVerdict ();
    public void      tciErrorReq (String message);
}

```

8.5.3 The TCI-CH interface

8.5.3.1 TCI-CH provided

The TCI-CH Provided interface is mapped to the following interface:

```
// TciCHProvided
// TE -> CH
package org.etsi.ttcn.tci;
public interface TciCHProvided {
    public void tciSendConnected (TriPortId sender, TriComponentId receiver, Value sendMessage) ;
    public void tciSendConnectedBC (TriPortId sender, Value sendMessage) ;
    public void tciSendConnectedMC (TriPortId sender, TriComponentIdList receivers,
        Value sendMessage) ;

    public void tciCallConnected(TriPortId sender,
        TriComponentId receiver,
        TriSignatureId signature,
        TciParameterList parameterList) ;
    public void tciCallConnectedBC(TriPortId sender,
        TriSignatureId signature,
        TciParameterList parameterList) ;
    public void tciCallConnectedMC(TriPortId sender,
        TriComponentIdList receivers,
        TriSignatureId signature,
        TciParameterList parameterList) ;

    public void tciReplyConnected(TriPortId sender,
        TriComponentId receiver,
        TriSignatureId signature,
        TciParameterList parameterList,
        Value returnValue) ;
    public void tciReplyConnectedBC(TriPortId sender,
        TriSignatureId signature,
        TciParameterList parameterList,
        Value returnValue) ;
    public void tciReplyConnectedMC(TriPortId sender,
        TriComponentIdList receivers,
        TriSignatureId signature,
        TciParameterList parameterList,
        Value returnValue) ;

    public void tciRaiseConnected(TriPortId sender,
        TriComponentId receiver,
        TriSignatureId signature,
        Value except) ;
    public void tciRaiseConnectedBC(TriPortId sender,
        TriSignatureId signature,
        Value except) ;
    public void tciRaiseConnectedMC(TriPortId sender,
        TriComponentIdList receivers,
        TriSignatureId signature,
        Value except) ;

    public TriComponentId tciCreateTestComponentReq(int kind,
        Type componentType,
        String name,
        Value hostId) ;

    public void tciStartTestComponentReq(TriComponentId comp,
        TciBehaviourId behaviour,
        TciParameterList parameterList) ;

    public void tciStopTestComponentReq(TriComponentId comp) ;

    public void tciConnectReq(TriPortId fromPort, TriPortId toPort) ;

    public void tciDisconnectReq(TriPortId fromPort, TriPortId toPort) ;

    public void tciTestComponentTerminatedReq(TriComponentId comp, VerdictValue verdict) ;

    public boolean tciTestComponentRunningReq(TriComponentId comp) ;

    public TriComponentId tciGetMTCReq() ;

    public void tciMapReq(TriPortId fromPort, TriPortId toPort);
}
```

```

public void    tciMapParamReq(TriPortId fromPort, TriPortId toPort,
                             TciParameterList parameterList);

public void    tciUnmapReq(TriPortId fromPort, TriPortId toPort);

public void    tciUnmapParamReq(TriPortId fromPort, TriPortId toPort,
                                TciParameterList parameterList);

public void    tciExecuteTestCaseReq(TriComponentId testComponentId,
                                      TriPortIdList tsiPortList);

public void    tciResetReq() ;

public boolean tciTestComponentDoneReq(TriComponentId testComponentId) ;

public void    tciKillTestComponentReq(TriComponentId component)

public boolean tciTestComponentAliveReq (TriComponentId component)

public boolean tciTestComponentKilledReq (TriComponentId component)
}

```

8.5.3.2 TCI-CH required

The TCI-CH Required interface is mapped to the following interface:

```

// TciCHRequired
// CH -> TE
package org.etsi.ttcn.tci;
public interface TciCHRequired extends TciCDRequired {
    public void    tciEnqueueMsgConnected(TriPortId sender,
                                         TriComponentId receiver,
                                         Value receivedMessage) ;

    public void    tciEnqueueCallConnected(TriPortId sender,
                                         TriComponentId receiver,
                                         TriSignatureId signature,
                                         TciParameterList parameterList) ;

    public void    tciEnqueueReplyConnected(TriPortId sender,
                                         TriComponentId receiver,
                                         TriSignatureId signature,
                                         TciParameterList parameterList,
                                         Value returnValue) ;

    public void    tciEnqueueRaiseConnected(TriPortId sender,
                                         TriComponentId receiver,
                                         TriSignatureId signature,
                                         Value except) ;

    public TriComponentId    tciCreateTestComponent(int kind, Type componentType, String name) ;

    public void    tciStartTestComponent(TriComponentId comp,
                                         TciBehaviourId behaviour,
                                         TciParameterList parameterList) ;

    public void    tciStopTestComponent(TriComponentId comp) ;

    public void    tciConnect(TriPortId fromPort, TriPortId toPort) ;

    public void    tciDisconnect(TriPortId fromPort, TriPortId toPort) ;

    public void    tciTestComponentTerminated(TriComponentId comp, VerdictValue verdict);

    public boolean tciTestComponentRunning(TriComponentId comp);

    public boolean tciTestComponentDone(TriComponentId comp);

    public TriComponentId    tciGetMTC ();

    public void    tciExecuteTestCase (TciTestCaseId TestCaseId, TriPortIdList tsiPortList);

    public void    tciReset ();

    public void    tciMap (TriPortId fromPort, TriPortId toPort);
}

```

```

public void    tciMapParam (TriPortId fromPort, TriPortId toPort,
                          TciParameterList parameterList);

public void    tciUnmap (TriPortId fromPort, TriPortId toPort);

public void    tciUnmapParam (TriPortId fromPort, TriPortId toPort,
                              TciParameterList parameterList);

public void    tciKillTestComponent (TriComponentId component)

public boolean tciTestComponentAlive (TriComponentId component)

public boolean tciTestComponentKilled (TriComponentId component)
}

```

8.5.4 The TCI-TL interface

8.5.4.1 TCI-TL provided

The TCI-TL Provided interface is mapped to the following interface:

```

// TCI-TL
// TE, TM,CH,CD, SA,PA -> TL
package org.etsi.ttcn.tci;
public interface TciTLProvided {
    public void tliTcExecute(String am, int ts, String src, int line, TriComponentId c,
                            TciTestCaseId tcId, TriParameterList triPars, TriTimerDuration dur);
    public void tliTcStart(String am, int ts, String src, int line, TriComponentId c,
                          TciTestCaseId tcId, TciParameterList tciPars, TriTimerDuration dur);
    public void tliTcStop(String am, int ts, String src, int line, TriComponentId c, String reason);
    public void tliTcStarted(String am, int ts, String src, int line, TriComponentId c,
                             TciTestCaseId tcId, TciParameterList tciPars, TriTimerDuration dur);
    public void tliTcTerminated(String am, int ts, String src, int line, TriComponentId c,
                                TciTestCaseId tcId, TciParameterList tciPars, VerdictValue verdict, String reason);
    public void tliCtrlStart(String am, int ts, String src, int line, TriComponentId c);
    public void tliCtrlStop(String am, int ts, String src, int line, TriComponentId c);
    public void tliCtrlTerminated(String am, int ts, String src, int line, TriComponentId c);
    public void tliMSend_m(String am, int ts, String src, int line, TriComponentId c,
                           TriPortId at, TriPortId to, Value msgValue, Value addrValue,
                           TciStatus encoderFailure, TriMessage msg, TriAddress address,
                           TriStatus transmissionFailure);
    public void tliMSend_m_BC(String am, int ts, String src, int line, TriComponentId c,
                              TriPortId at, TriPortId to, Value msgValue
                              TciStatus encoderFailure, TriMessage msg, TriStatus transmissionFailure) ;
    public void tliMSend_m_MC(String am, int ts, String src, int line, TriComponentId c,
                              TriPortId at, TriPortId to, Value msgValue, TciValueList addrValues,
                              TciStatus encoderFailure, TriMessage msg, TriAddressList addresses,
                              TriStatus transmissionFailure);
    public void tliMSend_c(String am, int ts, String src, int line, TriComponentId c,
                           TriPortId at, TriPortId to, Value msgValue, TriStatus transmissionFailure);
    public void tliMSend_c_BC(String am, int ts, String src, int line, TriComponentId c,
                              TriPortId at, TriPortIdList to, Value msgValue, TriStatus transmissionFailure);
    public void tliMSend_c_MC(String am, int ts, String src, int line, TriComponentId c,
                              TriPortId at, TriPortIdList to, Value msgValue, TriStatus transmissionFailure);
    public void tliMDetected_m(String am, int ts, String src, int line, TriComponentId c,
                               TriPortId at, TriPortId from, TriMessage msg, TriAddress address);
    public void tliMDetected_c(String am, int ts, String src, int line, TriComponentId c,
                               TriPortId at, TriPortId from, Value msgValue );
    public void tliMMismatch_m(String am, int ts, String src, int line, TriComponentId c,
                               TriPortId at, Value msgValue, TciValueTemplate msgTmpl, TciValueDifferenceList diffs,
                               Value addrValue, TciValueTemplate addressTmpl);
    public void tliMMismatch_c(String am, int ts, String src, int line, TriComponentId c,
                               TriPortId at, Value msgValue, TciValueTemplate msgTmpl, TciValueDifferenceList diffs,
                               TriComponentId from, TciNonValueTemplate fromTmpl);
    public void tliMReceive_m(String am, int ts, String src, int line, TriComponentId c,
                              TriPortId at, Value msgValue, TciValueTemplate msgTmpl,
                              Value addrValue, TciValueTemplate addressTmpl);
    public void tliMReceive_c(String am, int ts, String src, int line, TriComponentId c,
                              TriPortId at, Value msgValue, TciValueTemplate msgTmpl,
                              TriComponentId from, TciNonValueTemplate fromTmpl);
    public void tliPrCall_m(String am, int ts, String src, int line, TriComponentId c,
                           TriPortId at, TriPortId to, TriSignatureId signature, TciParameterList tciPars,
                           Value addrValue, TciStatus encoderFailure, TriParameterList triPars,
                           TriAddress address, TriStatus transmissionFailure);
    public void tliPrCall_m_BC(String am, int ts, String src, int line, TriComponentId c,

```

```

    TriPortId at, TriPortId to, TriSignatureId signature, TciParameterList tciPars,
    TciStatus encoderFailure, TriParameterList triPars,
    TriStatus transmissionFailure);
public void tliPrCall_m_MC(String am, int ts, String src, int line, TriComponentId c,
    TriPortId at, TriPortId to, TriSignatureId signature, TciParameterList tciPars,
    TciValueList addrValues, TciStatus encoderFailure, TriParameterList triPars,
    TriAddressList addresses, TriStatus transmissionFailure);
public void tliPrCall_c(String am, int ts, String src, int line, TriComponentId c,
    TriPortId at, TriPortId to, TriSignatureId signature, TciParameterList tciPars,
    TriStatus transmissionFailure);
public void tliPrCall_c_BC(String am, int ts, String src, int line, TriComponentId c,
    TriPortId at, TriPortIdList to, TriSignatureId signature, TciParameterList tciPars,
    TriStatus transmissionFailure);
public void tliPrCall_c_MC(String am, int ts, String src, int line, TriComponentId c,
    TriPortId at, TriPortIdList to, TriSignatureId signature, TciParameterList tciPars,
    TriStatus transmissionFailure);
public void tliPrGetCallDetected_m(String am, int ts, String src, int line, TriComponentId c,
    TriPortId at, TriPortId from, TriSignatureId signature, TriParameterList triPars,
    TriAddress address);
public void tliPrGetCallDetected_c(String am, int ts, String src, int line, TriComponentId c,
    TriPortId at, TriPortId from, TriSignatureId signature, TciParameterList tciPars );
public void tliPrGetCallMismatch_m(String am, int ts, String src, int line, TriComponentId c,
    TriPortId at, TriSignatureId signature,
    TciParameterList tciPars, TciValueTemplate parsTmpl, TciValueDifferenceList diffs,
    Value addrValue, TciValueTemplate addressTmpl);
public void tliPrGetCallMismatch_c(String am, int ts, String src, int line, TriComponentId c,
    TriPortId at, TriSignatureId signature,
    TciParameterList tciPars, TciValueTemplate parsTmpl, TciValueDifferenceList diffs,
    TriComponentId from, TciNonValueTemplate fromTmpl);
public void tliPrGetCall_m(String am, int ts, String src, int line, TriComponentId c,
    TriPortId at, TriSignatureId signature,
    TciParameterList tciPars, TciValueTemplate parsTmpl,
    Value addrValue, TciValueTemplate addressTmpl);
public void tliPrGetCall_c(String am, int ts, String src, int line, TriComponentId c,
    TriPortId at, TriSignatureId signature,
    TciParameterList tciPars, TciValueTemplate parsTmpl,
    TriComponentId from, TciNonValueTemplate fromTmpl);
public void tliPrReply_m(String am, int ts, String src, int line, TriComponentId c,
    TriPortId at, TriPortId to, TriSignatureId signature, TciParameterList tciPars,
    Value replValue, Value addrValue,
    TciStatus encoderFailure, TriParameterList triPars,
    TriParameter repl, TriAddress address, TriStatus transmissionFailure);
public void tliPrReply_m_BC(String am, int ts, String src, int line, TriComponentId c,
    TriPortId at, TriPortId to, TriSignatureId signature, TciParameterList tciPars,
    Value replValue, TciStatus encoderFailure,
    TriParameterList triPars, TriParameter repl, TriStatus transmissionFailure);
public void tliPrReply_m_MC(String am, int ts, String src, int line, TriComponentId c,
    TriPortId at, TriPortId to, TriSignatureId signature, TciParameterList tciPars,
    Value replValue, TciValueList addrValues,
    TciStatus encoderFailure, TriParameterList triPars,
    TriParameter repl, TriAddressList addresses, TriStatus transmissionFailure);
public void tliPrReply_c(String am, int ts, String src, int line, TriComponentId c,
    TriPortId at, TriPortId to, TriSignatureId signature,
    TciParameterList tciPars, Value replValue,
    TriStatus transmissionFailure);
public void tliPrReply_c_BC(String am, int ts, String src, int line, TriComponentId c,
    TriPortId at, TriPortIdList to, TriSignatureId signature, TciParameterList tciPars,
    Value replValue, TriStatus transmissionFailure);
public void tliPrReply_c_MC(String am, int ts, String src, int line, TriComponentId c,
    TriPortId at, TriPortIdList to, TriSignatureId signature, TciParameterList tciPars,
    Value replValue, TriStatus transmissionFailure);
public void tliPrGetReplyDetected_m(String am, int ts, String src, int line, TriComponentId c,
    TriPortId at, TriPortId from, TriSignatureId signature, in TriParameterListType triPars,
    TriParameter repl, TriAddress address);
public void tliPrGetReplyDetected_c(String am, int ts, String src, int line, TriComponentId c,
    TriPortId at, TriPortId from, TriSignatureId signature, in TciParameterList tciPars,
    Value replValue);
public void tliPrGetReplyMismatch_m(String am, int ts, String src, int line, TriComponentId c,
    TriPortId at, TriSignatureId signature,
    TciParameterList tciPars, in TciValueTemplate parsTmpl,
    Value replValue, TciValueTemplate replyTmpl, TciValueDifferenceList diffs,
    Value addrValue, TciValueTemplate addressTmpl);
public void tliPrGetReplyMismatch_c(String am, int ts, String src, int line, TriComponentId c,
    TriPortId at, TriSignatureId signature,
    TciParameterList tciPars, in TciValueTemplate parsTmpl,
    Value replValue, TciValueTemplate replyTmpl, TciValueDifferenceList diffs,
    TriComponentId from, TciNonValueTemplate fromTmpl);
public void tliPrGetReply_m(String am, int ts, String src, int line, TriComponentId c,

```

```

    TriPortId at, TriSignatureId signature,
    TciParameterList tciPars, in TciValueTemplate parsTmpl,
    Value replValue, TciValueTemplate replyTmpl,
    Value addrValue, TciValueTemplate addressTmpl);
public void tliPrGetReply_c(String am, int ts, String src, int line, TriComponentId c,
    TriPortId at, TriSignatureId signature,
    TciParameterList tciPars, in TciValueTemplate parsTmpl,
    Value replValue, TciValueTemplate replyTmpl,
    TriComponentId from, TciNonValueTemplate fromTmpl);
public void tliPrRaise_m(String am, int ts, String src, int line, TriComponentId c,
    TriPortId at, TriPortId to,
    TriSignatureId signature, TciParameterList tciPars, Value excValue,
    Value addrValue, TciStatus encoderFailure, TriException exc,
    TriAddress address, TriStatus transmissionFailure);
public void tliPrRaise_m_BC(String am, int ts, String src, int line, TriComponentId c,
    TriPortId at, TriPortId to,
    TriSignatureId signature, TciParameterList tciPars, Value excValue,
    TciStatus encoderFailure, TriException exc, TriStatus transmissionFailure);
public void tliPrRaise_m_MC(String am, int ts, String src, int line, TriComponentId c,
    TriPortId at, TriPortId to,
    TriSignatureId signature, TciParameterList tciPars, Value excValue,
    TciValueList addrValues, TciStatus encoderFailure, TriException exc,
    TriAddressList addresses, TriStatus transmissionFailure);
public void tliPrRaise_c(String am, int ts, String src, int line, TriComponentId c,
    TriPortId at, TriPortId to, TriSignatureId signature,
    TciParameterList tciPars, Value excValue, TriStatus transmissionFailure);
public void tliPrRaise_c_BC(String am, int ts, String src, int line, TriComponentId c,
    TriPortId at, TriPortIdList to, TriSignatureId signature, TciParameterList tciPars,
    Value excValue, TriStatus transmissionFailure);
public void tliPrRaise_c_MC(String am, int ts, String src, int line, TriComponentId c,
    TriPortId at, TriPortIdList to, TriSignatureId signature, TciParameterList tciPars,
    Value excValue, TriStatus transmissionFailure);
public void tliPrCatchDetected_m(String am, int ts, String src, int line, TriComponentId c,
    TriPortId at, TriPortId from, TriSignatureId signature,
    TriException exc, TriAddress address);
public void tliPrCatchDetected_c(String am, int ts, String src, int line, TriComponentId c,
    TriPortId at, TriPortId from, TriSignatureId signature,
    Value excValue);
public void tliPrCatchMismatch_m(String am, int ts, String src, int line, TriComponentId c,
    TriPortId at, TriSignatureId signature,
    Value excValue, TciValueTemplate excTmpl, TciValueDifferenceList diffs,
    Value addrValue, TciValueTemplate addressTmpl);
public void tliPrCatchMismatch_c(String am, int ts, String src, int line, TriComponentId c,
    TriPortId at, TriSignatureId signature,
    Value excValue, TciValueTemplate excTmpl, TciValueDifferenceList diffs,
    TriComponentId from, TciNonValueTemplate fromTmpl);
public void tliPrCatch_m(String am, int ts, String src, int line, TriComponentId c,
    TriPortId at, TriSignatureId signature,
    Value excValue, TciValueTemplate excTmpl,
    Value addrValue, TciValueTemplate addressTmpl);
public void tliPrCatch_c(String am, int ts, String src, int line, TriComponentId c,
    TriPortId at, TriSignatureId signature,
    Value excValue, TciValueTemplate excTmpl,
    TriComponentId from, TciNonValueTemplate fromTmpl);
public void tliPrCatchTimeoutDetected(String am, int ts, String src, int line, TriComponentId c,
    TriPortId at, TriSignatureId signature);
public void tliPrCatchTimeout(String am, int ts, String src, int line, TriComponentId c,
    TriPortId at, TriSignatureId signature);
public void tliCCreate(String am, int ts, String src, int line, TriComponentId c,
    TriComponentId comp, String name, Boolean alive);
public void tliCStart(String am, int ts, String src, int line, TriComponentId c,
    TriComponentId comp, TciBehaviourId name, TciParameterList tciPars);
public void tliCRunning(String am, int ts, String src, int line, TriComponentId c,
    TriComponentId comp, ComponentStatus status);
public void tliCAlive(String am, int ts, String src, int line, TriComponentId c,
    TriComponentId comp, ComponentStatus status);
public void tliCStop(String am, int ts, String src, int line, TriComponentId c,
    TriComponentId comp);
public void tliCKill(String am, int ts, String src, int line, TriComponentId c,
    TriComponentId comp);
public void tliCDoneMismatch(String am, int ts, String src, int line, TriComponentId c,
    TriComponentId comp, TciNonValueTemplate compTmpl);
public void tliCDone(String am, int ts, String src, int line, TriComponentId c,
    TciNonValueTemplate compTmpl);
public void tliCKilledMismatch(String am, int ts, String src, int line, TriComponentId c,
    TriComponentId comp, TciNonValueTemplate compTmpl);
public void tliCKilled(String am, int ts, String src, int line, TriComponentId c,
    TciNonValueTemplate compTmpl);

```

```

public void tliCTerminated(String am, int ts, String src, int line, TriComponentId c,
    VerdictValue verdict, String reason);
public void tliPConnect(String am, int ts, String src, int line, TriComponentId c,
    TriPortId port1, TriPortId port2);
public void tliPDisconnect(String am, int ts, String src, int line, TriComponentId c,
    TriPortId port1, TriPortId port2);
public void tliPMap(String am, int ts, String src, int line, TriComponentId c,
    TriPortId port1, TriPortId port2);
public void tliPMapParam(String am, int ts, String src, int line, TriComponentId c,
    TriPortId port1, TriPortId port2, TciParameterList tciPars,
    TciStatus encoderFailure, TriParameterList triPars);
public void tliPUnmap(String am, int ts, String src, int line, TriComponentId c,
    TriPortId port1, TriPortId port2);
public void tliPUnmapParam(String am, int ts, String src, int line, TriComponentId c,
    TriPortId port1, TriPortId port2, TciParameterList tciPars,
    TciStatus encoderFailure, TriParameterList triPars);
public void tliPClear(String am, int ts, String src, int line, TriComponentId c,
    TriPortId port);
public void tliPStart(String am, int ts, String src, int line, TriComponentId c,
    TriPortId port);
public void tliPStop(String am, int ts, String src, int line, TriComponentId c,
    TriPortId port);
public void tliPHalt(String am, int ts, String src, int line, TriComponentId c,
    TriPortId port);
public void tliEncode(String am, int ts, String src, int line, TriComponentId c,
    Value val, TciStatus encoderFailure, TriMessage msg, String codec);
public void tliDecode(String am, int ts, String src, int line, TriComponentId c,
    TriMessage msg, TciStatus decoderFailure, Value val, String codec);
public void tliTimeoutDetected(String am, int ts, String src, int line, TriComponentId c,
    TriTimerId timer);
public void tliTimeoutMismatch(String am, int ts, String src, int line, TriComponentId c,
    TriTimerId timer, TciNonValueTemplate timerTpl);
public void tliTimeout(String am, int ts, String src, int line, TriComponentId c,
    TriTimerId timer, TciNonValueTemplate timerTpl);
public void tliTStart(String am, int ts, String src, int line, TriComponentId c,
    TriTimerId timer, TriTimerDuration dur);
public void tliTStop(String am, int ts, String src, int line, TriComponentId c,
    TriTimerId timer, in TriTimerDuration dur);
public void tliTRead(String am, int ts, String src, int line, TriComponentId c,
    TriTimerId timer, TriTimerDuration elapsed);
public void tliTRunning(String am, int ts, String src, int line, TriComponentId c,
    TriTimerId timer, TimerStatus status);
public void tliEnter(String am, int ts, String src, int line, TriComponentId c,
    QualifiedName name, TciParameterList tciPars, String kind);
public void tliSLeave(String am, int ts, String src, int line, TriComponentId c,
    QualifiedName name, TciParameterList tciPars, Value returnValue, String kind);
public void tliVar(String am, int ts, String src, int line, TriComponentId c,
    QualifiedName name, Value varValue);
public void tliModulePar(String am, int ts, String src, int line, TriComponentId c,
    QualifiedName name, Value parValue);
public void tliGetVerdict(String am, int ts, String src, int line, TriComponentId c,
    VerdictValue verdict);
public void tliSetVerdict(String am, int ts, String src, int line, TriComponentId c,
    VerdictValue verdict, String reason);
public void tliLog(String am, int ts, String src, int line, TriComponentId c,
    Tstring log);
public void tliAEnter(String am, int ts, String src, int line, TriComponentId c);
public void tliALeave(String am, int ts, String src, int line, TriComponentId c);
public void tliADefaults(String am, int ts, String src, int line, TriComponentId c);
public void tliAActivate(String am, int ts, String src, int line, TriComponentId c,
    QualifiedName name, TciParameterList tciPars, Value ref);
public void tliADeactivate(String am, int ts, String src, int line, TriComponentId c,
    Value ref);
public void tliANomatch(String am, int ts, String src, int line, TriComponentId c);
public void tliARepeat(String am, int ts, String src, int line, TriComponentId c);
public void tliAwait(String am, int ts, String src, int line, TriComponentId c);
public void tliAction(String am, int ts, String src, int line, TriComponentId c, String action);
public void tliMatch(String am, int ts, String src, int line, TriComponentId c, Value expr,
    TciValueTemplate tpl);
public void tliMatchMismatch(String am, int ts, String src, int line, TriComponentId c,
    Value expr, TciValueTemplate tpl, TciValueDifferenceList diffs);
public void tliInfo (String am, int ts, String src, int line, TriComponent c,
    int level, String info)
}

```

8.6 Optional parameters

Clause 7.3 defines that a reserved value shall be used to indicate the absence of an optional parameter. For the Java language mapping the Java `null` value shall be used to indicate the absence of an optional value. For example, if in the `tciReplyConnected` operation the value parameter shall be omitted the operation invocation shall be `tciReplyConnected (sender, receiver, signature, parameterList, null)`.

8.7 TCI initialization

All methods are non-static, i.e. operations can only be called on objects. As the present document does not define concrete implementation strategies of TE, TM, CD and CH the mechanism how the TE, the TM, the CD or the CH get to know the handles on the respective objects is out of scope of the present document.

Tool vendors shall provide methods to the developers of TM, CD and CH to register the TE, TM, CD and CH to their respective communication partner.

8.8 Error handling

All operations called from the TM, CH or CD that return have succeeded. If an erroneous situation has been identified by the TE a test case error will be communicated to the user using the procedures as defined in clause 7.3.1.2.6 (`tciError`). If an operation called by the TE in the TM, CH, CD, or TL produces an error, this erroneous situation should be communicated to the TE using the procedures as defined in clause 7.3.2.1.12 (`tciErrorReq`).

Beside this error handling no additional error handling is defined with this Java language mapping. In particular, no exception handling mechanisms are defined.

9 ANSI C language mapping

9.1 Introduction

This clause defines the TCI ANSI-C [8] language mapping for the TCI data specified in clause 7.2 and for the TCI operations specified in clause 7.3.

9.2 Value interfaces

TCI IDL Interface	ANSI C representation	Notes and comments
Type		
<code>TciModuleIdType getDefiningModule()</code>	<code>TciModuleIdType tciGetDefiningModule(Type inst)</code>	
<code>Tstring getName()</code>	<code>String tciGetName(Type inst)</code>	String type reused from IDL (OMG recommendation)
<code>TciTypeClassType getTypeClass()</code>	<code>TciTypeClassType tciGetTypeClass (Type inst)</code>	
<code>Value newInstance()</code>	<code>Value tciNewInstance(Type inst)</code>	
<code>Tstring getTypeEncoding()</code>	<code>String tciGetTypeEncoding(Type inst)</code>	
<code>TstringSeq getTypeExtension()</code>	<code>String* getTypeExtension(Type inst)</code>	
<code>Tstring getTypeEncodingVariant()</code>	<code>String tciGetTypeEncodingVariant (Type inst)</code>	
Value		
<code>Tstring getValueEncoding()</code>	<code>String tciGetValueEncoding (Value inst)</code>	
<code>Tstring getValueEncodingVariant()</code>	<code>String tciGetValueEncodingVariant (Value inst)</code>	
<code>Type getType()</code>	<code>Type tciGetType (Value inst)</code>	
<code>Tboolean notPresent()</code>	<code>Boolean tciNotPresent (Value inst)</code>	Boolean type reused from IDL (OMG recommendation)

TCI IDL Interface	ANSI C representation	Notes and comments
	<code>void tciSetNull(Value inst)</code>	For optional parameters of operations, see clause 9.7
	<code>Boolean tciIsNull(Value inst)</code>	For optional parameters of operations, see clause 9.7. Boolean type reused from IDL (OMG recommendation)
IntegerValue		
<code>Tinteger getInt()</code>	<code>String tciGetIntAbs(Value inst)</code>	Returns the (10-base) integer absolute value as an ASCII string.
	<code>unsigned long int tciGetIntNumberOfDigits (Value inst)</code>	Returns the number of digits in an integer value.
	<code>Boolean tciGetIntSign(Value inst)</code>	Returns true if the number is positive, false otherwise.
	<code>char tciGetIntDigit (Value inst, unsigned long int position)</code>	Returns the value of the digit at position 'position', where position 0 is the least significant digit.
<code>void setInt(in Tinteger value)</code>	<code>void tciSetIntAbs (Value inst, String value)</code>	Sets the (10-base) absolute value of the integer via an ASCII string. The first digit must not be 0 unless the value is 0.
	<code>Void tciSetIntNumberOfDigits (Value inst, unsigned long int dig_num)</code>	Sets the number of digits in an integer value.
	<code>void tciSetIntSign (Value inst, Boolean sign)</code>	Sets the sign to + (true) or - (false).
	<code>void tciSetIntDigit (Value inst, unsigned long int position, char digit)</code>	Sets the value of the digit at position 'position', where position 0 is the least significant digit.
FloatValue		
<code>Tfloat getFloat()</code>	<code>double tciGetFloatValue(Value inst)</code>	
<code>void setFloat(in Tfloat value)</code>	<code>void tciSetFloatValue(Value inst, double value)</code>	
BooleanValue		
<code>Tboolean getBoolean()</code>	<code>Boolean tciGetBooleanValue(Value inst)</code>	
<code>void setBoolean (in Tboolean value)</code>	<code>void tciSetBooleanValue (Value inst, Boolean value)</code>	
CharstringValue		
<code>Tstring getString()</code>	<code>TciCharStringValue tciGetCStringValue(Value inst)</code>	
<code>void setString(in Tstring value)</code>	<code>void tciSetCStringValue (Value inst, TciCharStringValue value)</code>	
<code>Tchar getChar (in Tinteger position)</code>	<code>char tciGetCStringCharValue (Value inst, long int position)</code>	
<code>void setChar (in Tinteger position, in Tchar value)</code>	<code>void tciSetCStringCharValue (Value inst, long int position, char value)</code>	

TCI IDL Interface	ANSI C representation	Notes and comments
Tinteger getLength()	unsigned long int tciGetCStringLength (Value inst)	
void setLength(in Tinteger len)	void tciSetCStringLength (Value inst, unsigned long int len)	
UniversalCharstringValue		
Tstring getString()	TciUCStringValue tciGetUCStringValue(Value inst)	
void setString(in Tstring value)	void tciSetUCStringValue (Value inst, TciUCStringValue value)	
TuniversalChar getChar (in Tinteger position)	void tciGetUCStringCharValue (Value inst, unsigned long int position, TciUCValue result)	
void setChar (in Tinteger position, in TuniversalChar value)	void tciSetUCStringCharValue (Value inst, unsigned long int position, TciUCValue value)	
Tinteger getLength()	unsigned long int tciGetUCStringLength(Value inst)	
void setLength(in Tinteger len)	void tciSetUCStringLength (Value inst, unsigned long int len)	
BitstringValue		
Tstring getString()	String tciGetBStringValue(Value inst)	
void setString(in Tstring value)	void tciSetBStringValue (Value inst, String value)	
Tchar getBit (in integer position)	int tciGetBStringBitValue (Value inst, long int position)	
void setBit (in Tinteger position, in Tinteger value)	void tciSetBStringBitValue (Value inst, unsigned long int position, int value)	
Tinteger getLength()	unsigned long int tciGetBStringLength(Value inst)	
void setLength(in Tinteger len)	void tciSetBStringLength (Value inst, long int len)	
HexstringValue		
Tstring getString()	String tciGetHStringValue(Value inst)	
void setString(in Tstring value)	void tciSetHStringValue (Value inst, String value)	
Tchar getHex (in Tinteger position)	int tciGetHStringHexValue (Value inst, unsigned long int position)	
void setBit (in Tinteger position, in Tinteger value)	void tciSetHStringHexValue (Value inst, unsigned long int position, int value)	
Tinteger getLength()	long int tciGetHStringLength(Value inst)	
void setLength(in Tinteger len)	void tciSetHStringLength (Value inst, unsigned long int len)	
OctetstringValue		
Tstring getString()	String tciGetOStringValue(Value inst)	
void setString(in Tstring value)	void tciSetOStringValue (Value inst, String value)	
Tchar getOctet(in Tinteger position)	int tciGetOStringOctetValue (Value inst, unsigned long int position)	
void setOctet (in Tinteger position, in Tinteger value)	void tciSetOStringOctetValue (Value inst, unsigned long int position, int value)	
Tinteger getLength()	unsigned long int tciGetOStringLength(Value inst)	
void setLength(in Tinteger len)	void tciSetOStringLength (Value inst, unsigned long int len)	
RecordValue		
Value getField(in Tstring fieldName int)	Value tciGetRecFieldValue (Value inst, String fieldName int)	
void setField (in Tstring fieldName int, in Value value)	void tciSetRecFieldValue (Value inst, String fieldName int, Value value)	

TCI IDL Interface	ANSI C representation	Notes and comments
Tstring[] getFieldNames()	char** tciGetRecFieldNames(Value inst)	Returns a NULL-terminated array of the field names.
void setFieldOmitted (in Tstring fieldName int)	void setFieldOmitted (Value inst, String fieldName int)	
RecordOfValue		
Value getField(in Tinteger position)	Value tciGetRecOfFieldValue (Value inst, unsigned long int position)	
void setField (in Tinteger position, in Value value)	void tciSetRecOfFieldValue (Value inst, unsigned long int position, Value value)	
void appendField(in Value value)	void tciAppendRecOfFieldValue (Value inst, Value value)	
Type getElementType()	Type tciGetRecOfElementType(Value inst)	
Tinteger getLength()	unsigned long int tciGetRecOfLength(Value inst)	
void setLength(in Tinteger len)	void tciSetRecOfLength (Value inst, unsigned long int len)	
Tinteger getOffset()	unsigned long int tciGetOffset(Value inst)	
UnionValue		
Value getVariant (in Tstring variantName)	Value tciGetUnionVariant (Value inst, String variantName)	
void setVariant (in Tstring variantName, in Value value)	void tciSetUnionVariant (Value inst, String variantName, Value value)	
Tstring getPresentVariantName()	String tciGetUnionPresentVariantName (Value inst)	
Tstring[] getVariantNames()	char** tciGetUnionVariantNames(Value inst)	Returns a NULL-terminated array of the field names.
EnumeratedValue		
Tstring getEnum()	String tciGetEnumValue(Value inst)	
void setEnum(in Tstring enumValue)	void tciSetEnumValue (Value inst, String enumValue)	
Tinteger getInt()	unsigned long tciGetEnumInt(Value inst);	
setInt(in Tinteger intValue)	void tciSetEnumInt(Value inst, unsigned long intValue);	
VerdictValue		
Tinteger getVerdict()	int tciGetVerdictValue(Value inst)	
void setVerdict(in Tinteger verdict)	void tciSetVerdictValue(Value inst, int verdict)	
AddressValue		
Value getAddress()	Value tciGetAddressValue(Value inst)	
void setAddress(in Value value)	void tciSetAddressValue(Value inst, Value value)	

9.3 Logging interface

TCI IDL Interface	ANSI C representation	Notes and comments
TciValueTemplate		
Tboolean isOmit()	Boolean tciIsOmit(TciValueTemplate inst)	Boolean type reused from IDL (OMG recommendation)
Tboolean isAny()	Boolean tciIsAny(TciValueTemplate inst)	Boolean type reused from IDL (OMG recommendation)
Tboolean isAnyOrOmit()	Boolean tciIsAnyOrOmit(TciValueTemplate inst)	Boolean type reused from IDL (OMG recommendation)

TCI IDL Interface	ANSI C representation	Notes and comments
Tstring getTemplateDef()	String tciGetTemplateDef(TciValueTemplate inst)	String type reused from IDL (OMG recommendation)
TciNonValueTemplate		
Tboolean isAny()	Boolean tciIsAnyNonValue (TciNonValueTemplate inst)	Boolean type reused from IDL (OMG recommendation)
Tboolean isAll()	Boolean tciIsAllNonValue (TciNonValueTemplate inst)	Boolean type reused from IDL (OMG recommendation)
Tstring getTemplateDef()	String tciGetTemplateDefNonValue (TciNonValueTemplate inst)	String type reused from IDL (OMG recommendation)
TciValueList		
Tinteger size()	int size(TciValueList inst)	
Tboolean isEmpty()	Boolean isEmpty(TciValueList inst)	Boolean type reused from IDL (OMG recommendation)
Value get(Tinteger index)	Value get(TciValueList inst, int index)	
TciValueDifference		
Value getValue()	Value getValue(TciValueDifference inst)	
TciValueTemplate getTciValueTemplate()	TciValueTemplate getTciValueTemplate(TciValueDifference inst)	
Tstring getDescription()	String getDescription(TciValueDifference inst)	String type reused from IDL (OMG recommendation)
TciValueDifferenceList		
Tinteger size()	int size(TciValueDifferenceList inst)	
Tboolean isEmpty()	Boolean isEmpty(TciValueDifferenceList inst)	Boolean type reused from IDL (OMG recommendation)
TciValueDifference get(Tinteger index)	TciValueDifference get(TciValueDifferenceList inst, int index)	

9.4 Operation interfaces

9.4.1 The TCI-TM interface

9.4.1.1 TCI-TM provided

The TCI-TM Provided interface is mapped to the following interface:

```
void tciTestCaseStarted
    (TciTestCaseIdType testCaseId, TciParameterListType parameterList, double timer)
void tciTestCaseTerminated (VerdictValue verdict, TciParameterListType parameterlist)
void tciControlTerminated()
Value tciGetModulePar (TciModuleParameterIdType parameterId)
void tciLog(String message)
void tciError(String message)
```

9.4.1.2 TCI-TM required

The TCI-TM Required interface is mapped to the following interface:

```
void tciRootModule(String moduleId)
TciModuleIdListType tciGetImportedModules()
TciModuleParameterListType tciGetModuleParameters(TciModuleIdType moduleName)
TciTestCaseIdListType tciGetTestCases()
TciParameterTypeListType tciGetTestCaseParameters (TciTestCaseIdType testCaseId)
TriPortIdList tciGetTestCaseTSI (TciTestCaseIdType testCaseId)
void tciStartTestCase (TciTestCaseIdType testCaseId, TciParameterListType parameterlist)
void tciStopTestCase()
```

```
TriComponentId tciStartControl()
void tciStopControl()
```

9.4.2 The TCI-CD interface

9.4.2.1 TCI-CD provided

The TCI-CD Provided interface is mapped to the following interface:

```
Value tciDecode (BinaryString message, Type decHypothesis)
BinaryString tciEncode(Value value)
```

NOTE: BinaryString type reused from TRI.

9.4.2.2 TCI-CD required

The TCI-CD Required interface is mapped to the following interface:

```
Type tciGetTypeForName(String typeName)
Type tciGetIntegerType()
Type tciGetFloatType()
Type tciGetBooleanType()
Type tciGetCharType()
Type tciGetUniversalCharType()
Type tciGetTciCharstringType()
Type tciGetUniversalCharstringType()
Type tciGetHexstringType()
Type tciGetBitstringType()
Type tciGetOctetstringType()
Type tciGetVerdictType()
void tciErrorReq(String message)
```

9.4.3 The TCI-CH interface

9.4.3.1 TCI-CH provided

The TCI-CH Provided interface is mapped to the following interface:

```
void tciSendConnected(TriPortId sender, TriComponentId receiver, Value sendMessage)
void tciSendConnectedBC(TriPortId sender, Value sendMessage)
void tciSendConnectedMC
    (TriPortId sender, TriComponentIdList receivers, Value sendMessage)
void tciCallConnected
    (TriPortId sender, TriComponentId receiver, TriSignatureId signature,
    TciParameterListType parameterList)
void tciCallConnectedBC
    (TriPortId sender, TriSignatureId signature, TciParameterListType parameterList)
void tciCallConnectedMC
    (TriPortId sender, TriComponentIdList receivers, TriSignatureId signature,
    TciParameterListType parameterList)
void tciReplyConnected
    (TriPortId sender, TriComponentId receiver, TriSignatureId signature,
    TciParameterListType parameterList, Value returnValue)
void tciReplyConnectedBC
    (TriPortId sender, TriSignatureId signature, TciParameterListType parameterList,
    Value returnValue)
void tciReplyConnectedMC
    (TriPortId sender, TriComponentIdList receivers, TriSignatureId signature,
    TciParameterListType parameterList, Value returnValue)
void tciRaiseConnected
    (TriPortId sender, TriComponentId receiver, TriSignatureId signature, Value exception)
void tciRaiseConnectedBC
    (TriPortId sender, TriSignatureId signature, Value exception)
void tciRaiseConnectedMC
    (TriPortId sender, TriComponentIdList receivers, TriSignatureId signature, Value exception)
TriComponentId tciCreateTestComponentReq
    (TciTestComponentKindType kind, Type componentType, String name, Value hostId)
void tciStartTestComponentReq
    (TriComponentId component, TciBehaviourIdType behaviour, TciParameterListType parameterList)
void tciStopTestComponentReq (TriComponentId component)
void tciConnectReq(TriPortId fromPort, TriPortId toPort)
```

```

void          tciDisconnectReq(TriPortId fromPort, TriPortId toPort)
void          tciMapReq(TriPortId fromPort, TriPortId toPort)
void          tciMapParamReq
  (TriPortId fromPort, TriPortId toPort, TciParameterListType parameterList)
void          tciUnmapReq(TriPortId fromPort, TriPortId toPort)
void          tciUnmapParamReq
  (TriPortId fromPort, TriPortId toPort, TciParameterListType parameterList)
void          tciTestComponentTerminatedReq(TriComponentId component, VerdictValue verdict)
Boolean      tciTestComponentRunningReq(TriComponentId component)
Boolean      tciTestComponentDoneReq(TriComponentId component)
TriComponentId tciGetMTCReq()
void          tciExecuteTestCaseReq(TciTestCaseIdType testCaseId, TriPortIdList tsiPortList)
void          tciResetReq()
void          tciKillTestComponentReq(TriComponentId component)
Boolean      tciTestComponentAliveReq (TriComponentId component)
Boolean      tciTestComponentKilledReq (TriComponentId component)

```

9.4.3.2 TCI-CH required

The TCI-CH Required interface is mapped to the following interface:

```

void          tciEnqueueMsgConnected
  (TriPortId sender, TriComponentId receiver, Value rcvdMessage)
void          tciEnqueueCallConnected
  (TriPortId sender, TriComponentId receiver, TriSignatureId signature,
  TciParameterListType parameterList)
void          tciEnqueueReplyConnected
  (TriPortId sender, TriComponentId receiver, TriSignatureId signature,
  TciParameterListType parameterList, Value returnValue)
void          tciEnqueueRaiseConnected
  (TriPortId sender, TriComponentId receiver, TriSignatureId signature, Value exception)
TriComponentId tciCreateTestComponent
  (TciTestComponentKindType kind, Type componentType, String name)
void          tciStartTestComponent
  (TriComponentId component, TciBehaviourIdType behaviour, TciParameterListType parameterList)
void          tciStopTestComponent(TriComponentId component)
void          tciConnect(TriPortId fromPort, TriPortId toPort)
void          tciDisconnect(TriPortId fromPort, TriPortId toPort)
void          tciMap (TriPortId fromPort, TriPortId toPort)
void          tciMapParam
  (TriPortId fromPort, TriPortId toPort, TciParameterListType parameterList)
void          tciUnmap(TriPortId fromPort, TriPortId toPort)
void          tciUnmapParam
  (TriPortId fromPort, TriPortId toPort, TciParameterListType parameterList)
void          tciTestComponentTerminated(TriComponentId component, VerdictValue verdict)
Boolean      tciTestComponentRunning(TriComponentId component)
Boolean      tciTestComponentDone(TriComponentId component)
TriComponentId tciGetMTC()
void          tciExecuteTestCase(TciTestCaseIdType testCaseId, TriPortIdList tsiPortList)
void          tciReset()
void          tciKillTestComponent(TriComponentId component)
Boolean      tciTestComponentAlive(TriComponentId component)
Boolean      tciTestComponentKilled(TriComponentId component)

```

9.4.4 The TCI-TL interface

9.4.4.1 TCI-TL provided

The TCI-TL Provided interface is mapped to the following interface:

```

void tliTcExecute
  (String am, int ts, String src, int line, TriComponentId c, TciTestCaseIdType tcId,
  TciParameterListType tciPars, TriTimerDuration dur)
void tliTcStart
  (String am, int ts, String src, int line, TriComponentId c, TciTestCaseIdType tcId,
  TciParameterListType tciPars, TriTimerDuration dur)
void tliTcStop
  (String am, int ts, String src, int line, TriComponentId c, String reason)
void tliTcStarted
  (String am, int ts, String src, int line, TriComponentId c, TciTestCaseIdType tcId,
  TciParameterListType tciPars, TriTimerDuration dur)
void tliTcTerminated
  (String am, int ts, String src, int line, TriComponentId c, TciTestCaseIdType tcId,
  TciParameterListType tciPars, VerdictValue verdict, String reason)

```

```

void tliCtrlStart(String am, int ts, String src, int line, TriComponentId c)
void tliCtrlStop(String am, int ts, String src, int line, TriComponentId c)
void tliCtrlTerminated(String am, int ts, String src, int line, TriComponentId c)

void tliMSend_m
  (String am, int ts, String src, int line, TriComponentId c, TriPortId at, TriPortId to,
   Value msgValue, Value addrValue, TciStatus encoderFailure, TriMessage msg,
   TriAddress address, TriStatus transmissionFailure)
void tliMSend_m_BC
  (String am, int ts, String src, int line, TriComponentId c, TriPortId at, TriPortId to,
   Value msgValue, TciStatus encoderFailure, TriMessage msg, TriStatus transmissionFailure)
void tliMSend_m_MC
  (String am, int ts, String src, int line, TriComponentId c, TriPortId at, TriPortId to,
   Value msgValue, TciValueList addrValues, TciStatus encoderFailure, TriMessage msg,
   TriAddressList addresses, TriStatus transmissionFailure)
void tliMSend_c
  (String am, int ts, String src, int line, TriComponentId c, TriPortId at, TriPortId to,
   Value msgValue, TriStatus transmissionFailure)
void tliMSend_c_BC
  (String am, int ts, String src, int line, TriComponentId c, TriPortId at, TriPortIdList to,
   Value msgValue, TriStatus transmissionFailure)
void tliMSend_c_MC
  (String am, int ts, String src, int line, TriComponentId c, TriPortId at, TriPortIdList to,
   Value msgValue, TriStatus transmissionFailure)
void tliMDetected_m
  (String am, int ts, String src, int line, TriComponentId c, TriPortId at, TriPortId from,
   TriMessage msg, TriAddress address)
void tliMDetected_c
  (String am, int ts, String src, int line, TriComponentId c, TriPortId at, TriPortId from,
   Value msgValue)
void tliMMismatch_m
  (String am, int ts, String src, int line, TriComponentId c, TriPortId at, Value msgValue,
   TciValueTemplate msgTmpl, TciValueDifferenceList diffs, Value addrValue,
   TciValueTemplate addressTmpl)
void tliMMismatch_c
  (String am, int ts, String src, int line, TriComponentId c, TriPortId at, Value msgValue,
   TciValueTemplate msgTmpl, TciValueDifferenceList diffs, TriComponentId from,
   TciNonValueTemplate fromTmpl)
void tliMReceive_m
  (String am, int ts, String src, int line, TriComponentId c, TriPortId at, Value msgValue,
   TciValueTemplate msgTmpl, Value addrValue, TciValueTemplate addressTmpl)
void tliMReceive_c
  (String am, int ts, String src, int line, TriComponentId c, TriPortId at, Value msgValue,
   TciValueTemplate msgTmpl, TriComponentId from, TciNonValueTemplate fromTmpl)

void tliPrCall_m
  (String am, int ts, String src, int line, TriComponentId c, TriPortId at,
   TriPortId to, TriSignatureId signature,
   TciParameterListType tciPars, Value addrValue, TciStatus encoderFailure,
   TriParameterList triPars, TriAddress address, TriStatus transmissionFailure)
void tliPrCall_m_BC
  (String am, int ts, String src, int line, TriComponentId c, TriPortId at, TriPortId to,
   TriSignatureId signature, TciParameterListType tciPars, TciStatus encoderFailure,
   TriParameterList triPars, TriStatus transmissionFailure)
void tliPrCall_m_MC
  (String am, int ts, String src, int line, TriComponentId c, TriPortId at, TriPortId to,
   TriSignatureId signature, TciParameterListType tciPars, TciValueList addrValues,
   TciStatus encoderFailure, TriParameterList triPars, TriAddressList addresses,
   TriStatus transmissionFailure)
void tliPrCall_c
  (String am, int ts, String src, int line, TriComponentId c, TriPortId at,
   TriPortId to, TriSignatureId signature,
   TciParameterListType tciPars, TriStatus transmissionFailure)
void tliPrCall_c_BC
  (String am, int ts, String src, int line, TriComponentId c, TriPortId at, TriPortIdList to,
   TriSignatureId signature, TciParameterListType tciPars, TriStatus transmissionFailure)
void tliPrCall_c_MC
  (String am, int ts, String src, int line, TriComponentId c, TriPortId at, TriPortIdList to,
   TriSignatureId signature, TciParameterListType tciPars, TriStatus transmissionFailure)
void tliPrGetCallDetected_m
  (String am, int ts, String src, int line, TriComponentId c, TriPortId at, TriPortId from,
   TriSignatureId signature, TriParameterList triPars, TriAddress address)
void tliPrGetCallDetected_c
  (String am, int ts, String src, int line, TriComponentId c, TriPortId at, TriPortId from,
   TriSignatureId signature, TciParameterListType tciPars)
void tliPrGetCallMismatch_m
  (String am, int ts, String src, int line, TriComponentId c, TriPortId at, TriSignatureId signature,

```



```

    TciParameterListType tciPars, TciValueTemplate parsTpl, TciValueDifferenceList diffs,
    Value addrValue, TciValueTemplate addressTpl)
void tliPrGetCallMismatch_c
(String am, int ts, String src, int line, TriComponentId c, TriPortId at, TriSignatureId signature,
 TciParameterListType tciPars, TciValueTemplate parsTpl, TciValueDifferenceList diffs,
 TriComponentId from, TciNonValueTemplate fromTpl)
void tliPrGetCall_m
(String am, int ts, String src, int line, TriComponentId c, TriPortId at, TriSignatureId signature,
 TciParameterListType tciPars, TciValueTemplate parsTpl, Value addrValue,
 TciValueTemplate addressTpl)
void tliPrGetCall_c
(String am, int ts, String src, int line, TriComponentId c, TriPortId at, TriSignatureId signature,
 TciParameterListType tciPars, TciValueTemplate parsTpl, TriComponentId from,
 TciNonValueTemplate fromTpl)
void tliPrReply_m
(String am, int ts, String src, int line, TriComponentId c, TriPortId at, TriPortId to,
 TriSignatureId signature, TciParameterListType tciPars, Value replValue,
 Value addrValue, TciStatus encoderFailure, TriParameterList triPars,
 TriParameter repl, TriAddress address, TriStatus transmissionFailure)
void tliPrReply_m_BC
(String am, int ts, String src, int line, TriComponentId c, TriPortId at, TriPortId to,
 TriSignatureId signature, TciParameterListType tciPars, Value replValue,
 TciStatus encoderFailure, TriParameterList triPars, TriParameter repl,
 TriStatus transmissionFailure)
void tliPrReply_m_MC
(String am, int ts, String src, int line, TriComponentId c, TriPortId at, TriPortId to,
 TriSignatureId signature, TciParameterListType tciPars, Value replValue,
 TciValueList addrValues, TriStatus encoderFailure, TriParameterList triPars,
 TriParameter repl, TriAddressList addresses, TciStatus transmissionFailure)
void tliPrReply_c
(String am, int ts, String src, int line, TriComponentId c, TriPortId at, TriPortId to,
 TriSignatureId signature, TciParameterListType tciPars, Value replValue,
 TriStatus transmissionFailure)
void tliPrReply_c_BC
(String am, int ts, String src, int line, TriComponentId c, TriPortId at, TriPortIdList to,
 TriSignatureId signature, TciParameterListType tciPars, Value replValue,
 TriStatus transmissionFailure)
void tliPrReply_c_MC
(String am, int ts, String src, int line, TriComponentId c, TriPortId at, TriPortIdList to,
 TriSignatureId signature, TciParameterListType tciPars, Value replValue,
 TriStatus transmissionFailure)
void tliPrGetReplyDetected_m
(String am, int ts, String src, int line, TriComponentId c, TriPortId at, TriPortId from,
 TriSignatureId signature, TriParameterList triPars, TriParameter repl, TriAddress address)
void tliPrGetReplyDetected_c
(String am, int ts, String src, int line, TriComponentId c, TriPortId at, TriPortId from,
 TriSignatureId signature, TciParameterListType tciPars, Value replValue)
void tliPrGetReplyMismatch_m
(String am, int ts, String src, int line, TriComponentId c, TriPortId at, TriSignatureId signature,
 TciParameterListType tciPars, TciValueTemplate parsTpl, Value replValue,
 TciValueTemplate replyTpl, TciValueDifferenceList diffs, Value addrValue,
 TciValueTemplate addressTpl)
void tliPrGetReplyMismatch_c
(String am, int ts, String src, int line, TriComponentId c, TriPortId at, TriSignatureId signature,
 TciParameterListType tciPars, TciValueTemplate parsTpl, Value replValue,
 TciValueTemplate replyTpl, TciValueDifferenceList diffs, TriComponentId from,
 TciNonValueTemplate fromTpl)
void tliPrGetReply_m
(String am, int ts, String src, int line, TriComponentId c, TriPortId at, TriSignatureId signature,
 TciParameterListType tciPars, TciValueTemplate parsTpl, Value replValue,
 TciValueTemplate replyTpl, Value addrValue, TciValueTemplate addressTpl)
void tliPrGetReply_c
(String am, int ts, String src, int line, TriComponentId c, TriPortId at, TriSignatureId signature,
 TciParameterListType tciPars, TciValueTemplate parsTpl, Value replValue,
 TciValueTemplate replyTpl, TriComponentId from, TciNonValueTemplate fromTpl)
void tliPrRaise_m
(String am, int ts, String src, int line, TriComponentId c, TriPortId at, TriPortId to,
 TriSignatureId signature, TciParameterListType tciPars, Value excValue, Value addrValue,
 TciStatus encoderFailure, TriException exc, TriAddress address, TriStatus transmissionFailure)
void tliPrRaise_m_BC
(String am, int ts, String src, int line, TriComponentId c, TriPortId at, TriPortId to,
 TriSignatureId signature, TciParameterListType tciPars, Value excValue,
 TciStatus encoderFailure, TriException exc, TriStatus transmissionFailure)
void tliPrRaise_m_MC
(String am, int ts, String src, int line, TriComponentId c, TriPortId at, TriPortId to,
 TriSignatureId signature, TciParameterListType tciPars, Value excValue,
 TciValueList addrValues, TciStatus encoderFailure, TriException exc,
 TriAddressList addresses, TriStatus transmissionFailure)

```

```

void tliPrRaise_c
  (String am, int ts, String src, int line, TriComponentId c, TriPortId at, TriPortId to,
   TriSignatureId signature, TciParameterListType tciPars, Value excValue,
   TriStatus transmissionFailure)
void tliPrRaise_c_BC
  (String am, int ts, String src, int line, TriComponentId c, TriPortId at, TriPortIdList to,
   TriSignatureId signature, TciParameterListType tciPars, Value excValue,
   TriStatus transmissionFailure)
void tliPrRaise_c_MC
  (String am, int ts, String src, int line, TriComponentId c, TriPortId at, TriPortIdList to,
   TriSignatureId signature, TciParameterListType tciPars, Value excValue,
   TriStatus transmissionFailure)
void tliPrCatchDetected_m
  (String am, int ts, String src, int line, TriComponentId c, TriPortId at, TriPortId from,
   TriSignatureId signature, TriException exc, TriAddress address)
void tliPrCatchDetected_c
  (String am, int ts, String src, int line, TriComponentId c, TriPortId at, TriPortId from,
   TriSignatureId signature, Value excValue)
void tliPrCatchMismatch_m
  (String am, int ts, String src, int line, TriComponentId c, TriPortId at, TriSignatureId signature,
   Value excValue, TciValueTemplate excTmpl, TciValueDifferenceList diffs, Value addrValue,
   TciValueTemplate addressTmpl)
void tliPrCatchMismatch_c
  (String am, int ts, String src, int line, TriComponentId c, TriPortId at, TriSignatureId signature,
   Value excValue, TciValueTemplate excTmpl, TciValueDifferenceList diffs, TriComponentId from,
   TciNonValueTemplate fromTmpl)
void tliPrCatch_m
  (String am, int ts, String src, int line, TriComponentId c, TriPortId at, TriSignatureId signature,
   Value excValue, TciValueTemplate excTmpl, Value addrValue, TciValueTemplate addressTmpl)
void tliPrCatch_c
  (String am, int ts, String src, int line, TriComponentId c, TriPortId at, TriSignatureId signature,
   Value excValue, TciValueTemplate excTmpl, TriComponentId from, TciNonValueTemplate fromTmpl)
void tliPrCatchTimeoutDetected
  (String am, int ts, String src, int line, TriComponentId c, TriPortId at, TriSignatureId signature)
void tliPrCatchTimeout
  (String am, int ts, String src, int line, TriComponentId c, TriPortId at, TriSignatureId signature)

void tlicCreate
  (String am, int ts, String src, int line, TriComponentId c, TriComponentId comp, String name,
   Boolean alive)
void tlicStart
  (String am, int ts, String src, int line, TriComponentId c, TriComponentId comp,
   TciBehaviourIdType name, TciParameterListType tciPars)
void tlicRunning
  (String am, int ts, String src, int line, TriComponentId c, TriComponentId comp,
   ComponentStatus status)
void tlicAlive
  (String am, int ts, String src, int line, TriComponentId c, TriComponentId comp,
   ComponentStatus status)
void tlicStop
  (String am, int ts, String src, int line, TriComponentId c, TriComponentId comp)
void tlicKill
  (String am, int ts, String src, int line, TriComponentId c, TriComponentId comp)
void tlicDoneMismatch
  (String am, int ts, String src, int line, TriComponentId c, TriComponentId comp,
   TciNonValueTemplate compTmpl)
void tlicDone
  (String am, int ts, String src, int line, TriComponentId c, TciNonValueTemplate compTmpl)
void tlicTerminated
  (String am, int ts, String src, int line, TriComponentId c, VerdictValue verdict, String reason)
void tlicKilledMismatch
  (String am, int ts, String src, int line, TriComponentId c, TriComponentId comp,
   TciNonValueTemplate compTmpl)
void tlicKilled
  (String am, int ts, String src, int line, TriComponentId c, TciNonValueTemplate compTmpl)

void tliPConnect
  (String am, int ts, String src, int line, TriComponentId c, TriPortId port1, TriPortId port2)
void tliPDisconnect
  (String am, int ts, String src, int line, TriComponentId c, TriPortId port1,
   TriPortId port2)
void tliPMap
  (String am, int ts, String src, int line, TriComponentId c, TriPortId port1, TriPortId port2)
void tliPMapParam
  (String am, int ts, String src, int line, TriComponentId c, TriPortId port1, TriPortId port2,
   TciParameterListType tciPars, TciStatus encoderFailure, TriParameterList triPars)
void tliPUnmap
  (String am, int ts, String src, int line, TriComponentId c, TriPortId port1,

```

```

    TriPortId port2)
void tliUnmapParam
    (String am, int ts, String src, int line, TriComponentId c, TriPortId port1,
    TriPortId port2, TciParameterListType tciPars, TciStatus encoderFailure, TriParameterList triPars)
void tliPClear
    (String am, int ts, String src, int line, TriComponentId c, TriPortId port)
void tliPStart
    (String am, int ts, String src, int line, TriComponentId c, TriPortId port)
void tliPStop
    (String am, int ts, String src, int line, TriComponentId c, TriPortId port)
void tliPHalt
    (String am, int ts, String src, int line, TriComponentId c, TriPortId port)

void tliEncode
    (String am, int ts, String src, int line, TriComponentId c, Value val, TciStatus encoderFailure,
    TriMessage msg, String codec)
void tliDecode
    (String am, int ts, String src, int line, TriComponentId c, TriMessage msg,
    TciStatus decoderFailure, Value val, String codec)

void tliTimeoutDetected
    (String am, int ts, String src, int line, TriComponentId c, TriTimerId timer)
void tliTimeoutMismatch
    (String am, int ts, String src, int line, TriComponentId c, TriTimerId timer,
    TciNonValueTemplate timerTpl)
void tliTimeout
    (String am, int ts, String src, int line, TriComponentId c, TriTimerId timer,
    TciNonValueTemplate timerTpl)
void tliTStart
    (String am, int ts, String src, int line, TriComponentId c, TriTimerId timer, TriTimerDuration dur)
void tliTStop
    (String am, int ts, String src, int line, TriComponentId c, TriTimerId timer, TriTimerDuration dur)
void tliTRead
    (String am, int ts, String src, int line, TriComponentId c, TriTimerId timer,
    TriTimerDuration elapsed)
void tliTRunning
    (String am, int ts, String src, int line, TriComponentId c, TriTimerId timer, TimerStatus status)

void tliSEnter
    (String am, int ts, String src, int line, TriComponentId c, QualifiedName name,
    TciParameterListType tciPars, String kind)
void tliSLeave
    (String am, int ts, String src, int line, TriComponentId c, QualifiedName name,
    TciParameterListType tciPars, Value returnValue, String kind)

void tliVar
    (String am, int ts, String src, int line, TriComponentId c, QualifiedName name, Value varValue)
void tliModulePar
    (String am, int ts, String src, int line, TriComponentId c, QualifiedName name, Value parValue)

void tliGetVerdict(String am, int ts, String src, int line, TriComponentId c, VerdictValue verdict)
void tliSetVerdict
    (String am, int ts, String src, int line, TriComponentId c, VerdictValue verdict, String reason)

void tliLog(String am, int ts, String src, int line, TriComponentId c, String log)

void tliAEnter(String am, int ts, String src, int line, TriComponentId c)
void tliALeave(String am, int ts, String src, int line, TriComponentId c)
void tliADefaults(String am, int ts, String src, int line, TriComponentId c)
void tliAActivate
    (String am, int ts, String src, int line, TriComponentId c, QualifiedName name,
    TciParameterListType tciPars, Value ref)
void tliAdeactivate(String am, int ts, String src, int line, TriComponentId c, Value ref)
void tliANomatch(String am, int ts, String src, int line, TriComponentId c)
void tliARepet(String am, int ts, String src, int line, TriComponentId c)
void tliAWait(String am, int ts, String src, int line, TriComponentId c)

void tliAction(String am, int ts, String src, int line, TriComponentId c, String action)

void tliMatch
    (String am, int ts, String src, int line, TriComponentId c, Value expr, TciValueTemplate tpl)
void tliMatchMismatch
    (String am, int ts, String src, int line, TriComponentId c, Value expr, TciValueTemplate tpl,
    TciValueDifferenceList diffs);

void tliInfo
    (String am, int ts, String src, int line, TriComponentId c, int level, String info)

```

9.5 Data

TCI IDL ADT	ANSI C representation (Type definition)	Notes and comments
TciModuleIdType	QualifiedName	
TciModuleParameterType	typedef struct TciModuleParameterType { String parName; Value defaultValue; } TciModuleParameterType;	
TciModuleParameterListType	typedef struct TciModuleParameterListType { long int length; TciModuleParameterType *modParList; } TciModuleParameterListType;	
TciParameterType	typedef struct TciParameterType { String parName; TciParameterPassingModeType parPassMode; Value parValue; } TciParameterType;	
TciParameterPassingModeType	typedef enum { TCI_IN_PAR = 0, TCI_INOUT_PAR = 1, TCI_OUT_PAR = 2 } TciParameterPassingModeType;	
TciParameterListType	typedef struct TciParameterListType { long int length; TciParameterType *parList; } TciParameterListType;	length 0 shall be interpreted as "empty list".
TciParameterTypeListType	typedef struct TciParameterTypeListType { long int length; TciParameterTypeType *parList; } TciParameterTypeListType;	length 0 shall be interpreted as "empty list".
TciParameterTypeType	typedef struct TciParameterTypeType { Type parameterType; TciParameterPassingModeType mode; } TciParameterTypeType;	
TciTestCaseldListType	typedef struct TciTestCaseIdListType { long int length; QualifiedName *idList; } TciTestCaseIdListType;	length 0 shall be interpreted as "empty list".
TciTypeClassType	typedef enum { TCI_ADDRESS_TYPE = 0, TCI_ANYTYPE_TYPE = 1, TCI_BITSTRING_TYPE = 2, TCI_BOOLEAN_TYPE = 3, TCI_CHARSTRING_TYPE = 5, TCI_COMPONENT_TYPE = 6, TCI_ENUMERATED_TYPE = 7, TCI_FLOAT_TYPE = 8, TCI_HEXSTRING_TYPE = 9, TCI_INTEGER_TYPE = 10, TCI_OCTETSTRING_TYPE = 12, TCI_RECORD_TYPE = 13, TCI_RECORD_OF_TYPE = 14, TCI_ARRAY_TYPE = 15, TCI_SET_TYPE = 16, TCI_SET_OF_TYPE = 17, TCI_UNION_TYPE = 18, TCI_UNIVERSAL_CHARSTRING_TYPE = 20, TCI_VERDICT_TYPE = 21 } TciTypeClassType;	

TCI IDL ADT	ANSI C representation (Type definition)	Notes and comments
TciTestComponentKindType	<pre>typedef enum { TCI_CTRL_COMP, TCI_MTC_COMP, TCI_PTC_COMP, TCI_SYS_COMP, TCI_ALIVE_COMP } TciTestComponentKindType;</pre>	
TciBehaviourIdType	QualifiedName	
TciValueDifference	<pre>typedef struct TciValueDifference { Value val; TciValueTemplate tmpl; String desc; } TciValueDifference;</pre>	
TciValueDifferenceList	<pre>typedef struct TciValueDifferenceList { long int length; TciValueDifference* diffList; } TciValueDifferenceList;</pre>	length 0 shall be interpreted as "empty list".

9.6 Miscellaneous

TCI concept	ANSI C representation	Notes and comments
Verdict representation		
NONE	const int TCI_VERDICT_NONE = 0	Since the VerdictValue interface is defined in terms of integers, consensus must be established on which value defines which verdict.
PASS	const int TCI_VERDICT_PASS = 1	
INCONC	const int TCI_VERDICT_INCONC = 2	
FAIL	const int TCI_VERDICT_FAIL = 3	
ERROR	const int TCI_VERDICT_ERROR = 4	
USER_ERROR	const int TCI_VERDICT_USER_ERROR = 5	
ComponentStatus		
INACTIVE_C	const int TCI_INACTIVE_C = 0	
RUNNING_C	const int TCI_RUNNING_C = 1	
STOPPED_C	const int TCI_STOPPED_C = 2	
KILLED_C	const int TCI_KILLED_C = 3	
NULL_C	const int TCI_NULL_C = 4	
TimerStatus		
RUNNING_T	const int TCI_RUNNING_T = 0	
INACTIVE_T	const int TCI_INACTIVE_T = 1	
EXPIRED_T	const int TCI_EXPIRED_T = 2	
NULL_T	const int TCI_NULL_T = 3	
TciStatus		
TCI_OK	const int TCI_OK = 0	
TCI_ERROR	const int TCI_ERROR = -1	
CharstringValue representation		
TciCharString	<pre>typedef struct TciCharStringValue { unsigned long int length; char* string; } TciCharStringValue</pre>	
Universal Character[string] representation		
Universal Char	typedef unsigned char TciUCValue[4]	
Universal Charstring	<pre>typedef struct TciUCStringValue { unsigned long int length; TciUCValue *string; } TciUCStringValue;</pre>	

9.7 Optional parameters

Clause 7.4 defines that a reserved value shall be used to indicate the absence of an optional parameter. For the C language mapping an explicit null shall be used. The function `tciSetNull` can be used to set a value to null and `tciIsNull` can be used to check whether a value represents null. `tciIsNull` returns true if the value is null, false otherwise.

For example, if in the `tciReplyConnected` operation the value parameter shall be omitted, then a value `reply` shall be created and set to null; the operation invocation shall be:

```
tciSetNull(reply);
tciReplyConnected (sender, receiver, signature, parameterList, reply).
```

10 C++ language mapping

10.1 Introduction

This clause introduces the TCI C++ language [9] mapping for the definitions given in clause 7.

10.2 Names and scopes

The namespace `ORG_ETSI_TTCN3_TCI` has been defined for the TCI C++ mapping, in order to avoid conflicts with the different names used, for example, in the C mapping.

C++ class identifiers are omitting the trailing "Type" at the end of the abstract definitions, e.g. the type `TciModuleIdType` is mapped to `TciModuleId` in C++.

10.3 Memory management

A general policy for memory management is not defined in this mapping. However, parameters are passed as pointers (or references) where possible, and a clone method has been added to the definition of every interface. The clone method can be used by the receiving entity to make a local copy where needed.

10.4 Error handling

No additional error handling has been defined for this mapping.

10.5 Type mapping

This clause introduces the TRI C++ language mapping for the abstract types defined in clause 7.2. The following concepts have been used:

- Pure virtual classes have been used following the concept of an interface.
- C++ types have been encapsulated under abstract definitions like `Tfloat` or `Tinteger`.

10.5.1 Encapsulated C++ types

The following types have been defined in order to keep the definitions of data types and operations as general as possible:

Boolean type definition:	<code>typedef bool Tboolean</code>
Integer type definition:	<code>typedef long int Tinteger</code>
Size type definition:	<code>typedef unsigned long int Tsize</code>
Index type definition	<code>typedef unsigned long int Tindex</code>

Float type definition: typedef double Tfloat
String type definition: typedef std::string Tstring
Universal string type definition: typedef std::wstring TuniversalString
Bit type definition: typedef unsigned char Tbit
Char type definition: typedef unsigned char Tchar

10.5.2 General abstract data types

10.5.2.1 TciBehaviourId

Identifies a TTCN-3 behaviour functions. It is mapped to the following pure virtual class:

```
class TciBehaviourId: ORG_ETSI_TTCN3_TRI::QualifiedName {
public:
    virtual ~TciBehaviourId ();
    virtual Tboolean operator== (const TciBehaviourId &bid) const =0;
    virtual TciBehaviourId * clone () const =0;
    virtual Tboolean operator< (const TciBehaviourId &bid) const =0;
}
```

10.5.2.1.1 Methods

~TciBehaviourId
Destructor
operator==
Returns true if both objects are equal
clone
Return a copy of the TciBehaviourId
operator<
Operator < overload

10.5.2.2 TciModuleId

A value of TciModuleId specifies the name of a TTCN-3 module. It is mapped to the following pure virtual class:

```
class TciModuleId {
public:
    virtual ~TciModuleId ()
    virtual const Tstring & getObjectname() const = 0;
    virtual void setObjectname (const Tstring &p_name)=0;
    virtual Tboolean operator== (const TciModuleId &mid) const =0;
    virtual TciModuleId * clone () const =0;
    virtual Tboolean operator< (const TciModuleId &mid) const =0;
}
```

10.5.2.2.1 Methods

~TciModuleId
Destructor
getObjectname
Get the moduleId name
setObjectName
Set the moduleId name
operator==
Returns true if both objects are equal
clone
Return a copy of the TciModuleId
operator<
Operator < overload

10.5.2.3 TciModuleParameterId

A value of TciModuleParameterId specifies the name of a TTCN-3 module parameter as defined in the TTCN-3 module. It is mapped to the following pure virtual class:

```
class TciModuleParameterId : ORG_ETSI_TTCN3_TRI::QualifiedName {
public:
    virtual ~TciModuleParameterId ();
    virtual Tboolean operator== (const TciModuleParameterId &mparId) const =0;
    virtual TciModuleParameterId * clone () const =0;
    virtual Tboolean operator< (const TciModuleParameterId &mparId) const =0;
}
```

10.5.2.3.1 Methods

```
~TciModuleParameterId
    Destructor
operator==
    Returns true if both objects are equal
clone
    Return a copy of the TciModuleParameterId
operator<
    Operator < overload
```

10.5.2.4 TciTestCaseId

A value of TciModuleParameterId specifies the name of a TTCN-3 testcase as defined in the TTCN-3 module. It is mapped to the following pure virtual class:

```
class TciTestCaseId : TciBehaviourId {
public:
    virtual ~TciTestCaseId();
    virtual Tboolean operator== (const TciTestCaseId &tcid) const =0;
    virtual TciTestCaseId * clone () const =0;
    virtual Tboolean operator< (const TciTestCaseId &tcid) const =0;
}
```

10.5.2.4.1 Methods

```
~TciTestCaseId
    Destructor
operator==
    Returns true if both objects are equal
clone
    Return a copy of the TciTestCaseId
operator<
    Operator < overload
```

10.5.2.5 TciModuleIdList

A value of TciModuleIdList defines a list of TciModuleId elements. It is mapped to the following pure virtual class:

```
class TciModuleIdList {
public:
    virtual ~TciModuleIdList();
    virtual Tsize size () const =0;
    virtual Tboolean empty () const =0;
    virtual const TciModuleId *get (Tsize p_index) const =0;
    virtual void clear ()=0;
    virtual void push_back (const TciModuleId &comp)=0;
    virtual Tboolean operator== (const TciModuleIdList &midList) const =0;
    virtual TciModuleIdList * clone () const =0;
    virtual Tboolean operator< (const TciModuleIdList &midList) const =0;
}
```

10.5.2.5.1 Methods

```

~TciModuleIdList
    Destructor
size
    Return the size of the list
empty
    Return true if the list is empty
get
    Return the requested element
clear
    Remove all the components from this list
push_back
    Add a component to the end of this list
operator==
    Returns true if both objects are equal
clone
    Return a copy of the TciModuleId
operator<
    Operator < overload

```

10.5.2.6 TciModuleParameter

This abstract type is used to represent the parameter name and the default value of a module parameter. It is mapped to the following pure virtual class:

```

class TciModuleParameter {
public:
    virtual ~TciModuleParameter ();
    virtual const TciValue & getDefaultValue () const =0;
    virtual const Tstring & getModuleParameterName () const =0;
    virtual const TciModuleParameterId & getTciModuleParameterId () const =0;
    virtual Tboolean operator== (const TciModuleParameter &mpar) const =0;
    virtual TciModuleParameter * clone () const =0;
    virtual Tboolean operator< (const TciModuleParameter &mpar) const =0;
}

```

10.5.2.6.1 Methods

```

~TciModuleParameter
    Destructor
getDefaultValue
    Return default value of the parameter
getModuleParameterName
    Return parameter name
getTciModuleParameterId
    Get the name of the module parameter as defined in the TTCN-3 module
operator==
    Returns true if both objects are equal
clone
    Return a copy of the TciModuleParameter
operator<
    Operator < overload

```

10.5.2.7 TciModuleParameterList

A value of TciModuleParameterList is a list of TciModuleParameter elements. It is mapped to the following pure virtual class:

```

class TciModuleParameterList {
public:
    virtual ~TciModuleParameterList ();
    virtual Tsize size () const =0;
    virtual Tboolean empty () const =0;
    virtual const TciModuleParameter *get (Tindex p_index) const =0;
    virtual void clear ()=0;
    virtual void push_back (const TciModuleParameter &comp)=0;
    virtual Tboolean operator== (const TciModuleParameterList &mparList) const =0;
    virtual TciModuleParameterList * clone () const =0;
}

```

```

    virtual Tboolean operator< (const TciModuleParameterList &mparList) const =0;
}

```

10.5.2.7.1 Methods

```

~TciModuleParameterList
    Destructor
size
    Return the size of the list
empty
    Return true if the list is empty
get
    Retrieve the specified element
clear
    Remove all components from this list
push_back
    Add a component to the end of this list
operator==
    Returns true if both objects are equal
clone
    Return a copy of the TciModuleParameterList
operator<
    Operator < overload

```

10.5.2.8 TciParameterPassingMode

Defines the parameter passing mode. It is mapped to an enumeration:

```

typedef enum
{
    IN = 0,
    OUT = 1,
    INOUT = 2
} TciParameterPassingMode;

```

10.5.2.9 TciParameter

Includes a TTCN-3 Value and a TciParameterPassingMode. It is mapped to the following pure virtual class:

```

class TciParameter {
public:
    virtual ~TciParameter ();
    virtual const TciValue & getValue () const =0;
    virtual void setValue (TciValue &value)=0;
    virtual const TciParameterPassingMode &getParameterPassingMode () const =0;
    virtual void setParameterPassingMode (const TciParameterPassingMode &mode)=0;
    virtual const Tstring & getParameterName () const =0;
    virtual void setParameterName (const Tstring &name)=0;
    virtual Tboolean operator== (const TciParameter &param) const =0;
    virtual TciParameter * clone () const =0;
    virtual Tboolean operator< (const TciParameter &param) const =0;
}

```

10.5.2.9.1 Methods

```

~TciParameter
    Destructor
getValue
    Retrieve the TTCN-3 value
setValue
    Set the TTCN-3 value
getParameterPassingMode
    Return the parameter passing mode
setParameterPassingMode
    Set the parameter passing mode
getParameterName
    Return the name of the parameter
setParameterName
    Set the name of the parameter

```

```

operator==
    Returns true if both objects are equal
clone
    Return a copy of the TciParameter
operator<
    Operator < overload

```

10.5.2.10 TciParameterList

Defines a list of TciParameter elements. It is mapped to the following pure virtual class:

```

class TciParameterList {
public:
    virtual ~TciParameterList ();
    virtual Tsize size () const =0;
    virtual Tboolean empty () const =0;
    virtual const TciParameter *get (Tindex p_index) const =0;
    virtual void clear ()=0;
    virtual void push_back (const TciParameter &comp)=0;
    virtual Tboolean operator== (const TciParameterList &param) const =0;
    virtual TciParameterList * clone () const =0;
    virtual Tboolean operator< (const TciParameterList &param) const =0;
}

```

10.5.2.10.1 Methods

```

~TciParameterList
    Destructor
size
    Return the size of the list
empty
    Return true if the list is empty
get
    Get the specified element
clear
    Remove all the components from this list
push_back
    Add a component to the end of this list
operator==
    Returns true if both objects are equal
clone
    Return a copy of the TciParameterList
operator<
    Operator < overload

```

10.5.2.11 TciParameterType

Includes a TTCN-3 Type and a TciParameterPassingMode. It is mapped to the following pure virtual class:

```

class TciParameterType {
public:
    virtual ~TciParameterType ();
    virtual const TciType &getType () const =0;
    virtual const TciParameterPassingMode &getParameterPassingMode () const =0;
    virtual Tboolean operator== (const TciParameterType &parType) const =0;
    virtual TciParameterType * clone () const =0;
    virtual Tboolean operator< (const TciParameterType &parType) const =0;
}

```

10.5.2.11.1 Methods

```

~TciParameterType
    Destructor
getType
    Return the TTCN-3 Type
getParameterPassingMode
    Get the parameter passing mode
operator==
    Returns true if both objects are equal

```

```

clone
    Return a copy of the TciParameterType
operator<
    Operator < overload

```

10.5.2.12 TciParameterTypeList

Specifies a list of TciParameterType elements. It is mapped to the following pure virtual class:

```

class TciParameterTypeList {
public:
    virtual ~TciParameterTypeList ();
    virtual Tsize size () const =0;
    virtual Tboolean empty () const =0;
    virtual const TciParameterType *get (Tindex p_position) const =0;
    virtual void clear ()=0;
    virtual void push_back (const TciParameterType &comp)=0;
    virtual Tboolean operator== (const TciParameterTypeList &ptypeList) const =0;
    virtual TciParameterTypeList * clone () const =0;
    virtual Tboolean operator< (const TciParameterTypeList &ptypeList) const =0;
}

```

10.5.2.12.1 Methods

```

~TciParameterTypeList
    Destructor
size
    Return the size of the list
empty
    Returns true if the list is empty
get
    Return the requested element
clear
    Remove all the components from this list
push_back
    Add a component to the end of this list
operator==
    Returns true if both objects are equal
clone ()
    Returns a copy of the TciParameterTypeList
operator< (const TciParameterTypeList &ptypeList)
    Operator < overload

```

10.5.2.13 TciTestComponentKind

Defines the test component kind. It is mapped to an enumeration:

```

typedef enum
{
    SYSTEM_COMP = 0,
    PTC_COMP = 1,
    PTC_ALIVE_COMP = 2,
    MTC_COMP = 3,
    CTRL_COMP = 4
} TciTestComponentKind;

```

10.5.2.14 TciTypeClass

Defines the type class. It is mapped to an enumeration:

```

typedef enum
{
    TCI_ADDRESS = 0,
    TCI_ANYTYPE = 1,
    TCI_BITSTRING = 2,
    TCI_BOOLEAN = 3,
    TCI_CHARSTRING = 5,
    TCI_COMPONENT = 6,
    TCI_ENUMERATED = 7,
    TCI_FLOAT = 8,

```

```

TCI_HEXSTRING = 9,
TCI_INTEGER = 10,
TCI_OCTETSTRING = 12,
TCI_RECORD = 13,
TCI_RECORD_OF = 14,
TCI_ARRAY = 15,
TCI_SET = 16,
TCI_SET_OF = 17,
TCI_UNION = 18,
TCI_UNIVERSAL_CHARSTRING = 20,
TCI_VERDICT = 21
} TciTypeClass;

```

10.5.2.15 TciTestCaseIdList

Specifies a list of TciTestCaseId elements. It is mapped to the following pure virtual class:

```

class TciTestCaseIdList {
public:
    virtual ~TciTestCaseIdList ();
    virtual Tsize size () const =0;
    virtual Tboolean empty () const =0;
    virtual const TciTestCaseId *get (Tindex p_position) const =0;
    virtual void clear ()=0;
    virtual void push_back (const TciTestCaseId &comp)=0;
    virtual Tboolean operator== (const TciTestCaseIdList &ptypeList) const =0;
    virtual TciTestCaseIdList * clone () const =0;
    virtual Tboolean operator< (const TciTestCaseIdList &ptypeList) const =0;
}

```

10.5.2.15.1 Methods

```

~TciTestCaseIdList
    Destructor
size
    Return the size of the list
empty
    Returns true if the list is empty
get
    Return the requested element
clear
    Remove all the components from this list
push_back
    Add a component to the end of this list
operator==
    Returns true if both objects are equal
clone ()
    Returns a copy of the TciTestCaseIdList
operator< (const TciTestCaseIdList &ptypeList)
    Operator < overload

```

10.5.3 Abstract TTCN-3 data types and values

10.5.3.1 TciType

A value of TciType represents one of the TTCN-3 types in a TTCN-3 module. It is mapped to the following pure virtual class:

```

class TciType {
public:
    virtual ~TciType ();
    virtual const TciModuleId & getDefiningModule () const =0;
    virtual const Tstring & getName () const =0;
    virtual const TciTypeClass & getTypeClass () const =0;
    virtual const Tstring & getTypeEncoding () const =0;
    virtual const Tstring & getTypeEncodingVariant () const =0;
    virtual const std::vector<Tstring*> & getTypeExtension() const =0;
    virtual TciValue * newInstance () const =0;
    virtual Tboolean operator== (const TciType &typ) const =0;
    virtual TciType * clone () const =0;

```

```

    virtual Tboolean operator< (const TciType &typ) const =0;
}

```

10.5.3.1.1 Methods

```

~TciType
    Destructor
getDefiningModule
    Return the defining module as defined in the TTCN-3 module
getName
    Return type name as defined in the TTCN-3 module
getTypeClass
    Return this type class
getTypeEncoding
    Return type encoding as defined in the TTCN-3 module
getTypeEncodingVariant
    Return encoding variant as defined in the TTCN-3 module
getTypeExtension
    Return type extension as defined in the TTCN-3 module
newInstance
    Return a new Value instance of this type
operator==
    Return true if the types are equal
clone
    Return a copy of the TciType
operator<
    Operator < overload

```

10.5.3.2 TciValue

A value of TciValue represents TTCN-3 values for a given type. It is mapped to the following pure virtual class:

```

class TciValue {
public:
    virtual ~TciValue ();
    virtual const TciType & getType () const =0;
    virtual const Tstring & getValueEncoding () const =0;
    virtual const Tstring & getValueEncodingVariant () const =0;
    virtual Tboolean notPresent () const =0;
    virtual Tboolean operator== (const TciValue &val) const =0;
    virtual TciValue * clone () const =0;
    virtual Tboolean operator< (const TciValue &val) const =0;
}

```

10.5.3.2.1 Methods

```

~TciValue
    Destructor
getType
    Returns the type of the specified value
getValueEncoding
    Returns the value encoding attribute as defined in the TTCN-3 module
getValueEncodingVariant
    Returns the value encoding variant attribute as defined in the TTCN-3 module
notPresent
    Returns true if the specified value is omit
operator==
    Returns true if both objects are equal
clone
    Return a copy of the TciValue
operator<
    Operator < overload

```

10.5.3.3 IntegerValue

TTCN-3 integer value support. It is mapped to the following pure virtual class:

```
class IntegerValue : public virtual TciValue {
public:
    virtual ~IntegerValue ();
    virtual Tinteger getInt () const =0;
    virtual void setInt (Tinteger p_value)=0;
    virtual Tboolean operator== (const IntegerValue &intVal) const =0;
    virtual IntegerValue * clone () const =0;
    virtual Tboolean operator< (const IntegerValue &intVal) const =0;
}
```

10.5.3.3.1 Methods

```
~IntegerValue
    Destructor
getInt
    Return integer value
setInt
    Set integer value
operator==
    Returns true if both objects are equal
clone
    Return a copy of the IntegerValue
operator<
    Operator < overload
```

10.5.3.4 FloatValue

TTCN-3 float value support. It is mapped to the following pure virtual class:

```
class FloatValue : public virtual TciValue {
public:
    virtual ~FloatValue ();
    virtual Tfloat getFloat () const =0;
    virtual void setFloat (Tfloat p_floatValue)=0;
    virtual Tboolean operator== (const FloatValue &floatVal) const =0;
    virtual FloatValue * clone () const =0;
    virtual Tboolean operator< (const FloatValue &floatVal) const =0;
}
```

10.5.3.4.1 Methods

```
~FloatValue
    Destructor
getFloat
    Return the float value
setFloat
    Set float value
operator==
    Returns true if both objects are equal
clone
    Return a copy of the FloatValue
operator<
    Operator < overload
```

10.5.3.5 BooleanValue

TTCN-3 boolean values support. It is mapped to the following pure virtual class:

```
class BooleanValue : public virtual TciValue {
public:
    virtual ~BooleanValue ();
    virtual Tboolean getBoolean () const =0;
    virtual void setBoolean (Tboolean p_booleanValue)=0;
    virtual Tboolean operator== (const BooleanValue &booleanVal) const =0;
```

```

virtual BooleanValue * clone () const =0;
virtual Tboolean operator< (const BooleanValue &booleanVal) const =0;
}

```

10.5.3.5.1 Methods

```

~BooleanValue
    Destructor
getBoolean
    Return the boolean value
setBoolean
    Set the variable to booleanValue
operator==
    Returns true if both objects are equal
clone
    Return a copy of the BooleanValue
operator<
    Operator < overload

```

10.5.3.6 CharstringValue

TTCN-3 charstring value support. It is mapped to the following pure virtual class:

```

class CharstringValue : public virtual TciValue {
public:
    virtual ~CharstringValue ();
    virtual char getChar (Tindex p_position) const =0;
    virtual Tsize getLength () const =0;
    virtual const Tstring & getString () const =0;
    virtual void setChar (Tsize p_position, char p_char)=0;
    virtual void setLength (Tsize p_length)=0;
    virtual void setString (const Tstring &p_charValue)=0;
    virtual Tboolean operator== (const CharstringValue &charStr) const =0;
    virtual CharstringValue * clone () const =0;
    virtual Tboolean operator< (const CharstringValue &charStr) const =0;
}

```

10.5.3.6.1 Methods

```

~CharstringValue
    Destructor
getChar
    Return the char at the specified position
getLength
    Return length of the string
getString
    Return the value of the string
setChar
    Set the char at the specified position
setLength
    Set length of the string
setString
    Set the value of the string
operator==
    Returns true if both objects are equal
clone
    Return a copy of the CharstringValue
operator<
    Operator < overload

```

10.5.3.7 UniversalCharstringValue

TTCN-3 universal charstring value support. It is mapped to the following pure virtual class:

```

class UniversalCharstringValue : public virtual TciValue {
public:
    virtual ~UniversalCharstringValue ();
    virtual wchar_t getChar (Tindex p_position) const =0;
    virtual Tsize getLength () const =0;
}

```



```

virtual const TuniversalString & getString () const =0;
virtual void setChar (Tindex p_position, const wchar_t p_ucValue)=0;
virtual void setLength (Tsize p_length)=0;
virtual void setString (const TuniversalString &p_ucsValue)=0;
virtual Tboolean operator== (const UniversalCharstringValue &uniCharstr) const =0;
virtual UniversalCharstringValue * clone () const =0;
virtual Tboolean operator< (const UniversalCharstringValue &uniCharstr) const =0;
}

```

10.5.3.7.1 Methods

```

~UniversalCharstringValue
  Destructor
getChar
  Return the requested element
getLength
  Return the length of the universal charstring
getString
  Return the textual representation of the string
setChar
  Set the char at the specified position
setLength
  Set the length of the string
setString
  Set the value of the string
operator==
  Returns true if both objects are equal
clone
  Return a copy of the UniversalCharstringValue
operator<
  Operator < overload

```

10.5.3.8 BitstringValue

TTCN-3 bitstring value support. It is mapped to the following pure virtual class:

```

class BitstringValue : public virtual TciValue {
public:
  virtual ~BitstringValue ();
  virtual Tbit getBit (Tindex p_position) const =0;
  virtual Tsize getLength () const =0;
  virtual const Tstring & getString () const =0;
  virtual void setBit (Tindex p_position, Tbit p_bsValue)=0;
  virtual void setLength (Tindex p_new_length)=0;
  virtual void setString (const Tstring &p_bsValue)=0;
  virtual Tboolean operator== (const BitstringValue &bitStr) const =0;
  virtual BitstringValue * clone () const =0;
  virtual Tboolean operator< (const BitstringValue &bitStr) const =0;
}

```

10.5.3.8.1 Methods

```

~BitstringValue
  Destructor
getBit
  Returns the bit at the specified position
getLength
  Returns the length of the string
getString
  Set the value of the string
setBit
  Set the bit value at the specified position
setLength
  Set the length of the string
setString
  Set the string value
operator==
  Returns true if both objects are equal
clone
  Return a copy of the BitstringValue

```

```
operator<
    Operator < overload
```

10.5.3.9 OctetstringValue

TTCN-3 octetstring value support. It is mapped to the following pure virtual class:

```
class OctetstringValue : public virtual TciValue {
public:
    virtual ~OctetstringValue ();
    virtual Tsize getLength () const =0;
    virtual const Tchar getOctet (Tindex p_position) const =0;
    virtual const Tstring & getString () const =0;
    virtual void setLength (Tsize p_length)=0;
    virtual void setOctet (Tindex p_position, Tchar p_ochar)=0;
    virtual void setString (const Tstring &p_osValue)=0;
    virtual Tboolean operator== (const OctetstringValue &octStr) const =0;
    virtual OctetstringValue * clone () const =0;
    virtual Tboolean operator< (const OctetstringValue &octStr) const =0;
}
```

10.5.3.9.1 Methods

```
~OctetstringValue
    Destructor
getLength
    Return the length of the string
getOctet
    Return the textual representation of the octetchar at the specified position
getString
    Set the string value
setLength
    Set the length of the string
setOctet
    Set the char at specified position
setString
    Set the value of the string
operator==
    Returns true if both objects are equal
clone
    Return a copy of the OctetstringValue
operator<
    Operator < overload
```

10.5.3.10 HexstringValue

TTCN-3 hexstring value support. It is mapped to the following pure virtual class:

```
class HexstringValue : public virtual TciValue {
public:
    virtual ~HexstringValue ();
    virtual Tchar getHex (Tindex p_position) const =0;
    virtual Tsize getLength () const =0;
    virtual const Tstring & getString () const =0;
    virtual void setHex (Tindex p_position, Tchar p_hcValue)=0;
    virtual void setLength (Tsize p_length)=0;
    virtual void setString (const Tstring &p_hsValue)=0;
    virtual Tboolean operator== (const HexstringValue &hexStr) const =0;
    virtual HexstringValue * clone () const =0;
    virtual Tboolean operator< (const HexstringValue &hexStr) const =0;
}
```

10.5.3.10.1 Methods

```
~HexstringValue
    Destructor
getHex
    Return the element at the specified position
getLength
    Return the length of the string
```

```

getString
    Return the string value
setHex
    Set the hex value at the specified position
setLength
    Set the length of the string
setString
    Set the value of the string
operator==
    Returns true if both objects are equal
clone
    Return a copy of the HexstringValue
operator<
    Operator < overload

```

10.5.3.11 RecordValue

TTCN-3 record value support. It is mapped to the following pure virtual class:

```

class RecordValue : public virtual TciValue {
public:
    virtual ~RecordValue ();
    virtual const TciValue &getField (const Tstring &p_field_name) const =0;
    virtual void setField (const Tstring &p_field_name, const TciValue &p_new_value)=0;
    virtual const std::vector< Tstring *> &getFieldNames () const =0;
    virtual void setFieldOmitted (const Tstring &fieldName)=0;
    virtual Tboolean operator== (const RecordValue &rec) const =0;
    virtual RecordValue * clone () const =0;
    virtual Tboolean operator< (const RecordValue &rec) const =0;
}

```

10.5.3.11.1 Methods

```

~RecordValue
    Destructor
getField
    Return a reference to the field name
setField
    Set the value of a field
getFieldNames
    Return a list which containing the names of all the fields
setFieldOmitted
    Set omit in one field
operator==
    Returns true if both objects are equal
clone
    Return a copy of the RecordValue
operator<
    Operator < overload

```

10.5.3.12 RecordOfValue

TTCN-3 record of value support. It is mapped to the following pure virtual class:

```

class RecordOfValue : public virtual TciValue {
public:
    virtual ~RecordOfValue ();
    virtual const TciValue & getField (Tindex p_position)=0;
    virtual void setField (Tindex p_position, const TciValue &p_value)=0;
    virtual void appendField (const TciValue &p_value)=0;
    virtual const TciType & getElementType () const =0;
    virtual Tsize getLength () const =0;
    virtual void setLength (Tsize p_length)=0;
    virtual Tindex getOffset() const =0;
    virtual Tboolean operator== (const RecordOfValue &recOf) const =0;
    virtual RecordOfValue * clone () const =0;
    virtual Tboolean operator< (const RecordOfValue &recOf) const =0;
}

```

10.5.3.12.1 Methods

~RecordOfValue
Destructor
 getField
 Return the field at the specified position
 setField
 Set the value at the specified position
 appendField
 Add a value at the end of the record of
 getElementType
 Return the type of the elements of this record of
 getLength
 Return the length of the object
 setLength
 Set length of the record of
 getOffset
 For arrays, return the lower index bound used in the type definition of arrays. Return 0 for record of
 and set of
 operator==
 Returns true if both objects are equal
 clone
 Return a copy of the RecordOfValue
 operator<
 Operator < overload

10.5.3.13 UnionValue

TTCN-3 union value support. It is mapped to the following pure virtual class:

```
class UnionValue : public virtual TciValue {
public:
    virtual ~UnionValue ()
    virtual void setVariant (const Tstring &p_variantName, const TciValue &p_value)=0;
    virtual const TciValue & getVariant (const Tstring &p_variantName) const =0;
    virtual const Tstring & getPresentVariantName () const =0;
    virtual const std::set< Tstring *> & getVariantNames () const =0;
    virtual Tboolean operator== (const UnionValue &unionVal) const =0;
    virtual UnionValue * clone () const =0;
    virtual Tboolean operator< (const UnionValue &unionVal) const =0;
}
```

10.5.3.13.1 Methods

~UnionValue
Destructor
 setVariant
 Set the variant name to a value
 getVariant
 Return the value of the variant if exists
 getPresentVariantName
 Return the name of the current variant value. null if no initialized
 getVariantNames
 Return a list which contains the variant names as defined in the TTCN-3 module
 operator==
 Returns true if both objects are equal
 clone
 Return a copy of the UnionValue
 operator<
 Operator < overload

10.5.3.14 EnumeratedValue

TTCN-3 enumerated value support. It is mapped to the following pure virtual class:

```
class EnumeratedValue : public virtual TciValue {
public:
    virtual ~EnumeratedValue ();
    virtual const Tstring & getEnum () const =0;
```

```

virtual void setEnum (const Tstring &p_value)=0;
virtual Tinteger getInt() const =0;
virtual void setInt(Tinteger p_int);
virtual Tboolean operator== (const EnumeratedValue &enumVal) const =0;
virtual EnumeratedValue * clone () const =0;
virtual Tboolean operator< (const EnumeratedValue &enumVal) const =0;
}

```

10.5.3.14.1 Methods

```

~EnumeratedValue
    Destructor
getNum
    Return current value
setEnum
    Set the enumeration value
getInt
    Return current integer value
setInt
    Set the integer value
operator==
    Returns true if both objects are equal
clone
    Return a copy of the EnumeratedValue
operator<
    Operator < overload

```

10.5.3.15 VerdictValue

TTCN-3 verdict value support. It is mapped to the following pure virtual class:

```

class VerdictValue : public virtual TciValue {
public:
    virtual ~VerdictValue ();
    virtual const VerdictValueEnum & getVerdict () const =0;
    virtual void setVerdict (const VerdictValueEnum & p_enum)=0;
    virtual Tboolean operator== (const VerdictValue &verdictVal) const =0;
    virtual VerdictValue * clone () const =0;
    virtual Tboolean operator< (const VerdictValue &verdictVal) const =0;
}

```

10.5.3.15.1 Methods

```

~VerdictValue
    Destructor
getVerdict
    Return the value of the verdict
setVerdict
    Set the value of the verdict
operator==
    Returns true if both objects are equal
clone
    Return a copy of the VerdictValue
operator<
    Operator < overload

```

10.5.3.16 VerdictValueEnum

Defines verdict values as an enumeration:

```

typedef enum
{
    NONE = 0,
    PASS = 1,
    FAIL = 2,
    INCONC = 3,
    ERROR = 4,
    USER_ERROR = 5
} VerdictValueEnum;

```

10.5.3.17 AddressValue

TTCN-3 address value support. It is mapped to the following pure virtual class:

```
class AddressValue {
public:
    virtual ~AddressValue ();
    virtual const TciValue & getAddress () const =0;
    virtual void setAddress ( const TciValue& T)=0;
    virtual Tboolean operator== (const AddressValue &addr) const =0;
    virtual AddressValue * cloneAddressValue () const =0;
    virtual Tboolean operator< (const AddressValue &addr) const =0;
}
```

10.5.3.17.1 Methods

```
~AddressValue
    Destructor
getAddress
    Return the value of the address
setAddress
    Set the value of the address
operator==
    Returns true if both objects are equal
clone
    Return a copy of the AddressValue
operator<
    Operator < overload
```

10.5.4 Abstract logging types

10.5.4.1 TciValueTemplate

Interface that defines the concrete operations of the TTCN-3 template. It is mapped to the following pure virtual class:

```
class TciValueTemplate {
public:
    virtual ~TciValueTemplate ();
    virtual Tboolean isOmit () const =0;
    virtual Tboolean isAny () const =0;
    virtual Tboolean isAnyOrOmit () const =0;
    virtual const Tstring & getTemplateDef () const =0;
    virtual Tboolean operator== (const TciValueTemplate &vtmpl) const =0;
    virtual TciValueTemplate * clone () const =0;
    virtual Tboolean operator< (const TciValueTemplate &vtmpl) const =0;
}
```

10.5.4.1.1 Methods

```
~TciValueTemplate ()
    Destructor
isOmit ()
    Return true if value of template is omit
isAny ()
    Return true if value of template is any
isAnyOrOmit ()
    Return true value of template if any or omit
getTemplateDef ()
    Return the template definition as defined in the TTCN-3 module
operator== (const TciValueTemplate &vtmpl)
    Returns true if both objects are equal
clone ()
    Return a copy of the TciValueTemplate
operator< (const TciValueTemplate &vtmpl)
    Operator < overload
```

10.5.4.2 TciNonValueTemplate

Support *all* and *any* matching mechanisms over TTCN-3 components and timers. It is mapped to the following pure virtual class:

```
class TciNonValueTemplate {
public:
    virtual ~TciNonValueTemplate ();
    virtual Tboolean isAny () const =0;
    virtual Tboolean isAll () const =0;
    virtual const Tstring & getTemplateDef () const =0;
    virtual Tboolean operator== (const TciNonValueTemplate &nvtempl) const =0;
    virtual TciNonValueTemplate * clone () const =0;
    virtual Tboolean operator< (const TciNonValueTemplate &nvtempl) const =0;
}
```

10.5.4.2.1 Methods

```
~TciNonValueTemplate ()
    Destructor
isAny ()
    Return true if value is any
isAll ()
    Return true if is value all
getTemplateDef ()
    Return template definition as defined in the TTCN-3 module
operator== (const TciNonValueTemplate &nvtempl)
    Returns true if both objects are equal
clone ()
    Return a copy of the TciNonValueTemplate
operator< (const TciNonValueTemplate &nvtempl)
    Operator < overload
```

10.5.4.3 TciValueList

A list of TciValues. It is mapped to the following pure virtual class:

```
class TciValueList {
public:
    virtual ~TciValueList (void);
    virtual Tsize size () const =0;
    virtual Tboolean empty () const =0;
    virtual const TciValue *get (Tindex index) const =0;
    virtual void clear ()=0;
    virtual void add (const TciValue &comp)=0;
    virtual Tboolean operator== (const TciValueList &valList) const =0;
    virtual TciValueList * clone () const =0;
    virtual Tboolean operator< (const TciValueList &valList) const =0;
}
```

10.5.4.3.1 Methods

```
~TciValueList ()
    Destructor
size ()
    Return the size of the list
empty ()
    Return true if the list is empty
get (Tindex index)
    Return the value at the specified position
clear ()
    Remove all the elements from this list
add (const TciValue &comp)
    Add an element to the end of this list
operator== (const TciValueList &valList)
    Returns true if both objects are equal
clone ()
    Return a copy of the TciValueList
```

```
operator< (const TciValueList &valList)
    Operator < overload
```

10.5.4.4 TciValueDifference

Represents the differences during a match operation. It is mapped to the following pure virtual class:

```
class TciValueDifference {
public:
    virtual ~TciValueDifference ();
    virtual const TciValue &getValue () const =0;
    virtual void setValue (TciValue &val)=0;
    virtual const TciValueTemplate &getTciValueTemplate () const =0;
    virtual void setTciValueTemplate (TciValueTemplate &valT)=0;
    virtual const Tstring &getDescription () const =0;
    virtual void setDescription (const Tstring &descr)=0;
    virtual Tboolean operator== (const TciValueDifference &vdiff) const =0;
    virtual TciValueDifference * clone () const =0;
    virtual Tboolean operator< (const TciValueDifference &vdiff) const =0;
}
```

10.5.4.4.1 Methods

```
~TciValueDifference ()
    Destructor
getValue ()
    Return the value definition
setValue (TciValue &val)
    Set the value definition
getTciValueTemplate ()
    Return the template definition
setTciValueTemplate (TciValueTemplate &valT)
    Set the template definition
getDescription ()
    Return a string which describes the difference
setDescription (const Tstring &descr)
    Set description
operator== (const TciValueDifference &vdiff)
    Returns true if both objects are equal
clone ()
    Return a copy of the TciValueDifference
operator< (const TciValueDifference &vdiff)
    Operator < overload
```

10.5.4.5 TciValueDifferenceList

Collection of TciValueDifferences. It is mapped to the following pure virtual class:

```
class TciValueDifferenceList {
public:
    virtual ~TciValueDifferenceList ();
    virtual Tsize size () const =0;
    virtual Tboolean empty () const =0;
    virtual const TciValueDifference *get (Tinteger p_position) const =0;
    virtual void clear ()=0;
    virtual void add (const TciValueDifference &comp)=0;
    virtual Tboolean operator== (const TciValueDifferenceList &vdList) const =0;
    virtual TciValueDifferenceList * clone () const =0;
    virtual Tboolean operator< (const TciValueDifferenceList &vdList) const =0;
}
```

10.5.4.5.1 Methods

```
~TciValueDifferenceList ()
    Destructor
size ()
    Return the size of the list
empty ()
    Return true if this list contains no elements
```



```

get (Tinteger p_position)
    Return the requested difference
clear ()
    Remove all the components from this list
add (const TciValueDifference &comp)
    Add a component to the end of the list
operator== (const TciValueDifferenceList &vdList)
    Returns true if both objects are equal
clone ()
    Return a copy of the TciValueDifferenceList
operator< (const TciValueDifferenceList &vdList)
    Operator < overload

```

10.5.4.6 ComponentStatus

Defines component status as an enumeration:

```

typedef enum
{
    INACTIVE_C = 0,
    RUNNING_C = 1,
    STOPPED_C = 2,
    KILLED_C = 3
    NULL_C = 4
} ComponentStatus;

```

10.5.4.7 TimerStatus

Defines timer status as an enumeration:

```

typedef enum
{
    RUNNING_T = 0,
    INACTIVE_T = 1,
    EXPIRED_T = 2
    NULL_T = 3
} TimerStatus;

```

10.5.4.8 TciStatus

Defines TCI status as an enumeration:

```

typedef enum
{
    TCI_OK = 0,
    TCI_ERROR = -1
} TciStatus;

```

10.6 Operations mapping

10.6.1 TCI-TM

10.6.1.1 TciTmRequired

Specifies the operations the TM requires from TE. It is mapped to the following interface:

```

//Destructor
virtual ~TciTmRequired ();

//Selects the indicated module for execution
virtual void tciRootModule (const TciModuleId *moduleName)=0;

//The TE provides to the management a list of imported modules of the root module
virtual const TciModuleIdList * getImportedModules () const =0;

//The TE provides to the management a list of module parameters of the identified module
virtual const TciModuleParameterList * tciGetModuleParameters (const TciModuleId *moduleName)=0;

```

```

//The TE provides to the management a list of test cases
virtual const TciTestCaseIdList * tciGetTestCases () const =0;

//The TE provides to the management a list of parameter types of the given test case
virtual const TciParameterTypeList * tciGetTestCaseParameters (const TciTestCaseId *testCaseId)
const =0;

//The TE provides to the management a list of system ports of the given test case
virtual const TriPortIdList * tciGetTestCaseTSI (const TciTestCaseId &testCaseId) const =0;

//Starts a testcase in the currently selected module with the given parameters
virtual void tciStartTestCase (const TciTestCaseId *testCaseId, const TciParameterList
*parameterList)=0;

//Stops the testcase currently being executed
virtual void tciStopTestCase ()=0;

//Starts the control part of the selected module
virtual const TriComponentId * tciStartControl ()=0;

//Stops execution of the control part
virtual void tciStopControl ()=0;

```

10.6.1.2 TciTmProvided

Specifies the operation the TM has to provide to the TE. It is mapped to the following interface:

```

//Destructor
virtual ~TciTmProvided ();

//Indicates to the TM that a test case with testCaseId has been started
virtual void tciTestCaseStarted (const TciTestCaseId &testCaseId, const TciParameterList
&parameterList, const Tfloat &timer)=0;

//Called to indicate that the test case has terminated execution
virtual void tciTestCaseTerminated (const VerdictValue &verdict, const TciParameterList
&parameterList)=0;

//Called to indicate that the control part of the selected module has just terminated execution
virtual void tciControlTerminated ()=0;

//The management provides to the TE a Value for the indicated parameterId
virtual TciValue * tciGetModulePar (const TciModuleParameterId &parameterId)=0;

//Indicates the occurrence of an unrecoverable error situation
virtual void tciError (const Tstring &message)=0;

//The TE indicates a message of a test component
virtual void tciLog (const TriComponentId &testComponentId, const Tstring &message)=0;

```

10.6.2 TCI-CD

10.6.2.1 TciCdRequired

This class defines the TCI_CD required interface. It is mapped to the following interface:

```

//Destructor
virtual ~TciCdRequired ();

//Returns a type representing a ttcn type
virtual const TciType * getTypeForName (const Tstring typeName) const =0;

//Constructs and returns a basic TTCN-3 integer type
virtual const TciType &getInteger () const =0;

//Constructs and returns a basic TTCN-3 float type
virtual const TciType &getFloat () const =0;

//Constructs and returns a basic TTCN-3 boolean type
virtual const TciType &getBoolean () const =0;

//Constructs and returns a basic TTCN-3 charstring type
virtual const TciType &getCharstring () const =0;

```

```

//Constructs and returns a basic TTCN-3 universal charstring type
virtual const TciType & getUniversalCharstring () const =0;

//Constructs and returns a basic TTCN-3 hexstring type
virtual const TciType & getHexstring () const =0;

//Constructs and returns a basic TTCN-3 bitstring type
virtual const TciType & getBitstring () const =0;

//Constructs and returns a basic TTCN-3 octetstring type
virtual const TciType & getOctetstring () const =0;

//Constructs and returns a basic TTCN-3 verdict type
virtual const TciType & getVerdict () const =0;

//The TE will be notified about an unrecoverable error situation within the CD
virtual void tciErrorReq (const Tstring message)=0;

```

10.6.2.2 TciCdProvided

This class defines the TCI_CD provided interface. It is mapped to the following interface:

```

//Destructor
virtual ~TciCdProvided ();

//This operation is called whenever the TE has to decode and encode value
virtual TciValue * decode (const TriMessage *p_message, const TciType *p_decodingHypothesis)=0;

//This operation is called whenever the TE has to encode a Value
virtual TriMessage * encode (const TciValue *p_value)=0;

```

10.6.3 TCI-CH

10.6.3.1 TciChRequired

This class defines the TCI_CH required interface. It is mapped to the following interface:

```

//Default destructor
virtual ~TciChRequired ();

//This operation is called by the CH at the local TE when at a remote TE a provided
//tciSendConnected has been called
virtual void tciEnqueueMsgConnected (const TriPortId *sender, const TriComponentId *receiver,
const TciValue *rcvdMessage)=0;

//This operation is called by the CH at the local TE when at a remote TE a provided
//tciCallConnected has been called
virtual void tciEnqueueCallConnected (const TriPortId *sender, const TriComponentId *receiver,
const TriSignatureId *signature, const TciParameterList *parameterList)=0;

//This operation is called by the CH at the local TE when at a remote TE a provided
//tciReplyConnected has been called
virtual void tciEnqueueReplyConnected (const TriPortId *sender, const TriComponentId *receiver,
const TriSignatureId *signature, const TciParameterList *parameterList,
const TciValue *returnValue)=0;

//This operation is called by the CH at the local TE when at a remote TE a provided
//tciRaiseConnected has been called
virtual void tciEnqueueRaiseConnected (const TriPortId *sender, const TriComponentId *receiver,
const TriSignatureId *signature, const TciValue *exception)=0;

//This operation is called by the CH at the local TE when at a remote TE a provided
//tciCreateTestComponentReq has been called
virtual const TriComponentId * tciCreateTestComponent (const TciTestComponentKind *kind,
const TciType *componentType, const Tstring *name)=0;

//This operation is called by the CH at the local TE when at a remote TE a provided
//tciStartTestComponentReq has been called
virtual void tciStartTestComponent (const TriComponentId *component,
const TciBehaviourId *behaviour, const TciParameterList *parameterList)=0;

//This operation is called by the CH at the local TE when at a remote TE a provided
//tciStopTestComponentReq has been called
virtual void tciStopTestComponent (const TriComponentId *component)=0;

```

```

//This operation is called by the CH at the local TE when at a remote TE a provided tciConnect
//has been called
virtual void tciConnect (const TriPortId *fromPort, const TriPortId *toPort)

//This operation is called by the CH at the local TE when at a remote TE a provided
//tciDisconnect has been called
virtual void tciDisconnect (const TriPortId *fromPort, const TriPortId *toPort)=0;

//This operation is called by the CH at the local TE when at a remote TE a provided tciMapReq
//has been called
virtual void tciMap (const TriPortId *fromPort, const TriPortId *toPort)=0;

//This operation is called by the CH at the local TE when at a remote TE a provided
//tciMapParamReq has been called
virtual void tciMapParam (const TriPortId *fromPort, const TriPortId *toPort,
    const TciParameterList *parameterList)=0

//This operation is called by the CH at the local TE when at a remote TE a provided tciUnmapReq
//has been called
virtual void tciUnmap (const TriPortId *fromPort, const TriPortId *toPort)=0;

//This operation is called by the CH at the local TE when at a remote TE a provided
//tciUnmapParamReq has been called
virtual void tciUnmapParam (const TriPortId *fromPort, const TriPortId *toPort,
    const TciParameterList *parameterList)=0

//This operation is called by the CH at the local TE when at a remote TE a provided tciUnmapReq
//has been called
virtual void tciTestComponentTerminated (const TriComponentId *component,
    const VerdictValue *verdict) const =0

//This operation is called by the CH at the local TE when at a remote TE a provided
//tciTestComponentRunningReq has been called
virtual Tboolean tciTestComponentRunning (const TriComponentId *component) const =0

//This operation is called by the CH at the local TE when at a remote TE a provided
//tciTestComponentDoneReq has been called
virtual Tboolean tciTestComponentDone (const TriComponentId *comp) const =0

//This operation can be called by the CH at the appropriate local TE when at a remote TE a
//provided tciGetMTCReq has been called
virtual const TriComponentId * tciGetMTC () const =0

//This operation is called by the CH at the appropriate local TE when at a remote TE a provided
//tciExecuteTestCaseReq has been called
virtual void tciExecuteTestCase (const TciTestCaseId *testCaseId,
    const TriPortIdList *tsiPortList)=0;

//This operation is called by the CH at appropriate local TEs when at a remote TE a provided
//tciResetReq has been called
virtual void tciReset ()=0;

//This operation is called by the CH at the local TE when at a remote TE a provided
//tciKillTestComponentReq has been called
virtual void tciKillTestComponent (const TriComponentId *comp)=0;

//This operation is called by the CH at the local TE when at a remote TE a provided
//tciTestComponentAliveReq has been called
virtual Tboolean tciTestComponentAlive (const TriComponentId *comp) const =0

//This operation is called by the CH at the local TE when at a remote TE a provided
//tciTestComponentKilledReq has been called
virtual Tboolean tciTestComponentKilled (const TriComponentId *comp) const =0

```

10.6.3.2 TciChProvided

This class defines the TCI_CH provided interface. It is mapped to the following interface:

```

//Destructor
virtual ~TciChProvided ();

//Called by the TE when it executes a TTCN-3 unicast send operation on a component port
virtual void tciSendConnected (const TriPortId *sender, const TriComponentId *receiver,
    const TciValue *sendMessage)=0;

```

```

//Called by the TE when it executes a TTCN-3 broadcast send operation on a component port
virtual void tciSendConnectedBC (const TriPortId *sender, const TciValue *sendMessage)=0;

//Called by the TE when it executes a TTCN-3 multicast send operation on a component port
virtual void tciSendConnectedMC (const TriPortId *sender, const TriComponentIdList *receivers,
const TciValue *sendMessage)=0;

//Called by the TE when it executes a TTCN-3 unicast call operation on a component port
virtual void tciCallConnected (const TriPortId *sender, const TriComponentId *receiver,
const TriSignatureId *signature, const TciParameterList *parameterList)=0;

//Called by the TE when it executes a TTCN-3 broadcast call operation on a component port
virtual void tciCallConnectedBC (const TriPortId *sender, const TriSignatureId *signature,
const TciParameterList *parameterList)=0;

//Called by the TE when it executes a TTCN-3 multicast call operation on a component port
virtual void tciCallConnectedMC (const TriPortId *sender, const TriComponentIdList *receivers,
const TriSignatureId *signature, const TciParameterList *parameterList)=0;

//Called by the TE when it executes a TTCN-3 unicast reply operation on a component port
virtual void tciReplyConnected (const TriPortId *sender, const TriComponentId *receiver,
const TriSignatureId *signature, const TciParameterList *parameterList,
const TciValue *returnValue)=0;

//Called by the TE when it executes a TTCN-3 broadcast reply operation on a component port
virtual void tciReplyConnectedBC (const TriPortId *sender, const TriSignatureId *signature,
const TciParameterList *parameterList, const TciValue *returnValue)=0;

//Called by the TE when it executes a TTCN-3 multicast reply operation on a component
virtual void tciReplyConnectedMC (const TriPortId *sender, const TriComponentIdList *receivers,
const TriSignatureId *signature, const TciParameterList *parameterList,
const TciValue *returnValue)=0;

//Called by the TE when it executes a TTCN-3 unicast raise operation on a component port
virtual void tciRaiseConnected (const TriPortId *sender, const TriComponentId *receiver,
const TriSignatureId *signature, const TciValue *exception)=0;

//Called by the TE when it executes a TTCN-3 broadcast raise operation on a component portvirtual
void tciRaiseConnectedBC (const TriPortId *sender, const TriSignatureId *signature,
const TciValue *exception)=0;

//Called by the TE when it executes a TTCN-3 multicast raise operation on a component
virtual void tciRaiseConnectedMC (const TriPortId *sender, const TriComponentIdList *receiver,
const TriSignatureId *signature, const TciValue *exception)=0;

//Called from the TE when a component has to be created
virtual const TriComponentId * tciCreateTestComponentReq (const TciTestComponentKind *kind,
const QualifiedName *componentType, const Tstring &name, const TciValue *hostId)=0;

//Called by the TE when it executes the TTCN-3 start operation
virtual void tciStartTestComponentReq (const TriComponentId *component,
const TciBehaviourId *behaviour, const TciParameterList *parameterList)=0;

//Called by the TE when it executes the TTCN-3 stop operation
virtual void tciStopTestComponentReq (const TriComponentId *component)=0;

//Called by the TE when it executes a TTCN-3 connect operation
virtual void tciConnectReq (const TriPortId *fromPort, const TriPortId *toPort)=0;

//Called by the TE when it executes a TTCN-3 disconnect operation
virtual void tciDisconnectReq (const TriPortId *fromPort, const TriPortId *toPort)=0;

//Called by the TE when it executes a TTCN-3 map operation
virtual void tciMapReq (const TriPortId *fromPort, const TriPortId *toPort)=0;

//Called by the TE when it executes a TTCN-3 map operation including parameters
virtual void tciMapParamReq (const TriPortId *fromPort, const TriPortId *toPort,
const TciParameterList *parameterList)=0

//Called by the TE when it executes a TTCN-3 unmap operation
virtual void tciUnmapReq (const TriPortId *fromPort, const TriPortId *toPort)=0;

//Called by the TE when it executes a TTCN-3 unmap operation including parameters
virtual void tciUnmapParamReq (const TriPortId *fromPort, const TriPortId *toPort,
const TciParameterList *parameterList)=0

```

```

//Called by the TE when a test component terminates execution
virtual void tciTestComponentTerminatedReq (const TriComponentId *component,
const VerdictValue *verdict)=0;

//Called by the TE when it executes a TTCN-3 running operation
virtual Tboolean tciTestComponentRunningReq (const TriComponentId *component) const =0

//Called by the TE when it executes a TTCN-3 done operation
virtual Tboolean tciTestComponentDoneReq (const TriComponentId *comp) const =0

//Called by the TE when it executes a TTCN-3 mtc operation
virtual const TriComponentId * tciGetMTCReq () const =0

//Called by the TE immediately before it starts the test case behaviour on the MTC
virtual void tciExecuteTestCaseReq (const TciTestCaseId *testCaseId,
const TriPortIdList *tsiPortList)=0;

//Called by the TE at any time to reset the test system
virtual void tciResetReq ()=0;

//Called by the TE when it executes the TTCN-3 kill operation
virtual void tciKillTestComponentReq (const TriComponentId *comp)=0;

//Called by the TE when it executes the TTCN-3 alive operation
virtual Tboolean tciTestComponentAliveReq (const TriComponentId *comp) const =0

//Called by the TE when it executes the TTCN-3 killed operation
virtual Tboolean tciTestComponentKilledReq (const TriComponentId *comp) const =0

```

10.6.4 TCI-TL

10.6.4.1 TciTlProvided

This class defines the TCI_TL provided Tinterface:

```

//Default constructor
TciTlProvided ();

// Destructor
virtual ~TciTlProvided ();

//Called by TE to log the execute test case request
virtual void tliTcExecute (const Tstring &am, const timeval ts, const Tinteger
line, const TriComponentId *c, const TciTestCaseId *tcId, const TriParameterList *triPars, const
TriTimerDuration *dur)=0;

//Called by TE to log the start of a testcase. This event occurs before the testcase is started
virtual void tliTcStart (const Tstring &am, const timeval ts, const Tstring &src, const Tinteger
line, const TriComponentId *c, const TciTestCaseId *tcId, const TciParameterList *tciPars, const
TriTimerDuration *dur)=0;

//Called by TE to log the stop of a testcase
virtual void tliTcStop (const Tstring &am, const timeval ts, const Tstring &src, const Tinteger
line, const TriComponentId *c, const Tstring &reason)=0;

//Called by TE to log the start of a testcase
virtual void tliTcStarted (const Tstring &am, const timeval ts, const Tstring &src, const Tinteger
line, const TriComponentId *c, const TciTestCaseId *tcId, const TciParameterList *tciPars, const
TriTimerDuration *dur)=0;

//Called by TE to log the termination of a testcase
virtual void tliTcTerminated (const Tstring &am, const timeval ts, const Tstring &src, const
Tinteger line, const TriComponentId *c, const TciTestCaseId *tcId, const TciParameterList *tciPars,
const VerdictValue *verdict, const Tstring &reason)=0;

//Called by TE to log the start of the control part
virtual void tliCtrlStart (const Tstring &am, const timeval ts, const Tstring &src, const Tinteger
line, const TriComponentId *c)=0;

//Called by TE to log the stop of the control part. This event occurs after the control has
//stopped. If the control is not represented by TRI component, c is null
virtual void tliCtrlStop (const Tstring &am, const timeval ts, const Tstring &src, const Tinteger
line, const TriComponentId *c)=0;

```

```

//Called by TE to log the termination of the control part
virtual void tliCtrlTerminated (const Tstring &am, const timeval ts, const Tstring &src, const
Tinteger line, const TriComponentId *c)=0;

//Called by TE to log a unicast send operation
virtual void tliMSend_m (const Tstring &am, const timeval ts, const Tstring &src, const Tinteger
line, const TriComponentId *c, const TriPortId *at, const TriPortId *to, const TciValue *msgValue,
const TriAddress *address, const TciStatus *encoderFailure, const TriMessage *msg, const TriStatus
*transmissionFailure)=0;

//Called by TE to log a broadcast send operation
virtual void tliMSend_m_BC (const Tstring &am, const timeval ts, const Tstring &src, const Tinteger
line, const TriComponentId *c, const TriPortId *at, const TriPortId *to, const TciValue *msgValue,
const TciStatus *encoderFailure, const TriMessage *msg, const TriStatus *transmissionFailure)=0;

//Called by TE to log a multicast send operation
virtual void tliMSend_m_MC (const Tstring &am, const timeval ts, const Tstring &src, const Tinteger
line, const TriComponentId *c, const TriPortId *at, const TriPortId *to, const TciValue *msgValue,
const TriAddressList *addresses, const TciStatus *encoderFailure, const TriMessage *msg, const
TriStatus *transmissionFailure)=0;

//Called by TE to log a unicast send operation
virtual void tliMSend_c (const Tstring &am, const timeval ts, const Tstring src, const Tinteger
line, const TriComponentId *c, const TriPortId *at, const TriPortId *to, const TciValue *msgValue,
const TriStatus *transmissionFailure)=0;

//Called by TE to log a broadcast send operation
virtual void tliMSend_c_BC (const Tstring &am, const timeval ts, const Tstring src, const Tinteger
line, const TriComponentId *c, const TriPortId *at, const TriPortIdList *to, const TciValue
*msgValue, const TriStatus *transmissionFailure)=0;

//Called by TE to log a multicast send operation
virtual void tliMSend_c_MC (const Tstring &am, const timeval ts, const Tstring src, const Tinteger
line, const TriComponentId *c, const TriPortId *at, const TriPortIdList *to, const TciValue
*msgValue, const TriStatus *transmissionFailure)=0;

//Called by TE to log the enqueueing of a message
virtual void tliMDetected_m (const Tstring &am, const timeval ts, const Tstring &src, const Tinteger
line, const TriComponentId *c, const TriPortId *at, const TriPortId *from, const TriMessage *msg,
const TriAddress *address)=0;

//Called by CH to log the enqueueing of a message
virtual void tliMDetected_c (const Tstring &am, const timeval ts, const Tstring src, const Tinteger
line, const TriComponentId *c, const TriPortId *at, const TriPortId *from, const TciValue
*msgValue)=0;

//Called by TE to log the mismatch of a template
virtual void tliMMismatch_m (const Tstring &am, const timeval ts, const Tstring &src, const Tinteger
line, const TriComponentId *c, const TriPortId *at, const TciValue *msgValue, const TciValueTemplate
*msgTpl, const TciValueDifferenceList *diffs, const TriAddress *address, const TciValueTemplate
*addressTpl)=0;

//Called by TE to log the mismatch of a template
virtual void tliMMismatch_c (const Tstring &am, const timeval ts, const Tstring &src, const Tinteger
line, const TriComponentId *c, const TriPortId *at, const TciValue *msgValue, const TciValueTemplate
*msgTpl, const TciValueDifferenceList *diffs, const TriComponentId *from, const TciNonValueTemplate
*fromTpl)=0;

// Called by TE to log the receiving of a message
virtual void tliMRecieve_m (const Tstring &am, const timeval ts, const Tstring &src, const Tinteger
line, const TriComponentId *c, const TriPortId *at, const TciValue *msgValue, const TciValueTemplate
*msgTpl, const TriAddress *address, const TciValueTemplate *addressTpl)=0;

//Called by TE to log the mismatch of a template
virtual void tliMReceive_c (const Tstring &am, const timeval ts, const Tstring &src, const Tinteger
line, const TriComponentId *c, const TriPortId *at, const TciValue *msgValue, const TciValueTemplate
*msgTpl, const TriComponentId *fromComp, const TciNonValueTemplate *fromTpl)=0;

//Called by TE to log a unicast call operation
virtual void tliPrCall_m (const Tstring &am, const timeval ts, const Tstring src, const Tinteger
line, const TriComponentId *c, const TriPortId *at, const TriPortId *to, const TriSignatureId
*signature, const TciParameterList *tciPars, const TriAddress *address, const TciStatus
*encoderFailure, const TriParameterList *triPars, const TriStatus *transmissionFailure)=0;

```

```

//Called by TE to log a broadcast call operation
virtual void tliPrCall_m_BC (const Tstring &am, const timeval ts, const Tstring src, const Tinteger
line, const TriComponentId *c, const TriPortId *at, const TriPortId *to, const TriSignatureId
*signature, const TciParameterList *tciPars, const TciStatus *encoderFailure, const TriParameterList
*triPars, const TriStatus *transmissionFailure)=0;

//Called by TE to log a multicast call operation
virtual void tliPrCall_m_MC (const Tstring &am, const timeval ts, const Tstring src, const Tinteger
line, const TriComponentId *c, const TriPortId *at, const TriPortId *to, const TriSignatureId
*signature, const TciParameterList *tciPars, const TriAddressList *addresses, const TciStatus
*encoderFailure, const TriParameterList *triPars, const TriStatus *transmissionFailure)=0;

//Called by TE to log a unicast call operation
virtual void tliPrCall_c (const Tstring &am, const timeval ts, const Tstring src, const Tinteger
line, const TriComponentId *c, const TriPortId *at, const TriPortId *to, const TriSignatureId
*signature, const TciParameterList *tciPars, const TriStatus *transmissionFailure)=0;

//Called by TE to log a broadcast call operation
virtual void tliPrCall_c_BC (const Tstring &am, const timeval ts, const Tstring src, const Tinteger
line, const TriComponentId *c, const TriPortId *at, const TriPortIdList *to, const TriSignatureId
*signature, const TciParameterList *tciPars, const TriStatus *transmissionFailure)=0;

//Called by TE to log a multicast call operation
virtual void tliPrCall_c_MC (const Tstring &am, const timeval ts, const Tstring src, const Tinteger
line, const TriComponentId *c, const TriPortId *at, const TriPortIdList *to, const TriSignatureId
*signature, const TciParameterList *tciPars, const TriStatus *transmissionFailure)=0;

//Called by TE to log the getcall enqueue operation
virtual void tliPrGetCallDetected_m (const Tstring &am, const timeval ts, const Tstring src, const
Tinteger line, const TriComponentId *c, const TriPortId *at, const TriPortId *from, const
TriSignatureId *signature, const TriParameterList *triPars, const TriAddress *address)=0;

//Called by TE to log the getcall enqueue operation
virtual void tliPrGetCallDetected_c (const Tstring &am, const timeval ts, const Tstring src, const
Tinteger line, const TriComponentId *c, const TriPortId *at, const TriPortId *from, const
TriSignatureId *signature, const TciParameterList *tciPars)=0;

//Called by TE to log the mismatch of a getcall
virtual void tliPrGetCallMismatch_m (const Tstring &am, const timeval ts, const Tstring src, const
Tinteger line, const TriComponentId *c, const TriPortId *at, const TriSignatureId *signature, const
TciParameterList *tciPars, const TciValueTemplate *parsTmpl, const TciValueDifferenceList *diffs,
const TriAddress *address, const TciValueTemplate *addressTmpl)=0;

//Called by TE to log the mismatch of a getcall
virtual void tliPrGetCallMismatch_c (const Tstring &am, const timeval ts, const Tstring src, const
Tinteger line, const TriComponentId *c, const TriPortId *at, const TriSignatureId *signature, const
TciParameterList *tciPars, const TciValueTemplate *parsTmpl, const TciValueDifferenceList *diffs,
const TriComponentId *from, const TciValueTemplate *fromTmpl)=0;

//Called by TE to log getting a call
virtual void tliPrGetCall_m (const Tstring &am, const timeval ts, const Tstring src, const Tinteger
line, const TriComponentId *c, const TriPortId *at, const TriSignatureId *signature, const
TciParameterList *tciPars, const TciValueTemplate *parsTmpl, const TriAddress *address, const
TciValueTemplate *addressTmpl)=0;

//Called by TE to log getting a call
virtual void tliPrGetCall_c (const Tstring &am, const timeval ts, const Tstring src, const Tinteger
line, const TriComponentId *c, const TriPortId *at, const TriSignatureId *signature, const
TciParameterList *tciPars, const TciValueTemplate *parsTmpl, const TriComponentId *from, const
TciNonValueTemplate *fromTmpl)=0;

//Called by TE to log a unicast reply operation
virtual void tliPrReply_m (const Tstring &am, const timeval ts, const Tstring src, const Tinteger
line, const TriComponentId *c, const TriPortId *at, const TriPortId *to, const TriSignatureId
*signature, const TciParameterList *tciPars, const TciValue *replValue, const TriAddress *address,
const TciStatus *encoderFailure, const TriParameterList *triPars, const TriParameter *repl, const
TriStatus *transmissionFailure)=0;

//Called by TE to log a broadcast reply operation
virtual void tliPrReply_m_BC (const Tstring &am, const timeval ts, const Tstring src, const Tinteger
line, const TriComponentId *c, const TriPortId *at, const TriPortId *to, const TriSignatureId
*signature, const TciParameterList *tciPars, const TciValue *replValue, const TciStatus
*encoderFailure, const TriParameterList *triPars, const TriParameter *repl, const TriStatus
*transmissionFailure)=0;

```



```

//Called by TE to log a multicast reply operation
virtual void tliPrReply_m_MC (const Tstring &am, const timeval ts, const Tstring src, const Tinteger
line, const TriComponentId *c, const TriPortId *at, const TriPortId *to, const TriSignatureId
*signature, const TciParameterList *tciPars, const TciValue *replValue, const TriAddressList
*addresses, const TciStatus *encoderFailure, const TriParameterList *triPars, const TriParameter
*repl, const TriStatus *transmissionFailure)=0;

//Called by TE to log a unicast reply operation
virtual void tliPrReply_c (const Tstring &am, const timeval ts, const Tstring src, const Tinteger
line, const TriComponentId *c, const TriPortId *at, const TriPortId *to, const TriSignatureId
*signature, const TciValue *parsValue, const TciValue *replValue, const TriStatus
*transmissionFailure)=0;

//Called by TE to log a broadcast reply operation
virtual void tliPrReply_c_BC (const Tstring &am, const timeval ts, const Tstring src, const Tinteger
line, const TriComponentId *c, const TriPortId *at, const TriPortIdList *to, const TriSignatureId
*signature, const TciValue *parsValue, const TciValue *replValue, const TriStatus
*transmissionFailure)=0;

//Called by TE to log og a multicast reply operation
virtual void tliPrReply_c_MC (const Tstring &am, const timeval ts, const Tstring src, const Tinteger
line, const TriComponentId *c, const TriPortId *at, const TriPortIdList *to, const TriSignatureId
*signature, const TciValue *parsValue, const TciValue *replValue, const TriStatus
*transmissionFailure)=0;

//Called by TE to log the getreply enqueue operation
virtual void tliPrGetReplyDetected_m (const Tstring &am, const timeval ts, const Tstring src, const
Tinteger line, const TriComponentId *c, const TriPortId *at, const TriPortId *from, const
TriSignatureId *signature, const TriParameterList *triPars, const TriParameter *repl, const
TriAddress *address)=0;

//Called by CH to log the getreply enqueue operation
virtual void tliPrGetReplyDetected_c (const Tstring &am, const timeval ts, const Tstring src, const
Tinteger line, const TriComponentId *c, const TriPortId *at, const TriPortId *from, const
TriSignatureId *signature, const TciParameterList *tciPars, const TciValue *replValue)=0;

//Called by TE to log the mismatch of a getreply operation
virtual void tliPrGetReplyMismatch_m (const Tstring &am, const timeval ts, const Tstring src, const
Tinteger line, const TriComponentId *c, const TriPortId *at, const TriSignatureId *signature, const
TciParameterList *tciPars, const TciValueTemplate *parsTmpl, const TciValue *replValue, const
TciValueTemplate *replyTmpl, const TciValueDifferenceList *diffs, const TriAddress *address, const
TciValueTemplate *addressTmpl)=0;

//Called by TE to log the mismatch of a getreply operation
virtual void tliPrGetReplyMismatch_c (const Tstring &am, const timeval ts, const Tstring src, const
Tinteger line, const TriComponentId *c, const TriPortId *at, const TriSignatureId *signature, const
TciParameterList *tciPars, const TciValueTemplate *parsTmpl, const TciValue *replValue, const
TciValueTemplate *replyTmpl, const TciValueDifferenceList *diffs, const TriComponentId *from, const
TciNonValueTemplate *fromTmpl)=0;

//Called by TE to log getting a reply
virtual void tliPrGetReply_m (const Tstring &am, const timeval ts, const Tstring src, const Tinteger
line, const TriComponentId *c, const TriPortId *at, const TriSignatureId *signature, const
TciParameterList *tciPars, const TciValueTemplate *parsTmpl, const TciValue *replValue, const
TciValueTemplate *replyTmpl, const TriAddress *address, const TciValueTemplate *addressTmpl)=0;

//Called by TE to log getting a reply
virtual void tliPrGetReply_c (const Tstring &am, const timeval ts, const Tstring src, const Tinteger
line, const TriComponentId *c, const TriPortId *at, const TriSignatureId *signature, const
TciParameterList *tciPars, const TciValueTemplate *parsTmpl, const TciValue *replValue, const
TciValueTemplate *replyTmpl, const TriComponentId *from, const TciNonValueTemplate *fromTmpl)=0;

//Called by TE to log a unicast raise operation
virtual void tliPrRaise_m (const Tstring &am, const timeval ts, const Tstring src, const Tinteger
line, const TriComponentId *c, const TriPortId *at, const TriPortId *to, const TriSignatureId
*signature, const TciParameterList *tciPars, const TciValue *excValue, const TriAddress *address,
const TriStatus *encoderFailure, const TriException *exc, const TriStatus *transmissionFailure)=0;

//Called by TE to log a broadcast raise operation
virtual void tliPrRaise_m_BC (const Tstring &am, const timeval ts, const Tstring src, const Tinteger
line, const TriComponentId *c, const TriPortId *at, const TriPortId *to, const TriSignatureId
*signature, const TciParameterList *tciPars, const TciValue *excValue, const TriStatus
*encoderFailure, const TriException *exc, const TriStatus *transmissionFailure)=0;

```

```

//Called by TE to log a multicast raise operation
virtual void tliPrRaise_m_MC (const Tstring &am, const timeval ts, const Tstring src, const Tinteger
line, const TriComponentId *c, const TriPortId *at, const TriPortId *to, const TriSignatureId
*signature, const TciParameterList *tciPars, const TciValue *excValue, const TriAddressList
*addresses, const TriStatus *encoderFailure, const TriException *exc, const TriStatus
*transmissionFailure)=0;
//Called by TE to log a unicast raise operation
virtual void tliPrRaise_c (const Tstring &am, const timeval ts, const Tstring src, const Tinteger
line, const TriComponentId *c, const TriPortId *at, const TriPortId *to, const TriSignatureId
*signature, const TciParameterList *tciPars, const TciValue *excValue, const TriStatus
*transmissionFailure)=0;

//Called by TE to log a broadcast raise operation
virtual void tliPrRaise_c_BC (const Tstring &am, const timeval ts, const Tstring src, const Tinteger
line, const TriComponentId *c, const TriPortId *at, const TriPortIdList *to, const TriSignatureId
*signature, const TciParameterList *tciPars, const TciValue *excValue, const TriStatus
*transmissionFailure)=0;

//Called by TE to log a multicast raise operation
virtual void tliPrRaise_c_MC (const Tstring &am, const timeval ts, const Tstring src, const Tinteger
line, const TriComponentId *c, const TriPortId *at, const TriPortIdList *to, const TriSignatureId
*signature, const TciParameterList *tciPars, const TciValue *excValue, const TriStatus
*transmissionFailure)=0;

//Called by TE to log the catch enqueue operation
virtual void tliPrCatchDetected_m (const Tstring &am, const timeval ts, const Tstring src, const
Tinteger line, const TriComponentId *c, const TriPortId *at, const TriPortId *from, const
TriSignatureId *signature, const TriException *exc, const TriAddress *address)=0;

//Called by TE to log the catch enqueue operation
virtual void tliPrCatchDetected_c (const Tstring &am, const timeval ts, const Tstring src, const
Tinteger line, const TriComponentId *c, const TriPortId *at, const TriPortId *from, const
TriSignatureId *signature, const TciValue *excValue)=0;

//Called by TE to log the mismatch of a catch operation
virtual void tliPrCatchMismatch_m (const Tstring &am, const timeval ts, const Tstring src, const
Tinteger line, const TriComponentId *c, const TriPortId *at, const TriSignatureId *signature, const
TciValue *excValue, const TciValueTemplate *excTmpl, const TciValueDifferenceList *diffs, const
TriAddress *address, const TciValueTemplate *addressTmpl)=0;

//Called by TE to log the mismatch of a catch operation
virtual void tliPrCatchMismatch_c (const Tstring &am, const timeval ts, const Tstring src, const
Tinteger line, const TriComponentId *c, const TriPortId *at, const TriSignatureId *signature, const
TciValue *excValue, const TciValueTemplate *excTmpl, const TciValueDifferenceList *diffs, const
TriComponentId *from, const TciNonValueTemplate *fromTmpl)=0;

//Called by TE to log catching an exception
virtual void tliPrCatch_m (const Tstring &am, const timeval ts, const Tstring src, const Tinteger
line, const TriComponentId *c, const TriPortId *at, const TriSignatureId *signature, const TciValue
*excValue, const TciValueTemplate *excTmpl, const TriAddress *address, const TciValueTemplate
*addressTmpl)=0;

//Called by TE to log catching an exception
virtual void tliPrCatch_c (const Tstring &am, const timeval ts, const Tstring src, const Tinteger
line, const TriComponentId *c, const TriPortId *at, const TriSignatureId *signature, const TciValue
*excValue, const TciValueTemplate *excTmpl, const TriComponentId *from, const TciNonValueTemplate
*fromTmpl)=0;

//Called by TE to log the detection of a catch timeout
virtual void tliPrCatchTimeoutDetected (const Tstring &am, const timeval ts, const Tstring src,
const Tinteger line, const TriComponentId *c, const TriPortId *at, const TriSignatureId
*signature)=0;

//Called by TE to log catching a timeout
virtual void tliPrCatchTimeout (const Tstring &am, const timeval ts, const Tstring src, const
Tinteger line, const TriComponentId *c, const TriPortId *at, const TriSignatureId *signature)=0;

//Called by TE to log the create component operation
virtual void tliCCreate (const Tstring &am, const timeval ts, const Tstring src, const Tinteger
line, const TriComponentId *c, const TriComponentId *comp, const Tstring &name, const Tboolean
alive)=0;

//Called by TE to log the start component operation
virtual void tliCStart (const Tstring &am, const timeval ts, const Tstring &src, const Tinteger
line, const TriComponentId *c, const TriComponentId *comp, const TciBehaviourId *beh, const
TciParameterList *tciPars)=0;

```

```
//Called by TE to log the running component operation
virtual void tliCRunning (const Tstring &am, const timeval ts, const Tstring &src, const Tinteger
line, const TriComponentId *c, const TriComponentId *comp, const ComponentStatus status)=0;

//Called by TE to log the alive component operation
virtual void tliCALive (const Tstring &am, const timeval ts, const Tstring &src, const Tinteger
line, const TriComponentId *c, const TriComponentId *comp, const ComponentStatus status)=0;

//Called by TE to log the stop component operation
virtual void tliCStop (const Tstring &am, const timeval ts, const Tstring &src, const Tinteger line,
const TriComponentId *c, const TriComponentId *comp)=0;

//Called by TE to log the kill component operation
virtual void tliCKill (const Tstring &am, const timeval ts, const Tstring &src, const Tinteger line,
const TriComponentId *c, const TriComponentId *comp)=0;

//Called by TE to log the mismatch of a done component operation
virtual void tliCDoneMismatch (const Tstring &am, const timeval ts, const Tstring &src, const
Tinteger line, const TriComponentId *c, const TriComponentId *comp, const TciNonValueTemplate
*compTpl)=0;

//Called by TE to log the done component operation
virtual void tliCDone (const Tstring &am, const timeval ts, const Tstring &src, const Tinteger line,
const TriComponentId *c, const TciNonValueTemplate *compTpl)=0;

//Called by TE to log the mismatch of a killed component operation
virtual void tliCKilledMismatch (const Tstring &am, const timeval ts, const Tstring &src, const
Tinteger line, const TriComponentId *c, const TciNonValueTemplate *compTpl)=0;

//Called by TE to log the killed component operation
virtual void tliCKilled (const Tstring &am, const timeval ts, const Tstring &src, const Tinteger
line, const TriComponentId *c, const TciNonValueTemplate *compTpl)=0;

//Called by TE to log the termination of a component
virtual void tliCTerminated (const Tstring &am, const timeval ts, const Tstring &src, const Tinteger
line, const TriComponentId *c, const VerdictValue *verdict, const Tstring &reason)=0;

//Called by TE to log the connect operation
virtual void tliPConnect (const Tstring &am, const timeval ts, const Tstring src, const Tinteger
line, const TriComponentId *c, const TriPortId *port1, const TriPortId *port2)=0;

//Called by TE to log the disconnect operation
virtual void tliPDisconnect (const Tstring &am, const timeval ts, const Tstring src, const Tinteger
line, const TriComponentId *c, const TriPortId *port1, const TriPortId *port2)=0;

//Called by TE to log the map operation
virtual void tliPMap (const Tstring &am, const timeval ts, const Tstring &src, const Tinteger line,
const TriComponentId *c, const TriPortId *port1, const TriPortId *port2)=0;

//Called by TE to log the map operation including param
virtual void tliPMapParam (const Tstring &am, const timeval ts, const Tstring &src, const Tinteger
line, const TriComponentId *c, const TriPortId *port1, const TriPortId *port2, const
TciParameterList *tciPars, const TriStatus *encoderFailure,
const TriParameterList *triPars)=0

//Called by TE to log the unmap operation
virtual void tliPUnmap (const Tstring &am, const timeval ts, const Tstring &src, const Tinteger
line, const TriComponentId *c, const TriPortId *port1, const TriPortId *port2)=0;

//Called by TE to log the unmap operation including param
virtual void tliPUnmapParam (const Tstring &am, const timeval ts, const Tstring &src, const Tinteger
line, const TriComponentId *c, const TriPortId *port1, const TriPortId *port2, const
TciParameterList *tciPars, const TriStatus *encoderFailure,
const TriParameterList *triPars)=0

//Called by TE to log the port clear operation
virtual void tliPClear (const Tstring &am, const timeval ts, const Tstring &src, const Tinteger
line, const TriComponentId *c, const TriPortId *port)=0;

//Called by TE to log the port start operation
virtual void tliPStart (const Tstring &am, const timeval ts, const Tstring &src, const Tinteger
line, const TriComponentId *c, const TriPortId *port)=0;

//Called by TE to log the port stop operation
virtual void tliPStop (const Tstring &am, const timeval ts, const Tstring &src, const Tinteger line,
const TriComponentId *c, const TriPortId *port)=0;
```

```

//Called by TE to log the port stop operation
virtual void tliPHalt (const Tstring &am, const timeval ts, const Tstring &src, const Tinteger line,
const TriComponentId *c, const TriPortId *port)=0;

//Called by TE to log the encode operation
virtual void tliEncode (const Tstring &am, const timeval ts, const Tstring &src, const Tinteger
line, const TriComponentId *c, const TciValue *val, const TciStatus *encoderFailure, const
TriMessage *msg, const Tstring &codec)=0;

//Called by TE to log the decode operation
virtual void tliDecode (const Tstring &am, const timeval ts, const Tstring &src, const Tinteger
line, const TriComponentId *c, const TriMessage *msg, const TciStatus *decoderFailure, const
TciValue *val, const Tstring &codec)=0;

//Called by TE to log the detection of a timeout
virtual void tliTTimeoutDetected (const Tstring &am, const timeval ts, const Tstring &src, const
Tinteger line, const TriComponentId *c, const TriTimerId *timer)=0;

//Called by TE to log a timeout mismatch
virtual void tliTTimeoutMismatch (const Tstring &am, const timeval ts, const Tstring &src, const
Tinteger line, const TriComponentId *c, const TriTimerId *timer, const TciNonValueTemplate
*timerTpl)=0;

//Called by TE to log a timeout match
virtual void tliTTimeout (const Tstring &am, const timeval ts, const Tstring &src, const Tinteger
line, const TriComponentId *c, const TriTimerId *timer, const TciNonValueTemplate *timerTpl)=0;

//Called by TE to log the start of a timer
virtual void tliTStart (const Tstring &am, const timeval ts, const Tstring &src, const Tinteger
line, const TriComponentId *c, const TriTimerId *timer, const TriTimerDuration *dur)=0;

//Called by TE to log the stop of a timer
virtual void tliTStop (const Tstring &am, const timeval ts, const Tstring &src, const Tinteger line,
const TriComponentId *c, const TriTimerId *timer, const TriTimerDuration *dur)=0;

//Called by TE to log the reading of a timer
virtual void tliTRead (const Tstring &am, const timeval ts, const Tstring &src, const Tinteger line,
const TriComponentId *c, const TriTimerId *timer, const TriTimerDuration *elapsed)=0;

//Called by TE to log the running timer operation
virtual void tliTRunning (const Tstring &am, const timeval ts, const Tstring &src, const Tinteger
line, const TriComponentId *c, const TriTimerId *timer, const TimerStatus status)=0;

//Called by TE to log the entering of a scope
virtual void tliSEnter (const Tstring &am, const timeval ts, const Tstring &src, const Tinteger
line, const TriComponentId *c, const QualifiedName &name, const TciParameterList *tciPars, const
Tstring &kind)=0;

//Called by TE to log the leaving of a scope
virtual void tliSLeave (const Tstring &am, const timeval ts, const Tstring &src, const Tinteger
line, const TriComponentId *c, const QualifiedName &name, const TciParameterList *tciPars, const
TciValue *returnValue, const Tstring &kind)=0;

//Called by TE to log the modification of the value of a variable
virtual void tliVar (const Tstring &am, const timeval ts, const Tstring &src, const Tinteger line,
const TriComponentId *c, const QualifiedName &name, const TciValue *varValue)=0;

//Called by TE to log the value of a module parameter
virtual void tliModulePar (const Tstring &am, const timeval ts, const Tstring &src, const Tinteger
line, const TriComponentId *c, const QualifiedName &name, const TciValue *parValue)=0;

//Called by TE to log the value of a module parameter
virtual void tliGetVerdict (const Tstring &am, const timeval ts, const Tstring &src, const Tinteger
line, const TriComponentId *c, const VerdictValue *verdict)=0;

//Called by TE to log the setverdict operation
virtual void tliSetVerdict (const Tstring &am, const timeval ts, const Tstring &src, const Tinteger
line, const TriComponentId *c, const VerdictValue *verdict, const Tstring &reason)=0;

//Called by TE to log the TTCN-3 statement log
virtual void tliLog (const Tstring &am, const timeval ts, const Tstring &src, const Tinteger line,
const TriComponentId *c, const Tstring *log)=0;

//Called by TE to log entering an alt
virtual void tliAEnter (const Tstring &am, const timeval ts, const Tstring &src, const Tinteger
line, const TriComponentId *c)=0;

```

```

//Called by TE to log leaving an alt
virtual void tliALeave (const Tstring &am, const timeval ts, const Tstring &src, const Tinteger
line, const TriComponentId *c)=0;

//Called by TE to log the nomatch of an alt
virtual void tliANomatch (const Tstring &am, const timeval ts, const Tstring &src, const Tinteger
line, const TriComponentId *c)=0;

//Called by TE to log repeating an alt
virtual void tliARepeat (const Tstring &am, const timeval ts, const Tstring &src, const Tinteger
line, const TriComponentId *c)=0;

//Called by TE to log entering the default section
virtual void tliADefaults (const Tstring &am, const timeval ts, const Tstring &src, const Tinteger
line, const TriComponentId *c)=0;

//Called by TE to log the activation of a default
virtual void tliAActivate (const Tstring &am, const timeval ts, const Tstring &src, const Tinteger
line, const TriComponentId *c, const QualifiedName &name, const TciParameterList *tciPars, const
TciValue *ref)=0;

//Called by TE to log the deactivation of a default
virtual void tliAdeactivate (const Tstring &am, const timeval ts, const Tstring &src, const Tinteger
line, const TriComponentId *c, const TciValue *ref)=0;

//Called by TE to log entering an alt
virtual void tliAWait (const Tstring &am, const timeval ts, const Tstring &src, const Tinteger line,
const TriComponentId *c)=0;

//Called by TE to log that the component executed an SUT action
virtual void tliAction (const Tstring &am, const timeval ts, const Tstring &src, const Tinteger
line, const TriComponentId *c, const Tstring &action)=0;

//Called by TE to log that the component successfully executed a match operation
virtual void tliMatch (const Tstring &am, const timeval ts, const Tstring &src, const Tinteger line,
const TriComponentId *c, const TciValue &expr, const TciValueTemplate &tmpl)=0;

//Called by TE to log that the component executed a match operation, and a mismatch occurred
virtual void tliMatchMismatch (const Tstring &am, const timeval ts, const Tstring &src, const
Tinteger line, const TriComponentId *c, const TciValue &expr, const TciValueTemplate &tmpl, const
TciValueDifferenceList &diffs)=0;

//Can be called by the TE to log additional information during test execution
virtual void tliInfo (const Tstring &am, const timeval ts, const Tstring &src, const Tinteger line,
const TriComponentId *c, const Tinteger level, const Tstring &info)=0;

```

11 W3C XML mapping

11.1 Introduction

This clause introduces the TCI XML mapping [10], [11] and [12] for the logging interface of TCI. The XML mapping for the logging interface defines how the IDL definitions for TCI-TL described in clause 7 are mapped to XML. The complete schema definitions for this mapping are given in annex B.

11.2 Scopes

The IDL module **tciInterface** is mapped to an XML schema with the name space http://uri.etsi.org/ttcn-3/tci/TLI_v4_4_1.xsd.

This schema uses further schemas:

- http://uri.etsi.org/ttcn-3/tci/SimpleTypes_v4_4_1.xsd
for the mapping of simple types to XML.
- http://uri.etsi.org/ttcn-3/tci/Types_v4_4_1.xsd
for the mapping of structured types to XML.

- http://uri.etsi.org/ttcn-3/tci/Values_v4_4_1.xsd
for the mapping of values to XML.
- http://uri.etsi.org/ttcn-3/tci/Templates_v4_4_1.xsd
for the mapping of templates to XML.
- http://uri.etsi.org/ttcn-3/tci/Events_v4_4_1.xsd
for the mapping of logging events to XML.

11.3 Type mapping

11.3.1 Mapping of simple types

11.3.1.1 TBoolean

The IDL **TBoolean** type is mapped to the xsd basic type `boolean`.

11.3.1.2 TString

The IDL **TString** type is mapped to the xsd basic type `string`.

11.3.1.3 TInteger

The IDL **TInteger** type is mapped to the xsd basic type `integer`.

11.3.1.4 TriTimerDurationType

The IDL **TriTimerDurationType** type is mapped to the xsd basic type `float`.

11.3.1.5 TciParameterPassingModeType

The IDL **TciParameterPassingModeType** type is mapped to the xsd basic type `string` with enumeration values `"in"`, `"out"` and `"inout"`.

11.3.1.6 TriStatusType

The IDL **TriStatusType** type is mapped to the xsd basic type `string` with enumeration values `"TRI_Ok"` and `"TRI_Error"`.

11.3.1.7 TciStatusType

The IDL **TriStatusType** type is mapped to the xsd basic type `string` with enumeration values `"TCI_Ok"` and `"TCI_Error"`.

11.3.1.8 ComponentStatusType

The IDL **ComponentStatusType** type is mapped to the xsd basic type `string` with enumeration values `"inactiveC"`, `"runningC"`, `"stoppedC"`, `"killedC"` and `"nullC"`.

11.3.1.9 TimerStatusType

The IDL **TimerStatusType** type is mapped to the xsd basic type `string` with enumeration values `"runningT"`, `"inactiveT"`, `"expiredT"`, and `"nullT"`.

11.3.1.10 PortStatusType

The IDL **PortStatusType** type is mapped to the xsd basic type `string` with enumeration values "startedP", "haltedP" and "stoppedP".

11.3.2 Complex type mapping

11.3.2.1 TriPortIdType

TriPortIdType is mapped to the following complex type:

```
<xsd:complexType name="TriPortIdType">
  <xsd:sequence>
    <xsd:element name="comp" type="Types:TriComponentIdType" />
    <xsd:element name="port" type="Types:Port"/>
  </xsd:sequence>
</xsd:complexType>
```

Elements:

- `comp` The TRI component identifier.
- `port` The identification of the port.

Attributes:

- none.

11.3.2.2 TriComponentIdType

TriComponentIdType is mapped to the following complex type:

```
<xsd:complexType name="TriComponentIdType">
  <xsd:sequence>
    <xsd:choice>
      <xsd:element name="null" type="Templates:null"/>
      <xsd:element name="id" type="Types:Id"/>
    </xsd:choice>
  </xsd:sequence>
</xsd:complexType>
```

Elements:

- `id` The identifier of the TRI component.
- `null` The null identifier. To be used if there is no TRI component identifier.

Attributes:

- none.

11.3.2.3 TriComponentIdListType

TriComponentIdListType is mapped to the following complex type:

```
<xsd:complexType name="TriComponentIdListType">
  <xsd:sequence>
    <xsd:element name="comp" type="Types:TriComponentIdType" minOccurs="0"
      maxOccurs="unbounded"/>
  </xsd:sequence>
</xsd:complexType>
```

Elements:

- `comp` The identifiers of TRI components in that list.

Attributes:

- none.

11.3.2.4 Port

Port is mapped to the following complex type:

```
<xsd:complexType name="Port">
  <xsd:sequence>
    <xsd:element name="id" type="Types:Id"/>
    <xsd:element name="index" type="xsd:int"/>
  </xsd:sequence>
</xsd:complexType>
```

Elements:

- `id` The port identifier.
- `port` The port index.

Attributes:

- none.

11.3.2.5 Id

Id is used as identification for components, ports and timers and is mapped to the following complex type:

```
<xsd:complexType name="Id">
  <xsd:sequence>
    <xsd:element name="name" type="SimpleTypes:TString"/>
    <xsd:element name="id" type="SimpleTypes:TString" minOccurs="0"/>
    <xsd:element name="type" type="SimpleTypes:TString" minOccurs="0"/>
  </xsd:sequence>
</xsd:complexType>
```

Elements:

- `name` The name of the component, port or timer.
- `id` The internal representation of the component, port or timer.
- `type` The type of the component, port or timer.

Attributes:

- none.

11.3.2.6 TriMessageType

TriMessageType is mapped to the following complex type:

```
<xsd:complexType name="TriMessageType">
  <xsd:attribute name="val" type="xsd:hexBinary"/>
  <xsd:attribute name="paddingBits" type="xsd:integer" use="optional" default="0"/>
</xsd:complexType>
```

NOTE: `paddingBits` is optional with a default value of 0 and should only take values between 0 and 7.

The relation between `paddingBits` and `numberOfBits` is:

`numberOfBits == (length(val-attribute)/2)*8-paddingBits`

In the byte-aligned case which is the typical one, the `paddingBits` attribute can be left out.

Elements:

- `val` The encoded message.

Attributes:

- none.

11.3.2.7 TriParameterType

TriParameterType is mapped to the following complex type:

```
<xsd:complexType name="TriParameterType">
  <xsd:element name="val" type="xsd:hexBinary"/>
  <xsd:attribute name="paddingBits" type="xsd:integer" use="optional" default="0"/>
  <xsd:attribute name="name" type="SimpleTypes:TString"/>
  <xsd:attribute name="mode" type="SimpleTypes:TciParameterPassingModeType"/>
</xsd:complexType>
```

NOTE: paddingBits is optional with a default value of 0 and should only take values between 0 and 7.
 The relation between paddingBits and numberOfBits is:
 $numberOfBits == (\text{length}(\text{val-attribute})/2) * 8 - \text{paddingBits}$
 In the byte-aligned case which is the typical one, the paddingBits attribute can be left out.

Elements:

- val The encoded parameter.

Attributes:

- name The parameter name.
- mode The parameter passing mode.

11.3.2.8 TriParameterListType

TriParameterListType is mapped to the following complex type:

```
<xsd:complexType name="TriParameterListType">
  <xsd:sequence>
    <xsd:element name="par" type="Types:TriParameterType" minOccurs="0"
      maxOccurs="unbounded"/>
  </xsd:sequence>
</xsd:complexType>
```

Sequence of Elements:

- par The parameters in that list.

Attributes:

- none.

11.3.2.9 TriAddressType

TriAddressType is mapped to the following complex type:

```
<xsd:complexType name="TriAddressType">
  <xsd:attribute name="val" type="xsd:hexBinary"/>
  <xsd:attribute name="paddingBits" type="xsd:integer" use="optional" default="0"/>
</xsd:complexType>
```

NOTE: paddingBits is optional with a default value of 0 and should only take values between 0 and 7.
 The relation between paddingBits and numberOfBits is:
 $numberOfBits == (\text{length}(\text{val-attribute})/2) * 8 - \text{paddingBits}$
 In the byte-aligned case which is the typical one, the paddingBits attribute can be left out.

Elements:

- val The address value.

Attributes:

- none.

11.3.2.10 TriAddressListType

TriAddressListType is mapped to the following complex type:

```
<xsd:complexType name="TriAddressListType">
  <xsd:sequence>
    <xsd:element name="addr" type="Types:TriAddressType" minOccurs="0"
      maxOccurs="unbounded"/>
  </xsd:sequence>
</xsd:complexType>
```

Elements:

- `addr` The addresses in that list.

Attributes:

- none.

11.3.2.11 TriExceptionType

TriExceptionType is mapped to the following complex type:

```
<xsd:complexType name="TriExceptionType">
  <xsd:attribute name="val" type="xsd:hexBinary"/>
  <xsd:attribute name="paddingBits" type="xsd:integer" use="optional" default="0"/>
</xsd:complexType>
```

NOTE: `paddingBits` is optional with a default value of 0 and should only take values between 0 and 7.
 The relation between `paddingBits` and `numberOfBits` is:
 $numberOfBits == (\text{length}(\text{val-attribute})/2) * 8 - \text{paddingBits}$
 In the byte-aligned case which is the typical one, the `paddingBits` attribute can be left out.

Elements:

- `val` The exception.

Attributes:

- none.

11.3.2.12 TriSignatureIdType

TriSignatureIdType is mapped to the following complex type:

```
<xsd:complexType name="TriSignatureIdType">
  <xsd:attribute name="val" type="SimpleTypes:TString" use="required"/>
</xsd:complexType>
```

Elements:

- `val` The signature.

Attributes:

- none.

11.3.2.13 TriTimerIdType

TriTimerIdType is mapped to the following complex type:

```
<xsd:complexType name="TriTimerIdType">
  <xsd:sequence>
```

```

    <xsd:element name="id" type="Types:Id"/>
  </xsd:sequence>
</xsd:complexType>

```

Elements:

- `id` The identification of the timer.

Attributes:

- none.

11.3.2.14 TriTimerDurationType

TriTimerDurationType is mapped to the following simple type:

```

<xsd:simpleType name="TriTimerDurationType">
  <xsd:restriction base="xsd:float"/>
</xsd:simpleType>

```

11.3.2.15 QualifiedName

QualifiedName is used to fully qualify module parameters, variables, etc and is mapped to the following complex type:

```

<xsd:complexType name="QualifiedName">
  <xsd:attribute name="moduleName" type="SimpleTypes:TString" use="required"/>
  <xsd:attribute name="baseName" type="SimpleTypes:TString" use="required"/>
</xsd:complexType>

```

Elements:

- `moduleName` The module name of the TTCN-3 module.
- `baseName` The name of the object that is fully qualified.

Attributes:

- none.

11.3.2.16 TciBehaviourIdType

TciBehaviourIdType is mapped to the following complex type:

```

<xsd:complexType name="TciBehaviourIdType">
  <xsd:sequence>
    <xsd:element name="name" type="Types:QualifiedName"/>
  </xsd:sequence>
</xsd:complexType>

```

Elements:

- `name` The qualified name of the behaviour.

Attributes:

- none.

11.3.2.17 TciTestCaseIdType

TciTestCaseIdType is mapped to the following complex type:

```

<xsd:complexType name="TciTestCaseIdType">
  <xsd:sequence>
    <xsd:element name="name" type="Types:QualifiedName"/>
  </xsd:sequence>
</xsd:complexType>

```

Elements:

- name The qualified name of the test case.

Attributes:

- none.

11.3.2.18 TciParameterType

TciParameterType is mapped to the following complex type:

```
<xsd:complexType name="TciParameterType">
  <xsd:sequence>
    <xsd:element name="val" type="Values:Value"/>
  </xsd:sequence>
  <xsd:attribute name="name" type="SimpleTypes:TString"/>
  <xsd:attribute name="mode" type="SimpleTypes:TciParameterPassingModeType"/>
</xsd:complexType>
```

Elements:

- val The encoded parameter.

Attributes:

- name The parameter name.
- mode The parameter passing mode.

11.3.2.19 TciParameterListType

TciParameterListType is mapped to the following complex type:

```
<xsd:complexType name="TciParameterListType">
  <xsd:sequence>
    <xsd:element name="par" type="Types:TciParameterType"
      minOccurs="0" maxOccurs="unbounded"/>
  </xsd:sequence>
</xsd:complexType>
```

Sequence of Elements:

- par The parameters in that list.

Attributes:

- none.

11.3.3 Abstract value mapping

11.3.3.1 Value

Value is mapped to the following complex type:

```
<xsd:complexType name="Value" mixed="true">
  <xsd:choice>
    <xsd:element name="integer" type="Values:IntegerValue"/>
    <xsd:element name="float" type="Values:FloatValue"/>
    <xsd:element name="boolean" type="Values:BooleanValue"/>
    <xsd:element name="verdicttype" type="Values:VerdictValue"/>
    <xsd:element name="bitstring" type="Values:BitstringValue"/>
    <xsd:element name="hexstring" type="Values:HexstringValue"/>
    <xsd:element name="octetstring" type="Values:OctetstringValue"/>
    <xsd:element name="charstring" type="Values:CharstringValue"/>
    <xsd:element name="universal_charstring" type="Values:UniversalCharstringValue"/>
    <xsd:element name="record" type="Values:RecordValue"/>
    <xsd:element name="record_of" type="Values:RecordOfValue"/>
  </xsd:choice>
</xsd:complexType>
```

```

    <xsd:element name="array" type="Values:ArrayValue"/>
    <xsd:element name="set" type="Values:SetValue"/>
    <xsd:element name="set_of" type="Values:SetOfValue"/>
    <xsd:element name="enumerated" type="Values:EnumeratedValue"/>
    <xsd:element name="union" type="Values:UnionValue"/>
    <xsd:element name="anytype" type="Values:AnytypeValue"/>
    <xsd:element name="address" type="Values:AddressValue"/>
  </xsd:choice>
  <xsd:attributeGroup ref="Values:ValueAtts"/>
</xsd:complexType>

<xsd:attributeGroup name="ValueAtts">
  <xsd:attribute name="name" type="SimpleTypes:TString" use="optional"/>
  <xsd:attribute name="type" type="SimpleTypes:TString" use="optional"/>
  <xsd:attribute name="module" type="SimpleTypes:TString" use="optional"/>
  <xsd:attribute name="annotation" type="SimpleTypes:TString" use="optional"/>
</xsd:attributeGroup>

```

Choice of Elements:

- integer An integer value.
- float A float value.
- boolean A boolean value.
- verdicttype A verdicttype value.
- bitstring A bitstring value.
- hexstring A hexstring value.
- octetstring An octetstring value.
- charstring A charstring value.
- universal_charstring A universal charstring value.
- record A record value.
- record_of A record of value.
- array An array value.
- set A set value.
- set_of A set of value.
- enumerated An enumerated value.
- union A union value.
- anytype An anytype value.
- address An address value.

Attributes:

- name The name of the value, if known.
- type The type of the value, if known.
- module The module of the value, if known.
- annotation A helper attribute to provide additional matching/mismatching information, etc.

11.3.3.2 IntegerValue

IntegerValue is mapped to the following complex type:

```
<xsd:complexType name="IntegerValue">
  <xsd:choice >
    <xsd:element name="value" type="SimpleTypes:TString"/>
    <xsd:element name="null" type="Templates:null"/>
    <xsd:element name="omit" type="Templates:omit"/>
  </xsd:choice>
  <xsd:attributeGroup ref="Values:ValueAtts"/>
</xsd:complexType>
```

Simple Content:

- value The integer value as string.
- null If no value is given.
- omit If the value is omitted.

Attributes:

- The same attributes as those of Value.

11.3.3.3 FloatValue

FloatValue is mapped to the following complex type:

```
<xsd:complexType name="FloatValue">
  <xsd:simpleContent>
    <xsd:extension base="SimpleTypes:TString">
      <xsd:attributeGroup ref="Values:ValueAtts"/>
    </xsd:extension>
  </xsd:simpleContent>
</xsd:complexType>
```

Simple Content:

- value The float value as string.
- null If no value is given.
- omit If the value is omitted.

Attributes:

- The same attributes as those of Value.

11.3.3.4 BooleanValue

BooleanValue is mapped to the following complex type:

```
<xsd:complexType name="BooleanValue">
  <xsd:simpleContent>
    <xsd:extension base="SimpleTypes:TString">
      <xsd:attributeGroup ref="Values:ValueAtts"/>
    </xsd:extension>
  </xsd:simpleContent>
</xsd:complexType>
```

Simple Content:

- value The boolean value as string.
- null If no value is given.
- omit If the value is omitted.

Attributes:

- The same attributes as those of Value.

11.3.3.5 Void**11.3.3.6 VerdictValue**

VerdictValue is mapped to the following complex type:

```
<xsd:complexType name="VerdictValue">
  <xsd:simpleContent>
    <xsd:extension base="SimpleTypes:TString">
      <xsd:attributeGroup ref="Values:ValueAtts"/>
    </xsd:extension>
  </xsd:simpleContent>
</xsd:complexType>
```

Simple Content:

- value The verdict value as string.
- null If no value is given.
- omit If the value is omitted.

Attributes:

- The same attributes as those of Value.

11.3.3.7 BitstringValue

BitstringValue is mapped to the following complex type:

```
<xsd:complexType name="BitstringValue">
  <xsd:simpleContent>
    <xsd:extension base="SimpleTypes:TString">
      <xsd:attributeGroup ref="Values:ValueAtts"/>
    </xsd:extension>
  </xsd:simpleContent>
</xsd:complexType>
```

Simple Content:

- value The bitstring value as string.
- null If no value is given.
- omit If the value is omitted.

Attributes:

- The same attributes as those of Value.

11.3.3.8 HexstringValue

HexstringValue is mapped to the following complex type:

```
<xsd:complexType name="HexstringValue">
  <xsd:simpleContent>
    <xsd:extension base="SimpleTypes:TString">
      <xsd:attributeGroup ref="Values:ValueAtts"/>
    </xsd:extension>
  </xsd:simpleContent>
</xsd:complexType>
```

Simple Content:

- value The hexstring value as string.
- null If no value is given.
- omit If the value is omitted.

Attributes:

- The same attributes as those of Value.

11.3.3.9 OctetstringValue

OctetstringValue is mapped to the following complex type:

```
<xsd:complexType name="OctetstringValue">
  <xsd:simpleContent>
    <xsd:extension base="SimpleTypes:TString">
      <xsd:attributeGroup ref="Values:ValueAtts"/>
    </xsd:extension>
  </xsd:simpleContent>
</xsd:complexType>
```

Simple Content:

- value The octetstring value as string.
- null If no value is given.
- omit If the value is omitted.

Attributes:

- The same attributes as those of Value.

11.3.3.10 CharstringValue

CharstringValue is mapped to the following complex type:

```
<xsd:complexType name="CharstringValue">
  <xsd:simpleContent>
    <xsd:extension base="SimpleTypes:TString">
      <xsd:attributeGroup ref="Values:ValueAtts"/>
    </xsd:extension>
  </xsd:simpleContent>
</xsd:complexType>
```

Simple Content:

- value The charstring value as string.
- null If no value is given.
- omit If the value is omitted.

Attributes:

- The same attributes as those of Value.

11.3.3.11 UniversalCharstringValue

UniversalCharstringValue is mapped to the following complex type:

```
<xsd:complexType name="UniversalCharstringValue">
  <xsd:simpleContent>
    <xsd:extension base="SimpleTypes:TString">
      <xsd:attributeGroup ref="Values:ValueAtts"/>
    </xsd:extension>
  </xsd:simpleContent>
</xsd:complexType>
```



```

    </xsd:extension>
  </xsd:simpleContent>
</xsd:complexType>

```

Simple Content:

- value The universal charstring value as string.
- null If no value is given.
- omit If the value is omitted.

Attributes:

- The same attributes as those of Value.

11.3.3.12 RecordValue

RecordValue is mapped to the following complex type:

```

<xsd:complexType name="RecordValue">
  <xsd:choice>
    <xsd:choice minOccurs="0" maxOccurs="unbounded">
      <xsd:element name="integer" type="Values:IntegerValue"/>
      <xsd:element name="float" type="Values:FloatValue"/>
      <xsd:element name="boolean" type="Values:BooleanValue"/>
      <xsd:element name="verdicttype" type="Values:VerdictValue"/>
      <xsd:element name="bitstring" type="Values:BitstringValue"/>
      <xsd:element name="hexstring" type="Values:HexstringValue"/>
      <xsd:element name="octetstring" type="Values:OctetstringValue"/>
      <xsd:element name="charstring" type="Values:CharstringValue"/>
      <xsd:element name="universal_charstring"
        type="Values:UniversalCharstringValue"/>
      <xsd:element name="record" type="Values:RecordValue"/>
      <xsd:element name="record_of" type="Values:RecordOfValue"/>
      <xsd:element name="array" type="Values:ArrayValue"/>
      <xsd:element name="set" type="Values:SetValue"/>
      <xsd:element name="set_of" type="Values:SetOfValue"/>
      <xsd:element name="enumerated" type="Values:EnumeratedValue"/>
      <xsd:element name="union" type="Values:UnionValue"/>
      <xsd:element name="anytype" type="Values:AnytypeValue"/>
      <xsd:element name="address" type="Values:AddressValue"/>
    </xsd:choice>
    <xsd:element name="null" type="Templates:null"/>
    <xsd:element name="omit" type="Templates:omit"/>
  </xsd:choice>
  <xsd:attributeGroup ref="Values:ValueAtts"/>
</xsd:complexType>

```

Sequence of Elements:

- integer An integer value.
- float A float value.
- boolean A boolean value.
- verdicttype A verdicttype value.
- bitstring A bitstring value.
- hexstring A hexstring value.
- octetstring An octetstring value.
- charstring A charstring value.
- universal_charstring A universal charstring value.
- record A record value.

- `record_of` A record of value.
- `array` An array value.
- `set` A set value.
- `set_of` A set of value.
- `enumerated` An enumerated value.
- `union` A union value.
- `anytype` An anytype value.
- `address` An address value.
- `null` If no field is given.
- `omit` If the field is omitted.

Attributes:

- The same attributes as those of `Value`.

11.3.3.13 RecordOfValue

`RecordOfValue` is mapped to the following complex type:

```

<xsd:complexType name="RecordOfValue">
  <xsd:choice>
    <xsd:element name="integer" type="Values:IntegerValue" minOccurs="0"
      maxOccurs="unbounded"/>
    <xsd:element name="float" type="Values:FloatValue" minOccurs="0"
      maxOccurs="unbounded"/>
    <xsd:element name="boolean" type="Values:BooleanValue" minOccurs="0"
      maxOccurs="unbounded"/>
    <xsd:element name="verdicttype" type="Values:VerdictValue" minOccurs="0"
      maxOccurs="unbounded"/>
    <xsd:element name="bitstring" type="Values:BitstringValue"
      minOccurs="0" maxOccurs="unbounded"/>
    <xsd:element name="hexstring" type="Values:HexstringValue"
      minOccurs="0" maxOccurs="unbounded"/>
    <xsd:element name="octetstring" type="Values:OctetstringValue"
      minOccurs="0" maxOccurs="unbounded"/>
    <xsd:element name="charstring" type="Values:CharstringValue"
      minOccurs="0" maxOccurs="unbounded"/>
    <xsd:element name="universal_charstring"
      type="Values:UniversalCharstringValue" minOccurs="0"
      maxOccurs="unbounded"/>
    <xsd:element name="record" type="Values:RecordValue" minOccurs="0"
      maxOccurs="unbounded"/>
    <xsd:element name="record_of" type="Values:RecordOfValue"
      minOccurs="0" maxOccurs="unbounded"/>
    <xsd:element name="array" type="Values:ArrayValue"
      minOccurs="0" maxOccurs="unbounded"/>
    <xsd:element name="set" type="Values:SetValue" minOccurs="0"
      maxOccurs="unbounded"/>
    <xsd:element name="set_of" type="Values:SetOfValue"
      minOccurs="0" maxOccurs="unbounded"/>
    <xsd:element name="enumerated" type="Values:EnumeratedValue"
      minOccurs="0" maxOccurs="unbounded"/>
    <xsd:element name="union" type="Values:UnionValue" minOccurs="0"
      maxOccurs="unbounded"/>
    <xsd:element name="anytype" type="Values:AnytypeValue" minOccurs="0"
      maxOccurs="unbounded"/>
    <xsd:element name="address" type="Values:AddressValue" minOccurs="0"
      maxOccurs="unbounded"/>
    <xsd:element name="null" type="Templates:null"/>
    <xsd:element name="omit" type="Templates:omit"/>
  </xsd:choice>
  <xsd:attributeGroup ref="Values:ValueAtts"/>
</xsd:complexType>

```

Choice of Sequence of Elements:

- integer An integer value.
- float A float value.
- boolean A boolean value.
- verdicttype A verdicttype value.
- bitstring A bitstring value.
- hexstring A hexstring value.
- octetstring An octetstring value.
- charstring A charstring value.
- universal_charstring A universal charstring value.
- record A record value.
- record_of A record of value.
- array An array value.
- set A set value.
- set_of A set of value.
- enumerated An enumerated value.
- union A union value.
- anytype An anytype value.
- address An address value.
- null If no field is given.
- omit If the field is omitted.

Attributes:

- The same attributes as those of Value.

11.3.3.14 ArrayValue

ArrayValue is mapped to the following complex type:

```
<xsd:complexType name="ArrayValue">
  <xsd:choice>
    <xsd:element name="integer" type="Values:IntegerValue" minOccurs="0"
      maxOccurs="unbounded"/>
    <xsd:element name="float" type="Values:FloatValue" minOccurs="0"
      maxOccurs="unbounded"/>
    <xsd:element name="boolean" type="Values:BooleanValue" minOccurs="0"
      maxOccurs="unbounded"/>
    <xsd:element name="verdicttype" type="Values:VerdictValue" minOccurs="0"
      maxOccurs="unbounded"/>
    <xsd:element name="bitstring" type="Values:BitstringValue"
      minOccurs="0" maxOccurs="unbounded"/>
    <xsd:element name="hexstring" type="Values:HexstringValue"
      minOccurs="0" maxOccurs="unbounded"/>
    <xsd:element name="octetstring" type="Values:OctetstringValue"
      minOccurs="0" maxOccurs="unbounded"/>
    <xsd:element name="charstring" type="Values:CharstringValue"
      minOccurs="0" maxOccurs="unbounded"/>
    <xsd:element name="universal_charstring" type="Values:UniversalCharstringValue"
      minOccurs="0" maxOccurs="unbounded"/>
  </xsd:choice>
</xsd:complexType>
```

```

        type="Values:UniversalCharstringValue" minOccurs="0"
        maxOccurs="unbounded"/>
<xsd:element name="record" type="Values:RecordValue" minOccurs="0"
        maxOccurs="unbounded"/>
<xsd:element name="record_of" type="Values:RecordOfValue"
        minOccurs="0" maxOccurs="unbounded"/>
<xsd:element name="array" type="Values:ArrayValue"
        minOccurs="0" maxOccurs="unbounded"/>
<xsd:element name="set" type="Values:SetValue" minOccurs="0"
        maxOccurs="unbounded"/>
<xsd:element name="set_of" type="Values:SetOfValue"
        minOccurs="0" maxOccurs="unbounded"/>
<xsd:element name="enumerated" type="Values:EnumeratedValue"
        minOccurs="0" maxOccurs="unbounded"/>
<xsd:element name="union" type="Values:UnionValue" minOccurs="0"
        maxOccurs="unbounded"/>
<xsd:element name="anytype" type="Values:AnytypeValue" minOccurs="0"
        maxOccurs="unbounded"/>
        <xsd:element name="address" type="Values:AddressValue" minOccurs="0"
        maxOccurs="unbounded"/>
        <xsd:element name="null" type="Templates:null"/>
        <xsd:element name="omit" type="Templates:omit"/>
</xsd:choice>
<xsd:attributeGroup ref="Values:ValueAtts"/>
</xsd:complexType>

```

Choice of Sequence of Elements:

- integer An integer value.
- float A float value.
- boolean A boolean value.
- verdicttype A verdicttype value.
- bitstring A bitstring value.
- hexstring A hexstring value.
- octetstring An octetstring value.
- charstring A charstring value.
- universal_charstring A universal charstring value.
- record A record value.
- record_of A record of value.
- array An array value.
- set A set value.
- set_of A set of value.
- enumerated An enumerated value.
- union A union value.
- anytype An anytype value.
- address An address value.
- null If no field is given.
- omit If the field is omitted.

Attributes:

- The same attributes as those of Value.

11.3.3.15 SetValue

SetValue is mapped to the following complex type:

```
<xsd:complexType name="SetValue">
  <xsd:choice>
    <xsd:choice minOccurs="0" maxOccurs="unbounded">
      <xsd:element name="integer" type="Values:IntegerValue"/>
      <xsd:element name="float" type="Values:FloatValue"/>
      <xsd:element name="boolean" type="Values:BooleanValue"/>
      <xsd:element name="verdicttype" type="Values:VerdictValue"/>
      <xsd:element name="bitstring" type="Values:BitstringValue"/>
      <xsd:element name="hexstring" type="Values:HexstringValue"/>
      <xsd:element name="octetstring" type="Values:OctetstringValue"/>
      <xsd:element name="charstring" type="Values:CharstringValue"/>
      <xsd:element name="universal_charstring"
        type="Values:UniversalCharstringValue"/>
      <xsd:element name="record" type="Values:RecordValue"/>
      <xsd:element name="record_of" type="Values:RecordOfValue"/>
      <xsd:element name="array" type="Values:ArrayValue"/>
      <xsd:element name="set" type="Values:SetValue"/>
      <xsd:element name="set_of" type="Values:SetOfValue"/>
      <xsd:element name="enumerated" type="Values:EnumeratedValue"/>
      <xsd:element name="union" type="Values:UnionValue"/>
      <xsd:element name="anytype" type="Values:AnytypeValue"/>
      <xsd:element name="address" type="Values:AddressValue"/>
    </xsd:choice>
    <xsd:element name="null" type="Templates:null"/>
    <xsd:element name="omit" type="Templates:omit"/>
  </xsd:choice>
  <xsd:attributeGroup ref="Values:ValueAtts"/>
</xsd:complexType>
```

Sequence of Elements:

- integer An integer value.
- float A float value.
- boolean A boolean value.
- verdicttype A verdicttype value.
- bitstring A bitstring value.
- hexstring A hexstring value.
- octetstring An octetstring value.
- charstring A charstring value.
- universal_charstring A universal charstring value.
- record A record value.
- record_of A record of value.
- array An array value.
- set A set value.
- set_of A set of value.
- enumerated An enumerated value.
- union A union value.

- anytype An anytype value.
- address An address value.
- null If no field is given.
- omit If the field is omitted.

Attributes:

- The same attributes as those of Value.

11.3.3.16 SetOfValue

SetOfValue is mapped to the following complex type:

```

<xsd:complexType name="SetOfValue">
  <xsd:choice>
    <xsd:element name="integer" type="Values:IntegerValue" minOccurs="0"
      maxOccurs="unbounded"/>
    <xsd:element name="float" type="Values:FloatValue" minOccurs="0"
      maxOccurs="unbounded"/>
    <xsd:element name="boolean" type="Values:BooleanValue" minOccurs="0"
      maxOccurs="unbounded"/>
    <xsd:element name="verdicttype" type="Values:VerdictValue" minOccurs="0"
      maxOccurs="unbounded"/>
    <xsd:element name="bitstring" type="Values:BitstringValue"
      minOccurs="0" maxOccurs="unbounded"/>
    <xsd:element name="hexstring" type="Values:HexstringValue"
      minOccurs="0" maxOccurs="unbounded"/>
    <xsd:element name="octetstring" type="Values:OctetstringValue"
      minOccurs="0" maxOccurs="unbounded"/>
    <xsd:element name="charstring" type="Values:CharstringValue"
      minOccurs="0" maxOccurs="unbounded"/>
    <xsd:element name="universal_charstring"
      type="Values:UniversalCharstringValue" minOccurs="0"
      maxOccurs="unbounded"/>
    <xsd:element name="record" type="Values:RecordValue" minOccurs="0"
      maxOccurs="unbounded"/>
    <xsd:element name="record_of" type="Values:RecordOfValue"
      minOccurs="0" maxOccurs="unbounded"/>
    <xsd:element name="array" type="Values:ArrayValue"
      minOccurs="0" maxOccurs="unbounded"/>
    <xsd:element name="set" type="Values:SetValue" minOccurs="0"
      maxOccurs="unbounded"/>
    <xsd:element name="set_of" type="Values:SetOfValue"
      minOccurs="0" maxOccurs="unbounded"/>
    <xsd:element name="enumerated" type="Values:EnumeratedValue"
      minOccurs="0" maxOccurs="unbounded"/>
    <xsd:element name="union" type="Values:UnionValue" minOccurs="0"
      maxOccurs="unbounded"/>
    <xsd:element name="anytype" type="Values:AnytypeValue" minOccurs="0"
      maxOccurs="unbounded"/>
    <xsd:element name="address" type="Values:AddressValue" minOccurs="0"
      maxOccurs="unbounded"/>
    <xsd:element name="null" type="Templates:null"/>
    <xsd:element name="omit" type="Templates:omit"/>
  </xsd:choice>
  <xsd:attributeGroup ref="Values:ValueAtts"/>
</xsd:complexType>

```

Choice of Sequence of Elements:

- integer An integer value.
- float A float value.
- boolean A boolean value.
- verdicttype A verdicttype value.
- bitstring A bitstring value.

- `hexstring` A hexstring value.
- `octetstring` An octetstring value.
- `charstring` A charstring value.
- `universal_charstring` A universal charstring value.
- `record` A record value.
- `record_of` A record of value.
- `array` An array value.
- `set` A set value.
- `set_of` A set of value.
- `enumerated` An enumerated value.
- `union` A union value.
- `anytype` An anytype value.
- `address` An address value.
- `null` If no field is given.
- `omit` If the field is omitted.

Attributes:

- The same attributes as those of Value.

11.3.3.17 EnumeratedValue

EnumeratedValue is mapped to the following complex type:

```
<xsd:complexType name="EnumeratedValue">
  <xsd:choice>
    <xsd:element name="value" type="SimpleTypes:TString"/>
    <xsd:element name="intValue" type="SimpleTypes:TInteger" minOccurs="0"/>
    <xsd:element name="null" type="Templates:null"/>
    <xsd:element name="omit" type="Templates:omit"/>
  </xsd:choice>
</xsd:sequence>
<xsd:attributeGroup ref="Values:ValueAtts"/>
</xsd:complexType>
```

Sequence of Elements:

- `value` The enumeration value.
- `intValue` The integer value.
- `null` If no value is given.
- `omit` If the value is omitted.

Attributes:

- The same attributes as those of Value.

11.3.3.18 UnionValue

UnionValue is mapped to the following complex type:

```
<xsd:complexType name="UnionValue">
  <xsd:choice>
    <xsd:element name="integer" type="Values:IntegerValue"/>
    <xsd:element name="float" type="Values:FloatValue"/>
    <xsd:element name="boolean" type="Values:BooleanValue"/>
    <xsd:element name="verdicttype" type="Values:VerdictValue"/>
    <xsd:element name="bitstring" type="Values:BitstringValue"/>
    <xsd:element name="hexstring" type="Values:HexstringValue"/>
    <xsd:element name="octetstring" type="Values:OctetstringValue"/>
    <xsd:element name="charstring" type="Values:CharstringValue"/>
    <xsd:element name="universal_charstring"
      type="Values:UniversalCharstringValue"/>
    <xsd:element name="record" type="Values:RecordValue"/>
    <xsd:element name="record_of" type="Values:RecordOfValue"/>
    <xsd:element name="array" type="Values:ArrayValue"/>
    <xsd:element name="set" type="Values:SetValue"/>
    <xsd:element name="set_of" type="Values:SetOfValue"/>
    <xsd:element name="enumerated" type="Values:EnumeratedValue"/>
    <xsd:element name="union" type="Values:UnionValue"/>
    <xsd:element name="anytype" type="Values:AnytypeValue"/>
    <xsd:element name="address" type="Values:AddressValue"/>
    <xsd:element name="null" type="Templates:null"/>
    <xsd:element name="omit" type="Templates:omit"/>
  </xsd:choice>
  <xsd:attributeGroup ref="Values:ValueAtts"/>
</xsd:complexType>
```

Choice of Elements:

- integer An integer value.
- float A float value.
- boolean A boolean value.
- verdicttype A verdicttype value.
- bitstring A bitstring value.
- hexstring A hexstring value.
- octetstring An octetstring value.
- charstring A charstring value.
- universal_charstring A universal charstring value.
- record A record value.
- record_of A record of value.
- array An array value.
- set A set value.
- set_of A set of value.
- enumerated An enumerated value.
- union A union value.
- anytype An anytype value.
- address An address value.

Attributes:

- The same attributes as those of Value.

11.3.3.19 AnytypeValue

AnytypeValue is mapped to the following complex type:

```
<xsd:complexType name="AnytypeValue">
  <xsd:choice minOccurs="0" maxOccurs="unbounded">
    <xsd:element name="integer" type="Values:IntegerValue"/>
    <xsd:element name="float" type="Values:FloatValue"/>
    <xsd:element name="boolean" type="Values:BooleanValue"/>
    <xsd:element name="verdicttype" type="Values:VerdictValue"/>
    <xsd:element name="bitstring" type="Values:BitstringValue"/>
    <xsd:element name="hexstring" type="Values:HexstringValue"/>
    <xsd:element name="octetstring" type="Values:OctetstringValue"/>
    <xsd:element name="charstring" type="Values:OctetstringValue"/>
    <xsd:element name="universal_charstring"
      type="Values:UniversalCharstringValue"/>
    <xsd:element name="record" type="Values:RecordValue"/>
    <xsd:element name="record_of" type="Values:RecordOfValue"/>
    <xsd:element name="array" type="Values:ArrayValue"/>
    <xsd:element name="set" type="Values:SetValue"/>
    <xsd:element name="set_of" type="Values:SetOfValue"/>
    <xsd:element name="enumerated" type="Values:EnumeratedValue"/>
    <xsd:element name="union" type="Values:UnionValue"/>
    <xsd:element name="address" type="Values:AddressValue"/>
    <xsd:element name="null" type="Templates:null"/>
    <xsd:element name="omit" type="Templates:omit"/>
  </xsd:choice>
  <xsd:attributeGroup ref="Values:ValueAtts"/>
</xsd:complexType>
```

Choice of Elements:

- integer An integer value.
- float A float value.
- boolean A boolean value.
- verdicttype A verdicttype value.
- bitstring A bitstring value.
- hexstring A hexstring value.
- octetstring An octetstring value.
- charstring A charstring value.
- universal_charstring A universal charstring value.
- record A record value.
- record_of A record of value.
- array An array value.
- set A set value.
- set_of A set of value.
- enumerated An enumerated value.
- union A union value.
- address An address value.

Attributes:

- The same attributes as those of Value.

11.3.3.20 AddressValue

AddressValue is mapped to the following complex type:

```
<xsd:complexType name="AddressValue">
  <xsd:choice minOccurs="0" maxOccurs="unbounded">
    <xsd:element name="integer" type="Values:IntegerValue"/>
    <xsd:element name="float" type="Values:FloatValue"/>
    <xsd:element name="boolean" type="Values:BooleanValue"/>
    <xsd:element name="verdicttype" type="Values:VerdictValue"/>
    <xsd:element name="bitstring" type="Values:BitstringValue"/>
    <xsd:element name="hexstring" type="Values:HexstringValue"/>
    <xsd:element name="octetstring" type="Values:OctetstringValue"/>
    <xsd:element name="charstring" type="Values:OctetstringValue"/>
    <xsd:element name="universal_charstring"
      type="Values:UniversalCharstringValue"/>
    <xsd:element name="record" type="Values:RecordValue"/>
    <xsd:element name="record_of" type="Values:RecordOfValue"/>
    <xsd:element name="array" type="Values:ArrayValue"/>
    <xsd:element name="set" type="Values:SetValue"/>
    <xsd:element name="set_of" type="Values:SetOfValue"/>
    <xsd:element name="enumerated" type="Values:EnumeratedValue"/>
    <xsd:element name="union" type="Values:UnionValue"/>
    <xsd:element name="anytype" type="Values:AnytypeValue"/>
    <xsd:element name="null" type="Templates:null"/>
    <xsd:element name="omit" type="Templates:omit"/>
  </xsd:choice>
  <xsd:attributeGroup ref="Values:ValueAtts"/>
</xsd:complexType>
```

Choice of Elements:

- integer An integer value.
- float A float value.
- boolean A boolean value.
- verdicttype A verdicttype value.
- bitstring A bitstring value.
- hexstring A hexstring value.
- octetstring An octetstring value.
- charstring A charstring value.
- universal_charstring A universal charstring value.
- record A record value.
- record_of A record of value.
- array An array of value.
- set A set value.
- set_of A set of value.
- enumerated An enumerated value.
- union A union value.
- anytype An anytype value.

Attributes:

- The same attributes as those of Value.

11.3.4 Abstract logging types mapping

Additional types are defined to ease the logging of matches between values and templates.

11.3.4.1 TciValueTemplate

TciValueTemplate is mapped to the following complex type:

```
<xsd:complexType name="TciValueTemplate">
  <xsd:complexContent mixed="true">
    <xsd:extension base="Values:Value">
      <xsd:choice minOccurs="0">
        <xsd:element name="integer" type="Templates:IntegerTemplate"/>
        <xsd:element name="float" type="Templates:FloatTemplate"/>
        <xsd:element name="boolean" type="Templates:BooleanTemplate"/>
        <xsd:element name="verdicttype" type="Templates:VerdictTemplate"/>
        <xsd:element name="bitstring" type="Templates:BitstringTemplate"/>
        <xsd:element name="hexstring" type="Templates:HexstringTemplate"/>
        <xsd:element name="octetstring" type="Templates:OctetstringTemplate"/>
        <xsd:element name="charstring" type="Templates:CharstringTemplate"/>
        <xsd:element name="universal_charstring"
          type="Templates:UniversalCharstringTemplate"/>
        <xsd:element name="record" type="Templates:RecordTemplate"/>
        <xsd:element name="record_of" type="Templates:RecordOfTemplate"/>
        <xsd:element name="array" type="Templates:ArrayTemplate"/>
        <xsd:element name="set" type="Templates:SetTemplate"/>
        <xsd:element name="set_of" type="Templates:SetOfTemplate"/>
        <xsd:element name="enumerated" type="Templates:EnumeratedTemplate"/>
        <xsd:element name="union" type="Templates:UnionTemplate"/>
        <xsd:element name="anytype" type="Templates:AnytypeTemplate"/>
        <xsd:element name="address" type="Templates:AddressTemplate"/>
        <xsd:element name="omit" type="Templates:omit"/>
        <xsd:element name="any" type="Templates:any"/>
        <xsd:element name="anyoromit" type="Templates:anyoromit"/>
        <xsd:element name="templateDef" type="SimpleTypes:TString"/>
      </xsd:choice>
    </xsd:extension>
  </xsd:complexContent>
</xsd:complexType>
```

Choice of Elements:

- integer An integer template.
- float A float template.
- boolean A boolean template.
- verdicttype A verdicttype template.
- bitstring A bitstring template.
- hexstring A hexstring template.
- octetstring An octetstring template.
- charstring A charstring template.
- universal_charstring A universal charstring template.
- record A record template.
- record_of A record of template.
- array An array template.

- `set` A set template.
- `set_of` A set of template.
- `enumerated` An enumerated template.
- `union` A union template.
- `anytype` An anytype template.
- `address` An address template.
- `omit` An omit template.
- `any` An any template.
- `anyoromit` An anyoromit template.
- `templateDef` A complex template definition.

Attributes:

- `none`.

11.3.4.2 TciNonValueTemplate

TciNonValueTemplate is mapped to the following complex type:

```
<xsd:complexType name="TciNonValueTemplate">
  <xsd:sequence>
    <xsd:choice>
      <xsd:element name="any" type="Templates:any"/>
      <xsd:element name="all" type="Templates:all"/>
      <xsd:element name="templateDef" type="SimpleTypes:TString"/>
      <xsd:element name="null" type="Templates:null"/>
    </xsd:choice>
  </xsd:sequence>
</xsd:complexType>
```

Choice of Elements:

- `any` An any template.
- `all` An all template.
- `templateDef` A complex template definition.
- `null` No template is given.

Attributes:

- `none`.

11.3.4.3 TciValueList

TciValueList is mapped to the following complex type:

```
<xsd:complexType name="TciValueListType">
  <xsd:sequence>
    <xsd:element name="val" type="Values:Value"
      maxOccurs="unbounded"/>
  </xsd:sequence>
</xsd:complexType>
```

Sequence of Elements:

- `val` The values in the value list.

Attributes:

- none.

11.3.4.4 TciValueDifference

TciValueDifference is mapped to the following complex type:

```
<xsd:complexType name="TciValueDifference">
  <xsd:sequence>
    <xsd:element name="val" type="SimpleTypes:xpath"/>
    <xsd:element name="tmpl"
type="SimpleTypes:xpath"/>
  </xsd:sequence>
  <xsd:attributeGroup ref="Values:ValueAtts"/>
  <xsd:attribute name="desc" type="SimpleTypes:TString"
use="optional"/>
</xsd:complexType>
```

Sequence of Elements:

- val A reference to the mismatching value.
- tmpl A reference to the template.

Attributes:

- The same attributes as those of Value.
- desc The reason of the mismatch.

11.3.4.5 TciValueDifferenceList

TciValueDifferenceList is mapped to the following complex type:

```
<xsd:complexType name="TciValueDifferenceList">
  <xsd:sequence>
    <xsd:element name="diff" type="Templates:TciValueDifference"
maxOccurs="unbounded"/>
  </xsd:sequence>
</xsd:complexType>
```

Sequence of Elements:

- diff The value/template differences in the value difference list.

Attributes:

- none.

11.4 Mapping of the operations on the logging interface

Every operation provided at the logging interface has a corresponding complex type definition in XML. These complex type definitions are extensions of Event.

11.4.1 Event

Event is mapped to the following complex type:

```
<!-- common definition for all events -->
<xsd:complexType name="Event" mixed="true">
  <xsd:sequence>
    <xsd:element name="am" type="SimpleTypes:TString"/>
  </xsd:sequence>
  <xsd:attribute name="ts" type="xsd:long" use="required"/>
  <xsd:attribute name="src" type="SimpleTypes:TString" use="optional"/>
  <xsd:attribute name="line" type="SimpleTypes:TInteger" use="optional"/>
```

```

<!-- general identifier structure for test components, ports and timer -->
  <xsd:attribute name="name" type="SimpleTypes:TString" use="required"/>
  <xsd:attribute name="id" type="SimpleTypes:TString" use="required"/>
  <xsd:attribute name="type" type="SimpleTypes:TString" use="required"/>
</xsd:complexType>

```

Elements:

- `am` A message, to be used for further information in the log.

Attributes:

- `ts` The time when the event is produced.
- `src` The source file of the test specification.
- `line` The line number where the request is performed.
- `name` The name of the component which produces this event.
- `id` The id of the component which produces this event.
- `type` The type of the component which produces this event.

11.4.2 The TCI-TL interface

11.4.2.1 TCI-TL provided

The TCI-TL Provided interface is mapped to the following interface:

```

<!-- testcases -->
<xsd:complexType name="tliTcExecute">
  <xsd:complexContent mixed="true">
    <xsd:extension base="Events:Event">
      <xsd:sequence>
        <xsd:element name="tcId" type="Types:TciTestCaseIdType"/>
        <xsd:element name="tciPars" type="Types:TciParameterListType" minOccurs="0"/>
        <xsd:element name="dur" type="SimpleTypes:TriTimerDurationType" minOccurs="0"/>
      </xsd:sequence>
    </xsd:extension>
  </xsd:complexContent>
</xsd:complexType>

<xsd:complexType name="tliTcStart">
  <xsd:complexContent mixed="true">
    <xsd:extension base="Events:Event">
      <xsd:sequence>
        <xsd:element name="tcId" type="Types:TciTestCaseIdType"/>
        <xsd:element name="tciPars" type="Types:TciParameterListType" minOccurs="0"/>
        <xsd:element name="dur" type="SimpleTypes:TriTimerDurationType" minOccurs="0"/>
      </xsd:sequence>
    </xsd:extension>
  </xsd:complexContent>
</xsd:complexType>

<xsd:complexType name="tliTcStop">
  <xsd:complexContent mixed="true">
    <xsd:extension base="Events:Event"/>
    <xsd:sequence>
      <xsd:element name="reason" type="SimpleTypes:TString" minOccurs="0"/>
    </xsd:sequence>
  </xsd:complexContent>
</xsd:complexType>

<xsd:complexType name="tliTcStarted">
  <xsd:complexContent mixed="true">
    <xsd:extension base="Events:Event">
      <xsd:sequence>
        <xsd:element name="tcId" type="Types:TciTestCaseIdType"/>
        <xsd:element name="tciPars" type="Types:TciParameterListType" minOccurs="0"/>
        <xsd:element name="dur" type="SimpleTypes:TriTimerDurationType" minOccurs="0"/>
      </xsd:sequence>
    </xsd:extension>
  </xsd:complexContent>
</xsd:complexType>

```

```

        </xsd:sequence>
      </xsd:extension>
    </xsd:complexContent>
  </xsd:complexType>

  <xsd:complexType name="tliTcTerminated">
    <xsd:complexContent mixed="true">
      <xsd:extension base="Events:Event">
        <xsd:sequence>
          <xsd:element name="tcId" type="Types:TciTestCaseIdType"/>
          <xsd:element name="tciPars" type="Types:TciParameterListType" minOccurs="0"/>
          <xsd:element name="verdict" type="Values:VerdictValue"/>
          <xsd:element name="reason" type="SimpleTypes:TString" minOccurs="0"/>
        </xsd:sequence>
      </xsd:extension>
    </xsd:complexContent>
  </xsd:complexType>

  <!-- control -->
  <xsd:complexType name="tliCtrlStart">
    <xsd:complexContent>
      <xsd:extension base="Events:Event"/>
    </xsd:complexContent>
  </xsd:complexType>

  <xsd:complexType name="tliCtrlStop">
    <xsd:complexContent>
      <xsd:extension base="Events:Event"/>
    </xsd:complexContent>
  </xsd:complexType>

  <xsd:complexType name="tliCtrlTerminated">
    <xsd:complexContent>
      <xsd:extension base="Events:Event"/>
    </xsd:complexContent>
  </xsd:complexType>

  <!-- asynchronous communication -->
  <xsd:complexType name="tliMSend_m">
    <xsd:complexContent mixed="true">
      <xsd:extension base="Events:Event">
        <xsd:sequence>
          <xsd:element name="at" type="Types:TriPortIdType"/>
          <xsd:element name="to" type="Types:TriPortIdType" minOccurs="0"/>
          <xsd:element name="msgValue" type="Values:Value"/>
          <xsd:element name="addrValue" type="Values:Value" minOccurs="0"/>
          <xsd:choice>
            <xsd:element name="encoder-failure" type="SimpleTypes:TciStatusType"
minOccurs="0"/>
            <xsd:sequence>
              <xsd:element name="msg" type="Types:TriMessageType" minOccurs="0"/>
              <xsd:element name="address" type="Types:TriAddressType" minOccurs="0"/>
              <xsd:element name="transmission-failure"
type="SimpleTypes:TriStatusType" minOccurs="0"/>
            </xsd:sequence>
          </xsd:choice>
        </xsd:sequence>
      </xsd:extension>
    </xsd:complexContent>
  </xsd:complexType>

  <xsd:complexType name="tliMSend_m_BC">
    <xsd:complexContent mixed="true">
      <xsd:extension base="Events:Event">
        <xsd:sequence>
          <xsd:element name="at" type="Types:TriPortIdType"/>
          <xsd:element name="to" type="Types:TriPortIdType" minOccurs="0"/>
          <xsd:element name="msgValue" type="Values:Value"/>
          <xsd:choice>
            <xsd:element name="encoder-failure" type="SimpleTypes:TciStatusType"
minOccurs="0"/>
            <xsd:sequence>
              <xsd:element name="msg" type="Types:TriMessageType" minOccurs="0"/>
              <xsd:element name="transmission-failure"
type="SimpleTypes:TriStatusType" minOccurs="0"/>
            </xsd:sequence>
          </xsd:choice>
        </xsd:sequence>
      </xsd:extension>
    </xsd:complexContent>
  </xsd:complexType>

```

```

        </xsd:extension>
      </xsd:complexContent>
    </xsd:complexType>

    <xsd:complexType name="tliMSend_m_MC">
      <xsd:complexContent mixed="true">
        <xsd:extension base="Events:Event">
          <xsd:sequence>
            <xsd:element name="at" type="Types:TriPortIdType"/>
            <xsd:element name="to" type="Types:TriPortIdType" minOccurs="0"/>
            <xsd:element name="msgValue" type="Values:Value"/>
            <xsd:element name="addrValues" type="Types:TciValueListType" minOccurs="0"/>
            <xsd:choice>
              <xsd:element name="encoder-failure" type="SimpleTypes:TciStatusType"
minOccurs="0"/>
              <xsd:sequence>
                <xsd:element name="msg" type="Types:TriMessageType" minOccurs="0"/>
                <xsd:element name="addresses" type="Types:TriAddressListType"
minOccurs="0"/>
                <xsd:element name="transmission-failure"
type="SimpleTypes:TriStatusType" minOccurs="0"/>
              </xsd:sequence>
            </xsd:choice>
          </xsd:sequence>
        </xsd:extension>
      </xsd:complexContent>
    </xsd:complexType>

    <xsd:complexType name="tliMSend_c">
      <xsd:complexContent mixed="true">
        <xsd:extension base="Events:Event">
          <xsd:sequence>
            <xsd:element name="at" type="Types:TriPortIdType"/>
            <xsd:element name="to" type="Types:TriPortIdType" minOccurs="0"/>
            <xsd:element name="msgValue" type="Values:Value"/>
            <xsd:element name="transmission-failure" type="SimpleTypes:TriStatusType"
minOccurs="0"/>
          </xsd:sequence>
        </xsd:extension>
      </xsd:complexContent>
    </xsd:complexType>

    <xsd:complexType name="tliMSend_c_BC">
      <xsd:complexContent mixed="true">
        <xsd:extension base="Events:Event">
          <xsd:sequence>
            <xsd:element name="at" type="Types:TriPortIdType"/>
            <xsd:element name="to" type="Types:TriPortIdListType" minOccurs="0"/>
            <xsd:element name="msgValue" type="Values:Value"/>
            <xsd:element name="transmission-failure" type="SimpleTypes:TriStatusType"
minOccurs="0"/>
          </xsd:sequence>
        </xsd:extension>
      </xsd:complexContent>
    </xsd:complexType>

    <xsd:complexType name="tliMSend_c_MC">
      <xsd:complexContent mixed="true">
        <xsd:extension base="Events:Event">
          <xsd:sequence>
            <xsd:element name="at" type="Types:TriPortIdType"/>
            <xsd:element name="to" type="Types:TriPortIdListType" minOccurs="0"/>
            <xsd:element name="msgValue" type="Values:Value"/>
            <xsd:element name="transmission-failure" type="SimpleTypes:TriStatusType"
minOccurs="0"/>
          </xsd:sequence>
        </xsd:extension>
      </xsd:complexContent>
    </xsd:complexType>

    <xsd:complexType name="tliMDetected_m">
      <xsd:complexContent mixed="true">
        <xsd:extension base="Events:Event">
          <xsd:sequence>
            <xsd:element name="at" type="Types:TriPortIdType"/>
            <xsd:element name="from" type="Types:TriPortIdType" minOccurs="0"/>
            <xsd:element name="msgValue" type="Types:TriMessageType"/>
            <xsd:element name="address" type="Types:TriAddressType" minOccurs="0"/>

```



```

        </xsd:sequence>
      </xsd:extension>
    </xsd:complexContent>
  </xsd:complexType>

  <xsd:complexType name="tliMDetected_c">
    <xsd:complexContent mixed="true">
      <xsd:extension base="Events:Event">
        <xsd:sequence>
          <xsd:element name="at" type="Types:TriPortIdType"/>
          <xsd:element name="from" type="Types:TriPortIdType" minOccurs="0"/>
          <xsd:element name="msgValue" type="Values:Value"/>
        </xsd:sequence>
      </xsd:extension>
    </xsd:complexContent>
  </xsd:complexType>

  <xsd:complexType name="tliMMismatch_m">
    <xsd:complexContent mixed="true">
      <xsd:extension base="Events:Event">
        <xsd:sequence>
          <xsd:element name="at" type="Types:TriPortIdType"/>
          <xsd:element name="msgValue" type="Values:Value"/>
          <xsd:element name="msgTpl" type="Templates:TciValueTemplate"/>
          <xsd:element name="diffs" type="Templates:TciValueDifferenceList"/>
          <xsd:element name="addrValue" type="Values:Value" minOccurs="0"/>
          <xsd:element name="addressTpl" type="Templates:TciValueTemplate"
minOccurs="0"/>
        </xsd:sequence>
      </xsd:extension>
    </xsd:complexContent>
  </xsd:complexType>

  <xsd:complexType name="tliMMismatch_c">
    <xsd:complexContent mixed="true">
      <xsd:extension base="Events:Event">
        <xsd:sequence>
          <xsd:element name="at" type="Types:TriPortIdType"/>
          <xsd:element name="msgValue" type="Values:Value"/>
          <xsd:element name="msgTpl" type="Templates:TciValueTemplate"/>
          <xsd:element name="diffs" type="Templates:TciValueDifferenceList"/>
          <xsd:element name="from" type="Types:TriComponentIdType" minOccurs="0"/>
          <xsd:element name="fromTpl" type="Templates:TciNonValueTemplate"
minOccurs="0"/>
        </xsd:sequence>
      </xsd:extension>
    </xsd:complexContent>
  </xsd:complexType>

  <xsd:complexType name="tliMReceive_m">
    <xsd:complexContent mixed="true">
      <xsd:extension base="Events:Event">
        <xsd:sequence>
          <xsd:element name="at" type="Types:TriPortIdType"/>
          <xsd:element name="msgValue" type="Values:Value" minOccurs="0"/>
          <xsd:element name="msgTpl" type="Templates:TciValueTemplate"
minOccurs="0"/>
          <xsd:element name="addrValue" type="Values:Value" minOccurs="0"/>
          <xsd:element name="addressTpl" type="Templates:TciValueTemplate"
minOccurs="0"/>
        </xsd:sequence>
      </xsd:extension>
    </xsd:complexContent>
  </xsd:complexType>

  <xsd:complexType name="tliMReceive_c">
    <xsd:complexContent mixed="true">
      <xsd:extension base="Events:Event">
        <xsd:sequence>
          <xsd:element name="at" type="Types:TriPortIdType"/>
          <xsd:element name="msgValue" type="Values:Value" minOccurs="0"/>
          <xsd:element name="msgTpl" type="Templates:TciValueTemplate"
minOccurs="0"/>
          <xsd:element name="from" type="Types:TriComponentIdType" minOccurs="0"/>
          <xsd:element name="fromTpl" type="Templates:TciNonValueTemplate"
minOccurs="0"/>
        </xsd:sequence>
      </xsd:extension>
    </xsd:complexContent>
  </xsd:complexType>

```

```

    </xsd:complexContent>
  </xsd:complexType>

  <!-- synchronous communication -->
  <xsd:complexType name="tliPrCall_m">
    <xsd:complexContent mixed="true">
      <xsd:extension base="Events:Event">
        <xsd:sequence>
          <xsd:element name="at" type="Types:TriPortIdType"/>
          <xsd:element name="to" type="Types:TriPortIdType" minOccurs="0"/>
          <xsd:element name="signature" type="Types:TriSignatureIdType"/>
          <xsd:element name="tciPars" type="Types:TciParameterListType" minOccurs="0"/>
          <xsd:element name="addrValue" type="Values:Value" minOccurs="0"/>
          <xsd:choice>
            <xsd:element name="encoder-failure" type="SimpleTypes:TciStatusType"
minOccurs="0"/>
            <xsd:sequence>
              <xsd:element name="triPars" type="Types:TriParameterListType"
minOccurs="0"/>
              <xsd:element name="address" type="Types:TriAddressType" minOccurs="0"/>
              <xsd:element name="transmission-failure"
type="SimpleTypes:TriStatusType" minOccurs="0"/>
            </xsd:sequence>
          </xsd:choice>
        </xsd:sequence>
      </xsd:extension>
    </xsd:complexContent>
  </xsd:complexType>

  <xsd:complexType name="tliPrCall_m_BC">
    <xsd:complexContent mixed="true">
      <xsd:extension base="Events:Event">
        <xsd:sequence>
          <xsd:element name="at" type="Types:TriPortIdType"/>
          <xsd:element name="to" type="Types:TriPortIdType" minOccurs="0"/>
          <xsd:element name="signature" type="Types:TriSignatureIdType"/>
          <xsd:element name="tciPars" type="Types:TciParameterListType" minOccurs="0"/>
          <xsd:choice>
            <xsd:element name="encoder-failure" type="SimpleTypes:TciStatusType"
minOccurs="0"/>
            <xsd:sequence>
              <xsd:element name="triPars" type="Types:TriParameterListType"
minOccurs="0"/>
              <xsd:element name="transmission-failure"
type="SimpleTypes:TriStatusType" minOccurs="0"/>
            </xsd:sequence>
          </xsd:choice>
        </xsd:sequence>
      </xsd:extension>
    </xsd:complexContent>
  </xsd:complexType>

  <xsd:complexType name="tliPrCall_m_MC">
    <xsd:complexContent mixed="true">
      <xsd:extension base="Events:Event">
        <xsd:sequence>
          <xsd:element name="at" type="Types:TriPortIdType"/>
          <xsd:element name="to" type="Types:TriPortIdType" minOccurs="0"/>
          <xsd:element name="signature" type="Types:TriSignatureIdType"/>
          <xsd:element name="tciPars" type="Types:TciParameterListType" minOccurs="0"/>
          <xsd:element name="addrValues" type="Types:TciValueListType" minOccurs="0"/>
          <xsd:choice>
            <xsd:element name="encoder-failure" type="SimpleTypes:TciStatusType"
minOccurs="0"/>
            <xsd:sequence>
              <xsd:element name="triPars" type="Types:TriParameterListType"
minOccurs="0"/>
              <xsd:element name="addresses" type="Types:TriAddressListType"
minOccurs="0"/>
              <xsd:element name="transmission-failure"
type="SimpleTypes:TriStatusType" minOccurs="0"/>
            </xsd:sequence>
          </xsd:choice>
        </xsd:sequence>
      </xsd:extension>
    </xsd:complexContent>
  </xsd:complexType>

```

```

<xsd:complexType name="tliPrCall_c">
  <xsd:complexContent mixed="true">
    <xsd:extension base="Events:Event">
      <xsd:sequence>
        <xsd:element name="at" type="Types:TriPortIdType"/>
        <xsd:element name="to" type="Types:TriPortIdType" minOccurs="0"/>
        <xsd:element name="signature" type="Types:TriSignatureIdType"/>
        <xsd:element name="tciPars" type="Types:TciParameterListType" minOccurs="0"/>
        <xsd:element name="transmission-failure" type="SimpleTypes:TriStatusType"
minOccurs="0"/>
      </xsd:sequence>
    </xsd:extension>
  </xsd:complexContent>
</xsd:complexType>

<xsd:complexType name="tliPrCall_c_BC">
  <xsd:complexContent mixed="true">
    <xsd:extension base="Events:Event">
      <xsd:sequence>
        <xsd:element name="at" type="Types:TriPortIdType"/>
        <xsd:element name="to" type="Types:TriPortIdListType" minOccurs="0"/>
        <xsd:element name="signature" type="Types:TriSignatureIdType"/>
        <xsd:element name="tciPars" type="Types:TciParameterListType" minOccurs="0"/>
        <xsd:element name="transmission-failure" type="SimpleTypes:TriStatusType"
minOccurs="0"/>
      </xsd:sequence>
    </xsd:extension>
  </xsd:complexContent>
</xsd:complexType>

<xsd:complexType name="tliPrCall_c_MC">
  <xsd:complexContent mixed="true">
    <xsd:extension base="Events:Event">
      <xsd:sequence>
        <xsd:element name="at" type="Types:TriPortIdType"/>
        <xsd:element name="to" type="Types:TriPortIdListType" minOccurs="0"/>
        <xsd:element name="signature" type="Types:TriSignatureIdType"/>
        <xsd:element name="tciPars" type="Types:TciParameterListType" minOccurs="0"/>
        <xsd:element name="transmission-failure" type="SimpleTypes:TriStatusType"
minOccurs="0"/>
      </xsd:sequence>
    </xsd:extension>
  </xsd:complexContent>
</xsd:complexType>

<xsd:complexType name="tliPrGetCallDetected_m">
  <xsd:complexContent mixed="true">
    <xsd:extension base="Events:Event">
      <xsd:sequence>
        <xsd:element name="at" type="Types:TriPortIdType"/>
        <xsd:element name="from" type="Types:TriPortIdType" minOccurs="0"/>
        <xsd:element name="signature" type="Types:TriSignatureIdType"/>
        <xsd:element name="triPars" type="Types:TriParameterListType" minOccurs="0"/>
        <xsd:element name="address" type="Types:TriAddressType" minOccurs="0"/>
      </xsd:sequence>
    </xsd:extension>
  </xsd:complexContent>
</xsd:complexType>

<xsd:complexType name="tliPrGetCallDetected_c">
  <xsd:complexContent mixed="true">
    <xsd:extension base="Events:Event">
      <xsd:sequence>
        <xsd:element name="at" type="Types:TriPortIdType"/>
        <xsd:element name="from" type="Types:TriPortIdType" minOccurs="0"/>
        <xsd:element name="signature" type="Types:TriSignatureIdType"/>
        <xsd:element name="tciPars" type="Types:TciParameterListType" minOccurs="0"/>
      </xsd:sequence>
    </xsd:extension>
  </xsd:complexContent>
</xsd:complexType>

<xsd:complexType name="tliPrGetCallMismatch_m">
  <xsd:complexContent mixed="true">
    <xsd:extension base="Events:Event">
      <xsd:sequence>
        <xsd:element name="at" type="Types:TriPortIdType"/>
        <xsd:element name="signature" type="Types:TriSignatureIdType"/>

```

```

        <xsd:element name="tciPars" type="Types:TciParameterListType" minOccurs="0"/>
        <xsd:element name="parsTmpl" type="Templates:TciValueTemplate" minOccurs="0"/>
        <xsd:element name="diffs" type="Templates:TciValueDifferenceList"/>
        <xsd:element name="addrValue" type="Values:Value" minOccurs="0"/>
        <xsd:element name="addressTmpl" type="Templates:TciValueTemplate"
minOccurs="0"/>
    </xsd:sequence>
</xsd:extension>
</xsd:complexContent>
</xsd:complexType>

<xsd:complexType name="tliPrGetCallMismatch_c">
    <xsd:complexContent mixed="true">
        <xsd:extension base="Events:Event">
            <xsd:sequence>
                <xsd:element name="at" type="Types:TriPortIdType"/>
                <xsd:element name="signature" type="Types:TriSignatureIdType"/>
                <xsd:element name="tciPars" type="Types:TciParameterListType" minOccurs="0"/>
                <xsd:element name="parsTmpl" type="Templates:TciValueTemplate" minOccurs="0"/>
                <xsd:element name="diffs" type="Templates:TciValueDifferenceList"/>
                <xsd:element name="from" type="Types:TriComponentIdType" minOccurs="0"/>
                <xsd:element name="fromTmpl" type="Templates:TciValueTemplate" minOccurs="0"/>
            </xsd:sequence>
        </xsd:extension>
    </xsd:complexContent>
</xsd:complexType>

<xsd:complexType name="tliPrGetCall_m">
    <xsd:complexContent mixed="true">
        <xsd:extension base="Events:Event">
            <xsd:sequence>
                <xsd:element name="at" type="Types:TriPortIdType"/>
                <xsd:element name="signature" type="Types:TriSignatureIdType"/>
                <xsd:element name="tciPars" type="Types:TciParameterListType" minOccurs="0"/>
                <xsd:element name="parsTmpl" type="Templates:TciValueTemplate" minOccurs="0"/>
                <xsd:element name="addrValue" type="Values:Value" minOccurs="0"/>
                <xsd:element name="addressTmpl" type="Templates:TciValueTemplate"
minOccurs="0"/>
            </xsd:sequence>
        </xsd:extension>
    </xsd:complexContent>
</xsd:complexType>

<xsd:complexType name="tliPrGetCall_c">
    <xsd:complexContent mixed="true">
        <xsd:extension base="Events:Event">
            <xsd:sequence>
                <xsd:element name="at" type="Types:TriPortIdType"/>
                <xsd:element name="signature" type="Types:TriSignatureIdType"/>
                <xsd:element name="tciPars" type="Types:TciParameterListType" minOccurs="0"/>
                <xsd:element name="parsTmpl" type="Templates:TciValueTemplate" minOccurs="0"/>
                <xsd:element name="from" type="Types:TriComponentIdType" minOccurs="0"/>
                <xsd:element name="fromTmpl" type="Templates:TciNonValueTemplate"
minOccurs="0"/>
            </xsd:sequence>
        </xsd:extension>
    </xsd:complexContent>
</xsd:complexType>

<xsd:complexType name="tliPrReply_m">
    <xsd:complexContent mixed="true">
        <xsd:extension base="Events:Event">
            <xsd:sequence>
                <xsd:element name="at" type="Types:TriPortIdType"/>
                <xsd:element name="to" type="Types:TriPortIdType" minOccurs="0"/>
                <xsd:element name="signature" type="Types:TriSignatureIdType"/>
                <xsd:element name="tciPars" type="Types:TciParameterListType" minOccurs="0"/>
                <xsd:element name="replValue" type="Values:Value" minOccurs="0"/>
                <xsd:element name="addrValue" type="Values:Value" minOccurs="0"/>
                <xsd:choice>
                    <xsd:element name="encoder-failure" type="SimpleTypes:TciStatusType"
minOccurs="0"/>
                    <xsd:sequence>
                        <xsd:element name="triPars" type="Types:TriParameterListType"
minOccurs="0"/>
                        <xsd:element name="repl" type="Types:TriParameterType" minOccurs="0"/>
                        <xsd:element name="address" type="Types:TriAddressType" minOccurs="0"/>
                        <xsd:element name="transmission-failure"

```

```

        type="SimpleTypes:TriStatusType" minOccurs="0"/>
      </xsd:sequence>
    </xsd:choice>
  </xsd:sequence>
</xsd:extension>
</xsd:complexContent>
</xsd:complexType>

<xsd:complexType name="tliPrReply_m_BC">
  <xsd:complexContent mixed="true">
    <xsd:extension base="Events:Event">
      <xsd:sequence>
        <xsd:element name="at" type="Types:TriPortIdType"/>
        <xsd:element name="to" type="Types:TriPortIdType" minOccurs="0"/>
        <xsd:element name="signature" type="Types:TriSignatureIdType"/>
        <xsd:element name="tciPars" type="Types:TciParameterListType" minOccurs="0"/>
        <xsd:element name="replValue" type="Values:Value" minOccurs="0"/>
        <xsd:choice>
          <xsd:element name="encoder-failure" type="SimpleTypes:TciStatusType"
            minOccurs="0"/>
          <xsd:sequence>
            <xsd:element name="triPars" type="Types:TriParameterListType"
              minOccurs="0"/>
            <xsd:element name="repl" type="Types:TriParameterType" minOccurs="0"/>
            <xsd:element name="transmission-failure"
              type="SimpleTypes:TriStatusType" minOccurs="0"/>
          </xsd:sequence>
        </xsd:choice>
      </xsd:sequence>
    </xsd:extension>
  </xsd:complexContent>
</xsd:complexType>

<xsd:complexType name="tliPrReply_m_MC">
  <xsd:complexContent mixed="true">
    <xsd:extension base="Events:Event">
      <xsd:sequence>
        <xsd:element name="at" type="Types:TriPortIdType"/>
        <xsd:element name="to" type="Types:TriPortIdType" minOccurs="0"/>
        <xsd:element name="signature" type="Types:TriSignatureIdType"/>
        <xsd:element name="tciPars" type="Types:TciParameterListType" minOccurs="0"/>
        <xsd:element name="replValue" type="Values:Value" minOccurs="0"/>
        <xsd:element name="addrValues" type="Types:TciValueListType" minOccurs="0"/>
        <xsd:choice>
          <xsd:element name="encoder-failure" type="SimpleTypes:TciStatusType"
            minOccurs="0"/>
          <xsd:sequence>
            <xsd:element name="triPars" type="Types:TriParameterListType"
              minOccurs="0"/>
            <xsd:element name="repl" type="Types:TriParameterType" minOccurs="0"/>
            <xsd:element name="addresses" type="Types:TriAddressListType"
              minOccurs="0"/>
            <xsd:element name="transmission-failure"
              type="SimpleTypes:TriStatusType" minOccurs="0"/>
          </xsd:sequence>
        </xsd:choice>
      </xsd:sequence>
    </xsd:extension>
  </xsd:complexContent>
</xsd:complexType>

<xsd:complexType name="tliPrReply_c">
  <xsd:complexContent mixed="true">
    <xsd:extension base="Events:Event">
      <xsd:sequence>
        <xsd:element name="at" type="Types:TriPortIdType"/>
        <xsd:element name="to" type="Types:TriPortIdType" minOccurs="0"/>
        <xsd:element name="signature" type="Types:TriSignatureIdType"/>
        <xsd:element name="tciPars" type="Types:TciParameterListType" minOccurs="0"/>
        <xsd:element name="replValue" type="Values:Value" minOccurs="0"/>
        <xsd:element name="transmission-failure" type="SimpleTypes:TriStatusType"
          minOccurs="0"/>
      </xsd:sequence>
    </xsd:extension>
  </xsd:complexContent>
</xsd:complexType>

<xsd:complexType name="tliPrReply_c_BC">

```

```

<xsd:complexContent mixed="true">
  <xsd:extension base="Events:Event">
    <xsd:sequence>
      <xsd:element name="at" type="Types:TriPortIdType"/>
      <xsd:element name="to" type="Types:TriPortIdListType" minOccurs="0"/>
      <xsd:element name="signature" type="Types:TriSignatureIdType"/>
      <xsd:element name="tciPars" type="Types:TciParameterListType" minOccurs="0"/>
      <xsd:element name="replValue" type="Values:Value" minOccurs="0"/>
      <xsd:element name="transmission-failure" type="SimpleTypes:TriStatusType"
minOccurs="0"/>
    </xsd:sequence>
  </xsd:extension>
</xsd:complexContent>
</xsd:complexType>

<xsd:complexType name="tliPrReply_c_MC">
  <xsd:complexContent mixed="true">
    <xsd:extension base="Events:Event">
      <xsd:sequence>
        <xsd:element name="at" type="Types:TriPortIdType"/>
        <xsd:element name="to" type="Types:TriPortIdListType" minOccurs="0"/>
        <xsd:element name="signature" type="Types:TriSignatureIdType"/>
        <xsd:element name="tciPars" type="Types:TciParameterListType" minOccurs="0"/>
        <xsd:element name="replValue" type="Values:Value" minOccurs="0"/>
        <xsd:element name="transmission-failure" type="SimpleTypes:TriStatusType"
minOccurs="0"/>
      </xsd:sequence>
    </xsd:extension>
  </xsd:complexContent>
</xsd:complexType>

<xsd:complexType name="tliPrGetReplyDetected_m">
  <xsd:complexContent mixed="true">
    <xsd:extension base="Events:Event">
      <xsd:sequence>
        <xsd:element name="at" type="Types:TriPortIdType"/>
        <xsd:element name="from" type="Types:TriPortIdType" minOccurs="0"/>
        <xsd:element name="signature" type="Types:TriSignatureIdType"/>
        <xsd:element name="triPars" type="Types:TriParameterListType" minOccurs="0"/>
        <xsd:element name="repl" type="Types:TriParameterType" minOccurs="0"/>
        <xsd:element name="address" type="Types:TriAddressType" minOccurs="0"/>
      </xsd:sequence>
    </xsd:extension>
  </xsd:complexContent>
</xsd:complexType>

<xsd:complexType name="tliPrGetReplyDetected_c">
  <xsd:complexContent mixed="true">
    <xsd:extension base="Events:Event">
      <xsd:sequence>
        <xsd:element name="at" type="Types:TriPortIdType"/>
        <xsd:element name="from" type="Types:TriPortIdType" minOccurs="0"/>
        <xsd:element name="signature" type="Types:TriSignatureIdType"/>
        <xsd:element name="tciPars" type="Types:TciParameterListType" minOccurs="0"/>
        <xsd:element name="replValue" type="Values:Value" minOccurs="0"/>
      </xsd:sequence>
    </xsd:extension>
  </xsd:complexContent>
</xsd:complexType>

<xsd:complexType name="tliPrGetReplyMismatch_m">
  <xsd:complexContent mixed="true">
    <xsd:extension base="Events:Event">
      <xsd:sequence>
        <xsd:element name="at" type="Types:TriPortIdType"/>
        <xsd:element name="signature" type="Types:TriSignatureIdType"/>
        <xsd:element name="tciPars" type="Types:TciParameterListType" minOccurs="0"/>
        <xsd:element name="parsTpl" type="Templates:TciValueTemplate" minOccurs="0"/>
        <xsd:element name="replValue" type="Values:Value" minOccurs="0"/>
        <xsd:element name="replTpl" type="Templates:TciValueTemplate" minOccurs="0"/>
        <xsd:element name="diffs" type="Templates:TciValueDifferenceList"/>
        <xsd:element name="addrValue" type="Values:Value" minOccurs="0"/>
        <xsd:element name="addressTpl" type="Templates:TciValueTemplate"
minOccurs="0"/>
      </xsd:sequence>
    </xsd:extension>
  </xsd:complexContent>
</xsd:complexType>

```

```

<xsd:complexType name="tliPrGetReplyMismatch_c">
  <xsd:complexContent mixed="true">
    <xsd:extension base="Events:Event">
      <xsd:sequence>
        <xsd:element name="at" type="Types:TriPortIdType"/>
        <xsd:element name="signature" type="Types:TriSignatureIdType"/>
        <xsd:element name="tciPars" type="Types:TciParameterListType" minOccurs="0"/>
        <xsd:element name="parsTmpl" type="Templates:TciValueTemplate" minOccurs="0"/>
        <xsd:element name="replValue" type="Values:Value" minOccurs="0"/>
        <xsd:element name="replTmpl" type="Templates:TciValueTemplate" minOccurs="0"/>
        <xsd:element name="diffs" type="Templates:TciValueDifferenceList"/>
        <xsd:element name="from" type="Types:TriComponentIdType" minOccurs="0"/>
        <xsd:element name="fromTmpl" type="Templates:TciNonValueTemplate"
minOccurs="0"/>
      </xsd:sequence>
    </xsd:extension>
  </xsd:complexContent>
</xsd:complexType>

<xsd:complexType name="tliPrGetReply_m">
  <xsd:complexContent mixed="true">
    <xsd:extension base="Events:Event">
      <xsd:sequence>
        <xsd:element name="at" type="Types:TriPortIdType"/>
        <xsd:element name="signature" type="Types:TriSignatureIdType"/>
        <xsd:element name="tciPars" type="Types:TciParameterListType" minOccurs="0"/>
        <xsd:element name="parsTmpl" type="Templates:TciValueTemplate" minOccurs="0"/>
        <xsd:element name="replValue" type="Values:Value" minOccurs="0"/>
        <xsd:element name="replTmpl" type="Templates:TciValueTemplate" minOccurs="0"/>
        <xsd:element name="addrValue" type="Values:Value" minOccurs="0"/>
        <xsd:element name="addressTmpl" type="Templates:TciValueTemplate"
minOccurs="0"/>
      </xsd:sequence>
    </xsd:extension>
  </xsd:complexContent>
</xsd:complexType>

<xsd:complexType name="tliPrGetReply_c">
  <xsd:complexContent mixed="true">
    <xsd:extension base="Events:Event">
      <xsd:sequence>
        <xsd:element name="at" type="Types:TriPortIdType"/>
        <xsd:element name="signature" type="Types:TriSignatureIdType"/>
        <xsd:element name="tciPars" type="Types:TciParameterListType" minOccurs="0"/>
        <xsd:element name="parsTmpl" type="Templates:TciValueTemplate" minOccurs="0"/>
        <xsd:element name="replValue" type="Values:Value" minOccurs="0"/>
        <xsd:element name="replTmpl" type="Templates:TciValueTemplate" minOccurs="0"/>
        <xsd:element name="from" type="Types:TriComponentIdType" minOccurs="0"/>
        <xsd:element name="fromTmpl" type="Templates:TciNonValueTemplate"
minOccurs="0"/>
      </xsd:sequence>
    </xsd:extension>
  </xsd:complexContent>
</xsd:complexType>

<xsd:complexType name="tliPrRaise_m">
  <xsd:complexContent mixed="true">
    <xsd:extension base="Events:Event">
      <xsd:sequence>
        <xsd:element name="at" type="Types:TriPortIdType"/>
        <xsd:element name="to" type="Types:TriPortIdType" minOccurs="0"/>
        <xsd:element name="signature" type="Types:TriSignatureIdType"/>
        <xsd:element name="tciPars" type="Types:TciParameterListType" minOccurs="0"/>
        <xsd:element name="excValue" type="Values:Value" minOccurs="0"/>
        <xsd:element name="addrValue" type="Values:Value" minOccurs="0"/>
        <xsd:choice>
          <xsd:element name="encoder-failure" type="SimpleTypes:TciStatusType"
minOccurs="0"/>
          <xsd:sequence>
            <xsd:element name="exc" type="Types:TriExceptionType" minOccurs="0"/>
            <xsd:element name="address" type="Types:TriAddressType" minOccurs="0"/>
            <xsd:element name="transmission-failure"
type="SimpleTypes:TriStatusType" minOccurs="0"/>
          </xsd:sequence>
        </xsd:choice>
      </xsd:sequence>
    </xsd:extension>
  </xsd:complexContent>
</xsd:complexType>

```

```

    </xsd:complexContent>
  </xsd:complexType>

  <xsd:complexType name="tliPrRaise_m_BC">
    <xsd:complexContent mixed="true">
      <xsd:extension base="Events:Event">
        <xsd:sequence>
          <xsd:element name="at" type="Types:TriPortIdType"/>
          <xsd:element name="to" type="Types:TriPortIdType" minOccurs="0"/>
          <xsd:element name="signature" type="Types:TriSignatureIdType"/>
          <xsd:element name="tciPars" type="Types:TciParameterListType" minOccurs="0"/>
          <xsd:element name="excValue" type="Values:Value" minOccurs="0"/>
          <xsd:choice>
            <xsd:element name="encoder-failure" type="SimpleTypes:TciStatusType"
minOccurs="0"/>
            <xsd:sequence>
              <xsd:element name="exc" type="Types:TriExceptionType" minOccurs="0"/>
              <xsd:element name="transmission-failure"
type="SimpleTypes:TriStatusType" minOccurs="0"/>
            </xsd:sequence>
          </xsd:choice>
        </xsd:sequence>
      </xsd:extension>
    </xsd:complexContent>
  </xsd:complexType>

  <xsd:complexType name="tliPrRaise_m_MC">
    <xsd:complexContent mixed="true">
      <xsd:extension base="Events:Event">
        <xsd:sequence>
          <xsd:element name="at" type="Types:TriPortIdType"/>
          <xsd:element name="to" type="Types:TriPortIdType" minOccurs="0"/>
          <xsd:element name="signature" type="Types:TriSignatureIdType"/>
          <xsd:element name="tciPars" type="Types:TciParameterListType" minOccurs="0"/>
          <xsd:element name="excValue" type="Values:Value" minOccurs="0"/>
          <xsd:element name="addrValues" type="Types:TciValueListType" minOccurs="0"/>
          <xsd:choice>
            <xsd:element name="encoder-failure" type="SimpleTypes:TciStatusType"
minOccurs="0"/>
            <xsd:sequence>
              <xsd:element name="exc" type="Types:TriExceptionType" minOccurs="0"/>
              <xsd:element name="addresses" type="Types:TriAddressListType"
minOccurs="0"/>
              <xsd:element name="transmission-failure"
type="SimpleTypes:TriStatusType" minOccurs="0"/>
            </xsd:sequence>
          </xsd:choice>
        </xsd:sequence>
      </xsd:extension>
    </xsd:complexContent>
  </xsd:complexType>

  <xsd:complexType name="tliPrRaise_c">
    <xsd:complexContent mixed="true">
      <xsd:extension base="Events:Event">
        <xsd:sequence>
          <xsd:element name="at" type="Types:TriPortIdType"/>
          <xsd:element name="to" type="Types:TriPortIdType" minOccurs="0"/>
          <xsd:element name="signature" type="Types:TriSignatureIdType"/>
          <xsd:element name="tciPars" type="Types:TciParameterListType" minOccurs="0"/>
          <xsd:element name="excValue" type="Values:Value" minOccurs="0"/>
          <xsd:element name="transmission-failure" type="SimpleTypes:TriStatusType"
minOccurs="0"/>
        </xsd:sequence>
      </xsd:extension>
    </xsd:complexContent>
  </xsd:complexType>

  <xsd:complexType name="tliPrRaise_c_BC">
    <xsd:complexContent mixed="true">
      <xsd:extension base="Events:Event">
        <xsd:sequence>
          <xsd:element name="at" type="Types:TriPortIdType"/>
          <xsd:element name="to" type="Types:TriPortIdListType" minOccurs="0"/>
          <xsd:element name="signature" type="Types:TriSignatureIdType"/>
          <xsd:element name="tciPars" type="Types:TciParameterListType" minOccurs="0"/>
          <xsd:element name="excValue" type="Values:Value" minOccurs="0"/>
          <xsd:element name="transmission-failure" type="SimpleTypes:TriStatusType"

```



```

minOccurs="0"/>
    </xsd:sequence>
  </xsd:extension>
</xsd:complexContent>
</xsd:complexType>

<xsd:complexType name="tliPrRaise_c_MC">
  <xsd:complexContent mixed="true">
    <xsd:extension base="Events:Event">
      <xsd:sequence>
        <xsd:element name="at" type="Types:TriPortIdType"/>
        <xsd:element name="to" type="Types:TriPortIdListType" minOccurs="0"/>
        <xsd:element name="signature" type="Types:TriSignatureIdType"/>
        <xsd:element name="tciPars" type="Types:TciParameterListType" minOccurs="0"/>
        <xsd:element name="excValue" type="Values:Value" minOccurs="0"/>
        <xsd:element name="transmission-failure" type="SimpleTypes:TriStatusType"
minOccurs="0"/>
      </xsd:sequence>
    </xsd:extension>
  </xsd:complexContent>
</xsd:complexType>

<xsd:complexType name="tliPrCatchDetected_m">
  <xsd:complexContent mixed="true">
    <xsd:extension base="Events:Event">
      <xsd:sequence>
        <xsd:element name="at" type="Types:TriPortIdType"/>
        <xsd:element name="from" type="Types:TriPortIdType" minOccurs="0"/>
        <xsd:element name="signature" type="Types:TriSignatureIdType"/>
        <xsd:element name="exc" type="Types:TriExceptionType" minOccurs="0"/>
        <xsd:element name="address" type="Types:TriAddressType" minOccurs="0"/>
      </xsd:sequence>
    </xsd:extension>
  </xsd:complexContent>
</xsd:complexType>

<xsd:complexType name="tliPrCatchDetected_c">
  <xsd:complexContent mixed="true">
    <xsd:extension base="Events:Event">
      <xsd:sequence>
        <xsd:element name="at" type="Types:TriPortIdType"/>
        <xsd:element name="from" type="Types:TriPortIdType" minOccurs="0"/>
        <xsd:element name="signature" type="Types:TriSignatureIdType"/>
        <xsd:element name="excValue" type="Values:Value" minOccurs="0"/>
      </xsd:sequence>
    </xsd:extension>
  </xsd:complexContent>
</xsd:complexType>

<xsd:complexType name="tliPrCatchMismatch_m">
  <xsd:complexContent mixed="true">
    <xsd:extension base="Events:Event">
      <xsd:sequence>
        <xsd:element name="at" type="Types:TriPortIdType"/>
        <xsd:element name="signature" type="Types:TriSignatureIdType"/>
        <xsd:element name="excValue" type="Values:Value" minOccurs="0"/>
        <xsd:element name="excTmpl" type="Templates:TciValueTemplate" minOccurs="0"/>
        <xsd:element name="diffs" type="Templates:TciValueDifferenceList"/>
        <xsd:element name="addrValue" type="Values:Value" minOccurs="0"/>
        <xsd:element name="addressTmpl" type="Templates:TciValueTemplate"
minOccurs="0"/>
      </xsd:sequence>
    </xsd:extension>
  </xsd:complexContent>
</xsd:complexType>

<xsd:complexType name="tliPrCatchMismatch_c">
  <xsd:complexContent mixed="true">
    <xsd:extension base="Events:Event">
      <xsd:sequence>
        <xsd:element name="at" type="Types:TriPortIdType"/>
        <xsd:element name="signature" type="Types:TriSignatureIdType"/>
        <xsd:element name="excValue" type="Values:Value" minOccurs="0"/>
        <xsd:element name="excTmpl" type="Templates:TciValueTemplate" minOccurs="0"/>
        <xsd:element name="diffs" type="Templates:TciValueDifferenceList"/>
        <xsd:element name="from" type="Types:TriComponentIdType" minOccurs="0"/>
        <xsd:element name="fromTmpl" type="Templates:TciNonValueTemplate"
minOccurs="0"/>
      </xsd:sequence>
    </xsd:extension>
  </xsd:complexContent>
</xsd:complexType>

```

```

        </xsd:sequence>
      </xsd:extension>
    </xsd:complexContent>
  </xsd:complexType>

  <xsd:complexType name="tliPrCatch_m">
    <xsd:complexContent mixed="true">
      <xsd:extension base="Events:Event">
        <xsd:sequence>
          <xsd:element name="at" type="Types:TriPortIdType"/>
          <xsd:element name="signature" type="Types:TriSignatureIdType"/>
          <xsd:element name="excValue" type="Values:Value"/>
          <xsd:element name="excTpl" type="Templates:TciValueTemplate"/>
          <xsd:element name="addrValue" type="Values:Value" minOccurs="0"/>
          <xsd:element name="addressTpl" type="Templates:TciValueTemplate"
minOccurs="0"/>
        </xsd:sequence>
      </xsd:extension>
    </xsd:complexContent>
  </xsd:complexType>

  <xsd:complexType name="tliPrCatch_c">
    <xsd:complexContent mixed="true">
      <xsd:extension base="Events:Event">
        <xsd:sequence>
          <xsd:element name="at" type="Types:TriPortIdType"/>
          <xsd:element name="signature" type="Types:TriSignatureIdType"/>
          <xsd:element name="excValue" type="Values:Value" minOccurs="0"/>
          <xsd:element name="excTpl" type="Templates:TciValueTemplate" minOccurs="0"/>
          <xsd:element name="from" type="Types:TriComponentIdType" minOccurs="0"/>
          <xsd:element name="fromTpl" type="Templates:TciNonValueTemplate"
minOccurs="0"/>
        </xsd:sequence>
      </xsd:extension>
    </xsd:complexContent>
  </xsd:complexType>

  <xsd:complexType name="tliPrCatchTimeoutDetected">
    <xsd:complexContent mixed="true">
      <xsd:extension base="Events:Event">
        <xsd:sequence>
          <xsd:element name="at" type="Types:TriPortIdType"/>
          <xsd:element name="signature" type="Types:TriSignatureIdType"/>
        </xsd:sequence>
      </xsd:extension>
    </xsd:complexContent>
  </xsd:complexType>

  <xsd:complexType name="tliPrCatchTimeout">
    <xsd:complexContent mixed="true">
      <xsd:extension base="Events:Event">
        <xsd:sequence>
          <xsd:element name="at" type="Types:TriPortIdType"/>
          <xsd:element name="signature" type="Types:TriSignatureIdType"/>
        </xsd:sequence>
      </xsd:extension>
    </xsd:complexContent>
  </xsd:complexType>

  <!-- components -->
  <xsd:complexType name="tliCCreate">
    <xsd:complexContent mixed="true">
      <xsd:extension base="Events:Event">
        <xsd:sequence>
          <xsd:element name="comp" type="Types:TriComponentIdType"/>
          <xsd:element name="name" type="SimpleTypes:TString"/>
          <xsd:element name="hostId" type="Values:Value" minOccurs="0"/>
          <xsd:element name="alive" type="SimpleTypes:TBoolean"/>
        </xsd:sequence>
      </xsd:extension>
    </xsd:complexContent>
  </xsd:complexType>

  <xsd:complexType name="tliCStart">
    <xsd:complexContent mixed="true">
      <xsd:extension base="Events:Event">
        <xsd:sequence>
          <xsd:element name="comp" type="Types:TriComponentIdType"/>

```

```

        <xsd:element name="name" type="Types:TciBehaviourIdType"/>
        <xsd:element name="tciPars" type="Types:TciParameterListType" minOccurs="0"/>
      </xsd:sequence>
    </xsd:extension>
  </xsd:complexContent>
</xsd:complexType>

<xsd:complexType name="tlicRunning">
  <xsd:complexContent mixed="true">
    <xsd:extension base="Events:Event">
      <xsd:sequence>
        <xsd:element name="comp" type="Types:TriComponentIdType"/>
        <xsd:element name="status" type="SimpleTypes:ComponentStatusType"/>
      </xsd:sequence>
    </xsd:extension>
  </xsd:complexContent>
</xsd:complexType>

<xsd:complexType name="tlicAlive">
  <xsd:complexContent mixed="true">
    <xsd:extension base="Events:Event">
      <xsd:sequence>
        <xsd:element name="comp" type="Types:TriComponentIdType"/>
        <xsd:element name="status" type="SimpleTypes:ComponentStatusType"/>
      </xsd:sequence>
    </xsd:extension>
  </xsd:complexContent>
</xsd:complexType>

<xsd:complexType name="tlicStop">
  <xsd:complexContent mixed="true">
    <xsd:extension base="Events:Event">
      <xsd:sequence>
        <xsd:element name="comp" type="Types:TriComponentIdType"/>
      </xsd:sequence>
    </xsd:extension>
  </xsd:complexContent>
</xsd:complexType>

<xsd:complexType name="tlicKill">
  <xsd:complexContent mixed="true">
    <xsd:extension base="Events:Event">
      <xsd:sequence>
        <xsd:element name="comp" type="Types:TriComponentIdType"/>
      </xsd:sequence>
    </xsd:extension>
  </xsd:complexContent>
</xsd:complexType>

<xsd:complexType name="tlicDoneMismatch">
  <xsd:complexContent mixed="true">
    <xsd:extension base="Events:Event">
      <xsd:sequence>
        <xsd:element name="comp" type="Types:TriComponentIdType"/>
        <xsd:element name="compTpl" type="Templates:TciNonValueTemplate"/>
      </xsd:sequence>
    </xsd:extension>
  </xsd:complexContent>
</xsd:complexType>

<xsd:complexType name="tlicKilledMismatch">
  <xsd:complexContent mixed="true">
    <xsd:extension base="Events:Event">
      <xsd:sequence>
        <xsd:element name="comp" type="Types:TriComponentIdType"/>
        <xsd:element name="compTpl" type="Templates:TciNonValueTemplate"/>
      </xsd:sequence>
    </xsd:extension>
  </xsd:complexContent>
</xsd:complexType>

<xsd:complexType name="tlicDone">
  <xsd:complexContent mixed="true">
    <xsd:extension base="Events:Event">
      <xsd:sequence>
        <xsd:element name="compTpl" type="Templates:TciNonValueTemplate"/>
      </xsd:sequence>
    </xsd:extension>
  </xsd:complexContent>
</xsd:complexType>

```

```

        </xsd:extension>
      </xsd:complexContent>
    </xsd:complexType>

    <xsd:complexType name="tliCKilled">
      <xsd:complexContent mixed="true">
        <xsd:extension base="Events:Event">
          <xsd:sequence>
            <xsd:element name="compTpl" type="Templates:TciNonValueTemplate"/>
          </xsd:sequence>
        </xsd:extension>
      </xsd:complexContent>
    </xsd:complexType>

    <xsd:complexType name="tliCTerminated">
      <xsd:complexContent mixed="true">
        <xsd:extension base="Events:Event">
          <xsd:sequence>
            <xsd:element name="verdict" type="Values:VerdictValue" />
            <xsd:element name="reason" type="SimpleTypes:TString" minOccurs="0"/>
          </xsd:sequence>
        </xsd:extension>
      </xsd:complexContent>
    </xsd:complexType>

    <!-- ports -->
    <xsd:complexType name="tliPConnect">
      <xsd:complexContent mixed="true">
        <xsd:extension base="Events:PortConfiguration"/>
      </xsd:complexContent>
    </xsd:complexType>

    <xsd:complexType name="tliPDisconnect">
      <xsd:complexContent mixed="true">
        <xsd:extension base="Events:PortConfiguration"/>
      </xsd:complexContent>
    </xsd:complexType>

    <xsd:complexType name="tliPMap">
      <xsd:complexContent mixed="true">
        <xsd:extension base="Events:PortConfiguration"/>
      </xsd:complexContent>
    </xsd:complexType>

    <xsd:complexType name="tliPMapParam">
      <xsd:complexContent mixed="true">
        <xsd:extension base="Events:tliPMap">
          <xsd:sequence>
            <xsd:element name="tciPars" type="Types:TciParameterListType" />
            <xsd:choice>
              <xsd:element name="encoder-failure" type="SimpleTypes:TciStatusType"
minOccurs="0"/>
              <xsd:element name="triPars" type="Types:TriParameterListType" />
            </xsd:choice>
          </xsd:sequence>
        </xsd:extension>
      </xsd:complexContent>
    </xsd:complexType>

    <xsd:complexType name="tliPUnmap">
      <xsd:complexContent mixed="true">
        <xsd:extension base="Events:PortConfiguration"/>
      </xsd:complexContent>
    </xsd:complexType>

    <xsd:complexType name="tliPUnmapParam">
      <xsd:complexContent mixed="true">
        <xsd:extension base="Events:tliPUnmap">
          <xsd:sequence>
            <xsd:element name="tciPars" type="Types:TciParameterListType" />
            <xsd:choice>
              <xsd:element name="encoder-failure" type="SimpleTypes:TciStatusType"
minOccurs="0"/>
              <xsd:element name="triPars" type="Types:TriParameterListType"/>
            </xsd:choice>
          </xsd:sequence>
        </xsd:extension>
      </xsd:complexContent>
    </xsd:complexType>

```

```

    </xsd:complexContent>
  </xsd:complexType>

  <xsd:complexType name="tliPClear">
    <xsd:complexContent mixed="true">
      <xsd:extension base="Events:PortStatus"/>
    </xsd:complexContent>
  </xsd:complexType>

  <xsd:complexType name="tliPStart">
    <xsd:complexContent mixed="true">
      <xsd:extension base="Events:PortStatus"/>
    </xsd:complexContent>
  </xsd:complexType>

  <xsd:complexType name="tliPStop">
    <xsd:complexContent mixed="true">
      <xsd:extension base="Events:PortStatus"/>
    </xsd:complexContent>
  </xsd:complexType>

  <xsd:complexType name="tliPHalt">
    <xsd:complexContent mixed="true">
      <xsd:extension base="Events:PortStatus"/>
    </xsd:complexContent>
  </xsd:complexType>

  <!-- codec -->
  <xsd:complexType name="tliEncode">
    <xsd:complexContent mixed="true">
      <xsd:extension base="Events:Event">
        <xsd:sequence>
          <xsd:element name="val" type="Values:Value"/>
          <xsd:choice>
            <xsd:element name="msg" type="Types:TriMessageType"/>
            <xsd:element name="encoder-failure" type="SimpleTypes:TciStatusType"
minOccurs="0"/>
          </xsd:choice>
          <xsd:element name="codec" type="SimpleTypes:TString"
minOccurs="0"/>
        </xsd:sequence>
      </xsd:extension>
    </xsd:complexContent>
  </xsd:complexType>

  <xsd:complexType name="tliDecode" mixed="true">
    <xsd:complexContent mixed="true">
      <xsd:extension base="Events:Event">
        <xsd:sequence>
          <xsd:element name="msg" type="Types:TriMessageType"/>
          <xsd:choice>
            <xsd:element name="decoder-failure" type="SimpleTypes:TciStatusType"
minOccurs="0"/>
            <xsd:element name="val" type="Values:Value"/>
          </xsd:choice>
          <xsd:element name="codec" type="SimpleTypes:TString"
minOccurs="0"/>
        </xsd:sequence>
      </xsd:extension>
    </xsd:complexContent>
  </xsd:complexType>

  <!-- timers -->
  <xsd:complexType name="tliTimeoutDetected">
    <xsd:complexContent mixed="true">
      <xsd:extension base="Events:Event">
        <xsd:sequence>
          <xsd:element name="timer" type="Types:TriTimerIdType" />
        </xsd:sequence>
      </xsd:extension>
    </xsd:complexContent>
  </xsd:complexType>

  <xsd:complexType name="tliTimeoutMismatch">
    <xsd:complexContent mixed="true">
      <xsd:extension base="Events:Event">
        <xsd:sequence>
          <xsd:element name="timer" type="Types:TriTimerIdType" />

```

```

        <xsd:element name="timerTpl" type="Templates:TciNonValueTemplate" />
      </xsd:sequence>
    </xsd:extension>
  </xsd:complexContent>
</xsd:complexType>

<xsd:complexType name="tliTimeout">
  <xsd:complexContent mixed="true">
    <xsd:extension base="Events:Event">
      <xsd:sequence>
        <xsd:element name="timer" type="Types:TriTimerIdType" />
        <xsd:element name="timerTpl" type="Templates:TciNonValueTemplate" />
      </xsd:sequence>
    </xsd:extension>
  </xsd:complexContent>
</xsd:complexType>

<xsd:complexType name="tliTStart">
  <xsd:complexContent mixed="true">
    <xsd:extension base="Events:Event">
      <xsd:sequence>
        <xsd:element name="timer" type="Types:TriTimerIdType"/>
        <xsd:element name="dur" type="SimpleTypes:TriTimerDurationType"/>
      </xsd:sequence>
    </xsd:extension>
  </xsd:complexContent>
</xsd:complexType>

<xsd:complexType name="tliTStop">
  <xsd:complexContent mixed="true">
    <xsd:extension base="Events:Event">
      <xsd:sequence>
        <xsd:element name="timer" type="Types:TriTimerIdType"/>
        <xsd:element name="dur" type="SimpleTypes:TriTimerDurationType"/>
      </xsd:sequence>
    </xsd:extension>
  </xsd:complexContent>
</xsd:complexType>

<xsd:complexType name="tliTRead">
  <xsd:complexContent mixed="true">
    <xsd:extension base="Events:Event">
      <xsd:sequence>
        <xsd:element name="timer" type="Types:TriTimerIdType"/>
        <xsd:element name="elapsed" type="SimpleTypes:TriTimerDurationType"/>
      </xsd:sequence>
    </xsd:extension>
  </xsd:complexContent>
</xsd:complexType>

<xsd:complexType name="tliTRunning">
  <xsd:complexContent mixed="true">
    <xsd:extension base="Events:Event">
      <xsd:sequence>
        <xsd:element name="timer" type="Types:TriTimerIdType"/>
      </xsd:sequence>
      <xsd:attribute name="status" type="SimpleTypes:TimerStatusType"/>
    </xsd:extension>
  </xsd:complexContent>
</xsd:complexType>

<!-- scope -->
<xsd:complexType name="tliSEnter">
  <xsd:complexContent mixed="true">
    <xsd:extension base="Events:Event">
      <xsd:sequence>
        <xsd:element name="name" type="Types:QualifiedName" />
        <xsd:element name="tciPars" type="Types:TciParameterListType" minOccurs="0"/>
        <xsd:element name="kind" type="SimpleTypes:TString"/>
      </xsd:sequence>
    </xsd:extension>
  </xsd:complexContent>
</xsd:complexType>

<xsd:complexType name="tliSLeave">
  <xsd:complexContent mixed="true">
    <xsd:extension base="Events:Event">
      <xsd:sequence>

```

```

        <xsd:element name="name" type="Types:QualifiedName" />
        <xsd:element name="tciPars" type="Types:TciParameterListType" minOccurs="0"/>
        <xsd:element name="returnValue" type="Values:Value" minOccurs="0"/>
        <xsd:element name="kind" type="SimpleTypes:TString"/>
    </xsd:sequence>
</xsd:extension>
</xsd:complexContent>
</xsd:complexType>

<!-- variables and module parameter -->
<xsd:complexType name="tliVar">
    <xsd:complexContent mixed="true">
        <xsd:extension base="Events:Event">
            <xsd:sequence>
                <xsd:element name="name" type="Types:QualifiedName" />
                <xsd:element name="val" type="Values:Value" minOccurs="0"/>
            </xsd:sequence>
        </xsd:extension>
    </xsd:complexContent>
</xsd:complexType>

<xsd:complexType name="tliModulePar">
    <xsd:complexContent mixed="true">
        <xsd:extension base="Events:Event">
            <xsd:sequence>
                <xsd:element name="name" type="Types:QualifiedName" />
                <xsd:element name="val" type="Values:Value" minOccurs="0"/>
            </xsd:sequence>
        </xsd:extension>
    </xsd:complexContent>
</xsd:complexType>

<!-- verdicts -->
<xsd:complexType name="tliGetVerdict">
    <xsd:complexContent mixed="true">
        <xsd:extension base="Events:Event">
            <xsd:sequence>
                <xsd:element name="verdict" type="Values:VerdictValue"/>
            </xsd:sequence>
        </xsd:extension>
    </xsd:complexContent>
</xsd:complexType>

<xsd:complexType name="tliSetVerdict">
    <xsd:complexContent mixed="true">
        <xsd:extension base="Events:Event">
            <xsd:sequence>
                <xsd:element name="verdict" type="Values:VerdictValue"/>
                <xsd:element name="reason" type="SimpleTypes:TString" minOccurs="0"/>
            </xsd:sequence>
        </xsd:extension>
    </xsd:complexContent>
</xsd:complexType>

<!-- log -->
<xsd:complexType name="tliLog">
    <xsd:complexContent mixed="true">
        <xsd:extension base="Events:Event">
            <xsd:sequence>
                <xsd:element name="log" type="SimpleTypes:TString"/>
            </xsd:sequence>
        </xsd:extension>
    </xsd:complexContent>
</xsd:complexType>

<!-- alt -->
<xsd:complexType name="tliAEnter">
    <xsd:complexContent>
        <xsd:extension base="Events:Event"/>
    </xsd:complexContent>
</xsd:complexType>

<xsd:complexType name="tliALeave">
    <xsd:complexContent>
        <xsd:extension base="Events:Event"/>
    </xsd:complexContent>
</xsd:complexType>

```

```

<xsd:complexType name="tliADefaults">
  <xsd:complexContent>
    <xsd:extension base="Events:Event"/>
  </xsd:complexContent>
</xsd:complexType>

<xsd:complexType name="tliAActivate">
  <xsd:complexContent mixed="true">
    <xsd:extension base="Events:Event">
      <xsd:sequence>
        <xsd:element name="name" type="Types:QualifiedName" />
        <xsd:element name="tciPars" type="Types:TciParameterListType" minOccurs="0"/>
        <xsd:element name="ref" type="Values:Value"/>
      </xsd:sequence>
    </xsd:extension>
  </xsd:complexContent>
</xsd:complexType>

<xsd:complexType name="tliADeactivate">
  <xsd:complexContent mixed="true">
    <xsd:extension base="Events:Event">
      <xsd:sequence>
        <xsd:element name="ref" type="Values:Value"/>
      </xsd:sequence>
    </xsd:extension>
  </xsd:complexContent>
</xsd:complexType>

<xsd:complexType name="tliANomatch">
  <xsd:complexContent mixed="true">
    <xsd:extension base="Events:Event"/>
  </xsd:complexContent>
</xsd:complexType>

<xsd:complexType name="tliARepeat">
  <xsd:complexContent>
    <xsd:extension base="Events:Event"/>
  </xsd:complexContent>
</xsd:complexType>

<xsd:complexType name="tliAwait">
  <xsd:complexContent>
    <xsd:extension base="Events:Event"/>
  </xsd:complexContent>
</xsd:complexType>

<xsd:complexType name="tliAction">
  <xsd:complexContent mixed="true">
    <xsd:extension base="Events:Event">
      <xsd:sequence>
        <xsd:element name="action" type="SimpleTypes:TString"/>
      </xsd:sequence>
    </xsd:extension>
  </xsd:complexContent>
</xsd:complexType>

<xsd:complexType name="tliMatch">
  <xsd:complexContent mixed="true">
    <xsd:extension base="Events:Event">
      <xsd:sequence>
        <xsd:element name="expr" type="Values:Value"/>
        <xsd:element name="tpl" type="Templates:TciValueTemplate"/>
      </xsd:sequence>
    </xsd:extension>
  </xsd:complexContent>
</xsd:complexType>

<xsd:complexType name="tliMatchMismatch">
  <xsd:complexContent mixed="true">
    <xsd:extension base="Events:Event">
      <xsd:sequence>
        <xsd:element name="expr" type="Values:Value"/>
        <xsd:element name="tpl" type="Templates:TciValueTemplate"/>
        <xsd:element name="diffs" type="Templates:TciValueDifferenceList"/>
      </xsd:sequence>
    </xsd:extension>
  </xsd:complexContent>
</xsd:complexType>

```



```
<xsd:complexType name="tliInfo">
  <xsd:complexContent mixed="true">
    <xsd:extension base="Events:Event">
      <xsd:sequence>
        <xsd:element name="level" type="SimpleTypes:TInteger"/>
        <xsd:element name="info" type="SimpleTypes:TString"/>
      </xsd:sequence>
    </xsd:extension>
  </xsd:complexContent>
</xsd:complexType>
```

12 C# mapping

12.1 Introduction

The C# mapping for the TTCN-3 Control Interface defines how the IDL [6] definitions described in clause 7 are mapped to the .Net language C# [13].

12.2 Names and scopes

12.2.1 Names

Although there are almost no conflicts between identifiers used in the IDL definition and C#, some naming translation rules are applied to the IDL identifiers.

C# interfaces are omitting the trailing Type used in the IDL definition. In addition to that, the capital letter "I" is added to the beginning of interface names.

EXAMPLE 1: The IDL type **TciTestCaseIdType** maps to **ITciTestCaseId** in C#.

C# names of enumerated items start with a capital letter and the remaining letters are low-case letters. If the enumerated item name is composed of several words, each word starts with a capital letter.

EXAMPLE 2: The identifier for boolean type defined in **TciTypeClassType** enumeration is **BooleanType** in C#.

The resulting mapping conforms to the standard C# coding conventions.

12.2.2 Scopes

The TCI interfaces are mapped to the namespace **Etsi.Ttcn3.Tci**. All IDL type declarations are mapped to C# interface declarations within this namespace. The associated assembly file is **Etsi.Ttcn3.Tci.dll**.

12.3 Null value mapping

The distinct value `null` specified in the IDL definition is equal to `null` in C#.

12.4 Type mapping

12.4.1 Basic type mapping

Table 5 gives an overview on how the used basic IDL types are mapped to the .NET types.

Table 5: Basic type mapping

IDL Type	C# Type/Interface
TBoolean	bool
TChar	char
TFloat	double
TInteger	int / TciVerdict
TString	string
TStringSeq	string[]
TUniversalChar	uint

TBoolean

The IDL TBoolean type is mapped to the C# type `bool`.

TFloat

The IDL TFloat type is mapped to the C# type `double`.

TChar

The IDL TChar type is mapped to the C# type `char`.

TInteger

The IDL TInteger type is usually mapped to the C# type `int`. Only in case of operations defined for the IDL type `TciVerdictValue`, the IDL TInteger type is mapped to `Etsi.Ttcn3.Tci.TciVerdict` enumeration.

TString

The IDL TString type is mapped to the C# class `string` without range checking or bounds for characters in the string. All possible strings defined in TTCN-3 can be converted to C# string class.

TStringSeq

The IDL TStringSeq type is mapped to a string array.

TUniversalChar

The IDL TUniversalChar type is mapped to the C# type `uint`. The integer uses the canonical form as defined in ISO/IEC 10646 [5], clause 6.2.

12.4.1.1 TciVerdict

In case of verdict operations, the IDL TInteger type is mapped to the **TciVerdict** enumeration. This enumeration is defined as follows:

```
public enum TciVerdict {
    None = 0,
    Pass = 1,
    Inconc = 2,
    Fail = 3,
    Error = 4
    User_Error = 5
}
```

12.4.2 Structured type mapping

The TCI IDL description defines user-defined types as native types. In the C# mapping, these types are mapped to C# interfaces. The interfaces define methods and properties being available for classes implementing this interface.

12.4.2.1 TciParameterPassingModeType

TciParameterPassingModeType is mapped to the following enumeration:

```
public enum TciParameterPassingMode {
    TciIn = 0,
    TciInOut = 1,
    TciOut = 2
}
```

12.4.2.2 TciParameterType

TciParameterType is mapped to the following interface:

```
public interface ITciParameter {
    string ParameterName { get; set; }
    TciParameterPassingMode ParameterPassingMode { get; set; }
    ITciValue Parameter { get; set; }
}
```

Members:

- **ParameterName**
Gets or sets the parameter name.
- **ParameterPassingMode**
Gets or sets the parameter passing mode of this parameter.
- **Parameter**
Used for getting or setting value of the parameter. The parameter can be an instance of **ITciValue** or the distinct value **null**.

12.4.2.3 TciParameterListType

TciParameterListType is mapped to the following interface:

```
public interface ITciParameterList: System.Collections.IEnumerable {
    int Size { get; }
    bool IsEmpty { get; }
    ITciParameter this[int index] { get; }
    void Clear();
    void Add(ITciParameter comp);
}
```

Members:

- **Size**
Returns the number of parameters in this list.
- **IsEmpty**
Returns **true** if this list contains no parameters.
- **GetEnumerator**
Inherited from **IEnumerable**. Returns an enumerator for this object and allows to use the list in a **foreach** loop.
- **operator**
Returns a **ITciParameter** instance at the specified position. **IndexOutOfRangeException** is thrown if the index is less than zero or greater or equal to the list size.
- **Clear**
Removes all parameters from the list.
- **Add**
Adds a parameter to the end of the list.

12.4.2.4 TciTypeClassType

TciTypeClassType is mapped to the following enumeration:

```
public enum TciTypeClass {
    Address = 0,
    Anytype = 1,
    Bitstring = 2,
    BooleanType = 3,
    Charstring = 5,
    Component = 6,
    Enumerated = 7,
    Float = 8,
    Hexstring = 9,
    IntegerType = 10,
    Octetstring = 12,
    Record = 13,
    RecordOf = 14,
    Array = 15
    Set = 16,
    SetOf = 17,
    Union = 18,
    UniversalCharstring = 20,
    Verdict = 21
}
```

12.4.2.5 TciTestComponentKindType

TciTestComponentKindType is mapped to the following enumeration:

```
public enum TciTestComponentKind {
    TciCtrlComp = 0,
    TciMtcComp = 1,
    TciPtcComp = 2,
    TciSystemComp = 3,
    TciAliveComp = 4
}
```

12.4.2.6 TciBehaviourIdType

TciBehaviourIdType C# mapping is derived from the Etsi.Ttcn3.Tri.IQualifiedName interface:

```
public interface ITciBehaviourId : Etsi.Ttcn3.Tri.IQualifiedName {}
```

12.4.2.7 TciTestCaseIdType

TciTestCaseIdType C# mapping is derived from the Etsi.Ttcn3.Tri.IQualifiedName interface:

```
public interface ITciTestCaseId : Etsi.Ttcn3.Tri.IQualifiedName {}
```

12.4.2.8 TciTestCaseIdListType

TciTestCaseIdListType is mapped to the following interface:

```
public interface ITciTestCaseIdList: System.Collections.IEnumerable {
    int Size { get; }
    bool IsEmpty { get; }
    ITciTestCaseId this[int index] { get; }
}
```

Members:

- **Size**
Returns the number of test case identifiers in this list.
- **IsEmpty**
Returns true if this list contains no parameters.

- `GetEnumerator`
Inherited from `IEnumerable`. Returns an enumerator for this object and allows to use the list in a foreach loop.
- `operator`
Returns a `ITciTestCaseId` instance at the specified position. `IndexOutOfRangeException` is thrown if the index is less than zero or greater or equal to the list size.

12.4.2.9 TciModuleIdType

TciModuleIdType C# mapping is derived from the `Etsi.Ttcn3.Tri.IQualifiedName` interface:

```
public interface ITciModuleId : Etsi.Ttcn3.Tri.IQualifiedName {
}
```

12.4.2.10 TciModuleIdListType

TciModuleIdListType is mapped to the following interface:

```
public interface ITciModuleIdList: System.Collections.IEnumerable {
    int Size { get; }
    bool IsEmpty { get; }
    ITciModuleId this[int index] { get; }
}
```

Members:

- `Size`
Returns the number of module identifiers in this list.
- `IsEmpty`
Returns `true` if this list contains no parameters.
- `GetEnumerator`
Inherited from `IEnumerable`. Returns an enumerator for this object and allows to use the list in a foreach loop.
- `operator`
Returns a `ITciModuleId` instance at the specified position. `IndexOutOfRangeException` is thrown if the index is less than zero or greater or equal to the list size.

12.4.2.11 TciModuleParameterIdType

TciModuleIdType C# mapping is derived from the `Etsi.Ttcn3.Tri.IQualifiedName` interface:

```
public interface ITciModuleParameterId : Etsi.Ttcn3.Tri.IQualifiedName {
}
```

12.4.2.12 TciModuleParameterType

TciModuleParameterType is mapped to the following interface:

```
public interface ITciModuleParameter {
    ITciModuleParameterId ModuleParameterName { get; }
    ITciValue DefaultValue { get; }
}
```

Members:

- `ModuleParameterName`
Returns the qualified module parameter name as defined in the TTCN-3 specification.
- `DefaultValue`
Returns the default value of this `TciModuleParameter` or the distinct value `null` if the default value is not specified.

12.4.2.13 TciModuleParameterListType

TciModuleParameterListType is mapped to the following interface:

```
public interface ITciModuleParameterList: System.Collections.IEnumerable {
    int Size { get; }
    bool IsEmpty { get; }
    ITciModuleParameter this[int index] { get; }
}
```

Members:

- **Size**
Returns the number of module identifiers in this list.
- **IsEmpty**
Returns `true` if this list contains no parameters.
- **GetEnumerator()**
Inherited from `IEnumerable`. Returns an enumerator for this object and allows to use the list in a `foreach` loop.
- **Indexing operator**
Returns a `ITciModuleId` instance at the specified position. `IndexOutOfRangeException` is thrown if the index is less than zero or greater or equal to the list size.

12.4.2.14 TciParameterTypeType

TciParameterTypeType is mapped to the following interface:

```
public interface ITciParameterType {
    ITciType ParameterType { get; }
    TciParameterPassingMode ParameterPassingMode { get; }
}
```

Members:

- **ParameterType**
Returns the type of the parameter.
- **ParameterPassingMode**
Returns the passing mode of this parameter.

12.4.2.15 TciParameterTypeListType

TciParameterListType is mapped to the following interface:

```
public interface ITciParameterTypeList: System.Collections.IEnumerable {
    int Size { get; }
    bool IsEmpty { get; }
    ITciParameterType this[int index] { get; }
}
```

Members:

- **Size**
Returns the number of parameters in this list.
- **IsEmpty**
Returns `true` if this list contains no parameters.
- **GetEnumerator**
Inherited from `IEnumerable`. Returns an enumerator for this object and allows to use the list in a `foreach` loop.

- **Indexing operator**
Returns a `ITciParameter` instance at the specified position. `IndexOutOfRangeException` is thrown if the index is less than zero or greater or equal to the list size.
- **Clear**
Removes all parameters from the list.
- **Add**
Adds a parameter to the end of the list.

12.4.3 Abstract type mapping

The TTCN-3 data types are modelled in C# using the abstract type mapping as defined in this clause. The `ITciType` interface defines only operations used to retrieve in TTCN-3 defined types. No TTCN-3 types can be constructed using the `ITciType` interface. Types are modelled using the single interface `ITciType`, that provides methods to identify types and to retrieve values of a given type.

12.4.3.1 Type

The IDL type **Type** is mapped to the following interface:

```
public interface ITciType {
    ITciModuleId DefiningModule { get; }
    string Name { get; }
    TciTypeClass TypeClass { get; }
    ITciValue NewInstance();
    string TypeEncoding { get; }
    string TypeEncodingVariant { get; }
    string[] TypeExtension { get; }
}
```

Members:

- **DefiningModule**
Returns the module identifier of the module the type has been defined in. If the type represents a TTCN-3 base type the distinct value `null` will be returned.
- **Name**
Returns name of the type as defined in the TTCN-3 module.
- **TypeClass**
Returns the type class of the respective type.
- **NewInstance**
Returns a freshly created value of the given type. This initial value of the created value is undefined.
- **TypeEncoding**
Returns the type encoding attribute as defined in the TTCN-3 module, if any. If no encoding attribute has been defined, the distinct value `null` will be returned.
- **TypeEncodingVariant**
This property returns the type encoding variant attribute as defined in TTCN-3, if any. If no encoding variant attribute has been defined, the distinct value `null` will be returned.
- **TypeExtension**
Returns the type extension attributes as defined in the TTCN-3 module. If no extension attributes have been defined, the distinct value `null` will be returned.

12.4.4 Abstract value mapping

TTCN-3 values can be retrieved from the TE and constructed using the `ITciValue` interface. The value mapping interface is constructed hierarchically with `ITciValue` as the basic interface. Specialized interfaces for different types of values have been defined.

12.4.4.1 Value

The IDL type **Value** is mapped to the following interface:

```
public interface ITciValue {
    ITciType Type { get; }
    bool NotPresent { get; }
    string ValueEncoding { get; }
    string ValueEncodingVariant { get; }
}
```

Members:

- **Type**
Returns the type of the specified value.
- **NotPresent**
Returns `true` if the specified value is omit, `false` otherwise.
- **ValueEncoding**
This property returns the value encoding attribute as defined in TTCN-3, if any. If no encoding attribute has been defined the distinct value `null` will be returned.
- **ValueEncodingVariant**
This property returns the value encoding variant attribute as defined in TTCN-3, if any. If no encoding variant attribute has been defined the distinct value `null` will be returned.

12.4.4.2 IntegerValue

IntegerValue is mapped to the following interface:

```
public interface ITciIntegerValue : ITciValue {
    long IntegerValue { get; set; }
    string StringValue { get; set; }
}
```

Members:

- **IntegerValue**
Gets or sets the numeric value of the object. In case the numeric value exceeds the allowed value range of the `long` type, `long.MaxValue` or `long.MinValue` is returned.
- **StringValue**
Get or sets the value of the object. The string assigned to the property shall have the same format as TTCN-3 integer literals. The integer literal can be optionally preceded by a sign character ('+' or '-').

12.4.4.3 FloatValue

FloatValue is mapped to the following interface:

```
public interface ITciFloatValue : ITciValue {
    double FloatValue { get; set; }
    string StringValue { get; set; }
}
```

Members:

- **FloatValue**
Gets or sets the numeric value of the object. In case the numeric value exceeds the allowed value range of the `double` type, `double.MaxValue` or `double.MinValue` is returned.
- **StringValue**
Get or sets the value of the object. The string assigned to the property shall have the same format as TTCN-3 float literals. The float literal can be optionally preceded by a sign character ('+' or '-').

12.4.4.4 BooleanValue

BooleanValue is mapped to the following interface:

```
public interface ITciBooleanValue : ITciValue {
    bool BooleanValue { get; set; }
}
```

Members:

- `BooleanValue`
Gets or sets the boolean value of the object.

12.4.4.5 CharstringValue

CharstringValue is mapped to the following interface:

```
public interface ITciCharstringValue : ITciValue {
    string StringValue { get; set; }
    char this[int position] { get; set; }
    int Length { get; set; }
}
```

Members:

- `StringValue`
Gets or sets the string value of the TTCN-3 charstring. Strings assigned to this property shall contain only characters allowed in TTCN-3 charstring type.
- `Indexing operator`
Get or sets the character value of the TTCN-3 charstring at the specified position. `IndexOutOfRangeException` is thrown if the position is less than zero or greater or equal to the string length.
- `Length`
Gets or sets the length of this `ITciCharstringValue` in characters. The property returns zero if the value of this object is `omit`. In case the new length is greater than the length of the current string, characters with ordinal value 0 are added to the end of the string. If the new length is less than the length of the current string, the current string is truncated.

12.4.4.6 BitstringValue

BitstringValue is mapped to the following interface:

```
public interface ITciBitstringValue : ITciValue {
    string StringValue { get; set; }
    byte this[int position] { get; set; }
    int Length { get; set; }
}
```

Members:

- `StringValue`
Gets or sets the string value of the TTCN-3 bitstring. The only allowed characters in the string passed to this property are '0' and '1'. The string returned by the property contains a sequence of '0' and '1' digits.
- `Indexing operator`
Get or sets the value of the bit at the specified position. All non-zero values shall be interpreted as if the bit was present. `IndexOutOfRangeException` is thrown if the position is less than zero or greater or equal to the string length.

- **Length**
Gets or sets the length of this `ITciBitstringValue` in bits. The property returns zero if the value of this object is `omit`. In case the new length is greater than the length of the current bitstring, the bitstring is padded with empty bits. If the new length is less than the length of the current bitstring, the current bitstring is truncated.

12.4.4.7 OctetstringValue

OctetstringValue is mapped to the following interface:

```
public interface ITciOctetstringValue : ITciValue {
    string StringValue { get; set; }
    byte this[int position] { get; set; }
    int Length { get; set; }
}
```

Members:

- **StringValue**
Gets or sets the string value of the TTCN-3 octetstring. The only allowed characters in the string passed to this property are hexadecimal digits. The length of the string passed to this property shall be even. The string returned by this property is a sequence of pairs of hexadecimal digits.
- **Indexing operator**
Get or sets the value of the octet at the specified position. `IndexOutOfRangeException` is thrown if the position is less than zero or greater or equal to the string length.
- **Length**
Gets or sets the length of this `ITciOctetstringValue` in octets. The property returns zero if the value of this object is `omit`. In case the new length is greater than the length of the current octetstring, the octetstring is padded with empty octets. If the new length is less than the length of the current octetstring, the current octetstring is truncated.

12.4.4.8 UniversalCharstringValue

UniversalCharstringValue is mapped to the following interface:

```
public interface ITciUniversalCharstringValue : ITciValue {
    string StringValue { get; set; }
    uint this[int position] { get; set; }
    int Length { get; set; }
}
```

Members:

- **StringValue**
Gets or sets the string value of the TTCN-3 universal charstring. If the TTCN-3 universal charstring value contains characters that have higher ordinal value than `char.MaxValue`, these characters will be represented by a character `0xFFFFD` (the Unicode replacement character) in the string returned by this property.
- **Indexing operator**
Get or sets the character value of the TTCN-3 universal charstring at the specified position. The unsigned number used by this property is character ordinal value. `IndexOutOfRangeException` is thrown if the position is less than zero or greater or equal to the string length.
- **Length**
Gets or sets the length of this `ITciUniversalCharstringValue` in characters. The property returns zero if the value of this object is `omit`. In case the new length is greater than the length of the current string, characters with ordinal value 0 are added to the end of the string. If the new length is less than the length of the current string, the current string is truncated.

12.4.4.9 HexstringValue

HexstringValue is mapped to the following interface:

```
public interface ITciHexstringValue : ITciValue {
    string StringValue { get; set; }
    byte this[int position] { get; set; }
    int Length { get; set; }
}
```

Members:

- **StringValue**
Gets or sets the string value of the TTCN-3 hexstring. The only allowed characters in the string passed to this property are hexadecimal digits. The string returned by this property is a sequence of hexadecimal digits.
- **Indexing operator**
Get or sets the hex digit at the specified position. Only the lower four bits of the passed value are used in this assignment. The upper four bits are ignored. `IndexOutOfRangeException` is thrown if the position is less than zero or greater or equal to the string length.
- **Length**
Gets or sets the length of this `ITciHexstringValue` in hex digits. The property returns zero if the value of this object is `omit`. In case the new length is greater than the length of the current hexstring, the hexstring is padded with zeroes. If the new length is less than the length of the current hexstring, the current hexstring is truncated.

12.4.4.10 RecordValue

RecordValue is mapped to the following interface:

```
public interface ITciRecordValue : ITciValue {
    ITciValue GetField(string fieldName);
    void SetField(string fieldName, ITciValue value);
    string[] GetFieldNames();
    void SetFieldOmitted(string fieldName);
}
```

Members:

- **GetField**
Returns the value of the field named `fieldName`. The return value is the common abstract base type `ITciValue`, as a record field can have any type defined in TTCN-3. If the field cannot be obtained from the record the distinct value `null` will be returned.
- **SetField**
Sets the field named `fieldName` of the record to `value`. No assumption shall be made on how a field is stored in a record. An internal implementation might choose to store a reference to this value or to copy the value. It is safe to assume that the value will be copied. Therefore it should be assumed that subsequent modifications of value will not be considered in the record.
- **GetFieldNames**
Returns an array of `String` of field names, the empty sequence, if the record has no fields.
- **SetFieldOmitted**
Sets the field named `fieldName` of the record to `omit`.

12.4.4.11 RecordOfValue

RecordOfValue is mapped to the following interface:

```
public interface ITciRecordOfValue : ITciValue, System.Collections.IEnumerable {
    ITciValue this[int position] { get; set; }
    void AppendField(ITciValue value);
    ITciType ElementType { get; }
    int Length { get; set; }
}
```

```
int Offset { get; }
}
```

Members:

- **Indexing operator**
Returns or sets the value of the record of at the specified position. The class of this property is the common abstract base interface `ITciValue`, as a `record of` can have fields of any type defined in TTCN-3. When getting the value an `ITciValue` instance is returned only if `position` is between zero and $(length - 1)$. The distinct value `null` is returned otherwise. When setting the value, if `position` is greater than the current length, the record of will be extended to have the length $(position + 1)$. The record of elements between the original position at `length` and $(position - 1)$ will be set to `omit`. No assumption shall be made on how a field is stored in a `record of`. An internal implementation might choose to store a reference to this value or to copy the value. It is safe to assume that the value will be copied. Therefore it should be assumed that subsequent modifications of value will not be considered in the `record of`.
- **GetEnumerator**
Inherited from `IEnumerable`. Returns an enumerator for this object and allows to use the object in a `foreach` loop.
- **appendField**
Appends the value at the end of the `record of`, i.e. at position `length`. No assumption shall be made on how a field is stored in a `record of`. An internal implementation might choose to store a reference to this value or to copy the value. It is safe to assume that the value will be copied. Therefore it should be assumed that subsequent modifications of value will not be considered in the `record of`.
- **ElementType**
Returns the type of the elements of this `record of`.
- **Length**
Gets or sets the actual length of the `record of` value. When getting the length, zero is returned if the `record of` value is `omit`. When setting the length, if the new length is greater than the original length, newly created elements have the value `omit`. If the new length is less or equal than the original length, this operation will be ignored.
- **Offset**
Returns the lowest possible index. For a record of or set of value this is always 0. For an array value, this is the lower index bound used in the type definition.

12.4.4.12 UnionValue

UnionValue is mapped to the following interface:

```
public interface ITciUnionValue : ITciValue {
    ITciValue GetVariant(string variantName);
    void SetVariant(string variantName, ITciValue value);
    string PresentVariantName { get; }
    string[] GetVariantNames();
}
```

Members:

- **GetVariant**
Returns the value of the TTCN-3 union variant, if `variantName` equals the result of `GetPresentVariantName`. The distinct value `null` is returned otherwise. `variantName` denotes the name of the union variant as defined in TTCN-3.
- **SetVariant**
Sets `variantName` of the union to `value`. If `variantName` is not defined for this union this operation will be ignored. If another variant was selected the new variant will be selected instead.

- `GetPresentVariantName`
Returns the variant name that has a value in this union set as a `string`. The distinct value `null` will be returned if no variant is selected.
- `GetVariantNames`
Returns an array of `string` of variant names, the empty sequence, if the union has no fields. If the `UnionValue` represents the TTCN-3 `anytype`, i.e. the value of the `Type` property is `TciTypeClass.Anytype`, all predefined and user-defined TTCN-3 types will be returned.

12.4.4.13 EnumeratedValue

EnumeratedValue is mapped to the following interface:

```
public interface ITciEnumeratedValue : ITciValue {
    string EnumValue { get; set; }
    int IntValue { get; set; }
}
```

Members:

- `EnumValue`
Returns or sets the enumerated value. The value of the property is equal to the identifier in the TTCN-3 specification. If the value assigned to the property is not an allowed value for this enumeration, the assignment will be ignored.
- `IntValue`
Returns or sets the integer value. This integer should equal the user-assigned integer value in the TTCN-3 specification or the automatically assigned integer value. If the integer assigned to the property is not allowed for this enumeration, the assignment will be ignored.

12.4.4.14 VerdictValue

VerdictValue is mapped to the following interface:

```
public interface ITciVerdictValue : ITciValue {
    TciVerdict Verdict { get; set; }
}
```

Members:

- `Verdict`
Returns the value of this `VerdictValue`. Note that a `VerdictValue` can be set to any of the verdicts defined in the `TciVerdict` enumeration at any time. The `VerdictValue` does not perform any verdict calculations as defined in TTCN-3. For example, it is legal to set the `VerdictValue` first to `TciVerdict.ErrorVerdict` and then to `TciVerdict.Pass`.

12.4.4.15 AddressValue

AddressValue is mapped to the following interface:

```
public interface ITciAddressValue : ITciValue {
    ITciValue Address { get; set; }
}
```

Members:

- `Address`
Gets or sets the value represented by this `AddressValue`.

12.4.5 Abstract logging types mapping

Additional types are defined to ease the logging of object states and matches between values and templates.

12.4.5.1 TciValueTemplate

TciValueTemplate is mapped to the following interface:

```
public interface ITciValueTemplate {
    bool IsOmit { get; }
    bool IsAny { get; }
    bool IsAnyOrOmit { get; }
    string TemplateDef { get; }
}
```

Members:

- **IsOmit**
Returns `true` if the template is omit, `false` otherwise.
- **IsAny**
Returns `true` if the template is any, `false` otherwise.
- **IsAnyOrOmit**
Returns `true` if the template is `AnyValueOrNone`, `false` otherwise.
- **TemplateDef**
This property returns the template definition.

12.4.5.2 TciNonValueTemplate

TciNonValueTemplate is mapped to the following interface:

```
public interface ITciNonValueTemplate {
    bool IsAny { get; }
    bool IsAll { get; }
    string TemplateDef { get; }
}
```

Members:

- **IsAny**
Returns `true` if the template is any, `false` otherwise.
- **IsAll**
Returns `true` if the template is all, `false` otherwise.
- **TemplateDef**
This operation returns the template definition.

12.4.5.3 TciValueList

TciValueList is mapped to the following interface:

```
public interface ITciValueList: IEnumerable {
    int Size { get; }
    bool IsEmpty { get; }
    ITciValue this[int index] { get; }
}
```

Members:

- **Size**
Returns the number of values in this list.
- **IsEmpty**
Returns `true` if this list contains no values.

- `GetEnumerator`
Inherited from `IEnumerable`. Returns an enumerator for this object and allows to use the list in a foreach loop.
- Indexing operator
Returns a `ITciValue` instance at the specified position. `IndexOutOfRangeException` is thrown if the index is less than zero or greater or equal to the list size.

12.4.5.4 TciValueDifference

TciValueDifference is mapped to the following interface:

```
public interface ITciValueDifference {
    ITciValue Value { get; }
    ITciValueTemplate ValueTemplate { get; }
    string Description { get; }
}
```

Members:

- `Value`
Returns the value of this `ITciValueDifference`.
- `Template`
Returns the template of this `ITciValueDifference`.
- `Description`
Returns the description of the mismatch.

12.4.5.5 TciValueDifferenceList

TciValueDifferenceList is mapped to the following interface:

```
public interface ITciValueDifferenceList : IEnumerable {
    int Size { get; }
    bool IsEmpty { get; }
    ITciValueDifference this[int index] { get; }
}
```

Members:

- `Size`
Returns the number of differences in this list.
- `IsEmpty`
Returns `true` if this list contains no parameters.
- `GetEnumerator`
Inherited from `IEnumerable`. Returns an enumerator for this object and allows to use the list in a foreach loop.
- Indexing operator
Returns a `ITciValueDifference` instance at the specified position. `IndexOutOfRangeException` is thrown if the index is less than zero or greater or equal to the list size.

12.4.5.6 TciStatusType

TciStatusType is mapped to the following enumeration:

```
public enum TciStatus {
    TciOk = 0,
    TciError = -1
}
```

12.4.5.7 ComponentStatusType

ComponentStatusType is mapped to the following enumeration:

```
public enum TciComponentStatus {
    InactiveC = 0,
    RunningC = 1,
    StoppedC = 2,
    KilledC = 3,
    NullC = 4
}
```

12.4.5.8 TimerStatusType

TimerStatusType is mapped to the following enumeration:

```
public enum TciTimerStatus {
    RunningT = 0,
    InactiveT = 1,
    ExpiredT = 2,
    NullT = 3
}
```

12.5 Mapping of interfaces

The TCI IDL definition defines four interfaces, the TCI-TM, the TCI-CH, the TCI-CD, and the TCI-TL interface. The operations are defined for different directions within this interface, i.e. some operations can only be called by the TTCN-3 Executable (TE), the System Adaptor (SA) or the Platform Adaptor (PA) on the Test Management and Control (TMC) while others can only be called by the TMC on the TE. This is reflected by dividing the TCI IDL interfaces in two sub interfaces, each suffixed by Required or Provided.

Table 6: TCI sub-interfaces

Calling	Called	Interface
TE	TMC	ITciTMProvided
TMC	TE	ITciTMRequired
TE	CD	ITciCDProvided
CD	TE	ITciCDRequired
TE	CH	ITciCHProvided
CH	TE	ITciCHRequired
TE, TMC, CD, CH, SA, PA	TL	ITciTLProvided

All methods defined in this interfaces should behave as defined in clause 7 of [1].

12.5.1 TCI-TM interface

12.5.1.1 TCI-TM provided

The **TCI-TM provided** interface is mapped to the following interface:

```
public interface ITciTMProvided {
    void TciTestCaseStarted(ITciTestCaseId testCaseId,
        ITciParameterList parameterList, double timer);
    void TciTestCaseTerminated(ITciVerdictValue verdict,
        ITciParameterList parameterList);
    void TciControlTerminated();
    ITciValue TciGetModulePar(ITciModuleParameterId parameterId);
    void TciLog(Etsi.Ttcn3.Tri.ITriComponentId testComponentId,
        string message);
    void TciError(string message);
}
```

12.5.1.2 TCI-TM provided

The **TCI-TM provided** interface is mapped to the following interface:

```
public interface ITciTMRequired {
    void TciRootModule(ITciModuleId moduleId);
    ITciModuleIdList TciGetImportedModules();
    ITciModuleParameterList TciGetModuleParameters(ITciModuleId moduleId);
    ITciTestCaseIdList TciGetTestCases();
    ITciParameterTypeList TciGetTestCaseParameters(ITciTestCaseId testCaseId);
    Etsi.Ttcn3.Tri.ITriPortIdList TciGetTestCaseTsi(
        ITciTestCaseId testCaseId);
    void TciStartTestCase(ITciTestCaseId testCaseId,
        ITciParameterList parameterList);
    void TciStopTestCase();
    Etsi.Ttcn3.Tri.ITriComponentId TciStartControl();
    void TciStopControl();
}
```

12.5.2 TCI-CD interface

12.5.2.1 TCI-CD provided

The **TCI-CD provided** interface is mapped to the following interface:

```
public interface ITciCDProvided {
    ITciValue Decode(Etsi.Ttcn3.Tri.ITriMessage message,
        ITciType decodingHypothesis);
    Etsi.Ttcn3.Tri.ITriMessage Encode(ITciValue value);
}
```

12.5.2.2 TCI-CD required

The **TCI-CD required** interface is mapped to the following interface:

```
public interface ITciCDRequired {
    ITciType GetTypeForName(string typeName);
    ITciType GetInteger();
    ITciType GetFloat();
    ITciType GetBoolean();
    ITciType GetCharstring();
    ITciType GetUniversalCharstring();
    ITciType GetHexstring();
    ITciType GetBitstring();
    ITciType GetOctetstring();
    ITciType GetVerdict();
    void TciErrorReq(string message);
}
```

12.5.3 TCI-CH interface

12.5.3.1 TCI-CH provided

The **TCI-CH provided** interface is mapped to the following interface:

```
public interface ITciCHProvided {
    void TciSendConnected(Etsi.Ttcn3.Tri.ITriPortId sender,
        Etsi.Ttcn3.Tri.ITriComponentId receiver, ITciValue sendMessage);
    void TciSendConnectedBC(Etsi.Ttcn3.Tri.ITriPortId sender,
        ITciValue sendMessage);
    void TciSendConnectedMC(Etsi.Ttcn3.Tri.ITriPortId sender,
        Etsi.Ttcn3.Tri.ITriComponentIdList receivers,
        ITciValue sendMessage);
    void TciCallConnected(Etsi.Ttcn3.Tri.ITriPortId sender,
        Etsi.Ttcn3.Tri.ITriComponentId receiver,
        Etsi.Ttcn3.Tri.ITriSignatureId signature,
        ITciParameterList parameterList);
    void TciCallConnectedBC(Etsi.Ttcn3.Tri.ITriPortId sender,
        Etsi.Ttcn3.Tri.ITriSignatureId signature,
        ITciParameterList parameterList);
}
```

```

void TciCallConnectedMC(Etsi.Ttcn3.Tri.ITriPortId sender,
    Etsi.Ttcn3.Tri.ITriComponentIdList receivers,
    Etsi.Ttcn3.Tri.ITriSignatureId signature,
    ITciParameterList parameterList);
void TciReplyConnected(Etsi.Ttcn3.Tri.ITriPortId sender,
    Etsi.Ttcn3.Tri.ITriComponentId receiver,
    Etsi.Ttcn3.Tri.ITriSignatureId signature,
    ITciParameterList parameterList, ITciValue returnValue);
void TciReplyConnectedBC(Etsi.Ttcn3.Tri.ITriPortId sender,
    Etsi.Ttcn3.Tri.ITriSignatureId signature,
    ITciParameterList parameterList, ITciValue returnValue);
void TciReplyConnectedMC(Etsi.Ttcn3.Tri.ITriPortId sender,
    Etsi.Ttcn3.Tri.ITriComponentIdList receivers,
    Etsi.Ttcn3.Tri.ITriSignatureId signature,
    ITciParameterList parameterList, ITciValue returnValue);
void TciRaiseConnected(Etsi.Ttcn3.Tri.ITriPortId sender,
    Etsi.Ttcn3.Tri.ITriComponentId receiver,
    Etsi.Ttcn3.Tri.ITriSignatureId signature, ITciValue except);
void TciRaiseConnectedBC(Etsi.Ttcn3.Tri.ITriPortId sender,
    Etsi.Ttcn3.Tri.ITriSignatureId signature, ITciValue except);
void TciRaiseConnectedMC(Etsi.Ttcn3.Tri.ITriPortId sender,
    Etsi.Ttcn3.Tri.ITriComponentIdList receivers,
    Etsi.Ttcn3.Tri.ITriSignatureId signature, ITciValue except);
Etsi.Ttcn3.Tri.ITriComponentId TciCreateTestComponentReq(int kind,
    ITciType componentType, string name, ITciValue hostId);
void TciStartTestComponentReq(Etsi.Ttcn3.Tri.ITriComponentId comp,
    ITciBehaviourId behavior, ITciParameterList parameterList);
void TciStopTestComponentReq(Etsi.Ttcn3.Tri.ITriComponentId comp);
void TciConnectReq(Etsi.Ttcn3.Tri.ITriPortId fromPort,
    Etsi.Ttcn3.Tri.ITriPortId toPort);
void TciDisconnectReq(Etsi.Ttcn3.Tri.ITriPortId fromPort,
    Etsi.Ttcn3.Tri.ITriPortId toPort);
void TciTestComponentTerminatedReq(Etsi.Ttcn3.Tri.ITriComponentId comp,
    ITciVerdictValue verdict);
bool TciTestComponentRunningReq(Etsi.Ttcn3.Tri.ITriComponentId comp);
Etsi.Ttcn3.Tri.ITriComponentId TciGetMmcReq();
void TciMapReq(Etsi.Ttcn3.Tri.ITriPortId fromPort,
    Etsi.Ttcn3.Tri.ITriPortId toPort);
void TciUnmapReq(Etsi.Ttcn3.Tri.ITriPortId fromPort,
    Etsi.Ttcn3.Tri.ITriPortId toPort);
void TciExecuteTestCaseReq(Etsi.Ttcn3.Tri.ITriComponentId component,
    Etsi.Ttcn3.Tri.ITriPortIdList tsiPortList);
void TciResetReq();
bool TciTestComponentDoneReq(Etsi.Ttcn3.Tri.ITriComponentId component);
void TciKillTestComponentReq(Etsi.Ttcn3.Tri.ITriComponentId component);
bool TciTestComponentAliveReq(Etsi.Ttcn3.Tri.ITriComponentId component);
bool TciTestComponentKilledReq(Etsi.Ttcn3.Tri.ITriComponentId component);
}

```

12.5.3.2 TCI-CH required

The **TCI-CH required** interface is mapped to the following interface:

```
public interface ITciCHRequired {
    void TciEnqueueMsgConnected(Etsi.Ttcn3.Tri.ITriPortId sender,
        Etsi.Ttcn3.Tri.ITriComponentId receiver,
        ITciValue receivedMessage);
    void TciEnqueueCallConnected(Etsi.Ttcn3.Tri.ITriPortId sender,
        Etsi.Ttcn3.Tri.ITriComponentId receiver,
        Etsi.Ttcn3.Tri.ITriSignatureId signature,
        ITciParameterList parameterList);
    void TciEnqueueReplyConnected(Etsi.Ttcn3.Tri.ITriPortId sender,
        Etsi.Ttcn3.Tri.ITriComponentId receiver,
        Etsi.Ttcn3.Tri.ITriSignatureId signature,
        ITciParameterList parameterList, ITciValue returnValue);
    void TciEnqueueRaiseConnected(Etsi.Ttcn3.Tri.ITriPortId sender,
        Etsi.Ttcn3.Tri.ITriComponentId receiver,
        Etsi.Ttcn3.Tri.ITriSignatureId signature, ITciValue except);
    Etsi.Ttcn3.Tri.ITriComponentId TciCreateTestComponent(int kind,
        ITciType componentType, string name);
    void TciStartTestComponent(Etsi.Ttcn3.Tri.ITriComponentId comp,
        ITciBehaviourId behavior, ITciParameterList parameterList);
    void TciStopTestComponent(Etsi.Ttcn3.Tri.ITriComponentId comp);
    void TciConnect(Etsi.Ttcn3.Tri.ITriPortId fromPort,
        Etsi.Ttcn3.Tri.ITriPortId toPort);
    void TciDisconnect(Etsi.Ttcn3.Tri.ITriPortId fromPort,
        Etsi.Ttcn3.Tri.ITriPortId toPort);
    void TciTestComponentTerminated(Etsi.Ttcn3.Tri.ITriComponentId comp,
        ITciVerdictValue verdict);
    bool TciTestComponentRunning(Etsi.Ttcn3.Tri.ITriComponentId comp);
    bool TciTestComponentDone(Etsi.Ttcn3.Tri.ITriComponentId comp);
    Etsi.Ttcn3.Tri.ITriComponentId TciGetMtc();
    void TciExecuteTestCase (ITciTestCaseId testCaseId,
        Etsi.Ttcn3.Tri.ITriPortIdList tsiPortList);
    void TciReset();
    void TciMap(Etsi.Ttcn3.Tri.ITriPortId fromPort,
        Etsi.Ttcn3.Tri.ITriPortId toPort);
    void TciUnmap(Etsi.Ttcn3.Tri.ITriPortId fromPort,
        Etsi.Ttcn3.Tri.ITriPortId toPort);
    void TciKillTestComponent(Etsi.Ttcn3.Tri.ITriComponentId component);
    bool TciTestComponentAlive (Etsi.Ttcn3.Tri.ITriComponentId component);
    bool TciTestComponentKilled(Etsi.Ttcn3.Tri.ITriComponentId component);
}
```

12.5.4 TCI-TL interface

12.5.4.1 TCI-TL provided

The **TCI-TL provided** interface is mapped to the following interface:

```
public interface ITciTLProvided {
    void TliTcExecute(string am, System.DateTime ts, string src, int line,
        Etsi.Ttcn3.Tri.ITriComponentId c, ITciTestCaseId tcId,
        ITciParameterList tciPars, Etsi.Ttcn3.Tri.ITriTimerDuration dur);
    void TliTcStart(string am, System.DateTime ts, string src, int line,
        Etsi.Ttcn3.Tri.ITriComponentId c, ITciTestCaseId tcId,
        ITciParameterList tciPars, Etsi.Ttcn3.Tri.ITriTimerDuration dur);
    void TliTcStop(string am, System.DateTime ts, string src, int line,
        Etsi.Ttcn3.Tri.ITriComponentId c, string reason);
    void TliTcStarted(string am, System.DateTime ts, string src, int line,
        Etsi.Ttcn3.Tri.ITriComponentId c, ITciTestCaseId tcId,
        ITciParameterList tciPars, Etsi.Ttcn3.Tri.ITriTimerDuration dur);
    void TliTcTerminated(string am, System.DateTime ts, string src, int line,
        Etsi.Ttcn3.Tri.ITriComponentId c, ITciTestCaseId tcId,
        ITciParameterList tciPars, ITciVerdictValue verdict,
        string reason);
    void TliCtrlStart(string am, System.DateTime ts, string src, int line,
        Etsi.Ttcn3.Tri.ITriComponentId c);
    void TliCtrlStop(string am, System.DateTime ts, string src, int line,
        Etsi.Ttcn3.Tri.ITriComponentId c);
    void TliCtrlTerminated(string am, System.DateTime ts, string src, int
        line, Etsi.Ttcn3.Tri.ITriComponentId c);
    void TliMsend_m(string am, System.DateTime ts, string src, int line,
        Etsi.Ttcn3.Tri.ITriComponentId c, Etsi.Ttcn3.Tri.ITriPortId at,
```

```

    Etsi.Ttcn3.Tri.ITriPortId to, ITciValue msgValue,
    ITciValue addrValue, TciStatus encoderFailure,
    Etsi.Ttcn3.Tri.ITriMessage msg, Etsi.Ttcn3.Tri.ITriAddress address,
    Etsi.Ttcn3.Tri.TriStatus transmissionFailure);
void TliMSend_m_BC(string am, System.DateTime ts, string src, int line,
    Etsi.Ttcn3.Tri.ITriComponentId c, Etsi.Ttcn3.Tri.ITriPortId at,
    Etsi.Ttcn3.Tri.ITriPortId to, ITciValue msgValue,
    TciStatus encoderFailure, Etsi.Ttcn3.Tri.ITriMessage msg,
    Etsi.Ttcn3.Tri.TriStatus transmissionFailure);
void TliMSend_m_MC(string am, System.DateTime ts, string src, int line,
    Etsi.Ttcn3.Tri.ITriComponentId c, Etsi.Ttcn3.Tri.ITriPortId at,
    Etsi.Ttcn3.Tri.ITriPortId to, ITciValue msgValue,
    ITciValueList addrValues, TciStatus encoderFailure,
    Etsi.Ttcn3.Tri.ITriMessage msg,
    Etsi.Ttcn3.Tri.ITriAddressList addresses,
    Etsi.Ttcn3.Tri.TriStatus transmissionFailure);
void TliMSend_c(string am, System.DateTime ts, string src, int line,
    Etsi.Ttcn3.Tri.ITriComponentId c, Etsi.Ttcn3.Tri.ITriPortId at,
    Etsi.Ttcn3.Tri.ITriPortId to, ITciValue msgValue,
    Etsi.Ttcn3.Tri.TriStatus transmissionFailure);
void TliMSend_c_BC(string am, System.DateTime ts, string src, int line,
    Etsi.Ttcn3.Tri.ITriComponentId c, Etsi.Ttcn3.Tri.ITriPortId at,
    Etsi.Ttcn3.Tri.ITriPortIdList to, ITciValue msgValue,
    Etsi.Ttcn3.Tri.TriStatus transmissionFailure);
void TliMSend_c_MC(string am, System.DateTime ts, string src, int line,
    Etsi.Ttcn3.Tri.ITriComponentId c, Etsi.Ttcn3.Tri.ITriPortId at,
    Etsi.Ttcn3.Tri.ITriPortIdList to, ITciValue msgValue,
    Etsi.Ttcn3.Tri.TriStatus transmissionFailure);
void TliMDetected_m(string am, System.DateTime ts, string src, int line,
    Etsi.Ttcn3.Tri.ITriComponentId c, Etsi.Ttcn3.Tri.ITriPortId at,
    Etsi.Ttcn3.Tri.ITriPortId from, Etsi.Ttcn3.Tri.ITriMessage msg,
    Etsi.Ttcn3.Tri.ITriAddress address);
void TliMDetected_c(string am, System.DateTime ts, string src, int line,
    Etsi.Ttcn3.Tri.ITriComponentId c, Etsi.Ttcn3.Tri.ITriPortId at,
    Etsi.Ttcn3.Tri.ITriPortId from, ITciValue msgValue);
void TliMMismatch_m(string am, System.DateTime ts, string src, int line,
    Etsi.Ttcn3.Tri.ITriComponentId c, Etsi.Ttcn3.Tri.ITriPortId at,
    ITciValue msgValue, ITciValueTemplate msgTmpl,
    ITciValueDifferenceList diffs, ITciValue address,
    ITciValueTemplate addressTmpl);
void TliMMismatch_c(string am, System.DateTime ts, string src, int line,
    Etsi.Ttcn3.Tri.ITriComponentId c, Etsi.Ttcn3.Tri.ITriPortId at,
    ITciValue msgValue, ITciValueTemplate msgTmpl,
    ITciValueDifferenceList diffs, Etsi.Ttcn3.Tri.ITriComponentId from,
    ITciNonValueTemplate fromTmpl);
void TliMReceive_m(string am, System.DateTime ts, string src, int line,
    Etsi.Ttcn3.Tri.ITriComponentId c, Etsi.Ttcn3.Tri.ITriPortId at,
    ITciValue msgValue, ITciValueTemplate msgTmpl, ITciValue address,
    ITciValueTemplate addressTmpl);
void TliMReceive_c(string am, System.DateTime ts, string src, int line,
    Etsi.Ttcn3.Tri.ITriComponentId c, Etsi.Ttcn3.Tri.ITriPortId at,
    ITciValue msgValue, ITciValueTemplate msgTmpl,
    Etsi.Ttcn3.Tri.ITriComponentId fromComp,
    ITciNonValueTemplate fromTmpl);
void TliPrCall_m(string am, System.DateTime ts, string src, int line,
    Etsi.Ttcn3.Tri.ITriComponentId c, Etsi.Ttcn3.Tri.ITriPortId at,
    Etsi.Ttcn3.Tri.ITriPortId to,
    Etsi.Ttcn3.Tri.ITriSignatureId signature,
    ITciParameterList tciPars, ITciValue addrValue,
    TciStatus encoderFailure, Etsi.Ttcn3.Tri.ITriParameterList triPars,
    Etsi.Ttcn3.Tri.ITriAddress address,
    Etsi.Ttcn3.Tri.TriStatus transmissionFailure);
void TliPrCall_m_BC(string am, System.DateTime ts, string src, int line,
    Etsi.Ttcn3.Tri.ITriComponentId c, Etsi.Ttcn3.Tri.ITriPortId at,
    Etsi.Ttcn3.Tri.ITriPortId to,
    Etsi.Ttcn3.Tri.ITriSignatureId signature, ITciParameterList tciPars,
    TciStatus encoderFailure, Etsi.Ttcn3.Tri.ITriParameterList triPars,
    Etsi.Ttcn3.Tri.TriStatus transmissionFailure);
void TliPrCall_m_MC(string am, System.DateTime ts, string src, int line,
    Etsi.Ttcn3.Tri.ITriComponentId c, Etsi.Ttcn3.Tri.ITriPortId at,
    Etsi.Ttcn3.Tri.ITriPortId to,
    Etsi.Ttcn3.Tri.ITriSignatureId signature, ITciParameterList tciPars,
    ITciValueList addrValues, TciStatus encoderFailure,
    Etsi.Ttcn3.Tri.ITriParameterList triPars,
    Etsi.Ttcn3.Tri.ITriAddressList addresses,
    Etsi.Ttcn3.Tri.TriStatus transmissionFailure);
void TliPrCall_c(string am, System.DateTime ts, string src, int line,
    Etsi.Ttcn3.Tri.ITriComponentId c, Etsi.Ttcn3.Tri.ITriPortId at,

```

```

    Etsi.Ttcn3.Tri.ITriPortId to,
    Etsi.Ttcn3.Tri.ITriSignatureId signature,
    ITciParameterList tciPars,
    Etsi.Ttcn3.Tri.TriStatus transmissionFailure);
void TliPrCall_c_BC(string am, System.DateTime ts, string src, int line,
    Etsi.Ttcn3.Tri.ITriComponentId c, Etsi.Ttcn3.Tri.ITriPortId at,
    Etsi.Ttcn3.Tri.ITriPortIdList to,
    Etsi.Ttcn3.Tri.ITriSignatureId signature, ITciParameterList tciPars,
    Etsi.Ttcn3.Tri.TriStatus transmissionFailure);
void TliPrCall_c_MC(string am, System.DateTime ts, string src, int line,
    Etsi.Ttcn3.Tri.ITriComponentId c, Etsi.Ttcn3.Tri.ITriPortId at,
    Etsi.Ttcn3.Tri.ITriPortIdList to,
    Etsi.Ttcn3.Tri.ITriSignatureId signature, ITciParameterList tciPars,
    Etsi.Ttcn3.Tri.TriStatus transmissionFailure);
void TliPrGetCallDetected_m(string am, System.DateTime ts, string src,
    int line, Etsi.Ttcn3.Tri.ITriComponentId c,
    Etsi.Ttcn3.Tri.ITriPortId at, Etsi.Ttcn3.Tri.ITriPortId from,
    Etsi.Ttcn3.Tri.ITriSignatureId signature,
    Etsi.Ttcn3.Tri.ITriParameterList triPars,
    Etsi.Ttcn3.Tri.ITriAddress address);
void TliPrGetCallDetected_c(string am, System.DateTime ts, string src,
    int line, Etsi.Ttcn3.Tri.ITriComponentId c,
    Etsi.Ttcn3.Tri.ITriPortId at, Etsi.Ttcn3.Tri.ITriPortId from,
    Etsi.Ttcn3.Tri.ITriSignatureId signature,
    ITciParameterList tciPars);
void TliPrGetCallMismatch_m(string am, System.DateTime ts, string src,
    int line, Etsi.Ttcn3.Tri.ITriComponentId c,
    Etsi.Ttcn3.Tri.ITriPortId at,
    Etsi.Ttcn3.Tri.ITriSignatureId signature, ITciParameterList tciPars,
    ITciValueTemplate parsTpl, ITciValueDifferenceList diffs,
    ITciValue address, ITciValueTemplate addressTpl);
void TliPrGetCallMismatch_c(string am, System.DateTime ts, string src,
    int line, Etsi.Ttcn3.Tri.ITriComponentId c,
    Etsi.Ttcn3.Tri.ITriPortId at,
    Etsi.Ttcn3.Tri.ITriSignatureId signature,
    ITciParameterList tciPars, ITciValueTemplate parsTpl,
    ITciValueDifferenceList diffs, Etsi.Ttcn3.Tri.ITriComponentId from,
    ITciNonValueTemplate fromTpl);
void TliPrGetCall_m(string am, System.DateTime ts, string src, int line,
    Etsi.Ttcn3.Tri.ITriComponentId c, Etsi.Ttcn3.Tri.ITriPortId at,
    Etsi.Ttcn3.Tri.ITriSignatureId signature,
    ITciParameterList tciPars, ITciValueTemplate parsTpl,
    ITciValue address, ITciValueTemplate addressTpl);
void TliPrGetCall_c(string am, System.DateTime ts, string src, int line,
    Etsi.Ttcn3.Tri.ITriComponentId c, Etsi.Ttcn3.Tri.ITriPortId at,
    Etsi.Ttcn3.Tri.ITriSignatureId signature,
    ITciParameterList tciPars, ITciValueTemplate parsTpl,
    Etsi.Ttcn3.Tri.ITriComponentId from, ITciNonValueTemplate fromTpl);
void TliPrReply_m(string am, System.DateTime ts, string src, int line,
    Etsi.Ttcn3.Tri.ITriComponentId c, Etsi.Ttcn3.Tri.ITriPortId at,
    Etsi.Ttcn3.Tri.ITriPortId to,
    Etsi.Ttcn3.Tri.ITriSignatureId signature, ITciParameterList tciPars,
    ITciValue replValue, ITciValue addrValue, TciStatus encoderFailure,
    Etsi.Ttcn3.Tri.ITriParameterList triPars,
    Etsi.Ttcn3.Tri.ITriParameter repl,
    Etsi.Ttcn3.Tri.ITriAddress address,
    Etsi.Ttcn3.Tri.TriStatus transmissionFailure);
void TliPrReply_m_BC(string am, System.DateTime ts, string src, int line,
    Etsi.Ttcn3.Tri.ITriComponentId c, Etsi.Ttcn3.Tri.ITriPortId at,
    Etsi.Ttcn3.Tri.ITriPortId to,
    Etsi.Ttcn3.Tri.ITriSignatureId signature, ITciParameterList tciPars,
    ITciValue replValue, TciStatus encoderFailure,
    Etsi.Ttcn3.Tri.ITriParameterList triPars,
    Etsi.Ttcn3.Tri.ITriParameter repl,
    Etsi.Ttcn3.Tri.TriStatus transmissionFailure);
void TliPrReply_m_MC(string am, System.DateTime ts, string src, int line,
    Etsi.Ttcn3.Tri.ITriComponentId c, Etsi.Ttcn3.Tri.ITriPortId at,
    Etsi.Ttcn3.Tri.ITriPortId to,
    Etsi.Ttcn3.Tri.ITriSignatureId signature, ITciParameterList tciPars,
    ITciValue replValue, ITciValueList addrValues,
    TciStatus encoderFailure, Etsi.Ttcn3.Tri.ITriParameterList triPars,
    Etsi.Ttcn3.Tri.ITriParameter repl,
    Etsi.Ttcn3.Tri.ITriAddressList addresses,
    Etsi.Ttcn3.Tri.TriStatus transmissionFailure);
void TliPrReply_c(string am, System.DateTime ts, string src, int line,
    Etsi.Ttcn3.Tri.ITriComponentId c, Etsi.Ttcn3.Tri.ITriPortId at,
    Etsi.Ttcn3.Tri.ITriPortId to,
    Etsi.Ttcn3.Tri.ITriSignatureId signature, ITciParameterList tciPars,

```

```

    ITciValue replValue, Etsi.Ttcn3.Tri.TriStatus transmissionFailure);
void TliPrReply_c_BC(string am, System.DateTime ts, string src, int line,
    Etsi.Ttcn3.Tri.ITriComponentId c, Etsi.Ttcn3.Tri.ITriPortId at,
    Etsi.Ttcn3.Tri.ITriPortIdList to,
    Etsi.Ttcn3.Tri.ITriSignatureId signature, ITciParameterList tciPars,
    ITciValue replValue, Etsi.Ttcn3.Tri.TriStatus transmissionFailure);
void TliPrReply_c_MC(string am, System.DateTime ts, string src, int line,
    Etsi.Ttcn3.Tri.ITriComponentId c, Etsi.Ttcn3.Tri.ITriPortId at,
    Etsi.Ttcn3.Tri.ITriPortIdList to,
    Etsi.Ttcn3.Tri.ITriSignatureId signature, ITciParameterList tciPars,
    ITciValue replValue, Etsi.Ttcn3.Tri.TriStatus transmissionFailure);
void TliPrGetReplyDetected_m(string am, System.DateTime ts, string src,
    int line, Etsi.Ttcn3.Tri.ITriComponentId c,
    Etsi.Ttcn3.Tri.ITriPortId at, Etsi.Ttcn3.Tri.ITriPortId from,
    Etsi.Ttcn3.Tri.ITriSignatureId signature,
    Etsi.Ttcn3.Tri.ITriParameterList triPars,
    Etsi.Ttcn3.Tri.ITriParameter repl,
    Etsi.Ttcn3.Tri.ITriAddress address);
void TliPrGetReplyDetected_c(string am, System.DateTime ts, string src,
    int line, Etsi.Ttcn3.Tri.ITriComponentId c,
    Etsi.Ttcn3.Tri.ITriPortId at, Etsi.Ttcn3.Tri.ITriPortId from,
    Etsi.Ttcn3.Tri.ITriSignatureId signature, ITciParameterList tciPars,
    ITciValue replValue);
void TliPrGetReplyMismatch_m(string am, System.DateTime ts, string src,
    int line, Etsi.Ttcn3.Tri.ITriComponentId c,
    Etsi.Ttcn3.Tri.ITriPortId at,
    Etsi.Ttcn3.Tri.ITriSignatureId signature, ITciParameterList tciPars,
    ITciValueTemplate parsTpl, ITciValue replValue,
    ITciValueTemplate replyTpl, ITciValueDifferenceList diffs,
    ITciValue address, ITciValueTemplate addressTpl);
void TliPrGetReplyMismatch_c(string am, System.DateTime ts, string src,
    int line, Etsi.Ttcn3.Tri.ITriComponentId c,
    Etsi.Ttcn3.Tri.ITriPortId at,
    Etsi.Ttcn3.Tri.ITriSignatureId signature, ITciParameterList tciPars,
    ITciValueTemplate parsTpl, ITciValue replValue,
    ITciValueTemplate replyTpl, ITciValueDifferenceList diffs,
    Etsi.Ttcn3.Tri.ITriComponentId from, ITciNonValueTemplate fromTpl);
void TliPrGetReply_m(string am, System.DateTime ts, string src, int line,
    Etsi.Ttcn3.Tri.ITriComponentId c, Etsi.Ttcn3.Tri.ITriPortId at,
    Etsi.Ttcn3.Tri.ITriSignatureId signature, ITciParameterList tciPars,
    ITciValueTemplate parsTpl, ITciValue replValue,
    ITciValueTemplate replyTpl, ITciValue address,
    ITciValueTemplate addressTpl);
void TliPrGetReply_c(string am, System.DateTime ts, string src, int line,
    Etsi.Ttcn3.Tri.ITriComponentId c, Etsi.Ttcn3.Tri.ITriPortId at,
    Etsi.Ttcn3.Tri.ITriSignatureId signature,
    ITciParameterList tciPars, ITciValueTemplate parsTpl,
    ITciValue replValue, ITciValueTemplate replyTpl,
    Etsi.Ttcn3.Tri.ITriComponentId from, ITciNonValueTemplate fromTpl);
void TliPrRaise_m(string am, System.DateTime ts, string src, int line,
    Etsi.Ttcn3.Tri.ITriComponentId c, Etsi.Ttcn3.Tri.ITriPortId at,
    Etsi.Ttcn3.Tri.ITriPortId to,
    Etsi.Ttcn3.Tri.ITriSignatureId signature, ITciParameterList tciPars,
    ITciValue excValue, ITciValue addrValue, TciStatus encoderFailure,
    Etsi.Ttcn3.Tri.ITriException exc,
    Etsi.Ttcn3.Tri.ITriAddress address,
    Etsi.Ttcn3.Tri.TriStatus transmissionFailure);
void TliPrRaise_m_BC(string am, System.DateTime ts, string src, int line,
    Etsi.Ttcn3.Tri.ITriComponentId c, Etsi.Ttcn3.Tri.ITriPortId at,
    Etsi.Ttcn3.Tri.ITriPortId to,
    Etsi.Ttcn3.Tri.ITriSignatureId signature, ITciParameterList tciPars,
    ITciValue excValue, TciStatus encoderFailure,
    Etsi.Ttcn3.Tri.ITriException exc,
    Etsi.Ttcn3.Tri.TriStatus transmissionFailure);
void TliPrRaise_m_MC(string am, System.DateTime ts, string src, int line,
    Etsi.Ttcn3.Tri.ITriComponentId c, Etsi.Ttcn3.Tri.ITriPortId at,
    Etsi.Ttcn3.Tri.ITriPortId to,
    Etsi.Ttcn3.Tri.ITriSignatureId signature, ITciParameterList tciPars,
    ITciValue excValue, ITciValueList addrValues,
    TciStatus encoderFailure, Etsi.Ttcn3.Tri.ITriException exc,
    Etsi.Ttcn3.Tri.ITriAddressList addresses,
    Etsi.Ttcn3.Tri.TriStatus transmissionFailure);
void TliPrRaise_c(string am, System.DateTime ts, string src, int line,
    Etsi.Ttcn3.Tri.ITriComponentId c, Etsi.Ttcn3.Tri.ITriPortId at,
    Etsi.Ttcn3.Tri.ITriPortId to,
    Etsi.Ttcn3.Tri.ITriSignatureId signature, ITciParameterList tciPars,
    ITciValue excValue, Etsi.Ttcn3.Tri.TriStatus transmissionFailure);
void TliPrRaise_c_BC(string am, System.DateTime ts, string src, int line,

```

```

    Etsi.Ttcn3.Tri.ITriComponentId c, Etsi.Ttcn3.Tri.ITriPortId at,
    Etsi.Ttcn3.Tri.ITriPortIdList to,
    Etsi.Ttcn3.Tri.ITriSignatureId signature,
    ITciParameterList tciPars, ITciValue excValue,
    Etsi.Ttcn3.Tri.TriStatus transmissionFailure);
void TliPrRaise_c_MC(string am, System.DateTime ts, string src, int line,
    Etsi.Ttcn3.Tri.ITriComponentId c, Etsi.Ttcn3.Tri.ITriPortId at,
    Etsi.Ttcn3.Tri.ITriPortIdList to,
    Etsi.Ttcn3.Tri.ITriSignatureId signature, ITciParameterList tciPars,
    ITciValue excValue, Etsi.Ttcn3.Tri.TriStatus transmissionFailure);
void TliPrCatchDetected_m(string am, System.DateTime ts, string src,
    int line, Etsi.Ttcn3.Tri.ITriComponentId c,
    Etsi.Ttcn3.Tri.ITriPortId at, Etsi.Ttcn3.Tri.ITriPortId from,
    Etsi.Ttcn3.Tri.ITriSignatureId signature,
    Etsi.Ttcn3.Tri.ITriException exc,
    Etsi.Ttcn3.Tri.ITriAddress address);
void TliPrCatchDetected_c(string am, System.DateTime ts, string src,
    int line, Etsi.Ttcn3.Tri.ITriComponentId c,
    Etsi.Ttcn3.Tri.ITriPortId at, Etsi.Ttcn3.Tri.ITriPortId from,
    Etsi.Ttcn3.Tri.ITriSignatureId signature, ITciValue excValue);
void TliPrCatchMismatch_m(string am, System.DateTime ts, string src,
    int line, Etsi.Ttcn3.Tri.ITriComponentId c,
    Etsi.Ttcn3.Tri.ITriPortId at,
    Etsi.Ttcn3.Tri.ITriSignatureId signature, ITciValue excValue,
    ITciValueTemplate excTpl, ITciValueDifferenceList diffs,
    ITciValue address, ITciValueTemplate addressTpl);
void TliPrCatchMismatch_c(string am, System.DateTime ts, string src,
    int line, Etsi.Ttcn3.Tri.ITriComponentId c,
    Etsi.Ttcn3.Tri.ITriPortId at,
    Etsi.Ttcn3.Tri.ITriSignatureId signature,
    ITciValue excValue, ITciValueTemplate excTpl,
    ITciValueDifferenceList diffs, Etsi.Ttcn3.Tri.ITriComponentId from,
    ITciNonValueTemplate fromTpl);
void TliPrCatch_m(string am, System.DateTime ts, string src, int line,
    Etsi.Ttcn3.Tri.ITriComponentId c, Etsi.Ttcn3.Tri.ITriPortId at,
    Etsi.Ttcn3.Tri.ITriSignatureId signature,
    ITciValue excValue, ITciValueTemplate excTpl, ITciValue address,
    ITciValueTemplate addressTpl);
void TliPrCatch_c(string am, System.DateTime ts, string src, int line,
    Etsi.Ttcn3.Tri.ITriComponentId c, Etsi.Ttcn3.Tri.ITriPortId at,
    Etsi.Ttcn3.Tri.ITriSignatureId signature,
    ITciValue excValue, ITciValueTemplate excTpl,
    Etsi.Ttcn3.Tri.ITriComponentId from, ITciNonValueTemplate fromTpl);
void TliPrCatchTimeoutDetected(string am, System.DateTime ts, string src,
    int line, Etsi.Ttcn3.Tri.ITriComponentId c,
    Etsi.Ttcn3.Tri.ITriPortId at,
    Etsi.Ttcn3.Tri.ITriSignatureId signature);
void TliPrCatchTimeout(string am, System.DateTime ts, string src,
    int line, Etsi.Ttcn3.Tri.ITriComponentId c,
    Etsi.Ttcn3.Tri.ITriPortId at,
    Etsi.Ttcn3.Tri.ITriSignatureId signature);
void TliCCreate(string am, System.DateTime ts, string src, int line,
    Etsi.Ttcn3.Tri.ITriComponentId c,
    Etsi.Ttcn3.Tri.ITriComponentId comp, string name, bool alive);
void TliCStart(string am, System.DateTime ts, string src, int line,
    Etsi.Ttcn3.Tri.ITriComponentId c,
    Etsi.Ttcn3.Tri.ITriComponentId comp, ITciBehaviourId name,
    ITciParameterList tciPars);
void TliCRunning(string am, System.DateTime ts, string src, int line,
    Etsi.Ttcn3.Tri.ITriComponentId c,
    Etsi.Ttcn3.Tri.ITriComponentId comp, TciComponentStatus status);
void TliCAlive(string am, System.DateTime ts, string src, int line,
    Etsi.Ttcn3.Tri.ITriComponentId c,
    Etsi.Ttcn3.Tri.ITriComponentId comp, TciComponentStatus status);
void TliCStop(string am, System.DateTime ts, string src, int line,
    Etsi.Ttcn3.Tri.ITriComponentId c,
    Etsi.Ttcn3.Tri.ITriComponentId comp);
void TliCKill(string am, System.DateTime ts, string src, int line,
    Etsi.Ttcn3.Tri.ITriComponentId c,
    Etsi.Ttcn3.Tri.ITriComponentId comp);
void TliCDoneMismatch(string am, System.DateTime ts, string src, int line,
    Etsi.Ttcn3.Tri.ITriComponentId c,
    Etsi.Ttcn3.Tri.ITriComponentId comp, ITciNonValueTemplate compTpl);
void TliCDone(string am, System.DateTime ts, string src, int line,
    Etsi.Ttcn3.Tri.ITriComponentId c, ITciNonValueTemplate compTpl);
void TliCKilledMismatch(string am, System.DateTime ts, string src,
    int line, Etsi.Ttcn3.Tri.ITriComponentId c,
    Etsi.Ttcn3.Tri.ITriComponentId comp, ITciNonValueTemplate compTpl);

```

```

void TliCKilled(string am, System.DateTime ts, string src, int line,
    Etsi.Ttcn3.Tri.ITriComponentId c, ITciNonValueTemplate compTpl);
void TliCTerminated(string am, System.DateTime ts, string src, int line,
    Etsi.Ttcn3.Tri.ITriComponentId c, ITciVerdictValue verdict,
    string reason);
void TliPConnect(string am, System.DateTime ts, string src, int line,
    Etsi.Ttcn3.Tri.ITriComponentId c, Etsi.Ttcn3.Tri.ITriPortId port1,
    Etsi.Ttcn3.Tri.ITriPortId port2);
void TliPDisconnect(string am, System.DateTime ts, string src, int line,
    Etsi.Ttcn3.Tri.ITriComponentId c, Etsi.Ttcn3.Tri.ITriPortId port1,
    Etsi.Ttcn3.Tri.ITriPortId port2);
void TliPMap(string am, System.DateTime ts, string src, int line,
    Etsi.Ttcn3.Tri.ITriComponentId c, Etsi.Ttcn3.Tri.ITriPortId port1,
    Etsi.Ttcn3.Tri.ITriPortId port2);
void TliPUnmap(string am, System.DateTime ts, string src, int line,
    Etsi.Ttcn3.Tri.ITriComponentId c, Etsi.Ttcn3.Tri.ITriPortId port1,
    Etsi.Ttcn3.Tri.ITriPortId port2);
void TliPClear(string am, System.DateTime ts, string src, int line,
    Etsi.Ttcn3.Tri.ITriComponentId c, Etsi.Ttcn3.Tri.ITriPortId port);
void TliPStart(string am, System.DateTime ts, string src, int line,
    Etsi.Ttcn3.Tri.ITriComponentId c, Etsi.Ttcn3.Tri.ITriPortId port);
void TliPStop(string am, System.DateTime ts, string src, int line,
    Etsi.Ttcn3.Tri.ITriComponentId c, Etsi.Ttcn3.Tri.ITriPortId port);
void TliPHalt(string am, System.DateTime ts, string src, int line,
    Etsi.Ttcn3.Tri.ITriComponentId c, Etsi.Ttcn3.Tri.ITriPortId port);
void TliEncode(string am, System.DateTime ts, string src, int line,
    Etsi.Ttcn3.Tri.ITriComponentId c, ITciValue val,
    TciStatus encoderFailure, Etsi.Ttcn3.Tri.ITriMessage msg,
    string codec);
void TliDecode(string am, System.DateTime ts, string src, int line,
    Etsi.Ttcn3.Tri.ITriComponentId c, Etsi.Ttcn3.Tri.ITriMessage msg,
    TciStatus decoderFailure, ITciValue val, string codec);
void TliTTimeoutDetected(string am, System.DateTime ts, string src,
    int line, Etsi.Ttcn3.Tri.ITriComponentId c,
    Etsi.Ttcn3.Tri.ITriTimerId timer);
void TliTTimeoutMismatch(string am, System.DateTime ts, string src,
    int line, Etsi.Ttcn3.Tri.ITriComponentId c,
    Etsi.Ttcn3.Tri.ITriTimerId timer, ITciNonValueTemplate timerTpl);
void TliTTimeout(string am, System.DateTime ts, string src, int line,
    Etsi.Ttcn3.Tri.ITriComponentId c, Etsi.Ttcn3.Tri.ITriTimerId timer,
    ITciNonValueTemplate timerTpl);
void TliTStart(string am, System.DateTime ts, string src, int line,
    Etsi.Ttcn3.Tri.ITriComponentId c, Etsi.Ttcn3.Tri.ITriTimerId timer,
    Etsi.Ttcn3.Tri.ITriTimerDuration dur);
void TliTStop(string am, System.DateTime ts, string src, int line,
    Etsi.Ttcn3.Tri.ITriComponentId c, Etsi.Ttcn3.Tri.ITriTimerId timer,
    Etsi.Ttcn3.Tri.ITriTimerDuration dur);
void TliTRead(string am, System.DateTime ts, string src, int line,
    Etsi.Ttcn3.Tri.ITriComponentId c, Etsi.Ttcn3.Tri.ITriTimerId timer,
    Etsi.Ttcn3.Tri.ITriTimerDuration elapsed);
void TliTRunning(string am, System.DateTime ts, string src, int line,
    Etsi.Ttcn3.Tri.ITriComponentId c, Etsi.Ttcn3.Tri.ITriTimerId timer,
    TciTimerStatus status);
void TliSEnter(string am, System.DateTime ts, string src, int line,
    Etsi.Ttcn3.Tri.ITriComponentId c,
    Etsi.Ttcn3.Tri.IQualifiedName name, ITciParameterList tciPars,
    string kind);
void TliSLeave(string am, System.DateTime ts, string src, int line,
    Etsi.Ttcn3.Tri.ITriComponentId c,
    Etsi.Ttcn3.Tri.IQualifiedName name, ITciParameterList tciPars,
    ITciValue returnValue, string kind);
void TliVar(string am, System.DateTime ts, string src, int line,
    Etsi.Ttcn3.Tri.ITriComponentId c,
    Etsi.Ttcn3.Tri.IQualifiedName name, ITciValue varValue);
void TliModulePar(string am, System.DateTime ts, string src, int line,
    Etsi.Ttcn3.Tri.ITriComponentId c,
    Etsi.Ttcn3.Tri.IQualifiedName name, ITciValue parValue);
void TliGetVerdict(string am, System.DateTime ts, string src, int line,
    Etsi.Ttcn3.Tri.ITriComponentId c, ITciVerdictValue verdict);
void TliSetVerdict(string am, System.DateTime ts, string src, int line,
    Etsi.Ttcn3.Tri.ITriComponentId c, ITciVerdictValue verdict,
    string reason);
void TliLog(string am, System.DateTime ts, string src, int line,
    Etsi.Ttcn3.Tri.ITriComponentId c, string log);
void TliAEnter(string am, System.DateTime ts, string src, int line,
    Etsi.Ttcn3.Tri.ITriComponentId c);
void TliALeave(string am, System.DateTime ts, string src, int line,
    Etsi.Ttcn3.Tri.ITriComponentId c);

```



```

void TliADefaults(string am, System.DateTime ts, string src, int line,
    Etsi.Ttcn3.Tri.ITriComponentId c);
void TliAActivate(string am, System.DateTime ts, string src, int line,
    Etsi.Ttcn3.Tri.ITriComponentId c,
    Etsi.Ttcn3.Tri.IQualifiedName name, ITciParameterList tciPars,
    ITciValue expr);
void TliAdeactivate(string am, System.DateTime ts, string src, int line,
    Etsi.Ttcn3.Tri.ITriComponentId c, ITciValue expr);
void TliANomatch(string am, System.DateTime ts, string src, int line,
    Etsi.Ttcn3.Tri.ITriComponentId c);
void TliARepeat(string am, System.DateTime ts, string src, int line,
    Etsi.Ttcn3.Tri.ITriComponentId c);
void TliAwait(string am, System.DateTime ts, string src, int line,
    Etsi.Ttcn3.Tri.ITriComponentId c);
void TliAction(string am, System.DateTime ts, string src, int line,
    Etsi.Ttcn3.Tri.ITriComponentId c, string action);
void TliMatch(string am, System.DateTime ts, string src, int line,
    Etsi.Ttcn3.Tri.ITriComponentId c, ITciValue expr,
    ITciValueTemplate tpl);
void TliMatchMismatch(string am, System.DateTime ts, string src, int line,
    Etsi.Ttcn3.Tri.ITriComponentId c, ITciValue expr,
    ITciValueTemplate tpl, ITciValueDifferenceList diffs);
void TliInfo (string am, System.DateTime ts, string src, int line,
    Etsi.Ttcn3.Tri.ITriComponentId c, int level, string info);
}

```

12.6 Optional parameters

Clause 7.3 in [1] defines that a reserved value shall be used to indicate the absence of an optional parameter. For the C# language mapping the distinct value `null` shall be used to indicate the absence of an optional value. For example, if in the `TciReplyConnected` operation the value parameter shall be omitted the operation invocation shall be `TciReplyConnected (sender, receiver, signature, parameterList, null)`.

12.7 Error Handling

All operations called from the TM, CH or CD that return have succeeded. If an erroneous situation has been identified by the TE a test case error will be communicated to the user using the procedures as defined in clause 7.3.1.2.6 (`TciError`). If an operation called by the TE in the TM, CH, CD, or TL produces an error, this erroneous situation should be communicated to the TE using the procedures as defined in clause 7.3.2.1.12 (`TciErrorReq`).

Beside this error handling and exceptions specified for indexing operators no additional error handling is defined in the C# mapping.

Annex A (normative): IDL Specification of TCI

This annex defines the TTCN-3 Control Interfaces using the Interface Definition Language (IDL).

```
// *****
// * Interface definitions for the TTCN-3 Control Interfaces
// *****

module tciInterface {

    /* Forward declaration */
    interface Value;
    interface Type;

    // *****
    // * Data types taken from the TRI definitions
    // *****

    // Connection
    native TriPortIdType ;
    native TriPortIdListType;
    native TriComponentIdType ;
    native TriComponentIdListType;

    // Communications
    native TriMessageType;
    native TriParameterType;
    native TriParameterListType;
    native TriAddressType;
    native TriAddressListType;
    native TriExceptionType;
    native TriSignatureIdType;

    // Miscellaneous
    native TriStatusType;
    native TriTimerIdType;
    native TriTimerDurationType;

    native TciStatusType;

    // *****
    // * General Abstract Data Types
    // *****

    // Basic definitions
    native TBoolean;
    native TFloat;
    native TChar;
    native TInteger;
    native TString;
    native TUniversalChar;
    typedef sequence <TString> TStringSeq;

    struct QualifiedName {
        TString moduleName;
        TString baseName;
    };

    // General TCI abstract data types
    typedef QualifiedName TciBehaviourIdType;
    typedef QualifiedName TciModuleIdType;
    typedef QualifiedName TciModuleParameterIdType;
    typedef QualifiedName TciTestCaseIdType;

    enum TciParameterPassingModeType {
        IN_MODE,
        OUT_MODE,
        INOUT_MODE
    };

    struct TciParameterType {
        TciModuleParameterIdType parameterName;
        Value parameterValue;
    };
};
```

```

    TciParameterPassingModeType mode;
};

typedef sequence <TciParameterType> TciParameterListType;

struct TciParameterTypeType {
    Type parameterType;
    TciParameterPassingModeType mode;
};

typedef sequence <TciParameterTypeType> TciParameterTypeListType;

struct TciModuleParameterType {
    TciModuleParameterIdType parameterName;
    Value defaultValue;
};

typedef sequence <TciModuleIdType> TciModuleIdListType ;

typedef sequence <TciModuleParameterType> TciModuleParameterListType;

typedef sequence <TciTestCaseIdType> TciTestCaseIdListType;

enum TciTestComponentKindType {
    CONTROL,
    MTC,
    PTC,
    SYSTEM,
    PTC_ALIVE
};

enum ComponentStatusType{
    inactiveC,
    runningC,
    stoppedC,
    killedC,
    nullC
};

enum TimerStatusType{
    runningT,
    inactiveT,
    expiredT,
    nullT
};

enum PortStatusType{
    startedP,
    haltedP,
    stoppedP
};

enum TciTypeClassType {
    ADDRESS_CLASS,
    ANYTYPE_CLASS,
    BITSTRING_CLASS,
    BOOLEAN_CLASS,
    CHARSTRING_CLASS,
    COMPONENT_CLASS,
    ENUMERATED_CLASS,
    FLOAT_CLASS,
    HEXSTRING_CLASS,
    INTEGER_CLASS,
    OCTETSTRING_CLASS,
    RECORD_CLASS,
    RECORDOF_CLASS,
    ARRAY_CLASS,
    SET_CLASS,
    SETOF_CLASS,
    UNION_CLASS,
    UNIVERSALCHARSTRING_CLASS,
    VERDICT_CLASS
};

```

```

// *****
// * Abstract TTCN-3 Data Types And Values
// *****

// Abstract data type "Type"
interface Type {
  TciModuleIdType  getDefiningModule ();
  TString          getName ();
  TciTypeClassType getTypeClass ();
  Value            newInstance ();
  TString          getTypeEncoding ();
  TString          getTypeEncodingVariant ();
  TStringSeq       getTypextension ();
};

// Abstract TTCN-3 Values
interface Value {
  TString          getValueEncoding ();
  TString          getValueEncodingVariant ();
  Type            getType ();
  TBoolean        notPresent ();
};

interface RecordOfValue : Value {
  Value          getField (in TInteger position);
  void           setField (
    in TInteger position,
    in Value value
  );
  void           appendField (in Value value);
  Type           getElementType ();
  TInteger       getLength ();
  void           setLength (in TInteger len);
  TInteger       getOffset ();
};

interface RecordValue : Value {
  Value          getField (in TString fieldName);
  void           setField (
    in TString fieldName,
    in Value value
  );
  TStringSeq     getFieldNames ();
  void           setFieldOmitted (in TString fieldName);
};

interface VerdictValue : Value {
  TInteger       getVerdict ();
  void           setVerdict (in TInteger verdict);
};

interface BitstringValue : Value {
  TString        getString ();
  void           setString (in TString value);
  TInteger       getBit (in TInteger position);
  void           setBit (
    in TInteger position,
    in TInteger value
  );
  TInteger       getLength ();
  void           setLength (in TInteger len);
};

interface OctetstringValue : Value {
  TString        getString ();
  void           setString (in TString value);
  TInteger       getOctet (in TInteger position);
  void           setOctet (
    in TInteger position,
    in TInteger value
  );
  TInteger       getLength ();
  void           setLength (in TInteger len);
};

interface FloatValue : Value {
  TFloat         getFloat ();
  void           setFloat (in TFloat value);
};

```

```

};

interface HexstringValue : Value {
    TString getString ();
    void setString (in TString value);
    TInteger getHex (in TInteger position);
    void setHex (
        in TInteger position,
        in TInteger value
    );
    TInteger getLength ();
    void setLength (in TInteger len);
};

interface EnumeratedValue : Value {
    void setEnum (in TString enumValue);
    TString getEnum ();
};

interface IntegerValue : Value {
    TInteger getInt ();
    void setInt (in TInteger value);
};

interface CharValue : Value {
    TChar getChar ();
    void setChar (in TChar value);
};

interface CharstringValue : Value {
    TString getString ();
    void setString (in TString value);
    TChar getChar (in TInteger position);
    void setChar (
        in TInteger position,
        in TChar value
    );
    TInteger getLength ();
    void setLength (in TInteger len);
};

interface BooleanValue : Value {
    TBoolean getBoolean ();
    void setBoolean (in TBoolean value);
};

interface UniversalCharValue : Value {
    TUniversalChar getUniversalChar ();
    void setUniversalChar (in TUniversalChar value);
};

interface UniversalCharstringValue : Value {
    TString getString ();
    void setString (in TString value);
    TUniversalChar getChar (in TInteger position);
    void setChar (
        in TInteger position,
        in TUniversalChar value
    );
    TInteger getLength ();
    void setLength (in TInteger len);
};

interface UnionValue : Value {
    Value getVariant (in TString variantName);
    void setVariant (
        in TString variantName,
        in Value value
    );
    TString getPresentVariantName ();
    TStringSeq getVariantNames ();
};

```

```

// *****
// * Abstract Logging Types
// *****

interface TciValueTemplate : Value {
    TBoolean isOmit ();
    TBoolean isAny ();
    TBoolean isAnyOrOmit ();
    TString getTemplateDef ();
};

interface TciNonValueTemplate {
    TBoolean isAny ();
    TBoolean isAll ();
    TString getTemplateDef ();
};

typedef sequence <Value> TciValueListType;

struct TciValueDifferenceType
{
    TString desc;
    Value val;
    TciValueTemplate tmpl;
};

typedef sequence <TciValueDifferenceType> TciValueDifferenceListType;

interface TciValueList {
    attribute TciValueListType inst;
    TInteger size ();
    TBoolean isEmpty ();
    Value get (in TInteger index);
};

interface TciValueDifference {
    attribute TciValueDifferenceType inst;
    Value getValue ();
    TciValueTemplate getTciValueTemplate ();
    TString getDescription ();
};

interface TciValueDifferenceList {
    attribute TciValueDifferenceListType inst;
    TInteger size ();
    TBoolean isEmpty ();
    TciValueDifference get (in TInteger index);
};

// *****
// Coding Decoding Interface
// - Required
// *****

interface TCI_CD_Required {
    Type getTypeForName (in TString typeName);
    Type getInteger ();
    Type getFloat ();
    Type getBoolean ();
    Type getChar ();
    Type getUniversalChar ();
    Type getCharstring ();
    Type getUniversalCharstring ();
    Type getHexstring ();
    Type getBitstring ();
    Type getOctetstring ();
    Type getVerdict ();
    void tciErrorReq (in TString message);
};

```

```

// *****
// Coding Decoding interface
// - Provided
// *****

interface TCI_CD_Provided {
    Value decode (
        in TriMessageType message,
        in Type decodingHypothesis
    );
    TriMessageType encode (in Value value);
};

// *****
// Test Management Interface
// - Required
// *****

interface TCI_TM_Required : TCI_CD_Required {
    void tciRootModule (in TciModuleIdType moduleName);
    TciModuleIdListType tciGetImportedModules();
    TciModuleParameterListType tciGetModuleParameters (in TciModuleIdType moduleName);
    TciTestCaseIdListType tciGetTestCases ();
    TciParameterTypeListType tciGetTestCaseParameters (
        in TciTestCaseIdType testCaseId
    );
    TriPortIdListType tciGetTestCaseTSI (
        in TciTestCaseIdType testCaseId
    );
    void tciStartTestCase (
        in TciTestCaseIdType testCaseId,
        in TciParameterListType parameterList
    );
    void tciStopTestCase ();
    TriComponentIdType tciStartControl ();
    void tciStopControl ();
};

// *****
// Test Management Interface
// - Provided
// *****

interface TCI_TM_Provided {
    void tciTestCaseStarted (
        in TciTestCaseIdType testCaseId,
        in TciParameterListType parameterList,
        in TFloat timer
    );
    void tciTestCaseTerminated (
        in VerdictValue verdict,
        in TciParameterListType parameterList
    );
    void tciControlTerminated ();
    Value tciGetModulePar (
        in TciModuleParameterIdType parameterId
    );
    void tciLog (
        in TriComponentIdType testComponentId,
        in TString message
    );
    void tciError (in TString message);
};

// *****
// Component Handling Interface
// - Required
// *****

interface TCI_CH_Required : TCI_CD_Required {
    void tciEnqueueMsgConnected (
        in TriPortIdType sender,
        in TriComponentIdType receiver,
        in Value receivedMessage
    );
};

```

```

void tciEnqueueCallConnected (
    in TriPortIdType sender,
    in TriComponentIdType receiver,
    in TriSignatureIdType signature,
    in TciParameterListType parameterList
);
void tciEnqueueReplyConnected (
    in TriPortIdType sender,
    in TriComponentIdType receiver,
    in TriSignatureIdType signature,
    in TciParameterListType parameterList,
    in Value returnValue
);
void tciEnqueueRaiseConnected (
    in TriPortIdType sender,
    in TriComponentIdType receiver,
    in TriSignatureIdType signature,
    in Value except
);
TriComponentIdType tciCreateTestComponent (
    in TciTestComponentKindType kind,
    in Type componentType,
    in TString name,
    in Value hostId
);
void tciStartTestComponent (
    in TriComponentIdType comp,
    in TciBehaviourIdType behavior,
    in TciParameterListType parameterList
);
void tciStopTestComponent (
    in TriComponentIdType comp
);
void tciConnect (
    in TriPortIdType fromPort,
    in TriPortIdType toPort
);
void tciDisconnect (
    in TriPortIdType fromPort,
    in TriPortIdType toPort
);
void tciTestComponentTerminated (
    in TriComponentIdType comp,
    in VerdictValue verdict
);
TBoolean tciTestComponentRunning (
    in TriComponentIdType comp
);
TriComponentIdType tciGetMTC ();
void tciMap (
    in TriPortIdType fromPort,
    in TriPortIdType toPort
);
void tciUnmap (
    in TriPortIdType fromPort,
    in TriPortIdType toPort
);
void tciExecuteTestCase (
    in TciTestCaseIdType testCaseId,
    in TriPortIdListType tsiPortList
);
TBoolean tciTestComponentDone (
    in TriComponentIdType comp
);
void tciReset ();
};

// *****
// Component Handling Interface
// - Provided
// *****

interface TCI_CH_Provided {
    void tciSendConnected (
        in TriPortIdType sender,
        in TriComponentIdType receiver,
        in Value sendMessage
    );

```



```

void tciSendConnectedBC (
    in TriPortIdType sender,
    in Value sendMessage
);
void tciSendConnectedMC (
    in TriPortIdType sender,
    in TriComponentIdListType receivers,
    in Value sendMessage
);

void tciCallConnected (
    in TriPortIdType sender,
    in TriComponentIdType receiver,
    in TriSignatureIdType signature,
    in TciParameterListType parameterList
);
void tciCallConnectedBC (
    in TriPortIdType sender,
    in TriSignatureIdType signature,
    in TciParameterListType parameterList
);
void tciCallConnectedMC (
    in TriPortIdType sender,
    in TriComponentIdListType receivers,
    in TriSignatureIdType signature,
    in TciParameterListType parameterList
);

void tciReplyConnected (
    in TriPortIdType sender,
    in TriComponentIdType receiver,
    in TriSignatureIdType signature,
    in TciParameterListType parameterList,
    in Value returnValue
);
void tciReplyConnectedBC (
    in TriPortIdType sender,
    in TriSignatureIdType signature,
    in TciParameterListType parameterList,
    in Value returnValue
);
void tciReplyConnectedMC (
    in TriPortIdType sender,
    in TriComponentIdListType receivers,
    in TriSignatureIdType signature,
    in TciParameterListType parameterList,
    in Value returnValue
);

void tciRaiseConnected (
    in TriPortIdType sender,
    in TriComponentIdType receiver,
    in TriSignatureIdType signature,
    in Value except
);
void tciRaiseConnectedBC (
    in TriPortIdType sender,
    in TriSignatureIdType signature,
    in Value except
);
void tciRaiseConnectedMC (
    in TriPortIdType sender,
    in TriComponentIdListType receivers,
    in TriSignatureIdType signature,
    in Value except
);

TriComponentIdType tciCreateTestComponentReq (
    in TciTestComponentKindType kind,
    in Type componentType,
    in TString name
);
void tciStartTestComponentReq (
    in TriComponentIdType comp,
    in TciBehaviourIdType behavior,
    in TciParameterListType parameterList
);
void tciStopTestComponentReq (

```

```

        in TriComponentIdType comp
    );
void tciConnectReq (
    in TriPortIdType fromPort,
    in TriPortIdType toPort
);
void tciDisconnectReq (
    in TriPortIdType fromPort,
    in TriPortIdType toPort
);
void tciTestComponentTerminatedReq (
    in TriComponentIdType comp,
    in VerdictValue verdict
);
TBoolean tciTestComponentRunningReq (
    in TriComponentIdType comp
);
TriComponentIdType tciGetMTCReq ();
void tciMapReq (
    in TriPortIdType fromPort,
    in TriPortIdType toPort
);
void tciUnmapReq (
    in TriPortIdType fromPort,
    in TriPortIdType toPort
);
void tciExecuteTestCaseReq (
    in TciTestCaseIdType testCaseId,
    in TriPortIdListType tsiPortList
);
void tciResetReq ();
TBoolean tciTestComponentDoneReq (
    in TriComponentIdType comp
);
};

// *****
// Test Logging Interface
// - Provided
// *****

interface TCI_TL_Provided {
    void tliTcExecute(
        in TString am, in TInteger ts, in TString src, in TInteger line,
        in TriComponentIdType c, in TciTestCaseIdType tcId,
        in TciParameterListType tciPars, in TriTimerDurationType dur
    );
    void tliTcStart(
        in TString am, in TInteger ts, in TString src, in TInteger line,
        in TriComponentIdType c, in TciTestCaseIdType tcId,
        in TciParameterListType tciPars, in TriTimerDurationType dur
    );
    void tliTcStop(
        in TString am, in TInteger ts, in TString src, in TInteger line,
        in TriComponentIdType c, in TString reason
    );
    void tliTcStarted(
        in TString am, in TInteger ts, in TString src, in TInteger line,
        in TriComponentIdType c, in TciTestCaseIdType tcId,
        in TciParameterListType tciPars, in TriTimerDurationType dur
    );
    void tliTcTerminated(
        in TString am, in TInteger ts, in TString src, in TInteger line,
        in TriComponentIdType c, in TciTestCaseIdType tcId,
        in TciParameterListType tciPars, in VerdictValue verdict, in TString reason);

    void tliCtrlStart(
        in TString am, in TInteger ts, in TString src, in TInteger line,
        in TriComponentIdType c
    );
    void tliCtrlStop(
        in TString am, in TInteger ts, in TString src, in TInteger line,
        in TriComponentIdType c
    );
    void tliCtrlTerminated(
        in TString am, in TInteger ts, in TString src, in TInteger line,
        in TriComponentIdType c);
};

```

```

void tliMSend_m(
    in TString am, in TInteger ts, in TString src, in TInteger line,
    in TriComponentIdType c, in TriPortIdType at, in TriPortIdType to, in Value msgValue,
    in Value addrValue, in TciStatusType encoderFailure,
    in TriMessageType msg, in TriAddressType address, in TriStatusType transmissionFailure
);
void tliMSend_m_BC(
    in TString am, in TInteger ts, in TString src, in TInteger line,
    in TriComponentIdType c, in TriPortIdType at, in TriPortIdType to, in Value msgValue,
    in TciStatusType encoderFailure, in TriMessageType msg,
    in TriStatusType transmissionFailure
);
void tliMSend_m_MC(
    in TString am, in TInteger ts, in TString src, in TInteger line,
    in TriComponentIdType c, in TriPortIdType at, in TriPortIdType to, in Value msgValue,
    in TciValueList addrValues, in TciStatusType encoderFailure,
    in TriMessageType msg, in TriAddressListType addresses,
    in TriStatusType transmissionFailure
);

void tliMSend_c(
    in TString am, in TInteger ts, in TString src, in TInteger line,
    in TriComponentIdType c, in TriPortIdType at, in TriPortIdType to, in Value msgValue,
    in TriStatusType transmissionFailure
);
void tliMSend_c_BC(
    in TString am, in TInteger ts, in TString src, in TInteger line,
    in TriComponentIdType c, in TriPortIdType at, in TriPortIdListType to, in Value msgValue,
    in TriStatusType transmissionFailure
);
void tliMSend_c_MC(
    in TString am, in TInteger ts, in TString src, in TInteger line,
    in TriComponentIdType c, in TriPortIdType at, in TriPortIdListType to, in Value msgValue,
    in TriStatusType transmissionFailure);

void tliMDetected_m(
    in TString am, in TInteger ts, in TString src, in TInteger line,
    in TriComponentIdType c, in TriPortIdType at, in TriPortIdType from,
    in TriMessageType msg,
    in TriAddressType address
);
void tliMDetected_c(
    in TString am, in TInteger ts, in TString src, in TInteger line,
    in TriComponentIdType c, in TriPortIdType at, in TriPortIdType from, in Value msgValue
);
void tliMMismatch_m(
    in TString am, in TInteger ts, in TString src, in TInteger line,
    in TriComponentIdType c, in TriPortIdType at, in Value msgValue,
    in TciValueTemplate msgTpl, in TciValueDifferenceList diffs,
    in Value addrValue, in TciValueTemplate addressTpl
);
void tliMMismatch_c(
    in TString am, in TInteger ts, in TString src, in TInteger line,
    in TriComponentIdType c, in TriPortIdType at, in Value msgValue,
    in TciValueTemplate msgTpl, in TciValueDifferenceList diffs,
    in TriComponentIdType from, in TciNonValueTemplate fromTpl
);
void tliMReceive_m(
    in TString am, in TInteger ts, in TString src, in TInteger line,
    in TriComponentIdType c, in TriPortIdType at, in Value msgValue,
    in TciValueTemplate msgTpl, in Value addrValue,
    in TciValueTemplate addressTpl
);
void tliMReceive_c(
    in TString am, in TInteger ts, in TString src, in TInteger line,
    in TriComponentIdType c, in TriPortIdType at, in Value msgValue,
    in TciValueTemplate msgTpl, in TriComponentIdType from,
    in TciNonValueTemplate fromTpl
);

void tliPrCall_m(
    in TString am, in TInteger ts, in TString src, in TInteger line,
    in TriComponentIdType c, in TriPortIdType at, in TriPortIdType to,
    in TriSignatureIdType signature, in TciParameterListType tciPars,
    in Value addrValue, in TciStatusType encoderFailure,
    in TriParameterListType triPars, in TriAddressType address,
    in TriStatusType transmissionFailure
);

```

```

void tliPrCall_m_BC(
    in TString am, in TInteger ts, in TString src, in TInteger line,
    in TriComponentIdType c, in TriPortIdType at, in TriPortIdType to,
    in TriSignatureIdType signature, in TciParameterListType tciPars,
    in TciStatusType encoderFailure, in TriParameterListType triPars,
    in TriStatusType transmissionFailure
);
void tliPrCall_m_MC(
    in TString am, in TInteger ts, in TString src, in TInteger line,
    in TriComponentIdType c, in TriPortIdType at, in TriPortIdType to,
    in TriSignatureIdType signature, in TciParameterListType tciPars,
    in TciValueList addrValues, in TciStatusType encoderFailure,
    in TriParameterListType triPars, in TriAddressListType addresses,
    in TriStatusType transmissionFailure
);

void tliPrCall_c(
    in TString am, in TInteger ts, in TString src, in TInteger line,
    in TriComponentIdType c, in TriPortIdType at, in TriPortIdType to,
    in TriSignatureIdType signature, in TciParameterListType tciPars,
    in TriStatusType transmissionFailure
);
void tliPrCall_c_BC(
    in TString am, in TInteger ts, in TString src, in TInteger line,
    in TriComponentIdType c, in TriPortIdType at, in TriPortIdListType to,
    in TriSignatureIdType signature, in TciParameterListType tciPars,
    in TriStatusType transmissionFailure
);
void tliPrCall_c_MC(
    in TString am, in TInteger ts, in TString src, in TInteger line,
    in TriComponentIdType c, in TriPortIdType at, in TriPortIdListType to,
    in TriSignatureIdType signature, in TciParameterListType tciPars,
    in TriStatusType transmissionFailure
);

void tliPrGetCallDetected_m(
    in TString am, in TInteger ts, in TString src, in TInteger line,
    in TriComponentIdType c, in TriPortIdType at, in TriPortIdType from,
    in TriSignatureIdType signature, in TriParameterListType triPars,
    in TriAddressType address
);
void tliPrGetCallDetected_c(
    in TString am, in TInteger ts, in TString src, in TInteger line,
    in TriComponentIdType c, in TriPortIdType at, in TriPortIdType from,
    in TriSignatureIdType signature, in TciParameterListType tciPars
);
void tliPrGetCallMismatch_m(
    in TString am, in TInteger ts, in TString src, in TInteger line,
    in TriComponentIdType c, in TriPortIdType at,
    in TriSignatureIdType signature, in TciParameterListType tciPars,
    in TciValueTemplate parsTpl, in TciValueDifferenceList diffs,
    in Value addrValue, in TciValueTemplate addressTpl
);
void tliPrGetCallMismatch_c(
    in TString am, in TInteger ts, in TString src, in TInteger line,
    in TriComponentIdType c, in TriPortIdType at,
    in TriSignatureIdType signature, in TciParameterListType tciPars,
    in TciValueTemplate parsTpl, in TciValueDifferenceList diffs,
    in TriComponentIdType from, in TciNonValueTemplate fromTpl
);
void tliPrGetCall_m(
    in TString am, in TInteger ts, in TString src, in TInteger line,
    in TriComponentIdType c, in TriPortIdType at,
    in TriSignatureIdType signature, in TciParameterListType tciPars,
    in TciValueTemplate parsTpl, in Value addrValue,
    in TciValueTemplate addressTpl
);
void tliPrGetCall_c(
    in TString am, in TInteger ts, in TString src, in TInteger line,
    in TriComponentIdType c, in TriPortIdType at,
    in TriSignatureIdType signature, in TciParameterListType tciPars,
    in TciValueTemplate parsTpl, in TriComponentIdType from,
    in TciNonValueTemplate fromTpl
);

```

```

void tliPrReply_m(
    in TString am, in TInteger ts, in TString src, in TInteger line,
    in TriComponentIdType c, in TriPortIdType at, in TriPortIdType to,
    in TriSignatureIdType signature, in TciParameterListType tciPars,
    in Value replValue, in Value addrValue,
    in TciStatusType encoderFailure, in TriParameterListType triPars,
    in TriParameterType repl, in TriAddressType address, in TriStatusType transmissionFailure
);
void tliPrReply_m_BC(
    in TString am, in TInteger ts, in TString src, in TInteger line,
    in TriComponentIdType c, in TriPortIdType at, in TriPortIdType to,
    in TriSignatureIdType signature, in TciParameterListType tciPars, in Value replValue,
    in TciStatusType encoderFailure, in TriParameterListType triPars,
    in TriParameterType repl, in TriStatusType transmissionFailure
);
void tliPrReply_m_MC(
    in TString am, in TInteger ts, in TString src, in TInteger line,
    in TriComponentIdType c, in TriPortIdType at, in TriPortIdType to,
    in TriSignatureIdType signature, in TciParameterListType tciPars, in Value replValue,
    in TciValueListType addrValues, in TciStatusType encoderFailure,
    in TriParameterListType triPars, in TriParameterType repl,
    in TriAddressListType addresses, in TriStatusType transmissionFailure
);

void tliPrReply_c(
    in TString am, in TInteger ts, in TString src, in TInteger line,
    in TriComponentIdType c, in TriPortIdType at, in TriPortIdType to,
    in TriSignatureIdType signature, in TciParameterListType tciPars,
    in Value replValue, in TriStatusType transmissionFailure
);
void tliPrReply_c_BC(
    in TString am, in TInteger ts, in TString src, in TInteger line,
    in TriComponentIdType c, in TriPortIdType at, in TriPortIdListType to,
    in TriSignatureIdType signature, in Value parsValue, in Value replValue,
    in TriStatusType transmissionFailure
);
void tliPrReply_c_MC(
    in TString am, in TInteger ts, in TString src, in TInteger line,
    in TriComponentIdType c, in TriPortIdType at, in TriPortIdListType to,
    in TriSignatureIdType signature, in Value parsValue, in Value replValue,
    in TriStatusType transmissionFailure
);

void tliPrGetReplyDetected_m(
    in TString am, in TInteger ts, in TString src, in TInteger line,
    in TriComponentIdType c, in TriPortIdType at, in TriPortIdType from,
    in TriSignatureIdType signature, in TriParameterListType triPars,
    in TriParameterType repl, in TriAddressType address
);
void tliPrGetReplyDetected_c(
    in TString am, in TInteger ts, in TString src, in TInteger line,
    in TriComponentIdType c, in TriPortIdType at, in TriPortIdType from,
    in TriSignatureIdType signature, in TciParameterListType tciPars,
    in Value replValue
);
void tliPrGetReplyMismatch_m(
    in TString am, in TInteger ts, in TString src, in TInteger line,
    in TriComponentIdType c, in TriPortIdType at,
    in TriSignatureIdType signature,
    in TciParameterListType tciPars, in TciValueTemplate parsTpl,
    in Value replValue, in TciValueTemplate replyTpl,
    in TciValueDifferenceList diffs, in Value addrValue,
    in TciValueTemplate addressTpl
);
void tliPrGetReplyMismatch_c(
    in TString am, in TInteger ts, in TString src, in TInteger line,
    in TriComponentIdType c, in TriPortIdType at,
    in TriSignatureIdType signature,
    in TciParameterListType tciPars, in TciValueTemplate parsTpl,
    in Value replValue, in TciValueTemplate replyTpl,
    in TciValueDifferenceList diffs, in TriComponentIdType from,
    in TciNonValueTemplate fromTpl
);
void tliPrGetReply_m(
    in TString am, in TInteger ts, in TString src, in TInteger line,
    in TriComponentIdType c, in TriPortIdType at,
    in TriSignatureIdType signature,
    in TciParameterListType tciPars, in TciValueTemplate parsTpl,

```

```

        in Value replValue, in TciValueTemplate replyTmpl,
        in Value addrValue, in TciValueTemplate addressTmpl
    );
void tliPrGetReply_c(
    in TString am, in TInteger ts, in TString src, in TInteger line,
    in TriComponentIdType c, in TriPortIdType at,
    in TriSignatureIdType signature,
    in TciParameterListType tciPars, in TciValueTemplate parsTmpl,
    in Value replValue, in TciValueTemplate replyTmpl,
    in TriComponentIdType from, in TciNonValueTemplate fromTmpl
);

void tliPrRaise_m(
    in TString am, in TInteger ts, in TString src, in TInteger line,
    in TriComponentIdType c, in TriPortIdType at, in TriPortIdType to,
    in TriSignatureIdType signature, in TciParameterListType tciPars,
    in Value excValue, in Value addrValue, in TciStatusType encoderFailure,
    in TriExceptionType exc, in TriAddressType address, in TriStatusType transmissionFailure
);

void tliPrRaise_m_BC(
    in TString am, in TInteger ts, in TString src, in TInteger line,
    in TriComponentIdType c, in TriPortIdType at, in TriPortIdType to,
    in TriSignatureIdType signature, in TciParameterListType tciPars,
    in Value excValue, in TciStatusType encoderFailure, in TriExceptionType exc,
    in TriStatusType transmissionFailure
);

void tliPrRaise_m_MC(
    in TString am, in TInteger ts, in TString src, in TInteger line,
    in TriComponentIdType c, in TriPortIdType at, in TriPortIdType to,
    in TriSignatureIdType signature, in TciParameterListType tciPars,
    in Value excValue, in TciValueListType addrValues,
    in TciStatusType encoderFailure, in TriExceptionType exc,
    in TriAddressListType addresses, in TriStatusType transmissionFailure
);

void tliPrRaise_c(
    in TString am, in TInteger ts, in TString src, in TInteger line,
    in TriComponentIdType c, in TriPortIdType at, in TriPortIdType to,
    in TriSignatureIdType signature, in TciParameterListType tciPars,
    in Value excValue, in TriStatusType transmissionFailure
);

void tliPrRaise_c_BC(
    in TString am, in TInteger ts, in TString src, in TInteger line,
    in TriComponentIdType c, in TriPortIdType at, in TriPortIdListType to,
    in TriSignatureIdType signature, in TciParameterListType tciPars,
    in Value excValue, in TriStatusType transmissionFailure
);

void tliPrRaise_c_MC(
    in TString am, in TInteger ts, in TString src, in TInteger line,
    in TriComponentIdType c, in TriPortIdType at, in TriPortIdListType to,
    in TriSignatureIdType signature, in TciParameterListType tciPars,
    in Value excValue, in TriStatusType transmissionFailure
);

void tliPrCatchDetected_m(
    in TString am, in TInteger ts, in TString src, in TInteger line,
    in TriComponentIdType c, in TriPortIdType at, in TriPortIdType from,
    in TriSignatureIdType signature,
    in TriExceptionType exc, in TriAddressType address
);

void tliPrCatchDetected_c(
    in TString am, in TInteger ts, in TString src, in TInteger line,
    in TriComponentIdType c, in TriPortIdType at, in TriPortIdType from,
    in TriSignatureIdType signature, in Value excValue
);

void tliPrCatchMismatch_m(
    in TString am, in TInteger ts, in TString src, in TInteger line,
    in TriComponentIdType c, in TriPortIdType at,
    in TriSignatureIdType signature,
    in Value excValue, in TciValueTemplate excTmpl,
    in TciValueDifferenceList diffs, in Value addrValue,
    in TciValueTemplate addressTmpl
);

void tliPrCatchMismatch_c(
    in TString am, in TInteger ts, in TString src, in TInteger line,
    in TriComponentIdType c, in TriPortIdType at,
    in TriSignatureIdType signature,
    in Value excValue, in TciValueTemplate excTmpl,

```

```

        in TciValueDifferenceList diffs, in TriComponentIdType from,
        in TciNonValueTemplate fromTmpl
    );
void tliPrCatch_m(
    in TString am, in TInteger ts, in TString src, in TInteger line,
    in TriComponentIdType c, in TriPortIdType at,
    in TriSignatureIdType signature,
    in Value excValue, in TciValueTemplate excTmpl,
    in Value addrValue, in TciValueTemplate addressTmpl);

void tliPrCatch_c(
    in TString am, in TInteger ts, in TString src, in TInteger line,
    in TriComponentIdType c, in TriPortIdType at,
    in TriSignatureIdType signature,
    in Value excValue, in TciValueTemplate excTmpl,
    in TriComponentIdType from, in TciNonValueTemplate fromTmpl
);
void tliPrCatchTimeoutDetected(
    in TString am, in TInteger ts, in TString src, in TInteger line,
    in TriComponentIdType c, in TriPortIdType at,
    in TriSignatureIdType signature
);
void tliPrCatchTimeout(
    in TString am, in TInteger ts, in TString src, in TInteger line,
    in TriComponentIdType c, in TriPortIdType at,
    in TriSignatureIdType signature
);
void tlicCreate(
    in TString am, in TInteger ts, in TString src, in TInteger line,
    in TriComponentIdType c, in TriComponentIdType comp,
    in TString name, in TBoolean alive
);
void tlicStart(
    in TString am, in TInteger ts, in TString src, in TInteger line,
    in TriComponentIdType c, in TriComponentIdType comp,
    in TciBehaviourIdType name, in TciParameterListType tciPars
);
void tlicRunning(
    in TString am, in TInteger ts, in TString src, in TInteger line,
    in TriComponentIdType c, in TriComponentIdType comp, in ComponentStatusType status
);
void tlicAlive(
    in TString am, in TInteger ts, in TString src, in TInteger line,
    in TriComponentIdType c,
    in TriComponentIdType comp, in ComponentStatusType status
);
void tlicStop(
    in TString am, in TInteger ts, in TString src, in TInteger line,
    in TriComponentIdType c, in TriComponentIdType comp
);
void tlicKill(
    in TString am, in TInteger ts, in TString src, in TInteger line,
    in TriComponentIdType c, in TriComponentIdType comp
);
void tlicDoneMismatch(
    in TString am, in TInteger ts, in TString src, in TInteger line,
    in TriComponentIdType c, in TriComponentIdType comp, in TciNonValueTemplate compTmpl
);
void tlicKilledMismatch(
    in TString am, in TInteger ts, in TString src, in TInteger line,
    in TriComponentIdType c, in TriComponentIdType comp, in TciNonValueTemplate compTmpl
);
void tlicDone(in TString am, in TInteger ts, in TString src, in TInteger line,
    in TriComponentIdType c, in TciNonValueTemplate compTmpl
);
void tlicKilled(
    in TString am, in TInteger ts, in TString src, in TInteger line,
    in TriComponentIdType c, in TciNonValueTemplate compTmpl
);
void tlicTerminated(
    in TString am, in TInteger ts, in TString src, in TInteger line,
    in TriComponentIdType c, in VerdictValue verdict, in TString reason
);
void tliPConnect(
    in TString am, in TInteger ts, in TString src, in TInteger line,
    in TriComponentIdType c, in TriPortIdType port1, in TriPortIdType port2
);

```

```

void tliPDisconnect(
    in TString am, in TInteger ts, in TString src, in TInteger line,
    in TriComponentIdType c, in TriPortIdType port1,
    in TriPortIdType port2
);
void tliPMap(
    in TString am, in TInteger ts, in TString src, in TInteger line,
    in TriComponentIdType c, in TriPortIdType port1, in TriPortIdType port2
);
void tliPUnmap(
    in TString am, in TInteger ts, in TString src, in TInteger line,
    in TriComponentIdType c, in TriPortIdType port1,
    in TriPortIdType port2
);
void tliPClear(
    in TString am, in TInteger ts, in TString src, in TInteger line,
    in TriComponentIdType c, in TriPortIdType port
);
void tliPStart(
    in TString am, in TInteger ts, in TString src, in TInteger line,
    in TriComponentIdType c, in TriPortIdType port
);
void tliPStop(
    in TString am, in TInteger ts, in TString src, in TInteger line,
    in TriComponentIdType c, in TriPortIdType port
);
void tliPHalt(
    in TString am, in TInteger ts, in TString src, in TInteger line,
    in TriComponentIdType c, in TriPortIdType port
);
void tliEncode(
    in TString am, in TInteger ts, in TString src, in TInteger line,
    in TriComponentIdType c, in Value val, in TciStatusType encoderFailure,
    in TriMessageType msg, in TString codec
);
void tliDecode(
    in TString am, in TInteger ts, in TString src, in TInteger line,
    in TriComponentIdType c, in TriMessageType msg,
    in TciStatusType decoderFailure, in Value val, in TString codec
);
void tliTimeoutDetected(
    in TString am, in TInteger ts, in TString src, in TInteger line,
    in TriComponentIdType c, in TriTimerIdType timer
);
void tliTimeoutMismatch(
    in TString am, in TInteger ts, in TString src, in TInteger line,
    in TriComponentIdType c, in TriTimerIdType timer, in TciNonValueTemplate timerTpl
);
void tliTimeout(
    in TString am, in TInteger ts, in TString src, in TInteger line,
    in TriComponentIdType c, in TriTimerIdType timer, in TciNonValueTemplate timerTpl
);
void tliTStart(
    in TString am, in TInteger ts, in TString src, in TInteger line,
    in TriComponentIdType c, in TriTimerIdType timer,
    in TriTimerDurationType dur
);
void tliTStop(
    in TString am, in TInteger ts, in TString src, in TInteger line,
    in TriComponentIdType c, in TriTimerIdType timer, in TriTimerDurationType dur
);
void tliTRead(
    in TString am, in TInteger ts, in TString src, in TInteger line,
    in TriComponentIdType c, in TriTimerIdType timer,
    in TriTimerDurationType elapsed
);
void tliTRunning(
    in TString am, in TInteger ts, in TString src, in TInteger line,
    in TriComponentIdType c, in TriTimerIdType timer, in TimerStatusType status
);
void tliSEnter(
    in TString am, in TInteger ts, in TString src, in TInteger line,
    in TriComponentIdType c, in QualifiedName name, in TciParameterListType tciPars,
    in TString kind
);
void tliSLeave(
    in TString am, in TInteger ts, in TString src, in TInteger line,
    in TriComponentIdType c, in QualifiedName name, in TciParameterListType tciPars,

```



```

        in Value returnValue, in TString kind
    );
void tliVar(
    in TString am, in TInteger ts, in TString src, in TInteger line,
    in TriComponentIdType c, in QualifiedName name, in Value varValue
);
void tliModulePar(
    in TString am, in TInteger ts, in TString src, in TInteger line,
    in TriComponentIdType c, in QualifiedName name, in Value parValue
);
void tliGetVerdict(
    in TString am, in TInteger ts, in TString src, in TInteger line,
    in TriComponentIdType c, in VerdictValue verdict
);
void tliSetVerdict(
    in TString am, in TInteger ts, in TString src, in TInteger line,
    in TriComponentIdType c, in VerdictValue verdict, in TString reason
);
void tliLog(
    in TString am, in TInteger ts, in TString src, in TInteger line,
    in TriComponentIdType c, in TString log
);
void tliAEnter(
    in TString am, in TInteger ts, in TString src, in TInteger line,
    in TriComponentIdType c
);
void tliALeave(
    in TString am, in TInteger ts, in TString src, in TInteger line,
    in TriComponentIdType c
);
void tliADefaults(
    in TString am, in TInteger ts, in TString src, in TInteger line,
    in TriComponentIdType c
);
void tliAActivate(
    in TString am, in TInteger ts, in TString src, in TInteger line,
    in TriComponentIdType c, in QualifiedName name, in TciParameterListType tciPars,
    in Value ref
);
void tliAdeactivate(
    in TString am, in TInteger ts, in TString src, in TInteger line,
    in TriComponentIdType c, in Value ref
);
void tliANomatch(
    in TString am, in TInteger ts, in TString src, in TInteger line,
    in TriComponentIdType c
);
void tliARepeat(
    in TString am, in TInteger ts, in TString src, in TInteger line,
    in TriComponentIdType c
);
void tliAwait(
    in TString am, in TInteger ts, in TString src, in TInteger line,
    in TriComponentIdType c
);
void tliAction(
    in TString am, in TInteger ts, in TString src, in TInteger line,
    in TriComponentIdType c, in TString action
);
void tliMatch(
    in TString am, in TInteger ts, in TString src, in TInteger line,
    in TriComponentIdType c, in Value expr, in TciValueTemplate tpl
);
void tliMatchMismatch(
    in TString am, in TInteger ts, in TString src,
    in TInteger line, in TriComponentIdType c, in Value expr,
    in TciValueTemplate tpl, in TciValueDifferenceList diffs
);
void tliInfo(
    in TString am, in TInteger ts, in TString src,
    in TInteger line, in TriComponentIdType c,
    in TInteger level, in TString info
);
};
};
};

```

Annex B (normative): XML Mapping for TCI TL Provided

This annex defines a mapping for the logging interface of TCI using eXtended Markup Language (XML) schema definitions.

B.1 TCI-TL XML Schema for Simple Types

```
<?xml version="1.0" encoding="UTF-8"?>
<xsd:schema xmlns:xsd="http://www.w3.org/2001/XMLSchema"
  targetNamespace="http://uri.etsi.org/ttcn-3/tci/SimpleTypes_v4_4_1.xsd"
  xmlns:SimpleTypes="http://uri.etsi.org/ttcn-3/tci/SimpleTypes_v4_4_1.xsd"
  elementFormDefault="qualified">

  <!-- Basic definitions -->
  <xsd:simpleType name="xpath">
    <!-- this string should be XPATH compliant -->
    <xsd:restriction base="xsd:string"/>
  </xsd:simpleType>

  <xsd:simpleType name="TBoolean">
    <xsd:restriction base="xsd:boolean"/>
  </xsd:simpleType>

  <xsd:simpleType name="TString">
    <xsd:restriction base="xsd:string"/>
  </xsd:simpleType>

  <xsd:simpleType name="TInteger">
    <xsd:restriction base="xsd:integer"/>
  </xsd:simpleType>

  <!-- Miscellaneous -->
  <xsd:simpleType name="TriTimerDurationType">
    <xsd:restriction base="xsd:float"/>
  </xsd:simpleType>

  <xsd:simpleType name="TciParameterPassingModeType">
    <xsd:restriction base="xsd:string">
      <xsd:enumeration value="in"/>
      <xsd:enumeration value="inout"/>
      <xsd:enumeration value="out"/>
    </xsd:restriction>
  </xsd:simpleType>

  <xsd:simpleType name="TriStatusType">
    <xsd:restriction base="xsd:string">
      <xsd:enumeration value="TRI_Ok"/>
      <xsd:enumeration value="TRI_Error"/>
    </xsd:restriction>
  </xsd:simpleType>

  <xsd:simpleType name="TciStatusType">
    <xsd:restriction base="xsd:string">
      <xsd:enumeration value="TCI_Ok"/>
      <xsd:enumeration value="TCI_Error"/>
    </xsd:restriction>
  </xsd:simpleType>

  <xsd:simpleType name="ComponentStatusType">
    <xsd:restriction base="xsd:string">
      <xsd:enumeration value="inactiveC"/>
      <xsd:enumeration value="runningC"/>
      <xsd:enumeration value="stoppedC"/>
      <xsd:enumeration value="killedC"/>
      <xsd:enumeration value="nullC"/>
    </xsd:restriction>
  </xsd:simpleType>
</xsd:schema>
```

```

<xsd:simpleType name="TimerStatusType">
  <xsd:restriction base="xsd:string">
    <xsd:enumeration value="runningT"/>
    <xsd:enumeration value="inactiveT"/>
    <xsd:enumeration value="expiredT"/>
    <xsd:enumeration value="nullT"/>
  </xsd:restriction>
</xsd:simpleType>

<xsd:simpleType name="PortStatusType">
  <xsd:restriction base="xsd:string">
    <xsd:enumeration value="startedP"/>
    <xsd:enumeration value="haltedP"/>
    <xsd:enumeration value="stoppedP"/>
  </xsd:restriction>
</xsd:simpleType>
</xsd:schema>

```

B.2 TCI-TL XML Schema for Types

```

<?xml version="1.0" encoding="UTF-8"?>
<xsd:schema xmlns:xsd="http://www.w3.org/2001/XMLSchema"
  targetNamespace="http://uri.etsi.org/ttcn-3/tci/Types_v4_4_.xsd"
  xmlns:Types="http://uri.etsi.org/ttcn-3/tci/Types_v4_4_.xsd"
  xmlns:SimpleTypes="http://uri.etsi.org/ttcn-3/tci/SimpleTypes_v4_4_.xsd"
  xmlns:Values="http://uri.etsi.org/ttcn-3/tci/Values_v4_4_.xsd"
  xmlns:Templates="http://uri.etsi.org/ttcn-3/tci/Templates_v4_4_.xsd"
  elementFormDefault="qualified">

  <xsd:import namespace="http://uri.etsi.org/ttcn-3/tci/Values_v4_4_.xsd"
    schemaLocation="Values_v4_4_.xsd"/>
  <xsd:import namespace="http://uri.etsi.org/ttcn-3/tci/SimpleTypes_v4_4_1.xsd"
    schemaLocation="SimpleTypes_v4_4_1.xsd"/>
  <xsd:import namespace="http://uri.etsi.org/ttcn-3/tci/Templates_v4_4_1.xsd"
    schemaLocation="Templates_v4_4_1.xsd"/>

  <!-- Connection -->
  <xsd:complexType name="TriPortIdType">
    <xsd:sequence>
      <xsd:element name="comp" type="Types:TriComponentIdType" />
      <xsd:element name="port" type="Types:Port" />
    </xsd:sequence>
  </xsd:complexType>

  <xsd:complexType name="TriPortIdListType">
    <xsd:sequence>
      <xsd:element name="comp" type="Types:TriPortIdType" minOccurs="0"
        maxOccurs="unbounded"/>
    </xsd:sequence>
  </xsd:complexType>

  <xsd:complexType name="Port">
    <xsd:sequence>
      <xsd:element name="id" type="Types:Id" />
      <xsd:element name="index" type="xsd:int" minOccurs="0" />
    </xsd:sequence>
  </xsd:complexType>

  <xsd:complexType name="TriComponentIdType">
    <xsd:sequence>
      <xsd:choice>
        <xsd:element name="null" type="Templates:null"/>
        <xsd:element name="id" type="Types:Id" />
      </xsd:choice>
    </xsd:sequence>
  </xsd:complexType>

  <xsd:complexType name="TriComponentIdListType">
    <xsd:sequence>
      <xsd:element name="comp" type="Types:TriComponentIdType" minOccurs="0"
        maxOccurs="unbounded"/>
    </xsd:sequence>
  </xsd:complexType>

```

```

<!-- Communication -->
<xsd:complexType name="TriMessageType">
  <xsd:attribute name="val" type="xsd:hexBinary"/>
</xsd:complexType>

<xsd:complexType name="TriParameterType">
  <xsd:sequence>
    <xsd:element name="val" type="xsd:hexBinary" />
  </xsd:sequence>
  <xsd:attribute name="name" type="SimpleTypes:TString"/>
  <xsd:attribute name="mode" type="SimpleTypes:TciParameterPassingModeType"/>
</xsd:complexType>

<xsd:complexType name="TriParameterListType">
  <xsd:sequence>
    <xsd:element name="par" type="Types:TriParameterType" minOccurs="0"
maxOccurs="unbounded"/>
  </xsd:sequence>
</xsd:complexType>

<xsd:complexType name="TriExceptionType">
  <xsd:attribute name="val" type="xsd:hexBinary"/>
</xsd:complexType>

<xsd:complexType name="TciValueListType">
  <xsd:complexContent>
    <xsd:extension base="Values:RecordValue"/>
  </xsd:complexContent>
</xsd:complexType>

<xsd:complexType name="TriSignatureIdType">
  <xsd:attribute name="val" type="SimpleTypes:TString" use="required"/>
</xsd:complexType>

<xsd:complexType name="TriAddressType">
  <xsd:attribute name="val" type="xsd:hexBinary"/>
</xsd:complexType>

<xsd:complexType name="TriAddressListType">
  <xsd:sequence>
    <xsd:element name="addr" type="Types:TriAddressType" minOccurs="0"
maxOccurs="unbounded"/>
  </xsd:sequence>
</xsd:complexType>

<!-- Miscellaneous -->
<xsd:complexType name="TriTimerIdType">
  <xsd:sequence>
    <xsd:element name="id" type="Types:Id" />
  </xsd:sequence>
</xsd:complexType>

<!-- Basic definitions -->
<xsd:complexType name="QualifiedName">
  <xsd:attribute name="moduleName" type="SimpleTypes:TString" use="required"/>
  <xsd:attribute name="baseName" type="SimpleTypes:TString" use="required"/>
</xsd:complexType>

<!-- general TCI abstract data types -->
<xsd:complexType name="TciBehaviourIdType">
  <xsd:sequence>
    <xsd:element name="name" type="Types:QualifiedName" />
  </xsd:sequence>
</xsd:complexType>

<xsd:complexType name="TciTestCaseIdType">
  <xsd:sequence>
    <xsd:element name="name" type="Types:QualifiedName" />
  </xsd:sequence>
</xsd:complexType>

```

```

<xsd:complexType name="TciParameterType">
  <xsd:sequence>
    <xsd:element name="val" type="Values:Value" />
  </xsd:sequence>
  <xsd:attribute name="name" type="SimpleTypes:TString"/>
  <xsd:attribute name="mode" type="SimpleTypes:TciParameterPassingModeType"/>
</xsd:complexType>

<xsd:complexType name="TciParameterListType">
  <xsd:sequence>
    <xsd:element name="par" type="Types:TciParameterType" minOccurs="0"
maxOccurs="unbounded"/>
  </xsd:sequence>
</xsd:complexType>

<!-- general identifier structure for test components, ports and timer -->
<xsd:complexType name="Id">
  <xsd:sequence>
    <xsd:element name="name" type="SimpleTypes:TString" />
    <xsd:element name="id" type="SimpleTypes:TString" minOccurs="0"/>
    <xsd:element name="type" type="SimpleTypes:TString" minOccurs="0"/>
  </xsd:sequence>
</xsd:complexType>
</xsd:schema>

```

B.3 TCI-TL XML Schema for Values

```

<?xml version="1.0" encoding="UTF-8"?>
<xsd:schema xmlns:xsd="http://www.w3.org/2001/XMLSchema"
  targetNamespace="http://uri.etsi.org/ttcn-3/tci/Values_v4_4_1.xsd"
  xmlns:Values="http://uri.etsi.org/ttcn-3/tci/Values_v4_4_1.xsd"
  xmlns:Templates="http://uri.etsi.org/ttcn-3/tci/Templates_v4_4_1.xsd"
  xmlns:SimpleTypes="http://uri.etsi.org/ttcn-3/tci/SimpleTypes_v4_4_1.xsd"
  elementFormDefault="qualified">

  <xsd:import namespace="http://uri.etsi.org/ttcn-3/tci/Templates_v4_4_1.xsd"
    schemaLocation="Templates_v4_4_1.xsd"/>
  <xsd:import namespace="http://uri.etsi.org/ttcn-3/tci/SimpleTypes_v4_4_1.xsd"
    schemaLocation="SimpleTypes_v4_4_1.xsd"/>

  <xsd:attributeGroup name="ValueAtts">
    <xsd:attribute name="name" type="SimpleTypes:TString" use="optional"/>
    <xsd:attribute name="type" type="SimpleTypes:TString" use="optional"/>
    <xsd:attribute name="module" type="SimpleTypes:TString" use="optional"/>
    <xsd:attribute name="annotation" type="SimpleTypes:TString" use="optional"/>
  </xsd:attributeGroup>

  <xsd:complexType name="Value" mixed="true">
    <xsd:choice>
      <xsd:element name="integer" type="Values:IntegerValue"/>
      <xsd:element name="float" type="Values:FloatValue"/>
      <xsd:element name="boolean" type="Values:BooleanValue"/>
      <xsd:element name="verdicttype" type="Values:VerdictValue"/>
      <xsd:element name="bitstring" type="Values:BitstringValue"/>
      <xsd:element name="hexstring" type="Values:HexstringValue"/>
      <xsd:element name="octetstring" type="Values:OctetstringValue"/>
      <xsd:element name="charstring" type="Values:CharstringValue"/>
      <xsd:element name="universal_charstring" type="Values:UniversalCharstringValue"/>
      <xsd:element name="record" type="Values:RecordValue"/>
      <xsd:element name="record_of" type="Values:RecordOfValue"/>
      <xsd:element name="array" type="Values:ArrayValue"/>
      <xsd:element name="set" type="Values:SetValue"/>
      <xsd:element name="set_of" type="Values:SetOfValue"/>
      <xsd:element name="enumerated" type="Values:EnumeratedValue"/>
      <xsd:element name="union" type="Values:UnionValue"/>
      <xsd:element name="anytype" type="Values:AnytypeValue"/>
      <xsd:element name="address" type="Values:AddressValue"/>
    </xsd:choice>
    <xsd:attributeGroup ref="Values:ValueAtts"/>
  </xsd:complexType>

```

```

<!-- general event elements -->
<xsd:complexType name="IntegerValue">
  <xsd:choice>
    <xsd:element name="value" type="SimpleTypes:TString"/>
    <xsd:element name="null" type="Templates:null"/>
    <xsd:element name="omit" type="Templates:omit"/>
  </xsd:choice>
  <xsd:attributeGroup ref="Values:ValueAtts"/>
</xsd:complexType>

<xsd:complexType name="FloatValue">
  <xsd:choice>
    <xsd:element name="value" type="SimpleTypes:TString"/>
    <xsd:element name="null" type="Templates:null"/>
    <xsd:element name="omit" type="Templates:omit"/>
  </xsd:choice>
  <xsd:attributeGroup ref="Values:ValueAtts"/>
</xsd:complexType>

<xsd:complexType name="BooleanValue">
  <xsd:choice>
    <xsd:element name="value" type="SimpleTypes:TString"/>
    <xsd:element name="null" type="Templates:null"/>
    <xsd:element name="omit" type="Templates:omit"/>
  </xsd:choice>
  <xsd:attributeGroup ref="Values:ValueAtts"/>
</xsd:complexType>

<xsd:complexType name="VerdictValue">
  <xsd:choice>
    <xsd:element name="value" type="SimpleTypes:TString"/>
    <xsd:element name="null" type="Templates:null"/>
    <xsd:element name="omit" type="Templates:omit"/>
  </xsd:choice>
  <xsd:attributeGroup ref="Values:ValueAtts"/>
</xsd:complexType>

<xsd:complexType name="BitstringValue">
  <xsd:choice>
    <xsd:element name="value" type="SimpleTypes:TString"/>
    <xsd:element name="null" type="Templates:null"/>
    <xsd:element name="omit" type="Templates:omit"/>
  </xsd:choice>
  <xsd:attributeGroup ref="Values:ValueAtts"/>
</xsd:complexType>

<xsd:complexType name="HexstringValue">
  <xsd:choice>
    <xsd:element name="value" type="SimpleTypes:TString"/>
    <xsd:element name="null" type="Templates:null"/>
    <xsd:element name="omit" type="Templates:omit"/>
  </xsd:choice>
  <xsd:attributeGroup ref="Values:ValueAtts"/>
</xsd:complexType>

<xsd:complexType name="OctetstringValue">
  <xsd:choice>
    <xsd:element name="value" type="SimpleTypes:TString"/>
    <xsd:element name="null" type="Templates:null"/>
    <xsd:element name="omit" type="Templates:omit"/>
  </xsd:choice>
  <xsd:attributeGroup ref="Values:ValueAtts"/>
</xsd:complexType>

<xsd:complexType name="CharstringValue">
  <xsd:choice>
    <xsd:element name="value" type="SimpleTypes:TString"/>
    <xsd:element name="null" type="Templates:null"/>
    <xsd:element name="omit" type="Templates:omit"/>
  </xsd:choice>
  <xsd:attributeGroup ref="Values:ValueAtts"/>
</xsd:complexType>

<xsd:complexType name="UniversalCharstringValue">
  <xsd:choice>
    <xsd:element name="value" type="SimpleTypes:TString"/>
    <xsd:element name="null" type="Templates:null"/>
    <xsd:element name="omit" type="Templates:omit"/>
  </xsd:choice>

```

```

</xsd:choice>
<xsd:attributeGroup ref="Values:ValueAtts"/>
</xsd:complexType>

<xsd:complexType name="RecordValue">
  <xsd:choice>
    <xsd:choice minOccurs="0" maxOccurs="unbounded">
      <xsd:element name="integer" type="Values:IntegerValue"/>
      <xsd:element name="float" type="Values:FloatValue"/>
      <xsd:element name="boolean" type="Values:BooleanValue"/>
      <xsd:element name="verdicttype" type="Values:VerdictValue"/>
      <xsd:element name="bitstring" type="Values:BitstringValue"/>
      <xsd:element name="hexstring" type="Values:HexstringValue"/>
      <xsd:element name="octetstring" type="Values:OctetstringValue"/>
      <xsd:element name="charstring" type="Values:CharstringValue"/>
      <xsd:element name="universal_charstring"
        type="Values:UniversalCharstringValue"/>
      <xsd:element name="record" type="Values:RecordValue"/>
      <xsd:element name="record_of" type="Values:RecordOfValue"/>
      <xsd:element name="array" type="Values:ArrayValue"/>
      <xsd:element name="set" type="Values:SetValue"/>
      <xsd:element name="set_of" type="Values:SetOfValue"/>
      <xsd:element name="enumerated" type="Values:EnumeratedValue"/>
      <xsd:element name="union" type="Values:UnionValue"/>
      <xsd:element name="anytype" type="Values:AnytypeValue"/>
      <xsd:element name="address" type="Values:AddressValue"/>
    </xsd:choice>
    <xsd:element name="null" type="Templates:null"/>
    <xsd:element name="omit" type="Templates:omit"/>
  </xsd:choice>
  <xsd:attributeGroup ref="Values:ValueAtts"/>
</xsd:complexType>

<xsd:complexType name="RecordOfValue">
  <xsd:choice>
    <xsd:element name="integer" type="Values:IntegerValue" minOccurs="0"
      maxOccurs="unbounded"/>
    <xsd:element name="float" type="Values:FloatValue" minOccurs="0"
      maxOccurs="unbounded"/>
    <xsd:element name="boolean" type="Values:BooleanValue" minOccurs="0"
      maxOccurs="unbounded"/>
    <xsd:element name="verdicttype" type="Values:VerdictValue" minOccurs="0"
      maxOccurs="unbounded"/>
    <xsd:element name="bitstring" type="Values:BitstringValue"
      minOccurs="0" maxOccurs="unbounded"/>
    <xsd:element name="hexstring" type="Values:HexstringValue"
      minOccurs="0" maxOccurs="unbounded"/>
    <xsd:element name="octetstring" type="Values:OctetstringValue"
      minOccurs="0" maxOccurs="unbounded"/>
    <xsd:element name="charstring" type="Values:CharstringValue"
      minOccurs="0" maxOccurs="unbounded"/>
    <xsd:element name="universal_charstring"
      type="Values:UniversalCharstringValue" minOccurs="0"
      maxOccurs="unbounded"/>
    <xsd:element name="record" type="Values:RecordValue" minOccurs="0"
      maxOccurs="unbounded"/>
    <xsd:element name="record_of" type="Values:RecordOfValue"
      minOccurs="0" maxOccurs="unbounded"/>
    <xsd:element name="array" type="Values:ArrayValue"
      minOccurs="0" maxOccurs="unbounded"/>
    <xsd:element name="set" type="Values:SetValue" minOccurs="0"
      maxOccurs="unbounded"/>
    <xsd:element name="set_of" type="Values:SetOfValue"
      minOccurs="0" maxOccurs="unbounded"/>
    <xsd:element name="enumerated" type="Values:EnumeratedValue"
      minOccurs="0" maxOccurs="unbounded"/>
    <xsd:element name="union" type="Values:UnionValue" minOccurs="0"
      maxOccurs="unbounded"/>
    <xsd:element name="anytype" type="Values:AnytypeValue" minOccurs="0"
      maxOccurs="unbounded"/>
    <xsd:element name="address" type="Values:AddressValue" minOccurs="0"
      maxOccurs="unbounded"/>
    <xsd:element name="null" type="Templates:null"/>
    <xsd:element name="omit" type="Templates:omit"/>
  </xsd:choice>
  <xsd:attributeGroup ref="Values:ValueAtts"/>
</xsd:complexType>

```

```

<xsd:complexType name="ArrayValue">
  <xsd:choice>
    <xsd:element name="integer" type="Values:IntegerValue" minOccurs="0"
      maxOccurs="unbounded"/>
    <xsd:element name="float" type="Values:FloatValue" minOccurs="0"
      maxOccurs="unbounded"/>
    <xsd:element name="boolean" type="Values:BooleanValue" minOccurs="0"
      maxOccurs="unbounded"/>
    <xsd:element name="verdicttype" type="Values:VerdictValue" minOccurs="0"
      maxOccurs="unbounded"/>
    <xsd:element name="bitstring" type="Values:BitstringValue"
      minOccurs="0" maxOccurs="unbounded"/>
    <xsd:element name="hexstring" type="Values:HexstringValue"
      minOccurs="0" maxOccurs="unbounded"/>
    <xsd:element name="octetstring" type="Values:OctetstringValue"
      minOccurs="0" maxOccurs="unbounded"/>
    <xsd:element name="charstring" type="Values:CharstringValue"
      minOccurs="0" maxOccurs="unbounded"/>
    <xsd:element name="universal_charstring"
      type="Values:UniversalCharstringValue" minOccurs="0"
      maxOccurs="unbounded"/>
    <xsd:element name="record" type="Values:RecordValue" minOccurs="0"
      maxOccurs="unbounded"/>
    <xsd:element name="record_of" type="Values:RecordOfValue"
      minOccurs="0" maxOccurs="unbounded"/>
    <xsd:element name="array" type="Values:ArrayValue"
      minOccurs="0" maxOccurs="unbounded"/>
    <xsd:element name="set" type="Values:SetValue" minOccurs="0"
      maxOccurs="unbounded"/>
    <xsd:element name="set_of" type="Values:SetOfValue"
      minOccurs="0" maxOccurs="unbounded"/>
    <xsd:element name="enumerated" type="Values:EnumeratedValue"
      minOccurs="0" maxOccurs="unbounded"/>
    <xsd:element name="union" type="Values:UnionValue" minOccurs="0"
      maxOccurs="unbounded"/>
    <xsd:element name="anytype" type="Values:AnytypeValue" minOccurs="0"
      maxOccurs="unbounded"/>
    <xsd:element name="address" type="Values:AddressValue" minOccurs="0"
      maxOccurs="unbounded"/>
    <xsd:element name="null" type="Templates:null"/>
    <xsd:element name="omit" type="Templates:omit"/>
  </xsd:choice>
  <xsd:attributeGroup ref="Values:ValueAtts"/>
</xsd:complexType>

<xsd:complexType name="SetValue">
  <xsd:choice>
    <xsd:choice minOccurs="0" maxOccurs="unbounded">
      <xsd:element name="integer" type="Values:IntegerValue"/>
      <xsd:element name="float" type="Values:FloatValue"/>
      <xsd:element name="boolean" type="Values:BooleanValue"/>
      <xsd:element name="verdicttype" type="Values:VerdictValue"/>
      <xsd:element name="bitstring" type="Values:BitstringValue"/>
      <xsd:element name="hexstring" type="Values:HexstringValue"/>
      <xsd:element name="octetstring" type="Values:OctetstringValue"/>
      <xsd:element name="charstring" type="Values:CharstringValue"/>
      <xsd:element name="universal_charstring"
        type="Values:UniversalCharstringValue"/>
      <xsd:element name="record" type="Values:RecordValue"/>
      <xsd:element name="record_of" type="Values:RecordOfValue"/>
      <xsd:element name="array" type="Values:ArrayValue"/>
      <xsd:element name="set" type="Values:SetValue"/>
      <xsd:element name="set_of" type="Values:SetOfValue"/>
      <xsd:element name="enumerated" type="Values:EnumeratedValue"/>
      <xsd:element name="union" type="Values:UnionValue"/>
      <xsd:element name="anytype" type="Values:AnytypeValue"/>
      <xsd:element name="address" type="Values:AddressValue"/>
    </xsd:choice>
    <xsd:element name="null" type="Templates:null"/>
    <xsd:element name="omit" type="Templates:omit"/>
  </xsd:choice>
  <xsd:attributeGroup ref="Values:ValueAtts"/>
</xsd:complexType>

<xsd:complexType name="SetOfValue">
  <xsd:choice>
    <xsd:element name="integer" type="Values:IntegerValue" minOccurs="0"

```



```

        maxOccurs="unbounded"/>
<xsd:element name="float" type="Values:FloatValue" minOccurs="0"
maxOccurs="unbounded"/>
<xsd:element name="boolean" type="Values:BooleanValue" minOccurs="0"
maxOccurs="unbounded"/>
<xsd:element name="verdicttype" type="Values:VerdictValue" minOccurs="0"
maxOccurs="unbounded"/>
<xsd:element name="bitstring" type="Values:BitstringValue"
minOccurs="0" maxOccurs="unbounded"/>
<xsd:element name="hexstring" type="Values:HexstringValue"
minOccurs="0" maxOccurs="unbounded"/>
<xsd:element name="octetstring" type="Values:OctetstringValue"
minOccurs="0" maxOccurs="unbounded"/>
<xsd:element name="charstring" type="Values:CharstringValue"
minOccurs="0" maxOccurs="unbounded"/>
<xsd:element name="universal_charstring"
type="Values:UniversalCharstringValue" minOccurs="0"
maxOccurs="unbounded"/>
<xsd:element name="record" type="Values:RecordValue" minOccurs="0"
maxOccurs="unbounded"/>
<xsd:element name="record_of" type="Values:RecordOfValue"
minOccurs="0" maxOccurs="unbounded"/>
<xsd:element name="array" type="Values:ArrayValue"
minOccurs="0" maxOccurs="unbounded"/>
<xsd:element name="set" type="Values:SetValue" minOccurs="0"
maxOccurs="unbounded"/>
<xsd:element name="set_of" type="Values:SetOfValue"
minOccurs="0" maxOccurs="unbounded"/>
<xsd:element name="enumerated" type="Values:EnumeratedValue"
minOccurs="0" maxOccurs="unbounded"/>
<xsd:element name="union" type="Values:UnionValue" minOccurs="0"
maxOccurs="unbounded"/>
<xsd:element name="anytype" type="Values:AnytypeValue" minOccurs="0"
maxOccurs="unbounded"/>
<xsd:element name="address" type="Values:AddressValue" minOccurs="0"
maxOccurs="unbounded"/>
<xsd:element name="null" type="Templates:null"/>
<xsd:element name="omit" type="Templates:omit"/>
</xsd:choice>
<xsd:attributeGroup ref="Values:ValueAtts"/>
</xsd:complexType>

<xsd:complexType name="EnumeratedValue">
<xsd:choice>
<xsd:element name="value" type="SimpleTypes:TString"/>
<xsd:element name="intValue" type="SimpleTypes:TInteger" minOccurs="0"/>
<xsd:element name="null" type="Templates:null"/>
<xsd:element name="omit" type="Templates:omit"/>
</xsd:choice>
<xsd:attributeGroup ref="Values:ValueAtts"/>
</xsd:complexType>

<xsd:complexType name="UnionValue">
<xsd:choice>
<xsd:element name="integer" type="Values:IntegerValue"/>
<xsd:element name="float" type="Values:FloatValue"/>
<xsd:element name="boolean" type="Values:BooleanValue"/>
<xsd:element name="verdicttype" type="Values:VerdictValue"/>
<xsd:element name="bitstring" type="Values:BitstringValue"/>
<xsd:element name="hexstring" type="Values:HexstringValue"/>
<xsd:element name="octetstring" type="Values:OctetstringValue"/>
<xsd:element name="charstring" type="Values:CharstringValue"/>
<xsd:element name="universal_charstring"
type="Values:UniversalCharstringValue"/>
<xsd:element name="record" type="Values:RecordValue"/>
<xsd:element name="record_of" type="Values:RecordOfValue"/>
<xsd:element name="array" type="Values:ArrayValue"/>
<xsd:element name="set" type="Values:SetValue"/>
<xsd:element name="set_of" type="Values:SetOfValue"/>
<xsd:element name="enumerated" type="Values:EnumeratedValue"/>
<xsd:element name="union" type="Values:UnionValue"/>
<xsd:element name="anytype" type="Values:AnytypeValue"/>
<xsd:element name="address" type="Values:AddressValue"/>
<xsd:element name="null" type="Templates:null"/>
<xsd:element name="omit" type="Templates:omit"/>
</xsd:choice>
<xsd:attributeGroup ref="Values:ValueAtts"/>
</xsd:complexType>

```

```

<xsd:complexType name="AnytypeValue">
  <xsd:choice minOccurs="0" maxOccurs="unbounded">
    <xsd:element name="integer" type="Values:IntegerValue"/>
    <xsd:element name="float" type="Values:FloatValue"/>
    <xsd:element name="boolean" type="Values:BooleanValue"/>
    <xsd:element name="verdicttype" type="Values:VerdictValue"/>
    <xsd:element name="bitstring" type="Values:BitstringValue"/>
    <xsd:element name="hexstring" type="Values:HexstringValue"/>
    <xsd:element name="octetstring" type="Values:OctetstringValue"/>
    <xsd:element name="charstring" type="Values:OctetstringValue"/>
    <xsd:element name="universal_charstring"
      type="Values:UniversalCharstringValue"/>
    <xsd:element name="record" type="Values:RecordValue"/>
    <xsd:element name="record_of" type="Values:RecordOfValue"/>
    <xsd:element name="array" type="Values:ArrayValue"/>
    <xsd:element name="set" type="Values:SetValue"/>
    <xsd:element name="set_of" type="Values:SetOfValue"/>
    <xsd:element name="enumerated" type="Values:EnumeratedValue"/>
    <xsd:element name="union" type="Values:UnionValue"/>
    <xsd:element name="address" type="Values:AddressValue"/>
    <xsd:element name="null" type="Templates:null"/>
    <xsd:element name="omit" type="Templates:omit"/>
  </xsd:choice>
  <xsd:attributeGroup ref="Values:ValueAtts"/>
</xsd:complexType>

<xsd:complexType name="AddressValue">
  <xsd:choice minOccurs="0" maxOccurs="unbounded">
    <xsd:element name="integer" type="Values:IntegerValue"/>
    <xsd:element name="float" type="Values:FloatValue"/>
    <xsd:element name="boolean" type="Values:BooleanValue"/>
    <xsd:element name="verdicttype" type="Values:VerdictValue"/>
    <xsd:element name="bitstring" type="Values:BitstringValue"/>
    <xsd:element name="hexstring" type="Values:HexstringValue"/>
    <xsd:element name="octetstring" type="Values:OctetstringValue"/>
    <xsd:element name="charstring" type="Values:OctetstringValue"/>
    <xsd:element name="universal_charstring"
      type="Values:UniversalCharstringValue"/>
    <xsd:element name="record" type="Values:RecordValue"/>
    <xsd:element name="record_of" type="Values:RecordOfValue"/>
    <xsd:element name="array" type="Values:ArrayValue"/>
    <xsd:element name="set" type="Values:SetValue"/>
    <xsd:element name="set_of" type="Values:SetOfValue"/>
    <xsd:element name="enumerated" type="Values:EnumeratedValue"/>
    <xsd:element name="union" type="Values:UnionValue"/>
    <xsd:element name="anytype" type="Values:AnytypeValue"/>
    <xsd:element name="null" type="Templates:null"/>
    <xsd:element name="omit" type="Templates:omit"/>
  </xsd:choice>
  <xsd:attributeGroup ref="Values:ValueAtts"/>
</xsd:complexType>
</xsd:schema>

```

B.4 TCI-TL XML Schema for Templates

```

<?xml version="1.0" encoding="UTF-8"?>
<xsd:schema xmlns:xsd="http://www.w3.org/2001/XMLSchema"
  targetNamespace="http://uri.etsi.org/ttcn-3/tci/Templates_v4_4_1.xsd"
  xmlns:Templates="http://uri.etsi.org/ttcn-3/tci/Templates_v4_4_1.xsd"
  xmlns:Values="http://uri.etsi.org/ttcn-3/tci/Values_v4_4_1.xsd"
  xmlns:SimpleTypes="http://uri.etsi.org/ttcn-3/tci/SimpleTypes_v4_4_1.xsd"
  elementFormDefault="qualified">

  <xsd:import namespace="http://uri.etsi.org/ttcn-3/tci/Values_v4_4_1.xsd"
    schemaLocation="Values_v4_4_1.xsd"/>
  <xsd:import namespace="http://uri.etsi.org/ttcn-3/tci/SimpleTypes_v4_4_1.xsd"
    schemaLocation="SimpleTypes_v4_4_1.xsd"/>

  <xsd:complexType name="TciValueTemplate">
    <xsd:complexContent mixed="true">
      <xsd:extension base="Values:Value">
        <xsd:choice>
          <xsd:element name="integer" type="Templates:IntegerTemplate"/>
          <xsd:element name="float" type="Templates:FloatTemplate"/>

```

```

<xsd:element name="boolean" type="Templates:BooleanTemplate"/>
<xsd:element name="verdicttype" type="Templates:VerdictTemplate"/>
<xsd:element name="bitstring" type="Templates:BitstringTemplate"/>
<xsd:element name="hexstring" type="Templates:HexstringTemplate"/>
<xsd:element name="octetstring" type="Templates:OctetstringTemplate"/>
<xsd:element name="charstring" type="Templates:CharstringTemplate"/>
<xsd:element name="universal_charstring"
  type="Templates:UniversalCharstringTemplate"/>
<xsd:element name="record" type="Templates:RecordTemplate"/>
<xsd:element name="record_of" type="Templates:RecordOfTemplate"/>
<xsd:element name="array" type="Values:ArrayValue"/>
<xsd:element name="set" type="Templates:SetTemplate"/>
<xsd:element name="set_of" type="Templates:SetOfTemplate"/>
<xsd:element name="enumerated" type="Templates:EnumeratedTemplate"/>
<xsd:element name="union" type="Templates:UnionTemplate"/>
<xsd:element name="anytype" type="Templates:AnytypeTemplate"/>
<xsd:element name="address" type="Templates:AddressTemplate"/>
<xsd:element name="omit" type="Templates:omit"/>
<xsd:element name="any" type="Templates:any"/>
<xsd:element name="anyoromit" type="Templates:anyoromit"/>
<xsd:element name="templateDef" type="SimpleTypes:TString"/>
</xsd:choice>
</xsd:extension>
</xsd:complexContent>
</xsd:complexType>

<xsd:complexType name="omit">
  <xsd:attributeGroup ref="Values:ValueAtts"/>
</xsd:complexType>

<xsd:complexType name="any">
  <xsd:attributeGroup ref="Values:ValueAtts"/>
</xsd:complexType>

<xsd:complexType name="anyoromit">
  <xsd:attributeGroup ref="Values:ValueAtts"/>
</xsd:complexType>

<xsd:complexType name="TciNonValueTemplate">
  <xsd:sequence>
    <xsd:choice>
      <xsd:element name="any" type="Templates:any"/>
      <xsd:element name="all" type="Templates:all"/>
      <xsd:element name="templateDef" type="SimpleTypes:TString"/>
      <xsd:element name="null" type="Templates:null"/>
    </xsd:choice>
  </xsd:sequence>
</xsd:complexType>

<xsd:complexType name="all">
  <xsd:attributeGroup ref="Values:ValueAtts"/>
</xsd:complexType>

<xsd:complexType name="null">
  <xsd:attributeGroup ref="Values:ValueAtts"/>
</xsd:complexType>

<xsd:complexType name="TciValueDifference">
  <xsd:sequence>
    <xsd:element name="val" type="SimpleTypes:xpath"/>
    <xsd:element name="tmpl" type="SimpleTypes:xpath"/>
  </xsd:sequence>
  <xsd:attributeGroup ref="Values:ValueAtts"/>
  <xsd:attribute name="desc" type="SimpleTypes:TString" use="optional"/>
</xsd:complexType>

<xsd:complexType name="TciValueDifferenceList">
  <xsd:sequence>
    <xsd:element name="diff" type="Templates:TciValueDifference"
maxOccurs="unbounded"/>
  </xsd:sequence>
</xsd:complexType>

<xsd:complexType name="IntegerTemplate">
  <xsd:choice>
    <xsd:element name="value" type="SimpleTypes:TString"/>
    <xsd:element name="templateDef" type="SimpleTypes:TString"/>
  </xsd:choice>

```



```

</xsd:complexType>

<xsd:complexType name="UniversalCharstringTemplate">
  <xsd:choice>
    <xsd:element name="value" type="SimpleTypes:TString"/>
    <xsd:element name="templateDef" type="SimpleTypes:TString"/>
    <xsd:element name="omit" type="Templates:omit"/>
    <xsd:element name="any" type="Templates:any"/>
    <xsd:element name="anyoromit" type="Templates:anyoromit"/>
    <xsd:element name="null" type="Templates:null"/>
  </xsd:choice>
  <xsd:attributeGroup ref="Values:ValueAtts"/>
</xsd:complexType>

<xsd:complexType name="VerdictTemplate">
  <xsd:choice>
    <xsd:element name="value" type="SimpleTypes:TString"/>
    <xsd:element name="templateDef" type="SimpleTypes:TString"/>
    <xsd:element name="omit" type="Templates:omit"/>
    <xsd:element name="any" type="Templates:any"/>
    <xsd:element name="anyoromit" type="Templates:anyoromit"/>
    <xsd:element name="null" type="Templates:null"/>
  </xsd:choice>
  <xsd:attributeGroup ref="Values:ValueAtts"/>
</xsd:complexType>

<xsd:complexType name="RecordTemplate">
  <xsd:complexContent>
    <xsd:extension base="Values:RecordValue">
      <xsd:choice>
        <xsd:choice minOccurs="0">
          <xsd:element name="integer" type="Templates:IntegerTemplate"/>
          <xsd:element name="float" type="Templates:FloatTemplate"/>
          <xsd:element name="boolean" type="Templates:BooleanTemplate"/>
          <xsd:element name="verdicttype" type="Templates:VerdictTemplate"/>
          <xsd:element name="bitstring" type="Templates:BitstringTemplate"/>
          <xsd:element name="hexstring" type="Templates:HexstringTemplate"/>
          <xsd:element name="octetstring" type="Templates:OctetstringTemplate"/>
          <xsd:element name="charstring" type="Templates:CharstringTemplate"/>
          <xsd:element name="universal_charstring"
            type="Templates:UniversalCharstringTemplate"/>
          <xsd:element name="record" type="Templates:RecordTemplate"/>
          <xsd:element name="record_of" type="Templates:RecordOfTemplate"/>
          <xsd:element name="array" type="Values:ArrayValue"/>
          <xsd:element name="set" type="Templates:SetTemplate"/>
          <xsd:element name="set_of" type="Templates:SetOfTemplate"/>
          <xsd:element name="enumerated" type="Templates:EnumeratedTemplate"/>
          <xsd:element name="union" type="Templates:UnionTemplate"/>
          <xsd:element name="anytype" type="Templates:AnytypeTemplate"/>
          <xsd:element name="address" type="Templates:AddressTemplate"/>
        </xsd:choice>
        <xsd:element name="omit" type="Templates:omit"/>
        <xsd:element name="any" type="Templates:any"/>
        <xsd:element name="anyoromit" type="Templates:anyoromit"/>
        <xsd:element name="templateDef" type="SimpleTypes:TString"/>
        <xsd:element name="null" type="Templates:null"/>
      </xsd:choice>
    </xsd:extension>
  </xsd:complexContent>
</xsd:complexType>

<xsd:complexType name="RecordOfTemplate">
  <xsd:complexContent>
    <xsd:extension base="Values:RecordOfValue">
      <xsd:choice minOccurs="0" maxOccurs="unbounded">
        <xsd:element name="integer" type="Templates:IntegerTemplate" minOccurs="0"
          maxOccurs="unbounded"/>
        <xsd:element name="float" type="Templates:FloatTemplate" minOccurs="0"
          maxOccurs="unbounded"/>
        <xsd:element name="boolean" type="Templates:BooleanTemplate" minOccurs="0"
          maxOccurs="unbounded"/>
        <xsd:element name="verdicttype" type="Templates:VerdictTemplate" minOccurs="0"
          maxOccurs="unbounded"/>
        <xsd:element name="bitstring" type="Templates:BitstringTemplate"
          minOccurs="0" maxOccurs="unbounded"/>
        <xsd:element name="hexstring" type="Templates:HexstringTemplate"
          minOccurs="0" maxOccurs="unbounded"/>
        <xsd:element name="octetstring" type="Templates:OctetstringTemplate"

```

```

        minOccurs="0" maxOccurs="unbounded"/>
<xsd:element name="charstring" type="Templates:CharstringTemplate"
minOccurs="0" maxOccurs="unbounded"/>
<xsd:element name="universal_charstring"
type="Templates:UniversalCharstringTemplate" minOccurs="0"
maxOccurs="unbounded"/>
<xsd:element name="record" type="Templates:RecordTemplate" minOccurs="0"
maxOccurs="unbounded"/>
<xsd:element name="record_of" type="Templates:RecordOfTemplate"
minOccurs="0" maxOccurs="unbounded"/>
<xsd:element name="array" type="Templates:ArrayTemplate" minOccurs="0"
maxOccurs="unbounded"/>
<xsd:element name="set" type="Templates:SetTemplate" minOccurs="0"
maxOccurs="unbounded"/>
<xsd:element name="set_of" type="Templates:SetOfTemplate"
minOccurs="0" maxOccurs="unbounded"/>
<xsd:element name="enumerated" type="Templates:EnumeratedTemplate"
minOccurs="0" maxOccurs="unbounded"/>
<xsd:element name="union" type="Templates:UnionTemplate" minOccurs="0"
maxOccurs="unbounded"/>
<xsd:element name="anytype" type="Templates:AnytypeTemplate" minOccurs="0"
maxOccurs="unbounded"/>
<xsd:element name="address" type="Templates:AddressTemplate" minOccurs="0"
maxOccurs="unbounded"/>
<xsd:element name="omit" type="Templates:omit"/>
<xsd:element name="any" type="Templates:any"/>
<xsd:element name="anyoromit" type="Templates:anyoromit"/>
<xsd:element name="templateDef" type="SimpleTypes:TString"/>
<xsd:element name="null" type="Templates:null"/>
</xsd:choice>
</xsd:extension>
</xsd:complexContent>
</xsd:complexType>

<xsd:complexType name="ArrayTemplate">
  <xsd:complexContent>
    <xsd:extension base="Values:ArrayValue">
      <xsd:choice minOccurs="0" maxOccurs="unbounded">
        <xsd:element name="integer" type="Templates:IntegerTemplate" minOccurs="0"
maxOccurs="unbounded"/>
        <xsd:element name="float" type="Templates:FloatTemplate" minOccurs="0"
maxOccurs="unbounded"/>
        <xsd:element name="boolean" type="Templates:BooleanTemplate" minOccurs="0"
maxOccurs="unbounded"/>
        <xsd:element name="verdicttype" type="Templates:VerdictTemplate" minOccurs="0"
maxOccurs="unbounded"/>
        <xsd:element name="bitstring" type="Templates:BitstringTemplate"
minOccurs="0" maxOccurs="unbounded"/>
        <xsd:element name="hexstring" type="Templates:HexstringTemplate"
minOccurs="0" maxOccurs="unbounded"/>
        <xsd:element name="octetstring" type="Templates:OctetstringTemplate"
minOccurs="0" maxOccurs="unbounded"/>
        <xsd:element name="charstring" type="Templates:CharstringTemplate"
minOccurs="0" maxOccurs="unbounded"/>
        <xsd:element name="universal_charstring"
type="Templates:UniversalCharstringTemplate" minOccurs="0"
maxOccurs="unbounded"/>
        <xsd:element name="record" type="Templates:RecordTemplate" minOccurs="0"
maxOccurs="unbounded"/>
        <xsd:element name="record_of" type="Templates:RecordOfTemplate"
minOccurs="0" maxOccurs="unbounded"/>
        <xsd:element name="array" type="Templates:ArrayTemplate" minOccurs="0"
maxOccurs="unbounded"/>
        <xsd:element name="set" type="Templates:SetTemplate" minOccurs="0"
maxOccurs="unbounded"/>
        <xsd:element name="set_of" type="Templates:SetOfTemplate"
minOccurs="0" maxOccurs="unbounded"/>
        <xsd:element name="enumerated" type="Templates:EnumeratedTemplate"
minOccurs="0" maxOccurs="unbounded"/>
        <xsd:element name="union" type="Templates:UnionTemplate" minOccurs="0"
maxOccurs="unbounded"/>
        <xsd:element name="anytype" type="Templates:AnytypeTemplate" minOccurs="0"
maxOccurs="unbounded"/>
        <xsd:element name="address" type="Templates:AddressTemplate" minOccurs="0"
maxOccurs="unbounded"/>
        <xsd:element name="omit" type="Templates:omit"/>
        <xsd:element name="any" type="Templates:any"/>
        <xsd:element name="anyoromit" type="Templates:anyoromit"/>
      </xsd:choice>
    </xsd:extension>
  </xsd:complexContent>
</xsd:complexType>

```

```

        <xsd:element name="templateDef" type="SimpleTypes:TString"/>
        <xsd:element name="null" type="Templates:null"/>
    </xsd:choice>
</xsd:extension>
</xsd:complexContent>
</xsd:complexType>

<xsd:complexType name="SetTemplate">
    <xsd:complexContent>
        <xsd:extension base="Values:SetValue">
            <xsd:choice>
                <xsd:choice minOccurs="0">
                    <xsd:element name="integer" type="Templates:IntegerTemplate"/>
                    <xsd:element name="float" type="Templates:FloatTemplate"/>
                    <xsd:element name="boolean" type="Templates:BooleanTemplate"/>
                    <xsd:element name="verdicttype" type="Templates:VerdictTemplate"/>
                    <xsd:element name="bitstring" type="Templates:BitstringTemplate"/>
                    <xsd:element name="hexstring" type="Templates:HexstringTemplate"/>
                    <xsd:element name="octetstring" type="Templates:OctetstringTemplate"/>
                    <xsd:element name="charstring" type="Templates:CharstringTemplate"/>
                    <xsd:element name="universal_charstring"
                        type="Templates:UniversalCharstringTemplate"/>
                    <xsd:element name="record" type="Templates:RecordTemplate"/>
                    <xsd:element name="record_of" type="Templates:RecordOfTemplate"/>
                    <xsd:element name="array" type="Templates:ArrayTemplate"/>
                    <xsd:element name="set" type="Templates:SetTemplate"/>
                    <xsd:element name="set_of" type="Templates:SetOfTemplate"/>
                    <xsd:element name="enumerated" type="Templates:EnumeratedTemplate"/>
                    <xsd:element name="union" type="Templates:UnionTemplate"/>
                    <xsd:element name="anytype" type="Templates:AnytypeTemplate"/>
                    <xsd:element name="address" type="Templates:AddressTemplate"/>
                </xsd:choice>
                <xsd:element name="omit" type="Templates:omit"/>
                <xsd:element name="any" type="Templates:any"/>
                <xsd:element name="anyoromit" type="Templates:anyoromit"/>
                <xsd:element name="templateDef" type="SimpleTypes:TString"/>
                <xsd:element name="null" type="Templates:null"/>
            </xsd:choice>
        </xsd:extension>
    </xsd:complexContent>
</xsd:complexType>

<xsd:complexType name="SetOfTemplate">
    <xsd:complexContent>
        <xsd:extension base="Values:SetOfValue">
            <xsd:choice minOccurs="0" maxOccurs="unbounded">
                <xsd:element name="integer" type="Templates:IntegerTemplate" minOccurs="0"
                    maxOccurs="unbounded"/>
                <xsd:element name="float" type="Templates:FloatTemplate" minOccurs="0"
                    maxOccurs="unbounded"/>
                <xsd:element name="boolean" type="Templates:BooleanTemplate" minOccurs="0"
                    maxOccurs="unbounded"/>
                <xsd:element name="verdicttype" type="Templates:VerdictTemplate" minOccurs="0"
                    maxOccurs="unbounded"/>
                <xsd:element name="bitstring" type="Templates:BitstringTemplate"
                    minOccurs="0" maxOccurs="unbounded"/>
                <xsd:element name="hexstring" type="Templates:HexstringTemplate"
                    minOccurs="0" maxOccurs="unbounded"/>
                <xsd:element name="octetstring" type="Templates:OctetstringTemplate"
                    minOccurs="0" maxOccurs="unbounded"/>
                <xsd:element name="charstring" type="Templates:CharstringTemplate"
                    minOccurs="0" maxOccurs="unbounded"/>
                <xsd:element name="universal_charstring"
                    type="Templates:UniversalCharstringTemplate" minOccurs="0"
                    maxOccurs="unbounded"/>
                <xsd:element name="record" type="Templates:RecordTemplate" minOccurs="0"
                    maxOccurs="unbounded"/>
                <xsd:element name="record_of" type="Templates:RecordOfTemplate"
                    minOccurs="0" maxOccurs="unbounded"/>
                <xsd:element name="array" type="Templates:ArrayTemplate" minOccurs="0"
                    maxOccurs="unbounded"/>
                <xsd:element name="set" type="Templates:SetTemplate" minOccurs="0"
                    maxOccurs="unbounded"/>
                <xsd:element name="set_of" type="Templates:SetOfTemplate"
                    minOccurs="0" maxOccurs="unbounded"/>
                <xsd:element name="enumerated" type="Templates:EnumeratedTemplate"
                    minOccurs="0" maxOccurs="unbounded"/>
                <xsd:element name="union" type="Templates:UnionTemplate" minOccurs="0"
                    maxOccurs="unbounded"/>
            </xsd:choice>
        </xsd:extension>
    </xsd:complexContent>
</xsd:complexType>

```

```

        maxOccurs="unbounded"/>
<xsd:element name="anytype" type="Templates:AnytypeTemplate" minOccurs="0"
maxOccurs="unbounded"/>
<xsd:element name="address" type="Templates:AddressTemplate" minOccurs="0"
maxOccurs="unbounded"/>
<xsd:element name="omit" type="Templates:omit"/>
<xsd:element name="any" type="Templates:any"/>
<xsd:element name="anyoromit" type="Templates:anyoromit"/>
<xsd:element name="templateDef" type="SimpleTypes:TString"/>
<xsd:element name="null" type="Templates:null"/>
    </xsd:choice>
</xsd:extension>
</xsd:complexContent>
</xsd:complexType>

<xsd:complexType name="EnumeratedTemplate">
    <xsd:complexContent>
        <xsd:extension base="Values:EnumeratedValue">
            <xsd:choice minOccurs="0">
                <xsd:element name="value" type="SimpleTypes:TString"/>
                <xsd:element name="templateDef" type="SimpleTypes:TString"/>
                <xsd:element name="omit" type="Templates:omit"/>
                <xsd:element name="any" type="Templates:any"/>
                <xsd:element name="anyoromit" type="Templates:anyoromit"/>
                <xsd:element name="null" type="Templates:null"/>
            </xsd:choice>
        </xsd:extension>
    </xsd:complexContent>
</xsd:complexType>

<xsd:complexType name="UnionTemplate">
    <xsd:complexContent>
        <xsd:extension base="Values:UnionValue">
            <xsd:choice minOccurs="0">
                <xsd:element name="integer" type="Templates:IntegerTemplate"/>
                <xsd:element name="float" type="Templates:FloatTemplate"/>
                <xsd:element name="boolean" type="Templates:BooleanTemplate"/>
                <xsd:element name="verdicttype" type="Templates:VerdictTemplate"/>
                <xsd:element name="bitstring" type="Templates:BitstringTemplate"/>
                <xsd:element name="hexstring" type="Templates:HexstringTemplate"/>
                <xsd:element name="octetstring" type="Templates:OctetstringTemplate"/>
                <xsd:element name="charstring" type="Templates:CharstringTemplate"/>
                <xsd:element name="universal_charstring"
                    type="Templates:UniversalCharstringTemplate"/>
                <xsd:element name="record" type="Templates:RecordTemplate"/>
                <xsd:element name="record_of" type="Templates:RecordOfTemplate"/>
                <xsd:element name="array" type="Templates:ArrayTemplate"/>
                <xsd:element name="set" type="Templates:SetTemplate"/>
                <xsd:element name="set_of" type="Templates:SetOfTemplate"/>
                <xsd:element name="enumerated" type="Templates:EnumeratedTemplate"/>
                <xsd:element name="union" type="Templates:UnionTemplate"/>
                <xsd:element name="anytype" type="Templates:AnytypeTemplate"/>
                <xsd:element name="address" type="Templates:AddressTemplate"/>
                <xsd:element name="omit" type="Templates:omit"/>
                <xsd:element name="any" type="Templates:any"/>
                <xsd:element name="anyoromit" type="Templates:anyoromit"/>
                <xsd:element name="templateDef" type="SimpleTypes:TString"/>
                <xsd:element name="null" type="Templates:null"/>
            </xsd:choice>
        </xsd:extension>
    </xsd:complexContent>
</xsd:complexType>

<xsd:complexType name="AnytypeTemplate">
    <xsd:complexContent>
        <xsd:extension base="Values:AnytypeValue">
            <xsd:choice minOccurs="0">
                <xsd:element name="integer" type="Templates:IntegerTemplate"/>
                <xsd:element name="float" type="Templates:FloatTemplate"/>
                <xsd:element name="boolean" type="Templates:BooleanTemplate"/>
                <xsd:element name="verdicttype" type="Templates:VerdictTemplate"/>
                <xsd:element name="bitstring" type="Templates:BitstringTemplate"/>
                <xsd:element name="hexstring" type="Templates:HexstringTemplate"/>
                <xsd:element name="octetstring" type="Templates:OctetstringTemplate"/>
                <xsd:element name="charstring" type="Templates:CharstringTemplate"/>
                <xsd:element name="universal_charstring"
                    type="Templates:UniversalCharstringTemplate"/>
                <xsd:element name="record" type="Templates:RecordTemplate"/>
            </xsd:choice>
        </xsd:extension>
    </xsd:complexContent>
</xsd:complexType>

```



```

<xsd:element name="record_of" type="Templates:RecordOfTemplate"/>
<xsd:element name="array" type="Templates:ArrayTemplate"/>
<xsd:element name="set" type="Templates:SetTemplate"/>
<xsd:element name="set_of" type="Templates:SetOfTemplate"/>
<xsd:element name="enumerated" type="Templates:EnumeratedTemplate"/>
<xsd:element name="union" type="Templates:UnionTemplate"/>
<xsd:element name="address" type="Templates:AddressTemplate"/>
<xsd:element name="omit" type="Templates:omit"/>
<xsd:element name="any" type="Templates:any"/>
<xsd:element name="anyoromit" type="Templates:anyoromit"/>
<xsd:element name="templateDef" type="SimpleTypes:TString"/>
<xsd:element name="null" type="Templates:null"/>
</xsd:choice>
</xsd:extension>
</xsd:complexContent>
</xsd:complexType>

<xsd:complexType name="AddressTemplate">
  <xsd:complexContent>
    <xsd:extension base="Values:AnytypeValue">
      <xsd:choice minOccurs="0">
        <xsd:element name="integer" type="Templates:IntegerTemplate"/>
        <xsd:element name="float" type="Templates:FloatTemplate"/>
        <xsd:element name="boolean" type="Templates:BooleanTemplate"/>
        <xsd:element name="bitstring" type="Templates:BitstringTemplate"/>
        <xsd:element name="hexstring" type="Templates:HexstringTemplate"/>
        <xsd:element name="octetstring" type="Templates:OctetstringTemplate"/>
        <xsd:element name="charstring" type="Templates:CharstringTemplate"/>
        <xsd:element name="universal_charstring"
          type="Templates:UniversalCharstringTemplate"/>
        <xsd:element name="record" type="Templates:RecordTemplate"/>
        <xsd:element name="record_of" type="Templates:RecordOfTemplate"/>
        <xsd:element name="array" type="Templates:ArrayTemplate"/>
        <xsd:element name="set" type="Templates:SetTemplate"/>
        <xsd:element name="set_of" type="Templates:SetOfTemplate"/>
        <xsd:element name="enumerated" type="Templates:EnumeratedTemplate"/>
        <xsd:element name="union" type="Templates:UnionTemplate"/>
        <xsd:element name="anytype" type="Templates:AnytypeTemplate"/>
        <xsd:element name="omit" type="Templates:omit"/>
        <xsd:element name="any" type="Templates:any"/>
        <xsd:element name="anyoromit" type="Templates:anyoromit"/>
        <xsd:element name="templateDef" type="SimpleTypes:TString"/>
        <xsd:element name="null" type="Templates:null"/>
      </xsd:choice>
    </xsd:extension>
  </xsd:complexContent>
</xsd:complexType>
</xsd:schema>

```

B.5 TCI-TL XML Schema for Events

```

<?xml version="1.0" encoding="UTF-8"?>
<xsd:schema xmlns:xsd="http://www.w3.org/2001/XMLSchema"
  targetNamespace="http://uri.etsi.org/ttcn-3/tci/Events_v4_4_1.xsd"
  xmlns:Events="http://uri.etsi.org/ttcn-3/tci/Events_v4_4_1.xsd"
  xmlns:Types="http://uri.etsi.org/ttcn-3/tci/Types_v4_4_1.xsd"
  xmlns:Templates="http://uri.etsi.org/ttcn-3/tci/Templates_v4_4_1.xsd"
  xmlns:SimpleTypes="http://uri.etsi.org/ttcn-3/tci/SimpleTypes_v4_4_1.xsd"
  xmlns:Values="http://uri.etsi.org/ttcn-3/tci/Values_v4_4_1.xsd"
  elementFormDefault="qualified">

  <xsd:import namespace="http://uri.etsi.org/ttcn-3/tci/SimpleTypes_v4_4_1.xsd"
    schemaLocation="SimpleTypes_v4_4_1.xsd"/>
  <xsd:import namespace="http://uri.etsi.org/ttcn-3/tci/Types_v4_4_1.xsd"
    schemaLocation="Types_v4_4_1.xsd"/>
  <xsd:import namespace="http://uri.etsi.org/ttcn-3/tci/Values_v4_4_1.xsd"
    schemaLocation="Values_v4_4_1.xsd"/>
  <xsd:import namespace="http://uri.etsi.org/ttcn-3/tci/Templates_v4_4_1.xsd"
    schemaLocation="Templates_v4_4_1.xsd"/>

  <!-- common definition for all events -->
  <xsd:complexType name="Event" mixed="true">
    <xsd:sequence>
      <xsd:element name="am" type="SimpleTypes:TString"/>
    </xsd:sequence>

```

```

<xsd:attribute name="ts" type="xsd:long" use="required"/>
<xsd:attribute name="src" type="SimpleTypes:TString" use="optional"/>
<xsd:attribute name="line" type="SimpleTypes:TInteger" use="optional"/>

<!-- general identifier structure for test components, ports and timer -->
<xsd:attribute name="name" type="SimpleTypes:TString" use="required"/>
<xsd:attribute name="id" type="SimpleTypes:TString" use="required"/>
<xsd:attribute name="type" type="SimpleTypes:TString" use="required"/>
</xsd:complexType>

<!-- this event is extended by all port configuration events -->
<xsd:complexType name="PortConfiguration">
  <xsd:complexContent mixed="true">
    <xsd:extension base="Events:Event">
      <xsd:sequence>
        <xsd:element name="port1" type="Types:TriPortIdType" />
        <xsd:element name="port2" type="Types:TriPortIdType" />
      </xsd:sequence>
    </xsd:extension>
  </xsd:complexContent>
</xsd:complexType>

<!-- this event is extended by all port status events -->
<xsd:complexType name="PortStatus">
  <xsd:complexContent mixed="true">
    <xsd:extension base="Events:Event">
      <xsd:sequence>
        <xsd:element name="port" type="Types:TriPortIdType"/>
        <xsd:element name="stat" type="SimpleTypes:PortStatusType" minOccurs="0"/>
      </xsd:sequence>
    </xsd:extension>
  </xsd:complexContent>
</xsd:complexType>

<!-- testcases -->
<xsd:complexType name="tliTcExecute">
  <xsd:complexContent mixed="true">
    <xsd:extension base="Events:Event">
      <xsd:sequence>
        <xsd:element name="tcId" type="Types:TciTestCaseIdType"/>
        <xsd:element name="tciPars" type="Types:TciParameterListType" minOccurs="0"/>
        <xsd:element name="dur" type="SimpleTypes:TriTimerDurationType" minOccurs="0"/>
      </xsd:sequence>
    </xsd:extension>
  </xsd:complexContent>
</xsd:complexType>

<xsd:complexType name="tliTcStart">
  <xsd:complexContent mixed="true">
    <xsd:extension base="Events:Event">
      <xsd:sequence>
        <xsd:element name="tcId" type="Types:TciTestCaseIdType"/>
        <xsd:element name="tciPars" type="Types:TciParameterListType" minOccurs="0"/>
        <xsd:element name="dur" type="SimpleTypes:TriTimerDurationType" minOccurs="0"/>
      </xsd:sequence>
    </xsd:extension>
  </xsd:complexContent>
</xsd:complexType>

<xsd:complexType name="tliTcStop">
  <xsd:complexContent mixed="true">
    <xsd:extension base="Events:Event"/>
    <xsd:sequence>
      <xsd:element name="reason" type="SimpleTypes:TString" minOccurs="0"/>
    </xsd:sequence>
  </xsd:complexContent>
</xsd:complexType>

<xsd:complexType name="tliTcStarted">
  <xsd:complexContent mixed="true">
    <xsd:extension base="Events:Event">
      <xsd:sequence>
        <xsd:element name="tcId" type="Types:TciTestCaseIdType"/>
        <xsd:element name="tciPars" type="Types:TciParameterListType" minOccurs="0"/>
        <xsd:element name="dur" type="SimpleTypes:TriTimerDurationType" minOccurs="0"/>
      </xsd:sequence>
    </xsd:extension>
  </xsd:complexContent>

```

```

</xsd:complexType>

<xsd:complexType name="tliTcTerminated">
  <xsd:complexContent mixed="true">
    <xsd:extension base="Events:Event">
      <xsd:sequence>
        <xsd:element name="tcId" type="Types:TciTestCaseIdType"/>
        <xsd:element name="tciPars" type="Types:TciParameterListType" minOccurs="0"/>
        <xsd:element name="verdict" type="Values:VerdictValue"/>
        <xsd:element name="reason" type="SimpleTypes:TString" minOccurs="0"/>
      </xsd:sequence>
    </xsd:extension>
  </xsd:complexContent>
</xsd:complexType>

<!-- control -->
<xsd:complexType name="tliCtrlStart">
  <xsd:complexContent>
    <xsd:extension base="Events:Event"/>
  </xsd:complexContent>
</xsd:complexType>

<xsd:complexType name="tliCtrlStop">
  <xsd:complexContent>
    <xsd:extension base="Events:Event"/>
  </xsd:complexContent>
</xsd:complexType>

<xsd:complexType name="tliCtrlTerminated">
  <xsd:complexContent>
    <xsd:extension base="Events:Event"/>
  </xsd:complexContent>
</xsd:complexType>

<!-- asynchronous communication -->
<xsd:complexType name="tliMSend_m">
  <xsd:complexContent mixed="true">
    <xsd:extension base="Events:Event">
      <xsd:sequence>
        <xsd:element name="at" type="Types:TriPortIdType"/>
        <xsd:element name="to" type="Types:TriPortIdType" minOccurs="0"/>
        <xsd:element name="msgValue" type="Values:Value"/>
        <xsd:element name="addrValue" type="Values:Value" minOccurs="0"/>
        <xsd:choice>
          <xsd:element name="encoder-failure" type="SimpleTypes:TciStatusType"
minOccurs="0"/>
          <xsd:sequence>
            <xsd:element name="msg" type="Types:TriMessageType" minOccurs="0"/>
            <xsd:element name="address" type="Types:TriAddressType" minOccurs="0"/>
            <xsd:element name="transmission-failure"
type="SimpleTypes:TriStatusType" minOccurs="0"/>
          </xsd:sequence>
        </xsd:choice>
      </xsd:sequence>
    </xsd:extension>
  </xsd:complexContent>
</xsd:complexType>

<xsd:complexType name="tliMSend_m_BC">
  <xsd:complexContent mixed="true">
    <xsd:extension base="Events:Event">
      <xsd:sequence>
        <xsd:element name="at" type="Types:TriPortIdType"/>
        <xsd:element name="to" type="Types:TriPortIdType" minOccurs="0"/>
        <xsd:element name="msgValue" type="Values:Value"/>
        <xsd:choice>
          <xsd:element name="encoder-failure" type="SimpleTypes:TciStatusType"
minOccurs="0"/>
          <xsd:sequence>
            <xsd:element name="msg" type="Types:TriMessageType" minOccurs="0"/>
            <xsd:element name="transmission-failure"
type="SimpleTypes:TriStatusType" minOccurs="0"/>
          </xsd:sequence>
        </xsd:choice>
      </xsd:sequence>
    </xsd:extension>
  </xsd:complexContent>
</xsd:complexType>

```

```

<xsd:complexType name="tliMSend_m_MC">
  <xsd:complexContent mixed="true">
    <xsd:extension base="Events:Event">
      <xsd:sequence>
        <xsd:element name="at" type="Types:TriPortIdType"/>
        <xsd:element name="to" type="Types:TriPortIdType" minOccurs="0"/>
        <xsd:element name="msgValue" type="Values:Value"/>
        <xsd:element name="addrValues" type="Types:TciValueListType" minOccurs="0"/>
        <xsd:choice>
          <xsd:element name="encoder-failure" type="SimpleTypes:TciStatusType"
minOccurs="0"/>
          <xsd:sequence>
            <xsd:element name="msg" type="Types:TriMessageType" minOccurs="0"/>
            <xsd:element name="addresses" type="Types:TriAddressListType"
minOccurs="0"/>
            <xsd:element name="transmission-failure"
type="SimpleTypes:TriStatusType" minOccurs="0"/>
          </xsd:sequence>
        </xsd:choice>
      </xsd:sequence>
    </xsd:extension>
  </xsd:complexContent>
</xsd:complexType>

<xsd:complexType name="tliMSend_c">
  <xsd:complexContent mixed="true">
    <xsd:extension base="Events:Event">
      <xsd:sequence>
        <xsd:element name="at" type="Types:TriPortIdType"/>
        <xsd:element name="to" type="Types:TriPortIdType" minOccurs="0"/>
        <xsd:element name="msgValue" type="Values:Value"/>
        <xsd:element name="transmission-failure" type="SimpleTypes:TriStatusType"
minOccurs="0"/>
      </xsd:sequence>
    </xsd:extension>
  </xsd:complexContent>
</xsd:complexType>

<xsd:complexType name="tliMSend_c_BC">
  <xsd:complexContent mixed="true">
    <xsd:extension base="Events:Event">
      <xsd:sequence>
        <xsd:element name="at" type="Types:TriPortIdType"/>
        <xsd:element name="to" type="Types:TriPortIdListType" minOccurs="0"/>
        <xsd:element name="msgValue" type="Values:Value"/>
        <xsd:element name="transmission-failure" type="SimpleTypes:TriStatusType"
minOccurs="0"/>
      </xsd:sequence>
    </xsd:extension>
  </xsd:complexContent>
</xsd:complexType>

<xsd:complexType name="tliMSend_c_MC">
  <xsd:complexContent mixed="true">
    <xsd:extension base="Events:Event">
      <xsd:sequence>
        <xsd:element name="at" type="Types:TriPortIdType"/>
        <xsd:element name="to" type="Types:TriPortIdListType" minOccurs="0"/>
        <xsd:element name="msgValue" type="Values:Value"/>
        <xsd:element name="transmission-failure" type="SimpleTypes:TriStatusType"
minOccurs="0"/>
      </xsd:sequence>
    </xsd:extension>
  </xsd:complexContent>
</xsd:complexType>

<xsd:complexType name="tliMDetected_m">
  <xsd:complexContent mixed="true">
    <xsd:extension base="Events:Event">
      <xsd:sequence>
        <xsd:element name="at" type="Types:TriPortIdType"/>
        <xsd:element name="from" type="Types:TriPortIdType" minOccurs="0"/>
        <xsd:element name="msgValue" type="Types:TriMessageType"/>
        <xsd:element name="address" type="Types:TriAddressType" minOccurs="0"/>
      </xsd:sequence>
    </xsd:extension>
  </xsd:complexContent>

```

```

</xsd:complexType>

<xsd:complexType name="tliMDetected_c">
  <xsd:complexContent mixed="true">
    <xsd:extension base="Events:Event">
      <xsd:sequence>
        <xsd:element name="at" type="Types:TriPortIdType"/>
        <xsd:element name="from" type="Types:TriPortIdType" minOccurs="0"/>
        <xsd:element name="msgValue" type="Values:Value"/>
      </xsd:sequence>
    </xsd:extension>
  </xsd:complexContent>
</xsd:complexType>

<xsd:complexType name="tliMMismatch_m">
  <xsd:complexContent mixed="true">
    <xsd:extension base="Events:Event">
      <xsd:sequence>
        <xsd:element name="at" type="Types:TriPortIdType"/>
        <xsd:element name="msgValue" type="Values:Value"/>
        <xsd:element name="msgTpl" type="Templates:TciValueTemplate"/>
        <xsd:element name="diffs" type="Templates:TciValueDifferenceList"/>
        <xsd:element name="addrValue" type="Values:Value" minOccurs="0"/>
        <xsd:element name="addressTpl" type="Templates:TciValueTemplate"
minOccurs="0"/>
      </xsd:sequence>
    </xsd:extension>
  </xsd:complexContent>
</xsd:complexType>

<xsd:complexType name="tliMMismatch_c">
  <xsd:complexContent mixed="true">
    <xsd:extension base="Events:Event">
      <xsd:sequence>
        <xsd:element name="at" type="Types:TriPortIdType"/>
        <xsd:element name="msgValue" type="Values:Value"/>
        <xsd:element name="msgTpl" type="Templates:TciValueTemplate"/>
        <xsd:element name="diffs" type="Templates:TciValueDifferenceList"/>
        <xsd:element name="from" type="Types:TriComponentIdType" minOccurs="0"/>
        <xsd:element name="fromTpl" type="Templates:TciNonValueTemplate"
minOccurs="0"/>
      </xsd:sequence>
    </xsd:extension>
  </xsd:complexContent>
</xsd:complexType>

<xsd:complexType name="tliMReceive_m">
  <xsd:complexContent mixed="true">
    <xsd:extension base="Events:Event">
      <xsd:sequence>
        <xsd:element name="at" type="Types:TriPortIdType"/>
        <xsd:element name="msgValue" type="Values:Value" minOccurs="0"/>
        <xsd:element name="msgTpl" type="Templates:TciValueTemplate"
minOccurs="0"/>
        <xsd:element name="addrValue" type="Values:Value" minOccurs="0"/>
        <xsd:element name="addressTpl" type="Templates:TciValueTemplate"
minOccurs="0"/>
      </xsd:sequence>
    </xsd:extension>
  </xsd:complexContent>
</xsd:complexType>

<xsd:complexType name="tliMReceive_c">
  <xsd:complexContent mixed="true">
    <xsd:extension base="Events:Event">
      <xsd:sequence>
        <xsd:element name="at" type="Types:TriPortIdType"/>
        <xsd:element name="msgValue" type="Values:Value" minOccurs="0"/>
        <xsd:element name="msgTpl" type="Templates:TciValueTemplate"
minOccurs="0"/>
        <xsd:element name="from" type="Types:TriComponentIdType" minOccurs="0"/>
        <xsd:element name="fromTpl" type="Templates:TciNonValueTemplate"
minOccurs="0"/>
      </xsd:sequence>
    </xsd:extension>
  </xsd:complexContent>
</xsd:complexType>

```

```

<!-- synchronous communication -->
<xsd:complexType name="tliPrCall_m">
  <xsd:complexContent mixed="true">
    <xsd:extension base="Events:Event">
      <xsd:sequence>
        <xsd:element name="at" type="Types:TriPortIdType"/>
        <xsd:element name="to" type="Types:TriPortIdType" minOccurs="0"/>
        <xsd:element name="signature" type="Types:TriSignatureIdType"/>
        <xsd:element name="tciPars" type="Types:TciParameterListType" minOccurs="0"/>
        <xsd:element name="addrValue" type="Values:Value" minOccurs="0"/>
        <xsd:choice>
          <xsd:element name="encoder-failure" type="SimpleTypes:TciStatusType"
minOccurs="0"/>
          <xsd:sequence>
            <xsd:element name="triPars" type="Types:TriParameterListType"
minOccurs="0"/>
            <xsd:element name="address" type="Types:TriAddressType" minOccurs="0"/>
            <xsd:element name="transmission-failure"
type="SimpleTypes:TriStatusType" minOccurs="0"/>
          </xsd:sequence>
        </xsd:choice>
      </xsd:sequence>
    </xsd:extension>
  </xsd:complexContent>
</xsd:complexType>

<xsd:complexType name="tliPrCall_m_BC">
  <xsd:complexContent mixed="true">
    <xsd:extension base="Events:Event">
      <xsd:sequence>
        <xsd:element name="at" type="Types:TriPortIdType"/>
        <xsd:element name="to" type="Types:TriPortIdType" minOccurs="0"/>
        <xsd:element name="signature" type="Types:TriSignatureIdType"/>
        <xsd:element name="tciPars" type="Types:TciParameterListType" minOccurs="0"/>
        <xsd:choice>
          <xsd:element name="encoder-failure" type="SimpleTypes:TciStatusType"
minOccurs="0"/>
          <xsd:sequence>
            <xsd:element name="triPars" type="Types:TriParameterListType"
minOccurs="0"/>
            <xsd:element name="transmission-failure"
type="SimpleTypes:TriStatusType" minOccurs="0"/>
          </xsd:sequence>
        </xsd:choice>
      </xsd:sequence>
    </xsd:extension>
  </xsd:complexContent>
</xsd:complexType>

<xsd:complexType name="tliPrCall_m_MC">
  <xsd:complexContent mixed="true">
    <xsd:extension base="Events:Event">
      <xsd:sequence>
        <xsd:element name="at" type="Types:TriPortIdType"/>
        <xsd:element name="to" type="Types:TriPortIdType" minOccurs="0"/>
        <xsd:element name="signature" type="Types:TriSignatureIdType"/>
        <xsd:element name="tciPars" type="Types:TciParameterListType" minOccurs="0"/>
        <xsd:element name="addrValues" type="Types:TciValueListType" minOccurs="0"/>
        <xsd:choice>
          <xsd:element name="encoder-failure" type="SimpleTypes:TciStatusType"
minOccurs="0"/>
          <xsd:sequence>
            <xsd:element name="triPars" type="Types:TriParameterListType"
minOccurs="0"/>
            <xsd:element name="addresses" type="Types:TriAddressListType"
minOccurs="0"/>
            <xsd:element name="transmission-failure"
type="SimpleTypes:TriStatusType" minOccurs="0"/>
          </xsd:sequence>
        </xsd:choice>
      </xsd:sequence>
    </xsd:extension>
  </xsd:complexContent>
</xsd:complexType>

<xsd:complexType name="tliPrCall_c">
  <xsd:complexContent mixed="true">
    <xsd:extension base="Events:Event">

```

```

    <xsd:sequence>
      <xsd:element name="at" type="Types:TriPortIdType"/>
      <xsd:element name="to" type="Types:TriPortIdType" minOccurs="0"/>
      <xsd:element name="signature" type="Types:TriSignatureIdType"/>
      <xsd:element name="tciPars" type="Types:TciParameterListType" minOccurs="0"/>
      <xsd:element name="transmission-failure" type="SimpleTypes:TriStatusType"
minOccurs="0"/>
    </xsd:sequence>
  </xsd:extension>
</xsd:complexType>

<xsd:complexType name="tliPrCall_c_BC">
  <xsd:complexContent mixed="true">
    <xsd:extension base="Events:Event">
      <xsd:sequence>
        <xsd:element name="at" type="Types:TriPortIdType"/>
        <xsd:element name="to" type="Types:TriPortIdListType" minOccurs="0"/>
        <xsd:element name="signature" type="Types:TriSignatureIdType"/>
        <xsd:element name="tciPars" type="Types:TciParameterListType" minOccurs="0"/>
        <xsd:element name="transmission-failure" type="SimpleTypes:TriStatusType"
minOccurs="0"/>
      </xsd:sequence>
    </xsd:extension>
  </xsd:complexType>

<xsd:complexType name="tliPrCall_c_MC">
  <xsd:complexContent mixed="true">
    <xsd:extension base="Events:Event">
      <xsd:sequence>
        <xsd:element name="at" type="Types:TriPortIdType"/>
        <xsd:element name="to" type="Types:TriPortIdListType" minOccurs="0"/>
        <xsd:element name="signature" type="Types:TriSignatureIdType"/>
        <xsd:element name="tciPars" type="Types:TciParameterListType" minOccurs="0"/>
        <xsd:element name="transmission-failure" type="SimpleTypes:TriStatusType"
minOccurs="0"/>
      </xsd:sequence>
    </xsd:extension>
  </xsd:complexType>

<xsd:complexType name="tliPrGetCallDetected_m">
  <xsd:complexContent mixed="true">
    <xsd:extension base="Events:Event">
      <xsd:sequence>
        <xsd:element name="at" type="Types:TriPortIdType"/>
        <xsd:element name="from" type="Types:TriPortIdType" minOccurs="0"/>
        <xsd:element name="signature" type="Types:TriSignatureIdType"/>
        <xsd:element name="triPars" type="Types:TriParameterListType" minOccurs="0"/>
        <xsd:element name="address" type="Types:TriAddressType" minOccurs="0"/>
      </xsd:sequence>
    </xsd:extension>
  </xsd:complexType>

<xsd:complexType name="tliPrGetCallDetected_c">
  <xsd:complexContent mixed="true">
    <xsd:extension base="Events:Event">
      <xsd:sequence>
        <xsd:element name="at" type="Types:TriPortIdType"/>
        <xsd:element name="from" type="Types:TriPortIdType" minOccurs="0"/>
        <xsd:element name="signature" type="Types:TriSignatureIdType"/>
        <xsd:element name="tciPars" type="Types:TciParameterListType" minOccurs="0"/>
      </xsd:sequence>
    </xsd:extension>
  </xsd:complexType>

<xsd:complexType name="tliPrGetCallMismatch_m">
  <xsd:complexContent mixed="true">
    <xsd:extension base="Events:Event">
      <xsd:sequence>
        <xsd:element name="at" type="Types:TriPortIdType"/>
        <xsd:element name="signature" type="Types:TriSignatureIdType"/>
        <xsd:element name="tciPars" type="Types:TciParameterListType" minOccurs="0"/>
        <xsd:element name="parsTpl" type="Templates:TciValueTemplate" minOccurs="0"/>
        <xsd:element name="diffs" type="Templates:TciValueDifferenceList"/>

```

```

        <xsd:element name="addrValue" type="Values:Value" minOccurs="0"/>
        <xsd:element name="addressTmpl" type="Templates:TciValueTemplate"
minOccurs="0"/>
    </xsd:sequence>
</xsd:extension>
</xsd:complexContent>
</xsd:complexType>

<xsd:complexType name="tliPrGetCallMismatch_c">
    <xsd:complexContent mixed="true">
        <xsd:extension base="Events:Event">
            <xsd:sequence>
                <xsd:element name="at" type="Types:TriPortIdType"/>
                <xsd:element name="signature" type="Types:TriSignatureIdType"/>
                <xsd:element name="tciPars" type="Types:TciParameterListType" minOccurs="0"/>
                <xsd:element name="parsTmpl" type="Templates:TciValueTemplate" minOccurs="0"/>
                <xsd:element name="diffs" type="Templates:TciValueDifferenceList"/>
                <xsd:element name="from" type="Types:TriComponentIdType" minOccurs="0"/>
                <xsd:element name="fromTmpl" type="Templates:TciValueTemplate" minOccurs="0"/>
            </xsd:sequence>
        </xsd:extension>
    </xsd:complexContent>
</xsd:complexType>

<xsd:complexType name="tliPrGetCall_m">
    <xsd:complexContent mixed="true">
        <xsd:extension base="Events:Event">
            <xsd:sequence>
                <xsd:element name="at" type="Types:TriPortIdType"/>
                <xsd:element name="signature" type="Types:TriSignatureIdType"/>
                <xsd:element name="tciPars" type="Types:TciParameterListType" minOccurs="0"/>
                <xsd:element name="parsTmpl" type="Templates:TciValueTemplate" minOccurs="0"/>
                <xsd:element name="addrValue" type="Values:Value" minOccurs="0"/>
                <xsd:element name="addressTmpl" type="Templates:TciValueTemplate"
minOccurs="0"/>
            </xsd:sequence>
        </xsd:extension>
    </xsd:complexContent>
</xsd:complexType>

<xsd:complexType name="tliPrGetCall_c">
    <xsd:complexContent mixed="true">
        <xsd:extension base="Events:Event">
            <xsd:sequence>
                <xsd:element name="at" type="Types:TriPortIdType"/>
                <xsd:element name="signature" type="Types:TriSignatureIdType"/>
                <xsd:element name="tciPars" type="Types:TciParameterListType" minOccurs="0"/>
                <xsd:element name="parsTmpl" type="Templates:TciValueTemplate" minOccurs="0"/>
                <xsd:element name="from" type="Types:TriComponentIdType" minOccurs="0"/>
                <xsd:element name="fromTmpl" type="Templates:TciNonValueTemplate"
minOccurs="0"/>
            </xsd:sequence>
        </xsd:extension>
    </xsd:complexContent>
</xsd:complexType>

<xsd:complexType name="tliPrReply_m">
    <xsd:complexContent mixed="true">
        <xsd:extension base="Events:Event">
            <xsd:sequence>
                <xsd:element name="at" type="Types:TriPortIdType"/>
                <xsd:element name="to" type="Types:TriPortIdType" minOccurs="0"/>
                <xsd:element name="signature" type="Types:TriSignatureIdType"/>
                <xsd:element name="tciPars" type="Types:TciParameterListType" minOccurs="0"/>
                <xsd:element name="replValue" type="Values:Value" minOccurs="0"/>
                <xsd:element name="addrValue" type="Values:Value" minOccurs="0"/>
                <xsd:choice>
                    <xsd:element name="encoder-failure" type="SimpleTypes:TciStatusType"
minOccurs="0"/>
                    <xsd:sequence>
                        <xsd:element name="triPars" type="Types:TriParameterListType"
minOccurs="0"/>
                        <xsd:element name="repl" type="Types:TriParameterType" minOccurs="0"/>
                        <xsd:element name="address" type="Types:TriAddressType" minOccurs="0"/>
                        <xsd:element name="transmission-failure"
type="SimpleTypes:TciStatusType" minOccurs="0"/>
                    </xsd:sequence>
                </xsd:choice>
            </xsd:sequence>
        </xsd:extension>
    </xsd:complexContent>
</xsd:complexType>

```



```

        </xsd:sequence>
      </xsd:extension>
    </xsd:complexContent>
  </xsd:complexType>

  <xsd:complexType name="tliPrReply_m_BC">
    <xsd:complexContent mixed="true">
      <xsd:extension base="Events:Event">
        <xsd:sequence>
          <xsd:element name="at" type="Types:TriPortIdType"/>
          <xsd:element name="to" type="Types:TriPortIdType" minOccurs="0"/>
          <xsd:element name="signature" type="Types:TriSignatureIdType"/>
          <xsd:element name="tciPars" type="Types:TciParameterListType" minOccurs="0"/>
          <xsd:element name="replValue" type="Values:Value" minOccurs="0"/>
          <xsd:choice>
            <xsd:element name="encoder-failure" type="SimpleTypes:TciStatusType"
              minOccurs="0"/>
            <xsd:sequence>
              <xsd:element name="triPars" type="Types:TriParameterListType"
                minOccurs="0"/>
              <xsd:element name="repl" type="Types:TriParameterType" minOccurs="0"/>
              <xsd:element name="transmission-failure"
                type="SimpleTypes:TriStatusType" minOccurs="0"/>
            </xsd:sequence>
          </xsd:choice>
        </xsd:sequence>
      </xsd:extension>
    </xsd:complexContent>
  </xsd:complexType>

  <xsd:complexType name="tliPrReply_m_MC">
    <xsd:complexContent mixed="true">
      <xsd:extension base="Events:Event">
        <xsd:sequence>
          <xsd:element name="at" type="Types:TriPortIdType"/>
          <xsd:element name="to" type="Types:TriPortIdType" minOccurs="0"/>
          <xsd:element name="signature" type="Types:TriSignatureIdType"/>
          <xsd:element name="tciPars" type="Types:TciParameterListType" minOccurs="0"/>
          <xsd:element name="replValue" type="Values:Value" minOccurs="0"/>
          <xsd:element name="addrValues" type="Types:TciValueListType" minOccurs="0"/>
          <xsd:choice>
            <xsd:element name="encoder-failure" type="SimpleTypes:TciStatusType"
              minOccurs="0"/>
            <xsd:sequence>
              <xsd:element name="triPars" type="Types:TriParameterListType"
                minOccurs="0"/>
              <xsd:element name="repl" type="Types:TriParameterType" minOccurs="0"/>
              <xsd:element name="addresses" type="Types:TriAddressListType"
                minOccurs="0"/>
              <xsd:element name="transmission-failure"
                type="SimpleTypes:TriStatusType" minOccurs="0"/>
            </xsd:sequence>
          </xsd:choice>
        </xsd:sequence>
      </xsd:extension>
    </xsd:complexContent>
  </xsd:complexType>

  <xsd:complexType name="tliPrReply_c">
    <xsd:complexContent mixed="true">
      <xsd:extension base="Events:Event">
        <xsd:sequence>
          <xsd:element name="at" type="Types:TriPortIdType"/>
          <xsd:element name="to" type="Types:TriPortIdType" minOccurs="0"/>
          <xsd:element name="signature" type="Types:TriSignatureIdType"/>
          <xsd:element name="tciPars" type="Types:TciParameterListType" minOccurs="0"/>
          <xsd:element name="replValue" type="Values:Value" minOccurs="0"/>
          <xsd:element name="transmission-failure" type="SimpleTypes:TriStatusType"
            minOccurs="0"/>
        </xsd:sequence>
      </xsd:extension>
    </xsd:complexContent>
  </xsd:complexType>

  <xsd:complexType name="tliPrReply_c_BC">
    <xsd:complexContent mixed="true">
      <xsd:extension base="Events:Event">
        <xsd:sequence>

```

```

        <xsd:element name="at" type="Types:TriPortIdType"/>
        <xsd:element name="to" type="Types:TriPortIdListType" minOccurs="0"/>
        <xsd:element name="signature" type="Types:TriSignatureIdType"/>
        <xsd:element name="tciPars" type="Types:TciParameterListType" minOccurs="0"/>
        <xsd:element name="replValue" type="Values:Value" minOccurs="0"/>
        <xsd:element name="transmission-failure" type="SimpleTypes:TriStatusType"
minOccurs="0"/>
    </xsd:sequence>
</xsd:extension>
</xsd:complexContent>
</xsd:complexType>

<xsd:complexType name="tliPrReply_c_MC">
    <xsd:complexContent mixed="true">
        <xsd:extension base="Events:Event">
            <xsd:sequence>
                <xsd:element name="at" type="Types:TriPortIdType"/>
                <xsd:element name="to" type="Types:TriPortIdListType" minOccurs="0"/>
                <xsd:element name="signature" type="Types:TriSignatureIdType"/>
                <xsd:element name="tciPars" type="Types:TciParameterListType" minOccurs="0"/>
                <xsd:element name="replValue" type="Values:Value" minOccurs="0"/>
                <xsd:element name="transmission-failure" type="SimpleTypes:TriStatusType"
minOccurs="0"/>
            </xsd:sequence>
        </xsd:extension>
    </xsd:complexContent>
</xsd:complexType>

<xsd:complexType name="tliPrGetReplyDetected_m">
    <xsd:complexContent mixed="true">
        <xsd:extension base="Events:Event">
            <xsd:sequence>
                <xsd:element name="at" type="Types:TriPortIdType"/>
                <xsd:element name="from" type="Types:TriPortIdType" minOccurs="0"/>
                <xsd:element name="signature" type="Types:TriSignatureIdType"/>
                <xsd:element name="triPars" type="Types:TriParameterListType" minOccurs="0"/>
                <xsd:element name="repl" type="Types:TriParameterType" minOccurs="0"/>
                <xsd:element name="address" type="Types:TriAddressType" minOccurs="0"/>
            </xsd:sequence>
        </xsd:extension>
    </xsd:complexContent>
</xsd:complexType>

<xsd:complexType name="tliPrGetReplyDetected_c">
    <xsd:complexContent mixed="true">
        <xsd:extension base="Events:Event">
            <xsd:sequence>
                <xsd:element name="at" type="Types:TriPortIdType"/>
                <xsd:element name="from" type="Types:TriPortIdType" minOccurs="0"/>
                <xsd:element name="signature" type="Types:TriSignatureIdType"/>
                <xsd:element name="tciPars" type="Types:TciParameterListType" minOccurs="0"/>
                <xsd:element name="replValue" type="Values:Value" minOccurs="0"/>
            </xsd:sequence>
        </xsd:extension>
    </xsd:complexContent>
</xsd:complexType>

<xsd:complexType name="tliPrGetReplyMismatch_m">
    <xsd:complexContent mixed="true">
        <xsd:extension base="Events:Event">
            <xsd:sequence>
                <xsd:element name="at" type="Types:TriPortIdType"/>
                <xsd:element name="signature" type="Types:TriSignatureIdType"/>
                <xsd:element name="tciPars" type="Types:TciParameterListType" minOccurs="0"/>
                <xsd:element name="parsTmpl" type="Templates:TciValueTemplate" minOccurs="0"/>
                <xsd:element name="replValue" type="Values:Value" minOccurs="0"/>
                <xsd:element name="replTmpl" type="Templates:TciValueTemplate" minOccurs="0"/>
                <xsd:element name="diffs" type="Templates:TciValueDifferenceList"/>
                <xsd:element name="addrValue" type="Values:Value" minOccurs="0"/>
                <xsd:element name="addressTmpl" type="Templates:TciValueTemplate"
minOccurs="0"/>
            </xsd:sequence>
        </xsd:extension>
    </xsd:complexContent>
</xsd:complexType>

<xsd:complexType name="tliPrGetReplyMismatch_c">
    <xsd:complexContent mixed="true">

```

```

    <xsd:extension base="Events:Event">
      <xsd:sequence>
        <xsd:element name="at" type="Types:TriPortIdType"/>
        <xsd:element name="signature" type="Types:TriSignatureIdType"/>
        <xsd:element name="tciPars" type="Types:TciParameterListType" minOccurs="0"/>
        <xsd:element name="parsTpl" type="Templates:TciValueTemplate" minOccurs="0"/>
        <xsd:element name="replValue" type="Values:Value" minOccurs="0"/>
        <xsd:element name="replTpl" type="Templates:TciValueTemplate" minOccurs="0"/>
        <xsd:element name="diffs" type="Templates:TciValueDifferenceList"/>
        <xsd:element name="from" type="Types:TriComponentIdType" minOccurs="0"/>
        <xsd:element name="fromTpl" type="Templates:TciNonValueTemplate"
minOccurs="0"/>
      </xsd:sequence>
    </xsd:extension>
  </xsd:complexContent>
</xsd:complexType>

<xsd:complexType name="tliPrGetReply_m">
  <xsd:complexContent mixed="true">
    <xsd:extension base="Events:Event">
      <xsd:sequence>
        <xsd:element name="at" type="Types:TriPortIdType"/>
        <xsd:element name="signature" type="Types:TriSignatureIdType"/>
        <xsd:element name="tciPars" type="Types:TciParameterListType" minOccurs="0"/>
        <xsd:element name="parsTpl" type="Templates:TciValueTemplate" minOccurs="0"/>
        <xsd:element name="replValue" type="Values:Value" minOccurs="0"/>
        <xsd:element name="replTpl" type="Templates:TciValueTemplate" minOccurs="0"/>
        <xsd:element name="addrValue" type="Values:Value" minOccurs="0"/>
        <xsd:element name="addressTpl" type="Templates:TciValueTemplate"
minOccurs="0"/>
      </xsd:sequence>
    </xsd:extension>
  </xsd:complexContent>
</xsd:complexType>

<xsd:complexType name="tliPrGetReply_c">
  <xsd:complexContent mixed="true">
    <xsd:extension base="Events:Event">
      <xsd:sequence>
        <xsd:element name="at" type="Types:TriPortIdType"/>
        <xsd:element name="signature" type="Types:TriSignatureIdType"/>
        <xsd:element name="tciPars" type="Types:TciParameterListType" minOccurs="0"/>
        <xsd:element name="parsTpl" type="Templates:TciValueTemplate" minOccurs="0"/>
        <xsd:element name="replValue" type="Values:Value" minOccurs="0"/>
        <xsd:element name="replTpl" type="Templates:TciValueTemplate" minOccurs="0"/>
        <xsd:element name="from" type="Types:TriComponentIdType" minOccurs="0"/>
        <xsd:element name="fromTpl" type="Templates:TciNonValueTemplate"
minOccurs="0"/>
      </xsd:sequence>
    </xsd:extension>
  </xsd:complexContent>
</xsd:complexType>

<xsd:complexType name="tliPrRaise_m">
  <xsd:complexContent mixed="true">
    <xsd:extension base="Events:Event">
      <xsd:sequence>
        <xsd:element name="at" type="Types:TriPortIdType"/>
        <xsd:element name="to" type="Types:TriPortIdType" minOccurs="0"/>
        <xsd:element name="signature" type="Types:TriSignatureIdType"/>
        <xsd:element name="tciPars" type="Types:TciParameterListType" minOccurs="0"/>
        <xsd:element name="excValue" type="Values:Value" minOccurs="0"/>
        <xsd:element name="addrValue" type="Values:Value" minOccurs="0"/>
        <xsd:choice>
          <xsd:element name="encoder-failure" type="SimpleTypes:TciStatusType"
minOccurs="0"/>
          <xsd:sequence>
            <xsd:element name="exc" type="Types:TriExceptionType" minOccurs="0"/>
            <xsd:element name="address" type="Types:TriAddressType" minOccurs="0"/>
            <xsd:element name="transmission-failure"
type="SimpleTypes:TriStatusType" minOccurs="0"/>
          </xsd:sequence>
        </xsd:choice>
      </xsd:sequence>
    </xsd:extension>
  </xsd:complexContent>
</xsd:complexType>

```

```

<xsd:complexType name="tliPrRaise_m_BC">
  <xsd:complexContent mixed="true">
    <xsd:extension base="Events:Event">
      <xsd:sequence>
        <xsd:element name="at" type="Types:TriPortIdType"/>
        <xsd:element name="to" type="Types:TriPortIdType" minOccurs="0"/>
        <xsd:element name="signature" type="Types:TriSignatureIdType"/>
        <xsd:element name="tciPars" type="Types:TciParameterListType" minOccurs="0"/>
        <xsd:element name="excValue" type="Values:Value" minOccurs="0"/>
        <xsd:choice>
          <xsd:element name="encoder-failure" type="SimpleTypes:TciStatusType"
minOccurs="0"/>
          <xsd:sequence>
            <xsd:element name="exc" type="Types:TriExceptionType" minOccurs="0"/>
            <xsd:element name="transmission-failure"
type="SimpleTypes:TriStatusType" minOccurs="0"/>
          </xsd:sequence>
        </xsd:choice>
      </xsd:sequence>
    </xsd:extension>
  </xsd:complexContent>
</xsd:complexType>

<xsd:complexType name="tliPrRaise_m_MC">
  <xsd:complexContent mixed="true">
    <xsd:extension base="Events:Event">
      <xsd:sequence>
        <xsd:element name="at" type="Types:TriPortIdType"/>
        <xsd:element name="to" type="Types:TriPortIdType" minOccurs="0"/>
        <xsd:element name="signature" type="Types:TriSignatureIdType"/>
        <xsd:element name="tciPars" type="Types:TciParameterListType" minOccurs="0"/>
        <xsd:element name="excValue" type="Values:Value" minOccurs="0"/>
        <xsd:element name="addrValues" type="Types:TciValueListType" minOccurs="0"/>
        <xsd:choice>
          <xsd:element name="encoder-failure" type="SimpleTypes:TciStatusType"
minOccurs="0"/>
          <xsd:sequence>
            <xsd:element name="exc" type="Types:TriExceptionType" minOccurs="0"/>
            <xsd:element name="addresses" type="Types:TriAddressListType"
minOccurs="0"/>
            <xsd:element name="transmission-failure"
type="SimpleTypes:TriStatusType" minOccurs="0"/>
          </xsd:sequence>
        </xsd:choice>
      </xsd:sequence>
    </xsd:extension>
  </xsd:complexContent>
</xsd:complexType>

<xsd:complexType name="tliPrRaise_c">
  <xsd:complexContent mixed="true">
    <xsd:extension base="Events:Event">
      <xsd:sequence>
        <xsd:element name="at" type="Types:TriPortIdType"/>
        <xsd:element name="to" type="Types:TriPortIdType" minOccurs="0"/>
        <xsd:element name="signature" type="Types:TriSignatureIdType"/>
        <xsd:element name="tciPars" type="Types:TciParameterListType" minOccurs="0"/>
        <xsd:element name="excValue" type="Values:Value" minOccurs="0"/>
        <xsd:element name="transmission-failure" type="SimpleTypes:TriStatusType"
minOccurs="0"/>
      </xsd:sequence>
    </xsd:extension>
  </xsd:complexContent>
</xsd:complexType>

<xsd:complexType name="tliPrRaise_c_BC">
  <xsd:complexContent mixed="true">
    <xsd:extension base="Events:Event">
      <xsd:sequence>
        <xsd:element name="at" type="Types:TriPortIdType"/>
        <xsd:element name="to" type="Types:TriPortIdListType" minOccurs="0"/>
        <xsd:element name="signature" type="Types:TriSignatureIdType"/>
        <xsd:element name="tciPars" type="Types:TciParameterListType" minOccurs="0"/>
        <xsd:element name="excValue" type="Values:Value" minOccurs="0"/>
        <xsd:element name="transmission-failure" type="SimpleTypes:TriStatusType"
minOccurs="0"/>
      </xsd:sequence>
    </xsd:extension>
  </xsd:complexContent>
</xsd:complexType>

```

```

    </xsd:complexContent>
  </xsd:complexType>

  <xsd:complexType name="tliPrRaise_c_MC">
    <xsd:complexContent mixed="true">
      <xsd:extension base="Events:Event">
        <xsd:sequence>
          <xsd:element name="at" type="Types:TriPortIdType"/>
          <xsd:element name="to" type="Types:TriPortIdListType" minOccurs="0"/>
          <xsd:element name="signature" type="Types:TriSignatureIdType"/>
          <xsd:element name="tciPars" type="Types:TciParameterListType" minOccurs="0"/>
          <xsd:element name="excValue" type="Values:Value" minOccurs="0"/>
          <xsd:element name="transmission-failure" type="SimpleTypes:TriStatusType"
minOccurs="0"/>
        </xsd:sequence>
      </xsd:extension>
    </xsd:complexContent>
  </xsd:complexType>

  <xsd:complexType name="tliPrCatchDetected_m">
    <xsd:complexContent mixed="true">
      <xsd:extension base="Events:Event">
        <xsd:sequence>
          <xsd:element name="at" type="Types:TriPortIdType"/>
          <xsd:element name="from" type="Types:TriPortIdType" minOccurs="0"/>
          <xsd:element name="signature" type="Types:TriSignatureIdType"/>
          <xsd:element name="exc" type="Types:TriExceptionType" minOccurs="0"/>
          <xsd:element name="address" type="Types:TriAddressType" minOccurs="0"/>
        </xsd:sequence>
      </xsd:extension>
    </xsd:complexContent>
  </xsd:complexType>

  <xsd:complexType name="tliPrCatchDetected_c">
    <xsd:complexContent mixed="true">
      <xsd:extension base="Events:Event">
        <xsd:sequence>
          <xsd:element name="at" type="Types:TriPortIdType"/>
          <xsd:element name="from" type="Types:TriPortIdType" minOccurs="0"/>
          <xsd:element name="signature" type="Types:TriSignatureIdType"/>
          <xsd:element name="excValue" type="Values:Value" minOccurs="0"/>
        </xsd:sequence>
      </xsd:extension>
    </xsd:complexContent>
  </xsd:complexType>

  <xsd:complexType name="tliPrCatchMismatch_m">
    <xsd:complexContent mixed="true">
      <xsd:extension base="Events:Event">
        <xsd:sequence>
          <xsd:element name="at" type="Types:TriPortIdType"/>
          <xsd:element name="signature" type="Types:TriSignatureIdType"/>
          <xsd:element name="excValue" type="Values:Value" minOccurs="0"/>
          <xsd:element name="excTpl" type="Templates:TciValueTemplate" minOccurs="0"/>
          <xsd:element name="diffs" type="Templates:TciValueDifferenceList"/>
          <xsd:element name="addrValue" type="Values:Value" minOccurs="0"/>
          <xsd:element name="addressTpl" type="Templates:TciValueTemplate"
minOccurs="0"/>
        </xsd:sequence>
      </xsd:extension>
    </xsd:complexContent>
  </xsd:complexType>

  <xsd:complexType name="tliPrCatchMismatch_c">
    <xsd:complexContent mixed="true">
      <xsd:extension base="Events:Event">
        <xsd:sequence>
          <xsd:element name="at" type="Types:TriPortIdType"/>
          <xsd:element name="signature" type="Types:TriSignatureIdType"/>
          <xsd:element name="excValue" type="Values:Value" minOccurs="0"/>
          <xsd:element name="excTpl" type="Templates:TciValueTemplate" minOccurs="0"/>
          <xsd:element name="diffs" type="Templates:TciValueDifferenceList"/>
          <xsd:element name="from" type="Types:TriComponentIdType" minOccurs="0"/>
          <xsd:element name="fromTpl" type="Templates:TciNonValueTemplate"
minOccurs="0"/>
        </xsd:sequence>
      </xsd:extension>
    </xsd:complexContent>
  </xsd:complexType>

```

```

</xsd:complexType>

<xsd:complexType name="tliPrCatch_m">
  <xsd:complexContent mixed="true">
    <xsd:extension base="Events:Event">
      <xsd:sequence>
        <xsd:element name="at" type="Types:TriPortIdType"/>
        <xsd:element name="signature" type="Types:TriSignatureIdType"/>
        <xsd:element name="excValue" type="Values:Value"/>
        <xsd:element name="excTpl" type="Templates:TciValueTemplate"/>
        <xsd:element name="addrValue" type="Values:Value" minOccurs="0"/>
        <xsd:element name="addressTpl" type="Templates:TciValueTemplate"
minOccurs="0"/>
      </xsd:sequence>
    </xsd:extension>
  </xsd:complexContent>
</xsd:complexType>

<xsd:complexType name="tliPrCatch_c">
  <xsd:complexContent mixed="true">
    <xsd:extension base="Events:Event">
      <xsd:sequence>
        <xsd:element name="at" type="Types:TriPortIdType"/>
        <xsd:element name="signature" type="Types:TriSignatureIdType"/>
        <xsd:element name="excValue" type="Values:Value" minOccurs="0"/>
        <xsd:element name="excTpl" type="Templates:TciValueTemplate" minOccurs="0"/>
        <xsd:element name="from" type="Types:TriComponentIdType" minOccurs="0"/>
        <xsd:element name="fromTpl" type="Templates:TciNonValueTemplate"
minOccurs="0"/>
      </xsd:sequence>
    </xsd:extension>
  </xsd:complexContent>
</xsd:complexType>

<xsd:complexType name="tliPrCatchTimeoutDetected">
  <xsd:complexContent mixed="true">
    <xsd:extension base="Events:Event">
      <xsd:sequence>
        <xsd:element name="at" type="Types:TriPortIdType"/>
        <xsd:element name="signature" type="Types:TriSignatureIdType"/>
      </xsd:sequence>
    </xsd:extension>
  </xsd:complexContent>
</xsd:complexType>

<xsd:complexType name="tliPrCatchTimeout">
  <xsd:complexContent mixed="true">
    <xsd:extension base="Events:Event">
      <xsd:sequence>
        <xsd:element name="at" type="Types:TriPortIdType"/>
        <xsd:element name="signature" type="Types:TriSignatureIdType"/>
      </xsd:sequence>
    </xsd:extension>
  </xsd:complexContent>
</xsd:complexType>

<!-- components -->
<xsd:complexType name="tliCCreate">
  <xsd:complexContent mixed="true">
    <xsd:extension base="Events:Event">
      <xsd:sequence>
        <xsd:element name="comp" type="Types:TriComponentIdType"/>
        <xsd:element name="name" type="SimpleTypes:TString"/>
        <xsd:element name="hostId" type="Values:Value" minOccurs="0"/>
        <xsd:element name="alive" type="SimpleTypes:TBoolean"/>
      </xsd:sequence>
    </xsd:extension>
  </xsd:complexContent>
</xsd:complexType>

<xsd:complexType name="tliCStart">
  <xsd:complexContent mixed="true">
    <xsd:extension base="Events:Event">
      <xsd:sequence>
        <xsd:element name="comp" type="Types:TriComponentIdType"/>
        <xsd:element name="name" type="Types:TciBehaviourIdType"/>
        <xsd:element name="tciPars" type="Types:TciParameterListType" minOccurs="0"/>
      </xsd:sequence>
    </xsd:extension>
  </xsd:complexContent>
</xsd:complexType>

```

```

        </xsd:extension>
    </xsd:complexContent>
</xsd:complexType>

<xsd:complexType name="tliCRunning">
    <xsd:complexContent mixed="true">
        <xsd:extension base="Events:Event">
            <xsd:sequence>
                <xsd:element name="comp" type="Types:TriComponentIdType"/>
                <xsd:element name="status" type="SimpleTypes:ComponentStatusType"/>
            </xsd:sequence>
        </xsd:extension>
    </xsd:complexContent>
</xsd:complexType>

<xsd:complexType name="tliCAlive">
    <xsd:complexContent mixed="true">
        <xsd:extension base="Events:Event">
            <xsd:sequence>
                <xsd:element name="comp" type="Types:TriComponentIdType"/>
                <xsd:element name="status" type="SimpleTypes:ComponentStatusType"/>
            </xsd:sequence>
        </xsd:extension>
    </xsd:complexContent>
</xsd:complexType>

<xsd:complexType name="tliCStop">
    <xsd:complexContent mixed="true">
        <xsd:extension base="Events:Event">
            <xsd:sequence>
                <xsd:element name="comp" type="Types:TriComponentIdType"/>
            </xsd:sequence>
        </xsd:extension>
    </xsd:complexContent>
</xsd:complexType>

<xsd:complexType name="tliCKill">
    <xsd:complexContent mixed="true">
        <xsd:extension base="Events:Event">
            <xsd:sequence>
                <xsd:element name="comp" type="Types:TriComponentIdType"/>
            </xsd:sequence>
        </xsd:extension>
    </xsd:complexContent>
</xsd:complexType>

<xsd:complexType name="tliCDoneMismatch">
    <xsd:complexContent mixed="true">
        <xsd:extension base="Events:Event">
            <xsd:sequence>
                <xsd:element name="comp" type="Types:TriComponentIdType"/>
                <xsd:element name="compTpl" type="Templates:TciNonValueTemplate"/>
            </xsd:sequence>
        </xsd:extension>
    </xsd:complexContent>
</xsd:complexType>

<xsd:complexType name="tliCKilledMismatch">
    <xsd:complexContent mixed="true">
        <xsd:extension base="Events:Event">
            <xsd:sequence>
                <xsd:element name="comp" type="Types:TriComponentIdType"/>
                <xsd:element name="compTpl" type="Templates:TciNonValueTemplate"/>
            </xsd:sequence>
        </xsd:extension>
    </xsd:complexContent>
</xsd:complexType>

<xsd:complexType name="tliCDone">
    <xsd:complexContent mixed="true">
        <xsd:extension base="Events:Event">
            <xsd:sequence>
                <xsd:element name="compTpl" type="Templates:TciNonValueTemplate"/>
            </xsd:sequence>
        </xsd:extension>
    </xsd:complexContent>
</xsd:complexType>

```

```

<xsd:complexType name="tliCKilled">
  <xsd:complexContent mixed="true">
    <xsd:extension base="Events:Event">
      <xsd:sequence>
        <xsd:element name="compTpl" type="Templates:TciNonValueTemplate"/>
      </xsd:sequence>
    </xsd:extension>
  </xsd:complexContent>
</xsd:complexType>

<xsd:complexType name="tliCTerminated">
  <xsd:complexContent mixed="true">
    <xsd:extension base="Events:Event">
      <xsd:sequence>
        <xsd:element name="verdict" type="Values:VerdictValue" />
        <xsd:element name="reason" type="SimpleTypes:TString" minOccurs="0"/>
      </xsd:sequence>
    </xsd:extension>
  </xsd:complexContent>
</xsd:complexType>

<!-- ports -->
<xsd:complexType name="tliPConnect">
  <xsd:complexContent mixed="true">
    <xsd:extension base="Events:PortConfiguration"/>
  </xsd:complexContent>
</xsd:complexType>

<xsd:complexType name="tliPDisconnect">
  <xsd:complexContent mixed="true">
    <xsd:extension base="Events:PortConfiguration"/>
  </xsd:complexContent>
</xsd:complexType>

<xsd:complexType name="tliPMap">
  <xsd:complexContent mixed="true">
    <xsd:extension base="Events:PortConfiguration"/>
  </xsd:complexContent>
</xsd:complexType>

<xsd:complexType name="tliPMapParam">
  <xsd:complexContent mixed="true">
    <xsd:extension base="Events:tliPMap">
      <xsd:sequence>
        <xsd:element name="tciPars" type="Types:TciParameterListType" />
        <xsd:choice>
          <xsd:element name="encoder-failure" type="SimpleTypes:TciStatusType"
minOccurs="0"/>
          <xsd:element name="triPars" type="Types:TriParameterListType" />
        </xsd:choice>
      </xsd:sequence>
    </xsd:extension>
  </xsd:complexContent>
</xsd:complexType>

<xsd:complexType name="tliPUnmap">
  <xsd:complexContent mixed="true">
    <xsd:extension base="Events:PortConfiguration"/>
  </xsd:complexContent>
</xsd:complexType>

<xsd:complexType name="tliPUnmapParam">
  <xsd:complexContent mixed="true">
    <xsd:extension base="Events:tliPUnmap">
      <xsd:sequence>
        <xsd:element name="tciPars" type="Types:TciParameterListType" />
        <xsd:choice>
          <xsd:element name="encoder-failure" type="SimpleTypes:TciStatusType"
minOccurs="0"/>
          <xsd:element name="triPars" type="Types:TriParameterListType"/>
        </xsd:choice>
      </xsd:sequence>
    </xsd:extension>
  </xsd:complexContent>
</xsd:complexType>

<xsd:complexType name="tliPClear">

```



```

        <xsd:complexContent mixed="true">
            <xsd:extension base="Events:PortStatus"/>
        </xsd:complexContent>
    </xsd:complexType>

    <xsd:complexType name="tliPStart">
        <xsd:complexContent mixed="true">
            <xsd:extension base="Events:PortStatus"/>
        </xsd:complexContent>
    </xsd:complexType>

    <xsd:complexType name="tliPStop">
        <xsd:complexContent mixed="true">
            <xsd:extension base="Events:PortStatus"/>
        </xsd:complexContent>
    </xsd:complexType>

    <xsd:complexType name="tliPHalt">
        <xsd:complexContent mixed="true">
            <xsd:extension base="Events:PortStatus"/>
        </xsd:complexContent>
    </xsd:complexType>

    <!-- codec -->
    <xsd:complexType name="tliEncode">
        <xsd:complexContent mixed="true">
            <xsd:extension base="Events:Event">
                <xsd:sequence>
                    <xsd:element name="val" type="Values:Value"/>
                    <xsd:choice>
                        <xsd:element name="msg" type="Types:TriMessageType"/>
                        <xsd:element name="encoder-failure" type="SimpleTypes:TciStatusType"
minOccurs="0"/>
                    </xsd:choice>
                    <xsd:element name="codec" type="SimpleTypes:TString"
                        minOccurs="0"/>
                </xsd:sequence>
            </xsd:extension>
        </xsd:complexContent>
    </xsd:complexType>

    <xsd:complexType name="tliDecode" mixed="true">
        <xsd:complexContent mixed="true">
            <xsd:extension base="Events:Event">
                <xsd:sequence>
                    <xsd:element name="msg" type="Types:TriMessageType"/>
                    <xsd:choice>
                        <xsd:element name="decoder-failure" type="SimpleTypes:TciStatusType"
minOccurs="0"/>
                        <xsd:element name="val" type="Values:Value"/>
                    </xsd:choice>
                    <xsd:element name="codec" type="SimpleTypes:TString"
                        minOccurs="0"/>
                </xsd:sequence>
            </xsd:extension>
        </xsd:complexContent>
    </xsd:complexType>

    <!-- timers -->
    <xsd:complexType name="tliTimeoutDetected">
        <xsd:complexContent mixed="true">
            <xsd:extension base="Events:Event">
                <xsd:sequence>
                    <xsd:element name="timer" type="Types:TriTimerIdType" />
                </xsd:sequence>
            </xsd:extension>
        </xsd:complexContent>
    </xsd:complexType>

    <xsd:complexType name="tliTimeoutMismatch">
        <xsd:complexContent mixed="true">
            <xsd:extension base="Events:Event">
                <xsd:sequence>
                    <xsd:element name="timer" type="Types:TriTimerIdType" />
                    <xsd:element name="timerTpl" type="Templates:TciNonValueTemplate" />
                </xsd:sequence>
            </xsd:extension>
        </xsd:complexContent>
    </xsd:complexType>

```

```

</xsd:complexType>

<xsd:complexType name="tliTimeout">
  <xsd:complexContent mixed="true">
    <xsd:extension base="Events:Event">
      <xsd:sequence>
        <xsd:element name="timer" type="Types:TriTimerIdType" />
        <xsd:element name="timerTpl" type="Templates:TciNonValueTemplate" />
      </xsd:sequence>
    </xsd:extension>
  </xsd:complexContent>
</xsd:complexType>

<xsd:complexType name="tliTStart">
  <xsd:complexContent mixed="true">
    <xsd:extension base="Events:Event">
      <xsd:sequence>
        <xsd:element name="timer" type="Types:TriTimerIdType"/>
        <xsd:element name="dur" type="SimpleTypes:TriTimerDurationType"/>
      </xsd:sequence>
    </xsd:extension>
  </xsd:complexContent>
</xsd:complexType>

<xsd:complexType name="tliTStop">
  <xsd:complexContent mixed="true">
    <xsd:extension base="Events:Event">
      <xsd:sequence>
        <xsd:element name="timer" type="Types:TriTimerIdType"/>
        <xsd:element name="dur" type="SimpleTypes:TriTimerDurationType"/>
      </xsd:sequence>
    </xsd:extension>
  </xsd:complexContent>
</xsd:complexType>

<xsd:complexType name="tliTRead">
  <xsd:complexContent mixed="true">
    <xsd:extension base="Events:Event">
      <xsd:sequence>
        <xsd:element name="timer" type="Types:TriTimerIdType"/>
        <xsd:element name="elapsed" type="SimpleTypes:TriTimerDurationType"/>
      </xsd:sequence>
    </xsd:extension>
  </xsd:complexContent>
</xsd:complexType>

<xsd:complexType name="tliTRunning">
  <xsd:complexContent mixed="true">
    <xsd:extension base="Events:Event">
      <xsd:sequence>
        <xsd:element name="timer" type="Types:TriTimerIdType"/>
      </xsd:sequence>
      <xsd:attribute name="status" type="SimpleTypes:TimerStatusType"/>
    </xsd:extension>
  </xsd:complexContent>
</xsd:complexType>

<!-- scope -->
<xsd:complexType name="tliSEnter">
  <xsd:complexContent mixed="true">
    <xsd:extension base="Events:Event">
      <xsd:sequence>
        <xsd:element name="name" type="Types:QualifiedName" />
        <xsd:element name="tciPars" type="Types:TciParameterListType" minOccurs="0"/>
        <xsd:element name="kind" type="SimpleTypes:TString"/>
      </xsd:sequence>
    </xsd:extension>
  </xsd:complexContent>
</xsd:complexType>

<xsd:complexType name="tliSLeave">
  <xsd:complexContent mixed="true">
    <xsd:extension base="Events:Event">
      <xsd:sequence>
        <xsd:element name="name" type="Types:QualifiedName" />
        <xsd:element name="tciPars" type="Types:TciParameterListType" minOccurs="0"/>
        <xsd:element name="returnValue" type="Values:Value" minOccurs="0"/>
        <xsd:element name="kind" type="SimpleTypes:TString"/>
      </xsd:sequence>
    </xsd:extension>
  </xsd:complexContent>
</xsd:complexType>

```

```

        </xsd:sequence>
      </xsd:extension>
    </xsd:complexContent>
  </xsd:complexType>

  <!-- variables and module parameter -->
  <xsd:complexType name="tliVar">
    <xsd:complexContent mixed="true">
      <xsd:extension base="Events:Event">
        <xsd:sequence>
          <xsd:element name="name" type="Types:QualifiedName" />
          <xsd:element name="val" type="Values:Value" minOccurs="0"/>
        </xsd:sequence>
      </xsd:extension>
    </xsd:complexContent>
  </xsd:complexType>

  <xsd:complexType name="tliModulePar">
    <xsd:complexContent mixed="true">
      <xsd:extension base="Events:Event">
        <xsd:sequence>
          <xsd:element name="name" type="Types:QualifiedName" />
          <xsd:element name="val" type="Values:Value" minOccurs="0"/>
        </xsd:sequence>
      </xsd:extension>
    </xsd:complexContent>
  </xsd:complexType>

  <!-- verdicts -->
  <xsd:complexType name="tliGetVerdict">
    <xsd:complexContent mixed="true">
      <xsd:extension base="Events:Event">
        <xsd:sequence>
          <xsd:element name="verdict" type="Values:VerdictValue"/>
        </xsd:sequence>
      </xsd:extension>
    </xsd:complexContent>
  </xsd:complexType>

  <xsd:complexType name="tliSetVerdict">
    <xsd:complexContent mixed="true">
      <xsd:extension base="Events:Event">
        <xsd:sequence>
          <xsd:element name="verdict" type="Values:VerdictValue"/>
          <xsd:element name="reason" type="SimpleTypes:TString" minOccurs="0"/>
        </xsd:sequence>
      </xsd:extension>
    </xsd:complexContent>
  </xsd:complexType>

  <!-- log -->
  <xsd:complexType name="tliLog">
    <xsd:complexContent mixed="true">
      <xsd:extension base="Events:Event">
        <xsd:sequence>
          <xsd:element name="log" type="SimpleTypes:TString"/>
        </xsd:sequence>
      </xsd:extension>
    </xsd:complexContent>
  </xsd:complexType>

  <!-- alt -->
  <xsd:complexType name="tliAEnter">
    <xsd:complexContent>
      <xsd:extension base="Events:Event"/>
    </xsd:complexContent>
  </xsd:complexType>

  <xsd:complexType name="tliALeave">
    <xsd:complexContent>
      <xsd:extension base="Events:Event"/>
    </xsd:complexContent>
  </xsd:complexType>

  <xsd:complexType name="tliADefaults">
    <xsd:complexContent>
      <xsd:extension base="Events:Event"/>
    </xsd:complexContent>
  </xsd:complexType>

```

```

</xsd:complexType>

<xsd:complexType name="tliAActivate">
  <xsd:complexContent mixed="true">
    <xsd:extension base="Events:Event">
      <xsd:sequence>
        <xsd:element name="name" type="Types:QualifiedName" />
        <xsd:element name="tciPars" type="Types:TciParameterListType" minOccurs="0"/>
        <xsd:element name="ref" type="Values:Value"/>
      </xsd:sequence>
    </xsd:extension>
  </xsd:complexContent>
</xsd:complexType>

<xsd:complexType name="tliADeactivate">
  <xsd:complexContent mixed="true">
    <xsd:extension base="Events:Event">
      <xsd:sequence>
        <xsd:element name="ref" type="Values:Value"/>
      </xsd:sequence>
    </xsd:extension>
  </xsd:complexContent>
</xsd:complexType>

<xsd:complexType name="tliANomatch">
  <xsd:complexContent mixed="true">
    <xsd:extension base="Events:Event"/>
  </xsd:complexContent>
</xsd:complexType>

<xsd:complexType name="tliARepeat">
  <xsd:complexContent>
    <xsd:extension base="Events:Event"/>
  </xsd:complexContent>
</xsd:complexType>

<xsd:complexType name="tliAwait">
  <xsd:complexContent>
    <xsd:extension base="Events:Event"/>
  </xsd:complexContent>
</xsd:complexType>

<xsd:complexType name="tliAction">
  <xsd:complexContent mixed="true">
    <xsd:extension base="Events:Event">
      <xsd:sequence>
        <xsd:element name="action" type="SimpleTypes:TString"/>
      </xsd:sequence>
    </xsd:extension>
  </xsd:complexContent>
</xsd:complexType>

<xsd:complexType name="tliMatch">
  <xsd:complexContent mixed="true">
    <xsd:extension base="Events:Event">
      <xsd:sequence>
        <xsd:element name="expr" type="Values:Value"/>
        <xsd:element name="tmpl" type="Templates:TciValueTemplate"/>
      </xsd:sequence>
    </xsd:extension>
  </xsd:complexContent>
</xsd:complexType>

<xsd:complexType name="tliMatchMismatch">
  <xsd:complexContent mixed="true">
    <xsd:extension base="Events:Event">
      <xsd:sequence>
        <xsd:element name="expr" type="Values:Value"/>
        <xsd:element name="tmpl" type="Templates:TciValueTemplate"/>
        <xsd:element name="diffs" type="Templates:TciValueDifferenceList"/>
      </xsd:sequence>
    </xsd:extension>
  </xsd:complexContent>
</xsd:complexType>

<xsd:complexType name="tliInfo">
  <xsd:complexContent mixed="true">
    <xsd:extension base="Events:Event">

```

```

        <xsd:sequence>
            <xsd:element name="level" type="SimpleTypes:TInteger"/>
            <xsd:element name="info" type="SimpleTypes:TString"/>
        </xsd:sequence>
    </xsd:extension>
</xsd:complexContent>
</xsd:complexType>
</xsd:schema>

```

B.6 TCI-TL XML Schema for a Log

```

<?xml version="1.0" encoding="UTF-8"?>
<xsd:schema xmlns:xsd="http://www.w3.org/2001/XMLSchema"
    targetNamespace="http://uri.etsi.org/ttcn-3/tci/TLI_v4_4_1.xsd"
    xmlns:TLI="http://uri.etsi.org/ttcn-3/tci/TLI_v4_4_1.xsd"
    xmlns:Events="http://uri.etsi.org/ttcn-3/tci/Events_v4_4_1.xsd"
    elementFormDefault="qualified">

    <xsd:import namespace="http://uri.etsi.org/ttcn-3/tci/Events_v4_4_1.xsd"
        schemaLocation="Events_v4_4_1.xsd"/>

    <xsd:element name="logfile" type="TLI:LogModule"/>
    <xsd:complexType name="LogModule">
        <xsd:sequence>
            <xsd:element name="header" type="TLI:Header"/>
            <xsd:element name="body" type="TLI:Body"/>
            <xsd:element name="trailer" type="TLI:Trailer" minOccurs="0"/>
        </xsd:sequence>
    </xsd:complexType>
    <xsd:complexType name="Header">
        <xsd:sequence>
            <!-- logging version -->
            <xsd:element name="version" type="xsd:string"/>
            <!-- begin of the log -->
            <xsd:element name="ts" type="xsd:long"/>
        </xsd:sequence>
    </xsd:complexType>
    <xsd:complexType name="Trailer">
        <xsd:choice>
            <xsd:any namespace="##any" processContents="skip" minOccurs="0" maxOccurs="unbounded"/>
        </xsd:choice>
    </xsd:complexType>

    <xsd:complexType name="Body">
        <xsd:choice maxOccurs="unbounded">

            <!-- test cases operations -->
            <xsd:element name="tliTcExecute" type="Events:tliTcExecute"/>
            <xsd:element name="tliTcStart" type="Events:tliTcStart"/>
            <xsd:element name="tliTcStop" type="Events:tliTcStop"/>
            <xsd:element name="tliTcStarted" type="Events:tliTcStarted"/>
            <xsd:element name="tliTcTerminated" type="Events:tliTcTerminated"/>

            <!-- control operations -->
            <xsd:element name="tliCtrlStart" type="Events:tliCtrlStart"/>
            <xsd:element name="tliCtrlStop" type="Events:tliCtrlStop"/>
            <xsd:element name="tliCtrlTerminated" type="Events:tliCtrlTerminated"/>

            <!-- asynchronous communication -->
            <xsd:element name="tliMSend_m" type="Events:tliMSend_m"/>
            <xsd:element name="tliMSend_c" type="Events:tliMSend_c"/>
            <xsd:element name="tliMSend_m_BC" type="Events:tliMSend_m_BC"/>
            <xsd:element name="tliMSend_c_BC" type="Events:tliMSend_c_BC"/>
            <xsd:element name="tliMSend_m_MC" type="Events:tliMSend_m_MC"/>
            <xsd:element name="tliMSend_c_MC" type="Events:tliMSend_c_MC"/>
            <xsd:element name="tliMDetected_m" type="Events:tliMDetected_m"/>
            <xsd:element name="tliMDetected_c" type="Events:tliMDetected_c"/>
            <xsd:element name="tliMMismatch_m" type="Events:tliMMismatch_m"/>
            <xsd:element name="tliMMismatch_c" type="Events:tliMMismatch_c"/>
            <xsd:element name="tliMReceive_m" type="Events:tliMReceive_m"/>
            <xsd:element name="tliMReceive_c" type="Events:tliMReceive_c"/>

            <!-- synchronous communication -->
            <xsd:element name="tliPrCall_m" type="Events:tliPrCall_m"/>
            <xsd:element name="tliPrCall_c" type="Events:tliPrCall_c"/>

```

```

<xsd:element name="tliPrCall_m_BC" type="Events:tliPrCall_m_BC"/>
<xsd:element name="tliPrCall_c_BC" type="Events:tliPrCall_c_BC"/>
<xsd:element name="tliPrCall_m_MC" type="Events:tliPrCall_m_MC"/>
<xsd:element name="tliPrCall_c_MC" type="Events:tliPrCall_c_MC"/>

<xsd:element name="tliPrGetCallDetected_m" type="Events:tliPrGetCallDetected_m"/>
<xsd:element name="tliPrGetCallDetected_c" type="Events:tliPrGetCallDetected_c"/>
<xsd:element name="tliPrGetCallMismatch_m" type="Events:tliPrGetCallMismatch_m"/>
<xsd:element name="tliPrGetCallMismatch_c" type="Events:tliPrGetCallMismatch_c"/>
<xsd:element name="tliPrGetCall_m" type="Events:tliPrGetCall_m"/>
<xsd:element name="tliPrGetCall_c" type="Events:tliPrGetCall_c"/>

<xsd:element name="tliPrReply_m" type="Events:tliPrReply_m"/>
<xsd:element name="tliPrReply_c" type="Events:tliPrReply_c"/>
<xsd:element name="tliPrReply_m_BC" type="Events:tliPrReply_m_BC"/>
<xsd:element name="tliPrReply_c_BC" type="Events:tliPrReply_c_BC"/>
<xsd:element name="tliPrReply_m_MC" type="Events:tliPrReply_m_MC"/>
<xsd:element name="tliPrReply_c_MC" type="Events:tliPrReply_c_MC"/>

<xsd:element name="tliPrGetReplyDetected_m" type="Events:tliPrGetReplyDetected_m"/>
<xsd:element name="tliPrGetReplyDetected_c" type="Events:tliPrGetReplyDetected_c"/>
<xsd:element name="tliPrGetReplyMismatch_m" type="Events:tliPrGetReplyMismatch_m"/>
<xsd:element name="tliPrGetReplyMismatch_c" type="Events:tliPrGetReplyMismatch_c"/>
<xsd:element name="tliPrGetReply_m" type="Events:tliPrGetReply_m"/>
<xsd:element name="tliPrGetReply_c" type="Events:tliPrGetReply_c"/>

<xsd:element name="tliPrRaise_m" type="Events:tliPrRaise_m"/>
<xsd:element name="tliPrRaise_c" type="Events:tliPrRaise_c"/>
<xsd:element name="tliPrRaise_m_BC" type="Events:tliPrRaise_m_BC"/>
<xsd:element name="tliPrRaise_c_BC" type="Events:tliPrRaise_c_BC"/>
<xsd:element name="tliPrRaise_m_MC" type="Events:tliPrRaise_m_MC"/>
<xsd:element name="tliPrRaise_c_MC" type="Events:tliPrRaise_c_MC"/>

<xsd:element name="tliPrCatchDetected_m" type="Events:tliPrCatchDetected_m"/>
<xsd:element name="tliPrCatchDetected_c" type="Events:tliPrCatchDetected_c"/>
<xsd:element name="tliPrCatchMismatch_m" type="Events:tliPrCatchMismatch_m"/>
<xsd:element name="tliPrCatchMismatch_c" type="Events:tliPrCatchMismatch_c"/>
<xsd:element name="tliPrCatch_m" type="Events:tliPrCatch_m"/>
<xsd:element name="tliPrCatch_c" type="Events:tliPrCatch_c"/>

<xsd:element name="tliPrCatchTimeoutDetected"
                type="Events:tliPrCatchTimeoutDetected"/>
<xsd:element name="tliPrCatchTimeout" type="Events:tliPrCatchTimeout"/>

<!-- components -->
<xsd:element name="tliCCreate" type="Events:tliCCreate"/>
<xsd:element name="tliCStart" type="Events:tliCStart"/>
<xsd:element name="tliCRunning" type="Events:tliCRunning"/>
<xsd:element name="tliCAlive" type="Events:tliCAlive"/>
<xsd:element name="tliCStop" type="Events:tliCStop"/>
<xsd:element name="tliCKill" type="Events:tliCKill"/>
<xsd:element name="tliCDoneMismatch" type="Events:tliCDoneMismatch"/>
<xsd:element name="tliCDone" type="Events:tliCDone"/>
<xsd:element name="tliCKilledMismatch" type="Events:tliCKilledMismatch"/>
<xsd:element name="tliCKilled" type="Events:tliCKilled"/>
<xsd:element name="tliCTerminated" type="Events:tliCTerminated"/>

<!-- ports -->
<xsd:element name="tliPConnect" type="Events:tliPConnect"/>
<xsd:element name="tliPDisconnect" type="Events:tliPDisconnect"/>
<xsd:element name="tliPMap" type="Events:tliPMap"/>
<xsd:element name="tliPMapParam" type="Events:tliPMapParam"/>
<xsd:element name="tliPUnmap" type="Events:tliPUnmap"/>
<xsd:element name="tliPUnmapParam" type="Events:tliPUnmapParam"/>
<xsd:element name="tliPClear" type="Events:tliPClear"/>
<xsd:element name="tliPStart" type="Events:tliPStart"/>
<xsd:element name="tliPStop" type="Events:tliPStop"/>
<xsd:element name="tliPHalt" type="Events:tliPHalt"/>

<!-- codec -->
<xsd:element name="tliDecode" type="Events:tliDecode"/>
<xsd:element name="tliEncode" type="Events:tliEncode"/>

<!-- timers -->
<xsd:element name="tliTTimeoutDetected" type="Events:tliTTimeoutDetected"/>
<xsd:element name="tliTTimeoutMismatch" type="Events:tliTTimeoutMismatch"/>
<xsd:element name="tliTTimeout" type="Events:tliTTimeout"/>
<xsd:element name="tliTStart" type="Events:tliTStart"/>

```

```
<xsd:element name="tliTStop" type="Events:tliTStop"/>
<xsd:element name="tliTRead" type="Events:tliTRead"/>
<xsd:element name="tliTRunning" type="Events:tliTRunning"/>

<!-- scopes -->
<xsd:element name="tliSEnter" type="Events:tliSEnter"/>
<xsd:element name="tliSLeave" type="Events:tliSLeave"/>

<!-- statements -->
<xsd:element name="tliVar" type="Events:tliVar"/>
<xsd:element name="tliModulePar" type="Events:tliModulePar"/>
<xsd:element name="tliGetVerdict" type="Events:tliGetVerdict"/>
<xsd:element name="tliSetVerdict" type="Events:tliSetVerdict"/>
<xsd:element name="tliLog" type="Events:tliLog"/>

<!-- alt -->
<xsd:element name="tliAEnter" type="Events:tliAEnter"/>
<xsd:element name="tliALeave" type="Events:tliALeave"/>
<xsd:element name="tliADefaults" type="Events:tliADefaults"/>
<xsd:element name="tliAActivate" type="Events:tliAActivate"/>
<xsd:element name="tliADeactivate" type="Events:tliADeactivate"/>
<xsd:element name="tliANomatch" type="Events:tliANomatch"/>
<xsd:element name="tliARepeat" type="Events:tliARepeat"/>
<xsd:element name="tliAwait" type="Events:tliAwait"/>

<!-- action -->
<xsd:element name="tliAction" type="Events:tliAction"/>

<!-- match -->
<xsd:element name="tliMatch" type="Events:tliMatch"/>
<xsd:element name="tliMatchMismatch" type="Events:tliMatchMismatch"/>

<!-- info -->
<xsd:element name="tliInfo" type="Events:tliInfo"/>
</xsd:choice>
</xsd:complexType>
</xsd:schema>
```

Annex C (informative): Use scenarios

This annex contains use scenarios that should help users of the TCI and tool vendors providing the TCI understand the semantics of the operations defined within the present document.

The scenarios are defined in terms of UML sequence diagrams. The sequence diagram shows the interactions between the TCI entities. The scenarios are explained and where applicable underpinned with a TTCN-3 fragment corresponding to the scenario.

C.1 Initialization, collecting information, logging

C.1.1 Use scenario: initialization

The scenario in figure C.1 shows the initialization phase for a test system when a TTCN-3 module is to be selected for execution. At first, a root module has to be set with `tciRootModule`. The module parameters of the root module can be obtained with `tciGetModuleParameters`. Module parameter information can be used to ask the test system user for concrete values for each module parameter. The list of test cases available in the root module can be retrieved with `tciGetTestCases`. These test cases can be directly executed from the test management. Their parameters and their test system interface can be obtained with `tciGetTestCaseParameters` and `tciGetTestCaseTSI`, respectively.

C.1.1.1 Sequence diagram

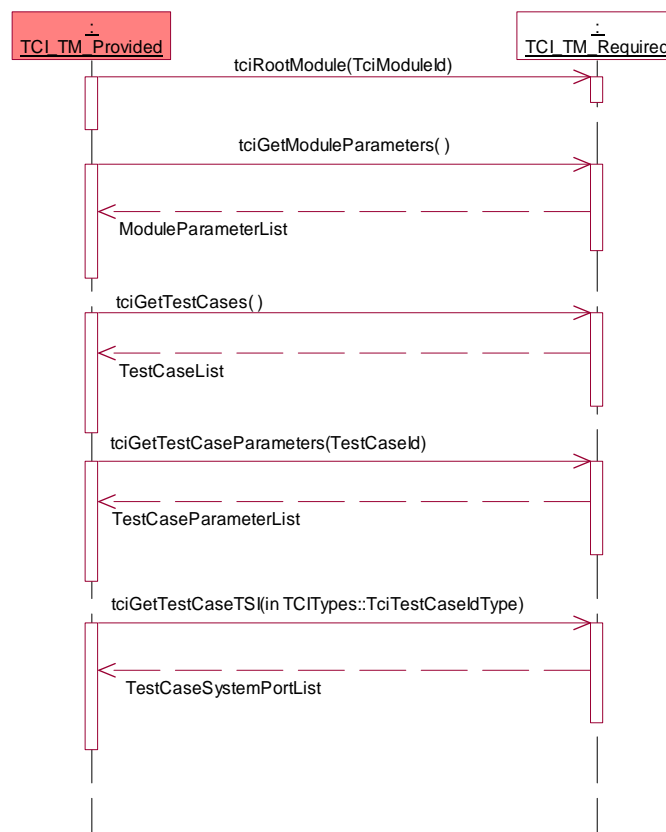

Figure C.1: Use scenario - initialization

C.1.1.2 TTCN-3 fragment

The initialization is outside the scope of TTCN-3.

C.1.2 Use scenario: requesting module parameters

The scenario in figure C.2 shows how a test component requests the actual value of a module parameter needed for the execution of its test behaviour. At first, the type of a module parameter is requested, then the value can be constructed by the TM and given to the TE.

C.1.2.1 Sequence diagram

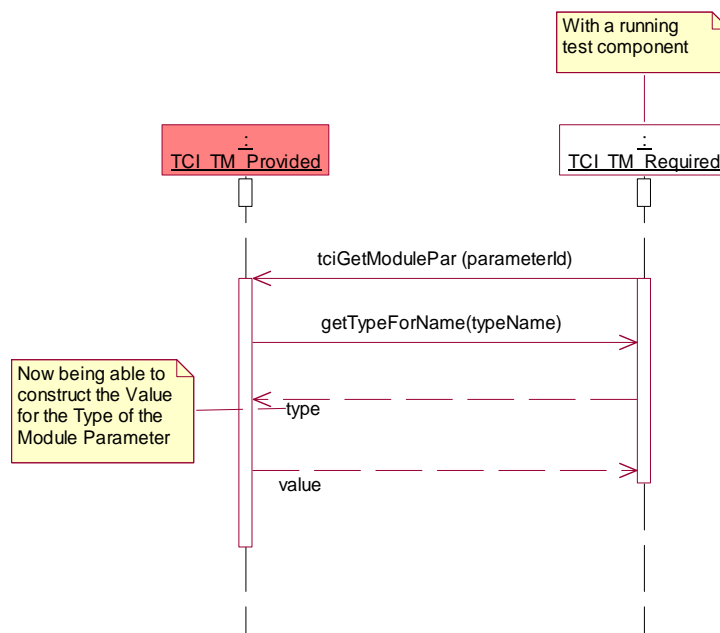

Figure C.2: Use scenario - requesting module Pars

C.1.2.2 TTCN-3 fragment

```

module AModule {
  ...
  modulepar {
    integer AModulePar
  }
  ...
  function AFunction (...) ... {
    integer x;
    ...
    x:= 2+AModulePar; // an expression with a module parameter
    ...
  }
  ...
}
  
```

C.1.3 Use scenario: logging

The scenario in figure C.3 shows logging of information during the execution of a test behaviour by a test component. The message to be logged is propagated to the test logging.

C.1.3.1 Sequence diagram

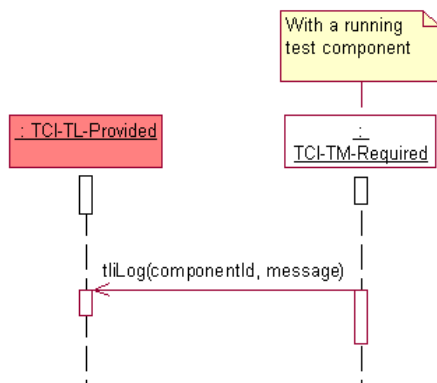

Figure C.3: Use scenario - logging

C.1.3.2 TTCN-3 fragment

```

module AModule {
    ...
    function AFunction (...) ... {
        ...
        log("AMessage");
        ...
    }
    ...
}

```

C.2 Execution of test cases and control

C.2.1 Use scenario: execution of control

The scenario in figure C.4 shows the sequence of operations to execute the control part of a TTCN-3 module. The module containing the control part is selected first, then the control is started, then it is executed until the execution is terminated by TE.

C.2.1.1 Sequence diagram

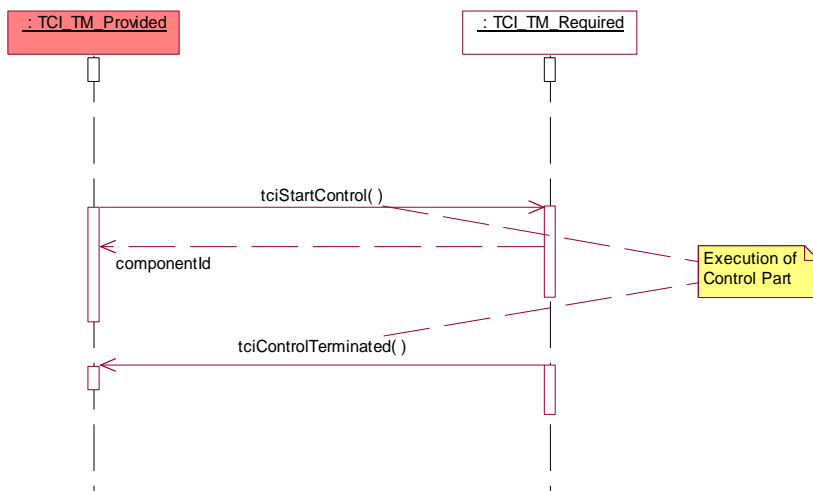

Figure C.4: Use scenario - execution of control

C.2.1.2 TTCN-3 fragment

```

module AModule {
  ...
  control {
    ...
  }
  ...
}

```

C.2.2 Use scenario: test case execution within control

The scenario in figure C.5 shows how a test case is executed within the control part.

C.2.2.1 Sequence diagram

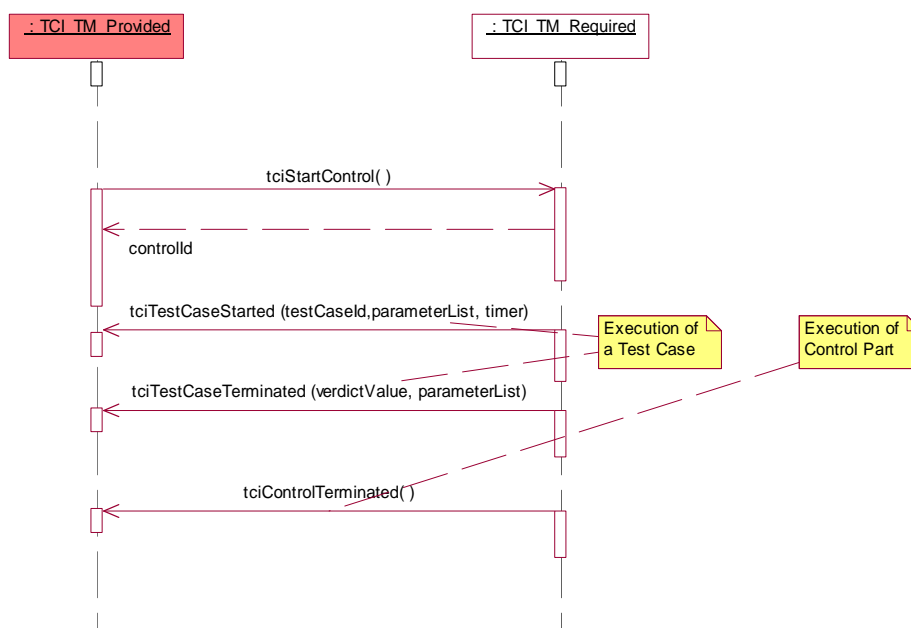

Figure C.5: Use scenario - test case execution within control

C.2.2.2 TTCN-3 fragment

```

module AModule {
  ...
  testcase ATestCase(...)... {
    ... //the test case behaviour
  }
  ...
  control {
    ...
    execute (ATestCase (...));
    ...
  }
  ...
}

```

C.2.3 Use scenario: direct test case execution

The scenario in figure C.6 shows how a test case can be directly executed from the test management outside the control part. After selecting the TTCN-3 module containing the test case to be executed, the start of the test case is requested. When the test case completes its execution, the test management is informed by the TE of the test case termination.

C.2.3.1 Sequence diagram

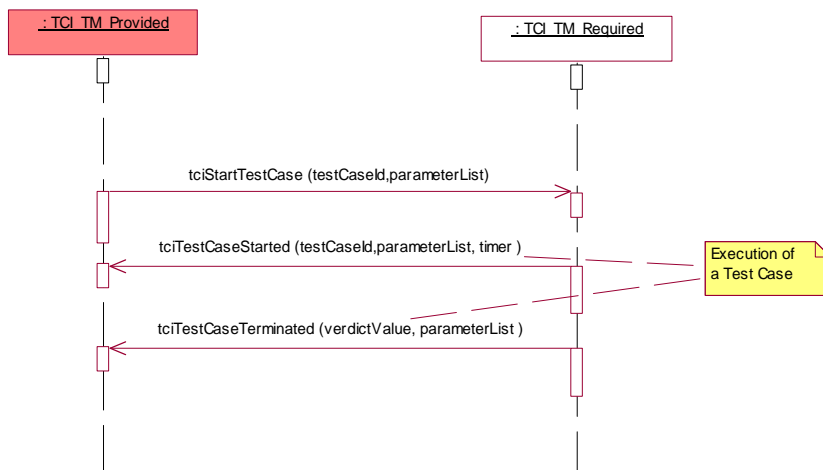

Figure C.6: Use scenario - direct test case execution

C.2.3.2 TTCN-3 fragment

The direct execution of a test case is outside the scope of TTCN-3.

C.2.4 Use scenario: execute test case to TRI

The scenario in figure C.7 shows how the TRI is informed about the execution of a test case so that it can set up and initialize system ports when needed. The execute test case request has to be issued before the test behaviour on the MTC of the current test case is started.

C.2.4.1 Sequence diagram

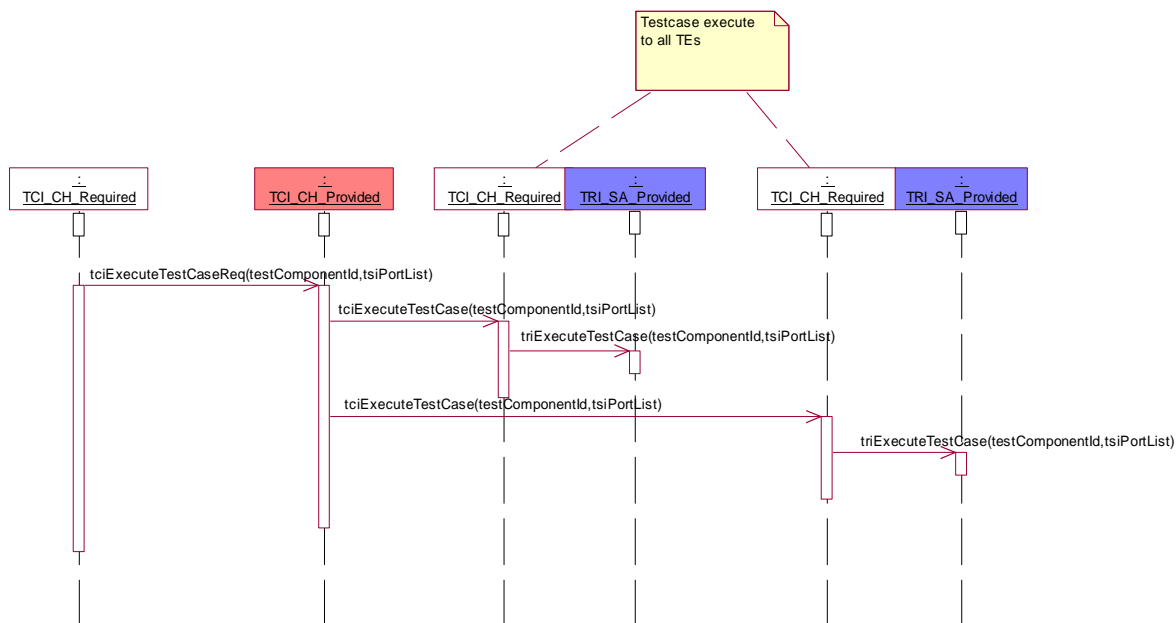

Figure C.7: Use scenario - execute test case to TRI

C.2.4.2 TTCN-3 fragment

```

module AModule {
  ...
  testcase ATestCase(...)... {
    ... //the test case behaviour
  }
  ...
  control {
    ...
    execute (ATestCase (...));
    ...
  }
  ...
}
    
```

C.3 Component handling

C.3.1 Use scenario: local control component creation

The scenario in figure C.8 demonstrates the creation of the control component on the same node where the user interface to the test management TCI-TM resides. A control component is created whenever the control part of a TTCN-3 module is executed. Whenever the test management TCI-TM issues the start of the control part, a create test component request is sent to the TCI-CH, which propagates it to the TE where the control component should be created. In this case it is the TE on the same node. The identifier for the control component is returned and given to the TCI-TM. The identifier is then used to start the behaviour of the control part on the control component.

C.3.1.1 Sequence diagram

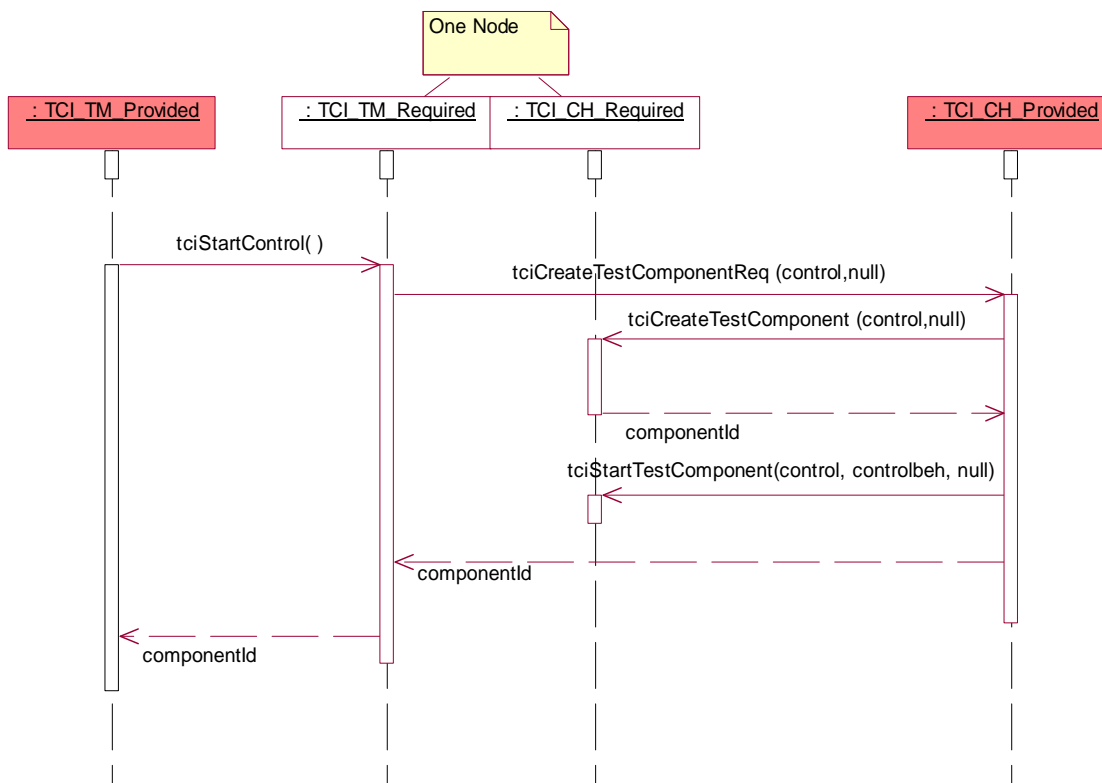

Figure C.8: Use scenario - local control component creation

C.3.1.2 TTCN-3 fragment

```

module AModule {
  ...
  control {
    ...
  }
  ...
}

```

C.3.2 Use scenario: remote control component creation

The scenario in figure C.9 demonstrates the creation of the control component on another node than where the user interface to the test management TCI-TM resides. A control component is created whenever the control part of a TTCN-3 module is executed. Whenever the test management TCI-TM issues the start of the control part, a create test component request is sent to the TCI-CH, which propagates it to the TE where the control component should be created. In this case it is the TE on another remote node. The identifier for the control component is returned and given to the TCI-TM. The identifier is then used to start the behaviour of the control part on the control component.

C.3.2.1 Sequence diagram

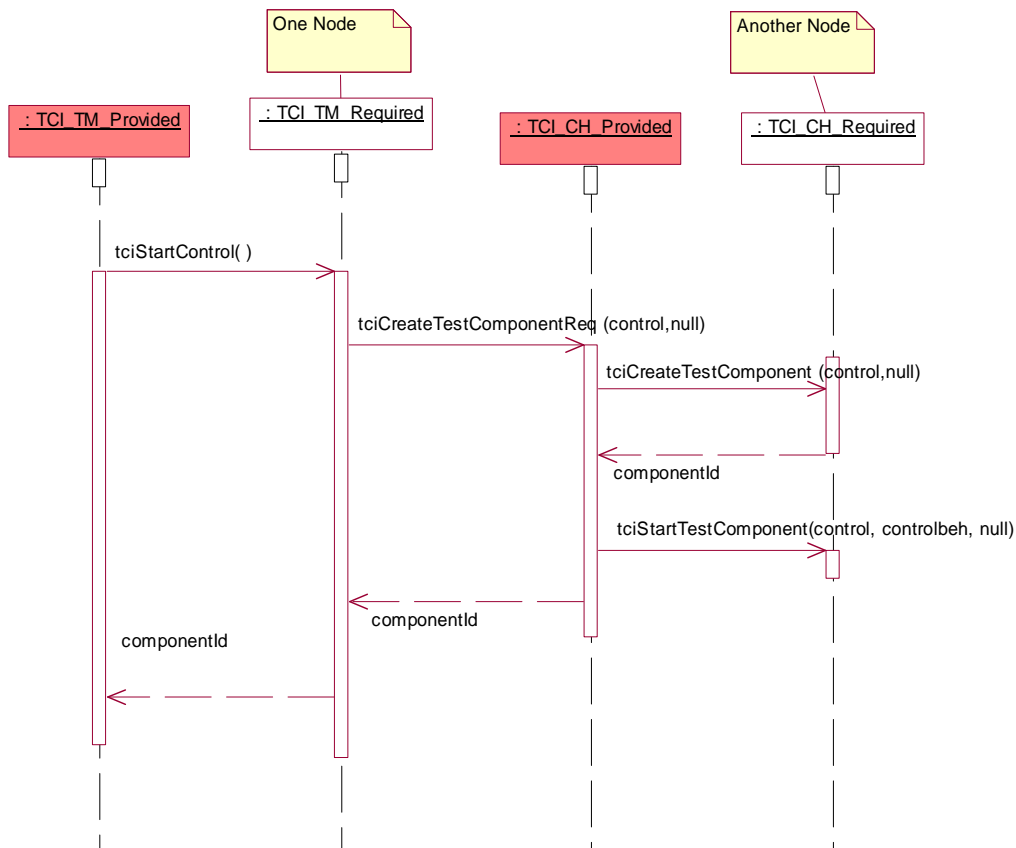

Figure C.9: Use scenario - remote control component creation

C.3.2.2 TTCN-3 fragment

```

module AModule {
  ...
  control {
    ...
  }
  ...
}

```

C.3.3 Use scenario: local MTC creation

The scenario in figure C.10 demonstrates the local creation of the main test component. Local is meant for two cases:

- 1) on the same node where the user interface to the test management TCI-TM resides (when a test case is started directly); or
- 2) on the same node where the control component resides (when a test case is executed from a control part).

A main test component is created whenever a test case is executed: a create test component request is sent to the TCI-CH, which propagates it to the TE where the main test component should be created. In this case it is the TE on the same node. The identifier for the main test component is returned and given to the TCI-TM. The identifier is then used to start the test case behaviour on the main test component (this is not shown here, but handled the same way as in the scenarios described in clauses C.2.2 and C.2.3).

C.3.3.1 Sequence diagram

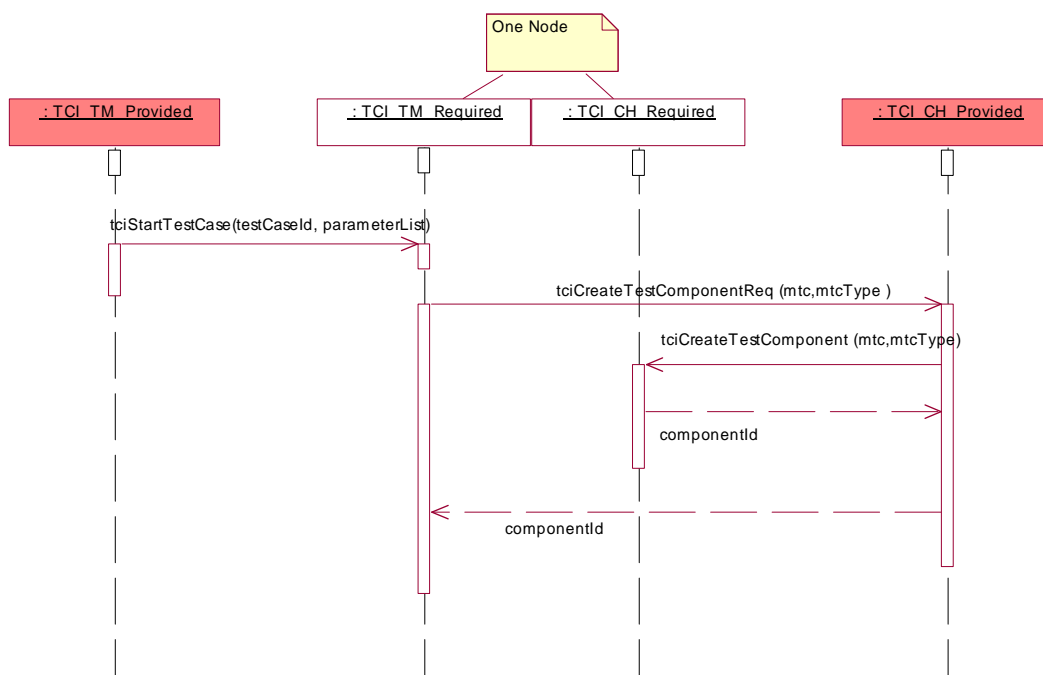

Figure C.10: Use scenario - local MTC creation

C.3.3.2 TTCN-3 fragment

```

module AModule {
  ...
  testcase ATestCase (...) runs on MTCType... {
    ... //the test case behaviour
  }
  ...
}
  
```

C.3.4 Use scenario: remote MTC creation

The scenario in figure C.11 demonstrates the remote creation of the main test component. Remote is meant for two cases:

- 1) on another node than where the user interface to the test management TCI-TM resides (when a test case is started directly); or
- 2) on another node than where the control component resides (when a test case is executed from a control part).

A main test component is created whenever a test case is executed: a create test component request is sent to the TCI-CH, which propagates it to the TE where the main test component should be created. In this case it is the TE on another node. The identifier for the main test component is returned and given to the TCI-TM. The identifier is then used to start the test case behaviour on the main test component (this is not shown here, but handled the same way as in the scenarios described in clauses C.2.2 and C.2.3).

C.3.4.1 Sequence diagram

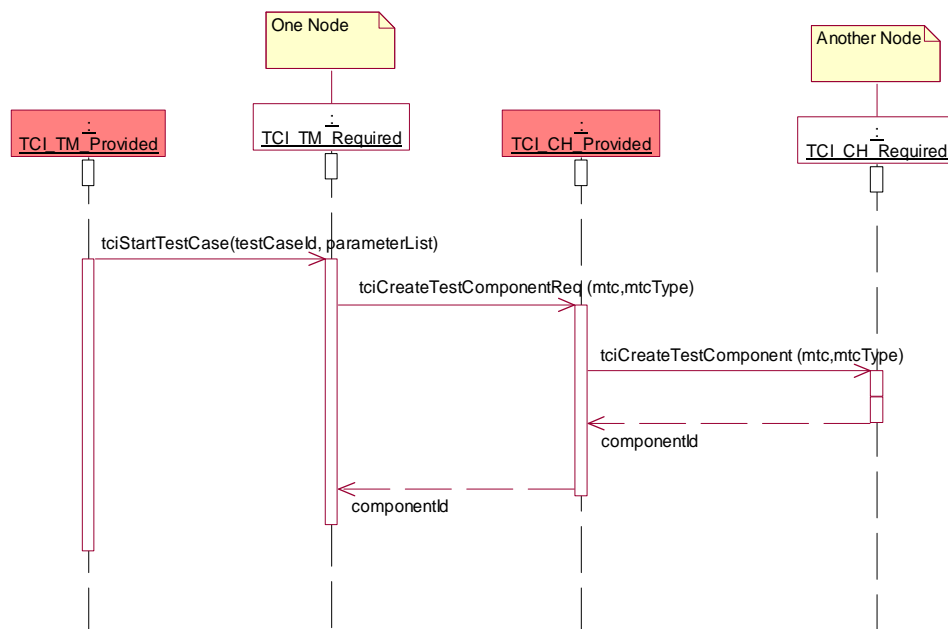

Figure C.11: Use scenario - remote MTC creation

C.3.4.2 TTCN-3 fragment

```

module AModule {
  ...
  testcase ATestCase(...) runs on MTCType ... {
    ... //the test case behaviour
  }
  ...
}
  
```

C.3.5 Use scenario: component handling for test case execution within control

The scenario in figure C.12 demonstrates the handling of components for the test case execution within a control part. When the control part is started, a control component is created and its component identifier returned to the test management. For each test case to be executed within the control part, a main test component is created and the component identifier returned to the control component. Afterwards, the test case behaviour is started on the main test component and the test management is informed about the start of the test case. When the main test component terminates, a request for the main test component termination together with the local verdict of the main test component is propagated to enable the derivation of the global test verdict and to enable the information about the test case termination.

C.3.5.1 Sequence diagram

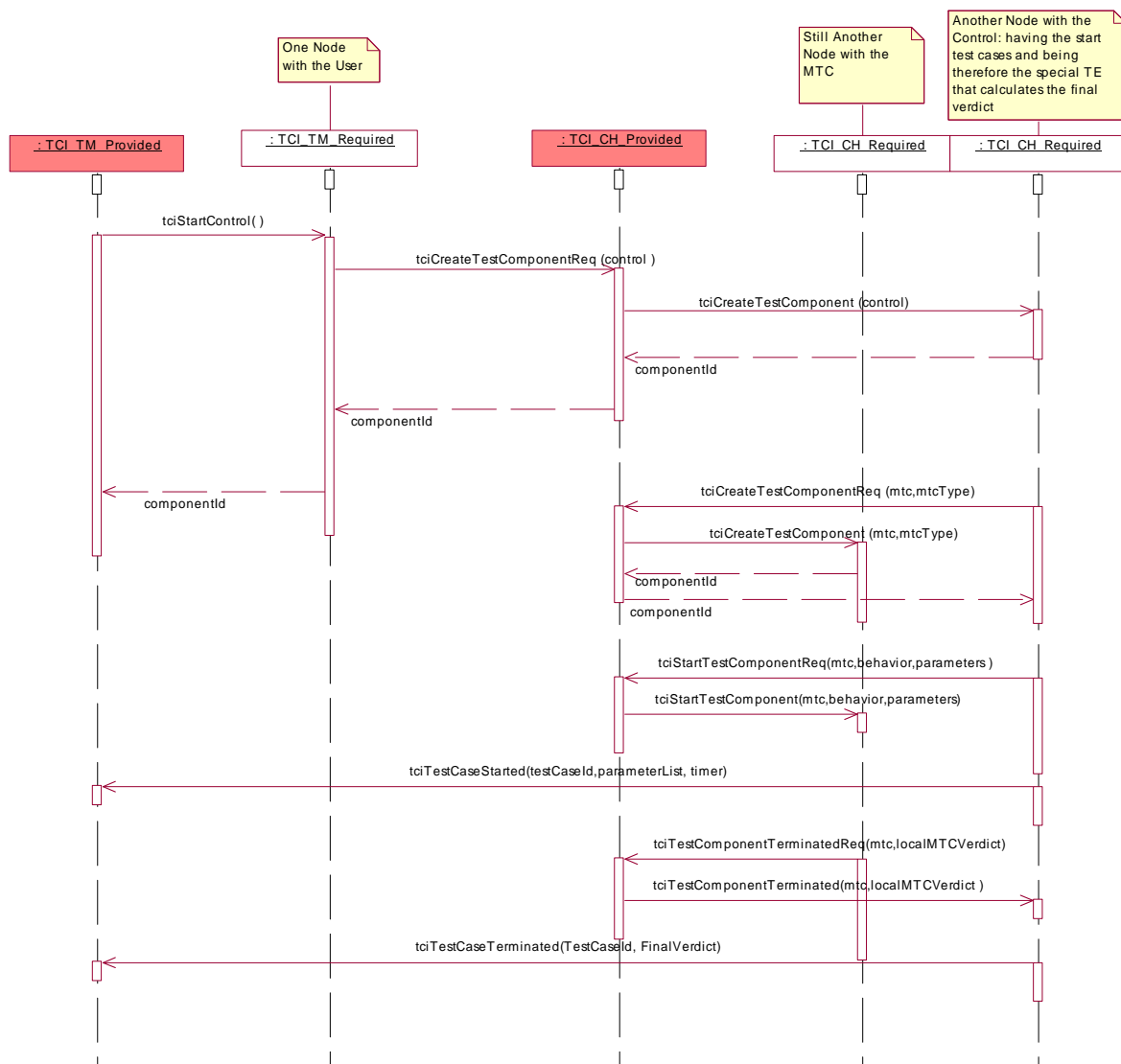

Figure C.12: Use scenario: component handling for test case execution within control

C.3.5.2 TTCN-3 fragment

```
module AModule {
  ...
  testcase ATestCase(...)... {
    ... //the test case behaviour
  }
  ...
  control {
    ...
    execute (ATestCase (...));
    ...
  }
  ...
}
```

C.3.6 Use scenario: component handling for direct test case execution

The scenario in figure C.13 shows how test components are handled when a test case is executed directly, i.e. outside a control part. When a test case is started, the main test component is created and the test case behaviour started on this main test component at first. Whenever a parallel test component is used within a test case, it is handled the same: the parallel test component is started first: giving a test component create request to the TCI-CH entity, which propagates the test component create to the TE in which the parallel test component is to be created. The identifier for the created parallel test component is returned. The identifier is then used to start the PTC behaviour for the start operation. When the PTC terminates its execution, a test component terminate request together with the local test verdict is issued to inform TCI-CH about this termination. The same is done when the main test component terminates. In addition, the termination of the main test component leads to the overall termination of the test case.

C.3.6.1 Sequence diagram

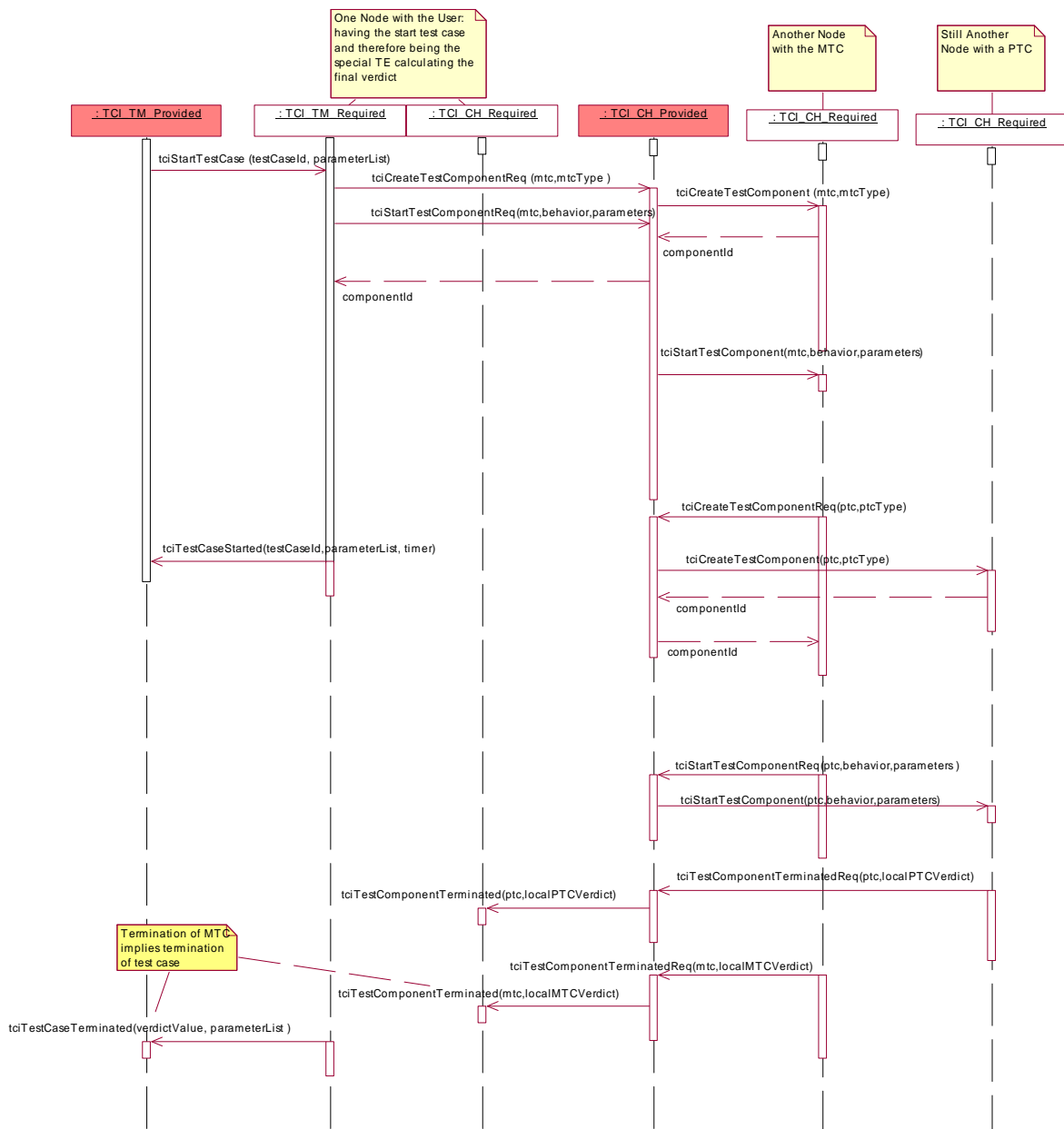

Figure C.13: Use scenario: component handling for direct test case execution

C.3.6.2 TTCN-3 fragment

```

module AModule {
  ...
  function APTCBehaviour(...) runs on APTCType {
    ... //the PTC behaviour
  }
  ...
  testcase ATestCase(...)... {
    ... //the test case behaviour
    var APTCType PTC:= APTCType.create;
    ...
    PTC.start(APTCBehaviour(...));
    ...
  }
  ...
}

```

C.3.7 Use scenario: propagation of map/connect

The scenario in figure C.14 shows how ports are mapped. The request to map a port is propagated to the TE where the map is finally performed. The propagation of connect requests works analogously.

C.3.7.1 Sequence diagram

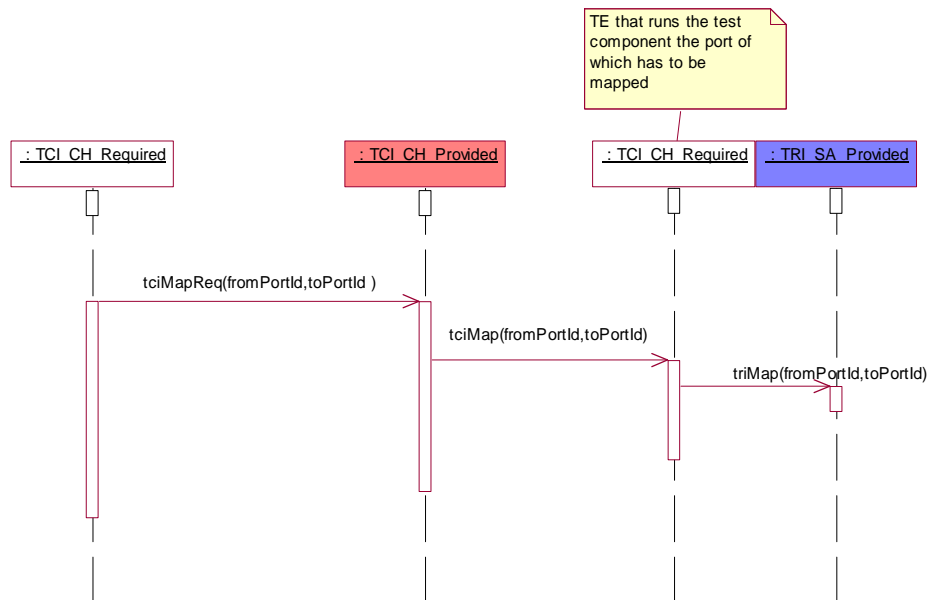

Figure C.14: Use scenario: propagation of map

C.3.7.2 TTCN-3 fragment

```

module AModule {
  ...
  type port A { ... }
  type component CA { port A a }
  type component CB { port A a }
  ...
  testcase ATestCase(...)runs on CA system CB {
    var CA ptc := CA.create;
    ... //the test case behaviour
    map(ptc:a, System:a);
    ...
  }
  ...
}

```

C.3.8 Use scenario: propagation of unmap/disconnect

The scenario in figure C.15 shows how ports are unmapped. The request to unmap a port is propagated to the TE where the unmap is finally performed. The propagation of disconnect requests works analogously.

C.3.8.1 Sequence diagram

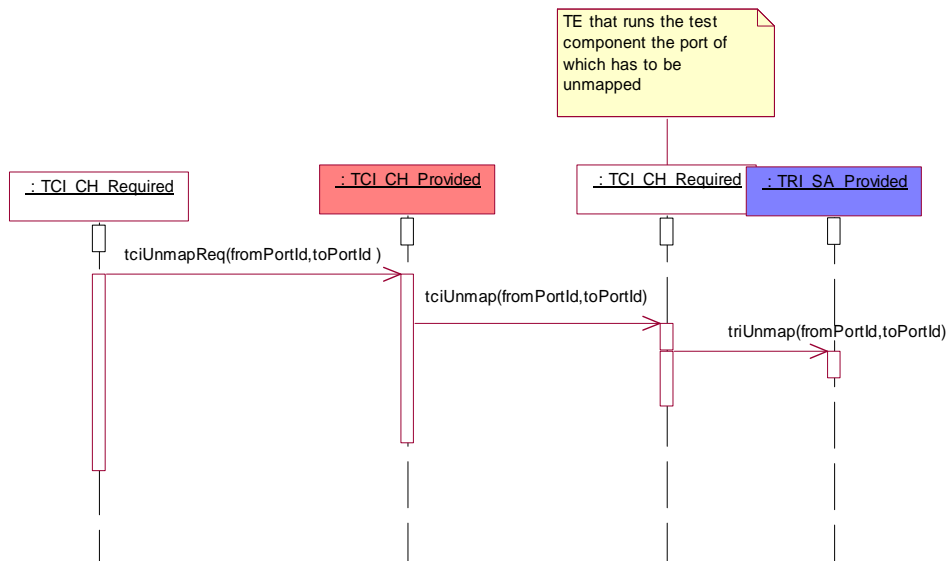

Figure C.15: Use scenario - propagation of map

C.3.8.2 TTCN-3 fragment

```

module AModule {
  ...
  type port A { ... }
  type component CA { port A a }
  type component CB { port A a }
  ...
  testcase ATestCase(...) runs on CA system CB {
    var CA ptc := CA.create;
    ... //the test case behaviour
    unmap(ptc:a,system:a);
  }
  ...
}

```

C.4 Termination of test cases and control

C.4.1 Use scenario: stop a test case

The scenario in figure C.16 shows how a test case is stopped from the test management during test case execution. Once the TM has received information about a started test case, a stop test case can be requested up until receiving the information that the test case has been terminated. Upon stopping a test case, all parallel test components will be stopped and the test system will be reset.

C.4.1.1 Sequence diagram

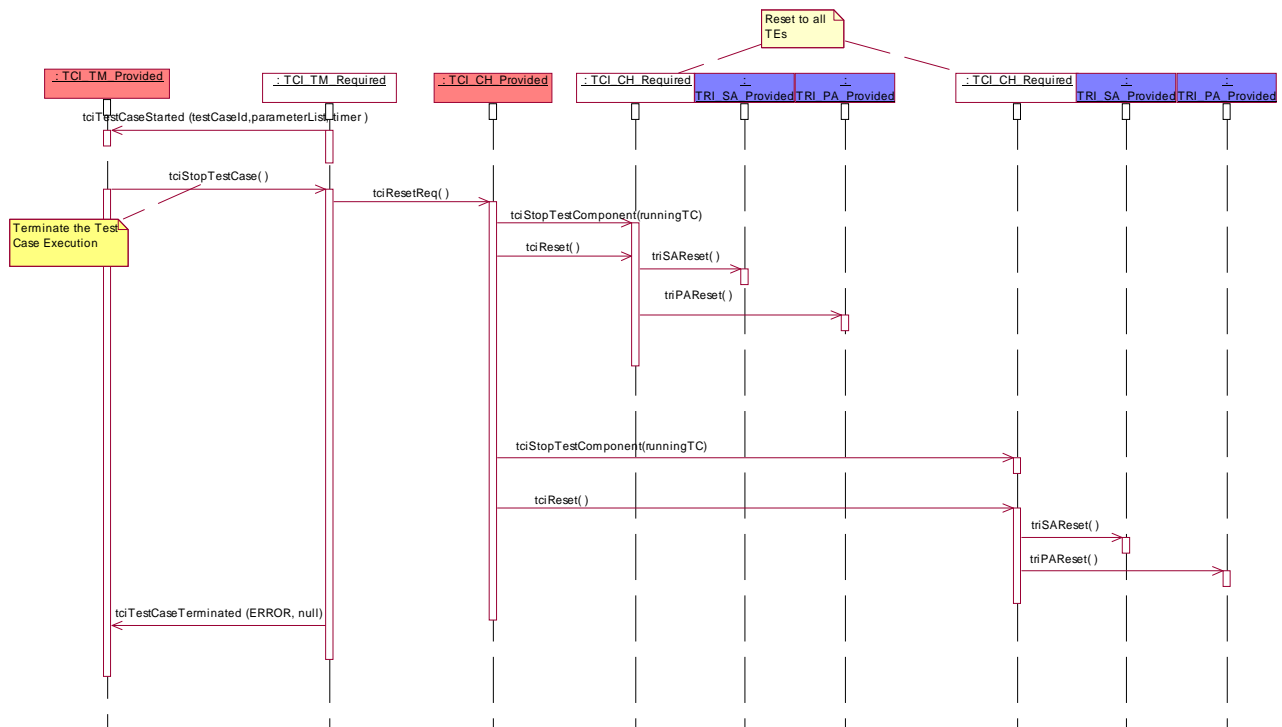

Figure C.16: Use scenario: stop a test case

C.4.1.2 TTCN-3 fragment

There is no TTCN-3 code related to how the TM chooses to implement test case termination. This is outside the scope of TTCN-3.

C.4.2 Use scenario: stop control

The scenario in figure C.17 shows how a control part is stopped from the test management during control part execution. A control part can be stopped in between starting the control and its termination. If the control part receives a stop test case request while a test case is executing, the executing test case is to be stopped. Furthermore, the test system is to be reset as described in figure C.16.

C.4.2.1 Sequence diagram

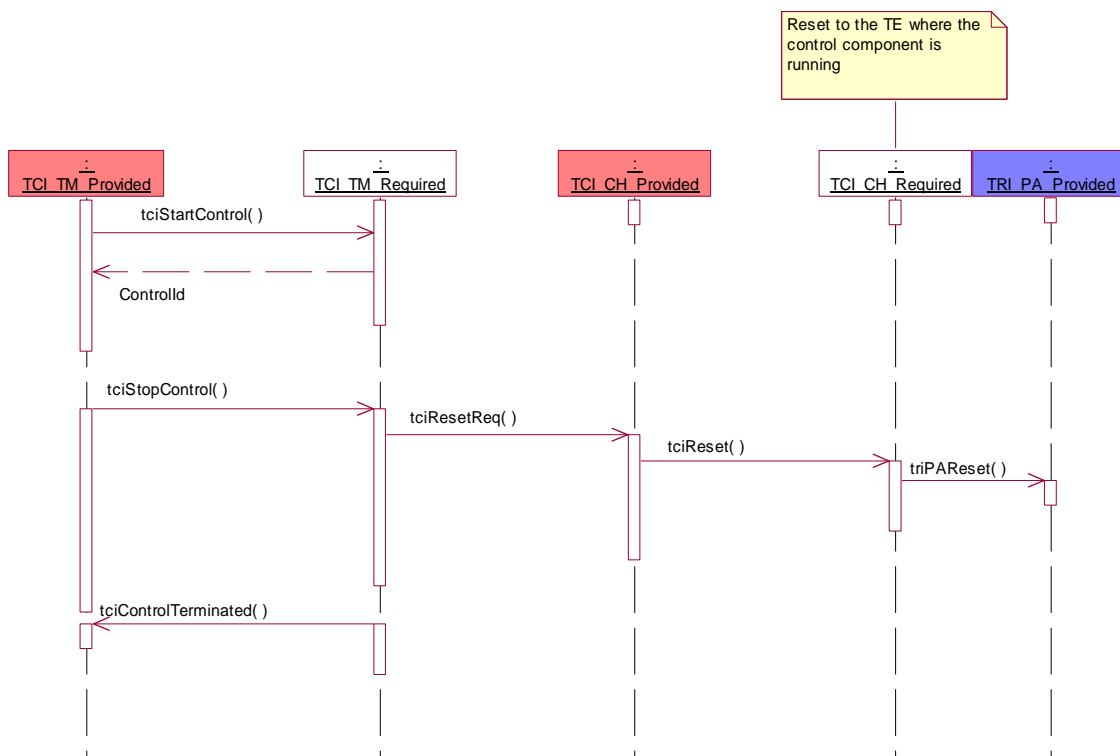

Figure C.17: Use scenario - stop control

C.4.2.2 TTCN-3 fragment

Stopping a control part from the test management is outside the scope of TTCN-3 so that no TTCN-3 fragment exists.

C.4.3 Use scenario: termination of control after error

The scenario in figure C.18 shows the handling of error situations during the execution of a control part when no test case is being executed. The test management is informed about the error situation and has then to terminate the execution of the control part explicitly. Upon termination of the control part, the test system will be reset.

C.4.3.1 Sequence diagram

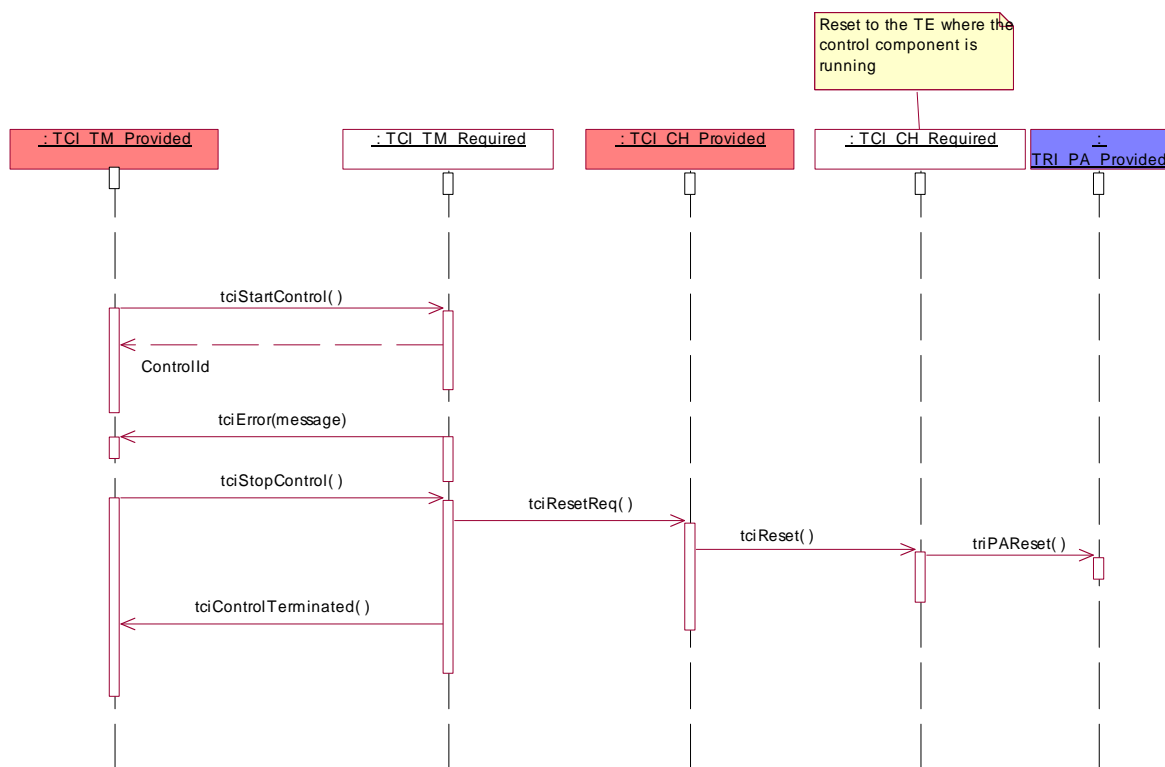

Figure C.18: Use scenario - termination of control after error

C.4.3.2 TTCN-3 fragment

There is no TTCN-3 fragment for this scenario since error situations are exceptional cases in a test system and not a TTCN-3 concept as such. Rather, the TTCN-3 semantics describes various potential error situations in a test system.

C.4.4 Use scenario: termination of a test case after error

The scenario in figure C.19 shows the handling of error situations during the direct execution of a test case. The test management is informed about the error situation. The TM has then to explicitly terminate test case execution. Upon stopping a test case, the parallel test components will be stopped and the test system is to be reset.

C.4.4.1 Sequence diagram

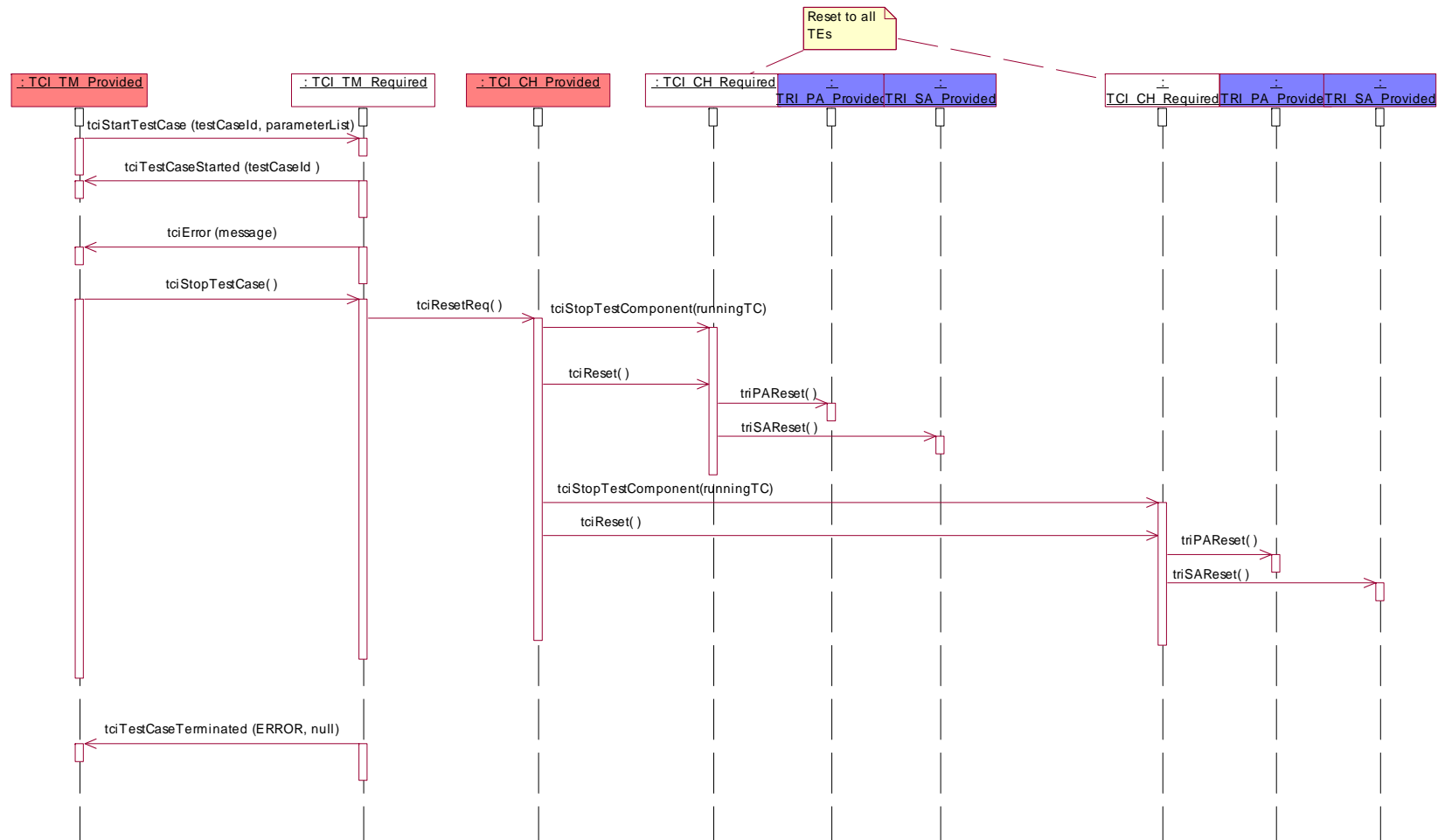

Figure C.19: Use scenario - termination of a test case after error

C.4.4.2 TTCN-3 fragment

There is no TTCN-3 fragment for this scenario since error situations are exceptional cases in a test system and not a TTCN-3 concept as such. Rather, the TTCN-3 semantics describes various potential error situations in a test system.

C.4.5 Use scenario: reset

The scenario in figure C.20 shows the reset of the test system. In that case all involved TEs together with their TRI System Adaptors (SA) and Platform Adaptors (PA) are reset.

C.4.5.1 Sequence diagram

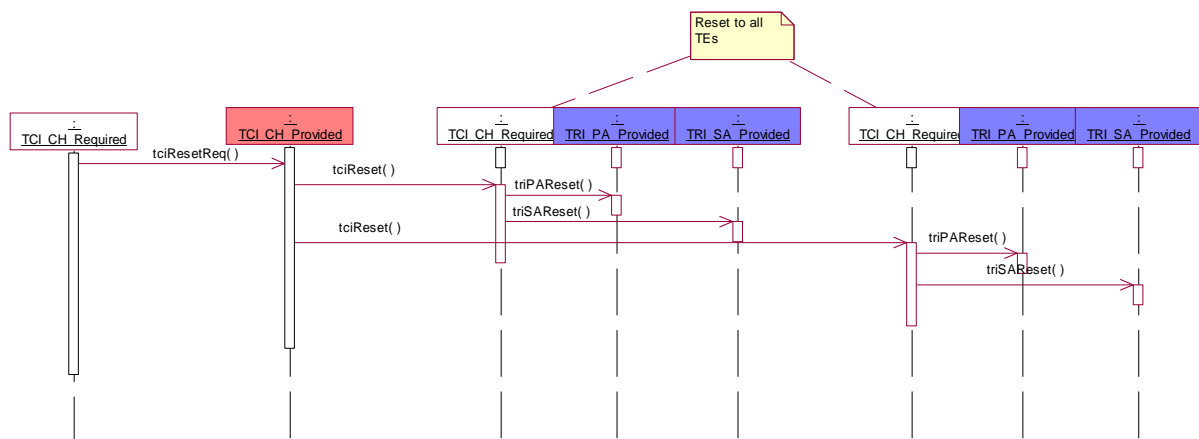

Figure C.20: Use scenario - reset

C.4.5.2 TTCN-3 fragment

There is no TTCN-3 fragment for this scenario since reset as required after error situations are exceptional cases in a test system and not a TTCN-3 concept as such.

C.5 Communication

C.5.1 Use scenario: local intercomponent communication

The scenario in figure C.21 shows the communication between test components (main test component or parallel test components), which reside on the same node. A communication request is given to the TCI-CH, which then decide where to enqueue this communication template. In this case, the communication is done locally via the TE on the same node. The scenario shows a message-based communication using the send operation - the scenario is the same for call, reply, and raise operations.

C.5.1.1 Sequence diagram

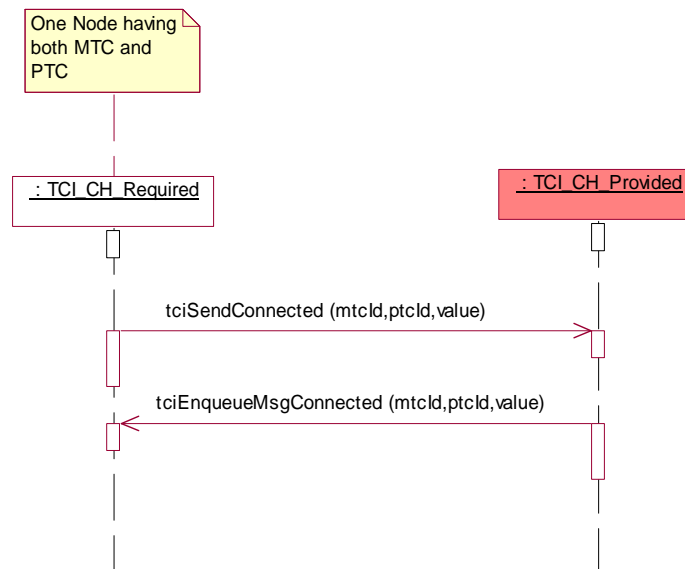

Figure C.21: Use scenario - local intercomponent communication

C.5.1.2 TTCN-3 fragment

```

module AModule {
  ...
  type port APortType message { ... }
  ...
  type component ATCType {
    ...
    APortType APort;
    ...
  }
  ...
  template AType AMessageTemplate { ... }
  ...
  function APTCBehaviour(...) runs on APTCType {
    ... //the PTC behaviour
  }
  ...
  testcase ATestCase(...) runs on ATCType... {
    ... //the test case behaviour
    var ATCType PTC1:= ATCType.create;
    connect (PTC1:APort,mtc:APort);
    ...
    PTC1.start(APTCBehaviour(...));
    APort.send(AMessageTemplate); //sending data to a test component
  }
  ...
}
  
```

C.5.2 Use scenario: internode communication between test components

The scenario in figure C.22 shows the communication between test components (main test component or parallel test components), which reside on different nodes. A communication request is given to the TCI-CH, which then decides where to enqueue this communication template. In this case, the communication is done remotely via the TE on another node. The scenario shows a message based communication using the send operation - the scenario is the same for call, reply, and raise operations.

C.5.2.1 Sequence diagram

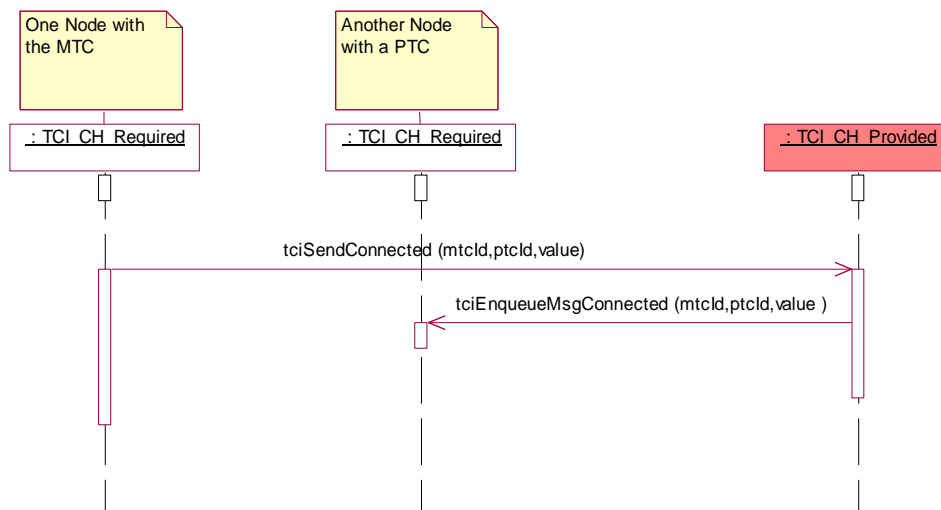

Figure C.22: Use scenario - internode communication between test components

C.5.2.2 TTCN-3 fragment

```

module AModule {
  ...
  type port APortType message { ... }
  ...
  type component ATCType {
    ...
    APortType APort;
    ...
  }
  ...
  template AType AMessageTemplate { ... }
  ...
  function APTCBehaviour(...) runs on APTCType {
    ... //the PTC behaviour
  }
  ...
  testcase ATestCase(...) runs on ATCType... {
    ... //the test case behaviour
    var ATCType PTC1:= ATCType.create;
    connect (PTC1:APort,mtc:APort);
    ...
    PTC1.start(APTCBehaviour(...));
    APort.send(AMessageTemplate); //sending data to a test component
  }
  ...
}

```

C.5.3 Use scenario: encoding

The scenario in figure C.23 shows the encoding of data, which is sent to the SUT. The encoded data is received from the coding/decoding entity via the TCI-CD. The encoded value is sent to the SUT via the TRI-SA. The scenario is the same for the call, the reply, and the raise operations.

C.5.3.1 Sequence diagram

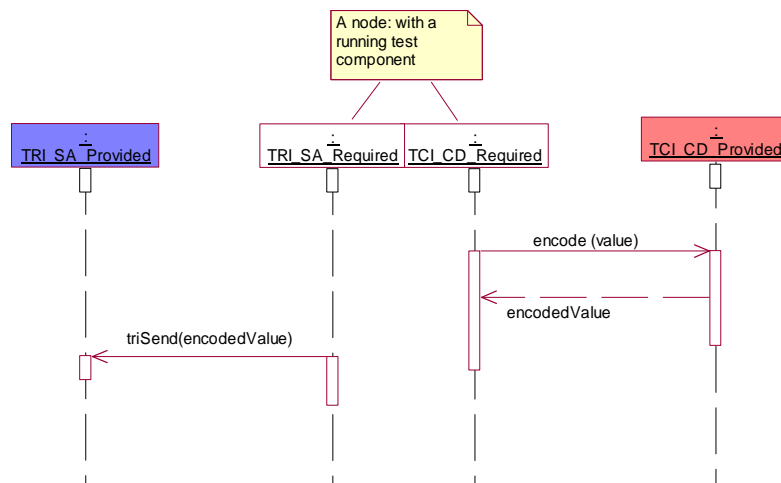

Figure C.23: Use scenario - encoding

C.5.3.2 TTCN-3 fragment

```

module AModule {
  ...
  type port APortType message { ... }
  ...
  type component APTCType {
    ...
    APortType APort;
    ...
  }
  ...
  template AType AMessageTemplate { ... }
  ...
  testcase ATestCase(...) runs on APTCType system APTCType {
    ... //the test case behaviour
    map(mtc:APort, system:APort);
    ...
    APort.send(AMessageTemplate); //sending data to the SUT
    ...
  }
  ...
} with { encoding "..."}
  
```

C.5.4 Use scenario: decoding

The scenario in figure C.24 shows the decoding of data, which is received from the SUT via the TRI-SA. The decoded data is received from the coding/decoding entity via the TCI-CD. The scenario is the same for the receive, the getcall, the getreply, the catch, and the check operations.

C.5.4.1 Sequence diagram

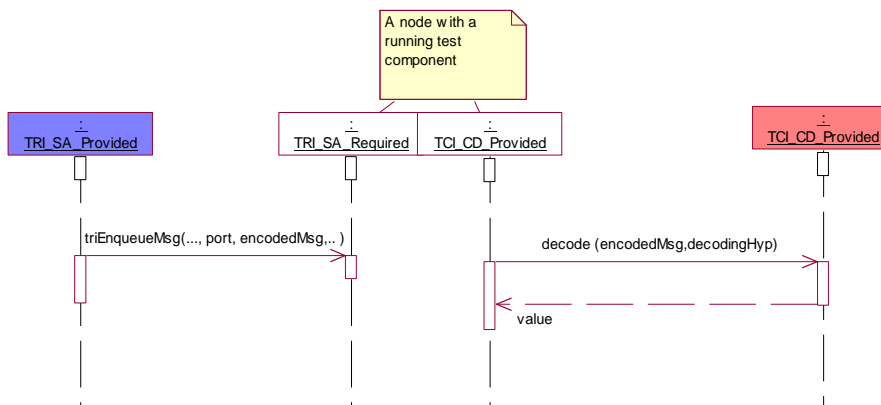

Figure C.24: Use scenario - decoding

C.5.4.2 TTCN-3 fragment

```

module AModule {
  ...
  type port APortType message { ... }
  ...
  type component APTCType {
    ...
    APortType APort;
    ...
  }
  ...
  template AType AMessageTemplate { ... }
  ...
  testcase ATestCase(...) runs on APTCType system APTCType {
    ... //the test case behaviour
    map (mtc:APort, system:APort);
    ...
    APort.receive(AMessageTemplate); //receiving data from the SUT
    ...
  }
  ...
} with { encoding "..."}
  
```

Annex D (informative): Bibliography

- INTOOL CGI/NPL038 (V2.2): "Generic Compiler/Interpreter interface; GCI Interface Specification" Infrastructural Tools, December 1996.
- ISO/IEC 9646-3 (1998): "Information technology - Open Systems Interconnection - Conformance testing methodology and framework - Part 3: The Tree and Tabular combined Notation (TTCN)".

History

Document history		
V1.1.1	July 2003	Publication
V3.1.1	June 2005	Publication
V3.2.1	February 2007	Publication
V3.3.1	April 2008	Publication
V3.4.1	September 2008	Publication
V4.1.1	June 2009	Publication
V4.2.1	July 2010	Publication
V4.3.1	June 2011	Publication
V4.4.0	February 2012	Membership Approval Procedure MV 20120401: 2012-02-01 to 2012-04-02
V4.4.1	April 2012	Publication