

**Methods for Testing and Specification (MTS);  
The Testing and Test Control Notation version 3;  
Part 6: TTCN-3 Control Interface (TCI)**

---



---

**Reference**

RES/MTS-00090-6 ttcn3 tci

---

**Keywords**

control, interface, methodology, MTS, TCI,  
testing, TTCN

**ETSI**

650 Route des Lucioles  
F-06921 Sophia Antipolis Cedex - FRANCE

Tel.: +33 4 92 94 42 00 Fax: +33 4 93 65 47 16

Siret N° 348 623 562 00017 - NAF 742 C  
Association à but non lucratif enregistrée à la  
Sous-Préfecture de Grasse (06) N° 7803/88

---

**Important notice**

Individual copies of the present document can be downloaded from:

<http://www.etsi.org>

The present document may be made available in more than one electronic version or in print. In any case of existing or perceived difference in contents between such versions, the reference version is the Portable Document Format (PDF). In case of dispute, the reference shall be the printing on ETSI printers of the PDF version kept on a specific network drive within ETSI Secretariat.

Users of the present document should be aware that the document may be subject to revision or change of status. Information on the current status of this and other ETSI documents is available at

<http://portal.etsi.org/tb/status/status.asp>

If you find errors in the present document, please send your comment to one of the following services:

[http://portal.etsi.org/chaicor/ETSI\\_support.asp](http://portal.etsi.org/chaicor/ETSI_support.asp)

---

**Copyright Notification**

No part may be reproduced except as authorized by written permission.  
The copyright and the foregoing restriction extend to reproduction in all media.

© European Telecommunications Standards Institute 2005.  
All rights reserved.

**DECT**<sup>TM</sup>, **PLUGTESTS**<sup>TM</sup> and **UMTS**<sup>TM</sup> are Trade Marks of ETSI registered for the benefit of its Members.  
**TIPHON**<sup>TM</sup> and the **TIPHON logo** are Trade Marks currently being registered by ETSI for the benefit of its Members.  
**3GPP**<sup>TM</sup> is a Trade Mark of ETSI registered for the benefit of its Members and of the 3GPP Organizational Partners.

# Contents

Intellectual Property Rights .....	11
Foreword.....	11
1 Scope .....	12
2 References .....	12
3 Definitions and abbreviations.....	13
3.1 Definitions .....	13
3.2 Abbreviations .....	14
4 Introduction .....	14
5 Compliance.....	15
6 General structure of a TTCN-3 test system.....	15
6.1 Entities in a TTCN-3 test system.....	15
6.1.1 Test Management and Control (TMC).....	16
6.1.1.1 Test Management (TM) .....	16
6.1.1.2 Coding and Decoding (CD) .....	16
6.1.1.3 Component Handling (CH) .....	17
6.1.1.4 Test Logging (TL).....	18
6.1.2 TTCN-3 Executable (TE) .....	18
6.1.3 SUT Adaptor (SA).....	18
6.1.4 Platform Adaptor (PA).....	18
6.2 Execution requirements for a TTCN-3 test system .....	18
7 TTCN-3 control interface and operations.....	18
7.1 Overview of the TCI.....	19
7.1.1 Correlation between TTCN-3 and TCI operation invocations .....	19
7.2 TCI data.....	20
7.2.1 General abstract data types .....	21
7.2.1.1 Management.....	21
7.2.1.2 Communication .....	22
7.2.2 Abstract TTCN-3 data types and values .....	22
7.2.2.1 Abstract TTCN-3 data types .....	22
7.2.2.2 Abstract TTCN-3 values .....	23
7.2.2.2.1 The abstract data type Value .....	24
7.2.2.2.2 The abstract data type IntegerValue .....	25
7.2.2.2.3 The abstract data type FloatValue .....	25
7.2.2.2.4 The abstract data type BooleanValue .....	25
7.2.2.2.5 The abstract data type ObjidValue .....	25
7.2.2.2.6 The abstract data type CharstringValue .....	25
7.2.2.2.7 The abstract data type UniversalCharstringValue.....	26
7.2.2.2.8 The abstract data type BitstringValue.....	26
7.2.2.2.9 The abstract data type OctetstringValue.....	27
7.2.2.2.10 The abstract data type HexstringValue.....	27
7.2.2.2.11 The abstract data type RecordValue.....	28
7.2.2.2.12 The abstract data type RecordOfValue .....	28
7.2.2.2.13 The abstract data type UnionValue .....	29
7.2.2.2.14 The abstract data type EnumeratedValue .....	30
7.2.2.2.15 The abstract data type VerdictValue .....	30
7.2.2.2.16 The abstract data type AddressValue .....	30
7.2.3 Abstract logging types .....	30
7.2.3.1 The abstract data type TciValueTemplate.....	30
7.2.3.2 The abstract data type TciNonValueTemplate .....	31
7.2.3.3 The Value List and Mismatch Types .....	31
7.3 TCI operations.....	31

7.3.1	The TCI-TM interface .....	32
7.3.1.1	TCI-TM required.....	32
7.3.1.1.1	tciRootModule.....	32
7.3.1.1.2	getImportedModules.....	33
7.3.1.1.3	tciGetModuleParameters .....	33
7.3.1.1.4	tciGetTestCases .....	33
7.3.1.1.5	tciGetTestCaseParameters .....	33
7.3.1.1.6	tciGetTestCaseTSI.....	33
7.3.1.1.7	tciStartTestCase .....	34
7.3.1.1.8	tciStopTestCase .....	34
7.3.1.1.9	tciStartControl .....	34
7.3.1.1.10	tciStopControl .....	34
7.3.1.2	TCI-TM provided.....	35
7.3.1.2.1	tciTestCaseStarted .....	35
7.3.1.2.2	tciTestCaseTerminated .....	35
7.3.1.2.3	tciControlTerminated .....	35
7.3.1.2.4	tciGetModulePar.....	36
7.3.1.2.5	tciError.....	36
7.3.2	The TCI-CD interface.....	36
7.3.2.1	TCI-CD required .....	37
7.3.2.1.1	getTypeForName .....	37
7.3.2.1.2	getInteger.....	37
7.3.2.1.3	getFloat .....	37
7.3.2.1.4	getBoolean.....	37
7.3.2.1.5	getObjid .....	37
7.3.2.1.6	getCharstring .....	38
7.3.2.1.7	getUniversalCharstring.....	38
7.3.2.1.8	getHexstring .....	38
7.3.2.1.9	getBitstring .....	38
7.3.2.1.10	getOctetstring .....	38
7.3.2.1.11	getVerdict .....	38
7.3.2.1.12	tciErrorReq .....	38
7.3.2.2	TCI-CD provided .....	39
7.3.2.2.1	decode.....	39
7.3.2.2.2	encode.....	39
7.3.3	The TCI-CH interface.....	39
7.3.3.1	TCI-CH required .....	40
7.3.3.1.1	tciEnqueueMsgConnected .....	40
7.3.3.1.2	tciEnqueueCallConnected .....	40
7.3.3.1.3	tciEnqueueReplyConnected.....	41
7.3.3.1.4	tciEnqueueRaiseConnected .....	41
7.3.3.1.5	tciCreateTestComponent .....	41
7.3.3.1.6	tciStartTestComponent .....	42
7.3.3.1.7	tciStopTestComponent .....	42
7.3.3.1.8	tciConnect.....	42
7.3.3.1.9	tciDisconnect .....	42
7.3.3.1.10	tciMap.....	43
7.3.3.1.11	tciUnmap .....	43
7.3.3.1.12	tciTestComponentTerminated .....	43
7.3.3.1.13	tciTestComponentRunning.....	43
7.3.3.1.14	tciTestComponentDone .....	43
7.3.3.1.15	tciGetMTC.....	44
7.3.3.1.16	tciExecuteTestCase.....	44
7.3.3.1.17	tciReset .....	44
7.3.3.1.18	tciKillTestComponent .....	44
7.3.3.1.19	tciTestComponentAlive.....	44
7.3.3.1.20	tciTestComponentKilled.....	45
7.3.3.2	TCI-CH provided .....	45
7.3.3.2.1	tciSendConnected .....	45
7.3.3.2.2	tciSendConnectedBC.....	45
7.3.3.2.3	tciSendConnectedMC.....	45
7.3.3.2.4	tciCallConnected .....	46

7.3.3.2.5	tciCallConnectedBC .....	46
7.3.3.2.6	tciCallConnectedMC .....	47
7.3.3.2.7	tciReplyConnected .....	47
7.3.3.2.8	tciReplyConnectedBC .....	48
7.3.3.2.9	tciReplyConnectedMC .....	48
7.3.3.2.10	tciRaiseConnected .....	49
7.3.3.2.11	tciRaiseConnectedBC .....	49
7.3.3.2.12	tciRaiseConnectedMC .....	49
7.3.3.2.13	tciCreateTestComponentReq .....	50
7.3.3.2.14	tciStartTestComponentReq .....	50
7.3.3.2.15	tciStopTestComponentReq .....	50
7.3.3.2.16	tciConnectReq .....	50
7.3.3.2.17	tciDisconnectReq .....	51
7.3.3.2.18	tciMapReq .....	51
7.3.3.2.19	tciUnmapReq .....	51
7.3.3.2.20	tciTestComponentTerminatedReq .....	51
7.3.3.2.21	tciTestComponentRunningReq .....	51
7.3.3.1.22	tciTestComponentDoneReq .....	52
7.3.3.2.23	tciGetMTCReq .....	52
7.3.3.2.24	tciExecuteTestCaseReq .....	52
7.3.3.2.25	tciResetReq .....	52
7.3.3.1.26	tciKillTestComponentReq .....	52
7.3.3.1.27	tciTestComponentAliveReq .....	53
7.3.3.1.28	tciTestComponentKilledReq .....	53
7.3.4	The TCI-TL interface .....	53
7.3.4.1	TCI-TL provided .....	53
7.3.4.1.1	tliTcExecute .....	54
7.3.4.1.2	tliTcStart .....	54
7.3.4.1.3	tliTcStop .....	54
7.3.4.1.4	tliTcStarted .....	55
7.3.4.1.5	tliTcTerminated .....	55
7.3.4.1.6	tliCtrlStart .....	55
7.3.4.1.7	tliCtrlStop .....	56
7.3.4.1.8	tliCtrlTerminated .....	56
7.3.4.1.9	tliMSend_m .....	56
7.3.4.1.10	tliMSend_m_BC .....	57
7.3.4.1.11	tliMSend_m_MC .....	57
7.3.4.1.12	tliMSend_c .....	58
7.3.4.1.13	tliMSend_c_BC .....	58
7.3.4.1.14	tliMSend_c_MC .....	58
7.3.4.1.15	tliMDetected_m .....	59
7.3.4.1.16	tliMDetected_c .....	59
7.3.4.1.17	tliMMismatch_m .....	60
7.3.4.1.18	tliMMismatch_c .....	60
7.3.4.1.19	tliMReceive_m .....	61
7.3.4.1.20	tliMReceive_c .....	61
7.3.4.1.21	tliPrCall_m .....	62
7.3.4.1.22	tliPrCall_m_BC .....	62
7.3.4.1.23	tliPrCall_m_MC .....	63
7.3.4.1.24	tliPrCall_c .....	63
7.3.4.1.25	tliPrCall_c_BC .....	64
7.3.4.1.26	tliPrCall_c_MC .....	64
7.3.4.1.27	tliPrGetCallDetected_m .....	65
7.3.4.1.28	tliPrGetCallDetected_c .....	65
7.3.4.1.29	tliPrGetCallMismatch_m .....	66
7.3.4.1.30	tliPrGetCallMismatch_c .....	66
7.3.4.1.31	tliPrGetCall_m .....	67
7.3.4.1.32	tliPrGetCall_c .....	67
7.3.4.1.33	tliPrReply_m .....	68
7.3.4.1.34	tliPrReply_m_BC .....	68
7.3.4.1.35	tliPrReply_m_MC .....	69
7.3.4.1.36	tliPrReply_c .....	69

7.3.4.1.37	tliPrReply_c_BC.....	70
7.3.4.1.38	tliPrReply_c_MC.....	70
7.3.4.1.39	tliPrGetReplyDetected_m.....	71
7.3.4.1.40	tliPrGetReplyDetected_c.....	71
7.3.4.1.41	tliPrGetReplyMismatch_m.....	72
7.3.4.1.42	tliPrGetReplyMismatch_c.....	72
7.3.4.1.43	tliPrGetReply_m.....	73
7.3.4.1.44	tliPrGetReply_c.....	73
7.3.4.1.45	tliPrRaise_m.....	74
7.3.4.1.46	tliPrRaise_m_BC.....	74
7.3.4.1.47	tliPrRaise_m_MC.....	75
7.3.4.1.48	tliPrRaise_c.....	75
7.3.4.1.49	tliPrRaise_c_BC.....	76
7.3.4.1.50	tliPrRaise_c_MC.....	76
7.3.4.1.51	tliPrCatchDetected_m.....	77
7.3.4.1.52	tliPrCatchDetected_c.....	77
7.3.4.1.53	tliPrCatchMismatch m.....	78
7.3.4.1.54	tliPrCatchMismatch c.....	78
7.3.4.1.55	tliPrCatch m.....	79
7.3.4.1.56	tliPrCatch c.....	79
7.3.4.1.57	tliPrCatchTimeoutDetected.....	80
7.3.4.1.58	tliPrCatchTimeout.....	80
7.3.4.1.59	tliCCreate.....	80
7.3.4.1.60	tliCStart.....	81
7.3.4.1.61	tliCRunning.....	81
7.3.4.1.62	tliCALive.....	81
7.3.4.1.63	tliCStop.....	82
7.3.4.1.64	tliCKill.....	82
7.3.4.1.65	tliCDoneMismatch.....	82
7.3.4.1.66	tliCDone.....	83
7.3.4.1.67	tliCKilledMismatch.....	83
7.3.4.1.68	tliCKilled.....	83
7.3.4.1.69	tliCTerminated.....	84
7.3.4.1.70	tliPConnect.....	84
7.3.4.1.71	tliPDisconnect.....	84
7.3.4.1.72	tliPMap.....	85
7.3.4.1.73	tliPUnmap.....	85
7.3.4.1.74	tliPClear.....	85
7.3.4.1.75	tliPStart.....	86
7.3.4.1.76	tliPStop.....	86
7.3.4.1.77	tliPHalt.....	86
7.3.4.1.78	tliEncode.....	87
7.3.4.1.79	tliDecode.....	87
7.3.4.1.80	tliTTimeoutDetected.....	87
7.3.4.1.81	tliTTimeoutMismatch.....	88
7.3.4.1.82	tliTTimeout.....	88
7.3.4.1.83	tliTStart.....	88
7.3.4.1.84	tliTStop.....	89
7.3.4.1.85	tliTRead.....	89
7.3.4.1.86	tliTRunning.....	89
7.3.4.1.87	tliSEnter.....	90
7.3.4.1.88	tliSLeave.....	90
7.3.4.1.89	tliVar.....	90
7.3.4.1.90	tliModulePar.....	91
7.3.4.1.91	tliGetVerdict.....	91
7.3.4.1.92	tliSetVerdict.....	91
7.3.4.1.93	tliLog.....	92
7.3.4.1.94	tliAEnter.....	92
7.3.4.1.95	tliALeave.....	92
7.3.4.1.96	tliANomatch.....	92
7.3.4.1.97	tliARepeat.....	93
7.3.4.1.98	tliADefaults.....	93

7.3.4.1.99	tliAActivate .....	93
7.3.4.1.100	tliADeactivate.....	94
7.3.4.1.101	tliAWait.....	94
8	Java language mapping .....	94
8.1	Introduction .....	94
8.2	Names and scopes .....	94
8.2.1	Names .....	94
8.2.2	Scopes .....	95
8.2.2.1	TciParameterType .....	96
8.2.2.2	TciParameterPassingModeType.....	96
8.2.2.3	TciParameterListType.....	96
8.2.2.4	TciTypeClassType .....	97
8.2.2.5	TciTestComponentKindType.....	97
8.2.2.6	TciBehaviourIdType .....	97
8.2.2.7	TciTestCaseIdType .....	98
8.2.2.8	TciModuleIdType .....	98
8.2.2.9	TciModuleParameterIdType .....	98
8.2.2.10	TciModuleParameterListType .....	98
8.2.2.11	TciModuleParameterType.....	98
8.2.2.12	TciParameterTypeListType.....	99
8.2.2.13	TciModuleIdListType .....	99
8.2.3	Abstract type mapping .....	99
8.2.3.1	Type .....	99
8.2.4	Abstract value mapping .....	100
8.2.4.1	Value .....	100
8.2.4.2	IntegerValue.....	101
8.2.4.3	FloatValue.....	101
8.2.4.4	BooleanValue.....	101
8.2.4.5	ObjidValue.....	101
8.2.4.6	TciObjId.....	102
8.2.4.7	TciObjIdElement.....	102
8.2.4.8	CharstringValue .....	102
8.2.4.9	BitstringValue .....	103
8.2.4.10	OctetstringValue .....	104
8.2.4.11	UniversalCharstringValue.....	104
8.2.4.12	HexstringValue .....	105
8.2.4.13	RecordValue.....	106
8.2.4.14	RecordOfValue .....	106
8.2.4.15	UnionValue .....	107
8.2.4.16	EnumeratedValue.....	107
8.2.4.17	VerdictValue .....	108
8.2.4.18	AddressValue .....	108
8.2.5	Abstract logging types mapping .....	108
8.2.5.1	TciValueTemplate.....	108
8.2.5.2	TciNonValueTemplate.....	109
8.2.5.3	TciValueList.....	109
8.2.5.4	TciValueDifference.....	109
8.2.5.5	TciValueDifferenceList.....	110
8.3	Constants .....	110
8.4	Mapping of interfaces.....	111
8.4.1	The TCI-TM interface .....	111
8.4.1.1	TCI-TM provided.....	112
8.4.1.2	TCI-TM required.....	112
8.4.2	The TCI-CD interface .....	112
8.4.2.1	TCI-CD provided .....	112
8.4.2.2	TCI-CD required .....	112
8.4.3	The TCI-CH interface.....	113
8.4.3.1	TCI-CH provided .....	113
8.4.3.2	TCI-CH required .....	114
8.4.4	The TCI-TL interface.....	115
8.4.4.1	TCI-TL provided.....	115

8.5	Optional parameters .....	118
8.6	TCI initialization .....	118
8.7	Error handling .....	118
9	ANSI C language mapping.....	119
9.1	Introduction .....	119
9.2	Value interfaces.....	119
9.3	Logging interface .....	122
9.4	Operation interfaces .....	122
9.5	Data .....	136
9.6	Miscellaneous.....	137
10	W3C XML mapping.....	138
10.1	Introduction .....	138
10.2	Scopes .....	138
10.3	Type mapping.....	138
10.3.1	Mapping of simple types.....	138
10.3.1.1	TBoolean.....	138
10.3.1.2	TString .....	138
10.3.1.3	TInteger.....	138
10.3.1.4	TriTimerDurationType.....	138
10.3.1.5	TciParameterPassingModeType.....	138
10.3.1.6	TriStatusType.....	138
10.3.1.7	TciStatusType .....	139
10.3.2	Complex type mapping .....	139
10.3.2.1	TriPortIdType.....	139
10.3.2.2	TriComponentIdType.....	139
10.3.2.3	TriComponentIdListType .....	139
10.3.2.4	Port.....	140
10.3.2.5	Id .....	140
10.3.2.6	TriMessageType.....	140
10.3.2.7	TriParameterType .....	141
10.3.2.8	TriParameterListType .....	141
10.3.2.9	TriAddressType .....	141
10.3.2.10	TriAddressListType .....	142
10.3.2.11	TriExceptionType .....	142
10.3.2.12	TriSignatureIdType .....	142
10.3.2.13	TriAddressType .....	142
10.3.2.14	TriTimerIdType .....	143
10.3.2.15	TriTimerDurationType.....	143
10.3.2.16	QualifiedName .....	143
10.3.2.17	TciBehaviourIdType .....	143
10.3.2.18	TciTestCaseIdType .....	144
10.3.2.19	TciParameterType.....	144
10.3.2.20	TciParameterListType.....	144
10.3.3	Abstract value mapping .....	145
10.3.3.1	Value .....	145
10.3.3.2	IntegerValue.....	146
10.3.3.3	FloatValue.....	146
10.3.3.4	BooleanValue.....	146
10.3.3.5	ObjidValue .....	147
10.3.3.6	VerdictValue .....	147
10.3.3.7	BitstringValue .....	147
10.3.3.8	HexstringValue .....	147
10.3.3.9	OctetstringValue .....	148
10.3.3.10	CharstringValue .....	148
10.3.3.11	UniversalCharstringValue.....	148
10.3.3.12	RecordValue.....	149
10.3.3.13	RecordOfValue .....	150
10.3.3.14	SetValue .....	151
10.3.3.15	SetOfValue.....	152
10.3.3.16	EnumeratedValue.....	154



10.3.3.17	UnionValue .....	154
10.3.3.18	AnytypeValue .....	155
10.3.3.19	AddressValue .....	156
10.3.4	Abstract logging types mapping .....	157
10.3.4.1	TciValueTemplate.....	157
10.3.4.2	TciNonValueTemplate.....	159
10.3.4.3	TciValueList.....	159
10.3.4.4	TciValueDifference.....	159
10.3.4.5	TciValueDifferenceList.....	160
10.4	Mapping of the operations on the logging interface.....	160
10.4.1	Event.....	160
10.4.2	Mapping of Operations .....	161
11	Use scenarios.....	181
11.1	Initialization, collecting information, logging.....	181
11.1.1	Use scenario: initialization.....	181
11.1.1.1	Sequence diagram .....	182
11.1.1.2	TTCN-3 fragment .....	182
11.1.2	Use scenario: requesting module parameters.....	182
11.1.2.1	Sequence diagram .....	183
11.1.2.2	TTCN-3 fragment .....	183
11.1.3	Use scenario: logging.....	183
11.1.3.1	Sequence diagram .....	184
11.1.3.2	TTCN-3 fragment .....	184
11.2	Execution of test cases and control.....	184
11.2.1	Use scenario: execution of control.....	184
11.2.1.1	Sequence diagram .....	185
11.2.1.2	TTCN-3 fragment .....	185
11.2.2	Use scenario: test case execution within control.....	185
11.2.2.1	Sequence diagram .....	186
11.2.2.2	TTCN-3 fragment .....	186
11.2.3	Use scenario: direct test case execution.....	186
11.2.3.1	Sequence diagram .....	187
11.2.3.2	TTCN-3 fragment .....	187
11.2.4	Use scenario: execute test case to TRI.....	187
11.2.4.1	Sequence diagram .....	187
11.2.4.2	TTCN-3 fragment .....	188
11.3	Component handling .....	188
11.3.1	Use scenario: local control component creation .....	188
11.3.1.1	Sequence diagram .....	188
11.3.1.2	TTCN-3 fragment .....	189
11.3.2	Use scenario: remote control component creation .....	189
11.3.2.1	Sequence diagram .....	189
11.3.2.2	TTCN-3 fragment .....	190
11.3.3	Use scenario: local MTC creation.....	190
11.3.3.1	Sequence diagram .....	190
11.3.3.2	TTCN-3 fragment .....	190
11.3.4	Use scenario: remote MTC creation .....	191
11.3.4.1	Sequence diagram .....	191
11.3.4.2	TTCN-3 fragment .....	191
11.3.5	Use scenario: component handling for test case execution within control .....	192
11.3.5.1	Sequence diagram .....	192
11.3.5.2	TTCN-3 fragment .....	193
11.3.6	Use scenario: component handling for direct test case execution.....	193
11.3.6.1	Sequence diagram .....	194
11.3.6.2	TTCN-3 fragment .....	195
11.3.7	Use scenario: propagation of map/connect .....	195
11.3.7.1	Sequence diagram .....	195
11.3.7.2	TTCN-3 fragment .....	195
11.3.8	Use scenario: propagation of unmap/disconnect.....	196
11.3.8.1	Sequence diagram .....	196
11.3.8.2	TTCN-3 fragment .....	196

11.4	Termination of test cases and control .....	196
11.4.1	Use scenario: stop a test case .....	196
11.4.1.1	Sequence diagram .....	197
11.4.1.2	TTCN-3 fragment .....	197
11.4.2	Use scenario: stop control .....	197
11.4.2.1	Sequence diagram .....	198
11.4.2.2	TTCN-3 fragment .....	198
11.4.3	Use scenario: termination of control after error .....	198
11.4.3.1	Sequence diagram .....	199
11.4.3.2	TTCN-3 fragment .....	199
11.4.4	Use scenario: termination of a test case after error .....	199
11.4.4.1	Sequence diagram .....	200
11.4.4.2	TTCN-3 fragment .....	201
11.4.5	Use scenario: reset .....	201
11.4.5.1	Sequence diagram .....	201
11.4.5.2	TTCN-3 fragment .....	201
11.5	Communication .....	201
11.5.1	Use scenario: local intercomponent communication .....	201
11.5.1.1	Sequence diagram .....	202
11.5.1.2	TTCN-3 fragment .....	202
11.5.2	Use scenario: internode communication between test components .....	202
11.5.2.1	Sequence diagram .....	203
11.5.2.2	TTCN-3 fragment .....	203
11.5.3	Use scenario: encoding .....	203
11.5.3.1	Sequence diagram .....	204
11.5.3.2	TTCN-3 fragment .....	204
11.5.4	Use scenario: decoding .....	204
11.5.4.1	Sequence diagram .....	205
11.5.4.2	TTCN-3 fragment .....	205
<b>Annex A (normative):</b>	<b>IDL Specification of TCI.....</b>	<b>206</b>
<b>Annex B (normative):</b>	<b>XML Mapping for TCI TL Provided.....</b>	<b>222</b>
B.1	TCI-TL XML Schema for Simple Types .....	222
B.2	TCI-TL XML Schema for Types .....	223
B.3	TCI-TL XML Schema for Values .....	224
B.4	TCI-TL XML Schema for Templates .....	230
B.5	TCI-TL XML Schema for Events .....	237
B.6	TCI-TL XML Schema for a Log .....	255
<b>Annex C (informative):</b>	<b>Bibliography.....</b>	<b>258</b>
History	.....	259

---

## Intellectual Property Rights

IPRs essential or potentially essential to the present document may have been declared to ETSI. The information pertaining to these essential IPRs, if any, is publicly available for **ETSI members and non-members**, and can be found in ETSI SR 000 314: "*Intellectual Property Rights (IPRs); Essential, or potentially Essential, IPRs notified to ETSI in respect of ETSI standards*", which is available from the ETSI Secretariat. Latest updates are available on the ETSI Web server (<http://webapp.etsi.org/IPR/home.asp>).

Pursuant to the ETSI IPR Policy, no investigation, including IPR searches, has been carried out by ETSI. No guarantee can be given as to the existence of other IPRs not referenced in ETSI SR 000 314 (or the updates on the ETSI Web server) which are, or may be, or may become, essential to the present document.

---

## Foreword

This ETSI Standard (ES) has been produced by ETSI Technical Committee Methods for Testing and Specification (MTS).

The present document is part 6 of a multi-part deliverable. Full details of the entire series can be found in part 1 [2].

---

# 1 Scope

The present document specifies the control interfaces for TTCN-3 test system implementations. The TTCN-3 Control Interfaces provide a standardized adaptation for management, test component handling and encoding/decoding of a test system to a particular test platform. The present document defines the interfaces as a set of operations independent of a target language.

The interfaces are defined to be compatible with the TTCN-3 standard (see references below). The interface definition uses the CORBA Interface Definition Language (IDL) to specify the TCI completely. Clauses 8 and 9 present language mappings for this abstract specification to the target languages Java and ANSI C. A summary of the IDL-based interface specification is provided in annex A.

---

# 2 References

The following documents contain provisions which, through reference in this text, constitute provisions of the present document.

- References are either specific (identified by date of publication and/or edition number or version number) or non-specific.
- For a specific reference, subsequent revisions do not apply.
- For a non-specific reference, the latest version applies.

Referenced documents which are not found to be publicly available in the expected location might be found at <http://docbox.etsi.org/Reference>.

- [1] ETSI ES 201 873-5: "Methods for Testing and Specification (MTS); The Testing and Test Control Notation version 3; Part 5: TTCN-3 Runtime Interface (TRI)".
- [2] ETSI ES 201 873-1: "Methods for Testing and Specification (MTS); The Testing and Test Control Notation version 3; Part 1: TTCN-3 Core Language".
- [3] ETSI ES 201 873-4: "Methods for Testing and Specification (MTS); The Testing and Test Control Notation version 3; Part 4: TTCN-3 Operational Semantics".
- [4] ISO/IEC 9646-1: "Information technology - Open Systems Interconnection - Conformance testing methodology and framework - Part 1: General concepts".
- [5] W3C Recommendation (2 May 2001): "XML Schema Part 0: Primer".

NOTE: See at <http://www.w3.org/TR/2001/REC-xmlschema-0-20010502/>.

- [6] W3C Recommendation (2 May 2001): "XML Schema Part 1: Structures".

NOTE: See at <http://www.w3.org/TR/2001/REC-xmlschema-1-20010502/>.

- [7] W3C Recommendation (2 May 2001): "XML Schema Part 2: Datatypes".

NOTE: See at <http://www.w3.org/TR/2001/REC-xmlschema-2-20010502/>.

## 3 Definitions and abbreviations

### 3.1 Definitions

For the purpose of the present document, the terms and definitions given in ISO/IEC 9646-1 [4] and the following apply:

**Abstract Test Suite (ATS):** test suite composed of abstract test cases

**codec:** encoder/decoder entity used for encoding and decoding data to be transmitted and received, respectively

**Coding/Decoding (CD):** entity that administers the value and type handling incl. encoding and decoding in the TTCN-3 test system

**Component Handling (CH):** entity that administers the handling of test components in the TTCN-3 test system

**communication port:** abstract mechanism facilitating communication between test components

NOTE: A communication port is modelled as a FIFO queue in the receiving direction. Ports can be message-based, procedure-based or a mixture of the two.

**control component:** component that executes the behaviour of the control part of a TTCN-3 module

**Executable Test Suite (ETS):** Refer to ISO/IEC 9646-1 [4].

**Implementation eXtra Information for Testing (IXIT):** Refer to ISO/IEC 9646-1 [4].

**Platform Adaptor (PA):** entity that adapts the TTCN-3 Executable to a particular execution platform

NOTE: The Platform Adaptor creates a single notion of time for a TTCN-3 test system, and implements both, explicit and implicit, timers as well as external functions.

**real test system interface:** Refer to ISO/IEC 9646-1 [4].

**System Under Test (SUT):** Refer to ISO/IEC 9646-1 [4].

**SUT Adaptor (SA):** entity that adapts the TTCN-3 communication operations with the SUT based on an abstract test system interface. It implements the real test system interface

**Testing and Test Control Notation (TTCN-3):** Refer to ISO/IEC 9646-1 [4].

**test case:** Refer to ISO/IEC 9646-1 [4].

**test event:** either sent or received test data (message or procedure call) on a communication port that is part of the test system interface as well as timeout events of timers

**Test Management (TM):** entity which provides a user interface to as well as the administration of the TTCN-3 test system

**Test Logging (TL):** entity which provides logging information about test execution (including also the information provided by the TTCN-3 log statement)

**Test Management and Control (TMC):** set of three entities providing test management and control; consists of the Test Management (TM), the Component Handling (CH), the Test Logging (TL) and the Coding/Decoding (CD)

NOTE: The TMC is an implementation of TCI.

**test system:** Refer to ISO/IEC 9646-1 [4].

**Test system interface (TSI):** test component that provides a mapping of the ports available in the (abstract) TTCN-3 test system to those offered by a real test system

**TTCN-3 Executable (TE):** part of a test system that deals with interpretation or execution of a TTCN-3 ETS

**TTCN-3 Control Interfaces (TCI):** three interfaces that define the interaction of the TTCN-3 Executable with the test management, the coding and decoding, and the test component handling in a test system

**TTCN-3 Runtime Interface (TRI):** interface that defines the interaction of the TTCN-3 Executable with the SUT and platform adaptors in a test system

## 3.2 Abbreviations

For the purposes of the present document, the following abbreviations apply:

ATS	Abstract Test Suite
CD	Coding/Decoding
CH	Component Handler
ETS	Executable Test Suite
IDL	Interface Definition Language
IXIT	Implementation eXtra Information for Testing
MSC	Message Sequence Chart
MTC	Main Test Component
OMG	Object Management Group
PA	Platform Adaptor
PTC	Parallel Test Component
SA	SUT Adaptor
SUT	System Under Test
TC	Test Control
TCI	TTCN-3 Control Interfaces
TE	TTCN-3 Executable
TL	Test Logging
TM	Test Management
TMC	Test Management and Control
TRI	TTCN-3 Runtime Interface
TSI	Test System Interface
TTCN-3	Testing and Test Control Notation Version 3

---

## 4 Introduction

The present document consists of two distinct parts, the first part describing the structure of a TTCN-3 test system implementation and the second part presenting the TTCN-3 Control Interfaces specification.

The first part introduces the decomposition of a TTCN-3 test system into four main entities:

- Test Management and Control (TMC);
- TTCN-3 Executable (TE);
- SUT Adaptor (SA); and
- Platform Adaptor (PA).

The TMC consists itself of three entities: Test Management (TM), Coder/Decoder (CD), and Test Component Handler (CH). In addition, the interaction between these entities, i.e. the corresponding interfaces, is defined.

The second part of the present document specifies the TTCN-3 Control Interfaces (TCI). The interfaces are defined in terms of operations implemented as part of one entity and called by other test system entities. For each operation, the interface specification defines associated data structures, the intended effect on the test system and any constraints on the usage of the operation. Note that these interface specifications only define interactions between the TE and TM, TE and CD, and TE and CH. For interactions between the TE and SA and the TE and PA please refer to the TTCN-3 Runtime Interface specification (ES 201 873-5 [1]).

## 5 Compliance

The minimum required for a TCI compliant TTCN-3 test system is to adhere to the interface specification stated in the present document. The TTCN-3 semantics in the test system must adhere to the operational semantics defined in ES 201 873-4 [3]. In addition, one language mapping must be supported. For example, if a vendor supports Java, the TCI operation calls and implementations, which are part of the TTCN-3 executable, must comply with the IDL to Java mapping specified in the present document. For the logging interface, the XML mapping can be used instead of the Java or the C mapping.

## 6 General structure of a TTCN-3 test system

A TTCN-3 test system can be thought of conceptually as a set of interacting entities. Each entity implements specific test system functionality. These entities:

- manage test execution;
- interpret or execute compiled TTCN-3 code;
- realize proper communication with the SUT;
- administer types, values and test components;
- implement external functions; and
- handle timer operations.

### 6.1 Entities in a TTCN-3 test system

The structure of a TTCN-3 test system implementation is illustrated in figure 1.

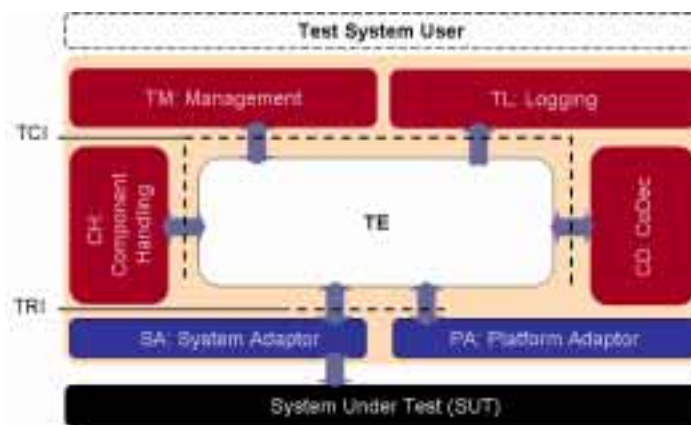

**Figure 1: General structure of a TTCN-3 test system**

As shown in figure 1, the TTCN-3 Executable (TE), also referred to as the Executable Test Suite (ETS), interprets and executes TTCN-3 modules. Various TE structural elements can be identified: control, behaviour, components, types, values and queues. The structural elements within the TE represent functionality that is defined within a TTCN-3 module or by the TTCN-3 standard (ES 201 873-1 [2]) itself. For example, the structural element "Control" represents the control part within a TTCN-3 module, while the structural element "Queues" represents the requirement on a TTCN-3 Executable that each port of a test component maintains its own port queue. While the first is specified within a TTCN-3 module, the latter is required by the TTCN-3 specification.

Refinement of the TE, as shown in figure 1, is provided as an aid in defining the TTCN-3 Control Interfaces. The TE would typically correspond in a test system implementation either to the executable code produced by a TTCN-3 compiler or by a TTCN-3 interpreter.

The TE may be executed in a centralized or in a distributed manner. That is, on a single test device or across several test devices respectively. Although the structural entities of the TE implement a complete TTCN-3 module, single structural entities might be distributed over several test devices.

The TE implements a TTCN-3 module on an abstract level. The other entities of a TTCN-3 test system make these abstract concepts concrete. For example, the abstract concept of sending a message or receiving a timeout cannot be implemented within the TE. The remaining part of the test system implements the encoding of the message and its sending over concrete physical means or measuring the time and determining when a timer has expired, respectively.

The SA and PA and their interaction with the TE are defined in ES 201 873-5 [1]. The TCI specification defines the interaction between the TE and the TMC.

The logging interface provides logging capabilities to all elements of the test system architecture, i.e. the TE, the TM, the CH, the CD, the SA and the PA are able to log information on the test execution via TL. Figure 2 represents a more detailed view on TL.

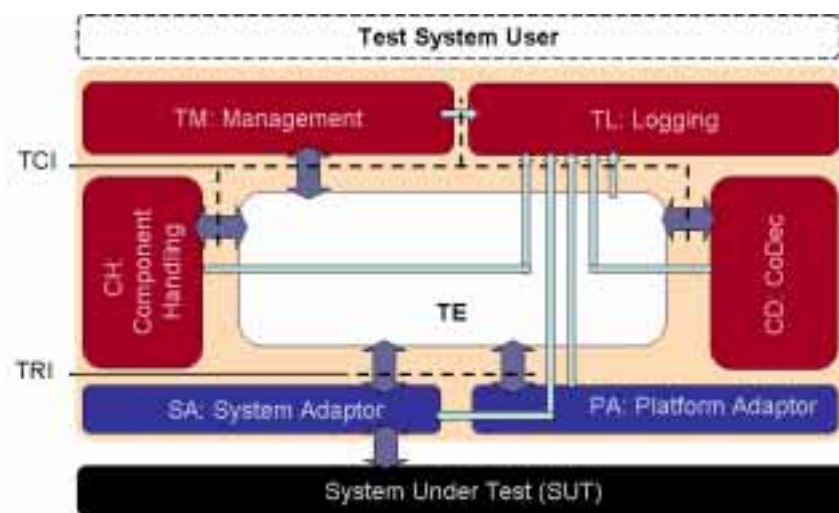

Figure 2: Detailed View on TL

## 6.1.1 Test Management and Control (TMC)

The TMC entity includes functionality related to management of:

- test execution;
- components; and
- encoding and decoding.

### 6.1.1.1 Test Management (TM)

The TM entity is responsible for the overall management of a test system. After the test system has been initialized, test execution starts within the TM entity. The entity is responsible for the proper invocation of TTCN-3 modules, i.e. propagating module parameters such as IXIT information to the TE if necessary. Typically, this entity would also implement a test system user interface.

### 6.1.1.2 Coding and Decoding (CD)

The CD entity is responsible for the encoding and decoding of TTCN-3 values into bitstrings suitable to be sent to the System Under Tests. The TE determines which codecs shall be used. It passes the TTCN-3 data to the appropriate encoder to obtain the encoded data. Received data is decoded in the CD entity by using the appropriate decoder, which translates the received data into TTCN-3 values.



### 6.1.1.3 Component Handling (CH)

The TE can be distributed among several test devices. The CH implements communication between distributed test system entities. The CH entity provides the means to synchronize test system entities which might be distributed onto several nodes.

NOTE 1: Nodes and test devices are used as synonyms.

The general structure of a test system distributed among several nodes is depicted in figure 3.

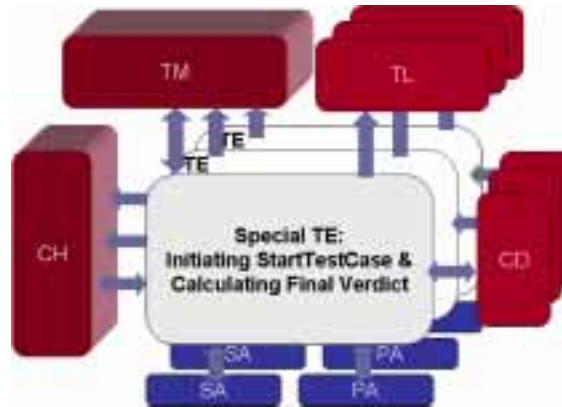

**Figure 3: General structure of a distributed TTCN-3 test system**

Each node within a test system includes the TE, SA, PA, CD and TL entities. The entities CH and TM mediate the test management and test component handling between the TEs on each node. The TE which starts a test case is a special TE. It shall calculate the final test case verdict. Besides this, all TEs are handled the same.

NOTE 2: A test system shall execute at most one test case at a given point in time. That is, a TTCN-3 module cannot execute multiple test cases at the same time.

The creation of the MTC, PTCs and the control component in TEs is controlled by CH. Please note the special role of the system component, which exists only conceptually and not as a running test component in a TE. System ports, i.e. the ports of the system component, may be distributed among several nodes. Further, test components on different nodes may have access to the same physical port of the SUT, i.e. they may be mapped to the same port of the test system interface.

EXAMPLE: Access to remote real SUT ports can be realized by TEs via local proxies.

Communication between TTCN-3 components is either message or procedure based. Therefore, the CH adapts message and procedure based communication of TTCN-3 components to the particular execution platform of the test system. It is aware of connections between TTCN-3 test component communication ports. It propagates send request operations from one TTCN-3 component to another TTCN-3 component. The receiving component may reside in a different instance of the same TE located on a different node. It then notifies the TE of any received test events by enqueueing them in the port queues of the TE.

Procedure based communication operations between TTCN-3 components are also visible at the CH. The CH shall distinguish between the different kinds of procedure-based communication, i.e. call, reply, and exception, and shall propagate them in the appropriate manner to the TE where the target component resides. TTCN-3 procedure based communication semantics, i.e. the effect of such operation on TTCN-3 test component execution, are to be handled in the TE.

Additional communication is needed to implement the distribution of test components onto several nodes. Component management communication includes the indication of the creation of test components, the starting of execution of a test component, verdict distribution, as well as component termination indication. The CH does not implement the TTCN-3 component behaviour. Rather, it implements the communication between several components implemented by a TE.

#### 6.1.1.4 Test Logging (TL)

The TL entity performs test event logging and presentation to the test system user. It provides the logging of information about the test execution such as which test components have been created, started and terminated, which data is sent to the SUT, received from the SUT and matched to TTCN-3 templates, which timers have been started, stopped or timed out, etc.

#### 6.1.2 TTCN-3 Executable (TE)

The TE entity executes or interprets a TTCN-3 module. Conceptually, the TE can be decomposed into six interacting entities: a Control, Behaviour, Component, Type, Value, and Queue entity. This structural decomposition of the TE is defined in ES 201 873-5 [1]. The terminology for TE defined in ES 201 873-5 [1] is used within the present document.

#### 6.1.3 SUT Adaptor (SA)

The SA is the implementation of the System under Test Adaptor (SA) as defined in [1]. The terminology for SA defined in ES 201 873-5 [1] is used within the present document.

#### 6.1.4 Platform Adaptor (PA)

The PA is the implementation of the Platform Adaptor (PA) as defined in ES 201 873-5 [1]. The terminology for PA defined in ES 201 873-5 [1] is used within the present document.

### 6.2 Execution requirements for a TTCN-3 test system

Each TCI operation call shall be treated as an atomic operation in the calling entity. The called entity, which implements a TCI operation, shall return control to the calling entity as soon as its intended effect has been accomplished or if the operation cannot be completed successfully. The called entity shall not block in the implementation of procedure-based communication.

As stated before, no assumption is made as to whether the TTCN-3 test system or individual entities are implemented in a single executable or process or whether they are distributed among different processes or even test devices.

A TCI implementation shall fulfil the above mentioned requirements.

---

## 7 TTCN-3 control interface and operations

This clause defines a set of abstract data types used to represent data communicated between the TE and the TMC. In addition, it defines TCI operations in terms of their signatures, when they are to be used and what their effects on the TTCN-3 test system are.

This definition also includes a more detailed description of the input parameters required for each TCI operation call and its return value.

## 7.1 Overview of the TCI

The TCI defines the interaction between the TTCN-3 Executable (TE), Component Handling (CH), the Test Management (TM), the Coding/Decoding (CD), the Test Logging (TL) entities within a TTCN-3 test system. It provides means for the TE to:

- manage test execution;
- distribute execution of test components among different test devices;
- encode and decode test data; and
- logging of information about test execution.

The TCI consists of four sub-interfaces:

- **TCI Test Management Interface (TCI-TM):** This interface includes all operations needed to manage test execution, provide module parameters and external constants and provide test event logging.
- **TCI Component Handling Interface (TCI-CH):** This interface consists of operations needed to implement the management of, and communication between TTCN-3 test components in a centralized or distributed test system. It includes operations to create, start and stop test components, establish connection between TTCN-3 components, manage test components and their verdicts, and handle message and procedure based communication between TTCN-3 components.
- **TCI Coding/Decoding Interface (TCI-CD):** This interface includes all operations needed to retrieve and access codecs, i.e. encoders or decoders, for encoding data to be sent, defined using the TTCN-3 encode attribute, and to decode received data.
- **TCI Test Logging Interface (TCI-TL):** This interface includes all operations needed to retrieve information about test execution and to control the level of detail of these information.

All interfaces are bi-directional so that calling and called parts reside in the TE and in the TMC of the test system. The provided interfaces (those operations which an interface offers to the TE) and the required operations (those operation which an interface needs to use from the TE) are combined into the respective provided and required subinterface for each interface, i.e. TCI-TM Provided/ TCI-TM Required, TCI-CH Provided/ TCI-CH Required, TCI-CD Provided/ TCI-CD Required, and TCI-TL Provided/TCI-TL Required.

### 7.1.1 Correlation between TTCN-3 and TCI operation invocations

For some TTCN-3 operation invocations, there is a direct correlation to a TCI operation invocation, which is shown in table 1. Some of the TTCN-3 operations correlate to a pair of TCI operation request and TCI operation to implement the propagation of TTCN-3 operations through the test system. For the other TCI operation invocations there is an indirect correlation - they are needed to implement the TTCN-3 semantics of underlying concepts.

The correlation shown for TTCN-3 communication operations (i.e. *send*, *call*, *reply*, and *raise*) only holds if these operations are invoked on a test component port connected to another test component port. The correlation for communication operations that are invoked on test component ports that are mapped to test system interface ports is defined in ES 201 873-5 [1].

Table 1: Correlation between TTCN-3 and TCI operation invocations

TTCN-3 Operation Name	TCI Operation Name	TCI Interface Name
send	tciSendConnected (see note 1)	TCI-CH Provided
	tciSendConnectedBC (see note 2)	
	tciSendConnectedMC (see note 3)	
	tciEnqueueMsgConnected	TCI-CH Required
call	tciCallConnected (see note 1)	TCI-CH Provided
	tciCallConnectedBC (see note 2)	
	tciCallConnectedMC (see note 3)	
	tciEnqueueCallConnected	TCI-CH Required
reply	tciReplyConnected (see note 1)	TCI-CH Provided
	tciReplyConnectedBC (see note 2)	
	tciReplyConnectedMC (see note 3)	
	tciEnqueueReplyConnected	TCI-CH Required
raise	tciRaiseConnected (see note 1)	TCI-CH Provided
	tciRaiseConnectedBC (see note 2)	
	tciRaiseConnectedMC (see note 3)	
	tciEnqueueRaiseConnected	TCI-CH Required
create	tciCreateTestComponentReq	TCI-CH Provided
	tciCreateTestComponent	TCI-CH Required
start (a component)	tciStartTestComponentReq	TCI-CH Provided
	tciStartTestComponent	TCI-CH Required
stop (a component)	tciStopTestComponentReq	TCI-CH Provided
	tciStopTestComponent	TCI-CH Required
kill	tciKillTestComponentReq	TCI-CH Provided
	tciKillTestComponent	TCI-CH Required
connect	tciConnectReq	TCI-CH Provided
	tciConnect	TCI-CH Required
disconnect	tciDisconnectReq	TCI-CH Provided
	tciDisconnect	TCI-CH Required
map	tciMapReq	TCI-CH Provided
	tciMap	TCI-CH Required
unmap	tciUnmapReq	TCI-CH Provided
	tciUnmap	TCI-CH Required
running	tciTestComponentRunningReq	TCI-CH Provided
	tciTestComponentRunning	TCI-CH Required
alive	tciTestComponentAliveReq	TCI-CH Provided
	tciTestComponentAlive	TCI-CH Required
done	tciTestComponentDoneReq	TCI-CH Provided
	tciTestComponentDone	TCI-CH Required
killed	tciTestComponentKilledReq	TCI-CH Provided
	tciTestComponentKilled	TCI-CH Required
mtc	tciGetMTCReq	TCI-CH Provided
	tciGetMTC	TCI-CH Required
execute	tciTestCaseExecuteReq	TCI-CH Provided
	tciTestCaseExecute	TCI-CH Required
log	tliLog	TCI-TL Provided
NOTE 1: For unicast communication.		
NOTE 2: For broadcast communication.		
NOTE 3: For multicast communication.		

## 7.2 TCI data

The TCI specification defines a set of abstract data types. These describe, at a very high level, which kind of data shall be passed from a calling to a called entity. The abstract data types are used to determine:

- how TTCN-3 data is passed from a TE to an encoder, to encode TTCN-3 value representations into a bitstring; and in the reverse case;
- how data passed from a decoder to the TE shall be decoded from a bitstring into its TTCN-3 value representation.

For these abstract data types a set of operations is defined to process the data by the coder/decoder.

The concrete representation of these abstract data types as well as the definition of basic data types like `string` and `boolean` are defined in the respective language mappings in clauses 8 and 9.

Notice that the values for any identifier data type shall be unique in the test system implementation where uniqueness is defined as being globally distinct at any point in time. This guarantees that different objects, e.g. two timers, are identified by different identifiers and identifiers are not reused.

## 7.2.1 General abstract data types

The following abstract data types are defined and used for the definition of TCI operations:

### 7.2.1.1 Management

<code>TciModuleIdType</code>	A value of <code>TciModuleIdType</code> is the name of a TTCN-3 module as specified in the TTCN-3 ATS. This abstract type is used for module handling.
<code>TciModuleParameterIdType</code>	A value of <code>TciModuleIdType</code> is the qualified name of a TTCN-3 module parameter as specified in the TTCN-3 ATS. This abstract type is used for module parameter handling.
<code>TciTestCaseIdType</code>	A value of <code>TciTestCaseIdType</code> is the qualified name of a TTCN-3 testcase as specified in the TTCN-3 ATS. This abstract type is used for testcase handling.
<code>TciModuleIdListType</code>	A value of type <code>TciModuleIdListType</code> is a list of <code>TciModuleIdType</code> . This abstract type is used when retrieving the list of modules which are imported by a TTCN-3 module.
<code>TciModuleParameterType</code>	A value of type <code>TciModuleParameterType</code> is a structure of <code>TciModuleParameterIdType</code> and <code>Value</code> . This abstract type is used to represent the parameter name and the default value of a module parameter.
<code>TciModuleParameterListType</code>	A value of type <code>TciModuleParameterListType</code> is a list of <code>TciModuleParameterType</code> . This abstract type is used when retrieving the module parameters of a TTCN-3 module.
<code>TciParameterType</code>	A value of type <code>TciParameterType</code> includes a TTCN-3 <code>Value</code> and a value of <code>TciParameterPassingModeType</code> to represent the parameter passing mode specified for the parameter in the TTCN-3 ATS.
<code>TciParameterPassingModeType</code>	A value of type <code>TciParameterPassingModeType</code> is either <code>IN</code> , <code>INOUT</code> , or <code>OUT</code> . This abstract type is used when starting a test case or when the termination of a test case is indicated.
<code>TciParameterListType</code>	A value of type <code>TciParameterListType</code> is a list of <code>TciParameterType</code> . This abstract type is used when starting a test case or when the termination of a test case is indicated.
<code>TciParameterTypeType</code>	A value of type <code>TciParameterTypeType</code> is a structure of <code>Type</code> and <code>TciParameterPassingModeType</code> . This abstract type is used to represent the type and the parameter passing mode of a test case parameter.
<code>TciParameterTypeListType</code>	A value of type <code>TciParameterTypeListType</code> is a list of <code>TciParameterTypeType</code> . This abstract type is used to represent the list of parameters of a test case.
<code>TciTestComponentKindType</code>	A value of type <code>TciTestComponentKindType</code> is a literal of the set of kinds of TTCN-3 test components, i.e. <code>MTC</code> , <code>PTC</code> , <code>PTC_ALIVE</code> , and <code>CONTROL</code> . This abstract type is used for component handling.

`TciTypeClassType` A value of type `TciTypeClassType` is a literal of the set of type classes in TTCN-3 such as `boolean`, `float`, `record`, etc. This abstract type is used for value handling.

### 7.2.1.2 Communication

`TciBehaviourIdType` A value of type `TciBehaviourIdType` identifies a TTCN-3 behaviour functions.

Additional abstract data types with the prefix `Tri` are taken from ES 201 873-5 [1]: `TriPortIdType`, `TriPortIdListType`, `TriComponentIdType`, `TriComponentIdListType`, `TriAddressType`, `TriAddressListType`, and `TriMessageType`.

## 7.2.2 Abstract TTCN-3 data types and values

This clause defines the set of abstract data types that build up the TTCN-3 type and value representation. Functionality of each data type is defined by an accompanying set of operations. Operations on or using this abstract data type return either a value of this abstract type or a basic type like `boolean`.

All operations have been defined using the Interface Description Language (IDL). Concrete language mappings for the operations on the abstract data types are given in clauses 8 and 9. In certain languages, the application of an operation on an abstract data type is represented by passing (either by-value or by-reference, depending on the mapping) the concrete value as a parameter to the operation. Other languages might choose other referencing method to the concrete value, e.g. by considering the value as an object on which a method corresponding to the operation is invoked. To indicate the inability to perform a certain task or to indicate the absence of an optional parameter in the following, the distinct value `null` is used. It can be considered as being a reserved value indicating a special value. The language mappings will define a concrete representation of this distinct value `null`.

The abstract TTCN-3 type and value representation consists of two parts:

- an abstract data type `Type` that represents all TTCN-3 types in a TTCN-3 module;
- different abstract data types that represent TTCN-3 values, i.e. TTCN-3 values of a given TTCN-3 type. This can be either values of TTCN-3 predefined types or of TTCN-3 user-defined types.

For accessing, evaluating, and coding the TTCN-3 data the test system uses the abstract data type `Type` and the different abstract value data types. Therefore, these abstract data types define the abstraction level between the TTCN-3 Executable (TE) and the remaining test system using the TCI interfaces.

### 7.2.2.1 Abstract TTCN-3 data types

According to the present document TTCN-3 types, either predefined or user-defined, will be represented at the TCI interfaces using the abstract data type `Type`.

For the abstract data type `Type` a set of operations is defined to:

- reference predefined and user-defined TTCN-3 data types; and
- create and maintain TTCN-3 values.

The following operations are defined for the abstract data type `Type`:

`TciModuleIdType getDefiningModule()` Returns the module identifier of the module in which type is defined.  
Returns the distinct value `null` if type is a TTCN-3 base type, e.g. `boolean`, `integer`, etc.).

`TString getName()` Returns the name of the type as defined in the TTCN-3 module.

<code>TciTypeClassType getTypeClass()</code>	Returns the type class of the respective type. A value of <code>TciTypeClassType</code> can have one of the following constants: <code>ADDRESS</code> , <code>ANYTYPE</code> , <code>BITSTRING</code> , <code>BOOLEAN</code> , <code>CHARSTRING</code> , <code>COMPONENT</code> , <code>ENUMERATED</code> , <code>FLOAT</code> , <code>HEXSTRING</code> , <code>INTEGER</code> , <code>OBJID</code> , <code>OCTETSTRING</code> , <code>RECORD</code> , <code>RECORD_OF</code> , <code>SET</code> , <code>SET_OF</code> , <code>UNION</code> , <code>UNIVERSAL_CHARSTRING</code> , <code>VERDICT</code> .
<code>Value newInstance()</code>	Returns a freshly created value of the given type. This initial value of the created value is undefined.
<code>TString getTypeEncoding()</code>	Returns the type encoding attribute as defined in the TTCN-3 module.
<code>TString getTypeEncodingVariant()</code>	This operation returns the value encoding variant attribute as defined in TTCN-3, if any. If no encoding variant attribute is defined the distinct value <code>null</code> is returned.
<code>TStringseq getTypeExtension()</code>	Returns the type extension attribute as defined in the TTCN-3 module.

### 7.2.2.2 Abstract TTCN-3 values

According to the present document, TTCN-3 values are represented at the TCI interfaces via numerous abstract data types.

4 presents the hierarchy between the abstract data types for TTCN-3 values (short: abstract values).

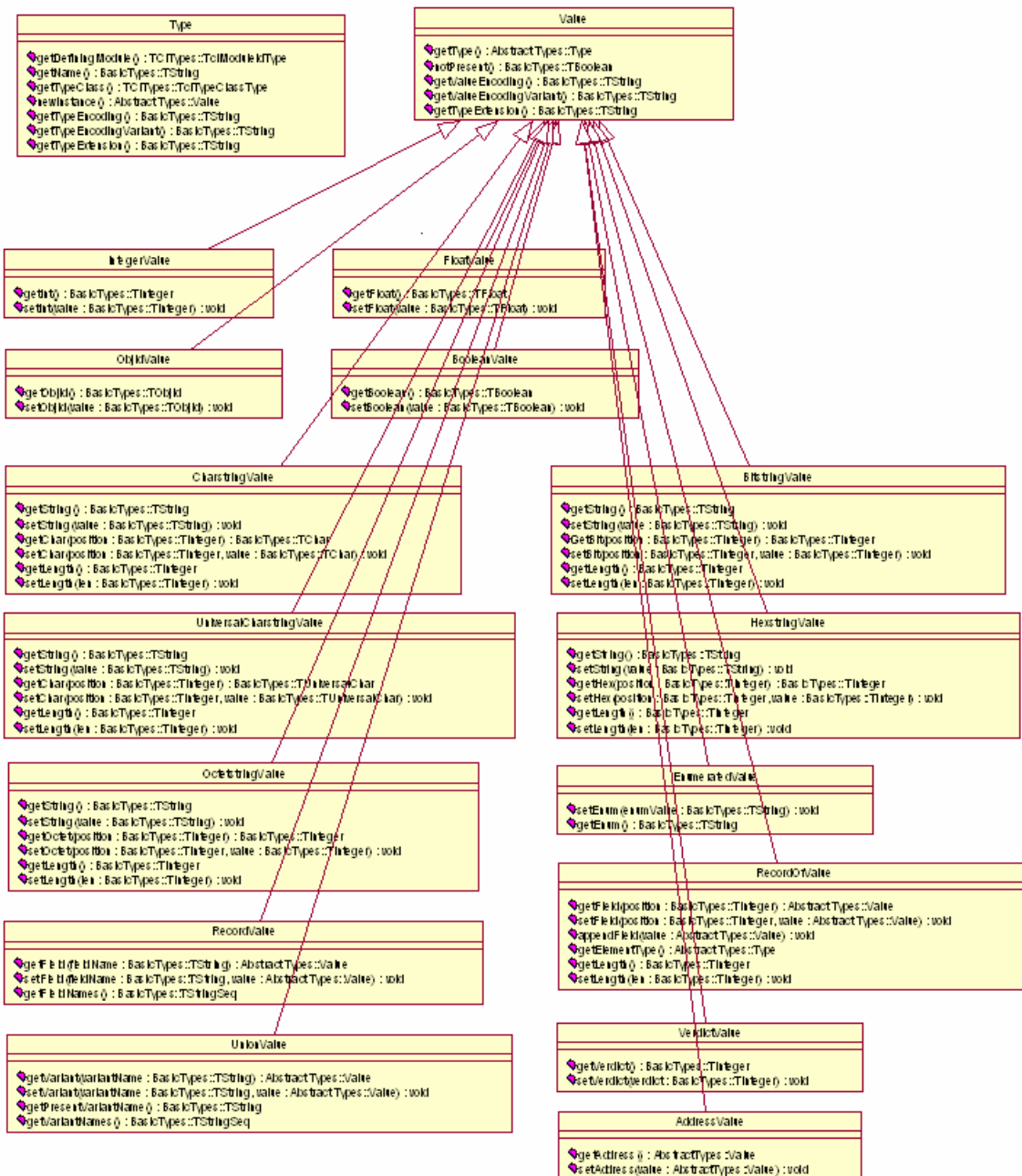

Figure 4: Hierarchy of abstract values

As shown in figure 4, all TTCN-3 abstract values share the same base abstract data type `Value`. All operations defined on this common base data type are implicitly defined also for the abstract value types derived from it.

#### 7.2.2.2.1 The abstract data type `Value`

The following operations are defined on the base abstract data type `Value`. The concrete representations of these operations are defined in the respective language mapping sections:

<code>Type</code> <code>getType()</code>	Returns the type of the specified value.
<code>TBoolean</code> <code>notPresent()</code>	Returns <code>true</code> if the specified value is omit, <code>false</code> otherwise.



`TString getValueEncoding()` Returns the value encoding attribute as defined in TTCN-3, if any. If no encoding attribute is defined the distinct value `null` is returned.

`TString getValueEncodingVariant()` Returns the value encoding variant attribute as defined in TTCN-3, if any. If no encoding variant attribute is defined the distinct value `null` is returned.

#### 7.2.2.2.2 The abstract data type `IntegerValue`

The abstract data type `IntegerValue` is based on the abstract data type `Value`. It represents TTCN-3 `integer` values.

The following operations are defined on the abstract data type `IntegerValue`:

`TInteger getInt()` Returns the integer value of this TTCN-3 integer.

`void setInt(in TInteger value)` Sets this `IntegerValue` to value.

#### 7.2.2.2.3 The abstract data type `FloatValue`

The abstract data type `FloatValue` is based on the abstract data type `Value`. It represents TTCN-3 `float` values.

The following operations are defined on the abstract data type `FloatValue`:

`TFloat getFloat()` Returns the float value of this TTCN-3 float.

`void setFloat(in TFloat value)` Sets this `FloatValue` to value.

#### 7.2.2.2.4 The abstract data type `BooleanValue`

The abstract data type `BooleanValue` is based on the abstract data type `Value`. It represents TTCN-3 `boolean` values.

The following operations are defined on the abstract data type `BooleanValue`:

`TBoolean getBoolean ()` Returns the boolean value of the TTCN-3 boolean.

`void setBoolean(in TBoolean value)` Sets this boolean value to value.

#### 7.2.2.2.5 The abstract data type `ObjidValue`

The abstract data type `ObjidValue` is based on the abstract data type `Value`. It represents TTCN-3 `objid` values.

The following operations are defined on the abstract data type `ObjidValue`:

`TObjid getObjid()` Returns the object id value of the TTCN-3 `objid`.

`void setObjid(in TObjid value)` Sets this `ObjidValue` to value.

#### 7.2.2.2.6 The abstract data type `CharstringValue`

The abstract data type `CharstringValue` is based on the abstract data type `Value`. It represents TTCN-3 `charstring` values. `TChar` is a character within a `charstring` value.

The following operations are defined on the abstract data type `CharstringValue`:

`TString getString()` Returns the string value of the TTCN-3 `charstring`. The textual representation of the empty TTCN-3 `charstring` is `' '`, while its length is zero.

`void setString(in TString value)` Sets this `CharstringValue` to value.

<code>TChar getChar(in TInteger position)</code>	Returns the char value of the TTCN-3 charstring at <code>position</code> . Position 0 denotes the first char of the TTCN-3 charstring. Valid values for <code>position</code> are from 0 to <code>length - 1</code> .
<code>void setChar(in TInteger position, in TChar value)</code>	Set the character at <code>position</code> to <code>value</code> . Valid values for <code>position</code> are from 0 to <code>length - 1</code> .
<code>TInteger getLength()</code>	Returns the length of this CharstringValue in chars, zero if the value of this CharstringValue is omit.
<code>void setLength(in TInteger len)</code>	<code>setLength</code> first resets this CharstringValue to its initial value and afterwards sets the length of this CharstringValue in chars to <code>len</code> .

#### 7.2.2.2.7 The abstract data type UniversalCharstringValue

The abstract data type `UniversalCharstringValue` is based on the abstract data type `Value`. It represents TTCN-3 universal charstring values. `TUniversalChar` is a character within a universal charstring value.

The following operations are defined on the abstract data type `UniversalCharstringValue`:

<code>TString getString()</code>	Returns the textual representation of this <code>UniversalCharstringValue</code> , as defined in TTCN-3.
<code>void setString(in TString value)</code>	Sets the value of this <code>UniversalCharstringValue</code> according to the textual representation as defined by <code>value</code> .
<code>TUniversalChar getChar(in TInteger position)</code>	Returns the universal char value of the TTCN-3 universal charstring at <code>position</code> . Position 0 denotes the first <code>TUniversalChar</code> of the TTCN-3 universal charstring. Valid values for <code>position</code> are from 0 to <code>length - 1</code> .
<code>void setChar(in TInteger position, in TUniversalChar value)</code>	Sets the universal char at <code>position</code> to <code>value</code> . Valid values for <code>position</code> are from 0 to <code>length - 1</code> .
<code>TInteger getLength()</code>	Returns the length of this universal charstring value in universal chars, zero if the value of this universal charstring value is omit.
<code>void setLength(in TInteger len)</code>	<code>setLength</code> first resets this <code>UniversalCharstringValue</code> to its initial value and afterwards sets the length of this <code>UniversalCharstringValue</code> in universal chars to <code>len</code> .

#### 7.2.2.2.8 The abstract data type BitstringValue

The abstract data type `BitstringValue` is based on the abstract data type `Value`. It represents TTCN-3 bitstring values:

The following operations are defined on the abstract data type `BitstringValue`.

<code>TString getString()</code>	Returns the textual representation of this <code>BitstringValue</code> , as defined in TTCN-3. E.g. the textual representation of 0101 is "0101"B. The textual representation of the empty TTCN-3 bitstring is ""B, while its length is zero.
<code>void setString(in TString value)</code>	Sets the value of this <code>BitstringValue</code> according to the textual representation as defined by <code>value</code> . E.g. the value of this <code>BitstringValue</code> is 0101 if the textual representation in <code>value</code> is "0101"B.

<code>TChar getBit(in TInteger position)</code>	Returns the value (0   1) at position of this TTCN-3 bitstring as a character. Position 0 denotes the first bit of the TTCN-3 bitstring. Valid values for position are from 0 to length - 1.
<code>void setBit(in TInteger position, in TInteger value)</code>	Sets the bit at position to the value (0   1). Position 0 denotes the first bit in this BitstringValue. Valid values for position are from 0 to length - 1.
<code>TInteger getLength()</code>	Returns the length of this BitstringValue in bits, zero if the value of this BitstringValue is omit.
<code>void setLength(in TInteger len)</code>	setLength first resets this BitstringValue to its initial value and afterwards sets the length of this BitstringValue in bits to len.

### 7.2.2.2.9 The abstract data type OctetstringValue

The abstract data type `OctetstringValue` is based on the abstract data type `Value`. It represents TTCN-3 `octetstring` values.

The following operations are defined on the abstract data type `OctetstringValue`:

<code>TString getString()</code>	Returns the textual representation of this <code>OctetstringValue</code> , as defined in TTCN-3. E.g. the textual representation of <code>0xCAFFEE</code> is <code>"CAFFEE"O</code> . The textual representation of the empty TTCN-3 <code>octetstring</code> is <code>"O</code> , while its length is zero.
<code>void setString(in TString value)</code>	Sets the value of this <code>OctetstringValue</code> according to the textual representation as defined by value. E.g. The value of this <code>OctetstringValue</code> is <code>0xCAFFEE</code> if the textual representation in value is <code>"CAFFEE"O</code> .
<code>TChar getOctet(in TInteger position)</code>	Returns the value (0..255) at position of this TTCN-3 <code>octetstring</code> . Position 0 denotes the first octet of the TTCN-3 <code>octetstring</code> . Valid values for position are from 0 to length - 1.
<code>void setOctet(in TInteger position, in TInteger value)</code>	Sets the octet at position to value (0..255). Position 0 denotes the first octet in the <code>octetstring</code> . Valid values for position are from 0 to length - 1.
<code>TInteger getLength()</code>	Returns the length of this <code>OctetstringValue</code> in octets, zero if the value of this <code>OctetstringValue</code> is omit.
<code>void setLength(in TInteger len)</code>	setLength first resets this <code>OctetstringValue</code> to its initial value and afterwards sets the length of this <code>OctetstringValue</code> in octets to len.

### 7.2.2.2.10 The abstract data type HexstringValue

The abstract data type `HexstringValue` is based on the abstract data type `Value`. It represents TTCN-3 `hexstring` values.

The following operations are defined on the abstract data type `HexstringValue`:

<code>TString getString()</code>	Returns the textual representation of this <code>HexstringValue</code> , as defined in TTCN-3. E.g. the textual representation of <code>0xAFFEE</code> is <code>"AFFEE"H</code> . The textual representation of the empty TTCN-3 <code>hexstring</code> is <code>"H</code> , while its length is zero.
----------------------------------	--

<code>void setString(in TString value)</code>	Sets the value of this <code>HexstringValue</code> according to the textual representation as defined by <code>value</code> . E.g. The value of this <code>HexstringValue</code> is <code>0xAFFEE</code> if the textual representation in <code>value</code> is <code>"AFFEE" H</code> .
<code>TChar getHex(in TInteger position)</code>	Returns the value (0..15) at <code>position</code> of this TTCN-3 hexstring. Position 0 denotes the first hex digits of the TTCN-3 hexstring. Valid values for <code>position</code> are from 0 to <code>length - 1</code> .
<code>void setHex(in TInteger position, in TInteger value)</code>	Sets the hex digit at <code>position</code> to <code>value</code> (0..15). Position 0 denotes the first octet in the hexstring. Valid values for <code>position</code> are from 0 to <code>length - 1</code> .
<code>TInteger getLength()</code>	Returns the length of this <code>HexstringValue</code> in octets, zero if the value of this <code>HexstringValue</code> is <code>omit</code> .
<code>void setLength(in TInteger len)</code>	<code>setLength</code> first resets this <code>HexstringValue</code> to its initial value and afterwards sets the length of this <code>HexstringValue</code> in hex digits to <code>len</code> .

#### 7.2.2.2.11 The abstract data type `RecordValue`

The abstract data type `RecordValue` is based on the abstract data type `Value`. It specifies how to get and set the TTCN-3 record type. The same abstract data type applies for values whose type class is `SET`. The distinction between `record` and `set` is only relevant at matching time.

The following operations are defined on the abstract data type `RecordValue`:

<code>Value getField(in TString fieldName)</code>	Returns the value of the field named <code>fieldName</code> . The return value is the common abstract base type <code>Value</code> , as a record field can have any type defined in TTCN-3. If the field can not be obtained from the record the distinct value <code>null</code> is returned.
<code>void setField(in TString fieldName, in Value value)</code>	Sets the field named <code>fieldName</code> of the record to <code>value</code> . No assumption shall be made on how a field is stored in a record. An internal implementation might choose to store a reference to this value or to copy the value. It is safe to assume that the value is copied. Therefore it should be relied on that subsequent modifications of <code>value</code> will not be considered in the record.
<code>TStringSeq getFieldNames()</code>	Returns a sequence of string of field names, the empty sequence, if the record has no fields.

#### 7.2.2.2.12 The abstract data type `RecordOfValue`

The abstract data type `RecordOfValue` is based on the abstract data type `Value`. It specifies how to get and set elements in TTCN-3 record of types. The same abstract data type applies for value whose type class is `SET_OF`. The distinction between `record of` and `set of` is only relevant at matching time.

The following operations are defined on the abstract data type `RecordOfValue`:

<code>Value getField(in TInteger position)</code>	Returns the value of the record <code>of</code> at <code>position</code> if <code>position</code> is between zero and <code>length - 1</code> , the distinct value <code>null</code> otherwise. The return value is the common abstract base type <code>Value</code> , as a record <code>of</code> can have fields of any type defined in TTCN-3.
---	---

<code>void setField(in TInteger position, in Value value)</code>	Sets the field at <code>position</code> to <code>value</code> . If <code>position</code> is greater than <code>(length - 1)</code> the record of is extended to have the length <code>(position + 1)</code> . The record of elements between the original position at <code>length</code> and <code>position - 1</code> is set to omit. No assumption shall be made on how a field is stored in a record of. An internal implementation might choose to store a reference to this value or to copy the value. It is safe to assume that the value is copied. Therefore, it should be relied on that subsequent modifications of <code>value</code> will not be considered in the record of.
<code>void appendField(in Value value)</code>	Appends the value at the end of the record of, i.e. at position <code>length</code> . No assumption shall be made on how a field is stored in a record of. An internal implementation might choose to store a reference to this value or to copy the value. It is safe to assume that the value is copied. Therefore, it should be relied on that subsequent modifications of <code>value</code> will not be considered in the record of.
<code>Type getElementType()</code>	Returns the <code>Type</code> of the elements of this record of.
<code>TInteger getLength()</code>	Returns the actual length of the record of <code>value</code> , zero if the record of <code>value</code> is omit.
<code>void setLength(in TInteger len)</code>	Sets the length of the record of to <code>len</code> . If <code>len</code> is greater than the original length, newly created elements have the value omit. If <code>len</code> is less or equal than the original length this operation is ignored.

### 7.2.2.2.13 The abstract data type `UnionValue`

The abstract data type `UnionValue` is based on the abstract data type `Value`. It specifies how to get and set variants in a TTCN-3 union type. The TTCN-3 anytype is represented by a `UnionValue` where the type class of the type obtained by `getType()` is ANYTYPE. For details on type classes see clause 7.2.2.1.

The following operations are defined on the abstract data type `UnionValue`:

<code>Value getVariant(in TString variantName)</code>	Returns the value of the TTCN-3 union <code>variantName</code> , if <code>variantName</code> equals the result of <code>getPresentVariantName</code> , the distinct value <code>null</code> otherwise. <code>variantName</code> denotes the name of the union variant as defined in TTCN-3.
<code>void setVariant(in TString variantName, in Value value)</code>	Sets <code>variantName</code> of the union to <code>value</code> . If <code>variantName</code> is not defined for this union this operation is ignored. If another variant was selected the new variant is selected instead.
<code>TString getPresentVariantName()</code>	Returns a <code>String</code> representing the currently selected variant name in the given TTCN-3 union. The distinct value <code>null</code> is returned if no variant is selected.
<code>TStringSeq getVariantNames()</code>	Returns a sequence of string of variant names, the distinct value <code>null</code> , if the union has no fields. If the <code>UnionValue</code> represents the TTCN-3 anytype, i.e. the type class of the type obtained by <code>getType()</code> is ANYTYPE, all predefined and user-defined TTCN-3 types is returned.

#### 7.2.2.2.14 The abstract data type `EnumeratedValue`

The abstract data type `EnumeratedValue` is based on the abstract data type `Value`. It specifies how TTCN-3 `enumerated` can be set and get.

The following operations are defined on the abstract data type `EnumeratedValue`:

<code>TString getEnum()</code>	Returns the string identifier of this <code>EnumeratedValue</code> . This identifier equals the identifier in the TTCN-3 specification.
<code>void setEnum(in TString enumValue)</code>	Sets the enum to <code>enumValue</code> . If <code>enumValue</code> is not an allowed value for this enumeration the operation is ignored.

#### 7.2.2.2.15 The abstract data type `VerdictValue`

The abstract data type `VerdictValue` is based on the abstract data type `Value`. It specifies how TTCN-3 `verdict` can be set and get.

The following operations are defined on the abstract data type `VerdictValue`:

<code>TInteger getVerdict()</code>	Returns the integer value for this <code>VerdictValue</code> . The integer is one of the following constants: <code>ERROR</code> , <code>FAIL</code> , <code>INCONC</code> , <code>NONE</code> , <code>PASS</code> .
<code>void setVerdict(in TInteger verdict)</code>	Sets this <code>VerdictValue</code> to <code>verdict</code> . Note that a <code>VerdictValue</code> can be set to any of the above mentioned verdicts at any time. The <code>VerdictValue</code> does not perform any verdict calculations as defined in TTCN-3. For example, it is legal to set the <code>VerdictValue</code> first to <code>ERROR</code> and then to <code>PASS</code> .

#### 7.2.2.2.16 The abstract data type `AddressValue`

The following operations are defined on the base abstract data type `AddressValue`. The concrete representations of these operations are defined in the respective language mapping sections:

<code>Value getAddress()</code>	Returns the address value, which will no longer be of type class <code>ADDRESS</code> but rather of the actual type used for address.
<code>void setAddress(in Value value)</code>	Sets this address value to <code>value</code> .

### 7.2.3 Abstract logging types

#### 7.2.3.1 The abstract data type `TciValueTemplate`

The following operations are defined on the abstract data type `TciValueTemplate`. The concrete representations of these operations are defined in the respective language mapping sections:

<code>boolean isOmit()</code>	Returns <code>true</code> if the template is an omit template.
<code>boolean isAny()</code>	Returns <code>true</code> if the template is an any template.
<code>boolean isAnyOrOmit()</code>	Returns <code>true</code> if the template is an any or omit template.
<code>TString getTemplateDef()</code>	Returns the definition of that template.

### 7.2.3.2 The abstract data type `TciNonValueTemplate`

The following operations are defined on the abstract data type `TciNonValueTemplate`. The concrete representations of these operations are defined in the respective language mapping sections:

<code>boolean isAny()</code>	Returns <code>true</code> if the template is an any template.
<code>boolean isAll()</code>	Returns <code>true</code> if the template is an all template.
<code>TString getTemplateDef()</code>	Returns the definition of that template.

### 7.2.3.3 The Value List and Mismatch Types

The following abstract data types are defined and used for the logging of differences between values and templates:

<code>TciValueList</code>	A value of <code>TciValueList</code> is a list of values.
<code>TciValueDifference</code>	A value of <code>TciValueDifference</code> is a structure containing a value, a template, and a description for the reason of this difference.
<code>TciValueDifferenceList</code>	A value of <code>TciValueDifferenceList</code> is a sequence of value differences.

## 7.3 TCI operations

This clause specifies the operations that a TTCN-3 Executable shall provide to a test system (*required operations*) and which functionality shall be provided by the test system to the TTCN-3 Executable (*provided operations*).

The terms "required" and "provided" reflect the fact that the present document defines the requirements on a TTCN-3 Executable from a user's point of view. The user "requires" from a TTCN-3 Executable certain functionality to build a complete TTCN-3-based test system. To fulfil its task the TTCN-3 Executable has to inform the user on certain events where the user has to "provide" this possibility to the TTCN-3 Executable.

All operation definitions in this clause are defined using the Interface Definition Language (IDL). Concrete language mappings are defined in clause 8 and 9. Annex B provides for the logging interface an alternative mapping to XML.

For every TCI operation call all *in*, *inout*, and *out* parameters listed in the particular operation definition are mandatory. The value of an *in* parameter is specified by the calling entity. Calling entity refers to the direction of the call. For operations on a *required* interface the calling entity is the test system while the called entity is the TTCN-3 Executable. For operations on a *provided* interface the calling entity is the TTCN-3 Executable while the test system is the called entity.

Similarly, the value of an *out* parameter is specified by the called entity. In the case of an *inout* parameter, a value is first specified by the calling entity but may be replaced with a new value by the called entity. Note that although TTCN-3 also uses *in*, *inout*, and *out* for signature definitions the denotations used in TCI IDL specification are not related to those in a TTCN-3 specification.

Operation calls should use a reserved value to indicate the absence of parameters. The reserved values for these types are defined in each language mapping and will be subsequently referred to as the `null` value.

In addition, the `null` value will also be used to indicate the inability to perform a certain task.

As this clause specifies interfaces only and does not suggest concrete implementations on how to perform the specified functionality the term entity will be used to identify the part of the test system implementation that implements this interface and performs the requested functionality. For example, the calling entity in the `tcisendConnected` operation is the TE, i.e. the part of test system implementation that provides the TE functionality.

All functions in the interface are described using the following template. Descriptions that are not applicable for certain operations are removed.

<b>Signature</b>	IDL Signature
<b>In Parameters</b>	Description of data passed as parameters to the operation from the calling entity to the called entity.
<b>Out Parameters</b>	Description of data passed as parameters to the operation from the called entity to the calling entity.
<b>InOut Parameters</b>	Description of data passed as parameters to the operation from the calling entity to the called entity and from the called entity back to the calling entity.
<b>Return Value</b>	Description of data returned from the operation to the calling entity.
<b>Constraint</b>	Description of any constraints when the operation can be called.
<b>Effect</b>	Behaviour required of the called entity before the operation may return.

### 7.3.1 The TCI-TM interface

The TCI Test Management Interface (TCI-TM) describes the operations a TTCN-3 Executable is required to implement and the operations a test management implementation shall provide to the TE (figure 5).

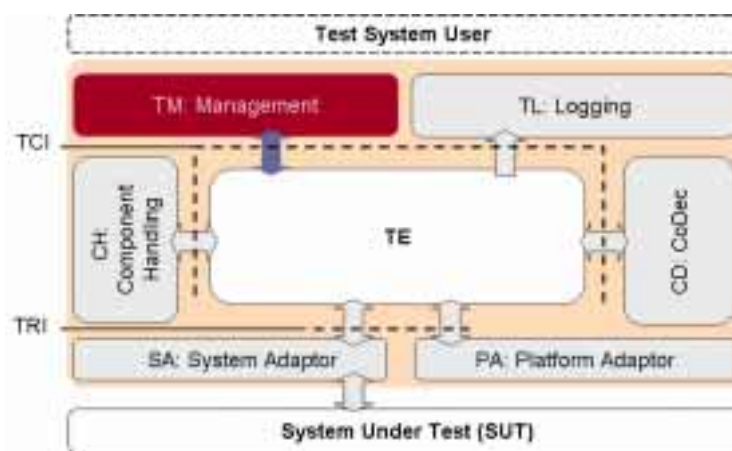

Figure 5: The TCI-TM interface

A test management implementation provides overall test management to the test system user. It requires from the TE the presence of operations to start and stop test execution of a TTCN-3 module or of certain test cases in a TTCN-3 module. In turn it provides operations to the TE for resolving module parameter at runtime and the indication of execution termination.

Clause 10 illustrates the usage and sequential ordering of operation calls by either the TE or the test management.

#### 7.3.1.1 TCI-TM required

This clause specifies the operations the TM requires from the TE. In addition to the operations specified in this clause, a test management requires the operations as required at the TCI-CD interface.

##### 7.3.1.1.1 tciRootModule

<b>Signature</b>	void tciRootModule (in TciModuleIdType moduleName)	
<b>In Parameters</b>	moduleName	The moduleName denotes the module identifiers as defined in TTCN-3.
<b>Return Value</b>	void	
<b>Constraint</b>	Shall be used only if neither the control part nor a test case is currently being executed.	
<b>Effect</b>	tciRootModule selects the indicated module for execution through a subsequent call using tciStartTestCase or tciStartControl. A tciError will be issued by the TE if no such module exists.	



## 7.3.1.1.2 getImportedModules

<b>Signature</b>	TciModuleIdListType getImportedModules()
<b>Return Value</b>	A list of all imported modules of the root module. The modules are ordered as they appear in the TTCN-3 module. If no imported modules exist, an empty module list is returned.
<b>Constraint</b>	Shall be used only if a root module has been set before.
<b>Effect</b>	The TE provides to the management a list of imported modules of the root module. If no imported module exist, an empty module list is returned. If the TE cannot provide a list, the distinct null value shall be returned.

## 7.3.1.1.3 tciGetModuleParameters

<b>Signature</b>	TciModuleParameterListType tciGetModuleParameters (in TciModuleIdType moduleName)
<b>In Parameters</b>	moduleName The moduleName denotes the module identifiers for which the module parameters should be retrieved.
<b>Return Value</b>	A list of all module parameters of the identified module. The parameters are ordered as they appear in the TTCN-3 module. If no parameters exist, an empty module parameter list is returned.
<b>Constraint</b>	Shall be used only if a root module has been set before.
<b>Effect</b>	The TE provides to the management a list of module parameters of the identified module. If no module parameters exist, an empty module parameter list is returned. If the TE cannot provide a list, the distinct null value shall be returned.

## 7.3.1.1.4 tciGetTestCases

<b>Signature</b>	TciTestCaseIdListType tciGetTestCases ()
<b>Return Value</b>	A list of all test cases that are either defined in or imported into the root module.
<b>Constraint</b>	Shall be used only if a root module has been set before.
<b>Effect</b>	The TE provides to the management a list of test cases. If no test cases exist, an empty test case list is returned. If the TE cannot provide a list, the distinct null value shall be returned.

## 7.3.1.1.5 tciGetTestCaseParameters

<b>Signature</b>	TciParameterTypeListType tciGetTestCaseParameters (in TciTestCaseIdType testCaseId)
<b>In Parameters</b>	testCaseId A test case identifier as defined in the TTCN-3 module.
<b>Return Value</b>	A list of all parameter types of the given test case. The parameter types are ordered as they appear in the TTCN-3 signature of the test case. If no parameters exist, an empty parameter type list is returned.
<b>Constraint</b>	Shall be used only if a root module has been set before.
<b>Effect</b>	The TE provides to the management a list of parameter types of the given test case. If no test case parameters exist, an empty parameter type list is returned. If the TE cannot provide a list, the distinct null value shall be returned.

## 7.3.1.1.6 tciGetTestCaseTSI

<b>Signature</b>	TriPortIdListType tciGetTestCaseTSI (in TciTestCaseIdType testCaseId)
<b>In Parameters</b>	testCaseId A test case identifier as defined in the TTCN-3 module.
<b>Return Value</b>	A list of all system ports of the given test case that have been declared in the definition of the system component for the test case, i.e. the TSI ports. If a system component has not been explicitly defined for the test case, then the list contains all communication ports of the MTC test component. The ports are ordered as they appear in the respective TTCN-3 component type declaration. If no system ports exist, an empty list, i.e. a list of length zero is returned.
<b>Constraint</b>	Shall be used only if a root module has been set before.
<b>Effect</b>	The TE provides to the management a list of system ports of the given test case. If no system ports exist, an empty port list is returned. If the TE cannot provide a list, the distinct null value shall be returned.

## 7.3.1.1.7 tciStartTestCase

<b>Signature</b>	void tciStartTestCase(in TciTestCaseIdType testCaseId, in TciParameterListType parameterList)	
<b>In Parameters</b>	testCaseId	A test case identifier as defined in the TTCN-3 module.
	parameterList	A list of Values where each value defines a parameter from the parameter list as defined in the TTCN-3 test case definition. The parameters in parameterList are ordered as they appear in the TTCN-3 signature of the test case. If no parameters have to be passed either the null value or an empty parameterList, i.e. a list of length zero shall be passed.
<b>Return Value</b>	void	
<b>Constraint</b>	Shall be called only if a module has been selected before. Only testCaseIds for test cases that are declared in the currently selected TTCN-3 module shall be passed. Test cases that are imported in a referenced module can not be started. To start imported test cases the referenced (imported) module must be selected first using the tciRootModule operation.	
<b>Effect</b>	tciStartTestCase starts a test case in the currently selected module with the given parameters. A tciError will be issued by the TE if no such test case exists. All in and inout test case parameters in parameterList contain Value. All out test case parameters in parameterList shall contain the distinct value of null since they are only of relevance when the test case terminates.	

## 7.3.1.1.8 tciStopTestCase

<b>Signature</b>	void tciStopTestCase()	
<b>Return Value</b>	void	
<b>Constraint</b>	Shall be called only if a module has been selected before.	
<b>Effect</b>	tciStopTestCase stops the test case currently being executed. If the TE is not executing a test case, the operation will be ignored. If the control part is being executed, tciStopTestCase will stop execution of the currently executed test case, i.e. the execution of the test case that has recently been indicated using the provided operation tciTestCaseStarted. A possible executing control part will continue execution as if the test case has stopped normally and returned with verdict ERROR.	

## 7.3.1.1.9 tciStartControl

<b>Signature</b>	TriComponentId tciStartControl()	
<b>Return Value</b>	A TriComponentId that represents the test component the module control part is executed on. If the TE cannot start control part of the selected module the distinct value null will be returned.	
<b>Constraint</b>	Shall be called only if a module has been selected before.	
<b>Effect</b>	Starts the control part of the selected module. The control part will start TTCN-3 test cases as described in TTCN-3. While executing the control part the TE will call the provided operation tciTestCaseStarted and tciTestCaseTerminated for every test case that has been started and that has terminated. After termination of the control part the TE will call the provided operation tciControlPartTerminated.	

## 7.3.1.1.10 tciStopControl

<b>Signature</b>	void tciStopControl()	
<b>Return Value</b>	void	
<b>Constraint</b>	Shall only be called if a module has been selected before.	
<b>Effect</b>	tciStopControl stops execution of the control part. If no control part is currently being executed the operation will be ignored. If a test case has been started directly this will stop execution of the current test case as if tciStopTestCase has been called.	

### 7.3.1.2 TCI-TM provided

This clause specifies the operations the TM has to provide to the TE.

#### 7.3.1.2.1 tciTestCaseStarted

<b>Signature</b>	void tciTestCaseStarted(in TciTestCaseIdType testCaseId, in TciParameterListType parameterList, in TFloat timer)	
<b>In Parameters</b>	testCaseId	A test case identifier as defined in the TTCN-3 module.
	parameterList	A list of values that are part of the test case signature. The parameters in parameterList are ordered as they appear in the TTCN-3 test case declaration.
	timer	A float value representing the duration of the test case timer.
<b>Return Value</b>	void	
<b>Constraint</b>	Shall only be called after either the control part of the module or a test case has been started using the <i>required</i> operations tciStartControl or tciStartTestCase.	
<b>Effect</b>	tciTestCaseStarted indicates to the TM that a test case with testCaseId has been started. It will not be distinguished whether the test case has been started explicitly using the <i>required</i> operation tciStartTestCase or implicitly while executing the control part.	

#### 7.3.1.2.2 tciTestCaseTerminated

<b>Signature</b>	void tciTestCaseTerminated(in VerdictValue verdict, in TciParameterListType parameterList)	
<b>In Parameters</b>	verdict	The final verdict of the test case.
	parameterList	A list of values that are part of the test case signature. The parameters in parameterList are ordered as they appear in the TTCN-3 test case declaration.
<b>Return Value</b>	void	
<b>Constraint</b>	Shall only be called after either the control part of the module or a test cases has been started using the <i>required</i> operations tciStartControl or tciStartTestCase.	
<b>Effect</b>	This operation will be called by the TE to indicate the test management that the test case that has been currently executed on the MTC has terminated and that the final verdict was verdict. On the invocation of a tciTestCaseTerminated operation all <i>out</i> and <i>inout</i> test case parameters contain values. All in test case parameters contain the distinct value of null because they are only of relevance to the test case start but not in the reply to the call.	

#### 7.3.1.2.3 tciControlTerminated

<b>Signature</b>	void tciControlTerminated ()
<b>Return Value</b>	void
<b>Constraint</b>	Shall only be called when the module execution has been started using the tciStartControl operation.
<b>Effect</b>	This operation will be called by the TE to indicate the test management that the control part of the selected module has just terminated execution.

## 7.3.1.2.4 tciGetModulePar

<b>Signature</b>	Value tciGetModulePar (in TciModuleParameterIdType parameterId)
<b>In Parameters</b>	parameterId   The identifier of the module parameter as defined in TTCN-3.
<b>Return Value</b>	A value.
<b>Constraint</b>	This operation shall be called whenever the TE needs to access the value of a module parameter. Every accessed module parameter will be resolved only once between a tciStartTestCase and tciTestCaseTerminated pair if a test case has been started explicitly or between a tciStartControl and tciControlTerminated pair if the control part of a module has been started.
<b>Effect</b>	The management provides to the TE a Value for the indicated parameterId. Every call of tciGetModulePar() will return the same value throughout the execution of an explicitly started test case or throughout the execution of a control part. If the management cannot provide a TTCN-3 value, the distinct null value shall be returned.

## 7.3.1.2.5 tciError

<b>Signature</b>	void tciError(in TString message)
<b>In Parameters</b>	message   A string value, i.e. the message error
<b>Return Value</b>	void
<b>Constraint</b>	Can be called at any time by the TE to indicate an unrecoverable error situation. This error situation could either be indicated by the CH or the CD or could occur within the TE.
<b>Effect</b>	The TE indicates the occurrence of an unrecoverable error situation. message contains a reason phrase that might be communicated to the test system user. It is up to the test management to terminate execution of test cases or control parts if running. The test management has to take explicit measures to terminate test execution immediately.

## 7.3.2 The TCI-CD interface

The TCI Codec Interface (TCI-CD) describes the operations a TTCN-3 Executable is required to implement and the operations a codec implementation for a certain encoding scheme shall provide to the TE (figure 6).

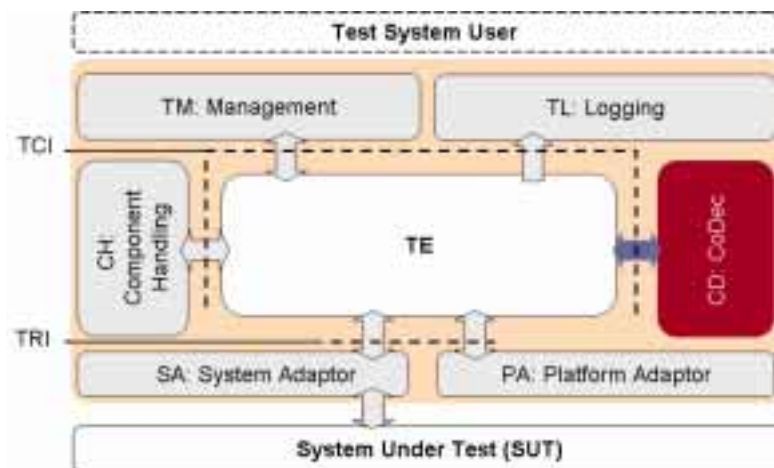

Figure 6: The TCI-CD interface

A codec implementation encodes TTCN-3 values according to the encoding attribute into a bitstring and decodes a bitstring according to decoding hypothesis. To be able to decode a bitstring into a TTCN-3 value the CD requires certain functionality from the TE. In turn the CD provides encoding and decoding functionality to the TTCN-3 Executable.

Clause 10 illustrates the usage and sequential ordering of operation calls by either the TE or the CD.

### 7.3.2.1 TCI-CD required

This clause specifies the operations the CD requires from the TE. All operations specified in this clause are also required at the TCI-TM and TCI-CH interfaces.

#### 7.3.2.1.1 getTypeForName

<b>Signature</b>	Type getTypeForName(in TString typeName)	
<b>In Parameters</b>	typeName	The TTCN-3 name of the type as defined in the TTCN-3 module. The following are reserved type names and will return a predefined type: "integer" "float" "bitstring" "hexstring" "octetstring" "charstring" "universal charstring" "boolean" "verdicttype" "objid"  typeName has to be the fully qualified type name, i.e. module.typeName
<b>Return Value</b>	A type representing the requested TTCN-3 type.	
<b>Constraint</b>	---	
<b>Effect</b>	Returns a type representing a TTCN-3 type. Predefined TTCN-3 types can be retrieved from the TE by using the TTCN-3 keywords for the predefined types. In this case typeName denotes to the basic TTCN-3 type like "charstring", "bitstring" etc. Returns the distinct value null if the requested type can not be returned. Note that the anytype and address can not be obtained with module set to null. Although they are predefined types they might be distinct between modules. For example, address can either be the unmodified predefined type, or a user-defined type in a module. Other predefined types can not be redefined.	

#### 7.3.2.1.2 getInteger

<b>Signature</b>	Type getInteger()
<b>Return Value</b>	An instance of Type representing a TTCN-3 integer type.
<b>Effect</b>	Constructs and returns a basic TTCN-3 integer type.

#### 7.3.2.1.3 getFloat

<b>Signature</b>	Type getFloat()
<b>Return Value</b>	An instance of Type representing a TTCN-3 float type.
<b>Effect</b>	Constructs and returns a basic TTCN-3 float type.

#### 7.3.2.1.4 getBoolean

<b>Signature</b>	Type getBoolean()
<b>Return Value</b>	An instance of Type representing a TTCN-3 boolean type.
<b>Effect</b>	Constructs and returns a basic TTCN-3 boolean type.

#### 7.3.2.1.5 getObjid

<b>Signature</b>	Type getObjid()
<b>Return Value</b>	An instance of Type representing a TTCN-3 object id type.
<b>Effect</b>	Constructs and returns a basic TTCN-3 object id type.

## 7.3.2.1.6 getCharstring

<b>Signature</b>	Type getCharstring ()
<b>Return Value</b>	An instance of Type representing a TTCN-3 charstring type.
<b>Effect</b>	Constructs and returns a basic TTCN-3 charstringtype.

## 7.3.2.1.7 getUniversalCharstring

<b>Signature</b>	Type getUniversalCharstring ()
<b>Return Value</b>	An instance of Type representing a TTCN-3 universal charstring type.
<b>Effect</b>	Constructs and returns a basic TTCN-3 universal charstring type.

## 7.3.2.1.8 getHexstring

<b>Signature</b>	Type getHexstring ()
<b>Return Value</b>	An instance of Type representing a TTCN-3 hexstring type.
<b>Effect</b>	Constructs and returns a basic TTCN-3 hexstring type.

## 7.3.2.1.9 getBitstring

<b>Signature</b>	Type getBitstring()
<b>Return Value</b>	An instance of Type representing a TTCN-3 bitstring type.
<b>Effect</b>	Constructs and returns a basic TTCN-3 bitstring type.

## 7.3.2.1.10 getOctetstring

<b>Signature</b>	Type getOctetstring ()
<b>Return Value</b>	An instance of Type representing a TTCN-3 octetstring type.
<b>Effect</b>	Constructs and returns a basic TTCN-3 octetstring type.

## 7.3.2.1.11 getVerdict

<b>Signature</b>	Type getVerdict()
<b>Return Value</b>	An instance of Type representing a TTCN-3 verdict type.
<b>Effect</b>	Constructs and returns a basic TTCN-3 verdict type.

## 7.3.2.1.12 tciErrorReq

<b>Signature</b>	void tciErrorReq(in TString message)
<b>In Parameters</b>	Message   A string value, i.e. the error phrase describing the problem.
<b>Return Value</b>	void
<b>Constraint</b>	Shall be called whenever an error situation has occurred.
<b>Effect</b>	The TE will be notified about an unrecoverable error situation within the CD and forward the error indication to the test management.

### 7.3.2.2 TCI-CD provided

This clause specifies the operations the TM shall provide to the TE.

#### 7.3.2.2.1 decode

<b>Signature</b>	Value decode(in TriMessageType message, in Type decodingHypothesis)	
<b>In Parameters</b>	message	The encoded message to be decoded.
	decodingHypothesis	The hypothesis the decoding can be based on.
<b>Return Value</b>	Returns the decoded value, if the value is of a compatible type as the decodingHypothesis, else the distinct value null.	
<b>Constraint</b>	This operation shall be called whenever the TE has to decode an encoded value. The TE might decode immediately after reception of a encoded value, or might for performance considerations postpone the decoding until the actual access of the encoded value.	
<b>Effect</b>	This operations decodes message according to the encoding rules and returns a TTCN-3 value. The decodingHypothesis shall be used to determine whether the encoded value can be decoded. If an encoding rule is not self-sufficient, i.e. if the encoded message does not inherently contain its type decodingHypothesis shall be used. If the encoded value can be decoded without the decoding hypothesis, the distinct null value shall be returned if the type determined from the encoded message is not compatible with the decoding hypothesis.	

#### 7.3.2.2.2 encode

<b>Signature</b>	TriMessageType encode(in Value value)	
<b>In Parameters</b>	value	The value to be encoded.
<b>Return Value</b>	Returns an encoded TriMessage for the specified encoding rule.	
<b>Constraint</b>	This operation shall be called whenever the TE has to encode a Value.	
<b>Effect</b>	Returns an encoded TriMessage according to the encoding rules.	

### 7.3.3 The TCI-CH interface

The TCI Component Handling Interface (TCI-CH) describes the operations a TTCN-3 Executable is required to implement and the operations a component handling implementation shall provide to the TE (figure 7).

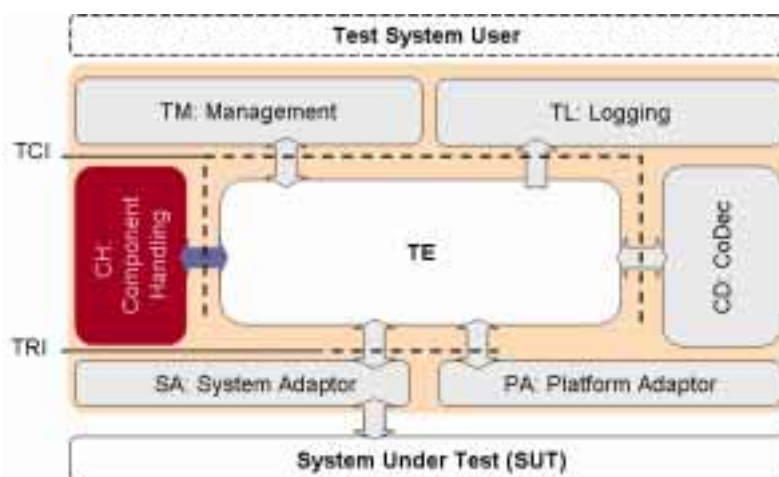

Figure 7: The TCI-CH interface

A component handling implementation distributes TTCN-3 configuration operations like create, connect and start and intercomponent communication like send on a connected port among one or more TTCN-3 Executables participating in a test session. Note that although multiple instances of a TE might participate in a test session this is not mandatory.

The basic principle is that TCI-CH is not *implementing* any kind of TTCN-3 functionality. Instead it will be informed by the TE that for example a test component shall be created. Based on Component Handling (CH) internal knowledge the request for creation of a test component will be transmitted to another (remote) participating TE. This second (remote) participating TE will create the TTCN-3 component and will provide a handle back to the requesting (local) TE. The requesting (local) TE can now operate on the created test component via this component handle.

Within the operation definitions the terms local TE and remote TE is used to highlight the fact that a test system implementation might be distributed over several test devices, each of them hosting a complete TE. The terms "local" and "remote" always refer to the interfaces currently being described. For convenience, the term "local" refers always to the TE being either the callee of an operation (for *required* operations) or the caller of an operation (for *provided* operations). While the TE is conceptually considered as being distributed, the CH is considered to be non-distributed. This can either be achieved using a centralized architecture or by using a middleware-platform that abstracts from distribution aspects. Although the TE might be distributed over different physical devices, there might be configurations where only one, non-distributed TE will participate in a test session. In this case the term "local" and "remote" refer to the same TE instance.

Clause 10 illustrates the usage and sequential ordering of operation calls by either the TE or the CH.

Although all TTCN-3 Executables participating in a test session are equal, there is a distinct TE\*. This TE\* is the TE where the explicit `tciStartTestCase()` or `tciStartControl()` has been processed. The reason for this distinction is, that TE\* shall calculate the global verdict. TE\* will notify the test management upon termination of test execution and shall provide then the global verdict of the test case.

### 7.3.3.1 TCI-CH required

This clause specifies the operations the CH requires from the TE. In addition to the operations specified in this clause, all *required* operation of the TCI-CD interface are also required.

#### 7.3.3.1.1 tciEnqueueMsgConnected

<b>Signature</b>	void tciEnqueueMsgConnected (in TriPortIdType sender, in TriComponentIdType receiver, in Value rcvdMessage)	
<b>In Parameters</b>	sender	Port identifier at the sending component via which the message is sent.
	receiver	Identifier of the receiving component.
	rcvdMessage	The value to be enqueued.
<b>Return Value</b>	void	
<b>Constraint</b>	This operation shall be called by the CH at the local TE when at remote TE a <i>provided</i> <code>tciSendConnected</code> has been called.	
<b>Effect</b>	The TE enqueues the received value into the local port queue of the indicated receiver component.	

#### 7.3.3.1.2 tciEnqueueCallConnected

<b>Signature</b>	void tciEnqueueCallConnected (in TriPortIdType sender, in TriComponentIdType receiver, in TriSignatureIdType signature, in TciParameterListType parameterList)	
<b>In Parameters</b>	sender	Port identifier at the sending component via which the message is sent.
	receiver	Identifier of the receiving component.
	signature	Identifier of the signature of the procedure call.
	parameterList	A list of value parameters which are part of the indicated signature. The parameters in <code>parameterList</code> are ordered as they appear in the TTCN-3 signature declaration.
<b>Return Value</b>	void	
<b>Constraint</b>	This operation shall be called by the CH at the local TE when at a remote TE a <i>provided</i> <code>tciCallConnected</code> has been called. All <i>in</i> and <i>inout</i> procedure parameters contain values. All <i>out</i> procedure parameters shall contain the distinct value of <code>null</code> because they are only of relevance in a reply to the procedure call but not in the procedure call itself. The procedure parameters are the parameters specified in the TTCN-3 signature template.	
<b>Effect</b>	The TE enqueues the calls at the local port queue of the indicated receiver component.	



## 7.3.3.1.3 tciEnqueueReplyConnected

<b>Signature</b>	void tciEnqueueReplyConnected (in TriPortIdType sender, in TriComponentIdType receiver, in TriSignatureIdType signature, in TciParameterListType parameterList, in Value returnValue)	
<b>In Parameters</b>	sender	Identifier of the port sending the reply.
	receiver	Identifier of the component receiving the reply.
	signature	Identifier of the signature of the procedure call.
	parameterList	A list of value parameters which are part of the indicated signature. The parameters in parameterList are ordered as they appear in the TTCN-3 signature declaration.
	returnValue	(Optional) return value of the procedure call.
<b>Return Value</b>	void	
<b>Constraint</b>	This operation shall be called by the CH at the local TE when at a remote TE a <i>provided</i> tciReplyConnected has been called. All <i>out</i> and <i>inout</i> procedure parameters and the return value contain values. All <i>in</i> procedure parameters shall contain the distinct value of null since they are only of relevance to the procedure call but not in the reply to the call. The parameterList contains procedure call parameters. These parameters are the parameters specified in the TTCN-3 signature template. If no return type has been defined for the procedure signature in the TTCN-3 ATS, the distinct value null shall be passed for the returnValue.	
<b>Effect</b>	The TE enqueues the reply at the local port queue of the indicated receiver component.	

## 7.3.3.1.4 tciEnqueueRaiseConnected

<b>Signature</b>	void tciEnqueueRaiseConnected (in TriPortIdType sender, in TriComponentIdType receiver, in TriSignatureIdType signature, in Value exception)	
<b>In Parameters</b>	sender	Identifier of the port sending the reply.
	receiver	Identifier of the component receiving the reply.
	signature	Identifier of the signature of the procedure call.
	exception	The exception.
<b>Return Value</b>	void	
<b>Constraint</b>	This operation shall be called by the CH at the local TE when at a remote TE a <i>provided</i> tciRaiseConnected has been called.	
<b>Effect</b>	The TE enqueues the exception at the local port queue of the indicated receiver component.	

## 7.3.3.1.5 tciCreateTestComponent

<b>Signature</b>	TriComponentIdType tciCreateTestComponent (in TciTestComponentKindType kind, in Type componentType), in TString name)	
<b>In Parameters</b>	kind	The kind of component that shall be created, either MTC, PTC or CONTROL.
	componentType	Identifier of the TTCN-3 component type that shall be created.
	name	Name of the component that shall be created
<b>Return Value</b>	A TriComponentIdType value for the created component.	
<b>Constraint</b>	This operation shall be called by the CH at the local TE when at a remote TE a <i>provided</i> tciCreateTestComponentReq has been called. componentType shall be set to the distinct value null if a test component of kind control shall be created. name shall be set to the distinct value null if no name is given in the TTCN-3 create statement.	
<b>Effect</b>	The TE creates a TTCN-3 test component of the componentType and passes a TriComponentIdType reference back to the CH. The CH communicates the reference back to the remote TE.	

## 7.3.3.1.6 tciStartTestComponent

<b>Signature</b>	void tciStartTestComponent(in TriComponentIdType component, in TciBehaviourIdType behaviour, in TciParameterListType parameterList)	
<b>In Parameters</b>	component	Identifier of the component to be started. Refers to an identifier previously created by a call of tciCreateTestComponent
	behaviour	Identifier of the behaviour to be started on the component.
	parameterList	A list of Values where each value defines a parameter from the parameter list as defined in the TTCN-3 function declaration of the function being started. The parameters in parameterList are ordered as they appear in the TTCN-3 signature of the test case. If no parameters have to be passed either the null value or an empty parameterList, i.e. a list of length zero shall be passed.
<b>Return Value</b>	void	
<b>Constraint</b>	This operation shall be called by the CH at the local TE when at a remote TE a <i>provided</i> tciStartTestComponentReq has been called. Since only <i>in</i> parameters are allowed for functions being started (ES 201 873-1 [2]), parameterList contains only <i>in</i> parameters.	
<b>Effect</b>	The TE shall start the indicated behaviour on the indicated component.	

## 7.3.3.1.7 tciStopTestComponent

<b>Signature</b>	void tciStopTestComponent(in TriComponentIdType component)	
<b>In Parameters</b>	component	Identifier of the component to be stopped.
<b>Return Value</b>	void	
<b>Constraint</b>	This operation shall be called by the CH at the local TE when at a remote TE a <i>provided</i> tciStopTestComponentReq has been called.	
<b>Effect</b>	The TE shall stop the indicated behaviour on the indicated component.	

## 7.3.3.1.8 tciConnect

<b>Signature</b>	void tciConnect (in TriPortIdType fromPort, in TriPortIdType toPort)	
<b>In Parameters</b>	fromPort	Identifier of the test component port to be connected from.
	toPort	Identifier of the test component port to be connected to.
<b>Return Value</b>	void	
<b>Constraint</b>	This operation shall be called by the CH at the local TE when at a remote TE a <i>provided</i> tciConnect has been called.	
<b>Effect</b>	The TE shall connect the indicated ports to one another.	

## 7.3.3.1.9 tciDisconnect

<b>Signature</b>	void tciDisconnect (in TriPortIdType fromPort, in TriPortIdType toPort)	
<b>In Parameters</b>	fromPort	Identifier of the test component port to be disconnected.
	toPort	Identifier of the test component port to be disconnected.
<b>Return Value</b>	void	
<b>Constraint</b>	This operation shall be called by the CH at the local TE when at a remote TE a <i>provided</i> tciDisconnect has been called.	
<b>Effect</b>	The TE shall disconnect the indicated ports.	

## 7.3.3.1.10 tciMap

<b>Signature</b>	void tciMap (in TriPortIdType fromPort, in TriPortIdType toPort)	
<b>In Parameters</b>	fromPort	Identifier of the test component port to be mapped from.
	toPort	Identifier of the test component port to be mapped to.
<b>Return Value</b>	void	
<b>Constraint</b>	This operation shall be called by the CH at the local TE when at a remote TE a <i>provided</i> tciMapReq has been called.	
<b>Effect</b>	The TE shall map the indicated ports to one another.	

## 7.3.3.1.11 tciUnmap

<b>Signature</b>	void tciUnmap (in TriPortIdType fromPort, in TriPortIdType toPort)	
<b>In Parameters</b>	fromPort	Identifier of the test component port to be unmapped.
	toPort	Identifier of the test component port to be unmapped.
<b>Return Value</b>	void	
<b>Constraint</b>	This operation shall be called by the CH at the local TE when at a remote TE a <i>provided</i> tciUnmapReq has been called.	
<b>Effect</b>	The TE shall unmap the indicated ports.	

## 7.3.3.1.12 tciTestComponentTerminated

<b>Signature</b>	void tciTestComponentTerminated (in TriComponentIdType component, in VerdictValue verdict)	
<b>In Parameters</b>	component	Identifier of the component that has terminated.
	verdict	Verdict after termination of the component.
<b>Return Value</b>	void	
<b>Constraint</b>	This operation shall be called by the CH at the local TE when at a remote TE a <i>provided</i> tciTestComponentTerminatedReq has been called.	
<b>Effect</b>	The local TE is notified of the termination of the indicated test component on a remote TE. Since a function being executed on a test component can only have <i>in</i> parameters (ES 201 873-1 [2]), the tciTestComponentTerminated operation does not have a parameterList parameter.	

## 7.3.3.1.13 tciTestComponentRunning

<b>Signature</b>	TBoolean tciTestComponentRunning (in TriComponentIdType component)	
<b>In Parameters</b>	component	Identifier of the component to be checked for running.
<b>Return Value</b>	true if the indicated component is still executing a behaviour, false otherwise.	
<b>Constraint</b>	This operation shall be called by the CH at the local TE when at a remote TE a <i>provided</i> tciTestComponentRunningReq has been called.	
<b>Effect</b>	The local TE determines whether the indicated component is executing a test behaviour. If the component is executing a behaviour true will be returned. In any other case, e.g. test component has finished execution, or test component has not been started, etc. false will be returned. After the operation returns, the CH will communicate the value back to the remote TE.	

## 7.3.3.1.14 tciTestComponentDone

<b>Signature</b>	TBoolean tciTestComponentDone (in TriComponentIdType comp)	
<b>In Parameters</b>	comp	Identifier of the component to be checked for done.
<b>Return Value</b>	true if the indicated component has completed executing its behaviour, false otherwise	
<b>Constraint</b>	This operation shall be called by the CH at the local TE when at a remote TE a <i>provided</i> tciTestComponentDoneReq has been called.	
<b>Effect</b>	The local TE determines whether the indicated component has completed executing its test behaviour. If the component has completed its behaviour true will be returned. In any other case, e.g. test component has not been started, or test component is still executing, false will be returned. After the operation returns, the CH will communicate the value back to the remote TE.	

## 7.3.3.1.15 tciGetMTC

<b>Signature</b>	TriComponentIdType tciGetMTC()
<b>Return Value</b>	A TriComponentIdType value of the MTC if the MTC executes on the local TE, the distinct value null otherwise.
<b>Constraint</b>	This operation can be called by the CH at the appropriate local TE when at a remote TE a <i>provided</i> tciGetMTCReq has been called.
<b>Effect</b>	The local TE determines whether the MTC is executing on the local TE. If the MTC executes on the local TE the component id of the MTC is being returned. If the MTC is not executed on the local TE the distinct value null will be returned. The operation will have no effect on the execution of the MTC. After the operation returns, the CH will communicate the value back to the remote TE.

## 7.3.3.1.16 tciExecuteTestCase

<b>Signature</b>	void tciExecuteTestCase (in TciTestCaseIdType testCaseId, in TriPortIdListType tsiPortList)	
<b>In Parameters</b>	testCaseId	A test case identifier as defined in the TTCN-3 module.
	tsiPortList	Contains all ports that have been declared in the definition of the system component for the test case, i.e. the TSI ports. If a system component has not been explicitly defined for the test case, then the tsiPortList contains all communication ports of the MTC. The ports in tsiPortList are ordered as they appear in the respective TTCN-3 component type declaration. If no ports have to be passed either the null value or an empty tsiPortList, i.e. a list of length zero shall be passed.
<b>Return Value</b>	void	
<b>Constraint</b>	This operation shall be called by the CH at the appropriate local TE when at a remote TE a <i>provided</i> tciExecuteTestCaseReq has been called.	
<b>Effect</b>	The local TE determines whether static connections to the SUT and the initialization of communication means for TSI ports should be done.	

## 7.3.3.1.17 tciReset

<b>Signature</b>	void tciReset ()
<b>Return Value</b>	void
<b>Constraint</b>	This operation shall be called by the CH at appropriate local TEs when at a remote TE a <i>provided</i> tciResetReq has been called.
<b>Effect</b>	The TE can decide to take any means to reset the test system locally.

## 7.3.3.1.18 tciKillTestComponent

<b>Signature</b>	void tciKillTestComponent(in TriComponentIdType comp)	
<b>In Parameters</b>	comp	Identifier of the component to be killed.
<b>Return Value</b>	void	
<b>Constraint</b>	This operation shall be called by the CH at the local TE when at a remote TE a <i>provided</i> tciKillTestComponentReq has been called.	
<b>Effect</b>	The TE stops the behaviour on the indicated component if necessary and transfers it into the killed state.	

## 7.3.3.1.19 tciTestComponentAlive

<b>Signature</b>	TBoolean tciTestComponentAlive (in TriComponentIdType comp)	
<b>In Parameters</b>	comp	Identifier of the component to be checked for being alive.
<b>Return Value</b>	true if the indicated component is alive, false otherwise.	
<b>Constraint</b>	This operation shall be called by the CH at the local TE when at a remote TE a <i>provided</i> tciTestComponentAliveReq has been called.	
<b>Effect</b>	The local TE determines whether the indicated component is alive. After the operation returns, the CH will communicate the value back to the remote TE.	

## 7.3.3.1.20 tciTestComponentKilled

<b>Signature</b>	TBoolean tciTestComponentKilled (in TriComponentIdType comp)	
<b>In Parameters</b>	comp	Identifier of the component to be checked for being killed.
<b>Return Value</b>	true if the indicated component has been killed, false otherwise.	
<b>Constraint</b>	This operation shall be called by the CH at the local TE when at a remote TE a <i>provided</i> tciTestComponentKilledReq has been called.	
<b>Effect</b>	The local TE determines whether the indicated component is in the killed state. If it is, true will be returned. In any other case, false will be returned. After the operation returns, the CH will communicate the value back to the remote TE.	

## 7.3.3.2 TCI-CH provided

This clause specifies the operations the CH shall provide to the TE.

## 7.3.3.2.1 tciSendConnected

<b>Signature</b>	void tciSendConnected (in TriPortIdType sender, in TriComponentIdType receiver, in Value sendMessage)	
<b>In Parameters</b>	sender	Port identifier at the sending component via which the message is sent.
	receiver	Identifier of the receiving component.
	sendMessage	The message to be send.
<b>Return Value</b>	void	
<b>Constraint</b>	This operation shall be called by the TE when it executes a TTCN-3 unicast send operation on a component port, which has been connected to another component port.	
<b>Effect</b>	Sends an asynchronous transmission only to the given receiver component. CH transmits the message to the remote TE on which receiver is being executed and enqueues the data in the remote TE.	

## 7.3.3.2.2 tciSendConnectedBC

<b>Signature</b>	void tciSendConnectedBC (in TriPortIdType sender, in Value sendMessage)	
<b>In Parameters</b>	sender	Port identifier at the sending component via which the message is sent.
	sendMessage	The message to be send.
<b>Return Value</b>	void	
<b>Constraint</b>	This operation shall be called by the TE when it executes a TTCN-3 broadcast send operation on a component port, which has been connected to other component ports.	
<b>Effect</b>	Sends an asynchronous transmission to all components being connected to this port. CH transmits the message to all remote TEs on which receivers are being executed and enqueues the data in the remote TEs.	

## 7.3.3.2.3 tciSendConnectedMC

<b>Signature</b>	void tciSendConnectedMC (in TriPortIdType sender, in TriComponentIdListType receivers, in Value sendMessage)	
<b>In Parameters</b>	sender	Port identifier at the sending component via which the message is sent.
	receivers	Identifiers of the receiving components.
	sendMessage	The message to be send.
<b>Return Value</b>	void	
<b>Constraint</b>	This operation shall be called by the TE when it executes a TTCN-3 multicast send operation on a component port, which has been connected to other component ports.	
<b>Effect</b>	Sends an asynchronous transmission to all given receiver components. CH transmits the message to all remote TEs on which receivers are being executed and enqueues the data in the remote TEs.	

## 7.3.3.2.4 tciCallConnected

<b>Signature</b>	void tciCallConnected (in TriPortIdType sender, in TriComponentIdType receiver, in TriSignatureIdType signature, in TciParameterListType parameterList)	
<b>In Parameters</b>	sender	Port identifier at the sending component via which the message is sent.
	receiver	Identifier of the receiving component.
	signature	Identifier of the signature of the procedure call.
	parameterList	A list of value parameters which are part of the indicated signature. The parameters in parameterList are ordered as they appear in the TTCN-3 signature declaration.
<b>Return Value</b>	void	
<b>Constraint</b>	This operation shall be called by the TE when it executes a TTCN-3 unicast call operation on a component port, which has been connected to another component port. All <i>in</i> and <i>inout</i> procedure parameters contain values. All <i>out</i> procedure parameters shall contain the distinct value of null because they are only of relevance in a reply to the procedure call but not in the procedure call itself. The procedure parameters are the parameters specified in the TTCN-3 signature template.	
<b>Effect</b>	On invocation of this operation the TE can initiate the procedure call corresponding to the signature identifier signature at the called component receiver. The tciCallConnected operation shall return without waiting for the return of the issued procedure call. Note that an optional timeout value, which can be specified in the TTCN-3 ATS for a call operation, is not included in the tciCallConnected operation signature. The TE is responsible to address this issue by starting a timer for the TTCN-3 call operation in the PA with a separate TRI operation call, i.e. triStartTimer. CH transmits the call to the remote TE on which receiver is being executed and enqueues the call in the remote TE.	

## 7.3.3.2.5 tciCallConnectedBC

<b>Signature</b>	void tciCallConnectedBC (in TriPortIdType sender, in TriSignatureIdType signature, in TciParameterListType parameterList)	
<b>In Parameters</b>	sender	Port identifier at the sending component via which the message is sent.
	signature	Identifier of the signature of the procedure call.
	parameterList	A list of value parameters which are part of the indicated signature. The parameters in parameterList are ordered as they appear in the TTCN-3 signature declaration.
<b>Return Value</b>	void	
<b>Constraint</b>	This operation shall be called by the TE when it executes a TTCN-3 broadcast call operation on a component port, which has been connected to other component ports. All <i>in</i> and <i>inout</i> procedure parameters contain values. All <i>out</i> procedure parameters shall contain the distinct value of null because they are only of relevance in a reply to the procedure call but not in the procedure call itself. The procedure parameters are the parameters specified in the TTCN-3 signature template.	
<b>Effect</b>	On invocation of this operation the TE can initiate the procedure call corresponding to the signature identifier signature at the called component receiver. The tciCallConnected operation shall return without waiting for the return of the issued procedure call. Note that an optional timeout value, which can be specified in the TTCN-3 ATS for a call operation, is not included in the tciCallConnected operation signature. The TE is responsible to address this issue by starting a timer for the TTCN-3 call operation in the PA with a separate TRI operation call, i.e. triStartTimer. CH transmits the call to all remote TEs on which areceiver is being executed and enqueues the call in the remote TEs.	

## 7.3.3.2.6 tciCallConnectedMC

<b>Signature</b>	void tciCallConnectedMC (in TriPortIdType sender, in TriComponentIdListType receivers, in TriSignatureIdType signature, in TciParameterListType parameterList)	
<b>In Parameters</b>	sender	Port identifier at the sending component via which the message is sent.
	receivers	Identifier of the receiving components.
	signature	Identifier of the signature of the procedure call.
	parameterList	A list of value parameters which are part of the indicated signature. The parameters in parameterList are ordered as they appear in the TTCN-3 signature declaration.
<b>Return Value</b>	void	
<b>Constraint</b>	This operation shall be called by the TE when it executes a TTCN-3 multicast call operation on a component port, which has been connected to other component ports. All <i>in</i> and <i>inout</i> procedure parameters contain values. All <i>out</i> procedure parameters shall contain the distinct value of null because they are only of relevance in a reply to the procedure call but not in the procedure call itself. The procedure parameters are the parameters specified in the TTCN-3 signature template.	
<b>Effect</b>	On invocation of this operation the TE can initiate the procedure call corresponding to the signature identifier signature at the called component receiver. The tciCallConnected operation shall return without waiting for the return of the issued procedure call. Note that an optional timeout value, which can be specified in the TTCN-3 ATS for a call operation, is not included in the tciCallConnected operation signature. The TE is responsible to address this issue by starting a timer for the TTCN-3 call operation in the PA with a separate TRI operation call, i.e. triStartTimer. CH transmits the call to all remote TEs on which a receiver is being executed and enqueues the call in the remote TEs.	

## 7.3.3.2.7 tciReplyConnected

<b>Signature</b>	void tciReplyConnected (in TriPortIdType sender, in TriComponentIdType receiver, in TriSignatureIdType signature, in TciParameterListType parameterList, in Value returnValue)	
<b>In Parameters</b>	sender	Identifier of the port sending the reply.
	receiver	Identifier of the component receiving the reply.
	signature	Identifier of the signature of the procedure call.
	parameterList	A list of encoded parameters which are part of the indicated signature. The parameters in parameterList are ordered as they appear in the TTCN-3 signature declaration.
	returnValue	(Optional) return value of the procedure call.
<b>Return Value</b>	void	
<b>Constraint</b>	This operation shall be called by the TE when it executes a TTCN-3 unicast reply operation on a component port which has been connected to another component port. All <i>out</i> and <i>inout</i> procedure parameters and the return value contain values. All <i>in</i> procedure parameters shall contain the distinct value of null since they are only of relevance to the procedure call but not in the reply to the call. The parameterList contains procedure call parameters. These parameters are the parameters specified in the TTCN-3 signature template. If no return type has been defined for the procedure signature in the TTCN-3 ATS, the distinct value null shall be passed for the return value.	
<b>Effect</b>	On invocation of this operation the CH can issue the reply to a procedure call corresponding to the signature identifier signature and component identifier receiver. CH transmits the reply to the remote TE on which receiver is being executed and enqueues the reply in the remote TE.	

## 7.3.3.2.8 tciReplyConnectedBC

<b>Signature</b>	void tciReplyConnectedBC (in TriPortIdType sender, in TriSignatureIdType signature, in TciParameterListType parameterList, in Value returnValue)	
<b>In Parameters</b>	sender	Identifier of the port sending the reply.
	signature	Identifier of the signature of the procedure call.
	parameterList	A list of encoded parameters which are part of the indicated signature. The parameters in parameterList are ordered as they appear in the TTCN-3 signature declaration.
	returnValue	(Optional) return value of the procedure call.
<b>Return Value</b>	void	
<b>Constraint</b>	This operation shall be called by the TE when it executes a TTCN-3 broadcast reply operation on a component port which has been connected to other component ports. All <i>out</i> and <i>inout</i> procedure parameters and the return value contain values. All <i>in</i> procedure parameters shall contain the distinct value of <code>null</code> since they are only of relevance to the procedure call but not in the reply to the call. The <code>parameterList</code> contains procedure call parameters. These parameters are the parameters specified in the TTCN-3 signature template. If no return type has been defined for the procedure signature in the TTCN-3 ATS, the distinct value <code>null</code> shall be passed for the return value.	
<b>Effect</b>	On invocation of this operation the CH can issue the reply to a procedure call corresponding to the signature identifier <code>signature</code> and all components connected to <code>sender</code> . CH transmits the exception to all remote TEs on which receivers are being executed and enqueues the exception in the remote TEs.	

## 7.3.3.2.9 tciReplyConnectedMC

<b>Signature</b>	void tciReplyConnectedMC (in TriPortIdType sender, in TriComponentIdListType receivers, in TriSignatureIdType signature, in TciParameterListType parameterList, in Value returnValue)	
<b>In Parameters</b>	sender	Identifier of the port sending the reply.
	receivers	Identifier of the components receiving the reply.
	signature	Identifier of the signature of the procedure call.
	parameterList	A list of encoded parameters which are part of the indicated signature. The parameters in parameterList are ordered as they appear in the TTCN-3 signature declaration.
	returnValue	(Optional) return value of the procedure call.
<b>Return Value</b>	void	
<b>Constraint</b>	This operation shall be called by the TE when it executes a TTCN-3 multicast reply operation on a component port which has been connected to other component ports. All <i>out</i> and <i>inout</i> procedure parameters and the return value contain values. All <i>in</i> procedure parameters shall contain the distinct value of <code>null</code> since they are only of relevance to the procedure call but not in the reply to the call. The <code>parameterList</code> contains procedure call parameters. These parameters are the parameters specified in the TTCN-3 signature template. If no return type has been defined for the procedure signature in the TTCN-3 ATS, the distinct value <code>null</code> shall be passed for the return value.	
<b>Effect</b>	On invocation of this operation the CH can issue the reply to a procedure call corresponding to the signature identifier <code>signature</code> and one of the component identifier in <code>receivers</code> . CH transmits the reply to the remote TEs on which <code>receivers</code> are being executed and enqueues the reply in the remote TEs.	



## 7.3.3.2.10 tciRaiseConnected

<b>Signature</b>	void tciRaiseConnected (in TriPortIdType sender, in TriComponentIdType receiver, in TriSignatureIdType signature, in Value exception)	
<b>In Parameters</b>	sender	Identifier of the port sending the reply.
	receiver	Identifier of the component receiving the reply.
	signature	Identifier of the signature of the procedure call.
	exception	The exception value.
<b>Return Value</b>	void	
<b>Constraint</b>	This operation shall be called by the TE when it executes a TTCN-3 unicast raise operation on a component port which has been connected to another component port.	
<b>Effect</b>	On invocation of this operation the CH can raise an exception to a procedure call corresponding to the signature identifier <i>signature</i> and component identifier <i>receiver</i> . CH transmits the exception to the remote TE on which <i>receiver</i> is being executed and enqueues the exception in the remote TE.	

## 7.3.3.2.11 tciRaiseConnectedBC

<b>Signature</b>	void tciRaiseConnectedBC (in TriPortIdType sender, in TriSignatureIdType signature, in Value exception)	
<b>In Parameters</b>	sender	Identifier of the port sending the reply.
	signature	Identifier of the signature of the procedure call.
	exception	The exception value.
<b>Return Value</b>	void	
<b>Constraint</b>	This operation shall be called by the TE when it executes a TTCN-3 broadcast raise operation on a component port which has been connected to other component ports.	
<b>Effect</b>	On invocation of this operation the CH can raise an exception to a procedure call corresponding to the signature identifier <i>signature</i> and all components connected to <i>sender</i> . CH transmits the exception to all remote TEs on which receivers are being executed and enqueues the exception in the remote TEs.	

## 7.3.3.2.12 tciRaiseConnectedMC

<b>Signature</b>	void tciRaiseConnectedMC (in TriPortIdType sender, in TriComponentIdListType receiver, in TriSignatureIdType signature, in Value exception)	
<b>In Parameters</b>	sender	Identifier of the port sending the reply.
	receivers	Identifiers of the component receiving the reply.
	signature	Identifier of the signature of the procedure call.
	exception	The exception value.
<b>Return Value</b>	void	
<b>Constraint</b>	This operation shall be called by the TE when it executes a TTCN-3 multicast raise operation on a component port which has been connected to another component port.	
<b>Effect</b>	On invocation of this operation the CH can raise an exception to a procedure call corresponding to the signature identifier <i>signature</i> and one of the component identifier <i>receivers</i> . CH transmits the exception to all remote TEs on which <i>receivers</i> are being executed and enqueues the exception in the remote TEs.	

## 7.3.3.2.13 tciCreateTestComponentReq

<b>Signature</b>	TriComponentIdType tciCreateTestComponentReq (in TciTestComponentKindType kind, in Type componentType, in TString name)	
<b>In Parameters</b>	kind	The kind of component that shall be created, either MTC, PTC or CONTROL.
	componentType	Identifier of the TTCN-3 component type that shall be created.
<b>Return Value</b>	A TriComponentIdType value for the created component.	
<b>Constraint</b>	This operation shall be called from the TE when a component has to be created, either explicitly when the TTCN-3 create operation is called or implicitly when the master test component (MTC) or a control component has to be created. name shall be set to the distinct value null if no name is given in the TTCN-3 create statement.	
<b>Effect</b>	CH transmits the component creation request to the remote TE and calls there the tciCreateTestComponent operation to obtain a component identifier for this component.	

## 7.3.3.2.14 tciStartTestComponentReq

<b>Signature</b>	void tciStartTestComponentReq(in TriComponentIdType component, in TciBehaviourIdType behaviour, in TciParameterListType parameterList)	
<b>In Parameters</b>	component	Identifier of the component to be started.
	behaviour	Identifier of the behaviour to be started on the component.
	parameterList	A list of Values where each value defines a parameter from the parameter list as defined in the TTCN-3 function declaration of the function being started. The parameters in parameterList are ordered as they appear in the TTCN-3 signature of the test case. If no parameters have to be passed either the null value or an empty parameterList, i.e. a list of length zero shall be passed.
<b>Return Value</b>	void	
<b>Constraint</b>	This operation shall be called by the TE when it executes the TTCN-3 start operation. Since only <i>in</i> parameters are allowed for functions being started (ES 201 873-1 [2]), parameterList contains only <i>in</i> parameters.	
<b>Effect</b>	CH transmits the start component request to the remote TE and calls there the tciStartTestComponent operation.	

## 7.3.3.2.15 tciStopTestComponentReq

<b>Signature</b>	void tciStopTestComponentReq(in TriComponentIdType component)	
<b>In Parameters</b>	component	Identifier of the component to be stopped.
<b>Return Value</b>	void	
<b>Constraint</b>	This operation shall be called by the TE when it executes the TTCN-3 stop operation.	
<b>Effect</b>	CH transmits the stop component request to the remote TE and calls there the tciStopTestComponent operation.	

## 7.3.3.2.16 tciConnectReq

<b>Signature</b>	void tciConnectReq (in TriPortIdType fromPort, in TriPortIdType toPort)	
<b>In Parameters</b>	fromPort	Identifier of the test component port to be connected from.
	toPort	Identifier of the test component port to be connected to.
<b>Return Value</b>	void	
<b>Constraint</b>	This operation shall be called by the TE when it executes a TTCN-3 connect operation.	
<b>Effect</b>	CH transmits the connection request to the remote TE where it calls the tciConnect operation to establish a logical connection between the two indicated ports. Note that both ports can be on remote TEs. In this case, the operation returns only after calling the tciConnect operation on both remote TEs.	

## 7.3.3.2.17 tciDisconnectReq

<b>Signature</b>	void tciDisconnectReq (in TriPortIdType fromPort, in TriPortIdType toPort)	
<b>In Parameters</b>	fromPort	Identifier of the test component port to be disconnected.
	toPort	Identifier of the test component port to be disconnected.
<b>Return Value</b>	void	
<b>Constraint</b>	This operation shall be called by the TE when it executes a TTCN-3 disconnect operation.	
<b>Effect</b>	CH transmits the disconnect request to the remote TE where it calls the tciDisconnect operation to tear down the logical connection between the two indicated ports. Note that both ports can be on remote TEs. In this case, the operation returns only after calling the tciDisconnect operation on both remote TEs.	

## 7.3.3.2.18 tciMapReq

<b>Signature</b>	void tciMapReq (in TriPortIdType fromPort, in TriPortIdType toPort)	
<b>In Parameters</b>	fromPort	Identifier of the test component port to be mapped from.
	toPort	Identifier of the test component port to be mapped to.
<b>Return Value</b>	void	
<b>Constraint</b>	This operation shall be called by the TE when it executes a TTCN-3 map operation.	
<b>Effect</b>	CH transmits the map request to the remote TE where it calls the tciMap operation to establish a logical connection between the two indicated ports.	

## 7.3.3.2.19 tciUnmapReq

<b>Signature</b>	void tciUnmapReq (in TriPortIdType fromPort, in TriPortIdType toPort)	
<b>In Parameters</b>	fromPort	Identifier of the test component port to be unmapped.
	toPort	Identifier of the test component port to be unmapped.
<b>Return Value</b>	void	
<b>Constraint</b>	This operation shall be called by the TE when it executes a TTCN-3 unmap operation.	
<b>Effect</b>	CH transmits the unmap request to the remote TE where it calls the tciUnmap operation to tear down the logical connection between the two indicated ports.	

## 7.3.3.2.20 tciTestComponentTerminatedReq

<b>Signature</b>	void tciTestComponentTerminatedReq (in TriComponentIdType component, in VerdictValue verdict)	
<b>In Parameters</b>	component	Identifier of the component that has terminated.
	verdict	Verdict after termination of the component.
<b>Return Value</b>	void	
<b>Constraint</b>	This operation shall be called by the TE when a test component terminates execution, either explicitly with the TTNC-3 stop operation or implicitly, if it has reached the last statement	
<b>Effect</b>	The CH is notified of the termination of the indicated test component. Since a function being executed on a test component can only have <i>in</i> parameters (ES 201 873-1 [2]), the tciTestComponentTerminateReq operation does not have a parameterList parameter. CH communicates the termination of the indicated component to all participating TEs and to the special TE*, which keeps track of the overall verdict.	

## 7.3.3.2.21 tciTestComponentRunningReq

<b>Signature</b>	TBoolean tciTestComponentRunningReq (in TriComponentIdType component)	
<b>In Parameters</b>	component	Identifier of the component to be checked for running.
<b>Return Value</b>	true if the indicated component is still executing a behaviour, false otherwise.	
<b>Constraint</b>	This operation shall be called by the TE when it executes a TTCN-3 running operation.	
<b>Effect</b>	CH transmits the running request to the remote TE having the test component to be checked, where it calls the tciTestComponentRunning operation to check the execution status of the indicated test component.	

## 7.3.3.1.22 tciTestComponentDoneReq

<b>Signature</b>	TBoolean tciTestComponentDoneReq (in TriComponentIdType comp)	
<b>In Parameters</b>	comp	Identifier of the component to be checked for done.
<b>Return Value</b>	true if the indicated component has completed executing its behaviour, false otherwise.	
<b>Constraint</b>	This operation shall be called by the TE when it executes a TTCN-3 done operation.	
<b>Effect</b>	CH transmits the done request to the remote TE having the test component to be checked, where it calls the tciTestComponentDone operation to check the status of the indicated test component.	

## 7.3.3.2.23 tciGetMTCReq

<b>Signature</b>	TriComponentIdType tciGetMTCReq()	
<b>Return Value</b>	A TriComponentIdType value of the MTC.	
<b>Constraint</b>	This operation shall be called by the TE when it executes a TTCN-3 mtc operation.	
<b>Effect</b>	The CH determines the component id of the MTC.	

## 7.3.3.2.24 tciExecuteTestCaseReq

<b>Signature</b>	void tciExecuteTestCaseReq (in TciTestCaseIdType testCaseId, in TriPortIdListType tsiPortList)	
<b>In Parameters</b>	testCaseId	A test case identifier as defined in the TTCN-3 module.
	tsiPortList	tsiPortList contains all ports that have been declared in the definition of the system component for the test case, i.e. the TSI ports. If a system component has not been explicitly defined for the test case, then the tsiPortList contains all communication ports of the MTC. The ports in tsiPortList are ordered as they appear in the respective TTCN-3 component type declaration. If no ports have to be passed either the null value or an empty tsiPortList, i.e. a list of length zero shall be passed.
<b>Return Value</b>	void	
<b>Constraint</b>	This operation can be called by the TE immediately before it starts the test case behaviour on the MTC (in course of a TTCN-3 execute operation).	
<b>Effect</b>	CH transmits the execute test case request to the remote TEs having system ports of the indicated test case. Static connections to the SUT and the initialization of communication means for TSI ports can be set up.	

## 7.3.3.2.25 tciResetReq

<b>Signature</b>	void tciResetReq ()	
<b>Return Value</b>	void	
<b>Constraint</b>	This operation can be called by the TE at any time to reset the test system.	
<b>Effect</b>	CH transmits the reset request to all involved TEs.	

## 7.3.3.1.26 tciKillTestComponentReq

<b>Signature</b>	void tciKillTestComponentReq(in TriComponentIdType comp)	
<b>In Parameters</b>	comp	Identifier of the component to be killed.
<b>Return Value</b>	void	
<b>Constraint</b>	This operation shall be called by the TE when it executes the TTCN-3 kill operation.	
<b>Effect</b>	CH transmits the kill component request to the remote TE and calls there the tciKillTestComponent operation.	

## 7.3.3.1.27 tciTestComponentAliveReq

<b>Signature</b>	TBoolean tciTestComponentAliveReq (in TriComponentIdType comp)
<b>In Parameters</b>	comp Identifier of the component to be checked for being alive.
<b>Return Value</b>	true if the indicated component is alive, false otherwise.
<b>Constraint</b>	This operation shall be called by the TE when it executes the TTCN-3 <i>alive</i> operation.
<b>Effect</b>	CH transmits the request to the remote TE that created the test component in question, where it calls the <i>tciTestComponentAlive</i> operation to check the status of the indicated test component.

## 7.3.3.1.28 tciTestComponentKilledReq

<b>Signature</b>	TBoolean tciTestComponentKilledReq (in TriComponentIdType comp)
<b>In Parameters</b>	comp Identifier of the component to be checked for being killed.
<b>Return Value</b>	true if the indicated component has been killed, false otherwise.
<b>Constraint</b>	This operation shall be called by the TE when it executes the TTCN-3 <i>killed</i> operation.
<b>Effect</b>	CH transmits the request to the remote TE that created the test component in question, where it calls the <i>tciTestComponentKilled</i> operation to check the status of the indicated test component.

## 7.3.4 The TCI-TL interface

The TCI Test Logging Interface (TCI-TL) describes the operations a TTCN-3 Executable is required to implement and the operations a test logging implementation shall provide to the TE (figure 8).

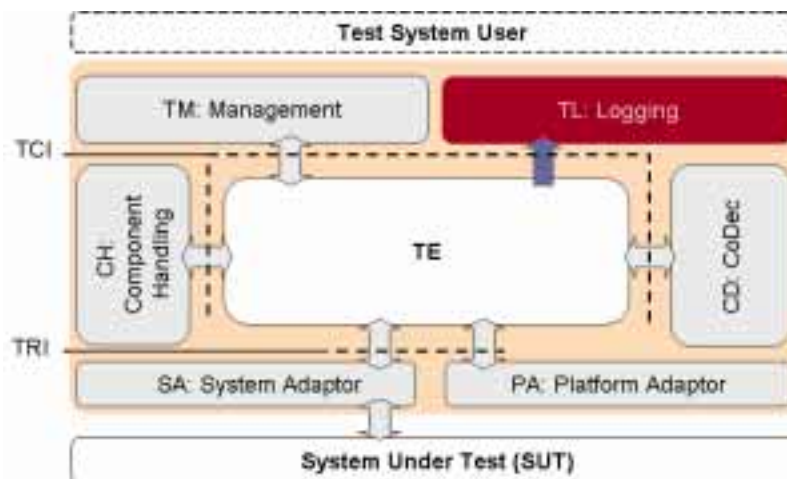

**Figure 8: The TCI-TL interface**

The logging provides for all TTCN-3 level operations an operation to log the respective event being performed by the TE, the SA, the PA, the CH or the CD to the user.

## 7.3.4.1 TCI-TL provided

This clause specifies the operations the TL shall provide to the TE.

## 7.3.4.1.1 tliTcExecute

<b>Signature</b>	void tliTcExecute(in TString am, in TInteger ts, in TString src, in TInteger line, in TriComponentIdType c, in TciTestCaseIdType tcId, in TriParameterListType pars, in TriTimerDurationType dur)	
<b>In Parameters</b>	am	An additional message.
	ts	The time when the event is produced.
	src	The source file of the test specification.
	line	The line number where the request is performed.
	c	The component which produces this event.
	tcId	The testcase to be executed.
	pars	The list of parameters required by the testcase.
	dur	Duration of the execution.
<b>Return Value</b>	void	
<b>Constraint</b>	Shall be called by TE to log the execute test case request.	
<b>Effect</b>	The TL presents all the information provided in the parameters of this operation to the user, how this is done is not within the scope of the present document.	

## 7.3.4.1.2 tliTcStart

<b>Signature</b>	void tliTcStart(in TString am, in TInteger ts, in TString src, in TInteger line, in TriComponentIdType c, in TciTestCaseIdType tcId, in TriParameterListType pars, in TriTimerDurationType dur)	
<b>In Parameters</b>	am	An additional message.
	ts	The time when the event is produced.
	src	The source file of the test specification.
	line	The line number where the request is performed.
	c	The component which produces this event.
	tcId	The testcase to be executed.
	pars	The list of parameters required by the testcase.
	dur	Duration of the execution.
<b>Return Value</b>	void	
<b>Constraint</b>	Shall be called by TE to log the start of a testcase. This event occurs before the testcase is started.	
<b>Effect</b>	The TL presents all the information provided in the parameters of this operation to the user, how this is done is not within the scope of the present document.	

## 7.3.4.1.3 tliTcStop

<b>Signature</b>	void tliTcStop(in TString am, in TInteger ts, in TString src, in TInteger line, in TriComponentIdType c)	
<b>In Parameters</b>	Am	An additional message.
	Ts	The time when the event is produced.
	Src	The source file of the test specification.
	Line	The line number where the request is performed.
	C	The component which produces this event.
<b>Return Value</b>	Void	
<b>Constraint</b>	Shall be called by TE to log the stop of a testcase.	
<b>Effect</b>	The TL presents all the information provided in the parameters of this operation to the user, how this is done is not within the scope of the present document.	

## 7.3.4.1.4 tliTcStarted

<b>Signature</b>	void tliTcStarted(in TString am, in TInteger ts, in TString src, in TInteger line, in TriComponentIdType c, in TciTestCaseIdType tcId, in TriParameterListType pars, in TriTimerDurationType dur)	
<b>In Parameters</b>	Am	An additional message.
	Ts	The time when the event is produced.
	Src	The source file of the test specification.
	Line	The line number where the request is performed.
	C	The component which produces this event.
	tcId	The testcase to be executed.
	Pars	The list of parameters required by the testcase.
dur	Duration of the execution.	
<b>Return Value</b>	Void	
<b>Constraint</b>	Shall be called by TM to log the start of a testcase. This event occurs after the testcase was started.	
<b>Effect</b>	The TL presents all the information provided in the parameters of this operation to the user, how this is done is not within the scope of the present document.	

## 7.3.4.1.5 tliTcTerminated

<b>Signature</b>	void tliTcTerminated(in TString am, in TInteger ts, in TString src, in TInteger line, in TriComponentIdType c, in TciTestCaseIdType tcId, in TriParameterListType pars, in VerdictValue outcome)	
<b>In Parameters</b>	am	An additional message.
	ts	The time when the event is produced.
	src	The source file of the test specification.
	line	The line number where the request is performed.
	c	The component which produces this event.
	tcId	The testcase to be executed.
	pars	The list of parameters required by the testcase.
	outcome	The verdict of the testcase.
<b>Return Value</b>	void	
<b>Constraint</b>	Shall be called by TM to log the termination of a testcase. This event occurs after the testcase terminated.	
<b>Effect</b>	The TL presents all the information provided in the parameters of this operation to the user, how this is done is not within the scope of the present document.	

## 7.3.4.1.6 tliCtrlStart

<b>Signature</b>	void tliCtrlStart(in TString am, in TInteger ts, in TString src, in TInteger line, in TriComponentIdType c)	
<b>In Parameters</b>	am	An additional message.
	ts	The time when the event is produced.
	src	The source file of the test specification.
	line	The line number where the request is performed.
	c	The component which produces this event.
<b>Return Value</b>	void	
<b>Constraint</b>	Shall be called by TE to log the start of the control part. This event occurs before the control is started. If the control is not represented by a TRI component, c is null.	
<b>Effect</b>	The TL presents all the information provided in the parameters of this operation to the user, how this is done is not within the scope of the present document.	

## 7.3.4.1.7 tliCtrlStop

<b>Signature</b>	void tliCtrlStop(in TString am, in TInteger ts, in TString src, in TInteger line, in TriComponentIdType c)	
<b>In Parameters</b>	am	An additional message.
	ts	The time when the event is produced.
	src	The source file of the test specification.
	line	The line number where the request is performed.
	c	The component which produces this event.
<b>Return Value</b>	void	
<b>Constraint</b>	Shall be called by TE to log the stop of the control part. This event occurs before the control is stopped. If the control is not represented by a TRI component, c is null.	
<b>Effect</b>	The TL presents all the information provided in the parameters of this operation to the user, how this is done is not within the scope of the present document.	

## 7.3.4.1.8 tliCtrlTerminated

<b>Signature</b>	void tliCtrlTerminated (in TString am, in TInteger ts, in TString src, in TInteger line, in TriComponentIdType c)	
<b>In Parameters</b>	am	An additional message.
	ts	The time when the event is produced.
	src	The source file of the test specification.
	line	The line number where the request is performed.
	c	The component which produces this event.
<b>Return Value</b>	void	
<b>Constraint</b>	Shall be called by TM to log the termination of the control part. This event occurs after the control has terminated. If the control is not represented by a TRI component, c is null.	
<b>Effect</b>	The TL presents all the information provided in the parameters of this operation to the user, how this is done is not within the scope of the present document.	

## 7.3.4.1.9 tliMSend\_m

<b>Signature</b>	void tliMSend_m(in TString am, in TInteger ts, in TString src, in TInteger line, in TriComponentIdType c, in TriPortIdType port, in Value msgValue, in TriAddressType address, in TriStatusType encoderFailure, in TriMessageType msg, in TriStatusType transmissionFailure)	
<b>In Parameters</b>	am	An additional message.
	ts	The time when the event is produced.
	src	The source file of the test specification.
	line	The line number where the request is performed.
	c	The component which produces this event.
	port	The port via which the message is sent.
	msgValue	The value to be encoded and sent.
	address	The address of the destination within the SUT.
	encoderFailure	The failure message which might occur at encoding.
	msg	The encoded message.
	transmissionFailure	The failure message which might occur at transmission.
<b>Return Value</b>	void	
<b>Constraint</b>	Shall be called by SA to log a unicast send operation. This event occurs after sending. This event is used for logging the communication with the SUT.	
<b>Effect</b>	The TL presents all the information provided in the parameters of this operation to the user, how this is done is not within the scope of the present document.	



## 7.3.4.1.10 tliMSend\_m\_BC

<b>Signature</b>	void tliMSend_m_BC(in TString am, in TInteger ts, in TString src, in TInteger line, in TriComponentIdType c, in TriPortIdType port, in Value msgValue, in TriStatusType encoderFailure, in TriMessageType msg, in TriStatusType transmissionFailure)	
<b>In Parameters</b>	am	An additional message.
	ts	The time when the event is produced.
	src	The source file of the test specification.
	line	The line number where the request is performed.
	c	The component which produces this event.
	port	The port via which the message is sent.
	msgValue	The value to be encoded and sent.
	encoderFailure	The failure message which might occur at encoding.
	msg	The encoded message.
	transmissionFailure	The failure message which might occur at transmission.
<b>Return Value</b>	void	
<b>Constraint</b>	Shall be called by SA to log a broadcast send operation. This event occurs after sending. This event is used for logging the communication with the SUT.	
<b>Effect</b>	The TL presents all the information provided in the parameters of this operation to the user, how this is done is not within the scope of the present document.	

## 7.3.4.1.11 tliMSend\_m\_MC

<b>Signature</b>	void tliMSend_m_MC(in TString am, in TInteger ts, in TString src, in TInteger line, in TriComponentIdType c, in TriPortIdType port, in Value msgValue, in TriAddressListType addresses, in TriStatusType encoderFailure, in TriMessageType msg, in TriStatusType transmissionFailure)	
<b>In Parameters</b>	am	An additional message.
	ts	The time when the event is produced.
	src	The source file of the test specification.
	line	The line number where the request is performed.
	c	The component which produces this event.
	port	The port via which the message is sent.
	msgValue	The value to be encoded and sent.
	addresses	The addresses of the destinations within the SUT.
	encoderFailure	The failure message which might occur at encoding.
	msg	The encoded message.
		transmissionFailure
<b>Return Value</b>	void	
<b>Constraint</b>	Shall be called by SA to log a multicast send operation. This event occurs after sending. This event is used for logging the communication with the SUT.	
<b>Effect</b>	The TL presents all the information provided in the parameters of this operation to the user, how this is done is not within the scope of the present document.	

## 7.3.4.1.12 tliMSend\_c

<b>Signature</b>	void tliMSend_c(in TString am, in TInteger ts, in TString src, in TInteger line, in TriComponentIdType c, in TriPortIdType port, in Value msgValue, in TriComponentIdType to, in TriStatusType transmissionFailure)	
<b>In Parameters</b>	am	An additional message.
	ts	The time when the event is produced.
	src	The source file of the test specification.
	line	The line number where the request is performed.
	c	The component which produces this event.
	port	The port via which the message is sent.
	msgValue	The value to be encoded and sent.
	to	The component which will receive the message.
transmissionFailure	The failure message which might occur at transmission.	
<b>Return Value</b>	void	
<b>Constraint</b>	Shall be called by CH to log a unicast send operation. This event occurs after sending. This event is used for logging the intercomponent communication.	
<b>Effect</b>	The TL presents all the information provided in the parameters of this operation to the user, how this is done is not within the scope of the present document.	

## 7.3.4.1.13 tliMSend\_c\_BC

<b>Signature</b>	void tliMSend_c_BC(in TString am, in TInteger ts, in TString src, in TInteger line, in TriComponentIdType c, in TriPortIdType port, in Value msgValue, in TriStatusType transmissionFailure)	
<b>In Parameters</b>	am	An additional message.
	ts	The time when the event is produced.
	src	The source file of the test specification.
	line	The line number where the request is performed.
	c	The component which produces this event.
	port	The port via which the message is sent.
	msgValue	The value to be encoded and sent.
	transmissionFailure	The failure message which might occur at transmission.
<b>Return Value</b>	void	
<b>Constraint</b>	Shall be called by CH to log a broadcast send operation. This event occurs after sending. This event is used for logging the intercomponent communication.	
<b>Effect</b>	The TL presents all the information provided in the parameters of this operation to the user, how this is done is not within the scope of the present document.	

## 7.3.4.1.14 tliMSend\_c\_MC

<b>Signature</b>	void tliMSend_c_MC(in TString am, in TInteger ts, in TString src, in TInteger line, in TriComponentIdType c, in TriPortIdType port, in Value msgValue, in TriComponentIdListType toList, in TriStatusType transmissionFailure)	
<b>In Parameters</b>	am	An additional message.
	ts	The time when the event is produced.
	src	The source file of the test specification.
	line	The line number where the request is performed.
	c	The component which produces this event.
	port	The port via which the message is sent.
	msgValue	The value to be encoded and sent.
	toList	The components which will receive the message.
	transmissionFailure	The failure message which might occur at transmission.
<b>Return Value</b>	void	
<b>Constraint</b>	Shall be called by CH to log a multicast send operation. This event occurs after sending. This event is used for logging the intercomponent communication.	
<b>Effect</b>	The TL presents all the information provided in the parameters of this operation to the user, how this is done is not within the scope of the present document.	

## 7.3.4.1.15 tliMDetected\_m

<b>Signature</b>	void tliMDetected_m(in TString am, in TInteger ts, in TString src, in TInteger line, in TriComponentIdType c, in TriPortIdType port, in TriMessageType msg, in TriAddressType address)	
<b>In Parameters</b>	am	An additional message.
	ts	The time when the event is produced.
	src	The source file of the test specification.
	line	The line number where the request is performed.
	c	The component which produces this event.
	port	The port via which the message is received.
	msg	The received encoded message.
	address	The address of the source within the SUT.
<b>Return Value</b>	Void	
<b>Constraint</b>	Shall be called by SA to log the enqueueing of a message. This event occurs after the message is enqueue. This event is used for logging the communication with the SUT.	
<b>Effect</b>	The TL presents all the information provided in the parameters of this operation to the user, how this is done is not within the scope of the present document.	

## 7.3.4.1.16 tliMDetected\_c

<b>Signature</b>	void tliMDetected_c(in TString am, in TInteger ts, in TString src, in TInteger line, in TriComponentIdType c, in TriPortIdType port, in Value msgValue, in TriComponentIdType from)	
<b>In Parameters</b>	am	An additional message.
	ts	The time when the event is produced.
	src	The source file of the test specification.
	line	The line number where the request is performed.
	c	The component which produces this event.
	port	The port via which the message is received.
	msgValue	The received message.
	from	The component which sent the message.
<b>Return Value</b>	Void	
<b>Constraint</b>	Shall be called by CH to log the enqueueing of a message. This event occurs after the message is enqueue. This event is used for logging the intercomponent communication.	
<b>Effect</b>	The TL presents all the information provided in the parameters of this operation to the user, how this is done is not within the scope of the present document.	

## 7.3.4.1.17 tliMMismatch\_m

<b>Signature</b>	void tliMMismatch_m(in TString am, in TInteger ts, in TString src, in TInteger line, in TriComponentIdType c, in TriPortIdType port, in Value msgValue, in TciValueTemplate msgTpl, in TciValueDifferenceList diffs, in TriAddressType address, in TciValueTemplate addressTpl)	
<b>In Parameters</b>	am	An additional message.
	ts	The time when the event is produced.
	src	The source file of the test specification.
	line	The line number where the request is performed.
	c	The component which produces this event.
	port	The port via which the message is received.
	msgValue	The message which is checked against the template.
	msgTpl	The template used to check the message match.
	diffs	The difference/the mismatch between message and template
	address	The address of the source within the SUT.
addressTpl	The expected address of the source within the SUT.	
<b>Return Value</b>	Void	
<b>Constraint</b>	Shall be called by TE to log the mismatch of a template. This event occurs after checking a template match. This event is used for logging the communication with the SUT.	
<b>Effect</b>	The TL presents all the information provided in the parameters of this operation to the user, how this is done is not within the scope of the present document.	

## 7.3.4.1.18 tliMMismatch\_c

<b>Signature</b>	void tliMMismatch_c(in TString am, in TInteger ts, in TString src, in TInteger line, in TriComponentIdType c, in TriPortIdType port, in Value msgValue, in TciValueTemplate msgTpl, in TciValueDifferenceList diffs, in TriComponentIdType from, in TciNonValueTemplate fromTpl)	
<b>In Parameters</b>	am	An additional message.
	ts	The time when the event is produced.
	src	The source file of the test specification.
	line	The line number where the request is performed.
	c	The component which produces this event.
	port	The port via which the message is received.
	msgValue	The message which is checked against the template.
	msgTpl	The template used to check the message match.
	diffs	The difference/the mismatch between message and template
	from	The component which sent the message.
fromTpl	The expected sender component.	
<b>Return Value</b>	Void	
<b>Constraint</b>	Shall be called by TE to log the mismatch of a template. This event occurs after checking a template match. This event is used for logging the intercomponent communication.	
<b>Effect</b>	The TL presents all the information provided in the parameters of this operation to the user, how this is done is not within the scope of the present document.	

## 7.3.4.1.19 tliMReceive\_m

<b>Signature</b>	void tliMReceive_m(in TString am, in TInteger ts, in TString src, in TInteger line, in TriComponentIdType c, in TriPortIdType port, in Value msgValue, in TciValueTemplate msgTpl, in TriAddressType address, in TciValueTemplate addressTpl)	
<b>In Parameters</b>	am	An additional message.
	ts	The time when the event is produced.
	src	The source file of the test specification.
	line	The line number where the request is performed.
	c	The component which produces this event.
	port	The port via which the message is received.
	msgValue	The message which is checked against the template.
	msgTpl	The template used to check the message match.
	address	The address of the source within the SUT.
	addressTpl	The expected address of the source within the SUT.
<b>Return Value</b>	Void	
<b>Constraint</b>	Shall be called by TE to log the receive of a message. This event occurs after checking a template match. This event is used for logging the communication with SUT.	
<b>Effect</b>	The TL presents all the information provided in the parameters of this operation to the user, how this is done is not within the scope of the present document.	

## 7.3.4.1.20 tliMReceive\_c

<b>Signature</b>	void tliMReceive_c(in TString am, in TInteger ts, in TString src, in TInteger line, in TriComponentIdType c, in TriPortIdType port, in Value msgValue, in TciValueTemplate msgTpl, in TriComponentIdType from, in TciNonValueTemplate fromTpl)	
<b>In Parameters</b>	am	An additional message.
	ts	The time when the event is produced.
	src	The source file of the test specification.
	line	The line number where the request is performed.
	c	The component which produces this event.
	port	The port via which the message is received.
	msgValue	The message which is checked against the template.
	msgTpl	The template used to check the message match.
	from	The component which sent the message.
	fromTpl	The expected sender component.
<b>Return Value</b>	Void	
<b>Constraint</b>	Shall be called by TE to log the receive of a message. This event occurs after checking a template match. This event is used for logging the intercomponent communication.	
<b>Effect</b>	The TL presents all the information provided in the parameters of this operation to the user, how this is done is not within the scope of the present document.	

## 7.3.4.1.21 tliPrCall\_m

<b>Signature</b>	void tliPrCall_m(in TString am, in TInteger ts, in TString src, in TInteger line, in TriComponentIdType c, in TriPortIdType port, in TriSignatureIdType signature, in TciParameterListType parsValue, in TriAddressType address, in TriStatusType encoderFailure, in TriParameterListType pars, in TriStatusType transmissionFailure)	
<b>In Parameters</b>	am	An additional message.
	ts	The time when the event is produced.
	src	The source file of the test specification.
	line	The line number where the request is performed.
	c	The component which produces this event.
	port	The port via which the call is invoked.
	signature	The signature of the called operation.
	parsValue	The parameters of the called operation.
	address	The address of the destination within the SUT.
	encoderFailure	The failure message which might occur at encoding.
	pars	The encoded parameters.
transmissionFailure	The failure message which might occur at transmission.	
<b>Return Value</b>	Void	
<b>Constraint</b>	Shall be called by SA to log a unicast call operation. This event occurs after call execution. This event is used for logging the communication with the SUT.	
<b>Effect</b>	The TL presents all the information provided in the parameters of this operation to the user, how this is done is not within the scope of the present document.	

## 7.3.4.1.22 tliPrCall\_m\_BC

<b>Signature</b>	void tliPrCall_m_BC(in TString am, in TInteger ts, in TString src, in TInteger line, in TriComponentIdType c, in TriPortIdType port, in TriSignatureIdType signature, in TciParameterListType parsValue, in TriStatusType encoderFailure, in TriParameterListType pars, in TriStatusType transmissionFailure)	
<b>In Parameters</b>	am	An additional message.
	ts	The time when the event is produced.
	src	The source file of the test specification.
	line	The line number where the request is performed.
	c	The component which produces this event.
	port	The port via which the call is invoked.
	signature	The signature of the called operation.
	parsValue	The parameters of the called operation.
	encoderFailure	The failure message which might occur at encoding.
	pars	The encoded parameters.
	transmissionFailure	The failure message which might occur at transmission.
<b>Return Value</b>	Void	
<b>Constraint</b>	Shall be called by SA to log a broadcast call operation. This event occurs after call execution. This event is used for logging the communication with the SUT.	
<b>Effect</b>	The TL presents all the information provided in the parameters of this operation to the user, how this is done is not within the scope of the present document.	

## 7.3.4.1.23 tliPrCall\_m\_MC

<b>Signature</b>	void tliPrCall_m_MC(in TString am, in TInteger ts, in TString src, in TInteger line, in TriComponentIdType c, in TriPortIdType port, in TriSignatureIdType signature, in TciParameterListType parsValue, in TriAddressListType addresses, in TriStatusType encoderFailure, in TriParameterListType pars, in TriStatusType transmissionFailure)	
<b>In Parameters</b>	am	An additional message.
	ts	The time when the event is produced.
	src	The source file of the test specification.
	line	The line number where the request is performed.
	c	The component which produces this event.
	port	The port via which the call is invoked.
	signature	The signature of the called operation.
	parsValue	The parameters of the called operation.
	addresses	The addresses of the destinations within the SUT.
	encoderFailure	The failure message which might occur at encoding.
	pars	The encoded parameters.
	transmissionFailure	The failure message which might occur at transmission.
<b>Return Value</b>	Void	
<b>Constraint</b>	Shall be called by SA to log a multicast call operation. This event occurs after call execution. This event is used for logging the communication with the SUT.	
<b>Effect</b>	The TL presents all the information provided in the parameters of this operation to the user, how this is done is not within the scope of the present document.	

## 7.3.4.1.24 tliPrCall\_c

<b>Signature</b>	void tliPrCall_c(in TString am, in TInteger ts, in TString src, in TInteger line, in TriComponentIdType c, in TriPortIdType port, in TriSignatureIdType signature, in TciParameterListType parsValue, in TriComponentIdType to, in TriStatusType transmissionFailure)	
<b>In Parameters</b>	am	An additional message.
	ts	The time when the event is produced.
	src	The source file of the test specification.
	line	The line number where the request is performed.
	c	The component which produces this event.
	port	The port via which the call is invoked.
	signature	The signature of the called operation.
	parsValue	The parameters of the called operation.
	to	The component which will receive the message.
	transmissionFailure	The failure message which might occur at transmission.
<b>Return Value</b>	Void	
<b>Constraint</b>	Shall be called by CH to log a unicast call operation. This event occurs after call execution. This event is used for logging the intercomponent communication.	
<b>Effect</b>	The TL presents all the information provided in the parameters of this operation to the user, how this is done is not within the scope of the present document.	

## 7.3.4.1.25 tliPrCall\_c\_BC

<b>Signature</b>	void tliPrCall_c_BC(in TString am, in TInteger ts, in TString src, in TInteger line, in TriComponentIdType c, in TriPortIdType port, in TriSignatureIdType signature, in TciParameterListType parsValue, in TriStatusType transmissionFailure)	
<b>In Parameters</b>	am	An additional message.
	ts	The time when the event is produced.
	src	The source file of the test specification.
	line	The line number where the request is performed.
	c	The component which produces this event.
	port	The port via which the call is invoked.
	signature	The signature of the called operation.
	parsValue	The parameters of the called operation.
	transmissionFailure	The failure message which might occur at transmission.
<b>Return Value</b>	Void	
<b>Constraint</b>	Shall be called by CH to log a broadcast call operation. This event occurs after call execution. This event is used for logging the intercomponent communication.	
<b>Effect</b>	The TL presents all the information provided in the parameters of this operation to the user, how this is done is not within the scope of the present document.	

## 7.3.4.1.26 tliPrCall\_c\_MC

<b>Signature</b>	void tliPrCall_c_MC(in TString am, in TInteger ts, in TString src, in TInteger line, in TriComponentIdType c, in TriPortIdType port, in TriSignatureIdType signature, in TciParameterListType parsValue, in TriComponentIdListType toList, in TriStatusType transmissionFailure)	
<b>In Parameters</b>	am	An additional message.
	ts	The time when the event is produced.
	src	The source file of the test specification.
	line	The line number where the request is performed.
	c	The component which produces this event.
	port	The port via which the call is invoked.
	signature	The signature of the called operation.
	parsValue	The parameters of the called operation.
	toList	The component which will receive the message.
	transmissionFailure	The failure message which might occur at transmission.
<b>Return Value</b>	Void	
<b>Constraint</b>	Shall be called by CH to log a multicast call operation. This event occurs after call execution. This event is used for logging the intercomponent communication.	
<b>Effect</b>	The TL presents all the information provided in the parameters of this operation to the user, how this is done is not within the scope of the present document.	



## 7.3.4.1.27 tliPrGetCallDetected\_m

<b>Signature</b>	void tliPrGetCallDetected_m(in TString am, in TInteger ts, in TString src, in TInteger line, in TriComponentIdType c, in TriPortIdType port, in TriSignatureIdType signature, in TriParameterListType pars, in TriAddressType address)	
<b>In Parameters</b>	am	An additional message.
	ts	The time when the event is produced.
	src	The source file of the test specification.
	line	The line number where the request is performed.
	c	The component which produces this event.
	port	The port via which the call is received.
	signature	The signature of the detected call.
	pars	The encoded parameters of detected call.
address	The address of the destination within the SUT.	
<b>Return Value</b>	Void	
<b>Constraint</b>	Shall be called by SA to log the getcall enqueue operation. This event occurs after call is enqueued. This event is used for logging the communication with the SUT.	
<b>Effect</b>	The TL presents all the information provided in the parameters of this operation to the user, how this is done is not within the scope of the present document.	

## 7.3.4.1.28 tliPrGetCallDetected\_c

<b>Signature</b>	void tliPrGetCallDetected_c(in TString am, in TInteger ts, in TString src, in TInteger line, in TriComponentIdType c, in TriPortIdType port, in TriSignatureIdType signature, in TciParameterListType parsValue, in TriComponentIdType from)	
<b>In Parameters</b>	am	An additional message.
	ts	The time when the event is produced.
	src	The source file of the test specification.
	line	The line number where the request is performed.
	c	The component which produces this event.
	port	The port via which the call is received.
	signature	The signature of the called operation.
	parsValue	The encoded parameters of detected call.
	from	The component which called the operation.
<b>Return Value</b>	Void	
<b>Constraint</b>	Shall be called by CH to log the getcall enqueue operation. This event occurs after call is enqueued. This event is used for logging the intercomponent communication.	
<b>Effect</b>	The TL presents all the information provided in the parameters of this operation to the user, how this is done is not within the scope of the present document.	

## 7.3.4.1.29 tliPrGetCallMismatch\_m

<b>Signature</b>	void tliPrGetCallMismatch_m(in TString am, in TInteger ts, in TString src, in TInteger line, in TriComponentIdType c, in TriPortIdType port, in TriSignatureIdType signature, in TciParameterListType parsValue, in TciValueTemplate parsTpl, in TciValueDifferenceList diff, in TriAddressType address, in TciValueTemplate addressTpl)	
<b>In Parameters</b>	am	An additional message.
	ts	The time when the event is produced.
	src	The source file of the test specification.
	line	The line number where the request is performed.
	c	The component which produces this event.
	port	The port via which the call is received.
	signature	The signature of the detected call.
	parsValue	The parameters of detected call.
	parsTpl	The template used to check the parameter match.
	diffs	The difference/the mismatch between call and template
	address	The address of the source within the SUT.
	addressTpl	The expected address of the source within the SUT.
<b>Return Value</b>	Void	
<b>Constraint</b>	Shall be called by TE to log the mismatch of a getcall. This event occurs after getcall is checked against a template. This event is used for logging the communication with the SUT.	
<b>Effect</b>	The TL presents all the information provided in the parameters of this operation to the user, how this is done is not within the scope of the present document.	

## 7.3.4.1.30 tliPrGetCallMismatch\_c

<b>Signature</b>	void tliPrGetCallMismatch_c(in TString am, in TInteger ts, in TString src, in TInteger line, in TriComponentIdType c, in TriPortIdType port, in TriSignatureIdType signature, in TciParameterListType parsValue, in TciValueTemplate parsTpl, in TciValueDifferenceList diffs, in TriComponentIdType from, in TciNonValueTemplate fromTpl)	
<b>In Parameters</b>	am	An additional message.
	ts	The time when the event is produced.
	src	The source file of the test specification.
	line	The line number where the request is performed.
	c	The component which produces this event.
	port	The port via which the call is received.
	signature	The signature of the detected call.
	parsValue	The parameters of detected call.
	parsTpl	The template used to check the parameter match.
	diffs	The difference/the mismatch between message and template
	from	The component which called the operation.
	fromTpl	The expected calling component.
<b>Return Value</b>	Void	
<b>Constraint</b>	Shall be called by TE to log the mismatch of a getcall. This event occurs after getcall is checked against a template. This event is used for logging the intercomponent communication.	
<b>Effect</b>	The TL presents all the information provided in the parameters of this operation to the user, how this is done is not within the scope of the present document.	

## 7.3.4.1.31 tliPrGetCall\_m

<b>Signature</b>	void tliPrGetCall_m(in TString am, in TInteger ts, in TString src, in TInteger line, in TriComponentIdType c, in TriPortIdType port, in TriSignatureIdType signature, in TciParameterListType parsValue, in TciValueTemplate parsTpl, in TriAddressType address, in TciValueTemplate addressTpl)	
<b>In Parameters</b>	am	An additional message.
	ts	The time when the event is produced.
	src	The source file of the test specification.
	line	The line number where the request is performed.
	c	The component which produces this event.
	port	The port via which the call is received.
	signature	The signature of the detected call.
	parsValue	The parameters of detected call.
	parsTpl	The template used to check the parameter match.
	address	The address of the source within the SUT.
addressTpl	The expected address of the source within the SUT.	
<b>Return Value</b>	void	
<b>Constraint</b>	Shall be called by TE to log getting a call. This event occurs after getcall has matched against a template. This event is used for logging the communication with the SUT.	
<b>Effect</b>	The TL presents all the information provided in the parameters of this operation to the user, how this is done is not within the scope of the present document.	

## 7.3.4.1.32 tliPrGetCall\_c

<b>Signature</b>	void tliPrGetCall_c(in TString am, in TInteger ts, in TString src, in TInteger line, in TriComponentIdType c, in TriPortIdType port, in TriSignatureIdType signature, in TciParameterListType parsValue, in TciValueTemplate parsTpl, in TriComponentIdType from, in TciNonValueTemplate fromTpl)	
<b>In Parameters</b>	am	An additional message.
	ts	The time when the event is produced.
	src	The source file of the test specification.
	line	The line number where the request is performed.
	c	The component which produces this event.
	port	The port via which the call is received.
	signature	The signature of the detected call.
	parsValue	The parameters of detected call.
	parsTpl	The template used to check the parameter match.
	from	The component which called the operation.
fromTpl	The expected calling component.	
<b>Return Value</b>	void	
<b>Constraint</b>	Shall be called by TE to log getting a call. This event occurs after getcall has matched against a template. This event is used for logging the intercomponent communication.	
<b>Effect</b>	The TL presents all the information provided in the parameters of this operation to the user, how this is done is not within the scope of the present document.	

## 7.3.4.1.33 tliPrReply\_m

<b>Signature</b>	void tliPrReply_m(in TString am, in TInteger ts, in TString src, in TInteger line, in TriComponentIdType c, in TriPortIdType port, in TriSignatureIdType signature, in Value parsValue, in Value replValue, in TriAddressType address, in TriStatusType encoderFailure, in TriParameterType repl, in TriStatusType transmissionFailure)	
<b>In Parameters</b>	am	An additional message.
	ts	The time when the event is produced.
	src	The source file of the test specification.
	line	The line number where the request is performed.
	c	The component which produces this event.
	port	The port via which the reply is sent.
	signature	The signature relating to the reply.
	parsValue	The signature parameters relating to the reply.
	replValue	The reply to be sent.
	address	The address of the destination within the SUT.
	encoderFailure	The failure message which might occur at encoding.
	repl	The encoded reply.
	transmissionFailure	The failure message which might occur at transmission.
<b>Return Value</b>	void	
<b>Constraint</b>	Shall be called by SA to log a unicast reply operation. This event occurs after reply execution. This event is used for logging the communication with the SUT.	
<b>Effect</b>	The TL presents all the information provided in the parameters of this operation to the user, how this is done is not within the scope of the present document.	

## 7.3.4.1.34 tliPrReply\_m\_BC

<b>Signature</b>	void tliPrReply_m_BC(in TString am, in TInteger ts, in TString src, in TInteger line, in TriComponentIdType c, in TriPortIdType port, in TriSignatureIdType signature, in Value parsValue, in Value replValue, in TriStatusType encoderFailure, in TriParameterType repl, in TriStatusType transmissionFailure)	
<b>In Parameters</b>	am	An additional message.
	ts	The time when the event is produced.
	src	The source file of the test specification.
	line	The line number where the request is performed.
	c	The component which produces this event.
	port	The port via which the reply is sent.
	signature	The signature relating to the reply.
	parsValue	The signature parameters relating to the reply.
	replValue	The reply to be sent.
	encoderFailure	The failure message which might occur at encoding.
	repl	The encoded reply.
	transmissionFailure	The failure message which might occur at transmission.
	<b>Return Value</b>	void
<b>Constraint</b>	Shall be called by SA to log a broadcast reply operation. This event occurs after reply execution. This event is used for logging the communication with the SUT.	
<b>Effect</b>	The TL presents all the information provided in the parameters of this operation to the user, how this is done is not within the scope of the present document.	

## 7.3.4.1.35 tliPrReply\_m\_MC

<b>Signature</b>	void tliPrReply_m_MC(in TString am, in TInteger ts, in TString src, in TInteger line, in TriComponentIdType c, in TriPortIdType port, in TriSignatureIdType signature, in Value parsValue, in Value replValue, in TriAddressListType addresses, in TriStatusType encoderFailure, in TriParameterType repl, in TriStatusType transmissionFailure)	
<b>In Parameters</b>	am	An additional message.
	ts	The time when the event is produced.
	src	The source file of the test specification.
	line	The line number where the request is performed.
	c	The component which produces this event.
	port	The port via which the reply is sent.
	signature	The signature relating to the reply.
	parsValue	The signature parameters relating to the reply.
	replValue	The reply to be sent.
	addresses	The addresses of the destinations within the SUT.
	encoderFailure	The failure message which might occur at encoding.
	repl	The encoded reply.
	transmissionFailure	The failure message which might occur at transmission.
<b>Return Value</b>	void	
<b>Constraint</b>	Shall be called by SA to log a multicast reply operation. This event occurs after reply execution. This event is used for logging the communication with the SUT.	
<b>Effect</b>	The TL presents all the information provided in the parameters of this operation to the user, how this is done is not within the scope of the present document.	

## 7.3.4.1.36 tliPrReply\_c

<b>Signature</b>	void tliPrReply_c(in TString am, in TInteger ts, in TString src, in TInteger line, in TriComponentIdType c, in TriPortIdType port, in TriSignatureIdType signature, in Value parsValue, in Value replValue, in TriComponentIdType to, in TriStatusType transmissionFailure)	
<b>In Parameters</b>	am	An additional message.
	ts	The time when the event is produced.
	src	The source file of the test specification.
	line	The line number where the request is performed.
	c	The component which produces this event.
	port	The port via which the reply is sent.
	signature	The signature relating to the reply.
	parsValue	The signature parameters relating to the reply.
	replValue	The reply to be sent.
	to	The component which will receive the reply.
	transmissionFailure	The failure message which might occur at transmission.
<b>Return Value</b>	void	
<b>Constraint</b>	Shall be called by CH to log a unicast reply operation. This event occurs after reply execution. This event is used for logging the intercomponent communication.	
<b>Effect</b>	The TL presents all the information provided in the parameters of this operation to the user, how this is done is not within the scope of the present document.	

## 7.3.4.1.37 tliPrReply\_c\_BC

<b>Signature</b>	void tliPrReply_c_BC(in TString am, in TInteger ts, in TString src, in TInteger line, in TriComponentIdType c, in TriPortIdType port, in TriSignatureIdType signature, in Value parsValue, in Value replValue, in TriStatusType transmissionFailure)	
<b>In Parameters</b>	am	An additional message.
	ts	The time when the event is produced.
	src	The source file of the test specification.
	line	The line number where the request is performed.
	c	The component which produces this event.
	port	The port via which the reply is sent.
	signature	The signature relating to the reply.
	parsValue	The signature parameters relating to the reply.
	replValue	The reply to be sent.
	transmissionFailure	The failure message which might occur at transmission.
<b>Return Value</b>	void	
<b>Constraint</b>	Shall be called by CH to log a broadcast reply operation. This event occurs after reply execution. This event is used for logging the intercomponent communication.	
<b>Effect</b>	The TL presents all the information provided in the parameters of this operation to the user, how this is done is not within the scope of the present document.	

## 7.3.4.1.38 tliPrReply\_c\_MC

<b>Signature</b>	void tliPrReply_c_MC(in TString am, in TInteger ts, in TString src, in TInteger line, in TriComponentIdType c, in TriPortIdType port, in TriSignatureIdType signature, in Value parsValue, in Value replValue, in TriComponentIdListType toList, in TriStatusType transmissionFailure)	
<b>In Parameters</b>	am	An additional message.
	ts	The time when the event is produced.
	src	The source file of the test specification.
	line	The line number where the request is performed.
	c	The component which produces this event.
	port	The port via which the reply is sent.
	signature	The signature relating to the reply.
	parsValue	The signature parameters relating to the reply.
	replValue	The reply to be sent.
	toList	The components which will receive the reply.
		transmissionFailure
<b>Return Value</b>	void	
<b>Constraint</b>	Shall be called by CH to log a multicast reply operation. This event occurs after reply execution. This event is used for logging the intercomponent communication.	
<b>Effect</b>	The TL presents all the information provided in the parameters of this operation to the user, how this is done is not within the scope of the present document.	

## 7.3.4.1.39 tliPrGetReplyDetected\_m

<b>Signature</b>	void tliPrGetReplyDetected_m(in TString am, in TInteger ts, in TString src, in TInteger line, in TriComponentIdType c, in TriPortIdType port, in TriSignatureIdType signature, in TriParameterType repl, in TriAddressType address)	
<b>In Parameters</b>	am	An additional message.
	ts	The time when the event is produced.
	src	The source file of the test specification.
	line	The line number where the request is performed.
	c	The component which produces this event.
	port	The port via which the reply is received.
	signature	The signature relating to the reply.
	repl	The received encoded reply.
address	The address of the source within the SUT.	
<b>Return Value</b>	void	
<b>Constraint</b>	Shall be called by SA to log the getreply enqueue operation. This event occurs after getreply is enqueued. This event is used for logging the communication with the SUT.	
<b>Effect</b>	The TL presents all the information provided in the parameters of this operation to the user, how this is done is not within the scope of the present document.	

## 7.3.4.1.40 tliPrGetReplyDetected\_c

<b>Signature</b>	void tliPrGetReplyDetected_c(in TString am, in TInteger ts, in TString src, in TInteger line, in TriComponentIdType c, in TriPortIdType port, in TriSignatureIdType signature, in Value replValue, in TriComponentIdType from)	
<b>In Parameters</b>	am	An additional message.
	ts	The time when the event is produced.
	src	The source file of the test specification.
	line	The line number where the request is performed.
	c	The component which produces this event.
	port	The port via which the reply is received.
	signature	The signature relating to the reply.
	replValue	The received reply.
from	The component which sent the reply.	
<b>Return Value</b>	void	
<b>Constraint</b>	Shall be called by CH to log the getreply enqueue operation. This event occurs after getreply is enqueued. This event is used for logging the intercomponent communication.	
<b>Effect</b>	The TL presents all the information provided in the parameters of this operation to the user, how this is done is not within the scope of the present document.	

## 7.3.4.1.41 tliPrGetReplyMismatch\_m

<b>Signature</b>	void tliPrGetReplyMismatch_m(in TString am, in TInteger ts, in TString src, in TInteger line, in TriComponentIdType c, in TriPortIdType port, in TriSignatureIdType signature, in TciParameterListType parsValue, in Value replValue, in TciValueTemplate replyTmpl, in TciValueDifferenceList diffs, in TriAddressType address, in TciValueTemplate addressTmpl)	
<b>In Parameters</b>	am	An additional message.
	ts	The time when the event is produced.
	src	The source file of the test specification.
	line	The line number where the request is performed.
	c	The component which produces this event.
	port	The port via which the reply is received.
	signature	The signature relating to the reply.
	parsValue	The signature parameters relating to the reply.
	replValue	The received reply.
	replyTmpl	The template used to check the reply match.
	diffs	The difference/the mismatch between reply and template
	address	The address of the source within the SUT.
addressTmpl	The expected address of the source within the SUT.	
<b>Return Value</b>	void	
<b>Constraint</b>	Shall be called by TE to log the mismatch of a getreply operation. This event occurs after getreply is checked against a template. This event is used for logging the communication with SUT.	
<b>Effect</b>	The TL presents all the information provided in the parameters of this operation to the user, how this is done is not within the scope of the present document.	

## 7.3.4.1.42 tliPrGetReplyMismatch\_c

<b>Signature</b>	void tliPrGetReplyMismatch_c(in TString am, in TInteger ts, in TString src, in TInteger line, in TriComponentIdType c, in TriPortIdType port, in TriSignatureIdType signature, in TciParameterListType parsValue, in Value replValue, in TciValueTemplate replyTmpl, in TciValueDifferenceList diffs, in TriComponentIdType from, in TciNonValueTemplate fromTmpl)	
<b>In Parameters</b>	am	An additional message.
	ts	The time when the event is produced.
	src	The source file of the test specification.
	line	The line number where the request is performed.
	c	The component which produces this event.
	port	The port via which the reply is received.
	signature	The signature relating to the reply.
	parsValue	The signature parameters relating to the reply.
	repl	The received reply.
	replyTmpl	The template used to check the reply match.
	diffs	The difference/the mismatch between reply and template
	from	The component which sent the reply.
fromTmpl	The expected replying component.	
<b>Return Value</b>	void	
<b>Constraint</b>	Shall be called by TE to log the mismatch of a getreply operation. This event occurs after getreply is checked against a template. This event is used for logging the intercomponent communication.	
<b>Effect</b>	The TL presents all the information provided in the parameters of this operation to the user, how this is done is not within the scope of the present document.	



## 7.3.4.1.43 tliPrGetReply\_m

<b>Signature</b>	void tliPrGetReply_m(in TString am, in TInteger ts, in TString src, in TInteger line, in TriComponentIdType c, in TriPortIdType port, in TriSignatureIdType signature, in TciParameterListType parsValue, in Value replValue, in TciValueTemplate replyTpl, in TriAddressType address, in TciValueTemplate addressTpl)	
<b>In Parameters</b>	am	An additional message.
	ts	The time when the event is produced.
	src	The source file of the test specification.
	line	The line number where the request is performed.
	c	The component which produces this event.
	port	The port via which the reply is received.
	signature	The signature relating to the reply.
	parsValue	The signature parameters relating to the reply.
	replValue	The received reply.
	replyTpl	The template used to check the reply match.
	address	The address of the source within the SUT.
addressTpl	The expected address of the source within the SUT.	
<b>Return Value</b>	void	
<b>Constraint</b>	Shall be called by TE to log getting a reply. This event occurs after getreply is checked against a template. This event is used for logging the communication with SUT.	
<b>Effect</b>	The TL presents all the information provided in the parameters of this operation to the user, how this is done is not within the scope of the present document.	

## 7.3.4.1.44 tliPrGetReply\_c

<b>Signature</b>	void tliPrGetReply_c(in TString am, in TInteger ts, in TString src, in TInteger line, in TriComponentIdType c, in TriPortIdType port, in TriSignatureIdType signature, in TciParameterListType parsValue, in Value replValue, in TciValueTemplate replyTpl, in TriComponentIdType from, in TciNonValueTemplate fromTpl)	
<b>In Parameters</b>	am	An additional message.
	ts	The time when the event is produced.
	src	The source file of the test specification.
	line	The line number where the request is performed.
	c	The component which produces this event.
	port	The port via which the reply is received.
	signature	The signature relating to the reply.
	parsValue	The signature parameters relating to the reply.
	replValue	The received reply.
	replyTpl	The template used to check the reply match.
	from	The component which sent the reply.
fromTpl	The expected replying component.	
<b>Return Value</b>	void	
<b>Constraint</b>	Shall be called by TE to log getting a reply. This event occurs after getreply is checked against a template. This event is used for logging the intercomponent communication.	
<b>Effect</b>	The TL presents all the information provided in the parameters of this operation to the user, how this is done is not within the scope of the present document.	

## 7.3.4.1.45 tliPrRaise\_m

<b>Signature</b>	void tliPrRaise_m(in TString am, in TInteger ts, in TString src, in TInteger line, in TriComponentIdType c, in TriPortIdType port, in TriSignatureIdType signature, in TciParameterListType parsValue, in Value excValue, in TriAddressType address, in TriStatusType encoderFailure, in TriExceptionType exc, in TriStatusType transmissionFailure)	
<b>In Parameters</b>	am	An additional message.
	ts	The time when the event is produced.
	src	The source file of the test specification.
	line	The line number where the request is performed.
	c	The component which produces this event.
	port	The port via which the exception is sent.
	signature	The signature relating to the exception.
	parsValue	The signature parameters relating to the exception.
	excValue	The exception to be sent.
	address	The address of the destination within the SUT.
	encoderFailure	The failure message which might occur at encoding.
	exc	The encoded exception.
transmissionFailure	The failure message which might occur at transmission.	
<b>Return Value</b>	void	
<b>Constraint</b>	Shall be called by SA to log a unicast raise operation. This event occurs after reply execution. This event is used for logging the communication with the SUT.	
<b>Effect</b>	The TL presents all the information provided in the parameters of this operation to the user, how this is done is not within the scope of the present document.	

## 7.3.4.1.46 tliPrRaise\_m\_BC

<b>Signature</b>	void tliPrRaise_m_BC(in TString am, in TInteger ts, in TString src, in TInteger line, in TriComponentIdType c, in TriPortIdType port, in TriSignatureIdType signature, in TciParameterListType parsValue, in Value excValue, in TriStatusType encoderFailure, in TriExceptionType exc, in TriStatusType transmissionFailure)	
<b>In Parameters</b>	am	An additional message.
	ts	The time when the event is produced.
	src	The source file of the test specification.
	line	The line number where the request is performed.
	c	The component which produces this event.
	port	The port via which the exception is sent.
	signature	The signature relating to the exception.
	parsValue	The signature parameters relating to the exception.
	excValue	The exception to be sent.
	encoderFailure	The failure message which might occur at encoding.
	exc	The encoded exception.
	transmissionFailure	The failure message which might occur at transmission.
<b>Return Value</b>	void	
<b>Constraint</b>	Shall be called by SA to log a broadcast raise operation. This event occurs after reply execution. This event is used for logging the communication with the SUT.	
<b>Effect</b>	The TL presents all the information provided in the parameters of this operation to the user, how this is done is not within the scope of the present document.	

## 7.3.4.1.47 tliPrRaise\_m\_MC

<b>Signature</b>	void tliPrRaise_m_MC(in TString am, in TInteger ts, in TString src, in TInteger line, in TriComponentIdType c, in TriPortIdType port, in TriSignatureIdType signature, in TciParameterListType parsValue, in Value excValue, in TriAddressListType addresses, in TriStatusType encoderFailure, in TriExceptionType exc, in TriStatusType transmissionFailure)	
<b>In Parameters</b>	am	An additional message.
	ts	The time when the event is produced.
	src	The source file of the test specification.
	line	The line number where the request is performed.
	c	The component which produces this event.
	port	The port via which the exception is sent.
	signature	The signature relating to the exception.
	parsValue	The signature parameters relating to the exception.
	excValue	The exception to be sent.
	addresses	The addresses of the destinations within the SUT.
	encoderFailure	The failure message which might occur at encoding.
	exc	The encoded exception.
	transmissionFailure	The failure message which might occur at transmission.
<b>Return Value</b>	void	
<b>Constraint</b>	Shall be called by SA to log a multicast raise operation. This event occurs after reply execution. This event is used for logging the communication with the SUT.	
<b>Effect</b>	The TL presents all the information provided in the parameters of this operation to the user, how this is done is not within the scope of the present document.	

## 7.3.4.1.48 tliPrRaise\_c

<b>Signature</b>	void tliPrRaise_c(in TString am, in TInteger ts, in TString src, in TInteger line, in TriComponentIdType c, in TriPortIdType port, in TriSignatureIdType signature, in TciParameterListType parsValue, in Value excValue, in TriComponentIdType to, in TriStatusType transmissionFailure)	
<b>In Parameters</b>	am	An additional message.
	ts	The time when the event is produced.
	src	The source file of the test specification.
	line	The line number where the request is performed.
	c	The component which produces this event.
	port	The port via which the exception is sent.
	signature	The signature relating to the exception.
	parsValue	The signature parameters relating to the exception.
	excValue	The exception to be sent.
	to	The component which will receive the reply.
	transmissionFailure	The failure message which might occur at transmission.
<b>Return Value</b>	void	
<b>Constraint</b>	Shall be called by CH to log a unicast raise operation. This event occurs after reply execution. This event is used for logging the intercomponent communication.	
<b>Effect</b>	The TL presents all the information provided in the parameters of this operation to the user, how this is done is not within the scope of the present document.	

## 7.3.4.1.49 tliPrRaise\_c\_BC

<b>Signature</b>	void tliPrRaise_c_BC(in TString am, in TInteger ts, in TString src, in TInteger line, in TriComponentIdType c, in TriPortIdType port, in TriSignatureIdType signature, in TciParameterListType parsValue, in Value excValue, in TriStatusType transmissionFailure)	
<b>In Parameters</b>	am	An additional message.
	ts	The time when the event is produced.
	src	The source file of the test specification.
	line	The line number where the request is performed.
	c	The component which produces this event.
	port	The port via which the exception is sent.
	signature	The signature relating to the exception.
	parsValue	The signature parameters relating to the exception.
	excValue	The exception to be sent.
	transmissionFailure	The failure message which might occur at transmission.
<b>Return Value</b>	void	
<b>Constraint</b>	Shall be called by CH to log a broadcast raise operation. This event occurs after reply execution. This event is used for logging the intercomponent communication.	
<b>Effect</b>	The TL presents all the information provided in the parameters of this operation to the user, how this is done is not within the scope of the present document.	

## 7.3.4.1.50 tliPrRaise\_c\_MC

<b>Signature</b>	void tliPrRaise_c_MC(in TString am, in TInteger ts, in TString src, in TInteger line, in TriComponentIdType c, in TriPortIdType port, in TriSignatureIdType signature, in TciParameterListType parsValue, in Value excValue, in TriComponentIdListType toList, in TriStatusType transmissionFailure)	
<b>In Parameters</b>	am	An additional message.
	ts	The time when the event is produced.
	src	The source file of the test specification.
	line	The line number where the request is performed.
	c	The component which produces this event.
	port	The port via which the exception is sent.
	signature	The signature relating to the exception.
	parsValue	The signature parameters relating to the exception.
	excValue	The exception to be sent.
		toList
	transmissionFailure	The failure message which might occur at transmission.
<b>Return Value</b>	void	
<b>Constraint</b>	Shall be called by CH to log a multicast raise operation. This event occurs after reply execution. This event is used for logging the intercomponent communication.	
<b>Effect</b>	The TL presents all the information provided in the parameters of this operation to the user, how this is done is not within the scope of the present document.	

## 7.3.4.1.51 tliPrCatchDetected\_m

<b>Signature</b>	void tliPrCatchDetected_m(in TString am, in TInteger ts, in TString src, in TInteger line, in TriComponentIdType c, in TriPortIdType port, in TriSignatureIdType signature, in TriExceptionType exc, in TriAddressType address)	
<b>In Parameters</b>	am	An additional message.
	ts	The time when the event is produced.
	src	The source file of the test specification.
	line	The line number where the request is performed.
	c	The component which produces this event.
	port	The port via which the exception is received.
	signature	The signature relating to the exception.
	exc	The caught exception.
	address	The address of the source within the SUT.
<b>Return Value</b>	void	
<b>Constraint</b>	Shall be called by SA to log the catch enqueue operation. This event occurs after catch is enqueued. This event is used for logging the communication with the SUT.	
<b>Effect</b>	The TL presents all the information provided in the parameters of this operation to the user, how this is done is not within the scope of the present document.	

## 7.3.4.1.52 tliPrCatchDetected\_c

<b>Signature</b>	void tliPrCatchDetected_c(in TString am, in TInteger ts, in TString src, in TInteger line, in TriComponentIdType c, in TriPortIdType port, in TriSignatureIdType signature, in Value excValue, in TriAddressType address)	
<b>In Parameters</b>	am	An additional message.
	ts	The time when the event is produced.
	src	The source file of the test specification.
	line	The line number where the request is performed.
	c	The component which produces this event.
	port	The port via which the exception is received.
	signature	The signature relating to the exception.
	excValue	The caught exception.
	address	The address of the source within the SUT.
<b>Return Value</b>	void	
<b>Constraint</b>	Shall be called by CH to log the catch enqueue operation. This event occurs after catch is enqueued. This event is used for logging the intercomponent communication.	
<b>Effect</b>	The TL presents all the information provided in the parameters of this operation to the user, how this is done is not within the scope of the present document.	

## 7.3.4.1.53 tliPrCatchMismatch m

<b>Signature</b>	void tliPrCatchMismatch_m(in TString am, in TInteger ts, in TString src, in TInteger line, in TriComponentIdType c, in TriPortIdType port, in TriSignatureIdType signature, in TciParameterListType parsValue, in Value excValue, in TciValueTemplate excTpl, in TciValueDifferenceList diffs, in TriAddressType address, in TciValueTemplate addressTpl)	
<b>In Parameters</b>	am	An additional message.
	ts	The time when the event is produced.
	src	The source file of the test specification.
	line	The line number where the request is performed.
	c	The component which produces this event.
	port	The port via which the exception is received.
	signature	The signature relating to the exception.
	parsValue	The signature parameters relating to the exception.
	excValue	The received exception.
	excTpl	The template used to check the exception match.
	diffs	The difference/the mismatch between exception and template
	address	The address of the source within the SUT.
addressTpl	The expected address of the source within the SUT.	
<b>Return Value</b>	void	
<b>Constraint</b>	Shall be called by TE to log the mismatch of a catch operation. This event occurs after catch is checked against a template. This event is used for logging the communication with SUT.	
<b>Effect</b>	The TL presents all the information provided in the parameters of this operation to the user, how this is done is not within the scope of the present document.	

## 7.3.4.1.54 tliPrCatchMismatch c

<b>Signature</b>	void tliPrCatchMismatch_c(in TString am, in TInteger ts, in TString src, in TInteger line, in TriComponentIdType c, in TriPortIdType port, in TriSignatureIdType signature, in TciParameterListType parsValue, in Value excValue, in TciValueTemplate excTpl, in TciValueDifferenceList diffs, in TriComponentIdType from, in TciNonValueTemplate fromTpl)	
<b>In Parameters</b>	am	An additional message.
	ts	The time when the event is produced.
	src	The source file of the test specification.
	line	The line number where the request is performed.
	c	The component which produces this event.
	port	The port via which the exception is received.
	signature	The signature relating to the exception.
	parsValue	The signature parameters relating to the exception.
	excValue	The received exception.
	excTpl	The template used to check the exception match.
	diffs	The difference/the mismatch between exception and template
	from	The component which sent the reply.
fromTpl	The expected replying component.	
<b>Return Value</b>	void	
<b>Constraint</b>	Shall be called by TE to log the mismatch of a catch operation. This event occurs after catch is checked against a template. This event is used for logging the intercomponent communication.	
<b>Effect</b>	The TL presents all the information provided in the parameters of this operation to the user, how this is done is not within the scope of the present document.	

## 7.3.4.1.55 tliPrCatch m

<b>Signature</b>	void tliPrCatch_m(in TString am, in TInteger ts, in TString src, in TInteger line, in TriComponentIdType c, in TriPortIdType port, in TriSignatureIdType signature, in TciParameterListType parsValue, in Value excValue, in TciValueTemplate excTmpl, in TriAddressType address, in TciValueTemplate addressTmpl)	
<b>In Parameters</b>	am	An additional message.
	ts	The time when the event is produced.
	src	The source file of the test specification.
	line	The line number where the request is performed.
	c	The component which produces this event.
	port	The port via which the exception is received.
	signature	The signature relating to the exception.
	parsValue	The signature parameters relating to the exception.
	excValue	The received exception.
	excTmpl	The template used to check the exception match.
	address	The address of the source within the SUT.
	addressTmpl	The expected address of the source within the SUT.
<b>Return Value</b>	void	
<b>Constraint</b>	Shall be called by SA to log catching an exception. This event occurs after catch is checked against a template. This event is used for logging the communication with SUT.	
<b>Effect</b>	The TL presents all the information provided in the parameters of this operation to the user, how this is done is not within the scope of the present document.	

## 7.3.4.1.56 tliPrCatch c

<b>Signature</b>	void tliPrCatch_c(in TString am, in TInteger ts, in TString src, in TInteger line, in TriComponentIdType c, in TriPortIdType port, in TriSignatureIdType signature, in TciParameterListType parsValue, in Value excValue, in TciValueTemplate excTmpl, in TriComponentIdType from, in TciNonValueTemplate fromTmpl)	
<b>In Parameters</b>	am	An additional message.
	ts	The time when the event is produced.
	src	The source file of the test specification.
	line	The line number where the request is performed.
	c	The component which produces this event.
	port	The port via which the exception is received.
	signature	The signature relating to the exception.
	parsValue	The signature parameters relating to the exception.
	excValue	The received exception.
	excTmpl	The template used to check the exception match.
	from	The component which sent the reply.
	fromTmpl	The expected replying component.
<b>Return Value</b>	void	
<b>Constraint</b>	Shall be called by CH to log catching an exception. This event occurs after catch is checked against a template. This event is used for logging the intercomponent communication.	
<b>Effect</b>	The TL presents all the information provided in the parameters of this operation to the user, how this is done is not within the scope of the present document.	

## 7.3.4.1.57 tliPrCatchTimeoutDetected

<b>Signature</b>	void tliPrCatchTimeoutDetected(in TString am, in TInteger ts, in TString src, in TInteger line, in TriComponentIdType c, in TriPortIdType port, in TriSignatureIdType signature)	
<b>In Parameters</b>	am	An additional message.
	ts	The time when the event is produced.
	src	The source file of the test specification.
	line	The line number where the request is performed.
	c	The component which produces this event.
	port	The port via which the exception is received.
signature	The signature relating to the exception.	
<b>Return Value</b>	void	
<b>Constraint</b>	Shall be called by PA to log the detection of a catch timeout. This event occurs after the timeout is enqueued.	
<b>Effect</b>	The TL presents all the information provided in the parameters of this operation to the user, how this is done is not within the scope of the present document.	

## 7.3.4.1.58 tliPrCatchTimeout

<b>Signature</b>	void tliPrCatchTimeout (in TString am, in TInteger ts, in TString src, in TInteger line, in TriComponentIdType c, in TriPortIdType port, in TriSignatureIdType signature)	
<b>In Parameters</b>	am	An additional message.
	ts	The time when the event is produced.
	src	The source file of the test specification.
	line	The line number where the request is performed.
	c	The component which produces this event.
	port	The port via which the exception is received.
signature	The signature relating to the exception.	
<b>Return Value</b>	void	
<b>Constraint</b>	Shall be called by TE to log catching a timeout. This event occurs after the catch timeout has been performed.	
<b>Effect</b>	The TL presents all the information provided in the parameters of this operation to the user, how this is done is not within the scope of the present document.	

## 7.3.4.1.59 tliCCreate

<b>Signature</b>	void tliCCreate(in TString am, in TInteger ts, in TString src, in TInteger line, in TriComponentIdType c, in TriComponentIdType comp, in TString name)	
<b>In Parameters</b>	am	An additional message.
	ts	The time when the event is produced.
	src	The source file of the test specification.
	line	The line number where the request is performed.
	c	The component which produces this event.
	comp	The component which is created.
name	The name of the component which is created.	
<b>Return Value</b>	void	
<b>Constraint</b>	Shall be called by TE to log the create component operation. This event occurs after component creation.	
<b>Effect</b>	The TL presents all the information provided in the parameters of this operation to the user, how this is done is not within the scope of the present document.	



## 7.3.4.1.60 tliCStart

<b>Signature</b>	void tliCStart(in TString am, in TInteger ts, in TString src, in TInteger line, in TriComponentIdType c, in TriComponentIdType comp, in TciBehaviourIdType beh, in TciParameterListType pars)	
<b>In Parameters</b>	am	An additional message.
	ts	The time when the event is produced.
	src	The source file of the test specification.
	line	The line number where the request is performed.
	c	The component which produces this event.
	comp	The component which is started.
	beh	The behaviour being started on the component.
	pars	The parameters of the started behaviour.
<b>Return Value</b>	void	
<b>Constraint</b>	Shall be called by TE to log the start component operation. This event occurs after component start.	
<b>Effect</b>	The TL presents all the information provided in the parameters of this operation to the user, how this is done is not within the scope of the present document.	

## 7.3.4.1.61 tliCRunning

<b>Signature</b>	void tliCRunning(in TString am, in TInteger ts, in TString src, in TInteger line, in TriComponentIdType c, in TriComponentIdType comp, in TBoolean status)	
<b>In Parameters</b>	am	An additional message.
	ts	The time when the event is produced.
	src	The source file of the test specification.
	line	The line number where the request is performed.
	c	The component which produces this event.
	comp	The component which is checked to be running.
	status	The status of this component.
<b>Return Value</b>	void	
<b>Constraint</b>	Shall be called by TE to log the running component operation. This event occurs after component running.	
<b>Effect</b>	The TL presents all the information provided in the parameters of this operation to the user, how this is done is not within the scope of the present document.	

## 7.3.4.1.62 tliCAlive

<b>Signature</b>	void tliCAlive(in TString am, in TInteger ts, in TString src, in TInteger line, in TriComponentIdType c, in TriComponentIdType comp, in TBoolean status)	
<b>In Parameters</b>	am	An additional message.
	ts	The time when the event is produced.
	src	The source file of the test specification.
	line	The line number where the request is performed.
	c	The component which produces this event.
	comp	The component which is checked to be running.
	status	The status of this component.
<b>Return Value</b>	void	
<b>Constraint</b>	Shall be called by TE to log the alive component operation. This event occurs after component alive.	
<b>Effect</b>	The TL presents all the information provided in the parameters of this operation to the user, how this is done is not within the scope of the present document.	

## 7.3.4.1.63 tliCStop

<b>Signature</b>	void tliCStop(in TString am, in TInteger ts, in TString src, in TInteger line, in TriComponentIdType c, in TriComponentIdType comp)	
<b>In Parameters</b>	am	An additional message.
	ts	The time when the event is produced.
	src	The source file of the test specification.
	line	The line number where the request is performed.
	c	The component which produces this event.
	comp	The component which is stopped.
<b>Return Value</b>	void	
<b>Constraint</b>	Shall be called by TE to log the stop component operation. This event occurs after component stop.	
<b>Effect</b>	The TL presents all the information provided in the parameters of this operation to the user, how this is done is not within the scope of the present document.	

## 7.3.4.1.64 tliCKill

<b>Signature</b>	void tliCKill(in TString am, in TInteger ts, in TString src, in TInteger line, in TriComponentIdType c, in TriComponentIdType comp)	
<b>In Parameters</b>	am	An additional message.
	ts	The time when the event is produced.
	src	The source file of the test specification.
	line	The line number where the request is performed.
	c	The component which produces this event.
	comp	The component which is stopped.
<b>Return Value</b>	void	
<b>Constraint</b>	Shall be called by TE to log the kill component operation. This event occurs after component kill.	
<b>Effect</b>	The TL presents all the information provided in the parameters of this operation to the user, how this is done is not within the scope of the present document.	

## 7.3.4.1.65 tliCDoneMismatch

<b>Signature</b>	void tliCDoneMismatch(in TString am, in TInteger ts, in TString src, in TInteger line, in TriComponentIdType c, in TciNonValueTemplate compTpl)	
<b>In Parameters</b>	am	An additional message.
	ts	The time when the event is produced.
	src	The source file of the test specification.
	line	The line number where the request is performed.
	c	The component which produces this event.
	compTpl	The template used to check the done match.
<b>Return Value</b>	void	
<b>Constraint</b>	Shall be called by TE to log the mismatch of a done component operation. This event occurs after done is checked against a template.	
<b>Effect</b>	The TL presents all the information provided in the parameters of this operation to the user, how this is done is not within the scope of the present document.	

## 7.3.4.1.66 tliCDone

<b>Signature</b>	void tliCDone (in TString am, in TInteger ts, in TString src, in TInteger line, in TriComponentIdType c, in TriComponentIdType comp, in TciNonValueTemplate compTpl)	
<b>In Parameters</b>	am	An additional message.
	ts	The time when the event is produced.
	src	The source file of the test specification.
	line	The line number where the request is performed.
	c	The component which produces this event.
	compTpl	The template used to check the done match.
<b>Return Value</b>	void	
<b>Constraint</b>	Shall be called by TE to log the done component operation. This event occurs after the done operation.	
<b>Effect</b>	The TL presents all the information provided in the parameters of this operation to the user, how this is done is not within the scope of the present document.	

## 7.3.4.1.67 tliCKilledMismatch

<b>Signature</b>	void tliCKilledMismatch(in TString am, in TInteger ts, in TString src, in TInteger line, in TriComponentIdType c, in TciNonValueTemplate compTpl)	
<b>In Parameters</b>	am	An additional message.
	ts	The time when the event is produced.
	src	The source file of the test specification.
	line	The line number where the request is performed.
	c	The component which produces this event.
	compTpl	The template used to check the done match.
<b>Return Value</b>	void	
<b>Constraint</b>	Shall be called by TE to log the mismatch of a killed component operation. This event occurs after killed is checked against a template.	
<b>Effect</b>	The TL presents all the information provided in the parameters of this operation to the user, how this is done is not within the scope of the present document.	

## 7.3.4.1.68 tliCKilled

<b>Signature</b>	void tliCKilled (in TString am, in TInteger ts, in TString src, in TInteger line, in TriComponentIdType c, in TriComponentIdType comp, in TciNonValueTemplate compTpl)	
<b>In Parameters</b>	am	An additional message.
	ts	The time when the event is produced.
	src	The source file of the test specification.
	line	The line number where the request is performed.
	c	The component which produces this event.
	compTpl	The template used to check the done match.
<b>Return Value</b>	void	
<b>Constraint</b>	Shall be called by TE to log the killed component operation. This event occurs after the killed operation.	
<b>Effect</b>	The TL presents all the information provided in the parameters of this operation to the user, how this is done is not within the scope of the present document.	

## 7.3.4.1.69 tliCTerminated

<b>Signature</b>	void tliCTerminated(in TString am, in TInteger ts, in TString src, in TInteger line, in TriComponentIdType c, in TriComponentIdType comp, in VerdictValue verdict)	
<b>In Parameters</b>	am	An additional message.
	ts	The time when the event is produced.
	src	The source file of the test specification.
	line	The line number where the request is performed.
	c	The component which produces this event.
	verdict	The verdict of the component.
<b>Return Value</b>	void	
<b>Constraint</b>	Shall be called by TE to log the termination of a component. This event occurs after the termination of the component.	
<b>Effect</b>	The TL presents all the information provided in the parameters of this operation to the user, how this is done is not within the scope of the present document.	

## 7.3.4.1.70 tliPConnect

<b>Signature</b>	void tliPConnect(in TString am, in TInteger ts, in TString src, in TInteger line, in TriComponentIdType c, in TriComponentIdType c1, in TriPortIdType port1, in TriComponentIdType c2, in TriPortIdType port2)	
<b>In Parameters</b>	am	An additional message.
	ts	The time when the event is produced.
	src	The source file of the test specification.
	line	The line number where the request is performed.
	c	The component which produces this event.
	c1	The component of the first port to be connected.
	port1	The first port to be connected.
	c2	The component of the second port to be connected.
<b>Return Value</b>	void	
<b>Constraint</b>	Shall be called by CH to log the connect operation. This event occurs after the connect operation.	
<b>Effect</b>	The TL presents all the information provided in the parameters of this operation to the user, how this is done is not within the scope of the present document.	

## 7.3.4.1.71 tliPDisconnect

<b>Signature</b>	void tliPDisconnect(in TString am, in TInteger ts, in TString src, in TInteger line, in TriComponentIdType c, in TriComponentIdType c1, in TriPortIdType port1, in TriComponentIdType c2, in TriPortIdType port2)	
<b>In Parameters</b>	am	An additional message.
	ts	The time when the event is produced.
	src	The source file of the test specification.
	line	The line number where the request is performed.
	c	The component which produces this event.
	c1	The component of the first port to be disconnected.
	port1	The first port to be disconnected.
	c2	The component of the second port to be disconnected.
<b>Return Value</b>	void	
<b>Constraint</b>	Shall be called by CH to log the disconnect operation. This event occurs after the disconnect operation.	
<b>Effect</b>	The TL presents all the information provided in the parameters of this operation to the user, how this is done is not within the scope of the present document.	

## 7.3.4.1.72 tliPMap

<b>Signature</b>	void tliPMap(in TString am, in TInteger ts, in TString src, in TInteger line, in TriComponentIdType c, in TriComponentIdType c1, in TriPortIdType port1, in TriComponentIdType c2, in TriPortIdType port2)	
<b>In Parameters</b>	am	An additional message.
	ts	The time when the event is produced.
	src	The source file of the test specification.
	line	The line number where the request is performed.
	c	The component which produces this event.
	c1	The component of the first port to be mapped.
	port1	The first port to be mapped.
	port2	The second port to be mapped.
<b>Return Value</b>	void	
<b>Constraint</b>	Shall be called by SA to log the map operation. This event occurs after the map operation.	
<b>Effect</b>	The TL presents all the information provided in the parameters of this operation to the user, how this is done is not within the scope of the present document.	

## 7.3.4.1.73 tliPUnmap

<b>Signature</b>	void tliPUnmap(in TString am, in TInteger ts, in TString src, in TInteger line, in TriComponentIdType c, in TriComponentIdType c1, in TriPortIdType port1, in TriComponentIdType c2, in TriPortIdType port2)	
<b>In Parameters</b>	am	An additional message.
	ts	The time when the event is produced.
	src	The source file of the test specification.
	line	The line number where the request is performed.
	c	The component which produces this event.
	c1	The component of the first port to be unmapped.
	port1	The first port to be unmapped.
	port2	The second port to be unmapped.
<b>Return Value</b>	void	
<b>Constraint</b>	Shall be called by SA to log the unmap operation. This event occurs after the unmap operation.	
<b>Effect</b>	The TL presents all the information provided in the parameters of this operation to the user, how this is done is not within the scope of the present document.	

## 7.3.4.1.74 tliPClear

<b>Signature</b>	void tliPClear(in TString am, in TInteger ts, in TString src, in TInteger line, in TriComponentIdType c, in TriPortIdType port)	
<b>In Parameters</b>	am	An additional message.
	ts	The time when the event is produced.
	src	The source file of the test specification.
	line	The line number where the request is performed.
	c	The component which produces this event.
	port	The port to be cleared.
<b>Return Value</b>	void	
<b>Constraint</b>	Shall be called by TE to log the port clear operation. This event occurs after the port clear operation.	
<b>Effect</b>	The TL presents all the information provided in the parameters of this operation to the user, how this is done is not within the scope of the present document.	

## 7.3.4.1.75 tliPStart

<b>Signature</b>	void tliPStart(in TString am, in TInteger ts, in TString src, in TInteger line, in TriComponentIdType c, in TriPortIdType port)	
<b>In Parameters</b>	am	An additional message.
	ts	The time when the event is produced.
	src	The source file of the test specification.
	line	The line number where the request is performed.
	c	The component which produces this event.
	port	The port to be started.
<b>Return Value</b>	void	
<b>Constraint</b>	Shall be called by TE to log the port start operation. This event occurs after the port start operation.	
<b>Effect</b>	The TL presents all the information provided in the parameters of this operation to the user, how this is done is not within the scope of the present document.	

## 7.3.4.1.76 tliPStop

<b>Signature</b>	void tliPStop(in TString am, in TInteger ts, in TString src, in TInteger line, in TriComponentIdType c, in TriPortIdType port)	
<b>In Parameters</b>	am	An additional message.
	ts	The time when the event is produced.
	src	The source file of the test specification.
	line	The line number where the request is performed.
	c	The component which produces this event.
	port	The port to be stopped.
<b>Return Value</b>	void	
<b>Constraint</b>	Shall be called by TE to log the port stop operation. This event occurs after the port stop operation.	
<b>Effect</b>	The TL presents all the information provided in the parameters of this operation to the user, how this is done is not within the scope of the present document.	

## 7.3.4.1.77 tliPHalt

<b>Signature</b>	void tliPHalt(in TString am, in TInteger ts, in TString src, in TInteger line, in TriComponentIdType c, in TriPortIdType port)	
<b>In Parameters</b>	am	An additional message.
	ts	The time when the event is produced.
	src	The source file of the test specification.
	line	The line number where the request is performed.
	c	The component which produces this event.
	port	The port to be stopped.
<b>Return Value</b>	void	
<b>Constraint</b>	Shall be called by TE to log the port stop operation. This event occurs after the port halt operation.	
<b>Effect</b>	The TL presents all the information provided in the parameters of this operation to the user, how this is done is not within the scope of the present document.	

## 7.3.4.1.78 tliEncode

<b>Signature</b>	void tliEncode(in TString am, in TInteger ts, in TString src, in TInteger line, in TriComponentIdType c, in Value val, in TriStatusType encoderFailure, in TriMessageType msg, in TString codec)	
<b>In Parameters</b>	am	An additional message.
	ts	The time when the event is produced.
	src	The source file of the test specification.
	line	The line number where the request is performed.
	c	The component which produces this event.
	value	The value to be encoded.
	encoderFailure	The failure message which might occur at encoding.
	msg	The encoded value.
	codec	The used encoder.
<b>Return Value</b>	void	
<b>Constraint</b>	Shall be called by CD to log the encode operation.	
<b>Effect</b>	The TL presents all the information provided in the parameters of this operation to the user, how this is done is not within the scope of the present document.	

## 7.3.4.1.79 tliDecode

<b>Signature</b>	void tliDecode(in TString am, in TInteger ts, in TString src, in TInteger line, in TriComponentIdType c, in Value val, in TriStatusType decoderFailure, in TriMessageType msg, in TString codec)	
<b>In Parameters</b>	am	An additional message.
	ts	The time when the event is produced.
	src	The source file of the test specification.
	line	The line number where the request is performed.
	c	The component which produces this event.
	msg	The value to be decoded.
	decoderFailure	The failure message which might occur at decoding.
	value	The decoded value.
	codec	The used decoder.
<b>Return Value</b>	void	
<b>Constraint</b>	Shall be called by CD to log the decode operation.	
<b>Effect</b>	The TL presents all the information provided in the parameters of this operation to the user, how this is done is not within the scope of the present document.	

## 7.3.4.1.80 tliTimeoutDetected

<b>Signature</b>	void tliTimeoutDetected(in TString am, in TInteger ts, in TString src, in TInteger line, in TriComponentIdType c, in TriTimerIdType timer)	
<b>In Parameters</b>	am	An additional message.
	ts	The time when the event is produced.
	src	The source file of the test specification.
	line	The line number where the request is performed.
	c	The component which produces this event.
	timer	The timer that timed out.
<b>Return Value</b>	void	
<b>Constraint</b>	Shall be called by PA to log the detection of a timeout. This event occurs after timeout is enqueued.	
<b>Effect</b>	The TL presents all the information provided in the parameters of this operation to the user, how this is done is not within the scope of the present document.	

## 7.3.4.1.81 tliTTimeoutMismatch

<b>Signature</b>	void tliTTimeoutMismatch(in TString am, in TInteger ts, in TString src, in TInteger line, in TriComponentIdType c, in TciNonValueTemplate timerTpl)	
<b>In Parameters</b>	am	An additional message.
	ts	The time when the event is produced.
	src	The source file of the test specification.
	line	The line number where the request is performed.
	c	The component which produces this event.
	timerTpl	The timer template that did not match.
<b>Return Value</b>	void	
<b>Constraint</b>	Shall be called by TE to log a timeout mismatch. This event occurs after a timeout match failed.	
<b>Effect</b>	The TL presents all the information provided in the parameters of this operation to the user, how this is done is not within the scope of the present document.	

## 7.3.4.1.82 tliTTimeout

<b>Signature</b>	void tliTTimeoutMismatch(in TString am, in TInteger ts, in TString src, in TInteger line, in TriComponentIdType c, in TciNonValueTemplate timerTpl)	
<b>In Parameters</b>	am	An additional message.
	ts	The time when the event is produced.
	src	The source file of the test specification.
	line	The line number where the request is performed.
	c	The component which produces this event.
	timerTpl	The timer template that matched.
<b>Return Value</b>	void	
<b>Constraint</b>	Shall be called by TE to log a timeout match. This event occurs after a timeout matched.	
<b>Effect</b>	The TL presents all the information provided in the parameters of this operation to the user, how this is done is not within the scope of the present document.	

## 7.3.4.1.83 tliTStart

<b>Signature</b>	void tliTStart(in TString am, in TInteger ts, in TString src, in TInteger line, in TriComponentIdType c, in TriTimerIdType timer, in TriTimerDurationType dur)	
<b>In Parameters</b>	am	An additional message.
	ts	The time when the event is produced.
	src	The source file of the test specification.
	line	The line number where the request is performed.
	c	The component which produces this event.
	timer	The timer that is started.
	dur	The timer duration.
<b>Return Value</b>	void	
<b>Constraint</b>	Shall be called by PA to log the start of a timer. This event occurs after the start timer operation.	
<b>Effect</b>	The TL presents all the information provided in the parameters of this operation to the user, how this is done is not within the scope of the present document.	



## 7.3.4.1.84 tliTStop

<b>Signature</b>	void tliTStop(in TString am, in TInteger ts, in TString src, in TInteger line, in TriComponentIdType c, in TriTimerIdType timer)	
<b>In Parameters</b>	am	An additional message.
	ts	The time when the event is produced.
	src	The source file of the test specification.
	line	The line number where the request is performed.
	c	The component which produces this event.
	timer	The timer that is stopped.
<b>Return Value</b>	void	
<b>Constraint</b>	Shall be called by PA to log the stop of a timer. This event occurs after the stop timer operation.	
<b>Effect</b>	The TL presents all the information provided in the parameters of this operation to the user, how this is done is not within the scope of the present document.	

## 7.3.4.1.85 tliTRead

<b>Signature</b>	void tliTRead(in TString am, in TInteger ts, in TString src, in TInteger line, in TriComponentIdType c, in TriTimerIdType timer, in TriTimerDurationType elapsed)	
<b>In Parameters</b>	am	An additional message.
	ts	The time when the event is produced.
	src	The source file of the test specification.
	line	The line number where the request is performed.
	c	The component which produces this event.
	timer	The timer that is started.
	elapsed	The elapsed time of the timer.
<b>Return Value</b>	void	
<b>Constraint</b>	Shall be called by PA to log the reading of a timer. This event occurs after the read timer operation.	
<b>Effect</b>	The TL presents all the information provided in the parameters of this operation to the user, how this is done is not within the scope of the present document.	

## 7.3.4.1.86 tliTRunning

<b>Signature</b>	void tliTRunning(in TString am, in TInteger ts, in TString src, in TInteger line, in TriComponentIdType c, in TriTimerIdType timer, in TBoolean status)	
<b>In Parameters</b>	am	An additional message.
	ts	The time when the event is produced.
	src	The source file of the test specification.
	line	The line number where the request is performed.
	c	The component which produces this event.
	timer	The timer which is checked to be running.
	status	The status of this component.
<b>Return Value</b>	void	
<b>Constraint</b>	Shall be called by PA to log the running timer operation. This event occurs after the running timer operation.	
<b>Effect</b>	The TL presents all the information provided in the parameters of this operation to the user, how this is done is not within the scope of the present document.	

## 7.3.4.1.87 tliSEnter

<b>Signature</b>	void tliSEnter(in TString am, in TInteger ts, in TString src, in TInteger line, in TriComponentIdType c, in TString name, in TciParameterListType parsValue, in TString kind)	
<b>In Parameters</b>	am	An additional message.
	ts	The time when the event is produced.
	src	The source file of the test specification.
	line	The line number where the request is performed.
	c	The component which produces this event.
	name	The name of the scope.
	parsValue	The parameters of the scope.
	kind	The kind of the scope.
<b>Return Value</b>	void	
<b>Constraint</b>	Shall be called by TE to log the entering of a scope. This event occurs after the scoped has been entered.	
<b>Effect</b>	The TL presents all the information provided in the parameters of this operation to the user, how this is done is not within the scope of the present document.	

## 7.3.4.1.88 tliSLeave

<b>Signature</b>	void tliSLeave(in TString am, in TInteger ts, in TString src, in TInteger line, in TriComponentIdType c, in TString name, in Value val, in TString kind)	
<b>In Parameters</b>	am	An additional message.
	ts	The time when the event is produced.
	src	The source file of the test specification.
	line	The line number where the request is performed.
	c	The component which produces this event.
	name	The name of the scope.
	val	The return value of the scope.
	kind	The kind of the scope.
<b>Return Value</b>	void	
<b>Constraint</b>	Shall be called by TE to log the leaving of a scope. This event occurs after the scoped has been leaved.	
<b>Effect</b>	The TL presents all the information provided in the parameters of this operation to the user, how this is done is not within the scope of the present document.	

## 7.3.4.1.89 tliVAr

<b>Signature</b>	void tliVAr(in TString am, in TInteger ts, in TString src, in TInteger line, in TriComponentIdType c, in TString name, in Value varValue)	
<b>In Parameters</b>	am	An additional message.
	ts	The time when the event is produced.
	src	The source file of the test specification.
	line	The line number where the request is performed.
	c	The component which produces this event.
	name	The name of the variable.
	varValue	The new value of the variable.
<b>Return Value</b>	void	
<b>Constraint</b>	Shall be called by TE to log the modification of the value of a variable. This event occurs after the values has been changed.	
<b>Effect</b>	The TL presents all the information provided in the parameters of this operation to the user, how this is done is not within the scope of the present document.	

## 7.3.4.1.90 tliModulePar

<b>Signature</b>	void tliModulePar(in TString am, in TInteger ts, in TString src, in TInteger line, in TriComponentIdType c, in TString name, in Value parValue)	
<b>In Parameters</b>	am	An additional message.
	ts	The time when the event is produced.
	src	The source file of the test specification.
	line	The line number where the request is performed.
	c	The component which produces this event.
	name	The name of the module parameter.
	parValue	The value of the module parameter.
<b>Return Value</b>	void	
<b>Constraint</b>	Shall be called by TE to log the value of a module parameter. This event occurs after the access to the value of a module parameter.	
<b>Effect</b>	The TL presents all the information provided in the parameters of this operation to the user, how this is done is not within the scope of the present document.	

## 7.3.4.1.91 tliGetVerdict

<b>Signature</b>	void tliGetVerdict(in TString am, in TInteger ts, in TString src, in TInteger line, in TriComponentIdType c, in VerdictValue verdict)	
<b>In Parameters</b>	am	An additional message.
	ts	The time when the event is produced.
	src	The source file of the test specification.
	line	The line number where the request is performed.
	c	The component which produces this event.
	verdict	The current value of the local verdict.
	<b>Return Value</b>	void
<b>Constraint</b>	Shall be called by TE to log the getverdict operation. This event occurs after the getverdict operation.	
<b>Effect</b>	The TL presents all the information provided in the parameters of this operation to the user, how this is done is not within the scope of the present document.	

## 7.3.4.1.92 tliSetVerdict

<b>Signature</b>	void tliSetVerdict(in TString am, in TInteger ts, in TString src, in TInteger line, in TriComponentIdType c, in VerdictValue verdict)	
<b>In Parameters</b>	am	An additional message.
	ts	The time when the event is produced.
	src	The source file of the test specification.
	line	The line number where the request is performed.
	c	The component which produces this event.
	verdict	The value to be set to the local verdict.
	<b>Return Value</b>	void
<b>Constraint</b>	Shall be called by TE to log the setverdict operation. This event occurs after the setverdict operation.	
<b>Effect</b>	The TL presents all the information provided in the parameters of this operation to the user, how this is done is not within the scope of the present document.	

## 7.3.4.1.93 tliLog

<b>Signature</b>	void tliLog (in TString am, in TInteger ts, in TString src, in TInteger line, in TriComponentIdType c, in TciValueList log)	
<b>In Parameters</b>	am	An additional message.
	ts	The time when the event is produced.
	src	The source file of the test specification.
	line	The line number where the request is performed.
	c	The component which produces this event.
	log	The string to be logged.
<b>Return Value</b>	void	
<b>Constraint</b>	Shall be called by TM to log the TTCN-3 statement log. This event occurs after the TTCN-3 log operation.	
<b>Effect</b>	The TL presents all the information provided in the parameters of this operation to the user, how this is done is not within the scope of the present document.	

## 7.3.4.1.94 tliAEnter

<b>Signature</b>	void tliAEnter(in TString am, in TInteger ts, in TString src, in TInteger line, in TriComponentIdType c)	
<b>In Parameters</b>	am	An additional message.
	ts	The time when the event is produced.
	src	The source file of the test specification.
	line	The line number where the request is performed.
	c	The component which produces this event.
	<b>Return Value</b>	void
<b>Constraint</b>	Shall be called by TE to log entering an alt. This event occurs after an alt has been entered.	
<b>Effect</b>	The TL presents all the information provided in the parameters of this operation to the user, how this is done is not within the scope of the present document.	

## 7.3.4.1.95 tliALeave

<b>Signature</b>	void tliALeave(in TString am, in TInteger ts, in TString src, in TInteger line, in TriComponentIdType c)	
<b>In Parameters</b>	am	An additional message.
	ts	The time when the event is produced.
	src	The source file of the test specification.
	line	The line number where the request is performed.
	c	The component which produces this event.
	<b>Return Value</b>	void
<b>Constraint</b>	Shall be called by TE to log leaving an alt. This event occurs after the alt has been left.	
<b>Effect</b>	The TL presents all the information provided in the parameters of this operation to the user, how this is done is not within the scope of the present document.	

## 7.3.4.1.96 tliANomatch

<b>Signature</b>	void tliANomatch (in TString am, in TInteger ts, in TString src, in TInteger line, in TriComponentIdType c)	
<b>In Parameters</b>	am	An additional message.
	ts	The time when the event is produced.
	src	The source file of the test specification.
	line	The line number where the request is performed.
	c	The component which produces this event.
	<b>Return Value</b>	void
<b>Constraint</b>	Shall be called by TE to log the nomatch of an alt. This event occurs after the alt has not matched.	
<b>Effect</b>	The TL presents all the information provided in the parameters of this operation to the user, how this is done is not within the scope of the present document.	

## 7.3.4.1.97 tliARepeat

<b>Signature</b>	void tliARepeat(in TString am, in TInteger ts, in TString src, in TInteger line, in TriComponentIdType c)	
<b>In Parameters</b>	am	An additional message.
	ts	The time when the event is produced.
	src	The source file of the test specification.
	line	The line number where the request is performed.
	c	The component which produces this event.
<b>Return Value</b>	void	
<b>Constraint</b>	Shall be called by TE to log repeating an alt. This event occurs when the alt is been repeated.	
<b>Effect</b>	The TL presents all the information provided in the parameters of this operation to the user, how this is done is not within the scope of the present document.	

## 7.3.4.1.98 tliADefaults

<b>Signature</b>	void tliADefaults(in TString am, in TInteger ts, in TString src, in TInteger line, in TriComponentIdType c)	
<b>In Parameters</b>	am	An additional message.
	ts	The time when the event is produced.
	src	The source file of the test specification.
	line	The line number where the request is performed.
	c	The component which produces this event.
<b>Return Value</b>	void	
<b>Constraint</b>	Shall be called by TE to log entering the default section. This event occurs after the default section has been entered.	
<b>Effect</b>	The TL presents all the information provided in the parameters of this operation to the user, how this is done is not within the scope of the present document.	

## 7.3.4.1.99 tliAActivate

<b>Signature</b>	void tliAActivate(in TString am, in TInteger ts, in TString src, in TInteger line, in TriComponentIdType c, in TString name, in TciParameterListType pars, in Value ref)	
<b>In Parameters</b>	am	An additional message.
	ts	The time when the event is produced.
	src	The source file of the test specification.
	line	The line number where the request is performed.
	c	The component which produces this event.
	name	The name of the default.
	pars	The parameter of the default.
	ref	The resulting default reference.
<b>Return Value</b>	void	
<b>Constraint</b>	Shall be called by TE to log the activation of a default. This event occurs after the default activation.	
<b>Effect</b>	The TL presents all the information provided in the parameters of this operation to the user, how this is done is not within the scope of the present document.	

## 7.3.4.1.100 tliADeactivate

<b>Signature</b>	void tliADeactivate(in TString am, in TInteger ts, in TString src, in TInteger line, in TriComponentIdType c, in Value ref)	
<b>In Parameters</b>	am	An additional message.
	ts	The time when the event is produced.
	src	The source file of the test specification.
	line	The line number where the request is performed.
	c	The component which produces this event.
	ref	The resulting default reference.
<b>Return Value</b>	void	
<b>Constraint</b>	Shall be called by TE to log the deactivation of a default. This event occurs after the default deactivation.	
<b>Effect</b>	The TL presents all the information provided in the parameters of this operation to the user, how this is done is not within the scope of the present document.	

## 7.3.4.1.101 tliAWait

<b>Signature</b>	void tliAWait(in string am, in long ts, in string src, in long line, in TriComponentId c)	
<b>In Parameters</b>	am	An additional message.
	ts	The time when the event is produced.
	src	The source file of the test specification.
	line	The line number where the request is performed.
	c	The component which produces this event.
<b>Return Value</b>	void	
<b>Constraint</b>	Shall be called by TE to log that the component awaits events for a new snapshot.	
<b>Effect</b>	The TL presents all the information provided in the parameters of this operation to the user, how this is done is not within the scope of the present document.	

---

## 8 Java language mapping

### 8.1 Introduction

This clause introduces the TCI Java language mapping. For efficiency reasons a dedicated language mapping is introduced instead of using the OMG IDL to Java language.

The Java language mapping for the TTCN-3 Control Interface defines how the IDL definitions described in clause 7 are mapped to the Java language. The language mapping is independent of the used Java version as only basic Java language constructs are used.

### 8.2 Names and scopes

#### 8.2.1 Names

Although there are no conflicts between identifiers used in the IDL definition and the Java language some naming translation rules are applied to the IDL identifiers.

Java interfaces or class identifiers are omitting the trailing `Type` used in the IDL definition.

EXAMPLE: the IDL type `TciTestCaseIdType` maps to `TciTestCaseId` in Java.

The resulting mapping conforms to the standard Java coding conventions.

## 8.2.2 Scopes

The IDL module **tcInterface** is mapped to the Java package `org.etsi.ttcn3.tci`. All IDL type declarations within this module are mapped to Java classes or interface declarations within this package.

### Type mapping

#### Basic type mapping

Table 2 gives an overview on how the native types `TBoolean`, `TFloat`, `TInteger`, `TString`, and `TStringSeq` are mapped to the Java types.

**Table 2: Basic type mappings**

IDL Type	Java Type
<code>TBoolean</code>	<code>boolean</code>
<code>TFloat</code>	<code>float</code>
<code>TInteger</code>	<code>int</code>
<code>TString</code>	<code>java.lang.String</code>
<code>TStringSeq</code>	<code>java.lang.String[]</code>

The native type `TObjId` is defined in the respective section of the `ObjidValue` interface.

#### boolean

The IDL **TBoolean** type is mapped to the java basic type `boolean`.

#### float

The IDL **TFloat** type is mapped to the java basic type `float`.

#### char

The IDL **TChar** type is mapped to the java basic type `char`.

#### int

The IDL **TInteger** type is mapped to the java basic type `int`.

#### String

The IDL **TString** type is mapped to the `java.lang.String` class without range checking or bounds for characters in the string. All possible strings defined in TTCN-3 can be converted to `java.lang.String`.

#### String[]

The IDL **TStringSeq** type is mapped to an array of the `java.lang.String` class.

#### Universal Char

The IDL **TUniversalChar** type is mapped to a java basic type `int`. The integer uses the canonical form as defined in ISO/IEC 10646-1, clause 6.2.

### Structured type mapping

The TCI IDL description defines user defined types as native types. In the Java language mapping these types are mapped to Java interfaces. The interfaces define methods and attributes being available for objects implementing this interface.

### 8.2.2.1 TciParameterType

**TciParameterType** is mapped to the following interface:

```
// TCI IDL TciParameterType
package org.etsi.ttcn.tci;
public interface TciParameter {
    public String    getParameterName();
    public void      setParameterName(String name);
    public int       getParameterPassingMode();
    public void      setParameterPassingMode(TciParameterPassingMode mode);
    public Value     getParameter();
    public void      setParameter(Value parameter);
}
```

#### Methods:

- `getParameterName ()` Returns the parameter name as defined in the TTCN-3 specification;
- `setParameterName (String name)` Sets the name of this `TciParameter` parameter to name;
- `getParameterPassingMode()` Returns the parameter passing mode of this parameter;
- `setParameterPassingMode(TciParameterPassingMode mode)` Sets the parameter mode of this `TriParameter` parameter to mode;
- `getParameter()` Returns the `Value` parameter of this `TciParameter`, or the null object if the parameter contains the distinct value null;
- `setParameter(Value parameter)` Sets the `Value` parameter of this `TciParameter` to parameter. If the distinct value null shall be set to indicate that this parameter holds no value, the Java null shall be passed as parameter.

### 8.2.2.2 TciParameterPassingModeType

**TciParameterPassingModeType** is mapped to the following interface:

```
// TCI IDL TciParameterPassingModeType
package org.etsi.ttcn.tci;
public interface TciParameterPassingMode {
    public final static int TCI_IN      = 0;
    public final static int TCI_INOUT   = 1;
    public final static int TCI_OUT     = 2;
}
```

#### Constants:

- `TCI_IN` Will be used to indicate that a `TciParameter` is an in parameter;
- `TCI_INOUT` Will be used to indicate that a `TciParameter` is an inout parameter;
- `TCI_OUT` Will be used to indicate that a `TciParameter` is an out parameter.

### 8.2.2.3 TciParameterListType

**TciParameterListType** is mapped to the following interface:

```
// TCI IDL TciParameterListType
package org.etsi.ttcn.tci;
public interface TciParameterList {
    public int          size() ;
    public boolean      isEmpty() ;
    public java.util.Enumeration getParameters() ;
    public TciParameter get(int index) ;
    public void         clear() ;
    public void         add(TciParameter parameter) ;
    public void         setParameters(TciParameter[] parameters) ;
}
```



**Methods:**

- `size()` Returns the number of parameters in this list;
- `isEmpty()` Returns true if this list contains no parameters;
- `getParameters()` Returns an Enumeration over the parameters in the list. The enumeration provides the parameters in the same order as they appear in the list;
- `get(int index)` Returns the `TciParameter` at the specified position;
- `clear()` Removes all parameters from this `TciParameterList`;
- `add(TciParameter parameter)` Adds parameter to the end of this `TciParameterList`;
- `setParameter(TciParameter[] parameters)` Fills this `TciParameterList` with parameters.

**8.2.2.4 TciTypeClassType**

**TciTypeClassType** is mapped to the following interface:

```
// TCI IDL TciTypeClassType
package org.etsi.ttcn.tci;
public interface TciTypeClass {
    public final static int ADDRESS           = 0 ;
    public final static int ANYTYPE          = 1 ;
    public final static int BITSTRING       = 2 ;
    public final static int BOOLEAN         = 3 ;
    public final static int CHARSTRING      = 5 ;
    public final static int COMPONENT       = 6 ;
    public final static int ENUMERATED      = 7 ;
    public final static int FLOAT           = 8 ;
    public final static int HEXSTRING       = 9 ;
    public final static int INTEGER         = 10 ;
    public final static int OBJID           = 11 ;
    public final static int OCTETSTRING     = 12 ;
    public final static int RECORD          = 13 ;
    public final static int RECORD_OF       = 14 ;
    public final static int SET             = 15 ;
    public final static int SET_OF          = 16 ;
    public final static int UNION           = 17 ;
    public final static int UNIVERSAL_CHARSTRING = 19 ;
    public final static int VERDICT         = 20 ;
}
```

**8.2.2.5 TciTestComponentKindType**

**TciTestComponentKindType** is mapped to the following interface:

```
// TCI IDL TciTestComponentKindType
public interface TciTestComponentKind {
    public final static int TCI_CTRL_COMP    = 0 ;
    public final static int TCI_MTC_COMP    = 1 ;
    public final static int TCI_PTC_COMP    = 2 ;
    public final static int TCI_SYSTEM_COMP = 3 ;
}
```

**8.2.2.6 TciBehaviourIdType**

**TciBehaviourIdType** is mapped to the following interface:

```
// TCI IDL TciBehaviourIdType
package org.etsi.ttcn.tci;
public interface TciBehaviourId extends QualifiedName {
}
```

### 8.2.2.7 TciTestCaseIdType

**TciTestCaseIdType** is mapped to the following interface:

```
// TCI IDL TciTestCaseIdType
package org.etsi.ttcn.tci;
public interface TciTestCaseId extends QualifiedName {
}
```

### 8.2.2.8 TciModuleIdType

**TciModuleIdType** is mapped to the following interface:

```
// TCI IDL TciModuleIdType
package org.etsi.ttcn.tci;
public interface TciModuleId extends QualifiedName {
}
```

### 8.2.2.9 TciModuleParameterIdType

**TciModuleParameterIdType** is mapped to the following interface:

```
// TCI IDL TciModuleParameterIdType
package org.etsi.ttcn.tci;
public interface TciModuleParameterId extends QualifiedName {
}
```

### 8.2.2.10 TciModuleParameterListType

**TciModuleParameterListType** is mapped to the following interface:

```
// TCI IDL TciModuleParameterListType
package org.etsi.ttcn.tci;
public interface TciModuleParameterList {
    public int size() ;
    public boolean isEmpty() ;
    public java.util.Enumeration getModuleParameters() ;
    public TciModuleParameter get(int index) ;
}
```

#### Methods:

- `size()` Returns the number of module parameters in this list;
- `isEmpty()` Returns `true` if this list contains no module parameters;
- `getModuleParameters()` Returns an `Enumeration` over the module parameters in the list. The enumeration provides the module parameters in the same order as they appear in the list;
- `get(int index)` Returns the `TciModuleParameter` at the specified position.

### 8.2.2.11 TciModuleParameterType

**TciModuleParameterType** is mapped to the following interface:

```
// TCI IDL TciModuleParameterType
package org.etsi.ttcn.tci;
public interface TciModuleParameter {
    public String getModuleParameterName();
    public Value getDefaultValue();
}
```

#### Methods:

- `getModuleParameterName ()` Returns the module parameter name as defined in the TTCN-3 specification;

- `getDefaultValue()` Returns the default Value module parameter of this `TciModuleParameter`, or the `null` object if the module parameter contains the distinct value `null`.

### 8.2.2.12 TciParameterTypeListType

**TciParameterTypeListType** is mapped to the following interface:

```
// TCI IDL TciParameterTypeListType
package org.etsi.ttcn.tci;
public interface TciParameterTypeList {
    public int size() ;
    public boolean isEmpty() ;
    public java.util.Enumeration getParameterTypes() ;
    public TciParameterType get(int index) ;
}
```

#### Methods:

- `size()` Returns the number of parameter types in this list;
- `isEmpty()` Returns `true` if this list contains no parameter types;
- `getParameterTypes()` Returns an `Enumeration` over the parameter types in the list. The enumeration provides the parameter types in the same order as they appear in the list;
- `get(int index)` Returns the `TciParameterType` at the specified position.

### 8.2.2.13 TciModuleIdListType

**TciModuleIdListType** is mapped to the following interface:

```
// TCI IDL TciModuleIdListType
package org.etsi.ttcn.tci;
public interface TciModuleIdList {
    public int size() ;
    public boolean isEmpty() ;
    public java.util.Enumeration getImportedModules() ;
    public TciModuleId get(int index) ;
}
```

#### Methods:

- `size()` Returns the number of modules in this list;
- `isEmpty()` Returns `true` if this list contains no modules;
- `getImportedModules()` Returns an `Enumeration` over the modules in the list. The enumeration provides the modules in the same order as they appear in the list;
- `get(int index)` Returns the `TciModuleId` at the specified position.

## 8.2.3 Abstract type mapping

The TTCN-3 data types are modelled in Java using the abstract type mapping as defined in this clause. The `Type` interface defines only operations used to retrieve in TTCN-3 defined types. No TTCN-3 types can be constructed using the `Type` interface. Types are modelled using the single interface `Type`, that provides methods to identify types and to retrieve values of a given type.

### 8.2.3.1 Type

**Type** is mapped to the following interface:

```
// TCI IDL Type
package org.etsi.ttcn.tci;
public interface Type {
    public TciModuleId getDefiningModule ();
}
```

```

public String      getName ();
public int         getTypeClass ();
public Value       newInstance ();
public String     getTypeEncoding ();
public String     getTypeEncodingVariant();
public String[]   getTypeExtension();
}

```

**Methods:**

- `getDefiningModule()` Returns the module identifier of the module the type has been defined in. If the type represents a TTCN-3 base type the distinct value `null` will be returned;
- `getName()` Returns name of the type as defined in the TTCN-3 module;
- `getTypeClass()` Returns the type class of the respective type. A value of `TciTypeClassType` can have one of the following constants: `ADDRESS`, `ANYTYPE`, `BITSTRING`, `BOOLEAN`, `CHARSTRING`, `COMPONENT`, `ENUMERATED`, `FLOAT`, `HEXSTRING`, `INTEGER`, `OBJID`, `OCTETSTRING`, `RECORD`, `RECORD_OF`, `SET`, `SET_OF`, `UNION`, `UNIVERSAL_CHARSTRING`, `VERDICT`;
- `newInstance()` Returns a freshly created value of the given type. This initial value of the created value is undefined;
- `getTypeEncoding()` Returns the type encoding attribute as defined in the TTCN-3 module;
- `getTypeEncodingVariant()` This operation returns the value encoding variant attribute as defined in TTCN-3, if any. If no encoding variant attribute has been defined the distinct value `null` will be returned;
- `getTypeExtension()` Returns the type extension attribute as defined in the TTCN-3 module.

## 8.2.4 Abstract value mapping

TTCN-3 values can be retrieved from the TE and constructed using the Value interface. The value mapping interface is constructed hierarchically with Value as the basic interface. Specialized interfaces for different types of values have been defined.

### 8.2.4.1 Value

**Value** is mapped to the following interface:

```

// TCI IDL Value
package org.etsi.ttcn.tci;
public interface Value {
    public Type      getType() ;
    public boolean   notPresent() ;
    public String    getValueEncoding() ;
    public String    getValueEncodingVariant();
}

```

**Methods:**

- `getType()` Returns the type of the specified value;
- `notPresent()` Returns `true` if the specified value is omit, `false` otherwise;
- `getValueEncoding()` This operation returns the value encoding attribute as defined in TTCN-3, if any. If no encoding attribute has been defined the distinct value `null` will be returned;
- `getValueEncodingVariant()` This operation returns the value encoding variant attribute as defined in TTCN-3, if any. If no encoding variant attribute has been defined the distinct value `null` will be returned.

### 8.2.4.2 IntegerValue

**IntegerValue** type is mapped to the following interface:

```
// IntegerValue
package org.etsi.ttcn.tci;
public interface IntegerValue {
    public void    setInteger(int value);
    public int     getInteger();
}
```

**Methods:**

- `setInteger(int value)` Sets this `IntegerValue` to the int value `value`;
- `getInteger()` Returns the int value represented by this `IntegerValue`.

### 8.2.4.3 FloatValue

**FloatValue** type is mapped to the following interface:

```
// FloatValue
package org.etsi.ttcn.tci;
public interface FloatValue {
    public void    setFloat(float value);
    public float   getFloat();
}
```

**Methods:**

- `setFloat(float value)` Sets this `FloatValue` to the float value `value`;
- `getFloat()` Returns the float value represented by this `FloatValue`.

### 8.2.4.4 BooleanValue

**BooleanValue** type is mapped to the following interface:

```
// BooleanValue
package org.etsi.ttcn.tci;
public interface BooleanValue {
    public void    setBoolean(boolean value);
    public boolean getBoolean();
}
```

**Methods:**

- `setBoolean(boolean value)` Sets this `BooleanValue` to the boolean value `value`;
- `getBoolean()` Returns the boolean value represented by this `BooleanValue`.

### 8.2.4.5 ObjidValue

**ObjidValue** is mapped to the following interface:

```
// TCI IDL ObjidValue
package org.etsi.ttcn.tci;
public interface ObjidValue {
    TciObjId    getObjid ();
    void        setObjid (TciObjId value);
}
```

**Methods:**

- `getObjid()` Returns the object id value of the TTCN-3 `objid`;
- `setObjid(TciObjId value)` Sets this `ObjidValue` to `value`.

### 8.2.4.6 TciObjId

**TciObjId** is mapped to the following interface. The native java representation of a TTCN-3 ObjectId consists of an ordered sequence of TciObjIdElements.

```
package org.etsi.ttcn.tci;
public interface TciObjId {
    public int          size() ;
    public void        setObjElement(TciObjIdElement[] objElements) ;
    public TciObjIdElement getObjElement(int index) ;
}
```

#### Methods:

- `size()` Returns the size of this Object Id in TciObjIdElements;
- `setObjElement(TciObjIdElement[] objElements)` Sets this ObjId to the list of objElements;
- `getObjElement(int index)` Return the TciObjIdElement at position index.

### 8.2.4.7 TciObjIdElement

A TciObjIdElement represent a single object element within a TTCN-3 ObjId value. It can be set using different representations like the ASCII representation or as integer.

**TciObjIdElement** is mapped to the following interface:

```
package org.etsi.ttcn.tci;
public interface TciObjIdElement {
    public void      setElementAsAscii(String element) ;
    public void      setElementAsNumber(int element) ;
    public String    getElementAsAscii() ;
    public int       getElementAsNumber() ;
}
```

#### Methods:

- `setElementAsAscii(String element)` Sets the internal representation of this ObjIdElement to string value element;
- `setElementAsNumber(int element)` Set this the internal representation of this ObjIdElement to the integer value element;
- `getElementAsAscii()` Returns the internal representation of this ObjIdElement as string;
- `getElementAsNumber()` Returns the internal representation of this ObjIdElement as integer.

### 8.2.4.8 CharstringValue

**CharstringValue** is mapped to the following interface:

```
// TCI IDL CharstringValue
package org.etsi.ttcn.tci;
public interface CharstringValue {
    String  getString ();
    void    setString (String value);
    char    getChar (int position);
    void    setChar (int position, char value);
    int     getLength ();
    void    setLength (int len);
}
```

#### Methods:

- `getString()` Returns the string of the TTCN-3 charstring. The textual representation of the empty TTCN-3 charstring is ' ', while its length is zero;

- `setString(String value)` Sets this `CharstringValue` to `value`;
- `getChar(int position)` Returns the char value of the TTCN-3 charstring at `position`. `position 0` denotes the first char of the TTCN-3 charstring. Valid values for `position` are `0` to `length - 1`;
- `setChar(int position, char value)` Set the char at `position` to `value`. Valid values for `position` are `0` to `length - 1`;
- `getLength()` Returns the length of this `CharstringValue` in chars, zero if the value of this `CharstringValue` is omit;
- `setLength(int len)` Sets the length of this `CharstringValue` in chars to `len`.

### 8.2.4.9 BitstringValue

**BitstringValue** is mapped to the following interface:

```
// TCI IDL BitstringValue
package org.etsi.ttcn.tci;
public interface BitstringValue {
    String getString ();
    void    setString (String value);
    int     getBit (int position);
    void    setBit (int position, int value);
    int     getLength ();
    void    setLength (int len);
}
```

#### Methods:

- `getString()` Returns the textual representation of this `BitstringValue`, as defined in TTCN-3. E.g. the textual representation of `0101` is `"0101"B`. The textual representation of the empty TTCN-3 bitstring is `"B`, while its length is zero;
- `setString(String value)` Sets the value of this `BitstringValue` according to the textual representation as defined by `value`. E.g. The value of this `BitstringValue` will be `0101` if the textual representation in `value` is `"0101"B`;
- `getBit(int position)` Returns the value (`0` | `1`) at `position` of this TTCN-3 bitstring. `position 0` denotes the first bit of the TTCN-3 bitstring. Valid values for `position` are `0` to `length - 1`;
- `setBit(int position, int value)` Set the bit at `position` to value (`0` | `1`). `position 0` denotes the first bit in this `BitstringValue`. Valid values for `position` are `0` to `length - 1`;
- `getLength()` Returns the length of this `BitstringValue` in bits, zero if the value of this `BitstringValue` is omit;
- `setLength(int len)` Sets the length of this `BitstringValue` in bits to `len`.

### 8.2.4.10 OctetstringValue

**OctetstringValue** is mapped to the following interface:

```
// TCI IDL OctetstringValue
package org.etsi.ttcn.tci;
public interface OctetstringValue {
    String getString ();
    void setString (String value);
    int getOctet (int position);
    void setOctet (int position, int value);
    int getLength ();
    void setLength (int len);
}
```

#### Methods:

- `getString()` Returns the textual representation of this `OctetstringValue`, as defined in TTCN-3. E.g. the textual representation of `0xCAFFEE` is `"CAFFEE"O`. The textual representation of the empty TTCN-3 octetstring is `"O`, while its length is zero;
- `setString(String value)` Sets the value of this `OctetstringValue` according to the textual representation as defined by `value`. E.g. The value of this `OctetstringValue` will be `0xCAFFEE` if the textual representation in `value` is `"CAFFEE"O`;
- `getOctet(int position)` Returns the value (0..255) at `position` of this TTCN-3 octetstring. `position 0` denotes the first octet of the TTCN-3 octetstring. Valid values for `position` are `0` to `length - 1`;
- `setOctet(int position, int value)` Set the octet at `position` to `value` (0..255). `position 0` denotes the first octet in the octetstring. Valid values for `position` are `0` to `length - 1`;
- `getLength()` Returns the length of this `OctetstringValue` in octets, zero if the value of this `OctetstringValue` is omit;
- `setLength(int len)` Sets the length of this `OctetstringValue` in octets to `len`.

### 8.2.4.11 UniversalCharstringValue

**UniversalCharstringValue** is mapped to the following interface:

```
// TCI IDL UniversalCharstringValue
package org.etsi.ttcn.tci;
public interface UniversalCharstringValue {
    String getString ();
    void setString (String value);
    int getChar (int position);
    void setChar (int position, int value);
    int getLength ();
    void setLength (int len);
}
```

#### Methods:

- `getString()` Returns the textual representation of this `UniversalCharstringValue`, as defined in TTCN-3;
- `setString(String value)` Sets the value of this `UniversalCharstringValue` according to the textual representation as defined by `value`;



- `getChar(int position)` Returns the `UniversalChar` value of the TTCN-3 universal charstring at position. position 0 denotes the first `UniversalChar` of the TTCN-3 universal charstring. Valid values for position are 0 to length - 1;
- `setChar(int position, char value)` Set the `UniversalChar` at position to value. Valid values for position are 0 to length - 1;
- `getLength()` Returns the length of this `UniversalCharstringValue` in `UniversalChars`, zero if the value of this `UniversalCharstringValue` is omit;
- `setLength(int len)` Sets the length of this `UniversalCharstringValue` in `UniversalChars` to len.

### 8.2.4.12 HexstringValue

**HexstringValue** is mapped to the following interface:

```
// TCI IDL HexstringValue
package org.etsi.ttcn.tci;
public interface HexstringValue {
    String  getString ();
    void    setString (String value);
    int     getHex (int position);
    void    setHex (int position, int value);
    int     getLength ();
    void    setLength (int len);
}
```

#### Methods:

- `getString()` Returns the textual representation of this `HexstringValue`, as defined in TTCN-3. E.g. the textual representation of `0xAFFEE` is "AFFEE"H. The textual representation of the empty TTCN-3 hexstring is "H, while its length is zero;
- `setString(String value)` Sets the value of this `HexstringValue` according to the textual representation as defined by value. E.g. The value of this `HexstringValue` will be `0xAFFEE` if the textual representation in value is "AFFEE"H;
- `getHex(int position)` Returns the value (0..15) at position of this TTCN-3 hexstring. position 0 denotes the first hex digits of the TTCN-3 hexstring. Valid values for position are 0 to length - 1;
- `setHex(int position, int value)` Set the hex digit at position to value (0..16). position 0 denotes the first octet in the hexstring. Valid values for position are 0 to length - 1;
- `getLength()` Returns the length of this `HexstringValue` in octets, zero if the value of this `HexstringValue` is omit;
- `setLength(int len)` Sets the length of this `HexstringValue` in hex digits to len.

### 8.2.4.13 RecordValue

**RecordValue** is mapped to the following interface:

```
// TCI IDL RecordValue
package org.etsi.ttcn.tci;
public interface RecordValue {
    public Value    getField(String fieldName) ;
    public void    setField(String fieldName, Value value) ;
    public String[] getFieldNames() ;
}
```

#### Methods:

- `getField(String fieldName)` Returns the value of the field named `fieldName`. The return value is the common abstract base type `Value`, as a record field can have any type defined in TTCN-3. If the field can not be obtained from the record the distinct value `null` will be returned;
- `setField(String fieldName, Value value)` Set the field named `fieldName` of the record to `value`. No assumption shall be made on how a field is stored in a record. An internal implementation might choose to store a reference to this value or to copy the value. It is safe to assume that the value will be copied. Therefore it should be relied on that subsequent modifications of `value` will not be considered in the record;
- `getFieldNames()` Returns an array of `String` of field names, the distinct value `null`, if the record has no fields.

### 8.2.4.14 RecordOfValue

**RecordOfValue** is mapped to the following interface:

```
// TCI IDL RecordOfValue
package org.etsi.ttcn.tci;
public interface RecordOfValue {
    public Value    getField(String fieldName) ;
    public void    setField(int position, Value value) ;
    public void    appendField(Value value) ;
    public Type    getElementType() ;
    public int     getLength() ;
    public void    setLength(int len) ;
}
```

#### Methods:

- `getField(String fieldName)` Returns the value of the record `of` at position `position` if `position` is between zero and `length - 1`, the distinct value `null` otherwise. The return value is the common abstract base type `Value`, as a `record of` can have fields of any type defined in TTCN-3;
- `setField(int position, Value value)` Sets the field at `position` to `value`. If `position` is greater than `(length - 1)` the record `of` will be extended to have the `length (position + 1)`. The record `of` elements between the original position at `length` and `position - 1` will be set to OMIT. No assumption shall be made on how a field is stored in a `record of`. An internal implementation might choose to store a reference to this value or to copy the value. It is safe to assume that the value will be copied. Therefore it should be relied on that subsequent modifications of `value` will not be considered in the `record of`;

- `appendField(Value value)` Appends the value at the end of the `record of`, i.e. at position `length`. No assumption shall be made on how a field is stored in a `record of`. An internal implementation might choose to store a reference to this value or to copy the value. It is safe to assume that the value will be copied. Therefore it should be relied on that subsequent modifications of `value` will not be considered in the `record of`;
- `getElementType()` This operation will return the `Type` of the elements of this `record of`;
- `getLength()` Returns the actual length of the `record of value`, zero if the `record of value` is OMIT;
- `setLength(int len)` Set the length of the `record of` to `len`. If `len` is greater than the original length, newly created elements have the value OMIT. If `len` is less or equal than the original length this operation will be ignored.

### 8.2.4.15 UnionValue

**UnionValue** is mapped to the following interface:

```
// TCI IDL UnionValue
package org.etsi.ttcn.tci;
public interface UnionValue {
    Value      getVariant (String variantName);
    void       setVariant (String variantName, Value value);
    String     getPresentVariantName ();
    String[]   getVariantNames ();
}
```

#### Methods:

- `getVariant(String variantName)` Returns the value of the TTCN-3 union `variantName`, if `variantName` equals the result of `getPresentVariantName`, the distinct value `null` otherwise. `variantName` denotes the name of the union variant as defined in TTCN-3;
- `setVariant(String variantName, Value value)` Sets `variantName` of the union to `value`. If `variantName` is not defined for this union this operation will be ignored. If another variant was selected the new variant will be selected instead;
- `getPresentVariantName()` Returns the variant name that has a value in this union set as a `String`. The distinct value `null` will be returned if no variant is selected;
- `getVariantNames()` Returns an array of `String` of variant names, the distinct value `null`, if the union has no fields. If the `UnionValue` represents the TTCN-3 anytype, i.e. the type class of the type obtained by `getType()` is ANYTYPE, all predefined and user-defined TTCN-3 types will be returned.

### 8.2.4.16 EnumeratedValue

**EnumeratedValue** is mapped to the following interface:

```
// TCI IDL EnumeratedValue
package org.etsi.ttcn.tci;
public interface EnumeratedValue {
    String  getEnum ();
    void    setEnum (String enumValue);
}
```

**Methods:**

- `getEnum()` Returns the string identifier of this `EnumeratedValue`. This identifier equals the identifier in the TTCN-3 specification;
- `setEnum(String enumValue)` Set the enum to `enumValue`. If `enumValue` is not an allowed value for this enumeration the operation will be ignored.

### 8.2.4.17 VerdictValue

**VerdictValue** is mapped to the following interface:

```
// TCI IDL VerdictValue
package org.etsi.ttcn.tci;
public interface VerdictValue {
    public static final int NONE      = 0;
    public static final int PASS      = 1;
    public static final int INCONC    = 2;
    public static final int FAIL      = 3;
    public static final int ERROR     = 4;

    public int      getVerdict() ;
    public void     setVerdict(int verdict) ;
}

```

**Methods:**

- `verdictValue()` Returns the integer value for this `VerdictValue`. The integer is one of the following constants: `ERROR`, `FAIL`, `INCONC`, `NONE`, `PASS`;
- `setVerdict(int verdict)` Sets this `VerdictValue` to `verdict`. Note that a `VerdictValue` can be set to any of the above mentioned verdicts at any time. The `VerdictValue` does not perform any verdict calculations as defined in TTCN-3. For example, it is legal to set the `VerdictValue` first to `ERROR` and then to `PASS`.

### 8.2.4.18 AddressValue

**AddressValue** is mapped to the following interface:

```
// TCI IDL VerdictValue
package org.etsi.ttcn.tci;
public interface AddressValue {
    public int      getAddress() ;
    public void     setAddress(Value value) ;
}

```

**Methods:**

- `getAddress()` Returns the value represented by this `AddressValue`;
- `setAddress(Value value)` Sets this `AddressValue` to the value `value`.

## 8.2.5 Abstract logging types mapping

Additional types are defined to ease the logging of matches between values and templates.

### 8.2.5.1 TciValueTemplate

**TciValueTemplate** is mapped to the following interface:

```
// TCI IDL TciValueTemplate
package org.etsi.ttcn.tci;
public interface TciValueTemplate {
    public boolean isOmit();
    public boolean isAny();
    public boolean isAnyOrOmit();
    public String getTemplateDef();
}

```

**Methods:**

- `isOmit()` Returns `true` if the template is `omit`, `false` otherwise;
- `isAny()` Returns `true` if the template is `any`, `false` otherwise;
- `isAnyOrOmit()` Returns `true` if the template is `anyoromit`, `false` otherwise;
- `getTemplateDef()` This operation returns the template definition.

**8.2.5.2 TciNonValueTemplate**

**TciNonValueTemplate** is mapped to the following interface:

```
// TCI IDL TciNonValueTemplate
package org.etsi.ttcn.tci;
public interface TciNonValueTemplate {
    public boolean isAny();
    public boolean isAll();
    public String getTemplateDef();
}
```

**Methods:**

- `isAny()` Returns `true` if the template is `any`, `false` otherwise;
- `isAll()` Returns `true` if the template is `all`, `false` otherwise;
- `getTemplateDef()` This operation returns the template definition.

**8.2.5.3 TciValueList**

**TciValueList** is mapped to the following interface:

```
// TCI IDL TciValueList
package org.etsi.ttcn.tci;
public interface TciValueList{
    public int size() ;
    public boolean isEmpty() ;
    public TciValue get(int index) ;
}
```

**Methods:**

- `size()` Returns the number of values in this list;
- `isEmpty()` Returns `true` if this list contains no values;
- `get(int index)` Returns the `Value` at the specified position.

**8.2.5.4 TciValueDifference**

**TciValueDifference** is mapped to the following interface:

```
// TCI IDL TciValueDifference
package org.etsi.ttcn.tci;
public interface TciValueDifference {
    public Value getValue();
    public TciValueTemplate getTciValueTemplate();
    public String getDescription()
}
```

**Methods:**

- `getValue()` Returns the value of this `TciValueDifference`;
- `getTciValueTemplate ()` Returns the template of this `TciValueDifference`;
- `getDescription()` Returns the description of the mismatch.

**8.2.5.5 TciValueDifferenceList**

**TciValueDifferenceList** is mapped to the following interface:

```
// TCI IDL TciValueDifferenceList
package org.etsi.ttcn.tci;
public interface TciValueDifferenceList{
    public int                size() ;
    public boolean            isEmpty() ;
    public TciValueDifference  get(int index) ;
}
```

**Methods:**

- `size()` Returns the number of differences in this list;
- `isEmpty()` Returns `true` if this list contains no differences;
- `get(int index)` Returns the `TciValueDifference` at the specified position.

**8.3 Constants**

Within this Java language mapping constants have been specified. All constants are defined `public final static` and are accessible from every object from every package. The constants defined within this clause are not defined with the IDL clause. Instead they result from the specification of the TCI IDL types marked as native.

The following constants can be used to determine the parameter passing mode of TTCN-3 parameters (see also clause 8.3.2.2).

- `org.etsi.ttcn.tci.TciParameterPassingMode.TCI_IN;`
- `org.etsi.ttcn.tci.TciParameterPassingMode.TCI_INOUT;`
- `org.etsi.ttcn.tci.TciParameterPassingMode.TCI_OUT;`

For the distinct parameter value `null`, the encoded parameter value shall be set to Java `null`.

The following constants shall be used for value handling (see also clause 8.3.2.4).

- `org.etsi.ttcn.tci.TciTypeClass.ADDRESS;`
- `org.etsi.ttcn.tci.TciTypeClass.ANYTYPE;`
- `org.etsi.ttcn.tci.TciTypeClass.BITSTRING;`
- `org.etsi.ttcn.tci.TciTypeClass.BOOLEAN;`
- `org.etsi.ttcn.tci.TciTypeClass.CHARSTRING;`
- `org.etsi.ttcn.tci.TciTypeClass.COMPONENT;`
- `org.etsi.ttcn.tci.TciTypeClass.ENUMERATED;`
- `org.etsi.ttcn.tci.TciTypeClass.FLOAT;`
- `org.etsi.ttcn.tci.TciTypeClass.HEXSTRING;`
- `org.etsi.ttcn.tci.TciTypeClass.INTEGER;`
- `org.etsi.ttcn.tci.TciTypeClass.OBJID;`

- `org.etsi.ttcn.tci.TciTypeClass.OCTETSTRING;`
- `org.etsi.ttcn.tci.TciTypeClass.RECORD;`
- `org.etsi.ttcn.tci.TciTypeClass.RECORD_OF;`
- `org.etsi.ttcn.tci.TciTypeClass.SET;`
- `org.etsi.ttcn.tci.TciTypeClass.SET_OF;`
- `org.etsi.ttcn.tci.TciTypeClass.UNION;`
- `org.etsi.ttcn.tci.TciTypeClass.UNIVERSAL_CHARSTRING;`
- `org.etsi.ttcn.tci.TciTypeClass.VERDICT;`

The following constants shall be used for component handling (see also clause 8.3.2.5).

- `org.etsi.ttcn.tci.TciTestComponentKind.TCI_CTRL_COMP;`
- `org.etsi.ttcn.tci.TciTestComponentKind.TCI_MTC_COMP;`
- `org.etsi.ttcn.tci.TciTestComponentKind.TCI_PTC_COMP;`
- `org.etsi.ttcn.tci.TciTestComponentKind.TCI_SYSTEM_COMP;`

## 8.4 Mapping of interfaces

The TCI IDL definition defines four interfaces, the **TCI-TM**, the **TCI-CH**, the **TCI-CD**, and the **TCI-TL** interface. The operations are defined for different directions within this interface, i.e. some operations can only be called by the TTCN-3 Executable (TE), the System Adaptor (SA) or the Platform Adaptor (PA) on the Test Management and Control (TMC) while others can only be called by the TMC on the TE. This is reflected by dividing the TCI IDL interfaces in two sub interfaces, each suffixed by Required or Provided.

**Table 3: Sub interfaces**

Calling/Called	TE	TM	CD	CH	SA	PA	TL
<b>TE</b>	-	TCI-TM Provided	TCI-CD Provided	TCI-CH Provided	See ES 201 873-5 [1]	See ES 201 873-5 [1]	TCI-TL Provided
<b>TM</b>	TCI-TM Required	-	-	-	-	-	TCI-TL Provided
<b>CD</b>	TCI-CD Required	-	-	-	-	-	TCI-TL Provided
<b>CH</b>	TCI-CH Required	-	-	-	-	-	TCI-TL Provided
<b>SA</b>	See Part 5				-	-	TCI-TL Provided
<b>PA</b>	See Part 5				-	-	TCI-TL Provided
<b>TL</b>	-	-	-	-	-	-	-

All methods defined in these interfaces should behave as defined in clause 7.

### 8.4.1 The TCI-TM interface

The **TCI-TM** interface is divided into two sub interfaces, the **TCI-TM Provided** interface, defining calls from the TE to the TM and the **TCI-TM Required** interface, defining calls from the TM to the TE.

### 8.4.1.1 TCI-TM provided

The TCI-TM Provided interface is mapped to the following interface:

```
// TCI-TM
// TE -> TM
package org.etsi.ttcn.tci;
public interface TciTMPProvided {
    public void tciTestCaseStarted (TciTestCaseId testCaseId, TciParameterList parameterList, Float
timer);
    public void tciTestCaseTerminated ( VerdictValue verdict, TciParameterList parameterList);
    public void tciControlTerminated ();
    public Value tciGetModulePar (TciModuleParameterId parameterId);
    public void tciLog (TriComponentId testComponentId, String message);
    public void tciError (String message);
}
```

### 8.4.1.2 TCI-TM required

The TCI-TM Required interface is mapped to the following interface:

```
// TCI-TM
// TM -> TE
package org.etsi.ttcn.tci;
public interface TciTMRequired {
    public void tciRootModule (TciModuleId moduleName) ;
    public TciModuleParameterList tciGetModuleParameters (TciModuleId moduleId);
    public TciTestCaseIdList tciGetTestCases ();
    public TciParameterTypeList tciGetTestCaseParameters (TciTestCaseId testCaseId);
    public TriPortIdList tciGetTestCaseTSI (TciTestCaseId testCaseId);
    public void tciStartTestCase(String testCaseId, TciParameterList parameterList );
    public void tciStopTestCase ();
    public TriComponentId tciStartControl ();
    public void tciStopControl ();
}
```

## 8.4.2 The TCI-CD interface

The **TCI-CD** interface is divided into two sub interfaces, the TCI-CD Provided interface, defining calls from the TE to the CD and the TCI-CD Required interface, defining calls from the CD to the TE.

### 8.4.2.1 TCI-CD provided

The TCI-CD Provided interface is mapped to the following interface:

```
// TCI-CD
// TE -> CD
package org.etsi.ttcn.tci;
public interface TciCDProvided {
    public Value decode (TriMessage message, Type decodingHypothesis );
    public TriMessage encode (Value value);
}
```

### 8.4.2.2 TCI-CD required

The TCI-CD Required interface is mapped to the following interface:

```
// TCI-CD
// CD -> TE
package org.etsi.ttcn.tci;
public interface TciCDRequired {
    public Type getTypeForName (String typeName);
    public Type getInteger ();
    public Type getFloat ();
    public Type getBoolean ();
    public Type getObjid ();
    public Type getCharstring ();
    public Type getUniversalCharstring ();
    public Type getHexstring ();
    public Type getBitstring ();
    public Type getOctetstring ();
}
```



```

    public Type    getVerdict ();
    public void    tciErrorReq (String message);
}

```

### 8.4.3 The TCI-CH interface

The **TCI-CH** interface is divided into two sub interfaces, the TCI-CH Provided interface, defining calls from the TE to the CH and the TCI-CH Required interface, defining calls from the CH to the TE.

#### 8.4.3.1 TCI-CH provided

The TCI-CH Provided interface is mapped to the following interface:

```

// TciCHProvided
// TE -> CH
package org.etsi.ttcn.tci;
public interface TciCHProvided {
    public void tciSendConnected (TriPortId sender, TriComponentId receiver, Value sendMessage) ;
    public void tciSendConnectedBC (TriPortId sender, Value sendMessage) ;
    public void tciSendConnectedMC (TriPortId sender, TriComponentIdList receivers,
                                    Value sendMessage) ;

    public void tciCallConnected(TriPortId sender,
                                TriComponentId receiver,
                                TriSignatureId signature,
                                TciParameterList parameterList) ;
    public void tciCallConnectedBC(TriPortId sender,
                                   TriSignatureId signature,
                                   TciParameterList parameterList) ;
    public void tciCallConnectedMC(TriPortId sender,
                                   TriComponentIdList receivers,
                                   TriSignatureId signature,
                                   TciParameterList parameterList) ;

    public void tciReplyConnected(TriPortId sender,
                                  TriComponentId receiver,
                                  TriSignatureId signature,
                                  TciParameterList parameterList,
                                  Value returnValue) ;
    public void tciReplyConnectedBC(TriPortId sender,
                                    TriSignatureId signature,
                                    TciParameterList parameterList,
                                    Value returnValue) ;
    public void tciReplyConnectedMC(TriPortId sender,
                                    TriComponentIdList receivers,
                                    TriSignatureId signature,
                                    TciParameterList parameterList,
                                    Value returnValue) ;

    public void tciRaiseConnected(TriPortId sender,
                                  TriComponentId receiver,
                                  TriSignatureId signature,
                                  Value except) ;
    public void tciRaiseConnectedBC(TriPortId sender,
                                    TriSignatureId signature,
                                    Value except) ;
    public void tciRaiseConnectedMC(TriPortId sender,
                                    TriComponentIdList receivers,
                                    TriSignatureId signature,
                                    Value except) ;

    public TriComponentId tciCreateTestComponentReq(int kind, Type componentType, String name) ;

    public void tciStartTestComponentReq(TriComponentId comp,
                                          TciBehaviourId behavior,
                                          TciParameterList parameterList) ;

    public void tciStopTestComponentReq(TriComponentId comp) ;

    public void tciConnectReq(TriPortId fromPort, TriPortId toPort) ;

    public void tciDisconnectReq(TriPortId fromPort, TriPortId toPort) ;

    public void tciTestComponentTerminatedReq(TriComponentId comp, VerdictValue verdict) ;
}

```

```

public boolean tciTestComponentRunningReq(TriComponentId comp) ;

public TriComponentId tciGetMTCReq() ;

public void tciMapReq(TriPortId fromPort, TriPortId toPort);

public void tciUnmapReq(TriPortId fromPort, TriPortId toPort);

public void tciExecuteTestCaseReq(TriComponentId testComponentId,
                                   TriPortIdList tsiPortList);

public void tciResetReq() ;

public boolean tciTestComponentDoneReq(TriComponentId testComponentId) ;

public void tciKillTestComponentReq(TriComponentId component)

public boolean tciTestComponentAliveReq (TriComponentId component)

public boolean tciTestComponentKilledReq (TriComponentId component)
}

```

### 8.4.3.2 TCI-CH required

The TCI-CH Required interface is mapped to the following interface:

```

// TciCHRequired
// CH -> TE
package org.etsi.ttcn.tci;
public interface TciCHRequired extends TciCDRequired {
    public void tciEnqueueMsgConnected(TriPortId sender,
                                       TriComponentId receiver,
                                       Value receivedMessage) ;

    public void tciEnqueueCallConnected(TriPortId sender,
                                       TriComponentId receiver,
                                       TriSignatureId signature,
                                       TciParameterList parameterList) ;

    public void tciEnqueueReplyConnected(TriPortId sender,
                                       TriComponentId receiver,
                                       TriSignatureId signature,
                                       TciParameterList parameterList,
                                       Value returnValue) ;

    public void tciEnqueueRaiseConnected(TriPortId sender,
                                       TriComponentId receiver,
                                       TriSignatureId signature,
                                       Value except) ;

    public TriComponentId tciCreateTestComponent(int kind, Type componentType, String name) ;

    public void tciStartTestComponent(TriComponentId comp,
                                       TciBehaviourId behavior,
                                       TciParameterList parameterList) ;

    public void tciStopTestComponent(TriComponentId comp) ;

    public void tciConnect(TriPortId fromPort, TriPortId toPort) ;

    public void tciDisconnect(TriPortId fromPort, TriPortId toPort) ;

    public void tciTestComponentTerminated(TriComponentId comp, VerdictValue verdict);

    public boolean tciTestComponentRunning(TriComponentId comp);

    public boolean tciTestComponentDone(TriComponentId comp);

    public TriComponentId tciGetMTC ();

    public void tciExecuteTestCase (TciTestCaseId TestCaseId, TriPortIdList tsiPortList);

    public void tciReset ();

    public void tciMap (TriPortId fromPort, TriPortId toPort);

    public void tciUnmap (TriPortId fromPort, TriPortId toPort);
}

```

```

public void          tciKillTestComponent(TriComponentId component)
public boolean      tciTestComponentAlive (TriComponentId component)
public boolean      tciTestComponentKilled (TriComponentId component)
}

```

## 8.4.4 The TCI-TL interface

The **TCI-TL** interface contains only the sub interfaces, the TCI-TL Provided interface, defining calls from the TE, TM, CH, CD, SA and PA to the TL.

### 8.4.4.1 TCI-TL provided

The TCI-TL Provided interface is mapped to the following interface:

```

// TCI-TL
// TE,TM,CH,CD,SA,PA -> TL
package org.etsi.ttcn.tci;
public interface TciTLProvided {
    public void tliTcExecute(String am, int ts, String src, int line, TriComponentId c,
        TciTestCaseId tcId, TriParameterList pars, TriTimerDuration dur);
    public void tliTcStart(String am, int ts, String src, int line, TriComponentId c,
        TciTestCaseId tcId, TriParameterList pars, TriTimerDuration dur);
    public void tliTcStop(String am, int ts, String src, int line, TriComponentId c);
    public void tliTcStarted(String am, int ts, String src, int line, TriComponentId c,
        TciTestCaseId tcId, TriParameterList pars, TriTimerDuration dur);
    public void tliTcTerminated(String am, int ts, String src, int line, TriComponentId c,
        TciTestCaseId tcId, TriParameterList pars, VerdictValue outcome);
    public void tliCtrlStart(String am, int ts, String src, int line, TriComponentId c);
    public void tliCtrlStop(String am, int ts, String src, int line, TriComponentId c);
    public void tliCtrlTerminated(String am, int ts, String src, int line, TriComponentId c);
    public void tliMSend_m(String am, int ts, String src, int line, TriComponentId c,
        TriPortId port, Value msgValue, TriAddress address,
        TriStatus encoderFailure, TriMessage msg, TriStatus transmissionFailure);
    public void tliMSend_m_BC(String am, int ts, String src, int line, TriComponentId c,
        TriPortId port, Value msgValue
        TriStatus encoderFailure, TriMessage msg, TriStatus transmissionFailure);
    public void tliMSend_m_MC(String am, int ts, String src, int line, TriComponentId c,
        TriPortId port, Value msgValue, TriAddressList addresses,
        TriStatus encoderFailure, TriMessage msg, TriStatus transmissionFailure);
    public void tliMSend_c(String am, int ts, String src, int line, TriComponentId c,
        TriPortId port, Value msgValue, TriComponentId to, TriStatus transmissionFailure);
    public void tliMSend_c_BC(String am, int ts, String src, int line, TriComponentId c,
        TriPortId port, Value msgValue, TriStatus transmissionFailure);
    public void tliMSend_c_MC(String am, int ts, String src, int line, TriComponentId c,
        TriPortId port, Value msgValue, TriComponentIdList toList,
        TriStatus transmissionFailure);
    public void tliMDetected_m(String am, int ts, String src, int line, TriComponentId c,
        TriPortId port, TriMessage msg, TriAddress address);
    public void tliMDetected_c(String am, int ts, String src, int line, TriComponentId c,
        TriPortId port, Value msgValue, TriComponentId from);
    public void tliMMismatch_m(String am, int ts, String src, int line, TriComponentId c,
        TriPortId port, Value msgValue, TciValueTemplate msgTmpl, TciValueDifferenceList diffs,
        TriAddress address, TciValueTemplate addressTmpl);
    public void tliMMismatch_c(String am, int ts, String src, int line, TriComponentId c,
        TriPortId port, Value msgValue, TciValueTemplate msgTmpl, TciValueDifferenceList diffs,
        TriComponentId from, TciNonValueTemplate fromTmpl);
    public void tliMReceive_m(String am, int ts, String src, int line, TriComponentId c,
        TriPortId port, Value msgValue, TciValueTemplate msgTmpl,
        TriAddress address, TciValueTemplate addressTmpl);
    public void tliMReceive_c(String am, int ts, String src, int line, TriComponentId c,
        TriPortId port, Value msgValue, TciValueTemplate msgTmpl,
        TriComponentId from, TciNonValueTemplate fromTmpl);
    public void tliPrCall_m(String am, int ts, String src, int line, TriComponentId c,
        TriPortId port, TriSignatureId signature, TciParameterList parsValue,
        TriAddress address, TriStatus encoderFailure, TriParameterList pars,
        TriStatus transmissionFailure);
    public void tliPrCall_m_BC(String am, int ts, String src, int line, TriComponentId c,
        TriPortId port, TriSignatureId signature, TciParameterList parsValue,
        TriStatus encoderFailure, TriParameterList pars,
        TriStatus transmissionFailure);
    public void tliPrCall_m_MC(String am, int ts, String src, int line, TriComponentId c,
        TriPortId port, TriSignatureId signature, TciParameterList parsValue,

```

```

    TriAddressList addresses, TriStatus encoderFailure, TriParameterList pars,
    TriStatus transmissionFailure);
public void tliPrCall_c(String am, int ts, String src, int line, TriComponentId c,
    TriPortId port, TriSignatureId signature, TciParameterList parsValue, TriComponentId to,
    TriStatus transmissionFailure);
public void tliPrCall_c_BC(String am, int ts, String src, int line, TriComponentId c,
    TriPortId port, TriSignatureId signature, TciParameterList parsValue,
    TriStatus transmissionFailure);
public void tliPrCall_c_MC(String am, int ts, String src, int line, TriComponentId c,
    TriPortId port, TriSignatureId signature, TciParameterList parsValue,
    TriComponentIdList toList, TriStatus transmissionFailure);
public void tliPrGetCallDetected_m(String am, int ts, String src, int line, TriComponentId c,
    TriPortId port, TriSignatureId signature, TriParameterList pars, TriAddress address);
public void tliPrGetCallDetected_c(String am, int ts, String src, int line, TriComponentId c,
    TriPortId port, TriSignatureId signature, TciParameterList parsValue,
    TriComponentId from);
public void tliPrGetCallMismatch_m(String am, int ts, String src, int line, TriComponentId c,
    TriPortId port, TriSignatureId signature,
    TciParameterList parsValue, TciValueTemplate parsTpl, TciValueDifferenceList diffs,
    TriAddress address, TciValueTemplate addressTpl);
public void tliPrGetCallMismatch_c(String am, int ts, String src, int line, TriComponentId c,
    TriPortId port, TriSignatureId signature,
    TciParameterList parsValue, TciValueTemplate parsTpl, TciValueDifferenceList diffs,
    TriComponentId from, TciNonValueTemplate fromTpl);
public void tliPrGetCall_m(String am, int ts, String src, int line, TriComponentId c,
    TriPortId port, TriSignatureId signature,
    TciParameterList parsValue, TciValueTemplate parsTpl,
    TriAddress address, TciValueTemplate addressTpl);
public void tliPrGetCall_c(String am, int ts, String src, int line, TriComponentId c,
    TriPortId port, TriSignatureId signature,
    TciParameterList parsValue, TciValueTemplate parsTpl,
    TriComponentId from, TciNonValueTemplate fromTpl);
public void tliPrReply_m(String am, int ts, String src, int line, TriComponentId c,
    TriPortId port, TriSignatureId signature, TciParameterList parsValue, Value replValue,
    TriAddress address, TriStatus encoderFailure,
    TriParameter repl, TriStatus transmissionFailure);
public void tliPrReply_m_BC(String am, int ts, String src, int line, TriComponentId c,
    TriPortId port, TriSignatureId signature, TciParameterList parsValue, Value replValue,
    TriStatus encoderFailure,
    TriParameter repl, TriStatus transmissionFailure);
public void tliPrReply_m_MC(String am, int ts, String src, int line, TriComponentId c,
    TriPortId port, TriSignatureId signature, TciParameterList parsValue, Value replValue,
    TriAddressList addresses, TriStatus encoderFailure,
    TriParameter repl, TriStatus transmissionFailure);
public void tliPrReply_c(String am, int ts, String src, int line, TriComponentId c,
    TriPortId port, TriSignatureId signature, TciParameterList parsValue, Value replValue,
    TriComponentId to, TriStatus transmissionFailure);
public void tliPrReply_c_BC(String am, int ts, String src, int line, TriComponentId c,
    TriPortId port, TriSignatureId signature, TciParameterList parsValue, Value replValue,
    TriStatus transmissionFailure);
public void tliPrReply_c_MC(String am, int ts, String src, int line, TriComponentId c,
    TriPortId port, TriSignatureId signature, TciParameterList parsValue, Value replValue,
    TriComponentIdList toList, TriStatus transmissionFailure);
public void tliPrGetReplyDetected_m(String am, int ts, String src, int line, TriComponentId c,
    TriPortId port, TriSignatureId signature, TriParameter repl, TriAddress address);
public void tliPrGetReplyDetected_c(String am, int ts, String src, int line, TriComponentId c,
    TriPortId port, TriSignatureId signature, Value replValue, TriComponentId from);
public void tliPrGetReplyMismatch_m(String am, int ts, String src, int line, TriComponentId c,
    TriPortId port, TriSignatureId signature, TciParameterList parsValue,
    Value replValue, TciValueTemplate replyTpl, TciValueDifferenceList diffs,
    TriAddress address, TciValueTemplate addressTpl);
public void tliPrGetReplyMismatch_c(String am, int ts, String src, int line, TriComponentId c,
    TriPortId port, TriSignatureId signature, TciParameterList parsValue,
    Value replValue, TciValueTemplate replyTpl, TciValueDifferenceList diffs,
    TriComponentId from, TciNonValueTemplate fromTpl);
public void tliPrGetReply_m(String am, int ts, String src, int line, TriComponentId c,
    TriPortId port, TriSignatureId signature, TciParameterList parsValue,
    Value replValue, TciValueTemplate replyTpl,
    TriAddress address, TciValueTemplate addressTpl);
public void tliPrGetReply_c(String am, int ts, String src, int line, TriComponentId c,
    TriPortId port, TriSignatureId signature, TciParameterList parsValue,
    Value replValue, TciValueTemplate replyTpl,
    TriComponentId from, TciNonValueTemplate fromTpl);
public void tliPrRaise_m(String am, int ts, String src, int line, TriComponentId c,
    TriPortId port, TriSignatureId signature, TciParameterList parsValue, Value excValue,
    TriAddress address, TriStatus encoderFailure, TriException exc,
    TriStatus transmissionFailure);
public void tliPrRaise_m_BC(String am, int ts, String src, int line, TriComponentId c,

```

```

    TriPortId port, TriSignatureId signature, TciParameterList parsValue, Value excValue,
    TriStatus encoderFailure, TriException exc, TriStatus transmissionFailure);
public void tliPrRaise_m_MC(String am, int ts, String src, int line, TriComponentId c,
    TriPortId port, TriSignatureId signature, TciParameterList parsValue, Value excValue,
    TriAddressList addresses, TriStatus encoderFailure, TriException exc,
    TriStatus transmissionFailure);
public void tliPrRaise_c(String am, int ts, String src, int line, TriComponentId c,
    TriPortId port, TriSignatureId signature, TciParameterList parsValue, Value excValue,
    TriComponentId to, TriStatus transmissionFailure);
public void tliPrRaise_c_BC(String am, int ts, String src, int line, TriComponentId c,
    TriPortId port, TriSignatureId signature, TciParameterList parsValue, Value excValue,
    TriStatus transmissionFailure);
public void tliPrRaise_c_MC(String am, int ts, String src, int line, TriComponentId c,
    TriPortId port, TriSignatureId signature, TciParameterList parsValue, Value excValue,
    TriComponentIdList toList, TriStatus transmissionFailure);
public void tliPrCatchDetected_m(String am, int ts, String src, int line, TriComponentId c,
    TriPortId port, TriSignatureId signature, TriException exc, TriAddress address);
public void tliPrCatchDetected_c(String am, int ts, String src, int line, TriComponentId c,
    TriPortId port, TriSignatureId signature, Value excValue, TriComponentId from);
public void tliPrCatchMismatch_m(String am, int ts, String src, int line, TriComponentId c,
    TriPortId port, TriSignatureId signature, TciParameterList parsValue,
    Value excValue, TciValueTemplate excTmpl, TciValueDifferenceList diffs,
    TriAddress address, TciValueTemplate addressTmpl);
public void tliPrCatchMismatch_c(String am, int ts, String src, int line, TriComponentId c,
    TriPortId port, TriSignatureId signature, TciParameterList parsValue,
    Value excValue, TciValueTemplate excTmpl, TciValueDifferenceList diffs,
    TriComponentId from, TciNonValueTemplate fromTmpl);
public void tliPrCatch_m(String am, int ts, String src, int line, TriComponentId c,
    TriPortId port, TriSignatureId signature, TciParameterList parsValue,
    Value excValue, TciValueTemplate excTmpl,
    TriAddress address, TciValueTemplate addressTmpl);
public void tliPrCatch_c(String am, int ts, String src, int line, TriComponentId c,
    TriPortId port, TriSignatureId signature, TciParameterList parsValue,
    Value excValue, TciValueTemplate excTmpl,
    TriComponentId from, TciNonValueTemplate fromTmpl);
public void tliPrCatchTimeoutDetected(String am, int ts, String src, int line, TriComponentId c,
    TriPortId port, TriSignatureId signature);
public void tliPrCatchTimeout(String am, int ts, String src, int line, TriComponentId c,
    TriPortId port, TriSignatureId signature, TciParameterList parsValue);
public void tliCCreate(String am, int ts, String src, int line, TriComponentId c,
    TriComponentId comp, String name);
public void tliCStart(String am, int ts, String src, int line, TriComponentId c,
    TriComponentId comp, TciBehaviourId name, TciParameterList parsValue);
public void tliCRunning(String am, int ts, String src, int line, TriComponentId c,
    TriComponentId comp, TBoolean status);
public void tliCAlive(String am, int ts, String src, int line, TriComponentId c,
    TriComponentId comp, TBoolean status);
public void tliCStop(String am, int ts, String src, int line, TriComponentId c,
    TriComponentId comp);
public void tliCKill(String am, int ts, String src, int line, TriComponentId c,
    TriComponentId comp);
public void tliCDoneMismatch(String am, int ts, String src, int line, TriComponentId c,
    TciNonValueTemplate compTmpl);
public void tliCDone(String am, int ts, String src, int line, TriComponentId c,
    TciNonValueTemplate compTmpl);
public void tliCKilledMismatch(String am, int ts, String src, int line, TriComponentId c,
    TciNonValueTemplate compTmpl);
public void tliCKilled(String am, int ts, String src, int line, TriComponentId c,
    TciNonValueTemplate compTmpl);
public void tliCTerminated(String am, int ts, String src, int line, TriComponentId c,
    VerdictValue verdict);
public void tliPConnect(String am, int ts, String src, int line, TriComponentId c,
    TriComponentId c1, TriPortId port1, TriComponentId c2, TriPortId port2);
public void tliPDisconnect(String am, int ts, String src, int line, TriComponentId c,
    TriComponentId c1, TriPortId port1, TriComponentId c2, TriPortId port2);
public void tliPMap(String am, int ts, String src, int line, TriComponentId c,
    TriComponentId c1, TriPortId port1, TriComponentId c2, TriPortId port2);
public void tliPUnmap(String am, int ts, String src, int line, TriComponentId c,
    TriComponentId c1, TriPortId port1, TriComponentId c2, TriPortId port2);
public void tliPClear(String am, int ts, String src, int line, TriComponentId c,
    TriPortId port);
public void tliPStart(String am, int ts, String src, int line, TriComponentId c,
    TriPortId port);
public void tliPStop(String am, int ts, String src, int line, TriComponentId c,
    TriPortId port);
public void tliPHalt(String am, int ts, String src, int line, TriComponentId c,
    TriPortId port);
public void tliEncode(String am, int ts, String src, int line, TriComponentId c,

```

```

    Value val, TriStatus encoderFailure, TriMessage msg, String codec);
public void tliDecode(String am, int ts, String src, int line, TriComponentId c,
    TriMessage msg, TriStatus decoderFailure, Value val, String codec);
public void tliTimeoutDetected(String am, int ts, String src, int line, TriComponentId c,
    TriTimerId timer);
public void tliTimeoutMismatch(String am, int ts, String src, int line, TriComponentId c,
    TciNonValueTemplate timerTmpl);
public void tliTimeout(String am, int ts, String src, int line, TriComponentId c,
    TciNonValueTemplate timerTmpl);
public void tliStart(String am, int ts, String src, int line, TriComponentId c,
    TriTimerId timer, TriTimerDuration dur);
public void tliStop(String am, int ts, String src, int line, TriComponentId c,
    TriTimerId timer);
public void tliRead(String am, int ts, String src, int line, TriComponentId c,
    TriTimerId timer, TriTimerDuration elapsed);
public void tliRunning(String am, int ts, String src, int line, TriComponentId c,
    TriTimerId timer, TBoolean status);
public void tliEnter(String am, int ts, String src, int line, TriComponentId c,
    String name, TciParameterList parsValue, String kind);
public void tliLeave(String am, int ts, String src, int line, TriComponentId c,
    String name, Value returnValue, String kind);
public void tliVar(String am, int ts, String src, int line, TriComponentId c,
    String name, Value varValue);
public void tliModulePar(String am, int ts, String src, int line, TriComponentId c,
    String name, Value parValue);
public void tliGetVerdict(String am, int ts, String src, int line, TriComponentId c,
    VerdictValue verdict);
public void tliSetVerdict(String am, int ts, String src, int line, TriComponentId c,
    VerdictValue verdict);
public void tliLog(String am, int ts, String src, int line, TriComponentId c,
    TciValueList log);
public void tliAEnter(String am, int ts, String src, int line, TriComponentId c);
public void tliALeave(String am, int ts, String src, int line, TriComponentId c);
public void tliADefaults(String am, int ts, String src, int line, TriComponentId c);
public void tliAActivate(String am, int ts, String src, int line, TriComponentId c,
    String name, TciParameterList pars, Value ref);
public void tliADeactivate(String am, int ts, String src, int line, TriComponentId c,
    Value ref);
public void tliANomatch(String am, int ts, String src, int line, TriComponentId c);
public void tliARepeat(String am, int ts, String src, int line, TriComponentId c);
public void tliAwait(String am, int ts, String src, int line, TriComponentId c);
}

```

## 8.5 Optional parameters

Clause 7.4 defines that a reserved value shall be used to indicate the absence of an optional parameter. For the Java language mapping the Java null value shall be used to indicate the absence of an optional value. For example, if in the `tciReplyConnected` operation the value parameter shall be omitted the operation invocation shall be `tciReplyConnected (sender, receiver, signature, parameterList, null)`.

## 8.6 TCI initialization

All methods are non-static, i.e. operations can only be called on objects. As the present document does not define concrete implementation strategies of TE, TM, CD and CH the mechanism how the TE, the TM, the CD or the CH get to know the handles on the respective objects is out of scope of the present document.

Tool vendors shall provide methods to the developers of TM, CD and CH to register the TE, TM, CD and CH to their respective communication partner.

## 8.7 Error handling

All operations called from the TM, CH or CD that return have succeeded. If an erroneous situation has been identified by the TE a test case error will be communicated to the user using the procedures as defined in clause 7.3.1.2.6 (`tciError`). If an operation called by the TE in the TM, CH, CD, or TL produces an error, this erroneous situation should be communicated to the TE using the procedures as defined in clause 7.3.2.1.14 (`tciErrorReq`).

Beside this error handling no additional error handling is defined with this Java language mapping. In particular, no exception handling mechanisms are defined.

## 9 ANSI C language mapping

### 9.1 Introduction

This clause defines the TRI ANSI-C language mapping for the TCI data specified in clause 7.2 and for the TCI operations specified in clause 7.3.

### 9.2 Value interfaces

TCI IDL Interface	ANSI C representation	Notes and comments
<b>Type</b>		
TciModuleIdType getDefiningModule()	TciModuleIdType tciGetDefiningModule(TciType inst)	
TString getName()	String tciGetName(TciType inst)	String type reused from IDL (OMG recommendation)
TciTypeClassType getTypeClass()	TciTypeClassType tciGetTypeClass (TciType inst)	
Value newInstance()	TciValue tciNewInstance(TciType inst)	
TString getTypeEncoding()	String tciGetTypeEncoding(TciType inst)	
TStringSeq getTypeExtension()	String* getTypeExtension(TciType inst)	
TString getTypeEncodingVariant()	String tciGetTypeEncodingVariant(TciType inst)	
<b>Value</b>		
TString getValueEncoding()	String tciGetValueEncoding(TciValue inst)	
TString getValueEncodingVariant()	String tciGetValueEncodingVariant(TciValue inst)	
Type getType()	TciType tciGetType(TciValue inst)	
TBoolean notPresent()	Boolean tciNotPresent(TciValue inst)	Boolean type reused from IDL (OMG recommendation)
<b>IntegerValue</b>		
TInteger getInt()	String tciGetIntAbs(TciValue inst)	Returns the (10-base) integer absolute value as an ASCII string.
	unsigned long int tciGetIntNumberOfDigits (TciValue inst)	Returns the number of digits in an integer value.
	Boolean tciGetIntSign(TciValue inst)	Returns true if the number is positive, false otherwise
	char tciGetIntDigit (TciValue inst, unsigned long int position)	Returns the value of the digit at position 'position', where position 0 is the least significant digit.
void setInt(in TInteger value)	void tciSetIntAbs(TciValue inst, String value)	Sets the (10-base) absolute value of the integer via an ASCII string. The first digit must not be 0 unless the value is 0.
	void tciSetIntNumberOfDigits (TciValue inst, unsigned long int dig_num)	Sets the number of digits in an integer value.
	void tciSetIntSign (TciValue inst, Boolean sign)	Sets the sign to + (true) or - (false).

TCI IDL Interface	ANSI C representation	Notes and comments
	void tciSetIntDigit (TciValue inst, unsigned long int position, char digit)	Sets the value of the digit at position 'position', where position 0 is the least significant digit.
<b>FloatValue</b>		
TFloat getFloat()	double tciGetFloatValue(TciValue inst)	
void setFloat(in TFloat value)	void tciSetFloatValue(TciValue inst, double value)	
<b>BooleanValue</b>		
TBoolean getBoolean()	Boolean tciGetBooleanValue(TciValue inst)	
void setBoolean (in TBoolean value)	void tciSetBooleanValue (TciValue inst, Boolean value)	
<b>ObjidValue</b>		
TObjid getObjid()	TciObjidValue tciGetTciObjidValue(TciValue inst)	
void setObjid(in TObjid value)	void tciSetObjidValue(TciValue inst, TciObjidValue value)	
<b>CharstringValue</b>		
TString getString()	TciCharStringValue tciGetCStringValue(TciValue inst)	
void setString(in TString value)	void tciSetCStringValue (TciValue inst, TciCharStringValue value)	
TChar getChar (in TInteger position)	char tciGetCStringCharValue (TciValue inst, long int position)	
void setChar (in TInteger position, in char value)	void tciSetCStringCharValue (TciValue inst, long int position, char value)	
TInteger getLength()	unsigned long int tciGetCStringLength (TciValue inst)	
void setLength(in TInteger len)	void tciSetCStringLength (TciValue inst, unsigned long int len)	
<b>UniversalCharstringValue</b>		
TString getString()	TciUCStringValue tciGetUCStringValue(TciValue inst)	
void setString(in TString value)	void tciSetUCStringValue (TciValue inst, TciUCStringValue value)	
TUniversalChar getChar (in TInteger position)	void tciGetUCStringCharValue (TciValue inst, unsigned long int position, TciUCValue result)	
void setChar (in TInteger position, in TUniversalChar value)	void tciSetUCStringCharValue (TciValue inst, unsigned long int position, TciUCValue value)	
TInteger getLength()	unsigned long int tciGetUCStringLength(TciValue inst)	
void setLength(in TInteger len)	void tciSetUCStringLength (TciValue inst, unsigned long int len)	
<b>BitstringValue</b>		
TString getString()	String tciGetBStringValue(TciValue inst)	
void setString(in TString value)	void tciSetBStringValue (TciValue inst, String value)	
TChar getBit (in integer position)	int tciGetBStringBitValue (TciValue inst, long int position)	
void setBit (in TInteger position, in TInteger value)	void tciSetBStringBitValue (TciValue inst, unsigned long int position, int value)	
TInteger getLength()	unsigned long int tciGetBStringLength(TciValue inst)	
void setLength(in TInteger len)	void tciSetBStringLength (TciValue inst, long int len)	
<b>HexstringValue</b>		
TString getString()	String tciGetHStringValue(TciValue inst)	
void setString(in TString value)	void tciSetHStringValue (TciValue inst, String value)	



TCI IDL Interface	ANSI C representation	Notes and comments
TChar getHex (in TInteger position)	int tciGetHStringHexValue (TciValue inst, unsigned long int position)	
void setBit (in TInteger position, in TInteger value)	void tciSetHStringHexValue (TciValue inst, unsigned long int position, int value)	
TInteger getLength()	long int tciGetHStringLength(TciValue inst)	
void setLength(in TInteger len)	void tciSetHStringLength (TciValue inst, unsigned long int len)	
<b>OctetstringValue</b>		
TString getString()	String tciGetOStringValue(TciValue inst)	
void setString(in TString value)	void tciSetOStringValue (TciValue inst, String value)	
TChar getOctet(in TInteger position)	int tciGetOStringOctetValue (TciValue inst, unsigned long int position)	
void setOctet (in TInteger position, in TInteger value)	void tciSetOStringOctetValue (TciValue inst, unsigned long int position, int value)	
TInteger getLength()	unsigned long int tciGetOStringLength(TciValue inst)	
void setLength(in TInteger len)	void tciSetOStringLength (TciValue inst, unsigned long int len)	
<b>RecordValue</b>		
Value getField(in TString fieldName)	TciValue tciGetRecFieldValue (TciValue inst, String fieldName)	
void setField (in TString fieldName, in Value value)	void tciSetRecFieldValue (TciValue inst, String fieldName, TciValue value)	
TString[] getFieldNames()	char** tciGetRecFieldNames(TciValue inst)	Returns a NULL-terminated array of the field names.
<b>RecordOfValue</b>		
Value getField(in TInteger position)	TciValue tciGetRecOfFieldValue (TciValue inst, unsigned long int position)	
void setField (in TInteger position, in Value value)	void tciSetRecOfFieldValue (TciValue inst, unsigned long int position, TciValue value)	
void appendField(in Value value)	void tciAppendRecOfFieldValue (TciValue inst, TciValue value)	
Type getElementType()	TciType tciGetRecOfElementType(TciValue inst)	
TInteger getLength()	unsigned long int tciGetRecOfLength(TciValue inst)	
void setLength(in TInteger len)	void tciSetRecOfLength (TciValue inst, unsigned long int len)	
<b>UnionValue</b>		
Value getVariant (in TString variantName)	TciValue tciGetUnionVariant (TciValue inst, String variantName)	
void setVariant (in TString variantName, in Value value)	void tciSetUnionVariant (TciValue inst, String variantName, TciValue value)	
TString getPresentVariantName()	String tciGetUnionPresentVariantName (TciValue inst)	
TString[] getVariantNames()	char** tciGetUnionVariantNames(TciValue inst)	Returns a NULL-terminated array of the field names.
<b>EnumeratedValue</b>		
TString getEnum()	String tciGetEnumValue(TciValue inst)	
void setEnum(in TString enumValue)	void tciSetEnumValue (TciValue inst, String enumValue)	
<b>VerdictValue</b>		

TCI IDL Interface	ANSI C representation	Notes and comments
TInteger getVerdict()	int tciGetVerdictValue(TciValue inst)	
void setVerdict(in TInteger verdict)	void tciSetVerdictValue(TciValue inst, int verdict)	
<b>AddressValue</b>		
Value getAddress()	TciValue tciGetAddressValue(TciValue inst)	
void setAddress(in Value value)	void tciSetAddressValue(TciValue inst, TciValue value)	

### 9.3 Logging interface

TCI IDL Interface	ANSI C representation	Notes and comments
<b>TciValueTemplate</b>		
TBoolean isOmit()	Boolean tciIsOmit(TciValueTemplate inst)	Boolean type reused from IDL (OMG recommendation)
TBoolean isAny()	Boolean tciIsAny(TciValueTemplate inst)	Boolean type reused from IDL (OMG recommendation)
TBoolean isAnyOrOmit()	Boolean tciIsAnyOrOmit(TciValueTemplate inst)	Boolean type reused from IDL (OMG recommendation)
TString getTemplateDef()	String tciGetTemplateDef(TciValueTemplate inst)	String type reused from IDL (OMG recommendation)
<b>TciNonValueTemplate</b>		
TBoolean isAny()	Boolean tciIsAny(TciNonValueTemplate inst)	Boolean type reused from IDL (OMG recommendation)
TBoolean isAll()	Boolean tciIsAll(TciNonValueTemplate inst)	Boolean type reused from IDL (OMG recommendation)
TString getTemplateDef()	String tciGetTemplateDef(TciNonValueTemplate inst)	String type reused from IDL (OMG recommendation)

### 9.4 Operation interfaces

<b>TCI-TM required</b>		
void tciRootModule (in TciModuleIdType moduleId)	void tciRootModule(String moduleId)	
TciModuleParameterListType tciGetModuleParameters (in TciModuleIdType moduleName)	TciModuleParameterListType tciGetModuleParameters (TciModuleIdType moduleName)	
TciTestCaseIdListType tciGetTestCases()	TciTestCaseIdListType tciGetTestCases()	
TciParameterTypeListType tciGetTestCaseParameters (in TciTestCaseIdType testCaseId)	TciParameterTypeListType tciGetTestCaseParameters (TciTestCaseIdType testCaseId)	
TriPortIdListType tciGetTestCaseTSI (in TciTestCaseIdType testCaseId)	TriPortIdList tciGetTestCaseTSI (TciTestCaseIdType testCaseId)	
void tciStartTestCase (in TciTestCaseIdType testCaseId, in TciParameterListType parameterlist)	void tciStartTestCase (TciTestCaseIdType testCaseId, TciParameterListType parameterlist)	
void tciStopTestCase()	void tciStopTestCase()	
TriComponentId tciStartControl()	TriComponentId tciStartControl()	
void tciStopControl()	void tciStopControl()	

<b>TCI-TM provided</b>		
void tciTestCaseStarted (in TciTestCaseIdType testCaseId, in TciParameterListType parameterList, in Tfloat timer)	void tciTestCaseStarted (TciTestCaseIdType testCaseId, TciParameterListType parameterList, double timer)	
void tciTestCaseTerminated (in VerdictValue verdict, in TciParameterListType parameterlist)	void tciTestCaseTerminated (TciVerdictValue verdict, TciParameterListType parameterlist)	
void tciControlTerminated()	void tciControlTerminated()	
Value tciGetModulePar (in TciModuleParameterIdType parameterId)	tciValue tciGetModulePar (TciModuleParameterIdType parameterId)	
void tciLog(in TString message)	void tciLog(String message)	
void tciError(in TString message)	void tciError(String message)	
<b>TCI-CD required</b>		
Type getTypeForName (in String typeName)	TciType tciGetTypeForName (String typeName)	
Type getInteger()	TciType tciGetIntegerType()	
Type getFloat()	TciType tciGetFloatType()	
Type getBoolean()	TciType tciGetBooleanType()	
Type getChar()	TciType tciGetCharType()	
Type getUniversalChar()	TciType tciGetUniversalCharType()	
Type getObjid()	TciType tciGetTciObjidType()	
Type getCharstring()	TciType tciGetTciCharstringType()	
Type getUniversalCharstring()	TciType tciGetUniversalCharstringType()	
Type getHexstring()	TciType tciGetHexstringType()	
Type getBitstring()	TciType tciGetBitstringType()	
Type getOctetstring()	TciType tciGetOctetstringType()	
Type getVerdict()	TciType tciGetVerdictType()	
void tciErrorReq(in String message)	void tciErrorReq(String message)	
<b>TCI-CD provided</b>		
Value decode (in TriMessageType message, in Type decodingHypothesis)	TciValue tciDecode (BinaryString message, TciType decHypothesis)	BinaryString type reused from TRI
TriMessageType encode (in Value value)	BinaryString tciEncode(TciValue value)	
<b>TCI-CH required</b>		
void tciEnqueueMsgConnected (in TriPortIdType sender, in TriComponentIdType receiver, in Value rcvdMessage)	void tciEnqueueMsgConnected (TriPortId sender, TriComponentId receiver, TciValue rcvdMessage)	
void tciEnqueueCallConnected (in TriPortIdType sender, in TriComponentIdType receiver, in TriSignatureIdType signature, in TciParameterListType parameterList)	void tciEnqueueCallConnected (TriPortId sender, TriComponentId receiver, TriSignatureId signature, TciParameterListType parameterList)	
void tciEnqueueReplyConnected (in TriPortIdType sender, in TriComponentIdType receiver, in TriSignatureIdType signature, in TciParameterListType parameterList, in Value returnValue)	void tciEnqueueReplyConnected (TriPortId sender, TriComponentId receiver, TriSignatureId signature, TciParameterListType parameterList, TciValue returnValue)	
void tciEnqueueRaiseConnected (in TriPortIdType sender, in TriComponentIdType receiver, in TriSignatureIdType signature, in Value exception)	void tciEnqueueRaiseConnected (TriPortId sender, TriComponentId receiver, TriSignatureIdType signature, TciValue exception)	
TriComponentIdType tciCreateTestComponent (in TciTestComponentKindType kind in Type componentType, in TString name)	TriComponentId tciCreateTestComponent (TciTestComponentKindType kind, TciType componentType, String name)	
void tciStartTestComponent (in TriComponentIdType component, in TciBehaviourIdType behavior, in TciParameterListType parameterList)	void tciStartTestComponent (TriComponentId component, TciBehaviourIdType behavior, TciParameterListType parameterList)	
void tciStopTestComponent (in TriComponentIdType component)	void tciStopTestComponent (TriComponentId component)	

void tciConnect (in TriPortIdType fromPort, in TriPortIdType toPort)	void tciConnect (TriPortId fromPort, TriPortId toPort)	
void tciDisconnect (in TriPortIdType fromPort, in TriPortIdType toPort)	void tciDisconnect (TriPortId fromPort, TriPortId toPort)	
void tciMap (in TriPortIdType fromPort, in TriPortIdType toPort)	void tciMap (TriPortId fromPort, TriPortId toPort)	
void tciUnmap (in TriPortIdType fromPort, in TriPortIdType toPort)	void tciUnmap (TriPortId fromPort, TriPortId toPort)	
void tciTestComponentTerminated (in TriComponentIdType component, in VerdictValue verdict)	void tciTestComponentTerminated (TriComponentId component, TciVerdictValue verdict)	
boolean tciTestComponentRunning (in TriComponentIdType component)	Boolean tciTestComponentRunning (TriComponentId component)	
boolean tciTestComponentDone (in TriComponentIdType component)	boolean tciTestComponentDone (TriComponentId component)	
TriComponentIdType tciGetMTC()	TriComponentId tciGetMTC()	
void tciExecuteTestCase (in TciTestCaseIdType testCaseId, in TriPortIdListType tsiPortList)	void tciExecuteTestCase (TciTestCaseIdType testCaseId, TriPortIdList tsiPortList)	
void tciReset()	void tciReset()	
void tciKillTestComponent (in TriComponentIdType component)	void tciKillTestComponent (TriComponentId component)	
TBoolean tciTestComponentAlive (in TriComponentIdType component)	Boolean tciTestComponentAlive (TriComponentId component)	
TBoolean tciTestComponentKilled (in TriComponentIdType component)	Boolean tciTestComponentKilled (TriComponentId component)	
<b>TCI-CH provided</b>		
void tciSendConnected (in TriPortIdType sender, in TriComponentIdType receiver, in Value sendMessage)	void tciSendConnected (TriPortId sender, TriComponentId receiver, TciValue sendMessage)	
void tciSendConnectedBC (in TriPortIdType sender, in Value sendMessage)	void tciSendConnectedBC (TriPortId sender, TciValue sendMessage)	
void tciSendConnectedMC (in TriPortIdType sender, in TriComponentIdListType receivers, in Value sendMessage)	void tciSendConnectedMC (TriPortId sender, TriComponentIdList receivers, TciValue sendMessage)	
void tciCallConnected (in TriPortIdType sender, in TriComponentIdType receiver, in TriSignatureIdType signature, in TciParameterListType parameterList)	void tciCallConnected (TriPortId sender, TriComponentId receiver, TriSignatureId signature, TciParameterListType parameterList)	
void tciCallConnectedBC (in TriPortIdType sender, in TriSignatureIdType signature, in TciParameterListType parameterList)	void tciCallConnectedBC (TriPortId sender, TriSignatureId signature, TciParameterListType parameterList)	
void tciCallConnectedMC (in TriPortIdType sender, in TriComponentIdListType receivers, in TriSignatureIdType signature, in TciParameterListType parameterList)	void tciCallConnectedMC (TriPortId sender, TriComponentIdList receivers, TriSignatureId signature, TciParameterListType parameterList)	
void tciReplyConnected (in TriPortIdType sender, in TriComponentIdType receiver, in TriSignatureIdType signature, in TciParameterListType parameterList, in Value returnValue)	void tciReplyConnected (TriPortId sender, TriComponentId receiver, TriSignatureIdType signature, TciParameterListType parameterList, TciValue returnValue)	
void tciReplyConnectedBC (in TriPortIdType sender, in TriSignatureIdType signature, in TciParameterListType parameterList, in Value returnValue)	void tciReplyConnectedBC (TriPortId sender, TriSignatureIdType signature, TciParameterListType parameterList, TciValue returnValue)	

void tciReplyConnectedMC (in TriPortIdType sender, in TriComponentIdListType receivers, in TriSignatureIdType signature, in TciParameterListType parameterList, in Value returnValue)	void tciReplyConnectedMC (TriPortId sender, TriComponentIdList receivers, TriSignatureIdType signature, TciParameterListType parameterList, TciValue returnValue)	
void tciRaiseConnected (in TriPortIdType sender, in TriComponentIdType receiver, in TriSignatureIdType signature, in Value exception)	void tciRaiseConnected (TriPortId sender, TriComponentId receiver, TriSignatureId signature, TciValue exception)	
void tciRaiseConnectedBC (in TriPortIdType sender, in TriSignatureIdType signature, in Value exception)	void tciRaiseConnectedBC (TriPortId sender, TriSignatureId signature, TciValue exception)	
void tciRaiseConnectedMC (in TriPortIdType sender, in TriComponentIdListType receivers, in TriSignatureIdType signature, in Value exception)	void tciRaiseConnectedMC (TriPortId sender, TriComponentIdList receivers, TriSignatureId signature, TciValue exception)	
TriComponentIdType tciCreateTestComponentReq (in TciTestComponentKindType kind, in Type componentType, in TString name)	TriComponentId tciCreateTestComponentReq (TciTestComponentKindType kind, TciType componentType, String name)	
void tciStartTestComponentReq (in TriComponentIdType component, in TciBehaviourIdType behavior, in TciParameterListType parameterList)	void tciStartTestComponentReq (TriComponentId component, TciBehaviourIdType behavior, TciParameterListType parameterList)	
void tciStopTestComponentReq (in TriComponentIdType component)	void tciStopTestComponentReq (TriComponentId component)	
void tciConnectReq (in TriPortIdType fromPort, in TriPortIdType toPort)	void tciConnectReq (TriPortId fromPort, TriPortId toPort)	
void tciDisconnectReq (in TriPortIdType fromPort, in TriPortIdType toPort)	void tciDisconnectReq (TriPortId fromPort, TriPortId toPort)	
void tciMapReq (in TriPortIdType fromPort, in TriPortIdType toPort)	void tciMapReq (TriPortId fromPort, TriPortId toPort)	
void tciUnmapReq (in TriPortIdType fromPort, in TriPortIdType toPort)	void tciUnmapReq (TriPortId fromPort, TriPortId toPort)	
void tciTestComponentTerminatedReq (in TriComponentIdType component, in VerdictValue verdict)	void tciTestComponentTerminatedReq (TriComponentId component, TciVerdictValue verdict)	
boolean tciTestComponentRunningReq (in TriComponentIdType component)	Boolean tciTestComponentRunningReq (TriComponentId component)	
boolean tciTestComponentDoneReq (in TriComponentIdType component)	Boolean tciTestComponentDoneReq (TriComponentId component)	
TriComponentIdType tciGetMTCReq()	TriComponentId tciGetMTCReq()	
void tciExecuteTestCaseReq (in TciTestCaseIdType testCaseId, in TriPortIdListType tsiPortList)	void tciExecuteTestCaseReq (TciTestCaseIdType testCaseId, TriPortIdList tsiPortList)	
void tciResetReq()	void tciResetReq()	
void tciKillTestComponentReq (in TriComponentIdType component)	void tciKillTestComponentReq (TriComponentId component)	
TBoolean tciTestComponentAliveReq (in TriComponentIdType component)	TBoolean tciTestComponentAliveReq (TriComponentId component)	
TBoolean tciTestComponentKilledReq (in TriComponentIdType component)	TBoolean tciTestComponentKilledReq (TriComponentId component)	

<b>TCI-TL provided</b>	
void tliTcExecute (in TString am, in TInteger ts, in TString src, in TInteger line, in TriComponentIdType c, in TciTestCaseIdType tcId, in TriParameterListType pars, in TriTimerDurationType dur)	void tliTcExecute (String am, int ts, String src, int line, TriComponentId c, TciTestCaseIdType tcId, TriParameterListType pars, TriTimerDurationType dur)
void tliTcStart (in TString am, in TInteger ts, in TString src, in TInteger line, in TriComponentIdType c, in TciTestCaseIdType tcId, in TriParameterListType pars, in TriTimerDurationType dur)	void tliTcStart (String am, int ts, String src, int line, TriComponentId c, TciTestCaseIdType tcId, TriParameterListType pars, TriTimerDurationType dur)
void tliTcStop (in TString am, in TInteger ts, in TString src, in TInteger line, in TriComponentIdType c)	void tliTcStop (String am, int ts, String src, int line, TriComponentId c)
void tliTcStarted (in TString am, in TInteger ts, in TString src, in TInteger line, in TriComponentIdType c, in TciTestCaseIdType tcId, in TriParameterListType pars, in TriTimerDurationType dur)	void tliTcStarted (String am, int ts, String src, int line, TriComponentId c, TciTestCaseIdType tcId, TriParameterListType pars, TriTimerDurationType dur)
void tliTcTerminated (in TString am, in TInteger ts, in TString src, in TInteger line, in TriComponentIdType c, in TciTestCaseIdType tcId, in TriParameterListType pars, in VerdictValue outcome)	void tliTcTerminated (String am, int ts, String src, int line, TriComponentId c, TciTestCaseIdType tcId, TriParameterListType pars, VerdictValue outcome)
void tliCtrlStart (in TString am, in TInteger ts, in TString src, in TInteger line, in TriComponentIdType c)	void tliCtrlStart (String am, int ts, String src, int line, TriComponentId c)
void tliCtrlStop (in TString am, in TInteger ts, in TString src, in TInteger line, in TriComponentIdType c)	void tliCtrlStop (String am, int ts, String src, int line, TriComponentId c)
void tliCtrlTerminated (in TString am, in TInteger ts, in TString src, in TInteger line, in TriComponentIdType c)	void tliCtrlTerminated (String am, int ts, String src, int line, TriComponentId c)
void tliMSend_m (in TString am, in TInteger ts, in TString src, in TInteger line, in TriComponentIdType c, in TriPortIdType port, in Value msgValue, in TriAddressType address, in TriStatusType encoderFailure, in TriMessageType msg, in TriStatusType transmissionFailure)	void tliMSend_m (String am, int ts, String src, int line, TriComponentId c, TriPortId port, Value msgValue, TriAddressType address, TriStatusType encoderFailure, TriMessageType msg, TriStatusType transmissionFailure)
void tliMSend_m_BC (in TString am, in TInteger ts, in TString src, in TInteger line, in TriComponentIdType c, in TriPortIdType port, in Value msgValue, in TriStatusType encoderFailure, in TriMessageType msg, in TriStatusType transmissionFailure)	void tliMSend_m_BC (String am, int ts, String src, int line, TriComponentId c, TriPortId port, Value msgValue, TriStatusType encoderFailure, TriMessageType msg, TriStatusType transmissionFailure)
void tliMSend_m_MC (in TString am, in TInteger ts, in TString src, in TInteger line, in TriComponentIdType c, in TriPortIdType port, in Value msgValue, in TriAddressListType addresses, in TriStatusType encoderFailure, in TriMessageType msg, in TriStatusType transmissionFailure)	void tliMSend_m_MC (String am, int ts, String src, int line, TriComponentId c, TriPortId port, Value msgValue, TriAddressListType addresses, TriStatusType encoderFailure, TriMessageType msg, TriStatusType transmissionFailure)
void tliMSend_c (in TString am, in TInteger ts, in TString src, in TInteger line, in TriComponentIdType c, in TriPortIdType port, in Value msgValue, in TriComponentIdType to, in TriStatusType transmissionFailure)	void tliMSend_c (String am, int ts, String src, int line, TriComponentId c, TriPortId port, Value msgValue, TriComponentId to, TriStatusType transmissionFailure)

void tliMSend_c_BC (in TString am, in TInteger ts, in TString src, in TInteger line, in TriComponentIdType c, in TriPortIdType port, in Value msgValue, in TriStatusType transmissionFailure)	void tliMSend_c_BC (String am, int ts, String src, int line, TriComponentId c, TriPortId port, Value msgValue, TriStatus transmissionFailure)	
void tliMSend_c_MC (in TString am, in TInteger ts, in TString src, in TInteger line, in TriComponentIdType c, in TriPortIdType port, in Value msgValue, in TriComponentIdListType toList, in TriStatusType transmissionFailure)	void tliMSend_c_MC (String am, int ts, String src, int line, TriComponentId c, TriPortId port, Value msgValue, TriComponentIdList toList, TriStatus transmissionFailure)	
void tliMDetected_m (in TString am, in TInteger ts, in TString src, in TInteger line, in TriComponentIdType c, in TriPortIdType port, in TriMessageType msg, in TriAddressType address)	void tliMDetected_m (String am, int ts, String src, int line, TriComponentId c, TriPortId port, TriMessage msg, TriAddress address)	
void tliMDetected_c (in TString am, in TInteger ts, in TString src, in TInteger line, in TriComponentIdType c, in TriPortIdType port, in Value msgValue, in TriComponentIdType from)	void tliMDetected_c (String am, int ts, String src, int line, TriComponentId c, TriPortId port, Value msgValue, TriComponentId from)	
void tliMMismatch_m (in TString am, in TInteger ts, in TString src, in TInteger line, in TriComponentIdType c, in TriPortIdType port, in Value msgValue, in TciValueTemplate msgTpl, in TciValueDifferenceList diffs, in TriAddressType address, in TciValueTemplate addressTpl)	void tliMMismatch_m (String am, int ts, String src, int line, TriComponentId c, TriPortId port, Value msgValue, TciValueTemplate msgTpl, TciValueDifferenceList diffs, TriAddress address, TciValueTemplate addressTpl)	
void tliMMismatch_c (in TString am, in TInteger ts, in TString src, in TInteger line, in TriComponentIdType c, in TriPortIdType port, in Value msgValue, in TciValueTemplate msgTpl, in TciValueDifferenceList diffs, in TriComponentIdType from, in TciNonValueTemplate fromTpl)	void tliMMismatch_c (String am, int ts, String src, int line, TriComponentId c, TriPortId port, Value msgValue, TciValueTemplate msgTpl, TciValueDifferenceList diffs, TriComponentId from, TciNonValueTemplate fromTpl)	
void tliMReceive_m (in TString am, in TInteger ts, in TString src, in TInteger line, in TriComponentIdType c, in TriPortIdType port, in Value msgValue, in TciValueTemplate msgTpl, in TriAddressType address, in TciValueTemplate addressTpl)	void tliMReceive_m(String am, int ts, String src, int line, TriComponentId c, TriPortId port, Value msgValue, TciValueTemplate msgTpl, TriAddress address, TciValueTemplate addressTpl)	
void tliMReceive_c (in TString am, in TInteger ts, in TString src, in TInteger line, in TriComponentIdType c, in TriPortIdType port, in Value msgValue, in TciValueTemplate msgTpl, in TriComponentIdType from, in TciNonValueTemplate fromTpl)	void tliMReceive_c (String am, int ts, String src, int line, TriComponentId c, TriPortId port, Value msgValue, TciValueTemplate msgTpl, TriComponentId from, TciNonValueTemplate fromTpl)	
void tliPrCall_m (in TString am, in TInteger ts, in TString src, in TInteger line, in TriComponentIdType c, in TriPortIdType port, in TriSignatureIdType signature, in TciParameterListType parsValue, in TriAddressType address, in TriStatusType encoderFailure, in TriParameterListType pars, in TriStatusType transmissionFailure)	void tliPrCall_m (String am, int ts, String src, int line, TriComponentId c, TriPortId port, TriSignatureId signature, TciParameterListType parsValue, TriAddress address, TriStatus encoderFailure, TriParameterListType pars, TriStatus transmissionFailure)	

<p>void tliPrCall_m_BC (in TString am, in TInteger ts, in TString src, in TInteger line, in TriComponentIdType c, in TriPortIdType port, in TriSignatureIdType signature, in TciParameterListType parsValue, in TriStatusType encoderFailure, in TriParameterListType pars, in TriStatusType transmissionFailure)</p>	<p>void tliPrCall_m_BC (String am, int ts, String src, int line, TriComponentId c, TriPortId port, TriSignatureId signature, TciParameterListType parsValue, TriStatusType encoderFailure, TriParameterListType pars, TriStatusType transmissionFailure)</p>	
<p>void tliPrCall_m_MC (in TString am, in TInteger ts, in TString src, in TInteger line, in TriComponentIdType c, in TriPortIdType port, in TriSignatureIdType signature, in TciParameterListType parsValue, in TriAddressListType addresses, in TriStatusType encoderFailure, in TriParameterListType pars, in TriStatusType transmissionFailure)</p>	<p>void tliPrCall_m_MC (String am, int ts, String src, int line, TriComponentId c, TriPortId port, TriSignatureId signature, TciParameterListType parsValue, TriAddressListType addresses, TriStatusType encoderFailure, TriParameterListType pars, TriStatusType transmissionFailure)</p>	
<p>void tliPrCall_c (in TString am, in TInteger ts, in TString src, in TInteger line, in TriComponentIdType c, in TriPortIdType port, in TriSignatureIdType signature, in TciParameterListType parsValue, in TriComponentIdType to, in TriStatusType transmissionFailure)</p>	<p>void tliPrCall_c (String am, int ts, String src, int line, TriComponentId c, TriPortId port, TriSignatureId signature, TciParameterListType parsValue, TriComponentId to, TriStatusType transmissionFailure)</p>	
<p>void tliPrCall_c_BC (in TString am, in TInteger ts, in TString src, in TInteger line, in TriComponentIdType c, in TriPortIdType port, in TriSignatureIdType signature, in TciParameterListType parsValue, in TriStatusType transmissionFailure)</p>	<p>void tliPrCall_c_BC (String am, int ts, String src, int line, TriComponentId c, TriPortId port, TriSignatureId signature, TciParameterListType parsValue, TriStatusType transmissionFailure)</p>	
<p>void tliPrCall_c_MC (in TString am, in TInteger ts, in TString src, in TInteger line, in TriComponentIdType c, in TriPortIdType port, in TriSignatureIdType signature, in TciParameterListType parsValue, in TriComponentIdListType toList, in TriStatusType transmissionFailure)</p>	<p>void tliPrCall_c_MC (String am, int ts, String src, int line, TriComponentId c, TriPortId port, TriSignatureId signature, TciParameterListType parsValue, TriComponentIdListType toList, TriStatusType transmissionFailure)</p>	
<p>void tliPrGetCallDetected_m (in TString am, in TInteger ts, in TString src, in TInteger line, in TriComponentIdType c, in TriPortIdType port, in TriSignatureIdType signature, in TriParameterListType pars, in TriAddressType address)</p>	<p>void tliPrGetCallDetected_m (String am, int ts, String src, int line, TriComponentId c, TriPortId port, TriSignatureId signature, TriParameterListType pars, TriAddressType address)</p>	
<p>void tliPrGetCallDetected_c (in TString am, in TInteger ts, in TString src, in TInteger line, in TriComponentIdType c, in TriPortIdType port, in TriSignatureIdType signature, in TciParameterListType parsValue, in TriComponentIdType from)</p>	<p>void tliPrGetCallDetected_c (String am, int ts, String src, int line, TriComponentId c, TriPortId port, TriSignatureId signature, TciParameterListType parsValue, TriComponentIdType from)</p>	
<p>void tliPrGetCallMismatch_m (in TString am, in TInteger ts, in TString src, in TInteger line, in TriComponentIdType c, in TriPortIdType port, in TriSignatureIdType signature, in TciParameterListType parsValue, in TciValueTemplateType parsTpl, in TciValueDifferenceListType diffs, in TriAddressType address, in TciValueTemplateType addressTpl)</p>	<p>void tliPrGetCallMismatch_m (String am, int ts, String src, int line, TriComponentId c, TriPortId port, TriSignatureId signature, TciParameterListType parsValue, TciValueTemplateType parsTpl, TciValueDifferenceListType diffs, TriAddressType address, TciValueTemplateType addressTpl)</p>	



<p>void tliPrGetCallMismatch_c (in TString am, in TInteger ts, in TString src, in TInteger line, in TriComponentIdType c, in TriPortIdType port, in TriSignatureIdType signature, in TciParameterListType parsValue, in TciValueTemplate parsTpl, in TciValueDifferenceList diffs, in TriComponentIdType from, in TciNonValueTemplate fromTpl)</p>	<p>void tliPrGetCallMismatch_c (String am, int ts, String src, int line, TriComponentId c, TriPortId port, TriSignatureId signature, TciParameterListType parsValue, TciValueTemplate parsTpl, TciValueDifferenceList diffs, TriComponentId from, TciNonValueTemplate fromTpl)</p>	
<p>void tliPrGetCall_m (in TString am, in TInteger ts, in TString src, in TInteger line, in TriComponentIdType c, in TriPortIdType port, in TriSignatureIdType signature, in TciParameterListType parsValue, in TciValueTemplate parsTpl, in TriAddressType address, in TciValueTemplate addressTpl)</p>	<p>void tliPrGetCall_m (String am, int ts, String src, int line, TriComponentId c, TriPortId port, TriSignatureId signature, TciParameterListType parsValue, TciValueTemplate parsTpl, TriAddress address, TciValueTemplate addressTpl)</p>	
<p>void tliPrGetCall_c (in TString am, in TInteger ts, in TString src, in TInteger line, in TriComponentIdType c, in TriPortIdType port, in TriSignatureIdType signature, in TciParameterListType parsValue, in TciValueTemplate parsTpl, in TriComponentIdType from, in TciNonValueTemplate fromTpl)</p>	<p>void tliPrGetCall_c (String am, int ts, String src, int line, TriComponentId c, TriPortId port, TriSignatureId signature, TciParameterListType parsValue, TciValueTemplate parsTpl, TriComponentId from, TciNonValueTemplate fromTpl)</p>	
<p>void tliPrReply_m (in TString am, in TInteger ts, in TString src, in TInteger line, in TriComponentIdType c, in TriPortIdType port, in TriSignatureIdType signature, in TciParameterListType parsValue, in Value replValue, in TriAddressType address, in TriStatusType encoderFailure, in TriParameterType repl, in TriStatusType transmissionFailure)</p>	<p>void tliPrReply_m (String am, int ts, String src, int line, TriComponentId c, TriPortId port, TriSignatureIdType signature, TciParameterListType parsValue, Value replValue, TriAddress address, TriStatus encoderFailure, TriParameter repl, TriStatus transmissionFailure)</p>	
<p>void tliPrReply_m_BC (in TString am, in TInteger ts, in TString src, in TInteger line, in TriComponentIdType c, in TriPortIdType port, in TriSignatureIdType signature, in TciParameterListType parsValue, in Value replValue, in TriStatusType encoderFailure, in TriParameterType repl, in TriStatusType transmissionFailure)</p>	<p>void tliPrReply_m_BC (String am, int ts, String src, int line, TriComponentId c, TriPortId port, TriSignatureIdType signature, TciParameterListType parsValue, Value replValue, TriStatus encoderFailure, TriParameter repl, TriStatus transmissionFailure)</p>	
<p>void tliPrReply_m_MC (in TString am, in TInteger ts, in TString src, in TInteger line, in TriComponentIdType c, in TriPortIdType port, in TriSignatureIdType signature, in TciParameterListType parsValue, in Value replValue, in TriAddressListType addresses, in TriStatusType encoderFailure, in TriParameterType repl, in TriStatusType transmissionFailure)</p>	<p>void tliPrReply_m_MC (String am, int ts, String src, int line, TriComponentId c, TriPortId port, TriSignatureIdType signature, TciParameterListType parsValue, Value replValue, TriAddressList addresses, TriStatus encoderFailure, TriParameter repl, TriStatus transmissionFailure)</p>	
<p>void tliPrReply_c (in TString am, in TInteger ts, in TString src, in TInteger line, in TriComponentIdType c, in TriPortIdType port, in TriSignatureIdType signature, in TciParameterListType parsValue, in Value replValue, in TriComponentIdType to, in TriStatusType transmissionFailure)</p>	<p>void tliPrReply_c (String am, int ts, String src, int line, TriComponentId c, TriPortId port, TriSignatureId signature, TciParameterListType parsValue, Value replValue, TriComponentId to, TriStatus transmissionFailure)</p>	

<p>void tliPrReply_c_BC (in TString am, in TInteger ts, in TString src, in TInteger line, in TriComponentIdType c, in TriPortIdType port, in TriSignatureIdType signature, in TciParameterListType parsValue, in Value replValue, in TriStatusType transmissionFailure)</p>	<p>void tliPrReply_c_BC (String am, int ts, String src, int line, TriComponentId c, TriPortId port, TriSignatureId signature, TciParameterListType parsValue, Value replValue, TriStatus transmissionFailure)</p>	
<p>void tliPrReply_c_MC (in TString am, in TInteger ts, in TString src, in TInteger line, in TriComponentIdType c, in TriPortIdType port, in TriSignatureIdType signature, in TciParameterListType parsValue, in Value replValue, in TriComponentIdListType toList, in TriStatusType transmissionFailure)</p>	<p>void tliPrReply_c_MC (String am, int ts, String src, int line, TriComponentId c, TriPortId port, TriSignatureId signature, TciParameterListType parsValue, Value replValue, TriComponentIdList toList, TriStatus transmissionFailure)</p>	
<p>void tliPrGetReplyDetected_m (in TString am, in TInteger ts, in TString src, in TInteger line, in TriComponentIdType c, in TriPortIdType port, in TriSignatureIdType signature, in TriParameterType repl, in TriAddressType address)</p>	<p>void tliPrGetReplyDetected_m (String am, int ts, String src, int line, TriComponentId c, TriPortId port, TriSignatureId signature, TriParameter repl, TriAddress address)</p>	
<p>void tliPrGetReplyDetected_c (in TString am, in TInteger ts, in TString src, in TInteger line, in TriComponentIdType c, in TriPortIdType port, in TriSignatureIdType signature, in Value replValue, in TriComponentIdType from)</p>	<p>void tliPrGetReplyDetected_c (String am, int ts, String src, int line, TriComponentId c, TriPortId port, TriSignatureId signature, Value replValue, TriComponentId from)</p>	
<p>void tliPrGetReplyMismatch_m (in TString am, in TInteger ts, in TString src, in TInteger line, in TriComponentIdType c, in TriPortIdType port, in TriSignatureIdType signature, in TciParameterListType parsValue, in Value replValue, in TciValueTemplate replyTmpl, in TciValueDifferenceList diffs, in TriAddressType address, in TciValueTemplate addressTmpl)</p>	<p>void tliPrGetReplyMismatch_m (String am, int ts, String src, int line, TriComponentId c, TriPortId port, TriSignatureId signature, TciParameterListType parsValue, Value replValue, TciValueTemplate replyTmpl, TciValueDifferenceList diffs, TriAddress address, TciValueTemplate addressTmpl)</p>	
<p>void tliPrGetReplyMismatch_c (in TString am, in TInteger ts, in TString src, in TInteger line, in TriComponentIdType c, in TriPortIdType port, in TriSignatureIdType signature, in TciParameterListType parsValue, in Value replValue, in TciValueTemplate replyTmpl, in TciValueDifferenceList diffs, in TriComponentIdType from, in TciNonValueTemplate fromTmpl)</p>	<p>void tliPrGetReplyMismatch_c (String am, int ts, String src, int line, TriComponentId c, TriPortId port, TriSignatureId signature, TciParameterListType parsValue, Value replValue, TciValueTemplate replyTmpl, TciValueDifferenceList diffs, TriComponentId from, TciNonValueTemplate fromTmpl)</p>	
<p>void tliPrGetReply_m (in TString am, in TInteger ts, in TString src, in TInteger line, in TriComponentIdType c, in TriPortIdType port, in TriSignatureIdType signature, in TciParameterListType parsValue, in Value replValue, in TciValueTemplate replyTmpl, in TriAddressType address, in TciValueTemplate addressTmpl)</p>	<p>void tliPrGetReply_m (String am, int ts, String src, int line, TriComponentId c, TriPortId port, TriSignatureId signature, TciParameterListType parsValue, Value replValue, TciValueTemplate replyTmpl, TriAddress address, TciValueTemplate addressTmpl)</p>	

<p>void tliPrGetReply_c (in TString am, in TInteger ts, in TString src, in TInteger line, in TriComponentIdType c, in TriPortIdType port, in TriSignatureIdType signature, in TciParameterListType parsValue, in Value replValue, in TciValueTemplate replyTmpl, in TriComponentIdType from, in TciNonValueTemplate fromTmpl)</p>	<p>void tliPrGetReply_c (String am, int ts, String src, int line, TriComponentId c, TriPortId port, TriSignatureId signature, TciParameterListType parsValue, Value replValue, TciValueTemplate replyTmpl, TriComponentId from, TciNonValueTemplate fromTmpl)</p>	
<p>void tliPrRaise_m (in TString am, in TInteger ts, in TString src, in TInteger line, in TriComponentIdType c, in TriPortIdType port, in TriSignatureIdType signature, in TciParameterListType parsValue, in Value excValue, in TriAddressType address, in TriStatusType encoderFailure, in TriExceptionType exc, in TriStatusType transmissionFailure)</p>	<p>void tliPrRaise_m (String am, int ts, String src, int line, TriComponentId c, TriPortId port, TriSignatureId signature, TciParameterListType parsValue, Value excValue, TriAddress address, TriStatus encoderFailure, TriException exc, TriStatus transmissionFailure)</p>	
<p>void tliPrRaise_m_BC (in TString am, in TInteger ts, in TString src, in TInteger line, in TriComponentIdType c, in TriPortIdType port, in TriSignatureIdType signature, in TciParameterListType parsValue, in Value excValue, in TriStatusType encoderFailure, in TriExceptionType exc, in TriStatusType transmissionFailure)</p>	<p>void tliPrRaise_m_BC (String am, int ts, String src, int line, TriComponentId c, TriPortId port, TriSignatureId signature, TciParameterListType parsValue, Value excValue, TriStatus encoderFailure, TriException exc, TriStatus transmissionFailure)</p>	
<p>void tliPrRaise_m_MC (in TString am, in TInteger ts, in TString src, in TInteger line, in TriComponentIdType c, in TriPortIdType port, in TriSignatureIdType signature, in TciParameterListType parsValue, in Value excValue, in TriAddressListType addresses, in TriStatusType encoderFailure, in TriExceptionType exc, in TriStatusType transmissionFailure)</p>	<p>void tliPrRaise_m_MC (String am, int ts, String src, int line, TriComponentId c, TriPortId port, TriSignatureId signature, TciParameterListType parsValue, Value excValue, TriAddressList addresses, TriStatus encoderFailure, TriException exc, TriStatus transmissionFailure)</p>	
<p>void tliPrRaise_c (in TString am, in TInteger ts, in TString src, in TInteger line, in TriComponentIdType c, in TriPortIdType port, in TriSignatureIdType signature, in TciParameterListType parsValue, in Value excValue, in TriComponentIdType to, in TriStatusType transmissionFailure)</p>	<p>void tliPrRaise_c (String am, int ts, String src, int line, TriComponentId c, TriPortId port, TriSignatureId signature, TciParameterListType parsValue, Value excValue, TriComponentId to, TriStatus transmissionFailure)</p>	
<p>void tliPrRaise_c_BC (in TString am, in TInteger ts, in TString src, in TInteger line, in TriComponentIdType c, in TriPortIdType port, in TriSignatureIdType signature, in TciParameterListType parsValue, in Value excValue, in TriStatusType transmissionFailure)</p>	<p>void tliPrRaise_c_BC (String am, int ts, String src, int line, TriComponentId c, TriPortId port, TriSignatureId signature, TciParameterListType parsValue, Value excValue, TriStatus transmissionFailure)</p>	
<p>void tliPrRaise_c_MC (in TString am, in TInteger ts, in TString src, in TInteger line, in TriComponentIdType c, in TriPortIdType port, in TriSignatureIdType signature, in TciParameterListType parsValue, in Value excValue, in TriComponentIdListType toList, in TriStatusType transmissionFailure)</p>	<p>void tliPrRaise_c_MC (String am, int ts, String src, int line, TriComponentId c, TriPortId port, TriSignatureId signature, TciParameterListType parsValue, Value excValue, TriComponentIdList toList, TriStatus transmissionFailure)</p>	

void tliPrCatchDetected_m (in TString am, in TInteger ts, in TString src, in TInteger line, in TriComponentIdType c, in TriPortIdType port, in TriSignatureIdType signature, in TriExceptionType exc, in TriAddressType address)	void tliPrCatchDetected_m (String am, int ts, String src, int line, TriComponentId c, TriPortId port, TriSignatureId signature, TriException exc, TriAddress address)	
void tliPrCatchDetected_c (in TString am, in TInteger ts, in TString src, in TInteger line, in TriComponentIdType c, in TriPortIdType port, in TriSignatureIdType signature, in Value excValue, in TriComponentIdType from)	void tliPrCatchDetected_c (String am, int ts, String src, int line, TriComponentId c, TriPortId port, TriSignatureId signature, Value excValue, TriComponentId from)	
void tliPrCatchMismatch_m (in TString am, in TInteger ts, in TString src, in TInteger line, in TriComponentIdType c, in TriPortIdType port, in TriSignatureIdType signature, in TciParameterListType parsValue, in Value excValue, in TciValueTemplate excTmpl, in TciValueDifferenceList diffs, in TriAddressType address, in TciValueTemplate addressTmpl)	void tliPrCatchMismatch_m (String am, int ts, String src, int line, TriComponentId c, TriPortId port, TriSignatureId signature, TciParameterListType parsValue, Value excValue, TciValueTemplate excTmpl, TciValueDifferenceList diffs, TriAddress address, TciValueTemplate addressTmpl)	
void tliPrCatchMismatch_c (in TString am, in TInteger ts, in TString src, in TInteger line, in TriComponentIdType c, in TriPortIdType port, in TriSignatureIdType signature, in TciParameterListType parsValue, in Value excValue, in TciValueTemplate excTmpl, in TciValueDifferenceList diffs, in TriComponentIdType from, in TciNonValueTemplate fromTmpl)	void tliPrCatchMismatch_c (String am, int ts, String src, int line, TriComponentId c, TriPortId port, TriSignatureId signature, TciParameterListType parsValue, Value excValue, TciValueTemplate excTmpl, TciValueDifferenceList diffs, TriComponentId from, TciNonValueTemplate fromTmpl)	
void tliPrCatch_m (in TString am, in TInteger ts, in TString src, in TInteger line, in TriComponentIdType c, in TriPortIdType port, in TriSignatureIdType signature, in TciParameterListType parsValue, in Value excValue, in TciValueTemplate excTmpl, in TriAddressType address, in TciValueTemplate addressTmpl)	void tliPrCatch_m (String am, int ts, String src, int line, TriComponentId c, TriPortId port, TriSignatureId signature, TciParameterListType parsValue, Value excValue, TciValueTemplate excTmpl, TriAddress address, TciValueTemplate addressTmpl)	
void tliPrCatch_c (in TString am, in TInteger ts, in TString src, in TInteger line, in TriComponentIdType c, in TriPortIdType port, in TriSignatureIdType signature, in TciParameterListType parsValue, in Value excValue, in TciValueTemplate excTmpl, in TriComponentIdType from, in TciNonValueTemplate fromTmpl)	void tliPrCatch_c (String am, int ts, String src, int line, TriComponentId c, TriPortId port, TriSignatureId signature, TciParameterListType parsValue, Value excValue, TciValueTemplate excTmpl, TriComponentId from, TciNonValueTemplate fromTmpl)	
void tliPrCatchTimeoutDetected(in TString am, in TInteger ts, in TString src, in TInteger line, in TriComponentIdType c, in TriPortIdType port, in TriSignatureIdType signature)	void tliPrCatchTimeoutDetected (String am, int ts, String src, int line, TriComponentId c, TriPortId port, TriSignatureId signature)	
void tliPrCatchTimeout (in TString am, in TInteger ts, in TString src, in TInteger line, in TriComponentIdType c, in TriPortIdType port, in TriSignatureIdType signature, in TciParameterListType parsValue)	void tliPrCatchTimeout (String am, int ts, String src, int line, TriComponentId c, TriPortId port, TriSignatureId signature, TciParameterListType parsValue)	

void tliCCreate (in TString am, in TInteger ts, in TString src, in TInteger line, in TriComponentIdType c, in TriComponentIdType comp, in TString name)	void tliCCreate (String am, int ts, String src, int line, TriComponentId c, TriComponentId comp, String name)	
void tliCStart (in TString am, in TInteger ts, in TString src, in TInteger line, in TriComponentIdType c, in TriComponentIdType comp, in TciBehaviourIdType name, in TciParameterListType parsValue)	void tliCStart (String am, int ts, String src, int line, TriComponentId c, TriComponentId comp, TciBehaviourIdType name, TciParameterListType parsValue)	
void tliCRunning (in TString am, in TInteger ts, in TString src, in TInteger line, in TriComponentIdType c, in TriComponentIdType comp, in TBoolean status)	void tliCRunning (String am, int ts, String src, int line, TriComponentId c, TriComponentId comp, TBoolean status)	
void tliCStop (in TString am, in TInteger ts, in TString src, in TInteger line, in TriComponentIdType c, in TriComponentIdType comp)	void tliCStop (String am, int ts, String src, int line, TriComponentId c, TriComponentId comp)	
void tliCDoneMismatch (in TString am, in TInteger ts, in TString src, in TInteger line, in TriComponentIdType c, in TciNonValueTemplate compTpl)	void tliCDoneMismatch (String am, int ts, String src, int line, TriComponentId c, TciNonValueTemplate compTpl)	
void tliCDone (in TString am, in TInteger ts, in TString src, in TInteger line, in TriComponentIdType c, in TciNonValueTemplate compTpl)	void tliCDone (String am, int ts, String src, int line, TriComponentId c, TciNonValueTemplate compTpl)	
void tliCTerminated (in TString am, in TInteger ts, in TString src, in TInteger line, in TriComponentIdType c, in VerdictValue verdict)	void tliCTerminated (String am, int ts, String src, int line, TriComponentId c, VerdictValue verdict)	
void tliPConnect (in TString am, in TInteger ts, in TString src, in TInteger line, in TriComponentIdType c, in TriComponentIdType c1, in TriPortIdType port1, in TriComponentIdType c2, in TriPortIdType port2)	void tliPConnect (String am, int ts, String src, int line, TriComponentId c, TriComponentId c1, TriPortId port1, TriComponentId c2, TriPortId port2)	
void tliPDisconnect (in TString am, in TInteger ts, in TString src, in TInteger line, in TriComponentIdType c, in TriComponentIdType c1, in TriPortIdType port1, in TriComponentIdType c2, in TriPortIdType port2)	void tliPDisconnect (String am, int ts, String src, int line, TriComponentId c, TriComponentId c1, TriPortId port1, TriComponentId c2, TriPortId port2)	
void tliPMap (in TString am, in TInteger ts, in TString src, in TInteger line, in TriComponentIdType c, in TriComponentIdType c1, in TriPortIdType port1, in TriComponentIdType c2, in TriPortIdType port2)	void tliPMap (String am, int ts, String src, int line, TriComponentId c, TriComponentId c1, TriPortId port1, TriComponentId c2, TriPortId port2)	
void tliPUnmap (in TString am, in TInteger ts, in TString src, in TInteger line, in TriComponentIdType c, in TriComponentIdType c1, in TriPortIdType port1, in TriComponentIdType c2, in TriPortIdType port2)	void tliPUnmap (String am, int ts, String src, int line, TriComponentId c, TriComponentId c1, TriPortId port1, TriComponentId c2, TriPortId port2)	
void tliPClear (in TString am, in TInteger ts, in TString src, in TInteger line, in TriComponentIdType c, in TriPortIdType port)	void tliPClear (String am, int ts, String src, int line, TriComponentId c, TriPortId port)	
void tliPStart (in TString am, in TInteger ts, in TString src, in TInteger line, in TriComponentIdType c, in TriPortIdType port)	void tliPStart (String am, int ts, String src, int line, TriComponentId c, TriPortId port)	

void tliPStop (in TString am, in TInteger ts, in TString src, in TInteger line, in TriComponentIdType c, in TriPortIdType port)	void tliPStop (String am, int ts, String src, int line, TriComponentId c, TriPortId port)	
void tliPHalt (in TString am, in TInteger ts, in TString src, in TInteger line, in TriComponentIdType c, in TriPortIdType port)	void tliPHalt (String am, int ts, String src, int line, TriComponentId c, TriPortId port)	
void tliEncode (in TString am, in TInteger ts, in TString src, in TInteger line, in TriComponentIdType c, in Value val, in TriStatusType encoderFailure, in TriMessageType msg, in TString codec)	void tliEncode (String am, int ts, String src, int line, TriComponentId c, Value val, TriStatus encoderFailure, TriMessage msg, String codec)	
void tliDecode (in TString am, in TInteger ts, in TString src, in TInteger line, in TriComponentIdType c, in TriMessageType msg, in TriStatusType decoderFailure, in Value val, in TString codec)	void tliDecode (String am, int ts, String src, int line, TriComponentId c, TriMessage msg, TriStatus decoderFailure, Value val, String codec)	
void tliTimeoutDetected (in TString am, in TInteger ts, in TString src, in TInteger line, in TriComponentIdType c, in TriTimerIdType timer)	void tliTimeoutDetected (String am, int ts, String src, int line, TriComponentId c, TriTimerId timer)	
void tliTimeoutMismatch (in TString am, in TInteger ts, in TString src, in TInteger line, in TriComponentIdType c, in TciNonValueTemplate timerTmpl)	void tliTimeoutMismatch (String am, int ts, String src, int line, TriComponentId c, TciNonValueTemplate timerTmpl)	
void tliTimeout (in TString am, in TInteger ts, in TString src, in TInteger line, in TriComponentIdType c, in TciNonValueTemplate timerTmpl)	void tliTimeout (String am, int ts, String src, int line, TriComponentId c, TciNonValueTemplate timerTmpl)	
void tliTStart (in TString am, in TInteger ts, in TString src, in TInteger line, in TriComponentIdType c, in TriTimerIdType timer, in TriTimerDurationType dur)	void tliTStart (String am, int ts, String src, int line, TriComponentId c, TriTimerId timer, TriTimerDuration dur)	
void tliTStop (in TString am, in TInteger ts, in TString src, in TInteger line, in TriComponentIdType c, in TriTimerIdType timer)	void tliTStop (String am, int ts, String src, int line, TriComponentId c, TriTimerId timer)	
void tliTRead (in TString am, in TInteger ts, in TString src, in TInteger line, in TriComponentIdType c, in TriTimerIdType timer, in TriTimerDurationType elapsed)	void tliTRead (String am, int ts, String src, int line, TriComponentId c, TriTimerId timer, TriTimerDuration elapsed)	
void tliTRunning (in TString am, in TInteger ts, in TString src, in TInteger line, in TriComponentIdType c, in TriTimerIdType timer, in TBoolean status)	void tliTRunning (String am, int ts, String src, int line, TriComponentId c, TriTimerId timer, Boolean status)	
void tliSEnter (in TString am, in TInteger ts, in TString src, in TInteger line, in TriComponentIdType c, in TString name, in TciParameterListType parsValue, in TString kind)	void tliSEnter (String am, int ts, String src, int line, TriComponentId c, String name, TciParameterListType parsValue, String kind)	
void tliSLeave (in TString am, in TInteger ts, in TString src, in TInteger line, in TriComponentIdType c, in TString name, in Value returnValue, in TString kind)	void tliSLeave (String am, int ts, String src, int line, TriComponentId c, String name, Value returnValue, String kind)	
void tliVar (in TString am, in TInteger ts, in TString src, in TInteger line, in TriComponentIdType c, in TString name, in Value varValue)	void tliVar (String am, int ts, String src, int line, TriComponentId c, String name, Value varValue)	

void tliModulePar (in TString am, in TInteger ts, in TString src, in TInteger line, in TriComponentIdType c, in TString name, in Value parValue)	void tliModulePar (String am, int ts, String src, int line, TriComponentId c, String name, Value parValue)	
void tliGetVerdict (in TString am, in TInteger ts, in TString src, in TInteger line, in TriComponentIdType c, in VerdictValue verdict)	void tliGetVerdict (String am, int ts, String src, int line, TriComponentId c, VerdictValue verdict)	
void tliSetVerdict (in TString am, in TInteger ts, in TString src, in TInteger line, in TriComponentIdType c, in VerdictValue verdict)	void tliSetVerdict (String am, int ts, String src, int line, TriComponentId c, VerdictValue verdict)	
void tliLog (in TString am, in TInteger ts, in TString src, in TInteger line, in TriComponentIdType c, in TciValueList log)	void tliLog (String am, int ts, String src, int line, TriComponentId c, Value[] log)	
void tliAEnter (in TString am, in TInteger ts, in TString src, in TInteger line, in TriComponentIdType c)	void tliAEnter (String am, int ts, String src, int line, TriComponentId c)	
void tliALeave (in TString am, in TInteger ts, in TString src, in TInteger line, in TriComponentIdType c)	void tliALeave (String am, int ts, String src, int line, TriComponentId c)	
void tliADefaults (in TString am, in TInteger ts, in TString src, in TInteger line, in TriComponentIdType c)	void tliADefaults (String am, int ts, String src, int line, TriComponentId c)	
void tliAActivate (in TString am, in TInteger ts, in TString src, in TInteger line, in TriComponentIdType c, in TString name, in TciParameterListType pars, in Value ref)	void tliAActivate (String am, int ts, String src, int line, TriComponentId c, String name, TciParameterListType pars, Value ref)	
void tliADeactivate (in TString am, in TInteger ts, in TString src, in TInteger line, in TriComponentIdType c, in Value ref)	void tliADeactivate (String am, int ts, String src, int line, TriComponentId c, Value ref)	
void tliANomatch (in TString am, in TInteger ts, in TString src, in TInteger line, in TriComponentIdType c)	void tliANomatch (String am, int ts, String src, int line, TriComponentId c)	
void tliARepeat (in TString am, in TInteger ts, in TString src, in TInteger line, in TriComponentIdType c)	void tliARepeat (String am, int ts, String src, int line, TriComponentId c)	
void tliAwait (in TString am, in TInteger ts, in TString src, in TInteger line, in TriComponentIdType c)	void tliAwait (String am, int ts, String src, int line, TriComponentId c)	

## 9.5 Data

TCI IDL ADT	ANSI C representation (Type definition)	Notes and comments
TciModuleIdType	QualifiedName	
TciModuleParameterType	typedef struct TciModuleParameterType { String parName; TciValue defaultValue; } TciModuleParameterType;	
TciModuleParameterListType	typedef struct TciModuleParameterListType { long int length; TciModuleParameterType *modParList; } TciModuleParameterListType;	
TciParameterType	typedef struct TciParameterType { String parName; TciParameterPassingModeType parPassMode; TciValue parValue; } TciParameterType;	
TciParameterPassingModeType	typedef enum { TCI_IN_PAR = 0, TCI_INOUT_PAR = 1, TCI_OUT_PAR = 2 } TciParameterPassingModeType;	
TciParameterListType	typedef struct TciParameterListType { long int length; TciParameterType *parList; } TciParameterListType;	length 0 shall be interpreted as "empty list".
TciParameterTypeListType	typedef struct TciParameterTypeListType { long int length; TciType *parList; } TciParameterTypeListType;	length 0 shall be interpreted as "empty list".
TciTestCaseIdListType	typedef struct TciTestCaseIdListType { long int length; QualifiedName *idList; } TciTestCaseIdListType;	length 0 shall be interpreted as "empty list".
TciTypeClassType	typedef enum { TCI_ADDRESS_TYPE, TCI_ANYTYPE_TYPE, TCI_BITSTRING_TYPE, TCI_BOOLEAN_TYPE, TCI_CHAR_TYPE, TCI_CHARSTRING_TYPE, TCI_COMPONENT_TYPE, TCI_ENUMERATED_TYPE, TCI_FLOAT_TYPE, TCI_HEXSTRING_TYPE, TCI_INTEGER_TYPE, TCI_OBJID_TYPE, TCI_OCTETSTRING_TYPE, TCI_RECORD_TYPE, TCI_RECORD_OF_TYPE, TCI_SET_TYPE, TCI_SET_OF_TYPE, TCI_UNION_TYPE, TCI_UNIVERSAL_CHAR_TYPE, TCI_UNIVERSAL_CHARSTRING_TYPE, TCI_VERDICT_TYPE } TciTypeClassType;	



TCI IDL ADT	ANSI C representation (Type definition)	Notes and comments
TciTestComponentKindType	<pre>typedef enum {     TCI_CTRL_COMP,     TCI_MTC_COMP,     TCI_PTC_COMP,     TCI_SYS_COMP } TciTestComponentKindType;</pre>	
TciBehaviourIdType	QualifiedName	
TciValueDifference	<pre>typedef struct TciValueDifference {     TciValue val;     TciValueTemplate tmpl;     String desc; } TciValueDifference;</pre>	
TciValueDifferenceList	<pre>typedef struct TciValueDifferenceList {     long int length;     TciValueDifference[] diffList; } TciValueDifferenceList;</pre>	length 0 shall be interpreted as "empty list".

## 9.6 Miscellaneous

TCI concept	ANSI C representation	Notes and comments
<b>Verdict representation</b>		
NONE	const int TCI_VERDICT_NONE = 0	Since the TciVerdictValue interface is defined in terms of integers, consensus must be established on which value defines which verdict.
PASS	const int TCI_VERDICT_PASS = 1	
INCONC	const int TCI_VERDICT_INCONC = 2	
FAIL	const int TCI_VERDICT_FAIL = 3	
ERROR	const int TCI_VERDICT_ERROR = 4	
<b>Objid representation</b>		
Objid	<pre>typedef struct TciObjidValue {     long int length;     TciObjidElem *elements; } TciObjidValue;</pre>	Since the Objid value is returned "as is" via the Objid value interface, a representation must be defined.
TciObjidElem	<pre>typedef struct TciObjidElemValue {     char* elem_as_ascii;     long int elem_as_number;     void* aux; } TciObjidElemValue;</pre>	
<b>CharstringValue representation</b>		
TciCharString	<pre>typedef struct TciCharStringValue {     unsigned long int length;     char* string; } TciCharStringValue</pre>	
<b>Universal Character[string] representation</b>		
Universal Char	typedef unsigned char[4] TciUCValue	
Universal Charstring	<pre>typedef struct TciUCStringValue {     unsigned long int length;     TciUCType *string; } TciUCStringValue;</pre>	

---

## 10 W3C XML mapping

### 10.1 Introduction

This clause introduces the TCI XML mapping [5], [6] and [7] for the logging interface of TCI. The XML mapping for the logging interface defines how the IDL definitions described in clause 7 are mapped to XML. The schema definitions for this mapping are given in annex B.

### 10.2 Scopes

The IDL module **tciInterface** is mapped to an XML schema with the name space `http://uri.etsi.org/ttcn-3/3.0.0/tci/TLI`.

This schema uses further schemas:

- <http://uri.etsi.org/ttcn-3/3.0.0/tci/SimpleTypes> for the mapping of simple types to XML.
- <http://uri.etsi.org/ttcn-3/3.0.0/tci/Types> for the mapping of structured types to XML.
- <http://uri.etsi.org/ttcn-3/3.0.0/tci/Values> for the mapping of values to XML.
- <http://uri.etsi.org/ttcn-3/3.0.0/tci/Templates> for the mapping of templates to XML.
- <http://uri.etsi.org/ttcn-3/3.0.0/tci/Events> for the mapping of logging events to XML.

### 10.3 Type mapping

#### 10.3.1 Mapping of simple types

##### 10.3.1.1 TBoolean

The IDL **TBoolean** type is mapped to the xsd basic type `boolean`.

##### 10.3.1.2 TString

The IDL **TString** type is mapped to the xsd basic type `string`.

##### 10.3.1.3 TInteger

The IDL **TInteger** type is mapped to the xsd basic type `integer`.

##### 10.3.1.4 TriTimerDurationType

The IDL **TriTimerDurationType** type is mapped to the xsd basic type `float`.

##### 10.3.1.5 TciParameterPassingModeType

The IDL **TciParameterPassingModeType** type is mapped to the xsd basic type `string` with enumeration values `'in'`, `'out'` and `'inout'`.

##### 10.3.1.6 TriStatusType

The IDL **TriStatusType** type is mapped to the xsd basic type `string` with enumeration values `'TRI_Ok'` and `'TRI_Error'`.

### 10.3.1.7 TciStatusType

The IDL **TriStatusType** type is mapped to the xsd basic type `string` with enumeration values 'TCI\_Ok' and 'TCI\_Error'.

## 10.3.2 Complex type mapping

### 10.3.2.1 TriPortIdType

**TriPortIdType** is mapped to the following complex type

```
<xsd:complexType name="TriPortIdType">
  <xsd:sequence>
    <xsd:element name="comp" type="Types:TriComponentIdType" minOccurs="1" maxOccurs="1"/>
    <xsd:element name="port" type="Types:Port" minOccurs="1" maxOccurs="1"/>
  </xsd:sequence>
</xsd:complexType>
```

#### Elements:

- `comp` The TRI component identifier;
- `port` The identification of the port.

**Attributes:** none

### 10.3.2.2 TriComponentIdType

**TriComponentIdType** is mapped to the following complex type

```
<xsd:complexType name="TriComponentIdType">
  <xsd:sequence>
    <xsd:choice>
      <xsd:element name="null"/>
      <xsd:element name="id" type="Types:Id" minOccurs="1" maxOccurs="1"/>
    </xsd:choice>
  </xsd:sequence>
</xsd:complexType>
```

#### Elements:

- `id` The identifier of the TRI component;
- `null` The null identifier. To be used if there is no TRI component identifier.

**Attributes:**

- none.

### 10.3.2.3 TriComponentIdListType

**TriComponentIdListType** is mapped to the following complex type

```
<xsd:complexType name="TriComponentIdListType">
  <xsd:sequence>
    <xsd:element name="comp" type="Types:TriComponentIdType" minOccurs="0"
      maxOccurs="unbounded"/>
  </xsd:sequence>
</xsd:complexType>
```

#### Elements:

- `comp` The identifiers of TRI components in that list.

**Attributes:**

- none.

### 10.3.2.4 Port

**Port** is mapped to the following complex type

```
<xsd:complexType name="Port">
  <xsd:sequence>
    <xsd:element name="id" type="Types:Id" minOccurs="1" maxOccurs="1"/>
    <xsd:element name="index" type="xsd:int" minOccurs="0" maxOccurs="1"/>
  </xsd:sequence>
</xsd:complexType>
```

#### Elements:

- id           The port identifier;
- port         The port index.

#### Attributes:

- none.

### 10.3.2.5 Id

**Id** is used as identification for components, ports and timers and is mapped to the following complex type

```
<xsd:complexType name="Id">
  <xsd:sequence>
    <xsd:element name="name" type="SimpleTypes:TString" minOccurs="1" maxOccurs="1"/>
    <xsd:element name="id" type="SimpleTypes:TInteger" minOccurs="1" maxOccurs="1"/>
    <xsd:element name="type" type="SimpleTypes:TString" minOccurs="1" maxOccurs="1"/>
  </xsd:sequence>
</xsd:complexType>
```

#### Elements:

- name         The name of the component, port or timer;
- id           The internal representation of the component, port or timer;
- type         The type of the component, port or timer.

#### Attributes:

- none.

### 10.3.2.6 TriMessageType

**TriMessageType** is mapped to the following complex type

```
<xsd:complexType name="TriMessageType">
  <xsd:attribute name="val" type="xsd:hexBinary"/>
</xsd:complexType>
```

#### Elements:

- val          The encoded message.

#### Attributes:

- none.

### 10.3.2.7 TriParameterType

**TriParameterType** is mapped to the following complex type

```
<xsd:complexType name="TriParameterType">
  <xsd:sequence>
    <xsd:element name="val" type="Values:Value" minOccurs="1" maxOccurs="1"/>
  </xsd:sequence>
  <xsd:attribute name="name" type="SimpleTypes:TString"/>
  <xsd:attribute name="mode" type="SimpleTypes:TciParameterPassingModeType"/>
</xsd:complexType>
```

#### Elements:

- val The encoded parameter.

#### Attributes:

- name The parameter name;
- mode The parameter passing mode.

### 10.3.2.8 TriParameterListType

**TriParameterListType** is mapped to the following complex type

```
<xsd:complexType name="TriParameterListType">
  <xsd:sequence>
    <xsd:element name="par" type="Types:TriParameterType" minOccurs="0"
      maxOccurs="unbounded"/>
  </xsd:sequence>
</xsd:complexType>
```

#### Sequence of Elements:

- par The parameters in that list.

#### Attributes:

- none.

### 10.3.2.9 TriAddressType

**TriAddressType** is mapped to the following complex type

```
<xsd:complexType name="TriAddressType">
  <xsd:attribute name="val" type="SimpleTypes:TString"/>
</xsd:complexType>
```

#### Elements:

- val The address value.

#### Attributes:

- none.

### 10.3.2.10 TriAddressListType

**TriAddressListType** is mapped to the following complex type

```
<xsd:complexType name="TriAddressListType">
  <xsd:sequence>
    <xsd:element name="addr" type="Types:TriAddressType" minOccurs="0"
      maxOccurs="unbounded"/>
  </xsd:sequence>
</xsd:complexType>
```

**Elements:**

- `addr` The addresses in that list.

**Attributes:**

- none.

### 10.3.2.11 TriExceptionType

**TriExceptionType** is mapped to the following complex type

```
<xsd:complexType name="TriExceptionType">
  <xsd:attribute name="val" type="SimpleTypes:TString"/>
</xsd:complexType>
```

**Elements:**

- `val` The exception.

**Attributes:**

- none.

### 10.3.2.12 TriSignatureIdType

**TriSignatureIdType** is mapped to the following complex type

```
<xsd:complexType name="TriSignatureIdType">
  <xsd:attribute name="val" type="SimpleTypes:TString"/>
</xsd:complexType>
```

**Elements:**

- `val` The signature.

**Attributes:**

- none.

### 10.3.2.13 TriAddressType

**TriAddressType** is mapped to the following complex type

```
<xsd:complexType name="TriAddressType">
  <xsd:attribute name="val" type="SimpleTypes:TString"/>
</xsd:complexType>
```

**Elements:**

- `val` The address within the SUT.

**Attributes:**

- none.

### 10.3.2.14 TriTimerIdType

**TriTimerIdType** is mapped to the following complex type

```
<xsd:complexType name="TriTimerIdType">
  <xsd:sequence>
    <xsd:element name="id" type="Types:Id" minOccurs="1" maxOccurs="1"/>
  </xsd:sequence>
</xsd:complexType>
```

**Elements:**

- `id` The identification of the timer.

**Attributes:**

- none.

### 10.3.2.15 TriTimerDurationType

**TriTimerDurationType** is mapped to the following complex type

```
<xsd:complexType name="TriTimerDurationType">
  <xsd:attribute name="val" type="SimpleTypes:TriTimerDurationType"/>
</xsd:complexType>
```

**Elements:**

- `val` The timer duration.

**Attributes:**

- none.

### 10.3.2.16 QualifiedName

**QualifiedName** is used to fully qualify module parameters, variables, etc and is mapped to the following complex type

```
<xsd:complexType name="QualifiedName">
  <xsd:attribute name="moduleName" type="SimpleTypes:TString" use="required"/>
  <xsd:attribute name="baseName" type="SimpleTypes:TString" use="required"/>
</xsd:complexType>
```

**Elements:**

- `moduleName` The module name of the TTCN-3 module.
- `baseName` The name of the object that is fully qualified.

**Attributes:**

- none.

### 10.3.2.17 TciBehaviourIdType

**TciBehaviourIdType** is mapped to the following complex type

```
<xsd:complexType name="TciBehaviourIdType">
  <xsd:sequence>
    <xsd:element name="name" type="Types:QualifiedName" minOccurs="1" maxOccurs="1"/>
  </xsd:sequence>
</xsd:complexType>
```

**Elements:**

- `name` The qualified name of the behaviour.

**Attributes:**

- none.

**10.3.2.18 TciTestCaseIdType**

**TciTestCaseIdType** is mapped to the following complex type

```
<xsd:complexType name="TciTestCaseIdType">
  <xsd:sequence>
    <xsd:element name="name" type="Types:QualifiedName" minOccurs="1" maxOccurs="1"/>
  </xsd:sequence>
</xsd:complexType>
```

**Elements:**

- name The qualified name of the test case.

**Attributes:**

- none.

**10.3.2.19 TciParameterType**

**TciParameterType** is mapped to the following complex type

```
<xsd:complexType name="TciParameterType">
  <xsd:sequence>
    <xsd:element name="val" type="Values:Value" minOccurs="1" maxOccurs="1"/>
  </xsd:sequence>
  <xsd:attribute name="name" type="SimpleTypes:TString"/>
  <xsd:attribute name="mode" type="SimpleTypes:TciParameterPassingModeType"/>
</xsd:complexType>
```

**Elements:**

- val The encoded parameter.

**Attributes:**

- name The parameter name.
- mode The parameter passing mode.

**10.3.2.20 TciParameterListType**

**TciParameterListType** is mapped to the following complex type

```
<xsd:complexType name="TciParameterListType">
  <xsd:sequence>
    <xsd:element name="par" type="Types:TriParameterType"
      minOccurs="0" maxOccurs="unbounded"/>
  </xsd:sequence>
</xsd:complexType>
```

**Sequence of Elements:**

- par The parameters in that list.

**Attributes:**

- none.



## 10.3.3 Abstract value mapping

### 10.3.3.1 Value

**Value** is mapped to the following complex type

```
<xsd:complexType name="Value" mixed="true">
  <xsd:choice>
    <xsd:element name="integer" type="Values:IntegerValue"/>
    <xsd:element name="float" type="Values:FloatValue"/>
    <xsd:element name="boolean" type="Values:BooleanValue"/>
    <xsd:element name="objid" type="Values:ObjidValue"/>
    <xsd:element name="verdicttype" type="Values:VerdictValue"/>
    <xsd:element name="bitstring" type="Values:BitstringValue"/>
    <xsd:element name="hexstring" type="Values:HexstringValue"/>
    <xsd:element name="octetstring" type="Values:OctetstringValue"/>
    <xsd:element name="charstring" type="Values:CharstringValue"/>
    <xsd:element name="universal_charstring" type="Values:UniversalCharstringValue"/>
    <xsd:element name="record" type="Values:RecordValue"/>
    <xsd:element name="record_of" type="Values:RecordOfValue"/>
    <xsd:element name="set" type="Values:SetValue"/>
    <xsd:element name="set_of" type="Values:SetOfValue"/>
    <xsd:element name="enumerated" type="Values:EnumeratedValue"/>
    <xsd:element name="union" type="Values:UnionValue"/>
    <xsd:element name="anytype" type="Values:AnytypeValue"/>
    <xsd:element name="address" type="Values:AddressValue"/>
  </xsd:choice>
  <xsd:attributeGroup ref="Values:ValueAtts"/>
</xsd:complexType>

<xsd:attributeGroup name="ValueAtts">
  <xsd:attribute name="name" type="SimpleTypes:TString" use="optional"/>
  <xsd:attribute name="type" type="SimpleTypes:TString" use="optional"/>
  <xsd:attribute name="module" type="SimpleTypes:TString" use="optional"/>
</xsd:attributeGroup>
```

#### Choice of Elements:

- integer                      An integer value.
- float                        A float value.
- boolean                      A boolean value.
- objid                        An objid value.
- verdicttype                 A verdicttype value.
- bitstring                    A bitstring value.
- hexstring                    An hexstring value.
- octetstring                 An octetstring value.
- charstring                  A charstring value.
- universal\_charstring      A universal charstring value.
- record                      A record value.
- record\_of                    A record of value.
- set                          A set value.
- set\_of                        A set of value.
- enumerated                 An enumerated value.
- union                        A union value.

- `anytype` An anytype value.
- `address` An address value.

**Attributes:**

- `name` The name of the value, if known.
- `type` The type of the value, if known.
- `module` The module of the value, if known.

### 10.3.3.2 IntegerValue

**IntegerValue** is mapped to the following complex type

```
<xsd:complexType name="IntegerValue">
  <xsd:simpleContent>
    <xsd:extension base="SimpleTypes:TString">
      <xsd:attributeGroup ref="Values:ValueAtts"/>
    </xsd:extension>
  </xsd:simpleContent>
</xsd:complexType>
```

**Simple Content:**

- `base` The integer value as string.
- `extension` The same attributes as those of Value.

### 10.3.3.3 FloatValue

**FloatValue** is mapped to the following complex type

```
<xsd:complexType name="FloatValue">
  <xsd:simpleContent>
    <xsd:extension base="SimpleTypes:TString">
      <xsd:attributeGroup ref="Values:ValueAtts"/>
    </xsd:extension>
  </xsd:simpleContent>
</xsd:complexType>
```

**Simple Content:**

- `base` The float value as string.
- `extension` The same attributes as those of Value.

### 10.3.3.4 BooleanValue

**BooleanValue** is mapped to the following complex type

```
<xsd:complexType name="BooleanValue">
  <xsd:simpleContent>
    <xsd:extension base="SimpleTypes:TString">
      <xsd:attributeGroup ref="Values:ValueAtts"/>
    </xsd:extension>
  </xsd:simpleContent>
</xsd:complexType>
```

**Simple Content:**

- `base` The boolean value as string.
- `extension` The same attributes as those of Value.

### 10.3.3.5 ObjidValue

**ObjidValue** is mapped to the following complex type

```
<xsd:complexType name="ObjidValue">
  <xsd:simpleContent>
    <xsd:extension base="SimpleTypes:TString">
      <xsd:attributeGroup ref="Values:ValueAtts" />
    </xsd:extension>
  </xsd:simpleContent>
</xsd:complexType>
```

#### Simple Content:

- **base** The objid value as string.
- **extension** The same attributes as those of Value.

### 10.3.3.6 VerdictValue

**VerdictValue** is mapped to the following complex type

```
<xsd:complexType name="VerdictValue">
  <xsd:simpleContent>
    <xsd:extension base="SimpleTypes:TString">
      <xsd:attributeGroup ref="Values:ValueAtts" />
    </xsd:extension>
  </xsd:simpleContent>
</xsd:complexType>
```

#### Simple Content:

- **base** The verdict value as string.
- **extension** The same attributes as those of Value.

### 10.3.3.7 BitstringValue

**BitstringValue** is mapped to the following complex type

```
<xsd:complexType name="BitstringValue">
  <xsd:simpleContent>
    <xsd:extension base="SimpleTypes:TString">
      <xsd:attributeGroup ref="Values:ValueAtts" />
    </xsd:extension>
  </xsd:simpleContent>
</xsd:complexType>
```

#### Simple Content:

- **base** The bitstring value as string.
- **extension** The same attributes as those of Value.

### 10.3.3.8 HexstringValue

**HexstringValue** is mapped to the following complex type

```
<xsd:complexType name="HexstringValue">
  <xsd:simpleContent>
    <xsd:extension base="SimpleTypes:TString">
      <xsd:attributeGroup ref="Values:ValueAtts" />
    </xsd:extension>
  </xsd:simpleContent>
</xsd:complexType>
```

**Simple Content:**

- `base` The hexstring value as string.
- `extension` The same attributes as those of `Value`.

**10.3.3.9 OctetstringValue**

**OctetstringValue** is mapped to the following complex type

```
<xsd:complexType name="OctetstringValue">
  <xsd:simpleContent>
    <xsd:extension base="SimpleTypes:TString">
      <xsd:attributeGroup ref="Values:ValueAtts" />
    </xsd:extension>
  </xsd:simpleContent>
</xsd:complexType>
```

**Simple Content:**

- `base` The octetstring value as string.
- `extension` The same attributes as those of `Value`.

**10.3.3.10 CharstringValue**

**CharstringValue** is mapped to the following complex type

```
<xsd:complexType name="CharstringValue">
  <xsd:simpleContent>
    <xsd:extension base="SimpleTypes:TString">
      <xsd:attributeGroup ref="Values:ValueAtts" />
    </xsd:extension>
  </xsd:simpleContent>
</xsd:complexType>
```

**Simple Content:**

- `base` The charstring value as string.
- `extension` The same attributes as those of `Value`.

**10.3.3.11 UniversalCharstringValue**

**UniversalCharstringValue** is mapped to the following complex type

```
<xsd:complexType name="UniversalCharstringValue">
  <xsd:simpleContent>
    <xsd:extension base="SimpleTypes:TString">
      <xsd:attributeGroup ref="Values:ValueAtts" />
    </xsd:extension>
  </xsd:simpleContent>
</xsd:complexType>
```

**Simple Content:**

- `base` The universal charstring value as string.
- `extension` The same attributes as those of `Value`.

### 10.3.3.12 RecordValue

**RecordValue** is mapped to the following complex type

```
<xsd:complexType name="RecordValue">
  <xsd:sequence>
    <xsd:choice minOccurs="0" maxOccurs="unbounded">
      <xsd:element name="integer" type="Values:IntegerValue"/>
      <xsd:element name="float" type="Values:FloatValue"/>
      <xsd:element name="boolean" type="Values:BooleanValue"/>
      <xsd:element name="objid" type="Values:ObjidValue"/>
      <xsd:element name="verdicttype" type="Values:VerdictValue"/>
      <xsd:element name="bitstring" type="Values:BitstringValue"/>
      <xsd:element name="hexstring" type="Values:HexstringValue"/>
      <xsd:element name="octetstring" type="Values:OctetstringValue"/>
      <xsd:element name="charstring" type="Values:CharstringValue"/>
      <xsd:element name="universal_charstring"
        type="Values:UniversalCharstringValue"/>
      <xsd:element name="record" type="Values:RecordValue"/>
      <xsd:element name="record_of" type="Values:RecordOfValue"/>
      <xsd:element name="set" type="Values:SetValue"/>
      <xsd:element name="set_of" type="Values:SetOfValue"/>
      <xsd:element name="enumerated" type="Values:EnumeratedValue"/>
      <xsd:element name="union" type="Values:UnionValue"/>
      <xsd:element name="anytype" type="Values:AnytypeValue"/>
      <xsd:element name="address" type="Values:AddressValue"/>
    </xsd:choice>
  </xsd:sequence>
  <xsd:attributeGroup ref="Values:ValueAtts"/>
</xsd:complexType>
```

#### Sequence of Elements:

- integer                    An integer value.
- float                     A float value.
- boolean                  A boolean value.
- objid                     An objid value.
- verdicttype              A verdicttype value.
- bitstring                A bitstring value.
- hexstring                An hexstring value.
- octetstring              An octetstring value.
- charstring               A charstring value.
- universal\_charstring    A universal charstring value.
- record                    A record value.
- record\_of                A record of value.
- set                        A set value.
- set\_of                    A set of value.
- enumerated               An enumerated value.
- union                    A union value.
- anytype                  An anytype value.
- address                  An address value.

**Attributes:**

- The same attributes as those of Value.

**10.3.3.13 RecordOfValue**

**RecordOfValue** is mapped to the following complex type

```

<xsd:complexType name="RecordOfValue">
  <xsd:choice>
    <xsd:sequence>
      <xsd:element name="integer" type="Values:IntegerValue" minOccurs="0"
        maxOccurs="unbounded"/>
    </xsd:sequence>
    <xsd:sequence>
      <xsd:element name="float" type="Values:FloatValue" minOccurs="0"
        maxOccurs="unbounded"/>
    </xsd:sequence>
    <xsd:sequence>
      <xsd:element name="boolean" type="Values:BooleanValue" minOccurs="0"
        maxOccurs="unbounded"/>
    </xsd:sequence>
    <xsd:sequence>
      <xsd:element name="objid" type="Values:ObjidValue" minOccurs="0"
        maxOccurs="unbounded"/>
    </xsd:sequence>
    <xsd:sequence>
      <xsd:element name="bitstring" type="Values:BitstringValue"
        minOccurs="0" maxOccurs="unbounded"/>
    </xsd:sequence>
    <xsd:sequence>
      <xsd:element name="hexstring" type="Values:HexstringValue"
        minOccurs="0" maxOccurs="unbounded"/>
    </xsd:sequence>
    <xsd:sequence>
      <xsd:element name="octetstring" type="Values:OctetstringValue"
        minOccurs="0" maxOccurs="unbounded"/>
    </xsd:sequence>
    <xsd:sequence>
      <xsd:element name="charstring" type="Values:CharstringValue"
        minOccurs="0" maxOccurs="unbounded"/>
    </xsd:sequence>
    <xsd:sequence>
      <xsd:element name="universal_charstring"
        type="Values:UniversalCharstringValue" minOccurs="0"
        maxOccurs="unbounded"/>
    </xsd:sequence>
    <xsd:sequence>
      <xsd:element name="record" type="Values:RecordValue" minOccurs="0"
        maxOccurs="unbounded"/>
    </xsd:sequence>
    <xsd:sequence>
      <xsd:element name="record_of" type="Values:RecordOfValue"
        minOccurs="0" maxOccurs="unbounded"/>
    </xsd:sequence>
    <xsd:sequence>
      <xsd:element name="set" type="Values:SetValue" minOccurs="0"
        maxOccurs="unbounded"/>
    </xsd:sequence>
    <xsd:sequence>
      <xsd:element name="set_of" type="Values:SetOfValue"
        minOccurs="0" maxOccurs="unbounded"/>
    </xsd:sequence>
    <xsd:sequence>
      <xsd:element name="enumerated" type="Values:EnumeratedValue"
        minOccurs="0" maxOccurs="unbounded"/>
    </xsd:sequence>
    <xsd:sequence>
      <xsd:element name="union" type="Values:UnionValue" minOccurs="0"
        maxOccurs="unbounded"/>
    </xsd:sequence>
    <xsd:sequence>
      <xsd:element name="anytype" type="Values:AnytypeValue" minOccurs="0"
        maxOccurs="unbounded"/>
    </xsd:sequence>
  </xsd:choice>
</xsd:complexType>

```

```

        <xsd:element name="address" type="Values:AddressValue" minOccurs="0"
            maxOccurs="unbounded" />
    </xsd:sequence>
</xsd:choice>
<xsd:attributeGroup ref="Values:ValueAtts" />
</xsd:complexType>

```

#### Choice of Sequence of Elements:

- integer                    An integer value.
- float                     A float value.
- boolean                  A boolean value.
- objid                     An objid value.
- verdicttype              A verdicttype value.
- bitstring                A bitstring value.
- hexstring                An hexstring value.
- octetstring              An octetstring value.
- charstring               A charstring value.
- universal\_charstring    A universal charstring value.
- record                    A record value.
- record\_of                A record of value.
- set                        A set value.
- set\_of                    A set of value.
- enumerated               An enumerated value.
- union                    A union value.
- anytype                  An anytype value.
- address                  An address value.

#### Attributes:

- The same attributes as those of Value.

### 10.3.3.14 SetValue

**SetValue** is mapped to the following complex type

```

<xsd:complexType name="SetValue">
  <xsd:sequence>
    <xsd:choice minOccurs="0" maxOccurs="unbounded">
      <xsd:element name="integer" type="Values:IntegerValue" />
      <xsd:element name="float" type="Values:FloatValue" />
      <xsd:element name="boolean" type="Values:BooleanValue" />
      <xsd:element name="objid" type="Values:ObjidValue" />
      <xsd:element name="verdicttype" type="Values:VerdictValue" />
      <xsd:element name="bitstring" type="Values:BitstringValue" />
      <xsd:element name="hexstring" type="Values:HexstringValue" />
      <xsd:element name="octetstring" type="Values:OctetstringValue" />
      <xsd:element name="charstring" type="Values:CharstringValue" />
      <xsd:element name="universal_charstring"
        type="Values:UniversalCharstringValue" />
      <xsd:element name="record" type="Values:RecordValue" />
      <xsd:element name="record_of" type="Values:RecordOfValue" />
    </xsd:choice>
  </xsd:sequence>
</xsd:complexType>

```

```

<xsd:element name="set" type="Values:SetValue"/>
<xsd:element name="set_of" type="Values:SetOfValue"/>
<xsd:element name="enumerated" type="Values:EnumeratedValue"/>
<xsd:element name="union" type="Values:UnionValue"/>
<xsd:element name="anytype" type="Values:AnytypeValue"/>
<xsd:element name="address" type="Values:AddressValue"/>
</xsd:choice>
</xsd:sequence>
<xsd:attributeGroup ref="Values:ValueAtts"/>
</xsd:complexType>

```

### Sequence of Elements:

- integer An integer value.
- float A float value.
- boolean A boolean value.
- objid An objid value.
- verdicttype A verdicttype value.
- bitstring A bitstring value.
- hexstring An hexstring value.
- octetstring An octetstring value.
- charstring A charstring value.
- universal\_charstring A universal charstring value.
- record A record value.
- record\_of A record of value.
- set A set value.
- set\_of A set of value.
- enumerated An enumerated value.
- union A union value.
- anytype An anytype value.
- address An address value.

### Attributes:

- The same attributes as those of Value.

### 10.3.3.15 SetOfValue

**SetOfValue** is mapped to the following complex type

```

<xsd:complexType name="SetOfValue">
  <xsd:choice>
    <xsd:sequence>
      <xsd:element name="integer" type="Values:IntegerValue" minOccurs="0"
        maxOccurs="unbounded"/>
    </xsd:sequence>
    <xsd:sequence>
      <xsd:element name="float" type="Values:FloatValue" minOccurs="0"
        maxOccurs="unbounded"/>
    </xsd:sequence>
    <xsd:sequence>
      <xsd:element name="boolean" type="Values:BooleanValue" minOccurs="0"

```



```

        maxOccurs="unbounded" />
</xsd:sequence>
<xsd:sequence>
  <xsd:element name="objid" type="Values:ObjidValue" minOccurs="0"
    maxOccurs="unbounded" />
</xsd:sequence>
<xsd:sequence>
  <xsd:element name="bitstring" type="Values:BitstringValue"
    minOccurs="0" maxOccurs="unbounded" />
</xsd:sequence>
<xsd:sequence>
  <xsd:element name="hexstring" type="Values:HexstringValue"
    minOccurs="0" maxOccurs="unbounded" />
</xsd:sequence>
<xsd:sequence>
  <xsd:element name="octetstring" type="Values:OctetstringValue"
    minOccurs="0" maxOccurs="unbounded" />
</xsd:sequence>
<xsd:sequence>
  <xsd:element name="charstring" type="Values:CharstringValue"
    minOccurs="0" maxOccurs="unbounded" />
</xsd:sequence>
<xsd:sequence>
  <xsd:element name="universal_charstring"
    type="Values:UniversalCharstringValue" minOccurs="0"
    maxOccurs="unbounded" />
</xsd:sequence>
<xsd:sequence>
  <xsd:element name="record" type="Values:RecordValue" minOccurs="0"
    maxOccurs="unbounded" />
</xsd:sequence>
<xsd:sequence>
  <xsd:element name="record_of" type="Values:RecordOfValue"
    minOccurs="0" maxOccurs="unbounded" />
</xsd:sequence>
<xsd:sequence>
  <xsd:element name="set" type="Values:SetValue" minOccurs="0"
    maxOccurs="unbounded" />
</xsd:sequence>
<xsd:sequence>
  <xsd:element name="set_of" type="Values:SetOfValue"
    minOccurs="0" maxOccurs="unbounded" />
</xsd:sequence>
<xsd:sequence>
  <xsd:element name="enumerated" type="Values:EnumeratedValue"
    minOccurs="0" maxOccurs="unbounded" />
</xsd:sequence>
<xsd:sequence>
  <xsd:element name="union" type="Values:UnionValue" minOccurs="0"
    maxOccurs="unbounded" />
</xsd:sequence>
<xsd:sequence>
  <xsd:element name="anytype" type="Values:AnytypeValue" minOccurs="0"
    maxOccurs="unbounded" />
</xsd:sequence>
<xsd:sequence>
  <xsd:element name="address" type="Values:AddressValue" minOccurs="0"
    maxOccurs="unbounded" />
</xsd:sequence>
</xsd:choice>
<xsd:attributeGroup ref="Values:ValueAtts" />
</xsd:complexType>

```

### Choice of Sequence of Elements:

- integer                    An integer value.
- float                     A float value.
- boolean                  A boolean value.
- objid                     An objid value.
- verdicttype              A verdicttype value.
- bitstring                 A bitstring value.

- `hexstring` An hexstring value.
- `octetstring` An octetstring value.
- `charstring` A charstring value.
- `universal_charstring` A universal charstring value.
- `record` A record value.
- `record_of` A record of value.
- `set` A set value.
- `set_of` A set of value.
- `enumerated` An enumerated value.
- `union` A union value.
- `anytype` An anytype value.
- `address` An address value.

**Attributes:**

- The same attributes as those of Value.

**10.3.3.16 EnumeratedValue**

**EnumeratedValue** is mapped to the following complex type

```
<xsd:complexType name="EnumeratedValue">
  <xsd:sequence>
    <xsd:element name="element" type="SimpleTypes:TString"/>
  </xsd:sequence>
  <xsd:attributeGroup ref="Values:ValueAtts"/>
</xsd:complexType>
```

**Sequence of Elements:**

- `element` The enumeration value.

**Attributes:**

- The same attributes as those of Value.

**10.3.3.17 UnionValue**

**UnionValue** is mapped to the following complex type

```
<xsd:complexType name="UnionValue">
  <xsd:choice minOccurs="0" maxOccurs="unbounded">
    <xsd:element name="integer" type="Values:IntegerValue"/>
    <xsd:element name="float" type="Values:FloatValue"/>
    <xsd:element name="boolean" type="Values:BooleanValue"/>
    <xsd:element name="objid" type="Values:ObjidValue"/>
    <xsd:element name="verdicttype" type="Values:VerdictValue"/>
    <xsd:element name="bitstring" type="Values:BitstringValue"/>
    <xsd:element name="hexstring" type="Values:HexstringValue"/>
    <xsd:element name="octetstring" type="Values:OctetstringValue"/>
    <xsd:element name="charstring" type="Values:CharstringValue"/>
    <xsd:element name="universal_charstring"
      type="Values:UniversalCharstringValue"/>
    <xsd:element name="record" type="Values:RecordValue"/>
    <xsd:element name="record_of" type="Values:RecordOfValue"/>
    <xsd:element name="set" type="Values:SetValue"/>
    <xsd:element name="set_of" type="Values:SetOfValue"/>
  </xsd:choice>
</xsd:complexType>
```

```

    <xsd:element name="enumerated" type="Values:EnumeratedValue"/>
    <xsd:element name="union" type="Values:UnionValue"/>
    <xsd:element name="anytype" type="Values:AnytypeValue"/>
    <xsd:element name="address" type="Values:AddressValue"/>
  </xsd:choice>
  <xsd:attributeGroup ref="Values:ValueAtts"/>
</xsd:complexType>

```

### Choice of Elements:

- integer                    An integer value.
- float                     A float value.
- boolean                  A boolean value.
- objid                     An objid value.
- verdicttype              A verdicttype value.
- bitstring                 A bitstring value.
- hexstring                An hexstring value.
- octetstring              An octetstring value.
- charstring               A charstring value.
- universal\_charstring    A universal charstring value.
- record                    A record value.
- record\_of                A record of value.
- set                        A set value.
- set\_of                    A set of value.
- enumerated               An enumerated value.
- union                     A union value.
- anytype                  An anytype value.
- address                  An address value.

### Attributes:

- The same attributes as those of Value.

### 10.3.3.18 AnytypeValue

**AnytypeValue** is mapped to the following complex type

```

<xsd:complexType name="AnytypeValue">
  <xsd:choice minOccurs="0" maxOccurs="unbounded">
    <xsd:element name="integer" type="Values:IntegerValue"/>
    <xsd:element name="float" type="Values:FloatValue"/>
    <xsd:element name="boolean" type="Values:BooleanValue"/>
    <xsd:element name="objid" type="Values:ObjidValue"/>
    <xsd:element name="verdicttype" type="Values:VerdictValue"/>
    <xsd:element name="bitstring" type="Values:BitstringValue"/>
    <xsd:element name="hexstring" type="Values:HexstringValue"/>
    <xsd:element name="octetstring" type="Values:OctetstringValue"/>
    <xsd:element name="charstring" type="Values:OctetstringValue"/>
    <xsd:element name="universal_charstring"
      type="Values:UniversalCharstringValue"/>
    <xsd:element name="record" type="Values:RecordValue"/>
    <xsd:element name="record_of" type="Values:RecordOfValue"/>
  </xsd:choice>
</xsd:complexType>

```

```

<xsd:element name="set" type="Values:SetValue"/>
<xsd:element name="set_of" type="Values:SetOfValue"/>
<xsd:element name="enumerated" type="Values:EnumeratedValue"/>
<xsd:element name="union" type="Values:UnionValue"/>
<xsd:element name="address" type="Values:AddressValue"/>
</xsd:choice>
<xsd:attributeGroup ref="Values:ValueAtts"/>
</xsd:complexType>

```

### Choice of Elements:

- integer                    An integer value.
- float                     A float value.
- boolean                  A boolean value.
- objid                     An objid value.
- verdicttype              A verdicttype value.
- bitstring                A bitstring value.
- hexstring                An hexstring value.
- octetstring              An octetstring value.
- charstring               A charstring value.
- universal\_charstring    A universal charstring value.
- record                    A record value.
- record\_of                A record of value.
- set                        A set value.
- set\_of                    A set of value.
- enumerated               An enumerated value.
- union                    A union value.
- address                  An address value.

### Attributes:

- The same attributes as those of Value.

### 10.3.3.19 AddressValue

**AddressValue** is mapped to the following complex type

```

<xsd:complexType name="AddressValue">
  <xsd:choice minOccurs="0" maxOccurs="unbounded">
    <xsd:element name="integer" type="Values:IntegerValue"/>
    <xsd:element name="float" type="Values:FloatValue"/>
    <xsd:element name="boolean" type="Values:BooleanValue"/>
    <xsd:element name="objid" type="Values:ObjidValue"/>
    <xsd:element name="verdicttype" type="Values:VerdictValue"/>
    <xsd:element name="bitstring" type="Values:BitstringValue"/>
    <xsd:element name="hexstring" type="Values:HexstringValue"/>
    <xsd:element name="octetstring" type="Values:OctetstringValue"/>
    <xsd:element name="charstring" type="Values:OctetstringValue"/>
    <xsd:element name="universal_charstring"
      type="Values:UniversalCharstringValue"/>
    <xsd:element name="record" type="Values:RecordValue"/>
    <xsd:element name="record_of" type="Values:RecordOfValue"/>
    <xsd:element name="set" type="Values:SetValue"/>
    <xsd:element name="set_of" type="Values:SetOfValue"/>
  </xsd:choice>
</xsd:complexType>

```

```

    <xsd:element name="enumerated" type="Values:EnumeratedValue"/>
    <xsd:element name="union" type="Values:UnionValue"/>
    <xsd:element name="anytype" type="Values:AnytypeValue"/>
  </xsd:choice>
  <xsd:attributeGroup ref="Values:ValueAtts"/>
</xsd:complexType>

```

### Choice of Elements:

- integer                    An integer value.
- float                     A float value.
- boolean                  A boolean value.
- objid                     An objid value.
- verdicttype              A verdicttype value.
- bitstring                 A bitstring value.
- hexstring                An hexstring value.
- octetstring              An octetstring value.
- charstring               A charstring value.
- universal\_charstring    A universal charstring value.
- record                    A record value.
- record\_of                A record of value.
- set                        A set value.
- set\_of                    A set of value.
- enumerated               An enumerated value.
- union                     A union value.
- anytype                  An anytype value.

### Attributes:

- The same attributes as those of Value.

## 10.3.4 Abstract logging types mapping

Additional types are defined to ease the logging of matches between values and templates.

### 10.3.4.1 TciValueTemplate

**TciValueTemplate** is mapped to the following complex type

```

<xsd:complexType name="TciValueTemplate">
  <xsd:complexContent mixed="true">
    <xsd:extension base="Values:Value">
      <xsd:choice>
        <xsd:element name="integer" type="Templates:IntegerTemplate"/>
        <xsd:element name="float" type="Templates:FloatTemplate"/>
        <xsd:element name="boolean" type="Templates:BooleanTemplate"/>
        <xsd:element name="objid" type="Templates:ObjidTemplate"/>
        <xsd:element name="bitstring" type="Templates:BitstringTemplate"/>
        <xsd:element name="hexstring" type="Templates:HexstringTemplate"/>
        <xsd:element name="octetstring" type="Templates:OctetstringTemplate"/>
        <xsd:element name="charstring" type="Templates:CharstringTemplate"/>
        <xsd:element name="universal_charstring"

```

```

    type="Templates:UniversalCharstringTemplate"/>
<xsd:element name="record" type="Templates:RecordTemplate"/>
<xsd:element name="record_of" type="Templates:RecordOfTemplate"/>
<xsd:element name="set" type="Templates:SetTemplate"/>
<xsd:element name="set_of" type="Templates:SetOfTemplate"/>
<xsd:element name="enumerated" type="Templates:EnumeratedTemplate"/>
<xsd:element name="union" type="Templates:UnionTemplate"/>
<xsd:element name="anytype" type="Templates:AnytypeTemplate"/>
<xsd:element name="address" type="Templates:AddressTemplate"/>
<xsd:element name="omit" type="Templates:omit"/>
<xsd:element name="any" type="Templates:any"/>
<xsd:element name="anyoromit" type="Templates:anyoromit"/>
<xsd:element name="templateDef" type="SimpleTypes:TString"/>
</xsd:choice>
</xsd:extension>
</xsd:complexContent>
</xsd:complexType>

```

### Choice of Elements:

- integer                    An integer template.
- float                     A float template.
- boolean                  A boolean template.
- objid                     An objid template.
- verdicttype              A verdicttype template.
- bitstring                A bitstring template.
- hexstring                An hexstring template.
- octetstring              An octetstring template.
- charstring               A charstring template.
- universal\_charstring    A universal charstring template.
- record                    A record template.
- record\_of                A record of template.
- set                        A set template.
- set\_of                    A set of template.
- enumerated               An enumerated template.
- union                    A union template.
- anytype                  An anytype template.
- address                  An address template.
- omit                     An omit template.
- any                        An any template.
- anyoromit                An anyoromit template.
- templateDef             A complex template definition.

### Attributes:

- none.

### 10.3.4.2 TciNonValueTemplate

**TciNonValueTemplate** is mapped to the following complex type

```
<xsd:complexType name="TciNonValueTemplate">
  <xsd:sequence>
    <xsd:choice>
      <xsd:element name="any" type="Templates:any"/>
      <xsd:element name="all" type="Templates:all"/>
      <xsd:element name="templateDef" type="SimpleTypes:TString"/>
    </xsd:choice>
  </xsd:sequence>
</xsd:complexType>
```

#### Choice of Elements:

- any                    An any template.
- all                    An all template.
- templateDef        A complex template definition.

**Attributes:** none

### 10.3.4.3 TciValueList

**TciValueList** is mapped to the following complex type

```
<xsd:complexType name="TciValueList">
  <xsd:sequence>
    <xsd:element name="val" type="Values:Value" minOccurs="1"
      maxOccurs="unbounded"/>
  </xsd:sequence>
</xsd:complexType>
```

#### Sequence of Elements:

- val                    The values in the value list.

**Attributes:**

- none.

### 10.3.4.4 TciValueDifference

**TciValueDifference** is mapped to the following complex type

```
<xsd:complexType name="TciValueDifference">
  <xsd:attribute name="desc" type="SimpleTypes:TString" use="optional"/>
  <xsd:attribute name="val" type="SimpleTypes:xpath" use="required"/>
  <xsd:attribute name="tmpl" type="SimpleTypes:xpath" use="required"/>
</xsd:complexType>
```

#### Sequence of Elements:

- desc                    The reason of the mismatch.
- val                    A reference to the mismatching value.
- tmpl                    A reference to the template.

**Attributes:**

- none.

### 10.3.4.5 TciValueDifferenceList

**TciValueDifferenceList** is mapped to the following complex type

```
<xsd:complexType name="TciValueDifferenceList">
  <xsd:sequence>
    <xsd:element name="diff" type="Templates:TciValueDifference" minOccurs="1"
      maxOccurs="unbounded" />
  </xsd:sequence>
</xsd:complexType>
```

#### Sequence of Elements:

- `diff` The value/template differences in the value difference list.

#### Attributes:

- none.

## 10.4 Mapping of the operations on the logging interface

Every operation provided at the logging interface has a corresponding complex type definition in XML. These complex type definitions are extensions of `Event`.

### 10.4.1 Event

**Event** is mapped to the following complex type

```
<!-- common definition for all events -->
<xsd:complexType name="Event" mixed="true">
  <xsd:sequence>
    <xsd:element name="am" type="SimpleTypes:TString" />
  </xsd:sequence>
  <xsd:attribute name="ts" type="xsd:time" use="required" />
  <xsd:attribute name="src" type="SimpleTypes:TString" use="optional" />
  <xsd:attribute name="line" type="SimpleTypes:TInteger" use="optional" />

  <!-- general identifier structure for test components, ports and timer -->
  <xsd:attribute name="name" type="SimpleTypes:TString" use="required" />
  <xsd:attribute name="id" type="SimpleTypes:TInteger" use="required" />
  <xsd:attribute name="type" type="SimpleTypes:TString" use="required" />
</xsd:complexType>
```

#### Elements:

- `am` A message, to be used for further information in the log.

#### Attributes:

- `ts` The time when the event is produced.
- `src` The source file of the test specification.
- `line` The line number where the request is performed.
- `name` The name of the component which produces this event.
- `id` The id of the component which produces this event.
- `type` The type of the component which produces this event.



## 10.4.2 Mapping of Operations

The mapping for the operations is given in the following.

<b>TCI-TL provided</b>	
void tliTcExecute (in TString am, in TInteger ts, in TString src, in TInteger line, in TriComponentIdType c, in TciTestCaseldType tcld, in TriParameterListType pars, in TriTimerDurationType dur)	<xsd:complexType name="tliTcExecute"> <xsd:complexContent mixed="true"> <xsd:extension base="Events:Event"> <xsd:sequence> <xsd:element name="tcId" type="Types:TciTestCaseIdType"/> <xsd:element name="pars" type="Types:TriParameterListType" minOccurs="0"/> <xsd:element name="dur" type="Types:TriTimerDurationType" minOccurs="0"/> </xsd:sequence> </xsd:extension> </xsd:complexContent> </xsd:complexType>
void tliTcStart (in TString am, in TInteger ts, in TString src, in TInteger line, in TriComponentIdType c, in TciTestCaseldType tcld, in TriParameterListType pars, in TriTimerDurationType dur)	<xsd:complexType name="tliTcStart"> <xsd:complexContent mixed="true"> <xsd:extension base="Events:Event"> <xsd:sequence> <xsd:element name="tcId" type="Types:TciTestCaseIdType"/> <xsd:element name="pars" type="Types:TriParameterListType" minOccurs="0"/> <xsd:element name="dur" type="Types:TriTimerDurationType" minOccurs="0"/> </xsd:sequence> </xsd:extension> </xsd:complexContent> </xsd:complexType>
void tliTcStop(in TString am, in TInteger ts, in TString src, in TInteger line, in TriComponentIdType c)	<xsd:complexType name="tliTcStop"> <xsd:complexContent mixed="true"> <xsd:extension base="Events:Event"/> </xsd:complexContent> </xsd:complexType>
void tliTcStarted (in TString am, in TInteger ts, in TString src, in TInteger line, in TriComponentIdType c, in TciTestCaseldType tcld, in TriParameterListType pars, in TriTimerDurationType dur)	<xsd:complexType name="tliTcStarted"> <xsd:complexContent mixed="true"> <xsd:extension base="Events:Event"> <xsd:sequence> <xsd:element name="tcId" type="Types:TciTestCaseIdType"/> <xsd:element name="pars" type="Types:TriParameterListType" minOccurs="0"/> <xsd:element name="dur" type="Types:TriTimerDurationType" minOccurs="0"/> </xsd:sequence> </xsd:extension> </xsd:complexContent> </xsd:complexType>
void tliTcTerminated (in TString am, in TInteger ts, in TString src, in TInteger line, in TriComponentIdType c, in TciTestCaseldType tcld, in TriParameterListType pars, in VerdictValue outcome)	<xsd:complexType name="tliTcTerminated"> <xsd:complexContent mixed="true"> <xsd:extension base="Events:Event"> <xsd:sequence> <xsd:element name="tcId" type="Types:TciTestCaseIdType"/> <xsd:element name="pars" type="Types:TriParameterListType" minOccurs="0"/> <xsd:element name="outcome" type="Values:VerdictValue"/> </xsd:sequence> </xsd:extension> </xsd:complexContent> </xsd:complexType>
void tliCtrlStart (in TString am, in TInteger ts, in TString src, in TInteger line, in TriComponentIdType c)	<xsd:complexType name="tliCtrlStart"> <xsd:complexContent> <xsd:extension base="Events:Event"/> </xsd:complexContent> </xsd:complexType>
void tliCtrlStop (in TString am, in TInteger ts, in TString src, in TInteger line, in TriComponentIdType c)	<xsd:complexType name="tliCtrlStop"> <xsd:complexContent> <xsd:extension base="Events:Event"/> </xsd:complexContent> </xsd:complexType>

<b>TCI-TL provided</b>	
void tliCtrlTerminated (in TString am, in TInteger ts, in TString src, in TInteger line, in TriComponentIdType c)	<pre>&lt;xsd:complexType name="tliCtrlTerminated"&gt; &lt;xsd:complexContent&gt; &lt;xsd:extension base="Events:Event"/&gt; &lt;/xsd:complexContent&gt; &lt;/xsd:complexType&gt;</pre>
void tliMSend_m (in TString am, in TInteger ts, in TString src, in TInteger line, in TriComponentIdType c, in TriPortIdType port, in Value msgValue, in TriAddressType address, in TriStatusType encoderFailure, in TriMessageType msg, in TriStatusType transmissionFailure)	<pre>&lt;xsd:complexType name="tliMSend_m"&gt; &lt;xsd:complexContent mixed="true"&gt; &lt;xsd:extension base="Events:Event"&gt; &lt;xsd:sequence&gt; &lt;xsd:element name="port" type="Types:TriPortIdType"/&gt; &lt;xsd:element name="msgValue" type="Values:Value"/&gt; &lt;xsd:element name="address" type="Types:TriAddressType" minOccurs="0"/&gt; &lt;xsd:choice&gt; &lt;xsd:element name="encoder-failure" type="SimpleTypes:TciStatusType"/&gt; &lt;xsd:sequence&gt; &lt;xsd:element name="msg" type="Types:TriMessageType" minOccurs="0"/&gt; &lt;xsd:element name="transmission-failure" type="SimpleTypes:TriStatusType" minOccurs="0"/&gt; &lt;/xsd:sequence&gt; &lt;/xsd:choice&gt; &lt;/xsd:sequence&gt; &lt;/xsd:extension&gt; &lt;/xsd:complexContent&gt; &lt;/xsd:complexType&gt;</pre>
void tliMSend_m_BC (in TString am, in TInteger ts, in TString src, in TInteger line, in TriComponentIdType c, in TriPortIdType port, in Value msgValue, in TriStatusType encoderFailure, in TriMessageType msg, in TriStatusType transmissionFailure)	<pre>&lt;xsd:complexType name="tliMSend_m_BC"&gt; &lt;xsd:complexContent mixed="true"&gt; &lt;xsd:extension base="Events:Event"&gt; &lt;xsd:sequence&gt; &lt;xsd:element name="port" type="Types:TriPortIdType"/&gt; &lt;xsd:element name="msgValue" type="Values:Value"/&gt; &lt;xsd:choice&gt; &lt;xsd:element name="encoder-failure" type="SimpleTypes:TciStatusType"/&gt; &lt;xsd:sequence&gt; &lt;xsd:element name="msg" type="Types:TriMessageType" minOccurs="0"/&gt; &lt;xsd:element name="transmission-failure" type="SimpleTypes:TriStatusType" minOccurs="0"/&gt; &lt;/xsd:sequence&gt; &lt;/xsd:choice&gt; &lt;/xsd:sequence&gt; &lt;/xsd:extension&gt; &lt;/xsd:complexContent&gt; &lt;/xsd:complexType&gt;</pre>
void tliMSend_m_MC (in TString am, in TInteger ts, in TString src, in TInteger line, in TriComponentIdType c, in TriPortIdType port, in Value msgValue, in TriAddressListType addresses, in TriStatusType encoderFailure, in TriMessageType msg, in TriStatusType transmissionFailure)	<pre>&lt;xsd:complexType name="tliMSend_m_MC"&gt; &lt;xsd:complexContent mixed="true"&gt; &lt;xsd:extension base="Events:Event"&gt; &lt;xsd:sequence&gt; &lt;xsd:element name="port" type="Types:TriPortIdType"/&gt; &lt;xsd:element name="msgValue" type="Values:Value"/&gt; &lt;xsd:element name="addresses" type="Types:TriAddressListType" minOccurs="0"/&gt; &lt;xsd:choice&gt; &lt;xsd:element name="encoder-failure" type="SimpleTypes:TciStatusType"/&gt; &lt;xsd:sequence&gt; &lt;xsd:element name="msg" type="Types:TriMessageType" minOccurs="0"/&gt; &lt;xsd:element name="transmission-failure" type="SimpleTypes:TriStatusType" minOccurs="0"/&gt; &lt;/xsd:sequence&gt; &lt;/xsd:choice&gt; &lt;/xsd:sequence&gt; &lt;/xsd:extension&gt; &lt;/xsd:complexContent&gt; &lt;/xsd:complexType&gt;</pre>

<b>TCI-TL provided</b>	
void tliMSend_c (in TString am, in TInteger ts, in TString src, in TInteger line, in TriComponentIdType c, in TriPortIdType port, in Value msgValue, in TriComponentIdType to, in TriStatusType transmissionFailure)	<xsd:complexType name="tliMSend_c"> <xsd:complexContent mixed="true"> <xsd:extension base="Events:Event"> <xsd:sequence> <xsd:element name="port" type="Types:TriPortIdType"/> <xsd:element name="msgValue" type="Values:Value"/> <xsd:element name="to" type="Types:TriComponentIdType" minOccurs="0"/> <xsd:element name="transmission-failure" type="SimpleTypes:TriStatusType" minOccurs="0"/> </xsd:sequence> </xsd:extension> </xsd:complexContent> </xsd:complexType>
void tliMSend_c_BC (in TString am, in TInteger ts, in TString src, in TInteger line, in TriComponentIdType c, in TriPortIdType port, in Value msgValue, in TriStatusType transmissionFailure)	<xsd:complexType name="tliMSend_c_BC"> <xsd:complexContent mixed="true"> <xsd:extension base="Events:Event"> <xsd:sequence> <xsd:element name="port" type="Types:TriPortIdType"/> <xsd:element name="msgValue" type="Values:Value"/> <xsd:element name="transmission-failure" type="SimpleTypes:TriStatusType" minOccurs="0"/> </xsd:sequence> </xsd:extension> </xsd:complexContent> </xsd:complexType>
void tliMSend_c_MC (in TString am, in TInteger ts, in TString src, in TInteger line, in TriComponentIdType c, in TriPortIdType port, in Value msgValue, in TriComponentIdListType toList, in TriStatusType transmissionFailure)	<xsd:complexType name="tliMSend_c_MC"> <xsd:complexContent mixed="true"> <xsd:extension base="Events:Event"> <xsd:sequence> <xsd:element name="port" type="Types:TriPortIdType"/> <xsd:element name="msgValue" type="Values:Value"/> <xsd:element name="toList" type="Types:TriComponentIdListType" minOccurs="0"/> <xsd:element name="transmission-failure" type="SimpleTypes:TriStatusType" minOccurs="0"/> </xsd:sequence> </xsd:extension> </xsd:complexContent> </xsd:complexType>
void tliMDetected_m (in TString am, in TInteger ts, in TString src, in TInteger line, in TriComponentIdType c, in TriPortIdType port, in TriMessageType msg, in TriAddressType address)	<xsd:complexType name="tliMDetected_m"> <xsd:complexContent mixed="true"> <xsd:extension base="Events:Event"> <xsd:sequence> <xsd:element name="port" type="Types:TriPortIdType"/> <xsd:element name="msgValue" type="Types:TriMessageType"/> <xsd:element name="address" type="Types:TriAddressType" minOccurs="0"/> </xsd:sequence> </xsd:extension> </xsd:complexContent> </xsd:complexType>
void tliMDetected_c (in TString am, in TInteger ts, in TString src, in TInteger line, in TriComponentIdType c, in TriPortIdType port, in Value msgValue, in TriComponentIdType from)	<xsd:complexType name="tliMDetected_c"> <xsd:complexContent mixed="true"> <xsd:extension base="Events:Event"> <xsd:sequence> <xsd:element name="port" type="Types:TriPortIdType"/> <xsd:element name="msgValue" type="Types:TriMessageType"/> <xsd:element name="from" type="Types:TriComponentIdType" minOccurs="0"/> </xsd:sequence> </xsd:extension> </xsd:complexContent> </xsd:complexType>

<b>TCI-TL provided</b>	
void tliMMismatch_m (in TString am, in TInteger ts, in TString src, in TInteger line, in TriComponentIdType c, in TriPortIdType port, in Value msgValue, in TciValueTemplate msgTmpl, in TciValueDifferenceList diffs, in TriAddressType address, in TciValueTemplate addressTmpl)	<pre> &lt;xsd:complexType name="tliMMismatch_m"&gt;   &lt;xsd:complexContent mixed="true"&gt;     &lt;xsd:extension base="Events:Event"&gt;       &lt;xsd:sequence&gt;         &lt;xsd:element name="port" type="Types:TriPortIdType"/&gt;         &lt;xsd:element name="msgValue" type="Values:Value"/&gt;         &lt;xsd:element name="msgTmpl"           type="Templates:TciValueTemplate"/&gt;         &lt;xsd:element name="diffs"           type="Templates:TciValueDifferenceList"/&gt;         &lt;xsd:element name="address" type="Types:TriAddressType"           minOccurs="0"/&gt;         &lt;xsd:element name="addressTmpl"           type="Templates:TciValueTemplate" minOccurs="0"/&gt;       &lt;/xsd:sequence&gt;     &lt;/xsd:extension&gt;   &lt;/xsd:complexContent&gt; &lt;/xsd:complexType&gt; </pre>
void tliMMismatch_c (in TString am, in TInteger ts, in TString src, in TInteger line, in TriComponentIdType c, in TriPortIdType port, in Value msgValue, in TciValueTemplate msgTmpl, in TciValueDifferenceList diffs, in TriComponentIdType from, in TciNonValueTemplate fromTmpl)	<pre> &lt;xsd:complexType name="tliMMismatch_c"&gt;   &lt;xsd:complexContent mixed="true"&gt;     &lt;xsd:extension base="Events:Event"&gt;       &lt;xsd:sequence&gt;         &lt;xsd:element name="port" type="Types:TriPortIdType"/&gt;         &lt;xsd:element name="msgValue" type="Values:Value"/&gt;         &lt;xsd:element name="msgTmpl"           type="Templates:TciValueTemplate"/&gt;         &lt;xsd:element name="diffs"           type="Templates:TciValueDifferenceList"/&gt;         &lt;xsd:element name="from"           type="Types:TriComponentIdType" minOccurs="0"/&gt;         &lt;xsd:element name="fromTmpl"           type="Templates:TciNonValueTemplate" minOccurs="0"/&gt;       &lt;/xsd:sequence&gt;     &lt;/xsd:extension&gt;   &lt;/xsd:complexContent&gt; &lt;/xsd:complexType&gt; </pre>
void tliMReceive_m (in TString am, in TInteger ts, in TString src, in TInteger line, in TriComponentIdType c, in TriPortIdType port, in Value msgValue, in TciValueTemplate msgTmpl, in TriAddressType address, in TciValueTemplate addressTmpl)	<pre> &lt;xsd:complexType name="tliMReceive_m"&gt;   &lt;xsd:complexContent mixed="true"&gt;     &lt;xsd:extension base="Events:Event"&gt;       &lt;xsd:sequence&gt;         &lt;xsd:element name="port" type="Types:TriPortIdType"/&gt;         &lt;xsd:element name="msgValue" type="Values:Value"           minOccurs="0"/&gt;         &lt;xsd:element name="msgTmpl"           type="Templates:TciValueTemplate" minOccurs="0"/&gt;         &lt;xsd:element name="address" type="Types:TriAddressType"           minOccurs="0"/&gt;         &lt;xsd:element name="addressTmpl"           type="Templates:TciValueTemplate" minOccurs="0"/&gt;       &lt;/xsd:sequence&gt;     &lt;/xsd:extension&gt;   &lt;/xsd:complexContent&gt; &lt;/xsd:complexType&gt; </pre>
void tliMReceive_c (in TString am, in TInteger ts, in TString src, in TInteger line, in TriComponentIdType c, in TriPortIdType port, in Value msgValue, in TciValueTemplate msgTmpl, in TriComponentIdType from, in TciNonValueTemplate fromTmpl)	<pre> &lt;xsd:complexType name="tliMReceive_c"&gt;   &lt;xsd:complexContent mixed="true"&gt;     &lt;xsd:extension base="Events:Event"&gt;       &lt;xsd:sequence&gt;         &lt;xsd:element name="port" type="Types:TriPortIdType"/&gt;         &lt;xsd:element name="msgValue" type="Values:Value"           minOccurs="0"/&gt;         &lt;xsd:element name="msgTmpl"           type="Templates:TciValueTemplate" minOccurs="0"/&gt;         &lt;xsd:element name="from"           type="Types:TriComponentIdType" minOccurs="0"/&gt;         &lt;xsd:element name="fromTmpl"           type="Templates:TciNonValueTemplate" minOccurs="0"/&gt;       &lt;/xsd:sequence&gt;     &lt;/xsd:extension&gt;   &lt;/xsd:complexContent&gt; &lt;/xsd:complexType&gt; </pre>

<b>TCI-TL provided</b>	
void tliPrCall_m (in TString am, in TInteger ts, in TString src, in TInteger line, in TriComponentIdType c, in TriPortIdType port, in TriSignatureIdType signature, in TciParameterListType parsValue, in TriAddressType address, in TriStatusType encoderFailure, in TriParameterListType pars, in TriStatusType transmissionFailure)	<pre> &lt;xsd:complexType name="tliPrCall_m"&gt;   &lt;xsd:complexContent mixed="true"&gt;     &lt;xsd:extension base="Events:Event"&gt;       &lt;xsd:sequence&gt;         &lt;xsd:element name="port" type="Types:TriPortIdType"/&gt;         &lt;xsd:element name="signature"           type="Types:TriSignatureIdType"/&gt;         &lt;xsd:element name="parsValue"           type="Types:TriParameterListType" minOccurs="0"/&gt;         &lt;xsd:element name="address" type="Types:TriAddressType"           minOccurs="0"/&gt;         &lt;xsd:choice&gt;           &lt;xsd:element name="encoder-failure"             type="SimpleTypes:TciStatusType" minOccurs="0"/&gt;           &lt;xsd:element name="transmission-failure"             type="SimpleTypes:TriStatusType" minOccurs="0"/&gt;         &lt;/xsd:choice&gt;       &lt;/xsd:sequence&gt;     &lt;/xsd:extension&gt;   &lt;/xsd:complexContent&gt; &lt;/xsd:complexType&gt; </pre>
void tliPrCall_m_BC (in TString am, in TInteger ts, in TString src, in TInteger line, in TriComponentIdType c, in TriPortIdType port, in TriSignatureIdType signature, in TciParameterListType parsValue, in TriStatusType encoderFailure, in TriParameterListType pars, in TriStatusType transmissionFailure)	<pre> &lt;xsd:complexType name="tliPrCall_m_BC"&gt;   &lt;xsd:complexContent mixed="true"&gt;     &lt;xsd:extension base="Events:Event"&gt;       &lt;xsd:sequence&gt;         &lt;xsd:element name="port" type="Types:TriPortIdType"/&gt;         &lt;xsd:element name="signature"           type="Types:TriSignatureIdType"/&gt;         &lt;xsd:element name="parsValue"           type="Types:TriParameterListType" minOccurs="0"/&gt;         &lt;xsd:choice&gt;           &lt;xsd:element name="encoder-failure"             type="SimpleTypes:TciStatusType" minOccurs="0"/&gt;           &lt;xsd:element name="transmission-failure"             type="SimpleTypes:TriStatusType" minOccurs="0"/&gt;         &lt;/xsd:choice&gt;       &lt;/xsd:sequence&gt;     &lt;/xsd:extension&gt;   &lt;/xsd:complexContent&gt; &lt;/xsd:complexType&gt; </pre>
void tliPrCall_m_MC (in TString am, in TInteger ts, in TString src, in TInteger line, in TriComponentIdType c, in TriPortIdType port, in TriSignatureIdType signature, in TciParameterListType parsValue, in TriAddressListType addresses, in TriStatusType encoderFailure, in TriParameterListType pars, in TriStatusType transmissionFailure)	<pre> &lt;xsd:complexType name="tliPrCall_m_MC"&gt;   &lt;xsd:complexContent mixed="true"&gt;     &lt;xsd:extension base="Events:Event"&gt;       &lt;xsd:sequence&gt;         &lt;xsd:element name="port" type="Types:TriPortIdType"/&gt;         &lt;xsd:element name="signature"           type="Types:TriSignatureIdType"/&gt;         &lt;xsd:element name="parsValue"           type="Types:TriParameterListType" minOccurs="0"/&gt;         &lt;xsd:element name="addresses"           type="Types:TriAddressListType" minOccurs="0"/&gt;         &lt;xsd:choice&gt;           &lt;xsd:element name="encoder-failure"             type="SimpleTypes:TciStatusType" minOccurs="0"/&gt;           &lt;xsd:element name="transmission-failure"             type="SimpleTypes:TriStatusType" minOccurs="0"/&gt;         &lt;/xsd:choice&gt;       &lt;/xsd:sequence&gt;     &lt;/xsd:extension&gt;   &lt;/xsd:complexContent&gt; &lt;/xsd:complexType&gt; </pre>

<b>TCI-TL provided</b>	
void tliPrCall_c (in TString am, in TInteger ts, in TString src, in TInteger line, in TriComponentIdType c, in TriPortIdType port, in TriSignatureIdType signature, in TciParameterListType parsValue, in TriComponentIdType to, in TriStatusType transmissionFailure)	<pre> &lt;xsd:complexType name="tliPrCall_c"&gt;   &lt;xsd:complexContent mixed="true"&gt;     &lt;xsd:extension base="Events:Event"&gt;       &lt;xsd:sequence&gt;         &lt;xsd:element name="port" type="Types:TriPortIdType"/&gt;         &lt;xsd:element name="signature"           type="Types:TriSignatureIdType"/&gt;         &lt;xsd:element name="parsValue"           type="Types:TciParameterListType" minOccurs="0"/&gt;         &lt;xsd:element name="to" type="Types:TriComponentIdType"           minOccurs="0"/&gt;         &lt;xsd:element name="transmission-failure"           type="SimpleTypes:TriStatusType" minOccurs="0"/&gt;       &lt;/xsd:sequence&gt;     &lt;/xsd:extension&gt;   &lt;/xsd:complexContent&gt; &lt;/xsd:complexType&gt; </pre>
void tliPrCall_c_BC (in TString am, in TInteger ts, in TString src, in TInteger line, in TriComponentIdType c, in TriPortIdType port, in TriSignatureIdType signature, in TciParameterListType parsValue, in TriStatusType transmissionFailure)	<pre> &lt;xsd:complexType name="tliPrCall_c_BC"&gt;   &lt;xsd:complexContent mixed="true"&gt;     &lt;xsd:extension base="Events:Event"&gt;       &lt;xsd:sequence&gt;         &lt;xsd:element name="port" type="Types:TriPortIdType"/&gt;         &lt;xsd:element name="signature"           type="Types:TriSignatureIdType"/&gt;         &lt;xsd:element name="parsValue"           type="Types:TciParameterListType" minOccurs="0"/&gt;         &lt;xsd:element name="transmission-failure"           type="SimpleTypes:TriStatusType" minOccurs="0"/&gt;       &lt;/xsd:sequence&gt;     &lt;/xsd:extension&gt;   &lt;/xsd:complexContent&gt; &lt;/xsd:complexType&gt; </pre>
void tliPrCall_c_MC (in TString am, in TInteger ts, in TString src, in TInteger line, in TriComponentIdType c, in TriPortIdType port, in TriSignatureIdType signature, in TciParameterListType parsValue, in TriComponentIdListType toList, in TriStatusType transmissionFailure)	<pre> &lt;xsd:complexType name="tliPrCall_c_MC"&gt;   &lt;xsd:complexContent mixed="true"&gt;     &lt;xsd:extension base="Events:Event"&gt;       &lt;xsd:sequence&gt;         &lt;xsd:element name="port" type="Types:TriPortIdType"/&gt;         &lt;xsd:element name="signature"           type="Types:TriSignatureIdType"/&gt;         &lt;xsd:element name="parsValue"           type="Types:TciParameterListType" minOccurs="0"/&gt;         &lt;xsd:element name="toList"           type="Types:TriComponentIdListType" minOccurs="0"/&gt;         &lt;xsd:element name="transmission-failure"           type="SimpleTypes:TriStatusType" minOccurs="0"/&gt;       &lt;/xsd:sequence&gt;     &lt;/xsd:extension&gt;   &lt;/xsd:complexContent&gt; &lt;/xsd:complexType&gt; </pre>
void tliPrGetCallDetected_m (in TString am, in TInteger ts, in TString src, in TInteger line, in TriComponentIdType c, in TriPortIdType port, in TriSignatureIdType signature, in TriParameterListType pars, in TriAddressType address)	<pre> &lt;xsd:complexType name="tliPrGetcallDetected_m"&gt;   &lt;xsd:complexContent mixed="true"&gt;     &lt;xsd:extension base="Events:Event"&gt;       &lt;xsd:sequence&gt;         &lt;xsd:element name="port" type="Types:TriPortIdType"/&gt;         &lt;xsd:element name="signature"           type="Types:TriSignatureIdType"/&gt;         &lt;xsd:element name="pars"           type="Types:TriParameterListType"/&gt;         &lt;xsd:element name="address" type="Types:TriAddressType"           minOccurs="0"/&gt;       &lt;/xsd:sequence&gt;     &lt;/xsd:extension&gt;   &lt;/xsd:complexContent&gt; &lt;/xsd:complexType&gt; </pre>

<b>TCI-TL provided</b>	
void tliPrGetCallDetected_c (in TString am, in TInteger ts, in TString src, in TInteger line, in TriComponentIdType c, in TriPortIdType port, in TriSignatureIdType signature, in TciParameterListType parsValue, in TriComponentIdType from)	<xsd:complexType name="tliPrGetcallDetected_c"> <xsd:complexContent mixed="true"> <xsd:extension base="Events:Event"> <xsd:sequence> <xsd:element name="port" type="Types:TriPortIdType"/> <xsd:element name="signature" type="Types:TriSignatureIdType"/> <xsd:element name="pars" type="Types:TciParameterListType"/> <xsd:element name="from" type="Types:TriComponentIdType" minOccurs="0"/> </xsd:sequence> </xsd:extension> </xsd:complexContent> </xsd:complexType>
void tliPrGetCallMismatch_m (in TString am, in TInteger ts, in TString src, in TInteger line, in TriComponentIdType c, in TriPortIdType port, in TriSignatureIdType signature, in TciParameterListType parsValue, in TciValueTemplate parsTpl, in TciValueDifferenceList diffs, in TriAddressType address, in TciValueTemplate addressTpl)	<xsd:complexType name="tliPrGetcallMismatch_m"> <xsd:complexContent mixed="true"> <xsd:extension base="Events:Event"> <xsd:sequence> <xsd:element name="port" type="Types:TriPortIdType"/> <xsd:element name="address" type="Types:TriAddressType" minOccurs="0"/> <xsd:element name="signature" type="Types:TriSignatureIdType"/> <xsd:element name="signatureTpl" type="Templates:TciValueTemplate"/> <xsd:element name="pars" type="Types:TriParameterListType"/> <xsd:element name="parsTpl" type="Templates:TciValueTemplate"/> </xsd:sequence> </xsd:extension> </xsd:complexContent> </xsd:complexType>
void tliPrGetCallMismatch_c (in TString am, in TInteger ts, in TString src, in TInteger line, in TriComponentIdType c, in TriPortIdType port, in TriSignatureIdType signature, in TciParameterListType parsValue, in TciValueTemplate parsTpl, in TciValueDifferenceList diffs, in TriComponentIdType from, in TciNonValueTemplate fromTpl)	<xsd:complexType name="tliPrGetcallMismatch_c"> <xsd:complexContent mixed="true"> <xsd:extension base="Events:Event"> <xsd:sequence> <xsd:element name="port" type="Types:TriPortIdType"/> <xsd:element name="address" type="Types:TriAddressType" minOccurs="0"/> <xsd:element name="signature" type="Types:TriSignatureIdType"/> <xsd:element name="signatureTpl" type="Templates:TciValueTemplate"/> <xsd:element name="pars" type="Types:TciParameterListType"/> <xsd:element name="parsTpl" type="Templates:TciValueTemplate"/> </xsd:sequence> </xsd:extension> </xsd:complexContent> </xsd:complexType>
void tliPrGetCall_m (in TString am, in TInteger ts, in TString src, in TInteger line, in TriComponentIdType c, in TriPortIdType port, in TriSignatureIdType signature, in TciParameterListType parsValue, in TciValueTemplate parsTpl, in TriAddressType address, in TciValueTemplate addressTpl)	<xsd:complexType name="tliPrGetcall_m"> <xsd:complexContent mixed="true"> <xsd:extension base="Events:Event"> <xsd:sequence> <xsd:element name="port" type="Types:TriPortIdType"/> <xsd:element name="from" type="Types:TriAddressType" minOccurs="0"/> <xsd:element name="signature" type="Types:TriSignatureIdType"/> <xsd:element name="signatureTpl" type="Templates:TciValueTemplate"/> <xsd:element name="pars" type="Types:TriParameterListType"/> <xsd:element name="parsTpl" type="Templates:TciValueTemplate"/> </xsd:sequence> </xsd:extension> </xsd:complexContent> </xsd:complexType>

<b>TCI-TL provided</b>	
<p>void tliPrGetCall_c (in TString am, in TInteger ts, in TString src, in TInteger line, in TriComponentIdType c, in TriPortIdType port, in TriSignatureIdType signature, in TciParameterListType parsValue, in TciValueTemplate parsTpl, in TriComponentIdType from, in TciNonValueTemplate fromTpl)</p>	<pre>&lt;xsd:complexType name="tliPrGetcall_c"&gt; &lt;xsd:complexContent mixed="true"&gt; &lt;xsd:extension base="Events:Event"&gt; &lt;xsd:sequence&gt; &lt;xsd:element name="port" type="Types:TriPortIdType"/&gt; &lt;xsd:element name="from" type="Types:TriAddressType" minOccurs="0"/&gt; &lt;xsd:element name="signature" type="Types:TriSignatureIdType"/&gt; &lt;xsd:element name="signatureTpl" type="Templates:TciValueTemplate"/&gt; &lt;xsd:element name="pars" type="Types:TciParameterListType"/&gt; &lt;xsd:element name="parsTpl" type="Templates:TciValueTemplate"/&gt; &lt;/xsd:sequence&gt; &lt;/xsd:extension&gt; &lt;/xsd:complexContent&gt; &lt;/xsd:complexType&gt;</pre>
<p>void tliPrReply_m (in TString am, in TInteger ts, in TString src, in TInteger line, in TriComponentIdType c, in TriPortIdType port, in TriSignatureIdType signature, in TciParameterListType parsValue, in Value replValue, in TriAddressType address, in TriStatusType encoderFailure, in TriParameterType repl, in TriStatusType transmissionFailure)</p>	<pre>&lt;xsd:complexType name="tliPrReply_m"&gt; &lt;xsd:complexContent mixed="true"&gt; &lt;xsd:extension base="Events:Event"&gt; &lt;xsd:sequence&gt; &lt;xsd:element name="port" type="Types:TriPortIdType"/&gt; &lt;xsd:element name="signature" type="Types:TriSignatureIdType"/&gt; &lt;xsd:element name="parsValue" type="Types:TciParameterListType"/&gt; &lt;xsd:element name="replValue" type="Values:Value"/&gt; &lt;xsd:element name="address" type="Types:TriAddressType" minOccurs="0"/&gt; &lt;xsd:choice&gt; &lt;xsd:element name="encoder-failure" type="SimpleTypes:TciStatusType"/&gt; &lt;xsd:sequence&gt; &lt;xsd:element name="repl" type="Types:TriParameterType" minOccurs="0"/&gt; &lt;xsd:element name="transmission-failure" type="SimpleTypes:TciStatusType" minOccurs="0"/&gt; &lt;/xsd:sequence&gt; &lt;/xsd:choice&gt; &lt;/xsd:sequence&gt; &lt;/xsd:extension&gt; &lt;/xsd:complexContent&gt; &lt;/xsd:complexType&gt;</pre>
<p>void tliPrReply_m_BC (in TString am, in TInteger ts, in TString src, in TInteger line, in TriComponentIdType c, in TriPortIdType port, in TriSignatureIdType signature, in TciParameterListType parsValue, in Value replValue, in TriStatusType encoderFailure, in TriParameterType repl, in TriStatusType transmissionFailure)</p>	<pre>&lt;xsd:complexType name="tliPrReply_m_BC"&gt; &lt;xsd:complexContent mixed="true"&gt; &lt;xsd:extension base="Events:Event"&gt; &lt;xsd:sequence&gt; &lt;xsd:element name="port" type="Types:TriPortIdType"/&gt; &lt;xsd:element name="signature" type="Types:TriSignatureIdType"/&gt; &lt;xsd:element name="parsValue" type="Types:TciParameterListType"/&gt; &lt;xsd:element name="replValue" type="Values:Value"/&gt; &lt;xsd:choice&gt; &lt;xsd:element name="encoder-failure" type="SimpleTypes:TciStatusType"/&gt; &lt;xsd:sequence&gt; &lt;xsd:element name="repl" type="Types:TriParameterType" minOccurs="0"/&gt; &lt;xsd:element name="transmission-failure" type="SimpleTypes:TciStatusType" minOccurs="0"/&gt; &lt;/xsd:sequence&gt; &lt;/xsd:choice&gt; &lt;/xsd:sequence&gt; &lt;/xsd:extension&gt; &lt;/xsd:complexContent&gt; &lt;/xsd:complexType&gt;</pre>



<b>TCI-TL provided</b>	
void tliPrReply_m_MC (in TString am, in TInteger ts, in TString src, in TInteger line, in TriComponentIdType c, in TriPortIdType port, in TriSignatureIdType signature, in TciParameterListType parsValue, in Value replValue, in TriAddressListType addresses, in TriStatusType encoderFailure, in TriParameterType repl, in TriStatusType transmissionFailure)	<pre> &lt;xsd:complexType name="tliPrReply_m_MC"&gt;   &lt;xsd:complexContent mixed="true"&gt;     &lt;xsd:extension base="Events:Event"&gt;       &lt;xsd:sequence&gt;         &lt;xsd:element name="port" type="Types:TriPortIdType"/&gt;         &lt;xsd:element name="signature"           type="Types:TriSignatureIdType"/&gt;         &lt;xsd:element name="parsValue"           type="Types:TriParameterListType"/&gt;         &lt;xsd:element name="replValue" type="Values:Value"/&gt;         &lt;xsd:element name="addresses"           type="Types:TriAddressListType" minOccurs="0"/&gt;         &lt;xsd:choice&gt;           &lt;xsd:element name="encoder-failure"             type="SimpleTypes:TciStatusType"/&gt;           &lt;xsd:sequence&gt;             &lt;xsd:element name="repl" type="Types:TriParameterType"               minOccurs="0"/&gt;             &lt;xsd:element name="transmission-failure"               type="SimpleTypes:TriStatusType" minOccurs="0"/&gt;           &lt;/xsd:sequence&gt;         &lt;/xsd:choice&gt;       &lt;/xsd:sequence&gt;     &lt;/xsd:extension&gt;   &lt;/xsd:complexContent&gt; &lt;/xsd:complexType&gt; </pre>
void tliPrReply_c (in TString am, in TInteger ts, in TString src, in TInteger line, in TriComponentIdType c, in TriPortIdType port, in TriSignatureIdType signature, in TciParameterListType parsValue, in Value replValue, in TriComponentIdType to, in TriStatusType transmissionFailure)	<pre> &lt;xsd:complexType name="tliPrReply_c"&gt;   &lt;xsd:complexContent mixed="true"&gt;     &lt;xsd:extension base="Events:Event"&gt;       &lt;xsd:sequence&gt;         &lt;xsd:element name="port" type="Types:TriPortIdType"/&gt;         &lt;xsd:element name="signature"           type="Types:TriSignatureIdType"/&gt;         &lt;xsd:element name="parsValue"           type="Types:TciParameterListType"/&gt;         &lt;xsd:element name="replValue" type="Values:Value"/&gt;         &lt;xsd:element name="to" type="Types:TriComponentIdType"           minOccurs="0"/&gt;         &lt;xsd:element name="transmission-failure"           type="SimpleTypes:TriStatusType" minOccurs="0"/&gt;       &lt;/xsd:sequence&gt;     &lt;/xsd:extension&gt;   &lt;/xsd:complexContent&gt; &lt;/xsd:complexType&gt; </pre>
void tliPrReply_c_BC (in TString am, in TInteger ts, in TString src, in TInteger line, in TriComponentIdType c, in TriPortIdType port, in TriSignatureIdType signature, in TciParameterListType parsValue, in Value replValue, in TriStatusType transmissionFailure)	<pre> &lt;xsd:complexType name="tliPrReply_c_BC"&gt;   &lt;xsd:complexContent mixed="true"&gt;     &lt;xsd:extension base="Events:Event"&gt;       &lt;xsd:sequence&gt;         &lt;xsd:element name="port" type="Types:TriPortIdType"/&gt;         &lt;xsd:element name="signature"           type="Types:TriSignatureIdType"/&gt;         &lt;xsd:element name="parsValue"           type="Types:TciParameterListType"/&gt;         &lt;xsd:element name="replValue" type="Values:Value"/&gt;         &lt;xsd:element name="transmission-failure"           type="SimpleTypes:TriStatusType" minOccurs="0"/&gt;       &lt;/xsd:sequence&gt;     &lt;/xsd:extension&gt;   &lt;/xsd:complexContent&gt; &lt;/xsd:complexType&gt; </pre>

<b>TCI-TL provided</b>	
void tliPrReply_c_MC (in TString am, in TInteger ts, in TString src, in TInteger line, in TriComponentIdType c, in TriPortIdType port, in TriSignatureIdType signature, in TciParameterListType parsValue, in Value replValue, in TriComponentIdListType toList, in TriStatusType transmissionFailure)	<pre>&lt;xsd:complexType name="tliPrReply_c_MC"&gt; &lt;xsd:complexContent mixed="true"&gt; &lt;xsd:extension base="Events:Event"&gt; &lt;xsd:sequence&gt; &lt;xsd:element name="port" type="Types:TriPortIdType"/&gt; &lt;xsd:element name="signature" type="Types:TriSignatureIdType"/&gt; &lt;xsd:element name="parsValue" type="Types:TciParameterListType"/&gt; &lt;xsd:element name="replValue" type="Values:Value"/&gt; &lt;xsd:element name="toList" type="Types:TriComponentIdListType" minOccurs="0"/&gt; &lt;xsd:element name="transmission-failure" type="SimpleTypes:TriStatusType" minOccurs="0"/&gt; &lt;/xsd:sequence&gt; &lt;/xsd:extension&gt; &lt;/xsd:complexContent&gt; &lt;/xsd:complexType&gt;</pre>
void tliPrGetReplyDetected_m (in TString am, in TInteger ts, in TString src, in TInteger line, in TriComponentIdType c, in TriPortIdType port, in TriSignatureIdType signature, in TriParameterType repl, in TriAddressType address)	<pre>&lt;xsd:complexType name="tliPrGetReplyDetected_m"&gt; &lt;xsd:complexContent mixed="true"&gt; &lt;xsd:extension base="Events:Event"&gt; &lt;xsd:sequence&gt; &lt;xsd:element name="port" type="Types:TriPortIdType"/&gt; &lt;xsd:element name="signature" type="Types:TriSignatureIdType"/&gt; &lt;xsd:element name="replValue" type="Values:Value"/&gt; &lt;xsd:element name="address" type="Types:TriAddressType"/&gt; &lt;/xsd:sequence&gt; &lt;/xsd:extension&gt; &lt;/xsd:complexContent&gt; &lt;/xsd:complexType&gt;</pre>
void tliPrGetReplyDetected_c (in TString am, in TInteger ts, in TString src, in TInteger line, in TriComponentIdType c, in TriPortIdType port, in TriSignatureIdType signature, in Value replValue, in TriComponentIdType from)	<pre>&lt;xsd:complexType name="tliPrGetReplyDetected_c"&gt; &lt;xsd:complexContent mixed="true"&gt; &lt;xsd:extension base="Events:Event"&gt; &lt;xsd:sequence&gt; &lt;xsd:element name="port" type="Types:TriPortIdType"/&gt; &lt;xsd:element name="signature" type="Types:TriSignatureIdType"/&gt; &lt;xsd:element name="replValue" type="Values:Value"/&gt; &lt;xsd:element name="from" type="Types:TriComponentIdType"/&gt; &lt;/xsd:sequence&gt; &lt;/xsd:extension&gt; &lt;/xsd:complexContent&gt; &lt;/xsd:complexType&gt;</pre>
void tliPrGetReplyMismatch_m (in TString am, in TInteger ts, in TString src, in TInteger line, in TriComponentIdType c, in TriPortIdType port, in TriSignatureIdType signature, in TciParameterListType parsValue, in Value replValue, in TciValueTemplate replyTmpl, in TciValueDifferenceList diffs, in TriAddressType address, in TciValueTemplate addressTmpl)	<pre>&lt;xsd:complexType name="tliPrGetReplyMismatch_m"&gt; &lt;xsd:complexContent mixed="true"&gt; &lt;xsd:extension base="Events:Event"&gt; &lt;xsd:sequence&gt; &lt;xsd:element name="port" type="Types:TriPortIdType"/&gt; &lt;xsd:element name="signature" type="Types:TriSignatureIdType"/&gt; &lt;xsd:element name="parsValue" type="Types:TciParameterListType"/&gt; &lt;xsd:element name="replValue" type="Values:Value"/&gt; &lt;xsd:element name="replyTmpl" type="Values:Value"/&gt; &lt;xsd:element name="diffs" type="Templates:TciValueDifferenceList"/&gt; &lt;xsd:element name="address" type="Types:TriAddressType"/&gt; &lt;xsd:element name="addressTmpl" type="Templates:TciValueTemplate"/&gt; &lt;/xsd:sequence&gt; &lt;/xsd:extension&gt; &lt;/xsd:complexContent&gt; &lt;/xsd:complexType&gt;</pre>

<b>TCI-TL provided</b>	
void tliPrGetReplyMismatch_c (in TString am, in TInteger ts, in TString src, in TInteger line, in TriComponentIdType c, in TriPortIdType port, in TriSignatureIdType signature, in TciParameterListType parsValue, in Value replValue, in TciValueTemplate replyTmpl, in TciValueDifferenceList diffs, in TriComponentIdType from, in TciNonValueTemplate fromTmpl)	<pre> &lt;xsd:complexType name="tliPrGetReplyMismatch_c"&gt; &lt;xsd:complexContent mixed="true"&gt; &lt;xsd:extension base="Events:Event"&gt; &lt;xsd:sequence&gt; &lt;xsd:element name="port" type="Types:TriPortIdType"/&gt; &lt;xsd:element name="signature" type="Types:TriSignatureIdType"/&gt; &lt;xsd:element name="parsValue" type="Types:TciParameterListType"/&gt; &lt;xsd:element name="replValue" type="Values:Value"/&gt; &lt;xsd:element name="replTmpl" type="Values:Value"/&gt; &lt;xsd:element name="diffs" type="Templates:TciValueDifferenceList"/&gt; &lt;xsd:element name="from" type="Types:TriComponentIdType"/&gt; &lt;xsd:element name="fromTmpl" type="Templates:TciNonValueTemplate"/&gt; &lt;/xsd:sequence&gt; &lt;/xsd:extension&gt; &lt;/xsd:complexContent&gt; &lt;/xsd:complexType&gt; </pre>
void tliPrGetReply_m (in TString am, in TInteger ts, in TString src, in TInteger line, in TriComponentIdType c, in TriPortIdType port, in TriSignatureIdType signature, in TciParameterListType parsValue, in Value replValue, in TciValueTemplate replyTmpl, in TriAddressType address, in TciValueTemplate addressTmpl)	<pre> &lt;xsd:complexType name="tliPrGetReply_m"&gt; &lt;xsd:complexContent mixed="true"&gt; &lt;xsd:extension base="Events:Event"&gt; &lt;xsd:sequence&gt; &lt;xsd:element name="port" type="Types:TriPortIdType"/&gt; &lt;xsd:element name="signature" type="Types:TriSignatureIdType"/&gt; &lt;xsd:element name="parsValue" type="Types:TciParameterListType"/&gt; &lt;xsd:element name="replValue" type="Values:Value"/&gt; &lt;xsd:element name="replTmpl" type="Values:Value"/&gt; &lt;xsd:element name="address" type="Types:TriAddressType"/&gt; &lt;xsd:element name="addressTmpl" type="Templates:TciValueTemplate"/&gt; &lt;/xsd:sequence&gt; &lt;/xsd:extension&gt; &lt;/xsd:complexContent&gt; &lt;/xsd:complexType&gt; </pre>
void tliPrGetReply_c (in TString am, in TInteger ts, in TString src, in TInteger line, in TriComponentIdType c, in TriPortIdType port, in TriSignatureIdType signature, in TciParameterListType parsValue, in Value replValue, in TciValueTemplate replyTmpl, in TriComponentIdType from, in TciNonValueTemplate fromTmpl)	<pre> &lt;xsd:complexType name="tliPrGetReply_c"&gt; &lt;xsd:complexContent mixed="true"&gt; &lt;xsd:extension base="Events:Event"&gt; &lt;xsd:sequence&gt; &lt;xsd:element name="port" type="Types:TriPortIdType"/&gt; &lt;xsd:element name="signature" type="Types:TriSignatureIdType"/&gt; &lt;xsd:element name="parsValue" type="Types:TciParameterListType"/&gt; &lt;xsd:element name="replValue" type="Values:Value"/&gt; &lt;xsd:element name="replTmpl" type="Values:Value"/&gt; &lt;xsd:element name="from" type="Types:TriComponentIdType"/&gt; &lt;xsd:element name="fromTmpl" type="Templates:TciNonValueTemplate"/&gt; &lt;/xsd:sequence&gt; &lt;/xsd:extension&gt; &lt;/xsd:complexContent&gt; &lt;/xsd:complexType&gt; </pre>

<b>TCI-TL provided</b>	
void tliPrRaise_m (in TString am, in TInteger ts, in TString src, in TInteger line, in TriComponentIdType c, in TriPortIdType port, in TriSignatureIdType signature, in TciParameterListType parsValue, in Value excValue, in TriAddressType address, in TriStatusType encoderFailure, in TriExceptionType exc, in TriStatusType transmissionFailure)	<pre> &lt;xsd:complexType name="tliPrRaise_m"&gt;   &lt;xsd:complexContent mixed="true"&gt;     &lt;xsd:extension base="Events:Event"&gt;       &lt;xsd:sequence&gt;         &lt;xsd:element name="port" type="Types:TriPortIdType"/&gt;         &lt;xsd:element name="signature"           type="Types:TriSignatureIdType"/&gt;         &lt;xsd:element name="parsValue"           type="Types:TriParameterListType"/&gt;         &lt;xsd:element name="excValue" type="Values:Value"/&gt;         &lt;xsd:element name="address" type="Types:TriAddressType"           minOccurs="0"/&gt;         &lt;xsd:choice&gt;           &lt;xsd:element name="encoder-failure"             type="SimpleTypes:TciStatusType"/&gt;           &lt;xsd:sequence&gt;             &lt;xsd:element name="exc" type="Types:TriExceptionType"               minOccurs="0"/&gt;             &lt;xsd:element name="transmission-failure"               type="SimpleTypes:TriStatusType" minOccurs="0"/&gt;           &lt;/xsd:sequence&gt;         &lt;/xsd:choice&gt;       &lt;/xsd:sequence&gt;     &lt;/xsd:extension&gt;   &lt;/xsd:complexContent&gt; &lt;/xsd:complexType&gt; </pre>
void tliPrRaise_m_BC (in TString am, in TInteger ts, in TString src, in TInteger line, in TriComponentIdType c, in TriPortIdType port, in TriSignatureIdType signature, in TciParameterListType parsValue, in Value excValue, in TriStatusType encoderFailure, in TriExceptionType exc, in TriStatusType transmissionFailure)	<pre> &lt;xsd:complexType name="tliPrRaise_m_BC"&gt;   &lt;xsd:complexContent mixed="true"&gt;     &lt;xsd:extension base="Events:Event"&gt;       &lt;xsd:sequence&gt;         &lt;xsd:element name="port" type="Types:TriPortIdType"/&gt;         &lt;xsd:element name="signature"           type="Types:TriSignatureIdType"/&gt;         &lt;xsd:element name="parsValue"           type="Types:TriParameterListType"/&gt;         &lt;xsd:element name="excValue" type="Values:Value"/&gt;         &lt;xsd:choice&gt;           &lt;xsd:element name="encoder-failure"             type="SimpleTypes:TciStatusType"/&gt;           &lt;xsd:sequence&gt;             &lt;xsd:element name="exc" type="Types:TriExceptionType"               minOccurs="0"/&gt;             &lt;xsd:element name="transmission-failure"               type="SimpleTypes:TriStatusType" minOccurs="0"/&gt;           &lt;/xsd:sequence&gt;         &lt;/xsd:choice&gt;       &lt;/xsd:sequence&gt;     &lt;/xsd:extension&gt;   &lt;/xsd:complexContent&gt; &lt;/xsd:complexType&gt; </pre>
void tliPrRaise_m_MC (in TString am, in TInteger ts, in TString src, in TInteger line, in TriComponentIdType c, in TriPortIdType port, in TriSignatureIdType signature, in TciParameterListType parsValue, in Value excValue, in TriAddressListType addresses, in TriStatusType encoderFailure, in TriExceptionType exc, in TriStatusType transmissionFailure)	<pre> &lt;xsd:complexType name="tliPrRaise_m_MC"&gt;   &lt;xsd:complexContent mixed="true"&gt;     &lt;xsd:extension base="Events:Event"&gt;       &lt;xsd:sequence&gt;         &lt;xsd:element name="port" type="Types:TriPortIdType"/&gt;         &lt;xsd:element name="signature"           type="Types:TriSignatureIdType"/&gt;         &lt;xsd:element name="parsValue"           type="Types:TriParameterListType"/&gt;         &lt;xsd:element name="excValue" type="Values:Value"/&gt;         &lt;xsd:element name="addresses"           type="Types:TriAddressListType" minOccurs="0"/&gt;         &lt;xsd:choice&gt;           &lt;xsd:element name="encoder-failure"             type="SimpleTypes:TciStatusType"/&gt;           &lt;xsd:sequence&gt;             &lt;xsd:element name="exc" type="Types:TriExceptionType"               minOccurs="0"/&gt;             &lt;xsd:element name="transmission-failure"               type="SimpleTypes:TriStatusType" minOccurs="0"/&gt;           &lt;/xsd:sequence&gt;         &lt;/xsd:choice&gt;       &lt;/xsd:sequence&gt;     &lt;/xsd:extension&gt;   &lt;/xsd:complexContent&gt; &lt;/xsd:complexType&gt; </pre>

<b>TCI-TL provided</b>	
void tliPrRaise_c (in TString am, in TInteger ts, in TString src, in TInteger line, in TriComponentIdType c, in TriPortIdType port, in TriSignatureIdType signature, in TciParameterListType parsValue, in Value excValue, in TriComponentIdType to, in TriStatusType transmissionFailure)	<pre> &lt;xsd:complexType name="tliPrRaise_c"&gt;   &lt;xsd:complexContent mixed="true"&gt;     &lt;xsd:extension base="Events:Event"&gt;       &lt;xsd:sequence&gt;         &lt;xsd:element name="port" type="Types:TriPortIdType"/&gt;         &lt;xsd:element name="signature"           type="Types:TriSignatureIdType"/&gt;         &lt;xsd:element name="parsValue"           type="Types:TciParameterListType"/&gt;         &lt;xsd:element name="excValue" type="Values:Value"/&gt;         &lt;xsd:element name="to" type="Types:TriComponentIdType"           minOccurs="0"/&gt;         &lt;xsd:element name="transmission-failure"           type="SimpleTypes:TriStatusType" minOccurs="0"/&gt;       &lt;/xsd:sequence&gt;     &lt;/xsd:extension&gt;   &lt;/xsd:complexContent&gt; &lt;/xsd:complexType&gt; </pre>
void tliPrRaise_c_BC (in TString am, in TInteger ts, in TString src, in TInteger line, in TriComponentIdType c, in TriPortIdType port, in TriSignatureIdType signature, in TciParameterListType parsValue, in Value excValue, in TriStatusType transmissionFailure)	<pre> &lt;xsd:complexType name="tliPrRaise_c_BC"&gt;   &lt;xsd:complexContent mixed="true"&gt;     &lt;xsd:extension base="Events:Event"&gt;       &lt;xsd:sequence&gt;         &lt;xsd:element name="port" type="Types:TriPortIdType"/&gt;         &lt;xsd:element name="signature"           type="Types:TriSignatureIdType"/&gt;         &lt;xsd:element name="parsValue"           type="Types:TciParameterListType"/&gt;         &lt;xsd:element name="excValue" type="Values:Value"/&gt;         &lt;xsd:element name="transmission-failure"           type="SimpleTypes:TriStatusType" minOccurs="0"/&gt;       &lt;/xsd:sequence&gt;     &lt;/xsd:extension&gt;   &lt;/xsd:complexContent&gt; &lt;/xsd:complexType&gt; </pre>
void tliPrRaise_c_MC (in TString am, in TInteger ts, in TString src, in TInteger line, in TriComponentIdType c, in TriPortIdType port, in TriSignatureIdType signature, in TciParameterListType parsValue, in Value excValue, in TriComponentIdListType toList, in TriStatusType transmissionFailure)	<pre> &lt;xsd:complexType name="tliPrRaise_c_MC"&gt;   &lt;xsd:complexContent mixed="true"&gt;     &lt;xsd:extension base="Events:Event"&gt;       &lt;xsd:sequence&gt;         &lt;xsd:element name="port" type="Types:TriPortIdType"/&gt;         &lt;xsd:element name="signature"           type="Types:TriSignatureIdType"/&gt;         &lt;xsd:element name="parsValue"           type="Types:TciParameterListType"/&gt;         &lt;xsd:element name="excValue" type="Values:Value"/&gt;         &lt;xsd:element name="toList"           type="Types:TriComponentIdListType" minOccurs="0"/&gt;         &lt;xsd:element name="transmission-failure"           type="SimpleTypes:TriStatusType" minOccurs="0"/&gt;       &lt;/xsd:sequence&gt;     &lt;/xsd:extension&gt;   &lt;/xsd:complexContent&gt; &lt;/xsd:complexType&gt; </pre>
void tliPrCatchDetected_m (in TString am, in TInteger ts, in TString src, in TInteger line, in TriComponentIdType c, in TriPortIdType port, in TriSignatureIdType signature, in TriExceptionType exc, in TriAddressType address)	<pre> &lt;xsd:complexType name="tliPrCatchDetected_m"&gt;   &lt;xsd:complexContent mixed="true"&gt;     &lt;xsd:extension base="Events:Event"&gt;       &lt;xsd:sequence&gt;         &lt;xsd:element name="port" type="Types:TriPortIdType"/&gt;         &lt;xsd:element name="signature"           type="Types:TriSignatureIdType"/&gt;         &lt;xsd:element name="exc" type="Types:TriExceptionType"/&gt;         &lt;xsd:element name="address" type="Types:TriAddressType"           minOccurs="0"/&gt;       &lt;/xsd:sequence&gt;     &lt;/xsd:extension&gt;   &lt;/xsd:complexContent&gt; &lt;/xsd:complexType&gt; </pre>

<b>TCI-TL provided</b>	
void tliPrCatchDetected_c (in TString am, in TInteger ts, in TString src, in TInteger line, in TriComponentIdType c, in TriPortIdType port, in TriSignatureIdType signature, in Value excValue, in TriComponentIdType from)	<pre>&lt;xsd:complexType name="tliPrCatchDetected_c"&gt; &lt;xsd:complexContent mixed="true"&gt; &lt;xsd:extension base="Events:Event"&gt; &lt;xsd:sequence&gt; &lt;xsd:element name="port" type="Types:TriPortIdType"/&gt; &lt;xsd:element name="signature" type="Types:TriSignatureIdType"/&gt; &lt;xsd:element name="exc" type="Types:TriExceptionType"/&gt; &lt;xsd:element name="from" type="Types:TriComponentIdType" minOccurs="0"/&gt; &lt;/xsd:sequence&gt; &lt;/xsd:extension&gt; &lt;/xsd:complexContent&gt; &lt;/xsd:complexType&gt;</pre>
void tliPrCatchMismatch_m (in TString am, in TInteger ts, in TString src, in TInteger line, in TriComponentIdType c, in TriPortIdType port, in TriSignatureIdType signature, in TciParameterListType parsValue, in Value excValue, in TciValueTemplate excTpl, in TciValueDifferenceList diffs, in TriAddressType address, in TciValueTemplate addressTpl)	<pre>&lt;xsd:complexType name="tliPrCatchMismatch_m"&gt; &lt;xsd:complexContent mixed="true"&gt; &lt;xsd:extension base="Events:Event"&gt; &lt;xsd:sequence&gt; &lt;xsd:element name="port" type="Types:TriPortIdType"/&gt; &lt;xsd:element name="signature" type="Types:TriSignatureIdType"/&gt; &lt;xsd:element name="parsValue" type="Types:TciParameterListType"/&gt; &lt;xsd:element name="exc" type="Values:Value"/&gt; &lt;xsd:element name="excTpl" type="Templates:TciValueTemplate"/&gt; &lt;xsd:element name="diffs" type="Templates:TciValueDifferenceList"/&gt; &lt;xsd:element name="address" type="Types:TriAddressType"/&gt; &lt;xsd:element name="addressTpl" type="Templates:TciValueTemplate"/&gt; &lt;/xsd:sequence&gt; &lt;/xsd:extension&gt; &lt;/xsd:complexContent&gt; &lt;/xsd:complexType&gt;</pre>
void tliPrCatchMismatch_c (in TString am, in TInteger ts, in TString src, in TInteger line, in TriComponentIdType c, in TriPortIdType port, in TriSignatureIdType signature, in TciParameterListType parsValue, in Value excValue, in TciValueTemplate excTpl, in TciValueDifferenceList diffs, in TriComponentIdType from, in TciNonValueTemplate fromTpl)	<pre>&lt;xsd:complexType name="tliPrCatchMismatch_c"&gt; &lt;xsd:complexContent mixed="true"&gt; &lt;xsd:extension base="Events:Event"&gt; &lt;xsd:sequence&gt; &lt;xsd:element name="port" type="Types:TriPortIdType"/&gt; &lt;xsd:element name="signature" type="Types:TriSignatureIdType"/&gt; &lt;xsd:element name="parsValue" type="Types:TciParameterListType"/&gt; &lt;xsd:element name="exc" type="Values:Value"/&gt; &lt;xsd:element name="excTpl" type="Templates:TciValueTemplate"/&gt; &lt;xsd:element name="address" type="Types:TriAddressType"/&gt; &lt;xsd:element name="addressTpl" type="Templates:TciValueTemplate"/&gt; &lt;/xsd:sequence&gt; &lt;/xsd:extension&gt; &lt;/xsd:complexContent&gt; &lt;/xsd:complexType&gt;</pre>
void tliPrCatch_m (in TString am, in TInteger ts, in TString src, in TInteger line, in TriComponentIdType c, in TriPortIdType port, in TriSignatureIdType signature, in TciParameterListType parsValue, in Value excValue, in TciValueTemplate excTpl, in TriAddressType address, in TciValueTemplate addressTpl)	<pre>&lt;xsd:complexType name="tliPrCatch_m"&gt; &lt;xsd:complexContent mixed="true"&gt; &lt;xsd:extension base="Events:Event"&gt; &lt;xsd:sequence&gt; &lt;xsd:element name="port" type="Types:TriPortIdType"/&gt; &lt;xsd:element name="signature" type="Types:TriSignatureIdType"/&gt; &lt;xsd:element name="signatureTpl" type="Templates:TciValueTemplate"/&gt; &lt;xsd:element name="exception" type="Values:Value"/&gt; &lt;xsd:element name="exceptionTpl" type="Templates:TciValueTemplate"/&gt; &lt;/xsd:sequence&gt; &lt;/xsd:extension&gt; &lt;/xsd:complexContent&gt; &lt;/xsd:complexType&gt;</pre>

<b>TCI-TL provided</b>	
void tliPrCatch_c (in TString am, in TInteger ts, in TString src, in TInteger line, in TriComponentIdType c, in TriPortIdType port, in TriSignatureIdType signature, in TciParameterListType parsValue, in Value excValue, in TciValueTemplate excTmpl, in TriComponentIdType from, in TciNonValueTemplate fromTmpl)	<pre>&lt;xsd:complexType name="tliPrCatch_c"&gt; &lt;xsd:complexContent mixed="true"&gt; &lt;xsd:extension base="Events:Event"&gt; &lt;xsd:sequence&gt; &lt;xsd:element name="port" type="Types:TriPortIdType"/&gt; &lt;xsd:element name="signature" type="Types:TriSignatureIdType"/&gt; &lt;xsd:element name="signatureTmpl" type="Templates:TciValueTemplate"/&gt; &lt;xsd:element name="exception" type="Values:Value"/&gt; &lt;xsd:element name="exceptionTmpl" type="Templates:TciValueTemplate"/&gt; &lt;xsd:element name="from" type="Types:TriComponentIdType"/&gt; &lt;xsd:element name="fromTmpl" type="Templates:TciNonValueTemplate"/&gt; &lt;/xsd:sequence&gt; &lt;/xsd:extension&gt; &lt;/xsd:complexContent&gt; &lt;/xsd:complexType&gt;</pre>
void tliPrCatchTimeoutDetected(in TString am, in TInteger ts, in TString src, in TInteger line, in TriComponentIdType c, in TriPortIdType port, in TriSignatureIdType signature)	<pre>&lt;xsd:complexType name="tliPrCatchTimeoutDetected"&gt; &lt;xsd:complexContent mixed="true"&gt; &lt;xsd:extension base="Events:Event"&gt; &lt;xsd:sequence&gt; &lt;xsd:element name="port" type="Types:TriPortIdType"/&gt; &lt;xsd:element name="signature" type="Types:TriSignatureIdType"/&gt; &lt;/xsd:sequence&gt; &lt;/xsd:extension&gt; &lt;/xsd:complexContent&gt; &lt;/xsd:complexType&gt;</pre>
void tliPrCatchTimeout (in TString am, in TInteger ts, in TString src, in TInteger line, in TriComponentIdType c, in TriPortIdType port, in TriSignatureIdType signature, in TciParameterListType parsValue)	<pre>&lt;xsd:complexType name="tliPrCatchTimeout"&gt; &lt;xsd:complexContent mixed="true"&gt; &lt;xsd:extension base="Events:Event"&gt; &lt;xsd:sequence&gt; &lt;xsd:element name="port" type="Types:TriPortIdType"/&gt; &lt;xsd:element name="signature" type="Types:TriSignatureIdType"/&gt; &lt;xsd:element name="parsValue" type="Types:TriParameterListType"/&gt; &lt;/xsd:sequence&gt; &lt;/xsd:extension&gt; &lt;/xsd:complexContent&gt; &lt;/xsd:complexType&gt;</pre>
void tliCCreate (in TString am, in TInteger ts, in TString src, in TInteger line, in TriComponentIdType c, in TriComponentIdType comp, in TString name)	<pre>&lt;xsd:complexType name="tliCCreate"&gt; &lt;xsd:complexContent mixed="true"&gt; &lt;xsd:extension base="Events:Event"&gt; &lt;xsd:sequence&gt; &lt;xsd:element name="comp" type="Types:TriComponentIdType"/&gt; &lt;xsd:element name="name" type="SimpleTypes:TString"/&gt; &lt;/xsd:sequence&gt; &lt;/xsd:extension&gt; &lt;/xsd:complexContent&gt; &lt;/xsd:complexType&gt;</pre>
void tliCStart (in TString am, in TInteger ts, in TString src, in TInteger line, in TriComponentIdType c, in TriComponentIdType comp, in TciBehaviourIdType name, in TciParameterListType parsValue)	<pre>&lt;xsd:complexType name="tliCStart"&gt; &lt;xsd:complexContent mixed="true"&gt; &lt;xsd:extension base="Events:Event"&gt; &lt;xsd:sequence&gt; &lt;xsd:element name="comp" type="Types:TriComponentIdType"/&gt; &lt;xsd:element name="name" type="Types:TciBehaviourIdType"/&gt; &lt;xsd:element name="pars" type="Types:TciParameterListType" minOccurs="0"/&gt; &lt;/xsd:sequence&gt; &lt;/xsd:extension&gt; &lt;/xsd:complexContent&gt; &lt;/xsd:complexType&gt;</pre>

<b>TCI-TL provided</b>	
void tliCRunning (in TString am, in TInteger ts, in TString src, in TInteger line, in TriComponentIdType c, in TriComponentIdType comp, in TBoolean status)	<pre>&lt;xsd:complexType name="tliCRunning"&gt; &lt;xsd:complexContent mixed="true"&gt; &lt;xsd:extension base="Events:Event"&gt; &lt;xsd:sequence&gt; &lt;xsd:element name="comp" type="Types:TriComponentIdType"/&gt; &lt;xsd:element name="status" type="SimpleTypes:TBoolean"/&gt; &lt;/xsd:sequence&gt; &lt;/xsd:extension&gt; &lt;/xsd:complexContent&gt; &lt;/xsd:complexType&gt;</pre>
void tliCAlive, in TInteger ts, in TString src, in TInteger line, in TriComponentIdType c, in TriComponentIdType comp, in TBoolean status)	<pre>&lt;xsd:complexType name="tliCAlive"&gt; &lt;xsd:complexContent mixed="true"&gt; &lt;xsd:extension base="Events:Event"&gt; &lt;xsd:sequence&gt; &lt;xsd:element name="comp" type="Types:TriComponentIdType"/&gt; &lt;xsd:element name="status" type="SimpleTypes:TBoolean"/&gt; &lt;/xsd:sequence&gt; &lt;/xsd:extension&gt; &lt;/xsd:complexContent&gt; &lt;/xsd:complexType&gt;</pre>
void tliCStop (in TString am, in TInteger ts, in TString src, in TInteger line, in TriComponentIdType c, in TriComponentIdType comp)	<pre>&lt;xsd:complexType name="tliCStop"&gt; &lt;xsd:complexContent mixed="true"&gt; &lt;xsd:extension base="Events:Event"&gt; &lt;xsd:sequence&gt; &lt;xsd:element name="comp" type="Types:TriComponentIdType"/&gt; &lt;/xsd:sequence&gt; &lt;/xsd:extension&gt; &lt;/xsd:complexContent&gt; &lt;/xsd:complexType&gt;</pre>
void tliCKill (in TString am, in TInteger ts, in TString src, in TInteger line, in TriComponentIdType c, in TriComponentIdType comp)	<pre>&lt;xsd:complexType name="tliCKill"&gt; &lt;xsd:complexContent mixed="true"&gt; &lt;xsd:extension base="Events:Event"&gt; &lt;xsd:sequence&gt; &lt;xsd:element name="comp" type="Types:TriComponentIdType"/&gt; &lt;/xsd:sequence&gt; &lt;/xsd:extension&gt; &lt;/xsd:complexContent&gt; &lt;/xsd:complexType&gt;</pre>
void tliCDoneMismatch (in TString am, in TInteger ts, in TString src, in TInteger line, in TriComponentIdType c, in TciNonValueTemplate compTpl)	<pre>&lt;xsd:complexType name="tliCDoneMismatch"&gt; &lt;xsd:complexContent mixed="true"&gt; &lt;xsd:extension base="Events:Event"&gt; &lt;xsd:sequence&gt; &lt;xsd:element name="comp" type="Types:TriComponentIdType"/&gt; &lt;xsd:element name="compTpl" type="Templates:TciNonValueTemplate"/&gt; &lt;/xsd:sequence&gt; &lt;xsd:attribute name="done" type="SimpleTypes:TBoolean"/&gt; &lt;/xsd:extension&gt; &lt;/xsd:complexContent&gt; &lt;/xsd:complexType&gt;</pre>
void tliCDone (in TString am, in TInteger ts, in TString src, in TInteger line, in TriComponentIdType c, in TciNonValueTemplate compTpl)	<pre>&lt;xsd:complexType name="tliCDone"&gt; &lt;xsd:complexContent mixed="true"&gt; &lt;xsd:extension base="Events:Event"&gt; &lt;xsd:sequence&gt; &lt;xsd:element name="comp" type="Types:TriComponentIdType"/&gt; &lt;xsd:element name="compTpl" type="Templates:TciNonValueTemplate"/&gt; &lt;/xsd:sequence&gt; &lt;xsd:attribute name="done" type="SimpleTypes:TBoolean"/&gt; &lt;/xsd:extension&gt; &lt;/xsd:complexContent&gt; &lt;/xsd:complexType&gt;</pre>



<b>TCI-TL provided</b>	
void tliCKilledMismatch (in TString am, in TInteger ts, in TString src, in TInteger line, in TriComponentIdType c, in TciNonValueTemplate compTmpl)	<pre>&lt;xsd:complexType name="tliCKilledMismatch"&gt; &lt;xsd:complexContent mixed="true"&gt; &lt;xsd:extension base="Events:Event"&gt; &lt;xsd:sequence&gt; &lt;xsd:element name="comp" type="Types:TriComponentIdType"/&gt; &lt;xsd:element name="compTmpl" type="Templates:TciNonValueTemplate"/&gt; &lt;/xsd:sequence&gt; &lt;xsd:attribute name="done" type="SimpleTypes:TBoolean"/&gt; &lt;/xsd:extension&gt; &lt;/xsd:complexContent&gt; &lt;/xsd:complexType&gt;</pre>
void tliCKill (in TString am, in TInteger ts, in TString src, in TInteger line, in TriComponentIdType c, in TciNonValueTemplate compTmpl)	<pre>&lt;xsd:complexType name="tliCKill"&gt; &lt;xsd:complexContent mixed="true"&gt; &lt;xsd:extension base="Events:Event"&gt; &lt;xsd:sequence&gt; &lt;xsd:element name="comp" type="Types:TriComponentIdType"/&gt; &lt;xsd:element name="compTmpl" type="Templates:TciNonValueTemplate"/&gt; &lt;/xsd:sequence&gt; &lt;xsd:attribute name="done" type="SimpleTypes:TBoolean"/&gt; &lt;/xsd:extension&gt; &lt;/xsd:complexContent&gt; &lt;/xsd:complexType&gt;</pre>
void tliCTerminated (in TString am, in TInteger ts, in TString src, in TInteger line, in TriComponentIdType c, in VerdictValue verdict)	<pre>&lt;xsd:complexType name="tliCTerminated"&gt; without verdict) --&gt; &lt;xsd:complexContent mixed="true"&gt; &lt;xsd:extension base="Events:Event"&gt; &lt;xsd:sequence&gt; &lt;xsd:element name="comp" type="Types:TriComponentIdType"/&gt; &lt;xsd:element name="verdict" type="Values:VerdictValue" maxOccurs="1"/&gt; &lt;/xsd:sequence&gt; &lt;/xsd:extension&gt; &lt;/xsd:complexContent&gt; &lt;/xsd:complexType&gt;</pre>
void tliPConnect (in TString am, in TInteger ts, in TString src, in TInteger line, in TriComponentIdType c, in TriComponentIdType c1, in TriPortIdType port1, in TriComponentIdType c2, in TriPortIdType port2)	<pre>&lt;xsd:complexType name="tliPConnect"&gt; &lt;xsd:complexContent mixed="true"&gt; &lt;xsd:extension base="Events:PortConfiguration"/&gt; &lt;/xsd:complexContent&gt; &lt;/xsd:complexType&gt;</pre>
void tliPDisconnect (in TString am, in TInteger ts, in TString src, in TInteger line, in TriComponentIdType c, in TriComponentIdType c1, in TriPortIdType port1, in TriComponentIdType c2, in TriPortIdType port2)	<pre>&lt;xsd:complexType name="tliPDisconnect"&gt; &lt;xsd:complexContent mixed="true"&gt; &lt;xsd:extension base="Events:PortConfiguration"/&gt; &lt;/xsd:complexContent&gt; &lt;/xsd:complexType&gt;</pre>
void tliPMap (in TString am, in TInteger ts, in TString src, in TInteger line, in TriComponentIdType c, in TriComponentIdType c1, in TriPortIdType port1, in TriComponentIdType c2, in TriPortIdType port2)	<pre>&lt;xsd:complexType name="tliPMap"&gt; &lt;xsd:complexContent mixed="true"&gt; &lt;xsd:extension base="Events:PortConfiguration"/&gt; &lt;/xsd:complexContent&gt; &lt;/xsd:complexType&gt;</pre>
void tliPUnmap (in TString am, in TInteger ts, in TString src, in TInteger line, in TriComponentIdType c, in TriComponentIdType c1, in TriPortIdType port1, in TriComponentIdType c2, in TriPortIdType port2)	<pre>&lt;xsd:complexType name="tliPUnmap"&gt; &lt;xsd:complexContent mixed="true"&gt; &lt;xsd:extension base="Events:PortConfiguration"/&gt; &lt;/xsd:complexContent&gt; &lt;/xsd:complexType&gt;</pre>

<b>TCI-TL provided</b>	
void tliPClear (in TString am, in TInteger ts, in TString src, in TInteger line, in TriComponentIdType c, in TriPortIdType port)	<xsd:complexType name="tliPClear"> <xsd:complexContent mixed="true"> <xsd:extension base="Events:PortConfiguration"/> </xsd:complexContent> </xsd:complexType>
void tliPStart(in TString am, in TInteger ts, in TString src, in TInteger line, in TriComponentIdType c, in TriPortIdType port)	<xsd:complexType name="tliPStart"> <xsd:complexContent mixed="true"> <xsd:extension base="Events:PortConfiguration"/> </xsd:complexContent> </xsd:complexType>
void tliPStop (in TString am, in TInteger ts, in TString src, in TInteger line, in TriComponentIdType c, in TriPortIdType port)	<xsd:complexType name="tliPStop"> <xsd:complexContent mixed="true"> <xsd:extension base="Events:PortConfiguration"/> </xsd:complexContent> </xsd:complexType>
void tliPHalt (in TString am, in TInteger ts, in TString src, in TInteger line, in TriComponentIdType c, in TriPortIdType port)	<xsd:complexType name="tliPHalt"> <xsd:complexContent mixed="true"> <xsd:extension base="Events:PortConfiguration"/> </xsd:complexContent> </xsd:complexType>
void tliEncode (in TString am, in TInteger ts, in TString src, in TInteger line, in TriComponentIdType c, in Value val, in TriStatusType encoderFailure, in TriMessageType msg, in TString codec)	<xsd:complexType name="tliEncode"> <xsd:complexContent mixed="true"> <xsd:extension base="Events:Event"> <xsd:sequence> <xsd:element name="val" type="Values:Value"/> <xsd:choice> <xsd:element name="msg" type="Types:TriMessageType"/> <xsd:element name="encoder-failure" type="SimpleTypes:TciStatusType"/> </xsd:choice> </xsd:sequence> <xsd:attribute name="codec" type="SimpleTypes:TString" use="optional"/> </xsd:extension> </xsd:complexContent> </xsd:complexType>
void tliDecode (in TString am, in TInteger ts, in TString src, in TInteger line, in TriComponentIdType c, in TriMessageType msg, in TriStatusType decoderFailure, in Value val, in TString codec)	<xsd:complexType name="tliDecode" mixed="true"> <xsd:complexContent mixed="true"> <xsd:extension base="Events:Event"> <xsd:sequence> <xsd:choice> <xsd:element name="val" type="Values:Value"/> <xsd:element name="decoder-failure" type="SimpleTypes:TciStatusType"/> </xsd:choice> <xsd:element name="msg" type="Types:TriMessageType"/> </xsd:sequence> <xsd:attribute name="codec" type="SimpleTypes:TString" use="optional"/> </xsd:extension> </xsd:complexContent> </xsd:complexType>
void tliTimeoutDetected (in TString am, in TInteger ts, in TString src, in TInteger line, in TriComponentIdType c, in TriTimerIdType timer)	<xsd:complexType name="tliTimeoutDetected"> <xsd:complexContent mixed="true"> <xsd:extension base="Events:Event"> <xsd:sequence> <xsd:element name="timer" type="Types:TriTimerIdType" maxOccurs="1" minOccurs="1"/> </xsd:sequence> </xsd:extension> </xsd:complexContent> </xsd:complexType>
void tliTimeoutMismatch (in TString am, in TInteger ts, in TString src, in TInteger line, in TriComponentIdType c, in TciNonValueTemplate timerTpl)	<xsd:complexType name="tliTimeoutMismatch"> <xsd:complexContent mixed="true"> <xsd:extension base="Events:Event"> <xsd:sequence> <xsd:element name="timer" type="Types:TriTimerIdType" maxOccurs="1" minOccurs="1"/> <xsd:element name="timerTpl" type="Templates:TciNonValueTemplate" maxOccurs="1" minOccurs="1"/> </xsd:sequence> </xsd:extension> </xsd:complexContent> </xsd:complexType>

<b>TCI-TL provided</b>	
void tliTTimeout (in TString am, in TInteger ts, in TString src, in TInteger line, in TriComponentIdType c, in TciNonValueTypeTemplate timerTpl)	<pre>&lt;xsd:complexType name="tliTTimeout"&gt; &lt;xsd:complexContent mixed="true"&gt; &lt;xsd:extension base="Events:Event"&gt; &lt;xsd:sequence&gt; &lt;xsd:element name="timer" type="Types:TriTimerIdType" maxOccurs="1" minOccurs="1"/&gt; &lt;xsd:element name="timerTpl" type="Templates:TciNonValueTypeTemplate" maxOccurs="1" minOccurs="1"/&gt; &lt;/xsd:sequence&gt; &lt;/xsd:extension&gt; &lt;/xsd:complexContent&gt; &lt;/xsd:complexType&gt;</pre>
void tliTStart (in TString am, in TInteger ts, in TString src, in TInteger line, in TriComponentIdType c, in TriTimerIdType timer, in TriTimerDurationType dur)	<pre>&lt;xsd:complexType name="tliTStart"&gt; &lt;xsd:complexContent mixed="true"&gt; &lt;xsd:extension base="Events:Event"&gt; &lt;xsd:sequence&gt; &lt;xsd:element name="timer" type="Types:TriTimerIdType"/&gt; &lt;xsd:element name="dur" type="Types:TriTimerDurationType"/&gt; &lt;/xsd:sequence&gt; &lt;/xsd:extension&gt; &lt;/xsd:complexContent&gt; &lt;/xsd:complexType&gt;</pre>
void tliTStop (in TString am, in TInteger ts, in TString src, in TInteger line, in TriComponentIdType c, in TriTimerIdType timer)	<pre>&lt;xsd:complexType name="tliTStop"&gt; &lt;xsd:complexContent mixed="true"&gt; &lt;xsd:extension base="Events:Event"&gt; &lt;xsd:sequence&gt; &lt;xsd:element name="timer" type="Types:TriTimerIdType"/&gt; &lt;/xsd:sequence&gt; &lt;/xsd:extension&gt; &lt;/xsd:complexContent&gt; &lt;/xsd:complexType&gt;</pre>
void tliTRead (in TString am, in TInteger ts, in TString src, in TInteger line, in TriComponentIdType c, in TriTimerIdType timer, in TriTimerDurationType elapsed)	<pre>&lt;xsd:complexType name="tliTRead"&gt; &lt;xsd:complexContent mixed="true"&gt; &lt;xsd:extension base="Events:Event"&gt; &lt;xsd:sequence&gt; &lt;xsd:element name="timer" type="Types:TriTimerIdType"/&gt; &lt;xsd:element name="elapsed" type="Types:TriTimerDurationType"/&gt; &lt;/xsd:sequence&gt; &lt;/xsd:extension&gt; &lt;/xsd:complexContent&gt; &lt;/xsd:complexType&gt;</pre>
void tliTRunning (in TString am, in TInteger ts, in TString src, in TInteger line, in TriComponentIdType c, in TriTimerIdType timer, in TBoolean status)	<pre>&lt;xsd:complexType name="tliTRunning"&gt; &lt;xsd:complexContent mixed="true"&gt; &lt;xsd:extension base="Events:Event"&gt; &lt;xsd:sequence&gt; &lt;xsd:element name="timer" type="Types:TriTimerIdType"/&gt; &lt;/xsd:sequence&gt; &lt;xsd:attribute name="status" type="SimpleTypes:TBoolean"/&gt; &lt;/xsd:extension&gt; &lt;/xsd:complexContent&gt; &lt;/xsd:complexType&gt;</pre>
void tliSEnter (in TString am, in TInteger ts, in TString src, in TInteger line, in TriComponentIdType c, in TString name, in TciParameterListType parsValue, in TString kind)	<pre>&lt;xsd:complexType name="tliSEnter"&gt; &lt;xsd:complexContent mixed="true"&gt; &lt;xsd:extension base="Events:Event"&gt; &lt;xsd:sequence&gt; &lt;xsd:element name="name" type="Types:QualifiedName" minOccurs="1" maxOccurs="1"/&gt; &lt;xsd:element name="pars" type="Types:TriParameterListType" minOccurs="0"/&gt; &lt;xsd:element name="kind" type="SimpleTypes:TString"/&gt; &lt;/xsd:sequence&gt; &lt;/xsd:extension&gt; &lt;/xsd:complexContent&gt; &lt;/xsd:complexType&gt;</pre>

<b>TCI-TL provided</b>	
void tliSLeave (in TString am, in TInteger ts, in TString src, in TInteger line, in TriComponentIdType c, in TString name, in Value returnValue, in TString kind)	<xsd:complexType name="tliSLeave"> <xsd:complexContent mixed="true"> <xsd:extension base="Events:Event"> <xsd:sequence> <xsd:element name="name" type="Types:QualifiedName" minOccurs="1" maxOccurs="1"/> <xsd:element name="return" type="Values:Value" minOccurs="0"/> <xsd:element name="kind" type="SimpleTypes:TString"/> </xsd:sequence> </xsd:extension> </xsd:complexContent> </xsd:complexType>
void tliVar (in TString am, in TInteger ts, in TString src, in TInteger line, in TriComponentIdType c, in TString name, in Value varValue)	<xsd:complexType name="tliVar"> <xsd:complexContent mixed="true"> <xsd:extension base="Events:Event"> <xsd:sequence> <xsd:element name="name" type="Types:QualifiedName" minOccurs="1" maxOccurs="1"/> <xsd:element name="val" type="Values:Value" minOccurs="0"/> </xsd:sequence> </xsd:extension> </xsd:complexContent> </xsd:complexType>
void tliModulePar (in TString am, in TInteger ts, in TString src, in TInteger line, in TriComponentIdType c, in TString name, in Value parValue)	<xsd:complexType name="tliModulePar"> <xsd:complexContent mixed="true"> <xsd:extension base="Events:Event"> <xsd:sequence> <xsd:element name="name" type="Types:QualifiedName" minOccurs="1" maxOccurs="1"/> <xsd:element name="val" type="Values:Value" minOccurs="0"/> </xsd:sequence> </xsd:extension> </xsd:complexContent> </xsd:complexType>
void tliGetVerdict (in TString am, in TInteger ts, in TString src, in TInteger line, in TriComponentIdType c, in VerdictValue verdict)	<xsd:complexType name="tliGetVerdict"> <xsd:complexContent mixed="true"> <xsd:extension base="Events:Event"> <xsd:sequence> <xsd:element name="verdict" type="Values:VerdictValue"/> </xsd:sequence> </xsd:extension> </xsd:complexContent> </xsd:complexType>
void tliSetVerdict (in TString am, in TInteger ts, in TString src, in TInteger line, in TriComponentIdType c, in VerdictValue verdict)	<xsd:complexType name="tliSetVerdict"> <xsd:complexContent mixed="true"> <xsd:extension base="Events:Event"> <xsd:sequence> <xsd:element name="verdict" type="Values:VerdictValue"/> </xsd:sequence> </xsd:extension> </xsd:complexContent> </xsd:complexType>
void tliLog (in TString am, in TInteger ts, in TString src, in TInteger line, in TriComponentIdType c, in TciValueList log)	<xsd:complexType name="tliLog"> <xsd:complexContent mixed="true"> <xsd:extension base="Events:Event"> <xsd:sequence> <xsd:element name="log" type="Values:Value"/> </xsd:sequence> </xsd:extension> </xsd:complexContent> </xsd:complexType>
void tliAEnter (in TString am, in TInteger ts, in TString src, in TInteger line, in TriComponentIdType c)	<xsd:complexType name="tliAEnter"> <xsd:complexContent> <xsd:extension base="Events:Event"/> </xsd:complexContent> </xsd:complexType>
void tliALeave (in TString am, in TInteger ts, in TString src, in TInteger line, in TriComponentIdType c)	<xsd:complexType name="tliALeave"> <xsd:complexContent> <xsd:extension base="Events:Event"/> </xsd:complexContent> </xsd:complexType>

<b>TCI-TL provided</b>	
void tliADefaults (in TString am, in TInteger ts, in TString src, in TInteger line, in TriComponentIdType c)	<xsd:complexType name="tliADefaults"> <xsd:complexContent> <xsd:extension base="Events:Event"/> </xsd:complexContent> </xsd:complexType>
void tliAActivate (in TString am, in TInteger ts, in TString src, in TInteger line, in TriComponentIdType c, in TString name, in TciParameterListType pars, in Value ref)	<xsd:complexType name="tliAActivate"> <xsd:complexContent mixed="true"> <xsd:extension base="Events:Event"> <xsd:sequence> <xsd:element name="name" type="Types:QualifiedName" minOccurs="1" maxOccurs="1"/> <xsd:element name="pars" type="Types:TriParameterListType" minOccurs="0"/> <xsd:element name="ref" type="Values:Value"/> </xsd:sequence> </xsd:extension> </xsd:complexContent> </xsd:complexType>
void tliADeactivate (in TString am, in TInteger ts, in TString src, in TInteger line, in TriComponentIdType c, in Value ref)	<xsd:complexType name="tliADeactivate"> <xsd:complexContent mixed="true"> <xsd:extension base="Events:Event"> <xsd:sequence> <xsd:element name="ref" type="Values:Value"/> </xsd:sequence> </xsd:extension> </xsd:complexContent> </xsd:complexType>
void tliANomatch (in TString am, in TInteger ts, in TString src, in TInteger line, in TriComponentIdType c)	<xsd:complexType name="tliANomatch"> <xsd:complexContent mixed="true"> <xsd:extension base="Events:Event"/> </xsd:complexContent> </xsd:complexType>
void tliARepeat (in TString am, in TInteger ts, in TString src, in TInteger line, in TriComponentIdType c)	<xsd:complexType name="tliARepeat"> <xsd:complexContent> <xsd:extension base="Events:Event"/> </xsd:complexContent> </xsd:complexType>
void tliAwait (in TString am, in TInteger ts, in TString src, in TInteger line, in TriComponentIdType c)	<xsd:complexType name="tliAwait"> <xsd:complexContent> <xsd:extension base="Events:Event"/> </xsd:complexContent> </xsd:complexType>

## 11 Use scenarios

This clause contains use scenarios that should help users of the TCI and tool vendors providing the TCI understand the semantics of the operations defined within the present document.

The scenarios are defined in terms of UML sequence diagrams. The sequence diagram shows the interactions between the TCI entities. The scenarios are explained and where applicable underpinned with a TTCN-3 fragment corresponding to the scenario.

### 11.1 Initialization, collecting information, logging

#### 11.1.1 Use scenario: initialization

The scenario in figure 9 shows the initialization phase for a test system when a TTCN-3 module is to be selected for execution. At first, a root module has to be set with `tciRootModule`. The module parameters of the root module can be obtained with `tciGetModuleParameters`. Module parameter information can be used to ask the test system user for concrete values for each module parameter. The list of test cases available in the root module can be retrieved with `tciGetTestCases`. These test cases can be directly executed from the test management. Their parameters and their test system interface can be obtained with `tciGetTestCaseParameters` and `tciGetTestCaseTSI`, respectively.

## 11.1.1.1 Sequence diagram

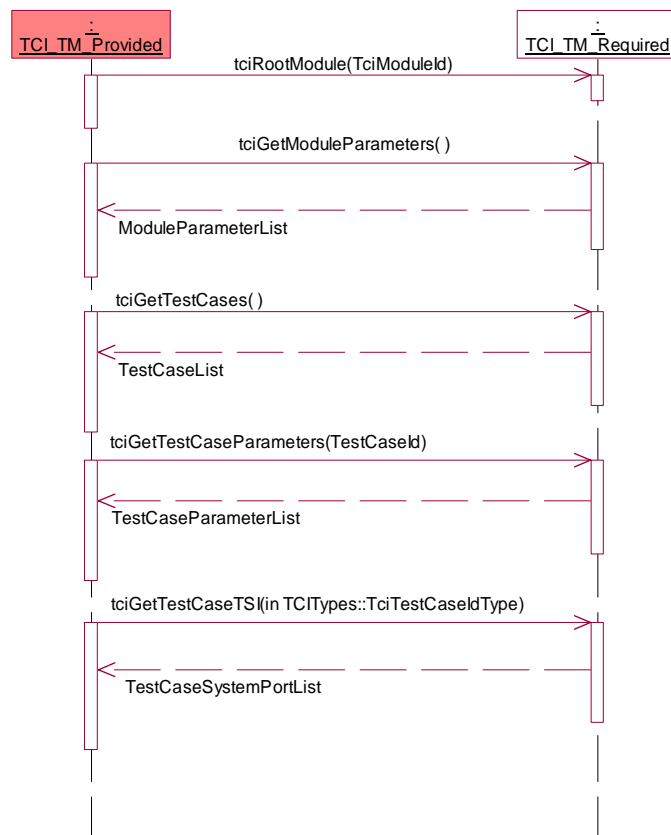

Figure 9: Use scenario - initialization

## 11.1.1.2 TTCN-3 fragment

The initialization is outside the scope of TTCN-3.

## 11.1.2 Use scenario: requesting module parameters

The scenario in figure 10 shows how a test component requests the actual value of a module parameter needed for the execution of its test behaviour. At first, the type of a module parameter is requested, then the value can be constructed by the TM and given to the TE.

### 11.1.2.1 Sequence diagram

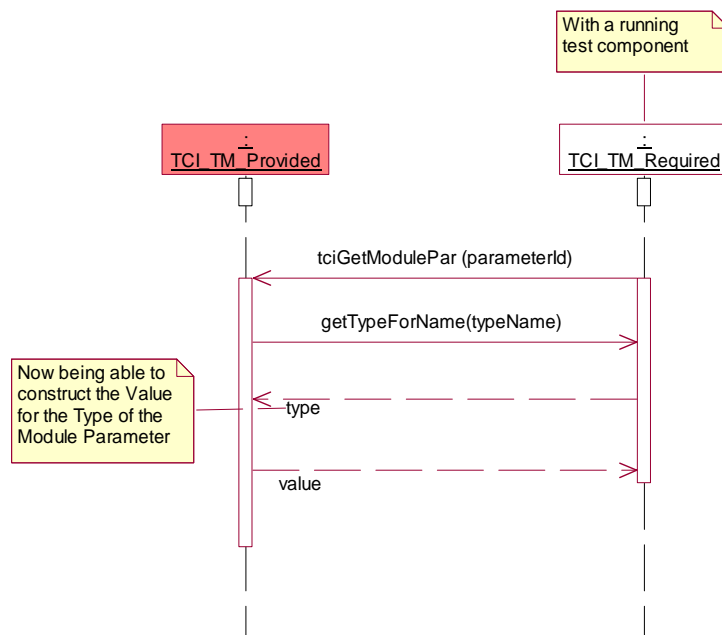

Figure 10: Use scenario - requesting module Pars

### 11.1.2.2 TTCN-3 fragment

```

module AModule {
  ...
  modulepar {
    integer AModulePar
  }
  ...
  function AFunction (...) ... {
    integer x;
    ...
    x:= 2+AModulePar; // an expression with a module parameter
    ...
  }
  ...
}
  
```

### 11.1.3 Use scenario: logging

The scenario in figure 11 shows logging of information during the execution of a test behaviour by a test component. The message to be logged is propagated to the test logging.

### 11.1.3.1 Sequence diagram

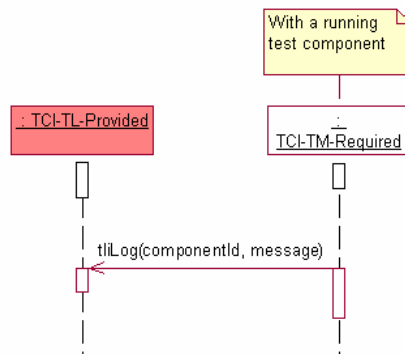

**Figure 11: Use scenario - logging**

### 11.1.3.2 TTCN-3 fragment

```

module AModule {
  ...
  function AFunction (...) ... {
    ...
    log('AMessage');
    ...
  }
  ...
}

```

## 11.2 Execution of test cases and control

### 11.2.1 Use scenario: execution of control

The scenario in figure 12 shows the sequence of operations to execute the control part of a TTCN-3 module. The module containing the control part is selected first, then the control is started, then it is executed until the execution is terminated by TE.



## 11.2.1.1 Sequence diagram

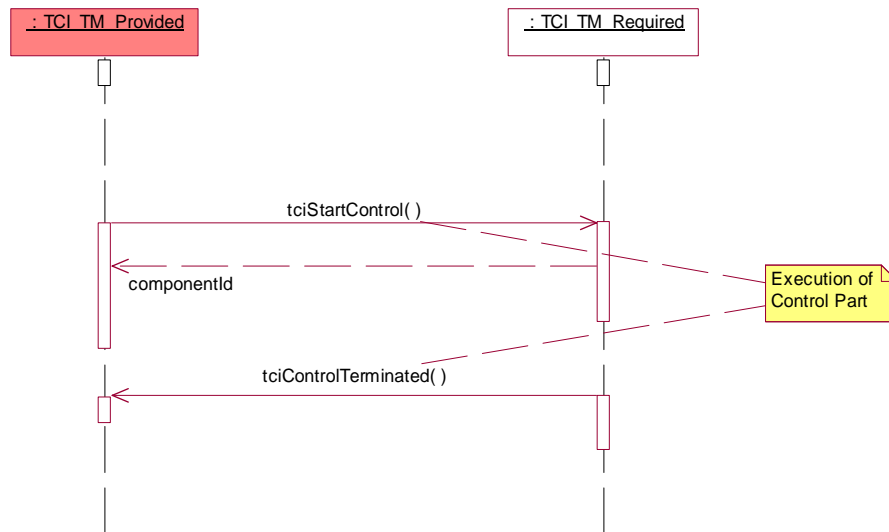

Figure 12: Use scenario - execution of control

## 11.2.1.2 TTCN-3 fragment

```

module AModule {
  ...
  control {
    ...
  }
  ...
}

```

## 11.2.2 Use scenario: test case execution within control

The scenario in figure 13 shows how a test case is executed within the control part.

### 11.2.2.1 Sequence diagram

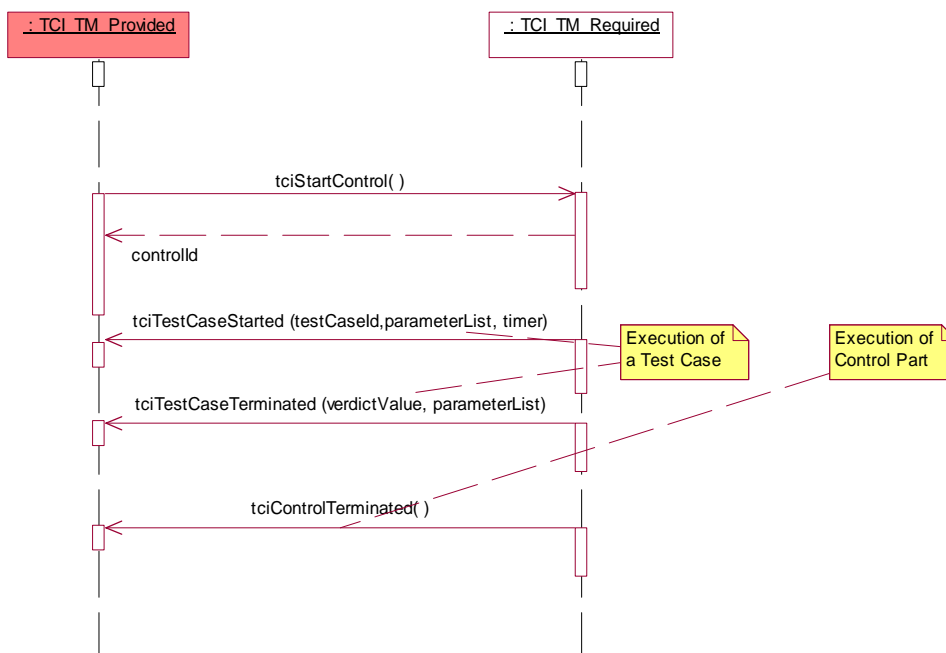

Figure 13: Use scenario - test case execution within control

### 11.2.2.2 TTCN-3 fragment

```

module AModule {
  ...
  testcase ATestCase(...)... {
    ... //the test case behaviour
  }
  ...
  control {
    ...
    execute(ATestCase(...));
    ...
  }
  ...
}

```

### 11.2.3 Use scenario: direct test case execution

The scenario in figure 14 shows how a test case can be directly executed from the test management outside the control part. After selecting the TTCN-3 module containing the test case to be executed, the start of the test case is requested. When the test case completes its execution, the test management is informed by the TE of the test case termination.

### 11.2.3.1 Sequence diagram

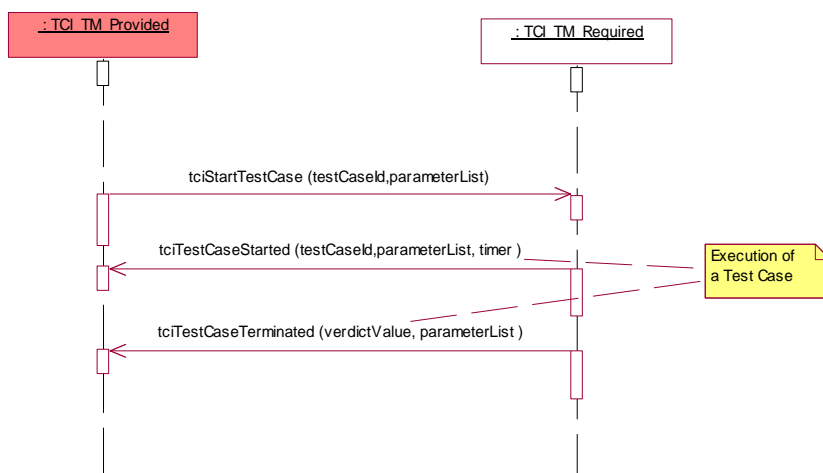

**Figure 14: Use scenario - direct test case execution**

### 11.2.3.2 TTCN-3 fragment

The direct execution of a test case is outside the scope of TTCN-3.

### 11.2.4 Use scenario: execute test case to TRI

The scenario in figure 15 shows how the TRI is informed about the execution of a test case so that it can set up and initialize system ports when needed. The execute test case request has to be issued before the test behaviour on the MTC of the current test case is started.

#### 11.2.4.1 Sequence diagram

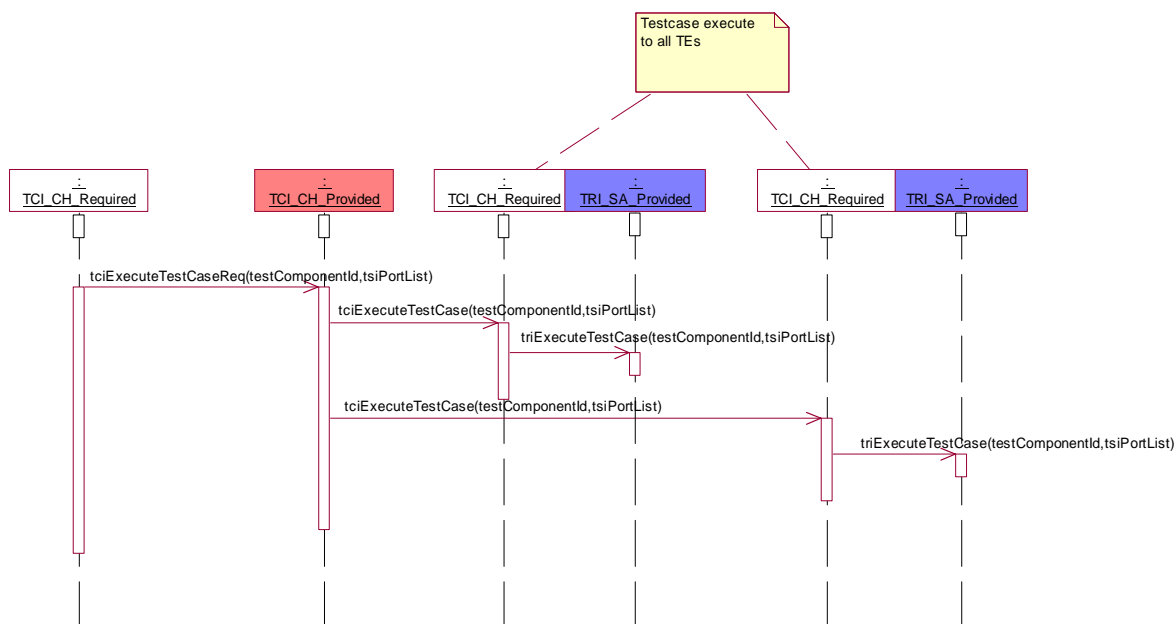

**Figure 15: Use scenario - execute test case to TRI**

### 11.2.4.2 TTCN-3 fragment

```

module AModule {
  ...
  testcase ATestCase(...)... {
    ... //the test case behaviour
  }
  ...
  control {
    ...
    execute(ATestCase(...));
    ...
  }
  ...
}
    
```

## 11.3 Component handling

### 11.3.1 Use scenario: local control component creation

The scenario in figure 16 demonstrates the creation of the control component on the same node where the user interface to the test management TCI-TM resides. A control component is created whenever the control part of a TTCN-3 module is executed. Whenever the test management TCI-TM issues the start of the control part, a create test component request is sent to the TCI-CH, which propagates it to the TE where the control component should be created. In this case it is the TE on the same node. The identifier for the control component is returned and given to the TCI-TM. The identifier is then used to start the behaviour of the control part on the control component.

#### 11.3.1.1 Sequence diagram

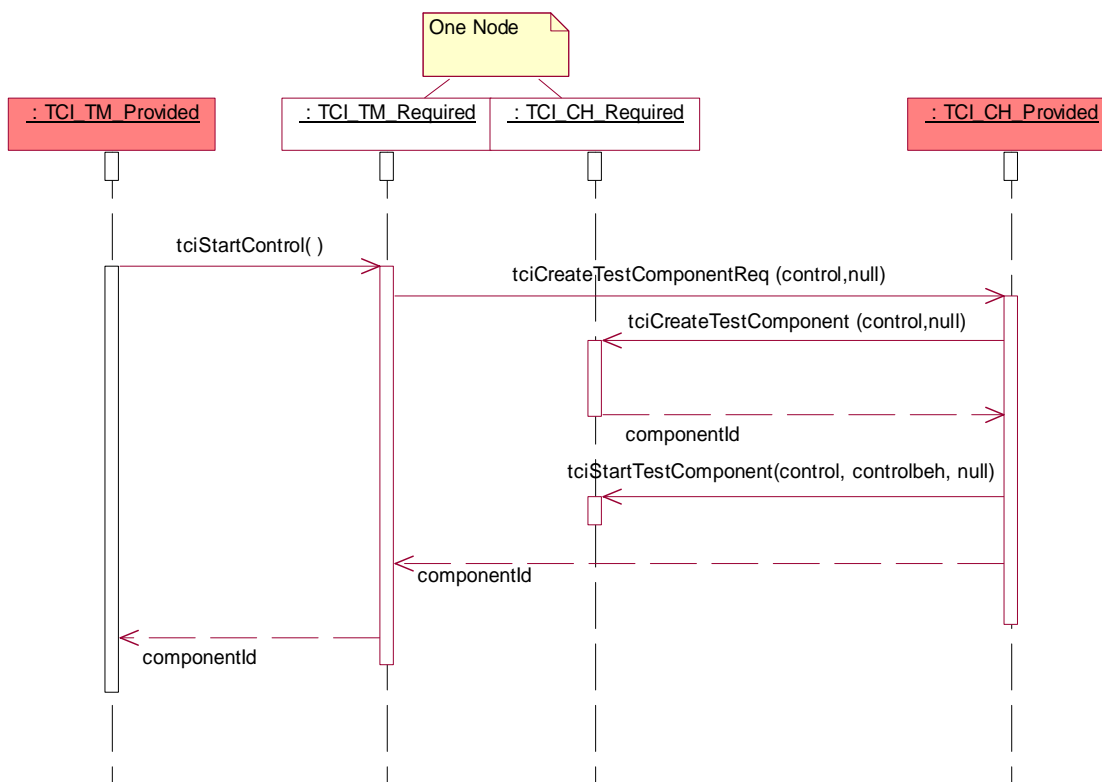

Figure 16: Use scenario - local control component creation

### 11.3.1.2 TTCN-3 fragment

```

module AModule {
  ...
  control {
    ...
  }
  ...
}
    
```

### 11.3.2 Use scenario: remote control component creation

The scenario in figure 17 demonstrates the creation of the control component on another node than where the user interface to the test management TCI-TM resides. A control component is created whenever the control part of a TTCN-3 module is executed. Whenever the test management TCI-TM issues the start of the control part, a create test component request is sent to the TCI-CH, which propagates it to the TE where the control component should be created. In this case it is the TE on another remote node. The identifier for the control component is returned and given to the TCI-TM. The identifier is then used to start the behaviour of the control part on the control component.

#### 11.3.2.1 Sequence diagram

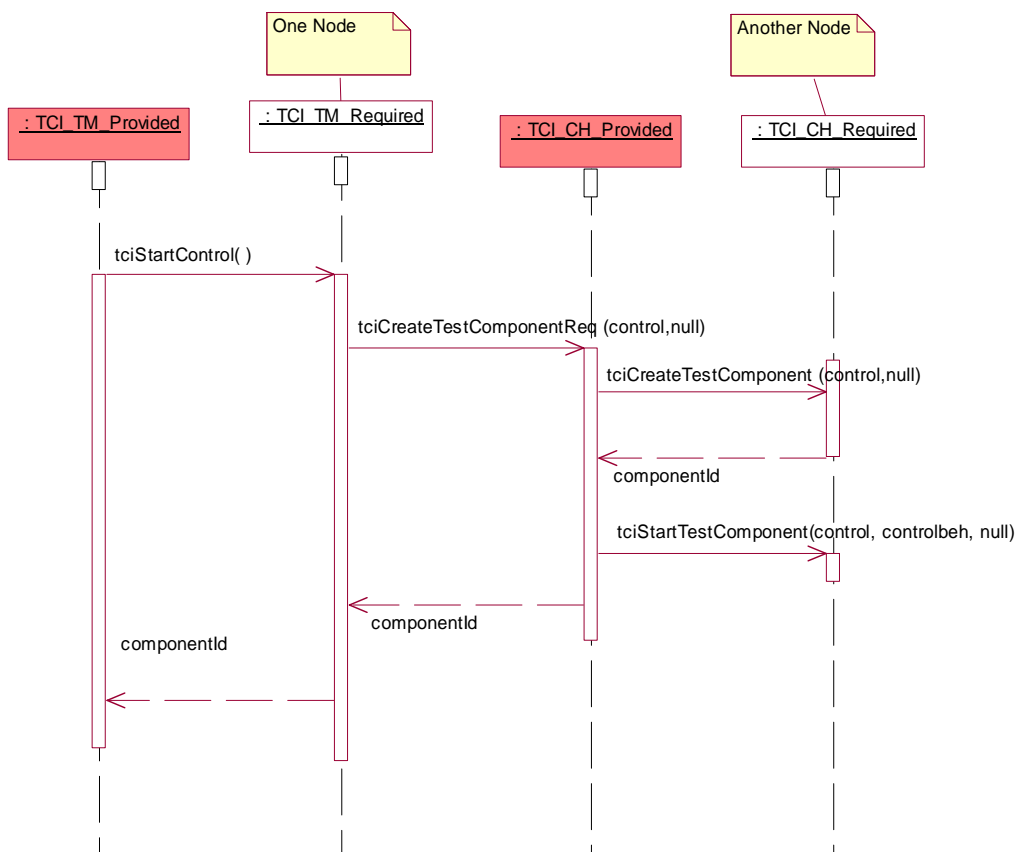

Figure 17: Use scenario - remote control component creation

### 11.3.2.2 TTCN-3 fragment

```

module AModule {
  ...
  control {
    ...
  }
  ...
}

```

### 11.3.3 Use scenario: local MTC creation

The scenario in figure 18 demonstrates the local creation of the main test component. Local is meant for two cases:

- (1) on the same node where the user interface to the test management TCI-TM resides (when a test case is started directly); or
- (2) on the same node where the control component resides (when a test case is executed from a control part).

A main test component is created whenever a test case is executed: a create test component request is sent to the TCI-CH, which propagates it to the TE where the main test component should be created. In this case it is the TE on the same node. The identifier for the main test component is returned and given to the TCI-TM. The identifier is then used to start the test case behaviour on the main test component (this is not shown here, but handled the same way as in the scenarios described in clauses 11.3.5 and 11.3.6).

#### 11.3.3.1 Sequence diagram

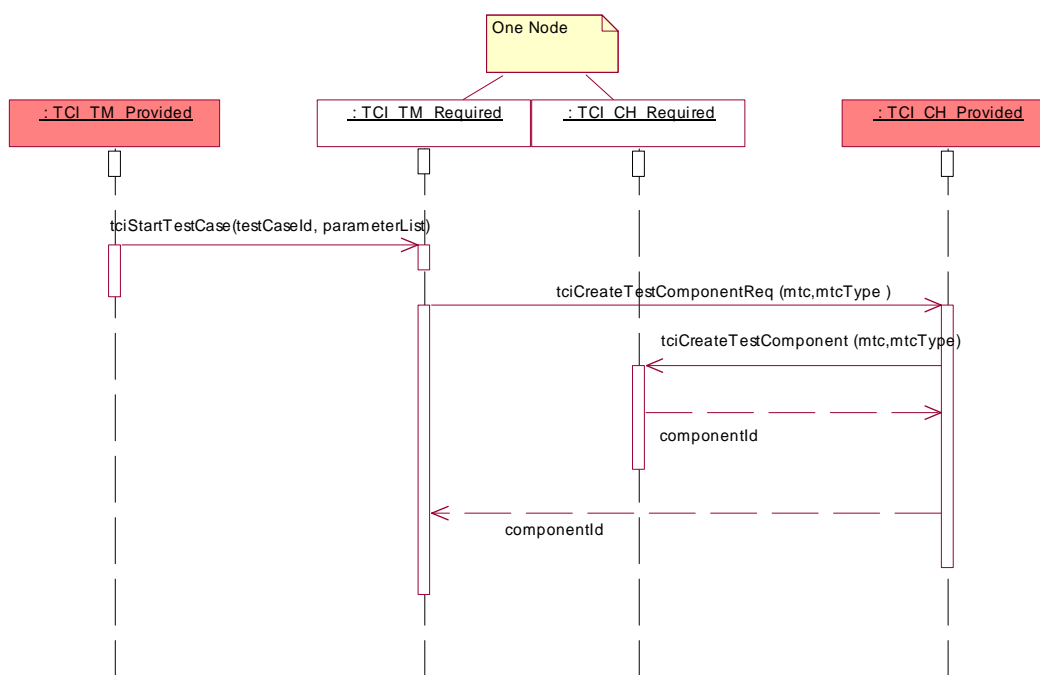

Figure 18: Use scenario - local MTC creation

### 11.3.3.2 TTCN-3 fragment

```

module AModule {
  ...
  testcase ATestCase (...)runs on MTCType... {
    ... //the test case behaviour
  }
  ...
}

```

### 11.3.4 Use scenario: remote MTC creation

The scenario in figure 19 demonstrates the remote creation of the main test component. Remote is meant for two cases:

- (1) on another node than where the user interface to the test management TCI-TM resides (when a test case is started directly); or
- (2) on another node than where the control component resides (when a test case is executed from a control part).

A main test component is created whenever a test case is executed: a create test component request is sent to the TCI-CH, which propagates it to the TE where the main test component should be created. In this case it is the TE on another node. The identifier for the main test component is returned and given to the TCI-TM. The identifier is then used to start the test case behaviour on the main test component (this is not shown here, but handled the same way as in the scenarios described in clauses 11.3.5 and 11.3.6).

#### 11.3.4.1 Sequence diagram

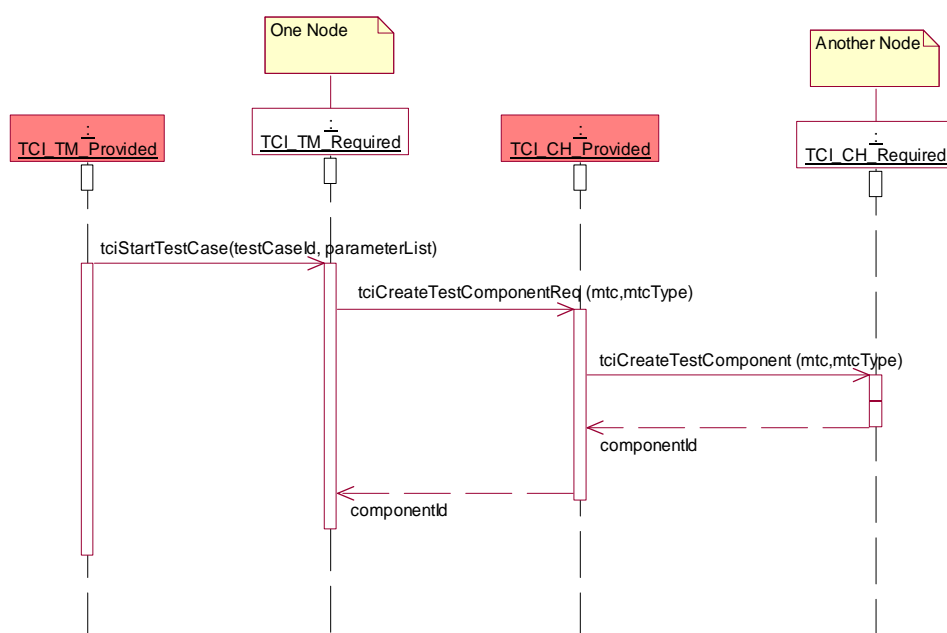

Figure 19: Use scenario - remote MTC creation

#### 11.3.4.2 TTCN-3 fragment

```

module AModule {
  ...
  testcase ATestCase(...)runs on MTCType ... {
    ... //the test case behaviour
  }
  ...
}
  
```

### 11.3.5 Use scenario: component handling for test case execution within control

The scenario in figure 20 demonstrates the handling of components for the test case execution within a control part. When the control part is started, a control component is created and its component identifier returned to the test management. For each test case to be executed within the control part, a main test component is created and the component identifier returned to the control component. Afterwards, the test case behaviour is started on the main test component and the test management is informed about the start of the test case. When the main test component terminates, a request for the main test component termination together with the local verdict of the main test component is propagated to enable the derivation of the global test verdict and to enable the information about the test case termination.

#### 11.3.5.1 Sequence diagram

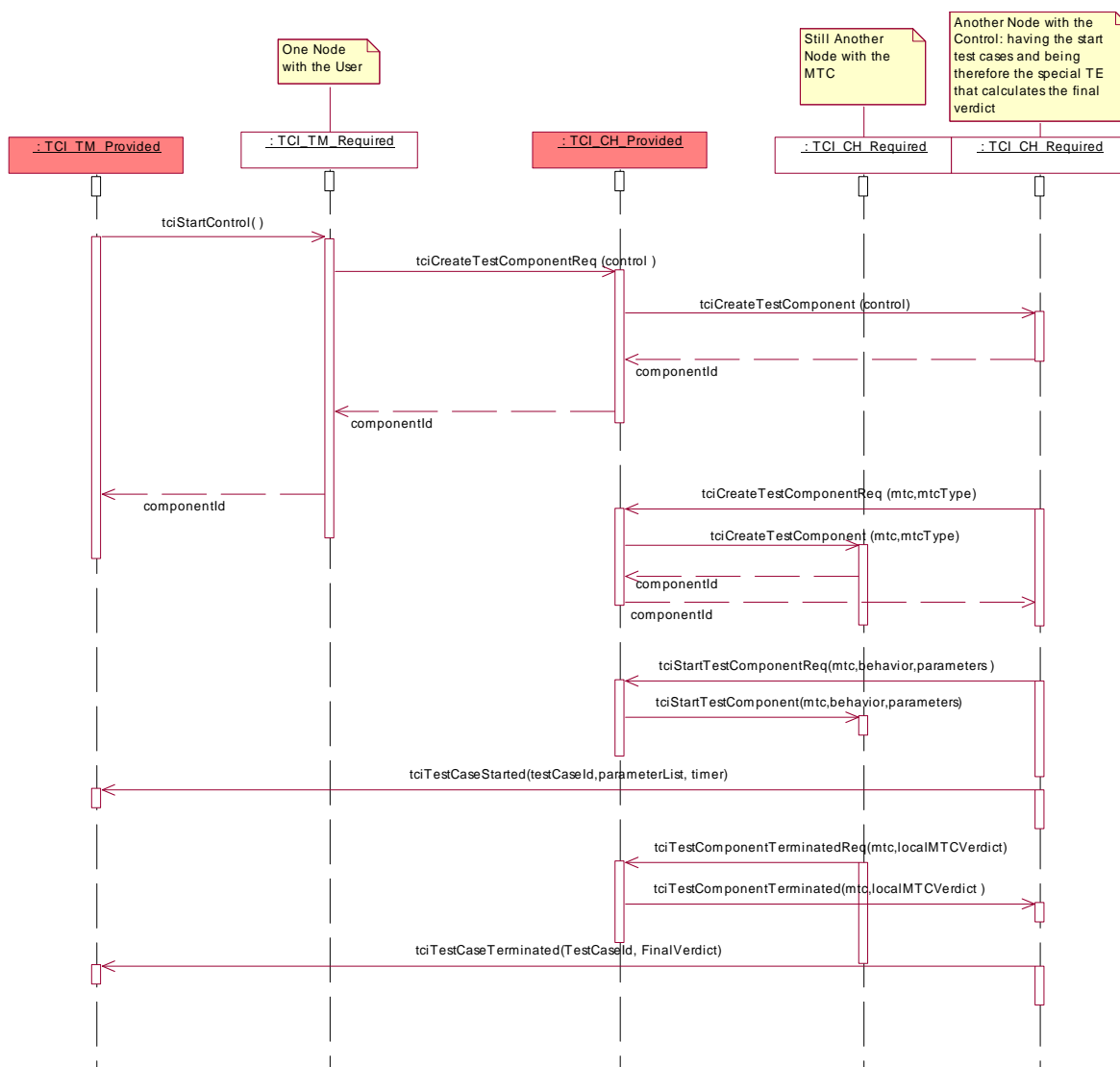

Figure 20: Use scenario: component handling for test case execution within control



### 11.3.5.2 TTCN-3 fragment

```
module AModule {
  ...
  testcase ATestCase(...)... {
    ... //the test case behaviour
  }
  ...
  control {
    ...
    execute(ATestCase(...));
    ...
  }
  ...
}
```

### 11.3.6 Use scenario: component handling for direct test case execution

The scenario in figure 21 shows how test components are handled when a test case is executed directly, i.e. outside a control part. When a test case is started, the main test component is created and the test case behaviour started on this main test component at first. Whenever a parallel test component is used within a test case, it is handled the same: the parallel test component is started first: giving a test component create request to the TCI-CH entity, which propagates the test component create to the TE in which the parallel test component shall be created. The identifier for the created parallel test component is returned. The identifier is then used to start the PTC behaviour for the start operation. When the PTC terminates its execution, a test component terminate request together with the local test verdict is issued to inform TCI-CH about this termination. The same is done when the main test component terminates. In addition, the termination of the main test component leads to the overall termination of the test case.

11.3.6.1 Sequence diagram

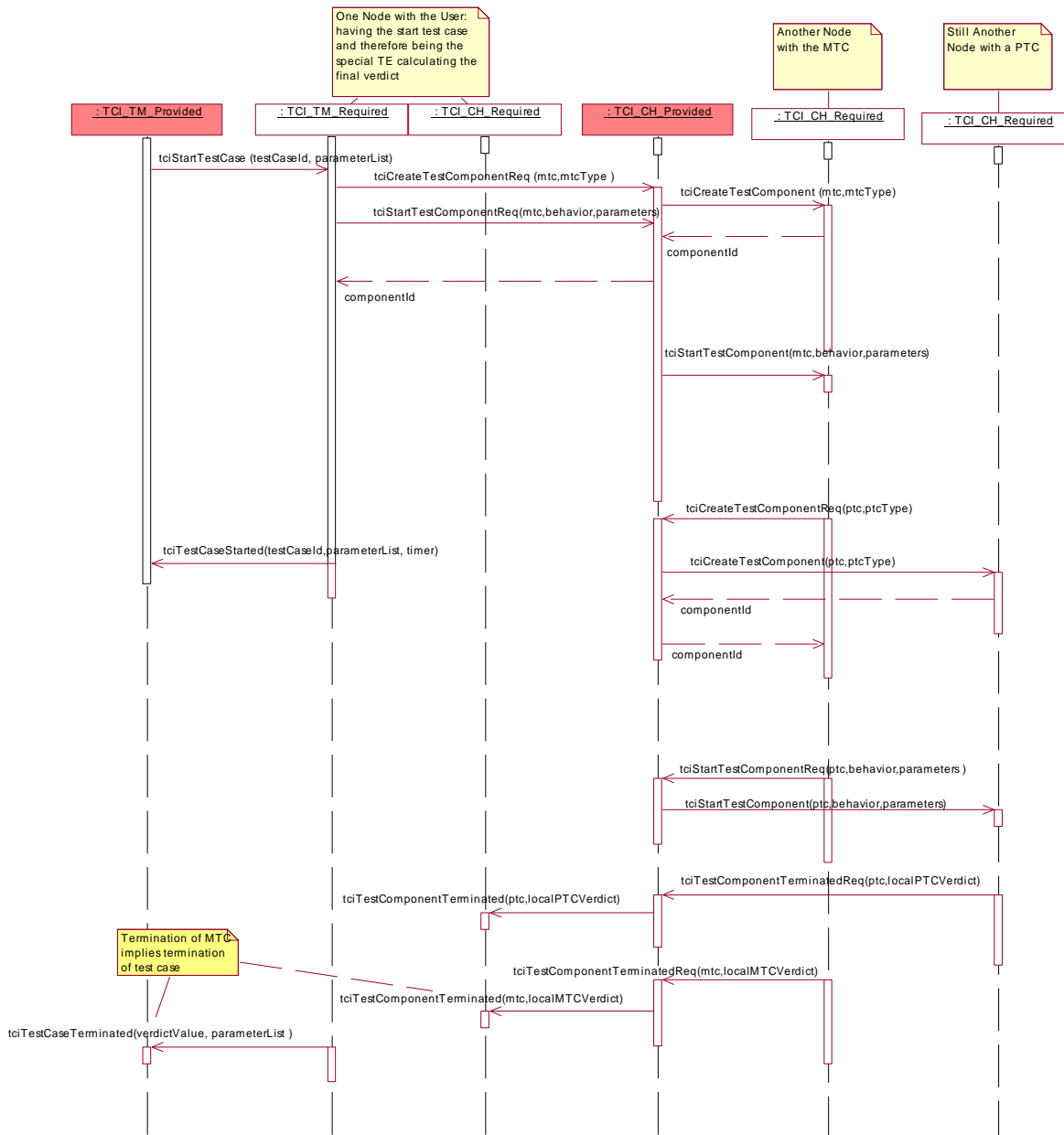

Figure 21: Use scenario: component handling for direct test case execution

### 11.3.6.2 TTCN-3 fragment

```

module AModule {
  ...
  function APTCBehaviour(...) runs on APTCType {
    ... //the PTC behaviour
  }
  ...
  testcase ATestCase(...)... {
    ... //the test case behaviour
    var APTCType PTC:= APTCType.create;
    ...
    PTC.start(APTCBehaviour(...));
    ...
  }
  ...
}

```

### 11.3.7 Use scenario: propagation of map/connect

The scenario in figure 22 shows how ports are mapped. The request to map a port is propagated to the TE where the map is finally performed. The propagation of connect requests works analogously.

#### 11.3.7.1 Sequence diagram

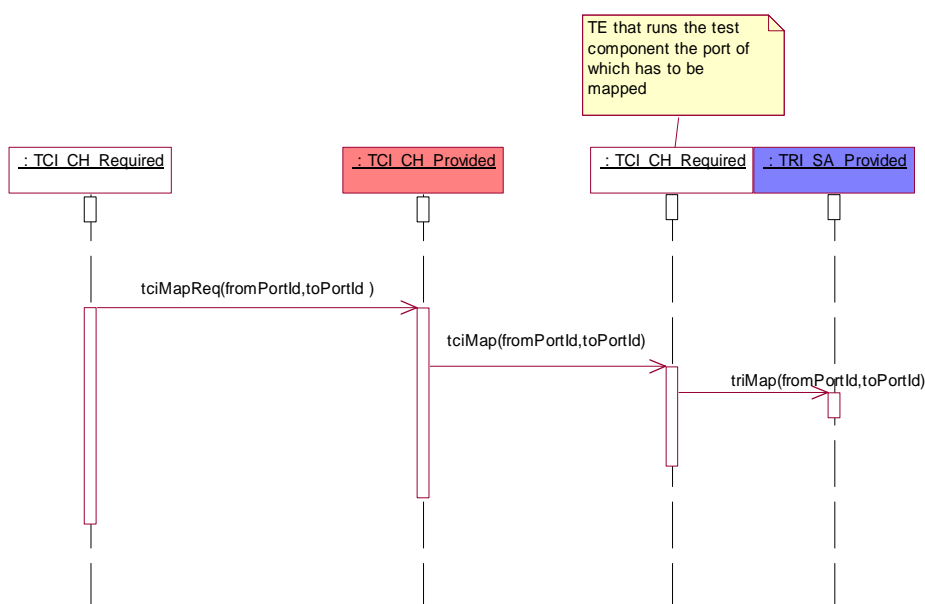

Figure 22: Use scenario: propagation of map

### 11.3.7.2 TTCN-3 fragment

```

module AModule {
  ...
  type port A { ... }
  type component CA { port A a }
  type component CB { port A a }
  ...
  testcase ATestCase(...)runs on CA system CB {
    var CA ptc := CA.create;
    ... //the test case behaviour
    map(ptc:a,system:a);
    ...
  }
  ...
}

```

### 11.3.8 Use scenario: propagation of unmap/disconnect

The scenario in figure 23 shows how ports are unmapped. The request to unmap a port is propagated to the TE where the unmap is finally performed. The propagation of disconnect requests works analogously.

#### 11.3.8.1 Sequence diagram

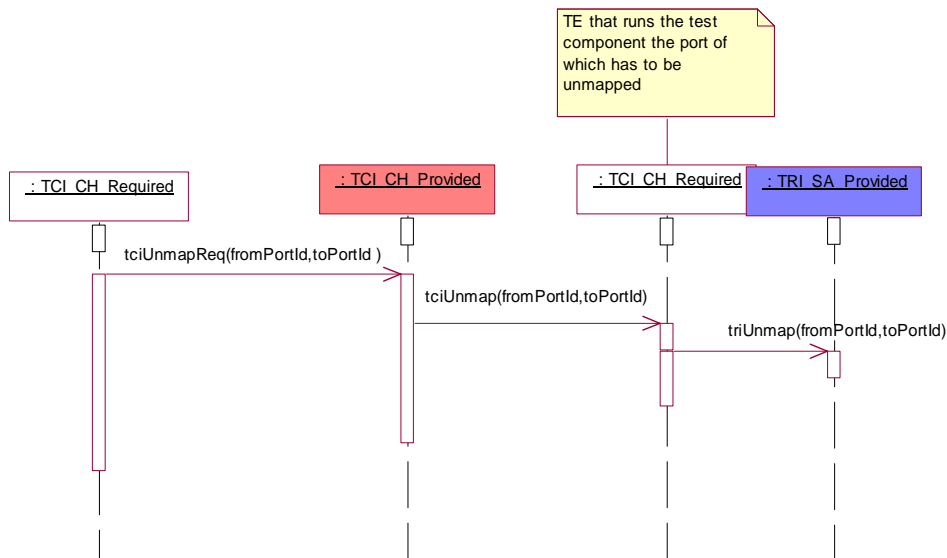

Figure 23: Use scenario - propagation of map

#### 11.3.8.2 TTCN-3 fragment

```

module AModule {
  ...
  type port A { ... }
  type component CA { port A a }
  type component CB { port A a }
  ...
  testcase ATestCase(...)runs on CA system CB {
    var CA ptc := CA.create;
    ... //the test case behaviour
    unmap(ptc:a,system:a);
  }
  ...
}

```

## 11.4 Termination of test cases and control

### 11.4.1 Use scenario: stop a test case

The scenario in figure 24 shows how a test case is stopped from the test management during test case execution. Once the TM has received information about a started test case, a stop test case can be requested up until receiving the information that the test case has been terminated. Upon stopping a test case, all parallel test components will be stopped and the test system will be reset.

### 11.4.1.1 Sequence diagram

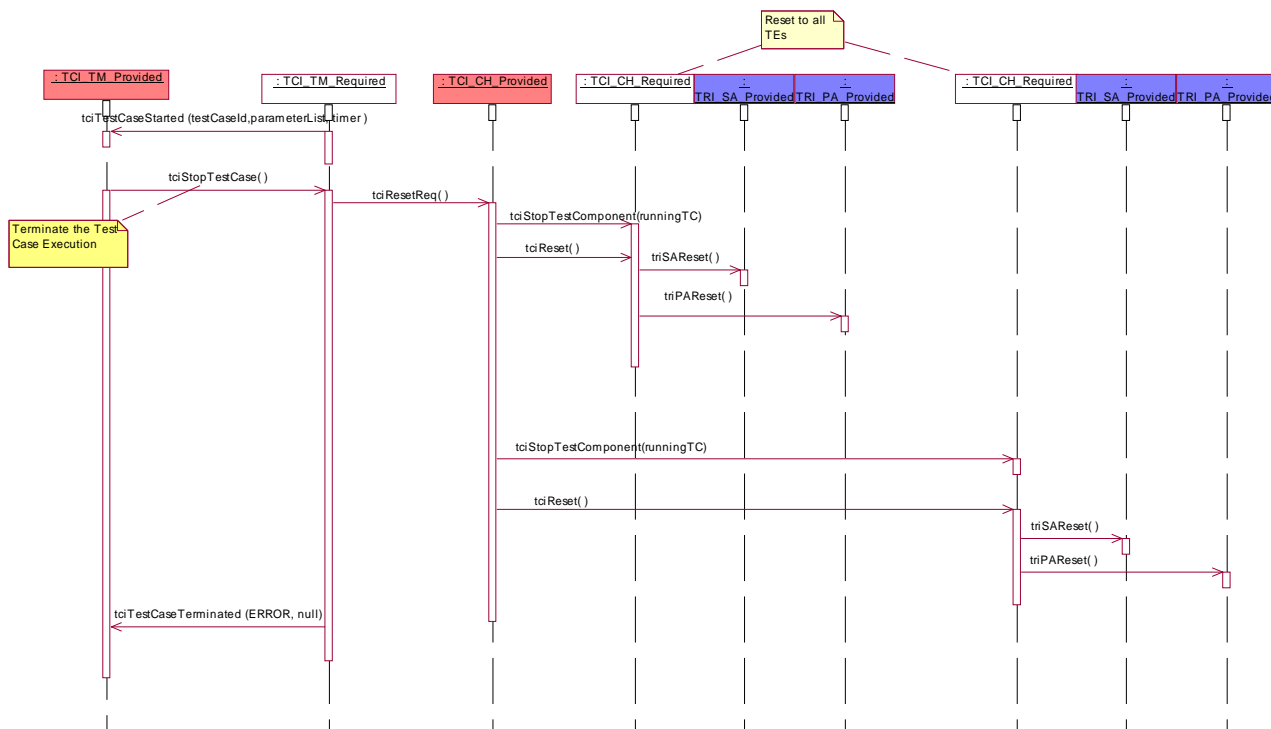

Figure 24: Use scenario: stop a test case

### 11.4.1.2 TTCN-3 fragment

There is no TTCN-3 code related to how the TM chooses to implement test case termination. This is outside the scope of TTCN-3.

### 11.4.2 Use scenario: stop control

The scenario in figure 25 shows how a control part is stopped from the test management during control part execution. A control part can be stopped in between starting the control and its termination. If the control part receives a stop test case request while a test case is executing, the executing test case shall be stopped. Furthermore, the test system shall be reset as described in figure 24.

### 11.4.2.1 Sequence diagram

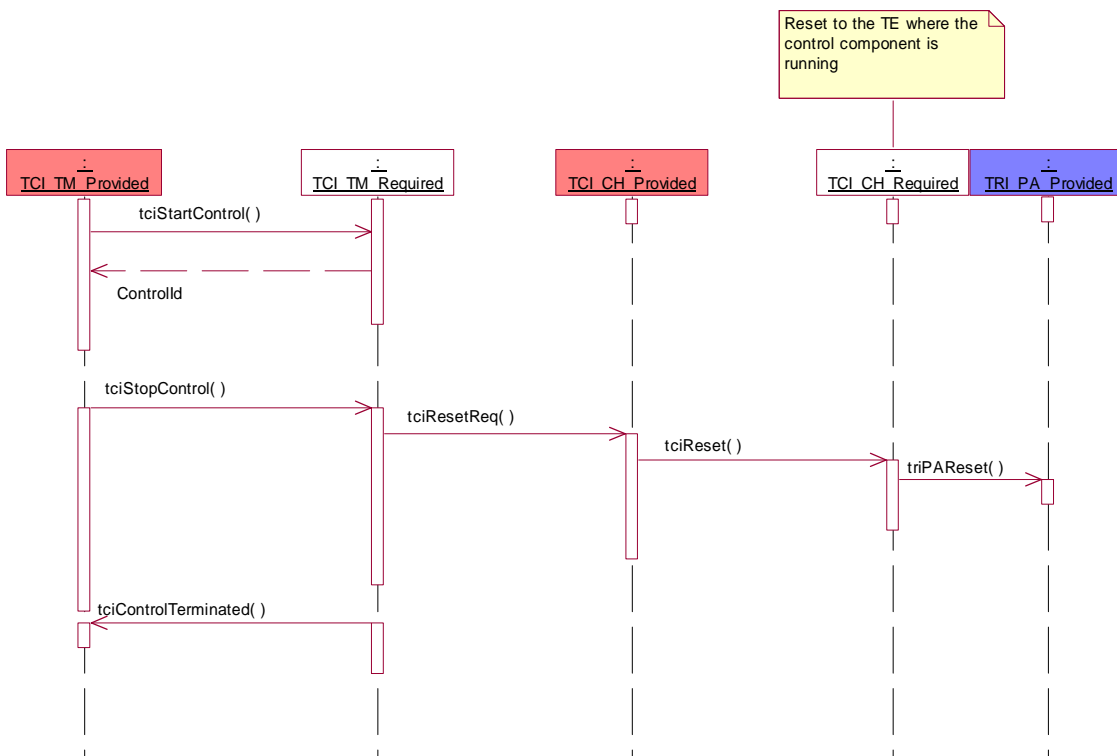

Figure 25: Use scenario - stop control

### 11.4.2.2 TTCN-3 fragment

Stopping a control part from the test management is outside the scope of TTCN-3 so that no TTCN-3 fragment exists.

### 11.4.3 Use scenario: termination of control after error

The scenario in figure 26 shows the handling of error situations during the execution of a control part when no test case is being executed. The test management is informed about the error situation and has then to terminate the execution of the control part explicitly. Upon termination of the control part, the test system will be reset.

11.4.3.1 Sequence diagram

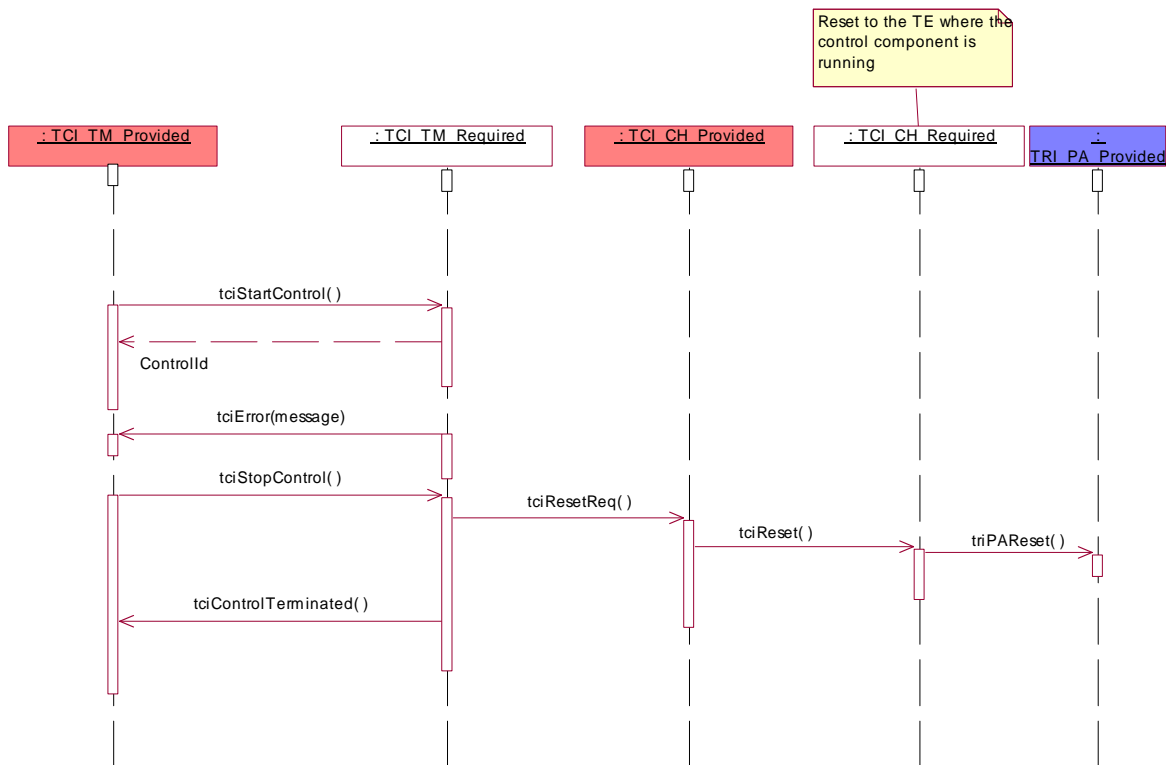

Figure 26: Use scenario - termination of control after error

11.4.3.2 TTCN-3 fragment

There is no TTCN-3 fragment for this scenario since error situations are exceptional cases in a test system and not a TTCN-3 concept as such. Rather, the TTCN-3 semantics describes various potential error situations in a test system.

11.4.4 Use scenario: termination of a test case after error

The scenario in figure 27 shows the handling of error situations during the direct execution of a test case. The test management is informed about the error situation. The TM must then explicitly terminate test case execution. Upon stopping a test case, the parallel test components will be stopped and the test system shall be reset.

## 11.4.4.1 Sequence diagram

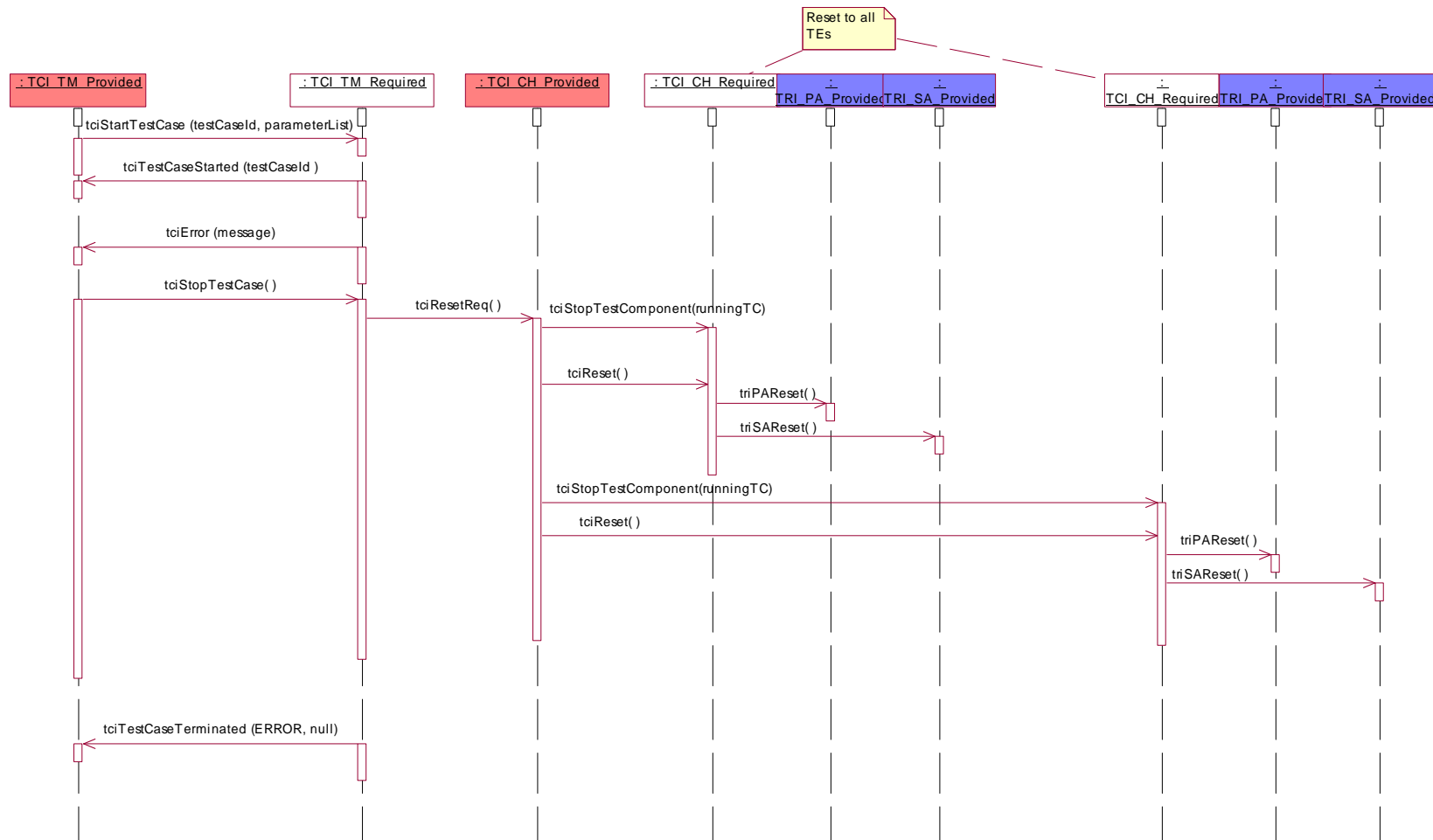

Figure 27: Use scenario - termination of a test case after error



### 11.4.4.2 TTCN-3 fragment

There is no TTCN-3 fragment for this scenario since error situations are exceptional cases in a test system and not a TTCN-3 concept as such. Rather, the TTCN-3 semantics describes various potential error situations in a test system.

### 11.4.5 Use scenario: reset

The scenario in figure 28 shows the reset of the test system. In that case all involved TEs together with their TRI System Adaptors (SA) and Platform Adaptors (PA) are reset.

#### 11.4.5.1 Sequence diagram

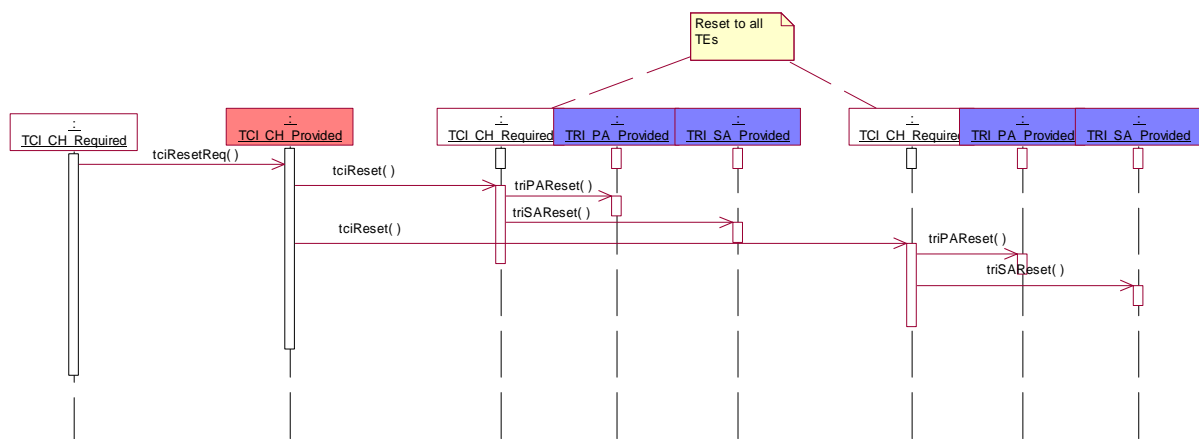

Figure 28: Use scenario - reset

#### 11.4.5.2 TTCN-3 fragment

There is no TTCN-3 fragment for this scenario since reset as required after error situations are exceptional cases in a test system and not a TTCN-3 concept as such.

## 11.5 Communication

### 11.5.1 Use scenario: local intercomponent communication

The scenario in figure 29 shows the communication between test components (main test component or parallel test components), which reside on the same node. A communication request is given to the TCI-CH, which then decide where to enqueue this communication template. In this case, the communication is done locally via the TE on the same node. The scenario shows a message-based communication using the send operation - the scenario is the same for call, reply, and raise operations.

### 11.5.1.1 Sequence diagram

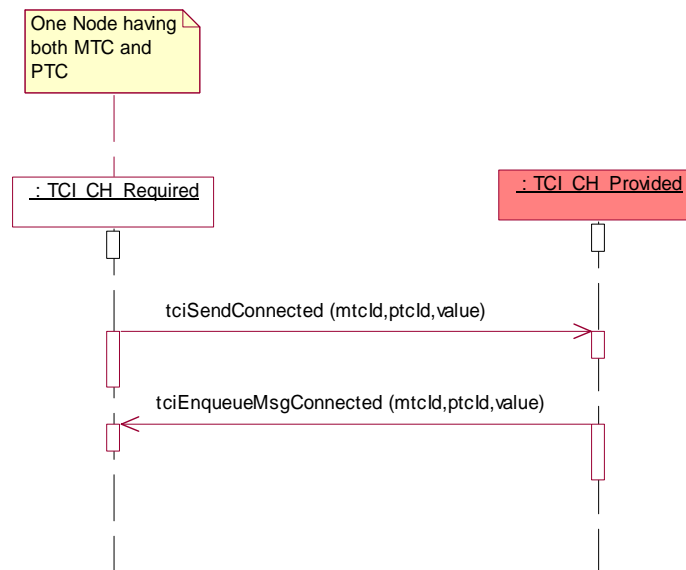

Figure 29: Use scenario - local intercomponent communication

### 11.5.1.2 TTCN-3 fragment

```

module AModule {
  ...
  type port APortType message { ... }
  ...
  type component ATCType {
    ...
    APortType APort;
    ...
  }
  ...
  template AType AMessageTemplate { ... }
  ...
  function APTCBehaviour(...) runs on APTCType {
    ... //the PTC behaviour
  }
  ...
  testcase ATestCase(...) runs on ATCType... {
    ... //the test case behaviour
    var ATCType PTC1:= ATCType.create;
    connect (PTC1:APort,mtc:APort);
    ...
    PTC1.start(APTCBehaviour(...));
    APort.send(AMessageTemplate); //sending data to a test component
    ...
  }
  ...
}
  
```

## 11.5.2 Use scenario: internode communication between test components

The scenario in figure 30 shows the communication between test components (main test component or parallel test components), which reside on different nodes. A communication request is given to the TCI-CH, which then decides where to enqueue this communication template. In this case, the communication is done remotely via the TE on another node. The scenario shows a message based communication using the send operation - the scenario is the same for call, reply, and raise operations.

### 11.5.2.1 Sequence diagram

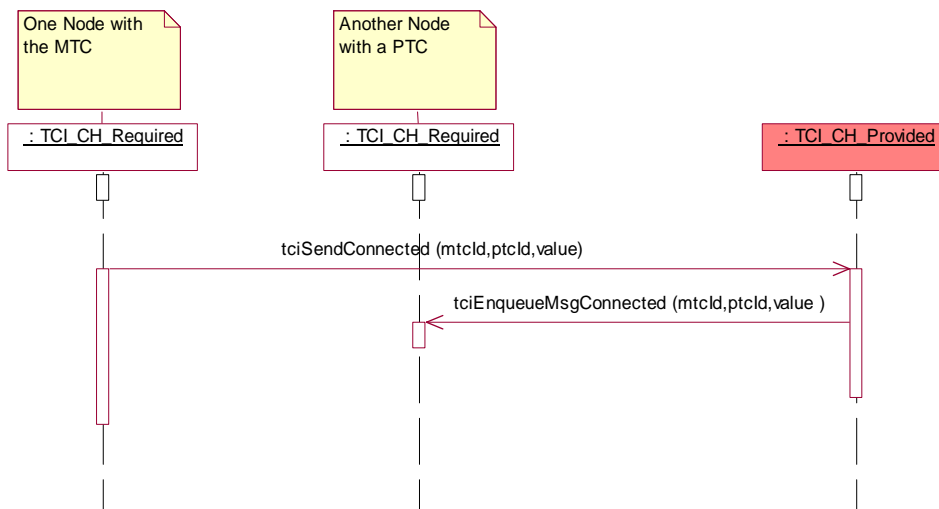

Figure 30: Use scenario - internode communication between test components

### 11.5.2.2 TTCN-3 fragment

```

module AModule {
  ...
  type port APortType message { ... }
  ...
  type component ATCType {
    ...
    APortType APort;
    ...
  }
  ...
  template AType AMessageTemplate { ... }
  ...
  function APTCBehaviour(...) runs on APTCType {
    ... //the PTC behaviour
  }
  ...
  testcase ATestCase(...) runs on ATCType... {
    ... //the test case behaviour
    var ATCType PTC1:= ATCType.create;
    connect(PTC1:APort,mtc:APort);
    ...
    PTC1.start(APTCBehaviour(...));
    APort.send(AMessageTemplate); //sending data to a test component
  }
  ...
}

```

### 11.5.3 Use scenario: encoding

The scenario in figure 31 shows the encoding of data, which is sent to the SUT. The encoded data is received from the coding/decoding entity via the TCI-CD. The encoded value is sent to the SUT via the TRI-SA. The scenario is the same for the call, the reply, and the raise operations.

### 11.5.3.1 Sequence diagram

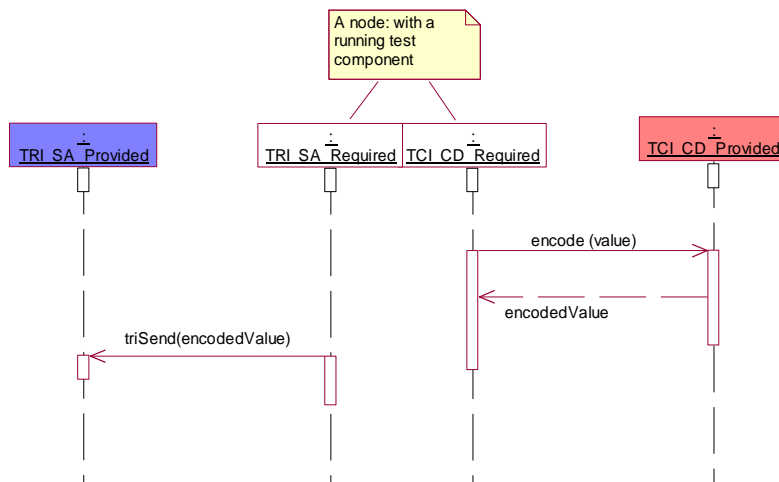

Figure 31: Use scenario - encoding

### 11.5.3.2 TTCN-3 fragment

```

module AModule {
  ...
  type port APortType message { ... }
  ...
  type component APTCType {
    ...
    APortType APort;
    ...
  }
  ...
  template AType AMessageTemplate { ... }
  ...
  testcase ATestCase(...) runs on APTCType system APTCType {
    ... //the test case behaviour
    map(mtc:APort, system:APort);
    ...
    APort.send(AMessageTemplate); //sending data to the SUT
    ...
  }
  ...
} with { encoding = '...' }
  
```

### 11.5.4 Use scenario: decoding

The scenario in figure 32 shows the decoding of data, which is received from the SUT via the TRI-SA. The decoded data is received from the coding/decoding entity via the TCI-CD. The scenario is the same for the receive, the getcall, the getreply, the catch, and the check operations.

## 11.5.4.1 Sequence diagram

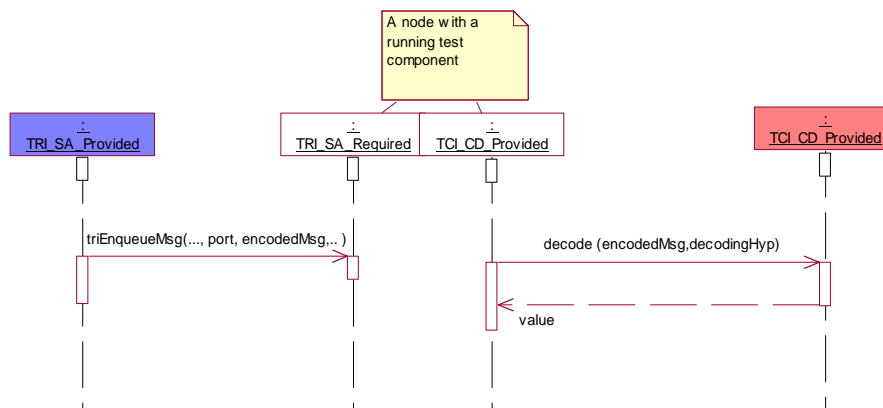

Figure 32: Use scenario - decoding

## 11.5.4.2 TTCN-3 fragment

```

module AModule {
  ...
  type port APortType message { ... }
  ...
  type component APTCType {
    ...
    APortType APort;
    ...
  }
  ...
  template AType AMessageTemplate { ... }
  ...
  testcase ATestCase(...) runs on APTCType system APTCType {
    ... //the test case behaviour
    map(mtc:APort,system:APort);
    ...
    APort.receive(AMessageTemplate); //receiving data from the SUT
    ...
  }
  ...
} with { encoding = '...' }
  
```

## Annex A (normative): IDL Specification of TCI

This annex defines the TTCN-3 Control Interfaces using the Interface Definition Language (IDL).

```
// *****
// * Interface definitions for the TTCN-3 Control Interfaces
// *****

module tciInterface {

    /* Forward declaration */
    interface Value;
    interface Type;

    // *****
    // * Data types taken from the TRI definitions
    // *****

    // Connection
    native TriPortIdType ;
    native TriPortIdListType;
    native TriComponentIdType ;
    native TriComponentIdListType;

    // Communications
    native TriMessageType;
    native TriParameterType;
    native TriParameterListType;
    native TriAddressType;
    native TriAddressListType;
    native TriExceptionType;
    native TriSignatureIdType;

    // Miscellaneous
    native TriStatusType;
    native TriTimerIdType;
    native TriTimerDurationType;

    // *****
    // * General Abstract Data Types
    // *****

    // Basic definitions
    native TBoolean;
    native TFloat;
    native TChar;
    native TInteger;
    native TString;
    native TUniversalChar;
    typedef sequence <TString> TStringSeq;
    native TObjid;

    struct QualifiedName {
        TString moduleName;
        TString baseName;
    };

    // General TCI abstract data types
    typedef QualifiedName TciBehaviourIdType;
    typedef QualifiedName TciModuleIdType;
    typedef QualifiedName TciModuleParameterIdType;
    typedef QualifiedName TciTestCaseIdType;

    enum TciParameterPassingModeType {
        IN_MODE,
        OUT_MODE,
        INOUT_MODE
    };
};
```

```

struct TciParameterType {
    TciModuleParameterIdType parameterName;
    Value parameterValue;
    TciParameterPassingModeType mode;
};

typedef sequence <TciParameterType> TciParameterListType;

struct TciParameterTypeType {
    Type parameterType;
    TciParameterPassingModeType mode;
};

typedef sequence <TciParameterTypeType> TciParameterTypeListType;

struct TciModuleParameterType {
    TciModuleParameterIdType parameterName;
    Value defaultValue;
};

typedef sequence <TciModuleIdType> TciModuleIdListType ;

typedef sequence <TciModuleParameterType> TciModuleParameterListType;

typedef sequence <TciTestCaseIdType> TciTestCaseIdListType;

enum TciTestComponentKindType {
    MTC,
    PTC,
    CONTROL
};

enum TciTypeClassType {
    ADDRESS_CLASS,
    ANYTYPE_CLASS,
    BITSTRING_CLASS,
    BOOLEAN_CLASS,
    CHAR_CLASS,
    CHARSTRING_CLASS,
    COMPONENT_CLASS,
    ENUMERATED_CLASS,
    FLOAT_CLASS,
    HEXSTRING_CLASS,
    INTEGER_CLASS,
    OBJID_CLASS,
    OCTETSTRING_CLASS,
    RECORD_CLASS,
    RECORDOF_CLASS,
    SET_CLASS,
    SETOF_CLASS,
    UNION_CLASS,
    UNIVERSALCHAR_CLASS,
    UNIVERSALCHARSTRING_CLASS,
    VERDICT_CLASS
};

// *****
// * Abstract TTCN-3 Data Types And Values
// *****

// Abstract data type "Type"
interface Type {
    TciModuleIdType    getDefiningModule ();
    TString            getName ();
    TciTypeClassType   getTypeClass ();
    Value              newInstance ();
    TString            getTypeEncoding ();
    TString            getTypeEncodingVariant ();
    TStringSeq         getTypextension ();
};

```

```

// Abstract TTCN-3 Values
interface Value {
    TString  getValueEncoding ();
    TString  getValueEncodingVariant ();
    Type     getType ();
    TBoolean notPresent ();
};

interface RecordOfValue : Value {
    Value    getField (in TInteger position);
    void     setField (
        in TInteger position,
        in Value value
    );
    void     appendField (in Value value);
    Type     getElementType ();
    TInteger getLength ();
    void     setLength (in TInteger len);
};

interface RecordValue : Value {
    Value    getField (in TString fieldName);
    void     setField (
        in TString fieldName,
        in Value value
    );
    TStringSeq getFieldNames ();
};

interface VerdictValue : Value {
    TInteger getVerdict ();
    void     setVerdict (in TInteger verdict);
};

interface BitstringValue : Value {
    TString  getString ();
    void     setString (in TString value);
    TInteger getBit (in TInteger position);
    void     setBit (
        in TInteger position,
        in TInteger value
    );
    TInteger getLength ();
    void     setLength (in TInteger len);
};

interface OctetstringValue : Value {
    TString  getString ();
    void     setString (in TString value);
    TInteger getOctet (in TInteger position);
    void     setOctet (
        in TInteger position,
        in TInteger value
    );
    TInteger getLength ();
    void     setLength (in TInteger len);
};

interface FloatValue : Value {
    TFloat  getFloat ();
    void    setFloat (in TFloat value);
};

interface HexstringValue : Value {
    TString  getString ();
    void     setString (in TString value);
    TInteger getHex (in TInteger position);
    void     setHex (
        in TInteger position,
        in TInteger value
    );
    TInteger getLength ();
    void     setLength (in TInteger len);
};

```



```

interface ObjidValue : Value {
    TObjid getObjid ();
    void    setObjid (in TObjid value);
};

interface EnumeratedValue : Value {
    void    setEnum (in TString enumValue);
    TString getEnum ();
};

interface IntegerValue : Value {
    TInteger getInt ();
    void    setInt (in TInteger value);
};

interface CharValue : Value {
    TChar getChar ();
    void   setChar (in TChar value);
};

interface CharstringValue : Value {
    TString getString ();
    void    setString (in TString value);
    TChar   getChar   (in TInteger position);
    void    setChar   (
        in TInteger position,
        in TChar value
    );
    TInteger getLength ();
    void     setLength (in TInteger len);
};

interface BooleanValue : Value {
    TBoolean getBoolean ();
    void     setBoolean (in TBoolean value);
};

interface UniversalCharValue : Value {
    TUniversalChar getUniversalChar ();
    void           setUniversalChar (in TUniversalChar value);
};

interface UniversalCharstringValue : Value {
    TString         getString ();
    void           setString (in TString value);
    TUniversalChar getChar   (in TInteger position);
    void           setChar   (
        in TInteger position,
        in TUniversalChar value
    );
    TInteger       getLength ();
    void           setLength (in TInteger len);
};

interface UnionValue : Value {
    Value         getVariant (in TString variantName);
    void         setVariant (
        in TString variantName,
        in Value value
    );
    TString      getPresentVariantName ();
    TStringSeq   getVariantNames ();
};

// *****
// * Abstract Logging Types
// *****

interface TciValueTemplate : Value {
    boolean isOmit ();
    boolean isAny();
    boolean isAnyOrOmit();
    TString getTemplateDef();
};

```

```

interface TciNonValueTemplate {
    boolean isAny();
    boolean isAll();
    TString getTemplateDef();
};

typedef sequence <Value> TciValueList;

struct TciValueDifference
{
    TString desc;
    Value val;
    TciValueTemplate tmpl;
};

typedef sequence <TciValueDifference> TciValueDifferenceList;

// *****
// Coding Decoding Interface
// - Required
// *****

interface TCI_CD_Required {
    Type getTypeForName (in TString typeName);
    Type getInteger ();
    Type getFloat ();
    Type getBoolean ();
    Type getChar ();
    Type getUniversalChar ();
    Type getObjid ();
    Type getCharstring ();
    Type getUniversalCharstring ();
    Type getHexstring ();
    Type getBitstring ();
    Type getOctetstring ();
    Type getVerdict ();
    void tciErrorReq (in TString message);
};

// *****
// Coding Decoding interface
// - Provided
// *****

interface TCI_CD_Provided {
    Value decode (
        in TriMessageType message,
        in Type decodingHypothesis
    );
    TriMessageType encode (in Value value);
};

// *****
// Test Management Interface
// - Required
// *****

interface TCI_TM_Required : TCI_CD_Required {
    void tciRootModule (in TciModuleIdType moduleName);
    TciModuleIdListType getImportedModules();
    TciModuleParameterListType tciGetModuleParameters (in TciModuleIdType moduleName);
    TciTestCaseIdListType tciGetTestCases ();
    TciParameterTypeListType tciGetTestCaseParameters (
        in TciTestCaseIdType testCaseId
    );
    TriPortIdListType tciGetTestCaseTSI (
        in TciTestCaseIdType testCaseId
    );
    void tciStartTestCase (
        in TciTestCaseIdType testCaseId,
        in TciParameterListType parameterList
    );
    void tciStopTestCase ();
    TriComponentIdType tciStartControl ();
    void tciStopControl ();
};

```

```

// *****
// Test Management Interface
// - Provided
// *****

interface TCI_TM_Provided {
    void tciTestCaseStarted (
        in TciTestCaseIdType testCaseId,
        in TciParameterListType parameterList,
        in TFloat timer
    );
    void tciTestCaseTerminated (
        in VerdictValue verdict,
        in TciParameterListType parameterList
    );
    void tciControlTerminated ();
    Value tciGetModulePar (
        in TciModuleParameterIdType parameterId
    );
    void tciLog (
        in TriComponentIdType testComponentId,
        in TString message
    );
    void tciError (in TString message);
};

// *****
// Component Handling Interface
// - Required
// *****

interface TCI_CH_Required : TCI_CD_Required {
    void tciEnqueueMsgConnected (
        in TriPortIdType sender,
        in TriComponentIdType receiver,
        in Value receivedMessage
    );
    void tciEnqueueCallConnected (
        in TriPortIdType sender,
        in TriComponentIdType receiver,
        in TriSignatureIdType signature,
        in TciParameterListType parameterList
    );
    void tciEnqueueReplyConnected (
        in TriPortIdType sender,
        in TriComponentIdType receiver,
        in TriSignatureIdType signature,
        in TciParameterListType parameterList,
        in Value returnValue
    );
    void tciEnqueueRaiseConnected (
        in TriPortIdType sender,
        in TriComponentIdType receiver,
        in TriSignatureIdType signature,
        in Value except
    );
    TriComponentIdType tciCreateTestComponent (
        in TciTestComponentKindType kind,
        in Type componentType,
        in String name
    );
    void tciStartTestComponent (
        in TriComponentIdType comp,
        in TciBehaviourIdType behavior,
        in TciParameterListType parameterList
    );
    void tciStopTestComponent (
        in TriComponentIdType comp
    );
    void tciConnect (
        in TriPortIdType fromPort,
        in TriPortIdType toPort
    );
};

```

```

void tciDisconnect (
    in TriPortIdType fromPort,
    in TriPortIdType toPort
);
void tciTestComponentTerminated (
    in TriComponentIdType comp,
    in VerdictValue verdict
);
TBoolean tciTestComponentRunning (
    in TriComponentIdType comp
);
TriComponentIdType tciGetMTC ();
void tciMap (
    in TriPortIdType fromPort,
    in TriPortIdType toPort
);
void tciUnmap (
    in TriPortIdType fromPort,
    in TriPortIdType toPort
);
void tciExecuteTestCase (
    in TciTestCaseIdType testCaseId,
    in TriPortIdListType tsiPortList
);
TBoolean tciTestComponentDone (
    in TriComponentIdType comp
);
void tciReset ();
};

// *****
// Component Handling Interface
// - Provided
// *****

interface TCI_CH_Provided {
    void tciSendConnected (
        in TriPortIdType sender,
        in TriComponentIdType receiver,
        in Value sendMessage
    );
    void tciSendConnectedBC (
        in TriPortIdType sender,
        in Value sendMessage
    );
    void tciSendConnectedMC (
        in TriPortIdType sender,
        in TriComponentIdListType receivers,
        in Value sendMessage
    );

    void tciCallConnected (
        in TriPortIdType sender,
        in TriComponentIdType receiver,
        in TriSignatureIdType signature,
        in TciParameterListType parameterList
    );
    void tciCallConnectedBC (
        in TriPortIdType sender,
        in TriSignatureIdType signature,
        in TciParameterListType parameterList
    );
    void tciCallConnectedMC (
        in TriPortIdType sender,
        in TriComponentIdListType receivers,
        in TriSignatureIdType signature,
        in TciParameterListType parameterList
    );

    void tciReplyConnected (
        in TriPortIdType sender,
        in TriComponentIdType receiver,
        in TriSignatureIdType signature,
        in TciParameterListType parameterList,
        in Value returnValue
    );
};

```

```

void tciReplyConnectedBC (
    in TriPortIdType sender,
    in TriSignatureIdType signature,
    in TciParameterListType parameterList,
    in Value returnValue
);
void tciReplyConnectedMC (
    in TriPortIdType sender,
    in TriComponentIdListType receivers,
    in TriSignatureIdType signature,
    in TciParameterListType parameterList,
    in Value returnValue
);

void tciRaiseConnected (
    in TriPortIdType sender,
    in TriComponentIdType receiver,
    in TriSignatureIdType signature,
    in Value except
);
void tciRaiseConnectedBC (
    in TriPortIdType sender,
    in TriSignatureIdType signature,
    in Value except
);
void tciRaiseConnectedMC (
    in TriPortIdType sender,
    in TriComponentIdListType receivers,
    in TriSignatureIdType signature,
    in Value except
);

TriComponentIdType tciCreateTestComponentReq (
    in TciTestComponentKindType kind,
    in Type componentType,
    in String name
);
void tciStartTestComponentReq (
    in TriComponentIdType comp,
    in TciBehaviourIdType behavior,
    in TciParameterListType parameterList
);
void tciStopTestComponentReq (
    in TriComponentIdType comp
);
void tciConnectReq (
    in TriPortIdType fromPort,
    in TriPortIdType toPort
);
void tciDisconnectReq (
    in TriPortIdType fromPort,
    in TriPortIdType toPort
);
void tciTestComponentTerminatedReq (
    in TriComponentIdType comp,
    in VerdictValue verdict
);
TBoolean tciTestComponentRunningReq (
    in TriComponentIdType comp
);
TriComponentIdType tciGetMTCReq ();
void tciMapReq (
    in TriPortIdType fromPort,
    in TriPortIdType toPort
);
void tciUnmapReq (
    in TriPortIdType fromPort,
    in TriPortIdType toPort
);
void tciExecuteTestCaseReq (
    in TciTestCaseIdType testCaseId,
    in TriPortIdListType tsiPortList
);
void tciResetReq ();
TBoolean tciTestComponentDoneReq (
    in TriComponentIdType comp
);
};

```

```

// *****
// Test Logging Interface
// - Provided
// *****

interface TCI_TL_Provided {
    void tliTcExecute(
        in TString am, in TInteger ts, in TString src, in TInteger line,
        in TriComponentIdType c, in TciTestCaseIdType tcId,
        in TriParameterListType pars, in TriTimerDurationType dur
    );
    void tliTcStart(
        in TString am, in TInteger ts, in TString src, in TInteger line,
        in TriComponentIdType c, in TciTestCaseIdType tcId,
        in TriParameterListType pars, in TriTimerDurationType dur
    );
    void tliTcStop(
        in TString am, in TInteger ts, in TString src, in TInteger line,
        in TriComponentIdType c
    );
    void tliTcStarted(
        in TString am, in TInteger ts, in TString src, in TInteger line,
        in TriComponentIdType c, in TciTestCaseIdType tcId,
        in TriParameterListType pars, in TriTimerDurationType dur
    );
    void tliTcTerminated(
        in TString am, in TInteger ts, in TString src, in TInteger line,
        in TriComponentIdType c, in TciTestCaseIdType tcId,
        in TriParameterListType pars, in VerdictValue outcome);

    void tliCtrlStart(
        in TString am, in TInteger ts, in TString src, in TInteger line,
        in TriComponentIdType c
    );
    void tliCtrlStop(
        in TString am, in TInteger ts, in TString src, in TInteger line,
        in TriComponentIdType c
    );
    void tliCtrlTerminated(
        in TString am, in TInteger ts, in TString src, in TInteger line,
        in TriComponentIdType c);

    void tliMSend_m(
        in TString am, in TInteger ts, in TString src, in TInteger line,
        in TriComponentIdType c, in TriPortIdType port, in Value msgValue,
        in TriAddressType address, in TriStatusType encoderFailure,
        in TriMessageType msg, in TriStatusType transmissionFailure
    );
    void tliMSend_m_BC(
        in TString am, in TInteger ts, in TString src, in TInteger line,
        in TriComponentIdType c, in TriPortIdType port, in Value msgValue,
        in TriStatusType encoderFailure, in TriMessageType msg,
        in TriStatusType transmissionFailure
    );
    void tliMSend_m_MC(
        in TString am, in TInteger ts, in TString src, in TInteger line,
        in TriComponentIdType c, in TriPortIdType port, in Value msgValue,
        in TriAddressListType addresses, in TriStatusType encoderFailure,
        in TriMessageType msg, in TriStatusType transmissionFailure
    );

    void tliMSend_c(
        in TString am, in TInteger ts, in TString src, in TInteger line,
        in TriComponentIdType c, in TriPortIdType port, in Value msgValue,
        in TriComponentIdType to, in TriStatusType transmissionFailure
    );
    void tliMSend_c_BC(
        in TString am, in TInteger ts, in TString src, in TInteger line,
        in TriComponentIdType c, in TriPortIdType port, in Value msgValue,
        in TriStatusType transmissionFailure
    );
    void tliMSend_c_MC(
        in TString am, in TInteger ts, in TString src, in TInteger line,
        in TriComponentIdType c, in TriPortIdType port, in Value msgValue,
        in TriComponentIdListType toList, in TriStatusType transmissionFailure);
}

```

```

void tliMDetected_m(
    in TString am, in TInteger ts, in TString src, in TInteger line,
    in TriComponentIdType c, in TriPortIdType port, in TriMessageType msg,
    in TriAddressType address
);
void tliMDetected_c(
    in TString am, in TInteger ts, in TString src, in TInteger line,
    in TriComponentIdType c, in TriPortIdType port, in Value msgValue,
    in TriComponentIdType from
);
void tliMMismatch_m(
    in TString am, in TInteger ts, in TString src, in TInteger line,
    in TriComponentIdType c, in TriPortIdType port, in Value msgValue,
    in TciValueTemplate msgTpl, in TciValueDifferenceList diffs,
    in TriAddressType address, in TciValueTemplate addressTpl
);
void tliMMismatch_c(
    in TString am, in TInteger ts, in TString src, in TInteger line,
    in TriComponentIdType c, in TriPortIdType port, in Value msgValue,
    in TciValueTemplate msgTpl, in TciValueDifferenceList diffs,
    in TriComponentIdType from, in TciNonValueTemplate fromTpl
);
void tliMReceive_m(
    in TString am, in TInteger ts, in TString src, in TInteger line,
    in TriComponentIdType c, in TriPortIdType port, in Value msgValue,
    in TciValueTemplate msgTpl, in TriAddressType address,
    in TciValueTemplate addressTpl
);
void tliMReceive_c(
    in TString am, in TInteger ts, in TString src, in TInteger line,
    in TriComponentIdType c, in TriPortIdType port, in Value msgValue,
    in TciValueTemplate msgTpl, in TriComponentIdType from,
    in TciNonValueTemplate fromTpl
);

void tliPrCall_m(
    in TString am, in TInteger ts, in TString src, in TInteger line,
    in TriComponentIdType c, in TriPortIdType port,
    in TriSignatureIdType signature, in TciParameterListType parsValue,
    in TriAddressType address, in TriStatusType encoderFailure,
    in TriParameterListType pars, in TriStatusType transmissionFailure
);
void tliPrCall_m_BC(
    in TString am, in TInteger ts, in TString src, in TInteger line,
    in TriComponentIdType c, in TriPortIdType port,
    in TriSignatureIdType signature, in TciParameterListType parsValue,
    in TriStatusType encoderFailure, in TriParameterListType pars,
    in TriStatusType transmissionFailure
);
void tliPrCall_m_MC(
    in TString am, in TInteger ts, in TString src, in TInteger line,
    in TriComponentIdType c, in TriPortIdType port,
    in TriSignatureIdType signature, in TciParameterListType parsValue,
    in TriAddressListType addresses, in TriStatusType encoderFailure,
    in TriParameterListType pars, in TriStatusType transmissionFailure
);

void tliPrCall_c(
    in TString am, in TInteger ts, in TString src, in TInteger line,
    in TriComponentIdType c, in TriPortIdType port,
    in TriSignatureIdType signature, in TciParameterListType parsValue,
    in TriComponentIdType to, in TriStatusType transmissionFailure
);
void tliPrCall_c_BC(
    in TString am, in TInteger ts, in TString src, in TInteger line,
    in TriComponentIdType c, in TriPortIdType port,
    in TriSignatureIdType signature, in TciParameterListType parsValue,
    in TriStatusType transmissionFailure
);
void tliPrCall_c_MC(
    in TString am, in TInteger ts, in TString src, in TInteger line,
    in TriComponentIdType c, in TriPortIdType port,
    in TriSignatureIdType signature, in TciParameterListType parsValue,
    in TriComponentIdListType toList, in TriStatusType transmissionFailure
);

```

```

void tliPrGetCallDetected_m(
    in TString am, in TInteger ts, in TString src, in TInteger line,
    in TriComponentIdType c, in TriPortIdType port,
    in TriSignatureIdType signature, in TriParameterListType pars,
    in TriAddressType address
);
void tliPrGetCallDetected_c(
    in TString am, in TInteger ts, in TString src, in TInteger line,
    in TriComponentIdType c, in TriPortIdType port,
    in TriSignatureIdType signature, in TciParameterListType parsValue,
    in TriComponentIdType from
);
void tliPrGetCallMismatch_m(
    in TString am, in TInteger ts, in TString src, in TInteger line,
    in TriComponentIdType c, in TriPortIdType port,
    in TriSignatureIdType signature, in TciParameterListType parsValue,
    in TciValueTemplate parsTpl, in TciValueDifferenceList diffs,
    in TriAddressType address, in TciValueTemplate addressTpl
);
void tliPrGetCallMismatch_c(
    in TString am, in TInteger ts, in TString src, in TInteger line,
    in TriComponentIdType c, in TriPortIdType port,
    in TriSignatureIdType signature, in TciParameterListType parsValue,
    in TciValueTemplate parsTpl, in TciValueDifferenceList diffs,
    in TriComponentIdType from, in TciNonValueTemplate fromTpl
);
void tliPrGetCall_m(
    in TString am, in TInteger ts, in TString src, in TInteger line,
    in TriComponentIdType c, in TriPortIdType port,
    in TriSignatureIdType signature, in TciParameterListType parsValue,
    in TciValueTemplate parsTpl, in TriAddressType address,
    in TciValueTemplate addressTpl
);
void tliPrGetCall_c(
    in TString am, in TInteger ts, in TString src, in TInteger line,
    in TriComponentIdType c, in TriPortIdType port,
    in TriSignatureIdType signature, in TciParameterListType parsValue,
    in TciValueTemplate parsTpl, in TriComponentIdType from,
    in TciNonValueTemplate fromTpl
);
void tliPrReply_m(
    in TString am, in TInteger ts, in TString src, in TInteger line,
    in TriComponentIdType c, in TriPortIdType port,
    in TriSignatureIdType signature, in TciParameterListType parsValue,
    in Value replValue, in TriAddressType address,
    in TriStatusType encoderFailure, in TriParameterType repl,
    in TriStatusType transmissionFailure
);
void tliPrReply_m_BC(
    in TString am, in TInteger ts, in TString src, in TInteger line,
    in TriComponentIdType c, in TriPortIdType port,
    in TriSignatureIdType signature, in Value parsValue, in Value replValue,
    in TriStatusType encoderFailure, in TriParameterType repl,
    in TriStatusType transmissionFailure
);
void tliPrReply_m_MC(
    in TString am, in TInteger ts, in TString src, in TInteger line,
    in TriComponentIdType c, in TriPortIdType port,
    in TriSignatureIdType signature, in Value parsValue, in Value replValue,
    in TriAddressListType addresses, in TriStatusType encoderFailure,
    in TriParameterType repl, in TriStatusType transmissionFailure
);
void tliPrReply_c(
    in TString am, in TInteger ts, in TString src, in TInteger line,
    in TriComponentIdType c, in TriPortIdType port,
    in TriSignatureIdType signature, in TciParameterListType parsValue,
    in Value replValue, in TriComponentIdType to,
    in TriStatusType transmissionFailure
);
void tliPrReply_c_BC(
    in TString am, in TInteger ts, in TString src, in TInteger line,
    in TriComponentIdType c, in TriPortIdType port,
    in TriSignatureIdType signature, in Value parsValue, in Value replValue,
    in TriStatusType transmissionFailure
);

```



```

void tliPrReply_c_MC(
    in TString am, in TInteger ts, in TString src, in TInteger line,
    in TriComponentIdType c, in TriPortIdType port,
    in TriSignatureIdType signature, in Value parsValue, in Value replValue,
    in TriComponentIdListType toList, in TriStatusType transmissionFailure
);

void tliPrGetReplyDetected_m(
    in TString am, in TInteger ts, in TString src, in TInteger line,
    in TriComponentIdType c, in TriPortIdType port,
    in TriSignatureIdType signature, in TriParameterType repl,
    in TriAddressType address
);
void tliPrGetReplyDetected_c(
    in TString am, in TInteger ts, in TString src, in TInteger line,
    in TriComponentIdType c, in TriPortIdType port,
    in TriSignatureIdType signature, in Value replValue,
    in TriComponentIdType from
);
void tliPrGetReplyMismatch_m(
    in TString am, in TInteger ts, in TString src, in TInteger line,
    in TriComponentIdType c, in TriPortIdType port,
    in TriSignatureIdType signature, in TciParameterListType parsValue,
    in Value replValue, in TciValueTemplate replyTpl,
    in TciValueDifferenceList diffs, in TriAddressType address,
    in TciValueTemplate addressTpl
);
void tliPrGetReplyMismatch_c(
    in TString am, in TInteger ts, in TString src, in TInteger line,
    in TriComponentIdType c, in TriPortIdType port,
    in TriSignatureIdType signature, in TciParameterListType parsValue,
    in Value replValue, in TciValueTemplate replyTpl,
    in TciValueDifferenceList diffs, in TriComponentIdType from,
    in TciNonValueTemplate fromTpl
);
void tliPrGetReply_m(
    in TString am, in TInteger ts, in TString src, in TInteger line,
    in TriComponentIdType c, in TriPortIdType port,
    in TriSignatureIdType signature, in TciParameterListType parsValue,
    in Value replValue, in TciValueTemplate replyTpl,
    in TriAddressType address, in TciValueTemplate addressTpl
);
void tliPrGetReply_c(
    in TString am, in TInteger ts, in TString src, in TInteger line,
    in TriComponentIdType c, in TriPortIdType port,
    in TriSignatureIdType signature, in TciParameterListType parsValue,
    in Value replValue, in TciValueTemplate replyTpl,
    in TriComponentIdType from, in TciNonValueTemplate fromTpl
);

void tliPrRaise_m(
    in TString am, in TInteger ts, in TString src, in TInteger line,
    in TriComponentIdType c, in TriPortIdType port,
    in TriSignatureIdType signature, in TciParameterListType parsValue,
    in Value excValue, in TriAddressType address, in TriStatusType encoderFailure,
    in TriExceptionType exc, in TriStatusType transmissionFailure
);
void tliPrRaise_m_BC(
    in TString am, in TInteger ts, in TString src, in TInteger line,
    in TriComponentIdType c, in TriPortIdType port,
    in TriSignatureIdType signature, in TciParameterListType parsValue,
    in Value excValue, in TriStatusType encoderFailure, in TriExceptionType exc,
    in TriStatusType transmissionFailure
);
void tliPrRaise_m_MC(
    in TString am, in TInteger ts, in TString src, in TInteger line,
    in TriComponentIdType c, in TriPortIdType port,
    in TriSignatureIdType signature, in TciParameterListType parsValue,
    in Value excValue, in TriAddressListType addresses,
    in TriStatusType encoderFailure, in TriExceptionType exc,
    in TriStatusType transmissionFailure
);

```

```

void tliPrRaise_c(
    in TString am, in TInteger ts, in TString src, in TInteger line,
    in TriComponentIdType c, in TriPortIdType port,
    in TriSignatureIdType signature, in TciParameterListType parsValue,
    in Value excValue, in TriComponentIdType to,
    in TriStatusType transmissionFailure
);
void tliPrCatchDetected_m(
    in TString am, in TInteger ts, in TString src, in TInteger line,
    in TriComponentIdType c, in TriPortIdType port,
    in TriSignatureIdType signature, in TriExceptionType exc,
    in TriAddressType address
);
void tliPrCatchDetected_c(
    in TString am, in TInteger ts, in TString src, in TInteger line,
    in TriComponentIdType c, in TriPortIdType port,
    in TriSignatureIdType signature, in Value excValue,
    in TriComponentIdType from
);
void tliPrCatchMismatch_m(
    in TString am, in TInteger ts, in TString src, in TInteger line,
    in TriComponentIdType c, in TriPortIdType port,
    in TriSignatureIdType signature, in TciParameterListType parsValue,
    in Value excValue, in TciValueTemplate excTmpl,
    in TciValueDifferenceList diffs, in TriAddressType address,
    in TciValueTemplate addressTmpl
);
void tliPrCatchMismatch_c(
    in TString am, in TInteger ts, in TString src, in TInteger line,
    in TriComponentIdType c, in TriPortIdType port,
    in TriSignatureIdType signature, in TciParameterListType parsValue,
    in Value excValue, in TciValueTemplate excTmpl,
    in TciValueDifferenceList diffs, in TriComponentIdType from,
    in TciNonValueTemplate fromTmpl
);
void tliPrCatch_m(
    in TString am, in TInteger ts, in TString src, in TInteger line,
    in TriComponentIdType c, in TriPortIdType port,
    in TriSignatureIdType signature, in TciParameterListType parsValue,
    in Value excValue, in TciValueTemplate excTmpl,
    in TriAddressType address, in TciValueTemplate addressTmpl);

void tliPrCatch_c(
    in TString am, in TInteger ts, in TString src, in TInteger line,
    in TriComponentIdType c, in TriPortIdType port,
    in TriSignatureIdType signature, in TciParameterListType parsValue,
    in Value excValue, in TciValueTemplate excTmpl,
    in TriComponentIdType from, in TciNonValueTemplate fromTmpl
);
void tliPrCatchTimeoutDetected(
    in TString am, in TInteger ts, in TString src, in TInteger line,
    in TriComponentIdType c, in TriPortIdType port,
    in TriSignatureIdType signature
);
void tliPrCatchTimeout(
    in TString am, in TInteger ts, in TString src, in TInteger line,
    in TriComponentIdType c, in TriPortIdType port,
    in TriSignatureIdType signature, in TciParameterListType parsValue
);
void tliCCreate(
    in TString am, in TInteger ts, in TString src, in TInteger line,
    in TriComponentIdType c, in TriComponentIdType comp,
    in String name
);
void tliCStart(
    in TString am, in TInteger ts, in TString src, in TInteger line,
    in TriComponentIdType c, in TriComponentIdType comp,
    in TciBehaviourIdType name, in TciParameterListType parsValue
);
void tliCRunning(
    in TString am, in TInteger ts, in TString src, in TInteger line,
    in TriComponentIdType c, in TriComponentIdType comp, in TBoolean status
);
void tliCAlive(
    in TString am, in TInteger ts, in TString src, in TInteger line,
    in TriComponentIdType c,
    in TriComponentIdType comp, in TBoolean status
);

```

```

void tliCStop(
    in TString am, in TInteger ts, in TString src, in TInteger line,
    in TriComponentIdType c, in TriComponentIdType comp
);
void tliCKill(
    in TString am, in TInteger ts, in TString src, in TInteger line,
    in TriComponentIdType c, in TriComponentIdType comp
);
void tliCDoneMismatch(
    in TString am, in TInteger ts, in TString src, in TInteger line,
    in TriComponentIdType c, in TciNonValueTemplate compTmpl
);
void tliCKilledMismatch(
    in TString am, in TInteger ts, in TString src, in TInteger line,
    in TriComponentIdType c, in TciNonValueTemplate compTmpl
);
void tliCDone(in TString am, in TInteger ts, in TString src, in TInteger line,
    in TriComponentIdType c, in TciNonValueTemplate compTmpl
);
void tliCKilled(
    in TString am, in TInteger ts, in TString src, in TInteger line,
    in TriComponentIdType c, in TciNonValueTemplate compTmpl
);
void tliCTerminated(
    in TString am, in TInteger ts, in TString src, in TInteger line,
    in TriComponentIdType c, in VerdictValue verdict
);
void tliPConnect(
    in TString am, in TInteger ts, in TString src, in TInteger line,
    in TriComponentIdType c, in TriComponentIdType c1, in TriPortIdType port1,
    in TriComponentIdType c2, in TriPortIdType port2
);
void tliPDisconnect(
    in TString am, in TInteger ts, in TString src, in TInteger line,
    in TriComponentIdType c, in TriComponentIdType c1, in TriPortIdType port1,
    in TriComponentIdType c2, in TriPortIdType port2
);
void tliPMap(
    in TString am, in TInteger ts, in TString src, in TInteger line,
    in TriComponentIdType c, in TriComponentIdType c1, in TriPortIdType port1,
    in TriComponentIdType c2, in TriPortIdType port2
);
void tliPUnmap(
    in TString am, in TInteger ts, in TString src, in TInteger line,
    in TriComponentIdType c, in TriComponentIdType c1, in TriPortIdType port1,
    in TriComponentIdType c2, in TriPortIdType port2
);
void tliPClear(
    in TString am, in TInteger ts, in TString src, in TInteger line,
    in TriComponentIdType c, in TriPortIdType port
);
void tliPStart(
    in TString am, in TInteger ts, in TString src, in TInteger line,
    in TriComponentIdType c, in TriPortIdType port
);
void tliPStop(
    in TString am, in TInteger ts, in TString src, in TInteger line,
    in TriComponentIdType c, in TriPortIdType port
);
void tliPHalt(
    in TString am, in TInteger ts, in TString src, in TInteger line,
    in TriComponentIdType c, in TriPortIdType port
);
void tliEncode(
    in TString am, in TInteger ts, in TString src, in TInteger line,
    in TriComponentIdType c, in Value val, in TriStatusType encoderFailure,
    in TriMessageType msg, in TString codec
);
void tliDecode(
    in TString am, in TInteger ts, in TString src, in TInteger line,
    in TriComponentIdType c, in TriMessageType msg,
    in TriStatusType decoderFailure, in Value val, in TString codec
);
void tliTimeoutDetected(
    in TString am, in TInteger ts, in TString src, in TInteger line,
    in TriComponentIdType c, in TriTimerIdType timer
);

```

```

void tliTimeoutMismatch(
    in TString am, in TInteger ts, in TString src, in TInteger line,
    in TriComponentIdType c, in TciNonValueTemplate timerTpl
);
void tliTimeout(
    in TString am, in TInteger ts, in TString src, in TInteger line,
    in TriComponentIdType c, in TciNonValueTemplate timerTpl
);
void tliTStart(
    in TString am, in TInteger ts, in TString src, in TInteger line,
    in TriComponentIdType c, in TriTimerIdType timer,
    in TriTimerDurationType dur
);
void tliTStop(
    in TString am, in TInteger ts, in TString src, in TInteger line,
    in TriComponentIdType c, in TriTimerIdType timer
);
void tliTRead(
    in TString am, in TInteger ts, in TString src, in TInteger line,
    in TriComponentIdType c, in TriTimerIdType timer,
    in TriTimerDurationType elapsed
);
void tliTRunning(
    in TString am, in TInteger ts, in TString src, in TInteger line,
    in TriComponentIdType c, in TriTimerIdType timer, in TBoolean status
);
void tliSEnter(
    in TString am, in TInteger ts, in TString src, in TInteger line,
    in TriComponentIdType c, in TString name, in TciParameterListType parsValue,
    in TString kind
);
void tliSLeave(
    in TString am, in TInteger ts, in TString src, in TInteger line,
    in TriComponentIdType c, in TString name, in Value returnValue,
    in TString kind
);
void tliVar(
    in TString am, in TInteger ts, in TString src, in TInteger line,
    in TriComponentIdType c, in TString name, in Value varValue
);
void tliModulePar(
    in TString am, in TInteger ts, in TString src, in TInteger line,
    in TriComponentIdType c, in TString name, in Value parValue
);
void tliGetVerdict(
    in TString am, in TInteger ts, in TString src, in TInteger line,
    in TriComponentIdType c, in VerdictValue verdict
);
void tliSetVerdict(
    in TString am, in TInteger ts, in TString src, in TInteger line,
    in TriComponentIdType c, in VerdictValue verdict
);
void tliLog(
    in TString am, in TInteger ts, in TString src, in TInteger line,
    in TriComponentIdType c, in TciValueList log
);
void tliAEnter(
    in TString am, in TInteger ts, in TString src, in TInteger line,
    in TriComponentIdType c
);
void tliALeave(
    in TString am, in TInteger ts, in TString src, in TInteger line,
    in TriComponentIdType c
);
void tliADefaults(
    in TString am, in TInteger ts, in TString src, in TInteger line,
    in TriComponentIdType c
);
void tliAActivate(
    in TString am, in TInteger ts, in TString src, in TInteger line,
    in TriComponentIdType c, in TString name, in TciParameterListType pars,
    in Value ref
);
void tliAdeactivate(
    in TString am, in TInteger ts, in TString src, in TInteger line,
    in TriComponentIdType c, in Value ref
);

```

```
void tliANomatch(
    in TString am, in TInteger ts, in TString src, in TInteger line,
    in TriComponentIdType c
);
void tliARepeat(
    in TString am, in TInteger ts, in TString src, in TInteger line,
    in TriComponentIdType c
);
void tliAwait(
    in TString am, in TInteger ts, in TString src, in TInteger line,
    in TriComponentIdType c
);
};
```

## Annex B (normative): XML Mapping for TCI TL Provided

This annex defines a mapping for the logging interface of TCI using eXtended Markup Language (XML) schema definitions.

### B.1 TCI-TL XML Schema for Simple Types

```
<xsd:schema xmlns:xsd="http://www.w3.org/2001/XMLSchema"
  targetNamespace="http://uri.etsi.org/ttcn-3/3.0.0/tci/SimpleTypes"
  xmlns:SimpleTypes="http://uri.etsi.org/ttcn-3/3.0.0/tci/SimpleTypes"
  elementFormDefault="qualified">

  <!-- Basic definitions -->
  <xsd:simpleType name="xpath">
    <!-- this string should be XPATH compliant -->
    <xsd:restriction base="xsd:string"/>
  </xsd:simpleType>

  <xsd:simpleType name="TBoolean">
    <xsd:restriction base="xsd:boolean"/>
  </xsd:simpleType>

  <xsd:simpleType name="TString">
    <xsd:restriction base="xsd:string"/>
  </xsd:simpleType>

  <xsd:simpleType name="TInteger">
    <xsd:restriction base="xsd:integer"/>
  </xsd:simpleType>

  <!-- Miscellaneous -->
  <xsd:simpleType name="TriTimerDurationType">
    <xsd:restriction base="xsd:float"/>
  </xsd:simpleType>

  <xsd:simpleType name="TciParameterPassingModeType">
    <xsd:restriction base="xsd:string">
      <xsd:enumeration value="in"/>
      <xsd:enumeration value="inout"/>
      <xsd:enumeration value="out"/>
    </xsd:restriction>
  </xsd:simpleType>

  <xsd:simpleType name="TriStatusType">
    <xsd:restriction base="xsd:string">
      <xsd:enumeration value="TRI_Ok"/>
      <xsd:enumeration value="TRI_Error"/>
    </xsd:restriction>
  </xsd:simpleType>

  <xsd:simpleType name="TciStatusType">
    <xsd:restriction base="xsd:string">
      <xsd:enumeration value="TCI_Ok"/>
      <xsd:enumeration value="TCI_Error"/>
    </xsd:restriction>
  </xsd:simpleType>

</xsd:schema>
```

## B.2 TCI-TL XML Schema for Types

```

<xsd:schema xmlns:xsd="http://www.w3.org/2001/XMLSchema"
  targetNamespace="http://uri.etsi.org/ttcn-3/3.0.0/tci/Types"
  xmlns:Types="http://uri.etsi.org/ttcn-3/3.0.0/tci/Types"
  xmlns:SimpleTypes="http://uri.etsi.org/ttcn-3/3.0.0/tci/SimpleTypes"
  xmlns:Values="http://uri.etsi.org/ttcn-3/3.0.0/tci/Values"
  elementFormDefault="qualified">

  <xsd:import namespace="http://uri.etsi.org/ttcn-3/3.0.0/tci/Values.xsd"
    schemaLocation="Values.xsd"/>
  <xsd:import namespace="http://uri.etsi.org/ttcn-3/3.0.0/tci/SimpleTypes.xsd"
    schemaLocation="SimpleTypes.xsd"/>

  <!-- Connection -->
  <xsd:complexType name="TriPortIdType">
    <xsd:sequence>
      <xsd:element name="comp" type="Types:TriComponentIdType" minOccurs="1" maxOccurs="1"/>
      <xsd:element name="port" type="Types:Port" minOccurs="1" maxOccurs="1"/>
    </xsd:sequence>
  </xsd:complexType>

  <xsd:complexType name="Port">
    <xsd:sequence>
      <xsd:element name="id" type="Types:Id" minOccurs="1" maxOccurs="1"/>
      <xsd:element name="index" type="xsd:int" minOccurs="0" maxOccurs="1"/>
    </xsd:sequence>
  </xsd:complexType>

  <xsd:complexType name="TriComponentIdType">
    <xsd:sequence>
      <xsd:choice>
        <xsd:element name="null"/>
        <xsd:element name="id" type="Types:Id" minOccurs="1" maxOccurs="1"/>
      </xsd:choice>
    </xsd:sequence>
  </xsd:complexType>

  <xsd:complexType name="TriComponentIdListType">
    <xsd:sequence>
      <xsd:element name="comp" type="Types:TriComponentIdType" minOccurs="0"
        maxOccurs="unbounded"/>
    </xsd:sequence>
  </xsd:complexType>

  <!-- Communication -->
  <xsd:complexType name="TriMessageType">
    <xsd:attribute name="val" type="xsd:hexBinary"/>
  </xsd:complexType>

  <xsd:complexType name="TriParameterType">
    <xsd:sequence>
      <xsd:element name="val" type="Values:Value" minOccurs="1" maxOccurs="1"/>
    </xsd:sequence>
    <xsd:attribute name="name" type="SimpleTypes:TString"/>
    <xsd:attribute name="mode" type="SimpleTypes:TciParameterPassingModeType"/>
  </xsd:complexType>

  <xsd:complexType name="TriParameterListType">
    <xsd:sequence>
      <xsd:element name="par" type="Types:TriParameterType" minOccurs="0"
maxOccurs="unbounded"/>
    </xsd:sequence>
  </xsd:complexType>

  <xsd:complexType name="TriExceptionType">
    <xsd:attribute name="val" type="SimpleTypes:TString"/>
  </xsd:complexType>

  <xsd:complexType name="TriSignatureIdType">
    <xsd:attribute name="val" type="SimpleTypes:TString"/>
  </xsd:complexType>

  <xsd:complexType name="TriAddressType">
    <xsd:attribute name="val" type="SimpleTypes:TString"/>
  </xsd:complexType>

```

```

<xsd:complexType name="TriAddressListType">
  <xsd:sequence>
    <xsd:element name="addr" type="Types:TriAddressType" minOccurs="0"
      maxOccurs="unbounded"/>
  </xsd:sequence>
</xsd:complexType>

<!-- Miscellaneous -->
<xsd:complexType name="TriTimerIdType">
  <xsd:sequence>
    <xsd:element name="id" type="Types:Id" minOccurs="1" maxOccurs="1"/>
  </xsd:sequence>
</xsd:complexType>

<xsd:complexType name="TriTimerDurationType">
  <xsd:attribute name="val" type="SimpleTypes:TriTimerDurationType"/>
</xsd:complexType>

<!-- Basic definitions -->
<xsd:complexType name="QualifiedName">
  <xsd:attribute name="moduleName" type="SimpleTypes:TString" use="required"/>
  <xsd:attribute name="baseName" type="SimpleTypes:TString" use="required"/>
</xsd:complexType>

<!-- general TCI abstract data types -->
<xsd:complexType name="TciBehaviourIdType">
  <xsd:sequence>
    <xsd:element name="name" type="Types:QualifiedName" minOccurs="1" maxOccurs="1"/>
  </xsd:sequence>
</xsd:complexType>

<xsd:complexType name="TciTestCaseIdType">
  <xsd:sequence>
    <xsd:element name="name" type="Types:QualifiedName" minOccurs="1" maxOccurs="1"/>
  </xsd:sequence>
</xsd:complexType>

<xsd:complexType name="TciParameterType">
  <xsd:sequence>
    <xsd:element name="val" type="Values:Value" minOccurs="1" maxOccurs="1"/>
  </xsd:sequence>
  <xsd:attribute name="name" type="SimpleTypes:TString"/>
  <xsd:attribute name="mode" type="SimpleTypes:TciParameterPassingModeType"/>
</xsd:complexType>

<xsd:complexType name="TciParameterListType">
  <xsd:sequence>
    <xsd:element name="par" type="Types:TciParameterType" minOccurs="0"
maxOccurs="unbounded"/>
  </xsd:sequence>
</xsd:complexType>

<!-- general identifier structure for test components, ports and timer -->
<xsd:complexType name="Id">
  <xsd:sequence>
    <xsd:element name="name" type="SimpleTypes:TString" minOccurs="1" maxOccurs="1"/>
    <xsd:element name="id" type="SimpleTypes:TInteger" minOccurs="1" maxOccurs="1"/>
    <xsd:element name="type" type="SimpleTypes:TString" minOccurs="1" maxOccurs="1"/>
  </xsd:sequence>
</xsd:complexType>

</xsd:schema>

```

---

## B.3 TCI-TL XML Schema for Values

```

<xsd:schema xmlns:xsd="http://www.w3.org/2001/XMLSchema"
  targetNamespace="http://uri.etsi.org/ttcn-3/3.0.0/tci/Values"
  xmlns:Values="http://uri.etsi.org/ttcn-3/3.0.0/tci/Values"
  xmlns:Templates="http://uri.etsi.org/ttcn-3/3.0.0/tci/Templates"
  xmlns:Types="http://uri.etsi.org/ttcn-3/3.0.0/tci/Types"
  xmlns:SimpleTypes="http://uri.etsi.org/ttcn-3/3.0.0/tci/SimpleTypes"
  elementFormDefault="qualified">

  <xsd:import namespace="http://uri.etsi.org/ttcn-3/3.0.0/tci/Templates.xsd"

```



```

    schemaLocation="Templates.xsd"/>
<xsd:import namespace="http://uri.etsi.org/ttcn-3/3.0.0/tci/Types.xsd"
schemaLocation="Types.xsd"/>
<xsd:import namespace="http://uri.etsi.org/ttcn-3/3.0.0/tci/SimpleTypes.xsd"
    schemaLocation="SimpleTypes.xsd"/>

<xsd:attributeGroup name="ValueAtts">
    <xsd:attribute name="name" type="SimpleTypes:TString" use="optional"/>
    <xsd:attribute name="type" type="SimpleTypes:TString" use="optional"/>
    <xsd:attribute name="module" type="SimpleTypes:TString" use="optional"/>
</xsd:attributeGroup>

<xsd:complexType name="Value" mixed="true">
    <xsd:choice>
        <xsd:element name="integer" type="Values:IntegerValue"/>
        <xsd:element name="float" type="Values:FloatValue"/>
        <xsd:element name="boolean" type="Values:BooleanValue"/>
        <xsd:element name="objid" type="Values:ObjidValue"/>
        <xsd:element name="verdicttype" type="Values:VerdictValue"/>
        <xsd:element name="bitstring" type="Values:BitstringValue"/>
        <xsd:element name="hexstring" type="Values:HexstringValue"/>
        <xsd:element name="octetstring" type="Values:OctetstringValue"/>
        <xsd:element name="charstring" type="Values:CharstringValue"/>
        <xsd:element name="universal_charstring" type="Values:UniversalCharstringValue"/>
        <xsd:element name="record" type="Values:RecordValue"/>
        <xsd:element name="record_of" type="Values:RecordOfValue"/>
        <xsd:element name="set" type="Values:SetValue"/>
        <xsd:element name="set_of" type="Values:SetOfValue"/>
        <xsd:element name="enumerated" type="Values:EnumeratedValue"/>
        <xsd:element name="union" type="Values:UnionValue"/>
        <xsd:element name="anytype" type="Values:AnytypeValue"/>
        <xsd:element name="address" type="Values:AddressValue"/>
    </xsd:choice>
    <xsd:attributeGroup ref="Values:ValueAtts"/>
</xsd:complexType>

<!-- general event elements -->
<xsd:complexType name="IntegerValue">
    <xsd:simpleContent>
        <xsd:extension base="SimpleTypes:TString">
            <xsd:attributeGroup ref="Values:ValueAtts"/>
        </xsd:extension>
    </xsd:simpleContent>
</xsd:complexType>

<xsd:complexType name="FloatValue">
    <xsd:simpleContent>
        <xsd:extension base="SimpleTypes:TString">
            <xsd:attributeGroup ref="Values:ValueAtts"/>
        </xsd:extension>
    </xsd:simpleContent>
</xsd:complexType>

<xsd:complexType name="BooleanValue">
    <xsd:simpleContent>
        <xsd:extension base="SimpleTypes:TString">
            <xsd:attributeGroup ref="Values:ValueAtts"/>
        </xsd:extension>
    </xsd:simpleContent>
</xsd:complexType>

<xsd:complexType name="ObjidValue">
    <xsd:simpleContent>
        <xsd:extension base="SimpleTypes:TString">
            <xsd:attributeGroup ref="Values:ValueAtts"/>
        </xsd:extension>
    </xsd:simpleContent>
</xsd:complexType>

<xsd:complexType name="VerdictValue">
    <xsd:simpleContent>
        <xsd:extension base="SimpleTypes:TString">
            <xsd:attributeGroup ref="Values:ValueAtts"/>
        </xsd:extension>
    </xsd:simpleContent>
</xsd:complexType>

<xsd:complexType name="BitstringValue">

```

```

    <xsd:simpleContent>
      <xsd:extension base="SimpleTypes:TString">
        <xsd:attributeGroup ref="Values:ValueAtts" />
      </xsd:extension>
    </xsd:simpleContent>
  </xsd:complexType>

  <xsd:complexType name="HexstringValue">
    <xsd:simpleContent>
      <xsd:extension base="SimpleTypes:TString">
        <xsd:attributeGroup ref="Values:ValueAtts" />
      </xsd:extension>
    </xsd:simpleContent>
  </xsd:complexType>

  <xsd:complexType name="OctetstringValue">
    <xsd:simpleContent>
      <xsd:extension base="SimpleTypes:TString">
        <xsd:attributeGroup ref="Values:ValueAtts" />
      </xsd:extension>
    </xsd:simpleContent>
  </xsd:complexType>

  <xsd:complexType name="CharstringValue">
    <xsd:simpleContent>
      <xsd:extension base="SimpleTypes:TString">
        <xsd:attributeGroup ref="Values:ValueAtts" />
      </xsd:extension>
    </xsd:simpleContent>
  </xsd:complexType>

  <xsd:complexType name="UniversalCharstringValue">
    <xsd:simpleContent>
      <xsd:extension base="SimpleTypes:TString">
        <xsd:attributeGroup ref="Values:ValueAtts" />
      </xsd:extension>
    </xsd:simpleContent>
  </xsd:complexType>

  <xsd:complexType name="RecordValue">
    <xsd:sequence>
      <xsd:choice minOccurs="0" maxOccurs="unbounded">
        <xsd:element name="integer" type="Values:IntegerValue" />
        <xsd:element name="float" type="Values:FloatValue" />
        <xsd:element name="boolean" type="Values:BooleanValue" />
        <xsd:element name="objid" type="Values:ObjidValue" />
        <xsd:element name="verdicttype" type="Values:VerdictValue" />
        <xsd:element name="bitstring" type="Values:BitstringValue" />
        <xsd:element name="hexstring" type="Values:HexstringValue" />
        <xsd:element name="octetstring" type="Values:OctetstringValue" />
        <xsd:element name="charstring" type="Values:CharstringValue" />
        <xsd:element name="universal_charstring"
          type="Values:UniversalCharstringValue" />
        <xsd:element name="record" type="Values:RecordValue" />
        <xsd:element name="record_of" type="Values:RecordOfValue" />
        <xsd:element name="set" type="Values:SetValue" />
        <xsd:element name="set_of" type="Values:SetOfValue" />
        <xsd:element name="enumerated" type="Values:EnumeratedValue" />
        <xsd:element name="union" type="Values:UnionValue" />
        <xsd:element name="anytype" type="Values:AnytypeValue" />
        <xsd:element name="address" type="Values:AddressValue" />
      </xsd:choice>
    </xsd:sequence>
    <xsd:attributeGroup ref="Values:ValueAtts" />
  </xsd:complexType>

  <xsd:complexType name="RecordOfValue">
    <xsd:choice>
      <xsd:sequence>
        <xsd:element name="integer" type="Values:IntegerValue" minOccurs="0"
          maxOccurs="unbounded" />
      </xsd:sequence>
      <xsd:sequence>
        <xsd:element name="float" type="Values:FloatValue" minOccurs="0"
          maxOccurs="unbounded" />
      </xsd:sequence>
      <xsd:sequence>
        <xsd:element name="boolean" type="Values:BooleanValue" minOccurs="0"

```

```

        maxOccurs="unbounded" />
</xsd:sequence>
<xsd:sequence>
  <xsd:element name="objid" type="Values:ObjidValue" minOccurs="0"
    maxOccurs="unbounded" />
</xsd:sequence>
<xsd:sequence>
  <xsd:element name="bitstring" type="Values:BitstringValue"
    minOccurs="0" maxOccurs="unbounded" />
</xsd:sequence>
<xsd:sequence>
  <xsd:element name="hexstring" type="Values:HexstringValue"
    minOccurs="0" maxOccurs="unbounded" />
</xsd:sequence>
<xsd:sequence>
  <xsd:element name="octetstring" type="Values:OctetstringValue"
    minOccurs="0" maxOccurs="unbounded" />
</xsd:sequence>
<xsd:sequence>
  <xsd:element name="charstring" type="Values:CharstringValue"
    minOccurs="0" maxOccurs="unbounded" />
</xsd:sequence>
<xsd:sequence>
  <xsd:element name="universal_charstring"
    type="Values:UniversalCharstringValue" minOccurs="0"
    maxOccurs="unbounded" />
</xsd:sequence>
<xsd:sequence>
  <xsd:element name="record" type="Values:RecordValue" minOccurs="0"
    maxOccurs="unbounded" />
</xsd:sequence>
<xsd:sequence>
  <xsd:element name="record_of" type="Values:RecordOfValue"
    minOccurs="0" maxOccurs="unbounded" />
</xsd:sequence>
<xsd:sequence>
  <xsd:element name="set" type="Values:SetValue" minOccurs="0"
    maxOccurs="unbounded" />
</xsd:sequence>
<xsd:sequence>
  <xsd:element name="set_of" type="Values:SetOfValue"
    minOccurs="0" maxOccurs="unbounded" />
</xsd:sequence>
<xsd:sequence>
  <xsd:element name="enumerated" type="Values:EnumeratedValue"
    minOccurs="0" maxOccurs="unbounded" />
</xsd:sequence>
<xsd:sequence>
  <xsd:element name="union" type="Values:UnionValue" minOccurs="0"
    maxOccurs="unbounded" />
</xsd:sequence>
<xsd:sequence>
  <xsd:element name="anytype" type="Values:AnytypeValue" minOccurs="0"
    maxOccurs="unbounded" />
</xsd:sequence>
<xsd:sequence>
  <xsd:element name="address" type="Values:AddressValue" minOccurs="0"
    maxOccurs="unbounded" />
</xsd:sequence>
</xsd:choice>
<xsd:attributeGroup ref="Values:ValueAtts" />
</xsd:complexType>

<xsd:complexType name="SetValue">
  <xsd:sequence>
    <xsd:choice minOccurs="0" maxOccurs="unbounded">
      <xsd:element name="integer" type="Values:IntegerValue" />
      <xsd:element name="float" type="Values:FloatValue" />
      <xsd:element name="boolean" type="Values:BooleanValue" />
      <xsd:element name="objid" type="Values:ObjidValue" />
      <xsd:element name="verdicttype" type="Values:VerdictValue" />
      <xsd:element name="bitstring" type="Values:BitstringValue" />
      <xsd:element name="hexstring" type="Values:HexstringValue" />
      <xsd:element name="octetstring" type="Values:OctetstringValue" />
      <xsd:element name="charstring" type="Values:CharstringValue" />
      <xsd:element name="universal_charstring"
        type="Values:UniversalCharstringValue" />
      <xsd:element name="record" type="Values:RecordValue" />
    </xsd:choice>
  </xsd:sequence>
</xsd:complexType>

```

```

    <xsd:element name="record_of" type="Values:RecordOfValue"/>
    <xsd:element name="set" type="Values:SetValue"/>
    <xsd:element name="set_of" type="Values:SetOfValue"/>
    <xsd:element name="enumerated" type="Values:EnumeratedValue"/>
    <xsd:element name="union" type="Values:UnionValue"/>
    <xsd:element name="anytype" type="Values:AnytypeValue"/>
    <xsd:element name="address" type="Values:AddressValue"/>
  </xsd:choice>
</xsd:sequence>
<xsd:attributeGroup ref="Values:ValueAtts"/>
</xsd:complexType>

<xsd:complexType name="SetOfValue">
  <xsd:choice>
    <xsd:sequence>
      <xsd:element name="integer" type="Values:IntegerValue" minOccurs="0"
        maxOccurs="unbounded"/>
    </xsd:sequence>
    <xsd:sequence>
      <xsd:element name="float" type="Values:FloatValue" minOccurs="0"
        maxOccurs="unbounded"/>
    </xsd:sequence>
    <xsd:sequence>
      <xsd:element name="boolean" type="Values:BooleanValue" minOccurs="0"
        maxOccurs="unbounded"/>
    </xsd:sequence>
    <xsd:sequence>
      <xsd:element name="objid" type="Values:ObjidValue" minOccurs="0"
        maxOccurs="unbounded"/>
    </xsd:sequence>
    <xsd:sequence>
      <xsd:element name="bitstring" type="Values:BitstringValue"
        minOccurs="0" maxOccurs="unbounded"/>
    </xsd:sequence>
    <xsd:sequence>
      <xsd:element name="hexstring" type="Values:HexstringValue"
        minOccurs="0" maxOccurs="unbounded"/>
    </xsd:sequence>
    <xsd:sequence>
      <xsd:element name="octetstring" type="Values:OctetstringValue"
        minOccurs="0" maxOccurs="unbounded"/>
    </xsd:sequence>
    <xsd:sequence>
      <xsd:element name="charstring" type="Values:CharstringValue"
        minOccurs="0" maxOccurs="unbounded"/>
    </xsd:sequence>
    <xsd:sequence>
      <xsd:element name="universal_charstring"
        type="Values:UniversalCharstringValue" minOccurs="0"
        maxOccurs="unbounded"/>
    </xsd:sequence>
    <xsd:sequence>
      <xsd:element name="record" type="Values:RecordValue" minOccurs="0"
        maxOccurs="unbounded"/>
    </xsd:sequence>
    <xsd:sequence>
      <xsd:element name="record_of" type="Values:RecordOfValue"
        minOccurs="0" maxOccurs="unbounded"/>
    </xsd:sequence>
    <xsd:sequence>
      <xsd:element name="set" type="Values:SetValue" minOccurs="0"
        maxOccurs="unbounded"/>
    </xsd:sequence>
    <xsd:sequence>
      <xsd:element name="set_of" type="Values:SetOfValue"
        minOccurs="0" maxOccurs="unbounded"/>
    </xsd:sequence>
    <xsd:sequence>
      <xsd:element name="enumerated" type="Values:EnumeratedValue"
        minOccurs="0" maxOccurs="unbounded"/>
    </xsd:sequence>
    <xsd:sequence>
      <xsd:element name="union" type="Values:UnionValue" minOccurs="0"
        maxOccurs="unbounded"/>
    </xsd:sequence>
    <xsd:sequence>
      <xsd:element name="anytype" type="Values:AnytypeValue" minOccurs="0"
        maxOccurs="unbounded"/>
    </xsd:sequence>
  </xsd:choice>
</xsd:complexType>

```

```

    </xsd:sequence>
  </xsd:sequence>
  <xsd:element name="address" type="Values:AddressValue" minOccurs="0"
    maxOccurs="unbounded" />
</xsd:sequence>
</xsd:choice>
<xsd:attributeGroup ref="Values:ValueAtts" />
</xsd:complexType>

<xsd:complexType name="EnumeratedValue">
  <xsd:sequence>
    <xsd:element name="element" type="SimpleTypes:TString" />
  </xsd:sequence>
  <xsd:attributeGroup ref="Values:ValueAtts" />
</xsd:complexType>

<xsd:complexType name="UnionValue">
  <xsd:choice minOccurs="0" maxOccurs="unbounded">
    <xsd:element name="integer" type="Values:IntegerValue" />
    <xsd:element name="float" type="Values:FloatValue" />
    <xsd:element name="boolean" type="Values:BooleanValue" />
    <xsd:element name="objid" type="Values:ObjidValue" />
    <xsd:element name="verdicttype" type="Values:VerdictValue" />
    <xsd:element name="bitstring" type="Values:BitstringValue" />
    <xsd:element name="hexstring" type="Values:HexstringValue" />
    <xsd:element name="octetstring" type="Values:OctetstringValue" />
    <xsd:element name="charstring" type="Values:CharstringValue" />
    <xsd:element name="universal_charstring"
      type="Values:UniversalCharstringValue" />
    <xsd:element name="record" type="Values:RecordValue" />
    <xsd:element name="record_of" type="Values:RecordOfValue" />
    <xsd:element name="set" type="Values:SetValue" />
    <xsd:element name="set_of" type="Values:SetOfValue" />
    <xsd:element name="enumerated" type="Values:EnumeratedValue" />
    <xsd:element name="union" type="Values:UnionValue" />
    <xsd:element name="anytype" type="Values:AnytypeValue" />
    <xsd:element name="address" type="Values:AddressValue" />
  </xsd:choice>
  <xsd:attributeGroup ref="Values:ValueAtts" />
</xsd:complexType>

<xsd:complexType name="AnytypeValue">
  <xsd:choice minOccurs="0" maxOccurs="unbounded">
    <xsd:element name="integer" type="Values:IntegerValue" />
    <xsd:element name="float" type="Values:FloatValue" />
    <xsd:element name="boolean" type="Values:BooleanValue" />
    <xsd:element name="objid" type="Values:ObjidValue" />
    <xsd:element name="verdicttype" type="Values:VerdictValue" />
    <xsd:element name="bitstring" type="Values:BitstringValue" />
    <xsd:element name="hexstring" type="Values:HexstringValue" />
    <xsd:element name="octetstring" type="Values:OctetstringValue" />
    <xsd:element name="charstring" type="Values:OctetstringValue" />
    <xsd:element name="universal_charstring"
      type="Values:UniversalCharstringValue" />
    <xsd:element name="record" type="Values:RecordValue" />
    <xsd:element name="record_of" type="Values:RecordOfValue" />
    <xsd:element name="set" type="Values:SetValue" />
    <xsd:element name="set_of" type="Values:SetOfValue" />
    <xsd:element name="enumerated" type="Values:EnumeratedValue" />
    <xsd:element name="union" type="Values:UnionValue" />
    <xsd:element name="address" type="Values:AddressValue" />
  </xsd:choice>
  <xsd:attributeGroup ref="Values:ValueAtts" />
</xsd:complexType>

<xsd:complexType name="AddressValue">
  <xsd:choice minOccurs="0" maxOccurs="unbounded">
    <xsd:element name="integer" type="Values:IntegerValue" />
    <xsd:element name="float" type="Values:FloatValue" />
    <xsd:element name="boolean" type="Values:BooleanValue" />
    <xsd:element name="objid" type="Values:ObjidValue" />
    <xsd:element name="verdicttype" type="Values:VerdictValue" />
    <xsd:element name="bitstring" type="Values:BitstringValue" />
    <xsd:element name="hexstring" type="Values:HexstringValue" />
    <xsd:element name="octetstring" type="Values:OctetstringValue" />
    <xsd:element name="charstring" type="Values:OctetstringValue" />
    <xsd:element name="universal_charstring"
      type="Values:UniversalCharstringValue" />
  </xsd:choice>
  <xsd:attributeGroup ref="Values:ValueAtts" />
</xsd:complexType>

```

```

    <xsd:element name="record" type="Values:RecordValue"/>
    <xsd:element name="record_of" type="Values:RecordOfValue"/>
    <xsd:element name="set" type="Values:SetValue"/>
    <xsd:element name="set_of" type="Values:SetOfValue"/>
    <xsd:element name="enumerated" type="Values:EnumeratedValue"/>
    <xsd:element name="union" type="Values:UnionValue"/>
    <xsd:element name="anytype" type="Values:AnytypeValue"/>
  </xsd:choice>
  <xsd:attributeGroup ref="Values:ValueAtts"/>
</xsd:complexType>
</xsd:schema>

```

## B.4 TCI-TL XML Schema for Templates

```

<xsd:schema xmlns:xsd="http://www.w3.org/2001/XMLSchema"
  targetNamespace="http://uri.etsi.org/ttcn-3/3.0.0/tci/Templates"
  xmlns:Templates="http://uri.etsi.org/ttcn-3/3.0.0/tci/Templates"
  xmlns:Values="http://uri.etsi.org/ttcn-3/3.0.0/tci/Values"
  xmlns:Types="http://uri.etsi.org/ttcn-3/3.0.0/tci/Types"
  xmlns:SimpleTypes="http://uri.etsi.org/ttcn-3/3.0.0/tci/SimpleTypes"
  elementFormDefault="qualified">

  <xsd:import namespace="http://uri.etsi.org/ttcn-3/3.0.0/tci/Values.xsd"
    schemaLocation="Values.xsd"/>
  <xsd:import namespace="http://uri.etsi.org/ttcn-3/3.0.0/tci/Types.xsd"
    schemaLocation="Types.xsd"/>
  <xsd:import namespace="http://uri.etsi.org/ttcn-3/3.0.0/tci/SimpleTypes.xsd"
    schemaLocation="SimpleTypes.xsd"/>

  <xsd:complexType name="TciValueTemplate">
    <xsd:complexContent mixed="true">
      <xsd:extension base="Values:Value">
        <xsd:choice>
          <xsd:element name="integer" type="Templates:IntegerTemplate"/>
          <xsd:element name="float" type="Templates:FloatTemplate"/>
          <xsd:element name="boolean" type="Templates:BooleanTemplate"/>
          <xsd:element name="objid" type="Templates:ObjidTemplate"/>
          <xsd:element name="bitstring" type="Templates:BitstringTemplate"/>
          <xsd:element name="hexstring" type="Templates:HexstringTemplate"/>
          <xsd:element name="octetstring" type="Templates:OctetstringTemplate"/>
          <xsd:element name="charstring" type="Templates:CharstringTemplate"/>
          <xsd:element name="universal_charstring"
            type="Templates:UniversalCharstringTemplate"/>
          <xsd:element name="record" type="Templates:RecordTemplate"/>
          <xsd:element name="record_of" type="Templates:RecordOfTemplate"/>
          <xsd:element name="set" type="Templates:SetTemplate"/>
          <xsd:element name="set_of" type="Templates:SetOfTemplate"/>
          <xsd:element name="enumerated" type="Templates:EnumeratedTemplate"/>
          <xsd:element name="union" type="Templates:UnionTemplate"/>
          <xsd:element name="anytype" type="Templates:AnytypeTemplate"/>
          <xsd:element name="address" type="Templates:AddressTemplate"/>
          <xsd:element name="omit" type="Templates:omit"/>
          <xsd:element name="any" type="Templates:any"/>
          <xsd:element name="anyoromit" type="Templates:anyoromit"/>
          <xsd:element name="templateDef" type="SimpleTypes:TString"/>
        </xsd:choice>
      </xsd:extension>
    </xsd:complexContent>
  </xsd:complexType>

  <xsd:complexType name="omit">
    <xsd:simpleContent>
      <xsd:extension base="SimpleTypes:TString">
        <xsd:attributeGroup ref="Values:ValueAtts"/>
      </xsd:extension>
    </xsd:simpleContent>
  </xsd:complexType>

  <xsd:complexType name="any">
    <xsd:simpleContent>
      <xsd:extension base="SimpleTypes:TString">
        <xsd:attributeGroup ref="Values:ValueAtts"/>
      </xsd:extension>
    </xsd:simpleContent>
  </xsd:complexType>

```

```

<xsd:complexType name="anyoromit">
  <xsd:simpleContent>
    <xsd:extension base="SimpleTypes:TString">
      <xsd:attributeGroup ref="Values:ValueAtts" />
    </xsd:extension>
  </xsd:simpleContent>
</xsd:complexType>

<xsd:complexType name="TciNonValueTemplate">
  <xsd:sequence>
    <xsd:choice>
      <xsd:element name="any" type="Templates:any" />
      <xsd:element name="all" type="Templates:all" />
      <xsd:element name="templateDef" type="SimpleTypes:TString" />
    </xsd:choice>
  </xsd:sequence>
</xsd:complexType>

<xsd:complexType name="all">
  <xsd:simpleContent>
    <xsd:extension base="SimpleTypes:TString">
      <xsd:attributeGroup ref="Values:ValueAtts" />
    </xsd:extension>
  </xsd:simpleContent>
</xsd:complexType>

<xsd:complexType name="TciValueDifference">
  <xsd:attribute name="desc" type="SimpleTypes:TString" use="optional" />
  <xsd:attribute name="val" type="SimpleTypes:xpath" use="required" />
  <xsd:attribute name="tpl" type="SimpleTypes:xpath" use="required" />
</xsd:complexType>

<xsd:complexType name="TciValueDifferenceList">
  <xsd:sequence>
    <xsd:element name="diff" type="Templates:TciValueDifference" minOccurs="1"
maxOccurs="unbounded" />
  </xsd:sequence>
</xsd:complexType>

<xsd:complexType name="IntegerTemplate">
  <xsd:complexContent>
    <xsd:extension base="Values:IntegerValue">
      <xsd:choice>
        <xsd:element name="templateDef" type="SimpleTypes:TString" />
        <xsd:element name="omit" type="Templates:omit" />
        <xsd:element name="any" type="Templates:any" />
        <xsd:element name="anyoromit" type="Templates:anyoromit" />
        <xsd:element name="null" type="xsd:string" />
      </xsd:choice>
    </xsd:extension>
  </xsd:complexContent>
</xsd:complexType>

<xsd:complexType name="FloatTemplate">
  <xsd:complexContent>
    <xsd:extension base="Values:FloatValue">
      <xsd:choice>
        <xsd:element name="templateDef" type="SimpleTypes:TString" />
        <xsd:element name="omit" type="Templates:omit" />
        <xsd:element name="any" type="Templates:any" />
        <xsd:element name="anyoromit" type="Templates:anyoromit" />
        <xsd:element name="null" type="xsd:string" />
      </xsd:choice>
    </xsd:extension>
  </xsd:complexContent>
</xsd:complexType>

<xsd:complexType name="BooleanTemplate">
  <xsd:complexContent>
    <xsd:extension base="Values:BooleanValue">
      <xsd:choice>
        <xsd:element name="templateDef" type="SimpleTypes:TString" />
        <xsd:element name="omit" type="Templates:omit" />
        <xsd:element name="any" type="Templates:any" />
      </xsd:choice>
    </xsd:extension>
  </xsd:complexContent>
</xsd:complexType>

```

```

        <xsd:element name="anyoromit" type="Templates:anyoromit"/>
        <xsd:element name="null" type="xsd:string"/>
    </xsd:choice>
</xsd:extension>
</xsd:complexContent>
</xsd:complexType>

<xsd:complexType name="ObjidTemplate">
    <xsd:complexContent>
        <xsd:extension base="Values:ObjidValue">
            <xsd:choice>
                <xsd:element name="templateDef" type="SimpleTypes:TString"/>
                <xsd:element name="omit" type="Templates:omit"/>
                <xsd:element name="any" type="Templates:any"/>
                <xsd:element name="anyoromit" type="Templates:anyoromit"/>
                <xsd:element name="null" type="xsd:string"/>
            </xsd:choice>
        </xsd:extension>
    </xsd:complexContent>
</xsd:complexType>

<xsd:complexType name="BitstringTemplate">
    <xsd:complexContent>
        <xsd:extension base="Values:BitstringValue">
            <xsd:choice>
                <xsd:element name="templateDef" type="SimpleTypes:TString"/>
                <xsd:element name="omit" type="Templates:omit"/>
                <xsd:element name="any" type="Templates:any"/>
                <xsd:element name="anyoromit" type="Templates:anyoromit"/>
                <xsd:element name="null" type="xsd:string"/>
            </xsd:choice>
        </xsd:extension>
    </xsd:complexContent>
</xsd:complexType>

<xsd:complexType name="HexstringTemplate">
    <xsd:complexContent>
        <xsd:extension base="Values:BitstringValue">
            <xsd:choice>
                <xsd:element name="templateDef" type="SimpleTypes:TString"/>
                <xsd:element name="omit" type="Templates:omit"/>
                <xsd:element name="any" type="Templates:any"/>
                <xsd:element name="anyoromit" type="Templates:anyoromit"/>
                <xsd:element name="null" type="xsd:string"/>
            </xsd:choice>
        </xsd:extension>
    </xsd:complexContent>
</xsd:complexType>

<xsd:complexType name="OctetstringTemplate">
    <xsd:complexContent>
        <xsd:extension base="Values:OctetstringValue">
            <xsd:choice>
                <xsd:element name="templateDef" type="SimpleTypes:TString"/>
                <xsd:element name="omit" type="Templates:omit"/>
                <xsd:element name="any" type="Templates:any"/>
                <xsd:element name="anyoromit" type="Templates:anyoromit"/>
                <xsd:element name="null" type="xsd:string"/>
            </xsd:choice>
        </xsd:extension>
    </xsd:complexContent>
</xsd:complexType>

<xsd:complexType name="CharstringTemplate">
    <xsd:complexContent>
        <xsd:extension base="Values:CharstringValue">
            <xsd:choice>
                <xsd:element name="templateDef" type="SimpleTypes:TString"/>
                <xsd:element name="omit" type="Templates:omit"/>
                <xsd:element name="any" type="Templates:any"/>
                <xsd:element name="anyoromit" type="Templates:anyoromit"/>
                <xsd:element name="null" type="xsd:string"/>
            </xsd:choice>
        </xsd:extension>
    </xsd:complexContent>
</xsd:complexType>

<xsd:complexType name="UniversalCharstringTemplate">

```



```

<xsd:complexContent>
  <xsd:extension base="Values:UniversalCharstringValue">
    <xsd:choice>
      <xsd:element name="templateDef" type="SimpleTypes:TString"/>
      <xsd:element name="omit" type="Templates:omit"/>
      <xsd:element name="any" type="Templates:any"/>
      <xsd:element name="anyoromit" type="Templates:anyoromit"/>
      <xsd:element name="null" type="xsd:string"/>
    </xsd:choice>
  </xsd:extension>
</xsd:complexContent>
</xsd:complexType>

<xsd:complexType name="RecordTemplate">
  <xsd:complexContent>
    <xsd:extension base="Values:RecordValue">
      <xsd:sequence>
        <xsd:choice minOccurs="0" maxOccurs="unbounded">
          <xsd:element name="integer" type="Templates:IntegerTemplate"/>
          <xsd:element name="float" type="Templates:FloatTemplate"/>
          <xsd:element name="boolean" type="Templates:BooleanTemplate"/>
          <xsd:element name="objid" type="Templates:ObjidTemplate"/>
          <xsd:element name="bitstring" type="Templates:BitstringTemplate"/>
          <xsd:element name="hexstring" type="Templates:HexstringTemplate"/>
          <xsd:element name="octetstring" type="Templates:OctetstringTemplate"/>
          <xsd:element name="charstring" type="Templates:CharstringTemplate"/>
          <xsd:element name="universal_charstring"
            type="Templates:UniversalCharstringTemplate"/>
          <xsd:element name="record" type="Templates:RecordTemplate"/>
          <xsd:element name="record_of" type="Templates:RecordOfTemplate"/>
          <xsd:element name="set" type="Templates:SetTemplate"/>
          <xsd:element name="set_of" type="Templates:SetOfTemplate"/>
          <xsd:element name="enumerated" type="Templates:EnumeratedTemplate"/>
          <xsd:element name="union" type="Templates:UnionTemplate"/>
          <xsd:element name="anytype" type="Templates:AnytypeTemplate"/>
          <xsd:element name="address" type="Templates:AddressTemplate"/>
          <xsd:element name="omit" type="Templates:omit"/>
          <xsd:element name="any" type="Templates:any"/>
          <xsd:element name="anyoromit" type="Templates:anyoromit"/>
          <xsd:element name="templateDef" type="SimpleTypes:TString"/>
        </xsd:choice>
      </xsd:sequence>
    </xsd:extension>
  </xsd:complexContent>
</xsd:complexType>

<xsd:complexType name="RecordOfTemplate">
  <xsd:complexContent>
    <xsd:extension base="Values:RecordOfValue">
      <xsd:choice>
        <xsd:sequence>
          <xsd:element name="integer" type="Templates:IntegerTemplate" minOccurs="0"
            maxOccurs="unbounded"/>
        </xsd:sequence>
        <xsd:sequence>
          <xsd:element name="float" type="Templates:FloatTemplate" minOccurs="0"
            maxOccurs="unbounded"/>
        </xsd:sequence>
        <xsd:sequence>
          <xsd:element name="boolean" type="Templates:BooleanTemplate" minOccurs="0"
            maxOccurs="unbounded"/>
        </xsd:sequence>
        <xsd:sequence>
          <xsd:element name="objid" type="Templates:ObjidTemplate" minOccurs="0"
            maxOccurs="unbounded"/>
        </xsd:sequence>
        <xsd:sequence>
          <xsd:element name="bitstring" type="Templates:BitstringTemplate"
            minOccurs="0" maxOccurs="unbounded"/>
        </xsd:sequence>
        <xsd:sequence>
          <xsd:element name="hexstring" type="Templates:HexstringTemplate"
            minOccurs="0" maxOccurs="unbounded"/>
        </xsd:sequence>
        <xsd:sequence>
          <xsd:element name="octetstring" type="Templates:OctetstringTemplate"
            minOccurs="0" maxOccurs="unbounded"/>
        </xsd:sequence>
      </xsd:choice>
    </xsd:extension>
  </xsd:complexContent>
</xsd:complexType>

```

```

<xsd:sequence>
  <xsd:element name="charstring" type="Templates:CharstringTemplate"
    minOccurs="0" maxOccurs="unbounded" />
</xsd:sequence>
<xsd:sequence>
  <xsd:element name="universal_charstring"
    type="Templates:UniversalCharstringTemplate" minOccurs="0"
    maxOccurs="unbounded" />
</xsd:sequence>
<xsd:sequence>
  <xsd:element name="record" type="Templates:RecordTemplate" minOccurs="0"
    maxOccurs="unbounded" />
</xsd:sequence>
<xsd:sequence>
  <xsd:element name="record_of" type="Templates:RecordOfTemplate"
    minOccurs="0" maxOccurs="unbounded" />
</xsd:sequence>
<xsd:sequence>
  <xsd:element name="set" type="Templates:SetTemplate" minOccurs="0"
    maxOccurs="unbounded" />
</xsd:sequence>
<xsd:sequence>
  <xsd:element name="set_of" type="Templates:SetOfTemplate"
    minOccurs="0" maxOccurs="unbounded" />
</xsd:sequence>
<xsd:sequence>
  <xsd:element name="enumerated" type="Templates:EnumeratedTemplate"
    minOccurs="0" maxOccurs="unbounded" />
</xsd:sequence>
<xsd:sequence>
  <xsd:element name="union" type="Templates:UnionTemplate" minOccurs="0"
    maxOccurs="unbounded" />
</xsd:sequence>
<xsd:sequence>
  <xsd:element name="anytype" type="Templates:AnytypeTemplate" minOccurs="0"
    maxOccurs="unbounded" />
</xsd:sequence>
<xsd:sequence>
  <xsd:element name="address" type="Templates:AddressTemplate" minOccurs="0"
    maxOccurs="unbounded" />
</xsd:sequence>
  <xsd:element name="omit" type="Templates:omit" />
  <xsd:element name="any" type="Templates:any" />
  <xsd:element name="anyoromit" type="Templates:anyoromit" />
  <xsd:element name="templateDef" type="SimpleTypes:TString" />
</xsd:choice>
</xsd:extension>
</xsd:complexContent>
</xsd:complexType>

<xsd:complexType name="SetTemplate">
  <xsd:complexContent>
    <xsd:extension base="Values:SetValue">
      <xsd:sequence>
        <xsd:choice minOccurs="0" maxOccurs="unbounded">
          <xsd:element name="integer" type="Templates:IntegerTemplate" />
          <xsd:element name="float" type="Templates:FloatTemplate" />
          <xsd:element name="boolean" type="Templates:BooleanTemplate" />
          <xsd:element name="objid" type="Templates:ObjidTemplate" />
          <xsd:element name="bitstring" type="Templates:BitstringTemplate" />
          <xsd:element name="hexstring" type="Templates:HexstringTemplate" />
          <xsd:element name="octetstring" type="Templates:OctetstringTemplate" />
          <xsd:element name="charstring" type="Templates:CharstringTemplate" />
          <xsd:element name="universal_charstring"
            type="Templates:UniversalCharstringTemplate" />
          <xsd:element name="record" type="Templates:RecordTemplate" />
          <xsd:element name="record_of" type="Templates:RecordOfTemplate" />
          <xsd:element name="set" type="Templates:SetTemplate" />
          <xsd:element name="set_of" type="Templates:SetOfTemplate" />
          <xsd:element name="enumerated" type="Templates:EnumeratedTemplate" />
          <xsd:element name="union" type="Templates:UnionTemplate" />
          <xsd:element name="anytype" type="Templates:AnytypeTemplate" />
          <xsd:element name="address" type="Templates:AddressTemplate" />
          <xsd:element name="omit" type="Templates:omit" />
          <xsd:element name="any" type="Templates:any" />
          <xsd:element name="anyoromit" type="Templates:anyoromit" />
          <xsd:element name="templateDef" type="SimpleTypes:TString" />
        </xsd:choice>
      </xsd:sequence>
    </xsd:extension>
  </xsd:complexContent>
</xsd:complexType>

```

```

        </xsd:sequence>
    </xsd:extension>
</xsd:complexContent>
</xsd:complexType>

<xsd:complexType name="SetOfTemplate">
    <xsd:complexContent>
        <xsd:extension base="Values:SetOfValue">
            <xsd:choice>
                <xsd:sequence>
                    <xsd:element name="integer" type="Templates:IntegerTemplate" minOccurs="0"
                        maxOccurs="unbounded" />
                </xsd:sequence>
                <xsd:sequence>
                    <xsd:element name="float" type="Templates:FloatTemplate" minOccurs="0"
                        maxOccurs="unbounded" />
                </xsd:sequence>
                <xsd:sequence>
                    <xsd:element name="boolean" type="Templates:BooleanTemplate" minOccurs="0"
                        maxOccurs="unbounded" />
                </xsd:sequence>
                <xsd:sequence>
                    <xsd:element name="objid" type="Templates:ObjidTemplate" minOccurs="0"
                        maxOccurs="unbounded" />
                </xsd:sequence>
                <xsd:sequence>
                    <xsd:element name="bitstring" type="Templates:BitstringTemplate"
                        minOccurs="0" maxOccurs="unbounded" />
                </xsd:sequence>
                <xsd:sequence>
                    <xsd:element name="hexstring" type="Templates:HexstringTemplate"
                        minOccurs="0" maxOccurs="unbounded" />
                </xsd:sequence>
                <xsd:sequence>
                    <xsd:element name="octetstring" type="Templates:OctetstringTemplate"
                        minOccurs="0" maxOccurs="unbounded" />
                </xsd:sequence>
                <xsd:sequence>
                    <xsd:element name="charstring" type="Templates:CharstringTemplate"
                        minOccurs="0" maxOccurs="unbounded" />
                </xsd:sequence>
                <xsd:sequence>
                    <xsd:element name="universal_charstring"
                        type="Templates:UniversalCharstringTemplate" minOccurs="0"
                        maxOccurs="unbounded" />
                </xsd:sequence>
                <xsd:sequence>
                    <xsd:element name="record" type="Templates:RecordTemplate" minOccurs="0"
                        maxOccurs="unbounded" />
                </xsd:sequence>
                <xsd:sequence>
                    <xsd:element name="record_of" type="Templates:RecordOfTemplate"
                        minOccurs="0" maxOccurs="unbounded" />
                </xsd:sequence>
                <xsd:sequence>
                    <xsd:element name="set" type="Templates:SetTemplate" minOccurs="0"
                        maxOccurs="unbounded" />
                </xsd:sequence>
                <xsd:sequence>
                    <xsd:element name="set_of" type="Templates:SetOfTemplate"
                        minOccurs="0" maxOccurs="unbounded" />
                </xsd:sequence>
                <xsd:sequence>
                    <xsd:element name="enumerated" type="Templates:EnumeratedTemplate"
                        minOccurs="0" maxOccurs="unbounded" />
                </xsd:sequence>
                <xsd:sequence>
                    <xsd:element name="union" type="Templates:UnionTemplate" minOccurs="0"
                        maxOccurs="unbounded" />
                </xsd:sequence>
                <xsd:sequence>
                    <xsd:element name="anytype" type="Templates:AnytypeTemplate" minOccurs="0"
                        maxOccurs="unbounded" />
                </xsd:sequence>
                <xsd:sequence>
                    <xsd:element name="address" type="Templates:AddressTemplate" minOccurs="0"
                        maxOccurs="unbounded" />
                </xsd:sequence>
            </xsd:choice>
        </xsd:extension>
    </xsd:complexContent>
</xsd:complexType>

```

```

        <xsd:element name="omit" type="Templates:omit"/>
        <xsd:element name="any" type="Templates:any"/>
        <xsd:element name="anyoromit" type="Templates:anyoromit"/>
    <xsd:element name="templateDef" type="SimpleTypes:TString"/>
</xsd:choice>
</xsd:extension>
</xsd:complexContent>
</xsd:complexType>

<xsd:complexType name="EnumeratedTemplate">
    <xsd:complexContent>
        <xsd:extension base="Values:EnumeratedValue">
            <xsd:choice>
                <xsd:element name="omit" type="Templates:omit"/>
                <xsd:element name="any" type="Templates:any"/>
                <xsd:element name="anyoromit" type="Templates:anyoromit"/>
                <xsd:element name="templateDef" type="SimpleTypes:TString"/>
            </xsd:choice>
        </xsd:extension>
    </xsd:complexContent>
</xsd:complexType>

<xsd:complexType name="UnionTemplate">
    <xsd:complexContent>
        <xsd:extension base="Values:UnionValue">
            <xsd:choice minOccurs="0" maxOccurs="unbounded">
                <xsd:element name="integer" type="Templates:IntegerTemplate"/>
                <xsd:element name="float" type="Templates:FloatTemplate"/>
                <xsd:element name="boolean" type="Templates:BooleanTemplate"/>
                <xsd:element name="objid" type="Templates:ObjidTemplate"/>
                <xsd:element name="bitstring" type="Templates:BitstringTemplate"/>
                <xsd:element name="hexstring" type="Templates:HexstringTemplate"/>
                <xsd:element name="octetstring" type="Templates:OctetstringTemplate"/>
                <xsd:element name="charstring" type="Templates:CharstringTemplate"/>
                <xsd:element name="universal_charstring"
                    type="Templates:UniversalCharstringTemplate"/>
                <xsd:element name="record" type="Templates:RecordTemplate"/>
                <xsd:element name="record_of" type="Templates:RecordOfTemplate"/>
                <xsd:element name="set" type="Templates:SetTemplate"/>
                <xsd:element name="set_of" type="Templates:SetOfTemplate"/>
                <xsd:element name="enumerated" type="Templates:EnumeratedTemplate"/>
                <xsd:element name="union" type="Templates:UnionTemplate"/>
                <xsd:element name="anytype" type="Templates:AnytypeTemplate"/>
                <xsd:element name="address" type="Templates:AddressTemplate"/>
                <xsd:element name="omit" type="Templates:omit"/>
                <xsd:element name="any" type="Templates:any"/>
                <xsd:element name="anyoromit" type="Templates:anyoromit"/>
                <xsd:element name="templateDef" type="SimpleTypes:TString"/>
            </xsd:choice>
        </xsd:extension>
    </xsd:complexContent>
</xsd:complexType>

<xsd:complexType name="AnytypeTemplate">
    <xsd:complexContent>
        <xsd:extension base="Values:AnytypeValue">
            <xsd:choice minOccurs="0" maxOccurs="unbounded">
                <xsd:element name="integer" type="Templates:IntegerTemplate"/>
                <xsd:element name="float" type="Templates:FloatTemplate"/>
                <xsd:element name="boolean" type="Templates:BooleanTemplate"/>
                <xsd:element name="objid" type="Templates:ObjidTemplate"/>
                <xsd:element name="bitstring" type="Templates:BitstringTemplate"/>
                <xsd:element name="hexstring" type="Templates:HexstringTemplate"/>
                <xsd:element name="octetstring" type="Templates:OctetstringTemplate"/>
                <xsd:element name="charstring" type="Templates:CharstringTemplate"/>
                <xsd:element name="universal_charstring"
                    type="Templates:UniversalCharstringTemplate"/>
                <xsd:element name="record" type="Templates:RecordTemplate"/>
                <xsd:element name="record_of" type="Templates:RecordOfTemplate"/>
                <xsd:element name="set" type="Templates:SetTemplate"/>
                <xsd:element name="set_of" type="Templates:SetOfTemplate"/>
                <xsd:element name="enumerated" type="Templates:EnumeratedTemplate"/>
                <xsd:element name="union" type="Templates:UnionTemplate"/>
                <xsd:element name="address" type="Templates:AddressTemplate"/>
                <xsd:element name="omit" type="Templates:omit"/>
                <xsd:element name="any" type="Templates:any"/>
                <xsd:element name="anyoromit" type="Templates:anyoromit"/>
                <xsd:element name="templateDef" type="SimpleTypes:TString"/>
            </xsd:choice>
        </xsd:extension>
    </xsd:complexContent>
</xsd:complexType>

```

```

        </xsd:choice>
    </xsd:extension>
</xsd:complexContent>
</xsd:complexType>

<xsd:complexType name="AddressTemplate">
    <xsd:complexContent>
        <xsd:extension base="Values:AnytypeValue">
            <xsd:choice minOccurs="0" maxOccurs="unbounded">
                <xsd:element name="integer" type="Templates:IntegerTemplate"/>
                <xsd:element name="float" type="Templates:FloatTemplate"/>
                <xsd:element name="boolean" type="Templates:BooleanTemplate"/>
                <xsd:element name="objid" type="Templates:ObjidTemplate"/>
                <xsd:element name="bitstring" type="Templates:BitstringTemplate"/>
                <xsd:element name="hexstring" type="Templates:HexstringTemplate"/>
                <xsd:element name="octetstring" type="Templates:OctetstringTemplate"/>
                <xsd:element name="charstring" type="Templates:CharstringTemplate"/>
                <xsd:element name="universal_charstring"
                    type="Templates:UniversalCharstringTemplate"/>
                <xsd:element name="record" type="Templates:RecordTemplate"/>
                <xsd:element name="record_of" type="Templates:RecordOfTemplate"/>
                <xsd:element name="set" type="Templates:SetTemplate"/>
                <xsd:element name="set_of" type="Templates:SetOfTemplate"/>
                <xsd:element name="enumerated" type="Templates:EnumeratedTemplate"/>
                <xsd:element name="union" type="Templates:UnionTemplate"/>
                <xsd:element name="anytype" type="Templates:AnytypeTemplate"/>
                <xsd:element name="omit" type="Templates:omit"/>
                <xsd:element name="any" type="Templates:any"/>
                <xsd:element name="anyoromit" type="Templates:anyoromit"/>
            </xsd:choice>
        </xsd:extension>
    </xsd:complexContent>
</xsd:complexType>
</xsd:schema>

```

## B.5 TCI-TL XML Schema for Events

```

<xsd:schema xmlns:xsd="http://www.w3.org/2001/XMLSchema"
    targetNamespace="http://uri.etsi.org/ttcn-3/3.0.0/tci/Events"
    xmlns:Events="http://uri.etsi.org/ttcn-3/3.0.0/tci/Events"
    xmlns:Types="http://uri.etsi.org/ttcn-3/3.0.0/tci/Types"
    xmlns:Templates="http://uri.etsi.org/ttcn-3/3.0.0/tci/Templates"
    xmlns:SimpleTypes="http://uri.etsi.org/ttcn-3/3.0.0/tci/SimpleTypes"
    xmlns:Values="http://uri.etsi.org/ttcn-3/3.0.0/tci/Values" elementFormDefault="qualified">

    <xsd:import namespace="http://uri.etsi.org/ttcn-3/3.0.0/tci/SimpleTypes.xsd"
        schemaLocation="SimpleTypes.xsd"/>
    <xsd:import namespace="http://uri.etsi.org/ttcn-3/3.0.0/tci/Types.xsd"
        schemaLocation="Types.xsd"/>
    <xsd:import namespace="http://uri.etsi.org/ttcn-3/3.0.0/tci/Values.xsd"
        schemaLocation="Values.xsd"/>
    <xsd:import namespace="http://uri.etsi.org/ttcn-3/3.0.0/tci/Templates.xsd"
        schemaLocation="Templates.xsd"/>

    <!-- common definition for all events -->
    <xsd:complexType name="Event" mixed="true">
        <xsd:sequence>
            <xsd:element name="am" type="SimpleTypes:TString"/>
        </xsd:sequence>
        <xsd:attribute name="ts" type="xsd:time" use="required"/>
        <xsd:attribute name="src" type="SimpleTypes:TString" use="optional"/>
        <xsd:attribute name="line" type="SimpleTypes:TInteger" use="optional"/>

        <!-- general identifier structure for test components, ports and timer -->
        <xsd:attribute name="name" type="SimpleTypes:TString" use="required"/>
        <xsd:attribute name="id" type="SimpleTypes:TInteger" use="required"/>
        <xsd:attribute name="type" type="SimpleTypes:TString" use="required"/>
    </xsd:complexType>

    <!-- this event is extended by all port configuration events -->
    <xsd:complexType name="PortConfiguration">
        <xsd:complexContent mixed="true">
            <xsd:extension base="Events:Event">
                <xsd:sequence>

```

```

        <xsd:element name="port1" type="Types:TriPortIdType" minOccurs="1"
maxOccurs="1"/>
        <xsd:element name="port2" type="Types:TriPortIdType" minOccurs="1"
maxOccurs="1"/>
    </xsd:sequence>
</xsd:extension>
</xsd:complexContent>
</xsd:complexType>

<!-- this event is extended by all port status events -->
<xsd:complexType name="PortStatus">
    <xsd:complexContent mixed="true">
        <xsd:extension base="Events:Event">
            <xsd:sequence>
                <xsd:element name="port" type="Types:TriPortIdType"/>
            </xsd:sequence>
        </xsd:extension>
    </xsd:complexContent>
</xsd:complexType>

<!-- testcases -->
<xsd:complexType name="tliTcExecute">
    <xsd:complexContent mixed="true">
        <xsd:extension base="Events:Event">
            <xsd:sequence>
                <xsd:element name="tcId" type="Types:TciTestCaseIdType"/>
                <xsd:element name="pars" type="Types:TriParameterListType" minOccurs="0"/>
                <xsd:element name="dur" type="Types:TriTimerDurationType" minOccurs="0"/>
            </xsd:sequence>
        </xsd:extension>
    </xsd:complexContent>
</xsd:complexType>

<xsd:complexType name="tliTcStart">
    <xsd:complexContent mixed="true">
        <xsd:extension base="Events:Event">
            <xsd:sequence>
                <xsd:element name="tcId" type="Types:TciTestCaseIdType"/>
                <xsd:element name="pars" type="Types:TriParameterListType" minOccurs="0"/>
                <xsd:element name="dur" type="Types:TriTimerDurationType" minOccurs="0"/>
            </xsd:sequence>
        </xsd:extension>
    </xsd:complexContent>
</xsd:complexType>

<xsd:complexType name="tliTcStop">
    <xsd:complexContent mixed="true">
        <xsd:extension base="Events:Event"/>
    </xsd:complexContent>
</xsd:complexType>

<xsd:complexType name="tliTcStarted">
    <xsd:complexContent mixed="true">
        <xsd:extension base="Events:Event">
            <xsd:sequence>
                <xsd:element name="tcId" type="Types:TciTestCaseIdType"/>
                <xsd:element name="pars" type="Types:TriParameterListType" minOccurs="0"/>
                <xsd:element name="dur" type="Types:TriTimerDurationType" minOccurs="0"/>
            </xsd:sequence>
        </xsd:extension>
    </xsd:complexContent>
</xsd:complexType>

<xsd:complexType name="tliTcTerminated">
    <xsd:complexContent mixed="true">
        <xsd:extension base="Events:Event">
            <xsd:sequence>
                <xsd:element name="tcId" type="Types:TciTestCaseIdType"/>
                <xsd:element name="pars" type="Types:TriParameterListType" minOccurs="0"/>
                <xsd:element name="outcome" type="Values:VerdictValue"/>
            </xsd:sequence>
        </xsd:extension>
    </xsd:complexContent>
</xsd:complexType>

<!-- control -->
<xsd:complexType name="tliCtrlStart">
    <xsd:complexContent>

```

```

        <xsd:extension base="Events:Event" />
    </xsd:complexContent>
</xsd:complexType>

<xsd:complexType name="tliCtrlStop">
    <xsd:complexContent>
        <xsd:extension base="Events:Event" />
    </xsd:complexContent>
</xsd:complexType>

<xsd:complexType name="tliCtrlTerminated">
    <xsd:complexContent>
        <xsd:extension base="Events:Event" />
    </xsd:complexContent>
</xsd:complexType>

<!-- asynchronous communication -->
<xsd:complexType name="tliMSend_m">
    <xsd:complexContent mixed="true">
        <xsd:extension base="Events:Event">
            <xsd:sequence>
                <xsd:element name="port" type="Types:TriPortIdType"/>
                <xsd:element name="msgValue" type="Values:Value"/>
                <xsd:element name="address" type="Types:TriAddressType" minOccurs="0"/>
                <xsd:choice>
                    <xsd:element name="encoder-failure" type="SimpleTypes:TciStatusType"/>
                    <xsd:sequence>
                        <xsd:element name="msg" type="Types:TriMessageType" minOccurs="0"/>
                        <xsd:element name="transmission-failure"
type="SimpleTypes:TriStatusType" minOccurs="0"/>
                    </xsd:sequence>
                </xsd:choice>
            </xsd:sequence>
        </xsd:extension>
    </xsd:complexContent>
</xsd:complexType>

<xsd:complexType name="tliMSend_m_BC">
    <xsd:complexContent mixed="true">
        <xsd:extension base="Events:Event">
            <xsd:sequence>
                <xsd:element name="port" type="Types:TriPortIdType"/>
                <xsd:element name="msgValue" type="Values:Value"/>
                <xsd:choice>
                    <xsd:element name="encoder-failure" type="SimpleTypes:TciStatusType"/>
                    <xsd:sequence>
                        <xsd:element name="msg" type="Types:TriMessageType" minOccurs="0"/>
                        <xsd:element name="transmission-failure"
type="SimpleTypes:TriStatusType" minOccurs="0"/>
                    </xsd:sequence>
                </xsd:choice>
            </xsd:sequence>
        </xsd:extension>
    </xsd:complexContent>
</xsd:complexType>

<xsd:complexType name="tliMSend_m_MC">
    <xsd:complexContent mixed="true">
        <xsd:extension base="Events:Event">
            <xsd:sequence>
                <xsd:element name="port" type="Types:TriPortIdType"/>
                <xsd:element name="msgValue" type="Values:Value"/>
                <xsd:element name="addresses" type="Types:TriAddressListType" minOccurs="0"/>
                <xsd:choice>
                    <xsd:element name="encoder-failure" type="SimpleTypes:TciStatusType"/>
                    <xsd:sequence>
                        <xsd:element name="msg" type="Types:TriMessageType" minOccurs="0"/>
                        <xsd:element name="transmission-failure"
type="SimpleTypes:TriStatusType" minOccurs="0"/>
                    </xsd:sequence>
                </xsd:choice>
            </xsd:sequence>
        </xsd:extension>
    </xsd:complexContent>
</xsd:complexType>

<xsd:complexType name="tliMSend_c">
    <xsd:complexContent mixed="true">

```

```

    <xsd:extension base="Events:Event">
      <xsd:sequence>
        <xsd:element name="port" type="Types:TriPortIdType"/>
        <xsd:element name="msgValue" type="Values:Value"/>
        <xsd:element name="to" type="Types:TriComponentIdType" minOccurs="0"/>
        <xsd:element name="transmission-failure" type="SimpleTypes:TriStatusType"
minOccurs="0"/>
      </xsd:sequence>
    </xsd:extension>
  </xsd:complexContent>
</xsd:complexType>

<xsd:complexType name="tliMSend_c_BC">
  <xsd:complexContent mixed="true">
    <xsd:extension base="Events:Event">
      <xsd:sequence>
        <xsd:element name="port" type="Types:TriPortIdType"/>
        <xsd:element name="msgValue" type="Values:Value"/>
        <xsd:element name="transmission-failure" type="SimpleTypes:TriStatusType"
minOccurs="0"/>
      </xsd:sequence>
    </xsd:extension>
  </xsd:complexContent>
</xsd:complexType>

<xsd:complexType name="tliMSend_c_MC">
  <xsd:complexContent mixed="true">
    <xsd:extension base="Events:Event">
      <xsd:sequence>
        <xsd:element name="port" type="Types:TriPortIdType"/>
        <xsd:element name="msgValue" type="Values:Value"/>
        <xsd:element name="toList" type="Types:TriComponentIdListType" minOccurs="0"/>
        <xsd:element name="transmission-failure" type="SimpleTypes:TriStatusType"
minOccurs="0"/>
      </xsd:sequence>
    </xsd:extension>
  </xsd:complexContent>
</xsd:complexType>

<xsd:complexType name="tliMDetected_m">
  <xsd:complexContent mixed="true">
    <xsd:extension base="Events:Event">
      <xsd:sequence>
        <xsd:element name="port" type="Types:TriPortIdType"/>
        <xsd:element name="msgValue" type="Types:TriMessageType"/>
        <xsd:element name="address" type="Types:TriAddressType" minOccurs="0"/>
      </xsd:sequence>
    </xsd:extension>
  </xsd:complexContent>
</xsd:complexType>

<xsd:complexType name="tliMDetected_c">
  <xsd:complexContent mixed="true">
    <xsd:extension base="Events:Event">
      <xsd:sequence>
        <xsd:element name="port" type="Types:TriPortIdType"/>
        <xsd:element name="msgValue" type="Types:TriMessageType"/>
        <xsd:element name="from" type="Types:TriComponentIdType" minOccurs="0"/>
      </xsd:sequence>
    </xsd:extension>
  </xsd:complexContent>
</xsd:complexType>

<xsd:complexType name="tliMMismatch_m">
  <xsd:complexContent mixed="true">
    <xsd:extension base="Events:Event">
      <xsd:sequence>
        <xsd:element name="port" type="Types:TriPortIdType"/>
        <xsd:element name="msgValue" type="Values:Value"/>
        <xsd:element name="msgTpl" type="Templates:TciValueTemplate"/>
        <xsd:element name="diffs" type="Templates:TciValueDifferenceList"/>
        <xsd:element name="address" type="Types:TriAddressType" minOccurs="0"/>
        <xsd:element name="addressTpl" type="Templates:TciValueTemplate"
minOccurs="0"/>
      </xsd:sequence>
    </xsd:extension>
  </xsd:complexContent>
</xsd:complexType>

```



```

<xsd:complexType name="tliMismatch_c">
  <xsd:complexContent mixed="true">
    <xsd:extension base="Events:Event">
      <xsd:sequence>
        <xsd:element name="port" type="Types:TriPortIdType"/>
        <xsd:element name="msgValue" type="Values:Value"/>
        <xsd:element name="msgTpl" type="Templates:TciValueTemplate"/>
        <xsd:element name="diffs" type="Templates:TciValueDifferenceList"/>
        <xsd:element name="from" type="Types:TriComponentIdType" minOccurs="0"/>
        <xsd:element name="fromTpl" type="Templates:TciNonValueTemplate"
minOccurs="0"/>
      </xsd:sequence>
    </xsd:extension>
  </xsd:complexContent>
</xsd:complexType>

<xsd:complexType name="tliMReceive_m">
  <xsd:complexContent mixed="true">
    <xsd:extension base="Events:Event">
      <xsd:sequence>
        <xsd:element name="port" type="Types:TriPortIdType"/>
        <xsd:element name="msgValue" type="Values:Value" minOccurs="0"/>
        <xsd:element name="msgTpl" type="Templates:TciValueTemplate"
minOccurs="0"/>
        <xsd:element name="address" type="Types:TriAddressType" minOccurs="0"/>
        <xsd:element name="addressTpl" type="Templates:TciValueTemplate"
minOccurs="0"/>
      </xsd:sequence>
    </xsd:extension>
  </xsd:complexContent>
</xsd:complexType>

<xsd:complexType name="tliMReceive_c">
  <xsd:complexContent mixed="true">
    <xsd:extension base="Events:Event">
      <xsd:sequence>
        <xsd:element name="port" type="Types:TriPortIdType"/>
        <xsd:element name="msgValue" type="Values:Value" minOccurs="0"/>
        <xsd:element name="msgTpl" type="Templates:TciValueTemplate"
minOccurs="0"/>
        <xsd:element name="from" type="Types:TriComponentIdType" minOccurs="0"/>
        <xsd:element name="fromTpl" type="Templates:TciNonValueTemplate"
minOccurs="0"/>
      </xsd:sequence>
    </xsd:extension>
  </xsd:complexContent>
</xsd:complexType>

<!-- synchronous communication -->
<xsd:complexType name="tliPrCall_m">
  <xsd:complexContent mixed="true">
    <xsd:extension base="Events:Event">
      <xsd:sequence>
        <xsd:element name="port" type="Types:TriPortIdType"/>
        <xsd:element name="signature" type="Types:TriSignatureIdType"/>
        <xsd:element name="parsValue" type="Types:TriParameterListType" minOccurs="0"/>
        <xsd:element name="address" type="Types:TriAddressType" minOccurs="0"/>
        <xsd:choice>
          <xsd:element name="encoder-failure" type="SimpleTypes:TciStatusType"
minOccurs="0"/>
          <xsd:element name="transmission-failure" type="SimpleTypes:TriStatusType"
minOccurs="0"/>
        </xsd:choice>
      </xsd:sequence>
    </xsd:extension>
  </xsd:complexContent>
</xsd:complexType>

<xsd:complexType name="tliPrCall_m_BC">
  <xsd:complexContent mixed="true">
    <xsd:extension base="Events:Event">
      <xsd:sequence>
        <xsd:element name="port" type="Types:TriPortIdType"/>
        <xsd:element name="signature" type="Types:TriSignatureIdType"/>
        <xsd:element name="parsValue" type="Types:TriParameterListType" minOccurs="0"/>
        <xsd:choice>

```

```

                <xsd:element name="encoder-failure" type="SimpleTypes:TciStatusType"
minOccurs="0"/>
                <xsd:element name="transmission-failure" type="SimpleTypes:TriStatusType"
minOccurs="0"/>
            </xsd:choice>
        </xsd:sequence>
    </xsd:extension>
</xsd:complexContent>
</xsd:complexType>

<xsd:complexType name="tliPrCall_m_MC">
    <xsd:complexContent mixed="true">
        <xsd:extension base="Events:Event">
            <xsd:sequence>
                <xsd:element name="port" type="Types:TriPortIdType"/>
                <xsd:element name="signature" type="Types:TriSignatureIdType"/>
                <xsd:element name="parsValue" type="Types:TriParameterListType" minOccurs="0"/>
                <xsd:element name="addresses" type="Types:TriAddressListType" minOccurs="0"/>
            <xsd:choice>
                <xsd:element name="encoder-failure" type="SimpleTypes:TciStatusType"
minOccurs="0"/>
                <xsd:element name="transmission-failure" type="SimpleTypes:TriStatusType"
minOccurs="0"/>
            </xsd:choice>
        </xsd:sequence>
    </xsd:extension>
</xsd:complexContent>
</xsd:complexType>

<xsd:complexType name="tliPrCall_c">
    <xsd:complexContent mixed="true">
        <xsd:extension base="Events:Event">
            <xsd:sequence>
                <xsd:element name="port" type="Types:TriPortIdType"/>
                <xsd:element name="signature" type="Types:TriSignatureIdType"/>
                <xsd:element name="parsValue" type="Types:TciParameterListType" minOccurs="0"/>
                <xsd:element name="to" type="Types:TriComponentIdType" minOccurs="0"/>
                <xsd:element name="transmission-failure" type="SimpleTypes:TriStatusType"
minOccurs="0"/>
            </xsd:sequence>
        </xsd:extension>
    </xsd:complexContent>
</xsd:complexType>

<xsd:complexType name="tliPrCall_c_BC">
    <xsd:complexContent mixed="true">
        <xsd:extension base="Events:Event">
            <xsd:sequence>
                <xsd:element name="port" type="Types:TriPortIdType"/>
                <xsd:element name="signature" type="Types:TriSignatureIdType"/>
                <xsd:element name="parsValue" type="Types:TciParameterListType" minOccurs="0"/>
                <xsd:element name="transmission-failure" type="SimpleTypes:TriStatusType"
minOccurs="0"/>
            </xsd:sequence>
        </xsd:extension>
    </xsd:complexContent>
</xsd:complexType>

<xsd:complexType name="tliPrCall_c_MC">
    <xsd:complexContent mixed="true">
        <xsd:extension base="Events:Event">
            <xsd:sequence>
                <xsd:element name="port" type="Types:TriPortIdType"/>
                <xsd:element name="signature" type="Types:TriSignatureIdType"/>
                <xsd:element name="parsValue" type="Types:TciParameterListType" minOccurs="0"/>
                <xsd:element name="toList" type="Types:TriComponentIdListType" minOccurs="0"/>
                <xsd:element name="transmission-failure" type="SimpleTypes:TriStatusType"
minOccurs="0"/>
            </xsd:sequence>
        </xsd:extension>
    </xsd:complexContent>
</xsd:complexType>

<xsd:complexType name="tliPrGetcallDetected_m">
    <xsd:complexContent mixed="true">
        <xsd:extension base="Events:Event">
            <xsd:sequence>
                <xsd:element name="port" type="Types:TriPortIdType"/>

```

```

        <xsd:element name="signature" type="Types:TriSignatureIdType"/>
        <xsd:element name="pars" type="Types:TriParameterListType"/>
        <xsd:element name="address" type="Types:TriAddressType" minOccurs="0"/>
    </xsd:sequence>
</xsd:extension>
</xsd:complexType>
</xsd:complexType>

<xsd:complexType name="tliPrGetcallDetected_c">
    <xsd:complexContent mixed="true">
        <xsd:extension base="Events:Event">
            <xsd:sequence>
                <xsd:element name="port" type="Types:TriPortIdType"/>
                <xsd:element name="signature" type="Types:TriSignatureIdType"/>
                <xsd:element name="pars" type="Types:TciParameterListType"/>
                <xsd:element name="from" type="Types:TriComponentIdType" minOccurs="0"/>
            </xsd:sequence>
        </xsd:extension>
    </xsd:complexContent>
</xsd:complexType>

<xsd:complexType name="tliPrGetcallMismatch_m">
    <xsd:complexContent mixed="true">
        <xsd:extension base="Events:Event">
            <xsd:sequence>
                <xsd:element name="port" type="Types:TriPortIdType"/>
                <xsd:element name="address" type="Types:TriAddressType" minOccurs="0"/>
                <xsd:element name="signature" type="Types:TriSignatureIdType"/>
                <xsd:element name="signatureTmpl" type="Templates:TciValueTemplate"/>
                <xsd:element name="pars" type="Types:TriParameterListType"/>
                <xsd:element name="parsTmpl" type="Templates:TciValueTemplate"/>
            </xsd:sequence>
        </xsd:extension>
    </xsd:complexContent>
</xsd:complexType>

<xsd:complexType name="tliPrGetcallMismatch_c">
    <xsd:complexContent mixed="true">
        <xsd:extension base="Events:Event">
            <xsd:sequence>
                <xsd:element name="port" type="Types:TriPortIdType"/>
                <xsd:element name="address" type="Types:TriAddressType" minOccurs="0"/>
                <xsd:element name="signature" type="Types:TriSignatureIdType"/>
                <xsd:element name="signatureTmpl" type="Templates:TciValueTemplate"/>
                <xsd:element name="pars" type="Types:TciParameterListType"/>
                <xsd:element name="parsTmpl" type="Templates:TciValueTemplate"/>
            </xsd:sequence>
        </xsd:extension>
    </xsd:complexContent>
</xsd:complexType>

<xsd:complexType name="tliPrGetcall_m">
    <xsd:complexContent mixed="true">
        <xsd:extension base="Events:Event">
            <xsd:sequence>
                <xsd:element name="port" type="Types:TriPortIdType"/>
                <xsd:element name="from" type="Types:TriAddressType" minOccurs="0"/>
                <xsd:element name="signature" type="Types:TriSignatureIdType"/>
                <xsd:element name="signatureTmpl" type="Templates:TciValueTemplate"/>
                <xsd:element name="pars" type="Types:TriParameterListType"/>
                <xsd:element name="parsTmpl" type="Templates:TciValueTemplate"/>
            </xsd:sequence>
        </xsd:extension>
    </xsd:complexContent>
</xsd:complexType>

<xsd:complexType name="tliPrGetcall_c">
    <xsd:complexContent mixed="true">
        <xsd:extension base="Events:Event">
            <xsd:sequence>
                <xsd:element name="port" type="Types:TriPortIdType"/>
                <xsd:element name="from" type="Types:TriAddressType" minOccurs="0"/>
                <xsd:element name="signature" type="Types:TriSignatureIdType"/>
                <xsd:element name="signatureTmpl" type="Templates:TciValueTemplate"/>
                <xsd:element name="pars" type="Types:TciParameterListType"/>
                <xsd:element name="parsTmpl" type="Templates:TciValueTemplate"/>
            </xsd:sequence>
        </xsd:extension>
    </xsd:complexContent>
</xsd:complexType>

```

```

    </xsd:complexContent>
  </xsd:complexType>

  <xsd:complexType name="tliPrReply_m">
    <xsd:complexContent mixed="true">
      <xsd:extension base="Events:Event">
        <xsd:sequence>
          <xsd:element name="port" type="Types:TriPortIdType"/>
          <xsd:element name="signature" type="Types:TriSignatureIdType"/>
          <xsd:element name="parsValue" type="Types:TriParameterListType"/>
          <xsd:element name="replValue" type="Values:Value"/>
          <xsd:element name="address" type="Types:TriAddressType" minOccurs="0"/>
          <xsd:choice>
            <xsd:element name="encoder-failure" type="SimpleTypes:TciStatusType"/>
            <xsd:sequence>
              <xsd:element name="repl" type="Types:TriParameterType" minOccurs="0"/>
              <xsd:element name="transmission-failure"
type="SimpleTypes:TriStatusType" minOccurs="0"/>
            </xsd:sequence>
          </xsd:choice>
        </xsd:sequence>
      </xsd:extension>
    </xsd:complexContent>
  </xsd:complexType>

  <xsd:complexType name="tliPrReply_m_BC">
    <xsd:complexContent mixed="true">
      <xsd:extension base="Events:Event">
        <xsd:sequence>
          <xsd:element name="port" type="Types:TriPortIdType"/>
          <xsd:element name="signature" type="Types:TriSignatureIdType"/>
          <xsd:element name="parsValue" type="Types:TriParameterListType"/>
          <xsd:element name="replValue" type="Values:Value"/>
          <xsd:choice>
            <xsd:element name="encoder-failure" type="SimpleTypes:TciStatusType"/>
            <xsd:sequence>
              <xsd:element name="repl" type="Types:TriParameterType" minOccurs="0"/>
              <xsd:element name="transmission-failure"
type="SimpleTypes:TriStatusType" minOccurs="0"/>
            </xsd:sequence>
          </xsd:choice>
        </xsd:sequence>
      </xsd:extension>
    </xsd:complexContent>
  </xsd:complexType>

  <xsd:complexType name="tliPrReply_m_MC">
    <xsd:complexContent mixed="true">
      <xsd:extension base="Events:Event">
        <xsd:sequence>
          <xsd:element name="port" type="Types:TriPortIdType"/>
          <xsd:element name="signature" type="Types:TriSignatureIdType"/>
          <xsd:element name="parsValue" type="Types:TriParameterListType"/>
          <xsd:element name="replValue" type="Values:Value"/>
          <xsd:element name="addresses" type="Types:TriAddressListType" minOccurs="0"/>
          <xsd:choice>
            <xsd:element name="encoder-failure" type="SimpleTypes:TciStatusType"/>
            <xsd:sequence>
              <xsd:element name="repl" type="Types:TriParameterType" minOccurs="0"/>
              <xsd:element name="transmission-failure"
type="SimpleTypes:TriStatusType" minOccurs="0"/>
            </xsd:sequence>
          </xsd:choice>
        </xsd:sequence>
      </xsd:extension>
    </xsd:complexContent>
  </xsd:complexType>

  <xsd:complexType name="tliPrReply_c">
    <xsd:complexContent mixed="true">
      <xsd:extension base="Events:Event">
        <xsd:sequence>
          <xsd:element name="port" type="Types:TriPortIdType"/>
          <xsd:element name="signature" type="Types:TriSignatureIdType"/>
          <xsd:element name="parsValue" type="Types:TciParameterListType"/>
          <xsd:element name="replValue" type="Values:Value"/>
          <xsd:element name="to" type="Types:TriComponentIdType" minOccurs="0"/>

```

```

        <xsd:element name="transmission-failure" type="SimpleTypes:TriStatusType"
minOccurs="0"/>
    </xsd:sequence>
</xsd:extension>
</xsd:complexContent>
</xsd:complexType>

<xsd:complexType name="tliPrReply_c_BC">
    <xsd:complexContent mixed="true">
        <xsd:extension base="Events:Event">
            <xsd:sequence>
                <xsd:element name="port" type="Types:TriPortIdType"/>
                <xsd:element name="signature" type="Types:TriSignatureIdType"/>
                <xsd:element name="parsValue" type="Types:TciParameterListType"/>
                <xsd:element name="replValue" type="Values:Value"/>
                <xsd:element name="transmission-failure" type="SimpleTypes:TriStatusType"
minOccurs="0"/>
            </xsd:sequence>
        </xsd:extension>
    </xsd:complexContent>
</xsd:complexType>

<xsd:complexType name="tliPrReply_c_MC">
    <xsd:complexContent mixed="true">
        <xsd:extension base="Events:Event">
            <xsd:sequence>
                <xsd:element name="port" type="Types:TriPortIdType"/>
                <xsd:element name="signature" type="Types:TriSignatureIdType"/>
                <xsd:element name="parsValue" type="Types:TciParameterListType"/>
                <xsd:element name="replValue" type="Values:Value"/>
                <xsd:element name="toList" type="Types:TriComponentIdListType" minOccurs="0"/>
                <xsd:element name="transmission-failure" type="SimpleTypes:TriStatusType"
minOccurs="0"/>
            </xsd:sequence>
        </xsd:extension>
    </xsd:complexContent>
</xsd:complexType>

<xsd:complexType name="tliPrGetReplyDetected_m">
    <xsd:complexContent mixed="true">
        <xsd:extension base="Events:Event">
            <xsd:sequence>
                <xsd:element name="port" type="Types:TriPortIdType"/>
                <xsd:element name="signature" type="Types:TriSignatureIdType"/>
                <xsd:element name="replValue" type="Values:Value"/>
                <xsd:element name="address" type="Types:TriAddressType"/>
            </xsd:sequence>
        </xsd:extension>
    </xsd:complexContent>
</xsd:complexType>

<xsd:complexType name="tliPrGetReplyDetected_c">
    <xsd:complexContent mixed="true">
        <xsd:extension base="Events:Event">
            <xsd:sequence>
                <xsd:element name="port" type="Types:TriPortIdType"/>
                <xsd:element name="signature" type="Types:TriSignatureIdType"/>
                <xsd:element name="replValue" type="Values:Value"/>
                <xsd:element name="from" type="Types:TriComponentIdType"/>
            </xsd:sequence>
        </xsd:extension>
    </xsd:complexContent>
</xsd:complexType>

<xsd:complexType name="tliPrGetReplyMismatch_m">
    <xsd:complexContent mixed="true">
        <xsd:extension base="Events:Event">
            <xsd:sequence>
                <xsd:element name="port" type="Types:TriPortIdType"/>
                <xsd:element name="signature" type="Types:TriSignatureIdType"/>
                <xsd:element name="parsValue" type="Types:TriParameterListType"/>
                <xsd:element name="replValue" type="Values:Value"/>
                <xsd:element name="replTmpl" type="Values:Value"/>
                <xsd:element name="diffs" type="Templates:TciValueDifferenceList"/>
                <xsd:element name="address" type="Types:TriAddressType"/>
                <xsd:element name="addressTmpl" type="Templates:TciValueTemplate"/>
            </xsd:sequence>
        </xsd:extension>
    </xsd:complexContent>
</xsd:complexType>

```

```

    </xsd:complexContent>
  </xsd:complexType>

  <xsd:complexType name="tliPrGetReplyMismatch_c">
    <xsd:complexContent mixed="true">
      <xsd:extension base="Events:Event">
        <xsd:sequence>
          <xsd:element name="port" type="Types:TriPortIdType"/>
          <xsd:element name="signature" type="Types:TriSignatureIdType"/>
          <xsd:element name="parsValue" type="Types:TciParameterListType"/>
          <xsd:element name="replValue" type="Values:Value"/>
          <xsd:element name="replTmpl" type="Values:Value"/>
          <xsd:element name="diffs" type="Templates:TciValueDifferenceList"/>
          <xsd:element name="from" type="Types:TriComponentIdType"/>
          <xsd:element name="fromTmpl" type="Templates:TciNonValueTemplate"/>
        </xsd:sequence>
      </xsd:extension>
    </xsd:complexContent>
  </xsd:complexType>

  <xsd:complexType name="tliPrGetReply_m">
    <xsd:complexContent mixed="true">
      <xsd:extension base="Events:Event">
        <xsd:sequence>
          <xsd:element name="port" type="Types:TriPortIdType"/>
          <xsd:element name="signature" type="Types:TriSignatureIdType"/>
          <xsd:element name="parsValue" type="Types:TciParameterListType"/>
          <xsd:element name="replValue" type="Values:Value"/>
          <xsd:element name="replTmpl" type="Values:Value"/>
          <xsd:element name="address" type="Types:TriAddressType"/>
          <xsd:element name="addressTmpl" type="Templates:TciValueTemplate"/>
        </xsd:sequence>
      </xsd:extension>
    </xsd:complexContent>
  </xsd:complexType>

  <xsd:complexType name="tliPrGetReply_c">
    <xsd:complexContent mixed="true">
      <xsd:extension base="Events:Event">
        <xsd:sequence>
          <xsd:element name="port" type="Types:TriPortIdType"/>
          <xsd:element name="signature" type="Types:TriSignatureIdType"/>
          <xsd:element name="parsValue" type="Types:TciParameterListType"/>
          <xsd:element name="replValue" type="Values:Value"/>
          <xsd:element name="replTmpl" type="Values:Value"/>
          <xsd:element name="from" type="Types:TriComponentIdType"/>
          <xsd:element name="fromTmpl" type="Templates:TciNonValueTemplate"/>
        </xsd:sequence>
      </xsd:extension>
    </xsd:complexContent>
  </xsd:complexType>

  <xsd:complexType name="tliPrRaise_m">
    <xsd:complexContent mixed="true">
      <xsd:extension base="Events:Event">
        <xsd:sequence>
          <xsd:element name="port" type="Types:TriPortIdType"/>
          <xsd:element name="signature" type="Types:TriSignatureIdType"/>
          <xsd:element name="parsValue" type="Types:TciParameterListType"/>
          <xsd:element name="excValue" type="Values:Value"/>
          <xsd:element name="address" type="Types:TriAddressType" minOccurs="0"/>
          <xsd:choice>
            <xsd:element name="encoder-failure" type="SimpleTypes:TciStatusType"/>
            <xsd:sequence>
              <xsd:element name="exc" type="Types:TriExceptionType" minOccurs="0"/>
              <xsd:element name="transmission-failure"
type="SimpleTypes:TciStatusType" minOccurs="0"/>
            </xsd:sequence>
          </xsd:choice>
        </xsd:sequence>
      </xsd:extension>
    </xsd:complexContent>
  </xsd:complexType>

  <xsd:complexType name="tliPrRaise_m_BC">
    <xsd:complexContent mixed="true">
      <xsd:extension base="Events:Event">
        <xsd:sequence>

```

```

<xsd:element name="port" type="Types:TriPortIdType"/>
<xsd:element name="signature" type="Types:TriSignatureIdType"/>
<xsd:element name="parsValue" type="Types:TriParameterListType"/>
<xsd:element name="excValue" type="Values:Value"/>
<xsd:choice>
  <xsd:element name="encoder-failure" type="SimpleTypes:TciStatusType"/>
  <xsd:sequence>
    <xsd:element name="exc" type="Types:TriExceptionType" minOccurs="0"/>
    <xsd:element name="transmission-failure"
type="SimpleTypes:TriStatusType" minOccurs="0"/>
  </xsd:sequence>
</xsd:choice>
</xsd:sequence>
</xsd:extension>
</xsd:complexContent>
</xsd:complexType>

<xsd:complexType name="tliPrRaise_m_MC">
  <xsd:complexContent mixed="true">
    <xsd:extension base="Events:Event">
      <xsd:sequence>
        <xsd:element name="port" type="Types:TriPortIdType"/>
        <xsd:element name="signature" type="Types:TriSignatureIdType"/>
        <xsd:element name="parsValue" type="Types:TriParameterListType"/>
        <xsd:element name="excValue" type="Values:Value"/>
        <xsd:element name="addresses" type="Types:TriAddressListType" minOccurs="0"/>
        <xsd:choice>
          <xsd:element name="encoder-failure" type="SimpleTypes:TciStatusType"/>
          <xsd:sequence>
            <xsd:element name="exc" type="Types:TriExceptionType" minOccurs="0"/>
            <xsd:element name="transmission-failure"
type="SimpleTypes:TriStatusType" minOccurs="0"/>
          </xsd:sequence>
        </xsd:choice>
      </xsd:sequence>
    </xsd:extension>
  </xsd:complexContent>
</xsd:complexType>

<xsd:complexType name="tliPrRaise_c">
  <xsd:complexContent mixed="true">
    <xsd:extension base="Events:Event">
      <xsd:sequence>
        <xsd:element name="port" type="Types:TriPortIdType"/>
        <xsd:element name="signature" type="Types:TriSignatureIdType"/>
        <xsd:element name="parsValue" type="Types:TciParameterListType"/>
        <xsd:element name="excValue" type="Values:Value"/>
        <xsd:element name="to" type="Types:TriComponentIdType" minOccurs="0"/>
        <xsd:element name="transmission-failure" type="SimpleTypes:TriStatusType"
minOccurs="0"/>
      </xsd:sequence>
    </xsd:extension>
  </xsd:complexContent>
</xsd:complexType>

<xsd:complexType name="tliPrRaise_c_BC">
  <xsd:complexContent mixed="true">
    <xsd:extension base="Events:Event">
      <xsd:sequence>
        <xsd:element name="port" type="Types:TriPortIdType"/>
        <xsd:element name="signature" type="Types:TriSignatureIdType"/>
        <xsd:element name="parsValue" type="Types:TciParameterListType"/>
        <xsd:element name="excValue" type="Values:Value"/>
        <xsd:element name="transmission-failure" type="SimpleTypes:TriStatusType"
minOccurs="0"/>
      </xsd:sequence>
    </xsd:extension>
  </xsd:complexContent>
</xsd:complexType>

<xsd:complexType name="tliPrRaise_c_MC">
  <xsd:complexContent mixed="true">
    <xsd:extension base="Events:Event">
      <xsd:sequence>
        <xsd:element name="port" type="Types:TriPortIdType"/>
        <xsd:element name="signature" type="Types:TriSignatureIdType"/>
        <xsd:element name="parsValue" type="Types:TciParameterListType"/>
        <xsd:element name="excValue" type="Values:Value"/>

```

```

        <xsd:element name="toList" type="Types:TriComponentIdListType" minOccurs="0"/>
        <xsd:element name="transmission-failure" type="SimpleTypes:TriStatusType"
minOccurs="0"/>
    </xsd:sequence>
</xsd:extension>
</xsd:complexContent>
</xsd:complexType>

<xsd:complexType name="tliPrCatchDetected_m">
    <xsd:complexContent mixed="true">
        <xsd:extension base="Events:Event">
            <xsd:sequence>
                <xsd:element name="port" type="Types:TriPortIdType"/>
                <xsd:element name="signature" type="Types:TriSignatureIdType"/>
                <xsd:element name="exc" type="Types:TriExceptionType"/>
                <xsd:element name="address" type="Types:TriAddressType" minOccurs="0"/>
            </xsd:sequence>
        </xsd:extension>
    </xsd:complexContent>
</xsd:complexType>

<xsd:complexType name="tliPrCatchDetected_c">
    <xsd:complexContent mixed="true">
        <xsd:extension base="Events:Event">
            <xsd:sequence>
                <xsd:element name="port" type="Types:TriPortIdType"/>
                <xsd:element name="signature" type="Types:TriSignatureIdType"/>
                <xsd:element name="exc" type="Types:TriExceptionType"/>
                <xsd:element name="from" type="Types:TriComponentIdType" minOccurs="0"/>
            </xsd:sequence>
        </xsd:extension>
    </xsd:complexContent>
</xsd:complexType>

<xsd:complexType name="tliPrCatchMismatch_m">
    <xsd:complexContent mixed="true">
        <xsd:extension base="Events:Event">
            <xsd:sequence>
                <xsd:element name="port" type="Types:TriPortIdType"/>
                <xsd:element name="signature" type="Types:TriSignatureIdType"/>
                <xsd:element name="parsValue" type="Types:TciParameterListType"/>
                <xsd:element name="exc" type="Values:Value"/>
                <xsd:element name="excTmpl" type="Templates:TciValueTemplate"/>
                <xsd:element name="diffs" type="Templates:TciValueDifferenceList"/>
                <xsd:element name="address" type="Types:TriAddressType"/>
                <xsd:element name="addressTmpl" type="Templates:TciValueTemplate"/>
            </xsd:sequence>
        </xsd:extension>
    </xsd:complexContent>
</xsd:complexType>

<xsd:complexType name="tliPrCatchMismatch_c">
    <xsd:complexContent mixed="true">
        <xsd:extension base="Events:Event">
            <xsd:sequence>
                <xsd:element name="port" type="Types:TriPortIdType"/>
                <xsd:element name="signature" type="Types:TriSignatureIdType"/>
                <xsd:element name="parsValue" type="Types:TciParameterListType"/>
                <xsd:element name="exc" type="Values:Value"/>
                <xsd:element name="excTmpl" type="Templates:TciValueTemplate"/>
                <xsd:element name="address" type="Types:TriAddressType"/>
                <xsd:element name="addressTmpl" type="Templates:TciValueTemplate"/>
            </xsd:sequence>
        </xsd:extension>
    </xsd:complexContent>
</xsd:complexType>

<xsd:complexType name="tliPrCatch_m">
    <xsd:complexContent mixed="true">
        <xsd:extension base="Events:Event">
            <xsd:sequence>
                <xsd:element name="port" type="Types:TriPortIdType"/>
                <xsd:element name="signature" type="Types:TriSignatureIdType"/>
                <xsd:element name="signatureTmpl" type="Templates:TciValueTemplate"/>
                <xsd:element name="exception" type="Values:Value"/>
                <xsd:element name="exceptionTmpl" type="Templates:TciValueTemplate"/>
            </xsd:sequence>
        </xsd:extension>
    </xsd:complexContent>
</xsd:complexType>

```



```

    </xsd:complexContent>
  </xsd:complexType>

  <xsd:complexType name="tliPrCatch_c">
    <xsd:complexContent mixed="true">
      <xsd:extension base="Events:Event">
        <xsd:sequence>
          <xsd:element name="port" type="Types:TriPortIdType"/>
          <xsd:element name="signature" type="Types:TriSignatureIdType"/>
          <xsd:element name="signatureTmpl" type="Templates:TciValueTemplate"/>
          <xsd:element name="exception" type="Values:Value"/>
          <xsd:element name="exceptionTmpl" type="Templates:TciValueTemplate"/>
          <xsd:element name="from" type="Types:TriComponentIdType"/>
          <xsd:element name="fromTmpl" type="Templates:TciNonValueTemplate"/>
        </xsd:sequence>
      </xsd:extension>
    </xsd:complexContent>
  </xsd:complexType>

  <xsd:complexType name="tliPrCatchTimeoutDetected">
    <xsd:complexContent mixed="true">
      <xsd:extension base="Events:Event">
        <xsd:sequence>
          <xsd:element name="port" type="Types:TriPortIdType"/>
          <xsd:element name="signature" type="Types:TriSignatureIdType"/>
        </xsd:sequence>
      </xsd:extension>
    </xsd:complexContent>
  </xsd:complexType>

  <xsd:complexType name="tliPrCatchTimeout">
    <xsd:complexContent mixed="true">
      <xsd:extension base="Events:Event">
        <xsd:sequence>
          <xsd:element name="port" type="Types:TriPortIdType"/>
          <xsd:element name="signature" type="Types:TriSignatureIdType"/>
          <xsd:element name="parsValue" type="Types:TriParameterListType"/>
        </xsd:sequence>
      </xsd:extension>
    </xsd:complexContent>
  </xsd:complexType>

  <!-- components -->
  <xsd:complexType name="tliCCreate">
    <xsd:complexContent mixed="true">
      <xsd:extension base="Events:Event">
        <xsd:sequence>
          <xsd:element name="comp" type="Types:TriComponentIdType"/>
          <xsd:element name="name" type="SimpleTypes:TString"/>
        </xsd:sequence>
      </xsd:extension>
    </xsd:complexContent>
  </xsd:complexType>

  <xsd:complexType name="tliCStart">
    <xsd:complexContent mixed="true">
      <xsd:extension base="Events:Event">
        <xsd:sequence>
          <xsd:element name="comp" type="Types:TriComponentIdType"/>
          <xsd:element name="name" type="Types:TciBehaviourIdType"/>
          <xsd:element name="pars" type="Types:TciParameterListType" minOccurs="0"/>
        </xsd:sequence>
      </xsd:extension>
    </xsd:complexContent>
  </xsd:complexType>

  <xsd:complexType name="tliCRunning">
    <xsd:complexContent mixed="true">
      <xsd:extension base="Events:Event">
        <xsd:sequence>
          <xsd:element name="comp" type="Types:TriComponentIdType"/>
          <xsd:element name="status" type="SimpleTypes:TBoolean"/>
        </xsd:sequence>
      </xsd:extension>
    </xsd:complexContent>
  </xsd:complexType>

```

```

<xsd:complexType name="tliCAlive">
  <xsd:complexContent mixed="true">
    <xsd:extension base="Events:Event">
      <xsd:sequence>
        <xsd:element name="comp" type="Types:TriComponentIdType"/>
        <xsd:element name="status" type="SimpleTypes:TBoolean"/>
      </xsd:sequence>
    </xsd:extension>
  </xsd:complexContent>
</xsd:complexType>

<xsd:complexType name="tliCStop">
  <xsd:complexContent mixed="true">
    <xsd:extension base="Events:Event">
      <xsd:sequence>
        <xsd:element name="comp" type="Types:TriComponentIdType"/>
      </xsd:sequence>
    </xsd:extension>
  </xsd:complexContent>
</xsd:complexType>

<xsd:complexType name="tliCKill">
  <xsd:complexContent mixed="true">
    <xsd:extension base="Events:Event">
      <xsd:sequence>
        <xsd:element name="comp" type="Types:TriComponentIdType"/>
      </xsd:sequence>
    </xsd:extension>
  </xsd:complexContent>
</xsd:complexType>

<xsd:complexType name="tliCDoneMismatch">
  <xsd:complexContent mixed="true">
    <xsd:extension base="Events:Event">
      <xsd:sequence>
        <xsd:element name="comp" type="Types:TriComponentIdType"/>
        <xsd:element name="compTmpl" type="Templates:TciNonValueTemplate"/>
      </xsd:sequence>
      <xsd:attribute name="done" type="SimpleTypes:TBoolean"/>
    </xsd:extension>
  </xsd:complexContent>
</xsd:complexType>

<xsd:complexType name="tliCKilledMismatch">
  <xsd:complexContent mixed="true">
    <xsd:extension base="Events:Event">
      <xsd:sequence>
        <xsd:element name="comp" type="Types:TriComponentIdType"/>
        <xsd:element name="compTmpl" type="Templates:TciNonValueTemplate"/>
      </xsd:sequence>
      <xsd:attribute name="done" type="SimpleTypes:TBoolean"/>
    </xsd:extension>
  </xsd:complexContent>
</xsd:complexType>

<xsd:complexType name="tliCDone">
  <xsd:complexContent mixed="true">
    <xsd:extension base="Events:Event">
      <xsd:sequence>
        <xsd:element name="comp" type="Types:TriComponentIdType"/>
        <xsd:element name="compTmpl" type="Templates:TciNonValueTemplate"/>
      </xsd:sequence>
      <xsd:attribute name="done" type="SimpleTypes:TBoolean"/>
    </xsd:extension>
  </xsd:complexContent>
</xsd:complexType>

<xsd:complexType name="tliCKilled">
  <xsd:complexContent mixed="true">
    <xsd:extension base="Events:Event">
      <xsd:sequence>
        <xsd:element name="comp" type="Types:TriComponentIdType"/>
        <xsd:element name="compTmpl" type="Templates:TciNonValueTemplate"/>
      </xsd:sequence>
      <xsd:attribute name="done" type="SimpleTypes:TBoolean"/>
    </xsd:extension>
  </xsd:complexContent>
</xsd:complexType>

```

```

<xsd:complexType name="tliCTerminated">
  <xsd:complexContent mixed="true">
    <xsd:extension base="Events:Event">
      <xsd:sequence>
        <xsd:element name="comp" type="Types:TriComponentIdType"/>
        <xsd:element name="verdict" type="Values:VerdictValue" maxOccurs="1"/>
      </xsd:sequence>
    </xsd:extension>
  </xsd:complexContent>
</xsd:complexType>

<!-- ports -->
<xsd:complexType name="tliPConnect">
  <xsd:complexContent mixed="true">
    <xsd:extension base="Events:PortConfiguration"/>
  </xsd:complexContent>
</xsd:complexType>

<xsd:complexType name="tliPDisconnect">
  <xsd:complexContent mixed="true">
    <xsd:extension base="Events:PortConfiguration"/>
  </xsd:complexContent>
</xsd:complexType>

<xsd:complexType name="tliPMap">
  <xsd:complexContent mixed="true">
    <xsd:extension base="Events:PortConfiguration"/>
  </xsd:complexContent>
</xsd:complexType>

<xsd:complexType name="tliPUnmap">
  <xsd:complexContent mixed="true">
    <xsd:extension base="Events:PortConfiguration"/>
  </xsd:complexContent>
</xsd:complexType>

<xsd:complexType name="tliPClear">
  <xsd:complexContent mixed="true">
    <xsd:extension base="Events:PortConfiguration"/>
  </xsd:complexContent>
</xsd:complexType>

<xsd:complexType name="tliPStart">
  <xsd:complexContent mixed="true">
    <xsd:extension base="Events:PortConfiguration"/>
  </xsd:complexContent>
</xsd:complexType>

<xsd:complexType name="tliPStop">
  <xsd:complexContent mixed="true">
    <xsd:extension base="Events:PortConfiguration"/>
  </xsd:complexContent>
</xsd:complexType>

<xsd:complexType name="tliPHalt">
  <xsd:complexContent mixed="true">
    <xsd:extension base="Events:PortConfiguration"/>
  </xsd:complexContent>
</xsd:complexType>

<!-- codec -->
<xsd:complexType name="tliEncode">
  <xsd:complexContent mixed="true">
    <xsd:extension base="Events:Event">
      <xsd:sequence>
        <xsd:element name="val" type="Values:Value"/>
        <xsd:choice>
          <xsd:element name="msg" type="Types:TriMessageType"/>
          <xsd:element name="encoder-failure" type="SimpleTypes:TciStatusType"/>
        </xsd:choice>
      </xsd:sequence>
      <xsd:attribute name="codec" type="SimpleTypes:TString" use="optional"/>
    </xsd:extension>
  </xsd:complexContent>
</xsd:complexType>

<xsd:complexType name="tliDecode" mixed="true">

```

```

<xsd:complexContent mixed="true">
  <xsd:extension base="Events:Event">
    <xsd:sequence>
      <xsd:choice>
        <xsd:element name="val" type="Values:Value"/>
        <xsd:element name="decoder-failure" type="SimpleTypes:TciStatusType"/>
      </xsd:choice>
      <xsd:element name="msg" type="Types:TriMessageType"/>
    </xsd:sequence>
    <xsd:attribute name="codec" type="SimpleTypes:TString" use="optional"/>
  </xsd:extension>
</xsd:complexContent>
</xsd:complexType>

<!-- timers -->
<xsd:complexType name="tliTimeoutDetected">
  <xsd:complexContent mixed="true">
    <xsd:extension base="Events:Event">
      <xsd:sequence>
        <xsd:element name="timer" type="Types:TriTimerIdType" maxOccurs="1"
minOccurs="1"/>
      </xsd:sequence>
    </xsd:extension>
  </xsd:complexContent>
</xsd:complexType>

<xsd:complexType name="tliTimeoutMismatch">
  <xsd:complexContent mixed="true">
    <xsd:extension base="Events:Event">
      <xsd:sequence>
        <xsd:element name="timer" type="Types:TriTimerIdType" maxOccurs="1"
minOccurs="1"/>
        <xsd:element name="timerTpl" type="Templates:TciNonValueTemplate" maxOccurs="1"
minOccurs="1"/>
      </xsd:sequence>
    </xsd:extension>
  </xsd:complexContent>
</xsd:complexType>

<xsd:complexType name="tliTimeout">
  <xsd:complexContent mixed="true">
    <xsd:extension base="Events:Event">
      <xsd:sequence>
        <xsd:element name="timer" type="Types:TriTimerIdType" maxOccurs="1"
minOccurs="1"/>
        <xsd:element name="timerTpl" type="Templates:TciNonValueTemplate" maxOccurs="1"
minOccurs="1"/>
      </xsd:sequence>
    </xsd:extension>
  </xsd:complexContent>
</xsd:complexType>

<xsd:complexType name="tliTStart">
  <xsd:complexContent mixed="true">
    <xsd:extension base="Events:Event">
      <xsd:sequence>
        <xsd:element name="timer" type="Types:TriTimerIdType"/>
        <xsd:element name="dur" type="Types:TriTimerDurationType"/>
      </xsd:sequence>
    </xsd:extension>
  </xsd:complexContent>
</xsd:complexType>

<xsd:complexType name="tliTStop">
  <xsd:complexContent mixed="true">
    <xsd:extension base="Events:Event">
      <xsd:sequence>
        <xsd:element name="timer" type="Types:TriTimerIdType"/>
      </xsd:sequence>
    </xsd:extension>
  </xsd:complexContent>
</xsd:complexType>

<xsd:complexType name="tliTRead">
  <xsd:complexContent mixed="true">
    <xsd:extension base="Events:Event">
      <xsd:sequence>
        <xsd:element name="timer" type="Types:TriTimerIdType"/>

```

```

        <xsd:element name="elapsed" type="Types:TriTimerDurationType"/>
      </xsd:sequence>
    </xsd:extension>
  </xsd:complexContent>
</xsd:complexType>

<xsd:complexType name="tliTRunning">
  <xsd:complexContent mixed="true">
    <xsd:extension base="Events:Event">
      <xsd:sequence>
        <xsd:element name="timer" type="Types:TriTimerIdType"/>
      </xsd:sequence>
      <xsd:attribute name="status" type="SimpleTypes:TBoolean"/>
    </xsd:extension>
  </xsd:complexContent>
</xsd:complexType>

<!-- scope -->
<xsd:complexType name="tliSEnter">
  <xsd:complexContent mixed="true">
    <xsd:extension base="Events:Event">
      <xsd:sequence>
        <xsd:element name="name" type="Types:QualifiedName" minOccurs="1"
maxOccurs="1"/>
        <xsd:element name="pars" type="Types:TriParameterListType" minOccurs="0"/>
        <xsd:element name="kind" type="SimpleTypes:TString"/>
      </xsd:sequence>
    </xsd:extension>
  </xsd:complexContent>
</xsd:complexType>

<xsd:complexType name="tliSLeave">
  <xsd:complexContent mixed="true">
    <xsd:extension base="Events:Event">
      <xsd:sequence>
        <xsd:element name="name" type="Types:QualifiedName" minOccurs="1"
maxOccurs="1"/>
        <xsd:element name="return" type="Values:Value" minOccurs="0"/>
        <xsd:element name="kind" type="SimpleTypes:TString"/>
      </xsd:sequence>
    </xsd:extension>
  </xsd:complexContent>
</xsd:complexType>

<!-- variables and module parameter -->
<xsd:complexType name="tliVar">
  <xsd:complexContent mixed="true">
    <xsd:extension base="Events:Event">
      <xsd:sequence>
        <xsd:element name="name" type="Types:QualifiedName" minOccurs="1"
maxOccurs="1"/>
        <xsd:element name="val" type="Values:Value" minOccurs="0"/>
      </xsd:sequence>
    </xsd:extension>
  </xsd:complexContent>
</xsd:complexType>

<xsd:complexType name="tliModuleParr">
  <xsd:complexContent mixed="true">
    <xsd:extension base="Events:Event">
      <xsd:sequence>
        <xsd:element name="name" type="Types:QualifiedName" minOccurs="1"
maxOccurs="1"/>
        <xsd:element name="val" type="Values:Value" minOccurs="0"/>
      </xsd:sequence>
    </xsd:extension>
  </xsd:complexContent>
</xsd:complexType>

<!-- verdicts -->
<xsd:complexType name="tliGetVerdict">
  <xsd:complexContent mixed="true">
    <xsd:extension base="Events:Event">
      <xsd:sequence>
        <xsd:element name="verdict" type="Values:VerdictValue"/>
      </xsd:sequence>
    </xsd:extension>
  </xsd:complexContent>

```

```

</xsd:complexType>

<xsd:complexType name="tliSetVerdict">
  <xsd:complexContent mixed="true">
    <xsd:extension base="Events:Event">
      <xsd:sequence>
        <xsd:element name="verdict" type="Values:VerdictValue"/>
      </xsd:sequence>
    </xsd:extension>
  </xsd:complexContent>
</xsd:complexType>

<!-- log -->
<xsd:complexType name="tliLog">
  <xsd:complexContent mixed="true">
    <xsd:extension base="Events:Event">
      <xsd:sequence>
        <xsd:element name="log" type="SimpleTypes:TString"/>
      </xsd:sequence>
    </xsd:extension>
  </xsd:complexContent>
</xsd:complexType>

<!-- alt -->
<xsd:complexType name="tliAEnter">
  <xsd:complexContent>
    <xsd:extension base="Events:Event"/>
  </xsd:complexContent>
</xsd:complexType>

<xsd:complexType name="tliALeave">
  <xsd:complexContent>
    <xsd:extension base="Events:Event"/>
  </xsd:complexContent>
</xsd:complexType>

<xsd:complexType name="tliADefaults">
  <xsd:complexContent>
    <xsd:extension base="Events:Event"/>
  </xsd:complexContent>
</xsd:complexType>

<xsd:complexType name="tliAActivate">
  <xsd:complexContent mixed="true">
    <xsd:extension base="Events:Event">
      <xsd:sequence>
        <xsd:element name="name" type="Types:QualifiedName" minOccurs="1"
maxOccurs="1"/>
        <xsd:element name="pars" type="Types:TriParameterListType" minOccurs="0"/>
        <xsd:element name="ref" type="Values:Value"/>
      </xsd:sequence>
    </xsd:extension>
  </xsd:complexContent>
</xsd:complexType>

<xsd:complexType name="tliADeactivate">
  <xsd:complexContent mixed="true">
    <xsd:extension base="Events:Event">
      <xsd:sequence>
        <xsd:element name="ref" type="Values:Value"/>
      </xsd:sequence>
    </xsd:extension>
  </xsd:complexContent>
</xsd:complexType>

<xsd:complexType name="tliANomatch">
  <xsd:complexContent mixed="true">
    <xsd:extension base="Events:Event"/>
  </xsd:complexContent>
</xsd:complexType>

<xsd:complexType name="tliARepeat">
  <xsd:complexContent>
    <xsd:extension base="Events:Event"/>
  </xsd:complexContent>
</xsd:complexType>

<xsd:complexType name="tliAwait">

```

```

    <xsd:complexContent>
      <xsd:extension base="Events:Event" />
    </xsd:complexContent>
  </xsd:complexType>
</xsd:schema>

```

## B.6 TCI-TL XML Schema for a Log

```

<xsd:schema xmlns:xsd="http://www.w3.org/2001/XMLSchema"
  targetNamespace="http://uri.etsi.org/ttcn-3/3.0.0/tci/TLI"
  xmlns:TLI="http://uri.etsi.org/ttcn-3/3.0.0/tci/TLI"
  xmlns:Types="http://uri.etsi.org/ttcn-3/3.0.0/tci/Types"
  xmlns:Values="http://uri.etsi.org/ttcn-3/3.0.0/tci/Values"
  xmlns:Events="http://uri.etsi.org/ttcn-3/3.0.0/tci/Events" elementFormDefault="qualified">

  <xsd:import namespace="http://uri.etsi.org/ttcn-3/3.0.0/tci/Types.xsd"
    schemaLocation="Types.xsd" />
  <xsd:import namespace="http://uri.etsi.org/ttcn-3/3.0.0/tci/Values.xsd"
    schemaLocation="Values.xsd" />
  <xsd:import namespace="http://uri.etsi.org/ttcn-3/3.0.0/tci/Events.xsd"
    schemaLocation="Events.xsd" />

  <xsd:element name="logfile" type="TLI:LogModule" />
  <xsd:complexType name="LogModule">
    <xsd:sequence>
      <xsd:element name="header" type="TLI:Header" />
      <xsd:element name="body" type="TLI:Body" />
      <xsd:element name="trailer" type="TLI:Trailer" />
    </xsd:sequence>
  </xsd:complexType>
  <xsd:complexType name="Header">
    <xsd:sequence>
      <!-- logging version -->
      <xsd:element name="version" type="xsd:string" />
      <!-- begin of the log -->
      <xsd:element name="ts" type="xsd:time" />
    </xsd:sequence>
  </xsd:complexType>
  <xsd:complexType name="Trailer">
    <xsd:sequence />
  </xsd:complexType>

  <xsd:complexType name="Body">
    <xsd:choice maxOccurs="unbounded">

      <!-- test cases operations -->
      <xsd:element name="tliTcExecute" type="Events:tliTcExecute" />
      <xsd:element name="tliTcStart" type="Events:tliTcStart" />
      <xsd:element name="tliTcStop" type="Events:tliTcStop" />
      <xsd:element name="tliTcStarted" type="Events:tliTcStarted" />
      <xsd:element name="tliTcTerminated" type="Events:tliTcTerminated" />

      <!-- control operations -->
      <xsd:element name="tliCtrlStart" type="Events:tliCtrlStart" />
      <xsd:element name="tliCtrlStop" type="Events:tliCtrlStop" />
      <xsd:element name="tliCtrlTerminated" type="Events:tliCtrlTerminated" />

      <!-- asynchronous communication -->
      <xsd:element name="tliMSend_m" type="Events:tliMSend_m" />
      <xsd:element name="tliMSend_c" type="Events:tliMSend_c" />
      <xsd:element name="tliMDetected_m" type="Events:tliMDetected_m" />
      <xsd:element name="tliMDetected_c" type="Events:tliMDetected_c" />
      <xsd:element name="tliMMismatch_m" type="Events:tliMMismatch_m" />
      <xsd:element name="tliMMismatch_c" type="Events:tliMMismatch_c" />
      <xsd:element name="tliMReceive_m" type="Events:tliMReceive_m" />
      <xsd:element name="tliMReceive_c" type="Events:tliMReceive_c" />

      <!-- synchronous communication -->
      <xsd:element name="tliPrCall_m" type="Events:tliPrCall_m" />
      <xsd:element name="tliPrCall_c" type="Events:tliPrCall_c" />

      <xsd:element name="tliPrGetcallDetected_m" type="Events:tliPrGetcallDetected_m" />
      <xsd:element name="tliPrGetcallDetected_c" type="Events:tliPrGetcallDetected_c" />
      <xsd:element name="tliPrGetcallMismatch_m" type="Events:tliPrGetcallMismatch_m" />
    </xsd:choice>
  </xsd:complexType>

```

```

<xsd:element name="tliPrGetcallMismatch_c" type="Events:tliPrGetcallMismatch_c"/>
<xsd:element name="tliPrGetcall_m" type="Events:tliPrGetcall_m"/>
<xsd:element name="tliPrGetcall_c" type="Events:tliPrGetcall_c"/>

<xsd:element name="tliPrReply_m" type="Events:tliPrReply_m"/>
<xsd:element name="tliPrReply_c" type="Events:tliPrReply_c"/>

<xsd:element name="tliPrGetReplyDetected_m" type="Events:tliPrGetReplyDetected_m"/>
<xsd:element name="tliPrGetReplyDetected_c" type="Events:tliPrGetReplyDetected_c"/>
<xsd:element name="tliPrGetReplyMismatch_m" type="Events:tliPrGetReplyMismatch_m"/>
<xsd:element name="tliPrGetReplyMismatch_c" type="Events:tliPrGetReplyMismatch_c"/>
<xsd:element name="tliPrGetReply_m" type="Events:tliPrGetReply_m"/>
<xsd:element name="tliPrGetReply_c" type="Events:tliPrGetReply_c"/>

<xsd:element name="tliPrRaise_m" type="Events:tliPrRaise_m"/>
<xsd:element name="tliPrRaise_c" type="Events:tliPrRaise_c"/>

<xsd:element name="tliPrCatchDetected_m" type="Events:tliPrCatchDetected_m"/>
<xsd:element name="tliPrCatchDetected_c" type="Events:tliPrCatchDetected_c"/>
<xsd:element name="tliPrCatchMismatch_m" type="Events:tliPrCatchMismatch_m"/>
<xsd:element name="tliPrCatchMismatch_c" type="Events:tliPrCatchMismatch_c"/>
<xsd:element name="tliPrCatch_m" type="Events:tliPrCatch_m"/>
<xsd:element name="tliPrCatch_c" type="Events:tliPrCatch_c"/>

<xsd:element name="tliPrCatchTimeout" type="Events:tliPrCatchTimeout"/>

<!-- components -->
<xsd:element name="tliCCreate" type="Events:tliCCreate"/>
<xsd:element name="tliCStart" type="Events:tliCStart"/>
<xsd:element name="tliCRunning" type="Events:tliCRunning"/>
<xsd:element name="tliCAlive" type="Events:tliCRunning"/>
<xsd:element name="tliCStop" type="Events:tliCStop"/>
<xsd:element name="tliCKill" type="Events:tliCStop"/>
<xsd:element name="tliCDoneMismatch" type="Events:tliCDone"/>
<xsd:element name="tliCDone" type="Events:tliCDone"/>
<xsd:element name="tliCKilledMismatch" type="Events:tliCDone"/>
<xsd:element name="tliCKilled" type="Events:tliCDone"/>
<xsd:element name="tliCTerminated" type="Events:tliCTerminated"/>

<!-- ports -->
<xsd:element name="tliPConnect" type="Events:tliPConnect"/>
<xsd:element name="tliPDisconnect" type="Events:tliPDisconnect"/>
<xsd:element name="tliPMap" type="Events:tliPMap"/>
<xsd:element name="tliPUnmap" type="Events:tliPUnmap"/>
<xsd:element name="tliPClear" type="Events:tliPClear"/>
<xsd:element name="tliPStart" type="Events:tliPStart"/>
<xsd:element name="tliPStop" type="Events:tliPStop"/>
<xsd:element name="tliPHalt" type="Events:tliPStop"/>

<!-- codec -->
<xsd:element name="tliDecode" type="Events:tliDecode"/>
<xsd:element name="tliEncode" type="Events:tliEncode"/>

<!-- timers -->
<xsd:element name="tliTTimeoutDetected" type="Events:tliTTimeoutDetected"/>
<xsd:element name="tliTTimeoutMismatch" type="Events:tliTTimeoutMismatch"/>
<xsd:element name="tliTTimeout" type="Events:tliTTimeout"/>
<xsd:element name="tliTStart" type="Events:tliTStart"/>
<xsd:element name="tliTStop" type="Events:tliTStop"/>
<xsd:element name="tliTRead" type="Events:tliTRead"/>
<xsd:element name="tliTRunning" type="Events:tliTRunning"/>

<!-- scopes -->
<xsd:element name="tliSEnter" type="Events:tliSEnter"/>
<xsd:element name="tliSLeave" type="Events:tliSLeave"/>

<!-- statements -->
<xsd:element name="tliVar" type="Events:tliVar"/>
<xsd:element name="tliGetVerdict" type="Events:tliGetVerdict"/>
<xsd:element name="tliSetVerdict" type="Events:tliSetVerdict"/>
<xsd:element name="tliLog" type="Events:tliLog"/>

<!-- alt -->
<xsd:element name="tliAEnter" type="Events:tliAEnter"/>
<xsd:element name="tliALeave" type="Events:tliALeave"/>
<xsd:element name="tliADefaults" type="Events:tliADefaults"/>
<xsd:element name="tliAActivate" type="Events:tliAActivate"/>
<xsd:element name="tliADeactivate" type="Events:tliADeactivate"/>

```



```
<xsd:element name="tliANomatch" type="Events:tliANomatch"/>
<xsd:element name="tliARepet" type="Events:tliARepet"/>
<xsd:element name="tliAWait" type="Events:tliAWait"/>

</xsd:choice>
</xsd:complexType>
</xsd:schema>
```

---

## Annex C (informative): Bibliography

- INTOOL CGI/NPL038 (V2.2): "Generic Compiler/Interpreter interface; GCI Interface Specification" Infrastructural Tools, December 1996.
- ISO/IEC 9646-3 (1998): "Information technology - Open Systems Interconnection - Conformance testing methodology and framework - Part 3: The Tree and Tabular combined Notation (TTCN)".
- ISO/IEC 10646-1: "Information technology - Universal Multiple-Octet Coded Character Set (UCS) - Part 1: Architecture and Basic Multilingual Plane".
- OMG CORBA v2.2: "The Common Object Request Broker: Architecture and Specification, Section 3, February 1998".

---

## History

<b>Document history</b>		
V1.1.1	July 2003	Publication
V3.0.0	March 2005	Membership Approval Procedure    MV 20050527: 2005-03-29 to 2005-05-27
V3.1.1	June 2005	Publication