

ES 201 386 V1.1.1 (1999-02)

ETSI Standard

**Telecommunications Management Network (TMN);
Service Switching Function (SSF)
management information model**



Reference

DES/TMN-00001 (cu000icp.PDF)

Keywords

IN, TMN, management, SSF

ETSI

Postal address

F-06921 Sophia Antipolis Cedex - FRANCE

Office address

650 Route des Lucioles - Sophia Antipolis
Valbonne - FRANCE
Tel.: +33 4 92 94 42 00 Fax: +33 4 93 65 47 16
Siret N° 348 623 562 00017 - NAF 742 C
Association à but non lucratif enregistrée à la
Sous-Préfecture de Grasse (06) N° 7803/88

Internet

secretariat@etsi.fr
Individual copies of this ETSI deliverable
can be downloaded from
<http://www.etsi.org>
If you find errors in the present document, send your
comment to: editor@etsi.fr

Copyright Notification

No part may be reproduced except as authorized by written permission.
The copyright and the foregoing restriction extend to reproduction in all media.

© European Telecommunications Standards Institute 1999.
All rights reserved.

Contents

Intellectual Property Rights.....	8
Foreword	8
1 Scope.....	9
2 References.....	9
3 Abbreviations.....	10
4 Rationale	11
5 Overview	11
6 Technical approach	11
6.1 SSF functional decomposition	12
6.1.1 Rationale	12
6.1.2 Method	12
6.2 SSF management requirements	14
6.2.1 Rationale	14
6.2.2 Method	14
6.3 SSF management information model.....	16
6.3.1 Rationale	16
6.3.2 Method.....	16
7 Introduction to the SSF model	18
8 Management requirements for the SSF sub entities	24
8.1 Introduction.....	24
8.2 Operational Requirements and Activities.....	25
9 Informal description of Managed Object Classes.....	38
9.1 SSF Object Model (informal)	38
9.1.1 The Relationship diagrams	38
9.1.1.1 SSF Overall Model.....	38
9.1.1.2 Inheritance Hierarchy	40
9.1.1.3 Naming Hierarchy	40
9.1.2 Requirement: Configure triggering of IN based service feature control.....	42
9.1.2.1 Information Model Diagram.....	42
9.1.2.2 Informal description of managed objects.....	44
9.1.2.2.1 IN Trigger	44
9.1.2.2.2 Origination Attempt Accepted Trigger	45
9.1.2.2.3 Information Collected Trigger	45
9.1.2.2.4 Information Analysed Trigger.....	46
9.1.2.2.5 Route Select Failure Trigger	46
9.1.2.2.6 Busy Trigger	46
9.1.2.2.7 No Answer Trigger	47
9.1.2.2.8 Terminating Attempt Accepted Trigger	47
9.1.2.2.9 Mid Call Event Trigger.....	47
9.1.2.2.10 Disconnect Trigger.....	48
9.1.2.2.11 Line Trigger Base	48
9.1.2.2.12 OLT Base	49
9.1.2.2.13 TLT Base	49
9.1.2.2.14 Trunk Group Trigger Base.....	49
9.1.2.2.15 OTT Base.....	50
9.1.2.2.16 TTT Base	50
9.1.2.2.17 Private Facility Trigger Base	51
9.1.2.2.18 Office Trigger Base.....	51
9.1.2.2.19 Service Feature Control	52
9.1.3 Requirement: IN-Authorization.....	53
9.1.4 Requirement: Configure SCF access	54

9.1.4.1	SSF Application Process	55
9.1.4.1.1	SCF-SSF AE	56
9.1.4.1.2	TCAP ASE.....	56
9.1.4.1.3	INAP ASE.....	56
9.1.4.1.4	Service Feature Control	56
9.1.4.1.5	SCF access	56
9.1.4.1.6	Point Code based SCF access	56
9.1.4.1.7	Global Title based SCF access.....	57
9.1.5	Configure SRF/SCF relaying capabilities and Configure SRF assisting Relationships	58
9.1.5.1	SSF AP	59
9.1.5.2	SSF/SRF AE.....	59
9.1.5.3	SSF/SCF AE.....	59
9.1.5.4	SSF/SSF AE	59
9.1.5.5	Assist Treatment	59
9.1.5.6	IN Trigger.....	59
9.1.5.7	Timer	60
9.1.5.8	SCF Access.....	60
9.1.6	MOC: callgap	60
9.1.6.1	Informal description	60
9.1.6.2	Behaviour	60
9.1.6.3	Attributes	60
9.1.7	MOC: Service Filtering	61
9.1.7.1	Informal description	61
9.1.7.2	Behaviour	61
9.1.7.3	Attributes	61
9.1.8	MOC: Service Filtering Default	62
9.1.8.1	Informal description	62
9.1.8.2	Behaviour	62
9.1.8.3	Attributes	62
9.1.9	MOC: Default Initiate Call Information	62
9.1.9.1	Informal description	62
9.1.9.2	Behaviour	62
9.1.9.3	Attributes	62
9.1.10	INAP Measurement Counters.....	62
9.1.10.1	Informal description	62
9.1.10.2	Behaviour	62
9.1.10.3	Attributes	63
9.2	Relation to other object models	63
9.2.1	The OSI Application Layer model	63
9.2.1.1	IN managed objects	64
9.2.1.2	Relationship with other management functionality's present in the network element (example)	64
9.2.2	Relation to routing management (ORM)	65
9.2.2.1	Administration of IN triggering as a result of digit analysis of the called party address.....	66
9.2.2.2	Administration of IN triggering relative to a specific trunk group.....	67
9.2.3	Relation SS#7 management (Q.751)	69
9.2.3.1	Rationale.....	69
9.2.3.2	MTP related information	70
9.2.3.3	SCCP related information.....	70
9.2.4	Relation to customer administration.....	70
9.2.4.1	Relation to CENTREX Managed Object Classes	73
9.2.5	Relation to traffic management (OTM)	74
9.2.5.1	The OTM Model	74
9.2.5.2	Traffic Management versus IN Management.....	74
9.2.6	Relation to the usage metering information management.....	75
Annex A (informative): SSF scenarios		77
A.1	Basic IN Call scenarios	77
A.1.1	Introduction.....	77
A.1.2	Triggering of IN service control	78
A.1.2.1	DFP description.....	78

A.1.2.2	SSF Model mapping.....	79
A.1.2.3	Description of the impacted sub-entities	80
A.1.3	Call Setup Capabilities.....	83
A.1.3.1	DFP description.....	83
A.1.3.2	SSF Model Mapping	85
A.1.3.3	Description of the impacted sub-entities	86
A.1.4	Event Report Capabilities	87
A.1.4.1	DFP description.....	87
A.1.4.2	SSF Model Mapping	88
A.1.4.3	Description of the impacted SSF entities	90
A.1.5	Call party handling capabilities.....	91
A.1.6	Release call capabilities	91
A.2	Specialized Resource scenarios	91
A.2.1	Introduction.....	91
A.2.1.1	SSF as Relay for SCF/SRF-signalling	92
A.2.1.2	IP has direct signalling connection to SCP.....	93
A.2.1.3	Using a central assist or hand-off SSP.....	94
A.2.2	DFP description	95
A.2.2.1	Scenario 1, SSF is SRF/SCF-relay, direct SSP/SRP bearer connection	95
A.2.2.2	Scenario 2, SSF is SRF/SCF-relay, signalling link between SRP and SSP	95
A.2.2.3	Scenario 3, Assist case	96
A.2.2.4	Scenario 4, SRF initiated disconnect (normal disconnect).....	97
A.2.2.5	Scenario 5, SRF initiated disconnect (abnormal disconnect)	98
A.2.2.6	Scenario 6, SCF initiated disconnect ('relay case').....	99
A.2.2.7	Scenario 7, SCF initiated disconnect (Assist case).....	100
A.2.2.8	AssistRequestInstructions error handling	100
A.2.3	SSF Model mapping	102
A.2.4	Description of the impacted SSF sub-entities	104
A.2.4.1	SCF Access Manager	104
A.2.4.1.1	Description of functionality	104
A.2.4.1.2	Description of data	104
A.2.4.2	SRF Relay Manager	104
A.2.4.2.1	Description of functionality	104
A.2.4.2.2	Description of data	105
A.2.4.3	INAP Service Access Point (INAP SAP).....	105
A.2.4.3.1	Description of functionality	105
A.2.4.3.2	Description of data	105
A.2.4.4	Service Feature Manager (SFM)	105
A.2.4.4.1	Description of functionality	105
A.2.4.4.2	Description of data	105
A.2.4.5	BCSM control	106
A.2.4.5.1	Description of functionality	106
A.2.4.5.2	Description of data	106
A.3	Charging scenarios	106
A.3.1	Introduction.....	106
A.3.2	DFP description	107
A.3.2.1	Charging scenarios	107
A.3.2.2	Charging interactions	107
A.3.2.3	Charging scenario 2.1.....	107
A.3.2.4	Charging scenario 2.2.....	108
A.3.2.5	Charging scenario 2.3.....	108
A.3.2.6	Charging scenario 2.4.....	109
A.3.2.7	Charging scenario 3.2.....	109
A.3.2.8	Charging scenario 4.1.....	110
A.3.2.9	Charging scenario 4.2.....	111
A.3.2.10	Interaction scenario 1	112
A.3.2.11	Interaction scenario 2	113
A.3.3	SSF Model mapping	113
A.3.3.1	Mapping of charging scenario 2.1	114

A.3.3.2	Mapping of charging scenario 2.2	116
A.3.3.3	Mapping of charging scenario 2.3	118
A.3.3.4	Mapping of charging scenario 2.4	120
A.3.3.5	Mapping of charging scenario 3.2	122
A.3.3.6	Mapping of charging scenario 4.1	124
A.3.3.7	Mapping of charging scenario 4.2	126
A.3.3.8	Mapping of interaction scenario 1	128
A.3.3.9	Mapping of interaction scenario 2	129
A.3.4	Description of the impacted SSF functionalities	129
A.3.4.1	EDP&CI Processing	130
A.3.4.2	CE Processing	130
A.3.4.3	Default Charging Info	131
A.3.4.4	Charge Gen.....	132
A.3.4.5	Charge Reg.....	133
A.3.4.6	CCF Charging	134
A.4	Call Gapping and Service Filtering scenarios.....	134
A.4.1	Introduction.....	134
A.4.1.1	Call Gapping	134
A.4.1.2	Service Filtering	134
A.4.2	DFP description	134
A.4.2.1	Call Gapping	134
A.4.2.2	Service Filtering	135
A.4.3	SSF Model mapping	135
A.4.3.1	Mapping of activation onto SSF model.....	136
A.4.3.2	Mapping of a gapped / filtered call onto SSF model.....	137
A.4.3.3	Mapping of gapping / filtering response onto SSF model.....	139
A.4.4	Description of the impacted SSF sub-entities	140
A.5	Activity Test scenario	141
A.5.1	Introduction.....	141
A.5.2	DFP description	141
A.5.3	SSF Model mapping	142
A.5.4	Description of the impacted SSF sub-entities	142
A.6	"Call Information" scenario	142
A.6.1	Introduction.....	142
A.6.2	DFP description	142
A.6.3	SSF Model mapping	143
A.6.3.1	CallInformationReport	144
A.6.3.2	CallInformation Report	144
A.6.4	Description of the impacted SSF sub-entities	144
A.7	"InitiateCallAttempt" scenarios	145
A.7.1	Introduction.....	145
A.7.2	DFP description	145
A.7.2.1	Scenario SCF initiated 'one party' call.....	145
A.7.3	Description of the impacted SSF sub-entities	148
A.7.3.1	SCF Access Manager	148
A.7.3.1.1	Description of functionality	148
A.7.3.1.2	Description of data	148
A.7.3.2	SSF Resource Manager	148
A.7.3.2.1	Description of functionality	148
A.7.3.2.2	Description of data	149
A.7.3.3	INAP Service Access Point (INAP SAP).....	150
A.7.3.3.1	Description of functionality	150
A.7.3.3.2	Description of data	150
A.7.3.4	Feature Interaction Manager (SFM).....	150
A.7.3.4.1	Description of functionality	150
A.7.3.4.2	Description of data	150
A.7.3.5	EDP&CI Processing.....	150
A.7.3.5.1	Description of functionality	150

A.7.3.5.2	Description of data	150
A.7.3.6	Basic Call State Manager (BCSM) control	150
A.7.3.6.1	Description of functionality	150
A.7.3.6.2	Description of data	150
A.7.3.7	Exchange Function	151
A.7.3.7.1	Description of functionality	151
A.7.3.7.2	Description of data	151
A.8	"ResetTimer" scenarios	151
A.8.1	Introduction	151
A.8.2	DFP description	151
A.8.3	SSF Model mapping	152
A.8.4	Description of the impacted subentities.	153
A.8.5	Description of the impacted SSF sub-entities	153
Annex B (informative): The Basic Call State Model control (BCSM control)		154
B.1	BCSM control	156
B.2	TDP Processing	156
B.2.1	PIC1 - O_NULL&Authorize_Origination_Attempt	156
B.2.2	PIC2 - O_Collect_Information	156
B.2.3	PIC3 - O_Analyse_Information	157
B.2.4	PIC 4 - Routing and Alerting	158
B.2.5	PIC 5 - O_Active	158
B.2.6	PIC 6 - O_Exception	158
B.2.7	PIC 7 - T_Null & Authorize_Termination_Attempt	159
B.2.8	PIC 8 - Select_Facility & Present_Call	159
B.2.9	PIC 9 - T_Alerting	159
B.2.10	PIC 10 - T_Active	160
B.2.11	PIC 11 - T_Exception	160
Annex C (informative): Modelling the relationship between Trigger Bases and IN Triggers		161
History		162

Intellectual Property Rights

IPRs essential or potentially essential to the present document may have been declared to ETSI. The information pertaining to these essential IPRs, if any, is publicly available for **ETSI members and non-members**, and can be found in SR 000 314: *"Intellectual Property Rights (IPRs); Essential, or potentially Essential, IPRs notified to ETSI in respect of ETSI standards"*, which is available **free of charge** from the ETSI Secretariat. Latest updates are available on the ETSI Web server (<http://www.etsi.org/ipr>).

Pursuant to the ETSI IPR Policy, no investigation, including IPR searches, has been carried out by ETSI. No guarantee can be given as to the existence of other IPRs not referenced in SR 000 314 (or the updates on the ETSI Web server) which are, or may be, or may become, essential to the present document.

Foreword

This ETSI Standard (ES) has been produced by ETSI Technical Committee Telecommunications Management Network (TMN).

1 Scope

The present document describes management requirements and a management information model for the IN CS-1 SSF functionality, based on Core INAP (CS1). Conformance statements (MOCS etc.) will not be included in the present document. Only the management of IN specific functionality is subject to the present document: it includes the management of TC and INAP, it does not address non IN specific call control functionality. The management information model for INAP that has been developed as part of the SSF management specifications is expected to be largely re-usable for the INAP stacks in other IN functional entities (e.g. SCF, SRF).

The present document provides a management requirement interface ES that can be used by operators and vendors in the procurement / offerings of new SSF functionality.

2 References

The following documents contain provisions which, through reference in this text, constitute provisions of the present document.

- References are either specific (identified by date of publication, edition number, version number, etc.) or non-specific.
- For a specific reference, subsequent revisions do not apply.
- For a non-specific reference, the latest version applies.
- A non-specific reference to an ETS shall also be taken to refer to later versions published as an EN with the same number.

- [1] EN 301 070-1: "Integrated Services Digital Network (ISDN); Signalling System No.7; ISDN User Part (ISUP) version 3 interactions with the Intelligent Network Application Part (INAP); Part 1: Protocol specification [ITU-T Recommendation Q.1600 (1997), modified]".
- [2] EN 300 291: "Telecommunications Management Network (TMN); Functional specification of Customer Administration (CA) on the Operations System/Network Element (OS/NE) interface".
- [3] EN 300 292: "Telecommunications Management Network (TMN); Functional specification of call routing information management on the Operations System/Network Element (OS/NE) interface".
- [4] EN 300 356-1: "Integrated Services Digital Network (ISDN); Signalling System No.7; ISDN User Part (ISUP) version 3 for the international interface; Part 1: Basic services [ITU-T Recommendations Q.761 to Q.764 (1997), modified]".
- [5] ETR 047: "Network Aspects (NA); Telecommunications Management Network (TMN); Management services".
- [6] ETR 062: "Network Aspects (NA); Baseline document on the integration of Intelligent Network (IN) and Telecommunication Management Network (TMN)".
- [7] ETR 224: "Intelligent Network (IN); IN Capability Set 2 (CS2); IN intra-domain management requirements for CS2".
- [8] ETS 300 293: "Telecommunications Management Network (TMN); Generic managed objects".
- [9] ETS 300 374-1 (1994): "Intelligent Network (IN); Intelligent Network Capability Set 1 (CS1) - Core Intelligent Network Application Protocol (INAP) - Part 1: Protocol specification".
- [10] I-ETS 300 637: "Network Aspects (NA); Functional specification of traffic management on the Network Element/Operations System (NE/OS) interface".
- [11] I-ETS 300 819: "Telecommunications Management Network (TMN); Functional specification of usage metering information management on the Operations System/Network Element (OS/NE) interface".

- [12] ISO/IEC JTC1/SC21 N8434 (1994): "Managed Objects for Upper Layers".
- [13] ITU-T Recommendation M.3100: "Generic network information model".
- [14] ITU-T Recommendation, Q.751.1: "Network element management information model for the Message Transfer Part (MTP)".
- [15] ITU-T Recommendation Q.751.2: "Network element management information model for the Signalling Connection Control Part".
- [16] ITU-T Recommendation Q.824.0: "Common information".
- [17] ITU-T Recommendation Q.1214 (1995): "Distributed functional plane for intelligent network CS-1".
- [18] ITU-T Recommendation Q.1218 (1995): "Interface Recommendation for Intelligent Network CS-1".

3 Abbreviations

For the purposes of the present document, the following abbreviations apply:

AD	Adjunct
BCSM	Basic Call State Model
BCP	Basic Call Process
CCF	Call Control Function
CG&SF	Call Gap and Service Filtering
CI	Charge Information
DFP	Detection Function Part
DLE	Destination Local Exchange
DPC	Destination Point Code
EDP	Event Detection Point
FIM	Feature Interaction Manager
GT	Global Title
INAP	Intelligent Network Application Protocol
INAP SAP	INAP Service Access Point
ISUP	ISDN Signalling User Part
OCA	Objectmodel for Customer Administration
OCH	Objectmodel on Charging Management
OLE	Originating Local Exchange
OLT	Originating Line Trigger
ORM	Call Routing Information Model
OTM	Objectmodel on Traffic Management
PIC	Point In Call
SCF	Service Control Function
SCP	Signalling Control Point
SFC	Service Feature Control
SFM	Service Feature Manager
SIB	Service Independent Buildingblock
SII	Service Interaction Indicators
SLPI	Service Logic Program Instance
SN	Service Node
SRF	Service Resource Function
SRP	Specialized Resource Point
SS7	Signalling System No.7
SSF	Service Switching Function
SSN	Sub System Number
TDP	Trigger Detection Point
TLT	Terminating Line Trigger
UMR	Usage Metering Control

4 Rationale

A large number of network operators are implementing IN solutions in the network. Although standards (INAP) are available for the interconnection of the IN equipment to the existing infrastructure, standards for the management of the new functionality are not yet available. As a result, incorporation of the new IN functionality into the installed base proves to be a very difficult and time consuming process.

Typically, in an IN implementation a large number of SSPs will be necessary. This may impact the management situation of a large number of exchanges of different vendors. Therefore it is very interesting, both for network operators (higher degree of independence in the procurement process) and for vendors (larger market of products based on standards), to standardize the management of the SSF functionality.

As the SSF functionality is seen as relatively simple in comparison with other IN FEs (SCF, SRF, SDF), the work on SSF information models can be seen as the first step towards a more complete specification of standard IN management solutions.

5 Overview

This clause gives an overview of the contents of the present document.

Clause 6 describes the three step technical approach used to specify the management of the SSF. The result of the first step, scenarios of the SSF, can be found in A. Clause 8 contains the requirements for management of the SSF (step 2), derived from the functional description. The actual specifications (step 3 in the approach) are given in subclauses 9.1 and 9.2, handles with the relation to other object models.

6 Technical approach

The approach used to eventually provide the specifications for management of the SSF is divided into three steps. A iteration is possible at any time.

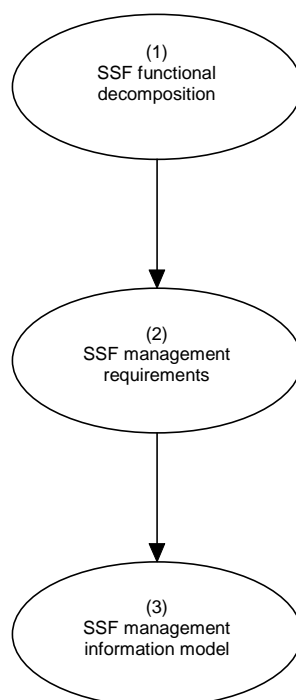

Figure 6.1: Overview of the approach

In the following subclauses these steps will be described in more detail.

6.1 SSF functional decomposition

6.1.1 Rationale

In order to come to the specification of a management information model of an SSF, it should first of all be clear what is to be managed. Therefore it is necessary to establish a common understanding of the functionality of an SSF. The basis for such a common understanding can be provided by a functional decomposition of the SSF functionality. This functional decomposition is based on the definition of the SSF as given in the ITU CS-1 Distributed Functional Plane (DFP) ITU-T Recommendation Q.1214 [17] and validated and detailed using the ETSI Core Intelligent Network Application Protocol (INAP).

The purpose of the functional decomposition is to:

- provide the basis for the common understanding of the SSF basic functionality (the target of the management study);
- provide a basis for the identification of management requirements and management modelling (the MIM modelling of the SSF);
- improve the readability.

NOTE: This functional decomposition is one of many possible decompositions. The implementor is not constrained to the derived internal SSF structure or the perceived interactions. It is possible for other SSF functionality to exist.

6.1.2 Method

The method used to come to the functional decomposition of the SSF contains the following steps (see also figure 6.2):

1.1 Analyse SSF documentation

In ITU-T Recommendation Q.1214 [17] (subclause 4.2) the SSF and its relationships with other IN-FEs are described. Based on this description an initial functional decomposition of the SSF, i.e. a 'SSF subentities model', can be made.

1.2 Analyse and select Core-INAP procedures

In the Physical Plane specification (Core-INAP) the information flow exchange between the IN-FEs are described with most detail. Identify which of the Core-INAP operations involve the SSF. Describe DFP scenarios for these operations.

1.3 Pick scenario

Choose a scenario that has not yet been mapped.

1.4 Correct / extend model

For the chosen scenario, identify the required data and functions in the SSF and try to map these to the identified SSF subentities.

If the mapping can be made, detail and validate the decomposition by considering the detailed operations and parameters in the DFP scenarios. Check also whether specific functionality has already been studied elsewhere, such as charging or routing. If this is the case, try to harmonize / re-use these.

If a mapping cannot be made, the functional decomposition should be adapted to allow the mapping.

1.5 Next Scenario ?

If all identified scenarios have been mapped, and the model appears complete (i.e., all SSF functions and data relevant for management seems to be identified sufficiently well), this model can be used as the basis for the requirements capture (see subclause 6.2 below).

If there are any scenarios left that have to be mapped, repeat steps 1.3 to 1.5.

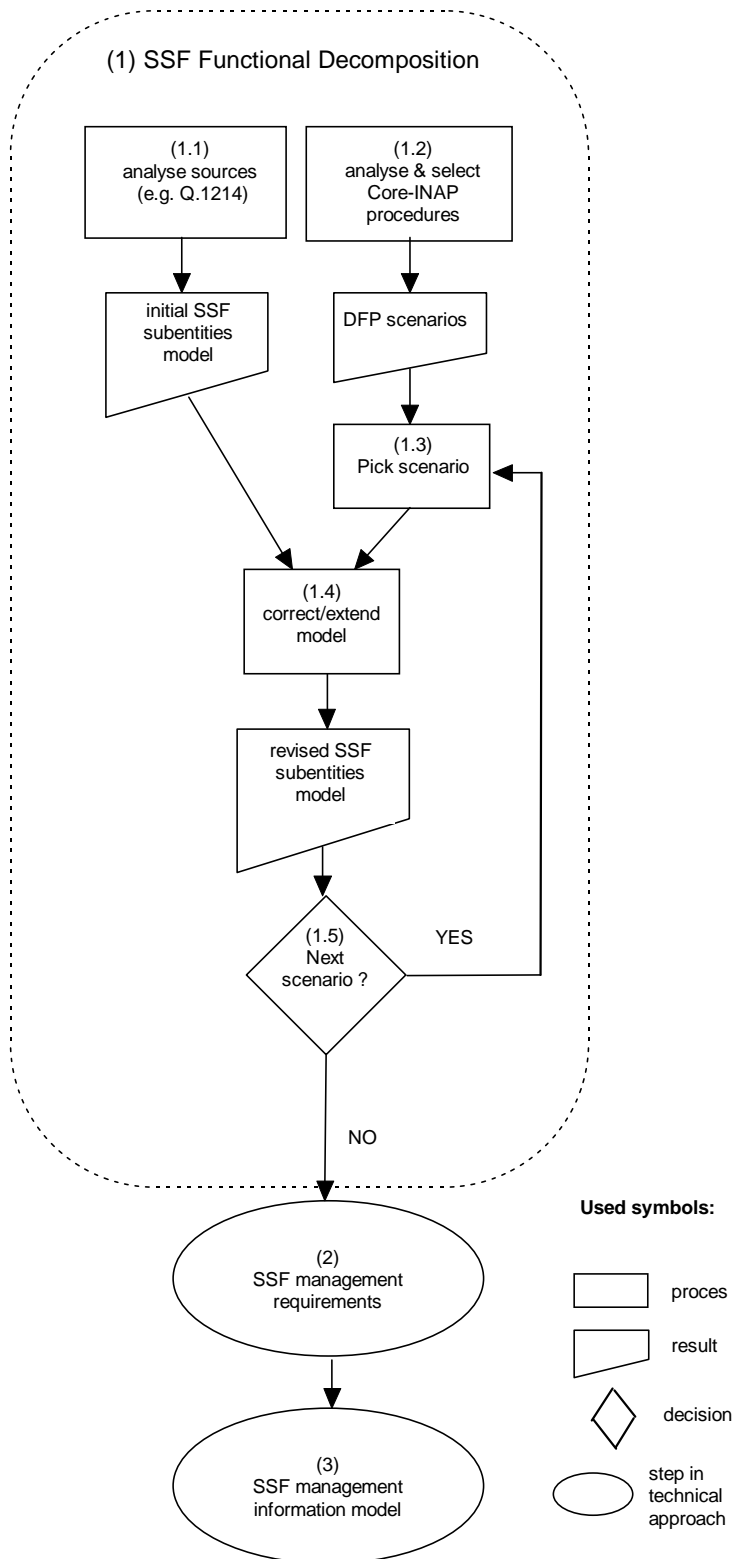

Figure 6.2: Method for SSF Functional decomposition related to the overall approach

The result of the functional decomposition of the SSF is given in clause 7.

6.2 SSF management requirements

6.2.1 Rationale

For each SSF sub-entity as identified in the SSF functional decomposition it should be analysed what part of the identified functionality and data should be subject to management (bottom-up). In order to put these management requirements in to perspective, and to check whether they are really required from an operational perspective, they should be related to real (or envisionable) operational requirements. It should be possible to map each operational requirement - at least partly - to operations on the data and functions of the SSF subentities. The operational requirements and the management activities that are derived in this subprocess are completely arbitrary. These steps are only taken to categorize the management requirements. The only goal is to identify the resulting management operations on SSF data.

6.2.2 Method

In the process of SSF Management requirements capture, the following terminology is used:

- operational requirement = a description of a management process that an IN operator would be needing for its business;
- management activity = set of management (OSF) operations upon one or more data entities.

In this requirements capture phase, the following steps are identified:

2.1 Identify operational requirements

The operational requirements are the basis for the top-down approach to derive the SSF management requirements. To identify these operational requirements use can be made of the experience of operational staff in managing IN structured networks; the DFP scenarios identified in step 1.2 can be used as a starting point in this analysis.

To fulfil an operational requirement, one or more 'management activities' need to be performed (a many to many containment relationship). The description of the operational requirements and the list of the containing management activities is recorded in an 'operational requirement template'.

2.2 Identify management activities

The management activities are the basic activities required to fulfil the operational requirements. Certain (and may be most) management activities will be found relevant for a number of operational requirements (see note 1). To fulfil a management activities, one or more management operations on SSF data need to be performed (a many to many containment relationship). The description of the management activities and the list of the containing management operations is recorded in a 'management activity template'.

2.3 Identify management operations on SSF data

The identification of the SSF data is based on the SSF sub-entity model provided in step 1.4. From this, it can be derived what management operations on data are *possible* (bottom-up). From step 2.2 it can be derived what management operations on data are *required* (to satisfy the operational management requirements). So this activity performs a cross-checking between the top-down and the bottom-up requirements. From this, a conclusion has to be drawn on the SSF data that is really required to be managed. The 'management operations on data' are formulated here as CRUD (note 2) operations on the data elements identified in the SSF sub-entities. A fairly detailed description of the data elements and the operations should be provided, so that a straightforward mapping to actual specifications can be made.

NOTE 1: The relation / functional overlap between the operational requirements can therefore be implicitly derived from these overlapping activities. It is however felt out of scope of the SSF Management study to make these interrelations explicit.

NOTE 2: CRUD = Create, Read, Update, Delete. These CRUD operations can be mapped directly to CMIP operations on managed objects. This however is for later concern.

The analysis of the operational requirements, the management activities and the management operations on data in SSF sub-entities will influence each other and the results will evolve in an iterative manner.

When the description of the management requirements is stable, the next step of providing the specifications for management of an SSF can be started.

This methodology for deriving the management requirements is depicted in figure 6.3.

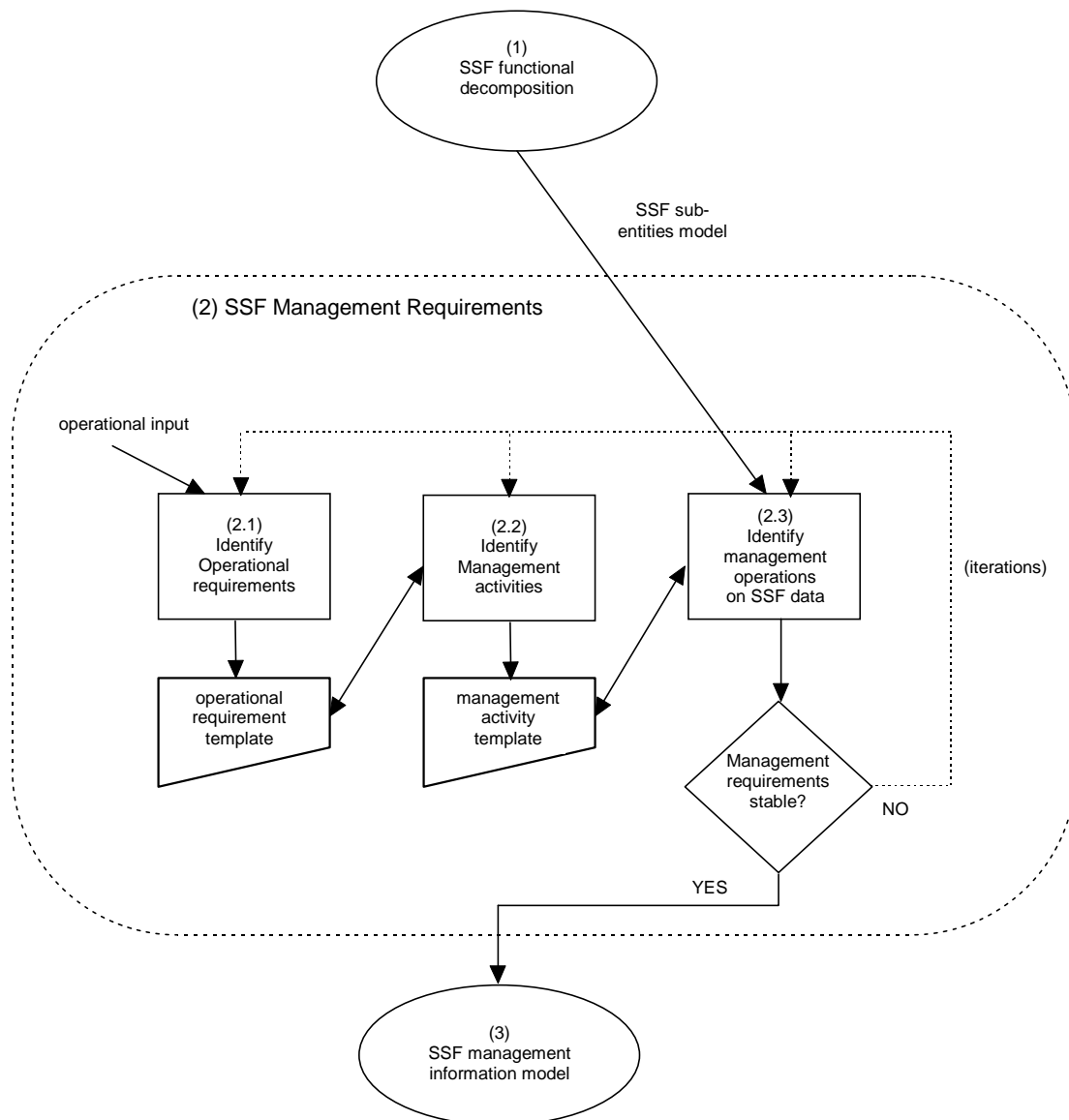

Figure 6.3: Method for capturing SSF management requirements related to the overall approach

The management requirements are provided in clause 8.

6.3 SSF management information model

6.3.1 Rationale

The definition of managed objects and their components have to fulfil clearly justified requirements related to the particular management objectives (see ITU Recommendation X.722, clause 7, "General principles for managed object definition"). Therefore the requirement definitions for SSF management are the starting point for the management information definitions. The step in the requirement capture "Identify operations on SSF data" is the principle source for identifying managed object classes, their attributes and possible operations related to them. In order to get from this to a management information model, several steps have to be worked through. Initially the structure and behaviour of managed objects is described informally and checked against the requirements and management examples. Only when stable, this information is going to be formalized using GDMO notation. This includes: the set of managed objects, their attributes, their structure (inheritance, subclass-relationship, naming attributes, etc.), the possible operations on managed objects and the related behaviour definitions, the possible contexts of definitions (leading to optionality and conditionality of parts of the definitions). The formal Managed Object Class Definitions resulting from this procedure are the normative representation of the structure and behaviour of SSF management information.

6.3.2 Method

The SSF management information model is captured using the following techniques:

3.1 Draw relational models for management parts

Starting from the nouns and verbal phrases in the Management Activity / Requirement tables draw an initial picture of managed objects and their relations (using verbal phrases to denote the associations between objects). This relational model is to be formalized by producing an entity relationship diagram using the OMT notation (this also includes inheritance and containment relations!). The diagram is supplemented by prose descriptions of every depicted managed object and attribute. These descriptions should include justifications of the information items in regard to the underlying requirements.

3.2 Define managed objects and their attributes

For every identified managed object: identify used attribute types, the object identification, possible operations on the managed object, behaviour of the managed object, possible notifications. This information is gathered into an informal managed object template. For every operational requirement this managed object model is checked against a dynamic representation of this requirement in "IN management scenarios". It has to be checked whether the management activities can be fulfilled by using the defined managed objects and the operations possible on them. In this step also examples of management scenarios are produced.

3.3 Integration of the management information definitions

The managed object definitions defined for different operational requirements have to be integrated into one model. Also managed object definitions from other management areas may have to be included. This may lead to a redesign of the model (i.e. go back to step 3.1) and/or a new refinement of the class definitions (i.e. go back to step 3.2).

3.4 Structure management information

The relationship between the defined management items has to be structured by: defining inheritance and subclass-relationships, defining naming attributes for every object class, identifying data packages and attribute groups. This leads to a further refinement of the managed object definitions, which is included in the informal templates. Also in this step separated inheritance and containment diagrams are produced.

3.5 Analyse optionality and conditionality

By analysing different views of a variety of possible SSF managers (network operator, IN service provider, IN service subscriber, IN service user) different aspects of the defined managed objects and the possible operations on them may be relevant or not. This is the basis for declaring certain items optional or making them conditional on certain constraints. It also may lead to a redesign of the model, if an object has to be split because only a part of it is used in every context. Finally the definition of packages is highly influenced by these aspects.

3.6 GDMO-formalization of the SSF management information model

Fill information into GDMO templates (Managed Object, Package, Parameter, Name binding, Attribute, Attribute group, Behaviour, Action, Notification templates), definition of abstract syntax, definition of object identifier values.

The results of step 3.1 to 3.5, i.e. the entity relationship, the inheritance, the containment diagrams and the informal descriptions of the managed objects, its attributes, its behaviour and the possible operations on them as well as an informal description of optionality and conditionality are included in the subclause 10.1 "SSF Object Model (informal)". The results of step 3.6 are out of scope of the present document.

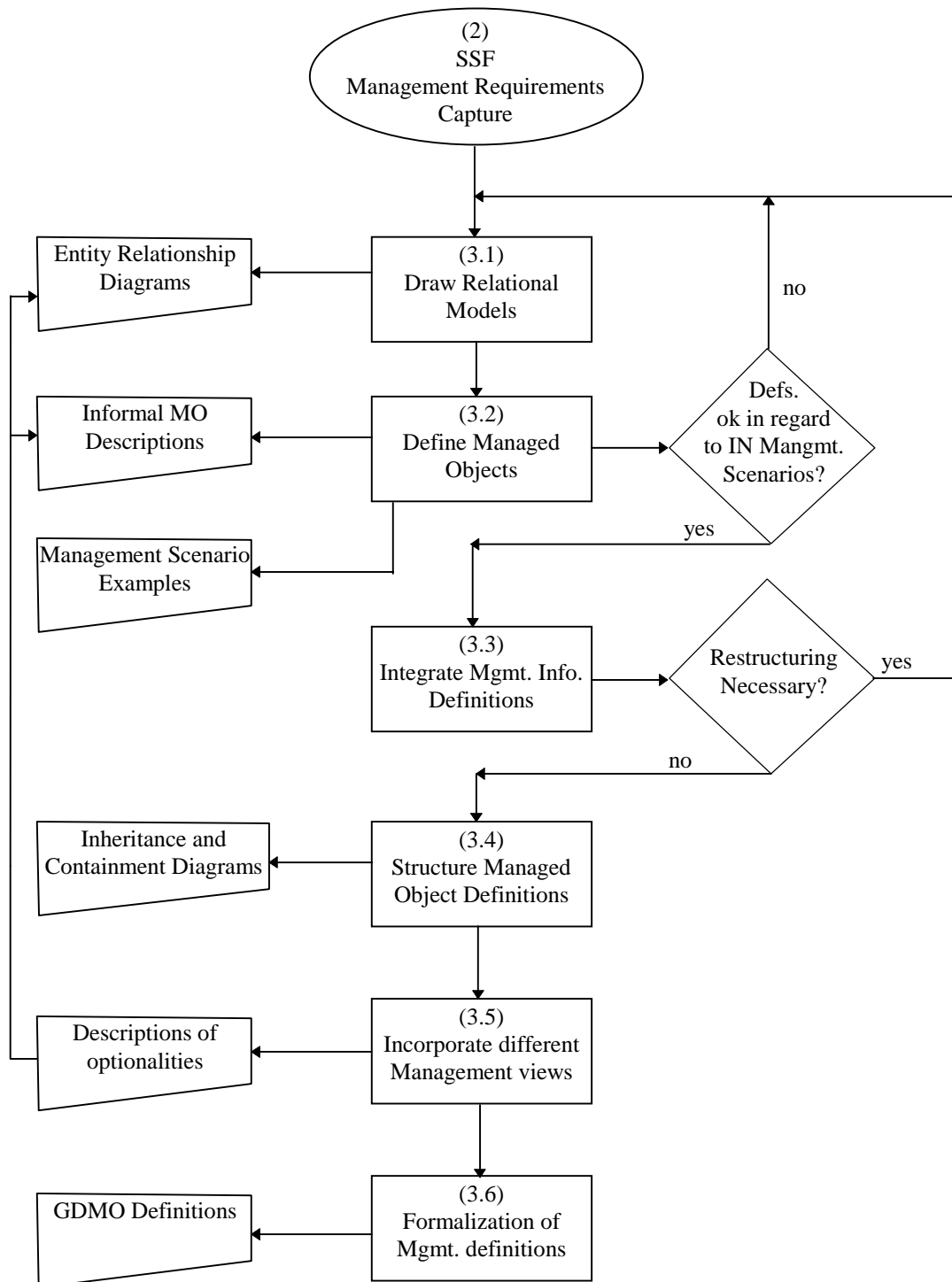

Figure 6.4: Method for defining the SSF management information model related to the overall approach

7 Introduction to the SSF model

This clause provides an overview of the functional decomposition of the SSF and a short description of each of the identified SSF sub-entities. How these sub-entities are related is described in the scenarios in annex A.

The figures in this clause shall clarify the distinction between the application process and the communication process (INAP) in the SSF as well as the relationship between the SSF sub-entities model and the models and figures in other documents, such as CS1 Core INAP and ITU-T Recommendation Q.1214 [17].

Figure 7.1 depicts the three basic parts that are the subject of study in the present document, i.e. the INAP service, the SSF application and the CCF application (only those parts directly related to IN). The SSF sub-entities will be allocated to the relevant three parts later.



Figure 7.1: SSF/CCF model

In figure 7.2 the relationship between the SSF/CCF model and the Core-INAP example architectures is given. This figure mainly focuses on the content of the INAP service part and the relationship with underlying signalling services.

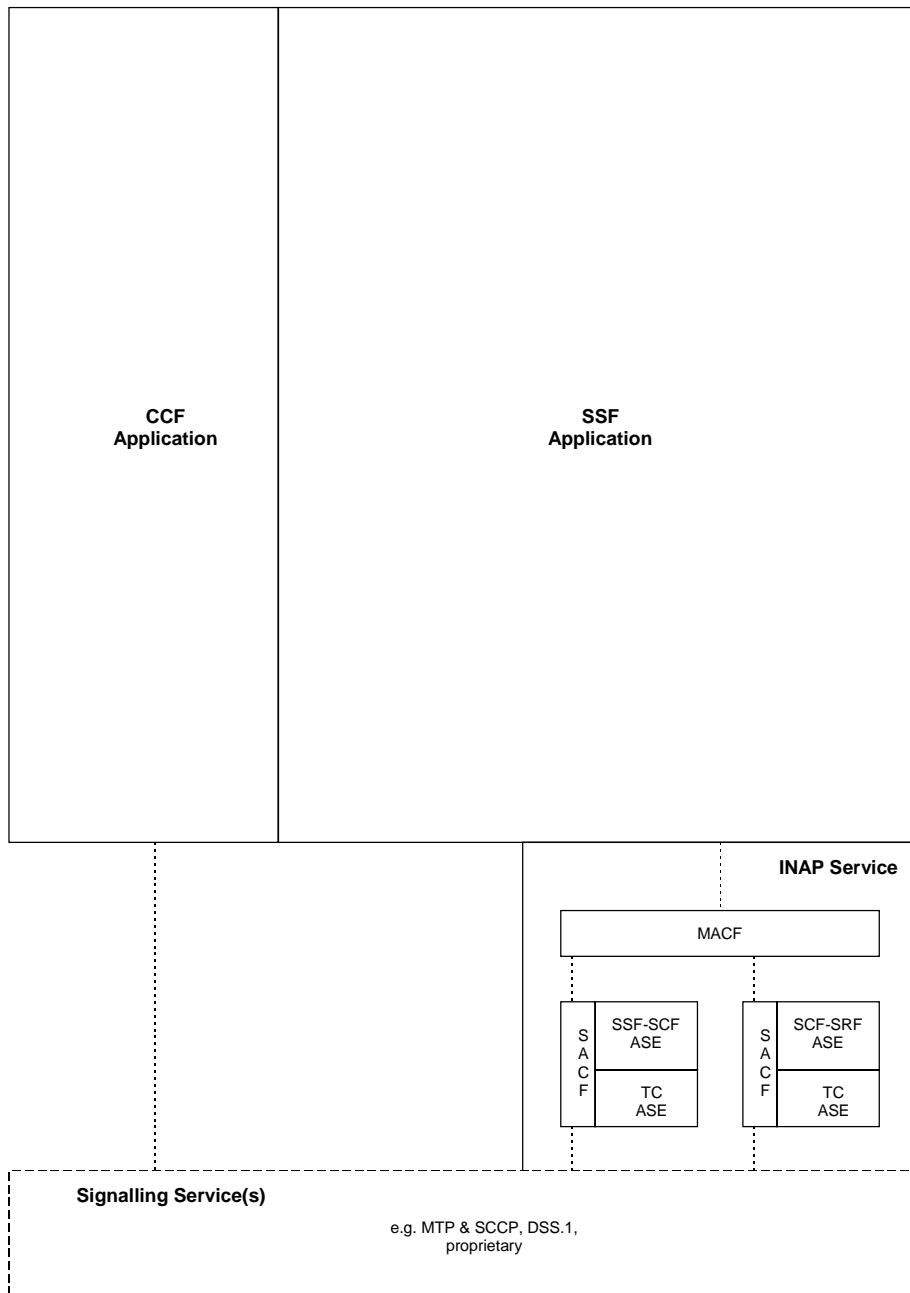

Figure 7.2: Relationship between SSF/CCF model and Core INAP example architectures

Figure 7.3 shows the relationship between the SSF/CCF model and the SSF/CCF model of ITU-T Recommendation Q.1214 [17]. The SSF functionality's identified in ITU-T Recommendation Q.1214 [17] are mapped on the SSF/CCF model.

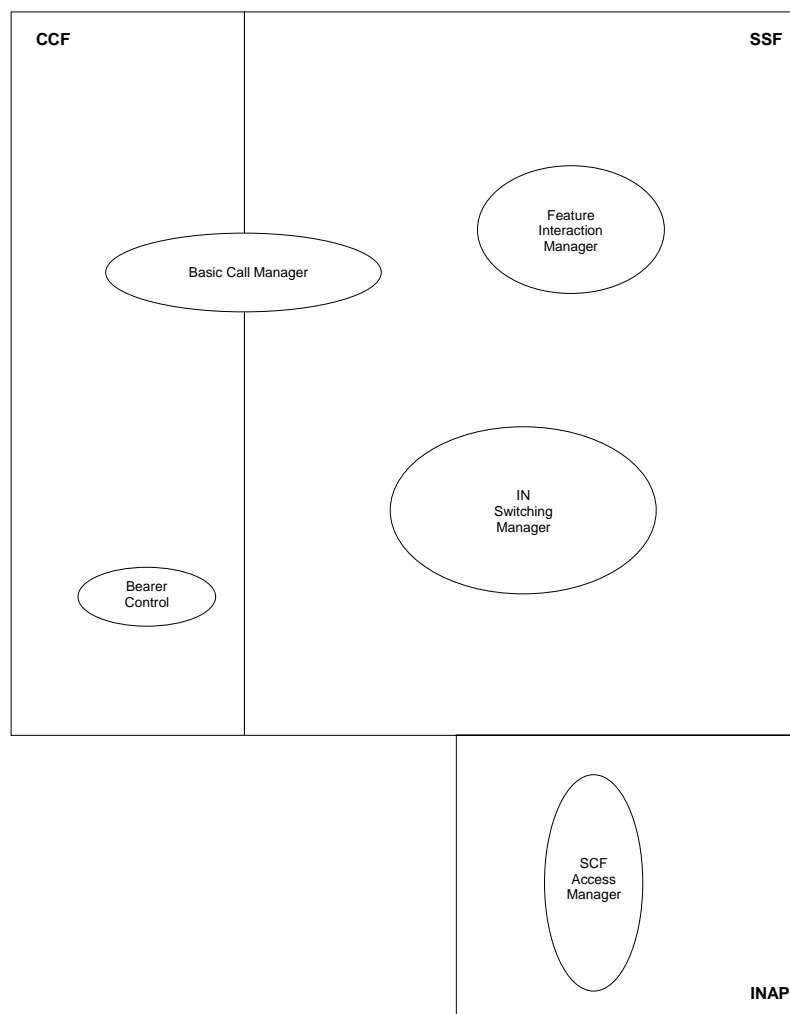

Figure 7.3: Relationship between SSF/CCF model and ITU-T Recommendation Q.1214 [17] clause 4 SSF/CCF model

Figure 7.4 shows the mapping of the SSF sub-entities identified in the scenarios on the SSF/CCF model.

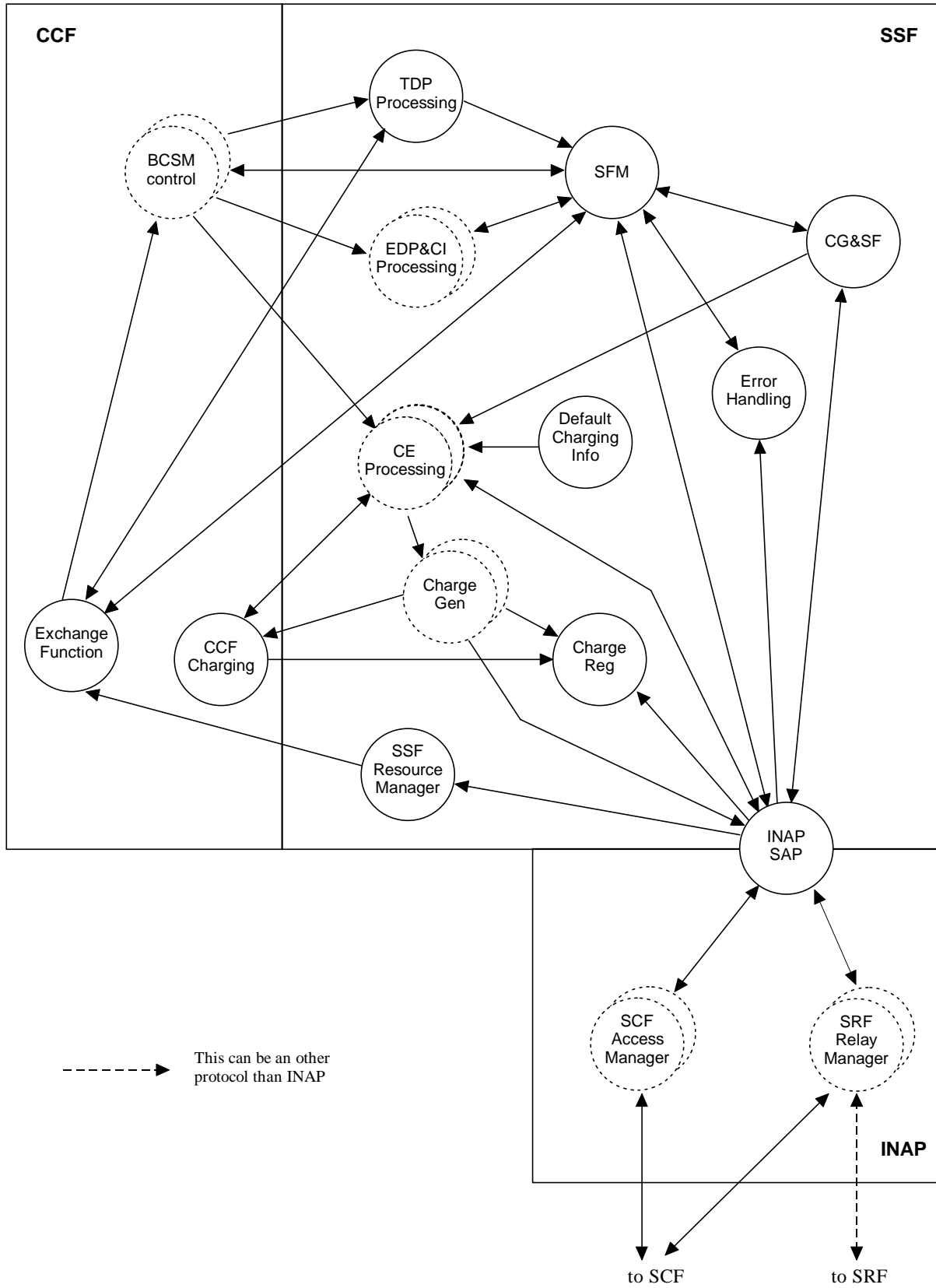

Figure 7.4: SSF/CCF functional decomposition (including INAP)

There is also a relationship between figure 7.3 and 7.4 where the SSF-sub-entities of figure 7.4 could be mapped onto the SSF functionality's in figure 7.3. However, since the functional decomposition of the SSF is only informative, and not the main part of the present document, this relationship is not further described here.

The following sub-entities in the SSF FE are identified:

Basic Call State Model control (BCSM control)

The BCSM provides a high-level model of the CCF activities. It identifies a set of connection and setup activities in a CCF and shows how these activities are joined together to process a basic call and connection. Aspects of the BCSM are reflected upwards to the SSF, and the BCSM Control sub-entity controls what these aspects are.

Call Gap and Service Filtering (CG&SF)

The CG&SF sub-entity controls the call gapping and service filtering capabilities of the SSF, and information on how to further process gapped or filtered calls.

Charge Event processing (CE processing)

The CE processing sub-entity is an event processing mechanism, that based on criteria provided by the SCF controls the charging generation in the SSF.

CCF charging

This sub-entity is a high-level abstraction of the charging functionality in the CCF. This sub-entity may provide the charge record from the CCF to the Charge Registration sub-entity for registration.

Charge generation (Charge Gen.)

The Charge Generation sub-entity performs the usage metering for IN calls. It should be noted, that charge generation may be done in local exchanges or in the SCF as well.

Charge Registration (Charge Reg.)

This sub-entity perform the recording of charge records if charge records should be stored in the SSF.

Default Charging information

The default charging information sub-entity provides default (static) information for usage metering in the SSF in cases, where necessary information may not be provided by the BCSM or SCF.

Error Handling

The Error Handling sub-entity holds the necessary information to handle error situation in IN call processing in cases, where service logic control is unable to control the call.

Event Detection Point and Charge Information Processing (EDP&CI processing)

The EDP&CI processing sub-entity is an event detection mechanism, that may be set up to detect events in a call. The detection criteria are set up by the SCF, and call processing / usage metering may be influenced at detection of an event.

Exchange Functionality

This sub-entity holds some default (static) information to be used in cases, where the BCSM does not provide enough information for the SCF to set up a call or to process an existing call.

INAP Service Access Point (INAP SAP)

The INAP SAP sub-entity is a protocol translation sub-entity, that translates proprietary signalling inside the SSF to INAP signalling.

Service Feature Manager (SFM)

The SFM determines the IN services to be initiated and manages the feature interaction.

SCF Access Manager

This sub-entity controls the dialogue to a specific SCF.

SRF Relay Manager

This sub-entity controls the dialogue to the SRFs, and also the protocol translations in cases where the signalling capabilities between SSF and SRF are not INAP.

SSF Resource Manager

This sub-entity provides the SCF with information about and access to the resources necessary to set up a call. This information may be useful when the SCF initiates call by itself.

TDP Processing

The TDP processing in a trigger detection sub-entity, that based on the information in the BCSM detects calls that activate an IN or non-IN service.

Multiple instances of call processes

Within the functional decomposition of the SSF a number of processes are defined. These processes are understood to be sub entities of the SSF and could be implemented as physically integrated or separated entities; this however is manufacturer / operator specific and does not effect the operation or understanding of each process depicted. For each call instance a number of call instance processes are created. For the sake of understanding the management processes figure 7.4 depicts some of the processes as 'multiple'. This is because at any one instance in time more than one call instance is up and running. In other cases more than one process may be created for one call instance. The following text explains the reason for each of the multiple depiction of processes in figure 7.4:

- **Multiple BCSM controls**

For each instance of a call an originating BCSM control instance is created (originating half call). After processing of the call set-up phase (and possible interaction with the SCF) a terminating instance of the BCSM control will be created (terminating half call), i.e. a call instance consists both of an originating and a terminating half call portion. An IN trigger may be detected either within an originating half call (O_BCSM control instance) or within a terminating half call (T_BCSM control instance) causing the SCF (SLPI) invocation. At any one point in time more than one call instance in the CCF will be interacting with the SSF and therefore many BCSM processes.

Multiple EDP&CI Processing For each instance of originating BCSM control and a terminating BCSM control an EDP&CI processing instance may be created. Therefore for each instance of O_BCSM control and T_BCSM control within one call segment, one instance of a EDP&CI Processing may be created.

- **Multiple instances of Charge Event Process**

For each instance of a BCSM control, a relationship is made to a Charge Event Processing (CEP). Because any time within an SSF, 1 to n instances of a BCSM control may exist, 1 to n instances of a CEP will also exist.

- **Multiple Charge Generation**

For each instance of a call a separate Charge Generation (CG) needs to be invoked that will receive charging information from the SCF and duration information from the CCF. As with CEP, 1 - n instances of CG may exist at any one point in time in the SSF.

- **Multiple SCF Access Managers and SRF Relay Managers**

During any active call phase, interaction will be made between the SSF and the SCF and in many instances with an SRF. Multiplicity relates to the dialogues between SSF and SCF respective SRF.

In annex A the functionality of each of these sub-entities is derived via analysis of the required functions and data for a number of service invocation scenarios.

8 Management requirements for the SSF sub entities

8.1 Introduction

This clause contains a description of requirements identified for management of the SSF functionality. I.e. it contains a description of the management services that a network element manager has to provide to a service manager in regard to managing the SSF functionality (see also ETR 224 [7], subclause 5.3, IN functional management requirements between Service Manager - Network / Element Manager).

The operational requirements templates forms the base of identifying objects. The following operational requirements are defined:

- Configure triggering of IN based service feature control;
- Start call gapping;
- Stop call gapping;
- Read current gapping criteria;
- Configure default values (call gapping);
- Configure SRF/SCF relaying capabilities of the SSF;
- Configure SRF assisting;
- Configure default parameters (service filtering);
- Read service filtering;
- Configure a set of originating call set-up data for SCF initiated call;
- Read current defined originating call set-up data for SCF initiated call;
- Configure IN charging;
- Configure error handling;
- Start INAP Measurements counters;
- Stop INAP Measurements counters;
- Read current INAP Measurement counters.

8.2 Operational Requirements and Activities

Operational Requirement (OR1)	
Name	Configure triggering of IN based service feature control
Description	The network element manager is able to configure trigger conditions within basic call processing and associate them with requests of IN based service feature control.
Activities	Configure trigger detection point Configure service feature control information Configure SCF access Read trigger data
Name	Configure trigger detection point
Description	Configure relationship of trigger detection points with basic call processing.
Management operations on data	<p>IN trigger (CREATE)</p> <p>An IN trigger is defined by a trigger detection point category (related to the point in call where triggering might occur). There may be different trigger categories depending on the used BCSM model. IN triggering may be dependent on trigger criteria that are modifiable by administration. A (detected) IN trigger activates a service feature control, as far as itself is not in state "inactive".</p> <p>An IN trigger will be in general related to service type specific management (i.e. it will be installed during deployment of a service logic and removed, when removing associated service logic; actors: service provider, network operator). However it might be used to activate more than one service logic and it may be used also in some cases only for a customer specific service control instance.</p> <p>Trigger Criteria (CREATE / UPDATE / DELETE)</p> <p>Trigger criteria may be for example a digit string, cause value, specific origin, feature activation, nature of address or a combination of them (AND, OR, NOT). Trigger Criteria may be used by an IN trigger or they may be directly part of digit analysis when triggering TDP "Analysed Information".</p> <p>Trigger base (CREATE)</p> <p>Triggering may be relative to the following basic facilities of call processing: customer accesses, private facilities, trunk groups, digit analysis.</p> <p>E.g. a customer line based trigger may be associated to a single directory number, a group of directory numbers, a specific access channel related to a PBX-subscriber, a special supplementary service related to a customer profile (e.g. triggering only if the customer is reached with teleservice "fax").</p> <p>If a base object (customer access, trunk group, private facility, digit tree entry) bears a trigger base at all, it bears at most one of them for the terminating and/or one for the originating side of the BCSM (e.g. for OLTs and TLTs). There may be several IN triggers associated to the same trigger base.</p> <p>Trigger bases can be deactivated temporarily.</p> <p>Trigger bases will in general be managed only service instance specific (not service type specific). I.e. management of them will happen in the service life cycle in the phases "service instance provisioning", "activation activities" and "service instance withdrawal" (actors: service provider, service subscriber, service user, network operator).</p>

Activity (OR1-A1)
<p>Beside network element management the configuration of a line trigger base may involve interaction between the network operator, service provider, service user.</p> <p>Office based triggering (CREATE)</p> <p>An office based trigger is attached to digit analysis items (e.g. specific digit string, access code, national destination). It can be detected only after the PIC "Analysed Information". Digit analysis is a special kind of trigger base. Either the digit analysis leads directly to IN triggering or there may be further trigger conditions to be checked or later events (e.g. "busy", "no answer") that then initiate IN triggering.</p> <p>Customer / trunk group / private facility / digit analysis object</p> <p>Objects of this kind may or may not be attached to trigger bases.</p> <p>Escape Conditions (CREATE / UPDATE / DELETE)</p> <p>Criteria related to call data that result in a return to normal call processing while processing an IN trigger.</p> <p>Selection Criteria (CREATE / UPDATE / DELETE)</p> <p>For the same IN trigger and trigger criteria different IN service controls may be selected depending on connection characteristics (e.g. in the case of broadband usage).</p> <p>IN Authorization (CREATE / UPDATE / DELETE)</p> <p>For customer related features in exchanges where their direct access is not located it should be possible to restrict IN triggering to calls that originate or terminate at a specified customer access at a local exchange different from the exchange, where this features are implemented as IN service feature. The customer may be identified by a specific calling or called party number. This number may also include the extension number within a private branch exchange.</p>

Activity (OR1-A2)
<p>Name</p> <p>Configure service feature control</p>
<p>Description</p> <p>Configure access to service feature control or exit from it.</p>
<p>Management operations on data</p> <p>IN service name (CREATE)</p> <p>Identifies the service logic in an abstract manner (logical service key). The service feature control may be activated by a IN trigger or digit analysis and will use an SCF access to get instructions for controlling the service. A service feature control is in general managed service type specific. I.e. it is created during service deployment, modified during service type related control activities and deleted during service removal (actors: service provider, network operator).</p> <p>Beside network element management the configuration of an IN service feature control may involve interaction between the network operator and the service provider.</p> <p>Processing instructions (CREATE / UPDATE / DELETE)</p> <p>Criteria related to call data that result in a reject of the service control access and lead to an exception handling. E.g. "IN-IN interworking inhibited for this service" or "IN service is not allowed to influence calling line charging".</p> <p>Service activation state (CREATE / UPDATE)</p> <p>Information, whether IN control for the service feature is possible or not at the moment.</p> <p>exception handling (CREATE / UPDATE)</p> <p>Information how (and in which state) to proceed call processing (e.g. play an announcement).</p> <p>Mapping of SCF routing information onto CCF routing objects (CREATE / UPDATE)</p> <p>A service feature control will use a specific SCF access and a specific IN application protocol ASE.</p> <p>Customization of a Service type in the SSF</p> <p>This activity may be done on several levels: (i) set properties of the service feature control (like processing instructions, used application protocols, etc.), (ii) assign different IN triggers to the service feature control that may activate it (thereby defining different possible conditions on which the service may be triggered by different customers), (iii) assign line trigger bases associated to specific customer lines or trunks to the IN triggers defined before or assign a digit analysis output to the service feature control (thereby relating the IN service control to actual telecommunication resources).</p> <p>This customization may also be realized by assigning a Provisioning Profile to a service subscriber. Depending on the selected provisioning profile different IN triggers, SCF accesses, announcements, etc. are selected for one service feature control. The provisioning profile may be located in the SMF, the SCF or SSF (or distributed between them).</p>

Activity (OR1-A3)	
Name	Configure SCF access
Description	Configure IN application protocol specifics and SCF address data.
Management operations on data	<p>INAP ASE (CREATE)</p> <p>A service feature control uses for its control activities an INAP ASE restricted by a specific application context which defines which operations of the protocol can be received or send. The configuration of SCF accesses and IN application protocols is independent of the management of services. Its actor is in general the network operator.</p> <p>An INAP ASE is part of the SCF-SSF Application Entity used within an network element. There may be several INAP ASEs within one SCF-SSF AEs. An other part of the SCF-SSF AEs are the TCAP ASEs. In case of protocol errors, the SCF-SSF AE may use fallback protocols instead of those originally chosen.</p> <p>SCF access (CREATE)</p> <p>A service feature control uses either MTP addresses or SCCP addresses to invoke associations with service control points.</p>

Activity (OR1-A4)	
Name	Read trigger data
Description	It should be possible, to retrieve information about the trigger base, the activation state of the trigger, the trigger criteria and the association to service feature controls.
Management operations on data	<p>trigger base (READ)</p> <p>It should be possible for trigger base objects (customer lines, trunk groups, code points, centrex groups, etc.) to get all attached triggers. This may be all triggers or only those of a specific trigger category. Especially it should be possible to get information about the activation or deactivation of this attachment.</p> <p>IN trigger (READ)</p> <p>It should be possible to get information about the trigger criteria of a specific IN trigger and to determine the associated service feature control.</p> <p>service feature control (READ)</p> <p>It should be possible to retrieve all the information related to a specific service Id. It should also be possible to get information about the SCF access and SSF/SCF application protocol used by the service feature control.</p>

Operational Requirement (OR2)	
Name	The network element manager can start Call Gapping
Description	This operation is issued in order to start Call gapping from the OSF
Activities	Configure call gapping

Activity (OR2-A1)	
Name	Configure call gapping
Description	<p>This activity performs all necessary configuration for OSF controlled call gapping. If the parameter gapTreatment is omitted, the default values are used.</p> <p>NOTE: Stopping and removing call gapping is done by setting gapInterval to '0' for a specific value of gapCriteria.</p>
Management operations on data	<p>gapCriteria (CREATE, UPDATE, DELETE)</p> <p>gapIndicators</p> <ul style="list-style-type: none"> • duration (CREATE, UPDATE, DELETE) • gapInterval (CREATE, UPDATE, (delete)) <p>controlType (CREATE, UPDATE, DELETE)</p> <p>gapTreatment (CREATE, UPDATE, DELETE)</p>

Operational Requirement (OR3)	
Name	The network element manager can stop Call Gapping
Description	This operation is issued in order to stop Call gapping from the OSF
Activities	Configure call gapping (only gapIndicators and gapCriteria are mandatory)

Activity (OR3-A1)	
Name	Configure call gapping
Description	This activity performs all necessary configuration for OSF controlled call gapping. If the parameter gapTreatment is omitted, the default values are used. NOTE: Stopping and removing call gapping is done by setting gapInterval to '0' for a specific value of gapCriteria.
Management operations on data	gapCriteria (CREATE, UPDATE, DELETE) gapIndicators <ul style="list-style-type: none"> • duration (CREATE, UPDATE, DELETE) • gapInterval (CREATE, UPDATE, (delete)) controlType (CREATE, UPDATE, DELETE) gapTreatment (CREATE, UPDATE, DELETE)

Operational Requirement (OR4)	
Name	The network element manager can read current gapping criteria
Description	Reads parameters for ongoing call gapping, if any.
Activities	Read current gapping criteria

Activity (OR4-A1)	
Name	Read current gapping criteria
Description	Reads parameters for ongoing call gapping, if any.
Management operations on data	gapCriteria (READ) gapIndicators <ul style="list-style-type: none"> • duration (READ) • gapInterval (READ) controlType (READ) gapTreatment (READ)

Operational Requirement (OR5)	
Name	The network element manager is able to configure default call Gapping values
Description	This operation configures all parameters, that are optional in the CallGap operation sent from the SCF (The gapTreatment parameter)
Activities	Set default treatment of calls subject to gapping

Activity (OR5-A1)	
Name	Set default treatment of calls subject to gapping
Description	This activity set the default values for gapTreatment for use with SCF initiated call gapping. The gapTreatment is optional in the CallGap operation.
Management operations on data	gapTreatment (CREATE, UPDATE)

Operational Requirements (OR6)	
Name	The network element manager is able to configure SRF/SCF-relaying capabilities of the SSF
Description	Handling information about the possibilities of relaying SCF/SRF-control at an SSF
Activities	Configure SRF resource availability

Activity (OR6-A1)	
Name	Configure SRF resource availability
Description	Handling information about the availability of SRF resources at the SSF
Management operations on data	IP Available (UPDATE) Indicates the availability of a SRF resource IP/SSP Capabilities (UPDATE) Description of SRF resources available at the SSF

Operational Requirements (OR7)	
Name	The network element manager is able to configure SRF assisting
Description	Configure handling of assist requests for SCF/SRF-relaying in the initiating and assisting SSF
Activities	Configure trigger detection point Configure assist treatment Configure establishment of temporary connection

Activity (OR7-A1)	
Name	Configure trigger detection point
Description	Configure trigger detection point within basic call processing and associate it with an assist treatment
Management operations on data	Trigger detection point (CREATE) See basic call scenarios. A TDP (e.g. TDP3) may be associated to a assist treatment. Trigger criteria (CREATE / UPDATE / DELETE) See basic call scenarios.

Activity (OR7-A2)	
Name	Configure assist treatment
Description	Configure handling of assist requests in an assisting SSF
Management operations on data	IP availability (UPDATE) Information about the availability of the requested SRPs at the assisting SSF IP/SSP capabilities (UPDATE) Information about the capabilities of the SRF resources available at the assisting SSP. Mapping of digit strings to correlation ID (UPDATE) Mapping of digit strings to SCF ID (UPDATE) Associate assist request to SCF access

Activity (OR7-A3)	
Name	Configure establishment of temporary connection
Description	Configure handling of assist relationship establishments in the initiating SSP
Management operations on data	Supervision timer for "waiting for end of temporary connection" (UPDATE)

Operational Requirement (OR8)	
Name	The network element manager is able to configure default parameters for service filtering
Description	This operation configures all default parameters in service filtering
Activities	Set default duration

Activity (OR8-A1)	
Name	Set default duration
Description	This activity sets the default duration of service filtering in case the filtering-TimeOut(duration) = -2 for a ActivateServiceFiltering operation
Management operations on data	filteringTimeOut duration (CREATE, UPDATE)

Operational Requirement (OR9)	
Name	The network element manager can read service filtering data
Description	This operation reads all pending and ongoing service filtering data
Activities	Read current filtering data and status

Activity (OR9-A1)
Name Read current filtering data and status
Description This activity reads all ongoing and pending service filtering data and defined counters values
Management operations on data <ul style="list-style-type: none"> filteredCallTreatment • sFBillingChargingCharacteriztics (READ) • informationToSend (READ) • maxNumbersOfCounters (READ) • releaseCause (READ) filteringCharacteriztics (READ) filteringTimeOut (READ) filteringCriteria (READ) startTime (READ) CountersValue (READ)

Operational Requirement (OR10)
Name The network element manager is able to configure a set of originating call set-up data for SCF initiated call
Description <p>This operation configures the properties and capabilities required for a call set-up initiated from the SCF. It will be network dependent default originating call data to be defined, normally received or associated with the calling party number.</p> <p>At least one mandatory set of call set-up data shall be defined. More than one set may optionally be defined. This should be done in case the option conditional selection of originating call set-up data is used.</p> <p>If the parameter calling party number is not received from SCF, the mandatory defined default set (set 1) of originating call set-up data values are used.</p> <p>This operation allows in case a calling party number is supplied by the SCF, that these properties may be dependent on the received calling party number.</p> <p>If a received calling party number does not match the criteria for conditional selection of a specific set of originating call set-up data values, the mandatory defined default set (set 1) of originating call set-up data values are used (note).</p> <p>NOTE: SCF received values will have precedence over SSF provided default values, i.e. the SCF received calling partynumber will in this case be used in the call set-up, even if a SSF defined default value is defined.</p>
Activities Set default originating call set-up information

Activity (OR10-A1)
<p>Name Set default originating call set-up information</p>
<p>Description This activity defines one complete set of default originating call set-up data values needed to perform a SCF initiated call set-up upon receipt of an InitiateCallAttempt operation. The call set-up data set is identified by the default defined calling party number. This activity allows dependent on calling party number the selection of a default originating call set-up information set. More than one set of originating call set-up information values may be defined to allow conditional selection of properties dependent on received calling party number from the SCF. NOTE: Guiding values are indicated in the EN 301 070-1 [1] 'Interaction between IN Application Protocol and ISDN User Part version 3.</p>
<p>Management operations on data <i>Calling Party Number</i> (CREATE, UPDATE, DELETE) Value: Refer to ETS 300 356-1 [4] or Q.763 for encoding <i>Calling Party's Category</i> (CREATE, UPDATE, DELETE) Value: Refer to ETS 300 356-1 [4] or ITU-T Recommendation Q.763 or for encoding <i>Forward Call Indicators</i>: Values: Refer to ETS 300 356-1 or ITU-T Recommendation Q.763 for encoding <ul style="list-style-type: none"> • National / International call indicator (CREATE, UPDATE, DELETE) • end-to-end method indicator (CREATE, UPDATE, DELETE) • interworking indicator (CREATE, UPDATE, DELETE) • end-to-end information indicator (CREATE, UPDATE, DELETE) • ISDN user part indicator (CREATE, UPDATE, DELETE) • ISDN user part preference indicator (CREATE, UPDATE, DELETE) • ISDN originating access indicator (CREATE, UPDATE, DELETE) • SCCP method indicator (CREATE, UPDATE, DELETE) Nature of connection indicators Values: Refer to ETS 300 356-1 [4] or ITU-T Recommendation Q.763 for encoding <ul style="list-style-type: none"> • satellite indicator (CREATE, UPDATE, DELETE) • continuity check indicator (CREATE, UPDATE, DELETE) • echo control device indicator (CREATE, UPDATE, DELETE) Bearer service (transmission medium) (CREATE, UPDATE, DELETE) Value: Refer to ETS 300 356-1 [4] or ITU-T Recommendation Q.763 TMR for encoding</p>

Operational Requirement (OR11)
<p>Name The network element manager can read current defined originating call set-up data for SCF initiated call</p>
<p>Description This operation reads the defined properties and capabilities required for a call set-up initiated from the SCF, if any defined. One or more set of originating call set-up information may be read.</p>
<p>Management operations on data Read a set of default originating call set-up information</p>

Activity (OR11-A1)
<p>Name Read a set of default originating call set-up information</p>
<p>Description Read the default originating call set-up information needed to perform a call set-up upon receipt of an InitiateCallAttempt operation, if any.</p>
<p>Management operations on data <i>Calling Party Number (READ)</i> <i>Calling Party's Category (READ)</i> <i>Forward Call Indicators:</i></p> <ul style="list-style-type: none"> • National / International call indicator (READ) • end-to-end method indicator (READ) • interworking indicator (READ) • end-to-end information indicator (READ) • ISDN user part indicator (READ) • ISDN user part preference indicator (READ) • ISDN originating access indicator (READ) • SCCP method indicator (READ) <p>Nature of connection indicators:</p> <ul style="list-style-type: none"> • satellite indicator (READ) • continuity check indicator (READ) • echo control device indicator (READ) <p>Bearer service (transmission medium) (READ)</p>

Operational Requirement (OR12)
<p>Name The network element manager is able to configure IN related extensions of usage metering and its charging</p>
<p>Description It should be possible to extend the usage metering and its charging, as it is given for non-IN operation of telecommunication resources, for the needs of IN controlled operation. Normally this IN extension is controlled by the SCF itself, using the SCI/FCI-operations of INAP. But there are some cases where this has to be supplemented by management. This may be the case, if no INAP-charging operation is used at all (default charging), or the information for determining the usage control type is incomplete. Furthermore, IN-specific information should be notified in a flexible manner in usage metering records.</p>
<p>Activities Configure Default Charging Configure Usage Recording Notification of IN specific data in usage metering records</p>

Activity (OR12-A1)
<p>Name Configure Default charging</p>
<p>Description In case the SCF did not provide information on how to charge an IN call, it has to be decided per service feature control how to charge this call. Either: the charging determined before (non-IN-related, e.g. in a local exchange) may be left unchanged; or the call may be set free of charge; or the call may be released; or a specified tariff may be activated.</p>
<p>Management operation on data Default Charge Handling within a service feature control (READ, UPDATE)</p>

Activity (OR12-A2)
<p>Name Configure Usage Recording</p>
<p>Description In case of insufficient information for determining the usage metering control function (e.g. because of IN-triggering before digit-analysis is complete), it may be necessary to IN-service-specifically give some input into the control function (e.g. to determine the record type or the accountable object).</p>
<p>Management operation on data Charging Profile within a service feature control (READ, UPDATE)</p>

Activity (OR12-A3)
Name Notify IN related information within usage metering log
Description Notify IN service and service-subscriber related data within the usage meterin log for IN calls
Management operation on data IN Service Subscriber specific Information (NOTIFY) IN Service usage information (NOTIFY)

Operational Requirement (OR13)
Name The network element manager is able to configure Error handling
Description This operation configures the SSF to handle error situation.
Activities Configure <i>InitialDP</i> error handling Configure <i>ApplyCharging</i> error handling Configure Timer expiration (T_{SSF}) handling

Activity (OR13-A1)
Name Configure <i>InitialDP</i> error handling
Description This activity defines the handling of operational related errors after an <i>InitialDP</i> has failed. For each error response from the SCF, the network operator has to decide what default treatment that applies. Some possibilities are listed as examples. For each error procedure, the actual management action is listed in brackets.
Management operations on data <i>MissingCustomerRecord</i> Call Released, optionally play announcement (CREATE, UPDATE) <i>MissingParameter, SystemFailure, TaskRefused, UnexpectedDataValue, UnexpectedParameter</i> : If the <i>InitialDP</i> was send after a mid call trigger, the network operator may chose to maintain the call or release it. If the call is released, an announcement may be played. (CREATE, UPDATE)

Activity (OR13-A2)
Name Configure <i>ApplyCharging</i> error handling
Description This activity defines the handling of operational related errors after an <i>ApplyCharging</i> has failed. For each error response from the SCF, the network operator has to decide what default treatment that applies. Some possibilities are listed as examples. For each error procedure, the actual management action is listed in brackets.
Management operations on data <i>MissingParameter</i> Maintain / release call (CREATE, UPDATE) <i>ParameterOutOfRange</i> Maintain / release call (CREATE, UPDATE) <i>SystemFailure</i> , Maintain / release call (CREATE, UPDATE) <i>TaskRefused</i> , Maintain / release call (CREATE, UPDATE) <i>UnexpectedComponentSequence</i> Maintain / release call (CREATE, UPDATE) <i>UnexpectedDataValue</i> Maintain / release call (CREATE, UPDATE) <i>UnexpectedParameter</i> Maintain / release call (CREATE, UPDATE)

Activity (OR13-A3)
Name Configure T_{SSF} expiration Handling.
Description This activity defines handling of expiration of the T_{SSF} timer. Criteria for continuing / interrupting the ongoing call has to be defined and stored in the Service Feature Manager, handling of the interrupted call is to be defined and stored in the Error handling sub-entity.
Management operations on data Define default bearer connection (CREATE, UPDATE) Define criteria for continuing / interrupting the call. (CREATE, UPDATE)

Operational Requirement (OR14)
<p>Name The network element manager can start INAP Measurement counters.</p>
<p>Description This operation is used in order to start INAP Measurement. The counters required for the SSF to handle INAP measurements for the SSF -SCF (INAP) interface are activated. Applicable counters related to INAP measurements provided by the SSF has to be defined. These counters, associated with the establishment or terminating of a SSF-SCF relationship are to provide INAP measurements useful to design network configuration and detect errors. One or more INAP Measurement counters shall be possible to start. All counters in the SSF for INAP Measurements are optional (i.e. may not be provided). If a counter is available, the initial default status value is 'Non-Active' (Stopped). When a counter is started the initial counter value is set to zero.</p>
<p>Activities <i>Configure</i> INAP Measurement counter</p>

Operational Requirement (OR15)
<p>Name The network element manager can stop INAP Measurement counters.</p>
<p>Description This operation is used in order to stop ongoing INAP Measurement. The counters required for the SSF to handle INAP measurements for the SSF -SCF (INAP) interface are deactivated (Status Non-Active). One or more INAP Measurement counters shall be possible to stop. All counters in the SSF for INAP Measurements are optional, i.e. may not be available.</p>
<p>Activities <i>Configure</i> INAP Measurement counter</p>

Activity (OR14/15-A1)
<p>Name The network element manager is able to configure INAP Measurement counters</p>
<p>Description Configure the settings of the INAP Measurements counters. This activity can be used to activate or deactivate an INAP Measurement counter.</p>
<p>Management operations on data INAP Measurement Counter The IN Measurement counter is categorized by a counter "category" used to a) identify the counter (defined at CREATE) and b) indicate its status (Active / Non-active). The status may be updated, i.e. set to 'non-Active' / 'Active (stop / start counting)'. The stepping of the counter occurs each time when the defined measuring point for the counter is encountered and the status is set to 'Active'. When a counter is stopped (UPDATE) the status is set to 'Non-Active' When the counter is started again the status is set to 'Active' and the counter value is zero. A defined counter may also be removed (DELETE). Set of Pre-defined optional INAP Measurement Counters: Dialogue Initiation Attempt (CREATE / UPDATE / DELETE) This counter is incremented by one at the begin of each attempt to open a dialogue to the SCF (SCP) or a from the SCF. A Counter may be defined to count all attempts, but a counter may also be defined for each of the following conditions: SSF initiated dialogues counters - Dialogue initiated with InitialDP (CREATE / UPDATE / DELETE). - Dialogue initiated with AssistRequestInstructions (CREATE / UPDATE / DELETE). - Dialogue Initiated with ServiceFilteringResponse (CREATE / UPDATE / DELETE). SCF initiated dialogues counters - Dialogues initiated with InitiateCallAttempt (CREATE / UPDATE / DELETE) - Dialogues initiated with CallGap (CREATE / UPDATE / DELETE). - Dialogues initiated with ServiceFiltering (CREATE / UPDATE / DELETE) Dialogue congestion (CREATE / UPDATE / DELETE) This counter is incremented by one each time a dialogue to SCF cannot be opened, i.e. at unsuccessful attempt to open a dialogue. The opening may fail due to SSP overload or SSP lack of resources TC- Message not accepted (CREATE / UPDATE / DELETE) This counter is incremented by one each time a SSF initiated dialogue attempt is rejected by TC/SCCP (E.g. TC_Notice, TC_P_Abort received, sending of TC-Continue not accepted), i.e. when TC-message is not accepted by lower layer. SSF initiated Dialogues processed (CREATE / UPDATE / DELETE) This counter is incremented by one each time the SSF has sent a TC-Begin message successfully. The successful criteria being the receipt of the first TC-message (e.g. a TC_Continue) from SCF (full duplex) SCF initiated Dialogues processed (CREATE / UPDATE / DELETE) This counter is incremented by one each time the SSFhas received a TC_Begin message successfully (e.g. with InitiateCallAttempt, CallGap, ActivateServiceFiltering). The successful criteria being the sending of the first TC-message from SSF (full duplex). Error / Reject Messages sent by SSP (CREATE / UPDATE / DELETE) This counter is incremented by one each time the SSF sends a TC_U_ERR_REQ or TC_U_REJ_REQ. Error / Reject Messages from SCP (CREATE / UPDATE / DELETE) This counter is incremented by one each time the SSF receives a TC_U_ERR, TC_U_REJ or TC_R_REJ.</p>

Activity (OR14/15-A1)
<p>Timeout on SCF response (CREATE / UPDATE / DELETE) This counter is incremented by one each time the Tssf timer expires in the SSF.</p> <p>Dialogues aborted by SCP or remote TC (CREATE / UPDATE / DELETE) This counter is incremented by one each time a TC_U_Abort is received in SSF</p> <p>Dialogues aborted by SSP (CREATE / UPDATE / DELETE) This counter is incremented by one each time the SSF aborts the dialogue, except if caused by 'Time-out on response' (i.e. if Tssf expires)</p> <p>Dialogues in progress (CREATE / UPDATE / DELETE) Traffic level measurement on number of current ongoing dialogues, i.e. the current number of dialogues in progress is measured. This counter is incremented by one: <ul style="list-style-type: none"> - each time the SSF has sent a TC-Begin message. - each time the SSF receives a TC_Begin message. <i>(e.g. with InitiateCallAttempt, CallGap, ActivateServiceFiltering).</i> This counter is decremented by one: <ul style="list-style-type: none"> - each time a dialogue is ended <i>(e.g. TC-End received, dialogue aborted, Error / reject message received, Pre-arranged End).</i></p>

Operational Requirement (OR16)
<p>Name The network element manager is able to read current INAP Measurement counters</p>
<p>Description This operation reads the counter values of ongoing INAP Measurements.. The value of indicated counter is read. More than one counter may be specified, i.e. read one counter, a set of counters or all counters.</p>
<p>Activities Read current INAP Measurement counter value.</p>

Activity (OR16-A1)
<p>Name <i>Read current INAP Measurement Counter value</i></p>
<p>Description Read one or more INAP Measurements counter values, if any active counter.</p>
<p>Management operations on data INAP Measurement counters: Dialogue Initiation Attempt counter (READ) SSF initiated dialogues counters <ul style="list-style-type: none"> - Dialogue initiated with InitialDP (READ). - Dialogue initiated with AssistRequestInstructions (READ). - Dialogue Initiated with ServiceFilteringResponse (READ). SCF initiated dialogues counters <ul style="list-style-type: none"> - Dialogues initiated with InitiateCallAttempt (READ) - Dialogues initiated with CallGap (READ). - Dialogues initiated with ServiceFiltering (READ) <ul style="list-style-type: none"> • Dialogue congestion (READ) • Message not accepted (READ) • SSF initiated Dialogues processed (READ) • SCF initiated Dialogues processed (READ) • Error / Reject Messages sent by SSP (READ) • Error / Reject Messages from SCP (READ) • Time out on SCF response (READ) • Dialogues aborted by SCP or remote TC (READ) • Dialogues aborted by SSP (READ) • Dialogues in progress (READ) </p>

9 Informal description of Managed Object Classes

This clause provides an informal description of the managed objects that model the management functionality for the SSF, as identified in the annex A. It also indicates how to relate the SSF management information model to other models; it identifies the relations with other object models that may be supported for SSPs.

9.1 SSF Object Model (informal)

9.1.1 The Relationship diagrams

9.1.1.1 SSF Overall Model

The following figure shows the main Objects of the SSF Model and the relationship to each other. A detailed description will be given in the next clauses.

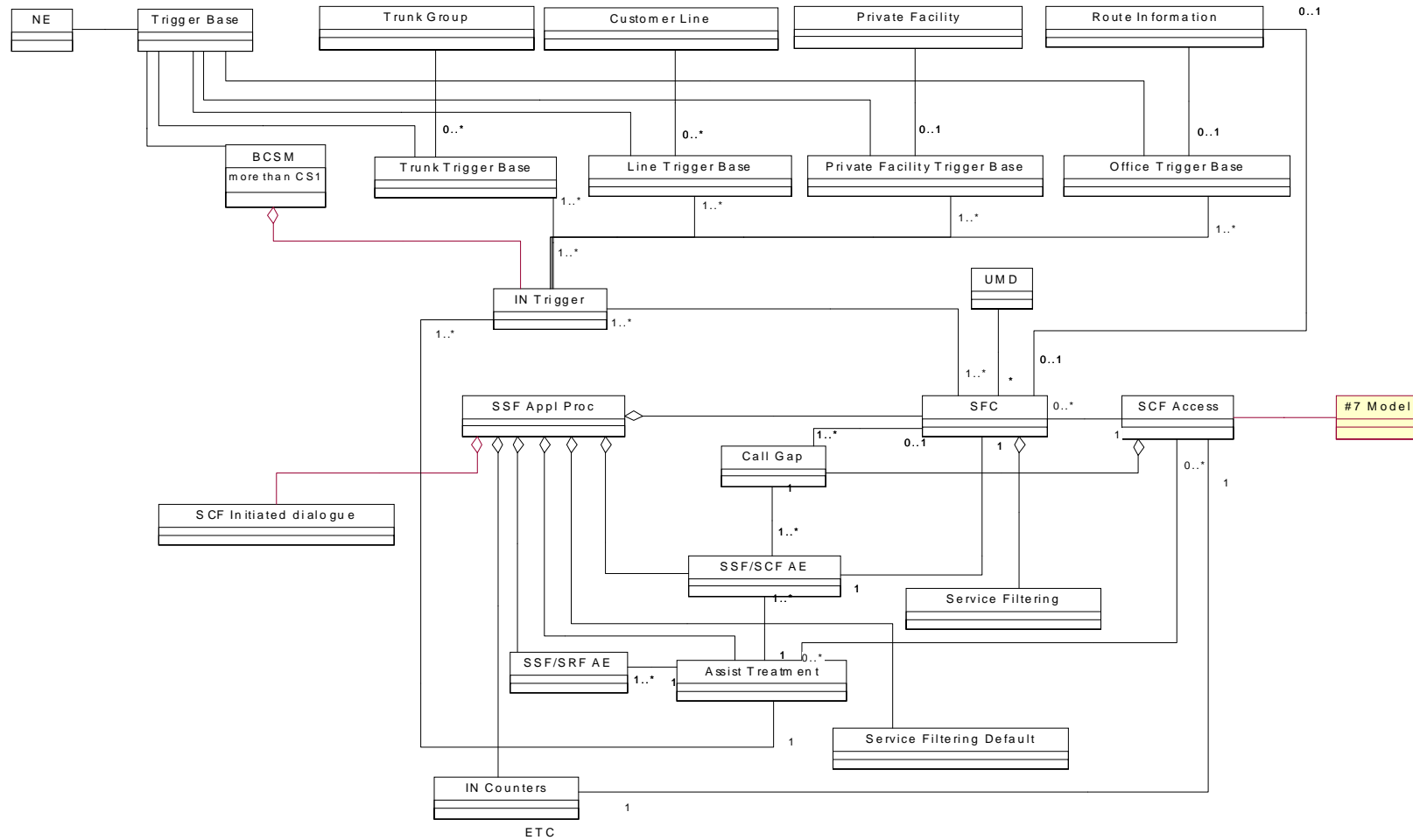

Figure 9.1.1

9.1.1.2 Inheritance Hierarchy

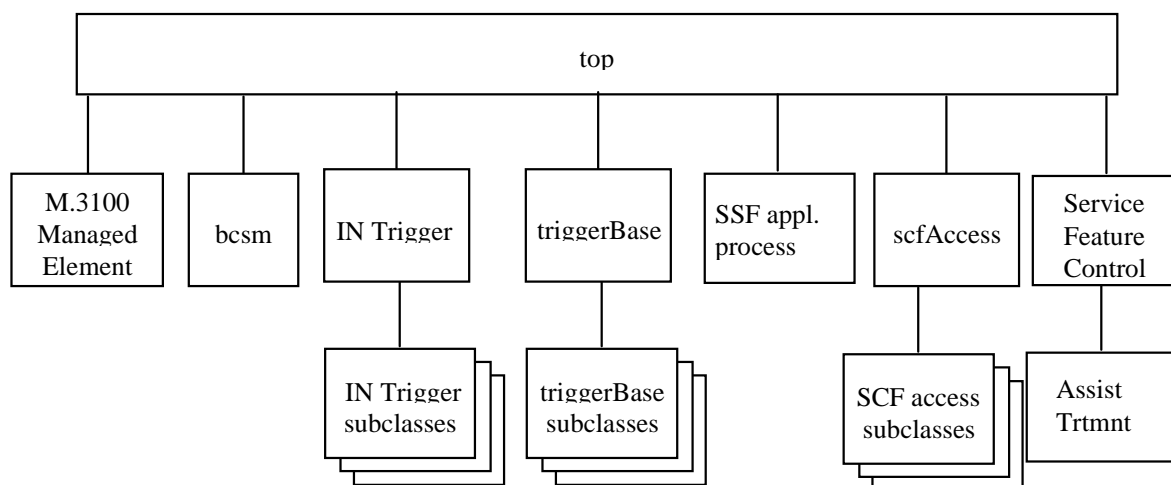

Figure 9.1.2

9.1.1.3 Naming Hierarchy

A SSF-related managed element essentially consists of the following objects:

- a BCSM representing the basic call processing according to a specific BCSM-model. It contains different types of IN triggers, depending on the BCSM-model. The TDPs (IN triggers) contain the different trigger criteria.
- the different trigger bases and their base objects (like customer accesses, trunk groups, etc.).
- the SSF application process containing different service feature controls and interface objects (e.g. SSF/SCF AE, SSF/SRF AE), assist treatments, call gappings and service filterings, data for SCF initiated calls, INAP counters.
- the SCF Access containing the information about the addressing of the SCF.

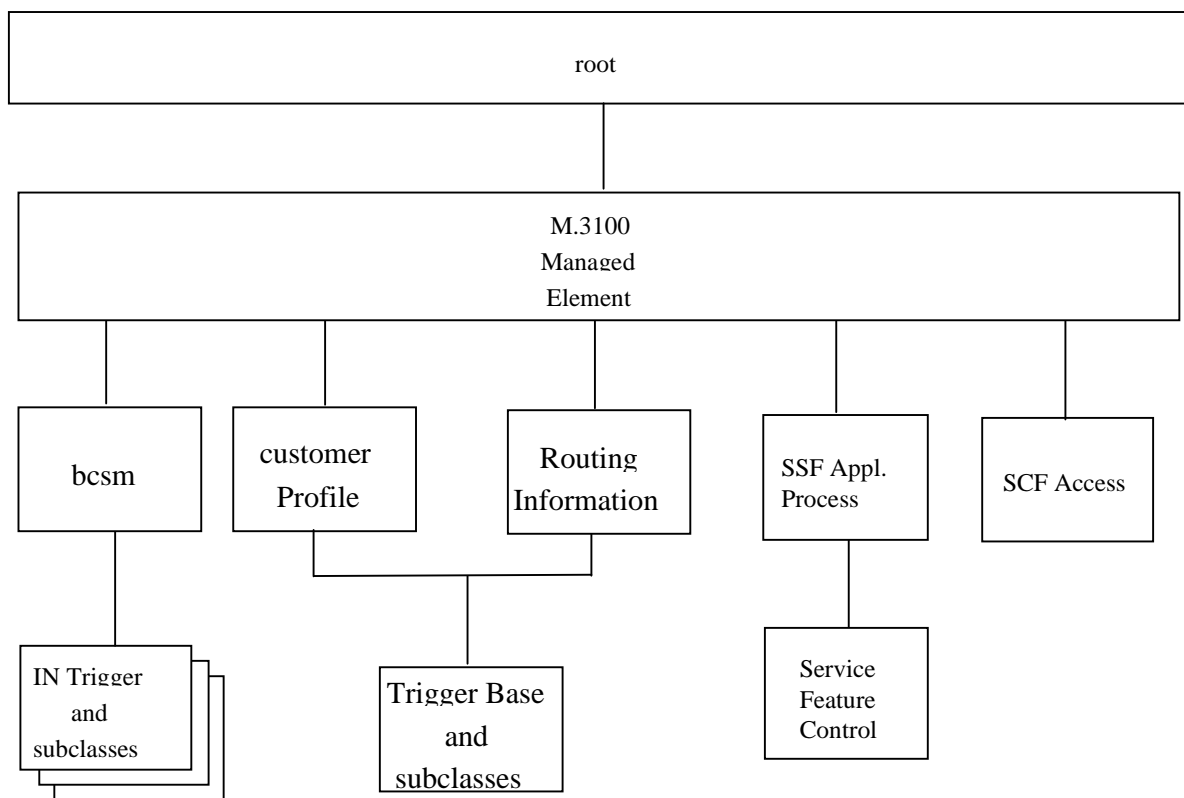

Figure 9.1.3

9.1.2 Requirement: Configure triggering of IN based service feature control

9.1.2.1 Information Model Diagram

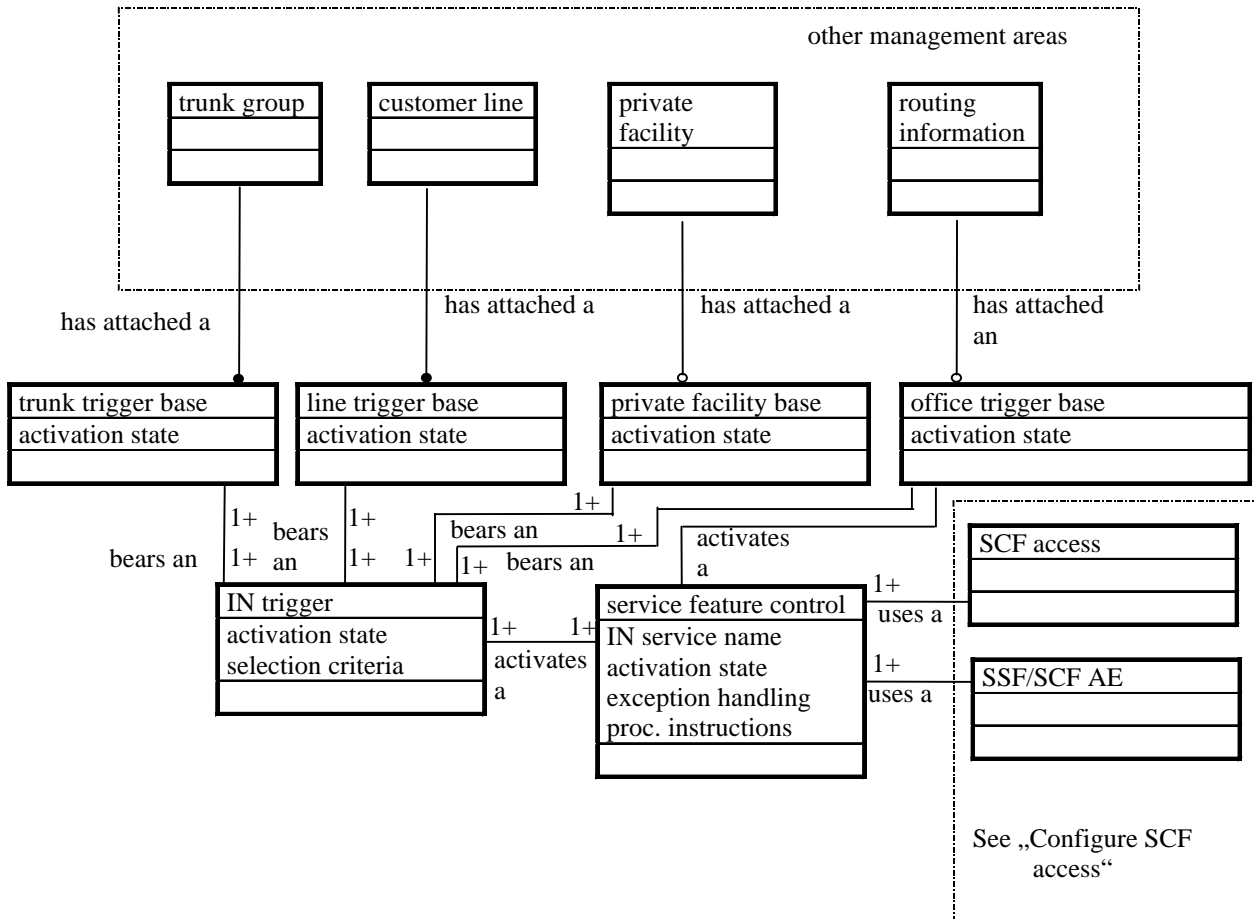
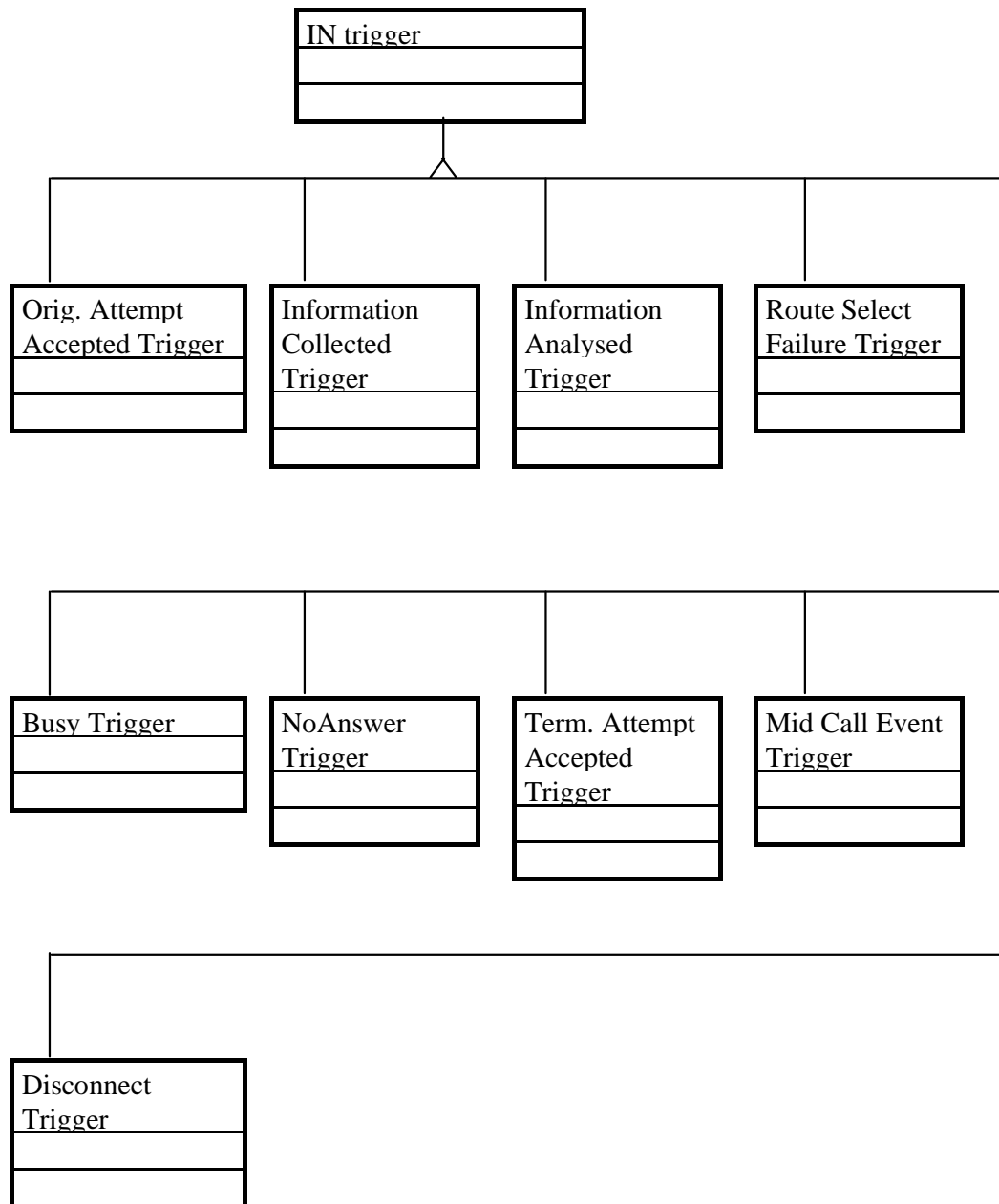

Figure 9.1.4

MOCs of class ServiceFeatureControl are contained in "SSF Application Process" (which also contains the INAP ASEs). All other MOCs are contained in "Network Element".

Inheritance-Relations:**Figure 9.1.5****Remarks on the ER- and inheritance diagrams:**

IN triggers may be associated to "termination points" (e.g. single customer lines, PBX-lines, trunk groups, etc.) or to routing objects (e.g. a specific destination code, a special access code, a national destination code, etc.). The latter is only relevant for triggering because of office based triggers after point-in-call "Analysed Information" (TDP3). The information elements that might be associated to triggers are represented in the ER-diagram by the MO-classes "trunk group", "customer line", "private facility" and "routing information".

They are only examples for possible "termination point" objects that might be bases for IN triggering. They are subject of other management areas, like customer administration or call routing models (see also subclause on the relationship to other object models). Considering customer-administration-based IN-triggering, this may relate e.g. to a single directory-number, a group of directory-numbers, a specific access channel related to a PBX-subscriber, a special service related to a subscriber (e.g. triggering only if the subscriber is reached with teleservice "fax"). In order to be open for a variety of such object classes from different TMN standardization areas, the association object classes "line / trunk / private-facility trigger base" was introduced (otherwise each of this termination point objects would have to include IN-specific association attributes, or there may be a need to introduce a derived, IN-specific class for the association purpose). In the trigger base object classes a pointer to objects of customer / trunk / private-facility administration will be introduced. For one termination point object only one trigger base object will exist (for line or trunk objects: one for the terminating and one for the originating side).

The case of "private facility" based IN triggering relates to uses of public network accesses by private (or virtually private) networks, that use their own routing and numbering procedures. The only relevant example at the moment are centrex groups using their own group dialling plans. It may be required e.g. to administer a number translation service for a whole area wide centrex group using the TDP2-trigger. In this case a "centrexGroupProfile" may be associated via a "private facility trigger base" with an IN trigger object "Information Collected Trigger".

In general trigger criteria are located in the OC "IN trigger". Only in the case of office based TDP3-triggering trigger criteria might be located directly in the routing object "analysis criteria" (but also for TDP3, further criteria might be found in the OC "IN trigger"). Several trigger criteria might lead to triggering the same IN based service feature control. To one termination point, several IN triggers may be attached. The trigger criteria will determine which one of them actually triggers. As several trigger criteria might be true for the same call, there has to be a prioritization handling: (1) if the IN triggers are of different category then the earlier point in call decides (TDP_i triggers instead of TDP_j, if $i < j$ and $i = 1, \dots, 18$); (2) if IN triggers of the same category are associated to the same termination point, then a priority position has to be assigned to each trigger of the same category for one trigger base object.

A service feature control will include data about how to send INAP operations to which SCP in order to perform the specific service control. This is represented in the "use"-relationships of the service feature control object class to classes defined in the section on "Configure SCF access".

9.1.2.2 Informal description of managed objects

9.1.2.2.1 IN Trigger

General description

The information items of the MOC "IN Trigger" are used by the functional sub-entity "TDP Processing" of the "SSF sub-entity model" to decide on which conditions normal call processing has to be suspended and IN based service feature control has to be activated (see subclause A.1.2). In the case of TDP3 (triggering after call information is completely received by call processing) the "TDP Processing" may base its decisions directly on information from the call routing MOC "analysisCriteria" (see subclause 9.2.2.1). In this case it will not use the MOC "IN Trigger", except in cases where further criteria have to be checked.

The definition of the MOC "IN Trigger" is based on the operational requirement "Configure triggering of IN based service feature control", activity "Configure trigger detection point".

The information items of the MOC "IN Trigger" are also used to select a service feature control depending on specific general properties of a call. E.g. different IN services (and INAP protocol versions) may be selected for broadband or narrowband applications.

For the definition of the various subclasses of this OC refer to the description of the BCSM model in annex B.

Attributes

- "Activation State": active or inactive. An IN trigger may be deactivated temporarily.
- "Connection characteristics": placeholder for broad / narrowband properties (e.g. "traffic category" in broadband).
- "customer service specific criteria": reference to tele / bearer service.

Operations and behaviour

When created an instance of MOC "IN Trigger" has to be associated to a "Service Feature Control". An MOC "IN Trigger" without this association would lead to an error in TDP processing. This error situation would have to be notified to the management system.

The MOC is activated as soon as it is associated with a "line trigger base" or "Analysed Info trigger base" in active state and the activation state is set to "active" by management.

An instance of the MOC is identified by an identification-number. The TDP category can not be changed after creation of the object. Trigger criteria and escape codes may be modified or deleted also after creation of the MOC.

9.1.2.2.2 Origination Attempt Accepted Trigger

General description

This OC is derived from "IN Trigger". It is used to trigger IN control at point in call "O_NULL & Authorize Origination Attempt" when a seizure event was accepted. Triggering might be unconditional or dependent on trigger criteria.

Attributes

Unconditional: Boolean.

Combination of: calling party number, bearer capability, class of service.

NOTE: For trunk based triggers only "calling party number", "bearer capability" are allowed.

For customer based triggers only "class of service" is allowed.

General note for all trigger criteria:

It is possible to combine criteria by any possible Boolean construction of them with AND, OR, NOT. Several instances of the same criteria might be used. E.g.: "(Triggering if calling party number = N1 OR calling party number <> N2) AND bearer capability = B1".

Operations and behaviour

- N/A.

9.1.2.2.3 Information Collected Trigger

General description

This OC is derived from "IN Trigger". It is used to trigger IN control at point in call "Collect Information" always when a new digit is received. Triggering might be unconditional or dependent on trigger criteria.

Attributes

Unconditional: Boolean.

Combination of: number of digits, specific digit string, called party number, calling party number.

NOTE: For OLT based triggers "calling party number" is not allowed.

Escape Code: digit string.

Operations and behaviour

- N/A.

9.1.2.2.4 Information Analysed Trigger

General description

This OC is derived from "IN Trigger". It is used to trigger IN control at point in call "Analyse Information" when the received called information is analysed by digit analysis. Triggering might be unconditional or dependent on trigger criteria.

Attributes

Unconditional: Boolean.

Combination of: specific digit string, called party number, facility information, feature activation, nature of address, calling party number.

NOTE: For OLT based triggers "calling party number" is not allowed.

Operations and behaviour

- N/A.

9.1.2.2.5 Route Select Failure Trigger

General description

This OC is derived from "IN Trigger". It is used to trigger IN control at point in call "routing and alerting" when a route-select failure event is detected. Triggering might be unconditional or dependent on trigger criteria.

Attributes

Unconditional: Boolean.

Combination of: cause, feature activation, calling party number, called party number.

NOTE: For OLT based triggers "calling party number is not allowed", for OTT and office based triggers "feature activation" is not allowed.

Operations and behaviour

- N/A.

9.1.2.2.6 Busy Trigger

General description

This OC is derived from "IN Trigger". It is used to trigger IN control at point in call "routing and alerting" when a busy event for the B-side is detected. Triggering might be unconditional or dependent on trigger criteria.

Attributes

BCSM part: choice of (originating side, terminating side).

Unconditional: Boolean.

Combination of: cause, feature activation, calling party number, called party number.

NOTE: For OLT based triggers "calling party number" is not allowed, for trunk and office based triggers "feature activation" is not allowed.

Operations and behaviour

An originating busy trigger can be associated only to an originating line / trunk trigger base or to an office trigger base. An terminating busy trigger can be associated only to a terminating line / trunk trigger base or to a private facility trigger base.

9.1.2.2.7 No Answer Trigger

General description

This OC is derived from "IN Trigger". It is used to trigger IN control at point in call "routing and alerting" when a no answer event for the B-side is detected. For this trigger also a No-Answer-Time is to be managed, that is used for the timer, started at ACM-receipt. Triggering might be unconditional or dependent on trigger criteria.

Attributes

BCSM part: choice of (originating side, terminating side).

No Answer timer: time duration to detect the no answer event.

Unconditional: Boolean.

Combination of: cause, feature activation, calling party number, called party number.

NOTE: For OLT based triggers "calling party number" is not allowed, for trunk and office based triggers "feature activation" is not allowed.

Operations and behaviour

An originating no answer trigger can be associated only to an originating line / trunk trigger base or to an office trigger base. An terminating no answer trigger can be associated only to a terminating line / trunk trigger base or to a private facility trigger base.

9.1.2.2.8 Terminating Attempt Accepted Trigger

General description

This OC is derived from "IN Trigger". It is used to trigger IN control at point in call "T_Null& Authorize Termination_Attempt" when the terminating call control accepts seizure. Triggering might be unconditional or dependent on trigger criteria.

Attributes

Unconditional: Boolean.

Combination of: calling party number, class of service.

NOTE: "class of service" is not allowed for trunk group based triggers.

Operations and behaviour

An terminating attempt accepted trigger can be associated only to a terminating line / trunk trigger base or to a private facility trigger base.

9.1.2.2.9 Mid Call Event Trigger

General description

This OC is derived from "IN Trigger". It is used to trigger IN control at point in call "O_Active" or "T_Active" when feature activation event occurs from the originating or terminating side. Triggering can be only conditionally.

Attributes

BCSM part: choice of (originating side, terminating side).

feature activation.

Operations and behaviour

A originating mid call event trigger can be associated only to a originating line / trunk trigger base or an office / private facility base. A terminating mid call event trigger can be associated only to a terminating line / trunk trigger base or a private facility base.

9.1.2.2.10 Disconnect Trigger

General description

This OC is derived from "IN Trigger". It is used to trigger IN control at point in call "O_Active" or "T_Active" when a disconnect event occurs. Triggering might be unconditional or dependent on trigger criteria.

Attributes

BCSM part: choice of (originating side, terminating side).

Unconditional: Boolean.

Choice of: feature activation, cause, leg identification.

Operations and behaviour

A originating disconnect trigger can be associated only to a originating line trigger base. A terminating disconnect trigger can be associated only to a terminating line trigger base.

9.1.2.2.11 Line Trigger Base

General description

The information items of the MOC "Line Trigger Base" are used during normal call processing by the functional sub-entity "BCSM control" of the "SSF sub-entity model" to decide at (originating or terminating) line seizure whether TDP processing has to be invoked (see subclause A.1.2). The MOC associates a line object (customer profile, customer group, PBX-line, etc.) to an instance of MOC "IN trigger". In some cases (Origination / Termination Attempt Accepted Trigger) the line seizure directly leads to triggering IN. In the other cases the trigger information is only stored by call processing and triggering is performed with this information, if certain points in call are reached (e.g. "collected information", "analysed information") or certain network events happen (e.g. "B-party busy", "route select failure", "no answer", "feature activation during call").

The definition of the MOC "Line Trigger Base" is based on the operational requirement "Configure triggering of IN based service feature control", activity "Configure trigger detection point".

Attributes

- "Activation State": for every TDP category it is stated whether triggers of this category are active or not. When objects of this class are created, every TDP category is marked as "active".

Operations and behaviour

When created an instance of MOC "Line Trigger Base" has to be associated to a "IN trigger". A MOC "Line Trigger Base" without this association would lead to an error in call processing. This error situation would have to be notified to the management system.

When created an instance of the MOC has by default the value "active" in its activation state, if nothing other was stated in the create-operation. The state can be modified during the life-time of the instance.

The naming of a line trigger base object depends on the customer line object it is associated to. This may be an ETSI customer profile (identified by a specific directory number) or an ETSI customized resource (e.g. for PBX lines).

9.1.2.2.12 OLT Base

General description

An object of this kind is used to bear an IN trigger for the originating side of the BCSM (OLT = originating line trigger). I.e. it bears triggers TDP1, TDP2, TDP3, TDP4, TDP5, TDP6, TDP7, TDP8, TDP9.

Attributes

- TriggerList of Category X: for every TDP x (x = 1, 2, 3, 4, 5, 6, 7, 8, 9) the pointers to IN trigger objects are sequenced in a order that relates to the priority of the trigger criteria (or empty sequence).
If e.g. a customer line has associated two IN triggers of TDP2, one with number of digits 8 (which is ordered first) and one with a called party number with 8 digits (which is ordered second). If the customer dials 8 digits that are also identical with the specified called party number, then the IN service related to "8 digits dialled" is triggered first. If this service sends a CONTINUE then a new triggering for the service associated to the called party number is possible.

Operations and behaviour

Some properties of customer line objects can lead to the rejection of the association of an OLT Base to this object (e.g. a customer OC with subscriber category "virtual subscriber" may not be associated to an OLT Base).

If the line object that is going to be associated to the OLTBase has already assigned an other OLTBase then the association has to be rejected.

If a new originating IN trigger object is associated to an OLT it has to be chained at the last position of the according TriggerList. The positions in the TriggerList can be changed by modification-operations.

9.1.2.2.13 TLT Base

General description

An object of this kind is used to bear an IN trigger for the terminating side of the BCSM (TLT = terminating line trigger). I.e. it bears triggers TDP12, TDP13, TDP14, TDP15, TDP16, TDP17.

Attributes

- TriggerList of Category X (X = 12, 13, 14, 15, 16, 17).

Operations and behaviour

Some properties of customer line objects can lead to the rejection of the association of an TLT Base to this object (e.g. Centrex users). This may be different properties then those for OLT Bases.

If the line object that is going to be associated to the TLTBase has already assigned an other TLTBase then the association has to be rejected.

If a new terminating IN trigger object is associated to an TLT it has to be chained at the last position of the according TriggerList. The positions in the TriggerList can be changed by modification-operations.

9.1.2.2.14 Trunk Group Trigger Base

General description

The information items of the MOC "Trunk Group Trigger Base" are used during normal call processing by the functional sub-entity "BCSM control" of the "SSF sub-entity model" to decide at (originating or terminating) trunk seizure whether TDP processing has to be invoked (see subclause A.1.2). The MOC associates a trunk group object to an instance of MOC "IN trigger". In some cases (Origination / Termination Attempt Accepted Trigger) the trunk seizure directly leads to triggering IN. In the other cases the trigger information is only stored by call processing and triggering is performed with this information, if certain points in call are reached (e.g. "collected information", "analysed information") or certain network events happen (e.g. "B-party busy", "route select failure", "no answer", "feature activation during call").

The definition of the MOC "Trunk Group Trigger Base" is based on the operational requirement "Configure triggering of IN based service feature control", activity "Configure trigger detection point".

Attributes

- "Activation State": for every TDP category it is stated whether triggers of this category are active or not. When objects of this class are created, every TDP category is marked as "active".

Operations and behaviour

When created an instance of MOC "Trunk Trigger Base" has to be associated to an "IN trigger". A MOC "Trunk Trigger Base" without this association would lead to an error in call processing. This error situation would have to be notified to the management system.

The naming of a trunk trigger base object depends on the trunk group object it is associated to. This will be a cepsg (circuit end point sub group) or cepsgComb as defined in EN 300 292 [3].

9.1.2.2.15 OTT Base

General description

An object of this kind is used to bear an IN trigger for the originating side of the BCSM (OTT = originating trunk trigger). I.e. it bears triggers TDP1, TDP2, TDP3, TDP4, TDP5, TDP6, TDP7, TDP8, TDP9.

Attributes

- TriggerList of Category X (X = 1, 2, 3, 4, 5, 6, 7, 8, 9).

Operations and behaviour

Some properties of trunk group objects can lead to the rejection of the association of an OTT Base to this object (e.g. a specific bearer capability).

If the trunk group object that is going to be associated to the OTTBase has already assigned an other OTTBase then the association has to be rejected.

If a new originating IN trigger object is associated to an OTT it has to be chained at the last position of the according TriggerList. The positions in the TriggerList can be changed by modification-operations.

9.1.2.2.16 TTT Base

General description

An object of this kind is used to bear an IN trigger for the terminating side of the BCSM (TTT = terminating trunk trigger). I.e. it bears triggers TDP12, TDP13, TDP14, TDP15, TDP16, TDP17.

Attributes

- TriggerList of Category X (X = 12, 13, 14, 15, 16, 17).

Operations and behaviour

Some properties of customer line objects can lead to the rejection of the association of an TTT Base to this object. This may be different properties then those for OTT Bases.

If the trunk group object that is going to be associated to the TTTBase has already assigned an other TTTBase then the association has to be rejected.

If a new terminating IN trigger object is associated to an TTT it has to be chained at the last position of the according TriggerList. The positions in the TriggerList can be changed by modification-operations.

9.1.2.2.17 Private Facility Trigger Base

General Description

The information items of the MOC "Private Facility Trigger Base" are used during normal call processing by the functional sub-entity "BCSM control" of the "SSF sub-entity model" to decide at specific events related to the access of private facilities to the public network whether TDP processing has to be invoked (see subclause A.1.2). The MOC associates a private facility object to an instance of MOC "IN trigger".

The definition of the MOC "Private Facility Trigger Base" is based on the operational requirement "Configure triggering of IN based service feature control", activity "Configure trigger detection point".

Attributes

- "Activation State".
- TriggerList of Category X ($1 < x <= 18$).

Operations and behaviour

When created an instance of MOC "Private Facility Trigger Base" has to be associated to a "IN trigger". A MOC "Private Facility Trigger Base" without this association would lead to an error in call processing. This error situation would have to be notified to the management system.

When created an instance of the MOC has by default the value "active" in its activation state, if nothing other was stated in the create-operation. The state can be modified during the life-time of the instance.

The naming of a trigger base object depends on the private facility object it is associated to. This may be e.g. a Centrex group or a member of such a group.

If the private facility object that is going to be associated to the trigger base has already assigned an other private facility base then the association has to be rejected.

If a new IN trigger object is associated to an private facility trigger base, it has to be chained at the last position of the according TriggerList. The positions in the TriggerList can be changed by modification-operations.

9.1.2.2.18 Office Trigger Base

General description

The information items of the MOC "Analysed Information Trigger Base" are used during normal call processing by the functional sub-entity "BCSM control" of the "SSF sub-entity model" to decide at normal digit analysis (or a specific IN digit analysis) whether TDP processing has to be invoked (see subclause A.1.2). The MOC associates a routing object (digit translator entry) to an instance of MOC "IN trigger" (in case of further criteria checks for triggering) or the routing object is directly associated to a "Service Feature Control". In case of further criteria to be checked, triggering might not take place immediately after digit analysis: The trigger information are only stored, and used to decide on triggering later, at specific network events (e.g. "B-party busy", "route select failure", "no answer", "feature activation during call").

The definition of the MOC "Analysed Information Trigger Base" is based on the operational requirement "Configure triggering of IN based service feature control", activity "Configure trigger detection point".

Attributes

- "Activation State".
- TriggerList of category X ($3 < x <= 18$).

Operations and behaviour

When created an instance of MOC "Analysed Information Trigger Base" has to be associated to an "IN trigger". A MOC "Analysed Information Trigger Base" without this association would lead to an error in call processing. This error situation would have to be notified to the management system.

When created an instance of the MOC has by default the value "active" in its activation state, if nothing other was stated in the create-operation. The state can be modified during the life-time of the instance.

If the routing object that is going to be associated to the trigger base has already assigned an other Analysed Information Trigger Base then the association has to be rejected.

If a new IN trigger object is associated to an Analysed Information Trigger Base it has to be chained at the last position of the according TriggerList. The positions in the TriggerList can be changed by modification-operations.

9.1.2.2.19 Service Feature Control

General description

The information items of the MOC "Service Feature Control" are used by the functional sub-entity "Service Feature Manager" of the "SSF sub-entity model" to control the feature processing of a specific IN service (see subclause A.1.2). The MOC includes conditions for invoking the service feature control (association to trigger objects) and information on how to perform the feature control (e.g. to which SCF a control relationship should be established).

Instances of this MOC are contained in an instance of MOC "SSF Application Process".

The definition of the MOC "Service feature Control" is based on the operational requirement "Configure triggering of IN based service feature control", activity "Configure service feature control".

Attributes

- "Service Name": name of the IN service for which service feature control is started (not identifying attribute!).
- "Activation State": active or inactive. The IN service might be deactivated temporarily.
- "exception handling": In case of deactivation or other causes of rejection of IN control, this attributes contains continuation information for the call processing (e.g. intercept treatment, announcements, etc.). Includes pointers to customizable resources.
- "processing instructions": Call processing relevant default values for feature control. E.g. indication that IN-IN-interworking is not allowed for this service, or indication, that this IN-service is not allowed to influence charging, etc.
- "routeList mapping" (see subclause on the relation to EN 300 292 [3]).
- "default charging": some services do not necessarily result in charging information being sent from the SCF to the SSF. Thereby the SSF needs to be able to refer to a choice of default charging options. This attribute is made up of the following value set:
 - indication that same charging level has to be used as that determined by PSTN before (single value);
 - indication for setting the call to "free of charge" (single value);
 - indication to reject the call (single value);
 - specific charge level (set of values).
- "charging profile": IN triggering may occur before the SSP specific usage metering control function determines the kind of usage metering. In this cases the "charging profile" of the IN service determines the kind of usage metering recording. This attribute is defined network operator specific (see subclause on the relation to I-ETS 300 819 [11]).

Operations and behaviour

When created an instance of MOC "Service Feature Control" has to be associated to a "SCF access" and an "IN application protocol ASE". A MOC "Service Feature Control" without this two associations would lead to an error in call processing. This error situation would have to be notified to the management system.

An instance of the MOC "Service Feature Control" can be associated to several trigger objects. It is identified by a specific "service name". This attribute can not be changed after creation. All other attributes can be modified, deleted or added.

When created an instance of the MOC has by default the value "inactive" in its activation state. The state can be modified during the life-time of the instance.

If a service feature control can not be established this may be notified to the management system with a fault indication.

9.1.3 Requirement: IN-Authorization

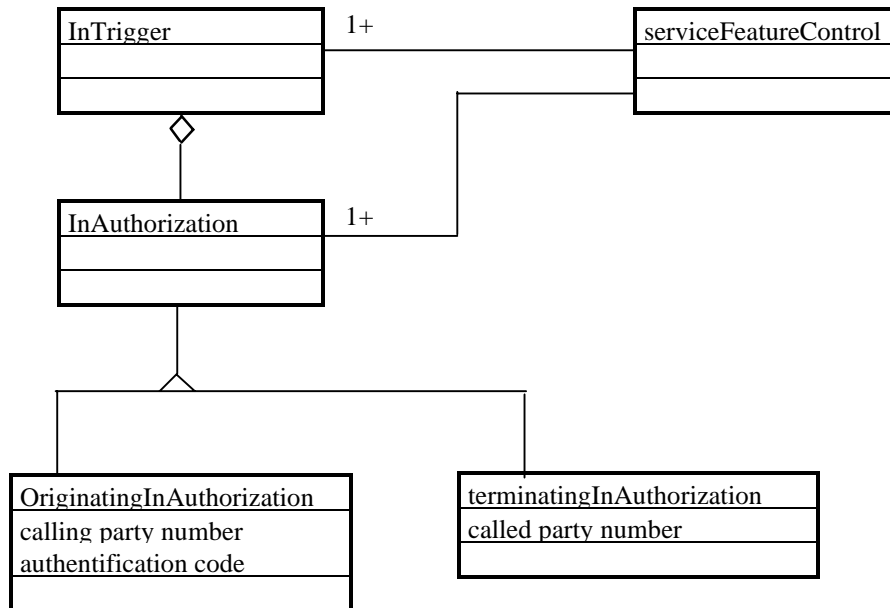

Figure 9.1.6

Special customer related features may be situated on exchanges where the direct customer access is not administered (e.g. for network operators that do not have customers at local exchanges but only at transit exchanges). This customer related features can be implemented as IN based service features. For such features it is vital, that only those calls are authorized to use them, that originate or terminate at a specified customer. i.e. only calls with a specific calling party number or called party number are subject to IN triggering.

This "authorization criterion" could be modelled as part of the criteria-list of the InTrigger object class. But as there could be a large quantity of such customers related to the same "service class" (i.e. IN-Trigger with the same trigger category, criteria and trigger profile), it is proposed to model the "InAuthorization" as a separate object class, contained within the InTrigger object class.

Connected to the calling party authorization there may be a further personal authentication code.

9.1.4 Requirement: Configure SCF access

Configure SCF accesses in a managed element:

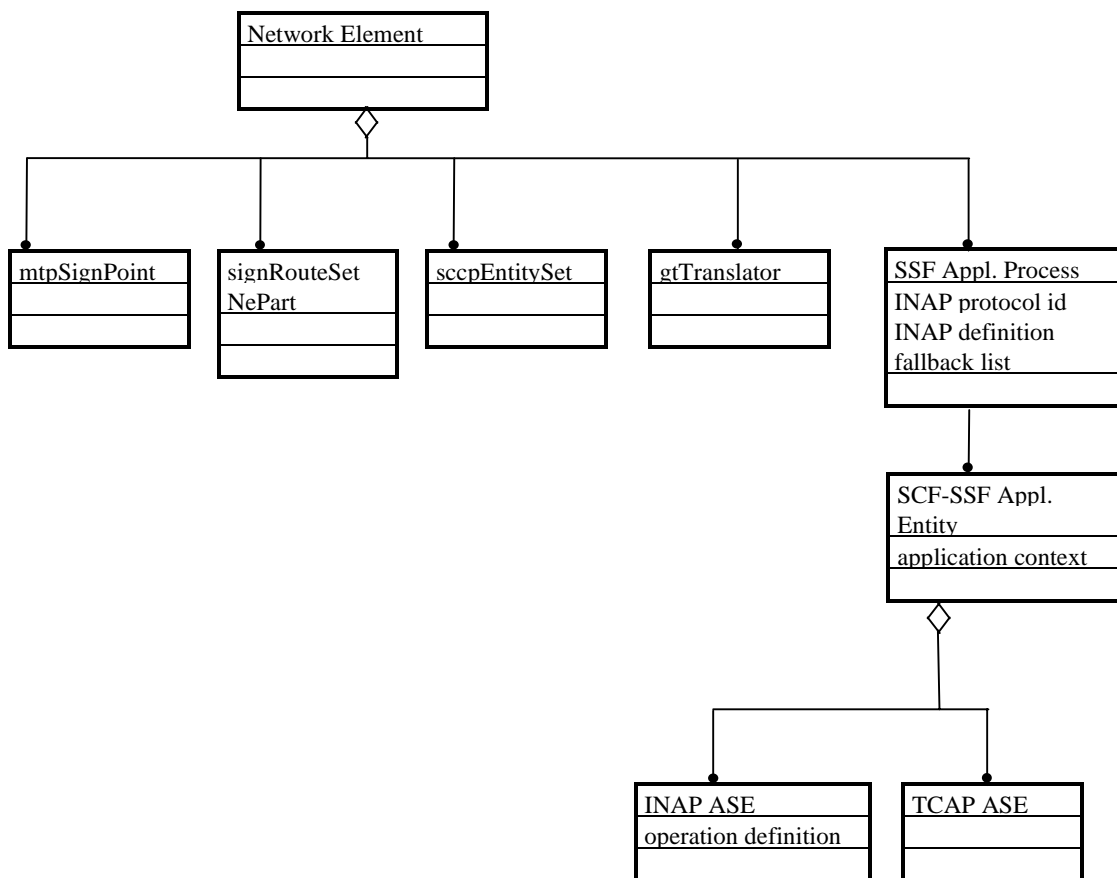

Figure 9.1.7

Assignment of SCF access data to a service feature control:

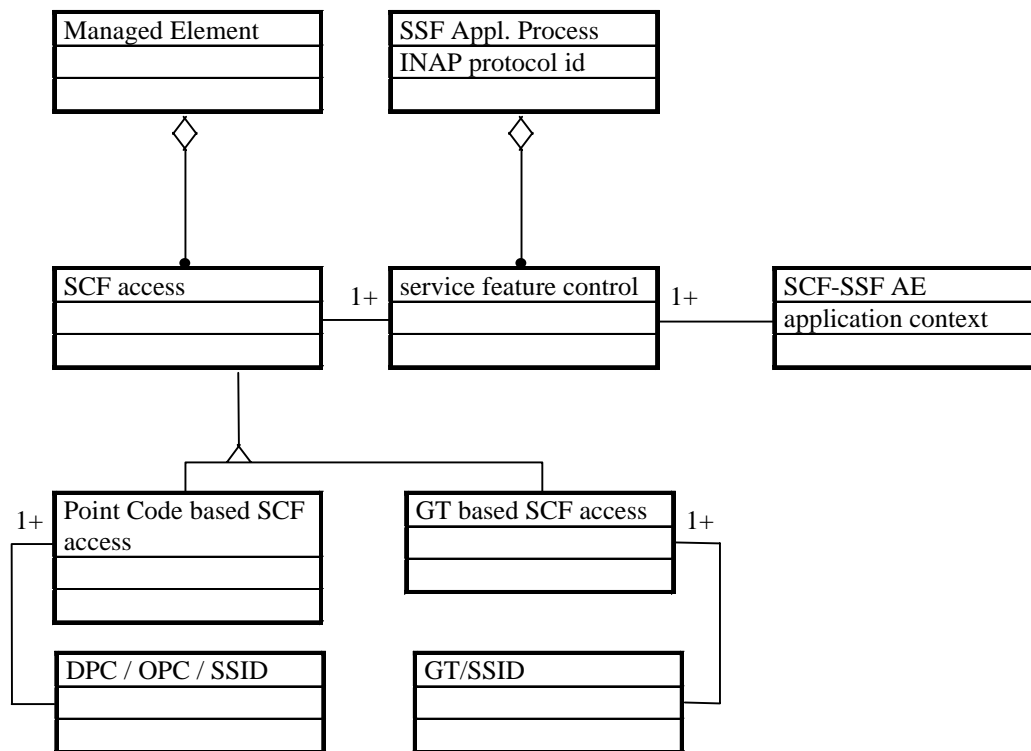

Figure 9.1.8

Remarks on the ER diagrams:

The address information of the MTP-related or the SCCP-related MOCs are used by the functional sub-entity "SCF access Manager" of the "SSF sub-entity model" to perform SCF-SSF transactions based on a TCAP ASE using operations from the INAP ASE (see subclause A.1.2). A managed element may contain several "IN application protocol" objects. But every IN service will belong to only one of them. If the chosen protocol is not accepted by the partner side the "SSF Application Process" will select a fallback protocol.

In regard to the MTP-/SCCP MOCs, see subclause 9.2.3. "DPC/OPC" ("destination / origination point code") is a place holder for MTP-related MOCs selected for a service feature control. "GT/SSID" ("Global Title / Subsystem Id") is a place holder for SCCP-related MOCs selected for a service feature control.

9.1.4.1 SSF Application Process

General description

The information items of the MOC "INAP ASE" are used by the functional sub-entity "INAP SAP" of the "SSF sub-entity model" to control protocol dependant creation / retrieval of operations for SSF-SCF or SSF-SRF transactions (see subclause A.1.2). The protocol might differ for different application contexts depending on the chosen application entity for the IN service. Also other IN application protocols than ETSI Core INAP CS1 might be used.

Attributes

- protocol identifier: unique identification of used IN application protocol (not necessarily naming attribute!).
- fallback list: reference to alternative SSF/SCF protocol that has to be used in case the SCF rejects the current protocol.
- "TSSF state change": When the Tssf timer expires, the management system is notified.

Operations and behaviour

- N/A.

9.1.4.1.1 SCF-SSF AE

The SCF-SSF Application Entity is used by the functional entity "INAP SAP" to perform protocol translations and start / continue / end transactions to the SCF. This object class is derived from the OSI application layer model MOC "Network Element Application Entity". It includes several component protocol machines (INAP, TCAP) depending on the application context (e.g. SSP-to-SCP-AC, assist-handoff-SSP-to-SCP-AC).

Attributes

- application context: identification of specific ASE sets for INAP and TCAP.

Operations and behaviour

- N/A.

9.1.4.1.2 TCAP ASE

Information items from this MOC are used by the functional entity "SCF access" when creating a transaction to the SCF. This MOC is used mainly for measurement purposes.

9.1.4.1.3 INAP ASE

Information items from this MOC are used by the functional entity "INAP SAP" when creating a specific INAP operation. This MOC is used mainly for measurement purposes.

9.1.4.1.4 Service Feature Control

Further attribute: IN application protocol - pointer to a MOC "SCF-SSF AE".

- SCF access - pointer to a MOC "SCF access".

Operations and behaviour

When created an instance of MOC "Service Feature Control" has to be associated to a "SCF access" object.

9.1.4.1.5 SCF access

This OC is a single point of reference to bind together the different data items used for an IN service control for the protocol specific address data handling.

9.1.4.1.6 Point Code based SCF access

Derived from MOC "SCF access" further attributes:

- DPC: pointer to an object of class mtpSignPoint (ITU-T Recommendation Q.751.2 [15]).
- OPC: pointer to an object of class mtp SignPoint.
- SSID: pointer to an object of class sccpAccessPoint.

Operations and behaviour

When created an instance of MOC "Point Code based SCF access" has to be associated to a DPC and an OPC and a SSID.

9.1.4.1.7 Global Title based SCF access

Derived from MOC "SCF access" further attributes:

- SSID: pointer to an object of class sccpAccessPoint (ITU-T Recommendation Q.751.2 [15]).
- Global Title rule: pointer to an object class gtRule.
- SCP address: choice of object classes according to gtRule.
- all this attributes one time for origin and one time for destination.

Operations and behaviour

When created an instance of MOC "Global title based SCF access" has to be associated to global titles and subsystems for destination and origin. An MOC "Global Title based SCF access" without this association would lead to an error in TDP processing. This error situation would have to be notified to the management system.

9.1.5 Configure SRF/SCF relaying capabilities and Configure SRF assisting Relationships

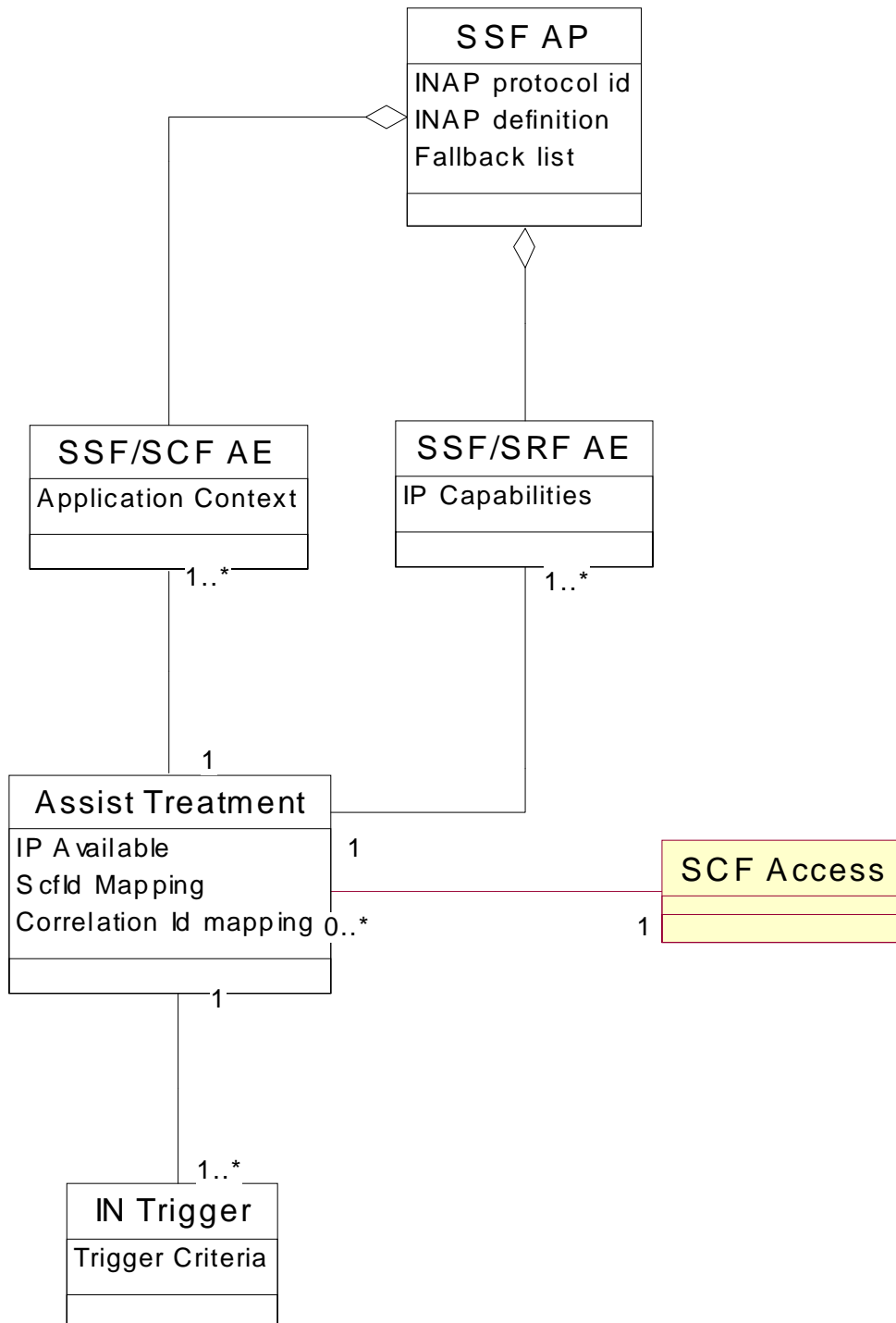

Figure 9.1.9

9.1.5.1 SSF AP

General Description

The SSF Application Process MOC represents all of the possible SSF processes associated with the SSF-SCF, SSF-SRF and SSF-SSF interface. Contained within this class are all the Application Entities, i.e. the set of INAP messages.

9.1.5.2 SSF/SRF AE

General Description

The 'SSF/SRF AE' MOC represents the set of INAP messages defined for the SSF-SRF interface. It has a many to one relationship with the Assist Treatment MOC.

Attributes

- IP Capabilities: describes which type of feature interactions are possible by the SRF.

9.1.5.3 SSF/SCF AE

General Description

The SSF/SCF Application Entity MOC represents the set of INAP messages defined for the SSF-SCF interface. It has a many to one relationship with the Assist Treatment MOC.

Attributes

- application context: select a specific application context for assist treatment.

9.1.5.4 SSF/SSF AE

General description

The SSF/SSF Application Entity MOC represents the set of INAP messages defined for the SSF-SSF interface. These messages will be enveloped in ISUP.

9.1.5.5 Assist Treatment

General Description

The 'Assist Treatment' MOC represents the set of operations contained within the SSF/SRF and SSF/SCF Application Entities. The Assist Treatment MOC has a 1 to 1 relationship with the TDP MOC.

Attributes

- IP Available specifies which SRF is available and what features it can support.
- SCF Id mapping is used to identify which SCF the Assist treatment is to be sent to.
- Correlation Id is used to identify which call is related to the SRF association.

9.1.5.6 IN Trigger

General Description

The IN Trigger MOC is used to describe at which conditions normal call processing has to be suspended and IN based service feature control is activated. It has a 1 to 1 relationship with the Assist Treatment MOC.

Attributes

- Trigger Criteria represents the conditions upon which the trigger is initiated.

9.1.5.7 Timer

General Description

The Timer MOC represents the timer that is set at association time between the SSF control and assisting. The timer is controlled and reset if necessary by the controlling SSF.

9.1.5.8 SCF Access

General Description

The SCF Access MOC represents the facilities enabling the SSF/SCF dialogue.

Attributes

- MTP or GT based address of SCF in assisting SSP.

9.1.6 MOC: callgap

9.1.6.1 Informal description

Information items of the MOC *callgap* are used to identify the calls that should be subject to gapping and how these are treated. The *callgap* MOC is used by the 'CG&SF' sub-entity defined in the SSF sub-entity model when an IN trigger is met and the SCF is about to be asked what to do with the call.

9.1.6.2 Behaviour

When created, a *callgap* instance must relate to one or more *SSF/SCF Application entities*. When gapping is made upon *serviceKey*, a relation to the corresponding SCF is made. When gapping is called *addressvalue* dependent, an association should exist to all created *SFC* instances.

This behaviour models the content of the parameter *gapCriteria* of the *callgap* operation.

The *callgap* instance is deleted when a *callGap operation* with *duration = 0* is received.

9.1.6.3 Attributes

An 'M' in brackets indicate mandatory attributes, an 'O' indicates optionality.

gapindicators (M), choice between:

- *duration*, specifies in seconds for how long the gapping should be active (-1 = infinite, -2 = network specific).
- *interval*, specifies the minimum time interval (0 = no gapping, 1 = all calls gapped).

controltype (O) choice between:

- *sCPOverloaded* (gapping started automatically by the SCF); or
- *manuallyInitiated* (gapping started by OSF means).

gaptreatment (O). The SCF may request call gapping without specifying the *gaptreatment*. If not specified, a default *gaptreatment* is defined in the MOC *IN Trigger*. If defined, the following attributes are defined and a choice is made:

- *informationToSend* choice of:
 - *inbandinfo*;
 - *tone*;
 - *displayinformation*;
- *releasecause*;
- *both*.

9.1.7 MOC: Service Filtering

9.1.7.1 Informal description

Instances of the MOC *Service filtering* are used by the sub-entity 'CG&SF' as defined in the 'SSF sub-entity model'. Each instance define when and how filtering of IN calls meeting a specific filtering criteria should be done. Each instance is identified by its filtering criteria.

9.1.7.2 Behaviour

When the parameter *filteringcriteria* within the *activateservicefiltering* operation is set to *servicekey*, an instance of the MOC is created and an association to the *SFC* instance defining the service is made. Associations to all *SFC* instances are made when the *filteringscriteria* are set to *dialled number* or *calling party number*.

When the network specific default duration is to be used (indicated by setting the attribute *duration* to '-2'), the duration is found in the MOC *ServiceFilteringDefault*.

The object instance is deleted when the stoptime is reached or duration expires. Before deletion, the object id (*filteringcriteria*) and the countersvalues are used by the INAP operation *servicefilteringresponse*.

9.1.7.3 Attributes

An 'M' in brackets indicate mandatory attributes, an 'O' indicates optionality.

Filteringcharacteristics (M): choice of:

- *interval*, the time interval between calls send to the SCF;
- *numberofcalls*, every Nth call is send to the SCF.

Filteredcalltreatment (M):

- *billingchargingcharacteristics* (M), defines charging characteristics for every filtered call;
- *informationtosend* (M), choice of:
 - *inbandinfo*;
 - *tone*;
 - *displayinformation*;
- *releasecause* (O), defines the release cause for the call;
- an optional sequence of *counterID* and *value*. The number of counters are defined en the optional parameter *maximumnumberofcounters*.

Starttime (O), identifies the start time of service filtering.

FilteringTimeout (M), choice between:

- *stoptime*, the stop time of service filtering;
- *duration*, the duration of the service filtering.

9.1.8 MOC: Service Filtering Default

9.1.8.1 Informal description

This MOC holds the network specific attribute *default duration* to be used in service filtering. The object is used by the 'CG&SF' sub-entity in the 'SSF sub-entity model'.

9.1.8.2 Behaviour

This object is created as part of the object "SSF Application Process".

9.1.8.3 Attributes

Default duration: the network dependant duration of service filtering.

9.1.9 MOC: Default Initiate Call Information

9.1.9.1 Informal description

This MOC holds the default values used if a call is set up by the SCF but certain optional parameters are not sent in the INAP operation InitiateCallAttempt but needed for call setup.

9.1.9.2 Behaviour

This object is created as part of an object "SSF application process".

9.1.9.3 Attributes

Calling Party Number, Calling Party Category, Forward Call Indicators, Nature of connection indicators, Bearer Service: all encoded according to EN 300 356-1 [4].

9.1.10 INAP Measurement Counters

9.1.10.1 Informal description

For every counter mentioned in OR14/15-A1 a MOC will be defined. Each of this MOC holds a INAP Measurements Counter to be used according to the described purpose. The objects are used by the 'INAP SAP' sub-entity in the 'SSF sub-entity model'. Activation and Evaluation of the counters are the task of the management system.

9.1.10.2 Behaviour

This objects are created when the SSF is made and is contained in the SSF Application Process. When creating a counter it is in status "inactive".

9.1.10.3 Attributes

- Counter.
- Status: active or inactive.
- SCF Access List: List of SCF Accesses for which the counter applies (i.e. there may be several counter objects of the same counter category but for different SCF accesses).

9.2 Relation to other object models

9.2.1 The OSI Application Layer model

This subclause briefly introduces the OSI Application Layer managed objects as described in ISO/IEC JTC1/SC21 N8434 [12]. Figure 9.2.1 shows the proposed naming hierarchy of OSI application layer managed objects as is defined in ISO/IEC JTC1/SC21 N8434 [12].

An application process is part of an open system. An open system (represented by a 'system' managed object) may contain zero or more application processes. An application entity is part of an application process that is concerned with OSI application layer communications. An Application Entity Invocation carries out the function of an Application entity. It may be thought of as an upper layer protocol machine, which consists of component protocol machines to carry out the function of each Application Service Element (ASE) component (i.e., ASE invocations).

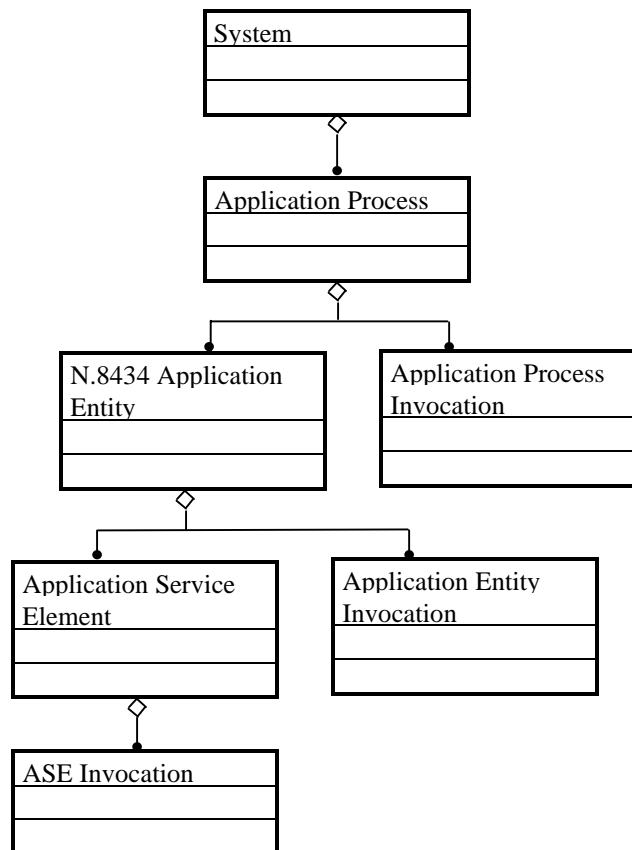

Figure 9.2.1: Naming schema for managed objects for the OSI Application Layer

9.2.1.1 IN managed objects

Figure 9.2.2 shows the ISO upper layer model and the corresponding IN model. **Note** that managed objects for *invocations* are *not* included in the model. An invocation can be associated with an (ISO) application association between two parties, for example, with dialogues in Transaction Capabilities. (Management of this kind of single peer-to-peer connections is not necessary. That is, we are not interested in management of TC-ASE invocations (dialogues), but we are interested in TC-ASE as a single entity that abstracts from the dialogues.)

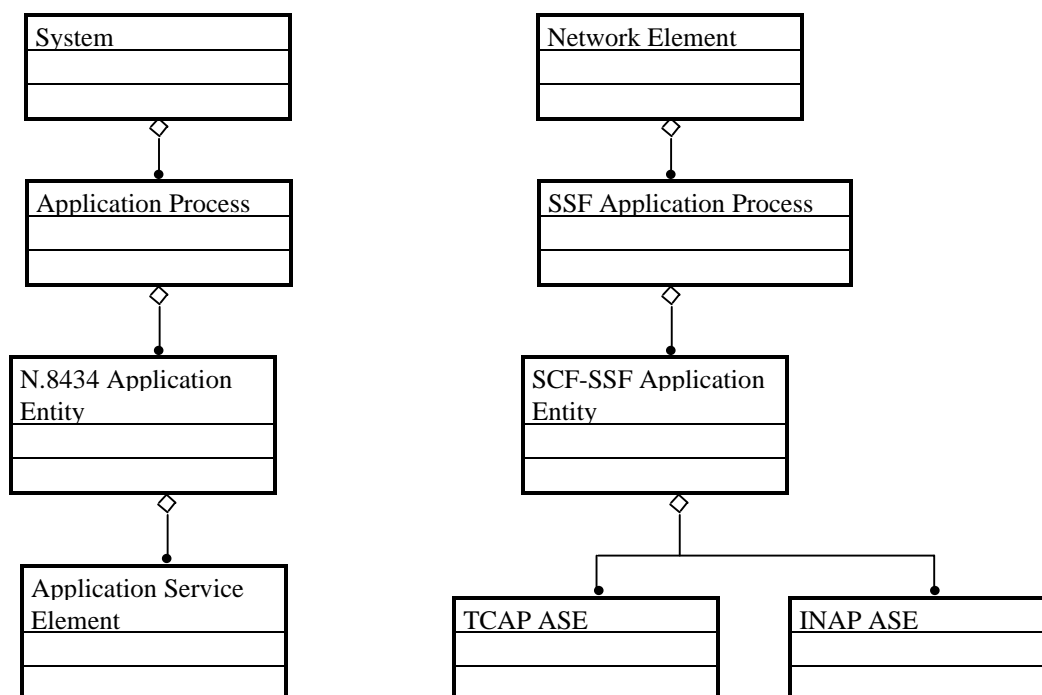

Figure 9.2.2: Comparison of managed objects for OSI upper layers with IN managed objects

9.2.1.2 Relationship with other management functionality's present in the network element (example)

In a network element also other functionality than IN functionality might be present. Examples are ISDN and supplementary services or SS No. 7 functionality. The naming hierarchy for the SSP proposed in the previous sections does not impose that all functionality is managed via a single interface. Figure 9.2.3 shows how the naming hierarchy for the SSP might relate to other managed objects (naming) defined for a given network element. On the left, the top part of the current naming scheme for the SS No. 7 protocol parts MTP and SCCP ITU-T Recommendation Q.751.1 [14] is visible. The middle branch denotes the IN naming, while the right branch shows the naming for ISDN supplementary services.

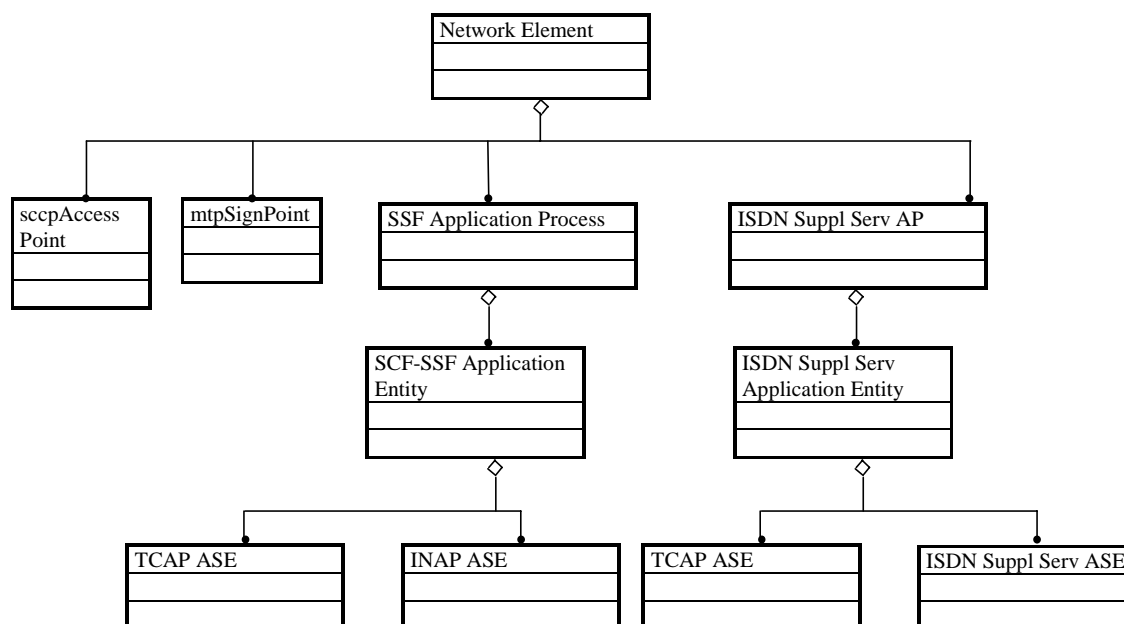

Figure 9.2.3: Relationship to possible other functionality in a network element

9.2.2 Relation to routing management (ORM)

IN management aspects that might affect routing objects can be:

- configure triggering of IN based service feature control during routing activities;
- influencing routing during IN based service feature control.

(i) Configure triggering of IN based service feature control.

Triggering may occur or be prepared as soon as a specific customer line or trunk group is seized (in incoming or outgoing direction) or if a specific result of digit analysis is reached.

In EN 300 292 [3] managed object classes are defined that represent routing relevant groups of communication endpoints and such that represent manageable aspects of digit analysis.

In subclause 12.1 of the present document it is described, that IN-Trigger related objects ("IN trigger", "service feature control") can be related to managed objects of ORM using the object classes "line trigger base" and "analysed info trigger base":

- A communication end point sub group that is seized during the routing process can be pointed at by an object of class "line trigger base". If so, the criteria of the associated object "IN trigger" have to be checked in order to decide whether the IN service control of the related object "service feature control" has to be started.
- If digit analysis has as output "result determined", represented in the ORM-model by an object class of type "analysis criteria", this analysis criteria may be pointed at by an object class of type "analysed info trigger base". If, so, the criteria of the associated object "IN trigger" may be checked - if existent -, in order to decide whether the IN service control of the related object "service feature control" has to be started.

(ii) Influencing routing during IN based service feature control

An IN service logic program may decide on the routing of the call by sending a parameter "routeList" in CONNECT-operations. This parameter will consist of logical route designators, that represent an abstract view of the routing model seen by the SCF.

SSF management will include mapping tables of logical route designators to physical routing facilities, represented by managed objects as defined in the "routing possibility selection" fragment of the ORM-model.

9.2.2.1 Administration of IN triggering as a result of digit analysis of the called party address

In INAP-terminology this is normally called "office based triggering".

Three cases of office based IN triggering can be distinguished:

- IN triggering for TDP3 directly to be determined by digit analysis of the called party address:

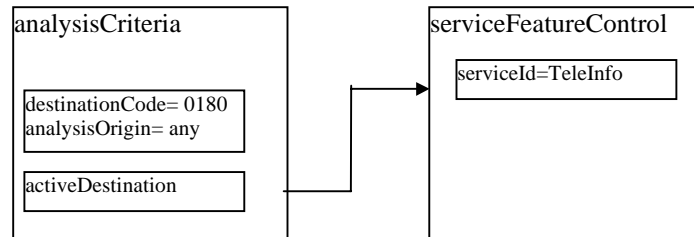

(The object class analysisCriteria is defined in the ETSI ORM model).

This case is modelled via a direct relationship between ORM and SSFM: The determined result of the digit analysis of a called party address beginning with the digits "0180" is a reference to an object instance of a class "serviceFeatureControl". No mediating trigger-base or trigger-criteria object classes are necessary for this, since a eventually determined real routing destination would not be used after SCP query (the SCP sends the real destination number).

- IN triggering for TDP3 with further criteria:

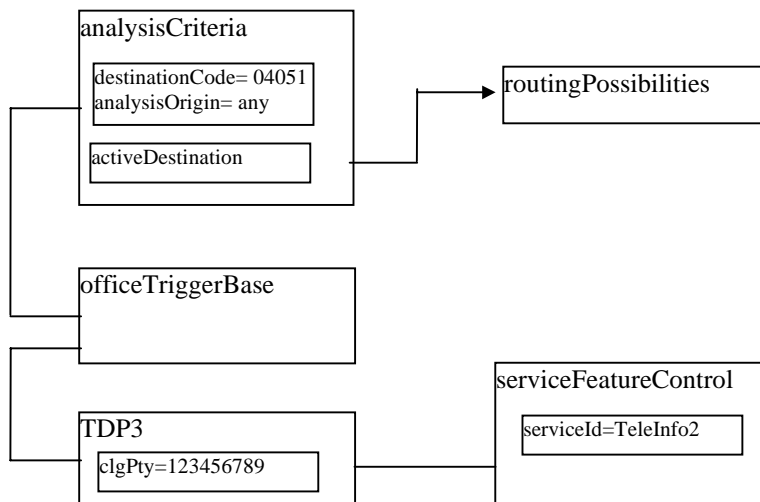

In this case first the normal digit analysis determines a result (in this case the determination of a real destination is useful, since the result of the SCP query can be to route to that destination). Following this an IN specific digit analysis has to be performed, checking whether a office trigger base is assigned to the dialled digits. If this is the case, normal call processing is suspended and the associated trigger criteria are checked (in the example a specific calling party number). In case the criteria do not match or a CONTINUE is sent, the call processing is resumed at the point after IN digit analysis. If the criteria match, the according service feature control (in the example "TeleInfo2") is performed.

- IN triggering after digit analysis because of route select failure, busy or no answer:

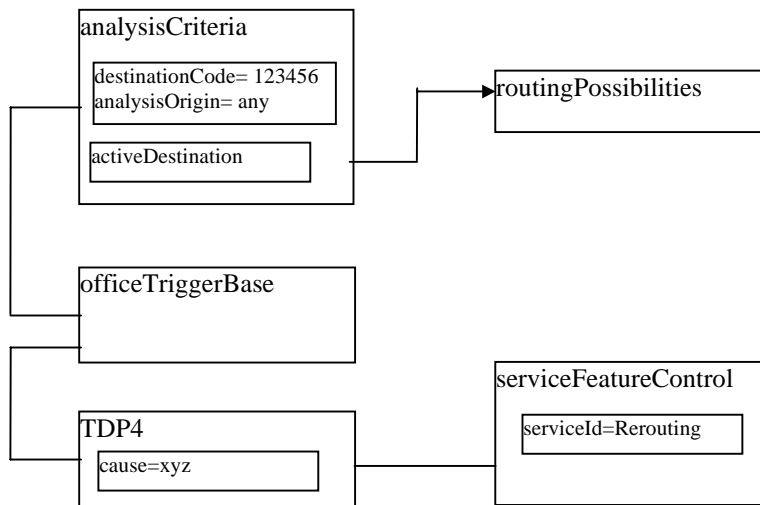

(routingPossibilities is an object class of ETSI ORM).

In this example all destination codes starting with "123456" are subject to a IN based rerouting capability: After digit analysis determines for "123456" a specific entry for call routing, IN digit analysis will determine that a trigger base is associated to this destination code. This result and the according trigger criteria have to be stored by the call processing facilities. After this call processing is resumed with call routing. In case call routing fails with cause "xyz" call processing will "remind" the IN trigger possibility, check the condition and if it is fulfilled turn over the control to the service feature control "Rerouting" of the IN.

9.2.2.2 Administration of IN triggering relative to a specific trunk group

Again three cases of trunk group based IN triggering can be distinguished:

- Trunk group based triggering before digit analysis:

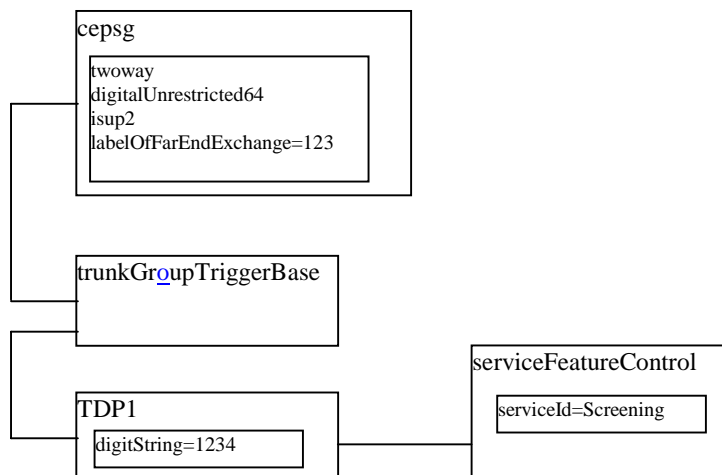

(The object class cepsg is defined in ETSI ORM and is a subclass of ITU-T Recommendation M.3100 [13] and ISO/IEC JTC1/SC21 N8434 [12] class circuitEndPointSubgroup).

In this case the relationship of the trunk group object to any other object of call routing is of no further relevance. As soon as a call is seizing a trunk belonging to this trunk group it has to be checked whether a TDP1 or TDP2 is related to this group via a trunkGroupTriggerBase. The trigger criteria can be checked immediately because the dialled information will be present already at trunk seizure (eventually some information has to be retrieved, e.g. the calling party number in case of analogue trunks).

- IN triggering for TDP3:

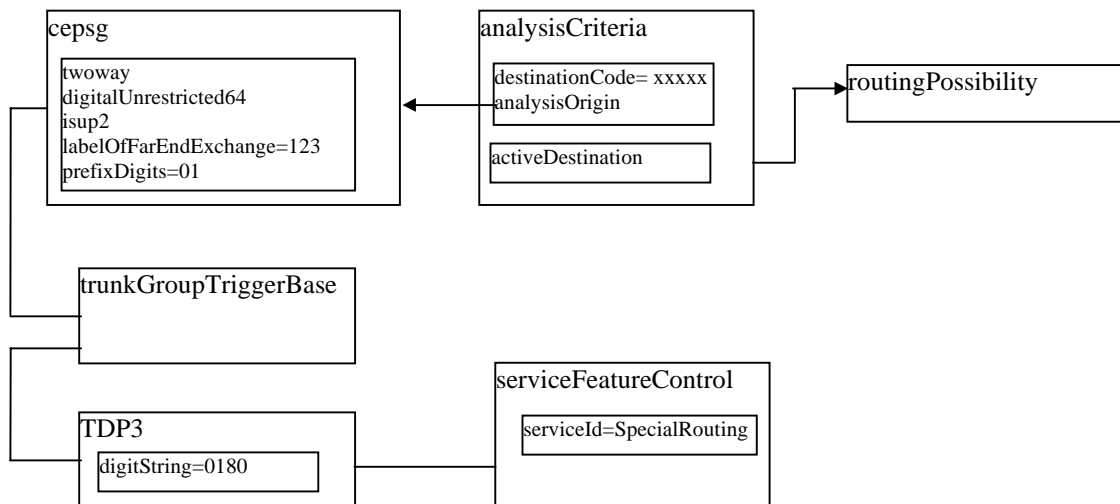

In this example all calls with dialled digits starting with "80" will get a special IN treatment if they come to the SSP via trunk group "123" (**note** that the prefix "01" has to be pasted before the dialled number before starting of digit/IN analysis). Calls coming on this trunk group without such a called party number will be routed origin-dependent according to the analysisCriteria.

Before the start of digit analysis call processing will check the association to a trunkGroupTriggerBase and mark its presence. Then digit analysis will be performed. This may lead to the determination of routing aims or to an office based trigger condition (whose triggering is postponed till the trunk group trigger conditions are checked). After this call processing is suspended and the trigger conditions for TDP3 are checked. If the condition is not met or the SCP sends CONTINUE, call processing is resumed at the point it was left after digit analysis.

- IN triggering after digit analysis because of route select failure, busy or no answer:

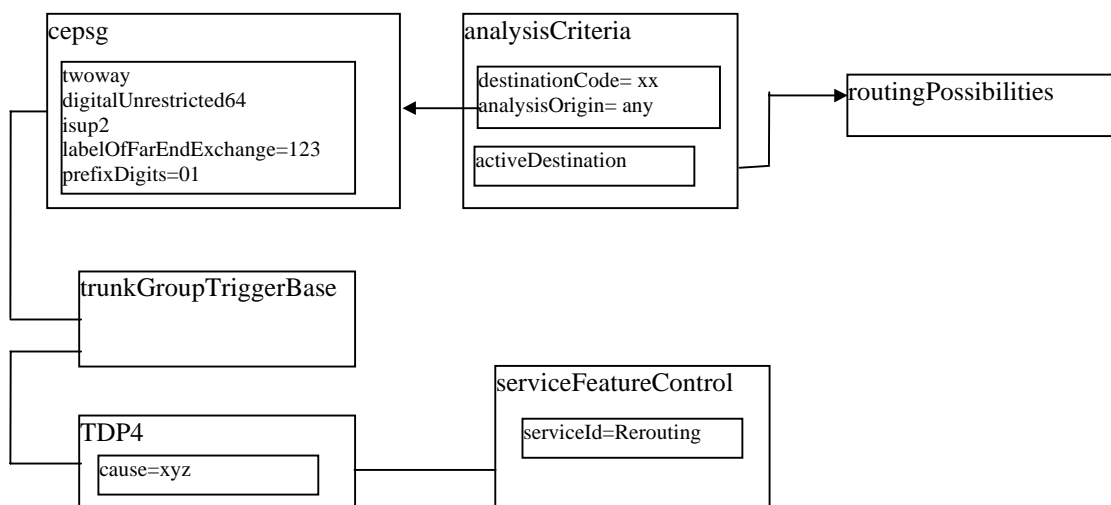

In this example all calls coming over trunk "123" are subject to a IN based rerouting capability: For all calls coming over this trunk an origin-dependent digit analysis is performed that will result in a specific input for call routing. At the same time a trunk group based IN trigger for TDP4 will be noted and marked by call processing. As soon as call routing fails, call processing will check this TDP4 trigger conditions and eventually start an IN based rerouting.

9.2.3 Relation SS#7 management (Q.751)

This subclause describes how the SSF manager can obtain the required information about the SS7 Network from the SS7 Manager.

9.2.3.1 Rationale

An Intelligent Network may use the Signalling System Nr.7 (SS7) network for the communication between its physical entities. In this case, the SSF Manager needs the information about how the SSF can route messages to its peer entities (i.e. SCF and SRF).

The SS7 network may be used by many other networks beside the IN (e.g. PSTN, ISDN, GSM). For performance reasons it is not recommended that every individual management system of these networks reads the same information from the SS7 network elements. If the SSF Manager requires SS7 related information it shall obtain it from the SS7 Manager either via a q Reference Point or via an x Reference Point. Via the same Reference Points, the SSF Manager may request configuration changes from the SS7 Manager. For the purpose of modelling the information to be transferred between the SSF Manager and the SS7 Manager, the Managed Objects defined in ITU-T Recommendations Q.751.1 [14] (MTP) and Q.751.2 [15] (SCCP) are re-used. It is left to the network operator to restrict the management capabilities of the SSF Manager (e.g. to allow only GET operations). The Functional Unit Negotiation mechanism may be used for this purpose.

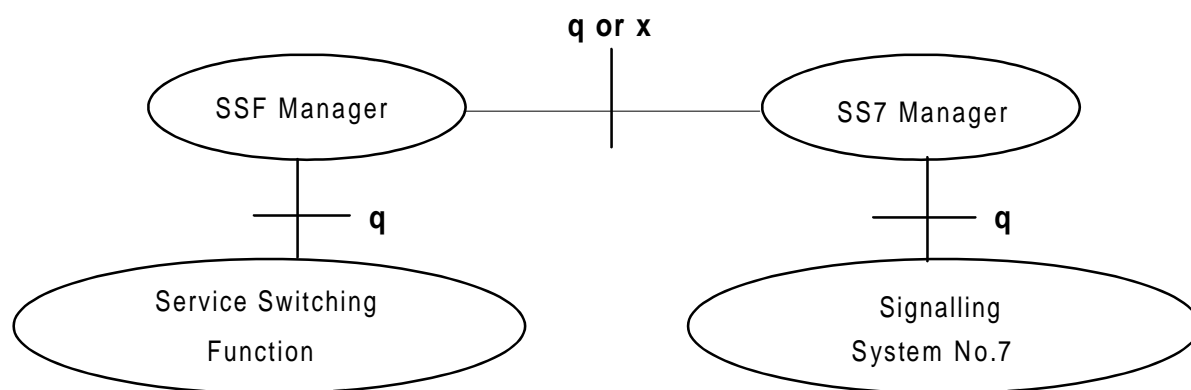

Figure 9.2.4

9.2.3.2 MTP related information

The following Managed Objects defined in ITU-T Recommendation Q.751.1 [14] are used for the transfer of MTP related formation between the SSF Manager and the SS7 Manager:

- mtpSignPoint
(Holds the management information about the Local Signalling Point where the SSF resides);
- signRouteSetNePart
(Holds the information about the Destination Signalling Points which can be reached from the Local Signalling Point).

9.2.3.3 SCCP related information

The following Managed Objects defined in ITU-T Recommendation Q.751.2 [15] are used for the transfer of SCCP related information between the SSF Manager and the SS7 Manager:

- sccpAccessPoint
(Holds the information about the SCCP Subsystems);
- gtTranslator
(Defines the selection of a Global Title Rule for the translation of a Global Title. Points to a Managed Object gtRule);
- gtRule
(Defines the Global Title Translation, Points to an SCCP Entity Set);
- sccpEntitySet
(Points to one or two SCCP Access Points);
- gtConversionRule
(Defines how a Global Title shall be translated into a new Global Title).

NOTE: The links between the Information Model for SSF Management and the Managed Objects for SS7 Management will be realized by including the Naming Attributes as pointers within the related SSF Managed Objects.

9.2.4 Relation to customer administration

The main part of the OCA model EN 300 291 [2] concerns the modelling of configuration management for analogue, digital, ISDN and PBX based customer installations.

The central object class for customer administration is the OC customerProfile inherited from ITU-T Recommendation Q.824.0 [16]. It represents a single point of reference used to bind together a range of services and resources belonging to one customer. It includes a directory number pointer list attribute that represents the directory number(s) assigned to the customer and an accessPortProfile pointer attribute that represents his access port(s) (trail termination points that terminates trails between the switching network and the customer premise equipment). Especially in the case of PBXs the access port object may contain several access channels, representing e.g. different d-Channels.

The assignment of services and supplementary services is modelled by containment within the OC customerProfile of the OC teleService, bearerService, supplementaryServiceService Independent, whereby the tele / bearerService OC again may contain objects of class supplementaryServiceServiceDependent.

By introducing the OC customizedResource as contained in customerProfile different directory numbers, access channels and access ports of a customer may be assigned different (supplementary) services.

The relationship of the customer administration object model to SSF-management concerns the configuration management of line based IN triggers. Essentially IN triggering is possible as soon as an access port of the customer is seized for an incoming or outgoing call of/to the customer. IN triggering may be relative to the different directory numbers, access channels, access ports or ISDN/PSTN services of the customer.

The principle of modelling line based IN triggers is to assign "trigger base" objects to objects of the OCA model that directly model a customer related access line. Specific services (e.g. teleservices) or routing properties (e.g. directory numbers) associated to the customer and that may be relevant as IN trigger criteria are not modelled as relations between trigger bases and OCA objects but as trigger criteria attributes within "IN trigger" objects of the SSFM model. Therefore trigger base objects are in general assigned to customerProfile objects. Only in the case of several access lines associated to one customer (as in the case of PBX customers) they may be assigned to customizedResource objects that assign several accessChannel objects to a customerProfile.

EXAMPLES:

TDP12 for an ordinary PSTN-customer with one directory number and one access port:

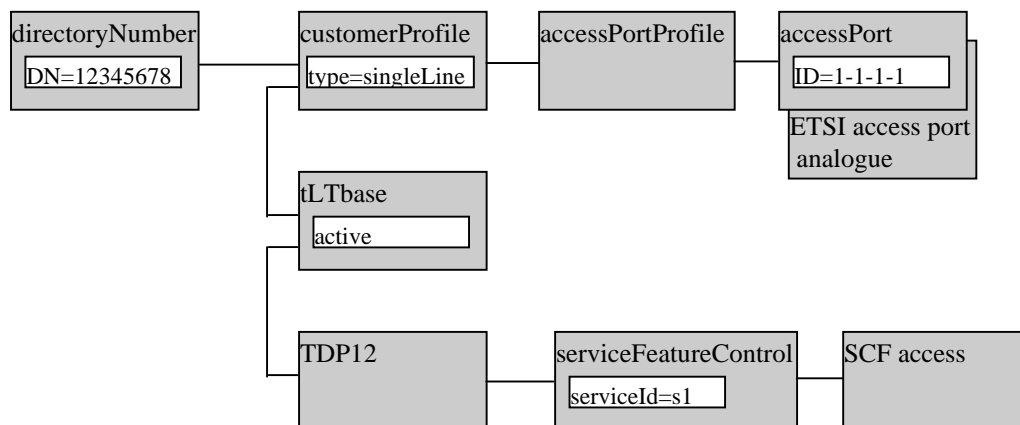

Figure 9.2.5

Different TDP12 for one line of a PBX-customer with 3 directory numbers, one primary access, 3 PBX lines, the two other lines get TDP13.

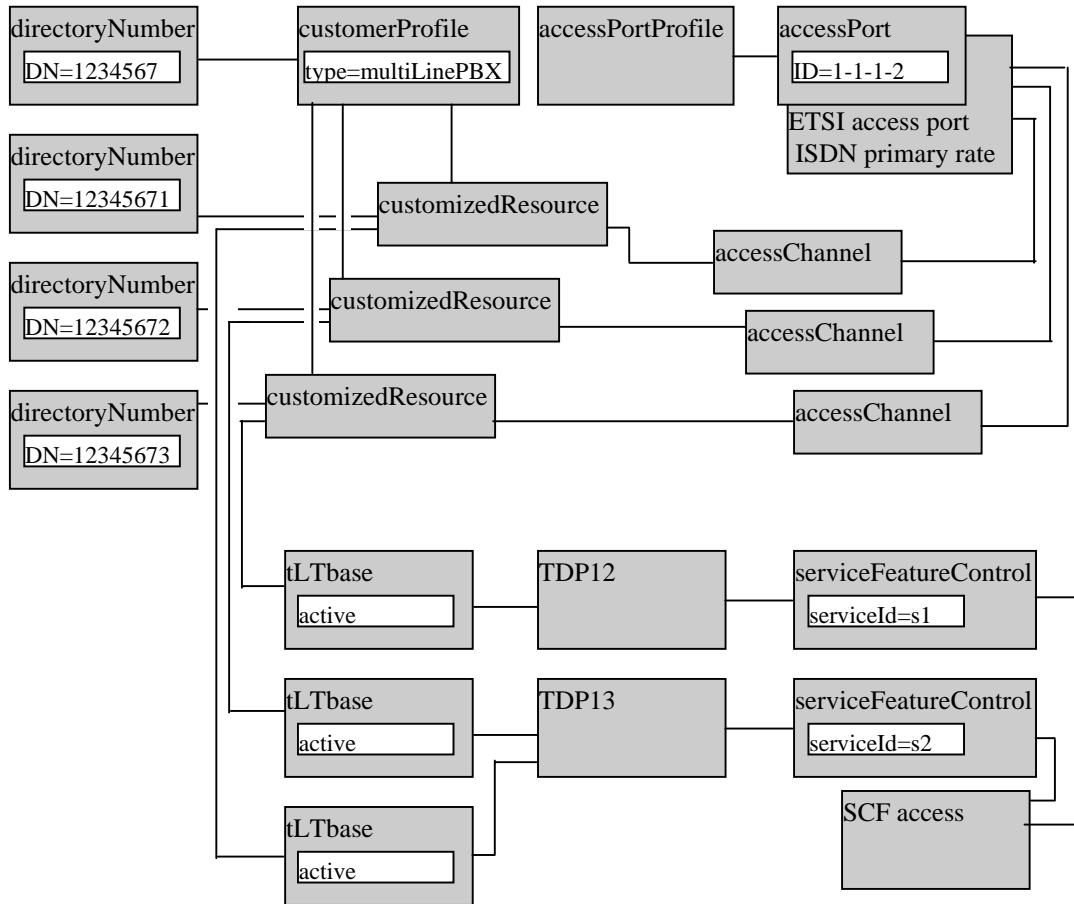

Figure 9.2.6

TDP12 for an ISDN basic access with one directory number - but activated only for phone service not for fax service:

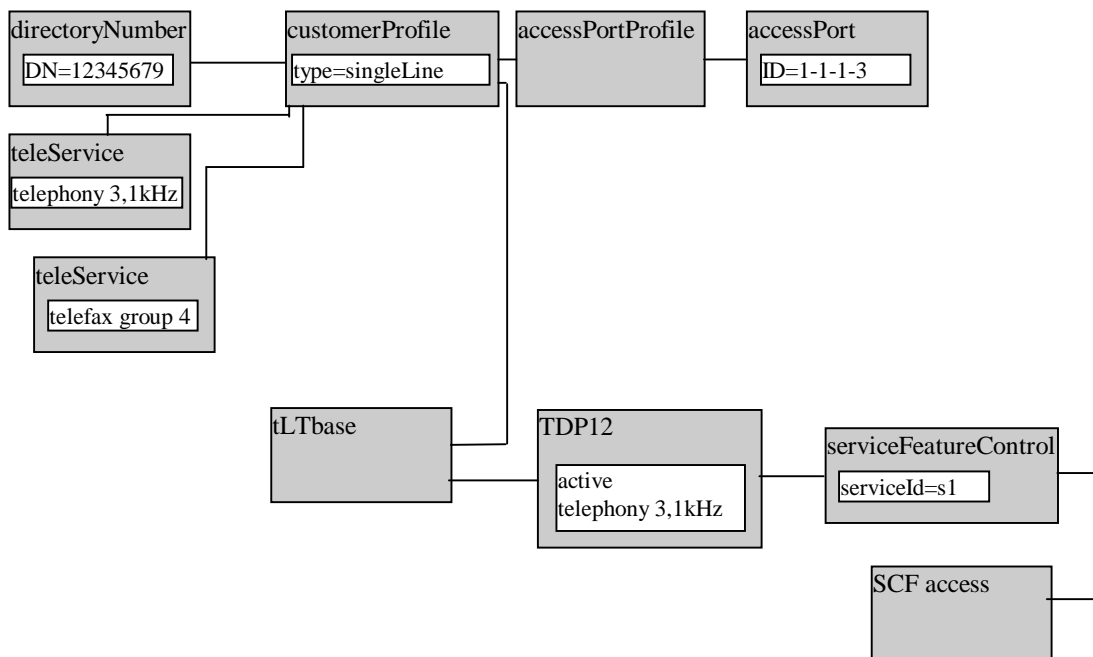

Figure 9.2.7

9.2.4.1 Relation to CENTREX Managed Object Classes

This is an informative example of the integration of CENTRIC in the SSF model.

Management of CENTREX groups and their members is modeled in an annex of the ETSI OCA model. It includes the following object classes:

- "centrexGroupProfile": is derived from the ITU-T Recommendation Q.824.0 [16] object class "customerProfile". It provides a single point of reference (within one managed element) to the (supplementary) services associated with all users of the group and includes as attribute a list of pointers to all associated members within the managed element.
- "centrexMemberProfile": is derived from the object class etsiSupplementaryServiceServiceIndependent. Only one instance of it will be contained in a given customerProfile object. It provides a single point of reference to the resources and services associated to the customer as member of the CENTREX group. It directly contains a pointer to an centrexGroupProfile and the intercom number of the customer.
- "groupDialPlan": This OC represents the treatment of dialled digits on the terminating equipment of centrex users. It is contained within a centrexGroupProfile. It includes information on allowed dialled codes and a translation table.
- "centrexGroupSupplService": is derived from the etsiSupplementaryServiceServiceIndependent object class. It allows to define supplementary services associated to all members of the CENTREX group.
- "centrexMemberSupplService": is derived from the etsiSupplementaryServiceServiceIndependent object class. It allows to define supplementary services associated to one members of the CENTREX group.

IN management affects CENTREX management, because IN triggering can be associated to a CENTREX group as a whole, i.e. for all the members of the group IN triggering will be checked in this case.

This is modelled in the SSF-Management model by associating a "privateFacilityTriggerBase" object to a "centrexGroupProfile". Hereby the IN triggers (and trigger criteria) associated with this trigger base are assigned to the CENTREX group. If a customer line is attached with a centrexMemberProfile associated with such an centrexGroupProfile, during call processing the trigger conditions related to the trigger base will be checked at the appropriate points in call.

Additionally IN specific subclasses of "centrexGroupSupplService" may be defined, that allow the association of certain types of IN services to the CENTREX group. E.g. there may be an object class of this kind, that defines the group as IN-based "area wide CENTREX (AWC)".

In case of an IN trigger to be assigned to an individual member of a CENTREX group (customerProfile contains centrexMemberProfile) this is modeled like a line based trigger (a lineTriggerBase is associated to the customerProfile).

In general line triggers have precedence before CENTREX group based triggers (i.e. the more specific criteria are prior to the more general ones). Because of the same principle office based triggers have the lowest priority.

EXAMPLE: IN-based AWC using TDP2.

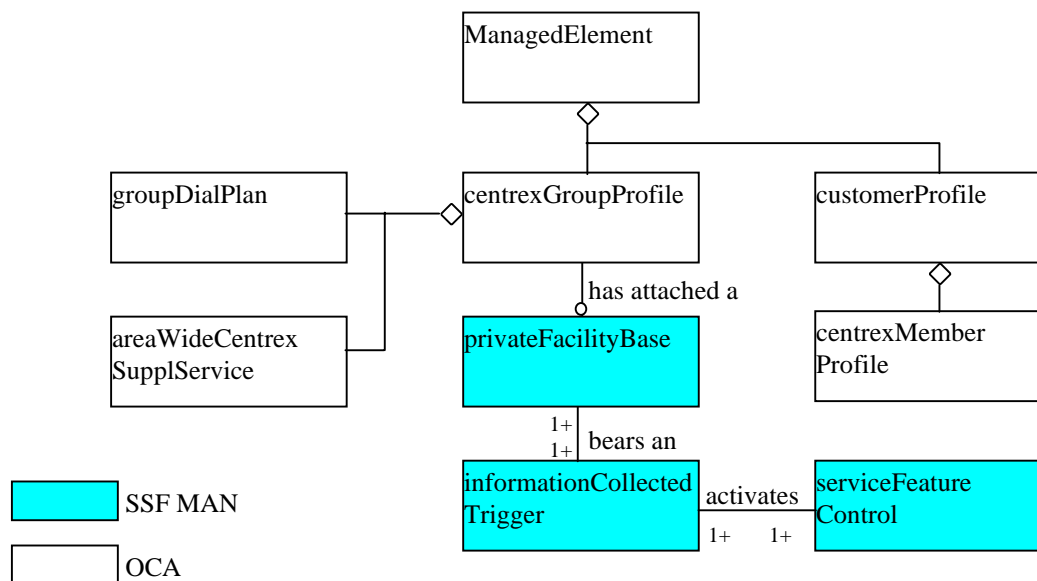

Figure 9.2.8

Explanation: If a customer, whose customerProfile contains a centrexMemberProfile, has dialed a complete intercom number according to the groupDialPlan of the CENTREX group he belongs to (i.e. the centrexMemberProfile points to the according centrexGroupProfile), then the TDP2 is triggered that is associated via privateFacilityBase to the CENTREX group (there may be indeed several TDP2s associated to the group, for each of which the trigger criteria have to be checked). IN service control (initiated via the serviceFeatureControl informations) then may be used to translate the dialled intercom number into a public directory number (sent in the INAP operation CONNECT), which is then used to route the call. This is especially useful, if the CENTREX members are not located at the same local exchange, so that number translation for remote CENTREX calls is done centrally in the SCP and not duplicated in all the local switches of the distributed CENTREX group. So in the areaWideCentrexSupplService it can be decided that the IN translated number is ignored for the case that the called CENTREX member is within the same local exchange (no remote AWC call).

The areaWideCentrexSupplService OC is necessary to have an indication for every member of the according CENTREX group that the call processing of intercom calls has to be processed via IN.

9.2.5 Relation to traffic management (OTM)

9.2.5.1 The OTM Model

The OTM model defined in I-ETS 300 637 [10] main concern is to enable as many call as possible to be successfully completed. This objective is met by maximizing the use of all available resources in any situation. It is also to be seen as the function of supervising the performance of a network, and to be able, if necessary, to control the flow of traffic for optimizing the utilization of the network capacity.

The scope of the traffic management model is to provide a model for the traffic management service functions in an exchange. Management of Intelligent Networks and CCS7 networks are out of the scope for the model.

As a basis, the model uses the call routing information model (ORM) in ETS 300 292 and the ETS 300 293 [8] "Generic network object model" (GOM).

9.2.5.2 Traffic Management versus IN Management.

ETR 047 [5] (M.3200) defines a number of management services, amongst them Traffic Management and Management of Intelligent Networks. Within ETSI, no specific activities except the preparation of the Baseline Document (ETR 062 [6]) and the SSF modelling (the present document) have been done.

Part of IN Management covers the area of Traffic Management which is to enable as many calls as possible to be successfully completed.

The figure below shows this point.

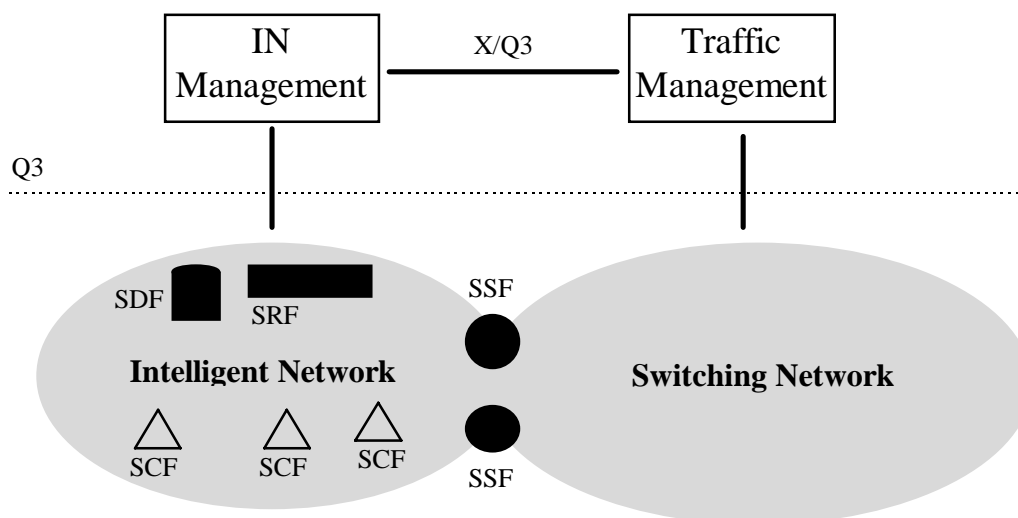

Figure 9.2.9

In respect to all calls requiring IN treatment, the Traffic Management functions ensures connection to a 'useable' SSP whenever possible. Within the SSP, the routing mechanism will form the relations between the switched network and the IN network. This relation is described elsewhere in the present document.

Processing of the call within the IN from trigger detection to selection of an outgoing route is responsibility of Intelligent Network Management.

Any information, that one manager should require from the network for which it is not responsible should be provided on the X interface between the managers.

9.2.6 Relation to the usage metering information management

I-ETS 300 819 [11] contains management interface definitions in regard to information that are gathered for the usage of metering accountable network resources.

The following concepts are relevant here:

- the gathering of usage metering information in a network element is controlled by a "**usage metering control function**", which decides when to start / stop or sequencing metering and which kind of information has to be gathered. It also determines when this information has to be reported, i.e. records have to be generated;
- usage metering data objects (generated by the control function for a specific accountable object) notify according to the control function their collected information in form of a "**usage metering record**" (UMR);
- there are specified types of UMRs that contain different mandatory, optional and conditional data packages;
- there are different kinds of functionalities in regard to logging the UMRs and retrieving the UMR logs.

As part of the UMR the following IN-specific data packages are defined:

- "IN Specific Information": This contains information about the user / subscriber of the IN service. This may be: "personal User Id", "charged Participant", "charged directory number", "percentage to be billed", "account code input".
- "IN Service Information List": This is a list of IN services involved within the recorded usage. Hereby the IN service is identified by the service Id. Following the service Id there may be some service specific information (defined as OCTET STRING) and queuing information, if some queuing resources were used during the usage of the service.

Therefore the requirement OR12-A3 ("Notify IN related information within usage metering log") is fulfilled, if using a management information system conforming to OCH.

In the OCH model the usage metering control function is only defined as placeholder. There is no manageable information about it. I.e. its functionality's are fixed within the logic of the network element. But it can indeed be influenced by the IN service logic using the operations SCI and FCI of INAP. So also the "SCI/FCIbillingChargingCharacteristics"-parameter in its relation to usage metering control has to be a part of the fixed logic within the network element. Especially the gathering of the above mentioned data "IN Specific information" and "IN Service Information List" is controlled by this INAP operations.

However there may be circumstances in relation to IN calls, where the network element logic lacks information to determine usage metering control. This may be the case e.g. when triggering IN before digit analysis is complete (e.g. originating line triggers TDP1/TDP2). In this case the network element logic does not know what kind of call it is, but the service feature control can know this. Therefore in the SSFMGT model an attribute "chargingProfile" of the serviceFeatureControl class is defined that contains input for the usage metering control function. I.e. using this input the control function can determine the record type, the data packages to be collected, etc. As there is no standardized management information modelling for the usage metering control function, this "chargingProfile" attribute has to be defined operator specifically, i.e. as OCTET STRING in the SSFMGT model. Should there be any extensions of the OCH model in defining such charging profiles for usage metering control, this has to be taken into account in the SSFMGT model.

Annex A (informative): SSF scenarios

This clause is only meant to introduce / illustrate the entities and their relationships within the model.

For the elaboration of the scenarios the following working assumptions hold:

- 1) in the SSF only the concept of 'logical' service key is used; the mapping from service key to SLP location in a specific SCP is a matter for the SCF, this mapping will not be modelled in the SSF; no alternative routing and load sharing mechanisms will be defined in the SSF; SCCP will be kept responsible for the actual routing and load sharing (mapping of the global title to DPCs); the SCF access manager will be responsible for mapping of the service key to the appropriate address information needed to establish the connection between SSF and SCF. The address information will depend on the physical configuration. For a connection between SSP and SCP this may either be Global Title (GT) or Destination Point Code (DPC) with or without a Sub System Number (SSN). In case of a direct connection (e.g. SCP or Service Node (SN) or Adjunct (AD)) the connection type is proprietary (e.g. TCP/IP based).; As a result of this the ES will not support call gapping per SSP-SCP pair; for this to be achievable two options were identified: a) wait for SCCP to provide mechanisms for this; b) declare this the responsibility of traffic management (TMN network management layer);
- 2) the SSF Management standard is not intended to solve temporary shortcomings of Core INAP CS1 implementations. Therefore, no management mechanisms are defined for e.g. setting values of the service interaction indicators (SII).

NOTE: The usage of arrows in the following flow diagrams:

- ▶ for INAP messages
- - - - -▶ for non-INAP messages (for clarification, not discussed)
-▶ for return result with parameters

A.1 Basic IN Call scenarios

A.1.1 Introduction

The "Basic Call Process" (BCP) scenarios are based on the stage 2 description of the BASIC CALL PROCESS SIB for IN CS-1 (ITU-T Recommendation Q.1214 [17], subclause 5.3). The BCP SIB provides the IN based service control with access to special CCF/SSF call processing capabilities in the following areas:

- call setup capabilities;
- call party handling capabilities;
- call initiation capabilities;
- call clearing capabilities;
- event reporting capabilities.

This BCP capabilities can be invoked by the CCF/SSF or the SCF.

The CCF/SSF invokes BCP capabilities when it detects a Trigger Detection Point (TDP) during basic call processing.

The SCF invokes BCP capabilities when it sends an Initiate Call Attempt information flow.

The "Initiate Call Attempt" scenario and the call initiation capabilities of the BCP SIB are described in subclause 9.9. In this subclause the CCF/SSF based triggering of IN service control and the remaining BCP capabilities are examined in regard to management requirements.

A.1.2 Triggering of IN service control

A.1.2.1 DFP description

At specific points in call, defined by the Basic Call State Model (BCSM), trigger conditions are checked by the CCF/SSF. If a TDP is detected, the SSF sends a Initial DP information flow to the SCF. TDPs may be armed in request mode (TDP-R). For a TDP-R, the Initial DP establishes a control relationship between the SCF and the SSF, enabling the SCF to return instructions to the SSF.

NOTE: In ITU CS-1 instead of the Initial DP information flow, DP-specific information flows (e.g. OMidCall, TCalledPartyBusy) may be sent as initial information flow. As this is not included in ETSI CS-1 this is out of scope of the present document.

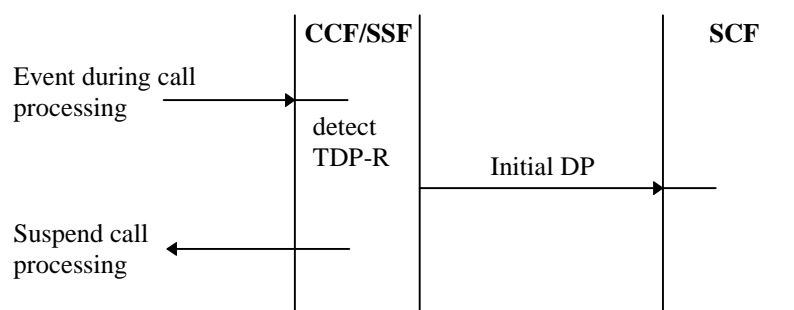

Figure A.1.1

In case the SSF detects a TDP-R, the CCF instructs the basic call processing to go into a waiting state (suspend call processing) until the SCF starts an information flow that includes instructions how to proceed. These instructions use the BCP capabilities of the CCF to influence further call processing.

A.1.2.2 SSF Model mapping

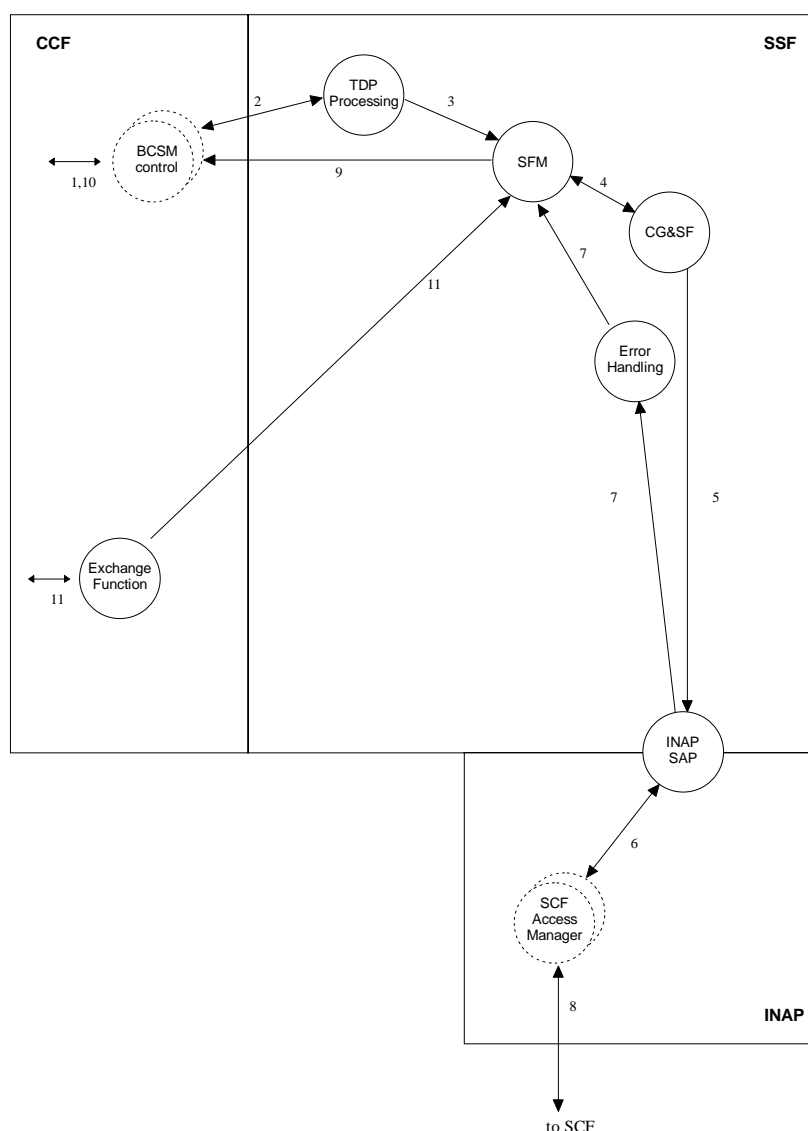

Figure A.1.2

- 1) Basic call processing maps a normal call processing event to an event of the BCSM model and delivers call related information as requested by the BCSM.
- 2) The information about the point in call of the BCSM and the call related information are delivered to the "TDP processing" entity. This entity either triggers IN control UNCONDITIONAL or CONDITIONAL on the basis of TRIGGER CRITERIA. In case no IN control is triggered, the BCSM control is instructed to continue call processing without IN control (10). Also TDP processing decides whether some call information deactivate the IN triggering (e.g. an escape code has been dialled).
- 3) The detected TDP category and mode is delivered to the SFM service feature manager together with the call related information. The SFM decides whether there is an IN based service feature control associated to the TDP and call information. If so, it decides whether the service feature was deactivated (by SSF management). If the service feature is active, the SFM requests the sending of an Initial DP information flow from the INAP SAP. If there is no service feature or if the service feature is deactivated, the SFM instructs the BCSM control how to proceed.
- 4) The information elements of the Initial DP information flow are delivered to the INAP SAP via the CallGap & Service-Filtering Entity. If the call is to be gapped or filtered, the SFM is informed how to proceed with the call.

- 5) If there is no gapping or filtering, the InitialDP is delivered to the INAP SAP. The address data for the sending of the Initial DP are determined and the transaction to the related SCF is started.
- 6) If no SCF fulfilling the Initial DP information flow request is reachable, this is notified to the error handling.
- 7) Error handling determines the reason for failure of sending the InitialDP. Errors may be of the following kind:
 - *MissingCustomerRecord*: The call may be released or an announcement may be played. The maintenance functions in the SCF are informed.
 - *MissingParameter, SystemFailure, TaskRefused, UnexpectedDataValue, UnexpectedParameter*: If the *InitialDP* was sent after a mid call trigger, the network operator may chose to maintain the call or release it. If not, an announcement may be played. The SL and the maintenance function in the SCF are informed.
 - *UnexpectedComponentSequence*: The SSF moves to Idle and notifies the SFM. Whether the call should be released or a bearer connection to an announcement device should be established depends on the error operation received and the network operator.
- 8) If a SSF/SCF transaction is possible, transfer the Initial DP information flow.
- 9) If no service feature is related to the triggering, if the service feature is deactivated or if no related SCF was reachable, the SFM instructs the BCSM control to proceed with the call processing. This may be: (a) proceed with the call processing at a specific point in call (e.g. delete escape code from called party number and start at point in call "collected information" again), (b) exception handling with a specific cause.
- 10) Restart call processing at the indicated point in call. If the call is to be abandoned, a specific intercept handling may be necessary.
- 11) A service feature may require the sending of optional parameters in the Initial DP that is not included in the call data received. Therefore the SFM may request resending of some feature information elements (see ETS 300 374-1[9], subclause 9.19.2.1, for an example).

A.1.2.3 Description of the impacted sub-entities

1) BCSM control

Description of functionality

Check if internal event at an internal state maps to a point in call of the BCSM model.

Transfer call related information between call processing and IN related information elements.

Start TDP processing.

Restart call processing at specified points in call.

Description of data

none

2) TDP processing

Description of functionality

Unconditional triggering: If the TDP processing is called at a specific point in call by the BCSM control for a specific customer (line), private facility (e.g. Centrex group), trunkgroup, IN call control is triggered without any further check of conditions.

Conditional triggering: If the TDP processing is called at a specific point in call by the BCSM control, IN call control is triggered because of specific (call data related) criteria. Conditional triggering can be customer, trunkgroup, private facility or office (e.g. code point) based.

Inform the SFM about a triggered TDP and transfer call data.

Determine TDP-mode (request) and inform BCSM Control about continuation / suspension of call processing.

Description of data

Customer / trunkgroup / private-facility / office based association of a TDP to a BCSM point in call.

Customer / trunkgroup / private-facility / office based association of trigger criteria to a TDP.

Mode of TDP (request mode).

In the following a set of TDP/TDP-criteria combinations is described (see also ETS 300 374-1, annex C). The tables represent only a minimal set of requirements. More combinations than those listed are conceivable.

Unconditional Triggering:

TDP-category:	1	2	3	4	5	6	7	8	9	10	12	13	14	15	16	17	18
line based	x	x	x	x	x	x	-	-	x	-	x	x	x	-	-	x	-
trunkgroup based	x	x	x	x	x	x	-	-	x	-	x	x	x	-	-	x	-
private facility based	x	x	x	x	x	x	-	-	x	-	x	x	x	-	-	x	-
key:																	
x : applicable																	
- : not applicable																	

NOTE: In CS-2, also unconditional triggering for DP8 (O_MID_CALL) is allowed.

Conditional Triggering:

The following trigger criteria are conceivable (minimal set of criteria):

- 1) Digit strings: A single digit combination (analysis can be based on the complete number of received digits or can be based on a predefined number of digits starting from the most significant digit of the received information) or a combination of several digits linked with OR. A single digit combination may be also negated with NOT.
- 2) Number of digits: Count of the dialled digits.
- 3) Causes: A single release cause or a range of causes.
- 4) Specific Origins: A digit string specifying the whole or a part of the calling party number or location number, or a wildcard.
- 5) Nature of address: Only special traffic shall be triggered (e.g. national, international).
- 6) Feature activation: Signalling specific service feature activation (e.g. via ISDN D channel signalling, DTMF inband signalling).
- 7) Combination of the mentioned criteria (AND, OR, NOT).

Line / private-facility based conditional triggering is conceivable for the following TDP-categories:

TDP-category:	1	2	3	4	5	6	7	8	9	10	12	13	14	15	16	17	18
digit strings			x	x													
number of digits		x															
cause values				x								x	x				
specific origins											x	x	x				
nature of address			x														
combinations			x	x								x	x				
key:																	
x : applicable																	
blank : not applicable																	

Office based conditional triggering is conceivable for the following TDP-categories:

TDP-category:	1	2	3	4	5	6	7	8	9	10	12	13	14	15	16	17	18
digit strings			x									x	x				
number of digits				x													
cause values				x								x					
specific origins			x	x							x	x	x				
nature of address			x														
combinations			x	x								x	x				
key:																	
x : applicable																	
blank : not applicable																	

Trunk group based conditional triggering is conceivable for the following TDP-categories:

TDP-category:	1	2	3	4	5	6	7	8	9	10	12	13	14	15	16	17	18
digit strings			x	x								x	x				
number of digits		x										x	x				
cause values				x								x	x				
specific origins	x	x		x							x	x	x				
nature of address			x														
combinations			x	x								x	x				
key:																	
x : applicable																	
blank : not applicable																	

3) SFM Service Feature Manager

Description of functionality

Associate trigger data to service feature (service key).

Check escape conditions for the service feature (no IN call control for the specific call data).

Check feature interaction conditions for the service feature.

Check if service is deactivated.

Give advice to BCSM control for call processing continuation.

Determine optional parameters to be sent in InitialDP. Eventually request further information from exchange functionality.

Request INAP SAP to send InitialDP information flow with data necessary for the service feature.

Start service control process for service feature if all checks are ok.

Description of data

Mapping of trigger data to service keys.

Feature interaction allowed / forbidden.

Service feature active / deactive.

Instructions for call continuation or exception handling.

List of optional parameters of Initial DP needed for the service feature.

Reference to an application context identifier for the INAP SAP.

Reference to a specific set of SCF accesses.

NOTE: Manageable data to control compatibility and precedence of service features (in case of interworking) is beyond the scope of CS-1.

4) SCF Access Manager

Description of functionality

Control the transaction to a specific SCF.

Notify SFM via INAP SAP of success / failure of Initial DP transmittal.

Description of data

Address information of SCF and SSF.

5) INAP SAP

Interface between SSF and INAP protocol stack. The only data are global parameters of the INAP protocol, e.g. it will contain a list of possible application contexts and their ASE definitions. If the Initial DP delivered by the SFM does not confirm to the application context requested by the SFM, rejection will be notified to the SFM.

6) CG&SF

see clause A.4

7) Error Handling

For each error operation the necessary data to establish a bearer connection should be defined. The decision how to proceed the call is taken by the SFM.

ES

A.1.3 Call Setup Capabilities

A.1.3.1 DFP description

After triggering of IN-service control via a TDP-R a control relationship exists between SCF and SSF. After the Initial DP or some event report, the SLPI in the SCF may demand a call setup from the CCF/SSF via the information flows CONTINUE or CONNECT. After receiving CONTINUE, the CCF/SSF instructs the basic call processing to continue at the point where it was interrupted after IN triggering. In the case of CONNECT, parameters like destinationRoutingAddress or routeList determine the further call setup. In case only a destinationRoutingAddress is received, the call processing is resumed at PIC 3 (Analyze Info, i.e. start digit analysis again), if a routeList parameter is received, the call processing is resumed at PIC 4 (routing & alerting).

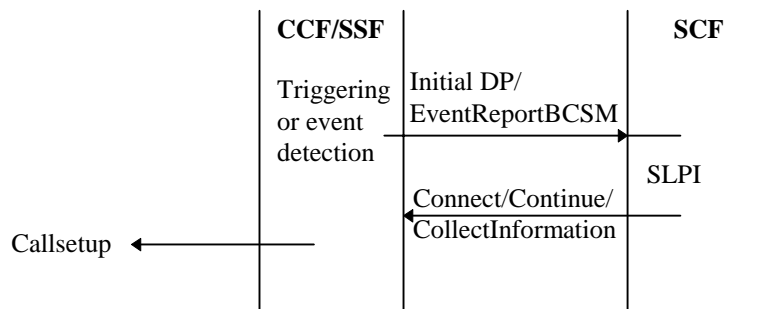

Figure A.1.3

A special case of this scenario is the "collect information scenario". This information flow requests the SSF to perform the originating basic call processing actions to prompt a calling party for destination information, then collect information from a calling party according to a specified numbering plan indicator. The information flow for CollectInformation in ETSI CS-1 is not specified explicitly (only contains the "extension field" as argument; this is a difference to ITU-T Recommendation Q.1218 [18]). The information flow for collect information may also be performed by using a RequestReportBCSMEvent operation containing arming of EDP2 and a requested number of digits (see subclause on event report capabilities, subclause A.1.4), resuming the call by CONTINUE.

Call processing for the collect information scenario is resumed at PIC 2 (Collect Information; i.e. new digits can be received even if digit analysis had been performed before).

This scenario is an alternative to the PromptAndCollectUserInformation flow of the SRF scenarios. It uses only call setup and event reporting capabilities of the SSF and no SRF capabilities. This scenario therefore includes prompting the calling party with in-band or out-band signals for further digit input.

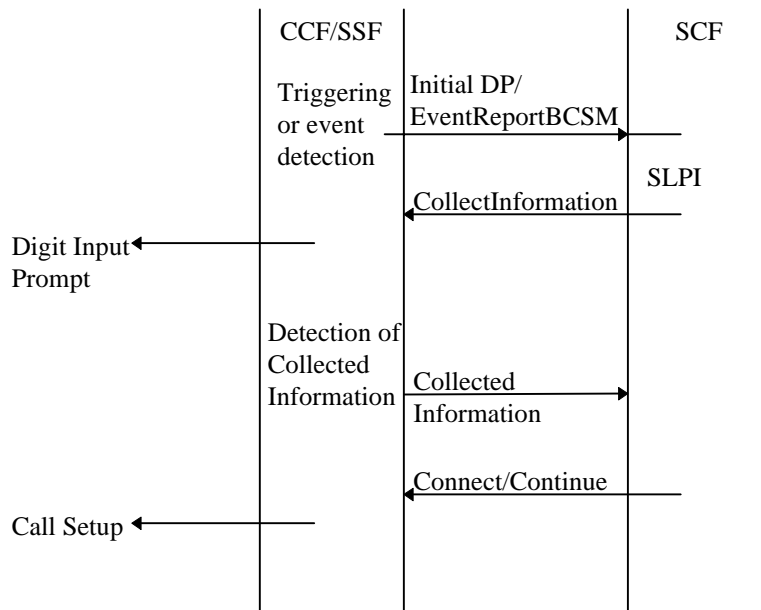

Figure A.1.4

A.1.3.2 SSF Model Mapping

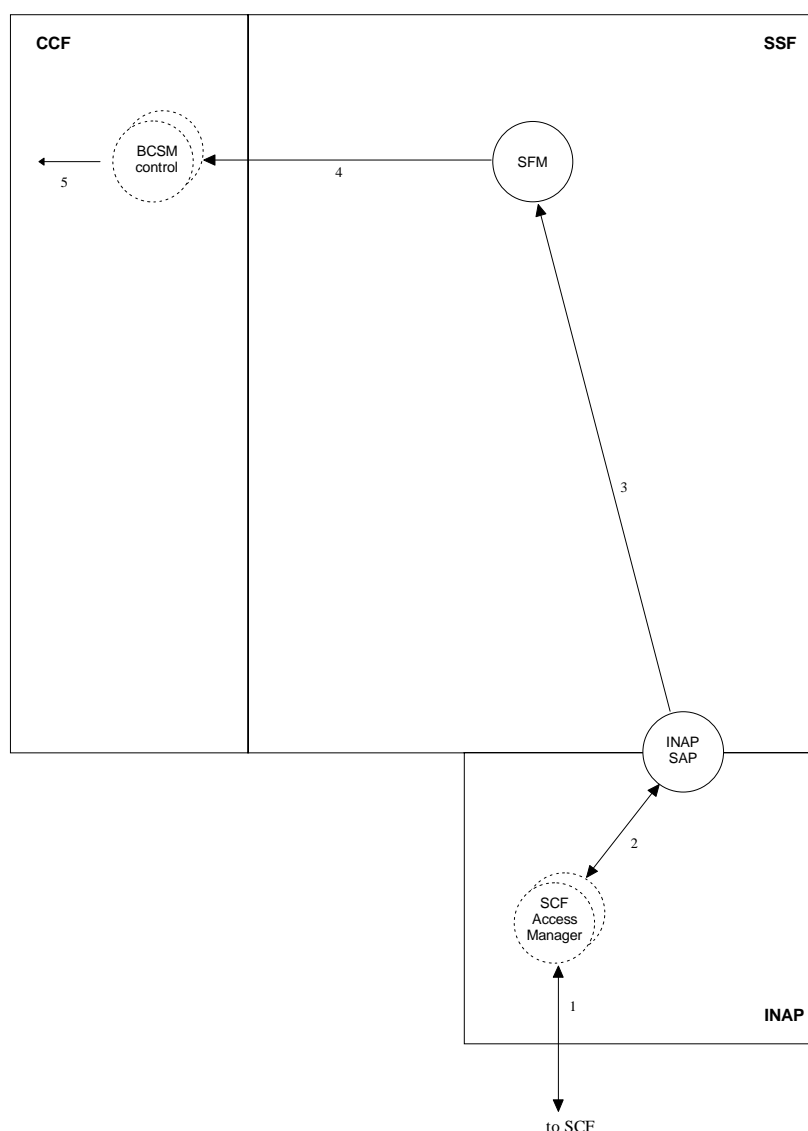

Figure A.1.5

- 1) The Connect / Continue / CollectInformation information flow is received from the SCF by the SCF access manager. If some error condition is detected (e.g. MissingParameter) this is reported to the SCF.
- 2) The Connect / Continue / CollectInformation information flow is protocol checked by the INAP SAP and decoded. If an error occurs this is reported to the SCF access manager.
- 3) If the information flow is correct and decoded it is delivered to the SFM.
- 4) The SFM instructs the BCSM-control-instance that is related to the control process to continue call processing at PIC2, PIC 3 or PIC 4, delivering the necessary information for call setup.
- 5) The BCSM-control maps the CONNECT / COLLECTINFORMATION parameters onto the call data and resumes the call processing in the state indicated by the SFM. In case of a collect information the BCSM-control may be instructed to prompt the calling party with specific in- or out-band signals.

A.1.3.3 Description of the impacted sub-entities

1) SFM

Description of functionality

Decide at which PIC the call setup has to be continued by basic call processing.

Deliver parameters of CONNECT / COLLECTINFORMATION to the BCSM-control related to the service control process.

Decide what to do if CONNECT / CONTINUE / COLLECTINFORMATION information flow was not correct (e.g. exception handling).

Plausibility check of parameters (e.g. redirectionInformation in CONNECT is not allowed without redirectingPartyId). Again this may lead to exception handling.

Description of data

Exception handling procedure.

NOTE: No implicit EDP-arming is assumed in ETSI CS-1.

2) BCSM-control

Description of functionality

Inform basic call processing to resume at states corresponding to PIC2 or PIC 3 or PIC 4.

Mapping of CONNECT / COLLECTINFORMATION parameters to internal call data representation.

Description of data

Data about signals to prompt calling party for input of further digits.

Mapping of the routeList from the CONNECT operation to actual routing objects.

Mapping to call data and states is internal, i.e. is in general not an object of management.

No new functionality and data are involved for error handling, INAP SAP and SCF access manager.

A.1.4 Event Report Capabilities

A.1.4.1 DFP description

If a control relationship exists between SSF and SCF and call processing was suspended (e.g. because of IN triggering), the SCF can send an information flow RequestReportBCSMEvent. This request has to contain an event detection point (EDP), specifying an event in the BCSM, a monitor mode (request / notification) and the legId (calling or called party). It also may contain some event specific criteria (e.g. No-Answer-timer). If call processing is resumed (after CONTINUE or CONNECT) and the specified event is detected by the BCSM Control, this is reported to the SCF via the information flow EventReportBCSM. In case of an EDP-R the call processing is suspended, waiting for new instructions from the SCF. In case of an EDP-N call processing is continued immediately after reporting the event to the SCF. E.g. in the case of EDP-R for DP5 (Busy) call processing will be suspended after disconnecting the called party but holding the calling party and resumed after a CONNECT is received with a new destinationRoutingAddress.

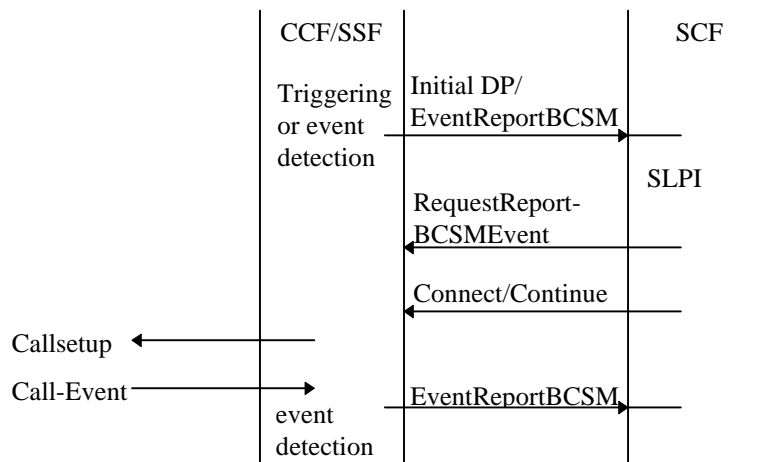

Figure A.1.6

A.1.4.2 SSF Model Mapping

RequestReportBCSMEvent

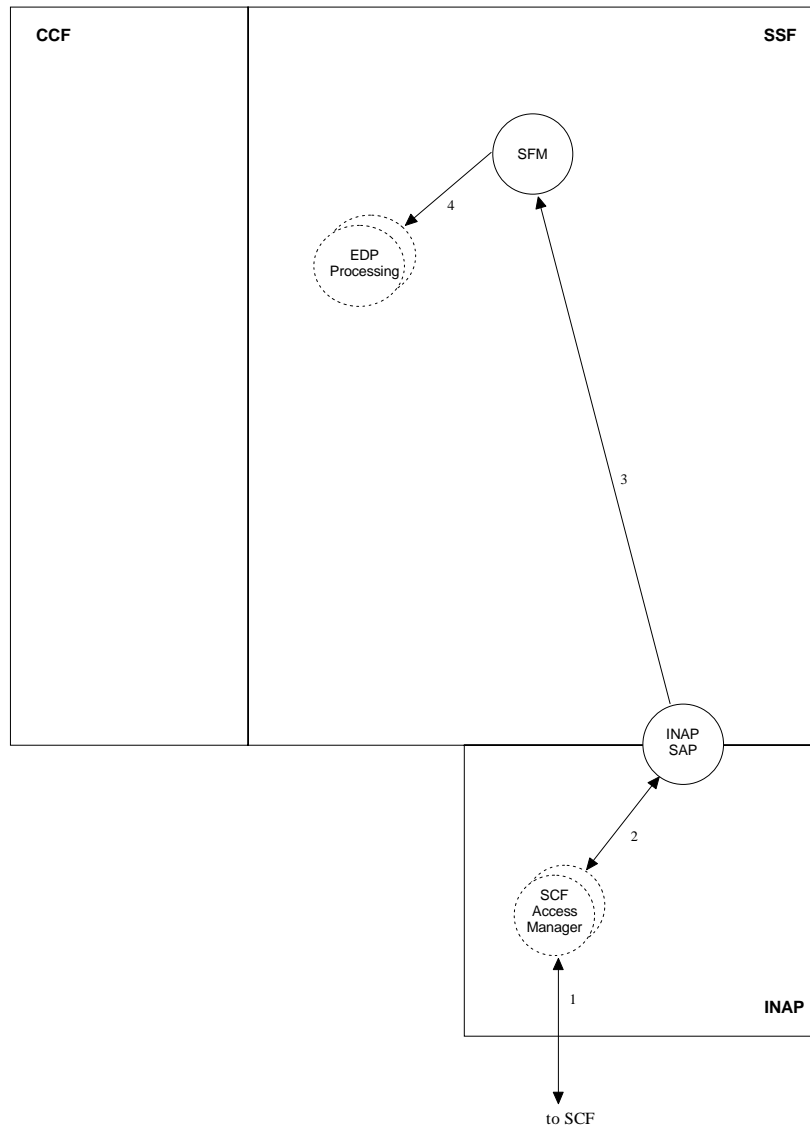

Figure A.1.7

- 1) The RequestReportBCSMEvent information flow is received from the SCF by the SCF access manager. If some error condition is detected (e.g. MissingParameter) this is reported to the SCF.
- 2) The information flow is protocol checked by the INAP SAP and decoded. If an error occurs this is reported to the SCF access manager.
- 3) If the information flow is correct and decoded it is delivered to the SFM.
- 4) The SFM instructs the EDP handling to arm a EDP with bcsmEventType, mode, legId and dPspecificCriteria like requested in the RequestReportBCSMEvent and associates it with the service control process.

EventReportBCSM

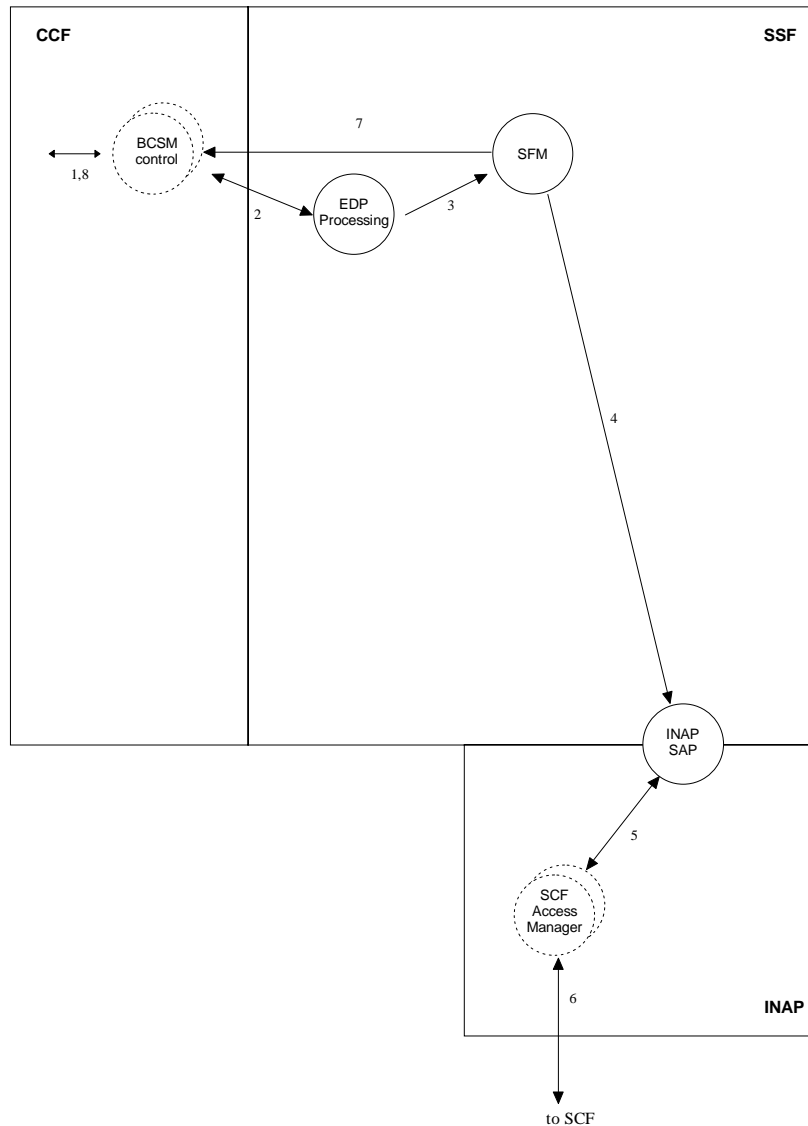

Figure A.1.8

- 1) During basic call processing events that happen in specific states may be mapped by the BCSM Control entity to an EDP in the BCSM. If this is successful the event is delivered to the EDP processing.
- 2,3) (a) if it is an event "Address complete" and EDP-6 (NoAnswer) is armed, then the No-Answer-Timer (parameter dPSpecificCriteria from RequestReportBCSMEvent) is delivered to the BCSM Control and started, (b) for other events or if the No-Answer-Timer expires, this is notified to the SFM (service control process related to EDP). In case of an EDP-N, the BCSM Control is instructed to continue call processing.
- 4) The SFM assigns the event report to an existing service control and delivers it to the INAP SAP.
- 5) The address data for the sending of the Initial DP are determined and the transaction to the related SCF is started.
- 6) If a SSF/SCF control relation is still active, transfer the Event Report BCSM information flow.
- 7) If no service feature control is related to the EDP, or if the transaction was not successful, or if there was call gapping, the SFM instructs the BCSM Control to proceed with the call processing (e.g. exception handling with a specific cause).
- 8) Continue call processing at the indicated point in call. If the call is to be abandoned, a specific intercept handling may be necessary.

A.1.4.3 Description of the impacted SSF entities

1) BCSM Control

Description of functionality

Mapping of call processing events to BCSM events.

Starting of application timer.

Resume call processing.

Description of data.

Mapping of causes to BCSM events (Busy, RouteSelectFailure, No Answer).

Mapping of feature activation to BCSM events (Mid Call).

2) EDP Handling

Description of functionality

Check if application timer has to be started by BCSM.

Check if EDP is armed and in which mode, check DP specific criteria.

Inform BCSM of call continuation in case of notification mode.

Send event report to service control process related to EDP.

Description of data

Default value of NoAnswer timer

Default value of digits to collect number (for EDP2)

3) SFM

Description of functionality

Determine service control process and relay event report to the SCF related to this process. If no service control process can be determined, an error handling has to be performed.

Determine precedence of detection points (order of priority according to ITU-T Recommendation Q.1214 [17], figure 4.11a: EDP-N, EDP-R, TDP-R).

Description of data

none

There are no new descriptions related to INAP SAP, SCF Access Manager, Error Handling.

A.1.5 Call party handling capabilities

The call party handling capabilities in regard to "Initiate Call Attempt" are described in subclause 9.9. Beside this, only rerouting capabilities are of interest, i.e. after a release event related to the called party the line from the calling party to the SSP is hold, while waiting for new instructions from IN service control. After reporting the event (busy, noAnswer, disconnect) to the SCF via an eventReportBCSM, the call can be rerouted by the SCF to a new direction by sending an information flow CONNECT from the SCF.

A.1.6 Release call capabilities

If a service control relationship is established and the CCF call processing is suspended, a basic call release event can be produced by sending a RELEASE information flow to the SCF. This can be used to release the called party and to reroute the call to a new direction (follow on during call).

A.2 Specialized Resource scenarios

A.2.1 Introduction

The scenarios as described here are based on the example physical scenarios in Core INAP CS1 (ETS 300 374-1 [9]; subclauses 4.2 and 7.3.5). This scenarios deal with different possibilities how to give access to a specialized resource function (SRF) to an SCF using a SSF-relay function. The scenarios also deal with different possibilities how to connect or disconnect an physical entity (e.g. SRP) containing an SRF to the SSP.

While other scenarios are possible than those described, they are not included because they either duplicate the functionality presented or they otherwise do not add value from a management perspective. For example call clearing cases like call party release and release of a temporary connection are not modelled.

Possible SCF/SRF control relationships:

- SSF is acting as relay station for the controlling of the SRF by the SCF.
- The SCF has a direct control relationship to the SRF (via INAP), while there is a signalling link (e.g. ISUP) between IP and SSP for the bearer connection to the end-user.

Possible SSF/SRF-relay relationships:

The initiating SSP may be able to connect to

- the SRP directly;
- an SRP via an "assisting SSP";
- an SRP via an "hand-off SSP".

General methods to disconnect an SRP from an SSP:

- "SCF Initiated Disconnect";
Forward disconnection initiated from SCF.
- "SRF Initiated Disconnect";
Backward disconnection initiated from SRF.

The disconnection procedure selected by the SCF is to either allow the SRF to disconnect on completion of user interaction, or to have the SCF explicitly order the SSF to disconnect.

A disconnect procedure is used to disconnect the SRF and its interconnection (bearer connection) with the end-user and to terminate the SCF-SRF relationship.

A.2.1.1 SSF as Relay for SCF/SRF-signalling

The SRF is integrated into the SSP or directly connected (e.g. via DSS1). Operations of the SCF for the SRF are sent from the SCF to the SSF and relayed there to the SRF. The SSF needs to perform protocol conversion.

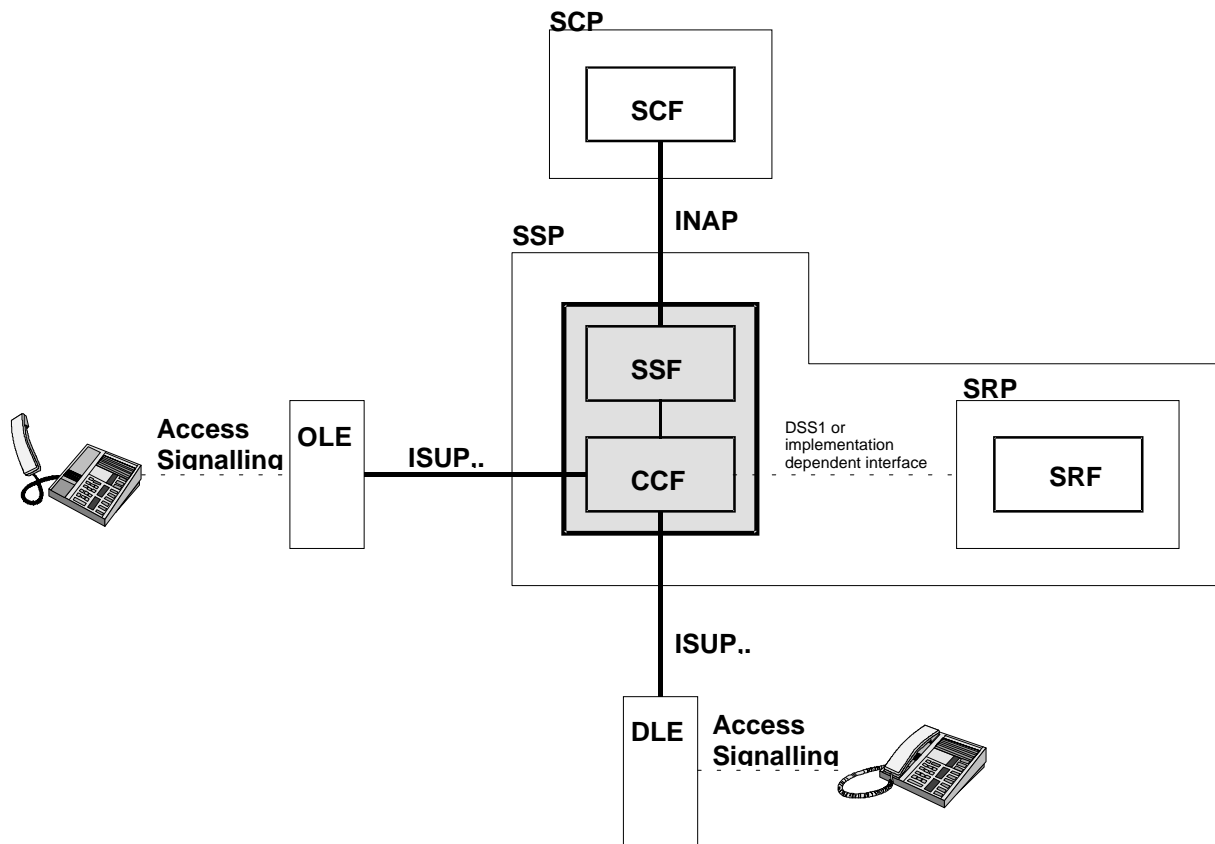

Figure A.2.1

(Signalling between the exchanges may be different from ISUP - is only an example.)

A.2.1.2 IP has direct signalling connection to SCP

The SRF is directly attached to the SCF that is interacting with the SSF (initiating SSP). But the controlling operations are sent by the SCF directly to the SRF. Signalling between SSF and SRF is only related to BCSM-processing of the bearer-connection user / SRP. The following is a realistic scenario:

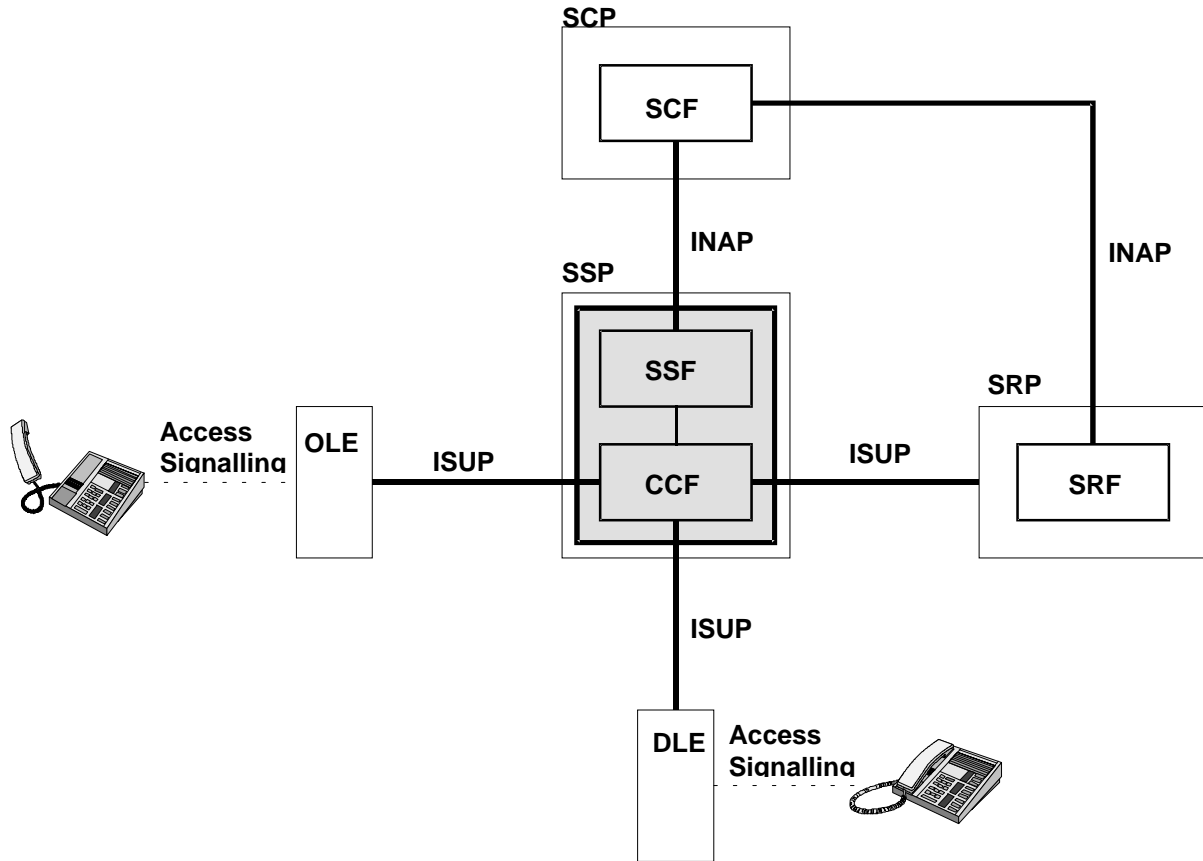

Figure A.2.2

A.2.1.3 Using a central assist or hand-off SSP

The SCF realizes, that an SRF-functionality is needed and no appropriate SRP is available at the initiating SSP (reached via DSS1 or ISUP). But there is an "assist" or "hand-off" SSP in the network, that is connected directly to an appropriate SRP. The Call is forwarded to this SSP and the signalling to the SRF is done by relaying it via the assisting SSP. After disconnecting the resource in the "assist" case, call control returns to the initiating SSP, while it remains in the hand-off SSP in the hand-off case.

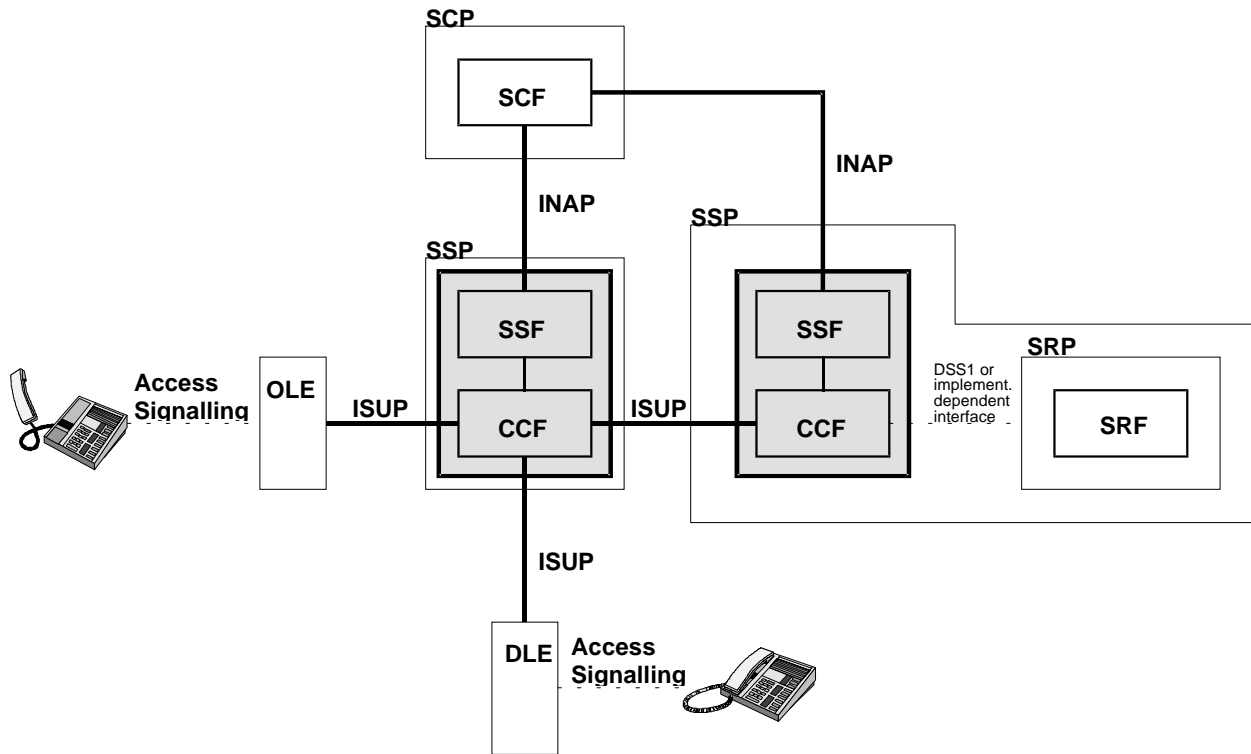

Figure A.2.3

In the picture only the case is shown, where the SRP is directly connected to the assist / hand-off SSP. Again, the SRP also may be connected to the assist / hand-off SSP via ISUP and to the SCF via INAP.

A.2.2 DFP description

A.2.2.1 Scenario 1, SSF is SRF/SCF-relay, direct SSP/SRP bearer connection

Precondition: An SLP in the SCF realizes the need for a user-dialogue with a specialized resource and it realizes that an appropriate SRP is available at the initiating SSP (iPAavailable is a parameter that may be sent with initialDP). The SSP has a direct bearer and signalling connection to the SRP, but not the SCP.

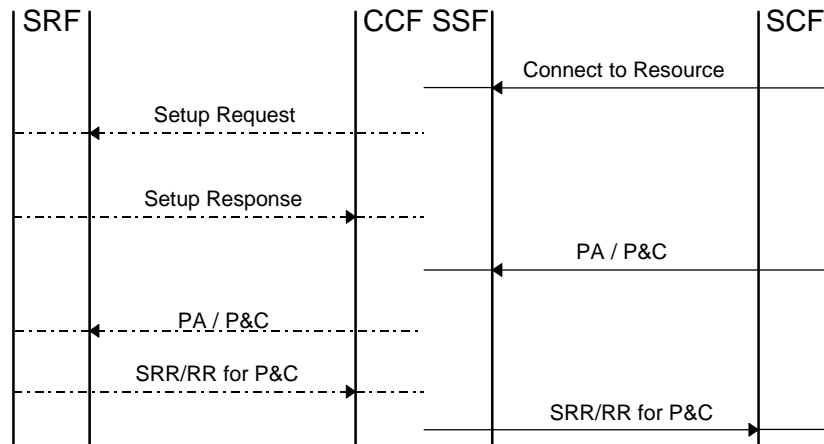

Figure A.2.4

(PA: PlayAnnouncement; P&C: PromptAndCollectUserInformation; SRR: SpecialicedResourceReport; RR for P&C: Result Report for Prompt and Collect User Information.)

A.2.2.2 Scenario 2, SSF is SRF/SCF-relay, signalling link between SRP and SSP

Precondition: An SLP in the SCF realizes the need for an user-dialogue with a specialized resource and it realizes that there is an appropriate SRP that can be reached via ISUP by the SSP and directly via INAP by the SCP. The SSP has a direct bearer and signalling connection to the SRP, the SCP has a signalling connection to the SRP.

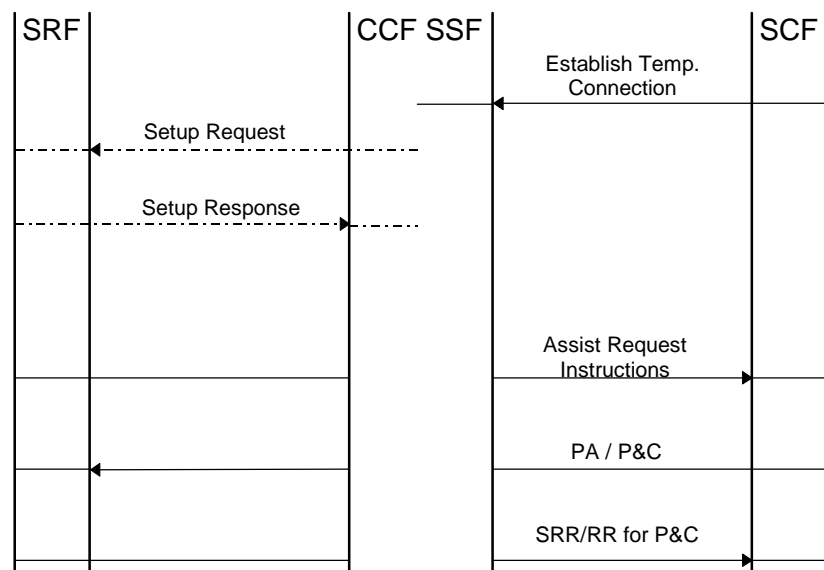

Figure A.2.5

A.2.2.3 Scenario 3, Assist case

Precondition: An SLP in the SCF realizes the need for a user-dialogue with a specialized resource and it realizes that there is an appropriate SRP that is attached to a remote SSP (not the initiating SSP). The assisting SSP has a direct bearer and signalling connection to the SRP, the SCP has a signalling connection to initiating and assisting SSP.

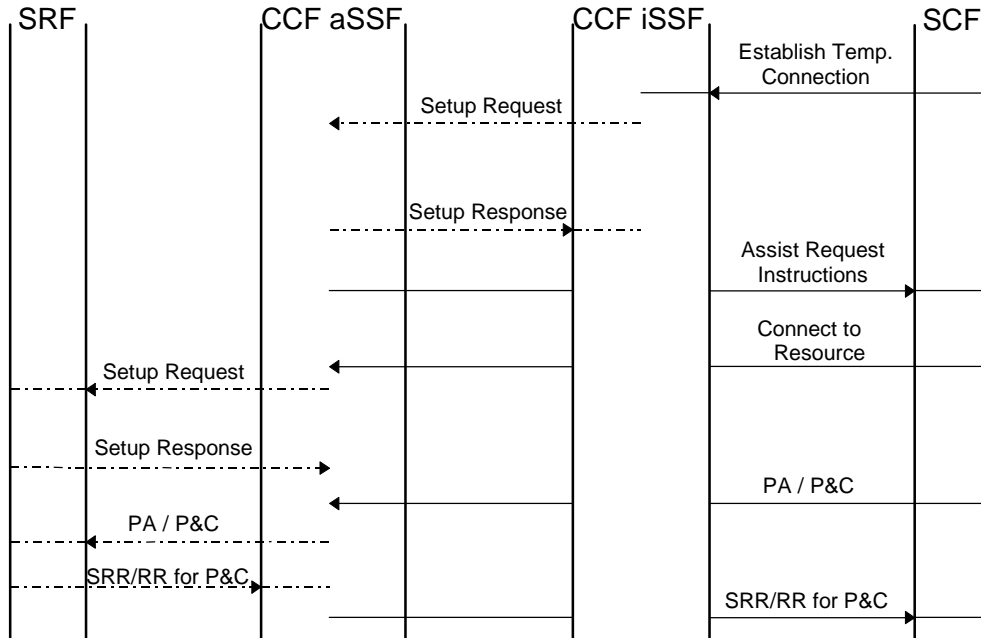

Figure A.2.6

A.2.2.4 Scenario 4, SRF initiated disconnect (normal disconnect)

Precondition: The SSF has a direct bearer and signalling connection to the SRF. An SLP in the SCF performs a user-interaction (UI) dialogue with a specialized resource and it realizes the need for enabling disconnection of the SRP to be performed from the SRF when UI is concluded (last PA/P&C has set parameter DisconnectFromIPForbidden to 'False').

SRF controlled backward disconnection implies that once the SRF realizes that UI is ended, it initiates a bearer channel disconnect sequence to the SSF using the applicable bearer channel signalling system (SSF-SRF bearer connection control messages are not subject for standardization).

The connection from the SSF to the end user remains.

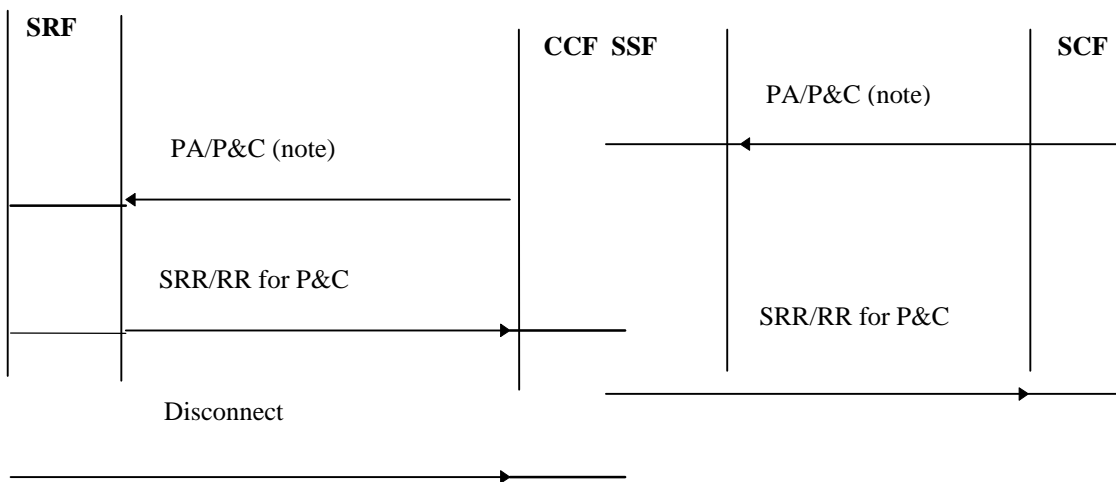

Figure A.2.7

SRF Disconnection: Initiated at End of User Interaction.

PA: PlayAnnouncement; P&C: PromptAndCollectUserInformation; SRR: SpecialicedResourceReport; RR for P&C: Result Report for Prompt and Collect User Information. Bearer related messages are shown with dotted lines.

SSF-SRF bearer connection control messages are not subject for standardization.

NOTE: Parameter DisconnectFromIPForbidden set to False.

A.2.2.5 Scenario 5, SRF initiated disconnect (abnormal disconnect)

Precondition: The SSF (SSP) has a direct bearer and signalling connection to the SRF (IP). An SLP in the SCF performs a user interaction (UI) dialogue with a specialized resource.

A SRF sanity time-out occurs due to an error condition (e.g. due to a SCF-SSF dialogue error). This event occurs when the SRF has been connected for a network operator defined period of time (timer T_{sr}) without having a UI (e.g. PA/P&C) operation to execute. The SRF autonomously initiates a bearer channel disconnect sequence to the SSF using the applicable bearer channel signalling system.

This SRF sanity timing value will depend on the nature of interaction the SRF supports and should be selected by the network operator accordingly.

The SRF initiates a bearer channel disconnect sequence to the SSF using the applicable bearer channel signalling control messages and makes a state transition to Idle state, i.e. the relationship SCF-SRF is ended. The connection from the SSF to the end user remains.

Another error case with similar treatment would be e.g. failure of the user-SRF bearer connection.

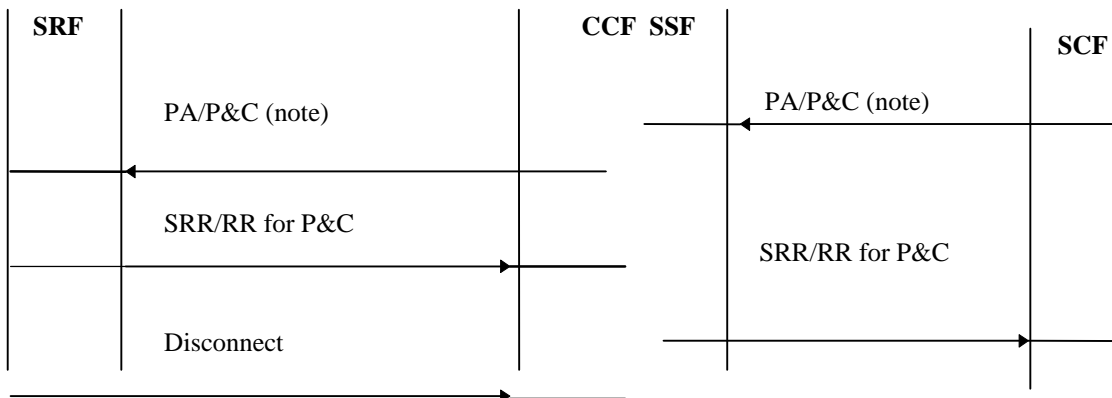

Figure A.2.8

SRF Disconnection: Initiated at T_{sr} timer expiry - or other abnormal SRF error.

PA: PlayAnnouncement; P&C: PromptAndCollectUserInformation; SRR: SpecialicedResourceReport; RR for P&C: Result Report for Prompt and Collect User Information. Bearer related messages are shown with dotted lines.

SSF-SRF bearer connection control messages are not subject for standardization.

NOTE: Parameter DisconnectFromIPForbidden set to False.

A.2.2.6 Scenario 6, SCF initiated disconnect ('relay case')

Precondition: The SSF has a direct bearer and signalling connection to the SRF. An SLP in the SCF performs a user interaction (UI) dialogue with a specialized resource and it realizes the need for disconnection of the SRF (SRP) to be performed from the SCF when UI is concluded, i.e. when a reply is received to the last PA/P&C operation.

The SCF initiated disconnect uses DisconnectForwardConnection (DCF) operation. Once the DCF operation is received by the SCF, it will initiate a "release" of the bearer channel connection between the SSF and the SRF, using applicable bearer channel signalling.

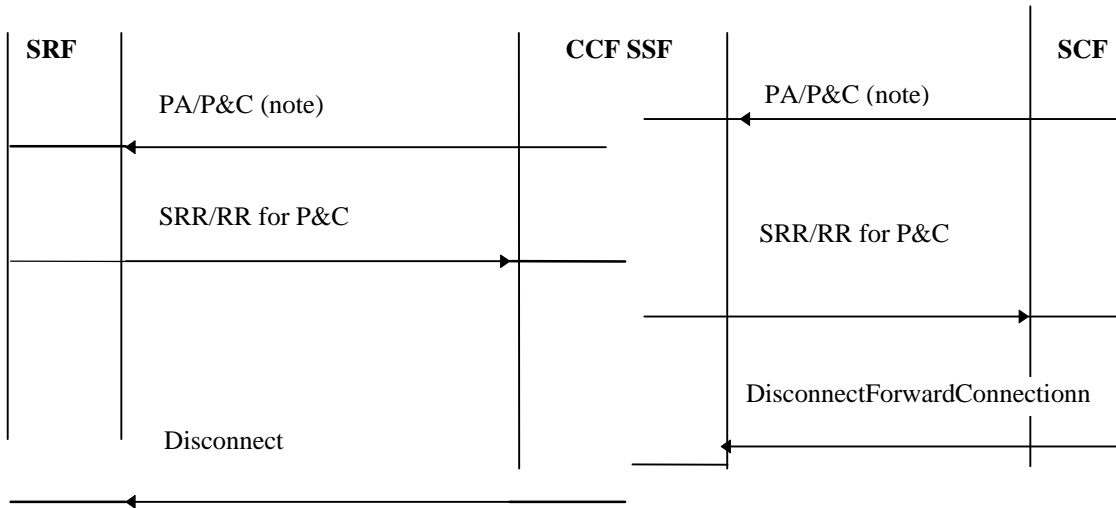

Figure A.2.9

SRF Disconnection: SCF initiated disconnection.

PA: PlayAnnouncement; P&C: PromptAndCollectUserInformation; SRR: SpecialicedResourceReport; RR for P&C: Result Report for Prompt and Collect User Information, DFC: disconnectForwardConnection. Bearer related messages are shown with dotted lines. SSF-SRF bearer connection control messages are not subject for standardization.

NOTE: Parameter DisconnectFromIPForbidden set to True (default).

A.2.2.7 Scenario 7, SCF initiated disconnect (Assist case)

Precondition: The assist SSF has a direct signalling connection to the SCF.

An SLP in the SCF performs a user interaction (UI) dialogue with a specialized resource and it is aware that the appropriate SRF (SRP) is attached to a remote assisting SSF (SSP). The assisting SSF (SSP) has a direct bearer and signalling connection to the SRF (SRP), the SCF (SCP) has a signalling connection to initiating and assisting SSF.

The SLP in the SCF realizes the need for disconnection of the SRF (SRP) to be performed from the SCF when UI is concluded, i.e. when a reply is received to the last PA/P&C operation.

The SCF initiated disconnect uses DisconnectForwardConnection (DCF) operation. Once the DCF operation is received by the SCF, it will initiate a forward disconnection of the temporary connection from the initiating SSF to the assisting SSF, and this disconnection is propagated to its associated SRF (IP), using applicable bearer channel signalling.

The initiating SSF, knowing that the forward connection was initiated as the result of an EstablishTemporaryConnection operation, does not disconnect the connection to end user.

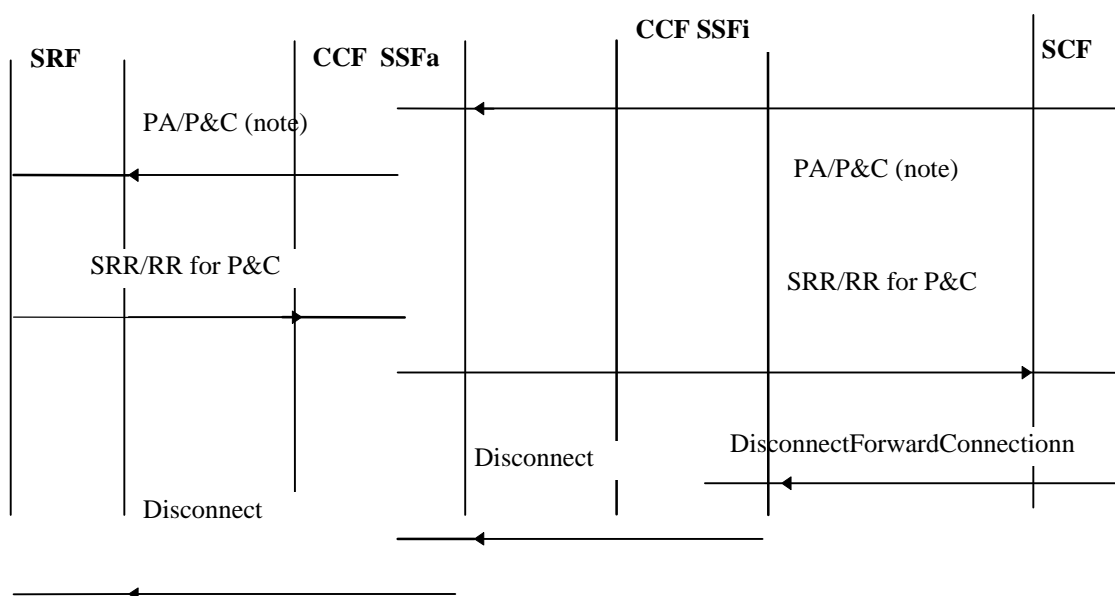

Figure A.2.10

SRF Disconnection: SCF initiated disconnection.

PA: PlayAnnouncement; P&C: PromptAndCollectUserInformation; SRR: SpecialicedResourceReport; RR for P&C: Result Report for Prompt and Collect User Information, DFC: DisconnectForwardConnection. Bearer related messages are shown with dotted lines. SSF-SRF bearer connection control messages are not subject for standardization.

NOTE: Parameter DisconnectFromIPForbidden set to True.

A.2.2.8 AssistRequestInstructions error handling

After the SRP or the assisting SSP has sent the *AssistRequestInstructions* operation, several errors may happen in the SCF. These are:

MissingCustomerRecord, if the SLP cannot be found due to missing customer record.

MissingParameter, if an essential parameter is missing in the operation.

TaskRefused. These error operations are returned by a physical entity if it is was not able to fulfil a specific task s requested by a operation, and a recovery is not expected to be complete within the current call instance.

UnexpectedComponentSequence. The SCF cannot start processing of the requested operation because a SACF or MACF rule is violated, or the current state of the FSM does not allow processing of the operation.

UnexpectedDataValue. The SCF cannot process the operation because a data value is unexpected. This does not overlap the *ParameterOutOfRange* error.

UnexpectedParameter. There is an error in the received operation argument. A valid, but unexpected parameter was present in the argument and the responding entity cannot start processing of the operation.

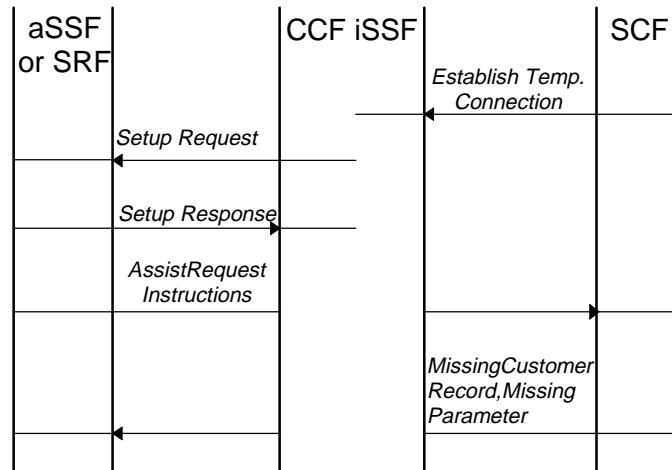

Figure A.2.11

A.2.3 SSF Model mapping

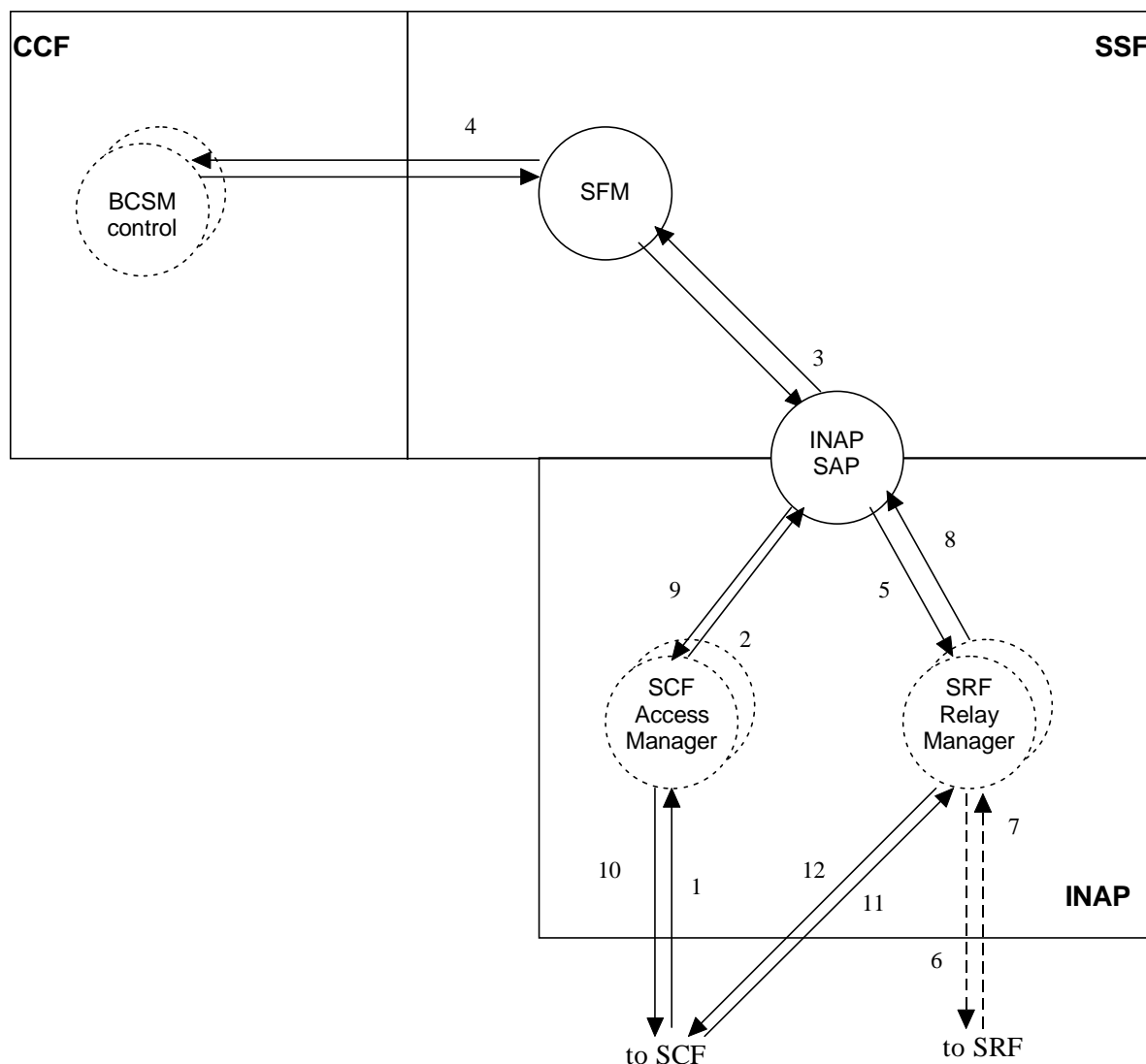

Figure A.2.12

ConnectToResource

- 1) The SRF scenarios will be invoked in the context of basic call scenarios. Therefore the SCF will know via InitialDP (parameter iPAvailable) which SRP scenario has to be handled. In case of "initiating SSP relay" the SCF will send a ConnectToResource INAP operation to the SSF. This operation contains the following information elements:
resourceAddress: indicating the physical address of the SRP.
- 2) The INAP operation is forwarded by the SCF Access Manager to the INAP SAP sub-entity that decodes it.
- 3) The INAP SAP sub-entity passes the request for a bearer connection (end-user to SRP) to the SFM.
- 4) The SFM instructs the BCSM (that is suspended, e.g. after an InitialDP) to connect to an SRP with address resourceAddress (i.e. to create a bearer connection between end-user and SRP).
- 5) The INAP SAP creates a new SRF Relay Manager instance and forwards the ConnectToResource operation to it.
- 6) 11,6) Simultaneously the ConnectToResource operation is relayed to the SRF (protocol translation by the SRF Relay Manager).

PlayAnnouncement / PromptAndCollectUserInformation

- 11) This UI-operation may be sent following the ConnectToResource / AssistRequestInstructions operation and forwarded immediately to the SRF (protocol translation by the SRF Relay Manager).
- 12) The SRF Manager relays responses of the SRF to the UI-operation (response to PromptAndCollectUserInformation or SpecializedResourceReport) to the SCF.
- 6) The SRP requests UI-operations from the SCF or reacts on UI-operations with result reports.
- 7) The SRF Relay Manager forwards UI-operations received from the SCF to the SRF.

EstablishTemporaryConnection

Similar to ConnectToResource. The differences are:

The INAP operation contains further information elements - correlationId and scfID - that identify the SCF and corresponding SLP, when the AssistRequestInstruction is sent. Also the information element ServiceInteractionIndicator is of importance when forwarding the assist request via ISUP.

After instructing the BCSM to continue call setup, there is no direct connecting to an SRP. Instead an ISUP-message IAM is sent to the assistingSSPIPRoutingAddress, including in the message the parameters correlationID and scfID (they also may be implicitly transmitted via the routing address).

AssistRequestInstructions

Similar to the handling of InitialDP. The differences are:

The assist procedure is detected at TDP3 (AnalysedInfo). A TDP has to be armed for the assistingSSPIPRoutingAddress.

The SFM determines that an assist case is detected and provides (if not received already) the parameters correlationId and scfID. According to the scfID the information is forwarded to a SCF Access Manager, to send an AssistRequestInstructions operation with the information element correlationID using also SRP-related information from the SRFAccessManager (IPAvailable, iPSSPCapabilities).

If the assisting SSP or the SRP receives an error operation as described, the connection is released by the assisting SSP or by the SRP.

Forward Disconnection (from SSF)

- 1) The SCF will send a DisconnectForwardConnection INAP operation to the SSF. The operation DisconnectForwardConnection applies to a forward disconnection. This operation is used either to disconnect a forward temporary connection to an assisting SSF or the PE containing the SRF, e.g. an SRP ("SSF assist procedure") or to clear a connection to a SRF resource ("SSF relay procedure"). The SRF will have been invoked in the context of basic call scenarios. The SCF will know which procedure (SRP scenario) has to be handled.
- 2) The DisconnectForwardConnection INAP operation is forwarded by the SCF Access Manager to the INAP SAP sub-entity that decodes it. The SRF will have been invoked in the context of basic call scenarios. The SCF will know which procedure (IP scenario) has to be handled.
- 5,6) The INAP SAP will in case of an attached SRF initiate a disconnection of the SRF instance via the SRF Relay Manager using the applicable SSF-SRF connection control message. The SRF Relay Manager instance is terminated.
- 3) The SAP sub-entity decodes the 'Disconnect' request and passes the encoded information to the SFM.
- 4) The SFM passes the instruction to disconnect the bearer connection to SRP (SRF) to the BCSM (that is suspended, e.g. after an EventReportBCSM or InitialDP). The bearer relationship between SRP and SSP is ended as resources for SRF connection are released by the BCSM.

Resource Backward Disconnection (from SRF)

- 7) The SRF Relay Manager receives from SRF a request for SRF initiated disconnection. The SRF sends the applicable bearer control signalling request message to initiate a 'Disconnect' of the SRF resource.
- 8) The request message for release of bearer connection from SRF resource is passed to the INAP SAP sub-entity that encodes a SRF bearer disconnection order.. The SRF Relay Manager instance is terminated.
- 3) The INAP SAP sub-entity decodes the 'Disconnect' request and passes the information to the SFM.
- 4) The SFM passes the instruction to disconnect the bearer connection to the BCSM (that is suspended). The bearer relationship between SRP and SSP is ended as all resources for SRF connection are released by the BCSM.

A.2.4 Description of the impacted SSF sub-entities

This subclause describes and summarizes the main functions and data of each SSF sub-entity required for the "SRF Resource" scenarios.

A.2.4.1 SCF Access Manager

A.2.4.1.1 Description of functionality

This entity manages the access from the SSF to the SCF and vice versa (see ITU-T Recommendation Q.1214 [17]; subclause 4.2.3.1). The INAP protocol stack will be contained in this process.

The SCF may request the SCF Access Manager to build up a direct connection with an SRF(SRP) via operation `ConnectToResource` or an indirect (assist case) via operation `EstablishTemporaryConnection`.

The SSF may initiate the SCF/SRF-control relationship by sending an operation `AssistRequestInstructions` via the SCF Access Manager to a SCF (that may react with an operation `ConnectToResource`).

If the SCF can not establish a direct control relationship to a SRF via the SSF, it may send an operation `EstablishTemporaryConnection`, that is forwarded via ISUP to an SSP, that may trigger an assist request case. The SCF may request the SCF Access Manager to release a connection with an SRF(IP) via operation `DisconnectForwardConnection`. A similar case can be found when an assisting SSF (and its connection with an SRF) is requested by the SCF via operation `DisconnectForwardConnection` (and via the initiating SSF) to be released (assist case).

A.2.4.1.2 Description of data

None.

NOTE: Tssf timer will be used in the SSF communication with the SCF (management will provide the initial value and may want to register time out occurrences) (see subclauses 9.26 / CoreINAP and clause A.8). It contains parameters (timerValue, timerID).

A.2.4.2 SRF Relay Manager

A.2.4.2.1 Description of functionality

This entity manages the relay of operations via the SSF to the SRF and vice versa. Conversion to protocol for communication with SRF (e.g. DSS1) will be contained in this process.

In case of the direct SRF/SCF-relay scenario the operations `PlayAnnouncement` and `PromptAndCollectUserInformation` form the SCF and the responses from the SRF (`SpecializedResourceReport`, `PromptAndCollectUserInformation` response) are forwarded to the corresponding entity according to the connection established after `ConnectToResource`.

Whenever a connection is set up to an SRF, timer Tsr is started. The default value of this timer is settable by management in the SRF.

A.2.4.2.2 Description of data

Tsrf: this is a timer in the SRF that will be used for the communication between the SRF and the SCF. Management will provide the initial value and may want to register time out occurrences.

A.2.4.3 INAP Service Access Point (INAP SAP)

A.2.4.3.1 Description of functionality

(ITU-T Recommendation Q.1214 [17]; subclause 4.2.3.1)

Whenever messages must be sent from the SSF to the SCF this process will take care of the message formulation. In other words, this process will create the INAP message that will be sent to the SCF by the SCF Access Manager. It will also interpret (decode) incoming INAP messages and send these to other SSF sub entities for further processing.

A.2.4.3.2 Description of data

None.

A.2.4.4 Service Feature Manager (SFM)

A.2.4.4.1 Description of functionality

(ITU-T Recommendation Q.1214 [17]; subclause 4.2.4)

- When triggering IN service control, the IP availability and capabilities at the SSP have to be notified to the SCF via operation InitialDP. Because of this information the SCF may detect an assist case.
- The SFM receives the request to connect the call to the resource address received from the SCF via ConnectToResource or to the routing address of the assisting SSP received via EstablishTemporaryConnection and instructs the BCSM to continue call processing with the new call information.
- After triggering IN control the SFM has to decide whether the call is an assist request case, whether assisting is possible in the SSP, determine the correlationId of the SCF-application, determine the requested SCF and initiate the sending of the operation AssistRequestInstructions.
- The SFM receives and processes the SRF resource release request from INAP SAP and passes it to BCSM sub-entity.

A.2.4.4.2 Description of data

- IP Available (indicates that SRF resources are available at the SSP).
- IP/SSP Capabilities (indicates the kind of SRF resources available at the SSP).
- Association of a trigger detection point to assist request data.
- Information about the availability and capabilities of SRPs directly connected to the SSP (the SCF has to be informed about this in the operation AssistRequestInstructions).
- Mapping of digit strings to correlation Ids (used by the SCF to identify the corresponding service logic).
- Mapping of digit strings to SCF ID (used to identify the requested SCF).

A.2.4.5 BCSM control

A.2.4.5.1 Description of functionality

The BCSM control sub-entity is the abstraction of Call Control Function (CCF) activities for IN service logic instances. It will initiate release of the bearer connection to the SRF using the appropriate bearer control signalling.

The allocation and de-allocation of the bearer connection to SRF resource is provided via the CCF.

In case of establishing an assisting connection, the T_{SSF} -timer has to be set to the signalling dependent value T_{ETC} and the expiration of this timer has to be supervised (the timer may be reset from the SCF via operation ResetTimer).

A.2.4.5.2 Description of data

Maximum duration of temporary connection (T_{ETC}).

A.3 Charging scenarios

A.3.1 Introduction

The charging scenarios as described here are based on the charging scenarios described in annex B of Core INAP (ETS 300 374-1 [9]). The numbering of the charging scenarios described below is identical to the numbering used in this Core INAP document. Scenario 1, where charging is completely in the PSTN, is not considered here.

The charging scenarios depicted here are only examples of how the relevant information flows could be used in the charging scenarios. These are by no means normative.

In the charging scenarios described below, the initialDP flow is not described, as this Core INAP operation, and its mapping to the SSF Model is already provided in subclause A.1.2.

The following charging related terminology is used in these charging scenarios:

Charge determination process (DET)	:	determine charge party, level of charge and items to be charged
Charge generation process (GEN)	:	generation of charge information (pulses / signalling)
Charge registration process (REG)	:	registration of charge information (call records / charge meters)
On-line charge information provision to the user access (ONC)	:	provision of charge information (e.g. pulses) to the user / network interface, e.g. for hot billing

Subclause A.3.2 describes the information flows between the IN FEs for each of the charging scenarios and the charging interactions. Subclause A.3.3 provides a mapping from the charging scenarios and charging interactions to the subentities in the SSF model. Subclause A.3.4 describes and summarizes the main functions and data of each SSF sub-entity required for the charging scenarios and interactions.

A.3.2 DFP description

A.3.2.1 Charging scenarios

The following table provides an overview of the positioning of the GENERation and REGistration in the SSF and SCF for all the scenarios described below. The subclauses of this clause will further explain this table.

Scenario	SSF GEN	SSF REG	SCF GEN	SCF REG
2.1	-	-	EventReportBCSM	EventReportBCSM
2.2	-	FCI	EventReportBCSM	-
2.3	FCI	FCI	-	-
2.4	-	(FCI)	EventReportBCSM	EventReportBCSM
3.2	SCI	-	-	-
4.1	AC	-	-	ACR
4.2	AC/FCI	AC/FCI	-	-

A.3.2.2 Charging interactions

Interactions related to the charging of an IN call can occur in the following cases:

- a higher exchange (e.g. an international exchange) generates charge related signalling towards the SSP;
- a call party is controlled by different Service Logics (e.g. UPT to UPT or UPT to VPN calls).

In both cases, two scenarios ('options') are identified in Core INAP (clause B.5) that describe new communication between the SSF and the SCF; these are therefore considered below for their (potential) impact on SSF management.

NOTE: Any interaction scenario takes place in the context of a specific charging scenario.

A.3.2.3 Charging scenario 2.1

In charging scenario 2.1 the DETermination, GENERation and REGistration activities are performed by the SCF. The trigger for the charging process is the InitialDP received by the SCF.

The SCF sets an EDP in the SSF for O_Answer and O_Disconnect, using the RequestReportBCSMEvent. When the EDPs are encountered, i.e. when the call has been answered or disconnected, the SSF notifies the SCF by means of the EventReportBCSM.

Based on the information received through both EventReportBCSM operations the SCF GENERates and REGisters the charging record.

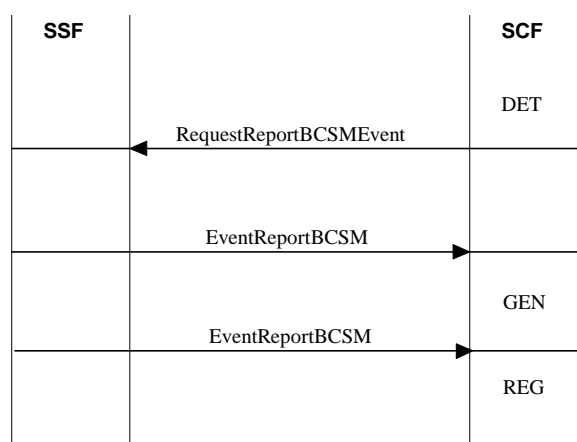

Figure A.3.1

A.3.2.4 Charging scenario 2.2

In charging scenario 2.2 the DETermination and GENeration activities are performed by the SCF, while the REGistration is done by the SSF. The trigger for the charging process is the InitialDP received by the SCF.

The information flows for this charging scenarios are almost identical to the flows in charging scenario 2.1. The only difference is that after receiving the second EventReportBCSM operation and after GENerating the charging record, the SCF sends the complete charging record to the SSF using the FurnishChargingInformation. Then, the SSF REGisters the charging record.

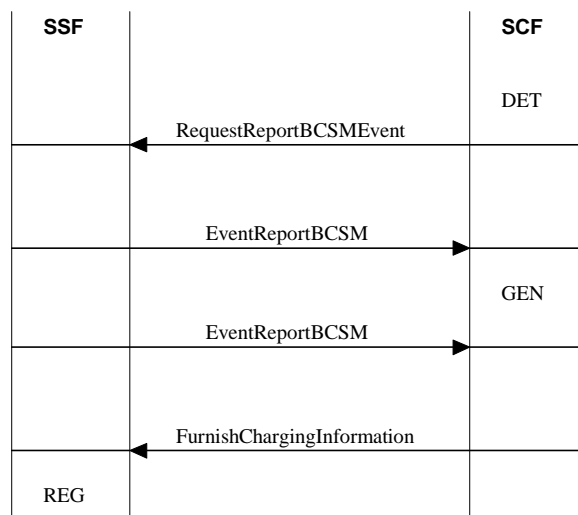

Figure A.3.2

A.3.2.5 Charging scenario 2.3

In charging scenario 2.3 the DETermination is done by the SCF, while the GENeration and REGistration activities are performed by the SSF. The trigger for the charging process is the InitialDP received by the SCF.

The SCF then instructs the SSF on how to generate the charging record for that call via the information elements in the FurnishChargingInformation operation. These information elements are:

- charge party - indicating whether the A-party of the B-party should be charged for the call;
- charge level - indicating the rate of the call;
- charge items - indicating which items of the call should be charged, such as duration of the call.

Based on this information, the SSF GENerates the charging record and stores it.



Figure A.3.3

A.3.2.6 Charging scenario 2.4

In charging scenario 2.4 the DETermination and GENeration activities are performed by the SCF. The REGistration is done by the SCF as well as the SSF, each registering their own type of charging record with possible different fields. In order to allow correlation between these two charging records by the off-line billing process, the same unique correlation-id should be included in both records. The trigger for the charging process is the InitialDP received by the SCF.

These information flows for this charging scenario are almost identical to the flows in charging scenario 2.2. The only difference is the content of the information elements in the FurnishCharging operation. After receiving the second EventReportBCSM the SCF REGisters the charging record. Then the SSF is informed of the correlation-id to be used in charging records REGistered by the SSF for the same call; it is assumed that these charging records are GENerated by the CCF. The correlation-id is sent to the SSF using the FurnishChargingInformation operation.

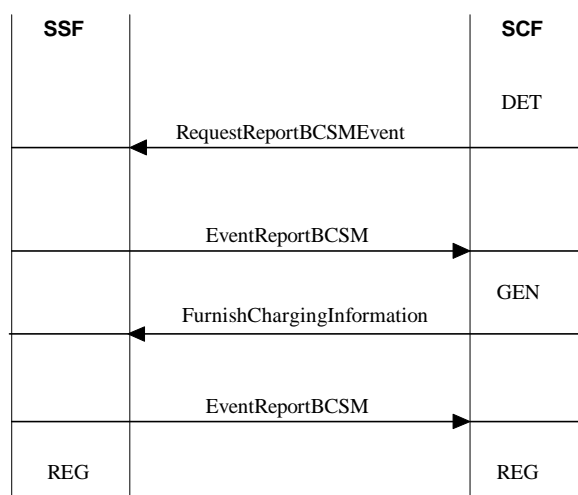

Figure A.3.4

A.3.2.7 Charging scenario 3.2

In charging scenario 3.2 the DETermination is performed by the SCF, the GENeration by the SSF and the REGistration, and possibly the ONC (Online charging), by the LE (local exchange). The trigger for the charging process is the InitialDP received by the SCF.

The SCF instructs the SSF, via the SendChargingInformation operation, on the information to be generated and sent to the LE. The parameters of the SendChargingOperation are network operator specific, but could include:

- charge level - indicating the rate of the call (e.g. default charging);
- chargePulses - indicating the pulse rate to be applied for the call by the LE;
- chargeMessages - indicating specific messages to be sent to the LE.

The SSF generates the charging record and sends the requested information to the LE using the normal (i.e. not Core-INAP) protocol. The LE REGister the charging record (or updates a charge meter) and may generate charge pulses.

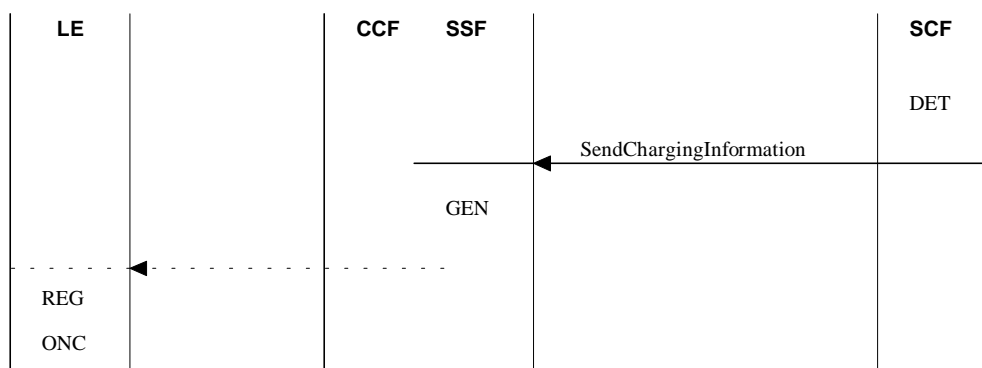

Figure A.3.5

A.3.2.8 Charging scenario 4.1

In charging scenario 4.1 the DETermination is performed by the SCF, the GENeration by the SSF and the REGistration again by the SCF. The trigger for the charging process is the InitialDP received by the SCF.

The SCF instructs the SSF to generate a charging record for the call using the ApplyCharging procedure. One of the information elements in this procedure is aChBillingCharacteristics ('network operator specific'). This information element includes the information to be generated by the SSF, and the conditions for informing the SCF on results (e.g. only when a call record was generated for a successful call, or when credit card limits are exceeded).

After GENerating the charging record, the record is sent to the SCF using the ApplyChargingReport procedure (at the end of the call and/or at the conditions requested in ApplyCharging). The parameter callResult of the ApplyChargingReport operation will contain the complete charging record (this is also a 'network operator specific' parameter).

When the SCF receives the *ApplyChargingRecord*, the SCF REGisters the received record. If an error occurs, the following error operations may be send depending on the situation:

MissingParameter, if an essential parameter is missing in the operation.

ParameterOutOfRange, if the value of one of the parameters is out of range.

SystemFailure, taskrefused. These error operations are returned by a physical entity if it is was not able to fulfil a specific task as requested by a operation, and a recovery is not expected to be completed within the current call instance.

UnexpectedComponentSequence. The SCF cannot start processing of the requested operation because a SACF or MACF rule is violated, or the current state of the FSM does not allow processing of the operation.

UnexpectedDataValue. The SCF cannot process the operation because a data value is unexpected. This does not overlap the *ParameterOutOfRange* error.

UnexpectedParameter. There is an error in the received operation argument. A valid, but unexpected parameter was present in the argument and the responding entity cannot start processing of the operation.

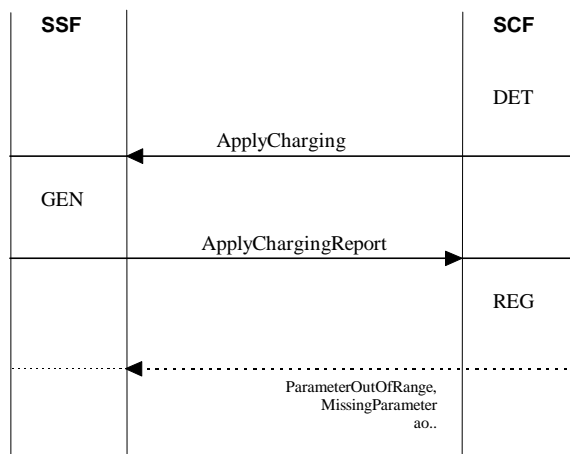

Figure A.3.6

A.3.2.9 Charging scenario 4.2

In charging scenario 4.2 the DETermination is performed by the SCF, the GENeration and the REGistration are done by the SSF. The trigger for the charging process is the InitialDP received by the SCF.

The SCF instructs the SSF to GENerate the charging record, by means of the ApplyCharging operation (identical to charging scenario 4.1). The FCI operation may be used in this scenario to control the record generation at the SSF, but the parameters for this are not defined in Core INAP (network operator specific). Therefore, this is not described here any further.

The SSF GENerates and REGisters the charging record. At the end or at a threshold (e.g. credit card limit) the SSF may report charging information (e.g. threshold passing or a charging record) back to the SCF via ApplyChargingReport.

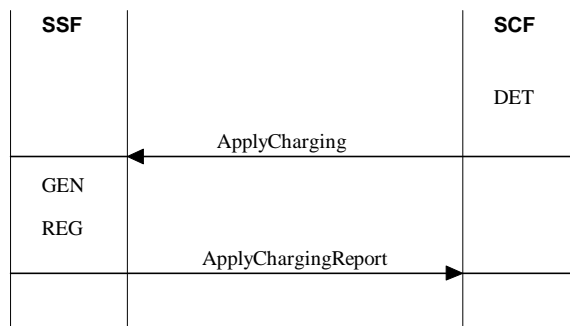

Figure A.3.7

A.3.2.10 Interaction scenario 1

This scenario describes Option 1 of subclauses B.5.1 and Option 1 of subclauses B.5.2.1 of ETS 300 374-1 [9].

In this scenario the SCF has control of the charging process for a specific call and instructs the SSF to monitor and intercept the charge related signalling messages for that call, received from a higher exchange or another SSF (SSP). This is done by sending the RequestNotificationChargingEvent operation with the monitorMode parameter set to "interrupted".

When the SSF receives a charge related signalling message from the higher exchange or other SSF, it will send a EventNotificationCharging to the SCF.

Based on this information the SCF can either GENERate a charge record and e.g. use the charging scenarios 2.2 and 2.4 to complete the charging process, or the SCF can instruct the SSF to send new or adjusted charge rates / pulses to the LE, e.g. using charging scenario 3.2.

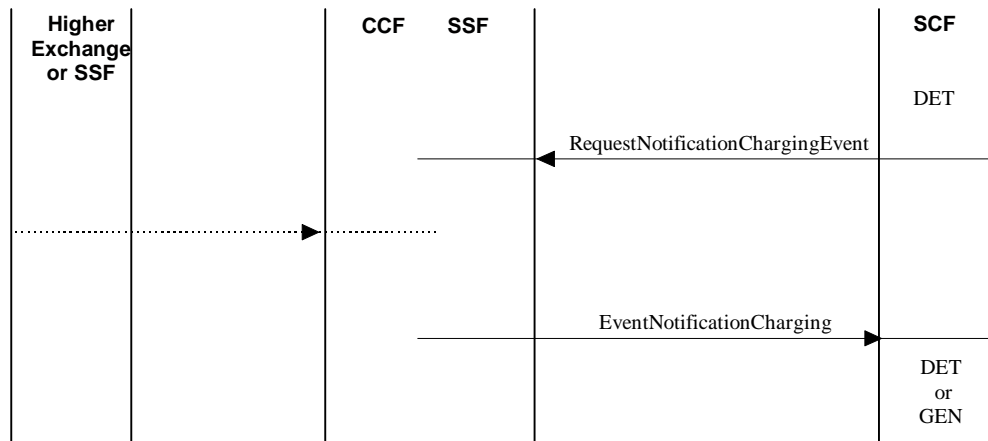

Figure A.3.8

A.3.2.11 Interaction scenario 2

This scenario describes Option 2 of subclauses B.5.1 and Option 2 of subclauses B.5.2.1 of ETS 300 374-1 [9]

In this scenario the higher exchange or other service logic has control of the charging process for a specific call. The SCF instructs the SSF only to monitor the charge related signalling messages for that call received from the higher exchange or other SSF (SSP) and to inform the SCF of these messages. This is done by sending the RequestNotificationChargingEvent operation with the monitorMode parameter set to "NotifyAndContinue".

When the SSF receives a charge related signalling message(s) from the higher exchange, it will send a EventNotificationCharging to the SCF and continue with the normal charging process.

The SCF does not perform any further charging related activities.

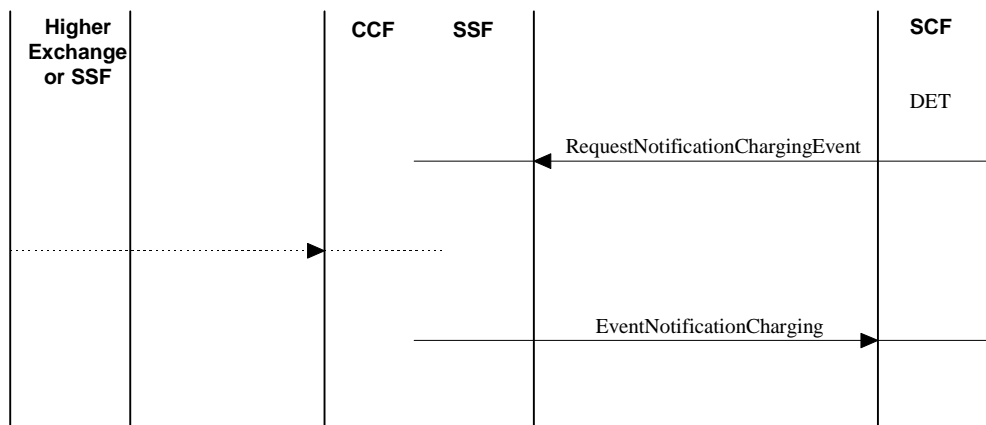

Figure A.3.9

A.3.3 SSF Model mapping

This subclause provides a mapping from the charging scenarios and charging interactions to the subtentities in the SSF model.

A.3.3.1 Mapping of charging scenario 2.1

See below how charging scenario 2.1 as described above could be mapped onto the SSF model. For this charging scenario only one EventReportBCSM operation is mapped. The other set has no different mapping.

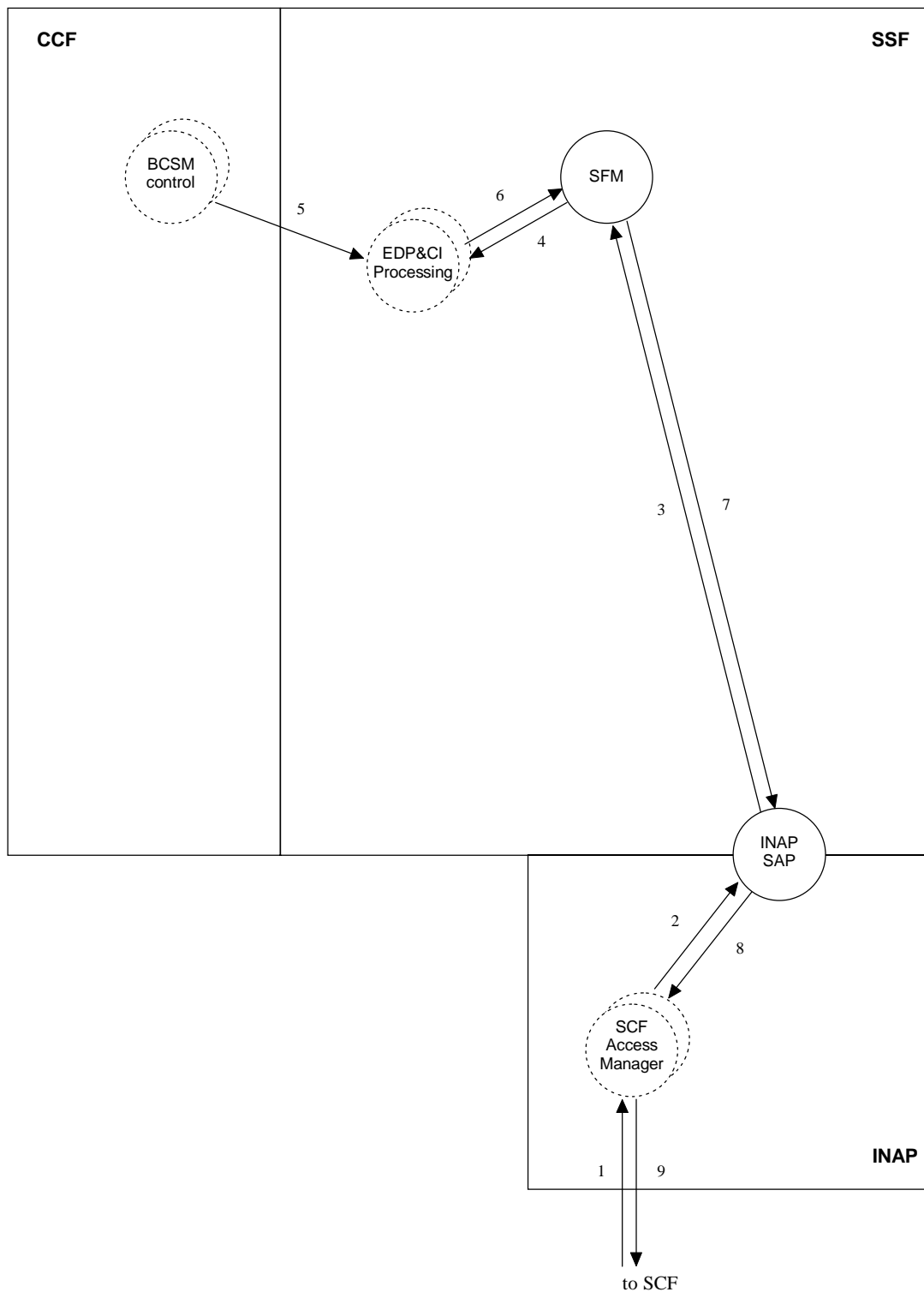

Figure A.3.10

RequestReportBCSMEvent

- 1) The SCF has DETERmined the charging activity that has to be performed for the call and sends a RequestReportBCSMEvent operation to the SSF. This operation contains the information element bcsmEvents, with the following parameters:

eventTypeBCSM - indicating the EDP that should be armed (e.g. O_Answer or O_Disconnect).

monitorMode - indicating how the event should be reported. This can be either as a request or a notification. The type of the event report will be contained in the miscCallInfo parameter of the EventReportBCSM operation.

legID - indicating for which party in the call the event will be reported.

dPspecificCriteria - indicating information specific to the EDP to be armed.

numberOfDigits - indicating the number of digits to be collected for the CollectedInfo event.

applicationTimer - indicating the timer for the NoAnswer event.

- 2) The SCF Access Manager receives the operation and passes it to the INAP SAP sub-entity.
- 3) The INAP SAP decodes the INAP message and sends the information elements in the message to the SFM.
- 4) The SFM either:
 - transparently passes the information from the INAP SAP to the existing EDP&CI Processing sub-entity for that call; or
 - instantiates an EDP&CI Processing sub-entity for that call using the information received from the INAP SAP.

Based on the information contained in the "bcsmEvents" information element the EDP&CI Processing sets one or more EDPs for the call.

EventReportBCSM

- 5) An event occurs in the BCSM, for example an O_Answer or an O_Disconnect. This event is signalled to the EDP&CI Processing sub-entity. The following information is made available by the BCSM:

eventTypeBCSM - indicating which event has occurred (e.g. O_Answer, O_Disconnect)

eventSpecificInformationBCSM - indicating call related information specific to the call. For example, for CollectedInfo, it will contain the calledPartyNumber.

legID - indicating for which party in the call the event will be reported.

miscCallInfo - indicating whether the message is a request or a notification (in relation with the monitorMode parameter of the RequestReportBCSMEvent).

- 6) The EDP&CI Processing sub-entity detects that an EDP for the event has been set, and forwards the information elements to the SFM
- 7) The SFM transparently passes the information to the INAP SAP sub-entity
- 8) The INAP SAP uses the provided information elements to formulate the INAP message for the EventReportBCSM operation. The encoded message is passed to the SCF Access Manager
- 9) The SCF Access Manager sends the INAP operation to the SCF. Based on the information provided in this operation the SCF can perform the GENERation and REGistration of the charging record.

At the end of the call the EDP&CI Processing sub-entity for that call is deleted.

A.3.3.2 Mapping of charging scenario 2.2

See below how charging scenario 2.2 as described above could be mapped onto the current SSF described. For this charging scenario only the mapping of the FurnishCharging operation is made. The mapping of the other information flows is identical to the mapping described for charging scenario 2.1.

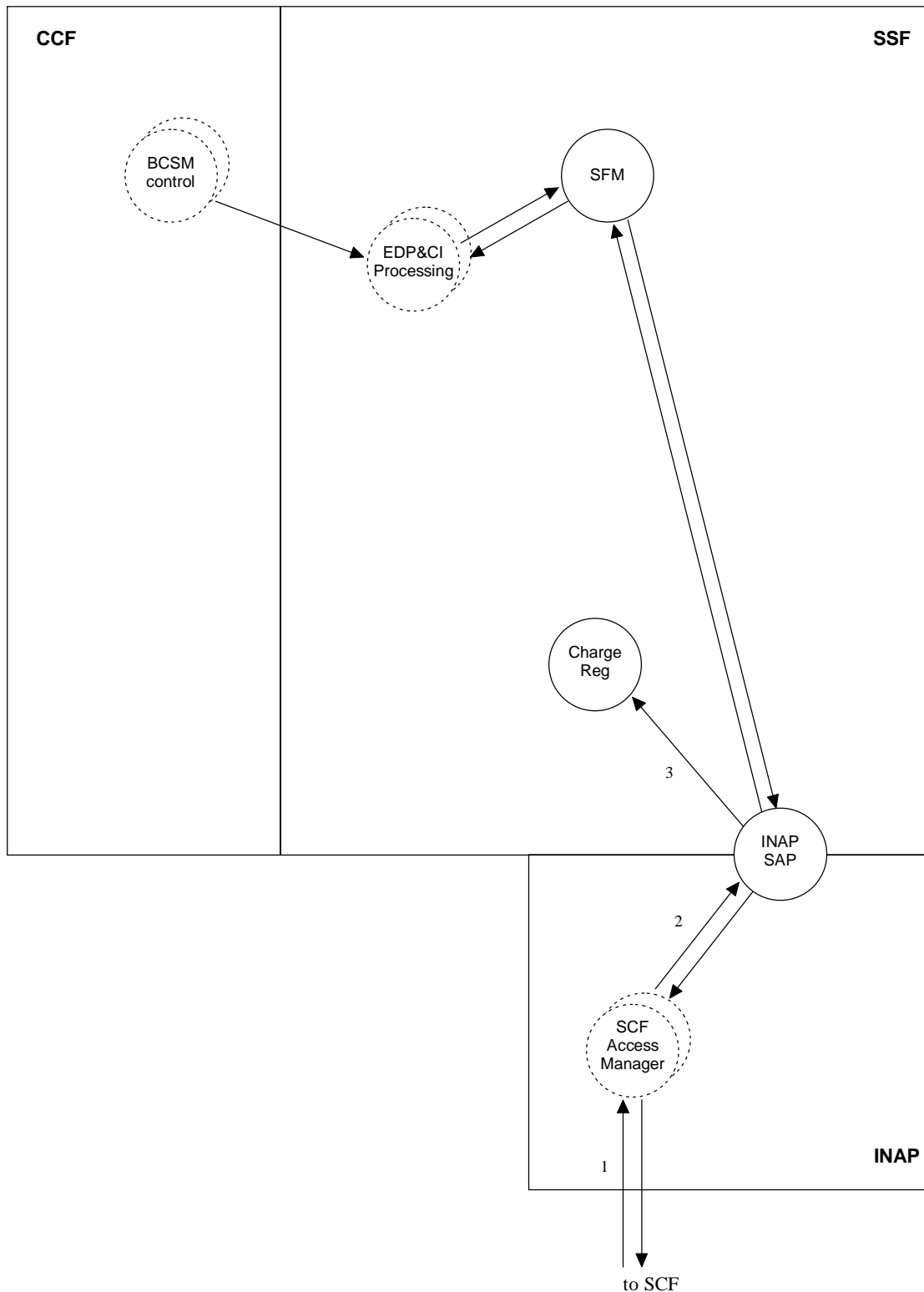

Figure A.3.11

FurnishChargingInformation

- 1) Based on the information received through the EventReportBCSM operation the SCF has GENERATED the call record. The SCF sends the record to the SSF using the FurnishChargingInformation operation. This operation contains the following information element:

fCIBillingChargingCharacteristics - this information element defines the complete charging record for the call.

- 2) The SCF Access Manager receives the operation and passes it to the INAP SAP sub-entity
- 3) The INAP SAP passes the information element containing the complete charging record to the Charge Reg sub-entity. This sub-entity performs the REGistration of the record.

At the end of the call the EDP&CI Processing sub-entity for that call is deleted.

A.3.3.3 Mapping of charging scenario 2.3

See below how charging scenario 2.3 as described above could be mapped onto the current SSF model.

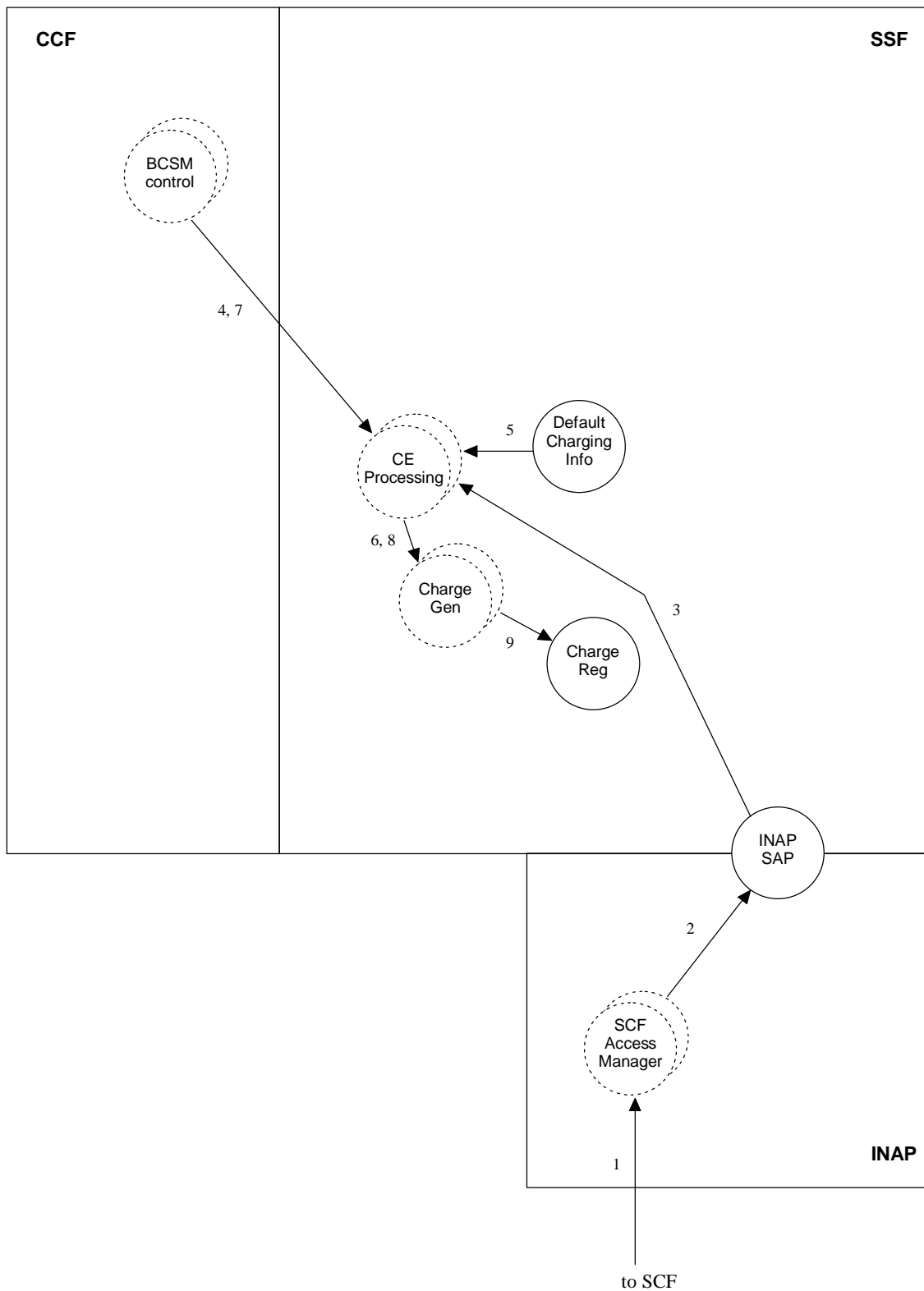

Figure A.3.12

FurnishChargingInformation

- 1) The SCF has DETermined the charging activity that has to be performed for the call and sends a FurnishChargingInformation operation to the SSF. This operation contains the following relevant information elements:

fCIBillingChargingCharacteristics - this information element defines the charge party, charge level and charge items for the call.
- 2) The SCF Access Manager receives the operation and passes it to the INAP SAP sub-entity.
- 3) The INAP SAP decodes the INAP message and either:

instantiates a CE Processing sub-entity for the call, using the information elements in the INAP message, or
provides the existing CE Processing sub-entity for that call with the information elements in the INAP message.

The CE Processing sub-entity starts monitoring the call for recording triggers.
- 4) A charging event occurs in the BCSM, which is signalled to the CE Processing sub-entity.

NOTE: The Information elements that will be made available by the BCSM can, in this charging scenario, not be derived from INAP operation. It is assumed that the same information as for the EventNotificationCharging operation will be made available.
- 5) The CE Processing sub-entity detects an event that is a recording trigger, which should start the usage metering. It passes the information elements received from the BCSM control to the Charge Gen sub-entity. This sub-entity uses the information received through the FurnishChargingInformation operation (3) and the information received from the CE Processing sub-entity (6) to GENerate the charge record for the call. The CE processing requests and receives default information from the Default Charging Info sub-entity, for those information elements whose value was not provided in the FurnishChargingInformation operation.
- 6) The CE Processing instantiates a new Charge Gen sub-entity using the information in the FurnishChargingInformation operation and the default charging information. The Charge Gen sub-entity start the usage metering for the call.
- 7) The CE Processing sub-entity detects a reporting trigger that should end the usage metering.
- 8) The CE Processing orders the Charge Gen sub-entity to GENerate the charge record.
- 9) Finally, the charging record is passed from the Charge Gen to the Charge Reg sub-entity. Then, the Charge Gen sub-entity is deleted. The Charge Reg sub-entity later performs the REGistration of the charge record.

At the end of the call the CE processing sub-entity for that call is deleted.

A.3.3.4 Mapping of charging scenario 2.4

See below how charging scenario 2.4 as described above could be mapped onto the current SSF model. For this charging scenario only the mapping of the FurnishCharging operation is described. The mapping of the other information flows is identical to the mapping described for charging scenario 2.1.

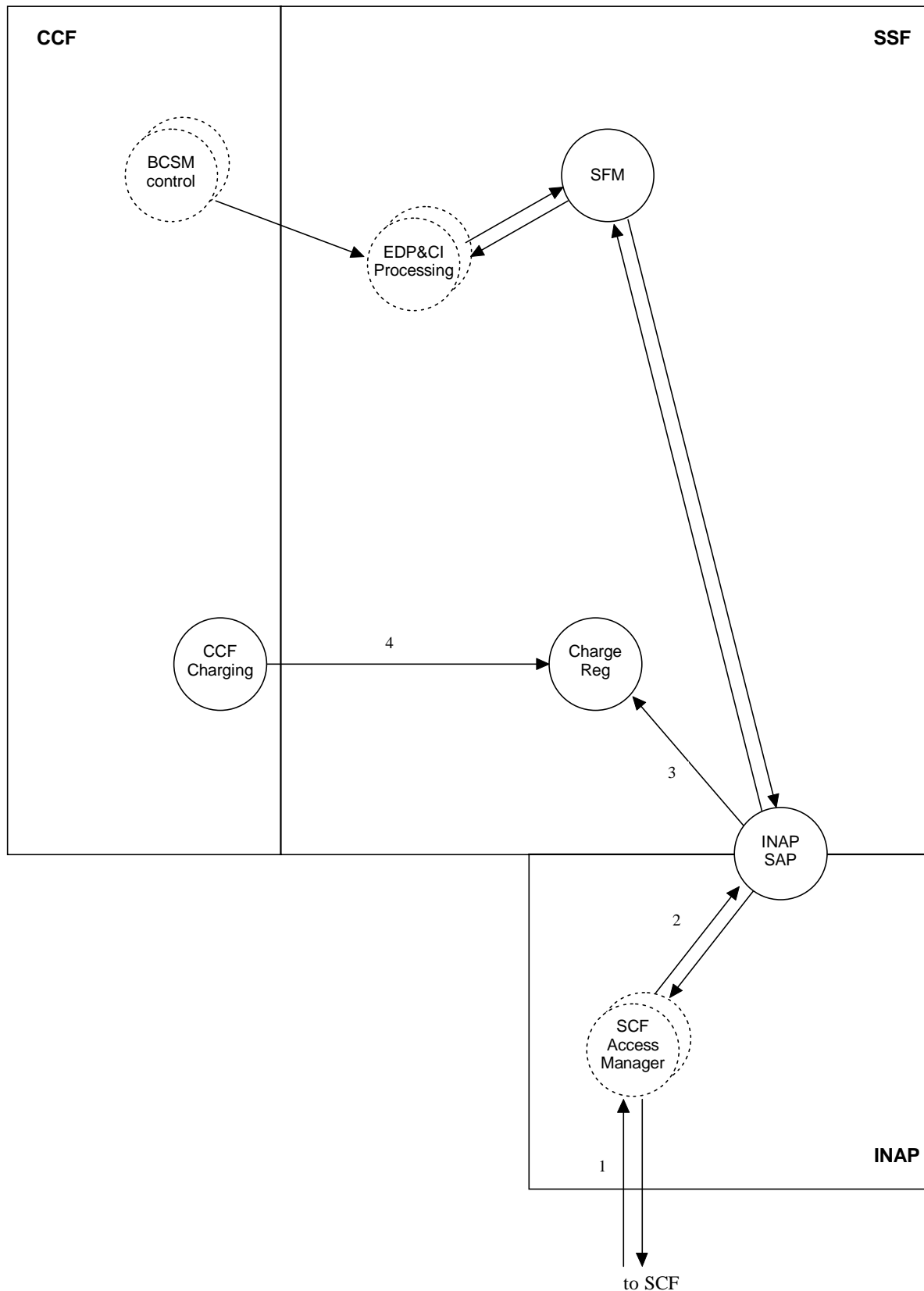

Figure A.3.13

FurnishChargingInformation

- 1) The SCF has DETERmined the charging activity that has to be performed for the call, and it has GENErated and REGistered a charge record for the call. It now sends a FurnishChargingInformation operation to the SSF. This operation contains the following relevant information elements:

fCIBillingChargingCharacteristics - this information element defines a correlationID to be used for the correlation of the charge records GENErated by the CCF and the SCF.

- 2) The SCF Access Manager receives the operation and passes it to the INAP SAP sub-entity
- 3) The INAP SAP decodes the INAP message and sends the correlation-id in the message to the Charge Reg sub-entity.
- 4) The CCF charging record is sent to the Charge Reg sub-entity by the CCF Charging sub-entity. The correlation ID is used to correlate the CCF generated charging record with the SCF generated one, i.e., the same correlationID will be included in the charging record REGistered in the SCF and SSF.

At the end of the call the EDP&CI Processing sub-entity for that call is deleted.

A.3.3.5 Mapping of charging scenario 3.2

See below how charging scenario 3.2 as described above could be mapped onto the current SSF model.

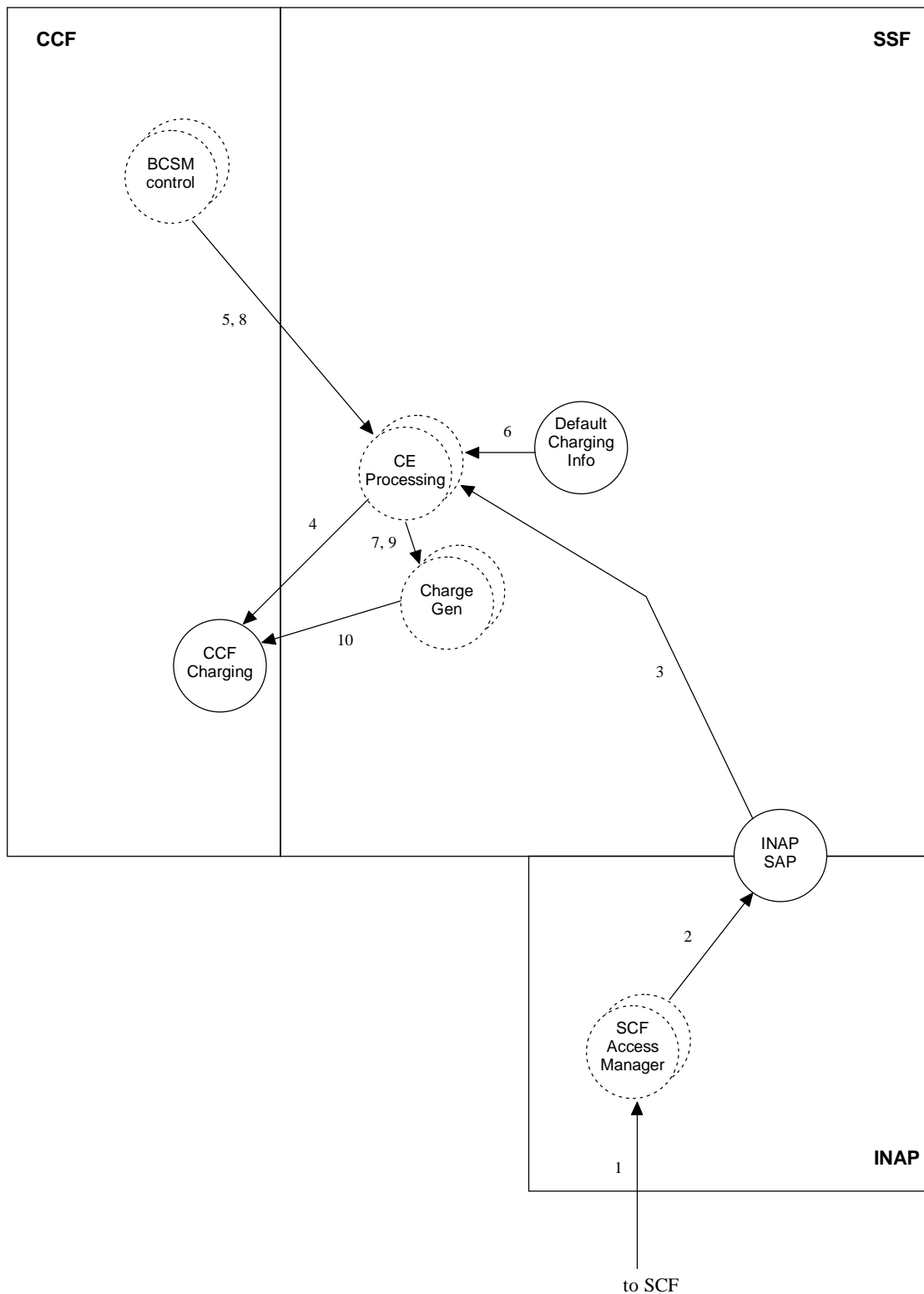

Figure A.3.14

SendChargingInformation

- 1) The SCF has DETERmined the charging activity that has to be performed for the call. It sends a SendChargingInformation operation to the SSF. This operation contains the following relevant information elements:

sCIBillingChargingCharacteristics - this information element can include:

- charge level - indicating the rate of the call;
- chargePulses - indicating the pulse rate to be applied for the call by the LE;
- chargeMessages - indicating specific messages to be sent to the LE.

legID - indicating to where the charge information is to be sent (A-party, B-party)

- 2) The SCF Access Manager receives the operation and passes it to the INAP SAP sub-entity
- 3) The INAP SAP decodes the INAP message and either:
 - instantiates a CE Processing sub-entity for the call, using the sCIBillingChargingCharacteristics in the INAP message; or
 - provides the existing CE Processing sub-entity for that call with the sCIBillingChargingCharacteristics in the INAP message.

The CE Processing sub-entity starts monitoring the call for recording triggers.

- 4) The CE Processing sub-entity provides the CCF Charging sub-entity with the operator specific information in case the normal charging activities in the CCF are influenced by this charging scenario.
- 5) A charging event occurs in the BCSM control, which is signalled to the CE Processing sub-entity.
- 6) The CE Processing sub-entity detects an event that is a recording trigger, which should start the usage metering. The CE Processing sub-entity requests and receives default information from the Default Charging Info sub-entity, for those information elements whose value was not provided in the SendChargingInformation operation.
- 7) The CE Processing instantiates a new Charge Gen sub-entity using the information in the SendChargingInformation operation and the default charging information. The Charge Gen sub-entity starts the usage metering for the call.
- 8) The CE Processing sub-entity detects a reporting trigger that should end the usage metering.
- 9) The CE Processing orders the Charge Gen sub-entity to GENerate the charge record.
- 10) The Charge Gen sub-entity generates the necessary information for the LE. It then sends this information to the CCF Charging entity. After that, the Charge Gen sub-entity is deleted.

The CCF Charging will send the charging information to the LE, using the appropriate protocols. The LE will REGister the charging information for the call.

At the end of the call the CE processing entity for that call is deleted.

A.3.3.6 Mapping of charging scenario 4.1

See below how charging scenario 4.1 as described above could be mapped onto the current SSF model.

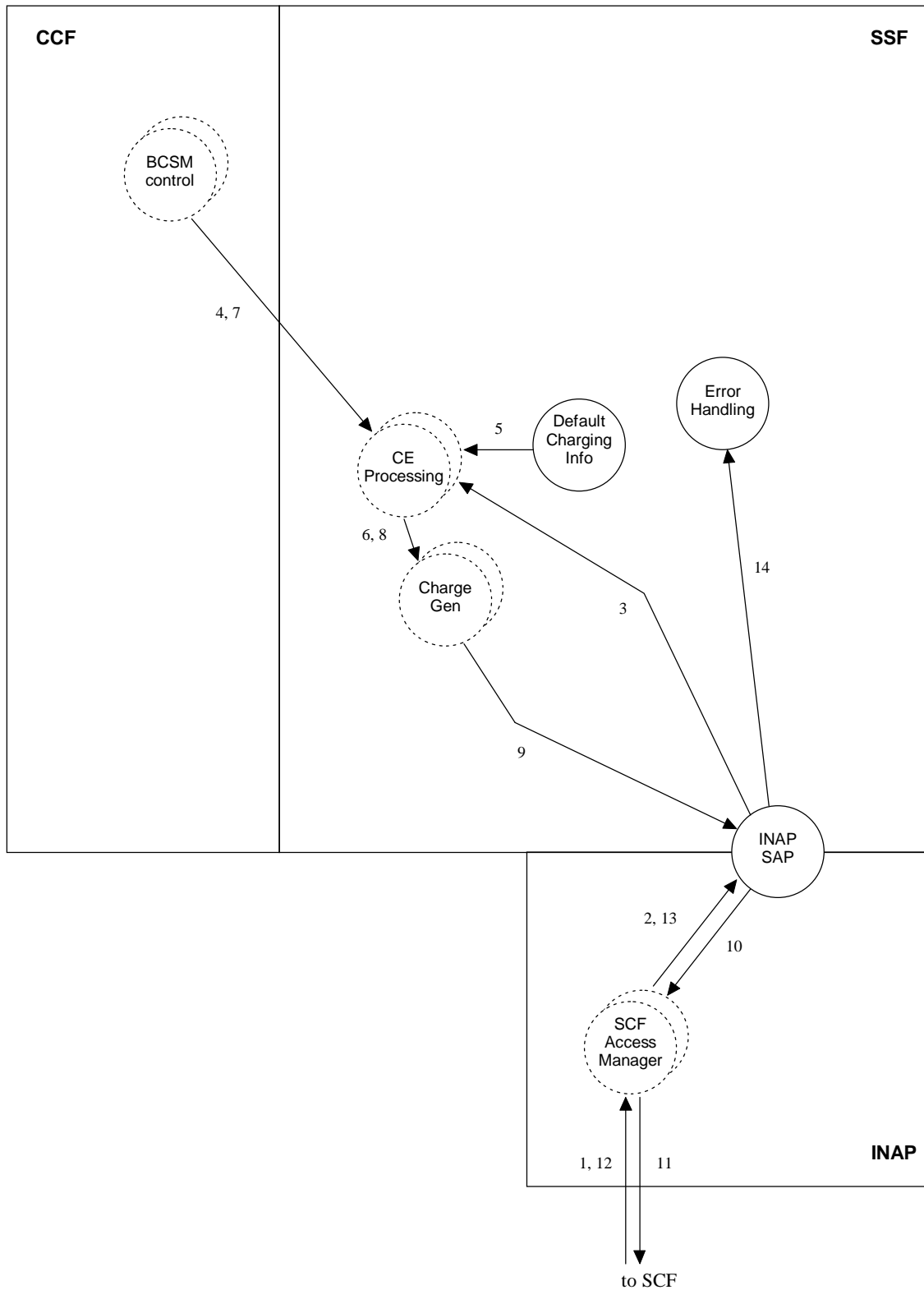

Figure A.3.15

ApplyCharging

- 1) The SCF has DETERmined the charging activity that has to be performed for the call and sends an ApplyCharging operation to the SSF. This operation contains the following relevant information elements:
 - aChBillingChargingCharacteristics - indicates which charging related information is to be returned by the SSF and under which conditions, e.g. only for successful calls.
 - sendCalculationToSCPIndication - indicates whether or not the SSF should return an ApplyChargingResult operation for the call.
 - partyToCharge - indicates which party in the call should be charged for the call.
- 2) The SCF Access Manager receives the operation and passes it to the INAP SAP sub-entity.
- 3) The INAP SAP decodes the INAP message and either:
 - instantiates a CE Processing sub-entity for the call, using the information elements in the INAP message;
 - provides the existing CE Processing sub-entity for that call with the information elements in the INAP message.
 The CE Processing sub-entity starts monitoring the call for recording triggers.

ApplyChargingReport

- 4) A charging event occurs in the BCSM control, which is signalled to the CE Processing sub-entity.
- 5) The CE Processing sub-entity detects an event that is a recording trigger, which should start the usage metering. The CE Processing sub-entity requests and receives default information from the Default Charging Info sub-entity, for those information elements whose value was not provided in the ApplyCharging operation.
- 6) The CE Processing instantiates a new Charge Gen sub-entity using the information in the ApplyCharging operation and the default charging information. The Charge Gen sub-entity starts the usage metering for the call.
- 7) The CE Processing sub-entity detects a reporting trigger that should end the usage metering.
- 8) The CE Processing orders the Charge Gen sub-entity to GENERate the charge record.
- 9) The Charge Gen sub-entity GENERates the charge record for the call. This record is passed to the INAP SAP using the ApplyChargingReport operation with the following information element:
 - callResult - this information element contains the complete charging record.
 After that, the Charge Gen sub-entity is deleted.
- 10) The INAP SAP uses the provided information element to formulate the INAP message for the ApplyChargingReport operation. The encoded message is passed to the SCF Access Manager.
- 11) The SCF Access Manager sends the INAP operation to the SCF. Based on the information provided in this operation the SCF can perform the REGistration of the charging record.
- 12, 13, 14) If an error occurs at the SCF, one of the described error operations are sent from the SCF to the SSF. The SCF Access Manager receives it and passes it to the INAP SAP for translation. The INAP SAP passes the operation to the Error Handling FE where information on how to handle the error is stored. The network operator may choose to maintain the call or release it.

At the end of the call the CE processing entity for that call is deleted.

A.3.3.7 Mapping of charging scenario 4.2

See below how charging scenario 4.2 as described above could be mapped onto the current SSF model. For this charging scenario only the mapping of the ApplyChargingReport information flow is described. The mapping of the ApplyCharging information flow is identical to the mapping described for charging scenario 4.1. The mapping of the FCI operation used for controlling the record generation is not described here, due to lack of clarity in Core INAP on this (see also ETS 300 374-1 [9] subclause 9.18).

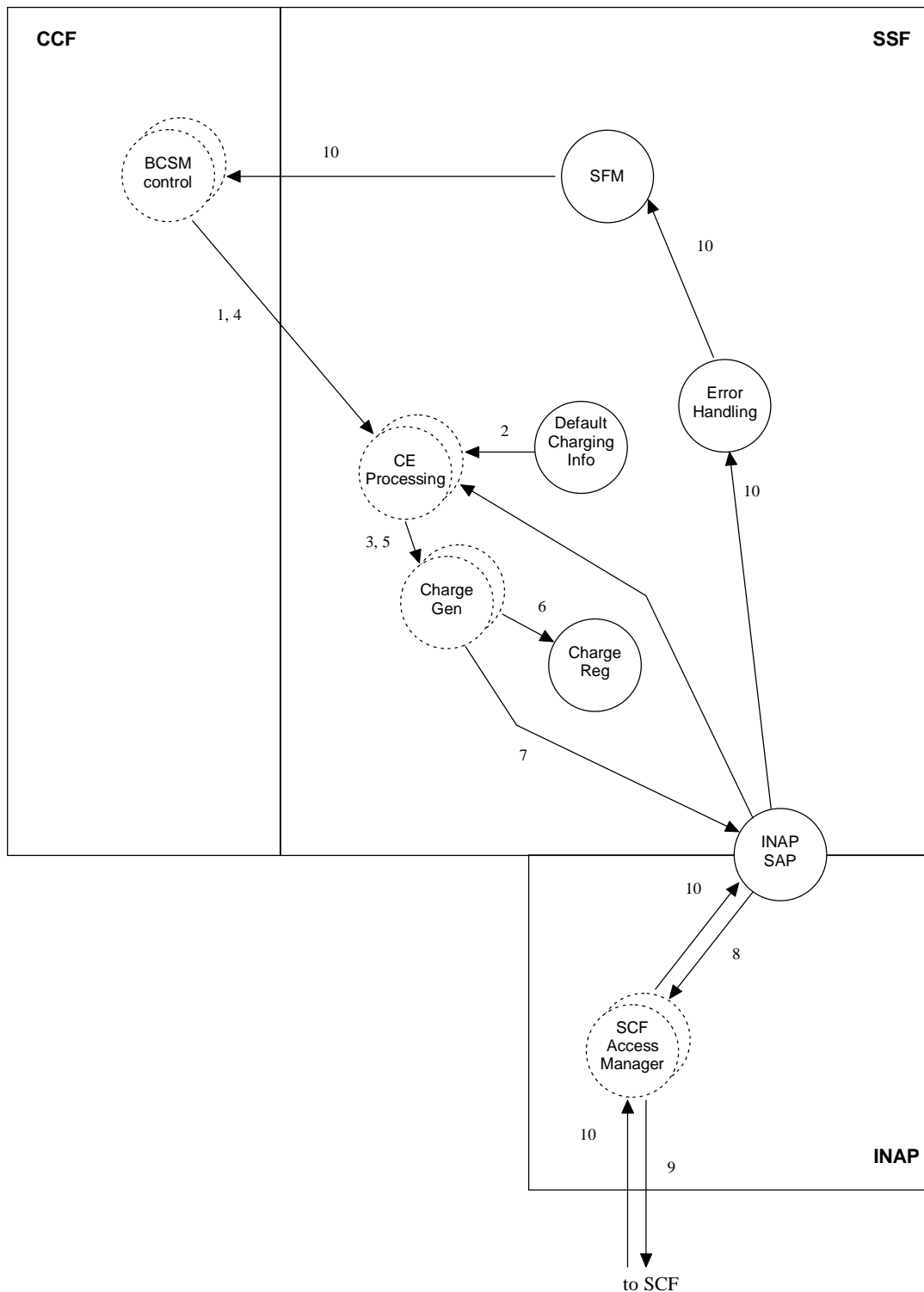

Figure A.3.16

ApplyChargingReport

- 1) A charging event occurs in the BCSM control, which is signalled to the CE Processing sub-entity.
- 2) The CE Processing sub-entity detects an event that is a recording trigger, which should start the usage metering. The CE Processing sub-entity requests and receives default information from the Default Charging Info sub-entity, for those information elements whose value was not provided in the ApplyCharging operation.
- 3) The CE Processing instantiates a new Charge Gen sub-entity using the information in the ApplyCharging operation and the default charging information. The Charge Gen sub-entity starts the usage metering for the call.
- 4) The CE Processing sub-entity detects a reporting trigger that should end the usage metering.
- 5) The CE Processing orders the Charge Gen sub-entity to GENERate the charge record.
- 6) The Charge Gen sub-entity GENERates the charge record for the call and sends it to the Charge Reg entity where the record is REGISTERed.
- 7) The Charge Gen entity sends charging information (e.g. threshold passing or a charging record) to the INAP SAP sub-entity. After this, the Charge Gen sub-entity is deleted.
- 8) The INAP SAP uses the provided information elements to formulate the INAP message for the ApplyChargingReport operation. The encoded message is passed to the SCF Access Manager.
- 9) The SCF Access Manager sends the INAP operation to the SCF.
- 10) The applycharging operation may cause the SCF to send an error operation to the SSF as indicated in charging scenario 4.1. The Error Handling sub-entity provides the necessary information to set up a bearer connection and passes it to the SFM. The SFM decides, if the call should go on in the current context or be interrupted to set up the bearer connection.

At the end of the call the CE processing entity for that call is deleted.

A.3.3.8 Mapping of interaction scenario 1

See below how interaction scenario 1 as described above could be mapped onto the current SSF model.

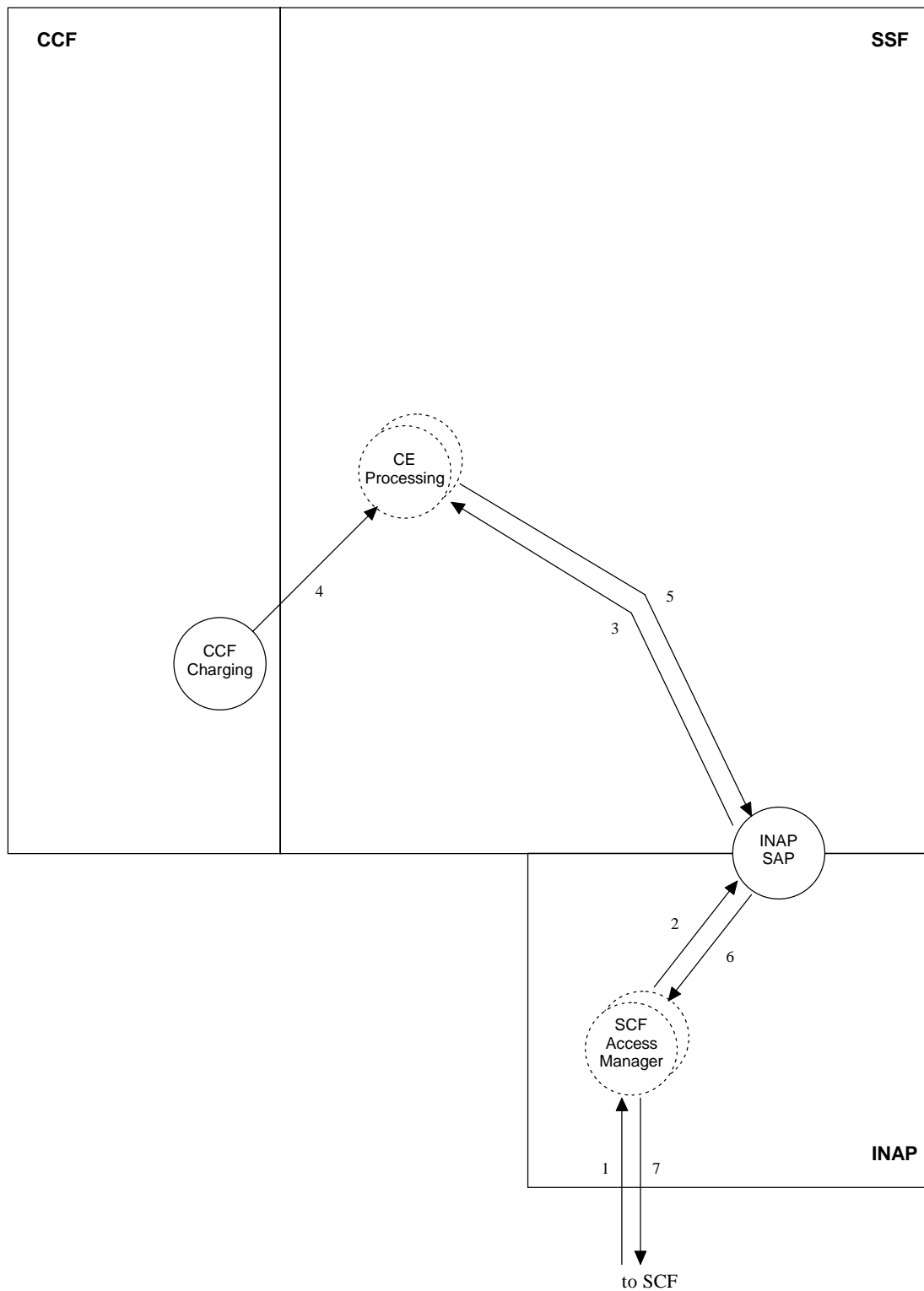

Figure A.3.17

RequestNotificationChargingEvent

- 1) The SCF has DETermined the charging activity that has to be performed for the call and sends a RequestNotificationChargingEvent operation to the SSF. This operation contains the following relevant information elements:

eventTypeCharging - indicating the charge event or message that should trigger the notification

legID - indicating the leg on which the charging event applies

monitorMode - indicating the type of response to be given by the SSF. In this scenario the value will be Interrupted, for scenario 2 (clause A.3.3.9) it will be NotifyAndContinue.

- 2) The SCF Access Manager receives the operation and passes it to the INAP SAP sub-entity
- 3) The INAP SAP decodes the INAP message and either:
 - provides the existing CE Processing sub-entity for that call with the information elements in the INAP message; or
 - instantiates a CE Processing sub-entity for the call, using the information elements in the message.

The CE Processing sub-entity now starts monitoring the call for the event defined on the INAP operation.

EventNotificationCharging

- 4) A charging event occurs in the CCF, which is signalled to the CE Processing sub-entity by the CCF Charging entity. The following information is made available by the CCF Charging entity:

eventTypeCharging - indicating the charge event or message that triggered the notification

eventSpecificInformationCharging - indicating charging information related to the specific event

legID - indicating the leg on which the charging event applies

monitorMode - indicating the type of response (see RequestNotificationChargingEvent)

- 5) The CE Processing sub-entity detects that this event is the event that should trigger the EventNotificationCharging operation, and forwards the information elements to the INAP SAP sub-entity
- 6) The INAP SAP uses the provided information elements to formulate the INAP message for the EventNotificationCharging operation. The encoded message is passed to the SCF Access Manager
- 7) The SCF Access Manager sends the INAP operation to the SCF. Based on the information provided in this operation the SCF can decide what further action in the charging process should be performed.

At the end of the call the CE processing entity for that call is deleted.

A.3.3.9 Mapping of interaction scenario 2

The mapping of the information flows for this scenario is identical to the mapping made for the interaction scenario 1. Only the monitorMode information element has a different value (see subclause A.3.3.8).

A.3.4 Description of the impacted SSF functionalities

An overview of the charging scenarios is provided in the table at the start of subclause A.3.2. This subclause describes and summarizes the main functions and data of each SSF sub-entity required for the charging scenarios and interactions as described above.

A.3.4.1 EDP&CI Processing

An EDP&CI Processing sub-entity is able to arm EDPs. In the charging scenarios this capability is used to notify the SCF of the occurrence of a charging related event in the BCSM. The applicable charging scenarios are 2.1, 2.2 and 2.4. For each call not more than one EDP&CI Processing sub-entity exists. If no EDP&CI Processing sub-entity exists when using one of these charging scenarios, a new sub-entity is created for that call.

Arming of an EDP is initiated when an SCF sends a RequestReportBCSMEvent operation to the SSF. This operation contains the information element bcsmEvents, with the following parameters:

eventTypeBCSM - indicating the EDP that should be armed (e.g. O_Answer or O_Disconnect)

monitorMode - indicating how the event should be reported. This can be either as a request or a notification. The type of the event report will be contained in the miscCallInfo parameter of the EventReportBCSM operation.

legID - indicating for which party in the call the event will be reported.

dPSpecificCriteria - indicating information specific to the EDP to be armed

numberOfDigits - indicating the number of digits to be collected for the CollectedInfo event

applicationTimer - indicating the timer for the NoAnswer event.

These parameters are received by the EDP&CI Processing entity from the SFM.

When an event occurs the EDP&CI Processing entity checks if an EDP has been set for that event. If such is the case, then the EDP&CI Processing entity will collect the following information from the BCSM control and forward it to the SFM:

eventTypeBCSM - indicating which event has occurred (e.g. O_Answer, O_Disconnect)

eventSpecificInformationBCSM - indicating call related information specific to the call. For example, for CollectedInfo, it will contain the calledPartyNumber.

legID - indicating for which party in the call the event will be reported.

miscCallInfo - indicating whether the message is a request or a notification (in relation with the monitorMode parameter of the RequestReportBCSMEvent).

A.3.4.2 CE Processing

A CE Processing entity is able to monitor a call and to notify other processes of occurred charging related events. These other processes are the Charge Gen entity in the charging scenarios 2.3, 3.2, 4.1 and 4.2 and the INAP SAP sub-entity in the interaction scenarios. Each CE Processing sub-entity is related to one and only one BCSM control. It can be created either in a charging scenario or an interaction scenario, when call monitoring is required for charging purposes. Each CE Processing sub-entity is deleted when the related BCSM control ceases to exist.

Charging scenarios

For the charging scenarios the CE Processing sub-entity contains the following information:

one recording trigger - indicates the event that should start the usage metering process for that call. This can be a specific EDP (e.g. EDP = T-Answer). It can also have the value 'immediate', which means that the usage metering process (the charge GENERation) should start immediately upon reception of the INAP message (FCI, SCI, AC).

one or more reporting triggers - indicating the events (e.g. T-disconnect) or time period (each 5 minutes) that trigger the sending of the usage notification by the Charge Gen entity.

Parameters for the creation of the Charge Gen entity (see below). These are supplied by:

- BCSM - the call related parameters, such as calling party, called number, etc.;
- INAP operations - charge level, charge item, charge party, etc.;
- Default Charging Info - supplies the parameters not supplied by the INAP message.

When the INAP SAP receives an FurnishChargingInformation, SendChargingInformation or ApplyCharging operation (charging scenarios 2.3, 3.2, 4.1 and 4.2) a CE Processing sub-entity is instantiated by the INAP SAP. A CE Processing sub-entity is related to one and only one BCSM control (call) and vice versa.

Only when the recording trigger is met for a specific call, a Charge Gen sub-entity will be instantiated for that call. As CE Processing is the sub-entity that detects a recording trigger, this entity will also instantiate a Charge Gen sub-entity for that call, when the recording trigger has been met. The CE Processing sub-entity has all the information elements necessary for the instantiation of the Charge Gen sub-entity available. These information elements are provided either by the Default Charging Info sub-entity or by the INAP SAP (via the FCI, SCI or AC operations). The parameters provided by INAP SAP overrule the default parameters.

When a reporting trigger has been met for this call, the Charge Gen sub-entity will be notified of this.

In scenario 3.2 the CE Processing sub-entity provides the CCF Charging sub-entity with the operator specific information in case the normal charging activities in the CCF are influenced by this charging scenario.

Interaction scenarios

The monitoring of a call for charge related signalling messages received from another exchange / SSP by the CE Processing entity is initiated by the SCF when it sends a RequestNotificationChargingEvent operation to the SSF. This operation contains the following information elements, necessary to start the monitoring of the call:

eventTypeCharging - indicating the charge event or message that should trigger the notification

legID - indicating the leg on which the charging event applies

monitorMode - indicating the type of response to be given by the SSF. In this scenario the value will be Interrupted, for scenario 2 (clause A.3.3.9) it will be NotifyAndContinue.

These information elements are provided to the existing CE Processing sub-entity, or are used to instantiate a new sub-entity.

When an event occurs for which the CE Processing entity is monitoring the call, the occurrence of the event is signalled to the INAP SAP sub-entity. The CE Processing sub-entity will forward the following information to the INAP SAP

eventTypeCharging - indicating the charge event or message that triggered the notification

legID - indicating the leg on which the charging event applies

monitorMode - indicating the type of response (see RequestNotificationChargingEvent)

eventSpecificInformationCharging - indicating charging information related to the specific event

A.3.4.3 Default Charging Info

This sub-entity contains the default charging info such as:

- charging units;
- charge level;
- charge party;
- usage notification layout;
- notification settings (e.g. enable notification to OSF), etc.

This information is used by the CE Processing sub-entity to instantiate the Charge Gen sub-entity. This information is overruled by any parameter contained in the INAP message that resulted in the instantiation of the CE Processing entity.

A.3.4.4 Charge Gen

This sub-entity starts recording the usage of the BCSM control upon creation by the CE Processing sub-entity, i.e. when the recording trigger has been met. When Charge Gen receives a reporting stimulus from CE Processing, it will provide the Charge Reg sub-entity (scenario 2.3 and 4.2), the CCF Charging sub-entity (scenario 3.2) or the INAP SAP sub-entity (scenario 4.1) with the charge record.

When the BCSM control ceases to exist (i.e. at the end of the call) the Charge Gen sub-entity will also cease to exist.

The generation of charge records is initiated when the SCF sends either a FurnishChargingInformation operation, a SendChargingInformation operation, or an ApplyCharging operation to the SSF. The Charge Gen sub-entity is instantiated with the following information:

1) FurnishChargingInformation (charging scenario 2.3)

fCIBillingChargingCharacteristics - this information element defines the charge party, charge level and charge items for the call.

2) SendChargingInformation (charging scenario 3.2)

sCIBillingChargingCharacteristics - this information element can include:

- charge level - indicating the rate of the call;
- chargePulses - indicating the pulse rate to be applied for the call by the LE;
- chargeMessages - indicating specific messages to be sent to the LE.

legID - indicating to where the charge information is to be sent (A-party, B-party).

3) ApplyCharging (charging scenario 4.1 and 4.2)

aChBillingChargingCharacteristics - indicates which charging related information is to be returned by the SSF and under which conditions, e.g. only for successful calls.

sendCalculationToSCPIndication - indicates whether or not the SSF should return an ApplyChargingResult operation for the call.

partyToCharge - indicates which party in the call should be charged for the call.

The actual generation of the charge record is performed when the Charge Gen sub-entity receives the reporting stimulus from the CE sub-entity.

The generated charge record can be registered by the:

1) Charge Reg sub-entity

The charge record is sent to the Charge Reg sub-entity to be registered (charging scenario 2.3, 2.4 and 4.2). See subclause A.2.4.5.

2) SCF

The charge record is sent to the SCF using the ApplyChargingReport operation with the following information element (charging scenario 4.1):

callResult - this information element contains the complete charging record.

For this purpose the Charge Gen sub-entity passes the charge record to the INAP SAP sub-entity

3) LE

The appropriate protocols will be used to transfer the relevant information from the SSF to the LE. For this purpose the Charge Gen sub-entity sends the relevant information to the CCF Charging sub-entity (charging scenario 3.2).

In charging scenario 4.2, also charging information can be sent to the SCF using the ApplyChargingReport operation. For this purpose charging information (e.g. threshold passing or a charging record) is sent to the INAP SAP sub-entity.

A.3.4.5 Charge Reg

Charge Reg sub-entity registers charge records. These registration capabilities are used in charging scenarios 2.2, 2.3, 2.4 and 4.2, where charge records are registered by the SSF.

The Charge Reg sub-entity can register charge records:

- received from the SCF;
- received from the CCF; or
- generated by the SSF itself.

Case a)

The Charge Reg sub-entity receives the following information from the INAP SAP sub-entity:

- 1) FurnishChargingInformation (charging scenario 2.2)

fCIBillingChargingCharacteristics - this information element defines the complete charging record for the call

Case b)

The Charge Reg sub-entity receives from the CCF charging sub-entity a charging record containing non IN specific call information (e.g. length, a-party, b-party etc.). To correlate this with the (partial) charging record registered at the SCF, the following information is received from the SCF (charging scenario 2.4):

fCIBillingChargingCharacteristics - this information element defines a correlationID to be used for the correlation of the charge records GENERATED by the CCF and the SCF.

Case c)

The Charge Reg sub-entity receives from the Charge Gen sub-entity a charging record containing the following information (charging scenario 2.3):

fCIBillingChargingCharacteristics - this information element defines the charge party, charge level and charge items for the call.

information elements made available by the CE Processing when instantiating the Charge Gen sub-entity

or (charging scenario 4.2):

callResult - this information element contains the complete charging record, which in turn will contain information provided by the information elements aCHBillingChargingCharacteristics and partyToCharge and information made available by CE Processing when instantiating the Charge Gen sub-entity

A.3.4.6 CCF Charging

This sub-entity represents the charging functionality in the CCF. In relation to IN charging, this functionality is used to:

- communicate by means of the appropriate protocols with local exchanges (LEs) for on-line charging (ONC) (charging scenario 3.2);
- identify charging events that should be handled according to one of the interaction scenarios and signal these events to the CE Processing sub-entity (interaction scenarios 1 and 2);
- generate non IN specific charging records and inform the SSF about this (charging scenario 2.4).

A.4 Call Gapping and Service Filtering scenarios

Call Gapping may be activated by the SCF or by OSF, and is initiated by the **network**. The main purpose of this functionality is to give some management functionality on the information flow between the IN functional entities, i.e. SSF-SCF. When the SCF detects nodal congestion, the SCF sends a *Callgap* request to the SSF. The request is sent within an existing control relationship as a part of another response of a SSF query and is not to be answered by the SSF. Call Gapping initiated by OSF has a higher priority than SCP initiated Call Gapping.

The possible clash between traffic management via the management interface and traffic management through a signalling (INAP) interface should be resolved (prevented) at the Network Management level.

Service Filtering is activated from the SCF at SLP processing when using the LIMIT SIB in the service. Service Filtering is **subscriber** initiated and the main purpose with this functionality is to allow a given subscriber to add a certain treatment to calls in a specific time period.

A.4.1 Introduction

A.4.1.1 Call Gapping

Call Gapping is network initiated, and related to nodal congestion. Therefore, Call Gapping does not apply for the service as such. In ETS 300 374-1 [9] and ITU-T Recommendation Q.1214 [17], 'gapped' calls are treated as specified in 'gapTreatment'. One has the possibility to give announcements and messages among others.

A.4.1.2 Service Filtering

Service Filtering is activated from the SCF at SLP processing when using the LIMIT SIB in the service. Service Filtering is subscriber initiated. The facility is part of ones service, and has nothing to do with network protection. Service filtering applies to IN calls that require the assistance of SCF IN functions (SLPs), i.e. applies to all TDPs that are used during the call establishment. Activation / deactivation of service filtering is initiated by the subscriber or management, who requires to give calls a special treatment. When "filtered", the calls are provided treatment for specific duration and specific intervals (announcements, release...).

A.4.2 DFP description

A.4.2.1 Call Gapping

Call Gapping may be initiated by the SCF or by the OSF. In the first case, the maintenance functionality in the SCF ([Core INAP], subclause 7.2.3) detects nodal overload and requests Call Gapping with the *CallGap* operation.

When Call Gapping is initiated, the parameter *gapCriteria* indicates the criteria, that must be met to activate Call Gapping, subclause 9.6.1.1 of ETS 300 374-1 [9] states, that the criteria are servicekey, called address, a combination of these or a combination of servicekey and calling address.

A.4.2.2 Service Filtering

Service Filtering is activated with the INAP operation `ActivateServiceFiltering`, and the SSF answers with `ServiceFilteringResponse` ([9] subclause 9.28).

The SCF (LIMIT SIB) issues an `ActivateServiceFiltering` request containing the `filteredCallTreatment`, `filteringCharacteristics`, `filteringCriteria`, `filteringTimeout` and `startTime` to the SSF.

The `ServiceFilteringResponse`, with parameters `CountersValue` and optionally `filteringCriteria`, is sent in the following circumstances:

- The Service Filtering is running, the interval time (in the `filteringCharacteristics`) is expired and a new call is received that matches the `filteringCriteria`. The Service Filtering for this `filteringCriteria` continues to be active after the new call is allowed to communicate to the SCP.
- The Service Filtering is running and the threshold value (`numberOfCalls` in `filtering-Characteristics`) is reached. The `numberOfCalls` threshold is reset and the `ServiceFiltering` continues to be active.
- The Service Filtering is completed, duration time is expired or stop time is reached, (duration, stop time as defined in `filteringTimeOut`). The service filtering for this `filteringCriteria` is stopped.
- The Service Filtering is running and a new `ActivateServiceFiltering` request is received with the same `filteringCharacteristics`. The Service Filtering for this `filteringCriteria` proceeds with the new set of `ServiceFiltering` attributes.

NOTE: Every time a `ServiceFiltering` response is sent all the counters related to `ServiceFiltering` are reset.

A.4.3 SSF Model mapping

This subclause provides a mapping from the Call Gapping and Service Filtering scenarios described to the SSF sub-entities in the model. The mapping is split into three scenarios, a scenario mapping information flow at activation of Call Gapping / Service filtering, a scenario showing information flow when a given call is gapped / filtered and a scenario showing the information flow when service filtering is removed.

A.4.3.1 Mapping of activation onto SSF model

The figure below describes how to map activation of call gapping and service filtering onto the SSF model.

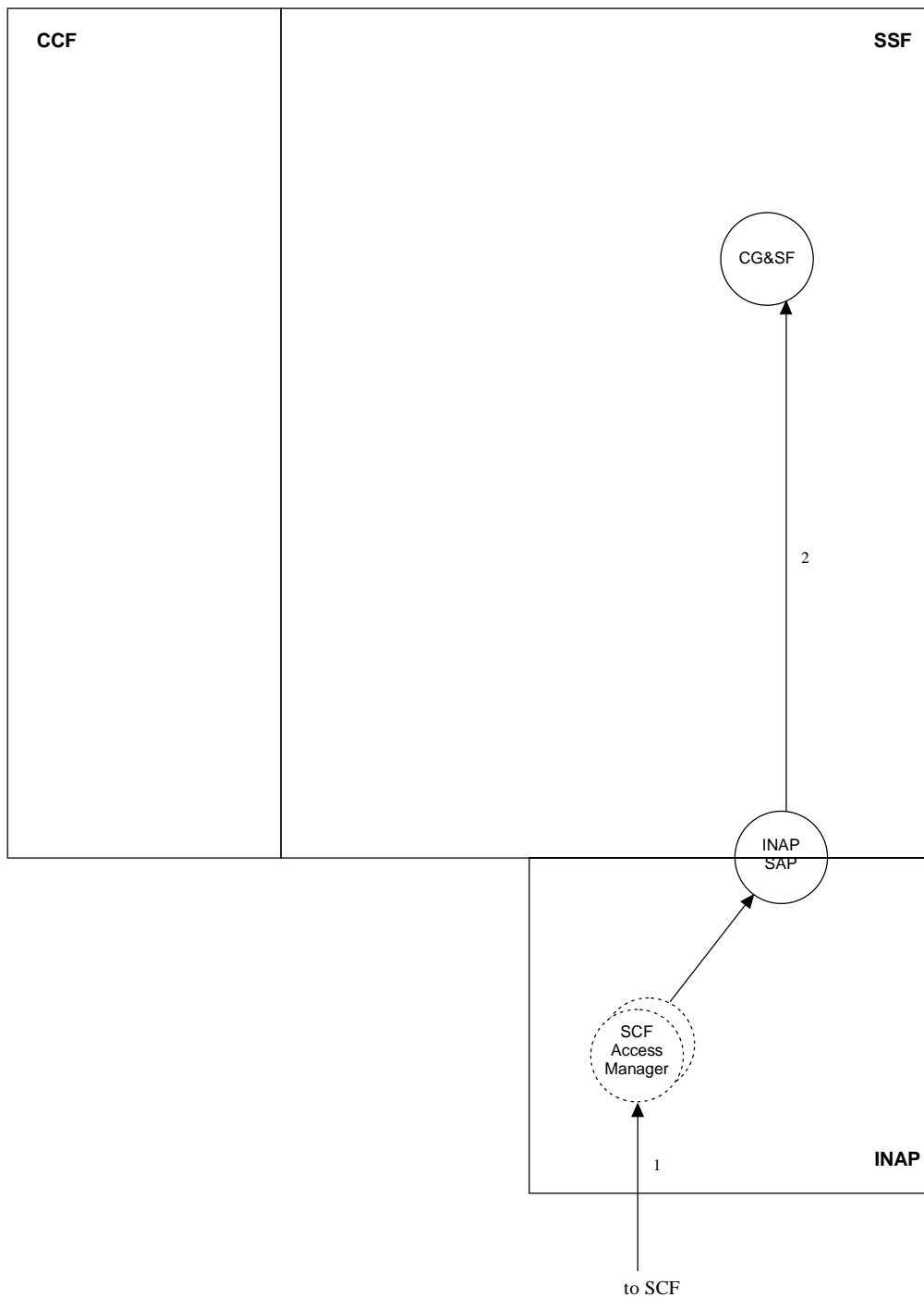

Figure A.4.1

The SCF Access Manager receives the CallGap or the ActivateServiceFiltering request from the SCF, and passes it to INAP SAP for translation.

The INAP SAP passes the information elements to the Call Gapping & Service Filtering sub-entity, where gapping or filtering is performed according to the parameters.

A.4.3.2 Mapping of a gapped / filtered call onto SSF model

The figure below shows the information flow of a given gapped or filtered call onto the SSF model.

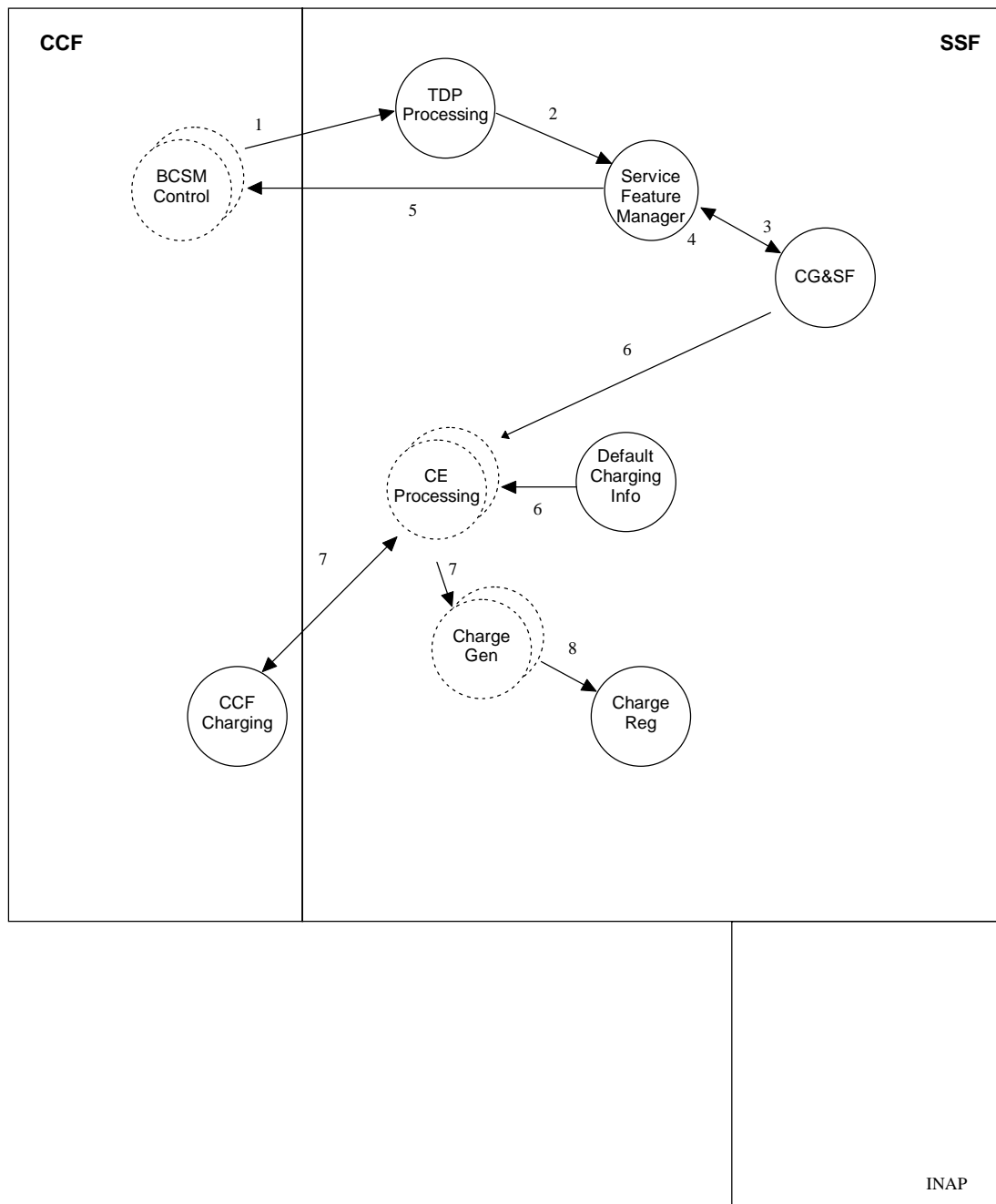

Figure A.4.2

- 1) At a specific time in a call, defined by the Basic Call State Model, trigger conditions are checked.
- 2) When a trigger condition is met, the Service Feature Manager determines whether the call is an IN call or not, If so, the Service Feature Manager passes the call to the
- 3) CG&SF sub-entity, where it is checked if the call should be gapped or filtered. The actual checking is done based on the gapCriteria parameters received with the Callgap operation or based on the filterCriteria received with the ActivateServiceFiltering operation. If gapping / filtering criteria is met, parameters gapIndicators or filteringCharacteriztics determine whether this certain call should be handled by the SCF or handled according to the parameters gapTreatment or filteredCallTreatment. If handled by the SCF, the information flow is described in clause A.1 'Basic Call Process scenarios'.
- 4) If the call is handled according to gapTreatment or filteredCallTreatment, any further information needed for the BCSM Control to set up a bearer connection to the device indicated by gapTreatment or filteredCallTreatment parameters is fetched from the CG&SF entity and the information is passed to the Service Feature Manager.
- 5) and further on to the BCSM Control, where the bearer connection is set up.
- 6) At the same time, a new instance of the CE Processing sub-entity is created in order to provide charging of the call. The information in the sBillingChargingCharacteristics is passed to the instance. In the call gapping case, the Default Charging Info sub-entity provides the information needed in order to charge the call as the callgap operation contains no information on charging.
- 7) A charge generation sub-entity is instantiated to generate the charge for the call. The charge generation might be dependent on the CCF charging of the call.
- 8) The charge is registered at the Charge Registration sub-entity.

A.4.3.3 Mapping of gapping / filtering response onto SSF model

When call gapping stops, determined by the gapIndicators, no response is sent to the SCF. When the service filtering stops because of one or more of the reasons listed in subclause A.4.2.2, a ServiceFilteringResponse is sent to the SCF. The mapping of the information flow is shown in the figure below.

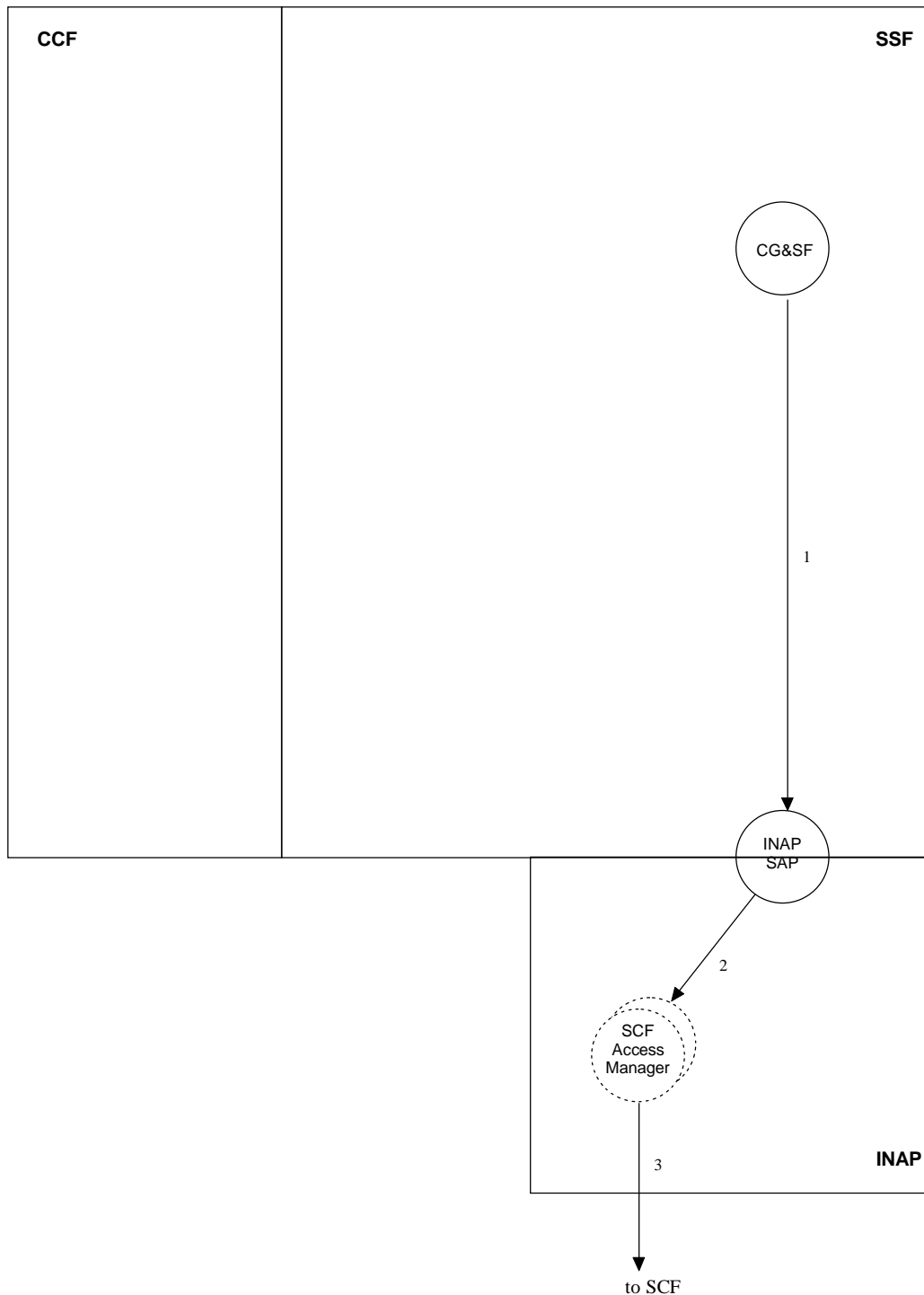

Figure A.4.3

The service filtering has ended, and the CG&SF passes the values of the associated counters (and optionally the filteringCriteria) to the INAP SAP.

The INAP SAP formulates the ServiceFilteringResponse operation and passes it to the SCF Access Manager instance that is responsible for the communication with the originating SCF.

The SCF Access Manager sends the INAP operation.

A.4.4 Description of the impacted SSF sub-entities

In the SSF model, the CG&SF performs the call gapping and service filtering functionality in the SSF. Upon receipt of the request for an IN service invocation from the Service Feature Manager, this sub-entity checks whether Call Gapping and/or Service Filtering conditions are met and based on stored parameters it decides whether to pass the call to the SCF for further execution or to apply a bearer connection.

Call Gapping and Service Filtering can be activated on a range of calling line numbers, a single directory number or a servicekey. The administration of these criteria are totally independent of the trigger criteria defined at the trigger detection point.

Call Gapping

The following parameters are stored in the CG&SF sub-entity.

Parameter	M/O	Description
gapCriteria , choice of - calledAddressValue - gapOnService - calledAddressAndService - callingAddressAndService	M	Defines what to gap on
gapIndicators - duration - gapInterval	M	Indicates how gapping should be performed - duration specifies the total time interval in seconds during which call gapping for the specific gap criteria will be active ('0' is remove gapping, '-1' is infinite duration, '-2' is network specific) - specifies the minimum time interval in milliseconds between calls being allowed through ('0' = no gap, '-1' = gap all)
controlType, choice of - sCPOverloaded - manuallyInitiated	O	Indicates how call gapping was activated - when call gapping is initiated by SCP after detecting congestion - when initiated by OSF
gapTreatment, one or both of - informationToSend - releaseCause	O	Defines how gapped calls should be treated - messageID, numberOfRepetitions, duration, interval - the call is released

As gapTreatment is not yet described in ITU-T Recommendation Q.1214 [17], management of this is for further study (note).

NOTE: Special treatment apply in case of OSF initiated Call Gapping. If Call Gapping is initiated by OSF with gapCriteria gapOnService, calledAddressAndService or callingAddressAndService, this does not necessarily apply for the whole service when the service is implemented in a mated pair configuration. Before the call is treated according to gapTreatment, the alternative SCP must be tried. As earlier stated, this mechanism should be implemented at the CCS7 level.

Service Filtering

The following parameters are stored in the Call Gapping and Service Filtering sub-entity:

Parameter	M/O	Description
filteredCallTreatment - informationToSend - maxNumberOfCounters - releaseCause	M	Specifies how filtered calls are treated - specifies the bearer connection to be set up for a filtered call - specifies the maximum number of counters for filter - specifies the cause value used for call release
filteringCharacteriztics , choice of - interval - numberOfCalls	M	Specifies how filtering should be performed - specifies the time interval between each call, that is passed to the SCF - specifies the number of calls, that are filtered before a call i passed to the SCF
filteringTimeOut , choice of - duration - stopTime	M	Specifies the duration of the filtering - value settable by SCP and by management (default duration - to be provided by management if value is -2 - in format YYMMDDHHMMSS, BCD coded
filteringCriteria - serviceKey - dialed number - calling party number	M(O)	Specifies the criteria for filtering, The parameter is optional inside the context of a specific call, but mandatory outside a specific call context
startTime	O	Specifies the start time of service filtering. When omitted, filtering starts immediately.
CountersValue	M	The ServiceFilteringResponse carries this information to the SCF when the operation is send.

Although the filteredCallTreatment parameter is mandatory, only the sBillingChargingCharacteriztics is mandatory (Q1218, Common Data Definitions)

A.5 Activity Test scenario

A.5.1 Introduction

The SCF issues an ActivityTest request to check for the continuity of the SCP/SSF relationship.

A.5.2 DFP description

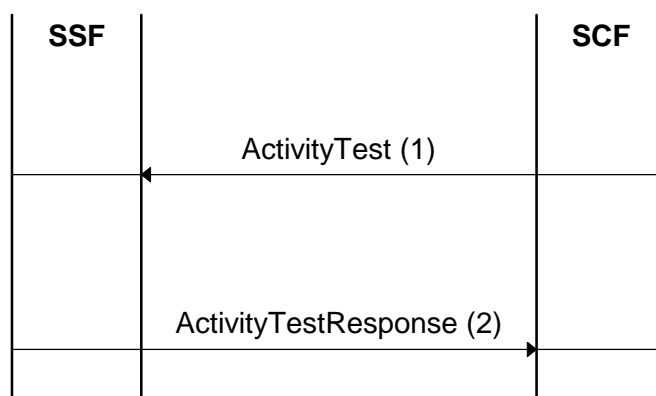

Figure A.5.1

This request is targeted to the SCF Access Manager that is monitoring the SCF/SSF relationship, on the SSF side.

If the relationship is still in existence, the SCF Access Manager issues an ActivityTestReponse to its SCF.

A.5.3 SSF Model mapping

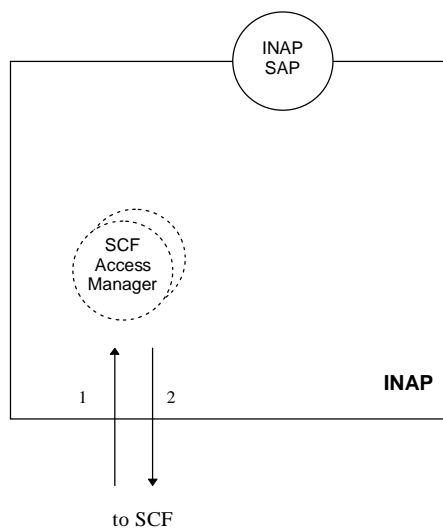

Figure A.5.2

- 1) The SCF issues the ActivityTest request.
- 2) The SCF AccessManager answers with the ActivityTestResponse.

A.5.4 Description of the impacted SSF sub-entities

The request and the response carries no information elements and there is no impact on the SCF Access manager sub-entity.

A.6 "Call Information" scenario

A.6.1 Introduction

The scenarios described in this subclause are based on the [CORE INAP] subclauses 9.7 and 9.8. The scenarios deal with the retrieval of Call Information initiated by the SCF and retrieved from the SSF. The chosen SSF sub-entities and their interactions are examples and it may be possible for this information to be retrieved using other sub-entities interaction.

A.6.2 DFP description

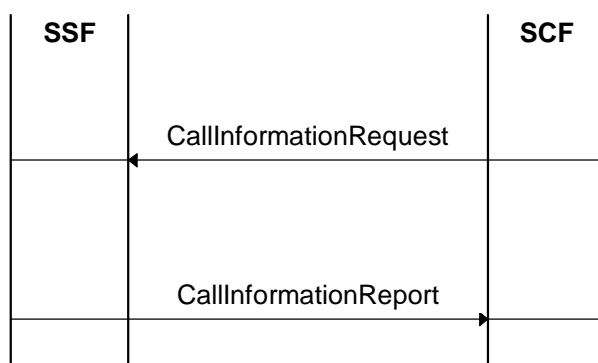

Figure A.6.1

From the time the CallInformationRequest operation is sent, and the CallInformationReport operation is returned, a control relationship exists between the SCF and the SSF, in other words the SCF Access manager is active throughout.

A.6.3 SSF Model mapping

As a result of SLPI the SCF issues a CallInformationRequest to the SSF. This operation is used to request the SSF to record specific information about a single call. When the requested information is available, the SSF sends the information to the SCF in a CallInformationReport operation.

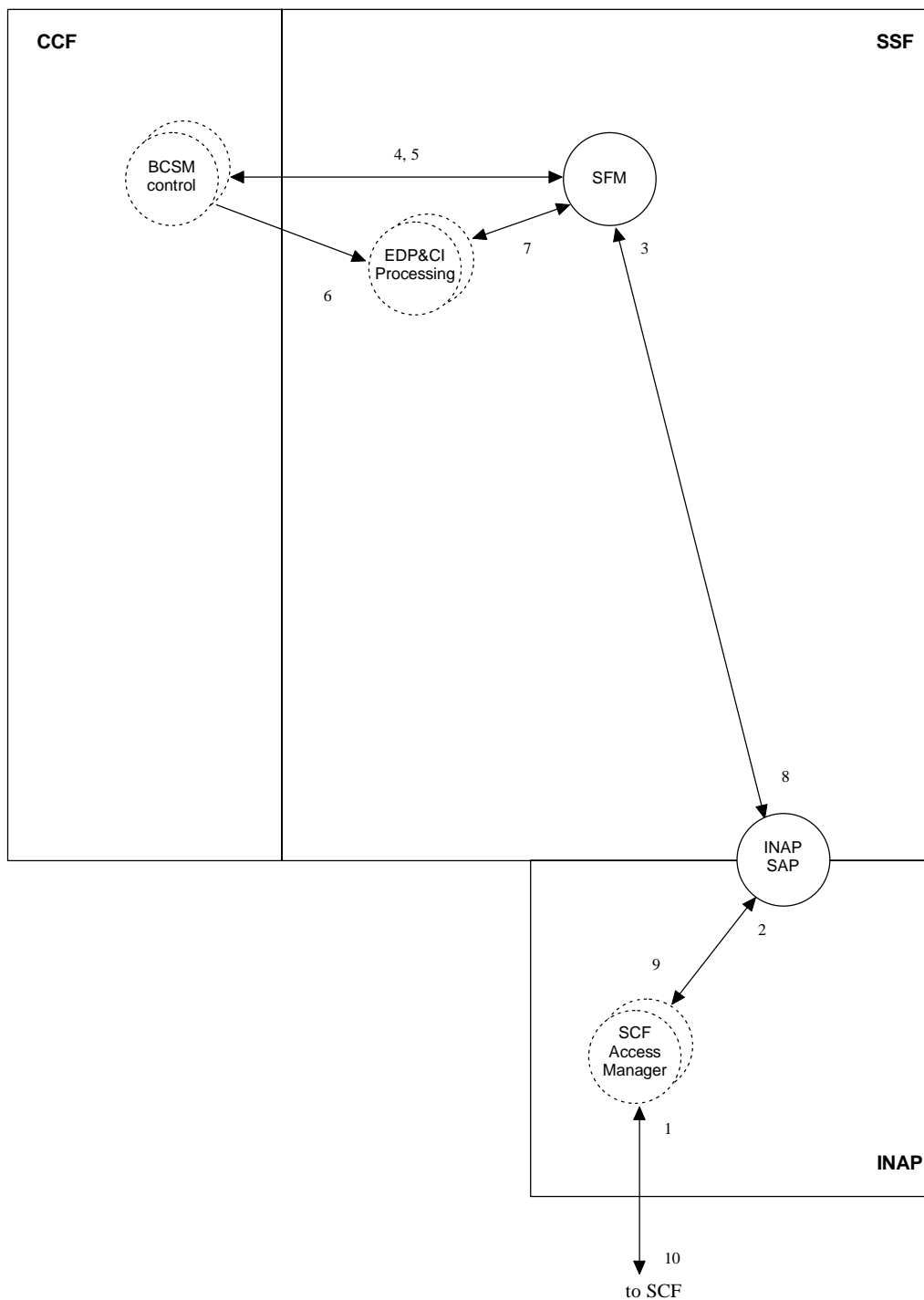

Figure A.6.2

A.6.3.1 CallInformationReport

- 1, 2) As a control relationship exists between the SCF and SSF, the SSF Access manager receives the CallInformationRequest operation and passes it to the INAP SAP for further processing. The 'CallInformationRequest' operation contains a list of information elements needed by the SCF to process information relating to the call, these are:
 - CallAttemptElapsedTime, callStopTime, callConnectElapsedTime, calledAddress and releaseCause. Any or all of these elements can be requested.
 - The CallInformationRequest operation is only received when the SSF FSM is in the state 'Waiting for instructions', the operation does not lead to a transition to any other state.

Information Flows and impacted SSF sub-entities

- 3) The INAP SAP unpacks the CallInformationRequest operation and sends the information elements to the SFM.
- 4, 5) The SFM allocates a record in which to store this information when available. If any already exists such as the CalledAddress this is retrieved from the BCSM control and assigned to the record.

A.6.3.2 CallInformation Report

This operation is used to send specific call information for a single call from the SSF as requested by the SCF in a previous CallInformationRequest operation.

The SSF FSM is in the state 'waiting for instruction'. The SSF FSM will execute a state transition as a result of the following events:

- A Party releases.
- A Party abandon.
- B Party Release.
- B party busy.
- SSF no answer timer expiration.
- Route select failure indicated by the network.
- Release call initiated by the SSF.

At this point the SSF having satisfied all the events needed, sends the CallInformationReport to the SCF.

Information Flows and impacted SSF sub-entities

- 6) When any of the release causes stated above (with the exception of the SCF initiated call release) are detected, the contents of the CallAttemptElapsed time, callStopTime and callConnectElapsedTime, calledAddress and releaseCause are sent from the BCSM Control to the EDP&CI.
- 7) On receipt of the information received from the BCSM control, a notification and the package of information elements are sent to the SFM.
- 8) The SFM, having received all the information required for the record, sends the information to the INAP SAP.
- 9) The INAP SAP having received all the information necessary constructs a CallInformationReport operation and sends this to the SCF Access manager
- 10) As an association already exists between the SSF and the SCF, the SSF Access Manager sends the CallInformationReport operation to the SCF

A.6.4 Description of the impacted SSF sub-entities

No impact of the sub-entities were found for this scenario.

A.7 "InitiateCallAttempt" scenarios

A.7.1 Introduction

The InitiateCallAttempt scenarios are based on the Basic Call Process SIB description (ITU-T Recommendation Q.1214 [17], subclauses 5.3). This scenarios describe the influence of a call set-up initiated from the SCF. The SCF requests the SSF to create a new originating call to one party using the address information provided by the SCF (e.g. wake up call service). This includes:

- the initial creation of an originating call process:
The SSF creates a new Call Segment and a basic call process (BCP) with an Originating BCSM instance suspended at 'Orig_Attempt_Authorized DP'. This implies receipt of operation InitiateCallAttempt from SCF outside context of any existing relationship.
- establishment of a new control relationship:
In order to enable the establishment of a control relationship between the SCF and the SSF and to allow the SCF to control the created call appropriately, the SLPI shall monitor for the BCSM event(s) which report the result of the created call set-up.
- the creation of a new call set-up:
The SLPI shall send a Continue operation to request the SSF resume basic call processing to route the call to the specified destination.

While other scenarios are possible than those described, they are not included because they either duplicate the functionality presented or they otherwise do not add value from a management perspective. For example Initiate Call Attempt scenarios do neither include any follow-on call nor any additional call set-up scenario (e.g. within an existing control relationship).

The Initiate Call Attempt scenarios also do not handle aspects of IN-based charging and user interaction dialogues.

A.7.2 DFP description

A.7.2.1 Scenario SCF initiated 'one party' call.

The SLPI in the SCF determines the destination to which the call has to be directed. The basic call process created by the SSF upon reception of the operation InitiateCallAttempt is suspended at a DP. The SCF may e.g. arm event detection points with the operation RequestReportBCSMEvent.

The call set-up procedure is resumed after receiving a Continue operation from the SCF and uses the destination address sent by the SCF to build the forward call set-up message for the call.

The call is initiated from the SSF/SCF simulating a call originating from a local exchange (calling party).

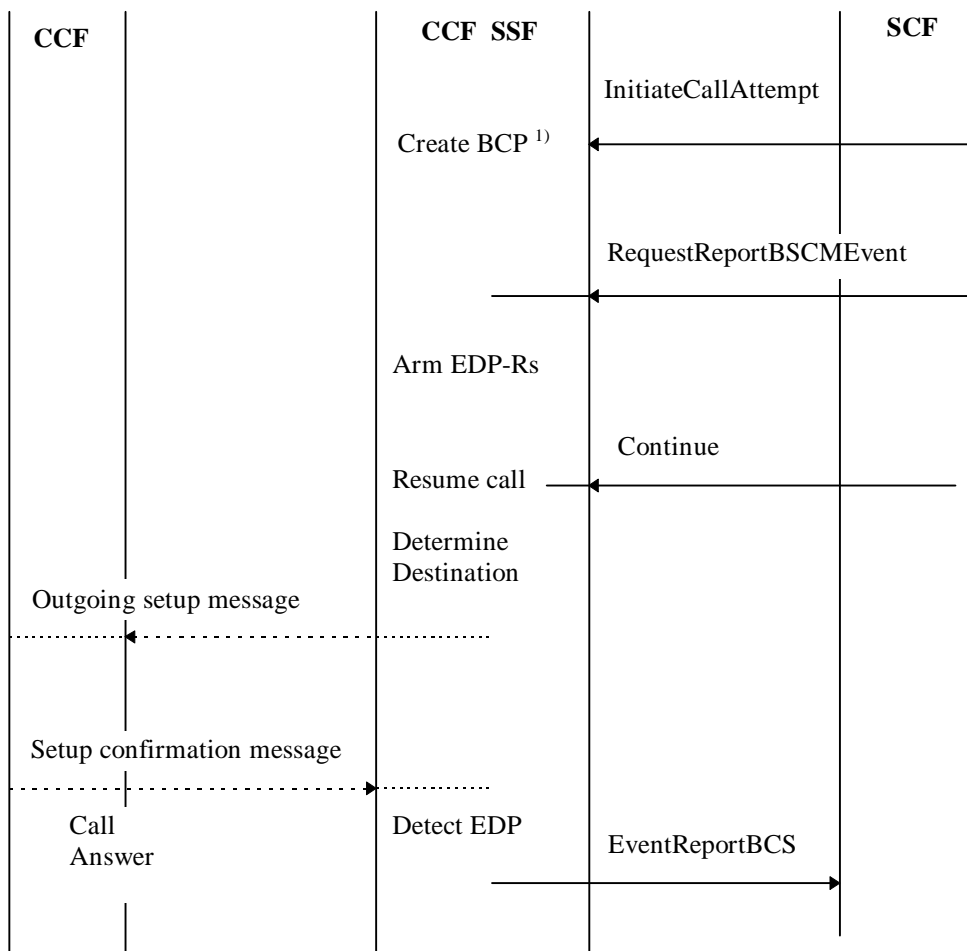

1): The properties and capabilities, normally received from or associated to the calling party , required for the call set-up shall have a network dependent default value.

Figure A.7.1

All subsequent operations are treated according to their normal procedures as described in other scenarios like Basic IN Call scenarios.

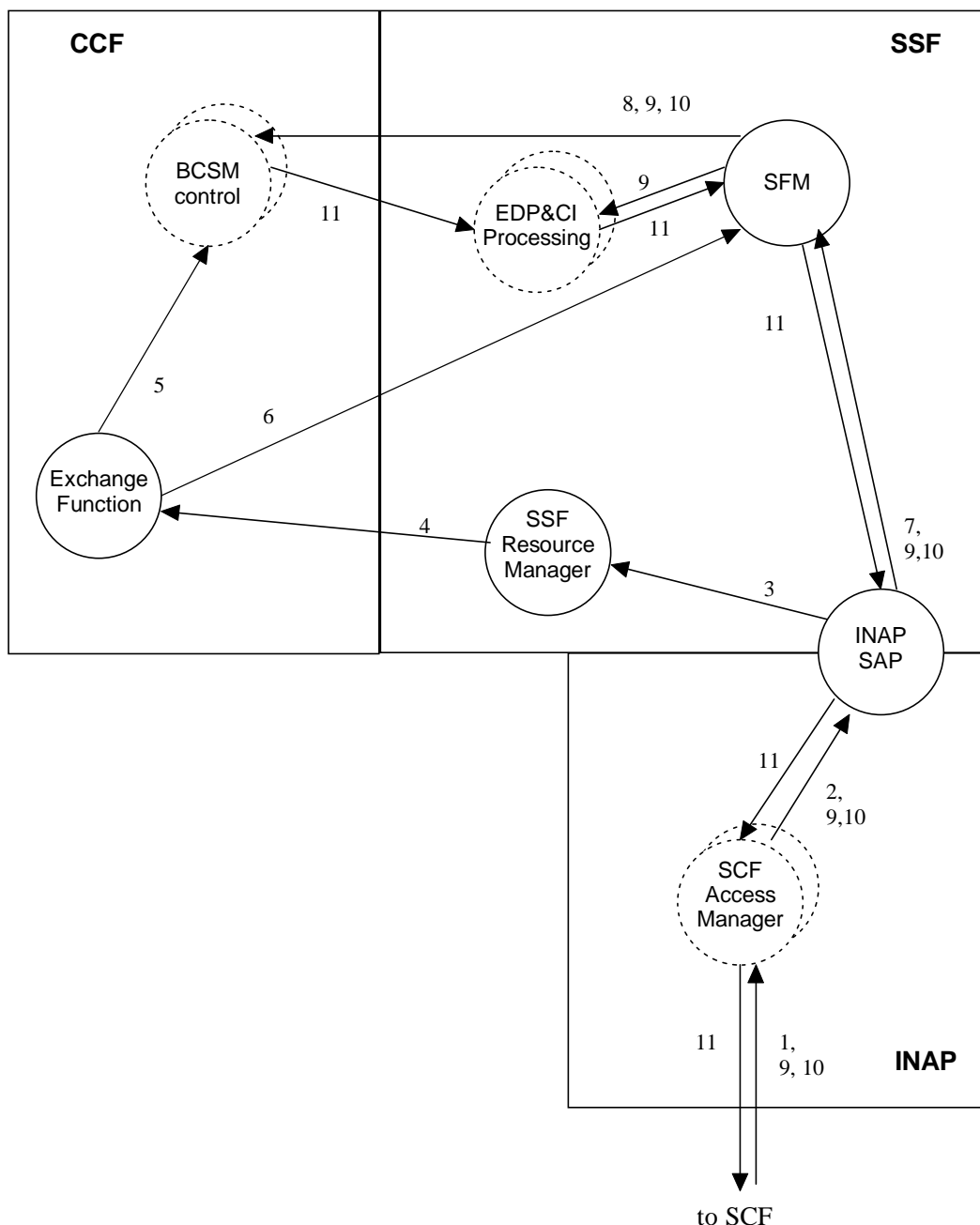

Figure A.7.2

InitiateCallAttempt

The SCF requests the SSF to create a new call to one call party using the address information provided by the SCF. Upon receipt of the InitiateCallAttempt operation in SSF a new SCF - SSF relationship shall be established. Therefore the INAP SAP creates and invokes an SCF Access Manager instance to initialize the dialogue with the SCF. This process is not shown.

- 1, 2) The SCF Access Manager receives the InitiateCallAttempt operation and passes it to the INAP SAP sub-entity for further processing. The InitiateCallAttempt operation contains a number of optional call routing relevant information (callingPartyNumber, alertingPattern and serviceInteractionIndicators).
- 3) The INAP SAP decodes the INAP message and sends a request to provide required default originating call set-up information to the SSF Resource Manager sub-entity.

- 4) The SSF Resource Manager provides the required access default originating call set-up data and sends the information elements to the Exchange Function sub-entity, which will make the information available for call processing and handle the appropriate mapping onto the applied network signalling system used when the new call set-up is performed.
- 5, 6) The Exchange Function will instantiate an Originating BCSM instance to be used by the SCF initiated originating call set-up and provide the access default originating call set-up data.

(In an ordinary basic call set-up this is done in the CCF on request from a user (calling party)). The Exchange Function sub-entity will then notify the SFM sub-entity about the identity of the BCSM instance to be applied for the call set-up.

- 7) The INAP SAP decodes the InitiateCallAttempt INAP operation and sends the information elements to the SFM.
- 8) The SFM sends the received InitiateCallAttempt information to the O_BCSM instance. With this call information the call processing is suspended at 'Orig._Attempt_Authorized DP' and is prepared to be resumed when a Continue operation is received.

RequestReportBCSMEvent

- 9) The service logic program in the SCF determines which BCSM events that should be reported to it. For this purpose it sends a RequestReportBCSM to the SSF. This operation is handled as described previously in the present document for "Basic IN Call scenarios".

Other reports may also be requested (e.g. ApplyChargingReport, CallInformationReport, EventNotificationCharging).

Continue

- 10) This operation is handled as described previously in the present document for "Basic IN Call scenarios".

EventReportBCSM

- 11) An event occurs in the BCSM, e.g. an O_Answer. This event is signalled to the EDP&CI Processing sub-entity. This operation is handled as described previously in the present document for "Basic IN Call scenarios".

A.7.3 Description of the impacted SSF sub-entities

This subclause describes and summarizes the main functions and data of each SSF sub-entity required for the "InitiateCallAttempt scenarios".

A.7.3.1 SCF Access Manager

A.7.3.1.1 Description of functionality

This entity manages the access from the SSF to the SCF and vice versa (see ITU-T Recommendation Q.1214 [17]; subclause 4.2.3.1). The INAP protocol stack will be contained in this process.

A.7.3.1.2 Description of data

No data identified for this scenario.

A.7.3.2 SSF Resource Manager

A.7.3.2.1 Description of functionality

This entity provides the SSF/CCF with access to resources as needed to perform IN call / service processing (see subclause 4.2.3.3 of ITU-T Recommendation Q.1214 [17]).

For an SCF initiated call, created with the InitiateCallAttempt operation, the properties and capabilities, normally received from or associated to the calling party, required for the call set-up shall have a network dependent default value (see subclause 9.20.3.1 / ETSI [Core INAP]).

This entity enables the SSF to simulate a call originating from a local exchange and to provide the network dependent default call set-up information required for the call set-up.

The required call set-up information may depend on the applied signalling system (e.g. DSS.1, ISUP) on which the information will be mapped by the sub-entity Exchange Functionality.

A default calling party number as to identify a number used as originating 'calling party' may be supplied by this entity to be used in case no calling party number is provided by the SCF in the InitiateCallAttempt operation. Default call set-up information properties should be associated with this calling party number.

However, a sequence of default call set-up information may be defined as to allow that these properties may be dependent on if a calling party number is supplied or not by the SCF.

If a calling party number is supplied by the SCF, these properties may be dependent on the received calling party number, see ETSI [Core INAP] (InitiateCallAttempt procedure, subclause 9.20.3.1).

A.7.3.2.2 Description of data

Default call set-up data:

A sequence of network default call set-up information for InitiateCallAttempt, e.g.:

- calling party number;
- calling party's category (ordinary subscriber);
- forward call indicators:
 - national / international call indicator (national);
 - end-to-end method indicator (no end-to-end method available);
 - interworking indicator (no interworking required);
 - end-to-end information indicator (no end-to-end information available);
 - ISDN user part indicator (ISDN user part used all the way);
 - ISDN user part preference indicator (ISDN user part preferred all the way);
 - ISDN originating access indicator (originating access non-ISDN);
 - SCCP method indicator (no indication).
- nature of connection indicators:
 - satellite indicator (e.g. no satellite circuit in the connection);
 - continuity check indicator (e.g. continuity check not required);
 - echo control device indicator (e.g. outgoing half echo control device not included);
 - required bearer service (3,1 kHz audio).

NOTE: Suggested guiding values are indicated in brackets where found appropriate. The indicated values are based on the EN 301 070-1 [1] 'Interaction between IN Application Protocol and ISDN User Part version 3.

A.7.3.3 INAP Service Access Point (INAP SAP)

A.7.3.3.1 Description of functionality

(ITU-T Recommendation Q.1214 [17]; subclause 4.2.3.1)

Whenever messages must be sent from the SSF to the SCF this process will take care of the message formulation. In other words, this process will create the INAP message that will be sent to the SCF by the SCF Access Manager.

It will also interpret (decode) incoming INAP messages and send these to other SSF subentities for further processing.

A.7.3.3.2 Description of data

No data identified for this scenario.

A.7.3.4 Feature Interaction Manager (SFM)

A.7.3.4.1 Description of functionality

(ITU-T Recommendation Q.1214 [17]; subclause 4.2.4)

The SFM receives and processes operations from INAP SAP.

The RequestReportBCSMEvent and Continue operations received are handled as described in previous subclauses in the present document (see "Basic IN Call scenarios").

A.7.3.4.2 Description of data

No data identified for this scenario.

A.7.3.5 EDP&CI Processing

A.7.3.5.1 Description of functionality

When the BCSM signals the encountering of an DP armed as EDP during call processing, the EDP&CI processing sub-entity checks whether any further actions are necessary at that DP. In case further actions are necessary, the event is reported to the SFM.

A.7.3.5.2 Description of data

No data identified for this scenario.

A.7.3.6 Basic Call State Manager (BCSM) control

A.7.3.6.1 Description of functionality

The BCSM control sub-entity is the abstraction of Call Control Function (CCF) activities for IN service logic instances.

It identifies points in call and connection processing at which events can be detected, the so-called Detection Points (DP). For each DP that is encountered, BCSM processing is suspended.

A.7.3.6.2 Description of data

No data identified for this scenario.

A.7.3.7 Exchange Function

A.7.3.7.1 Description of functionality

The Exchange Function sub-entity extends and translates the 'default call set-up' information received from the SSF Resource Manager to the format required for the specific signalling system used by the CCF for the call set-up.

A.7.3.7.2 Description of data

Mapping tables:

As an option mapping tables may be defined in order to map the provided default call setup information (i.e. signal primitives) toward used messages for the applied signalling systems (e.g. DSS.1, ISUP etc.) used in the network.

A.8 "ResetTimer" scenarios

A.8.1 Introduction

The SCF issues a ResetTimer procedure to request the SSF to refresh the T_{SSF} timer in the SSF. The T_{SRF} timer located in the SRF cannot be reset by this operation. The refresh of T_{SRF} and how to handle an expiration of the T_{SRF} timer is out of the scope of the present document.

A.8.2 DFP description

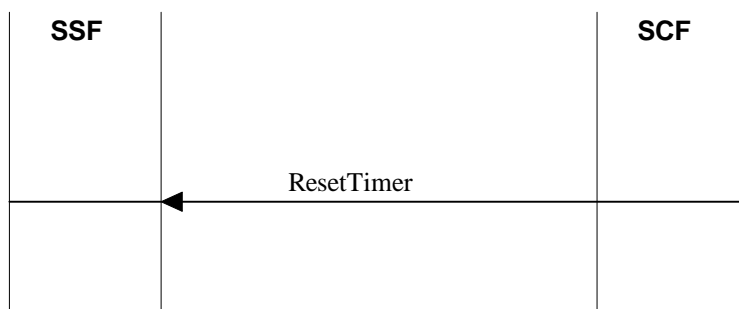

Figure A.8.1

ResetTimer is an unconfirmed information flow between the SCF and the SSF used to refresh the T_{SSF} timer in the SSF set by a previous IF. The purpose is to prevent the SSF from timing out the dialogue with the SCF while waiting for the SCF to provide further disposition (order) of a call.

A.8.3 SSF Model mapping

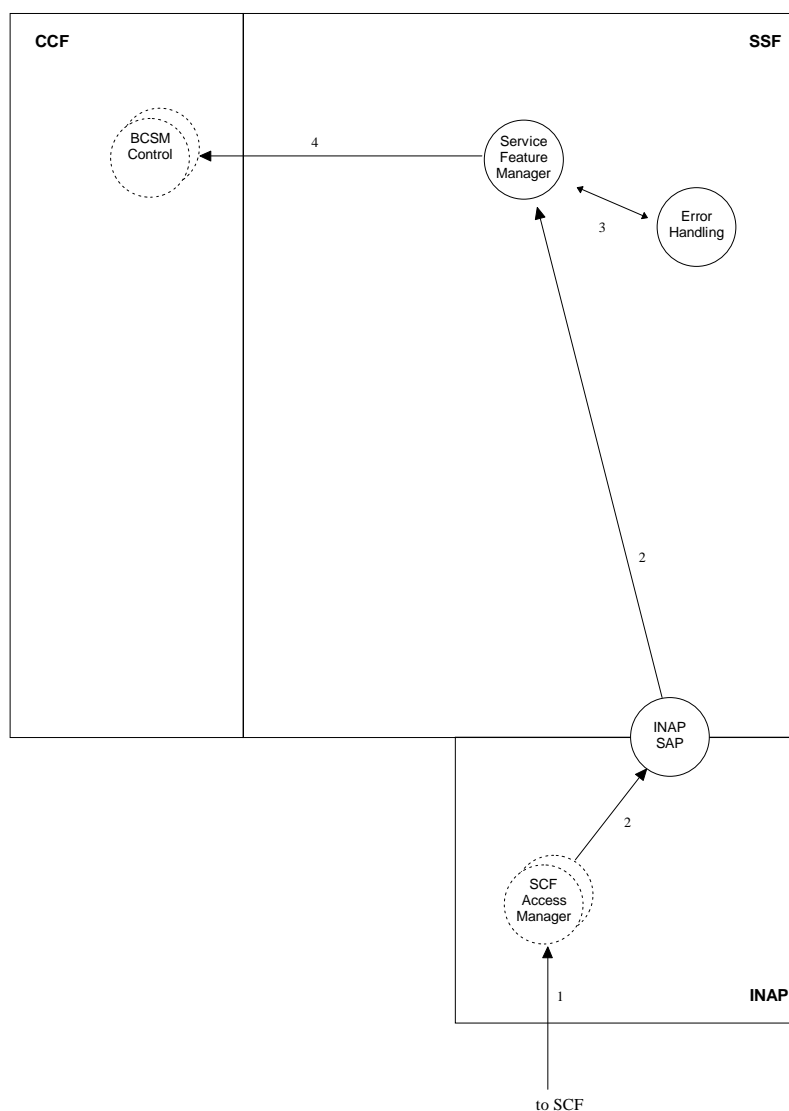

Figure A.8.2

A control relationship exists between the SCF and the SSF. The SLPI has determined that a ResetTimer IF should be sent by the SCF to the SCF Access Manager that has the T_{SSF} timer implemented.

Expiration of T_{SSF}

If the T_{SSF} expires the Finite State Machine of the SSF moves to idle and the interaction with the SCF is aborted.

To determine, whether or not the call should be progressed the T_{SSF} expiration is signalled to the Service Feature Manager. The Service Feature Manager decides, based on the call state and ServiceKey, if the call should be progressed. If so, nothing further happens.

If the call should be interrupted, information needed to handle the call is stored in the Error Handling sub-entity. The sub-entity contains information on how to set up a bearer connection to an SRF.

The Error Handling sub-entity provides the necessary information to the Service Feature Manager to make it possible for the CCF to progress the call. This default handling is network operator specific.

A.8.4 Description of the impacted subentities.

By the *ResetTimer* procedure, the T_{SSF} has been reset as specified. If Basic call processing has been suspended at a DP, the SSF is waiting for further instruction from the SCF. In case the T_{SSF} times out, the Service Feature Manager decides if the call should be progressed or not, based on information about the current call state and the Servicekey. The call may continue or the call may be interrupted and a default bearer connection may be set up. The default error handling is network operator specific.

A.8.5 Description of the impacted SSF sub-entities

By the *ResetTimer* procedure, the T_{SSF} timer has been reset as specified. If Basic call processing has been suspended at a DP, the SSF is waiting for further instructions from the SCF. In case the T_{SSF} times out, default information needed to progress the call is stored in the Error Handling sub-entity. The handling is network operator specific.

Annex B (informative): The Basic Call State Model control (BCSM control)

The Basic Call State Model (BCSM) represents an abstract view of call processing. It is call processing seen from the point of view of service feature control that is performed by a distinct functional entity, the Service Control Function (SCF). The BCSM defines a state / event model, where the state transition because of certain events is associated with detection points (DPs) for service feature control. The main concepts of the BCSM are:

Point in Call (PIC): The states in the BCSM are only defined by a set of call processing activities (functions and processes) associated to one or more of the basic call / connect states. These states and activities are summarized into PICs.

Transitions: Events are defined in the BCSM as Exit Events from one PIC that lead to the transition to another PIC. For every PIC the possible transitions are defined.

Detection Points (DP): To certain transitions exit points for IN service control are defined. These DPs can be source of new IN specific transitions (controlled by the SCF) to other PICs that are beyond basic call processing.

Information available: For every PIC the call related information is defined that is available before transition to another PIC. These informations are defined in the BCSM, that are relevant for the IN DPs associated to the transition.

Access Signalling Indications: At specific PICs indications from other network elements (exchanges, accesses) may be received and certain indications may be sent to them.

BCSM parts: The BCSM defines two separate state / event machines, one for the processing of the originating half of the call (O_BCSM) and one for the terminating half (T_BCSM). Intra local exchange indications are defined that signal events from PICs of the T_BCSM to PICs of the O_BCSM and vice versa.

Arming of DPs: If a DP is armed, it either initiates an IN service control (trigger detection point - TDP) or is associated to an existing IN service control (event detection point - EDP). Triggering may be unconditional for specific lines, trunk groups, private facilities or offices, or conditional on certain further criteria (based on the information available at the DP).

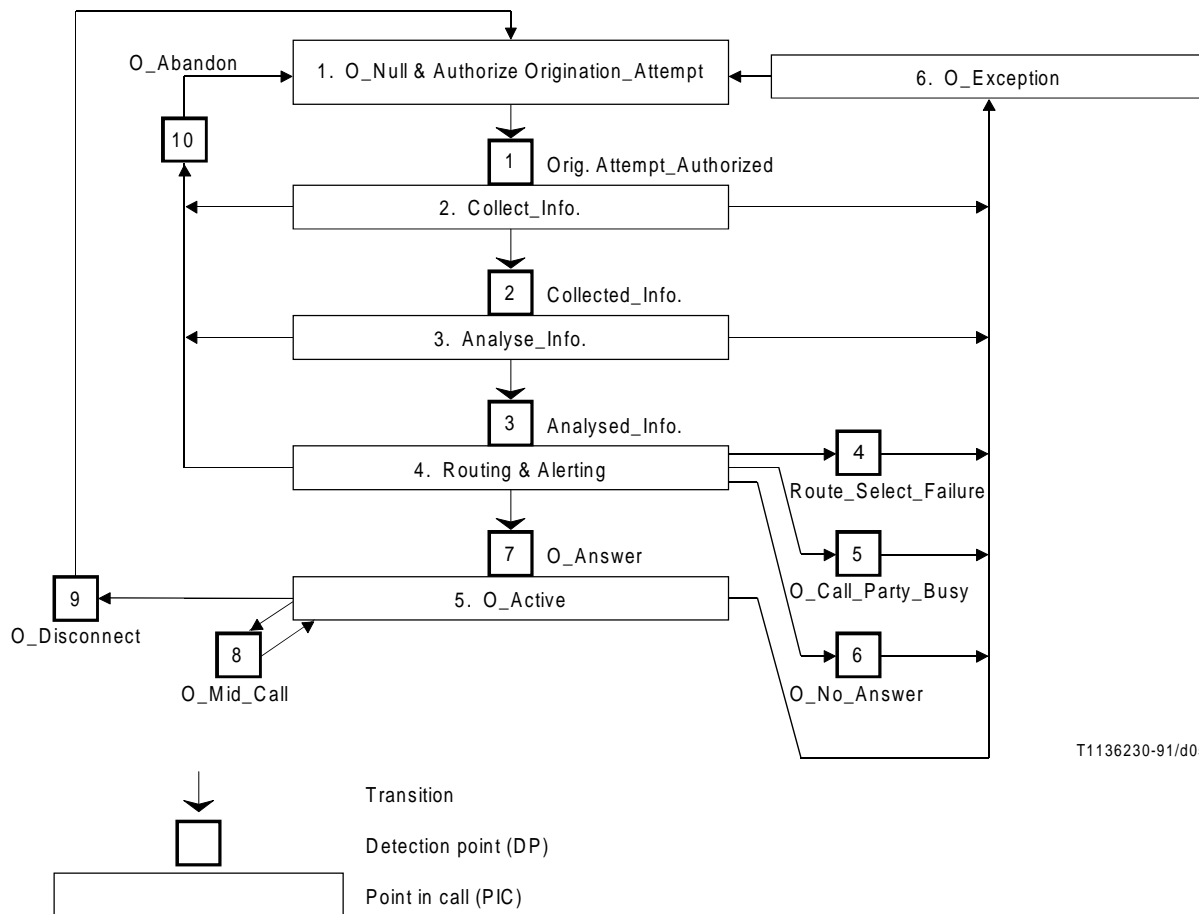

Figure B.1: Originating BCSM for CS-1 (figure 4-3 from ITU-T Recommendation Q.1214)

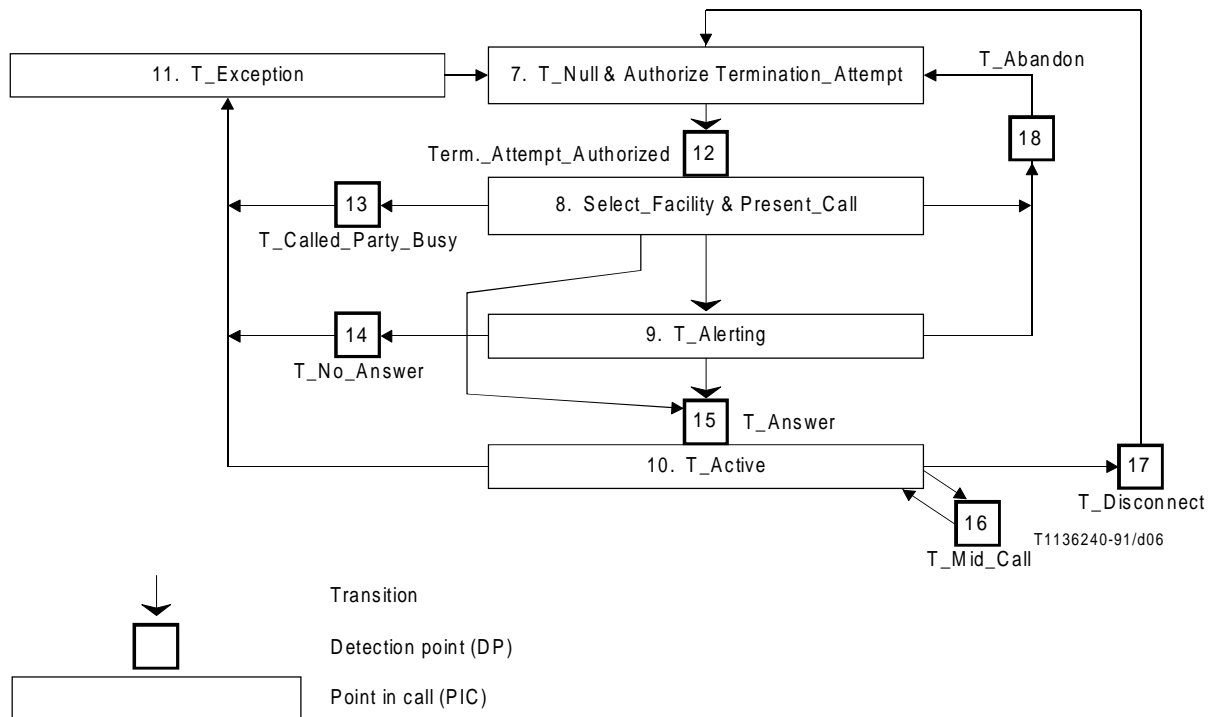

Figure B.2: Terminating BCSM for CS-1 (figure 4-4 from ITU-T Recommendation Q.1214)

B.1 BCSM control

The BCSM control entity of the SSF model is the entity that provides the access to call processing for the IN service control. Therefore this entity provides the following functionality:

- Mapping of state / event-transitions of basic call processing to transitions of the BCSM.
- Identify the BCSM part (O_BCSM, T_BCSM).
- Call DP processing in case a transition is associated to an DP.
- Make information available to DP processing that is required in the BCSM for the transition.
- Suspend call processing on request of the DP processing.
- Resume call processing on request of the SFM at a PIC requested from it, taking over new call related information.

B.2 TDP Processing

There are two kinds of IN triggering:

- **Termination Point based triggering:** A call processing instance and its related BCSM control is associated to a specific termination point in the exchange (originating / terminating customer access, trunk group, private facility access). A BCSM control instance of one termination point may contain different DP-arming then that of another termination point. The arming of this TDPs is therefore related to the management of this termination points.
- **Office based triggering:** The analysis of a set of called party numbers (e.g. starting with the same local area code) leads to a common routing target (abstract area to which the call has to be routed). Instead of starting routing with this analysis result, this may lead to IN service control. The arming of this TDPs is therefore related to the management of routing targets.

Termination points are defined in the ETS 300 293 [8]. Routing targets are defined in the EN 300 292 [3]. The different triggering possibilities are examined for every PIC in the following subclauses.

B.2.1 PIC1 - O_NULL&Authorize_Origination_Attempt

In this PIC the call processing process associated to a specific line or trunk group is waiting for an access signalling indication "Seizure from the originating party" (e.g. offhook, ISUP IAM message, Q.931 Setup message). If the properties of the incoming party are not sufficient to place the call, a release message is send to the originator and the call processing of the termination point remains in state idle. If the properties are acceptable, a message "Seizure accepted" is send and a transition to PIC 2 is performed. This transition may be associated to a DP 1 (O_Attempt_Authorized).

A TDP1 can only be associated to a termination point based triggering. I.e. as soon as the originating attempt is accepted for the termination point, TDP processing is started.

In case of a trunk group based triggering, the triggering may be conditional on the criterium "specific origin" (i.e. specific calling party number or number family).

Call processing may be resumed at PIC 2 (CONTINUE), PIC 3/4 (CONNECT).

B.2.2 PIC2 - O_Collect_Information

In this PIC the call processing instance waits for access signalling indications containing (dialled) information. According to a dialling plan the end of collection is determined. If "end of collection" is not reached before the timeout of the collect-information-timer, a transition to PIC 6 (O_Exception) is performed. Otherwise the transition is to PIC 3 (O_Analysed_Information). This later transition may be associated to the DP 2 (O_Collected_Information).

A TDP2 can only be associated to a termination point based triggering.

In case of a trunk group based triggering, the triggering may be conditional on the criteria "specific origin" (i.e. specific calling party number or number family). Trunk group or customer based triggering may be conditional on the number of dialled digits.

Call processing may be resumed a PIC 2 again (COLLECT), PIC 3/4 (CONTINUE, CONNECT).

If an escape code was dialled, the SFM instructs the BCSM control to resume call processing at PIC3, whereby the SFM delivers the call information (e.g. dialled digits without escape code).

B.2.3 PIC3 - O_Analyse_Information

After sending an access signalling indication to terminate the call information sending from the originating party and receiving an acknowledge, analysis of the call information is started (e.g. digit analysis).

According to EN 300 292 [3] there may be following results of basic call information analysis:

- local destination: call terminates in the local exchange;
- routing target: call has to be routed to a specific area;
- digit manipulation: call information is pre-processed and then analysed again;
- treatment: a special treatment like playing an announcement.

The determination of this results is dependent on analysis criteria which themselves may be different for different originating termination points.

The following assumptions are made in regard to the relationship to ORM:

No IN specific analysis is included into the basic call routing of ORM.

The basic call routing analysis may have a new result "IN treatment" (as specific routing target) for specific dialled digits. This result does not exclude the parallel determination of a routing target, local destination or treatment.

In case the analysis is not successful, a transition is performed to PIC 6, associated to a specific treatment. Otherwise a transition to PIC 4 is performed, that may be associated to a DP 3 (O_Analysed_Information).

Termination point and office based triggering is possible. In case of termination point triggering, the analysis criteria for digit analysis may be different for different termination points, while they are origin-independent for office based triggering.

Beside the result "IN treatment" other conditions may be examined by TDP processing. If this gives a negative result, the results of the normal digit analysis (besides "IN treatment") are activated. This is also true, if the related service feature control is not active at the moment. In this case a specific treatment may be activated.

TDP processing again may check the dialled digits, checking some other criteria than the digit analysis. It may also check specific origins (calling party number) in the case of office based triggering or the "nature of address indicator" for all types of triggering.

Call processing may be resumed at PIC 2 (COLLECT), PIC 3/4 (CONNECT).

B.2.4 PIC 4 - Routing and Alerting

Based on the routing target (local destination), an outgoing route (line) is determined. According ORM route selection is defined by:

- route selection criteria are determined depending on routing target, call history (e.g. echo suppressor required), origin and carrier selection;
- because of call data (e.g. requested bearer capabilities) and the route selection criteria a list of route termination points is selected;
- because of the algorithm associated to this list and priority-tables an outgoing trunk group is selected.

If an outgoing route has been determined, the authority of the originating party is verified. If it is not accepted (e.g. business group mismatch, toll restricted calling line) there is a transition to the PIC "O_Exception". In case the authority is accepted, there is an indication to the T_BCSM to process the call (PIC 7 "T_NULL & Authorize_Termination_Attempt"). The O_BCSM remains in PIC 4 in waiting state for indications from T_BCSM.

In case all trunks of the selected route are busy, this is indicated by the T_BCSM to the O_BCSM. A new trunk group may be selected out of the route list, as long as there are any. In case no more routes remain to be selected, there is a transition of the O_BCSM to O_Exception that is associated to the DP 4 "Route Select Failure".

In case the called party is indicated by the T_BCSM as busy to the O_BCSM, there is a transition of the O_BCSM to O_Exception. This is associated to DP 5 "O_Busy".

In case there is an indication from T_BCSM that the called party is alerted, the O_BCSM remains in PIC 4 and may start an application timer (for "No_Answer") if this was requested by the IN call control.

In case the No-Answer-timer expires before answer is indicated to the T_BCSM and there is an transition of the O_BCSM to O_Exception that is associated to DP6 "O_No_Answer".

In case the T_BCSM indicates that the called party has answered and the O_BCSM is still in waiting state, there is a transition of the O_BCSM to PIC 5 "O_Active". This transition is associated to DP 7 "O_Answer".

In case of TDP4 "Route Select Failure", the list of route termination points of ORM has to be enlarged by the possible association of an "IN treatment". I.e. in case all the routes of the list are exhausted, this leads to a message to TDP processing. TDP processing may check further criteria (e.g. digit strings, causes, origins, nature of address) before triggering IN control. This criteria may be origin dependent (trunk group, customer line, private facility) or not (office depended).

There may be unconditional triggering of DP "Busy", DP "No_Answer" for termination point based triggering.

Call processing may be resumed after triggering at PIC 2 (COLLECT), PIC 3/4 (CONNECT) or PIC 6 (CONTINUE).

In case the INAP operation CONNECT contains the parameter "route list", there has to be a mapping of the INAP information element to an ORM object (see subclause 9.2.2). Only after this mapping (e.g. to a list of route termination points to the same target but for a different carrier) the route selection can be continued.

B.2.5 PIC 5 - O_Active

In this state either a feature activation may occur (e.g. DTMF, hook flash, ISDN feature activator), leading to a transition to PIC 5 again, that is associated to DP 8 "O_Midcall". Or a disconnect event is indicated by the T_BCSM. This leads to an transition to PIC 1, that is associated to DP 9 "O_Disconnect".

There may be an unconditional triggering at TDP 9 for termination point related triggering.

Call processing may be resumed at PIC 2 (COLLECT), PIC 3/4 (CONNECT) or at PIC 1 (CONTINUE).

B.2.6 PIC 6 - O_Exception

Default handling of exception conditions. This may include an error information flow to the SCP, special treatments (e.g. announcements) and release of call resources. Transition to PIC 1. No triggering is associated to this PIC.

B.2.7 PIC 7 - T_Null & Authorize_Termination_Attempt

After an indication of an incoming call from the O_BCSM an T_BCSM instance for a certain termination point group is seized that is in state PIC 7 or a new one is created. The authority to route this call to the terminating party is verified. If it is not ok, the T_BCSM remains in PIC 7. Otherwise there is a transition to PIC 8 "Select_Facility & Present Call". This transition is associated to DP 12 ("Termination Attempt Authorized").

For TDP12 there may be an unconditional (outgoing) termination point based triggering (e.g. triggering because a certain trunk group or line was selected).

For (outgoing) termination point based and office based triggering TDP processing may check as further criteria for triggering the origin of the call.

NOTE: In the case of office based triggering the routing will determine a route-list / local-destination and a possible IN treatment. Only if DP 12 is reached and the trigger criteria are met, there is an IN treatment. Otherwise the call is continued (with the previously selected trunk group).

Call processing continuation: T_BCSM may return to PIC 7 (rerouting; indication of route select failure to O_BCSM) or go on to PIC 8 (continue call processing).

B.2.8 PIC 8 - Select_Facility & Present_Call

A special resource in the specified resource group (e.g. trunk group) is selected (a single resource is treated as a group of one element). If all the resources in the group are busy, there is an indication to the O_BCSM and a transition to PIC 11 ("T_Exception"). This transition is associated to DP 13 ("T_Busy"). If a terminating resource can be selected, this resource is informed about the incoming call (e.g. via ISUP-IAM, Q.931 Setup-message). After enough call information has been transferred to the terminating party and a "alerting" indication is received from it (e.g. ISUP-ACM, Q.931 Alerting message), there is a transition of the T_BCSM to PIC 9 ("T_Alerting"). This is also indicated to the O_BCSM. In case the T_BCSM receives a CONNECT indication in this state, there may also be an immediate transition to PIC 10 ("T_Active").

Triggering for TDP 13 is possible (outgoing) termination point based or office based. Digit analysis or termination point selection will lead to the result "IN treatment possible". Only if a busy event occurs this leads to triggering of IN. Specific cause values may be checked by TDP processing.

Conditional triggering may check the origin of the call. In case of trunk group or office based triggering also the destination digits may be checked by TDP processing.

Continuation of call processing: T_BCSM may fall back to PIC 7 (rerouting; busy indication to O_BCSM) or go on to PIC 11 ("T_Exception") in case the call has to be continued (SCF sends CONTINUE).

B.2.9 PIC 9 - T_Alerting

A call in PIC 9 is in waiting state for the call to be answered by the terminating party. Either an indication may be received that the No_Answer timer expires. In this case there is a transition to PIC 11, that is associated to DP 14 (T_No_Answer). In case the T_BCSM receives an answer indication from the terminating party (e.g. ISUP-ANS, Q.931 connect) there is a transition to PIC 10 (T_Active) that is associated to DP 15 (T_Answer).

The above remarks about TDP 13 are also true for TDP 14.

A No_Answer has to be associated to TDP 14 that has to be started as soon as PIC 9 is reached (if TDP 14 is armed).

There is no triggering required for T_Answer.

B.2.10 PIC 10 - T_Active

During call supervision specific events like feature activation (e.g. DTMF, hook flash, ISDN feature activator) may be received. This may lead to a transition to PIC 10 itself that is associated to DP 16 (T_Mid_Call). In case a disconnect indication is received from the terminating party or from the O_BCSM, there is a transition to PIC 7 (T_NULL). This is associated to DP 17 (T_Disconnect).

There may be an unconditional (outgoing) termination point based triggering for TDP 17.

Call processing may be resumed in any case at PIC 7.

There is no triggering required for T_Mid_Call.

B.2.11 PIC 11 - T_Exception

Default handling of exception conditions. This may include an error information flow to the SCP, special treatments (e.g. announcements) and release of call resources. Transition to PIC 7. No triggering is associated to this PIC.

Annex C (informative): Modelling the relationship between Trigger Bases and IN Triggers

In discussing administration of priorities and the activation state of IN-triggers assigned to the same customer line, it turned out that there are two different approaches to the relationship between trigger bases and IN-triggers:

View1: For a customer line a triggerBase object may be assigned; for every triggerBase object then several different inTrigger objects may be assigned (that include the trigger criteria for selecting a "service feature control"). Here the prioritization and activation is managed within the OC inTrigger, as every customer gets his own inTrigger objects.

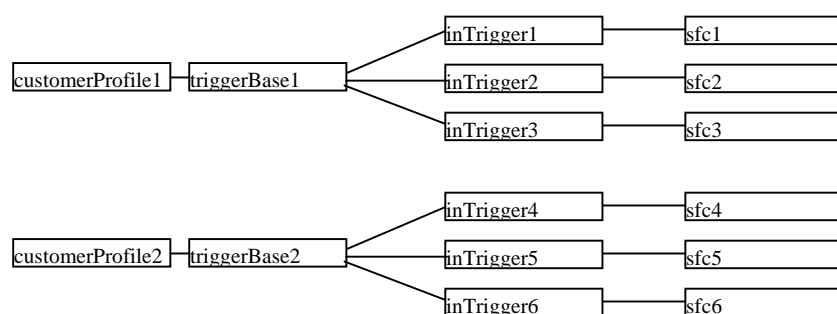

Figure C.1

View2: For a class of services several inTrigger objects (trigger criteria) are defined. A customer line is assigned to one of this service classes by associating its triggerBase object to an inTrigger object of this service class. In this case the priority ruling and activation has to be managed within the triggerBase object, because several inTrigger objects may be used by the same triggerBases.

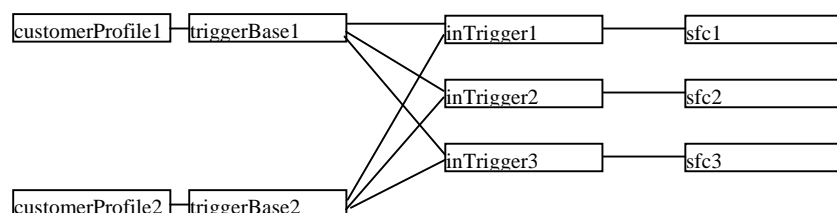

Figure C.2

In fact a compromise between the two views would be to split the inTrigger class, i.e. to introduce the distinction between customer related trigger criteria and service class related trigger criteria.

From our point of view, the introduction of customer related trigger criteria (i.e. view1) in distinction to service class related ones would be too much of flexibility within the SSP. If within a service class distinct treatment has to be performed because of different properties of the customer line, this can be done within the service logic, i.e. in the SCP. It is quite clear that service class related trigger criteria (i.e. view2) are common in IN service deployment. There may indeed be also IN-trigger objects that are used only by specific customers. But in general we should start from view2 which includes as a special case view1 - one inTrigger object for only one customer triggerBase - and we should reject the idea of splitting the inTrigger object class. Therefore the trigger activation attribute and the priority ruling has to be located in the triggerBase object class.

History

Document history		
V1.1.1	October 1998	Membership Approval Procedure MV 9851: 1998-10-20 to 1998-12-18
V1.1.1	February 1999	Publication