

**Intelligent Transport Systems (ITS);  
Road Transport and Traffic Telematics (RTTT);  
Dedicated Short Range Communications (DSRC);  
Part 1: Technical characteristics and test methods for High  
Data Rate (HDR) data transmission equipment operating in  
the 5,8 GHz Industrial, Scientific and Medical (ISM) band**

---



---

Reference

RES/ITS-0020034

---

Keywords

DSRC, ITS, protocol, testing

**ETSI**

650 Route des Lucioles  
F-06921 Sophia Antipolis Cedex - FRANCE

Tel.: +33 4 92 94 42 00 Fax: +33 4 93 65 47 16

Siret N° 348 623 562 00017 - NAF 742 C  
Association à but non lucratif enregistrée à la  
Sous-Préfecture de Grasse (06) N° 7803/88

---

**Important notice**

Individual copies of the present document can be downloaded from:

<http://www.etsi.org>

The present document may be made available in more than one electronic version or in print. In any case of existing or perceived difference in contents between such versions, the reference version is the Portable Document Format (PDF). In case of dispute, the reference shall be the printing on ETSI printers of the PDF version kept on a specific network drive within ETSI Secretariat.

Users of the present document should be aware that the document may be subject to revision or change of status. Information on the current status of this and other ETSI documents is available at

<http://portal.etsi.org/tb/status/status.asp>

If you find errors in the present document, please send your comment to one of the following services:

[http://portal.etsi.org/chaicor/ETSI\\_support.asp](http://portal.etsi.org/chaicor/ETSI_support.asp)

---

**Copyright Notification**

No part may be reproduced except as authorized by written permission.  
The copyright and the foregoing restriction extend to reproduction in all media.

© European Telecommunications Standards Institute 2010.  
All rights reserved.

**DECT™**, **PLUGTESTS™**, **UMTS™**, **TIPHON™**, the TIPHON logo and the ETSI logo are Trade Marks of ETSI registered for the benefit of its Members.

**3GPP™** is a Trade Mark of ETSI registered for the benefit of its Members and of the 3GPP Organizational Partners.

**LTE™** is a Trade Mark of ETSI currently being registered

for the benefit of its Members and of the 3GPP Organizational Partners.

**GSM®** and the GSM logo are Trade Marks registered and owned by the GSM Association.

# Contents

Intellectual Property Rights .....	11
Foreword .....	11
Introduction .....	11
1 Scope .....	13
2 References .....	13
2.1 Normative references .....	13
2.2 Informative references .....	14
3 Definitions, symbols and abbreviations .....	14
3.1 Definitions .....	14
3.1.1 Layer 1 definitions .....	14
3.1.2 Layer 2 definitions .....	18
3.1.3 Layer 7 definitions .....	18
3.1.4 Security definitions .....	18
3.2 Definitions from other standards .....	19
3.2.1 Layer 2 related definitions .....	19
3.2.2 Layer 7 related definitions .....	19
3.3 Symbols .....	19
3.4 Abbreviations .....	20
4 General .....	21
4.1 Presentation of equipment for testing purposes .....	21
4.1.1 Choice of model for testing .....	21
4.1.2 Choice of operating frequencies .....	21
4.1.3 Testing of equipment with or without a permanent external RF port .....	21
4.1.4 Equipment with a permanent internal RF port .....	21
4.1.5 Equipment with a temporary RF port .....	22
4.1.6 Antennas .....	22
4.2 Mechanical and electrical design .....	22
4.2.1 General .....	22
4.2.2 Controls .....	22
4.2.3 Marking .....	22
4.2.3.1 Equipment identification .....	22
4.2.4 Receiver data squelch .....	22
4.3 Declarations by the applicant .....	22
4.4 Auxiliary test equipment .....	23
4.5 Interpretation of the measurement results .....	23
5 Test conditions, power sources and ambient temperatures .....	23
5.1 Normal and extreme test conditions .....	23
5.2 External test power source .....	23
5.3 Normal test conditions .....	24
5.3.1 Normal temperature and humidity .....	24
5.3.2 Normal test power source .....	24
5.3.2.1 Mains voltage .....	24
5.3.2.2 Regulated lead-acid battery power sources .....	24
5.3.2.3 Other power sources .....	24
5.4 Extreme test conditions .....	24
5.4.1 Extreme temperatures .....	24
5.4.1.1 Procedure for tests at extreme temperatures .....	24
5.4.1.1.1 Procedure for equipment designed for continuous transmit operation .....	24
5.4.1.1.2 Procedure for equipment designed for intermittent transmit operation .....	25
5.4.1.2 Extreme temperature ranges .....	25
5.4.2 Extreme test source voltages .....	25
5.4.2.1 Mains voltage .....	25
5.4.2.2 Lead-acid battery, regulated power sources .....	25
5.4.2.3 Power sources using other types of batteries .....	26
5.4.2.4 Other power sources .....	26
6 General conditions .....	26
6.1 Test signals and test modulation .....	26
6.1.1 Normal test signals (wanted and unwanted signals) .....	26

6.1.1.1	Signals for bit stream measurements .....	27
6.1.1.2	Signal for messages .....	27
6.2	Modes of operation of the transmitter .....	27
6.3	Encoder for receiver measurements .....	28
6.4	Facilities for access .....	28
6.4.1	Analogue access .....	28
6.4.2	Access points for data stream measurement .....	28
6.4.3	Coupling arrangements .....	29
6.4.3.1	Arrangements for measurements with continuous bit streams .....	29
6.4.3.2	Arrangement for measurements with messages .....	29
6.4.4	Message received indicator .....	29
6.5	Test sites and general arrangements for radiated measurements .....	29
6.6	Artificial antenna .....	29
6.7	Test fixture .....	29
6.7.1	Calibration .....	30
6.7.2	Mode of use .....	30
6.8	Specific RSU test conditions .....	30
6.8.1	Antenna characteristics .....	30
6.8.2	Signal modulation .....	31
6.8.3	Data coding .....	31
6.8.4	Bit rate .....	31
6.8.5	Angular E.I.R.P. mask .....	31
6.8.6	Wake-up trigger for OBU .....	31
6.9	Specific OBU test conditions .....	32
6.9.1	Antenna polarization .....	32
6.9.2	Modulation on carrier .....	32
6.9.3	Data coding .....	32
6.9.4	Use of sidebands .....	32
6.9.5	Responding bit rate and sub-carrier frequencies .....	32
6.9.6	Antenna characteristics .....	32
7	Layer 1: Methods of measurement and limits for road side unit transmitter parameters .....	33
7.1	Generalities .....	33
7.2	Equivalent isotropically radiated power (e.i.r.p.) .....	33
7.2.1	Definition .....	33
7.2.2	Method of measurement .....	33
7.2.3	Limits .....	34
7.3	Frequency error .....	34
7.3.1	Definition .....	34
7.3.2	Method of measurement .....	34
7.3.3	Limits .....	34
7.4	Transmitter spectrum mask .....	34
7.4.1	Definition .....	34
7.4.2	Method of measurement .....	35
7.4.3	Limits .....	35
7.5	Modulation depth .....	36
7.5.1	Definition .....	36
7.5.2	Method of measurement .....	36
7.5.3	Limits .....	36
7.6	Eye pattern .....	37
7.6.1	Definition .....	37
7.6.2	Method of measurement .....	37
7.6.3	Limits .....	38
7.7	Spurious emissions .....	38
7.7.1	Definition .....	38
7.7.2	Measuring receiver .....	38
7.7.3	Method of measurement conducted spurious emission .....	38
7.7.4	Method of measurement cabinet spurious radiation .....	39
7.7.5	Method of measurement radiated spurious emission .....	40
7.7.6	Limits .....	40
8	Layer 1: Methods of measurement and limits for road side unit receiver parameters .....	40
8.1	Maximum useable sensitivity .....	41
8.1.1	Definition .....	41
8.1.2	Method of measurements under normal and extreme test conditions .....	41
8.1.2.1	Test arrangement for equipment with integral antenna .....	41
8.1.2.2	Test arrangement for equipment with antenna connector .....	42
8.1.2.3	Test procedure for continuous bit streams .....	43
8.1.2.4	Test procedure for messages .....	43

8.1.3	Limits .....	43
8.2	Error behaviour at high wanted input signals.....	43
8.2.1	Definition .....	43
8.2.2	Method of measurement .....	43
8.2.3	Limits .....	44
8.3	Degradation measurements .....	44
8.3.1	Definition .....	44
8.3.2	General conditions .....	44
8.3.3	Co-channel rejection .....	45
8.3.3.1	Definition.....	45
8.3.3.2	Method of measurement .....	45
8.3.3.3	Limits .....	46
8.3.4	Adjacent channel selectivity .....	46
8.3.4.1	Definition.....	46
8.3.4.2	Method of measurement .....	46
8.3.4.3	Limits .....	47
8.3.5	Spurious response rejection and blocking/desensitization .....	47
8.3.5.1	Definition.....	47
8.3.5.2	Method of measurement .....	47
8.3.5.3	Limits .....	48
8.3.6	Intermodulation response rejection .....	48
8.3.6.1	Definition.....	48
8.3.6.2	Method of measurement .....	48
8.3.6.3	Limits .....	49
8.4	Spurious emissions.....	49
8.4.1	Definition.....	49
8.4.2	Method of measurement - conducted spurious emissions .....	49
8.4.3	Method of measurement - cabinet radiation.....	50
8.4.4	Method of measurement - radiated spurious components .....	50
8.4.5	Limits.....	51
9	Layer 1: Method of measurements and limits for on-board units .....	51
9.1	OBU sensitivity.....	51
9.1.1	Definition .....	51
9.1.2	Method of measurement .....	51
9.1.3	Limits .....	52
9.2	On board unit access .....	52
9.2.1	Definition.....	52
9.2.2	Method of measurement .....	52
9.2.3	Limits.....	54
9.3	Transponder conversion gain .....	54
9.3.1	Definition.....	54
9.3.2	Method of measurement .....	54
9.3.3	Limits.....	56
9.4	OBU maximum radiated subcarrier .....	56
9.4.1	Definition.....	56
9.4.2	Method of measurement .....	56
9.4.3	Limits.....	56
9.5	OBU frequency error .....	57
9.5.1	Definition.....	57
9.5.2	Method of measurement .....	57
9.5.3	Limits.....	58
9.6	OBU spurious radiation .....	58
9.6.1	Definition.....	58
9.6.2	Method of measurement .....	58
9.6.3	Limits.....	59
10	Layer 2 parameters and procedures.....	59
10.1	General conditions .....	59
10.2	Frame Structure.....	59
10.2.1	Definition .....	59
10.2.2	Limits.....	60
10.2.2.1	Validity of frames.....	60
10.2.2.2	Bit order.....	60
10.2.2.3	Transparency .....	60
10.2.2.4	Frame length.....	60
10.3	Opening and closing flags.....	60
10.3.1	Definition .....	60
10.3.2	Limits.....	61

10.4	LPDU .....	61
10.4.1	Definition .....	61
10.4.2	Limits .....	61
10.5	Frame check sequence .....	62
10.5.1	Definition .....	62
10.5.2	Limits .....	62
10.6	Frame transmission procedure .....	62
10.7	Frame reception procedure .....	62
10.8	Specific Road Side Unit parameters and procedures .....	62
10.8.1	Link ID allocation .....	62
10.8.2	Frame transmission .....	63
10.8.3	Frame reception .....	63
10.9	Specific On Board Units (OBUs) parameters and functions .....	63
10.9.1	Link ID allocation .....	63
10.9.2	Frame transmission .....	63
10.9.3	Frame reception .....	63
11	Layer 7 parameters and procedures .....	64
11.1	General conditions .....	64
11.2	General protocol rules .....	64
11.2.1	Protocol data unit formats .....	64
11.2.2	Concatenation .....	64
11.2.3	Sessions .....	64
11.3	Protocol messages and parameters: ASN.1 definitions .....	65
11.4	Encoding rules .....	69
11.4.1	Encoding of the primitive types .....	70
11.4.1.1	BIT STRING type .....	70
11.4.1.2	INTEGER type .....	70
11.4.2	Encoding of the structured types .....	70
11.4.2.1	SEQUENCE type .....	70
11.4.2.2	SEQUENCE OF type .....	70
11.4.2.3	CHOICE type .....	70
11.4.2.4	SET type .....	70
11.4.2.5	SET OF type .....	70
11.5	RSU specific parameters and procedures .....	71
11.5.1	Application protocol data unit formats .....	71
11.5.2	Open-Rq directive .....	71
11.5.2.1	Definition .....	71
11.5.2.2	Method of measurement .....	71
11.5.2.3	Limits .....	72
11.5.3	Close-Rq directive .....	72
11.5.3.1	Definition .....	72
11.5.3.2	Method of measurement .....	72
11.5.3.3	Limits .....	72
11.5.4	Select-TBA-Id-Rq directive .....	72
11.5.4.1	Definition .....	72
11.5.4.2	Method of measurement .....	72
11.5.4.3	Limits .....	72
11.5.5	Read-Display-Type-Rq directive .....	73
11.5.5.1	Definition .....	73
11.5.5.2	Method of measurement .....	73
11.5.5.3	Limits .....	73
11.5.6	Read-Master-Core-Rq directive .....	73
11.5.6.1	Definition .....	73
11.5.6.2	Method of measurement .....	73
11.5.6.3	Limits .....	73
11.5.7	Get-Master-Record-Rq directive .....	73
11.5.7.1	Definition .....	73
11.5.7.2	Method of measurement .....	73
11.5.6.3	Limits .....	74
11.5.8	Read-Appl-Core-Rq directive .....	74
11.5.8.1	Definition .....	74
11.5.8.2	Method of measurement .....	74
11.5.8.3	Limits .....	74
11.5.9	Write-Appl-Core-Rq directive .....	74
11.5.9.1	Definition .....	74
11.5.9.2	Method of measurement .....	74
11.5.9.3	Limits .....	74
11.5.10	Write-Appl-Core-Conf-Rq directive .....	75

11.5.10.1	Definition.....	75
11.5.10.2	Method of measurement .....	75
11.5.10.3	Limits .....	75
11.5.11	Write-Data-To-External-Rq directive .....	75
11.5.11.1	Definition.....	75
11.5.11.2	Method of measurement .....	76
11.5.11.3	Limits .....	76
11.5.12	Read-Data-From-External-Rq directive.....	76
11.5.12.1	Definition.....	76
11.5.12.2	Method of measurement .....	76
11.5.12.3	Limits .....	76
11.5.13	Read-Appl-Record-Rq directive .....	76
11.5.13.1	Definition.....	76
11.5.13.2	Method of measurement .....	77
11.5.13.3	Limits .....	77
11.5.14	Write-Appl-Record-Curr-Rq directive.....	77
11.5.14.1	Definition.....	77
11.5.14.2	Method of measurement .....	77
11.5.14.3	Limits .....	77
11.5.15	Write-Appl-Record-Curr-Conf-Rq directive.....	77
11.5.15.1	Definition.....	77
11.5.15.2	Method of measurement .....	77
11.5.15.3	Limits .....	78
11.5.16	Write-Appl-Record-Next-Rq directive .....	78
11.5.16.1	Definition.....	78
11.5.16.2	Method of measurement .....	78
11.5.16.3	Limits .....	78
11.5.17	Write-Appl-Record-Next-Conf-Rq directive .....	78
11.5.17.1	Definition.....	78
11.5.17.2	Method of measurement .....	78
11.5.17.3	Limits .....	79
11.5.18	Set-UIF-Rq directive.....	79
11.5.18.1	Definition.....	79
11.5.18.2	Method of measurement .....	79
11.5.18.3	Limits .....	79
11.5.19	Action-Rq directive.....	79
11.5.19.1	Definition.....	79
11.5.19.2	Method of measurement .....	80
11.5.19.3	Limits .....	80
11.5.20	Set-Password-Rq directive.....	80
11.5.20.1	Definition.....	80
11.5.20.2	Method of measurement .....	80
11.5.20.3	Limits .....	80
11.5.21	Use-Last-Password-Rq directive.....	81
11.5.21.1	Definition.....	81
11.5.21.2	Method of measurement .....	81
11.5.21.3	Limits .....	81
11.5.22	Get-TBA-Random-Rq directive.....	81
11.5.22.1	Definition.....	81
11.5.22.2	Method of measurement .....	81
11.5.22.3	Limits .....	81
11.5.23	Set-Credential-Rq directive .....	82
11.5.23.1	Definition.....	82
11.5.23.2	Method of measurement .....	82
11.5.23.3	Limits .....	82
11.5.24	Get-Credential-Rq directive.....	82
11.5.24.1	Definition.....	82
11.5.24.2	Method of measurement .....	82
11.5.24.3	Limits .....	82
11.6	OBU specific parameters and procedures .....	82
11.6.1	Application protocol data unit formats .....	83
11.6.2	Receiving Protocol Data Units.....	83
11.6.3	Response to Open-Rq .....	84
11.6.3.1	Definition.....	84
11.6.3.2	Method of measurement .....	84
11.6.3.3	Limits .....	84
11.6.4	Response to Close-Rq.....	84
11.6.4.1	Definition.....	84
11.6.4.2	Method of measurement .....	84

11.6.4.3	Limits .....	84
11.6.5	Response to Select-TBA-Id-Rq .....	85
11.6.5.1	Definition.....	85
11.6.5.2	Method of measurement .....	85
11.6.5.3	Limits .....	85
11.6.6	Response to Read-Display-Type-Rq.....	85
11.6.6.1	Definition.....	85
11.6.6.2	Method of measurement .....	85
11.6.6.3	Limits .....	85
11.6.7	Response to Read-Master-Core-Rq.....	86
11.6.7.1	Definition.....	86
11.6.7.2	Method of measurement .....	86
11.6.7.3	Limits .....	86
11.6.8	Response to Get-Master-record-Rq.....	86
11.6.8.1	Definition.....	86
11.6.8.2	Method of measurement .....	86
11.6.8.3	Limits .....	86
11.6.9	Response to Read-Appl-Core-Rq.....	87
11.6.9.1	Definition.....	87
11.6.9.2	Method of measurement .....	87
11.6.9.3	Limits .....	87
11.6.10	Response to Write-Appl-Core-Rq.....	87
11.6.10.1	Definition.....	87
11.6.10.2	Method of measurement .....	88
11.6.10.3	Limits .....	88
11.6.11	Response to Write-Appl-Core-Conf-Rq.....	88
11.6.11.1	Definition.....	88
11.6.11.2	Method of measurement .....	88
11.6.11.3	Limits .....	88
11.6.12	Response to Write-Data-To-External-Rq.....	88
11.6.12.1	Definition.....	88
11.6.12.2	Method of measurement .....	88
11.6.12.3	Limits .....	89
11.6.13	Response to Read-Data-From-External-Rq .....	89
11.6.13.1	Definition.....	89
11.6.13.2	Method of measurement .....	89
11.6.13.3	Limits .....	89
11.6.14	Response to Read-Appl-Record-Rq.....	89
11.6.14.1	Definition.....	89
11.6.14.2	Method of measurement .....	89
11.6.14.3	Limits .....	90
11.6.15	Response to Write-Appl-Record-Curr-Rq .....	90
11.6.15.1	Definition.....	90
11.6.15.2	Method of measurement .....	90
11.6.15.3	Limits .....	90
11.6.16	Response to Write-Appl-Record-Curr-Conf-Rq .....	90
11.6.16.1	Definition.....	90
11.6.16.2	Method of measurement .....	90
11.6.16.3	Limits .....	91
11.6.17	Response to Write-Appl-Record-Next-Rq .....	91
11.6.17.1	Definition.....	91
11.6.17.2	Method of measurement .....	91
11.6.17.3	Limits .....	91
11.6.18	Response to Write-Appl-Record-Next-Conf-Rq.....	91
11.6.18.1	Definition.....	91
11.6.18.2	Method of measurement .....	91
11.6.18.3	Limits .....	91
11.6.19	Response to Set-UIF-Rq .....	92
11.6.19.1	Definition.....	92
11.6.19.2	Method of measurement .....	92
11.6.19.3	Limits .....	92
11.6.20	Response to Action-Rq .....	92
11.6.20.1	Definition.....	92
11.6.20.2	Method of measurement .....	92
11.6.20.3	Limits .....	92
11.6.21	Response to Set-Password-Rq .....	93
11.6.21.1	Definition.....	93
11.6.21.2	Method of measurement .....	93
11.6.21.3	Limits .....	93



11.6.22	Response to Use-Last-Password-Rq .....	93
11.6.22.1	Definition.....	93
11.6.22.2	Method of measurement .....	93
11.6.22.3	Limits .....	94
11.6.23	Response to Get-TBA-Random-Rq .....	94
11.6.23.1	Definition.....	94
11.6.23.2	Method of measurement .....	94
11.6.23.3	Limits .....	94
11.6.24	Response to Set-Credential-Rq .....	94
11.6.24.1	Definition.....	94
11.6.24.2	Method of measurement .....	94
11.6.24.3	Limits .....	95
11.6.25	Response to Get-Credential-Rq .....	95
11.6.25.1	Definition.....	95
11.6.25.2	Method of measurement .....	95
11.6.25.3	Limits .....	95
12	Measurement uncertainty .....	95
<b>Annex A (normative): Radiated measurement.....</b>		<b>97</b>
A.1	Test sites and general arrangements for measurements involving the use of radiated fields .....	97
A.1.1	Anechoic chamber .....	97
A.1.2	Anechoic chamber with a conductive ground plane.....	98
A.1.3	Open Area Test Site (OATS) .....	99
A.1.4	Test antenna .....	100
A.1.5	Substitution antenna.....	101
A.1.6	Measuring antenna .....	101
A.2	Guidance on the use of radiation test sites .....	101
A.2.1	Verification of the test site .....	101
A.2.2	Preparation of the EUT .....	101
A.2.3	Power supplies to the EUT.....	101
A.2.4	Range length .....	102
A.2.5	Site preparation .....	102
A.3	Coupling of signals .....	103
A.3.1	General.....	103
A.3.2	Data Signals .....	103
<b>Annex B (normative): General description of measurement methods .....</b>		<b>105</b>
B.1	Conducted measurements .....	105
B.2	Radiated measurements.....	105
<b>Annex C (normative): Receiver methods of measurements using messages.....</b>		<b>106</b>
C.1	General.....	106
C.2	Test signals.....	106
C.3	Method of measurement for receiver sensitivity .....	106
C.4	Method of measurements for receiver degradation.....	107
<b>Annex D (normative): Profile for the European Electronic Fee Collection service .....</b>		<b>108</b>
D.1	General.....	108
D.2	Common limits.....	108
D.2.1	Data to be used for EETS transactions.....	108
D.2.2	Directives to be used for EETS applications .....	109
D.2.3	OBU memory structure.....	109
D.2.4	Security algorithms and requirements.....	110
D.2.4.1	Generalities .....	110
D.2.4.2	Authenticator computed on PaymentMeans attribute .....	110
D.2.4.3	Access credentials computation .....	112
D.2.4.4	Authentication key computation .....	112
D.2.4.5	Access key computation .....	113
D.2.4.6	Transaction counter.....	113
D.3	OBU specific limits.....	113

D.3.1	DSRC communication limits .....	113
D.3.2	Security requirements .....	114
D.4	RSU specific limits .....	114
History	.....	115

---

## Intellectual Property Rights

IPRs essential or potentially essential to the present document may have been declared to ETSI. The information pertaining to these essential IPRs, if any, is publicly available for **ETSI members and non-members**, and can be found in ETSI SR 000 314: "*Intellectual Property Rights (IPRs); Essential, or potentially Essential, IPRs notified to ETSI in respect of ETSI standards*", which is available from the ETSI Secretariat. Latest updates are available on the ETSI Web server (<http://webapp.etsi.org/IPR/home.asp>).

Pursuant to the ETSI IPR Policy, no investigation, including IPR searches, has been carried out by ETSI. No guarantee can be given as to the existence of other IPRs not referenced in ETSI SR 000 314 (or the updates on the ETSI Web server) which are, or may be, or may become, essential to the present document.

---

## Foreword

This ETSI Standard (ES) has been produced by ETSI Technical Committee Intelligent Transport System (ITS), and is now submitted for the ETSI standards Membership Approval Procedure.

The present document is part 1 of a multi-part deliverable covering the Road Transport and Traffic Telematics (RTTT), as identified below:

- Part 1: "Technical characteristics and test methods for High Data Rate (HDR) data transmission equipment operating in the 5,8 GHz Industrial, Scientific and Medical (ISM) band";**
- Part 2: "Technical characteristics and test methods for Low Data Rate (LDR) data transmission equipment operating in the 5,8 GHz Industrial, Scientific and Medical (ISM) band".

---

## Introduction

The present document was drafted on the assumption that type test measurements, performed in an accredited test laboratory, will be accepted by the various national regulatory authorities in order to grant type approval, provided the national regulatory requirements are met. This is in compliance with CEPT/ERC Recommendation 70-03 [2].

The present document specifies the requirements for a dedicated 5,8 GHz short range microwave link intended for High Data Rate communication system for Road Transport and Traffic Telematics (RTTT) applications.

The present document supports the necessary transmitter and receiver High Data Rate (HDR) of up to 1 Mbit/s.

The RSU transmitter operates on a non-exclusive basis on frequencies depending on the declared application according to CEPT/ECC/DEC(02)01 [1].

A channel spacing of 10 MHz is used, see table 1.

**Table 1: RTTT transmitter frequencies for 10 MHz channel spacing systems**

	<b>Initial road to Vehicle systems</b>	<b>Multi lane road junctions (options)</b>
Channel 1	5 800 MHz	
Channel 2		5 810 MHz

In order to permit the greatest freedom of design of equipment, whilst protecting other radio services from interference, a balance is required between the permitted range of frequencies on which the equipment may be used, and its frequency stability and modulation characteristics. The present document specifies the operational frequencies and system bandwidths. However, the present document does not fully describe the permitted range of optional frequencies as these are covered by national regulations. The optional range of frequencies offered should be specified on each type approval certificate issued.

Clauses 1 to 3 give a general description of the types of equipment covered by the present document and the definitions and abbreviations used. Clause 4 gives general requirement in order that type tests may be carried out and any markings on the equipment to be provided by the manufacturer.

Clauses 5 and 6 specify the test conditions.

Clauses 7 and 8 specify the limits of the Physical Layer parameters which are required to be tested for the RSU transmitters and receivers. These limits have been chosen to minimize harmful interference to and from other equipment and services. These clauses also specify how the equipment is to be tested and the conditions which are applied.

Clause 9.1 specifies the limits of the Physical Layer parameters which are required to be tested for transponders. These limits are chosen to restrict the access to and radiation from transponders. Details on the test methods for the transponders are also specified.

Clause 12 specifies the maximum measurement uncertainty values.

Clause 10 specifies the parameters and protocol procedures for testing Layer 2 (Data Link Layer).

Clause 11 specifies the parameters and protocol procedures for testing Layer 7 (Application Layer).

Annex A provides specifications concerning test sites for radiated measurements.

Annex B provides descriptions of measurement methods for radiated measurements.

Annex C provides descriptions of alternative measurement methods for receivers.

Annex D provides the choices for parameters and protocol procedures to be tested for a system to be compliant to the European Electronic Tolling Service (EETS).

---

# 1 Scope

The present document specifies radio parameters, data link services and protocol data units, and application services and protocol data units which are necessary for the efficient use of the radio spectrum and for the purpose of DSRC based applications. This includes methods of measurements for verifying the limits stated in the present document.

The present document applies to 5,8 GHz Short Range Devices (SRDs) for use in Road Transport Traffic and Telematics (RTTT):

- with a Radio Frequency (RF) output connection and specified antenna or with an integral antenna;
- for data transmission only;
- operating on radio frequencies in the 5 725 MHz to 5 875 MHz Industrial, Scientific and Medical (ISM) band.

The applicability of the present document covers both the Road Side Units (RSUs) and the On Board Units (OBUs) with transceivers and transponders.

The present document does not necessarily include all the characteristics which may be required by a user, nor does it necessarily represent the optimum performance achievable.

The present document complies with CEPT/ECC/DEC(02)01 [1] and CEPT/ERC Recommendation 70-03 [2]. It is a specific standard covering various RTTT applications. The RTTT data rate specified in the present document is:

- RTTT systems using down and up link data rate of up to 1 Mbit/s.

For non-harmonized parameters, national regulatory conditions may apply regarding the type of modulation, channel/frequency separation, maximum transmitter output power/effective radiated power, equipment marking as a condition of the issue of an individual or general license, or, as a condition of use under license exemption.

Additional standards or specifications may be required for equipment such as that intended for connection to the Public Switched Telephone Network (PSTN) or other systems.

---

## 2 References

References are either specific (identified by date of publication and/or edition number or version number) or non-specific. For specific references, only the cited version applies. For non-specific references, the latest version of the referenced document (including any amendments) applies.

Referenced documents which are not found to be publicly available in the expected location might be found at <http://docbox.etsi.org/Reference>.

NOTE: While any hyperlinks included in this clause were valid at the time of publication ETSI cannot guarantee their long term validity.

### 2.1 Normative references

The following referenced documents are necessary for the application of the present document.

- [1] CEPT/ECC/DEC(02)01: "ECC Decision of 15 March 2002 on the frequency bands to be designated for the coordinated introduction of Road Transport and Traffic Telematic Systems".
- [2] CEPT/ERC Recommendation 70-03: "Relating to the use of Short Range Devices (SRD)".
- [3] CISPR 16-1: "Specification for radio disturbance and immunity measuring apparatus and methods - Part 1: Radio disturbance and immunity measuring apparatus".
- [4] ETSI TR 100 028 (all parts): " Electromagnetic compatibility and Radio spectrum Matters (ERM); Uncertainties in the measurement of mobile radio equipment characteristics".

- [5] ITU-T Recommendation O.153: "Basic parameters for the measurement of error performance at bit rates below the primary rate".
- [6] IEC 60721-3-4: "Classification of environmental conditions - Part 3: Classification of groups of environmental parameters and their severities - Section 4: Stationary use at non-weather protected locations".
- [7] IEC 60721-3-5: "Classification of environmental conditions - Part 3: Classification of groups of environmental parameters and their severities - Section 5: Ground vehicle installations".
- [8] ITU-T Recommendation X.200/ISO/IEC 7498-1 (1994): "Information Technology - Open Systems Interconnection - Basic Reference Model: The Basic Model".
- [9] ITU-T Recommendation X.207/ISO/IEC 9545 (1994): "Information Technology - Open Systems Interconnection - Application layer structure".
- [10] ISO/IEC 13239 (2002): "Information technology - Telecommunications and information exchange between systems - High-level data link control (HDLC) procedures".
- [11] ANSI C63.5 (2004): "American National Standard for Electromagnetic Compatibility-Radiated Emission Measurements in Electromagnetic Interference (EMI) Control-Calibration of Antennas (9 kHz to 40 GHz)".
- [12] ANSI/INCITS 92-1981(R1998): "Data Encryption Algorithm", (formerly ANSI X3.92-1981(R1998)).

NOTE: Available at [http://www.techstreet.com/cgi-bin/detail?doc\\_no=INCITS%7C92\\_1981\\_R1998\\_&product\\_id=47334](http://www.techstreet.com/cgi-bin/detail?doc_no=INCITS%7C92_1981_R1998_&product_id=47334).

- [13] ISO/IEC 9797-1: "Information technology - Security techniques - Message Authentication Codes (MACs) - Part 1: Mechanisms using a block cipher".

## 2.2 Informative references

The following referenced documents are not necessary for the application of the present document but they assist the user with regard to a particular subject area.

- [i.1] ETSI TR 102 273 (all parts): "Electromagnetic compatibility and Radio spectrum Matters (ERM); Improvement on Radiated Methods of Measurement (using test site) and evaluation of the corresponding measurement uncertainties".
- [i.2] ISO 15509: "Adhesives - Determination of the bond strength of engineering-plastic joints".

---

## 3 Definitions, symbols and abbreviations

### 3.1 Definitions

For the purposes of the present document, the terms and definitions as per the following clauses apply. Definitions are grouped by layer.

#### 3.1.1 Layer 1 definitions

**assigned frequency band:** frequency band within which the device is authorized to operate

**boresight:** direction of maximum antenna gain

**channel:** means of transmission of signals in one direction between two points, i.e. either downlink or uplink

NOTE: A DSRC channel is referred to by the downlink centre frequency, by the direction of communication and, in case of uplink communication, by the sub-carrier frequency used.

**D10a wake-up Trigger for OBU:** signal which:

- a) indicates to the OBU that it is within a communication zone, i.e. that it may now communicate with an RSU; and
- b) can be used to switch the OBU main circuitry from sleep mode to the active mode.

**D10b maximum start time:** maximum time between the beginning of reception of the beginning of the wake-up pattern as defined by D10a of the wake-up trigger and the time when the OBU has switched to the active mode

**D10c wake-up sensitivity:** level of incident power referred to a lossless isotropic antenna in front of the OBU

NOTE: This is the level above which an OBU will be able to detect and process the wake-up trigger.

**D10d start of preamble:** time between beginning of eighth impulse in wake-up sequence and start of first bit of preamble

**D11a dynamic range of OBU receiver sensitivity level:** lower level of incident power referred to a lossless isotropic antenna in front of the OBU above which communication is guaranteed with a BER  $\leq 10^{-6}$

NOTE: Communication may take place below this limit, but is not guaranteed. Together with D11b it also specifies the minimum dynamic range of the OBU receiver. Power values are measured without any additional losses due to misalignment.

**D11b dynamic range of OBU receiver - upper communication power limit:** upper level of incident power referred to a lossless isotropic antenna in front of the OBU

NOTE: This is the level below which communication is guaranteed with a BER  $\leq 10^{-6}$ . Communication may take place above this limit, but is not guaranteed. Together with D11a it also specifies the minimum dynamic range of the OBU receiver. Power values are measured without any additional losses due to misalignment.

**D13 preamble:** signal directly preceding a layer 2 frame

NOTE: See figure 1. It is used for synchronization purposes.

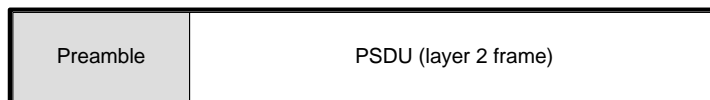

**Figure 1: Physical layer frame structure (PSDU)**

**D1a carrier frequency:** downlink carrier frequency, which is equal to the frequency of the carrier frequency transmitted by the RSU during receive mode and used by transponder OBUs for uplink communication

NOTE: The carrier frequency is the centre frequency of a downlink channel.

**D2 RSU transmitter spectrum mask:** maximum allowed power emitted by the RSU transmitter as a function of frequency, either expressed in power density versus frequency, or in total power within defined frequency band

**D3 OBU minimum receive frequency range:** minimum range of frequencies that has to be received by the OBU receiver in order to achieve the required performance

**D4a maximum E.I.R.P.:** maximum power transmitted by the RSU referred to an isotropic antenna

NOTE: The value is normally expressed in dBm. 0 dBm is equivalent to 1 mW.

**D4b angular E.I.R.P. mask:** E.I.R.P. as a function of the angle  $\Theta$ , where  $\Theta$  indicates the angle relative to a vector perpendicular to the road surface, pointing downwards

**D5a polarization:** locus of the tip of the vector of the electrical field strength in a plane perpendicular to the transmission vector

NOTE: Examples are horizontal and vertical linear polarization and left and right hand circular polarization.

**D5b cross polarization:** antenna designed to transmit vertical linear waves may transmit some horizontal linear waves in addition

NOTE: Cross-Polar Discrimination (XPD) is defined as the ratio between vertical and horizontal linear power PVH/PHL, when the total power transmitted is PVH + PHL.

**D6a modulation:** keying of the carrier wave by coded data. Examples are ASK, PSK and FSK

**D6b modulation index:** ratio of the variation of the modulation parameter, e.g. frequency, amplitude, phase, caused by the modulation signal, i.e. the data signal

NOTE: For ASK the modulation index is  $m = \frac{V_{\max} - V_{\min}}{V_{\max} + V_{\min}}$  where V is the envelope amplitude of the modulated signal.

**D7 data coding:** base band signal presentation, i.e. a mapping of logical bits to physical signals

NOTE: Examples for bi-phase schemes are Manchester, FM0, FM1, and differential Manchester.

EXAMPLE: Manchester coded signal has transition in the middle of the bit. A "zero" bit starts with a low level. A "one" bit starts with a high level.

**D8a bit rate:** number of bits per second, independent of the data coding

**D8b tolerance of bit rate:** maximum deviation of the bit clock from its nominal value resulting from any cause, expressed in ppm

EXAMPLE: 100 ppm of 921 kbit/s allows for the bit clock to be in the range of 921 kHz  $\pm$  92,1 Hz.

**D9 BER within dynamic range of OBU receiver:** maximum allowed BER valid within the dynamic range of the receiver as defined by D11a and D11b

**downlink:** direction of communication from RSU to OBU

**integral antenna:** antenna, with or without a connector, designed as an indispensable part of the equipment

**integrated antenna:** antenna, without connector, integrated as part of the equipment

**On Board Unit (OBU):** physical assembly that is located and operated in or on the vehicle to transmit and/or receive DSRC signals

NOTE: It may be in a form that is removable from the vehicle, or mountable in or on any part of the vehicle structure, or bonded to a part of the vehicle, or an integral part of a vehicle component, such as a windscreen, bumper or licence plate. In the present document, parameters that refer to an OBU relate to the form that the OBU takes as it is supplied to the vehicle manufacturer or constructor.

**operating frequency range:** range of operating frequencies over which the equipment can be adjusted through switching or reprogramming

**operating frequency:** nominal frequency at which equipment is operated; also referred to as the operating centre frequency. Equipment may be able to operate at more than one operating frequency

**portable station:** equipment intended to be carried, attached or implanted

**radiated measurements:** measurements which involve the absolute measurement of a radiated field

**Road Side Unit (RSU):** DSRC communication equipment intended for use in a fixed location (Fixed Station), usually residing by the side of the road or overhead the road

**successful message ratio:** proportion of transmitted messages that are received correctly under test conditions

**transceiver OBU:** On Board Unit (OBU) with local receiver and transmitter 5,8 GHz frequency generation

**transponder:** On Board Unit (OBU) without own 5,8 GHz frequency generation



**U11a dynamic range of RSU receiver - sensitivity level:** lower level of incident power measured at the antenna connector of the RSU above which communication is guaranteed with a BER  $\leq 10^{-6}$

NOTE: Communication may take place below this limit, but is not guaranteed. Together with U11b it also specifies the minimum dynamic range of the RSU receiver.

**U11b dynamic range of RSU receiver - upper communication power limit:** upper level of incident power measured at the antenna connector of the RSU below which communication is guaranteed with a BER  $\leq 10^{-6}$

NOTE: Communication may take place above this limit, but is not guaranteed. Together with U11b it also specifies the minimum dynamic range of the RSU receiver.

**U12a conversion gain (lower limit):** difference between OBU E.I.R.P. within one side band and the carrier incident power on OBU measured within a cone of  $35^\circ$  around boresight

NOTE: Conversion gain is measured at the minimum incident power within the communication zone given by D11a.

**U12b conversion gain (upper limit):** difference between OBU E.I.R.P. within one side band and the carrier incident power on OBU measured within a cone of  $35^\circ$  around boresight

NOTE: Conversion gain is measured at the minimum incident power within the communication zone given by D11a.

**U13 preamble:** See D13.

**U1a sub-carrier frequency:** frequency separation from the centre of the uplink band to the centre of the downlink band

**U1b tolerance of sub-carrier frequency:** maximum allowed deviation of the sub-carrier frequency from its nominal value resulting from any cause

NOTE: Normally it is expressed in percentage or in parts per million (ppm) of the sub-carrier frequency.

EXAMPLE: 1 % of 9,21 MHz sub-carrier allows for the sub-carrier frequency to be in the range of 9,21 MHz  $\pm 92,1$  kHz.

**U1c use of sidebands:** specification of the use of the uplink side bands

NOTE 1: Data can be modulated on the upper side band only, or the lower side band only, or on both side bands.

NOTE 2: In principle, different data can be modulated on the two side bands.

**U2 OBU transmitter spectrum mask:** maximum allowed power at a given frequency emitted by the OBU transmitter, either expressed in power density versus frequency, or in total power within defined frequency band

**U4 maximum single side band E.I.R.P.:** maximum E.I.R.P. transmitted by the OBU within a single side band, measured at the maximum incident power defined by D11b

NOTE: For a non-isotropic OBU antenna the single side band E.I.R.P. will vary with the direction of the incident power and the direction in which the emitted power is measured.

**U4a maximum single side band E.I.R.P. (boresight):** E.I.R.P. measured when the incident power is in boresight and the emitted power is measured in boresight

**U4b maximum single side band E.I.R.P. ( $35^\circ$ ):** E.I.R.P. measured when the incident power is in boresight and the emitted power is measured at any angle not less than  $35^\circ$  away from boresight

**U5a polarization:** See D5a.

**U5b cross polarization:** See D5b.

**U6a sub-carrier modulation:** keying of the sub-carrier wave by coded data

NOTE: Some examples are ASK, PSK and FSK.

**U6b frequency deviation for FSK:** U6b defines the difference between the central subcarrier value as defined by U1a and its instantaneous modulation frequency corresponding to a binary symbol

NOTE: The subcarrier is frequency modulated.

**U6c tolerance of frequency deviation for FSK:** maximum deviation of the frequency deviation from its nominal value resulting from any cause

NOTE: Normally it is expressed in percentage or in parts per million (ppm) of the sub-carrier frequency.

EXAMPLE: 2 % of 700 kHz sub-carrier allows for the frequency deviation to be in the range of 700 kHz  $\pm$  14 kHz.

**U6d modulation on carrier:** modulation of the carrier wave by the modulated sub-carrier

NOTE: Examples are AM, PM and FM.

**U7 data coding:** See D7.

**U8a bit rate:** See D8a.

**U8b tolerance of bit rate:** See D8b.

**U9 BER within dynamic range of RSU Receiver:** maximum allowed BER valid within the dynamic range of the receiver as defined by U11a and U11b

**uplink:** direction of communication from OBU to RSU

### 3.1.2 Layer 2 definitions

**fixed equipment:** communication equipment installed at a fixed location, i.e. at the roadside

**mobile equipment:** communication equipment installed at a mobile location, i.e. in a vehicle

### 3.1.3 Layer 7 definitions

**AP title:** unique identifier of a specific application process invocation

**ACSE service user:** part of an ASO that makes use of ACSE services

NOTE: It may be the control function (CF), an ASO, or an ASE or some combination of the three.

**Called AP title:** AP title in an OBU

**Calling AP title:** AP title in a RSU

**OBU EFC ASO:** that part of the EFC-ASO that supports the EFC On Board Unit Application Process

**Responding AP title:** AP title in an OBU

**RSU EFC ASO:** that part of the EFC-ASO that supports the EFC Road Side Equipment Application Process

### 3.1.4 Security definitions

**e [key] (value):** encryption of the value using the key

**ede [key] (value):** chained encryption, decryption and encryption of the value using the key

## 3.2 Definitions from other standards

### 3.2.1 Layer 2 related definitions

Layer 2 clauses make use of the following terms defined in [8]:

- Protocol
- Protocol Data Unit
- Service
- Service Access Point
- Service primitive

Layer 2 clauses make use of the following terms defined in [9]:

- Association

Layer 2 clauses make use of the following terms defined in [10]:

- Frame

### 3.2.2 Layer 7 related definitions

Layer 7 clauses make use of the following terms defined in [8]:

- Protocol
- Protocol Data Unit
- Service
- Service Access Point
- Service primitive
- System

Layer 7 clauses make use of the following terms defined in [9]:

- Application context
- Application Entity
- Application Service Object (ASO)
- Association

## 3.3 Symbols

For the purposes of the present document, the following symbols apply:

dBi	Gain relative to an isotropic antenna
E	Field strength
E <sub>0</sub>	Reference field strength
f <sub>S</sub>	Transmitter carrier frequency
f <sub>TX</sub>	Declared transponder subcarrier frequency
λ	Wavelength
ppm	parts per million (10 <sup>-6</sup> )
R	Distance

$R_o$	Reference distance
Rx	Receiver
Tx	Transmitter
$\Theta$	Angle relative to a vector perpendicular to the road surface, pointing downwards

### 3.4 Abbreviations

For the purposes of the present document, the following abbreviations apply:

ACSE	Application Common Service Element
AM	Amplitude Modulation
AP	Application Process
APDU	Application layer Protocol Data Unit
ASE	Application Service Entity
ASK	Amplitude Shift Key
ASO	Application Service Object
BER	Bit Error Ratio
CF	Control Function
DSRC	Dedicated Short Range Communication
DSRC-HDR	High Data Rate version of DSRC
DSRC-LDR	Low Data Rate version of DSRC
EETS	European Electronic Tolling Service
E.I.R.P., e.i.r.p.	Equivalent Isotropically Radiated Power
EFC	Electronic Fee Collection
EFC-ASO	Electronic Fee Collect Application Service Object
EN	European Norm
EUT	Equipment Under Test
FCS	Frame Check Sequence
FM	Frequency Modulation
FSK	Frequency Shift Keying
HDR	High Data Rate
IF	Intermediate Frequency
ISM	Industrial, Scientific and Medical

NOTE: The present document covers only the following designated ISM band: 5 725 MHz to 5 875 MHz.

ITS	Intelligent Transport Systems
L2	Layer 2
LaID	Link association IDentifier
LDR	Low Data Rate
LLC	Logical Link Control
LPDU	Link layer Protocol Data Unit
LSB	Least Significant Bit
OATS	Open Area Test Site
OBU	On Board Unit
OEM	Original Equipment Manufacturer
OOK	On/Off Key modulation
PDU	Protocol Data Unit
PM	Phase Modulation
PSDU	Physical layer Service Data Unit
PSK	Phase Shift Keying
PSTN	Public Switched Telephone Network
RF	Radio Frequency
RSE	Road Side Equipment
RSU	Road Side Unit
RTTT	Road Transport and Traffic Telematics
SRD	Short Range Device
VSWR	Voltage Standing Wave Ratio
XPD	Cross-Polar Discrimination

---

## 4 General

### 4.1 Presentation of equipment for testing purposes

Each equipment submitted for type testing shall fulfil the requirements of the present document on all frequencies over which it is intended to operate.

The applicant shall complete the appropriate application form when submitting equipment for type testing. Additionally, technical documentation and operating manuals shall be supplied.

The performance of the equipment submitted for testing shall be representative of the performance of the corresponding production model. In order to avoid any ambiguity in that assessment, the present document contains instructions for the presentation of equipment for type testing purposes (this clause), conditions of testing (see clauses 5 and 6) and measurement methods (see clauses 7, 8, 9.1, 10 and 11).

Stand alone equipment shall be offered by the applicant complete with any ancillary equipment needed for testing. The applicant shall declare the frequency range(s), the range of operation conditions and power requirements, as applicable, in order to establish the appropriate test conditions.

Test fixtures may be supplied by the applicant (see clause 6.7).

Original Equipment Manufacturers' (OEM) plug-in cards or units may be offered for testing together with a suitable test fixture. Alternatively, complete RTTT equipment may be supplied by the manufacturer to facilitate the tests.

To simplify and harmonize the testing procedures between the different test laboratories, measurements shall be performed, according to the present document, on samples of equipment defined in clauses 4.1.1 and 4.1.2.

These clauses are intended to give confidence that the requirements set out in the present document have been met without the necessity of performing measurements on all optional frequencies.

#### 4.1.1 Choice of model for testing

The applicant shall provide one or more production models of the equipment, as appropriate, for testing.

Equipment designed for use with an integral antenna may be supplied with a temporary external/internal or permanent internal 50  $\Omega$  connector for the purpose of testing, providing the characteristics being measured are not expected to be affected. The measurements, wherever possible, should be made by use of a direct connection to the equipment under test (antenna connector or temporary 50  $\Omega$  connector) as stated in the present document, in order to ensure that the measurement uncertainties are minimized. If applicable, the means to access and/or implement the internal connector should be provided by the applicant with the aid of a diagram (see clause 4.1.4). If a temporary 50  $\Omega$  RF connector is used, this shall be stated on the test report form.

#### 4.1.2 Choice of operating frequencies

Where equipment can be adjusted to operate at different operating frequencies other than channels 1 and 2 (see table 1), a minimum of two operating frequencies shall be chosen such that the lower and higher limits of the applicant's declared operating ranges of the equipment are covered.

#### 4.1.3 Testing of equipment with or without a permanent external RF port

To facilitate relative measurements, use may be made of a test fixture as described in clause 6.7, or the equipment may be supplied with a permanent internal/external or temporary internal/external RF port.

#### 4.1.4 Equipment with a permanent internal RF port

The way to access a permanent internal RF port shall be stated by the applicant with the aid of a diagram. The fact that use has been made of a permanent internal RF port shall be recorded in the test report.

## 4.1.5 Equipment with a temporary RF port

The applicant shall submit two sets of equipment to the test laboratory, one fitted with a temporary 50  $\Omega$  RF connector with the antenna disconnected and the other with the antenna connected. Each equipment shall be used for the appropriate tests.

The way the temporary RF port is implemented shall be stated by the applicant with the aid of a diagram. The fact that use has been made of the temporary RF port to facilitate measurements shall be stated in the test report. The addition of a temporary RF port should not influence the performance of the Equipment Under Test (EUT).

## 4.1.6 Antennas

If the equipment to be tested can be equipped with one or more antennas, the manufacturer shall declare and provide these together with the equipment. These antennas shall be used during the radiated measurements described in the present document. The manufacturer shall declare the gain of the antenna or antenna assembly(ies). The characteristics of the antenna assembly(ies) shall be included in the user documentation supplied with the equipment.

## 4.2 Mechanical and electrical design

### 4.2.1 General

The equipment submitted by the applicant or his representative, shall be designed, constructed and manufactured in accordance with good engineering practice, with the aim of minimizing harmful interference to other equipment and services.

Transmitters and receivers may be individual or combination units.

### 4.2.2 Controls

Those controls which if maladjusted might increase the interference possibilities to and from the equipment shall only be accessible by partial or complete disassembly of the device and requiring the use of tools.

### 4.2.3 Marking

The equipment shall be marked in a visible place. This marking shall be legible and durable. Where this is not possible due to physical constraints, the marking shall be included in the users manual.

#### 4.2.3.1 Equipment identification

The marking shall include as a minimum:

- the name of the applicant or his trade mark;
- the type designation.

### 4.2.4 Receiver data squelch

If the receiver is equipped with a data squelch or battery saving circuit, it shall be possible to override this circuit for the duration of some tests.

## 4.3 Declarations by the applicant

When submitting equipment for testing, the applicant shall supply the necessary information according to the appropriate application form for the present document.

## 4.4 Auxiliary test equipment

All necessary test signal sources and setting up information shall accompany the equipment when it is submitted for type testing.

## 4.5 Interpretation of the measurement results

The interpretation of the results recorded on the appropriate test report form for the measurements described in the present document shall be as follows:

- the measured value related to the corresponding limit shall be used to decide whether an equipment meets the requirements of the present document;
- the measurement uncertainty value for the measurement of each parameter shall be included in the test report;
- the recorded value of the measurement uncertainty shall be, for each measurement, equal to or lower than the figures of measurement uncertainty given in clause 12.

---

# 5 Test conditions, power sources and ambient temperatures

## 5.1 Normal and extreme test conditions

The test conditions and procedures shall be as specified in clauses 5.2 to 5.4.

## 5.2 External test power source

During the tests the power source of the equipment shall be replaced by an external test power source, capable of producing normal and extreme test voltages as specified in clauses 5.3.2 and 5.4.2. The internal impedance of the external test power source shall be low enough for its effect on the test results to be negligible. For the purpose of the tests, the voltage of the external test power source shall be measured at the input terminals of the equipment.

For battery operated equipment the battery shall be removed and the external test power source shall be suitably de-coupled and applied as close to the equipment battery terminals as practicable. For radiated measurements any external power leads should be so arranged so as not to affect the measurements. If necessary, the external test power source may be replaced with the supplied or recommended internal batteries at the required voltage, or a battery simulator. This shall be stated on the test report. For radiated measurements on portable equipment with an integral antenna, fully charged internal batteries should be used. The batteries used should be as supplied or recommended by the applicant.

If the equipment is powered from an external source, the test voltage shall be measured at the point of connection of the power cable to the equipment.

During tests the external test power source voltages shall be within a tolerance of  $\pm 1$  % relative to the voltage at the beginning of each test. The value of this tolerance can be critical for certain measurements. Using a smaller tolerance provides a better uncertainty value for these measurements. If internal batteries are used, at the end of each test the voltage shall be within a tolerance of  $\pm 5$  % relative to the voltage at the beginning of each test.

## 5.3 Normal test conditions

### 5.3.1 Normal temperature and humidity

The normal temperature and humidity conditions for tests shall be any convenient combination of temperature and humidity within the following ranges:

- temperature: +15 °C to +35 °C;
- relative humidity: 20 % to 75 %.

When it is impracticable to carry out tests under these conditions, a note to this effect, stating the ambient temperature and relative humidity during the tests, shall be added to the test report.

### 5.3.2 Normal test power source

#### 5.3.2.1 Mains voltage

For the purposes of the present document, the nominal voltage shall be the declared voltage, or any of the declared voltages, for which the equipment was designed.

The frequency of the test power source corresponding to the ac mains shall be between 49 Hz and 51 Hz.

#### 5.3.2.2 Regulated lead-acid battery power sources

When the radio equipment is intended for operation from the usual types of lead-acid battery regulated power source, the normal test voltage shall be multiplied by 1,1 of the nominal voltage of the battery (6 V × 1,1, 12 V × 1,1, etc.).

#### 5.3.2.3 Other power sources

For operation from other power sources or types of battery (primary or secondary), the normal test voltage shall be that declared by the applicant and shall be stated in the test report.

## 5.4 Extreme test conditions

### 5.4.1 Extreme temperatures

#### 5.4.1.1 Procedure for tests at extreme temperatures

Before measurements are made the equipment shall have reached thermal balance in the test chamber.

The equipment shall be switched off during the temperature stabilizing period.

In the case of equipment containing temperature stabilization circuits designed to operate continuously, the temperature stabilization circuits shall be switched on for 15 minutes after thermal balance has been obtained, and the equipment shall then meet the specified requirements.

If the thermal balance is not checked by measurements, a temperature stabilizing period of at least one hour, or such period as may be decided by the accredited test laboratory, shall be allowed. The sequence of measurements shall be chosen and the humidity content in the test chamber shall be controlled so that condensation does not occur.

##### 5.4.1.1.1 Procedure for equipment designed for continuous transmit operation

If the applicant states that the equipment is designed for continuous operation, the test procedure shall be as follows:

- before tests at the upper extreme temperature the equipment shall be placed in the test chamber and left until thermal balance is attained. The equipment shall then be switched on in the normal operating condition for a period of half an hour after which the equipment shall meet the specified requirements;



- for tests at the lower extreme temperature the equipment shall be left in the test chamber until thermal balance is attained, then switched on in the normal operating condition for a period of one minute after which the equipment shall meet the specified requirements.

#### 5.4.1.1.2 Procedure for equipment designed for intermittent transmit operation

If the applicant states that the equipment is designed for intermittent transmit operation, the test procedure shall be as follows:

- before tests at the upper extreme temperature the equipment shall be placed in the test chamber and left until thermal balance is attained. The equipment shall then either:
  - if the applicants declared "on" period exceeds one minute then equipment shall transmit in the on condition for a period not exceeding one minute, followed by a period in the off or standby mode for four minutes;
  - otherwise, equipment shall transmit on and off according to the applicants declared maximum duty cycle for a period of five minutes.
- after which the equipment shall meet the specified requirements in any of the operational modes immediately;
- for tests at the lower extreme temperature the equipment shall be left in the test chamber until thermal balance is attained, then switched to the standby or receive condition for one minute after which the equipment shall meet the specified requirements in any of the operational modes.

#### 5.4.1.2 Extreme temperature ranges

For tests at extreme temperature, measurements shall be made in accordance with the procedures specified in clause 5.4.1.1, at the upper and lower temperatures of one of the following ranges in accordance with the manufacturer's declared temperature category (IEC 60721-3-4 [6] and IEC 60721-3-5 [7]) or as a minimum as category I in table 2.

**Table 2: Extreme temperature ranges**

Temperature category	RSU (Road Side Unit)	OBU (On Board Unit)
Category I (General):	-20 °C to +55 °C	-20 °C to +55 °C
Category II:	IEC 60721-3-4 [6]/4K2	IEC 60721-3-5 [7]/5K2
Category III:	IEC 60721-3-4 [6]/4K3	IEC 60721-3-5 [7]/5K3
Category IV:	IEC 60721-3-4 [6]/4K4	IEC 60721-3-5 [7]/5K4

The test report shall state which temperature category has been used.

### 5.4.2 Extreme test source voltages

#### 5.4.2.1 Mains voltage

The extreme test voltages for equipment to be connected to an ac mains source shall be the nominal mains voltage +10 % / -15 %. The mains source frequency shall be between 49 Hz and 51 Hz.

#### 5.4.2.2 Lead-acid battery, regulated power sources

When the radio equipment is intended for operation from the usual type of regulated lead-acid battery power sources the extreme test voltages shall be 1,3 and 0,9 multiplied by the nominal voltage of the battery (6 V, 12 V, etc.).

For float charge applications using "gel-cell" type batteries the extreme test voltages shall be 1,15 and 0,85 multiplied by the nominal voltage of the declared battery voltage.

### 5.4.2.3 Power sources using other types of batteries

The lower extreme test voltages for equipment with power sources using batteries shall be as follows:

- for equipment with a battery indicator, the end point voltage as indicated;
- for equipment without a battery indicator the following end point voltage shall be used:
  - for the Leclanché or the lithium type of battery:
    - 0,85 multiplied by the nominal voltage of the battery.
  - for the nickel-cadmium type of battery:
    - 0,9 multiplied by the nominal voltage of the battery.
  - for other types of battery the lower extreme test voltage for the discharged condition shall be declared by the equipment applicant.

No upper extreme test voltages apply.

### 5.4.2.4 Other power sources

For equipment using other power sources, or capable of being operated from a variety of power sources, the extreme test voltages shall be those agreed between the equipment applicant and the accredited test laboratory and shall be recorded in the test report.

---

## 6 General conditions

### 6.1 Test signals and test modulation

Where appropriate, a test signal shall be used with the following characteristics:

- representative of normal operation as declared;
- causes greatest occupied bandwidth as declared.

The test modulation is a signal which modulates a carrier and is dependent upon the type of equipment under test and also the measurement to be performed.

For equipment using intermittent transmissions the test signal shall be such that:

- the generated RF signal is the same for each transmission;
- transmissions occur regularly in time;
- sequences of transmissions can be accurately repeated.

Details of test signals and test modulation shall be included in the test report.

Normal operating modulation shall be used where there is no provision for external test modulation.

During normal operation the RSU transmitter uses both modulated and unmodulated carrier. Consequently, both a modulated and unmodulated carrier are used during the transmitter tests.

#### 6.1.1 Normal test signals (wanted and unwanted signals)

The wanted signals for methods of measurement with bit streams and messages are defined in clauses 6.1.1.1 and 6.1.1.2 respectively.

At the manufacturer's choice, the test signals can either be applied externally or implemented into the equipment as a test mode. The method used shall be stated in the test report.

The data rate shall be the declared data rate.

### 6.1.1.1 Signals for bit stream measurements

When the equipment is intended to be tested with continuous bit streams the normal test signal shall be as follows:

- signal D-M0, consisting of an infinite series of 0-bits;
- signal D-M1, consisting of an infinite series of 1-bits;
- signal D-M2, consisting of a pseudo-random bit sequence of at least 511 bits according to ITU-T Recommendation O.153 [5];
- signal D-M2', this is the same type as D-M2, but the pseudo random bit sequence is independent of D-M2 perhaps identical with D-M2 but started at a different point of time with an incoherent clock.

Applying an infinite series of 0 bits or 1 bits does not normally produce the typical bandwidth. Signal D-M2 is designed to produce a good approximation of the typical bandwidth.

### 6.1.1.2 Signal for messages

The equipment may be tested by using messages when it is not possible to test with bit streams according to clause 6.1.1.1. In this case, the normal test signal shall be sequences of correctly coded bits or messages. Such messages can also be used for activation of OBUs (transponders) or performance test of an installed system.

The normal test signals and modulations shall be obtained as follows:

- D-M3 corresponds to single messages triggered either manually or by an automatic testing system;
- D-M4 consists of correctly coded messages transmitted sequentially, one by one, without gaps between them;
- D-M4' consists of incorrectly coded messages transmitted sequentially, one by one, without gaps between them.

D-M3 is used for receiver methods of measurement with messages where there is a need to transmit a single message a number of times (e.g. 20 times, see "normal test signal" of clauses 8.3.3.2, 8.3.4.2, 8.3.5.2 and 8.3.6.2). The corresponding normal test modulation shall be agreed between the manufacturer and the accredited test laboratory.

The test signal D-M4 is used for transmitter methods of measurement such as out of band power (clause 7.4.2), radiated spurious emissions (clauses 7.7.4 and 7.7.5) and interference test modulation during receiver degradation measurements (clause 8.3). The test signals D-M4 and D-M4' shall be agreed between the manufacturer and the accredited test laboratory.

For further details concerning receiver degradation measurements using messages, see annex C.

The test signal D-M4' is used for test of OBU access protection.

The test signal D-M4 shall be that, as agreed between the manufacturer and the test laboratory, which produces the greatest radio frequency occupied bandwidth.

The encoder, which is associated with the transmitter, shall be capable of supplying the normal test modulation for D-M3 and the test signal D-M4. Details of D-M3 and D-M4 shall be included in the test report.

## 6.2 Modes of operation of the transmitter

For the purposes of the measurements according to the present document, there shall be a facility to operate the transmitter unmodulated. The method of obtaining an unmodulated carrier or special types of modulation patterns may also be decided by agreement between the applicant and the testing laboratory. The method shall be described in the test report. It may involve suitable temporary internal modifications of the equipment under test. Alternatively, a test signal can be implemented as described in clause 6.1.1.

## 6.3 Encoder for receiver measurements

Whenever needed and in order to facilitate measurements on the receiver, an encoder for the data system shall accompany the model submitted, together with details of the normal modulation process. The encoder is used to modulate a signal generator for use as a test signal source.

In the case of equipment unable to operate with continuous bit streams, the encoder shall be capable of operation in a repetitive mode.

Complete details of all codes and code format(s) used shall be given.

## 6.4 Facilities for access

### 6.4.1 Analogue access

In order to simplify the measurements in clause 8.3.5.2 (receiver spurious response rejection), temporary access to a point where the amplitude of the analogue signal of the RF path can be measured should be provided, e.g. Intermediate Frequency (IF) output or demodulated subcarrier point may be provided for the equipment to be tested. This access can be used to determine or verify the frequency where a spurious response is expected.

### 6.4.2 Access points for data stream measurement

It is recognized that it is not always possible to measure an air interface data stream. The manufacturer shall define the points at which the equipment shall be tested in order to make the measurements on data streams or messages according to clauses 6.1.1.1 and 6.1.1.2.

Figure 2 is shown for clarification only.

The tests shall be performed by use of observation points (A,a or B,b or C,c or D,d).

The observation points shall be recorded in the test report.

**NOTE:** The closer the access point is located to the air interface (see figure 2) the fewer number of product variants need to be type tested because the measurement is less application dependent.

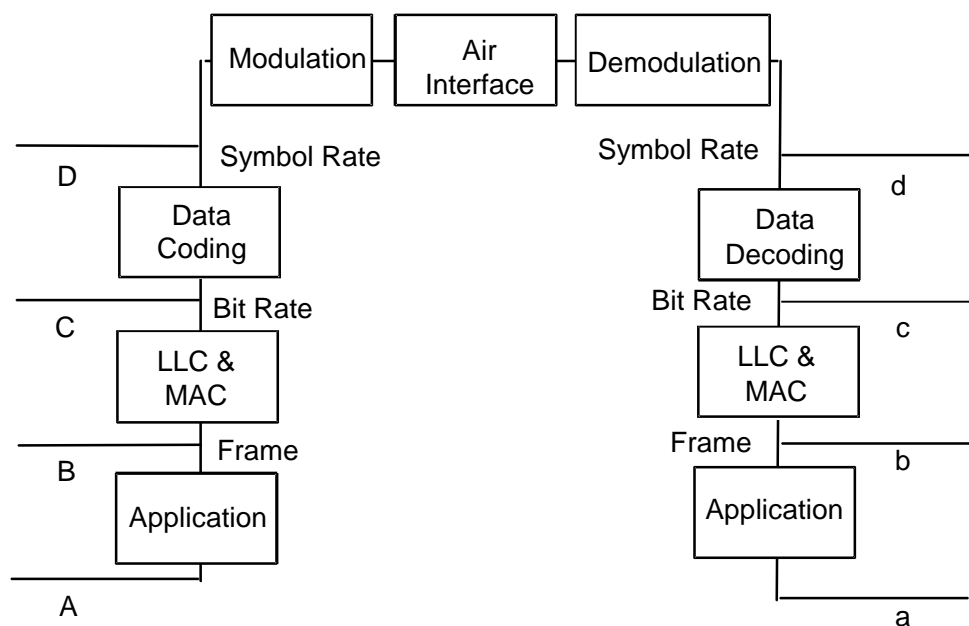

**Figure 2: Measuring points for data stream measurements**

### 6.4.3 Coupling arrangements

Arrangements shall be made by the manufacturer to couple the unit to be tested to the test equipment by a method which does not affect the radiated electromagnetic field (e.g. acoustic, ultra sonic or optic) according to clauses 6.4.3.1 and 6.4.3.2.

#### 6.4.3.1 Arrangements for measurements with continuous bit streams

For the measurements of the receiver on a test site, arrangements to couple the unit to be tested to the bit error ratio measuring device shall be available (see clause 6.1.1.1).

The manufacturer may provide an additional facility to give access to the analogue information (see clause 6.4.1).

#### 6.4.3.2 Arrangement for measurements with messages

For the measurements of the receiver on a test site, arrangements to couple the unit to be tested to the bit error ratio observation device (or to an operator) shall be available.

The manufacturer may provide an additional facility to give access to the analogue information (see clause 6.4.1).

### 6.4.4 Message received indicator

Any suitable means of indicating that the receiver has successfully received a correctly coded message may be provided.

## 6.5 Test sites and general arrangements for radiated measurements

For guidance on radiation test sites, see annex A. Detailed descriptions of the radiated measurement arrangements are included in this annex.

## 6.6 Artificial antenna

Where applicable, tests shall be carried out using an artificial antenna which shall be a substantially non-reactive non-radiating load of 50  $\Omega$ , connected to the antenna connector. The Voltage Standing Wave Ratio (VSWR) at the 50  $\Omega$  connector shall not be greater than 1,2:1 over the frequency range of the measurement.

## 6.7 Test fixture

The test fixture is a radio frequency coupling device associated with an integral antenna equipment for coupling the integral antenna to a 50  $\Omega$  radio frequency terminal at the working frequencies of the equipment under test. This allows certain measurements to be performed using conducted measurement methods. Only relative measurements may be performed and only those at or near frequencies for which the test fixture has been calibrated.

In addition, the test fixture shall provide:

- a connection to an external power supply;
- a data interface either by direct connection or by an acoustic or photo coupler.

The test fixture shall be calibrated, documented and supplied by the manufacturer.

The performance characteristics of the test fixture shall conform to the following basic parameters:

- the coupling loss shall not be greater than 30 dB;
- a coupling loss variation over the frequency range used in the measurement which does not exceed 2 dB;
- circuitry associated with the RF coupling shall contain no active or non linear devices;

- the VSWR at the 50  $\Omega$  socket shall not be greater than 1,5:1 over the frequency range of the measurements;
- the coupling loss shall be independent of the position of the test fixture and be unaffected by the proximity of surrounding objects or people. The coupling loss shall be reproducible when the equipment under test is removed and replaced;
- the coupling loss shall remain substantially constant when the environmental conditions are varied.

The characteristics and calibration shall be included in the test report.

### 6.7.1 Calibration

The calibration of the test fixture establishes a relationship between the output of the signal generator and the field strength applied to the equipment inside the test fixture.

The calibration is valid only at a given frequency and for a given polarization of the reference field.

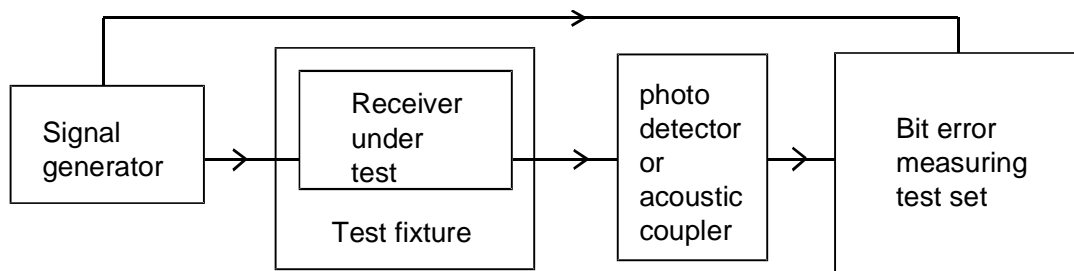

**Figure 3: Measuring arrangement for calibration**

- using the method described in clause 8.1, the sensitivity expressed as field strength shall be measured, and the value of this field strength expressed in dBm (received isotropically) and the polarization used shall be noted;
- the receiver shall be placed in the test fixture which is connected to the signal generator. The signal generator shall be set to the level producing normal sensitivity;
- the calibration of the test fixture is the tested linear relationship between the field strength expressed in dBm (received isotropically) and the signal generator level in dBm.

### 6.7.2 Mode of use

The test fixture may be used to facilitate some of the measurements in clauses 7, 8 and 9.1 on equipment with an integral antenna.

It is used in the measurements of radiated carrier power and measured useable sensitivity expressed as a field strength in clauses 7, 8 and 9.1 to enable a measurement to be made under extreme test conditions.

For the transmitter measurements calibration is not required.

For the receiver measurements calibration shall be performed.

To apply the specified wanted signal levels expressed in field strength, they shall be converted into the signal generator level (dBm) using the calibration of the test fixture. This value shall be applied to the signal generator.

## 6.8 Specific RSU test conditions

### 6.8.1 Antenna characteristics

The RSU antenna polarization is vertical linear (parameter D5a). The Cross polarization (D5b) parameter value shall be:

- In boresight: > 20 dB
- In the -3 dB area:  $\geq$  10 dB

## 6.8.2 Signal modulation

The signal modulation is ASK-OOK.

## 6.8.3 Data coding

Data shall be coded using Manchester encoding.

## 6.8.4 Bit rate

The RSU bit rate shall be 921 kbit/s, with a tolerance of  $\pm 0,2\%$ .

## 6.8.5 Angular E.I.R.P. mask

The Equivalent Isotropically Radiated Power is defined in clause 7.2 as the peak power of the transmitter. If  $\Theta$  indicates the angle relative to a vector perpendicular to the road surface, pointing downwards, the angular e.i.r.p. mask indicates the e.i.r.p. as a function of the angle  $\Theta$ .

**Table 3: Angular E.I.R.P. mask limits**

$\Theta$	Limit
$0^\circ \leq \Theta \leq 30^\circ$	$\leq +39$ dBm
$30^\circ < \Theta \leq 50^\circ$	$\leq +33$ dBm
$50^\circ < \Theta \leq 70^\circ$	$\leq +23$ dBm
$\Theta > 70^\circ$	$\leq +15$ dBm

## 6.8.6 Wake-up trigger for OBU

No assumptions are made on the way an OBU is made ready to establish communication with the RSU. However, for OBUs that need a specific trigger to start the communication phase, the RSU, when not engaged in communication, emits a burst of 100 pulses at 250 KHz, followed by a  $60\ \mu\text{s}$  pause, followed by a square-wave tone at 4 600 Hz consisting of 8 periods, starting with the maximum power state of the carrier modulation. Each 4 600 Hz period is characterized by a sequence of 6 pulses at 250 KHz before the semi-period transition to the lower level. The related duty cycle is  $50 \pm 5\%$ . This sequence (parameter D10a, or wake up Trigger for OBU)-is graphically depicted in figure 4.

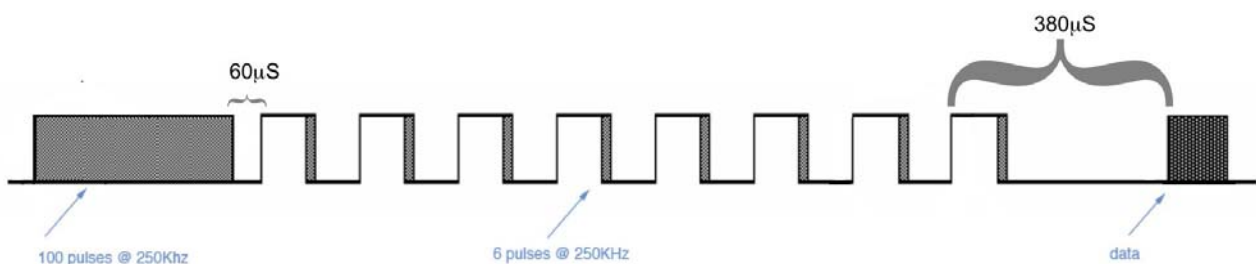

**Figure 4: Wake-up trigger waveform**

The actual communication, i.e. the start of the preamble (see clause 10.2) begins at least after  $380\ \mu\text{s}$  from the start of the rise edge of the last of the 8 periods at 4,6 kHz (parameter D10d).

The expected maximum start time for establishing communication-(parameter D10b) is about 2,4 ms, after which a new burst is emitted.

The wake-up sensitivity (parameter D10c) shall be as specified in clause 9.1.

## 6.9 Specific OBU test conditions

### 6.9.1 Antenna polarization

The OBU antenna polarization can be either vertical linear or left-hand circular (parameter U5a).

The Cross polarization parameter value shall be:

- In boresight:  $\geq 10$  dB
- In the -3 dB area:  $\geq 6$  dB

### 6.9.2 Modulation on carrier

The OBU modulation shall be AM.

### 6.9.3 Data coding

Data shall be coded using Manchester encoding.

### 6.9.4 Use of sidebands

Same data shall be sent simultaneously in both sidebands.

### 6.9.5 Responding bit rate and sub-carrier frequencies

The RSU may request different bit rates for OBU response messages. These are associated to different sub-carrier frequencies and modulations, as shown in table 4.

**Table 4: Bit rates and sub-carrier frequencies**

Bit rate	Sub-carrier frequency	Sub-carrier modulation
144 kbit/s $\pm 0,2$ %	10,7 MHz $\pm 0,1$ %	Binary FSK
921 kbit/s $\pm 0,2$ %	9,21 MHz $\pm 0,1$ %	BPSK
460 kbit/s $\pm 0,2$ %	4,6 MHz $\pm 0,1$ %	BPSK

The frequency deviation for FSK modulation is  $\pm 0,7$  MHz. The tolerance of frequency deviation for FSK is  $\pm 2$  %.

### 6.9.6 Antenna characteristics

The minimum operational direction of OBU receive and transmit antenna is characterized by a cone with an opening angle of  $\theta$  around boresight as depicted in figure 5. The Maximum Single Side Band E.I.R.P. is the maximum E.I.R.P. measured at the borders of a cone with  $\theta = 35^\circ$ , and shall be measured at a receiving antenna with the same polarization as the transmitting antenna.

The OBU shall provide specific properties inside the cone. The border of the cone itself is referred to as worst case direction. The directions M0 through M4 and the phase centre Mc of the OBU antenna are related to measurements described in the present document.



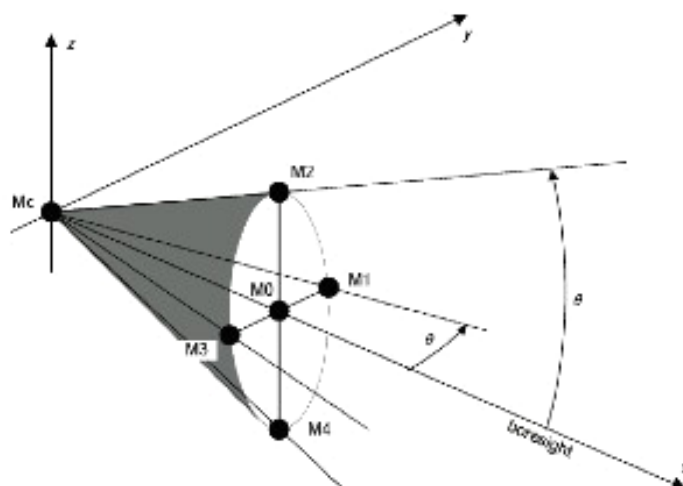

Figure 5: OBU antenna characteristics

---

## 7 Layer 1: Methods of measurement and limits for road side unit transmitter parameters

### 7.1 Generalities

To meet the requirements for all applications the transmitter shall be measured at the power level and antenna gain declared by the applicant. If the applicant intends to use different gain antennas to cover all applications the measurements shall be made at a power level corresponding to the lowest gain antenna and repeated concerning measurements of radiated spurious emissions at the power setting for the highest gain antenna (see clause 7.7). The declared power levels and antenna gains shall be stated in the application form and test report.

If the equipment to be tested is designed with an antenna connector, then this connector may be used, via a calibrated coupler or attenuator, if required, to provide the correct termination impedance, to facilitate the measurements.

If a temporary 50  $\Omega$  RF connector is used, this shall be stated in the test report (see clause 4.1.5).

### 7.2 Equivalent isotropically radiated power (e.i.r.p.)

#### 7.2.1 Definition

The e.i.r.p. is defined as the peak power of the transmitter and shall be calculated according to the procedure given in the clause 7.2.2. The equivalent isotropically radiated power is then calculated from the declared antenna gain. See clause 5 for the test conditions.

#### 7.2.2 Method of measurement

Using an applicable measurement procedure as described in annex B, the power output shall be measured and recorded in the test report.

For power measurements, a spectrum analyser or selective voltmeter shall be used and tuned to the transmitter carrier at which the highest output level is detected.

For measurements using a spectrum analyser, the resolution and video bandwidths shall be set to a maximum of 300 kHz.

The measurement shall be made in the unmodulated transmitter mode, see clause 6.2.

This measurement shall be performed at normal and at extreme conditions (see clauses 5.3 and 5.4).

The method of measurement shall be documented in the test report.

The actual e.i.r.p. is calculated according to the relevant method stated in annex B.

### 7.2.3 Limits

The transmitter maximum e.i.r.p. under normal and extreme test conditions shall not exceed the limits of CEPT/ERC Recommendation 70-03 [2] as stated in the appropriate annex, i.e. 8 W. Consequently, the in band power limit is 39 dBm.

## 7.3 Frequency error

### 7.3.1 Definition

The frequency error of the equipment is the difference between the unmodulated carrier frequency and the nominal frequency selected for the test.

### 7.3.2 Method of measurement

The following method of measurement shall be used:

- a) with an antenna connector:
  - the transmitter shall be connected to an artificial antenna. A frequency meter shall be connected to the artificial antenna via appropriate attenuation and the carrier frequency shall be measured without modulation;
  - the measurement shall be repeated under extreme test conditions.
- b) with an integrated antenna:
  - a test fixture with 50  $\Omega$  output connection shall be positioned for appropriate coupling to the radiated field. A frequency meter shall be connected to the test fixture via appropriate attenuation and the carrier frequency shall be measured without modulation;
  - the measurement shall be repeated under extreme test conditions.

with a test port:

- a frequency meter shall be connected to the test port via appropriate attenuation and the carrier frequency shall be measured without modulation;
- the measurement shall be repeated under extreme test conditions.

The method of measurement shall be stated in the test report.

### 7.3.3 Limits

The frequency error under normal and extreme conditions shall not exceed:  $\pm 200$  ppm.

## 7.4 Transmitter spectrum mask

### 7.4.1 Definition

The RSU transmitter spectrum mask is defined as the radiated power density around the carrier frequency caused by the modulated transmitter.

The reuse distance between multiple RSUs is determined by the spectrum-mask attenuation. The present document defines the performance for reused distance.

## 7.4.2 Method of measurement

The method of measurement depends on whether the equipment has an antenna connector or an integral antenna:

- a) equipment with an antenna connector:
  - the transmitter shall be connected to an artificial antenna. A spectrum analyser shall be connected to the artificial antenna via appropriate attenuation and the transmitter spectrum shall be measured with and without modulation;
  - the measurement shall be repeated under extreme test conditions.
- b) equipment with an integrated antenna:
  - a test fixture with 50  $\Omega$  output connection shall be positioned for appropriate coupling to the radiated field. A spectrum analyser shall be connected to the test fixture via appropriate attenuation and the transmitter spectrum shall be measured with and without modulation. The test fixture shall be supplied, calibrated and documented by the manufacturer;
  - the measurement shall be repeated under extreme test conditions.

The test shall be made with test modulation signal D-M4, see general conditions in clause 6.1.1.2.

Measurements shall be made at a number of test frequencies as specified in clause 7.4.3, table 5 and repeated under extreme test conditions.

The measurements shall be made with a 30 kHz bandwidth in the unmodulated and modulated case.

The measurements shall be made by using a standard spectrum analyser and using the following procedure:

- the bandwidth of the spectrum analyser shall be set to 30 kHz;
- the video filter shall be switched on with a bandwidth of 1 kHz.

The measurements shall be recorded in the test report.

## 7.4.3 Limits

The limits for the radiated transmitter spectrum mask during normal and extreme test conditions shall not exceed the values given in table 5.

**Table 5: Transmitter spectrum-mask limits (E.I.R.P.)**

	<b>Unmodulated</b>	<b>Modulated</b>
$F_{TX} \pm (3,0 \text{ MHz to } 14 \text{ MHz})$	-49 dBm	-
$F_{TX} \pm (3 \text{ MHz to } 8 \text{ MHz})$	-	-29 dBm
$F_{TX} \pm (2 \text{ MHz to } 14 \text{ MHz})$	-	-32 dBm

For transmitter spectrum-mask limits see also figure 6.

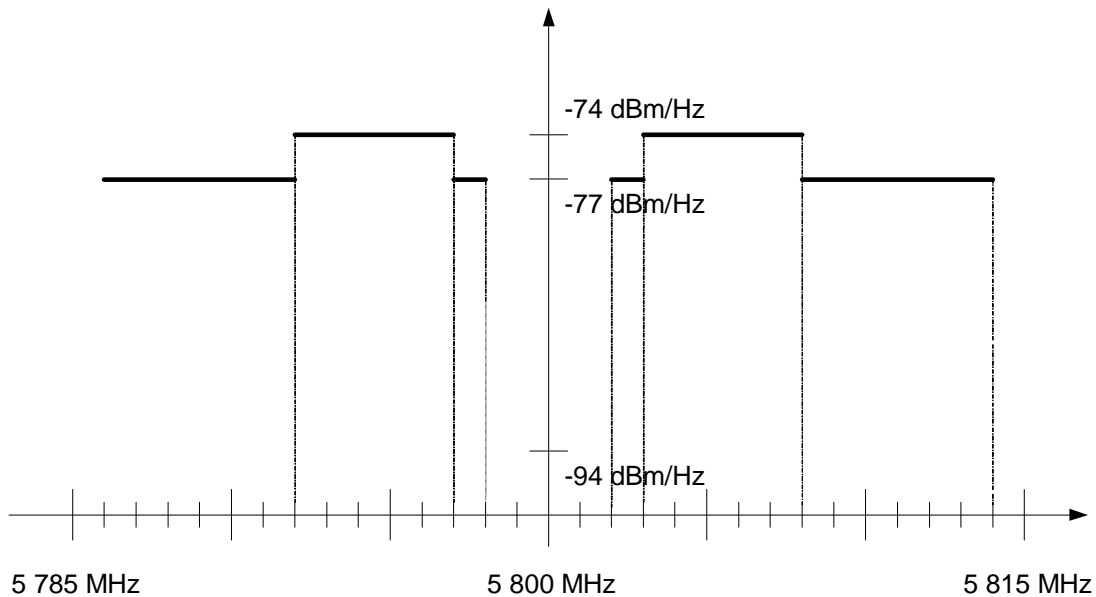

**Figure 6: RSU transmitter spectrum mask - unwanted emissions**

## 7.5 Modulation depth

### 7.5.1 Definition

The modulation depth indicates the size of modulation in relation to the maximum theoretically possible.

### 7.5.2 Method of measurement

The following method of measurement shall be used:

- a) equipment with an antenna connector:
  - the transmitter shall be connected to an artificial antenna. A diode detector with a dc-coupled oscilloscope shall be connected to the artificial antenna via appropriate attenuation and the diode detector voltage shall be measured with and without modulation.
- b) equipment with an integrated antenna:
  - a test fixture with 50  $\Omega$  output connection shall be positioned for appropriate coupling to the radiated field. A diode detector with a dc-coupled oscilloscope shall be connected to the test fixture via appropriate attenuation and the diode detector voltage shall be measured with and without modulation. The test fixture shall be documented by the manufacturer, see clause 6.7.

The transmitter shall be modulated with the test signal D-M2.

The modulation depth shall be calculated as:

$$\text{Modulation Depth} = \frac{V_{\max} - V_{\min}}{V_{\max} + V_{\min}}$$

### 7.5.3 Limits

The modulation depth during normal and extreme test conditions shall be between 0,5 and 0,9.

## 7.6 Eye pattern

### 7.6.1 Definition

The eye pattern defines the free decision of a digital signal pulse with respect to pulse width and amplitude.

### 7.6.2 Method of measurement

The following method of measurement shall be used:

- a) equipment with an antenna connector:
  - the transmitter shall be connected to an artificial antenna. A diode detector with a dc-coupled oscilloscope shall be connected to the artificial antenna via appropriate attenuation and the diode detector voltage shall be measured with modulation.
- b) equipment with an integrated antenna:
  - a test fixture with 50  $\Omega$  output connection shall be positioned for appropriate coupling to the radiated field. A diode detector with a dc coupled oscilloscope shall be connected to the test fixture via appropriate attenuation and the diode detector voltage shall be measured with modulation;
  - the test fixture shall be documented by the manufacturer.

The test modulation signal shall be D-M2.

With reference to the diagram in figure 7 the eye pattern is calculated as:

$$\text{a) Pulse amplitude} = \frac{2B}{A+B}$$

$$\text{b) Pulse width} = \frac{2B'}{A'+B'}$$

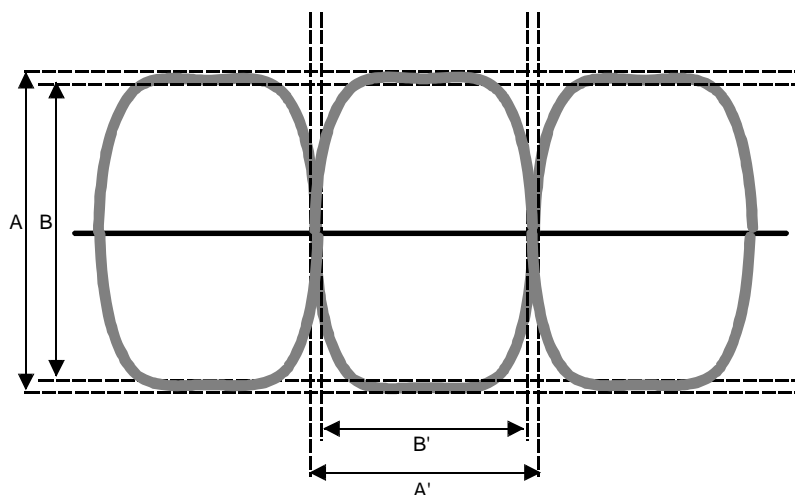

Figure 7: Eye pattern measurement

### 7.6.3 Limits

The values of pulse amplitude and pulse width calculated from the eye pattern during normal and extreme test conditions shall not be below the limits in table 6.

**Table 6: Eye pattern limits**

Pulse amplitude	> 85 %
Pulse width	> 90 %

## 7.7 Spurious emissions

### 7.7.1 Definition

Spurious emissions are emissions at frequencies, other than those of the carrier and sidebands associated with normal modulation. The level of spurious emissions shall be measured as either:

- a) their power level in a specified load (conducted emission); and their effective radiated power when radiated by the cabinet and structure of the equipment (cabinet radiation); or
- b) their effective radiated power when radiated by the cabinet and the integral antenna.

### 7.7.2 Measuring receiver

The term "measuring receiver" refers to either a selective voltmeter or spectrum analyser. The bandwidth of the measuring receiver shall, where possible, be according to CISPR 16-1 [3]. In order to obtain the required sensitivity a narrower bandwidth may be necessary, this shall be stated in the test report form.

However, a narrower bandwidth is only allowed if it does not reduce the measurement level for broad band spurious emissions. Otherwise, the measurement distance has to be reduced.

The bandwidth of the measuring receiver shall be less than the maximum given in table 7.

**Table 7: Maximum measuring receiver bandwidth**

Frequency being measured	Maximum measuring receiver bandwidth
$f < 1\,000$ MHz	100 kHz to 120 kHz
$f \geq 1\,000$ MHz	1 MHz

### 7.7.3 Method of measurement conducted spurious emission

This method of measurement applies to transmitters having a permanent antenna connector:

- a) The transmitter shall be connected to a measuring receiver through a test load, 50  $\Omega$  power attenuator, and if necessary, an appropriate filter to avoid overloading of the measuring receiver. The bandwidth of the measuring receiver shall be set to a suitable value to correctly measure a spurious emission at a level 6 dB below the limit value given in table 8, see clause 7.7.6. This bandwidth shall be recorded in the test report.

For the measurement of spurious emissions below the second harmonic of the carrier frequency the filter used shall be a high "Q" (notch) filter centred on the transmitter carrier frequency and attenuating this signal by at least 30 dB.

For the measurement of spurious emissions at and above the second harmonic of the carrier frequency the filter used shall be a high pass filter with a stop band rejection exceeding 40 dB. The cut-off frequency of the high pass filter shall be approximately 1,5 times the transmitter carrier frequency.

Precautions may be required to ensure that harmonics of the carrier are not generated by the test load or attenuated by the high pass filter.

- b) The transmitter shall be unmodulated and operating at the maximum limit of its specified power range. If modulation cannot be inhibited then the test shall be carried out with modulation (see clauses 6.1 and 6.2), and this fact shall be recorded in the test report.
- c) The frequency of the measuring receiver shall be adjusted over the frequency range 25 MHz to 40 GHz. The frequency and level of every spurious emission found shall be noted. The emissions within the channel occupied by the transmitter carrier and for channelized systems, its adjacent channels, shall not be recorded.
- d) If the measuring receiver has not been calibrated in terms of power level at the transmitter output, the level of any detected components shall be determined by replacing the transmitter by the signal generator and adjusting it to reproduce the frequency and level of every spurious emission noted in step c). The absolute power level of each of the emissions shall be noted.
- e) The frequency and level of each spurious emission measured and the bandwidth of the measuring receiver shall be recorded in the test report.
- f) If a user accessible power adjustment is provided then the tests in steps c) to e) shall be repeated at the lowest power setting available.
- g) The measurement in steps c) to f) shall be repeated with the transmitter in the standby condition if this option is available.

#### 7.7.4 Method of measurement cabinet spurious radiation

This method of measurement applies to transmitters having a permanent antenna connector. For equipment without a permanent antenna connector, see clause 7.7.5:

- a) A test site selected from annex A which fulfils the requirements of the specified frequency range of this measurement shall be used. The test antenna shall be oriented initially for vertical polarization and connected to a measuring receiver. The bandwidth of the measuring receiver shall be set to a suitable value to correctly measure a spurious emission at a level 6 dB below the limit value given in table 7, see clause 7.7.6. This bandwidth shall be recorded in the test report. The transmitter under test shall be placed on the support in its standard position, connected to an artificial antenna (see clause 6.6) and switched on without modulation. If modulation cannot be inhibited then the test shall be carried out with modulation, (see clauses 6.1 and 6.2), and this fact shall be recorded in the test report.
- b) The radiation of any spurious emission shall be detected by the test antenna and measuring receiver over the frequency range 25 MHz to 40 GHz, except for the channel on which the transmitter is intended to operate and, for channelized systems, its adjacent channels. The frequency of each spurious emission detected shall be noted. If the test site is disturbed by interference coming from outside the site, this qualitative search may be performed in a screened room, with a reduced distance between the transmitter and the test antenna.
- c) At each frequency at which an emission has been detected, the measuring receiver shall be tuned and the test antenna shall be raised or lowered through the specified height range until the maximum signal level is detected on the measuring receiver.
- d) The transmitter shall be rotated through 360° about a vertical axis, to maximize the received signal.
- e) The test antenna shall be raised or lowered again through the specified height range until a maximum is obtained. This level shall be noted.
- f) The substitution antenna (see clause A.2.3) shall replace the transmitter antenna in the same position and in vertical polarization. It shall be connected to the signal generator.
- g) At each frequency at which an emission has been detected, the signal generator, substitution antenna, and measuring receiver shall be tuned. The test antenna shall be raised or lowered through the specified height range until the maximum signal level is detected on the measuring receiver. The level of the signal generator giving the same signal level on the measuring receiver as in item e) above shall be noted. After corrections due to the gain of the substitution antenna and the cable loss between the signal generator and the substitution antenna, this level is the radiated spurious emission at this frequency.
- h) The frequency and level of each spurious emission measured and the bandwidth of the measuring receiver shall be recorded in the test report.

- i) Steps c) to h) shall be repeated with the test antenna oriented in horizontal polarization.
- j) If a user accessible power adjustment is provided then the tests in steps c) to h) shall be repeated at the lowest power setting available.

Steps c) to j) shall be repeated with the transmitter in the standby condition if this option is available.

## 7.7.5 Method of measurement radiated spurious emission

This method of measurement applies to transmitters having an integral antenna:

- a) A test site selected from annex A which fulfils the requirements of the specified frequency range of this measurement shall be used. The test antenna shall be oriented initially for vertical polarization and connected to a measuring receiver, through a suitable filter to avoid overloading of the measuring receiver if required. The bandwidth of the measuring receiver shall be set to a suitable value to correctly measure a spurious emission at a level 6 dB below the limit value given in table 8, see clause 7.7.6. This bandwidth shall be recorded in the test report.  
For the measurement of spurious emissions below the second harmonic of the carrier frequency the optional filter used shall be a high "Q" (notch) filter centred on the transmitter carrier frequency and attenuating this signal by at least 30 dB.  
For the measurement of spurious emissions at and above the second harmonic of the carrier frequency the optional filter used shall be a high pass filter with a stop band rejection exceeding 40 dB. The cut-off frequency of the high pass filter shall be approximately 1,5 times the transmitter carrier frequency.  
The transmitter under test shall be placed on the support in its standard position and shall be switched on without modulation.  
If modulation cannot be inhibited then the test shall be carried out with modulation, (see clauses 6.1 and 6.2), and this fact shall be recorded in the test report.
- b) The same method of measurement as steps b) and k) of clause 7.7.4.

## 7.7.6 Limits

The power of any spurious emission shall not exceed the values given in table 8.

**Table 8: Limits of radiated and conducted spurious emissions**

State	47 MHz to 74 MHz 87,5 MHz to 118 MHz 174 MHz to 230 MHz 470 MHz to 862 MHz	Other frequencies ≤ 1 000 MHz	Frequencies > 1 000 MHz outside the assigned frequency band
Operating	4 nW	250 nW	1 μW
Standby	2 nW	2 nW	20 nW

# 8 Layer 1: Methods of measurement and limits for road side unit receiver parameters

All receiver tests shall be referred to the antenna input terminal of the receiver. Where possible, the receiver measurements shall be made simultaneously with the transmitter in the transmit mode, without modulation.

All declared combinations of receiver sensitivity and modulation schemes shall be tested.

Where required, all tests at extreme temperatures shall be tested to the temperature category declared by the manufacturer, see clause 5.4.1.2.

The method of measurement using continuous bit streams should be used for all RSU receiver tests of the present document. The specified nominal bit error ratio is  $1 \times 10^{-6}$  but to facilitate fast receiver measurements, a bit error ratio range of  $0,5 \times 10^{-2}$  to  $2 \times 10^{-2}$  is used.



Alternatively, receiver measurements may be made using correctly-coded messages. The specified successful message ratio is 80 % over 20 message trials. The test procedure using messages may be used in special cases, e.g. to test a complete installed system. The method of measurement using messages is described in annex C.

## 8.1 Maximum useable sensitivity

### 8.1.1 Definition

The maximum useable data sensitivity is the power, expressed in dBm, produced by a carrier at the nominal frequency of the receiver, modulated with the normal test signal (clauses 6.1.1.1 and 6.1.1.2) which will, without interference, produce after demodulation a data signal with a specified bit error ratio or a specified successful message ratio.

The receiver sensitivity at the antenna connector shall be measured at a receiving antenna with the same polarization as the transmitting antenna. The receiver sensitivity, receiver demodulation capability (2, 4 or 8 Phase Shift Keying - PSK), temperature category and subcarrier frequencies shall be declared on the application form.

### 8.1.2 Method of measurements under normal and extreme test conditions

Arrangements shall be made by the manufacturer to couple the equipment to the bit error ratio measuring device by a method which does not affect the radiated electromagnetic field see also clauses 8.1.2, 8.1.2.2 and 8.1.2.3. An alternative method of measurement using messages is defined in annex C. During the receiver tests the transmitter shall be properly terminated.

#### 8.1.2.1 Test arrangement for equipment with integral antenna

The test arrangement is different for normal and extreme test conditions:

- a) normal test conditions:
  - the test arrangement shown in figure 8 shall be used;

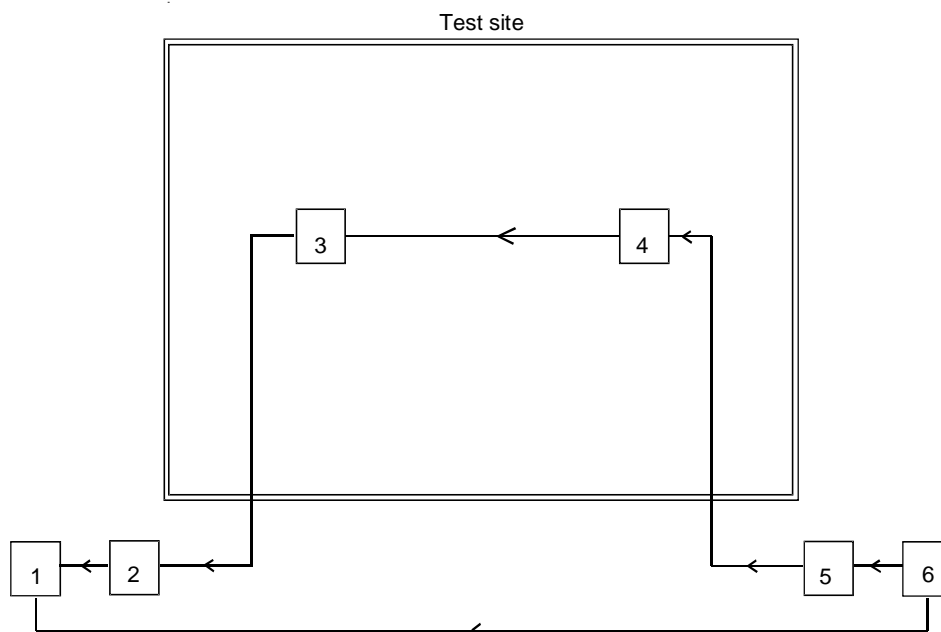

- NOTE:
- 1 bit error ratio measuring test set;
  - 2 photo detector/acoustic coupler;
  - 3 receiver with integral antenna under test;
  - 4 test antenna;
  - 5 signal generator;
  - 6 bit stream generator.

**Figure 8: Receiver measurement arrangement for integral antenna (normal conditions)**

A test site which fulfils the requirements for the specified frequency range of the measurement shall be used. The polarization of the test antenna shall match the requirement for the equipment antenna. The equipment under test shall be placed on the support in its standard position (see annex A).

b) extreme test conditions:

- the test arrangement shown in figure 9 shall be used.

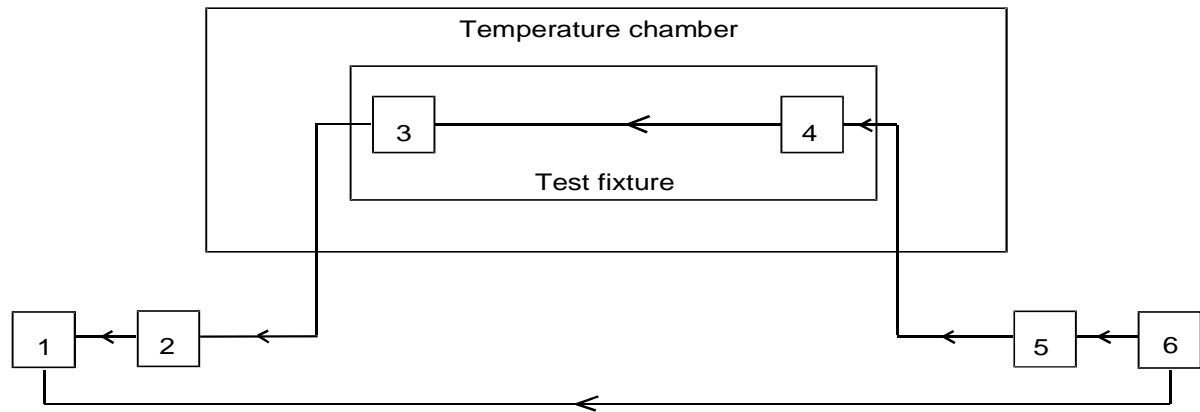

NOTE:

- 1 bit error ratio measuring test set;
- 2 photo detector/acoustic coupler;
- 3 receiver under test;
- 4 test fixture with RF coupler or test antenna (see clause 6.7);
- 5 signal generator;
- 6 bit stream generator.

**Figure 9: Receiver measurement arrangement for integral antenna (extreme conditions)**

The input of the test fixture shall be terminated with a fixed attenuator to achieve proper termination of the signal generator. The distance between the RF coupler (or test antenna) and the equipment under test shall not be less than 40 cm. The polarization of the test antenna shall match the requirement for the equipment antenna. Only relative measurements are made during the extreme test conditions.

### 8.1.2.2 Test arrangement for equipment with antenna connector

The test arrangement shown in figure 10 shall be used during normal and extreme test conditions.

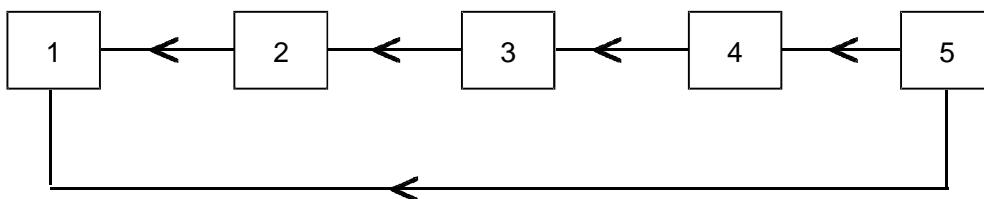

NOTE:

- 1 bit error ratio measuring test set;
- 2 photo detector/acoustic coupler;
- 3 receiver under test;
- 4 signal generator;
- 5 bit stream generator.

**Figure 10: Receiver measurement arrangement for antenna connector**

### 8.1.2.3 Test procedure for continuous bit streams

The following procedure shall apply:

- a) the signal generator shall be set to the nominal frequency of the RSU receiver and modulated with a normal test signal D-M2 (clause 6.1.1.1);
- b) the level of the signal generator shall be adjusted until the bit error ratio is in the range  $0,5 \times 10^{-2}$  to  $2 \times 10^{-2}$ . The signal generator level shall be recorded in the test report;
- c) this test only applies to transceiver type OBU's. In this case this shall be stated in the test report. steps a) and b) shall be repeated with the signal generator frequency set to the following frequencies: the nominal frequency of the RSU  $\pm 10$  ppm ( $\pm 58$  kHz, the transmit frequency error added to the error of the subcarrier);
- d) steps a) and b) shall be repeated under extreme test conditions.

### 8.1.2.4 Test procedure for messages

For this measurement, the test laboratory may request the manufacturer to provide a test fixture. The fixture shall be capable of counting the number of transmitted messages, the number of received error messages and the number of correctly received messages. The necessary documentation and calibration shall be supplied with the test fixture. The test conditions for this procedure shall be agreed with the test laboratory.

The following procedure shall apply:

- a) the signal generator shall be set to the nominal frequency of the RSU receiver and shall be modulated with a normal message test signal D-M3 (see clause 6.1.1.2);
- b) the level of the signal generator shall be adjusted until the successful message ratio is 80 % for 20 messages. For further details, see clause C.3. The level of the signal generator shall be recorded in the test report;
- c) this test only applies to transceiver type OBU's. In this case this shall be stated in the test report. Steps a) and b) shall be repeated with the frequency of the signal generator set to the following frequencies: the nominal frequency of the RSU receiver  $\pm 10$  ppm ( $\pm 58$  kHz, the transmit frequency error added to the subcarrier error);
- d) steps a) and b) shall be repeated under extreme test conditions.

## 8.1.3 Limits

Under normal test and extreme test conditions the maximum usable sensitivity shall not be worse than -92 dBm.

## 8.2 Error behaviour at high wanted input signals

### 8.2.1 Definition

This measures the receiver's capability to receive signals from the sensitivity level to a high signal level.

### 8.2.2 Method of measurement

The test arrangement shall be the same as that used for the measurement of maximum usable sensitivity (see clauses 8.1.2, 8.1.2.2 and 8.1.2.3). The signal generator level is slowly increased and the bit error ratio or the successful message ratio is monitored until a point is reached where they are independent of the signal generator level.

The measuring procedure is dependent on the criteria chosen:

- a) for bit error measurements:
  - the signal generator shall be modulated with D-M2 test modulation;

- the level of the signal generator shall be adjusted to +6 dB above the declared sensitivity point and the bit error ratio shall be measured and recorded in the test report;
  - the level of the signal generator shall be adjusted to -50 dBm and the bit error ratio shall be measured and recorded in the test report;
  - the measurements shall be repeated under extreme test conditions.
- b) for measurements using messages:
- the signal generator shall be modulated with messages (D-M3 modulation);
  - the level of the signal generator shall be adjusted to +6 dB above the declared sensitivity point and the successful message ratio shall be measured and recorded in the test report;
  - the level of the signal generator shall be adjusted to -50 dBm;
  - 4 000 messages shall be transmitted and the number of error messages shall be recorded. This test shall be repeated five times. The highest number of errors recorded from the five tests shall be the final figure recorded in the test report;
  - the measurements shall be repeated under extreme conditions.

### 8.2.3 Limits

The limit under normal and extreme test conditions shall be either:

- a) for bit error measurements:
- for signal generator level +6 dB above the declared sensitivity point the bit error ratio shall be less than  $10^{-2}$ ;
  - for signal generator level at -50 dBm for a bit error ratio shall be less than  $10^{-6}$ ; or
- b) for measurements using messages:
- for signal generator level +6 dB above the declared sensitivity point the successful message ratio shall be greater than 80 %;
  - for signal generator level at -50 dBm there shall be less than two errors.

## 8.3 Degradation measurements

### 8.3.1 Definition

Degradation measurements are those measurements which are made on the receiver to establish the degradation of the performance of the receiver due to presence of unwanted interfering signals.

### 8.3.2 General conditions

The degradation measurements should be made at the antenna connector, or on a temporary antenna connector made for the test. For equipment with integral antenna where a permanent or temporary antenna can not be made available, the signal shall be coupled to the integral antenna via a test antenna as described in clause 8.1.2.

All degradation measurements using bit streams shall be made with continuous bit stream modulation, D-M2, at the wanted channel. If the alternative method of measurement using message modulation is used, see annex C, measurements shall be made with message modulation, D-M4.

The necessary number of signal generators (2 or 3, as appropriate) shall be coupled via a combination network to provide simultaneous wanted and unwanted signals to the receiver:

- a) the level of each the signal generators shall be set to the sensitivity level of the receiver determined as described in clause 8.1;

- b) the signal level of the wanted signal A shall be adjusted to a level +6 dB above the declared sensitivity;
- c) the level of the unwanted signal(s) B and C, unmodulated or modulated with appropriate modulation depending on the test, shall be increased until the normal criteria for bit error ratio or successful message ratio are achieved;
- d) the interfering generator level (item c)), or for some measurements the level difference between the interfering generator level and the declared sensitivity level (item a)), is the degradation rejection. This figure shall be recorded in the test report.

### 8.3.3 Co-channel rejection

#### 8.3.3.1 Definition

The co-channel rejection is a measure of the capability of the receiver to receive a wanted modulated signal without exceeding a given degradation due to the presence of an unwanted signal, both being at the nominal frequency of the receiver. The up-link modulation type shall be declared by the applicant and stated in the test report.

#### 8.3.3.2 Method of measurement

The test arrangement shown in figure 11 shall be used.

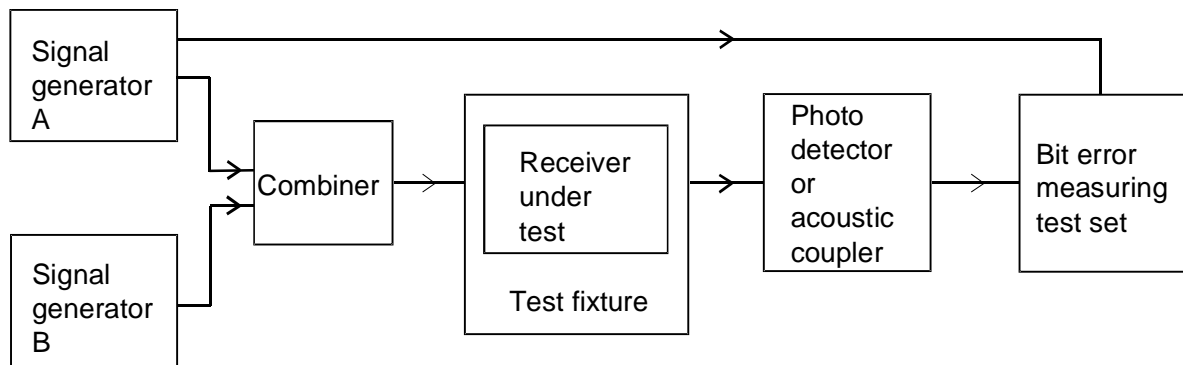

**Figure 11: Measurement arrangement - co-channel rejection**

- a) for equipment with integrated antenna the receiver antenna shall be coupled to the combiner via a test fixture as described in figure 9 (clause 8.1.2) and clause 6.7;
- b) for equipment with permanent or temporary antenna connector the combiner shall be connected directly to the equipment antenna connector.

With the general conditions as described in clause 8.3.2:

- the frequency of signal generator A shall be tuned to the nominal frequency of the wanted signal;
- signal generator B shall be switched off;
- the level of the wanted signal, signal generator A, modulated with test modulation D-M2, shall be adjusted to a level +6 dB above the declared sensitivity of the receiver under test;
- signal generator B shall be switched on without modulation. The level of signal generator B shall be increased until the receiver operates at a bit error ratio in the range  $0,5 \times 10^{-2}$  to  $2 \times 10^{-2}$ ;
- the level difference between the signal generators A and B is the co-channel rejection.

### 8.3.3.3 Limits

The level for the co-channel rejection under normal test conditions shall be less than the limit given in table 9.

**Table 9: Co-channel rejection limits**

Receiver modulation	Limit
FSK	6 dB
2 - PSK	6 dB
4 - PSK	9 dB
8 - PSK	12 dB

### 8.3.4 Adjacent channel selectivity

#### 8.3.4.1 Definition

The adjacent channel selectivity is a measure of the capability of the receiver to receive a wanted modulated signal without exceeding degradation due to the presence of an unwanted signal differing in frequency by an amount equal to the adjacent channel separation for which the equipment is intended.

#### 8.3.4.2 Method of measurement

The test arrangement shown in figure 12 shall be used.

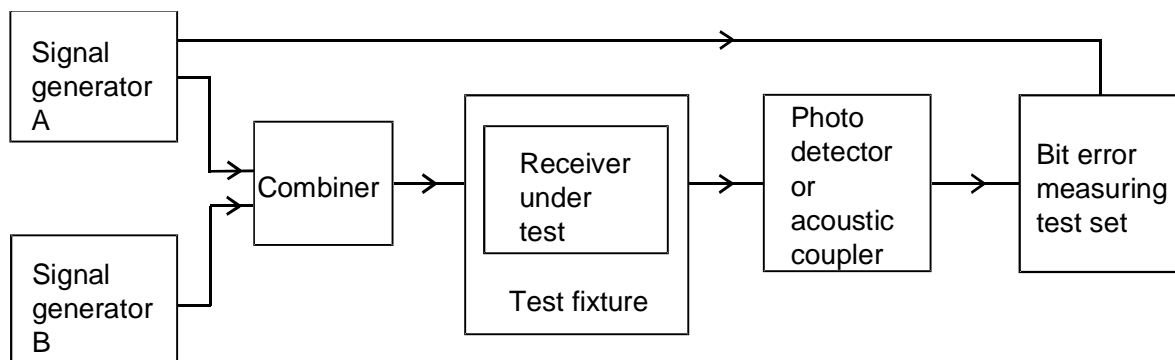

**Figure 12: Measurement arrangement - adjacent channel selectivity**

- for equipment with permanent integral antenna the receiver antenna shall be coupled to the combiner via a test fixture as described in clause 8.1.2, figure 8 and clause 6.7;
- for equipment with permanent or temporary antenna connector the combiner shall be connected directly to the equipment antenna connector.

With the general conditions as described in clause 8.3.2:

- the frequency of signal generator A shall be tuned to the nominal frequency of the wanted signal;
- signal generator B shall be switched off;
- the level of the wanted signal, signal generator A, modulated with test modulation D-M2, shall be adjusted to a level +6 dB above the declared sensitivity of the receiver under test;
- the unwanted signal, signal generator B, shall be switched on unmodulated and tuned to one of the relevant off-set test frequencies for the system as given in clause 8.3.4.3;
- the level of signal generator B shall be increased until the receiver operates at a bit error ratio in the range of  $0,5 \times 10^{-2}$  to  $2 \times 10^{-2}$ ;

- the output power of signal generator B is the adjacent channel selectivity and shall be recorded in the test report;
- the above procedure is repeated for each of the other test frequencies given in clause 8.3.4.3 for the unwanted signal;
- the total procedure is repeated for other declared subcarrier frequencies;
- the total procedure is repeated under extreme test conditions.

### 8.3.4.3 Limits

The adjacent channel selectivity at normal and extreme test conditions shall be greater than the limit given in table 10.

**Table 10: Adjacent selectivity limits**

Frequency off-set from nominal transmit frequency				
	$\pm 50$ kHz	$\pm (f_s \pm 2,0$ MHz)	$\pm 5$ MHz	$\pm 15$ MHz
Adjacent channel selectivity	-50 dBm	-80 dBm	-50 dBm	-50 dBm

Where  $f_s$  is the declared transponder sub-carrier frequency in the system.

## 8.3.5 Spurious response rejection and blocking/desensitization

### 8.3.5.1 Definition

The spurious response rejection is a measure of the capability of the receiver to receive a wanted modulated signal without exceeding a given degradation due to the presence of an unwanted modulated signal at any other frequency outside an exclusion band of  $\pm 15$  MHz from the transmit frequency at which a response is obtained.

Tests shall also be made at subcarrier frequencies and any IF frequency. The manufacturer shall declare these frequencies on the application form.

This definition also includes blocking/desensitization.

### 8.3.5.2 Method of measurement

The test arrangements shown in figure 13 shall be used.

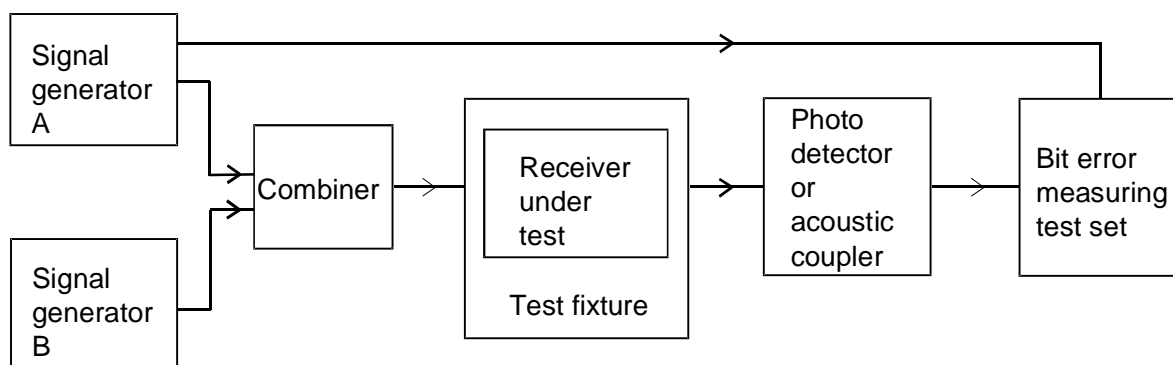

**Figure 13: Measurement arrangement - spurious response rejection**

- for equipment with permanent integral antenna the receiver antenna shall be coupled to the combiner via a test fixture as described in clause 8.1.2.1, figure 8 and clause 6.7;
- for equipment with permanent or temporary antenna connector the combiner shall be connected directly to the equipment's antenna connector.

To facilitate the measurements an analogue access measuring point may be used, see clause 6.4.

With the general conditions as described in clause 8.3.2:

- signal generator A, shall be tuned to the nominal frequency of the receiver;
- the level of signal generator A, modulated with test modulation D-M2, shall be adjusted to a level +6 dB above at the declared sensitivity;
- signal generator B shall be switched on without modulation at a level of > -10 dBm;
- the frequency of signal generator B shall be slowly tuned over the frequency range 25 MHz to 40 GHz, except for an exclusion band either side of the nominal transmit carrier frequency, see clause 8.3.5. At each where the wanted signal is degraded, the level of signal generator B shall be adjusted until the receiver operates at a bit error ratio in the range of  $0,5 \times 10^{-2}$  to  $2 \times 10^{-2}$ . For each frequency where a degradation occurs, the corresponding level of signal generator B shall be recorded in the test report;
- the power level of signal generator B is the spurious response rejection.

Receiver spurious response rejection shall not be measured under extreme conditions.

### 8.3.5.3 Limits

The measured value for the receiver spurious response rejection under normal test conditions shall be  $\geq -30$  dBm.

## 8.3.6 Intermodulation response rejection

### 8.3.6.1 Definition

The intermodulation response rejection is a measure of the capability of the receiver to receive a wanted modulated signal, without exceeding a given degradation due to the presence of two or more unwanted signals with a specific frequency relationship to the wanted signal frequency.

### 8.3.6.2 Method of measurement

The test arrangement shown in figure 14 shall be used.

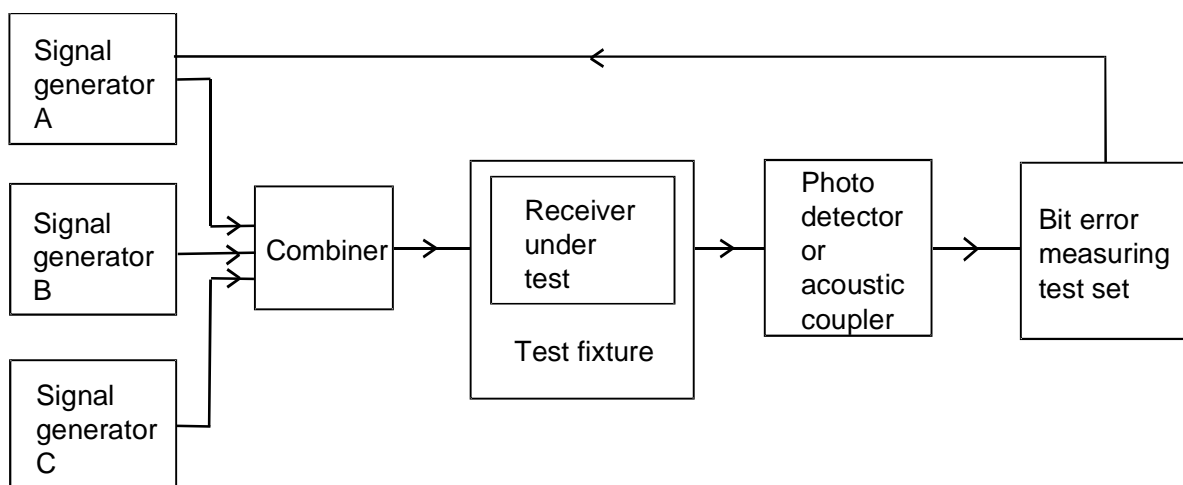

**Figure 14: Measurement arrangement - intermodulation response rejection**

- for equipment with permanent integral antenna the receiver antenna shall be coupled to the combiner via a test fixture as described in clause 8.1.2, figure 8 and clause 6.7;
- for equipment with permanent or temporary antenna connector the combiner shall be connected directly to the equipment antenna connector.



With the general conditions as described in clause 8.2.3:

- signal generator A, shall be modulated with D-M2, and shall be tuned to the nominal frequency of the receiver. The output level shall be adjusted to +6 dB above the declared sensitivity of the receiver;
- the frequencies of the unwanted signal generators B and C shall be adjusted to +15 MHz and +30 MHz above the frequency of the nominal wanted signal respectively;
- signal generator B shall be unmodulated and signal generator C shall be modulated with test modulation D-M2'. The output levels of signal generators B and C shall be kept equal and shall both be increased until the receiver is operating at a bit error ratio in the range  $0,5 \times 10^{-2}$  to  $2 \times 10^{-2}$ . The level shall be recorded;
- the measurement shall be repeated with the unwanted signals at -15 MHz and -30 MHz relative to the wanted signal;
- the power level of signal generators B and C is the intermodulation response rejection;
- the measured levels shall be recorded in the test report.

Intermodulation response rejection shall not be measured under extreme conditions.

### 8.3.6.3 Limits

The measured value for intermodulation response rejection under normal test conditions shall be  $\geq -25$  dBm.

## 8.4 Spurious emissions

### 8.4.1 Definition

Spurious emissions from the receiver are components at any frequency, radiated by the equipment and antenna.

The level of spurious emissions shall be measured as either:

- a) their power level in a specified load (conducted emission); and their effective radiated power when radiated by the cabinet and structure of the equipment (cabinet radiation); or
- b) their effective radiated power when radiated by the cabinet and the integral antenna.

Separate radiated spurious measurements need not be made on receivers co-located with transmitters which operate at continuous duty.

### 8.4.2 Method of measurement - conducted spurious emissions

This method of measurement applies to receivers which have a permanent antenna connector.

A 50  $\Omega$  power attenuator may be used to protect the measuring receiver (see clause 7.6.2) against damage when testing a receiver combined in one unit with a transmitter.

The measuring receiver used shall have sufficient dynamic range and sensitivity to achieve the required measurement accuracy at the specified limit. The resolution bandwidth shall be set to a suitable value to correctly measure a spurious emission at a level 6 dB below the limit value given in clause 8.4.5.

This bandwidth shall be recorded in the test report:

- a) the input terminals of the receiver under test shall be connected to a measuring receiver having an input impedance of 50  $\Omega$  and the receiver under test shall be switched on;
- b) the frequency of the measuring receiver shall be adjusted over the frequency range 25 MHz to 40 GHz. The frequency and the absolute power level of each of the spurious emissions found shall be noted;

- c) if the detecting device is not calibrated in terms of power input, the level of any detected components shall be determined by replacing the receiver by a signal generator and adjusting the signal generator to reproduce the frequency and level of every spurious emission noted in step b). The absolute power level of each spurious emission shall be noted;
- d) the frequency and level of each spurious emission measured and the bandwidth of the measuring receiver shall be recorded in the test report.

### 8.4.3 Method of measurement - cabinet radiation

This method of measurement applies to receivers which have a permanent antenna connector:

- a) a test site selected from annex A which fulfils the requirements of the specified frequency range of this measurement shall be used. The test antenna shall be oriented initially for vertical polarization and connected to a measuring receiver. The bandwidth of the measuring receiver shall be set to a suitable value to correctly measure a spurious emission at a level 6 dB below the limit value given in clause 8.4.5. This bandwidth shall be recorded in the test report.

The receiver under test shall be placed on the support in its standard position and connected to an artificial antenna, see clause 6.6;

- b) the radiation of any spurious component shall be detected by the test antenna and measuring receiver over the frequency range 25 MHz to 40 GHz. The frequency of each spurious emission shall be noted. If the test site is disturbed by radiation coming from outside the site, this qualitative search may be performed in a screened room with a reduced distance between the transmitter and the test antenna;
- c) at each frequency at which an emission has been detected, the measuring receiver shall be tuned and the test antenna shall be raised or lowered through the specified height range until the maximum signal level is detected on the measuring receiver;
- d) the receiver shall be rotated up to 360° about a vertical axis, to maximize the received signal;
- e) the test antenna shall be raised or lowered again through the specified height range until a maximum is obtained. This level shall be noted;
- f) the receiver antenna shall be replaced with the substitution antenna (see clause A.2.3) in the same position and in vertical polarization. The substitution antenna shall be connected to the signal generator;
- g) at each frequency at which an emission has been detected, the signal generator, substitution antenna and measuring receiver shall be tuned. The test antenna shall be raised or lowered through the specified height range until the maximum signal level is detected on the measuring receiver. The level of the signal generator giving the same signal level on the measuring receiver as in item e) shall be noted. This level, after correction due to the gain of the substitution antenna and the cable loss between the signal generator and the substitution antenna, is the level of the radiated spurious emission at this frequency;
- h) the frequency and level of each spurious emission measured and the bandwidth of the measuring receiver shall be recorded in the test report;
- i) measurements b) to h) shall be repeated with the test antenna oriented in horizontal polarization.

### 8.4.4 Method of measurement - radiated spurious components

This method of measurement applies to receivers which have an integral antenna:

- a) a test site selected from annex A which fulfils the requirements of the specified frequency range of this measurement shall be used. The test antenna shall be oriented initially for vertical polarization and connected to a measuring receiver. The bandwidth of the measuring receiver shall be set to a suitable value to correctly measure a spurious emission at a level 6 dB below the limit given in clause 8.4.5. This bandwidth shall be recorded in the test report.

The receiver under test shall be placed on the support in its standard position;

- b) the same method of measurement as items b) to i) of clause 8.4.3 shall apply.

## 8.4.5 Limits

The power of any spurious emission, outside the assigned frequency band, shall not exceed 2 nW in the range 25 MHz to 1 GHz and shall not exceed 20 nW on frequencies in the range 1 GHz to 40 GHz.

# 9 Layer 1: Method of measurements and limits for on-board units

## 9.1 OBU sensitivity

### 9.1.1 Definition

The OBU sensitivity is the minimum level power density expressed in dBm (received isotropically) that produces a wanted response from the OBU.

### 9.1.2 Method of measurement

To cover all applications the OBU shall be measured without material positioned in the radio path e.g. windscreen glass for vehicle installations.

The test arrangement shown in figure 15 shall be used.

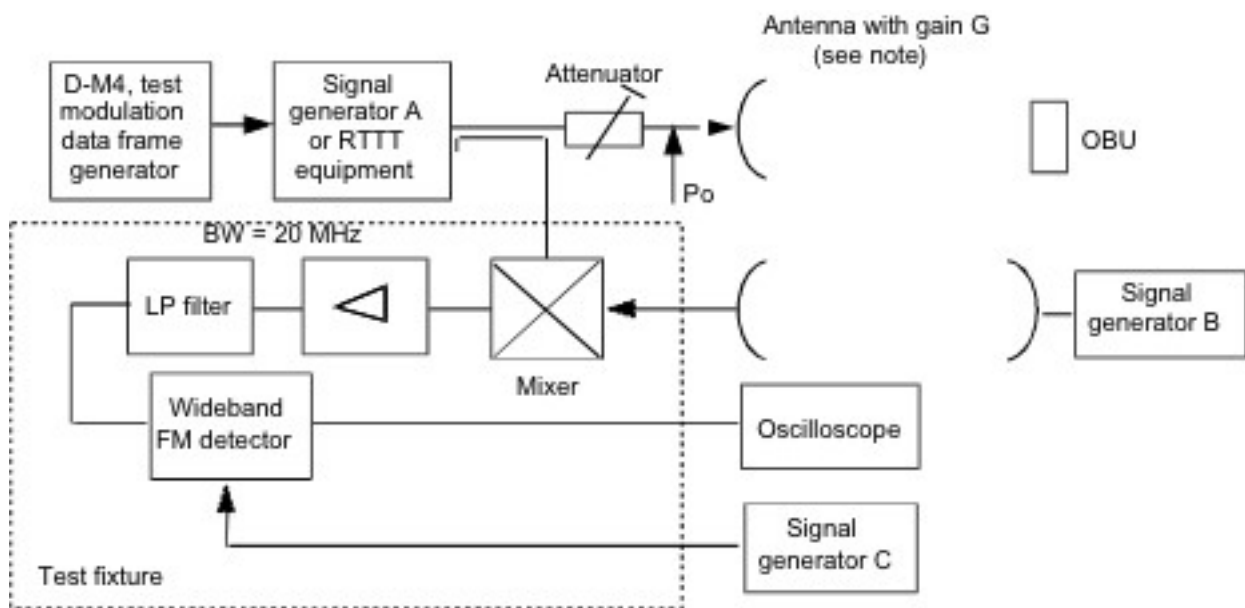

NOTE: The polarization of the test antenna shall be the same as defined for the RSU antenna.

**Figure 15: Measurement arrangement - OBU sensitivity**

- the test modulation, D-M4, shall conform with the access protocol for the application as declared by the manufacturer and shall be agreed with the test laboratory. The modulation index of the signal generator or the RTTT equipment shall be 0,5 or higher as declared by the manufacturer;
- before the measurements the transponder orientation angle,  $\alpha$ , shall be adjusted to a  $35^\circ$  angle in the worst-case direction. The worst case direction may be declared by the applicant. The angle  $\alpha$  shall be measured from the direction perpendicular to the intended direction of propagation;
- the correct OBU response shall be monitored at the RTTT receiver;

- d) the output power  $P_o$  shall be reduced by increasing the attenuator in steps of 1 dB until the correct response of the OBU stops;
- e) the attenuation shall be reduced by 1 dB;

NOTE 1: The OBU will start responding again.

- f) the output power  $P_o$  shall be measured with a spectrum analyser;
- g) the test shall be repeated with angle  $\alpha$  adjusted to  $0^\circ$  (boresight).

The OBU sensitivity in dBm,  $P_{sens}$ , is calculated as:

$$P_{sens} = (\text{output power } P_o) + (\text{antenna gain } G) - (\text{circulator loss}) - (\text{propagation loss}).$$

The propagation loss is calculated as  $20 \log(4 \pi D) / \lambda$ .

NOTE 2: At 5,8 GHz and a measuring distance  $D = 0,5$  m the propagation loss is 41,7 dB.

### 9.1.3 Limits

The sensitivity of the OBU during normal and extreme test conditions shall be better than the limits given in table 11.

**Table 11: Sensitivity limit**

OBU orientation	Normal test conditions	Extreme test conditions
in boresight	-40 dBm	-40 dBm

## 9.2 On board unit access

### 9.2.1 Definition

The OBU shall be designed to respond to appropriately modulated signals only and shall not respond to wrong codes or to any simple carrier frequency.

### 9.2.2 Method of measurement

The test arrangement in figure 16 shall be used.

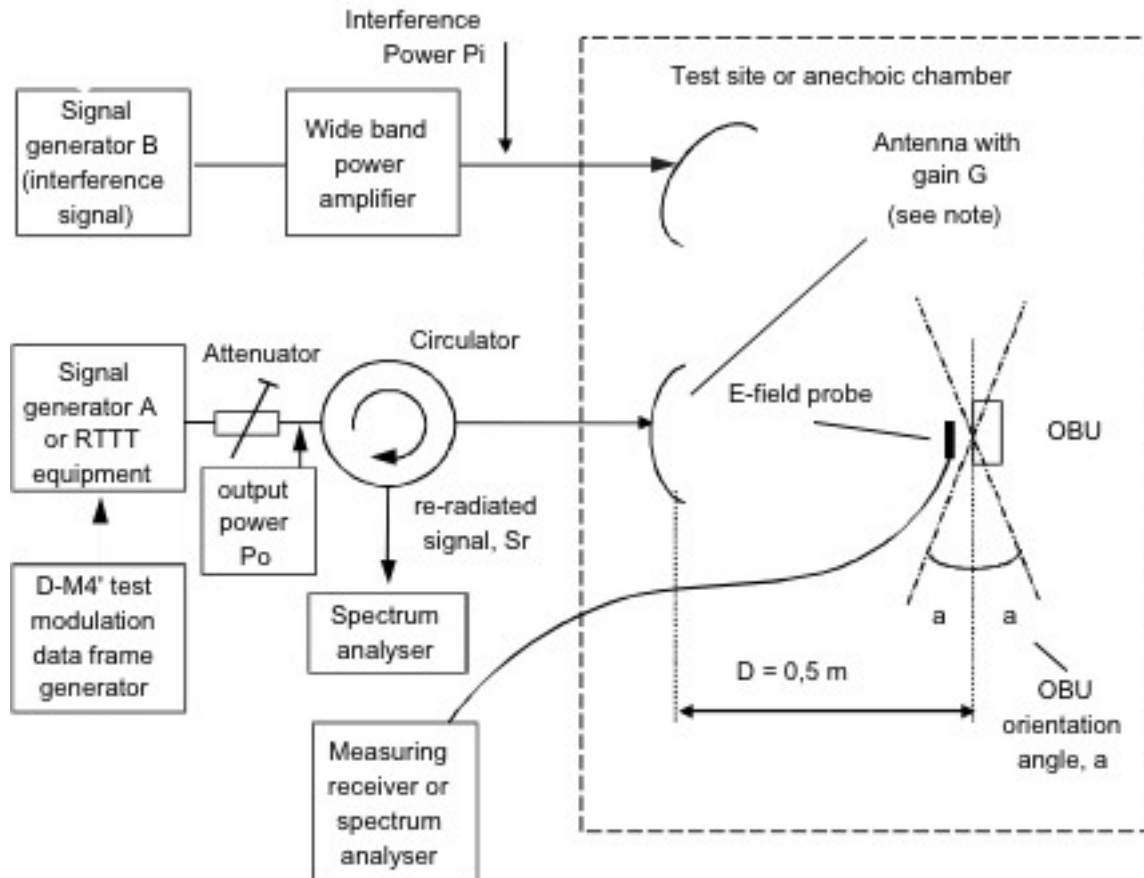

NOTE: The polarization of the test antenna shall be the same as defined for the RSU antenna.

**Figure 16: Test arrangement - OBU access**

For measurements at 5,8 GHz, the output power of signal generator A shall be adjusted to a level approximately 10 dB above the OBU sensitivity, see clause 9.1.

The orientation angle  $a$  shall be set to  $0^\circ$ .

With signal generator B switched off the OBU shall be exposed to fields modulated with incorrect data frames by modulating signal generator A or a RTTT equipment with test modulation D-M4'.

The OBU response shall be monitored at the spectrum analyser.

The signal generator B shall be switched on. The above measurements shall be repeated in the presence of an unmodulated interference field at the spot frequencies as shown in table 12.

**Table 12: Interference test frequencies and levels**

Frequency	100 MHz	250 MHz	900 MHz	1,8 GHz	2,45 GHz	5,8 GHz	7,5 GHz	12 GHz
Interference Field strength V/m	10	10	10	10	15	15	1,5	1,5

To set the interference frequency and field strength the following procedure shall be used:

- signal generator B shall be adjusted to the specified frequency according to table 12;
- the output level of signal generator B shall be adjusted to the required field strength according to table 12, by one if the following methods;
- either:
  - the OBU shall be replaced with a calibrated E-field probe;
  - the level of signal generator B shall be adjusted until the specified E-field according to table 12 is measured on the E-field probe;
  - the E-field probe shall be replaced by the OBU and the interference measurement shall be performed; or
  - the necessary interference power  $P_i$  shall be calculated by using the following formula:

$$P_i(\text{dBm}) = 20 \log E + 20 \log d_2 - G_2 + 15,2$$

- $P_i$  is power in dBm into the interference antenna with gain;
- $d_2$  is the distance in metres between the reference antenna and the OBU;
- $G_2$  is the gain in dB of the interference antenna.

### 9.2.3 Limits

Under normal test conditions the OBU shall meet the following requirements:

- the OBU shall not respond to D-M4' test signals;
- the OBU shall not respond to interference fields at spot frequencies defined in clause 9.2.2;
- the OBU shall respond to D-M4 after the interference field tests.

## 9.3 Transponder conversion gain

This clause only applies to transponders. Transceivers are measured for maximum output power according to clause 9.4.

### 9.3.1 Definition

The conversion gain is the difference between the transponder received and the re-radiated subcarrier power.

### 9.3.2 Method of measurement

The test arrangement shown in figure 17 shall be used.

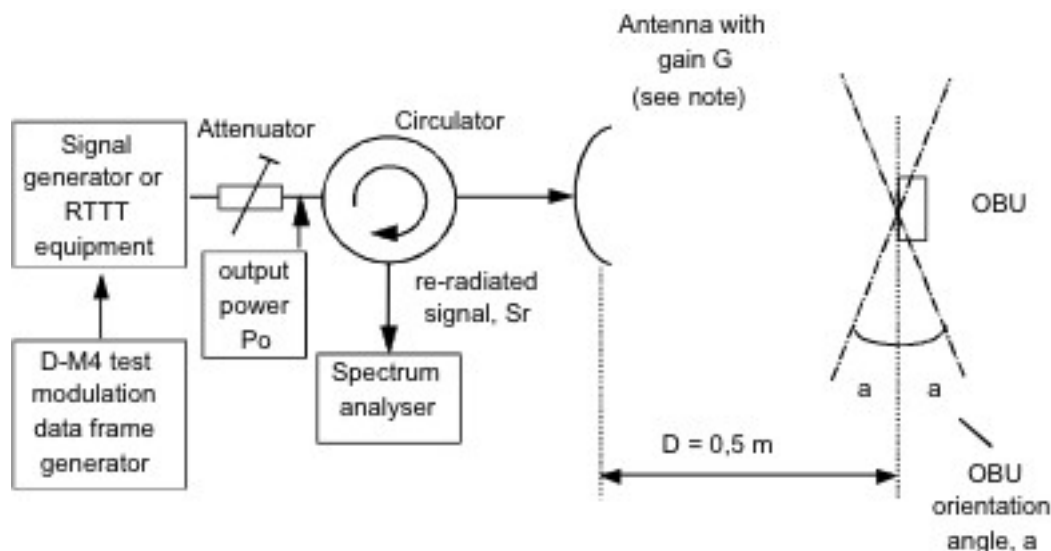

NOTE: The polarization of the test antenna shall be identical to that of the OBU.

**Figure 17: Measurement arrangement - OBU conversion gain**

The procedure is as follows:

- a) the modulation of RTTT transmitter or the signal generator shall conform with the access protocol intended for the application;
- b) if possible, the transponder shall be commanded or by other means set to a test mode that only is re-radiating an unmodulated subcarrier (test mode);
- c) before the measurements the transponder orientation angle,  $a$ , shall be adjusted to a  $35^\circ$  angle in the worst-case direction. The worst case direction may be declared by the applicant. The angle  $a$  shall be measured from the direction perpendicular to the intended direction of propagation;
- d) the output power level of the RTTT transmitter or the signal generator after the attenuator,  $P_0$  shall be adjusted to approximately 6 dB above the declared OBU sensitivity level;
- e) the modulation of the RTTT transmitter or signal generator shall be switched off;
- f) the re-radiated signal,  $S_r$  of the upper sideband, is measured with the spectrum analyser adjusted to 100 kHz bandwidth;
- g) the output power  $P_0$  is measured with a spectrum analyser;
- h) the procedure shall be repeated with angle  $a$  adjusted to  $0^\circ$  (boresight).

The conversion gain (CG) in dB at the upper side band is calculated as:

$$CG = (\text{re-radiated signal, } S_r) - 2 [(\text{antenna gain, } G) - (\text{propagation loss})] + (\text{circulator and cable loss}) - P_0.$$

The propagation loss shall be calculated according to clause 9.1.2.

### 9.3.3 Limits

The conversion gain of the transponder during normal and extreme test conditions shall be higher than the value given in table 13. No upper limits are mandated for Conversion Gain. The maximum radiation subcarrier output power is limited in the next Clause.

**Table 13: Transponder conversion gain limit**

Transponder orientation	Normal test conditions	Extreme test conditions
In boresight	> 0 dB	> 0 dB
Boresight $\pm 35^\circ$	> -5 dB	> -5 dB

## 9.4 OBU maximum radiated subcarrier

### 9.4.1 Definition

The OBU maximum radiated subcarrier(s) is the maximum re-radiated subcarrier from the OBU independent of the incident signal level. This test method also applies to the output power of a transceiver.

### 9.4.2 Method of measurement

The test arrangement is shown in clause 9.3.2 (figure 17). The procedure is as follows:

- the modulation test signal D-M4 of the RTTT transmitter or the signal generator shall conform with the access protocol intended for the application;
- the OBU shall be commanded or set by other means in a test mode that only radiates a subcarrier without modulation;
- the transponder orientation angle,  $\alpha$ , shall be adjusted to  $0^\circ$ . The angle  $\alpha$  shall be measured from the direction perpendicular to the intended direction of propagation;
- the modulation of the RTTT transmitter or signal generator shall be switched off;
- the output power level after the attenuator,  $P_o$  shall be increased from the declared sensitivity level (approximately -40 dBm) to -14 dBm referred to the input of the OBU. These levels are calculated based on the input power to the test antenna and the propagation loss;
- the re-radiated signal,  $S_r$ , shall be measured on each side band with the spectrum analyser bandwidth adjusted to 100 kHz;
- the procedure shall be repeated under extreme test conditions.

The OBU maximum radiated subcarrier in dBm,  $P_r$ , is calculated as:

$$P_r = (\text{measured re-radiated signal, } S_r) - (\text{antenna gain, } G) + (\text{circulator \& cable loss}) + (\text{propagation loss}).$$

### 9.4.3 Limits

The measured value for the maximum re-radiated e.i.r.p. subcarrier for the transponder for each side band during normal and extreme test conditions shall be less than -14 dBm. The Upper Communication Power Limit (parameter D11b) shall be limited to -17 dBm.



## 9.5 OBU frequency error

### 9.5.1 Definition

The frequency error of the OBU is the difference between the unmodulated carrier frequency and the nominal frequency after the time when the first OBU data bits are transmitted in response to a RSU command, see illustration in figure 18.

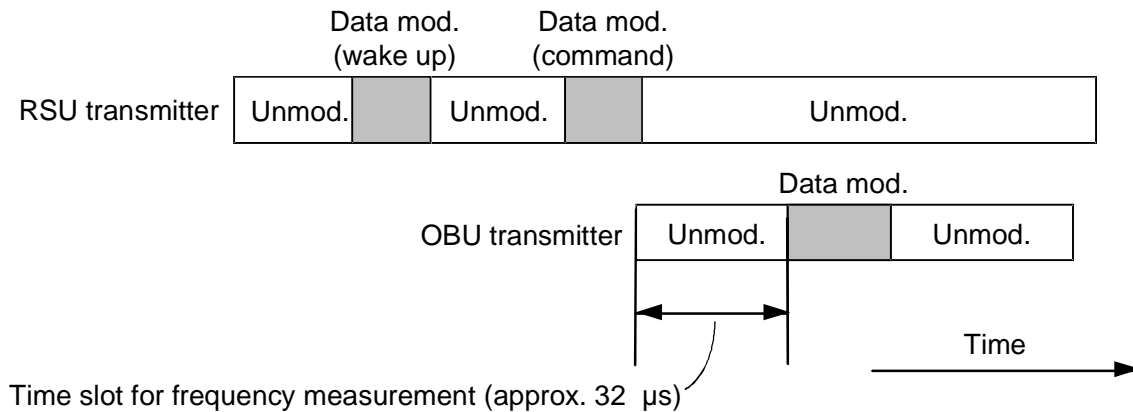

**Figure 18: Time slot for measuring OBU frequency error**

### 9.5.2 Method of measurement

The test arrangement shown in figure 19 shall be used.

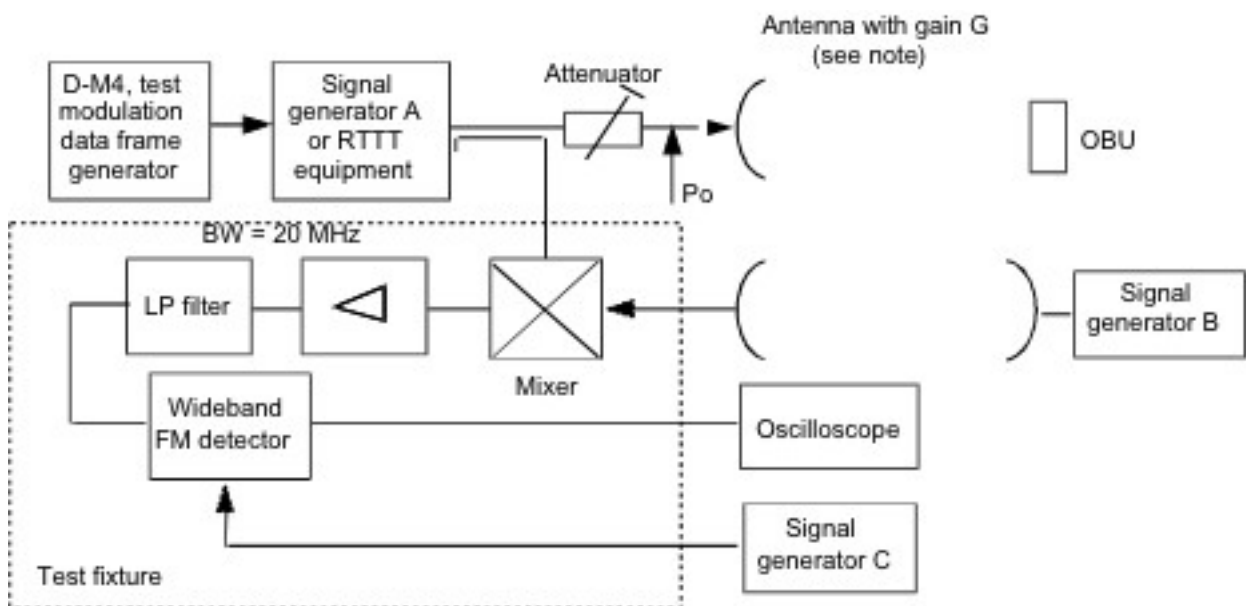

NOTE: The polarization of the test antenna shall be identical to that of the OBU.

**Figure 19: Measurement arrangement - OBU frequency error**

The test fixture shall be supplied by the manufacturer together with the necessary documentation and calibration information.

The measurement procedure shall be as follows:

- the frequency of signal generator C shall be adjusted to the nominal subcarrier frequency of the OBU. The level of signal generator C shall be adjusted as declared by the manufacturer's documentation;
- signal generator B shall be switched off;

- c) the test modulation of signal generator A (or RTTT equipment) shall be switched off;
- d) the output power of signal generator A (or RTTT equipment) after the attenuator,  $P_o$ , shall be adjusted to achieve a power density producing an input level of -14 dBm, as measured with a 0 dBi antenna, at the position of the OBU;
- e) signal generator B shall be switched on without modulation. The output level is adjusted to achieve a power density producing an input level -14 dBm, as measured with a 0 dBi antenna, at the position at the position of the OBU;
- f) the frequency of signal generator B shall be adjusted to the nominal frequency of the RTTT receiver; The storage oscilloscope shall be adjusted for full positive and negative deflection for frequency changes of signal generator B of plus and minus 5 ppm (29 kHz);
- g) signal generator B shall be switched off;
- h) signal generator A (or RTTT equipment) shall be modulated with a single interrogating burst of test modulation D-M4. The frequency change shall be measured on the oscilloscope and recorded in the test report. This shall be repeated 10 times;
- i) the frequency error is the largest measured deviation from nominal frequency during the time slot shown in figure 18;
- j) the procedure shall be repeated under extreme test conditions.

### 9.5.3 Limits

The frequency error under normal and extreme conditions shall not exceed:

- $\pm 5$  ppm (transceiver OBU only);
- $\pm 0,1$  % of declared subcarrier freq.

## 9.6 OBU spurious radiation

### 9.6.1 Definition

The OBU spurious emissions are emissions at frequencies, other than those of the OBU subcarriers and sidebands associated with normal modulation, radiated by the OBU.

The spurious radiations are specified as the radiated power of any discrete signal.

### 9.6.2 Method of measurement

The measurements shall be made at the following spot frequencies except at the declared sub-carrier frequency(ies):

- $f_o \pm 1,0$  MHz;
- $f_o \pm 1,5$  MHz;
- $f_o \pm 2,0$  MHz;
- $f_o \pm 3,0$  MHz;
- $f_o \pm 3,5$  MHz;
- $f_o \pm 4,0$  MHz; and
- $f_o \pm 5,0$  MHz;

where  $f_o$  is RSU transmit frequency.

The test arrangement is shown in clause 9.3.2, figure 17. The procedure shall be as follows:

- a) the modulation test signal D-M4 of the RTTT transmitter or the signal generator shall conform with the access data frame protocol intended for the application;
- b) if possible, the OBU shall be commanded or set by other means into a test mode that only radiates subcarrier(s) without modulation;
- c) the transponder orientation angle,  $\alpha$ , shall be adjusted to  $0^\circ$ . The angle  $\alpha$  is measured from the direction perpendicular to the intended direction of propagation;
- d) the output power level after the attenuator,  $P_o$  shall be adjusted to achieve a power density producing an input of -14 dBm at the OBU as measured with a 0 dBi antenna;
- e) the spurious emissions are measured according to annex B;
- f) the OBU spurious emissions are measured in the frequency range 25 MHz to 40 GHz. The measuring bandwidth shall be adjusted to 100 kHz.

### 9.6.3 Limits

Under normal test conditions, the OBU spurious emissions shall be below the limit shown in table 14.

**Table 14: OBU spurious emission limits**

State	< 1 GHz	Inside allocated frequency band except at subcarrier frequency(ies)	Outside the allocated frequency band in the 1 GHz to 40 GHz range
Operating	-36 dBm	-42 dBm	-30 dBm
Stand-by	-57 dBm	-47 dBm	-47 dBm

---

## 10 Layer 2 parameters and procedures

### 10.1 General conditions

The frame format, fields and related limits shall be as specified in this clause, and shall be valid both for the RSU and the OBU. Specific protocol procedures, parameters and related limits for the RSU shall be as specified in clause 10.7. Specific protocol procedures, parameters and related limits for the OBU shall be as specified in clause 10.9.

### 10.2 Frame Structure

#### 10.2.1 Definition

All transmissions shall be in frames. Each frame shall conform to the structure according to [10] as shown in figure 20.



**Figure 20: Frame structure**

As indicated in figure 20, a single frame shall be made of four different fields: an opening flag, a closing flag, a field containing the Layer 2 Protocol Data Unit (LPDU) and a frame check sequence for error detection.

## 10.2.2 Limits

### 10.2.2.1 Validity of frames

The LLC shall inspect all received frames to assess their validity.

A received frame shall be considered valid if:

- the frame is correctly delimited by start and end flags according to clause 10.3;
- the frame, after deletion of zero bits inserted for transparency, contains a number of bits corresponding exactly to an integer multiple number of octets;
- the LPDU does not consist of too many octets, see parameters N2 and N3 in clause 10.2.2.4;
- the frame contains a valid FCS field according to clause 10.5; and
- the frame contains a valid LPDU.

If the frame received is not valid it shall be discarded.

### 10.2.2.2 Bit order

Flag and LPDU field shall be transmitted with the LSB first in each octet. The FCS shall be transmitted with the coefficient of the highest term first.

### 10.2.2.3 Transparency

The occurrence of the flag within a frame other than the start and end flags shall be prevented by a zero bit insertion procedure as follows.

The transmitter shall insert a 0 bit following five contiguous 1 bits anywhere between the start flag and the end flag of the frame. The insertion of the 0 bit thus applies to the contents of the LPDU Field and the FCS.

The receiver shall continuously monitor the received bit stream. After receiving five contiguous '1' bits, the receiver shall inspect the following bit. If it is a '0' bit, the five '1' bits shall be passed as data and the '0' bit shall be deleted. If the sixth bit is a '1' bit, the receiver shall inspect the seventh bit. If this bit is a '0' bit, a valid flag has been received; if it is a '1' bit, an abort has been received, and the receiving station shall ignore that frame.

### 10.2.2.4 Frame length

Frames shall not exceed the lengths as specified in table 15.

**Table 15: Frame length limits**

N2	maximum number of octets in frame in downlink	64 octets
N3	maximum number of octets in frame in uplink	64 octets

NOTE: The maximum number of octets as presented in table 15 does not include zero bits inserted as presented above. Thus bit insertion may increase the frame length above the limits given in table 15.

## 10.3 Opening and closing flags

### 10.3.1 Definition

All frames shall start and end with a flag. A flag is a '0' bit followed by six '1' bits followed by a zero bit, i.e. '0111110'B = '7E'H.

## 10.3.2 Limits

When in receiving state, all stations shall continuously check on a bit-by-bit basis for the flag sequence. A transmitter shall send only complete eight bit flags.

The flag which ends a frame shall not be used as the start flag for the next frame.

There shall be only a single start flag and a single stop flag per frame.

## 10.4 LPDU

### 10.4.1 Definition

All LPDUs being part of the frame presented in figure 20 shall conform to the format shown in figure 21.

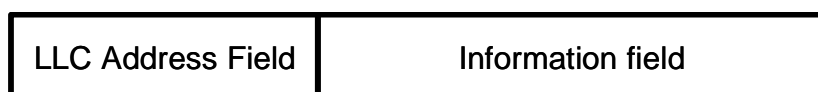

Figure 21: LPDU format

The LLC address field shall conform to the format shown in figure 22,

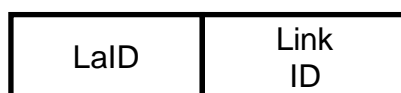

Figure 22: LLC Address field

where:

- **LaID** identifies the L2 endpoint, i.e. the LaID points to an instance of an application in the application layer. The format of the LaID shall be as shown in figure 23. The most significant bit is presented on the left hand side.



Figure 23: LaID Field format

- **Link ID:** LPDU address field extension.

### 10.4.2 Limits

The information field shall consist of an integral number of octets.

The LaID shall be two octets long. Its most significant six bits are fixed and shall be set as shown in the diagram. The 10 least significant bits shall be set by the Application Layer. In transmit mode, the value in the complete LaID field shall be equal to the "AP Invocation Identifier" presented in tables 16 and 40. Evaluation of the value in the LaID field in receive mode shall be done at the application layer.

The Link ID shall be two octets long. It shall be set as specified in clauses 10.8.1 and 10.9.1.

An invalid LPDU shall be defined as one which meets the following condition:

- The LPDU length is 0 (no LLC address field and no information field).

## 10.5 Frame check sequence

### 10.5.1 Definition

All frames shall include a FCS just prior to the closing flag for error detection purposes. The contents of the LPDU shall be included in the calculation of the FCS.

### 10.5.2 Limits

The FCS shall be compliant with a 16-bit frame checking sequence as defined in [10]. The generator polynomial shall be  $X^{16} + X^{12} + X^5 + 1$ , and the initial value used shall be 'FFFF'H. The ones complement of the resulting remainder shall be transmitted as the 16-bit FCS.

## 10.6 Frame transmission procedure

Upon request of the application layer to transmit a frame, the LLC layer shall:

- Allocate a Link ID as explained in clause 10.8.1 for the RSU case, and in clause 10.9.1 for the OBU case.
- Build an LLC address field as shown in figure 22.
- Calculate the FCS.
- Create a frame.
- Use Layer 1 services to deliver the frame.

## 10.7 Frame reception procedure

If a frame received from Layer 1 is valid, see clause 10.2.2, then the LPDU contained in it shall be further processed:

- the value of the LaID part of the LLC address field shall be used to identify uniquely the application entity to which the content of the information field shall be passed;
- the information field value, see figure 21, shall be passed to the entity of the application layer identified by the value of the LaID field.

## 10.8 Specific Road Side Unit parameters and procedures

The Layer 2 unit of observation and test is the frame. The frame format, fields and related limits are specified in clause 10, and are valid both for the RSU and the OBU. This clause contains the definition of RSU specific procedures.

### 10.8.1 Link ID allocation

Different behaviours may occur according to the type of transmission chosen by the application layer:

- For broadcast transmission, all bits of the Link ID shall be set to zero.
- For a private transmission with communication already in place, the Link ID shall be the same as previously used.
- A new private Link ID shall be generated in case communication to a new OBU is to be established, with the following rules:
  - the Link ID shall be an integer number;
  - each new Link ID shall be generated on a random basis by taking the latest generated Link ID and incrementing it by at least three modulo 65 536. The value zero shall not be used as it is reserved for broadcast transmission.

## 10.8.2 Frame transmission

Whenever the RSU sends a message, a reply is expected from the OBU. The maximum time for transmission of a frame shall be  $T_{dmax} = 590 \mu s$ .

If the reply is not received or the frame received is invalid, the RSU shall retransmit the same message after an interval of time  $T_1 = 10 \text{ ms} \pm 1 \text{ ms}$  defined as polling time. Figure 24 shows an RSU-OBU communication diagram.

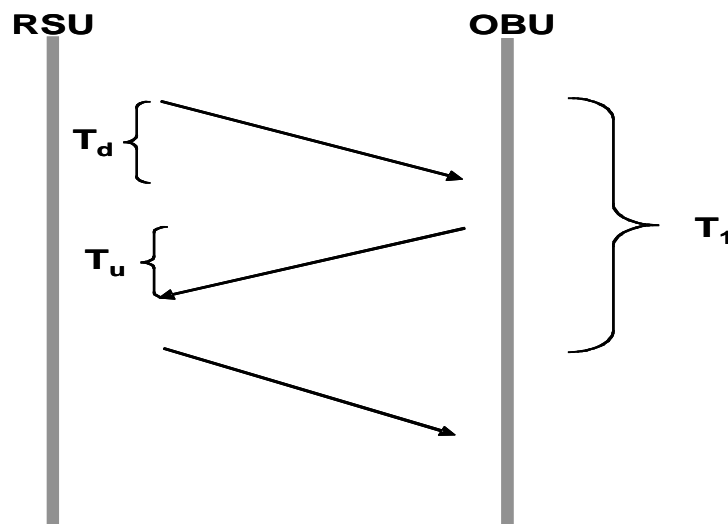

Figure 24: RSU - OBU communication diagram

NOTE: The Polling Time  $T_1$  basically depends on the allowed maximum  $T_{dmax} = 590 \mu s$  of the communication time  $T_d$  in the downlink and the allowed maximum  $T_{umax} = 3,8 \text{ ms}$  of the communication time  $T_u$  in the uplink:

$$T_1 > T_{dmax} + T_{umax}$$

## 10.8.3 Frame reception

An RSU shall only process responses to previously issued commands. Consequently, any other responses shall be discarded.

## 10.9 Specific On Board Units (OBUs) parameters and functions

The Layer 2 unit of observation and test is the frame. The frame format, fields and related limits are specified in clause 10, and are valid both for the RSU and the OBU. This clause contains the definition of OBU specific procedures.

### 10.9.1 Link ID allocation

The Link ID at the OBU side shall be equal to the one received in the previous frame.

### 10.9.2 Frame transmission

There is no minimum time before starting transmission of the response PDU. The maximum time for transmission of a frame shall be  $T_{umax} = 3,8 \text{ ms}$  (see clause 10.8.2).

### 10.9.3 Frame reception

The Data Link Layer shall not keep track of sequences of messages, as on reception of a duplicate message, the previously prepared response shall be sent again by the application layer.

---

# 11 Layer 7 parameters and procedures

## 11.1 General conditions

Application protocol data units (APDUs), protocol messages and parameters shall be as specified in ASN.1 in clause 11.2, and coded according to the encoding rules specified in clause 11.4.

For each protocol message, this clause gives the general definitions and parameters to be measured. Clause 11.5 bears RSU specific parameters and procedures. Clause 11.6 bears OBU specific parameters and procedures.

## 11.2 General protocol rules

The Layer 7 protocol is highly asymmetrical, i.e. it identifies two distinct roles:

- a) The master role, which is always played by the RSU.
- b) The slave role, which is always played by the OBU.

Request protocol messages, referred to as directives, shall only be issued by the RSU, while response protocol messages shall only be issued by the OBU.

### 11.2.1 Protocol data unit formats

An APDU shall be carried in the Information field of the LPDU (see clause 10.4.1).

An APDU can be either a Request - PDU or a Response - PDU. Both Request - PDU and Response - PDU are sub-structured in a header part and in a body part. The body part may contain a single directive or several concatenated directives.

The PDU formats for these two types are formally specified in clause 11.2, and described separately for the RSU in clause 11.5.1 and for the OBU in clause 11.6.1.

### 11.2.2 Concatenation

Multiple directives may be concatenated in the body part of a single APDU. Rules for concatenating directives are given in clause 11.5.1.

The Close-Rq directive, if present in a frame, shall be the last directive in a concatenated sequence of directives. An OBU shall ignore all directives following a Close-Rq directive in a concatenated sequence of directives, and shall indicate an error with "Result"='15'H and "Diagnostic"='02'H in the response frame.

On reception of a set of concatenated directives, a corresponding set of concatenated responses shall be generated. Rules for concatenating response messages are given in clause 11.6.1.

### 11.2.3 Sessions

A session between a RSU and an OBU is created with the Open-Rq directive and deleted with the Close-Rq directive. Different sessions shall be distinguished by the value of "Link ID" contained in the LLC address field presented in figure 22.

The following rules shall apply:

- All directives issued by the RSU in order to retrieve parameter values from an OBU, i.e.:
  - Read-Master-Core-Rq
  - Read-Appl-Core-Rq
  - Read-Appl-Record-Rq



- Read-Data-From-External-Rq

shall be accepted and processed by the OBU without the need of a valid active session.

- A Close-Rq directive shall only be issued by a RSU within a valid active session.
- A Get-Master-Record-Rq directive shall only be issued by a RSU within a valid active session.
- A Set-UIF-Rq directive shall be accepted and processed by the OBU without the need of a valid active session.
- All directives issued by the RSU in order to set parameter values in an OBU, i.e.:
  - Write-Appl-Core-Rq
  - Write-App-Core-Conf-Rq
  - Write-Appl-Record-Curr-Rq
  - Write-Appl-Record-Curr-Conf-Rq
  - Write-Appl-Record-Next-Rq
  - Write-Data-To-External-Rq

shall be accepted and processed by the OBU only within a valid active session. Otherwise the request shall be acknowledged with an error code.

- All directives issued by the RSU to provide the means for security mechanisms, i.e.:
  - Set-Password-Rq
  - Use-Last-Password-Rq
  - Get-TBA-Random-Rq
  - Set-Credential-Rq
  - Get-Credential-Rq

shall be accepted and processed by the OBU only within a valid active session. Otherwise the request shall be acknowledged with an error code.

- A Read-Display-Type-Rq directive shall only be accepted and processed by an OBU within a valid active session. Otherwise the request shall be acknowledged with an error code.
- A Select-TBA-Id-Rq directive shall only be issued by a RSU within a valid active session. The OBU may signal an invalid behaviour with an error code.

## 11.3 Protocol messages and parameters: ASN.1 definitions

The following ASN.1 modules contain the definitions of protocol data units and related parameters.

```
EFC-ACSE { itu-t(0) identified-organization(4) etsi(0) itsDomain(5) wg2(2) en3006740301-1 }
```

```
DEFINITIONS ::= BEGIN
  EXPORTS Data-String, Bit-String-1B, Integer-0-1B, Integer-1-1B,
    Read-Data, Write-Data,
    RequestPduHeader, ResponsePduHeader,
    RequestMessages,
    Open-Rq, Close-Rq, Read-Display-Type-Rq;

  Request-PDU ::= SEQUENCE {
    header RequestPduHeader,
    body RequestPduBody OPTIONAL}

  Response-PDU ::= SEQUENCE {
    header ResponsePduHeader,
    body ResponsePduBody }
```

```
RequestPduHeader ::= SEQUENCE {
    callingApTitle      CallingApTitle,
    respondingMode      RespondingMode,
    numberOfDirectives  NumberOfDirectives }

```

CallingApTitle ::= Data-String (SIZE(4)) -- see "Calling AP Title" in table 16

RespondingMode ::= Bit-String-1B -- see "Responding Mode" in table 16

response-not-required RespondingMode ::= { bit1 }

response-fast-speed RespondingMode ::= { bit2 }

response-normal-speed RespondingMode ::= { bit3, bit2 }

-- Note that bit8 + bit4 are reserved and that:

	bit	8	7	6	5	4	3	2	1
-- a) response-not-required:		r	r	r	r	r	x	x	1
-- b.1) response-required-and-fast-speed:		r	r	r	r	r	r	0	1
-- b.2) response-required-and-slow-speed:		r	r	r	r	r	x	0	0
-- b.3) response-required-and-normal-speed:		r	r	r	r	r	1	1	0

-- where r = reserved and x = any.

NumberOfDirectives ::= Integer-1-1B -- see "Number of Directives" in table 16

```
RequestPduBody ::= SEQUENCE {
    open-message          [0] Open-Rq OPTIONAL,
    request-messages      [1] RequestMessages OPTIONAL,
    close-message         [2] Close-Rq OPTIONAL }

```

RequestMessages ::= SET OF RequestMessage

```
RequestMessage ::= CHOICE {
    read-display-type      [0] Read-Display-Type-Rq,
    read-appl-core        [1] Read-Appl-Core-Rq,
    read-appl-record      [2] Read-Appl-Record-Rq,
    read-master-core      [3] Read-Master-Core-Rq,
    select-tba-id         [4] Select-TBA-Id-Rq,
    write-appl-core       [5] Write-Appl-Core-Rq,
    write-appl-core-conf  [6] Write-Appl-Core-Conf-Rq,
    write-appl-record-curr [7] Write-Appl-Record-Curr-Rq,
    write-appl-record-curr-conf [8] Write-Appl-Record-Curr-Conf-Rq,
    write-appl-record-next [9] Write-Appl-Record-Next-Rq,
    write-appl-record-next-conf [10] Write-Appl-Record-Next-Conf-Rq,
    action                [11] Action-Rq }

```

```
ResponsePduHeader ::= SEQUENCE {
    calledApTitle      CalledApTitle,
    response-area      Response-Area }

```

CalledApTitle ::= Data-String (SIZE(5)) -- see "Called AP Title" in table 40

Response-Area ::= CHOICE { -- see A-Association.response parameters in table 40

```
ack          [0] Ack-Response,
mismatch     [1] Mismatch-Response,
nack         [2] Nack-Response }

```

Ack-Response ::= SEQUENCE {

```
ack          Bit-String-1B ({bit3, bit2}), -- '06'H, see "Result" in table 40
ack-sense-code CHOICE { -- see "Diagnostic" in table 40
    no-sense      [0] Bit-String-1B ({}), -- '00'H
    no-card       [1] Bit-String-1B ({bit1}), -- '01'H
    wrong-tba-id  [2] Bit-String-1B ({bit3, bit1}), -- '05'H
    not-configured [3] Bit-String-1B ({bit3, bit2}) } -- '06'H

```

Mismatch-Response ::= SEQUENCE {

```
mismatch      Bit-String-1B ({bit1}), -- '01'H, see "Result" in table 40
mismatch-sense-code Bit-String-1B ({} ) -- '00'H, see "Diagnostic" in table 40

```

Nack-Response ::= SEQUENCE {

```
nack          Bit-String-1B ({bit5, bit3, bit1}), -- '15'H, see "Result" in table 40
nack-sense-code CHOICE { -- see "Diagnostic" in table 40
    no-card       [0] Bit-String-1B ({bit1}), -- '01'H
    not-in-session [1] Bit-String-1B ({bit2}), -- '02'H
    directive-unknown [2] Bit-String-1B ({bit2, bit1}), -- '03'H
    directive-failure [3] Bit-String-1B ({bit3}), -- '04'H
    opc-failure    [4] Bit-String-1B ({bit3, bit1}), -- '05'H

```

```

    not-configured      [5] Bit-String-1B ({bit3, bit2}), -- '06'H
    buffer-overflow     [6] Bit-String-1B ({bit3, bit2, bit1}), -- '07'H
    buffer-full        [7] Bit-String-1B ({bit4, bit1}), -- '09'H
    hardware-error     [8] Bit-String-1B ({bit5}), -- '10'H
    invalid-operation  [9] Bit-String-1B ({bit5, bit1}) } } -- '11'H

ResponsePduBody ::= SET OF ResponseMessage

ResponseMessage ::= CHOICE {
    read-display-type      [0] Read-Display-Type-Rs,
    read-appl-core        [1] Read-AppI-Core-Rs,
    read-appl-record-curr [2] Read-AppI-Record-Rs,
    read-master-core      [3] Read-Master-Core-Rs,
    action-results        [4] Action-Rs }

Open-Rq ::= SEQUENCE { id Bit-String-1B ({bit5}) }

Close-Rq ::= SEQUENCE { id Bit-String-1B ({bit5, bit1}) }

Read-Display-Type-Rq ::= SEQUENCE { id Bit-String-1B ({bit4, bit1}) }

Select-TBA-Id-Rq ::= SEQUENCE {
    id Bit-String-1B ({bit5, bit3, bit1}),
    lengthRespondingApTitle Integer-1-1B,
    respondingApTitle      Data-String }

Read-Master-Core-Rq ::= SEQUENCE {
    id Bit-String-1B ({bit1}),
    read-data-info      Data-Info }

Read-AppI-Core-Rq ::= SEQUENCE {
    id Bit-String-1B ({bit2}),
    read-data-info      Data-Info }

Read-AppI-Record-Rq ::= SEQUENCE {
    id Bit-String-1B ({bit2, bit1}),
    read-data-info      Data-Info }

Write-AppI-Core-Rq ::= SEQUENCE {
    id Bit-String-1B ({bit3, bit1}),
    common-part         Write-Common-Part }

Write-AppI-Core-Conf-Rq ::= SEQUENCE {
    id Bit-String-1B ({bit5, bit4, bit1}),
    common-part         Write-Common-Part }

Write-AppI-Record-Curr-Rq ::= SEQUENCE {
    id Bit-String-1B ({bit3, bit2}),
    common-part         Write-Common-Part }

Write-AppI-Record-Curr-Conf-Rq ::= SEQUENCE {
    id Bit-String-1B ({bit6}),
    common-part         Write-Common-Part }

Write-AppI-Record-Next-Rq ::= SEQUENCE {
    id Bit-String-1B ({bit3, bit2, bit1}),
    common-part         Write-Common-Part }

Write-AppI-Record-Next-Conf-Rq ::= SEQUENCE {
    id Bit-String-1B ({bit6, bit1}),
    common-part         Write-Common-Part }

Action-Rq ::= SEQUENCE {
    write-data-to-external-rq SEQUENCE {
        id          Bit-String-1B ({bit6, bit5, bit1}),
        mode        CHOICE {
            immediate [0] Bit-String-1B ({bit1}),
            deferred  [1] Bit-String-1B ({bit2})},
        address     Bit-String-1B ({bit8, bit7, bit6, bit5, bit4, bit3, bit2, bit1}),
        wait-time   Integer-0-1B (0),
        data-length Integer-1-1B,
        data        Write-Data },
    read-data-from-external-rq SEQUENCE {id Bit-String-1B ({bit5, bit3, bit2, bit1})} }

Data-Info ::= SEQUENCE {
    data-offset Integer-0-1B,
    data-length Integer-0-1B }

```

```

Write-Data ::= Data-String

Write-Common-Part ::= SEQUENCE {
    write-data-info    Data-Info,
    data               Write-Data }

Read-Display-Type-Rs ::= CHOICE {
    numeric-display    [0] Bit-String-1B ({bit7, bit1} ),
    alpha-numeric-display [1] Bit-String-1B ({bit7, bit4, bit3, bit2}) }

Read-Appl-Core-Rs ::= Read-Data

Read-Appl-Record-Rs ::= Read-Data

Read-Master-Core-Rs ::= Read-Data

Action-Rs ::= SEQUENCE {
    data-length        Integer-1-1B,
    data               Read-Data }

Read-Data ::= Data-String

Data-String ::= OCTET STRING

Bit-String-1B ::= BIT STRING {
    bit8(0), bit7(1), bit6(2), bit5(3), bit4(4), bit3(5), bit2(6), bit1(7) } (SIZE(8))

Integer-0-1B ::= INTEGER (lower-bound-0 .. upper-bound-1B)

Integer-1-1B ::= INTEGER (lower-bound-1 .. upper-bound-1B)

lower-bound-0    INTEGER ::= 0

lower-bound-1    INTEGER ::= 1

upper-bound-1B   INTEGER ::= 255

```

END

```
Module-EFC-ASO { itu-t(0) identified-organization(4) etsi(0) itsDomain(5) wg2(2) en3006740301-2 }
```

DEFINITIONS ::=

BEGIN

EXPORT;

```
IMPORT      Data-String, Bit-String-1B, Integer-0-1B, Integer-1-1B,
            Read-Data, Write-Data, Data-Info,
            Request-Msg-Header, Response-Msg-Header,
            Without-Envelope-Rq,
            Open-Rq, Close-Rq, Read-Display-Type-Rq,
            FROM Module-EFC-ACSE
```

```
{ itu-t(0) identified-organization(4) etsi(0) itsDomain(5) wg2(2) en3006740301-1 };
```

```
ASO-Request-Msg ::= SEQUENCE {
    header    Request-Msg-Header,
    body      ASO-Request-Msg-Body }
ASO-Response-Msg ::= SEQUENCE {
    header    Response-Msg-Header,
    body      ASO-Response-Msg-Body OPTIONAL}
ASO-Request-Msg-Body ::= CHOICE {
    with-envelope    ASO-With-Envelope-Rq,
    without-envelope ASO-Without-Envelope-Rq }
ASO-With-Envelope-Rq ::= SEQUENCE {
    open        Open-Rq,
    without-envelope ASO-Without-Envelope-Rq,
    close       Close-Rq OPTIONAL }
ASO-Without-Envelope-Rq ::= SET OF {
    without-envelope-rq    Without-Envelope-Rq,
    get-tba-random         Get-TBA-Random-Rq,
    get-master-record      Get-Master-Record-Rq,
    set-credential          Set-Credential-Rq,
    get-credential          Get-Credential-Rq,
    read-data-from-external Read-Data-From-External-Rq,
    set-password            Set-Password-Rq,
    set-user-interface      Set-User-Interface-Rq,
    use-last-password       Use-Last-Password-Rq,
    write-data-to-external  Write-Data-To-External-Rq }
ASO-Response-Msg-Body ::= SET OF {
    get-tba-random         Get-TBA-Random-Rs,
    read-certificate       Read-Certificate-Rs,

```

```

    read-data-from-external      Read-Data-From-External-Rs }
Use-Last-Password-Rq           ::= SEQUENCE {id          Bit-String-1B ::= '30'H }
Set-Password-Rq                ::= SEQUENCE {id          Bit-String-1B ::= '13'H,
    password-length            Integer-1-1B,
    password                    Password }
Get-TBA-Random-Rq              ::= SEQUENCE {id          Bit-String-1B ::= '37'H,
    random-number-lgh          Integer-1-1B }
Get-Master-Record-Rq           ::= SEQUENCE {id          Bit-String-1B ::= '4C'H,
    data-info                   Data-Info }
Set-Credential-Rq              ::= SEQUENCE {id          Bit-String-1B ::= '4B'H,
    credential-length           Integer-1-1B,
    credential                   Data-String }
Get-Credential-Rq              ::= SEQUENCE {id          Bit-String-1B ::= '4A'H,
    data-info                   Data-Info,
    nonce-len                   Integer-1-1B
    nonce                       Data-String
    key                         Integer-1-1B }
Read-Data-From-External-Rq     ::= SEQUENCE {id          Bit-String-1B ::= '17'H }
Write-Data-To-External-Rq      ::= SEQUENCE {id          Bit-String-1B ::= '31'H,
    mode                        Mode,
    address                     Bit-String-1B,
    wait-time                   Integer-1-1B,
    data-length                 Integer-1-1B,
    data                         Write-Data }
Set-User-Interface-Rq         ::= SEQUENCE {id          Bit-String-1B ::= '14'H,
    video                       Video-Action,
    audio                       Audio-Action,
    number-of-second            Integer-0-1B,
    count                       Integer-0-1B }
Password                       ::= Data-String
TBA-Id                         ::= Data-String
Mode                           ::= CHOICE {
    to-send-c                   Bit-String-1B ::= '00'H,
    to-exchange                 Bit-String-1B ::= '01'H,
    to-send                     Bit-String-1B ::= '02'H,
    to-get                      Bit-String-1B ::= '03'H }
Video-Action                   ::= CHOICE {
    three-signal                CHOICE {
        none                    Bit-String-1B ::= '00'H,
        ko                      Bit-String-1B ::= '01'H,
        ok                      Bit-String-1B ::= '02'H,
        warning                  Bit-String-1B ::= '03'H,
        ok-and-warning          Bit-String-1B ::= '04'H,
        ok-and-ko               Bit-String-1B ::= '05'H,
        warning-and-ko          Bit-String-1B ::= '06'H,
        all-on                  Bit-String-1B ::= '07'H },
    two-signal                  CHOICE {
        none                    Bit-String-1B ::= '00'H,
        ko                      Bit-String-1B ::= '01'H,
        ok                      Bit-String-1B ::= '02'H,
        all-on                  Bit-String-1B ::= '03'H,
        none                    Bit-String-1B ::= '04'H,
        none                    Bit-String-1B ::= '05'H,
        none                    Bit-String-1B ::= '06'H,
        all-on                  Bit-String-1B ::= '07'H } }
Audio-Action                   ::= CHOICE {
    none                        Bit-String-1B ::= '00'H,
    ok                          Bit-String-1B ::= '01'H,
    ko                          Bit-String-1B ::= '02'H,
    warning                      Bit-String-1B ::= '03'H }
Get-TBA-Random-Rs              ::= Read-Data
Get-Master-Record-Rs           ::= Read-Data
Get-Credential-Rs              ::= Read-Data (SIZE(4))
Read-Data-From-External-Rs     ::= SEQUENCE {
    data-length                 Integer-1-1B,
    data                        Read-Data }

```

END

## 11.4 Encoding rules

The following encoding rules specify how primitives and constructed types shall be encoded.

## 11.4.1 Encoding of the primitive types

### 11.4.1.1 BIT STRING type

All BIT STRING types are groups of 8 bits, having a fixed size of exactly one byte defined by the size parameters in the ASN.1 definition of the type Bit-String-1B.

The value of a BIT STRING type shall be transmitted without any encoding of the BIT STRING type.

NOTE: This is equivalent to PER, as long as no constraints are used.

### 11.4.1.2 INTEGER type

The INTEGER types Integer-0-1B and Integer-1-1B are unsigned positive whole numbers having a fixed size of exactly one byte----

The value of an INTEGER type shall be transmitted without any encoding of the INTEGER type.

The carried value shall be right-justified and extended to the left with zeroes.

NOTE: Coding of Integer-0-1B is equivalent to PER. Coding of Integer-1-1B is not equivalent to PER.

## 11.4.2 Encoding of the structured types

### 11.4.2.1 SEQUENCE type

In a SEQUENCE type, the values of the fixed, ordered list of types component shall be transmitted in the order of their declaration without any encoding of the SEQUENCE type.

NOTE: This is equivalent to PER.

### 11.4.2.2 SEQUENCE OF type

In a SEQUENCE OF type, the values of the group of the fixed, ordered list of types component shall be transmitted in the order of their declaration without any encoding of the SEQUENCE OF type and length.

NOTE: This is not equivalent to PER.

### 11.4.2.3 CHOICE type

In a CHOICE type, the value of the exactly one type of the types component list shall be transmitted without any encoding of the CHOICE type.

NOTE: This is equivalent to PER.

### 11.4.2.4 SET type

In a SET type, the values of the types component shall be transmitted without any encoding of the SET type and length.

NOTE: This is not equivalent to PER.

### 11.4.2.5 SET OF type

In a SET OF type, the values of the types component shall be transmitted without any encoding of the SET OF type and length.

NOTE: This is not equivalent to PER.

## 11.5 RSU specific parameters and procedures

### 11.5.1 Application protocol data unit formats

Concatenated directives shall be contained in the body part of an APDU, which shall be prefixed with a set of parameters, called collectively A-Association.request parameters, which are described in table 16.

**Table 16: A-Association.request parameters**

Parameter Name	ASN.1 type	Limits and allowed values
AP Invocation Identifier	Not applicable	This parameter is contained in the LaID part of the LLC address field.
Calling AP Title	Data-String (SIZE(4))	4 octets
Responding Mode	Bit-String-1B	1 octet with 4 allowed values: response-not-required = rrrr001 response-fast-speed = rrrr 010 response-normal-speed = rrrr 110 response-slow-speed:= rrrr x00
Number of Directives	Integer-1-1B	Indicates the number of concatenated PDUs that are transmitted. If no concatenation is selected, its value is 1. The maximum number of concatenated primitives depends on the total length of the encoded data.

Concatenation can be selected by the user of the application layer, so as to build an APDU in a compact form. When concatenation is selected, the APDU is filled by means of the following rules in their given order:

- a) First, one set of A-Association.request parameters shall be encoded, which shall be built once per APDU, independently of the number of concatenated directives. The header part of the APDU shall contain the "Calling AP Title", "Responding Mode" and "Number of Directives".
- b) Then the directives shall be sequentially coded.

The overall length of an APDU after encoding shall not exceed 60 octets, including the following A-Association parameters:

- Calling AP Title (4 octets).
- Responding Mode (1 octet).
- Number of Directives (1 octet).

The "AP Invocation Identifier" parameter shall be directly mapped onto the LaID Link Layer Protocol Field and consequently is not included in the APDU.

When the RSU sets a particular value for the "Responding Mode" parameter in a particular APDU, it shall be ready to receive at the specified speed. The "response-not-required" and "response slow speed" values for this parameter shall always be supported on both the RSU and the OBU. This means that the RSU shall always be able to receive data at "response slow speed", independently of the actual requested speed in the Responding Mode parameter.

### 11.5.2 Open-Rq directive

#### 11.5.2.1 Definition

The Open-Rq directive is used by the RSU to create a new association between the RSU and the OBU.

#### 11.5.2.2 Method of measurement

This directive and related parameters encoding shall be as defined in clauses 11.2 and 11.4.

### 11.5.2.3 Limits

Table 17 lists the Open-Rq parameters, their ASN.1 types, limits and allowed values.

**Table 17: Open-Rq parameters**

Parameter Name	ASN.1 type	Limits and allowed values
Open-Rq	Bit-String-1B	Directive Code is '10'H

## 11.5.3 Close-Rq directive

### 11.5.3.1 Definition

The Close-Rq directive is used by the RSU to close an active association.

### 11.5.3.2 Method of measurement

This directive and related parameters encoding shall be as defined in clauses 11.2 and 11.4.

### 11.5.3.3 Limits

The directive can only be issued when an association is active.

Table 18 lists the Close-Rq parameters, their ASN.1 types, limits and allowed values.

**Table 18: Close-Rq parameters**

Parameter Name	ASN.1 type	Limits and allowed values
Close-Rq	Bit-String-1B	Directive Code is '11'H

## 11.5.4 Select-TBA-Id-Rq directive

### 11.5.4.1 Definition

The Select-TBS-Id-Rq protocol data unit allows an RSU to ensure that the responding OBU is exactly the one whose AP Title is specified. If concatenated with an Open-Rq directive, the service allows opening an association with a specific OBU (direct addressing).

### 11.5.4.2 Method of measurement

This directive and related parameters encoding shall be as defined in clauses 11.2 and 11.4.

### 11.5.4.3 Limits

Table 19 lists the Select-TBA-Id-Rq parameters, their ASN.1 types, limits and allowed values.

**Table 19: Select-TBA-Id-Rq parameters**

Parameter Name	ASN.1 type	Limits and allowed values
Select-TBA-Id-Rq	Bit-String-1B	Directive Code is '15'H
Length	Integer-1-1B	Length of Responding AP Title parameter. Allowed values from 1 to 5
Responding AP Title	Data-String	Max 5 octets This parameter contains the value of "Called AP Title" provided by an OBU.



## 11.5.5 Read-Display-Type-Rq directive

### 11.5.5.1 Definition

The Read-Display-Type-Rq directive allows an RSU to inquire the OBU's output device type, in order to subsequently send appropriate information.

This directive is optional, and maintained only for compatibility with previous implementations, so there is no obligation to implement it.

### 11.5.5.2 Method of measurement

This directive and related parameters encoding shall be as defined in clauses 11.2 and 11.4.

### 11.5.5.3 Limits

Table 20 lists the Read-Display-Type-Rq parameters, their ASN.1 types, limits and allowed values.

**Table 20: Read-Display-Type-Rq parameters**

Parameter Name	ASN.1 type	Limits and allowed values
Read-Display-Type-Rq	Bit-String-1B	Directive Code is '09'H

## 11.5.6 Read-Master-Core-Rq directive

### 11.5.6.1 Definition

The Read-Master-Core-Rq directive allows an RSU to read generic application context related information. Results of this service may be used to identify and further address specific applications.

### 11.5.6.2 Method of measurement

This directive and related parameters encoding shall be as defined in clauses 11.2 and 11.4.

### 11.5.6.3 Limits

Table 21 lists the Read-Master-Core-Rq parameters, their ASN.1 types, limits and allowed values.

**Table 21: Read-Master-Core-Rq parameters**

Parameter Name	ASN.1 type	Limits and allowed values
Read-Master-Core-Rq	Bit-String-1B	Directive Code is 01 Hexadecimal.
Offset	Integer-0-1B	Offset is a pointer in the context structure that specifies the starting point where the read operation starts from. Its value ranges from 0 to 255.
Length	Integer-1-1B	Expected length of information to be read. Ranges from 1 to 255.

## 11.5.7 Get-Master-Record-Rq directive

### 11.5.7.1 Definition

The Get-Master-Record-Rq directive allows an RSU to read generic application independent information contained in the OBE.

### 11.5.7.2 Method of measurement

This directive and related parameters encoding shall be as defined in clauses 11.2 and 11.4.

### 11.5.6.3 Limits

Table 22 lists the Get-Master-Record-Rq parameters, their ASN.1 types, limits and allowed values.

**Table 22: Get-Master-Record-Rq parameters**

Parameter Name	ASN.1 type	Limits and allowed values
Get-Master-Record-Rq	Bit-String-1B	Directive Code is '4C' Hexadecimal.
Offset	Integer-0-1B	Offset is a pointer in the context structure that specifies the starting point where the read operation starts from. Its value ranges from 0 to 255.
Length	Integer-1-1B	Expected length of information to be read. Ranges from 1 to 255.

## 11.5.8 Read-Appl-Core-Rq directive

### 11.5.8.1 Definition

The Read-Appl-Core-Rq directive allows an RSU to read a specific application context information. The application is selected by its AP Invocation Identifier.

### 11.5.8.2 Method of measurement

This directive and related parameters encoding shall be as defined in clauses 11.2 and 11.4.

### 11.5.8.3 Limits

Table 23 lists the Read-Appl-Core-Rq parameters, their ASN.1 types, limits and allowed values.

**Table 23: Read-Appl-Core-Rq parameters**

Parameter Name	ASN.1 type	Limits and allowed values
Read-Appl-Core-Rq	Bit-String-1B	Directive Code is '02'H.
Offset	Integer-0-1B	Offset is a pointer in the context structure that specifies the starting point where the read operation starts from. Its value ranges from 0 to 255.
Length	Integer-1-1B	Expected length of information to be read. Ranges from 1 to 255.

## 11.5.9 Write-Appl-Core-Rq directive

### 11.5.9.1 Definition

The Write-Appl-Core-Rq directive allows an RSU to modify a specific application context information. The application is selected by its AP Invocation Identifier. A response is expected after only formal controls are made on the requested operation.

### 11.5.9.2 Method of measurement

This directive and related parameters encoding shall be as defined in clauses 11.2 and 11.4.

### 11.5.9.3 Limits

Table 24 lists the Write-Appl-Core-Rq parameters, their ASN.1 types, limits and allowed values.

**Table 24: Write-Appl-Core-Rq parameters**

Parameter Name	ASN.1 type	Limits and allowed values
Write-Appl-Core-Rq	Bit-String-1B	Directive Code is '05'H.
Offset	Integer-0-1B	Offset is a pointer in the context structure that specifies the starting point where the read operation starts from. Its value ranges from 0 to 255.
Length	Integer-1-1B	Expected length of information to be written. Ranges from 1 to 255.
Data	Data-String	Data to be written.

## 11.5.10 Write-Appl-Core-Conf-Rq directive

### 11.5.10.1 Definition

The Write-Appl-Core-Conf-Rq directive allows an RSU to modify a specific application context information. The application is selected by its AP Invocation Identifier. A response can only be expected after the write operation has been completed.

### 11.5.10.2 Method of measurement

This directive and related parameters encoding shall be as defined in clauses 11.2 and 11.4.

### 11.5.10.3 Limits

Table 25 lists the Write-Appl-Core-Conf-Rq parameters, their ASN.1 types, limits and allowed values.

**Table 25: Write-Appl-Core-Conf-Rq parameters**

Parameter Name	ASN.1 type	Limits and allowed values
Write-Appl-Core-Conf-Rq	Bit-String-1B	Directive Code is '19'H.
Offset	Integer-0-1B	Offset is a pointer in the context structure that specifies the starting point where the read operation starts from. Its value ranges from 0 to 255.
Length	Integer-1-1B	Expected length of information to be read. Ranges from 1 to 255.
Data	Data-String	Data to be written.

## 11.5.11 Write-Data-To-External-Rq directive

### 11.5.11.1 Definition

The Write-Data-To-External-Rq directive allows an RSU to exchange commands and data to an external device that is connected to, but not part of, the OBE. Results and responses from the external device can be stored in the OBE in order to be retrieved later via a subsequent Read-Data-From-External-Rq directive.

This directive is optional, and maintained only for compatibility with older versions of the present document, so there is no obligation to implement it.

The expected behaviour of the OBE, when receiving a valid Write-Data-To-External-Rq directive, depends on the value of the parameter Mode, which can be:

- **to-send-c:** data are transferred to the external device. A response code is expected from the device.
- **to-exchange:** data (commands) are transferred to the external device. A response is expected within a maximum time as specified in the "Wait-time" parameter. After that time, no response is expected.
- **to-send:** data are transferred to the external device. No immediate response is expected from the device.
- **to-get:** data are expected from the external device for a maximum time as specified in the "Wait-time" parameter. After that time, no valid data are expected.

### 11.5.11.2 Method of measurement

This directive and related parameters encoding shall be as defined in clauses 11.2 and 11.4.

### 11.5.11.3 Limits

Table 26 lists the Write-Data-To-External-Rq parameters, their ASN.1 types, limits and allowed values.

**Table 26: Write-Data-To-External-Rq parameters**

Parameter Name	ASN.1 type	Limits and allowed values
Write-Data-To-External-Rq	Bit-String-1B	Directive Code is '31'H.
Mode	Choice {to-send-c Bit-String-1B, to-exchange Bit-String-1B, to-send Bit-String-1B, to-get Bit-String-1B}	Mode specifies the type of operation requested to-send-c = '00'Hexadecimal, to-exchange = '01'Hexadecimal to-send = '02'Hexadecimal to-get = '03'Hexadecimal
Address	Bit-String-1B	External device identifier.
Wait-time	Integer-1-1B	Time (in seconds) after which the response from the external device is no more valid. This parameter is meaningless when the Mode parameter is set to "to-send".
Data-length	Integer-1-1B	Length of information to be transferred. Ranges from 1 to 255. When the Mode parameter is set to "to-get", length shall be set to 0.
Data	Octet String	Data to be written.

## 11.5.12 Read-Data-From-External-Rq directive

### 11.5.12.1 Definition

The Read-Data-From-External-Rq directive allows an RSU to read results of commands previously issued with a Write-Data-To-External-Rq directive to an external device that is connected to, but not part of, the OBE.

This directive is optional, and maintained only for compatibility with older versions of the present document, so there is no obligation to implement it.

### 11.5.12.2 Method of measurement

This directive and related parameters encoding shall be as defined in clauses 11.2 and 11.4.

### 11.5.12.3 Limits

Table 27 lists the Read-Data-From-External-Rq parameters, their ASN.1 types, limits and allowed values.

**Table 27: Read-Data-From-External-Rq parameters**

Parameter Name	ASN.1 type	Limits and allowed values
Read-Data-From-External-Rq	Bit-String-1B	Directive Code is '17'H.

## 11.5.13 Read-Appl-Record-Rq directive

### 11.5.13.1 Definition

The Read-Appl-Record-Rq directive allows an RSU to retrieve information addressed by an Application Context. The application is selected by its AP Invocation Identifier.

### 11.5.13.2 Method of measurement

This directive and related parameters encoding shall be as defined in clauses 11.2 and 11.4.

### 11.5.13.3 Limits

Table 28 lists the Read-Appl-Record-Rq parameters, their ASN.1 types, limits and allowed values.

**Table 28: Read-Appl-Record-Rq parameters**

Parameter Name	ASN.1 type	Limits and allowed values
Read-Appl-Record- Rq	Bit-String-1B	Directive Code is '03'H.
Offset	Integer-0-1B	Offset is a pointer in the context structure (can be any kind of pointer, such as for example a label, a physical offset, a record number) that specifies the starting point where the read operation starts from. Its value ranges from 0 to 255.
Length	Integer-1-1B	Expected length of information to be read. Ranges from 1 to 255.

## 11.5.14 Write-Appl-Record-Curr-Rq directive

### 11.5.14.1 Definition

The Write-Appl-Record-Curr-Rq directive allows an RSU to modify a specific application record information. The application record to be modified is the current record. The application is selected by its AP Invocation Identifier. A response is expected after only formal controls are made on the requested operation.

### 11.5.14.2 Method of measurement

This directive and related parameters encoding shall be as defined in clauses 11.2 and 11.4.

### 11.5.14.3 Limits

Table 29 lists the Write-Appl-Record-Curr-Rq parameters, their ASN.1 types, limits and allowed values.

**Table 29: Write-Appl-Record-Curr-Rq parameters**

Parameter Name	ASN.1 type	Limits and allowed values
Write-Appl-Record-Curr-Rq	Bit-String-1B	Directive Code is '06'H.
Offset	Integer-0-1B	Offset is a pointer in the context structure (can be any kind of pointer, such as for example a label, a physical offset, a record number) that specifies the starting point where the read operation starts from. Its value ranges from 0 to 255.
Length	Integer-1-1B	Expected length of information to be read. Ranges from 1 to 255.
Data	Data-String	Data to be written.

## 11.5.15 Write-Appl-Record-Curr-Conf-Rq directive

### 11.5.15.1 Definition

The Write-Appl-Record-Curr-Conf-Rq directive allows an RSU to modify a specific application record information. The application record to be modified is the current record. The application is selected by its AP Invocation Identifier. A response can only be expected after the write operation has been completed.

### 11.5.15.2 Method of measurement

This directive and related parameters encoding shall be as defined in clauses 11.2 and 11.4.

### 11.5.15.3 Limits

Table 30 lists the Write-Appl-Record-Curr-Conf-Rq parameters, their ASN.1 types, limits and allowed values.

**Table 30: Write-Appl-Record-Curr-Conf-Rq parameters**

Parameter Name	ASN.1 type	Limits and allowed values
Write-Appl-Record-Curr-Conf-Rq	Bit-String-1B	Directive Code is '20'H.
Offset	Integer-0-1B	Offset is a pointer in the context structure (can be any kind of pointer, such as for example a label, a physical offset, a record number) that specifies the starting point where the read operation starts from. Its value ranges from 0 to 255.
Length	Integer-1-1B	Expected length of information to be read. Ranges from 1 to 255.
Data	Data-String	Data to be written.

## 11.5.16 Write-Appl-Record-Next-Rq directive

### 11.5.16.1 Definition

The Write-Appl-Record-Next-Rq directive allows an RSU to modify a specific application record information. The application record to be modified is the next (after the current) record. The application is selected by its AP Invocation Identifier. A response is expected after only formal controls are made on the requested operation.

NOTE: The current version of the present document only supports to read the current record.

### 11.5.16.2 Method of measurement

This directive and related parameters encoding shall be as defined in clauses 11.2 and 11.4.

### 11.5.16.3 Limits

Table 31 lists the Write-Appl-Record-Next-Rq parameters, their ASN.1 types, limits and allowed values.

**Table 31: Write-Appl-Record-Next-Rq parameters**

Parameter Name	ASN.1 type	Limits and allowed values
Write-Appl-Record-Next-Rq	Bit-String-1B	Directive Code is '07'H.
Offset	Integer-0-1B	Offset is a pointer in the context structure (can be any kind of pointer, such as for example a label, a physical offset, a record number) that specifies the starting point where the read operation starts from. Its value ranges from 0 to 255.
Length	Integer-1-1B	Expected length of information to be read. Ranges from 1 to 255.
Data	Data-String	Data to be written.

## 11.5.17 Write-Appl-Record-Next-Conf-Rq directive

### 11.5.17.1 Definition

The Write-Appl-Record-Next-Conf-Rq directive allows an RSU to modify a specific application record information. The application record to be modified is the current record. The application is selected by its AP Invocation Identifier. A response can only be expected after the write operation has been completed.

### 11.5.17.2 Method of measurement

This directive and related parameters encoding shall be as defined in clauses 11.2 and 11.4.

### 11.5.17.3 Limits

Table 32 lists the Write-AppI-Record-Next-Conf-Rq parameters, their ASN.1 types, limits and allowed values.

**Table 32: Write-AppI-Record-Next-Conf-Rq parameters**

Parameter Name	ASN.1 type	Limits and allowed values
Write-AppI-Record-Next-Conf-Rq	Bit-String-1B	Directive Code is '07'H.
Offset	Integer-0-1B	Offset is a pointer in the context structure (can be any kind of pointer, such as for example a label, a physical offset, a record number) that specifies the starting point where the read operation starts from. Its value ranges from 0 to 255.
Length	Integer-1-1B	Expected length of information to be read. Ranges from 1 to 255.
Data	Data-String	Data to be written.

### 11.5.18 Set-UIF-Rq directive

#### 11.5.18.1 Definition

The Set-UIF-Rq directive allows an RSU to set parameters for the OBE User Interface.

#### 11.5.18.2 Method of measurement

This directive and related parameters encoding shall be as defined in clauses 11.2 and 11.4.

#### 11.5.18.3 Limits

Table 33 lists the Set-UIF-Rq parameters, their ASN.1 types, limits and allowed values.

**Table 33: Set-UIF-Rq parameters**

Parameter Name	ASN.1 type	Limits and allowed values
Set-UIF-Rq	Bit-String-1B	Directive Code is '14'H.
Video	Bit-String-1B	Video indicates actions to be performed on a video interface. The action depends on the type of device. The parameter ranges from '00'H to '07'H, where the only assumed semantics is on the '00' value, which means "No action".
Audio	Integer-1-1B	Audio indicates actions to be performed on an audio interface. The parameter may assume the following values: none = '00'Hexadecimal, ok = '01'Hexadecimal, ko = '02'Hexadecimal, warning = '03'Hexadecimal.
Time	Integer-0-1B	Time (in seconds) of the duration of the external action.
Count	Integer-0-1B	Number of repetitions of the external action.

The Video parameter is maintained for compatibility with earlier versions of the present document, and should be normally set to '00'Hexadecimal, meaning "No action".

### 11.5.19 Action-Rq directive

#### 11.5.19.1 Definition

The Action-Rq directive allows an RSU to request an action to be executed at OBU side. The service is primarily defined to carry ASO-specific protocol data units containing commands to be carried and executed. The invocation of the A-Action service by an ACSE service user shall result in the performance of an action by a peer application. An action is qualified by the value of the Action Type parameter and further specified by action-specific parameters that can be carried by the Action Qualifiers parameter. The service may be requested in confirmed or deferred mode. In confirmed mode a response is expected.

If Immediate (default value) is specified, then a response can only be issued after the action has been executed.

If Deferred is specified, then only formal controls are made on the requested operation.

This particular directive comes out from the concatenation of two protocol data units existing in previous versions. For backward compatibility reasons, the two previous directive codes are included in the encoding of this directive (see clause 11.5.19.3). For the same reason, the value of the parameter "Number of Directives" included in the Association request parameters should be incremented by two (2), instead of by one.

This directive is optional, and maintained only for compatibility with older versions of the present document, so there is no obligation to implement it.

### 11.5.19.2 Method of measurement

This directive and related parameters encoding shall be as defined in clauses 11.2 and 11.4.

### 11.5.19.3 Limits

Table 34 lists the Action-Rq parameters, their ASN.1 types, limits and allowed values.

**Table 34: Action-Rq parameters**

Parameter Name	ASN.1 type	Limits and allowed values
write-data-to-external-rq	Bit-String-1B	Directive Code is '31'H.
Mode	CHOICE {immediate Bit-String-1B, deferred Bit-String-1B}	The following values are valid: Immediate = '01'Hexadecimal, Deferred = '02'Hexadecimal.
Address	Bit-String-1B	Value is 'FF' Hexadecimal.
Wait-time	Integer-0-1B	Value is '00' Hexadecimal.
Length	Integer-1-1B	Length of Action Qualifier parameter ranges from 1 to 255.
Action Qualifiers	DataString	
read-data-from-external-rq	Bit-String-1B	Directive Code is '17'H.

## 11.5.20 Set-Password-Rq directive

### 11.5.20.1 Definition

The Set-Password-Rq directive allows an RSU to modify the password to be used to access specific services. For example, application data to be read or written could reside on an external memory card that may require an access password. This directive allows an RSU to specify a different password for each different OBU. The password is stored in the OBU for later usage, but it is valid for the current session only. This means that in a subsequent session, a default (or no) password will be used for all those services that require authentication.

This directive is optional, and maintained only for compatibility with older versions of the present document, so there is no obligation to implement it.

### 11.5.20.2 Method of measurement

This directive and related parameters encoding shall be as defined in clauses 11.2 and 11.4.

### 11.5.20.3 Limits

Table 35 lists the Set-Password-Rq parameters, their ASN.1 types, limits and allowed values.



**Table 35: Set-Password-Rq parameters**

Parameter Name	ASN.1 type	Limits and allowed values
Set-Password-Rq	Bit-String-1B	Directive Code is '13'H.
Length	Integer-1-1B	Length of password to be stored. Ranges from 1 to 255.
Password	Data-String	

## 11.5.21 Use-Last-Password-Rq directive

### 11.5.21.1 Definition

The Use-Last-Password-Rq directive allows an RSU to request the OBU to use the last stored password (by means of a Set-Password-Rq directive) to access specific services that require a password.

This directive is optional, and maintained only for compatibility with older versions of the present document, so there is no obligation to implement it.

### 11.5.21.2 Method of measurement

This directive and related parameters encoding shall be as defined in clauses 11.2 and 11.4.

### 11.5.21.3 Limits

The Use-Last-Password-Rq directive does not bear parameters. Table 36 shows the Use-Last-Password-Rq directive code.

**Table 36: Use-Last-Password-Rq parameters**

Parameter Name	ASN.1 type	Limits and allowed values
Use-Last-Password-Rq	Bit-String-1B	Directive Code is '30'H.

## 11.5.22 Get-TBA-Random-Rq directive

### 11.5.22.1 Definition

The Get-TBA-Random-Rq directive allows an RSU to require a random value from the OBU. The value is intended to be used as a challenge (nonce) to be used in encryption algorithms.

### 11.5.22.2 Method of measurement

This directive and related parameters encoding shall be as defined in clauses 11.2 and 11.4.

### 11.5.22.3 Limits

Table 37 lists the Get-TBA-Random-Rq parameters, their ASN.1 types, limits and allowed values.

**Table 37: Get-TBA-Random-Rq parameters**

Parameter Name	ASN.1 type	Limits and allowed values
Get-TBA-Random-Rq	Bit-String-1B	Directive Code is '37'H.
Length	Integer-1-1B	Length of random number to be received to be stored. Ranges from 1 to 255.

## 11.5.23 Set-Credential-Rq directive

### 11.5.23.1 Definition

The Set-Credential-Rq directive allows an RSU to transmit its credentials to an OBU. Credentials are supposedly calculated on the basis of a nonce received previously by means of a Get-TBA-Random-Rq directive, and on data that are publicly available in the OBU. The position and length of these data are stated in specific profiles.

### 11.5.23.2 Method of measurement

This directive and related parameters encoding shall be as defined in clauses 11.2 and 11.4.

### 11.5.23.3 Limits

Table 38 lists the Set-Credential-Rq parameters, their ASN.1 types, limits and allowed values.

**Table 38: Set-Credential-Rq parameters**

Parameter Name	ASN.1 type	Limits and allowed values
Set-Credential-Rq	Bit-String-1B	Directive Code is '4B'H.
Length	Integer-1-1B	Length of credentials to be transmitted to the OBU. Ranges from 1 to 255.
Credentials	Data-String	

## 11.5.24 Get-Credential-Rq directive

### 11.5.24.1 Definition

The Get-Credential-Rq directive allows an RSU to request an OBU its credentials (Authenticator). Credentials shall be calculated by the OBU on the basis of a nonce, and on data that is stored in the Application Core memory structure.

### 11.5.24.2 Method of measurement

This directive and related parameters encoding shall be as defined in clauses 11.2 and 11.4.

### 11.5.24.3 Limits

Table 39 lists the Get-Credential-Rq parameters, their ASN.1 types, limits and allowed values.

**Table 39: Get-Credential-Rq parameters**

Parameter Name	ASN.1 type	Limits and allowed values
Get-Credential-Rq	Bit-String-1B	Directive Code is '4A'H.
Offset	Integer-0-1B	Offset in the Application Core memory area where data starts
Length	Integer-1-1B	Length of data to be used to calculate credentials. Ranges from 1 to 255.
Nonce-len	Integer-1-1B	Length of nonce to be used to calculate credentials. Ranges from 1 to 255.
Nonce	Data-String	Nonce value.
Key	Integer-1-1B	Key to be used to calculate the authenticator. Ranges from 1 to 8.

## 11.6 OBU specific parameters and procedures

The OBU does not generate APDUs unless it is requested to do so by the RSU. Consequently, all procedures that can be started in an OBU are results of receiving APDUs and may or may not cause the generation of responses, according to the conditions and limits stated in the following clauses.

## 11.6.1 Application protocol data unit formats

A response APDU shall be prefixed with a set of parameters, called collectively A-Association.response parameters, which are described in table 40.

**Table 40: A-Association.response parameters**

Parameter Name	ASN.1 type	Limits and allowed values
AP Invocation Identifier	Not applicable	Set to LAID parameter value (see clause 10.4.1)
Called AP Title	Data-String (SIZE(5))	5 octets
Result	Bit-String-1B	'01'H = mismatch '06'H = ack (success) '15'H = nack
Diagnostic	Bit-String-1B	If Result = mismatch: '00'H = no-sense (no diagnostic information) If Result = ack: '00'H = no-sense '01'H = no-card '05'H = wrong-TBA-id '06'H = not configured If Result = nack: '01'H = no-card '02'H = not-in-session '04'H = directive-failure '05'H = opc-failure (A-SLT failure) '06'H = not configured '07'H = buffer overflow '09'H = buffer full '10'H = hardware error '11'H = invalid operation

## 11.6.2 Receiving Protocol Data Units

On receiving a group of commands from an RSU, the responding OBU shall:

- execute all commands in the same sequence as they are grouped until a command results in error;
- in case a command results in error, stop execution;
- group all responses in a grouped response in the same order as the received commands;
- prepare the Result and Diagnostic field which, when indicating an error condition, give a general warning related to the whole group and, as such, are identical for all generated confirmations. This means that the transmission efficiency that is gained by grouping may cause non determination.

When the OBU receives a value for the Responding Mode parameter in a particular APDU, it shall consider that value as a preferred value for the corresponding Layer 1 Bit rate parameter. The OBU shall support at least the "response-not-required" and "response slow speed" values. If a response is required at a not supported speed, the OBU shall respond as if the "response slow speed" value had been received.

The response APDU is filled by means of the following rules in their given order:

- First, one set of A-Association.response parameters shall be encoded, which shall be built once per APDU, independently of the number of concatenated response messages. These include the Result and Diagnostic fields that shall be coded as specified above.
- Then, all responses messages shall be sequentially coded. This means that a concatenated response is generated whenever a concatenated request is received, with the same number of responses as the number of request messages (directives). Note that, according to the encoding rules, no explicit response message code shall be included, except in case response parameters must be encoded.

The overall length of a response APDU after encoding shall not exceed 60 octets, including the following A-Association parameter:

- Called IP Title (5 octets).
- Result.
- Diagnostic.

The AP Invocation Identifier is directly mapped onto the LaID Link Layer Protocol Field and consequently is not included in this count.

### 11.6.3 Response to Open-Rq

#### 11.6.3.1 Definition

Reception of an Open-Rq directive establish an association between the OBU and the requesting RSU.

#### 11.6.3.2 Method of measurement

This protocol message and related parameters encoding shall be as defined in clauses 11.2 and 11.4.

#### 11.6.3.3 Limits

As the response message bears no parameters, the only admitted values for the response shall be those in the "Result" and "Diagnostic" fields as presented in table 41. Dependent on specific exceptions, the value of "Diagnostic" may be different, see clause 11.6.1.

**Table 41: "Result" and "Diagnostic" in Open-Rs**

Active valid session	No		Yes		
	≠0	= 0	≠0, correct	≠0, wrong	= 0
Link ID	'06'H	'06'H	'06'H	'06'H	'06'H
Result	'06'H	'06'H	'06'H	'06'H	'06'H
Diagnostic	'00'H	'00'H	'00'H	'00'H	'00'H

### 11.6.4 Response to Close-Rq

#### 11.6.4.1 Definition

Reception of a Close-Rq directive will close an active association. If no association is active, the OBU shall ignore a received Close-Rq directive.

#### 11.6.4.2 Method of measurement

This protocol message and related parameters encoding shall be as defined in clauses 11.2 and 11.4.

#### 11.6.4.3 Limits

As the response message bears no parameters, the only admitted values for the response shall be those in the "Result" and "Diagnostic" fields as presented in table 42. Dependent on specific exceptions, the value of "Diagnostic" may be different, see clause 11.6.1.

**Table 42: "Result" and "Diagnostic" in Close-Rs**

Active valid session	No		Yes		
	≠0	= 0	≠0, correct	≠0, wrong	= 0
Link ID	'15'H	'15'H	'06'H	'01'H	'06'H
Result	'15'H	'15'H	'06'H	'01'H	'06'H
Diagnostic	'02'H	'02'H	'00'H	'00'H	'00'H

## 11.6.5 Response to Select-TBA-Id-Rq

### 11.6.5.1 Definition

The OBU shall answer to the reception of this directive by confirming the correctness of the address as specified in the request. When an OBU receives a PDU with a wrong Responding AP Title parameter value, or when not in session, it may choose not to answer.

### 11.6.5.2 Method of measurement

This protocol message and related parameters encoding shall be as defined in clauses 11.2 and 11.4.

### 11.6.5.3 Limits

As the response message bears no parameters, the only admitted values for the response shall be those in the "Result" and "Diagnostic" fields as presented in table 43. Dependent on specific exceptions, the value of "Diagnostic" may be different, see clause 11.6.1.

**Table 43: "Result" and "Diagnostic" in Select-TBA-Id-Rs**

Active valid session	No		Yes		
	≠0	= 0	≠0, correct	≠0, wrong	= 0
Link ID	'15'H	'06'H	'06'H	'01'H	'06'H
Result	'15'H	'06'H	'06'H	'01'H	'06'H
Diagnostic	'02'H	'00'H correct "Responding AP Title"	'00'H correct "Responding AP Title"	'00'H	'00'H correct "Responding AP Title"
		'05'H incorrect "Responding AP Title"	'05'H incorrect "Responding AP Title"		'05'H incorrect "Responding AP Title"

## 11.6.6 Response to Read-Display-Type-Rq

### 11.6.6.1 Definition

This response message is optional, and maintained only for compatibility with older versions of the present document, so there is no obligation to implement it. If implemented, when receiving a Read-Display-Type-Rq directive, the OBU shall respond with an indication of the type of external device. If not implemented, the OBU shall ignore a received Read-Display-Type-Rq directive.

### 11.6.6.2 Method of measurement

This protocol message and related parameters encoding shall be as defined in clauses 11.2 and 11.4.

### 11.6.6.3 Limits

Table 44 lists the Read-Display-Type-Rs parameters, their ASN.1 types, limits and allowed values.

**Table 44: Read-Display-Type-Rs parameters**

Parameter Name	ASN.1 type	Limits and allowed values
Read-Display-Type-Rs	CHOICE { {numeric-display Bit-String-1B, alpha-numeric-display Bit-String-1B}	The following values are valid: Numeric = '41'H; alpha-numeric = '4E'H

The admitted values for the "Result" and "Diagnostic" fields are presented in table 45. Dependent on specific exceptions, the value of "Diagnostic" may be different, see clause 11.6.1.

**Table 45: "Result" and "Diagnostic" in Read-Display-Type-Rs**

Active valid session	No		Yes		
	≠0	= 0	≠0, correct	≠0, wrong	= 0
Link ID	'15'H	'06'H	'06'H	'01'H	'06'H
Result	'15'H	'06'H	'06'H	'01'H	'06'H
Diagnostic	'02'H	'00'H	'00'H	'00'H	'00'H

## 11.6.7 Response to Read-Master-Core-Rq

### 11.6.7.1 Definition

On reception of a Read-Master-Core-Rq directive, the OBU shall respond with data stored in the Master Core memory area, starting with the specified offset and of the specified length.

### 11.6.7.2 Method of measurement

This protocol message and related parameters encoding shall be as defined in clauses 11.2 and 11.4.

### 11.6.7.3 Limits

Table 46 lists the Read-Master-Core-Rs parameters, their ASN.1 types, limits and allowed values.

**Table 46: Read-Master-Core-Rs parameters**

Parameter Name	ASN.1 type	Limits and allowed values
Read-Master-Core-Rs	SEQUENCE OF Bit-String-1B	Length of data shall be exactly that as specified in the related directive.

The admitted values for the "Result" and "Diagnostic" fields are presented in table 47. Dependent on specific exceptions, the value of "Diagnostic" may be different, see clause 11.6.1.

**Table 47: "Result" and "Diagnostic" in Read-Master-Core-Rs**

Active valid session	No		Yes		
	≠0	= 0	≠0, correct	≠0, wrong	= 0
Link ID	'15'H	'06'H	'06'H	'01'H	'06'H
Result	'15'H	'06'H	'06'H	'01'H	'06'H
Diagnostic	'02'H	'00'H	'00'H	'00'H	'00'H

## 11.6.8 Response to Get-Master-record-Rq

### 11.6.8.1 Definition

On reception of a Get-Master-Record-Rq directive, the OBU shall respond with data stored in the Master Record memory area, starting with the specified offset and of the specified length.

### 11.6.8.2 Method of measurement

This protocol message and related parameters encoding shall be as defined in clauses 11.2 and 11.4.

### 11.6.8.3 Limits

Table 48 lists the Get-Master-Record-Rs parameters, their ASN.1 types, limits and allowed values.

**Table 48: Get-Master-Record-Rs parameters**

Parameter Name	ASN.1 type	Limits and allowed values
Get-Master-Record-Rs	SEQUENCE OF Bit-String-1B	Length of data shall be exactly that as specified in the related directive.

The admitted values for the "Result" and "Diagnostic" fields are presented in table 49. Dependent on specific exceptions, the value of "Diagnostic" may be different, see clause 11.6.1.

**Table 49: "Result" and "Diagnostic" in Get-Master-Record-Rs**

Active valid session	No		Yes		
	≠0	= 0	≠0, correct	≠0, wrong	= 0
Link ID					
Result	'15'H	'06'H	'06'H	'01'H	'06'H
Diagnostic	'02'H	'00'H	'00'H	'00'H	'00'H

## 11.6.9 Response to Read-Appl-Core-Rq

### 11.6.9.1 Definition

On reception of a Read-Appl-Core-Rq directive, the OBU shall respond with data stored in the Application Core memory area, starting with the specified offset and of the specified length.

### 11.6.9.2 Method of measurement

This protocol message and related parameters encoding shall be as defined in clauses 11.2 and 11.4.

### 11.6.9.3 Limits

Table 50 lists the Read-Appl-Core-Rs parameters, their ASN.1 types, limits and allowed values.

**Table 50: Read-Appl-Core-Rs parameters**

Parameter Name	ASN.1 type	Limits and allowed values
Read-Appl-Core-Rs	SEQUENCE OF Bit-String-1B	Length of data shall be exactly that as specified in the related directive.

The admitted values for the "Result" and "Diagnostic" fields are presented in table 51. Dependent on specific exceptions, the value of "Diagnostic" may be different, see clause 11.6.1.

**Table 51: "Result" and "Diagnostic" in Read-Appl-Core-Rs**

Active valid session	No		Yes		
	≠0	= 0	≠0, correct	≠0, wrong	= 0
Link ID					
Result	'15'H	'06'H	'06'H	'01'H	'06'H
Diagnostic	'02'H	'00'H	'00'H	'00'H	'00'H

## 11.6.10 Response to Write-Appl-Core-Rq

### 11.6.10.1 Definition

On reception of a Write-Appl-Core-Rq directive, the OBU shall write specified data onto the Application Core memory structure. Only formal controls are made on the requested operation and the Result and Diagnostics parameters shall reflect the results of such controls.

### 11.6.10.2 Method of measurement

This protocol message and related parameters encoding shall be as defined in clauses 11.2 and 11.4.

### 11.6.10.3 Limits

As the response message bears no parameters, the only admitted values for the response shall be those in the "Result" and "Diagnostic" fields as presented in table 52. Dependent on specific exceptions, the value of "Diagnostic" may be different, see clause 11.6.1.

**Table 52: "Result" and "Diagnostic" in Write-Appl-Core-Rs**

Active valid session	No		Yes		
	≠0	= 0	≠0, correct	≠0, wrong	= 0
Link ID	'15'H	'15'H	'06'H	'01'H	'06'H
Result	'15'H	'15'H	'06'H	'01'H	'06'H
Diagnostic	'02'H	'02'H	'00'H	'00'H	'00'H

## 11.6.11 Response to Write-Appl-Core-Conf-Rq

### 11.6.11.1 Definition

On reception of a Write-Appl-Core-Conf-Rq directive, the OBU shall write specified data onto the Application Core memory structure. A response shall only be issued after the write operation has been completed. Result and Diagnostics in this case shall reflect the actual result codes of the write operation.

### 11.6.11.2 Method of measurement

This protocol message and related parameters encoding shall be as defined in clauses 11.2 and 11.4.

### 11.6.11.3 Limits

As the response message bears no parameters, the only admitted values for the response shall be those in the "Result" and "Diagnostic" fields as presented in table 53. Dependent on specific exceptions, the value of "Diagnostic" may be different, see clause 11.6.1.

**Table 53: "Result" and "Diagnostic" in Write-Appl-Core-Conf-Rs**

Active valid session	No		Yes		
	≠0	= 0	≠0, correct	≠0, wrong	= 0
Link ID	'15'H	'15'H	'06'H	'01'H	'06'H
Result	'15'H	'15'H	'06'H	'01'H	'06'H
Diagnostic	'02'H	'02'H	'00'H	'00'H	'00'H

## 11.6.12 Response to Write-Data-To-External-Rq

### 11.6.12.1 Definition

On reception of a Write-Data-To-External-Rq directive, the OBU shall behave according to the value of the Mode parameter, as specified in 11.5.11.

### 11.6.12.2 Method of measurement

This protocol message and related parameters encoding shall be as defined in clauses 11.2 and 11.4.



### 11.6.12.3 Limits

As the response message bears no parameters, the only admitted values for the response shall be those in the "Result" and "Diagnostic" fields as presented in table 54. Dependent on specific exceptions, the value of "Diagnostic" may be different, see clause 11.6.1.

**Table 54: "Result" and "Diagnostic" in Write-Data-To-External-Rs**

Active valid session	No		Yes		
	≠0	= 0	≠0, correct	≠0, wrong	= 0
Link ID	'15'H	'15'H	'06'H	'01'H	'06'H
Result	'15'H	'15'H	'06'H	'01'H	'06'H
Diagnostic	'02'H	'02'H	'00'H	'00'H	'00'H

### 11.6.13 Response to Read-Data-From-External-Rq

#### 11.6.13.1 Definition

On reception of a Read-Data-From-External-Rq directive, the OBU shall deliver to the RSE data or results from operations previously performed on external devices.

#### 11.6.13.2 Method of measurement

This protocol message and related parameters encoding shall be as defined in clauses 11.2 and 11.4.

#### 11.6.13.3 Limits

Table 55 lists the Read-Data-From-External-Rs parameters, their ASN.1 types, limits and allowed values.

**Table 55: Read-Data-From-External-Rs parameters**

Parameter Name	ASN.1 type	Limits and allowed values
Read-Data-From-External-Rs	SEQUENCE	
Data-length	Integer-1-1B	Length of information to be transferred. Ranges from 1 to 255.
Data	Octet String	Data read.

The admitted values for the "Result" and "Diagnostic" fields are presented in table 56. Dependent on specific exceptions, the value of "Diagnostic" may be different, see clause 11.6.1.

**Table 56: "Result" and "Diagnostic" in Read-Data-From-External-Rs**

Active valid session	No		Yes		
	≠0	= 0	≠0, correct	≠0, wrong	= 0
Link ID	'15'H	'06'H	'06'H	'01'H	'06'H
Result	'15'H	'06'H	'06'H	'01'H	'06'H
Diagnostic	'02'H	'00'H	'00'H	'00'H	'00'H

### 11.6.14 Response to Read-AppI-Record-Rq

#### 11.6.14.1 Definition

On reception of a Read-AppI-Record-Rq directive, the OBU shall respond with data stored in the Application Record memory area, starting with the specified offset and of the specified length.

#### 11.6.14.2 Method of measurement

This protocol message and related parameters encoding shall be as defined in clauses 11.2 and 11.4.

### 11.6.14.3 Limits

Table 57 lists the Read-Appl-Record-Rs parameters, their ASN.1 types, limits and allowed values.

**Table 57: Read-Appl-Record-Rs parameters**

Parameter Name	ASN.1 type	Limits and allowed values
Read-Appl-Record-Rs	SEQUENCE OF Bit-String-1B	Length of data shall be exactly that as specified in the related directive.

The admitted values for the "Result" and "Diagnostic" fields are presented in table 58. Dependent on specific exceptions, the value of "Diagnostic" may be different, see clause 11.6.1.

**Table 58: "Result" and "Diagnostic" in Read-Appl-Record-Rs**

Active valid session	No		Yes		
	#0	= 0	#0, correct	#0, wrong	= 0
Link ID	#0	= 0	#0, correct	#0, wrong	= 0
Result	'15'H	'06'H	'06'H	'01'H	'06'H
Diagnostic	'02'H	'00'H	'00'H	'00'H	'00'H

### 11.6.15 Response to Write-Appl-Record-Curr-Rq

#### 11.6.15.1 Definition

On reception of a Write-Appl-Record-Curr-Rq directive, the OBU shall write specified data onto the Application Record memory structure, pointing to the current record. Only formal controls are made on the requested operation and the Result and Diagnostics parameters shall reflect the results of such controls.

#### 11.6.15.2 Method of measurement

This protocol message and related parameters encoding shall be as defined in clauses 11.2 and 11.4.

#### 11.6.15.3 Limits

As the response message bears no parameters, the only admitted values for the response shall be those in the "Result" and "Diagnostic" fields as presented in table 59. Dependent on specific exceptions, the value of "Diagnostic" may be different, see clause 11.6.1.

**Table 59: "Result" and "Diagnostic" in Write-Appl-Record-Curr-Rs**

Active valid session	No		Yes		
	#0	= 0	#0, correct	#0, wrong	= 0
Link ID	#0	= 0	#0, correct	#0, wrong	= 0
Result	'15'H	'15'H	'06'H	'01'H	'06'H
Diagnostic	'02'H	'02'H	'00'H	'00'H	'00'H

### 11.6.16 Response to Write-Appl-Record-Curr-Conf-Rq

#### 11.6.16.1 Definition

On reception of a Write-Appl-Record-Curr-Conf-Rq directive, the OBU shall write specified data onto the Application Record memory structure, pointing to the current record. A response shall only be issued after the write operation has been completed. Result and Diagnostics in this case shall reflect the actual result codes of the write operation.

#### 11.6.16.2 Method of measurement

This protocol message and related parameters encoding shall be as defined in clauses 11.2 and 11.4.

### 11.6.16.3 Limits

As the response message bears no parameters, the only admitted values for the response shall be those in the "Result" and "Diagnostic" fields as presented in table 60. Dependent on specific exceptions, the value of "Diagnostic" may be different, see clause 11.6.1.

**Table 60: "Result" and "Diagnostic" in Write-Appl-Record-Curr-Conf-Rs**

Active valid session	No		Yes		
	≠0	= 0	≠0, correct	≠0, wrong	= 0
Link ID	'15'H	'15'H	'06'H	'01'H	'06'H
Result	'15'H	'15'H	'06'H	'01'H	'06'H
Diagnostic	'02'H	'02'H	'00'H	'00'H	'00'H

### 11.6.17 Response to Write-Appl-Record-Next-Rq

#### 11.6.17.1 Definition

On reception of a Write-Appl-Record-Next-Rq directive, the OBU shall write specified data onto the Application Record memory structure, pointing to the next available record. Only formal controls are made on the requested operation and the Result and Diagnostics parameters shall reflect the results of such controls.

#### 11.6.17.2 Method of measurement

This protocol message and related parameters encoding shall be as defined in clauses 11.2 and 11.4.

#### 11.6.17.3 Limits

As the response message bears no parameters, the only admitted values for the response shall be those in the "Result" and "Diagnostic" fields as presented in table 61. Dependent on specific exceptions, the value of "Diagnostic" may be different, see clause 11.6.1.

**Table 61: "Result" and "Diagnostic" in Write-Appl-Record-Next-Rs**

Active valid session	No		Yes		
	≠0	= 0	≠0, correct	≠0, wrong	= 0
Link ID	'15'H	'15'H	'06'H	'01'H	'06'H
Result	'15'H	'15'H	'06'H	'01'H	'06'H
Diagnostic	'02'H	'02'H	'00'H	'00'H	'00'H

### 11.6.18 Response to Write-Appl-Record-Next-Conf-Rq

#### 11.6.18.1 Definition

On reception of a Write-Appl-Record-Next-Conf-Rq directive, the OBU shall write specified data onto the Application Record memory structure, pointing to the next available record. A response shall only be issued after the write operation has been completed. Result and Diagnostics in this case shall reflect the actual result codes of the write operation.

#### 11.6.18.2 Method of measurement

This protocol message and related parameters encoding shall be as defined in clauses 11.2 and 11.4.

#### 11.6.18.3 Limits

As the response message bears no parameters, the only admitted values for the response shall be those in the "Result" and "Diagnostic" fields as presented in table 62. Dependent on specific exceptions, the value of "Diagnostic" may be different, see clause 11.6.1.

**Table 62: "Result" and "Diagnostic" in Write-Appl-Record-Next-Conf-Rs**

Active valid session	No		Yes		
	≠0	= 0	≠0, correct	≠0, wrong	= 0
Link ID	'15'H	'15'H	'06'H	'01'H	'06'H
Result	'15'H	'15'H	'06'H	'01'H	'06'H
Diagnostic	'02'H	'02'H	'00'H	'00'H	'00'H

## 11.6.19 Response to Set-UIF-Rq

### 11.6.19.1 Definition

On reception of a Set-UIF-Rq directive, the OBU shall perform actions on the user interface according to the parameters set in the directive. Result and Diagnostics shall reflect the result codes of the user interface operation.

### 11.6.19.2 Method of measurement

This protocol message and related parameters encoding shall be as defined in clauses 11.2 and 11.4.

### 11.6.19.3 Limits

As the response message bears no parameters, the only admitted values for the response shall be those in the "Result" and "Diagnostic" fields as presented in table 63. Dependent on specific exceptions, the value of "Diagnostic" may be different, see clause 11.6.1.

**Table 63: "Result" and "Diagnostic" in Set-UIF-Rs**

Active valid session	No		Yes		
	≠0	= 0	≠0, correct	≠0, wrong	= 0
Link ID	'15'H	'06'H	'06'H	'01'H	'06'H
Result	'15'H	'06'H	'06'H	'01'H	'06'H
Diagnostic	'02'H	'00'H	'00'H	'00'H	'00'H

## 11.6.20 Response to Action-Rq

### 11.6.20.1 Definition

This response message is optional, and maintained only for compatibility with older versions of the present document, so there is no obligation to implement it. If implemented, on reception of an Action-Rq directive, the OBU shall behave as follows:

- 1) If Immediate mode has been specified in the "Mode" parameter of the Action-Rq directive, then the OBU shall execute the requested action on the selected external device, and wait for the results before issuing a response.
- 2) If Deferred mode has been specified in the "Mode" parameter of the Action-Rq directive, then the OBU shall respond with the results of the formal controls on the Action-Rq directive, and execute the requested action on the selected external device without waiting for the results of such action.

### 11.6.20.2 Method of measurement

This protocol message and related parameters encoding shall be as defined in clauses 11.2 and 11.4.

### 11.6.20.3 Limits

Table 64 lists the Action-Rs parameters, their ASN.1 types, limits and allowed values.

Table 64: Action-Rs parameters

Parameter Name	ASN.1 type	Limits and allowed values
Data-length	Integer-1-1B	Length of data to be transmitted as result of the executed action.
Data	SEQUENCE OF Bit-String-1B	

The admitted values for the "Result" and "Diagnostic" fields are presented in table 65. Dependent on specific exceptions, the value of "Diagnostic" may be different, see clause 11.6.1.

Table 65: "Result" and "Diagnostic" in Action-Rs

Active valid session	No		Yes		
	≠0	= 0	≠0, correct	≠0, wrong	= 0
Link ID					
Result	'15'H	'15'H	'06'H	'01'H	'06'H
Diagnostic	'02'H	'02'H	'00'H	'00'H	'00'H

## 11.6.21 Response to Set-Password-Rq

### 11.6.21.1 Definition

On reception of a Set-Password-Rq directive, the OBU shall store the new value of the password on a permanent memory area, and use it for accessing password protected areas for the rest of the current session. On starting a new session, the OBU will use the default password again, but maintain the received password in the permanent storage area.

### 11.6.21.2 Method of measurement

This protocol message and related parameters encoding shall be as defined in clauses 11.2 and 11.4.

### 11.6.21.3 Limits

As the response message bears no parameters, the only admitted values for the response shall be those in the "Result" and "Diagnostic" fields as presented in table 66. Dependent on specific exceptions, the value of "Diagnostic" may be different, see clause 11.6.1.

Table 66: "Result" and "Diagnostic" in Set-Password-Rs

Active valid session	No		Yes		
	≠0	= 0	≠0, correct	≠0, wrong	= 0
Link ID					
Result	'15'H	'15'H	'06'H	'01'H	'06'H
Diagnostic	'02'H	'02'H	'00'H	'00'H	'00'H

## 11.6.22 Response to Use-Last-Password-Rq

### 11.6.22.1 Definition

On reception of a Use-Last-Password-Rq directive, the OBU shall use the previously stored (by means of a Set-Password-Rq directive) value of a password for accessing password protected areas for the rest of the current session. On starting a new session, the OBU will use the default password again, but maintain the received password in the permanent storage area.

### 11.6.22.2 Method of measurement

This protocol message and related parameters encoding shall be as defined in clauses 11.2 and 11.4.

### 11.6.22.3 Limits

As the response message bears no parameters, the only admitted values for the response shall be those in the "Result" and "Diagnostic" fields as presented in table 67. Dependent on specific exceptions, the value of "Diagnostic" may be different, see clause 11.6.1.

**Table 67: "Result" and "Diagnostic" in Use-Last-Password-Rs**

Active valid session	No		Yes		
	≠0	= 0	≠0, correct	≠0, wrong	= 0
Link ID	'15'H	'06'H	'06'H	'01'H	'06'H
Result	'15'H	'06'H	'06'H	'01'H	'06'H
Diagnostic	'02'H	'00'H	'00'H	'00'H	'00'H

## 11.6.23 Response to Get-TBA-Random-Rq

### 11.6.23.1 Definition

On reception of a Get-TBA-Random-Rq directive, the OBU shall respond with a pseudo-random generated number to be used in subsequent security exchanges. The length of the random number shall be exactly that specified in the corresponding request directive.

### 11.6.23.2 Method of measurement

This protocol message and related parameters encoding shall be as defined in clauses 11.2 and 11.4.

### 11.6.23.3 Limits

Table 68 lists the Get-TBA-Random-Rs parameters, their ASN.1 types, limits and allowed values.

**Table 68: Get-TBA-Random-Rs parameters**

Parameter Name	ASN.1 type	Limits and allowed values
Get-TBA-Random-Rs	SEQUENCE OF Bit-String-1B	Length of data shall be exactly that as specified in the related directive.

The admitted values for the "Result" and "Diagnostic" fields are presented in table 69. Dependent on specific exceptions, the value of "Diagnostic" may be different, see clause 11.6.1.

**Table 69: "Result" and "Diagnostic" in Get-TBA-Random-Rs**

Active valid session	No		Yes		
	≠0	= 0	≠0, correct	≠0, wrong	= 0
Link ID	'15'H	'06'H	'06'H	'01'H	'06'H
Result	'15'H	'06'H	'06'H	'01'H	'06'H
Diagnostic	'02'H	'00'H	'00'H	'00'H	'00'H

## 11.6.24 Response to Set-Credential-Rq

### 11.6.24.1 Definition

On reception of a Set-Credential-Rq directive, the OBU shall verify the received value of the RSU credentials against an agreed parameter value that is stored in its publicly available memory area. Result and Diagnostics in this case shall reflect the actual result codes of the verification operation.

### 11.6.24.2 Method of measurement

This protocol message and related parameters encoding shall be as defined in clauses 11.2 and 11.4.

### 11.6.24.3 Limits

As the response message bears no parameters, the only admitted values for the response shall be those in the "Result" and "Diagnostic" fields as presented in table 70. Dependent on specific exceptions, the value of "Diagnostic" may be different, see clause 11.6.1.

**Table 70: "Result" and "Diagnostic" in Set-Credential-Rs**

Active valid session	No		Yes		
	≠0	= 0	≠0, correct	≠0, wrong	= 0
Link ID	'15'H	'15'H	'06'H	'15'H	'06'H
Result	'15'H	'15'H	'06'H	'15'H	'06'H
Diagnostic	'02'H	'02'H	'00'H	'04'H	'00'H

### 11.6.25 Response to Get-Credential-Rq

#### 11.6.25.1 Definition

On reception of a Get-Credential-Rq directive, the OBU shall calculate its credentials on the basis of the value of the field, the password, and the nonce specified in the related Get-Credential-Rq directive. The calculated response shall be exactly four (4) octets in length.

#### 11.6.25.2 Method of measurement

This protocol message and related parameters encoding shall be as defined in clauses 11.2 and 11.4.

#### 11.6.25.3 Limits

Table 71 lists the Get-TBA-Random-Rs parameters, their ASN.1 types, limits and allowed values.

**Table 71: Get-Credential-Rs parameters**

Parameter Name	ASN.1 type	Limits and allowed values
Get-Credential-Rs	SEQUENCE OF Bit-String-1B	Length of data shall be exactly 4 octets.

The admitted values for the "Result" and "Diagnostic" fields are presented in table 72. Dependent on specific exceptions, the value of "Diagnostic" may be different, see clause 11.6.1.

**Table 72: "Result" and "Diagnostic" in Get-Credential-Rs**

Active valid session	No		Yes		
	≠0	= 0	≠0, correct	≠0, wrong	= 0
Link ID	'15'H	'06'H	'06'H	'15'H	'06'H
Result	'15'H	'06'H	'06'H	'15'H	'06'H
Diagnostic	'02'H	'00'H	'00'H	'04'H	'00'H

---

## 12 Measurement uncertainty

The accumulated measurement uncertainties of the test system in use, for the parameters to be measured, should not exceed those given in table 73, to ensure that the measurements remain within an acceptable standard.

**Table 73: Absolute measurement uncertainty**

<b>Parameter</b>	<b>Uncertainty</b>
RF power (conducted)	±4 dB
RF frequency, relative	± 1 x 10 <sup>-7</sup>
Radiated emission of transmitter, valid to 40 GHz	±6 dB
Adjacent channel power	±5 dB
Sensitivity	±5 dB
Two and three signal measurements	±4 dB
Two and three signal measurements using radiated fields	±6 dB
Radiated emission of receiver, valid to 40 GHz	±6 dB
Temperature	±1 K
Humidity	±5 %

For the test methods according to the present document the uncertainty figures are valid to a confidence level of 95 % calculated according to the methods described in TR 100 028 [4].



## Annex A (normative): Radiated measurement

### A.1 Test sites and general arrangements for measurements involving the use of radiated fields

This annex introduces three most commonly available test sites, an Anechoic Chamber, an Anechoic Chamber with a ground plane and an Open Area Test Site (OATS), which may be used for radiated tests. These test sites are generally referred to as free field test sites. Both absolute and relative measurements can be performed in these sites. Where absolute measurements are to be carried out, the chamber should be verified. A detailed verification procedure is described in TR 102 273 [i.1] relevant parts 2, 3 and 4.

**NOTE:** To ensure reproducibility and traceability of radiated measurements only these test sites should be used in measurements in accordance with the present document.

#### A.1.1 Anechoic chamber

An anechoic chamber is an enclosure, usually shielded, whose internal walls, floor and ceiling are covered with radio absorbing material, normally of the pyramidal urethane foam type. The chamber usually contains an antenna support at one end and a turntable at the other. A typical anechoic chamber is shown in figure A.1.

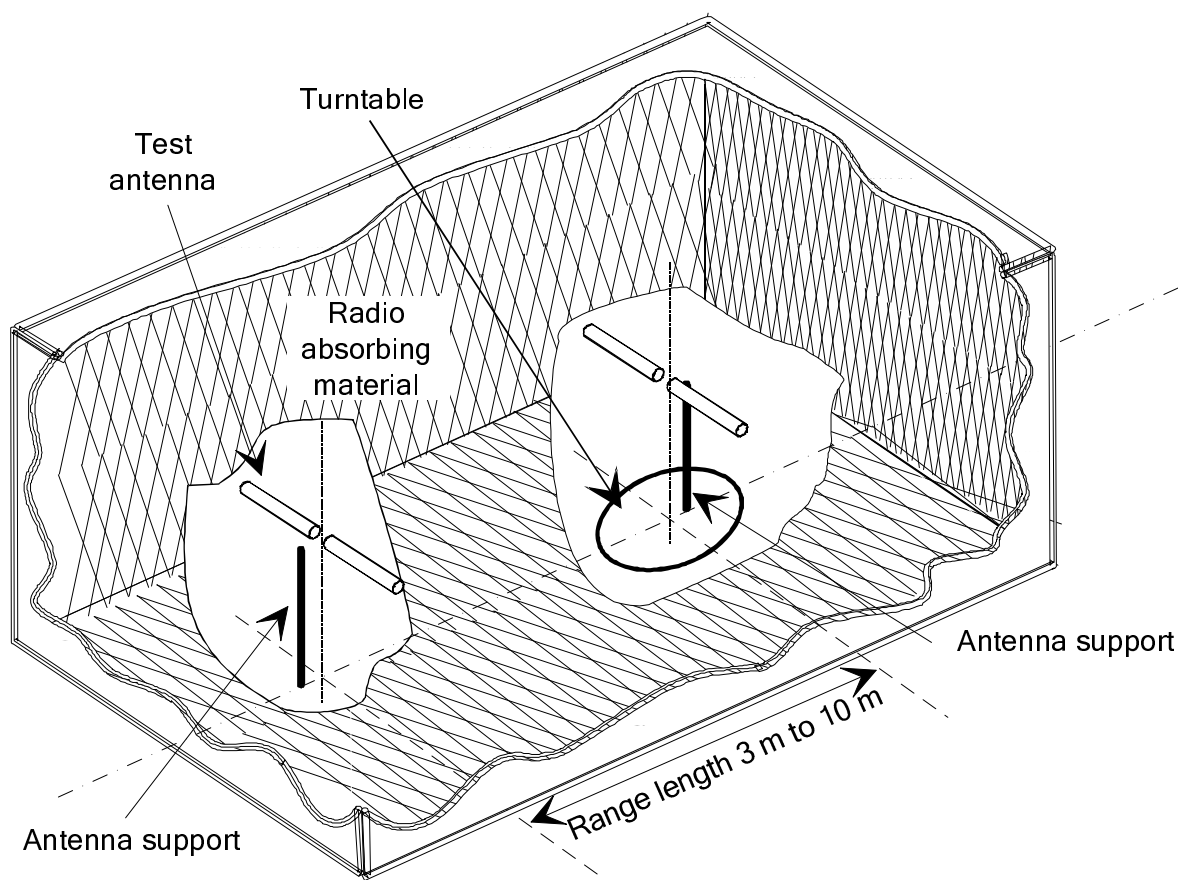

Figure A.1: A typical anechoic chamber

The chamber shielding and radio absorbing material work together to provide a controlled environment for testing purposes. This type of test chamber attempts to simulate free space conditions.

The shielding provides a test space, with reduced levels of interference from ambient signals and other outside effects, whilst the radio absorbing material minimizes unwanted reflections from the walls and ceiling which can influence the measurements. In practice it is relatively easy for shielding to provide high levels (80 dB to 140 dB) of ambient interference rejection, normally making ambient interference negligible.

A turntable is capable of rotation through 360° in the horizontal plane and it is used to support the test sample (EUT) at a suitable height (e.g. 1 m) above the ground plane. The chamber shall be large enough to allow the measuring distance of at least 3 m or  $2(d_1 + d_2)^2/\lambda$  (m), whichever is greater (see to clause A.2.5). The distance used in actual measurements shall be recorded with the test results.

The anechoic chamber generally has several advantages over other test facilities. There is minimal ambient interference, minimal floor, ceiling and wall reflections and it is independent of the weather. It does however have some disadvantages which include limited measuring distance and limited lower frequency usage due to the size of the pyramidal absorbers. To improve low frequency performance, a combination structure of ferrite tiles and urethane foam absorbers is commonly used.

All types of emission, sensitivity and immunity testing can be carried out within an Anechoic Chamber without limitation.

## A.1.2 Anechoic chamber with a conductive ground plane

An anechoic chamber with a conductive ground plane is an enclosure, usually shielded, whose internal walls and ceiling are covered with radio absorbing material, normally of the pyramidal urethane foam type. The floor, which is metallic, is not covered and forms the ground plane. The chamber usually contains an antenna mast at one end and a turntable at the other. A typical anechoic chamber with a conductive ground plane is shown in figure A.2.

This type of test chamber attempts to simulate an ideal Open Area Test Site whose primary characteristic is a perfectly conducting ground plane of infinite extent.

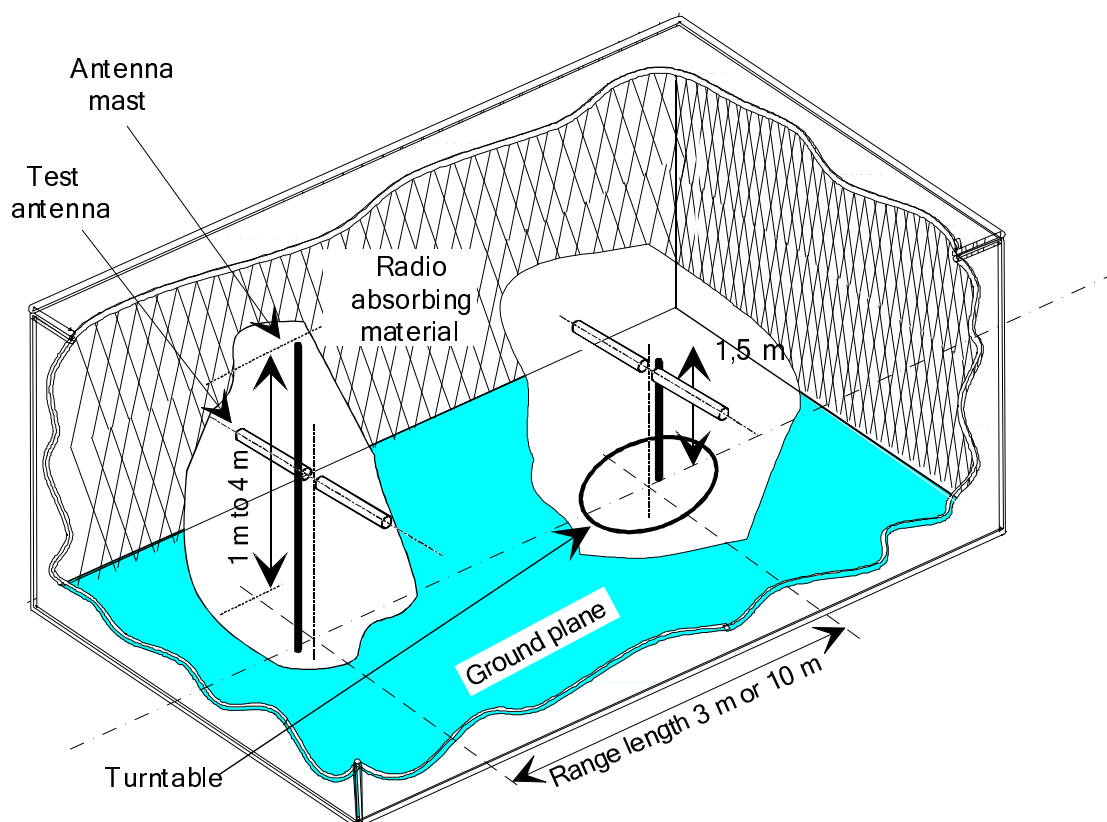

Figure A.2: A typical anechoic chamber with a conductive ground plane

In this facility the ground plane creates the wanted reflection path, such that the signal received by the receiving antenna is the sum of the signals from both the direct and reflected transmission paths. This creates a unique received signal level for each height of the transmitting antenna (or EUT) and the receiving antenna above the ground plane.

The antenna mast provides a variable height facility (from 1 m to 4 m) so that the position of the test antenna can be optimized for maximum coupled signal between antennas or between a EUT and the test antenna.

A turntable is capable of rotation through 360° in the horizontal plane and it is used to support the test sample (EUT) at a specified height, usually 1,5 m above the ground plane. The chamber shall be large enough to allow the measuring distance of at least 3 m or  $2(d_1 + d_2)^2/\lambda$  (m), whichever is greater (see clause A.2.5). The distance used in actual measurements shall be recorded with the test results.

Emission testing involves firstly "peaking" the field strength from the EUT by raising and lowering the receiving antenna on the mast (to obtain the maximum constructive interference of the direct and reflected signals from the EUT) and then rotating the turntable for a "peak" in the azimuth plane. At this height of the test antenna on the mast, the amplitude of the received signal is noted. Secondly the EUT is replaced by a substitution antenna (positioned at the EUT's phase or volume centre) which is connected to a signal generator. The signal is again "peaked" and the signal generator output adjusted until the level, noted in stage one, is again measured on the receiving device.

Receiver sensitivity tests over a ground plane also involve "peaking" the field strength by raising and lowering the test antenna on the mast to obtain the maximum constructive interference of the direct and reflected signals, this time using a measuring antenna which has been positioned where the phase or volume centre of the EUT will be during testing. A transform factor is derived. The test antenna remains at the same height for stage two, during which the measuring antenna is replaced by the EUT. The amplitude of the transmitted signal is reduced to determine the field strength level at which a specified response is obtained from the EUT.

### A.1.3 Open Area Test Site (OATS)

An Open Area Test Site comprises a turntable at one end and an antenna mast of variable height at the other end above a ground plane which, in the ideal case, is perfectly conducting and of infinite extent. In practice, while good conductivity can be achieved, the ground plane size has to be limited. A typical Open Area Test Site is shown in figure A.3.

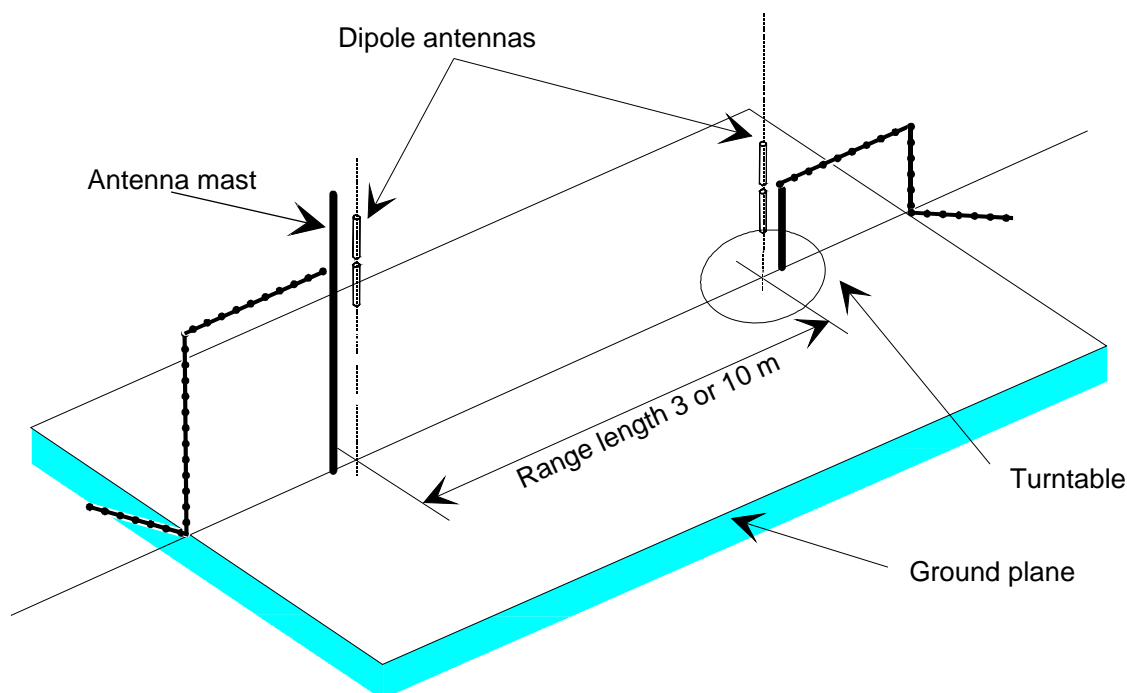
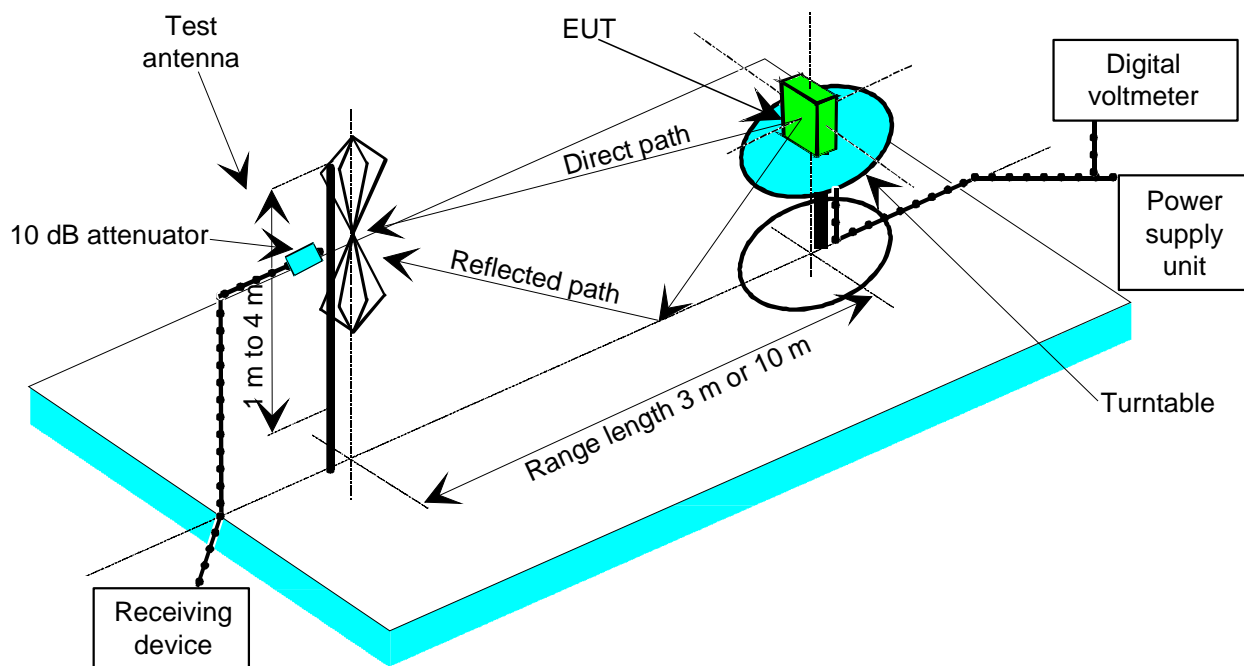

Figure A.3: A typical Open Area Test Site

The ground plane creates a wanted reflection path, such that the signal received by the receiving antenna is the sum of the signals received from the direct and reflected transmission paths. The phasing of these two signals creates a unique received level for each height of the transmitting antenna (or EUT) and the receiving antenna above the ground plane.

Site qualification concerning antenna positions, turntable, measurement distance and other arrangements are same as for anechoic chamber with a ground plane (see figure A.2). In radiated measurements an OATS is also used by the same way as anechoic chamber with a ground plane.

Typical measuring arrangement common for ground plane test sites is presented in figure A.4.



**Figure A.4: Measuring arrangement on ground plane test site (OATS set-up for spurious emission testing)**

### A.1.4 Test antenna

A test antenna is always used in radiated test methods. In emission tests (i.e. frequency error, effective radiated power, spurious emissions and adjacent channel power) the test antenna is used to detect the field from the EUT in one stage of the measurement and from the substitution antenna in the other stage. When the test site is used for the measurement of receiver characteristics (i.e. sensitivity and various immunity parameters) the antenna is used as the transmitting device.

The test antenna should be mounted on a support capable of allowing the antenna to be used in either horizontal or vertical polarization which, on ground plane sites (i.e. Anechoic Chambers with ground planes and Open Area Test Sites), should additionally allow the height of its centre above the ground to be varied over the specified range (usually 1 metre to 4 metres).

In the frequency band 30 MHz to 1 000 MHz, dipole antennas (constructed in accordance with ANSI C63.5 [11]) are generally recommended. For frequencies of 80 MHz and above, the dipoles should have their arm lengths set for resonance at the frequency of test. Below 80 MHz, shortened arm lengths are recommended. For spurious emission testing, however, a combination of biconical antennas (commonly termed "bicones" and log periodic dipole array antennas (commonly termed "log periodics") could be used to cover the entire 30 MHz to 1 000 MHz band. Above 1 000 MHz, waveguide horns are recommended although, again, log periodics could be used.

NOTE: The gain of a horn antenna is generally expressed relative to an isotropic radiator.

## A.1.5 Substitution antenna

The substitution antenna is used to replace the EUT for tests in which a transmitting parameter (i.e. frequency error, effective radiated power, spurious emissions and adjacent channel power) is being measured. For measurements in the frequency band 30 MHz to 1 000 MHz, the substitution antenna should be a dipole antenna (constructed in accordance with ANSI C63.5 [11]). For frequencies of 80 MHz and above, the dipoles should have their arm lengths set for resonance at the frequency of test. Below 80 MHz, shortened arm lengths are recommended. For measurements above 1 000 MHz, a waveguide horn is recommended. The centre of this antenna should coincide with either the phase centre or volume centre.

## A.1.6 Measuring antenna

The measuring antenna is used in tests on a EUT in which a receiving parameter (i.e. sensitivity and various immunity tests) is being measured. Its purpose is to enable a measurement of the electric field strength in the vicinity of the EUT. For measurements in the frequency band 30 MHz to 1 000 MHz, the measuring antenna should be a dipole antenna (constructed in accordance with ANSI C63.5 [11]). For frequencies of 80 MHz and above, the dipoles should have their arm lengths set for resonance at the frequency of test. Below 80 MHz, shortened arm lengths are recommended. The centre of this antenna should coincide with either the phase centre or volume centre (as specified in the test method) of the EUT.

---

# A.2 Guidance on the use of radiation test sites

This clause details procedures, test equipment arrangements and verification that should be carried out before any of the radiated test are undertaken. These schemes are common to all types of test sites described in annex A.

## A.2.1 Verification of the test site

No test should be carried out on a test site which does not possess a valid certificate of verification. The verification procedures for the different types of test sites described in annex A (i.e. Anechoic Chamber, Anechoic Chamber with a ground plane and Open Area Test Site) are given in TR 102 273 [i.1], parts 2, 3 and 4, respectively.

## A.2.2 Preparation of the EUT

The manufacturer should supply information about the EUT covering the operating frequency, polarization, supply voltage(s) and the reference face. Additional information, specific to the type of EUT should include, where relevant, transmitter power, channel separation, whether different operating modes are available (e.g. high and low power modes) and if operation is continuous or is subject to a maximum test duty cycle (e.g. 1 minute on, 4 minutes off).

Where necessary, a mounting bracket of minimal size should be available for mounting the EUT on the turntable. This bracket should be made from low conductivity, low relative dielectric constant (i.e. less than 1,5) material(s) such as expanded polystyrene, balsawood, etc.

## A.2.3 Power supplies to the EUT

All tests should be performed using power supplies wherever possible, including tests on EUT designed for battery-only use. In all cases, power leads should be connected to the EUT's supply terminals (and monitored with a digital voltmeter) but the battery should remain present, electrically isolated from the rest of the equipment, possibly by putting tape over its contacts.

The presence of these power cables can, however, affect the measured performance of the EUT. For this reason, they should be made to be "transparent" as far as the testing is concerned. This can be achieved by routing them away from the EUT and down to the either the screen, ground plane or facility wall (as appropriate) by the shortest possible paths. Precautions should be taken to minimize pick-up on these leads (e.g. the leads could be twisted together, loaded with ferrite beads at 0,15 m spacing or otherwise loaded).

## A.2.4 Range length

The range length for all these types of test facility should be adequate to allow for testing in the far-field of the EUT i.e. it should be equal to or exceed:

$$\frac{2(d_1 + d_2)^2}{\lambda}$$

where:

- $d_1$  is the largest dimension of the EUT/dipole after substitution (m);
- $d_2$  is the largest dimension of the test antenna (m);
- $\lambda$  is the test frequency wavelength (m).

It should be noted that in the substitution part of this measurement, where both test and substitution antennas are half wavelength dipoles, this minimum range length for far-field testing would be:

$$2\lambda$$

It should be noted in test reports when either of these conditions is not met so that the additional measurement uncertainty can be incorporated into the results.

NOTE 1: For the fully anechoic chamber, no part of the volume of the EUT should, at any angle of rotation of the turntable, fall outside the "quiet zone" of the chamber at the nominal frequency of the test.

NOTE 2: The "quiet zone" is a volume within the Anechoic Chamber (without a ground plane) in which a specified performance has either been proven by test, or is guaranteed by the designer/manufacturer. The specified performance is usually the reflectivity of the absorbing panels or a directly related parameter (e.g. signal uniformity in amplitude and phase). It should be noted however that the defining levels of the quiet zone tend to vary.

NOTE 3: For the anechoic chamber with a ground plane, a full height scanning capability, i.e. 1 m to 4 m, should be available for which no part of the test antenna should come within 1 m of the absorbing panels. For both types of Anechoic Chamber, the reflectivity of the absorbing panels should not be worse than -5 dB.

NOTE 4: For both the anechoic chamber with a ground plane and the Open Area Test Site, no part of any antenna should come within 0,25 m of the ground plane at any time throughout the tests. Where any of these conditions cannot be met, measurements should not be carried out.

## A.2.5 Site preparation

The cables for both ends of the test site should be routed horizontally away from the testing area for a minimum of 2 m (unless, in the case both types of anechoic chamber, a back wall is reached) and then allowed to drop vertically and out through either the ground plane or screen (as appropriate) to the test equipment. Precautions should be taken to minimize pick up on these leads (e.g. dressing with ferrite beads, or other loading). The cables, their routing and dressing should be identical to the verification set-up.

NOTE: For ground reflection test sites (i.e. anechoic chambers with ground planes and Open Area Test Sites) which incorporate a cable drum with the antenna mast, the 2 m requirement may be impossible to comply with.

Calibration data for all items of test equipment should be available and valid. For test, substitution and measuring antennas, the data should include gain relative to an isotropic radiator (or antenna factor) for the frequency of test. Also, the VSWR of the substitution and measuring antennas should be known.

The calibration data on all cables and attenuators should include insertion loss and VSWR throughout the entire frequency range of the tests. All VSWR and insertion loss figures should be recorded in the log book results sheet for the specific test.

Where correction factors/tables are required, these should be immediately available.

For all items of test equipment, the maximum errors they exhibit should be known along with the distribution of the error e.g.:

- cable loss:  $\pm 0,5$  dB with a rectangular distribution;
- measuring receiver: 1,0 dB (standard deviation) signal level accuracy with a Gaussian error distribution.

At the start of measurements, system checks should be made on the items of test equipment used on the test site.

---

## A.3 Coupling of signals

### A.3.1 General

The presence of leads in the radiated field may cause a disturbance of that field and lead to additional measurement uncertainty. These disturbances can be minimized by using suitable coupling methods, offering signal isolation and minimum field disturbance (e.g. optical and acoustic coupling).

### A.3.2 Data Signals

Isolation can be provided by the use of optical, ultrasonic or infra-red means. Field disturbance can be minimized by using a suitable fibre optic connection. ultrasonic or infra-red radiated connections require suitable measures for the minimization of ambient noise.

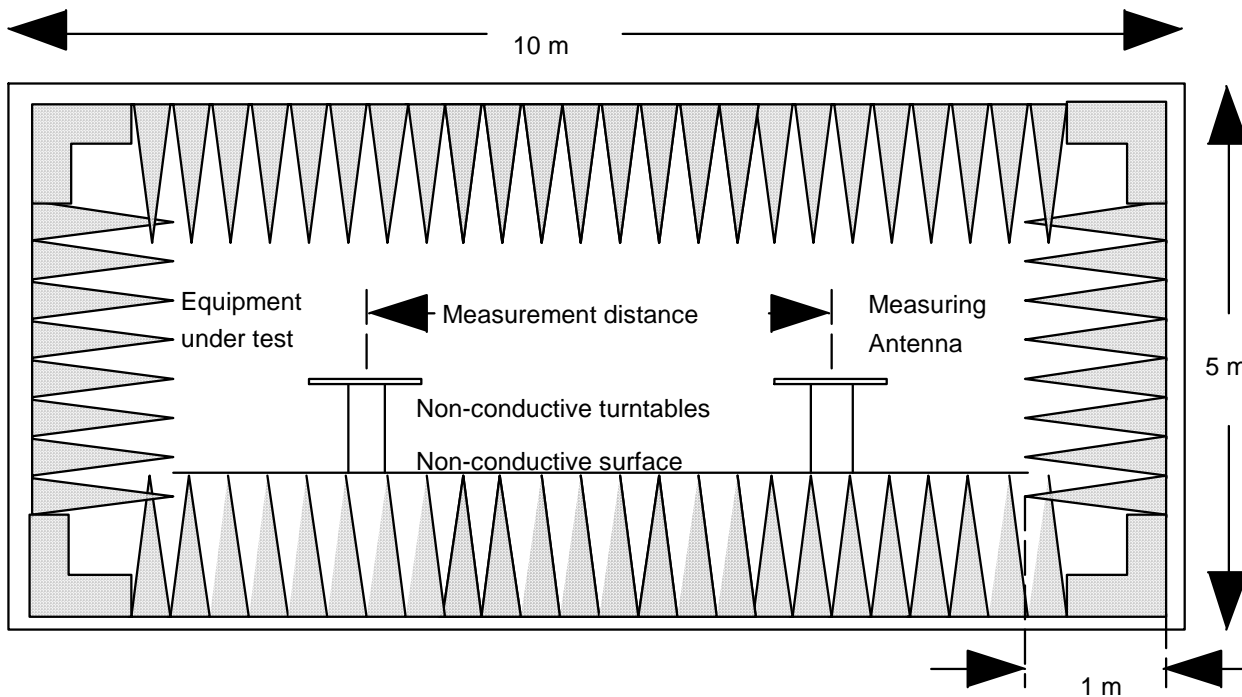

Ground plan

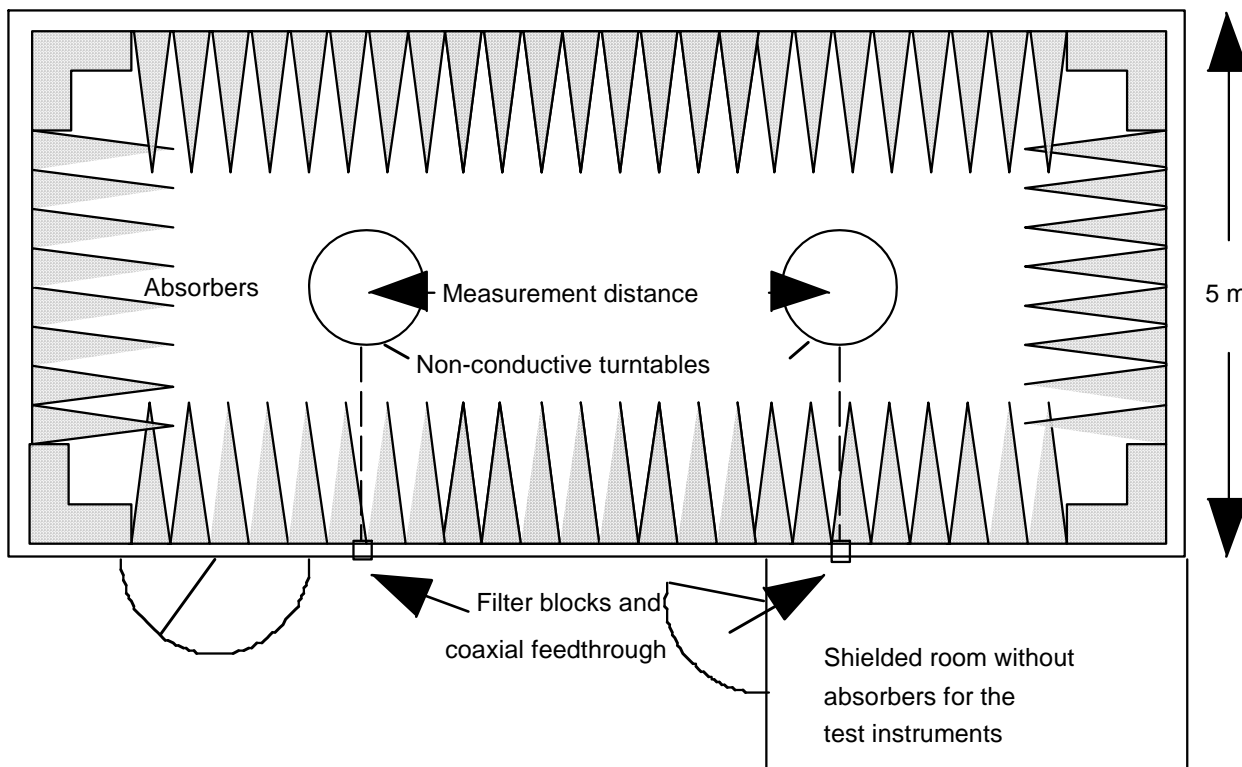

Figure A.5: Example of construction of an anechoic shielded chamber



---

## Annex B (normative): General description of measurement methods

This annex gives the general methods of measurements for RF signals using the test sites and arrangements described in annex A. In addition, this annex gives a simple measurement method for radiated emissions based on a calculated rather than measured path loss.

---

### B.1 Conducted measurements

In view of the low power levels of the equipment to be tested under the present document, conducted measurements may be applied to equipment provided with an antenna connector. Where the equipment to be tested does not provide a suitable termination, a coupler or attenuator that does provide the correct termination value shall be used.

The equivalent isotropically radiated power is then calculated from the measured value, the known antenna gain relative to an isotropic antenna and, if applicable, any losses due to cables and connectors in the measurement system.

---

### B.2 Radiated measurements

Radiated measurements shall be performed with the aid of a test antenna and measuring receiver as described in annex A. The test antenna and measurement receiver, spectrum analyser or selective voltmeter, shall be calibrated according to the procedure defined in this annex. The equipment to be measured and the test antenna shall be oriented to obtain the maximum emitted power level. This position shall be recorded in the measurement report. The frequency range shall be measured in this position.

Radiated measurements should be performed in an anechoic chamber. For other test sites corrections may be needed (see annex A):

- a) a test site which fulfils the requirements of the specified frequency range of this measurement shall be used;
- b) the transmitter under test shall be placed on the support in its standard position (clause A1.2) and switched on;
- c) the test antenna shall be oriented initially for vertical polarization unless otherwise stated. The test antenna shall be raised or lowered, through the specified height range until the maximum signal level is detected on the measuring receiver. (The test antenna need not be raised or lowered if the measurement is carried out on a test site according to clause A.3);
- d) the transmitter shall be rotated through 360° about a vertical axis to maximize the received signal;
- e) the test antenna shall be raised or lowered again, if necessary, through the specified height range until a maximum is obtained. This level shall be recorded. (This maximum may be a lower value than the value obtainable at heights outside the specified limits);
- f) this measurement shall be repeated for horizontal polarization;
- g) the substitution antenna shall replace the transmitter antenna in the same position and in vertical polarization. The frequency of the signal generator shall be adjusted to the transmitter (carrier) frequency;
- h) steps c) to f) shall be repeated;
- i) the input signal to the substitution antenna shall be adjusted in level until an equal or a known related level to that detected from the transmitter is obtained in the test receiver;
- j) this measurement shall be repeated with horizontal polarization;
- k) the radiated power is equal to the power supplied by the signal generator, increased by the gain of the substitution antenna and the cable losses between the signal generator and the substitution antenna.

---

## Annex C (normative): Receiver methods of measurements using messages

### C.1 General

The equipment may be tested by using messages when it is not possible to test with bit streams according to clause 6.1.1.1. In this case the normal test signal shall be trains of correctly coded bits or messages modulation D-M4. Such messages can also be used for activation of OBUs or performance test of a total installed system.

---

### C.2 Test signals

The normal test signals and modulations shall be obtained as follows:

- D-M3 corresponds to single messages, used for receiver measurements using the up-down method as described in clauses C.3 and C.4, triggered either manually or by an automatic testing system. This provides the "normal test signal" as required for receiver measurements (e.g. see clauses 8.1.2.4 and 8.3);
- D-M4 consists of correctly coded signals, messages transmitted sequentially, one by one, without gaps between them;
- D-M4' consists of incorrectly coded signals, messages transmitted sequentially, one by one, without gaps between them.

D-M3 is used for receiver methods of measurement with messages where there is a need to transmit single messages a number of times (e.g. 20 times, see "normal test signal" of clauses 8.3.3.2, 8.3.4.2, 8.3.5.2 and 8.3.6.2). The corresponding normal test modulation shall be agreed between the manufacturer and the test laboratory.

The test signal D-M4 is used for transmitter methods of measurement such as out of band power (clause 7.3.2), radiated spurious emissions (clauses 7.7.4 and 7.7.5) and interference test modulation during receiver degradation measurements (clause 8.3). The test signals D-M4 and D-M4' shall be agreed between the manufacturer and the test laboratory.

The encoder, which is associated with the transmitter, shall be capable of supplying the normal test modulation for D-M3, and the test signal D-M4. The details of D-M3, D-M4 and D-M4' shall be included in the test report.

---

### C.3 Method of measurement for receiver sensitivity

The appropriate test arrangement as shown in clause 8.1.2 and figures 14, 16 or 18 shall be used with the exception that the bit stream generator and bit error ratio measuring devices are replaced by a message generator and a message detection indication device.

The following procedure shall be used with the exception that the bit stream generator and bit error ratio measuring devices are replaced by a message generator and a message detection indication device.

The following test procedure shall be used:

- a) the wanted signal, signal generator A, operating at the nominal frequency of the receiver shall be modulated with normal test signal D-M3 in accordance with the instructions of the manufacturer and shall be approved by the test laboratory;
- b) the level of the signal generator A shall be such that a successful message ratio is less than 10 %;
- c) the nominal modulation test signal shall be transmitted repeatedly whilst observing in each case whether or not a successful response is obtained. The level of signal generator A shall be increased by 2 dB for each occasion that a successful response is not obtained. The procedure shall be continued until three successful responses are obtained. The level of signal generator A shall be recorded;

- d) the level of signal generator A shall be reduced by 1 dB and the new value recorded. The normal modulation test signal shall be repeated 20 times. In each case, if a response is not obtained the signal generator level shall be increased by 1 dB and the new value recorded. If a successful response is obtained, the signal generator level shall not be changed until three consecutive successful responses have been obtained. In this case, the signal generator level shall be reduced by 1 dB and the new value recorded. No signal generator levels shall be recorded unless preceded by a change in level;
- e) the maximum useable sensitivity is the average of the values recorded in steps c) and d);
- f) the measurement shall be repeated under extreme test conditions.

The sensitivity shall be stated in the test report.

The limit for sensitivity is the same as for the continuous bit stream method of measurements, see clause 8.1.3.

---

## C.4 Method of measurements for receiver degradation

The appropriate test arrangement as shown in figures 11, 12, 13, or 14, clause 8.3 shall be used with the following exception: the bit stream generator and bit error ratio measuring devices shall be replaced by a message generator and a message detection indication device.

The test procedure is the same as defined in clause 8.3 except for the following:

- a) the modulation test signal for the wanted signal, signal generator A, shall be modulated with test signal D-M3;
- b) the unwanted signal, signal generator B (and C, if appropriate), if modulated, shall be modulated with test signal D-M4;
- c) the level of the unwanted signal, signal generator B (and C, if appropriate), shall be such that a successful message ratio is less than 10 %;
- d) the nominal modulation test signal of the wanted signal, signal generator A, shall be transmitted repeatedly whilst observing in each case whether or not a successful response is obtained. The level of the unwanted signal, signal generator B (and C, if appropriate), shall be reduced by 2 dB for each occasion that a successful response is not obtained. The procedure shall be continued until three consecutive successful responses are obtained. The level of the signal generator B (and C, if appropriate) shall be recorded;
- e) the level of unwanted signal, signal generator B (and C, if appropriate), shall be increased by 1 dB and the new value recorded. The normal test signal shall be repeated 20 times. In each case, if a response is not obtained, the signal generator level shall be reduced by 1 dB and the new value recorded. If a successful response is obtained, the signal generator level shall not be changed until three consecutive successful responses have been obtained. In this case, the signal generator level shall be increased by 1 dB and the new value recorded. No signal generator levels shall be recorded unless preceded by a change in level;
- f) the degradation level is the average value of the values recorded in steps d) and e).

The degradation level shall be stated in the test report.

The limit value is identical with the limit for the continuous bit stream method of measurement, see clauses 8.3.3.3, 8.3.4.3, 8.3.5.3 and 8.3.6.3.

## Annex D (normative): Profile for the European Electronic Fee Collection service

### D.1 General

This annex limits the test procedures for OBUs to those directives and responses that are necessary to claim conformance for usage in the scope of the European Electronic Fee Collection service. It also specifies how the memory structure of the OBU shall be configured, and which data and algorithms shall be used for the implementation of security mechanisms.

### D.2 Common limits

The following lists limits that are common to both the RSU and the OBU. These limits include:

- The types and semantics of data to be used for EETS transactions.
- The directives and related responses to be used for EETS applications.
- The OBU memory structure. The OBU memory structure is a shared knowledge between the RSU and the OBU. For the purpose of the EETS, relevant parameters are stored in known memory areas, which are detailed in this clause.
- The security algorithms and requirements.

#### D.2.1 Data to be used for EETS transactions

Table D.1 lists the EETS data elements that shall be available in the OBU memory, and shall be used by the RSU for EETS transactions.

**Table D.1: EETS Data types**

Data element	Length (octets)	Value/Comment
EFC Context Mark	6	Stored in a Read/Only location
Payment Means	14	Stored in a Read/Only location
Equipment OBU ID	4	Stored in a Read/Only location
ManufacturerId	2	Stored in a Read/Only location
VehicleLicencePlateNumber	17	Stored in a Read/Only location
VehicleClass	1	Stored in a Read/Only location
VehicleDimensions	3	Stored in a Read/Only location
VehicleAxles	2	Stored in a Read/Only location
VehicleWeightLimits	6	Stored in a Read/Only location
VehicleSpecificCharacteristics	4	Stored in a Read/Only location
Equipment Status	2	Stored in a Read/Write location
Receipt Data 1	28	Stored in a Read/Write location
Receipt Data 2	28	Stored in a Read/Write location

Restrictions on the usage, encoding and values of the EETS attributes are the same as specified in ISO 15509 [i.2].

## D.2.2 Directives to be used for EETS applications

Table D.2 lists the protocol messages and their limits for EETS applications.

**Table D.2: Directives for EETS applications**

Directive	Parameter	Value	Limits
Open-Rq	Responding mode	Slow	Responding mode is part of "A-Association parameters" group, which is present also when the Open-Rq directive is not explicitly used. In all cases, the value of this parameter shall be set to "Slow".
Close-Rq			
Select-TBA-Id-Rq			An OBU which receives a PDU with a wrong Responding AP Title parameter value shall ignore the PDU
Read-Display-Type-Rq			Shall not be supported
Read-Master-Core-Rq			
Get-Master-Record-Rq			
Read-Appl-Core-Rq			
Write-Appl-Core-Rq			Limited to EquipmentStatus, ReceiptData1 and ReceiptData2 fields
Write-Appl-Core-Conf-Rq			Shall not be supported
Write-Data-To-External-Rq			Shall not be supported
Read-Data-From-External-Rq			Shall not be supported
Read-Appl-Record-Rq			
Write-Appl-Record-Curr-Rq			
Write-Appl-Record-Curr-Conf-Rq			
Write-Appl-Record-Next-Rq			Shall not be supported
Write-Appl-Record-Next-Conf-Rq			Shall not be supported
Set-UIF-Rq			Shall not be supported
Action-Rq			Shall not be supported
Set-Password-Rq			Shall not be supported
Use-Last-Password-Rq			Shall not be supported
Get-TBA-Random-Rq			
Set-Credential-Rq			
Get-Credential-Rq	NonceLen	4	The RSE generated casual number shall have a length of 4 octets.

In all Response Protocol messages, the first most significant four octets of the "Called AP Title" field of the A-Association.response parameters shall be used to carry the EquipmentOBUID parameter value. The fifth octet (the least significant octet) shall be reserved.

## D.2.3 OBU memory structure

The OBU memory structure for EETS applications shall be as shown in Table D.3. Names of the EETS attributes are shown in **bold**. The OBU memory structure is such that:

- 1) EFC Context Mark and AC\_CR-KeyReference parameters are to be used for security calculations and are store in the Master Record. The AC\_CR-KeyReference parameter can be stored permanently at OBU initialization time or it can be computed dynamically when the OBE enters the Communication area.
- 2) All data elements that characterize the vehicle are stored in the Application Core. As the Write-Appl-Core-Rq directive and response are not supported in this profile, this ensures that these elements are Read/Only.
- 3) All elements that are to be written (modified) by the RSE are stored in the Application Record.

Table D.3: OBU memory structure

Area	Field	Offset	Length (bytes)	Value	Usage
Master Header	Core Length	0	1	14 (decimal)	No
	Record Length	1	1	12(decimal)	No
	Record Number	2	1	Number of applications. Must be at least 1	No
	Current Record	3	1		No
Master Core	<b>Manufacturer ID</b>	0	2		Read/Only
	Reserved	2	12		No
Master Record	Application ID	0	2	50F0 (Hex)	Read/Only
	Reserved	2	2		No
	<b>EFC Context Mark</b>	4	6		Read/Only
	<b>AC_CR-KeyReference</b>	10	2		Read/Only
Application Header	Core Length	0	1	105 (decimal)	No
	Record Length	1	1	8 (decimal)	No
	Record Number	2	1	20 (decimal)	No
	Current Record	3	1		No
Application Core	<b>Payment Means</b>	0	14		Read/Only
	<b>Vehicle licence plate number</b>	14	17		Read/Only
	<b>VehicleClass</b>	31	1		Read/Only
	<b>VehicleDimensions</b>	32	3		Read/Only
	<b>VehicleAxles</b>	35	2		Read/Only
	<b>VehicleWeightLimits</b>	37	6		Read/Only
	<b>VehicleSpecificCharacteristics</b>	43	4		Read/Only
	<b>Equipment Status</b>	47	2		Read/Write
	<b>Receipt Data 1</b>	49	28		Read/Write
<b>Receipt Data 2</b>	77	28		Read/Write	
Application Record	<b>Available area</b>	0	160		Read/Write

The field "Usage" indicates how the corresponding memory field shall be used in a DSRC transaction:

- 1) If the "Usage" value is "Read/Only", the OBU shall ensure that no write access is permitted.
- 2) If the "Usage" value is "Read/Write", the OBU shall allow both read and write access to the field.
- 3) If the "Usage" value is "No", the related field shall not be accessible with a DSRC transaction. This means that the contents of that field are only specified in the table for clarification.

## D.2.4 Security algorithms and requirements

### D.2.4.1 Generalities

This clause gives the algorithms and limits to test devices conforming to the EETS specifications in terms of security requirements. Two levels of security are defined:

- Level 0, which shall be always implemented. When not otherwise specified, parameters, procedures and calculations refer to Level 0.
- Level 1, which can be optionally implemented, and relates to RSE authentication.

### D.2.4.2 Authenticator computed on PaymentMeans attribute

The RSE shall ask the OBE to authenticate itself on the basis of the PaymentMeans attribute in the following way:

- The Get-Credential-Rq identifies the PaymentMeans attribute by setting the value of Offset to 0, and the Length to 14. The Get-Credential-Rq specifies a value for RndRSE with a length of 10 octets. The OBE shall concatenate the values of PaymentMeans and RndRSE.

- The OBU shall divide the resulting field of 24 octets in 3 blocks  $D_1$ , (octets from 1 to 8),  $D_2$  (octets from 9 to 16), and  $D_3$  (octets from 17 to 24).
- The OBE shall calculate the Authenticator conforming to the algorithm specified in ISO/IEC 9797-1 [13]:1999, MAC Algorithm 1, which utilizes the DEA algorithm as specified in ANSI X3.92 [12] in three steps, as shown in figure D.1. The function that computes the DEA algorithm is named "e":

- Let AuK be the authentication key of the OBU for a given step k, referenced by the Key parameter in the Get-Credential-Rq directive.

- First step: be the first block  $I_1=D_1$  coded by means of AuK:

$$O_1 = e[\text{AuK}](I_1)$$

- The result  $O_1$  be XORed with  $D_2$ . The result of the XOR operation  $I_2$  be input to step 2:

$$I_2 = [O_1 \text{ XOR } D_2]$$

- Second step: be  $I_2$  coded by means of AuK:

$$O_2 = e[\text{AuK}](I_2)$$

- The result  $O_2$  be XORed with  $D_3$ . The result of the XOR operation  $I_3$  be input to step 3:

$$I_3 = [O_2 \text{ XOR } D_3]$$

- Third step: be  $I_3$  coded by means of AuK:

$$O_3 = e[\text{AuK}](I_3)$$

- The result  $O_3$  be truncated: the 32 leftmost bits (4 octets) give the value of the Authenticator attribute in the Get-Credential-Rs.

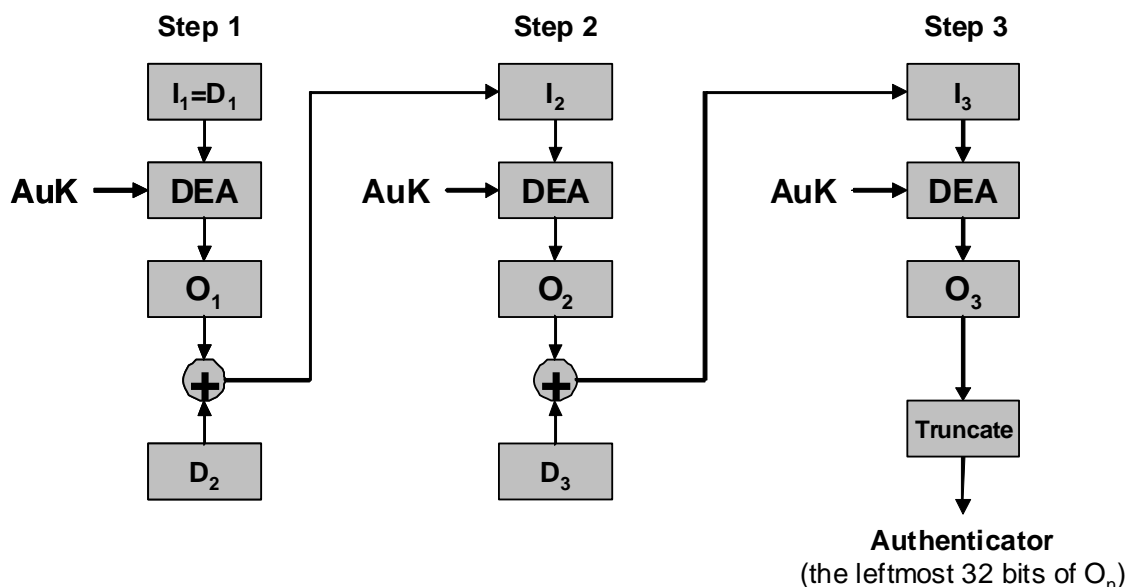

Note:  $\oplus$  denotes the XOR operator

Figure D.1: Authenticator computation

### D.2.4.3 Access credentials computation

The algorithm defined in this clause only applies when Level 1 of security is supported.

When an RSE requires access to an OBE protected memory structure, access is only permitted if valid access credentials are provided. The same credentials shall be used for all attributes contained in the same memory structure.

Access credentials computation is performed by both the RSE and the OBE using the following algorithm (see also figure D.2). Encryption is made using the DEA algorithm, as defined in ANSI X3.92 [12].

- The RSE shall require a random value to the OBE (RndOBU) of 4 octets by means of a Get-TBA-Random-Rq directive.
- be AcK the derived access key.
- The RSE shall append 4 octets of value 0 to the right of the RndOBU. The result be a string of 8 octets:

$$I = \text{'RndOBU'} \parallel \text{'00 00 00 00'Hex.}$$

- The RSE shall encode I as follows:

$$O = e [\text{AcK}] (\text{RndOBU} \parallel \text{'00 00 00 00'Hex}).$$

- Access credentials AC\_CR are derived by truncating the result (O) and maintaining the leftmost 4 octets.

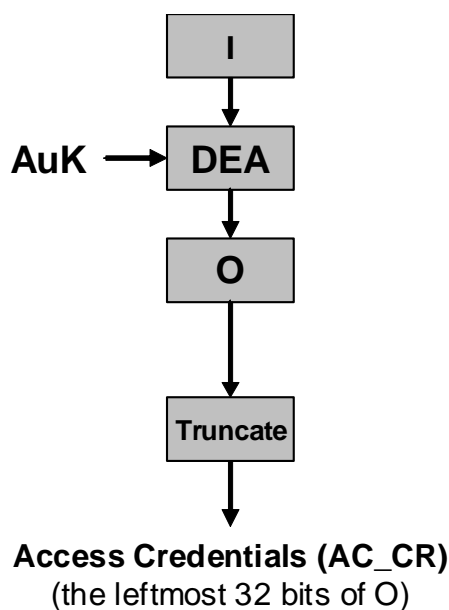

Figure D.2: Access Credentials computation

### D.2.4.4 Authentication key computation

The Authentication key of a Key Generation K shall have a length of 8 octets and shall be derived from the 16 octets Master Authentication Key with the following algorithm:

- Let MAuK(k) the Master Key for a given generation k;
- Let AuK(k) the derived authentication key;
- Compute the value of Compact\_PersonalAccountNumber by truncating the first 64 bits in the attribute PaymentMeans to 32 bits with the following algorithm:

$$\text{Compact\_PersonalAccountNumber} = [\text{HighDWord32(PAN)}] \text{ XOR } [\text{LowDWord32(PAN)}]$$



- Compute the value VAL of 8 octets by concatenating Compact\_PersonalAccountNumber with the value of the attribute ContractProvider, and padding it with '00':

$$\text{VAL} = \text{'Compact\_PersonalAccountNumber || ContractProvider || 00'}$$

- Compute AuK(k) for a given generation k (ede = encode,decode,encode):

$$\text{AuK}(k) = \text{ede [EAuK}(k)] (\text{VAL})$$

### D.2.4.5 Access key computation

This clause only applies when security Level 1 is chosen.

The Access key of a given generation k has a length of 8 octets, and is derived from the Master key of 16 octets by using the AC\_CR\_KeyRef parameter with the following algorithm:

- Let MAcK(k) the Master key for a given generation k.
- Let AcK(k) the derived Access key.
- Concatenate AC\_CR\_KeyReference || AC\_CR\_KeyReference || AC\_CR\_KeyReference || AC\_CR\_KeyReference to obtain an 8 octets value VAL:

$$\text{VAL} = \text{'AC\_CR\_KeyReference || AC\_CR\_KeyReference || AC\_CR\_KeyReference || AC\_CR\_KeyReference '}$$

- Compute AC\_CRKey(k):

$$\text{AC\_CRKey}(k) = \text{ede[MAcK}(k)] (\text{VAL}).$$

### D.2.4.6 Transaction counter

The RSE shall use the following procedure to compute the value of the Transaction Counter parameter:

- The RSE shall retrieve the value of the EquipmentStatus parameter by issuing a Read-Appl-Record-Rq directive. The EquipmentStatus parameter shall be stored at Offset 0, with a Length of 2 octets.
- Let Transaction Counter the value of the least significant (leftmost) 12 bits in EquipmentStatus (0...4095).
- Increase Transaction Counter by 1.
- Set the new value of the Transaction Counter in the least significant (leftmost) 12 bits of EquipmentStatus.
- Write the new value of EquipmentStatus by issuing a Write-Appl-Record-Curr-Conf-Rq directive to the same Offset and for the same length as used in the Read-Appl-Record-Rq directive.

---

## D.3 OBU specific limits

### D.3.1 DSRC communication limits

The OBU shall support all Layer1 characteristics. Table D.4 shows the limits for some Layer 1 parameters.

**Table D.4 Layer 1 parameters limits**

Parameter Number	Parameter Name	Value
U1a	Sub-Carrier Frequency	10,7 MHz
U6a	Sub-Carrier Modulation	Binary FSK
U8a	Bit Rate	144 kbit/s

The OBU shall support all protocol data units and procedures defined for Layer 2.

## D.3.2 Security requirements

Table D.5 lists the security elements that shall be supported by an OBU for EETS applications.

**Table D.5 Layer 1 parameters limits**

Name	Length (octets)	Comment
Authentication Key 1	8	Private
Authentication Key 2	8	Private
Authentication Key 3	8	Private
Authentication Key 4	8	Private
Authentication Key 5	8	Private
Authentication Key 6	8	Private
Authentication Key 7	8	Private
Authentication Key 8	8	Private
Key Reference	1	Reference to the authentication key is used to compute authenticators. The Service Provider decides which keys are to be shared with Toll Chargers and which are private. The former ones are referenced as AuKey_Op, while the latter ones are referenced as AuKey_Iss.
RndRSE	4	RSE generated casual number to be used to compute an authenticator.

The OBU shall be able to compute an authenticator by means of a key and a casual number specified by the RSE as KeyReference and RndRSE respectively, based on part of the Application Core, as indicated by the RSE in terms of offset and length. The algorithm to perform this calculation shall be as specified in clause D.2.2.

If Security Level 1 is to be supported, the OBU shall be able to verify the RSE authenticator by performing the related security algorithm as specified in clause D.2.2. This will require support of the specified security data elements.

---

## D.4 RSU specific limits

There are no RSU specific limits, other than the general limits as stated before.

---

## History

<b>Document history</b>		
V1.1.1	February 1999	Publication
V2.1.1	October 2007	Publication
V2.2.1	December 2010	Membership Approval Procedure    MV 20110214: 2010-12-16 to 2011-02-14