

Draft **ETSI EN 303 980** V1.2.0 (2021-02)



**Satellite Earth Stations and Systems (SES);
Fixed and in-motion Earth Stations communicating with
non-geostationary satellite systems (NEST)
in the 11 GHz to 14 GHz frequency bands;
Harmonised Standard for access to radio spectrum**

Reference

REN/SES-00456

Keywordsbroadband, earth station, mobile, regulation,
satellite**ETSI**

650 Route des Lucioles
F-06921 Sophia Antipolis Cedex - FRANCE

Tel.: +33 4 92 94 42 00 Fax: +33 4 93 65 47 16

Siret N° 348 623 562 00017 - NAF 742 C
Association à but non lucratif enregistrée à la
Sous-Préfecture de Grasse (06) N° 7803/88

Important notice

The present document can be downloaded from:

<http://www.etsi.org/standards-search>

The present document may be made available in electronic versions and/or in print. The content of any electronic and/or print versions of the present document shall not be modified without the prior written authorization of ETSI. In case of any existing or perceived difference in contents between such versions and/or in print, the prevailing version of an ETSI deliverable is the one made publicly available in PDF format at www.etsi.org/deliver.

Users of the present document should be aware that the document may be subject to revision or change of status.

Information on the current status of this and other ETSI documents is available at

<https://portal.etsi.org/TB/ETSIDeliverableStatus.aspx>

If you find errors in the present document, please send your comment to one of the following services:

<https://portal.etsi.org/People/CommiteeSupportStaff.aspx>

Copyright Notification

No part may be reproduced or utilized in any form or by any means, electronic or mechanical, including photocopying and microfilm except as authorized by written permission of ETSI.

The content of the PDF version shall not be modified without the written authorization of ETSI.

The copyright and the foregoing restriction extend to reproduction in all media.

© ETSI 2021.

All rights reserved.

DECT™, **PLUGTESTS™**, **UMTS™** and the ETSI logo are trademarks of ETSI registered for the benefit of its Members.

3GPP™ and **LTE™** are trademarks of ETSI registered for the benefit of its Members and of the 3GPP Organizational Partners.

oneM2M™ logo is a trademark of ETSI registered for the benefit of its Members and of the oneM2M Partners.

GSM® and the GSM logo are trademarks registered and owned by the GSM Association.

Contents

Intellectual Property Rights	7
Foreword.....	7
Modal verbs terminology.....	7
Introduction	8
1 Scope	9
2 References	10
2.1 Normative references	10
2.2 Informative references.....	10
3 Definition of terms, symbols and abbreviations.....	11
3.1 Terms.....	11
3.2 Symbols.....	12
3.3 Abbreviations	12
4 Technical requirements specifications	13
4.1 General	13
4.1.0 Objective.....	13
4.1.1 Environmental profile	14
4.1.2 Void	14
4.1.3 Operating configurations	14
4.1.4 Presentation of equipment for testing purposes	14
4.1.5 Choice of model for testing	14
4.1.6 Operation of multiple NEST on a single frequency.....	15
4.2 Conformance requirements	15
4.2.1 Void	15
4.2.2 Antenna beam pointing.....	15
4.2.2.1 Pointing accuracy.....	15
4.2.2.1.1 Purpose	15
4.2.2.1.2 Antenna Beam Pointing error	15
4.2.2.2 Pointing error detection.....	15
4.2.2.2.1 Purpose	15
4.2.2.2.2 Pointing error detection specification.....	15
4.2.2.3 Conformance tests.....	15
4.2.3 Off-axis spurious radiation	16
4.2.3.1 Justification	16
4.2.3.2 Specification.....	16
4.2.3.3 Conformance tests.....	17
4.2.4 On-axis spurious radiation.....	17
4.2.4.1 Justification	17
4.2.4.2 Specification.....	17
4.2.4.2.1 "Carrier-on" radio state.....	17
4.2.4.2.2 "Carrier-off" and "Emissions disabled" radio states	18
4.2.4.3 Conformance tests.....	18
4.2.5 Carrier suppression	18
4.2.5.1 Justification	18
4.2.5.2 Specification.....	18
4.2.5.3 Conformance tests.....	18
4.2.6 Cessation of emissions.....	18
4.2.6.1 Justification	18
4.2.6.2 Specification.....	18
4.2.6.2.1 Specification 1: Mode of cessation of emissions.....	18
4.2.6.2.2 Specification 2: Conditions under which the NEST shall cease emissions	19
4.2.6.2.3 Specification 3: Cessation of emissions	19
4.2.6.2.4 Specification 4: Fault conditions	19
4.2.6.3 Conformance tests.....	20
4.2.7 Identification of the NEST and its location	20

4.2.7.1	Justification	20
4.2.7.2	Specification.....	20
4.2.7.3	Conformance tests	20
4.2.8	Control and Monitoring Functions (CMFs).....	20
4.2.8.1	General - Finite State Machine Model	20
4.2.8.2	Processor monitoring	22
4.2.8.2.1	Justification	22
4.2.8.2.2	Specification.....	23
4.2.8.2.3	Conformance tests	23
4.2.8.3	Transmit subsystem monitoring.....	23
4.2.8.3.1	Justification	23
4.2.8.3.2	Specification.....	23
4.2.8.3.3	Conformance tests	23
4.2.8.4	Power-on/Reset	23
4.2.8.4.1	Justification	23
4.2.8.4.2	Specification.....	23
4.2.8.4.3	Conformance tests	23
4.2.8.5	Control Channel (CC) and Response Channel (RC)	24
4.2.8.5.1	Justification	24
4.2.8.5.2	Specification.....	24
4.2.8.5.3	Conformance tests	24
4.2.8.6	Network control commands	25
4.2.8.6.1	Justification	25
4.2.8.6.2	Specification.....	25
4.2.8.6.3	Conformance tests	25
4.2.8.7	Initial burst transmission	25
4.2.8.7.1	Justification	25
4.2.8.7.2	Specification.....	25
4.2.8.7.3	Conformance tests	26
4.2.8.8	Inhibition of transmissions.....	26
4.2.8.8.1	Justification	26
4.2.8.8.2	Specification.....	26
4.2.8.8.3	Conformance tests	26
4.2.9	Receive antenna off-axis gain pattern.....	26
4.2.9.1	Justification.....	26
4.2.9.2	Specification.....	26
4.2.9.3	Conformance tests.....	27
4.2.10	Blocking performance.....	27
4.2.10.1	Justification	27
4.2.10.2	Specification.....	27
4.2.10.3	Conformance tests.....	27
4.2.11	Adjacent Signal Selectivity.....	28
4.2.11.1	Justification	28
4.2.11.2	Specification.....	28
4.2.11.3	Conformance tests.....	28
5	Testing for compliance with technical requirements.....	28
5.1	Environmental conditions for testing	28
5.2	Ancillary Equipment	28
5.3	Nominated Bandwidth.....	29
5.4	Essential radio test suites.....	29
6	Test methods for all aspects of the NEST	29
6.1	General	29
6.1.1	General requirements.....	29
6.2	Off-axis spurious radiation.....	29
6.2.1	General.....	29
6.2.2	Test method	30
6.2.2.1	General	30
6.2.2.2	Multi-carrier operation.....	30
6.2.3	Measurements up to 1 000 MHz	30
6.2.3.1	Test site	30

6.2.3.2	Void.....	31
6.2.3.3	Procedure	31
6.2.4	Measurements above 1 000 MHz	31
6.2.4.1	General	31
6.2.4.2	Identification of the significant frequencies of spurious radiation	31
6.2.4.2.1	Test site.....	31
6.2.4.2.2	Procedure.....	32
6.2.4.3	Measurement of radiated power levels of identified spurious radiation.....	32
6.2.4.3.1	Test site.....	32
6.2.4.3.2	Procedure.....	32
6.2.4.4	Measurement of conducted spurious radiation at the antenna flange.....	33
6.2.4.4.1	Test site.....	33
6.2.4.4.2	Procedure.....	34
6.3	On-axis spurious radiation.....	34
6.3.1	Test method	34
6.3.1.1	General	34
6.3.1.2	Test site	34
6.3.1.3	Method of measurement.....	34
6.3.1.3.1	General	34
6.3.1.3.2	Method of measurement at the antenna flange	35
6.3.1.3.3	Method of measurement for an EUT with antenna.....	37
6.4	Void.....	38
6.5	Carrier suppression.....	38
6.5.1	General.....	38
6.5.2	Test method	38
6.6	Antenna beam pointing	38
6.6.1	General.....	38
6.6.2	Test methods.....	39
6.7	Cessation of emissions of the NEST	40
6.7.1	General.....	40
6.7.2	Test Method.....	40
6.7.2.1	Required documentation	40
6.7.2.2	Cessation of emissions from the "Transmission enabled" state	40
6.7.2.3	Cessation of emission from the "Transmission disabled" state	40
6.7.2.4	Cessation of emission from the "Initial Phase" state.....	41
6.7.2.4.1	EUTs transmitting initial bursts.....	41
6.7.2.4.2	EUTs not transmitting initial bursts.....	41
6.7.2.5	"Single action" means of cessation of emissions.....	41
6.7.2.6	Fault conditions.....	42
6.8	Identification of NEST and location determination.....	42
6.8.1	Test arrangement	42
6.8.2	Test method	42
6.9	Control and monitoring functions	43
6.9.1	General.....	43
6.9.2	Test arrangement	43
6.9.3	Processor monitoring-Test method	43
6.9.4	Transmit subsystem monitoring-Test method.....	43
6.9.5	Power-on/Reset-Test method.....	43
6.9.6	Control Channel and Response Channel - Test method.....	44
6.9.7	Network Control commands - Test method.....	45
6.9.8	Initial burst transmission - Test method.....	46
6.9.9	Inhibition of transmission - Test method	46
6.10	Antenna off-axis gain pattern	46
6.10.1	Test Method.....	46
6.10.1.1	Test site	46
6.10.1.2	Method of measurement for EUT antenna with linear polarization	47
6.10.1.3	Method of measurement for antennas with circular polarization	47
6.11	Blocking performance	48
6.11.0	General.....	48
6.11.1	Test method	48
6.12	Adjacent Signal Selectivity	48
6.12.0	General.....	48

6.12.1	Test method	49
Annex A (informative):	Relationship between the present document and the essential requirements of Directive 2014/53/EU	50
Annex B (normative):	Radiated measurement.....	52
B.1	General	52
B.2	Free Field Test sites and general arrangements for measurements involving the use of radiated fields.....	52
B.2.1	Anechoic Chamber	52
B.2.2	Anechoic Chamber with a conductive ground plane	53
B.2.3	Open Area Test Site (OATS)	55
B.2.4	Minimum requirements for free field test sites.....	56
B.2.4.1	Measurements above 18 GHz	56
B.2.4.2	Test antenna	56
B.2.4.3	Substitution antenna.....	57
B.2.4.4	Measuring antenna	57
B.2.5	Guidance on the use of free field radiation test sites	57
B.2.5.1	General.....	57
B.2.5.2	Verification of the test site.....	57
B.2.5.3	Preparation of the EUT	57
B.2.5.4	Power supplies to the EUT	57
B.2.5.5	Range length	58
B.2.5.6	Site preparation	58
B.2.5.7	Coupling of signals	59
B.2.5.8	Standard test methods	59
B.2.5.8.0	General	59
B.2.5.8.1	Calibrated setup.....	59
B.2.5.8.2	Substitution method	59
B.3	Guidance on the use of indirect far field test sites.....	60
B.3.1	General	60
B.3.2	Far-field criteria.....	61
B.3.3	Calibration Measurement Procedure	62
B.4	Guidance on the use of near-field-to-far-field transform test sites.....	63
B.4.1	General	63
B.4.2	Calibration Measurement Procedure	64
Annex C (normative):	Conducted measurements	66
Annex D (informative):	General Requirements for RF Cables.....	67
Annex E (informative):	RF Waveguides	68
Annex F (informative):	Measurement Equipment.....	69
F.1	Special considerations for the interpretation of measurement results	69
F.2	Maximum measurement uncertainty	69
F.3	Measuring receiver.....	70
F.4	Measurement results.....	71
Annex G (informative):	Applicability of parameters given in ETSI EG 203 336	72
Annex H (informative):	Bibliography	74
Annex I (informative):	Change history	75
History		76

Intellectual Property Rights

Essential patents

IPRs essential or potentially essential to normative deliverables may have been declared to ETSI. The information pertaining to these essential IPRs, if any, is publicly available for **ETSI members and non-members**, and can be found in ETSI SR 000 314: "*Intellectual Property Rights (IPRs); Essential, or potentially Essential, IPRs notified to ETSI in respect of ETSI standards*", which is available from the ETSI Secretariat. Latest updates are available on the ETSI Web server (<https://ipr.etsi.org>).

Pursuant to the ETSI IPR Policy, no investigation, including IPR searches, has been carried out by ETSI. No guarantee can be given as to the existence of other IPRs not referenced in ETSI SR 000 314 (or the updates on the ETSI Web server) which are, or may be, or may become, essential to the present document.

Trademarks

The present document may include trademarks and/or tradenames which are asserted and/or registered by their owners. ETSI claims no ownership of these except for any which are indicated as being the property of ETSI, and conveys no right to use or reproduce any trademark and/or tradename. Mention of those trademarks in the present document does not constitute an endorsement by ETSI of products, services or organizations associated with those trademarks.

Foreword

This draft Harmonised European Standard (EN) has been produced by ETSI Technical Committee Satellite Earth Stations and Systems (SES), and is now submitted for the combined Public Enquiry and Vote phase of the ETSI standards EN Approval Procedure.

The present document has been prepared under the Commission's standardisation request C(2015) 5376 final [i.1] to provide one voluntary means of conforming to the essential requirements of Directive 2014/53/EU on the harmonisation of the laws of the Member States relating to the making available on the market of radio equipment and repealing Directive 1999/5/EC [i.6].

Once the present document is cited in the Official Journal of the European Union under that Directive, compliance with the normative clauses of the present document given in Table A.1 confers, within the limits of the scope of the present document, a presumption of conformity with the corresponding essential requirements of that Directive, and associated EFTA regulations.

Proposed national transposition dates	
Date of latest announcement of this EN (doa):	3 months after ETSI publication
Date of latest publication of new National Standard or endorsement of this EN (dop/e):	6 months after doa
Date of withdrawal of any conflicting National Standard (dow):	18 months after doa

Modal verbs terminology

In the present document "**shall**", "**shall not**", "**should**", "**should not**", "**may**", "**need not**", "**will**", "**will not**", "**can**" and "**cannot**" are to be interpreted as described in clause 3.2 of the [ETSI Drafting Rules](#) (Verbal forms for the expression of provisions).

"**must**" and "**must not**" are **NOT** allowed in ETSI deliverables except when used in direct citation.

Introduction

The present document is part of a set of standards developed by ETSI and is designed to fit in a modular structure to cover all radio and telecommunications terminal equipment within the scope of the RE Directive [i.6]. The modular structure is shown in ETSI EG 201 399 [i.2].

The present document is largely based on ETSI EN 303 979 [i.4], for ESOMPs operating with NGSO satellites.

The present document may also be applicable to the frequency band 14,0 GHz to 14,50 GHz (Earth-to-space) and 10,70 GHz to 12,75 GHz (space-to-Earth) subject to national regulation.

Annex A (informative) provides HS Requirements specifications.

Annex B (normative) describes methods of taking radiated measurements.

Annex C (normative) describes methods of taking conducted measurements.

Annex D (informative) describes requirements for RF measurement cables.

Annex E (informative) describes use of RF waveguides.

Annex F (informative) describes measurement equipment.

Annex G (informative) describes the applicability of parameters in ETSI EG 203 336 [i.7].

Annex H (informative) Bibliography covers other supplementary information.

Recital 10 of Directive 2014/53/EU [i.6] states that "*in order to ensure that radio equipment uses the radio spectrum effectively and supports the efficient use of radio spectrum, radio equipment should be constructed so that: in the case of a transmitter, when the transmitter is properly installed, maintained and used for its intended purpose it generates radio waves emissions that do not create harmful interference, while unwanted radio waves emissions generated by the transmitter (e.g. in adjacent channels) with a potential negative impact on the goals of radio spectrum policy should be limited to such a level that, according to the state of the art, harmful interference is avoided; and, in the case of a receiver, it has a level of performance that allows it to operate as intended and protects it against the risk of harmful interference, in particular from shared or adjacent channels, and, in so doing, supports improvements in the efficient use of shared or adjacent channels*".

Recital 11 of Directive 2014/53/EU [i.6] states that "*although receivers do not themselves cause harmful interference, reception capabilities are an increasingly important factor in ensuring the efficient use of radio spectrum by way of an increased resilience of receivers against harmful interference and unwanted signals on the basis of the relevant essential requirements of Union harmonisation legislation*".

As a consequence, the present document includes both transmitting and receiving parameters aiming to maximize the efficient use of radio spectrum.

1 Scope

The present document specifies technical characteristics and methods of measurements for fixed and in-motion Earth Stations communicating with non-geostationary satellite systems (NEST) in the 11 GHz to 14 GHz FSS frequency bands, which have the following characteristics:

- The NEST is designed for both in-motion and stationary operation.
- The NEST operates in-motion on various platforms such as trains, maritime vessels, aircraft and other vehicles and, therefore, may be subject to occasional disturbances and interruptions in the satellite link.
- The NEST is operating as part of a satellite system used for the provision of broadband communications.
- The NEST is comprised of all the equipment, electrical and mechanical, from the antenna itself to the interface with other communications equipment on a mobile platform.
- The NEST comprises one or more emitters and the system overview as given in Figure 1 should be interpreted accordingly.
- The transmit and receive frequencies are shown in Table 1.

Table 1: Frequency bands

	Frequency Bands
Transmit (Earth-to-space)	14,0 GHz to 14,50 GHz
Receive (space-to-Earth)	10,70 GHz to 12,75 GHz

- The NEST transmits within the frequency range from 14,0 GHz to 14,50 GHz.
- The NEST receives within the range from 10,70 GHz to 12,75 GHz. The NEST transmits at elevation angles of 35° or greater, relative to the horizontal plane.
- The NEST uses linear or circular polarization.
- The NEST communicates with non-geostationary satellites.
- The NEST is designed for unattended operation.
- The NEST is controlled and monitored by a Network Control Facility (NCF). The NCF is outside the scope of the present document.

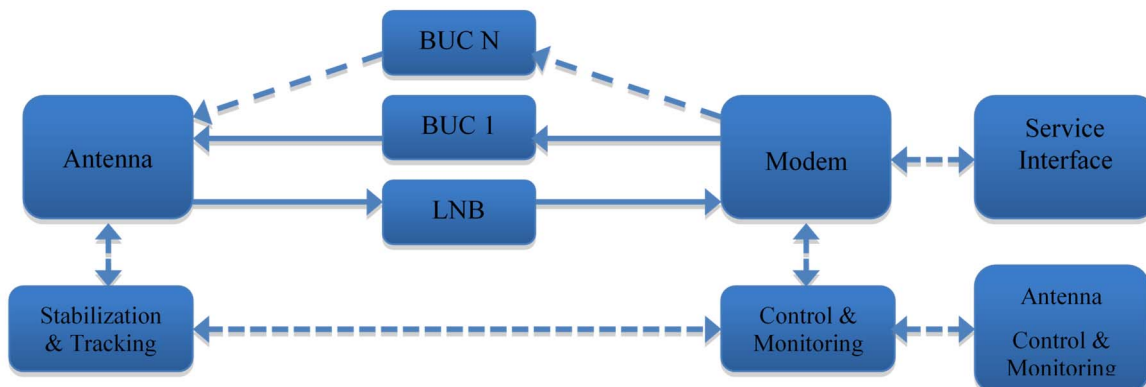

Figure 1: NEST System Overview

The present document applies to the NEST with its ancillary equipment and its various telecommunication ports, and when operated within the boundary limits of the operational environmental profile as declared by the manufacturer and when installed as required by the manufacturer's declaration or in the user documentation.

NOTE: The relationship between the present document and essential requirements of article 3.2 of Directive 2014/53/EU [i.6] is given in annex A.

2 References

2.1 Normative references

References are either specific (identified by date of publication and/or edition number or version number) or non-specific. For specific references, only the cited version applies. For non-specific references, the latest version of the referenced document (including any amendments) applies.

Referenced documents which are not found to be publicly available in the expected location might be found at <https://docbox.etsi.org/Reference/>.

NOTE: While any hyperlinks included in this clause were valid at the time of publication, ETSI cannot guarantee their long term validity.

The following referenced documents are necessary for the application of the present document.

- [1] CISPR 16-1-1:2019: "Specification for radio disturbance and immunity measuring apparatus and methods - Part 1-1: Radio disturbance and immunity measuring apparatus - Measuring apparatus".
- [2] CISPR 16-1-4:2019: "Specification for radio disturbance and immunity measuring apparatus and methods - Part 1-4: Radio disturbance and immunity measuring apparatus - Antennas and test sites for radiated disturbance measurements".
- [3] Recommendation ITU-R S.1503-3 (01/2018), Section 3.1: "Generation of Earth Station e.i.r.p density masks".

2.2 Informative references

References are either specific (identified by date of publication and/or edition number or version number) or non-specific. For specific references, only the cited version applies. For non-specific references, the latest version of the referenced document (including any amendments) applies.

NOTE: While any hyperlinks included in this clause were valid at the time of publication, ETSI cannot guarantee their long term validity.

The following referenced documents are not necessary for the application of the present document but they assist the user with regard to a particular subject area.

- [i.1] Commission Implementing Decision C(2015) 5376 final of 04.08.2015 on a standardisation request to the European Committee for Electrotechnical Standardisation and to the European Telecommunications Standards Institute as regards radio equipment in support of Directive 2014/53/EU of the European Parliament and of the Council.
- [i.2] ETSI EG 201 399: "Electromagnetic compatibility and Radio spectrum Matters (ERM); A guide to the production of Harmonized Standards for application under the Radio & Telecommunication Terminal Equipment Directive 1999/5/EC (R&TTE) and a first guide on the impact of the Radio Equipment Directive 2014/53/EU (RED) on Harmonized Standards".
- [i.3] ETSI TS 103 052: "Electromagnetic compatibility and Radio spectrum Matters (ERM); Radiated measurement methods and general arrangements for test sites up to 100 GHz".
- [i.4] ETSI EN 303 979 (V2.1.2): "Satellite Earth Stations and Systems (SES); Harmonised Standard for Earth Stations on Mobile Platforms (ESOMP) transmitting towards satellites in non-geostationary orbit, operating in the 27,5 GHz to 29,1 GHz and 29,5 GHz to 30,0 GHz frequency bands covering the essential requirements of article 3.2 of the Directive 2014/53/EU".
- [i.5] Void.

- [i.6] Directive 2014/53/EU of the European Parliament and of the Council of 16 April 2014 on the harmonisation of the laws of the Member States relating to the making available on the market of radio equipment and repealing Directive 1999/5/EC.
- [i.7] ETSI EG 203 336 (V1.2.1): "Guide for the selection of technical parameters for the production of Harmonised Standards covering article 3.1(b) and article 3.2 of Directive 2014/53/EU".
- [i.8] IEC 60153 (parts 1 to 7): "Hollow metallic waveguides".
- [i.9] Recommendation ITU-R BO.1213: "Reference receiving Earth station antenna pattern for the broadcasting-satellite service in the 11.7-12.75 GHz band".
- [i.10] ETSI TR 102 273 (all parts) (V1.2.1) (2001-12): "Electromagnetic compatibility and Radio spectrum Matters (ERM); Improvement on Radiated Methods of Measurement (using test site) and evaluation of the corresponding measurement uncertainties".
- [i.11] ANSI C63.5 (2006): "American National Standard for Electromagnetic Compatibility Radiated Emission Measurements in Electromagnetic Interference (EMI) Control Calibration of Antennas (9 kHz to 40 GHz)".

3 Definition of terms, symbols and abbreviations

3.1 Terms

For the purposes of the present document, the terms given in Directive 2014/53/EU [i.6] and the following apply:

ancillary equipment: equipment used in connection with a NEST

NOTE: See clause 5.2.

antenna controller: equipment used to maintain antenna stabilization and tracking accuracy based on inputs from the Control and Monitoring Function

carrier-off radio state: radio state in which the NEST may transmit and does not transmit any carrier

NOTE: See clause 4.2.8.

carrier-on radio state: radio state in which the NEST may transmit and transmits a carrier

Control Channel (CC): channel or channels by which NESTs receive and send control information from and to the NCF

EIRP_{max}: maximum EIRP capability of the NEST as declared by the manufacturer

emissions disabled radio state: radio state in which the NEST may not emit

NOTE: Examples of cases where the NEST is in this radio state:

- before system monitoring pass, before the control channel is received;
- when a failure is detected;
- when a NEST is commanded to disable; and
- when the NEST is in a location requiring cessation of emissions.

external control channel: control channel which is either:

- (i) carried by the NEST network via the same or another satellite, but not within the internal protocol of the NEST system; or
- (ii) carried by any other radio communication system.

external response channel: response channel which is either:

- (i) carried by the NEST network via the same or another satellite, but not within the internal protocol of the NEST system; or
- (ii) carried by any other radio communication system.

integral antenna: antenna which may not be removed during the tests according to the manufacturer's declaration

internal control channel: control channel which is carried by the NEST network via the same satellite as used for transmission of user data and within the internal protocol structure of the NEST system

internal response channel: response channel which is carried by the NEST network via the same satellite as used for transmission of user data and within the internal protocol structure of the NEST system

manufacturer: means any natural or legal person who manufactures radio equipment or has radio equipment designed or manufactured, and markets that equipment under his name or trade mark

Network Control Facility (NCF): set of functional entities that, at system level, monitor and control the correct operation of the NEST and, if appropriate, all of the NESTs in a network

nominated bandwidth: bandwidth of the NEST radio frequency transmission declared by the manufacturer

NOTE: See clause 5.3.

off-axis angle: angle between the direction of the axis of the antenna main beam and the considered direction

removable antenna: antenna which may be removed during the tests according to the manufacturer's declaration

Response Channel (RC): channel by which the NEST transmit monitoring information to the NCF

spurious radiation: in the present document, any radiation outside the nominated bandwidth

transmission disabled state: radio state in which the NEST is not authorized to transmit by the NCF

transmission enabled state: radio state in which the NEST is authorized to transmit by the NCF

Wanted signal occupied Bandwidth (BW):

- for a digital modulation scheme: the width of the signal spectrum 10 dB below the maximum in-band power density;
- for an analogue modulation scheme: the width of a frequency band such that, below the lower and above the upper frequency limits, the mean power emitted is equal to 0,5 % of the total mean power of the emission.

3.2 Symbols

For the purposes of the present document, the following symbols apply:

dB _i	ratio of an antenna gain to the gain of an isotropic antenna, expressed in decibels
dB _{sd}	ratio expressed in decibels relative to the spectral density
dBW	ratio of a power to 1 watt, expressed in decibels
dBpW	ratio of a power to 1 picowatt, expressed in decibels
dB μ V/m	ratio of an electric field to 1 μ V/m, expressed in decibels (20 log(electric field / 1 μ V/m))

3.3 Abbreviations

For the purposes of the present document, the following abbreviations apply:

BUC	Block Upconverter
BW	Wanted signal occupied Bandwidth
CATR	Compact Antenna Test Range
CC	Control Channel
CCF	Control Channel reception Failure

CCR	Control Channel correctly Received
CENR	Cessation of Emissions Not Required
CER	Cessation of Emissions Required
CISPR	Comité International Spécial des Perturbations Radioélectriques (International Special Committee on Radio Interference)
CMF	Control and Monitoring Functions
DC	Direct Current
EFTA	European Free Trade Association
EIRP	Effective Isotropic Radiated Power
EIRP _{max}	Maximum EIRP transmitted by the NEST
EMC	Electro-Magnetic Compatibility
EUT	Equipment Under Test
FEC	Forward Error Correction
FSS	Fixed Satellite Service
GEUT	Gain of EUT
GSO	Geostationary Satellite Orbit
HPA	High Power Amplifier
IFF	Indirect Far Field
IPR	Intellectual Property Rights
IT _{max}	maximum Inhibit Time
LNB	Low-Noise Block down converter
LO	Local Oscillator
LV	Low Voltage
NCF	Network Control Facility
NEST	Earth Station communicating with NGSO satellite system
NFTF	Near Field To Far Field Transform
NGSO	Non Geostationary Satellite Orbit
OATS	Open Area Test Site
R&TTE	Radio and Telecommunications Terminal Equipment
RBW	Reference BandWidth
RC	Response Channel
RE	Radio Equipment
RED	Radio Equipment Directive
RF	Radio Frequency
RMS	Root Mean Square
SMF	System Monitoring Fail
SMP	System Monitoring Pass
SNR	Signal to Noise Ratio
STE	Special Test Equipment
T _{trans}	time to transition from "Carrier off" to "Carrier on" radio state
TxD	Transmission Disable command
TxE	Transmission Enable command
VBW	Video BandWidth
VSWR	Voltage Standing Wave Ratio

4 Technical requirements specifications

4.1 General

4.1.0 Objective

Clause 4 includes information for the test house to be able to conduct the tests.

4.1.1 Environmental profile

The technical requirements of the present document apply under the environmental profile for operation of the equipment, which shall be in accordance with its intended use. The equipment shall comply with all the technical requirements of the present document at all times when operating within the boundary limits of the operational environmental profile defined by its intended use.

4.1.2 Void

4.1.3 Operating configurations

Operation of the NEST shall be able to comply with national regulations, including the use of sub-bands as authorized. The manufacturer shall declare all operational parameters including the maximum EIRP, EIRP densities in use, modulation, wanted signal occupied bandwidth and polarization.

The manufacturer shall declare the number of carrier signals of the NEST that may be radiated simultaneously. The specifications in this clause 4 shall be applied to such configuration as declared by the manufacturer.

Under operational conditions a NEST may dynamically change the wanted signal occupied bandwidth and other transmission parameters (e.g. FEC, modulation, symbol rate) of the transmitted signal.

For the purposes of verifying that the NEST complies with these specifications, the manufacturer shall declare the worst-case combination of transmission parameters that would produce the EIRP density mask, as declared by the manufacturer.

4.1.4 Presentation of equipment for testing purposes

NEST equipment submitted for testing, where applicable, shall fulfil the requirements of the present document on all frequencies over which it is intended to operate.

The manufacturer shall submit one or more samples of the equipment as appropriate for testing.

Additionally, technical documentation and operating manuals, sufficient to allow testing to be performed, shall be supplied.

The performance of the NEST equipment submitted for testing shall be representative of the performance of the corresponding production model. The manufacturer shall offer equipment complete with any auxiliary equipment needed for testing.

The manufacturer shall declare the frequency range(s), the range of operation conditions and power requirements, as applicable, in order to establish the appropriate test conditions.

4.1.5 Choice of model for testing

If a NEST equipment has several optional features, considered not to affect the RF parameters then the tests need only to be performed on one sample of the equipment configured with that combination of features considered to create the highest unintentional emissions.

In addition, when a device has the capability of using different dedicated antennas or other features that affect the RF parameters, at least the worst combination of features from an emission point of view as agreed between the manufacturer and the test laboratory shall be tested.

Where the transmitter is designed with adjustable output power, then all transmitter parameters shall be measured using the highest maximum mean power spectral density level, as declared by the manufacturer.

The choice of model(s) for testing shall be recorded in the test report.

4.1.6 Operation of multiple NEST on a single frequency

The manufacturer shall declare if the design and operation of the satellite network permits more than one NEST to transmit simultaneously on a given carrier frequency, from a signal location. In such a case, the manufacturer shall also declare the maximum number N of NEST that may transmit simultaneously on a given carrier frequency.

4.2 Conformance requirements

4.2.1 Void

4.2.2 Antenna beam pointing

4.2.2.1 Pointing accuracy

4.2.2.1.1 Purpose

To validate that the antenna points correctly within the $\delta\phi_{\max}$.

4.2.2.1.2 Antenna Beam Pointing error

The antenna beam pointing error is a difference between true azimuth and elevation position related to a given RF boresight of the NEST and the azimuth and elevation reported by the antenna control and tracking system.

The manufacturer shall declare the maximum antenna beam pointing error $\delta\phi_{\max}$.

4.2.2.2 Pointing error detection

4.2.2.2.1 Purpose

Protection to GSO satellites from NEST emissions caused by erroneous beam pointing.

4.2.2.2.2 Pointing error detection specification

Pointing error detection:

- The NEST shall have the means to detect antenna beam pointing errors specified in clause 4.2.2.1.2. This detection shall be performed over the range of azimuth and elevation angles for the intended purposes.
- The NEST, when in the "Carrier-on" radio state, shall enter the "Carrier-off" radio state when the antenna beam pointing error has exceeded the maximum pointing error, $\delta\phi_{\max}$. The NEST shall not re-enter the "Carrier-on" radio state until the pointing error is within $\delta\phi_{\max}$.
- The manufacturer shall declare the maximum inhibit time (IT_{\max}) that the NEST can remain in "Transmission enabled" state and "Carrier off" radio state (see also clause 4.2.8.8). If the pointing error threshold is exceeded for more than IT_{\max} then the NEST shall enter the "Initial phase" state.

NOTE: $\delta\phi_{\max}$ could be exceeded when the NEST is in any other state other than "Carrier-on" radio state. In this case, the behaviour of the NEST is in accordance with clause 4.2.6.

4.2.2.3 Conformance tests

Conformance tests shall be carried out in accordance with clause 6.6.

4.2.3 Off-axis spurious radiation

4.2.3.1 Justification

To limit the level of interference to terrestrial and satellite radio services.

4.2.3.2 Specification

The following specifications apply to the NEST transmitting at Equivalent Isotropically Radiated Power (EIRP) values up to and including $EIRP_{max}$.

- 1) The electric field strength level of any radiation from the NEST in the frequency range from 30 MHz to 1 GHz shall not exceed the limits specified in Table 2.

Table 2: Limits of radiated field strength at a test distance of 10 m in a 120 kHz bandwidth

Frequency range	Quasi-peak limits
30 MHz to 230 MHz	30 dB μ V/m
230 MHz to 1 000 MHz	37 dB μ V/m

The Quasi Peak detector shall be in accordance with CISPR 16-1-1 [1].

- 2) When the NEST is in the "Emissions disabled" radio state, the off-axis spurious EIRP from the NEST shall not exceed the limits in Table 3, for all off-axis angles greater than 7°.

Table 3: Limits of spurious EIRP - "Emissions disabled" radio state

Frequency band	EIRP limit	Measurement bandwidth
1,0 GHz to 2,0 GHz	52 dBpW	1 MHz
2,0 GHz to 10,7 GHz	58 dBpW	1 MHz
10,7 GHz to 21,2 GHz	64 dBpW	1 MHz
21,2 GHz to 60,0 GHz	70 dBpW	1 MHz

The lower limits shall apply at the transition frequency.

- 3) In the "Carrier-on" and "Carrier-off" radio states, the off-axis spurious EIRP density from the NEST, shall not exceed the limits in Table 4, for all off-axis angles greater than 7°.

Table 4: Limits of spurious EIRP - "Carrier-on" and "Carrier-off" radio states

Frequency band	EIRP limit	Measurement bandwidth
1,0 GHz to 2,0 GHz	53 dBpW	1 MHz
2,0 GHz to 3,4 GHz	59 dBpW	1 MHz
3,4 GHz to 10,7 GHz	65 dBpW	1 MHz
10,7 GHz to 13,75 GHz	71 dBpW	1 MHz
13,75 GHz to 14,0 GHz	95 dBpW (see note)	10 MHz
14,50 GHz to 14,75 GHz	95 dBpW (see note)	10 MHz
14,75 GHz to 21,2 GHz	71 dBpW	1 MHz
21,2 GHz to 27,35 GHz	77 dBpW	1 MHz
27,35 GHz to 27,50 GHz	85 dBpW	1 MHz
27,50 GHz to 30,00 GHz	85 dBpW	1 MHz
30,00 GHz to 31,00 GHz	85 dBpW	1 MHz
31,00 GHz to 31,15 GHz	85 dBpW	1 MHz
31,15 GHz to 60,0 GHz	77 dBpW	1 MHz
NOTE: This limit may be exceeded in a frequency band which shall not be greater than 125 MHz, centred on the carrier frequency, provided that the considered frequency is within the nominated bandwidth or spurious EIRP density at the considered frequency is 40 dB below the maximum on-axis EIRP density of the signal (within the nominated bandwidth) expressed in dBW/1 MHz.		

The lower limits shall apply at the transition frequency.

- 4) These limits are applicable to the complete NEST equipment, including cabling between the units.

4.2.3.3 Conformance tests

Conformance tests shall be carried out in accordance with clause 6.2.

4.2.4 On-axis spurious radiation

4.2.4.1 Justification

To limit the level of interference to satellite radio services.

4.2.4.2 Specification

4.2.4.2.1 "Carrier-on" radio state

The following specification applies to the NEST transmitting at EIRP values up to $EIRP_{max}$.

In the 14,0 GHz to 14,50 GHz band the EIRP spectral density of the spurious radiation outside the nominated bandwidth centred on the carrier centre frequency shall not exceed $14 - K$ dBW in any 1 MHz band.

Where K is the factor that accounts for a reduction on the on-axis spurious radiation level in case of multiple NESTs operating on the same frequency (see clause 4.1.6) and the value is given by one the following cases:

- 1) For the case where only one NEST transmits at any one time on a given carrier frequency, the value of K is 0.
- 2) For the case where several NESTs are expected to transmit simultaneously on a given carrier frequency at the same EIRP then $K = 10 \log(N)$ where N is the maximum number of these NESTs.
- 3) For the case where several NESTs are expected to transmit simultaneously on a given carrier frequency at different EIRP levels then $K = 10 \log(EIRP_{Aggregate} / EIRP_{term})$, where:

- $EIRP_{term}$ is the on-axis EIRP (Watts) of the NEST within the nominated bandwidth.

The value of EIRP_{Aggregate} and the operational conditions of the NEST network shall be declared by the manufacturer.

NOTE 1: The on-axis spurious radiations, outside the band 14,0 GHz to 14,50 GHz, are indirectly limited by clause 4.2.3.2. Consequently no specification is needed.

NOTE 2: Intermodulation limits inside the band of 14,0 GHz to 14,50 GHz are to be determined by system design and are subject to satellite operator specifications.

For NESTs designed to transmit several carriers on different frequencies simultaneously (multicarrier operation), the above limits only apply to each individual carrier when transmitted alone.

4.2.4.2.2 "Carrier-off" and "Emissions disabled" radio states

In the 14,0 GHz to 14,50 GHz band the EIRP spectral density of the spurious radiation outside the nominated bandwidth shall not exceed -11 dBW in any 1 MHz band.

4.2.4.3 Conformance tests

Conformance tests shall be carried out in accordance with clause 6.3.

4.2.5 Carrier suppression

4.2.5.1 Justification

To allow for the satisfactory suppression of transmissions of the NEST by the NCF, under any fault condition and under any cessation of emissions condition (see clause 4.2.6 for definition).

4.2.5.2 Specification

In the "Carrier-off" and in the "Emissions disabled" radio states the on-axis EIRP density shall not exceed 0 dBW in any 1 MHz band within the nominated bandwidth.

4.2.5.3 Conformance tests

Conformance tests shall be carried out in accordance with clause 6.5.

4.2.6 Cessation of emissions

4.2.6.1 Justification

Cessation of emissions of the NEST where the NEST is not allowed to transmit.

4.2.6.2 Specification

4.2.6.2.1 Specification 1: Mode of cessation of emissions

The following three modes of cessation of emissions shall be implemented:

- a) the NCF determines that the NEST shall cease emissions;
- b) the NEST autonomously determines that it shall cease emissions;
- c) a "single-action" means (e.g. operating a switch) by which a local operator may disable the NEST and thereby cease emissions.

The manufacturer shall declare the NEST interfaces involved in the cessation of emissions:

- the list of relevant parameters which are collected by the NEST or the NCF for determination as to whether the NEST should cease emissions;

- the list of these relevant parameters which are used by the NEST;
- the list of these relevant parameters which are transmitted by the NEST to the NCF;
- the list of the relevant parameters which are received by the NEST from the NCF;
- for the collected relevant parameters, the NEST interface(s), including the protocols, the timing, the ranges of the values, the speed of the variations and the required accuracies;
- for the relevant parameters transmitted to the NCF, the NEST interface with the NCF, including the protocols and the timing;
- for the transmission parameter received from the NCF, the NEST interface with the NCF, including the protocols and the timing.

These declared NEST interfaces shall be in accordance with the user documentation.

4.2.6.2.2 Specification 2: Conditions under which the NEST shall cease emissions

The relevant parameters and the exchange of information between the NEST and the NCF shall be sufficient to cease emissions within the location accuracy declared by the manufacturer.

The conditions for cessation of emissions shall take into account at least the following parameters:

- the location of the NEST and the boundaries of the authorized operating area so that cessation of emissions occurs prior to entering any exclusionary zone including any inaccuracy in determination of the geographic location of the NEST;

NOTE: The above zone may require a reduction of NEST transmit power, rather than a cessation of its emissions.

- the operating parameters specified in clauses 4.2.2 through 4.2.5;
- the carrier frequency and the authorized frequency bands.

4.2.6.2.3 Specification 3: Cessation of emissions

A condition requiring cessation of emissions occurs either when the NEST receives the command from the NCF at its input or when the NEST determines autonomously on the need to cease emissions.

When in the "Transmission enabled" state a condition requiring cessation of emissions occurs, the NEST shall cease transmissions and enter the "Initial Phase" state.

When in the "Transmission disabled" state, the NEST shall not leave that state for the "Transmission enable" state as long as a condition requiring cessation of emissions exists or the last CC command received from the NCF is a transmission disable command.

When in the "Initial phase-BurstOn" or "Initial phase-BurstOff" substate a condition requiring cessation of emissions occurs, the NEST shall cease transmissions and enter the "Initial phase-Standby" substate.

When in the "Initial phase-Standby" substate, the NEST shall not leave that state for the "Initial phase-BurstOn" or the "Transmission enabled" states as long as a condition requiring cessation of emissions exists.

The time for transition in any state from the occurrence of a condition requiring cessation of emissions to the "Emissions disabled" radio state shall not exceed 1 second.

4.2.6.2.4 Specification 4: Fault conditions

Any collection of the relevant parameters by the NEST or transmission of these parameters to the NCF, which have not been completed correctly within the required delay(s) as declared by the manufacturer, shall be considered as a fault condition.

Any transmission parameter not received or not correctly received from the NCF within the required delay declared by the manufacturer shall be considered as a fault condition.

These fault conditions shall be processed as conditions requiring cessation of emissions.

4.2.6.3 Conformance tests

Conformance tests shall be carried out in accordance with clause 6.7.

4.2.7 Identification of the NEST and its location

4.2.7.1 Justification

To fulfil the requirements for identification of individual NEST, whether operated at a fixed location or in-motion, and for potential use by duly authorized entities.

4.2.7.2 Specification

The NEST shall be designed such that it is possible for the NCF to identify which NESTs are transmitting in a given geographic area.

In the case where an external system is required, the manufacturer shall declare which additional means are necessary for identification of the NEST.

The NEST shall have a means of determining, reporting and logging at appropriate update rates, its geographic location within the accuracy and precision needed for the application in question, such as, but not limited to operations on:

- Vehicles and trains
- Aircraft
- Marine vessels
- Fixed locations

The manufacturer shall be responsible for identifying and declaring at the time of test these location requirements and the method of test.

4.2.7.3 Conformance tests

Conformance tests shall be carried out in accordance with clause 6.8.

4.2.8 Control and Monitoring Functions (CMFs)

4.2.8.1 General - Finite State Machine Model

For the purpose of testing the CMF the following four finite states of the NEST are defined, without presuming the effective implementation of the finite state machine model:

- "non valid";
- "initial phase";
- "transmission disabled"; and
- "transmission enabled".

The four finite states are represented on Figure 2, State Transition Diagram of the Control and Monitoring Functions (CMFs).

In the "Non-valid" state and in the "Transmission disabled" state the NEST is not allowed to transmit. In the "Transmission-enabled" state the NEST is allowed to transmit. In the "Initial phase" state the NEST is only allowed to transmit initial bursts or is waiting for a transmit enable/disable command.

The "Initial phase" is divided into three substates:

- "Initial phase-Standby" prior to the transmission of the first initial burst or when no initial bursts are transmitted;
- "Initial phase-BurstOn" during the transmission of the initial bursts;
- "Initial phase-BurstOff" between initial bursts.

NOTE 1: NESTs which do not transmit initial bursts have no "Initial phase-BurstOn" state and no "Initial phase-BurstOff" state.

The NEST is allowed to transmit when the following conditions for transmission are satisfied:

- in a state where transmissions are permitted;
- no failure detected;
- correctly pointed towards the satellite; and
- there is no requirement for cessation of emissions.

The following radio states of the NEST are defined:

- "Emissions disabled" when the NEST shall not transmit any carrier;
- "Carrier-off" when the NEST may transmit and does not transmit any carrier;

NOTE 2: The phrase "the NEST may transmit" means that all the conditions for transmission are satisfied (e.g. in a state where transmissions are permitted, no failure detected, and the NEST is correctly pointed towards the satellite).

NOTE 3: The existence of a "Carrier-off" radio state depends on the system of transmission used. For NESTs designed for continuous transmission mode there may be no "Carrier-off" state.

- "Carrier-on" when the NEST may transmit and transmits a carrier.

Table 5 gives the only possible combinations of the finite states and radio states which shall apply, with some examples of associated events.

Table 5: Finite states and radio states of the NEST

NEST finite states and substates	Radio states	Examples of events
"Non valid"	"Emissions disabled"	After-power on; or After any fault; or During the checking phase.
"Initial phase"		When waiting for a transmission enable or disable command from the NCF.
"Initial phase-Standby"	"Emissions disabled"	Before the first initial burst transmissions; or In locations where no transmission is allowed.
"Initial phase-BurstOn"	"Carrier-on"	During the transmission of each initial burst, and the pointing is correct.
"Initial phase-BurstOff"	"Carrier-off"	Between initial bursts; or When the pointing threshold is exceeded.
"Transmission enabled"	"Carrier-off"	When no carrier is transmitted; or When receive synchronization is lost; or When the pointing threshold is exceeded.
	"Carrier-on"	During transmission of carrier(s), and the pointing is correct.
"Transmission disabled"	"Emissions disabled"	When a disable command from the NCF has been received and waiting for a transmission enable command from the NCF; or In locations where no transmission is allowed.

The following minimum set of CMFs shall be implemented in NESTs in order to minimize the probability that they originate unwanted transmissions that may give rise to harmful interference to other systems.

In the "Non-valid" state and in the "Transmission disabled" state the NEST shall not transmit. In the "Transmission-enabled" state the NEST is allowed to transmit. In the "Initial phase" state the NEST is only allowed to transmit initial bursts.

NOTE 4: The restrictions in the "Initial phase" state are for the protection of other systems when the NEST is entering the system after a power-on or a reset. These initial burst restrictions do not apply to the NEST transmissions in the "Transmission-enabled" state and once a transmission enable command has been received by the NEST the NEST may transmit or not transmit as required.

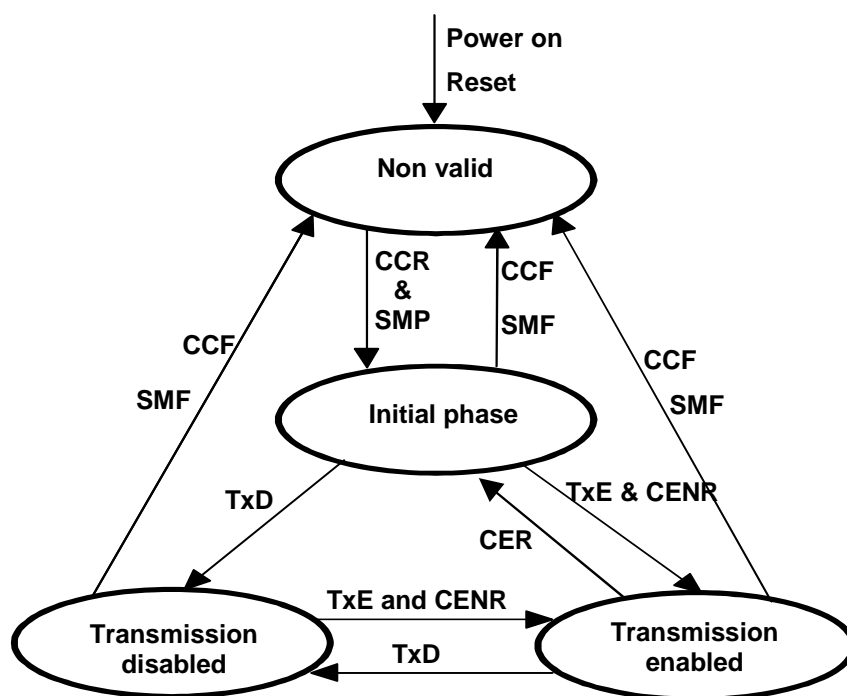

	Command	Requirement Clause
CER	Cessation of Emissions Required	4.2.8.2, 4.2.8.3, 4.2.8.7
CENR	Cessation of Emissions Not Required	4.2.8.6
SMP	System Monitoring Pass	4.2.8.4, 4.2.8.5
SMF	System Monitoring Fail	4.2.8.2, 4.2.8.3
TxE	Transmission Enable command	4.2.8.6
TxD	Transmission Disable command	4.2.8.6, 4.2.8.8
CCR	Control Channel correctly Received	4.2.8.4, 4.2.8.5
CCF	Control Channel reception Failure	4.2.8.5

Figure 2: State transition diagram of the control and monitoring function of a NEST

NOTE 5: From "Transmission disabled" state a TxE command may also result in a transition towards the "Initial phase" state.

When the NEST transmits several carriers having different frequencies, a NEST finite state machine as described above may be associated with each carrier or each set of carriers. The events then apply to the subsystem associated with the specific carrier or the specific set of carriers, rather than the whole NEST.

4.2.8.2 Processor monitoring

4.2.8.2.1 Justification

To ensure that the NEST can suppress its transmissions in the event of a processor sub-system failure.

4.2.8.2.2 Specification

The NEST shall incorporate a processor monitoring function for each of its processors involved in maintaining the performance requirements of the present document and in Control and Monitoring Functions (CMFs).

The processor monitoring function shall detect failures of these processors' hardware and software.

In the "Transmission enabled" state, the NEST shall enter the "Non valid" state or the "Carrier-off" radio state no later than 1 second after any fault condition occurs. In all states, the NEST shall enter the "Non valid" state within a maximum of 30 seconds after the occurrence of any persistent fault condition. Once in the "Non Valid" state, the NEST shall remain in the "Non Valid" state until the processor monitoring function has determined that all fault conditions have been cleared.

4.2.8.2.3 Conformance tests

Conformance tests shall be carried out in accordance with clause 6.9.3.

4.2.8.3 Transmit subsystem monitoring

4.2.8.3.1 Justification

To ensure the inhibition of transmissions that are potentially harmful to other systems in the event of incorrect operation of the transmit frequency generation sub-system.

4.2.8.3.2 Specification

The NEST shall monitor the operation of its transmit sub-system and shall be able to detect:

- a) loss of frequency lock;
- b) absence of Local Oscillator (LO) output signal;
- c) exceedance of $EIRP_{max}$ or EIRP density mask; or
- d) no later than 1 second after any of these fault conditions of the transmit sub-system occurs, the NEST shall enter the "Non-valid" state or the "Carrier-off" radio state until the transmit sub-system monitoring function has determined that all fault conditions have been cleared (see clause 4.2.8.2.2 for detailed specification).

4.2.8.3.3 Conformance tests

Conformance tests shall be carried out in accordance with clause 6.9.4.

4.2.8.4 Power-on/Reset

4.2.8.4.1 Justification

To demonstrate that the NEST achieves a controlled non-transmitting state following the powering of the unit, or the occurrence of a reset made by a local operator.

4.2.8.4.2 Specification

During and following a reset the NEST shall remain in the "Non-valid" state until all the conditions for entering "Initial phase" have been satisfied.

4.2.8.4.3 Conformance tests

Conformance tests shall be carried out in accordance with clause 6.9.5.

4.2.8.5 Control Channel (CC) and Response Channel (RC)

4.2.8.5.1 Justification

To ensure that the NEST cannot transmit unless it correctly receives the CC messages from the NCF.

Control Channels (CCs) are used by NESTs to receive control information from the NCF and Response Channels (RCs) to respond to the NCF. For a NEST designed to operate within networks where the NCF determines that the NEST shall cease emissions, then the CCs and RCs are also used for the dialogue with the NCF.

4.2.8.5.2 Specification

4.2.8.5.2.1 Specification 1: types of CCs and RCs

- a) The NEST shall have at least one CC from the NCF. If exchange of information with the NCF is necessary for operation of the NEST then the NEST shall have at least one RC to the NCF (see clause 4.2.6). Each CC and each RC may be internal or external.

The types (internal or external) of each CC and each RC shall be declared by the manufacturer.

NOTE 1: The availability of the network carrying the external CC(s) and RC(s) and the numbers of external CC(s) and RC(s) are not within the scope of the present document.

NOTE 2: Some satellite operators may require that internal CC(s) and or RC(s) are available.

- b) The connection between the NCF and the NEST via the CCs and RCs shall be either permanent or shall be set up on a call by call basis through a switched network. In case of connection through a switched network the NEST shall be able to receive calls from the NCF and to initiate calls towards the NCF in order to set up the CCs and RCs.
- c) The NEST with an external CC shall not transmit without receiving an appropriate signal from the NCF indicating to the NEST that the NCF is alive and insuring that the NEST is pointing to the target satellite.

4.2.8.5.2.2 Specification 2: CC Reception

- a) The NEST shall enter the "Non-valid" state if it does not correctly receive the CC from the NCF within a period not to exceed 30 seconds. This event is called a "CC disruption":
 - In the case of external CCs and RCs without permanent connection of the NCF with the NEST, the ability to receive CC messages from the NCF is the ability at any time to receive calls and messages within the timing requirements of the present document from the network through which is connected the NCF.
 - The inability to receive CC messages from the NCF may be due to the following various causes but not limited to them: no received signal from the NCF or from the network, a too low level received signal, no network accessible, the inability to lock onto the received carrier frequency, to demodulate, to decode, to receive calls and/or messages, a hardware failure or power off.
- b) The NEST shall remain in the "Non-valid" state as long as the NEST is unable to receive CC messages from the NCF.
- c) From the "Non-valid" state the NEST may enter the "Initial phase" state if the following conditions are met:
 - the NEST is able to receive CC messages from the NCF; and
 - no fault conditions are present.

4.2.8.5.3 Conformance tests

Conformance tests shall be carried out in accordance with clause 6.9.6.

4.2.8.6 Network control commands

4.2.8.6.1 Justification

These requirements ensure that the NEST is capable of:

- a) retaining a unique identification in the network;
- b) receiving commands from the NCF through its CC(s) and executing those commands.

4.2.8.6.2 Specification

The NEST shall hold, in non-volatile memory, its unique identification code in the network.

The NEST shall be capable of receiving through its CCs dedicated messages (addressed to the NEST) from the NCF, and which contain:

- Transmission Enable commands (TxE);
- Transmission Disable commands (TxD).

When in the "Initial phase" or "Transmission enabled" states, once a transmission disable command is received, within 1 second the NEST shall enter into, and shall remain in the "Transmission disabled" state until the transmission disable command is superseded by a subsequent transmission enable command (see also clause 4.2.6).

When in the "Initial phase" or "Transmission disabled" states, once a transmission enable command is received, the NEST may enter into the "Transmission enabled" state.

When entering the "Initial phase" from the "Non-valid" state, the last TxE or TxD command received from the NCF may be used by the NEST to enter the "Transmission enabled" state or the "Transmission disabled" state, respectively, if since the time of reception of that command no "CC disruption" has occurred.

NOTE: The physical unit in charge of the reception of the CCs, of the transmissions of the RCs and of the CC commands reception may be a separate and independent unit from the other units of the NEST or it may be common to several NESTs.

4.2.8.6.3 Conformance tests

Conformance tests shall be carried out in accordance with clause 6.9.7.

4.2.8.7 Initial burst transmission

4.2.8.7.1 Justification

Restrictions on the initial burst transmissions are necessary to limit disturbance to other services.

4.2.8.7.2 Specification

For systems where no transmission enable command is foreseen without request from the NEST, in the "Initial phase" state the NEST may transmit initial bursts:

- a) The NEST shall only transmit initial bursts after confirming that no cessation of emission applies where the NEST is located. This confirmation shall be obtained either by local means (see clause 4.2.6) or from the NCF via an external control channel.
- b) The duty cycle of the initial burst transmission shall not exceed 0,2 %, where the duty cycle is defined as the ratio of burst duration to the duration between two successive bursts.
- c) The initial burst shall be transmitted at an EIRP not greater than $EIRP_{max}$.

- d) The duration between two successive bursts shall not be less than the required NCF response time as declared by the manufacturer. This response time is defined as the duration, measured at the NEST, between an initial burst transmission and the reception and processing of a transmission enable or disable command from the NCF which is never exceeded during 99 % of the cases under normal conditions in the system for which the NEST is designed, as declared by the manufacturer.

4.2.8.7.3 Conformance tests

Conformance tests shall be carried out in accordance with clause 6.9.8.

4.2.8.8 Inhibition of transmissions

4.2.8.8.1 Justification

To ensure the correct inhibition of transmissions that are potentially harmful to other systems and persons in the event of signal blockage.

4.2.8.8.2 Specification

NEST shall enter the "Carrier-off" radio state within a period not exceeding 1 second, whenever there is a continuous and complete loss of the signal at the receiver, and shall remain in this radio state until the receiver carrier has been restored.

If the receive carrier is not restored within IT_{\max} (see clause 4.2.2.2), then the NEST shall transition to the "Initial phase" state.

The manufacturer shall declare the time to transition from "Carrier off" to "Carrier on" radio state (T_{trans}) when in "Transmission enabled" state after the receive carrier is restored within IT_{\max} .

4.2.8.8.3 Conformance tests

Conformance tests shall be carried out in accordance with clause 6.9.9.

4.2.9 Receive antenna off-axis gain pattern

4.2.9.1 Justification

To protect the wanted signals from interference from terrestrial services and from other satellite services.

4.2.9.2 Specification

The maximum antenna gain of each of the co-polarized components in any direction φ degrees from the antenna main beam axis shall not exceed the following limits:

$$G = 36 - 25 \log \varphi \quad \text{dBi} \quad \text{for } \varphi_{\min} \leq \varphi < 44^\circ$$

$$G = -5 \quad \text{dBi} \quad \text{for } 44^\circ \leq \varphi \leq 75^\circ$$

$$G = 0 \quad \text{dBi} \quad \text{for } 75^\circ \leq \varphi \leq 180^\circ$$

where:

$$\varphi_{\min} = 1^\circ \text{ or } 100 \lambda/D \text{ degrees, whichever is the greater, for } D/\lambda \geq 35.$$

$$\varphi_{\min} = 2^\circ \text{ or } 114 (D/\lambda)^{-1.09} \text{ degrees, whichever is the greater, for } D/\lambda < 35.$$

D is the nominal diameter of the antenna. (If the antenna is not circular, D is the numerical average of the two linear dimensions.)

In addition the maximum antenna gain of each of the cross-polarized components in any direction ϕ degrees from the antenna main beam axis shall not exceed the following limits:

$$G_x(\phi) = 23 - 20 \log \phi \quad \text{dBi} \quad \text{for } \phi_r \leq \phi \leq 7^\circ$$

$$G_x(\phi) = 20,2 - 16,7 \log \phi \quad \text{dBi} \quad \text{for } 7^\circ < \phi \leq 32,3^\circ$$

$$G_x(\phi) = -5 \quad \text{dBi} \quad \text{for } 32,3^\circ < \phi \leq 75^\circ$$

$$G_x(\phi) = 0 \quad \text{dBi} \quad \text{for } 75^\circ < \phi \leq 180^\circ$$

where ϕ_r is equal to 1° or $100 \lambda/D$, whichever is greater.

4.2.9.3 Conformance tests

Conformance tests shall be carried out in accordance with clause 6.10.

4.2.10 Blocking performance

4.2.10.1 Justification

To prevent high power signals outside the receive frequency band from blocking the reception of signals inside the receive frequency band.

4.2.10.2 Specification

Receiver blocking is characterized here through gain compression for a signal inside the receive frequency band that is caused by another signal outside the receive frequency band at high power. The level of the other signal is compared to the level of a signal inside the receive frequency band that would cause the same gain compression.

Receiver blocking rejection at a particular frequency is defined as the level of a second signal at this frequency that causes a certain gain compression to a first signal inside the receive frequency band, minus the level of a second signal at a frequency inside the receive frequency band that causes the same gain compression.

The first signal shall be at the centre frequency of the receive frequency band and have a level in the operational range. The second signal shall cause a gain compression for the first signal of 1 dB.

The rejection shall comply with Table 6.

Table 6: Receiver blocking rejection

Frequency	Minimum rejection
below 9 GHz	20 dB
9 GHz to 10 GHz	10 dB
14 GHz to 16 GHz	10 dB
Above 16 GHz	20 dB
NOTE: In the frequency ranges 10 GHz to 10,7 GHz and 12,75 GHz to 14 GHz, the rejection needs further studies.	

4.2.10.3 Conformance tests

Conformance tests shall be carried out in accordance with clause 6.11.

4.2.11 Adjacent Signal Selectivity

4.2.11.1 Justification

To enable reception of a wanted signal in presence of other signals on adjacent frequencies which are transmitted with high EIRP density from other satellites.

NOTE: The power level of signals transmitted from the same constellation are under control of the satellite operator. Signals transmitted from satellites in an adjacent orbit or from satellites in the GSO are attenuated by the discrimination available from antenna gain pattern.

4.2.11.2 Specification

Adjacent Signal Selectivity is a measure of a receiver's ability to receive a signal at its assigned channel frequency in the presence of an adjacent signal at a given frequency offset from the centre frequency of the assigned channel. The adjacent signal shall occupy the same bandwidth as the wanted signal. Frequency offset and relative power level of the adjacent signal compared to the wanted signal shall take the value given in Table 7. BW is the wanted signal occupied bandwidth.

Table 7: Adjacent signal frequency and Power level

Signal	Centre frequency offset from wanted signal	Power level relative to wanted signal
Adjacent Carrier	BW	7 dBsd

The decrease in the measured signal to noise ratio in the presence of the stated adjacent signal shall be no more than 0,5 dB.

4.2.11.3 Conformance tests

Conformance tests shall be carried out in accordance with clause 6.12.

5 Testing for compliance with technical requirements

5.1 Environmental conditions for testing

Tests defined in the present document shall be carried out at representative points within the boundary limits of the operational environmental profile defined by its intended use.

Where technical performance varies subject to environmental conditions, tests shall be carried out under a sufficient variety of environmental conditions (within the boundary limits of the operational environmental profile defined by its intended use) to give confidence of compliance for the affected technical requirements.

5.2 Ancillary Equipment

Equipment is considered as ancillary if the three following conditions are met:

- the equipment is intended for use in conjunction with the NEST to provide additional operational and/or control features (e.g. to extend control to another position or location); and
- the equipment cannot be used on a standalone basis, to provide user functions independently of the NEST; and
- the absence of the equipment does not inhibit the operation of the NEST.

5.3 Nominated Bandwidth

The nominated bandwidth is the bandwidth of the NEST radio frequency transmission, wide enough to encompass all spectral elements of the transmission that have a level greater than the specified spurious radiation limits. The nominated bandwidth is wide enough to take account of the transmit carrier frequency stability. This definition is chosen to allow flexibility regarding adjacent channel interference levels that will be taken into account by operational procedures depending on the exact transponder carrier assignment situation.

The nominated bandwidth is centred on the transmit frequency and is larger than the wanted signal occupied bandwidth. However, the manufacturer should be aware that the larger the declared nominated bandwidth, the fewer channels will be available within the assigned band.

5.4 Essential radio test suites

The essential radio test suites for a complete NEST are given in clause 6.

6 Test methods for all aspects of the NEST

6.1 General

6.1.1 General requirements

The present clause describes the general requirements for verifying that the performance of the EUT complies with the specifications. However, the specific testing methodology to be used for measuring performance is left to the manufacturer in order to allow the methodology to be matched to the EUT. The manufacturer shall maintain documentary evidence of the results obtained in performing the essential radio tests. At a minimum, the documentary evidence shall include:

- test setup (configurations, test equipment and calibration status);
- test conditions (environmental and operational parameters);
- method of testing;
- results of measurements, measurement resolution and uncertainty; and
- statement of compliance with technical specifications of the present document.

The test conditions for each test shall be representative of the intended operational environment and be noted in the test report where it has a significant effect on the measurement results.

The type, termination and length of each cable used shall be representative of the intended installation and recorded in the test report. For maximum cable lengths longer than 10 m, as declared by the manufacturer, the tests shall be performed with cables no shorter than 10 m.

6.2 Off-axis spurious radiation

6.2.1 General

The tests for the NEST specification in clause 4.2.3.2 shall be conducted in "Carrier on", "Carrier off" and "Emissions disabled" radio states as required. The tests in "Carrier on" radio state shall be undertaken with the transmitter operating at $EIRP_{max}$.

6.2.2 Test method

6.2.2.1 General

The manufacturer shall provide the test house with the test methods used to identify frequencies of off-axis spurious radiation and to measure (or calculate) the radiated power levels of identified spurious radiations.

NOTE: For the purposes of this procedure, the measuring antenna is aligned to the polarization which produces the largest response between the EUT and the measuring antenna.

The NEST may be tested with or without antenna. An "EUT with antenna" is a NEST with integral antenna. An "EUT without antenna" is a NEST with the removable antenna removed.

In the case where the NEST antenna is remotely mounted from the associated electronics, the connecting cable shall be of the same type and length as specified by the manufacturer in the installation manual. If the cable is normally longer than 10 m, a cable of 10 m in length may be used for the test. The type and length of cable used shall be entered in the test report.

The EUT shall be terminated with matched impedance at the terrestrial ports if recommended by the manufacturer in the user documentation and if there is no associated equipment connected to each port.

For frequencies up to 80 MHz the measuring antenna shall be a balanced dipole with a length equal to the 80 MHz resonant length and shall be matched to the feeder by a suitable balanced transforming device. Measurements with broadband antennas are also possible provided that the test site has been validated according to CISPR 16-1-4 [2].

For frequencies between 80 MHz and 1 000 MHz the measuring antenna shall be a balanced dipole which shall be resonant in length. Measurements with broadband antennas are also possible provided that the test site has been validated according to CISPR 16-1-4 [2].

For frequencies above 1 000 MHz the antenna shall be a horn radiator of known gain/frequency characteristics. The antenna is mounted on a support capable of allowing the antenna to be used in either horizontal or vertical polarization and at the specified height.

6.2.2.2 Multi-carrier operation

For NESTs designed to simultaneously transmit several carriers the verification up to 1 000 MHz shall be performed with one or more carriers due to the frequency separation from the fundamental; above 1 000 MHz the verification shall be repeated for each possible combination of carriers, as identified by the manufacturer.

For each combination of carriers the manufacturer shall provide the test house with the carriers' centre frequencies and characteristics, the maximum value of the total on-axis EIRP of the carriers and the relative levels of the carriers (in dBs) at the input or output of the HPA or antenna.

In the case of combinations of carriers with identical characteristics and when the power at the input of the HPA does not exceed the maximum input power with two carriers, the verification may be limited to the case with two carriers and with the maximum frequency separation between them.

In any other case, the number of configurations to be verified above may be limited to the cases which can be proven by the manufacturer, by documentary evidence or demonstration, to generate the maximum EIRP density level of the out-of-band emissions due to inter-modulation products.

6.2.3 Measurements up to 1 000 MHz

6.2.3.1 Test site

The test shall be performed either in an open area test site, a semi-anechoic chamber or an anechoic chamber. Ambient noise levels shall be at least 6 dB below the applicable unwanted emissions limit.

The open area test site shall be flat, free of overhead wires and nearby reflecting structures, sufficiently large to permit aerial placement at the specified measuring distance and provide adequate separation between aerial, test unit and reflecting structures, according to CISPR 16-1-4 [2].

For both the open area test site and the semi-anechoic chamber a metal ground plane shall be inserted on the natural ground plane and it shall extend at least 1 m beyond the perimeter of the EUT at one end and at least 1 m beyond the measurement antenna at the other end.

The distance between the EUT and the measuring antenna should be 10 m. For measurements at a different distance an inverse proportionality factor of 20 dB per decade shall be used to normalize the measured data to the specified distance for determining compliance. Care should be taken in measurement of large test units at 3 m at frequencies near 30 MHz due to near field effects.

6.2.3.2 Void

6.2.3.3 Procedure

- a) The EUT shall be an EUT with antenna or, preferably, without antenna but with the antenna flange terminated by a dummy load.
- b) The EUT shall be in the "Carrier-on" radio state.
- c) The EUT shall be rotated through 360° and, except in an anechoic chamber, the measuring antenna shall be rotated and height varied from 1 m to 4 m above the ground plane to determine the maximum emission.
- d) All identified spurious radiation shall be measured and noted in frequency and level.

6.2.4 Measurements above 1 000 MHz

6.2.4.1 General

The spectrum analyser resolution bandwidth shall be set to the specified measuring bandwidth or as close as possible. If the resolution bandwidth is different from the specified measuring bandwidth, bandwidth correction shall be performed for the noise-like wideband spurious.

For an EUT with antenna the tests shall be performed in two stages for both the "Carrier-on" and "Carrier-off" radio states:

- Procedure a): Identification of the significant frequencies of spurious radiation.
- Procedure b): Measurement of radiated power levels of identified spurious radiation.

For an EUT without antenna the tests shall be performed in three stages for both the "Carrier-on" and "Carrier-off" radio states:

- Procedure a): Identification of the significant frequencies of spurious radiation.
- Procedure b): Measurement of radiated power levels of identified spurious radiation.
- Procedure c): Measurement of conducted spurious radiation radiated through the antenna flange.

6.2.4.2 Identification of the significant frequencies of spurious radiation

6.2.4.2.1 Test site

The identification of frequencies emitting from the EUT shall be performed either in an anechoic chamber, an open area test site or a semi-anechoic chamber with the test antenna close to the EUT and at the same height as the volume centre of the EUT.

6.2.4.2.2 Procedure

- a) The EUT shall be in the "Carrier-off" radio state.
- b) For an EUT with antenna the main beam of the antenna shall have an angle of elevation corresponding to 8 dBi antenna gain, and, for an EUT without antenna the antenna flange shall be terminated by a dummy load.
- c) The receivers shall scan the frequency band while the EUT revolves.
- d) The EUT shall be rotated through 360° and the frequency of any spurious signals noted for further investigation.
- e) For an EUT with antenna the test shall be repeated with the test antenna being in the opposite polarization.
- f) The test shall be repeated in the "Carrier-on" radio state while transmitting one modulated carrier at maximum power.

6.2.4.3 Measurement of radiated power levels of identified spurious radiation

6.2.4.3.1 Test site

The measurement of each spurious radiation noted during procedure a) of the test shall be performed on a test site that is free from reflecting objects, i.e. either an open-area test site, a semi-anechoic chamber or an anechoic chamber.

6.2.4.3.2 Procedure

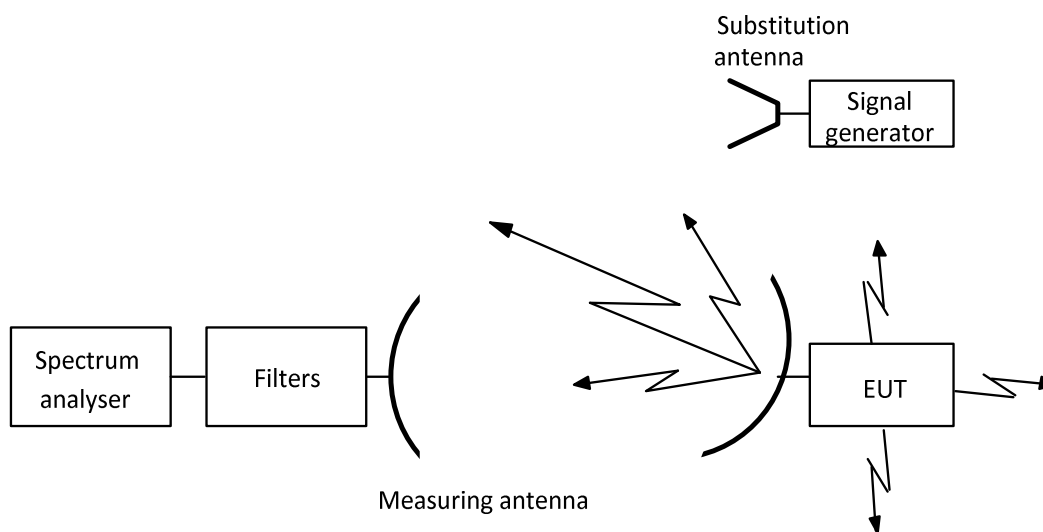

Figure 3: Test arrangement - spurious radiation measurement above 1 000 MHz for an EUT with antenna

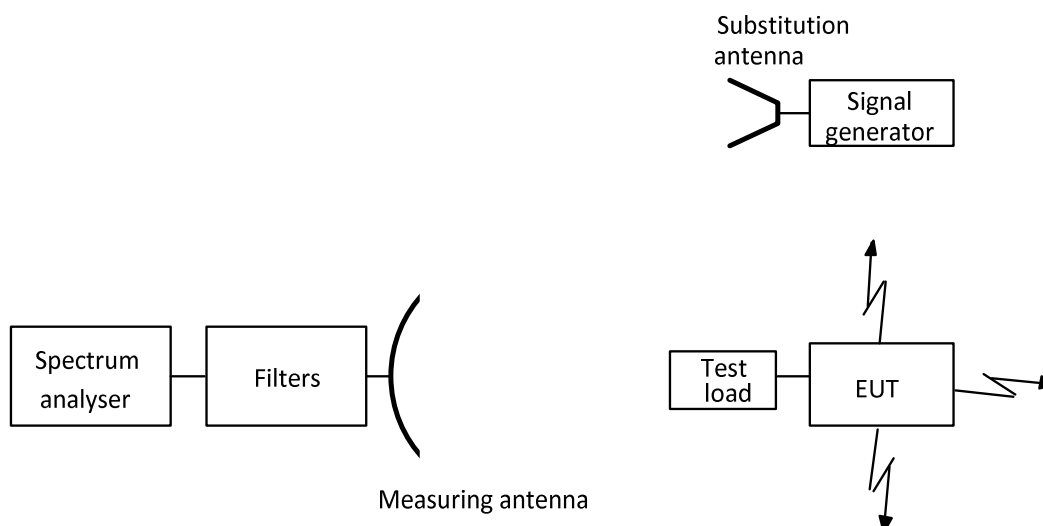

Figure 4: Test arrangement - spurious radiation measurements above 1 000 MHz for an EUT without antenna

- a) The test arrangement shall be as shown in Figure 3 or 4.
- b) The EUT shall be installed at a height between 0,5 m and 1,0 m on a non-metallic turntable. For an EUT with separable components, the components shall be separated by 1 m to 2 m. For the test arrangement shown in Figure 3 the main beam of the antenna shall have an angle of elevation sufficient to achieve a peak gain of 8 dBi in the direction the test receiver. Necessary precautions should be taken to avoid EUT emissions towards GSO satellite networks and NGSO satellite systems.
- c) The measuring antenna shall be positioned at a distance from the EUT (e.g. 3 m, 5 m, 10 m) relevant to the applied test site. The measuring antenna shall be adjusted in height and the EUT rotated, while the EUT is in the appropriate carrier condition, for a maximum response on the associated spectrum analyser at each spurious frequency previously identified, this response level shall be noted. The adjustment in height of the measuring antenna does not apply when an anechoic chamber is being used. The measuring antenna shall never enter the 8 dBi off-axis cone around the main beam direction.
- d) The investigation shall be repeated with the measuring antenna in the opposite polarization and the response level similarly noted.
- e) The EUT shall be replaced by the substitution antenna to which is connected a signal generator. The main beam axes of the measuring and substitution antennas shall be aligned. The distance between these antennas shall be the distance determined under test c).
- f) The substitution and measuring antennas shall be aligned in the polarization which produced the larger response between the EUT and the test antenna in steps c) and d).
- g) The output of the generator shall be adjusted so that the received level is identical to that of the previously noted largest spurious radiation.
- h) The output level of the signal generator shall be noted. The EIRP of the spurious radiation is the sum, in dB, of the signal generator output plus the substitution antenna isotropic gain minus the interconnection cable loss.

6.2.4.4 Measurement of conducted spurious radiation at the antenna flange

6.2.4.4.1 Test site

There are no requirements for the test site to be used for this test.

6.2.4.4.2 Procedure

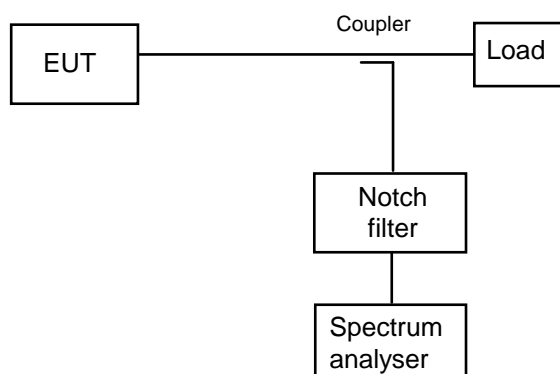

Figure 5: Test arrangement - conducted spurious radiation above the cut-off frequency

- a) The test arrangement shall be as shown in Figure 5 with the notch filter being optional. In order to protect the spectrum analyser while ensuring the necessary measurement accuracy, particularly close to the carrier, if a notch filter is used it shall be tuned to the transmit carrier frequency. In order to ensure that signals below the waveguide cut-off frequency are eliminated, the waveguide length shall be a minimum of 20 wavelengths (42,8 cm at 14,0 GHz) between the EUT and the spectrum analyser.
- b) The frequency range from the cut-off frequency of the waveguide of the EUT to 60 GHz shall be investigated for spurious radiation while in the "Carrier-on" radio state with the carrier being at maximum power and normally modulated.
- c) To obtain the off-axis spurious EIRP value for test, the measured antenna transmit gain, measured at the frequency of the identified unwanted emission, for the off-axis angle corresponding to the angle to the horizon shall be added to the measured power density and any correction or calibration factors summated with the result.
- d) The test shall be repeated in the "Carrier-off" radio state.

6.3 On-axis spurious radiation

6.3.1 Test method

6.3.1.1 General

The tests shall be undertaken with the transmitter operating at $EIRP_{max}$.

6.3.1.2 Test site

There are no requirements for the test site to be used for this test.

6.3.1.3 Method of measurement

6.3.1.3.1 General

For NEST equipment for which measurements at the antenna flange are possible and agreed by the manufacturer, the measurements shall be performed at the antenna flange.

For NEST equipment for which measurements at the antenna flange are not possible or not agreed by the manufacturer, the measurements shall be performed with a test antenna.

6.3.1.3.2 Method of measurement at the antenna flange

6.3.1.3.2.1 General

- a) The test arrangement shall be as shown in Figure 5 with the notch filter being optional. In order to protect the spectrum analyser while ensuring the necessary measurement accuracy, particularly close to the carrier, if a notch filter is used it shall be tuned to the transmit carrier frequency.
- b) The EUT shall transmit one modulated carrier continuously, or at its maximum burst rate where applicable, centred on a frequency as close to the lower limit of the operating frequency band of the EUT as possible. The EUT shall be operated at $EIRP_{max}$. The frequency range 14,0 GHz to 14,50 GHz shall be investigated.
- c) Due to the proximity of the carrier the spectrum analyser resolution bandwidth shall be set to a measurement bandwidth of 3 kHz, or as close as possible. If the measurement bandwidth is different from the specified measurement bandwidth, bandwidth correction shall be performed for noise-like wideband spurious radiation.
- d) To obtain the on-axis spurious EIRP, the antenna transmit gain shall be added to any figure obtained in the above measurement and any correction or calibration factor summated with the result. The antenna gain shall be as measured in clause 6.3.1.3.2.2 at the closest frequency to the spurious frequency.
- e) The tests in b) to e) shall be repeated with a transmit frequency in the centre of the operating frequency band.
- f) The tests in b) to e) shall be repeated with a transmit frequency as close to the upper limit of the operating frequency band of the EUT as possible.
- g) The tests in b) to f) shall be repeated in the "Carrier-off" radio state.

6.3.1.3.2.2 Antenna transmit gain

6.3.1.3.2.2.1 General

For the purpose of the present document, the antenna transmit gain is defined as the ratio, expressed in decibels (dBi), of the power that would have to be supplied to the reference antenna, i.e. an isotropic radiator isolated in space, to the power supplied to the antenna being considered, so that they produce the same field strength at the same distance in the same direction. Unless otherwise specified the gain is for the direction of maximum radiation.

For the purpose of this test the EUT is defined as the antenna and its flange. The antenna may include the reflector(s), feed, support struts and an enclosure of equal weight/distribution to any electrical equipment normally housed with the feed at the antenna focal point.

The manufacturer shall provide the test house with the operating frequency range of the EUT. For the tests in the clause 6.3.1.3.2.2 the following test frequencies shall be defined:

- Test Frequency A - the low test frequency shall be the middle of the lowest carrier in operating frequency range;
- Test Frequency B - the mid-range test frequency shall be the middle of the carrier that includes (or is adjacent to) the middle of the operating range; and
- Test Frequency C - the high test frequency shall be the middle of the highest carrier in the operating range.

6.3.1.3.2.2.2 Test site

This test shall be performed on either an outdoor far-field test site, compact test range or near-field scanner.

6.3.1.3.2.2.3 Method of measurement

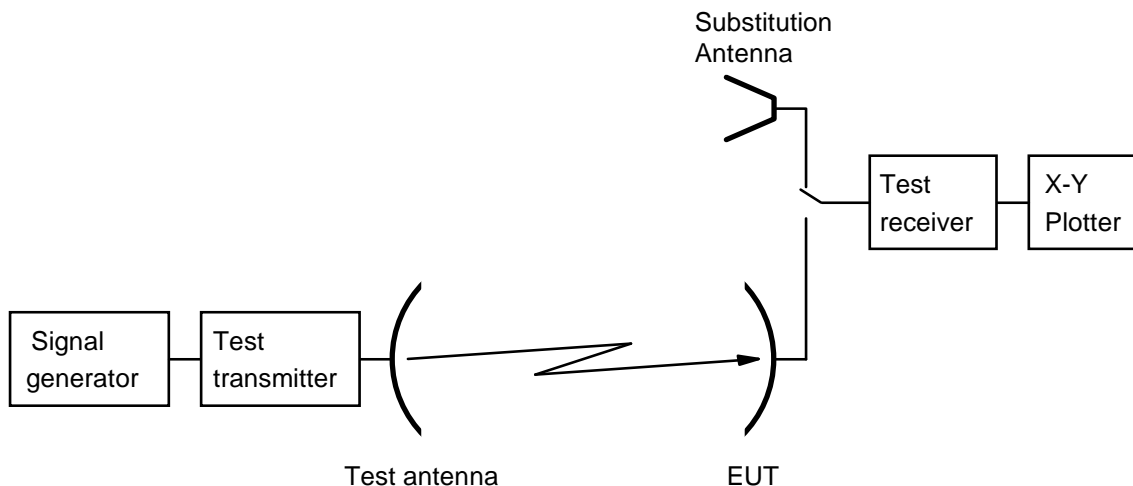

Figure 6: Test arrangement - antenna transmit gain measurement

- a) The test arrangement shall be as shown in Figure 6 with the EUT connected to the test receiver. A signal proportional to the angular position from the servo mechanism shall be applied to the X-axis and the signal level from the test receiver shall be applied to the Y-axis of the plotter.
- b) A test signal at Test Frequency B shall be transmitted by the test transmitter through the test antenna. The E-plane shall be vertical. The EUT antenna main beam axis shall be aligned with the main beam axis of the test transmitter. The polarizer of the EUT antenna shall be rotated and adjusted such that the E-plane coincides with the E-plane of the test transmitter.
- c) The EUT shall be aligned to maximize the received signal and the X-Y plotter adjusted to give the maximum reading on the chart.
- d) The EUT shall be driven in azimuth in one direction through 10°.
- e) The pattern measurement is then obtained by driving the EUT in azimuth back through boresight to 10° the other side with the plotter recording the results.
- f) The EUT shall be replaced by the substitution antenna and the received signal level maximized.
- g) This level shall be recorded on the X-Y plotter.
- h) The substitution antenna shall be driven in azimuth as in d) and e).
- i) The gain of the EUT shall be calculated from:

$$G_{\text{EUT}} = L_1 - L_2 + C$$

where:

- G_{EUT} is the gain of the EUT (dBi);
 - L_1 is the peak level obtained with the EUT (dB);
 - L_2 is the peak level obtained with the substitution antenna (dB);
 - C is the calibrated gain of the substituted antenna at the test frequency (dBi).
- j) The tests in c) to i) shall be repeated with the frequency changed to Test Frequency A.
 - k) The tests in c) to i) shall be repeated with the frequency changed to Test Frequency C.
 - l) The tests in b) to k) may be performed simultaneously.

6.3.1.3.3 Method of measurement for an EUT with antenna

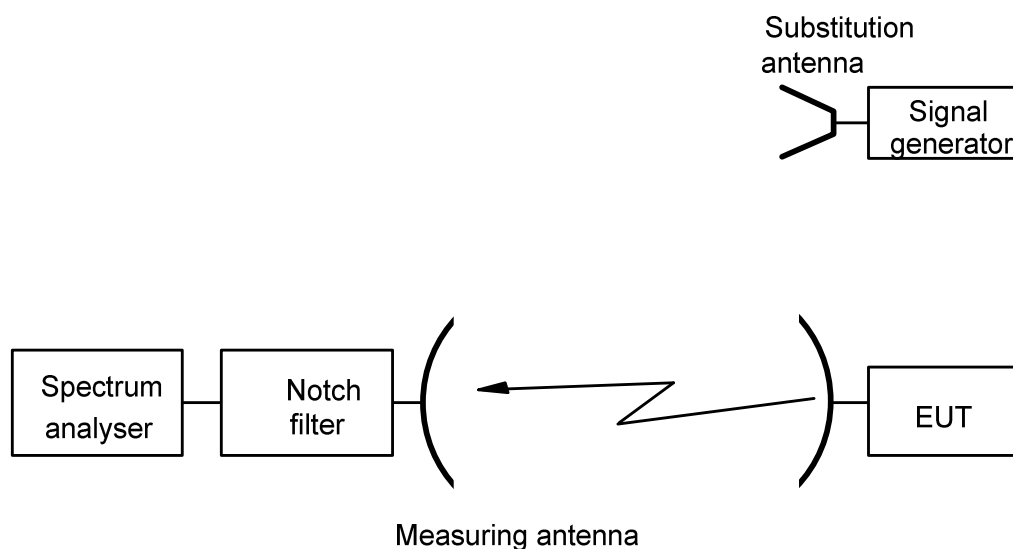

Figure 7: Test arrangement - on-axis spurious radiation measurements for an EUT with antenna

- a) The test arrangement shall be as shown in Figure 7 with the notch filter being optional.
- b) The EUT shall be installed such that the units are separated by 1 m to 2 m with the indoor unit at a height between 0,5 m and 1,0 m on a non-metallic turntable.
- c) The spectrum analyser resolution bandwidth shall be set to the specified measuring bandwidth or as close as possible. If the resolution bandwidth is different from the specified measuring bandwidth, bandwidth correction shall be performed for noise-like wideband spurious radiation.
- d) The EUT shall transmit one modulated carrier continuously, or at its maximum burst rate where applicable, centred on a frequency as close to the lower limit of the operating frequency band of the EUT as possible. The EUT shall be operated at $EIRP_{max}$. The frequency range 14,0 GHz to 14,50 GHz shall be investigated and each spurious frequency shall be noted.
- e) Due to the proximity of the carrier the spectrum analyser resolution bandwidth shall be set to a measurement bandwidth of 3 kHz, or lower. If the measurement bandwidth is different from the specified measurement bandwidth, bandwidth correction shall be performed for noise-like wideband spurious radiation.
- f) The measuring antenna shall be positioned at a distance from the EUT (e.g. 3 m, 5 m, 10 m) relevant to the applied test site and shall be aligned with the EUT antenna for the transmit frequency. The measuring antenna shall be adjusted in height, while the EUT is in the appropriate carrier condition, for a maximum response on the associated spectrum analyser at each spurious frequency previously identified, this response level shall be noted. The adjustment in height of the measuring antenna does not apply when an anechoic chamber is being used.
- g) The EUT shall be replaced by a representative substitution antenna to which a signal generator is connected. The main beam axes of the measuring and substitution antennas shall be aligned. The distance between these antennas shall be the distance determined under test f).
- h) The substitution and measuring antennas shall be aligned to that polarization which produced the largest response between the EUT and the test antenna.
- i) The output of the generator shall be adjusted so that the received level is identical to that of the previously noted largest spurious radiation.
- j) The output level of the signal generator shall be noted. The EIRP of the on-axis spurious radiation is the sum, in dB, of the signal generator output plus the substitution antenna isotropic gain minus the interconnection cable loss.
- k) The tests in d) to j) shall be repeated with a transmit frequency in the centre of the operating frequency band.

- l) The tests in d) to j) shall be repeated with a transmit frequency as close to the upper limit of the operating frequency band of the EUT as possible.
- m) The tests in b) to l) shall be repeated in the "Carrier-off" radio state.

6.4 Void

6.5 Carrier suppression

6.5.1 General

The EUT shall demonstrate the satisfactory suppression of transmissions, to a given emission power limit, upon receipt of the appropriate command from the NCF, or detection of certain fault conditions. (Clauses 4.2.5 and 4.2.6 define the carrier suppression requirement; clause 4.2.3 defines the applicable fault conditions.)

6.5.2 Test method

For the purposes of this test, the EUT shall transmit one carrier modulated continuously, or at its maximum burst rate where applicable, centred on the middle frequency of the operating frequency band as identified by the manufacturer. Whilst in transit mode, the "transmission disabled state" shall be initiated by use of the NCF or an STE:

- for conducted measurements the maximum residual carrier power density within the nominated bandwidth shall be measured and added to the antenna on-axis gain, and recorded; or
- for radiated measurements the maximum residual EIRP density within the nominated bandwidth shall be measured and recorded.

The EUT shall be declared compliant with the requirements if the resulting carrier-suppressed EIRP density is at or below the results obtained are within the limit given in clause 4.2.5.2.

6.6 Antenna beam pointing

6.6.1 General

The antenna beam pointing test method is designed to verify the ability of the EUT to detect and correctly respond to beam pointing errors that exceed the threshold, $\delta\phi_{\max}$, see clause 4.2.2.1.2.

For the purpose of these tests the EUT is the NEST with its antenna. Antenna systems may be mechanically or electrically steered, and so this method measures the angular offset between the radiated antenna beam peak and the intended direction of pointing.

6.6.2 Test methods

The test shall be carried out using radiated measurements; there is no equivalent method to undertake this test using conducted measurements.

There shall be a means for setting the pointing direction of the antenna provided to the test house by the manufacturer.

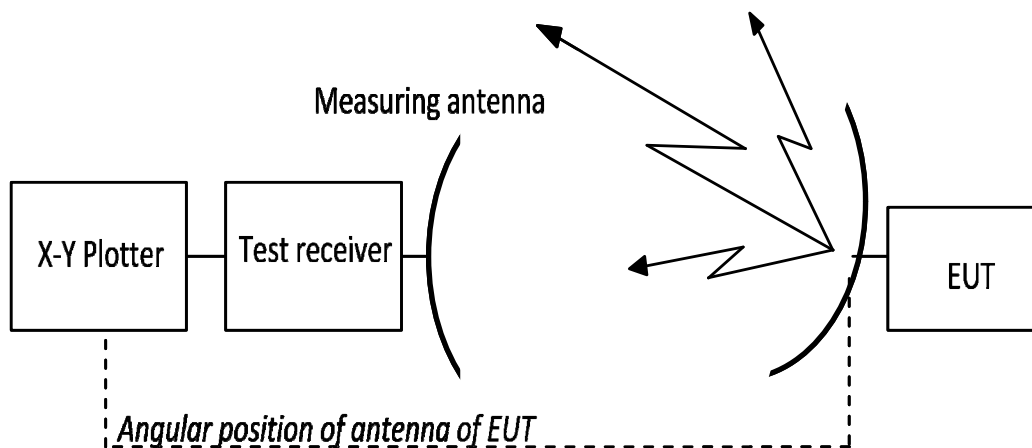

Figure 8: Test arrangement - antenna beam pointing

- a) The test arrangement shall be as shown in Figure 8.
- b) A signal proportional to the angular position from the servo mechanism controlling the antenna of the EUT shall be applied to the X-axis and the signal level from the test receiver shall be applied to the Y-axis of the plotter.
- c) The EUT shall be installed at a height between 0,5 m and 1,0 m on a non-metallic turntable. For an EUT with separable components, the components shall be separated by 1 m to 2 m. Necessary precautions should be taken to avoid EUT emissions towards GSO satellite networks and NGSO satellite systems.
- d) The test frequencies shall be the centre frequency of each applicable frequency range.
- e) The pointing direction of the antenna of the EUT shall be set using the method provided by the manufacturer, in the nominal direction of the measurement antenna.
- f) The measuring antenna shall be positioned at a distance from the EUT (e.g. 3 m, 5 m, 10 m) relevant to the applied test site. The measuring antenna shall be placed at the same height and facing the EUT, and the EUT placed in the appropriate carrier condition.
- g) The servo mechanism shall move the EUT through an angle equivalent to $\pm 3\delta\phi_{\max}$ so that the maximum received signal level is recorded on the X-Y plotter.
- h) The angular difference $\delta\phi$ between the direction of maximum signal level and the pointing direction set in e) shall be recorded.
- i) The tests in e) to h) shall be repeated in at least five pointing directions equivalent to normal operation of the EUT pointing to azimuths 0° , 90° , 180° and 270° at the lowest operating elevation angle, and at 90° elevation.

The EUT shall be considered compliant with the requirement if the measured $\delta\phi$ does not exceed $\delta\phi_{\max}$ in any of the pointing directions measured before transmission is immediately ceased.

6.7 Cessation of emissions of the NEST

6.7.1 General

There shall be a means of simulating a condition where cessation of emissions is required. The spectrum analyser or the oscilloscope may be used to measure the time difference between the occurrence of the condition and the cessation of emissions. In all test methods, it shall be verified that the time difference does not exceed 1 second as specified in clause 4.2.6.2.3.

Where the EUT adds an operational margin around areas where cessation of emissions is required to account for the position determination accuracy and latency, the test procedure may simulate the actual behaviour of an EUT as its enters into an area where cessation of emissions is required. For example, if the EUT adds a margin of X metres around areas where cessation of emissions is required, then the test may begin with the EUT being simulated at a position more than X metres outside of an area where cessation of emissions is required. The test may then simulate the motion of the EUT towards the area where cessation of emissions is required. In any event, the EUT shall enter the "emission disabled" radio state within 1 second of entering the actual area where cessation of emissions is required.

For the purpose of these tests the EUT is the NEST either with, or without its antenna.

6.7.2 Test Method

6.7.2.1 Required documentation

The manufacturer shall provide the test house with the mode(s) of cessation of emissions implemented in the EUT and the NEST interfaces involved in the cessation of emissions as specified in clause 4.2.6.2.1.

The manufacturer shall demonstrate by documentary evidence compliance with specification 2 in clause 4.2.6.2.2 for the determination of the conditions under which the NEST shall cease emissions.

6.7.2.2 Cessation of emissions from the "Transmission enabled" state

- a) The EUT shall be set in the "Transmission enabled" NEST state.
- b) The EUT shall be set in the "Carrier on" radio state.
- c) A condition requiring the cessation of emission shall be initiated either by the STE or the EUT.
- d) It shall be verified that the EUT enters the "Emissions disabled" radio state.
- e) In order to verify that the EUT is in the "Transmission disabled" NEST state, it shall be verified that the EUT remains in the "Emissions disabled" radio state when the EUT is requested to transmit data.

6.7.2.3 Cessation of emission from the "Transmission disabled" state

- a) The EUT shall be set in the "Transmission disabled" state.
- b) A condition requiring the cessation of emission shall be initiated either by the STE or the EUT.
- c) In order to verify that the EUT remains in the "Transmission disabled" NEST state, it shall be verified that the EUT remains in the "Emissions disabled" radio state when the EUT is requested to transmit data.
- d) The STE shall send a TxE command to the EUT.
- e) In order to verify that the EUT remains in the "Transmission disabled" NEST state, it shall be verified that the EUT remains in the "Emissions disabled" radio state when the EUT is requested to transmit data.
- f) The STE shall send a TxD command to the EUT.
- g) The condition requiring the cessation of emissions shall be removed.
- h) In order to verify that the EUT remains in the "Transmission disabled" NEST state, it shall be verified that the EUT remains in the "Emissions disabled" radio state when the EUT is requested to transmit data.

6.7.2.4 Cessation of emission from the "Initial Phase" state

6.7.2.4.1 EUTs transmitting initial bursts

- a) The EUT shall be set in "Initial phase-BurstOn" state.
- b) The STE shall not send the TxE command and the EUT shall be allowed to cycle between "Initial phase-BurstOn" and "Initial phase-BurstOff" as it would under normal operations.
- c) A condition requiring the cessation of emission shall be initiated either by the STE or the EUT.
- d) It shall be verified that the EUT enters the "Emissions disabled" radio state.
- e) In order to verify that the EUT is in the "Initial phase-Standby" NEST state, it shall be verified that the EUT remains in the "Emissions disabled" radio state when the EUT is requested to transmit data.
- f) The STE shall send a TxE command to the EUT.
- g) In order to verify that the EUT remains in the "Initial phase-Standby" NEST state or enters the "Transmission disabled" NEST state, it shall be verified that the EUT remains in the "Emissions disabled" radio state when the EUT is requested to transmit data.
- h) Repeat the test steps a) through g) using a TxD command in step f) instead of the TxE command.

6.7.2.4.2 EUTs not transmitting initial bursts

This applies only to EUTs that do not transmit initial bursts (i.e. where only "Initial phase-Standby" is implemented):

- a) The EUT shall be set in "Initial phase-Standby" NEST state.
- b) The STE shall not send the TxE command to maintain the EUT in "Initial phase-Standby" NEST state.
- c) A condition requiring the cessation of emission shall be initiated either by the STE or the EUT.
- d) In order to verify that the EUT remains in the "Initial phase-Standby" NEST state, it shall be verified that the EUT remains in the "Emissions disabled" radio state when the EUT is requested to transmit data.
- e) The STE shall send a TxE command to the EUT.
- f) In order to verify that the EUT remains in the "Initial phase-Standby" NEST state or enters the "Transmission disabled" NEST state, it shall be verified that the EUT remains in the "Emissions disabled" radio state when the EUT is requested to transmit data.
- g) Repeat the test steps a) through f) using a TxD command in step e) instead of the TxE command.

6.7.2.5 "Single action" means of cessation of emissions

- a) It shall be verified that there is a "single action" means of ceasing emissions of the EUT (e.g. the switch thrown).
- b) The EUT shall be set in the "Transmission enabled" NEST state.
- c) The EUT shall be set in the "Carrier on" radio state.
- d) The "single action" means of cessation of emissions shall be activated.
- e) It shall be verified that the EUT enters the "Emissions disabled" radio state.
- f) In order to verify that the EUT is in the "Transmission disabled" NEST state, it shall be verified that the EUT remains in the "Emissions disabled" radio state when the EUT is requested to transmit data.
- g) The STE shall send a TxE command to the EUT.
- h) In order to verify that the EUT remains in the "Transmission disabled" NEST state, it shall be verified that the EUT remains in the "Emissions disabled" radio state when the EUT is requested to transmit data.

- i) The EUT shall be switched off and then switched on and the EUT shall enter the "Initial phase" NEST state without receiving a TxE from the STE.
- j) The "single action" means of cessation of emissions shall be activated.
- k) The STE shall send a TxE command to the EUT.
- l) In order to verify that the EUT remains in the "Initial phase" NEST state or enters the "Transmission disabled" NEST state, it shall be verified that the EUT remains in the "Emissions disabled" radio state when the EUT is requested to transmit data.
- m) The EUT shall be switched off and then switched on and the EUT shall enter the "Initial phase" NEST state without receiving a TxE from the STE.
- n) The STE shall send a TxD command to the EUT so that it enters the "Transmission disabled" NEST state.
- o) The "single action" means of cessation of emissions shall be activated.
- p) The STE shall send a TxE command to the EUT.
- q) In order to verify that the EUT remains in the "Transmission disabled" NEST state, it shall be verified that the EUT remains in the "Emissions disabled" radio state when the EUT is requested to transmit data.

6.7.2.6 Fault conditions

The manufacturer shall provide the test house with the means of generating the fault conditions prescribed in clauses 4.2.8.2 (processor monitoring) and 4.2.8.3 (transmit subsystem monitoring):

- a) The EUT shall be set in the "Transmission enabled" NEST state.
- b) The EUT shall be set in the "Carrier on" radio state.
- c) A fault condition requiring the cessation of emission shall be generated either by the STE or directly on the EUT.
- d) It shall be verified that the EUT enters the "Emissions disabled" radio state as long as the fault condition persists.
- e) Steps a) through d) shall be repeated for each applicable fault condition.

6.8 Identification of NEST and location determination

6.8.1 Test arrangement

The test shall be arranged such that EUT can determine its own location, or if external means are employed, the test shall be arranged so that the EUT can be located by the means provided to the test house by the manufacturer. The STE shall be arranged to simulate the NCF.

The position accuracy, precision, resolution and update rates shall be declared by the manufacturer for the NEST type and its application in question.

6.8.2 Test method

- a) The EUT shall be in the "Transmission enabled" state.
- b) The EUT shall report its location to the STE.
- c) The difference between the reported EUT location and actual location of the EUT (as simulated in the test) shall meet the requirements declared by the manufacturer.

6.9 Control and monitoring functions

6.9.1 General

For the purpose of these tests the EUT is the NEST either with, or without its antenna connected.

The manufacturer may modify a NEST for the purpose of these tests provided that full documentation is given to prove that the modifications accurately simulate the required test conditions.

The EUT shall transmit at $EIRP_{max}$.

The measurement of the EIRP spectral density shall be limited within either the nominated bandwidth or to a 10 MHz bandwidth centred on the carrier frequency, whichever is the greater.

6.9.2 Test arrangement

The EUT shall be authorized to transmit and shall be in the "Transmission enabled" state at the commencement of each test, unless otherwise stated. The time difference between the command, or failure, and the occurrence of the expected event (e.g. the transmission suppression) shall be measured and recorded.

6.9.3 Processor monitoring-Test method

- a) Each of the processors within the EUT shall, in turn, be caused to fail.
- b) Within 1 second of such failure the EUT shall cease to transmit.
- c) It shall be confirmed that the transmissions have been suppressed within the limits of the "Carrier-off" radio state emission levels.
- d) Within 30 seconds of such failure it shall be confirmed that the transmissions have been suppressed within the limits of the "Emissions disabled" radio state emission levels.
- e) The failed processor shall be restored to normal working condition and the EUT shall restore automatically to normal working before the next processor shall be induced to fail.

6.9.4 Transmit subsystem monitoring-Test method

- a) The frequency generation subsystem within the EUT shall be caused to fail in respect of:
 - loss of frequency lock (if applicable);
 - absence of local oscillator (LO) output signal;
 - excess RF output power.
- b) Recognition of each failure in turn by the subsystem monitor shall constitute an SMF event.
- c) Within 1 second of such failure the EUT shall cease to transmit.
- d) It shall be observed that the transmissions have been suppressed within the limits of the "Emissions disabled" radio state emission levels.
- e) The failed elements shall be restored to normal working state and the EUT shall be restored to normal working condition before the next induced failure.

6.9.5 Power-on/Reset-Test method

- a) The EUT shall be switched off and the STE shall not transmit the CC.
- b) The EUT shall be switched on.
- c) The EUT shall not transmit during and after switching-on, and shall enter the "Non valid" state.

If a manual reset function is implemented the following test shall be performed:

- d) The EUT shall be restored to the "Initial phase" state and the STE shall transmit the CC.
- e) The EUT shall remain in the "Initial phase" state.
- f) The reset function shall be initiated.
- g) The EUT shall enter the "Non valid" state.
- h) The EUT shall be restored to the "Initial phase" state and the STE shall transmit the CC as well as a TxE.
- i) The EUT shall enter the "Transmission enabled" state.
- j) The reset function shall be initiated.
- k) The EUT shall enter the "Non valid" state.

6.9.6 Control Channel and Response Channel - Test method

For the purposes of these test, the period without correct reception of the CC (T1) shall be as specified in clause 4.2.8.5.2.2.

These test procedures require simulation of the following events:

- The CC has never been received by the EUT after power-on.
 - The CC is lost by the EUT after reception of a Transmission Enable command.
 - The CC is lost by the EUT without reception of a Transmission Enable command.
 - The CC is being lost by the EUT and a call is initiated within the period T1.
- a) Case where the CC has never been received by the EUT after power-on:
 - a1) the EUT shall be switched off and the STE shall not transmit the CC;
 - a2) the EUT shall be switched on;
 - a3) the EUT shall remain in the "Non valid" state.
 - b) Case where the CC is lost by the EUT after reception of a Transmission Enable command:
 - b1) the EUT shall be switched-on and the STE shall transmit the CC and a Transmission Enable command;
 - b2) the EUT shall enter the "Initial phase" state and go, if applicable, to the "Transmission enabled" state;
 - b3) a transmission request shall be initiated from the EUT;
 - b4) the STE shall stop transmitting the CC;
 - b5) within the period T1 from event b4), the EUT shall enter the "Non valid" state.
 - c) Case where the CC is lost by the EUT without reception of a Transmission Enable command:
 - c1) the EUT shall be switched on and the STE shall transmit the CC;
 - c2) the EUT shall enter the "Initial phase" state;
 - c3) the STE shall stop transmitting the CC;
 - c4) the EUT shall enter in the "Non valid" state not later than T1;
 - c5) a transmission request shall be initiated and the EUT shall remain in the "Non valid" state.
 - d) Case where the CC is being lost by the EUT and a call is initiated within the T1 period:
 - d1) the EUT shall be switched on and the STE shall transmit the CC;

- d2) the STE shall stop transmitting the CC;
- d3) within the period T1 from d2), a transmission request shall be initiated from the EUT;
- d4) the EUT may transmit but within the T1 period the EUT shall enter the "Non valid" state.

6.9.7 Network Control commands - Test method

The tests shall be performed in the following sequence:

- Transmission Enable command;
 - Transmission Disable command received in the "Transmission enabled" state;
 - Transmission Disable command received in the "Initial phase" state.
- a) Transmission Enable command:
 - a1) the EUT shall be switched-on and the STE shall transmit the CC;
 - a2) the EUT shall enter the "Initial phase" state;
 - a3) a transmission request shall be initiated from the EUT, the EUT shall remain in the "Initial phase" state;
 - a4) the STE shall transmit a transmit enable command to the EUT;
 - a5) a transmission request shall be initiated from the EUT;
 - a6) the EUT shall enter the "Transmission enabled" state and shall transmit.
 - b) Transmission Disable command received in the "Transmission enabled" state:
 - b1) continue from a6);
 - b2) the STE shall transmit a disable command to the EUT;
 - b3) the EUT shall enter the "Transmission disabled" state within 1 second;
 - b4) a transmission request shall be initiated from the EUT;
 - b5) the EUT shall remain in the "Transmission disabled" state;
 - b6) the STE shall transmit an enable command;
 - b7) the EUT shall enter either the "Transmission enabled" state or the "Initial phase" state;
 - b8) if the EUT is in the "Transmission enable" state then the test continues with b11);
 - b9) the STE shall transmit a TxE command;
 - b10) the EUT shall enter the "Transmission enable" state;
 - b11) if a transmission request is not active any more than a new transmission request shall be initiated;
 - b12) the EUT shall transmit;
 - b13) the EUT transmission shall be terminated.
 - c) Transmission disable command received in the "Initial phase" state:
 - c1) the EUT shall be switched-on and the STE shall transmit the CC;
 - c2) the EUT shall enter the "Initial phase" state;
 - c3) the STE shall transmit a Transmission Disable command to the EUT;
 - c4) the EUT shall enter the "Transmission disabled" state within 1 second;

- c5) a transmission request shall be initiated from the EUT;
- c6) the EUT shall remain in the "Transmission disabled" state;
- c7) the STE shall transmit a Transmission Enable command;
- c8) the EUT shall enter either the "Transmission enabled" state or the "Initial phase" state;
- c9) if the EUT is in the "Transmission enable" state then the test continues with c12);
- c10) the STE shall transmit a TxE command;
- c11) the EUT shall enter the "Transmission enable" state;
- c12) if a transmission request is not active any more than a new transmission request shall be initiated;
- c13) the EUT shall transmit;
- c14) the EUT transmission shall be terminated.

6.9.8 Initial burst transmission - Test method

The manufacturer shall declare the initial burst duration.

The following test shall be performed in sequence:

- a) the EUT shall be switched-off and the STE shall transmit the CC;
- b) the EUT shall be switched-on;
- c) the EUT shall not transmit, except the initial bursts;
- d) it shall be verified that the specifications given in clause 4.2.8.7.2 are fulfilled.

6.9.9 Inhibition of transmission - Test method

The manufacturer shall declare the values for IT_{max} and T_{trans} , as specified in clauses 4.2.2.2 and 4.2.8.8.

The receive carrier to the EUT shall be removed:

- a) Within 1 second of such failure the EUT shall cease to transmit.
- b) It shall be observed that the EUT remains in the "Transmission enabled" state and that transmissions have been suppressed within the limits of the "Carrier off" radio state emission levels given in clause 4.2.3.2, Table 3.
- c) The receive carrier to the EUT shall be restored within IT_{max} .
- d) It shall be observed that the EUT enters the "Carrier on" radio state and begins transmission within T_{trans} .
- e) The receive carrier to the EUT shall be removed.
- f) It shall be observed that after IT_{max} the EUT enters the "Initial phase" state.

6.10 Antenna off-axis gain pattern

6.10.1 Test Method

6.10.1.1 Test site

This test shall be performed on either an outdoor far field test site or compact test range.

6.10.1.2 Method of measurement for EUT antenna with linear polarization

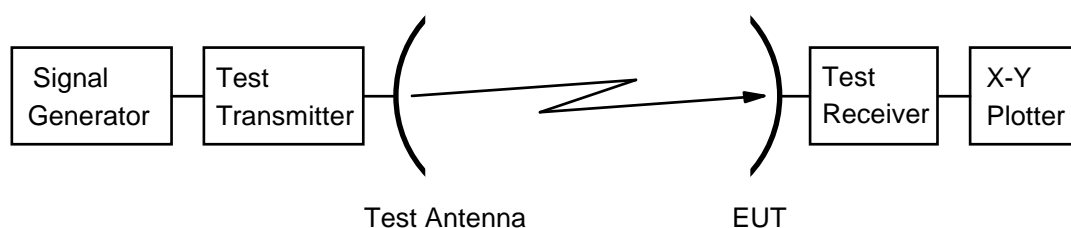

Figure 9: Test arrangement - antenna receive pattern measurement

- a) The test arrangement shall be as shown in Figure 9 with the EUT connected to the test receiver. A linearly polarized test antenna shall be used.
- b) A signal proportional to the angular position from the servo mechanism shall be applied to the X-axis and the signal level from the test receiver shall be applied to the Y-axis of the plotter.
- c) The test frequencies shall be the centre frequency of each applicable frequency range. The E plane shall be vertical.
- d) The EUT shall be aligned to maximize the received signal level and the X-Y plotter shall be adjusted to give the maximum reading on the chart.
- e) The EUT shall be driven in azimuth through 180°.
- f) The pattern measurement is then obtained by driving the EUT in azimuth through 360° with the plotter recording the results.
- g) The tests in b) to e) shall be repeated with the frequency changed to the lower limit of the applicable band as declared by the manufacturer.
- h) The tests in b) to e) shall be repeated with the frequency changed to the upper limit of the applicable band as declared by the manufacturer.
- i) The tests in b) to h) shall be repeated with the frequencies changed to the others specified if the design of the equipment is such that operation is possible, but not necessarily simultaneously, in all bands.
- j) The tests in b) to h) shall be repeated with the test signal being transmitted in the H-plane instead of the E-plane.
- k) The tests in b) to h) shall be repeated with the test signal being transmitted in a plane at 45° to the H-plane.
- l) The tests in b) to h) shall be repeated with the test signal being transmitted in a plane at 90° to that in k).
- m) The tests in b) to l) shall be repeated between the angles of φ_r and 7° with the EUT rotated through 90°, or the test antenna or the polarization subsystem of the EUT rotated by 90°, to give the cross-polar measurement.

6.10.1.3 Method of measurement for antennas with circular polarization

- a) The test arrangement shall be as shown in Figure 9 with the EUT connected to the test receiver. The sense of polarization for the test antenna and the antenna on the EUT shall be the same.
- b) A signal proportional to the angular position from the servo mechanism shall be applied to the X-axis and the signal level from the test receiver shall be applied to the Y-axis of the plotter.
- c) The test frequencies shall be the centre frequency of each applicable frequency range. A proper reference plane shall be selected and set vertical.
- d) The EUT shall be aligned to maximize the received signal level and the X-Y plotter shall be adjusted to give the maximum reading on the chart.
- e) The EUT shall be driven in azimuth through 180°.

- f) The pattern measurement is then obtained by driving the EUT in azimuth through 360° with the plotter recording the results.
- g) The tests in b) to e) shall be repeated with the frequency changed to the lower limit of the applicable band as declared by the manufacturer.
- h) The tests in b) to e) shall be repeated with the frequency changed to the upper limit of the applicable band as declared by the manufacturer.
- i) The tests in b) to h) shall be repeated with the frequencies changed to the others specified if the design of the equipment is such that operation is possible, but not necessarily simultaneously, in all bands.
- j) The tests in b) to h) shall be repeated with the test signal being transmitted in a plane perpendicular to the reference plane selected in c).
- k) The tests in b) to j) shall be repeated with the test antenna in different sense of circular polarization, to give the cross-polar measurement.

6.11 Blocking performance

6.11.0 General

For EUTs where the antenna may be removed, the test signal should be introduced into the antenna port. For integrated EUTs where it is not possible to remove the antenna, a radiated method shall be used.

6.11.1 Test method

- a) For radiated measurements, set up the EUT in an outdoor far field test site or compact test range as show in Figure 9. For conducted measurements, the output signals of two signal generators shall be combined with equal weight; the combined signal shall be coupled to the antenna port.
- b) The first signal generator shall be set up to present the desired signal. Adjust the signal source so that the EUT reports a signal-to-noise ratio of 15 dB.
- c) A second signal generator shall be used to create a continuous wave source, with the power level set for the appropriate frequency offset according to Table 6.
- d) The signal to noise ratio received at the EUT shall be measured.
- e) Record the frequencies for which the SNR degradation exceeds the test requirement.

6.12 Adjacent Signal Selectivity

6.12.0 General

For EUTs where the antenna may be removed, the test signal should be introduced into the antenna port. For integrated EUTs where it is not possible to remove the antenna, a radiated method shall be.

6.12.1 Test method

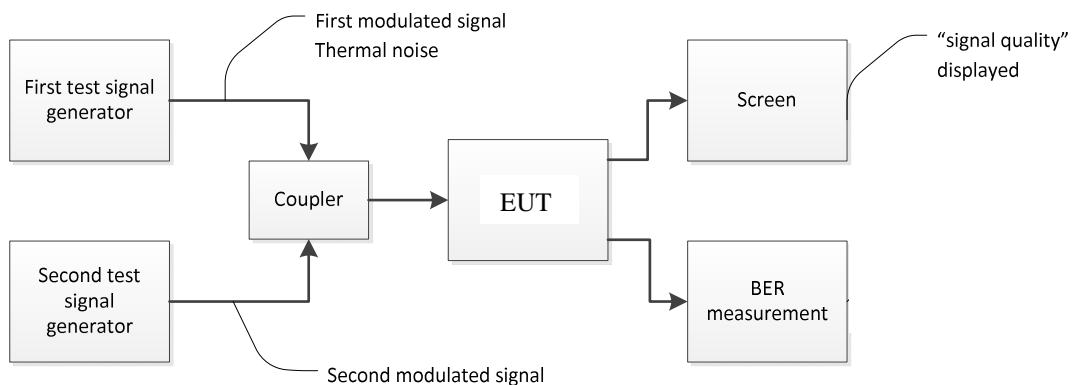

Figure 10: Test arrangement - adjacent signal selectivity

- a) Two test signal generators shall be used. Each signal generator shall generate a modulated signal in the RF input frequency range. One of the signal generators shall also generate thermal noise.
- b) The signal generators shall be connected to the EUT input through a splitter (combiner).
- c) The first signal generator signal frequency shall be set to the center of the EUT input frequency range. The signal level shall be set to the center of the EUT input level range.
- d) The second test signal generator shall be set to the frequencies and levels of the adjacent signals as defined in the requirement.
- e) The EUT shall be set to receive the signal of the first test signal generator.
- f) The second test signal generator shall be set to signal off.
- g) The noise level (or signal to noise ratio) of the first test signal generator shall be varied in order to determine the signal-to-noise ratio threshold.
- h) The second signal generator shall be set to signal on.
- i) The noise level (or signal to noise ratio) of the first test signal generator shall be varied in order to determine the signal-to-noise ratio threshold.
- j) The degradation is equal to the noise level (or signal to noise ratio) determined in step h minus that determined in step g).
- k) The result is the highest degradation found.

Annex A (informative): Relationship between the present document and the essential requirements of Directive 2014/53/EU

The present document has been prepared under the Commission's standardisation request C(2015) 5376 final [i.1] to provide one voluntary means of conforming to the essential requirements of Directive 2014/53/EU on the harmonisation of the laws of the Member States relating to the making available on the market of radio equipment and repealing Directive 1999/5/EC [i.6].

Once the present document is cited in the Official Journal of the European Union under that Directive, compliance with the normative clauses of the present document given in Table A.1 confers, within the limits of the scope of the present document, a presumption of conformity with the corresponding essential requirements of that Directive and associated EFTA regulations.

**Table A.1: Relationship between the present document and
the essential requirements of Directive 2014/53/EU**

Harmonised Standard ETSI EN 303 980					
Requirement				Requirement Conditionality	
No	Description	Essential requirements of Directive	Clause(s) of the present document	U/C	Condition
1	Antenna beam pointing	3.2	4.2.2	U	
2	Off-axis spurious radiation	3.2	4.2.3	U	
3	On-axis spurious radiation	3.2	4.2.4	U	
4	Carrier suppression	3.2	4.2.5	U	
5	Cessation of emissions	3.2	4.2.6	U	
6	Identification of the NEST and its location	3.2	4.2.7	U	
7	Control and Monitoring Functions (CMFs)	3.2	4.2.8	U	
8	Receive antenna off-axis gain pattern	3.2	4.2.9	C	Satellite communications networks may contain a central control unit that keeps received interference low by taking into account the actual antenna gain pattern of earth stations. The requirement is not relevant for earth stations that are always operated as part of such a network. The requirement is relevant in all other cases. If the receive antenna performance does not meet the requirement in clause 4.2.9, then the earth station will be subject to an additional co-frequency interference caused by its off-axis gain which is not compliant to the mask.
9	Blocking performance	3.2	4.2.10	U	
10	Adjacent Signal Selectivity	3.2	4.2.11	U	

Key to columns:

Requirement:

No A unique identifier for one row of the table which may be used to identify a requirement.

Description A textual reference to the requirement.

Essential requirements of Directive

Identification of article(s) defining the requirement in the Directive.

Clause(s) of the present document

Identification of clause(s) defining the requirement in the present document unless another document is referenced explicitly.

Requirement Conditionality:

U/C Indicates whether the requirement is unconditionally applicable (U) or is conditional upon the manufacturer's claimed functionality of the equipment (C).

Condition Explains the conditions when the requirement is or is not applicable for a requirement which is classified "conditional".

Presumption of conformity stays valid only as long as a reference to the present document is maintained in the list published in the Official Journal of the European Union. Users of the present document should consult frequently the latest list published in the Official Journal of the European Union.

Other Union legislation may be applicable to the product(s) falling within the scope of the present document.

Annex B (normative): Radiated measurement

B.1 General

This annex introduces several commonly available test sites:

- Free field test sites, such as an anechoic chamber, an anechoic chamber with a ground plane or an Open Area Test Site (OATS), which may be used for radiated tests.
- Indirect Far Field, also known as the Compact Antenna Test Range (CATR). This creates the far field radiated environment using a transformation with a parabolic reflector.
- Near Field To Far Field transform (NFTF). This method takes a series of near field radiated measurements, and computes the metrics defined in Far Field by using a mathematical Near Field to Far Field transformation.

Both absolute and relative measurements can be performed in these sites. Where absolute measurements are to be carried out, the chamber should be verified. A detailed verification procedure is described in the relevant parts of ETSI TR 102 273 [i.10] or equivalent.

NOTE: To ensure reproducibility and tractability of radiated measurements only these test sites should be used in measurements in accordance with the present document.

B.2 Free Field Test sites and general arrangements for measurements involving the use of radiated fields

B.2.1 Anechoic Chamber

An anechoic chamber is an enclosure, usually shielded, whose internal walls, floor and ceiling are covered with radio absorbing material, normally of the pyramidal urethane foam type. The chamber usually contains an antenna support at one end and a turntable at the other. A typical anechoic chamber is shown in Figure B.1.

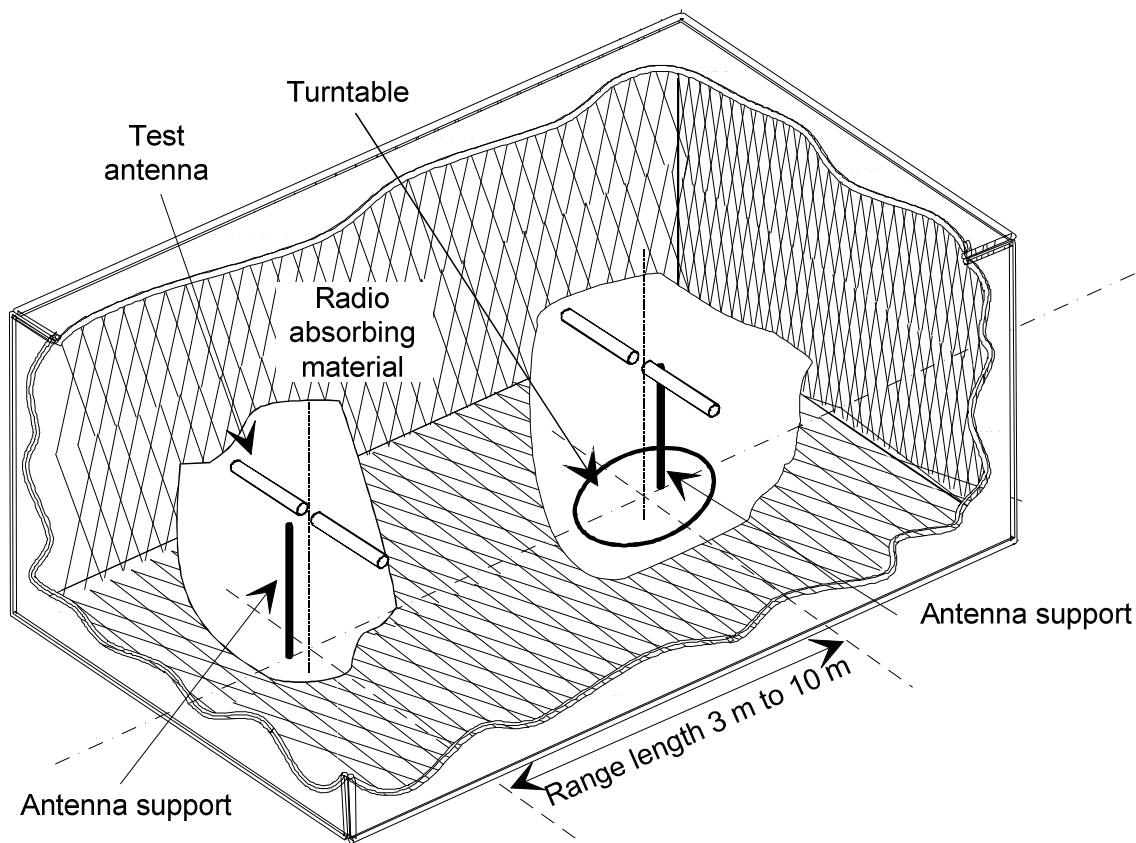

Figure B.1: A typical Anechoic Chamber

The chamber shielding and radio absorbing material work together to provide a controlled environment for testing purposes. This type of test chamber attempts to simulate free space conditions.

The shielding provides a test space, with reduced levels of interference from ambient signals and other outside effects, whilst the radio absorbing material minimizes unwanted reflections from the walls and ceiling which can influence the measurements. In practice it is relatively easy for shielding to provide high levels (80 dB to 140 dB) of ambient interference rejection, normally making ambient interference negligible.

A turntable is capable of rotation through 360° in the horizontal plane and it is used to support the test sample (EUT) at a suitable height (e.g. 1 m) above the ground plane. The chamber shall be large enough to allow the measuring distance of at least 3 m or $2(d_1 + d_2)^2/\lambda$ (m), whichever is greater (see clause B.2.5). For further information on measurements at shorter distances see annex D. The distance used in actual measurements shall be recorded with the test results.

The anechoic chamber generally has several advantages over other test facilities. There is minimal ambient interference, minimal floor, ceiling and wall reflections and it is independent of the weather. It does however have some disadvantages which include limited measuring distance and limited lower frequency usage due to the size of the pyramidal absorbers. To improve low frequency performance, a combination structure of ferrite tiles and urethane foam absorbers is commonly used.

All types of emission, sensitivity and immunity testing can be carried out within an anechoic chamber without limitation.

B.2.2 Anechoic Chamber with a conductive ground plane

An anechoic chamber with a conductive ground plane is an enclosure, usually shielded, whose internal walls and ceiling are covered with radio absorbing material, normally of the pyramidal urethane foam type. The floor, which is metallic, is not covered and forms the ground plane. The chamber usually contains an antenna mast at one end and a turntable at the other. A typical anechoic chamber with a conductive ground plane is shown in Figure B.2.

This type of test chamber attempts to simulate an ideal Open Area Test Site whose primary characteristic is a perfectly conducting ground plane of infinite extent.

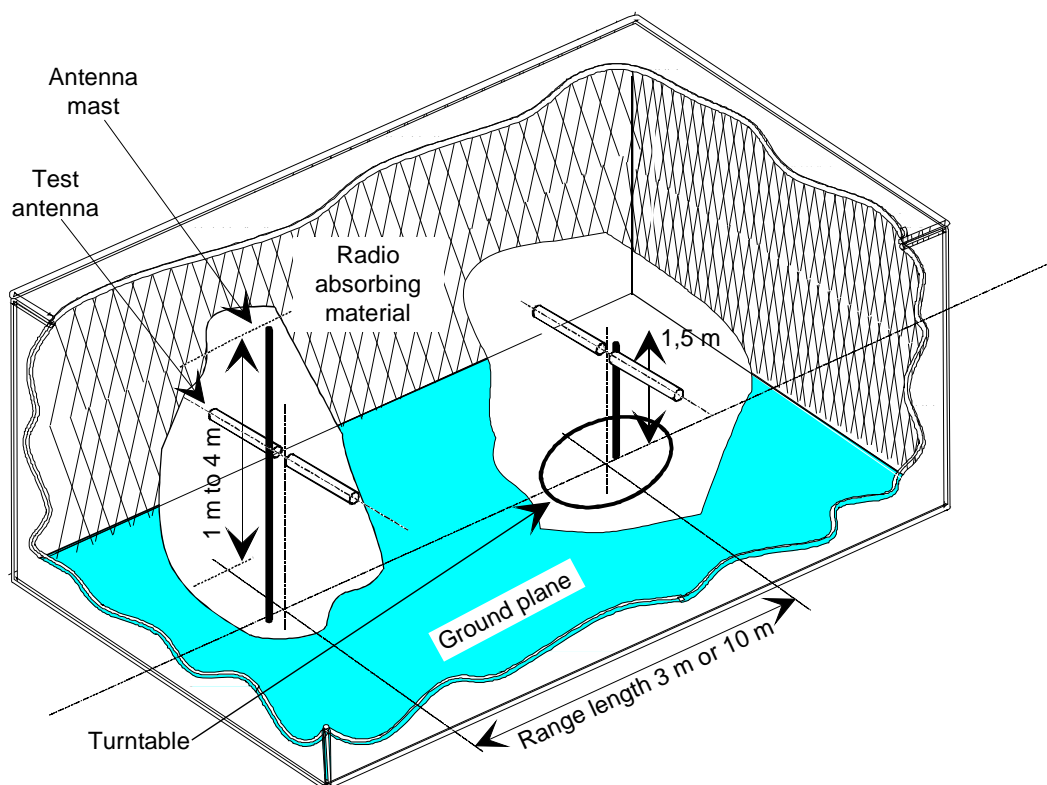

Figure B.2: A typical Anechoic Chamber with a conductive ground plane

In this facility the ground plane creates the wanted reflection path, such that the signal received by the receiving antenna is the sum of the signals from both the direct and reflected transmission paths. This creates a unique received signal level for each height of the transmitting antenna (or EUT) and the receiving antenna above the ground plane.

The antenna mast provides a variable height facility (from 1 m to 4 m) so that the position of the test antenna can be optimized for maximum coupled signal between antennas or between an EUT and the test antenna.

A turntable is capable of rotation through 360° in the horizontal plane and it is used to support the test sample (EUT) at a specified height, usually 1,5 m above the ground plane. The chamber shall be large enough to allow the measuring distance of at least 3 m or $2(d_1 + d_2)^2/\lambda$ (m), whichever is greater (see clause B.2.5). For further information on measurements at shorter distances see annex D. The distance used in actual measurements shall be recorded with the test results.

Emission testing involves firstly "peaking" the field strength from the EUT by raising and lowering the receiving antenna on the mast (to obtain the maximum constructive interference of the direct and reflected signals from the EUT) and then rotating the turntable for a "peak" in the azimuth plane. At this height of the test antenna on the mast, the amplitude of the received signal is noted. Secondly the EUT is replaced by a substitution antenna (positioned at the EUT's phase or volume centre) which is connected to a signal generator. The signal is again "peaked" and the signal generator output adjusted until the level, noted in stage one, is again measured on the receiving device.

Receiver sensitivity tests over a ground plane also involve "peaking" the field strength by raising and lowering the test antenna on the mast to obtain the maximum constructive interference of the direct and reflected signals, this time using a measuring antenna which has been positioned where the phase or volume centre of the EUT will be during testing. A transform factor is derived. The test antenna remains at the same height for stage two, during which the measuring antenna is replaced by the EUT. The amplitude of the transmitted signal is reduced to determine the field strength level at which a specified response is obtained from the EUT.

B.2.3 Open Area Test Site (OATS)

An Open Area Test Site comprises a turntable at one end and an antenna mast of variable height at the other end above a ground plane, which in the ideal case, is perfectly conducting and of infinite extent. In practice, whilst good conductivity can be achieved, the ground plane size has to be limited. A typical OATS is shown in Figure B.3.

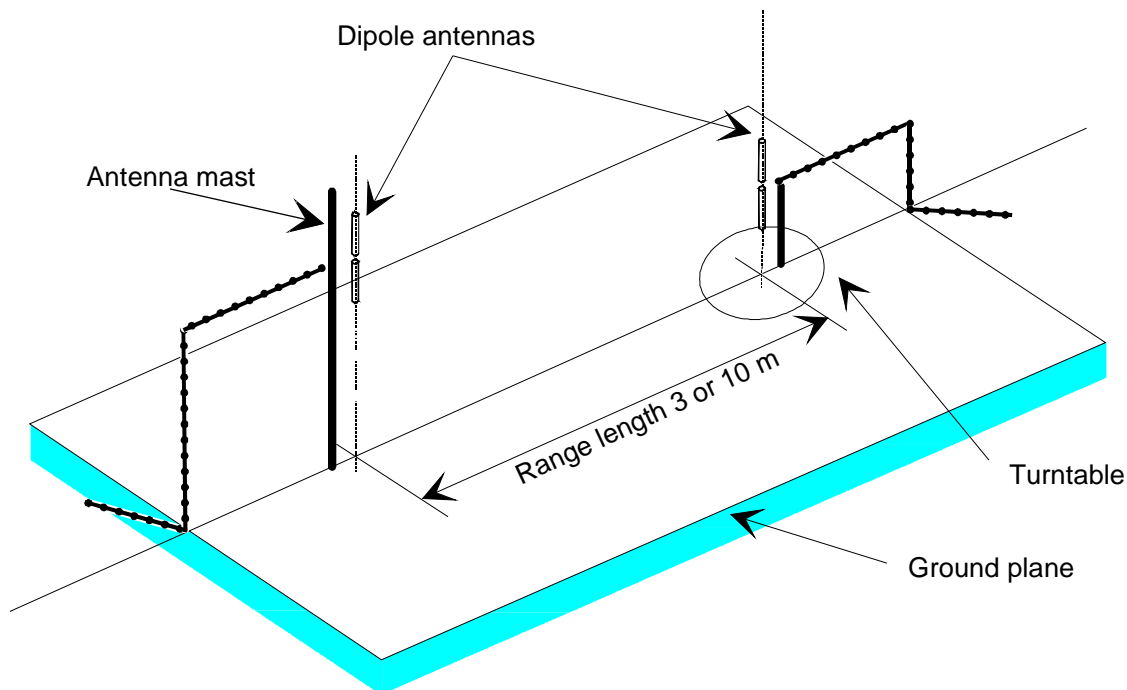

Figure B.3: A typical Open Area Test Site

The ground plane creates a wanted reflection path, such that the signal received by the receiving antenna is the sum of the signals received from the direct and reflected transmission paths. The phasing of these two signals creates a unique received level for each height of the transmitting antenna (or EUT) and the receiving antenna above the ground plane.

Site qualification concerning antenna positions, turntable, measurement distance and other arrangements are same as for anechoic chamber with a ground plane. In radiated measurements an OATS is also used by the same way as anechoic chamber with a ground plane.

Typical measuring arrangement common for ground plane test sites is presented in Figure B.4.

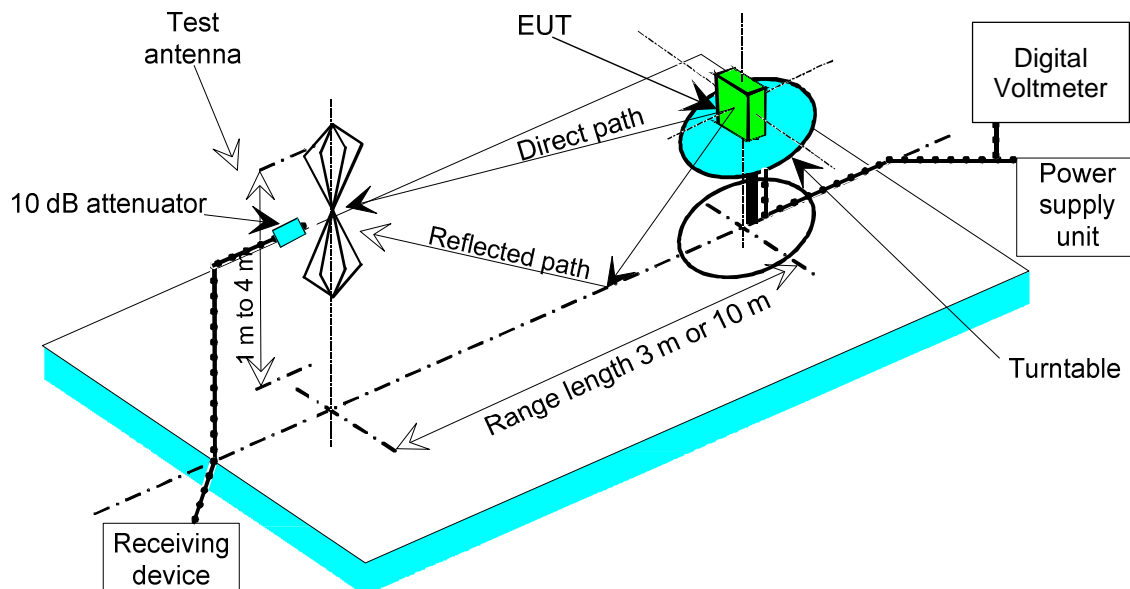

Figure B.4: Measuring arrangement on ground plane test site (OATS set-up for spurious emission testing)

B.2.4 Minimum requirements for free field test sites

B.2.4.1 Measurements above 18 GHz

Generally the test site shall be adequate to allow for testing in the far field of the EUT. The test site should therefore consist of an electromagnetic anechoic room where either at least the ground surface is covered with radio absorbing material or up to six surrounding surfaces are covered with radio absorbing material. The absorbing material shall have a minimum attenuation of 30 dB. It shall be verified that reflections are sufficiently reduced.

B.2.4.2 Test antenna

A test antenna is always used in radiated test methods. In emission tests (i.e. frequency error, effective radiated power, spurious emissions and adjacent channel power) the test antenna is used to detect the field from the EUT in one stage of the measurement and from the substitution antenna in the other stage. When the test site is used for the measurement of receiver characteristics (i.e. sensitivity and various immunity parameters) the antenna is used as the transmitting device.

The test antenna should be mounted on a support capable of allowing the antenna to be used in either horizontal or vertical polarization which, on ground plane sites (i.e. anechoic chambers with ground planes and Open Area Test Sites), should additionally allow the height of its centre above the ground to be varied over the specified range (usually 1 metre to 4 metres).

In the frequency band 30 MHz to 1 000 MHz, dipole antennas (constructed in accordance with ANSI C63.5 [i.11]) are generally recommended. For frequencies of 80 MHz and above, the dipoles should have their arm lengths set for resonance at the frequency of test. Below 80 MHz, shortened arm lengths are recommended. A combination of bicones and log periodic dipole array antennas (commonly termed "log periodics") could be used to cover the entire 30 MHz to 1 000 MHz band. Above 1 000 MHz, waveguide horns are recommended although, again, log periodics could be used.

NOTE: The gain of a horn antenna is generally expressed relative to an isotropic radiator.

B.2.4.3 Substitution antenna

The substitution antenna is used to replace the EUT for tests in which a transmitting parameter (i.e. frequency error, effective radiated power, spurious emissions and adjacent channel power) is being measured. For measurements in the frequency band 30 MHz to 1 000 MHz, the substitution antenna should be a dipole antenna (constructed in accordance with ANSI C63.5 [i.11]). For frequencies of 80 MHz and above, the dipoles should have their arm lengths set for resonance at the frequency of test. Below 80 MHz, shortened arm lengths are recommended. For measurements above 1 000 MHz, a waveguide horn is recommended. The centre of this antenna should coincide with either the phase centre or volume centre.

B.2.4.4 Measuring antenna

The measuring antenna is used in tests on an EUT in which a receiving parameter (i.e. sensitivity and various immunity tests) is being measured. Its purpose is to enable a measurement of the electric field strength in the vicinity of the EUT. For measurements in the frequency band 30 MHz to 1 000 MHz, the measuring antenna should be a dipole antenna (constructed in accordance with ANSI C63.5 [i.11]). For frequencies of 80 MHz and above, the dipoles should have their arm lengths set for resonance at the frequency of test. Below 80 MHz, shortened arm lengths are recommended. The centre of this antenna should coincide with either the phase centre or volume centre (as specified in the test method) of the EUT.

B.2.5 Guidance on the use of free field radiation test sites

B.2.5.1 General

This clause details procedures, test equipment arrangements and verification that should be carried out before any of the radiated test are undertaken. These schemes are common to all types of test sites described in annex B.

B.2.5.2 Verification of the test site

No test should be carried out on a test site, which does not possess a valid certificate of verification. The verification procedures for the different types of free field test sites described in this annex (i.e. anechoic chamber, anechoic chamber with a ground plane and Open Area Test Site) are given in the relevant parts of ETSI TR 102 273 [i.10] or equivalent.

B.2.5.3 Preparation of the EUT

The provider should supply information about the EUT covering the operating frequency, polarization, supply voltage(s) and the reference face. Additional information, specific to the type of EUT should include, where relevant, output power, whether different operating modes are available (e.g. high and low power modes) and if operation is continuous or is subject to a maximum test duty cycle (e.g. 1 minute on, 4 minutes off).

Where necessary, a mounting bracket of minimal size should be available for mounting the EUT on the turntable. This bracket should be made from low conductivity, low relative dielectric constant (i.e. less than 1,5) material(s) such as expanded polystyrene, balsa wood, etc.

B.2.5.4 Power supplies to the EUT

All tests should be performed using power supplies wherever possible, including tests on EUT designed for battery-only use. In all cases, power leads should be connected to the EUT's supply terminals (and monitored with a digital voltmeter) but the battery should remain present, electrically isolated from the rest of the equipment, possibly by putting tape over its contacts.

The presence of these power cables can, however, affect the measured performance of the EUT. For this reason, they should be made to be "transparent" as far as the testing is concerned. This can be achieved by routing them away from the EUT and down to either the screen, ground plane or facility wall (as appropriate) by the shortest possible paths. Precautions should be taken to minimize pick-up on these leads (e.g. the leads could be twisted together, loaded with ferrite beads at 0,15 m spacing or otherwise loaded).

B.2.5.5 Range length

The range length for all these types of test facility should be adequate to allow for testing in the far-field of the EUT i.e. it should be equal to or exceed:

$$\frac{2(d_1 + d_2)^2}{\lambda}$$

where:

d_1 is the largest dimension of the EUT/dipole after substitution (m);

d_2 is the largest dimension of the test antenna (m);

λ is the test frequency wavelength (m).

It should be noted that in the substitution part of this measurement, where both test and substitution antennas are half wavelength dipoles, this minimum range length for far-field testing would be:

$$10\lambda$$

It should be noted in the test report when either of these conditions is not met so that the additional measurement uncertainty can be incorporated into the results.

For further information on measurements at shorter distances see annex D.

NOTE 1: For the fully anechoic chamber, no part of the volume of the EUT should, at any angle of rotation of the turntable, fall outside the "quiet zone" of the chamber at the nominal frequency of the test.

NOTE 2: The "quiet zone" is a volume within the anechoic chamber (without a ground plane) in which a specified performance has either been proven by test, or is guaranteed by the designer/manufacture. The specified performance is usually the reflectivity of the absorbing panels or a directly related parameter (e.g. signal uniformity in amplitude and phase). It should be noted however that the defining levels of the quiet zone tend to vary.

NOTE 3: For the anechoic chamber with a ground plane, a full height scanning capability, i.e. 1 m to 4 m, should be available for which no part of the test antenna should come within 1 m of the absorbing panels. For both types of Anechoic Chamber, the reflectivity of the absorbing panels should not be worse than -5 dB.

NOTE 4: For both the anechoic chamber with a ground plane and the Open Area Test Site, no part of any antenna should come within 0,25 m of the ground plane at any time throughout the tests. Where any of these conditions cannot be met, measurements should not be carried out.

B.2.5.6 Site preparation

The cables for both ends of the test site should be routed horizontally away from the testing area for a minimum of 2 m (unless, in the case either type of anechoic chamber, a back wall is reached) and then allowed to drop vertically and out through either the ground plane or screen (as appropriate) to the test equipment. Precautions should be taken to minimize pick up on these leads (e.g. dressing with ferrite beads or other loading). The cables, their routing and dressing should be identical to the verification set-up.

NOTE: For ground reflection test sites (i.e. anechoic chambers with ground planes and Open Area Test Sites) which incorporate a cable drum with the antenna mast, the 2 m requirement may be impossible to comply with.

Calibration data for all items of test equipment should be available and valid. For test, substitution and measuring antennas, the data should include gain relative to an isotropic radiator (or antenna factor) for the frequency of test. Also, the VSWR of the substitution and measuring antennas should be known.

The calibration data on all cables and attenuators should include insertion loss and VSWR throughout the entire frequency range of the tests. All VSWR and insertion loss figures should be recorded in the log book results sheet for the specific test.

Where correction factors/tables are required, these should be immediately available.

For all items of test equipment, the maximum errors they exhibit should be known along with the distribution of the error e.g.:

- cable loss: $\pm 0,5$ dB with a rectangular distribution;
- measuring receiver: 1,0 dB (standard deviation) signal level accuracy with a Gaussian error distribution.

At the start of measurements, system checks should be made on the items of test equipment used on the test site.

B.2.5.7 Coupling of signals

The presence of leads in the radiated field may cause a disturbance of that field and lead to additional measurement uncertainty. These disturbances can be minimized by using suitable coupling methods, offering signal isolation and minimum field disturbance (e.g. optical and acoustic coupling).

B.2.5.8 Standard test methods

B.2.5.8.0 General

Two methods of determining the radiated power of a device are described in clauses B.2.5.8.1 and B.2.5.8.2.

B.2.5.8.1 Calibrated setup

The measurement receiver, test antenna and all associated equipment (e.g. cables, filters, amplifiers, etc.) shall have been recently calibrated against known standards at all the frequencies on which measurements of the equipment are to be made.

On a test site according to clause B.2, the equipment shall be placed at the specified height on a support, and in the position closest to normal use as declared by the provider.

The test antenna shall be oriented initially for vertical polarization and shall be chosen to correspond to the frequency of the transmitter.

The output of the test antenna shall be connected to the spectrum analyser via whatever (fully characterized) equipment is required to render the signal measurable (e.g. amplifiers).

The transmitter shall be switched on, if possible without modulation, and the spectrum analyser shall be tuned to the frequency of the transmitter under test.

The test antenna shall be raised and lowered through the specified range of height until a maximum signal level is detected by the spectrum analyser.

The transmitter shall then be rotated through 360° in the horizontal plane, until the maximum signal level is detected by the spectrum analyser.

The test antenna shall be raised and lowered again through the specified range of height until a maximum signal level is detected by the spectrum analyser.

The maximum signal level detected by the spectrum analyser shall be noted and converted into the radiated power by application of the pre-determined calibration coefficients for the equipment configuration used.

B.2.5.8.2 Substitution method

On a test site, selected from clause B.2, the equipment shall be placed at the specified height on a support, as specified in clause B.2, and in the position closest to normal use as declared by the provider.

The test antenna shall be oriented initially for vertical polarization and shall be chosen to correspond to the frequency of the transmitter.

The output of the test antenna shall be connected to the spectrum analyser.

The transmitter shall be switched on, if possible without modulation, and the measuring receiver shall be tuned to the frequency of the transmitter under test.

The test antenna shall be raised and lowered through the specified range of height until a maximum signal level is detected by the spectrum analyser.

The transmitter shall then be rotated through 360° in the horizontal plane, until the maximum signal level is detected by the spectrum analyser.

The test antenna shall be raised and lowered again through the specified range of height until a maximum signal level is detected by the spectrum analyser.

The maximum signal level detected by the spectrum analyser shall be noted.

The transmitter shall be replaced by a substitution antenna as defined in clause B.2.4.3.

The substitution antenna shall be orientated for vertical polarization and the length of the substitution antenna shall be adjusted to correspond to the frequency of the transmitter.

The substitution antenna shall be connected to a calibrated signal generator.

If necessary, the input attenuator setting of the spectrum analyser shall be adjusted in order to increase the sensitivity of the spectrum analyser.

The test antenna shall be raised and lowered through the specified range of height to ensure that the maximum signal is received. When a test site according clause B.2.1 is used, the height of the antenna shall not be varied.

The input signal to the substitution antenna shall be adjusted to the level that produces a level detected by the spectrum analyser, that is equal to the level noted while the transmitter radiated power was measured, corrected for the change of input attenuator setting of the spectrum analyser.

The input level to the substitution antenna shall be recorded as power level, corrected for any change of input attenuator setting of the spectrum analyser.

The measurement shall be repeated with the test antenna and the substitution antenna orientated for horizontal polarization.

The measure of the radiated power of the device is the larger of the two levels recorded at the input to the substitution antenna, corrected for gain of the substitution antenna if necessary.

B.3 Guidance on the use of indirect far field test sites

B.3.1 General

The Indirect Far Field (IFF) or Compact Antenna Test Range (CATR) measurement setup is shown in Figure B.5 below.

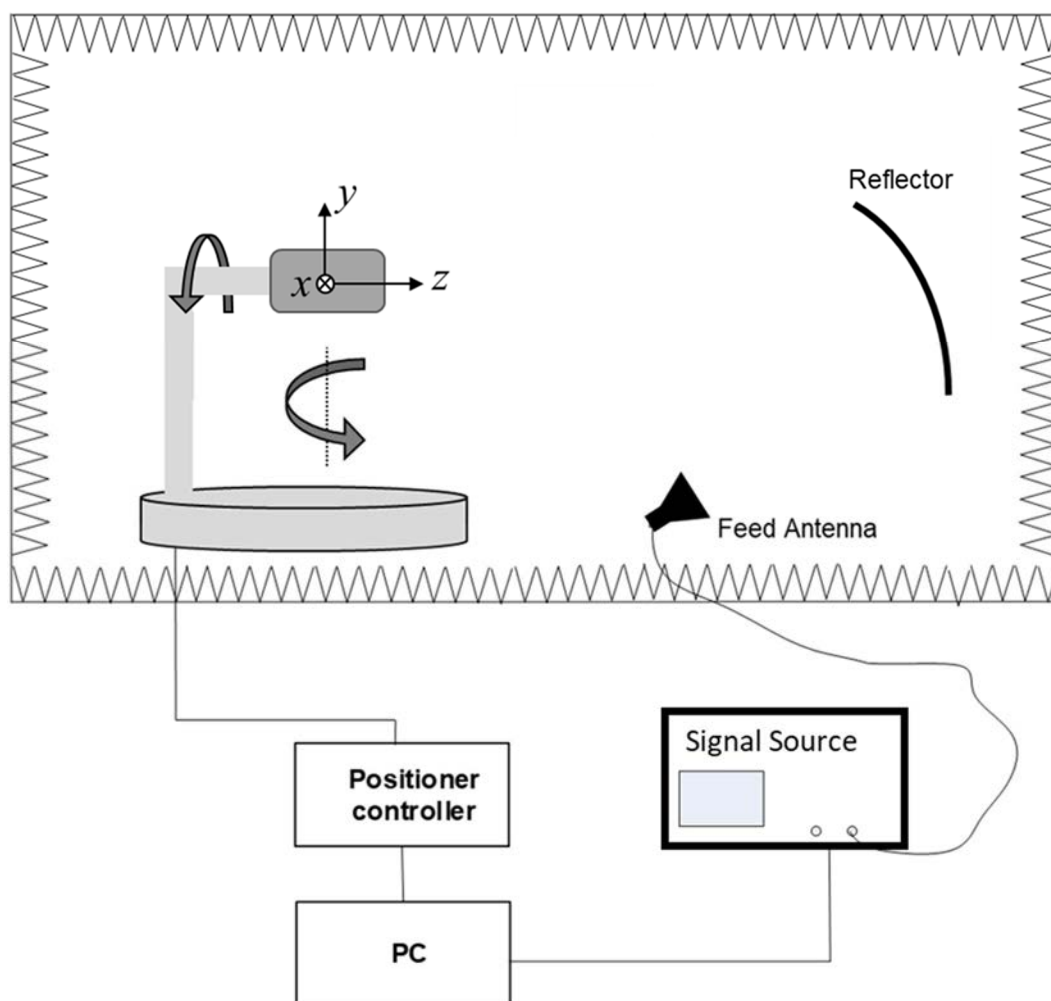

Figure B.5: IFF (CATR) measurement setup

The key aspects of this test method setup are:

- Indirect Far field of Compact Antenna Test Range as described in [3] with quiet zone diameter at least equal to D (where D is the nominal diameter of the antenna).
- A positioning system such that the angle between the dual-polarized measurement antenna and the DUT has at least two axes of freedom and maintains a polarization reference.

The applicability criteria of this test method are:

- The total test volume is a cylinder with diameter d and height h .
- EUT shall fit within the total test volume for the entire duration of the test.
- Either a single antenna or multiple antenna EUTs can be tested.
- EIRP, spurious emissions and blocking metrics can be tested.

B.3.2 Far-field criteria

The CATR system does not require a measurement distance of $R > \frac{2D^2}{\lambda}$ to achieve a plane wave as in a standard far field range.

Table B.1 and Table B.2 below show the paths losses which can be expected for the CATR compared to a Fraunhofer limit distance ($R > \frac{2D^2}{\lambda}$).

Table B.1: Examples of near field/far field boundary for different antenna sizes for a traditional far field anechoic chamber

D (cm)	Frequency (GHz)	Near/far boundary (cm)	Path Loss (dB)
5	28	47	54,8
10	28	187	66,8
15	28	420	73,9
30	28	1 681	85,9

Table B.2: Example of CATR path losses

EUT size (cm)	Frequency (GHz)	Path Loss (dB)
5	28	52,3
10	28	58,3
15	28	61,8
30	28	67,8
NOTE: Final values will depend on CATR specific implementation.		

For CATR, the far field distance is seen as the focal length R, distance between the feed and reflector for a CATR, which can be calculated as shown below (as a rule of thumb although it can vary depending on system implementation):

- Nominal diameter of antenna = D [m]
- Size of CATR reflector = $2 \times D$
- Focal length (R) = $3,5 \times (\text{size of reflector}) = 3,5 \times (2 \times D)$

In a CATR, from the reflector to the quiet zone, there is a plane wave with no space loss.

For both direct far field and CATR, free space path loss is calculated by applying the free space loss formula:

$$\left(\frac{4\pi R}{\lambda}\right)^2$$

(where R is the far field distance).

B.3.3 Calibration Measurement Procedure

The calibration measurement is done by using a reference antenna (marked "SGH" in Figure B.6) with known efficiency or gain values. In the calibration measurement the reference antenna is measured in the same place as the EUT, and the attenuation of the complete transmission path (C↔A, as in Figure B.6) from the EUT to the measurement receiver (EIRP), and from the RF source to EUT is calibrated out. Figure B.6 presents a setup of a typical compact antenna test range for EIRP calibration.

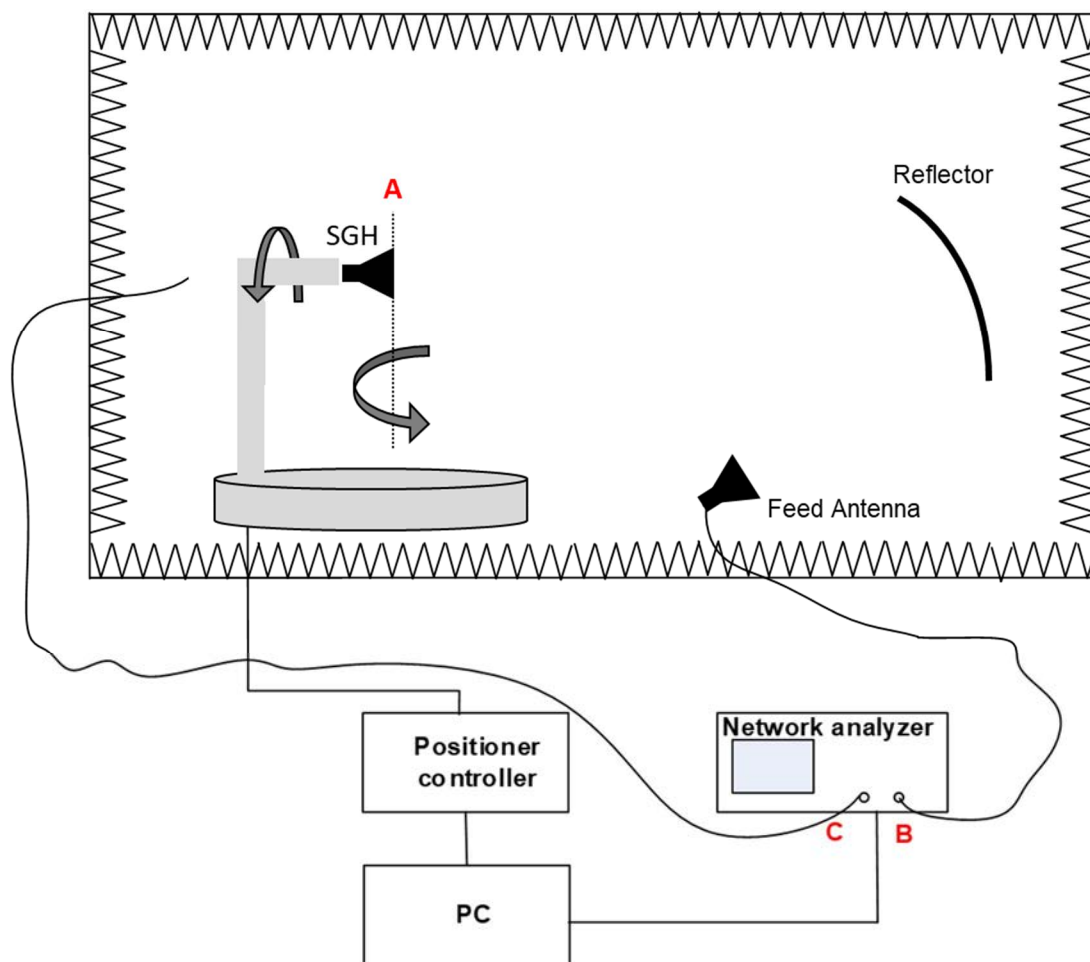

Figure B.6: CATR calibration system setup for EIRP

B.4 Guidance on the use of near-field-to-far-field transform test sites

B.4.1 General

The NFTF measurement setup of EUT RF characteristics is shown in Figure B.7.

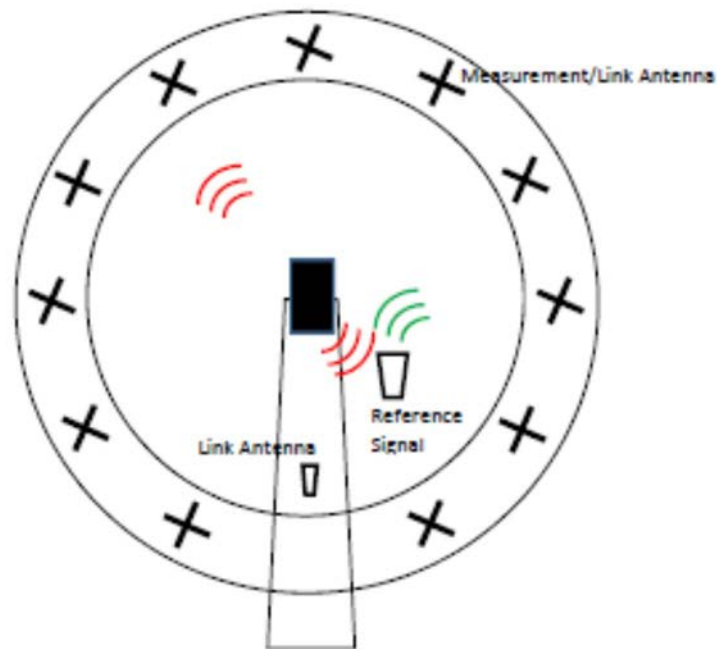

Figure B.7: Typical NFTF measurement setup

The key aspects of the Near Field test range are:

- Radiated Near Field beam pattern is measured and converted to a measurement metric (such as EIRP) using the NFTF mathematical transform.
- A positioning system such as the angle between the dual-polarized measurement/link antenna and the EUT has at least two axes of freedom and maintains a polarization reference.

B.4.2 Calibration Measurement Procedure

Calibration accounts for the various factors affecting the measurements of the EIRP. These factors include components such as range length path loss, cable losses, gain of the receiving antenna, etc. Each measured data point for radiated power is transformed from a relative value in dB to an absolute value in dBW. For doing that the total path loss from the EUT to the measurement receiver, named $L_{\text{path loss}}$ is calibrated out. The calibration measurement is usually done by using a reference antenna with known gain. This approach is based on the so called gain-comparison method. Figure B.8 shows the typical configuration for measuring path loss.

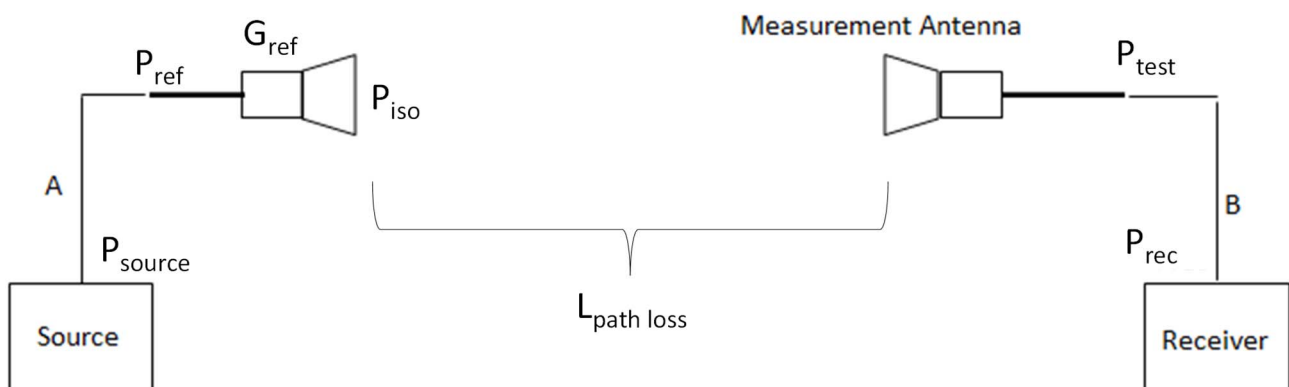

Figure B.8: NFTF - Typical setup for path loss measurement

The $L_{\text{path loss}}$ can be determined from the power into the reference antenna by adding the gain of the reference antenna:

$$P_{\text{iso}} = P_{\text{ref}} + G_{\text{ref}}$$

$$L_{\text{path loss}} = P_{\text{ref}} + G_{\text{ref}} - P_{\text{test}}$$

In order to determine P_{ref} , a cable reference measurement is performed in order to calibrate out the A and B paths of the test equipment-receiver. Assuming that the power at the source is fixed, it can be shown that:

$$P_{\text{ref}} - P_{\text{tes}} = P_{\text{rec}'} - P_{\text{rec}}$$

Where P_{rec} is the power measured at the receiver during the calibration measurement with the reference antenna and $P_{\text{rec}'}$ is the power measured at the receiver during the cable reference measurement respectively. $L_{\text{path loss}}$ is then given by:

$$L_{\text{path loss}} = G_{\text{ref}} + P_{\text{rec}'} - P_{\text{rec}}$$

Annex C (normative): Conducted measurements

In view of the low power levels of the equipment to be tested under the present document, conducted measurements may be applied to equipment provided with an antenna connector. Where the equipment to be tested does not provide a suitable termination, a coupler or attenuator that does provide the correct termination value shall be used.

The equivalent isotropically radiated power is then calculated from the measured value, the known antenna gain, relative to an isotropic antenna, and if applicable, any losses due to cables and connectors in the measurement system.

The Voltage Standing Wave Ratio (VSWR) shall not be greater than 1,5:1 over the frequency range of the measurement.

Annex D (informative): General Requirements for RF Cables

All RF cables including their connectors at both ends used within the measurement arrangements and set-ups should be of coaxial or waveguide type featuring within the frequency range they are used:

- a VSWR of less than 1,2 at either end;
- a shielding loss in excess of 60 dB.

When using coaxial cables for frequencies above 40 GHz attenuation features increase significantly and decrease of return loss due to mismatching caused by joints at RF connectors and impedance errors should be considered.

All RF cables and waveguide interconnects should be routed suitably in order to reduce impacts on antenna radiation pattern, antenna gain, antenna impedance. Table D.1 provides some information about connector systems that can be used in connection with the cables.

Table D.1: Connector systems

Connector System	Frequency	Recommended coupling torque
N	18 GHz	0,68 Nm to 1,13 Nm
SMA	18 GHz (some up to 26 GHz)	~ 0,56 Nm
3,50 mm	26,5 GHz	0,8 Nm to 1,1 Nm
2,92 mm	40 GHz (some up to 46 GHz)	0,8 Nm to 1,1 Nm
2,40 mm	50 GHz (some up to 60 GHz)	0,8 Nm to 1,1 Nm
1,85 mm	65 GHz (some up to 75 GHz)	0,8 Nm to 1,1 Nm

Annex E (informative): RF Waveguides

Wired signal transmission in the millimetre range is preferably realized by means of waveguides because they offer low attenuation and high reproducibility. Unlike coaxial cables, the frequency range in which waveguides can be used is limited also towards lower frequencies (highpass filter characteristics). Wave propagation in the waveguide is not possible below a certain cut-off frequency where attenuation of the waveguide is very high. Beyond a certain upper frequency limit, several wave propagation modes are possible so that the behaviour of the waveguide is no longer unambiguous. In the unambiguous range of a rectangular waveguide, only H10 waves are capable of propagation.

The dimensions of rectangular and circular waveguides are defined by international standards such as IEC 60153 [i.8] for various frequency ranges. These frequency ranges are also referred to as waveguide bands. They are designated using different capital letters depending on the standard. Table E.1 provides an overview of the different waveguide bands together with the designations of the associated waveguides and flanges.

For rectangular waveguides, which are mostly used in measurements, harmonic mixers with matching flanges are available for extending the frequency coverage of measuring receivers. Table E.1 provides some information on waveguides.

Table E.1: Waveguide bands and associated waveguides

Band	Frequency	Designations				Internal dimensions of waveguide		Designations of frequently used flanges		
		MIL-W-85	EIA	153-IEC	RCSC (British)	in mm	in inches	MIL-F-3922	UG-XXX/U equivalent (reference)	Remarks
Ka	26,5 to 40,0	3-006	WR-28	R320	WG-22	7,11 × 3,56	0,280 × 0,140	54-006 68-002 67B-005	UG-559/U - UG-381/U	Rectangular Rectangular Round
Q	33,0 to 55,0	3-010	WR-22	R400	WG-23	5,69 × 2,84	0,224 × 0,112	67B-006	UG-383/U	Round
U	40,0 to 60,0	3-014	WR-19	R500	WG-24	4,78 × 2,388	0,188 × 0,094	67B-007	UG-383/U-M	Round
V	50,0 to 75,0	3-017	WR-15	R620	WG-25	3,759 × 1,879	0,148 × 0,074	67B-008	UG-385/U	Round
E	60,0 to 90,0	3-020	WR-12	R740	WG-26	3,099 × 1,549	0,122 × 0,061	67B-009	UG-387/U	Round

As waveguides are rigid, it is impractical to set up connections between antenna and measuring receiver with waveguides. Either a waveguide transition to coaxial cable is used or - at higher frequencies - the harmonic mixer is used for frequency extension of the measuring receiver and is directly mounted at the antenna.

Annex F (informative): Measurement Equipment

F.1 Special considerations for the interpretation of measurement results

"Standard" measurement equipment is available up to a frequency range of around 66 GHz with a sensitivity of -72 dBm at 18 GHz down to around -64 dBm at 40 GHz (1 MHz RBW, 3 MHz VBW, 100 MHz span). For higher frequencies the sensitivity will further decrease.

Additional information on radiated measurements up to 100 GHz is available in ETSI TS 103 052 [i.3].

The test site and the method of measurement should also be in accordance with CISPR 16-1-4 [2] as applicable.

Where a radome is required in operation, the tests should be conducted with the radome in place or, if testing with the radome in place is impractical, then an appropriate analytic technique should be used to compensate for the absence of the radome.

To enable the performance tests to be carried out the use of an NCF or a Special Test Equipment (STE), made available by the manufacturer or system provider, may be necessary. Since this STE will be specific for the particular system, it is not possible to provide detailed specifications in the present document. However, the following baseline is provided:

- if the NEST requires to receive a modulated carrier from the satellite in order to transmit, then special test arrangements are required to simulate the satellite signal, thus enabling the NEST to transmit allowing measurement of transmission parameters;
- any characteristic of these special test arrangements which may have direct or indirect effects on the parameters to be measured should be clearly stated by the manufacturer.

All tests with carrier-on should be undertaken with the transmitter operating at $EIRP_{max}$, as per the specific requirement, and with the normal radio operating parameters, as declared by the manufacturer.

If the Equipment Under Test (EUT) is a NEST that requires hardware and/or software modification(s) performed by the manufacturer for these tests then full documentation of such modification(s) should be provided to demonstrate that the modification(s) will simulate the required test condition, without its main characteristics being changed.

F.2 Maximum measurement uncertainty

The measurements described in the present document are based on the following assumptions:

- the measured value related to the corresponding limit is used to decide whether an equipment meets the requirements of the present document;
- the value of the measurement uncertainty for the measurement of each parameter is included in the test report.

Table F.1 shows the recommended values for the maximum measurement uncertainty figures.

Table F.1: Maximum measurement uncertainty

Parameter	Uncertainty
Radio frequency	$\pm 1 \times 10^{-7}$
Radiated RF power ($f \leq 40$ GHz)	± 6 dB
Radiated RF power ($f > 40$ GHz)	± 8 dB
Calibrated measurement horn	± 2 dB
Conducted Measurements ($f \leq 18$ GHz)	$\pm 1,5$ dB
Conducted Measurements ($18 \text{ Hz} < f \leq 40$ GHz)	$\pm 2,5$ dB
Conducted Measurements ($f > 40$ GHz)	± 4 dB
Temperature	± 1 °C
Humidity	± 5 %
DC and low frequency voltages	± 3 %

F.3 Measuring receiver

The term "measuring receiver" refers to a frequency-selective voltmeter or a spectrum analyser. In order to obtain the required sensitivity, a narrower measurement bandwidth may be necessary. In such cases, this should be stated in the test report form. The bandwidth of the measuring receiver and the deployed detectors should be as given in Table F.2

Table F.2: Measurement receiver parameters

Frequency range: (f)	Measuring receiver bandwidth	Detector
$30 \text{ MHz} \leq f \leq 1\,000 \text{ MHz}$	100 kHz or 120 kHz	peak/RMS (see note 1)
$1\,000 \text{ MHz} < f \leq 40 \text{ GHz}$	1 MHz	peak/RMS
$f > 40 \text{ GHz}$	1 MHz (see note 2)	peak/RMS
NOTE 1: With the values from the peak and the RMS detector the quasi peak value can be calculated for particular measurement applications.		
NOTE 2: The actual frequency accuracy shall be taken into account to determine the minimum measurement bandwidth possible.		

In case a narrower measurement bandwidth was used, the following conversion formula should be applied:

$$B = A + 10 \log \frac{BW_{ref}}{BW_{MEASURED}}$$

Where:

- A is the value at the narrower measurement bandwidth;
- B is the value referred to the reference bandwidth; or
- use the measured value, A, directly if the measured spectrum is a discrete spectral line. (A discrete spectrum line is defined as a narrow peak with a level of at least 6 dB above the average level inside the measurement bandwidth.)

Wired signal transmission in the millimetre range is preferably realized by means of waveguides because they offer low attenuation and high reproducibility. Unlike coaxial cables, the frequency range in which waveguides can be used is limited also towards lower frequencies (highpass filter characteristics). Wave propagation in the waveguide is not possible below a certain cut-off frequency where attenuation of the waveguide is very high. Beyond a certain upper frequency limit, several wave propagation modes are possible so that the behaviour of the waveguide is no longer unambiguous. In the unambiguous range of a rectangular waveguide, only H10 waves are capable of propagation.

The dimensions of rectangular and circular waveguides are defined by international standards such as IEC 60153 [i.8] for various frequency ranges. These frequency ranges are also referred to as waveguide bands. They are designated using different capital letters depending on the standard. Table E.1 provides an overview of the different waveguide bands together with the designations of the associated waveguides and flanges.

For rectangular waveguides, which are mostly used in measurements, harmonic mixers with matching flanges are available for extending the frequency coverage of measuring receivers. Table E.1 provides some information on waveguides.

F.4 Measurement results

The measurements described in the present document should take into account the following elements:

- the measured value related to the corresponding limit should be used to decide whether an equipment meets the requirements of the present document;
- the measurement uncertainty value for the measurement of each parameter should be recorded;
- the recorded value of the measurement uncertainty should be wherever possible, for each measurement, equal to or less than the Maximum Measurement Uncertainties shown in Table F.1.

Annex G (informative): Applicability of parameters given in ETSI EG 203 336

ETSI EG 203 336 [i.7] gives guidance on the selection of technical parameters for the production of Harmonised Standards covering articles 3.1(b) and 3.2 of the Radio Equipment Directive [i.6]. Clause 5.3 of ETSI EG 203 336 [i.7] gives receiver parameters under article 3.2 that should be contained in a Harmonised Standard.

Table G.1 explains how these parameters are considered in the present document.

Table G.1: Parameters given in ETSI EG 203 336

ETSI EG 203 336 [i.7]		Present document		Explanation																
Clause	Parameter	Clause	Parameter																	
5.3.2	Receiver sensitivity	-	-	There is no causal relationship between receiver sensitivity and interference in the case of satellite communications. Therefore, a quantitative calculation is not possible.																
5.3.3	Receiver co-channel rejection	4.2.9	Receive antenna off-axis gain pattern	Co-channel signals transmitted by other satellite networks are rejected by means of low off-axis antenna gain. Typical rejection for a 50 cm antenna is 7,5 dB at 3° off-axis, and 21 dB at 5°.																
5.3.4.2.1	Single signal selectivity - receiver adjacent signal selectivity	4.2.11	Adjacent signal selectivity																	
5.3.4.2.2	Receiver spurious response rejection	-	-	This is covered by receiver blocking and adjacent channel requirements which are already included in the receiver parameters.																
5.3.4.3.1	Receiver blocking	4.2.10	Blocking performance																	
5.3.4.3.2	Receiver radio-frequency intermodulation	-	-	<p>In an FSS network, receiver radio-frequency intermodulation is not relevant, because possibly inter-modulating signals originating from other networks are rejected thanks to requirements on <i>receive antenna off-axis gain pattern</i>, <i>adjacent signal selectivity</i> Interfering signals up to 28 dB above the wanted carrier can be tolerated with minimal impact on performance. See calculation below:</p> <table border="1"> <tbody> <tr> <td>Gain of a typical 50cm parabolic antenna (see note) at 11 GHz:</td> <td>33,3 dBi</td> </tr> <tr> <td>Co-polar antenna discrimination (see note):</td> <td></td> </tr> <tr> <td style="text-align: right;">at 3°</td> <td>-7,5 dB</td> </tr> <tr> <td style="text-align: right;">at 5°</td> <td>-21,0 dB</td> </tr> <tr> <td>Adjacent channel selectivity:</td> <td></td> </tr> <tr> <td style="padding-left: 20px;">Relative power tolerated in adjacent channel for 0,5 dB degradation in wanted C/N (measured at receiver)</td> <td>+7,0 dB</td> </tr> <tr> <td style="padding-left: 20px;">Relative power (arriving at antenna from 3° off-axis)</td> <td>+14,0 dB</td> </tr> <tr> <td style="padding-left: 20px;">Relative power (arriving at antenna from 5° off-axis)</td> <td>+28,0 dB</td> </tr> </tbody> </table>	Gain of a typical 50cm parabolic antenna (see note) at 11 GHz:	33,3 dBi	Co-polar antenna discrimination (see note):		at 3°	-7,5 dB	at 5°	-21,0 dB	Adjacent channel selectivity:		Relative power tolerated in adjacent channel for 0,5 dB degradation in wanted C/N (measured at receiver)	+7,0 dB	Relative power (arriving at antenna from 3° off-axis)	+14,0 dB	Relative power (arriving at antenna from 5° off-axis)	+28,0 dB
Gain of a typical 50cm parabolic antenna (see note) at 11 GHz:	33,3 dBi																			
Co-polar antenna discrimination (see note):																				
at 3°	-7,5 dB																			
at 5°	-21,0 dB																			
Adjacent channel selectivity:																				
Relative power tolerated in adjacent channel for 0,5 dB degradation in wanted C/N (measured at receiver)	+7,0 dB																			
Relative power (arriving at antenna from 3° off-axis)	+14,0 dB																			
Relative power (arriving at antenna from 5° off-axis)	+28,0 dB																			
5.3.4.3.3	Receiver multiple signal selectivity - receiver adjacent signal selectivity	4.2.11	Adjacent signal selectivity																	

ETSI EG 203 336 [i.7]		Present document		Explanation
Clause	Parameter	Clause	Parameter	
5.3.4.4.1	Receiver dynamic range	-	-	The satellite earth stations are deployed in a manner that results in a situation where it is impossible to receive a wanted signal that is high enough to produce any overloading effect (satellite systems are power limited) so that it is not necessary to specify receiver dynamic range. (see ETSI EG 203 336 [i.7], clause 5.3.6.1).
5.3.4.4.2	Reciprocal mixing	-	-	It is considered that the reciprocal mixing effects are implicitly covered in HSs where comprehensive interference characteristics are specified in terms of selectivity and/or blocking requirements, thus removing the need for this parameter to be included in HSs as the effects of receiver selectivity and reciprocal mixing cannot be separated. (see ETSI EG 203 336 [i.7], clause 5.3.6.2).
5.3.4.4.3	Desensitization	-	-	From the latest version of ETSI EG 203 336 [i.7]: "As desensitization is a receiver effect addressed by other parameters, its inclusion as a separate parameter in an HS is not required".
5.3.5	Receiver unwanted emissions in the spurious domain	4.2.3	Off-axis spurious radiation	
		4.2.4	On-axis spurious radiation	
NOTE: Recommendation ITU-R BO.1213 [i.9], Reference receiving earth station antenna pattern for the broadcasting-satellite service in the 11,7-12,75 GHz band.				

Annex H (informative): Bibliography

- Council Directive 73/23/EEC of 19 February 1973 on the harmonization of the laws of Member States relating to Electrical Equipment designed for use within certain voltage limits (LV Directive).
- Council Directive 89/336/EEC of 3 May 1989 on the approximation of the laws of the Member States relating to electromagnetic compatibility (EMC Directive).
- Directive 2004/40/EC of the European Parliament and of the Council of 29 April 2004 on the minimum health and safety requirements regarding the exposure of workers to the risks arising from physical agents (electromagnetic fields) (18th individual Directive within the meaning of Article 16(1) of Directive 89/391/EEC).
- ETSI ETR 169 (1995): "Satellite Earth Stations and Systems (SES); Common Technical Regulations (CTRs) in the satellite earth station equipment field".
- BS EN 60068: "Environmental testing. Test methods for vibration and shock", produced by CENELEC.
- EN 55022: "Limits and methods of measurement of radio disturbance characteristics of information technology equipment", produced by CENELEC.
- SAE J1211: "Recommended Environmental Practices for Electronic Equipment Design, Recommended Practice".
- CEPT/ERC/Recommendation 74-01: "Unwanted emissions in the spurious domain".
- EN 60529 (1991): "Degrees of protection provided by enclosures (IP code)", produced by CENELEC.
- EN 60068-2-6 (2008): "Environmental testing - Part 2-6: Test - Test Fc: Vibration (sinusoidal)", produced by CENELEC.
- EN 60068-2-11 (1999): "Environmental testing - Part 2-11: Tests - Test KA: Salt mist", produced by CENELEC.
- EN 60068-2-27 (2007): "Environmental testing - Part 2-27: Tests - Test Ea and guidance: Shock", produced by CENELEC.
- Directive 1999/5/EC of the European Parliament and of the Council of 9 March 1999 on radio equipment and telecommunications terminal equipment and the mutual recognition of their conformity (R&TTE Directive).
- ITU Radio Regulations (Edition 2020).

Annex I (informative): Change history

Version	Information about changes
V1.1.1	First publication of the Harmonised Standard
V1.1.2	Revision of the EN to take into account comments from the EC
V1.1.3	Applying the latest template to annex A
V1.1.4	Clean version, without revision marks
V1.1.5	Resolution of EC comments addressed during the ETSI SES#97 meeting
V1.1.6	Correcting version number
V.1.1.7	Amendments to respond to HAS comments
V.1.1.8	Further amendments addressing HAS comments

History

Document history		
V1.1.1	December 2017	Publication
V1.2.0	February 2021	EN Approval Procedure AP 20210506: 2021-02-06 to 2021-05-06