



**Satellite Earth Stations and Systems (SES);
Fixed earth stations communicating with non-geostationary
satellite systems in the 20 GHz and 30 GHz FSS bands;
Harmonised Standard for access to radio spectrum**

Reference

DEN/SES-00444

Keywords

antenna, earth station, FSS, harmonised standard, non-GSO, regulation, satellite

ETSI

650 Route des Lucioles
F-06921 Sophia Antipolis Cedex - FRANCE

Tel.: +33 4 92 94 42 00 Fax: +33 4 93 65 47 16

Siret N° 348 623 562 00017 - NAF 742 C
Association à but non lucratif enregistrée à la
Sous-Préfecture de Grasse (06) N° 7803/88

Important notice

The present document can be downloaded from:

<http://www.etsi.org/standards-search>

The present document may be made available in electronic versions and/or in print. The content of any electronic and/or print versions of the present document shall not be modified without the prior written authorization of ETSI. In case of any existing or perceived difference in contents between such versions and/or in print, the prevailing version of an ETSI deliverable is the one made publicly available in PDF format at www.etsi.org/deliver.

Users of the present document should be aware that the document may be subject to revision or change of status.

Information on the current status of this and other ETSI documents is available at

<https://portal.etsi.org/TB/ETSIDeliverableStatus.aspx>

If you find errors in the present document, please send your comment to one of the following services:

<https://portal.etsi.org/People/CommitteeSupportStaff.aspx>

Copyright Notification

No part may be reproduced or utilized in any form or by any means, electronic or mechanical, including photocopying and microfilm except as authorized by written permission of ETSI.

The content of the PDF version shall not be modified without the written authorization of ETSI.

The copyright and the foregoing restriction extend to reproduction in all media.

© ETSI 2020.

All rights reserved.

DECT™, **PLUGTESTS™**, **UMTS™** and the ETSI logo are trademarks of ETSI registered for the benefit of its Members.

3GPP™ and **LTE™** are trademarks of ETSI registered for the benefit of its Members and of the 3GPP Organizational Partners.

oneM2M™ logo is a trademark of ETSI registered for the benefit of its Members and of the oneM2M Partners.

GSM® and the GSM logo are trademarks registered and owned by the GSM Association.

Contents

Intellectual Property Rights	7
Foreword.....	7
Modal verbs terminology.....	7
Introduction	8
1 Scope	9
2 References	10
2.1 Normative references	10
2.2 Informative references.....	10
3 Definition of terms, symbols and abbreviations.....	11
3.1 Terms.....	11
3.2 Symbols.....	13
3.3 Abbreviations	13
4 Technical requirements specifications	14
4.1 General	14
4.1.1 Environmental profile	14
4.1.2 Operational configurations	14
4.1.3 EIRP _{Aggregate} for networks of ESs	14
4.1.4 Presentation of equipment for testing purposes	15
4.1.5 Choice of model for testing	15
4.1.6 Void	15
4.1.7 Peak pointing accuracy	15
4.2 Conformance requirements	15
4.2.1 Off-axis spurious radiation	15
4.2.1.1 Justification	15
4.2.1.2 Specification.....	15
4.2.1.3 Conformance tests.....	16
4.2.2 On-axis spurious radiation.....	16
4.2.2.1 Justification	16
4.2.2.2 Specification.....	17
4.2.2.2.1 "Carrier-on" radio state.....	17
4.2.2.2.2 "Carrier-off" and "Emissions disabled" radio states	17
4.2.2.3 Conformance tests.....	17
4.2.3 Void	17
4.2.4 Void	17
4.2.5 Carrier suppression	17
4.2.5.1 Justification	17
4.2.5.2 Specification.....	18
4.2.5.3 Conformance tests.....	18
4.2.6 Antenna pointing accuracy	18
4.2.6.1 Purpose.....	18
4.2.6.2 Pointing accuracy specification.....	18
4.2.6.3 On-axis cross polarization isolation specification.....	18
4.2.6.4 Conformance tests.....	18
4.2.7 Cessation of emissions.....	18
4.2.7.1 Justification	18
4.2.7.2 Specification.....	18
4.2.7.2.1 Specification 1: Mode of cessation of emissions.....	18
4.2.7.2.2 Specification 2: Conditions under which the ES shall cease emissions.....	19
4.2.7.2.3 Specification 3: Cessation of emissions	19
4.2.7.2.4 Specification 4: Fault conditions	19
4.2.7.3 Conformance tests.....	20
4.2.8 Control and Monitoring Functions (CMFs).....	20
4.2.8.1 ES States	20
4.2.8.1.1 General	20

4.2.8.1.2	CMF state diagram	21
4.2.8.2	Processor monitoring	22
4.2.8.2.1	Justification	22
4.2.8.2.2	Specification	22
4.2.8.2.3	Conformance tests	22
4.2.8.3	Transmit subsystem monitoring	23
4.2.8.3.1	Justification	23
4.2.8.3.2	Specification	23
4.2.8.3.3	Conformance tests	23
4.2.8.4	Power-on/Reset	23
4.2.8.4.1	Justification	23
4.2.8.4.2	Specification	23
4.2.8.4.3	Conformance tests	23
4.2.8.5	Control Channel (CC) and Response Channel (RC)	23
4.2.8.5.1	Justification	23
4.2.8.5.2	Specification	23
4.2.8.5.3	Conformance tests	24
4.2.8.6	Network control commands	24
4.2.8.6.1	Justification	24
4.2.8.6.2	Specification	24
4.2.8.6.3	Conformance tests	25
4.2.8.7	Initial burst transmission	25
4.2.8.7.1	Justification	25
4.2.8.7.2	Specification	25
4.2.8.7.3	Conformance tests	25
4.2.8.8	Inhibition of transmissions	25
4.2.8.8.1	Justification	25
4.2.8.8.2	Specification	25
4.2.8.8.3	Conformance tests	26
4.2.9	Receive antenna off-axis gain pattern	26
4.2.9.1	Justification	26
4.2.9.2	Specification	26
4.2.9.3	Conformance tests	26
4.2.10	Blocking performance	26
4.2.10.1	Justification	26
4.2.10.2	Specification	27
4.2.10.3	Conformance tests	27
4.2.11	Adjacent Signal Selectivity	27
4.2.11.1	Justification	27
4.2.11.2	Specification	27
4.2.11.3	Conformance tests	27
4.2.12	Image frequency rejection	28
4.2.12.1	Justification	28
4.2.12.2	Specification	28
4.2.12.3	Conformance tests	28
5	Testing for compliance with technical requirements	28
5.1	Environmental conditions for testing	28
5.2	Ancillary Equipment	28
5.3	Nominated Bandwidth	28
5.4	Interpretation of the measurement results	29
6	Test methods for all aspects of the ES	29
6.1	General	29
6.1.1	General requirements	29
6.1.2	Special considerations for the interpretation of measurement results	29
6.1.3	Measuring receiver	30
6.2	Off-axis spurious radiation	31
6.2.1	General	31
6.2.2	Test method	31
6.2.2.1	General	31
6.2.2.2	Multi-carrier operation	31

6.2.3	Measurements up to 1 000 MHz	32
6.2.3.1	Test site	32
6.2.3.2	Measuring receivers	32
6.2.3.3	Procedure	32
6.2.4	Measurements above 1 000 MHz	32
6.2.4.1	General	32
6.2.4.2	Identification of the significant frequencies of spurious radiation	33
6.2.4.2.1	Test site.....	33
6.2.4.2.2	Procedure.....	33
6.2.4.3	Measurement of radiated power levels of identified spurious radiation.....	33
6.2.4.3.1	Test site.....	33
6.2.4.3.2	Procedure.....	34
6.2.4.4	Measurement of conducted spurious radiation at the antenna flange.....	35
6.2.4.4.1	Test site.....	35
6.2.4.4.2	Procedure.....	35
6.3	On-axis spurious radiation.....	36
6.3.1	Test method	36
6.3.1.1	General	36
6.3.1.2	Test site	36
6.3.1.3	Method of measurement.....	36
6.3.1.3.1	General	36
6.3.1.3.2	Method of measurement at the antenna flange	36
6.3.1.3.3	Method of measurement for an EUT with antenna.....	38
6.4	Void.....	39
6.5	Carrier suppression.....	39
6.5.1	General.....	39
6.5.2	Test method	39
6.6	Antenna pointing	40
6.6.1	General.....	40
6.6.2	Test method	40
6.7	Polarization angle alignment capability	41
6.7.1	General.....	41
6.7.2	Test site.....	41
6.7.3	Procedure	41
6.8	Cessation of emissions of the ES.....	42
6.8.1	General.....	42
6.8.2	Test Method.....	42
6.8.2.1	Required documentation	42
6.8.2.2	Cessation of emissions from the "Transmission enabled" state	42
6.8.2.3	Cessation of emission from the "Transmission disabled" state.....	42
6.8.2.4	Cessation of emission from the "Initial Phase" state	43
6.8.2.4.1	EUTs transmitting initial bursts.....	43
6.8.2.4.2	EUTs not transmitting initial bursts.....	43
6.8.2.5	"Single action" means of cessation of emissions.....	43
6.8.2.6	Fault conditions	44
6.9	Control and monitoring functions	44
6.9.1	General.....	44
6.9.2	Test arrangement	45
6.9.3	Processor monitoring- Test method	45
6.9.4	Transmit subsystem monitoring-Test method.....	45
6.9.5	Power-on/Reset-Test method.....	45
6.9.6	Control Channel and Response Channel -Test method.....	46
6.9.7	Network Control commands-Test method.....	46
6.9.8	Initial burst transmission-Test method.....	48
6.9.9	Inhibition of transmission-Test method	48
6.10	Receive antenna off-axis gain pattern	48
6.10.1	Test method	48
6.10.1.1	Test site	48
6.10.1.2	Method of measurement.....	48
6.10.1.3	Computation.....	49
6.11	Blocking performance	49
6.11.1	General.....	49

6.11.2	Test method	49
6.12	Adjacent Signal Selectivity	50
6.12.1	Test method	50
Annex A (informative):	Relationship between the present document and the essential requirements of Directive 2014/53/EU	52
Annex B (informative):	Linear Polarization Alignment Error Calculation	54
Annex C (normative):	Radiated measurement.....	55
C.1	Test sites and general arrangements for measurements involving the use of radiated fields	55
C.1.1	General	55
C.1.2	Anechoic Chamber	55
C.1.3	Anechoic Chamber with a conductive ground plane	56
C.1.4	Open Area Test Site (OATS)	57
C.1.5	Minimum requirements for test sites for measurements above 18 GHz.....	58
C.1.6	Test antenna.....	58
C.1.7	Substitution antenna	59
C.1.8	Measuring antenna	59
C.2	Guidance on the use of radiation test sites	59
C.2.1	General	59
C.2.2	Verification of the test site	59
C.2.3	Preparation of the EUT.....	59
C.2.4	Power supplies to the EUT	59
C.2.5	Range length.....	60
C.2.6	Site preparation	60
C.3	Coupling of signals.....	61
C.3.1	General	61
C.4	Standard test methods.....	61
C.4.1	General	61
C.4.2	Calibrated setup.....	61
C.4.3	Substitution method.....	62
Annex D (normative):	Conducted measurements	63
Annex E (informative):	General Requirements for RF Cables.....	64
Annex F (informative):	RF Waveguides	65
Annex G (informative):	Applicability of parameters given in ETSI EG 203 336	66
Annex H (informative):	Maximum Measurement Uncertainty.....	68
Annex I (informative):	Bibliography.....	69
Annex J (informative):	Change history	70
History		71

Intellectual Property Rights

Essential patents

IPRs essential or potentially essential to normative deliverables may have been declared to ETSI. The information pertaining to these essential IPRs, if any, is publicly available for **ETSI members and non-members**, and can be found in ETSI SR 000 314: "*Intellectual Property Rights (IPRs); Essential, or potentially Essential, IPRs notified to ETSI in respect of ETSI standards*", which is available from the ETSI Secretariat. Latest updates are available on the ETSI Web server (<https://ipr.etsi.org/>).

Pursuant to the ETSI IPR Policy, no investigation, including IPR searches, has been carried out by ETSI. No guarantee can be given as to the existence of other IPRs not referenced in ETSI SR 000 314 (or the updates on the ETSI Web server) which are, or may be, or may become, essential to the present document.

Trademarks

The present document may include trademarks and/or tradenames which are asserted and/or registered by their owners. ETSI claims no ownership of these except for any which are indicated as being the property of ETSI, and conveys no right to use or reproduce any trademark and/or tradename. Mention of those trademarks in the present document does not constitute an endorsement by ETSI of products, services or organizations associated with those trademarks.

Foreword

This draft Harmonised European Standard (EN) has been produced by ETSI Technical Committee Satellite Earth Stations and Systems (SES), and is now submitted for the combined Public Enquiry and Vote phase of the ETSI standards EN Approval Procedure.

The present document has been prepared under the Commission's standardisation request C(2015) 5376 final [i.1] to provide one voluntary means of conforming to the essential requirements of Directive 2014/53/EU on the harmonisation of the laws of the Member States relating to the making available on the market of radio equipment and repealing Directive 1999/5/EC [i.2].

Once the present document is cited in the Official Journal of the European Union under that Directive, compliance with the normative clauses of the present document given in table A.1 confers, within the limits of the scope of the present document, a presumption of conformity with the corresponding essential requirements of that Directive and associated EFTA regulations.

Proposed national transposition dates	
Date of latest announcement of this EN (doa):	3 months after ETSI publication
Date of latest publication of new National Standard or endorsement of this EN (dop/e):	6 months after doa
Date of withdrawal of any conflicting National Standard (dow):	18 months after doa

Modal verbs terminology

In the present document "**shall**", "**shall not**", "**should**", "**should not**", "**may**", "**need not**", "**will**", "**will not**", "**can**" and "**cannot**" are to be interpreted as described in clause 3.2 of the [ETSI Drafting Rules](#) (Verbal forms for the expression of provisions).

"**must**" and "**must not**" are **NOT** allowed in ETSI deliverables except when used in direct citation.

Introduction

The present document is part of a set of standards developed by ETSI and is designed to fit in a modular structure to cover all radio equipment within the scope of the Directive 2014/53/EU [i.1]. The modular structure is shown in ETSI EG 201 399 [i.3].

The present document is largely based on ETSI EN 303 979 [i.4], for ESOMPs operating with NGSO satellites.

The present document may also be applicable to the frequency bands 30,0 GHz to 31,0 GHz (Earth-to-space) and 20,2 GHz to 21,2 GHz (space-to-Earth) subject to national regulation:

- Annex A (normative) provides HS Requirements specifications.
- Annex B (informative) provides information on Linear Polarization Alignment Error Calculation.
- Annex C (normative) provides specifications concerning radiated measurements.
- Annex D (normative) provides specifications concerning conducted measurements.
- Annex E (informative) provides general information concerning RF cables.
- Annex F (informative) provides information concerning RF waveguides.
- Annex G (informative) covers other supplementary information.
- Annex H (informative) provides information on measurement uncertainty.

The present document is intended to cover the provisions of Directive 2014/53/EU [i.1] (RE Directive) article 3.2 which states that "*...radio equipment shall be so constructed that it both effectively uses and supports the efficient use of radio spectrum in order to avoid harmful interference*".

Recital 10 of Directive 2014/53/EU [i.1] states that "*in order to ensure that radio equipment uses the radio spectrum effectively and supports the efficient use of radio spectrum, radio equipment should be constructed so that: in the case of a transmitter, when the transmitter is properly installed, maintained and used for its intended purpose it generates radio waves emissions that do not create harmful interference, while unwanted radio waves emissions generated by the transmitter (e.g. in adjacent channels) with a potential negative impact on the goals of radio spectrum policy should be limited to such a level that, according to the state of the art, harmful interference is avoided; and, in the case of a receiver, it has a level of performance that allows it to operate as intended and protects it against the risk of harmful interference, in particular from shared or adjacent channels, and, in so doing, supports improvements in the efficient use of shared or adjacent channels.*"

Recital 11 of Directive 2014/53/EU [i.1] states that "*although receivers do not themselves cause harmful interference, reception capabilities are an increasingly important factor in ensuring the efficient use of radio spectrum by way of an increased resilience of receivers against harmful interference and unwanted signals on the basis of the relevant essential requirements of Union harmonisation legislation*".

As a consequence, the present document includes both transmitting and receiving parameters aiming to maximize the efficient use of radio spectrum.

1 Scope

The present document covers requirements to demonstrate that radio equipment both effectively uses and supports the efficient use of radio spectrum in order to avoid harmful interference. The present document applies to satellite communications Earth Stations (ES) with the following characteristics:

- The ES is designed for stationary operation.
- The ES is operating as part of a satellite network (e.g. star, mesh or point to point) used for the distribution and/or exchange of information.
- The transmit and receive frequencies are shown in table 1.

Table 1: Frequency bands

	Frequency Bands/frequencies
Transmit (Earth-to-space) 1	27,5 GHz to 29,1 GHz
Transmit (Earth-to-space) 2	29,5 GHz to 30,0 GHz
Receive (space-to-Earth)	17,30 GHz to 20,20 GHz

- The ES transmits within the frequency range from 27,5 GHz to 29,1 GHz and 29,5 GHz to 30,0 GHz, which is a band allocated to the Fixed Satellite Services (FSS) (Earth-to-space) among other services. National regulations will specify the bands available for the operation of the ES. Such regulations may designate some parts of the frequency range 27,5 GHz to 29,1 GHz to terrestrial services such as the Fixed Service. However, the operation of the ES may be permitted under national regulations in the 29,50 GHz to 30,00 GHz band since this band is allocated on a primary basis to the Fixed Satellite Service.
- The ES receives in one or more frequencies within the range from 17,30 GHz to 20,20 GHz (FSS).
- The ES uses linear or circular polarization.
- The ES operates through non-geostationary satellites.
- The ES is designed for unattended operation.
- The ES is controlled and monitored by a Network Control Facility (NCF). This function may be performed centrally (e.g. for a network of ESs with a central hub) or it could be performed within the ES for autonomous control. The NCF is outside the scope of the present document.
- The ES operating in the 27,5 GHz to 28,6 GHz and 29,5 GHz to 30 GHz bands: efd limits given in article 22 of the ITU Radio Regulations [i.5] apply for the ESs operating with the NGSO system for the protection of the GSO networks (see No. 22.5D of the ITU RR [i.5]).
- ES operating in the 28,6 GHz to 29,1 GHz band: No. 9.11A of the ITU RR [i.5] applies to the NGSO network of the ES, meaning that the NGSO will be required to coordinate with earlier filed GSO networks or NGSO systems (See No. 5.523A of the ITU RR [i.5]).
- The ES has one or more directive antennas that track satellites.

The present document applies to the ES with its ancillary equipment and its various telecommunication ports, and when operated within the boundary limits of the operational environmental profile as declared by the manufacturer and when installed as required by the manufacturer's declaration or in the user documentation.

NOTE 1: Operational requirements are defined by national administrations and by relevant ECC Decisions.

In addition to the present document, other ENs that specify technical requirements in respect of essential requirements under other parts of article 3 of the Directive 2014/53/EU [i.1] may apply to equipment within the scope of the present document.

NOTE 2: A list of such ENs is included on the web site <http://www.newapproach.org>.

NOTE 3: The relationship between the present document and essential requirements of article 3.2 of Directive 2014/53/EU [i.1] is given in annex A.

2 References

2.1 Normative references

References are either specific (identified by date of publication and/or edition number or version number) or non-specific. For specific references, only the cited version applies. For non-specific references, the latest version of the referenced document (including any amendments) applies.

Referenced documents which are not found to be publicly available in the expected location might be found at <https://docbox.etsi.org/Reference/>.

NOTE: While any hyperlinks included in this clause were valid at the time of publication, ETSI cannot guarantee their long term validity.

The following referenced documents are necessary for the application of the present document.

- [1] ANSI C63.5 (2006): "American National Standard for Electromagnetic Compatibility - Radiated Emission Measurements in Electromagnetic Interference (EMI) Control - Calibration of Antennas (9 kHz to 40 GHz)".
- [2] CISPR 16-1-1-2019: "Specification for radio disturbance and immunity measuring apparatus and methods - Part 1-1: Radio disturbance and immunity measuring apparatus - Measuring apparatus".
- [3] CISPR 16-1-4-2019: "Specification for radio disturbance and immunity measuring apparatus and methods - Part 1-4: Radio disturbance and immunity measuring apparatus - Antennas and test sites for radiated disturbance measurements".
- [4] ETSI ETS 300 457 (Edition 1) (11-1995): "Satellite Earth Stations and Systems (SES); Test methods for Television Receive Only (TVRO) operating in the 11/12 GHz frequency bands".

2.2 Informative references

References are either specific (identified by date of publication and/or edition number or version number) or non-specific. For specific references, only the cited version applies. For non-specific references, the latest version of the referenced document (including any amendments) applies.

NOTE: While any hyperlinks included in this clause were valid at the time of publication, ETSI cannot guarantee their long term validity.

The following referenced documents are not necessary for the application of the present document but they assist the user with regard to a particular subject area.

- [i.1] Commission Implementing Decision C(2015) 5376 final of 4.8.2015 on a standardisation request to the European Committee for Electrotechnical Standardisation and to the European Telecommunications Standards Institute as regards radio equipment in support of Directive 2014/53/EU of the European Parliament and of the Council.
- [i.2] Directive 2014/53/EU of the European Parliament and of the Council of 16 April 2014 on the harmonisation of the laws of the Member States relating to the making available on the market of radio equipment and repealing Directive 1999/5/EC (RE Directive).
- [i.3] ETSI EG 201 399: "Electromagnetic compatibility and Radio spectrum Matters (ERM); A guide to the production of Harmonized Standards for application under the Radio & Telecommunication Terminal Equipment Directive 1999/5/EC (R&TTE) and a first guide on the impact of the Radio Equipment Directive 2014/53/EU (RED) on Harmonized Standards".
- [i.4] ETSI EN 303 979 (V2.1.2): "Satellite Earth Stations and Systems (SES); Harmonised Standard for Earth Stations on Mobile Platforms (ESOMP) transmitting towards satellites in non-geostationary orbit, operating in the 27,5 GHz to 29,1 GHz and 29,5 GHz to 30,0 GHz frequency bands covering the essential requirements of article 3.2 of the Directive 2014/53/EU".
- [i.5] ITU Radio Regulations (2016).

- [i.6] ETSI TS 103 052: "Electromagnetic compatibility and Radio spectrum Matters (ERM); Radiated measurement methods and general arrangements for test sites up to 100 GHz".
- [i.7] IEC 60153 (all parts): "Hollow metallic waveguides".
- [i.8] ETSI TR 100 028 (all parts): "Electromagnetic compatibility and Radio spectrum Matters (ERM); Uncertainties in the measurement of mobile radio equipment characteristics".
- [i.9] ETSI TR 100 028-2: "Electromagnetic compatibility and Radio spectrum Matters (ERM); Uncertainties in the measurement of mobile radio equipment characteristics; Part 2".
- [i.10] ETSI EG 203 336 (V1.1.1): "Electromagnetic compatibility and Radio spectrum Matters (ERM); Guide for the selection of technical parameters for the production of Harmonised Standards covering article 3.1(b) and article 3.2 of Directive 2014/53/EU".
- [i.11] ETSI TR 102 273 (all parts) (V1.2.1) (12-2001): "Electromagnetic compatibility and Radio spectrum Matters (ERM); Improvement on Radiated Methods of Measurement (using test site) and evaluation of the corresponding measurement uncertainties".

3 Definition of terms, symbols and abbreviations

3.1 Terms

For the purposes of the present document, the following terms apply:

ancillary equipment: equipment used in connection with an ES (see clause 5.2)

antenna controller: equipment used to maintain antenna stabilization and tracking accuracy based on inputs from the Control and Monitoring Function

bandwidth of the ideal signal: bandwidth of a theoretical signal that is defined by the modulation scheme of the actual signal and contains no unwanted signal components that would increase the bandwidth

NOTE: In case of amplitude or phase shift keying signals the bandwidth of an ideal signal is $B = R_s \times (1 + \alpha)$, where R_s is the symbol rate and α is the roll-off.

carrier-off radio state: radio state in which the ES may transmit and does not transmit any carrier (see clause 4.2.8.1.1)

carrier-on radio state: radio state in which the ES may transmit and transmits a carrier

Control Channel (CC): channel or channels by which ESs receive control information from the NCF

EIRP_{Aggregate}: sum of the EIRP (Watts) within the nominated bandwidth of the ES network

EIRP_{max}: maximum EIRP capability of the ES as declared by the manufacturer

emissions disabled radio state: radio state in which the ES is not emitting

NOTE: Examples of cases where the ES is in this radio state: before system monitoring pass, before the control channel is received, when a failure is detected, when an ES is commanded to disable, and when the ES is in a location requiring cessation of emissions.

equivalent power flux density: sum of the power flux densities produced at a receive station in the geostationary orbit by all the transmit stations within a non-geostationary satellite system

external control channel: control channel which is either:

- i) carried by the ES network via the same or another satellite, but not within the internal protocol of the ES system; or
- ii) carried by any other radio communication system

external response channel: response channel which is either:

- i) carried by the ES network via the same or another satellite, but not within the internal protocol of the ES system; or
- ii) carried by any other radio communication system

integral antenna: antenna which may not be removed during the tests according to the manufacturer's declaration

internal control channel: control channel which is carried by the ES network via the same satellite as used for transmission of user data and within the internal protocol structure of the ES system

internal response channel: response channel which is carried by the ES network via the same satellite as used for transmission of user data and within the internal protocol structure of the ES system

mobile platform: any non-stationary platform such as a train, a vessel, an aircraft or other vehicles

Network Control Facility (NCF): set of functional entities that, at system level, monitor and control the correct operation of the ES and, if appropriate, all of the ESs in a network

nominal antenna diameter: antenna diameter declared by the manufacturer that is a parameter in performance characteristics and that allows reference to a certain performance

NOTE 1: An antenna with circular aperture of diameter equal to the nominal diameter does typically have the performance specified.

NOTE 2: Network operators might request antennas of a certain diameter. Then an antenna that is compliant with the requirement for nominal antenna diameter equal to the requested antenna diameter can be used. Manufacturers can mark their equipment with antenna diameters used in the requirements during compliance test.

nominated bandwidth: bandwidth of the ES radio frequency transmission declared by the manufacturer (see clause 5.3)

off-axis angle: angle between the direction of the axis of the antenna main beam and the considered direction

peak pointing accuracy: angular error of antenna pointing that is not exceeded during intended use of the ES

removable antenna: antenna which may be removed during the tests according to the manufacturer's declaration.

Response Channel (RC): channel by which ES transmit monitoring information to the NCF

spurious radiation: any radiation outside the nominated bandwidth

transmission disabled state: radio state in which the ES is not authorized to transmit by the NCF

transmission enabled state: radio state in which the ES is authorized to transmit by the NCF

Wanted signal occupied BandWidth (BW):

- for a digital modulation scheme: the width of the signal spectrum such that, at the lower and upper frequency limits, the power spectral density is 10 dB lower than the maximum;
- for an analogue modulation scheme: the width of a frequency band such that, below the lower and above the upper frequency limits, the mean power emitted is equal to 0,5 % of the total mean power of the emission

3.2 Symbols

For the purposes of the present document, the following symbols apply:

B	bandwidth
dBc	ratio expressed in decibels relative to the EIRP of the unmodulated carrier
dB _i	ratio of an antenna gain to the gain of an isotropic antenna, expressed in decibels
dBW	ratio of a power to 1 watt, expressed in decibels
dBpW	ratio of a power to 1 picowatt, expressed in decibels
dB μ V/m	ratio of an electric field to 1 μ V/m, expressed in decibels ($20 \log(\text{electric field} / 1 \mu\text{V/m})$)
$G(\varphi)$	antenna gain at off-axis angle
$G_x(\varphi)$	cross-polarized antenna gain at off-axis angle
φ	off-axis angle

3.3 Abbreviations

For the purposes of the present document, the following abbreviations apply:

BW	BandWidth
CC	Control Channel
CCF	Control Channel reception Failure
CCR	Control Channel correctly Received
CENR	Cessation of Emissions Not Required
CEPT	Conférence Européenne des Postes et Télécommunications (European Conference of Postal and Telecommunications)
CER	Cessation of Emissions Required
CISPR	Comité International Spécial des Perturbations Radioélectriques (International Special Committee on Radio Interference)
CMF	Control and Monitoring Functions
DC	Direct Current
ECC	Electronic Communications Committee (of CEPT)
EIA	Electronic Industries Alliance
EIRP	Equivalent Isotropically Radiated Power
EMC	Electro-Magnetic Compatibility
epfd	equivalent power flux-density
epfd \uparrow	Uplink equivalent power flux-density
EN	European Norm
ES	Earth Station
ESOMP	Earth Station On Mobile Platform
EUT	Equipment Under Test
FEC	Forward Error Correction
FSS	Fixed Satellite Service
GEUT	Gain of EUT
GSO	Geostationary Satellite Orbit
HPA	High Power Amplifier
IDU	Indoor Unit
IEC	International Electrotechnical Commission
IPR	Intellectual Property Rights
LNB	Low Noise Block downconverter
LO	Local Oscillator
LV	Low Voltage
NCF	Network Control Facility
NGSO	Non Geostationary Satellite Orbit
OATS	Open Area Test Site
OFDM	Orthogonal Frequency Division Multiplexing
R&TTE	Radio and Telecommunications Terminal Equipment
RBW	Reference BandWidth
RC	Response Channel
RCSC	Radio Components Standardization Committee
RE	Radio Equipment
RED	Radio Equipment Directive

RF	Radio Frequency
RMS	Root Mean Square
RR	Radio Regulations
SMA	SubMiniature version A
SMF	System Monitoring Fail
SMP	System Monitoring Pass
STE	Special Test Equipment
TxD	Transmission Disable command
TxE	Transmission Enable command
VBW	Video BandWidth
VSWR	Voltage Standing Wave Ratio
WG	WaveGuide
WR	Waveguide Rectangular
XPD	Cross-Polarization Discrimination

4 Technical requirements specifications

4.1 General

4.1.1 Environmental profile

The technical requirements of the present document apply under the environmental profile for operation of the equipment, which shall be in accordance with its intended use. The equipment shall comply with all the technical requirements of the present document at all times when operating within the boundary limits of the operational environmental profile defined by its intended use.

The equipment shall comply with all the technical requirements of the present document which are identified as applicable in annex A.

4.1.2 Operational configurations

Under operational conditions an ES may dynamically change the occupied bandwidth and other transmission parameters (e.g. FEC, modulation, symbol rate) of the transmitted signal. For each declared occupied bandwidth an $EIRP_{max}$ and a nominated bandwidth shall be declared by the manufacturer. For the purposes of verifying that the ES complies with these specifications, the manufacturer may declare the worst case combination of transmission parameters. The following specifications apply to the ES for each occupied bandwidth and other transmission parameters.

In the present document, ESs that use OFDM modulation shall be considered as transmitting a single carrier.

The manufacturer shall declare all operational parameters including the EIRP, modulation and occupied bandwidth.

The manufacturer shall declare the number of emitters of the ES that may be used simultaneously. The specifications in clause 4 shall be applied to such configuration as declared by the manufacturer.

4.1.3 $EIRP_{Aggregate}$ for networks of ESs

For the case where several ESs are transmitting simultaneously on the same carrier frequency, the $EIRP_{Aggregate}$ is the sum of the EIRP (Watts) within the nominated bandwidth of the ES network.

For ESs designed to operate in an FSS network where the EIRP of each ES is determined by the NCF, the NCF shall ensure compliance with the EIRP density requirements in the present document. The manufacturer shall declare the method(s) used to maintain compliance.

4.1.4 Presentation of equipment for testing purposes

ES equipment submitted for testing, where applicable, shall fulfil the requirements of the present document on all frequencies over which it is intended to operate.

The manufacturer shall submit one or more samples of the equipment as appropriate for testing.

Additionally, technical documentation and operating manuals, sufficient to allow testing to be performed, shall be supplied.

The performance of the ES equipment submitted for testing shall be representative of the performance of the corresponding production model. The manufacturer shall offer equipment complete with any auxiliary equipment needed for testing.

The manufacturer shall declare the frequency range(s), the range of operation conditions and power requirements, as applicable, in order to establish the appropriate test conditions.

4.1.5 Choice of model for testing

If an ES equipment has several optional features, considered not to affect the RF parameters then the tests need only to be performed on one sample of the equipment configured with that combination of features considered to create the highest unintentional emissions.

In addition, when a device has the capability of using different dedicated antennas or other features that affect the RF parameters, at least the worst combination of features from an emission point of view as agreed between the manufacturer and the test laboratory shall be tested.

Where the transmitter is designed with adjustable output power, then all transmitter parameters shall be measured using the highest maximum mean power spectral density level, as declared by the manufacturer.

The choice of model(s) for testing shall be recorded in the test report.

4.1.6 Void

4.1.7 Peak pointing accuracy

The manufacturer shall declare the peak pointing accuracy ($\delta\phi$) within which the antenna shall be maintained whilst transmissions are enabled.

4.2 Conformance requirements

4.2.1 Off-axis spurious radiation

4.2.1.1 Justification

To limit the level of interference to terrestrial and satellite radio services.

4.2.1.2 Specification

The following specifications apply to the ES transmitting at Equivalent Isotropically Radiated Power (EIRP) values up to and including $EIRP_{max}$:

- 1) The electric field strength level of any radiation from the ES in the frequency range from 30 MHz to 1 GHz shall not exceed the limits specified in table 2.

Table 2: Limits of radiated field strength at a test distance of 10 m in a 120 kHz bandwidth

Frequency range	Quasi-peak limits
30 MHz to 230 MHz	30 dB μ V/m
230 MHz to 1 000 MHz	37 dB μ V/m

The lower limits shall apply at the transition frequency, which is the frequency separating two adjacent frequency ranges.

The Quasi Peak detector shall be in accordance with CISPR 16-1-1 [2].

- 2) When the ES is in the "Emissions disabled" radio state, the off-axis spurious EIRP from the ES shall not exceed the limits in table 3, for all off-axis angles greater than 7° or greater than the minimum elevation angle declared by the manufacturer, whichever is lower.

Table 3: Limits of spurious EIRP - "Emissions disabled" radio state

Frequency band	EIRP limit	Measurement bandwidth
1,0 GHz to 2,0 GHz	52 dBpW	1 MHz
2,0 GHz to 10,7 GHz	58 dBpW	1 MHz
10,7 GHz to 21,2 GHz	64 dBpW	1 MHz
21,2 GHz to 60,0 GHz	70 dBpW	1 MHz

The lower limits shall apply at the transition frequency.

- 3) In the "Carrier-on" and "Carrier-off" radio states, the off-axis spurious EIRP density from the ES, shall not exceed the limits in table 4, for all off-axis angles greater than 7° or greater than the minimum elevation angle declared by the manufacturer, whichever is lower.

Table 4: Limits of spurious EIRP - "Carrier-on" and "Carrier-off" radio states

Frequency band	EIRP limit	Measurement bandwidth
1,0 GHz to 2,0 GHz	53 dBpW	1 MHz
2,0 GHz to 3,4 GHz	59 dBpW	1 MHz
3,4 GHz to 10,7 GHz	65 dBpW	1 MHz
10,7 GHz to 21,2 GHz	71 dBpW	1 MHz
21,2 GHz to 27,35 GHz	77 dBpW	1 MHz
27,35 GHz to 27,50 GHz	85 dBpW	1 MHz
27,50 GHz to 30,00 GHz	85 dBpW	1 MHz
30,00 GHz to 31,00 GHz	85 dBpW	1 MHz
31,00 GHz to 31,15 GHz	85 dBpW	1 MHz
31,15 GHz to 60,0 GHz	77 dBpW	1 MHz

The lower limits shall apply at the transition frequency.

- 4) These limits are applicable to the complete ES equipment, including cabling between the units.

4.2.1.3 Conformance tests

Conformance tests shall be carried out in accordance with clause 6.2.

4.2.2 On-axis spurious radiation

4.2.2.1 Justification

To limit the level of interference to satellite radio services.

4.2.2.2 Specification

4.2.2.2.1 "Carrier-on" radio state

The following specification applies to the ES transmitting at EIRP values up to $EIRP_{max}$.

In the 27,5 GHz to 29,1 GHz and 29,5 GHz to 30,0 GHz band the EIRP spectral density of the spurious radiation and outside a bandwidth of 5 times the occupied bandwidth centred on the carrier centre frequency shall not exceed 14 - K dBW in any 1 MHz band. At the network level, the limit shall not be exceeded for more than 0,01 % of the time.

The above limit may be exceeded in a bandwidth of 5 times the occupied bandwidth centred on the carrier centre frequency, in which case the EIRP spectral density of the spurious radiation outside the nominated bandwidth, shall not exceed 28 - K dBW in any 1 MHz band. At the network level, the higher limit shall not be exceeded for more than 0,01 % of the time.

Where K is the factor that accounts for a reduction on the on-axis spurious radiation level in case of multiple ESs operating on the same frequency and the value is given by one the following cases:

- 1) For the case where only one ES transmits at any one time on a given carrier frequency, the value of K is 0.
- 2) For the case where several ESs are expected to transmit simultaneously on a given carrier frequency at the same EIRP then $K = 10 \log(N)$ where N is the maximum number of these ESs. The value of N and the operational conditions of the system shall be declared by the manufacturer.
- 3) For the case where several ESs are expected to transmit simultaneously on a given carrier frequency at different EIRP levels then $K = 10 \log(EIRP_{Aggregate} / EIRP_{term})$, where:
 - $EIRP_{term}$ is the on-axis EIRP (Watts) of the ES within the nominated bandwidth.

The value of $EIRP_{Aggregate}$ and the operational conditions of the ES network shall be declared by the manufacturer.

NOTE 1: The on-axis spurious radiations, outside the bands 27,5 GHz to 29,1 GHz and 29,5 GHz to 30,0 GHz, are indirectly limited by clause 4.2.1.2. Consequently no specification is needed.

NOTE 2: Intermodulation limits inside the band of 27,5 GHz to 29,1 GHz and 29,5 GHz to 30,0 GHz may be determined by system design and may be subject to satellite operator specifications.

For ESs designed to transmit several carriers on different frequencies simultaneously (multicarrier operation), the above limits only apply to each individual carrier when transmitted alone.

4.2.2.2.2 "Carrier-off" and "Emissions disabled" radio states

In the 27,5 GHz to 29,1 GHz and 29,5 GHz to 30,0 GHz band the EIRP spectral density of the spurious radiation outside the nominated bandwidth shall not exceed -11 dBW in any 1 MHz band.

4.2.2.3 Conformance tests

Conformance tests shall be carried out in accordance with clause 6.3.

4.2.3 Void

4.2.4 Void

4.2.5 Carrier suppression

4.2.5.1 Justification

To allow for the satisfactory suppression of transmissions of the ES by the NCF, under any fault condition and under any cessation of emissions condition (see clause 4.2.7 for definition).

4.2.5.2 Specification

In the "Carrier-off" and in the "Emissions disabled" radio states the on-axis EIRP density shall not exceed 14 dBW in any 1 MHz band within the nominated bandwidth.

4.2.5.3 Conformance tests

Conformance tests shall be carried out in accordance with clause 6.5.

4.2.6 Antenna pointing accuracy

4.2.6.1 Purpose

Protection of transmissions to adjacent satellites and cross-polarized transponders on the same satellite.

4.2.6.2 Pointing accuracy specification

The antenna shall maintain the declared peak pointing accuracy ($\delta\phi$), such that regulatory efd limits are met when shifted by an angle of $\pm(\delta\phi^\circ)$, taking into account the following factors:

- the worst case operational environmental conditions;
- the range of latitude, longitude and altitude relative to the satellite location in the orbit.

4.2.6.3 On-axis cross polarization isolation specification

For linearly polarized ESs, the following specification is required. Polarization angle alignment capability:

- The polarization angle shall be continuously adjustable within the operational range as declared by the manufacturer.
- It shall be possible to fix the transmit antenna polarization angle with an accuracy of at least 1°.
- When linear polarization is used for both transmission and reception, the angle between the receive and corresponding transmit polarization planes shall not deviate by more than 1° from the nominal value declared by the manufacturer.

4.2.6.4 Conformance tests

Conformance tests shall be carried out in accordance with clause 6.6 for pointing accuracy and clause 6.7 for polarization alignment.

4.2.7 Cessation of emissions

4.2.7.1 Justification

Cessation of emissions of the ES where the ES is not allowed to transmit.

4.2.7.2 Specification

4.2.7.2.1 Specification 1: Mode of cessation of emissions

The following three modes of cessation of emissions shall be implemented:

- a) the NCF determines that the ES shall cease emissions;
- b) the ES autonomously determines that it shall cease emissions;

- c) a "single-action" means (e.g. operating a switch) by which a local operator may disable the ES and thereby cease emissions.

The manufacturer shall declare the ES interfaces involved in the cessation of emissions:

- the list of relevant parameters which are collected by the ES or the NCF for determination as to whether the ES should cease emissions;
- the list of these relevant parameters which are used by the ES;
- the list of these relevant parameters which are transmitted by the ES to the NCF;
- the list of the relevant parameters which are received by the ES from the NCF;
- for the collected relevant parameters, the ES interface(s), including the protocols, the timing, the ranges of the values, the speed of the variations and the required accuracies;
- for the relevant parameters transmitted to the NCF, the ES interface with the NCF, including the protocols and the timing;
- for the transmission parameter received from the NCF, the ES interface with the NCF, including the protocols and the timing.

These declared ES interfaces shall be in accordance with the user documentation.

4.2.7.2.2 Specification 2: Conditions under which the ES shall cease emissions

The relevant parameters and the exchange of information between the ES and the NCF shall be sufficient to cease emissions within the accuracy declared by the manufacturer.

The conditions for cessation of emissions shall take into account at least the following parameters:

- the operating parameters specified in clauses 4.1.1 through 4.1.5;
- the carrier frequency and the authorized frequency bands.

4.2.7.2.3 Specification 3: Cessation of emissions

A condition requiring cessation of emissions occurs either when the ES receives the command from the NCF at its input or when the ES determines autonomously on the need to cease emissions.

When in the "Transmission enabled" state a condition requiring cessation of emissions occurs, the ES shall cease transmissions and enter the "Initial Phase" state.

When in the "Transmission disabled" state, the ES shall not leave that state for the "Transmission enable" state as long as a condition requiring cessation of emissions exists or the last CC command received from the NCF is a transmission disable command.

When in the "Initial phase-BurstOn" or "Initial phase-BurstOff" substate a condition requiring cessation of emissions occurs, the ES shall cease transmissions and enter the "Initial phase-Standby" substate.

When in the "Initial phase-Standby" substate, the ES shall not leave that state for the "Initial phase-BurstOn" or the "Transmission enabled" states as long as a condition requiring cessation of emissions exists.

The time for transition in any state from the occurrence of a condition requiring cessation of emissions to the "Emissions disabled" radio state shall not exceed 1 second.

4.2.7.2.4 Specification 4: Fault conditions

Any collection of the relevant parameters by the ES or transmission of these parameters to the NCF, which have not been completed correctly within the required delay(s) as declared by the manufacturer, shall be considered as a fault condition.

Any transmission parameter not received or not correctly received from the NCF within the required delay declared by the manufacturer shall be considered as a fault condition.

These fault conditions shall be processed as conditions requiring cessation of emissions.

4.2.7.3 Conformance tests

Conformance tests shall be carried out in accordance with clause 6.8.

4.2.8 Control and Monitoring Functions (CMFs)

4.2.8.1 ES States

4.2.8.1.1 General

For the purpose of testing the CMFs the following four finite states states of the ES are defined, without presuming the effective implementation of the finite state machine model:

- "Non valid";
- "Initial phase";
- "Transmission disabled"; and
- "Transmission enabled".

The four finite states are represented on figure 2, State Transition Diagram of the Control and Monitoring Functions (CMFs).

In the "Non-valid" state and in the "Transmission disabled" state the ES is not allowed to transmit. In the "Transmission-enabled" state the ES is allowed to transmit. In the "Initial phase" state the ES is only allowed to transmit initial bursts or is waiting for a transmit enable/disable command.

The "Initial phase" is divided into three substates:

- "Initial phase-Standby" prior to the transmission of the first initial burst or when no initial bursts are transmitted;
- "Initial phase-BurstOn" during the transmission of the initial bursts;
- "Initial phase-BurstOff" between initial bursts.

NOTE 1: ESs which do not transmit initial bursts have no "Initial phase-BurstOn" state and no "Initial phase-BurstOff" state.

The ES is allowed to transmit when the following conditions for transmission are satisfied:

- in a state where transmissions are permitted;
- no failure detected;
- correctly pointed towards the satellite; and
- there is no requirement for cessation of emissions.

The following radio states of the ES are defined:

- "Emissions disabled" when the ES shall not transmit any carrier;
- "Carrier-off" when the ES may transmit and does not transmit any carrier;

NOTE 2: The phrase "the ES may transmit" means that all the conditions for transmission are satisfied (e.g. in a state where transmissions are permitted, no failure detected, and the ES is correctly pointed towards the satellite).

NOTE 3: The existence of a "Carrier-off" radio state depends on the system of transmission used. For ESs designed for continuous transmission mode there may be no "Carrier-off" state.

- "Carrier-on" when the ES may transmit and transmits a carrier.

Table 5 gives the only possible combinations of the finite states and radio states which shall apply, with some examples of associated events.

Table 5: Finite states and radio states of the ES

ES finite states and substates	Radio states	Examples of events
"Non valid"	"Emissions disabled"	After-power on; or After any fault; or During the checking phase.
"Initial phase"		When waiting for a transmission enable or disable command from the NCF.
"Initial phase-Standby"	"Emissions disabled"	Before the first initial burst transmissions; or In locations where no transmission is allowed.
"Initial phase-BurstOn"	"Carrier-on"	During the transmission of each initial burst, and the pointing is correct.
"Initial phase-BurstOff"	"Carrier-off"	Between initial bursts; or When the pointing threshold is exceeded.
"Transmission enabled"	"Carrier-off"	When no carrier is transmitted; or When receive synchronization is lost; or When the pointing threshold is exceeded.
	"Carrier-on"	During transmission of carrier(s), and the pointing is correct.
"Transmission disabled"	"Emissions disabled"	When a disable command from the NCF has been received and waiting for a transmission enable command from the NCF; or In locations where no transmission is allowed.

4.2.8.1.2 CMF state diagram

The following minimum set of CMFs shall be implemented in ESs in order to minimize the probability that they originate unwanted transmissions that may give rise to harmful interference to other systems.

In the "Non-valid" state and in the "Transmission disabled" state the ES shall not transmit. In the "Transmission-enabled" state the ES is allowed to transmit. In the "Initial phase" state the ES is only allowed to transmit initial bursts.

NOTE 1: The restrictions in the "Initial phase" state are for the protection of other systems when the ES is entering the system after a power-on or a reset. These initial burst restrictions do not apply to the ES transmissions in the "Transmission-enabled" state and once a transmission enable command has been received by the ES the ES may transmit or not transmit as required.

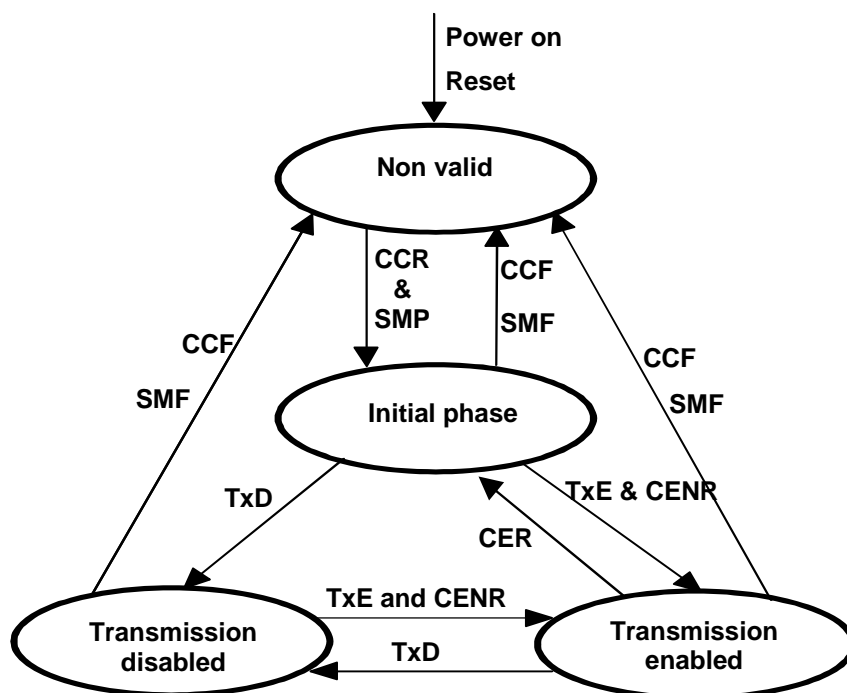

CER: Cessation of Emissions Required;
 CENR: Cessation of Emissions Not Required;
 SMP: System Monitoring Pass;
 SMF: System Monitoring Fail;
 TxE: Transmission Enable command;
 TxD: Transmission Disable command;
 CCR: Control Channel correctly Received;
 CCF: Control Channel reception Failure.

Figure 2: State transition diagram of the control and monitoring function of an ES

NOTE 2: From "Transmission disabled" state a TxE command may also result in a transition towards the "Initial phase" state.

When the ES transmits several carriers having different frequencies, an ES finite state machine as described above may be associated with each carrier or each set of carriers. The events then apply to the subsystem associated with the specific carrier or the specific set of carriers, rather than the whole ES.

4.2.8.2 Processor monitoring

4.2.8.2.1 Justification

To ensure that the ES can suppress its transmissions in the event of a processor sub-system failure.

4.2.8.2.2 Specification

The ES shall incorporate a processor monitoring function for each of its processors involved in maintaining the performance requirements of the present document and in Control and Monitoring Functions (CMF).

The processor monitoring function shall detect failures of these processors' hardware and software.

In the "Transmission enabled" state, the ES shall enter the "Non valid" state or the "Carrier-off" radio state no later than 1 second after any fault condition occurs. In all states, the ES shall enter the "Non valid" state within a maximum of 30 seconds after the occurrence of any persistent fault condition. Once in the "Non Valid" state, the ES shall remain in the "Non Valid" state until the processor monitoring function has determined that all fault conditions have been cleared.

4.2.8.2.3 Conformance tests

Conformance tests shall be carried out in accordance with clause 6.9.3.

4.2.8.3 Transmit subsystem monitoring

4.2.8.3.1 Justification

To ensure the inhibition of transmissions that are potentially harmful to other systems in the event of incorrect operation of the transmit frequency generation sub-system.

4.2.8.3.2 Specification

The ES shall monitor the operation of its transmit frequency generation sub-system and shall be able to detect:

- a) loss of frequency lock; or
- b) absence of Local Oscillator (LO) output signal.

No later than 1 second after any of these fault conditions of the transmit frequency generation sub-system occurs, the ES shall enter the "Non-valid" state or the "Carrier-off" radio state until the transmit sub-system monitoring function has determined that all fault conditions have been cleared (see clause 4.2.8.2.2 for detailed specification).

4.2.8.3.3 Conformance tests

Conformance tests shall be carried out in accordance with clause 6.9.4.

4.2.8.4 Power-on/Reset

4.2.8.4.1 Justification

To demonstrate that the ES achieves a controlled non-transmitting state following the powering of the unit, or the occurrence of a reset made by a local operator.

4.2.8.4.2 Specification

During and following a reset the ES shall remain in the "Non-valid" state until all the conditions for entering "Initial phase" have been satisfied.

4.2.8.4.3 Conformance tests

Conformance tests shall be carried out in accordance with clause 6.9.5.

4.2.8.5 Control Channel (CC) and Response Channel (RC)

4.2.8.5.1 Justification

To ensure that the ES cannot transmit unless it correctly receives the CC messages from the NCF.

Control Channels (CC) are used by ESs to receive control information from the NCF and Response Channels (RCs) to respond to the NCF. For an ES designed to operate within networks where the NCF determines that the ES shall cease emissions, then the CCs and RCs are also used for the dialogue with the NCF.

4.2.8.5.2 Specification

4.2.8.5.2.1 Specification 1: types of CCs and RCs

- a) The ES shall have at least one CC from the NCF. If exchange of information with the NCF is necessary for operation of the ES then the ES shall have at least one RC to the NCF (see clause 4.2.7). Each CC and each RC may be internal or external.

The types (internal or external) of each CC and each RC shall be declared by the manufacturer.

NOTE 1: The availability of the network carrying the external CC(s) and RC(s) and the numbers of external CC(s) and RC(s) are not within the scope of the present document.

NOTE 2: Some satellite operators may require that internal CC(s) and or RC(s) are available.

- b) The connection between the NCF and the ES via the CCs and RCs shall be either permanent or shall be set up on a call by call basis through a switched network. In case of connection through a switched network the ES shall be able to receive calls from the NCF and to initiate calls towards the NCF in order to set up the CCs and RCs.
- c) The ES with an external CC shall not transmit without receiving an appropriate signal from the NCF indicating to the ES that the NCF is alive and insuring that the ES is pointing to the target satellite.

4.2.8.5.2.2 Specification 2: CC Reception

- a) The ES shall enter the "Non-valid" state if it does not correctly receive the CC from the NCF within a period not to exceed 30 seconds. This event is called a "CC disruption":
 - In the case of external CCs and RCs without permanent connection of the NCF with the ES, the ability to receive CC messages from the NCF is the ability at any time to receive calls and messages within the timing requirements of the present document from the network through which is connected the NCF.
 - The inability to receive CC messages from the NCF may be due to the following various causes but not limited to them: no received signal from the NCF or from the network, a too low level received signal, no network accessible, the inability to lock onto the received carrier frequency, to demodulate, to decode, to receive calls and/or messages, a hardware failure or power off.
- b) The ES shall remain in the "Non-valid" state as long as the ES is unable to receive CC messages from the NCF.
- c) From the "Non-valid" state the ES may enter the "Initial phase" state if the following conditions are met:
 - the ES is able to receive CC messages from the NCF; and
 - no fault conditions are present.

4.2.8.5.3 Conformance tests

Conformance tests shall be carried out in accordance with clause 6.9.6.

4.2.8.6 Network control commands

4.2.8.6.1 Justification

These requirements ensure that the ES is capable of:

- a) retaining a unique identification in the network;
- b) receiving commands from the NCF through its CC(s) and executing those commands.

4.2.8.6.2 Specification

The ES shall hold, in non-volatile memory, its unique identification code in the network.

The ES shall be capable of receiving through its CCs dedicated messages (addressed to the ES) from the NCF, and which contain:

- Transmission Enable commands (TxE).
- Transmission Disable commands (TxD).

When in the "Initial phase" or "Transmission enabled" states, once a transmission disable command is received, within 1 second the ES shall enter into, and shall remain in the "Transmission disabled" state until the transmission disable command is superseded by a subsequent transmission enable command (see also clause 4.2.7).

When in the "Initial phase" or "Transmission disabled" states, once a transmission enable command is received, the ES may enter into the "Transmission enabled" state.

When entering the "Initial phase" from the "Non-valid" state, the last TxE or TxD command received from the NCF may be used by the ES to enter the "Transmission enabled" state or the "Transmission disabled" state, respectively, if since the time of reception of that command no "CC disruption" has occurred.

NOTE: The physical unit in charge of the reception of the CCs, of the transmissions of the RCs and of the CC commands reception may be a separate and independent unit from the other units of the ES or it may be common to several ESs.

4.2.8.6.3 Conformance tests

Conformance tests shall be carried out in accordance with clause 6.9.7.

4.2.8.7 Initial burst transmission

4.2.8.7.1 Justification

Restrictions on the initial burst transmissions are necessary to limit disturbance to other services.

4.2.8.7.2 Specification

For systems where no transmission enable command is foreseen without request from the ES, in the "Initial phase" state the ES may transmit initial bursts:

- a) The ES shall only transmit initial bursts after confirming that no cessation of emission applies where the ES is located. This confirmation shall be obtained either by local means (see clause 4.2.7) or from the NCF via an external control channel.
- b) The duty cycle of the initial burst transmission shall not exceed 0,2 %, where the duty cycle is defined as the ratio of burst duration to the duration between two successive bursts.
- c) The initial burst shall be transmitted at an EIRP no greater than $EIRP_{max}$.
- d) The duration between two successive bursts shall not be less than the required NCF response time as declared by the manufacturer. This response time is defined as the duration, measured at the ES, between an initial burst transmission and the reception and processing of a transmission enable or disable command from the NCF which is never exceeded during 99 % of the cases under normal conditions in the system for which the ES is designed, as declared by the manufacturer.

4.2.8.7.3 Conformance tests

Conformance tests shall be carried out in accordance with clause 6.9.8.

4.2.8.8 Inhibition of transmissions

4.2.8.8.1 Justification

To ensure the correct inhibition of transmissions that are potentially harmful to other systems and persons in the event of signal blockage.

4.2.8.8.2 Specification

ES shall enter the "Carrier-off" radio state within a period not exceeding 1 second, whenever there is a loss of receive carrier (e.g. synchronization or signal level), and shall remain in this radio state until the receiver carrier has been restored.

If the receive carrier is not restored within IT_{max} (see clause 4.2.6.2), then the ES shall transition to the "Initial phase" state.

The manufacturer shall declare the time to transition from "Carrier off" to "Carrier on" radio state (T_{trans}) when in "Transmission enabled" state after the receive carrier is restored within IT_{max} .

4.2.8.8.3 Conformance tests

Conformance tests shall be carried out in accordance with clause 6.9.9.

4.2.9 Receive antenna off-axis gain pattern

4.2.9.1 Justification

To protect the wanted signals from interference from terrestrial services and from other satellite services.

4.2.9.2 Specification

The maximum antenna gain of each of the co-polarized components in any direction φ degrees from the antenna main beam axis shall not exceed the following limits:

$$\begin{aligned} G &= 36 - 25 \log \varphi & \text{dBi} & \quad \text{for } \varphi_{\min} \leq \varphi < 44^\circ \\ G &= -5 & \text{dBi} & \quad \text{for } 44^\circ \leq \varphi < 75^\circ \\ G &= 0 & \text{dBi} & \quad \text{for } 75^\circ \leq \varphi \leq 180^\circ \end{aligned}$$

where:

- $\varphi_{\min} = 1^\circ$ or $100 \lambda/D$ degrees, whichever is the greater, for $D/\lambda \geq 50$.
- $\varphi_{\min} = 2^\circ$ or $114 (D/\lambda)^{-1.09}$ degrees, whichever is the greater, for $D/\lambda < 50$.
- D is the nominal diameter of the antenna.

In addition the maximum antenna gain of each of the cross-polarized components in any direction φ degrees from the antenna main beam axis shall not exceed the following limits:

$$\begin{aligned} G_x(\varphi) &= 23 - 20 \log \varphi & \text{dBi} & \quad \text{for } \varphi_r \leq \varphi \leq 7^\circ \\ G_x(\varphi) &= 20,2 - 16,7 \log \varphi & \text{dBi} & \quad \text{for } 7^\circ < \varphi \leq 32,3^\circ \\ G_x(\varphi) &= -5 & \text{dBi} & \quad \text{for } 32,3^\circ < \varphi \leq 75^\circ \\ G_x(\varphi) &= 0 & \text{dBi} & \quad \text{for } 75^\circ < \varphi \leq 180^\circ \end{aligned}$$

where:

- φ_r is equal to 1° or $100 \lambda/D$, whichever is greater.

4.2.9.3 Conformance tests

Conformance tests shall be carried out in accordance with clause 6.10.

4.2.10 Blocking performance

4.2.10.1 Justification

To prevent high power signals outside the receive frequency band from blocking the reception of signals inside the receive frequency band.

4.2.10.2 Specification

Receiver blocking is characterized here through gain compression for a signal inside the receive frequency band that is caused by another signal outside the receive frequency band at high power. The level of the other signal is compared to the level of a signal inside the receive frequency band that would cause the same gain compression.

Receiver blocking rejection at a particular frequency is defined as the level of a second signal at this frequency that causes a certain gain compression to a first signal inside the receive frequency band, minus the level of a second signal at a frequency inside the receive frequency band that causes the same gain compression.

The first signal shall be at the centre frequency of the receive frequency band and have a level in the operational range. The second signal shall cause a gain compression for the first signal of 1 dB.

The rejection shall comply with table 6.

Table 6: Receiver blocking rejection

Frequency	Minimum rejection
below 14 GHz	20 dB
14 to 16 GHz	10 dB
24 to 27,5 GHz	10 dB
Above 27,5 GHz	20 dB
NOTE: In the frequency ranges 16 to 17,5 GHz and 21,2 to 24 GHz, the rejection needs further studies.	

4.2.10.3 Conformance tests

Conformance tests shall be carried out in accordance with clause 6.11.

4.2.11 Adjacent Signal Selectivity

4.2.11.1 Justification

To enable reception of a wanted signal in presence of other signals on adjacent frequencies which are transmitted with high EIRP density from other satellites.

NOTE: The power level of signals transmitted from satellites in the same constellation are under control of the satellite operator. Signals transmitted from satellites in an adjacent orbit or from satellites in the GSO are attenuated by the discrimination available from antenna gain pattern.

4.2.11.2 Specification

Adjacent Signal Selectivity is a measure of a receiver's ability to receive a signal at its assigned channel frequency in the presence of an adjacent signal at a given frequency offset from the centre frequency of the assigned channel. The adjacent signal shall occupy the same bandwidth as the wanted signal. The frequency offset between adjacent signal and wanted signal shall be equal to the bandwidth of the ideal signal. The power level of the adjacent signal shall be 7 dB higher than the power level of the wanted signal.

The signal to noise ratio threshold for reception with target error rate shall be determined by adding generated thermal noise and varying the ratio of wanted signal to noise. This shall be done in presence as well as in absence of the adjacent signals. Then the signal to noise ratio threshold in presence of an adjacent signal shall be less than 0,4 dB higher than in absence of the adjacent signal.

NOTE: The adjacent signal and thermal noise are both cause impairment of the wanted signal. The impairment caused by the adjacent signal is compensated by lowering the level of generated thermal noise. In consequence, the signal to noise threshold is higher in presence of an adjacent signal.

4.2.11.3 Conformance tests

Conformance tests shall be carried out in accordance with clause 6.12.

4.2.12 Image frequency rejection

4.2.12.1 Justification

With a LO frequency lower than the received frequency, the image frequency lies in a spectrum region allocated to high-power systems including radiolocation. Protection is necessary against the resulting interference.

4.2.12.2 Specification

The LNB shall suppress the image frequencies of the received frequencies by at least 30 dB in case the image frequency falls inside the overall receive frequency band of the EUT and at least 40 dB otherwise.

4.2.12.3 Conformance tests

The test method specified in clause 6.1.8 of ETSI ETS 300 457 [4] shall apply.

NOTE 1: If the LNB is integrated with a feed horn, then the input signal may be injected by a feed horn adapter. The LNB manufacturer should supply the feed horn adaptor and characterization frequency and gain data. The data supplied should be used to correct the measurements taken.

NOTE 2: If signal injection through free space radiation in an anechoic chamber achieves higher accuracy of measurement results, this method may be used.

5 Testing for compliance with technical requirements

5.1 Environmental conditions for testing

Tests defined in the present document shall be carried out at representative points within the boundary limits of the operational environmental profile defined by its intended use.

Where technical performance varies subject to environmental conditions, tests shall be carried out under a sufficient variety of environmental conditions (within the boundary limits of the operational environmental profile defined by its intended use) to give confidence of compliance for the affected technical requirements.

5.2 Ancillary Equipment

Equipment is considered as ancillary if the three following conditions are met:

- the equipment is intended for use in conjunction with the ES to provide additional operational and/or control features (e.g. to extend control to another position or location); and
- the equipment cannot be used on a stand alone basis, to provide user functions independently of the ES; and
- the absence of the equipment does not inhibit the operation of the ES.

5.3 Nominated Bandwidth

The nominated bandwidth is centred on the transmit frequency and does not exceed 5 times the occupied bandwidth.

The nominated bandwidth is wide enough to encompass all spectral elements of the transmission which have a level greater than the specified spurious radiation limits. The nominated bandwidth is wide enough to take account of the transmit carrier frequency stability. This definition is chosen to allow flexibility regarding adjacent channel interference levels which will be taken into account by operational procedures depending on the exact transponder carrier assignment situation.

5.4 Interpretation of the measurement results

The interpretation of the results recorded in a test report for the measurements described in the present document shall be as follows:

- the measured value related to the corresponding limit will be used to decide whether an equipment meets the requirements of the present document;
- the value of the measurement uncertainty for the measurement of each parameter shall be included in the test report;
- the recorded value of the measurement uncertainty should be, for each measurement, equal to or less than the figures in table H.1.

For the test methods, according to the present document, the measurement uncertainty figures shall be calculated and shall correspond to an expansion factor (coverage factor) $k = 1,96$ or $k = 2$ (which provide confidence levels of respectively 95 % and 95,45 % in the case where the distributions characterizing the actual measurement uncertainties are normal (Gaussian)). Principles for the calculation of measurement uncertainty are contained in ETSI TR 100 028 [i.8], in particular in annex D of the ETSI TR 100 028-2 [i.9].

Table H.1 is based on such expansion factors.

6 Test methods for all aspects of the ES

6.1 General

6.1.1 General requirements

The present clause describes the general requirements for verifying that the performance of the EUT complies with the specifications. However, the specific testing methodology to be used for measuring performance is left to the manufacturer in order to allow the methodology to be matched to the EUT. The manufacturer shall maintain documentary evidence of the results obtained in performing the essential radio tests. At a minimum, the documentary evidence shall include:

- test setup (configurations, test equipment and calibration status);
- test conditions (environmental and operational parameters);
- method of testing;
- results of measurements, measurement resolution and uncertainty; and
- statement of compliance with technical specifications of the present document.

The test conditions for each test shall be representative of the intended operational environment and be noted in the test report where it has a significant effect on the measurement results.

The type, termination and length of each cable used shall be representative of the intended installation and recorded in the test report. For maximum cable lengths longer than 10 m, as declared by the manufacturer, the tests shall be performed with cables no shorter than 10 m.

6.1.2 Special considerations for the interpretation of measurement results

"Standard" measurement equipment is available up to a frequency range of around 66 GHz with a sensitivity of -72 dBm at 18 GHz down to around -64 dBm at 40 GHz (1 MHz RBW, 3 MHz VBW, 100 MHz span). For higher frequencies the sensitivity will further decrease.

The measurement uncertainty of measurements in the range above 40 GHz (millimetre domain) will be clearly above the initially assumed 6 dB for radiated measurements below 40 GHz. A value of 8 dB seems to be more adequate. Precise values of measurement uncertainty require calibration, and there are limitations.

This maximum uncertainty value above 40 GHz is also dependent upon the maximum dimensions of the antenna of the equipment under test and is also dependent upon gain specifications of antennae.

Additional information on radiated measurements up to 100 GHz is available in ETSI TS 103 052 [i.6].

The test site and the method of measurement shall also be in accordance with CISPR 16-1-4 [3] as applicable.

Where a radome is required in operation, the tests should be conducted with the radome in place or, if testing with the radome in place is impractical, then an appropriate analytic technique shall be used to compensate for the absence of the radome.

To enable the performance tests to be carried out the use of an NCF or a Special Test Equipment (STE), made available by the manufacturer, may be necessary. Since this STE will be specific for the particular system, it is not possible to provide detailed specifications in the present document. However, the following baseline is provided:

- if the ES requires to receive a modulated carrier from the satellite in order to transmit, then special test arrangements are required to simulate the satellite signal, thus enabling the ES to transmit allowing measurement of transmission parameters;
- any characteristic of these special test arrangements which may have direct or indirect effects on the parameters to be measured shall be clearly stated by the manufacturer.

All tests with carrier-on shall be undertaken with the transmitter operating at $EIRP_{max}$, as per the specific requirement, and with the normal radio operating parameters, as declared by the manufacturer.

If the Equipment Under Test (EUT) is an ES that requires hardware and/or software modification(s) performed by the manufacturer for these tests then full documentation of such modification(s) shall be provided to demonstrate that the modification(s) will simulate the required test condition, without its main characteristics being changed.

6.1.3 Measuring receiver

The term "measuring receiver" refers to a frequency-selective voltmeter or a spectrum analyser. In order to obtain the required sensitivity, a narrower measurement bandwidth may be necessary. In such cases, this shall be stated in the test report form. The bandwidth of the measuring receiver and the deployed detectors shall be as given in table 9.

Table 9: Measurement receiver parameters

Frequency range: (f)	Measuring receiver bandwidth	Detector
$30 \text{ MHz} \leq f \leq 1\,000 \text{ MHz}$	100 kHz or 120 kHz	peak/RMS (see note 1)
$1\,000 \text{ MHz} < f \leq 40 \text{ GHz}$	1 MHz	peak/RMS
$f > 40 \text{ GHz}$	1 MHz (see note 2)	peak/RMS
NOTE 1: With the values from the peak and the RMS detector the quasi peak value can be calculated for particular measurement applications.		
NOTE 2: The actual frequency accuracy shall be taken into account to determine the minimum measurement bandwidth possible.		

In case a narrower measurement bandwidth was used, the following conversion formula has to be applied:

$$B = A + 10 \log \frac{BW_{ref}}{BW_{MEASURED}}$$

where:

- A is the value at the narrower measurement bandwidth;
- B is the value referred to the reference bandwidth; or

- use the measured value, A, directly if the measured spectrum is a discrete spectral line. (A discrete spectrum line is defined as a narrow peak with a level of at least 6 dB above the average level inside the measurement bandwidth.)

6.2 Off-axis spurious radiation

6.2.1 General

The tests for the ES specification in clause 4.2.1.2 shall be conducted in "Carrier on", "Carrier off" and "Emissions disabled" radio states as required. The tests in "Carrier on" radio state shall be undertaken with the transmitter operating at $EIRP_{max}$.

6.2.2 Test method

6.2.2.1 General

The manufacturer shall declare the test methods used to identify frequencies of off-axis spurious radiation and to measure (or calculate) the radiated power levels of identified spurious radiations.

NOTE: For the purposes of this procedure, the measuring antenna is aligned to the polarization which produces the largest response between the EUT and the measuring antenna.

The tests for the specification in clause 4.2.1.2 shall be limited to the "Carrier-on" radio state. The tests shall be undertaken with the transmitter operating at $EIRP_{max}$.

The ES may be tested with or without antenna. An "EUT with antenna" is an ES with integral antenna. An "EUT without antenna" is an ES with the removable antenna removed.

In the case where the ES antenna is remotely mounted from the associated electronics, the connecting cable shall be of the same type and length as specified by the manufacturer in the installation manual. If the cable is normally longer than 10 m, a cable of 10 m in length may be used for the test. The type and length of cable used shall be entered in the test report.

The EUT shall be terminated with matched impedance at the terrestrial ports if recommended by the manufacturer in the user documentation and if there is no associated equipment connected to each port.

For frequencies up to 80 MHz the measuring antenna shall be a balanced dipole with a length equal to the 80 MHz resonant length and shall be matched to the feeder by a suitable balanced transforming device. Measurements with broad band antennas are also possible provided that the test site has been validated according to CISPR 16-1-4 [3].

For frequencies between 80 MHz and 1 000 MHz the measuring antenna shall be a balanced dipole which shall be resonant in length. Measurements with broadband antennas are also possible provided that the test site has been validated according to CISPR 16-1-4 [3].

For frequencies above 1 000 MHz the antenna shall be a horn radiator of known gain/frequency characteristics. The antenna is mounted on a support capable of allowing the antenna to be used in either horizontal or vertical polarization and at the specified height.

6.2.2.2 Multi-carrier operation

For ESs designed to transmit simultaneously several carriers the verification up to 1 000 MHz shall be performed with one or more carriers and the verification above 1 000 MHz shall be repeated for each combination of carriers declared by the manufacturer.

For each combination of carriers the manufacturer shall declare the carriers' centre frequencies and characteristics, the maximum value of the total on-axis EIRP of the carriers and the relative levels of the carriers (in dBs) at the input or output of the HPA or antenna.

In the case of combinations of carriers with identical characteristics and when the power at the input of the HPA does not exceed the maximum input power with two carriers, the verification may be limited to the case with two carriers and with the maximum frequency separation between them.

In any other case, the number of configurations to be verified above may be limited to the cases which can be proven by the manufacturer, by documentary evidence or demonstration, to generate the maximum EIRP density level of the out-of-band emissions due to inter-modulation products.

6.2.3 Measurements up to 1 000 MHz

6.2.3.1 Test site

The test shall be performed either in an open area test site, a semi-anechoic chamber or an anechoic chamber. Ambient noise levels shall be at least 6 dB below the applicable unwanted emissions limit.

The open area test site shall be flat, free of overhead wires and nearby reflecting structures, sufficiently large to permit aerial placement at the specified measuring distance and provide adequate separation between aerial, test unit and reflecting structures, according to CISPR 16-1-4 [3].

For both the open area test site and the semi-anechoic chamber a metal ground plane shall be inserted on the natural ground plane and it shall extend at least 1 m beyond the perimeter of the EUT at one end and at least 1 m beyond the measurement antenna at the other end.

The distance between the EUT and the measuring antenna should be 10 m. For measurements at a different distance an inverse proportionality factor of 20 dB per decade shall be used to normalize the measured data to the specified distance for determining compliance. Care should be taken in measurement of large test units at 3 m at frequencies near 30 MHz due to near field effects.

6.2.3.2 Measuring receivers

Measuring receivers shall conform to the following characteristics:

- the response to a constant amplitude sine wave signal shall remain within ± 1 dB across the frequency range of interest;
- quasi-peak detection shall be used in a -6 dB bandwidth of 120 kHz;
- the receiver shall be operated below the 1 dB compression point.

6.2.3.3 Procedure

- a) The EUT shall be an EUT with antenna or, preferably, without antenna but with the antenna flange terminated by a dummy load.
- b) The EUT shall be in the "Carrier-on" radio state.
- c) The EUT shall be rotated through 360° and, except in an anechoic chamber, the measuring antenna shall be rotated and height varied from 1 m to 4 m above the ground plane to determine the maximum emission.
- d) All identified spurious radiation shall be measured and noted in frequency and level.

6.2.4 Measurements above 1 000 MHz

6.2.4.1 General

The spectrum analyser resolution bandwidth shall be set to the specified measuring bandwidth or as close as possible. If the resolution bandwidth is different from the specified measuring bandwidth, bandwidth correction shall be performed for the noise-like wideband spurious.

For an EUT with antenna the tests shall be performed in two stages for both the "Carrier-on" and "Carrier-off" radio states:

- Procedure a): Identification of the significant frequencies of spurious radiation.
- Procedure b): Measurement of radiated power levels of identified spurious radiation.

For an EUT without antenna the tests shall be performed in three stages for both the "Carrier-on" and "Carrier-off" radio states:

- Procedure a): Identification of the significant frequencies of spurious radiation.
- Procedure b): Measurement of radiated power levels of identified spurious radiation.
- Procedure c): Measurement of conducted spurious radiation radiated through the antenna flange.

6.2.4.2 Identification of the significant frequencies of spurious radiation

6.2.4.2.1 Test site

The identification of frequencies emitting from the EUT shall be performed either in an anechoic chamber, an open area test site or a semi-anechoic chamber with the test antenna close to the EUT and at the same height as the volume centre of the EUT.

6.2.4.2.2 Procedure

- a) The EUT shall be in the "Carrier-off" radio state.
- b) For an EUT with antenna the main beam of the antenna shall have an angle of elevation corresponding to 8 dBi antenna gain, and, for an EUT without antenna the antenna flange shall be terminated by a dummy load.
- c) The receivers shall scan the frequency band while the EUT revolves.
- d) The EUT shall be rotated through 360° and the frequency of any spurious signals noted for further investigation.
- e) For an EUT with antenna the test shall be repeated with the test antenna being in the opposite polarization.
- f) The test shall be repeated in the "Carrier-on" radio state while transmitting one modulated carrier at maximum power.

6.2.4.3 Measurement of radiated power levels of identified spurious radiation

6.2.4.3.1 Test site

The measurement of each spurious radiation noted during procedure a) of the test shall be performed on a test site that is free from reflecting objects, i.e. either an open-area test site, a semi-anechoic chamber or an anechoic chamber.

6.2.4.3.2 Procedure

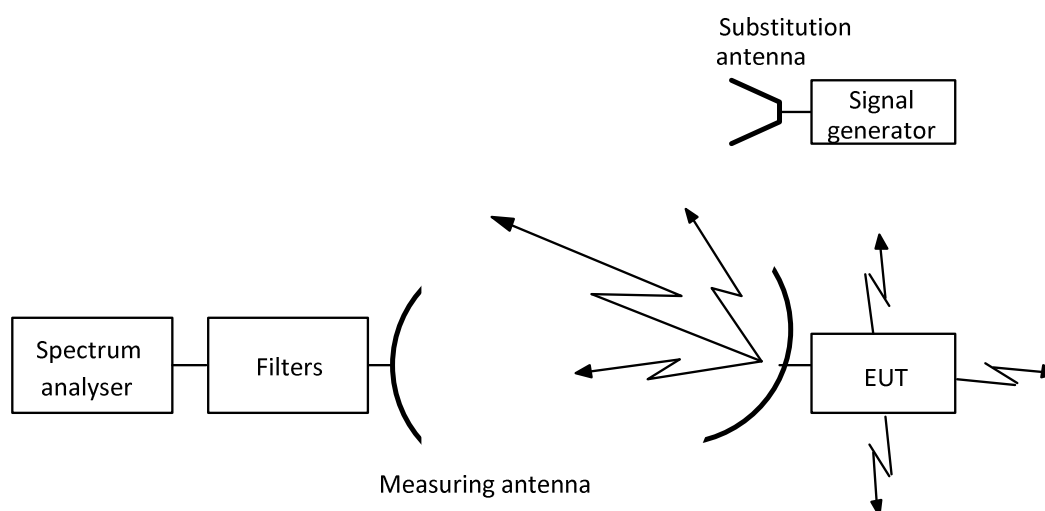

Figure 3: Test arrangement - Spurious radiation measurement above 1 000 MHz for an EUT with antenna

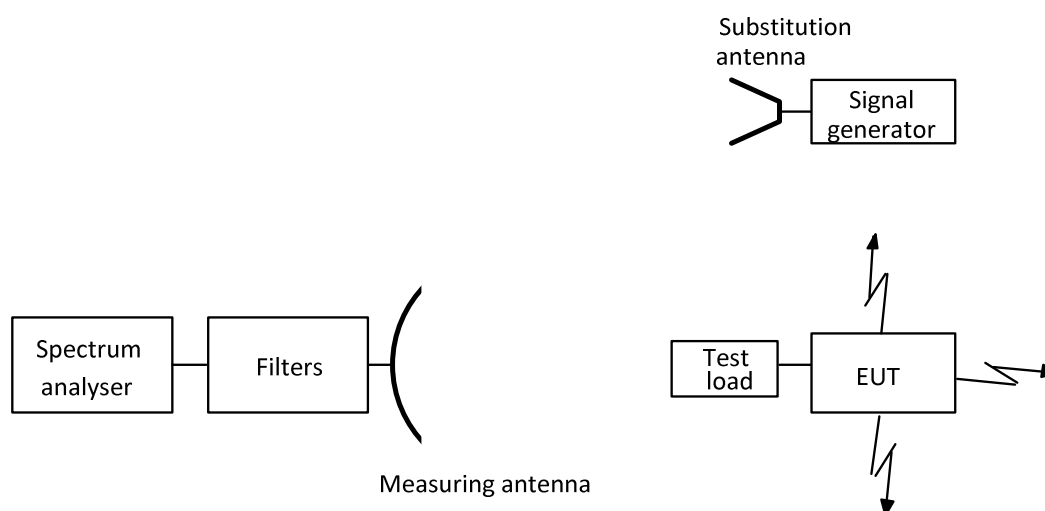

Figure 4: Test arrangement - spurious radiation measurements above 1 000 MHz for an EUT without antenna

- a) The test arrangement shall be as shown in figures 3 or 4.
- b) The EUT shall be installed at a height between 0,5 m and 1,0 m on a non-metallic turntable. For an EUT with separable components, the components shall be separated by 1 m to 2 m. For the test arrangement shown in figure 3 the main beam of the antenna shall have an angle of elevation sufficient to achieve a peak gain of 8 dBi in the direction the test receiver. Necessary precautions should be taken to avoid EUT emissions towards GSO satellite networks and NGSO satellite systems.
- c) The measuring antenna shall be positioned at a distance from the EUT (e.g. 3 m, 5 m, 10 m) relevant to the applied test site. The measuring antenna shall be adjusted in height and the EUT rotated, while the EUT is in the appropriate carrier condition, for a maximum response on the associated spectrum analyser at each spurious frequency previously identified, this response level shall be noted. The adjustment in height of the measuring antenna does not apply when an anechoic chamber is being used. The measuring antenna shall never enter the 8 dBi off-axis cone around the main beam direction.
- d) The investigation shall be repeated with the measuring antenna in the opposite polarization and the response level similarly noted.

- e) The EUT shall be replaced by the substitution antenna to which is connected a signal generator. The main beam axes of the measuring and substitution antennas shall be aligned. The distance between these antennas shall be the distance determined under test c).
- f) The substitution and measuring antennas shall be aligned in the polarization which produced the larger response between the EUT and the test antenna in steps c) and d).
- g) The output of the generator shall be adjusted so that the received level is identical to that of the previously noted largest spurious radiation.
- h) The output level of the signal generator shall be noted. The EIRP of the spurious radiation is the sum, in dB, of the signal generator output plus the substitution antenna isotropic gain minus the interconnection cable loss.

6.2.4.4 Measurement of conducted spurious radiation at the antenna flange

6.2.4.4.1 Test site

There are no requirements for the test site to be used for this test.

6.2.4.4.2 Procedure

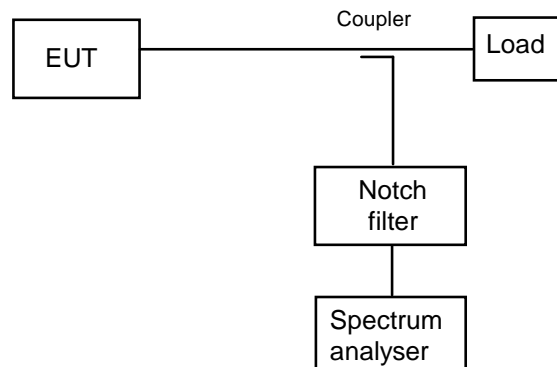

Figure 5: Test arrangement - conducted spurious radiation above the cut-off frequency

- a) The test arrangement shall be as shown in figure 5 with the notch filter being optional. In order to protect the spectrum analyser while ensuring the necessary measurement accuracy, particularly close to the carrier, if a notch filter is used it shall be tuned to the transmit carrier frequency.
- b) The frequency range from the cut-off frequency of the waveguide of the EUT to 60 GHz shall be investigated for spurious radiation while in the "Carrier-on" radio state with the carrier being at maximum power and normally modulated.
- c) To obtain the off-axis spurious EIRP the maximum measured antenna transmit gain, measured at the frequency of the identified unwanted emission, for off-axis angles greater than 7° , shall be added to the measured power density and any correction or calibration factors summated with the result. If agreed by the manufacturer, it shall be acceptable that the worst case value assumed (i.e. 8 dBi for off-axis angles greater than 7°) is used in place of the maximum off-axis antenna gain at the frequency of the identified unwanted emission.
- d) The test shall be repeated in the "Carrier-off" radio state.

6.3 On-axis spurious radiation

6.3.1 Test method

6.3.1.1 General

The tests shall be undertaken with the transmitter operating at $EIRP_{max}$.

6.3.1.2 Test site

There are no requirements for the test site to be used for this test.

6.3.1.3 Method of measurement

6.3.1.3.1 General

For ES equipment for which measurements at the antenna flange are possible and agreed by the manufacturer, the measurements shall be performed at the antenna flange.

For ES equipment for which measurements at the antenna flange are not possible or not agreed by the manufacturer, the measurements shall be performed with a test antenna.

6.3.1.3.2 Method of measurement at the antenna flange

6.3.1.3.2.1 General

- a) The test arrangement shall be as shown in figure 5 with the notch filter being optional. In order to protect the spectrum analyser while ensuring the necessary measurement accuracy, particularly close to the carrier, if a notch filter is used it shall be tuned to the transmit carrier frequency.
- b) The EUT shall transmit one modulated carrier continuously, or at its maximum burst rate where applicable, centred on a frequency as close to the lower limit of the operating frequency band of the EUT as possible. The EUT shall be operated at $EIRP_{max}$. The frequency range 27,5 GHz to 29,1 GHz and 29,5 GHz to 30,0 GHz shall be investigated.
- c) Due to the proximity of the carrier the spectrum analyser resolution bandwidth shall be set to a measurement bandwidth of 3 kHz, or as close as possible. If the measurement bandwidth is different from the specified measurement bandwidth, bandwidth correction shall be performed for noise-like wideband spurious radiation.
- d) To obtain the on-axis spurious EIRP, the antenna transmit gain shall be added to any figure obtained in the above measurement and any correction or calibration factor summated with the result. The antenna gain shall be as measured in clause 6.3.1.3.2.2 at the closest frequency to the spurious frequency.
- e) The tests in b) to e) shall be repeated with a transmit frequency in the centre of the operating frequency band.
- f) The tests in b) to e) shall be repeated with a transmit frequency as close to the upper limit of the operating frequency band of the EUT as possible.
- g) The tests in b) to f) shall be repeated in the "Carrier-off" radio state.

6.3.1.3.2.2 Antenna transmit gain

6.3.1.3.2.2.1 General

For the purpose of the present document, the antenna transmit gain is defined as the ratio, expressed in decibels (dBi), of the power that would have to be supplied to the reference antenna, i.e. an isotropic radiator isolated in space, to the power supplied to the antenna being considered, so that they produce the same field strength at the same distance in the same direction. Unless otherwise specified the gain is for the direction of maximum radiation.

For the purpose of this test the EUT is defined as the antenna and its flange. The antenna may include the reflector(s), feed, support struts and an enclosure of equal weight/distribution to any electrical equipment normally housed with the feed at the antenna focal point.

The manufacturer shall declare the operating frequency range of the EUT. For the tests in the clause 6.3.1.3.2.2 the following test frequencies shall be defined:

- Test Frequency A - the low test frequency shall be the middle of the lowest carrier in operating frequency range;
- Test Frequency B - the mid-range test frequency shall be the middle of the carrier that includes (or is adjacent to) the middle of the operating range; and
- Test Frequency C - the high test frequency shall be the middle of the highest carrier in the operating range.

6.3.1.3.2.2.2 Test site

This test shall be performed on either an outdoor far-field test site, compact test range or near-field scanner.

6.3.1.3.2.2.3 Method of measurement

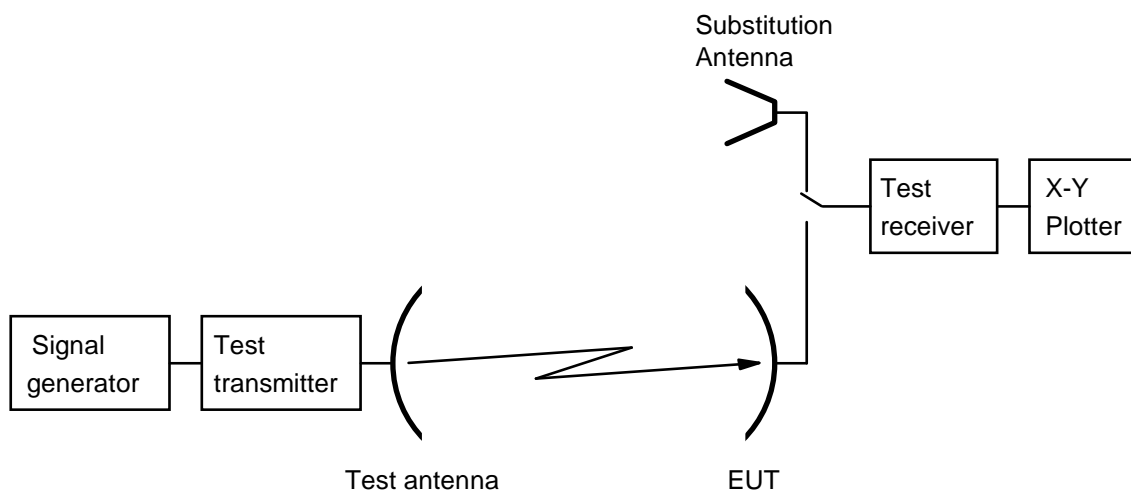

Figure 6: Test arrangement - antenna transmit gain measurement

- The test arrangement shall be as shown in figure 6 with the EUT connected to the test receiver. A signal proportional to the angular position from the servo mechanism shall be applied to the X-axis and the signal level from the test receiver shall be applied to the Y-axis of the plotter.
- A test signal at Test Frequency B shall be transmitted by the test transmitter through the test antenna. The E-plane shall be vertical. The EUT antenna main beam axis shall be aligned with the main beam axis of the test transmitter. The polarizer of the EUT antenna shall be rotated and adjusted such that the E-plane coincides with the E-plane of the test transmitter.
- The EUT shall be aligned to maximize the received signal and the X-Y plotter adjusted to give the maximum reading on the chart.
- The EUT shall be driven in azimuth in one direction through 10° .
- The pattern measurement is then obtained by driving the EUT in azimuth back through boresight to 10° the other side with the plotter recording the results.
- The EUT shall be replaced by the substitution antenna and the received signal level maximized.
- This level shall be recorded on the X-Y plotter.
- The substitution antenna shall be driven in azimuth as in d) and e).

- i) The gain of the EUT shall be calculated from:

$$G_{\text{EUT}} = L_1 - L_2 + C$$

where:

- G_{EUT} is the gain of the EUT (dBi);
 - L_1 is the peak level obtained with the EUT (dB);
 - L_2 is the peak level obtained with the substitution antenna (dB);
 - C is the calibrated gain of the substituted antenna at the test frequency (dBi).
- j) The tests in c) to i) shall be repeated with the frequency changed to Test Frequency A.
- k) The tests in c) to i) shall be repeated with the frequency changed to Test Frequency C.
- l) The tests in b) to k) may be performed simultaneously.

6.3.1.3.3 Method of measurement for an EUT with antenna

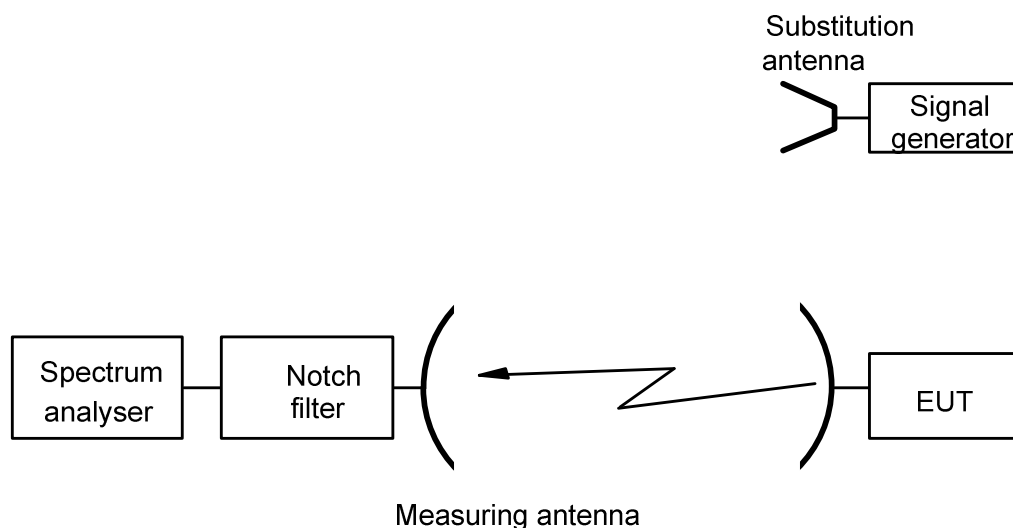

Figure 7: Test arrangement - on-axis spurious radiation measurements for an EUT with antenna

- a) The test arrangement shall be as shown in figure 7 with the notch filter being optional.
- b) The EUT shall be installed such that the units are separated by 1 m to 2 m with the indoor unit at a height between 0,5 m and 1,0 m on a non-metallic turntable.
- c) The spectrum analyser resolution bandwidth shall be set to the specified measuring bandwidth or as close as possible. If the resolution bandwidth is different from the specified measuring bandwidth, bandwidth correction shall be performed for noise-like wideband spurious radiation.
- d) The EUT shall transmit one modulated carrier continuously, or at its maximum burst rate where applicable, centred on a frequency as close to the lower limit of the operating frequency band of the EUT as possible. The EUT shall be operated at EIRP_{max} . The frequency range 27,5 GHz to 29,1 GHz and 29,5 GHz to 30,0 GHz shall be investigated and each spurious frequency shall be noted.
- e) Due to the proximity of the carrier the spectrum analyser resolution bandwidth shall be set to a measurement bandwidth of 3 kHz, or lower. If the measurement bandwidth is different from the specified measurement bandwidth, bandwidth correction shall be performed for noise-like wideband spurious radiation.

- f) The measuring antenna shall be positioned at a distance from the EUT (e.g. 3 m, 5 m, 10 m) relevant to the applied test site and shall be aligned with the EUT antenna for the transmit frequency. The measuring antenna shall be adjusted in height, while the EUT is in the appropriate carrier condition, for a maximum response on the associated spectrum analyser at each spurious frequency previously identified, this response level shall be noted. The adjustment in height of the measuring antenna does not apply when an anechoic chamber is being used.
- g) The EUT shall be replaced by a representative substitution antenna to which a signal generator is connected. The main beam axes of the measuring and substitution antennas shall be aligned. The distance between these antennas shall be the distance determined under test f).
- h) The substitution and measuring antennas shall be aligned to that polarization which produced the largest response between the EUT and the test antenna.
- i) The output of the generator shall be adjusted so that the received level is identical to that of the previously noted largest spurious radiation.
- j) The output level of the signal generator shall be noted. The EIRP of the on-axis spurious radiation is the sum, in dB, of the signal generator output plus the substitution antenna isotropic gain minus the interconnection cable loss.
- k) The tests in d) to j) shall be repeated with a transmit frequency in the centre of the operating frequency band.
- l) The tests in d) to j) shall be repeated with a transmit frequency as close to the upper limit of the operating frequency band of the EUT as possible.
- m) The tests in b) to l) shall be repeated in the "Carrier-off" radio state.

6.4 Void

6.5 Carrier suppression

6.5.1 General

The EUT shall demonstrate the satisfactory suppression of transmissions, to a given emission power limit, upon receipt of the appropriate command from the NCF, or detection of certain fault conditions. (Clauses 4.2.5 and 4.2.7 define the carrier suppression requirement; clause 4.2.7.2.4 defines the applicable fault conditions.)

6.5.2 Test method

For the purposes of this test, the EUT shall transmit one carrier modulated continuously, or at its maximum burst rate where applicable, centred on the middle frequency of the operating frequency band as declared by the manufacturer. Whilst in transmit mode, the "transmission disabled state" shall be initiated by use of the NCF or an STE.

- for conducted measurements the maximum residual carrier power density within the nominated bandwidth shall be measured and added to the antenna on-axis gain, and recorded; or
- for radiated measurements the maximum residual EIRP density within the nominated bandwidth shall be measured and recorded.

The EUT shall be declared compliant with the requirements if the resulting carrier-suppressed EIRP density is at or below the limit given in clause 4.2.5.2.

6.6 Antenna pointing

6.6.1 General

The antenna pointing test method is designed to verify the ability of the EUT to detect and correctly respond to pointing errors that exceed the threshold, $\delta\phi_{\max}$, see clause 4.2.6.

For the purpose of these tests the EUT is the ES with its antenna. Antenna systems may be mechanically or electrically steered, and so this method measures the angular offset between the radiated antenna beam peak and the intended direction of pointing.

6.6.2 Test method

The test shall be carried out using radiated measurements; there is no equivalent method to undertake this test using conducted measurements.

There shall be a means for setting the pointing direction of the antenna declared by the manufacturer.

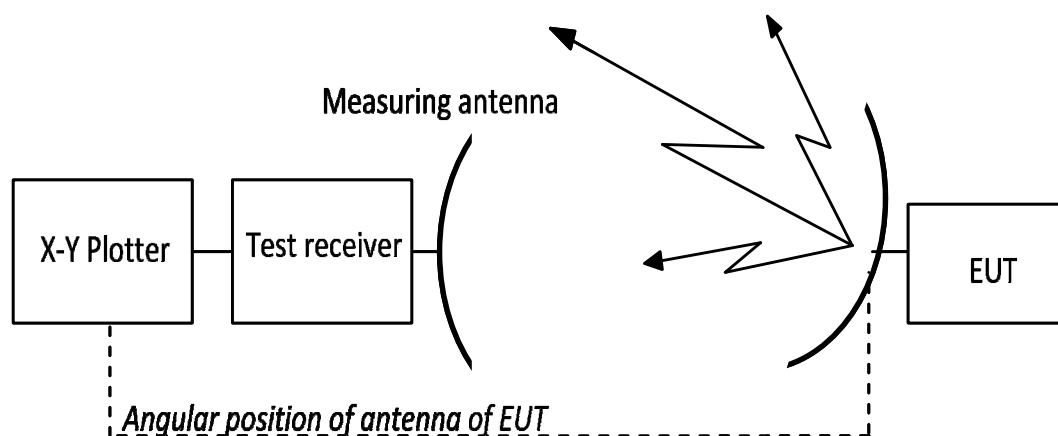

Figure 8: Test arrangement - antenna beam pointing

- The test arrangement shall be as shown in figure 8.
- A signal proportional to the angular position from the servo mechanism controlling the antenna of the EUT shall be applied to the X-axis and the signal level from the test receiver shall be applied to the Y-axis of the plotter.
- The EUT shall be installed at a height between 0,5 m and 1,0 m on a non-metallic turntable. For an EUT with separable components, the components shall be separated by 1 m to 2 m. Necessary precautions should be taken to avoid EUT emissions towards GSO satellite networks and NGSO satellite systems.
- The test frequencies shall be the centre frequency of each applicable frequency range.
- The pointing direction of the antenna of the EUT shall be set using the method provided by the manufacturer, in the nominal direction of the measurement antenna.
- The measuring antenna shall be positioned at a distance from the EUT (e.g. 3 m, 5 m, 10 m) relevant to the applied test site. The measuring antenna shall be placed at the same height and facing the EUT, and the EUT placed in the appropriate carrier condition.
- The servo mechanism shall move the EUT through an angle equivalent to $\pm 3\delta\phi_{\max}$ so that the maximum received signal level is recorded on the X-Y plotter.

- h) The angular difference $\delta\phi$ between the direction of maximum signal level and the pointing direction set in e) shall be recorded
- i) The tests in e) to h) shall be repeated in at least five pointing directions equivalent to normal operation of the EUT pointing to azimuths 0° , 90° , 180° and 270° at the lowest operating elevation angle and at 90° elevation.

The EUT shall be considered compliant with the requirement if the measured $\delta\phi$ does not exceed $\delta\phi_{\max}$ in any of the pointing directions measured before transmission is immediately ceased.

6.7 Polarization angle alignment capability

6.7.1 General

Requirements on polarization angle range and accuracy (or step size) shall be verified by inspection. The requirement on the angle between receive and transmit polarization planes shall be tested as described in the following.

The EUT is the ES antenna including possible ortho mode transducer or diplexer.

6.7.2 Test site

This test shall be performed either on an outdoor far field test site, on a compact test range, or by the near field scanner technology.

The servo mechanism shall be capable of driving the EUT in polarization. It may be capable of driving the EUT in azimuth and elevation.

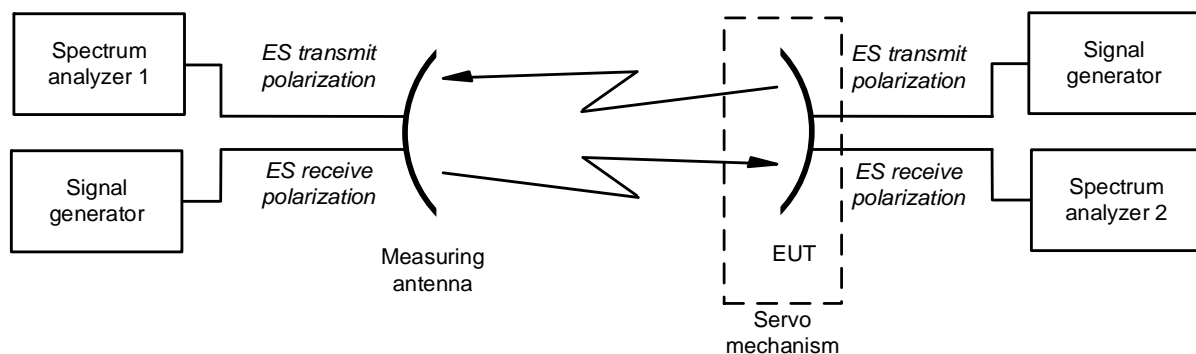

Figure 9: Test arrangement - polarization planes measurement

6.7.3 Procedure

- a) The test arrangement shall be as shown in figure 9.
- b) The test frequencies shall be the centre frequency of each applicable frequency range.
- c) The EUT shall be aligned in azimuth, elevation and polarization to maximize the signal level measured by spectrum analyser 2. The polarization position shall be memorized.
- d) The EUT shall be aligned in polarization to maximize the signal level measured by spectrum analyser 1. The polarization position shall be memorized.
- e) The polarization error is the difference of polarization positions obtained in steps c and d.
- f) Steps c to e shall be repeated for all combinations of transmit and receive test frequencies in accordance with the intended use of the ES.

- g) If the ES allows changing the transmit and receive polarization, then steps c to f shall be repeated for all combinations of transmit and receive polarization in accordance with the intended use of the ES.
- h) The maximum of polarization errors obtained in steps c to g shall be determined. If the maximum does not exceed the limit given in the requirement, then the EUT passed the test.

6.8 Cessation of emissions of the ES

6.8.1 General

There shall be a means of simulating a condition where cessation of emissions is required. The spectrum analyser or the oscilloscope may be used to measure the time difference between the occurrence of the condition and the cessation of emissions. In all test methods, it shall be verified that the time difference does not exceed 1 second as specified in clause 4.2.7.2.3.

Where the EUT adds an operational margin around areas where cessation of emissions is required to account for the position determination accuracy and latency, the test procedure may simulate the actual behaviour of an EUT as it enters into an area where cessation of emissions is required. For example, if the EUT adds a margin of X metres around areas where cessation of emissions is required, then the test may begin with the EUT being simulated at a position more than X metres outside of an area where cessation of emissions is required. The test may then simulate the motion of the EUT towards the area where cessation of emissions is required. In any event, the EUT shall enter the "emission disabled" radio state within 1 second of entering the actual area where cessation of emissions is required.

For the purpose of these tests the EUT is the ES either with, or without its antenna.

6.8.2 Test Method

6.8.2.1 Required documentation

The manufacturer shall declare the mode(s) of cessation of emissions implemented in the EUT and the ES interfaces involved in the cessation of emissions as specified in clause 4.2.7.2.1.

The manufacturer shall demonstrate by documentary evidence compliance with specification 2 in clause 4.2.7.2.2 for the determination of the conditions under which the ES shall cease emissions.

6.8.2.2 Cessation of emissions from the "Transmission enabled" state

- a) The EUT shall be set in the "Transmission enabled" ES state.
- b) The EUT shall be set in the "Carrier on" radio state.
- c) A condition requiring the cessation of emission shall be initiated either by the STE or the EUT.
- d) It shall be verified that the EUT enters the "Emissions disabled" radio state.
- e) In order to verify that the EUT is in the "Transmission disabled" ES state, it shall be verified that the EUT remains in the "Emissions disabled" radio state when the EUT is requested to transmit data.

6.8.2.3 Cessation of emission from the "Transmission disabled" state

- a) The EUT shall be set in the "Transmission disabled" state.
- b) A condition requiring the cessation of emission shall be initiated either by the STE or the EUT.
- c) In order to verify that the EUT remains in the "Transmission disabled" ES state, it shall be verified that the EUT remains in the "Emissions disabled" radio state when the EUT is requested to transmit data.
- d) The STE shall send a TxE command to the EUT.
- e) In order to verify that the EUT remains in the "Transmission disabled" ES state, it shall be verified that the EUT remains in the "Emissions disabled" radio state when the EUT is requested to transmit data.

- f) The STE shall send a TxD command to the EUT.
- g) The condition requiring the cessation of emissions shall be removed.
- h) In order to verify that the EUT remains in the "Transmission disabled" ES state, it shall be verified that the EUT remains in the "Emissions disabled" radio state when the EUT is requested to transmit data.

6.8.2.4 Cessation of emission from the "Initial Phase" state

6.8.2.4.1 EUTs transmitting initial bursts

This applies only to EUTs transmitting initial bursts (i.e. where "Initial phase-BurstOn" and "Initial phase-BurstOff" are implemented):

- a) The EUT shall be set in "Initial phase-BurstOn" state.
- b) The STE shall not send the TxE command and the EUT shall be allowed to cycle between "Initial phase-BurstOn" and "Initial phase-BurstOff" as it would under normal operations.
- c) A condition requiring the cessation of emission shall be initiated either by the STE or the EUT.
- d) It shall be verified that the EUT enters the "Emissions disabled" radio state.
- e) In order to verify that the EUT is in the "Initial phase-Standby" ES state, it shall be verified that the EUT remains in the "Emissions disabled" radio state when the EUT is requested to transmit data.
- f) The STE shall send a TxE command to the EUT.
- g) In order to verify that the EUT remains in the "Initial phase-Standby" ES state or enters the "Transmission disabled" ES state, it shall be verified that the EUT remains in the "Emissions disabled" radio state when the EUT is requested to transmit data.
- h) Repeat the test steps a) through g) using a TxD command in step f) instead of the TxE command.

6.8.2.4.2 EUTs not transmitting initial bursts

This applies only to EUTs that do not transmit initial bursts (i.e. where only "Initial phase-Standby" is implemented):

- a) The EUT shall be set in "Initial phase-Standby" ES state.
- b) The STE shall not send the TxE command to maintain the EUT in "Initial phase-Standby" ES state.
- c) A condition requiring the cessation of emission shall be initiated either by the STE or the EUT.
- d) In order to verify that the EUT remains in the "Initial phase-Standby" ES state, it shall be verified that the EUT remains in the "Emissions disabled" radio state when the EUT is requested to transmit data.
- e) The STE shall send a TxE command to the EUT.
- f) In order to verify that the EUT remains in the "Initial phase-Standby" ES state or enters the "Transmission disabled" ES state, it shall be verified that the EUT remains in the "Emissions disabled" radio state when the EUT is requested to transmit data.
- g) Repeat the test steps a) through f) using a TxD command in step e) instead of the TxE command.

6.8.2.5 "Single action" means of cessation of emissions

- a) It shall be verified that there is a "single action" means of ceasing emissions of the EUT (e.g. the switch thrown).
- b) The EUT shall be set in the "Transmission enabled" ES state.
- c) The EUT shall be set in the "Carrier on" radio state.
- d) The "single action" means of cessation of emissions shall be activated.

- e) It shall be verified that the EUT enters the "Emissions disabled" radio state.
- f) In order to verify that the EUT is in the "Transmission disabled" ES state, it shall be verified that the EUT remains in the "Emissions disabled" radio state when the EUT is requested to transmit data.
- g) The STE shall send a TxE command to the EUT.
- h) In order to verify that the EUT remains in the "Transmission disabled" ES state, it shall be verified that the EUT remains in the "Emissions disabled" radio state when the EUT is requested to transmit data.
- i) The EUT shall be switched off and then switched on and the EUT shall enter the "Initial phase" ES state without receiving a TxE from the STE.
- j) The "single action" means of cessation of emissions shall be activated.
- k) The STE shall send a TxE command to the EUT.
- l) In order to verify that the EUT remains in the "Initial phase" ES state or enters the "Transmission disabled" ES state, it shall be verified that the EUT remains in the "Emissions disabled" radio state when the EUT is requested to transmit data.
- m) The EUT shall be switched off and then switched on and the EUT shall enter the "Initial phase" ES state without receiving a TxE from the STE.
- n) The STE shall send a TxD command to the EUT so that it enters the "Transmission disabled" ES state.
- o) The "single action" means of cessation of emissions shall be activated.
- p) The STE shall send a TxE command to the EUT.
- q) In order to verify that the EUT remains in the "Transmission disabled" ES state, it shall be verified that the EUT remains in the "Emissions disabled" radio state when the EUT is requested to transmit data.

6.8.2.6 Fault conditions

The manufacturer shall declare the means of generating the fault conditions prescribed in clauses 4.2.8.2 (processor monitoring) and 4.2.8.3 (transmit subsystem monitoring):

- a) The EUT shall be set in the "Transmission enabled" ES state.
- b) The EUT shall be set in the "Carrier on" radio state.
- c) A fault condition requiring the cessation of emission shall be generated either by the STE or directly on the EUT.
- d) It shall be verified that the EUT enters the "Emissions disabled" radio state as long as the fault condition persists.
- e) Steps a) through d) shall be repeated for each applicable fault condition.

6.9 Control and monitoring functions

6.9.1 General

The manufacturer may modify an ES for the purpose of these tests provided that full documentation is given to prove that the modifications accurately simulate the required test conditions.

The EUT shall transmit at $EIRP_{max}$.

For the purpose of these tests the EUT is the ES either with, or without its antenna connected.

The measurement of the EIRP spectral density shall be limited within either the nominated bandwidth or to a 10 MHz bandwidth centred on the carrier frequency, whichever is the greater.

6.9.2 Test arrangement

The EUT shall be authorized to transmit and shall be in the "Transmission enabled" state at the commencement of each test, unless otherwise stated. The time difference between the command, or failure, and the occurrence of the expected event (e.g. the transmission suppression) shall be measured and recorded.

6.9.3 Processor monitoring- Test method

- a) Each of the processors within the EUT shall, in turn, be caused to fail.
- b) Within 1 second of such failure the EUT shall cease to transmit.
- c) It shall be confirmed that the transmissions have been suppressed within the limits of the "Carrier-off" radio state emission levels.
- d) Within 30 seconds of such failure it shall be confirmed that the transmissions have been suppressed within the limits of the "Emissions disabled" radio state emission levels.
- e) The failed processor shall be restored to normal working condition and the EUT shall restore automatically to normal working before the next processor shall be induced to fail.

6.9.4 Transmit subsystem monitoring-Test method

- a) The frequency generation subsystem within the EUT shall be caused to fail in respect of:
 - loss of frequency lock (if applicable);
 - absence of local oscillator (LO) output signal.
- b) Recognition of each failure in turn by the subsystem monitor shall constitute an SMF event.
- c) Within 1 second of such failure the EUT shall cease to transmit.
- d) It shall be observed that the transmissions have been suppressed within the limits of the "Emissions disabled" radio state emission levels.
- e) The failed elements shall be restored to normal working state and the EUT shall be restored to normal working condition before the next induced failure.

6.9.5 Power-on/Reset-Test method

- a) The EUT shall be switched off and the STE shall not transmit the CC.
- b) The EUT shall be switched on.
- c) The EUT shall not transmit during and after switching-on, and shall enter the "Non valid" state.

If a manual reset function is implemented the following test shall be performed:

- a) The EUT shall be restored to the "Initial phase" state and the STE shall transmit the CC.
- b) The EUT shall remain in the "Initial phase" state.
- c) The reset function shall be initiated.
- d) The EUT shall enter the "Non valid" state.
- e) The EUT shall be restored to the "Initial phase" state and the STE shall transmit the CC as well as a TxE.
- f) The EUT shall enter the "Transmission enabled" state.
- g) The reset function shall be initiated.
- h) The EUT shall enter the "Non valid" state.

6.9.6 Control Channel and Response Channel -Test method

For the purposes of these tests, the period without correct reception of the CC (T1) shall be as specified in clause 4.2.8.5.2.2.

These test procedures require simulation of the following events:

- The CC has never been received by the EUT after power-on.
 - The CC is lost by the EUT after reception of a Transmission Enable command.
 - The CC is lost by the EUT without reception of a Transmission Enable command.
 - The CC is being lost by the EUT and a call is initiated within the period T1.
- a) Case where the CC has never been received by the EUT after power-on:
- a1) the EUT shall be switched off and the STE shall not transmit the CC;
 - a2) the EUT shall be switched on;
 - a3) the EUT shall remain in the "Non valid" state.
- b) Case where the CC is lost by the EUT after reception of a Transmission Enable command:
- b1) the EUT shall be switched-on and the STE shall transmit the CC and a Transmission Enable command;
 - b2) the EUT shall enter the "Initial phase" state and go, if applicable, to the "Transmission enabled" state;
 - b3) a transmission request shall be initiated from the EUT;
 - b4) the STE shall stop transmitting the CC;
 - b5) within the period T1 from event b4), the EUT shall enter the "Non valid" state.
- c) Case where the CC is lost by the EUT without reception of a Transmission Enable command:
- c1) the EUT shall be switched on and the STE shall transmit the CC;
 - c2) the EUT shall enter the "Initial phase" state;
 - c3) the STE shall stop transmitting the CC;
 - c4) the EUT shall enter in the "Non valid" state not later than T1;
 - c5) a transmission request shall be initiated and the EUT shall remain in the "Non valid" state.
- d) Case where the CC is being lost by the EUT and a call is initiated within the T1 period:
- d1) the EUT shall be switched on and the STE shall transmit the CC;
 - d2) the STE shall stop transmitting the CC;
 - d3) within the period T1 from d2), a transmission request shall be initiated from the EUT;
 - d4) the EUT may transmit but within the T1 period the EUT shall enter the "Non valid" state.

6.9.7 Network Control commands-Test method

The tests shall be performed in the following sequence:

- Transmission Enable command.
- Transmission Disable command received in the "Transmission enabled" state.
- Transmission Disable command received in the "Initial phase" state.

- a) Transmission Enable command:
 - a1) the EUT shall be switched-on and the STE shall transmit the CC;
 - a2) the EUT shall enter the "Initial phase" state;
 - a3) a transmission request shall be initiated from the EUT, the EUT shall remain in the "Initial phase" state;
 - a4) the STE shall transmit a transmit enable command to the EUT;
 - a5) a transmission request shall be initiated from the EUT;
 - a6) the EUT shall enter the "Transmission enabled" state and shall transmit.
- b) Transmission Disable command received in the "Transmission enabled" state:
 - b1) continue from a6);
 - b2) the STE shall transmit a disable command to the EUT;
 - b3) the EUT shall enter the "Transmission disabled" state within 1 second;
 - b4) a transmission request shall be initiated from the EUT;
 - b5) the EUT shall remain in the "Transmission disabled" state;
 - b6) the STE shall transmit an enable command;
 - b7) the EUT shall enter either the "Transmission enabled" state or the "Initial phase" state;
 - b8) if the EUT is in the "Transmission enable" state then the test continues with b11);
 - b9) the STE shall transmit a TxE command;
 - b10) the EUT shall enter the "Transmission enable" state;
 - b11) if a transmission request is not active any more than a new transmission request shall be initiated;
 - b12) the EUT shall transmit;
 - b13) the EUT transmission shall be terminated.
- c) Transmission disable command received in the "Initial phase" state:
 - c1) the EUT shall be switched-on and the STE shall transmit the CC;
 - c2) the EUT shall enter the "Initial phase" state;
 - c3) the STE shall transmit a Transmission Disable command to the EUT;
 - c4) the EUT shall enter the "Transmission disabled" state within 1 second;
 - c5) a transmission request shall be initiated from the EUT;
 - c6) the EUT shall remain in the "Transmission disabled" state;
 - c7) the STE shall transmit a Transmission Enable command;
 - c8) the EUT shall enter either the "Transmission enabled" state or the "Initial phase" state;
 - c9) if the EUT is in the "Transmission enable" state then the test continues with c12);
 - c10) the STE shall transmit a TxE command;
 - c11) the EUT shall enter the "Transmission enable" state;
 - c12) if a transmission request is not active any more than a new transmission request shall be initiated;
 - c13) the EUT shall transmit;

c14) the EUT transmission shall be terminated.

6.9.8 Initial burst transmission-Test method

The manufacturer shall declare the initial burst duration.

The following test shall be performed in sequence:

- a) the EUT shall be switched-off and the STE shall transmit the CC;
- b) the EUT shall be switched-on;
- c) the EUT shall not transmit, except the initial bursts;
- d) it shall be verified that the specifications given in clause 4.2.8.7.2 are fulfilled.

6.9.9 Inhibition of transmission-Test method

The manufacturer shall declare the values for IT_{max} and IT_{trans} , as specified in clauses 4.2.6.2.2 and 4.2.8.8.

The receive carrier to the EUT shall be removed:

- a) Within 1 second of such failure the EUT shall cease to transmit.
- b) It shall be observed that the EUT remains in the "Transmission enabled" state and that transmissions have been suppressed within the limits of the "Carrier off" radio state emission levels given in clause 4.2.1.2, table 3.
- c) The receive carrier to the EUT shall be restored within IT_{max} .
- d) It shall be observed that the EUT enters the "Carrier on" radio state and begins transmission within IT_{trans} .
- e) The receive carrier to the EUT shall be removed.
- f) It shall be observed that after IT_{max} the EUT enters the "Initial phase" state.

6.10 Receive antenna off-axis gain pattern

6.10.1 Test method

6.10.1.1 Test site

This test shall be performed either on an outdoor far field test site, on a compact test range, or by the near field scanner technology.

6.10.1.2 Method of measurement

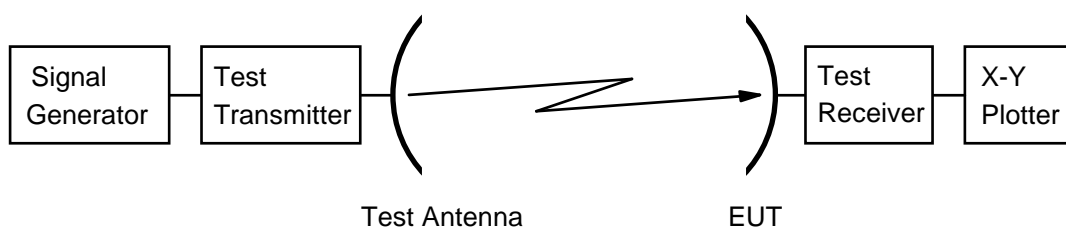

Figure 10: Test arrangement - antenna receive pattern measurement

- a) The test arrangement shall be as shown in figure 10 with the EUT connected to the test receiver.

- b) A signal proportional to the angular position from the servo mechanism shall be applied to the X-axis and the signal level from the test receiver shall be applied to the Y-axis of the plotter.
- c) The test frequencies shall be the centre frequency of each applicable frequency range. The E-plane shall be vertical.
- d) The EUT shall be aligned to maximize the received signal level and the X-Y plotter shall be adjusted to give the maximum reading on the chart.
- e) The EUT shall be driven in azimuth through 180°.
- f) The pattern measurement is then obtained by driving the EUT in azimuth through 360° with the plotter recording the results.
- g) The tests in b) to e) shall be repeated with the frequency changed to the lower limit of the applicable band as declared by the manufacturer.
- h) The tests in b) to e) shall be repeated with the frequency changed to the upper limit of the applicable band as declared by the manufacturer.
- i) The tests in b) to h) shall be repeated with the frequencies changed to the others specified if the design of the equipment is such that operation is possible, but not necessarily simultaneously, in all bands.
- j) The tests in b) to h) shall be repeated with the test signal being transmitted in the H-plane instead of the E-plane.
- k) The tests in b) to h) shall be repeated with the test signal being transmitted in a plane at 45° to the H-plane.
- l) The tests in b) to h) shall be repeated with the test signal being transmitted in a plane at 90° to that in k).
- m) The tests in b) to l) shall be repeated between the angles of φ_r and 7° with the EUT rotated through 90°, or the test antenna or the polarization subsystem of the EUT rotated by 90°, to give the cross-polar measurement.

6.10.1.3 Computation

The computation of results shall be carried out by producing a "mask" to the specified limits with the reference level being equal to the gain of the antenna. This reference shall then be placed on the maximum point of the plot obtained from the pattern measurements.

6.11 Blocking performance

6.11.1 General

The test is performed on the LNB of the ES.

For EUTs where the antenna may be removed, the test signal should be introduced into the LNB input. For integrated EUTs where it is not possible to remove the antenna, a radiated method shall be used.

The requirement gives in Table 6 the minimum rejection for signals in several frequency ranges.

6.11.2 Test method

- a) The output signals of two signal generators shall be combined with equal weight. The combined signal shall be coupled to the LNB input.
- b) A spectrum analyser shall be connected to the LNB output in a way that allows to supply the LNB with power.
- c) f_c is the center frequency of the receive frequency band.
- d) The first signal generator frequency shall be set to f_c .
- e) The first signal generator level shall be set to the center of the LNB input level range.

- f) The spectrum analyser shall be set for measuring the level of the converted first signal at the LNB output. In the following "measured level" refers to this measurement.
- g) The second signal generator frequency shall be set to $f_c - 20$ MHz.
- h) The second signal generator level shall be adjusted so that the measured level (see step f)) is 1 dB lower than in absence of the second signal.
- i) The second signal generator level shall be noted down as reference level.
- j) The second signal generator frequency shall be set to the center of the frequency range of interest.
- k) The second signal generator level shall be adjusted so that the measured level (see step f)) is 1 dB lower than in absence of the second signal.
- l) The second signal generator frequency shall be swept over the frequency range and the measured level (see step f)) shall be observed.
- m) The second signal generator shall be set to the frequency where the measured level in step l) was lowest.
- n) The second signal generator level shall be adjusted so that the measured level (see step f)) is 1 dB lower than in absence of the second signal.
- o) The rejection in the frequency range of interest is equal to the second signal generator level obtained in step n) minus the reference level determined in step i).
- p) Steps j) to o) shall be repeated for all frequency ranges.
- q) If in all frequency ranges the rejection obtained in step o) is less or equal the minimum rejection, then the EUT passes the test.

6.12 Adjacent Signal Selectivity

6.12.1 Test method

- a) Two test signal generators shall be used. Each signal generator shall generate a modulated signal in the IDU input frequency range. One of the signal generators shall generate in addition thermal noise.
- b) The signal generators shall be connected to the IDU input through a splitter (combiner).
- c) The first signal generator signal frequency shall be set to the center of the IDU input frequency range. The signal level shall be set to the center of the IDU input level range.
- d) The second signal generator shall be set to the frequencies and levels of the adjacent signal as defined in the requirement.
- e) The IDU shall be set to receive the signal of the first test signal generator.
- f) The second test signal generator shall be set to signal off.
- g) The noise level (or signal to noise ratio) of the first test signal generator shall be varied in order to determine the signal to noise ratio threshold.
- h) The second signal generator shall be set to signal on.
- i) The noise level (or signal to noise ratio) of the first test signal generator shall be varied in order to determine the signal to noise ratio threshold.
- j) The degradation is equal to the noise level (or signal to noise ratio) determined in step i)) minus that determined in step g)).
- k) The result is the highest degradation found.

NOTE 1: Some IDUs display on the connected screen an indication for the estimated bit error rate, for example as "signal quality" between 0 % and 100 %, with 100 % corresponding to quasi error free. This indication may be used for determining the signal to noise ratio thresholds.

NOTE 2: Figure 11 illustrates the test set-up.

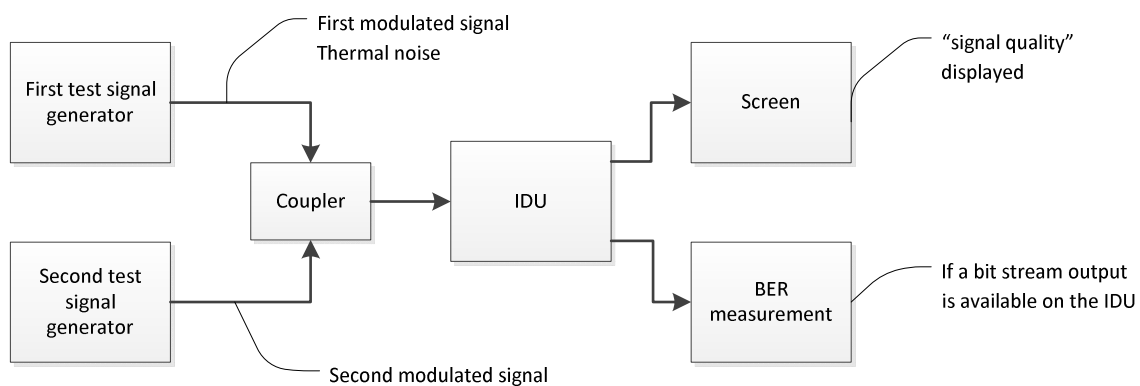

Figure 11: Test set-up for adjacent signal selectivity

Annex A (informative): Relationship between the present document and the essential requirements of Directive 2014/53/EU

The present document has been prepared under the Commission's standardisation request C(2015) 5376 final [i.1] to provide one voluntary means of conforming to the essential requirements of Directive 2014/53/EU on the harmonisation of the laws of the Member States relating to the making available on the market of radio equipment and repealing Directive 1999/5/EC [i.1].

Once the present document is cited in the Official Journal of the European Union under that Directive, compliance with the normative clauses of the present document given in table A.1 confers, within the limits of the scope of the present document, a presumption of conformity with the corresponding essential requirements of that Directive and associated EFTA regulations.

Table A.1: Relationship between the present document and the essential requirements of Directive 2014/53/EU [i.1]

Harmonised Standard ETSI EN 303 699					
Requirement				Requirement Conditionality	
No	Description	Essential requirements of Directive	Clause(s) of the present document	U/C	Condition
1	Off-axis spurious radiation	3.2	4.2.1	U	
2	On-axis spurious radiation	3.2	4.2.2	U	
3	Carrier suppression	3.2	4.2.5	U	
4	Antenna pointing accuracy	3.2	4.2.6	U	
5	Cessation of emissions	3.2	4.2.7	U	
6	Control and monitoring functions (CMFs)	3.2	4.2.8	U	
7	Receive antenna off-axis gain pattern	3.2	4.2.9	U	
8	Blocking performance	3.2	4.2.10	U	
9	Adjacent signal selectivity	3.2	4.2.11	U	

Key to columns:

Requirement:

No A unique identifier for one row of the table which may be used to identify a requirement.

Description A textual reference to the requirement.

Essential requirements of Directive

Identification of article(s) defining the requirement in the Directive.

Clause(s) of the present document

Identification of clause(s) defining the requirement in the present document unless another document is referenced explicitly.

Requirement Conditionality:

U/C Indicates whether the requirement is unconditionally applicable (U) or is conditional upon the manufacturer's claimed functionality of the equipment (C).

Condition Explains the conditions when the requirement is or is not applicable for a requirement which is classified "conditional".

Presumption of conformity stays valid only as long as a reference to the present document is maintained in the list published in the Official Journal of the European Union. Users of the present document should consult frequently the latest list published in the Official Journal of the European Union.

Other Union legislation may be applicable to the product(s) falling within the scope of the present document.

Annex B (informative): Linear Polarization Alignment Error Calculation

The maximum polarization alignment error for linearly polarized systems can be calculated as follows:

$$\alpha_{\max} = \text{ArcTan} \left(\sqrt{\frac{\text{XPD}_{\text{antenna}} - \text{XPD}_{\text{ES}}}{\text{XPD}_{\text{antenna}} \text{XPD}_{\text{ES}} - 1}} \right)$$

where:

- XPD_{ES} is the equivalent cross polarization discrimination (XPD) of the ES, expressed as a ratio, as declared by the manufacturer;
- $\text{XPD}_{\text{antenna}}$ is the antenna XPD at the centre frequency of the transmit band, expressed as a ratio.

NOTE 1: Satellite operators may require specific values for XPD_{ES} and they may also require the ES to stop its transmissions (e.g. to enter the "Carrier-off" radio state) if the value falls below XPD_{ES} .

NOTE 2: The lower bound XPD_{er} of the global XPD of the ES antenna with a receiving antenna is given by the following formula:

$$\text{XPD}_{\text{er}} \geq \frac{1 + \text{XPD}_{\text{ES}} \text{XPD}_{\text{r}} - 2\sqrt{\text{XPD}_{\text{ES}} \text{XPD}_{\text{r}}}}{\text{XPD}_{\text{ES}} + \text{XPD}_{\text{r}} + 2\sqrt{\text{XPD}_{\text{ES}} \text{XPD}_{\text{r}}}} = \left(\frac{1 + \sqrt{\text{XPD}_{\text{ES}} \text{XPD}_{\text{r}}}}{\sqrt{\text{XPD}_{\text{ES}} + \text{XPD}_{\text{r}}}} \right)^2$$

where XPD_{r} is the XPD of the receiving antenna.

Annex C (normative): Radiated measurement

C.1 Test sites and general arrangements for measurements involving the use of radiated fields

C.1.1 General

This annex introduces three most commonly available test sites, an anechoic chamber, an anechoic chamber with a ground plane and an Open Area Test Site (OATS), which may be used for radiated tests. These test sites are generally referred to as free field test sites. Both absolute and relative measurements can be performed in these sites. Where absolute measurements are to be carried out, the chamber should be verified. A detailed verification procedure is described in the relevant parts of ETSI TR 102 273 [i.11] or equivalent.

NOTE: To ensure reproducibility and tractability of radiated measurements only these test sites should be used in measurements in accordance with the present document.

C.1.2 Anechoic Chamber

An anechoic chamber is an enclosure, usually shielded, whose internal walls, floor and ceiling are covered with radio absorbing material, normally of the pyramidal urethane foam type. The chamber usually contains an antenna support at one end and a turntable at the other. A typical anechoic chamber is shown in figure C.1.

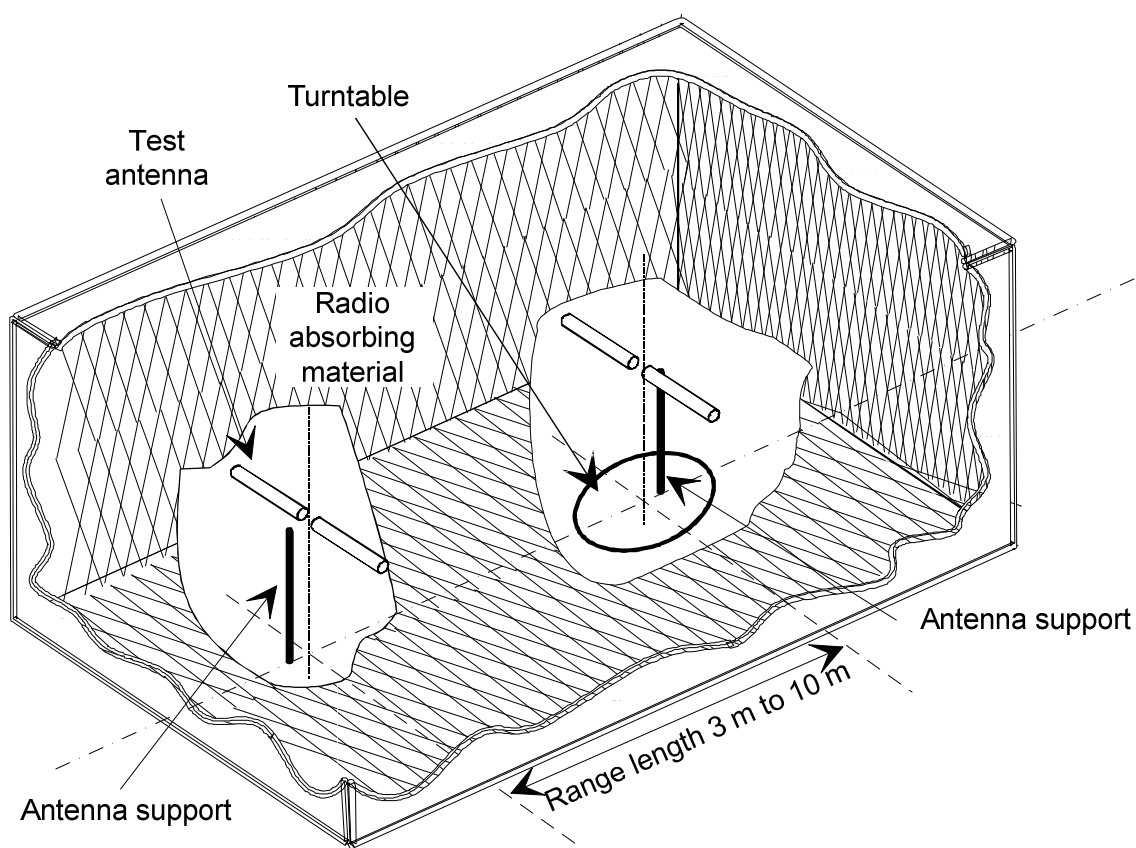

Figure C.1: A typical Anechoic Chamber

The chamber shielding and radio absorbing material work together to provide a controlled environment for testing purposes. This type of test chamber attempts to simulate free space conditions.

The shielding provides a test space, with reduced levels of interference from ambient signals and other outside effects, whilst the radio absorbing material minimizes unwanted reflections from the walls and ceiling which can influence the measurements. In practice it is relatively easy for shielding to provide high levels (80 dB to 140 dB) of ambient interference rejection, normally making ambient interference negligible.

A turntable is capable of rotation through 360° in the horizontal plane and it is used to support the test sample (EUT) at a suitable height (e.g. 1 m) above the ground plane. The chamber shall be large enough to allow the measuring distance of at least 3 m or $2(d_1 + d_2)^2/\lambda$ (m), whichever is greater (see clause C.2.5). For further information on measurements at shorter distances see annex E. The distance used in actual measurements shall be recorded with the test results.

The anechoic chamber generally has several advantages over other test facilities. There is minimal ambient interference, minimal floor, ceiling and wall reflections and it is independent of the weather. It does however have some disadvantages which include limited measuring distance and limited lower frequency usage due to the size of the pyramidal absorbers. To improve low frequency performance, a combination structure of ferrite tiles and urethane foam absorbers is commonly used.

All types of emission, sensitivity and immunity testing can be carried out within an anechoic chamber without limitation.

C.1.3 Anechoic Chamber with a conductive ground plane

An anechoic chamber with a conductive ground plane is an enclosure, usually shielded, whose internal walls and ceiling are covered with radio absorbing material, normally of the pyramidal urethane foam type. The floor, which is metallic, is not covered and forms the ground plane. The chamber usually contains an antenna mast at one end and a turntable at the other. A typical anechoic chamber with a conductive ground plane is shown in figure C.2.

This type of test chamber attempts to simulate an ideal Open Area Test Site whose primary characteristic is a perfectly conducting ground plane of infinite extent.

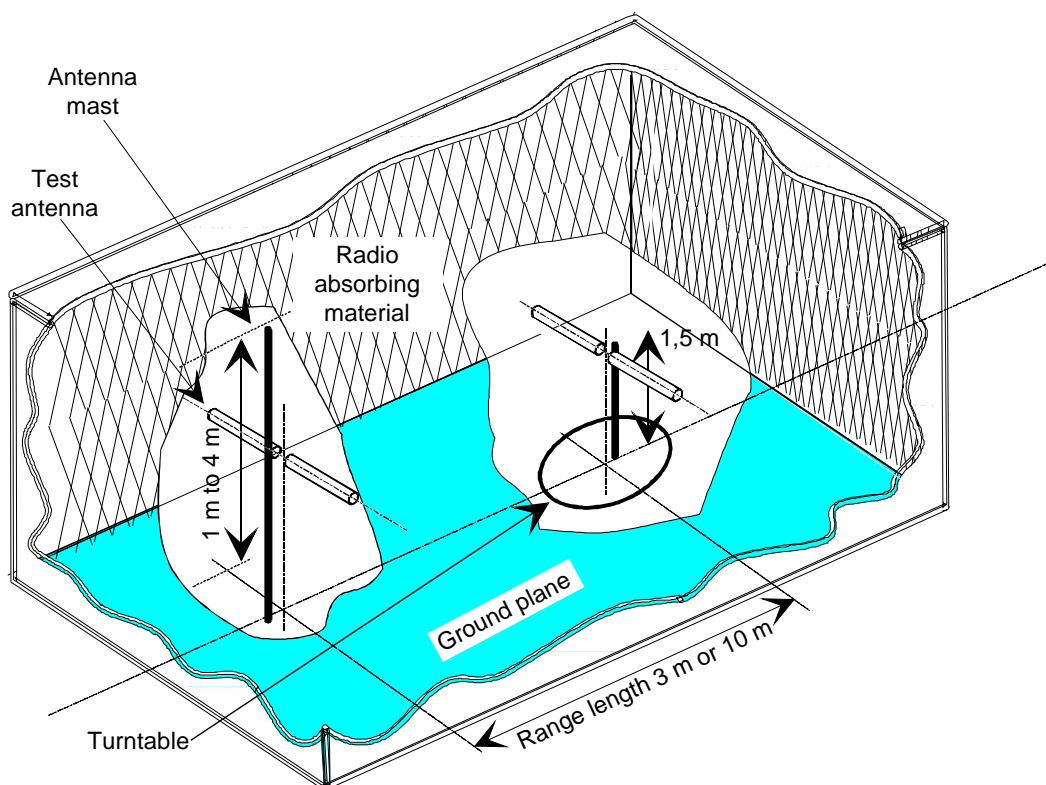

Figure C.2: A typical Anechoic Chamber with a conductive ground plane

In this facility the ground plane creates the wanted reflection path, such that the signal received by the receiving antenna is the sum of the signals from both the direct and reflected transmission paths. This creates a unique received signal level for each height of the transmitting antenna (or EUT) and the receiving antenna above the ground plane.

The antenna mast provides a variable height facility (from 1 m to 4 m) so that the position of the test antenna can be optimized for maximum coupled signal between antennas or between an EUT and the test antenna.

A turntable is capable of rotation through 360° in the horizontal plane and it is used to support the test sample (EUT) at a specified height, usually 1,5 m above the ground plane. The chamber shall be large enough to allow the measuring distance of at least 3 m or $2(d_1 + d_2)^2/\lambda$ (m), whichever is greater (see clause C.2.5). For further information on measurements at shorter distances see annex E. The distance used in actual measurements shall be recorded with the test results.

Emission testing involves firstly "peaking" the field strength from the EUT by raising and lowering the receiving antenna on the mast (to obtain the maximum constructive interference of the direct and reflected signals from the EUT) and then rotating the turntable for a "peak" in the azimuth plane. At this height of the test antenna on the mast, the amplitude of the received signal is noted. Secondly the EUT is replaced by a substitution antenna (positioned at the EUT's phase or volume centre) which is connected to a signal generator. The signal is again "peaked" and the signal generator output adjusted until the level, noted in stage one, is again measured on the receiving device.

Receiver sensitivity tests over a ground plane also involve "peaking" the field strength by raising and lowering the test antenna on the mast to obtain the maximum constructive interference of the direct and reflected signals, this time using a measuring antenna which has been positioned where the phase or volume centre of the EUT will be during testing. A transform factor is derived. The test antenna remains at the same height for stage two, during which the measuring antenna is replaced by the EUT. The amplitude of the transmitted signal is reduced to determine the field strength level at which a specified response is obtained from the EUT.

C.1.4 Open Area Test Site (OATS)

An Open Area Test Site comprises a turntable at one end and an antenna mast of variable height at the other end above a ground plane, which in the ideal case, is perfectly conducting and of infinite extent. In practice, whilst good conductivity can be achieved, the ground plane size has to be limited. A typical OATS is shown in figure C.3.

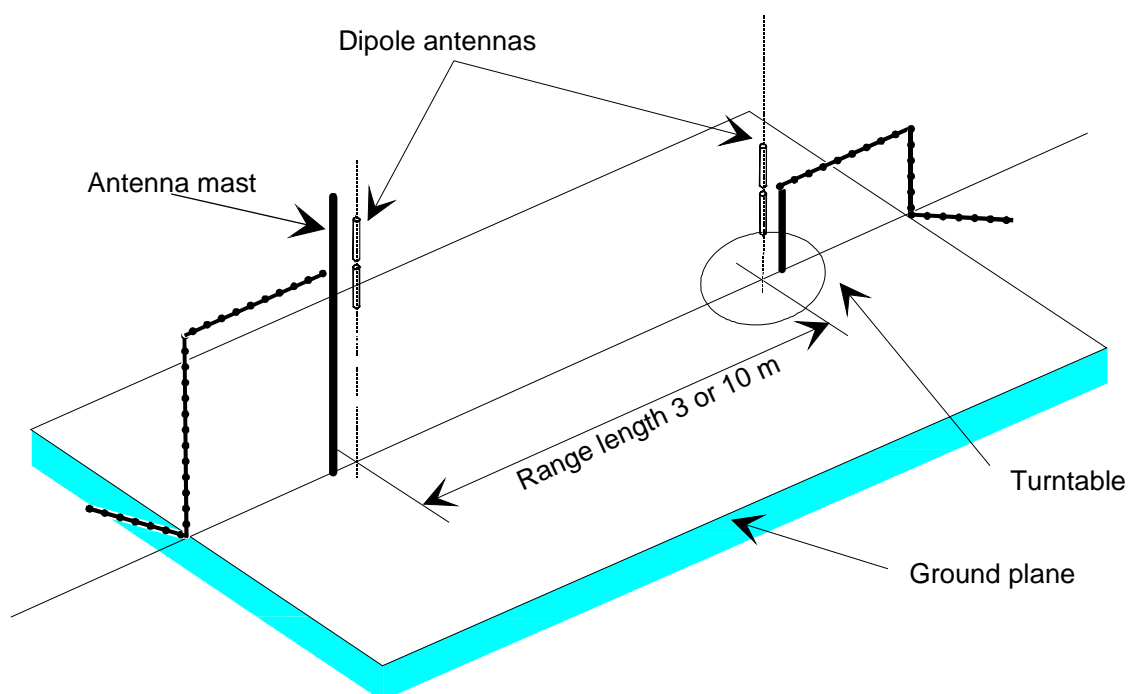

Figure C.3: A typical Open Area Test Site

The ground plane creates a wanted reflection path, such that the signal received by the receiving antenna is the sum of the signals received from the direct and reflected transmission paths. The phasing of these two signals creates a unique received level for each height of the transmitting antenna (or EUT) and the receiving antenna above the ground plane.

Site qualification concerning antenna positions, turntable, measurement distance and other arrangements are same as for anechoic chamber with a ground plane. In radiated measurements an OATS is also used by the same way as anechoic chamber with a ground plane.

Typical measuring arrangement common for ground plane test sites is presented in the figure C.4.

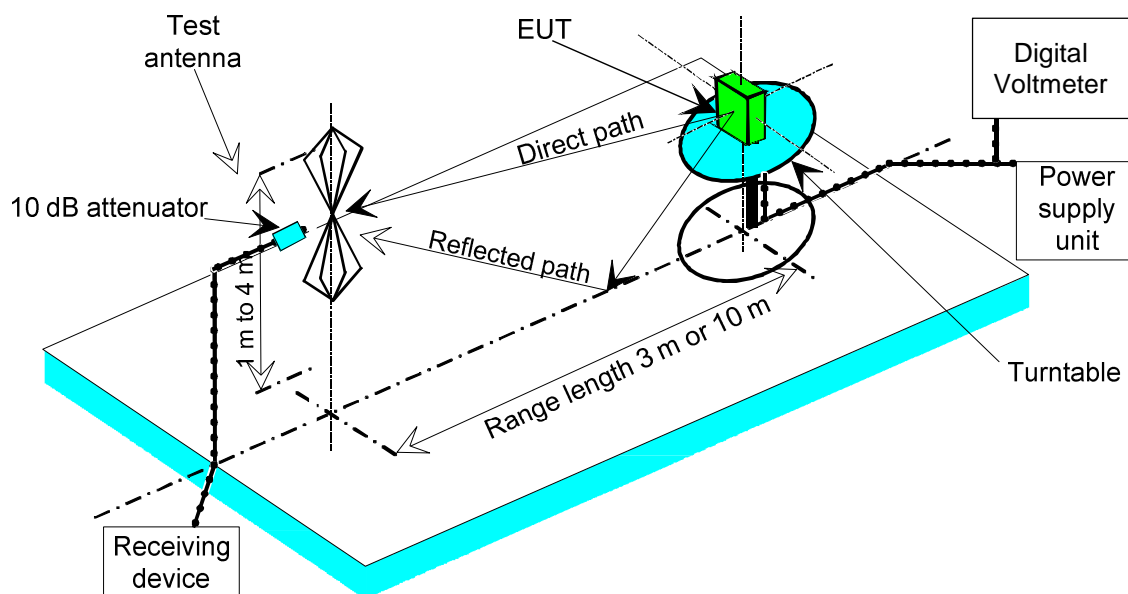

Figure C.4: Measuring arrangement on ground plane test site (OATS set-up for spurious emission testing)

C.1.5 Minimum requirements for test sites for measurements above 18 GHz

Generally the test site shall be adequate to allow for testing in the far field of the EUT. The test site should therefore consist of an electromagnetic anechoic room where either at least the ground surface is covered with radio absorbing material or up to six surrounding surfaces are covered with radio absorbing material. The absorbing material shall have a minimum attenuation of 30 dB. It shall be verified that reflections are sufficiently reduced.

C.1.6 Test antenna

A test antenna is always used in radiated test methods. In emission tests (i.e. frequency error, effective radiated power, spurious emissions and adjacent channel power) the test antenna is used to detect the field from the EUT in one stage of the measurement and from the substitution antenna in the other stage. When the test site is used for the measurement of receiver characteristics (i.e. sensitivity and various immunity parameters) the antenna is used as the transmitting device.

The test antenna should be mounted on a support capable of allowing the antenna to be used in either horizontal or vertical polarization which, on ground plane sites (i.e. anechoic chambers with ground planes and Open Area Test Sites), should additionally allow the height of its centre above the ground to be varied over the specified range (usually 1 metre to 4 metres).

In the frequency band 30 MHz to 1 000 MHz, dipole antennas (constructed in accordance with ANSI C63.5 [1]) are generally recommended. For frequencies of 80 MHz and above, the dipoles should have their arm lengths set for resonance at the frequency of test. Below 80 MHz, shortened arm lengths are recommended. A combination of bicones and log periodic dipole array antennas (commonly termed "log periodics") could be used to cover the entire 30 MHz to 1 000 MHz band. Above 1 000 MHz, waveguide horns are recommended although, again, log periodics could be used.

NOTE: The gain of a horn antenna is generally expressed relative to an isotropic radiator.

C.1.7 Substitution antenna

The substitution antenna is used to replace the EUT for tests in which a transmitting parameter (i.e. frequency error, effective radiated power, spurious emissions and adjacent channel power) is being measured. For measurements in the frequency band 30 MHz to 1 000 MHz, the substitution antenna should be a dipole antenna (constructed in accordance with ANSI C63.5 [1]). For frequencies of 80 MHz and above, the dipoles should have their arm lengths set for resonance at the frequency of test. Below 80 MHz, shortened arm lengths are recommended. For measurements above 1 000 MHz, a waveguide horn is recommended. The centre of this antenna should coincide with either the phase centre or volume centre.

C.1.8 Measuring antenna

The measuring antenna is used in tests on an EUT in which a receiving parameter (i.e. sensitivity and various immunity tests) is being measured. Its purpose is to enable a measurement of the electric field strength in the vicinity of the EUT. For measurements in the frequency band 30 MHz to 1 000 MHz, the measuring antenna should be a dipole antenna (constructed in accordance with ANSI C63.5 [1]). For frequencies of 80 MHz and above, the dipoles should have their arm lengths set for resonance at the frequency of test. Below 80 MHz, shortened arm lengths are recommended. The centre of this antenna should coincide with either the phase centre or volume centre (as specified in the test method) of the EUT.

C.2 Guidance on the use of radiation test sites

C.2.1 General

This clause details procedures, test equipment arrangements and verification that should be carried out before any of the radiated test are undertaken. These schemes are common to all types of test sites described in annex C.

C.2.2 Verification of the test site

No test should be carried out on a test site, which does not possess a valid certificate of verification. The verification procedures for the different types of test sites described in annex A (i.e. anechoic chamber, anechoic chamber with a ground plane and Open Area Test Site) are given in the relevant parts of ETSI TR 102 273 [i.11] or equivalent.

C.2.3 Preparation of the EUT

The manufacturer should supply information about the EUT covering the operating frequency, polarization, supply voltage(s) and the reference face. Additional information, specific to the type of EUT should include, where relevant, output power, whether different operating modes are available (e.g. high and low power modes) and if operation is continuous or is subject to a maximum test duty cycle (e.g. 1 minute on, 4 minutes off).

Where necessary, a mounting bracket of minimal size should be available for mounting the EUT on the turntable. This bracket should be made from low conductivity, low relative dielectric constant (i.e. less than 1,5) material(s) such as expanded polystyrene, balsa wood, etc.

C.2.4 Power supplies to the EUT

All tests should be performed using power supplies wherever possible, including tests on EUT designed for battery-only use. In all cases, power leads should be connected to the EUT's supply terminals (and monitored with a digital voltmeter) but the battery should remain present, electrically isolated from the rest of the equipment, possibly by putting tape over its contacts.

The presence of these power cables can, however, affect the measured performance of the EUT. For this reason, they should be made to be "transparent" as far as the testing is concerned. This can be achieved by routing them away from the EUT and down to either the screen, ground plane or facility wall (as appropriate) by the shortest possible paths. Precautions should be taken to minimize pick-up on these leads (e.g. the leads could be twisted together, loaded with ferrite beads at 0,15 m spacing or otherwise loaded).

C.2.5 Range length

The range length for all these types of test facility should be adequate to allow for testing in the far-field of the EUT i.e. it should be equal to or exceed:

$$\frac{2(d_1 + d_2)^2}{\lambda}$$

where:

d_1 is the largest dimension of the EUT/dipole after substitution (m);

d_2 is the largest dimension of the test antenna (m);

λ is the test frequency wavelength (m).

It should be noted that in the substitution part of this measurement, where both test and substitution antennas are half wavelength dipoles, this minimum range length for far-field testing would be:

$$2\lambda$$

It should be noted in the test report when either of these conditions is not met so that the additional measurement uncertainty can be incorporated into the results.

For further information on measurements at shorter distances see annex E.

NOTE 1: For the fully anechoic chamber, no part of the volume of the EUT should, at any angle of rotation of the turntable, fall outside the "quiet zone" of the chamber at the nominal frequency of the test.

NOTE 2: The "quiet zone" is a volume within the anechoic chamber (without a ground plane) in which a specified performance has either been proven by test, or is guaranteed by the designer/manufacture. The specified performance is usually the reflectivity of the absorbing panels or a directly related parameter (e.g. signal uniformity in amplitude and phase). It should be noted however that the defining levels of the quiet zone tend to vary.

NOTE 3: For the anechoic chamber with a ground plane, a full height scanning capability, i.e. 1 m to 4 m, should be available for which no part of the test antenna should come within 1 m of the absorbing panels. For both types of Anechoic Chamber, the reflectivity of the absorbing panels should not be worse than -5 dB.

NOTE 4: For both the anechoic chamber with a ground plane and the Open Area Test Site, no part of any antenna should come within 0,25 m of the ground plane at any time throughout the tests. Where any of these conditions cannot be met, measurements should not be carried out.

C.2.6 Site preparation

The cables for both ends of the test site should be routed horizontally away from the testing area for a minimum of 2 m (unless, in the case either type of anechoic chamber, a back wall is reached) and then allowed to drop vertically and out through either the ground plane or screen (as appropriate) to the test equipment. Precautions should be taken to minimize pick up on these leads (e.g. dressing with ferrite beads or other loading). The cables, their routing and dressing should be identical to the verification set-up.

NOTE: For ground reflection test sites (i.e. anechoic chambers with ground planes and Open Area Test Sites) which incorporate a cable drum with the antenna mast, the 2 m requirement may be impossible to comply with.

Calibration data for all items of test equipment should be available and valid. For test, substitution and measuring antennas, the data should include gain relative to an isotropic radiator (or antenna factor) for the frequency of test. Also, the VSWR of the substitution and measuring antennas should be known.

The calibration data on all cables and attenuators should include insertion loss and VSWR throughout the entire frequency range of the tests. All VSWR and insertion loss figures should be recorded in the log book results sheet for the specific test.

Where correction factors/tables are required, these should be immediately available.

For all items of test equipment, the maximum errors they exhibit should be known along with the distribution of the error e.g.:

- cable loss: $\pm 0,5$ dB with a rectangular distribution;
- measuring receiver: 1,0 dB (standard deviation) signal level accuracy with a Gaussian error distribution.

At the start of measurements, system checks should be made on the items of test equipment used on the test site.

C.3 Coupling of signals

C.3.1 General

The presence of leads in the radiated field may cause a disturbance of that field and lead to additional measurement uncertainty. These disturbances can be minimized by using suitable coupling methods, offering signal isolation and minimum field disturbance (e.g. optical and acoustic coupling).

C.4 Standard test methods

C.4.1 General

Two methods of determining the radiated power of a device are described in clauses C.4.2 and C.4.3.

C.4.2 Calibrated setup

The measurement receiver, test antenna and all associated equipment (e.g. cables, filters, amplifiers, etc.) shall have been recently calibrated against known standards at all the frequencies on which measurements of the equipment are to be made.

On a test site according to clause C.1, the equipment shall be placed at the specified height on a support, and in the position closest to normal use as declared by the manufacturer.

The test antenna shall be oriented initially for vertical polarization and shall be chosen to correspond to the frequency of the transmitter.

The output of the test antenna shall be connected to the spectrum analyser via whatever (fully characterized) equipment is required to render the signal measurable (e.g. amplifiers).

The transmitter shall be switched on, if possible without modulation, and the spectrum analyser shall be tuned to the frequency of the transmitter under test.

The test antenna shall be raised and lowered through the specified range of height until a maximum signal level is detected by the spectrum analyser.

The transmitter shall then be rotated through 360° in the horizontal plane, until the maximum signal level is detected by the spectrum analyser.

The test antenna shall be raised and lowered again through the specified range of height until a maximum signal level is detected by the spectrum analyser.

The maximum signal level detected by the spectrum analyser shall be noted and converted into the radiated power by application of the pre-determined calibration coefficients for the equipment configuration used.

C.4.3 Substitution method

On a test site, selected from clause C.1, the equipment shall be placed at the specified height on a support, as specified in clause C.1, and in the position closest to normal use as declared by the manufacturer.

The test antenna shall be oriented initially for vertical polarization and shall be chosen to correspond to the frequency of the transmitter.

The output of the test antenna shall be connected to the spectrum analyser.

The transmitter shall be switched on, if possible without modulation, and the measuring receiver shall be tuned to the frequency of the transmitter under test.

The test antenna shall be raised and lowered through the specified range of height until a maximum signal level is detected by the spectrum analyser.

The transmitter shall then be rotated through 360° in the horizontal plane, until the maximum signal level is detected by the spectrum analyser.

The test antenna shall be raised and lowered again through the specified range of height until a maximum signal level is detected by the spectrum analyser.

The maximum signal level detected by the spectrum analyser shall be noted.

The transmitter shall be replaced by a substitution antenna as defined in clause C.1.6.

The substitution antenna shall be orientated for vertical polarization and the length of the substitution antenna shall be adjusted to correspond to the frequency of the transmitter.

The substitution antenna shall be connected to a calibrated signal generator.

If necessary, the input attenuator setting of the spectrum analyser shall be adjusted in order to increase the sensitivity of the spectrum analyser.

The test antenna shall be raised and lowered through the specified range of height to ensure that the maximum signal is received. When a test site according clause C.1.1 is used, the height of the antenna shall not be varied.

The input signal to the substitution antenna shall be adjusted to the level that produces a level detected by the spectrum analyser, that is equal to the level noted while the transmitter radiated power was measured, corrected for the change of input attenuator setting of the spectrum analyser.

The input level to the substitution antenna shall be recorded as power level, corrected for any change of input attenuator setting of the spectrum analyser.

The measurement shall be repeated with the test antenna and the substitution antenna orientated for horizontal polarization.

The measure of the radiated power of the device is the larger of the two levels recorded at the input to the substitution antenna, corrected for gain of the substitution antenna if necessary.

Annex D (normative): Conducted measurements

In view of the low power levels of the equipment to be tested under the present document, conducted measurements may be applied to equipment provided with an antenna connector. Where the equipment to be tested does not provide a suitable termination, a coupler or attenuator that does provide the correct termination value shall be used.

The equivalent isotropically radiated power is then calculated from the measured value, the known antenna gain, relative to an isotropic antenna, and if applicable, any losses due to cables and connectors in the measurement system.

The Voltage Standing Wave Ratio (VSWR) shall not be greater than 1,5: 1 over the frequency range of the measurement.

Annex E (informative): General Requirements for RF Cables

All RF cables including their connectors at both ends used within the measurement arrangements and set-ups should be of coaxial or waveguide type featuring within the frequency range they are used:

- a VSWR of less than 1,2 at either end;
- a shielding loss in excess of 60 dB.

When using coaxial cables for frequencies above 40 GHz attenuation features increase significantly and decrease of return loss due to mismatching caused by joints at RF connectors and impedance errors should be considered.

All RF cables and waveguide interconnects should be routed suitably in order to reduce impacts on antenna radiation pattern, antenna gain, antenna impedance. Table E.1 provides some information about connector systems that can be used in connection with the cables.

Table E.1: Connector systems

Connector System	Frequency	Recommended coupling torque
N	18 GHz	0,68 Nm to 1,13 Nm
SMA	18 GHz (some up to 26 GHz)	~ 0,56 Nm
3,50 mm	26,5 GHz	0,8 Nm to 1,1 Nm
2,92 mm	40 GHz (some up to 46 GHz)	0,8 Nm to 1,1 Nm
2,40 mm	50 GHz (some up to 60 GHz)	0,8 Nm to 1,1 Nm
1,85 mm	65 GHz (some up to 75 GHz)	0,8 Nm to 1,1 Nm

Annex F (informative): RF Waveguides

Wired signal transmission in the millimetre range is preferably realized by means of waveguides because they offer low attenuation and high reproducibility. Unlike coaxial cables, the frequency range in which waveguides can be used is limited also towards lower frequencies (highpass filter characteristics). Wave propagation in the waveguide is not possible below a certain cutoff frequency where attenuation of the waveguide is very high. Beyond a certain upper frequency limit, several wave propagation modes are possible so that the behaviour of the waveguide is no longer unambiguous. In the unambiguous range of a rectangular waveguide, only H10 waves are capable of propagation.

The dimensions of rectangular and circular waveguides are defined by international standards such as IEC 60153 [i.7] for various frequency ranges. These frequency ranges are also referred to as waveguide bands. They are designated using different capital letters depending on the standard. Table F.1 provides an overview of the different waveguide bands together with the designations of the associated waveguides and flanges.

For rectangular waveguides, which are mostly used in measurements, harmonic mixers with matching flanges are available for extending the frequency coverage of measuring receivers. Table F.1 provides some information on waveguides.

Table F.1: Waveguide bands and associated waveguides

Band	Frequency	Designations				Internal dimensions of waveguide		Designations of frequently used flanges		
		MIL-W-85	EIA	153-IEC	RCSC (British)	in mm	in inches	MIL-F-3922	UG-XXX/U equivalent (reference)	Remarks
Ka	26,5 to 40,0	3-006	WR-28	R320	WG-22	7,11 x 3,56	0,280 x 0,140	54-006 68-002 67B-005	UG-559/U - UG-381/U	Rectangular Rectangular Round
Q	33,0 to 55,0	3-010	WR-22	R400	WG-23	5,69 x 2,84	0,224 x 0,112	67B-006	UG-383/U	Round
U	40,0 to 60,0	3-014	WR-19	R500	WG-24	4,78 x 2,388	0,188 x 0,094	67B-007	UG-383/U-M	Round
V	50,0 to 75,0	3-017	WR-15	R620	WG-25	3,759 x 1,879	0,148 x 0,074	67B-008	UG-385/U	Round
E	60,0 to 90,0	3-020	WR-12	R740	WG-26	3,099 x 1,549	0,122 x 0,061	67B-009	UG-387/U	Round

As waveguides are rigid, it is impractical to set up connections between antenna and measuring receiver with waveguides. Either a waveguide transition to coaxial cable is used or - at higher frequencies - the harmonic mixer is used for frequency extension of the measuring receiver and is directly mounted at the antenna.

Annex G (informative): Applicability of parameters given in ETSI EG 203 336

ETSI EG 203 336 [i.10] gives guidance on the selection of technical parameters for the production of Harmonised Standards covering articles 3.1(b) and 3.2 of the Radio Equipment Directive [i.1]. Clause 5.3 of ETSI EG 203 336 [i.10] gives receiver parameters under article 3.2 that should be contained in a Harmonised Standard.

Table E.1 explains how these parameters are considered in the present document.

Table G.1: Parameters given in ETSI EG 203 336 [i.10]

ETSI EG 203 336 [i.10]		Present document		Explanation																		
Clause	Parameter	Clause	Parameter																			
5.3.2	Receiver sensitivity	-	-	There is no causal relationship between receiver sensitivity and interference in the case of satellite communications. Therefore, a quantitative calculation is not possible.																		
5.3.3	Receiver co-channel rejection	4.2.9	Receive antenna off-axis gain pattern	Co-channel signals transmitted by other satellite networks are rejected by means of low off-axis antenna gain.																		
5.3.4.2.1	Single signal selectivity - receiver adjacent signal selectivity	4.2.11	Adjacent signal selectivity																			
5.3.4.2.2	Receiver spurious response rejection	4.2.12	Image frequency rejection	Frequencies other than the image frequency are not relevant because this is covered by receiver blocking and adjacent channel requirements which are already included in the receiver parameters.																		
5.3.4.3.1	Receiver blocking	4.2.10	Blocking performance																			
5.3.4.3.2	Receiver radio-frequency intermodulation	-	-	<p>In an FSS network, receiver radio-frequency intermodulation is not relevant, because possibly inter-modulating signals originating from other networks are rejected thanks to requirements on <i>receive antenna off-axis gain pattern</i> and <i>adjacent signal selectivity</i>. Interfering signals up to 28 dB above the wanted carrier can be tolerated with minimal impact on performance. See calculation below:</p> <table border="1" data-bbox="911 1368 1441 1809"> <tbody> <tr> <td>Co-polar antenna discrimination*:</td> <td>at 3°</td> <td>-7,5 dB</td> </tr> <tr> <td></td> <td>at 5°</td> <td>-21,0 dB</td> </tr> <tr> <td>Adjacent channel selectivity:</td> <td></td> <td></td> </tr> <tr> <td>Relative power tolerated in adjacent channel for 0,4 dB degradation in signal to noise ratio threshold.</td> <td></td> <td>+7,0 dB</td> </tr> <tr> <td>Relative power (arriving at antenna from 3° off-axis)</td> <td></td> <td>+14,5 dB</td> </tr> <tr> <td>Relative power (arriving at antenna from 5° off-axis)</td> <td></td> <td>+28,0 dB</td> </tr> </tbody> </table> <p>Concerning signals originating from the own network, the network operator has control over levels and can prevent intermodulation.</p>	Co-polar antenna discrimination*:	at 3°	-7,5 dB		at 5°	-21,0 dB	Adjacent channel selectivity:			Relative power tolerated in adjacent channel for 0,4 dB degradation in signal to noise ratio threshold.		+7,0 dB	Relative power (arriving at antenna from 3° off-axis)		+14,5 dB	Relative power (arriving at antenna from 5° off-axis)		+28,0 dB
Co-polar antenna discrimination*:	at 3°	-7,5 dB																				
	at 5°	-21,0 dB																				
Adjacent channel selectivity:																						
Relative power tolerated in adjacent channel for 0,4 dB degradation in signal to noise ratio threshold.		+7,0 dB																				
Relative power (arriving at antenna from 3° off-axis)		+14,5 dB																				
Relative power (arriving at antenna from 5° off-axis)		+28,0 dB																				

ETSI EG 203 336 [i.10]		Present document		Explanation
Clause	Parameter	Clause	Parameter	
5.3.4.3.3	Receiver multiple signal selectivity - receiver adjacent signal selectivity	4.2.11	Adjacent signal selectivity	
5.3.4.4.1	Receiver dynamic range	-	-	In an FSS network, receiver dynamic range has no influence on harmful interference. The satellite earth stations are deployed in a manner that results in a situation where it is impossible to receive a wanted signal that is high enough to produce any overloading effect (satellite systems are power limited). So that it is not necessary to specify receiver dynamic range. See clause 5.3.6.1 of ETSI EG 203 336 [i.10].
5.3.4.4.2	Reciprocal mixing	-	-	For FSS equipment, the parameter is excluded for the following reason. It is considered that the reciprocal mixing effects are implicitly covered in HSs where comprehensive interference characteristics are specified in terms of selectivity and/or blocking requirements, thus removing the need for this parameter to be included in HSs as the effects of receiver selectivity and reciprocal mixing cannot be separated. See clause 5.3.6.2 of ETSI EG 203 336 [i.10].
5.3.4.4.3	Desensitization	-	-	As desensitization is a receiver effect addressed by other parameters (including receiver blocking), its inclusion as a separate parameter in an HS is not required. See clause 5.3.2.3 of ETSI EG 203 336 [i.10].
5.3.5	Receiver unwanted emissions in the spurious domain	4.2.1	Off-axis spurious radiation	
		4.2.2	On-axis spurious radiation	

Annex H (informative): Maximum Measurement Uncertainty

The measurements described in the present document are based on the following assumptions:

- the measured value related to the corresponding limit is used to decide whether an equipment meets the requirements of the present document;
- the value of the measurement uncertainty for the measurement of each parameter is included in the test report;

Table H.1 shows the recommended values for the maximum measurement uncertainty figures.

Table H.1: Maximum measurement uncertainty

Parameter	Uncertainty
Radio frequency	$\pm 1 \times 10^{-7}$
Radiated RF power (up to 40 GHz)	± 6 dB
Radiated RF power (above 40 GHz)	± 8 dB
Conducted Measurements (up to 18GHz)	$\pm 1,5$ dB
Conducted Measurements (up to 40 GHz)	$\pm 2,5$ dB
Conducted Measurements (above 40 GHz)	± 4 dB
Temperature	± 1 °C
Humidity	± 5 %
DC and low frequency voltages	± 3 %

Annex I (informative): Bibliography

- Council Directive 73/23/EEC of 19 February 1973 on the harmonization of the laws of Member States relating to Electrical Equipment designed for use within certain voltage limits (LV Directive).
- Council Directive 89/336/EEC of 3 May 1989 on the approximation of the laws of the Member States relating to electromagnetic compatibility (EMC Directive).
- Directive 2004/40/EC of the European Parliament and of the Council of 29 April 2004 on the minimum health and safety requirements regarding the exposure of workers to the risks arising from physical agents (electromagnetic fields) (18th individual Directive within the meaning of Article 16(1) of Directive 89/391/EEC).
- ETSI ETR 169 (1995): "Satellite Earth Stations and Systems (SES); Common Technical Regulations (CTRs) in the satellite earth station equipment field".
- CENELEC BS EN 60068: "Environmental testing. Test methods for vibration and shock".
- CENELEC EN 55022: "Limits and methods of measurement of radio disturbance characteristics of information technology equipment".
- SAE J1211: "Recommended Environmental Practices for Electronic Equipment Design, Recommended Practice".
- CEPT/ERC/Recommendation 74-01: "Unwanted emissions in the spurious domain".
- CENELEC EN 60529 (1991): "Degrees of protection provided by enclosures (IP code)".
- CENELEC EN 60068-2-6 (2008): "Environmental testing - Part 2-6: Test - Test Fc: Vibration (sinusoidal)".
- CENELEC EN 60068-2-11 (1999): "Environmental testing - Part 2-11: Tests - Test KA: Salt mist".
- CENELEC EN 60068-2-27 (2007): "Environmental testing - Part 2-27: Tests - Test Ea and guidance: Shock".
- Directive 1999/5/EC of the European Parliament and of the Council of 9 March 1999 on radio equipment and telecommunications terminal equipment and the mutual recognition of their conformity (R&TTE Directive).

Annex J (informative): Change history

Version	Information about changes
0.2.1	Version submitted for 1 st HAS assessment
0.2.5	Comments made by HAS consultant are taken into account
0.2.6	Include both clean and revision marked version
0.2.7	Version submitted for 2 nd HAS assessment
0.2.8	Comments made by HAS consultant are taken into account

History

Document history			
V1.1.0	October 2020	EN Approval Procedure	AP 20210107: 2020-10-09 to 2021-01-07