



**Short Range Devices;  
Measurement Techniques for Automotive  
and Surveillance Radar Equipment**

---

Reference

DEN/ERM-TGSRR-77

---

Keywords

measurement uncertainty, power measurement,  
radio measurements

**ETSI**

650 Route des Lucioles  
F-06921 Sophia Antipolis Cedex - FRANCE

Tel.: +33 4 92 94 42 00 Fax: +33 4 93 65 47 16

Siret N° 348 623 562 00017 - NAF 742 C  
Association à but non lucratif enregistrée à la  
Sous-Préfecture de Grasse (06) N° 7803/88

---

**Important notice**

The present document can be downloaded from:  
<http://www.etsi.org/standards-search>

The present document may be made available in electronic versions and/or in print. The content of any electronic and/or print versions of the present document shall not be modified without the prior written authorization of ETSI. In case of any existing or perceived difference in contents between such versions and/or in print, the only prevailing document is the print of the Portable Document Format (PDF) version kept on a specific network drive within ETSI Secretariat.

Users of the present document should be aware that the document may be subject to revision or change of status. Information on the current status of this and other ETSI documents is available at  
<https://portal.etsi.org/TB/ETSIDeliverableStatus.aspx>

If you find errors in the present document, please send your comment to one of the following services:  
<https://portal.etsi.org/People/CommitteeSupportStaff.aspx>

---

**Copyright Notification**

No part may be reproduced or utilized in any form or by any means, electronic or mechanical, including photocopying and microfilm except as authorized by written permission of ETSI.

The content of the PDF version shall not be modified without the written authorization of ETSI.  
The copyright and the foregoing restriction extend to reproduction in all media.

© European Telecommunications Standards Institute 2016.  
All rights reserved.

**DECT™**, **PLUGTESTS™**, **UMTS™** and the ETSI logo are Trade Marks of ETSI registered for the benefit of its Members.  
**3GPP™** and **LTE™** are Trade Marks of ETSI registered for the benefit of its Members and of the 3GPP Organizational Partners.  
**GSM®** and the GSM logo are Trade Marks registered and owned by the GSM Association.

# Contents

Intellectual Property Rights .....	6
Foreword.....	6
Modal verbs terminology.....	6
Introduction .....	6
1 Scope .....	8
2 References .....	8
2.1 Normative references .....	8
2.2 Informative references.....	8
3 Definitions, symbols and abbreviations .....	9
3.1 Definitions .....	9
3.2 Symbols.....	11
3.3 Abbreviations .....	12
4 General Considerations for performing the tests.....	13
4.1 Overview .....	13
4.2 Product information.....	13
4.3 Requirements for the EUT.....	13
4.3.1 EUT version and configuration.....	13
4.3.2 Presentation.....	14
4.3.3 Multiple operating bandwidths .....	14
4.3.4 Requirement on the modulation during testing.....	14
4.3.5 Requirements in case of EUT with scanning antennas .....	14
4.3.5.1 Classification.....	14
4.3.5.2 Measurement of fixed beam EUT .....	14
4.3.5.3 Measurement of constant pattern EUT.....	14
4.3.5.4 Measurement of variable pattern EUT .....	15
4.4 Test conditions .....	15
4.4.1 Introduction.....	15
4.4.2 Power sources .....	15
4.4.3 Normal test conditions .....	15
4.4.3.1 Normal temperature and humidity .....	15
4.4.3.2 Normal power source .....	15
4.4.3.2.1 Mains voltage .....	15
4.4.3.2.2 Lead-acid battery power sources used on vehicles .....	15
4.4.3.2.3 Other power sources .....	16
4.4.4 Extreme test conditions.....	16
4.4.4.1 Extreme temperatures.....	16
4.4.4.1.1 Procedure for tests at extreme temperatures .....	16
4.4.4.1.2 Extreme temperature ranges .....	16
4.4.4.2 Extreme test source voltages .....	16
4.4.4.2.1 Mains voltage .....	16
4.4.4.2.2 Other power sources .....	16
4.5 Reference bandwidth of the measuring receiver .....	16
4.6 Interpretation of test results and permitted measurement uncertainty .....	17
4.6.0 General.....	17
4.6.1 Maximum permitted measurement uncertainty .....	18
4.6.2 Measurement uncertainty is equal to or less than maximum permitted uncertainty .....	18
4.6.3 Measurement uncertainty is larger than maximum permitted uncertainty .....	18
4.7 Test Report.....	18
5 Test setups and procedures.....	19
5.1 Introduction .....	19
5.2 Initial measurement steps .....	19
5.3 Radiated measurements .....	19
5.3.1 General.....	19

5.3.2	Guidance on the use of a radiation test site.....	19
5.3.2.0	Introduction.....	19
5.3.2.1	Verification of the test site .....	20
5.3.2.2	Mounting bracket .....	20
5.3.2.3	Range length .....	20
5.3.2.4	Test Site preparation .....	21
5.3.3	Standard test methods .....	21
5.4	Testing of host connected devices.....	21
6	Test procedures .....	21
6.1	General .....	21
6.2	Descriptions.....	22
6.2.1	Introduction.....	22
6.2.2	Operating frequency range.....	22
6.2.3	Total Power.....	22
6.2.4	Peak e.i.r.p. ....	23
6.2.5	Mean (average) e.i.r.p. ....	23
6.2.6	Mean e.i.r.p. spectral density .....	23
6.2.7	Power Duty Cycle.....	23
6.2.8	Spectrum Access Duty Cycle.....	24
6.2.9	Dwell time and repetition time .....	24
6.2.10	Frequency modulation range.....	24
6.2.11	Unwanted emissions in the out-of-band and spurious domains .....	24
6.2.12	Receiver spurious emissions .....	25
6.2.13	Receiver in-band, out-of-band and remote-band signals handling.....	25
6.3	Method of measurements of the EUT.....	25
6.3.1	Introduction.....	25
6.3.2	Operating Frequency Range .....	25
6.3.3	Peak e.i.r.p. ....	26
6.3.3.1	General .....	26
6.3.3.2	Method with a spectrum analyser.....	26
6.3.3.3	Method with an average power meter .....	26
6.3.3.4	Method with a peak power meter .....	26
6.3.4	Mean e.i.r.p. ....	26
6.3.4.1	General .....	26
6.3.4.2	Method with a spectrum analyser.....	27
6.3.4.3	Method with an average power meter .....	27
6.3.4.4	Method with a peak power meter .....	27
6.3.5	Mean E.I.R.P spectral density.....	27
6.3.6	Power Duty Cycle.....	28
6.3.6.1	General .....	28
6.3.6.2	Method with the spectrum analyser .....	28
6.3.6.3	Alternative method with an oscilloscope .....	28
6.3.6.3.1	Description .....	28
6.3.6.3.2	General test setup .....	28
6.3.7	Spectrum access duty cycle .....	29
6.3.7.1	Introduction.....	29
6.3.7.2	Measurement of spectrum access duty cycle.....	30
6.3.8	Dwell time and repetition time .....	30
6.3.8.1	Introduction.....	30
6.3.8.2	Measurement of accumulated dwell time over a given observation time interval .....	31
6.3.8.3	Measurement of a repeating dwell time .....	32
6.3.9	Frequency modulation range.....	32
6.3.9.1	Introduction.....	32
6.3.9.2	Measurement of frequency modulation range.....	33
6.3.10	Unwanted emissions in the out-of-band and spurious domains .....	33
6.3.11	Receiver spurious emissions .....	35
6.3.11.1	General .....	35
6.3.11.2	Test set-up .....	35
6.3.12	Receiver in-band, out-of-band and remote-band signals handling.....	36
6.3.12.1	Introduction.....	36
6.3.12.2	Test set-up.....	36

6.3.12.3	Test procedure.....	36
6.3.12.4	Unwanted signals specification.....	36
<b>Annex A (normative):</b>	<b>Test sites and general arrangements for measurements involving the use of radiated fields.....</b>	<b>37</b>
A.1	Introduction.....	37
A.2	Anechoic chamber.....	37
A.3	Anechoic chamber with a conductive ground plane.....	38
A.4	Extreme conditions test.....	39
A.4.1	Radio transparent temperature chamber.....	39
A.4.2	Use of a test fixture.....	39
A.4.2.0	General.....	39
A.4.2.1	Characteristics.....	39
A.4.2.2	Validation of the test fixture in the temperature chamber.....	40
A.4.2.3	Use of the test fixture for measurement in the temperature chamber.....	42
A.5	Test antenna.....	42
A.5.1	General.....	42
A.5.2	Substitution antenna.....	42
A.5.3	Measuring antenna.....	43
<b>Annex B (normative):</b>	<b>Standard test methods.....</b>	<b>44</b>
B.1	Radiated test set-up calibrated by using the Rx link budget calculation.....	44
B.2	Radiated test set-up calibrated by using substitution method.....	44
<b>Annex C (normative):</b>	<b>Rx link budget calculation.....</b>	<b>46</b>
<b>Annex D (normative):</b>	<b>Measuring receivers.....</b>	<b>49</b>
D.1	General remarks.....	49
D.2	Power Meter.....	49
D.3	Spectrum analyser.....	50
D.4	Signal analyser.....	50
D.5	Oscilloscope.....	51
<b>Annex E (informative):</b>	<b>Bibliography.....</b>	<b>52</b>
<b>Annex G (informative):</b>	<b>Change History.....</b>	<b>53</b>
History.....		54

---

## Intellectual Property Rights

IPRs essential or potentially essential to the present document may have been declared to ETSI. The information pertaining to these essential IPRs, if any, is publicly available for **ETSI members and non-members**, and can be found in ETSI SR 000 314: "*Intellectual Property Rights (IPRs); Essential, or potentially Essential, IPRs notified to ETSI in respect of ETSI standards*", which is available from the ETSI Secretariat. Latest updates are available on the ETSI Web server (<https://ipr.etsi.org>).

Pursuant to the ETSI IPR Policy, no investigation, including IPR searches, has been carried out by ETSI. No guarantee can be given as to the existence of other IPRs not referenced in ETSI SR 000 314 (or the updates on the ETSI Web server) which are, or may be, or may become, essential to the present document.

---

## Foreword

This final draft European Standard (EN) has been produced by ETSI Technical Committee Electromagnetic compatibility and Radio spectrum Matters (ERM), and is now submitted for the Vote phase of the ETSI standards EN Approval Procedure.

It is intended to be used in conjunction with an appropriate harmonised standard for the purposes of assessing conformity with the Radio Equipment Directive [1.3].

<b>Proposed national transposition dates</b>	
Date of latest announcement of this EN (doa):	3 months after ETSI publication
Date of latest publication of new National Standard or endorsement of this EN (dop/e):	6 months after doa
Date of withdrawal of any conflicting National Standard (dow):	6 months after doa

---

## Modal verbs terminology

In the present document "**shall**", "**shall not**", "**should**", "**should not**", "**may**", "**need not**", "**will**", "**will not**", "**can**" and "**cannot**" are to be interpreted as described in clause 3.2 of the [ETSI Drafting Rules](#) (Verbal forms for the expression of provisions).

"**must**" and "**must not**" are **NOT** allowed in ETSI deliverables except when used in direct citation.

---

## Introduction

Automotive and surveillance radar equipments are low power millimetre wave devices that are able to detect and characterize targets in their environment.

The following use cases are included (but are not limited to):

- automotive Advanced Driver Assistance Systems (ADAS) applications, such as Adaptive Cruise Control (ACC), Blind Spot Detection (BSD), parking aid, backup aid, autonomous braking and pre-crash systems (PCS),
- surveillance radars for other kind of ground based vehicles, such as trains, trams, aircrafts while taxiing,
- fixed infrastructure radars for traffic monitoring,
- railway/road crossings obstacle detection radars,

- helicopter obstacle detection radars.

Detailed information about use cases can be found in the related Harmonised Standards (ETSI EN 301 091-1 [i.7], ETSI EN 301 091-2 [i.8], ETSI EN 301 091-3 [i.9], ETSI EN 302 264 [i.10], ETSI EN 302 858 [i.11]).

The current generation of radars uses mainly FMCW modulations, such as slow-ramp and fast-ramp (chirp or pulse compression) modulations. Radars may have multiple transmitting antennas and receiving antennas to enable adaptive field-of-views or digital beam forming. Scanning systems, electronically or mechanically, also exist on the market.

---

# 1 Scope

The present document describes possible measurement techniques and procedures for the conformance measurements applicable to automotive and surveillance radar equipments.

The present document will be used as a reference for existing and future ETSI standards covering automotive and surveillance radar equipments.

---

## 2 References

### 2.1 Normative references

References are either specific (identified by date of publication and/or edition number or version number) or non-specific. For specific references, only the cited version applies. For non-specific references, the latest version of the referenced document (including any amendments) applies.

Referenced documents which are not found to be publicly available in the expected location might be found at <https://docbox.etsi.org/Reference/>.

NOTE: While any hyperlinks included in this clause were valid at the time of publication, ETSI cannot guarantee their long term validity.

The following referenced documents are necessary for the application of the present document.

- [1] CISPR 16-1-1 (2006), CISPR 16-1-4 (2010) and CISPR 16-1-5 (2014): "Specification for radio disturbance and immunity measuring apparatus and methods; Part 1: Radio disturbance and immunity measuring apparatus".
- [2] ETSI TR 100 028 (V1.4.1) (all parts): "Electromagnetic compatibility and Radio spectrum Matters (ERM); Uncertainties in the measurement of mobile radio equipment characteristics".
- [3] ETSI TR 102 273 (V1.2.1) (all parts): "Electromagnetic compatibility and Radio spectrum Matters (ERM); Improvement on Radiated Methods of Measurement (using test site) and evaluation of the corresponding measurement uncertainties".
- [4] ETSI TS 102 321 (V1.1.1): "Electromagnetic compatibility and Radio spectrum Matters (ERM); Normalized Site Attenuation (NSA) and validation of a fully lined anechoic chamber up to 40 GHz".
- [5] ANSI C63.5-2006: "American National Standard for Electromagnetic Compatibility - Radiated Emission Measurements in Electromagnetic Interference (EMI) Control - Calibration of Antennas (9 kHz to 40 GHz)".

### 2.2 Informative references

References are either specific (identified by date of publication and/or edition number or version number) or non-specific. For specific references, only the cited version applies. For non-specific references, the latest version of the referenced document (including any amendments) applies.

NOTE: While any hyperlinks included in this clause were valid at the time of publication, ETSI cannot guarantee their long term validity.

The following referenced documents are not necessary for the application of the present document but they assist the user with regard to a particular subject area.

- [i.1] CEPT/ERC/Recommendation 74-01: "Unwanted emissions in the spurious domain".
- [i.2] ITU Radio Regulations.



- [i.3] Directive 2014/53/EU of the European Parliament and of the Council of 16 April 2014 on the harmonisation of the laws of the Member States relating to the making available on the market of radio equipment and repealing Directive 1999/5/EC.
- [i.4] Recommendation ITU-R SM.329-12 (2012): "Unwanted emissions in the spurious domain".
- [i.5] Recommendation ITU-R SM.328-11 (2006): "Spectra and Bandwidth of Emissions".
- [i.6] Recommendation ITU-R SM.1754 (2006): "Measurement techniques of ultra-wideband transmissions".
- [i.7] ETSI EN 301 091-1: "Short Range Devices; Transport and Traffic Telematics (TTT); Radar equipment operating in the 76 GHz to 77 GHz range; Harmonised Standard covering the essential requirements of article 3.2 of the Directive 2014/53/EU; Part 1: Ground based vehicular radar".
- [i.8] ETSI EN 301 091-2: "Short Range Devices; Transport and Traffic Telematics (TTT); Radar equipment operating in the 76 GHz to 77 GHz range; Harmonised Standard covering the essential requirements of article 3.2 of the Directive 2014/53/EU; Part 2: Fixed infrastructure radar equipment".
- [i.9] ETSI EN 301 091-3: "Short Range Devices; Transport and Traffic Telematics (TTT); Radar equipment operating in the 76 GHz to 77 GHz range; Harmonised Standard covering the essential requirements of article 3.2 of the Directive 2014/53/EU; Part 3: Railway/Road Crossings obstacle detection system applications".
- [i.10] ETSI EN 302 264: "Short Range Devices; Transport and Traffic Telematics (TTT); Short Range Radar equipment operating in the 77 GHz to 81 GHz band; Harmonised Standard covering essential requirements of article 3.2 of the Directive 2014/53/EU".
- [i.11] ETSI EN 302 858: "Short Range Devices; Transport and Traffic Telematics (TTT); Harmonised Standard covering the essential requirements of article 3.2 of the Directive 2014/53/EU; Radar equipment operating in the 24,05 GHz to 24,25 GHz or 24,05 GHz to 24,50 GHz range".
- [i.12] ECC Recommendation (07)01: "Frequency Measurements Using Fast Fourier Transform (FFT) Techniques".
- [i.13] ETSI TR 103 366: "Short Range Devices (SRD) using Ultra Wide Band technology (UWB); Time Domain based Low Duty Cycle Measurement Procedure".
- [i.14] ETSI EG 203 367 (V1.1.1): "Guide to the application of harmonised standards covering article 3.1b and 3.2 of the Directive 2014/53/EU (RED) to multi-radio and combined radio and non-radio equipment".

---

## 3 Definitions, symbols and abbreviations

### 3.1 Definitions

For the purposes of the present document, the following terms and definitions apply:

**antenna cycle:** one complete sweep of a mechanically or electronically scanned antenna beam along a predefined spatial path

**antenna scan duty factor:** ratio of the solid angle of the antenna beam (measured at its 3 dB point) to the total solid angle scanned by the antenna

**associated antenna:** antenna and all its associated components which are designed as an indispensable part of the equipment

**averaging time:** time interval on which a mean measurement is integrated

**blanking period:** time period where no intentional emission occurs

**boresight:** direction of maximum gain of a directional antenna

NOTE: EUT may have different boresights for TX and RX antennas.

**bumper:** (automotive) generally 3D shaped plastic sheet normally mounted in front of the radar device

**co-located receiver:** receiver is located in the same device housing as the transmitter

**cycle time:** length of the time between periodic transmission patterns of the system

NOTE: In case of a random pattern, a default value of 1 minute is used.

**duty cycle:**  $\sum(T_{on})/t_o$  where  $T_{on}$  is the ON time of a single transmission and  $t_o$  is the observation period.  $T_{on}$  is measured in an observation frequency band ( $BW_o$ )

**dwel time:** in general, time interval for which a certain frequency range is occupied

NOTE: "Cumulated dwel time" is the sum of individual dwel times within a measurement time frame and in a defined frequency range.

"Absolute dwel time" is the time from first entrance into a defined frequency range until last exit from a defined frequency range.

**Equipment Under Test (EUT):** radar sensor including the integrated antenna together with any external antenna components which affect or influence its performance

**equivalent isotropically radiated power (e.i.r.p.):** product of the power supplied to the antenna and the antenna gain in a given direction relative to an isotropic antenna (absolute or isotropic gain)

NOTE 1: See ITU Radio Regulations [i.2], RR 1.161.

NOTE 2: e.i.r.p. may be used for peak or mean (average) power and peak or mean (average) spectral power density. If not otherwise noted, e.i.r.p. refers to the mean (average) power.

**far field measurement:** measurement at a distance from an antenna sufficient to ensure that the electro-magnetic field approximates a plane wave (see clause 5.3.2.3)

**illumination time:** (for equipment with scanning antennas) time for which a given point in the far field is within the main beam(s) of the antenna(s)

**maximum power:** maximum mean power with respect to azimuth and elevation (typically measured at antenna boresight)

**mean power:** power during an interval of time sufficiently long compared with the lowest frequency encountered in the modulation envelope

NOTE 1: See ITU Radio Regulations [i.2], RR 1.158.

NOTE 2: For pulsed systems the mean power is equal to the peak envelope power (see ITU Radio Regulations [i.2], RR 1.157) multiplied by the time gating duty factor. For CW systems without time gating the mean power is equal to the transmission power without modulation.

**operating frequency (operating centre frequency):** nominal frequency at which equipment is operated

NOTE: Equipment may be able to operate at more than one operating frequency.

**operating frequency range:** range of operating frequencies over which the equipment can be adjusted through switching or reprogramming or oscillator tuning

NOTE 1: For pulsed or phase shifting systems without further carrier tuning the operating frequency range is fixed on a single carrier line.

NOTE 2: For analogue or discrete frequency modulated systems (FSK, FMCW) the operating frequency range covers the difference between minimum and maximum of all carrier frequencies on which the equipment can be adjusted.

**peak power:** highest instantaneous power of the EUT

**permitted frequency range(s):** frequency range(s) within which the device is authorized to operate

**power envelope:** power supplied to the antenna by a transmitter during one radio frequency cycle at the crest of the modulation envelope taken under normal operating conditions

NOTE: See ITU Radio Regulations [1.2], RR 1.157.

**power flux density:** radiated power per unit area normal to the direction of the electromagnetic wave propagation

**Power Spectral Density (PSD):** ratio of the amount of power to the used radio measurement bandwidth

**Pulse Repetition Frequency (PRF):** inverse of the Pulse Repetition Interval, averaged over a time sufficiently long as to cover all PRI variations

**pulse radar:** EUT which determines distance (range) by the time-of-flight of short radar pulses which are not frequency modulated

**Pulse Repetition Interval (PRI):** time between the rising edges of the transmitted (pulsed) output power

**quiescent period:** time instant where no intentional emission occurs

**Radar Cross Section (RCS):** cross-sectional area of a perfectly reflecting sphere that would produce the same strength reflection as would the object in question

**scanning (steerable) antenna:** directional antenna which can move its beam along a predefined spatial path

NOTE: Scanning can be realized by mechanical, electrical or combined means. The antenna beamwidth may stay constant or change with the steering angle, dependent on the steering method.

**second (2<sup>nd</sup>) harmonic:** twice the frequency of the fundamental (e.g. 48 GHz for a 24 GHz device)

**spread spectrum modulation:** modulation technique in which the energy of a transmitted signal is spread throughout a relatively large portion of the frequency spectrum

**ultra-wideband bandwidth:** equipment using ultra-wideband technology means equipment incorporating, as an integral part or as an accessory, technology for short-range radiocommunication, involving the intentional generation and transmission of radio-frequency energy that spreads over a wider frequency range

## 3.2 Symbols

For the purposes of the present document, the following symbols apply:

$\lambda$	wavelength
B	(pulse) bandwidth
$B_{\text{FH}}$	Bandwidth used for frequency hopping systems
d	largest dimension of the antenna aperture
dB	decibel
$d_{\text{FF}}$	Far Field Distance
E	Field strength
$f_c$	Carrier frequency
$f_H$	highest frequency
$f_L$	lowest frequency
F	Permitted frequency bandwidth
$F_1$	Low boundary between OOB and Spurious domains
$F_2$	High boundary between OOB and Spurious domains
$\sigma$	Radar Cross Section
BW <sub>o</sub>	Observation bandwidth
$f_{\text{max}}$	Maximum frequency range of interest
$f_{\text{mod}}$	Modulation frequency range
$P_{\text{min}}$	Minimum relevant signal power
$P_{\text{CORR}}$	Measured power corrected with regard to the RBW
$P_{\text{MEASURED}}$	Measured power

RBW	Resolution Bandwidth
RBW <sub>REF</sub>	Reference Resolution Bandwidth
RBW <sub>MEASURED</sub>	Resolution Bandwidth used for the measurements
S	Power Flux Density
T <sub>C</sub>	Chip period
t <sub>d1,2,3</sub>	Individual dwell time contributions
t <sub>d</sub>	Dwell time
t <sub>o</sub>	Observation time
t <sub>r</sub>	Repetition time
TP	Total Power

### 3.3 Abbreviations

For the purposes of the present document, the following abbreviations apply:

AC	Alternating Current
ACC	Adaptive Cruise Control
ADAS	Advanced Driver Assistance Systems
ATT	ATTenuator
BSD	Blind Spot Detection
BW	BandWidth
CEPT	European Conference of Postal and Telecommunications administrations
CISPR	Comité International Spécial des Perturbations Radioélectriques
CW	Continuous Wave
DC	Direct Current
e.i.r.p.	equivalent isotropically radiated power
EC	European Commission
ECC	Electronic Communications Committee
EMC	Electro Magnetic Compatibility
ERC	European Radiocommunication Committee
EUT	Equipment Under Test
FFT	Fast Fourier Transform
FH	Frequency Hopping
FMCW	Frequency Modulation Continuous Wave
FSK	Frequency Shift Keying
HS	Harmonised Standards
IF	Intermediate Frequency
LNA	Low Noise Amplifier
OBW	Occupied BandWidth
OOB	Out-Of-Band
PCS	Pre-Crash System
PRF	Pulse Repetition Frequency
PRI	Pulse Repetition Interval
PSD	Power Spectral Density
RBW	Resolution BandWidth
RCS	Radar Cross Section
RE-D	Radio Equipment Directive
RF	Radio Frequency
RMS	Root Mean Square
RR	ITU-R Radio Regulations
Rx	Receiver (Receive)
SNR	Signal to Noise Ratio
SRD	Short Range Device
SRR	Short Range Radar
TTT	Transport & Traffic Telematics
Tx	Transmitter
UWB	Ultra Wide Band
VBW	Video BandWidth
VSWR	Voltage Standing Wave Ratio

---

## 4 General Considerations for performing the tests

### 4.1 Overview

In this clause, all general considerations for the testing of short-range radar devices will be given. These considerations and requirements are related to the presentation of the products to be tested (see clause 4.2), the requirement for the EUT (see clause 4.3), the general test conditions (see clause 4.4), the reference bandwidth for the measurements (see clause 4.5) the interpretation of test results (see clause 4.6) and the test report (see clause 4.7).

### 4.2 Product information

The following product information may be needed in order for the tests to be performed adequately and should be provided by the manufacturer, such as:

- relevant harmonised standard and environmental conditions of use/intended use;
- the nominal power supply voltages of the stand-alone radio equipment or the nominal power supply voltages of the host equipment or combined equipment in case of plug-in radio devices;
- the type of technology/modulation implemented in the equipment (e.g. pulse, pulse-Doppler, FMCW, etc.);
- for all modulation schemes, the modulation parameters need to be provided: for example modulation period, ramp sweep time, modulation bandwidth;
- high and low power modes;
- the equipment power duty cycle;
- the operating frequency range(s) of the equipment (see clause 6.3.2);
- the normal installation orientation of the EUT;
- the antenna polarization for both transmit and receive antennas;
- the antenna boresight direction, as well as the antenna beamwidth, horizontal and vertical 3 dB points for both transmit and receive antennas;
- details of any antenna switching or electronic or mechanical scanning. Where such features are present, information about whether they can be disabled for testing purposes should also be supplied;
- the desired range of temperature (see clause 4.4.4.1.2), including the necessary warm-up settling time of the EUT.
- information about equipment function to establish wanted performance criteria (clause 6.3.12)

See related HS for more information (ETSI EN 301 091-1 [i.7], ETSI EN 301 091-2 [i.8], ETSI EN 301 091-3 [i.9], ETSI EN 302 264 [i.10] and ETSI EN 302 858 [i.11]).

### 4.3 Requirements for the EUT

#### 4.3.1 EUT version and configuration

Testing may be carried out on production or on equivalent versions of the equipment.

**NOTE:** It is the responsibility of the manufacturer to ensure that the equipment that is put into service meets the relevant requirements of the applicable legislation, including the RE-D [i.3].

If an equipment has optional features that are considered not to affect directly the RF parameters then tests need only be performed on the equipment configured with the considered worst case combination of features as declared by the manufacturer.

## 4.3.2 Presentation

The manufacturer shall provide any necessary means to operate the EUT during the tests.

## 4.3.3 Multiple operating bandwidths

All operating bandwidths of the equipment shall be declared by the equipment manufacturer (see clause 4.2).

Where equipment has more than one operating bandwidths, sufficient number of operating bandwidths shall be chosen for testing so as to encompass the lower and higher limits of the operating frequency and the minimum and maximum bandwidth.

## 4.3.4 Requirement on the modulation during testing

The EUT modulation during testing should be representative of normal use of the equipment. The manufacturer shall employ the mode of operation of the equipment which results in the highest transmitter activity consistent with the requirement to measure the highest power transmission which would be available in operation, and should ensure that:

- transmissions occur regularly in time;
- sequences of transmissions can be repeated accurately.

For transmitters that have multi-modulation schemes incorporated, it may be necessary to test each scheme.

## 4.3.5 Requirements in case of EUT with scanning antennas

### 4.3.5.1 Classification

For the purposes of the present document, EUTs are divided into three types according to the behaviour in time of the transmit antenna:

- **Fixed beam.** In this type of EUT the antenna radiation pattern is constant and the boresight direction is fixed relative to the housing of the EUT.
- **Constant pattern.** In this type of EUT the radiation pattern of the antenna is constant and the boresight direction varies with time. The scanning of the boresight direction is at a constant angular rate of change.
- **Variable pattern.** This type of EUT is all those that are not fixed or constant pattern. Either the antenna radiation pattern varies with time and/or direction or the scanning is not at a constant rate.

For the purposes of the above classification, fixed and constant mean within 1 degree or 1 % as appropriate in normal operation.

NOTE 1: The classification depends only on the transmit antenna behaviour.

NOTE 2: In general, mechanically scanned antennas will be constant pattern and electronically scanned antennas will be variable pattern.

NOTE 3: Although the terms beam and pattern are used in the singular the same considerations and classifications apply to EUT with multiple beams.

### 4.3.5.2 Measurement of fixed beam EUT

No special considerations apply. Measurements shall be made on the boresight unless otherwise specified.

### 4.3.5.3 Measurement of constant pattern EUT

The scanning may be inhibited and measurements made on the boresight unless otherwise specified. The parameters of the EUT in normal operation may be calculated based on knowledge of the antenna behaviour. The manufacturer shall declare the relevant antenna parameters.

#### 4.3.5.4 Measurement of variable pattern EUT

Measurements shall be made with the antenna scanning. It may be necessary to perform a set of measurements over the full sphere or half sphere. For measurements of radiated energy (e.g. peak power, mean power, duty cycle) the direction shall be chosen which gives the highest value result.

### 4.4 Test conditions

#### 4.4.1 Introduction

Testing shall be performed under normal test conditions. For some requirements, it could be necessary to use extreme test conditions (see HS for more details).

The test conditions and procedures shall be performed as specified in the following clauses.

#### 4.4.2 Power sources

During testing, the power source of the equipment shall be replaced by a test power source capable of producing normal test voltages as specified in clause 4.4.3.2 and extreme test voltages as specified in clause 4.4.4.2. The internal impedance of the test power source shall be low enough for its effect on the test results to be negligible. For the purpose of tests, the voltage of the power source shall be measured at the input terminals of the equipment.

For battery operated equipment the battery may be removed and the test power source applied as close to the battery terminals as practicable.

During tests the power source voltages shall be maintained within a tolerance of  $\pm 1$  % relative to the voltage at the beginning of each test. The value of this tolerance is critical to power measurements; using a smaller tolerance will provide better measurement uncertainty values.

#### 4.4.3 Normal test conditions

##### 4.4.3.1 Normal temperature and humidity

The normal temperature and humidity conditions for tests shall be any convenient combination of temperature and humidity within the following ranges:

- temperature: +15 °C to +35 °C;
- relative humidity: 20 % to 75 %.

When it is impracticable to carry out the tests under these conditions, a note to this effect, stating the ambient temperature and relative humidity during the tests, shall be recorded in the test report.

The actual values during the tests shall be recorded in the test report.

##### 4.4.3.2 Normal power source

###### 4.4.3.2.1 Mains voltage

The normal test voltage for equipment to be connected to the mains shall be the nominal mains voltage. For the purpose of the present document, the nominal voltage shall be the voltage(s) for which the equipment was designed.

The frequency of the test power source corresponding to the AC mains shall be between 49 Hz and 51 Hz.

###### 4.4.3.2.2 Lead-acid battery power sources used on vehicles

When radio equipment is intended for operation from the usual, alternator fed lead-acid battery power source used on vehicles, then the normal test voltage shall be 1.1 times the nominal voltage of the battery (6 V, 12 V, etc.).

#### 4.4.3.2.3 Other power sources

For operation from other power sources or types of battery (primary or secondary), the nominal test voltage shall be as stated by the equipment manufacturer. This shall be recorded in the test report.

### 4.4.4 Extreme test conditions

#### 4.4.4.1 Extreme temperatures

##### 4.4.4.1.1 Procedure for tests at extreme temperatures

Before measurements are made, the equipment shall have reached thermal balance in the test chamber. The equipment shall not be switched off during the temperature stabilizing period.

If the thermal balance is not checked by measurements, a temperature stabilizing period of at least one hour, or such period as may be decided by the accredited test laboratory, shall be allowed. The sequence of measurements shall be chosen, and the humidity content in the test chamber shall be controlled so that excessive condensation does not occur.

##### 4.4.4.1.2 Extreme temperature ranges

For tests at extreme temperatures, measurements shall be made in accordance with the procedures specified in clause 5, at the upper and lower temperatures of one of the following ranges as declared by the manufacturer:

- Temperature category I: -10 °C to +55 °C.
- Temperature category II: -20 °C to +60 °C.
- Temperature category III: -40 °C to +70 °C.

The manufacturer can specify a wider temperature range than given as a minimum above. The test report shall state which range is used.

#### 4.4.4.2 Extreme test source voltages

##### 4.4.4.2.1 Mains voltage

The extreme test voltages for equipment to be connected to an AC main source shall be the nominal mains voltage  $\pm 10\%$ .

##### 4.4.4.2.2 Other power sources

For equipment using other power sources, or capable of being operated from a variety of power sources, the extreme test voltages shall be those that are declared by the manufacturer. These shall be recorded in the test report.

## 4.5 Reference bandwidth of the measuring receiver

In general, the resolution bandwidth of the measuring receiver (RBW) should be equal to the reference bandwidth ( $RBW_{REF}$ ) given in Table 1.

**Table 1: Reference bandwidth for the measurement receiver**

Frequency range: (f)	Measuring receiver resolution bandwidth ( $RBW_{REF}$ )
$30 \text{ MHz} \leq f \leq 1\,000 \text{ MHz}$	100 kHz
$f > 1\,000 \text{ MHz}$	1 MHz
NOTE: The frequency ranges and corresponding $RBW_{REF}$ values are derived from CISPR 16 [1].	



To improve measurement accuracy, sensitivity and efficiency, RBW may be different from  $RBW_{REF}$ .

When  $RBW_{measured} < RBW_{REF}$  the result should be integrated over  $RBW_{REF}$  for instance according to formula (1).

$$P_{CORR} = 10 \log \left( RBW_{REF} * \frac{\left( \frac{1}{n} \right) * \sum_{i=1}^n \left( 10^{\left( \frac{P(i)}{10} \right)} \right)}{RBW_{MEASURED}} \right) \quad (1)$$

Where:

- P(i) are the measured samples with  $RBW_{MEASURED}$ ;
- n is the number of samples inside  $RBW_{REF}$ ;
- $P_{CORR}$  is the corresponding value at  $RBW_{REF}$ .

When  $RBW_{measured} > RBW_{REF}$  the result for broadband emissions should be normalized to the bandwidth Ratio according to formula (2).

$$P_{CORR} = P_{MEASURED} + 10 \log \frac{RBW_{ref}}{RBW_{MEASURED}} \quad (2)$$

Where:

- $P_{MEASURED}$  is the measured value at the wider measurement bandwidth  $RBW_{MEASURED}$ ;
- $P_{CORR}$  is the corresponding value at  $RBW_{REF}$ .

For discrete emissions, defined as a narrow peak with a level of at least 6 dB above the average level inside the measurement bandwidth, the above correction is not applicable while integration over  $RBW_{REF}$  is still applicable.

## 4.6 Interpretation of test results and permitted measurement uncertainty

### 4.6.0 General

The interpretation of the results for the measurements described in the present document shall be as follows:

- 1) the measured value related to the corresponding limit shall be used to decide whether the equipment meets the requirements of the present document;
- 2) the measurement uncertainty value for the measurement of each parameter shall be recorded in the test report;
- 3) the recorded value of the measurement uncertainty shall be wherever possible, for each measurement, equal to or lower than the figures in Table 2, and the interpretation procedure specified in clause 4.6.2 shall be used.

For the test methods, according to the present document, the measurement uncertainty figures shall be calculated in accordance with the guidance provided in ETSI TR 100 028 [2] and shall correspond to an expansion factor (coverage factor)  $k = 1,96$  or  $k = 2$  (which provide confidence levels of respectively 95 % and 95,45 % in the case where the distributions characterizing the actual measurement uncertainties are normal (Gaussian)).

Table 2 is based on such expansion factors.

**Table 2: Maximum permitted measurement uncertainty**

Parameter	Uncertainty
Radio Frequency	$\pm 1 \times 10^{-5}$
all emissions, radiated	$\pm 6$ dB
temperature	$\pm 1$ °C
Humidity	$\pm 5$ %
DC and low frequency voltages	$\pm 3$ %

#### 4.6.1 Maximum permitted measurement uncertainty

In cases where the measurement uncertainty exceeds the limits in Table 2, the provisions of clause 4.6.3 shall apply.

#### 4.6.2 Measurement uncertainty is equal to or less than maximum permitted uncertainty

The interpretation of the results when comparing measurement values with specification limits shall be as follows:

- When the measured value does not exceed the limit value the equipment under test meets the requirements of the related HS.
- When the measured value exceeds the limit value the equipment under test does not meet the requirements of the related HS.
- The measurement uncertainty calculated by the test technician carrying out the measurement shall be recorded in the test report.
- The measurement uncertainty calculated by the test technician may be a maximum value for a range of values of measurement, or may be the measurement uncertainty for the specific measurement undertaken. The method used shall be recorded in the test report.

#### 4.6.3 Measurement uncertainty is larger than maximum permitted uncertainty

The interpretation of the results when comparing measurement values with specification limits should be as follows:

- When the measured value plus the difference between the measurement uncertainty calculated by the test technician and the maximum permitted measurement uncertainty does not exceed the limit value the equipment under test meets the requirements of the related HS.
- When the measured value plus the difference between the measurement uncertainty calculated by the test technician and the maximum acceptable measurement uncertainty exceeds the limit value the equipment under test does not meet the requirements of the related HS.
- The measurement uncertainty calculated by the test technician carrying out the measurement shall be recorded in the test report.
- The measurement uncertainty calculated by the test technician may be a maximum value for a range of values of measurement, or may be the measurement uncertainty for the specific measurement undertaken. The method used shall be recorded in the test report.

### 4.7 Test Report

The test report should contain all the necessary and relevant information to assess compliance with the essential requirements listed in annex A of the related HS (see ETSI EN 301 091-1 [i.7], ETSI EN 301 091-2 [i.8], ETSI EN 301 091-3 [i.9], ETSI EN 302 264 [i.10] and ETSI EN 302 858 [i.11]).

---

## 5 Test setups and procedures

### 5.1 Introduction

In general, a distinction is made between conducted and radiated RF measurements. However, for EUTs covered by the present document, it should be noted that there are no conducted RF measurements.

In this clause the general setup of a test environment for the radiated test of short range radar equipment will be described.

### 5.2 Initial measurement steps

The measurement procedure shall be planned by using the information provided by the manufacturer (see clause 4.2).

The settings of the measuring receiver shall be chosen based on the description of the signal provided, so as to ensure that the highest values of peak power and mean PSD are captured. This is particularly important for a swept frequency measurement receiver (spectrum analyser) and a signal that has a variation in time and/or frequency and/or direction. It is recommended that the signal should initially be observed with both peak and mean measuring modes, over its full bandwidth, to confirm the description and to establish where the highest values are. This will permit subsequent measurements to be made with a narrower RF span. Where there is any doubt about the effect of frequency sweeping, a measurement at a single RF (zero span) will provide confirmation.

### 5.3 Radiated measurements

#### 5.3.1 General

The test site, test antenna and substitution antenna used for radiated measurements shall be as described in annex A.

For guidance on use of radiation test sites, see clause 5.3.2.

For guidance on standard test positions used for radiated measurements, see annex B.

All reasonable efforts should be made to clearly demonstrate that emissions from the EUT transmitter do not exceed the specified levels, with the transmitter in the far field. To the extent practicable, the radio device under test shall be measured at the distance specified in clause 5.3.2.3 and with the specified measurement bandwidths. However, in order to obtain an adequate signal-to-noise ratio in the measurement system, radiated measurements may have to be made at distances less than those specified in clause 5.3.2.3 and/or with reduced measurement bandwidths. The revised measurement configuration should be stated on the test report, together with an explanation of why the signal levels involved necessitated measurement at the distance employed or with the measurement bandwidth used in order to be accurately detected by the measurement equipment and calculations demonstrating compliance.

Where it is not practical to further reduce the measurement bandwidth (either because of limitations of commonly-available test equipment or difficulties in converting readings taken using one measurement bandwidth to those used by the limits given in the relevant harmonised standard, and the required measurement distance would be so short that the radio device would not clearly be within the far field), the test report shall state this fact, the measurement distance and bandwidth used, the near field/far field distance for the measurement setup, the measured radio device emissions, the achievable measurement noise floor and the frequency range(s) involved.

#### 5.3.2 Guidance on the use of a radiation test site

##### 5.3.2.0 Introduction

This clause details procedures, test equipment arrangements and verification that should be carried out before any of the radiated tests are undertaken.

### 5.3.2.1 Verification of the test site

No test should be carried out on a test site which does not possess a valid certificate of verification. The verification procedures for the different types of test sites described in annex A (i.e. anechoic chamber and anechoic chamber with a ground plane) are given in the relevant parts of ETSI TR 102 273 [3] or equivalent.

### 5.3.2.2 Mounting bracket

Where necessary, a mounting bracket of minimal size should be available for mounting the EUT on the turntable. This bracket should be made from low conductivity, low relative dielectric constant (i.e. less than 1.5) material(s) such as expanded polystyrene, balsawood, etc.

### 5.3.2.3 Range length

The range length for all these types of test facility should be adequate to allow for testing in the far field of the EUT i.e. it should be equal to or exceed:

$$d_{FF} = \frac{2(d_1 + d_2)^2}{\lambda} \quad (3)$$

Where:

- $d_1$  is the largest dimension of the EUT/dipole after substitution (m);
- $d_2$  is the largest dimension of the test antenna (m);
- $\lambda$  is the test frequency wavelength (m).

This formula keeps the error due to the near-field effect to better than 0,25 dB on the antenna boresight, which could be required for precision measurement of an antenna radiation pattern. However, such high precision is not necessary for compliance purposes.

In addition, at millimetre waves, the resulting distance might be so large that the measured power level is close to the detector sensitivity level and/or measurement in a test chamber becomes impractical. Therefore, the following reduced far field distances are proposed.

**Table 3: Far field measurement distances**

Far field distance	Approximate power level error (due to near-field effect)
$d_{FF}$	0,25 dB
$\frac{d_{FF}}{2}$	0,9 dB
$\frac{d_{FF}}{3}$	2 dB
$\frac{d_{FF}}{4}$	3,5 dB

It should be noted in test reports which of these conditions is met so that any additional measurement uncertainty can be incorporated into the results.

NOTE 1: For the fully anechoic chamber, no part of the volume of the EUT should, at any angle of rotation of the turntable, fall outside the "quiet zone" of the chamber at the nominal frequency of the test.

NOTE 2: The "quiet zone" is a volume within the anechoic chamber (without a ground plane) in which a specified performance has either been proven by test, or is guaranteed by the designer/manufacturer. The specified performance is usually the reflectivity of the absorbing panels or a directly related parameter (e.g. signal uniformity in amplitude and phase). It should be noted however that the defining levels of the quiet zone tend to vary.

#### 5.3.2.4 Test Site preparation

The cables for both ends of the test site should be routed horizontally away from the testing area for a minimum of 2 m and then allowed to drop vertically and out through either the ground plane or screen (as appropriate) to the test equipment. Precautions should be taken to minimize pick up on these leads (e.g. dressing with ferrite beads, or other loading). The cables, their routing and dressing should be identical to the verification set-up.

Calibration data for all items of test equipment should be available and valid. For test, substitution and measuring antennas, the data should include gain relative to an isotropic radiator (or antenna factor) for the frequency of test. Also, the VSWR of the substitution and measuring antennas should be known.

The calibration data on all cables and attenuators should include insertion loss and VSWR throughout the entire frequency range of the tests. All VSWR and insertion loss figures should be recorded in the logbook results sheet for the specific test.

Where correction factors/tables are required, these should be immediately available.

For all items of test equipment, the maximum measurement uncertainty they exhibit should be known along with the distribution of the uncertainty.

At the start of measurements, system checks should be made on the items of test equipment used on the test site.

#### 5.3.3 Standard test methods

Two methods - calibrated method and substitution method - of determining the radiated power of a radio device are described respectively in clauses B.1 and B.2.

A standard calibration method is also provided in annex C.

### 5.4 Testing of host connected devices

For radar equipment for which connection to or integration with host equipment is required to offer functionality to the radar equipment, different alternative test approaches are permitted. Where more than one such combination is intended, testing shall not be repeated for combinations of the radar equipment and various host equipment where the latter are substantially similar.

Where more than one such combination is intended and the combinations are substantially dissimilar, one combination shall be tested against all requirements of the present document and all other combinations shall be tested separately for radiated spurious emissions only (see clause 6.3.10).

NOTE: For further information on this topic, see ETSI TR 102 070-2 [i.14].

---

## 6 Test procedures

### 6.1 General

This clause describes methods of measurement for the following transmitter and receiver parameters:

- the operating frequency range;
- the total power spectral density;
- the peak power (e.i.r.p.);
- the mean (average) e.i.r.p.;
- the mean e.i.r.p. spectral density;
- the power duty cycle;

- the spectrum access duty cycle;
- the dwell time and repetition time;
- the frequency modulation range;
- the unwanted emissions in the spurious and OOB domain;
- the receiver spurious emissions;
- the receiver in-band, out-of-band and remote band signals handling.

The following methods of measurement shall apply to the testing of stand-alone units and to the equipment configurations identified in clause 4.

The limits applicable to the parameters are specified in the relevant harmonised standards (ETSI EN 301 091-1 [i.7], ETSI EN 301 091-2 [i.8], ETSI EN 301 091-3 [i.9], ETSI EN 302 264 [i.10] and ETSI EN 302 858 [i.11]).

## 6.2 Descriptions

### 6.2.1 Introduction

In this clause the measured parameters of the EUT are described.

### 6.2.2 Operating frequency range

The operating frequency range is the frequency range over which the equipment is transmitting. The occupied frequency range of the equipment is determined by the lowest ( $f_L$ ) and highest frequency ( $f_H$ ) as occupied by the power envelope.

### 6.2.3 Total Power

The Total Power of the EUT is the integration of the time-averaged power flux density  $S$  of the EUT emissions across the entire spherical surface enclosing the EUT.

Measuring the field strength of the electric field, the average power flux density is given by:

$$S = \frac{|E_{rms}|^2}{Z_{F0}} \quad (4)$$

Where  $Z_{F0} = 120\pi\Omega$  represents the wave impedance of free space.

The RMS value of the field strength can be obtained using:

$$E_{rms} = \frac{|E|}{\sqrt{2}} \quad (5)$$

Where  $|E|$  is the amplitude of the electric field.

Using a spectrum analyser, the power flux density is given by:

$$S = \frac{P_r}{A_r} \quad (6)$$

Where  $P_r$  is the power at the connector of the receiving antenna and  $A_r$  is the effective area of the receiving antenna.

The Total Power is then given by:

$$TP = \int_{\Theta=0}^{\pi} \int_{\Phi=0}^{2\pi} S \times r^2 \times \sin(\Theta) d\Theta d\Phi \quad (7)$$

Where  $r$  is the radius of the sphere,  $\Theta$  is the elevation angle, and  $\Phi$  is the azimuth angle.

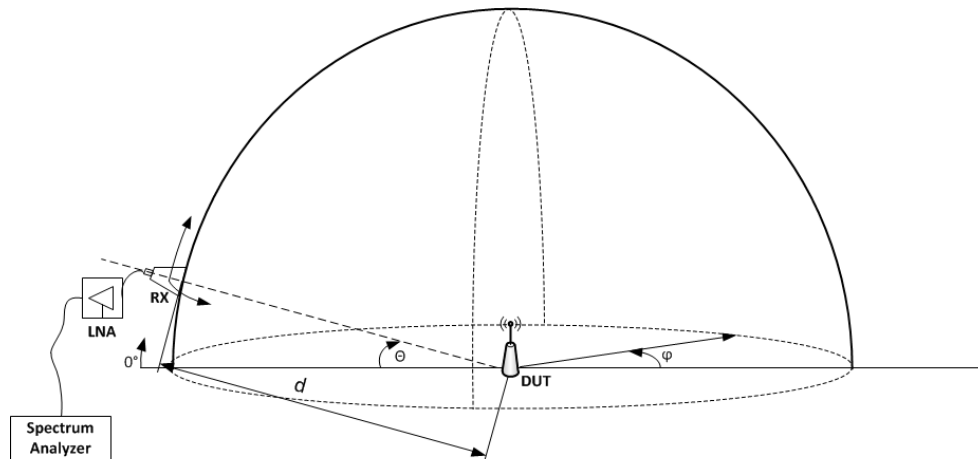

Figure 1: Azimuth and Elevation angle definitions

#### 6.2.4 Peak e.i.r.p.

The radiated peak power (e.i.r.p.) is the highest instantaneous power radiated by the equipment. It is measured in the permitted range of operating frequencies.

#### 6.2.5 Mean (average) e.i.r.p.

The radiated mean (average) power (e.i.r.p.) of the EUT, at a particular frequency is the product of the mean power supplied to the antenna times the antenna gain in a given direction relative to an isotropic antenna under the specified conditions of measurement.

The maximum mean power (e.i.r.p.) is the mean power radiated in the direction of the maximum level (usually the boresight of the antenna) under the specified conditions of measurement.

This radiated power is to be measured in the operating frequencies ranges (see clause 6.2.2).

The value is given in dBm.

#### 6.2.6 Mean e.i.r.p. spectral density

The mean power spectral density (e.i.r.p.) is defined as the emitted power spectral density over a defined bandwidth of the transmitter including antenna gain radiated in the direction of the maximum level under the specified conditions of measurement.

#### 6.2.7 Power Duty Cycle

Duty cycle with  $BW_o$  large enough to capture the whole transmission. (See definition of duty cycle in clause 3.1).

$t_o$  shall be a multiple of the EUT cycle time.

## 6.2.8 Spectrum Access Duty Cycle

Duty cycle with  $BW_o$  set to cover a given frequency range. (See definition of duty cycle in clause 3.1). The given frequency range is specified by the relevant HS.

$t_o$  shall be a multiple of the EUT cycle time.

## 6.2.9 Dwell time and repetition time

"Dwell time" in general denotes the absolute period of time that a parameter remains in a given state. Here, "dwell time" specifically refers to the period that the transmit frequency of the EUT occupies a given frequency bandwidth.

"Repetition time" in general denotes the period of time within which a parameter returns to a given state. Here, "repetition time" specifically refers to the period within which the transmit frequency of the EUT re-occupies a given frequency bandwidth.

## 6.2.10 Frequency modulation range

The frequency modulation range denotes the frequency range which is covered during a complete modulation sequence of a radar transmit cycle.

## 6.2.11 Unwanted emissions in the out-of-band and spurious domains

OOB emissions are emissions on a frequency or frequencies immediately outside the necessary bandwidth which results from the modulation process, but excluding spurious emissions.

The measurement results of  $f_H$  and  $f_L$  under clause 6.3.2 will be used to determine the operating BW of the device.

The operating bandwidth ( $f_H - f_L$ ) will be used to calculate the ranges of OOB and spurious domain.

Spurious emissions are emissions on a frequency or frequencies which are outside the necessary bandwidth and the level of which may be reduced without affecting the corresponding transmission of information. Spurious emissions include harmonic emissions, parasitic emissions, intermodulation products and frequency conversion products, but exclude out-of-band emissions.

According to CEPT/ERC/Recommendation 74-01 [i.1], and Recommendation ITU-R SM.329-12 [i.4], the boundary between the out-of-band and spurious domains is  $\pm 250\%$  of the operating bandwidth (OBW) from the centre frequency of the emission. Out-of-band and spurious emissions are measured as spectral power density under normal operating conditions.

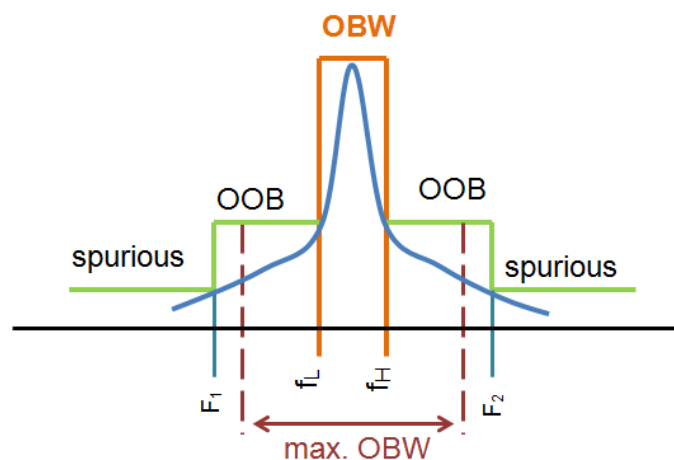

Figure 2: Overview OOB/spurious, depending on OBW



The borders are calculated as follows:

$$f_C = (f_L + f_H) / 2$$

$$F_1 = f_C - (2,5 \times (f_H - f_L))$$

$$F_2 = f_C + (2,5 \times (f_H - f_L))$$

This calculation taken into account that the border between OOB and spurious may be larger or smaller than the maximum permitted range of operation.

### 6.2.12 Receiver spurious emissions

Receiver spurious emissions are emissions at any frequency when the equipment is in receive mode. Consequently, receiver spurious emission testing applies only when the equipment can work in a receive-only mode or is a receive only device.

### 6.2.13 Receiver in-band, out-of-band and remote-band signals handling

Ability of the receiver to operate as intended when unwanted signals, located respectively in-band, out-of-band and at a remote band, are occurring.

## 6.3 Method of measurements of the EUT

### 6.3.1 Introduction

In this clause the detailed measurement procedures and settings for the measurements of the different transmitter and receiver parameters defined in clause 6.2 will be presented.

For these measurements, measuring receivers are used, as described in annex D.

### 6.3.2 Operating Frequency Range

A spectrum analyser with the following settings is used as measuring receiver in the test set-up described in clause 5:

- Start frequency: lower than the lower edge of the permitted frequency range.
- Stop frequency: higher than the upper edge of the permitted frequency range.
- Resolution Bandwidth: 1 MHz.
- Video Bandwidth:  $\geq 3$  MHz.
- Detector mode: RMS (see Recommendation ITU-R SM.328-11 [i.5]).
- Display mode: Maxhold.
- Averaging time:  $\geq 1$  ms per sweep point.

The 99 % OBW function is then used to determine the operating frequency range.

- $f_H$  is determined.  $f_H$  is the frequency of the upper marker resulting from the OBW.
- $f_L$  is determined.  $f_L$  is the frequency of the lower marker resulting from the OBW.
- $f_c$  is the centre frequency.  $f_c = \frac{f_H + f_L}{2}$ .

Alternatively, the recorded results from the mean power measurement described in clause 6.3.4.2 may be used.

### 6.3.3 Peak e.i.r.p.

#### 6.3.3.1 General

Three methods are described for measuring the peak e.i.r.p.

In clause 6.3.3.2 (Method with a spectrum analyser), settings are dependant of the EUT frequency sweep rate.

Clauses 6.3.3.3 and 6.3.3.4 are independent of the EUT frequency sweep rates.

#### 6.3.3.2 Method with a spectrum analyser

A spectrum analyser with the following settings is used as measuring receiver in the test set-up described in clause 5:

- Start frequency: lower than the lower edge of the operating frequency range.
- Stop frequency: higher than the upper edge of the operating frequency range.
- Resolution bandwidth: 1 MHz for EUT with a frequency sweep rate less than < 1 000 MHz/ms.

NOTE: For EUT with a higher frequency sweep rate, the RBW has to be increased until a stable peak power reading is obtained.

- Video bandwidth:  $VBW \geq RBW$ .
- Detector mode: Peak or auto peak detector.
- Display mode: Maxhold.
- Averaging time: larger than one EUT cycle time.
- Sweep time: averaging time  $\times$  number of sweep points.

The peak power to be considered is the maximum value recorded.

#### 6.3.3.3 Method with an average power meter

The power meter shall be connected to the measurement antenna. The frequency correction factor shall be taken into account. The power meter shall be a true RMS power meter (see clause D.2).

The measurement time shall be sufficiently long to cover the EUT cycle time.

The peak power is obtained by dividing the mean power measured by the average power meter by the power duty cycle (see clause 6.3.6).

$$Peak\ Power = \frac{Measured\ Mean\ Power}{Power\ Duty\ Cycle} \quad (8)$$

#### 6.3.3.4 Method with a peak power meter

The power meter shall be connected to the measurement antenna. The frequency correction factor shall be taken into account. The power meter shall be a true peak power meter (see clause D.2).

### 6.3.4 Mean e.i.r.p.

#### 6.3.4.1 General

Three methods are described. Each method is applicable to all EUT.

### 6.3.4.2 Method with a spectrum analyser

A spectrum analyser with the following settings is used as measuring receiver in the test set-up described in clause 5:

- Start frequency: lower than the lower edge of the operating frequency range.
- Stop frequency: higher than the upper edge of the operating frequency range.
- Resolution bandwidth: 1 MHz.
- Video bandwidth:  $VBW \geq RBW$ .
- Detector mode: RMS.
- Display mode: clear write.
- Averaging time: larger than one EUT cycle time.
- Sweep time: averaging time  $\times$  number of sweep points.

Channel Power function needs to be used to calculate the average power. Boundaries for the calculation needs to be defined. This is typically the operating frequency range.

### 6.3.4.3 Method with an average power meter

The power meter shall be connected to the measurement antenna. The frequency correction factor shall be taken into account. The power meter shall be a true RMS power meter (see clause D.2).

The measurement time shall be equal or longer than the EUT cycle time.

### 6.3.4.4 Method with a peak power meter

The power meter shall be connected to the measurement antenna. The frequency correction factor shall be taken into account. The power meter shall be a true peak power meter (see clause D.2)

The measurement time shall be sufficiently long to cover the EUT cycle time.

The mean power is obtained by multiplying the peak power measured by the peak power meter with the power duty cycle (see clause 6.3.6).

$$\text{Mean Power} = \text{Measured Peak Power} \times \text{Power Duty Cycle} \quad (9)$$

## 6.3.5 Mean E.I.R.P spectral density

Using the applicable measurement procedure as described in clause 5, the mean power spectral density shall be measured and recorded in the test report. The method of measurement shall be documented in the test report.

The tests shall be made in an anechoic-shielded chamber, as the measured levels often are lower than the ambient environmental noise.

The following spectrum analyser settings shall be used:

- Start frequency: lower than the lower edge of the operating frequency range.
- Stop frequency: higher than the upper edge of the operating frequency range.
- Resolution bandwidth: 1 MHz.
- Video bandwidth: 3 MHz.
- Detector mode: RMS.
- Display mode: clear write.

- Averaging time: larger than one EUT cycle time per sweep point.
- Sweep time: averaging time  $\times$  number of sweep points.

The measured spectrum curve at the spectrum analyser is recorded over an amplitude range of approximately 35 dB. Measurements of power densities below -40 dBm/MHz (e.i.r.p.) are not required.

The mean power spectral density to be considered is the maximum value recorded.

## 6.3.6 Power Duty Cycle

### 6.3.6.1 General

Duty cycle shall be declared by the manufacturer or measured using one of the method described below. Each method is applicable to all EUT.

### 6.3.6.2 Method with the spectrum analyser

This method uses the zero-span mode of the spectrum analyser at the frequency of the highest peak power.

The following spectrum analyser settings shall be used:

- Frequency: frequency of the highest peak power.
- Frequency span: zero-span mode.
- Resolution bandwidth: Maximum available bandwidth equal or greater than 3 MHz.

NOTE: Use always the highest available bandwidth for the signal to be measured.

- Video bandwidth: not less than RBW.
- Detector mode: peak.
- Sweep time: more than one EUT cycle time.

The power duty cycle is the percentage the EUT is ON over the total cycle time of the EUT.

The following information shall be determined:

- The EUT cycle time.
- The total ON time the EUT is transmitting.
- The power duty cycle which is the total ON time divided by the EUT cycle time.

### 6.3.6.3 Alternative method with an oscilloscope

#### 6.3.6.3.1 Description

Alternative time domain method, for details see ETSI TR 103 366 [i.13].

#### 6.3.6.3.2 General test setup

The following tools shall be used to execute the time domain procedure for DC measurement:

- A detector or a down converter might be needed to extract the envelope of the signal to be displayed on the oscilloscope.
- One Oscilloscope with the following minimum requirements:
  - Sampling frequency  $> 1\,000 / \text{EUT cycle time}$ .

- Input bandwidth  $> 10\,000 / \text{EUT cycle time}$ .

Figure 3 illustrates the general test setup to execute the time domain procedure for DC measurement in the case of radiated emission.

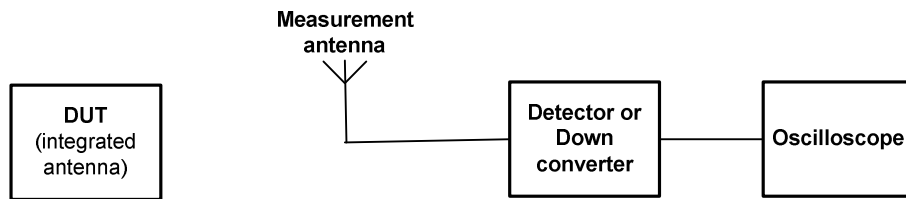

**Figure 3: General test setup to execute the time domain procedure for DC measurement in the case of radiated emission**

The power duty cycle is the percentage the EUT is ON over the total cycle time of the EUT.

The following information shall be determined:

- The EUT cycle time.
- The total ON time the EUT is transmitting.
- The power duty cycle which is the total ON time divided by the EUT cycle time.

## 6.3.7 Spectrum access duty cycle

### 6.3.7.1 Introduction

The spectrum access duty cycle is derived from frequency-vs-time measurements of a signal and refers to a given observation bandwidth  $BW_o$  and a given observation time  $t_o$ .

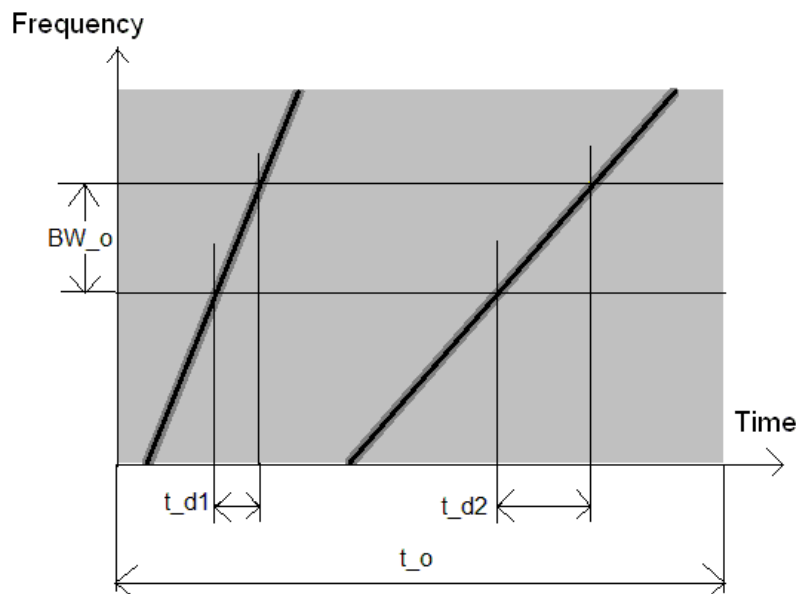

NOTE: Grey scale denotes signal power, two individual time contributions occur for a given observation bandwidth  $BW_o$  and over a given observation time interval  $t_o$ .

**Figure 4: Example of frequency-vs-time measurement**

A method is described below with a signal analyser. Alternative approaches giving comparable information may also be used in agreement with the EUT manufacturer and the test laboratory.

### 6.3.7.2 Measurement of spectrum access duty cycle

A signal analyser is used as measuring receiver with the following settings:

- Total measurement time (x-axis): Equal to desired observation time  $t_o$ .
- Time resolution (x-axis): Min. 500 time measurement points within  $t_o$ .
- Frequency range (y-axis):  $\geq BW_o$ .

If signal analyser does not allow to cover that frequency range in a single measurement, then frequency range can be split into several smaller frequency ranges which are measured one after the other.

- Frequency resolution (y-axis):  $\leq BW_o$ .

The measurement procedure shall be repeatedly performed until the obtained result shows a representative signal portion. The settings may be adjusted to better capture the special EUT signals in agreement with the EUT manufacturer and the test laboratory.

To obtain the spectrum access duty cycle, all individual contributions  $t_{d,i}$  (including contributions from split smaller frequency ranges, if applicable) within  $t_o$  are summed up and divided by  $t_o$ .

## 6.3.8 Dwell time and repetition time

### 6.3.8.1 Introduction

Dwell time and repetition time are derived from frequency-vs-time measurements of a signal and refer to a given observation bandwidth  $BW_o$ , and a minimum relevant signal power level  $P_{min}$ .

Two basic cases are distinguished:

- 1) Accumulated dwell time over a given observation time  $t_o$  (see example in Figure 5).
- 2) Repeating dwell time (see example in Figure 6).

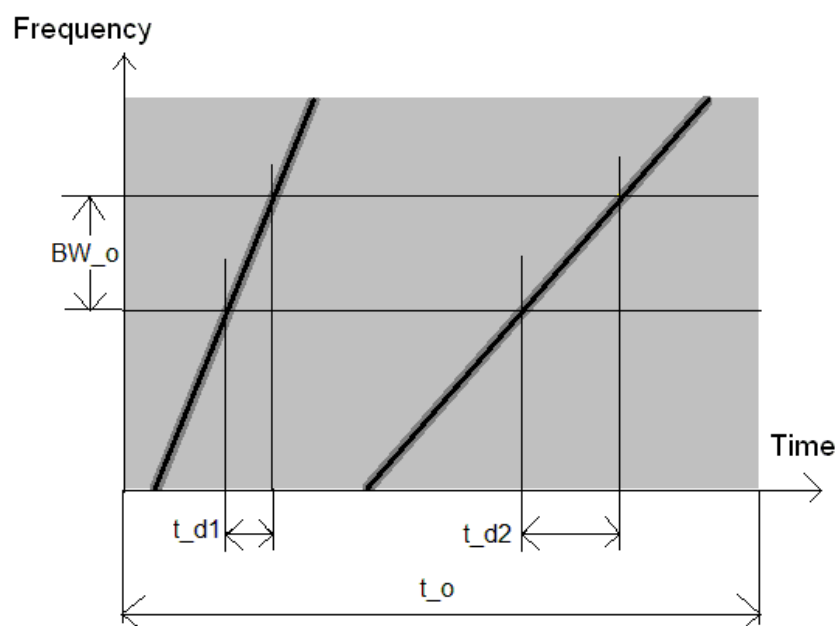

NOTE: Grey-scale denotes signal power, two individual dwell time contributions for accumulation over a given observation bandwidth  $BW_o$  and of a given observation time  $t_o$ .

**Figure 5: Example of frequency-vs-time measurement**

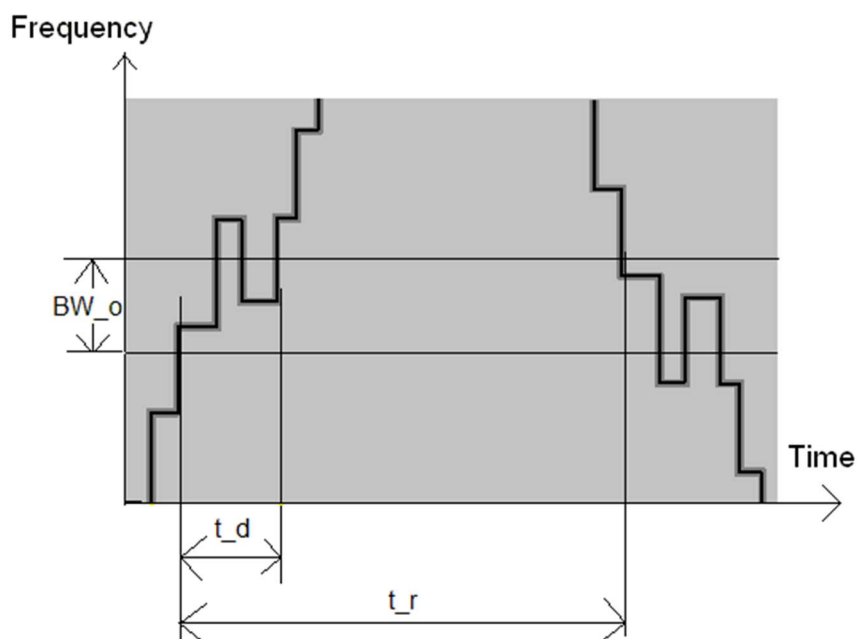

NOTE: Grey-scale denotes signal power, observation bandwidth  $BW_o$  is occupied for a certain dwell time  $t_d$  and re-entered again after a certain repetition time  $t_r$ .

**Figure 6: Example of frequency-vs-time measurement**

Methods described below use a signal analyser. Alternative approaches giving comparable information may also be used in agreement with the EUT manufacturer and the test laboratory.

### 6.3.8.2 Measurement of accumulated dwell time over a given observation time interval

A signal analyser is used as measuring receiver with the following settings:

- Total measurement time (x-axis): Equal to desired observation time  $t_o$ .
- Time resolution (x-axis): Min. 500 time measurement points within  $t_o$ .
- Frequency range (y-axis):  $\geq BW_o$ .

If signal analyser does not allow to cover that frequency range in a single measurement, then frequency range can be split into several smaller frequency ranges which are measured one after the other.

- Frequency resolution (y-axis):  $\leq BW_o$ .

The measurement procedure shall be repeatedly performed until the obtained result shows a representative signal portion. The settings may be adjusted to better capture the special EUT signals in agreement with the manufacturer and the test laboratory.

For reading individual dwell time contributions, only signal portions larger than  $P_{min}$  are relevant. If supported by the used signal analyser, power level values below  $P_{min}$  are not shown in the spectrogram at all.

To obtain the accumulated dwell time, all individual contributions  $t_{d,i}$  within  $t_o$  are summed up.

If the frequency range was split into several smaller frequency ranges, then the final result of accumulated dwell time is the maximum or minimum of the individual accumulated dwell time results (depending on whether a upper or lower limit is tested for) obtained for the individual smaller frequency ranges.

### 6.3.8.3 Measurement of a repeating dwell time

A signal analyser is used as measuring receiver with the following settings:

- Total measurement time (x-axis): Large enough to obtain two repeating dwell time events.
- Time resolution (x-axis): Min. 500 time measurement points within the total measurement time.
- Frequency range (y-axis):  $\geq BW_o$ .  
If signal analyser does not allow to cover that frequency range in a single measurement, then frequency range can be split into several smaller frequency ranges which are measured one after the other.
- Frequency resolution (y-axis):  $\leq BW_o$ .

The measurement procedure shall be repeatedly performed until the obtained result shows a representative signal portion. The settings may be adjusted to better capture the special EUT signals in agreement with the EUT manufacturer and the test laboratory.

For reading a dwell time and/or a repetition time, only signal portions larger than  $P_{min}$  are relevant. If supported by the used signal analyser, power level values below  $P_{min}$  are not shown in the spectrogram at all.

If the frequency range is split into several smaller frequency ranges, then the final result:

- for the dwell time is the maximum or minimum of the individual dwell time results (depending on whether a upper or lower limit is tested for);
- for the repetition time is the maximum or minimum of the individual repetition time results (depending on whether a upper or lower limit is tested for);

obtained for the smaller frequency ranges.

## 6.3.9 Frequency modulation range

### 6.3.9.1 Introduction

Frequency modulation range is derived from the frequency-vs-time measurement of a signal and refers to a given observation time  $t_o$ , given observation bandwidth  $BW_o$ , and a minimum relevant signal power level  $P_{min}$  (see Figure 7).



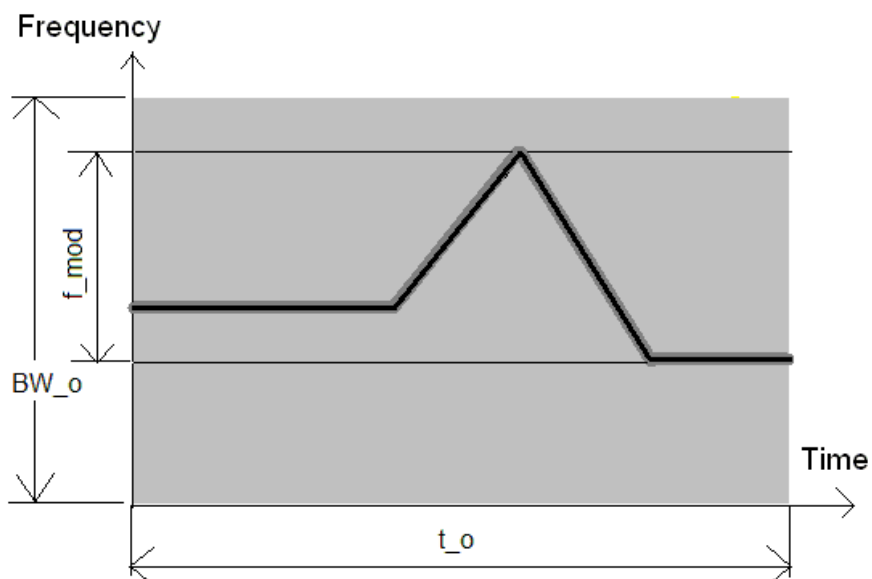

NOTE: Greyscale denotes signal power, reading modulation frequency range.

**Figure 7: Example of frequency-vs-time measurement**

A method is described below with a signal analyser. Alternative approaches giving comparable information may also be used in agreement with the EUT manufacturer and the test laboratory.

### 6.3.9.2 Measurement of frequency modulation range

A signal analyser is used as measuring receiver with the following settings:

- Total measurement time (x-axis): Equal to desired observation time  $t_o$ .
- Time resolution (x-axis): Min. 500 time measurement points within  $t_o$ .
- Frequency range (y-axis):  $\geq BW_o$ .

If signal analyser does not allow to cover that frequency range in a single measurement, then frequency range can be split into several smaller frequency ranges which are measured one after the other.

- Frequency resolution (y-axis): Smaller than minimum frequency modulation range tested for.

The measurement procedure shall be repeatedly performed until the obtained result shows a representative signal portion. The settings may be adjusted to better capture the special EUT signals in agreement with the manufacturer and the test laboratory.

For reading the frequency modulation range, only signal portions larger  $P_{min}$  are relevant. If supported by the used signal analyser, power level values below  $P_{min}$  are not shown in the spectrogram at all.

### 6.3.10 Unwanted emissions in the out-of-band and spurious domains

A spectrum analyser is used as a measuring receiver. The bandwidth of the measuring receiver shall, where possible, be according to CISPR 16 [1]. In order to obtain the required sensitivity a narrower resolution bandwidth may be necessary, this shall be stated in the test report and results scaled in accordance with clause 4.5.

In case of an EUT with multiple operation modes, only the mode given the highest peak e.i.r.p. (see clause 6.3.3) needs to be measured.

Measurements shall be conducted over the frequency ranges of the OOB and spurious domains as specified in the relevant HS or, if not so specified, in clause 6.2.11.

The following spectrum analyser settings shall be used:

- Start frequency: See relevant HS.
- Stop frequency: See relevant HS.
- Resolution bandwidth (RBW):
  - 100 kHz between 30MHz and 1 GHz.
  - 1 MHz above 1 GHz.
- Video bandwidth (VBW)  $\geq 3$  MHz.
- Detector mode:
  - Quasi-peak between 30 MHz and 1 GHz.
  - RMS > 1 GHz.
- Display mode: clear write.
- Averaging time: larger than one EUT cycle time.
- Sweep time: averaging time  $\times$  number of sweep points.

NOTE: The number of sweep points has to be higher than the span of the spectrum analyser divided by the RBW.

The measured spectrum curve at the spectrum analyser is recorded over an amplitude range of approximately 35 dB. Measurements of spectral mean power densities below -40 dBm/MHz (e.i.r.p.) are not required above 1 GHz.

A test site such as described in clause 5, which fulfils the requirements of the specified frequency range of this measurement shall be used. The bandwidth of the measuring receiver shall be set to a suitable value to correctly measure the unwanted emission. This bandwidth shall be recorded in the test report. For frequencies above 40 GHz a downconverter may be used as shown in Figure 8. The local oscillator used to downconvert the received signals shall be stable and with a phase noise of better than -80 dBc/Hz at 100 kHz offset. The local oscillator frequency shall be selected such that the downconverted signal is within the accepted band of the spectrum analyser, and maintaining an adequate IF bandwidth to capture the full spectrum of the signal.

For spurious emissions measurements it is strongly recommended to use a LNA (low noise amplifier) before the spectrum analyser input to achieve the required sensitivity.

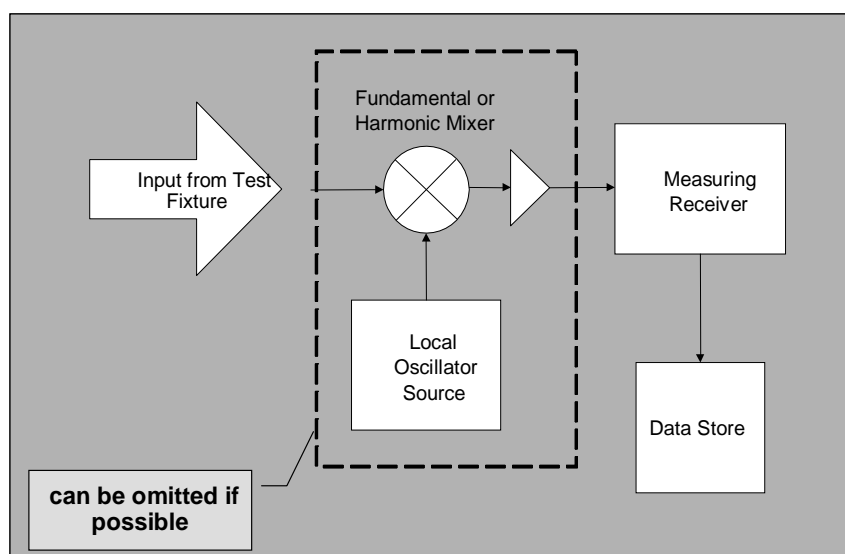

Figure 8: Principal Test setup for measuring out-of-band and spurious radiations

## 6.3.11 Receiver spurious emissions

### 6.3.11.1 General

Separate radiated spurious measurements need not be made for EUT where the receiver is co-located with, and operates simultaneously with, the transmitter. In this case, provisions of clause 6.3.10 on transmitter spurious and out-of-band emissions apply.

In all other cases, the following applies:

- a) A test site, as described by clause 5, which fulfils the requirements of the specified frequency range of this measurement shall be used. The test antenna shall be oriented initially for vertical polarization and connected to a measuring receiver. The measuring receiver should be a spectrum analyser with the setting defined in clause 6.3.10.

The receiver under test shall be placed on the support in its standard position.

- b) The frequency of the measuring receiver shall be adjusted over the frequency range defined in the related harmonised standard. The frequency of each spurious component shall be noted. If the test site is disturbed by radiation coming from outside the site, this qualitative search may be performed in a screened room with reduced distance between the transmitter and the test antenna.
- c) At each frequency at which a component has been detected, the measuring receiver shall be tuned and the test antenna shall be raised or lowered through the specified height range until the maximum signal level is detected on the measuring receiver.
- d) The receiver shall be rotated up to 360° about a vertical axis, to maximize the received signal.
- e) The test antenna shall be raised or lowered again through the specified height range until a maximum is obtained. This level shall be noted.
- f) The substitution antenna (see annex A) shall replace the receiver antenna in the same position and in vertical polarization. It shall be connected to the signal generator.
- g) At each frequency at which a component has been detected, the signal generator, substitution antenna and measuring receiver shall be tuned. The test antenna shall be raised or lowered through the specified height range until the maximum signal level is detected on the measuring receiver. The level of the signal generator giving the same signal level on the measuring receiver as in step e) shall be noted. This level, after correction due to the gain of the substitution antenna and the cable loss, is the radiated spurious component at this frequency.
- h) The frequency and level of each spurious emission measured and the bandwidth of the measuring receiver shall be recorded in the test report.
- i) Measurements b) to h) shall be repeated with the test antenna oriented in horizontal polarization.

### 6.3.11.2 Test set-up

For finding spurious emissions the spectrum analyser shall be set as follows:

- Resolution BW: 100 kHz
- Video BW: 100 kHz
- Detector Mode: positive peak
- Averaging: off
- Span: 100 MHz
- Sweep time: 1 second
- Amplitude: adjust for middle of the instrument's range

For measuring emissions that exceed the level of 6 dB below the applicable limit, the resolution bandwidth shall be switched to 30 kHz and the span shall be adjusted accordingly. If the level does not change by more than 2 dB, it is a narrowband emission; the observed value shall be recorded in the test report. If the level changes by more than 2 dB, the emission is a wideband emission and its level shall be measured and recorded in the test report. The method of measurement for wideband emissions, if applicable, shall be documented in the test report.

NOTE: The main spectrum of the device being tested may saturate the spectrum analyser's input circuits and so cause ghost "spurious" signals. Ghosts can be distinguished from real signals by increasing the input attenuator by 10 dB. If the spurious signal disappears, it is a ghost and should be ignored.

## 6.3.12 Receiver in-band, out-of-band and remote-band signals handling

### 6.3.12.1 Introduction

This clause presents the method of measurement to test the EUT capability to handle unwanted signals when in normal operation.

### 6.3.12.2 Test set-up

The target type (RCS), position and distance relative to the EUT are defined in the related HS.

The unwanted signal source is positioned within the 3 dB beamwidth at the operating centre frequency of the RX boresight. See clause 6.3.12.4 for the unwanted signal specification.

The wanted performance criteria are given in the related HS.

### 6.3.12.3 Test procedure

- The target and the unwanted signal source shall be positioned as defined in clause 6.3.12.2.
- The EUT shall be powered ON. Achievement of the relevant wanted performance criterion shall be verified.
- The unwanted signal transmitter shall be powered ON at a lower level of 20 dB below the specified unwanted signal level in clause 6.3.12.4.
- To simulate real use-cases, the unwanted signals level shall be increased in 5 dB steps until either the relevant wanted performance criterion is not met or the specified unwanted signal level in clause 6.3.12.4 is reached. The unwanted signal (see clause 6.3.12.4) shall be held at each power step for at least 5 s.

The measurement procedure shall be done again for each unwanted signal transmitter frequency mode, as defined in clause 6.3.12.4.

### 6.3.12.4 Unwanted signals specification

The unwanted signal transmitter shall be able to transmit signals at specific frequencies, as described in the related HSs.

## Annex A (normative): Test sites and general arrangements for measurements involving the use of radiated fields

### A.1 Introduction

This clause introduces the test site which may be used for radiated tests. The test site is generally referred to as a free field test site. Both absolute and relative measurements can be performed in these sites. Where absolute measurements are to be carried out, the chamber should be verified. A detailed verification procedure is described in ETSI TS 102 321 [4].

### A.2 Anechoic chamber

An anechoic chamber is the preferred test site to be used for radiated testing in accordance with the present document above 1 GHz. However, an anechoic chamber with ground plane as described in clause A.2 may be used above 1 GHz providing that suitable anechoic material is placed on the chamber floor to suppress any reflected signal.

An anechoic chamber is an enclosure, usually shielded, whose internal walls, floor and ceiling are covered with radio absorbing material, normally of the pyramidal urethane foam type. The chamber usually contains an antenna support at one end and a turntable at the other. A typical anechoic chamber is shown in Figure A.1.

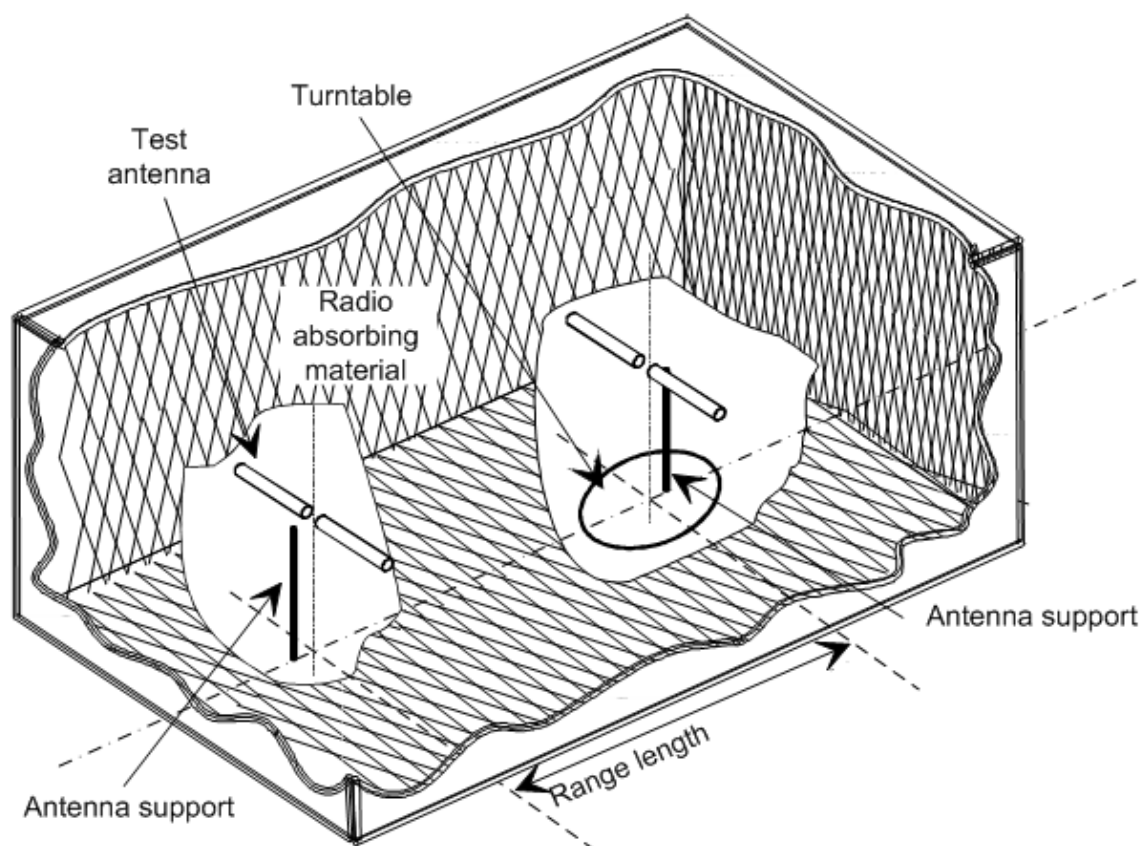

**Figure A.1: A typical anechoic chamber**

The chamber shielding and radio absorbing material work together to provide a controlled environment for testing purposes. This type of test chamber attempts to simulate free space conditions.

The shielding provides a test space, with reduced levels of interference from ambient signals and other outside effects, whilst the radio absorbing material minimizes unwanted reflections from the walls and ceiling which can influence the measurements. In practice it is relatively easy for shielding to provide high levels (80 dB to 140 dB) of ambient interference rejection, normally making ambient interference negligible.

A turntable is capable of rotation through 360° in the horizontal plane and it is used to support the test sample (EUT) at a suitable height (e.g. 1 m) above the ground plane. The chamber shall be large enough to allow measurement in the far field of the EUT. Further information on far field measurement requirements is given in clause 5.3.2.3.

The anechoic chamber generally has several advantages over other test facilities. There is minimal ambient interference, minimal floor, ceiling and wall reflections and it is independent of the weather. It does however have some disadvantages which include limited measuring distance and limited lower frequency usage due to the size of the pyramidal absorbers. To improve low frequency performance, a combination structure of ferrite tiles and urethane foam absorbers is commonly used.

All types of emission testing can be carried out within an anechoic chamber without limitation.

### A.3 Anechoic chamber with a conductive ground plane

An anechoic chamber with a conductive ground plane shall be used for radiated testing in accordance with the present document below 1 GHz.

An anechoic chamber with a conductive ground plane is an enclosure, usually shielded, whose internal walls and ceiling are covered with radio absorbing material, normally of the pyramidal urethane foam type. The floor, which is metallic, is not covered and forms the ground plane. The chamber usually contains an antenna mast at one end and a turntable at the other. A typical anechoic chamber with a conductive ground plane is shown in Figure A.2.

This type of test chamber attempts to simulate an ideal Open Area Test Site whose primary characteristic is a perfectly conducting ground plane of infinite extent.

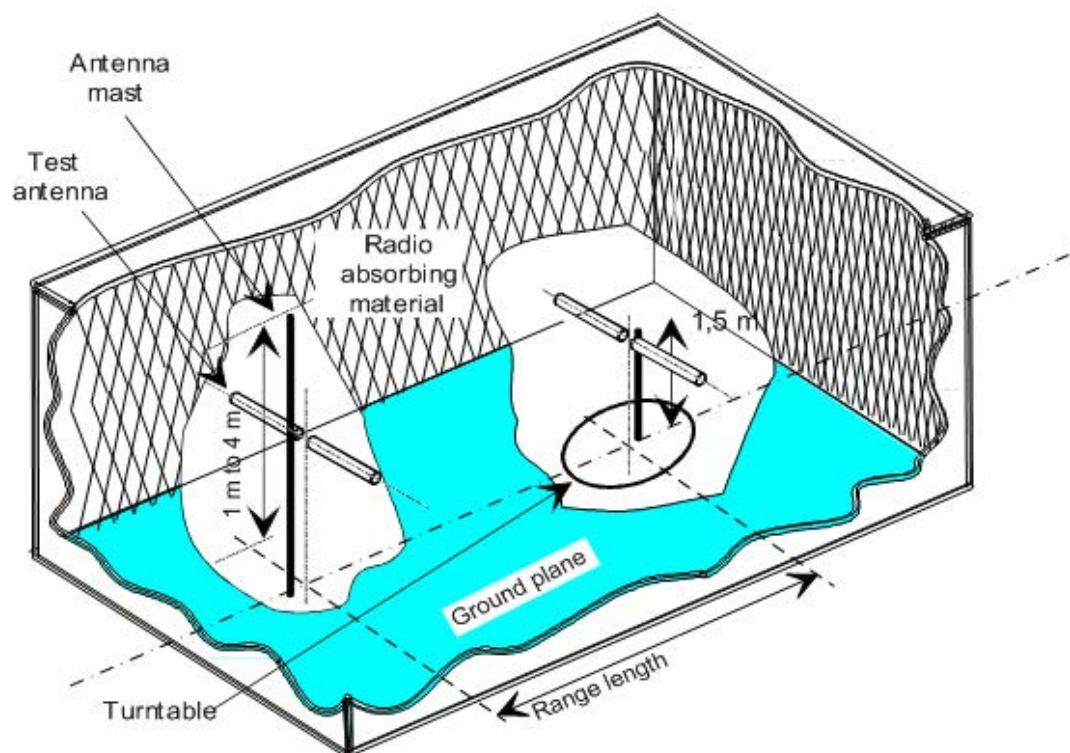

**Figure A.2: A typical anechoic chamber with a conductive ground plane**

In this facility the ground plane creates the wanted reflection path, such that the signal received by the receiving antenna is the sum of the signals from both the direct and reflected transmission paths. This creates a unique received signal level for each height of the transmitting antenna (or EUT) and the receiving antenna above the ground plane.

The antenna mast provides a variable height facility (from 1 m to 4 m) so that the position of the test antenna can be optimized for maximum coupled signal between antennas or between a EUT and the test antenna.

A turntable is capable of rotation through 360° in the horizontal plane and it is used to support the test sample (EUT) at a specified height, usually 1,5 m above the ground plane. The chamber shall be large enough to allow measurement in the far field of the EUT. Further information on far field measurement requirements is given in clause 5.3.2.3.

Emission testing involves firstly "peaking" the field strength from the EUT by raising and lowering the receiving antenna on the mast (to obtain the maximum constructive interference of the direct and reflected signals from the EUT) and then rotating the turntable for a "peak" in the azimuth plane. At this height of the test antenna on the mast, the amplitude of the received signal is noted. Secondly the EUT is replaced by a substitution antenna (positioned at the EUT's phase or volume centre), which is connected to a signal generator. The signal is again "peaked" and the signal generator output adjusted until the level, noted in stage one, and is again measured on the receiving radio device.

Receiver sensitivity tests over a ground plane also involve "peaking" the field strength by raising and lowering the test antenna on the mast to obtain the maximum constructive interference of the direct and reflected signals, this time using a measuring antenna which has been positioned where the phase or volume centre of the EUT will be during testing. A transform factor is derived. The test antenna remains at the same height for stage two, during which the measuring antenna is replaced by the EUT. The amplitude of the transmitted signal is reduced to determine the field strength level at which a specified response is obtained from the EUT.

## A.4 Extreme conditions test

### A.4.1 Radio transparent temperature chamber

A temperature chamber fitted with a radio transparent door or wall may be used to perform radiated measurements. The procedure would in this case be the same as the one specified under normal conditions.

The EUT shall be placed onto a radio transparent support. The distance between the test antenna and the EUT shall be in accordance with clause 5.3.2.3. Figure A.3 shows the test set-up.

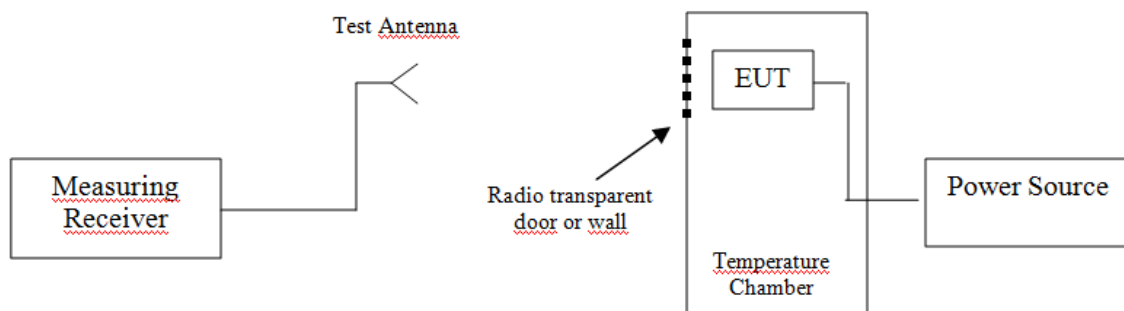

Figure A.3: Extreme conditions set-up

### A.4.2 Use of a test fixture

#### A.4.2.0 General

Alternatively, a test fixture may be used to facilitate measurements under extreme conditions.

#### A.4.2.1 Characteristics

The fixture is a radio frequency device for coupling the integral antenna of the EUT to a 50 Ω RF terminal at all frequencies for which measurements need to be performed.

The test fixture shall be fully described.

In addition, the test fixture shall provide:

- a) a connection to an external power supply;
- b) a method to provide the input to or output from the equipment. This may include coupling to or from the antenna. The test fixture could also provide the suitable coupling means e.g. for data or video outputs.

The test fixture is normally be supplied by the manufacturer.

The performance characteristics of the test fixture shall be approved by the testing laboratory and shall conform to the following basic parameters:

- a) the coupling loss shall not be greater than 30 dB;
- b) adequate bandwidth properties;
- c) a coupling loss variation over the frequency range used for the measurement shall not exceed 2 dB;
- d) circuitry associated with the RF coupling shall contain no active or non-linear devices;
- e) the VSWR at the 50  $\Omega$  socket shall not be more than 1,5 over the frequency range of the measurements;
- f) the coupling loss shall be independent of the position of the test fixture and be unaffected by the proximity of surrounding objects or people. The coupling loss shall be reproducible when the equipment under test is removed and replaced. Normally, the text fixture is in a fixed position and provides a fixed location for the EUT;
- g) the coupling loss shall remain substantially constant when the environmental conditions are varied.

The coupler attenuation of the test-fixture may amount to a maximum of the noise level of the measurement instrument +10 dB. If the attenuation is too high, a linear LNA can be used outside the test-fixture.

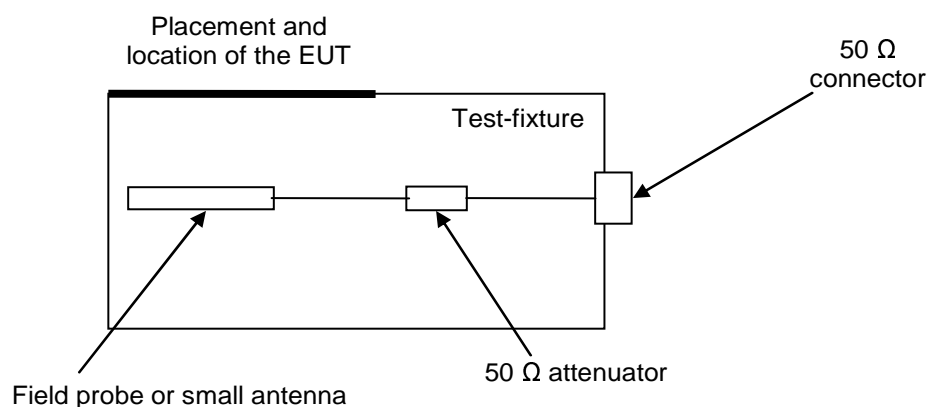

**Figure A.4: Test fixture**

The field probe (or small antenna) needs to be properly terminated.

The characteristics and validation shall be included in the test report.

#### A.4.2.2 Validation of the test fixture in the temperature chamber

The test fixture is brought into a temperature chamber (only needed if test fixture measurements performed under extreme temperature conditions).



### Step 1

A transmit antenna connected to a signal generator shall be positioned from the test-fixture at a far field distance of not less than one  $\lambda$  at the frequency. The test fixture consists of the mechanical support for the EUT, an antenna or field probe and a  $50\ \Omega$  attenuator for proper termination of the field probe. The test fixture shall be connected to a spectrum analyser via the  $50\ \Omega$  connector. A signal generator shall be set on the EUT's nominal frequency (see Figure A.5). The unmodulated output power of the signal generator shall be set to a value such that a sufficiently high level can be observed with the spectrum analyser. This reference value shall be recorded in the test report. The signal generator shall then be set to the upper and the lower band limit of the EUT's assigned frequency band. The measured values shall not deviate more than 1 dB from the value at the nominal frequency.

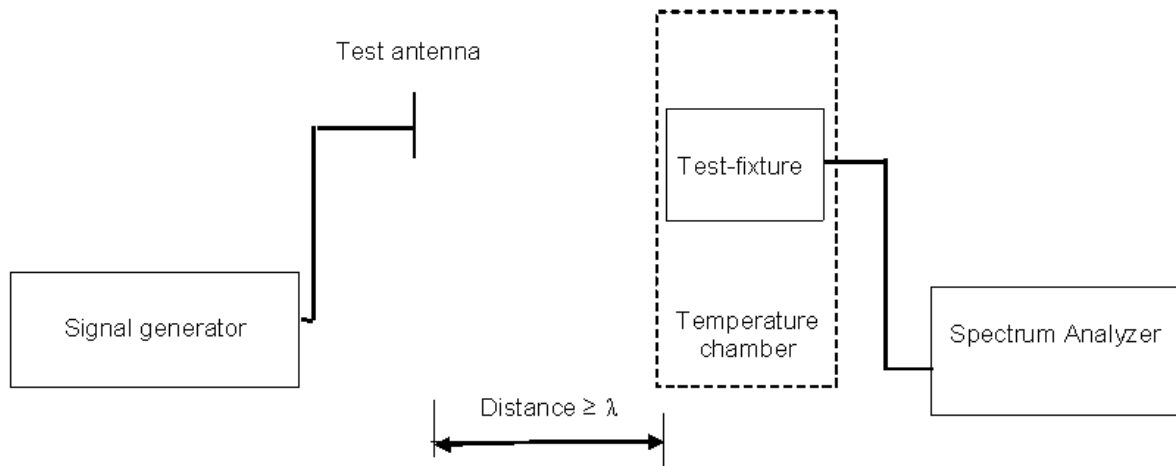

**Figure A.5: Validation of test fixture without EUT**

### Step 2

During validation and testing the EUT shall be fitted to the test fixture in a switched-off mode, see Figure A.6. The measurements of step 1 shall be repeated, this time with the EUT in place. The measured values shall be compared with those from step 1 and shall not vary by more than 2 dB. This shows that the EUT does not cause any significant shadowing of the radiated power.

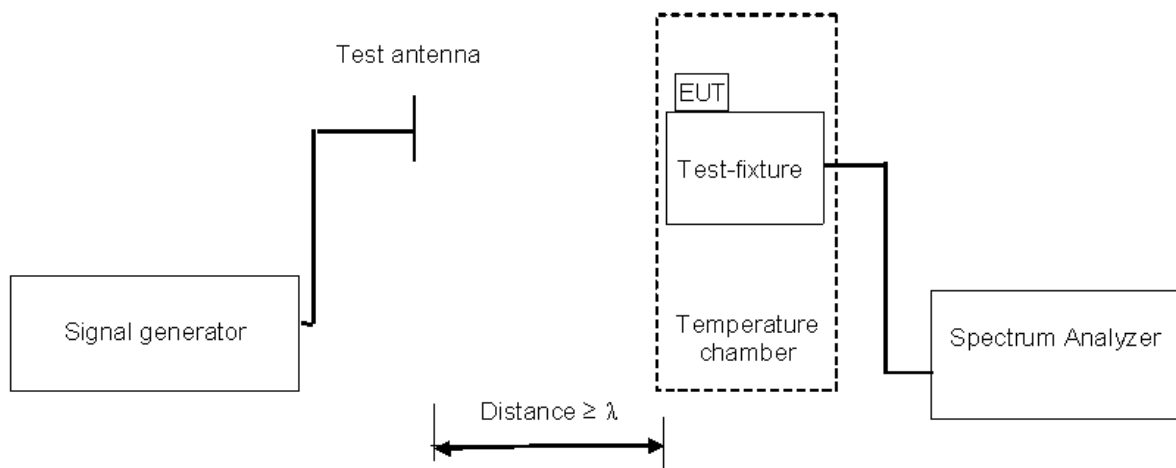

**Figure A.6: Validation of test fixture with EUT in place**

### A.4.2.3 Use of the test fixture for measurement in the temperature chamber

Here, the signal generator and the transmit antenna are removed. The EUT is DC supplied via an external power supply (see Figure A.7). In case of a battery operated EUT that is supplied by a temporary power supply as well as temporary signal- and control line, a decoupling filter shall be installed directly at the EUT in order to avoid parasitic, electromagnetic radiation.

At the 50  $\Omega$  port of the test fixture, a measuring receiver is connected for recording the parameter of interest.

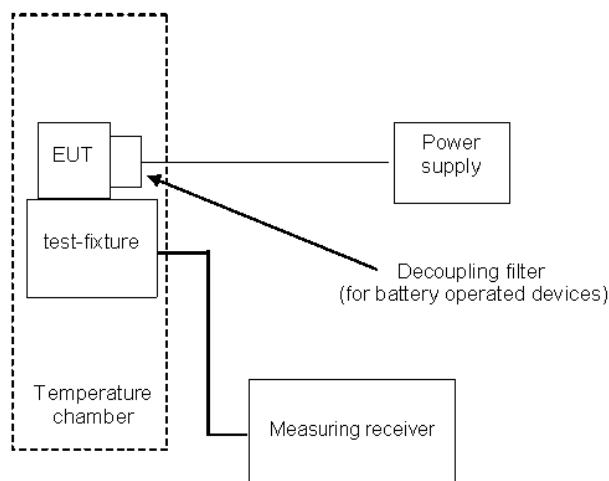

Figure A.7: Measurement of EUT performance in temperature chamber

## A.5 Test antenna

### A.5.1 General

A test antenna is always used in radiated test methods. In emission tests (i.e. effective radiated power, spurious emissions) the test antenna is used to detect the field from the EUT in one stage of the measurement and from the substitution antenna in the other stage. When the test site is used for the measurement of receiver characteristics (i.e. sensitivity and various immunity parameters) the antenna is used as the transmitting radio device.

The test antenna should be mounted on a support capable of allowing the antenna to be used in either horizontal or vertical polarization which, on ground plane sites (i.e. anechoic chambers with ground plane) should additionally allow the height of its centre above the ground to be varied over the specified range (usually 1 m to 4 m).

In the frequency band 30 MHz to 1 000 MHz, dipole antennas (constructed in accordance with ANSI C63.5 [5]) are generally recommended. For frequencies of 80 MHz and above, the dipoles should have their arm lengths set for resonance at the frequency of test. Below 80 MHz, shortened arm lengths are recommended. For spurious emission testing, however, a combination of bicones and log periodic dipole array antennas (commonly termed "log periodic") could be used to cover the entire 30 MHz to 1 000 MHz band. Above 1 000 MHz, waveguide horns are recommended although, again, log periodic could be used.

NOTE: The gain of a horn antenna is generally expressed relative to an isotropic radiator.

### A.5.2 Substitution antenna

The substitution antenna is used to replace the EUT for tests in which a transmitting parameter (i.e. frequency error, effective radiated power, spurious emissions and adjacent channel power) is being measured. For measurements in the frequency band 30 MHz to 1 000 MHz, the substitution antenna should be a dipole antenna (constructed in accordance with ANSI C63.5 [5]). For frequencies of 80 MHz and above, the dipoles should have their arm lengths set for resonance at the frequency of test. Below 80 MHz, shortened arm lengths are recommended. For measurements above 1 000 MHz, a waveguide standard gain horn is recommended.

### A.5.3 Measuring antenna

The measuring antenna is used in tests on a EUT in which a receiving parameter (i.e. sensitivity and various immunity tests) is being measured. Its purpose is to enable a measurement of the electric field strength in the vicinity of the EUT. For measurements in the frequency band 30 MHz to 1 000 MHz, the measuring antenna should be a dipole antenna (constructed in accordance with ANSI C63.5 [5]). For frequencies of 80 MHz and above, the dipoles should have their arm lengths set for resonance at the frequency of test. Below 80 MHz, shortened arm lengths are recommended. For measurements above 1 000 MHz, a waveguide standard gain horn is recommended. The centre of this antenna should coincide with either the phase centre or volume centre (as specified in the test method) of the EUT.

---

## Annex B (normative): Standard test methods

### B.1 Radiated test set-up calibrated by using the Rx link budget calculation

The measurement receiver, test antenna and all associated equipment (e.g. cables, filters, amplifiers, etc.) shall have been recently calibrated against known standards at all the frequencies on which measurements of the equipment are to be made. A suggested calibration method is given in annex C.

If an anechoic chamber with conductive ground plane is used, the ground shall be covered by absorbing material in the area of the direct ground reflection from the EUT to the test antenna.

The equipment shall be placed in an anechoic chamber (see annex A), which allows a spherical evaluation. The EUT shall be placed closest to the orientation of normal operation.

The test antenna shall be oriented initially for vertical polarization and shall be chosen to correspond to the frequency of the transmitter.

The output of the test antenna shall be connected to the spectrum analyser via whatever (fully characterized) equipment is required to render the signal measurable (e.g. amplifiers).

The EUT shall be switched on, if possible without modulation, and the spectrum analyser shall be tuned to the frequency of the transmitter under test.

The test antenna shall be raised and lowered through the specified range of height until a maximum signal level is detected by the spectrum analyser. An alternative is to tilt the EUT through a suitable range.

The EUT shall then be rotated through 360° in the horizontal plane, until the maximum signal level is detected by the spectrum analyser. Another possibility would be to rotate the test antenna around the EUT.

The test antenna shall be raised and lowered again through the specified range of height until a maximum signal level is detected by the spectrum analyser. An alternative is to tilt the EUT through a suitable range.

The measurement shall be repeated with the test antenna orientated for horizontal polarization.

The maximum signal level detected by the spectrum analyser shall be noted and converted into the radiated power by application of the pre-determined calibration coefficients for the equipment configuration used.

---

### B.2 Radiated test set-up calibrated by using substitution method

On a test site, selected from annex A, the equipment shall be placed at the specified height on a support, as specified in annex A, and in the position closest to normal use as declared by the manufacturer.

The test antenna shall be oriented initially for vertical polarization and shall be chosen to correspond to the frequency of the transmitter.

The output of the test antenna shall be connected to the spectrum analyser.

The EUT shall be switched on, if possible without modulation, and the measuring receiver shall be tuned to the frequency of the transmitter under test.

The test antenna shall be raised and lowered through the specified range of height until a maximum signal level is detected by the spectrum analyser. An alternative is to tilt the EUT through a suitable range.

The EUT shall then be rotated through 360° in the horizontal plane, until the maximum signal level is detected by the spectrum analyser. Another possibility would be to rotate the test antenna around the EUT.

The test antenna shall be raised and lowered again through the specified range of height until a maximum signal level is detected by the spectrum analyser. An alternative is to tilt the EUT through a suitable range.

The maximum signal level detected by the spectrum analyser shall be noted.

The EUT shall be replaced by a substitution antenna as defined in annex A.

The substitution antenna shall be orientated for vertical polarization and the length of the substitution antenna shall be adjusted to correspond to the frequency of the transmitter.

The substitution antenna shall be connected to a calibrated signal generator.

If necessary, the input attenuator setting of the spectrum analyser shall be adjusted in order to increase the sensitivity of the spectrum analyser.

The test antenna shall be raised and lowered through the specified range of height to ensure that the maximum signal is received. An alternative is to tilt the substitution antenna through a suitable range. When a test site according to the one defined in clause A.2 is used, the height of the antenna shall not be varied.

The input signal to the substitution antenna shall be adjusted to the level that produces a level detected by the spectrum analyser, that is equal to the level noted while the transmitter radiated power was measured, corrected for the change of input attenuator setting of the spectrum analyser.

The input level to the substitution antenna shall be recorded as power level, corrected for any change of input attenuator setting of the spectrum analyser.

The measurement shall be repeated with the test antenna and the substitution antenna orientated for horizontal polarization.

The measure of the radiated power of the radio device is the larger of the two levels recorded at the input to the substitution antenna, corrected for gain of the substitution antenna if necessary.

## Annex C (normative): Rx link budget calculation

This annex describes details of a calibration procedure to facilitate measurements as described in clause B.1.

The calibration of the test set-up establishes the relationship between the detected output from the test set-up, and the transmitted power (as sampled at the position of the antenna) from the EUT in the test site. This can be achieved (at higher frequencies) by using a calibrated horn antenna with a known gain, fed from an external signal source, in place of the EUT to determine the variations in detected power over frequency. The calibration setup is shown in Figure C.1.

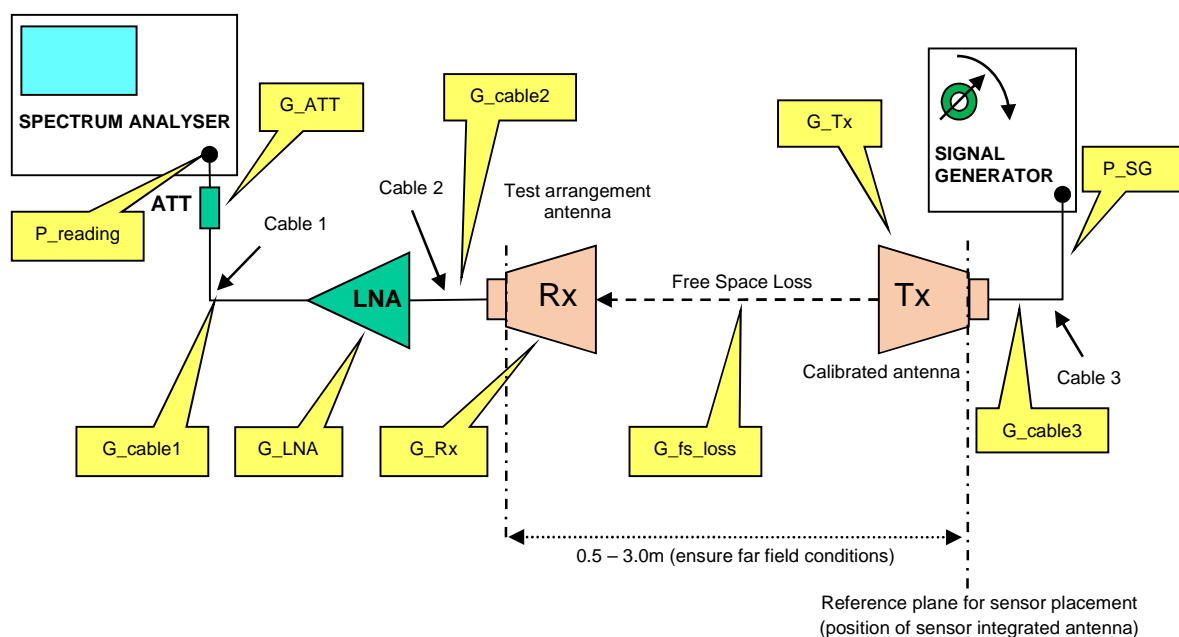

**Figure C.1: Calibration set-up configuration**

For higher frequencies, usually above 40 GHz, a downconverter/mixer may be used between the receiving antenna and the measurement receiver, as shown in Figure C.2.

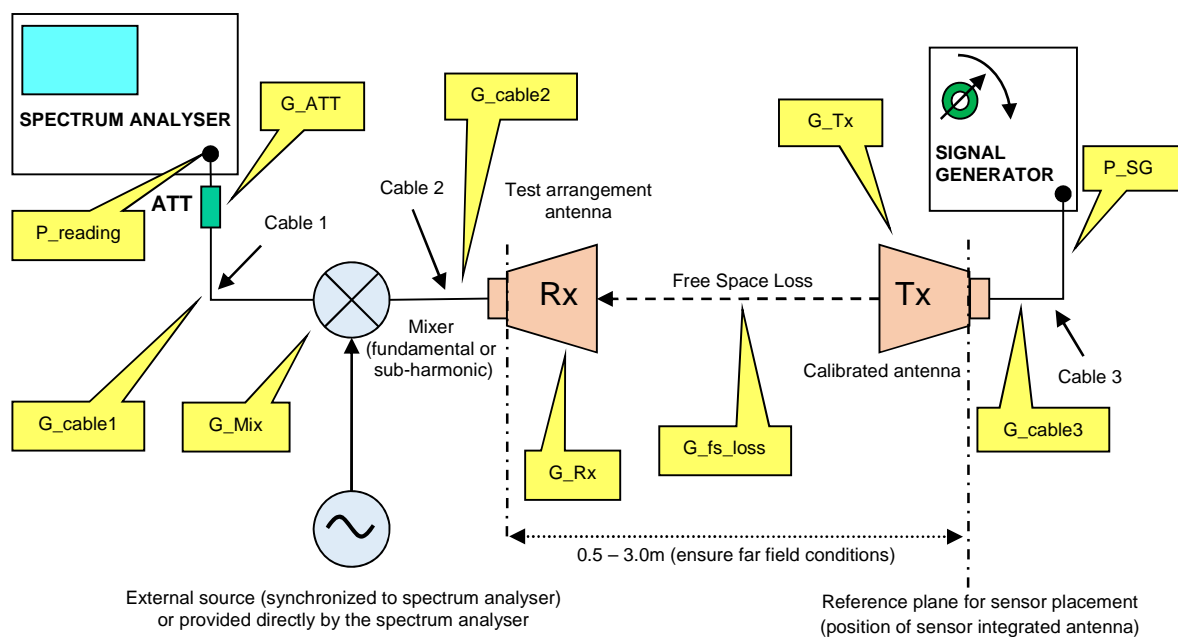

**Figure C.2: Calibration set-up configuration including a mixer**

The calibration of the test setup shall be carried out by either the manufacturer or the test laboratory. The results shall be approved by the test laboratory.

It is the responsibility of the tester to obtain sufficient measurement accuracy. The following description is an example of a proven and accurate calibration method:

- a) Calibrate all instruments using usual calibration routines.
- b) Remove the EUT from the test fixture and replace the EUT by a calibration antenna. Carefully orientate the calibration antenna in the test fixture towards the test arrangement antenna. The reference plane of the calibration antenna shall coincide with the EUT reference plane. The distance between the calibration antenna and the test arrangement antenna shall be based on the result of clause 5.3.2.3.
- c) Connect a signal generator to the calibrated antenna.
- d) Connect a 10 dB attenuator to the test arrangement antenna to improve the VSWR. If SNR of the test arrangement is low it might be necessary to omit the attenuator.
- e) Connect a power meter to the test arrangement antenna including a 10 dB attenuator, if required, and set the signal generator to a frequency and power level similar to the expected value of the EUT output.
- f) Take into account the gain from both the calibration and the test arrangement antenna, the losses from the attenuator and all cables in use, the gain of a LNA and the gain of the down converter/mixer, if required.
- g) Note the absolute reading of the power meter.
- h) Replace the power meter with a spectrum analyser.
- i) Adjust the frequency and power level of the signal generator to values similar to the EUT output. Apply this signal to the calibration antenna.
- j) Take into account the gain from both the calibration and the test arrangement antenna, the losses from the attenuator and all cables in use, the gain of a LNA and the gain of the down converter/mixer, if required. Instead of an external attenuator the built-in attenuator of the spectrum analyser may be used.
- k) Set the spectrum analyser detector in RMS mode with a RBW and VBW at least as large as the signal generator output signal bandwidth with an appropriate spectrum analyser sweep rate. Note the absolute reading of the spectrum analysers input signal.
- l) The noted absolute power reading of the power meter and the spectrum analyser shall not differ more than the specified uncertainty of the used measurement equipments.
- m) Calculate the total attenuation from the EUT reference plane to the spectrum analyser as follows:

$P_{\text{reading}}$  = the absolute power level (in e.g. dBm) noted from the power meter/spectrum analyser.

$G_{\text{Tx}}$  = antenna gain (in dB) of the calibrated antenna in the test fixture.

$G_{\text{Rx}}$  = antenna gain (in dB) of the test arrangement antenna.

$G_{\text{ATT}}$  = the 10 dB attenuator loss (0 dB, if attenuator not used).

$G_{\text{cable}}$  = the total loss (in dB) of all cables used in the test setup.

$G_{\text{LNA}}$  = the gain of the low noise amplifier (0 dB, if LNA not used).

$G_{\text{Mix}}$  = the gain of the mixer (0 dB, if mixer is not used).

NOTE: Usually, a mixer has a conversion loss but may include a LNA to provide some gain at the output.

$G_{fs\_loss}$  = the free space loss (in dB) between the calibrated antenna (Tx) in the test fixture and the test arrangement antenna (Rx).

$C_{ATT}$  = calculated attenuation (in dB) of all losses with referenced to the EUT position.

$C_{ATT}$  =  $G_{fs\_loss} - G_{Rx} + G_{cable2} - G_{LNA} + G_{cable1} + G_{ATT}$ .

$P_{e.i.r.p.}$  = the absolute power level (in e.g. dBm) of the EUT (e.i.r.p.).

$P_{e.i.r.p.}$  =  $P_{reading} - C_{ATT}$ .

The calibration should be carried out at a minimum of three frequencies within the operating frequency band.

$$P_{e.i.r.p.} = P_{reading} - G_{Rx} - G_{cable1} - G_{cable2} - G_{LNA} + 20 \cdot \log\left(\frac{4\pi r}{\lambda}\right)$$

Or, when a mixer is used

$$P_{e.i.r.p.} = P_{reading} - G_{Rx} - G_{cable1} - G_{cable2} - G_{Mix} + 20 \cdot \log\left(\frac{4\pi r}{\lambda}\right)$$

The values  $G_{cable1}$  and  $G_{cable2}$  are **negative**. Depending of the chosen mixer, it might be the same for  $G_{Mix}$ .

A test site, as described in annex A, which fulfils the requirements of the specified frequency range and undisturbed lowest specified emission levels of this measurement, shall be used.



## Annex D (normative): Measuring receivers

### D.1 General remarks

Measuring receivers include power meters, spectrum analysers, signal analysers and comparable instruments.

If no measuring receiver is available for directly processing EUT transmit frequencies, then an external down-converter is used to shift the EUT transmit frequency range towards a frequency range covered by the available measuring receiver (see Figure D.1). The pre-amplifier has to be chosen such that the amplitude of the measured signals is well above the sensitivity level of the measuring receiver.

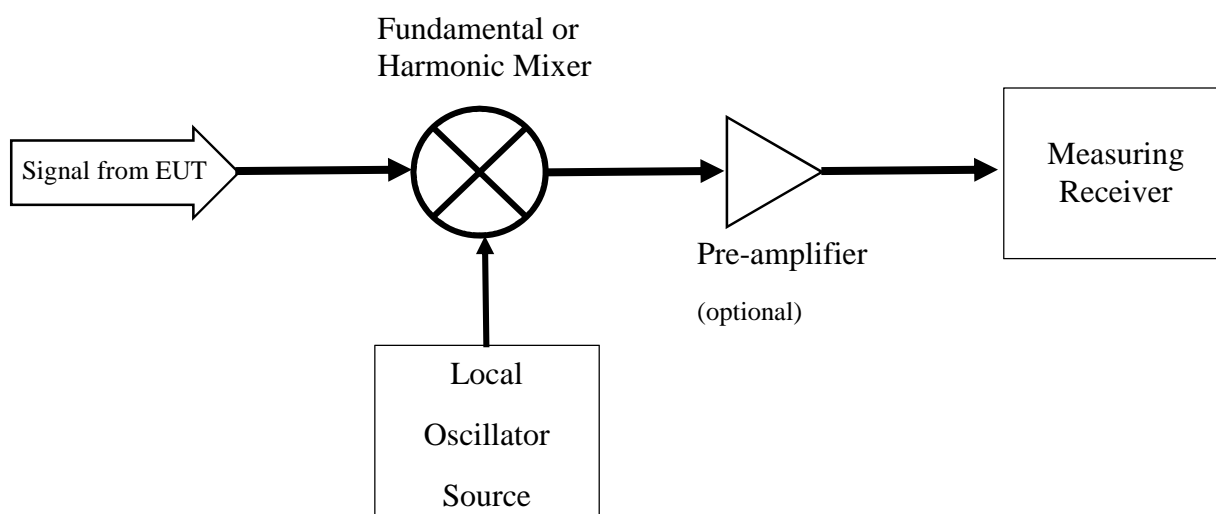

**Figure D.1: Using a down-converter in front of a measuring receiver**

To determine e.i.r.p. values, the readings from the measuring receiver (including a possible down-converter) have to be calibrated to include gains and losses, e.g. antenna gain, free space loss, etc. The amount of required correction is obtained by the substitution approach (see also annex B).

### D.2 Power Meter

For measuring power levels, a power meter is a suitable measuring receiver. Different power meter sensors are available:

- a) True peak power sensor
- b) Averaging power sensor (true RMS). This may be:
  - a thermistor based power meter; or
  - a diode based power meter with a sufficiently high averaging time.

Care has to be taken that the correct power correction coefficient is chosen for the occurring input frequencies.

## D.3 Spectrum analyser

For measuring simple quantities like occupied bandwidth, a spectrum analyser is a suitable measurement receiver.

This instrument is characterized by the following parameters:

- Start frequency
- Stop frequency
- Resolution bandwidth
- Video bandwidth
- Detector mode (for example peak, RMS, etc.)

NOTE: RMS average measurements can be accomplished directly using a spectrum analyser which incorporates an RMS detector. Alternatively, a true RMS level can be measured using a spectrum analyser that does not incorporate an RMS detector (see Recommendation ITU-R SM.1754 [i.6] for details).

- Display mode (for example Max-hold, etc.)
- Averaging time
- Sweep time
- Marker processing, for example:
  - the 99 % OBW function: within the Occupied BandWidth the power envelope shall contain 99 % of the emissions,
  - the channel power function which integrates the RMS power density over a certain frequency range.

The resolution bandwidth and the resolution filter response of the spectrum analyser shall be according to CISPR 16 [1]. In order to obtain the required sensitivity, a narrower measurement bandwidth may be necessary, and in such cases, this shall be stated in the test report form. The resolution bandwidth of the spectrum analyser shall be as given in Table D.1.

**Table D.1: Measuring receiver characteristic**

Frequency range: (f)	Measuring receiver bandwidth
30 MHz < f < 1 000 MHz	100 kHz
f > 1 000 MHz	1 MHz

## D.4 Signal analyser

For measuring complex parameters like frequency versus time, a signal analyser is a suitable measuring receiver.

Signal analysers are FFT-based instruments (see also [i.12]). The result of measurements using a signal analyser is the spectrogram, showing time on the x-axis, frequency on the y-axis and the amplitude as colour-coded dots (see example in Figure D.2). Using a marker, also quantitative power levels can be read out for a certain time, frequency-position.

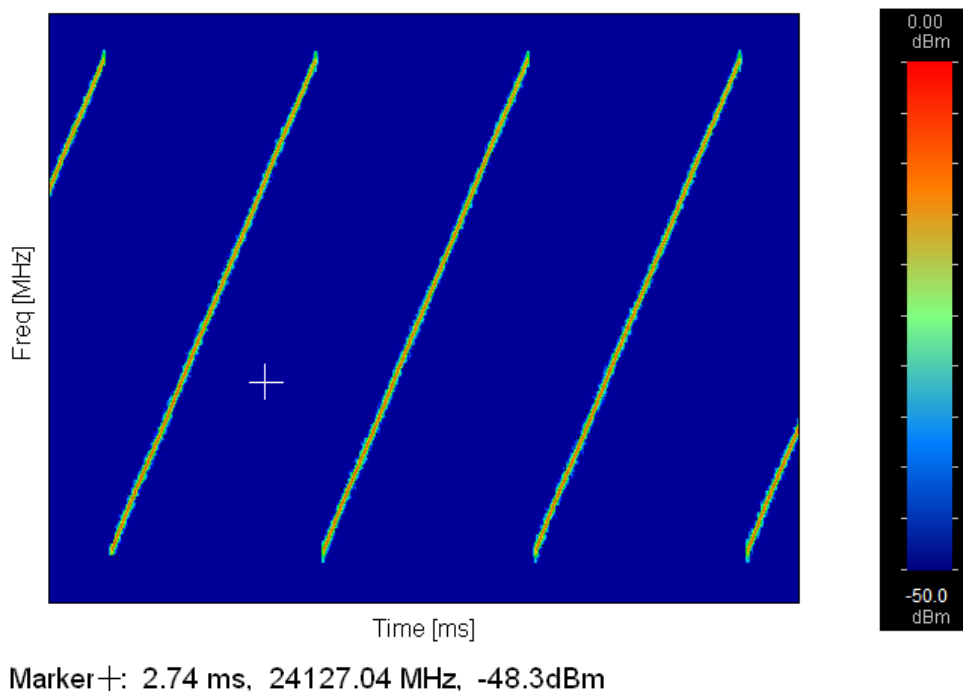

**Figure D.2: Example of spectrogram measurement result**

This instrument is characterized by the following parameters:

- Total measurement time
- Time resolution
- Frequency range
- Frequency resolution
- Minimum power level
- Maximum power level
- Power level resolution

That can be translated to the following settings for analogue-to-digital conversion and FFT:

- Sampling rate =  $2 \times$  maximum frequency occurring at signal analyser input  
(= down converter output if a down convert is used)
- FFT size = Sampling rate / frequency resolution
- Time difference between consecutive FFTs = Time resolution
- Number of FFTs = Total measurement time / time resolution

---

## D.5 Oscilloscope

For measuring time domain dependencies, an oscilloscope is a suitable measurement receiver.

For example, to measure power duty cycle, a test method using an oscilloscope is described in ETSI TR 103 366 [i.13].

In order to cover the desired signals, a pre-amplifier and/or an envelope detector may be needed in front of the oscilloscope input.

---

## Annex E (informative): Bibliography

CEPT/ERC Recommendation 70-03: "Relating to the use of Short Range Devices (SRD)".

CEPT/ERC Recommendation 01-06: "Procedure for mutual recognition of type testing and type approval for radio equipment".

Directive 2004/104/EC of 14 October 2004, adapting to technical progress Council Directive 72/245/EEC, relating to the radio interference (electromagnetic compatibility) of vehicles and amending Directive 70/156/EC on the approximation of the laws of the Member States relating to the type-approval of motor vehicles and their trailers (OJL 337, 13.11.2004).

ECC decision ECC/DEC/(04)03 of 19 March 2004 on the frequency band 77 - 81 GHz to be designated for the use of Automotive Short Range Radars.

EC Decision 2004/545/EC of 8 July 2004 on the harmonisation of radio spectrum in the 79 GHz range for the use of automotive short-range radar equipment in the Community.

Recommendation ITU-R M.1177-4 (2011): "Techniques for measurement of unwanted emissions of radar systems".

Recommendation ITU-R M.1452-2 (2012): "Millimetre wave vehicular collision avoidance radars and radiocommunication systems for intelligent transport system applications".

Recommendation ITU-R M.2057-0 (2014): "Systems characteristics of automotive radars operating in the frequency band 76-81 GHz for intelligent transport systems applications".

ITU-R Report SM.2153-5 (2015): "Technical and operating parameters and spectrum requirements for short-range devices".

ETSI EN 301 489-51: "Electromagnetic Compatibility (EMC) standard for radio equipment and services; Harmonised Standard covering the essential requirements of article 3.1b of the Directive 2014/53/EU; Part 51: Specific conditions for Automotive and Surveillance Radar Devices using 24,05 GHz to 24,5 GHz or 76 GHz to 81 GHz".

Commission implementing Decision 2013/752/EU of 11 December 2013 amending Decision 2006/771/EC on harmonisation of the radio spectrum for use by short-range devices and repealing Decision 2005/928/EC.

## Annex G (informative): Change History

Date	Version	Information about changes
10 <sup>th</sup> November 2015	1.1.1_0.0.3	Outcome of TGSRR-drafting webmeeting1
27 <sup>th</sup> November 2015	1.1.1_0.0.5	Outcome of TGSRR-drafting webmeeting2
30 <sup>th</sup> November 2015	1.1.1_0.0.6	Editorial cleaning
17 <sup>th</sup> December 2015	1.1.1_0.0.8	Outcome of TGSRR-AdHoc meeting
21 <sup>st</sup> December 2015	1.1.1_0.0.9	Outcome of online drafting session
20 <sup>th</sup> January 2016	1.1.1_0.0.11	Drafting version TGSRR#23 First day
21 <sup>th</sup> January 2016	1.1.1_0.0.13	Drafting version TGSRR#23 Second day
22 <sup>nd</sup> January 2016	1.1.1_1.0.0	Amended by TG SRR#23 for ENAP
5 <sup>th</sup> February 2016	1.1.1_1.0.1	Editorial and formal corrections during TG SRR Goto Meeting 4 <sup>th</sup> of February
20 <sup>th</sup> July 2016	1.1.1_1.1.1	Outcome resolution meeting @ TG SRR#25

---

## History

<b>Document history</b>		
V1.1.0	April 2016	EN Approval Procedure AP 20160717: 2016-04-18 to 2016-07-18
V1.1.1	October 2016	Vote V 20161205: 2016-10-06 to 2016-12-05