



**Wireless Industrial Applications (WIA);  
Equipment operating in the 5 725 MHz to 5 875 MHz  
frequency range with power levels ranging up to 400 mW;  
Harmonised Standard for access to radio spectrum**

---

**Reference**

DEN/ERM-TG41-003

---

**Keywords**

harmonised standard, radio, regulation, spread spectrum, SRD, testing, transmission

**ETSI**

---

650 Route des Lucioles  
F-06921 Sophia Antipolis Cedex - FRANCE

Tel.: +33 4 92 94 42 00 Fax: +33 4 93 65 47 16

Siret N° 348 623 562 00017 - NAF 742 C  
Association à but non lucratif enregistrée à la  
Sous-Préfecture de Grasse (06) N° 7803/88

---

**Important notice**

The present document can be downloaded from:

<http://www.etsi.org/standards-search>

The present document may be made available in electronic versions and/or in print. The content of any electronic and/or print versions of the present document shall not be modified without the prior written authorization of ETSI. In case of any existing or perceived difference in contents between such versions and/or in print, the prevailing version of an ETSI deliverable is the one made publicly available in PDF format at [www.etsi.org/deliver](http://www.etsi.org/deliver).

Users of the present document should be aware that the document may be subject to revision or change of status.

Information on the current status of this and other ETSI documents is available at

<https://portal.etsi.org/TB/ETSIDeliverableStatus.aspx>

If you find errors in the present document, please send your comment to one of the following services:

<https://portal.etsi.org/People/CommitteeSupportStaff.aspx>

---

**Copyright Notification**

No part may be reproduced or utilized in any form or by any means, electronic or mechanical, including photocopying and microfilm except as authorized by written permission of ETSI.

The content of the PDF version shall not be modified without the written authorization of ETSI.

The copyright and the foregoing restriction extend to reproduction in all media.

© ETSI 2020.

All rights reserved.

**DECT™**, **PLUGTESTS™**, **UMTS™** and the ETSI logo are trademarks of ETSI registered for the benefit of its Members.

**3GPP™** and **LTE™** are trademarks of ETSI registered for the benefit of its Members and of the 3GPP Organizational Partners.

**oneM2M™** logo is a trademark of ETSI registered for the benefit of its Members and of the oneM2M Partners.

**GSM®** and the GSM logo are trademarks registered and owned by the GSM Association.

# Contents

Intellectual Property Rights .....	7
Foreword.....	7
Modal verbs terminology.....	7
Introduction .....	8
1 Scope .....	9
2 References .....	9
2.1 Normative references .....	9
2.2 Informative references.....	9
3 Definition of terms, symbols and abbreviations.....	11
3.1 Terms.....	11
3.2 Symbols.....	12
3.3 Abbreviations .....	12
4 Technical requirements specifications .....	13
4.1 Environmental profile.....	13
4.2 Conformance requirements .....	13
4.2.1 RF output power and Adaptive Power Control.....	13
4.2.1.1 Definitions.....	13
4.2.1.1.1 RF Output Power .....	13
4.2.1.1.2 Adaptive Power Control .....	13
4.2.1.2 Limits .....	13
4.2.1.2.1 General requirements.....	13
4.2.1.2.2 Limits for RF output power and APC range.....	13
4.2.1.3 Conformance.....	13
4.2.2 Occupied channel bandwidth.....	14
4.2.2.1 Definition .....	14
4.2.2.2 Limits .....	14
4.2.2.3 Conformance .....	14
4.2.3 Transmitter unwanted emissions in the spurious domain .....	14
4.2.3.1 Definition .....	14
4.2.3.2 Limits .....	14
4.2.3.3 Conformance.....	14
4.2.4 Receiver spurious emissions .....	15
4.2.4.1 Definition .....	15
4.2.4.2 Limits .....	15
4.2.4.3 Conformance.....	15
4.2.5 Receiver Blocking .....	15
4.2.5.1 Applicability.....	15
4.2.5.2 Definition .....	15
4.2.5.3 Performance Criteria .....	15
4.2.5.4 Limits .....	16
4.2.5.5 Conformance.....	16
4.2.6 Dynamic Frequency Selection .....	16
4.2.6.1 General DFS operation.....	16
4.2.6.1.1 Applicability .....	16
4.2.6.1.2 General requirements.....	16
4.2.6.1.3 Applicable frequency range.....	16
4.2.6.1.4 DFS operational modes .....	16
4.2.6.1.5 DFS operation.....	17
4.2.6.2 DFS technical requirements specifications .....	17
4.2.6.2.1 Applicability .....	17
4.2.6.2.2 In-Service Monitoring .....	18
4.2.6.2.3 Channel Shutdown.....	18
4.2.6.2.4 Non-Occupancy Period .....	19
4.2.7 Adaptive Channel Access Mechanism.....	19

4.2.7.1	Overview .....	19
4.2.7.1.1	General requirements .....	19
4.2.7.1.2	Applicability .....	19
4.2.7.1.3	Applicable frequency range .....	20
4.2.7.2	DAA technical requirements specifications except ITS and TTT .....	20
4.2.7.2.1	Minimum Tx-off time .....	20
4.2.7.2.2	DAA minimum listening time .....	20
4.2.7.2.3	Maximum transmitter on-time (Tx on-time) .....	21
4.2.7.2.4	DAA threshold .....	21
4.2.7.3	DAA technical requirements specifications for ITS .....	22
4.2.7.3.1	General .....	22
4.2.7.3.2	Applicable frequency range .....	22
4.2.7.3.3	ITS Channel Availability Check time .....	22
4.2.7.3.4	<i>ITS Maximum TX<sub>on-time</sub></i> .....	22
4.2.7.3.5	<i>ITS Minimum TX<sub>off-time</sub></i> .....	23
4.2.7.3.6	<i>ITS DAA latency</i> .....	23
4.2.7.3.7	<i>ITS DAA Probability</i> .....	23
4.2.7.3.8	<i>ITS Non-Occupancy Period</i> .....	24
4.2.7.3.9	<i>ITS DAA threshold</i> .....	24
4.2.7.4	DAA technical requirements specifications for TTT, general conditions and applicable frequency range .....	24
4.2.7.5	DAA using TTT signal detection .....	25
4.2.7.5.1	General .....	25
4.2.7.5.2	DAA threshold for TTT .....	25
4.2.7.5.3	TTT Channel Availability Check .....	25
4.2.7.5.4	<i>TTT Non-Occupancy Period</i> .....	26
4.2.7.5.5	<i>TTT DAA Latency</i> .....	26
4.2.7.5.6	<i>TTT In-Service Monitoring</i> .....	26
4.2.8	User Access Restrictions .....	27
4.2.8.1	Definition .....	27
4.2.8.2	Requirement .....	27
4.2.9	Geo-localization capability .....	27
4.2.9.1	Applicability .....	27
4.2.9.2	Definition .....	27
4.2.9.3	Requirements .....	27
4.2.10	TTT Detection and Avoidance using a Geolocation Database .....	28
4.2.10.1	Applicability .....	28
4.2.10.2	Definition .....	28
4.2.10.3	Requirements .....	28
4.2.10.4	Conformance .....	28
5	Testing for compliance with technical requirements .....	29
5.1	Environmental conditions for testing .....	29
5.1.1	General requirements .....	29
5.1.2	Normal and extreme test conditions .....	29
5.1.3	Test sequences and traffic load .....	29
5.1.3.1	General test transmission sequences .....	29
5.1.3.2	Test transmission sequences for DFS tests .....	29
5.1.4	Test channels .....	29
5.1.5	Antennas .....	30
5.1.5.1	Integrated and dedicated antennas .....	30
5.1.5.2	Transmit operating modes .....	30
5.1.5.2.1	Operating mode 1 (single antenna) .....	30
5.1.5.2.2	Operating mode 2 (multiple antennas, no beamforming) .....	31
5.1.5.2.3	Operating mode 3 (multiple antennas, with beamforming) .....	31
5.2	Void .....	31
5.3	Conformance tests .....	31
5.3.1	Product information .....	31
5.3.2	RF output power and Adaptive Power Control .....	32
5.3.2.1	Test conditions .....	32
5.3.2.2	Test method .....	33
5.3.2.2.1	Conducted measurement .....	33

5.3.2.2.2	Radiated measurement.....	35
5.3.3	Occupied Channel Bandwidth .....	35
5.3.3.1	Test conditions .....	35
5.3.3.2	Test method.....	35
5.3.3.2.1	Conducted measurement.....	35
5.3.3.2.2	Radiated measurement.....	36
5.3.4	Transmitter unwanted emissions in the spurious domain .....	36
5.3.4.1	Test conditions .....	36
5.3.4.2	Test method.....	36
5.3.4.2.1	Conducted measurement.....	36
5.3.4.2.2	Radiated measurement.....	39
5.3.5	Receiver spurious emissions .....	39
5.3.5.1	Test conditions .....	39
5.3.5.2	Test method.....	39
5.3.5.2.1	Conducted measurement.....	39
5.3.5.2.2	Radiated measurement.....	41
5.3.6	Receiver Blocking .....	41
5.3.6.1	Test frequencies .....	41
5.3.6.2	Test conditions .....	41
5.3.6.3	Test Method .....	42
5.3.6.3.1	Conducted measurements .....	42
5.3.6.3.2	Radiated measurements .....	43
5.3.7	Dynamic Frequency Selection .....	43
5.3.7.1	Test conditions .....	43
5.3.7.1.1	General requirements.....	43
5.3.7.1.2	Selection of radar test signals .....	43
5.3.7.1.3	Test set-ups.....	44
5.3.7.2	Test method.....	45
5.3.7.2.1	Conducted measurement.....	45
5.3.7.2.2	Radiated measurement.....	47
5.3.8	Adaptivity (channel access mechanism) except for ITS and TTT .....	47
5.3.8.1	Test conditions .....	47
5.3.8.2	Test method.....	47
5.3.8.2.1	Conducted measurements .....	47
5.3.8.2.2	Generic test procedure for measuring channel/frequency usage .....	49
5.3.8.2.3	Radiated measurements .....	49
5.3.8.2.4	DAA minimum listening time measurements .....	50
5.3.9	Adaptivity (channel access mechanism) for ITS .....	51
5.3.9.1	General requirements .....	51
5.3.9.2	ITS test signal.....	51
5.3.9.3	Initial start-up test .....	51
5.3.9.3.1	Start-up procedure .....	51
5.3.9.3.2	Test without an ITS victim test signal during the <i>ITS Channel Availability Check time</i> , $T_{ITS\_check\_time}$ .....	51
5.3.9.3.3	Test with an ITS victim test signal during the <i>ITS Channel Availability Check time</i> , $T_{ITS\_check\_time}$ .....	52
5.3.9.4	Test of $ITS\_Maximum\_TX_{on}$ and $ITS\_minimum\_TX_{off}$ .....	53
5.3.9.5	ITS in-service DAA test with continuous ITS test signal .....	53
5.3.9.6	ITS in-service DAA test with ITS test signal switched off after detection .....	54
5.3.10	Adaptivity (channel access mechanism) for TTT .....	55
5.3.10.1	General .....	55
5.3.10.2	TTT test signal .....	55
5.3.10.3	Initial start-up test .....	56
5.3.10.3.1	Start-up procedure .....	56
5.3.10.3.2	Test without a TTT victim test signal during the <i>TTT Channel Availability Check time</i> , $T_{TTT\_check\_time}$ .....	56
5.3.10.3.3	Test with a TTT victim test signal during the <i>TTT Channel Availability Check time</i> .....	56
5.3.10.4	TTT in-service DAA test with continuous TTT test signal.....	57
5.3.10.5	TTT in-service DAA test with TTT test signal switched off after detection.....	58
5.3.10.6	TTT DAA using a Geolocation Database .....	59

<b>Annex A (informative):</b>	<b>Relationship between the present document and the essential requirements of Directive 2014/53/EU .....</b>	<b>60</b>
<b>Annex B (normative):</b>	<b>Test sites and arrangements for radiated measurements.....</b>	<b>62</b>
B.1	General requirements .....	62
B.2	Radiation test sites.....	62
B.2.1	Open Area Test Site .....	62
B.2.2	Semi Anechoic Room.....	63
B.2.3	Fully Anechoic Room .....	64
B.2.4	Measurement Distance .....	65
B.3	Antennas.....	66
B.3.1	General requirements .....	66
B.3.2	Measurement antenna.....	66
B.3.3	Substitution antenna .....	66
B.4	Test fixture .....	66
B.4.1	General requirements .....	66
B.4.2	Description of the test fixture.....	67
B.4.3	Using the test fixture for relative measurements .....	67
B.5	Guidance on the use of radiation test sites .....	67
B.5.1	General requirements .....	67
B.5.2	Power supplies for the battery powered UUT .....	67
B.5.3	Site preparation .....	68
B.6	Coupling of signals.....	68
B.6.1	General requirements .....	68
B.6.2	Data Signals.....	68
B.7	Interference Signal used for Adaptivity Tests .....	69
<b>Annex C (normative):</b>	<b>Procedures for radiated measurements.....</b>	<b>70</b>
C.1	General requirements .....	70
C.2	Radiated measurements in an OATS or SAR.....	70
C.3	Radiated measurements in a FAR .....	71
C.4	Substitution measurement .....	71
C.5	Guidance for testing technical requirements .....	71
C.5.1	Conformance tests and corresponding test sites .....	71
C.5.2	Guidance for testing Adaptivity (Channel Access Mechanism).....	71
C.5.2.1	General requirements.....	71
C.5.2.2	Measurement Set-up .....	72
C.5.2.3	Calibration of the measurement Set-up.....	72
C.5.2.4	Test method .....	72
<b>Annex D (normative):</b>	<b>DFS parameters .....</b>	<b>73</b>
D.1	Test signals.....	73
<b>Annex E (informative):</b>	<b>Receiver parameters.....</b>	<b>76</b>
E.1	General .....	76
E.2	Receiver parameters .....	76
<b>Annex F (informative):</b>	<b>Bibliography.....</b>	<b>78</b>
<b>Annex G (informative):</b>	<b>Change History .....</b>	<b>79</b>
History .....		80

---

## Intellectual Property Rights

### Essential patents

IPRs essential or potentially essential to normative deliverables may have been declared to ETSI. The information pertaining to these essential IPRs, if any, is publicly available for **ETSI members and non-members**, and can be found in ETSI SR 000 314: "*Intellectual Property Rights (IPRs); Essential, or potentially Essential, IPRs notified to ETSI in respect of ETSI standards*", which is available from the ETSI Secretariat. Latest updates are available on the ETSI Web server (<https://ipr.etsi.org/>).

Pursuant to the ETSI IPR Policy, no investigation, including IPR searches, has been carried out by ETSI. No guarantee can be given as to the existence of other IPRs not referenced in ETSI SR 000 314 (or the updates on the ETSI Web server) which are, or may be, or may become, essential to the present document.

### Trademarks

The present document may include trademarks and/or tradenames which are asserted and/or registered by their owners. ETSI claims no ownership of these except for any which are indicated as being the property of ETSI, and conveys no right to use or reproduce any trademark and/or tradename. Mention of those trademarks in the present document does not constitute an endorsement by ETSI of products, services or organizations associated with those trademarks.

---

## Foreword

This final draft Harmonised European Standard (EN) has been produced by ETSI Technical Committee Electromagnetic compatibility and Radio spectrum Matters (ERM), and is now submitted for the Vote phase of the ETSI standards EN Approval Procedure.

The present document has been prepared under the Commission's standardisation request C(2015) 5376 final [i.3] to provide one voluntary means of conforming to the essential requirements of Directive 2014/53/EU on the harmonisation of the laws of the Member States relating to the making available on the market of radio equipment and repealing Directive 1999/5/EC [i.2].

Once the present document is cited in the Official Journal of the European Union under that Directive, compliance with the normative clauses of the present document given in table A.1 confers, within the limits of the scope of the present document, a presumption of conformity with the corresponding essential requirements of that Directive and associated EFTA regulations.

<b>Proposed national transposition dates</b>	
Date of latest announcement of this EN (doa):	3 months after ETSI publication
Date of latest publication of new National Standard or endorsement of this EN (dop/e):	6 months after doa
Date of withdrawal of any conflicting National Standard (dow):	18 months after doa

---

## Modal verbs terminology

In the present document "**shall**", "**shall not**", "**should**", "**should not**", "**may**", "**need not**", "**will**", "**will not**", "**can**" and "**cannot**" are to be interpreted as described in clause 3.2 of the [ETSI Drafting Rules](#) (Verbal forms for the expression of provisions).

"**must**" and "**must not**" are **NOT** allowed in ETSI deliverables except when used in direct citation.

---

# Introduction

The market is in need of network solutions, each with different performance characteristics and functional capabilities, matching diverse application requirements. Industrial automation applications, covering different industrial application domains such as:

- process automation, covering for example the following industry branches:
  - oil and gas, refining;
  - chemical;
  - pharmaceutical;
  - mining;
  - pulp and paper;
  - water & wastewater;
  - steel;
- electric power like:
  - power generation, e.g. wind turbine;
  - power distribution (grid);
- factory automation, e.g. covering the following industry branches:
  - food and beverage;
  - automotive;
  - machinery;
  - semiconductor.

The technical characteristics and applications specific to radio spectrum requirements are identified in ETSI TR 102 889-2 [i.18].

In industrial automation, many different wireless communication networks may operate in the same premises. Examples of these networks are IEC 62591 (WirelessHART<sup>®</sup>, see note) [i.10], IEC 62601 (WIA-PA) [i.11] and IEC 62734 (ISA100.11a) [i.12]; all these networks use IEEE 802.15.4 [i.6] for the process automation applications. Other examples of wireless networks are specified in IEC 61784-1 [i.8] and IEC 61784-2 [i.9] CPs that use IEEE 802.11 [i.4] and IEEE 802.15.1 [i.5] for factory automation applications. Different to wired fieldbuses, the wireless communication interfaces can interfere with others on the same premises or environment, disturbing each other. Therefore, without a predictable assuredness of coexistence, it could be problematic to have multiple wireless communication networks in the same facility or environment, especially because the time-criticality, the safety and the security of the operation may not be ensured in such an environment.

**NOTE:** WirelessHART<sup>®</sup> is the registered trade name of the HART Communication Foundation. This information is given for the convenience of users of the present document and does not constitute an endorsement by ETSI of the product named. Equivalent products may be used if they can be shown to lead to the same results.

The mitigation techniques which have to be implemented to protect primary radio services limit the applicability to non-real-time applications with relaxed latencies e.g. above 1 s and limits the probability to fulfil the demands on high reliability and high Quality of Services (non-critical links) of the wireless industrial applications. Thus, the 5,8 GHz WIA band may be appropriate for non-real time, non-critical purposes, e.g. monitoring in wireless industrial applications.

Equipment covered by the present document is operated in accordance with the CEPT ECC ERC Recommendation 70-03 [i.7], annex 2.



---

# 1 Scope

The present document specifies technical characteristics and methods of measurements for Wireless Industrial Applications equipment operating in the 5 725 MHz to 5 875 MHz frequency band. The present document also specifies spectrum sharing mechanisms to enable co-existence with other equipment operating in the 5 725 MHz to 5 875 MHz frequency band.

The present document covers the essential requirements of article 3.2 of Directive 2014/53/EU [i.2] under the conditions identified in annex A.

---

## 2 References

### 2.1 Normative references

References are specific, identified by date of publication and/or edition number or version number. Only the cited version applies.

Referenced documents which are not found to be publicly available in the expected location might be found at <https://docbox.etsi.org/Reference/>.

NOTE: While any hyperlinks included in this clause were valid at the time of publication, ETSI cannot guarantee their long term validity.

The following referenced documents are necessary for the application of the present document.

Not applicable.

### 2.2 Informative references

References are either specific (identified by date of publication and/or edition number or version number) or non-specific. For specific references, only the cited version applies. For non-specific references, the latest version of the referenced document (including any amendments) applies.

NOTE: While any hyperlinks included in this clause were valid at the time of publication, ETSI cannot guarantee their long term validity.

The following referenced documents are not necessary for the application of the present document but they assist the user with regard to a particular subject area.

- [i.1] IEC/EN 62657-1 (Edition 1): "Industrial communication networks - Wireless communication networks - Part 1: Wireless communication requirements and spectrum considerations".
- [i.2] Directive 2014/53/EU of the European Parliament and of the Council of 16 April 2014 on the harmonisation of the laws of the Member States relating to the making available on the market of radio equipment and repealing Directive 1999/5/EC.
- [i.3] Commission Implementing Decision C(2015) 5376 final of 4.8.2015 on a standardisation request to the European Committee for Electrotechnical Standardisation and to the European Telecommunications Standards Institute as regards radio equipment in support of Directive 2014/53/EU of the European Parliament and of the Council.
- [i.4] IEEE Std. 802.11™-2016: "IEEE Standard for Information Technology - Telecommunications and information exchange between systems - Local and metropolitan area networks - Specific requirements. Part 11: Wireless LAN Medium Access Control (MAC) and Physical Layer (PHY) Specifications".
- [i.5] IEEE Std. 802.15.1™: "IEEE Standard for Information technology - Wireless medium access control (MAC) and physical layer (PHY) specifications for wireless personal area networks (WPANs)".

- [i.6] IEEE Std. 802.15.4™-2015: "IEEE Standard for Information technology - Telecommunications and information exchange between systems - Local and metropolitan area networks - Specific requirements. Part 15.4: Wireless Medium Access Control (MAC) and Physical Layer (PHY) Specifications for Low-Rate Wireless Personal Area Networks (WPANs)".
- [i.7] CEPT ECC ERC Recommendation 70-03: "Relating to the use of Short Range Devices (SRD)".
- [i.8] IEC 61784-1: "Industrial communication networks - Profiles - Part 1: Fieldbus profiles".
- [i.9] IEC 61784-2: "Industrial communication networks - Profiles - Part 2: Additional fieldbus profiles for real-time networks based on ISO/IEC 8802-3".
- [i.10] IEC 62591: "Industrial communication networks - Wireless communication network and communication profiles - WirelessHART®".
- [i.11] IEC 62601: "Industrial communication networks - Fieldbus specifications - WIA-PA communication network and communication profile".
- [i.12] IEC 62734: "Industrial communication networks - Fieldbus specifications - Wireless Systems for Industrial Automation: Process Control and Related Applications (based on ISA 100.11a)".
- [i.13] ETSI TR 100 028-1: "Electromagnetic compatibility and Radio spectrum Matters (ERM); Uncertainties in the measurement of mobile radio equipment characteristics; Part 1".
- [i.14] ETSI TR 100 028-2 (V1.4.1): "Electromagnetic compatibility and Radio spectrum Matters (ERM); Uncertainties in the measurement of mobile radio equipment characteristics; Part 2".
- [i.15] ETSI TR 102 273-2: "Electromagnetic compatibility and Radio spectrum Matters (ERM); Improvement on Radiated Methods of Measurement (using test site) and evaluation of the corresponding measurement uncertainties; Part 2: Anechoic chamber".
- [i.16] ETSI TR 102 273-3: "Electromagnetic compatibility and Radio spectrum Matters (ERM); Improvement on Radiated Methods of Measurement (using test site) and evaluation of the corresponding measurement uncertainties; Part 3: Anechoic chamber with a ground plane".
- [i.17] ETSI TR 102 273-4: " Electromagnetic compatibility and Radio spectrum Matters (ERM); Improvement on Radiated Methods of Measurement (using test site) and evaluation of the corresponding measurement uncertainties; Part 4: Open area test site".
- [i.18] ETSI TR 102 889-2 (V1.1.1): "Electromagnetic compatibility and Radio spectrum Matters (ERM); System Reference Document; Short Range Devices (SRD); Part 2: Technical characteristics for SRD equipment for wireless industrial applications using technologies different from Ultra-Wide Band (UWB)".
- [i.19] CEN EN 12253:2004: "Road transport and traffic telematics - Dedicated short-range communication - Physical layer using microwave at 5,8 GHz".
- [i.20] CEN EN 12795:2003: "Road transport and traffic telematics - Dedicated Short Range Communication (DSRC) - DSRC data link layer: medium access and logical link control".
- [i.21] CEPT ECC Report 206: "Compatibility studies in the band 5725-5875 MHz between SRD equipment for wireless industrial applications and other systems".
- [i.22] ETSI EG 203 336 (V1.1.1): "Electromagnetic compatibility and Radio spectrum Matters (ERM); Guide for the selection of technical parameters for the production of Harmonised Standards covering article 3.1(b) and article 3.2 of Directive 2014/53/EU".

## 3 Definition of terms, symbols and abbreviations

### 3.1 Terms

For the purposes of the present document, the terms given in Directive 2014/53/EU [i.2], IEC/EN 62657-1 [i.1] and the following apply:

**5,8 GHz WIA band:** Wireless Industrial Applications (WIA) assigned total frequency range of 5 725 MHz to 5 875 MHz

**available channel:** channel identified as available for immediate use as an *Operating Channel*:

- Channel Move Time.
- Channel Shutdown.
- Channel Closing Transmission Time.

**channel closing transmission time:** limitation of the aggregate duration of all transmissions of the device on this channel during the *Channel Move Time*

**channel move time:** time difference between the instant when the UUT has ceased all transmissions on the channel and the end of the radar test signal

**channel shutdown:** process initiated by the WIA device on an *Operating Channel* after a radar signal has been detected during the *In-Service Monitoring* on that channel

**frequency range:** range of operating frequencies over which the equipment can be adjusted

**nominal channel bandwidth:** band of frequencies assigned to a single channel

**operating frequency:** nominal frequency at which the equipment can be operated; this is also referred to as the operating centre frequency

NOTE: Equipment may be adjustable for operation at more than one operating frequency.

**outdoor:** outside of a building

**plant:** complete set of technical equipment and facilities to accomplish a defined technical task for process automation and factory automation

NOTE: A plant includes apparatus, machines, instruments, devices, means of transportation, control equipment and other operating equipment.

**spurious emissions:** emissions on a frequency or frequencies which are outside the necessary bandwidth and the level of which may be reduced without affecting the corresponding transmission of information

NOTE: Spurious emissions include harmonic emissions, parasitic emissions, intermodulation products and frequency conversion products, but exclude out-of-band emissions.

**Tx-off time:** period where a device remains off after a transmission or a polling sequence

**Tx power:** maximum RF output power; if the equipment is designed to operate with different power levels, the rated power for each level or range of levels, frequency or range of frequencies

**unavailable channel:** channel which cannot be considered by WIA device for a certain period of time (*Non Occupancy Period*) after a radar signal was detected on that channel

**WIA device:** radio equipment used for wireless industrial applications operating in the 5,8 GHz WIA band

**wireless communication:** communication in which electromagnetic radiations are used to transfer information

**wireless industrial application:** any use of electromagnetic waves with devices or equipment for the generation and use of radio frequency energy in a plant

## 3.2 Symbols

For the purposes of the present document, the following symbols apply:

A	power output A in dBm
ChS	Nominal occupied channel bandwidth
DAAthr	DAA threshold in dBm at the receiver input port
dBm	dB relative to 1 milliwatt
dBr	dB relative to peak power
dBW	dB relative to 1 Watt
G	Antenna gain in dBi
GHz	Gigahertz
Hz	Hertz
k	Total number of samples
kHz	kilohertz
MHz	Megahertz
mW	milliwatt
MS/s	Mega Samples per second
n	actual sample number or number of adjacent channels
$P_{burst}$	Power over the burst in dB
$P_d$	Detection probability
$P_H$	highest power level e.i.r.p. in dBm
$P_{sample}$	Power of the sample in dBm
$P_{tx}$	Transmit power e.i.r.p. for WIA device in dBm
$t_F$	Fixed listening time
$t_L$	Total listening time
$t_{PS}$	Pseudo random part of listening time
$x$	duty cycle
Y	Beamforming gain in dB

## 3.3 Abbreviations

For the purposes of the present document, the following abbreviations apply:

AFA	Adaptive Frequency Agility
APC	Adaptive Power Control
BFWA	Broadband Fixed Wireless Access
BW	BandWidth
CEN	Comité Européen de Normalisation (European Committee for Standardization)
CEPT	European Conference of Postal and Telecommunications administrations
CON	Conformance test condition
CP	Communication Profile
CW	Continuous Wave
DAA	Detect And Avoid
DFS	Dynamic Frequency Selection
dow	date of withdrawal
DSRC	Dedicated Short Range Communication
DUT	Device Under Test
ECC	Electronic Communications Committee
e.i.r.p.	equivalent isotropically radiated power
EN	European Norm
e.r.p.	equivalent radiated power
ERC	European Radiocommunications Committee
FAR	Fully Anechoic Room
GNSS	Global Navigation Satellite System
IEC	International Electrotechnical Commission
ITS	Intelligent Transport Systems
LPDA	Logarithmic Periodic Dipole Antenna
OATS	Open Area Test Site

PER	Packet Error Rate
PPB	Pulses Per Burst
ppm	parts per million
PPS	Pulses Per Second
PRF	Pulse Repetition Frequency
RBW	Resolution BandWidth
RF	Radio Frequency
RMS	Root Mean Square
SAR	Semi Anechoic Room
TP	Transmit Power
TTT	Transport and Traffic Telematics
Tx	Transmitter
UUT	Unit Under Test
VBW	Video BandWidth
VSWR	Voltage Standing Wave Ratio
WIA	Wireless Industrial Applications

---

## 4 Technical requirements specifications

### 4.1 Environmental profile

The technical requirements of the present document apply under the environmental profile for operation of the equipment under intended use. The equipment shall comply with all the technical requirements of the present document which are identified as applicable in annex A at all times when operating within the boundary limits of the declared operational environmental profile.

### 4.2 Conformance requirements

#### 4.2.1 RF output power and Adaptive Power Control

##### 4.2.1.1 Definitions

###### 4.2.1.1.1 RF Output Power

The RF Output Power is the mean equivalent isotropically radiated power (e.i.r.p.) during a transmission burst.

###### 4.2.1.1.2 Adaptive Power Control

Adaptive Power Control (APC) is a mechanism to be used by the WIA device to adjust the RF Output Power to the minimum necessary in order to maintain a reliable link.

##### 4.2.1.2 Limits

###### 4.2.1.2.1 General requirements

The limits given in clause 4.2.1.2.2 shall be applicable to the system as a whole and in any possible configuration.

###### 4.2.1.2.2 Limits for RF output power and APC range

Devices shall use APC. The maximum RF output power is 26 dBm e.i.r.p. The minimum APC range shall be 12 dB.

##### 4.2.1.3 Conformance

Conformance tests as defined in clause 5.3.2 shall be carried out.

## 4.2.2 Occupied channel bandwidth

### 4.2.2.1 Definition

The Occupied Channel Bandwidth is the bandwidth containing 99 % of the power of the signal.

### 4.2.2.2 Limits

The occupied channel bandwidth shall be between 1 MHz and 20 MHz. In case of smart antenna systems (devices with multiple transmit chains) each of the transmit chains shall meet this requirement.

A device is permitted to operate in one or more adjacent or non-adjacent channels simultaneously.

When equipment has simultaneous transmissions in adjacent channels, these transmissions may be considered as one signal with an actual Nominal Channel Bandwidth of "n" times the individual Nominal Channel Bandwidth where "n" is the number of adjacent channels. When equipment has simultaneous transmissions in non-adjacent channels, each power envelope shall be considered separately.

### 4.2.2.3 Conformance

Conformance tests as defined in clause 5.3.3 shall be carried out to determine the occupied channel bandwidth.

## 4.2.3 Transmitter unwanted emissions in the spurious domain

### 4.2.3.1 Definition

Transmitter unwanted emissions in the spurious domain are emissions beyond the limit of 250 % of the nominal bandwidth above and below the centre frequency of the emission.

### 4.2.3.2 Limits

The level of transmitter unwanted emissions in the spurious domain shall not exceed the limits given in table 1.

In case of equipment with antenna connectors, these limits apply to emissions at the antenna port (conducted) and to the emissions radiated by the cabinet. In case of integral antenna equipment (without temporary antenna connectors), these limits apply to emissions radiated by the equipment.

**Table 1: Transmitter spurious emission limits**

Frequency range	Maximum power	Bandwidth
30 MHz to 47 MHz	-36 dBm	100 kHz
47 MHz to 74 MHz	-54 dBm	100 kHz
74 MHz to 87,5 MHz	-36 dBm	100 kHz
87,5 MHz to 118 MHz	-54 dBm	100 kHz
118 MHz to 174 MHz	-36 dBm	100 kHz
174 MHz to 230 MHz	-54 dBm	100 kHz
230 MHz to 470 MHz	-36 dBm	100 kHz
470 MHz to 862 MHz	-54 dBm	100 kHz
862 MHz to 1 GHz	-36 dBm	100 kHz
1 GHz to 26 GHz	-30 dBm	1 MHz

### 4.2.3.3 Conformance

Conformance tests as defined in clause 5.3.4 shall be carried out.

## 4.2.4 Receiver spurious emissions

### 4.2.4.1 Definition

Receiver spurious emissions are emissions at any frequency when the equipment is in receive mode.

### 4.2.4.2 Limits

The spurious emissions of the receiver shall not exceed the limits given in table 2.

In case of equipment with antenna connectors, these limits apply to emissions at the antenna port (conducted) and to the emissions radiated by the cabinet. In case of integral antenna equipment (without temporary antenna connectors), these limits apply to emissions radiated by the equipment.

**Table 2: Receiver Spurious radiated emission limits**

Frequency range	Maximum power radiated	Maximum power conducted	Measurement bandwidth
30 MHz to 1 GHz	-57 dBm e.r.p.	-57 dBm	100 kHz
1 GHz to 26 GHz	-47 dBm e.i.r.p	-47 dBm	1 MHz

### 4.2.4.3 Conformance

Conformance tests as defined in clause 5.3.5 shall be carried out.

## 4.2.5 Receiver Blocking

### 4.2.5.1 Applicability

The present requirement applies to all equipment within the scope of the present document.

### 4.2.5.2 Definition

Receiver blocking is a measure of the capability of the equipment to receive a wanted signal on its operating channel without exceeding a given degradation due to the presence of an unwanted input signal (blocking signal) on frequencies other than those of the operating bands provided in clause 1.

### 4.2.5.3 Performance Criteria

The minimum performance criteria shall be a PER of less than or equal to 10 %.

#### 4.2.5.4 Limits

While maintaining the minimum performance criteria as defined in clause 4.2.5.3, the blocking levels at specified frequency offsets shall be equal to or greater than the limits defined in table 3.

**Table 3: Receiver Blocking parameters**

Wanted signal mean power from companion device (dBm)	Blocking signal frequency (MHz)	Blocking signal power (dBm e.i.r.p)	Type of blocking signal
$P_{\min} + 6$ dB	5 420 5 925	-42	CW
$P_{\min} + 6$ dB	5 320 6 025 6 125		CW
NOTE 1: $P_{\min}$ is the minimum level of the wanted signal (in dBm) required to meet the minimum performance criteria as defined in clause 4.2.5.3 in the absence of any blocking signal.			
NOTE 2: The levels specified are levels in front of the UUT antenna. In case of conducted measurements, the same levels in dBm should be used at the antenna connector irrespective of antenna gain.			

#### 4.2.5.5 Conformance

The conformance tests as defined in clause 5.3.6 shall be carried out.

### 4.2.6 Dynamic Frequency Selection

#### 4.2.6.1 General DFS operation

##### 4.2.6.1.1 Applicability

Clause 4.2.6 does not apply to WIA devices operating at the power level of less than 25 mW e.i.r.p.

##### 4.2.6.1.2 General requirements

A WIA device shall employ a Dynamic Frequency Selection (DFS) function to detect interference from radar systems (radar interference detection) and to avoid co-channel operation with these systems.

Whilst the DFS function described in clause 4.2.6 defines conditions under which the equipment may transmit, transmissions shall be allowed providing they are not prohibited by the adaptivity requirement defined in clause 4.2.7.

##### 4.2.6.1.3 Applicable frequency range

Radar detection is required when operating on channels whose nominal bandwidth falls partly or completely within the frequency range from 5 725 MHz to 5 850 MHz.

##### 4.2.6.1.4 DFS operational modes

Within the context of the operation of the DFS function, a WIA device shall operate as either a master or a slave. WIA devices operating as a slave shall only operate in a network controlled by a WIA device operating as a master. A device which is capable of operating as either a master or a slave shall comply with the requirements applicable to the mode in which it operates.

Some WIA devices are capable of communicating in ad-hoc manner without being attached to a network. WIA devices operating in this manner on channels whose nominal bandwidth falls partly or completely within the frequency range from 5 725 MHz to 5 850 MHz shall employ DFS and shall be tested against the requirements applicable to a master.

In fixed outdoor point to point or fixed outdoor point to multipoint applications either:

- a slave shall detect radar independent of its output power; or



- a master shall perform the radar detection using an omni-directional antenna.

#### 4.2.6.1.5 DFS operation

The operational behaviour and individual DFS requirements that are associated with the master and the slave devices are as follows:

##### Master device:

- The master device shall use a Radar Interference Detection function in order to detect radar signals:
  - The master device may rely on another device, associated with the master, to implement the Radar Interference Detection function. In such a case, the combination shall comply with the requirements applicable to a master.
- A master device shall only start operating on *Available Channels* if radar detection is fully ensured by the in-service monitoring (as defined in clause 4.2.6.2.2). When setup the WIA device to start operation, then all *Available Channels* shall be setup to be available.
- Once the WIA device has started operations on an *Available Channel*, then that channel becomes an *Operating Channel*. During normal operation, the master device shall monitor all *Operating Channels (In-Service Monitoring)* to ensure that there is no radar operating within these channel(s). If no radar was detected on an *Operating Channel* but the WIA device stops operating on that channel, then the channel becomes an *Available Channel*. An WIA is allowed to start transmissions on multiple (adjacent or non-adjacent) *Available Channels*. In this case all the multiple channels become *Operating Channels*.
- If the master device has detected a radar signal on an *Operating Channel* during *In-Service Monitoring*, the master device shall instruct all its associated slave devices to stop transmitting on this channel which becomes an *Unavailable Channel*. When operating on multiple (adjacent or non-adjacent) *Operating Channels* simultaneously, only the *Operating Channel* containing the frequency on which radar was detected shall become an *Unavailable Channel*.
- An *Unavailable Channel* can become an *Available Channel* again after the *Non-Occupancy Period*.
- In all cases, if radar detection has occurred, then the channel containing the frequency on which radar was detected becomes an *Unavailable Channel*.

##### Slave device:

- A slave device shall not transmit before receiving an appropriate enabling signal from an associated master device.
- A slave device shall stop its transmissions on a channel whenever instructed by a master device. The slave device shall not resume any transmissions on this channel until it has received an appropriate enabling signal from an associated master device.
- A slave device which is required to perform radar detection (see table D.2, note 2), shall stop its own transmissions on an *Operating Channel* if it has detected a radar on that channel. That *Operating Channel* becomes an *Unavailable Channel* for the slave device. It shall not resume any transmissions on this *Unavailable Channel* for a period of time equal to the *Non-Occupancy Period*.

#### 4.2.6.2 DFS technical requirements specifications

##### 4.2.6.2.1 Applicability

Table 4 lists the DFS related technical requirements and their applicability for every operational mode. If the WIA device is capable of operating in more than one operational mode then every operating mode shall be assessed separately. The DFS requirement applies only for devices with an RF output power ( $P_{tx}$ ) of  $25 \text{ mW} < P_{tx} \leq 400 \text{ mW}$ .

Table 4: Applicability of DFS requirements

Requirement	DFS Operational mode		
	Master	Slave without radar detection (see table D.2, note 2)	Slave with radar detection (see table D.2, note 2)
In-Service Monitoring	required	Not required	required
Channel Shutdown	required	required	required
Non-Occupancy Period	required	Not required	required

The radar detection requirements specified in clause 4.2.6.2.2 assume that the centre frequencies of the radar signals fall within the central 80 % of the *Occupied Channel Bandwidth* of the WIA channel.

#### 4.2.6.2.2 In-Service Monitoring

##### 4.2.6.2.2.1 Definition

The *In-Service Monitoring* is defined as the process by which a WIA device monitors each *Operating Channel* for the presence of radar signals.

##### 4.2.6.2.2.2 Limit

The In-Service Monitoring shall be used to monitor each Operating Channel.

The In-Service-Monitoring shall start immediately after the WIA device has started transmissions on a channel.

During the In-Service Monitoring, the WIA device shall be capable of detecting any of the radar test signals that fall within the ranges given by table D.4 with a level above the Radar Detection Threshold defined in table D.2.

The minimum required detection probability associated with a given radar test signal shall be as defined in table D.6.

Slave devices with a maximum transmit power of 400 mW e.i.r.p. or less do not have to implement the *In-service Monitoring* and the *Non-Occupancy Period*. In fixed outdoor point to point or fixed outdoor point to multipoint applications either:

- a slave shall detect radar independent of its output power; or
- a master shall perform the radar detection using an omni-directional antenna.

##### 4.2.6.2.2.3 Conformance

Conformance tests as defined in clause 5.3.7.2.1.2 shall be carried out.

#### 4.2.6.2.3 Channel Shutdown

##### 4.2.6.2.3.2 General requirements

The master device shall instruct all associated slave devices to stop transmitting on this channel, which they shall do within the *Channel Move Time*.

Slave devices with a DFS function, shall stop their own transmissions on an *Operating Channel* within the *Channel Move Time* upon detecting a radar signal within this channel.

The aggregate duration of all transmissions of the WIA device on this channel during the *Channel Move Time* shall be limited to the *Channel Closing Transmission Time*. The aggregate duration of all transmissions shall not include quiet periods in between transmissions.

For equipment having simultaneous transmissions on multiple (adjacent or non-adjacent) operating channels, only the channel(s) containing the frequency on which radar was detected is subject to the *Channel Shutdown* requirement. The equipment is allowed to continue transmissions on other *Operating Channels*.

#### 4.2.6.2.3.3 Limit

The *Channel Move Time* shall not exceed the limit defined in table D.1.

The *Channel Closing Transmission Time* shall not exceed the limit defined in table D.1.

#### 4.2.6.2.3.4 Conformance

Conformance tests as defined in clause 5.3.7.2.1.3 shall be carried out.

### 4.2.6.2.4 Non-Occupancy Period

#### 4.2.6.2.4.1 Definition

The *Non-Occupancy Period* is defined as the time during which the WIA device does not make any transmissions on a channel after a radar signal was detected on that channel.

For equipment having simultaneous transmissions on multiple (adjacent or non-adjacent) operating channels, only the channel(s) containing the frequency on which radar was detected is subject to the *Non-Occupancy Period* requirement. The equipment is allowed to continue transmissions on other *Operating Channels*.

After the *Non-Occupancy Period*, the channel needs to be identified again as an *Available Channel* before the WIA device may start transmitting again on this channel.

#### 4.2.6.2.4.2 Limit

The *Non-Occupancy Period* shall not be less than the value defined in table D.1.

#### 4.2.6.2.4.3 Conformance

Conformance tests as defined in clause 5.3.7.2.1.3 shall be carried out.

## 4.2.7 Adaptive Channel Access Mechanism

### 4.2.7.1 Overview

#### 4.2.7.1.1 General requirements

A WIA device shall employ an adaptive channel access mechanism to detect emissions from BFWA, ITS and TTT in the 5,8 GHz WIA band and to avoid co-channel operation with these systems.

Whilst the adaptive channel access mechanism described in clause 4.2.7 defines conditions under which the equipment may transmit, transmissions are only allowed providing they are not prohibited by the DFS requirements in clause 4.2.6.

In order to protect existing services in 5,8 GHz WIA band, an equipment shall use a Detect And Avoid (DAA) protocol.

#### 4.2.7.1.2 Applicability

Clause 4.2.7 does not apply to WIA devices operating at a power level of equal or less than 25 mW e.i.r.p.

### 4.2.7.1.3 Applicable frequency range

This requirement shall apply to all types of WIA devices regardless of the type of communication between these devices.

Broadband Fixed Wireless Access (BFWA) detection is required when operating on channels whose nominal bandwidth falls partly or completely within the frequency range from 5 725 MHz to 5 875 MHz. Intelligent Transport Systems (ITS) detection is required when operating on channels whose nominal bandwidth falls partly or completely within the frequency range from 5 855 MHz to 5 875 MHz. Transport and Traffic Telematics (TTT) detection is required when operating on channels whose nominal bandwidth falls partly or completely within the frequency range from 5 795 MHz to 5 815 MHz.

### 4.2.7.2 DAA technical requirements specifications except ITS and TTT

#### 4.2.7.2.1 Minimum Tx-off time

##### 4.2.7.2.1.1 Definition

The minimum Tx off-time is defined as the period where a WIA device shall remain off after a transmission or a polling sequence.

##### 4.2.7.2.1.2 Limit

The minimum Tx off-time shall be 5  $\mu$ s.

##### 4.2.7.2.1.3 Conformance

Conformance tests for this requirement shall be as defined in clause 5.3.8.2.2.

#### 4.2.7.2.2 DAA minimum listening time

##### 4.2.7.2.2.1 Definition

The minimum listening time is defined as the minimum time that the equipment listens for a received signal at or above the DAA threshold level (see clause 4.2.7.2.4.1) immediately prior to transmission to determine whether the intended channel is available for use.

##### 4.2.7.2.2.2 Limit

The total listen time,  $t_L$ , consists of a fixed part,  $t_F$ , and a pseudo random part,  $t_{PS}$ , as the following:

$$t_L = t_F + t_{PS}$$

- a) The fixed part of the minimum listening time,  $t_F$ , shall be not less than 18  $\mu$ s.
- b) The pseudo random listening time  $t_{PS}$  shall be randomly varied between 0 ms and a value of 5 ms or more in equal steps of approximately 0,5 ms as the following:
  - If the channel is free from traffic at the beginning of the listen time,  $t_L$ , and remains free throughout the fixed part of the listen time,  $t_F$ , then the pseudo random part,  $t_{PS}$ , is automatically set to zero by the equipment itself.
  - If the channel is occupied by traffic when the equipment either starts to listen or during the listen period, then the listen time commences from the instant that the intended channel is free. In this situation the total listen time  $t_L$  shall comprise  $t_F$  and the pseudo random part,  $t_{PS}$ .

The limit for total listen time for the receiver consists of the sum of a) and b) together.

#### 4.2.7.2.2.3 Conformance

Conformance tests for this requirement shall be as defined in clause 5.3.8.2.4.

#### 4.2.7.2.3 Maximum transmitter on-time (Tx on-time)

##### 4.2.7.2.3.1 Definition

The maximum transmitter on-time is defined as the maximum time the transmitter can be on during:

- a) A single transmission.
- b) Multiple transmissions and acknowledgements for a communication dialogue or polling sequence of other units under the condition that the channel is free.

An equipment intended for very long messages shall be capable of switching to a "free" channel before the maximum transmitter on-time is reached for each channel of operation.

##### 4.2.7.2.3.2 Limit

A transmitter shall only be allowed to transmit for a maximum specified period. This prevents a transmitter from occupying a channel for an extended period. The limit for a single transmission Tx on-time shall be 2 s.

The time for the transmission dialogue or a polling sequence shall be less than 10 s.

If this limit is reached then the minimum Tx off-time limit shall apply automatically.

##### 4.2.7.2.3.3 Conformance

Conformance tests for this requirement shall be as defined in clause 5.3.8.2.2.

#### 4.2.7.2.4 DAA threshold

##### 4.2.7.2.4.1 Limits

The DAA threshold for the receiver in the listen mode shall be according to the following formula using  $14 \text{ dBm} < P_{tx} \leq 26 \text{ dBm}$ :

$$DAA_{thr} = (-99 + (26 - P_{tx}) + G) \text{ dBm}$$

Where:

- DAA<sub>thr</sub> = DAA threshold in dBm at the receiver input port.
- P<sub>tx</sub> = The value of the radiated power of the WIA device in dBm e.i.r.p..
- G = The value of the antenna gain in dBi.

The measured DAA threshold shall be stated in the test report.

##### 4.2.7.2.4.2 Conformance

Conformance tests as defined in clause 5.3.8.2.2 shall be carried out.

### 4.2.7.3 DAA technical requirements specifications for ITS

#### 4.2.7.3.1 General

In order to protect the operation of ITS devices in the band 5 855 MHz to 5 875 MHz a WIA device shall implement a DAA operation for the two 10 MHz channel in that band. The DAA operation is defined based on the following timing parameters:

- *ITS Channel Availability Check time,  $T_{ITS\_check\_time}$*
- *ITS Maximum TX<sub>on</sub>-time,  $T_{ITS\_max\_on}$*
- *ITS minimum TX<sub>off</sub>-time,  $T_{ITS\_min\_off}$*
- *ITS Non-Occupancy Period,  $T_{ITS\_non\_occ}$*
- *ITS DAA latency,  $T_{ITS\_daa}$*
- *ITS DAA probability,  $Prob_{ITS\_daa}$*

and the detection threshold parameter for ITS  $D_{ITS\_thres}$ .

#### 4.2.7.3.2 Applicable frequency range

DAA for ITS is required when operating on channels whose nominal bandwidth falls partly or completely within the frequency range from 5 855 MHz to 5 875 MHz.

#### 4.2.7.3.3 ITS Channel Availability Check time

##### 4.2.7.3.3.1 Definition

The *ITS Channel Availability Check* is defined as a mechanism by which an WIA device checks channels for the presence of ITS signals. This mechanism is used for identifying available channels after the switch on of the device or the move to a relevant channel. There shall be no transmissions by the WIA device on the channels being checked during this process. The ITS Channel Availability Check shall be performed for each WIA operating channel that overlaps with the two 10 MHz ITS channels in the range of 5 855 MHz to 5 875 MHz.

##### 4.2.7.3.3.2 Limits

The ITS Channel Availability Check shall include a listening period of at least  $t_{ITS\_check\_time} \geq 10\,000$  ms for each ITS channel overlapped by the WIA operating channel.

##### 4.2.7.3.3.3 Conformance

Conformance tests for this requirement shall be as defined in clause 5.3.9.3.

#### 4.2.7.3.4 *ITS Maximum TX<sub>on</sub>-time*

##### 4.2.7.3.4.1 Definition

The *ITS maximum TX<sub>on</sub>-time* ( $t_{ITS\_on\_max}$ ) is the maximum allowed duration of a single transmission operation in the ITS operation bands between 5 855 MHz and 5 875 MHz. The limitation of the transmission duration will allow ITS devices to enter the channel and to be detected by the WIA devices.

#### 4.2.7.3.4.2 Limits

A WIA device operation in the band between 5 855 MHz and 5 875 MHz shall not exceed the *ITS maximum TXon-time* of 3 ms:

$$t_{\text{ITS\_on\_max}} \leq 3 \text{ ms}$$

#### 4.2.7.3.4.3 Conformance

Conformance tests for this requirement shall be as defined in clause 5.3.9.4.

#### 4.2.7.3.5 *ITS Minimum TX<sub>off</sub>-time*

##### 4.2.7.3.5.1 Definition

The *ITS Minimum TX<sub>off</sub>-time* ( $t_{\text{ITS\_min\_off}}$ ) defines the minimum time between two consecutive transmission of a WIA device in the ITS channels between 5 855 MHz to 5 875 MHz when no ITS device is present and thus no ITS signal is detected during the detection process.

##### 4.2.7.3.5.2 Limits

The minimum time between two consecutive transmissions of a WIA device shall be:

$$t_{\text{ITS\_min\_off}} \geq 100 \text{ ms}$$

##### 4.2.7.3.5.3 Conformance

Conformance tests for this requirement shall be as defined in clause 5.3.9.4.

#### 4.2.7.3.6 *ITS DAA latency*

##### 4.2.7.3.6.1 Definition

The *ITS\_DAA\_latency*  $T_{\text{ITS\_DAA}}$  defines the time between the first occurrence of an ITS victim signal above the detection threshold given in clause 4.2.7.3.9 and the switch off of the WIA transmission in the band 5 855 MHz to 5 875 MHz with the ITS DAA probability given in clause 4.2.7.3.6. After the detection of an ITS victim signal in the band the WIA device shall not operate in the band for at least  $T_{\text{ITS\_non\_occ}}$  as given in clause 4.2.7.3.8.

##### 4.2.7.3.6.2 Limits

The *ITS\_DAA\_Latency* shall be:

$$T_{\text{ITS\_DAA}} \leq 1\,000 \text{ ms}$$

##### 4.2.7.3.6.3 Conformance

Conformance tests for this requirement shall be as defined in clause 5.3.9.5.

#### 4.2.7.3.7 *ITS DAA Probability*

##### 4.2.7.3.7.1 Definition

The *ITS DAA probability*  $Prob_{\text{ITS\_DAA}}$  defines the probability that the limits for the ITS DAA latency are reached for a single time period of  $T_{\text{ITS\_DAA}}$  as defined in clause 4.2.7.3.6 and an ITS test signal defined in clause 5.3.9.2.

#### 4.2.7.3.7.2 Limits

The ITS DAA Probability shall be:

$$Prob_{ITS\_DAA} \geq 95 \%$$

#### 4.2.7.3.7.3 Conformance

Conformance tests for this requirement shall be as defined in clause 5.3.9.5.

#### 4.2.7.3.8 *ITS\_Non-Occupancy Period*

##### 4.2.7.3.8.1 Definition

The *ITS\_Non-Occupancy Period* ( $T_{ITS\_non\_occ}$ ) is defined as the time during which the WIA device does not make any transmissions in the band 5 855 MHz to 5 875 MHz on the ITS channels after an ITS signal was detected on that channel.

##### 4.2.7.3.8.2 Limits

The minimum time between two consecutive transmissions of a WIA device shall be:

$$T_{ITS\_non\_occ} \geq 30\,000 \text{ ms};$$

##### 4.2.7.3.8.3 Conformance

Conformance tests for this requirement shall be as defined in clause 5.3.9.6.

#### 4.2.7.3.9 *ITS DAA threshold*

##### 4.2.7.3.9.1 Definition

During the detection processes the WIA equipment listens for a received signal at or above the ITS DAA threshold level ( $D_{ITS\_thres}$ ). This limit is valid for the *ITS Channel Availability Check* and the in-service detection process.

##### 4.2.7.3.9.2 Limits

The ITS DAA threshold limit ( $D_{ITS\_thres}$ ) is depending on the actual TX power of the WIA device:

$$D_{ITS\_thres} = (-88 + (26 - TP)) \text{ dBm}$$

Where  $TP$  is the value of the actual e.i.r.p. TX power of the WIA device in dBm.

EXAMPLE: A WIA device operating with 26 dBm e.i.r.p. TX power in the ITS bands shall not transmit in these bands when a signal is detected exceeding the level of  $D_{ITS\_thres} \geq -88$  dBm.

##### 4.2.7.3.9.3 Conformance

Conformance tests for this requirement shall be as defined in clause 5.3.9.3.

#### 4.2.7.4 DAA technical requirements specifications for TTT, general conditions and applicable frequency range

DAA for TTT is required when operating on channels whose nominal bandwidth falls partly or completely within the frequency range from 5 795 MHz to 5 815 MHz.

One of the listed detection methods shall be implemented under the conditions given in clause 4.2.7.1:

- a) DAA according to clause 4.2.6 (DAA using TTT signal detection).



- b) DAA according to clause 4.2.9 and clause 4.2.10 (DAA using a geolocation database).

#### 4.2.7.5 DAA using TTT signal detection

##### 4.2.7.5.1 General

In order to protect the operation of T devices in the band 5 795 MHz to 5 815 MHz, a WIA device shall implement a DAA operation. The DAA operation is defined based on the following timing parameters:

- *TTT Channel Availability Check time,  $T_{TTT\_check\_time}$*
- *TTT Non-Occupancy Period,  $T_{TTT\_non\_occ}$*
- *TTT DAA latency,  $T_{TTT\_daa}$*

and the detection threshold parameter ITS  $D_{TTT\_thres}$ .

##### 4.2.7.5.2 DAA threshold for TTT

###### 4.2.7.5.2.1 Definition

During the detection processes the WIA equipment listens for a received signal at or above the TTT DAA threshold level ( $D_{TTT\_thres}$ ). This limit is valid for the *ITS Channel Availability Check* and the in-service detection process.

###### 4.2.7.5.2.2 Limits

The TTT DAA threshold limit ( $D_{TTT\_thres}$ ) is depending on the actual TX power of the WIA device:

$$D_{TTT\_thres} = (-85 + ((14 + (10 \times \log BW)) - TP) \text{ dBm}$$

Where  $TP$  is the value of the actual e.i.r.p. TX power of the WIA device in dBm, and  $BW$  is the value of the nominal bandwidth of the WIA device in MHz.

###### 4.2.7.5.2.3 Conformance

Conformance tests for this requirement shall be as defined in clause 5.3.10.3.

##### 4.2.7.5.3 TTT Channel Availability Check

###### 4.2.7.5.3.1 Definition

The *TTT Channel Availability Check* is defined as a mechanism by which an WIA device checks channels for the presence of TTT signals. This mechanism is used for identifying Available Channels. There shall be no transmissions by the WIA device on the channels being checked during this process. The TTT Channel Availability Check shall be performed for each WIA operating channel that overlaps with the TTT frequency range (5 795 MHz to 5 815 MHz).

###### 4.2.7.5.3.2 Limits

The TTT Channel Availability Check shall include a listening period  $t_{TTT\_check\_time}$  of at least 100 ms for each TTT channel fully or partially overlapped by the WIA channel. The TTT Channel Availability Check shall be performed directly before a WIA channel becomes an operating channel.

NOTE: The listening for TTT signals on each TTT channel could be implemented in parallel or sequentially.

Upon startup or after a non-occupancy period, a WIA device shall perform a TTT channel availability check for each operating channel that overlaps with the TTT frequency range (5 795 MHz to 5 815 MHz).

#### 4.2.7.5.3.3 Conformance

Conformance tests for this requirement shall be as defined in clause 5.3.10.3.

#### 4.2.7.5.4 *TTT Non-Occupancy Period*

##### 4.2.7.5.4.1 Definition

The *Non-Occupancy Period* is defined as the time during which the WIA device does not make any transmissions on a channel after a TTT signal was detected on that channel.

##### 4.2.7.5.4.2 Limits

If a TTT signal is detected, then a non-occupancy period  $T_{TTT\_non\_occ}$  of at least 10 minutes shall be employed.

##### 4.2.7.5.4.3 Conformance

Conformance tests for this requirement shall be as defined in clause 5.3.10.5.

#### 4.2.7.5.5 *TTT DAA Latency*

##### 4.2.7.5.5.1 Definition

The *TTT DAA latency* specifies the time from a TTT signal becoming present at the WIA device above the TTT detection threshold until the WIA device stops transmissions on the respective channel (due to TTT detection).

##### 4.2.7.5.5.2 Limits

The TTT DAA latency  $T_{TTT\_daa}$  shall be at most 30 s.

##### 4.2.7.5.5.3 Conformance

Conformance tests for this requirement shall be as defined in clause 5.3.10.4.

#### 4.2.7.5.6 *TTT In-Service Monitoring*

##### 4.2.7.5.6.1 Definition

The *TTT In-Service Monitoring* is defined as the process by which a WIA device monitors each Operating Channel for the presence of TTT signals.

##### 4.2.7.5.6.2 Limits

If no TTT signal is present, then the operating channel can be used under the condition of performing an in-service monitoring. During in-service monitoring, the WIA equipment shall be able to detect a TTT signal within the TTT DAA latency as specified in clause 4.2.7.5.5.

NOTE: The WIA device can use the channel while doing in-service monitoring.

If in-service monitoring is interrupted or the WIA device is restarted, a new TTT channel availability check shall be performed.

##### 4.2.7.5.6.3 Conformance

Conformance tests for this requirement shall be as defined in clause 5.3.10.4.

## 4.2.8 User Access Restrictions

### 4.2.8.1 Definition

User Access Restrictions are constraints implemented in the WIA device to restrict access of the user to any hardware and/or software settings of the equipment, including software replacement(s), which may impact (directly or indirectly) the compliance of the equipment with the requirements in the present document.

NOTE: The user should be understood as the end user, the operator or any person not responsible for the compliance of the equipment against the requirements in the present document.

### 4.2.8.2 Requirement

The equipment shall be so constructed that settings (hardware and/or software) related to mitigation techniques given in clause 4.2 (e.g. DFS, DAA, APC) shall not be accessible to the user if changing those settings results in the equipment no longer being compliant with the DFS requirements in clause 4.2.6.

The above requirement includes the prevention of indirect access to any setting that impacts mitigation techniques given in clause 4.2 (e.g. DFS, DAA, APC). The following is a non-exhaustive list of examples of such indirect access.

EXAMPLE 1: The equipment should not allow the user to change the country of operation and/or the operating frequency band if that results in the equipment no longer being compliant with the DFS requirements.

EXAMPLE 2: The equipment should not accept software and/or firmware which results in the equipment no longer being compliant with the DFS requirements, e.g.:

- software and/or firmware provided by the manufacturer but intended for other regulatory regimes;
- modified software and/or firmware where the software and/or firmware is available as open source code;
- previous versions of the software and/or firmware (downgrade).

## 4.2.9 Geo-localization capability

### 4.2.9.1 Applicability

This requirement only applies to equipment with geo-localization capability as defined in clause 4.2.9.2.

### 4.2.9.2 Definition

Geo-localization capability is a feature of the WIA device to determine its location at installation, at reinstallation and at each power up of the equipment, with the purpose to configure itself according to the regulatory requirements applicable at the location where it operates. The geo-localization capability may be present in the equipment or in an external device (temporary) associated with the equipment operating at the same geographic location during the initial power up of the equipment. The geographic location may also be available in equipment already installed and operating at the same geographic location.

### 4.2.9.3 Requirements

The geographic location determined by the equipment as defined in clause 4.2.9.2 shall not be accessible to the user. If the equipment cannot determine the geographic location, it shall operate in a mode compliant with the requirements applicable in any of the geographic locations where the equipment is intended to operate.

## 4.2.10 TTT Detection and Avoidance using a Geolocation Database

### 4.2.10.1 Applicability

This requirement only applies to equipment with geo-localization capability as defined in clause 4.2.9.2 and with the capability to detect TTT via a Geolocation Database as defined in clause 4.2.10.2.

### 4.2.10.2 Definition

WIA device with Geo-location capability (see clause 4.2.9) at a fixed location can use a TTT geolocation database to determine whether it is within the vicinity of TTT equipment.

The geographic locations of fixed TTT equipment is given in a geolocation database prepared and published by an international consortium of toll operators, such as the ASECAP Protected Zone Database, which acts as a database provider. The use of the Geolocation database is applicable in those countries covered by the database. The database can be downloaded from the database provider upon request via Internet in machine-readable form.

The geolocation database contains WIA protected zones. Each protected zone consists of a center location of the TTT equipment and a WIA protection radius.

NOTE 1: The WIA protection radius intends to reflect the extent of the TTT installation and the propagation conditions in the environment. As an example, a TTT installation in a tunnel needs a much smaller protection radius than a large toll plaza with multiple TTT equipment at elevated positions. Multiple TTT equipment, e.g. in a toll plaza, is combined into one protected zone.

NOTE 2: The geolocation database does not include mobile and portable TTT equipment, which is used in mobile road toll enforcement, smart tachograph, and weight and dimensions.

### 4.2.10.3 Requirements

The WIA equipment shall have access to a local representation of the full geolocation database or of a part of the database which is relevant for the country the WIA equipment operates in. If the equipment cannot determine the geographic location or cannot access a database which is relevant for its location of operation, it shall operate in a mode compliant with the requirements applicable in any of the geographic locations where the equipment is intended to operate.

The geolocation database used by the equipment as defined in clause 4.2.10.2 shall not be accessible to the user.

The local representation of the geolocation database shall be updated upon notification by the database provider, but at least every month.

The equipment shall be able to determine whether any geo-location within its operational range lies within a TTT protection zone by comparing its own location(s) with the center location and the nearest protected zone, which is given in the database by the TTT center location and a WIA protection radius.

If any geo-location of a WIA device within its operational range is located within a protected zone, it shall not operate on channels whose nominal bandwidth fall partly or completely within the TTT frequency range from 5 795 MHz to 5 815 MHz.

### 4.2.10.4 Conformance

Conformance tests for this requirement shall be as defined in clause 5.3.10.6.

## 5 Testing for compliance with technical requirements

### 5.1 Environmental conditions for testing

#### 5.1.1 General requirements

Tests defined in the present document shall be carried out at representative points within the boundary limits of the operational environmental profile.

Where technical performance varies subject to environmental conditions, tests shall be carried out under a sufficient variety of environmental conditions (within the boundary limits of the declared operational environmental profile) to give confidence of compliance for the affected technical requirements.

#### 5.1.2 Normal and extreme test conditions

Some tests in the present document shall be repeated at extreme temperatures. Where that is the case, measurements shall be made over the extremes of the operating temperature range.

#### 5.1.3 Test sequences and traffic load

##### 5.1.3.1 General test transmission sequences

Except for the DFS tests or if mentioned otherwise, all the tests in the present document shall be performed by using a test transmission sequence that shall consist of regularly transmitted packets (e.g. with an interval of 2 ms). The test transmissions shall be fixed in length in a sequence and shall exceed the transmitter minimum activity ratio of 10 %.

The general structure of the test transmission sequence is shown in figure 1.

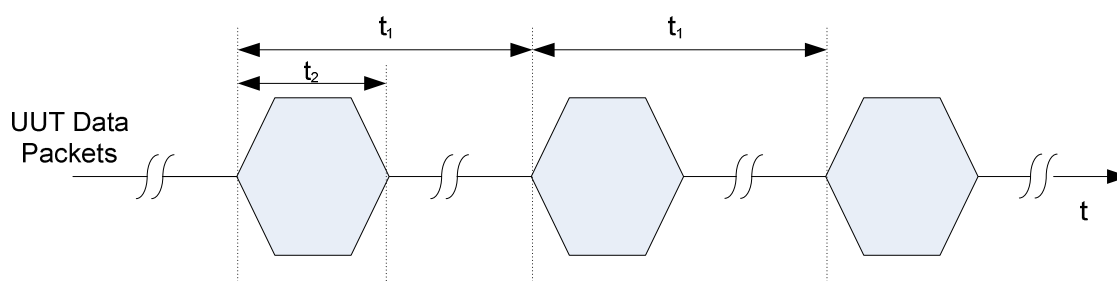

Figure 1: General structure of the test transmission sequences

##### 5.1.3.2 Test transmission sequences for DFS tests

The DFS tests related to the *In-Service Monitoring* (see clause 5.3.7.2.1.2) shall be performed by using a test transmission sequence on the *Operating Channel* that shall consist of packet transmissions that together exceed the transmitter minimum activity ratio of 30 % measured over an interval of 100 ms.

#### 5.1.4 Test channels

Unless otherwise stated in the test procedures (see clause 5.3), the channels to be used for testing shall be as given in table 5.

When testing devices that support simultaneous transmissions in adjacent or non-adjacent channels, DFS testing does not need to be performed simultaneously in these different channels.

Table 5: Test channels

Test	Clause	Test channels	
		5 725 MHz to 5 850 MHz	5 850 MHz to 5 875 MHz
RF output power and Adaptive Power Control	5.3.2	C1	C2
Occupied Channel Bandwidth	5.3.3	C4	
Transmitter unwanted emissions in the spurious domain	5.3.4	C4 (see note 1)	
Receiver spurious emissions	5.3.5	C4 (see note 1)	
Dynamic Frequency Selection	5.3.7	C3	n.a. (see note 2)
Adaptivity (channel access mechanism) except for ITS and TTT	5.3.8	C4	
C1:	The lowest declared channel for every declared nominal channel bandwidth within this band. For the power density testing, it is sufficient to only perform this test using the lowest nominal channel bandwidth.		
C2:	The highest declared channel for every declared nominal channel bandwidth within this band. For the power density testing, it is sufficient to only perform this test using the lowest nominal channel bandwidth.		
C3:	One channel out of the declared channels for this frequency range. If more than one nominal channel bandwidth has been declared, testing shall be performed using the lowest and highest nominal channel bandwidth.		
C4:	One channel out of the declared channels. For Occupied Channel Bandwidth, testing shall be repeated for every declared nominal channel bandwidth. For Adaptivity, testing shall be performed using the highest nominal channel bandwidth.		
NOTE 1:	In case of more than one channel plan has been declared, testing of these specific requirements need only be performed using one of the declared channel plans.		
NOTE 2:	Testing is not required for nominal channel bandwidths that fall completely within the frequency range 5 850 MHz to 5 875 MHz.		

## 5.1.5 Antennas

### 5.1.5.1 Integrated and dedicated antennas

The equipment can have either integrated antennas or dedicated antennas. Dedicated antennas, further referred to as *dedicated external antennas*, are antennas that are physically external to the equipment and are assessed in combination with the equipment against the requirements in the present document.

It should be noted that the result of an assessment does not necessarily lead to testing.

An antenna assembly referred to in the present document is understood as the combination of the antenna (integrated or dedicated), its coaxial cable and if applicable, its antenna connector and associated switching components. The gain of an antenna assembly  $G$  in dBi, does not include the additional gain that may result out of beamforming.

Smart antenna systems may use beamforming techniques which may result in additional (antenna) gain. This beamforming gain  $Y$  is specified in dB. Beamforming gain does not include the gain of the antenna assembly  $G$ .

Although the measurement methods in the present document allow conducted measurements to be performed, it should be noted that the equipment together with all its intended antenna assemblies shall comply with the applicable technical requirements defined in the present document.

### 5.1.5.2 Transmit operating modes

#### 5.1.5.2.1 Operating mode 1 (single antenna)

The equipment uses only one antenna when operating in this mode.

The following types of equipment and/or operating modes are examples covered by this category:

- Equipment with only one antenna.
- Equipment with two diversity antennas but at any moment in time only one antenna is used.

- Smart antenna system with two or more antennas, but operating in a mode where only one antenna is used.

#### 5.1.5.2.2 Operating mode 2 (multiple antennas, no beamforming)

The equipment that can operate in this mode contains a smart antenna system using two or more transmit chains simultaneously but without beamforming.

#### 5.1.5.2.3 Operating mode 3 (multiple antennas, with beamforming)

The equipment that can operate in this mode contains a smart antenna system using two or more transmit chains simultaneously with beamforming.

In addition to the antenna assembly gain  $G$ , the beamforming gain  $Y$  shall be considered when performing the measurements described in the present document.

## 5.2 Void

## 5.3 Conformance tests

### 5.3.1 Product information

The following information shall be declared by the manufacturer and shall be included in the test report. This information is required in order to carry out the test suites and/or to declare compliance to technical requirements (e.g. technical requirements for which no conformance test is included in the present document):

- a) The channel plan(s), being the centre frequencies and associated Nominal Channel Bandwidth(s).
- b) If the equipment can support simultaneous transmissions in one or more channels, the following shall be provided:
  - the number of channels used for these simultaneous transmissions;
  - whether or not these channels are adjacent or non-adjacent.
- c) The different transmit operating modes in which the equipment can operate (see clause 5.1.5.2).
- d) For each of the modes declared under c) the following shall be provided:
  - the number of transmit chains;
  - if more than one transmit chain is active, whether the power is distributed equally or not;
  - the number of receive chains;
  - whether or not antenna beamforming is implemented, and if so the maximum beamforming gain  $Y$  for this transmit operating mode.
- e) Whether or not the device has an APC feature containing one or more APC ranges.

NOTE: The equipment can have more than one APC range to accommodate different antennas and/or the different applicable power limits.

The manufacturer may decide to declare that the equipment can operate both with and without an APC feature in which case the manufacturer may provide details in response to both point f) and point g).

- f) For devices with an APC feature, for each APC range:
  - The lowest and highest transmitter output power level (or lowest and highest e.i.r.p level in case of integrated antenna equipment). If the equipment supports simultaneous transmissions, the lowest and highest transmitter output power or e.i.r.p. level.

- In case of smart antenna systems with different transmit operating modes (see clause 5.1.5.2) the transmitter power levels may differ depending on the transmitter operating mode.
  - The intended antenna assembly(ies), their corresponding maximum gain(s)  $G$ , the resulting e.i.r.p. values (taking also into account the beamforming gain  $Y$  if applicable) and the corresponding DFS threshold level(s).
  - The applicable operating frequency range(s).
- g) For devices operating in a mode without an APC feature:
- The maximum transmitter output power level (or maximum e.i.r.p. level in case of integrated antenna equipment).
- In case of smart antenna systems with different transmitter operating modes (see clause 5.1.5.2) the transmitter output power levels may differ depending on the operating mode.
- The intended antenna assembly(ies), their corresponding maximum gain(s)  $G$ , the resulting e.i.r.p. values (taking also into account the beamforming gain  $Y$  if applicable) and the corresponding DFS threshold level(s).
  - The applicable operating frequency range(s).
- h) With regards to DFS, the DFS operational modes in which the equipment can operate (master, slave with radar detection, slave without radar detection).
- i) With regards to User Access Restrictions, to confirm that the equipment is constructed to comply with the requirements contained in clause 4.2.8.
- j) Whether or not the device can operate in ad-hoc mode, and if so, the operating frequency range when operating in ad-hoc mode.
- k) The operating frequency range(s) of the equipment.
- l) The normal and the extreme operating conditions (e.g. voltage and temperature) of the equipment.
- m) The test sequence/test software used by the UUT.
- n) Type of Equipment, for example: stand-alone equipment, plug-in radio device, combined equipment, etc.

## 5.3.2 RF output power and Adaptive Power Control

### 5.3.2.1 Test conditions

The test shall be done using power in the range from 25 mW to 400 mW e.i.r.p.

The conformance requirements in clause 4.2.1.3 shall be verified on those channels and channel bandwidths defined in clause 5.1.4.

The measurements described in the present clause may need to be repeated to cover:

- each of the APC ranges (or transmitter output power levels for equipment without APC) and corresponding antenna assemblies declared by the manufacturer (see clause 5.3.1, item e), item f) and item g));
- each of the transmit operating modes declared by the manufacturer (see clause 5.1.5.2 and clause 5.3.1, item c)).

The measurements shall be performed with test signal specified in clause 5.1.3.1 applied. Alternatively, if special test functions are available, the equipment may also be configured in a continuous transmit mode or with a constant duty cycle (e.g. frame based systems) which is at least 10 %.

For a UUT with antenna connector(s) and using dedicated external antenna(s), or for a UUT with integral antenna(s) but with a temporary antenna connector(s) provided, conducted measurements shall be used in conjunction with the stated antenna assembly gain(s).



In the case of equipment intended for use with an integral antenna and where no external (temporary) antenna connectors are provided, a test fixture as described in clause B.4 may be used to perform relative measurements at the extremes of the operating temperature range.

### 5.3.2.2 Test method

#### 5.3.2.2.1 Conducted measurement

##### 5.3.2.2.1.1 RF output power

##### 5.3.2.2.1.1.1 Additional test conditions

These measurements shall be performed under both normal and extreme test conditions. The normal and extreme test conditions shall be declared by the manufacturer.

The UUT shall be configured to operate at:

- the highest stated transmitter RF output power level of the APC range; or
- the maximum stated transmitter RF output power level in case the equipment has no APC feature.

##### 5.3.2.2.1.1.2 Option 1

For equipment with continuous transmission capability or for equipment operating (or with the capability to operate) with a constant duty cycle.

#### Step 1:

For equipment configured into a continuous transmit mode ( $x = 1$ ), proceed immediately with step 2:

- The output power of the transmitter shall be coupled to a matched diode detector or equivalent thereof. The output of the diode detector shall be connected to the vertical channel of an oscilloscope.
- The combination of the diode detector and the oscilloscope shall be capable of faithfully reproducing the duty cycle of the transmitter output signal.
- The observed duty cycle of the transmitter ( $T_x \text{ on} / (T_x \text{ on} + T_x \text{ off})$ ) shall be noted as  $x$  ( $0 < x \leq 1$ ), and recorded in the test report.

#### Step 2:

- The RF output power shall be determined using a wideband RF power meter with a thermocouple detector or an equivalent thereof and with an integration period that exceeds the repetition period of the transmitter by a factor 5 or more. The observed value shall be noted as  $A$  (in dBm).
- In case of conducted measurements on smart antenna systems operating in a mode with multiple transmit chains active simultaneously, the output power of each transmit chain shall be measured separately to calculate the total power (value  $A$  in dBm) for the UUT.

#### Step 3:

- The RF output power at the highest power level  $P_H$  (e.i.r.p.) shall be calculated from the above measured power output  $A$  (in dBm), the observed duty cycle  $x$ , the stated antenna gain  $G$  in dBi and if applicable the beamforming gain  $Y$  in dB, according to the formula below. This value shall be recorded in the test report. If more than one antenna assembly is intended for this power setting or APC range, the gain of the antenna assembly with the highest gain shall be used.

$$P_H = A + G + Y + 10 \times \log(1/x) \text{ (dBm)}.$$

- This value  $P_H$  shall be compared to the applicable limit contained in clause 4.2.1.2.2.

## 5.3.2.2.1.1.3 Option 2

For equipment without continuous transmission capability the test procedure shall be as follows:

**Step 1:**

- Sample the transmit signal from the device using a fast power sensor suitable for 6 GHz. Save the raw samples. The samples shall represent the RMS power of the signal.
- Settings:
  - Sample speed: 1 MS/s or faster.
  - Measurement duration: Sufficient to capture a minimum of 10 transmitter bursts (see clause 5.1.3.1).

**Step 2:**

- For conducted measurements on devices with one transmit chain:
  - Connect the power sensor to the transmit port, sample the transmit signal and store the raw data. Use these stored samples in all following steps.
- For conducted measurements on devices with multiple transmit chains:
  - Connect a power sensor to each transmit port for a synchronous measurement on all transmit ports.
  - Trigger the power sensors so that they start sampling at the same time. Make sure the time difference between the samples of all sensors is less than 500 ns.
  - For each individual sampling point (time domain), sum the coincident power samples of all ports and store them. Use these summed samples in the following steps.

**Step 3:**

- Find the start and stop times of each burst in the stored measurement samples:
  - The start and stop times are defined as the points where the power is at least 30 dB below the highest value of the stored samples in step 2.
  - In case of insufficient dynamic range, the value of 30 dB may need to be reduced appropriately.

**Step 4:**

- Between the start and stop times of each individual burst, calculate the RMS (mean) power over the burst ( $P_{\text{burst}}$ ) using the formula below:

$$P_{\text{burst}} = \frac{1}{k} \sum_{n=1}^k P_{\text{sample}}(n)$$

with 'k' being the total number of samples and 'n' the actual sample number.

- The highest of all  $P_{\text{burst}}$  values is the value A in dBm.

**Step 5:**

- The RF output power (e.i.r.p) at the highest power level  $P_H$  shall be calculated from the above measured power output A (in dBm), the stated antenna assembly gain G in dBi and if applicable the beamforming gain Y in dB, according to the formula below. If more than one antenna assembly is intended for this power setting, the gain of the antenna assembly with the highest gain shall be used:

$$P_H = A + G + Y \text{ (dBm)}.$$

- This value  $P_H$  shall be compared to the applicable limit contained in clause 4.2.1.2.2 and shall be recorded in the report.

### 5.3.2.2.2 Radiated measurement

When performing radiated measurements on a UUT with a directional antenna (including smart antenna systems and systems capable of beamforming), the UUT shall be configured/positioned for maximum e.i.r.p. in the horizontal plane. This configuration/position shall be recorded for future use (see clause C.5.2.3).

A test site as described in annex B and using the applicable measurement procedures as described in annex C shall be used.

The test procedure is further as described under clause 5.3.2.2.1.

For measuring the RF output power at the highest and lowest power level, it is likely that a radiated measurement would be performed using a spectrum analyser or measurement receiver, rather than a wide band power sensor. If this is the case and if the resolution bandwidth capability of the measurement device is narrower than the Occupied Channel Bandwidth of the UUT signal measured, then the method of measurement shall be documented in the test report.

## 5.3.3 Occupied Channel Bandwidth

### 5.3.3.1 Test conditions

The conformance requirements in clause 4.2.2 shall be verified only under normal operating conditions, and on those channels and channel bandwidths defined in clause 5.1.4.

The measurements shall be performed using normal operation of the equipment with the test signal applied (see clause 5.1.3.1).

The UUT shall be configured to operate at a typical RF power output level used for normal operation.

When equipment has simultaneous transmissions in adjacent channels, these transmissions may be considered as one signal with an actual Nominal Channel Bandwidth of "n" times the individual Nominal Channel Bandwidth where "n" is the number of adjacent channels. When equipment has simultaneous transmissions in non-adjacent channels, each power envelope shall be considered separately.

For a UUT with antenna connector(s) and using dedicated external antenna(s), or for a UUT with integral antenna(s) but with a temporary antenna connector(s) provided, conducted measurements shall be used.

In case of conducted measurements on smart antenna systems (devices with multiple transmit chains) measurements need only to be performed on one of the active transmit chains (antenna outputs).

For a UUT with integral antenna(s) and without a temporary antenna connector(s), radiated measurements shall be used.

### 5.3.3.2 Test method

#### 5.3.3.2.1 Conducted measurement

The measurement procedure shall be as follows:

##### Step 1:

- Connect the UUT to the spectrum analyser and use the following settings:
  - Centre Frequency: The centre frequency of the channel under test.
  - Resolution Bandwidth: 100 kHz.
  - Video Bandwidth: 300 kHz.
  - Frequency Span:  $2 \times$  Nominal Bandwidth (e.g. 40 MHz for a 20 MHz channel).
  - Sweep time:  $> 1$  s; for larger Nominal Bandwidths, the sweep time may be increased until a value where the sweep time has no impact on the RMS value of the signal.
  - Detector Mode: RMS.

- Trace Mode: Max Hold.

**Step 2:**

- Wait for the trace to stabilize.

**Step 3:**

- Make sure that the power envelope is sufficiently above the noise floor of the analyser to avoid the noise signals left and right from the power envelope being taken into account by this measurement.
- Use the 99 % bandwidth function of the spectrum analyser to measure the Occupied Channel Bandwidth of the UUT. This value shall be recorded.

The measurement described in step 1 to step 3 above shall be repeated in case of simultaneous transmissions in non-adjacent channels.

### 5.3.3.2.2 Radiated measurement

The test set up as described in annex B and the applicable measurement procedures described in annex C shall be used.

## 5.3.4 Transmitter unwanted emissions in the spurious domain

### 5.3.4.1 Test conditions

The conformance requirements in clause 4.2.3 shall be verified only under normal operating conditions, and when operating on those channels defined in clause 5.1.4.

The equipment shall be configured to operate under its worst case situation with respect to unwanted emissions.

If possible, the UUT shall be set to continuous transmit ( $x = 1$ ) for the duration of this test.

If continuous transmit is not possible, the UUT should be configured to operate at its maximum duty cycle.

The level of transmitter unwanted emissions shall be measured as, either:

- a) their power in a specified load (conducted emissions) and their effective radiated power when radiated by the cabinet or structure of the equipment (cabinet radiation); or
- b) their effective radiated power when radiated by cabinet and antenna in case of integral antenna equipment with no temporary antenna connectors.

### 5.3.4.2 Test method

#### 5.3.4.2.1 Conducted measurement

##### 5.3.4.2.1.1 Pre-scan

This pre-scan test procedure shall be used to identify potential unwanted emissions of the UUT. The UUT shall be connected to a spectrum analyser capable of RF power measurements.

**Step 1:**

- The sensitivity of the spectrum analyser should be such that the noise floor is at least 12 dB below the limits given in clause 4.2.3.2, table 1.

**Step 2:**

- The unwanted emissions over the range 30 MHz to 1 000 MHz shall be identified.
- Spectrum analyser settings:
  - Resolution bandwidth: 100 kHz.

- Video bandwidth: 300 kHz.
- Detector mode: Peak.
- Trace Mode: Max Hold.
- Sweep Points:  $\geq 9\ 700$ .

For spectrum analysers not supporting this number of sweep points, the frequency band may be segmented. For spectrum analysers capable of supporting twice this number of sweep points, the frequency adjustment in clause 5.3.4.2.1.2 (step 1, last bullet) may be omitted.

- Sweep time: For non-continuous transmissions (duty cycle less than 100 %), the sweep time shall be sufficiently long, such that for each 100 kHz frequency step, the measurement time is greater than two transmissions of the UUT.

**EXAMPLE 1:** For non-continuous transmissions, if the UUT is using a test sequence as described in clause 5.1.3.1 with a transmitter on + off time of 2 ms, then the sweep time is greater than 4 ms per 100 kHz.

- Allow the trace to stabilize. Any emissions identified that have a margin of less than 6 dB with respect to the limits given in clause 4.2.3.2, table 1 shall be individually measured using the procedure in clause 5.3.4.2.1.2 and compared to the limits given in clause 4.2.3.2, table 1.

### Step 3:

- The unwanted emissions over the range 1 GHz to 26 GHz shall be identified.

- Spectrum analyser settings:

- Resolution bandwidth: 1 MHz.
- Video bandwidth: 3 MHz.
- Detector mode: Peak.
- Trace Mode: Max Hold.
- Sweep points:  $\geq 25\ 000$ .

For spectrum analysers not supporting this number of sweep points, the frequency band may be segmented. For spectrum analysers capable of supporting twice this number of sweep points, the frequency adjustment in clause 5.3.4.2.1.2 (step 1, last bullet) may be omitted.

- Sweep time: For non-continuous transmissions (duty cycle less than 100 %), the sweep time shall be sufficiently long, such that for each 1 MHz frequency step, the measurement time is greater than two transmissions of the UUT.

**EXAMPLE 2:** For non-continuous transmissions, if the UUT is using a test sequence as described in clause 5.1.3.1 with a transmitter on + off time of 2 ms, then the sweep time is greater than 4 ms per 1 MHz.

- Allow the trace to stabilize. Any emissions identified that have a margin of less than 6 dB with respect to the limits given in clause 4.2.3.2, table 1 shall be individually measured using the procedure in clause 5.3.4.2.1.2 and compared to the limits given in clause 4.2.3.2, table 1.

#### 5.3.4.2.1.2 Measurement of the emissions identified during the pre-scan

The limits for transmitter unwanted emissions in clause 4.2.3 refer to average power levels.

#### Continuous transmit signals:

For continuous transmit signals, a simple measurement using the RMS detector of the spectrum analyser is permitted. The measured values shall be recorded and compared with the limits in clause 4.2.3.2, table 1.

**Non-continuous transmit signals:**

For non-continuous transmit signals, the measurement shall be made only over the "on" part of the burst.

The test procedure is used to accurately measure the individual unwanted emissions identified during the pre-scan measurements above and shall be as follows:

**Step 1:**

- The level of the emissions shall be measured in the time domain, using the following spectrum analyser settings:
  - Centre Frequency: Frequency of emission identified during the pre-scan.
  - RBW: 100 kHz (< 1 GHz) / 1 MHz (> 1 GHz).
  - VBW: 300 kHz (< 1 GHz) / 3 MHz (> 1 GHz).
  - Frequency Span: 0 Hz.
  - Sweep mode: Single Sweep.
  - Sweep Time: Suitable to capture one transmission burst. Additional measurements may be needed to identify the length of the transmission burst. In case of continuous signals, the Sweep Time shall be set to 30 ms.
  - Sweep points: Sweep time [ $\mu$ s] / 1  $\mu$ s with a maximum of 30 000.
  - Trigger: Video (burst signals) or Manual (continuous signals).
  - Detector: RMS.
  - Trace Mode: Clear/Write.
- Adjust the centre frequency (fine tune) to capture the highest level of one burst of the emission to be measured.
- This fine tuning can be omitted for spectrum analysers capable of supporting twice this number of sweep points required in step 2 and step 3 from the pre-scan procedure in clause 5.3.4.2.1.1.

**Step 2:**

- Adjust the trigger level to select the transmissions with the highest power level.
- Set a window (start and stop lines) to match with the start and end of the burst and in which the RMS power shall be measured using the Time Domain Power function. If the spurious emission to be measured is a continuous signal, the measurement window shall be set to match the start and stop times of the sweep.
- Select RMS power to be measured within the selected window and note the result which is the RMS power of this particular spurious emission. Compare this value with the applicable limit provided by clause 4.2.3.2, table 1.

Repeat this procedure for every emission identified during the pre-scan. The values and corresponding frequencies shall be recorded.

In case of conducted measurements on smart antenna systems (equipment with multiple transmit chains), the measurements shall be repeated for each of the active transmit chains. Comparison with the applicable limits shall be done using either of the options given below:

- Option 1: the results for each of the transmit chains for the corresponding 1 MHz segments shall be added and compared with the limits provided by table 1 in clause 4.2.3.2.
- Option 2: the results for each of the transmit chains shall be individually compared with the limits provided by table 1 in clause 4.2.3.2 after these limits have been reduced by  $10 \times \log_{10}(T_{ch})$  (number of active transmit chains).

### 5.3.4.2.2 Radiated measurement

The test set up as described in annex B shall be used with a spectrum analyser attached to the test antenna (see clause 5.2). The applicable procedures shall be as specified in annex C.

The test procedure shall be as described under clause 5.3.4.2.1.

## 5.3.5 Receiver spurious emissions

### 5.3.5.1 Test conditions

The conformance requirements in clause 4.2 shall be verified only under normal operating conditions, and when operating on those channels defined in clause 5.1.4.

For equipment having different operating modes (see clause 5.1.5.2) the measurements described in the present clause may not need to be repeated for all the operating modes.

The level of receiver spurious emissions shall be measured as, either:

- a) their power in a specified load (conducted emissions) and their effective radiated power when radiated by the cabinet or structure of the equipment (cabinet radiation); or
- b) their effective radiated power when radiated by cabinet and antenna in case of integral antenna equipment with no temporary antenna connectors.

The test method in clause 5.3.5.2 assumes, that for the duration of the test, the UUT is configured into a continuous receive mode, or is operated in a mode where no transmissions occur.

### 5.3.5.2 Test method

#### 5.3.5.2.1 Conducted measurement

##### 5.3.5.2.1.1 Pre-scan

The test procedure below shall be used to identify potential receiver spurious emissions of the UUT and shall be as follow:

#### Step 1:

- The sensitivity of the spectrum analyser should be such that the noise floor is at least 12 dB below the limits given in clause 4.2.4.2, table 2.

#### Step 2:

- The emissions shall be measured over the range 30 MHz to 1 000 MHz.
- Spectrum analyser settings:
  - Resolution bandwidth: 100 kHz.
  - Video bandwidth: 300 kHz.
  - Detector mode: Peak.
  - Trace Mode: Max Hold.
  - Sweep Points:  $\geq 9\,700$ .

For spectrum analysers not supporting this number of sweep points, the frequency band may be segmented. For spectrum analysers capable of supporting twice this number of sweep points, the frequency adjustment in clause 5.3.5.2.1.2 (step 1, last bullet) may be omitted.

- Sweep time: Auto.
- Wait for the trace to stabilize. Any emissions identified that have a margin of less than 6 dB with respect to the limits given in clause 4.2.4.2, table 2, shall be individually measured using the procedure in clause 5.3.5.2.1.2 and compared to the limits given in clause 4.2.4.2, table 2.

**Step 3:**

- The emissions shall now be measured over the range 1 GHz to 26 GHz.
- Spectrum analyser settings:
  - Resolution bandwidth: 1 MHz.
  - Video bandwidth: 3 MHz.
  - Detector mode: Peak.
  - Trace mode: Max Hold.
  - Sweep Points:  $\geq 25\ 000$ .

For spectrum analysers not supporting this high number of sweep points, the frequency band may need to be segmented. For spectrum analysers capable of supporting twice this number of sweep points, the frequency adjustment in clause 5.3.5.2.1.2 (step 1, last bullet) may be omitted.

  - Sweep time: Auto.
- Wait for the trace to stabilize. Any emissions identified that have a margin of less than 6 dB with respect to the limits given in clause 4.2.4.2, table 2, shall be individually measured using the procedure in clause 5.3.5.2.1.2 and compared to the limits given in clause 4.2.4.2, table 2.

**5.3.5.2.1.2 Measurement of the emissions identified during the pre-scan**

The limits for receiver spurious emissions in clause 4.2.4 refer to average power levels.

Step 1 to step 4 below shall be used to accurately measure the individual unwanted emissions identified during the pre-scan measurements above and shall be as follows:

**Step 1:**

- The level of the emissions shall be measured using the following spectrum analyser settings:
  - Measurement Mode: Time Domain Power.
  - Centre Frequency: Frequency of the emission identified during the pre-scan.
  - Resolution Bandwidth: 100 kHz (emissions < 1 GHz) / 1 MHz (emissions > 1 GHz).
  - Video Bandwidth: 300 kHz (emissions < 1 GHz) / 3 MHz (emissions > 1 GHz).
  - Frequency Span: Zero Span.
  - Sweep mode: Single Sweep.
  - Sweep time: 30 ms.
  - Sweep points:  $\geq 30\ 000$ .
  - Trigger: Video (for burst signals) or Manual (for continuous signals).
  - Detector: RMS.
- Adjust the centre frequency (fine tune) to capture the highest level of one burst of the emission to be measured.



This fine tuning can be omitted for spectrum analysers capable of supporting twice this number of sweep points required in step 2 and step 3 from the pre-scan procedure in clause 5.3.5.2.1.1.

**Step 2:**

- Set a window where the start and stop indicators match the start and end of the burst with the highest level and record the value of the power measured within this window.
- If the spurious emission to be measured is a continuous transmission, the measurement window shall be set to the start and stop times of the sweep.

**Step 3:**

- In case of conducted measurements on smart antenna systems (equipment with multiple receive chains), step 2 shall be repeated for each of the active receive chains.
- Sum the measured power (within the observed window) for each of the active receive chains.

**Step 4:**

- The value defined in step 3 shall be compared to the limits defined in clause 4.2.4.2, table 2.

### 5.3.5.2.2 Radiated measurement

The test set up as described in annex B shall be used with a spectrum analyser attached to the test antenna (see clause 5.2). The applicable procedures shall be as specified in annex C.

The test procedure is as described under clause 5.3.5.2.1.1.

## 5.3.6 Receiver Blocking

### 5.3.6.1 Test frequencies

For all tests, the test frequencies to be used shall correspond to the lowest and highest nominal RF channel centre frequency from the operating frequency range.

For testing blocking frequencies less than 5 725 MHz, the equipment shall operate on the lowest operating channel.

For testing blocking frequencies greater than 5 875 MHz, the equipment shall operate on the highest operating channel.

### 5.3.6.2 Test conditions

See clause 5.1 for the environmental test conditions. These measurements shall only be performed at normal test conditions.

The channels on which the conformance requirements in clause 4.2.5.5 shall be verified are defined in clause 5.3.6.1.

The UUT shall operate in its normal operational mode.

Devices which can change their operating frequency automatically (adaptive channel allocation), this function shall be disabled.

If the equipment can operate with different Nominal Channel Bandwidths and different data rates, then the smallest channel bandwidth shall be used together with the lowest data rate for this channel bandwidth. This mode of operation shall be aligned with the performance criteria defined in clause 4.2.5.3 as declared by the manufacturer (see clause 5.3.1) and shall be described in the test report.

It shall be verified that this performance criteria as defined by the manufacturer is achieved during the blocking test.

### 5.3.6.3 Test Method

#### 5.3.6.3.1 Conducted measurements

For systems using multiple identical receive chains only one chain need to be tested. All other receiver inputs shall be terminated.

Figure 2 shows the test set-up which can be used for performing the receiver blocking test.

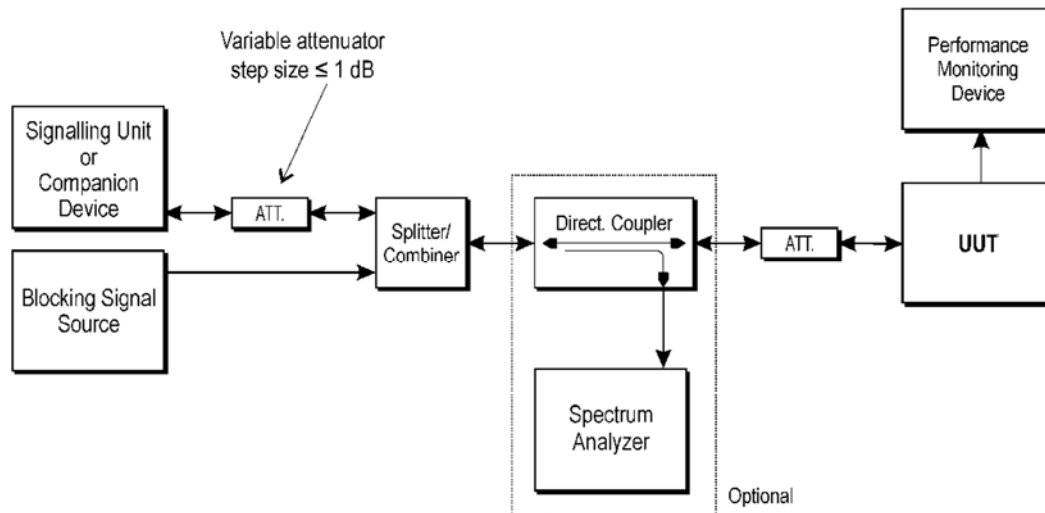

**Figure 2: Test Set-up for receiver blocking**

Step 1 to step 6 below define the procedure to verify the receiver blocking requirement as described in clause 4.2.5.

#### Step 1:

- The UUT shall be set to the operating frequency to be tested (see clause 5.3.6.1).

#### Step 2:

- The blocking signal generator is set to the first frequency as defined in table 3.

#### Step 3:

- With the blocking signal generator switched off a communication link is set up between the UUT and the associated companion device using the test setup shown in figure 2. The variable attenuator is set to the highest possible attenuation that still achieves the minimum performance criteria as specified in clause 4.2.5.3 with a resolution of at least 1 dB. The resulting level for the wanted signal at the input of the UUT is  $P_{\min}$ . This value shall be measured and recorded in the test report.
- Then the value of attenuation is reduced by 6 dB resulting in a new level ( $P_{\min} + 6$  dB) of the wanted signal at the UUT receiver input. This level shall be recorded.

#### Step 4:

- The level of the blocking signal at the UUT input is set to the level provided in table 3. It shall be verified and recorded in the test report that the performance criteria as specified in clause 4.2.5.3 is met.

#### Step 5:

- Repeat step 4 for each remaining combination of frequency and level as specified in table 3.

#### Step 6:

- Repeat step 2 to step 5 with the UUT operating at the other operating frequencies at which the blocking test has to be performed. See clause 5.3.6.2.

### 5.3.6.3.2 Radiated measurements

When performing radiated measurements on equipment with dedicated antennas, measurements shall be repeated for each alternative dedicated antenna.

A test site as described in annex B and applicable measurement procedures as described in annex C shall be used.

The test procedure is further as described under clause 5.3.6.3.1.

The level of the blocking signal at the UUT referred to in step 4 is assumed to be the level in front of the UUT antenna(s). The UUT shall be positioned with its main beam pointing towards the antenna radiating the blocking signal. If that position was recorded during the output power measurement that same position can be used.

## 5.3.7 Dynamic Frequency Selection

### 5.3.7.1 Test conditions

#### 5.3.7.1.1 General requirements

The conformance requirements in clause 4.2.8 shall be verified only under normal operating conditions.

The channels and the channel bandwidths to be used for testing are defined in clause 5.1.4.

Some of the tests may be facilitated by disabling certain operational features of the UUT for the duration of the test.

It should be noted that once a UUT is powered on, it will not start its normal operating functions immediately, as it will have to finish its power-up cycle first ( $T_{\text{power\_up}}$ ). As such, the UUT, as well as any other device used in the set-up, may be equipped with a feature that will indicate its status during the testing, e.g. power-up mode, normal operation mode, channel check status, radar detection event, etc.

The UUT is capable of transmitting a test transmission sequence as described in clause 5.1.3.2. The signal generator is capable of generating any of the radar test signals defined in table D.3 and table D.4.

A spectrum analyser or equivalent shall be used to measure the aggregate transmission time of the UUT.

Clause 5.3.7.1.3.1 to clause 5.3.7.1.3.3 describe the different set-ups to be used during the measurements.

#### 5.3.7.1.2 Selection of radar test signals

The radar test signals to be used during the DFS testing shall be as defined in table D.4.

For each of the variable radar test signals in table D.4, an arbitrary combination of Pulse Width, Pulse Repetition Frequency and if applicable the number of different PRFs, shall be chosen from the ranges given in table D.4 and recorded in the test report.

The radar test signals given in table D.4 simulate real radar systems.

Table D.6 provides for each radar test signal the required detection probability ( $P_d$ ).  $P_d$  represents a minimum level of detection performance under defined conditions. Therefore  $P_d$  does not represent the overall detection probability for any particular radar under real life conditions.

The pulse widths given in the table D.4 shall have an accuracy of  $\pm 5\%$ .

The tests related to the In-Service Monitoring, Channel Shutdown and Non-Occupancy Period (see clause 5.3.7.2.1.2 and clause 5.3.7.2.1.3) are performed with a single burst radar test signal.

### 5.3.7.1.3 Test set-ups

#### 5.3.7.1.3.1 Set-up A

*Set-up A* is a set-up whereby the UUT is a WIA device operating in master mode. Radar test signals are injected into the UUT. This set-up also contains a WIA device operating in slave mode which is associated with the UUT. The set-up used shall be documented in the test report.

Figure 3 shows an example for *Set-up A*.

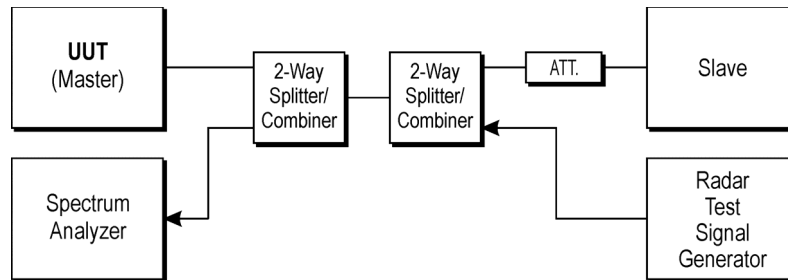
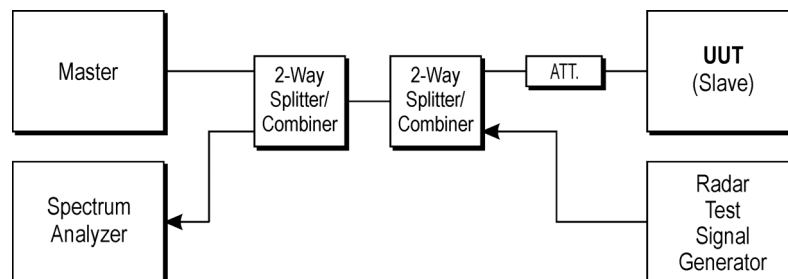

**Figure 3: Set-up A**

#### 5.3.7.1.3.2 Set-up B

*Set-up B* is a set-up whereby the UUT is a WIA device operating in slave mode, with or without Radar Interference Detection function. This set-up also contains a WIA device operating in master mode. The radar test signals are injected into the master device. The UUT (slave device) is associated with the master device. The set-up used shall be documented in the test report.

Figure 4 shows an example for *Set-up B*.

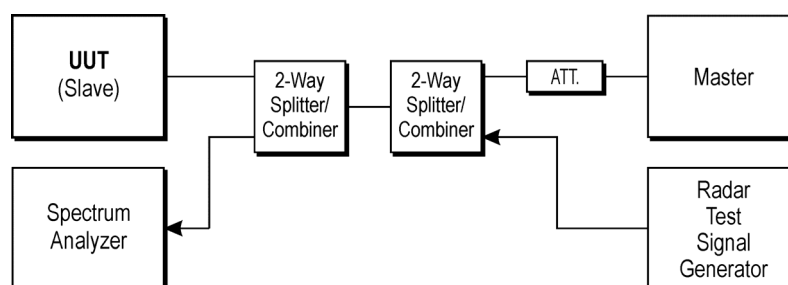

**Figure 4: Set-up B**

#### 5.3.7.1.3.3 Set-up C

The UUT is a WIA device operating in slave mode with Radar Interference Detection function. Radar test signals are injected into the slave device. This set-up also contains a WIA device operating in master mode. The UUT (slave device) is associated with the master device. The set-up used shall be documented in the test report.

Figure 5 shows an example for *Set-up C*.



**Figure 5: Set-up C**

## 5.3.7.2 Test method

### 5.3.7.2.1 Conducted measurement

#### 5.3.7.2.1.1 Additional test conditions

For a UUT with antenna connector(s) and using dedicated external antenna(s), or for a UUT with integral antenna(s) but with a temporary antenna connector(s) provided, conducted measurements shall be used.

When performing DFS testing on smart antenna systems, a power splitter/combiner shall be used to combine all the receive chains (antenna inputs) into a single test point. The insertion loss of the splitter/combiner shall be taken into account.

The UUT shall be configured to operate at the highest transmitter output power setting.

If the UUT has a Radar Interference Detection function, the output power of the signal generator producing the radar test signals, as selected using clause 5.3.7.1.2, shall (unless otherwise specified) provide a received signal power at the antenna connector of the UUT with a level equal to applicable *Radar Detection Threshold* level defined in table D.2. Parameter G (dBi) in table D.2 corresponds to the gain of the antenna assembly stated by the manufacturer. If more than one antenna assembly is intended for this power setting, the gain of the antenna assembly with the lowest gain shall be used.

NOTE: Beamforming gain Y of smart antenna systems, operating in a mode where beamforming is active, is ignored in order to test the worst case.

The centre frequencies of the radar test signals used in the test procedures below shall fall within the central 80 % of the *Occupied Channel Bandwidth* of the WIA channel under test.

#### 5.3.7.2.1.2 In-Service Monitoring

Step a) to step f) below define the procedure to verify the In-Service Monitoring and the Radar Detection Threshold during the In-Service Monitoring.

The channel, on which the In-Service Monitoring test will be performed, shall be selected in accordance with clause 5.1.4. This channel, designated as  $Ch_r$ , is an Operating Channel. The procedure shall be as follows:

- a) When the UUT is a master device, a slave device that associates with the UUT will be used. The signal generator and the UUT are connected using *Set-up A* described in clause 5.3.7.1.3.1.
 

When the UUT is a slave device with a Radar Interference Detection function, the UUT shall associate with a master device. The signal generator and the UUT are connected using *Set-up C* described in clause 5.3.7.1.3.3.
- b) The UUT shall transmit a test transmission sequence in accordance with clause 5.1.3.2 on the selected channel  $Ch_r$ . While the testing is performed on  $Ch_r$ , the equipment is allowed to have simultaneous transmissions on other adjacent or non-adjacent operating channels.
- c) At a certain time  $T_0$ , a single burst radar test signal is generated on  $Ch_r$  using radar test signal #1 defined in table D.4 and at a level defined in clause 5.3.7.2.1.1.  $T_1$  denotes the end of the radar burst.
- d) It shall be recorded if the radar test signal was detected.
- e) Step b) to step d) shall be performed 20 times, each time a random value shall be chosen for pulse width and pulse repetition frequency from the corresponding ranges provided in table D.4. For radar test signal #5 and radar test signal #6 provided in table D.4 the number of PRF values shall vary between 2 or 3.
- f) Step b) to step e) shall be repeated for each of the radar test signals defined in table D.4 and as described in clause 5.3.7.1.2.

Figure 6 provides an example of the timing of a UUT when radar signals are detected during the In-Service Monitoring.

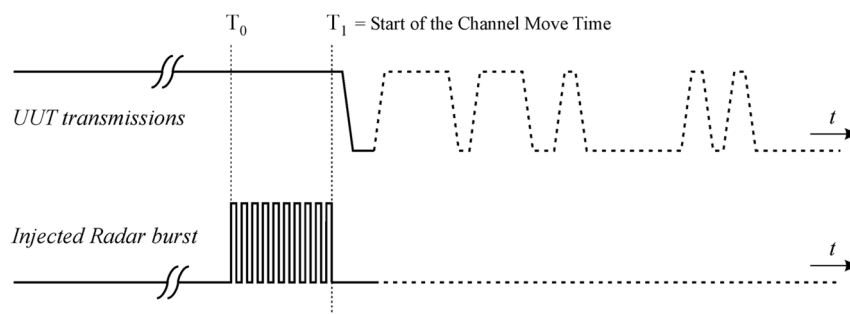

**Figure 6: Example of timing for radar testing during In-Service Monitoring**

#### 5.3.7.2.1.3 Channel Shutdown and Non-Occupancy period

Step a) to step g) below define the procedure to verify the *Channel Shutdown* process and to determine the *Channel Closing Transmission Time*, the *Channel Move Time* and the *Non-Occupancy Period* as shown in figure 7.

The channel, on which these tests will be performed, shall be selected in accordance with clause 5.1.4. This channel, designated as  $Ch_r$ , is an *Operating Channel*. The procedure shall be as follows:

- a) When the UUT is a master device, a slave device that associates with the UUT will be used. The signal generator and the UUT shall be connected using *Set-up A* described in clause 5.3.7.1.3.1.  
When the UUT is a slave device (with or without a Radar Interference Detection function), the UUT shall associate with a master device. The signal generator and the UUT shall be connected using *Set-up B* described in clause 5.3.7.1.3.2.
- b) The UUT shall transmit a test transmission sequence in accordance with clause 5.1.3.2 on the selected channel  $Ch_r$ . While the testing is performed on  $Ch_r$ , the equipment is allowed to have simultaneous transmissions on other adjacent or non-adjacent operating channels.
- c) At a certain time  $T_0$ , a single burst test signal is generated on  $Ch_r$  using the reference DFS test signal defined in table D.3 and at a level of up to 10 dB above the level defined in clause 5.3.7.2.1.1 on the selected channel.  $T_1$  denotes the end of the radar burst.
- d) The transmissions of the UUT following instant  $T_1$  on the selected channel  $Ch_r$  shall be observed for a period greater than or equal to the *Channel Move Time* defined in table D.1. The aggregate duration (*Channel Closing Transmission Time*) of all transmissions from the UUT on  $Ch_r$  during the *Channel Move Time* shall be compared to the limit defined in table D.1. For equipment capable of having simultaneous transmissions on multiple (adjacent or non-adjacent) operating channels, the equipment is allowed to continue transmissions on other *Operating Channels* (different from  $Ch_r$ ).

NOTE: The aggregate duration of all transmissions of the UUT does not include quiet periods in between transmissions of the UUT.

- e)  $T_2$  denotes the instant when the UUT has ceased all transmissions on the channel  $Ch_r$ . The time difference between  $T_1$  and  $T_2$  shall be measured. This value (*Channel Move Time*) shall be noted and compared with the limit defined in table D.1.
- f) Following instant  $T_2$ , the selected channel  $Ch_r$  shall be observed for a period equal to the *Non-Occupancy Period* ( $T_3 - T_2$ ) to verify that the UUT does not resume any transmissions on this channel.
- g) When the UUT is a slave device with a Radar Interference Detection function step b) to step f) shall be repeated with the generator connected to the UUT using *Set-up C* as described in clause 5.3.7.1.3.3. See also note 2 in table D.2.

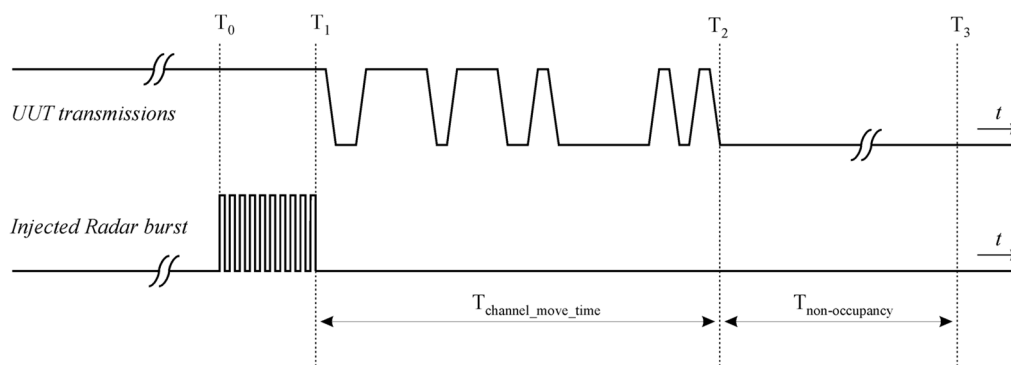

**Figure 7: Channel Closing Transmission Time, Channel Move Time and Non-Occupancy Period**

### 5.3.7.2.2 Radiated measurement

For a UUT with integral antenna(s) and without temporary antenna connector(s), radiated measurements shall be used.

If the UUT has a Radar Interference Detection function, the output power of the signal generator shall (unless otherwise specified) provide a signal power at the antenna of the UUT with a level equal to *Radar Detection Threshold* level defined in table D.2.

When performing radiated DFS testing on a UUT with a directional antenna (including smart antenna systems and systems capable of beamforming), the wanted communications link (between the UUT and the associated device) and the DFS radar test signals shall be aligned to the direction corresponding to the UUT's maximum antenna gain.

The test set up as described in annex B and applicable measurement procedures as described in annex C shall be used to test the different DFS features of the UUT. The test procedure shall be further as described in clause 5.3.7.2.1.

## 5.3.8 Adaptivity (channel access mechanism) except for ITS and TTT

### 5.3.8.1 Test conditions

See clause 5.1 for the test conditions. These measurements shall only be performed at normal test conditions.

The channels and the channel bandwidths to be used for testing are defined in clause 5.1.4. The device shall be configured to operate at its maximum output power level.

### 5.3.8.2 Test method

#### 5.3.8.2.1 Conducted measurements

Figure 8 shows an example of the test set-up.

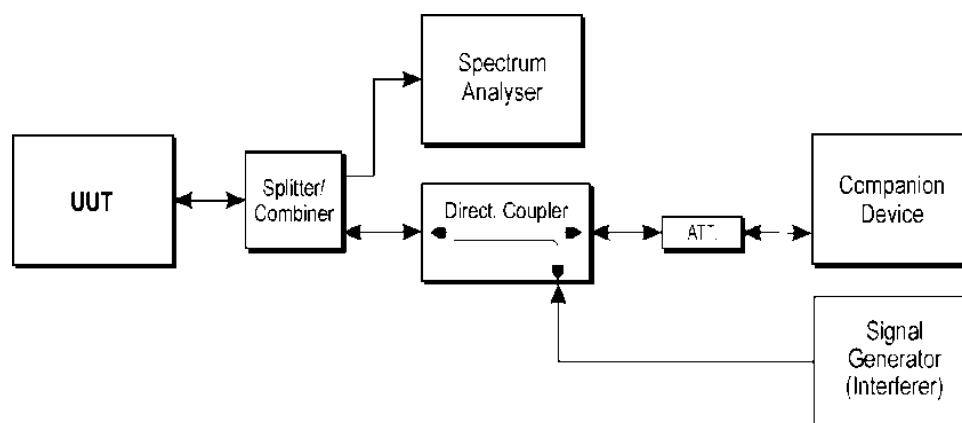

**Figure 8: Example Test Set-up for verifying the adaptivity of an equipment**

Step 1 to step 5 below define the procedure to verify the efficiency of the adaptivity mechanism of the equipment and shall be as follows:

**Step 1:**

- The UUT shall connect to a companion device during the test. The signal generator, spectrum analyser, UUT and the companion device are connected using a Set-up equivalent to the example given by figure 8 although the signal generator does not generate any signals at this point in time. The spectrum analyser is used to monitor the transmissions of the UUT in response to the interference signal.
- The received signal level (wanted signal from the companion device) at the UUT shall be sufficient to maintain a reliable link for the duration of the test. A typical value for the received signal level which can be used in most cases is -50 dBm/MHz.
- The analyser shall be set as follows:
  - RBW:  $\geq$  Occupied Channel Bandwidth (if the analyser does not support this setting, the highest available setting shall be used).
  - VBW:  $3 \times$  RBW (if the analyser does not support this setting, the highest available setting shall be used).
  - Detector Mode: RMS.
  - Centre Frequency: Equal to the centre frequency of the operating channel.
  - Span: 0 Hz.
  - Sweep time:  $>$  Channel Occupancy Time.
  - Trace Mode: Clear/Write.
  - Trigger Mode: Video or External.

**Step 2:**

- Configure the UUT for normal transmissions with a payload resulting in a minimum transmitter activity ratio of 30 %. Where this is not possible, the UUT shall be configured to the maximum payload possible.

**Step 3: Adding the interference signal.**

- An interference signal as defined in clause B.7 is injected on the current operating channel of the UUT. The power spectral density level (at the input of the UUT) of this interference signal shall be equal to the applicable detection threshold defined in table D.2.

**Step 4: Verification of reaction to the interference signal.**

- The spectrum analyser shall be used to monitor the transmissions of the UUT on the selected operating channel after the interference signal was injected. This may require the spectrum analyser sweep to be triggered by the start of the interfering signal.
- Using the procedure defined in clause 5.3.8.2.2, it shall be verified that the UUT stops transmissions on the current operating channel.
- To verify that the UUT is not resuming normal transmissions as long as the interference signal is present, the monitoring time may need to be 60 s or more, in which case a segmented measurement may need to be performed in order to achieve the required resolution.
- Once the test is completed and the interference signal is removed, the UUT may start transmissions again on this channel however this is not a requirement and therefore does not require testing.

**Step 5:**

- Step 2 to step 4 shall be repeated for each of the channels to be tested.



### 5.3.8.2.2 Generic test procedure for measuring channel/frequency usage

This is a generic test method to evaluate transmissions on the operating channel being investigated. This test is only performed as part of the procedure described in clause 5.3.8.2.1.

The test procedure shall be as follows:

#### Step 1:

- The analyser shall be set as follows:
  - Centre Frequency: equal to the centre frequency of the channel being investigated.
  - Frequency Span: 0 Hz.
  - RBW: approximately 50 % of the Occupied Channel Bandwidth (if the analyser does not support this setting, the highest available setting shall be used).
  - VBW:  $\geq$  RBW (if the analyser does not support this setting, the highest available setting shall be used).
  - Detector Mode: RMS.
  - Sweep time: > the Channel Occupancy Time.
  - Sweep points: at least one sweep point per  $\mu$ s.
  - Trace mode: Clear/Write.
  - Trigger: Video or External.

#### Step 2:

- Save the trace data to a file for further analysis by a computing device using an appropriate software application or program.

#### Step 3:

- Identify the data points related to the channel being investigated by applying a threshold.
- Count the number of consecutive data points identified as resulting from a single transmission on the channel being investigated and multiply this number by the time difference between two consecutive data points. Repeat this for all the transmissions within the measurement window.
- For measuring idle or silent periods, count the number of consecutive data points identified as resulting from a single transmitter off period on the channel being investigated and multiply this number by the time difference between two consecutive data points. Repeat this for all the transmitter off periods within the measurement window.

### 5.3.8.2.3 Radiated measurements

For a UUT with integral antenna(s) and without temporary antenna connector(s), radiated measurements shall be used.

The output power of the signal generator simulating the interference signal shall provide a signal power at the antenna of the UUT with a level equal to level defined in clause 4.2.7.2.4.1.

When performing radiated testing on a UUT with a directional antenna (including smart antenna systems and systems capable of beamforming), the wanted communications link (between the UUT and the companion device) and the interference test signals shall be aligned to the direction corresponding to the UUT's maximum antenna gain.

The test set up as described in annex B and applicable measurement procedures as described in annex C shall be used to test the adaptivity of the UUT. The test procedure shall be as described in clause 5.3.8.2.1.

#### 5.3.8.2.4 DAA minimum listening time measurements

The steps below define the procedure to verify the efficiency of the DAA minimum listening time.

For systems using multiple receive chains only one chain (antenna port) need to be tested. All other receiver inputs shall be terminated.

##### Step 1:

- The UUT shall connect to a companion device during the test. The signal generator (interferer), the spectrum analyser, the UUT and the companion device are connected using a set-up equivalent to the example given by figure 8 although the interference do not generate any signals at this point in time. The spectrum analyser is used to monitor the transmissions of both the UUT and the companion device and it should be possible to distinguish between either transmission. In addition, the spectrum analyser is used to monitor the transmissions of the UUT in response to the interfering signals.
- The analyser shall be set as follows:
  - RBW:  $\geq$  Occupied Channel Bandwidth (if the analyser does not support this setting, the highest available setting shall be used)
  - VBW:  $3 \times$  RBW (if the analyser does not support this setting, the highest available setting shall be used)
  - Detector Mode: RMS
  - Centre Frequency: Equal to the centre frequency of the operating channel
  - Span: 0 Hz
  - Sweep time:  $>$  maximum Channel Occupancy Time
  - Trace Mode: Clear Write
  - Trigger Mode: Video

##### Step 2:

- Configure the UUT for normal transmissions with a sufficiently high payload resulting in a minimum transmitter activity ratio ( $Tx\text{-on} / (Tx\text{-on} + Tx\text{-off})$ ) of 0,3. Where this is not possible, the UUT shall be configured to the maximum payload possible.
- It shall be verified that the UUT complies with the maximum transmitter on-time and minimum Tx-off time.

##### Step 3: Adding the interference signal

- An interference signal as defined in clause B.7 is injected on the current operating channel of the UUT. The power spectral density level at the input of the UUT of this interference signal shall be equal to the DAA threshold defined in clause 4.2.7.2.4.

##### Step 4: Verification of reaction to the interference signal

- The spectrum analyser shall be used to monitor the transmissions of the UUT on the selected operating channel with the interfering signal injected. This may require the spectrum analyser sweep to be triggered by the start of the interfering signal.
- Using the procedure defined in clause 5.3.8.2.2, it shall be verified that:
  - i) The UUT shall stop transmissions on the current operating channel.  
  
The UUT is assumed to stop transmissions within a period equal to the maximum Tx on-time defined in clause 4.2.7.2.3.
  - ii) There shall be no subsequent transmissions while the interfering signal is present.

To verify that the UUT is not resuming normal transmissions as long as the interference signal is present, the monitoring time may need to be 60 s or more.

## 5.3.9 Adaptivity (channel access mechanism) for ITS

### 5.3.9.1 General requirements

In the present clause the test procedure for the ITS DAA test is depicted. The WIA radio device under test shall be verified under normal operational conditions.

The DAA test is split into two main test conditions:

- start-up test with and without ITS test signal; and
- in-service DAA test.

The start-up test verifies the operation of the WIA radio device during the initial start-up when the WIA radio device intends to operate directly in the relevant bands from 5 855 MHz to 5 875 MHz. Thus the WIA radio device need to be set in an operational condition in which this is guaranteed. The test verifies that the WIA radio device respects the defined *ITS Channel Availability Check time*.

The In-service DAA test is intended to verify the dynamic behaviour of the WIA radio device under test. During this test the WIA radio device under test shall operate in a normal operational mode. The manufacturer shall declare this normal operational mode.

### 5.3.9.2 ITS test signal

The ITS test signal shall be a representative ITS signal with a bandwidth of 10 MHz operating in the band 5 855 MHz to 5 865 MHz or 5 865 MHz to 5 875 MHz. The duty cycle of the signal shall be between 0,1 % and 1 % with a packet length of between 0,6 ms to 1,2 ms. During the test runs the combination of the duty cycle and packet length shall randomly chosen for each of the test runs.

If required, the ITS test signal shall be similar to a typical standardized ITS signal including specific signal structures like pre-amble sequences. These characteristics could be used to improve the detection operation.

### 5.3.9.3 Initial start-up test

#### 5.3.9.3.1 Start-up procedure

The clauses below define the procedure to verify the *ITS Channel Availability Check time* by ensuring that the WIA device is capable of detecting ITS victim system signals during the *ITS Channel Availability Check time*. Furthermore, one initial test shall guarantee that the WIA device does not switch into TX operation before the end of the *ITS Channel Availability Check time*  $T_{\text{ITS\_check\_time}}$ .

#### 5.3.9.3.2 Test without an ITS victim test signal during the *ITS Channel Availability Check time*, $T_{\text{ITS\_check\_time}}$

Summary:

Verify the WIA device will not start transmitting before the end of the *ITS Channel Availability Check time*,  $T_{\text{ITS\_check\_time}}$  when no ITS victim test signal is present.

Pre-test Condition:

- WIA device supporting DAA in the ITS bands.
- WIA device switched off.

Test sequence:

- a) The WIA device will be switched off. No signal generator is connected to the test setup or the signal generator is switched off.

- b) The WIA device is powered on at  $T_0$ .  $T_1$  denotes the instant when the WIA device has completed its power-up sequence ( $T_{\text{power\_up}}$ ), enters into the operational mode using the ITS bands and is ready to start the ITS victim signal detection:
- **CON-1:** The WIA device shall not switch into TX mode before the end of  $T_1 + T_{\text{ITS\_check\_time}}$  after switch on of the radio device.
  - **CON-2:** A timing trace or description of the observed timing and behaviour of the WIA device shall be recorded.
- c) Repeat a) and b) for  $i = 10$  times in a row:
- **CON-3:** CON-1 and CON-2 shall be fulfilled in all  $i$  tests. If one failure occurs go to d). For more than one failure the test has not been passed.
- d) Repeat a) and b) for  $m = 10$  times in a row:
- **CON-4:** CON-1 and CON-2 shall be fulfilled in all  $m$  tests.
- e) Repeat a) to d) for each of the relevant ITS bands.
- f) End of test.

### 5.3.9.3.3 Test with an ITS victim test signal during the *ITS Channel Availability Check time*, $T_{\text{ITS\_check\_time}}$

#### Summary:

Verify the victim signal detection and avoidance capability for the selected WIA operational frequency band when an ITS victim signal occurs during the *ITS Channel Availability Check time*  $T_{\text{ITS\_check\_time}}$ .

#### Pre-test Condition:

- WIA device supporting DAA in the ITS bands.
- WIA device switched off.

#### Test sequence:

- a) The WIA device will be switched off. The signal generator used to generate the ITS test patterns defined in clause 5.3.9.2 will be connected to an antenna of suitable characteristics to permit the WIA device to be illuminated with a field equal to the threshold detection limit or connected to the corresponding connectors in the case of a conducted measurement setup.
- b) The WIA device is powered on at  $T_0$  using the ITS bands.  $T_1$  denotes the instant when the WIA device has completed its power-up sequence ( $T_{\text{power\_up}}$ ), enters into the operational mode and is ready to start the ITS victim signal detection.
- c) The ITS victim system test signal will be switched on at  $T_0$ :
- **CON-1:** The *ITS Channel Availability Check time* is expected to commence at  $T_1$  and is expected to end no sooner than  $T_1 + T_{\text{ITS\_check\_time}}$  unless an ITS victim signal is detected sooner.

NOTE: Additional verification may be needed to define  $T_1$  in case it is not exactly known or indicated by the WIA device.

- **CON-2:** It shall be recorded if the ITS victim test signal was detected.
- **CON-3:** A timing trace or description of the observed timing and behaviour of the WIA device shall be recorded.

- d) Repeat a) to c) for  $I = 10$  times in a row:
- **CON-4:** CON-1, CON-2 and CON-3 shall be fulfilled in all  $i$  tests. If CON-4 is fulfilled go to f). If one failure occurs go to e). For more than one failure the test has not been passed.
- e) Repeat a) to c) for  $m = 10$  times in a row:
- **CON-5:** CON-1, CON-2 and CON-3 shall be fulfilled in all  $m$  tests.
- f) Repeat b) to e) for each of the relevant ITS victim band at a level of 10 dB above the defined threshold level  $D_{ITS\_thres}$  and at exactly the threshold levels  $D_{ITS\_thres}$  as defined in clause 4.2.7.3.8:
- **CON-6:** A timing trace or description of the observed timing and behaviour of the WIA device shall be recorded.

#### 5.3.9.4 Test of ITS\_Maximum\_TX<sub>on</sub> and ITS\_minimum\_TX<sub>off</sub>

Summary:

Verify the WIA timing during the normal operation in the ITS bands without the presence of an ITS victim signal.

Pre-test Condition:

- Two WIA devices supporting DAA.
- Both WIA devices switched on.
- WIA device in normal communication mode with the maximum channel load defined in clause 4.2.7.3.1 and clause 4.2.7.3.4.

Test Sequence:

- a) Both WIA devices shall be switched on and in a stable operational mode.
- b) The timing behaviour of the WIA transmission shall be measured and recorded:
- **CON-1:** The measured on time shall not be larger than  $T_{ITS\_on\_max}$ .
  - **CON-2:** The measured off time shall be equal or larger than  $T_{ITS\_off\_min}$ .
- c) Repeat a) for at least 60 s.

#### 5.3.9.5 ITS in-service DAA test with continuous ITS test signal

Summary:

Verify the WIA timing ( $T_{ITS\_DAA}$ ) and detection probability ( $Prob_{ITS\_daa}$ ) during the normal operation in the ITS bands with the presence of an ITS victim signal in accordance with the signal defined in clause 5.3.9.2. In this test the ITS signal shall continuously operational after switch on at  $T_0$ .

Pre-test Condition:

- Two WIA devices supporting DAA.
- Both WIA devices switched on.

Test Sequence:

- a) Both WIA devices shall be switched on and in a stable operational mode using the ITS bands.
- b) The timing behaviour of the WIA transmission shall be measured and recorded:
- **CON-1:** The measured on time shall not be larger than  $T_{ITS\_on\_max}$ .
  - **CON-2:** The measured off time shall be equal or larger than  $T_{ITS\_off\_min}$ .

- c) The ITS victim system test signal will be switched on at  $T_0$ :
- **CON-1:** After the occurrence of the test signal the WIA device shall switch off faster than  $T_{ITS\_DAA}$ .
  - **CON-2:** It shall be recorded if the ITS victim test signal was detected.
  - **CON-3:** A timing trace or description of the observed timing and behaviour of the WIA device shall be recorded.
  - **CON-4:** The WIA device shall not switch TX on again before the end of  $T_{ITS\_non\_occ}$ .
- d) Repeat a) to c) for  $i = 10$  times in a row:
- **CON-5:** CON-1, CON-2 CON-3 and CON- 4 shall be fulfilled in all  $i$  tests. If CON-5 is fulfilled go to f). If one failure occurs go to e). For more than one failure the test has not been passed.
- e) Repeat a) to c) for  $m = 10$  times in a row:
- **CON-6:** CON-1, CON-2 CON-3 and CON- 4 shall be fulfilled in all  $m$  tests. If one failure occurs test has not been passed.
- f) Repeat a) to d) for each of the relevant ITS victim band at a level of 10 dB above the defined threshold level  $D_{ITS\_thres}$  and at exactly the threshold levels  $D_{ITS\_thres}$  as defined in clause 4.2.7.3.8:
- **CON-7:** A timing trace or description of the observed timing and behaviour of the WIA device shall be recorded.

### 5.3.9.6 ITS in-service DAA test with ITS test signal switched off after detection

Summary:

Verify the WIA timing ( $T_{ITS\_DAA}$ ), detection probability ( $Prob_{ITS\_daa}$ ) and the ITS\_Non\_Occupancy period during the normal operation in the ITS bands with the presence of an ITS victim signal in accordance with the signal defined in clause 5.3.9.2. In this test the ITS signal shall be switched off after the detection process at time  $T_1$ .

Pre-test Condition:

- Two WIA devices supporting DAA.
- Both WIA devices switched on.

Test Sequence:

- a) Both WIA devices shall be switched on and in a stable operational mode using the ITS bands.
- b) The timing behaviour of the WIA transmission shall be measured and recorded:
- **CON-1:** The measured on time shall not be larger than  $T_{ITS\_on\_max}$ .
  - **CON-2:** The measured off time shall be equal or larger than  $T_{ITS\_off\_min}$ .
- c) The ITS victim system test signal will be switched on at  $T_0$  and switched off again after  $T_1 = T_0 + 2 \times T_{ITS\_DAA}$ :
- **CON-1:** After the occurrence of the test signal the WIA device shall switch off faster than  $T_{ITS\_DAA}$ .
  - **CON-2:** It shall be recorded if the ITS victim test signal was detected.
  - **CON-3:** A timing trace or description of the observed timing and behaviour of the WIA device shall be recorded.
  - **CON-4:** The WIA device shall not switch TX on again before the time instance  $T_3 = T_{ITS\_non\_occ} + T_{ITS\_DAA}$ .

- d) Repeat a) to c) for  $i = 10$  times in a row:
- **CON-5:** CON-1, CON-2 CON-3 and CON- 4 shall be fulfilled in all  $i$  tests. If CON-5 is fulfilled go to f). If one failure occurs go to e). For more than one failure the test has not been passed.
- e) Repeat a) to c) for  $m = 10$  times in a row:
- **CON-6:** CON-1, CON-2 CON-3 and CON- 4 shall be fulfilled in all  $m$  tests. If one failure occurs test has not been passed.
- f) Repeat a) to d) for each of the relevant ITS victim band at a level of 10 dB above the defined threshold level  $D_{ITS\_thres}$  and at exactly the threshold levels  $D_{ITS\_thres}$  as defined in clause 4.2.7.3.8:
- **CON-7:** A timing trace or description of the observed timing and behaviour of the WIA device shall be recorded.

## 5.3.10 Adaptivity (channel access mechanism) for TTT

### 5.3.10.1 General

In the present clause the test procedure for the TTT DAA test is depicted. The WIA radio device under test shall be verified under normal operational conditions.

The DAA test is split into the following main test conditions:

- start-up test with and without TTT test signal; and
- in-service DAA test;
- test of DAA using the Geolocation Database.

The start-up test verifies the operation of the WIA radio device during the initial start-up when the WIA radio device intends to operate directly in the relevant bands from 5 855 MHz to 5 875 MHz. Thus the WIA radio device need to be set in an operational condition in which this is guaranteed. The test verifies that the WIA radio device respects the defined *TTT Channel Availability Check time*.

The In-service DAA test is intended to verify the dynamic behaviour of the WIA radio device under test. During this test the WIA radio device under test shall operate in a normal operational mode. The manufacturer shall declare this normal operational mode.

### 5.3.10.2 TTT test signal

The TTT test signal shall consist of at least one of the following:

- A real TTT signal according to CEN EN 12253 [i.19] and CEN EN 12795 [i.20] at any channel given in table 7.
- A continuous wave signal at any of the center frequencies given in table 7.  
If required, the TTT test signal shall be similar to a typical standardized TTT signal including specific signal structures containing unmodulated (continuous wave) and modulated sequences. These characteristics could be used to improve the detection operation.

**Table 6: TTT center frequencies within the band 5 795 MHz to 5 815 MHz**

TTT Channel	Center Frequency
TTT Channel 1	5 797,5 MHz
TTT Channel 2	5 802,5 MHz
TTT Channel 3	5 807,5 MHz
TTT Channel 4	5 812,5 MHz

### 5.3.10.3 Initial start-up test

#### 5.3.10.3.1 Start-up procedure

The clauses below define the procedure to verify the *TTT Channel Availability Check time* by ensuring that the WIA device is capable of detecting TTT victim system signals during the *TTT Channel Availability Check time*. Furthermore, one initial test shall guarantee that the WIA device does not switch into TX operation before the end of the *TTT Channel Availability Check time*  $T_{TTT\_check\_time}$ .

#### 5.3.10.3.2 Test without a TTT victim test signal during the *TTT Channel Availability Check time*, $T_{TTT\_check\_time}$

Summary:

Verify the WIA device will not start transmitting before the end of the *TTT Channel Availability Check time*,  $T_{TTT\_check\_time}$  when no TTT victim test signal is present.

Pre-test Condition:

- WIA device supporting DAA in the TTT band.
- WIA device switched off.

Test sequence:

- a) The WIA device will be switched off. No signal generator is connected to the test setup or the signal generator is switched off.
- b) The WIA device is powered on at  $T_0$  using the TTT band.  $T_1$  denotes the instant when the WIA device has completed its power-up sequence ( $T_{power\_up}$ ), enters into the operational mode and is ready to start the TTT victim signal detection:
  - **CON-1:** The WIA device shall not switch into TX mode before the end of  $T_1 + T_{TTT\_check\_time}$  after switch on of the radio device.
  - **CON-2:** A timing trace or description of the observed timing and behaviour of the WIA device shall be recorded.
- c) Repeat a) and b) for  $i = 10$  times in a row:
  - **CON-3:** CON-1 and CON-2 shall be fulfilled in all  $i$  tests. If one failure occurs go to d). For more than one failure the test has not been passed.
- d) Repeat a) and b) for  $m = 10$  times in a row:
  - **CON-4:** CON-1 and CON-2 shall be fulfilled in all  $m$  tests.
- e) Repeat a) to d) for each of the relevant WIA channels overlapping with the TTT band.
- f) End of test.

#### 5.3.10.3.3 Test with a TTT victim test signal during the *TTT Channel Availability Check time*

Summary:

Verify the victim signal detection and avoidance capability for the selected WIA operational frequency band when an TTT victim signal occurs during the *TTT Channel Availability Check time*  $T_{TTT\_CAC}$ .

Pre-test Condition:

- WIA device supporting DAA in the TTT frequency band.
- WIA device switched off.



Test sequence:

- a) The WIA device is switched off. The TTT equipment or the signal generator used to generate the TTT test signal defined in clause 5.3.10.2 is connected to an antenna of suitable characteristics to permit the WIA device to be illuminated with a field equal to the threshold detection limit or connected to the corresponding connectors in the case of a conducted measurement setup.
- b) The WIA device is powered on at  $T_0$  using the TTT band.  $T_1$  denotes the instant when the WIA device has completed its power-up sequence ( $T_{\text{power\_up}}$ ), enters into the operational mode and is ready to start the TTT victim signal detection.
- c) The TTT victim system test signal will be switched on at  $T_0$ :
  - **CON-1:** The *TTT Channel Availability Check time* is expected to commence at  $T_1$  and is expected to end no sooner than  $T_1 + T_{\text{TTT\_check\_time}}$  unless a TTT victim signal is detected sooner.

NOTE: Additional verification may be needed to define  $T_1$  in case it is not exactly known or indicated by the WIA device.

- **CON-2:** It shall be recorded if the TTT victim test signal was detected.
  - **CON-3:** A timing trace or description of the observed timing and behaviour of the WIA device shall be recorded.
- d) Repeat a) to c) for  $I = 10$  times in a row:
    - **CON-4:** CON-1, CON-2 and CON-3 shall be fulfilled in all  $i$  tests. If CON-4 is fulfilled go to f). If one failure occurs go to e). For more than one failure the test has not been passed.
  - e) Repeat a) to c) for  $m = 10$  times in a row:
    - **CON-5:** CON-1, CON-2 and CON-3 shall be fulfilled in all  $m$  tests.
  - f) Repeat b) to e) for each of the relevant WIA channels partially or fully overlapped with the TTT band as well as for a test signal for each of the TTT channels at a level of 10 dB above the defined threshold level  $D_{\text{TTT\_thres}}$  and at exactly the threshold levels  $D_{\text{TTT\_thres}}$  as defined in clause 4.2.7.5.2.
    - **CON-6:** A timing trace or description of the observed timing and behaviour of the WIA device shall be recorded.

#### 5.3.10.4 TTT in-service DAA test with continuous TTT test signal

Summary:

Verify the WIA timing ( $T_{\text{TTT\_DAA}}$ ) during the normal operation in the TTT band with the presence of a TTT victim signal in accordance with the signal defined in clause 5.3.9.2. In this test the TTT signal shall be continuously operational after switch on at  $T_0$ .

Pre-test Condition:

- Two WIA devices supporting DAA.
- Both WIA devices switched on.

Test Sequence:

- a) Both WIA devices shall be switched on and in a stable operational mode using the TTT band.
- b) The TTT victim system test signal will be switched on at  $T_0$ :
  - **CON-1:** After the occurrence of the test signal the WIA device shall switch off faster than  $T_{\text{TTT\_DAA}}$ .
  - **CON-2:** It shall be recorded if the TTT victim test signal was detected.

- **CON-3:** A timing trace or description of the observed timing and behaviour of the WIA device shall be recorded.
  - **CON-4:** The WIA device shall not switch TX on again before the end of  $T_{TTT\_non\_occ}$ .
- c) Repeat a) to c) for  $i = 10$  times in a row:
- **CON-5:** CON-1, CON-2 CON-3 and CON- 4 shall be fulfilled in all  $i$  tests. If CON-5 is fulfilled go to f). If one failure occurs go to e). For more than one failure the test has not been passed.
- d) Repeat a) to c) for  $m = 10$  times in a row:
- **CON-6:** CON-1, CON-2 CON-3 and CON- 4 shall be fulfilled in all  $m$  tests. If one failure occurs test has not been passed.
- e) Repeat a) to d) for each of the relevant WIA channels partially or fully overlapped with the TTT band as well as for a test signal for each of the TTT channels at a level of 10 dB above the defined threshold level  $D_{TTT\_thres}$  and at exactly the threshold levels  $D_{TTT\_thres}$  as defined in clause 4.2.7.3.8.
- **CON-7:** A timing trace or description of the observed timing and behaviour of the WIA device shall be recorded.

### 5.3.10.5 TTT in-service DAA test with TTT test signal switched off after detection

#### Summary:

Verify the WIA timing ( $T_{TTT\_DAA}$ ) and the TTT\_Non\_Occupancy period during the normal operation in the TTT band with the presence of a TTT victim signal in accordance with the signal defined in clause 5.3.10.2. In this test the TTT signal shall be switched off after the detection process at time  $T_1$ .

#### Pre-test Condition:

- Two WIA devices supporting DAA.
- Both WIA devices switched on.

#### Test Sequence:

- a) Both WIA devices shall be switched on and in a stable operational mode using the TTT band.
- b) The TTT victim system test signal will be switched on at  $T_0$  and switched off again after  $T_1 = T_0 + 2 \times T_{TTT\_DAA}$ :
- **CON-1:** After the occurrence of the test signal the WIA device shall switch off faster than  $T_{TTT\_DAA}$ .
  - **CON-2:** It shall be recorded if the TTT victim test signal was detected.
  - **CON-3:** A timing trace or description of the observed timing and behaviour of the WIA device shall be recorded.
  - **CON-4:** The WIA device shall not switch TX on again before the time instance  $T_3 = T_{TTT\_non\_occ} + T_{TTT\_DAA}$ .
- c) Repeat a) to c) for  $i = 10$  times in a row:
- **CON-5:** CON-1, CON-2 CON-3 and CON- 4 shall be fulfilled in all  $i$  tests. If CON-5 is fulfilled go to f). If one failure occurs go to e). For more than one failure the test has not been passed.
- d) Repeat a) to c) for  $m = 10$  times in a row!
- **CON-6:** CON-1, CON-2 CON-3 and CON- 4 shall be fulfilled in all  $m$  tests. If one failure occurs test has not been passed.

- e) Repeat a) to d) for each of the relevant WIA channels partially or fully overlapped with the TTT band as well as for a test signal for each of the TTT channels at a level of 10 dB above the defined threshold level  $D_{TTT\_thres}$  and at exactly the threshold levels  $D_{TTT\_thres}$  as defined in clause 4.2.7.3.8:
- **CON-7:** A timing trace or description of the observed timing and behaviour of the WIA device shall be recorded.

### 5.3.10.6 TTT DAA using a Geolocation Database

Summary:

Verify the TTT channel avoidance when the WIA device is located within a WIA Protected zone of the TTT Geolocation Database as defined in clause 4.2.10.

For the test purposes that assess the correct detection of a TTT location by its geolocation, a location simulator is necessary. The location simulator is connected to the GNSS antenna connector of the DUT and simulates the signals of GNSS satellites characteristic for a certain geolocation. Alternatively the geolocation can be transferred to the DUT via a test interface.

Pre-test Condition:

- A WIA device supporting DAA using the Geolocation Database as defined in clause 4.2.10.
- The WIA device connected to a position simulator as described above.

Test Sequence:

- a) Choose a set of 10 WIA protected zones from the official TTT DSRC Geolocation Database:
  - 1) The Protected Zones with maximum latitude.
  - 2) The Protected Zones with minimum latitude.
  - 3) The Protected Zones with maximum longitude.
  - 4) The Protected Zones with minimum longitude.
  - 5) Any 6 further randomly chosen Protected Zones.
- b) For each of the 10 WIA Protected Zones, choose a random location within the protected zone.
- c) Repeat for each of the aforementioned locations, and for each of the relevant WIA channels partially or fully overlapped with the TTT band: Activate the DUT for transmissions in the TTT band. Observe the behaviour for at least the time period of  $T_{TTT\_DAA}$ :
  - **CON-1:** The DUT shall not use any channel partially or fully overlapping the TTT band.
  - **CON-2:** A timing trace or description of the observed timing and behaviour of the WIA device shall be recorded.

## Annex A (informative): Relationship between the present document and the essential requirements of Directive 2014/53/EU

The present document has been prepared under the Commission's standardisation request C(2015) 5376 final [i.3] to provide one voluntary means of conforming to the essential requirements of Directive 2014/53/EU on the harmonisation of the laws of the Member States relating to the making available on the market of radio equipment and repealing Directive 1999/5/EC [i.2].

Once the present document is cited in the Official Journal of the European Union under that Directive, compliance with the normative clauses of the present document given in table A.1 confers, within the limits of the scope of the present document, a presumption of conformity with the corresponding essential requirements of that Directive and associated EFTA regulations.

**Table A.1: Relationship between the present document and the essential requirements of Directive 2014/53/EU**

Harmonised Standard ETSI EN 303 258					
Requirement				Requirement Conditionality	
No	Description	Essential requirements of Directive	Clause(s) of the present document	U/C	Condition
1	RF output power and Adaptive Power Control	3.2	4.2.1	U	
2	Occupied channel bandwidth	3.2	4.2.2	U	
3	Transmitter unwanted emissions in the spurious domain	3.2	4.2.3	U	
4	Receiver spurious emissions	3.2	4.2.4	U	
5	Receiver Blocking	3.2	4.2.5	U	
6	DFS	3.2	4.2.6	C	Required when operating on channels whose nominal bandwidth falls partly or completely within the frequency range from 5 725 MHz to 5 850 MHz.
7	Adaptive Channel Access Mechanism	3.2	4.2.7	U	Alternative approach to clauses 4.2.9 and 4.2.10.
8	User Access Restrictions	3.2	4.2.8	U	Alternative approach to clauses 4.2.9 and 4.2.10.
9	Geo-localization capability	3.2	4.2.9	U	Alternative approach to clauses 4.2.7 and 4.2.8.
10	TTT Detection and Avoidance using a Geolocation Database	3.2	4.2.10	U	Alternative approach to clauses 4.2.7 and 4.2.8.

### Key to columns:

#### Requirement:

**No** A unique identifier for one row of the table which may be used to identify a requirement.

**Description** A textual reference to the requirement.

#### Essential requirements of Directive

Identification of article(s) defining the requirement in the Directive.

**Clause(s) of the present document**

Identification of clause(s) defining the requirement in the present document unless another document is referenced explicitly.

**Requirement Conditionality:**

**U/C** Indicates whether the requirement is unconditionally applicable (U) or is conditional upon the manufacturer's claimed functionality of the equipment (C).

**Condition** Explains the conditions when the requirement is or is not applicable for a requirement which is classified "conditional".

Presumption of conformity stays valid only as long as a reference to the present document is maintained in the list published in the Official Journal of the European Union. Users of the present document should consult frequently the latest list published in the Official Journal of the European Union.

Other Union legislation may be applicable to the product(s) falling within the scope of the present document.

---

## Annex B (normative): Test sites and arrangements for radiated measurements

### B.1 General requirements

This annex describes the use of test sites (including antennas) to perform radiated measurements in accordance with the present document.

In addition this annex describes the use of a test fixture to perform conducted (relative) measurements on equipment with integral antennas. It also defines the interference signal to be used in the adaptivity tests.

Subsequently the following items will be described:

- Open Area Test Site (OATS).
- Semi Anechoic Room (SAR).
- Fully Anechoic Room (FAR).
- Test fixture for relative measurements.
- Interference Signal used for Adaptivity Tests.

The first three are generally referred to as free field test sites. Both absolute and relative measurements can be performed on these sites. They will be described in clause B.2. Clause B.3 describes the antennas used in these test sites.

Where absolute measurements are to be carried out, the chamber should be verified. A detailed verification procedure is described in clause 6 of ETSI TR 102 273-4 [i.17] for the OATS, in clause 6 of ETSI TR 102 273-3 [i.16] for the SAR, and in clause 6 of ETSI TR 102 273-2 [i.15] for the FAR.

Information for calculating the measurement uncertainty of measurements on one of these test sites can be found in ETSI TR 100 028-1 [i.13] and ETSI TR 100 028-2 [i.14], ETSI TR 102 273-2 [i.15], ETSI TR 102 273-3 [i.16] and ETSI TR 102 273-4 [i.17].

---

### B.2 Radiation test sites

#### B.2.1 Open Area Test Site

An Open Area Test Site (OATS) comprises a turntable at one end and an antenna mast of variable height at the other end above a ground plane which, in the ideal case, is perfectly conducting and of infinite extent. In practice, while good conductivity can be achieved, the ground plane size has to be limited. A typical Open Area Test Site is shown in figure B.1.

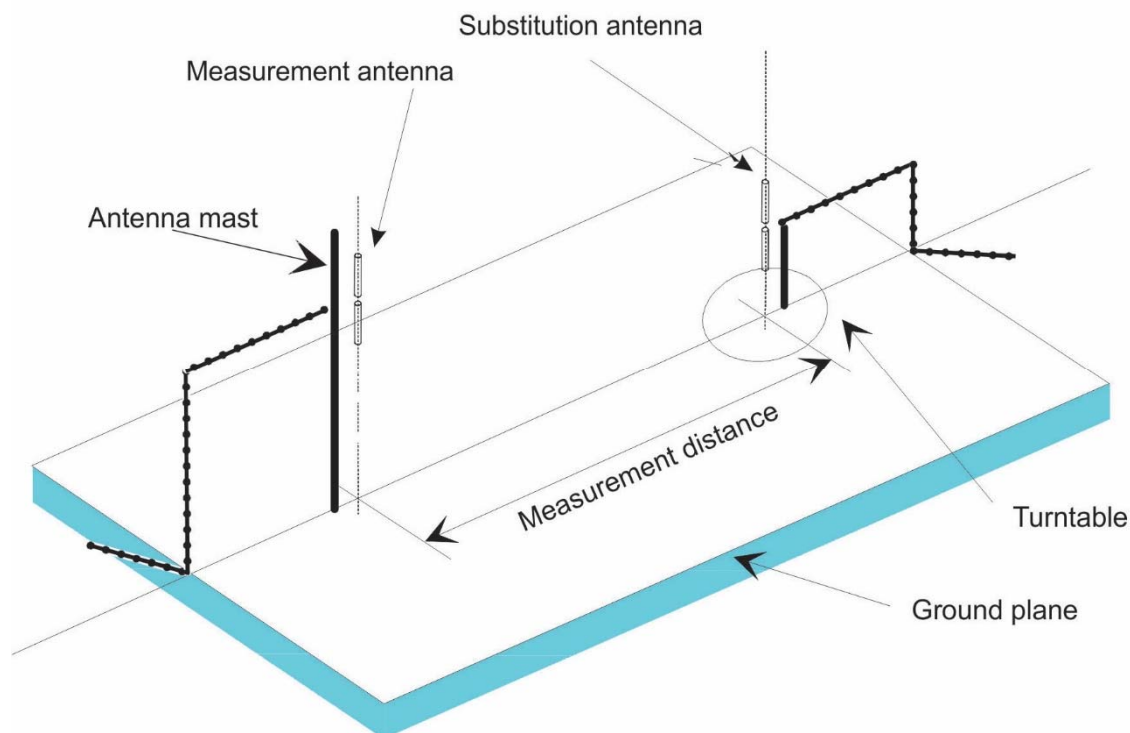

**Figure B.1: A typical Open Area Test Site**

The ground plane creates a wanted reflection path, such that the signal received by the receiving antenna is the sum of the signals received from the direct and reflected transmission paths. The phasing of these two signals creates a unique received level for each height of the transmitting antenna (or UUT) and the receiving antenna above the ground plane.

The antenna mast provides a variable height facility (from 1 m to 4 m) so that the position of the measurement antenna can be optimized for maximum coupled signal between antennas or between a UUT and the measurement antenna.

A turntable is capable of rotation through 360° in the horizontal plane and it is used to support the test sample (UUT) at a height of usually 1,5 m above the ground plane.

The measurement distance and minimum chamber dimensions can be found in clause B.2.4. The distance used in actual measurements shall be recorded with the test results.

Further information on Open Area Test Sites can be found in ETSI TR 102 273-4 [i.17].

## B.2.2 Semi Anechoic Room

A Semi Anechoic Room is - or anechoic chamber with a conductive ground plane - is an enclosure, usually shielded, whose internal walls and ceiling are covered with radio absorbing material. The floor, which is metallic, is not covered by absorbing material and forms the ground plane. The chamber usually contains an antenna mast at one end and a turntable at the other end. A typical anechoic chamber with a conductive ground plane is shown in figure B.2.

This type of test chamber attempts to simulate an ideal Open Area Test Site, whose primary characteristic is a perfectly conducting ground plane of infinite extent.

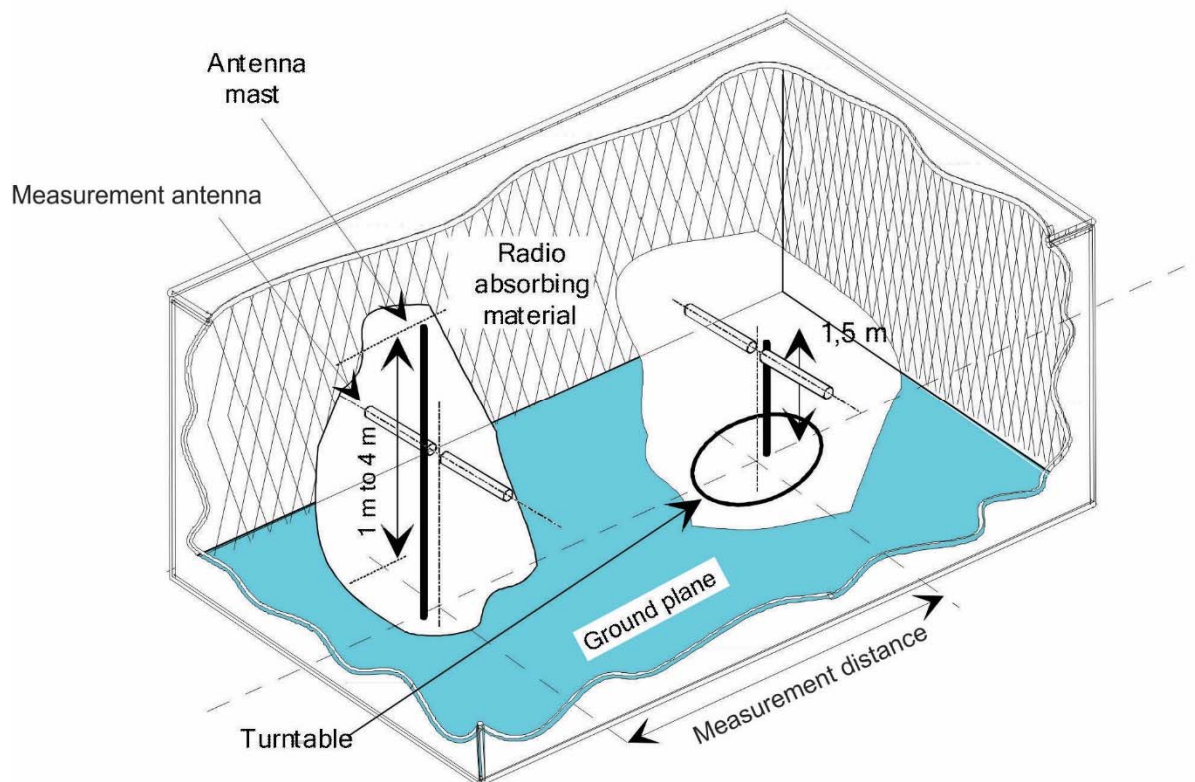

**Figure B.2: A typical Semi Anechoic Room**

In this facility the ground plane creates a wanted reflection path, such that the signal received by the receiving antenna is the sum of the signals received from the direct and reflected transmission paths. The phasing of these two signals creates a unique received level for each height of the transmitting antenna (or UUT) and the receiving antenna above the ground plane.

The antenna mast provides a variable height facility (from 1 m to 4 m) so that the position of the measurement antenna can be optimized for maximum coupled signal between antennas or between a UUT and the measurement antenna.

A turntable is capable of rotation through  $360^\circ$  in the horizontal plane and it is used to support the test sample (UUT) at a height of usually 1,5 m above the ground plane.

The measurement distance and minimum chamber dimensions can be found in clause B.2.4. The distance used in actual measurements shall be recorded with the test results.

Further information on Semi Anechoic Rooms can be found in ETSI TR 102 273-3 [i.16].

### B.2.3 Fully Anechoic Room

A Fully Anechoic Room (FAR) is an enclosure, usually shielded, whose internal walls, floor and ceiling are covered with radio absorbing material. The chamber usually contains an antenna support at one end and a turntable at the other end. A typical FAR is shown in figure B.3.



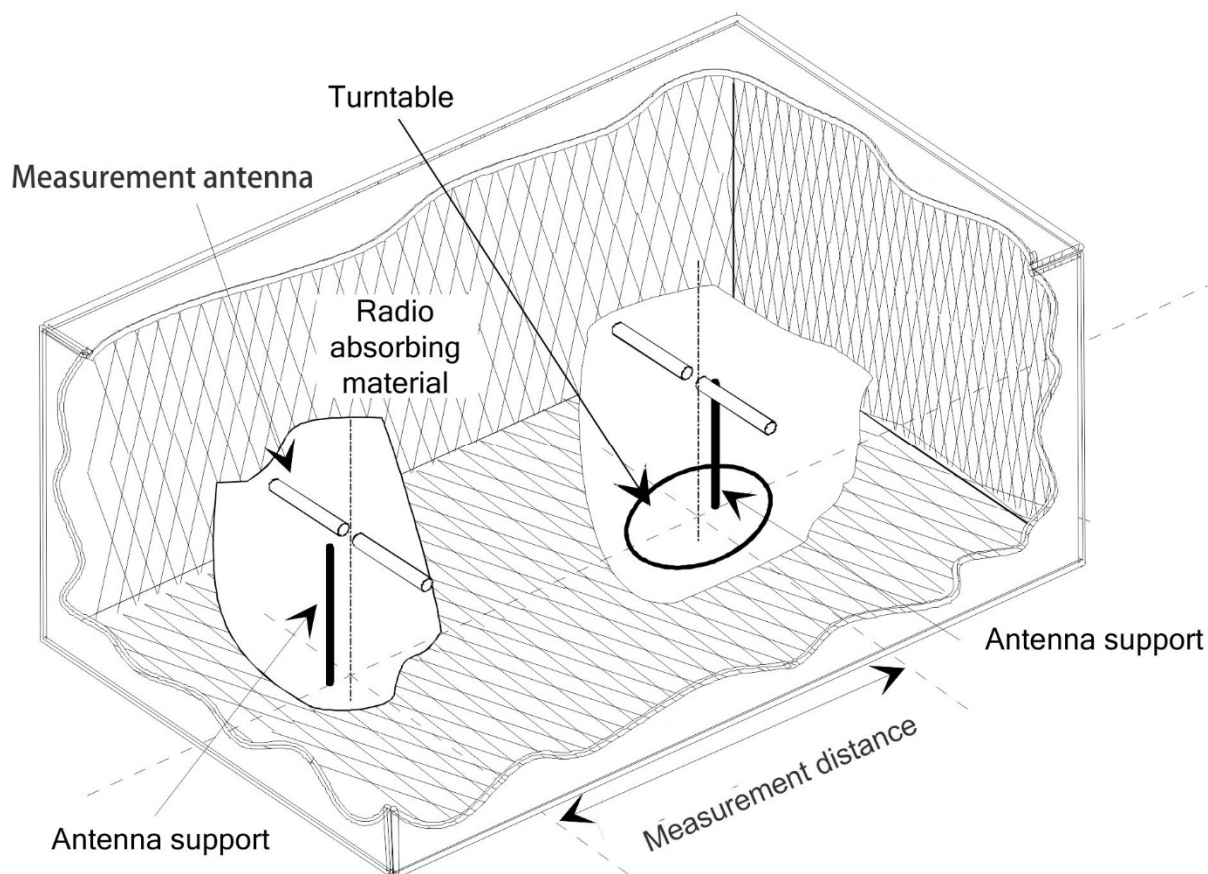

**Figure B.3: A typical Fully Anechoic Room**

The chamber shielding and radio absorbing material provide a controlled environment for testing purposes. This type of test chamber attempts to simulate free space conditions.

The shielding provides a test space, with reduced levels of interference from ambient signals and other outside effects, whilst the radio absorbing material minimizes unwanted reflections from the walls and ceiling which can influence the measurements. The shielding should be sufficient to eliminate interference from the external environment that would mask any signals that have to be measured.

A turntable is capable of rotation through 360° in the horizontal plane and it is used to support the UUT at a height of usually 1 m above the absorbing material.

The measurement distance and minimum chamber dimensions can be found in clause B.2.4. The distance used in actual measurements shall be recorded with the test results.

Further information on FAR can be found in ETSI TR 102 273-2 [i.15].

## B.2.4 Measurement Distance

The measurement distance should be chosen in order to measure the UUT at far-field conditions. The minimum measurement distance between the equipment and the measurement antenna should be  $\lambda$  or  $r_m \gg \frac{D^2}{\lambda}$ , whichever is the greater:

$\lambda$  = wavelength in m.

$r_m$  = minimum measurement distance between UUT and measurement antenna in m.

$D$  = largest dimension of physical aperture of the largest antenna in the measurement setup, in m.

$\frac{D^2}{\lambda} =$  distance between outer boundary of radiated near field (Fresnel region) and inner boundary of the radiated far-field (Fraunhofer region) in m, also known as Rayleigh distance.

For those measurements, where these conditions cannot be fulfilled and where the measurement distance would result in measurements in the near field (e.g. while measuring spurious emissions), this should be noted in the test report and the additional measurement uncertainty should be incorporated into the results.

---

## B.3 Antennas

### B.3.1 General requirements

Antennas are needed for the radiated measurements on the three test sites described in clause B.2. Depending on its use, the antenna will be designated as "measurement antenna" or "substitution antenna".

### B.3.2 Measurement antenna

The measurement antenna shall be used to determine the field from the UUT and from the substitution antenna. When the test site is used for the measurement of receiver characteristics, the antenna is used as the transmitting device.

The measurement antenna should be mounted on a support capable of allowing the antenna to be used in either horizontal or vertical polarization. Additionally, on an OATS or SAR, the height of the centre of the antenna above the ground should be variable over the specified range (usually 1 m to 4 m).

In the frequency band 30 MHz to 1 000 MHz, biconical or Logarithmic Periodic Dipole Antennas (LPDA) are recommended. Above 1 GHz, horn antennas or logarithmic periodic dipole antennas are recommended.

The measurement antenna does not require an absolute calibration.

### B.3.3 Substitution antenna

The substitution antenna shall be used to replace the equipment under test in substitution measurements.

The substitution antenna shall be suitable for the frequency range and the return loss of the antenna shall be taken into account when calculating the measurement uncertainty.

The reference point of the substitution antenna shall coincide with the volume centre of the UUT when its antenna is internal, or the point where an external antenna is connected to the UUT.

The distance between the lower extremity of the antenna and the ground shall be at least 30 cm.

The substitution antenna shall be calibrated. For below 1 GHz, the calibration is relative to a half wave dipole, while above 1 GHz, an isotropic radiator is the reference.

---

## B.4 Test fixture

### B.4.1 General requirements

Conducted measurements may be applied to equipment provided with a (temporary) antenna connector, e.g. by means of a spectrum analyser.

In the case of integral antenna equipment with no external (temporary) antenna connector(s) provided, a test fixture can be used to allow relative measurements to be performed at the extremes of temperature.

## B.4.2 Description of the test fixture

The test fixture shall provide a means of coupling to the radio frequency output(s) of the UUT.

The impedance of the external connection to the test fixture shall be 50  $\Omega$  at the working frequencies of the equipment.

The performance characteristics of this test fixture under normal and extreme conditions shall be such that:

- a) the coupling loss shall be limited to ensure a sufficient dynamic range of the setup;
- b) the variation of coupling loss with frequency shall not cause errors exceeding  $\pm 2$  dB;
- c) the coupling device shall not include any non-linear elements.

## B.4.3 Using the test fixture for relative measurements

Step 1 to step 4 below describe the principle for performing relative measurements for those requirements where testing needs to be repeated at the extremes of the temperature.

### Step 1:

Perform the measurement under normal conditions on a test site for radiated measurements as described in clause B.2. This will result in an absolute value for the requirement being tested. This value shall be recorded.

### Step 2:

Put the equipment with the test fixture in the temperature chamber. Perform the same measurement at normal conditions in this environment and normalize the measuring equipment to get the same reading as before in step 1.

### Step 3:

Ensure that the RF coupling accuracy remains within the range specified in clause B.4.2, item b).

### Step 4:

Change the temperature in the temperature chamber and perform the measurement again. Due to the normalization done in step 2, the result will be the value for this requirement at the extreme condition.

---

## B.5 Guidance on the use of radiation test sites

### B.5.1 General requirements

This clause details procedures, test equipment arrangements and verification that should be carried out before any of the radiated test are undertaken. These schemes are common to all types of test sites described in clause B.2.

Where necessary, a mounting bracket of minimal size should be available for mounting the UUT on the turntable. This bracket should be made from low conductivity, low relative permittivity (i.e.  $\frac{\epsilon}{\epsilon_0} < 1,5$ ) material(s) such as expanded polystyrene, balsawood, etc.

### B.5.2 Power supplies for the battery powered UUT

All tests should be performed using power supplies wherever possible, including tests on UUT designed for battery-only use. For battery powered equipment, power leads should be connected to the UUT's supply terminals (and monitored with a digital voltmeter) but the battery should remain present, electrically isolated from the rest of the equipment, possibly by putting tape over its contacts.

The presence of these power cables can, however, affect the measured performance of the UUT. For this reason, they should be made to be "transparent" as far as the testing is concerned. This can be achieved by routing them away from the UUT and down to either the screen, ground plane or facility wall (as appropriate) by the shortest possible paths. Precautions should be taken to minimize pick-up on these leads (e.g. the leads could be twisted together, loaded with ferrite beads at 0,15 m spacing or otherwise loaded).

### B.5.3 Site preparation

The cables to the measuring and substitution antenna should be routed horizontally away from the testing area for a minimum of 2 m (unless, in the case both types of anechoic chamber, a back wall is reached) and then allowed to drop vertically and out through either the ground plane or screen (as appropriate) to the test equipment. Precautions should be taken to minimize pick up on these leads (e.g. dressing with ferrite beads, or other loading). The cables, their routing and dressing should be identical to the verification set-up.

NOTE: For ground reflection test sites (i.e. anechoic chambers with ground planes and Open Area Test Sites) which incorporate a cable drum with the antenna mast, the 2 m requirement may be impossible to comply with.

Calibration data for all items of test equipment should be available and valid. For test, substitution and measuring antennas, the data should include gain relative to an isotropic radiator (or antenna factor) for the frequency of test. Also, the VSWR of the substitution and measuring antennas should be known.

The calibration data on all cables and attenuators should include insertion loss and VSWR throughout the entire frequency range of the tests. All VSWR and insertion loss figures should be recorded in the log book results sheet for the specific test.

Where correction factors/tables are required, these should be immediately available.

For all items of test equipment, the maximum errors they exhibit should be known along with the distribution of the error, e.g.:

- cable loss:  $\pm 0,5$  dB with a rectangular distribution;
- measuring receiver: 1,0 dB (standard deviation) signal level accuracy with a Gaussian error distribution.

At the start of measurements, system checks should be made on the items of test equipment used on the test site.

---

## B.6 Coupling of signals

### B.6.1 General requirements

The presence of leads in the radiated field may cause a disturbance of that field and lead to additional measurement uncertainty. These disturbances can be minimized by using suitable coupling methods, offering signal isolation and minimum field disturbance (e.g. optical coupling).

### B.6.2 Data Signals

Isolation can be provided by the use of optical, ultrasonic or infra-red means. Field disturbance can be minimized by using a suitable fibre optic connection. Ultrasonic or infra-red radiated connections require suitable measures for the minimization of ambient noise.

## B.7 Interference Signal used for Adaptivity Tests

The inference signal used in the adaptivity test described in clause 5.3.8, shall be a band limited noise signal with a 100 % duty cycle.

The flatness, bandwidth and power spectral density of the interference signal can be verified with the following procedure.

Connect the signal generator for generating the interference signal to a spectrum analyser:

- Centre Frequency: equal to the channel frequency to be tested.
- Span:  $2 \times$  nominal channel bandwidth.
- Resolution BW:  $\sim 1$  % of the nominal channel bandwidth.
- Video BW:  $3 \times$  Resolution BW.
- Sweep Points:  $2 \times$  the Span divided by the Resolution BW. For spectrum analysers not supporting this number of sweep points, the frequency band may be segmented.
- Detector: Peak.
- Trace Mode: Trace Averaging.
- Number of sweeps: Sufficient to let the signal stabilize.
- Sweep time: Auto.
- The 99 % bandwidth (the bandwidth containing 99 % of the power) of this inference signal shall be equal to 120 % of the Occupied Channel Bandwidth of the UUT, while the difference between the lowest level and the highest level within the Occupied Channel Bandwidth of the UUT shall be a maximum of 4 dB.
- The level of this interference signal can be measured with a spectrum analyser using the following settings:
  - Centre Frequency: equal to the channel frequency to be tested.
  - Span: Zero.
  - Resolution BW: 1 MHz.
  - Video BW:  $3 \times$  Resolution BW.
  - Filter: Channel.
  - Detector: RMS.
  - Trace Mode: Clear Write.
  - Number of sweeps: Single.
  - Sweep time: 1 s; the sweep time may be increased until a value where the sweep time has no impact on the RMS value of the signal.

## Annex C (normative): Procedures for radiated measurements

### C.1 General requirements

This annex gives the general procedures for radiated measurements using the test sites and arrangements described in annex B.

Radiated measurements should be performed in a FAR, see clause C.3. Radiated measurements in an OATS or SAR are described in clause C.2.

### C.2 Radiated measurements in an OATS or SAR

Radiated measurements shall be performed with the aid of a measurement antenna and a substitution antenna, in test sites described in annex B. The measurement set-up shall be calibrated according to the procedure defined in the present annex. The UUT and the measurement antenna shall be oriented such as to obtain the maximum emitted power level. This position shall be recorded in the measurement report.

- a) The measurement antenna (device 2 in figure C.1) shall be oriented initially for vertical polarization unless otherwise stated and the UUT (device 1 in figure C.1) shall be placed on the support in its standard position and switched on.
- b) The measurement equipment (device 3 in figure C.1) shall be connected to the measurement antenna and set-up according to the specifications of the test.

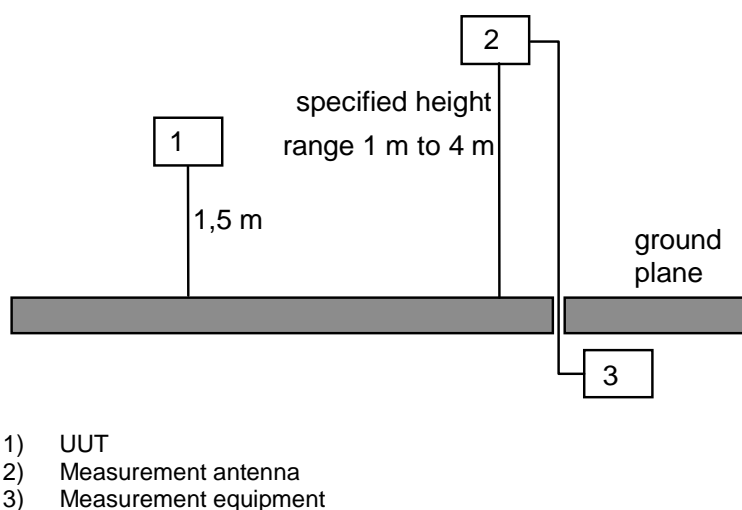

**Figure C.1: Measurement arrangement**

- c) The UUT shall be rotated through 360° in a horizontal plane until a higher maximum signal is received.
- d) The measurement antenna shall be raised or lowered again through the specified height range until a maximum is obtained. This level shall be recorded.
- e) This measurement procedure in step c) and step d) above shall be repeated for horizontal polarization.

This maximum may be a lower value than the value obtainable at heights outside the specified limits.

## C.3 Radiated measurements in a FAR

For radiated measurements using a FAR, the procedure is identical to the one described in clause C.2, except that the height scan in step d) is omitted.

## C.4 Substitution measurement

To determine the absolute measurement value a substitution measurement is performed. The following steps have to be performed:

- 1) Replacing the UUT with the substitution antenna that is depicted as device 1 in figure C.1. The substitution antenna shall have vertical polarization.
- 2) Connect a signal generator to the substitution antenna, and adjust it to the measurement frequency.
- 3) If an OATS or a SAR is used, the measurement antenna height shall be varied within the range provided in figure C.1, to ensure that the maximum signal is received.
- 4) Subsequently, the power of the signal generator is adjusted until the same level is obtained again at the measurement equipment.
- 5) The radiated power is equal to the power supplied by the signal generator, increased with the substitution antenna gain minus the cable losses (values in dB).
- 6) This measurement procedure described in step 2) to step 5) above shall be repeated with horizontal polarization for the substitution antenna.

For test sites with a fixed setup of the measurement antenna(s) and a reproducible positioning of the UUT, correction values from a verified site calibration can be used alternatively.

## C.5 Guidance for testing technical requirements

### C.5.1 Conformance tests and corresponding test sites

Table C.1 provides guidance on the test site to be used for each of the conformance test when performing radiated measurements on integral antenna equipment.

**Table C.1: Conformance tests and corresponding test sites**

Conformance test	Clause	Corresponding test site - Clause number(s)
Occupied Channel Bandwidth	5.3.3	B.4.3
RF output power and Adaptive Power Control	5.3.2	B.2.1, B.2.2, B.2.3
Transmitter unwanted emissions outside the 5,8 GHz WIA band	5.3.4	B.2.1, B.2.2, B.2.3
Receiver spurious emissions	5.3.5	B.2.1, B.2.2, B.2.3
Adaptivity (channel access mechanism)	5.3.8	C.5.2

### C.5.2 Guidance for testing Adaptivity (Channel Access Mechanism)

#### C.5.2.1 General requirements

Clause C.5.2 provides guidance on how the Adaptivity requirement (see clause 4.2.7) can be verified on integral antenna equipment using radiated measurements.

### C.5.2.2 Measurement Set-up

Figure C.2 describes an example of a set-up that can be used to perform radiated adaptivity tests.

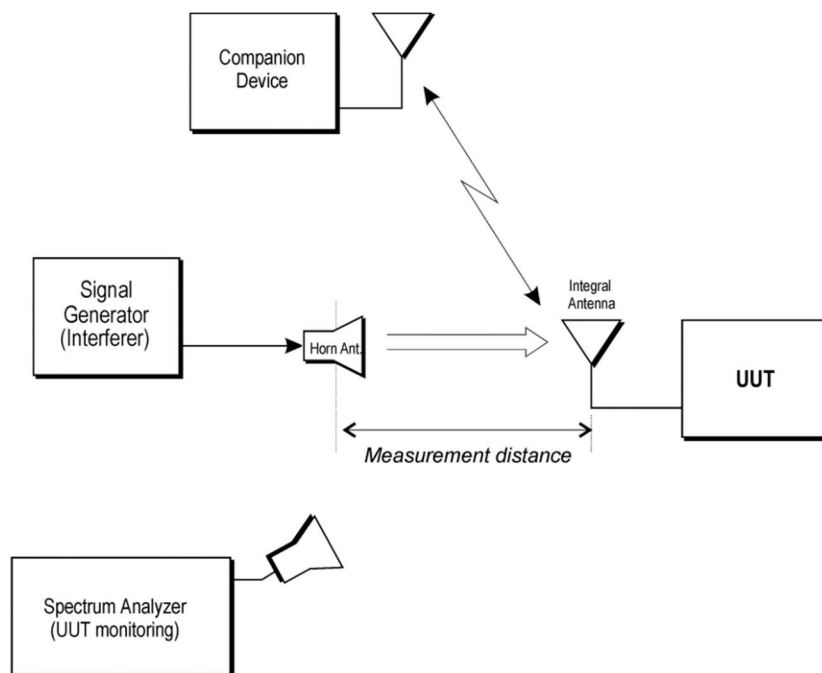
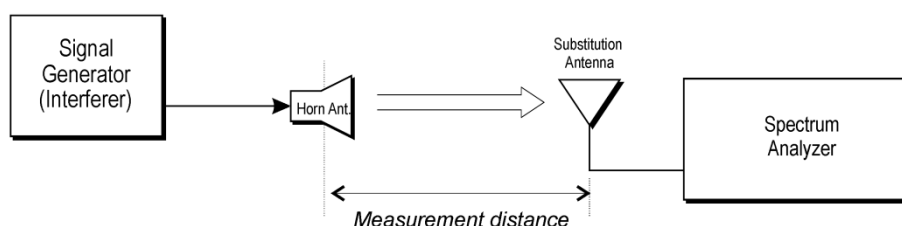

**Figure C.2: Measurement Set-up**

### C.5.2.3 Calibration of the measurement Set-up

Before starting the actual measurement, the setup shall be calibrated. Figure C.3 shows an example of a set-up that can be used for calibrating the set-up given in figure C.2 using a substitution antenna and a spectrum analyser. It shall be verified that the level of the interference signal at input of the substitution antenna correspond with the level used for conductive measurements assuming a 0 dBi antenna gain for the UUT (see clause 5.3.8).

For test sites with a fixed setup of the measurement antenna(s) and a reproducible positioning of the UUT, correction values from a verified site calibration can be used alternatively.



**Figure C.3: Measurement Set-up - Calibration**

### C.5.2.4 Test method

The test procedure shall be as follows:

- Replace the substitution antenna with the UUT once the calibration is performed.
- The UUT shall be positioned for maximum e.i.r.p. towards the horn antenna.

NOTE: This position was recorded as part of the procedure in clause 5.3.2.2.2 (second paragraph).

The test method is further as described under clause 5.3.8.2.1.



## Annex D (normative): DFS parameters

### D.1 Test signals

DFS parameters shall be as specified in table D.2, table D.3, table D.4, table D.5 and table D.6.

**Table D.1: DFS requirement values**

Parameter	Value
Channel Move Time	10 s
Channel Closing Transmission Time	1 s
Non-Occupancy Period	30 minutes

**Table D.2: Interference threshold values**

e.i.r.p. (dBm)	Value (dBm) (see note 1 and note 2)
26	-65
NOTE 1: This is the level at the input of the receiver of a WIA device with a maximum e.i.r.p. of 26 dBm and assuming a 0 dBi receive antenna. For devices employing different e.i.r.p. and/or a different receive antenna gain G (dBi) the DFS threshold level at the receiver input follows the following relationship: $\text{DFS Detection Threshold (dBm)} = -65 + 26 - \text{e.i.r.p. (dBm)} + G \text{ (dBi)}$	
NOTE 2: Slave devices do not have to implement radar detection unless these devices are used in fixed outdoor point to point or fixed outdoor point to multipoint applications (see clause 4.2.6.1.4).	

**Table D.3: Parameters of the reference DFS test signal**

Pulse width W ( $\mu\text{s}$ )	Pulse repetition frequency PRF (PPS)	Pulses per burst (PPB)
1	700	18

Table D.4: Parameters of radar test signals

Radar test signal # (see note 1 to note 3)	Pulse width W ( $\mu$ s)		Pulse repetition frequency PRF (PPS)		Number of different PRFs	Pulses per burst for each PRF (PPB)
	Min	Max	Min	Max		
1	0,5	5	200	1 000	1	10
2	0,5	15	200	1 600	1	15
3	0,5	15	2 300	4 000	1	25
4	20	30	2 000	4 000	1	20

NOTE 1: Radar test signals #1 to #4 are constant PRF based signals. See figure D.1.

NOTE 2: Radar test signal #4 is a modulated radar test signal. The modulation to be used is a chirp modulation with a  $\pm 2,5$  MHz frequency deviation which is described below.

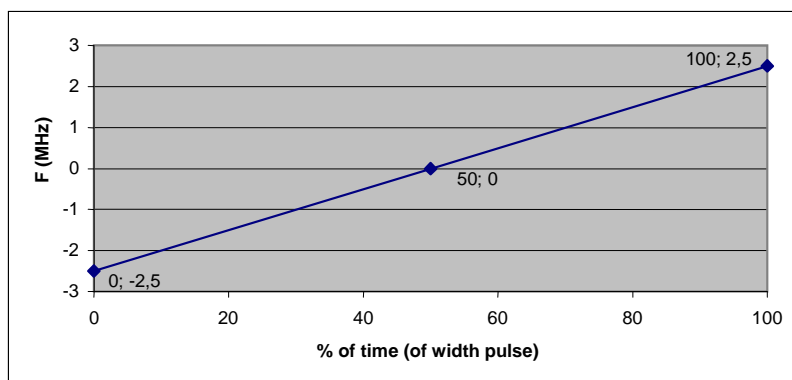

NOTE 3: The total number of pulses in a burst is equal to the number of pulses for a single PRF multiplied by the number of different PRFs used.

Table D.5: DFS Test Signals simulating Frequency Hopping radars

Radar test signal	Pulse width $W$ ( $\mu$ s)	Pulse repetition PRF (PPS)	Pulses per burst	Burst length (ms)	Bursts per Trial (see note 4)	Pulse modulation (see note 1)	Detection probability $P_d$ with 30 % channel load (see note 2)
1	1	3 000	9	3	8	none	(see note 3)
2	20	4 500	9	2	2	chirp	(see note 3)

NOTE 1: Modulation to be used for the radar test signal 6 is a chirp modulation with a  $\pm 2,5$  MHz frequency deviation which is illustrated below.

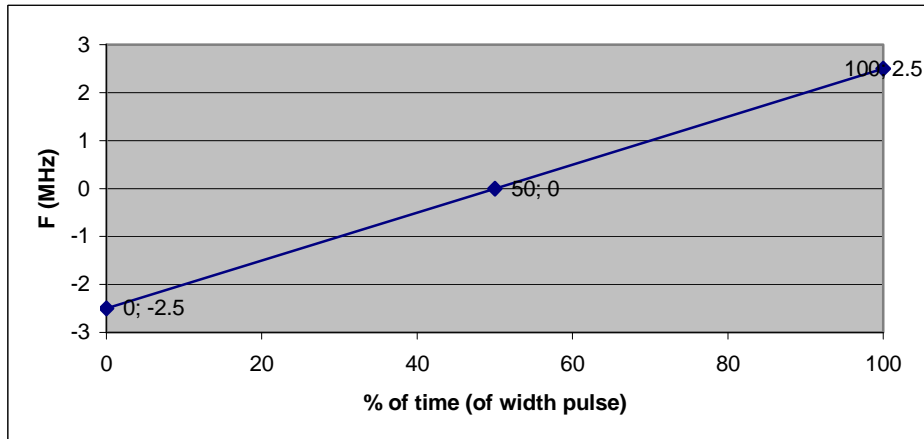

NOTE 2:  $P_d$  gives the probability of detection per simulated radar test signal and represents a minimum level of detection performance under defined conditions, see clause 5.3.7.

The test is performed using a minimum of 30 trials per test signal. The probability of detection is calculated by:

$$P_d = \frac{\text{TotalSetDetections}}{\text{TotalSetTrials}} \times 100 .$$

NOTE 3: Assuming  $P_d = 85$  % for a ChS of 125 MHz, then  $P_d = (\text{ChS} / 125 \text{ MHz}) \times 0,85 \times 100$  in %.

NOTE 4: For each of the trials, the burst interval will increase from 1,25 ms to 37,5 ms in steps of 1,25 ms for radar signal 1 and from 5 ms to 150 ms in steps of 5 ms for radar signal 2.

Table D.6: Detection probability

Parameter	Detection Probability ( $P_d$ )	
	Other Radars	Frequency Hopping Radars
In-Service Monitoring	60 %	80 %

NOTE:  $P_d$  gives the probability of detection per simulated radar burst and represents a minimum level of detection performance under defined conditions. Therefore,  $P_d$  does not represent the overall detection probability for any particular radar under real life conditions.

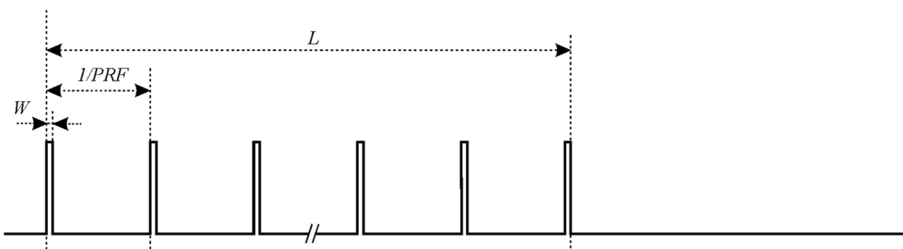

Figure D.1: General structure of a single burst/constant PRF based radar test signal

---

## Annex E (informative): Receiver parameters

### E.1 General

Clause 4 and clause 5 contain the technical requirements specifications and methods of measurements for Wireless Industrial Automation (WIA) applications equipment operating in the 5 725 MHz to 5 875 MHz frequency band. Applications requiring this kind of equipment are also described in detail in ETSI TR 102 889-2 [i.18] and listed in the introduction of the present document. According to the Technical Report, the requirements of a wide range of applications in different industrial application domains need to be accommodated, resulting in various systems with different characteristics, regarding channel bandwidth, type of modulation, data rate, range, capacity of nodes, and others. The potential use of WIA equipment was evaluated in-depth in a compatibility study accomplished by CEPT with the results reflected in ECC Report 206 [i.21]. The regulatory requirements for the use of WIA are given in CEPT ECC ERC Recommendation 70-03 [i.7], annex 2.

The band 5 725 MHz to 5 875 MHz is a non-channelized SRD band. Clause 4.2.2 specifies the occupied channel bandwidth between 1 MHz and 20 MHz. As a result, WIA equipment can operate at any frequency in the band and use bandwidths or channels ranging from 1 MHz up to 20 MHz, depending on the requirements of the respective application domain. In addition, technologies are allowed to operate using overlapping channels. Similar conditions, without a bandwidth limit, apply to other generic SRDs which can operate in this band at the same time, which lead to an infinite number of possible operating conditions.

Clause 4 defines the technical requirements to demonstrate presumption of conformity to article 3.2 of the RED [i.2]. This clause also contains certain receiver parameters:

- Receiver spurious emissions
- Receiver Blocking

Additionally, clause 4 contains requirements for mitigation techniques to avoid interference to with Radiolocation systems in the band 5 725 MHz to 5 850 MHz, Broadband Fixed Wireless Access (BFWA) systems in the band 5 725 MHz to 5 875 MHz, Transport and Traffic Telematics (TTT) in the band 5 795 MHz to 5 815 MHz and Intelligent Transport Systems (ITS) in the band 5 855 MHz to 5 875 MHz.

Clause E.2 lists further receiver parameters contained in the ETSI EG 203 336 [i.22]. For each of the parameters technical justifications are given as to why this parameter is not relevant in order to fulfil the essential requirement in article 3.2 of Directive 2014/53/EU [i.2] or why the parameter is covered by alternative requirements.

---

### E.2 Receiver parameters

#### E.2.1 Receiver sensitivity

Clause 4 includes several mitigation mechanisms to ensure coexistence with other radio systems in the 5 725 MHz to 5 875 MHz frequency band, such as Radiolocation systems, BFWA, ITS and TTT. Each of the mitigation mechanisms is based on a detection threshold, which requires a highly sensitive receiver that allows it to operate as intended.

The protection of BFWA is required in the whole frequency range from 5 725 MHz to 5 875 MHz. Protection is ensured by DAA with a generic DAA threshold given in clause 4.2.7.2.4. This DAA threshold is ambitious and well beyond values which are common for the receiver sensitivity of SRDs comparable in operation frequency and bandwidth. As this requirement, which is valid for all types of systems and bandwidths, implicitly demands a highly sensitive receiver, it was decided to not include a separate requirement on this parameter.

## E.2.2 Receiver co-channel rejection

Receiver co-channel rejection, (measure of the capability of a receiver to receive a wanted signal, without exceeding a given degradation, due to the presence of an unwanted signal, both signals being at the nominal frequency of the receiver, see ETSI EG 203 336 [i.22]), is an essential parameter in channelized spectrum to determine the spatial reuse of the same channel.

As explained in clause E.2.1, WIA equipment has to protect BFWA in the whole frequency range from 5 725 MHz to 5 875 MHz, and clause 4 includes DAA as the mitigation mechanism to ensure protection. Also co-channel interference will be avoided by the implemented DAA mechanism, as it forces WIA equipment to leave the channel if a signal beyond the threshold is detected. The generic DAA threshold given in clause 4.2.7.2.4 is ambitious and well beyond values which are common for the receiver co-channel rejection of SRDs comparable in operation frequency and bandwidth. This DAA requirement eliminates co-channel operation and therefore also the potential interference among equipment operating in the same frequency band.

Therefore, a separate requirement on receiver co-channel rejection was not included.

## E.2.3 Receiver adjacent signal selectivity

Receiver adjacent signal selectivity is the capability to receive a wanted signal, without exceeding a given degradation, due to the presence of an unwanted signal, which differs in frequency from the wanted signal by a specified amount, see ETSI EG 203 336 [i.22]. It has its roots in channelized systems operating in licensed bands such as cellular networks. As explained in clause E.1 above, the band 5 725 MHz to 5 875 MHz is a non-channelized SRD band resulting in WIA equipment and other SRDs using a wide variety of bandwidths or channels.

Receiver selectivity in general spans a range of frequencies covering both out-of-band signal and in-band sources and therefore it is generally important. Whereas In-band selectivity is not relevant for WIA equipment because of the reasons provided in clause E.1, Out-of-band selectivity is specified and verified as part of the Receiver Blocking requirement.

A separate requirement for receiver adjacent signal selectivity is therefore not required.

## E.2.4 Receiver spurious response rejection

A receiver spurious response is caused by an interfering signal at a specific discrete frequency offset from the victim wanted channel. Occurrence of spurious responses depend on receiver architecture, local oscillator frequencies and DSP design. The impact of spurious responses on receiver performance varies with the strength of the interfering signal: at high levels, this interference causes receiver blocking. The receiver blocking requirement has been designed to expose performance issues across a broader range of the frequency offsets resulting from the test frequencies defined. It specifies that the interference signal should be significantly higher than the wanted signal.

Therefore, the current receiver blocking test is a more stringent way to expose any inefficient use of spectrum resulting from poor receiver design.

## E.2.5 Receiver radio-frequency intermodulation response rejection

Receiver radio-frequency intermodulation response rejection is a measure of the capability of the receiver to receive a wanted modulated signal, without exceeding a given degradation due to the presence of two or more unwanted signals with a specific frequency relationship to the wanted signal frequency. This parameter is used in the planning of channelized systems operating in licensed bands and using a single technology which is often the case for cellular networks.

As explained in clause E.1 , the band 5 725 MHz to 5 875 MHz is a non-channelized SRD band resulting in WIA equipment and other SRDs using a wide variety of bandwidths or channels. It should further be noted that WIA equipment usually uses cyclic transmission, resulting in transmissions being intermittent on a particular frequency or combination of frequencies.

A separate requirement for receiver radio-frequency intermodulation response rejection is therefore not required.

---

## Annex F (informative): Bibliography

- ETSI TS 103 329: "Electromagnetic compatibility and Radio spectrum Matters (ERM); Wireless industrial automation; Radio equipment to be used in the 5,725 GHz to 5,875 GHz frequency range with power levels ranging up to 400 mW; TS on methods and concepts for a WIA system approach to sharing spectrum".

---

## Annex G (informative): Change History

Version	Information about changes
V1.1.1	First published version.

---

## History

<b>Document history</b>				
V1.0.6	January 2018	EN Approval Procedure	AP 20180418:	2018-01-18 to 2018-04-18
V1.0.8	January 2020	Vote	V 20200331:	2020-01-31 to 2020-03-31