



**Advanced Surface Movement Guidance
and Control System (A-SMGCS);
Part 6: Harmonised Standard covering the essential
requirements of article 3.2 of the Directive 2014/53/EU for
deployed surface movement radar sensors;
Sub-part 1: X-band sensors using pulsed signals and
transmitting power up to 100 kW**

Reference

REN/ERM-JTFEA-20

Keywords

aeronautical, ATM, interoperability, regulation

ETSI

650 Route des Lucioles
F-06921 Sophia Antipolis Cedex - FRANCE

Tel.: +33 4 92 94 42 00 Fax: +33 4 93 65 47 16

Siret N° 348 623 562 00017 - NAF 742 C
Association à but non lucratif enregistrée à la
Sous-Préfecture de Grasse (06) N° 7803/88

Important notice

The present document can be downloaded from:
<http://www.etsi.org/standards-search>

The present document may be made available in electronic versions and/or in print. The content of any electronic and/or print versions of the present document shall not be modified without the prior written authorization of ETSI. In case of any existing or perceived difference in contents between such versions and/or in print, the only prevailing document is the print of the Portable Document Format (PDF) version kept on a specific network drive within ETSI Secretariat.

Users of the present document should be aware that the document may be subject to revision or change of status. Information on the current status of this and other ETSI documents is available at
<https://portal.etsi.org/TB/ETSIDeliverableStatus.aspx>

If you find errors in the present document, please send your comment to one of the following services:
<https://portal.etsi.org/People/CommiteeSupportStaff.aspx>

Copyright Notification

No part may be reproduced or utilized in any form or by any means, electronic or mechanical, including photocopying and microfilm except as authorized by written permission of ETSI.

The content of the PDF version shall not be modified without the written authorization of ETSI.
The copyright and the foregoing restriction extend to reproduction in all media.

© European Telecommunications Standards Institute 2016.
All rights reserved.

DECT™, **PLUGTESTS™**, **UMTS™** and the ETSI logo are Trade Marks of ETSI registered for the benefit of its Members.
3GPP™ and **LTE™** are Trade Marks of ETSI registered for the benefit of its Members and of the 3GPP Organizational Partners.
GSM® and the GSM logo are Trade Marks registered and owned by the GSM Association.

Contents

| | |
|---|----|
| Intellectual Property Rights | 5 |
| Foreword..... | 5 |
| Modal verbs terminology..... | 6 |
| Executive Summary..... | 6 |
| 1 Scope | 7 |
| 2 References | 7 |
| 2.1 Normative references | 7 |
| 2.2 Informative references..... | 8 |
| 3 Definitions, symbols and abbreviations | 8 |
| 3.1 Definitions | 8 |
| 3.2 Symbols..... | 9 |
| 3.3 Abbreviations | 9 |
| 4 Technical requirements specifications | 10 |
| 4.1 Environmental profile..... | 10 |
| 4.2 Conformance requirements | 10 |
| 4.2.1 Transmitter requirements | 10 |
| 4.2.1.1 Operating frequency..... | 10 |
| 4.2.1.1.1 Definition..... | 10 |
| 4.2.1.1.2 Limits | 10 |
| 4.2.1.1.3 Conformance | 10 |
| 4.2.1.2 Transmitter power | 10 |
| 4.2.1.2.1 Definition..... | 10 |
| 4.2.1.2.2 Limits | 10 |
| 4.2.1.2.3 Conformance | 10 |
| 4.2.1.3 Out-of-band emissions | 11 |
| 4.2.1.3.1 Definition..... | 11 |
| 4.2.1.3.2 Limits | 12 |
| 4.2.1.3.3 Conformance | 13 |
| 4.2.1.4 Spurious emissions..... | 13 |
| 4.2.1.4.1 Definition..... | 13 |
| 4.2.1.4.2 Limits | 14 |
| 4.2.1.4.3 Conformance | 14 |
| 4.2.2 Receiver requirements | 14 |
| 4.2.2.1 Receiver Selectivity | 14 |
| 4.2.2.1.1 Limit | 14 |
| 4.2.2.1.2 Conformance | 15 |
| 5 Testing for compliance with technical requirements..... | 15 |
| 5.0 General requirements | 15 |
| 5.1 Environmental conditions for testing | 15 |
| 5.1.1 Introduction..... | 15 |
| 5.1.2 Standard operation mode for testing | 15 |
| 5.1.3 Normal temperature and humidity | 15 |
| 5.1.4 Normal test power supply | 15 |
| 5.2 Interpretation of the measurements results | 15 |
| 5.3 Radio test suites..... | 16 |
| 5.3.1 Transmitter test specification | 16 |
| 5.3.1.1 Operating frequency..... | 16 |
| 5.3.1.2 Transmitter power | 16 |
| 5.3.1.3 Out-of-Band-emissions | 17 |
| 5.3.1.4 Spurious emissions..... | 18 |
| 5.3.2 Receiver test specification | 19 |
| 5.3.2.1 Receiver Selectivity | 19 |
| 5.3.2.1.0 General | 19 |
| 5.3.2.1.1 Receiver Out-of-Band selectivity | 19 |

| | | |
|-------------------------------|---|-----------|
| 5.3.2.1.2 | Receiver spurious response rejection..... | 20 |
| Annex A (normative): | Relationship between the present document and the essential requirements of Directive 2014/53/EU | 21 |
| Annex B (normative): | Transmission power and unwanted emissions of radar systems with indirect methods..... | 22 |
| Annex C (informative): | Bibliography..... | 23 |
| History | | 24 |

Intellectual Property Rights

IPRs essential or potentially essential to the present document may have been declared to ETSI. The information pertaining to these essential IPRs, if any, is publicly available for **ETSI members and non-members**, and can be found in ETSI SR 000 314: "*Intellectual Property Rights (IPRs); Essential, or potentially Essential, IPRs notified to ETSI in respect of ETSI standards*", which is available from the ETSI Secretariat. Latest updates are available on the ETSI Web server (<https://ipr.etsi.org/>).

Pursuant to the ETSI IPR Policy, no investigation, including IPR searches, has been carried out by ETSI. No guarantee can be given as to the existence of other IPRs not referenced in ETSI SR 000 314 (or the updates on the ETSI Web server) which are, or may be, or may become, essential to the present document.

Foreword

This Harmonised European Standard (EN) has been produced by ETSI Technical Committee Electromagnetic compatibility and Radio spectrum Matters (ERM).

The present document has been prepared under the Commission's standardisation request C(2015) 5376 final [i.13] to provide one voluntary means of conforming to the essential requirements of Directive 2014/53/EU on the harmonisation of the laws of the Member States relating to the making available on the market of radio equipment and repealing Directive 1999/5/EC [i.1].

Once the present document is cited in the Official Journal of the European Union under that Directive, compliance with the normative clauses of the present document given in table A.1 confers, within the limits of the scope of the present document, a presumption of conformity with the corresponding essential requirements of that Directive, and associated EFTA regulations.

The present document is part 6, sub-part 1 of a multi-part deliverable covering Advanced Surface Movement Guidance and Control System (A-SMGCS), as identified below:

- Part 1: "Community Specification for application under the Single European Sky Interoperability Regulation EC 552/2004 for A-SMGCS Level 1 including external interfaces";
- Part 2: "Community Specification for application under the Single European Sky Interoperability Regulation EC 552/2004 for A-SMGCS Level 2 including external interfaces";
- Part 3: "Community Specification for application under the Single European Sky Interoperability Regulation EC 552/2004 for a deployed cooperative sensor including its interfaces";
- Part 4: "Community Specification for application under the Single European Sky Interoperability Regulation EC 552/2004 for a deployed non-cooperative sensor including its interfaces";
- Part 5: "Harmonised Standard covering the essential requirements of article 3.2 of the Directive 2014/53/EU for multilateration equipment";
- Part 6: "Harmonised Standard covering the essential requirements of article 3.2 of the Directive 2014/53/EU for deployed surface movement radar sensors";**

Sub-part 1: "X-band sensors using pulsed signals and transmitting power up to 100 kW".

NOTE: SMR systems using FM-CW signals may be covered by future sub-parts of this multi-part deliverable.

| National transposition dates | |
|--|------------------|
| Date of adoption of this EN: | 20 May 2016 |
| Date of latest announcement of this EN (doa): | 31 August 2016 |
| Date of latest publication of new National Standard or endorsement of this EN (dop/e): | 28 February 2017 |
| Date of withdrawal of any conflicting National Standard (dow): | 28 February 2018 |

Modal verbs terminology

In the present document "**shall**", "**shall not**", "**should**", "**should not**", "**may**", "**need not**", "**will**", "**will not**", "**can**" and "**cannot**" are to be interpreted as described in clause 3.2 of the [ETSI Drafting Rules](#) (Verbal forms for the expression of provisions).

"**must**" and "**must not**" are **NOT** allowed in ETSI deliverables except when used in direct citation.

Executive Summary

The present document covers the essential requirements for efficient use of radio spectrum by surface movement radar sensors in the bands 9 000 MHz to 9 200 MHz and 9 300 MHz to 9 500 MHz using pulsed signals and a transmitting power up to 100 kW. The current version includes necessary changes due to adaption to the new Radio Equipment Directive 2014/53/EU [i.1].

1 Scope

The present document applies to X-band radar sensors intended for the surveillance of airport surface movement traffic with the following characteristics:

- Operating in one or both of the following frequency ranges:
 - 9 000 MHz to 9 200 MHz and 9 300 MHz to 9 500 MHz utilizing modulated or unmodulated pulses.
- Transmitter Peak Envelope Power up to 100 kW.
- The transceiver-antenna connection is using a hollow metallic rectangular waveguide.
- The antenna is rotating, waveguide-based and passive.
- At the transceiver output an RF-circulator is used.

NOTE 1: Since transceiver and antenna are hollow metallic rectangular waveguide based the frequency range for measurements that needs to be addressed covers 6,56 GHz to 26 GHz. The lower limit of this frequency range is obtained as cut-off frequency of the combination of WR112/R84 taper section and a WR90/R100 Waveguide IEC 60153-2 [i.3]. The upper limit corresponds to the upper limit stated in ERC/Recommendation 74-01 [i.5].

NOTE 2: Since at the transceiver output an RF circulator is used, it is assumed that the transceiver characteristics remain independent from the antenna.

NOTE 3: Aeronautical Surface Movement Radars covered by the present document are expected to use the bands 9 000 MHz to 9 200 MHz and/or 9 300 MHz to 9 500 MHz. According article 5 of the ITU Radio Regulations [i.6] the band 9 000 MHz to 9 200 MHz is allocated to the Aeronautical Radionavigation Service on a primary basis and the band 9 300 MHz to 9 500 MHz is allocated to the Radionavigation Service on a primary basis.

The present document contains requirements to demonstrate that "*... Radio equipment shall be so constructed that it both effectively uses and supports the efficient use of radio spectrum in order to avoid harmful interference*" [i.1].

In addition to the present document, other ENs that specify technical requirements in respect of essential requirements under other parts of article 3 of the Radio Equipment Directive 2014/53/EU [i.1] as well as essential requirements under the SES Interoperability Regulation 552/2004 [i.9] and related implementing rules and/or essential requirements under the EASA basic regulation 216/2008 [i.12] may apply to equipment within the scope of the present document.

2 References

2.1 Normative references

References are either specific (identified by date of publication and/or edition number or version number) or non-specific. For specific references, only the cited version applies. For non-specific references, the latest version of the referenced document (including any amendments) applies.

Referenced documents which are not found to be publicly available in the expected location might be found at <http://docbox.etsi.org/Reference>.

NOTE: While any hyperlinks included in this clause were valid at the time of publication, ETSI cannot guarantee their long term validity.

The following referenced documents are necessary for the application of the present document.

Not applicable.

2.2 Informative references

References are either specific (identified by date of publication and/or edition number or version number) or non-specific. For specific references, only the cited version applies. For non-specific references, the latest version of the referenced document (including any amendments) applies.

NOTE: While any hyperlinks included in this clause were valid at the time of publication, ETSI cannot guarantee their long term validity.

The following referenced documents are not necessary for the application of the present document but they assist the user with regard to a particular subject area.

- [i.1] Directive 2014/53/EU of the European Parliament and of the Council of 16 April 2014 on the harmonisation of the laws of the Member States relating to the making available on the market of radio equipment and repealing Directive 1999/5/EC.
- [i.2] Merrill I. Skolnik: "Radar Handbook", 2nd Edition, McGraw Hill publications.
- [i.3] IEC 60153-2 (Edition 2.0, 1974): "Hollow metallic waveguides. Part 2: Relevant specifications for ordinary rectangular waveguides".
- [i.4] ECC/Recommendation (02)05 (2012): "Unwanted emissions".
- [i.5] ERC/Recommendation 74-01 (2011): "Unwanted emissions in the spurious domain".
- [i.6] ITU Radio Regulations (2012).
- [i.7] Recommendation ITU-R M.1177-4 (2011): "Techniques for measurement of unwanted emissions of radar systems".
- [i.8] Recommendation ITU-R SM.1541-5 (2013): "Unwanted emissions in the out-of-band domain".
- [i.9] EC Regulation No 552/2004 of the European Parliament and of the Council of 10 March 2004 on the interoperability of the European Air Traffic Management network (interoperability Regulation), OJ L 96, 31.03.2004, p. 26 as amended by Regulation (EC) No 1070/2009, OJ L 300, 14.11.2009, p. 34.
- [i.10] ETSI TR 100 028 (all parts) (V1.4.1): "Electromagnetic compatibility and Radio spectrum Matters (ERM); Uncertainties in the measurement of mobile radio equipment characteristics".
- [i.11] ETSI TR 100 028-2 (V1.4.1): "Electromagnetic compatibility and Radio spectrum Matters (ERM); Uncertainties in the measurement of mobile radio equipment characteristics; Part 2".
- [i.12] Regulation (EC) 216/2008 of the European Parliament and of the Council of 20 February 2008 on common rules in the field of civil aviation and establishing a European Aviation Safety Agency, and repealing Council Directive 91/670/EEC, Regulation (EC) No 1592/2002 and Directive 2004/36/EC.
- [i.13] Commission Implementing Decision C(2015) 5376 final of 4.8.2015 on a standardisation request to the European Committee for Electrotechnical Standardisation and to the European Telecommunications Standards Institute as regards radio equipment in support of Directive 2014/53/EU of the European Parliament and of the Council.

3 Definitions, symbols and abbreviations

3.1 Definitions

For the purposes of the present document, the following terms and definitions apply:

necessary bandwidth: width of the frequency band which is just sufficient to ensure the transmission of information at the rate and with the quality required under specified conditions for a given class of emission

NOTE: This definition is taken from ITU Radio Regulations [i.6].

occupied bandwidth: width of a frequency band such that, below the lower and above the upper frequency limits, the mean powers emitted are each equal to a specified percentage $\beta/2$ of the total mean power of a given emission

NOTE 1: This definition is taken from ITU Radio Regulations [i.6].

NOTE 2: Unless otherwise specified in an ITU-R Recommendation for the appropriate class of emission, the value of $\beta/2$ should be taken as 0,5 %.

peak envelope power: average power supplied to the antenna transmission line by a transmitter during one radio frequency cycle at the crest of the modulation envelope taken under normal operating conditions

NOTE: This definition is taken from ITU Radio Regulations [i.6].

pulse duration: time between the 50 % amplitude (voltage) points

pulse rise time: time taken for the leading edge of the pulse to increase from 10 % to 90 % of the maximum amplitude (voltage)

3.2 Symbols

For the purposes of the present document, the following symbols apply:

| | |
|----------------|---|
| B_{-40} | -40 dB bandwidth |
| B_C | Chirp bandwidth |
| B_N | Necessary bandwidth |
| B_{res} | 3 dB resolution bandwidth of transceiver |
| dB/dec | dB per decade |
| dB_{pp} | dB with respect to peak power |
| $D_{no\ spur}$ | Detectability Factor (function of PD & Pfa) |
| k | Boltzmann's constant |
| MDS | Minimum Detectable Signal |
| NF_{sys} | Noise Figure of the system |
| PD | Probability of detection |
| Pfa | Probability of false alarm |
| P_t | Pulse power of transmission |
| t | Time |
| t_p | Pulse duration |
| t_r | Pulse rise time |
| T_0 | Temperature in Kelvin |
| T_C | Chirp length in seconds |
| λ | Wavelength |

3.3 Abbreviations

For the purposes of the present document, the following abbreviations apply:

| | |
|---------|---|
| AC | Alternating Current |
| A-SMGCS | Advanced Surface Movement Guidance and Control System |
| EASA | European Aviation Safety Agency |
| FM | Frequency Modulation |
| FM-CW | Frequency Modulated Continuous Wave |
| LNA | Low Noise Amplifier |
| MDS | Minimum Detectable Signal |
| OoB | Out-of-Band |
| PEP | Peak Envelope Power |
| RF | Radio Frequency |
| SES | Single European Sky |
| SMR | Surface Movement Radar |

4 Technical requirements specifications

4.1 Environmental profile

The technical requirements of the present document apply under the environmental profile for operation of the equipment, which shall be declared by the supplier, but as a minimum, shall be that specified in the test conditions contained in the present document. The equipment shall comply with all the technical requirements of the present document at all times when operating within the boundary limits of the declared operational environmental profile.

4.2 Conformance requirements

4.2.1 Transmitter requirements

4.2.1.1 Operating frequency

4.2.1.1.1 Definition

The transmitter of a pulsed radar produces microwave pulses, which cause a broad frequency spectrum, depending on the pulse duration.

In the present document the operating frequency is considered to be the frequency of the microwave emission during the transmitting pulse and is represented by the spectral line of highest amplitude.

NOTE: It is only practicable to indicate an operating frequency for radars with unmodulated pulses. In this case a limit for the frequency tolerance is specified. For radars with modulated pulses such a limit is not applicable. In any case the occupied bandwidth is completely contained in the allocated frequency band(s).

4.2.1.1.2 Limits

The frequency tolerance for SMR applying unmodulated pulses shall be ± 30 MHz.

For all radar types covered by the present documents the occupied bandwidth of the signal shall be contained completely within the frequency ranges 9 000 MHz to 9 200 MHz or 9 300 MHz to 9 500 MHz in all operating modes.

4.2.1.1.3 Conformance

The conformance tests are specified in clause 5.3.1.1.

4.2.1.2 Transmitter power

4.2.1.2.1 Definition

In the present document the transmitter power of a pulse radar is considered to be the peak value of the transmitter pulse power during the transmission pulse (PEP).

If the transmitter power varies over the azimuth, the highest PEP over at least one rotation period has to be used.

The transmitter power shall be referenced with respect to the output port of the radar transmitter.

4.2.1.2.2 Limits

The transmitter power shall be as specified by the manufacturer with an accuracy of at least ± 1 dB. The peak power value shall not exceed 100 kW (50 dBW).

4.2.1.2.3 Conformance

The conformance tests are specified in clause 5.3.1.2.

4.2.1.3 Out-of-band emissions

4.2.1.3.1 Definition

An important parameter of the Out-of-Band (OoB) emissions mask of the radar is the -40 dB bandwidth. Annex 8 of Recommendation ITU-R SM.1541-5 [i.8] specifies the -40 dB bandwidth specified for various types of waveforms (e.g. pulsed radar signals). With the following assumptions which apply to most airport surface movement radars these specifications can be further simplified:

- the radar is operating in the bands 9 000 MHz to 9 200 MHz or 9 300 MHz to 9 500 MHz;
- the pulse power is below 100 kW;
- the pulse rise time t_r is greater than $0,0094 \cdot t$, where t is the pulse duration.

With the aforementioned assumptions the -40 dB bandwidth (B_{-40}) for primary non-FM pulse radars can be determined as follows:

$$B_{-40} = \frac{7.6}{\sqrt{t \times t_r}}$$

Where:

t is the pulse duration.

t_r is the rise time in the case of a trapezoidal pulse.

NOTE: For typical values of a pulse duration of $t = 50$ ns and a rise time of $t_r = 10$ ns the formula above yields a -40 dB bandwidth value of 340 MHz.

For radars with multiple pulse waveforms, the B_{-40} bandwidth should be calculated for each individual pulse type and the maximum B_{-40} bandwidth obtained shall be used to establish the shape of the emission mask.

For radars with a highly asymmetrical spectrum, the B_{-40} dB bandwidth can be offset from the frequency of maximum emission level, but the necessary bandwidth, B_N and preferably the overall occupied bandwidth should be contained completely within the allocated band as stipulated in section 4 of Annex 8 of Recommendation ITU-R SM.1541-5 [i.8].

The application of this rule is illustrated in figure 1.

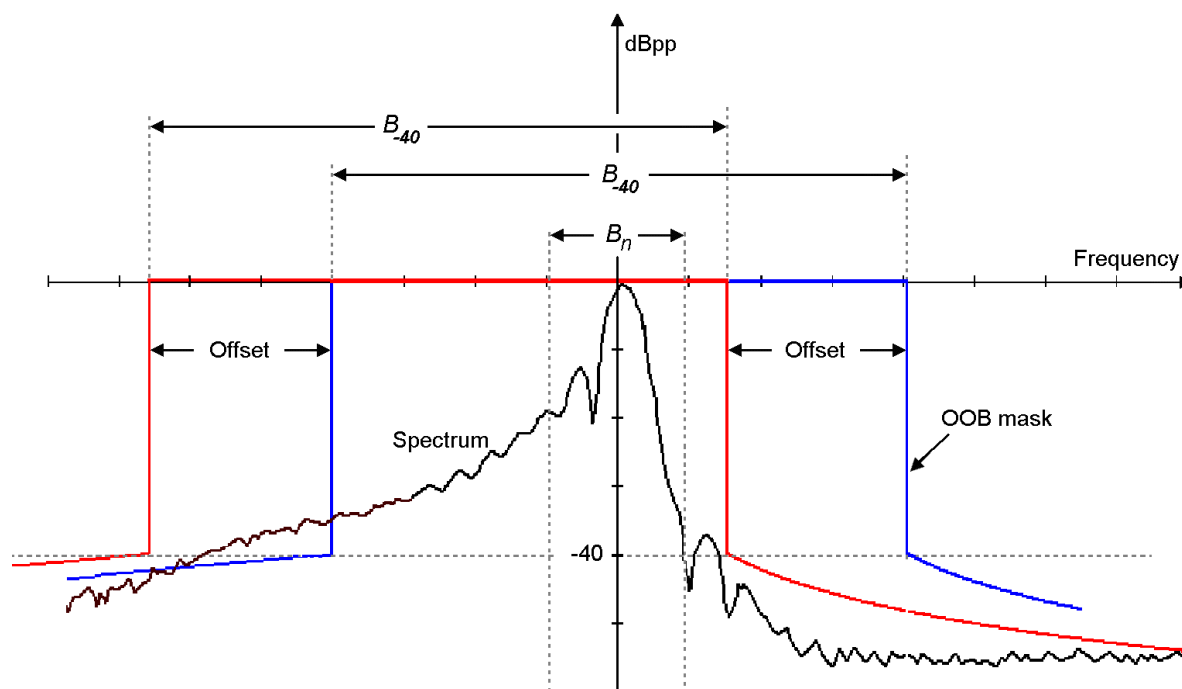

Figure 1: Application of the offset-rule for the Out-of-Band emission limit mask

The Out-of-Band emission limits and the spurious emission limits are defined based on the -40 dB bandwidth.

4.2.1.3.2 Limits

NOTE 1: In a future version of the present document more stringent requirements for OoB Emissions based on the design objective case in ECC/Recommendation (02)05 [i.4] (the solid line in figure A2.1c of [i.4] with a slope of 40 dB/decade) may need to be considered.

The maximum Out-of-Band emission power level shall not exceed the limits stated in table 1 and the corresponding mask depicted in figure 2. The roll-off of the OoB-mask beyond the -40 dB bandwidth, B_{-40} in relation to B_{-40} is specified as follows:

- The mask has a roll-off at -30 dB/dec from the calculated (identified) B_{-40} bandwidth to a level of -70 dBpp. The mask then continues to roll-off at 60 dB/dec to a spurious emission limit level of -100 dBpp.

NOTE 2: This mask corresponds to the limit specification in Annex 2 of i.e. the dashed line in figure A2.1c of ECC/Recommendation (02)05 [i.4].

- If an absolute limit of -30 dBm can be more easily achieved this limit applies instead of -100 dBpp.

NOTE 3: ERC/Recommendation 74-01 [i.5] stipulates in its table 1 for fixed radars a spurious emission limit in the reference bandwidth of "-30 dBm or 100 dB, whichever is less stringent".

Table 1: Limits for unwanted emissions

| Frequency offset relative to B_{-40} | Limit dBpp | Slope dB/decade |
|--|-----------------------|-----------------|
| 0 to 0,5 | 0 | 0 |
| 0,5 | -40 | $-\infty$ |
| 0,5 to 5 | -40 to -70 | -30 |
| 5 to 15,8 | -70 to -100 / -30 dBm | -60 |
| 15,8 to ∞ | -100 / -30 dBm | 0 |

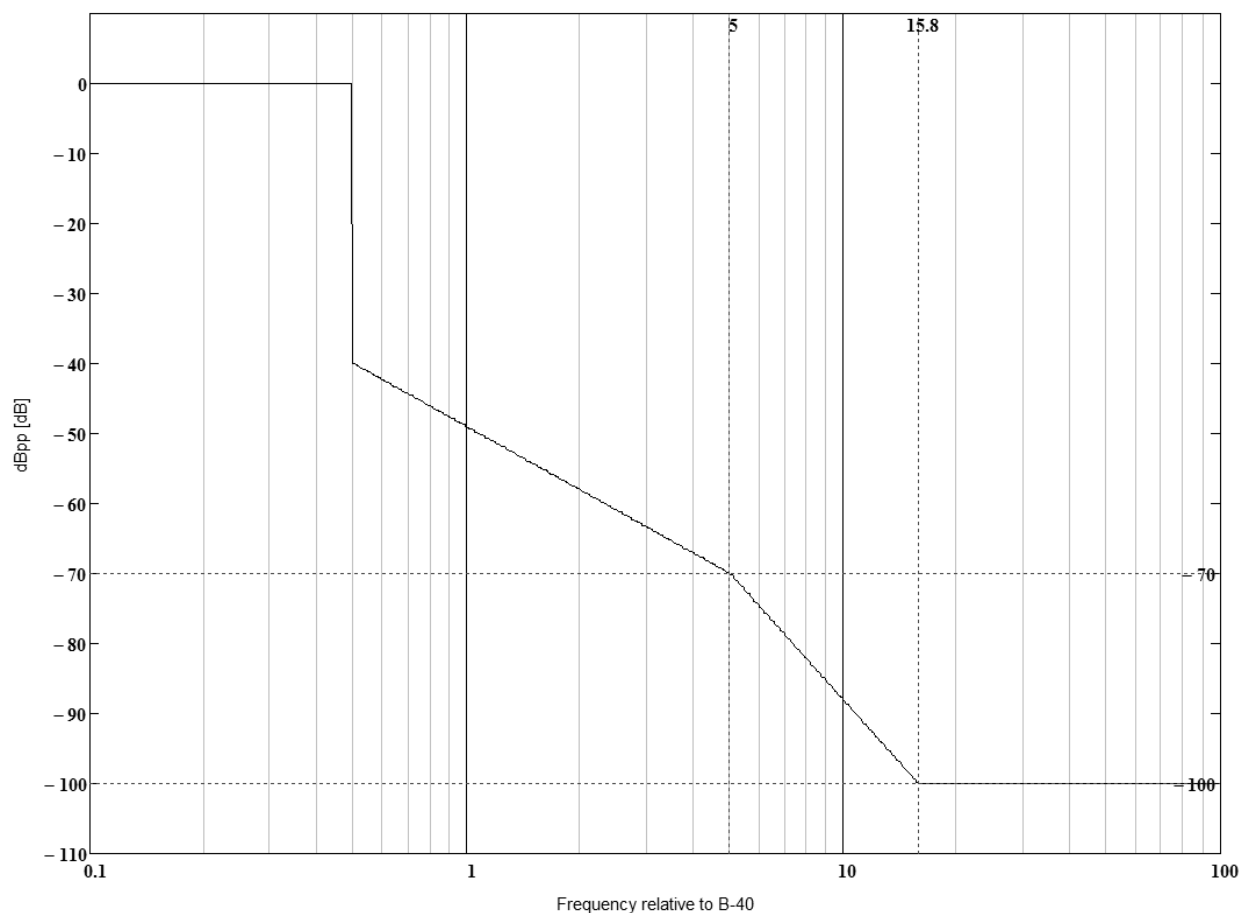

Figure 2: Out-of-Band emission limit masks

4.2.1.3.3 Conformance

The conformance tests are specified in clause 5.3.1.3.

4.2.1.4 Spurious emissions

4.2.1.4.1 Definition

Spurious emissions are defined as the entity of all emissions in the frequency range of the cut-off frequency 6,56 GHz of the waveguide section to 26 GHz, but outside the OoB-boundaries.

NOTE: The lower limit of this frequency range of 6,56 GHz is obtained as cut-off frequency of the combination of WR112/R84 taper section and a WR90/R100 Waveguide as defined in IEC 60153-2 [i.3]. The upper limit corresponds to the upper limit stated in ERC/Recommendation 74-01 [i.5].

They include:

- harmonic emissions (whole multiples of the operating frequency);
- parasitic emissions (independent, accidentally);
- intermodulation (between oscillator- and operation frequency or between oscillator and harmonics);
- emissions caused by frequency conversions.

The boundaries between OoB domain and the spurious domain are where the OoB limit mask specified in ECC/Recommendation (02)05 [i.4] reach the spurious emission limit of -100 dBpp according to ERC/Recommendation 74-01 [i.5]. This is illustrated in figure 3.

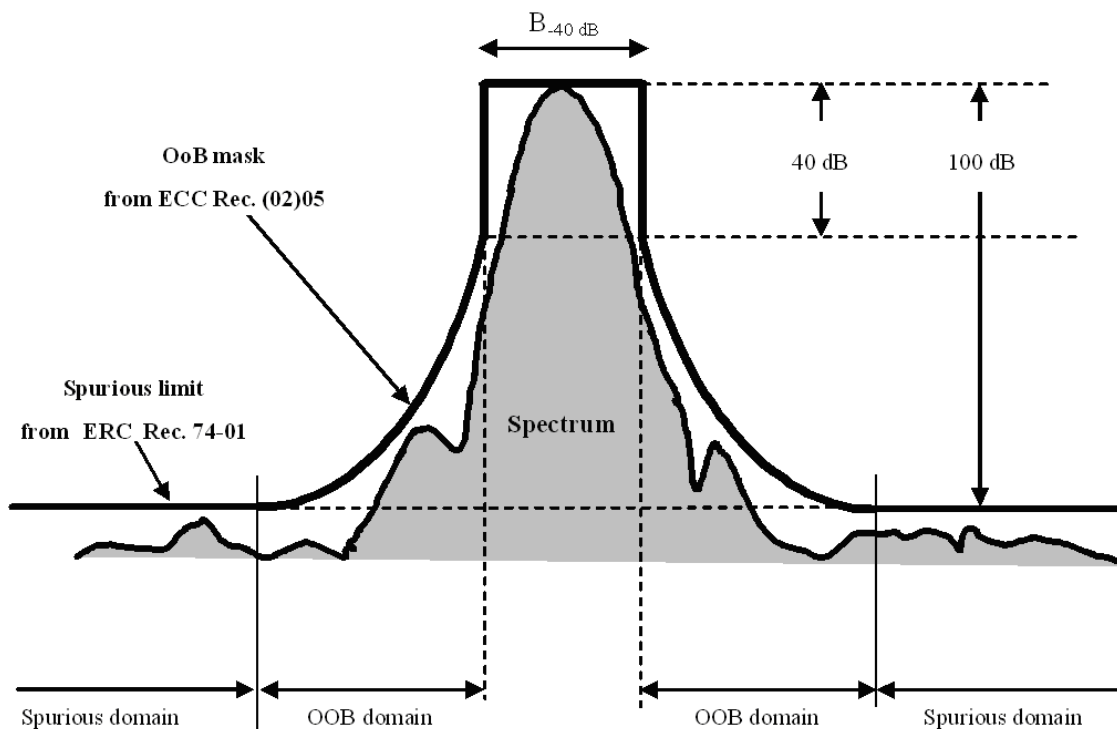

**Figure 3: Definition of OoB and spurious emission domains
(Not to scale)**

4.2.1.4.2 Limits

NOTE 1: In a future version of the present document more stringent requirements for OoB Emissions based on the design objective case in ECC/Recommendation (02)05 [i.4] (i.e. the solid line in figure A2.1c) of [i.4] with a slope of 40 dB/decade) may need to be considered.

For the spurious emissions the following requirement based on table 5.1 in annex 5 for the case of fixed stations in ERC/Recommendation 74-01 [i.5] shall apply:

- All spurious emission levels radar equipment shall have:
 - a minimum attenuation of 100 dB or a maximum power -30 dBm, whichever is less stringent;
 - measured as PEP in the reference bandwidth of 1 MHz.

NOTE 2: A reference bandwidth of 1 MHz is recommended for frequencies above 1 GHz as in ERC/Recommendation 74-01 [i.5].

NOTE 3: In the case of occurrence of interferences caused by unwanted emissions of the radar system much higher suppression of Out-of-Band or spurious emissions may be required. Therefore it is desirable that it is possible to attenuate or to suppress parts of the emitted signal in the feeder line.

4.2.1.4.3 Conformance

The conformance tests are specified in clause 5.3.1.4.

4.2.2 Receiver requirements

4.2.2.1 Receiver Selectivity

4.2.2.1.1 Limit

The input selectivity characteristic of the SMR receiver shall correspond to the requirements for the spectrum of the emitted signal as specified in clause 4.2.1.3. The derivation of the receiver Out-of-Band selectivity curve is described in clause 5.3.2.1.

4.2.2.1.2 Conformance

The conformance tests are specified in clause 5.3.2.1.

5 Testing for compliance with technical requirements

5.0 General requirements

For the purpose of the compliance tests described in the present document, the radar under test shall be set up in a realistic operation mode. This means that the transceiver shall be operating and set-up with parameters which produce the worst-case spectrum (e.g. shortest pulse length, highest peak frequency deviation). Furthermore, the radar shall be supplied with the necessary signals (e.g. antenna azimuth encoder signal, safety loop signals) to simulate normal operation.

NOTE: The standard operating parameters depend very much on the type of the radar.

5.1 Environmental conditions for testing

5.1.1 Introduction

Unless otherwise stated, all tests shall take place under the following normal test conditions.

5.1.2 Standard operation mode for testing

During the tests the radar equipment shall be operated in the standard operation mode. This means that the transceiver shall be operating and set-up with parameters which produce the worst-case spectrum i.e. with shortest pulse length and highest peak frequency deviation. Furthermore, the radar shall be supplied with the necessary signals i.e. antenna azimuth encoder signal and safety loop signals to simulate normal operation.

NOTE: The standard operating parameters depend very much on the type of the radar.

5.1.3 Normal temperature and humidity

The temperature and humidity conditions for tests shall be a combination of temperature and humidity within the following ranges:

- a) temperature: +15 °C to +35 °C;
- b) relative humidity: 20 % to 75 %.

When the relative humidity is lower than 20 %, it shall be stated in the test report.

5.1.4 Normal test power supply

The test voltage for equipment to be connected to an AC supply shall be the nominal mains voltage declared by the manufacturer -10 % to +10 %. For the purpose of the present document, the nominal voltage shall be the declared voltage or each of the declared voltages for which the equipment is indicated as having been designed. The frequency of the test voltage shall be 50 Hz \pm 1 Hz.

5.2 Interpretation of the measurements results

The interpretation of the results recorded in a test report for the measurements described in the present document shall be as follows:

- the measured value related to the corresponding limit will be used to decide whether an equipment meets the requirements of the present document;
- the value of the measurement uncertainty for the measurement of each parameter shall be included in the test report;

- the recorded value of the measurement uncertainty shall be, for each measurement, equal to or lower than the figures in table 2.

For the test methods, according to the present document, the measurement uncertainty figures shall be calculated and shall correspond to an expansion factor (coverage factor) $k = 1,96$ or $k = 2$ (which provide confidence levels of respectively 95 % and 95,45 % in the case where the distributions characterizing the actual measurement uncertainties are normal (Gaussian)). Principles for the calculation of measurement uncertainty are contained in ETSI TR 100 028 [i.10], in particular in annex D of the ETSI TR 100 028-2 [i.11].

Table 2 is based on such expansion factors.

Table 2: Maximum measurement uncertainty

| Parameter | Uncertainty |
|---------------------------------|------------------------|
| Transmitter measurements | |
| Operating frequency | $\pm 1 \times 10^{-5}$ |
| Transmitter power | $\pm 1,5$ dB |
| Out-of-Band emissions | ± 4 dB |
| Spurious emissions | ± 4 dB |
| Receiver measurements | |
| Receiver Selectivity | ± 4 dB |

5.3 Radio test suites

5.3.1 Transmitter test specification

5.3.1.1 Operating frequency

The antenna shall be replaced by a suitable adapter to adapt the rotary joint to a waveguide with a plane flange. On that flange a high-power directional coupler will be mounted with its main port terminated by a matching high-power dummy load. The coupled port shall have an adequate attenuation within the whole frequency band 8 600 MHz to 9 900 MHz (400 MHz outside edges of allocated bands) to protect the measurement equipment.

To measure and display the spectrum of the transmitted signal a suitable spectrum analyser shall be used. The acquisition time for the spectrum shall be at least 60 seconds. The spectrum shall be measured in the maximum hold mode of the spectrum analyzer. In this way the deviation of the emission peak frequency from the specified frequency is measured.

The results obtained shall be compared to the limits in clause 4.2.1.1.2 in order to prove compliance with the requirement.

To measure the frequency stability a spectrum analyzer with a frequency stability of equal or better than 10^{-5} (see table 2) is connected to the SMR transmitter via suitable couplers.

5.3.1.2 Transmitter power

The antenna shall be replaced by a suitable adapter to adapt the rotary joint to a waveguide with a plane flange. On that flange a high-power directional coupler will be mounted with its main port terminated by a matching high-power dummy load. The coupled port shall have a sufficient attenuation within the whole frequency band 8 600 MHz to 9 900 MHz to avoid saturation of the measurement equipment. The coupling factor shall be known in the allocated band with the necessary accuracy to achieve the required transmitter power accuracy of $\pm 0,5$ dB (see table 2).

To determine the Peak Envelope Power of the pulse a suitable pulse power meter with direct reading of the transmitter pulse power shall be used.

To reference the indicated transmitter power to the transmitter output flange the coupling factor has to be taken into account.

NOTE: Either the power meter allows already for compensation of the coupling loss, or the coupling loss has to be added to the meter reading.

The results obtained shall be compared to the limits in clause 4.2.1.2.2 in order to prove compliance with the requirement.

5.3.1.3 Out-of-Band-emissions

The so-called indirect method shall be applied for the measurement of unwanted emissions of radar systems. At first the transmitter output spectrum is measured with removed antenna at the output port of the transmitter as illustrated in figure B.1.

NOTE 1: To obtain a sufficient dynamic range the radar signal need to be suppressed by an additional notch-filter.

Further information how to perform the measurement can be found in Recommendation ITU-R M.1177-4 [i.7]. The Out-of-Band power emission shall be measured in the frequency bands given in table 3. The results obtained shall be compared to the limits in clause 4.2.1.3.2 and depicted in figure 2 in order to prove compliance with the requirement.

NOTE 2: These OoB-boundaries are taken from ECC/Recommendation (02)05 [i.4].

Table 3: Out-of-Band emissions boundaries

| Lower OoB boundary | Upper OoB boundary |
|-----------------------------------|------------------------------------|
| Carrier frequency -15,8 B_{-40} | Carrier frequency + 15,8 B_{-40} |

NOTE 3: Typical SMR parameters are e.g. a centre frequency of 9,1 GHz, a pulse duration of $t = 50$ ns and a rise time of $t_r = 10$ ns, the 40 dB bandwidth calculated applying the equation from clause 4.2.1.1.1 is 340 MHz. This leads to OoB boundaries at $15,8 \times 340$ MHz = 5,372 GHz away from the centre frequency (figure 4). For this example the absolute boundaries between out-of-band emission and spurious emission are: 9,1 GHz - 5,372 GHz = 3,728 GHz and 9,1 GHz + 5,372 GHz = 14,472 GHz (see figure 5 below).

Figures 4 and 5 depict the calculated emission masks for the aforementioned parameters of a typical SMR applying the mask specification in clause 4.2.1.3 which is corresponding to the standard mask in figure A2.1c of ECC/Recommendation (02)05 [i.4].

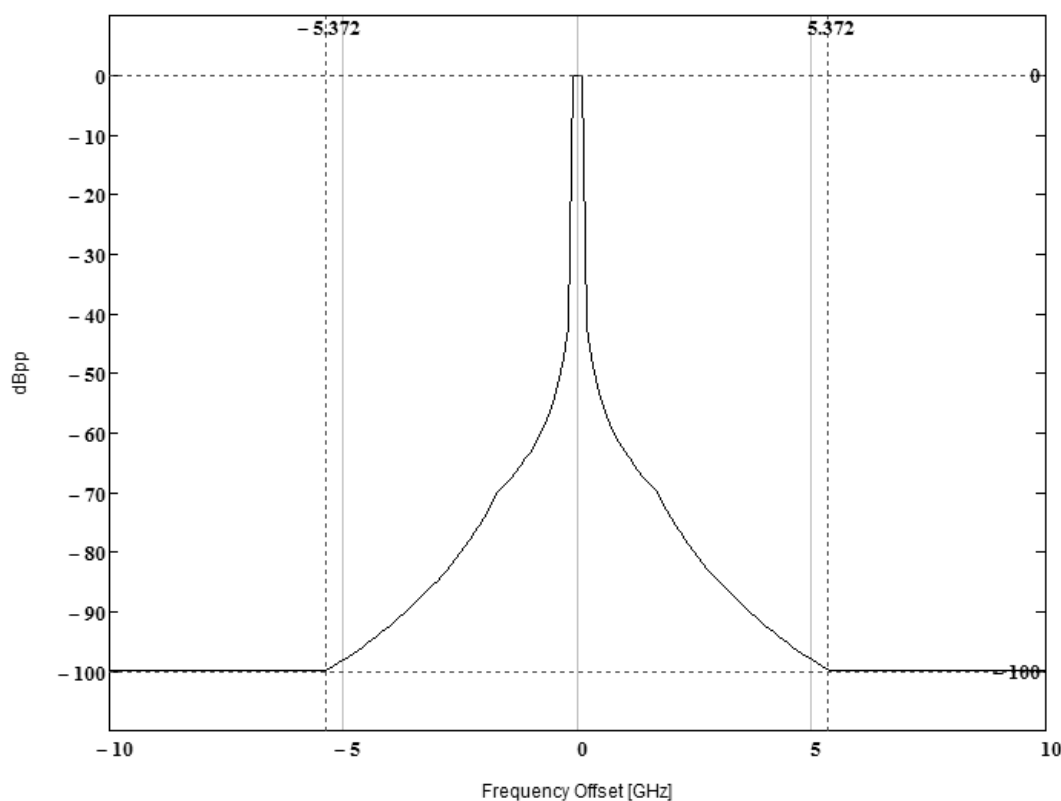

Figure 4: Theoretical emissions mask for typical pulse duration of $t = 50$ ns and rise time of $t_r = 10$ ns

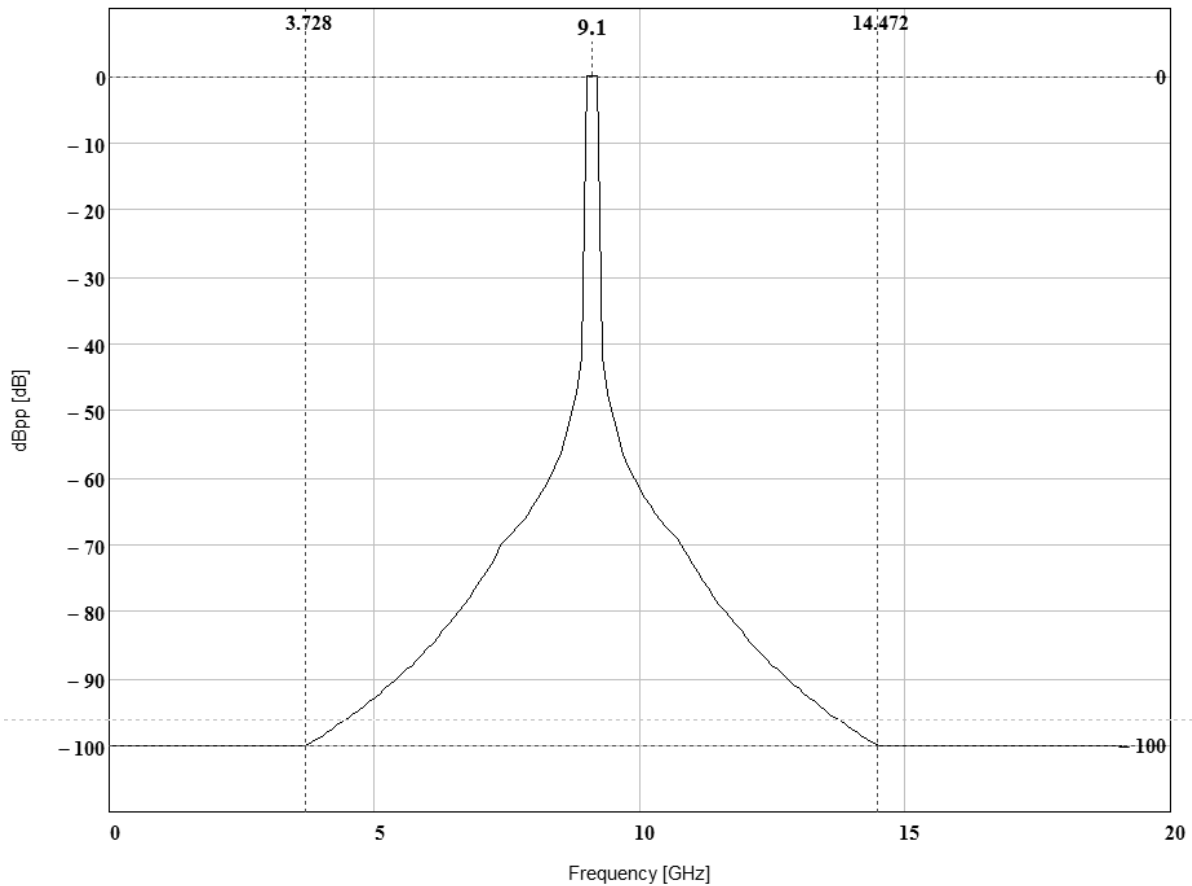

Figure 5: Calculated emissions mask for pulse duration of $t = 50$ ns and rise time of $t_r = 10$ ns at centre frequency of 9,1 GHz

5.3.1.4 Spurious emissions

For the spurious emission measurements the aforementioned indirect method shall be used. To perform the measurement the radar and the measuring equipment shall be installed as displayed in figure B.1. The spurious power emission shall be measured in frequency ranges outside the Out-of-Band emissions boundaries.

If required to reach a dynamic amplitude measuring range of 110 dB minimum, a Low Noise Amplifier (LNA), and a notch filter for the operating frequency should be used.

The results obtained shall be compared to the limits in clause 4.2.1.4.2 in order to prove compliance with the requirement.

Table 4: Spurious emissions measurement bands

| Lower measurement band | Upper measurement band |
|--|--|
| From 6,56 GHz to the lower OoB boundary | From the upper OoB boundary to 26 GHz |

5.3.2 Receiver test specification

5.3.2.1 Receiver Selectivity

5.3.2.1.0 General

Compliance is tested by calculating the minimum detectable signal (MDS) level of the receiver at the transmission frequency:

$$MDS = kT_0 B_{res} NF_{sys} D_{nospur} \frac{1}{T_C B_C} M$$

Where:

| | |
|----------------|---|
| MDS | Minimum Detectable Signal |
| k | Boltzmann constant |
| T_0 | Temperature in Kelvin |
| B_{res} | 3 dB resolution bandwidth of transceiver |
| NF_{sys} | Noise Figure of the system |
| $D_{no\ spur}$ | Detectability Factor (function of P_D & P_{fa}) = 0,1 |
| NOTE: | The value of 0,1 for $D_{no\ spur}$ is taken from figure 2.3 of "Radar Handbook" [i.2]. |
| P_D | Probability of detection = 10^{-3} (selected value) |
| P_{fa} | Probability of false detection = 10^{-3} (selected value) |
| T_C | Chirp length in seconds |
| B_C | Chirp bandwidth |
| M | Test margin = 0,1 (Without this margin the receiver should give a detectable signal) |

The factor $1/(T_C B_C) = 1$ is applicable for a simple pulse radar.

5.3.2.1.1 Receiver Out-of-Band selectivity

In order to determine if the receiver selectivity follows the required emission mask, a disturbance signal level at MDS level plus the required attenuation shall be applied at the antenna flange.

EXAMPLE: A typical power level, which is to be applied at the end points of B_{-40} is MDS + 40 dB. In such a case a maximum disturbance signal strength of -30 dBm is used in order to simulate another transmitter's spurious level transmissions.

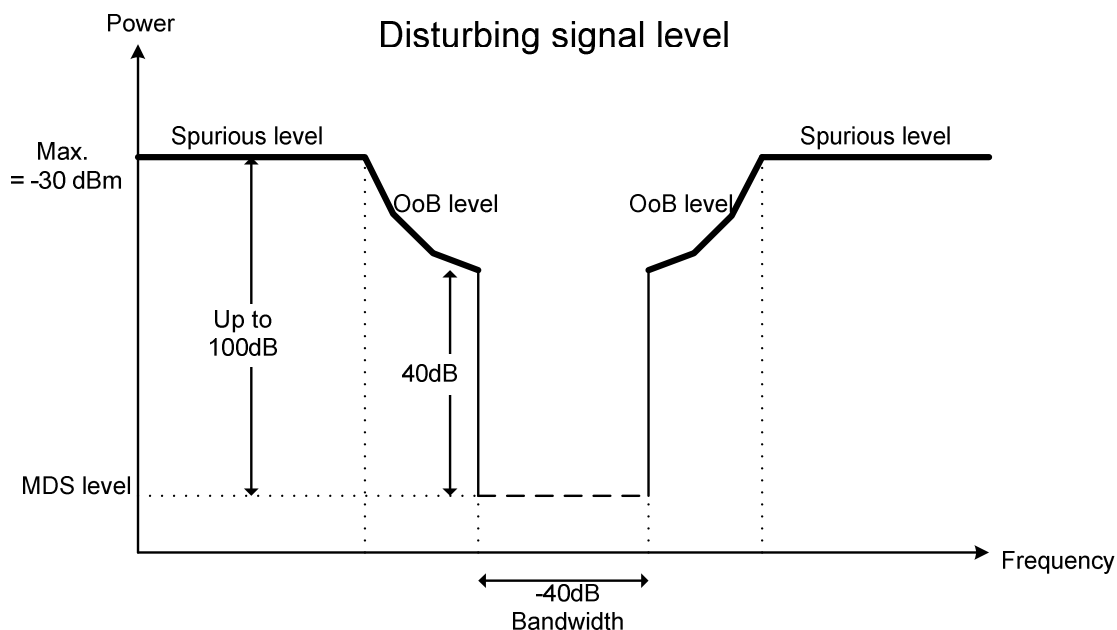

Figure 6: Receiver selectivity mask

The disturbance signal shall be a sinusoidal pulsed signal with pulse duration of 100 ns and a pulse repetition frequency of 1 kHz. The receiver selectivity curve shall be then checked beginning from the borders of B_{-40} at a number of test points over the Out-of-Band frequency span - each with a disturbance signal level of MDS plus the Out-of-Band level of the emission mask. This is illustrated in figure 6.

The radar video does not have to show any "targets" at any of the measurement points. The radar transceiver is setup in normal operating mode during the test.

5.3.2.1.2 Receiver spurious response rejection

The frequency band in which the spurious response shall be checked is the part of the transmission band of the waveguide which is outside the Out-of-Band frequency range.

A test signal with the following characteristics shall be applied:

Sinusoidal pulsed signal with a pulse duration of 100 ns and a pulse repetition frequency of 1 kHz, no modulation, signal amplitude MDS + spurious level of emission mask.

The radar transceiver is setup in normal operating mode during the test.

Due to the spurious signals, the radar video does not have to show any "targets" at any of the measurement points.

In the test setup a WR112/R84 Waveguide taper section shall be connected to the regular WR90/R100 Waveguide.

NOTE: In this way the measurement setup is able to cover the cut-off frequency, otherwise the measurement setup will itself be "blind" near the cut-off frequency. With the taper section the cut-off is lowered to 6,56 GHz.

Annex A (normative): Relationship between the present document and the essential requirements of Directive 2014/53/EU

The present document has been prepared under the Commission's standardisation request C(2015) 5376 final [i.13] to provide one voluntary means of conforming to the essential requirements of Directive 2014/53/EU on the harmonisation of the laws of the Member States relating to the making available on the market of radio equipment and repealing Directive 1999/5/EC [i.1].

Once the present document is cited in the Official Journal of the European Union under that Directive, compliance with the normative clauses of the present document given in table A.1 confers, within the limits of the scope of the present document, a presumption of conformity with the corresponding essential requirements of that Directive, and associated EFTA regulations.

Table A.1: Relationship between the present document and the essential requirements of Directive 2014/53/EU

| Harmonised Standard ETSI EN 303 213-6-1 | | | | |
|--|-----------------------|-----------------------------|-----------------------------------|------------------|
| The following requirements are relevant to the presumption of conformity under the article 3.2 of Directive 2014/53/EU [i.1] | | | | |
| Requirement | | | Requirement Conditionality | |
| No | Description | Reference: Clause No | U/C | Condition |
| 1 | Operating frequency | 4.2.1.1 | U | |
| 2 | Transmitter power | 4.2.1.2 | U | |
| 3 | Out-of-Band emissions | 4.2.1.3 | U | |
| 4 | Spurious emissions | 4.2.1.4 | U | |
| 5 | Receiver Selectivity | 4.2.2.1 | U | |

Key to columns:

Requirement:

- No** A unique identifier for one row of the table which may be used to identify a requirement.
- Description** A textual reference to the requirement.
- Clause Number** Identification of clause(s) defining the requirement in the present document unless another document is referenced explicitly.

Requirement Conditionality:

- U/C** Indicates whether the requirement shall be unconditionally applicable (U) or is conditional upon the manufacturers claimed functionality of the equipment (C).
- Condition** Explains the conditions when the requirement shall or shall not be applicable for a requirement which is classified "conditional".

Presumption of conformity stays valid only as long as a reference to the present document is maintained in the list published in the Official Journal of the European Union. Users of the present document should consult frequently the latest list published in the Official Journal of the European Union.

Other Union legislation may be applicable to the product(s) falling within the scope of the present document.

Annex B (normative): Transmission power and unwanted emissions of radar systems with indirect methods

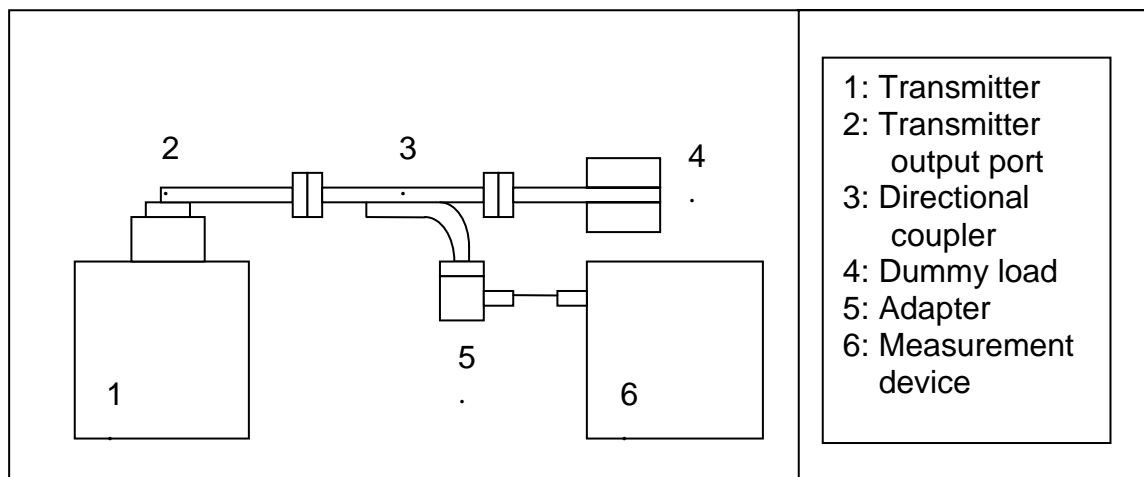

Figure B.1: Indirect method for radio frequency measurements with dismounted antenna

The method for measurement of the operation frequency, transmit power as well as out-of-band and spurious emission shown in figure B.1 shall be applied.

Annex C (informative): Bibliography

Recommendation ITU-R SM.328-11: "Spectra and bandwidth of emissions".

Recommendation ITU-R SM.329-12: "Unwanted emissions in the spurious domain".

ETSI TR 102 273 (2001): "Electromagnetic compatibility and Radio spectrum Matters (ERM); Improvement on Radiated Methods of Measurement (using test site) and evaluation of the corresponding measurement uncertainties".

ANSI C63.5 (2006): "American National Standard for Calibration of Antennas Used for Radiated Emission Measurements in Electro Magnetic Interference".

History

| Document history | | |
|------------------|----------------|---|
| V1.1.1 | September 2011 | Publication |
| V1.2.1 | November 2013 | Publication |
| V2.1.0 | August 2015 | EN Approval Procedure AP 20151205: 2015-08-07 to 2015-12-07 |
| V2.1.0 | March 2016 | Vote V 20160520: 2016-03-21 to 2016-05-20 |
| V2.1.1 | May 2016 | Publication |