



**Fixed Short Range Devices (SRD) in data networks;  
Radio equipment to be used in the 870 MHz to 876 MHz  
frequency range with power levels  
ranging up to 500 mW e.r.p.;**  
**Harmonised Standard for access to the radio spectrum**

---

**Reference**

REN/ERM-TG28-555

---

**Keywords**

harmonised standard, radio, SRD, testing

**ETSI**

---

650 Route des Lucioles  
F-06921 Sophia Antipolis Cedex - FRANCE

Tel.: +33 4 92 94 42 00 Fax: +33 4 93 65 47 16

Siret N° 348 623 562 00017 - NAF 742 C  
Association à but non lucratif enregistrée à la  
Sous-Préfecture de Grasse (06) N° 7803/88

---

**Important notice**

The present document can be downloaded from:

<http://www.etsi.org/standards-search>

The present document may be made available in electronic versions and/or in print. The content of any electronic and/or print versions of the present document shall not be modified without the prior written authorization of ETSI. In case of any existing or perceived difference in contents between such versions and/or in print, the prevailing version of an ETSI deliverable is the one made publicly available in PDF format at [www.etsi.org/deliver](http://www.etsi.org/deliver).

Users of the present document should be aware that the document may be subject to revision or change of status.

Information on the current status of this and other ETSI documents is available at

<https://portal.etsi.org/TB/ETSIDeliverableStatus.aspx>

If you find errors in the present document, please send your comment to one of the following services:

<https://portal.etsi.org/People/CommitteeSupportStaff.aspx>

---

**Copyright Notification**

No part may be reproduced or utilized in any form or by any means, electronic or mechanical, including photocopying and microfilm except as authorized by written permission of ETSI.

The content of the PDF version shall not be modified without the written authorization of ETSI.

The copyright and the foregoing restriction extend to reproduction in all media.

© ETSI 2020.

All rights reserved.

**DECT™**, **PLUGTESTS™**, **UMTS™** and the ETSI logo are trademarks of ETSI registered for the benefit of its Members.

**3GPP™** and **LTE™** are trademarks of ETSI registered for the benefit of its Members and of the 3GPP Organizational Partners.

**oneM2M™** logo is a trademark of ETSI registered for the benefit of its Members and of the oneM2M Partners.

**GSM®** and the GSM logo are trademarks registered and owned by the GSM Association.

# Contents

Intellectual Property Rights .....	14
Foreword.....	14
Modal verbs terminology.....	14
Introduction .....	15
1 Scope .....	19
2 References .....	20
2.1 Normative references .....	20
2.2 Informative references.....	20
3 Definition of terms, symbols and abbreviations.....	21
3.1 Terms.....	21
3.2 Symbols.....	23
3.3 Abbreviations .....	23
4 Technical requirements specifications .....	24
4.1 Environmental profile.....	24
4.2 Conformance requirements .....	24
4.2.1 General requirements .....	24
4.2.2 Performance criteria.....	24
4.2.3 Signal threshold .....	25
4.2.4 Disregard time .....	25
4.2.5 Transmission bandwidth .....	25
4.2.6 Fixed frequency operating .....	25
4.3 Requirements for transmitters .....	25
4.3.1 Frequency drift.....	25
4.3.1.1 Applicability.....	25
4.3.1.2 Description .....	25
4.3.1.3 Limits .....	25
4.3.1.4 Conformance .....	26
4.3.2 Operating frequencies and channel spacing.....	26
4.3.2.1 Applicability.....	26
4.3.2.2 Description.....	26
4.3.2.3 Limits .....	26
4.3.2.4 Conformance.....	27
4.3.3 Effective radiated power .....	27
4.3.3.1 Applicability.....	27
4.3.3.2 Description .....	27
4.3.3.3 Limits .....	27
4.3.3.4 Conformance.....	27
4.3.4 Transient power .....	28
4.3.4.1 Applicability.....	28
4.3.4.2 Description .....	28
4.3.4.3 Limits .....	28
4.3.4.4 Conformance.....	28
4.3.5 Occupied bandwidth .....	28
4.3.5.1 Applicability.....	28
4.3.5.2 Description .....	28
4.3.5.3 Limits .....	28
4.3.5.4 Conformance.....	29
4.3.6 Unwanted emissions in the out-of-band domain.....	29
4.3.6.1 Applicability.....	29
4.3.6.2 Description .....	29
4.3.6.3 Limits .....	30
4.3.6.4 Conformance.....	30
4.3.7 Unwanted emissions in the spurious domain .....	30
4.3.7.1 Applicability.....	30

4.3.7.2	Description .....	31
4.3.7.3	Limits .....	31
4.3.7.4	Conformance .....	31
4.3.8	Frequency stability under low-voltage conditions .....	31
4.3.8.1	Applicability .....	31
4.3.8.2	Description .....	31
4.3.8.3	Limits .....	32
4.3.8.4	Conformance .....	32
4.3.9	Duty cycle and transmission timing .....	32
4.3.9.1	Applicability .....	32
4.3.9.2	Description .....	32
4.3.9.3	Long term behaviour .....	32
4.3.9.4	Short term behaviour .....	33
4.3.9.5	Limits .....	33
4.3.9.6	Conformance .....	33
4.3.10	Automatic/adaptive power control .....	33
4.3.10.1	Applicability .....	33
4.3.10.2	Description .....	33
4.3.10.3	Limits .....	34
4.3.10.4	Conformance .....	34
4.4	Requirements for receivers .....	34
4.4.1	Receiver sensitivity .....	34
4.4.1.1	Applicability .....	34
4.4.1.2	Description .....	34
4.4.1.3	Limits .....	34
4.4.1.4	Conformance .....	34
4.4.2	Receiver maximum input signal level .....	34
4.4.2.1	Applicability .....	34
4.4.2.2	Description .....	35
4.4.2.3	Limits .....	35
4.4.2.4	Conformance .....	35
4.4.3	Clear channel assessment threshold .....	35
4.4.3.1	Applicability .....	35
4.4.3.2	Description .....	35
4.4.3.3	Limits .....	35
4.4.3.4	Conformance .....	35
4.4.4	Co-channel rejection .....	35
4.4.4.1	Applicability .....	35
4.4.4.2	Description .....	35
4.4.4.3	Limits .....	36
4.4.4.4	Conformance .....	36
4.4.5	Adjacent channel selectivity .....	36
4.4.5.1	Applicability .....	36
4.4.5.2	Description .....	36
4.4.5.3	Limits .....	36
4.4.5.4	Conformance .....	36
4.4.6	Blocking .....	36
4.4.6.1	Applicability .....	36
4.4.6.2	Description .....	36
4.4.6.3	Limits .....	37
4.4.6.4	Conformance .....	37
4.4.7	Receiver spurious response rejection .....	37
4.4.7.1	Applicability .....	37
4.4.7.2	Description .....	37
4.4.7.3	Limits .....	37
4.4.7.4	Conformance .....	37
4.4.8	Receiver intermodulation rejection .....	37
4.4.8.1	Applicability .....	37
4.4.8.2	Description .....	37
4.4.8.3	Limits .....	38
4.4.8.4	Conformance .....	38
4.4.9	Receiver spurious emissions .....	38

4.4.9.1	Applicability.....	38
4.4.9.2	Description.....	38
4.4.9.3	Limits.....	38
4.4.9.4	Conformance.....	38
4.5	Requirements for polite spectrum access.....	38
4.5.1	Listen before talk.....	38
4.5.1.1	Applicability.....	38
4.5.1.2	Description.....	38
4.5.1.3	Limits.....	39
4.5.1.4	Conformance.....	39
4.5.2	Short control signalling transmissions.....	39
4.5.2.1	Applicability.....	39
4.5.2.2	Description.....	39
4.5.2.3	Limits.....	40
4.5.2.4	Conformance.....	41
4.6	Functional requirements.....	41
4.6.1	General considerations.....	41
4.6.2	Network access point.....	41
4.6.2.1	Applicability.....	41
4.6.2.2	Description.....	41
4.6.2.3	Limits.....	41
4.6.2.4	Conformance.....	41
5	Testing for compliance with technical requirements.....	42
5.1	Environmental conditions for testing.....	42
5.2	General conditions for testing.....	42
5.2.1	General considerations.....	42
5.2.2	Presentation of equipment for testing purposes.....	42
5.2.2.1	General Considerations.....	42
5.2.2.2	Choice of model for testing.....	42
5.2.2.2.1	General considerations.....	42
5.2.2.2.2	EUT with an external RF connector.....	42
5.2.2.2.3	EUT without an external RF connector.....	43
5.2.2.3	Testing of modular equipment.....	43
5.2.2.4	Transmitter shut-off facility.....	43
5.2.2.5	Battery saving circuit.....	43
5.2.2.6	Test power source.....	44
5.2.2.6.1	General considerations.....	44
5.2.2.6.2	External test power source.....	44
5.2.2.6.3	Internal test power source.....	44
5.2.3	Normal and extreme test conditions.....	44
5.2.3.1	Normal temperature and humidity.....	44
5.2.3.2	Extreme temperatures.....	44
5.2.3.2.1	Procedure for tests at extreme temperatures.....	44
5.2.3.2.2	Procedure for equipment designed for continuous operation.....	45
5.2.3.2.3	Procedure for equipment designed for intermittent operation.....	45
5.2.3.2.4	Extreme temperature ranges.....	45
5.2.3.3	Normal test power source.....	45
5.2.3.3.1	Mains voltage.....	45
5.2.3.3.2	Regulated lead-acid battery power sources.....	45
5.2.3.3.3	Other power sources.....	45
5.2.3.4	Extreme test source voltages.....	46
5.2.3.4.1	Mains voltage.....	46
5.2.3.4.2	Regulated lead-acid battery power sources.....	46
5.2.3.4.3	Power sources using other types of batteries.....	46
5.2.3.4.4	Other power sources.....	46
5.2.4	Conducted measurements.....	46
5.2.4.1	Artificial antenna.....	46
5.2.4.2	Voltage Standing Wave Ratio (VSWR).....	46
5.2.5	Radiated measurements.....	46
5.2.6	Measuring receiver.....	47
5.2.6.1	General considerations.....	47

5.2.6.2	Reference Bandwidth .....	47
5.2.7	Transmitter test signals .....	47
5.2.8	Applicable measurement methods .....	48
5.2.9	Modes of operation .....	49
5.2.9.1	Test mode .....	49
5.2.9.2	Transmitter operation .....	49
5.2.9.3	Testing of multi-frequency or channel agile equipment .....	50
5.2.9.4	Non-uniform maximum transmit power .....	50
5.3	Conformance methods of measurement for transmitters .....	50
5.3.1	Frequency drift .....	50
5.3.1.1	Test conditions .....	50
5.3.1.2	Measurement procedure .....	51
5.3.2	Operating frequencies .....	52
5.3.2.1	Test conditions .....	52
5.3.2.2	Measurement procedure .....	52
5.3.3	Effective radiated power .....	53
5.3.3.1	Test conditions .....	53
5.3.3.2	Radiated measurement procedure .....	53
5.3.3.3	Conducted measurement procedure .....	55
5.3.4	Transient power .....	55
5.3.4.1	Test conditions .....	55
5.3.4.2	Measurement procedure .....	56
5.3.5	Occupied bandwidth .....	57
5.3.5.1	Test conditions .....	57
5.3.5.2	Measurement procedure .....	57
5.3.6	Unwanted emissions in the out-of-band domain .....	59
5.3.6.1	Test conditions .....	59
5.3.6.2	Measurement procedure .....	60
5.3.7	Unwanted emissions in the spurious domain .....	61
5.3.7.1	Test conditions .....	61
5.3.7.2	Radiated measurement .....	62
5.3.7.3	Cabinet radiation measurement .....	62
5.3.7.4	Conducted measurement .....	62
5.3.7.5	Measurement procedure .....	62
5.3.7.5.1	Conducted measurement .....	62
5.3.7.5.2	Radiated measurement .....	63
5.3.8	Frequency stability under low-voltage conditions .....	64
5.3.8.1	Test conditions .....	64
5.3.8.2	Measurement procedure .....	64
5.3.9	Duty cycle and transmission timing .....	65
5.3.9.1	Long term behaviour .....	65
5.3.9.1.1	Test conditions .....	65
5.3.9.1.2	Measurement procedure .....	65
5.3.9.2	Short term behaviour .....	66
5.3.9.2.1	Test conditions .....	66
5.3.9.2.2	Measurement procedure .....	66
5.3.10	Automatic/adaptive power control .....	67
5.3.10.1	Test conditions .....	67
5.3.10.2	Conducted measurement procedure .....	67
5.3.10.3	Radiated measurement procedure .....	68
5.3.10.4	Measurement procedure .....	68
5.4	Conformance test suites for receivers .....	69
5.4.1	Receiver sensitivity .....	69
5.4.1.1	Test conditions .....	69
5.4.1.2	Radiated measurement .....	69
5.4.1.3	Conducted measurement .....	72
5.4.1.4	Measurement procedure .....	72
5.4.2	Receiver maximum input signal level .....	73
5.4.2.1	Test conditions .....	73
5.4.2.2	Radiated measurement .....	73
5.4.2.3	Conducted measurement .....	73
5.4.2.4	Measurement procedure .....	74

5.4.3	Clear channel assessment threshold .....	74
5.4.3.1	Test conditions .....	74
5.4.3.2	Radiated measurement .....	75
5.4.3.3	Conducted measurement .....	75
5.4.3.4	Measurement procedure .....	76
5.4.4	Co-channel rejection .....	77
5.4.4.1	Test conditions .....	77
5.4.4.2	Measurement procedure .....	77
5.4.5	Adjacent channel selectivity .....	78
5.4.5.1	Test conditions .....	78
5.4.5.2	Measurement procedure .....	78
5.4.6	Blocking and spurious response rejection.....	79
5.4.6.1	Test conditions .....	79
5.4.6.2	Measurement procedure .....	79
5.4.7	Intermodulation rejection.....	80
5.4.7.1	Test conditions .....	80
5.4.7.2	Radiated measurement procedure .....	81
5.4.7.3	Conducted measurement procedure .....	82
5.4.7.4	Measurement procedure .....	83
5.4.8	Receiver spurious emissions .....	83
5.4.8.1	Test conditions .....	83
5.4.8.2	Radiated measurement .....	84
5.4.8.3	Cabinet radiation measurement.....	84
5.4.8.4	Conducted measurement .....	84
5.4.8.5	Measurement procedure .....	84
5.4.8.5.1	Conducted measurement.....	84
5.4.8.5.2	Radiated measurement.....	85
5.5	Conformance test suites for polite spectrum access .....	85
5.5.1	Listen before talk .....	85
5.5.1.1	Test conditions .....	85
5.5.1.2	Measurement procedure .....	86
5.5.2	Short control signalling transmissions .....	87
5.5.2.1	Test conditions .....	87
5.5.2.2	Measurement procedure .....	87
5.6	Conformance test suites for functional requirements .....	88
5.6.1	General test conditions.....	88
5.6.2	Network access point .....	88
5.6.2.1	Test conditions .....	88
5.6.2.2	Measurement Procedure.....	89

**Annex A (informative): Relationship between the present document and the essential requirements of Directive 2014/53/EU .....91**

A.0	General information .....	91
A.1	Equipment Type 1a terminal nodes.....	91
A.2	Equipment Type 1b network nodes.....	92
A.3	Equipment Type 1c network access points .....	93

**Annex B (normative): Test sites and arrangements for radiated measurement .....95**

B.1	General considerations .....	95
B.2	Radiation test sites.....	95
B.2.1	Open Area Test Site (OATS) .....	95
B.2.2	Semi Anechoic Room.....	96
B.2.3	Fully Anechoic Room (FAR).....	97
B.2.4	Measurement Distance .....	98
B.3	Antennae.....	99
B.3.1	General considerations .....	99
B.3.2	Measurement antenna.....	99

B.3.3	Substitution antenna .....	99
B.4	Guidance on the use of radiation test sites .....	100
B.4.1	General considerations .....	100
B.4.2	Power supplies for the battery powered EUT .....	100
B.4.3	Site preparation .....	100
B.5	Coupling of signals.....	101
B.5.1	General .....	101
B.5.2	Data signals .....	101
B.6	Measurement procedures for radiated measurement .....	101
B.6.1	General considerations .....	101
B.6.2	Radiated measurements in an OATS or SAR.....	101
B.6.3	Radiated measurements in a FAR .....	102
B.6.4	Substitution measurement .....	102
B.6.5	Radiated measurement methods for receivers .....	103
<b>Annex C (normative): Test fixture .....</b>		<b>104</b>
C.1	General considerations .....	104
C.2	Validation of the test-fixture in the temperature chamber.....	105
C.3	Mode of use.....	106
<b>Annex D (informative): Maximum measurement uncertainty .....</b>		<b>107</b>
<b>Annex E (normative): Transmission bandwidth.....</b>		<b>108</b>
<b>Annex F (normative): T<sub>On</sub> time measurements .....</b>		<b>109</b>
F.1	Measurement procedure .....	109
F.2	T <sub>Disregard</sub> procedure .....	109
<b>Annex G (normative): General receiver test case procedure .....</b>		<b>111</b>
G.1	Test procedure .....	111
G.1.0	General requirements .....	111
G.1.1	Radiated measurement .....	111
G.1.2	Conducted measurement .....	112
G.1.3	Minimum wanted signal level setup.....	112
G.1.4	High wanted signal level setup.....	112
<b>Annex H (normative): General transmitter test case procedure.....</b>		<b>113</b>
H.1	Test procedure where use of a test fixture is permitted.....	113
H.1.0	General requirements .....	113
H.1.1	Radiated measurement .....	113
H.1.2	Conducted measurement .....	113
H.1.3	Alternate conducted measurement .....	113
H.2	Test procedure where use of a test fixture is not permitted.....	113
H.2.0	General requirements .....	113
H.2.1	Radiated measurement .....	113
H.2.2	Conducted measurement .....	114
<b>Annex I (informative): Selection of receiver parameters.....</b>		<b>115</b>
I.1	Receiver parameters as listed in ETSI EG 203 336 (V1.1.1).....	115
I.1.1	Receiver sensitivity .....	115
I.1.2	Adjacent channel selectivity.....	115
I.1.3	Blocking .....	115
I.1.4	Co-channel rejection.....	115
I.1.5	Spurious response rejection.....	115
I.1.6	Intermodulation .....	115



I.1.7	Dynamic range .....	116
I.1.8	Reciprocal mixing .....	116
I.1.9	Desensitisation .....	116
I.1.10	Signal interferer handling .....	116
I.2	Other receiver parameters .....	116
I.2.1	CCA threshold.....	116
<b>Annex J (informative):</b>	<b>Properties of equipment under test.....</b>	<b>117</b>
<b>Annex K (informative):</b>	<b>Bibliography.....</b>	<b>118</b>
<b>Annex L (informative):</b>	<b>Change History .....</b>	<b>119</b>
History .....		120

## List of figures

Figure 1: Adjacent channel definitions.....	21
Figure 2: Signal Occupied Bandwidth .....	22
Figure 3: Transmission definitions.....	23
Figure 4: Out-of-band domain for operating channel.....	29
Figure 5: Out-of-band domain for operating frequency band.....	30
Figure 6: Spectrum mask for unwanted emissions in the spurious domain.....	31
Figure 7: SCS dialog timing constraints.....	40
Figure 8: APC conducted measurement setup.....	68
Figure 9: APC radiated measurement setup .....	68
Figure 10: Conducted clear channel assessment threshold measurement arrangement.....	75
Figure 11: Radiated clear channel assessment threshold measurement arrangement.....	75
Figure 12: Receiver intermodulation rejection radiated measurement arrangement .....	81
Figure 13: Receiver intermodulation rejection conducted measurement arrangement.....	82
Figure 14: SCS transmissions measurement arrangement.....	87
Figure 15: Network access point analyser arrangement .....	89
Figure B.1: A typical Open Area Test Site.....	96
Figure B.2: A typical Semi Anechoic Room.....	97
Figure B.3: A typical Fully Anechoic Room.....	98
Figure B.4: Measurement arrangement No.1 .....	102
Figure C.1: Test fixture .....	104
Figure C.2: Validation of test set-up without EUT .....	105
Figure C.3: Validation of test set-up with EUT in place .....	106
Figure C.4: Test of EUT.....	106
Figure F.1: Power samples reference timing .....	109
Figure F.2: $T_{\text{Disregard}}$ .....	109
Figure G.1: Conducted test measurement arrangement.....	111
Figure G.2: Radiated test measurement arrangement.....	111

## List of tables

Table 1: Operating frequency bands.....	19
Table 2: Frequency drift limits .....	26
Table 3: Operating frequency and channel spacing error limits .....	27
Table 4: Channel spacing limits .....	27
Table 5: Effective radiated power limits .....	27
Table 6: Transmitter transient power limits .....	28
Table 7: Occupied bandwidth limits.....	28
Table 8: Emission limits in the out-of-band domain .....	30
Table 9: Spurious domain emission limits .....	31
Table 10: Frequency stability under low voltage conditions limits.....	32
Table 11: Duty cycle parameters.....	32
Table 12: Transmission timing parameters .....	32
Table 13: Duty cycle limits .....	33
Table 14: Transmission timing limits.....	33
Table 15: APC power limit .....	34
Table 16: Limits for receiver sensitivity .....	34
Table 17: Limits for receiver maximum input signal level .....	35
Table 18: CCA threshold limit .....	35
Table 19: Co-channel rejection limit.....	36
Table 20: Adjacent channel selectivity limit .....	36
Table 21: Limits for receiver blocking.....	37
Table 22: Receiver spurious response rejection limits .....	37
Table 23: Receiver intermodulation rejection limits .....	38
Table 24: Receiver spurious emission limits.....	38
Table 25: Limits for listen before talk requirement.....	39
Table 26: Limits for SCS transmissions .....	41
Table 27: Network access point limits .....	41
Table 28: Resolution bandwidth for the measuring receiver.....	47
Table 29: Permitted test signals.....	48
Table 30: Applicable test methods .....	49
Table 31: Specific test procedures.....	50
Table 32: Information recorded in the test report for frequency drift .....	51
Table 33: Test parameters for operating frequencies measurement .....	52

Table 34: Information recorded in the test report for operating frequencies .....	52
Table 35: Test parameters for effective radiated power measurement .....	53
Table 36: Information recorded in the test report for effective radiated power under normal test conditions .....	54
Table 37: Information recorded in the test report for effective radiated power under extreme test conditions.....	55
Table 38: Information recorded in the test report for effective radiated power.....	55
Table 39: Measurement offsets & RBW for transient power measurement.....	56
Table 40: Test parameters for transient power measurement .....	56
Table 41: Information recorded in the test report for transmitter transient power .....	57
Table 42: Test parameters for occupied bandwidth measurement .....	57
Table 43: Information recorded in the test report for occupied bandwidth .....	58
Table 44: Information recorded in the test report for occupied bandwidth .....	59
Table 45: Test parameters for upper out-of-band measurement.....	60
Table 46: Test parameter setting for lower out-of-band measurement.....	60
Table 47: Information recorded in the test report for OOB emissions .....	60
Table 48: Test parameter setting for intermediate out-of-band measurement .....	61
Table 49: Information recorded in the test report for OOB emissions .....	61
Table 50: Conducted spurious radiations measurement frequency range .....	62
Table 51: Radiated spurious radiations measurement frequency range.....	63
Table 52: Information recorded in the test report for unwanted emissions in the spurious domain.....	64
Table 53: Test parameters for frequency stability under low voltage conditions measurement.....	64
Table 54: Information recorded in the test report for frequency stability under low voltage conditions .....	65
Table 55: Test parameters settings for long term behaviour measurement .....	65
Table 56: Information recorded in the test report for long term behaviour .....	66
Table 57: Test parameters settings for short term behaviour measurement .....	66
Table 58: Information recorded in the test report for short term behaviour .....	67
Table 59: Test parameters settings for automatic/adaptive power control measurement .....	68
Table 60: Information recorded in the test report for automatic/adaptive power control.....	69
Table 61: Information recorded in the test report for sensitivity under normal test conditions.....	70
Table 62: Information recorded in the test report for sensitivity under extreme test conditions .....	72
Table 63: Information recorded in the test report for sensitivity .....	73
Table 64: Information recorded in the test report for maximum input signal level.....	74
Table 65: Test parameters settings for CCA threshold measurement.....	76
Table 66: Information recorded in the test report for CCA threshold .....	77
Table 67: Information recorded in the test report for co-channel rejection.....	78
Table 68: Information recorded in the test report for adjacent channel selectivity .....	78

Table 69: Information recorded in the test report for spurious response rejection .....	80
Table 70: Information recorded in the test report for blocking .....	80
Table 71: Test parameters settings for receiver intermodulation measurement .....	81
Table 72: Information recorded in the test report for receiver intermodulation rejection .....	83
Table 73: Receiver spurious emissions measurement frequency range - conducted .....	84
Table 74: Information recorded in the test report for receiver spurious emissions .....	85
Table 75: Receiver spurious emissions measurement frequency range - radiated .....	85
Table 76: Test parameters settings for listen before talk measurement .....	86
Table 77: Information recorded in the test report for LBT.....	87
Table 78: Information recorded in the test report for SCS transmissions.....	88
Table 79: Test parameters settings for NAP observations.....	89
Table 80: Information recorded in the test report for NAP .....	90
Table A.1: Relationship between the present document equipment Type 1a and the essential requirements of Directive 2014/53/EU .....	91
Table A.2: Relationship between the present document equipment Type 1b and the essential requirements of Directive 2014/53/EU .....	92
Table A.3: Relationship between the present document equipment Type 1c and the essential requirements of Directive 2014/53/EU .....	93
Table D.1: Maximum measurement uncertainty .....	107
Table E.1: TBW for values of OBW .....	108

---

## Intellectual Property Rights

### Essential patents

IPRs essential or potentially essential to normative deliverables may have been declared to ETSI. The information pertaining to these essential IPRs, if any, is publicly available for **ETSI members and non-members**, and can be found in ETSI SR 000 314: "*Intellectual Property Rights (IPRs); Essential, or potentially Essential, IPRs notified to ETSI in respect of ETSI standards*", which is available from the ETSI Secretariat. Latest updates are available on the ETSI Web server (<https://ipr.etsi.org/>).

Pursuant to the ETSI IPR Policy, no investigation, including IPR searches, has been carried out by ETSI. No guarantee can be given as to the existence of other IPRs not referenced in ETSI SR 000 314 (or the updates on the ETSI Web server) which are, or may be, or may become, essential to the present document.

### Trademarks

The present document may include trademarks and/or tradenames which are asserted and/or registered by their owners. ETSI claims no ownership of these except for any which are indicated as being the property of ETSI, and conveys no right to use or reproduce any trademark and/or tradename. Mention of those trademarks in the present document does not constitute an endorsement by ETSI of products, services or organizations associated with those trademarks.

---

## Foreword

This final draft Harmonised European Standard (EN) has been produced by ETSI Technical Committee Electromagnetic compatibility and Radio spectrum Matters (ERM), and is now submitted for the Vote phase of the ETSI standards EN Approval Procedure.

The present document has been prepared under the Commission's standardisation request C(2015) 5376 final [i.4] to provide one voluntary means of conforming to the essential requirements of Directive 2014/53/EU on the harmonisation of the laws of the Member States relating to the making available on the market of radio equipment and repealing Directive 1999/5/EC [i.1].

Once the present document is cited in the Official Journal of the European Union under that Directive, compliance with the normative clauses of the present document given in Tables A.1 to A.3 confers, within the limits of the scope of the present document, a presumption of conformity with the corresponding essential requirements of that Directive, and associated EFTA regulations.

<b>Proposed national transposition dates</b>	
Date of latest announcement of this EN (doa):	3 months after ETSI publication
Date of latest publication of new National Standard or endorsement of this EN (dop/e):	6 months after doa
Date of withdrawal of any conflicting National Standard (dow):	36 months after doa

---

## Modal verbs terminology

In the present document "**shall**", "**shall not**", "**should**", "**should not**", "**may**", "**need not**", "**will**", "**will not**", "**can**" and "**cannot**" are to be interpreted as described in clause 3.2 of the [ETSI Drafting Rules](#) (Verbal forms for the expression of provisions).

"**must**" and "**must not**" are **NOT** allowed in ETSI deliverables except when used in direct citation.

---

# Introduction

This revision of the present document has three main purposes:

- To add technical requirements necessary for SRD in data networks introduced in EC Decision 2018/1538 [i.3] using the interpretation of under control of NAP provided by CEPT WGFM and SRD/MG.
- Add the 874,0 MHz - 874,4 MHz harmonised minimum core band to the operational frequency bands.
- To bring the present document in line with current Harmonised Standard editorial practices.

## Background

The present document describes performance requirements and conformance test procedures for Short Range Devices (SRDs) intended to operate in association with other SRDs in network topologies supporting the intended applications in the frequency range 870 MHz - 876 MHz at power levels up to 500 mW.

The frequency band is shared with other SRDs intended to support applications with more restrictive power levels.

In some countries the frequency band, or parts of the frequency band, are used for radio services for government and rail applications and use for networks of SRDs may be subject to restrictions. National radio interfaces should be consulted for all intended applications.

The specifications included in the present document are not intended for devices operating at low data rates and in narrow operating channels.

## Network of SRDs

Earlier versions of the present document permitted the construction of networks of SRDs with little or no restrictions on technology, topology or architecture. A network could be formed in any topology and be self-contained or form part of a larger inter-network. The latter class of SRD networks were facilitated by certain infrastructure SRDs (Network Relay Points (NRPs), with greater duty cycle allowance than non-NRP devices, providing the relay between the SRD network and an external network or service.

EC Decision 2018/1538 [i.3] identifies a harmonised minimum core band within the frequency range covered by the present document. This core band, 874,0 MHz - 874,4 MHz, is for *SRDs in data networks* and relevant definitions are contained in the EC Decision:

- A network access point in a data network is a fixed terrestrial short-range device that acts as a connection point for the other short-range devices in the data network to service platforms located outside of that data network.
- The term data network refers to several short-range devices, including the network access point, as network components and to the wireless connections between them.
- All devices within the data network shall be under the control of network access points.

The present document aligns its use of terms with those of the EC Decision 2018/1538 [i.3] and replaces NRP with NAP.

Guidance from CEPT WGFM and SRD/MG is adopted for the interpretation of under control of NAP to apply to nomadic and mobile SRDs. The scope of the present document is explicitly defined for only fixed SRD in data networks.

## Channel spacing

Earlier versions of the present document aligned with a narrowband/non-narrowband boundary at 25 kHz by specifying a minimum channel spacing/occupied bandwidth of 25 kHz. The present document adds a specific channel spacing requirement with a minimum spacing limit of 25 kHz, and a corresponding test suite to measure operating frequencies and verify correctness of operating frequencies and channel spacing.

### Transmission bandwidth

Previous versions of the present document aligned with other harmonised standards for SRDs by specifying operating and adjacent channels in terms of Occupied Channel Width (OCW). OCW and channel spacing were closely related and often identical.

The present document decouples channel spacing from the characterization of the signal. The signal constituting the transmission from the device occupies an amount of spectrum sufficient for the OBW, containing 99 % of the signal power, frequency uncertainties due to drift, and some implementation margin. The resulting bandwidth is defined in the present document as the transmission bandwidth (TBW). TBW is used in the specification of the OOB domain and several other requirements and measurement offsets in the test suites. The concept of TBW is very similar to the ITU concept of necessary bandwidth.

### Additional measurements

Certain requirements were previously satisfied by manufacturer declarations of the equipment characteristics. Measurement procedures have been included for all such requirements. Some requirements which were specified in terms of manufacturer declarations with no limits or test cases have been removed.

### Functional requirements

Specific requirements have been added to satisfy the EC Decision 2018/1538 [i.3] conditions associated with the core minimum harmonised band:

- A requirement and test suite for NAP has been added as the definition of data network includes a mandatory NAP component. The behaviour of a NAP is also defined in the EC Decision 2018/1538 [i.3].

It should be noted such *functional requirements* do not assess the radio or any characteristics of the emitted signal, but rather concern system level behaviour which is always the subject of higher layer protocols outside the scope of the present document. Thus these requirements and their associated test suites are, by necessity, general in nature in order to preserve technology neutrality throughout the present document.

### Disregard time

The present document includes the concept of disregard time which is used for two separate purposes:

- Disregard time  $> 0$  permits signals to be non-continuous e.g. on-off keying or pulsed signals.
- A suitable value of disregard time is also required to permit dialog exchanges.

Details of disregard time treatment are contained in Annex F and clause 4.5.2.

Disregard time is a property of the equipment but is not an intrinsic value which can be measured.

### Characteristics and requirements

The present document defines technical requirements to support the essential requirements of clause 3.2 of the Directive 2014/53/EU (Radio Equipment Directive) [i.1] which states "*radio equipment shall be so constructed that it both effectively uses and supports the efficient use of radio spectrum in order to avoid harmful interference*".

Equipment covered by the present document may operate on a specific frequency or may be channel agile and operate on a number of different frequencies:

- Channel agile SRDs operate on two or more channels with signals constrained to the same limits as non-agile devices.

Transmitter requirements include:

- Frequency accuracy and occupied bandwidth constraints to precisely locate the signal.
- Signal masks to ensure satisfactory out-of-band characteristics both within the operating frequency band and to protect frequencies above and below the operating frequency band.
- Transient emissions from switching of the radio transmitter on and off as occurs at the start and end of each packet or data transmission.



- Spurious domain behaviour to limit potential interference in frequencies far from the operating channel.
- Adaptive/automatic power control to reduce transmitted power in strong link conditions.

Taking into account that SRD in data network equipment operate in channels without specific channel raster, receiver performance is assured by a combination of requirements measured with both strong wanted signals and wanted signals close to sensitivity. Receiver requirements include:

- Sensitivity and co-channel rejection behaviour to ensure equipment operates effectively in the presence of other signals in, or overlapping, the operating channel.
- Adjacent channel selectivity performance to ensure equipment operates effectively in the presence of unwanted signals in frequencies adjacent to the operating channel.
- Blocking performance to ensure equipment operates effectively in the presence of unwanted signals beyond the adjacent channels.
- Maximum input signal level to ensure equipment has adequate dynamic range for the shared spectrum environment.

NOTE: Limits for requirements are set to values representative of state-of-the-art RF transceivers and relevant industry interoperability standards, in particular, leading application and industry interoperability specifications for smart energy products. ETSI TS 102 887-1 [i.7] was prepared to support such interoperability specifications.

Polite spectrum access supporting effective and efficient use of the spectrum resource is promoted by Listen Before Talk (LBT) and Short Control Signalling (SCS) transmission requirements. Equipment employing LBT procedures is subject to requirements governing channel sensing:

- Clear channel assessment threshold performance to ensure deferral in the presence of other signals, balanced by the sensitivity requirement to avoid unnecessary deferral where harmful interference would be unlikely.

Although use of LBT is encouraged for all equipment, LBT is only required to be implemented by:

- NAP equipment operating at a duty cycle higher than that permitted for terminal nodes or network nodes.

Equipment is subject to duty cycle limits for overall long term operation in the operational frequency band and timing constraints over short term intervals on any specific operating channel.

- Signal transmissions are constrained in maximum duration and devices are required to wait for specified intervals before again transmitting in a given channel. After transmission limits have been reached on a specific channel, channel agile device operation may continue on a different channel whilst respecting the limits on each channel and overall limits applicable in the operational frequency band.

Informative Annex A is expanded to unambiguously provide the harmonised requirements for each type of equipment.

An informative Annex I explains how the receiver requirements provide coverage for the essential properties of receivers compliant with the present document.

An informative J is added to concisely identify all properties of the equipment which are needed in order to execute the test suites. Such information is usually to be found in the technical specifications of the equipment.

The present document is structured as follows:

- Clause 1 provides a general description of the types of equipment and applicable frequency ranges covered by the present document.
- Clause 2 provides normative and informative references.
- Clause 3 provides the definition of terms, symbols and abbreviations used in the present document.
- Clause 4 specifies the technical requirements.
- Clause 5 specifies general conditions and test suites for testing the conformance of the EUT to the technical requirements.

- Annex A (informative) provides the relationship between the present document and the essential requirements of the Directive 2014/53/EU [i.1] for each type of equipment.
- Annex B (normative) provides specifications concerning radiated measurements.
- Annex C (normative) contains specifications for the test fixture.
- Annex D (informative) provides information on measurement uncertainty.
- Annex E (normative) provides specifications for transmitter measurement offsets.
- Annex F (normative) provides specifications on  $T_{On}$  measurements and  $T_{Disregard}$  processing.
- Annex G (normative) provides general specifications for receiver test case procedures.
- Annex H (normative) provides general specifications for transmitter test case procedures.
- Annex I (informative) provides explanations of the choice of receiver parameters.
- Annex J (informative) provides information on EUT properties necessary to execute the test suites.
- Annex K contains a bibliography of useful additional information sources.
- Annex L contains a summary of the main changes between versions of the present document.

# 1 Scope

The present document specifies technical characteristics and methods of measurements for the following types of equipment:

## Type 1 equipment: SRDs in data networks:

Type 1a: Terminal nodes

Type 1b: Network nodes

Type 1c: Network access points

Type 1a terminal nodes and type 1b network nodes are fixed SRDs, operating up to 500 mW e.r.p. and with adaptive power control, which are intended to operate in association with other SRDs to form data network topologies supporting the intended application.

Type 1c network access points are specific fixed SRDs, operating up to 500 mW e.r.p. and with adaptive power control, supporting interconnection of a network of SRDs with an external network or service.

These radio equipment types are capable of operating in all or part of the relevant frequency bands given in Table 1.

**Table 1: Operating frequency bands**

Networked and Network Based SRD frequency bands		
Transmit and receive	870,0 MHz to 874,4 MHz	Type 1a, 1b, 1c equipment
Transmit and receive	874,0 MHz to 874,4 MHz	Type 1a, 1b, 1c equipment
NOTE: The frequency range 870,0 MHz to 874,4 MHz is extended to 870,0 MHz to 875,6 MHz in some countries.		

NOTE 1: 874,0 MHz - 874,4 MHz is a harmonised core band according to EC Decision 2018/1538 [i.3].

NOTE 2: The availability of the frequency bands in Table 1 in European Union and CEPT countries can be obtained from the EFIS (<http://www.efis.dk/>) and is also listed in Appendices 1 and 3 of CEPT/ERC/REC 70-03 [i.2].

NOTE 3: In addition, it should be noted that, in some countries, part or all of the bands in Table 1 may be unavailable, and/or other frequency bands may be available, for networked and/or network based short range devices. See National Radio Interfaces (NRI) as relevant for additional guidance.

NOTE 4: On non-harmonized parameters, national administrations may impose certain conditions such as the type of modulation, frequency, channel/frequency separations, maximum transmitter radiated power, duty cycle, installation and operation only by professional users and the inclusion of an automatic transmitter shut-off facility, as a condition for the issue of Individual Rights for use of spectrum or General Authorization, or as a condition for use under "licence exemption" as it is in most cases for Short Range Devices.

The present document covers equipment intended for use in a fixed location.

The present document contains requirements to demonstrate that radio equipment both effectively uses and supports the efficient use of radio spectrum in order to avoid harmful interference.

NOTE 5: The relationship between the present document and essential requirements of article 3.2 of Directive 2014/53/EU [i.1] is given in Annex A.

---

## 2 References

### 2.1 Normative references

References are either specific (identified by date of publication and/or edition number or version number) or non-specific. For specific references, only the cited version applies. For non-specific references, the latest version of the referenced document (including any amendments) applies.

Referenced documents which are not found to be publicly available in the expected location might be found at <https://docbox.etsi.org/Reference/>.

NOTE: While any hyperlinks included in this clause were valid at the time of publication, ETSI cannot guarantee their long term validity.

The following referenced documents are necessary for the application of the present document.

[1] NIST/SEMATECH e-Handbook of Statistical Methods (clause 1.3.5.13): "Runs Test for Detecting Non-randomness", October 2013.

NOTE: Available at <http://www.itl.nist.gov/div898/handbook/>.

### 2.2 Informative references

References are either specific (identified by date of publication and/or edition number or version number) or non-specific. For specific references, only the cited version applies. For non-specific references, the latest version of the referenced document (including any amendments) applies.

NOTE: While any hyperlinks included in this clause were valid at the time of publication, ETSI cannot guarantee their long term validity.

The following referenced documents are not necessary for the application of the present document but they assist the user with regard to a particular subject area.

- [i.1] Directive 2014/53/EU of the European Parliament and of the Council of 16 April 2014 on the harmonisation of the laws of the Member States relating to the making available on the market of radio equipment and repealing Directive 1999/5/EC.
- [i.2] CEPT/ERC/REC 70-03: "Relating to the use of Short Range Devices (SRD)".
- [i.3] Commission Implementing Decision (EU) 2018/1538 of 11 October 2018 on the harmonisation of radio spectrum for use by short-range devices within the 874-876 and 915-921 MHz frequency bands.
- [i.4] Commission Implementing Decision C(2015) 5376 final of 4.8.2015 on a standardisation request to the European Committee for Electrotechnical Standardisation and to the European Telecommunications Standards Institute as regards radio equipment in support of Directive 2014/53/EU of the European Parliament and of the Council.
- [i.5] MATLAB® and Statistics Toolbox Release: "The MathWorks", Inc., Natick, Massachusetts, United States.
- [i.6] ECC Report 200: "Co-existence studies for proposed SRD and RFID applications in the frequency band 870-876 MHz and 915-921 MHz", September 2013.
- [i.7] ETSI TS 102 887-1: "Electromagnetic compatibility and Radio spectrum Matters (ERM); Short Range Devices; Smart Metering Wireless Access Protocol; Part 1: PHY layer".
- [i.8] Recommendation ITU-T O.153 (10-1992): "Basic parameters for the measurement of error performance at bit rates below the primary rate".

- [i.9] ETSI TR 100 028 (all parts) (V1.4.1) (12-2001): "Electromagnetic compatibility and Radio spectrum Matters (ERM); Uncertainties in the measurement of mobile radio equipment characteristics".
- [i.10] CISPR 16 (parts 1-1 and 1-4 (2010) part 1-5 (2014)): "Specification for radio disturbance and immunity measuring apparatus and methods; Part 1: Radio disturbance and immunity measuring apparatus".
- [i.11] ETSI TR 102 273 (all parts) (V1.2.1) (12-2001): "Electromagnetic compatibility and Radio spectrum Matters (ERM); Improvement on Radiated Methods of Measurement (using test site) and evaluation of the corresponding measurement uncertainties".
- [i.12] ETSI EG 203 336 (V1.1.1) (08-2015): "Electromagnetic compatibility and Radio spectrum Matters (ERM); Guide for the selection of technical parameters for the production of Harmonised Standards covering article 3.1(b) and article 3.2 of Directive 2014/53/EU".

## 3 Definition of terms, symbols and abbreviations

### 3.1 Terms

For the purposes of the present document, the terms given in Directive 2014/53/EU [i.1] and the following apply:

**adjacent channel:** frequency range equal to the width of the operating channel immediately above and immediately below the operating channel

NOTE: See Figure 1.

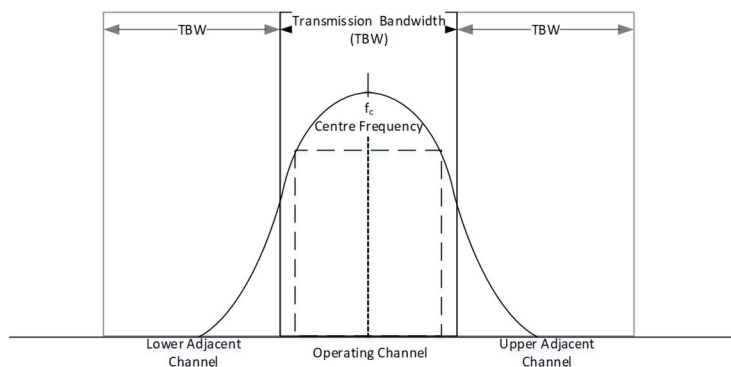

**Figure 1: Adjacent channel definitions**

**channel adaptivity:** capability of a device to avoid using permitted operating channels that it has determined are temporarily or permanently unsuitable for its use

**channel spacing:** distance, in hertz, between adjacent operating frequencies

**clear channel assessment:** procedure of sensing the operating channel to determine whether or not it is occupied by a transmission

**conducted measurements:** measurements which are made using a direct 50  $\Omega$  connection to the equipment under test

**data network:** group of wirelessly communicating SRDs composed of a network access point and one or more terminal nodes and/or network nodes

**dialog:** repeated transmit-response cycle between two devices within a transmission

**dialog-response ( $T_{\text{Dialog-Response}}$ ):** interval between the end of an emission by the first device in a dialog and the beginning of the response from the second device in the dialog

**disregard time ( $T_{\text{Disregard}}$ ):** manufacturer declared interval below which two separate radio emissions in a channel are considered a single continuous transmitted burst

**duty cycle:** ratio, expressed as a percentage, of the cumulative duration of transmissions in an observation bandwidth within an observation interval divided by the observation interval

**fixed SRD:** SRD able to operate only at a fixed geographical location

**integral antenna:** permanent fixed antenna, which may be built-in, designed as an indispensable part of the equipment

**minimum inter-transmission interval ( $T_{\text{off-min}}$ ):** minimum interval in a channel between two transmissions by the same device

**network access point:** fixed terrestrial SRD connecting one or more terminal nodes and/or network nodes to an external network or service

**network control information:** data intended to construct or maintain a data network

**network data:** application data carried over a data network

**network node:** SRD generating and/or consuming and/or forwarding network control information and/or network data

**occupied bandwidth:** width of a frequency range such that, below the lower and above the upper frequency limits, the mean powers emitted are each equal to 0,5 % of the total mean power of a given emission

NOTE: See Figure 2.

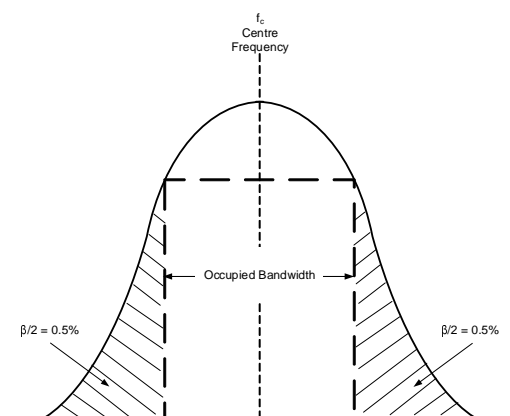

**Figure 2: Signal Occupied Bandwidth**

**operating channel:** frequency range in which transmissions from the device occur

**operating frequency:** centre frequency of a transmission

**operating frequency band:** frequency band or sub-band within which the device is authorized to operate and to perform the intended function of the equipment

**radiated measurements:** measurements which involve the absolute measurement of a radiated electromagnetic field

**signal threshold ( $P_{\text{Threshold}}$ ):** absolute signal level (in dBm) above which a transmission is considered to exist for a given receiver bandwidth

**spurious emissions:** emissions on a frequency or frequencies which are outside the occupied bandwidth and the level of which may be reduced without affecting the corresponding transmission of information

NOTE: Spurious emissions include harmonic emissions, parasitic emissions, intermodulation products and frequency conversion products, but exclude out-of-band emissions.

**terminal node:** SRD generating (e.g. sensor) and/or consuming (e.g. actuator) network data

**transmission:** continuous radio emission, or sequence of emissions each separated by an interval  $< T_{\text{Disregard}}$ , with a signal level greater than the signal threshold in an operating channel

NOTE: See Figure 3.

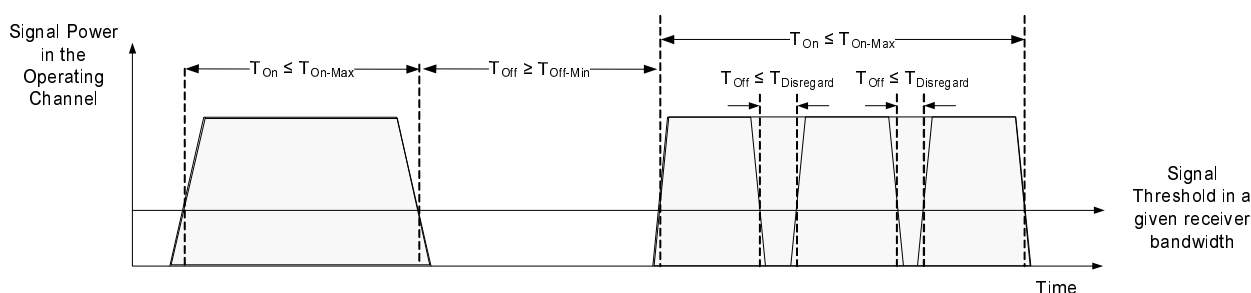

**Figure 3: Transmission definitions**

**transmission bandwidth:** width of the frequency range containing the transmitted signal plus frequency drift

NOTE: See also Annex E for more information.

## 3.2 Symbols

For the purposes of the present document, the following symbols apply:

dB	decibel
S	sensitivity of receiver
$\lambda$	wavelength

## 3.3 Abbreviations

For the purposes of the present document, the following abbreviations apply:

AC	Alternating Current
APC	Automatic/Adaptive Power Control
ARQ	Automatic Repeat reQuest
BER	Bit Error Ratio
CCA	Clear Channel Assessment
CEPT	Commission Européenne des Postes et Télécommunications
CISPR	International Special Committee on Radio Interference
CS	Channel Spacing
CW	Continuous Wave
e.r.p.	effective radiated power
EC	European Commission
EFIS	European Communications Office Frequency Information System
EFTA	European Free Trade Association
EMC	ElectroMagnetic Compatibility
EU	European Union
EUT	Equipment Under Test
FAR	Fully Anechoic Room
FEC	Forward Error Correction
ITU-R	International Telecommunication Union - Radiocommunication
ITU-T	International Telecommunication Union - Telecommunication
LBT	Listen Before Talk
LPDA	Logarithmic Periodic Dipole Antenna
LTB	Long Term Behaviour
MSR	Message Success Ratio
NAP	Network Access Point
NN	Network Node
NRI	National Radio Interfaces

NRP	Network Relay Point
OATS	Open Area Test Site
OBW	Occupied BandWidth
OCW	Occupied Channel Width
OOB	Out-Of-Band
RBW	Resolution BandWidth
RBW <sub>REF</sub>	Reference BandWidth
RF	Radio Frequency
RMS	Root Mean Square
Rx	Receiver
SAR	Semi-Anechoic Room
SCS	Short Control Signalling
SRD	Short Range Device
SRD/MG	SRD Management Group
STB	Short Term Behaviour
TBW	Transmission BandWidth
TN	Terminal Node
TR	Technical Report
Tx	Transmitter
UWB	Ultra Wide Band
VBW	Video BandWidth
VSWR	Voltage Standing Wave Ratio
WGFM	Working Group Frequency Management

---

## 4 Technical requirements specifications

### 4.1 Environmental profile

The technical requirements of the present document apply under the environmental profile for operation of the equipment, which shall be in accordance with its intended use. The equipment shall comply with all the technical requirements of the present document at all times when operating within the boundary limits of the operational environmental profile defined by its intended use.

### 4.2 Conformance requirements

#### 4.2.1 General requirements

The equipment tested shall be designed, constructed and manufactured in accordance with good engineering practice and with the aim of minimizing harmful interference to other equipment and services.

Each equipment submitted for testing, where applicable, shall fulfil the requirements of the present document on all frequencies over which it is intended to operate.

#### 4.2.2 Performance criteria

For the purpose of the receiver performance tests, under normal conditions the receiver shall produce:

- after demodulation, a raw data signal with a Bit Error Ratio  $\leq 10^{-3}$  without correction; or
- after demodulation, a message success ratio equivalent to the above Bit Error Ratio.

NOTE 1: The Message Success Ratio (MSR) can be computed by the expression:

$$\text{MSR} = (1-p)^n$$

where p is the probability of a single bit error ( $10^{-3}$ ) and n is the number of bits in the message.



NOTE 2: Some designs may include permanent channel coding as an integral part of information transmission. Such designs may not be able to operate without correction inherent in the channel coding. For the purposes of receiver test suites in the present document, the wanted performance criteria are specified with optional FEC and/or ARQ mechanisms disabled.

### 4.2.3 Signal threshold

The value used for  $P_{\text{Threshold}}$  in all requirements and test methods of the present document shall be:

- -75 dBm

### 4.2.4 Disregard time

The value used for  $T_{\text{Disregard}}$  is a property of the EUT (see Annex J).

A value  $> 0$  allows EUT modulations which are not continuous (e.g. on-off keying) to be used in the operating channel without the mandatory  $T_{\text{Off-min}}$  interval between each emission. This facility incurs a penalty against the permitted duty cycle since the off periods between each emission are included in the total transmission time. Duty cycle measurements use the sum of transmission times, not the sum of the individual emissions.

$T_{\text{Disregard}}$  is also used to allow a polite spectrum access dialog (see clause 4.5.2) in the operating channel.  $T_{\text{Disregard}}$  shall be  $>$  interval between each transmission by the EUT in the dialog in order to avoid the mandatory  $T_{\text{Off-min}}$  delay. Thus the duration of the response transmissions by the 2<sup>nd</sup> device in the dialog, together with the  $T_{\text{Dialog-response}}$  interval shall be  $<$  the EUT  $T_{\text{Disregard}}$ .

### 4.2.5 Transmission bandwidth

The value used for TBW in all requirements and test methods of the present document shall be as specified in Annex E.

### 4.2.6 Fixed frequency operating

For all equipment operating on a single operating frequency only, the value used for CS in all test methods of the present document shall be the smaller of:

- the maximum OBW (as specified in Table 7); and
- TBW (as specified in Annex E).

## 4.3 Requirements for transmitters

### 4.3.1 Frequency drift

#### 4.3.1.1 Applicability

The frequency drift requirement shall apply to transmitters able to generate, or be modulated by, test signal D-M1 (see clause 5.2.7).

#### 4.3.1.2 Description

Frequency drift is the difference between the measured unmodulated carrier frequency under normal and extreme test conditions.

#### 4.3.1.3 Limits

The measured frequency drift shall not exceed the limits specified in Table 2.

**Table 2: Frequency drift limits**

Frequency drift	Limit
$FH_{up}$ (as specified in Table 32)	$F_{high} + FH_{up} \leq FB_{high}$
$FL_{down}$ (as specified in Table 32)	$F_{low} - FL_{down} \geq FB_{low}$
NOTE: $F_{high}$ is highest measured operating frequency. $F_{low}$ is the lowest measured operating frequency. $FB_{low}$ is the lower edge of the operating frequency band defined in Table 1. $FB_{high}$ is the upper edge of the operating frequency band defined in Table 1.	

#### 4.3.1.4 Conformance

The conformance test suite for the frequency drift requirement shall be as defined in clause 5.3.1 of the present document.

### 4.3.2 Operating frequencies and channel spacing

#### 4.3.2.1 Applicability

The operating frequencies requirement shall apply to all transmitters. The channel spacing requirements shall apply to all transmitters operating on more than one operating frequency.

#### 4.3.2.2 Description

An operating frequency is the centre frequency of a transmission from the equipment and coincides with the centre frequency of the operating channel within which the transmission occurs.

The difference between the measured and nominal values of an operating frequency is the frequency error.

The nominal operating frequencies are given by:

$$F_n = F_{lowest} + n \times \text{nominal channel spacing}$$

Where:

- $F_n$  is a nominal operating frequency
- $F_{lowest}$  is the nominal lowest operating frequency
- $n$  is an integer value from 0 to  $m$  such that  $F_{lowest} + m \times (\text{nominal channel spacing}) = F_{highest}$
- $F_{highest}$  is the nominal highest operating frequency

NOTE 1: See Annex J for nominal operating frequencies and nominal channel spacing.

NOTE 2: It is not necessary to use all possible values derived by the expression. The operating frequencies also may be described as a discrete set of frequencies.

#### 4.3.2.3 Limits

Each measured operating frequency shall reside within the operating frequency band (as specified in Table 1).

The largest measured operating frequency error shall not exceed the limit specified in Table 3.

**Table 3: Operating frequency and channel spacing error limits**

Operating frequency band	Error limit
As specified in Table 1	The smaller of: <ul style="list-style-type: none"> <li>• <math>\pm 20</math> ppm</li> <li>• <math>\pm 10</math> % Nominal CS</li> </ul>

The measured channel spacing is the smallest difference between any two measured operating frequencies and shall not be less than the limit given in Table 4.

**Table 4: Channel spacing limits**

Operating frequency band	Limit
As specified in Table 1	The larger of: <ul style="list-style-type: none"> <li>• 25 kHz</li> <li>• (OBW + FDup + FDdown + frequency error) (see note)</li> </ul>
NOTE: OBW is the measured OBW (as specified in clause 4.3.5). FDup and FDdown are as specified in Table 30 if the frequency drift (as specified in clause 4.3.1) measurement is performed or as specified in Table 42 if the frequency drift (as specified in clause 4.3.1) measurement is not performed. Frequency error is the largest measured operating frequency error.	

The difference between the nominal channel spacing and the measured channel spacing shall not exceed the limit specified in Table 3.

#### 4.3.2.4 Conformance

The conformance test suite for the operating frequencies requirement shall be as defined in clause 5.3.2 of the present document.

### 4.3.3 Effective radiated power

#### 4.3.3.1 Applicability

The effective radiated power requirement shall apply to all transmitters.

#### 4.3.3.2 Description

The effective radiated power (e.r.p.) is the power radiated in the direction of the maximum field strength under specified conditions of measurements for any condition of modulation. For transmitters with a permanent or temporary antenna connector, the effective radiated power is the power, adjusted for equipment antenna gain, delivered from that connector into an artificial antenna (clause 5.2.4.1).

#### 4.3.3.3 Limits

The measured effective radiated power shall not exceed the maximum radiated power limit given in Table 5.

**Table 5: Effective radiated power limits**

Operating frequency band	Maximum radiated power
As specified in Table 1	$\leq 500$ mW e.r.p.

#### 4.3.3.4 Conformance

The conformance test suite for the effective radiated power requirement shall be as defined in clause 5.3.3 of the present document.

## 4.3.4 Transient power

### 4.3.4.1 Applicability

The transient power requirement shall apply to all transmitters.

### 4.3.4.2 Description

Transmitter transient power is power falling into frequencies other than the operating channel as a result of the transmitter being switched on and off.

### 4.3.4.3 Limits

The measured transient power shall not exceed the limits given in Table 6.

**Table 6: Transmitter transient power limits**

Offset from operating frequency	RBW <sub>REF</sub>	Peak power limit
< 400 kHz	1 kHz	0 dBm
≥ 400 kHz	1 kHz	-27 dBm

### 4.3.4.4 Conformance

The conformance test suite for the transient power requirement shall be as defined in clause 5.3.4 of the present document.

## 4.3.5 Occupied bandwidth

### 4.3.5.1 Applicability

The occupied bandwidth requirement shall apply to all transmitters.

### 4.3.5.2 Description

Occupied bandwidth is the width of the range of frequencies that contains 99 % of the power of the transmitted signal.

### 4.3.5.3 Limits

The occupied bandwidth shall reside entirely within the operating channel. The operating channel shall reside entirely within the operating frequency band as specified in Table 1.

The largest measured occupied bandwidth shall not exceed the limits given in Table 7.

**Table 7: Occupied bandwidth limits**

Operating frequency band	Limit
As specified in Table 1	200 kHz

If the frequency drift (as specified in clause 4.3.1) measurement is performed:

- The highest boundary of measured OBW plus  $FD_{up}$  (as specified in Table 32) shall reside within the operating frequency band (as specified in Table 1).
- The lowest boundary of the measured OBW (as specified in clause 4.3.5) minus  $FD_{down}$  (as specified in Table 32) shall reside within the operating frequency band (as specified in Table 1).

If the frequency drift (as specified in clause 4.3.1) measurement is not performed:

- The highest boundary of measured OBW plus  $FD_{up}$  (as specified in Table 44) shall reside within the operating frequency band (as specified in Table 1).
- The lowest boundary of the measured OBW minus  $FD_{down}$  (as specified in Table 44) shall reside within the operating frequency band (as specified in Table 1).

#### 4.3.5.4 Conformance

The conformance test suite for the occupied bandwidth requirement shall be as defined in clause 5.3.5 of the present document.

### 4.3.6 Unwanted emissions in the out-of-band domain

#### 4.3.6.1 Applicability

The unwanted emissions in the out-of-band domain requirement shall apply to all transmitters.

#### 4.3.6.2 Description

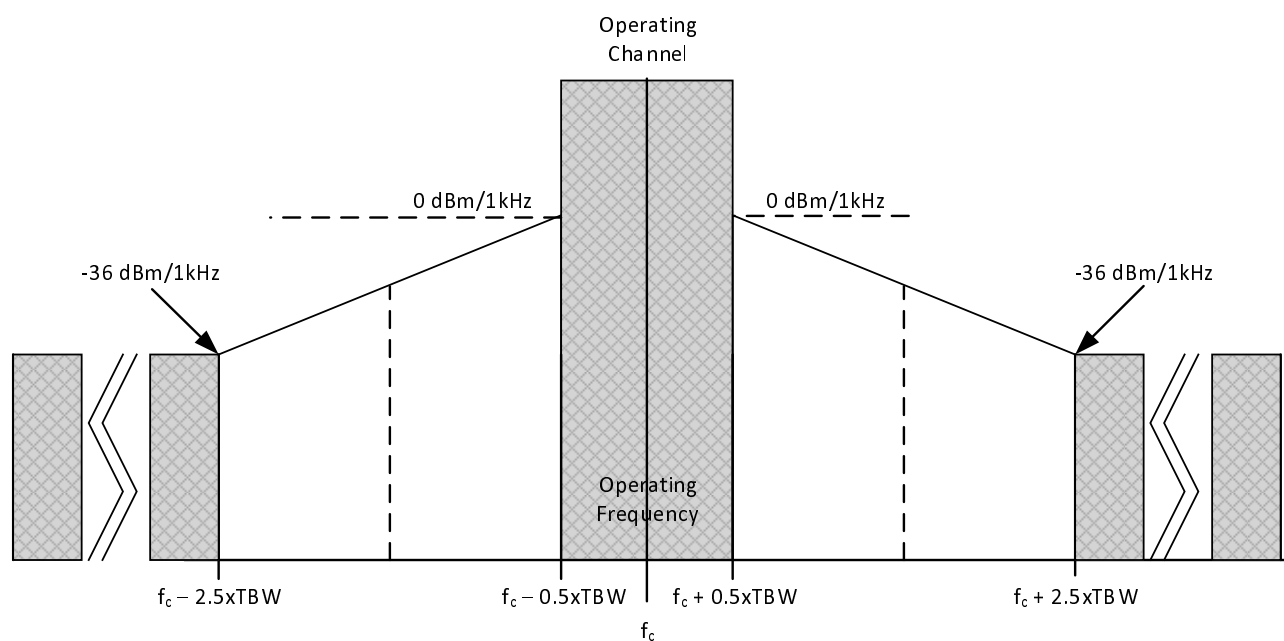

**Figure 4: Out-of-band domain for operating channel**

Unwanted emissions in the out-of-band domain are those falling in the frequency range immediately below the lower, and above the upper, frequency of the operating channel. The relevant out-of-band domain is shown in Figure 4 and applies within the operating frequency band.

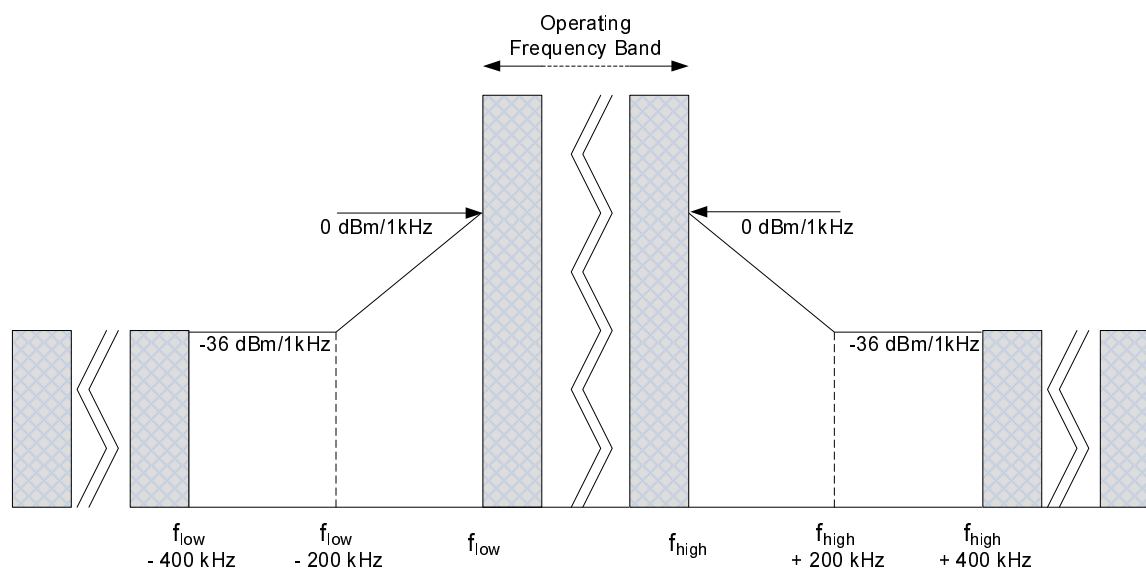

**Figure 5: Out-of-band domain for operating frequency band**

Specific limits apply at frequencies immediately above and below the operating frequency band as shown in Figure 5.

NOTE:  $f_{low}$  is the lower edge of the operating frequency band defined in Table 1.

$f_{high}$  is the upper edge of the operating frequency band edge defined in Table 1.

#### 4.3.6.3 Limits

The measured peak power within the lower and upper frequency ranges specified in Table 8 shall not exceed the corresponding peak power limit given in Table 8.

**Table 8: Emission limits in the out-of-band domain**

Reference Bandwidth ( $RBW_{REF}$ )	Peak power limit	Lower frequency	Upper frequency
1 kHz	-36 dBm	$f_{low} - 200$ kHz	$f_{high} + 200$ kHz
1 kHz	0 dBm	$f_{low}$	$f_{high}$
1 kHz	-36 dBm	$f_c - 2,5 \times TBW$	$f_c + 2,5 \times TBW$
1 kHz	0 dBm	$f_c - 0,5 \times TBW$	$f_c + 0,5 \times TBW$

NOTE:  $f_c$  is the operating frequency.  
 $f_{low}$  is the lower edge of the operating frequency band defined in Table 1.  
 $f_{high}$  is the upper edge of the operating frequency band defined in Table 1.  
 TBW is specified in Annex E.

#### 4.3.6.4 Conformance

The conformance test suite for the unwanted emissions in the out-of-band domain requirement shall be as defined in clause 5.3.6 of the present document.

### 4.3.7 Unwanted emissions in the spurious domain

#### 4.3.7.1 Applicability

The unwanted emissions in the spurious domain requirement shall apply to all transmitters.

### 4.3.7.2 Description

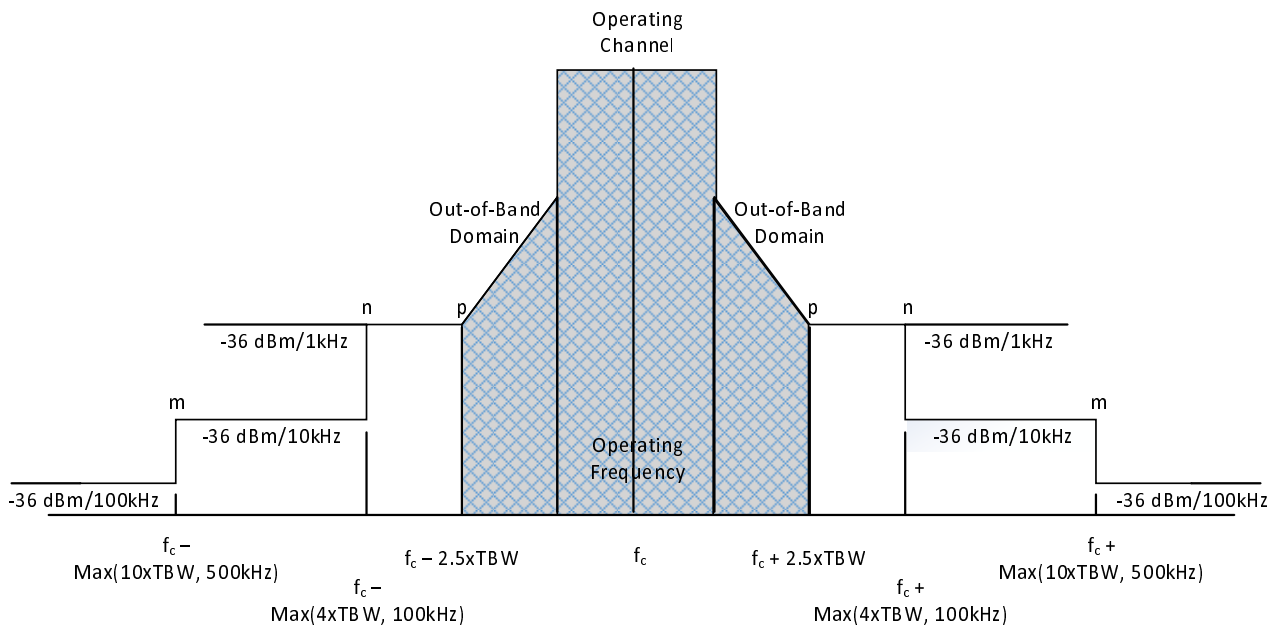

**Figure 6: Spectrum mask for unwanted emissions in the spurious domain**

Spurious emissions are unwanted emissions in the spurious domain at frequencies other than those of the operating channel and its out-of-band domain. The relevant spurious domain is shown in Figure 6.

### 4.3.7.3 Limits

The measured power of any unwanted emission in the spurious domain shall not exceed the values given in Table 9.

**Table 9: Spurious domain emission limits**

Frequency	87,5 MHz to 118 MHz 174 MHz to 230 MHz 470 MHz to 694 MHz	Other frequencies below 1 000 MHz	Frequencies above 1 000 MHz
State			
Operating	-54 dBm	-36 dBm	-30 dBm
Standby	-57 dBm	-57 dB	- 47 dBm

### 4.3.7.4 Conformance

The conformance test suite for the unwanted emissions in the spurious domain requirement shall be as defined in clause 5.3.7 of the present document.

## 4.3.8 Frequency stability under low-voltage conditions

### 4.3.8.1 Applicability

The frequency stability under low-voltage conditions requirement shall apply to all battery operated transmitters.

### 4.3.8.2 Description

Frequency stability under low voltage condition is the ability of the equipment to remain within the operating frequency band when the battery voltage falls below the lower extreme voltage level.

Under all voltage conditions the EUT duty cycle shall remain within limits specified in Table 13.

### 4.3.8.3 Limits

The measured centre frequencies shall not exceed the limits in Table 10.

The largest recorded duty cycle shall not exceed the limits specified in Table 13.

**Table 10: Frequency stability under low voltage conditions limits**

Requirement	Limit
Highest recorded centre frequency	$f_{\text{high}} - \frac{1}{2} \text{TBW}$
Lowest recorded centre frequency	$f_{\text{low}} + \frac{1}{2} \text{TBW}$
NOTE: $f_{\text{high}}$ is the upper operating frequency band limit. $f_{\text{low}}$ is the lower operating frequency band limit. The operating frequency bands are specified in Table 1. TBW is specified in Annex E.	

### 4.3.8.4 Conformance

The conformance test suite for the frequency stability under low-voltage conditions requirement shall be as defined in clause 5.3.8 of the present document.

## 4.3.9 Duty cycle and transmission timing

### 4.3.9.1 Applicability

The duty cycle and transmission timing requirement shall apply to all transmitters.

### 4.3.9.2 Description

**Table 11: Duty cycle parameters**

Parameter	Value
Long term behaviour observation period	3 600 seconds
Long term behaviour observation bandwidth	Operating frequency band as specified in Table 1.

Duty cycle is expressed as Long Term Behaviour with the observation interval and observation bandwidth specified in Table 11.

Transmission Timing is expressed as Short Term Behaviour with the parameters specified in Table 12.

**Table 12: Transmission timing parameters**

Parameter	Description
$T_{\text{On-max}}$	Longest transmission in an operating channel
$T_{\text{Off-min}}$	Shortest interval between transmission in an operating channel

### 4.3.9.3 Long term behaviour

The total duration of transmissions from the EUT within the operating frequency band is limited within any long term behaviour observation period. Long Term Behaviour (LTB) is expressed as:

$$\text{LTB} = \frac{\sum T_{\text{on}}}{T_{\text{obs}}}$$

Where:  $T_{\text{on}}$  is duration of a single transmission by the EUT;

$T_{\text{obs}}$  is the long term behaviour observation period.



#### 4.3.9.4 Short term behaviour

Each transmission consists of an RF emission, or sequence of RF emissions separated by intervals  $< T_{\text{Disregard}}$ , in the operating channel. The EUT shall wait a minimum period before beginning a subsequent transmission in the same operating channel. Short term behaviour (STB) is expressed as:

$$\text{STB} = \frac{T_{\text{on-max}}}{(T_{\text{on-max}} + T_{\text{off-min}})}$$

#### 4.3.9.5 Limits

The measured duty cycle,  $T_{\text{on-max}}$  and  $T_{\text{off-min}}$  values shall not exceed the limits defined in Table 13.

**Table 13: Duty cycle limits**

Equipment Type	Duty Cycle Limit	Notes
Type 1a Terminal Node	0,25 % (see note)	
Type 1b Network Node	2,5 %	
Type 1c NAP	10 %	
NOTE: Terminal Node limit is set to a value representative of average TN activity of 0,1 % assumed in CEPT spectrum compatibility studies (see ECC Report 200 [i.6], clause A2.4). The limit reflects an expected distribution of TN activity with only a small percentile exceeding the modelled average.		

The measured  $T_{\text{on-max}}$  and  $T_{\text{off-min}}$  values shall not exceed the limits defined in Table 14.

**Table 14: Transmission timing limits**

Parameter	Limit	Notes
$T_{\text{on-max}}$	400 ms	Maximum duration of a transmission from the EUT in the operating channel
$T_{\text{off-min}}$	400 ms	Minimum interval between two transmissions from the EUT in the operating channel

#### 4.3.9.6 Conformance

Conformance with the duty cycle and transmission timing requirement shall be as defined in clause 5.3.9 of the present document.

### 4.3.10 Automatic/adaptive power control

#### 4.3.10.1 Applicability

The automatic/adaptive power control requirement shall apply to all transmitters.

#### 4.3.10.2 Description

Automatic/Adaptive Power Control (APC) modifies the power transmitted by a device when communicating with a neighbour device. APC requires bi-directional communications to exchange information used to manage the transmitted power level. Such information exchange is out of scope of the present document.

### 4.3.10.3 Limits

The peak measured power shall not exceed the value shown in Table 15.

**Table 15: APC power limit**

Parameter	Limit
Transmitted Power	+7 dBm/5 mW

### 4.3.10.4 Conformance

The conformance test suite for the automatic/adaptive power control requirement shall be as defined in clause 5.3.10 of the present document.

## 4.4 Requirements for receivers

### 4.4.1 Receiver sensitivity

#### 4.4.1.1 Applicability

The receiver sensitivity requirement shall apply to all receivers.

#### 4.4.1.2 Description

Receiver sensitivity is the minimum signal power input to the receiver which produces the general performance criteria stated in clause 4.2.2 of the present document.

#### 4.4.1.3 Limits

The measured receiver sensitivity shall not be higher than the limits given in Table 16.

**Table 16: Limits for receiver sensitivity**

Parameter	Limit
Rx sensitivity	-91 dBm
<p>NOTE: The Rx sensitivity is based on a 50 kbps data rate. For other rates the sensitivity shall be adjusted according to the following formula:</p> $S = 10 \log_{10} \left( \frac{R}{R'} \right) - 91 \text{ dBm}$ <p>where:</p> <ul style="list-style-type: none"> <li>• S is the sensitivity in dBm;</li> <li>• R is the EUT data rate in kbps;</li> <li>• R' is 50 kbps.</li> </ul>	

#### 4.4.1.4 Conformance

The conformance test suite for the receiver sensitivity requirement shall be as defined in clause 5.4.1 of the present document.

### 4.4.2 Receiver maximum input signal level

#### 4.4.2.1 Applicability

The receiver maximum input signal level requirement shall apply to all receivers.

#### 4.4.2.2 Description

Maximum input signal level is the maximum signal power input to the receiver which produces the general performance criteria stated in clause 4.2.2 of the present document.

#### 4.4.2.3 Limits

The measured maximum input signal level shall not be less than the limits given in Table 17.

**Table 17: Limits for receiver maximum input signal level**

Parameter	Limit
Rx maximum input signal level	-19 dBm

#### 4.4.2.4 Conformance

The conformance test suite for the receiver maximum input signal level requirement shall be as defined in clause 5.4.2 of the present document.

### 4.4.3 Clear channel assessment threshold

#### 4.4.3.1 Applicability

The Clear Channel Assessment (CCA) threshold requirement shall apply to receivers of all equipment implementing LBT.

#### 4.4.3.2 Description

CCA threshold is the received signal level above which the receiver determines that the operating channel is not available for use.

#### 4.4.3.3 Limits

The measured CCA threshold shall not exceed the limits given in Table 18.

**Table 18: CCA threshold limit**

Parameter	Value
CCA threshold	10 dB above Rx sensitivity limit as given in Table 16.

#### 4.4.3.4 Conformance

The conformance test suite for the clear channel assessment threshold requirement shall be as defined in clause 5.4.3 of the present document.

### 4.4.4 Co-channel rejection

#### 4.4.4.1 Applicability

The co-channel rejection requirement applies to all receivers.

#### 4.4.4.2 Description

Co-channel rejection is a measure of the receiver capability to receive a wanted modulated signal without exceeding the general performance criteria stated in clause 4.2.2 of the present document due to the presence of an unwanted input signal in the operating channel.

#### 4.4.4.3 Limits

The measured co-channel rejection shall not be greater than the value specified in Table 19.

**Table 19: Co-channel rejection limit**

Parameter	Value
Co-channel rejection	12 dB

#### 4.4.4.4 Conformance

The conformance test suite for the co-channel rejection requirement shall be as defined in clause 5.4.4 of the present document.

### 4.4.5 Adjacent channel selectivity

#### 4.4.5.1 Applicability

The adjacent channel selectivity requirement applies to all receivers.

#### 4.4.5.2 Description

Adjacent channel selectivity is a measure of the receiver capability to receive a wanted modulated signal without exceeding the general performance criteria stated in clause 4.2.2 of the present document due to the presence of an unwanted input signal in the adjacent channels.

#### 4.4.5.3 Limits

The measured adjacent channel selectivity shall not be less than the value specified in Table 20.

**Table 20: Adjacent channel selectivity limit**

Parameter	Value	
	Wanted signal = S + 3 dB	Wanted signal = S + 23 dB
Adjacent channel selectivity	-61 dBm	-41 dBm

#### 4.4.5.4 Conformance

The conformance test suite for the adjacent channel selectivity requirement shall be as defined in clause 5.4.5 of the present document.

### 4.4.6 Blocking

#### 4.4.6.1 Applicability

The blocking requirement shall apply to all receivers.

#### 4.4.6.2 Description

Blocking is a measure of the receiver capability to receive a wanted modulated signal without exceeding the general performance criteria stated in clause 4.2.2 of the present document due to the presence of an unwanted input signal at any frequencies other than those of the spurious responses or the adjacent channels. Spurious response rejection is specified in clause 4.4.7 and adjacent channel selectivity is specified in clause 4.4.5.

### 4.4.6.3 Limits

The measured blocking level shall not be less than the values given in Table 21.

**Table 21: Limits for receiver blocking**

Frequency offset	Limit	
	Wanted signal = S + 3 dB	Wanted signal = S + 23 dB
±1 MHz	-50 dBm	-30 dBm
±2 MHz	-43 dBm	-23 dBm
±5 MHz	-38 dBm	-18 dBm
±10 MHz	-33 dBm	-13 dBm

### 4.4.6.4 Conformance

The conformance test suite for the blocking requirement shall be as defined in clause 5.4.6 of the present document.

## 4.4.7 Receiver spurious response rejection

### 4.4.7.1 Applicability

The receiver spurious response rejection requirement shall apply to all receivers.

### 4.4.7.2 Description

The spurious response rejection requirement is a measure of the capability of the receiver to receive a wanted modulated signal without exceeding the general performance criteria stated in clause 4.2.2 of the present document due to the presence of an unwanted unmodulated signal at any frequency at which a response is obtained.

### 4.4.7.3 Limits

The measured receiver rejection level for any spurious response shall not be less than the limits given in Table 22.

**Table 22: Receiver spurious response rejection limits**

Spurious response frequency offset	Limit
≤ ±1 MHz	-70 dBm
> ±1 MHz	-50 dBm

### 4.4.7.4 Conformance

The conformance test suite for the receiver spurious response rejection requirement shall be as defined in clause 5.4.6 of the present document.

## 4.4.8 Receiver intermodulation rejection

### 4.4.8.1 Applicability

The receiver intermodulation rejection requirement shall apply to all receivers.

### 4.4.8.2 Description

The intermodulation rejection requirement is a measure of the capability of the receiver to receive a wanted modulated signal without exceeding the general performance criteria stated in clause 4.2.2 of the present document due to the presence of two or more unwanted signals with a specific frequency relationship to the wanted signal.

### 4.4.8.3 Limits

The measured receiver intermodulation rejection level shall not be less than the limits given in Table 23.

**Table 23: Receiver intermodulation rejection limits**

Parameter	Limit
Receiver intermodulation rejection	28 dB

### 4.4.8.4 Conformance

The conformance test suite for the receiver spurious response rejection requirement shall be as defined in clause 5.4.7 of the present document.

## 4.4.9 Receiver spurious emissions

### 4.4.9.1 Applicability

The receiver spurious emissions requirement shall apply to all receivers.

### 4.4.9.2 Description

Spurious emissions from the receiver are components, at any frequency, radiated by the equipment and antenna.

### 4.4.9.3 Limits

The measured power of any spurious emission, radiated or conducted, shall not exceed the values given in Table 24.

**Table 24: Receiver spurious emission limits**

Frequency range	Maximum Power
< 1 000 MHz	-57 dBm
≥ 1 000 MHz	-47 dBm

### 4.4.9.4 Conformance

The conformance test suite for the receiver spurious emissions requirement shall be as defined in clause 5.4.8 of the present document.

## 4.5 Requirements for polite spectrum access

### 4.5.1 Listen before talk

#### 4.5.1.1 Applicability

The listen before talk requirement shall apply to NAPs operating at > 2,5 % long term behaviour duty cycle.

LBT is optional for other devices, but if it is implemented it shall be as described below.

#### 4.5.1.2 Description

In order to improve effective use of the spectrum by avoiding unnecessary collisions, polite equipment uses a Listen Before Talk (LBT) protocol.

NOTE 1: Unnecessary collisions are transmissions which would cause destructive interference to detectable transmissions from other devices.

Before transmitting, a device implementing LBT senses the channel for at least the minimum clear channel assessment period to determine if it is free. If the average signal level over the clear channel assessment period is below the CCA threshold specified in Table 18 the device proceeds with the transmission.

NOTE 2: The time between the end of the CCA period and the start of the transmission is the dead time and should be kept as short as possible to avoid losing the channel to another device implementing LBT.

If the average received signal level is above the CCA threshold specified in Table 18, the LBT device defers its transmission to a later time. The EUT shall not attempt re-transmission on the same channel until a random interval has expired. Alternatively, the EUT may select another channel and again start the listen before talk procedure.

NOTE 3: The random interval may be associated with a contention resolution algorithm provided by medium access protocol specifications.

#### 4.5.1.3 Limits

The measured minimum transmission delay shall not be less than the minimum CCA period specified in Table 25. The statistical randomness of the measured transmission delays shall be as specified in Table 25.

**Table 25: Limits for listen before talk requirement**

Parameter	Limit	Notes
Minimum CCA period	160 $\mu$ s	Minimum CCA listening period
Null hypothesis result	Not Reject	The null hypothesis is that the set of transmission delays is random
Null hypothesis confidence level	> 0,8	Probability that the null hypothesis result accurately reflects the randomness of the transmission delays

#### 4.5.1.4 Conformance

The conformance test suite for the listen before talk requirement shall be as defined in clause 5.5.1 of the present document.

### 4.5.2 Short control signalling transmissions

#### 4.5.2.1 Applicability

The short control signalling transmissions requirement shall apply to all equipment.

#### 4.5.2.2 Description

Transmissions may be acknowledged by the receiving device and hence carry information to control whether a transmission should be repeated or considered successful. Since acknowledgement avoids unnecessary re-transmission, it is considered part of polite spectrum access. Acknowledgements shall not be subject to clear channel assessment before transmission.

To avoid transmitting long data messages to a destination which is not available to receive them, a device may transmit a polling message and expect a confirmation acknowledgement response. If the response is successfully received the data message transmission may be attempted, otherwise the transmission attempt should be re-scheduled for a later time or a different channel.

## Timing constraints

$$T_{\text{Dialog-response}} \leq T_{\text{Dialog-interval}} \leq T_{\text{Disregard}}$$

$$T_{\text{Dialog}} \leq T_{\text{On-max}}$$

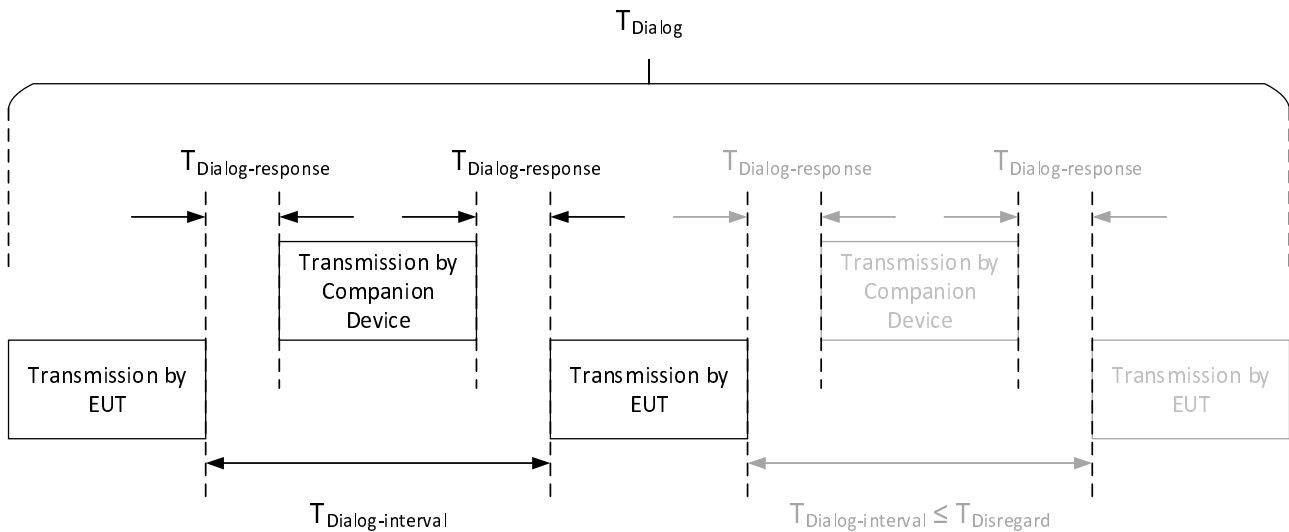

**Figure 7: SCS dialog timing constraints**

Within a channel, a device may exploit the  $T_{\text{Disregard}}$  property to permit the exchange of short control signalling messages separated by intervals shorter than the minimum inter-transmission interval ( $T_{\text{Off-min}}$ ). Such exchanges constitute a dialog and are subject to the timing constraints shown in Figure 7.

Within a dialog, accumulation of transmitter on time towards permitted duty cycle limits is as follows:

- Each transmission in the dialog ( $T_{\text{On}}$ ), whether SCS or data, is followed by an interval ( $T_{\text{Dialog-Response}}$ ) before the start of the corresponding response.

NOTE 1: Each transmission ( $T_{\text{On}}$ ) in the dialog is subject to  $T_{\text{Disregard}}$  processing.

- Each device in the dialog accumulates, towards its duty cycle, only the duration of its transmissions and response intervals:

$$T'_{\text{Cumulative}} = T_{\text{Cumulative}} + \Sigma(T_{\text{On}} + T_{\text{Dialog-Response}})$$

Where:

- $T_{\text{Cumulative}}$  is the accumulated  $T_{\text{On}}$  time towards its duty cycle before the dialog
- $T'_{\text{Cumulative}}$  is the resulting accumulated  $T_{\text{On}}$  time after the dialog

NOTE 2: The final emission in a dialog has a corresponding response interval of zero.

NOTE 3: A dialog will normally be subject to the specifications of a medium access protocol. Such specifications may require  $T_{\text{Dialog-Response}}$  to be a fixed value or a value within specified limits. Such specifications are outside the scope of the present document.

#### 4.5.2.3 Limits

The measured short control signalling transmissions shall not exceed the limits given in Table 26.



**Table 26: Limits for SCS transmissions**

Parameter	Limit	Notes
Dialog duration ( $T_{\text{Dialog}}$ )	$\leq T_{\text{On-max}}$	Maximum duration of any dialog
Dialog interval ( $T_{\text{Dialog-interval}}$ )	$< T_{\text{Disregard}}$	Interval between emissions from the EUT in a dialog

#### 4.5.2.4 Conformance

The conformance test suite for short control signalling requirement shall be as defined in clause 5.5.2 of the present document.

## 4.6 Functional requirements

### 4.6.1 General considerations

Functional tests verify that equipment in data networks perform required functions and, if applicable, that the actions are performed within specified time limits.

Functional tests are not intended to exercise radio links and requirement descriptions assume that all communications links operate normally for the intended use.

### 4.6.2 Network access point

#### 4.6.2.1 Applicability

The Network Access Point (NAP) requirement shall apply to all Type 1c equipment.

#### 4.6.2.2 Description

Type 1c equipment shall provide a means for terminal nodes and/or network nodes in a data network to communicate with a network or service outside the data network.

Messages to be transferred via the NAP may originate within or outside the data network. Once received by the NAP, such messages shall be transferred to the intended destination.

The delay between the message transfer request received by the NAP and the transfer of the message by the NAP to its intended destination is the NAP message transit delay.

**NOTE:** The mechanisms used to transfer the messages are outside the scope of the present document. For example, messages may be re-transmitted as received, may be transformed into different protocol encapsulations or may be translated in any manner required by the equipment under test, and may be transmitted reliably or unreliably.

#### 4.6.2.3 Limits

The NAP message transit delay shall not exceed the value specified in Table 27.

**Table 27: Network access point limits**

Parameter	Value
NAP message transit delay	60 minutes

#### 4.6.2.4 Conformance

The conformance test suite for the Network Access Point requirement shall be as defined in clause 5.6.2 of the present document.

---

## 5 Testing for compliance with technical requirements

### 5.1 Environmental conditions for testing

Tests defined in the present document shall be carried out at representative points within the boundary limits of the operational environmental profile defined by its intended use.

Where technical performance varies subject to environmental conditions, tests shall be carried out under a sufficient variety of environmental conditions (within the boundary limits of the operational environmental profile defined by its intended use) to give confidence of compliance for the affected technical requirements.

### 5.2 General conditions for testing

#### 5.2.1 General considerations

Technical documentation and operating manuals, sufficient to allow testing to be performed, shall be provided along with the EUT and any companion equipment necessary for normal operation of the EUT for its intended use. Annex J identifies various EUT properties required by the test suites specified in the present document.

Testing shall be made under normal test conditions, and also, where stated, under extreme test conditions.

Unless stated otherwise, tests performed under extreme test conditions shall apply the worst case temperature and voltage conditions simultaneously.

For each test method, appropriate test equipment, configuration settings and operation shall be selected by the test laboratory. The test equipment used, together with relevant settings for the test method, shall be recorded in the test report.

#### 5.2.2 Presentation of equipment for testing purposes

##### 5.2.2.1 General Considerations

To simplify and harmonize the testing procedures between the different testing laboratories, measurements shall be performed, according to the present document, on samples of equipment defined in clauses 5.2.2.2 to 5.2.2.3.

These clauses are intended to give confidence that the requirements set out in the present document have been met without the necessity of performing measurements on all frequencies.

##### 5.2.2.2 Choice of model for testing

###### 5.2.2.2.1 General considerations

One or more samples of the EUT, as appropriate, shall be tested.

Stand-alone EUT shall be tested complete with any ancillary equipment needed for testing.

All necessary test signal sources special to the equipment and set-up information shall accompany the equipment when it is submitted for testing.

###### 5.2.2.2.2 EUT with an external RF connector

Where practicable, an EUT offered for testing shall provide a 50  $\Omega$  connector for conducted RF power measurements.

### 5.2.2.2.3 EUT without an external RF connector

#### 5.2.2.2.3.1 General Considerations

Conducted measurements on an EUT with an integral antenna or with an antenna connection other than a 50  $\Omega$  coaxial connector may be made by:

- access to an internal connector;
- fitting of a temporary connector;
- use of a test fixture.

#### 5.2.2.2.3.2 EUT with an internal connector

Where the EUT has an internal conventional 50  $\Omega$  coaxial connector between the antenna and the circuitry, this may be utilized to perform conducted measurements. The means to access the connector, with the aid of a diagram, shall be stated by the manufacturer.

Use of an internal antenna connection shall be recorded in the test report.

#### 5.2.2.2.3.3 EUT with a temporary antenna connector

One EUT, with the normal antenna connected, may be tested using radiated measurement procedures. The manufacturer shall attend the test laboratory at the conclusion of the radiated measurements to disconnect the antenna and fit the temporary antenna connector. The test laboratory staff shall not connect or disconnect any temporary antenna connector.

Alternatively, two EUTs may be submitted to the test laboratory, one fitted with a temporary antenna connector with the antenna disconnected and another with the antenna connected. The appropriate EUT shall be used for each test case. The two EUTs shall be identical in all respects except for the temporary antenna connector.

Use of an EUT with a temporary antenna connection shall be recorded in the test report.

#### 5.2.2.2.3.4 Use of a Test Fixture

A test fixture is a structure for coupling an EUT with an integral antenna, at all frequencies for which measurements need to be performed, to a 50  $\Omega$  RF terminal.

A test fixture may only be used for relative measurements.

For further information on the test fixture, see Annex C.

### 5.2.2.3 Testing of modular equipment

If a family of equipment has alternative output power levels provided by the use of separate power modules or add on stages, or additionally has alternative frequency coverage, then each module or add on stage shall be tested in combination with the EUT over each applicable frequency range.

Measurements of the effective radiated power and spurious emissions shall be performed for each such combination and shall be recorded in the test report.

#### 5.2.2.4 Transmitter shut-off facility

If the transmitter is equipped with an automatic transmitter shut-off facility which can be disabled, it shall be made inoperative for the duration of the test.

#### 5.2.2.5 Battery saving circuit

If the receiver is equipped with a battery-saving circuit which can be disabled, this circuit shall be made inoperative for the duration of the tests.

## 5.2.2.6 Test power source

### 5.2.2.6.1 General considerations

The equipment shall be tested using the appropriate test power source as specified in clauses 5.2.2.6.2 or 5.2.2.6.3. Where equipment can be powered using either external or internal power sources, then the equipment shall be tested using the external power source as specified in clause 5.2.2.6.2 then repeated using the internal power source as specified in clause 5.2.2.6.3.

The test power source used shall be stated in the test report.

### 5.2.2.6.2 External test power source

During testing, the power source of the equipment shall be replaced by an external test power source capable of producing normal and extreme test voltages as specified in clauses 5.2.3.3 and 5.2.3.4. The internal impedance of the external test power source shall be low enough for its effect on the test results to be negligible. For the purpose of the tests, the voltage of the external test power source shall be measured at the input terminals of the equipment. The external test power source shall be suitably de-coupled and applied as close to the equipment battery terminals as practicable. For radiated measurements, any external power leads shall be so arranged so as not to affect the measurements.

During tests, the test power source voltages shall be within a tolerance of  $< \pm 1$  % relative to the voltage at the beginning of each test. The value of this tolerance can be critical for certain measurements. Using a smaller tolerance will provide a better uncertainty value for these measurements.

For radiated measurements, any external power leads should be so arranged so as not to affect the measurements.

### 5.2.2.6.3 Internal test power source

For radiated measurements on portable equipment with integral antenna, fully charged internal batteries shall be used. The batteries used shall be as supplied or recommended by the manufacturer. If internal batteries are used, at the end of each test the voltage shall be within a tolerance of  $< \pm 5$  % relative to the voltage at the beginning of each test. Where this is not appropriate, a note to this effect shall be appended to the test report.

If appropriate, for conducted measurements or where a test fixture is used, an external power supply at the required voltage may replace the supplied or recommended internal batteries. This shall be stated on the test report.

## 5.2.3 Normal and extreme test conditions

### 5.2.3.1 Normal temperature and humidity

The normal temperature and humidity conditions for tests shall be any convenient combination of temperature and humidity within the following ranges:

- Temperature +15 °C to +35 °C;
- Relative humidity 20 % to 75 %.

When it is impracticable to carry out tests under these conditions, a note to this effect, stating the ambient temperature and relative humidity during the tests, shall be added to the test report.

### 5.2.3.2 Extreme temperatures

#### 5.2.3.2.1 Procedure for tests at extreme temperatures

Before measurements are made the equipment shall have reached thermal balance in the test chamber. The equipment shall be switched off during the temperature stabilizing period.

In the case of equipment containing temperature stabilization circuits designed to operate continuously, the temperature stabilization circuits shall be switched on for 15 minutes after thermal balance has been obtained, and the equipment shall then meet the specified requirements.

If the thermal balance is not checked by measurements, a temperature stabilizing period of at least one hour, or such period as may be decided by the test laboratory, shall be allowed. The sequence of measurements shall be chosen, and the humidity content in the test chamber shall be controlled so that excessive condensation does not occur.

#### 5.2.3.2.2 Procedure for equipment designed for continuous operation

Before tests at the upper extreme temperature the equipment shall be placed in the test chamber and left until thermal balance is attained. The equipment shall then be switched on in the transmit condition for a period of 30 minutes after which the equipment shall meet the specified requirements.

For tests at the lower extreme temperature, the equipment shall be left in the test chamber until thermal balance is attained, then switched on for a period of one minute after which the equipment shall meet the specified requirements.

#### 5.2.3.2.3 Procedure for equipment designed for intermittent operation

Before tests at the upper extreme temperature the equipment shall be placed in the test chamber and left until thermal balance is attained. The equipment shall then either:

- transmit on and off in a manner representative of normal operation for a period of five minutes; or
- transmit in the on condition for a period not exceeding one minute, followed by a period in the off or standby mode for four minutes;

after which the equipment shall meet the specified requirements.

For tests at the lower extreme temperature, the equipment shall be left in the test chamber until thermal balance is attained, then switched to the standby or receive condition for one minute after which the equipment shall meet the specified requirements.

#### 5.2.3.2.4 Extreme temperature ranges

For tests at extreme temperatures, measurements shall be made in accordance with the procedures specified in clause 5.2.3.2.1, at the upper and lower temperatures of one of the following ranges, either:

- a) the temperature range for which the EUT was designed; or
- b) one of the following specified temperature ranges:
  - temperature category I (General): -20 °C to +55 °C;
  - temperature category II (Equipment for normal indoor use): +5 °C to +35 °C.

The test report shall state which range is used.

### 5.2.3.3 Normal test power source

#### 5.2.3.3.1 Mains voltage

The normal test voltage for equipment to be connected to the mains shall be the nominal mains voltage, or any of the mains voltages, for which the equipment was designed.

The frequency of the test power source corresponding to the AC mains shall be between 49 Hz and 51 Hz.

#### 5.2.3.3.2 Regulated lead-acid battery power sources

When the radio equipment is intended for operation with the usual types of regulated lead-acid battery power source, the normal test voltage shall be 1,1 multiplied by the nominal voltage of the battery (e.g. 6 V, 12 V, etc.).

#### 5.2.3.3.3 Other power sources

For operation from other power sources or types of battery (primary or secondary), details of the power source, the nominal voltage and normal test voltage shall be recorded in the test report.

### 5.2.3.4 Extreme test source voltages

#### 5.2.3.4.1 Mains voltage

The extreme test voltages for equipment to be connected to an AC mains source shall be the nominal mains voltage  $\pm 10\%$ . For equipment that operates over a range of mains voltages clause 5.2.3.4.4 applies.

#### 5.2.3.4.2 Regulated lead-acid battery power sources

When the radio equipment is intended for operation from the usual type of regulated lead-acid battery power sources the extreme test voltages shall be 1,3 and 0,9 multiplied by the nominal voltage of the battery (6 V, 12 V, etc.).

For float charge applications using "gel-cell" type batteries the extreme voltage shall be 1,15 and 0,85 multiplied by the nominal voltage of the battery.

#### 5.2.3.4.3 Power sources using other types of batteries

The lower extreme test voltages for equipment with power sources using batteries shall be recorded in the test report and shall be as follows:

- For equipment with a battery indicator, the end point voltage as indicated.
- For equipment without a battery indicator the following end point voltages shall be used:
  - For the Leclanché or the lithium type of battery:
    - 0,85 multiplied by the nominal voltage of the battery.
  - For the nickel-cadmium type of battery:
    - 0,9 multiplied the nominal voltage of the battery.
- For other types of battery or equipment, details of power source and the lower extreme test voltage for the discharged condition shall be recorded in the test report.

If the upper extreme voltage is different from the nominal voltage, details of the power source and the upper extreme voltage shall be recorded in the test report.

#### 5.2.3.4.4 Other power sources

For equipment using other power sources, or capable of being operated from a variety of power sources, details of the power sources, the lower extreme test voltage and the upper extreme test voltage (if different from the nominal voltage) shall be recorded in the test report.

## 5.2.4 Conducted measurements

### 5.2.4.1 Artificial antenna

Conducted tests shall be carried out using an artificial antenna (also called a dummy load) which shall be a substantially non-reactive non-radiating load connected to the EUT antenna connector and providing a 50  $\Omega$  coupling port for connection to test equipment.

### 5.2.4.2 Voltage Standing Wave Ratio (VSWR)

The VSWR at the 50  $\Omega$  connector of the artificial antenna shall not be greater than 1,5:1 over the frequency range of the measurement.

## 5.2.5 Radiated measurements

For all radiated measurements a suitable test site, selected from those described in clause B.2, and applicable measurement procedures, as described in clause B.6, shall be used.

When performing radiated transmitter measurements, the EUT shall be configured and antenna(s) positioned (including smart antenna systems and systems capable of beam forming) and oriented for maximum radiated power into the measuring antenna. The measuring antenna shall use the same polarization as the EUT and be chosen according to the frequency of the transmitter.

When performing radiated receiver measurements, the EUT shall be configured and antenna(s) positioned (including smart antenna systems and systems capable of beam forming) for maximum sensitivity towards the test antenna. The test antenna shall use the same polarization as the EUT and be chosen according to the frequency of the transmitter.

## 5.2.6 Measuring receiver

### 5.2.6.1 General considerations

The term "measuring receiver" refers to a frequency-selective voltmeter or a spectrum analyser. Unless stated otherwise, an RMS detector shall be used.

### 5.2.6.2 Reference Bandwidth

In general, the Resolution BandWidth of the measuring receiver (RBW) should be equal to the Reference BandWidth ( $RBW_{REF}$ ) given in Table 28.

**Table 28: Resolution bandwidth for the measuring receiver**

Frequency range in which the measured frequency (f) falls	Measuring receiver resolution bandwidth ( $RBW_{REF}$ )
$f < 150$ kHz	200 Hz or 300 Hz
$150$ kHz $\leq f < 25$ MHz	9 kHz or 10 kHz
$25$ MHz $\leq f \leq 1\ 000$ MHz	100 kHz or 120 kHz
$f > 1\ 000$ MHz	1 MHz
NOTE: The frequency ranges and corresponding $RBW_{REF}$ values are derived from CISPR 16 [i.10].	

To improve measurement accuracy, sensitivity and efficiency, RBW may be different from  $RBW_{REF}$ .

When  $RBW < RBW_{REF}$  the result should be integrated over  $RBW_{REF}$ .

When  $RBW > RBW_{REF}$  the result for broadband spurious emissions should be normalized to the bandwidth ratio according to the following formula:

$$B = A + 10 \log \frac{RBW_{REF}}{RBW_{MEASURED}}$$

Where:

- A is the measured value at the measurement bandwidth  $RBW_{MEASURED}$ ;
- B is the corresponding value at the reference bandwidth  $RBW_{REF}$ .

For discrete spurious emissions, defined as a narrow peak with a level of at least 6 dB above the average level inside the measurement bandwidth, normalization is not applicable, while integration over  $RBW_{REF}$  is still applicable.

## 5.2.7 Transmitter test signals

For the purposes of the present document a test signal is a modulated or unmodulated carrier generated by the EUT. The EUT should be capable of generating the following test signals:

- D-M1: a test signal consisting of an unmodulated carrier.

- D-M2: a test signal representative of normal operation and generating the greatest occupied RF bandwidth. The preferred test signal shall consist of a pseudo-random bit sequence of at least 511 bits in accordance with Recommendation ITU-T O.153 [i.8]. This sequence shall be continuously repeated.
- D-M2a: a test signal as described in D-M2 but generated intermittently. The generated RF signals shall be the same for each transmission except for the data sequence, occur regularly in time, be accurately repeatable and their timing duration shall represent normal operation of the EUT except for compliance with a duty cycle limit.
- D-M3: a test signal representative of normal operation of the EUT for its intended purpose.

Test signals may be generated by applying test baseband signals to a modulation port on the device or be generated internally by the device.

NOTE: Operation in a test mode may involve temporary internal modifications of the EUT or the use of special software. Details of any such modifications or use of test modes or special software should be recorded in the test report.

For each test performed, the test signal used shall be recorded in the test report. Permitted test signals for each test are shown in Table 29.

**Table 29: Permitted test signals**

Clause	Requirement	Test Signal
5.3.1	Frequency drift	D-M1
5.3.2	Operating frequencies and channel spacing	D-M1, D-M2, D-M2a, D-M3
5.3.3	Effective radiated power	D-M1, D-M2, D-M2a, D-M3
5.3.4	Transient power	D-M2a, D-M3
5.3.5	Occupied bandwidth	D-M2, D-M2a, D-M3
5.3.6	Unwanted emissions in the out-of-band domain	D-M2, D-M2a, D-M3
5.3.7	Unwanted emissions in the spurious domain	D-M2, D-M2a, D-M3
5.3.8	Frequency stability under low voltage conditions	D-M1, D-M2, D-M2a, D-M3
5.3.9	Duty cycle and transmission timing	D-M3
5.3.10	Automatic/adaptive power control	D-M3
5.4.1	Receiver sensitivity	D-M2, D-M2a, D-M3
5.4.2	Receiver maximum input signal level	D-M2, D-M2a, D-M3
5.4.3	Clear channel assessment threshold	D-M2, D-M2a, D-M3
5.4.4	Co-channel rejection	D-M2, D-M2a, D-M3
5.4.5	Adjacent channel selectivity	D-M2, D-M2a, D-M3
5.4.6	Blocking and spurious response rejection	D-M2, D-M2a, D-M3
5.4.7	Receiver intermodulation rejection	D-M2, D-M2a, D-M3
5.4.8	Receiver spurious radiations	N/A
5.5.1	Listen before talk	D-M3
5.5.2	Short control signalling transmissions	D-M3
5.6.2	Network access point	D-M3

## 5.2.8 Applicable measurement methods

Although the measurement methods in the present document allow conducted measurements to be performed, the EUT together with all its intended antenna assemblies shall comply with the applicable technical requirements.

For any test method described using a conducted connection, an equivalent radiated measurement may be used instead. For certain measurements, an equivalent test using a test fixture may be used. In such cases, procedures to establish reference levels shall be used and recorded in the test report.

Where a test method uses a radiated measurement, it is not generally possible to substitute a conducted or a test fixture measurement.

For equipment with pulse modulation, or where it is not possible to make a required measurement in the absence of modulation, the measurement shall be carried out by the use of a measuring receiver with appropriate receiver bandwidth (see clause 5.2.6).



A summary of the applicable measurement methods for each test suite are shown in Table 30.

**Table 30: Applicable test methods**

Clause	Requirement	Test method		
		Radiated	Conducted	Test fixture
5.3.1	Frequency drift	Yes	Yes	Yes
5.3.2	Operating frequencies and channel spacing	Yes	Yes	Yes
5.3.3	Effective radiated power	Yes	No	No (see note 2)
5.3.4	Transient power	Yes	Yes	No
5.3.5	Occupied bandwidth	Yes	Yes	Yes
5.3.6	Unwanted emissions in the out-of-band domain	Yes	Yes	No
5.3.7	Unwanted emissions in the spurious domain	Yes	Yes	No
5.3.8	Frequency stability under low voltage conditions	Yes	Yes	Yes
5.3.9	Duty cycle and transmission timing	Yes	Yes	Yes
5.3.10	Automatic/adaptive power control	Yes	Yes	No
5.4.1	Receiver sensitivity	Yes	Yes	No (see note 2)
5.4.2	Receiver maximum input signal level	Yes	Yes	No
5.4.3	Clear channel assessment threshold	Yes	Yes	No
5.4.4	Co-channel rejection	Yes	Yes	No
5.4.5	Adjacent channel selectivity	Yes	Yes	No
5.4.6	Blocking and spurious response rejection	Yes	Yes	No
5.4.7	Receiver intermodulation rejection	Yes	Yes	No
5.4.8	Receiver spurious radiations	Yes	Yes	No
5.5.1	Listen before talk	Yes	Yes	No
5.5.2	Short control signalling transmissions	Yes	Yes	No
5.6.2	Network access point	Yes	Yes	No
NOTE 1: See clause 5.2.2.2 'Choice of model for testing'.				
NOTE 2: Where test fixture use is 'No' but extreme radiated measurements are required, the difference between a radiated measurement and a test fixture measurement under normal test conditions may be used as a correction for a test fixture measurement made under extreme test conditions.				

## 5.2.9 Modes of operation

### 5.2.9.1 Test mode

Unless otherwise specified, the measurements shall be performed using normal operation of the equipment in the worst case operational mode (see Annex J).

NOTE: The worst case operational mode is that mode resulting in the worst results with regard to the requirement.

### 5.2.9.2 Transmitter operation

For each transmitter test an appropriate test signal shall be employed and recorded in the test report.

Unless otherwise specified, the transmitter shall be operated at its maximum transmit power level.

Equipment able to operate with different modulations shall be tested for each modulation separately.

When performing transmitter tests on equipment designed for intermittent operation it may be necessary to exceed the duty cycle associated with normal operation. Where this is the case, care should be taken to avoid heating effects having an adverse effect on the equipment and the parameters being measured. The maximum transmission duration shall be stated by the test laboratory, where applicable. This on-time shall not be exceeded and details shall be stated in the test report.

### 5.2.9.3 Testing of multi-frequency or channel agile equipment

Unless otherwise specified, equipment intended to operate on multiple frequencies, or channel agile equipment, shall be tested on the highest operating frequency and lowest operating frequency of the EUT.

Channel agile equipment should allow specific operating frequencies to be selected manually to facilitate some of the tests to be performed.

### 5.2.9.4 Non-uniform maximum transmit power

Where an EUT does not use the same power level on each operating frequency, specific test procedures are required for certain tests. Where the operating frequency does not materially impact the testing of the requirement, the highest and lowest operating frequencies on which the EUT operates at its highest power level shall be used in place of the highest and lowest operating frequencies of the EUT.

Where the operating frequency does materially impact the testing of the requirement, the tests shall be performed on the highest and lowest operating frequencies of the EUT. The tests shall then be repeated for each next highest and lowest operating frequency on which a greater power level is used until operating frequencies on which the highest power level is used have been tested.

The result of the test shall be recorded as the worst case of the sets of frequencies tested for the specific test suite.

The test suites where these specific procedures apply are shown in Table 31.

**Table 31: Specific test procedures**

Clause	Requirement	Specific Test Procedures
5.5.1	Frequency drift	No
5.3.2	Operating frequencies and channel spacing	No
5.3.3	Effective radiated power	Yes
5.3.4	Transient power	Yes
5.3.5	Occupied bandwidth	Yes
5.3.6	Unwanted emissions in the out-of-band domain	Yes
5.3.7	Unwanted emissions in the spurious domain	Yes
5.3.8	Frequency stability under low voltage conditions	No
5.3.9	Duty cycle and transmission timing	No
5.3.10	Automatic/adaptive power control	Yes
5.4.1	Receiver sensitivity	No
5.4.2	Receiver maximum input signal level	No
5.4.3	Clear channel assessment threshold	No
5.4.4	Co-channel rejection	No
5.4.5	Adjacent channel selectivity	No
5.4.6	Blocking	No
5.4.7	Receiver intermodulation rejection	No
5.4.8	Receiver spurious radiations	No
5.5.1	Listen before talk	No
5.5.2	Short control signalling transmissions	No
5.6.2	Network access point	No

## 5.3 Conformance methods of measurement for transmitters

### 5.3.1 Frequency drift

#### 5.3.1.1 Test conditions

- 1) The measurement shall be made under normal and extreme test conditions.
- 2) The measurement shall be performed on the highest and lowest operating frequencies.

- 3) The measurement shall be performed with an unmodulated carrier test signal.
- 4) The measurement method is selected according to clause H.1.

### 5.3.1.2 Measurement procedure

#### Step 1:

Under normal test conditions:

- Operation of the EUT shall be started using test signal D-M1 on the highest operating frequency. The frequency of the unmodulated carrier shall be measured and noted as  $F_{H.N}$ .
- The operation of the EUT shall be restarted using test signal D-M1 at the lowest operating frequency. The frequency of the unmodulated carrier shall be measured and noted as  $F_{L.N}$ .

#### Step 2:

Under extreme test conditions, maximum temperature:

- Operation of the EUT shall be started using test signal D-M1 on the highest operating frequency. The frequency of the unmodulated carrier shall be measured and noted as  $F_{H.H}$ .
- The operation of the EUT shall be restarted using test signal D-M1 at the lowest operating frequency. The frequency of the unmodulated carrier shall be measured and noted as  $F_{L.H}$ .

#### Step 3:

Under extreme test conditions, minimum temperature:

- Operation of the EUT shall be started using test signal D-M1 on the highest operating frequency. The frequency of the unmodulated carrier shall be measured and noted as  $F_{H.C}$ .
- The operation of the EUT shall be restarted using test signal D-M1 at the lowest operating frequency. The frequency of the unmodulated carrier shall be measured and noted as  $F_{L.C}$ .

The information shown in Table 32 shall be recorded in the test report for each test condition.

**Table 32: Information recorded in the test report for frequency drift**

Value	Notes
Test environment	Normal or extreme test conditions
Highest operating frequency	Measured unmodulated carrier frequency under: <ul style="list-style-type: none"> <li>• <math>F_{H.N}</math> normal test conditions</li> <li>• <math>F_{H.H}</math> extreme high temperature conditions</li> <li>• <math>F_{H.C}</math> extreme low temperature conditions</li> </ul>
$FH_{up}$	Maximum of $(F_{H.H} - F_{H.N})$ and $(F_{H.C} - F_{H.N})$
$FH_{down}$	Maximum of $(F_{H.N} - F_{H.C})$ and $(F_{H.N} - F_{H.H})$
Lowest operating frequency	Measured unmodulated carrier frequency under: <ul style="list-style-type: none"> <li>• <math>F_{L.N}</math> normal test conditions</li> <li>• <math>F_{L.H}</math> extreme high temperature conditions</li> <li>• <math>F_{L.C}</math> extreme low temperature conditions</li> </ul>
$FL_{up}$	Maximum of $(F_{L.H} - F_{L.N})$ and $(F_{L.C} - F_{L.N})$
$FL_{down}$	Maximum of $(F_{L.N} - F_{L.C})$ and $(F_{L.N} - F_{L.H})$
$FD_{up}$	Maximum of $FH_{up}$ and $FL_{up}$
$FD_{down}$	Maximum of $FH_{down}$ and $FL_{down}$

## 5.3.2 Operating frequencies

### 5.3.2.1 Test conditions

- 1) The measurements shall be performed under normal test conditions.
- 2) The measurement shall be performed on each nominal operating frequency of the EUT.
- 3) The measurement shall be performed with a spectrum analyser.
- 4) The measurement method is selected according to clause H.1.

### 5.3.2.2 Measurement procedure

**Table 33: Test parameters for operating frequencies measurement**

Setting	Value	Notes
Centre frequency	The nominal operating frequency	The nominal operating frequency of the EUT
RBW	1 kHz	
VBW	3 × RBW	Nearest available analyser setting to 3 × RBW
Span	At least 2x maximum OBW as specified in Table 7	Span should be large enough to include all major components of the signal and its side bands
Detector Mode	RMS	
Trace	Maximum hold	

The spectrum analyser shall be configured for the parameters shown in Table 33.

#### Step 1:

- Operation of the EUT shall be started, on the lowest operating frequency with a permitted test signal (see Table 29).
- The signal attenuation shall be adjusted to ensure that the signal power envelope is sufficiently above the noise floor of the analyser to avoid the noise signals on either side of the power envelope being included in the measurement.

#### Step 2:

- When the trace is completed the centre frequency of the trace shall be located and noted.

#### Step 3:

- Operation of the EUT shall be restarted on the next higher operating frequency with the same test signal.

#### Step 4:

- The measurement in step 2 and step 3 shall be repeated until each nominal operating frequency has been measured and recorded.

The information shown in Table 34 shall be recorded in the test report for each measured centre frequency.

**Table 34: Information recorded in the test report for operating frequencies**

Value	Notes
Test signal	The test signal used (see clause 5.2.7)
Nominal centre frequency (A)	Nominal operating frequency
Measured centre frequency (A')	Measured centre frequency
Operating frequency error	Absolute value of (A-A')

### 5.3.3 Effective radiated power

#### 5.3.3.1 Test conditions

- 1) The measurements shall be performed under normal and extreme conditions.
- 2) The measurement shall be performed on the highest and lowest operating frequencies.

NOTE: See clause 5.2.9.4 for specific test procedures for non-uniform maximum transmit power.

- 3) For an EUT with non-constant-envelope modulation, test signal D-M1 shall not be used.
- 4) For an EUT with non-constant-envelope modulation, the average power shall be measured.
- 5) An EUT without a permanent or temporary antenna connector shall be tested according to clause 5.3.3.2.
- 6) An EUT with a permanent or temporary antenna connector shall be tested according to clause 5.3.3.3.

#### 5.3.3.2 Radiated measurement procedure

A test site shall be selected from those described in clause B.2. The EUT shall be placed on the turntable and the following measurements performed using radiated measurement methods described in clause B.6 corresponding to the selected test site.

**Table 35: Test parameters for effective radiated power measurement**

Setting	Value	Notes
Centre frequency	The nominal operating frequency	The highest or lowest operating frequency
Detector mode	RMS or Peak	RMS if EUT provides unmodulated carrier or uses non-constant-envelope modulation; otherwise Peak
Span	Width of the operating frequency band (see note 1)	Span to cover the full operating frequency band
RBW	$2 \times \text{OBW}$ (see note 2)	RBW larger than the signal width
VBW	$3 \times \text{RBW}$	Nearest setting to $3 \times \text{RBW}$
NOTE 1: The operating frequency bands are specified in Table 1.		
NOTE 2: OBW is specified in clause 4.3.5.		

NOTE RBW can be verified to be large enough by measuring the signal at successively smaller RBW settings until the measured power is lower than the preceding measurement. At this point the measuring receiver is no longer capturing the full signal. RBW should be set to be no smaller than the preceding value for which no change was indicated with its preceding larger value.

The test equipment shall be configured for the parameters shown in Table 35.

The following procedure shall be carried out under normal conditions:

##### Step 1:

- Operation of the EUT shall be started, on the highest operating frequency, with a permitted test signal (see Table 29).

##### Step 2:

- The higher absolute power value measured for vertical or horizontal polarization shall be noted as  $\text{ERP}_{\text{NTC-H}}$ .

##### Step 3:

- Operation of the EUT shall be restarted on the lowest operating frequency with a permitted test signal (see Table 29).
- The higher absolute power value measured for vertical or horizontal polarization shall be noted as  $\text{ERP}_{\text{NTC-L}}$ .

**Step 4:**

- The information shown in Table 36 shall be recorded in the test report.

**Table 36: Information recorded in the test report for effective radiated power under normal test conditions**

Value	Notes
Test environment	Normal test conditions
Test signal	The test signal used (see clause 5.2.7)
ERP <sub>NTC-H</sub>	Measured effective radiated power at the highest operating frequency
ERP <sub>NTC-L</sub>	Measured effective radiated power at the lowest operating frequency
Measured effective radiated power	Larger of ERP <sub>NTC-H</sub> and ERP <sub>NTC-L</sub>

A reference test fixture measurement under normal test conditions shall be obtained by performing the following procedure:

**Step 1:**

- The EUT shall be fixed to a test fixture as specified in Annex C. The output of the test fixture shall be connected to a measuring receiver.

**Step 2:**

- The EUT shall be restarted on the highest operating frequency with a permitted test signal (see Table 29).

**Step 3:**

- The power into the measuring equipment shall be noted as ERP<sub>NTC-TF-H</sub>.

**Step 4:**

- The EUT shall be restarted on the lowest operating frequency with a permitted test signal (see Table 29).

**Step 5:**

- The power into the measuring equipment shall be noted as ERP<sub>NTC-TF-L</sub>.

The following procedure shall be carried out under extreme test conditions:

**Step 1:**

- The EUT shall be fixed to a test fixture as specified in Annex C. The output of the test fixture shall be connected to a measuring receiver. The test fixture shall be placed in the temperature controlled chamber and thermal equilibrium obtained.

**Step 2:**

- Operation of the EUT shall be started, on the highest operating frequency, with a permitted test signal (see Table 29).
- The power into the measuring equipment shall be noted as ERP<sub>ETC-TF-H</sub>.

**Step 3:**

- Operation of the EUT shall be restarted, on the lowest operating frequency, with a permitted test signal (see Table 29).
- The power into the measuring equipment shall be noted as ERP<sub>ETC-TF-L</sub>.

**Step 4:**

- The information shown in Table 37 shall be recorded in the test report.

**Table 37: Information recorded in the test report for effective radiated power under extreme test conditions**

Value	Notes
Test environment	Extreme test conditions
Test signal	The test signal used (see clause 5.2.7)
$ERP_{NTC-TF-H}$	Measured test fixture reference effective radiated power under normal test conditions at the highest operating frequency
$ERP_{NTC-TF-L}$	Measured test fixture reference effective radiated power under normal test conditions at the lowest operating frequency
$ERP_{Delta-TF-H}$	$ERP_{NTC-H} - ERP_{NTC-TF-H}$
$ERP_{Delta-TF-L}$	$ERP_{NTC-L} - ERP_{NTC-TF-L}$
$ERP_{ETC-TF-H}$	Measured test fixture effective radiated power under extreme test conditions at the highest operating frequency
$ERP_{ETC-TF-L}$	Measured test fixture effective radiated power under extreme test conditions at the lowest operating frequency
Measured effective radiated power	Larger of $(ERP_{ETC-TF-H} + ERP_{Delta-TF-H})$ and $(ERP_{ETC-TF-L} + ERP_{Delta-TF-L})$

### 5.3.3.3 Conducted measurement procedure

The EUT shall be connected to an artificial antenna which shall be connected to the measuring receiver.

The test equipment shall be configured for the parameters shown in Table 35.

#### Step 1:

- Operation of the EUT shall be started, on the highest operating frequency, with a permitted test signal (see Table 29).
- The power delivered to the artificial antenna shall be measured.

#### Step 2:

- The measurement in step 1 shall be repeated for the lowest operating frequency.

#### Step 3:

- The measurements in step 1 and step 2 shall be repeated under extreme test conditions.

The information shown in Table 38 shall be recorded in the test report for each test condition.

**Table 38: Information recorded in the test report for effective radiated power**

Value	Notes
Test environment	Normal or Extreme test conditions
Test signal	The test signal used (see clause 5.2.7)
Operating frequency	Frequency on which the test was performed
Average output power (conducted)	Measured power
NOTE:	The maximum permitted gain for any antenna used with the EUT is the e.r.p. limit specified in Table 5 minus the measured conducted output power.

## 5.3.4 Transient power

### 5.3.4.1 Test conditions

- 1) The measurements shall be performed under normal test conditions.
- 2) The measurements shall be performed using a spectrum analyser or equivalent measuring equipment.
- 3) The measurements shall be performed on the highest and lowest operating frequencies.

- 4) The measurement method is selected according to clause H.2.

#### 5.3.4.2 Measurement procedure

**Table 39: Measurement offsets & RBW for transient power measurement**

Offset frequency (kHz)	Analyser RBW (kHz)	RBW <sub>REF</sub> (kHz)
TBW	Max (RBW pattern 1,3,10) $\leq$ Offset frequency/6	1
0,5 $\times$ TBW+400 kHz	Max (RBW pattern 1,3,10) $\leq$ Offset frequency/4	1
0,5 $\times$ TBW+1 200 kHz	Max (RBW pattern 1,3,10) $\leq$ Offset frequency/4	1
NOTE: Max (RBW pattern 1, 3, 10) means the maximum bandwidth that falls into the incremental 1,3,10 RBW filter bandwidth pattern commonly implemented in spectrum analysers TBW is as specified in Annex E.		

**Table 40: Test parameters for transient power measurement**

Setting	Value	Notes
VBW/RBW	10	At higher RBW values VBW may be clipped to its maximum value
Sweep time	See note	Capture one full packet
RBW filter	Gaussian	
Scan Mode	Zero Span	Time domain power measurement
Trace Detector Function	Peak	Required to capture fast signal
Trace Mode	Clear Write	
NOTE: Long enough to accommodate at least one full transmitted packet.		

The spectrum analyser shall be configured for the parameters shown in Table 40.

- NOTE: If such a facility is provided, the analyser should be triggered from a signal generated by the EUT before packet transmission. In the absence of such a facility, the analyser should be configured in free run mode.

The operation of the EUT shall be started on the highest operating frequency using a permitted test signal (see Table 29).

The analyser centre frequency shall be set to the Offset Frequency in the first row of Table 39 above the EUT operating frequency and the analyser RBW set to the corresponding RBW given in Table 39.

##### Step 1:

- A single sweep shall be taken on the analyser and the peak value shall be noted.

##### Step 2:

- The noted peak power value shall be converted to the equivalent power value measured in RBW<sub>REF</sub> by the formula in clause 5.2.6, where A is the measured value and B is the value normalized to RBW<sub>REF</sub> given in the corresponding row of Table 39.

##### Step 3:

- The analyser centre frequency shall be set to the Offset Frequency in the first row of Table 39 below the EUT operating frequency.

Steps 1 and 2 shall be repeated.

##### Step 4:

- Steps 1, 2 and 3 shall be repeated using the Offset Frequency and corresponding RBW and RBW<sub>REF</sub> value from the 2<sup>nd</sup> and 3<sup>rd</sup> rows of Table 39.



**Step 5:**

- Operation of the EUT shall be restarted on the lowest operating frequency with a permitted test signal (see Table 29).
- The measurements in steps 1 through 4 shall be repeated.

The information shown in Table 41 shall be recorded in the test report for each test measurement.

**Table 41: Information recorded in the test report for transmitter transient power**

Value	Notes
Operating frequency	The highest or lowest operating frequency and any other frequencies used in the test case
Peak measured power	The peak power value displayed by the spectrum analyser
Peak power	Calculated peak power in $RBW_{REF}$

## 5.3.5 Occupied bandwidth

### 5.3.5.1 Test conditions

- 1) The measurements shall be performed under normal and extreme test conditions.

NOTE: If the frequency drift (see clause 4.3.1) measurement is performed then the measurements may be made under normal test conditions only.

- 2) The measurement shall be performed on the highest and lowest operating frequencies.
- 3) The measurement shall be performed with a spectrum analyser.
- 4) The measurement method is selected according to clause H.1.

### 5.3.5.2 Measurement procedure

**Table 42: Test parameters for occupied bandwidth measurement**

Setting	Value	Notes
Centre frequency	The nominal operating frequency	The highest or lowest operating frequency. Additional frequencies may be derived from these values using the nominal channel spacing
RBW	1 kHz	
VBW	3 × RBW	Nearest available analyser setting to 3 × RBW
Span	-	Span should be large enough to include all major components of the signal and its side bands
Detector Mode	RMS	
Trace	Maximum hold	

The spectrum analyser shall be configured for the parameters shown in Table 42.

Under normal test conditions:

**Step 1:**

- Operation of the EUT shall be started, on the highest operating frequency with a permitted test signal (see Table 29).
- The signal attenuation shall be adjusted to ensure that the signal power envelope is sufficiently above the noise floor of the analyser to avoid the noise signals on either side of the power envelope being included in the measurement.
- When the trace is completed the peak value of the trace shall be located and the analyser marker placed on this peak.

- The 99 % occupied bandwidth function of the spectrum analyser shall be used to measure the occupied bandwidth of the signal. The measured value of OBW is noted. The centre frequency of the signal is noted as  $F_{H.N}$ .

**Step 2:**

- Operation of the EUT shall be restarted on the lowest operating frequency with a permitted test signal (see Table 29).
- When the trace is completed the peak value of the trace shall be located and the analyser marker placed on this peak.
- The 99 % occupied bandwidth function of the spectrum analyser shall be used to measure the occupied bandwidth of the signal. The measured value of OBW is noted. The centre frequency of the signal is noted as  $F_{L.N}$ .
- The information shown in Table 43 shall be recorded in the test report.

**Table 43: Information recorded in the test report for occupied bandwidth**

Value	Notes
Test environment	Normal or extreme conditions
Test signal	The test signal used (see clause 5.2.7)
Operating frequency	The highest or lowest operating frequency
Occupied Bandwidth	The value displayed by the spectrum analyser for the 99 % occupied bandwidth for each operating frequency measured

If the frequency drift (see clause 4.3.1) measurement is not performed:

**Step 3:**

Under extreme test conditions, maximum temperature:

- Operation of the EUT shall be restarted on the highest operating frequency with a permitted test signal (see Table 29).
- When the trace is completed the peak value of the trace shall be located and the analyser marker placed on this peak.
- The 99 % occupied bandwidth function of the spectrum analyser shall be used to measure the occupied bandwidth of the signal. The measured OBW value is noted. The centre frequency of the signal is noted as  $F_{H.H}$ .
- Operation of the EUT shall be restarted on the lowest operating frequency with a permitted test signal (see Table 29).
- When the trace is completed the peak value of the trace shall be located and the analyser marker placed on this peak.
- The 99 % occupied bandwidth function of the spectrum analyser shall be used to measure the occupied bandwidth of the signal. The measured OBW value is noted. The centre frequency of the signal is noted as  $F_{L.H}$ .

**Step 4:**

Under extreme test conditions, minimum temperature:

- Operation of the EUT shall be restarted on the highest operating frequency with a permitted test signal (see Table 29).
- When the trace is completed the peak value of the trace shall be located and the analyser marker placed on this peak.

- The 99 % occupied bandwidth function of the spectrum analyser shall be used to measure the occupied bandwidth of the signal. The measured OBW value is noted. The centre frequency of the signal is noted as  $F_{H.C}$ .
- Operation of the EUT shall be restarted on the lowest operating frequency with a permitted test signal (see Table 29).
- When the trace is completed the peak value of the trace shall be located and the analyser marker placed on this peak.
- The 99 % occupied bandwidth function of the spectrum analyser shall be used to measure the occupied bandwidth of the signal. The measured OBW value is noted. The centre frequency of the signal is noted as  $F_{L.C}$ .

The information shown in Table 44 shall be recorded in the test report.

**Table 44: Information recorded in the test report for occupied bandwidth**

Value	Notes
Test environment	Normal or extreme test conditions
Occupied Bandwidth	The measured OBW for each operating frequency and test condition
Highest operating frequency	Measured unmodulated carrier frequency under: <ul style="list-style-type: none"> <li>• <math>F_{H.N}</math> normal test conditions</li> <li>• <math>F_{H.H}</math> extreme high temperature conditions</li> <li>• <math>F_{H.C}</math> extreme low temperature conditions</li> </ul>
$F_{H_{up}}$	Maximum of $(F_{H.H} - F_{H.N})$ and $(F_{H.C} - F_{H.N})$
$F_{H_{down}}$	Maximum of $(F_{H.N} - F_{H.C})$ and $(F_{H.N} - F_{H.H})$
Lowest operating frequency	Measured unmodulated carrier frequency under: <ul style="list-style-type: none"> <li><math>F_{L.N}</math> normal test conditions</li> <li><math>F_{L.H}</math> extreme high temperature conditions</li> <li><math>F_{L.C}</math> extreme low temperature conditions</li> </ul>
$F_{L_{up}}$	Maximum of $(F_{L.H} - F_{L.N})$ and $(F_{L.C} - F_{L.N})$
$F_{L_{down}}$	Maximum of $(F_{L.N} - F_{L.C})$ and $(F_{L.N} - F_{L.H})$
$FD_{up}$	Maximum of $F_{H_{up}}$ and $F_{L_{up}}$
$FD_{down}$	Maximum of $F_{H_{down}}$ and $F_{L_{down}}$

## 5.3.6 Unwanted emissions in the out-of-band domain

### 5.3.6.1 Test conditions

- 1) The measurements shall be performed under normal and extreme test conditions.

NOTE 1: If the frequency drift (see clause 4.3.1) measurement is performed then the measurements may be made under normal test conditions only.

- 2) The measurement shall be performed on the lowest and the highest frequency and an approximate middle frequency on which the EUT operates at its maximum transmit power.

NOTE 2: See clause 5.2.9.4 for specific test procedures for non-uniform maximum transmit power.

The approximate middle frequency should be chosen such that the out-of-band domain falls entirely within the operating frequency band.

- 3) The measurement method is selected according to clause H.2.

## 5.3.6.2 Measurement procedure

**Table 45: Test parameters for upper out-of-band measurement**

Spectrum Analyser Setting	Value	Notes
Centre frequency	$f_{\text{high}}$ (see note 1)	The upper band edge frequency
RBW	1 kHz (see note 2)	Resolution bandwidth for out-of-band domain measurements
Detector Function	Peak	
Trace Mode	Maximum Hold	
NOTE 1: $f_{\text{high}}$ is the upper band edge frequency defined in Table 1.		
NOTE 2: See clause 5.2.6 if the value of RBW used is different from $\text{RBW}_{\text{REF}}$ in Table 8.		

The test equipment shall be configured for the parameters shown in Table 45.

**Step 1:**

- Operation of the EUT shall be started, on the highest operating frequency with a permitted test signal (see Table 29).
- The highest frequency at which the EUT signal power envelope, corrected for attenuator values, equals the peak power limit for the first row of Table 8 is determined and noted.

**Step 2:**

- The test equipment shall be reconfigured as appropriate for the parameter shown in Table 46.

**Table 46: Test parameter setting for lower out-of-band measurement**

Spectrum Analyser Setting	Value	Notes
Centre frequency	$f_{\text{low}}$	The lower band edge frequency

- Operation of the EUT is restarted on the lowest operating frequency with a permitted test signal (see Table 29).
- The lowest frequency at which the EUT signal power envelope, corrected for attenuator values, equals the peak power limit for the first row of Table 8 is determined and noted.

**Step 3:**

- Step 1 and step 2 shall be repeated for the peak power limit of the second row of Table 8, adapting the test equipment configuration as required.

**Step 4:**

- The information shown in Table 47 shall be recorded in the test report for each test condition.

**Table 47: Information recorded in the test report for OOB emissions**

Parameter	Value Recorded in the Test Report
Test condition	Normal or extreme test conditions
Test signal	The test signal used (see clause 5.2.7)
Centre frequency	Upper or lower edge of the operating frequency band
Operating frequency	Highest or lowest operating frequency
Power limit	Peak power limit from the relevant row of Table 8
Upper frequencies	The measured values from step 3 for each row of Table 8
Lower frequencies	The measured values from step 4 for each row of Table 8

**Step 5:**

- The test equipment shall be reconfigured as appropriate for the parameter shown in Table 48.

**Table 48: Test parameter setting for intermediate out-of-band measurement**

Spectrum Analyser Setting	Value	Notes
Centre frequency	$f_c$	Approximate middle operating frequency

- Operation of the EUT shall be re-started on an approximate middle operating frequency with a permitted test signal (see Table 29).
- The highest and lowest frequencies at which the EUT signal power envelope, corrected for attenuator values, equals the peak power limit for the third row of Table 8 is determined and noted.

**Step 6:**

- The highest and lowest frequencies at which the EUT signal power envelope, corrected for attenuator values, equals the peak power limit for the fourth row of Table 8 is determined and noted.

**Step 7:**

- The information shown in Table 49 shall be recorded in the test report.

**Table 49: Information recorded in the test report for OOB emissions**

Parameter	Value Recorded in the Test Report
Test condition	Normal or extreme test conditions
Test signal	The test signal used (see clause 5.2.7)
Centre frequency	Test equipment centre frequency
Operating frequency	Intermediate operating frequency
Upper frequencies	The measured highest values from step 5 and step 6
Lower frequencies	The measured lowest values from step 5 and step 6

**Step 8:**

- Where required (see clause 5.3.6.1 condition 1), the measurements in step 1 to step 7 shall be repeated under extreme test conditions.

**5.3.7 Unwanted emissions in the spurious domain****5.3.7.1 Test conditions**

- 1) The measurements shall be performed under normal test conditions.
- 2) The measurement shall be performed on the highest and lowest operating frequencies.
- 3) The measurement shall be performed with the EUT operating at its maximum operating power level and with the EUT in powered-on stand-by mode.

NOTE 1: See clause 5.2.9.4 for specific test procedures for non-uniform maximum transmit power.

- 4) For measurements on transmitters with an e.r.p. exceeding 100 mW, additional external filtering or measurement equipment internal filtering may be used to avoid significant amount of energy from the out-of-band emissions being measured when performing spurious emission measurements close to the out-of-band domain. If additional filtering is used, this shall be stated in the test report.
- 5) An EUT without a permanent or temporary antenna connector shall be tested according to clause 5.3.7.2.
- 6) An EUT with a permanent or temporary antenna connector shall be tested according to both clause 5.3.7.3 and clause 5.3.7.4.

NOTE 2: In step 6, two measurements are made, one to capture power from the antenna connector and one to capture all other cabinet radiations.

### 5.3.7.2 Radiated measurement

A test site shall be selected from those described in clause B.2.

The EUT shall be connected to its normal operating antenna.

The output of the measurement antenna shall be connected to a measuring receiver.

The measurements in clause 5.3.7.5.2 shall be performed using radiated measurement methods described in clause B.6 corresponding to the selected test site.

### 5.3.7.3 Cabinet radiation measurement

A test site shall be selected from those described in clause B.2.

The EUT shall be connected to an artificial antenna (see clause 5.2.4.1). The output of the measurement antenna shall be connected to a measuring receiver.

The measurements in clause 5.3.7.5.2 shall be performed using radiated measurement methods described in clause B.6 corresponding to the selected test site.

### 5.3.7.4 Conducted measurement

The EUT shall be connected to an artificial antenna which shall be connected to the test equipment.

The measurements described in clause 5.3.7.5.1 shall be performed.

### 5.3.7.5 Measurement procedure

#### 5.3.7.5.1 Conducted measurement

##### Step 1:

- Operation of the EUT shall be started, on the highest operating frequency with a permitted test signal (see Table 29).
- The measuring receiver shall be tuned over the frequency range shown in Table 50.

**Table 50: Conducted spurious radiations measurement frequency range**

Frequency Range	RBW <sub>REF</sub> (see note 2)
$9 \text{ kHz} \leq f < 150 \text{ kHz}$	1 kHz
$150 \text{ kHz} \leq f < 30 \text{ MHz}$	10 kHz
$30 \text{ MHz} \leq f < f_c - m$	100 kHz
$f_c - m \leq f < f_c - n$	10 kHz
$f_c - n \leq f < f_c - p$	1 kHz
$f_c + p < f \leq f_c + n$	1 kHz
$f_c + n < f \leq f_c + m$	10 kHz
$f_c + m < f \leq 1 \text{ GHz}$	100 kHz
$1 \text{ GHz} < f \leq 6 \text{ GHz}$	1 MHz

NOTE 1: f is the measurement frequency.  
 f<sub>c</sub> is the operating frequency.  
 m is the larger of 10 x TBW or 500 kHz (see Figure 6).  
 n is 4 x TBW.  
 p is 2,5 x TBW.  
 TBW is specified in Annex E.

NOTE 2: See clause 5.2.6 if the value of RBW used for measurement is different from RBW<sub>REF</sub>.

**Step 2:**

- At each frequency at which a spurious emission is detected, the spurious emission power level shall be noted as the conducted spurious emission level delivered into the specified load.

**Step 3:**

- Operation of the EUT shall be restarted, on the lowest operating frequency with a permitted test signal (see Table 29).
- The measurements in step 2 shall be repeated.

**Step 4:**

- Operation of the EUT shall be restarted with the transmitter in stand-by mode.
- Step 2 and step 3 shall be repeated.

The information shown in Table 52 shall be recorded in the test report for each spurious emission.

### 5.3.7.5.2 Radiated measurement

**Step 1:**

- Operation of the EUT shall be started on the highest operating frequency with a permitted test signal (see Table 29).
- The measuring receiver shall be tuned over the frequency range shown in Table 51.

**Table 51: Radiated spurious radiations measurement frequency range**

Frequency Range	RBW <sub>REF</sub> (see note 2)
$25 \text{ MHz} \leq f < f_c - m$	100 kHz
$f_c - m \leq f < f_c - n$	10 kHz
$f_c - n \leq f < f_c - p$	1 kHz
$f_c + p < f \leq f_c + n$	1 kHz
$f_c + n < f \leq f_c + m$	10 kHz
$f_c + m < f \leq 1 \text{ GHz}$	100 kHz
$1 \text{ GHz} < f \leq 6 \text{ GHz}$	1 MHz
NOTE 1: $f$ is the measurement frequency. $f_c$ is the operating frequency. $m$ is the larger of $10 \times \text{TBW}$ or $500 \text{ kHz}$ (see Figure 6). $n$ is $4 \times \text{TBW}$ . $p$ is $2,5 \times \text{TBW}$ . TBW is specified in Annex E. NOTE 2: See clause 5.2.6 if the value of RBW used for measurement is different from RBW <sub>REF</sub> .	

**Step 2:**

- For each frequency at which a spurious emission is detected the appropriate measurement procedure for the selected test site as described in clause B.6 shall be performed.
- The maximum signal level detected by the measuring receiver for vertical and horizontal polarization shall be noted.
- The substitution measurement defined in clause B.6.4 shall be performed with the frequency of the calibrated signal generator set to the frequency of the spurious emission detected and, if necessary, the input attenuator setting of the measuring receiver adjusted in order to increase the sensitivity of the measuring receiver.
- The radiated power for vertical and horizontal polarization, corrected for any change of input attenuator setting of the measuring receiver, shall be noted.

- The measure of the effective radiated power of the spurious emission is the larger of the two power levels at the input to the substitution antenna and shall be noted.

**Step 3:**

- Operation of the EUT shall be restarted on the lowest operating frequency with a permitted test signal (see Table 29).
- The measurements in step 2 shall be repeated.

**Step 4:**

- Operation of the EUT shall be restarted with the transmitter in stand-by mode.
- Step 2 and step 3 shall be repeated.

The information shown in Table 52 shall be recorded in the test report for each spurious emission.

**Table 52: Information recorded in the test report for unwanted emissions in the spurious domain**

Value	Test condition	Notes
Test signal		The test signal used (see clause 5.2.7)
Frequency	Conducted or radiated	Measured frequency of the spurious emission
Power level	Conducted or radiated	Measured conducted or effective radiated power level of the spurious emission

## 5.3.8 Frequency stability under low-voltage conditions

### 5.3.8.1 Test conditions

- 1) The measurements shall be performed under normal test conditions.
- 2) The measurements shall be performed on the highest and lowest operating frequencies.
- 3) The measurement method is selected according to clause H.1.

### 5.3.8.2 Measurement procedure

**Table 53: Test parameters for frequency stability under low voltage conditions measurement**

Setting	Value	Notes
Centre frequency	The nominal operating frequency	The highest or lowest operating frequency

The test equipment shall be configured for the parameters shown in Table 53.

**Step 1:**

- Operation of the EUT shall be started, on the highest operating frequency with a permitted test signal (see Table 29) and with the EUT operating at nominal operating voltage.
- The centre frequency of the transmitted signal shall be measured and noted.

**Step 2:**

- The operating voltage shall be reduced by 10 % of the nominal operating voltage.
- The centre frequency of the transmitted signal shall be measured and noted.
- The duty cycle shall be measured, using the procedure defined in clause 5.3.9.1 using an observation period of 1 minute, and noted.



**Step 3:**

- Step 2 shall be repeated until either no transmitted signal greater than  $P_{\text{Threshold}}$  from the EUT is detected at the test equipment or the voltage reaches zero.

**Step 4:**

- Operation of the EUT shall be restarted, on the lowest operating frequency with a permitted test signal (see Table 29) and with the EUT operating at nominal operating voltage.
- The centre frequency of the transmitted signal shall be measured and noted.

**Step 5:**

- Step 2 and step 3 shall be repeated.

The information shown in Table 54 shall be recorded in the test report.

**Table 54: Information recorded in the test report for frequency stability under low voltage conditions**

Value	Notes
Test signal	The test signal used (see clause 5.2.7)
Highest centre frequency	Highest centre frequency valued noted
Lowest centre frequency	Lowest centre frequency value noted
Highest measured duty cycle	Highest duty cycle value noted over the voltage range

### 5.3.9 Duty cycle and transmission timing

#### 5.3.9.1 Long term behaviour

##### 5.3.9.1.1 Test conditions

- 1) The measurements shall be performed under normal test conditions.
- 2) The measurement shall be performed over the applicable operating frequency band defined in Table 1.
- 3) This test is performed using a fast power sensing equipment suitable for measurements at 800 MHz - 900 MHz. The test equipment shall be capable of not less than 1M samples/second to provide 1  $\mu$ s resolution.
- 4) The EUT shall be configured to transmit in a manner representative of normal operation for its intended use.
- 5) The measurement method is selected according to clause H.1.
- 6) Using the LTB observation bandwidth and observation period specified in Table 11 the measurements in clause 5.3.9.1.2 shall be performed.

##### 5.3.9.1.2 Measurement procedure

**Table 55: Test parameters settings for long term behaviour measurement**

Setting	Value	Notes
Sample rate	$\geq 1$ M samples/second	Sampling rate for at least 1 $\mu$ s resolution
Trigger	-	Trigger setting to capture leading edge of first transmission
Frequency	Centre frequency of the operating frequency band as specified in Table 1	Centre frequency of the power measurement bandwidth
Bandwidth	Operating frequency band as specified in Table 1	Bandwidth within which power measurements are made
NOTE: The trigger setting is determined by the test laboratory.		

The power sensing equipment shall be configured for the parameters specified in Table 55.

**Step 1:**

- The EUT shall be set to operate with a permitted test signal (see Table 29). The power sensing equipment shall be used to sample power in the observation bandwidth for the observation period.
- The sampled power readings shall be saved.

**Step 2:**

- The  $T_{On}$  times shall be determined using the procedures defined in clauses F.1 and F.2.
- Long term behaviour is the sum of the  $T_{On}$  times divided by the observation period.

The information shown in Table 56 shall be recorded in the test report.

**Table 56: Information recorded in the test report for long term behaviour**

Parameter	Value Recorded in the Test Report
Test signal	The test signal used (see clause 5.2.7)
Long term behaviour	The calculated value of $\sum T_{On} / \text{observation period}$

### 5.3.9.2 Short term behaviour

#### 5.3.9.2.1 Test conditions

- 1) The measurements shall be performed under normal test conditions.
- 2) The measurement shall be performed on a nominal operating frequency consistent with the highest and lowest operating frequencies and channel spacing.
- 3) This test is performed using a fast power sensing equipment suitable for measurements at 800 MHz - 900 MHz. The test equipment shall be capable of not less than 1M samples/second to provide 1 $\mu$ s resolution.
- 4) The EUT shall be configured to transmit in a manner representative of normal operation for its intended use using its maximum length transmissions.
- 5) The measurement method is selected according to clause H.1.

#### 5.3.9.2.2 Measurement procedure

**Table 57: Test parameters settings for short term behaviour measurement**

Setting	Value	Notes
Sample rate	$\geq 1$ M samples/second	Sampling rate for at least 1 $\mu$ s resolution
Trigger	See note 1	Trigger setting to capture leading edge of first transmission
Frequency	Nominal operating frequency	Centre frequency of the power measurement bandwidth
Bandwidth	TBW (see note 2)	Setting the measurement bandwidth to TBW ensures the full power envelope of the EUT transmission is captured by the power meter
NOTE 1: The trigger setting level is determined by the test laboratory.		
NOTE 2: TBW is specified in Annex E.		

The power sensing equipment shall be configured for the parameters specified in Table 57.

**Step 1:**

- The EUT shall be set to operate on the nominal operating frequency with a permitted test signal (see Table 29) for not less than 10 transmissions.

- The sampled power readings shall be saved.

**Step 2:**

- The  $T_{On}$  times shall be determined using the procedures defined in clauses F.1 and F.2.
- The lowest value of  $T_{Off}$  shall be noted.
- The highest value of  $T_{On}$  shall be noted.
- Short term behaviour is the highest value of  $T_{On}/(\text{highest value of } T_{On} + \text{the shortest value of } T_{Off})$ .

The information shown in Table 58 shall be recorded in the test report.

**Table 58: Information recorded in the test report for short term behaviour**

Parameter	Value recorded in the test report
Test signal	The test signal used (see clause 5.2.7)
Longest transmission duration $T_{On-max}$	Highest $T_{On}$ value
Shortest inter-transmission duration $T_{Off-Min}$	Lowest $T_{Off}$ value
Short term behaviour	$T_{On-max}/(T_{On-max} + T_{Off-min})$

## 5.3.10 Automatic/adaptive power control

### 5.3.10.1 Test conditions

- 1) The measurements shall be performed under normal test conditions.
- 2) The measurement shall be performed on a nominal operating frequency consistent with the highest and lowest operating frequencies and channel spacing.
- 3) The measurement shall be performed with the EUT operating at its highest supported maximum transmit power.
- 4) The EUT and companion device shall be configured to operate in normal operating mode.
- 5) The measurements shall be performed over the APC settling time interval.

NOTE: A test mode may be provided to ensure adequate traffic for the EUT APC mechanism to operate.

- 6) The measurement method is selected according to clause H.2.

### 5.3.10.2 Conducted measurement procedure

**Step 1:**

- Two EUTs shall be interconnected as shown in Figure 8.

**Step 2:**

- The variable attenuator shall be adjusted such that the attenuation between points A and B is 75 dB.

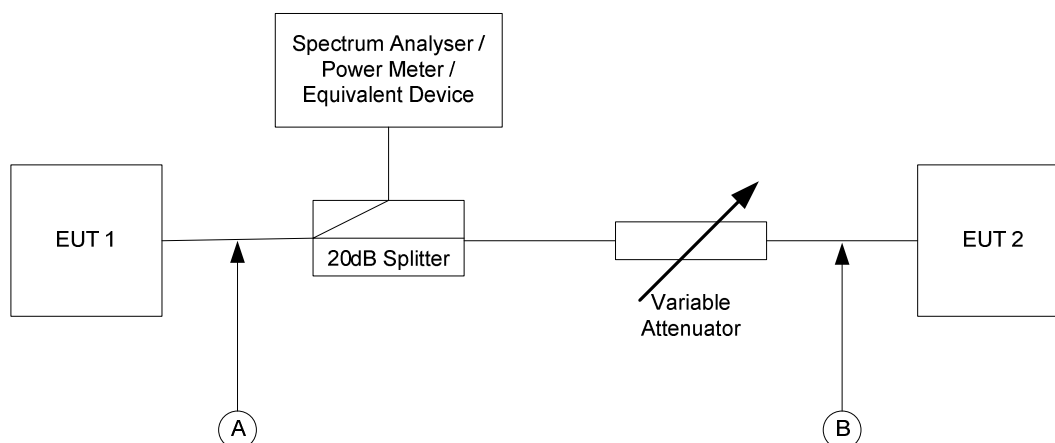
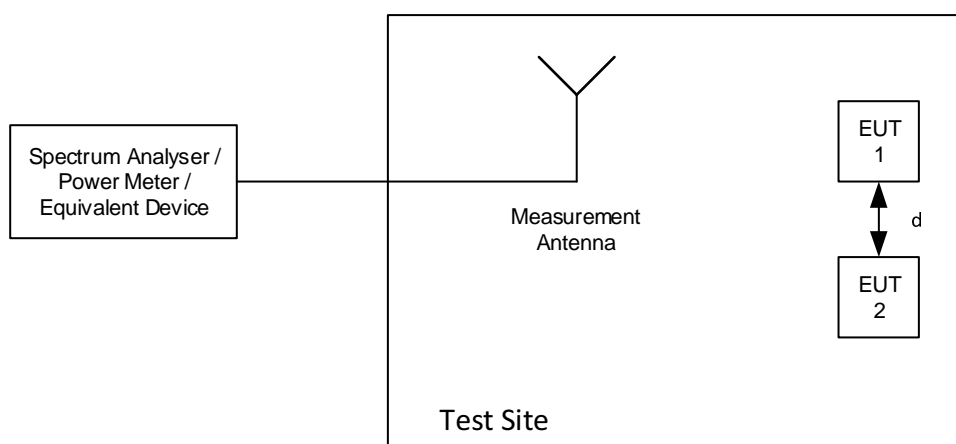

**Figure 8: APC conducted measurement setup**

**Step 3:**

- The measurement specified in clause 5.3.10.4 shall be performed.

### 5.3.10.3 Radiated measurement procedure



**Figure 9: APC radiated measurement setup**

NOTE 1: In this test procedure the EUT, as referenced in clause B.6, is the pair EUT1 + EUT2 which operate together to exercise the APC requirement.

**Step 1:**

- EUT1 and its companion device EUT2 shall be placed in the test site as shown in Figure 9.

NOTE 2: Separation 'd' respects any necessary minimum separation distance required by the EUT (see Annex J).

**Step 2:**

- The measurement specified in clause 5.3.10.4 shall be performed.

### 5.3.10.4 Measurement procedure

**Table 59: Test parameters settings for automatic/adaptive power control measurement**

Parameter	Value	Notes
RBW	Operating frequency band	Operating frequency band as defined in Table 1
Detector mode	Peak	

The test equipment shall be configured for the parameters shown in Table 59.

**Step 1:**

- The EUT and the companion device shall be set to communicate with each other, for at least the APC settling time, with a permitted test signal (see Table 29).

**Step 2:**

- The test equipment shall then be used to measure power for at least 60 seconds.

NOTE: The power measuring interval should be sufficiently long to capture transmissions from the EUT.

The information shown in Table 60 shall be recorded in the test report.

**Table 60: Information recorded in the test report for automatic/adaptive power control**

Value	Notes
Test signal	The test signal used (see clause 5.2.7)
Operating frequency	Operating frequency on which the EUTs operate
Settling time	APC settling time
Tx power level	Peak measured power

## 5.4 Conformance test suites for receivers

### 5.4.1 Receiver sensitivity

#### 5.4.1.1 Test conditions

- 1) The measurements shall be performed under normal and extreme test conditions.
- 2) The measurements shall be performed on the highest and lowest operating frequencies.
- 3) The EUT shall be operated with any optional FEC or automatic retransmission facility disabled (see clause 4.2.2).
- 4) The measurements shall be performed for each data rate at which the EUT is able to operate.
- 5) An EUT without a permanent or temporary antenna connector shall be tested according to clause 5.4.1.2.
- 6) An EUT with a permanent or temporary antenna connector shall be tested according to clause 5.4.1.3.

#### 5.4.1.2 Radiated measurement

A test site shall be selected from those described in clause B.2.

The following measurement shall be performed using radiated measurement methods described in clause B.6 corresponding to the selected test site.

Under normal operating conditions:

**Step 1:**

- The output of a signal generator shall be connected to a transmit test antenna with the same antenna polarization as the EUT. The transmit test antenna shall be placed in the test site.
- The EUT shall be placed on the turntable in the test site.

**Step 2:**

- The signal generator, modulated with a permitted test signal (see Table 29), shall be set to the highest operating frequency.

- The EUT shall be set to operate on the highest operating frequency.

**Step 3:**

- The operation of the EUT shall be started as a receiver.

NOTE 1: It is the responsibility of the test laboratory to ensure the test signal corresponds to the data rate of the EUT.

**Step 4:**

- The level of the signal generator shall be adjusted to the minimum level at which the wanted criteria (see clause 4.2.2) is just exceeded.

**Step 5:**

- With the signal generator settings unchanged, using the substitution measurement method specified in clause B.6.5, the power into the measuring equipment shall be measured and noted as  $S_{\text{NTC-H}}$ .

**Step 6:**

- Steps 3 to 4 shall be repeated with the EUT and signal generator set to the lowest operating frequency.
- With the signal generator settings unchanged, using the substitution measurement method specified in clause B.6.5, the power into the measuring equipment shall be measured and noted as  $S_{\text{NTC-L}}$ .
- The information shown in Table 61 shall be recorded in the test report.

**Table 61: Information recorded in the test report for sensitivity under normal test conditions**

Value	Notes
Test signal	The test signal used (see clause 5.2.7)
Data rate	EUT data rate
FEC or ARQ state	FEC/ARQ enabled or disabled
$S_{\text{NTC-H}}$	Sensitivity at highest operating frequency
$S_{\text{NTC-L}}$	Sensitivity at lowest operating frequency
Receiver sensitivity	Higher of $S_{\text{NTC-H}}$ and $S_{\text{NTC-L}}$

**Step 7:**

- Steps 2 to 6 shall be repeated for each data rate at which the EUT is able to operate.

A reference test fixture measurement under normal test conditions shall be obtained by performing the following procedure:

**Step 1:**

- The EUT shall be fixed to a test fixture as specified in Annex C. The test fixture shall be connected to the output of a signal generator.

**Step 2:**

- The signal generator, modulated with a permitted test signal (see Table 29), shall be set to the highest operating frequency.
- The EUT shall be set to operate as a receiver on the highest operating frequency.

NOTE 2: It is the responsibility of the test laboratory to ensure the test signal corresponds to the data rate of the EUT.

**Step 3:**

- The level of the signal generator shall be adjusted to the minimum level at which the wanted criteria (see clause 4.2.2) is just exceeded.

- With the signal generator settings unchanged, the output of the signal generator shall be connected to an RF power measuring equipment.
- The power into the measuring equipment shall be measured and noted as  $S_{\text{NTC-TF-H}}$ .

**Step 4:**

- The signal generator shall be set to operate on the lowest operating frequency with a permitted test signal (see Table 29).
- The EUT shall be set to operate as a receiver on the lowest operating frequency.

NOTE 3: It is the responsibility of the test laboratory to ensure the test signal corresponds to the data rate of the EUT.

- The level of the signal generator shall be adjusted to the minimum level at which the wanted criteria (see clause 4.2.2) is just exceeded.
- With the signal generator settings unchanged, the output of the signal generator shall be connected to an RF power measuring equipment.
- The power into the measuring equipment shall be measured and noted as  $S_{\text{NTC-TF-L}}$ .

The following procedure shall be carried out under extreme test conditions:

**Step 1:**

- The EUT shall be fixed to a test fixture as specified in Annex C. The test fixture shall be connected to the output of a signal generator. The test fixture shall be placed in the temperature controlled chamber and thermal equilibrium obtained.

**Step 2:**

- The signal generator shall be set to operate on the highest operating frequency with a permitted test signal (see Table 29).
- Operation of the EUT shall be started as a receiver on the highest operating frequency.

NOTE 4: It is the responsibility of the test laboratory to ensure the test signal corresponds to the data rate of the EUT.

- The level of the signal generator shall be adjusted to the minimum level at which the wanted criteria (see clause 4.2.2) is just exceeded.
- With the signal generator settings unchanged, the output of the signal generator shall be connected to an RF power measuring equipment.
- The power into the measuring equipment shall be measured and noted as  $S_{\text{ETC-TF-H}}$ .

**Step 3:**

- The signal generator shall be set to operate on the lowest operating frequency with a permitted test signal (see Table 29).
- Operation of the EUT shall be restarted, on the lowest operating frequency, with a permitted test signal (see Table 29).
- The power into the measuring equipment shall be noted as  $S_{\text{ETC-TF-L}}$ .

**Step 4:**

- The information in Table 62 shall be recorded in the test report.

**Table 62: Information recorded in the test report for sensitivity under extreme test conditions**

Value	Notes
Test signal	The test signal used (see clause 5.2.7)
Data rate	EUT data rate
FEC or ARQ state	FEC/ARQ enabled or disabled
$S_{\text{NTC-TF-H}}$	Measured test fixture reference sensitivity under normal test conditions at the highest operating frequency
$S_{\text{NTC-TF-L}}$	Measured test fixture reference sensitivity under normal test conditions at the lowest operating frequency
$S_{\text{Delta-TF-H}}$	$S_{\text{NTC-H}} - S_{\text{NTC-TF-H}}$
$S_{\text{Delta-TF-L}}$	$S_{\text{NTC-L}} - S_{\text{NTC-TF-L}}$
$S_{\text{ETC-TF-H}}$	Measured test fixture sensitivity under extreme test conditions at the highest operating frequency
$S_{\text{ETC-TF-L}}$	Measured test fixture sensitivity under extreme test conditions at the lowest operating frequency
Measured sensitivity	Larger of $(S_{\text{ETC-TF-H}} + S_{\text{Delta-TF-H}})$ and $(S_{\text{ETC-TF-L}} + S_{\text{Delta-TF-L}})$

**Step 5:**

- Steps 1 to 4 shall be repeated for each data rate at which the EUT is able to operate.

**5.4.1.3 Conducted measurement**

The EUT shall be connected to the output of a signal generator.

The measurements in clause 5.4.1.4 shall be performed.

**5.4.1.4 Measurement procedure****Step 1:**

- The signal generator, modulated with a permitted test signal (see Table 29), shall be set to the highest operating frequency.
- The EUT shall be set to operate on the highest operating frequency.

**Step 2:**

- The operation of the EUT shall be started as a receiver.

NOTE: It is the responsibility of the test laboratory to ensure the test signal corresponds to the data rate of the EUT.

**Step 3:**

- The level of the signal generator shall be adjusted to the minimum level at which the wanted criteria (see clause 4.2.2) is just exceeded.

**Step 4:**

- With the signal generator settings unchanged the output of the signal generator shall be connected to an RF power measuring equipment.
- The power into the measuring equipment shall be measured.
- The information shown in Table 63 shall be recorded in the test report.



**Table 63: Information recorded in the test report for sensitivity**

Value	Notes
Test conditions	Normal or extreme test conditions
Test signal	The test signal used (see clause 5.2.7)
Data rate	EUT data rate
FEC or ARQ state	FEC/ARQ enabled or disabled
Operating frequency	Highest or lowest operating frequency
Receiver sensitivity	Measured power

**Step 5:**

- Steps 2 to 4 shall be repeated with the EUT and signal generator set to the lowest operating frequency.

**Step 6:**

- Steps 1 to 5 shall be repeated for each data rate at which the EUT is able to operate.

**Step 7:**

- Steps 1 to 6 shall be repeated under extreme conditions.

## 5.4.2 Receiver maximum input signal level

### 5.4.2.1 Test conditions

- 1) The measurements shall be performed under normal test conditions.
- 2) The measurement is performed on a nominal operating frequency consistent with the highest and lowest operating frequencies and channel spacing.
- 3) The EUT shall be operated with any optional FEC or automatic retransmission facility disabled (see clause 4.2.2).
- 4) The measurements shall be performed for each data rate at which the EUT is able to operate.
- 5) An EUT without a permanent or temporary antenna connector shall be tested according to clause 5.4.2.2.
- 6) An EUT with a permanent or temporary antenna connector shall be tested according to clause 5.4.2.3.

### 5.4.2.2 Radiated measurement

A test site shall be selected from those described in clause B.2.

The output of a signal generator shall be connected to a transmit test antenna with the same antenna polarization as the EUT. The transmit test antenna shall be placed in the test site.

The EUT shall be placed on the turntable in the test site.

The measurement in clause 5.4.2.4 shall be performed using radiated measurement methods described in clause B.6 corresponding to the selected test site.

### 5.4.2.3 Conducted measurement

The EUT shall be connected to the output of a signal generator.

The measurements in clause 5.4.2.4 shall be performed.

#### 5.4.2.4 Measurement procedure

##### Step 1:

- The signal generator, modulated with a permitted test signal (see Table 29), shall be set to the highest operating frequency.
- The EUT shall be set to operate on the highest operating frequency.
- The minimum wanted signal level shall be established according to clause G.1.3.

##### Step 2:

- The EUT shall be started as a receiver.

NOTE: It is the responsibility of the test laboratory to ensure the test signal corresponds to the data rate of the EUT.

##### Step 3:

- The level of the input signal to the EUT shall be increased until the wanted criteria (see clause 4.2.2) is no longer obtained or the limit specified in Table 17 is reached.

##### Step 4:

- With the signal generator settings unchanged, the output of the signal generator shall be connected to an RF power measuring equipment.
- For a conducted test:
  - The power into the measuring equipment shall be measured.
- For a radiated test:
  - The power into the measuring equipment plus the gain of the test antenna minus cables losses shall be measured.
- The information shown in Table 64 shall be recorded in the test report.

**Table 64: Information recorded in the test report for maximum input signal level**

Value	Notes
Test signal	The test signal used (see clause 5.2.7)
Data rate	EUT data rate
FEC or ARQ state	FEC/ARQ enabled or disabled
Operating frequency	Highest or lowest operating frequency
Maximum input signal level	Measured power level

##### Step 5:

- Steps 2 to 4 shall be repeated with the EUT and signal generator set to the lowest operating frequency.

##### Step 6:

- Steps 1 to 5 shall be repeated for each data rate at which the EUT is able to operate.

### 5.4.3 Clear channel assessment threshold

#### 5.4.3.1 Test conditions

- 1) The measurements shall be performed under normal test conditions.
- 2) The measurement is performed on a nominal operating frequency consistent with the highest and lowest operating frequencies and channel spacing.

- 3) An EUT without a permanent or temporary antenna connector shall be tested according to clause 5.4.3.2.
- 4) An EUT with a permanent or temporary antenna connector shall be tested according to clause 5.4.3.3.

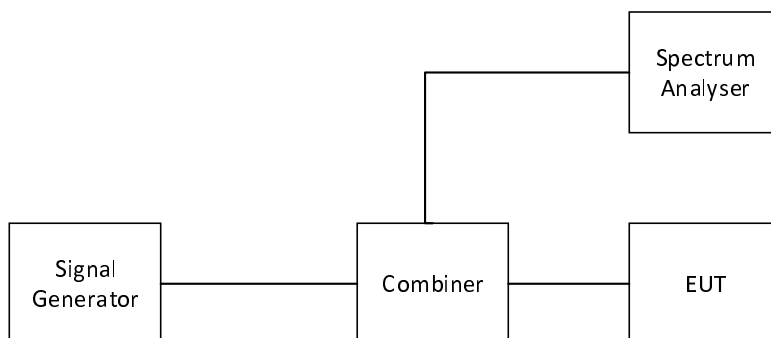

**Figure 10: Conducted clear channel assessment threshold measurement arrangement**

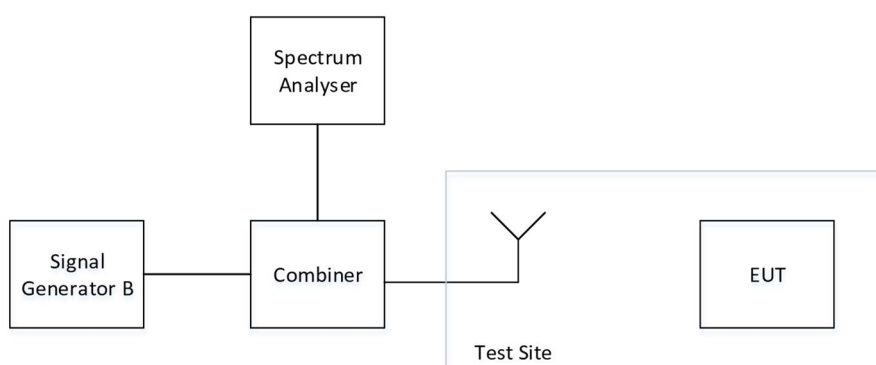

**Figure 11: Radiated clear channel assessment threshold measurement arrangement**

### 5.4.3.2 Radiated measurement

A test site shall be selected from those described in clause B.2.

The signal generator together with the combiner and spectrum analyser, as shown in Figure 11, shall be placed outside the test site.

The output of the combiner shall be connected to a transmit test antenna with the same antenna polarization as the EUT. The transmit test antenna shall be placed in the test site.

The EUT shall be placed at the location of the turntable at the orientation of the most sensitive position.

The measurement in clause 5.4.3.4 shall be performed using radiated measurement methods described in clause B.6 corresponding to the selected test site.

### 5.4.3.3 Conducted measurement

A signal generator and a spectrum analyser shall be connected to the EUT antenna connector via a combining network as shown in Figure 10.

The measurements in clause 5.4.3.4 shall be performed.

#### 5.4.3.4 Measurement procedure

**Table 65: Test parameters settings for CCA threshold measurement**

Setting	Value
Centre frequency	The nominal EUT operating frequency
RBW	3 × TBW
VBW	3 × RBW
Span	Zero span
Detector Mode	RMS
Trace Mode	Maximum Hold
NOTE:	TBW is specified in Annex E.

The spectrum analyser shall be configured for the parameters specified in Table 65.

##### Step 1:

- Operation of the EUT as a receiver shall be started with its CCA function active.
- The signal generator, modulated with a permitted test signal (see Table 29), shall be adjusted to the nominal operating frequency.
- The spectrum analyser levels shall be adjusted to provide satisfactory display of the signal generator signal.

##### Step 2:

- The output power level of the signal generator shall be set to 20 dB above the receiver sensitivity limit given in Table 16.
- The EUT shall be instructed to transmit.

NOTE 1: The means of instructing the EUT to transmit is outside the scope of the present document.

- The presence of any signal from the EUT detected by the spectrum analyser shall be noted.

NOTE 2: Allowance should be made for any EUT specific protocol delays associated with CCA operation before determining whether the EUT emits a signal or not.

##### Step 3:

- The level of the signal generator shall be reduced in steps of 1 dB until the equipment starts to transmit.

NOTE 3: There may be EUT specific protocol delays associated with collision avoidance operation before the EUT begins to transmit once the CCA threshold has been reached. Any such delays should be taken into account in the rate at which the signal generator level is reduced.

##### Step 4:

- With the signal generator settings unchanged, the output of the signal generator shall be connected to an RF power measuring equipment.
- The power into the measuring equipment shall be measured and noted.
- For a conducted test:
  - The power into the measuring equipment shall be measured.
- For a radiated test:
  - The power into the measuring equipment plus the gain of the test antenna minus cables losses shall be measured.
- The measured RF power level is the CCA threshold and shall be noted.

The information shown in Table 66 shall be recorded in the test report.

**Table 66: Information recorded in the test report for CCA threshold**

Value	Notes
Test signal	The test signal used (see clause 5.2.7)
CCA threshold	CCA threshold power level
Presence of unexpected EUT signal	Any transmission detected at the spectrum analyser in step 2
NOTE: The presence of unexpected EUT transmission is a test failure.	

## 5.4.4 Co-channel rejection

### 5.4.4.1 Test conditions

- 1) The measurements shall be performed under normal test conditions.
- 2) The measurement is performed on a nominal operating frequency consistent with the highest and lowest operating frequencies and channel spacing.
- 3) The measurement method is selected according to clause G.1.

### 5.4.4.2 Measurement procedure

Signal generator A shall be set to the nominal operating frequency of the receiver, modulated with a permitted test signal (see Table 29).

Signal generator B shall be powered off.

#### Step 1:

- The minimum wanted signal level shall be established according to clause G.1.3.
- With signal generator A settings unchanged, the connection to the combiner shall be replaced with a connection to an RF power measuring equipment.
- The power into the measuring equipment shall be measured and noted as signal generator A level and noted as  $P_{\text{Wanted}}$ .
- With signal generator A settings unchanged, signal generator A shall be reconnected to the combiner.

#### Step 2:

- Signal generator B shall be unmodulated and set to operate at the nominal operating frequency of the receiver.

#### Step 3:

- Signal generator B level shall be adjusted until the wanted criteria (see clause 4.2.2) is no longer obtained.
- With signal generator B settings unchanged, the connection to the combiner shall be replaced with a connection to an RF power measuring equipment.
- The power into the measuring equipment shall be measured and noted as signal generator B level and noted as  $P_{\text{Unwanted}}$ .

#### Step 4:

- The information shown in Table 67 shall be recorded in the test report.

**Table 67: Information recorded in the test report for co-channel rejection**

Value	Notes
Test signal	The test signal used (see clause 5.2.7)
Operating frequency	Nominal operating frequency of the receiver
$P_{\text{Wanted}}$	Measured signal generator A level
$P_{\text{Unwanted}}$	Measured signal generator B level
Co-channel rejection	$P_{\text{Wanted}} - P_{\text{Unwanted}}$

Co-channel rejection is the difference between the measured power levels of signal generator A and signal generator B.

## 5.4.5 Adjacent channel selectivity

### 5.4.5.1 Test conditions

- 1) The measurements shall be performed under normal test conditions.
- 2) The measurement is performed on a nominal operating frequency consistent with the highest and lowest operating frequencies and channel spacing.
- 3) The measurement method is selected according to clause G.1.

### 5.4.5.2 Measurement procedure

Signal generator A shall be set to the nominal operating frequency of the receiver, modulated with a permitted test signal (see Table 29).

Signal generator B shall be powered off.

#### Step 1:

- The minimum wanted signal level shall be established according to clause G.1.3.

#### Step 2:

- Signal generator B shall be unmodulated and set to operate at the (nominal operating frequency - CS).

#### Step 3:

- Signal generator B level shall be adjusted until the wanted criteria (see clause 4.2.2) is no longer obtained or the limit specified in Table 20 is reached.
- With signal generator B settings unchanged, the connection to the combiner shall be replaced with a connection to an RF power measuring equipment.
- The power into the measuring equipment shall be measured and noted.

#### Step 4:

- The information shown in Table 68 shall be recorded in the test report.

**Table 68: Information recorded in the test report for adjacent channel selectivity**

Value	Notes
Test signal	The test signal used (see clause 5.2.7)
Operating frequency	Nominal operating frequency of the receiver
Wanted signal level	Minimum or high wanted signal level
Signal generator B frequency	Lower or upper adjacent channel frequency
Adjacent channel selectivity	Power level of signal generator B

**Step 5:**

- Signal generator B is set to operate at the (nominal operating frequency + CS).
- The procedure in steps 3 to 4 is repeated.

**Step 6:**

- Signal generator B shall be powered off and reconnected to the combiner.
- The high wanted signal level is established according to clause G.1.4.
- The measurements in steps 1, 2, 3, 4 and 5 are repeated.

Adjacent channel selectivity is the lower of the two measured power levels of signal generator B for each wanted signal level.

## 5.4.6 Blocking and spurious response rejection

### 5.4.6.1 Test conditions

- 1) The measurements shall be performed under normal test conditions.
- 2) The measurement is performed on a nominal operating frequency consistent with the highest and lowest operating frequencies and channel spacing.
- 3) Measurements shall be carried out with the unwanted signal at  $\pm 1$  MHz,  $\pm 2$  MHz,  $\pm 5$  MHz and  $\pm 10$  MHz from the operating frequency.
- 4) The measurement method is selected according to clause G.1.

### 5.4.6.2 Measurement procedure

Signal generator A shall be set to the nominal operating frequency of the receiver, modulated with a permitted test signal (see Table 29).

Signal generator B shall be powered off.

The unwanted signal offset is set to -1 MHz.

**Step 1:**

- The minimum wanted signal level shall be established according to clause G.1.3.

**Step 2:**

- Signal generator B shall be unmodulated and set to operate at the nominal operating frequency of the receiver adjusted by the unwanted signal offset.
- Signal generator B level shall be adjusted until the wanted criteria (see clause 4.2.2) is no longer obtained or the limit specified in Table 21 is reached.
- With signal generator B settings unchanged, the connection to the combiner shall be replaced with a connection to an RF power measuring equipment.
- The power into the measuring equipment shall be measured and noted.

**Step 3:**

- The RF power measuring equipment shall be replaced with the EUT and the frequency of signal generator B adjusted by 5 kHz.

NOTE: The adjustment is intended only to estimate whether the frequency is a spurious response frequency. Adjustments by incrementing or decrementing the frequency value are equally valid.

- Signal generator B level shall be adjusted until the wanted criteria (see clause 4.2.2) is no longer obtained or the limit specified in Table 21 is reached.
- With signal generator B settings unchanged, the connection to the combiner shall be replaced with a connection to an RF power measuring equipment.
- The power into the measuring equipment shall be measured and noted.
- If the two measured values:
  - differ by  $> 10$  dB then the receiver spurious response rejection level is the lower of the two measured power levels.  
The information shown in Table 69 shall be recorded in the test report.

**Table 69: Information recorded in the test report for spurious response rejection**

Value	Notes
Test signal	The test signal used (see clause 5.2.7)
Operating frequency	Nominal operating frequency of the receiver
Wanted signal level	Measured power level of signal generator A
Spurious response frequency	Frequency of the lower measured value
Receiver spurious response rejection level	Lower of the two measured power levels

- differ by  $\leq 10$  dB then the higher of the two measurements is ignored.
- The blocking level is the measured power level of signal generator B.
- The information shown in Table 70 shall be recorded in the test report.

**Table 70: Information recorded in the test report for blocking**

Value	Notes
Test signal	The test signal used (see clause 5.2.7)
Operating frequency	Nominal operating frequency of the receiver
Blocking signal offset	$\pm 1$ MHz, $\pm 2$ MHz, etc.
Blocking level	Power level of signal generator B

#### Step 4:

- Signal generator B shall be powered off and reconnected to the combiner.
- The high wanted signal level is established according to clause G.1.4.
- The measurements in steps 2 and 3 are repeated.

#### Step 5:

- The measurement in steps 1 to 4 shall be repeated with unwanted signal offsets of +1 MHz, -2 MHz, +2 MHz, -5 MHz, +5 MHz, -10 MHz and +10 MHz.

## 5.4.7 Intermodulation rejection

### 5.4.7.1 Test conditions

- 1) The measurements shall be performed under normal test conditions.
- 2) The measurement is performed on an approximate middle operating frequency consistent with the highest and lowest operating frequencies and channel spacing.
- 3) An EUT without a permanent or temporary antenna connector shall be test according to clause 5.4.7.2.
- 4) An EUT with a permanent or temporary antenna connector shall be test according to clause 5.4.7.3.



**Table 71: Test parameters settings for receiver intermodulation measurement**

Setting	Value
EUT operating frequency	Approximate middle frequency
Signal generator A frequency	The EUT operating frequency
Offset <sub>B</sub>	2 x Channel spacing as specified in clause 4.3.2
Offset <sub>C</sub>	4 x Channel spacing as specified in clause 4.3.2

#### 5.4.7.2 Radiated measurement procedure

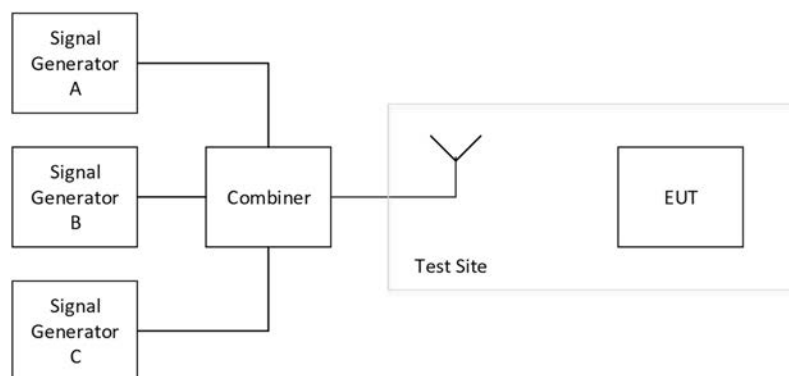
**Figure 12: Receiver intermodulation rejection radiated measurement arrangement**

A test site shall be selected from those described in clause B.2.

Signal generators A, B and C together with the combiner, arranged as shown in Figure 12, shall be placed outside the test site.

The output of the combiner shall be connected to a transmit test antenna with the same antenna polarization as the EUT. The transmit test antenna shall be placed in the test site.

The EUT shall be placed on the turntable in the test site.

##### Step 1:

- Signal generator A shall be set to the nominal operating frequency of the receiver and its output shall be modulated with a permitted test signal (see Table 29).
- Signal generator B shall be set to operate at signal generator A operating frequency + Offset<sub>B</sub> (as specified in Table 71).
- Signal generator C shall be set to operate at signal generator A operating frequency + Offset<sub>C</sub> (as specified in Table 71).

##### Step 2:

- The measurements specified in clause 5.4.7.4 shall be performed using radiated measurement methods described in clause B.6 corresponding to the selected test site.
- The lower of the measured signal generator output power for horizontal and vertical polarization shall be noted as  $P_{Upper}$ .

##### Step 3:

- Signal generator B shall be set to operate at signal generator A operating frequency - Offset<sub>B</sub> (as specified in Table 71).
- Signal generator C shall be set to operate at signal generator A operating frequency - Offset<sub>C</sub> (as specified in Table 71).

- The measurements specified in clause 5.4.7.4 shall be performed using radiated measurement methods described in clause B.6 corresponding to the selected test site.
- The lower of the measured signal generator output power for horizontal and vertical polarization shall be noted as  $P_{\text{Lower}}$

With signal generator A settings unchanged, the connection to the combiner shall be replaced with a connection to an RF power measuring equipment. The power from signal generator A into the measuring equipment shall be measured and noted as  $P_{\text{Wanted}}$ .

The information in Table 72 shall be recorded in the test report.

### 5.4.7.3 Conducted measurement procedure

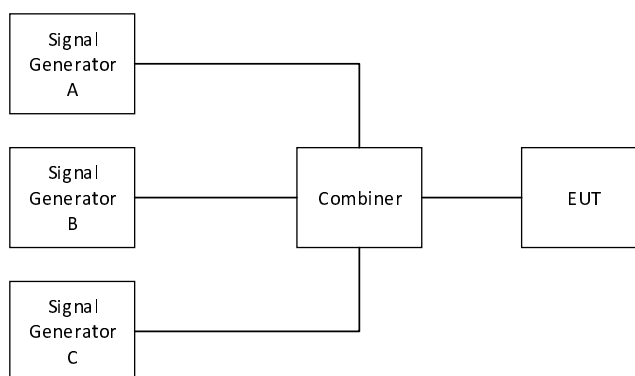

**Figure 13: Receiver intermodulation rejection conducted measurement arrangement**

Signal generators A, B and C shall be connected to the EUT via a combining network as shown in Figure 13.

Signal generator A shall be set to the nominal operating frequency of the receiver and its output shall be modulated with a permitted test signal (see Table 29).

Signal generator B shall be set to operate at signal generator A operating frequency +  $\text{Offset}_B$  (as specified in Table 71).

Signal generator C shall be set to operate at signal generator A operating frequency +  $\text{Offset}_C$  (as specified in Table 71).

#### Step 1:

- Signal generator A shall be set to the nominal operating frequency of the receiver and its output shall be modulated with a permitted test signal (see Table 29).
- Signal generator B shall be set to operate at signal generator A operating frequency +  $\text{Offset}_B$  (as specified in Table 71).
- Signal generator C shall be set to operate at signal generator A operating frequency +  $\text{Offset}_C$  (as specified in Table 71).

#### Step 2:

- The measurement specified in clause 5.4.7.4 shall be performed and the measured power noted as  $P_{\text{Upper}}$ .

#### Step 3:

- Signal generator B shall be set to operate at signal generator A operating frequency -  $\text{Offset}_B$  (as specified in Table 71).
- Signal generator C shall be set to operate at signal generator A operating frequency -  $\text{Offset}_C$  (as specified in Table 71).
- The measurements specified in clause 5.4.7.4 shall be performed and the measured power noted as  $P_{\text{Lower}}$ .

With signal generator A settings unchanged, the connection to the combiner shall be replaced with a connection to an RF power measuring equipment. The power from signal generator A into the measuring equipment shall be measured and noted as  $P_{\text{Wanted}}$ .

The information in Table 72 shall be recorded in the test report.

#### 5.4.7.4 Measurement procedure

##### Step 1:

- Signal generators B and C shall be powered off.
- The level of signal generator A shall be adjusted to the lowest level that provides the wanted criteria (see clause 4.2.2).
- The output level of generator A shall then be increased by 3 dB.

##### Step 2:

- Signal generator B shall be powered on and its output shall be modulated with a permitted test signal (see Table 29).
- Signal generator C shall be powered on and its output shall be unmodulated.
- The output power of signal generators B and C shall be maintained at the same level.

##### Step 3:

- The output levels of signal generators B and C shall be increased until the wanted criteria (see clause 4.2.2) is no longer obtained.
- With signal generator B settings unchanged, the connection to the combiner shall be replaced with a connection to an RF power measuring equipment.
- The power from signal generator B into the measuring equipment shall be measured.

**Table 72: Information recorded in the test report for receiver intermodulation rejection**

Value	Notes
Test signal	The test signal used (see clause 5.2.7)
$P_{\text{Upper}}$ (dBm)	Measured unwanted signal power in dBm for offset above the EUT operating frequency
$P_{\text{Lower}}$ (dBm)	Measured unwanted signal power in dBm for offset below the EUT operating frequency
$P_{\text{Wanted}}$ (dBm)	The measured power in dBm from signal generator A
Receiver intermodulation rejection (dB)	Lower of $(P_{\text{Upper}} - P_{\text{Wanted}})$ and $(P_{\text{Lower}} - P_{\text{wanted}})$

## 5.4.8 Receiver spurious emissions

### 5.4.8.1 Test conditions

- 1) The measurements shall be performed under normal test conditions.
- 2) The measurement is performed on a nominal operating frequency consistent with the highest and lowest operating frequencies and channel spacing.
- 3) Radiated measurements shall be performed on a test site selected from clause B.2, with corresponding measurement procedures, which fulfils the measurement requirements for the specified frequency range.
- 4) An EUT without a permanent or temporary antenna connector shall be tested according to clause 5.4.8.2.

- 5) An EUT with a permanent or temporary antenna connector shall be tested according to both clause 5.4.8.3 and clause 5.4.8.4.

NOTE: In step 5, two measurements are made, one to capture power from the antenna connector and one to capture all other cabinet radiations.

#### 5.4.8.2 Radiated measurement

The EUT shall be placed in a test site selected from those described in clause B.2 using a measurement antenna of length chosen to correspond to the frequency of the measuring receiver.

The EUT shall be connected to its normal operating antenna.

The output of the measurement antenna shall be connected to the measuring receiver.

The measurements described in clause 5.4.8.5.2 shall be performed using radiated measurement methods described in clause B.6 corresponding to the selected test site.

#### 5.4.8.3 Cabinet radiation measurement

The EUT shall be placed in a test site selected from those described in clause B.2 using a measurement antenna of length chosen to correspond to the frequency of the measuring receiver.

The EUT shall be connected to an artificial antenna (see clause 5.2.4.1). The output of the measurement antenna shall be connected to a measuring receiver.

The measurements in clause 5.4.8.5.2 shall be performed using radiated measurement methods described in clause B.6 corresponding to the selected test site.

#### 5.4.8.4 Conducted measurement

The EUT shall be connected to an artificial antenna which shall be connected to the test equipment.

The measurements described in clause 5.4.8.5.1 shall be performed.

#### 5.4.8.5 Measurement procedure

##### 5.4.8.5.1 Conducted measurement

###### Step 1:

- The operation of the EUT as a receiver shall be started.
- The measuring receiver shall be tuned over the frequency range shown in Table 73.

**Table 73: Receiver spurious emissions measurement frequency range - conducted**

Frequency range	
9 kHz to 6 GHz	
NOTE:	The measurements need only to be performed over the frequency range 4 GHz to 6 GHz if emissions are detected within 10 dB of the of the specified limit between 1,5 GHz and 4 GHz.

###### Step 2:

- At each frequency at which a spurious emission is detected, the power level shall be measured and noted.

The information shown in Table 74 shall be recorded in the test report for each spurious emission.

**Table 74: Information recorded in the test report for receiver spurious emissions**

Value	Notes
Frequency	Frequency of spurious emission
Power level	Measured power level of spurious emission
NOTE: The power level is the spurious level delivered into the artificial antenna load.	

#### 5.4.8.5.2 Radiated measurement

##### Step 1:

- The operation of the EUT as a receiver shall be started.
- The measuring receiver shall be tuned over the frequency range shown in Table 75.

**Table 75: Receiver spurious emissions measurement frequency range - radiated**

Frequency range
25 MHz to 6 GHz
NOTE: The measurements need only to be performed over the frequency range 4 GHz to 6 GHz if emissions are detected within 10 dB of the of the specified limit between 1,5 GHz and 4 GHz.

##### Step 2:

- For each frequency at which a spurious emission is detected the measurement procedure for the selected test site as described in clause B.6 shall be performed.
- The maximum signal level detected by the measuring receiver for vertical and horizontal polarization shall be noted.

##### Step 3:

- The substitution measurement defined in clause B.6.4 shall be performed with the frequency of the calibrated signal generator set to the frequency of the spurious emission detected and, if necessary, the input attenuator setting of the measuring receiver adjusted in order to increase the sensitivity of the measuring receiver.
- The radiated power for vertical and horizontal polarization, corrected for any change of input attenuator setting of the measuring receiver, shall be noted.
- The measure of the effective radiated power of the spurious emission is the larger of the two power levels at the input to the substitution antenna.

The information shown in Table 74 shall be recorded in the test report for each spurious emission.

## 5.5 Conformance test suites for polite spectrum access

### 5.5.1 Listen before talk

#### 5.5.1.1 Test conditions

- 1) The measurements shall be performed under normal test conditions.
- 2) The measurement shall be performed on a nominal operating frequency consistent with the highest and lowest operating frequencies and channel spacing.
- 3) This test is performed using a fast power sensing equipment suitable for measurements at 800 MHz - 900 MHz. The test equipment shall be capable of not less than 1 M samples/second to provide 1  $\mu$ s resolution.
- 4) The EUT shall be configured to transmit in a manner representative of normal operation for its intended use.

- 5) The measurement method is selected according to clause H.1.

### 5.5.1.2 Measurement procedure

**Table 76: Test parameters settings for listen before talk measurement**

Setting	Value	Notes
Sample rate	$\geq 1$ M samples/second	Sampling rate for at least 1 $\mu$ s resolution
Trigger	-	Trigger setting to capture leading edge of first transmission
Frequency	Nominal operating frequency	Centre frequency of the power measurement bandwidth
Bandwidth	TBW	Bandwidth within which power measurements are made
NOTE: The trigger setting is determined by the test laboratory. TBW is specified in Annex E.		

The power sensing equipment shall be configured for the parameters specified in Table 76.

#### Step 1:

- The signal generator, modulated with a permitted test signal (see Table 29), shall be adjusted to the nominal operating frequency.

#### Step 2:

- The output power level of the signal generator shall be set to 10 dB above the CCA threshold as determined in clause 5.4.3.
- The power meter shall be started.
- The EUT shall be instructed to transmit.

NOTE 1: The means of instructing the EUT to transmit is outside the scope of the present document.

#### Step 3:

- The level of the signal generator shall be reduced to 10 dB below the CCA threshold.

#### Step 4:

- The power meter shall be stopped when the EUT transmits any signal in the operating frequency channel.
- The power samples shall be saved.

#### Step 5:

- The time between the signal generator level falling to 10 dB below the CCA threshold and the start of the transmission from the EUT shall be calculated from the saved power meter samples and saved as a transmission delay sample.

#### Step 6:

- Steps 2 to 5 shall be repeated not less than 20 times.

#### Step 7:

- The transmission delay samples, in the order obtained, shall be used as input values to a runs test function according to NIST/SEMATECH e-Handbook [1].

NOTE 2: Most statistical software libraries or packages provide a runstest function e.g. as published in [i.5].  
 $[h, p, stats] = \text{runstest}(x, \text{median}(x))$ , where  $x$  is the input sample vector,  $h$  is the result of the null hypothesis,  $p$  is the probability that the samples are random and  $stats$  is an array providing counts of the runs and the test statistic value.

The information shown in Table 77 shall be recorded in the test report.

**Table 77: Information recorded in the test report for LBT**

Value	Notes
Test signal	The test signal used (see clause 5.2.7)
Minimum CCA period	The shortest measured transmit delay
Null hypothesis result	Not rejected: the test statistic < 1,96 or Rejected: the test statistic $\geq$ 1,96
Number of runs	The number of runs
Number of values above median	The number of values above median
Number of values below median	The number of values below median

## 5.5.2 Short control signalling transmissions

### 5.5.2.1 Test conditions

- 1) The measurements shall be performed under normal test conditions.
- 2) The measurement shall be performed on a nominal operating frequency consistent with the highest and lowest operating frequencies and channel spacing.
- 3) The EUT and a companion device able to respond to EUT transmissions with acknowledgements or dialog exchanges shall be configured to transmit in a manner representative of normal operation for the intended use of the EUT.

NOTE: Attenuators adequate to protect receivers from excess signal power are assumed.

- 4) This test is performed using a protocol analyser able to receive, interpret and timestamp transmissions from the EUT and companion device.
- 5) The measurement method is selected according to clause H.2.

### 5.5.2.2 Measurement procedure

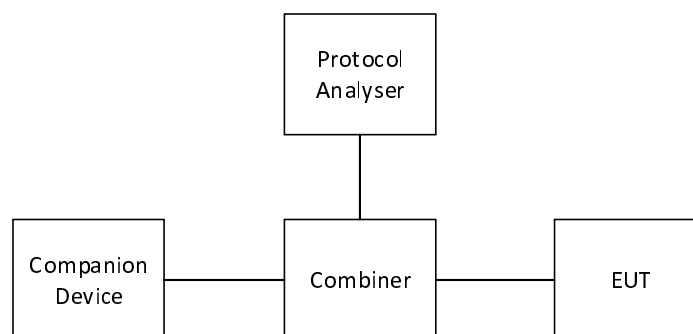
**Figure 14: SCS transmissions measurement arrangement**

#### Step 1:

- The EUT and companion device shall be set to operate with a permitted test signal (see Table 29).

#### Step 2:

- The EUT shall be instructed to transmit.

NOTE 1: The means of instructing the EUT to transmit is outside the scope of the present document.

- The protocol analyser capture shall be started.

**Step 3:**

- On completion of the communications exchange between the EUT and companion device, the protocol analyser shall be stopped and the captured transmissions saved.

NOTE 2: The means of determining the completion of the exchange is outside the scope of the present document.

**Step 4:**

- Steps 2 to 3 shall be repeated not less than 10 times.

**Step 5:**

- Each  $T_{\text{Dialog-interval}}$ , as shown in Figure 7, shall be derived from the saved protocol analyser transmission timestamps and saved.
- Each  $T_{\text{Dialog}}$ , as shown in Figure 7, shall be derived from the saved protocol analyser transmission timestamps and saved.

The information in Table 78 shall be recorded in the test report.

**Table 78: Information recorded in the test report for SCS transmissions**

Value	Notes
Test signal	The test signal used (see clause 5.2.7)
Largest value of $T_{\text{Dialog-interval}}$	Longest dialog response interval
Largest value of $T_{\text{Dialog}}$	Longest dialog duration

## 5.6 Conformance test suites for functional requirements

### 5.6.1 General test conditions

It is not the intention of test suites for functional requirements to test the link between the EUT and other devices. Device placement and operating parameters should be set to provide adequately reliable exchange of data between the devices for the purpose of the test.

Any necessary companion equipment, together with operating software and instructions, for normal operation of the EUT for its intended use should be provided.

Test suites for functional requirements may require observation of EUT behaviour specific to the implemented protocols used in the data network. Consequently, a protocol analyser able to receive and interpret the specific protocols used by the EUT may be necessary for such observations.

### 5.6.2 Network access point

#### 5.6.2.1 Test conditions

- 1) The measurements shall be performed under normal test conditions.
- 2) The measurement shall be performed over the operating frequency band.
- 3) This test is performed with:
  - a) Analyser A - a protocol analyser able to receive and interpret radio transmissions between the EUT and nodes in the data network.
  - b) Analyser B - a protocol analyser able to receive and interpret transmissions between the EUT and the external network or service.
- 4) The EUT shall be configured to operate in a manner representative of normal operation for its intended use.



### 5.6.2.2 Measurement Procedure

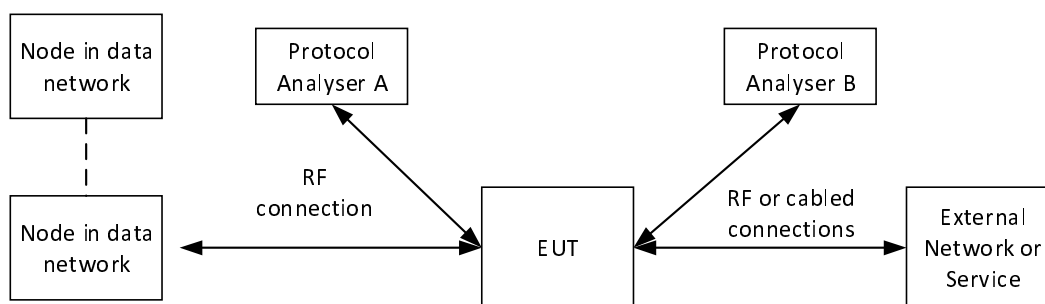

**Figure 15: Network access point analyser arrangement**

#### Step 1:

- If necessary, the EUT shall be connected to analyser B.
- Analyser A and analyser B shall be set to record all traffic.

**Table 79: Test parameters settings for NAP observations**

Setting	Value	Notes
Background observation period	30 minutes	Period to capture background traffic from data network and external network or service
NAP response period	< NAP message transit delay	Period to capture NAP response to requests (see note)
NOTE: The test may be shortened if the NAP response is smaller than the Limit defined in Table 27.		

- The EUT and all necessary companion equipment shall be set to operate in a normal manner for their intended use with a permitted test signal (see Table 29). traffic shall be recorded by both analysers over the background observation period defined in Table 79.
- The captured traffic shall be saved and traffic capture on the two analysers restarted.

#### Step 2:

- A request to transfer information from a node within the data network to the external network or service shall be generated.

NOTE 1: The means to generate such information is outside the scope of the present document.

- The traffic recorded by both analysers over the NAP response period defined in Table 79 shall be saved and traffic capture on the two analysers restarted.

#### Step 3:

- A request to transfer information from the external network or service to a node within the data network shall be generated.

NOTE 2: The means to generate such information is outside the scope of the present document.

- The traffic recorded by both analysers over the NAP response period defined in Table 79 shall be saved.

#### Step 4:

- Ignoring equivalent traffic to that recorded in step 1:
  - The saved traffic from step 2 shall be analysed to identify the generated request and any following response by the EUT on the link to the external network or service.
  - The saved traffic from step 3 is analysed to identify the generated request and any following response by the EUT into the data network.

The information in Table 80 is recorded in the test report.

**Table 80: Information recorded in the test report for NAP**

<b>Parameter</b>	<b>Value recorded in the test report</b>
NAP response to data network request	Whether the NAP responded to a request from within the data network to the external network or service
NAP response to external network or service request	Whether the NAP responded to a request from the external network or service to the data network

The pass criterion is that at least one NAP response shall be observed.

# Annex A (informative): Relationship between the present document and the essential requirements of Directive 2014/53/EU

## A.0 General information

The present document has been prepared under the Commission's standardisation request C(2015) 5376 final [i.4] to provide one voluntary means of conforming to the essential requirements of Directive 2014/53/EU on the harmonisation of the laws of the Member States relating to the making available on the market of radio equipment and repealing Directive 1999/5/EC [i.1].

Once the present document is cited in the Official Journal of the European Union under that Directive, compliance with the normative clauses of the present document given in Tables A.1 to A.3 confers, within the limits of the scope of the present document, a presumption of conformity with the corresponding essential requirements of that Directive, and associated EFTA regulations.

## A.1 Equipment Type 1a terminal nodes

**Table A.1: Relationship between the present document equipment Type 1a and the essential requirements of Directive 2014/53/EU**

Harmonised Standard ETSI EN 303 204					
Requirement				Requirement Conditionality	
No	Description	Essential requirements of Directive	Clause(s) of the present document	U/C	Condition
1	Frequency drift	3.2	4.3.1	C	Applies to transmitters capable of generating an unmodulated carrier
2	Operating frequencies and channel spacing	3.2	4.3.2	U	
3	Effective radiated power	3.2	4.3.3	U	
4	Transient power	3.2	4.3.4	U	
5	Occupied bandwidth	3.2	4.3.5	U	
6	Unwanted emissions in the out-of-band domain	3.2	4.3.6	U	
7	Unwanted emissions in the spurious domain	3.2	4.3.7	U	
8	Frequency stability under low-voltage conditions	3.2	4.3.8	C	Applies to battery-operated transmitters
9	Duty cycle and transmission timing	3.2	4.3.9	U	
10	Automatic/adaptive power control	3.2	4.3.10	U	
11	Receiver sensitivity	3.2	4.4.1	U	
12	Receiver maximum input signal level	3.2	4.4.2	U	
13	CCA threshold	3.2	N/A		
14	Co-channel rejection	3.2	4.4.4	U	
15	Adjacent channel selectivity	3.2	4.4.5	U	
16	Blocking	3.2	4.4.6	U	
17	Receiver spurious response rejection	3.2	4.4.7	U	
18	Receiver intermodulation rejection	3.2	4.4.8	U	
19	Receiver spurious emissions	3.2	4.4.9	U	
20	Listen before talk	3.2	N/A		
21	Short control signalling transmissions	3.2	4.5.2	C	Applies to EUT with $T_{\text{Disregard}} > 0$

Harmonised Standard ETSI EN 303 204					
Requirement				Requirement Conditionality	
No	Description	Essential requirements of Directive	Clause(s) of the present document	U/C	Condition
22	Network access point	3.2	N/A		

## A.2 Equipment Type 1b network nodes

**Table A.2: Relationship between the present document equipment Type 1b and the essential requirements of Directive 2014/53/EU**

Harmonised Standard ETSI EN 303 204					
Requirement				Requirement Conditionality	
No	Description	Essential requirements of Directive	Clause(s) of the present document	U/C	Condition
1	Frequency drift	3.2	4.3.1	C	Applies to transmitters capable of generating an unmodulated carrier
2	Operating frequencies and channel spacing	3.2	4.3.2	U	
3	Effective radiated power	3.2	4.3.3	U	
4	Transient power	3.2	4.3.4	U	
5	Occupied bandwidth	3.2	4.3.5	U	
6	Unwanted emissions in the out-of-band domain	3.2	4.3.6	U	
7	Unwanted emissions in the spurious domain	3.2	4.3.7	U	
8	Frequency stability under low-voltage conditions	3.2	4.3.8	C	Applies to battery-operated transmitters
9	Duty cycle and transmission timing	3.2	4.3.9	U	
10	Automatic/adaptive power control	3.2	4.3.10	U	
11	Receiver sensitivity	3.2	4.4.1	U	
12	Receiver maximum input signal level	3.2	4.4.2	U	
13	CCA threshold	3.2	N/A		
14	Co-channel rejection	3.2	4.4.4	U	
15	Adjacent channel selectivity	3.2	4.4.5	U	
16	Blocking	3.2	4.4.6	U	
17	Receiver spurious response rejection	3.2	4.4.7	U	
18	Receiver intermodulation rejection	3.2	4.4.8	U	
19	Receiver spurious emissions	3.2	4.4.9	U	
20	Listen before talk	3.2	N/A		
21	Short control signalling transmissions	3.2	4.5.2	C	Applies to EUT with $T_{Disregard} > 0$
22	Network access point	3.2	N/A		

## A.3 Equipment Type 1c network access points

**Table A.3: Relationship between the present document equipment Type 1c and the essential requirements of Directive 2014/53/EU**

Harmonised Standard ETSI EN 303 204					
Requirement				Requirement Conditionality	
No	Description	Essential requirements of Directive	Clause(s) of the present document	U/C	Condition
1	Frequency drift	3.2	4.3.1	C	Applies to transmitters capable of generating an unmodulated carrier
2	Operating frequencies and channel spacing	3.2	4.3.2	U	
3	Effective radiated power	3.2	4.3.3	U	
4	Transient power	3.2	4.3.4	U	
5	Occupied bandwidth	3.2	4.3.5	U	
6	Unwanted emissions in the out-of-band domain	3.2	4.3.6	U	
7	Unwanted emissions in the spurious domain	3.2	4.3.7	U	
8	Frequency stability under low-voltage conditions	3.2	4.3.8	C	Applies to battery-operated transmitters
9	Duty cycle and transmission timing	3.2	4.3.9	U	
10	Automatic/adaptive power control	3.2	4.3.10	U	
11	Receiver sensitivity	3.2	4.4.1	U	
12	Receiver maximum input signal level	3.2	4.4.2	U	
13	CCA threshold	3.2	4.4.3	U	
14	Co-channel rejection	3.2	4.4.4	U	
15	Adjacent channel selectivity	3.2	4.4.5	U	
16	Blocking	3.2	4.4.6	U	
17	Receiver spurious response rejection	3.2	4.4.7	U	
18	Receiver Intermodulation rejection	3.2	4.4.8	U	
19	Receiver spurious emissions	3.2	4.4.9	U	
20	Listen before talk	3.2	4.5.1	C	Applies to NAP operating with duty cycle (long term behaviour) > 2,5 %
21	Short control signalling transmissions	3.2	4.5.2	C	Applies to EUT with $T_{Disregard} > 0$
22	Network access point	3.2	4.6.2	U	

### Key to columns:

#### Requirement:

**No** A unique identifier for one row of the table which may be used to identify a requirement.

**Description** A textual reference to the requirement.

#### Essential requirements of Directive

Identification of article(s) defining the requirement in the Directive.

#### Clause(s) of the present document

Identification of clause(s) defining the requirement in the present document unless another document is referenced explicitly.

**Requirement Conditionality:**

<b>U/C</b>	Indicates whether the requirement is unconditionally applicable (U) or is conditional upon the manufacturer's claimed functionality of the equipment (C).
<b>Condition</b>	Explains the conditions when the requirement is or is not applicable for a requirement which is classified "conditional".

Presumption of conformity stays valid only as long as a reference to the present document is maintained in the list published in the Official Journal of the European Union. Users of the present document should consult frequently the latest list published in the Official Journal of the European Union.

Other Union legislation may be applicable to the product(s) falling within the scope of the present document.

---

## Annex B (normative): Test sites and arrangements for radiated measurement

### B.1 General considerations

This annex introduces three most commonly available test sites and a test fixture, to be used in the radiated measurements in accordance with the present document.

Subsequently the following items will be described:

- Open Area Test Site (OATS)
- Semi Anechoic Room (SAR)
- Fully Anechoic Room (FAR)
- Test fixture for relative measurements

The first three are generally referred to as free field test sites. Both absolute and relative measurements can be performed on these sites. They will be described in clause B.2. Clause B.3 describes the antennas used in these test sites. The test fixture can only be used for relative measurements, and will be described in Annex C.

Where absolute measurements are to be carried out, the chamber should be verified. A detailed verification procedure is described in clause 6 of ETSI TR 102 273-4 [i.11] for the OATS, in clause 6 of ETSI TR 102 273-3 [i.11] for the SAR, and in clause 6 of ETSI TR 102 273-2 [i.11] for the FAR.

Information for calculating the measurement uncertainty of measurements on one of these test sites can be found in ETSI TR 100 028-1 [i.9] and ETSI TR 100 028-2 [i.9], ETSI TR 102 273-2 [i.11], ETSI TR 102 273-3 [i.11] and ETSI TR 102 273-4 [i.11].

---

### B.2 Radiation test sites

#### B.2.1 Open Area Test Site (OATS)

An Open Area Test Site comprises a turntable at one end and an antenna mast of variable height at the other end above a ground plane which, in the ideal case, is perfectly conducting and of infinite extent. In practice, while good conductivity can be achieved, the ground plane size has to be limited. A typical Open Area Test Site is shown in Figure B.1.

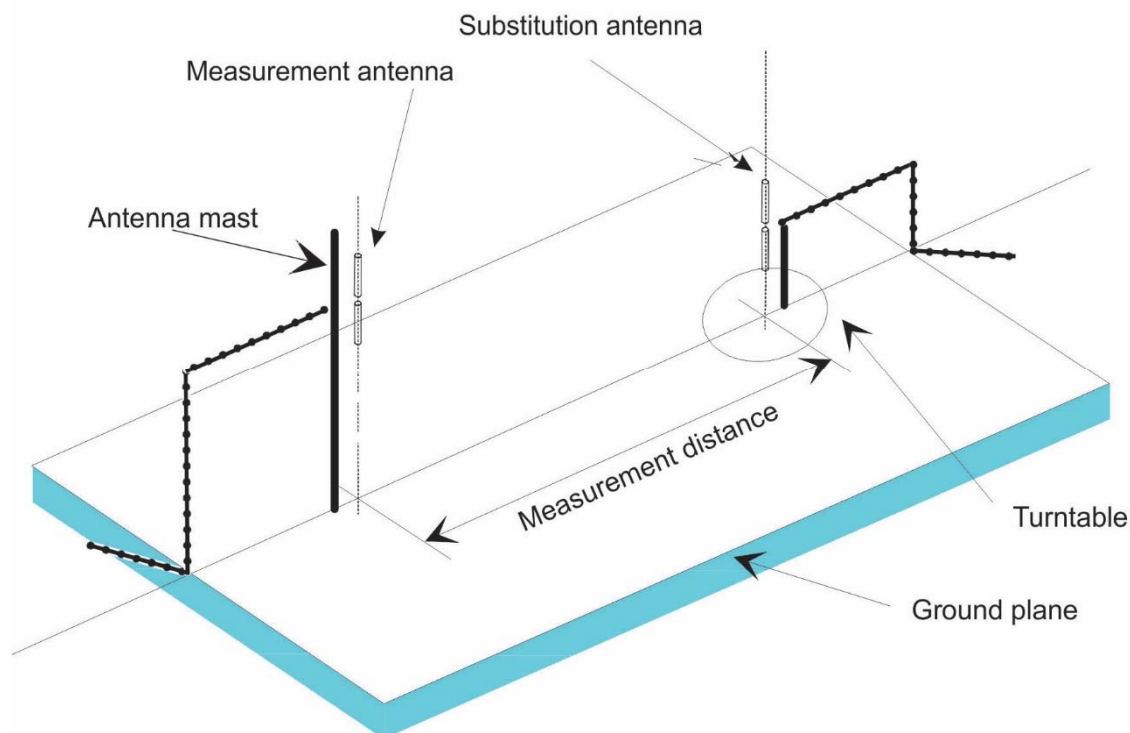

**Figure B.1: A typical Open Area Test Site**

The ground plane creates a wanted reflection path, such that the signal received by the receiving antenna is the sum of the signals received from the direct and reflected transmission paths. The phasing of these two signals creates a unique received level for each height of the transmitting antenna (or EUT) and the receiving antenna above the ground plane.

The antenna mast provides a variable height facility (from 1 m to 4 m) so that the position of the measurement antenna can be optimized for maximum coupled signal between antennas or between a EUT and the measurement antenna.

A turntable is capable of rotation through 360° in the horizontal plane and it is used to support the test sample (EUT) at a specified height, usually 1,5 m above the ground plane.

The measurement distance and minimum chamber dimensions can be found in clause B.2.4. The distance used in actual measurements shall be recorded with the test results.

Further information on Open Area Test Sites can be found in ETSI TR 102 273-4 [i.11].

## B.2.2 Semi Anechoic Room

A Semi Anechoic Room is - or anechoic chamber with a conductive ground plane - is an enclosure, usually shielded, whose internal walls and ceiling are covered with radio absorbing material. The floor, which is metallic, is not covered by absorbing material and forms the ground plane. The chamber usually contains an antenna mast at one end and a turntable at the other end. A typical anechoic chamber with a conductive ground plane is shown in Figure B.2.

This type of test chamber attempts to simulate an ideal Open Area Test Site, whose primary characteristic is a perfectly conducting ground plane of infinite extent.



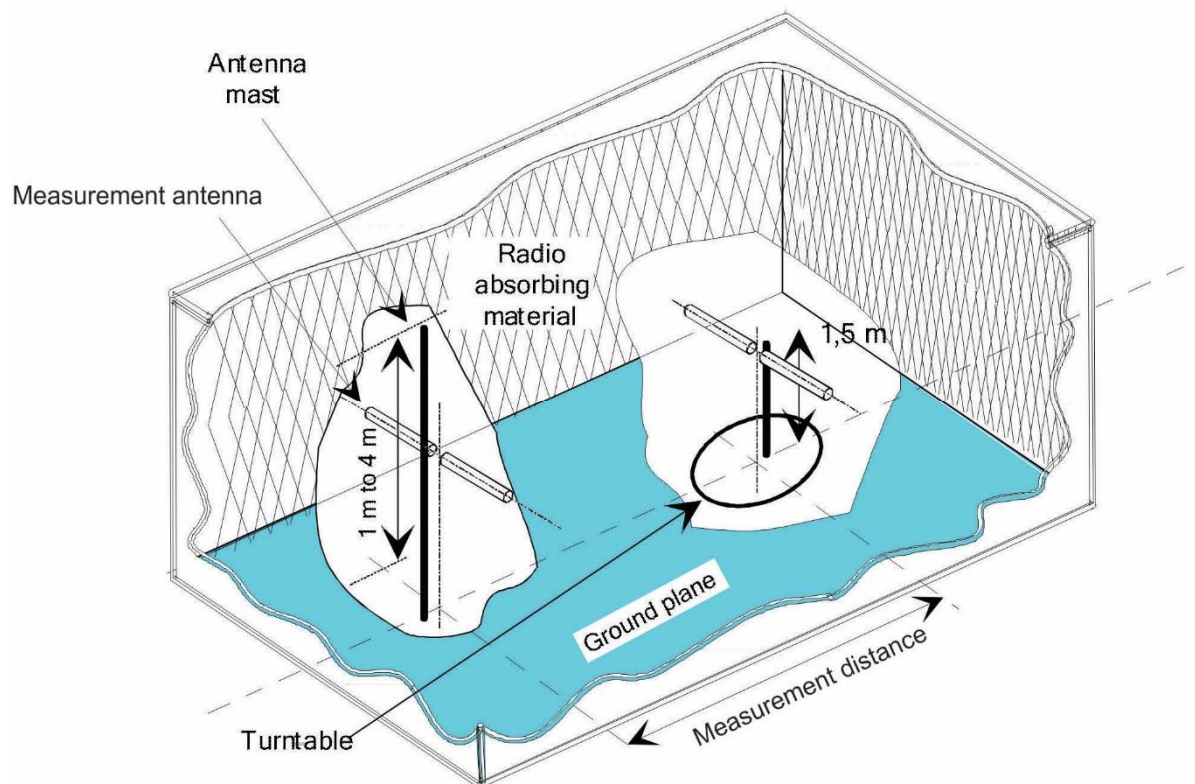

**Figure B.2: A typical Semi Anechoic Room**

In this facility the ground plane creates a wanted reflection path, such that the signal received by the receiving antenna is the sum of the signals received from the direct and reflected transmission paths. The phasing of these two signals creates a unique received level for each height of the transmitting antenna (or EUT) and the receiving antenna above the ground plane.

The antenna mast provides a variable height facility (from 1 m to 4 m) so that the position of the measurement antenna can be optimized for maximum coupled signal between antennas or between a EUT and the measurement antenna.

A turntable is capable of rotation through 360° in the horizontal plane and it is used to support the test sample (EUT) at a specified height, usually 1,5 m above the ground plane.

The measurement distance and minimum chamber dimensions can be found in clause B.2.4. The distance used in actual measurements shall be recorded with the test results.

Further information on Semi Anechoic Rooms can be found in ETSI TR 102 273-3 [i.11].

### B.2.3 Fully Anechoic Room (FAR)

A Fully Anechoic Room is an enclosure, usually shielded, whose internal walls, floor and ceiling are covered with radio absorbing material. The chamber usually contains an antenna support at one end and a turntable at the other end. A typical Fully Anechoic Room is shown in Figure B.3.

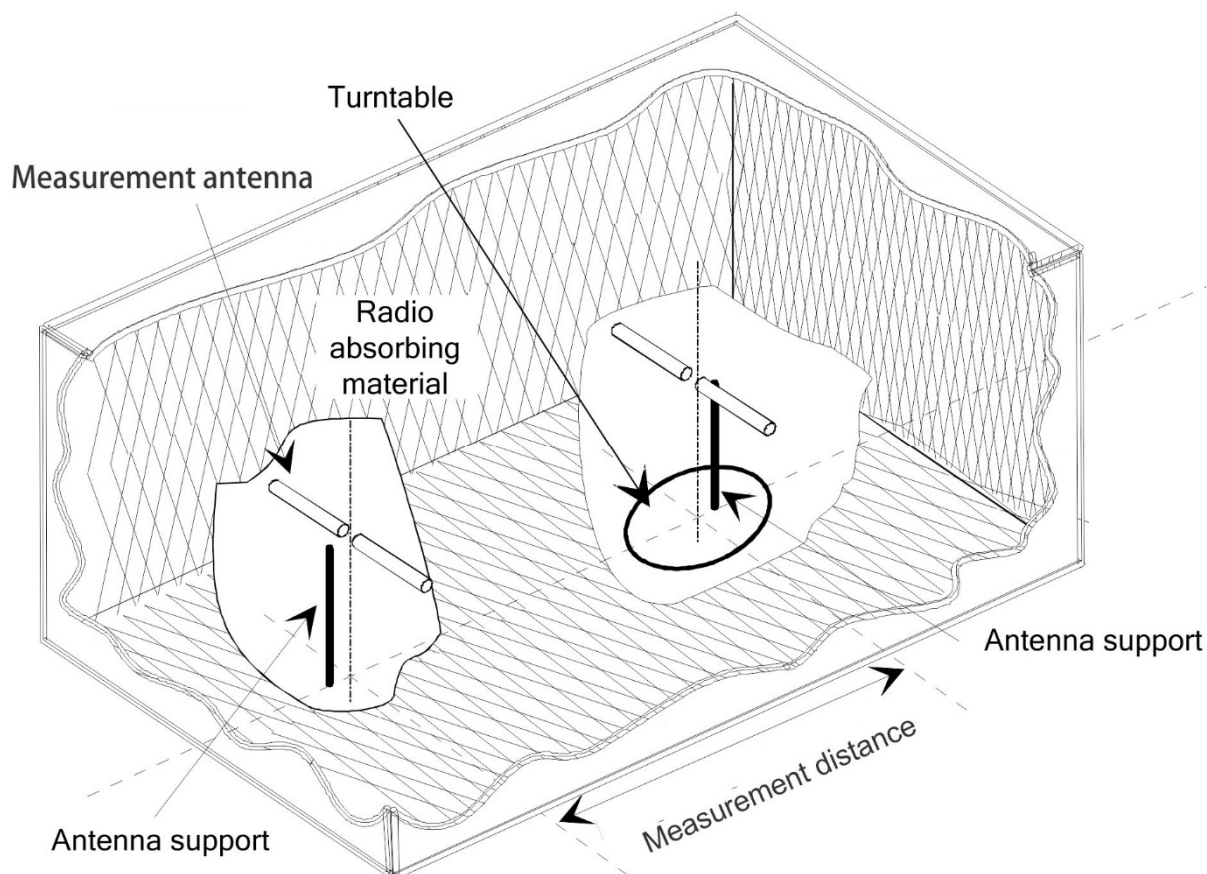

**Figure B.3: A typical Fully Anechoic Room**

The chamber shielding and radio absorbing material work together to provide a controlled environment for testing purposes. This type of test chamber attempts to simulate free space conditions.

The shielding provides a test space, with reduced levels of interference from ambient signals and other outside effects, whilst the radio absorbing material minimizes unwanted reflections from the walls and ceiling which can influence the measurements. The shielding should be sufficient to eliminate interference from the external environment that would mask any signals that shall be measured.

A turntable is capable of rotation through 360° in the horizontal plane and it is used to support the EUT at a suitable height (e.g. 1 m) above the ground plane.

The measurement distance and minimum chamber dimensions can be found in clause B.2.4. The distance used in actual measurements shall be recorded with the test results.

Further information on Fully Anechoic Rooms can be found in ETSI TR 102 273-2 [i.11].

## B.2.4 Measurement Distance

The measurement distance should be chosen in order to measure the EUT at far-field conditions. The minimum measurement distance between the equipment and the measurement antenna should be  $\lambda$  or  $r_m \gg \frac{D^2}{\lambda}$ , whichever is the greater.

$\lambda$  = wavelength in m

$r_m$  = minimum measurement distance between EUT and measurement antenna in m

$D$  = largest dimension of physical aperture of the largest antenna in the measurement setup, in m

$\frac{D^2}{\lambda}$  = distance between outer boundary of radiated near field (Fresnel region) and inner boundary of the radiated far-field (Fraunhofer region) in m, also known as Rayleigh distance.

For those measurements where these conditions cannot be fulfilled, and where the measurement distance would result in measurements in the near field (e.g. while measuring spurious emissions), this should be noted in the test report and the additional measurement uncertainty should be incorporated into the results.

## B.3 Antennae

### B.3.1 General considerations

Antennae are needed for the radiated measurements on the three test sites described in clause B.2. Depending on its use, the antenna will be designated as "measurement antenna" or "substitution antenna".

### B.3.2 Measurement antenna

In emission tests the measurement antenna is used to detect the field from the EUT in one stage of the measurement, and from the substitution antenna in the other stage. When the test site is used for the measurement of receiver characteristics, the antenna is used as the transmitting device.

The measurement antenna should be mounted on a support capable of allowing the antenna to be used in either horizontal or vertical polarization. Additionally, on an OATS or SAR, the height of the centre of the antenna above the ground should be variable over the specified range (usually 1 m to 4 m).

In the frequency band 30 MHz to 1 000 MHz, biconical or Logarithmic Periodic Dipole Antennas (LPDAs) are recommended. Above 1 GHz, horn antennas or logarithmic periodic dipole antennas are recommended.

For spurious emission testing, however, a combination of biconical antennas (commonly termed "bicones") and log periodic dipole array antennas (commonly termed "log periodics") could be used to cover the entire 30 MHz to 1 000 MHz band.

The measurement antenna does not require an absolute calibration.

### B.3.3 Substitution antenna

The substitution antenna shall be used to replace the equipment under test in substitution measurements and shall be suitable for the frequency range and the return loss of the antenna shall be taken into account when calculating the measurement uncertainty.

The phase centre of the substitution antenna shall coincide with the reference point of the test sample it has replaced. Therefore antennas with a phase centre that changes as a function of frequency (such as a LPDA) are not suitable for use as a substitution antenna.

The reference point of the substitution antenna shall coincide with the volume centre of the EUT when its antenna is internal, or the point where an external antenna is connected to the EUT.

The distance between the lower extremity of the antenna and the ground shall be at least 30 cm.

The substitution antenna shall be calibrated for the test site (OATS, SAR, FAR) in which it will be used. Below 1 GHz, the calibration is relative to a half wave dipole, while above 1 GHz, an isotropic radiator is the reference.

NOTE: Calibration figures intended for use above a reflective surface cannot be used in an anechoic chamber.

## B.4 Guidance on the use of radiation test sites

### B.4.1 General considerations

This clause details procedures, test equipment arrangements and verification that should be carried out before any of the radiated test are undertaken. These schemes are common to all types of test sites described in clause B.2.

Where necessary, a mounting bracket of minimal size should be available for mounting the EUT on the turntable. This

bracket should be made from low conductivity, low relative permittivity (i.e.  $\frac{\epsilon}{\epsilon_0} < 1,5$ ) material(s) such as expanded polystyrene, balsawood, etc.

### B.4.2 Power supplies for the battery powered EUT

All tests should be performed using power supplies wherever possible, including tests on EUT designed for battery-only use. For battery powered equipment, power leads should be connected to the EUT's supply terminals (and monitored with a digital voltmeter) but the battery should remain present, electrically isolated from the rest of the equipment, possibly by putting tape over its contacts.

The presence of these power cables can, however, affect the measured performance of the EUT. For this reason, they should be made to be "transparent" as far as the testing is concerned. This can be achieved by routing them away from the EUT and down to the either the screen, ground plane or facility wall (as appropriate) by the shortest possible paths. Precautions should be taken to minimize pick-up on these leads (e.g. the leads could be twisted together, loaded with ferrite beads at 0,15 m spacing or otherwise loaded).

### B.4.3 Site preparation

The cables to the measuring and substitution antenna should be routed horizontally away from the testing area for a minimum of 2 m (unless, in the case both types of anechoic chamber, a back wall is reached) and then allowed to drop vertically and out through either the ground plane or screen (as appropriate) to the test equipment. Precautions should be taken to minimize pick up on these leads (e.g. dressing with ferrite beads, or other loading). The cables, their routing and dressing should be identical to the verification set-up.

**NOTE:** For ground reflection test sites (i.e. anechoic chambers with ground planes and Open Area Test Sites) which incorporate a cable drum with the antenna mast, the 2 m requirement may be impossible to comply with.

Calibration data for all items of test equipment should be available and valid. For test, substitution and measuring antennas, the data should include gain relative to an isotropic radiator (or antenna factor) for the frequency of test. Also, the VSWR of the substitution and measuring antennas should be known.

The calibration data on all cables and attenuators should include insertion loss and VSWR throughout the entire frequency range of the tests. All VSWR and insertion loss figures should be recorded in the log book results sheet for the specific test.

Where correction factors/tables are required, these should be immediately available.

- For all items of test equipment, the maximum errors they exhibit should be known. See Annex D for guidance on maximum measurement uncertainty.

At the start of measurements, system checks should be made on the items of test equipment used on the test site.

---

## B.5 Coupling of signals

### B.5.1 General

The presence of leads in the radiated field may cause a disturbance of that field and lead to additional measurement uncertainty. These disturbances can be minimized by using suitable coupling methods, offering signal isolation and minimum field disturbance (e.g. optical coupling).

### B.5.2 Data signals

Isolation can be provided by the use of optical, ultrasonic or infra-red means. Field disturbance can be minimized by using a suitable fibre optic connection. Ultrasonic or infra-red radiated connections require suitable measures for the minimization of ambient noise.

---

## B.6 Measurement procedures for radiated measurement

### B.6.1 General considerations

This annex gives the general procedures for radiated measurements using the test sites and arrangements described in clause B.2.

Preferably, radiated measurements shall be performed in a FAR, see clause B.6.3. Radiated measurements in an OATS or SAR are described in clause B.6.2.

### B.6.2 Radiated measurements in an OATS or SAR

Radiated measurements shall be performed with the aid of a measurement antenna and a substitution antenna, in test sites described in Annex B. The measurement set-up shall be calibrated according to the procedure defined in this annex. The EUT and the measurement antenna shall be oriented such as to obtain the maximum emitted power level. This position shall be recorded in the measurement report.

- 1) The measurement antenna (device 2 in Figure B.4) shall be oriented initially for vertical polarization unless otherwise stated and the EUT (device 1 in Figure B.4) shall be placed on the support in its standard position and switched on.
- 2) The measurement equipment (device 3 in Figure B.4) shall be connected to the measurement antenna and set-up according to the specifications of the test.

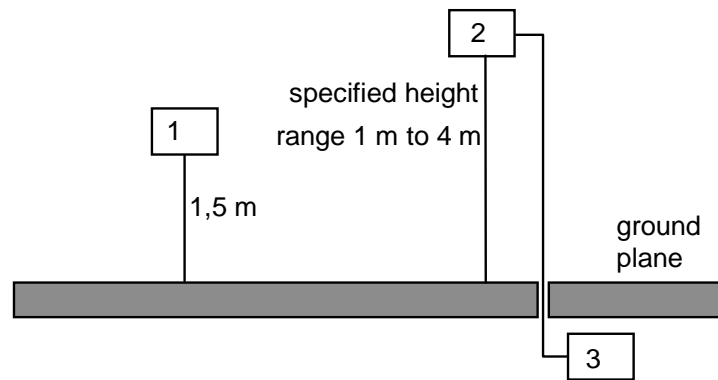

- 1) EUT
- 2) Measurement antenna
- 3) Measurement equipment

**Figure B.4: Measurement arrangement No.1**

- 3) The EUT shall be rotated through  $360^\circ$  in a horizontal plane until a maximum signal is received.
- 4) The measurement antenna shall be raised or lowered again through the specified height range until a maximum is obtained.
- 5) Steps 3 and 4 shall be repeated.
- 6) The maximum signal level shall be recorded.

NOTE: This maximum may be a lower value than the value obtainable at heights outside the specified limits.

- 7) The measurement shall be repeated with the measurement antenna oriented for horizontal polarization.

### B.6.3 Radiated measurements in a FAR

For radiated measurements using a FAR, the procedure is identical to the one described in clause B.6.2, except that the height scan is omitted.

### B.6.4 Substitution measurement

To determine the absolute measurement value a substitution measurement is performed. The following steps shall be performed:

- 1) The EUT, depicted as Device 1 in Figure B.4, shall be replaced by a substitution antenna oriented for vertical polarization. A calibrated signal generator shall be connected to the substitution antenna, and adjusted to the measurement frequency.
- 2) If an OATS or a SAR is used, the measurement antenna shall be raised or lowered, to ensure that the maximum signal is received.
- 3) Subsequently, the power of the signal generator shall be adjusted until the level obtained at the measurement equipment is the same as that recorded in the radiated measurement performed in clause B.6.2 or B.6.3 for the same polarization as the substitution antenna.
- 4) The absolute radiated power is equal to the power supplied by the signal generator, increased by the substitution antenna gain minus the cable losses (all values in dB).
- 5) This measurement shall be repeated with the substitution antenna oriented for horizontal polarization.

NOTE: For test sites with a fixed setup of the measurement antenna(e) and a reproducible positioning of the EUT, correction values from a verified site calibration can be used.

## B.6.5 Radiated measurement methods for receivers

Radiated measurements on receiving equipment are made with the output of the signal generator connected to the measurement antenna which is used as the test antenna as specified in clause B.3.2.

The power level at the receiver input is obtained by replacing the EUT with a substitution antenna (as specified in clause B.3.3) and suitable measuring equipment.

There are two measurement methods:

- a) Connect the substitution antenna to a calibrated measuring receiver and read the measurement result directly, corrected for the substitution antenna gain.
- b) Measure the path loss from the measurement antenna to the substitution antenna and subtract this, corrected for the substitution antenna gain, from the signal generator level to obtain the measurement result.

NOTE 1: For method a), if the level received is too low for accurate reading, the level of the signal generator may be increased by a suitable amount and the equivalent offset applied to the measurement result.

NOTE 2: Method b), one calibration measurement can be used for multiple tests.

## Annex C (normative): Test fixture

### C.1 General considerations

With equipment intended for use with an integral antenna, and not equipped with a 50  $\Omega$  RF output connector, a suitable test fixture as shown in Figure C.1 shall be used.

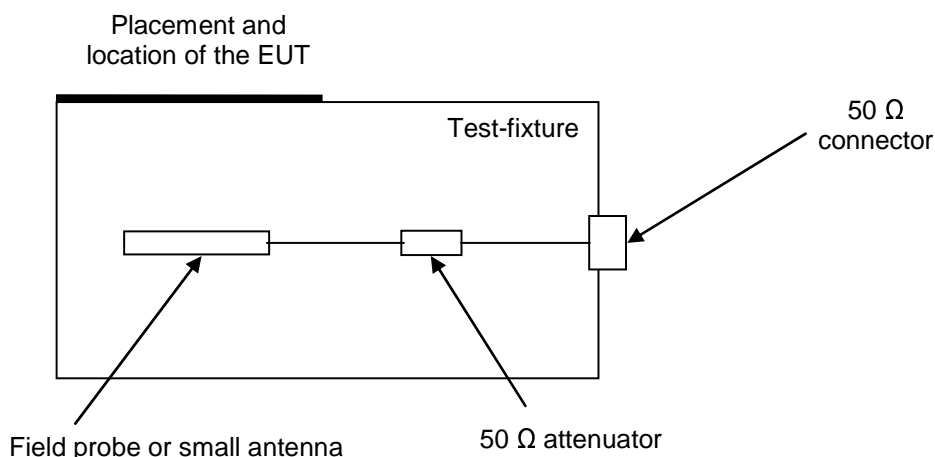

**Figure C.1: Test fixture**

Where a test fixture as defined in the present clause is used for measurements on integral antenna equipment, tests on radiated signals shall be carried out using the test fixture.

This fixture is a radio frequency device for coupling the integral antenna to a 50  $\Omega$  RF terminal at all frequencies for which measurements need to be performed.

In addition, the test fixture may provide:

- a connection to an external power supply;
- a method to provide the input to or output from the equipment.

**NOTE:** This may include coupling to or from the antenna. The test fixture could also provide suitable coupling means e.g. for data or video outputs.

The performance characteristics of the test fixture shall conform to the following basic parameters:

- the coupling loss shall not be greater than 30 dB;
- a coupling loss variation over the frequency range used in the measurement which does not exceed 2 dB under all test conditions;
- circuitry associated with the RF coupling shall contain no active or non-linear devices;
- the VSWR at the 50  $\Omega$  socket shall not be more than 1,5 over the frequency range of the measurements;
- the coupling loss shall be independent of the position of the test fixture and be unaffected by the proximity of surrounding objects or people. The coupling loss shall be reproducible when the equipment under test is removed and replaced. Normally, the test fixture is in a fixed position and provides a location for the EUT.

The attenuation of the test fixture coupling should be such that the received signal at the measuring instrument is at least 10 dB above the measuring instrument noise floor. If the attenuation is too great it can be compensated by linear amplification outside the test-fixture.



The characteristics and validation of the test fixture shall be documented in the test report.

## C.2 Validation of the test-fixture in the temperature chamber

The following is an example test fixture validation procedure to be followed if test fixture measurements are performed under extreme temperature conditions. Other validation procedures may be used.

A description of the validation procedure used shall be included in the test report.

The test fixture is brought into a temperature chamber.

### Step 1:

As shown in Figure C.2, a transmit antenna connected to a signal generator shall be positioned from the test-fixture at a far field distance of not less than one  $\lambda$  at the frequency. The test fixture consists of the mechanical support for the EUT, an antenna or field probe and a  $50\ \Omega$  attenuator for proper termination of the field probe. The test fixture shall be connected to a spectrum analyser via the  $50\ \Omega$  connector.

The signal generator shall be set to operate on the nominal frequency of the EUT. The unmodulated output power of the signal generator shall be set to a value such that a sufficiently high level can be observed with the spectrum analyser. This value shall be recorded in the test report. The signal generator shall then be set to the upper and the lower band limit of the EUT's operating frequency band. The measured values shall not deviate more than 1 dB from the value at the nominal frequency. The distance between test antenna and test fixture may be reduced to  $\lambda/2$  for frequencies below 100 MHz.

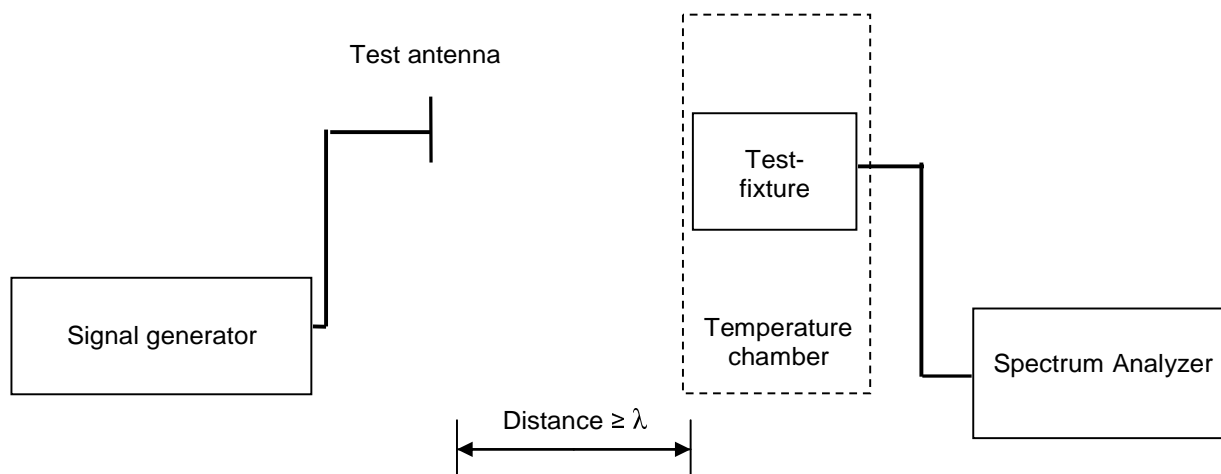

**Figure C.2: Validation of test set-up without EUT**

### Step 2:

During validation and testing the EUT shall be fitted to the test fixture in a switched-off mode as shown in Figure C.3. Step 1 shall be repeated, this time with the EUT in place. The measured values shall be compared with those from step 1 and may not vary by more than 2 dB. This shows that the EUT does not cause any significant shadowing of the radiated power.

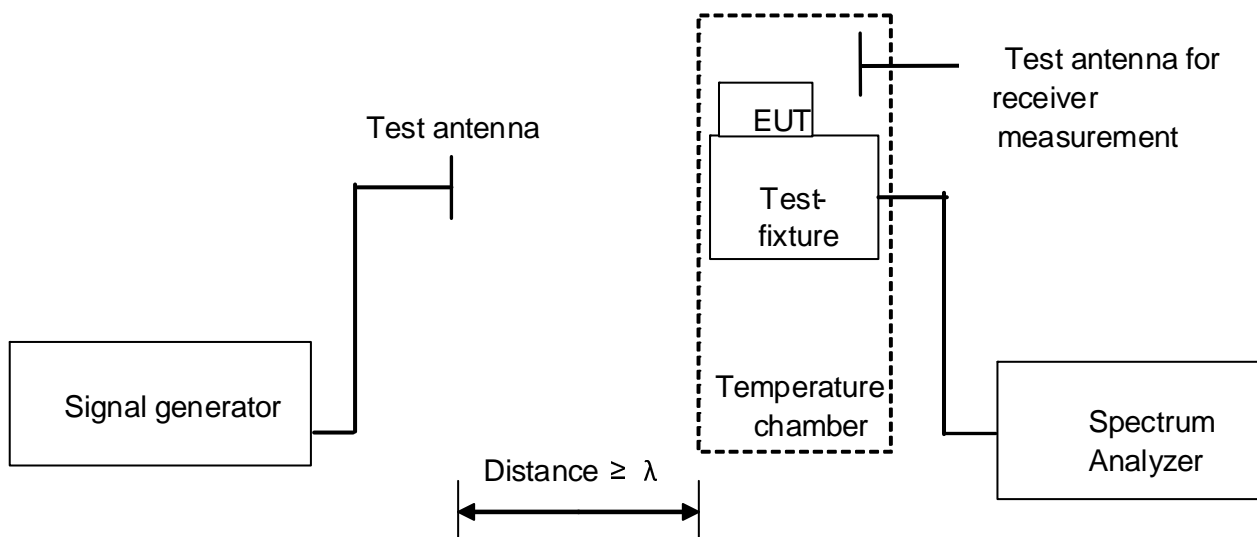
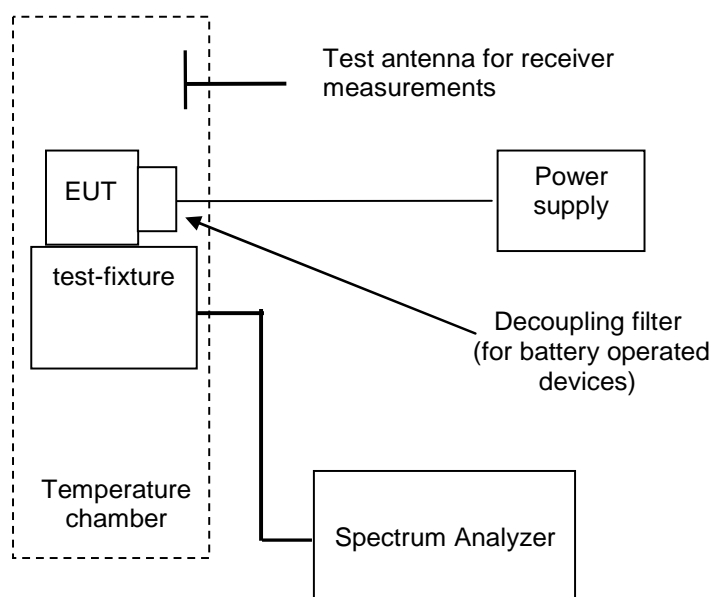

**Figure C.3: Validation of test set-up with EUT in place**

### Step 3:

In the case of a battery operated EUT that is supplied by a temporary voltage feed, a decoupling filter shall be installed directly at the EUT in order to avoid parasitic electromagnetic radiation. See Figure C.4.

In this step the signal generator and the transmit antenna are removed.



**Figure C.4: Test of EUT**

## C.3 Mode of use

The test fixture may be used to facilitate some of the transmitter and receiver measurements in the case of equipment having an integral antenna. See clause 5.2.8 for guidance on applicable use of the test fixture in conformance methods of measurement for the present document.

## Annex D (informative): Maximum measurement uncertainty

The measurements described in the present document are based on the following assumptions:

- the measured value related to the corresponding limit is used to decide whether an equipment meets the requirements of the present document;
- the value of the measurement uncertainty for the measurement of each parameter is included in the test report.

Table D.1 shows the recommended values for the maximum measurement uncertainty figures.

**Table D.1: Maximum measurement uncertainty**

Parameter	Uncertainty
Radio frequency	$\pm 1 \times 10^{-7}$
RF power, conducted	$\pm 1,5$ dB
Conducted spurious emission of transmitter, valid up to 6 GHz	$\pm 3$ dB
Conducted emission of receivers	$\pm 3$ dB
Radiated emission of transmitter, valid up to 6 GHz	$\pm 6$ dB
Radiated emission of receiver, valid up to 6 GHz	$\pm 6$ dB
RF level uncertainty for a given BER	$\pm 1,5$ dB
Temperature	$\pm 1$ °C
Humidity	$\pm 10$ %

## Annex E (normative): Transmission bandwidth

TBW shall be selected from Table E.1 for the value of OBW (as specified in clause 4.3.5) of the EUT.

**Table E.1: TBW for values of OBW**

OBW (kHz)	TBW (kHz)
< 15	25
$15 \leq \text{OBW} < 23$	37,5
$23 \leq \text{OBW} < 31$	50
$31 \leq \text{OBW} < 39$	62,5
$39 \leq \text{OBW} < 47$	75
$47 \leq \text{OBW} < 55$	87,5
$55 \leq \text{OBW} < 63$	100
$63 \leq \text{OBW} < 75$	112,5
$75 \leq \text{OBW} < 78$	125
$78 \leq \text{OBW} < 94$	150
$94 \leq \text{OBW} < 109$	175
$109 \leq \text{OBW} \leq 200$	200

If the measured channel spacing (as defined in clause 4.3.2) is less than the value in Table E.1 for the corresponding OBW (as specified in clause 4.3.5) then the value used for TBW shall be the value of the measured channel spacing.

## Annex F (normative): T<sub>On</sub> time measurements

### F.1 Measurement procedure

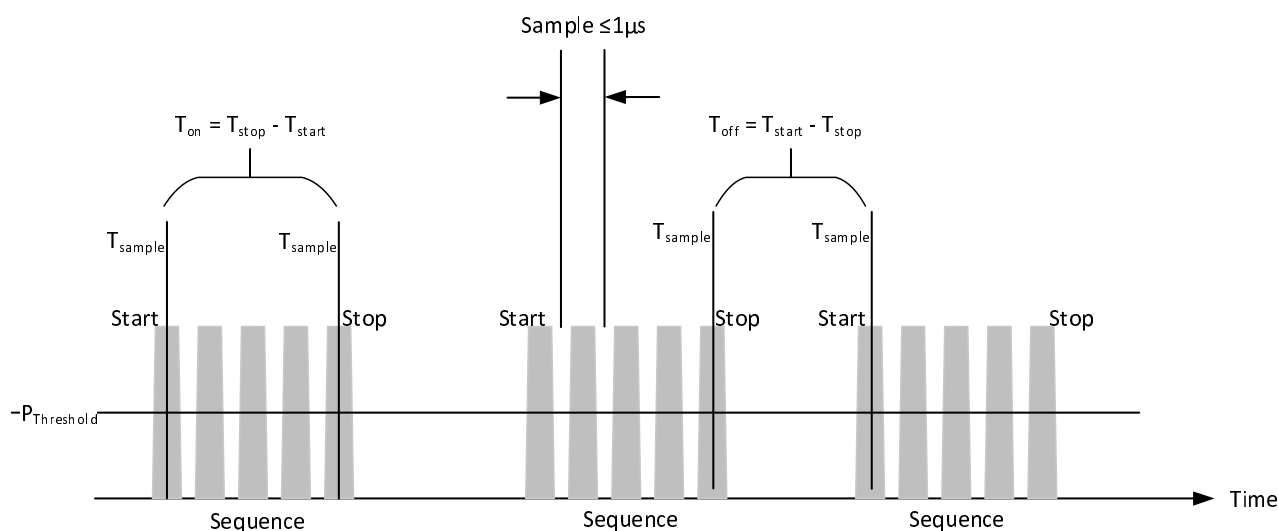

Figure F.1: Power samples reference timing

The start time and stop time of each sequence of samples above  $P_{\text{Threshold}}$  shall be determined. The timing reference for samples shall be as shown in Figure F.1. The  $T_{\text{On}}$  time shall be calculated from the difference between the time of the first and last samples of the sequence. The start time, stop time and  $T_{\text{On}}$  time for each sequence shall be saved.

Between the saved stop and start times of two adjacent sequences, the  $T_{\text{Off}}$  time shall be calculated. These  $T_{\text{Off}}$  values shall be saved.

### F.2 T<sub>Disregard</sub> procedure

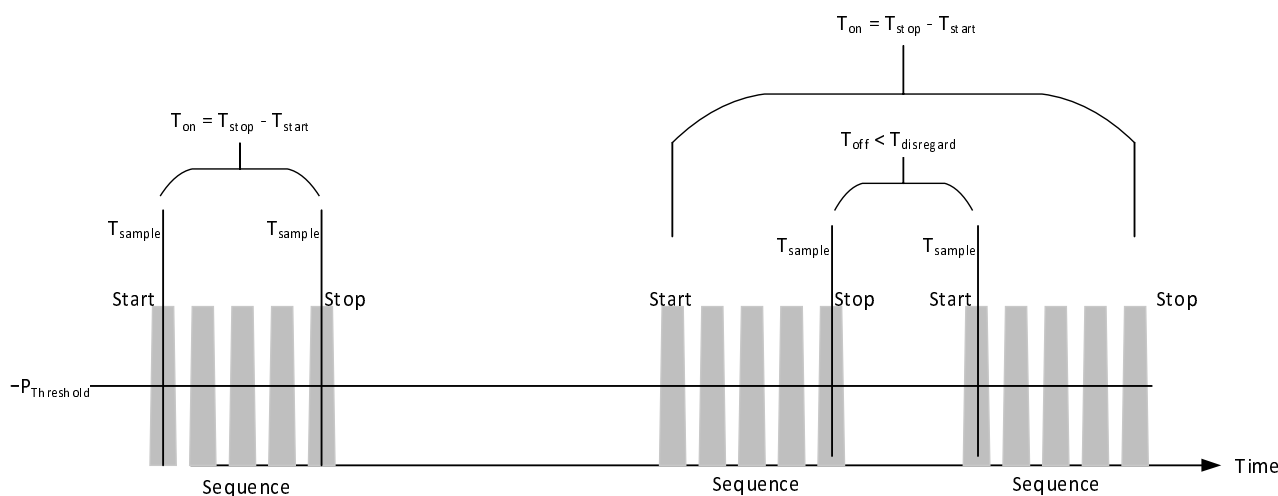

Figure F.2: T<sub>Disregard</sub>

Within the calculated  $T_{\text{Off}}$  times, for each interval less than  $T_{\text{Disregard}}$  the preceding sequence and the following sequence shall be merged with the  $T_{\text{Off}}$  interval and shall be replaced with the resulting combined start, stop and  $T_{\text{On}}$  times as shown in Figure F.2.

## Annex G (normative): General receiver test case procedure

### G.1 Test procedure

#### G.1.0 General requirements

- 1) An EUT without a permanent or temporary antenna connector shall be tested according to clause G.1.1.
- 2) An EUT with a permanent or temporary antenna connector shall be tested according to clause G.1.2.

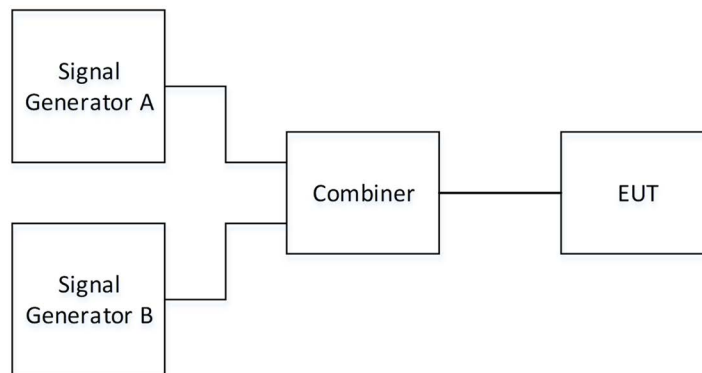

**Figure G.1: Conducted test measurement arrangement**

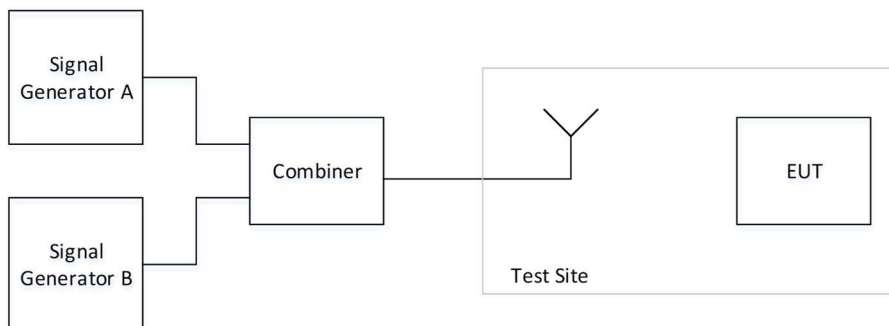

**Figure G.2: Radiated test measurement arrangement**

#### G.1.1 Radiated measurement

A test site shall be selected from those described in clause B.2.

Signal generators A and B together with the combiner, shown in Figure G.2, shall be placed outside the test site.

The output of the combiner shall be connected to a transmit test antenna with the same antenna polarization as the EUT. The transmit test antenna shall be placed in the test site.

The EUT shall be placed on the turntable in the test site.

All measurements in the test case shall be performed using radiated measurement methods described in clause B.6 corresponding to the selected test site.

## G.1.2 Conducted measurement

Two signal generators A and B shall be connected to the EUT via a combining network as shown in Figure G.1.

All measurements in the test case shall be performed directly with the measuring equipment.

## G.1.3 Minimum wanted signal level setup

The level of signal generator A shall be adjusted to the level that provides the reference sensitivity specified in Table 16.

The output level of generator A shall then be increased by 3 dB.

## G.1.4 High wanted signal level setup

The signal level from signal generator A is adjusted +20 dB higher, corresponding to a wanted signal of +23 dB above sensitivity.



---

## Annex H (normative): General transmitter test case procedure

### H.1 Test procedure where use of a test fixture is permitted

#### H.1.0 General requirements

- 1) An EUT without a permanent or temporary antenna connector shall be tested according to clause H.1.1 or clause H.1.3.
- 2) An EUT with a permanent or temporary antenna connector shall be tested according to clause H.1.2.

#### H.1.1 Radiated measurement

A test site shall be selected from those described in clause B.2.

All measurements in the test case shall be performed using radiated measurement methods described in clause B.6 corresponding to the selected test site.

#### H.1.2 Conducted measurement

The EUT shall be connected to an artificial antenna which shall be connected to the test equipment.

All measurements in the test case shall be performed directly with the measuring equipment.

#### H.1.3 Alternate conducted measurement

The EUT shall be installed in the manufacturer's test fixture which shall be connected to the test equipment.

All measurements in the test case shall be performed directly with the measuring equipment.

---

### H.2 Test procedure where use of a test fixture is not permitted

#### H.2.0 General requirements

- 1) An EUT without a permanent or temporary antenna connector shall be tested according to clause H.2.1.
- 2) An EUT with a permanent or temporary antenna connector shall be tested according to clause H.2.2.

#### H.2.1 Radiated measurement

A test site shall be selected from those described in clause B.2.

All measurements in the test case shall be performed using radiated measurement methods described in clause B.6 corresponding to the selected test site.

## H.2.2 Conducted measurement

The EUT shall be connected to an artificial antenna which shall be connected to the test equipment.

All measurements in the test case shall be performed directly with the measuring equipment.

---

## Annex I (informative): Selection of receiver parameters

### I.1 Receiver parameters as listed in ETSI EG 203 336 (V1.1.1)

#### I.1.1 Receiver sensitivity

The receiver sensitivity requirement measures the ability of the receiver to operate in the presence of an unwanted signal in the same channel as the operating frequency. The requirement is specified as a test signal representative of normal operation at the same frequency as the operating frequency. Receiver sensitivity is specified in clause 4.4.1.

#### I.1.2 Adjacent channel selectivity

The adjacent channel selectivity requirement measures the ability of the receiver to operate in the presence of an unwanted signal near the operating frequency. The requirement is specified as a CW signal at the centre frequency of the adjacent channel. Adjacent channel selectivity is specified in clause 4.4.5.

Adjacent channel selectivity is measured for a minimum wanted signal level to provide a measure of receiver performance at the limit of range, and with a strong wanted signal level to provide a measure of receiver saturation in the adjacent channels.

#### I.1.3 Blocking

The blocking requirement measures the ability of the receiver to operate in the presence of an unwanted signal far from the operating frequency. The requirement is specified as a CW signal and blocking is measured for multiple offsets of the unwanted CW signal from the operating frequency. Blocking is specified in clause 4.4.6.

Blocking is measured for a minimum wanted signal level to provide a measure of receiver performance at the limit of range, and with a strong wanted signal level to provide a measure of receiver saturation at frequencies far from the operating frequency.

In addition, measurements are taken at nominal frequencies and with small offsets from the nominal frequencies to avoid measurements at receiver spurious response frequencies. If such responses are noted in the blocking measurements, the relevant frequencies are added to those tested in the receiver spurious response rejection test suite.

#### I.1.4 Co-channel rejection

The co-channel rejection requirement measures the receiver ability to reject an unwanted signal in the same operating channel as the operating frequency. Co-channel rejection is specified in clause 4.4.4.

#### I.1.5 Spurious response rejection

The spurious response rejection requirement measures the ability of the receiver to operate in the presence of an unwanted signal at a frequency at which a spurious response is observed. Spurious response rejection is specified in clause 4.4.7.

#### I.1.6 Intermodulation

Intermodulation rejection is a measure of the ability of a receiver to operate in the presence of two or more unwanted signals the frequencies of which have a specific frequency relationship to the wanted signal. Intermodulation is specified in clause 4.4.8.

### I.1.7 Dynamic range

Dynamic range provides a measure of the range of signal levels over which the receiver is able to obtain the wanted criteria defined in clause 4.2.2. Dynamic range is provided by a combination of the sensitivity requirement and the maximum input signal level requirement. Maximum input signal level is specified in clause 4.4.2.

### I.1.8 Reciprocal mixing

Reciprocal mixing effects will manifest themselves as blocking effects and the present document relies on limits and test suites for blocking and adjacent channel selectivity to ensure receiver resilience in the shared spectrum environment.

### I.1.9 Desensitisation

Desensitisation is a measure of the ability of the receiver to operate in the presence of a strong interfering signal. Receiver susceptibility to desensitisation is provided by the blocking (clause 4.4.6) requirement, co-channel rejection (clause 4.4.4) requirement and adjacent channel selectivity (clause 4.4.5) requirement where interference rejection is measured for wanted signals at both +3 dB and +23 dB above sensitivity.

### I.1.10 Signal interferer handling

Signal interferer handling is an alternative method for specifying receiver parameters (clause I.1.1 through clause I.1.9) intended for use for receivers such as UWB and certain types of radar equipment.

The present document for communications equipment specifies receiver requirements and measurement methods for all receiver parameters listed in clause I.1.1 through clause I.1.9.

---

## I.2 Other receiver parameters

### I.2.1 CCA threshold

Receivers employing Listen Before Talk spectrum access sample the operating channel for energy above the CCA Threshold to determine whether the channel is occupied by another transmission. CCA threshold is specified in clause 4.4.3.

## Annex J (informative): Properties of equipment under test

This annex lists the EUT properties necessary for the execution of the conformance test suites used to determine the conformance of the EUT.

Property	Units
Operating Frequency Range	
Highest nominal operating frequency	MHz
Lowest nominal operating frequency	MHz
Nominal channel spacing	kHz
Receiver bandwidth	kHz
Local oscillator frequency $f_{LO}$	MHz
Intermediate frequency (or list of intermediate frequencies) $f_{IF}$	MHz
External Antenna gain relative to dipole	
For equipment with non-integral antenna	dBd
Worst case modulation and operational mode	
Equipment configuration settings for each test suite	
Maximum data rate	kbps
Technical description of D-M2, D-M2a, D-M3 (Information necessary to be able to synthesize test signals representative of normal operation)	
Unmodulated carrier	
Whether the equipment is able to generate test signal D-M1 or not	
Disregard time ( $T_{Disregard}$ )	$\mu$ s
Temperature range	$^{\circ}$ C
or one of the standard temperatures ranges described in clause 5.2.3.2.4	
Nominal mains voltage (or range of voltages)	Vac
Nominal battery voltage	V
APC settling time	$\mu$ s
Minimum separation distance	m

---

## Annex K (informative): Bibliography

- Bradley J.V. (Prentice Hall, 1968): "Distribution Free Statistical Tests".
- Ketterling, H-P: "Verification of the performance of fully and semi-anechoic chambers for radiation measurements and susceptibility/immunity testing", 1991, Leatherhead/Surrey.
- ETSI EN 301 489: "Electromagnetic compatibility and Radio spectrum Matters (ERM); ElectroMagnetic Compatibility (EMC) standard for radio equipment and services".
- ETSI EN 301 489-3: "Electromagnetic compatibility and Radio spectrum Matters (ERM); ElectroMagnetic Compatibility (EMC) standard for radio equipment and services; Part 3: Specific conditions for Short-Range Devices (SRD) operating on frequencies between 9 kHz and 40 GHz".
- ETSI TR 102 313 (V1.1.1): "Electromagnetic compatibility and Radio Spectrum Matters (ERM); Frequency-agile Generic Short Range Devices using listen-Before-Transmit (LBT); Technical Report".
- ANSI C63.5 (2006): "American National Standard for Calibration of Antennas Used for Radiated Emission Measurements in Electro Magnetic Interference".
- ITU-R Radio Regulations.
- Recommendation ITU-R SM 328: "Spectra and bandwidth of emissions".
- Recommendation ITU-R SM.853-1: "Necessary Bandwidth".
- ETSI EN 300 220: "Electromagnetic compatibility and Radio spectrum Matters (ERM); Short Range Devices (SRD); Radio equipment to be used in the 25 MHz to 1 000 MHz frequency range with power levels ranging up to 500 mW".
- Council Directive 89/336/EEC of 3 May 1989 on the approximation of the laws of the Member States relating to electromagnetic compatibility (EMC Directive).
- ETSI TS 102 887-2 (V1.1.1): "Electromagnetic compatibility and Radio spectrum Matters (ERM); Short Range Devices; Smart Metering Wireless Access Protocol; Part 2: Data Link Layer (MAC Sub-layer)".
- Code of Federal Regulations, Title 47: "Telecommunications", Section 15.247: "Operation within the bands 902-928 MHz, 2400-2483.5 MHz, and 5725-5850 MHz".

## Annex L (informative): Change History

Date	Version	Information about changes
October 2014	1.1.1	First publication as a 2-part HS
February 2016	2.1.1	Revision for compliance with Directive 2014/53/EU. Single part HS. New Transient method of measurement removing use of Quasi-Peak detector. New Adjacent channel selectivity requirement and method of measurement. Updated Blocking performance limits
September 2016	2.1.2	Clause 4.2.4 "Marking" is deleted
September 2019	3.1.1	<ol style="list-style-type: none"> <li>1. Update Title to align with EC/CEPT terminology for SRD in data networks</li> <li>2. Revise Introduction adding brief explanation of EC Decision on 870/915 MHz and introduction of data network concepts and usage restrictions. Add explanations of modified concepts and measurements</li> <li>3. Update Scope with core harmonised frequency range at 874-874,4 MHz and align terms used with EC/CEPT terminology and limit to fixed devices only</li> <li>4. Add reference to new EC Decision on SRD in 870/915 MHz frequency ranges</li> <li>5. Update Definitions and Abbreviations with precise entries for network entities network access point (NAP), network node (NN) and terminal node (TN). Replace OCW with TBW</li> <li>6. Update clause 4.2 Performance Criteria description to remove vendor declaration, add clear explanations for signal threshold, disregard time and new TBW concept and operation on single frequencies</li> <li>7. Amend clauses 4.3, 4.4 &amp; 4.5. Add new requirements for operating frequencies and channel spacing incorporating frequency error. Add new requirement for frequency drift. Update OBW requirement. Replace OCW with TBW. Add new receiver requirements for maximum input signal level, co-channel rejection, intermodulation rejection and spurious response rejection. Update blocking requirement to include spurious response rejection. Update requirements for Spectrum Access to add requirements and limits for NAP, remove requirements which are declared with no limits</li> <li>8. Update any sub-clauses of clause 4 which permit vendor declaration of technical characteristics which should be measured</li> <li>9. Update clause 5 methods of measurements sub-clauses with vendor declaration of technical characteristics which should be measured, including new test suites for new requirements. Adapt existing test suites for updated requirements. Add method for deriving frequency drift from measurements of unmodulated carrier and OBW. Replace use of OCE with TBW except for Adjacent Channel Selectivity where CS replaces OCW. Update blocking test method to include spurious response checking. Add high wanted signal to tests for selectivity and blocking requirements. Add intermodulation test method. Add radiated test methods under extreme test conditions for e.r.p. and sensitivity</li> <li>10. Replace clause 5.2.2 with informative Annex Properties of the EUT</li> <li>11. Add to clause 5.6 methods of measurement for NAP</li> <li>12. Amend clause 5.7 to split normative shared risk principle from informative measurement uncertainties. Move measurement uncertainties to an informative annex</li> <li>13. Amend Tables of recommended test signals, applicable measurement methods and specific test procedures adding new entries as necessary</li> <li>14. Amend Annex A as appropriate adding new requirements and dependencies</li> <li>15. Editorial changes to align terminology with EC/CEPT terminology for networked SRD and data networks</li> <li>16. Editorial changes to improve clarity of existing clauses as necessary</li> <li>17. Update Bibliography and Change History Annexes</li> <li>18. New Annexes for Selection of Receiver Parameters (informative), Determination of TBW, spurious responses (informative) and <math>T_{On}</math> time measurements (normative), common receiver and transmitter test procedures (normative)</li> <li>19. Amend clause B.4 to refer to clause 5.7</li> <li>20. Remove unnecessary specific measurement parameters in Annex C</li> <li>21. Annex D is deprecated and deleted</li> </ol>
December 2020	3.1.1	<ol style="list-style-type: none"> <li>22. Replace clause 5.7 by new informative Annex D Maximum measurement uncertainty. Update references to clause 5.7 accordingly</li> <li>23. Add radiated test case to clause 5.3.10</li> </ol>

---

## History

<b>Document history</b>		
V1.1.1	October 2014	Publication as ETSI EN 303 204 part 1 and part 2
V2.1.1	April 2016	Publication (withdrawn)
V2.1.2	September 2016	Publication
V3.0.0	May 2020	EN Approval Procedure                      AP 20200806:    2020-05-08 to 2020-08-06
V3.1.0	December 2020	Vote    V 20210220:    2020-12-22 to 2021-02-22