

Draft **ETSI EN 303 203** V2.1.0 (2015-07)



**Short Range Devices (SRD);
Medical Body Area Network Systems (MBANSs)
operating in the 2 483,5 MHz to 2 500 MHz range;
Harmonised Standard covering the essential requirements
of article 3.2 of the Directive 2014/53/EU**

Reference

REN/ERM-TG30-311

Keywords

health, network, radio, regulation, SRD, system

ETSI

650 Route des Lucioles
F-06921 Sophia Antipolis Cedex - FRANCE

Tel.: +33 4 92 94 42 00 Fax: +33 4 93 65 47 16

Siret N° 348 623 562 00017 - NAF 742 C
Association à but non lucratif enregistrée à la
Sous-Préfecture de Grasse (06) N° 7803/88

Important notice

The present document can be downloaded from:
<http://www.etsi.org/standards-search>

The present document may be made available in electronic versions and/or in print. The content of any electronic and/or print versions of the present document shall not be modified without the prior written authorization of ETSI. In case of any existing or perceived difference in contents between such versions and/or in print, the only prevailing document is the print of the Portable Document Format (PDF) version kept on a specific network drive within ETSI Secretariat.

Users of the present document should be aware that the document may be subject to revision or change of status. Information on the current status of this and other ETSI documents is available at
<http://portal.etsi.org/tb/status/status.asp>

If you find errors in the present document, please send your comment to one of the following services:
<https://portal.etsi.org/People/CommitteeSupportStaff.aspx>

Copyright Notification

No part may be reproduced or utilized in any form or by any means, electronic or mechanical, including photocopying and microfilm except as authorized by written permission of ETSI.

The content of the PDF version shall not be modified without the written authorization of ETSI.
The copyright and the foregoing restriction extend to reproduction in all media.

© European Telecommunications Standards Institute 2015.
All rights reserved.

DECT™, **PLUGTESTS™**, **UMTS™** and the ETSI logo are Trade Marks of ETSI registered for the benefit of its Members.
3GPP™ and **LTE™** are Trade Marks of ETSI registered for the benefit of its Members and of the 3GPP Organizational Partners.
GSM® and the GSM logo are Trade Marks registered and owned by the GSM Association.

Contents

Intellectual Property Rights	6
Foreword.....	6
Modal verbs terminology.....	6
Introduction	6
1 Scope	8
2 References	8
2.1 Normative references	8
2.2 Informative references.....	8
3 Definitions, symbols and abbreviations	9
3.1 Definitions.....	9
3.2 Symbols.....	11
3.3 Abbreviations	11
4 Technical requirements and specifications.....	12
4.1 Environmental profile.....	12
4.2 Conformance requirements	12
4.2.1 Transmitter requirements	12
4.2.1.1 Frequency Error	12
4.2.1.1.1 Definition.....	12
4.2.1.1.2 Limits	12
4.2.1.1.3 Conformance	12
4.2.1.2 Emission bandwidth.....	12
4.2.1.2.1 Definition.....	12
4.2.1.2.2 Limits	12
4.2.1.2.3 Conformance	12
4.2.1.3 Effective isotropic radiated power	12
4.2.1.3.1 Definition.....	12
4.2.1.3.2 Limits	12
4.2.1.3.3 Conformance	13
4.2.1.4 Spurious emissions.....	13
4.2.1.4.1 Definition.....	13
4.2.1.4.2 Limits	13
4.2.1.4.3 Conformance	13
4.2.1.5 Out-of-band emissions	13
4.2.1.5.1 Definition.....	13
4.2.1.5.2 Limits	13
4.2.1.5.3 Conformance	13
4.2.1.6 Frequency stability under low voltage conditions.....	14
4.2.1.6.0 Applicability.....	14
4.2.1.6.1 Definition.....	14
4.2.1.6.2 Limits	14
4.2.1.6.3 Conformance	14
4.2.1.7 Duty cycle	14
4.2.1.7.0 General remarks.....	14
4.2.1.7.1 Definition.....	14
4.2.1.7.2 Limits	14
4.2.1.7.3 Conformance	14
4.2.2 Receiver requirements	15
4.2.2.1 Spurious radiation	15
4.2.2.1.1 Definition.....	15
4.2.2.1.2 Limits	15
4.2.2.1.3 Conformance	15
4.2.2.2 Receiver blocking	15
4.2.2.2.1 Definition.....	15
4.2.2.2.2 Limits	15

4.2.2.2.3	Conformance	15
4.2.3	Spectrum access	15
4.2.3.0	General requirements	15
4.2.3.1	LBT threshold power level.....	17
4.2.3.1.1	Definition.....	17
4.2.3.1.2	Limits	17
4.2.3.1.3	Conformance	17
4.2.3.2	Monitoring system bandwidth.....	17
4.2.3.2.0	General remarks.....	17
4.2.3.2.1	Definition.....	17
4.2.3.2.2	Limits	17
4.2.3.2.3	Conformance	17
4.2.3.3	Minimum channel monitoring period	17
4.2.3.3.0	General remarks.....	17
4.2.3.3.1	Definition.....	17
4.2.3.3.2	Limits	17
4.2.3.3.3	Conformance	18
4.2.3.4	Channel access based on ambient levels relative to the calculated access LBT threshold level, P_{Th}	18
4.2.3.4.0	General requirements.....	18
4.2.3.4.1	Conformance	18
4.3	Mechanical and electrical design.....	18
4.3.1	General.....	18
4.3.2	Controls	18
4.3.3	Transmitter shut-off facility	18
5	Testing for compliance with technical requirements.....	18
5.1	Environmental conditions for testing	18
5.1.0	General requirements.....	18
5.1.1	Presentation for testing	19
5.1.1.0	General provisions	19
5.1.1.1	Choice of model for testing.....	19
5.1.1.2	Spurious emission testing for composite equipment	19
5.1.1.3	Testing of equipment with alternative power levels.....	19
5.1.1.4	Presentation of equipment that does not have an external RF connector (equipment with an integral antenna).....	20
5.1.1.4.1	Equipment with a permanent or temporary internal antenna connector	20
5.1.1.4.2	Equipment with a temporary antenna connector	20
5.1.2	Declarations by the applicant.....	20
5.1.3	Auxiliary test equipment.....	20
5.1.4	Test conditions.....	20
5.1.4.1	Normal and extreme test conditions.....	20
5.1.4.2	Test power source	20
5.1.4.2.0	General requirements.....	20
5.1.4.2.1	External test power source.....	20
5.1.4.2.2	Internal test power source	21
5.1.4.3	Normal test conditions	21
5.1.4.3.1	Normal temperature and humidity.....	21
5.1.4.3.2	Normal test power source	21
5.1.4.4	Extreme test conditions	21
5.1.4.4.1	Extreme temperatures.....	21
5.1.4.4.2	Extreme test source voltages	23
5.1.4.5	Normal test signals and test modulation.....	23
5.1.4.5.0	General requirements.....	23
5.1.4.5.1	Normal modulation test signals for data.....	23
5.1.4.6	Antennas	23
5.1.4.7	Test fixture	23
5.1.4.8	Test sites and general arrangements for radiated measurements.....	24
5.1.4.9	Modes of operation of the transmitter	24
5.1.4.10	Measuring receiver.....	24
5.1.4.11	General remarks on configuration for transmitter measurements	25
5.1.4.12	General remarks on configuration for receiver measurements.....	25
5.1.4.13	General remarks on configuration for monitoring system measurements.....	26

5.2	Interpretation of the measurement results	26
5.3	Methods of measurement	27
5.3.1	Frequency error.....	27
5.3.1.0	General requirements	27
5.3.1.1	Method of measurement for systems with an unmodulated carrier frequency operating mode	27
5.3.1.2	Method of measurement for systems with a modulated output frequency	27
5.3.2	Emission bandwidth.....	28
5.3.3	Effective isotropic radiated power	28
5.3.4	Transmitter spurious emissions.....	29
5.3.5	Out-of-band emissions.....	30
5.3.6	Frequency stability under low voltage conditions	32
5.3.7	Receiver spurious emissions	32
5.3.8	LBT threshold power level	33
5.3.8.0	General remarks	33
5.3.8.1	Measurement method using frequency administration commands	33
5.3.8.2	Results based on the above test method	33
5.3.9	Minimum channel monitoring period	33
5.3.9.0	General remarks	33
5.3.9.1	Measurement method using frequency administration commands	33
5.3.9.2	Results based on the above test method	34
5.3.10	Channel access based on ambient levels relative to the calculated access LBT threshold level, P_{Th}	34
5.3.10.0	Initial steps	34
5.3.10.1	Accessing an unoccupied channel	34
5.3.10.2	Results accessing an unoccupied channel	34
5.3.10.3	Accessing the Least Interfered Channel	34
5.3.10.4	Results accessing the Least Interfered Channel	34
5.3.11	Receiver blocking	34
5.3.11.0	General remarks	34
5.3.11.1	Measurement method using frequency administration commands	34
5.3.11.2	Results based on the above test method	35
Annex A (normative):	Relationship between the present document and the essential requirements of Directive 2014/53/EU	36
Annex B (normative):	Radiated measurements	38
B.1	Test sites and arrangements for radiated measurements	38
B.1.1	Outdoor test site	38
B.1.2	Indoor test site	38
B.1.3	Shielded anechoic test site.....	39
B.2	Antennas.....	41
B.2.1	Test antenna.....	41
B.2.2	Substitution antenna	41
B.3	Test practice and auxiliary test equipment	42
B.3.0	General requirements	42
B.3.1	Measuring distance.....	42
B.3.2	Auxiliary cables.....	42
Annex C (informative):	Bibliography.....	43
History		44

Intellectual Property Rights

IPRs essential or potentially essential to the present document may have been declared to ETSI. The information pertaining to these essential IPRs, if any, is publicly available for **ETSI members and non-members**, and can be found in ETSI SR 000 314: "*Intellectual Property Rights (IPRs); Essential, or potentially Essential, IPRs notified to ETSI in respect of ETSI standards*", which is available from the ETSI Secretariat. Latest updates are available on the ETSI Web server (<http://ipr.etsi.org>).

Pursuant to the ETSI IPR Policy, no investigation, including IPR searches, has been carried out by ETSI. No guarantee can be given as to the existence of other IPRs not referenced in ETSI SR 000 314 (or the updates on the ETSI Web server) which are, or may be, or may become, essential to the present document.

Foreword

This draft Harmonised European Standard (EN) has been produced by ETSI Technical Committee Electromagnetic compatibility and Radio spectrum Matters (ERM), and is now submitted for the combined Public Enquiry and Vote phase of the ETSI standards EN Approval Procedure.

The present document has been prepared to provide a means of conforming to the essential requirements of Directive 2014/53/EU of the European Parliament and of the Council of 16 April 2014 on the harmonisation of the laws of the Member States relating to the making available on the market of radio equipment and repealing Directive 1999/5/EC [i.3].

NOTE: The corresponding Commission's standardization request is expected shortly.

Once the present document is cited in the Official Journal of the European Union under that Directive, compliance with the normative clauses of the present document given in table A.1 confers, within the limits of the scope of the present document, a presumption of conformity with the corresponding essential requirements of that Directive, and associated EFTA regulations.

The present document covers Medical Body Area Network Systems (MBANSs) operating in the 2 483,5 MHz to 2 500 MHz range, as described in the systems reference document for the equipment, ETSI TR 101 557 [i.1].

Proposed national transposition dates	
Date of latest announcement of this EN (doa):	3 months after ETSI publication
Date of latest publication of new National Standard or endorsement of this EN (dop/e):	6 months after doa
Date of withdrawal of any conflicting National Standard (dow):	18 months after doa

Modal verbs terminology

In the present document "**shall**", "**shall not**", "**should**", "**should not**", "**may**", "**need not**", "**will**", "**will not**", "**can**" and "**cannot**" are to be interpreted as described in clause 3.2 of the [ETSI Drafting Rules](#) (Verbal forms for the expression of provisions).

"**must**" and "**must not**" are **NOT** allowed in ETSI deliverables except when used in direct citation.

Introduction

The present document is part of a set of standards developed by ETSI and is designed to fit in a modular structure to cover all radio and telecommunications terminal equipment within the scope of the Radio Equipment Directive (RE-D) [i.3]. The modular structure is shown in ETSI EG 201 399 [i.4].

The present document describes the technical characteristics and test and performance requirements for Medical Body Area Network Systems (MBANSs) operating in the 2 483,5 MHz to 2 500 MHz frequency range.

Medical Body Area Networks are short-range low-power wireless networks, consisting of a plurality of body-worn sensor devices and/or actuator devices and a hub device placed on/around the human body. The on-body sensor devices are responsible for measuring key patient-specific information, such as the temperature, pulse, blood glucose level, electrocardiogram, blood pressure level and respiratory function readings. The hub device acts as a central controller to maintain the connections with all devices associated with its MBANS and is responsible for device association/de-association and channel selection. The hub device also typically receives the data collected from the various sensor devices on the body and may, depending on applications, process the data locally and/or further forward it to a remote central station (e.g. remote nursing station) via an appropriate wired/wireless link for centralized processing, display and storage.

Usually, MBANS devices are highly resource-constrained in terms of battery capacity, MCU capability and memory size. Therefore, simple and low-power MBANS solutions are preferred from the application point of view. Currently, most of mature low-power low-cost short-range radio solutions have spectrum efficiency around or less than 1 bps/Hz and it is expected that MBANS solutions will have similar spectrum efficiency. Also to prolong battery life, MBANS devices are expected to transmit with a limited duty cycle. The MBANS devices' duty cycle is not more than 10 % for in-hospital applications and not more than 2 % for in-home applications.

In addition to the technical specifications, the present document provides measurement methods for MBANS equipment which should support operation in healthcare facility mode or home mode, or both modes. These measurement methods are to be implemented throughout the process of manufacturing and putting onto the market. Moreover, if the MBANS equipment is required to be checked for the purpose of market surveillance, it should be tested also in accordance with the methods of measurement specified in the present document.

The present document is structured as follows:

- Clauses 1 through 3 provide a general description of the types of equipment covered by the present document and the definitions of terms and symbols and abbreviations used.
- Clause 4 specifies the requirements and limits relative to transmitter, receiver, and spectrum access. The latter are primarily designed to minimize the possibility of disturbance between MBANS equipment and other users of the 2 483,5 MHz to 2 500 MHz frequency range.
- Clauses 5.1 and 5.2 specify the test and general conditions for testing of the equipment.
- Clause 5.3 specifies the methods of measurement for the parameters specified in clause 4, related to transmitter, receiver, and spectrum access.
- Annex A (informative) provides an overview of the relationship between the present document and the essential requirements of RE-D.
- Annex B (normative) gives the specifications concerning radiated measurements.
- Annex C (informative) provides bibliography.

1 Scope

The present document contains requirements to demonstrate that Medical Body Area Network System (MBANS) “...shall be so constructed that it both effectively uses and supports the efficient use of radio spectrum in order to avoid harmful interference” (article 3.2 of the Directive 2014/53/EU) [i.3]. The present document does not necessarily include all the requirements which may be required by a user, nor does it necessarily represent the optimum performance achievable.

The types of devices that can belong to MBANSs are on-body and off-body medical sensors, patient monitoring devices and medical actuators covered by the Medical Device Directive (Directive 93/42/EEC [i.5]).

The present document applies to the following MBANS applications which are considered to operate indoor:

- MBANS operating in the healthcare facility.
- MBANS operating in the patient's home.

The present document contains the following basic technical characteristics of MBANS radio equipment which are also addressed in annex 2 of CEPT/ERC/REC 70-03 [i.2]:

- Healthcare facility MBANS with 1 mW maximum e.i.r.p. and not more than 10 % duty cycle over a maximum emission bandwidth of 3 MHz.
- Patient's home MBANS with 10 mW maximum e.i.r.p. and not more than 2 % duty cycle over a maximum emission bandwidth of 3 MHz.

2 References

2.1 Normative references

References are either specific (identified by date of publication and/or edition number or version number) or non-specific. For specific references, only the cited version applies. For non-specific references, the latest version of the referenced document (including any amendments) applies.

Referenced documents which are not found to be publicly available in the expected location might be found at <http://docbox.etsi.org/Reference>.

NOTE: While any hyperlinks included in this clause were valid at the time of publication, ETSI cannot guarantee their long term validity.

The following referenced documents are necessary for the application of the present document.

- [1] CISPR 16-2-3 (2010) +AMD1:2010+AMD2:2014: "Specification for radio disturbance and immunity measuring apparatus and methods - Part 2-3: Methods of measurement of disturbances and immunity - Radiated disturbance measurements".

2.2 Informative references

References are either specific (identified by date of publication and/or edition number or version number) or non-specific. For specific references, only the cited version applies. For non-specific references, the latest version of the referenced document (including any amendments) applies.

NOTE: While any hyperlinks included in this clause were valid at the time of publication, ETSI cannot guarantee their long term validity.

The following referenced documents are not necessary for the application of the present document but they assist the user with regard to a particular subject area.

- [i.1] ETSI TR 101 557: "Electromagnetic compatibility and Radio spectrum Matters (ERM); System Reference document (SRdoc); Medical Body Area Network Systems (MBANSs) in the 1 785 MHz to 2 500 MHz range".

- [i.2] CEPT/ERC/REC 70-03: "Relating to the use of Short Range Devices (SRD)".
- [i.3] Directive 2014/53/EU of the European Parliament and of the Council of 16 April 2014 on the harmonisation of the laws of the Member States relating to the making available on the market of radio equipment and repealing Directive 1999/5/EC (RE-D).
- [i.4] ETSI EG 201 399 (V3.1.1): "Electromagnetic compatibility and Radio spectrum Matters (ERM); A guide to the production of Harmonized Standards for application under the Radio & Telecommunication Terminal Equipment Directive 1999/5/EC (R&TTE) and a first guide on the impact of the Radio Equipment Directive 2014/53/EU (RED) on Harmonized Standards".
- [i.5] Directive 93/42/EEC of the Council of 14 June 1993 concerning medical devices.
- [i.6] CEPT/ERC/REC 74-01: "Unwanted emissions in the spurious domain".
- [i.7] Recommendation ITU-T O.153: "Basic parameters for the measurement of error performance at bit rates below the primary rate".
- [i.8] ETSI TR 100 028 (V1.4.1) (12-2001): "Electromagnetic compatibility and Radio spectrum Matters (ERM); Uncertainties in the measurement of mobile radio equipment characteristics".

3 Definitions, symbols and abbreviations

3.1 Definitions

For the purposes of the present document, the terms and definitions given in the RE-D [i.3] and the following apply:

Adaptive Frequency Agility (AFA): ability to determine and change to an unoccupied or least interfered sub-band or channel of operation in order to maximize spectrum utilization

composite equipment: any combined equipment made of two or more individual products or functions

NOTE: The individual products or functions in composite equipment might be subject to different technical standards.

conducted measurements: measurements that are made using a direct connection to the equipment under test

dedicated antenna: removable antenna supplied and tested with the radio equipment, designed as an indispensable part of the equipment

duly authorized healthcare professional: physician or other individual authorized by law to provide healthcare services using prescription medical devices

duty cycle: ratio, expressed as a percentage, of the maximum transmitter "on" time monitored over one hour, relative to a one hour period

NOTE: See clause 4.2.1.7.

effective isotropically radiated power (e.i.r.p.): product of the power supplied to the antenna and the antenna gain in a given direction relative to an isotropic antenna

NOTE: See clause 4.2.1.3.

effective radiated power: power radiated within the emission bandwidth of the EUT in the direction of the maximum level under specified conditions of measurements in the presence of modulation or without modulation as appropriate

emission bandwidth: measured as the width of the signal between the points on either side of centre frequency that are 20 dB down relative to the maximum level of the modulated signal

frequency administration commands: commands, exclusively intended for testing purposes, which place the equipment under test in a specific frequency configuration, such as a channel or sub-set of channels

frequency error: difference between the nominal frequency as measured on the equipment under test and under normal test conditions and the frequency under extreme conditions

frequency range: range of operating frequencies over which the equipment can be adjusted

NOTE: See also clause 4.2.1.1.1.

frequency stability under low voltage condition: ability of the equipment to remain on the nominal operating frequency when the battery voltage falls below the lower extreme voltage level

NOTE: See also clause 4.2.1.6.1.

healthcare facility: hospital or other establishment where medical care is provided by authorized healthcare professionals

healthcare facility mode: operational regime by which MBANS equipment is intended to be operated exclusively within healthcare facilities

home mode: operational regime by which MBANS equipment is intended to be operated exclusively within patient residences

integral antenna: permanent fixed antenna, which may be built-in, designed as an indispensable part of the equipment

LBT threshold power level: ambient signal power level above which the monitoring system selects spectrum for MBANS transmissions according to the next available channel

Least Interfered Channel (LIC): channel, among the available channels, that has the lowest potential for causing disturbance to or receiving disturbance from other users of the band

Listen Before Talk (LBT): combination of the listen mode followed by the talk mode

listen mode: action taken by an interrogator to detect an unoccupied sub-band or channel

medical actuator: medical device responsible for performing an action on the human body for diagnostic and/or therapeutic purposes (e.g. an infusion pump)

MBANS hub: medical device that selects the frequency of operation, gives instructions to participating devices of the MBANS, and controls system operation

Medical Body Area Network System (MBANS): low power radio system used for the indoor transmission of non-voice data to and from medical devices for the purposes of monitoring, diagnosing and treating patients as prescribed by duly authorized healthcare professionals

NOTE: A MBANS consists of one or more on-body wireless medical sensor devices and/or medical actuator devices that can communicate with a monitoring device placed on/around the human body. Such monitoring devices, in their role of MBANS hub, display and process physiological parameters from MBANS devices and may also forward them (e.g. to a central nurse station) by using wired or wireless technologies other than MBANSs. MBANS hubs control MBANS devices for the purpose of providing monitoring, diagnosis and treatment of patients. Implantable devices are not part of MBANSs.

medical device: any instrument, apparatus, appliance, material or other article, falling under the Medical Device Directive (Directive 93/42/EEC [i.5]), whether used alone or in combination, together with any accessories or software for its proper functioning, intended by the manufacturer to be used for human beings in the:

- diagnosis, prevention, monitoring, treatment or alleviation of disease or injury;
- investigation, replacement or modification of the anatomy or of a physiological process;
- control of conception.

medical sensor: medical device responsible for the collection of physiological parameters for diagnostic and/or therapeutic purposes

monitoring system: circuitry that assures conformity with the spectrum access protocol requirements based on Listen Before Talk, Adaptive Frequency Agility and selection of the Least Interfered Channel for operation (LIC) or the unoccupied sub-band or channel

out-of-band emissions: emissions on a frequency or frequencies immediately outside the necessary emission bandwidth, which result from the modulation process, but excluding emissions in the spurious domain

Power Spectral Density (PSD): amount of the total power inside the measuring receiver bandwidth expressed in dBm/Hz

provider: manufacturer, or his authorized representative or the person responsible for placing the equipment on the market

spurious domain emissions: emissions at frequencies separated by more than 250 % of the occupied bandwidth from the centre of the occupied spectrum

spurious radiations from the receiver: components at any frequency, generated and radiated by active receiver circuitry and the antenna

NOTE: See clause 4.2.2.1.1.

talk mode: transmission of intentional radiation by a transmitter

3.2 Symbols

For the purposes of the present document, the following symbols apply:

B	emission bandwidth
dB	decibel
dBm	absolute power level referred to one milliwatt
e.i.r.p.	effective isotropically radiated power
f	frequency
f_c	channel centre frequency
f_e	frequency under extreme conditions
G	Antenna Gain
P	power
ppm	parts per million
R	distance
P_{Th}	maximum threshold power level (see clause 4.2.3)
T	temperature
t	time
λ	wavelength (lambda)

3.3 Abbreviations

For the purposes of the present document, the following abbreviations apply:

AC	Alternating Current
AFA	Adaptive Frequency Agility
BW	Bandwidth
CW	Continuous Wave
DC	Direct Current
EMC	ElectroMagnetic Compatibility
EUT	Equipment Under Test
LBT	Listen Before Talk
LIC	Least Interfered Channel
MBANS	Medical Body Area Network System
MCU	Micro Controller Unit
PSD	Power Spectral Density
r.m.s.	root mean square
RBW	Resolution BandWidth
RE-D	Radio Equipment Directive
RF	Radio Frequency
SRD	Short Range Device

4 Technical requirements and specifications

4.1 Environmental profile

The technical requirements of the present document apply under the environmental profile for operation of the equipment, which shall be declared by the provider. The equipment shall comply with all the technical requirements of the present document at all times when operating within the boundary limits of the declared operational environmental profile.

4.2 Conformance requirements

4.2.1 Transmitter requirements

4.2.1.1 Frequency Error

4.2.1.1.1 Definition

The frequency error, also known as frequency drift, is the relative difference between the nominal frequency as measured on the equipment under test and under normal test conditions (see clause 5.1.4.3) and the frequency under extreme test conditions (see clause 5.1.4.4).

4.2.1.1.2 Limits

The frequency error for equipment operating in the 2 483,5 MHz to 2 500 MHz band shall not exceed ± 100 ppm from the normal test conditions under any extreme or any intermediate set of test conditions.

4.2.1.1.3 Conformance

Conformance tests as defined in clause 5.3.1 of the present document shall be carried out.

4.2.1.2 Emission bandwidth

4.2.1.2.1 Definition

The emission bandwidth of a MBANS device is measured as the width of the signal between the points on either side of the centre frequency that are 20 dB down relative to the maximum level of the modulated emission.

4.2.1.2.2 Limits

The emission bandwidth shall be ≤ 3 MHz.

The emission bandwidth shall be \leq the provider's Declared Bandwidth.

4.2.1.2.3 Conformance

Conformance tests as defined in clause 5.3.2 of the present document shall be carried out.

NOTE: Conformance is determined using instrumentation employing a peak detector function and a resolution bandwidth approximately equal to 1 % of the emission bandwidth of the EUT.

4.2.1.3 Effective isotropic radiated power

4.2.1.3.1 Definition

The effective isotropic radiated power is the power radiated within the emission bandwidth of the EUT in the direction of the maximum level under specified conditions of measurements in the presence of modulation or without modulation as appropriate, see also clause 3.1.

4.2.1.3.2 Limits

When the MBANS equipment is configured to operate in healthcare facility mode, the effective isotropic radiated power of such equipment that operates as part of a system that incorporates a monitoring system to select the frequency of operation using LBT and AFA (as specified in clause 4.2.3) shall not exceed 1 mW e.i.r.p.

When the MBANS equipment is configured to operate in home mode, the effective isotropic radiated power of such equipment that operates as part of a system that incorporates a monitoring system to select the frequency of operation using LBT and AFA (as specified in clause 4.2.3) shall not exceed 10 mW e.i.r.p.

4.2.1.3.3 Conformance

Conformance tests as defined in clause 5.3.3 of the present document shall be carried out.

4.2.1.4 Spurious emissions

4.2.1.4.1 Definition

Spurious emissions are emissions at frequencies separated by more than 250 % of the occupied bandwidth from the centre of the emission.

4.2.1.4.2 Limits

The power in the reference bandwidth of any spurious emission shall not exceed the following values given in table 1 or the level of the fundamental power of the device whichever is lower. At band edge transitions, the tighter of the applicable limits applies.

Table 1: Emission limits in the spurious domain

State	47 MHz to 74 MHz 87,5 MHz to 118 MHz 174 MHz to 230 MHz 401 MHz to 406 MHz 470 MHz to 862 MHz (see note)	Other frequencies below 1 000 MHz	Frequencies between 1 000 MHz and 12 500 MHz
Operating	-54 dBm	-36 dBm	-30 dBm
Standby	-57 dBm	-57 dBm	-47 dBm
NOTE: Due to potential proximity between MBANS and implanted devices in the 401 MHz to 406 MHz band.			

4.2.1.4.3 Conformance

Conformance tests as defined in clause 5.3.4 of the present document shall be carried out.

4.2.1.5 Out-of-band emissions

4.2.1.5.1 Definition

Out-of-band emissions are emissions on a frequency or frequencies immediately outside the necessary emission bandwidth, which result from the modulation process, but excluding spurious domain emissions.

4.2.1.5.2 Limits

The transmitted power spectral density (PSD) shall be less than -20 dB (dB relative to the maximum spectral density of the wanted signal) in the upper and lower adjacent and alternate channels. See table 2.

Table 2: Out-of-band emission limits envelope

Channel	PSD, dB
Upper Alternate	$PSD_{ua} - PSD_w < -20$ dB
Upper Adjacent	$PSD_u - PSD_w < -20$ dB
Lower Adjacent	$PSD_l - PSD_w < -20$ dB
Lower Alternate	$PSD_{la} - PSD_w < -20$ dB

4.2.1.5.3 Conformance

Conformance tests as defined in clause 5.3.5 of the present document shall be carried out.

4.2.1.6 Frequency stability under low voltage conditions

4.2.1.6.0 Applicability

This requirement shall only apply to battery-operated MBANS equipment.

4.2.1.6.1 Definition

The frequency stability under low voltage condition is the ability of the equipment to remain on the nominal operating frequency when the battery voltage falls below the lower extreme voltage level, see also clause 3.1.

4.2.1.6.2 Limits

The equipment shall either:

- remain on the nominal operating frequency, within the limits stated in clause 4.2.1.1.2 whilst the radiated or conducted power is greater than the spurious emission limits; or
- the equipment shall cease to function below the provider's declared operating voltage.

4.2.1.6.3 Conformance

Conformance tests as defined in clause 5.3.6 of the present document shall be carried out.

4.2.1.7 Duty cycle

4.2.1.7.0 General remarks

MBANS operating under the provisions of the present document are subject to a duty cycle restriction as defined in this clause.

4.2.1.7.1 Definition

For the purposes of the present document the duty cycle is defined as the ratio, expressed as a percentage, of the maximum transmitter "on" time monitored over one hour, relative to a one hour period, see also clause 3.1. The transmitter "on" time is defined as accumulated across all carrier frequencies in the 2 483,5 MHz to 2 500 MHz range. The device may be triggered either automatically or manually.

4.2.1.7.2 Limits

In a period of 1 hour the duty cycle as defined in clause 4.2.1.7.1 shall not exceed:

- 10 %, when the EUT is configured to operate in healthcare facility mode.
- 2 %, when the EUT is configured to operate in home mode.

4.2.1.7.3 Conformance

Conformance with the duty cycle requirement is declared by the provider.

For automatic operated devices, either software controlled or pre-programmed devices, the provider shall declare the duty cycle for the equipment under test.

For manual operated or event dependant devices, with or without software controlled functions, the provider shall declare whether the device once triggered, follows a pre-programmed cycle, or whether the transmitter remains on until the trigger is released or the device is manually reset. The provider shall also give a description of the application for the device and include a typical usage pattern for maximizing duty cycle that would occur in a period of 1 hour. The typical usage pattern as declared by the provider shall be used to determine the duty cycle. The provider shall also declare any design characteristics or implemented measures relevant for compliance with the duty cycle limit.

The provider shall declare the duty cycle for the equipment under test. Whether pre-programmed, software controlled, or dependent on events or manual operation, such duty cycle shall be the maximum expected duty cycle when the device is operated within its intended use.

4.2.2 Receiver requirements

4.2.2.1 Spurious radiation

4.2.2.1.1 Definition

Spurious radiations from the receiver are components at any frequency, generated and radiated by active receiver circuitry and the antenna.

4.2.2.1.2 Limits

The power in the reference bandwidth of any spurious radiation of the receiver, radiated or conducted, shall not exceed the values given below:

- -57 dBm below 1 000 MHz;
- -47 dBm between 1 000 MHz and 12 500 MHz.

4.2.2.1.3 Conformance

Conformance tests as defined in clause 5.3.7 of the present document shall be carried out.

4.2.2.2 Receiver blocking

4.2.2.2.1 Definition

Receiver blocking is a measure of the capability of the adaptivity mechanism to operate as intended (see clause 4.2.3.0) in the presence of an unwanted signal (blocking signal) on frequencies other than those of the operating channel and the adjacent channels.

4.2.2.2.2 Limits

In the presence of a blocking CW signal ± 8 MHz away from the operating frequency and at a level 45 dB above the LBT threshold power level (P_{Th}) set forth in clause 4.2.3.1, the LBT threshold power level requirement shall still be met.

4.2.2.2.3 Conformance

Conformance tests as defined in clause 5.3.11 of the present document shall be carried out.

4.2.3 Spectrum access

4.2.3.0 General requirements

MBANS share the 2 483,5 MHz to 2 500 MHz band with other users on a non-interference, non-protected basis by the use of a non pre-emptive, non promiscuous channel access mechanism, which is defined in the following clauses. The following clauses set forth an LBT + AFA requirement designed to minimize the possibility of disturbance among MBANS devices and to other users of the band.

MBANS communications sessions shall be initiated via LBT. Before an MBANS communications session is initiated the requirements as stated specifically in clauses 4.2.3.1 to 4.2.3.4 shall be met. MBANS devices implement Adaptive Frequency Agility (AFA) to determine and change to an unoccupied or least interfered sub-band or channel of operation in order to maximize spectrum utilization.

MBANS hub devices determine spectrum occupancy by measuring the ambient power level and comparing it to the LBT threshold power level P_{Th} described in clause 4.2.3.4. MBANS hub devices shall use unoccupied channels with a power level below the LBT threshold power level if at least one is available. If all channels in the 2 483,5 MHz to 2 500 MHz band are assessed to be occupied, MBANS hub devices shall use a channel with the lowest ambient power level, which is called the Least Interfered Channel (LIC). Channel selection of any unoccupied channel has always priority over the Least Interfered Channel.

The procedure outlined in the previous paragraph is performed not only during the initiation of an MBANS communication session, but also periodically during the MBANS communication session. Figure 1 summarizes the initial phase of the AFA procedure, when a new communication session is started. Figure 2 summarizes the AFA procedure within a communication session.

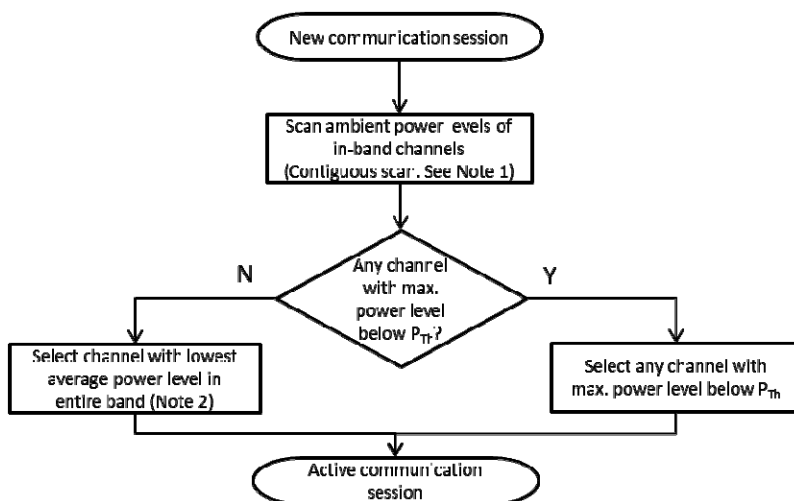

Note 1: the duration of the contiguous scan shall be ≥ 30 ms per channel

Note 2: all channels in the 2483,5–2500 MHz band shall be scanned

Figure 1: Initial phase of the AFA procedure

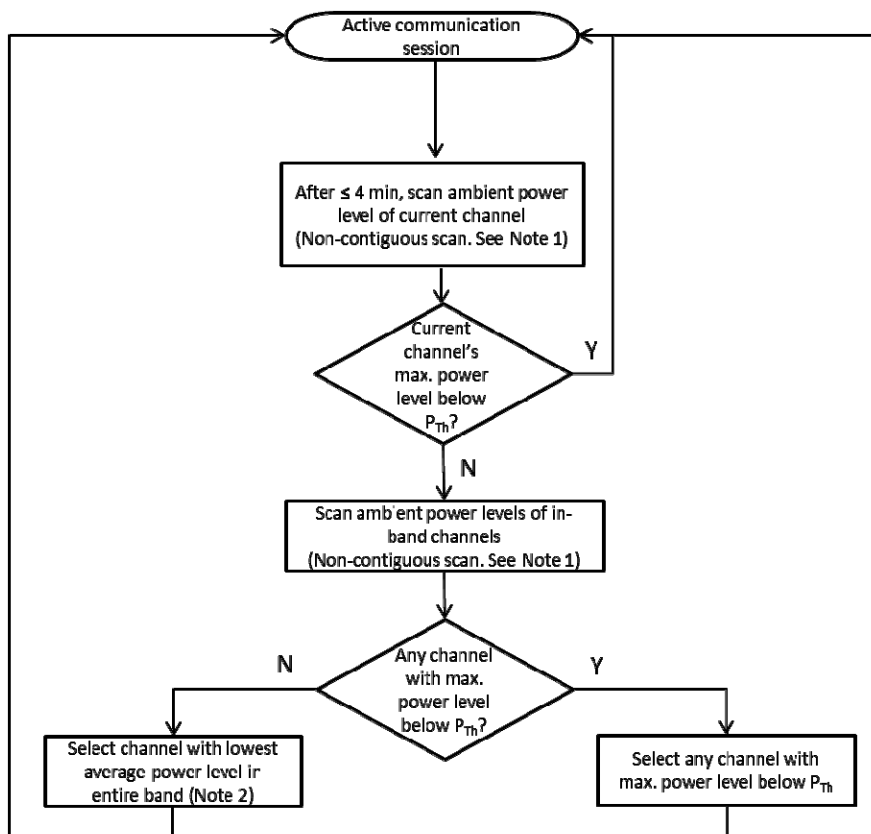

Note 1: the total duration of scan time shall be ≥ 30 ms per channel. A non-contiguous scan is an aggregation of contiguous scan segments. In the case of non-contiguous scan, the duration of scan segments shall not be < 5 ms.

Note 2: all channels in the 2483,5–2500 MHz band shall be scanned

Figure 2: Recursive phase of AFA procedure

The maximum ambient power level is defined as the peak power detected during the channel monitoring period. The average ambient power level is defined as the arithmetic mean of the power detected during the channel monitoring period.

MBANS devices that are not acting as MBANS hub shall follow the instructions of their hub device with regards to channel selection.

4.2.3.1 LBT threshold power level

4.2.3.1.1 Definition

LBT threshold power level is the level of ambient signal power above which the monitoring system selects spectrum for MBANS transmissions according to the next available channel.

4.2.3.1.2 Limits

The monitoring system threshold power level, P_{Th} (in dBm) shall not be greater than -150 dBm/Hz, calculated using the bandwidth as declared in clause 4.2.3.2.3.

4.2.3.1.3 Conformance

Conformance tests as defined in clause 5.3.8 of the present document shall be carried out.

4.2.3.2 Monitoring system bandwidth

4.2.3.2.0 General remarks

The intent of this requirement is to ensure that the EUT measures the power in a bandwidth that is equal to or greater than the emission bandwidth of the transmitter with the widest emission that it will participate with in a MBANS communications session. If an EUT is capable of adjusting its monitoring system bandwidth to correspond to differing emission bandwidths of devices participating in an MBANS communications session, this requirement applies to each emission bandwidth the EUT can use for communication.

4.2.3.2.1 Definition

Monitoring system bandwidth is the receiver bandwidth, measured at its 20 dB down points, used by the monitoring system for spectrum access purposes.

4.2.3.2.2 Limits

The monitoring system bandwidth shall be equal to or greater than the emission bandwidth (B , measured according to clause 5.3.2) of the intended transmission.

4.2.3.2.3 Conformance

The provider shall declare the monitoring system bandwidth for the EUT. Conformance with this requirement is declared by the provider.

4.2.3.3 Minimum channel monitoring period

4.2.3.3.0 General remarks

The intent of this requirement is to ensure that when the monitoring system updates the detected power levels in the 2 483,5 MHz to 2 500 MHz band during the initial phase of the AFA procedure described in clause 4.2.3.0, the monitoring period on each channel is never below 30 ms in order to detect transmissions that may have silent periods that are less than 30 ms in duration.

4.2.3.3.1 Definition

The minimum channel monitoring period is the minimum amount of receiver-on time used by the monitoring system for assessing spectrum occupancy during the initial phase of the AFA procedure.

4.2.3.3.2 Limits

Any MBANS channel shall be monitored for a minimum of 30 ms.

4.2.3.3.3 Conformance

Conformance tests as defined in clause 5.3.9 of the present document shall be carried out.

4.2.3.4 Channel access based on ambient levels relative to the calculated access LBT threshold level, P_{Th}

4.2.3.4.0 General requirements

MBANS hub transmitters are permitted to initiate a MBANS communications session immediately on any channel where the ambient signal level is below the maximum permitted LBT threshold power level, P_{Th} , referenced to the emission bandwidth (B , measured according to clause 5.3.2) of the MBANS device with the widest emission bandwidth that will participate in an MBANS communications session initiated by the EUT.

If no channel is available with an ambient power level at or below the maximum permitted P_{Th} , spectrum access is permitted based on the channel with the lowest ambient power level referred to as the LIC or "least interfered channel".

If LIC is used, spectrum access is permitted based on the LIC referenced to the emission bandwidth of the MBANS device with the widest emission bandwidth that will participate in an MBANS communications session initiated by the EUT.

4.2.3.4.1 Conformance

Conformance tests as defined in clause 5.3.10 of the present document shall be carried out.

4.3 Mechanical and electrical design

4.3.1 General

The equipment submitted by the provider shall be designed, constructed and manufactured in accordance with sound engineering practice and with the aim of minimizing harmful interference to other equipment and services.

Transmitters and receivers may be individual or combination units.

4.3.2 Controls

Those controls that, if maladjusted, might increase the interference potentialities of the equipment shall not be easily accessible to the user.

4.3.3 Transmitter shut-off facility

Transmitters may be equipped with an automatic transmitter shut-off facility or battery-saving feature. In this case please refer to clause 5.3 for specifics regarding testing requirements.

5 Testing for compliance with technical requirements

5.1 Environmental conditions for testing

5.1.0 General requirements

Tests defined in the present document shall be carried out at representative points within the boundary limits of the declared operational environmental profile.

Where technical performance varies subject to environmental conditions, tests shall be carried out under a sufficient variety of environmental conditions (within the boundary limits of the declared operational environmental profile) to give confidence of compliance for the affected technical requirements.

5.1.1 Presentation for testing

5.1.1.0 General provisions

Each equipment submitted for testing shall fulfil the requirements of the present document on all frequencies over which it is intended to operate. Compliance with this requirement should be shown by testing each unit on a frequency near 2 490 MHz according to its intended function.

In order to conduct measurements, the provider shall provide a means for causing the equipment under test to operate on a frequency closest to 2 490 MHz or provide samples that have been modified to operate on 2 490 MHz when activated. One possible technique is to use frequency administration commands that place the device in a test operating mode.

The provider shall declare the range of operating conditions and power requirements, as applicable; to establish the appropriate test conditions.

Additionally, technical documentation and operating manuals, sufficient to make the test, shall be supplied for all MBANS devices.

Measurements shall be performed, according to the present document, on samples of equipment defined in clause 5.1.1.

The physical arrangement used for the testing shall be fully documented in the test report.

5.1.1.1 Choice of model for testing

The provider shall supply one or more samples of each model or type of transmitter, as appropriate for testing. Any ancillary equipment needed for testing shall be provided as requested by the testing laboratory.

Depending on its intended use, MBANS equipment shall operate in either healthcare facility mode or home mode. The provider shall declare whether the MBANS equipment supports operation in healthcare facility mode, home mode, or both modes. The transmitter parameter tests according to clause 5.3 shall be carried out in all supported modes, as declared by the provider. Different test limits may be applicable for healthcare facility mode and home mode.

If an equipment has several optional features, considered not to affect the RF parameters, then the tests need only to be performed on the equipment configured with that combination of features considered to be the most complex or most likely to affect the RF parameters, as proposed by the provider, agreed to by the test laboratory and recorded in the test report.

5.1.1.2 Spurious emission testing for composite equipment

A composite equipment consisting of an MBANS transmitter and a specific type of host equipment such as a computer for digital data recovery or programming/controlling the MBANS device should be tested according to the following requirements.

For emission tests, the most appropriate EMC standard shall be applied to the non-radio part of the host equipment.

The emissions requirements in the applicable clauses of the present document apply only to the MBANS radio part of the composite equipment.

In the case where the radio device is integrated and cannot operate independently, emissions from the non-radio part shall be tested with the radio part disabled.

With the radio operating in transmit, receive and standby (if applicable) modes, the emission requirements of the present document shall be applied.

Additional requirements and limits for multi radio equipment are set out in the relevant radio product standards applicable to the other radio parts.

5.1.1.3 Testing of equipment with alternative power levels

Equipment designed to operate with different emitted powers shall have each transmitter parameter tested on samples of equipment defined in clause 5.1.1.1. See clause 5.3 for details on testing. Spurious emissions tests shall be performed in accordance with requirements in clause 5.3.4.

5.1.1.4 Presentation of equipment that does not have an external RF connector (equipment with an integral antenna)

5.1.1.4.1 Equipment with a permanent or temporary internal antenna connector

The means to access and/or implement the internal permanent or temporary connector shall be stated by the provider with the aid of a diagram. The fact that use has been made of the internal antenna connection, or of a temporary connection, to facilitate measurements shall be recorded in the test report.

5.1.1.4.2 Equipment with a temporary antenna connector

The provider may submit one set of equipment with the normal antenna connected, to enable the radiated measurements to be made. The provider shall attend the test laboratory at the conclusion of the radiated measurements, to disconnect the antenna and fit the temporary connector. The testing laboratory staff shall not connect or disconnect any temporary antenna connector unless directed to do so by the testing laboratory.

Alternatively, the provider may submit two sets of equipment to the test laboratory, one fitted with a temporary antenna connector with the antenna disconnected and the other with the antenna connected. Each equipment shall be used for the appropriate tests. The provider shall declare that two sets of equipment are identical in all respects.

5.1.2 Declarations by the applicant

When submitting equipment for testing, the provider shall supply the necessary information required by the test laboratory.

The equipment submitted for testing shall be a representative sample of the equipment as produced.

5.1.3 Auxiliary test equipment

All necessary test signal sources, test fixtures, specialized test apparatus and set-up information shall accompany the equipment when it is submitted for testing. This requirement is not applicable if the test laboratory and the provider agree on alternative arrangements, which shall be fully described in the test report.

5.1.4 Test conditions

5.1.4.1 Normal and extreme test conditions

Testing shall be made under normal test conditions, and also, where stated, under extreme test conditions.

The test conditions and procedures shall be as specified in clauses 5.1.4.2 to 5.1.4.4.

5.1.4.2 Test power source

5.1.4.2.0 General requirements

The equipment shall be tested using the appropriate test power source as specified in clauses 5.1.4.2.1 or 5.1.4.2.2. Where equipment can be powered using either external or internal power sources, the equipment shall be tested both using the external power source as specified in clause 5.1.4.2.1 and repeated using the internal power source as specified in clause 5.1.4.2.2.

The test power source used shall be stated in the test report.

5.1.4.2.1 External test power source

During tests, the power source of the equipment shall, if possible, be replaced by an external test power source capable of producing normal and extreme test voltages as specified in clauses 5.1.4.3.2 and 5.1.4.4.2. The internal impedance of the external test power source shall be low enough for its effect on the test results to be negligible. For the purpose of the tests, the voltage of the external test power source shall be measured at the input terminals of the equipment. The external test power source shall be suitably de-coupled as close to the equipment battery terminals as practicable. For radiated measurements any external power leads should be so arranged so as not to affect the measurements.

During tests the test power source voltages shall be within a tolerance of $< \pm 1$ % relative to the voltage at the beginning of each test. The value of this tolerance can be critical for certain measurements. Using a smaller tolerance will provide a better uncertainty value for these measurements.

5.1.4.2.2 Internal test power source

For radiated measurements on equipment with an internal power source, fully charged internal batteries should be used. The batteries used should be as supplied or recommended by the provider. If internal batteries are used, at the end of each test, the voltage shall be within a tolerance of $< \pm 5\%$ relative to the voltage at the beginning of each test.

If appropriate, for conducted measurements or where a test fixture is used, an external power supply at the required voltage may replace the supplied or recommended internal batteries. This shall be stated on the test report.

For devices that are hermetically sealed it may not be possible to measure the battery voltage directly or indirectly. For this type of equipment, it is not necessary to measure the voltage at the end of each test; however, care shall be taken to ensure that the internal battery supply voltage does not fall below the manufacturer's specification for normal operating voltage range.

For battery operated devices, it is acceptable to read the battery voltage via telemetry readout.

5.1.4.3 Normal test conditions

5.1.4.3.1 Normal temperature and humidity

The normal temperature and humidity test conditions for MBANS shall be any convenient combination of temperature and humidity within the following ranges:

- temperature +15 °C to +37 °C;
- relative humidity 20 % to 75 %.

When it is impracticable to carry out tests under these conditions, a note to this effect, stating the ambient temperature and relative humidity during the tests shall be added to the test report.

5.1.4.3.2 Normal test power source

5.1.4.3.2.1 Mains voltage

The normal test voltage for equipment to be connected to the mains shall be the nominal mains voltage. For the purpose of the present document, the nominal voltage shall be the declared voltage, or any of the declared voltages, for which the equipment was designed.

The frequency of the test power source corresponding to the AC mains shall be between 49 Hz and 51 Hz.

5.1.4.3.2.2 Other power sources

For operation from other power sources or batteries (primary or secondary), the normal test voltage shall be that declared by the equipment provider and agreed by the test laboratory. Such values shall be stated in the test report.

5.1.4.4 Extreme test conditions

5.1.4.4.1 Extreme temperatures

5.1.4.4.1.1 Procedure for tests at extreme temperatures

5.1.4.4.1.1.0 General requirements

Before measurements are made, the equipment shall have reached thermal balance in the test chamber. The equipment shall be switched off during the temperature-stabilizing period.

In the case of equipment containing temperature stabilization circuits designed to operate continuously, the temperature stabilization circuits shall be switched on for 15 minutes after thermal balance has been obtained, and the equipment shall then meet the specified requirements.

If the thermal balance is not checked by measurements, a temperature-stabilizing period of at least one hour, or such period as may be decided by the test laboratory, shall be allowed. The sequence of measurements shall be chosen, and the humidity content in the test chamber shall be controlled so that excessive condensation does not occur.

If the equipment is incapable of transmitting an unmodulated carrier, an actual digital data sequence or a pseudorandom sequence representative of an actual digital data transmission shall be used to modulate the carrier (see clauses 5.1.4.5 and 5.1.4.5.1).

5.1.4.4.1.1.1 Test procedure for equipment designed for continuous operation

If the provider states that the equipment is designed for continuous operation, the test procedure shall be as follows:

- before conducting tests at the upper extreme temperature the equipment shall be placed in the test chamber and left until thermal balance is attained. The equipment shall then be switched on in the transmit condition for a period of time specified by the manufacturer to be the maximum time the equipment will transmit in normal operation after which the equipment shall meet the specified requirements;
- for tests at the lower extreme temperature, the equipment shall be left in the test chamber until thermal balance is attained, then switched on for a period of one minute after which the equipment shall meet the specified requirements.

5.1.4.4.1.1.2 Test procedure for equipment designed for intermittent operation

If the provider states that the equipment is designed for intermittent operation, the test procedure shall be as follows:

- Before conducting tests at the upper extreme temperature the equipment shall be placed in the test chamber and left until thermal balance is attained. The equipment shall then either:
 - transmit on and off according to the provider's declared duty cycle or transmission protocol, as appropriate, for a period of five minutes or for the duration of an expected communications session as declared by the manufacturer and agreed by the test facility; or
 - if the provider's declared on period exceeds one minute, then:
 - transmit in the on condition for a period not exceeding one minute, followed by a period in the off or standby mode for four minutes; after which the equipment shall meet the specified requirements.
- For tests at the lower extreme temperature, the equipment shall be left in the test chamber until thermal balance is attained, then switched to the standby or receive condition for one minute after which the equipment shall meet the specified requirements.

5.1.4.4.1.2 Extreme temperature ranges

For tests at extreme temperatures, measurements shall be made in accordance with the procedures specified in clause 5.1.4.4.1, at the upper and lower temperatures of one of the following ranges.

Table 3: Extreme temperature ranges

Category I (General)	-20 °C to +55 °C
Category II (Portable equipment)	-10 °C to +55 °C
Category III (Equipment for normal indoor use)	5 °C to +55 °C

The manufacturer may define a different temperature range than specified above for any category provided the EUT meets the conditions set forth below. For specific applications, the manufacturer can specify wider temperature ranges than given as a minimum above. In this case the test report shall show compliance with the limits in the present document over the extended ranges specified by the manufacturer. This shall be reflected in the manufacturers' product literature. Narrower temperature ranges than given above may be implemented provided the reduced range is reflected in the manufacturers' product literature and the test report shows that the device implements techniques which do not allow it to exceed the limits specified in the present document over the minimum ranges given above.

The equipment shall comply with all the technical requirements of the present document at all times when operating within the boundary limits of the required operational temperature profile.

The test report shall state which range is used.

5.1.4.4.2 Extreme test source voltages

5.1.4.4.2.1 Mains voltage

The extreme test voltages for equipment to be connected to an AC mains source shall be the nominal mains voltage +10 %, -6 %. For equipment that operates over a range of mains voltages, clause 5.1.4.4.2 applies.

5.1.4.4.2.2 Other power sources

For equipment using other power sources, or capable of being operated from a variety of power sources, the extreme test voltages shall be those agreed between the equipment provider and the test laboratory. This shall be recorded in the test report.

For equipment capable of being operated from a variety of power sources, the extreme test conditions shall be those agreed between the provider and the test laboratory.

If the equipment is provided with a battery indicator, the end point indication voltage shall be the minimum voltage which testing is carried out. The nominal voltage of batteries is considered to be the upper extreme test voltage.

The voltages used for test shall be included in the test report.

5.1.4.5 Normal test signals and test modulation

5.1.4.5.0 General requirements

The test-modulating signal shall be a digital signal unless otherwise specified in the present document. It may be dependent upon the type of equipment under test and the measurement to be performed. The normal operating digital modulation shall be used.

5.1.4.5.1 Normal modulation test signals for data

Normal test signals for data are specified as follows:

- D-M1: A test signal representing a pseudorandom bit sequence of at least 511 bits in accordance with Recommendation ITU-T O.153 [i.7]. This sequence shall be continuously repeated. If the sequence cannot be continuously repeated, the actual method used shall be stated in the test report.
- D-M2: A test signal shall be agreed between the test laboratory and the provider that is representative of normal transmitter operation if the above pseudorandom sequence cannot be used. The actual method used shall be stated in the test report.

5.1.4.6 Antennas

Equipment operating in the 2 483,5 MHz to 2 500 MHz band shall have an integral antenna, an external dedicated antenna or both. If provision for an external antenna connection is made, the manufacturer or provider shall make provision to prevent the use of an antenna other than that authorized by the manufacturer or provider.

5.1.4.7 Test fixture

With equipment intended for use with an integral antenna, and not equipped with a 50 Ω RF output connector, a suitable test fixture may be used as agreed with the test laboratory.

This fixture is a RF coupling device for coupling the integral antenna to a 50 Ω RF terminal at the working frequencies of the equipment under test. This allows certain measurements to be performed using conducted measuring methods. However, only relative measurements may be performed. The test fixture is normally only required for extreme temperature measurements and shall be calibrated only with the equipment under test.

The test fixture shall be fully described by the provider. The test laboratory shall calibrate the test fixture by carrying out the required field measurements at normal temperatures at the prescribed test site. Then the same measurements shall be repeated on the equipment under test using the test fixture for all identified frequency components.

In addition, the test fixture may provide:

- a connection to an external power supply;

- a connection to a data interface.

The performance characteristics of the test fixture shall be agreed upon with the test laboratory and shall conform to the following basic parameters:

- the circuit associated with the RF coupling shall contain no active or non linear devices;
- the coupling loss shall not influence the measuring results;
- adequate bandwidth properties;
- a coupling loss variation over the frequency range used in the measurement which does not exceed 2 dB;
- the coupling loss shall be independent of the position of the test fixture and be unaffected by the proximity of the surrounding objects or people;
- the coupling loss shall be reproducible when the equipment under test is removed and replaced;
- the coupling loss shall remain substantially constant when the environmental conditions are varied.

5.1.4.8 Test sites and general arrangements for radiated measurements

For guidance on radiation test sites, see annex B. Detailed descriptions of radiated measurement arrangements are included in this annex.

5.1.4.9 Modes of operation of the transmitter

For the purpose of the measurements according to the present document, there should preferably be software or other technique allowing the transmitter to operate in an unmodulated state. The method of achieving an unmodulated carrier transmission or special types of modulation patterns may also be decided by agreement between the provider and the test laboratory. It shall be described in the test report and it may involve suitable temporary internal modifications of the equipment under test. If it is not possible to provide an unmodulated carrier then this shall be stated in the test report.

For the purpose of testing, the normal test signal, see clause 5.1.4.5, shall be used.

5.1.4.10 Measuring receiver

The term "measuring receiver" refers to a frequency-selective voltmeter or a spectrum analyser. The bandwidth and detector type of the measuring receiver is given in table 4. Some measurements specified in the present document require the use of a measuring receiver with a peak detector function and an adjustable resolution bandwidth capability typical of most spectrum analysers.

Table 4: Measuring receiver specifications

Frequency: (f)	Detector type	Bandwidth (see note)
9 kHz ≤ f < 150 kHz	r.m.s. detector	200 Hz to 300 Hz
150 kHz ≤ f < 30 MHz	r.m.s. detector	9 kHz to 10 kHz
30 MHz ≤ f ≤ 1 000 MHz	r.m.s. detector	100 kHz to 120 kHz
1 000 MHz ≤ f ≤ 12 500 MHz	r.m.s. and peak detector	1 MHz or ≥ emission bandwidth

NOTE: When making emissions measurements of modulated emissions, it is permissible to compute the transmit power over the required measurement interval using digitized samples of the waveform envelope. The spectrum analyzer sampled time-waveform data is converted to linear power. The average of all consecutive combinations of power samples covering the interval (30/emission bandwidth) over the EUT's maximum continuous transmission interval is computed. In other words, the waveform that is the sliding power average (window filter) of width (30/emission bandwidth) for the continuous transmission interval is computed. The measurement is made over the EUT's maximum continuous transmission interval. If the maximum of the smoothed power waveform does not exceed the power limit, then the unit passes the test for that sequence. The largest of these smoothed power output values over the required sequence types is the peak transmit power. An alternate method may be used in lieu of the above. It uses a narrow video bandwidth to provide analogue smoothing rather than using the calculated digital smoothing. The video bandwidth is set greater than or equal to the emission bandwidth/30. The averaging on a log power scale or on a linear voltage scale will give a result that is less than the true power average by an amount that depends on the variation in the amplitude envelope of the signal. For relatively constant amplitude modulations (less than 3 dB variation), the "scale-averaging" error is insignificant. For Gaussian noise, the amplitude envelope will have a Rayleigh distribution, and the scale-averaging error will be -2,5 dB on a log scale and -1,1 dB on a linear voltage scale. Adding a 2,5 dB or 1,1 dB correction to the result will compensate for this error. Other amplitude distributions require different corrections. Transmitter emissions may be measured in terms of r.m.s. levels.

5.1.4.11 General remarks on configuration for transmitter measurements

Where the transmitter is designed with an adjustable power, then all transmitter parameters shall be measured using the highest power level (e.i.r.p.), as declared by the provider. The equipment shall then be set to the lower output power setting(s) (e.i.r.p.), as declared by the provider, and the measurements for spurious emissions shall be repeated (see clause 5.3.4).

The following modes of operation are permitted:

- LBT and AFA and duty cycle ≤ 10 % (applicable to MBANS configured to operate in healthcare facility mode)
- LBT and AFA and duty cycle ≤ 2 % (applicable to MBANS configured to operate in home mode)

When making transmitter tests on equipment designed for intermittent operation, the duty cycle of the transmitter if applicable, as declared by the provider on the application form, shall not normally be exceeded. However, if it is necessary to exceed the duty cycle for the purpose of testing, this is permissible as long as the RF parameters of the transmitter are not degraded or compromised. The actual duty cycle used for the purpose of testing shall be stated on the test report.

No connection shall be made to any internal permanent or temporary antenna connector during the performance of radiated emissions measurements, unless such action forms an essential part of the normal intended operation of the equipment, as declared by the provider.

If a transmitter is equipped with an automatic transmitter shut-off facility or battery-saving feature that interferes with testing of the device, it should be made inoperative if possible for the duration of the test.

5.1.4.12 General remarks on configuration for receiver measurements

No connection shall be made to any internal permanent or temporary antenna connector during the performance of radiated emissions measurements, unless such action forms an essential part of the normal intended operation of the equipment, as declared by the provider.

5.1.4.13 General remarks on configuration for monitoring system measurements

The measurement processes generally described in clauses 5.3.8, 5.3.9, and 5.3.10 are written for conducted test arrangements and should be applicable to any system submitted for testing or for post market surveillance purposes. If equipment does not permit conducted tests to be performed, the equivalent conditions can be established using radiated signal techniques. If radiated signal techniques are used, the monitoring system antenna shall be oriented in the direction of maximum reception of the radiated broadband and CW RF disturbing fields and the radiated broadband and CW RF disturbance fields should be aligned to produce the maximum RF voltage in the monitoring system antenna.

Depending on the specific implementation of an individual manufacturer, some modification of these procedures may be required. In this case, the test facility and the provider should agree on any modification of the monitoring system measurement procedure. When the test facility and the provider agree that a modified procedure or procedures are required to test a system or component of the system due to a specific implementation of the MBANS, showing that the MBANS meets the technical parameter under investigation using the modified procedure is acceptable in lieu of using frequency administration commands to show compliance. For newly developed products, the report shall document the procedure used.

The monitoring system antenna-used to determine the power level of any ambient signals-shall be the antenna used by the MBANS equipment, which is either an integral antenna or an external dedicated antenna.

5.2 Interpretation of the measurement results

The interpretation of the results recorded in a test report for the measurements described in the present document shall be as follows:

- the measured value related to the corresponding limit shall be used to decide whether an equipment meets the requirements of the present document;
- the value of the measurement uncertainty for the measurement of each parameter shall be included in the test report;
- the recorded value of the measurement uncertainty shall be, for each measurement, equal to or lower than the figures given in table 5.

For the test methods, according to the present document, the measurement uncertainty figures shall be calculated and shall correspond to an expansion factor (coverage factor) $k = 1,96$ or $k = 2$ (which provide confidence levels of respectively 95 % and 95,45 % in the case where the distributions characterizing the actual measurement uncertainties are normal (Gaussian)). Principles for the calculation of measurement uncertainty are contained in ETSI TR 100 028 [i.8], in particular in Part 2, annex D of the ETSI TR 100 028 [i.8]. Table 5 is based on such expansion factors.

Table 5: Maximum measurement uncertainty up to 12,5 GHz for RF measurements

Parameter	Maximum Measurement Uncertainty
Radio frequency	±10 ppm
Adjacent channel power	±3 dB
RF power, conducted	±1,5 dB
Conducted emission of transmitter	±4 dB
Conducted emission of receivers	±3 dB
Radiated emission of transmitter	±6 dB
Radiated emission of receiver	±6 dB
Conducted monitoring test system	±4 dB
Radiated monitoring test system	±6 dB
Temperature	±1 °C
Humidity	±5 %
DC voltage	±1 %
AC voltage	±1 %

5.3 Methods of measurement

5.3.1 Frequency error

5.3.1.0 General requirements

This measurement shall be made for all equipment operating in the 2 483,5 MHz to 2 500 MHz band. Measurements shall be made using an antenna connector or a test fixture (see clause 5.1.4.7). Due to need to test at extremes of temperature the test cannot be performed using a radiated signal.

5.3.1.1 Method of measurement for systems with an unmodulated carrier frequency operating mode

The carrier frequency shall be measured (in the absence of modulation). The measurement shall be made under normal test conditions (see clause 5.1.4.3) and extreme test conditions (extreme temperature and supply voltage simultaneously, see clause 5.1.4.4).

The frequency error shall be determined as follows:

- under normal test conditions according to clause 5.1.4.3 the carrier frequency f is measured and recorded;
- under all extreme test conditions according to clause 5.1.4.4 the carrier frequency f_e is measured and recorded;

where:

- f = the frequency measured under normal test conditions;
- f_e = the frequency measured under extreme test conditions.

The value of $(f_e - f)/f$ is the frequency error.

The frequency error shall be recorded for each extreme test condition.

5.3.1.2 Method of measurement for systems with a modulated output frequency

This clause is applicable to equipment that can only operate in a modulated mode. The output frequency shall be measured (in the presence of modulation). The measurement shall be made under normal test conditions (see clause 5.1.4.3) and extreme test conditions (extreme temperature and supply voltage simultaneously, see clause 5.1.4.4).

The frequency error shall be determined as follows:

- under normal test conditions according to clause 5.1.4.3, the -20 dB emission bandwidth points, f_{high} and f_{low} shall be measured according to clause 5.3.2. The output frequency, f , is calculated as:

$$f = f_{\text{low}} + (f_{\text{high}} - f_{\text{low}})/2$$

- under all extreme test conditions according to clause 5.1.4.4, the -20 dB emission bandwidth points, f_{high} and f_{low} shall be measured according to clause 5.3.2. The output frequency, f_e , is calculated as:

$$f_e = f_{\text{low}} + (f_{\text{high}} - f_{\text{low}})/2$$

where:

- f = the frequency measured under normal test conditions;
- f_e = the frequency measured under extreme test conditions.

The value of $(f_e - f)/f$ is the frequency error.

The frequency error should be recorded for each extreme test condition.

5.3.2 Emission bandwidth

The provider shall declare the operating bandwidth of the EUT (Declared Bandwidth, BW_d). This shall be $\leq 3,0$ MHz.

The equipment may be directly connected to a spectrum analyser if it has a 50Ω connector or using a test fixture (see clause 5.1.4.8) if needed. If the equipment has an integral antenna or unique connector for a dedicated antenna and cannot be connected to the spectrum analyser, a signal from the equipment may be coupled to the spectrum analyser using an antenna connected to the spectrum analyser.

The transmitter shall be operated at its maximum output power measured under normal test conditions (see clause 5.1.4.3).

The transmitter shall be modulated by the normal test signal (see clause 5.1.4.5).

The output power of the transmitter, with or without a test fixture, shall be recorded using a spectrum analyser set to a frequency span 2 times greater than the emission bandwidth and a resolution bandwidth equal to or greater than the emission bandwidth. The detector function shall be set to peak hold with the video bandwidth setting \geq the resolution bandwidth. The two furthest frequencies, one above (f_{high}) and one below (f_{low}), the frequency of the maximum measured level of the modulated signal where the signal level is 20 dB below the maximum measured level of the modulated signal shall be determined. If it is found that the resolution bandwidth used was not approximately 1 % of the emission bandwidth, then the resolution bandwidth shall be adjusted and the procedure repeated until the resolution bandwidth used is approximately 1 % of the emission bandwidth that was measured with that resolution bandwidth setting. For spectrum analysers that have fixed values of resolution bandwidth, the setting that is nearest to 1 % of the emission bandwidth is acceptable, provided that it is no less than 0,5 % of the emission bandwidth and no greater than 2 % of the emission bandwidth.

The frequencies f_{high} and f_{low} for each device shall be recorded for later use. The difference in frequency between f_{high} and f_{low} is the emission bandwidth (B).

For systems designed to utilize multiple devices in an MBANS communications session, the emission bandwidth procedure shall be repeated for each device intended to operate in a session.

5.3.3 Effective isotropic radiated power

This measurement applies to equipment provided with an integral antenna and to equipment supplied with a dedicated antenna. Measurements shall be made with each type of antenna provided by the provider that attaches to the equipment.

If the equipment is designed to operate with different power levels, the rated power for each level, or range of levels, shall be declared by the provider.

These measurements shall be performed at the highest power level at which the transmitter is intended to operate.

The measurement for each type of transmitter operation shall be carried out under normal test conditions only (see clause 5.1.4.3).

On a test site, selected from annex B that is appropriate for the EUT, the equipment shall be placed at the specified height on a support, as explained in annex B, and in the position closest to normal use as declared by the provider.

The test antenna shall be oriented initially for vertical polarization and shall be chosen to correspond to the frequency of the transmitter. The output of the test antenna shall be connected to the measuring receiver.

The transmitter shall be switched on, if possible without modulation, and the measuring receiver shall be tuned to the frequency of the transmitter under test. In case of equipment where it is not possible to make the measurement in the absence of modulation, the measurement shall be carried out by the use of a spectrum analyser using a peak detector function with a resolution bandwidth setting \geq the emission bandwidth (see clause 5.3.2). For this measurement, analogue smoothing of the displayed waveform is permitted using a video filter set to approximately the resolution bandwidth/30 (see clause 5.1.4.10). The measurement shall be made over an interval of time when transmission is continuous and at its maximum power level.

The transmitter shall be rotated through 360° in the horizontal plane and the test antenna shall be raised and lowered through the specified range of height until a maximum signal level is detected by the measuring receiver.

The maximum signal level detected by the measuring receiver for vertical polarization shall be noted.

The transmitter shall be replaced by a substitution antenna as defined in clause B.2.2.

The substitution antenna shall be orientated for vertical polarization as noted above and the length of the substitution antenna shall be adjusted to correspond to the frequency of the transmitter. The substitution antenna shall be connected to a calibrated signal generator.

If necessary, the input attenuator setting of the measuring receiver shall be adjusted in order to increase the sensitivity of the measuring receiver.

The test antenna shall be raised and lowered through the specified range of height to ensure that the maximum signal is received.

The input signal to the substitution antenna shall be adjusted to the level that produces a level detected by the measuring receiver, that is equal to the level noted while the transmitter radiated power was measured.

The input level to the substitution antenna, corrected for any change of input attenuator setting of the measuring receiver, shall be recorded as the power level.

The measurement shall be repeated with the test antenna and the substitution antenna orientated for horizontal polarization.

The measure of the effective isotropic radiated power is the larger of the two levels recorded at the input to the substitution antenna, corrected for gain variance of the substitution antenna relative to the gain of a dipole.

5.3.4 Transmitter spurious emissions

The level of spurious emissions shall be measured as:

- their effective radiated power when radiated by the cabinet and the integral antenna;
- their effective radiated power when radiated by the cabinet and any dedicated antenna provided by the provider;
- measurements shall be made with the transmitter in operating (modulated) and stand-by modes.

This measurement applies to equipment provided with an integral antenna and to equipment supplied with a dedicated antenna. Measurements shall be made with each type of antenna provided with the equipment attached to it.

If the equipment is designed to operate with different power levels, the rated power for each level or range of levels shall be declared by the provider.

These measurements shall be performed at all power levels at which the transmitter is intended to operate.

The measurement shall be carried out by the use of a measuring receiver with bandwidth and detectors as specified in clause 5.1.4.10. For measurements above 1 000 MHz, the peak value shall be measured using a spectrum analyser with a resolution bandwidth setting 1 MHz.

Analogue smoothing of the displayed modulation is permitted (see clause 5.1.4.10). Different measurement bandwidth may be used if necessary and the results shall be adjusted to the reference bandwidth.

The following reference bandwidths should be used (CEPT/ERC/REC 74-01 [i.6]):

- 1 kHz between 9 kHz and 150 kHz;
- 10 kHz between 150 kHz and 30 MHz;
- 100 kHz between 30 MHz and 1 GHz;
- 1 MHz above 1 GHz.

On a test site, selected from annex B that is appropriate for the EUT, the equipment shall be placed at the specified height on a support, as specified in annex B, and in the position closest to normal use as declared by the provider.

The test antenna shall be oriented initially for vertical polarization and shall be tuned to each spurious emission frequency from the transmitter. The output of the test antenna shall be connected to the measuring receiver. The transmitter shall have the normal modulation applied (see clause 5.1.4.5) and the measuring receiver shall be tuned over the frequency range 30 MHz to 12,5 GHz, except for the maximum emission bandwidth measured according to clause 5.3.2.

At each frequency at which a spurious component is detected, the test antenna shall be raised and lowered through the specified range of heights until a maximum signal level is detected on the measuring receiver. The transmitter shall then be rotated through 360° in the horizontal plane, until the maximum signal level is detected by the measuring receiver and the test antenna height shall be adjusted again for maximum signal level. The test antenna shall be raised and lowered again through the specified range of height until a maximum signal level is detected by the measuring receiver.

The maximum signal level detected by the measuring receiver for vertical polarization shall be noted.

The transmitter shall be replaced by a substitution antenna as defined in clause B.2.2.

The substitution antenna shall be oriented for the vertical polarization as noted above and the length of the substitution antenna shall be adjusted to correspond to the frequency of the spurious emission from the transmitter. The substitution antenna shall be connected to a calibrated signal generator. If necessary, the input attenuator setting of the measuring receiver shall be adjusted in order to increase the sensitivity of the measuring receiver.

The test antenna shall be raised and lowered through the specified range of height to ensure that the maximum signal is received. The input signal to the substitution antenna shall be adjusted to the level that produces a level detected by the measuring receiver, which is equal to the level noted while the transmitter spurious emissions were measured.

The input level to the substitution antenna, corrected for any change of input attenuator setting of the measuring receiver, shall be recorded as the power level.

The measurement shall be repeated with the test antenna and the substitution antenna orientated for horizontal polarization.

The maximum signal level detected by the measuring receiver for both vertical and horizontal polarization shall be noted.

The measure of the effective radiated power for each spurious emission is the larger of the levels recorded at the input to the substitution antenna, corrected for any gain variance of the substitution antenna relative to the gain of a dipole.

5.3.5 Out-of-band emissions

These measurements shall only be performed at normal test conditions.

The EUT may be directly connected to a spectrum analyser if it has a 50 Ω connector or using a test fixture (see clause 5.1.4.8) if needed. If the EUT has an integral antenna or unique connector for a dedicated antenna and cannot be connected to the spectrum analyser, a signal from the equipment may be coupled to the spectrum analyser using an antenna connected to the spectrum analyser.

The EUT transmitter shall be operated in a continuous transmit mode on the closest frequency to the centre of the 2 483,5 MHz to 2 500 MHz band and at its maximum output power measured under normal test conditions (see clause 5.1.4.3). The transmitter shall be modulated by the normal test signal (see clause 5.1.4.5).

Step 1

The Spectrum Analyser should be adjusted as follows:

- Centre Frequency: Equal to the transmission frequency, f_c .
- Span: \geq Declared Bandwidth, BW_d , see clause 5.3.2.
- Resolution BW (RBW): \leq (Declared Bandwidth) / 30.
- Video BW: = Resolution BW.
- Sweep time: Auto.
- Detector: Average (often referred to as "r.m.s. Average" or "Sample").

- Trace Mode: Max Hold.
- Video Average: OFF.

The spectrum analyser should be allowed to scan until there is no discernible change to the trace or for 1 minute, whichever is the shorter.

Measure the highest level, P_w , found within the Declared Bandwidth, in dBm.

Calculate the Power Spectral Density, $PSD_w = P_w - 10 \times \log_{10}(RBW)$, in dBm/Hz.

Note the value of PSD_w .

Step 2

Change the spectrum analyser frequency to $f_c + BW_d$.

Clear the trace from Step 1 and then repeat the measurement.

Measure the highest level, P_u , found within the Declared Bandwidth, in dBm.

Calculate the Power Spectral Density, $PSD_u = P_u - 10 \times \log_{10}(RBW)$, in dBm/Hz.

Note the value of PSD_u , this is the PSD in the upper adjacent channel.

Step 3

Change the spectrum analyser frequency to $f_c - BW_d$.

Clear the trace from Step 2 and then repeat the measurement.

Measure the highest level, P_l , found within the Declared Bandwidth, in dBm.

Calculate the Power Spectral Density, $PSD_l = P_l - 10 \times \log_{10}(RBW)$, in dBm/Hz.

Note the value of PSD_l , this is the PSD in the lower adjacent channel.

Step 4

Change the spectrum analyser frequency to $f_c + (2 \times BW_d)$.

Clear the trace from Step 3 and then repeat the measurement.

Measure the highest level, P_{ua} , found within the Declared Bandwidth, in dBm.

Calculate the Power Spectral Density, $PSD_{ua} = P_{ua} - 10 \times \log_{10}(RBW)$, in dBm/Hz.

Note the value of PSD_{ua} , this is the PSD in the upper alternate channel.

Step 5

Change the spectrum analyser frequency to $f_c - (2 \times BW_d)$.

Clear the trace from Step 4 and then repeat the measurement.

Measure the highest level, P_{la} , found within the Declared Bandwidth, in dBm.

Calculate the Power Spectral Density, $PSD_{la} = P_{la} - 10 \times \log_{10}(RBW)$, in dBm/Hz.

Note the value of PSD_{la} , this is the PSD in the lower alternate channel.

5.3.6 Frequency stability under low voltage conditions

This test only applies to battery-operated MBANS equipment.

The procedures in clause 5.3.1 shall be repeated except the measurement shall be made under normal temperature and humidity conditions (see clause 5.1.4.3.1), and the voltage from the test power source shall be reduced below the lower extreme test voltage limit towards zero. As the voltage is reduced, the nominal centre frequency shall be monitored.

5.3.7 Receiver spurious emissions

This measurement applies to equipment provided with an integral antenna and to equipment supplied with a dedicated antenna.

The level of spurious radiation shall be measured by:

- their effective radiated power when radiated by the cabinet and the integral antenna; or
- their effective radiated power when radiated by the cabinet and any dedicated antenna provided by the provider.

Modulated signal bandwidths of the signal generators shall be equivalent to the signal bandwidths that are normally used by the MBANS equipment.

Measurements shall be made with each type of antenna provided by the provider that attaches to the equipment.

The measurement shall be carried out by the use of a measuring receiver with bandwidth and detectors as specified in clause 5.1.4.10. For measurements above 1 000 MHz, the peak value shall be measured using a spectrum analyser with a resolution bandwidth setting greater than or equal to the emission bandwidth or 1 MHz whichever is less.

On a test site, selected from annex B that is appropriate for the EUT, the equipment shall be placed at the specified height on a support, as specified in annex B, and in the position closest to normal use as declared by the provider.

The test antenna shall be oriented initially for vertical polarization and shall be tuned to each spurious radiation frequency from the equipment receiver. The output of the test antenna shall be connected to the measuring receiver. The equipment receiver shall be switched on and the measuring receiver shall be tuned over the frequency range 30 MHz to 12,5 GHz.

At each frequency at which a spurious component is detected, the test antenna shall be raised and lowered through the specified range of heights until a maximum signal level is detected on the measuring receiver. The receiver shall then be rotated through 360° in the horizontal plane, until the maximum signal level is detected by the measuring receiver and the test antenna height shall be adjusted again for maximum signal level. The test antenna shall be raised and lowered again through the specified range of height until the maximum signal level is detected by the measuring receiver.

The maximum signal level detected by the measuring receiver for vertical polarization shall be noted.

The equipment receiver shall be replaced by a substitution antenna as defined in clause B.2.2.

The substitution antenna shall be orientated for vertical polarization as noted above and the length of the substitution antenna shall be adjusted to correspond to the frequency of the spurious radiation from the equipment receiver. The substitution antenna shall be connected to a calibrated signal generator. If necessary, the input attenuator setting of the measuring receiver shall be adjusted in order to increase the sensitivity of the measuring receiver. The test antenna shall be raised and lowered through the specified range of height to ensure that the maximum signal is received.

The input signal to the substitution antenna shall be adjusted to the level that produces a level detected by the measuring receiver that is equal to the level noted while the equipment receiver spurious radiations were measured.

The input level to the substitution antenna, corrected for any change of input attenuator setting of the measuring receiver, shall be recorded as the power level for vertical polarization.

The measurement procedure shall be repeated with the test antenna and the substitution antenna oriented for horizontal polarization and the power level recorded.

The measure of the effective radiated power for each spurious radiation is the larger of the two power levels recorded at the input to the substitution antenna, corrected for any gain variance of the substitution antenna relative to the gain of a dipole.

Different measurement bandwidth may be used if necessary and the results shall be adjusted to the reference bandwidth.

The following reference bandwidths should be used (CEPT/ERC/REC 74-01 [i.6]):

- 1 kHz between 9 kHz and 150 kHz;
- 10 kHz between 150 kHz and 30 MHz;
- 100 kHz between 30 MHz and 1 GHz;
- 1 MHz above 1 GHz.

5.3.8 LBT threshold power level

5.3.8.0 General remarks

This test shows the system has sufficient sensitivity to recognize and accurately compare the ambient power level to the calculated LBT threshold power level P_{Th} .

5.3.8.1 Measurement method using frequency administration commands

The EUT shall provide an indication of whether it determines an occupying signal to be greater or less than the LBT threshold. This indication should be agreed between the provider and the test laboratory.

Using frequency administration commands, limit the Equipment Under Test to the single channel nearest the centre of the 2 483,5 MHz to 2 500 MHz band, f_c .

Using the modulated signal source defined in clause 5.1.4.5.1, inject a signal at f_c at a level 10 dB below the calculated LBT threshold power level P_{Th} .

Start a new communication session. If the EUT indicates an un-occupied channel, raise the level of the modulated signal by 1 dB. Determine if EUT indicates an un-occupied channel. This process is repeated until the EUT indicates an occupying signal on f_c .

5.3.8.2 Results based on the above test method

Record the level of the modulated signal source noted in clause 5.3.8.1. The recorded power level shall be less than or equal to the calculated LBT threshold power level P_{Th} .

5.3.9 Minimum channel monitoring period

5.3.9.0 General remarks

This test assures that the EUT monitoring period is at least 30 ms long.

5.3.9.1 Measurement method using frequency administration commands

The EUT shall provide an indication of whether it determines an occupying signal to be greater or less than the LBT threshold. This indication should be agreed between the manufacturer and the test laboratory.

Using frequency administration commands, limit the Equipment Under Test to the single channel nearest the centre of the 2 483,5 MHz to 2 500 MHz band, f_c .

Using the modulated signal source defined in clause 5.1.4.5.1, injects a disturbance signal on f_c at a level 10 dB above the calculated LBT threshold power level clause 4.2.3.1.2 and modulated with a 1 ms pulse whose repetition frequency can be adjusted to 33,33 Hz corresponding to a silent period between pulses of 29 ms.

Start a new communication session.

Determine if EUT indicates an occupied channel at f_c .

5.3.9.2 Results based on the above test method

The EUT shall indicate an occupied channel.

5.3.10 Channel access based on ambient levels relative to the calculated access LBT threshold level, P_{Th}

5.3.10.0 Initial steps

The EUT shall provide an indication of which channel it determines an occupying signal to be of the lowest average power level, as defined in clause 4.2.3. This indication should be agreed between the provider and the test laboratory.

Using frequency administration commands, limit the EUT to 2 channels, f_c and f_d . f_c shall be the channel nearest the centre of the 2 483,5 MHz to 2 500 MHz band.

The frequency of the two channels, f_c and f_d shall be recorded.

5.3.10.1 Accessing an unoccupied channel

Using the modulated signal source defined in clause 5.1.4.5.1, inject a signal on channel f_d at a level 10 dB above the calculated LBT threshold power level clause 4.2.3.1.2. No signal is applied to channel f_c .

f_c is the unoccupied channel. This shall be recorded as the desired un-occupied channel.

Either initiate a channel scan using frequency administration commands or wait until an automatic scan occurs.

Record the channel determined by the EUT to be unoccupied.

5.3.10.2 Results accessing an unoccupied channel

The channel determined as un-occupied shall be the same as the desired un-occupied channel, f_c .

5.3.10.3 Accessing the Least Interfered Channel

Using the modulated signal source defined in clause 5.1.4.5.1, inject a signal on channel f_c at a level 20 dB above the calculated LBT threshold power level clause 4.2.3.1.2.

Using the modulated signal source defined in clause 5.1.4.5.1, inject a signal on channel f_d at a level 10 dB above the calculated LBT threshold power level clause 4.2.3.1.2.

f_d is the Least Interfered Channel (LIC). This shall be recorded as the desired Least Interfered Channel.

Either initiate a channel scan using frequency administration commands or wait until an automatic scan occurs.

Record the channel determined by the EUT to be the LIC.

5.3.10.4 Results accessing the Least Interfered Channel

The channel determined as the LIC shall be the same as the desired LIC, f_d .

5.3.11 Receiver blocking

5.3.11.0 General remarks

This test shows the system has sufficient sensitivity to recognize and accurately compare the ambient power level to the calculated LBT threshold power level P_{Th} in the presence of an unwanted signal (blocking signal) on frequencies other than those of the operating channel and the adjacent channels.

5.3.11.1 Measurement method using frequency administration commands

The EUT shall provide an indication of whether it determines an occupying signal to be greater or less than the LBT threshold. This indication should be agreed between the manufacturer and the test laboratory.

Using frequency administration commands, limit the Equipment Under Test to the single channel nearest the centre of the 2 483,5 MHz to 2 500 MHz band, f_c .

Using the modulated signal source defined in clause 5.1.4.5.1, inject a signal at f_c at a level 10 dB below the calculated LBT threshold power level P_{Th} .

Using a CW signal source, inject a blocking signal at $f_c + 8$ MHz and at a level 45 dB above the calculated LBT threshold power level P_{Th} . This measurement shall be repeated with a blocking signal injected at $f_c - 8$ MHz.

Start a new communication session. If the EUT indicates an un-occupied channel, raise the level of the modulated signal by 1 dB. Determine if EUT indicates an un-occupied channel. This process is repeated until the EUT indicates an occupying signal on f_c .

5.3.11.2 Results based on the above test method

Record the level of the modulated signal source noted in clause 5.3.11.1 (of both measurements, with blocking the signal at $f_c + 8$ MHz and $f_c - 8$ MHz). The recorded power level shall be less than or equal to the calculated LBT threshold power level P_{Th} .

Annex A (normative): Relationship between the present document and the essential requirements of Directive 2014/53/EU

The present document has been prepared to provide a means of conforming to the essential requirements of Directive 2014/53/EU of the European Parliament and of the Council of 16 April 2014 on the harmonisation of the laws of the Member States relating to the making available on the market of radio equipment and repealing Directive 1999/5/EC [i.3].

NOTE: The corresponding Commission's standardization request is expected shortly.

Once the present document is cited in the Official Journal of the European Union under that Directive, compliance with the normative clauses of the present document given in table A.1 confers, within the limits of the scope of the present document, a presumption of conformity with the corresponding essential requirements of that Directive, and associated EFTA regulations.

Table A.1: Relationship between the present document and the essential requirements of Directive 2014/53/EU [i.3]

Harmonised Standard ETSI EN 303 203				
The following requirements are relevant to the presumption of conformity under the article 3.2 of Directive 2014/53/EU [i.3]				
Requirement			Requirement Conditionality	
No	Description	Reference: Clause(s) No	U/C	Condition
1	Frequency error	4.2.1.1	U	
2	Emission bandwidth	4.2.1.2	U	
3	Effective isotropic radiated power	4.2.1.3	U	
4	Transmitter spurious emissions	4.2.1.4	U	
5	Out-of-band emissions	4.2.1.5	U	
6	Frequency stability	4.2.1.6	C	Only applies to battery operated equipment
7	Duty cycle	4.2.1.7	U	
8	Receiver spurious emissions	4.2.2.1	U	
9	LBT threshold power level	4.2.3.1	U	
10	Monitoring system bandwidth	4.2.3.2	U	
11	Minimum channel monitoring period	4.2.3.3	U	
12	Channel access based on ambient power levels	4.2.3.4	U	
13	Receiver blocking	4.2.2.2	U	

Key to columns:

Requirement:

No A unique identifier for one row of the table which may be used to identify a requirement.

Description A textual reference to the requirement.

Clause Number Identification of clause(s) defining the requirement in the present document unless another document is referenced explicitly.

Requirement Conditionality:

U/C Indicates whether the requirement shall be unconditionally applicable (U) or is conditional upon the manufacturers claimed functionality of the equipment (C).

Condition Explains the conditions when the requirement shall or shall not be applicable for a requirement which is classified "conditional".

Presumption of conformity stays valid only as long as a reference to the present document is maintained in the list published in the Official Journal of the European Union. Users of the present document should consult frequently the [latest list published](#) in the Official Journal of the European Union.

Other Union legislation may be applicable to the product(s) falling within the scope of the present document.

Annex B (normative): Radiated measurements

B.1 Test sites and arrangements for radiated measurements

B.1.1 Outdoor test site

The outdoor test site shall be on a reasonably level surface or ground. For measurements at frequencies 30 MHz and above, a conducting ground plane of at least 5 m diameter shall be provided at one point on the site. In the middle of this ground plane, a non-conducting support, capable of rotation through 360° in the horizontal plane, shall be used to support the test sample in its standard position at 1 m above the ground plane.

The test site shall be large enough to allow the erection of measuring or transmitting antenna at a distance of $\lambda/2$ or 3 m whichever is greater, that can be moved between heights of at least 1 m to 4 m above the ground plane and rotated for operation in any plane of polarization. The distance actually used shall be recorded with the results of the tests carried out on the site. A typical outdoor test site is shown in figure B.1.

Sufficient precautions shall be taken to ensure that reflections from extraneous objects adjacent to the site do not degrade the measurement results according to the specification of CISPR 16-2-3 [1].

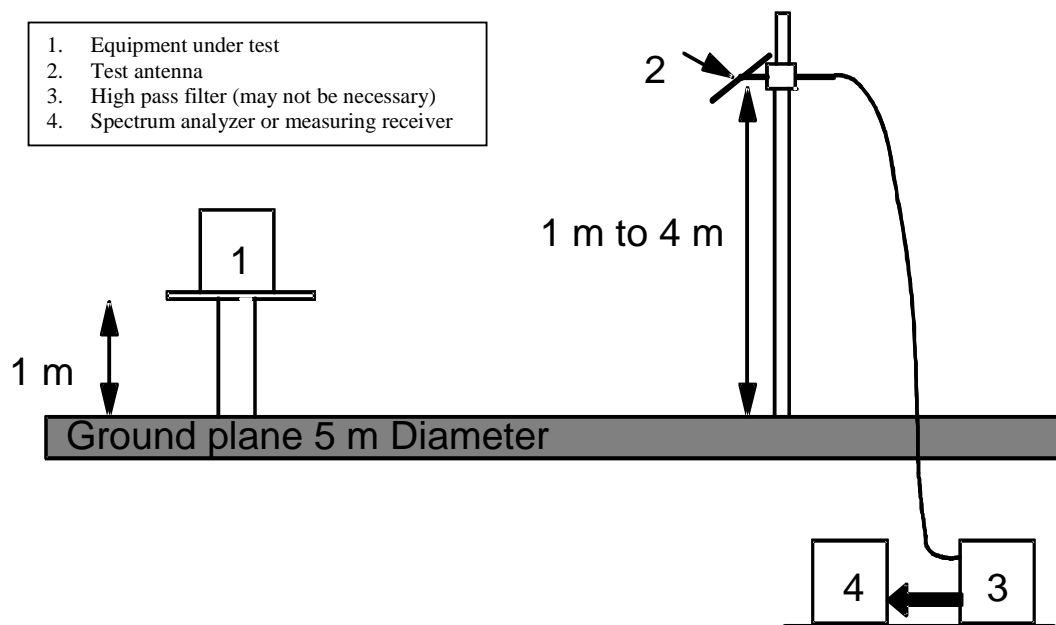

Figure B.1: Outdoor test site

B.1.2 Indoor test site

When the frequency of the signals being measured is greater than 80 MHz, use may be made of an indoor test site. If this alternative site is used, this shall be recorded in the test report.

The measurement site may be a laboratory room with a minimum area of 6 m by 7 m and at least 2,7 m in height.

Apart from the measuring apparatus and the operator, the room shall be as free as possible from reflecting objects other than the walls, floor and ceiling.

The potential reflections from the wall behind the equipment under test are reduced by placing a barrier of absorbent material in front of it. The corner reflector around the test antenna is used to reduce the effect of reflections from the opposite wall and from the floor and ceiling, in the case of horizontally polarized measurements. Similarly, the corner reflector reduces the effects of reflections from the sidewalls for vertically polarized measurements. For the lower part of the frequency range (below approximately 175 MHz), no corner reflector or absorbent barrier is needed. For practical reasons, the $\lambda/2$ antenna in figure B.2 may be replaced by an antenna of constant length, provided that this length is between $\lambda/4$ and λ at the frequency of measurement, and the sensitivity of the measuring system is sufficient. In the same way the distance of $\lambda/2$ to the apex may be varied.

The test antenna, measuring receiver, substitution antenna and calibrated signal generator are used in a way similar to that of the general method, clause B.1.1. To ensure that errors are not caused by the propagation path approaching the point at which phase cancellation between the direct and the remaining reflected signals occurs, the substitution antenna shall be moved through a distance of $\pm 0,1$ m in the direction of the test antenna as well as in the two directions perpendicular to this first direction.

If these changes of distance cause a signal change of greater than 2 dB, the test sample should be re-sited until a change of less than 2 dB is obtained.

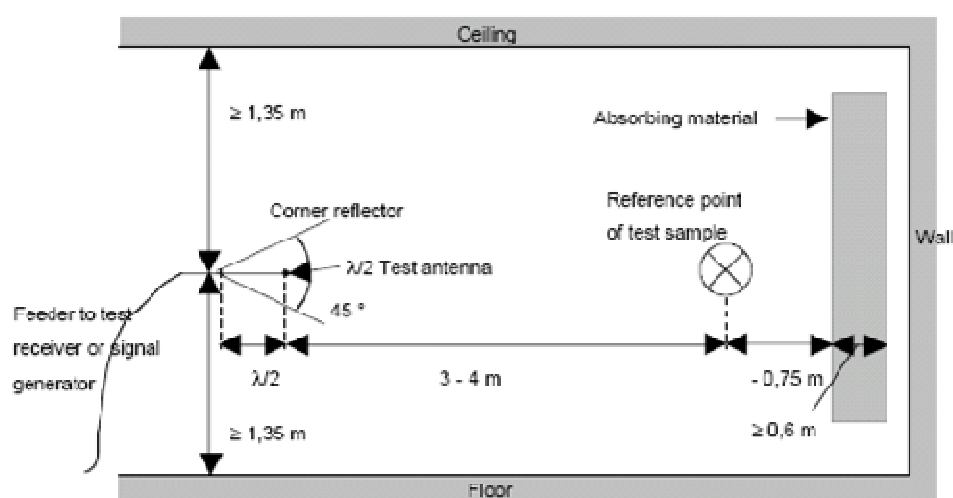

Figure B.2: Indoor test site

B.1.3 Shielded anechoic test site

For radiation measurements, when the test frequency of the signals being measured is greater than 30 MHz, use may be made of an indoor test site being a well-shielded anechoic chamber simulating a free space environment. If such a chamber is used, this shall be recorded in the test report.

The test antennas, measuring receiver, substitution antenna and calibrated signal generator are used in a way similar to that of the general method, clause B.1.1.

Figure B.3 shows the construction of an anechoic shielded measuring chamber having a base area of 5 m by 10 m and a height of 5 m. Ceilings and walls are coated with pyramidal formed RF absorbers approximately 1 m high. The base is covered with absorbers forming a non-conducting sub-floor or with special ground floor absorbers. The available internal dimensions of the room are 3 m by 8 m by 3 m, so that a maximum measuring distance of 5 m length in the middle axis of this room is available. The floor absorbers reduce floor reflections so that the antenna height need not be changed and floor reflection influences need not be considered.

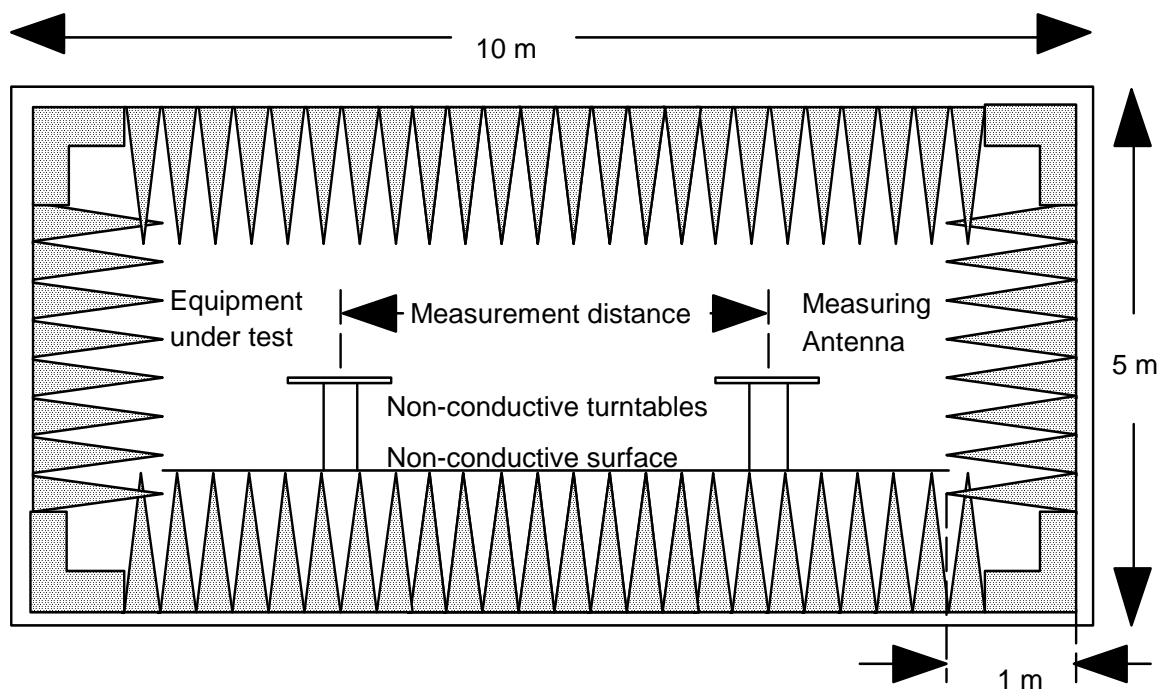

Ground plan

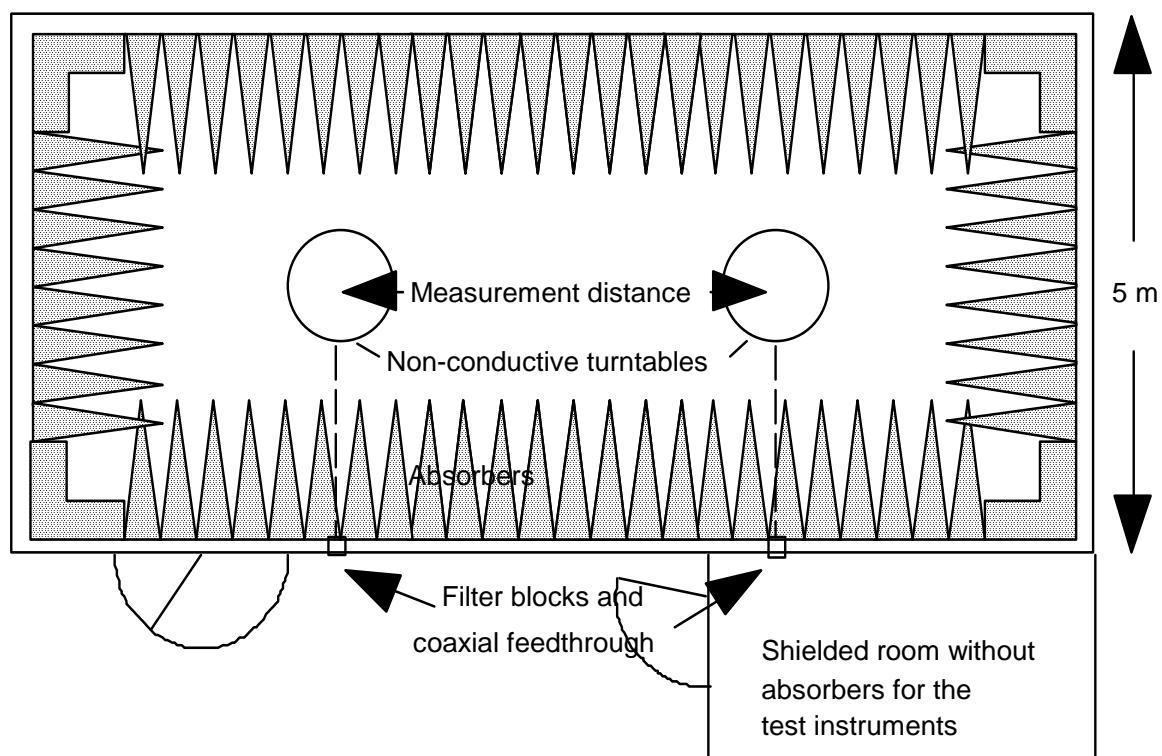

Figure B.3: Example of the construction of an anechoic shielded chamber

Figure B.4 shows the requirements for shielding loss and wall return loss of such a room. As dimensions and characteristics of usual absorber materials are critical below 100 MHz (height of absorbers < 1 m, reflection attenuation < 20 dB) such a room is more suitable for measurements above 100 MHz. The chamber shall be calibrated over the range 30 MHz to 12,5 GHz. In the range 30 MHz to 100 MHz, some additional calibration may be necessary. At 100 MHz, the measuring distance can be extended up to a maximum of 2λ .

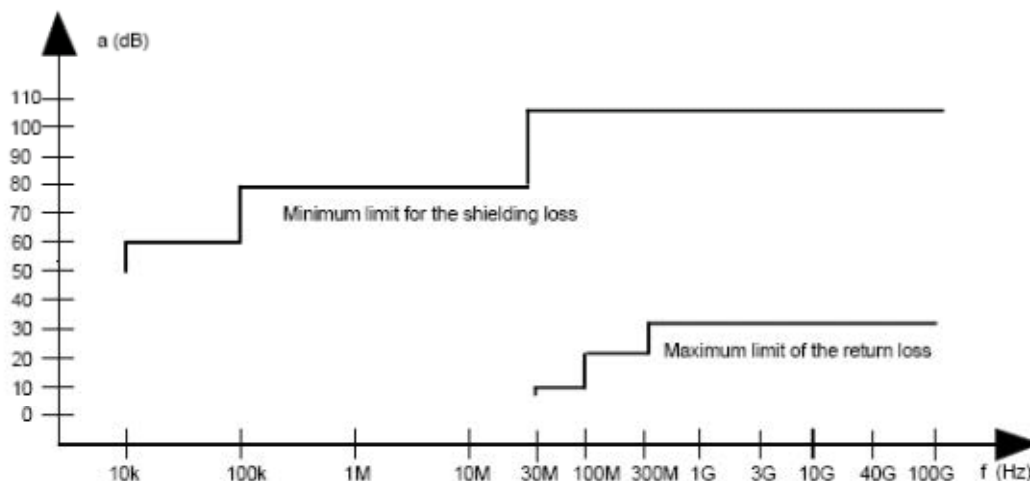

Figure B.4: Specification for shielding and reflections

B.2 Antennas

B.2.1 Test antenna

The test antenna is used to detect the radiation from both the test sample and the substitution antenna, when the site is used for radiation measurements. It is used as a transmitting antenna for the measurement of receiver characteristics.

This antenna is mounted on a support such as to allow the antenna to be used in either horizontal or vertical polarization and for the height of its centre above ground to be varied over the range 1 m to 4 m. Preferably, a test antenna with a gain characteristic similar to a dipole antenna should be used. The size of the test antenna along the measurement axis shall not exceed 20 % of the measuring distance.

For receiver and transmitter radiation measurements, the test antenna is connected to a measuring receiver, capable of being tuned to any frequency under investigation and of measuring accurately the relative levels of signals at its input. For receiver radiated sensitivity measurements, the test antenna is connected to a signal generator.

B.2.2 Substitution antenna

A substitution antenna may be used in place of the equipment under test when comparing equipment emissions with standard emissions.

When measuring in the frequency range up to 1 GHz the substitution antenna shall be a $\lambda/2$ dipole, resonant at the operating frequency, or a shortened dipole calibrated to the $\lambda/2$ dipole. When measuring in the frequency range above 4 GHz, a horn radiator shall be used. For measurements between 1 GHz and 4 GHz either a $\lambda/2$ or a horn radiator may be used. The centre of this antenna shall coincide with the reference point of the test sample it has replaced. This reference point shall be the volume centre of the sample when its antenna is mounted internally, or the phase centre of an external antenna.

The distance between the lower extremity of the dipole and the ground shall not be less than 0,3 m.

The substitution antenna shall be connected to a calibrated signal generator when the site is used for spurious radiation measurements and transmitter effective radiated power measurements. The substitution antenna shall be connected to a calibrated measuring receiver when the site is used for the measurement of receiver sensitivity.

The signal generator and the receiver shall be connected to the antenna through suitable matching and balancing networks.

B.3 Test practice and auxiliary test equipment

B.3.0 General requirements

Antenna characteristics and positions, test equipment settings and cable types or characteristics shall be recorded with each test result.

Test methods shall comply with operator instructions for each item of equipment, with the measurements and limits described in the present document, and with the provisions and guidelines given below.

All test equipment shall be calibrated with traceability to European standards and used in accordance with the manufacturer's recommended operating procedures.

B.3.1 Measuring distance

Evidence indicates that the measuring distance is not critical and does not significantly affect the measuring results, provided that the distance is not less than $\lambda/2$ at the frequency of measurement, and that the precautions described in this annex are observed. Measuring distances of 3 m, 5 m, 10 m and 30 m are in common use in European test laboratories.

B.3.2 Auxiliary cables

The position of auxiliary cables (power supply, etc.) which are not adequately decoupled may cause variations in the measurement results. In order to get reproducible results, cables and wires of auxiliaries should be arranged vertically downwards (through a hole in the non-conducting support), or as specified in the technical documentation supplied with the equipment.

Care shall be taken to ensure that test cables do not adversely affect the measuring result.

Annex C (informative): Bibliography

Council Directive 89/336/EEC of 3 May 1989 on the approximation of the laws of the Member States relating to electromagnetic compatibility (EMC Directive).

ETSI EN 301 489: "Electromagnetic compatibility and Radio spectrum Matters (ERM); ElectroMagnetic Compatibility (EMC) standard for radio equipment and services".

Council Directive 73/23/EEC of 19 February 1973 on the harmonization of the laws of Member States relating to electrical equipment designed for use within certain voltage limits (LV Directive).

ECC Report 201: "Compatibility study between MBANS operating in the 2400 - 2483.5 MHz and 2483.5 - 2500 MHz bands and other systems in the same bands or in adjacent bands".

ICNIRP: "Guidelines for Limiting Exposure to Time-Varying Electric, Magnetic, and Electromagnetic Fields (up to 300 GHz)", International Commission on Non-Ionizing Radiation Protection, Health Physics Vol. 74, No 4, pp 494-522, 1998.

Council Recommendation 1999/519/EC on limitation of exposure of the general public to electromagnetic fields 0 Hz-300 GHz.

ETSI TR 102 070-1 (V1.2.1): "Electromagnetic compatibility and Radio spectrum Matters (ERM); Guide to the application of harmonized standards to multi-radio and combined radio and non-radio equipment; Part 1: ElectroMagnetic Compatibility".

Directive 98/48/EC of the European Parliament and of the Council of 20 July 1998 amending Directive 98/34/EC laying down a procedure for the provision of information in the field of technical standards and regulations.

Directive 98/34/EC of the European Parliament and of the Council of 22 June 1998 laying down a procedure for the provision of information in the field of technical standards and regulations.

History

Document history		
V1.1.1	November 2014	Publication as ETSI EN 303 203-1
V1.1.1	November 2014	Publication as ETSI EN 303 203-2
V2.1.0	July 2015	EN Approval Procedure AP 20151031: 2015-07-03 to 2015-11-02