

ETSI EN 303 039 V2.1.1 (2016-03)



**Land Mobile Service;  
Multichannel transmitter specification for the PMR Service;  
Harmonised Standard covering the essential requirements  
of article 3.2 of the Directive 2014/53/EU**

---

**Reference**

REN/ERM-TGDMMR-342

---

**Keywords**

data, mobile, PMR, radio

**ETSI**

---

650 Route des Lucioles  
F-06921 Sophia Antipolis Cedex - FRANCE

Tel.: +33 4 92 94 42 00 Fax: +33 4 93 65 47 16

Siret N° 348 623 562 00017 - NAF 742 C  
Association à but non lucratif enregistrée à la  
Sous-Préfecture de Grasse (06) N° 7803/88

---

**Important notice**The present document can be downloaded from:  
<http://www.etsi.org/standards-search>

The present document may be made available in electronic versions and/or in print. The content of any electronic and/or print versions of the present document shall not be modified without the prior written authorization of ETSI. In case of any existing or perceived difference in contents between such versions and/or in print, the only prevailing document is the print of the Portable Document Format (PDF) version kept on a specific network drive within ETSI Secretariat.

Users of the present document should be aware that the document may be subject to revision or change of status. Information on the current status of this and other ETSI documents is available at  
<https://portal.etsi.org/TB/ETSIDeliverableStatus.aspx>

If you find errors in the present document, please send your comment to one of the following services:  
<https://portal.etsi.org/People/CommiteeSupportStaff.aspx>

---

**Copyright Notification**

No part may be reproduced or utilized in any form or by any means, electronic or mechanical, including photocopying and microfilm except as authorized by written permission of ETSI.

The content of the PDF version shall not be modified without the written authorization of ETSI.  
The copyright and the foregoing restriction extend to reproduction in all media.

© European Telecommunications Standards Institute 2016.  
All rights reserved.

**DECT™**, **PLUGTESTS™**, **UMTS™** and the ETSI logo are Trade Marks of ETSI registered for the benefit of its Members.  
**3GPP™** and **LTE™** are Trade Marks of ETSI registered for the benefit of its Members and of the 3GPP Organizational Partners.  
**GSM®** and the GSM logo are Trade Marks registered and owned by the GSM Association.

# Contents

Intellectual Property Rights .....	6
Foreword.....	6
Modal verbs terminology.....	6
1 Scope .....	7
2 References .....	8
2.1 Normative references .....	8
2.2 Informative references.....	8
3 Definitions, symbols and abbreviations .....	9
3.1 Definitions.....	9
3.2 Symbols.....	11
3.3 Abbreviations .....	11
4 General and operational requirements.....	12
4.1 General .....	12
4.1.0 Environmental profile .....	12
4.1.1 Choice of model for testing .....	12
4.1.1.0 General.....	12
4.1.1.1 Auxiliary test equipment .....	12
4.1.1.2 Declarations by the supplier.....	12
4.2 Multi-Mode equipment.....	13
4.3 Testing of equipment that does not have an external 50 $\Omega$ RF connector (integral antenna equipment) .....	13
5 Test conditions, power sources and ambient temperatures .....	13
5.1 Normal and extreme test conditions .....	13
5.2 Test power source.....	13
5.3 Normal test conditions.....	13
5.3.1 Normal temperature and humidity .....	13
5.3.2 Normal test power source .....	14
5.3.2.1 Mains voltage.....	14
5.3.2.2 Regulated lead-acid battery power sources used on vehicles.....	14
5.3.2.3 Other power sources.....	14
5.4 Extreme test conditions .....	14
5.4.1 Extreme temperatures .....	14
5.4.2 Extreme test source voltages.....	14
5.4.2.1 Mains voltage.....	14
5.4.2.2 Regulated lead-acid battery power sources used on vehicles.....	14
5.4.2.3 Power sources using other types of batteries.....	14
5.4.2.4 Other power sources.....	15
5.5 Procedure for tests at extreme temperatures.....	15
5.5.0 Thermal balance.....	15
5.5.1 Procedure for equipment designed for continuous transmission.....	15
5.5.2 Procedure for equipment designed for intermittent transmission .....	15
6 General conditions of measurement .....	15
6.1 Test bandwidth .....	15
6.2 Test load (artificial antenna).....	16
6.3 Test signals (wanted and unwanted signals).....	16
6.3.0 General.....	16
6.3.1 Transmitter test signals for digital transmissions.....	16
6.3.2 Encoder for digital transmitter measurements .....	16
6.3.3 Transmitter test signals for analogue transmissions.....	16
6.3.3.0 General .....	16
6.3.3.1 Test signals for frequency modulated channels.....	16
6.3.3.2 Test signals for amplitude modulated channels.....	17
6.3.3.3 Transmitter effective radiated power test signal (C1) .....	17
6.4 Transceiver data interface for digital transmissions .....	17
6.5 Impedance .....	17

6.6	PEP.....	17
6.7	Duplex equipment .....	17
6.8	Modes of operation of the transmitter .....	17
6.9	Measurement filter definition for digital transmissions.....	18
6.10	Test site and general arrangements for measurements involving the use of radiated fields .....	18
7	Technical characteristics of the transmitter .....	18
7.1	Transmitter output power (conducted) .....	18
7.1.0	General.....	18
7.1.1	Definitions .....	18
7.1.2	Method of measurement .....	18
7.1.3	Limits.....	19
7.2	Adjacent and alternate channel power.....	19
7.2.1	Definition.....	19
7.2.2	Method of measurement .....	20
7.2.3	Limits.....	22
7.3	Unwanted emissions.....	23
7.3.1	Definition.....	23
7.3.2	Method of measuring the power level .....	24
7.3.2.1	Measurement options .....	24
7.3.2.2	Method of measuring conducted spurious emissions (clause 7.3.2.1 a)) .....	24
7.3.2.3	Method of measuring the effective radiated power (clause 7.3.2.1 b)) .....	25
7.3.2.4	Method of measuring wideband noise.....	26
7.3.2.5	Method for measuring frequency conversion oscillator conducted spurious emissions.....	27
7.3.2.6	Method for measuring third order intermodulation products between wanted channels.....	28
7.3.3	Limits.....	28
7.3.3.1	Spurious emissions power.....	28
7.3.3.2	Wideband noise power.....	29
7.3.3.3	Frequency conversion oscillator spurious emission .....	30
7.3.3.4	Third order intermodulation product spurious emission .....	30
7.4	Intermodulation attenuation.....	31
7.4.0	Applicability .....	31
7.4.1	Definition.....	31
7.4.2	Method of measurement .....	31
7.4.3	Limits.....	32
7.5	Transient power measurements .....	32
7.5.1	Definition.....	32
7.5.2	Method of Measurement.....	32
7.5.3	Limits.....	33
8	Testing for compliance with technical requirements.....	33
8.1	Test conditions, power supply and ambient temperatures .....	33
8.2	Interpretation of the measurement results .....	34
<b>Annex A (normative):</b>	<b>Relationship between the present document and the essential requirements of Directive 2014/53/EU .....</b>	<b>35</b>
<b>Annex B (normative):</b>	<b>Radiated measurement.....</b>	<b>36</b>
B.1	Test sites and general arrangements for measurements involving the use of radiated fields .....	36
B.1.0	General .....	36
B.1.1	Anechoic chamber .....	36
B.1.2	Anechoic chamber with a conductive ground plane.....	37
B.1.3	Open Area Test Site (OATS) .....	38
B.1.4	Test antenna.....	39
B.1.5	Substitution antenna .....	39
B.1.6	Measuring antenna .....	40
B.2	Guidance on the use of radiation test sites .....	40
B.2.0	General .....	40
B.2.1	Verification of the test site .....	40
B.2.2	Preparation of the EUT.....	40
B.2.3	Power supplies to the EUT.....	40

B.2.4	Range length.....	40
B.2.5	Site preparation .....	41
B.3	Coupling of signals.....	42
B.3.0	General .....	42
B.3.1	Data signals .....	42
<b>Annex C (normative): Specification for some particular measurement arrangements.....</b>		<b>43</b>
C.1	Spectrum analyser specification.....	43
C.1.1	Adjacent and alternate channel power measurement.....	43
C.1.2	Unwanted emissions measurement.....	43
C.2	Integrating and power summing device .....	44
<b>Annex D (informative): Change History .....</b>		<b>45</b>
History .....		46

---

## Intellectual Property Rights

IPRs essential or potentially essential to the present document may have been declared to ETSI. The information pertaining to these essential IPRs, if any, is publicly available for **ETSI members and non-members**, and can be found in ETSI SR 000 314: "*Intellectual Property Rights (IPRs); Essential, or potentially Essential, IPRs notified to ETSI in respect of ETSI standards*", which is available from the ETSI Secretariat. Latest updates are available on the ETSI Web server (<https://ipr.etsi.org>).

Pursuant to the ETSI IPR Policy, no investigation, including IPR searches, has been carried out by ETSI. No guarantee can be given as to the existence of other IPRs not referenced in ETSI SR 000 314 (or the updates on the ETSI Web server) which are, or may be, or may become, essential to the present document.

---

## Foreword

This Harmonised European Standard (EN) has been produced by ETSI Technical Committee Electromagnetic compatibility and Radio spectrum Matters (ERM).

The present document has been prepared under the Commission's standardisation request C(2015) 5376 final [i.4] to provide one voluntary means of conforming to the essential requirements of Directive 2014/53/EU on the harmonisation of the laws of the Member States relating to the making available on the market of radio equipment and repealing Directive 1999/5/EC [i.3].

Once the present document is cited in the Official Journal of the European Union under that Directive, compliance with the normative clauses of the present document given in table A.1 confers, within the limits of the scope of the present document, a presumption of conformity with the corresponding essential requirements of that Directive, and associated EFTA regulations.

<b>National transposition dates</b>	
Date of adoption of this EN:	21 March 2016
Date of latest announcement of this EN (doa):	30 June 2016
Date of latest publication of new National Standard or endorsement of this EN (dop/e):	31 December 2016
Date of withdrawal of any conflicting National Standard (dow):	31 December 2017

---

## Modal verbs terminology

In the present document "**shall**", "**shall not**", "**should**", "**should not**", "**may**", "**need not**", "**will**", "**will not**", "**can**" and "**cannot**" are to be interpreted as described in clause 3.2 of the [ETSI Drafting Rules](#) (Verbal forms for the expression of provisions).

"**must**" and "**must not**" are **NOT** allowed in ETSI deliverables except when used in direct citation.

# 1 Scope

The present document covers the technical requirements for multiple channel radio transmitters used in stations in the Private Mobile Radio (PMR) service.

It applies to use in the land mobile service, operating on radio frequencies between 30 MHz and 3 GHz, with channel separations of < 10 kHz, 12,5 kHz, 20 kHz, 25 kHz, 50 kHz, 100 kHz and 150 kHz.

**Table 1: Radiocommunications service frequency bands**

Radiocommunications service frequency bands	
Transmit	30 MHz to 3 000 MHz

It applies to equipment for continuous and/or discontinuous transmission of data and/or digital speech and/or analogue speech and using constant envelope or non-constant envelope modulation.

The equipment comprises a transmitter capable of simultaneous amplification or transmission on two or more RF channels, or an amplifier which when operated with transmitter equipment provides simultaneous transmission on two or more RF channels. The types of equipment covered by the present document are as follows:

- base station (equipment fitted with an antenna connector, intended for use in a fixed location);
- mobile station (equipment fitted with an antenna connector, normally used in a vehicle or as a transportable);
- those hand portable stations:
  - a) fitted with an antenna connector; or
  - b) without an external antenna connector (integral antenna equipment), but fitted with a permanent internal or a temporary internal 50  $\Omega$  Radio Frequency (RF) connector which allows access to the transmitter output; and
- any equipment that may be used in combination with any of the above equipments when directly connected to those equipments for the amplification of the transmitter output signals of two or more individual equipments.

Types of equipment not covered by the present document are as follows:

- hand portable equipment without an external or internal RF connector and without the possibility of having a temporary internal 50  $\Omega$  RF connector is not covered by the present document;
- any equipment using passive combining solutions where each transmitter connected to the passive combining system transmits on a single channel, as detailed in ETSI EG 200 053 [i.2], clause H.3.

These specifications apply to the transmitter or transmitter amplifier only. If a receiver is fitted to the same equipment, the receiver specifications in the relevant specification (references [i.5] to [i.12]) also apply.

These specifications do not necessarily include all the characteristics that may be required by a user of equipment, nor do they necessarily represent the optimum performance achievable.

In addition to the present document, other ENs that specify technical requirements in respect of essential requirements under other parts of article 3 of the Radio Equipment Directive [i.3] may apply to equipment within the scope of the present document.

---

## 2 References

### 2.1 Normative references

References are either specific (identified by date of publication and/or edition number or version number) or non-specific. For specific references, only the cited version applies. For non-specific references, the latest version of the referenced document (including any amendments) applies.

Referenced documents which are not found to be publicly available in the expected location might be found at <http://docbox.etsi.org/Reference>.

NOTE: While any hyperlinks included in this clause were valid at the time of publication, ETSI cannot guarantee their long term validity.

The following referenced documents are necessary for the application of the present document.

- [1] Recommendation ITU-T O.153 (10-1992): "Basic parameters for the measurement of error performance at bit rates below the primary rate".
- [2] Void.
- [3] ETSI TR 102 273 (V1.2.1) (12-2001) (all parts): "Electromagnetic compatibility and Radio spectrum Matters (ERM); Improvement on Radiated Methods of Measurement (using test site) and evaluation of the corresponding measurement uncertainties".
- [4] ANSI C63.5 (2006): "American National Standard for Electromagnetic Compatibility-Radiated Emission Measurements in Electromagnetic Interference (EMI) Control-Calibration of Antennas (9 kHz to 40 GHz)".

### 2.2 Informative references

References are either specific (identified by date of publication and/or edition number or version number) or non-specific. For specific references, only the cited version applies. For non-specific references, the latest version of the referenced document (including any amendments) applies.

NOTE: While any hyperlinks included in this clause were valid at the time of publication, ETSI cannot guarantee their long term validity.

The following referenced documents are not necessary for the application of the present document but they assist the user with regard to a particular subject area.

- [i.1] CEPT/ERC/REC 74-01 (2011): "Unwanted Emissions in the Spurious domain".
- [i.2] ETSI EG 200 053: "Electromagnetic compatibility and Radio spectrum Matters (ERM); Radio site engineering for radio equipment and systems".
- [i.3] Directive 2014/53/EU of the European Parliament and of the Council of 16 April 2014 on the harmonisation of the laws of the Member States relating to the making available on the market of radio equipment and repealing Directive 1999/5/EC.

NOTE: Article 3.2 and article 10.8.

- [i.4] Commission Implementing Decision C(2015) 5376 final of 4.8.2015 on a standardisation request to the European Committee for Electrotechnical Standardisation and to the European Telecommunications Standards Institute as regards radio equipment in support of Directive 2014/53/EU of the European Parliament and of the Council.
- [i.5] ETSI EN 300 392-2: "Terrestrial Trunked Radio (TETRA); Voice plus Data (V+D); Part 2: Air Interface (AI)".
- [i.6] ETSI EN 302 561: "Land Mobile Service; Radio equipment using constant or non-constant envelope modulation operating in a channel bandwidth of 25 kHz, 50 kHz, 100 kHz or 150 kHz; Harmonised EN covering the essential requirements of article 3.2 of the Directive 2014/53/EU".



- [i.7] ETSI EN 300 086: "Land Mobile Service; Radio equipment with an internal or external RF connector intended primarily for analogue speech; Harmonised Standard covering the essential requirements of article 3.2 of the Directive 2014/53/EU".
- [i.8] ETSI EN 300 113: "Land Mobile Service; Radio equipment intended for the transmission of data (and/or speech) using constant or non-constant envelope modulation and having an antenna connector; Harmonised Standard covering the essential requirements of article 3.2 of the Directive 2014/53/EU".
- [i.9] ETSI EN 300 296: "Land Mobile Service; Radio equipment using integral antennas intended primarily for analogue speech; Harmonised Standard covering the essential requirements of article 3.2 of the Directive 2014/53/EU".
- [i.10] ETSI EN 300 341: "Land Mobile Service; Radio equipment using an integral antenna transmitting signals to initiate a specific response in the receiver; Harmonised Standard covering the essential requirements of article 3.2 of the Directive 2014/53/EU".
- [i.11] ETSI EN 300 390: "Land Mobile Service; Radio equipment intended for the transmission of data (and speech) and using an integral antenna; Harmonised Standard covering the essential requirements of article 3.2 of the Directive 2014/53/EU Harmonised Standard covering the essential requirements of article 3.2 of the Directive 2014/53/EU".
- [i.12] ETSI EN 301 166: "Land mobile service; Radio equipment for analogue and/or digital communication (speech and/or data) and operating on narrow band channels and having an antenna connector; Harmonised Standard covering essential requirements of article 3.2 of the Directive 2014/53/EU".
- [i.13] ETSI TR 100 028 (V1.4.1) (2001) (all parts): "Electromagnetic compatibility and Radio spectrum Matters (ERM); Uncertainties in the measurement of mobile radio equipment characteristics".
- [i.14] ETSI TR 100 028-2 (V1.4.1): "Electromagnetic compatibility and Radio spectrum Matters (ERM); Uncertainties in the measurement of mobile radio equipment characteristics; Part 2".

---

## 3 Definitions, symbols and abbreviations

### 3.1 Definitions

For the purposes of the present document, the following terms and definitions apply:

**base station:** equipment fitted with an antenna connector, for use with an external antenna, and intended for use in a fixed location

**bit:** binary digit

**block:** smallest quantity of information that is sent over the radio channel

NOTE: A constant number of useful bits are always sent together with the corresponding redundancy bits.

**burst or transmission (physical):** one or several packets transmitted between power on and power off of a particular transmitter

**channel:** width of a single frequency band which is just sufficient to ensure the transmission of all necessary information at the rate and with the quality required under specified conditions to one or more receivers

**conducted measurements:** measurements which are made using direct 50  $\Omega$  connection to the equipment under test

**data transmission systems:** systems which transmit and/or receive data and/or digitized voice

**hand portable station:** equipment either fitted with an antenna connector or integral antenna, or both, normally used on a stand-alone basis, to be carried on a person or held in the hand

**integral antenna:** antenna designed to be connected to the equipment without the use of a 50  $\Omega$  external connector and considered to be part of the equipment

NOTE: An integral antenna may be fitted internally or externally to the equipment.

**message:** user data to be transferred in one or more packets

**mobile station:** mobile equipment fitted with an antenna connector, for use with an external antenna, normally used in a vehicle or as a transportable station

**necessary bandwidth:** width of the frequency band covering the envelope of the transmitted channels, which is just sufficient to ensure the transmission of information at the rate and with the quality required under specified conditions for all transmitted channels

**packet:** one block or a contiguous stream of blocks sent by one (logical) transmitter to one particular receiver or one particular group of receivers

**radiated measurements:** measurements which involve the absolute measurement of a radiated field

**receive band:** frequency band which is used by one or more receivers paired with the transmitter

**spurious emissions:** unwanted emissions in the spurious domain

**switching range (sr):** maximum frequency range, as specified by the supplier, over which the receiver or the transmitter can be operated within the alignment range without reprogramming or realignment

**testing laboratory:** laboratory that performs tests

**transmit band of the equipment:** maximum frequency range (declared by the supplier) over which the transmitter can be operated without reprogramming or realignment

**useful part of the burst:** For digital modulation the period of time between the centre of the first modulation symbol and centre of the last modulation symbol of an individual transmission; for analogue modulation the period of time over which modulation is present or as defined by the power vs. time profile in figure 1.

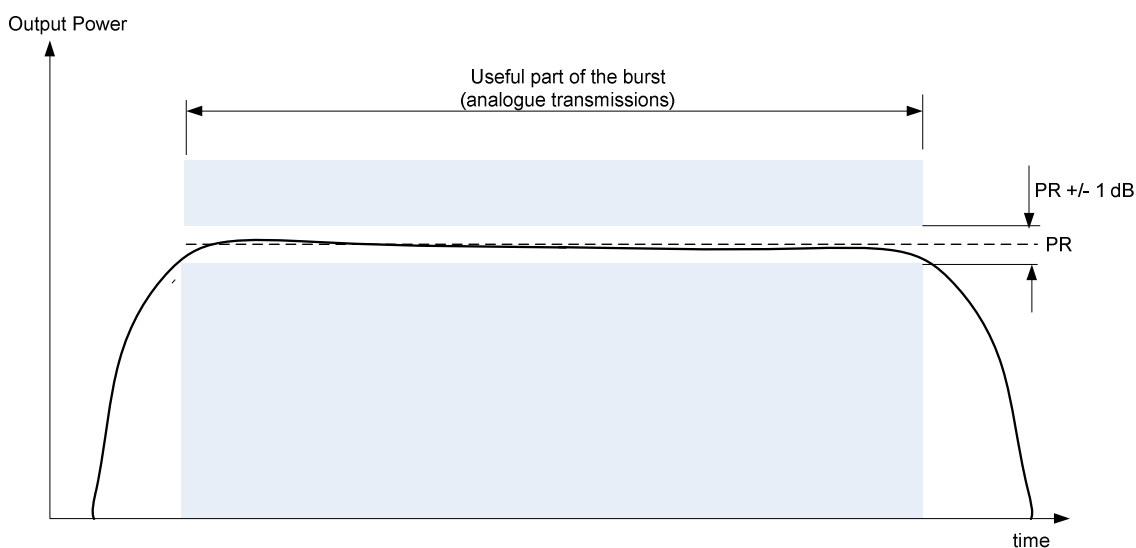

**Figure 1: Useful part of the burst shown for analogue transmissions (constant envelope)**

**wanted bandwidth of a channel:** bandwidth required for any single channel within the necessary bandwidth of the transmitter which is necessary to ensure the transmission of information at the rate and with the quality required under specified conditions for that channel only

## 3.2 Symbols

For the purposes of the present document, the following symbols apply:

A1, A2, B1, M1, M2, etc.	names of test signals defined in clause 6.3
$\alpha$	filter rolloff factor
$B_{\text{high}1}$	centre frequency of out-of-band domain at higher frequency than transmitter centre frequency
$B_{\text{high}2}$	highest frequency of out-of-band domain
$B_{\text{low}1}$	centre frequency of out-of-band domain at lower frequency than transmitter centre frequency
$B_{\text{low}2}$	lowest frequency of out-of-band domain
$B_N$	necessary bandwidth
BW	bandwidth of a channel
dB	decibel
dBm	dB relative to 1 mW
dB $\mu$ V	dB relative to 1 $\mu$ V
$f_c$	transmitter centre frequency
$f_{\text{ch}}$	channel centre frequency
$f_{\text{high}}$	highest frequency of transmitter necessary bandwidth
$f_{\text{LO}}$	Local Oscillator frequency
$f_{\text{low}}$	lowest frequency of transmitter necessary bandwidth
$f_{\text{rb}}$	the frequency offset corresponding to the near edge of the receive band
$I_i$	Intermodulation product generated between two wanted channels
PR	rms power of a single channel
PRX	the value of power PR for the channel with the greatest value of PR
PX	maximum power of transmitter
$T_{\text{min}}$	minimum extreme test Temperature
$T_{\text{max}}$	maximum extreme test Temperature
$V_{\text{min}}$	minimum extreme test Voltage
$V_{\text{max}}$	maximum extreme test Voltage
$\lambda$	wavelength

## 3.3 Abbreviations

For the purposes of the present document, the following abbreviations apply:

ac	alternating current
BW	BandWidth
CSP	Channel SeParation
CW	Continuous Wave
dBc	decibels relative to the transmitter power
DC	Direct Current
EUT	Equipment Under Test
GMSK	Gaussian Minimum Shift Keying
ITU-T	International Telecommunication Union - Telecommunication Standardization Sector
MBW	Measurement BandWidth
OATS	Open Area Test Site
OOB	Out-Of-Band
PEP	Peak Envelope Power
PMR	Private Mobile Radio
RF	Radio Frequency
rms	root mean square
sr	switching range
Tx	Transmitter
VSWR	Voltage Standing Wave Ratio

---

## 4 General and operational requirements

### 4.1 General

#### 4.1.0 Environmental profile

The technical requirements of the present document apply under the environmental profile for operation of the equipment, which shall be declared by the supplier, but as a minimum, shall be that specified in the test conditions contained in the present document. The equipment shall comply with all the technical requirements of the present document at all times when operating within the boundary limits of the declared operational environmental profile.

#### 4.1.1 Choice of model for testing

##### 4.1.1.0 General

Each equipment submitted to be tested shall fulfil the requirements of the present document on all frequencies over which it is intended to operate.

The radio tests shall be performed with the centre frequency of the equipment configured in turn on the lowest, the highest and the middle radio frequency of the tunable range of the equipment. In each case, tests shall be carried out using the maximum number of channels of which the equipment is capable, with the greatest bandwidth between highest and lowest channel frequencies transmitted by the equipment (i.e. with the maximum necessary bandwidth of the equipment).

The supplier shall declare the tunable frequency ranges, the maximum necessary bandwidth of the equipment, the minimum spacing between channels, the maximum number of channels, the modes of operation (e.g. continuous or intermittent transmission) and if transmission can be intermittent, the burst lengths and repetition frequencies and the range of operating conditions and power requirements as applicable, to establish the appropriate test conditions. The supplier shall also state the frequency range of the receive band intended for use with receivers paired with the equipment.

Specific parameters required for testing, such as frequency conversion oscillator frequency and tuning range, shall also be supplied.

Additionally, technical documentation and operating manuals, sufficient to make the test, shall be supplied.

The supplier shall provide one or more samples of the equipment, as appropriate for testing.

Stand-alone equipment shall be complete with any ancillary equipment needed for testing.

If an equipment has several optional features, considered not to affect the RF parameters then the tests need only to be performed on the equipment configured with the combination of features considered to be the most complex. Where practicable, equipment to be tested shall provide a 50  $\Omega$  connector for conducted RF power level measurements.

In the case of integral antenna equipment, if the equipment does not have an internal permanent 50  $\Omega$  connector then it is permissible to supply a second sample of the equipment with a temporary antenna connector fitted to facilitate testing.

The test connector shall also provide any test signalling data.

The performance of the equipment to be tested shall be representative of the performance of the corresponding production model.

##### 4.1.1.1 Auxiliary test equipment

All necessary test signal sources, setting up instructions and other product information shall be made available with the equipment to be tested.

##### 4.1.1.2 Declarations by the supplier

The supplier shall declare the necessary information about the equipment with respect to all technical requirements set by the present document.

## 4.2 Multi-Mode equipment

In the case of equipment where channels can be configured to operate with more than one channel bandwidth, measurements shall be performed at least with the highest and the lowest of each channel bandwidth implemented.

Where the equipment supports different modulation types, or different modulation levels within the same type, a representative set of modulation types and levels shall be tested. At least the modulation with the highest number of modulation states per modulation symbol shall be tested.

## 4.3 Testing of equipment that does not have an external 50 $\Omega$ RF connector (integral antenna equipment)

Where equipment has an internal 50  $\Omega$  connector it shall be permitted to perform the tests at this connector.

Equipment may also have a temporary internal 50  $\Omega$  connector installed for the purposes of testing.

No connection shall be made to any internal permanent or temporary antenna connector during the performance of radiated emissions measurements, unless such action forms an essential part of the normal intended operation of the equipment, as declared by the supplier.

---

# 5 Test conditions, power sources and ambient temperatures

## 5.1 Normal and extreme test conditions

Testing shall be performed under normal test conditions, and also, where stated, under extreme test conditions.

The test conditions and procedures shall be as specified in clauses 5.2 to 5.5.

## 5.2 Test power source

During testing the power source of the equipment shall be replaced by a test power source capable of producing normal and extreme test voltages as specified in clauses 5.3.2 and 5.4.2. The internal impedance of the test power source shall be low enough for its effect on the test results to be negligible. For the purpose of tests, the voltage of the power source shall be measured at the input terminals of the equipment.

For battery operated equipment the battery shall be removed and the test power source shall be applied as close to the battery terminals as practicable.

During tests of DC powered equipment the power source voltages shall be maintained within a tolerance of  $< \pm 1$  % relative to the voltage at the beginning of each test. The value of this tolerance is critical for power measurements. Using a smaller tolerance will provide better measurement uncertainty values.

## 5.3 Normal test conditions

### 5.3.1 Normal temperature and humidity

The normal temperature and humidity conditions for tests shall be any convenient combination of temperature and humidity within the following ranges:

- temperature: +15  $^{\circ}\text{C}$  to +35  $^{\circ}\text{C}$ ;
- relative humidity: 20 % to 75 %.

When it is impracticable to carry out the tests under these conditions, a note to this effect, stating the ambient temperature and relative humidity during the tests, shall be added to the test report.

## 5.3.2 Normal test power source

### 5.3.2.1 Mains voltage

The normal test voltage for equipment to be connected to the mains shall be the nominal mains voltage. For the purpose of the present document, the nominal voltage shall be the declared voltage or any of the declared voltages for which the equipment was designed.

The frequency of the test power source corresponding to the ac mains shall be between 49 Hz and 51 Hz.

### 5.3.2.2 Regulated lead-acid battery power sources used on vehicles

When the radio equipment is intended for operation from the usual types of regulated lead-acid battery power source used on vehicles the normal test voltage shall be 1,1 times the nominal voltage of the battery (for nominal voltages of 6 V and 12 V, these are 6,6 V and 13,2 V respectively).

### 5.3.2.3 Other power sources

For operation from other power sources or types of battery (primary or secondary), the normal test voltage shall be that declared by the equipment supplier.

## 5.4 Extreme test conditions

### 5.4.1 Extreme temperatures

For tests at extreme temperatures, measurements shall be made in accordance with the procedures specified in clause 5.5, at the upper and lower temperatures of one of the following two ranges:

- a) -20 °C to +55 °C.  
All mobile and handportable equipment.  
Base stations for outdoor/uncontrolled climate conditions.
- b) 0 °C to +40 °C.  
Base stations for indoor/controlled climate conditions.

In the case of base station equipment, the supplier shall declare which conditions the equipment is intended to be installed in.

### 5.4.2 Extreme test source voltages

#### 5.4.2.1 Mains voltage

The extreme test voltage for equipment to be connected to an ac mains source shall be the nominal mains voltage  $\pm 10\%$ .

#### 5.4.2.2 Regulated lead-acid battery power sources used on vehicles

When the equipment is intended for operation from the usual types of regulated lead-acid battery power sources used on vehicles the extreme test voltages shall be 1,3 and 0,9 times the nominal voltage of the battery (for a nominal voltage of 6 V, these are 7,8 V and 5,4 V respectively and for a nominal voltage of 12 V, these are 15,6 V and 10,8 V respectively).

#### 5.4.2.3 Power sources using other types of batteries

The lower extreme test voltages for equipment with power sources using batteries shall be as follows:

- for the nickel metal-hydride, leclanché or lithium type: 0,85 times the nominal battery voltage;
- for the mercury or nickel-cadmium type: 0,9 times the nominal battery voltage.

No upper extreme test voltages apply.

In the case where no upper extreme test voltage is applicable, the corresponding four extreme test conditions are:

- $V_{\min}/T_{\min}$ ,  $V_{\min}/T_{\max}$ ;

- $(V_{\max} = \text{nominal})/T_{\min}, (V_{\max} = \text{nominal})/T_{\max}$ .

#### 5.4.2.4 Other power sources

For equipment using other power sources, or capable of being operated from a variety of power sources, the extreme test voltages shall be those declared by the equipment supplier.

## 5.5 Procedure for tests at extreme temperatures

### 5.5.0 Thermal balance

Before measurements are made the equipment shall have reached thermal balance in the test chamber. The equipment shall be switched off during the temperature stabilizing period.

In the case of equipment containing temperature stabilization circuits designed to operate continuously, the temperature stabilization circuits may be switched on for 15 minutes after thermal balance has been obtained, and the equipment shall then meet the specified requirements. For such equipment the supplier shall provide for the power source circuit feeding the crystal oven (if any) to be independent of the power source for the rest of the equipment.

If the thermal balance is not checked by measurements, a temperature stabilizing period of at least one hour, or a longer period as may be decided by the testing laboratory, shall be allowed. The sequence of measurements shall be chosen, and the humidity content in the test chamber shall be controlled so that excessive condensation does not occur.

#### 5.5.1 Procedure for equipment designed for continuous transmission

If the supplier states that the equipment is designed for continuous transmission, the test procedure shall be as follows.

Before tests at the upper extreme temperature, the equipment shall be placed in the test chamber, and left until thermal balance is attained. The equipment shall then be switched on in the transmit condition with modulation M1, M2, A1 or B1 (as appropriate, see clause 6.3.1), for a period of half an hour, after which the equipment shall meet the specified requirements.

Before tests at the lower extreme temperature, the equipment shall be left in the test chamber until thermal balance is attained, then switched to the standby or receive condition for a period of one minute, after which the equipment shall meet the specified requirements.

#### 5.5.2 Procedure for equipment designed for intermittent transmission

If the supplier states that the equipment is designed for intermittent transmission, the test procedure shall be as follows.

Before tests at the upper extreme temperature, the equipment shall be placed in the test chamber and left until thermal balance is attained. The equipment shall then be switched on for one minute in the transmit condition with modulation M1, M2, A1 or B1 (as appropriate, see clause 6.3.1), followed by four minutes in the receive condition, after which the equipment shall meet the specified requirements.

For tests at the lower extreme temperature, the equipment shall be left in the test chamber until thermal balance is attained, then switched to the standby or receive condition for one minute, after which the equipment shall meet the specified requirements.

---

## 6 General conditions of measurement

### 6.1 Test bandwidth

The supplier shall declare the maximum bandwidth of the equipment, i.e. the maximum separation between the lowest and highest edges of the necessary bandwidth.

The equipment shall be configured with the maximum number of channels, and with the maximum possible bandwidth for test conditions.

## 6.2 Test load (artificial antenna)

For conducted measurements of the transmitter, a power attenuator ("artificial antenna") shall be used, exhibiting a substantially non-reactive, non-radiating load of 50  $\Omega$  to the antenna connector and capable of dissipating the transmitter output power.

## 6.3 Test signals (wanted and unwanted signals)

### 6.3.0 General

The supplier shall declare details of the modulation scheme(s) used on each of the simultaneously transmitted channels, and the maximum number of channels that can be simultaneously transmitted by the equipment.

If a frequency conversion oscillator is used which produces an in-band spurious emission, the supplier shall declare the frequency and the tunable range of this oscillator.

### 6.3.1 Transmitter test signals for digital transmissions

The supplier shall declare details of the modulation scheme(s) used on each of the simultaneously transmitted channels. This shall be considered the normal modulation of the equipment.

Test signal M1 shall consist of a pseudo-random bit sequence of at least 511 bits (according to Recommendation ITU-T O.153 [1]), at the appropriate data rate.

If the transmission of a continuous bit stream is not possible, test signal M2 shall be trains of correctly coded bits or messages. An encoder of the type defined in clause 6.3.2 may be used.

For the purpose of testing PX in clause 7.1 test signals M1 and M2 should produce the largest value of output power (PEP) possible. If this is not the case then a test signal that does produce the largest possible value of output power (PEP) shall be used in the testing in clause 7.1.

For equipment that supports adaptive rates, testing is only required at one bit rate. For transmitter tests in clause 7 this would normally be the highest bit-rate supported by the equipment.

Suppliers shall declare where any of the specific tests in clause 7, if conducted at rates other than the highest bit rate, are likely to give results which are worse than at the highest bit rate. In such cases the tests shall be carried out at the rate declared by the supplier that is likely to give the worst performance (least margin between measured results and test limits).

### 6.3.2 Encoder for digital transmitter measurements

It is permissible to use an encoder to provide coded data from a pseudo-random bit sequence of at least 511 bits (according to Recommendation ITU-T O.153 [1]). Whenever a transmitter is not rated for continuous operation, the coded data may be transmitted in a discontinuous manner following as closely as possible the normal transmission characteristics of the EUT.

### 6.3.3 Transmitter test signals for analogue transmissions

#### 6.3.3.0 General

Test signals may be introduced to a line input or microphone socket for each of the channels of the transmitter and are defined in the following clauses.

#### 6.3.3.1 Test signals for frequency modulated channels

The test modulation signals are baseband signals that modulate the carrier of a channel. They are dependent upon the type of equipment under test and also the measurement to be performed.

Test modulating signals are:

- A1: a 1 000 Hz tone at a level which produces a deviation of 12 % of the channel separation;



- A2: a 1 250 Hz tone at a level 20 dB greater than that which produces a deviation of 12 % of the channel separation.

### 6.3.3.2 Test signals for amplitude modulated channels

For tests on analogue equipment via the audio input socket terminals, the test signal B1 shall consist of two equal amplitude non harmonically related sinusoidal input signals selected to be in the range 500 Hz to 3 kHz with at least 500 Hz separation between them, each of which would independently drive the transmitter into its compression region. The composite signal level shall be 20 dB higher than the level which produces 60 % modulation unless the output power at this drive level is less than the highest Tx output power in which case the signal level shall be set to produce the highest possible Tx output power.

For tests via any facilities sockets, test signal B1 shall be of the nature described by the supplier for the purpose of the socket, at a level which produces the largest value of output power (PEP) possible with analogue modulation. The resulting RF spectrum should be equivalent to that of B1 applied to the audio input terminals.

### 6.3.3.3 Transmitter effective radiated power test signal (C1)

Test signal C1 shall be any signal that provides a constant envelope of output power for each of the channels present at the output of the transmitter, and where each of the channels present operates at its maximum amplitude. This may be a CW tone or a modulated signal with constant envelope (e.g. GMSK). The envelope shall be flat to  $\pm 1$  dB.

## 6.4 Transceiver data interface for digital transmissions

Equipment that does not integrate the keyboard and display used for normal operation shall provide a suitable interface.

In the case where the equipment uses a proprietary interface, appropriate means and documentation allowing for the equipment to be tested are expected to be provided in view of the measurements.

Variation in the level of the input signals, within the specified limits for that interface, shall have no measurable influence on the characteristics of the signals on the radio path.

## 6.5 Impedance

In the present document the term "50  $\Omega$ " is used for a 50  $\Omega$  non-reactive impedance.

## 6.6 PEP

The PEP of a transmitter is the average power supplied to the artificial antenna by the transmitter during one RF cycle at the highest crest of the modulation envelope.

## 6.7 Duplex equipment

If the equipment is provided with a built-in duplex filter or with a separate associated filter, the requirements of the present document shall be met when the measurements are carried out using the antenna connector of the filter.

Duplex equipment having integral antenna may be tested using the internal or temporary antenna connector.

## 6.8 Modes of operation of the transmitter

Measurements shall be made with the transmitter being modulated representative of normal operation. If the transmitter is capable of being operated in more than one mode (e.g. continuous and burst modes) then it shall be tested in all such modes. The maximum and minimum burst durations shall be declared (and shall be declared for all channels if different durations are used on different channels).

If the equipment is fitted with an automatic transmitter shut-off facility it shall be made inoperative for the duration of the type test, unless it has to be left operative to protect the equipment.

The characteristics (continuous or discontinuous transmission, burst duration) of the transmission modes used for each of the following measurements shall be stated in the test report.

## 6.9 Measurement filter definition for digital transmissions

The measurement filter shall be a linear phase filter which is defined by the magnitude of its frequency response:

$$|H(f)| = G(f).$$

$$G(f) = 1 \quad \text{for} \quad |f| \leq (1 - \alpha)/2T$$

$$G(f) = \sqrt{0.5 \left( 1 - \sin \left( \pi (2|f|T - 1) / 2\alpha \right) \right)} \quad \text{for} \quad (1 - \alpha)/2T \leq |f| \leq (1 + \alpha)/2T$$

$$G(f) = 0 \quad \text{for} \quad |f| \geq (1 + \alpha)/2T$$

Where:

- $T$  is the symbol duration;
- $\alpha$  is the roll-off factor, which determines the width of the filter band at a given symbol rate.

The value of  $\alpha$  shall be 0,35. The symbol rate shall be 18 000 symbols per second.

## 6.10 Test site and general arrangements for measurements involving the use of radiated fields

For guidance see annex B: descriptions of the radiated measurement arrangements are included in this annex.

# 7 Technical characteristics of the transmitter

## 7.1 Transmitter output power (conducted)

### 7.1.0 General

This measurement applies only to equipment with an external 50  $\Omega$  antenna connector.

#### 7.1.1 Definitions

The PX of the transmitter is the maximum value of the output power of the transmitter, i.e. the peak envelope power of the transmitter, for any condition of modulation.

The rated maximum power of the transmitter is that declared by the supplier.

#### 7.1.2 Method of measurement

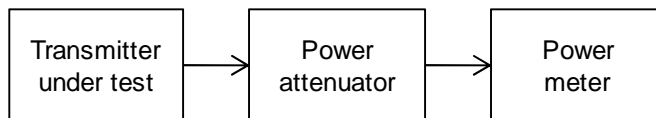

**Figure 2: Measurement arrangement**

The measurement shall be performed with test signal M1, M2, A1 or B1 (as appropriate, see clauses 6.3.1 and 6.3.3) applied to input ports for all channels of the transmitter. The modulation used shall be recorded in the test report.

All channels within the transmitter bandwidth shall be set to maximum power, and shall be set such that there is less than 1 dB variation in levels between channels. If this is not possible, then each channel shall be set to its maximum individual power, and the power settings recorded.

The transmitter shall be set in continuous transmission mode. If this is not possible, the measurements shall be carried out in a period shorter than the duration of the transmitted burst but not less than 90 % of the useful part of the burst. If the output power of the transmitter is adjustable the maximum output level shall be selected.

The transmitter shall be connected to a 50  $\Omega$  power attenuator, and the peak power delivered shall be measured. The measuring instrument shall have a measurement bandwidth not less than sixteen times the necessary bandwidth of the transmitter and shall be capable of measuring the PEP value of the modulated transmitter envelope.

The power measured is recorded as the value PX.

The measurement shall be made under normal test conditions (see clause 5.3) and extreme test conditions (see clauses 5.4.1 and 5.4.2).

### 7.1.3 Limits

The measured PX under normal test conditions shall be within  $\pm 2,0$  dB of the rated transmitter power (conducted).

The measured PX under extreme test conditions shall be within +3,0 dB and -4,0 dB of the rated output power.

It is assumed that the appropriate National Administration will state the maximum permitted transmitter output power.

## 7.2 Adjacent and alternate channel power

### 7.2.1 Definition

The adjacent channel power is that part of the total output power of a wanted channel under defined conditions of modulation, which falls within specified passbands centred on the nominal frequency of either of the channels adjacent to that wanted channel.

The alternate channel power is that part of the total output power of a transmitter, under defined conditions of modulation, which falls within specified passbands centred on the nominal frequency of any of the alternate channels, and measured with respect to the channel with the highest power output of the transmitter.

These powers are the sum of the rms powers produced by the modulation, hum and noise of the transmitter.

For equipment having a nominal channel bandwidth of 25 kHz and greater, the adjacent and 1<sup>st</sup> and 2<sup>nd</sup> alternate channels are defined as having channel bandwidths of 25 kHz, the specified passband of which is equal to the bandwidth of a square root raised cosine filter given in clause 6.9. The centre frequencies of the adjacent channels are frequencies of  $(f_c \pm (12,5 + BW/2))$  kHz, where  $f_c$  is the centre frequency of the wanted channel and BW is the channel bandwidth of the wanted channel. The centre frequencies of the alternate channels are frequencies of  $(f_c \pm (37,5 + BW/2))$  kHz (1<sup>st</sup> alternate channels) and  $(f_c \pm (62,5 + BW/2))$  kHz (2<sup>nd</sup> alternate channels).

For equipment using a nominal channel bandwidth of less than 25 kHz, the adjacent and alternate channels are defined as having measurement bandwidths of:

- For 20 kHz wanted channel bandwidth: measurement bandwidth equal to 14 kHz.
- For 12,5 kHz wanted channel bandwidth: measurement bandwidth equal to 8,5 kHz.
- For less than 12,5 kHz wanted channel bandwidth: measurement bandwidth equal to 70 % of the declared channel bandwidth.

For equipment using a nominal channel bandwidth of less than 25 kHz, the centre frequencies of the adjacent channels are frequencies of  $(f_c \pm BW)$  where  $f_c$  is the centre frequency of the wanted channel and BW is the channel bandwidth of the wanted channel. The centre frequencies of the alternate channels are frequencies of  $(f_c \pm 2 \times BW)$  for the 1<sup>st</sup> alternate channel, and  $(f_c \pm 3 \times BW)$  for the 2<sup>nd</sup> alternate channel.

The adjacent, alternate and wanted channels are depicted in figure 3.

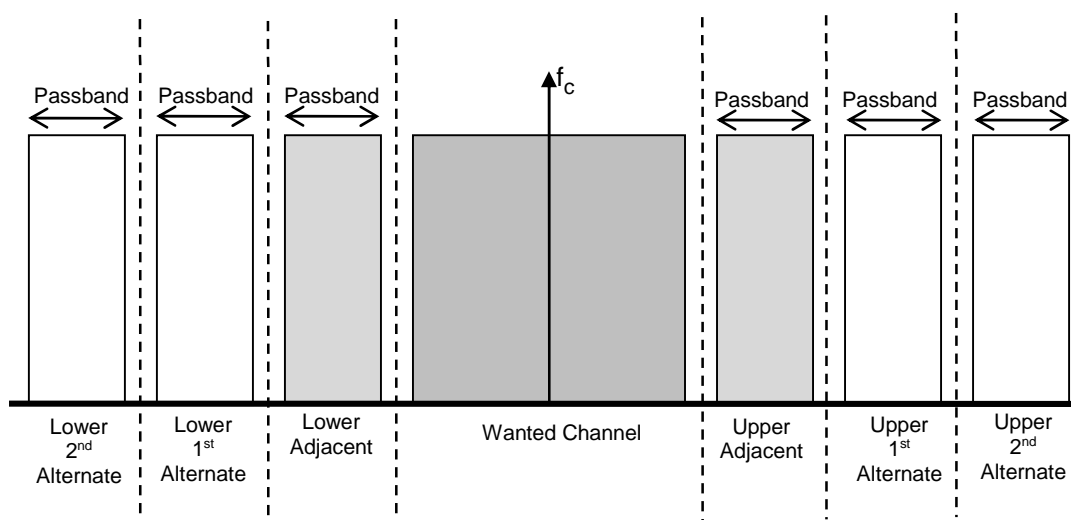

NOTE: This measurement is complemented by adjacent channel transient power measurements.

**Figure 3: Adjacent and alternate channel definitions**

A channel may be adjacent or alternate to more than one channel, or may be adjacent to one or more channels and alternate to one or more channels.

## 7.2.2 Method of measurement

The adjacent and alternate channel powers shall be measured with a spectrum analyser for channel bandwidths of greater than 25 kHz, or a spectrum analyser with an appropriate channel bandwidth for bandwidths of 25 kHz or less. An equivalent measurement instrument, which conforms with the requirements given in annex C may be used instead.

The transmitter shall be operated at the value of PX determined under normal test conditions. All channels within the transmitter bandwidth shall be set to maximum power, and shall be set such that there is less than 1 dB variation in levels between channels. If this is not possible, then each channel shall be set to its maximum individual power.

The transmitter shall be operated with its maximum number of channels, and with the maximum specified frequency spacing between highest and lowest frequency channels.

The wanted channels of the transmitter shall be modulated with test signal M1 M2, A2 or B1 as appropriate. The modulation used shall be recorded in the test report.

The transmitter shall be tested at the maximum and minimum burst mode durations as declared with all channels operating at their maximum power level (where maximum burst duration may be continuous operation). The measurements shall be carried out in a period shorter than the duration of the transmitted burst but not less than 90 % of the useful part of the burst.

The output of the transmitter shall be connected to the input of the spectrum analyser by a 50  $\Omega$  power attenuator, to ensure that the impedance presented to the transmitter is 50  $\Omega$  and the level at the test equipment input is appropriate.

The resolution bandwidth of the spectrum analyser, if used, shall be: 1 000 Hz for channels bandwidths  $\geq$  25 kHz; 500 Hz for channel bandwidths between greater than 10 kHz but less than 25 kHz and 300 Hz for channel bandwidths  $\leq$  10 kHz.

Initially the longest burst duration permitted by the EUT shall be used or a steady state measurement after 15 minutes of operation if continuous operation is permitted.

The rms power present in each of the wanted channels, measured on the spectrum analyser, shall be recorded as the reference wanted channel power, PR for each wanted channel. For the purposes of the measurement limit, the highest rms power PRX of all the individual PR measurements of the channels of the transmitter shall be determined.

For the purpose of the remainder of this test the measurement bandwidth (MBW) shall be equal to the specified passband of the adjacent and alternate channels (clause 7.2.1) relevant to the wanted channel to which the measured channel is adjacent, or if a spectrum analyser is used for wanted channel bandwidths of 25 kHz or greater, a power measurement bandwidth of 18 kHz shall be used.

For each wanted channel, the MBW shall be centred on the centre frequency of the upper adjacent channel. The rms power present in the MBW shall be recorded (the adjacent channel power).

The measurement shall be repeated with the MBW centred on the centre frequency of the lower adjacent channel.

The measurement shall be repeated for each of the channels of the transmitter in turn.

If an adjacent channel of one wanted channel is contained within or overlapped by the wanted bandwidth of another channel, the measurement shall not be made for that adjacent channel.

A channel may be adjacent to one or two wanted channels, and may also be alternate to one or more wanted channels. The highest value of all adjacent channel power measurements shall be taken as the adjacent channel power for the transmitter, irrespective of whether the measured channel is adjacent or alternate to more than one wanted channel.

The measurement shall be made under normal test conditions (see clause 5.3) and repeated under extreme test conditions (clauses 5.4.1 and 5.4.2 applied simultaneously).

Where all channels have been set with less than 1 dB power variation, the adjacent channel power ratio is the difference (in dB) between the highest rms measured wanted power of all channels (PRX) under normal test conditions and the largest measured adjacent channel power.

Where test are conducted under normal and extreme test conditions, this results in two values for the adjacent channel power ratio.

If the channels of the transmitter cannot be set such that the variation between channels is less than 1 dB, an adjacent channel power measurement shall be made for each channel of the transmitter in turn and the ratio for each channel calculated as the difference (in dB) between the measured wanted power of that channel and the higher of the two adjacent channel powers for that channel. If a channel is adjacent to two wanted channels, the adjacent channel power ratio shall be the ratio between the power of the higher of the wanted channel powers and the power measured in the adjacent channel. The lowest ratio of wanted power to adjacent channel power of all of the channels shall be recorded as the adjacent channel power ratio of the transmitter.

Alternatively, if the spectrum analyser measures rms adjacent channel power automatically, the adjacent channel power (in dB) may be measured directly at normal and extreme test conditions. The analyser should use an analogue measurement method without frequency weighting and not using an accelerated method. The adjacent channel power ratio is the smaller of the calculated ratios from the two channels above and below each wanted channel, excluding any adjacent channel which is contained within or overlapped by the wanted bandwidth of another carrier.

The measurement shall be repeated with the MBW centred on the centre frequencies of each of the 1<sup>st</sup> and 2<sup>nd</sup> upper and lower alternate channels for each wanted channel in the transmitter in turn. The rms power present in the MBW shall be recorded (the alternate channel power) for each of these channels. The measurement shall be made under normal test conditions (see clause 5.3) and repeated under extreme test conditions (see clauses 5.4.1 and 5.4.2 applied simultaneously). Automatic measurement may also be used if supported by the spectrum analyser. If an alternate channel is also adjacent to another wanted channel, the measurement shall not be made for that channel as it will already have been measured as an adjacent channel. If an alternate channel is also alternate to one or more other wanted channels, the number of channels to which the measured channel is alternate shall be recorded.

Where all channels have been set with less than 1 dB power variation, the alternate channel power ratio is the difference (in dB) between the highest rms measured integrated wanted channel power of all channels under normal test conditions (PRX) and the measured alternate channel power.

For measured channels that are alternate to only one wanted channel, the ratio obtained with the largest power reading from all alternate channels shall be recorded. For measured channels that are alternate to two wanted channels, the ratio obtained with the largest power reading for all measured channels that are alternate to two channels shall be recorded. For measured channels that are alternate to three or more channels, the ratio obtained with the largest power reading for all measured channels alternate the three or more channels shall be recorded. Thus up to three alternate power ratios may be recorded for the transmitter under test.

Where tests are conducted under normal and extreme test conditions, this results in two sets of values for the alternate channel power ratio.

If the channels of the transmitter cannot be set such that the variation between channels is less than 1 dB, a measurement shall be made independently of alternate power ratios for each channel of the transmitter in turn, except where an alternate channel is also a wanted channel or is adjacent to a wanted channel in which case no measurement shall be made. If a channel is alternate to two or more wanted channels, the alternate channel power ratio shall be the ratio between the power of the higher of the wanted channel powers and the power measured in the alternate channel. Alternate channel power ratios shall be recorded for channels that are alternate to one channel, alternate to two channels, and alternate to three or more channels, and in each case the lowest power ratio from all measurements of each combination (i.e. alternate to one, two or three or more channels) across all channels of the transmitter shall be recorded. Thus up to three alternate power ratios may be recorded for the transmitter under test.

The tests shall be repeated with the transmitter operated with its maximum number of channels, and with the minimum specified frequency spacing between highest and lowest frequency channels. Where the minimum spacing allows all the carriers to be adjacent then the test shall also be repeated with a spacing of one channel between each of the transmitter channels.

The tests shall be repeated using the shortest burst duration supported by the EUT.

**Table 2: Summary of measurement offset**

	5 kHz Channels	6,25 kHz Channels	10 kHz Channels	12,5 kHz Channels	20 kHz Channels	25 kHz Channels	50 kHz Channels	100 kHz Channels	150 kHz Channels
<b>Nominal Channel Bandwidth (for measurement of PR)</b>	5 kHz	6,25 kHz	10 kHz	12,5 kHz	20 kHz	25 kHz	50 kHz	100 kHz	150 kHz
<b>Centre of Adjacent Channel (relative to centre of the nominal channel)</b>	±5 kHz	±6,25 kHz	±10 kHz	±12,5 kHz	±20 kHz	±25 kHz	±37,5 kHz	±62,5 kHz	±87,5 kHz
<b>Centre of 1<sup>st</sup> Alternate Channel (relative to centre of the nominal channel)</b>	±10 kHz	±12,5 kHz	±20 kHz	±25 kHz	±40 kHz	±50 kHz	±62,5 kHz	±87,5 kHz	±112,5 kHz
<b>Centre of 2<sup>nd</sup> Alternate Channel (relative to centre of the nominal channel)</b>	±15 kHz	±18,75 kHz	±30 kHz	±37,5 kHz	±60 kHz	±75 kHz	±87,5 kHz	±112,5 kHz	±137,5 kHz

### 7.2.3 Limits

Table 3a specifies the limits for the adjacent and alternate channel power ratio according to the number of channels that a channel is adjacent to or alternate to under normal test conditions, see clause 5.3.

**Table 3a: Summary of specifications at different offset frequencies under normal test conditions**

Number of channels to which the channel is alternate:	Number of channels to which the channel is adjacent:		
	0	1	2
0	-	55 dB	55 dB
1	60 dB	55 dB	55 dB
2	57 dB	55 dB	55 dB
3 or more	55 dB	55 dB	55 dB

Table 3b specifies the limits for the adjacent channel power ratio according to the number of channels that a channel is adjacent to or alternate to under extreme test conditions, see clause 5.4.

**Table 3b: Summary of specifications at different offset frequencies under extreme test conditions**

Number of channels to which the channel is alternate:	Number of channels to which the channel is adjacent:		
	0	1	2
0	-	50 dB	50 dB
1	55 dB	50 dB	50 dB
2	52 dB	50 dB	50 dB
3 or more	50 dB	50 dB	50 dB

The power in an adjacent or alternate channel shall not need to be below  $0,2 \mu\text{W}$  (-37 dBm), under both normal and extreme conditions.

## 7.3 Unwanted emissions

### 7.3.1 Definition

Unwanted emissions are emissions on a frequency, or frequencies, which are outside the necessary bandwidth of the wanted channels of the transmitter equipment and the level of which may be reduced without affecting the corresponding transmission of information. Unwanted emissions include harmonic emissions, parasitic emissions, intermodulation products and frequency conversion products but exclude adjacent and alternate channel emissions. For the purpose of the present document there are three bands defined:

- The in-band domain is the necessary bandwidth of the transmitter, which includes the wanted bandwidths of the highest and lowest frequency channels transmitted. Unwanted emissions in the in-band domain shall not be measured on any frequency defined as an adjacent or alternate channel frequency to any channel transmitted by the equipment.
- The out-of-band (OOB) domain consists of frequencies within  $\pm 250\%$  of the transmitter necessary bandwidth, excluding the transmitter necessary bandwidth, and is measured from the centre frequency of the transmitter. The centre frequency of the transmitter is the mid frequency between the highest and lowest channel frequencies. The centre frequencies of the out-of-band domain are therefore those frequencies at  $\pm 150\%$  of the transmitter necessary bandwidth measured from the centre frequency of the transmitter. Unwanted emissions in the out-of-band domain shall not be measured on any frequency defined as an adjacent or alternate channel frequency to any channel transmitted by the equipment.
- The spurious domain is taken as all other frequencies which are not included in the in-band or the out-of-band domains.

The domains are illustrated in figure 4.

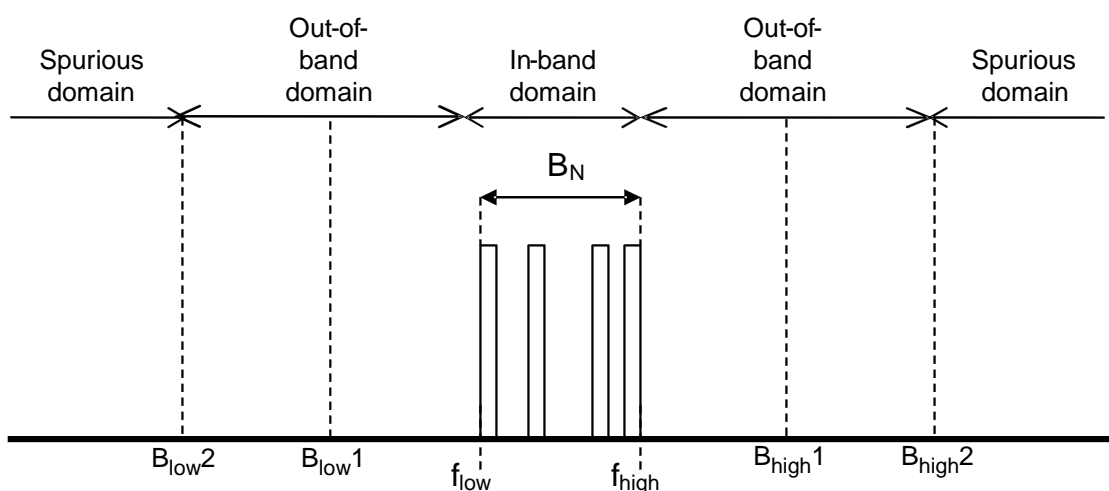

**Figure 4: Unwanted Emissions Boundaries**

Table 4

For $B_N \leq 10$ MHz	For $B_N > 10$ MHz
The lower boundary for OOB limits is: $B_{low2} = (f_{low} / 2) + (f_{high} / 2) - (2,5 B_N)$ $B_{high2} = (f_{low} / 2) + (f_{high} / 2) + (2,5 B_N)$	The lower boundary for OOB limits is: $B_{low2} = (f_{low} / 2) + (f_{high} / 2) - (1,5 B_N + 10)$ $B_{high2} = (f_{low} / 2) + (f_{high} / 2) + (1,5 B_N + 10)$
The centre frequency of the OOB domain is: $B_{low1} = (f_{low} / 2) + (f_{high} / 2) - (1,5 B_N)$ $B_{high1} = (f_{low} / 2) + (f_{high} / 2) + (1,5 B_N)$	The centre frequency of the OOB domain is: $B_{low1} = (f_{low} / 2) + (f_{high} / 2) - (0,5 B_N + 10)$ $B_{high1} = (f_{low} / 2) + (f_{high} / 2) + (0,5 B_N + 10)$
Where:	
<ul style="list-style-type: none"> <li>• All frequencies are in MHz.</li> <li>• <math>B_{low1}</math>, <math>B_{low2}</math>, <math>B_{high1}</math>, <math>B_{high2}</math>, <math>f_{high}</math>, <math>f_{low}</math> are shown in figure 4.</li> <li>• <math>B_N</math> is the necessary bandwidth.</li> </ul>	

Third order intermodulation products can arise between wanted channels of the transmitter. Limits are specified in clause 7.3.3.4 for these products where they arise between  $B_{low1}$  to  $B_{high1}$ ; outside this frequency range the limits in clause 7.3.3.1 shall apply. In order that it can be classified as a third order intermodulation product, the frequency of the spurious emission  $I_i$  caused by intermodulation between two wanted channels of frequencies  $F_a$  and  $F_b$  shall satisfy one of the equations:

$$I_i = 2F_a - F_b \text{ or } I_i = 2F_b - F_a$$

Alternatively the frequency of spurious emission  $I_i$  between three wanted channels of frequencies  $F_a$ ,  $F_b$  and  $F_c$  shall satisfy one of the equations:

$$I_i = F_a + F_b - F_c \text{ or } I_i = F_a + F_c - F_b \text{ or } I_i = F_b + F_c - F_a$$

## 7.3.2 Method of measuring the power level

### 7.3.2.1 Measurement options

The level of spurious emissions shall be considered to be either:

- a) their power level in a specified load (conducted spurious emission); and
- b) their effective radiated power when radiated by the cabinet and structure of the equipment (cabinet radiation);  
or
- c) their effective radiated power when radiated by the cabinet and by the integral antenna, in the case of hand portable equipment fitted with such an antenna and no external RF connector.

NOTE: There are only two options allowed: either both a) and b) or only c).

Specific measurements are made on frequencies where spurious emissions result from a frequency conversion oscillator (clause 7.3.2.5) and where third order intermodulation products exist between wanted channels (clause 7.3.2.6).

In addition equipment shall be specifically measured for wideband noise.

#### 7.3.2.2 Method of measuring conducted spurious emissions (clause 7.3.2.1 a))

Spurious emissions shall be measured as the mean power level of any signal delivered into a 50  $\Omega$  load. This may be done by connecting the transmitter output through an attenuator to either a spectrum analyser (see also annex C) or selective voltmeter or by monitoring the relative levels of the spurious signals delivered to an artificial antenna (see clause 6.2).



The transmitter shall be operated at power PX. All channels of the transmitter shall be modulated with the test signal M1, M2, A2 or B1 (as appropriate, see clause 6.3.1). If possible, the modulation should be continuous for the duration of the measurement. If this is not possible, the measurements shall be carried out in a period shorter than the duration of the transmitted burst but not less than 90 % of the useful part of the burst. For equipment operating below 1 GHz, measurements shall be made over the frequency range 30 MHz to 4 GHz. For equipment operating on frequencies in the range 470 MHz to 1 GHz the measurements shall also be performed over the frequency range 4 GHz to 12,75 GHz if emissions are detected within 10 dB of the specified limit between 1,5 GHz and 4 GHz. For equipment operating above 1 GHz measurements shall be made between 30 MHz and 12,75 GHz.

The measurements shall not be performed on any channel which is either a wanted channel or a channel that is adjacent or alternate to a wanted channel.

As a general rule, the resolution bandwidth of the measuring receiver should be equal to the reference bandwidth as given in clause 7.3.3.1 (see note). The bandwidth used in this measurement for each spurious emission shall be sufficiently narrow to reject emissions in the seven contiguous channels centred on the channel on which each channel of the transmitter is intended to operate.

The measurement shall be repeated with the transmitter in the "stand-by" position.

NOTE: *"To improve measurement accuracy, sensitivity and efficiency, the resolution bandwidth can be different from the reference bandwidth. When the resolution bandwidth is smaller than the reference bandwidth, the result should be integrated over the reference bandwidth. When the resolution bandwidth is greater than the reference bandwidth, the result for broadband spurious emissions should be normalized to the bandwidth ratio. For discrete spur, normalization is not applicable, while integration over the reference bandwidth is still applicable."* (extract from CEPT/ERC/REC 74-01 [i.1], recommend 4, page 5).

### 7.3.2.3 Method of measuring the effective radiated power (clause 7.3.2.1 b))

On a test site, selected from annex B, the equipment shall be placed at the specified height on a non-conducting support and in the position closest to normal use as declared by the supplier.

The transmitter antenna connector shall be connected to an artificial antenna (see clause 6.2).

The output of the test antenna shall be connected to a measuring receiver.

The test antenna shall be orientated for vertical polarization and the length of the test antenna shall be chosen to correspond to the frequency of the measuring receiver.

The transmitter shall be switched on with C1 modulation, and the measuring receiver shall be tuned over the frequency range 30 MHz to 4 GHz, except for any channel which is either a wanted channel or a channel that is adjacent or alternate to a wanted channel. At each frequency at which a discrete spurious component is detected, the test antenna shall be raised and lowered through the specified range of heights until a maximum signal level is detected on the measuring receiver. The resolution bandwidth of the measuring instrument shall be the smallest bandwidth available which is greater than the spectral width of the spurious component being measured. This shall be considered to be achieved when the next highest bandwidth causes less than 1 dB increase in amplitude.

When a test site according to clause B.1.1 is used, there is no need to vary the height of the antenna.

The transmitter shall then be rotated through 360° in the horizontal plane, until the maximum signal level is detected by the measuring receiver.

The transmitter shall be modulated by the test signal M1 M2, A2 or B1 (as appropriate, see clauses 6.3.1 or 6.3.3). If possible, the modulation should be continuous for the duration of the measurement. When burst transmission is used, the mean power of any spurious emissions shall be measured using averaging over the duration of the burst. The measuring receiver shall measure the mean power and this power shall be noted. The horizontal and vertical orientation of the antenna shall also be noted.

The transmitter shall be replaced by a substitution antenna as defined in clause B.1.5.

The substitution antenna shall be orientated for vertical polarization and the length of the substitution antenna shall be adjusted to correspond to the frequency of the spurious component detected.

The substitution antenna shall be connected to a calibrated signal generator.

The frequency of the calibrated signal generator shall be set to the frequency of the spurious component detected.

The input attenuator setting of the measuring receiver shall be adjusted in order to increase the sensitivity of the measuring receiver, if necessary.

The test antenna shall be raised and lowered through the specified range of heights to ensure that the maximum signal is received.

When a test site according to clause B.1.1 is used, there is no need to vary the height of the antenna.

The input signal to the substitution antenna shall be adjusted to the level that produced a level detected by the measuring receiver, that is equal to the level noted while the spurious component was measured, corrected for the change of input attenuator setting of the measuring receiver.

The input level to the substitution antenna shall be recorded as power level.

The measurement shall be repeated with the test antenna and the substitution antenna orientated for horizontal polarization.

The measure of the effective radiated power of the spurious components is the larger of the two power levels recorded for each spurious component at the input to the substitution antenna, corrected for the gain of the antenna if necessary.

For equipment operating on frequencies above 470 MHz the measurements shall also be performed over the frequency range 4 GHz to 12,75 GHz if emissions are detected within 10 dB of the specified limit between 1,5 GHz and 4 GHz.

As a general rule, the resolution bandwidth of the measuring receiver should be equal to the reference bandwidth as given in clause 7.3.3 (see note). The bandwidth used in this measurement for each spurious emission shall be sufficiently narrow to reject emissions in the seven contiguous channels centred on the channel on which the transmitter is intended to operate.

The measurement shall be repeated with the transmitter in the "stand-by" position.

NOTE: *"To improve measurement accuracy, sensitivity and efficiency, the resolution bandwidth can be different from the reference bandwidth. When the resolution bandwidth is smaller than the reference bandwidth, the result should be integrated over the reference bandwidth. When the resolution bandwidth is greater than the reference bandwidth, the result for broadband spurious emissions should be normalized to the bandwidth ratio. For discrete spur, normalization is not applicable, while integration over the reference bandwidth is still applicable."* (extract from CEPT/ERC/REC 74-01 [i.1], recommend 4, page 5).

#### 7.3.2.4 Method of measuring wideband noise

This method applies to all equipment.

Spurious emissions shall be measured as the mean power level of any signal delivered into a 50  $\Omega$  load from either the permanent or temporary antenna connector, as appropriate.

The transmitter shall be operated with power PX. All channels of the transmitter shall be modulated with the test signal M1, M2, A2 or B1 (as appropriate, see clauses 6.3.1 or 6.3.3). If possible, the modulation should be continuous for the duration of the measurement. If this is not possible, the measurements shall be carried out in a period shorter than the duration of the transmitted burst but not less than 90 % of the useful part of the burst.

Wideband noise level at selected frequency offsets from each wanted channel and outside the necessary bandwidth of the transmitter shall be measured through the measurement filter, refer to clause 6.9 or if a spectrum analyser is used a power measurement bandwidth of 18 kHz shall be used. The average power within the bandwidth shall be recorded. The measurements shall be not be performed on any channel which is either a wanted channel or a channel that is adjacent or alternate to any wanted channels.

The selected frequency offsets shall cover at least the frequencies indicated in tables 3a and 3b.

If a discrete spurious lies in one of these bands, then the closest discrete spurious free frequency with a larger frequency offset shall be chosen (frequency steps shall be in 25 kHz increments) provided it is possible to find such a frequency, as detailed below.

The measurement shall be performed at the specified offsets above and below the nominal frequency of each channel, and at the specified offsets from the necessary bandwidth of the transmitter.

For frequencies within the necessary bandwidth of the transmitter and within  $\pm 500$  kHz of the necessary bandwidth of the transmitter, tests shall be made at offsets from the individual channels both in between the channels, and outside the necessary bandwidth of the transmitter. The offsets are dependent on the bandwidth of the channels of the transmitter. Tests shall not be made at any test frequency offset from one channel where that test frequency has a lesser frequency offset from any other channel within the transmitter.

**EXAMPLE:** If a transmitter contains two 25 kHz bandwidth channels with centre frequencies  $F_1$  and  $F_2$  where  $F_2 - F_1 = 500$  kHz, tests shall be made at  $F_1 \pm 112,5$  kHz and  $F_2 \pm 112,5$  kHz. However as  $F_1 + 262,5$  kHz  $>$   $F_2 - 262,5$  kHz and therefore  $F_1 + 262,5$  kHz has a lesser offset to  $F_2$  than it has to  $F_1$ , measurements of  $F_1 + 262,5$  kHz (and greater offsets) and  $F_2 - 262,5$  kHz (and greater offsets) shall not be made.  $F_1 - 262,5$  kHz and  $F_2 + 262,5$  kHz shall be tested, as these lie within  $\pm 500$  kHz of the necessary bandwidth of the amplifier.  $F_1 - 512,5$  kHz and  $F_2 + 512,5$  kHz do not need to be tested against table 3a, as these will be encompassed by the test offsets detailed in table 3b.

**Table 5a: Selected frequency offsets from channel centre frequencies for wideband noise measurement within  $\pm 500$  kHz of the necessary bandwidth of the transmitter**

Channel Bandwidth (kHz)	Frequency offset (kHz)
$\leq 25$	112,5
$\leq 25$	262,5
$\leq 25$	512,5
$\leq 25$	1 012,5
50	137,5
50	262,5
50	512,5
50	1 012,5
100	162,5
100	312,5
100	512,5
100	1 012,5
150	187,5
150	337,5
150	512,5
150	1 012,5

For frequencies greater than  $\pm 500$  kHz from the necessary bandwidth of the transmitter, tests shall be made at frequencies in table 5b which are offset below  $f_{low}$  and above  $f_{high}$  (where  $f_{low}$  and  $f_{high}$  are defined in clause 7.3.1). These apply for any bandwidth of channels in the transmitter.

**Table 5b: Selected frequency offsets below  $f_{low}$  and above  $f_{high}$  for wideband noise measurement above  $\pm 500$  kHz of the necessary bandwidth of the transmitter**

Frequency offset from $f_{low}$ and $f_{high}$ (kHz)
512,5
1 012,5
2 512,5
$f_{rb} + 12,5$
NOTE: $f_{rb}$ denotes the frequency offset corresponding to the near edge of the receive band or 10 MHz (20 MHz for frequencies above 520 MHz) whichever is smaller.

### 7.3.2.5 Method for measuring frequency conversion oscillator conducted spurious emissions

This method applies only when the supplier declares a specific frequency conversion oscillator frequency that is located within the in-band domain of the transmitter, and is declared to be tunable by the supplier. The tuning capability shall be at least one or more wanted channel bandwidths. If these requirements are not met, any frequency conversion oscillator emissions shall be measured according to clause 7.3.2.2 with limits according to clause 7.3.3.1.

The measurement method of clause 7.3.2.2 shall apply to determine the power of the spurious emission. The measurement bandwidth shall be 1 kHz. The spurious power ratio shall be calculated as the ratio between the measured power of the spurious emission and the highest of the rms powers of all the wanted channel PR measurements, PRX, measured as defined in clause 7.2.2.

### 7.3.2.6 Method for measuring third order intermodulation products between wanted channels

For the intermodulation products  $I_i$  defined in clause 7.3.1, the measurement method of clause 7.3.2.2 shall apply to determine the power of the spurious emission. The measurement bandwidth shall be 30 kHz. The channels of the transmitter shall be set to their highest power outputs and shall have no more than 1 dB variation in power between channels. If the 1 dB variation cannot be achieved, all channels shall be set to their maximum power.

The spurious power ratio shall be calculated as the ratio between the measured power of the spurious emission and the highest of the rms powers of all the wanted channel PR measurements, PRX, measured as defined in clause 7.2.2 provided that the channels of the transmitter have no more than 1 dB variation in power level. If the variation between channel powers is greater than 1 dB, the spurious power ratio shall be calculated as the ratio between the measured power of the spurious emission and the greater of the power levels of the channels that are generating the intermodulation product.

## 7.3.3 Limits

### 7.3.3.1 Spurious emissions power

The mean power of any spurious emission in the in-band and out-of-band domains ( $B_{low2} < F < B_{high2}$ , clause 7.3.1) excluding any frequencies defined as adjacent or alternate frequencies to any channel (clause 7.2), excluding one single frequency declared to be that of a tunable frequency conversion oscillator by the supplier (clause 7.3.2.5) and excluding frequencies where third order intermodulation products between wanted channels arise (limits specified in clause 7.3.3.4), shall not exceed the values given in tables 6a and 6b.

**Table 6a: Conducted emissions in the in-band and out-of-band domains**

Frequency range	9 kHz to 1 GHz	Above 1 GHz to 4 GHz, or above 1 GHz to 12,75 GHz (see clause 7.3.2.2)
Tx operating with one channel	0,25 $\mu$ W (-36,0 dBm)	1,0 $\mu$ W (-30,0 dBm)
Tx operating with two channels	0,5 $\mu$ W (-33,0 dBm)	1,0 $\mu$ W (-30,0 dBm)
Tx operating with three channels	0,75 $\mu$ W (-31,0 dBm)	1,0 $\mu$ W (-30,0 dBm)
Tx operating with four or more channels	1,0 $\mu$ W (-30,0 dBm)	1,0 $\mu$ W (-30,0 dBm)
Tx Standby	2,0 nW (-57,0 dBm)	20,0 nW (-47,0 dBm)

**Table 6b: Radiated emissions in the in-band and out-of-band domains**

Frequency range	30 MHz to 1 GHz	Above 1 GHz to 4 GHz, or above 1 GHz to 12,75 GHz (see clause 7.3.2.3)
Tx operating	0,25 $\mu$ W (-36,0 dBm)	1,0 $\mu$ W (-30,0 dBm)
Tx Standby	2,0 nW (-57,0 dBm)	20,0 nW (-47,0 dBm)

The mean power of any spurious emission in the spurious domain, ( $F < B_{low2}$  or  $F > B_{high2}$ , clause 7.3.1) shall not exceed the values given in tables 6c and 6d.

**Table 6c: Conducted emissions in the spurious domain**

Frequency range	9 kHz to 1 GHz	Above 1 GHz to 4 GHz, or above 1 GHz to 12,75 GHz (see clause 7.3.2.2)
Tx operating with any number of channels	0,25 $\mu$ W (-36,0 dBm)	1,0 $\mu$ W (-30,0 dBm)
Tx Standby	2,0 nW (-57,0 dBm)	20,0 nW (-47,0 dBm)

**Table 6d: Radiated emissions in the spurious domain**

Frequency range	30 MHz to 1 GHz	Above 1 GHz to 4 GHz, or above 1 GHz to 12,75 GHz (see clause 7.3.2.3)
Tx operating	0,25 $\mu$ W (-36,0 dBm)	1,0 $\mu$ W (-30,0 dBm)
Tx Standby	2,0 nW (-57,0 dBm)	20,0 nW (-47,0 dBm)

**Table 7a: Reference bandwidths to be used for the measurement of spurious emissions outside the frequency offsets specified in table 5b**

Frequency range	Reference bandwidth
9 kHz to 150 kHz	1 kHz
150 kHz to 30 MHz	10 kHz
30 MHz to 1 GHz	100 kHz
1 GHz to 12,75 GHz	1 MHz

**Table 7b: Reference bandwidths to be used in-band and out-of-band domains**

Frequency offset from carrier	Reference bandwidth
From $B_{low1}$ to $B_{high1}$ See note	1 kHz
From $B_{low2}$ to $B_{low1}$ and $B_{high1}$ to $B_{high2}$ See note	10 kHz
NOTE: $B_{low1}$ , $B_{low2}$ , $B_{high1}$ and $B_{high2}$ are defined in clause 7.3.1.	

### 7.3.3.2 Wideband noise power

The wideband noise levels, measured at offsets from the channels of the transmitter, and from the necessary bandwidth of the transmitter specified in clause 7.3.2.4 shall not exceed the limits shown in tables 8a and 8b, when the transmitter is operated at power level (PX) as stated. When applicable, relative measurements (dBc) shall refer to the power level PRX derived in clause 7.2.2. The requirements apply symmetrically to both sides of the transmitter band. If any channel of the transmitter has a bandwidth in excess of 125 kHz, the limits in table 8b shall apply, otherwise the limits in table 8a shall apply.

**Table 8a: Wideband noise limits for wanted channel bandwidth < 125 kHz**

Frequency offset	Maximum wideband noise level
$f_{low} - 500 \text{ kHz}$ to $f_{high} + 500 \text{ kHz}$ Notes 1 and 2	$-70 + 10\log N \text{ dBc}$ ( $N_{max} = 4$ ) Note 3
$f_{low} - 500 \text{ kHz}$ to $f_{low} - 1 \text{ MHz}$ and $f_{high} + 500 \text{ kHz}$ to $f_{high} + 1 \text{ MHz}$ Note 1	-75 dBc
> 1 MHz from $f_{low}$ or $f_{high}$ to $f_{rb}$ Notes 1 and 4	-80 dBc
> $f_{rb}$ Note 4	-95 dBc
NOTE 1: $f_{low}$ and $f_{high}$ defined in clause 7.3.1. NOTE 2: Limits do not apply for frequencies defined as adjacent or alternate channels in clause 7.2. NOTE 3: N = Number of channels transmitted from N = 1 to N = 4. N = 4 if number of channels > 4. NOTE 4: $f_{rb}$ denotes the frequency offset corresponding to the near edge of the receive band or 10 MHz (20 MHz for frequencies above 520 MHz) whichever is smaller.	

**Table 8b: Wideband noise limits for wanted channel bandwidth  $\geq 125 \text{ kHz}$** 

Frequency offset	Maximum wideband noise level
$f_{low} - 500 \text{ kHz}$ to $f_{high} + 500 \text{ kHz}$ Notes 1 and 2	-60 dBc Note 3
$f_{low} - 500 \text{ kHz}$ to $f_{low} - 1 \text{ MHz}$ and $f_{high} + 500 \text{ kHz}$ to $f_{high} + 1 \text{ MHz}$ Note 1	-70 dBc
> 1 MHz from $f_{low}$ or $f_{high}$ to $f_{rb}$ Notes 1 and 4	-80 dBc
> $f_{rb}$ Note 4	-95 dBc
NOTE 1: $f_{low}$ and $f_{high}$ defined in clause 7.3.1. NOTE 2: Limits do not apply for frequencies defined as adjacent or alternate channels in clause 7.2. NOTE 3: There is no variation in the limit according to number of channels for wanted channel bandwidth $\geq 125 \text{ kHz}$ . NOTE 4: $f_{rb}$ denotes the frequency offset corresponding to the near edge of the receive band or 10 MHz (20 MHz for frequencies above 520 MHz) whichever is greater.	

For all levels in tables (8a to 8b) no limit tighter than -55 dBm for offsets  $< f_{rb}$  or -70 dBm for offsets  $> f_{rb}$  shall apply.

### 7.3.3.3 Frequency conversion oscillator spurious emission

The spurious power ratio from the frequency conversion oscillator with respect to the average wanted channel power PR, measured according to the method of clause 7.3.2.5 shall not exceed -70 dBc, The spurious power shall not need to be below 0,25  $\mu\text{W}$  (-36 dBm).

### 7.3.3.4 Third order intermodulation product spurious emission

The spurious power ratio from third order intermodulation products, measured according to the method of clause 7.3.2.6 between  $B_{low1}$  to  $B_{high1}$  as defined in clause 7.3.1 shall not exceed -60 dBc. The spurious power shall not need to be below 0,25  $\mu\text{W}$  (-36 dBm).

## 7.4 Intermodulation attenuation

### 7.4.0 Applicability

This requirement applies only to transmitters to be used in base stations.

### 7.4.1 Definition

For the purpose of the present document the intermodulation attenuation is a measure of the capability of a transmitter to inhibit the generation of signals in its non-linear elements caused by the presence of the transmitter and an interfering signal entering the transmitter via its antenna.

### 7.4.2 Method of measurement

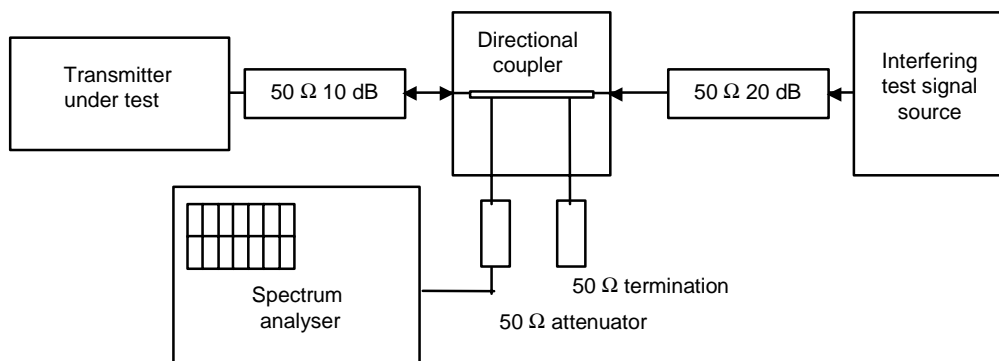

**Figure 5: Measurement arrangement**

The measurement arrangement shown in figure 5 shall be used.

The transmitter shall be connected to a 50 Ω 10 dB power attenuator and via a (directional) coupler to a spectrum analyser. An additional attenuator may be required between the directional coupler and the spectrum analyser to avoid overloading.

The interfering signal source may be either a transmitter providing the same power output as the transmitter under test and be of a similar type but only configured to generate a single channel signal or a signal generator and a power amplifier of equivalent intermodulation attenuation as that required from the transmitter, capable of delivering the same output power as the transmitter under test. In either case the interfering signal source shall be capable of generating a CW signal at power level equivalent to the rms power of that wanted channel of the transmitter that has the highest power, PRX.

The directional coupler shall have an insertion loss of less than 1 dB, a sufficient bandwidth and a directivity of more than 20 dB.

The transmitter under test and the test signal source shall be physically separated in such a way that the measurement is not influenced by direct radiation.

Prior to the measurement, the rms power level of each wanted channel, PR, of the transmitter under test shall be measured according to clause 7.3.2 and the value recorded. The maximum value of all the PR measurements shall be recorded as PRX. The transmitter shall be set to total power PX.

Modulation test signal M1, M2, A2 or B1 (as appropriate, see clauses 6.3.1 or 6.3.3) shall be applied to each of the channels of the transmitter. The transmitter under test shall be set in continuous transmission mode with all channels present and set to maximum transmitter power. If this is not possible, the measurements shall be carried out in a period shorter than the duration of the transmitted burst but not less than 90 % of the useful part of the burst.

The interfering test signal source shall be unmodulated and the frequency shall be within 400 kHz to 600 kHz above the frequency of the highest frequency channel of the transmitter under test.

The frequency shall be chosen in such a way that the intermodulation components to be measured do not coincide with other spurious components including intermodulation products generated within the transmitter. The power output of the interfering test signal source shall be adjusted to the PRX level recorded above. The intermodulation component shall be measured by direct observation on the spectrum analyser of the largest third order intermodulation component.

This value shall be recorded.

This measurement shall be repeated with the interfering test signal source at a frequency within 400 kHz to 600 kHz below the lowest frequency channel of the transmitter under test.

If channels within the amplifier are separated by greater than 800 kHz, the test shall be repeated between such channels. If separation of such channels is between 800 kHz and 1,2 MHz, a single frequency shall be chosen for the interfering test source that shall be more than 400 kHz from centre frequency of each channel. The value of largest third order product generated on either channel shall be recorded. If channels are separated by more than 1,2 MHz, interfering frequencies shall be chosen between 400 kHz and 600 kHz from the centre frequencies of these channels. In each case, the value of the largest third order intermodulation product recorded on the channel under test shall be recorded.

The intermodulation attenuation of the equipment under test is the highest of the values recorded in above. The intermodulation attenuation ratio is the difference between the intermodulation attenuation and PRX.

### 7.4.3 Limits

The intermodulation ratio of any intermodulation product shall have a ratio of at least 70 dB with respect to the rms power level of PRX. In the case where the performance is achieved by additional internal or external isolating devices (such as circulators) these are expected to be available at the time the measurements are made and shall be used for the measurements.

## 7.5 Transient power measurements

### 7.5.1 Definition

Transient power is the power falling into adjacent spectrum due to switching any or all channels of the transmitter on and off.

### 7.5.2 Method of Measurement

Modulation test signal M1, M2, A2 or B1 shall be applied at the transmitter.

The measurement procedure shall be as follows:

- a) The output of the transmitter shall be connected to the input of the spectrum analyser by a 50  $\Omega$  power attenuator to ensure that the impedance presented to the transmitter is 50  $\Omega$  and the level at the spectrum analyser input is appropriate. The spectrum analyser shall meet the requirements of annex C and its settings shall be adjusted to:
  - Zero frequency scan.
  - Resolution bandwidth: 1 kHz.
  - Video bandwidth: 10 kHz.
  - Peak hold.
- b) The transmitter shall be operated at the maximum rated transmitter power level (PX), under normal test conditions (see clause 5.3) with all channels present. By tuning the spectrum analyser centre frequency to the measurement frequencies the power level is measured at the frequencies given in table 9, the measurement being carried out at positive and negative frequency offsets from each channel.



- c) If the transmitter is capable of switching individual channels on and off, the measurements shall be taken for each channel in turn, with the remaining channels active. Measurements shall also be taken when all channels are switched on and off simultaneously. If the transmitter is not capable of switching individual channels on and off, the measurements shall be taken only when all channels are switched on and off simultaneously (i.e. when the transmitter is switched on and off).
- d) Adjacent channel measurements shall be taken for each channel, except where the adjacent channel is occupied by an active channel. The 1 MHz displacement measurement shall be taken 1 MHz below the  $f_{low}$  and 1 MHz above  $f_{high}$  where  $f_{low}$  and  $f_{high}$  are defined in clause 7.3.1.

**Table 9: Frequency displacements**

	Adjacent Channel Measurement	1 MHz Measurement
Wanted channel bandwidth (kHz)	Displacement from $f_{ch}$ (kHz)	Displacement from $f_{low}$ and $f_{high}$ (MHz)
$\leq 25$	25	1
50	37,5	1
100	62,5	1
150	87,5	1

- e) The duration of each measurement (at each frequency) will be such as to cover at least 10 transmissions at  $f_{ch}$ , each transmission consisting of a standby to Tx followed by a Tx to standby transition.
- f) The spectrum analyser shall be used to record the envelope of the transient power as a function of time. The peak envelope transient power shall be noted for each measurement offset.
- g) The test shall be repeated with the transmitter operated with its maximum number of channels, and with the minimum specified frequency spacing between highest and lowest frequency channels. Where the minimum spacing allows all the carriers to be adjacent then the test shall also be repeated with a spacing of one channel between each of the transmitter channels.

### 7.5.3 Limits

The transient power, in the adjacent channels shall not exceed a value of 45 dB below the PRX of the channels of the transmitter, without the need to be below  $2 \mu W$  (-27,0 dBm).

For measurements at 1 MHz the transient power shall not exceed 60 dB below PRX, without the need to be below  $2 \mu W$  (-27,0 dBm).

---

## 8 Testing for compliance with technical requirements

### 8.1 Test conditions, power supply and ambient temperatures

Tests defined in the present document shall be carried out at representative points within the boundary limits of the declared operational environmental profile which, as a minimum, shall be that specified in the test conditions contained in the present document.

As technical performance varies subject to environmental conditions, tests shall be carried out under a sufficient variety of environmental conditions as specified in this harmonised standard to give confidence of compliance for the affected technical requirements.

## 8.2 Interpretation of the measurement results

The interpretation of the results recorded in a test report for the measurements described in the present document shall be as follows:

- the measured value related to the corresponding limit will be used to decide whether an equipment meets the requirements of the present document;
- the value of the measurement uncertainty for the measurement of each parameter shall be included in the test report;
- the recorded value of the measurement uncertainty shall be, for each measurement, equal to or lower than the figures in table 10.

For the test methods, according to the present document, the measurement uncertainty figures shall be calculated and shall correspond to an expansion factor (coverage factor)  $k = 1,96$  or  $k = 2$  (which provide confidence levels of respectively 95 % and 95,45 % in the case where the distributions characterizing the actual measurement uncertainties are normal (Gaussian)). Principles for the calculation of measurement uncertainty are contained in ETSI TR 100 028 [i.13], in particular in annex D of the ETSI TR 100 028-2 [i.14].

Table 10 is based on such expansion factors.

**Table 10: Absolute measurement uncertainties: maximum values**

Parameter	Uncertainty
Radio Frequency	$\pm 1 \times 10^{-7}$
RF Power (up to 160 W)	$\pm 0,75$ dB
Radiated RF power	$\pm 6$ dB
Adjacent channel power	$\pm 5$ dB
Conducted spurious emission of transmitter valid up to 12,75 GHz	$\pm 4$ dB
Radiated emission of the transmitter, valid up to 4 GHz	$\pm 6$ dB
Transmitter transient frequency (frequency difference)	$\pm 250$ Hz
Transmitter intermodulation	$\pm 3$ dB
Temperature	$\pm 1$ K
Humidity	$\pm 10$ %
NOTE: Valid up to 1 GHz for the RF parameters unless otherwise stated.	

The particular expansion factor used for the evaluation of the measurement uncertainty shall be stated.

ETSI TR 102 273 [3] provides further information concerning the usage of test sites.

## Annex A (normative): Relationship between the present document and the essential requirements of Directive 2014/53/EU

The present document has been prepared under the Commission's standardisation request C(2015) 5376 final [i.4] to provide one voluntary means of conforming to the essential requirements of Directive 2014/53/EU on the harmonisation of the laws of the Member States relating to the making available on the market of radio equipment and repealing Directive 1999/5/EC [i.3].

Once the present document is cited in the Official Journal of the European Union under that Directive, compliance with the normative clauses of the present document given in table A.1 confers, within the limits of the scope of the present document, a presumption of conformity with the corresponding essential requirements of that Directive, and associated EFTA regulations.

**Table A.1: Relationship between the present document and the essential requirements of Directive 2014/53/EU**

<b>Harmonised Standard ETSI EN 303 039</b>				
The following requirements are relevant to the presumption of conformity under the article 3.2 of Directive 2014/53/EU [i.3]				
<b>Requirement</b>			<b>Requirement Conditionality</b>	
<b>No</b>	<b>Description</b>	<b>Reference: Clause No</b>	<b>U/C</b>	<b>Condition</b>
1	Transmitter output power (conducted)	7.1	U	
2	Transmitter adjacent and alternate channels power	7.2	U	
3	Transmitter unwanted emissions	7.3	U	
4	Transmitter intermodulation attenuation	7.4	C	Applies only to base station equipment
5	Transmitter transient power	7.5	U	

### Key to columns:

#### Requirement:

- No** A unique identifier for one row of the table which may be used to identify a requirement.
- Description** A textual reference to the requirement.
- Clause Number** Identification of clause(s) defining the requirement in the present document unless another document is referenced explicitly.

#### Requirement Conditionality:

- U/C** Indicates whether the requirement shall be unconditionally applicable (U) or is conditional upon the supplier's claimed functionality of the equipment (C).
- Condition** Explains the conditions when the requirement shall or shall not be applicable for a requirement which is classified "conditional".

Presumption of conformity stays valid only as long as a reference to the present document is maintained in the list published in the Official Journal of the European Union. Users of the present document should consult frequently the latest list published in the Official Journal of the European Union.

Other Union legislation may be applicable to the product(s) falling within the scope of the present document.

## Annex B (normative): Radiated measurement

### B.1 Test sites and general arrangements for measurements involving the use of radiated fields

#### B.1.0 General

This annex introduces three most commonly available test sites, an Anechoic Chamber, an Anechoic Chamber with a ground plane and an Open Area Test Site (OATS), which may be used for radiated tests. These test sites are generally referred to as free field test sites. Both absolute and relative measurements can be performed in these sites. Where absolute measurements are to be carried out, the chamber should be verified. A detailed verification procedure is described in ETSI TR 102 273 [3] relevant parts 2, 3 and 4.

NOTE: To ensure reproducibility and traceability of radiated measurements only these test sites should be used in measurements in accordance with the present document.

#### B.1.1 Anechoic chamber

An anechoic chamber is an enclosure, usually shielded, whose internal walls, floor and ceiling are covered with radio absorbing material, normally of the pyramidal urethane foam type. The chamber usually contains an antenna support at one end and a turntable at the other. A typical anechoic chamber is shown in figure B.1.

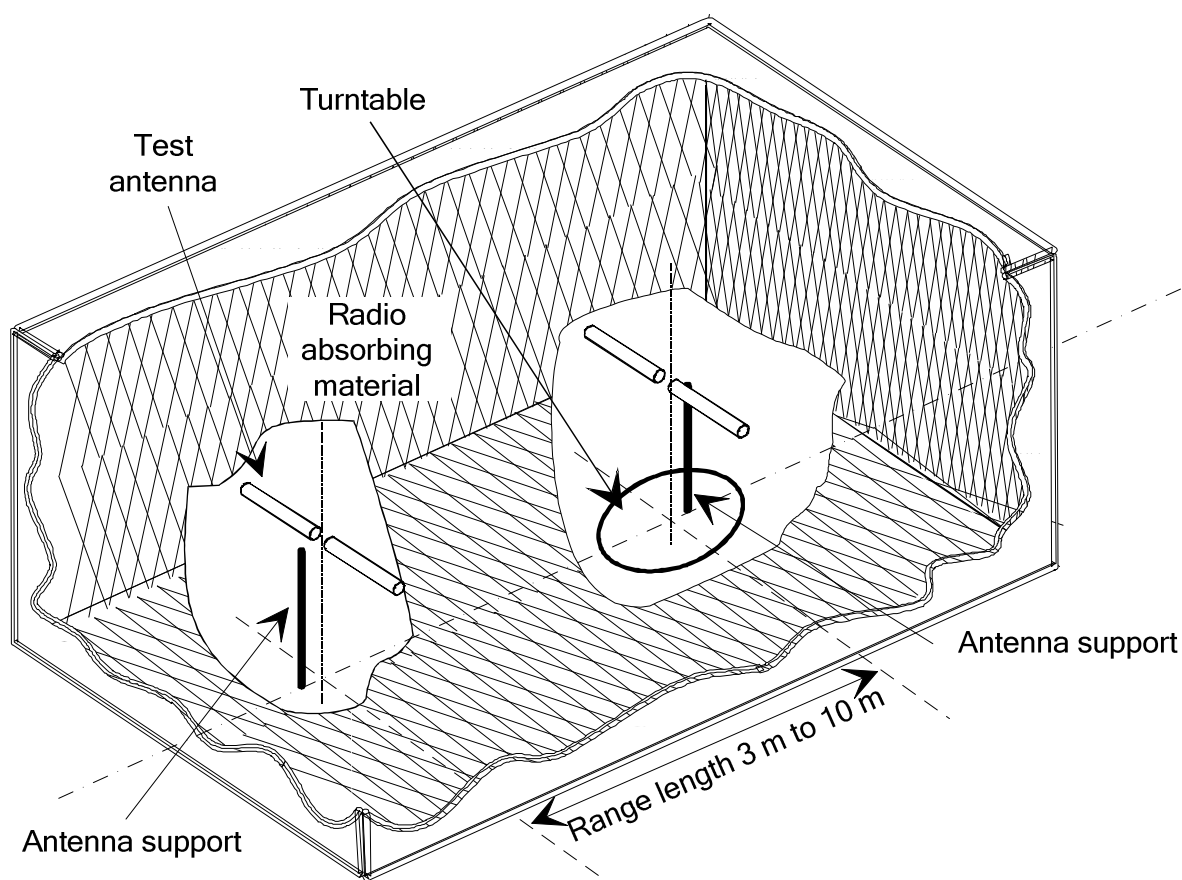

Figure B.1: A typical anechoic chamber

The chamber shielding and radio absorbing material work together to provide a controlled environment for testing purposes. This type of test chamber attempts to simulate free space conditions.

The shielding provides a test space, with reduced levels of interference from ambient signals and other outside effects, whilst the radio absorbing material minimizes unwanted reflections from the walls and ceiling which can influence the measurements. In practice it is relatively easy for shielding to provide high levels (80 dB to 140 dB) of ambient interference rejection, normally making ambient interference negligible.

A turntable is capable of rotation through 360° in the horizontal plane and it is used to support the test sample (EUT) at a suitable height (e.g. 1 m) above the ground plane. The chamber shall be large enough to allow the measuring distance of at least 3 m or  $2(d_1 + d_2)^2/\lambda$  (m), whichever is greater (see clause B.2.4). The distance used in actual measurements shall be recorded with the test results.

The anechoic chamber generally has several advantages over other test facilities. There is minimal ambient interference, minimal floor, ceiling and wall reflections and it is independent of the weather. It does however have some disadvantages which include limited measuring distance and limited lower frequency usage due to the size of the pyramidal absorbers. To improve low frequency performance, a combination structure of ferrite tiles and urethane foam absorbers is commonly used.

All types of emission, sensitivity and immunity testing can be carried out within an Anechoic Chamber without limitation.

## B.1.2 Anechoic chamber with a conductive ground plane

An anechoic chamber with a conductive ground plane is an enclosure, usually shielded, whose internal walls and ceiling are covered with radio absorbing material, normally of the pyramidal urethane foam type. The floor, which is metallic, is not covered and forms the ground plane. The chamber usually contains an antenna mast at one end and a turntable at the other. A typical anechoic chamber with a conductive ground plane is shown in figure B.2.

This type of test chamber attempts to simulate an ideal Open Area Test Site whose primary characteristic is a perfectly conducting ground plane of infinite extent.

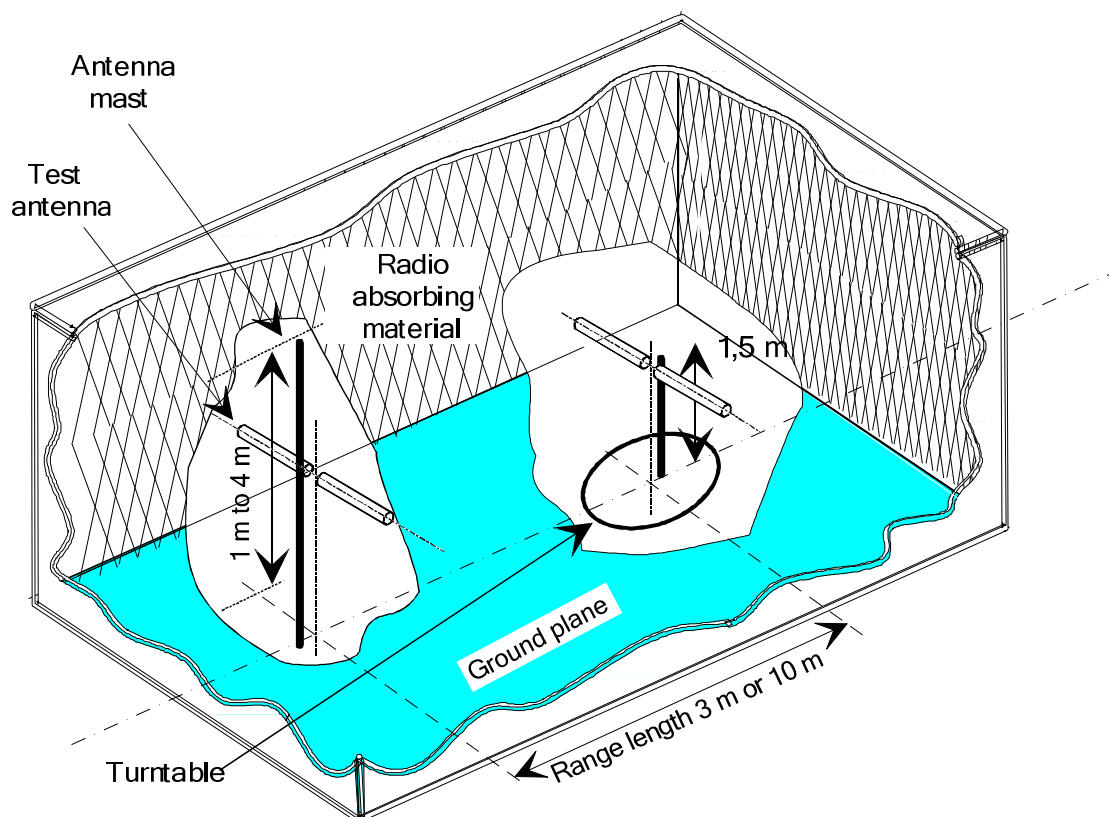

Figure B.2: A typical anechoic chamber with a conductive ground plane

In this facility the ground plane creates the wanted reflection path, such that the signal received by the receiving antenna is the sum of the signals from both the direct and reflected transmission paths. This creates a unique received signal level for each height of the transmitting antenna (or EUT) and the receiving antenna above the ground plane.

The antenna mast provides a variable height facility (from 1 to 4 metres) so that the position of the test antenna can be optimized for maximum coupled signal between antennas or between a EUT and the test antenna.

A turntable is capable of rotation through 360° in the horizontal plane and it is used to support the test sample (EUT) at a specified height, usually 1,5 metres above the ground plane. The chamber shall be large enough to allow the measuring distance of at least 3 m or  $2(d_1 + d_2)/\lambda$  (m), whichever is greater (see clause B.2.4). The distance used in actual measurements shall be recorded with the test results.

Emission testing involves firstly "peaking" the field strength from the EUT by raising and lowering the receiving antenna on the mast (to obtain the maximum constructive interference of the direct and reflected signals from the EUT) and then rotating the turntable for a "peak" in the azimuth plane. At this height of the test antenna on the mast, the amplitude of the received signal is noted. Secondly the EUT is replaced by a substitution antenna (positioned at the EUT's phase or volume centre) which is connected to a signal generator. The signal is again "peaked" and the signal generator output adjusted until the level, noted in stage one, is again measured on the receiving device.

Receiver sensitivity tests over a ground plane also involve "peaking" the field strength by raising and lowering the test antenna on the mast to obtain the maximum constructive interference of the direct and reflected signals, this time using a measuring antenna which has been positioned where the phase or volume centre of the EUT will be during testing. A transform factor is derived. The test antenna remains at the same height for stage two, during which the measuring antenna is replaced by the EUT. The amplitude of the transmitted signal is reduced to determine the field strength level at which a specified response is obtained from the EUT.

### B.1.3 Open Area Test Site (OATS)

An Open Area Test Site comprises a turntable at one end and an antenna mast of variable height at the other end above a ground plane which, in the ideal case, is perfectly conducting and of infinite extent. In practice, while good conductivity can be achieved, the ground plane size has to be limited. A typical Open Area Test Site is shown in figure B.3.

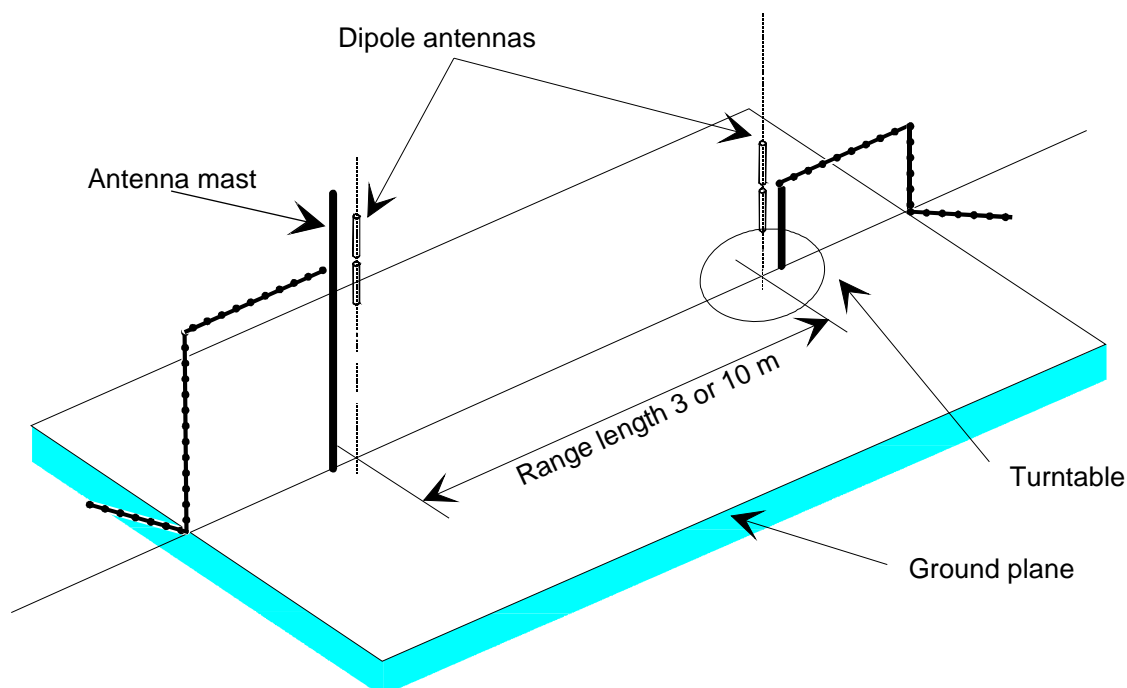
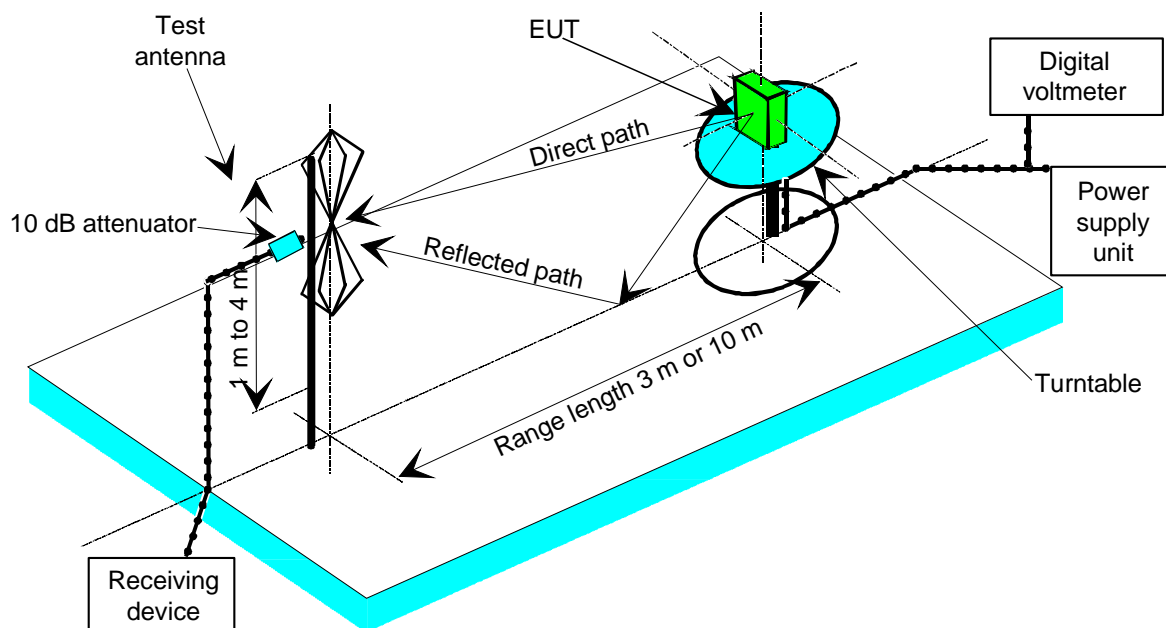

Figure B.3: A typical Open Area Test Site

The ground plane creates a wanted reflection path, such that the signal received by the receiving antenna is the sum of the signals received from the direct and reflected transmission paths. The phasing of these two signals creates a unique received level for each height of the transmitting antenna (or EUT) and the receiving antenna above the ground plane.

Site qualification concerning antenna positions, turntable, measurement distance and other arrangements are same as for anechoic chamber with a ground plane. In radiated measurements an OATS is also used by the same way as anechoic chamber with a ground plane.

Typical measuring arrangement common for ground plane test sites is presented in the figure B.4.



**Figure B.4: Measuring arrangement on ground plane test site (OATS set-up for spurious emission testing)**

## B.1.4 Test antenna

A test antenna is always used in radiated test methods. In emission tests (i.e. frequency error, effective radiated power, spurious emissions and adjacent channel power) the test antenna is used to detect the field from the EUT in one stage of the measurement and from the substitution antenna in the other stage. When the test site is used for the measurement of receiver characteristics (i.e. sensitivity and various immunity parameters) the antenna is used as the transmitting device.

The test antenna should be mounted on a support capable of allowing the antenna to be used in either horizontal or vertical polarization which, on ground plane sites (i.e. Anechoic Chambers with ground planes and Open Area Test Sites), should additionally allow the height of its centre above the ground to be varied over the specified range (usually 1 to 4 metres).

In the frequency band 30 MHz to 1 000 MHz, dipole antennas (constructed in accordance with ANSI C63.5 [4]) are generally recommended. For frequencies of 80 MHz and above, the dipoles should have their arm lengths set for resonance at the frequency of test. Below 80 MHz, shortened arm lengths are recommended. For spurious emission testing, however, a combination of biconical antennas (commonly termed "bicones") and log periodic dipole array antennas (commonly termed "log periodics") could be used to cover the entire 30 MHz to 1 000 MHz band. Above 1 000 MHz, waveguide horns are recommended although, again, log periodics could be used.

NOTE: The gain of a horn antenna is generally expressed relative to an isotropic radiator.

## B.1.5 Substitution antenna

The substitution antenna is used to replace the EUT for tests in which a transmitting parameter (i.e. frequency error, effective radiated power, spurious emissions and adjacent channel power) is being measured. For measurements in the frequency band 30 MHz to 1 000 MHz, the substitution antenna should be a dipole antenna (constructed in accordance with ANSI C63.5 [4]). For frequencies of 80 MHz and above, the dipoles should have their arm lengths set for resonance at the frequency of test. Below 80 MHz, shortened arm lengths are recommended. For measurements above 1 000 MHz, a waveguide horn is recommended. The centre of this antenna should coincide with either the phase centre or volume centre.

## B.1.6 Measuring antenna

The measuring antenna is used in tests on a EUT in which a receiving parameter (i.e. sensitivity and various immunity tests) is being measured. Its purpose is to enable a measurement of the electric field strength in the vicinity of the EUT. For measurements in the frequency band 30 MHz to 1 000 MHz, the measuring antenna should be a dipole antenna (constructed in accordance with ANSI C63.5 [4]). For frequencies of 80 MHz and above, the dipoles should have their arm lengths set for resonance at the frequency of test. Below 80 MHz, shortened arm lengths are recommended. The centre of this antenna should coincide with either the phase centre or volume centre (as specified in the test method) of the EUT.

---

## B.2 Guidance on the use of radiation test sites

### B.2.0 General

This clause details procedures, test equipment arrangements and verification that should be carried out before any of the radiated test are undertaken. These schemes are common to all types of test sites described in annex B.

### B.2.1 Verification of the test site

No test should be carried out on a test site which does not possess a valid certificate of verification. The verification procedures for the different types of test sites described in annex B (i.e. Anechoic Chamber, Anechoic Chamber with a ground plane and Open Area Test Site) are given in ETSI TR 102 273 [3] parts 2, 3 and 4, respectively.

### B.2.2 Preparation of the EUT

The supplier should supply information about the EUT covering the operating frequency, polarization, supply voltage(s) and the reference face. Additional information, specific to the type of EUT should include, where relevant, carrier power, channel separation, whether different operating modes are available (e.g. high and low power modes) and if operation is continuous or is subject to a maximum test duty cycle (e.g. 1 minute on, 4 minutes off).

Where necessary, a mounting bracket of minimal size should be available for mounting the EUT on the turntable. This bracket should be made from low conductivity, low relative dielectric constant (i.e. less than 1,5) material(s) such as expanded polystyrene, balsawood, etc.

### B.2.3 Power supplies to the EUT

All tests should be performed using power supplies wherever possible, including tests on EUT designed for battery-only use. In all cases, power leads should be connected to the EUT's supply terminals (and monitored with a digital voltmeter) but the battery should remain present, electrically isolated from the rest of the equipment, possibly by putting tape over its contacts.

The presence of these power cables can, however, affect the measured performance of the EUT. For this reason, they should be made to be "transparent" as far as the testing is concerned. This can be achieved by routing them away from the EUT and down to the either the screen, ground plane or facility wall (as appropriate) by the shortest possible paths. Precautions should be taken to minimize pick-up on these leads (e.g. the leads could be twisted together, loaded with ferrite beads at 0,15 metre spacing or otherwise loaded).

### B.2.4 Range length

The range length for all these types of test facility should be adequate to allow for testing in the far-field of the EUT i.e. it should be equal to or exceed:

$$\frac{2(d_1 + d_2)^2}{\lambda}$$

Where:

- $d_1$  is the largest dimension of the EUT/dipole after substitution (m);



- $d_2$  is the largest dimension of the test antenna (m);
- $\lambda$  is the test frequency wavelength (m).

It should be noted that in the substitution part of this measurement, where both test and substitution antennas are half wavelength dipoles, this minimum range length for far-field testing would be:

$$2\lambda$$

It should be noted in test reports when either of these conditions is not met so that the additional measurement uncertainty can be incorporated into the results.

NOTE 1: For the fully anechoic chamber, no part of the volume of the EUT should, at any angle of rotation of the turntable, fall outside the "quiet zone" of the chamber at the nominal frequency of the test.

NOTE 2: The "quiet zone" is a volume within the Anechoic Chamber (without a ground plane) in which a specified performance has either been proven by test, or is guaranteed by the designer/supplier. The specified performance is usually the reflectivity of the absorbing panels or a directly related parameter (e.g. signal uniformity in amplitude and phase). It should be noted however that the defining levels of the quiet zone tend to vary.

NOTE 3: For the anechoic chamber with a ground plane, a full height scanning capability, i.e. 1 to 4 metres, should be available for which no part of the test antenna should come within 1 metre of the absorbing panels. For both types of Anechoic Chamber, the reflectivity of the absorbing panels should not be worse than -5 dB.

NOTE 4: For both the anechoic chamber with a ground plane and the Open Area Test Site, no part of any antenna should come within 0,25 metre of the ground plane at any time throughout the tests. Where any of these conditions cannot be met, measurements should not be carried out.

## B.2.5 Site preparation

The cables for both ends of the test site should be routed horizontally away from the testing area for a minimum of 2 metres (unless, in the case both types of anechoic chamber, a back wall is reached) and then allowed to drop vertically and out through either the ground plane or screen (as appropriate) to the test equipment. Precautions should be taken to minimize pick up on these leads (e.g. dressing with ferrite beads, or other loading). The cables, their routing and dressing should be identical to the verification set-up.

NOTE: For ground reflection test sites (i.e. anechoic chambers with ground planes and Open Area Test Sites) which incorporate a cable drum with the antenna mast, the 2 metres requirement may be impossible to comply with.

Calibration data for all items of test equipment should be available and valid. For test, substitution and measuring antennas, the data should include gain relative to an isotropic radiator (or antenna factor) for the frequency of test. Also, the VSWR of the substitution and measuring antennas should be known.

The calibration data on all cables and attenuators should include insertion loss and VSWR throughout the entire frequency range of the tests. All VSWR and insertion loss figures should be recorded in the log book results sheet for the specific test.

Where correction factors/tables are required, these should be immediately available.

For all items of test equipment, the maximum errors they exhibit should be known along with the distribution of the error e.g.:

- cable loss:  $\pm 0,5$  dB with a rectangular distribution;
- measuring receiver: 1,0 dB (standard deviation) signal level accuracy with a Gaussian error distribution.

At the start of measurements, system checks should be made on the items of test equipment used on the test site.

---

## B.3 Coupling of signals

### B.3.0 General

The presence of leads in the radiated field may cause a disturbance of that field and lead to additional measurement uncertainty. These disturbances can be minimized by using suitable coupling methods, offering signal isolation and minimum field disturbance (e.g. optical and acoustic coupling).

### B.3.1 Data signals

Isolation can be provided by the use of optical, ultrasonic or infra-red means. Field disturbance can be minimized by using a suitable fibre optic connection. Ultrasonic or infra-red radiated connections require suitable measures for the minimization of ambient noise.

---

## Annex C (normative): Specification for some particular measurement arrangements

### C.1 Spectrum analyser specification

#### C.1.1 Adjacent and alternate channel power measurement

The characteristics of the spectrum analyser shall meet at least the following requirements:

- the reading accuracy of the frequency marker shall be within  $\pm 100$  Hz;
- the accuracy of relative amplitude measurements shall be within  $\pm 3,5$  dB.
- detector modes supported: Positive Peak and rms;

and if used for measurement in clause 7.3:

- frequency range: 9 kHz to 4 GHz (9 kHz to 12,75 GHz for equipment capable of operating at frequencies greater than 470 MHz).

It shall be possible to adjust the spectrum analyser to allow the separation on its screen of two equal amplitude components with a frequency difference of 500 Hz.

For statistically distributed modulations, the spectrum analyser and the integrating device (when appropriate) needs to allow determination of the power spectral density (energy per time and bandwidth), which has to be integrated over the bandwidth in question. It shall be possible to sum the effective power of all discrete components, the spectral power density and the noise power in the selected bandwidth and to measure this as a ratio relative to the carrier power.

The spectrum analyser should have a dynamic range greater than 90 dB and the average phase noise in the adjacent and alternate channels shall be such that measurement of adjacent and alternate channel power (see clause 7.2) is not limited by phase noise. In order to confirm this the selected measurement technique for clause 7.2.2 shall be used to measure the adjacent and alternate channel power with a CW signal source with average phase noise of less than -120 dBc/Hz at one CSP offset and -125 dBc/Hz at two CSP offset.

The following performance shall be achieved:

- the maximum adjacent channel power observed with these conditions shall not exceed -65 dBc;
- the maximum alternate channel power measured with these conditions shall not exceed -70 dBc.

NOTE: A resolution bandwidth of 500 Hz may be used for this measurement as an alternative to the usual 100 Hz to reduce measurement time.

#### C.1.2 Unwanted emissions measurement

The specification shall include the following requirements.

It shall be possible, using a resolution bandwidth of 1 kHz, to measure the amplitude of a signal, or noise at a level 3 dB or more above the noise level of the spectrum analyser, as displayed on the screen, to an accuracy of  $\pm 2$  dB in the presence of the wanted signal.

The accuracy of relative amplitude measurements shall be within  $\pm 1$  dB.

For statistically distributed modulations, the spectrum analyser and the integrating device (when appropriate) shall allow determination of the real spectral power density (energy per time and bandwidth), which has to be integrated over the bandwidth in question.

---

## C.2 Integrating and power summing device

The integrating and power summing device is connected to the video output of the spectrum analyser, referred to in clause C.1.

It shall be possible to sum the effective power of all discrete components, the spectral power density and the noise power in the selected bandwidth and to measure this as a ratio relative to the carrier power.

---

## Annex D (informative): Change History

Date	Version	Information about changes
August 2015	0.0.1	Revision under RE-D. Version 1.2.1.0.0.1 prepared by STF 493

---

## History

<b>Document history</b>		
V1.1.1	April 2014	Publication
V2.1.0	December 2015	EN Approval Procedure AP: 20160320: 2015-12-21 to 2016-03-21
V2.1.1	March 2016	Publication