

ETSI EN 302 885 V2.2.2 (2017-03)



**Portable Very High Frequency (VHF)  
radiotelephone equipment for the  
maritime mobile service operating in the VHF bands  
with integrated handheld class H DSC;  
Harmonised Standard covering the essential requirements  
of articles 3.2 and 3.3(g) of Directive 2014/53/EU**

---

Reference

REN/ERM-TG26-518C1

---

Keywords

harmonised standard, maritime, radio, VHF

**ETSI**

650 Route des Lucioles  
F-06921 Sophia Antipolis Cedex - FRANCE

Tel.: +33 4 92 94 42 00 Fax: +33 4 93 65 47 16

Siret N° 348 623 562 00017 - NAF 742 C  
Association à but non lucratif enregistrée à la  
Sous-Préfecture de Grasse (06) N° 7803/88

---

**Important notice**

The present document can be downloaded from:  
<http://www.etsi.org/standards-search>

The present document may be made available in electronic versions and/or in print. The content of any electronic and/or print versions of the present document shall not be modified without the prior written authorization of ETSI. In case of any existing or perceived difference in contents between such versions and/or in print, the only prevailing document is the print of the Portable Document Format (PDF) version kept on a specific network drive within ETSI Secretariat.

Users of the present document should be aware that the document may be subject to revision or change of status. Information on the current status of this and other ETSI documents is available at  
<https://portal.etsi.org/TB/ETSIDeliverableStatus.aspx>

If you find errors in the present document, please send your comment to one of the following services:  
<https://portal.etsi.org/People/CommiteeSupportStaff.aspx>

---

**Copyright Notification**

No part may be reproduced or utilized in any form or by any means, electronic or mechanical, including photocopying and microfilm except as authorized by written permission of ETSI.

The content of the PDF version shall not be modified without the written authorization of ETSI.  
The copyright and the foregoing restriction extend to reproduction in all media.

© European Telecommunications Standards Institute 2017.  
All rights reserved.

**DECT™**, **PLUGTESTS™**, **UMTS™** and the ETSI logo are Trade Marks of ETSI registered for the benefit of its Members.  
**3GPP™** and **LTE™** are Trade Marks of ETSI registered for the benefit of its Members and of the 3GPP Organizational Partners.  
**GSM®** and the GSM logo are Trade Marks registered and owned by the GSM Association.

# Contents

Intellectual Property Rights .....	8
Foreword.....	8
Modal verbs terminology.....	8
1 Scope .....	9
2 References .....	9
2.1 Normative references .....	9
2.2 Informative references.....	10
3 Definitions, symbols and abbreviations .....	10
3.1 Definitions.....	10
3.2 Symbols.....	11
3.3 Abbreviations .....	11
4 General and operational requirements.....	11
4.0 Conformance .....	11
4.1 Construction .....	11
4.2 Controls and indicators.....	12
4.3 Microphone and loudspeaker .....	13
4.4 Safety precautions .....	13
4.5 Labelling.....	13
5 Technical requirements .....	13
5.0 Conformance .....	13
5.1 Switching time.....	13
5.2 Class of emission and modulation characteristics .....	14
5.3 Battery capacity.....	14
5.4 DSC functionality.....	14
6 General conditions of measurement .....	14
6.1 Arrangements for RF connections to the equipment .....	14
6.1.1 RF connections to integral antenna equipment .....	14
6.1.2 RF connection to equipment with a detachable antenna .....	14
6.2 Arrangements for test signals applied to the receiver input.....	14
6.3 Squelch.....	15
6.4 Normal test modulation .....	15
6.5 Artificial antenna.....	15
6.6 Arrangements for test signals applied to the transmitter input .....	15
6.7 Test channels .....	15
6.8 Test conditions, power sources and ambient temperatures.....	15
6.8.1 Normal and extreme test conditions.....	15
6.8.2 Test power source .....	15
6.9 Normal test conditions.....	16
6.9.1 Normal temperature and humidity .....	16
6.9.2 Normal power sources .....	16
6.9.2.1 Battery power source.....	16
6.9.2.2 Other power sources.....	16
6.10 Extreme test conditions .....	16
6.10.0 General.....	16
6.10.1 Extreme temperatures .....	16
6.10.2 Extreme values of test power sources .....	16
6.10.2.1 Battery power source.....	16
6.10.2.2 Other power sources.....	16
6.11 Procedure for tests at extreme temperatures.....	17
6.12 Reference Bandwidths for emission measurements .....	17
7 Environmental tests .....	17
7.1 Procedure.....	17

7.2	Performance check .....	17
7.3	Drop test .....	17
7.3.1	Definition .....	17
7.3.2	Method of measurement .....	18
7.3.3	Requirement .....	18
7.4	Temperature tests .....	18
7.4.1	Definition .....	18
7.4.2	Dry heat .....	18
7.4.2.1	Definition .....	18
7.4.2.2	Method of measurement .....	18
7.4.2.3	Requirement .....	18
7.4.3	Damp heat .....	19
7.4.3.1	Definition .....	19
7.4.3.2	Method of measurement .....	19
7.4.3.3	Requirement .....	19
7.4.4	Low temperature cycle .....	19
7.4.4.1	Definition .....	19
7.4.4.2	Method of measurement .....	19
7.4.4.3	Requirement .....	19
8	Transmitter .....	20
8.0	General .....	20
8.1	Frequency error .....	20
8.1.1	Definition .....	20
8.1.2	Method of measurement .....	20
8.1.3	Limits .....	20
8.2	Carrier power .....	20
8.2.1	Definitions .....	20
8.2.2	Method of measurement .....	20
8.2.3	Limits, Normal and extreme test conditions .....	20
8.3	Frequency deviation .....	21
8.3.1	Definition .....	21
8.3.2	Maximum permissible frequency deviation .....	21
8.3.2.1	Method of measurement .....	21
8.3.2.2	Limits .....	21
8.3.3	Reduction of frequency deviation at modulation frequencies above 3 kHz .....	21
8.3.3.1	Method of measurement .....	21
8.3.3.2	Limits .....	21
8.4	Sensitivity of the modulator, including microphone .....	22
8.4.1	Definition .....	22
8.4.2	Method of measurement .....	22
8.4.3	Limits .....	22
8.5	Audio frequency response .....	22
8.5.1	Definition .....	22
8.5.2	Method of measurement .....	23
8.5.3	Limit .....	23
8.6	Audio frequency harmonic distortion of the emission .....	24
8.6.1	Definition .....	24
8.6.2	Method of measurement .....	24
8.6.2.0	General .....	24
8.6.2.1	Normal test conditions .....	24
8.6.2.2	Extreme test conditions .....	24
8.6.3	Limits .....	24
8.7	Adjacent channel power .....	24
8.7.1	Definition .....	24
8.7.2	Method of measurement .....	24
8.7.3	Limits .....	25
8.8	Conducted spurious emissions conveyed to the antenna .....	25
8.8.1	Definition .....	25
8.8.2	Method of measurement .....	25
8.8.3	Limit .....	25
8.9	Cabinet radiation and conducted spurious emissions other than those conveyed to the antenna .....	25

8.9.1	Definitions .....	25
8.9.2	Method of measurement .....	26
8.9.3	Limits .....	27
8.10	Residual modulation of the transmitter .....	27
8.10.1	Definition .....	27
8.10.2	Method of measurement .....	27
8.10.3	Limit .....	27
8.11	Transient frequency behaviour of the transmitter .....	27
8.11.1	Definitions .....	27
8.11.2	Method of measurement .....	28
8.11.3	Limits .....	31
8.12	Frequency error (demodulated DSC signal) .....	31
8.12.1	Definition .....	31
8.12.2	Method of measurement .....	31
8.12.3	Limits .....	31
8.13	Modulation index for DSC .....	31
8.13.1	Definition .....	31
8.13.2	Method of measurement .....	31
8.13.3	Limits .....	31
8.14	Modulation rate for DSC .....	31
8.14.1	Definition .....	31
8.14.2	Method of measurement .....	32
8.14.3	Limits .....	32
8.15	Testing of free channel transmission on DSC channel 70 .....	32
8.15.1	Definition .....	32
8.15.2	Method of measurement .....	32
8.15.3	Requirement .....	32
9	Receiver .....	33
9.1	Harmonic distortion and rated audio frequency output power .....	33
9.1.1	Definition .....	33
9.1.2	Methods of measurement .....	33
9.1.3	Limits .....	33
9.2	Audio frequency response .....	33
9.2.1	Definition .....	33
9.2.2	Method of measurement .....	33
9.2.3	Limits .....	34
9.3	Maximum usable sensitivity .....	34
9.3.1	Definition .....	34
9.3.2	Method of measurement .....	35
9.3.3	Limits .....	35
9.4	Co-channel rejection .....	35
9.4.1	Definition .....	35
9.4.2	Method of measurement .....	35
9.4.3	Limit .....	35
9.5	Adjacent channel selectivity .....	36
9.5.1	Definition .....	36
9.5.2	Method of measurement .....	36
9.5.3	Limits .....	36
9.6	Spurious response rejection .....	36
9.6.1	Definition .....	36
9.6.2	Method of measurement .....	36
9.6.3	Limit .....	37
9.7	Intermodulation response .....	37
9.7.1	Definition .....	37
9.7.2	Method of measurement .....	37
9.7.3	Limit .....	37
9.8	Blocking or desensitization .....	37
9.8.1	Definition .....	37
9.8.2	Method of measurement .....	38
9.8.3	Limit .....	38
9.9	Conducted spurious emissions .....	38

9.9.1	Definition .....	38
9.9.2	Method of measurement .....	38
9.9.3	Limit .....	38
9.10	Radiated spurious emissions.....	38
9.10.1	Definition .....	38
9.10.2	Method of measurements .....	39
9.10.3	Limit .....	39
9.11	Receiver noise and hum level.....	40
9.11.1	Definition .....	40
9.11.2	Method of measurement .....	40
9.11.3	Limit .....	40
9.12	Squelch operation.....	40
9.12.1	Definition .....	40
9.12.2	Method of measurement .....	40
9.12.3	Limits.....	41
9.13	Squelch hysteresis .....	41
9.13.1	Definition .....	41
9.13.2	Method of measurement .....	41
9.13.3	Limit .....	41
10	DSC Signalling.....	41
10.1	Test Method.....	41
10.2	Display .....	41
10.3	GNSS receiver.....	41
10.4	Individual DSC calls .....	42
10.5	All ships calls .....	42
10.6	DSC call functionality.....	42
10.7	DSC message composition.....	42
10.8	Prioritized wait .....	42
10.9	Alarms .....	42
10.10	Standby.....	42
10.11	GNSS fix - sending distress.....	42
10.12	Tasks - sending distress .....	42
10.13	Display - sending distress.....	42
10.14	Distress button sub procedure .....	42
10.15	Void.....	43
10.16	Updating position .....	43
10.17	Handling received DSC messages - sending distress .....	43
10.18	Alarms - sending distress .....	43
10.19	Determining subsequent communications - sending distress .....	43
10.20	Automated tuning - sending distress .....	43
10.21	Cancelling the distress alert.....	43
10.22	Acknowledgements - sending distress.....	43
10.23	Termination - sending distress.....	43
10.24	Warnings - sending distress.....	43
10.25	Tasks - receiving distress .....	43
10.26	Display - receiving distress .....	43
10.27	Handling received DSC messages - receiving distress.....	44
10.28	Alarms - receiving distress .....	44
10.29	Determining subsequent communications - receiving distress.....	44
10.30	Automated tuning - receiving distress .....	44
10.31	Acknowledgements - receiving distress .....	44
10.32	Termination - receiving distress .....	44
10.33	Warnings - receiving distress .....	44
10.34	Tasks - sending non distress .....	44
10.35	Display - sending non distress.....	44
10.36	Handling received DSC messages - sending non distress .....	44
10.37	Alarms - sending non distress.....	44
10.38	Automated tuning - sending non distress .....	45
10.39	Delayed acknowledgements - sending non distress.....	45
10.40	Termination - sending non distress.....	45
10.41	Warnings - sending non distress.....	45

10.42	Tasks - receiving non distress.....	45
10.43	Display - receiving non distress .....	45
10.44	Handling received DSC messages - receiving non distress.....	45
10.45	Alarms - receiving non distress .....	45
10.46	Automated tuning - receiving non distress .....	45
10.47	Acknowledgements - receiving non distress .....	45
10.48	Termination - receiving non distress .....	45
10.49	Warnings - receiving non distress .....	45
10.50	Communication automated procedure.....	46
10.51	Tasks - communication .....	46
10.52	Display - communication .....	46
10.53	Handling received DSC messages - communication.....	46
10.54	Tuning of the receiver and transmitter - communication .....	46
10.55	Termination - communication .....	46
10.56	Tasks of handling incoming calls while engaged.....	46
10.57	Termination of automated procedures.....	46
10.58	Actions after termination of an automated procedure .....	46
10.59	Putting automated procedures on hold .....	46
10.60	Controlling non-terminated automated procedures on hold.....	46
11	Testing for compliance with technical requirements.....	47
11.1	Environmental conditions for testing .....	47
11.2	Interpretation of the measurement results .....	47
<b>Annex A (informative):</b>	<b>Relationship between the present document and the essential requirements of Directive 2014/53/EU .....</b>	<b>48</b>
<b>Annex B (normative):</b>	<b>Measuring receiver for adjacent channel power measurement.....</b>	<b>51</b>
B.1	Power measuring receiver specification.....	51
B.1.0	General .....	51
B.1.1	IF filter .....	51
B.1.2	Attenuation indicator.....	52
B.1.3	Rms value indicator.....	52
B.1.4	Oscillator and amplifier.....	52
<b>Annex C (informative):</b>	<b>DSC test calls.....</b>	<b>53</b>
C.1	Interoperability tests.....	53
<b>Annex D (informative):</b>	<b>Change history .....</b>	<b>54</b>
History .....		55

---

## Intellectual Property Rights

IPRs essential or potentially essential to the present document may have been declared to ETSI. The information pertaining to these essential IPRs, if any, is publicly available for **ETSI members and non-members**, and can be found in ETSI SR 000 314: "*Intellectual Property Rights (IPRs); Essential, or potentially Essential, IPRs notified to ETSI in respect of ETSI standards*", which is available from the ETSI Secretariat. Latest updates are available on the ETSI Web server (<https://ipr.etsi.org>).

Pursuant to the ETSI IPR Policy, no investigation, including IPR searches, has been carried out by ETSI. No guarantee can be given as to the existence of other IPRs not referenced in ETSI SR 000 314 (or the updates on the ETSI Web server) which are, or may be, or may become, essential to the present document.

---

## Foreword

This Harmonised European Standard (EN) has been produced by ETSI Technical Committee Electromagnetic compatibility and Radio spectrum Matters (ERM).

The present document has been prepared under the Commission's standardisation request C(2015) 5376 final [i.8] to provide one voluntary means of conforming to the essential requirements of Directive 2014/53/EU on the harmonisation of the laws of the Member States relating to the making available on the market of radio equipment and repealing Directive 1999/5/EC [i.5].

Once the present document is cited in the Official Journal of the European Union under that Directive, compliance with the normative clauses of the present document given in tables A.1 and A.2 confers, within the limits of the scope of the present document, a presumption of conformity with the corresponding essential requirements of that Directive, and associated EFTA regulations.

<b>National transposition dates</b>	
Date of latest announcement of this EN (doa):	30 June 2017
Date of latest publication of new National Standard or endorsement of this EN (dop/e):	31 December 2017
Date of withdrawal of any conflicting National Standard (dow):	31 December 2018

---

## Modal verbs terminology

In the present document "**shall**", "**shall not**", "**should**", "**should not**", "**may**", "**need not**", "**will**", "**will not**", "**can**" and "**cannot**" are to be interpreted as described in clause 3.2 of the [ETSI Drafting Rules](#) (Verbal forms for the expression of provisions).

"**must**" and "**must not**" are **NOT** allowed in ETSI deliverables except when used in direct citation.



---

# 1 Scope

The present document states the minimum technical characteristics and methods of measurement required for portable Very High Frequency (VHF) radiotelephones with integrated handheld class H DSC operating in certain frequency bands allocated to the maritime mobile service using either 25 kHz channels or 25 kHz and 12,5 kHz channels. The present document does not cover requirements for the integrated GNSS receiver providing locating function.

The present document also specifies technical characteristics, methods of measurement and required test results.

The present document covers the essential requirements of articles 3.2 and 3.3(g) of Directive 2014/53/EU [i.5] under the conditions identified in annex A.

---

## 2 References

### 2.1 Normative references

References are specific, identified by date of publication and/or edition number or version number. Only the cited version applies.

Referenced documents which are not found to be publicly available in the expected location might be found at <https://docbox.etsi.org/Reference/>.

NOTE: While any hyperlinks included in this clause were valid at the time of publication, ETSI cannot guarantee their long term validity.

The following referenced documents are necessary for the application of the present document.

- [1] ITU Radio Regulations (2016), appendix 18: "Table of transmitting frequencies in the VHF maritime mobile band".
- [2] Recommendation ITU-T E.161 (2001): "Arrangement of digits, letters and symbols on telephones and other devices that can be used for gaining access to a telephone network".
- [3] Recommendation ITU-R M.493-14 (2015): "Digital selective-calling system for use in the maritime mobile service".
- [4] ETSI EN 300 225 (V1.5.1) (12-2015): "Electromagnetic compatibility and Radio spectrum Matters (ERM); Technical characteristics and methods of measurement for survival craft portable VHF radiotelephone apparatus".
- [5] Recommendation ITU-R M.1084-5 (2012): "Interim solutions for improved efficiency in the use of the band 156-174 MHz by stations in the maritime mobile service".
- [6] ETSI EN 300 338-5 (V1.2.1) (02-2017) : "Technical characteristics and methods of measurement for equipment for generation, transmission and reception of Digital Selective Calling (DSC) in the maritime MF, MF/HF and/or VHF mobile service; Part 5: Handheld VHF Class H DSC".
- [7] CENELEC EN 61108 (all parts) (1998 - 2003 - 2004 - 2010): "Maritime navigation and radiocommunication equipment and systems - Global navigation satellite systems (GNSS)".
- [8] CENELEC EN 60529:1991/A2:2013: "Degrees of protection provided by enclosures (IP Code)".
- [9] ETSI TS 103 052 (V1.1.1) (03-2011): "Electromagnetic compatibility and Radio spectrum Matters (ERM); Radiated measurement methods and general arrangements for test sites up to 100 GHz".

## 2.2 Informative references

References are either specific (identified by date of publication and/or edition number or version number) or non-specific. For specific references, only the cited version applies. For non-specific references, the latest version of the referenced document (including any amendments) applies.

NOTE: While any hyperlinks included in this clause were valid at the time of publication, ETSI cannot guarantee their long term validity.

The following referenced documents are not necessary for the application of the present document but they assist the user with regard to a particular subject area.

- [i.1] ETSI TS 101 570-5 (V1.1.1): "Electromagnetic compatibility and Radio spectrum Matters (ERM); Interoperability Testing for Maritime Digital Selective Calling (DSC) Radios; Part 5: Handheld VHF Class D Test Descriptions".
- [i.2] Recommendation ITU-R M.541-10 (2015): "Operational procedures for the use of digital selective-calling equipment in the maritime mobile service".
- [i.3] Recommendation ITU-T O.41 (1994): "Psophometer for use on telephone-type circuits".
- [i.4] Recommendation ITU-R SM.332-4 (1978): "Selectivity of receivers".
- [i.5] Directive 2014/53/EU of the European Parliament and of the Council of 16 April 2014 on the harmonisation of the laws of the Member States relating to the making available on the market of radio equipment and repealing Directive 1999/5/EC.
- [i.6] ETSI TR 100 028-1 (V1.4.1) (12-2001): "Electromagnetic compatibility and Radio spectrum Matters (ERM); Uncertainties in the measurement of mobile radio equipment characteristics; Part 1".
- [i.7] ETSI TR 100 028-2 (V1.4.1) (12-2001): "Electromagnetic compatibility and Radio spectrum Matters (ERM); Uncertainties in the measurement of mobile radio equipment characteristics; Part 2".
- [i.8] Commission Implementing Decision C(2015) 5376 final of 4.8.2015 on a standardisation request to the European Committee for Electrotechnical Standardisation and to the European Telecommunications Standards Institute as regards radio equipment in support of Directive 2014/53/EU of the European Parliament and of the Council.

---

## 3 Definitions, symbols and abbreviations

### 3.1 Definitions

For the purposes of the present document, the following terms and definitions apply:

**block:** to inhibit a function by making it inaccessible from the user interface

**detachable antenna:** antenna fixed to the equipment by means of an antenna connector and detachable by the user

**G3E:** phase-modulation (frequency modulation with a pre-emphasis of 6 dB/octave) for speech

**integral antenna:** antenna that is permanently fixed to the equipment and not detachable by the user

**modulation index:** ratio between the frequency deviation and the modulation frequency

**performance check:** check of:

- the transmitter carrier power and frequency; and
- receiver sensitivity

## 3.2 Symbols

For the purposes of the present document, the following symbols apply:

dBa                      Relative to  $2 \times 10^{-5}$  Pa

## 3.3 Abbreviations

For the purposes of the present document, the following abbreviations apply:

ad	amplitude difference
AIS	Automatic Identification System
CSP	Channel SPacing
DC	Direct Current
DSC	Digital Selective Calling
EFTA	European Free Trade Association
emf	electromotive force
EU	European Union
EUT	Equipment Under Test
fd	frequency difference
FM	Frequency Modulation
FSK	Frequency Shift Keying
GNSS	Global Navigation Satellite System
GPS	Global Positioning System
IF	Intermediate Frequency
ITU-R	International Telecommunication Union - Radiocommunication Sector
ITU-T	International Telecommunication Union - Telecommunication Sector
MPFD	Maximum Permissible Frequency Deviation
RBW	Reference BandWidth
RF	Radio Frequency
rms	root mean square
RT	Radio Telephony
SINAD	(Signal + Noise + Distortion)/(Noise + Distortion)
VHF	Very High Frequency

---

# 4 General and operational requirements

## 4.0 Conformance

The manufacturer shall declare that compliance to the requirements of clause 4 is achieved and shall provide relevant documentation.

## 4.1 Construction

The mechanical and electrical construction and finish of the equipment shall conform in all respects to good engineering practice, and the equipment shall be suitable for use on board ships.

All controls shall be of sufficient size to enable the usual control functions to be easily performed and the number of controls should be the minimum necessary for simple and satisfactory operation.

All parts of the equipment to be checked during inspection or maintenance operations shall be readily accessible. The components shall be readily identifiable.

Technical documentation shall be supplied with the equipment.

The VHF maritime mobile service uses both single-frequency and two-frequency channels. For two-frequency channels there shall be a separation of 4,6 MHz between the transmitting frequency and the receiving frequency (see ITU Radio Regulations appendix 18 [1]).

The equipment shall incorporate an integrated GNSS receiver. Manufacturers shall provide evidence that the GNSS device complies with the applicable part of CENELEC 61108 series [7], i.e. part 1 for a GPS receiver, part 2 for a GLONASS receiver and part 3 for a Galileo receiver.

The equipment shall have minimum protection levels of IP54 as specified in clauses 5 and 6 of CENELEC EN 60529 [8].

The equipment shall be capable of operating on single frequency and two-frequency channels with manual control (simplex).

The equipment shall be of a colour which distinguishes it from the portable VHF equipment specified in ETSI EN 300 225 [4].

The equipment shall be able to operate on appropriate channels defined in ITU Radio Regulations, appendix 18 [1], noting in particular footnotes m) and e).

Additional VHF channels for maritime use outside those defined by Appendix 18 to the Radio Regulations may also be provided where permitted by relevant administrations. These channels shall be clearly identified for use as relating to the relevant administration(s) and accessed through a positive action(s) for enabling use of these channel(s) but means shall be provided to block any or all of these additional channels if required by the relevant administration(s).

If 12,5 kHz channels are implemented in the equipment it shall be in accordance with annex 4 of Recommendation ITU-R M.1084-5 [5].

The equipment shall be so designed that use of channel 70 for purposes other than DSC is prevented (see Recommendations ITU-R M.493-14 [3] and M.541-10 [i.2]), and that use of channels AIS1 and AIS2 for purposes other than AIS is prevented.

Scan or multiple watch may be provided but means shall be provided to block or unblock these functions.

If the equipment is fitted with an auxiliary antenna connector, simultaneous connection of both the auxiliary antenna and the normal antenna shall be prevented.

It shall not be possible to transmit while any frequency synthesizer used within the transmitter is out of lock.

It shall not be possible to transmit during channel switching operations.

## 4.2 Controls and indicators

The equipment shall have a channel selector and shall indicate the designator, as shown in ITU Radio Regulations, appendix 18 [1], of the channel at which the equipment is set. The channel designator shall be legible irrespective of the external lighting conditions.

Channel 16 shall be distinctively marked. Selection of channel 16, shall be preferably by readily accessible means (e.g. a distinctively marked key). Selection of channel 16 by any means shall automatically set the transmitter output power to maximum. This power level may subsequently be reduced by manual user control if required.

Where an input panel on the equipment for entering the digits 0 to 9 is provided, this shall conform to Recommendation ITU-T E.161 [2].

The equipment shall have the following additional controls and indicators:

- on/off switch for the equipment with a visual indication that the equipment is in operation;
- a manual, non-locking push to talk switch to operate the transmitter with a visual indication that the transmitter is activated and facilities to limit the transmission time to a maximum of 5 minutes. A short audible alarm and a visual indication may be provided to show when the transmission will be automatically terminated within the next 10 s. It shall be possible to reoperate the push to talk switch and reactivate the transmitter after a 10 s period;
- a switch for reducing transmitter output power to no more than 1 W where the RF output power is more than 1 W;
- an audio frequency power volume control;

- a squelch control;
- a visual indication that the transmitter is activated.

The equipment shall also meet the following requirements:

- the user shall not have access to any control which, if wrongly set, might impair the technical characteristics of the equipment.

### 4.3 Microphone and loudspeaker

The equipment shall be fitted with an integral microphone and an integral loudspeaker.

During transmission the receiver output shall be muted.

### 4.4 Safety precautions

Measures shall be taken to protect the equipment against the effects of overcurrent or overvoltage.

Measures shall be taken to prevent damage to the equipment that might arise from an accidental reversal of polarity of the electrical power source.

No damage to the equipment shall occur when the antenna terminals are placed on open circuit or short circuit while transmitting for a period of at least 5 minutes in each case.

In order to provide protection against damage due to the build-up of static voltages at the antenna terminals, there shall be a dc path from the antenna terminals to chassis not exceeding 100 k $\Omega$ .

The information in any volatile memory device shall be protected from interruptions in the power supply of up to 60 s duration.

### 4.5 Labelling

All controls, instruments, indicators and terminals shall be clearly labelled.

Details of any external power supply from which the equipment is intended to operate shall be clearly indicated on the equipment.

The compass safe distance shall be stated on the equipment.

---

## 5 Technical requirements

### 5.0 Conformance

The manufacturer shall declare that compliance to the requirements of clause 5 is achieved and shall provide relevant documentation.

### 5.1 Switching time

The channel switching arrangement shall be such that the time necessary to change over from using one of the channels to using any other channel does not exceed 5 s.

The time necessary to change over from transmission to reception or vice versa, shall not exceed 0,3 s.

## 5.2 Class of emission and modulation characteristics

The equipment shall use phase modulation, G3E (frequency modulation with a pre-emphasis of 6 dB/octave) for speech and G2B for DSC signalling.

The equipment shall be designed to operate satisfactorily with channel separations of either 25 kHz or 12,5 kHz and 25 kHz.

## 5.3 Battery capacity

The equipment shall have a minimum operating time of 4 hours with a 80, 10, 10 duty cycle (80 % Standby, 10 % Tx and 10 % Rx) at normal temperature (clause 6.9.1).

The minimum operating time shall be met when:

- the battery is fully charged; or
- when new dry cells are installed (when appropriate).

## 5.4 DSC functionality

The equipment shall comply with ETSI EN 300 338-5 [6] for all aspects of DSC functionality.

Continuous monitoring of channel 70 for DSC reception purposes shall be provided and the equipment shall comply with all applicable DSC receive clauses of the present document while the transmitter is not active.

---

# 6 General conditions of measurement

## 6.1 Arrangements for RF connections to the equipment

### 6.1.1 RF connections to integral antenna equipment

For equipment without an antenna connector, the manufacturer shall prepare the equipment with a temporary 50  $\Omega$  connector to be used as the RF input/output port.

### 6.1.2 RF connection to equipment with a detachable antenna

Equipment having an antenna connector shall be tested using the antenna connector as the RF input/output port.

In the case where equipment has more than one antenna connector, the connector normally used to connect the portable antenna to the equipment shall be used.

## 6.2 Arrangements for test signals applied to the receiver input

Test signal sources shall be connected to the receiver input in such a way that the impedance presented to the receiver input is 50  $\Omega$ , irrespective of whether one or more test signals are applied to the receiver simultaneously.

The levels of the test signals shall be expressed in terms of the emf at the terminals to be connected to the receiver.

The nominal frequency of the receiver is the carrier frequency of the selected channel.

DSC test signals shall be DSC calls in accordance with tables A1-4.1 to A1-4.9 of Recommendation ITU-R M.493-14 [3] with a signal level of +6 dB $\mu$ V (emf). The standard test signal for a VHF DSC decoder shall be a phase-modulated signal at VHF channel 70 with modulation index = 2. The modulating signal shall have a nominal frequency of 1 700 Hz and a frequency shift of  $\pm$ 400 Hz with a modulation rate of 1 200 baud.

## 6.3 Squelch

Unless otherwise specified, the receiver squelch facility shall be made inoperative for the duration of the conformance tests.

## 6.4 Normal test modulation

For normal test modulation, the modulation frequency shall be:

- 25 kHz channels: 1 kHz and the frequency deviation shall be  $\pm 3$  kHz.
- 12,5 kHz channels: 1 kHz and the frequency deviation shall be  $\pm 1,5$  kHz.

For DSC conformance testing and maintenance purposes, the equipment shall have facilities not accessible to the operator to generate a continuous B or Y signal and dot pattern.

Additionally for conformance testing, the VHF equipment shall have facilities not accessible to the operator for generating an unmodulated carrier.

## 6.5 Artificial antenna

When tests are carried out with an artificial antenna, this shall be a non-reactive, non-radiating 50  $\Omega$  load.

## 6.6 Arrangements for test signals applied to the transmitter input

For the purpose of the present document, the audio frequency modulating signal applied to the transmitter shall be produced by a signal generator applied to the connection terminals replacing the microphone transducer.

## 6.7 Test channels

Conformance tests for 25 kHz channel operation shall be made on channel 16.

Conformance tests for 12,5 kHz channel operation shall be made on channel 276.

Conformance tests for DSC shall be made on channel 70.

## 6.8 Test conditions, power sources and ambient temperatures

### 6.8.1 Normal and extreme test conditions

Conformance tests shall be performed under normal test conditions and also, where stated, under extreme test conditions (clauses 6.10.1 and 6.10.2 applied simultaneously).

### 6.8.2 Test power source

During conformance testing, the equipment shall be supplied from a test power source capable of producing normal and extreme test voltages as specified in clauses 6.9.2 and 6.10.2.

The internal impedance of the test power source shall be low enough for its effect on the test results to be negligible. For the purpose of testing the power source voltage shall be measured at the input terminals of the equipment.

During testing, the power source voltages shall be maintained within a tolerance of  $\pm 3$  % relative to the voltage level at the beginning of each test.

## 6.9 Normal test conditions

### 6.9.1 Normal temperature and humidity

The normal temperature and humidity conditions for tests shall be a combination of temperature and humidity within the following ranges:

- temperature: +15 °C to +35 °C;
- relative humidity: 20 % to 75 %.

When the relative humidity is lower than 20 %, it shall be stated in the test report.

### 6.9.2 Normal power sources

#### 6.9.2.1 Battery power source

Where the equipment is designed to operate from a battery, the normal test voltage shall be the nominal voltage of the battery as declared by the manufacturer.

#### 6.9.2.2 Other power sources

For operation from other power sources the normal test voltage shall be that declared by the manufacturer.

## 6.10 Extreme test conditions

### 6.10.0 General

Unless otherwise stated the extreme tests conditions means that the Equipment Under Test (EUT) shall be tested at the upper temperature and at the upper limit of the supply voltage applied simultaneously, and at the low temperature and the lower limit of the supply voltage applied simultaneously.

#### 6.10.1 Extreme temperatures

For tests at extreme temperatures, measurements shall be made in accordance with clause 6.11, at a lower temperature of -15 °C and an upper temperature of +55 °C.

#### 6.10.2 Extreme values of test power sources

##### 6.10.2.1 Battery power source

The upper extreme test voltage shall be the terminal voltage of the battery (fresh primary battery or fully charged secondary battery) when loaded by the equipment at normal temperature in the receive condition with the squelch operated to mute the audio.

The lower extreme test voltage shall be 0,85 times the value determined above.

Where equipment can be powered by batteries of differing terminal voltage then the upper extreme test voltage shall be determined using the highest terminal voltage battery and the lower extreme test voltage shall be 0,85 times the upper extreme of the lowest terminal voltage battery.

##### 6.10.2.2 Other power sources

For operation from other power sources the extreme test voltages shall be that declared by the equipment manufacturer.



## 6.11 Procedure for tests at extreme temperatures

The equipment shall be switched off during the temperature stabilizing periods.

Before conducting tests at the upper temperature, the equipment shall be placed in the test chamber and left until thermal equilibrium is reached. The equipment shall then be switched on in the high power transmit condition at the normal voltage until the transmit timeout timer is activated and the equipment is returned to standby mode. The equipment shall then meet the relevant clauses of the present document.

For tests at the lower temperature, the equipment shall be left in the test chamber until thermal equilibrium is reached and shall then be switched to the standby or receive position for one minute. The equipment shall then meet the relevant clauses of the present document.

## 6.12 Reference Bandwidths for emission measurements

The reference bandwidths used shall be as stated in tables 1 and 2.

**Table 1: Reference bandwidths to be used for the measurement of spurious emission**

Frequency range	RBW
9 kHz to 150 kHz	1 kHz
150 kHz to 30 MHz	10 kHz
30 MHz to 1 GHz	100 kHz
1 GHz to 12,75 GHz	1 MHz

**Table 2: Reference bandwidths to be used close to the wanted emission for equipment operating below 1 GHz**

Frequency offset from carrier	RBW
250 % of the CSP to 100 kHz	1 kHz
100 kHz to 500 kHz	10 kHz

---

# 7 Environmental tests

## 7.1 Procedure

Environmental tests shall be carried out before testing the same equipment to the other requirements of the present document. Unless otherwise stated, the equipment shall be connected to an electrical power source during the periods for which it is specified that electrical tests shall be carried out. These tests shall be performed using the normal test voltage.

## 7.2 Performance check

A performance check shall be a check of transmitter frequency error, clause 8.1, transmitter carrier power, clause 8.2 and maximum usable sensitivity, clause 9.3. These performance checks shall only be performed under normal test conditions.

## 7.3 Drop test

### 7.3.1 Definition

This test simulates the effects of a free fall of the equipment onto the deck of a ship resulting from mishandling.

## 7.3.2 Method of measurement

The test shall consist of a series of 6 drops, one on each surface of the equipment.

The test shall be carried out under normal temperature and humidity.

The test surface shall consist of a piece of solid hard wood with a thickness of at least 150 mm and a mass of 30 kg or more.

The height of the lowest part of the equipment relative to the test surface at the moment of release shall be  $(1\ 000 \pm 10)$  mm.

The equipment shall be subjected to this test configured for use as in operational circumstances.

At the end of the test the equipment shall be subjected to a performance check and shall then be examined for external indications of damage. The findings shall be noted in the test report.

## 7.3.3 Requirement

The equipment shall meet the requirements of the performance check.

There shall be no harmful deterioration of the equipment visible.

The distress alert function shall not be activated.

The protection of the distress alert button shall function as required after the test.

## 7.4 Temperature tests

### 7.4.1 Definition

The immunity against the effects of temperature is the ability of the equipment to maintain the specified mechanical and electrical performance after the following tests has been carried out.

### 7.4.2 Dry heat

#### 7.4.2.1 Definition

This test determines the ability of equipment to be operated at high ambient temperatures and to operate through temperature changes.

#### 7.4.2.2 Method of measurement

The EUT shall be placed in a chamber at normal room temperature and relative humidity. The EUT and, if appropriate, any climatic control devices with which it is provided shall then be switched on. The temperature shall then be raised to and maintained at  $(+55 \pm 3)$  °C.

At the end of a soak period of 10 hours to 16 hours at  $(+55 \pm 3)$  °C, the EUT shall be subjected to the performance check. The temperature of the chamber shall be maintained at  $(+55 \pm 3)$  °C during the whole performance check period. At the end of the test, the EUT shall be returned to normal environmental conditions or to those required at the start of the next test. The maximum rate of raising or reducing the temperature of the chamber in which the equipment is being tested shall be 1 °C/minute.

#### 7.4.2.3 Requirement

The equipment shall meet the requirements of the performance check.

### 7.4.3 Damp heat

#### 7.4.3.1 Definition

This test determines the ability of equipment to be operated under conditions of high humidity.

#### 7.4.3.2 Method of measurement

The EUT shall be placed in a chamber at normal room temperature and relative humidity. The temperature shall then be raised to  $(+40 \pm 2)$  °C, and the relative humidity raised to  $(93 \pm 3)$  % over a period of  $(3 \pm 0,5)$  hour. These conditions shall be maintained for a period of 10 hours to 16 hours. Any climatic control devices provided in the EUT may be switched on at the conclusion of this period. The EUT shall be switched on 30 minutes later, or after such period as agreed by the manufacturer, and shall be kept operational for at least 2 hours during which period the EUT shall be subjected to the performance check once. The temperature and relative humidity of the chamber shall be maintained as specified during the whole test period. At the end of the test period and with the EUT still in the chamber, the chamber shall be brought to room temperature in not less than 1 hour. At the end of the test the EUT shall be returned to normal environmental conditions or to those required at the start of the next test. The maximum rate of raising or reducing the temperature of the chamber in which the equipment is being tested shall be 1 °C/minute.

#### 7.4.3.3 Requirement

The equipment shall meet the requirements of the performance check.

### 7.4.4 Low temperature cycle

#### 7.4.4.1 Definition

These tests determine the ability of equipment to be operated at low temperatures. They also allow equipment to demonstrate an ability to start up at low ambient temperatures.

#### 7.4.4.2 Method of measurement

The EUT shall be placed in a chamber at normal room temperature and relative humidity. The temperature shall then be reduced to and maintained at  $(-15 \pm 3)$  °C, for a period of 10 hours to 16 hours. Any climatic control devices provided in the EUT may be switched on at the conclusion of this period. The EUT shall be switched on 30 minutes later, and shall be kept operational for at least 2 hours during which period the EUT shall be subjected to the performance check once. The temperature of the chamber shall be maintained at  $(-15 \pm 3)$  °C during the whole test period. At the end of the test the EUT shall be returned to normal environmental conditions or to those required at the start of the next test. The maximum rate of raising or reducing the temperature of the chamber in which the equipment is being tested shall be 1 °C/minute.

#### 7.4.4.3 Requirement

The equipment shall meet the requirements of the performance check.

---

## 8 Transmitter

### 8.0 General

All tests on the transmitter shall be carried out with the output power switch set at its maximum except where otherwise stated.

### 8.1 Frequency error

#### 8.1.1 Definition

The frequency error is the difference between the measured carrier frequency and its nominal value.

#### 8.1.2 Method of measurement

The carrier frequency shall be measured in the absence of modulation, with the transmitter connected to an artificial antenna (clause 6.5). Measurements shall be made under normal test conditions (clause 6.9) and under extreme test conditions (clause 6.10).

This test shall be carried out with the output power switch being set at both maximum and minimum.

#### 8.1.3 Limits

The frequency error shall be within  $\pm 1,5$  kHz.

### 8.2 Carrier power

#### 8.2.1 Definitions

The carrier power is the mean power delivered to the artificial antenna during one radio frequency cycle in the absence of modulation.

The rated output power is the carrier power declared by the manufacturer.

#### 8.2.2 Method of measurement

The transmitter shall be connected to an artificial antenna (clause 6.5) and the power delivered to this artificial antenna shall be measured. The measurements shall be made under normal test conditions (clause 6.9) and also under extreme test conditions (clause 6.10) on the highest frequency channel, the lowest frequency channel and on channel 16.

#### 8.2.3 Limits, Normal and extreme test conditions

The rated output power shall be between 3W and 6W.

The carrier power on the appendix 18 channels, ITU Radio Regulations, appendix 18 [1], with the output power switch (clause 4.2) set at maximum, shall be between 3 W and 6 W.

With the output power switch at minimum, the carrier power shall remain between 0,1 W and 1 W.

## 8.3 Frequency deviation

### 8.3.1 Definition

For the purpose of the present document, the frequency deviation is the difference between the instantaneous frequency of the modulated radio frequency signal and the carrier frequency.

### 8.3.2 Maximum permissible frequency deviation

#### 8.3.2.1 Method of measurement

The frequency deviation shall be measured at the output with the transmitter connected to an artificial antenna (clause 6.5), by means of a deviation meter capable of measuring the maximum deviation, including that due to any harmonics and intermodulation products which may be generated in the transmitter.

The modulation frequency shall be varied between 300 Hz and 3 kHz. The level of this test signal shall be 20 dB above the level which produces normal test modulation (clause 6.4). This test shall be repeated with the output power switch set at maximum and minimum.

#### 8.3.2.2 Limits

The maximum permissible frequency deviation shall be:

- 25 kHz channels:  $\pm 5$  kHz.
- 12,5 kHz channels:  $\pm 2,5$  kHz.

### 8.3.3 Reduction of frequency deviation at modulation frequencies above 3 kHz

#### 8.3.3.1 Method of measurement

The transmitter shall be operated under normal test conditions (clause 6.9) connected to a load as specified in clause 6.5. The transmitter shall be modulated by the normal test modulation (clause 6.4). With the input level of the modulation signal being kept constant, the modulation frequency shall be varied between 3 kHz (see note) and a frequency equal to the channel separation for which the equipment is intended and the frequency deviation shall be measured.

NOTE: 2,55 kHz for transmitters intended for 12,5 kHz channel separation.

#### 8.3.3.2 Limits

The frequency deviation at modulation frequencies between 3,0 kHz (for equipment operating with 25 kHz channel separations) or 2,55 kHz (for equipment operating with 12,5 kHz channel separation) and 6,0 kHz shall not exceed the frequency deviation at a modulation frequency of 3,0 kHz / 2,55 kHz. At 6,0 kHz the deviation shall be not more than 30,0 % of the maximum permissible frequency deviation.

The frequency deviation at modulation frequencies between 6,0 kHz and a frequency equal to the channel separation for which the equipment is intended shall not exceed that given by a linear representation of the frequency deviation (dB) relative to the modulation frequency, starting at the 6,0 kHz limit and having a slope of -14,0 dB per octave. These limits are illustrated in figure 1.

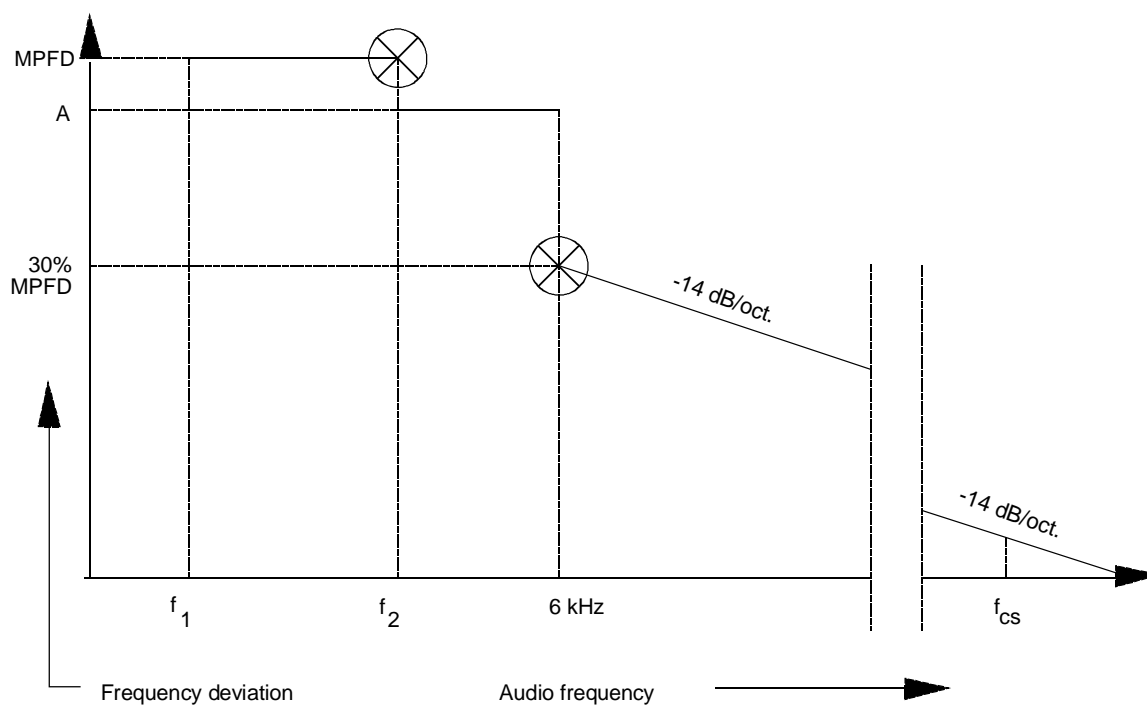

## NOTE:

## Abbreviations:

- f1 lowest appropriate frequency  
 f2 3,0 kHz (for 25 kHz channel separation), or  
 2,55 kHz (for 12,5 kHz channel separation)  
 MPFD maximum permissible frequency deviation, clause 8.3.2.1  
 A measured frequency deviation at f2  
 fcs frequency equal to channel separation

**Figure 1: Frequency deviation**

## 8.4 Sensitivity of the modulator, including microphone

### 8.4.1 Definition

This characteristic expresses the capability of the transmitter to produce sufficient modulation when an audio frequency signal corresponding to the normal mean speech level is applied to the microphone.

### 8.4.2 Method of measurement

A 25 kHz channel shall be selected and the transmitter activated. An acoustic signal with a frequency of 1 kHz and sound level of 94 dBA shall be applied to the microphone. The resulting deviation shall be measured.

### 8.4.3 Limits

The resulting frequency deviation shall be between  $\pm 1,5$  kHz and  $\pm 3$  kHz.

## 8.5 Audio frequency response

### 8.5.1 Definition

The audio frequency response is the frequency deviation of the transmitter as a function of the modulating frequency.

## 8.5.2 Method of measurement

A modulating signal at a frequency of 1 kHz shall be applied to the transmitter and the deviation shall be measured at the output. The audio input level shall be adjusted so that the frequency deviation is  $\pm 1$  kHz. This is the reference point in figure 2 (1 kHz corresponds to 0 dB).

The modulation frequency shall then be varied between 300 Hz and 3 kHz (see note), with the level of the audio frequency signal being kept constant and equal to the value specified above.

The test shall be carried out on one channel only (see clause 6.6).

NOTE: 2,55 kHz for transmitters intended for 12,5 kHz channel separation.

The test shall be carried out on one channel only (see clause 6.7).

## 8.5.3 Limit

The audio frequency response shall be within +1 dB and -3 dB of a 6 dB/octave line passing through the reference point (see figure 2). The upper limit frequency shall be 2,55 kHz for 12,5 kHz channels.

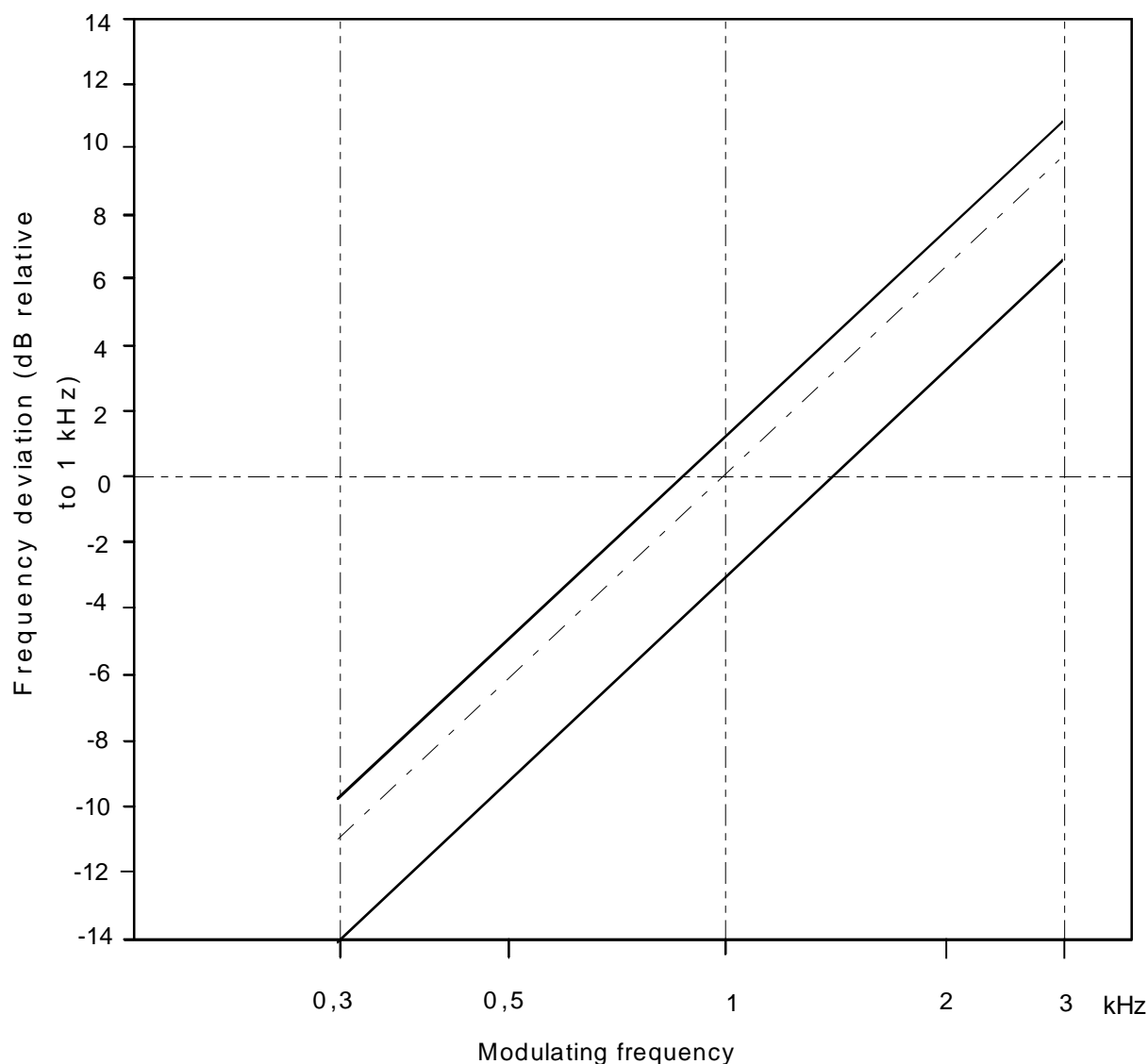

Figure 2: Audio frequency response

## 8.6 Audio frequency harmonic distortion of the emission

### 8.6.1 Definition

The harmonic distortion of the emission modulated by an audio frequency signal is defined as the ratio, expressed as a percentage, of the root mean square (rms) voltage of all the harmonic components of the fundamental modulation frequency to the total rms voltage of the modulation signal after linear demodulation.

### 8.6.2 Method of measurement

#### 8.6.2.0 General

The RF signal produced by the transmitter shall be applied via an appropriate coupling device to a linear demodulator with a de-emphasis network of 6 dB per octave. This test shall be carried out on a 25 kHz channel with the output power switch at both maximum and minimum.

#### 8.6.2.1 Normal test conditions

Under normal test conditions (clause 6.9) the RF signal shall be modulated successively at frequencies of 300 Hz, 500 Hz and 1 kHz with a constant modulation index of 3.

The distortion of the audio frequency signal shall be measured at all the frequencies specified above.

#### 8.6.2.2 Extreme test conditions

Under extreme test conditions (clauses 6.10.1 and 6.10.2 applied simultaneously), the measurements shall be carried out at 1 kHz with a frequency deviation of  $\pm 3$  kHz.

### 8.6.3 Limits

The harmonic distortion shall not exceed 10 %.

## 8.7 Adjacent channel power

### 8.7.1 Definition

The adjacent channel power is that part of the total power output of a transmitter under defined conditions of modulation, which falls within a specified passband centred on the nominal frequency of either of the adjacent channels. This power is the sum of the mean power produced by the modulation, hum and noise of the transmitter.

### 8.7.2 Method of measurement

The test shall be made on the lowest frequency channel, the highest frequency channel and on channel 16.

The adjacent channel power can be measured with a power measuring receiver which conforms to annex B (referred to in this clause and annex B as the "receiver") see also Recommendation ITU-R SM.332-4 [i.4]:

- a) The transmitter shall be operated at the carrier power determined in clause 8.2 under normal test conditions. The output of the transmitter shall be linked to the input of the "receiver" by a connecting device such that the impedance presented to the transmitter is 50  $\Omega$  and the level at the "receiver" input is appropriate.
- b) With the transmitter unmodulated, the tuning of the "receiver" shall be adjusted so that a maximum response is obtained. This is the 0 dB response point. The "receiver" attenuator setting and the reading of the meter shall be recorded.

The measurement may be made with the transmitter modulated with normal test modulation, in which case this fact shall be recorded with the test results.



- c) The tuning of the "receiver" shall be adjusted away from the carrier so that the "receiver" -6 dB response nearest to the transmitter carrier frequency is located at a displacement from the nominal carrier frequency of 17 kHz for 25 kHz channels or 8,25 kHz for 12,5 kHz channels.
- d) The transmitter shall be modulated with 1,25 kHz at a level which is 20 dB higher than that required to produce  $\pm 3$  kHz deviation for 25 kHz channels or  $\pm 1,5$  kHz deviation for 12,5 kHz channels.
- e) The "receiver" variable attenuator shall be adjusted to obtain the same meter reading as in step b) or a known relation to it.
- f) The ratio of adjacent channel power to carrier power is the difference between the attenuator settings in steps b) and e), corrected for any differences in the reading of the meter.
- g) The measurement shall be repeated with the "receiver" tuned to the other side of the carrier.

### 8.7.3 Limits

The adjacent channel power shall not exceed a value of:

- 25 kHz channel: 70 dB below the carrier power of the transmitter without any need to be below the spurious emission limit of 0,25  $\mu$ W.
- 12,5 kHz channel: 60 dB below the carrier power of the transmitter without any need to be below the spurious emission limit of 0,25  $\mu$ W.

## 8.8 Conducted spurious emissions conveyed to the antenna

### 8.8.1 Definition

Conducted spurious emissions are emissions on a frequency or frequencies which are outside the necessary bandwidth and the level of which may be reduced without affecting the corresponding transmission of information. Spurious emissions include harmonic emissions, parasitic emissions, intermodulation products and frequency conversion products, but exclude out of band emissions.

### 8.8.2 Method of measurement

Conducted spurious emissions shall be measured with the unmodulated transmitter connected to the artificial antenna (clause 6.5).

The measurements shall be made over a range from 9 kHz to 2 GHz, excluding the channel on which the transmitter is operating and its adjacent channels.

The measurements for each spurious emission shall be made using a tuned radio measuring instrument or a spectrum analyser.

### 8.8.3 Limit

The power of any conducted spurious emission on any discrete frequency shall not exceed 0,25  $\mu$ W.

## 8.9 Cabinet radiation and conducted spurious emissions other than those conveyed to the antenna

### 8.9.1 Definitions

Cabinet radiation consists of emissions at frequencies, other than those of the carrier and the sideband components resulting from the wanted modulation process, which are radiated by the equipment cabinet and structures.

Conducted spurious emissions other than those conveyed to the antenna are emissions at frequencies, other than those of the carrier and the sideband components resulting from the wanted modulation process, which are produced by conduction in the wiring and accessories used with the equipment.

Integral antenna equipment shall be tested with the normal antenna fitted and the carrier frequency emission shall be filtered as described in the method of measurement.

## 8.9.2 Method of measurement

On a test site, selected from clause 5 of ETSI TS 103 052 [9], the equipment shall be placed at the specified height on a non-conducting support and in a position which is closest to normal use as declared by the manufacturer.

The transmitter antenna connector shall be connected to an artificial antenna, clause 6.5.

The test antenna shall be orientated for vertical polarization and the length of the test antenna shall be chosen to correspond to the instantaneous frequency of the measuring receiver, or a suitable broadband antenna may be used.

The output of the test antenna shall be connected to a measuring receiver.

For integral antenna equipment testing, a filter shall be inserted between the test antenna and the measuring receiver. For the measurement of spurious emissions below the second harmonic of the carrier frequency the filter used shall be a high Q (notch) filter centred on the transmitter carrier frequency and attenuating this signal by at least 30 dB. For the measurement of spurious emissions at and above the second harmonic of the carrier frequency the filter used shall be a high pass filter with a stop band rejection exceeding 40 dB and the cut off frequency of this high pass filter shall be approximately 1,5 times the transmitter carrier frequency.

The transmitter shall be switched on without modulation, and the measuring receiver shall be tuned over the frequency range 30 MHz to 2 GHz, except for the channel on which the transmitter is intended to operate and its adjacent channels.

At each frequency at which a spurious component is detected:

- a) the test antenna shall be raised and lowered through the specified range of heights until a maximum signal level is detected on the measuring receiver;
- b) the transmitter shall be rotated through 360° in the horizontal plane, until the maximum signal level is detected by the measuring receiver;
- c) the maximum signal level detected by the measuring receiver shall be noted;
- d) the transmitter shall be replaced by a substitution antenna as defined in clause 5.3.2 of ETSI TS 103 052 [9];
- e) the substitution antenna shall be orientated for vertical polarization and the length of the substitution antenna shall be adjusted to correspond to the frequency of the spurious component detected;
- f) the substitution antenna shall be connected to a calibrated signal generator;
- g) the frequency of the calibrated signal generator shall be set to the frequency of the spurious component detected;
- h) the input attenuator setting of the measuring receiver shall be adjusted in order to increase the sensitivity of the measuring receiver, if necessary;
- i) the test antenna shall be raised and lowered through the specified range of heights to ensure that the maximum signal is received;
- j) the input signal to the substitution antenna shall be adjusted to the level that produces a level detected by the measuring receiver that is equal to the level noted while the spurious component was measured, corrected for the change of input attenuator setting of the measuring receiver;
- k) the input level to the substitution antenna shall be recorded as power level, corrected for the change of input attenuator setting of the measuring receiver;
- l) the measurement shall also be taken with the test antenna and the substitution antenna orientated for horizontal polarization;

- m) the effective radiated power of the spurious component is the larger of the two power levels recorded for that spurious component at the input to the substitution antenna, corrected to compensate for the gain of the antenna if necessary;
- n) the measurements shall be repeated with the transmitter in stand-by mode.

### 8.9.3 Limits

With the transmitter in stand-by mode the cabinet radiation and spurious emissions shall not exceed 2 nW.

With the transmitter in operation the cabinet radiation and spurious emissions shall not exceed 0,25  $\mu$ W.

## 8.10 Residual modulation of the transmitter

### 8.10.1 Definition

The residual modulation of the transmitter is the ratio, in dB, of the demodulated RF signal in the absence of wanted modulation, to the demodulated RF signal produced when the normal test modulation is applied.

### 8.10.2 Method of measurement

The normal test modulation defined in clause 6.4 shall be applied to the transmitter. The high frequency signal produced by the transmitter shall be applied, via an appropriate coupling device, to a linear demodulator with a de-emphasis network of 6 dB per octave. The time constant of this de-emphasis network shall be at least 750  $\mu$ s.

Precautions shall be taken to avoid the effects of emphasizing the low audio frequencies produced by internal noise.

The signal shall be measured at the demodulator output using an rms voltmeter.

The modulation shall then be switched off and the level of the residual audio frequency signal at the output shall be measured again.

### 8.10.3 Limit

The residual modulation shall not exceed -40 dB on either 25 kHz or 12,5 kHz channels.

## 8.11 Transient frequency behaviour of the transmitter

### 8.11.1 Definitions

The transient frequency behaviour of the transmitter is the variation in time of the difference between the instantaneous transmitter frequency and the nominal frequency of the transmitter when the RF output power is switched on and off:

- $t_{on}$ : according to the method of measurement described in clause 8.11.2 the switch-on instant  $t_{on}$  of a transmitter is defined by the condition when the output power, measured at the antenna terminal, exceeds 0,1 % of the nominal power;
- $t_1$ : period of time starting at  $t_{on}$  and finishing according to table 3;
- $t_2$ : period of time starting at the end of  $t_1$  and finishing according to table 3;
- $t_{off}$ : switch-off instant defined by the condition when the nominal power falls below 0,1 % of the nominal power;
- $t_3$ : period of time finishing at  $t_{off}$  and starting according to table 3.

**Table 3: transient timings**

$t_1$ (ms)	5,0
$t_2$ (ms)	20,0
$t_3$ (ms)	5,0
NOTE: During the periods $t_1$ and $t_3$ the frequency difference shall not exceed the value of 25 kHz. During the period $t_2$ the frequency difference shall not exceed the value of 12,5 kHz.	

### 8.11.2 Method of measurement

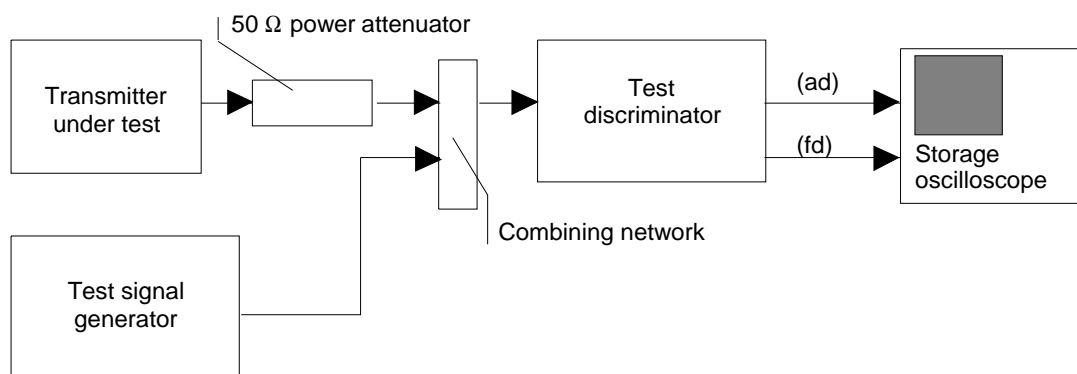
**Figure 3: Measurement arrangement**

Two signals shall be connected to the test discriminator via a combining network.

The transmitter shall be connected to a 50  $\Omega$  power attenuator.

The output of the power attenuator shall be connected to the test discriminator via one input of the combining network.

A test signal generator shall be connected to the second input of the combining network.

The test signal shall be adjusted to the nominal frequency of the transmitter.

The test signal shall be modulated by a frequency of 1 kHz with a deviation of  $\pm 25$  kHz.

The test signal level shall be adjusted to correspond to 0,1 % of the power of the transmitter under test measured at the input of the test discriminator. This level shall be maintained throughout the measurement.

The amplitude difference (ad) and the frequency difference (fd) output of the test discriminator shall be connected to a storage oscilloscope.

The storage oscilloscope shall be set to display the channel corresponding to the frequency difference (fd) input up to  $\pm 1$  channel frequency difference, corresponding to the relevant channel separation from the nominal frequency.

The storage oscilloscope shall be set to a sweep rate of 10 ms/division and set so that the triggering occurs at 1 division from the left edge of the display.

The display shows the 1 kHz test signal continuously.

The storage oscilloscope shall then be set to trigger on the channel corresponding to the amplitude difference (ad) input at a low input level, rising.

The transmitter shall then be switched on, without modulation, to produce the trigger pulse and a picture on the display.

The result of the change in the ratio of power between the test signal and the transmitter output, due to the capture ratio of the test discriminator, produces two separate sides on the picture, one showing the 1 kHz test signal, the other the frequency difference of the transmitter versus time:

- the moment when the 1 kHz test signal is completely suppressed is considered to provide  $t_{on}$ ;
- the periods of time  $t_1$  and  $t_2$  as defined in table 3 shall be used to define the appropriate template;
- the result shall be recorded as frequency difference versus time;
- the transmitter shall remain switched on.

The storage oscilloscope shall be set to trigger on the channel corresponding to the amplitude difference (ad) input at a high input level, decaying and set so that the triggering occurs at 1 division from the right edge of the display:

- the transmitter shall then be switched off;
- the moment when the 1 kHz test signal starts to rise is considered to provide  $t_{off}$ ;
- the period of time  $t_3$  as defined in table 3 shall be used to define the appropriate template;
- the result shall be recorded as frequency difference versus time.

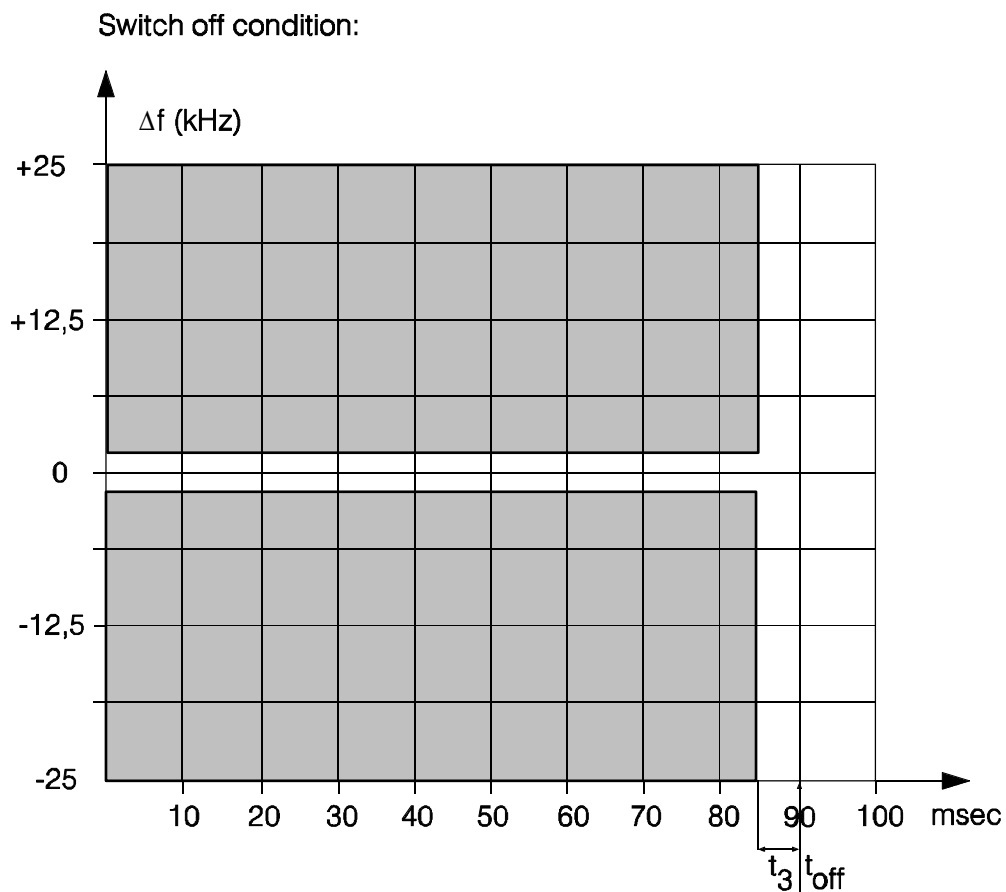
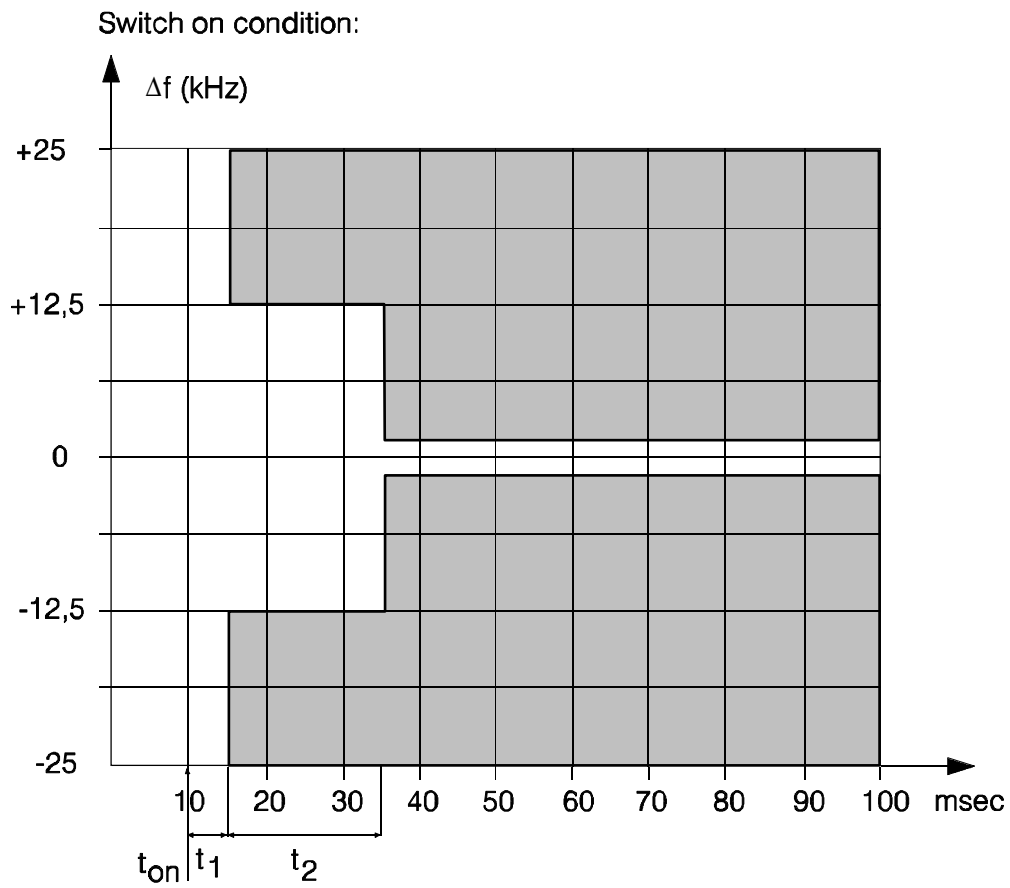

Figure 4

### 8.11.3 Limits

- During the period of time  $t_1$  the frequency difference shall not exceed the value of 25 kHz.
- During the period of time  $t_2$  the frequency difference shall not exceed the value of 12,5 kHz.
- The frequency difference, after  $t_2$ , shall not exceed the value of 1,5 kHz.
- Before the start of  $t_3$  the frequency difference shall not exceed the value of 1,5 kHz.
- During the period of time  $t_3$  the frequency difference shall not exceed the value of 25 kHz.

## 8.12 Frequency error (demodulated DSC signal)

### 8.12.1 Definition

The frequency error for the B- and the Y-state is the difference between the measured frequency from the demodulator and the nominal values.

### 8.12.2 Method of measurement

The transmitter shall be connected to the artificial antenna as specified in clause 6.5 and a suitable FM demodulator. The transmitter shall be set to channel 70.

The transmitter shall be set to transmit a continuous B- or Y- state.

The measurement shall be performed by measuring the demodulated output, for both the continuous B- and Y-state.

The measurements shall be carried out under normal test conditions (see clause 6.9) and extreme test conditions (see clauses 6.10.1 and 6.10.2 applied simultaneously).

### 8.12.3 Limits

The measured frequency from the demodulator at any time for the B-state shall be within  $2\,100\text{ Hz} \pm 10\text{ Hz}$  and for the Y-state within  $1\,300\text{ Hz} \pm 10\text{ Hz}$ .

## 8.13 Modulation index for DSC

### 8.13.1 Definition

This test measures the modulation index in the B and Y states.

### 8.13.2 Method of measurement

The transmitter shall be set to transmit continuous B and then Y signals. The frequency deviations shall be measured.

### 8.13.3 Limits

The modulation index shall be  $2,0 \pm 10\%$ .

## 8.14 Modulation rate for DSC

### 8.14.1 Definition

The modulation rate is the bit stream speed measured in bit/s.

## 8.14.2 Method of measurement

The transmitter shall be set to transmit continuous dot pattern.

The RF output terminal of the transmitter, suitably attenuated, shall be connected via a linear FM demodulator to a calibrated FSK demodulator. The output of the FSK demodulator shall be limited in bandwidth by a low pass filter with a cut-off frequency of 1 kHz and a slope of 12 dB/octave.

The frequency of the output shall be measured.

## 8.14.3 Limits

The frequency shall be 600 Hz  $\pm$  30 ppm corresponding to a modulation rate of 1 200 baud.

## 8.15 Testing of free channel transmission on DSC channel 70

### 8.15.1 Definition

This test verifies that the transmitter has a facility to prevent transmission of DSC calls if channel 70 is busy, except in case of distress calls.

### 8.15.2 Method of measurement

The output of the transmitter shall be suitably connected to a calibrated apparatus for decoding and printing out the information content of the call sequences generated by the equipment.

The receiver input is connected to a signal generator. The signal generator is set to the frequency of channel 70 (156,525 MHz) and the RF signal shall be modulated by a DSC dot pattern signal, see clause 6.4. The test is performed at an RF level; of +6 dB $\mu$ V (emf).

If the receiver input and transmitter output are combined in the same port it is necessary to combine the calibrated apparatus for decoding and printing out the information content of the call sequences and the signal generator through a suitable combining network, see clause 6.2. It may be necessary to protect the signal generator against the power output from the equipment through an attenuator.

For each available DSC call type:

- The signal generator output shall be turned on.
- The transmitter shall be set to transmit that DSC call (for guidance see annex C).
- The signal generator output shall be turned off.

### 8.15.3 Requirement

If the format specifier is distress in the transmitted DSC call, the call shall be transmitted while the signal generator output is still on.

Otherwise the call shall not be transmitted until the signal generator output has been turned off, and after a prioritized wait period defined in ETSI EN 300 338-5 [6].



---

## 9 Receiver

### 9.1 Harmonic distortion and rated audio frequency output power

#### 9.1.1 Definition

The harmonic distortion at the receiver output is defined as the ratio, expressed as a percentage, of the total rms voltage of all the harmonic components of the modulation audio frequency to the total rms voltage of the signal delivered by the receiver.

The rated audio frequency output power is the value stated by the manufacturer to be the maximum power available at the output, for which all the requirements of the present document are met.

#### 9.1.2 Methods of measurement

Test signals at a level of +100 dB $\mu$ V, at a carrier frequency equal to the nominal frequency of the receiver and modulated by the normal test modulation (clause 6.4) shall be applied in succession to the receiver input under the conditions specified in clause 6.1.

For each measurement, the receiver's audio frequency volume control shall be set so as to obtain, in a resistive load which simulates the receiver's operating load, the rated audio frequency output power (clause 9.1.1). The value of this load shall be stated by the manufacturer.

Under normal test conditions (clause 6.9) the test signal shall be modulated successively at 300 Hz, 500 Hz and 1 kHz with a constant modulation index of 3 (ratio between the frequency deviation and the modulation frequency). The harmonic distortion and audio frequency output power shall be measured at all the frequencies specified above.

Under extreme test conditions (clauses 6.10.1 and 6.10.2 applied simultaneously), the tests shall be made at the receiver's nominal frequency and at the nominal frequency  $\pm 1,5$  kHz. For these tests, the modulation shall be 1 kHz and the frequency deviation shall be  $\pm 3$  kHz.

#### 9.1.3 Limits

The rated audio frequency output power shall be at least 0,2 W in the loudspeaker.

The harmonic distortion shall not exceed 10 %.

### 9.2 Audio frequency response

#### 9.2.1 Definition

The audio frequency response is the variation in the receiver's audio frequency output level as a function of the modulating frequency of a received radio frequency signal modulated with constant deviation.

#### 9.2.2 Method of measurement

A test signal of +60 dB $\mu$ V (emf), at a carrier frequency equal to the nominal frequency of the receiver and modulated with normal test modulation (clause 6.4), shall be applied to the receiver antenna port under the conditions specified in clause 6.2.

The receiver's audio frequency power control shall be set so as to produce a power level of at least 50 % of the rated output power (clause 9.1). This setting shall remain unchanged during the test.

The frequency deviation shall then be reduced to 1 kHz and the audio output is the reference point in figure 5 (1 kHz corresponds to 0 dB).

The frequency deviation shall remain constant while the modulation frequency is varied between 300 Hz and 3 kHz and the output level shall then be measured.

The measurement shall be repeated with a test signal at frequencies 1,5 kHz above and below the nominal frequency of the receiver.

The test shall be carried out on one channel only (see clause 6.7).

### 9.2.3 Limits

The audio frequency response shall not deviate by more than +1 dB or -3 dB from a characteristic giving the output level as a function of the audio frequency, decreasing by 6 dB per octave and passing through the measured point at 1 kHz (figure 5).

Certified Intrinsically Safe equipment need not comply with the limits below 700 Hz.

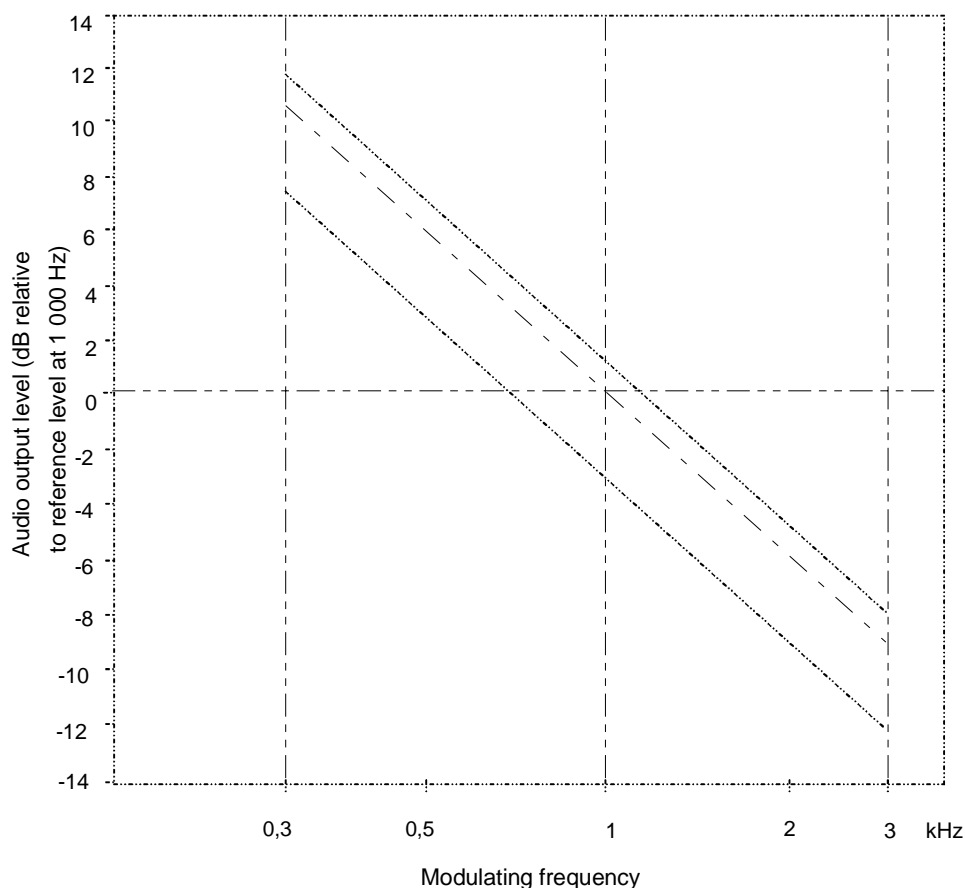

**Figure 5: Audio frequency response**

## 9.3 Maximum usable sensitivity

### 9.3.1 Definition

The maximum usable sensitivity of the receiver is the minimum level of the signal (emf) at the nominal frequency of the receiver which, when applied to the receiver input with normal test modulation (clause 6.4), will produce:

- in all cases, an audio frequency output power of at least 50 % of the rated output power (clause 9.1); and
- a SINAD ratio of 20 dB, measured at the receiver output through a sophonometric telephone filtering network such as described in Recommendation ITU-T O.41 [i.3].

### 9.3.2 Method of measurement

The test shall be performed on the lowest frequency channel, the highest frequency channel and on channel 16.

A test signal at a carrier frequency equal to the nominal frequency of the receiver, modulated by the normal test modulation (clause 6.4) shall be applied to the receiver input. An audio frequency load and a measuring instrument for measuring the SINAD ratio (through a psophometric network as specified in clause 9.3.1) shall be connected to the receiver output terminals.

The level of the test signal shall be adjusted until a SINAD ratio of 20 dB is obtained, using the psophometric network and with the receiver's audio frequency power control adjusted to produce at least 50 % of the rated output power. Under these conditions, the level of the test signal at the input is the value of the maximum usable sensitivity.

The measurements shall be taken under normal test conditions (clause 6.9) and under extreme test conditions (clauses 6.10.1 and 6.10.2 applied simultaneously).

A receiver output power variation of  $\pm 3$  dB relative to 50 % of the rated output power may be allowed for sensitivity measurements under extreme test conditions.

### 9.3.3 Limits

The maximum usable sensitivity for either 25 kHz or 12,5 kHz channels shall not exceed +6 dB $\mu$ V (emf) under normal test conditions and +12 dB $\mu$ V (emf) under extreme test conditions.

## 9.4 Co-channel rejection

### 9.4.1 Definition

The co-channel rejection is a measure of the capability of the receiver to receive a wanted modulated signal without exceeding a given degradation due to the presence of an unwanted modulated signal, both signals being at the nominal frequency of the receiver.

### 9.4.2 Method of measurement

The two input signals shall be connected to the receiver via a combining network (clause 6.2). The wanted signal shall have normal test modulation (clause 6.4). The unwanted signal shall be modulated by 400 Hz with a deviation of  $\pm 3$  kHz (see note). Both input signals shall be at the nominal frequency of the receiver under test and the measurement repeated for displacements of the unwanted signal of up to  $\pm 3$  kHz.

The wanted input signal level shall be set to the value corresponding to the maximum usable sensitivity as measured in clause 9.3. The amplitude of the unwanted input signal shall then be adjusted until the SINAD ratio (psophometrically weighted) at the output of the receiver is reduced to 14 dB.

The co-channel rejection ratio shall be expressed as the ratio in dB of the level of the unwanted signal to the level of the wanted signal at the receiver input for which the specified reduction in SINAD ratio occurs.

NOTE: For 12,5 kHz channels the frequency deviation and the displacement of the unwanted signal is  $\pm 1,5$  kHz.

### 9.4.3 Limit

The co-channel rejection ratio, at any frequency of the unwanted signal within the specified range, shall be between:

- -10 dB and 0 dB for 25 kHz channels;
- -12 dB and 0 dB for 12,5 kHz channels.

## 9.5 Adjacent channel selectivity

### 9.5.1 Definition

The adjacent channel selectivity is a measure of the capability of the receiver to receive a wanted modulated signal without exceeding a given degradation due to the presence of an unwanted modulated signal which differs in frequency from the wanted signal by the nominal channel spacing.

### 9.5.2 Method of measurement

The test shall be performed on the lowest frequency channel, the highest frequency channel and on channel 16.

The two input signals shall be applied to the receiver input via a combining network (clause 6.2). The wanted signal shall be at the nominal frequency of the receiver and shall have normal test modulation (clause 6.4). The unwanted signal shall be modulated by 400 Hz with a deviation of  $\pm 3$  kHz for 25 kHz channels or  $\pm 1,5$  kHz for 12,5 kHz channels, and shall be at the frequency of the channel immediately above that of the wanted signal.

The wanted input signal level shall be set to the value corresponding to the maximum usable sensitivity as measured in clause 9.3. The amplitude of the unwanted input signal shall then be adjusted until the SINAD ratio at the receiver output, psophometrically weighted, is reduced to 14 dB. The measurement shall be repeated with an unwanted signal at the frequency of the channel below that of the wanted signal.

The adjacent channel selectivity shall be expressed as the lower value of the ratios in dB for the upper and lower adjacent channels of the level of the unwanted signal to the level of the wanted signal.

The test shall then be repeated under extreme test conditions (clauses 6.10.1 and 6.10.2 applied simultaneously) with the wanted signal set to the value corresponding to the maximum usable sensitivity under these conditions.

### 9.5.3 Limits

25 kHz channels: The adjacent channel selectivity shall be not less than 70 dB under normal test conditions and not less than 60 dB under extreme test conditions.

12,5 kHz channels: The adjacent channel selectivity shall be not less than 60 dB under normal test conditions and not less than 50 dB under extreme test conditions.

## 9.6 Spurious response rejection

### 9.6.1 Definition

The spurious response rejection is a measure of the capability of the receiver to discriminate between the wanted modulated signal at the nominal frequency and an unwanted signal at any other frequency at which a response is obtained.

### 9.6.2 Method of measurement

Two input signals shall be applied to the receiver input via a combining network (clause 6.2). The wanted signal shall be at the nominal frequency of the receiver and shall have normal test modulation (clause 6.4).

The unwanted signal shall be modulated by 400 Hz with a deviation of  $\pm 3$  kHz.

The wanted input signal level shall be set to the value corresponding to the maximum usable sensitivity as measured in clause 9.3. The amplitude of the unwanted input signal shall be adjusted to an emf of +86 dB $\mu$ V. The frequency shall then be swept over the frequency range from 100 kHz to 2 000 MHz.

At any frequency at which a response is obtained, the input level shall be adjusted until the SINAD ratio psophometrically weighted, is reduced to 14 dB.

The spurious response rejection ratio shall be expressed as the ratio in dB between the unwanted signal and the wanted signal at the receiver input when the specified reduction in the SINAD ratio is obtained.

### 9.6.3 Limit

At any frequency separated from the nominal frequency of the receiver by more than 25 kHz, the spurious response rejection ratio shall be not less than 70 dB.

## 9.7 Intermodulation response

### 9.7.1 Definition

The intermodulation response is a measure of the capability of a receiver to receive a wanted modulated signal without exceeding a given degradation due to the presence of two or more unwanted signals with a specific frequency relationship to the wanted signal frequency.

### 9.7.2 Method of measurement

Three signal generators, A, B and C shall be connected to the receiver via a combining network (clause 6.2). The wanted signal, represented by signal generator A shall be at the nominal frequency of the receiver and shall have normal test modulation (clause 6.4). The unwanted signal from signal generator B shall be unmodulated and adjusted to the frequency 50 kHz above (or below) the nominal frequency of the receiver. The second unwanted signal from signal generator C shall be modulated by 400 Hz with a deviation of  $\pm 3$  kHz, and adjusted to a frequency 100 kHz above (or below) the nominal frequency of the receiver.

The wanted input signal shall be set to a value corresponding to the maximum usable sensitivity as measured in clause 9.3. The amplitude of the two unwanted signals shall be maintained equal and shall be adjusted until the SINAD ratio at the receiver output, psophometrically weighted, is reduced to 14 dB. The frequency of signal generator B shall be adjusted slightly to produce the maximum degradation of the SINAD ratio. The level of the two unwanted test signals shall be readjusted to restore the SINAD ratio of 14 dB. The intermodulation response ratio shall be expressed as the ratio in dB between the two unwanted signals and the wanted signal at the receiver input, when the specified reduction in the SINAD ratio is obtained.

### 9.7.3 Limit

The intermodulation response ratio shall not be less than 68 dB.

## 9.8 Blocking or desensitization

### 9.8.1 Definition

Blocking is a change (generally a reduction) in the wanted output power of the receiver or a reduction of the SINAD ratio due to an unwanted signal on another frequency.

## 9.8.2 Method of measurement

Two input signals shall be applied to the receiver via a combining network (clause 6.2). The modulated wanted signal shall be at the nominal frequency of the receiver and shall have normal test modulation (clause 6.4). Initially the unwanted signal shall be switched off and the wanted signal set to the value corresponding to the maximum usable sensitivity.

The output power of the wanted signal shall be adjusted, where possible, to 50 % of the rated output power and in the case of stepped volume controls, to the first step that provides an output power of at least 50 % of the rated output power. The unwanted signal shall be unmodulated and the frequency shall be swept between +1 MHz and +10 MHz, and also between -1 MHz and -10 MHz, relative to the nominal frequency of the receiver. For practical reasons the measurements will be carried out at frequency offsets of the unwanted signal at approximately 1 MHz, 2 MHz, 5 MHz and 10 MHz.

The input level of the unwanted signal, at all frequencies in the specified ranges, shall be so adjusted that the unwanted signal causes:

- a) a reduction of 3 dB in the output level of the wanted signal; or
- b) a reduction to 14 dB of the SINAD ratio at the receiver output using a psophometric telephone filtering network such as described in Recommendation ITU-T O.41 [i.3] whichever occurs first. This level shall be noted.

## 9.8.3 Limit

The blocking level for any frequency within the specified ranges, shall be not less than 90 dB $\mu$ V (emf), except at frequencies on which spurious responses are found (clause 9.6).

## 9.9 Conducted spurious emissions

### 9.9.1 Definition

Conducted spurious emissions from the receiver are components at any frequency, present at the receiver input port.

### 9.9.2 Method of measurement

The level of spurious emissions shall be measured as the power level at the antenna.

Conducted spurious radiations shall be measured as the power level of any discrete signal at the input terminals of the receiver. The receiver input terminals are connected to a spectrum analyser or selective voltmeter having an input impedance of 50  $\Omega$  and the receiver is switched on.

If the detecting device is not calibrated in terms of power input, the level of any detected components shall be determined by a substitution method using a signal generator.

The measurements shall extend over the frequency range of 9 kHz to 2 GHz.

### 9.9.3 Limit

The power of any spurious radiation shall not exceed 2 nW at any frequency in the range between 9 kHz and 2 GHz.

## 9.10 Radiated spurious emissions

### 9.10.1 Definition

Radiated spurious emissions from the receiver are components at any frequency radiated by the equipment cabinet and the structure.

Integral antenna equipment shall be tested with the normal antenna fitted.

### 9.10.2 Method of measurements

On a test site, selected from clause 5 of ETSI TS 103 052 [9], the equipment shall be placed at the specified height on a non-conducting support and in a position which is closest to normal use as declared by the manufacturer.

The test antenna shall be orientated for vertical polarization and the length of the test antenna shall be chosen to correspond to the instantaneous frequency of the measuring receiver, or a suitable broadband antenna may be used.

The output of the test antenna shall be connected to a measuring receiver.

The receiver shall be switched on without modulation, and measuring receiver shall be tuned over the frequency range 30 MHz to 2 GHz.

At each frequency at which a spurious component is detected:

- a) the test antenna shall be raised and lowered through the specified range of heights until a maximum signal level is detected on the measuring receiver;
- b) the receiver shall be rotated through 360° in the horizontal plane, until the maximum signal level is detected by the measuring receiver;
- c) the maximum signal level detected by the measuring receiver shall be noted;
- d) the receiver shall be replaced by a substitution antenna as defined in clause 5.3.2 of ETSI TS 103 052 [9];
- e) the substitution antenna shall be orientated for vertical polarization and the length of the substitution antenna shall be adjusted to correspond to the frequency of the spurious component detected;
- f) the substitution antenna shall be connected to a calibrated signal generator;
- g) the frequency of the calibrated signal generator shall be set to the frequency of the spurious component detected;
- h) the input attenuator setting of the measuring receiver shall be adjusted in order to increase the sensitivity of the measuring receiver, if necessary;
- i) the test antenna shall be raised and lowered through the specified range of heights to ensure that the maximum signal is received;
- j) the input signal to the substitution antenna shall be adjusted to the level that produces a level detected by the measuring receiver that is equal to the level noted while the spurious component was measured, corrected for the change of input attenuator setting of the measuring receiver;
- k) the input level to the substitution antenna shall be recorded as power level, corrected for the change of input attenuator setting of the measuring receiver;
- l) the measurement shall also be taken with the test antenna and the substitution antenna orientated for horizontal polarization;
- m) the effective radiated power of the spurious component is the larger of the two power levels recorded for that spurious component at the input to the substitution antenna, corrected to compensate for the gain of the antenna if necessary.

### 9.10.3 Limit

The power of any spurious radiation shall not exceed 2 nW at any frequency in the range between 30 MHz and 2 GHz.

## 9.11 Receiver noise and hum level

### 9.11.1 Definition

The receiver noise and hum level is defined as the ratio, in dB, of the audio frequency power of the noise and hum resulting from spurious effects of the power supply system or from other causes, to the audio frequency power produced by a high frequency signal of average level, modulated by the normal test modulation and applied to the receiver input.

### 9.11.2 Method of measurement

A test signal with a level of +30 dB $\mu$ V (emf) at a carrier frequency equal to the nominal frequency of the receiver, and modulated by the normal test modulation specified in clause 6.4, shall be applied to the receiver input. An audio frequency load shall be connected to the output terminals of the receiver. The audio frequency power control shall be set so as to produce the rated output power level conforming to clause 9.1.

The output signal shall be measured by an rms voltmeter having a -6 dB bandwidth of at least 20 kHz. The modulation shall then be switched off and the audio frequency output level measured again.

### 9.11.3 Limit

The receiver noise and hum level shall not exceed -40 dB, relative to the modulated signal.

## 9.12 Squelch operation

### 9.12.1 Definition

The purpose of the squelch facility is to mute the receiver audio output signal when the level of the signal at the receiver input is less than a given value.

### 9.12.2 Method of measurement

The following procedure shall be followed.

a) All equipment:

With the squelch facility switched off, a test signal of +30 dB $\mu$ V, at a carrier frequency equal to the nominal frequency of the receiver and modulated by the normal test modulation specified in clause 6.4, shall be applied to the input terminals of the receiver. An audio frequency load and a psophometric filtering network (clause 9.3.1) shall be connected to the output terminals of the receiver. The receiver's audio frequency power control shall be set so as to produce the rated output power defined in clause 9.1.

The output signal shall be measured with the aid of an rms voltmeter.

The input signal shall then be suppressed, the squelch facility switched on and the audio frequency output level measured again.

b) Equipment with a preset or automatic squelch:

With the squelch facility switched off again, a test signal modulated by the normal test modulation shall be applied to the receiver input at a level of +6 dB $\mu$ V (emf) and the receiver shall be set to produce at least 50 % of the rated output power. The level of the input signal shall then be reduced and the squelch facility shall be switched on. The input signal shall then be increased until the above-mentioned output power is reached. The SINAD ratio and the input level shall then be measured.



- c) Equipment with a user operated continuously variable squelch:

With the squelch facility switched off, a test signal with normal test modulation shall be applied to the receiver input at a level of +6 dB $\mu$ V (emf), and the receiver shall be set to produce at least 50 % of the rated audio output power. The level of the input signal shall then be reduced and the squelch facility shall be switched on. The squelch shall then be at its maximum position and the level of the input signal increased until the output power returns to at least 50 % of the rated audio output power.

### 9.12.3 Limits

Under the conditions specified in a) clause 9.11.2, the audio frequency output power shall not exceed -40 dB relative to the rated output power.

Under the conditions specified in b) clause 9.11.2, the input level shall not exceed +6 dB $\mu$ V (emf).

Under the conditions specified in c) clause 9.11.2, the input signal shall not exceed +6 dB $\mu$ V (emf) when the control is set at maximum.

## 9.13 Squelch hysteresis

### 9.13.1 Definition

Squelch hysteresis is the difference in dB between the receiver input signal levels at which the squelch opens and closes.

### 9.13.2 Method of measurement

If there is any squelch control on the exterior of the equipment it shall be placed in its maximum muted position. With the squelch facility switched on, an unmodulated input signal at a carrier frequency equal to the nominal frequency of the receiver shall be applied to the input of the receiver at a level sufficiently low to avoid opening the squelch. The input signal shall be increased to the level just opening the squelch. This input level shall be recorded. With the squelch still open, the level of the input signal shall be slowly decreased until the squelch mutes the receiver audio output again, the hysteresis being the difference between this level and the previously recorded level.

### 9.13.3 Limit

The squelch hysteresis shall be between 3 dB and 6 dB.

---

## 10 DSC Signalling

### 10.1 Test Method

The output of the transmitter shall be connected to apparatus for decoding the information contents of the call sequences generated by the EUT.

### 10.2 Display

The radio shall comply with the display requirements given in clause 4.1 of ETSI EN 300 338-5 [6].

### 10.3 GNSS receiver

The radio shall comply with the GNSS receiver requirements given in clause 5.1.1 of ETSI EN 300 338-5 [6].

## 10.4 Individual DSC calls

The radio shall comply with the individual calls requirements given in clause 5.2.2 of ETSI EN 300 338-5 [6].

## 10.5 All ships calls

The radio shall comply with the all ships calls requirements given in clause 5.2.3 of ETSI EN 300 338-5 [6].

## 10.6 DSC call functionality

The radio shall comply with the DSC call functionality requirements given in clause 5.2.4 of ETSI EN 300 338-5 [6], except for transmission of all ships Urgency and Safety RT calls.

## 10.7 DSC message composition

The radio shall comply with the DSC message composition requirements given in clause 6.2.1 of ETSI EN 300 338-5 [6].

## 10.8 Prioritized wait

The radio shall comply with the prioritized wait requirements given in clause 6.2.2 of ETSI EN 300 338-5 [6].

## 10.9 Alarms

The radio shall comply with the alarms requirements given in clause 6.2.3 of ETSI EN 300 338-5 [6].

## 10.10 Standby

The radio shall comply with the standby requirements given in clause 6.3 of ETSI EN 300 338-5 [6].

## 10.11 GNSS fix - sending distress

The radio shall comply with the sending distress automated procedure requirements for acquiring GNSS fix as given in clause 6.4.1 of ETSI EN 300 338-5 [6].

## 10.12 Tasks - sending distress

The radio shall comply with the task requirements given in clause 6.4.2 of ETSI EN 300 338-5 [6] except that figure 1 should be treated as an example and not as a mandatory requirement.

## 10.13 Display - sending distress

The radio shall comply with the display requirements given in clause 6.4.3 of ETSI EN 300 338-5 [6].

## 10.14 Distress button sub procedure

The radio shall comply with the dedicated distress button sub procedure requirements given in clause 6.4.4 of ETSI EN 300 338-5 [6] except for bullet (c) where the requirement "(when releasing the button the radio shall return to its previous state)" need not apply.

## 10.15 Void

## 10.16 Updating position

The radio shall comply with the updating position requirements given in clause 6.4.6 of ETSI EN 300 338-5 [6].

## 10.17 Handling received DSC messages - sending distress

The radio shall comply with the requirements for handling received DSC messages given in clause 6.4.7 of ETSI EN 300 338-5 [6].

## 10.18 Alarms - sending distress

The radio shall comply with the alarms requirements given in clause 6.4.8 of ETSI EN 300 338-5 [6].

## 10.19 Determining subsequent communications - sending distress

The radio shall comply with the requirements given in clause 6.4.9 of ETSI EN 300 338-5 [6].

## 10.20 Automated tuning - sending distress

The radio shall comply with the requirements given in clause 6.4.10 of ETSI EN 300 338-5 [6].

## 10.21 Cancelling the distress alert

The radio shall comply with the distress cancel requirements given in clause 6.4.11 of ETSI EN 300 338-5 [6].

## 10.22 Acknowledgements - sending distress

The radio shall comply with the acknowledgements requirements given in clause 6.4.12 of ETSI EN 300 338-5 [6].

## 10.23 Termination - sending distress

The radio shall comply with the termination requirements given in clause 6.4.13 of ETSI EN 300 338-5 [6].

## 10.24 Warnings - sending distress

The radio shall comply with the warnings requirements given in clause 6.4.14 of ETSI EN 300 338-5 [6].

## 10.25 Tasks - receiving distress

The radio shall comply with the task requirements given in clause 6.5.2 of ETSI EN 300 338-5 [6] except that figure 4 should be treated as an example and not as a mandatory requirement.

## 10.26 Display - receiving distress

The radio shall comply with the display requirements given in clause 6.5.3 of ETSI EN 300 338-5 [6].

## 10.27 Handling received DSC messages - receiving distress

The radio shall comply with the requirements for handling received DSC messages given in clause 6.5.4 of ETSI EN 300 338-5 [6].

## 10.28 Alarms - receiving distress

The radio shall comply with the alarms requirements given in clause 6.5.5 of ETSI EN 300 338-5 [6].

## 10.29 Determining subsequent communications - receiving distress

The radio shall comply with the requirements given in clause 6.5.6 of ETSI EN 300 338-5 [6].

## 10.30 Automated tuning - receiving distress

The radio shall comply with the requirements given in clause 6.5.7 of ETSI EN 300 338-5 [6].

## 10.31 Acknowledgements - receiving distress

The radio shall comply with the acknowledgements requirements given in clause 6.5.8 of ETSI EN 300 338-5 [6].

## 10.32 Termination - receiving distress

The radio shall comply with the termination requirements given in clause 6.5.9 of ETSI EN 300 338-5 [6].

## 10.33 Warnings - receiving distress

The radio shall comply with the warnings requirements given in clause 6.5.10 of ETSI EN 300 338-5 [6].

## 10.34 Tasks - sending non distress

The radio shall comply with the task requirements given in clause 6.6.2 of ETSI EN 300 338-5 [6] except that figure 6 should be treated as an example and not as a mandatory requirement.

## 10.35 Display - sending non distress

The radio shall comply with the display requirements given in clause 6.6.3 of ETSI EN 300 338-5 [6].

## 10.36 Handling received DSC messages - sending non distress

The radio shall comply with the requirements for handling received DSC messages given in clause 6.6.4 of ETSI EN 300 338-5 [6].

## 10.37 Alarms - sending non distress

The radio shall comply with the alarms requirements given in clause 6.6.5 of ETSI EN 300 338-5 [6].

### **10.38 Automated tuning - sending non distress**

The radio shall comply with the requirements given in clause 6.6.6 of ETSI EN 300 338-5 [6].

### **10.39 Delayed acknowledgements - sending non distress**

The radio shall comply with the acknowledgements requirements given in clause 6.6.7 of ETSI EN 300 338-5 [6].

### **10.40 Termination - sending non distress**

The radio shall comply with the termination requirements given in clause 6.6.8 of ETSI EN 300 338-5 [6].

### **10.41 Warnings - sending non distress**

The radio shall comply with the warnings requirements given in clause 6.6.9 of ETSI EN 300 338-5 [6].

### **10.42 Tasks - receiving non distress**

The radio shall comply with the task requirements given in clause 6.7.2 of ETSI EN 300 338-5 [6] except that figure 8 should be treated as an example and not as a mandatory requirement.

### **10.43 Display - receiving non distress**

The radio shall comply with the display requirements given in clause 6.7.3 of ETSI EN 300 338-5 [6].

### **10.44 Handling received DSC messages - receiving non distress**

The radio shall comply with the requirements for handling received DSC messages given in clause 6.7.4 of ETSI EN 300 338-5 [6].

### **10.45 Alarms - receiving non distress**

The radio shall comply with the alarms requirements given in clause 6.7.5 of ETSI EN 300 338-5 [6].

### **10.46 Automated tuning - receiving non distress**

The radio shall comply with the requirements given in clause 6.7.6 of ETSI EN 300 338-5 [6].

### **10.47 Acknowledgements - receiving non distress**

The radio shall comply with the acknowledgements requirements given in clause 6.7.7 of ETSI EN 300 338-5 [6].

### **10.48 Termination - receiving non distress**

The radio shall comply with the termination requirements given in clause 6.7.8 of ETSI EN 300 338-5 [6].

### **10.49 Warnings - receiving non distress**

The radio shall comply with the warnings requirements given in clause 6.7.9 of ETSI EN 300 338-5 [6].

## 10.50 Communication automated procedure

The radio shall comply with the requirements given in clause 6.8.1 of ETSI EN 300 338-5 [6] except that the bullets (i)-(iii) describing which specific events should result in the communication automated procedure need not apply.

## 10.51 Tasks - communication

The radio shall comply with the task requirements given in clause 6.8.2 of ETSI EN 300 338-5 [6].

## 10.52 Display - communication

The radio shall comply with the display requirements given in clause 6.8.3 of ETSI EN 300 338-5 [6].

## 10.53 Handling received DSC messages - communication

The radio shall comply with the requirements for handling received DSC messages given in clause 6.8.4 of ETSI EN 300 338-5 [6].

## 10.54 Tuning of the receiver and transmitter - communication

The radio shall comply with the requirements given in clause 6.8.5 of ETSI EN 300 338-5 [6].

## 10.55 Termination - communication

The procedure shall be able to be terminated either by the user or automatic timeout.

## 10.56 Tasks of handling incoming calls while engaged

The radio shall comply with the task requirements given in clause 6.9.2 of ETSI EN 300 338-5 [6], except that clauses 6.9.2.1 and 6.9.2.2 need not apply.

## 10.57 Termination of automated procedures

The radio shall comply with the requirements given in clause 6.9.2.3 of ETSI EN 300 338-5 [6].

## 10.58 Actions after termination of an automated procedure

The radio shall comply with the requirements given in clause 6.9.2.4 of ETSI EN 300 338-5 [6] except that bullet (b) need not apply.

## 10.59 Putting automated procedures on hold

The radio shall comply with the requirements given in clause 6.9.2.5 of ETSI EN 300 338-5 [6] where the equipment is designed for handing procedures on hold.

## 10.60 Controlling non-terminated automated procedures on hold

The radio shall comply with the requirements given in clause 6.9.2.6 of ETSI EN 300 338-5 [6] where the equipment is designed for handing procedures on hold.

# 11 Testing for compliance with technical requirements

## 11.1 Environmental conditions for testing

These shall be as described clause 6.

## 11.2 Interpretation of the measurement results

The interpretation of the results recorded in a test report for the measurements described in the present document shall be as follows:

- the measured value related to the corresponding limit will be used to decide whether an equipment meets the requirements of the present document;
- the value of the measurement uncertainty for the measurement of each parameter shall be included in the test report;
- the recorded value of the measurement uncertainty shall be, for each measurement, equal to or less than the figures in table 4.

For the test methods, according to the present document, the measurement uncertainty figures shall be calculated and shall correspond to an expansion factor (coverage factor)  $k = 1,96$  or  $k = 2$  (which provide confidence levels of respectively 95 % and 95,45 % in the case where the distributions characterizing the actual measurement uncertainties are normal (Gaussian)). Principles for the calculation of measurement uncertainty are contained in ETSI TR 100 028 (parts 1 and 2) [i.6] and [i.7], in particular in annex D of the ETSI TR 100 028-2 [i.7].

Table 4 is based on such expansion factors.

**Table 4: Maximum measurement uncertainty**

Parameter	Uncertainty
RF frequency	$\pm 1 \times 10^{-7}$
RF power	$\pm 0,75$ dB
Maximum frequency deviation:	
- within 300 Hz to 6 kHz of modulation frequency	$\pm 5$ %
- within 6 kHz to 25 kHz of modulation frequency	$\pm 3$ dB
Deviation limitation	$\pm 5$ %
Adjacent channel power	$\pm 5$ dB
Conducted spurious emission of transmitter	$\pm 4$ dB
Audio output power	$\pm 0,5$ dB
Amplitude characteristics of receiver limiter	$\pm 1,5$ dB
Sensitivity at 20 dB SINAD	$\pm 3$ dB
Conducted emission of receiver	$\pm 3$ dB
Two-signal measurement	$\pm 4$ dB
Three-signal measurement	$\pm 3$ dB
Radiated emission of transmitter	$\pm 6$ dB
Radiated emission of receiver	$\pm 6$ dB
Transmitter transient time	$\pm 20$ %
Transmitter transient frequency	$\pm 250$ Hz
Receiver desensitization (duplex operation)	$\pm 0,5$ dB

## Annex A (informative): Relationship between the present document and the essential requirements of Directive 2014/53/EU

The present document has been prepared under the Commission's standardisation request C(2015) 5376 final [i.8] to provide one voluntary means of conforming to the essential requirements of Directive 2014/53/EU on the harmonisation of the laws of the Member States relating to the making available on the market of radio equipment and repealing Directive 1999/5/EC [i.5].

Once the present document is cited in the Official Journal of the European Union under that Directive, compliance with the normative clauses of the present document given in tables A.1 and A.2 confers, within the limits of the scope of the present document, a presumption of conformity with the corresponding essential requirements of that Directive, and associated EFTA regulations.

**Table A.1: Relationship between the present document and  
the essential requirements of article 3.2 of Directive 2014/53/EU**

Harmonised Standard ETSI EN 302 885				
Requirement			Requirement Conditionality	
No	Description	Reference: Clause No	U/C	Condition
1	Transmitter frequency error	8.1	U	
2	Transmitter carrier power	8.2	U	
3	Transmitter maximum permissible frequency deviation	8.3.2	U	
4	Transmitter reduction of frequency deviation at modulation frequencies above 3 kHz	8.3.3	U	
5	Transmitter adjacent channel power	8.7	U	
6	Transmitter conducted spurious emissions conveyed to the antenna	8.8	U	
7	Transmitter cabinet radiation and conducted spurious emissions other than those conveyed to the antenna	8.9	U	
8	Transmitter transient frequency behaviour	8.11	U	
9	Transmitter DSC frequency error	8.12	U	
10	Transmitter DSC modulation index	8.13	U	
11	Transmitter DSC modulation rate	8.14	U	
12	Transmitter free channel transmission on DSC channel 70	8.15	U	
13	Receiver maximum usable sensitivity	9.3	U	
14	Receiver co-channel rejection	9.4	U	
15	Receiver adjacent channel selectivity	9.5	U	
16	Receiver spurious response rejection	9.6	U	
17	Receiver intermodulation response	9.7	U	
18	Receiver blocking or desensitization	9.8	U	
19	Receiver conducted spurious emissions	9.9	U	
20	Receiver radiated spurious emissions	9.10	U	



**Table A.2: Relationship between the present document and the essential requirements of article 3.3(g) of Directive 2014/53/EU**

Harmonised Standard ETSI EN 302 885				
Requirement			Requirement Conditionality	
No	Description	Reference: Clause No	U/C	Condition
1	General and operational requirements	4.0	U	
2	Technical requirements	5.0	U	
3	Drop test	7.3	U	
4	Dry heat	7.4.2	U	
5	Damp heat	7.4.3	U	
6	Low temperature	7.4.4	U	
7	Transmitter sensitivity of the modulator, including microphone	8.4	U	
8	Transmitter Audio frequency response	8.5	U	
9	Audio frequency harmonic distortion of the emission	8.6	U	
10	Transmitter residual modulation	8.10	U	
11	Receiver harmonic distortion and rated audio-frequency output power	9.1	U	
12	Receiver audio frequency response	9.2	U	
13	Receiver noise and hum level	9.11	U	
14	Receiver squelch operation	9.12	U	
15	Receiver squelch hysteresis	9.13	U	
16	DSC Display	10.2	U	
17	GNSS Receiver	10.3	U	
18	Individual DSC calls	10.4	U	
19	All ships calls	10.5	U	
20	DSC call functionality	10.6	U	
21	DSC message composition	10.7	U	
22	Prioritized wait	10.8	U	
23	Alarms	10.9	U	
24	Standby	10.10	U	
25	GNSS fix requirements - sending distress	10.11	U	
26	Tasks - sending distress	10.12	U	
27	Display - sending distress	10.13	U	
28	Distress button sub-procedure	10.14	U	
30	Updating position	10.16	U	
31	Handling received DSC messages - sending distress	10.17	U	
32	Alarms - sending distress	10.18	U	
33	Determining subsequent communication - sending distress	10.19	U	
34	Automated tuning - sending distress	10.20	U	
35	Cancelling the distress alert	10.21	U	
36	Acknowledgement - sending distress	10.22	U	
37	Terminating - sending distress	10.23	U	
38	Warnings - sending distress	10.24	U	
39	Tasks - receiving distress	10.25	U	
40	Display - receiving distress	10.26	U	
41	Handling received DSC messages - receiving distress	10.27	U	
42	Alarms - receiving distress	10.28	U	
43	Determining subsequent communication - receiving distress	10.29	U	
44	Automated tuning - receiving distress	10.30	U	
45	Acknowledgement - receiving distress	10.31	U	
46	Terminating - receiving distress	10.32	U	
47	Warnings - receiving distress	10.33	U	
48	Tasks - sending non distress	10.34	U	
49	Display - sending non distress	10.35	U	
50	Handling received DSC messages - sending non distress	10.36	U	
51	Alarms - sending non distress	10.37	U	
52	Automated tuning - sending non distress	10.38	U	
53	Delayed acknowledgement - sending non distress	10.39	U	
54	Terminating - sending non distress	10.40	U	
55	Warnings - sending non distress	10.41	U	

Harmonised Standard ETSI EN 302 885				
Requirement			Requirement Conditionality	
No	Description	Reference: Clause No	U/C	Condition
56	Tasks - receiving non distress	10.42	U	
57	Display - receiving non distress	10.43	U	
58	Handling received DSC messages - receiving non distress	10.44	U	
59	Alarms - receiving non distress	10.45	U	
60	Automated tuning - receiving non distress	10.46	U	
61	Acknowledgement - receiving non distress	10.47	U	
62	Terminating - receiving non distress	10.48	U	
63	Warnings - receiving non distress	10.49	U	
64	Communication automated procedure	10.50	U	
65	Tasks - communication	10.51	U	
66	Display - communication	10.52	U	
67	Handling received DSC messages - communication	10.53	U	
68	Tuning of the receiver and transmitter - communication	10.54	U	
69	Termination - communication	10.55	U	
70	Handling incoming calls while engaged	10.56	U	
71	Termination of automated procedures	10.57	U	
72	Actions after termination of an automated procedure	10.58	U	
73	Putting automated procedures on hold	10.59	C	If the equipment is designed for
74	Controlling non-terminated automatic procedures	10.60	C	handling procedures on hold

**Key to columns:****Requirement:**

**No** A unique identifier for one row of the table which may be used to identify a requirement.

**Description** A textual reference to the requirement.

**Clause Number** Identification of clause(s) defining the requirement in the present document unless another document is referenced explicitly.

**Requirement Conditionality:**

**U/C** Indicates whether the requirement is unconditionally applicable (U) or is conditional upon the manufacturer's claimed functionality of the equipment (C).

**Condition** Explains the conditions when the requirement is or is not applicable for a requirement which is classified "conditional".

Presumption of conformity stays valid only as long as a reference to the present document is maintained in the list published in the Official Journal of the European Union. Users of the present document should consult frequently the latest list published in the Official Journal of the European Union.

Other Union legislation may be applicable to the product(s) falling within the scope of the present document.

## Annex B (normative): Measuring receiver for adjacent channel power measurement

### B.1 Power measuring receiver specification

#### B.1.0 General

The power measuring receiver consists of a mixer, an Intermediate Frequency (IF) filter, an oscillator, an amplifier, a variable attenuator and an rms value indicator. Instead of the variable attenuator with the rms value indicator it is also possible to use an rms voltmeter calibrated in dB. The technical characteristics of the power measuring receiver are given in figure B.1 (see also Recommendation ITU-R SM.332-4 [i.4]).

#### B.1.1 IF filter

The IF filter shall be within the limits of the following selectivity characteristics.

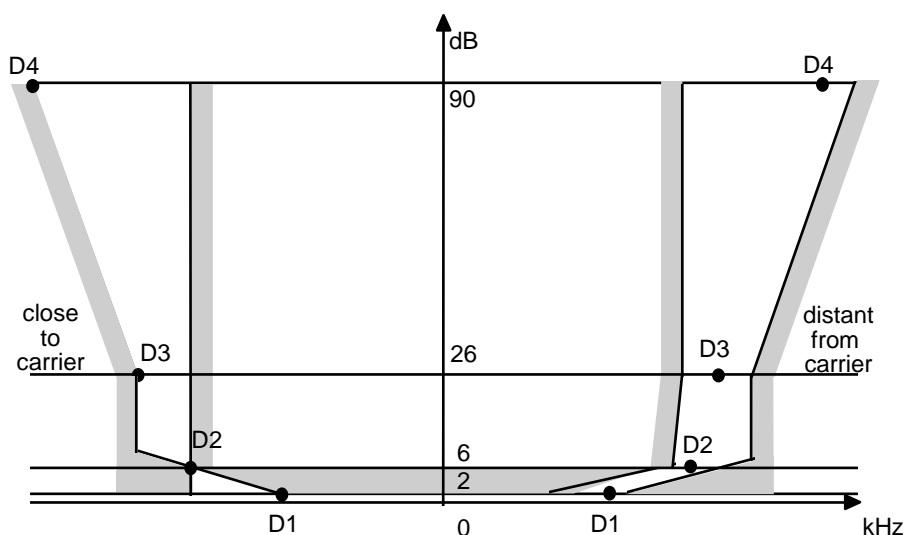

**Figure B.1: IF filter characteristics**

The selectivity characteristics shall keep the frequency separations shown in table B.1 from the nominal centre frequency of the adjacent channel.

**Table B.1: Selectivity characteristic**

Channel separation (kHz)	Frequency separation of filter curve from nominal centre frequency of adjacent channel (kHz)			
	D1	D2	D3	D4
12,5	3	4,25	5,5	9,5
25	5	8,0	9,25	13,25

The attenuation points shall not exceed following tolerances shown in table B.2.

**Table B.2: Tolerance of attenuation points close to carrier**

Channel separation (kHz)	Tolerance range (kHz)			
	D1	D2	D3	D4
12,5	+1,35	±0,1	-1,35	-5,35
25	+3,1	±0,1	-1,35	-5,35

**Table B.3: Tolerance of attenuation points distant from the carrier**

Channel separation (kHz)	Tolerance range (kHz)			
	D1	D2	D3	D4
12,5	±2,0	±2,0	±2,0	+2,0 -6,0
25	±3,5	±3,5	±3,5	+3,5 -7,5

The minimum attenuation of the filter outside the 90 dB attenuation points shall be equal to or greater than 90 dB.

## B.1.2 Attenuation indicator

The attenuation indicator shall have a minimum range of 80 dB and a reading accuracy of 1 dB. With a view to future regulations an attenuation of 90 dB or more is recommended.

## B.1.3 Rms value indicator

The instrument shall accurately indicate non-sinusoidal signals in ratio of up to 10:1 between peak value and rms value.

## B.1.4 Oscillator and amplifier

The oscillator and the amplifier shall be designed in such a way that the measurement of the adjacent channel power of a low-noise unmodulated transmitter, whose self-noise has a negligible influence on the measurement result, yields a measured value of less than -90 dB.

---

## Annex C (informative): DSC test calls

### C.1 Interoperability tests

Validation of the DSC functionality may be performed using applicable parts of the VHF class D handheld interoperability tests as defined in ETSI TS 101 570-5 [i.1].

---

## Annex D (informative): Change history

Version	Information about changes
V2.1.1	First version under the Radio Equipment Directive (2014/53/EU)
V2.2.0	Alignment with ITU-R M.493-14

## History

<b>Document history</b>		
V1.1.1	May 2011	Publication as ETSI EN 302 885 part 1
V1.1.1	September 2011	Publication as ETSI EN 302 885 part 2 and part 3
V1.2.1	November 2011	Publication as ETSI EN 302 885 part 1
V1.2.1	March 2014	Publication as ETSI EN 302 885 part 2 and part 3
V1.2.2	March 2014	Publication as ETSI EN 302 885 part 2 and part 3
V1.3.1	March 2014	Publication as ETSI EN 302 885 part 1
V2.1.1	March 2016	Publication
V2.2.1	March 2017	Publication
V2.2.2	March 2017	Publication