

**Electromagnetic compatibility  
and Radio spectrum Matters (ERM);  
Road Transport and Traffic Telematics (RTTT);  
Short range radar equipment operating in the 24,05 GHz to  
24,25 GHz frequency range for automotive application;  
Part 1: Technical characteristics and test methods**

---



---

Reference

DEN/ERM-TGSRR-051-1

---

Keywords

radar, radio, RTTT, SRD, testing

**ETSI**

650 Route des Lucioles  
F-06921 Sophia Antipolis Cedex - FRANCE

Tel.: +33 4 92 94 42 00 Fax: +33 4 93 65 47 16

Siret N° 348 623 562 00017 - NAF 742 C  
Association à but non lucratif enregistrée à la  
Sous-Préfecture de Grasse (06) N° 7803/88

---

**Important notice**

Individual copies of the present document can be downloaded from:

<http://www.etsi.org>

The present document may be made available in more than one electronic version or in print. In any case of existing or perceived difference in contents between such versions, the reference version is the Portable Document Format (PDF). In case of dispute, the reference shall be the printing on ETSI printers of the PDF version kept on a specific network drive within ETSI Secretariat.

Users of the present document should be aware that the document may be subject to revision or change of status. Information on the current status of this and other ETSI documents is available at

<http://portal.etsi.org/tb/status/status.asp>

If you find errors in the present document, please send your comment to one of the following services:

[http://portal.etsi.org/chaicor/ETSI\\_support.asp](http://portal.etsi.org/chaicor/ETSI_support.asp)

---

**Copyright Notification**

No part may be reproduced except as authorized by written permission.  
The copyright and the foregoing restriction extend to reproduction in all media.

© European Telecommunications Standards Institute 2011.  
All rights reserved.

**DECT™**, **PLUGTESTS™**, **UMTS™**, **TIPHON™**, the TIPHON logo and the ETSI logo are Trade Marks of ETSI registered for the benefit of its Members.

**3GPP™** is a Trade Mark of ETSI registered for the benefit of its Members and of the 3GPP Organizational Partners.

**LTE™** is a Trade Mark of ETSI currently being registered

for the benefit of its Members and of the 3GPP Organizational Partners.

**GSM®** and the GSM logo are Trade Marks registered and owned by the GSM Association.

# Contents

Intellectual Property Rights .....	5
Foreword.....	5
1 Scope .....	6
2 References .....	6
2.1 Normative references .....	6
2.2 Informative references.....	7
3 Definitions, symbols and abbreviations .....	7
3.1 Definitions.....	7
3.2 Symbols.....	8
3.3 Abbreviations .....	8
4 Equipment under test.....	9
4.1 Presentation of equipment for testing purposes.....	9
4.1.1 Choice of model for testing .....	9
4.2 Mechanical and electrical design.....	9
4.3 Auxiliary test equipment .....	10
5 Test conditions, power sources and ambient temperatures .....	10
5.1 Normal and extreme test conditions .....	10
5.2 External test power source.....	10
5.3 Normal test conditions.....	10
5.3.1 Normal temperature and humidity.....	10
5.3.2 Normal test power source .....	10
5.3.2.1 Test equipment voltage and nominal test voltage .....	10
5.3.2.2 Other power sources.....	11
5.4 Extreme test conditions .....	11
5.4.1 Extreme temperatures .....	11
5.4.1.1 Procedure for tests at extreme temperatures.....	11
5.4.1.2 Extreme temperature ranges.....	11
5.4.2 Extreme test source voltages.....	11
5.4.2.1 Mains voltage.....	11
5.4.2.2 Other power sources.....	11
6 Measurement setup.....	12
6.1 Test sites and general arrangements for radiated measurements .....	12
6.2 Test fixture .....	12
6.2.1 Characteristics.....	12
6.2.2 Validation of the test fixture in the temperature chamber.....	13
6.2.3 Use of the test fixture for measurement in the temperature chamber .....	14
6.3 RF cables .....	15
6.4 Measuring receiver .....	15
6.4.1 Frequency-selective voltmeter or spectrum analyzer.....	15
6.4.2 Signal analyzer.....	16
6.4.3 Amplitude calibration .....	16
7 Limits for transmitter parameters and methods of measurements.....	17
7.1 Introduction .....	17
7.2 Frequency, power limits and spectrum access conditions .....	17
7.3 Permitted range of operating frequencies .....	19
7.3.1 Definition.....	19
7.3.2 Method of measurement .....	19
7.3.3 Limits.....	20
7.4 Maximum radiated peak power (e.i.r.p.) .....	20
7.4.1 Definition.....	20
7.4.2 Method of measurement .....	20
7.4.3 Limits.....	21

7.5	Dwell time and repetition time .....	21
7.5.1	Definition .....	21
7.5.2	Methods of measurement .....	21
7.5.2.1	Signal analysis measurement .....	21
7.5.2.2	Measurement of dwell time for a single dwell time event per 40 kHz in 3 ms (category C1) .....	23
7.5.2.3	Measurement of cumulated dwell time for more than one dwell time event per 40 kHz in 3 ms (category C2).....	24
7.5.2.3.1	Statistical measurement procedure .....	24
7.5.2.3.2	Verification procedure .....	25
7.5.2.4	Measurement of absolute dwell time per 40 kHz (category D).....	26
7.5.2.5	Measurement of repetition time for absolute dwell times per 40 kHz (category D) .....	27
7.5.3	Limits.....	29
7.6	Frequency modulation range .....	29
7.6.1	Definition .....	29
7.6.2	Method of measurement .....	30
7.6.3	Limits.....	30
7.7	Radiated spurious emissions.....	30
7.7.1	Definition .....	30
7.7.2	Method of measurement .....	30
7.7.3	Limits.....	31
8	Methods of measurement and limits for receiver parameters.....	31
8.1	Receiver spurious emissions.....	31
8.1.1	Definition.....	31
8.1.2	Method of measurement - radiated spurious emissions .....	31
8.1.3	Limit .....	32
9	Interpretation of test results and measurement uncertainty .....	32
9.1	Interpretation of the measurement results .....	32
9.2	Absolute measurement uncertainty .....	33
<b>Annex A (normative): Radiated measurements .....</b>		<b>34</b>
A.1	General requirements for measurements involving the use of radiated fields.....	34
A.2	Test Sites .....	35
A.2.1	Outdoor test site .....	35
A.2.2	Indoor test site .....	36
A.2.3	Shielded anechoic test site.....	37
A.2.3.1	Influence of parasitic reflections in anechoic chambers .....	37
A.2.3.2	Calibration of the shielded RF anechoic chamber .....	37
A.3	Antennas.....	39
A.3.1	Test antenna.....	39
A.3.2	Substitution antenna .....	39
A.3.3	Artificial antenna.....	39
A.4	Test practice and auxiliary test equipment .....	40
A.5	Measuring distance.....	40
A.5.1	Standard position.....	40
A.5.2	Auxiliary cables.....	40
<b>Annex B (normative): Installation requirements .....</b>		<b>41</b>
B.1	Installation requirements of 24 GHz Narrow Band Short Range Radar (NB SRR) systems .....	41
<b>Annex C (informative): Conversion of power density to e.i.r.p.....</b>		<b>42</b>
C.1	Assumptions .....	42
C.2	Example.....	42
<b>Annex D (informative): Bibliography .....</b>		<b>43</b>
History	.....	44

---

## Intellectual Property Rights

IPRs essential or potentially essential to the present document may have been declared to ETSI. The information pertaining to these essential IPRs, if any, is publicly available for **ETSI members and non-members**, and can be found in ETSI SR 000 314: "*Intellectual Property Rights (IPRs); Essential, or potentially Essential, IPRs notified to ETSI in respect of ETSI standards*", which is available from the ETSI Secretariat. Latest updates are available on the ETSI Web server (<http://webapp.etsi.org/IPR/home.asp>).

Pursuant to the ETSI IPR Policy, no investigation, including IPR searches, has been carried out by ETSI. No guarantee can be given as to the existence of other IPRs not referenced in ETSI SR 000 314 (or the updates on the ETSI Web server) which are, or may be, or may become, essential to the present document.

---

## Foreword

This final draft European Standard (EN) has been produced by ETSI Technical Committee Electromagnetic compatibility and Radio spectrum Matters (ERM), and is now submitted for the Vote phase of the ETSI standards Two-step Approval Procedure.

For non EU countries the present document may be used for regulatory (Type Approval) purposes.

Equipment compliant with the present document is intended for fitment into road vehicles, therefore it is subject to automotive EMC type approval and needs to comply with Directive 95/54/EC [i.3].

For use on vehicles outside the scope of Directive 95/54/EC [i.3] compliance with an EMC directive/standard appropriate for that use is required.

The present document is part 1 of a multi-part deliverable covering Electromagnetic compatibility and Radio spectrum Matters (ERM); Road Transport and Traffic Telematics (RTTT); Short range radar equipment operating in the 24,05 GHz to 24,25 GHz frequency range for automotive application, as identified below:

**Part 1: "Technical characteristics and test methods";**

Part 2: "Harmonized EN covering the essential requirements of article 3.2 of the R&TTE Directive".

<b>Proposed national transposition dates</b>	
Date of latest announcement of this EN (doa):	3 months after ETSI publication
Date of latest publication of new National Standard or endorsement of this EN (dop/e):	6 months after doa
Date of withdrawal of any conflicting National Standard (dow):	6 months after doa

# 1 Scope

The present document specifies the technical requirements and methods of measurement for Short Range Devices (SRD) operating in the 24,05 GHz to 24,25 GHz frequency range intended for Narrow Band Short Range Radar (NB SRR) for Road Transport and Traffic Telematics (RTTT) applications such as Automotive Cruise Control (ACC), Collision Warning, Anti-Collision (AC) systems, obstacle detection, Stop and Go, blind spot detection, parking aid, precrash, backup aid and other safety relevant automotive applications.

The present document contains the technical characteristics and test methods for narrowband short range radar equipment fitted with integral antennas and applies to transmitters and receivers with integral antennas operating in all or part of the range from 24,05 GHz to 24,25 GHz.

The present document does not necessarily include all the characteristics which may be required by a user, nor does it necessarily represent the optimum performance achievable.

The present document covers only NB SRR equipment for vehicles.

The present document complies with field limits for human exposure to electromagnetic fields as provided by the EC Recommendation 1999/519/EC [i.4] and the methods for compliance demonstration in EN 50371 [i.5].

Table 1 shows the frequency bands as designated to narrow band short range radar devices.

**Table 1: Narrow band short range radar devices frequency of operation**

	<b>Frequency Bands/frequencies</b>	<b>Applications</b>
Transmit and Receive	24,05 GHz to 24,25 GHz	Short range radar for vehicle applications

# 2 References

References are either specific (identified by date of publication and/or edition number or version number) or non-specific. For specific references, only the cited version applies. For non-specific references, the latest version of the reference document (including any amendments) applies.

Referenced documents which are not found to be publicly available in the expected location might be found at <http://docbox.etsi.org/Reference>.

NOTE: While any hyperlinks included in this clause were valid at the time of publication ETSI cannot guarantee their long term validity.

## 2.1 Normative references

The following referenced documents are necessary for the application of the present document.

- [1] CISPR 16 (2006) (parts 1-1, 1-4 and 1-5): "Specification for radio disturbance and immunity measuring apparatus and methods; Part 1: Radio disturbance and immunity measuring apparatus".
- [2] ETSI TR 100 028 (V1.4.1) (all parts): "Electromagnetic compatibility and Radio spectrum Matters (ERM); Uncertainties in the measurement of mobile radio equipment characteristics".
- [3] ETSI TR 102 273 (V1.2.1) (all parts): "Electromagnetic compatibility and Radio spectrum Matters (ERM); Improvement on Radiated Methods of Measurement (using test site) and evaluation of the corresponding measurement uncertainties".

## 2.2 Informative references

The following referenced documents are not necessary for the application of the present document but they assist the user with regard to a particular subject area.

- [i.1] CEPT/ERC Recommendation 70-03: "Relating to the use of Short Range Devices (SRD)".
- [i.2] CEPT/ECC Report #134 on analysis of potential impact of mobile Vehicle Radars (VR) on Radar Speed Meters (RSM) operating at 24 GHz.
- [i.3] Commission Directive 95/54/EC of 31 October 1995 adapting to technical progress Council Directive 72/245/EEC on the approximation of the laws of the Member States relating to the suppression of radio interference produced by spark-ignition engines fitted to motor vehicles and amending Directive 70/156/EEC on the approximation of the laws of the Member States relating to the type-approval of motor vehicles and their trailers.
- [i.4] Council Recommendation 1999/519/EC of 12 July 1999 on the limitation of exposure of the general public to electromagnetic fields (0 Hz to 300 GHz).
- [i.5] CENELEC EN 50371 (2002): "Generic standard to demonstrate the compliance of low power electronic and electrical apparatus with the basic restrictions related to human exposure to electromagnetic fields (10 MHz - 300 GHz) - General public".
- [i.6] CEPT/ERC/REC 74-01: "Unwanted emissions in the spurious domain".
- [i.7] ITU-R Recommendation SM.328-10: "Spectra and Bandwidth of Emissions".
- [i.8] ITU-R Recommendation SM.329: "Variation of the boundary between the out-of-band and spurious domains".

---

## 3 Definitions, symbols and abbreviations

### 3.1 Definitions

For the purposes of the present document, the following terms and definitions apply:

**assigned frequency band:** frequency band within which the device is authorized to operate

**boresight:** axis of the main beam in a directional antenna

**bumper:** generally 3D shaped plastic sheet normally mounted in front of the NB SRR

**co-located receiver:** receiver is located in the same module box as the transmitter

**duty cycle:** ratio of the total on time of the "message" to the total off-time in any one hour period

NOTE: The device may be triggered either automatically or manually, whether the duty cycle is fixed or random depends on how the device is triggered.

**dwel time:** in general, a time interval for which a certain frequency range is occupied

NOTE: "Cumulated dwel time" is the sum of individual dwel times within a measurement time frame and in a defined frequency range.  
 "Absolute dwel time" is the time from first entrance into a defined frequency range until last exit from a defined frequency range.

**Equipment Under Test (EUT):** radar sensor including the integrated antenna together with any external antenna components which affect or influence its performance

**equivalent isotropically radiated power (e.i.r.p.):** total power or power density transmitted, assuming an isotropic radiator

NOTE: e.i.r.p. is conventionally the product of "power or power density into the antenna" and "antenna gain".  
e.i.r.p. is used for both peak or average power and peak or average power density.

**far field measurement:** measurement at a distance "X" of at least  $2d^2/\lambda$ , where d is the largest dimension of the antenna aperture of the EUT

**operating frequency (operating centre frequency):** nominal frequency at which equipment is operated

**power envelope:** power supplied to the antenna by a transmitter during one radio frequency cycle at the crest of the modulation envelope taken under normal operating conditions

**precrash:** time before the crash occurs when safety mechanism are deployed

**radome:** external protective cover which is independent of the associated antenna, and which may contribute to the overall performance of the antenna (and hence, the EUT)

## 3.2 Symbols

For the purposes of the present document, the following symbols apply:

DT	Dwell Time
DT0	Average dwell time value
E	Field strength
$f_c$	Carrier frequency
$f_H$	the frequency of the upper marker resulting from the OBW function
$f_L$	the frequency of the lower marker resulting from the OBW function
FMCW	Frequency Modulation Continuous Wave (transmission)
$G_a$	Antenna gain
NB	Narrow Band
$P_{rad}$	Radiated power
R	Distance
RSM	Radar Speed Meters
$R_o$	Reference distance
Rx	Receiver
$T_{dw}$	Dwell time
Tx	Transmitter

## 3.3 Abbreviations

For the purposes of the present document, the following abbreviations apply:

ac	alternating current
AC	Anti-Collision systems
ACC	Automotive Cruise Control
dB	decibel
DC	Direct Current
e.i.r.p.	equivalent isotropically radiated power
ECC	Electronic Communications Committee
EMC	Electro Magnetic Compatibility
ERC	European Radiocommunication Committee
EUT	Equipment Under Test
FFT	Fast Forward Transfer
FH	Frequency Hopping
FMCW	Frequency Modulated Continuous Wave
IF	Intermediate Frequency
LNA	Low Noise Amplifier
NB SRR	Narrow Band Short Range Radar



OBW	Occupied BandWidth
RBW	Resolution BandWidth
R&TTE	Radio and Telecommunications Terminal Equipment
RF	Radio Frequency
RTTT	Road Transport and Traffic Telematics
Rx	Receiver (Receive)
SA	Spectrum Analyzer
SRD	Short Range Device
Tx	Transmitter
VBW	Video BandWidth
VSWR	Voltage Standing Wave Ratio

---

## 4 Equipment under test

### 4.1 Presentation of equipment for testing purposes

Each equipment submitted for testing, where applicable, shall fulfil the requirements of the present document on all frequencies over which it is intended to operate. EMC type approval testing to Directive 95/54/EC [i.3] shall be done on the vehicle.

The provider shall provide one or more samples of the equipment, as appropriate for testing.

Additionally, technical documentation and operating manuals, sufficient to allow testing to be performed, shall be supplied.

The performance of the equipment submitted for testing shall be representative of the performance of the corresponding production model. In order to avoid any ambiguity in that assessment, the present document contains instructions for the presentation of equipment for testing purposes, conditions of testing (clause 5) and the measurement methods (clause 7). Instructions for installation of the equipment in a road vehicle are provided in annex B.

Stand alone equipment submitted for testing shall be offered by the provider complete with any ancillary equipment needed for testing. The provider shall declare the frequency range(s), the range of operation conditions and power requirements, as applicable, in order to establish the appropriate test conditions.

The EUT will comprise the sensor, antenna and radome if needed and is tested as a stand alone assembly. The EUTs test fixtures may be supplied by the provider to facilitate the tests (clause 6.2).

These clauses are intended to give confidence that the requirements set out in the present document have been met without the necessity of performing measurements on all frequencies.

#### 4.1.1 Choice of model for testing

If an equipment has several optional features, considered not to affect the RF parameters then the tests need only to be performed on the equipment configured with that combination of features considered to be the most complex, as proposed by the provider and agreed by the test laboratory.

If an equipment is designed to operate with different powers, measurements of each transmitter parameter shall be performed at the highest power level at which the transmitter is intended to operate.

### 4.2 Mechanical and electrical design

The equipment submitted by the provider shall be designed, constructed and manufactured in accordance with good engineering practice and with the aim of minimizing harmful interference to other equipment and services.

## 4.3 Auxiliary test equipment

All necessary test signal sources and set-up information shall accompany the equipment when it is submitted for testing.

---

# 5 Test conditions, power sources and ambient temperatures

## 5.1 Normal and extreme test conditions

Testing shall be carried out under normal test conditions, and also, where stated, under extreme test conditions.

The test conditions and procedures shall be as specified in clauses 5.2 to 5.4.

All measurements shall be preceded by calibrated measurements according to annex A.

## 5.2 External test power source

During tests the power source of the equipment shall be an external test power source, capable of producing normal and extreme test voltages as specified in clauses 5.3.2 and 5.4.2. The internal impedance of the external test power source shall be low enough for its effect on the test results to be negligible.

The test voltage shall be measured at the point of connection of the power cable to the equipment.

During tests the external test power source voltages shall be within a tolerance of  $\pm 1$  % relative to the voltage at the beginning of each test. The level of this tolerance can be critical for certain measurements. Using a smaller tolerance provides a reduced uncertainty level for these measurements.

## 5.3 Normal test conditions

### 5.3.1 Normal temperature and humidity

The normal temperature and humidity conditions for tests shall be any convenient combination of temperature and humidity within the following ranges:

- temperature: +15 °C to +35 °C;
- relative humidity: 20 % to 75 %.

When it is impracticable to carry out tests under these conditions, a note to this effect, stating the ambient temperature and relative humidity during the tests, shall be added to the test report.

### 5.3.2 Normal test power source

The internal impedance of the test power source shall be low enough for its effect on the test results to be negligible. For the purpose of the tests, the voltage of the external test power source shall be measured at the input terminals of the equipment.

#### 5.3.2.1 Test equipment voltage and nominal test voltage

The normal test voltage for equipment shall be the nominal mains voltage. For the purpose of the present document, the nominal voltage shall be the declared voltage, or any of the declared voltages, for which the equipment was designed.

The frequency of the test power source corresponding to the ac mains shall be between 49 Hz and 51 Hz.

### 5.3.2.2 Other power sources

For operation from other power sources the normal test voltage shall be that declared by the provider. Such values shall be stated in the test report.

## 5.4 Extreme test conditions

### 5.4.1 Extreme temperatures

#### 5.4.1.1 Procedure for tests at extreme temperatures

Before measurements are made, the equipment shall have reached thermal balance in the test chamber. The equipment shall not be switched off during the temperature stabilizing period.

If the thermal balance is not checked by measurements, a temperature stabilizing period of at least one hour, or such period as may be decided by the accredited test laboratory, shall be allowed. The sequence of measurements shall be chosen, and the humidity content in the test chamber shall be controlled so that excessive condensation does not occur.

#### 5.4.1.2 Extreme temperature ranges

For tests at extreme temperatures, measurements shall be made in accordance with the procedures specified in clause 5.4.1.1, at the upper and lower temperatures of one of the following ranges as declared by the provider:

- Temperature category I: -10 °C to +55 °C.
- Temperature category II: -20 °C to +55 °C.
- Temperature category III: -40 °C to +70 °C.

The manufacturer can specify a wider temperature range than given as a minimum above. The test report shall state which range is used.

### 5.4.2 Extreme test source voltages

#### 5.4.2.1 Mains voltage

The extreme test voltages for equipment to be connected to an ac mains source shall be the nominal mains voltage  $\pm 10\%$ .

#### 5.4.2.2 Other power sources

For equipment using other power sources, or capable of being operated from a variety of power sources, the extreme test voltages shall be that declared by the provider. These shall be recorded in the test report.

---

## 6 Measurement setup

### 6.1 Test sites and general arrangements for radiated measurements

Detailed descriptions of the radiated measurement arrangements are included in annex A. In general, measurements shall be carried out under far field conditions. The far field condition for the EUTs is considered to be fulfilled in a minimum radial distance "X" that shall be a minimum of  $2d^2/\lambda$ , where d is the largest dimension of the antenna aperture of the EUT, for a single device measurement.

Absolute power measurements shall be made using an appropriate method to ensure that the wave front is properly formed (i.e. operating in far field conditions).

### 6.2 Test fixture

The test fixture may be used to facilitate measurements for equipment having an integral antenna, if required even under extreme conditions. Tests on radiated signals may be carried out using the test fixture. For tests of unwanted emissions in the spurious domain, the test fixture bandwidth shall be used up to 50 GHz. If this is not the case, a radiated measurement according to annex A shall be used.

#### 6.2.1 Characteristics

The fixture is a radio frequency device for coupling the integral antenna of the NB SRR to a 50  $\Omega$  RF terminal at all frequencies for which measurements need to be performed.

The test fixture shall be fully described.

In addition, the test fixture shall provide:

- a) a connection to an external power supply;
- b) a method to provide the input to or output from the equipment. This may include coupling to or from the antenna. The test fixture could also provide the suitable coupling means e.g. for data or video outputs.

The test fixture is normally be supplied by the provider.

The performance characteristics of the test fixture shall be approved by the testing laboratory and shall conform to the following basic parameters:

- a) the coupling loss shall not be greater than 30 dB;
- b) adequate bandwidth properties;
- c) a coupling loss variation over the frequency range used for the measurement shall not exceed 2 dB;
- d) circuitry associated with the RF coupling shall contain no active or non-linear devices;
- e) the VSWR at the 50  $\Omega$  socket shall not be more than 1,5 over the frequency range of the measurements;
- f) the coupling loss shall be independent of the position of the test fixture and be unaffected by the proximity of surrounding objects or people. The coupling loss shall be reproducible when the equipment under test is removed and replaced. Normally, the text fixture is in a fixed position and provides a fixed location for the EUT;
- g) the coupling loss shall remain substantially constant when the environmental conditions are varied.

The coupler attenuation of the test-fixture may amount to a maximum of the noise level of the measurement instrument +10 dB. If the attenuation is too high, a linear LNA can be used outside the test-fixture.

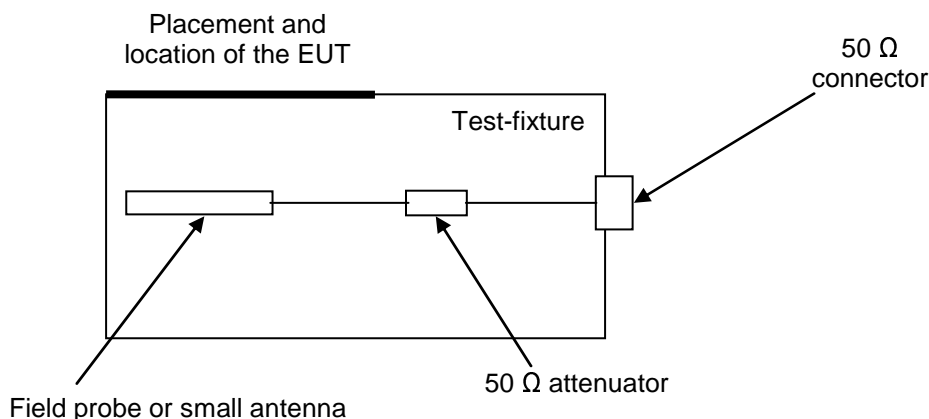

**Figure 1: Test fixture**

The field probe (or small antenna) needs to be properly terminated.

The characteristics and validation shall be included in the test report.

## 6.2.2 Validation of the test fixture in the temperature chamber

The test fixture is brought into a temperature chamber (only needed if test fixture measurements performed under extreme temperature conditions).

### Step 1

A transmit antenna connected to a signal generator shall be positioned from the test-fixture at a far field distance of not less than one  $\lambda$  at the frequency. The test fixture consists of the mechanical support for the EUT, an antenna or field probe and a 50  $\Omega$  attenuator for proper termination of the field probe. The test fixture shall be connected to a spectrum analyzer via the 50  $\Omega$  connector. A signal generator shall be set on the EUT's nominal frequency (see figure 2). The unmodulated output power of the signal generator shall be set to a value such that a sufficiently high level can be observed with the spectrum analyzer. This reference value shall be recorded. The signal generator shall then be set to the upper and the lower band limit of the EUT's assigned frequency band. The measured values shall not deviate more than 1 dB from the value at the nominal frequency.

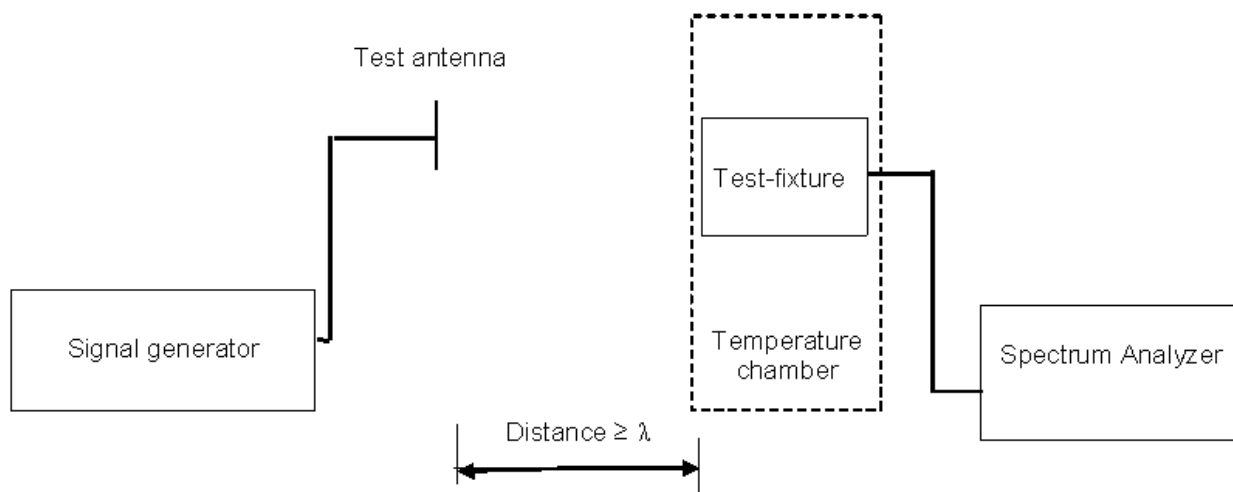

**Figure 2: Validation of test fixture without EUT**

## Step 2

During validation and testing the EUT shall be fitted to the test fixture in a switched-off mode, see figure 3. The measurements of step 1 shall be repeated, this time with the EUT in place. The measured values shall be compared with those from step 1 and shall not vary by more than 2 dB. This shows that the EUT does not cause any significant shadowing of the radiated power.

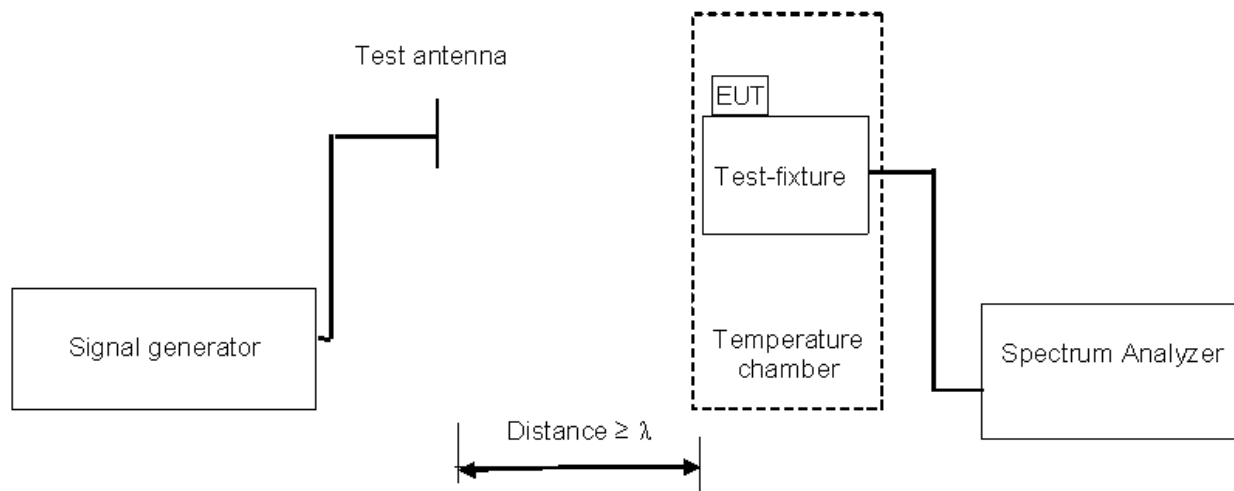
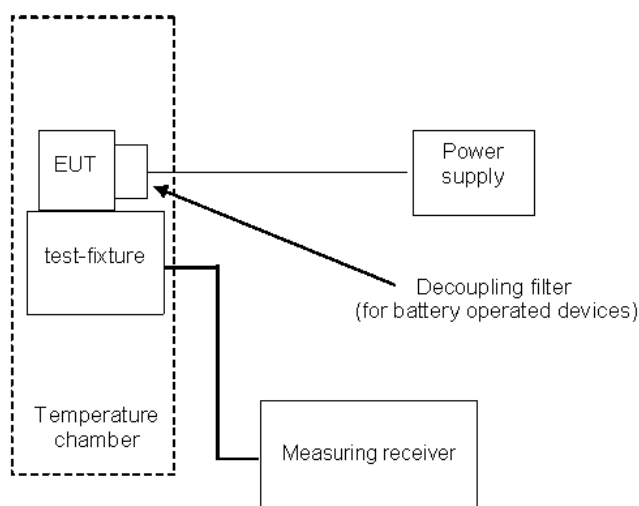

**Figure 3: Validation of test fixture with EUT in place**

## 6.2.3 Use of the test fixture for measurement in the temperature chamber

Here, the signal generator and the transmit antenna are removed. The EUT is DC supplied via an external power supply (see figure 4). In case of a battery operated EUT that is supplied by a temporary power supply as well as temporary signal- and control line, a decoupling filter shall be installed directly at the EUT in order to avoid parasitic, electromagnetic radiation.

At the 50  $\Omega$  port of the test fixture, a measuring receiver is connected for recording the quantities of interest.



**Figure 4: Measurement of EUT performance in temperature chamber**

## 6.3 RF cables

All RF cables including their connectors at both ends used within the measurement arrangements and set-ups shall be of coaxial type conforming to the below requirements for the used frequency range:

- a nominal characteristic impedance of 50  $\Omega$ ;
- a VSWR of less than 1,2 at either end;
- a shielding loss in excess of 60 dB.

All RF cables shall be routed suitably in order to reduce impacts on antenna radiation pattern, antenna gain, antenna impedance.

NOTE: Further details are provided in TR 102 273-2 [3].

## 6.4 Measuring receiver

Measuring receivers include spectrum analyzers, signal analyzers and comparable instruments.

If no measuring receiver is available for directly processing 24 GHz input signals, then an external down-converter is used to shift the frequency range 24,0 GHz to 24,3 GHz towards a frequency range covered by the available measuring receiver (see figure 5). The pre-amplifier has to be chosen such that the amplitude of the measured signals is well above the sensitivity level of the measuring receiver.

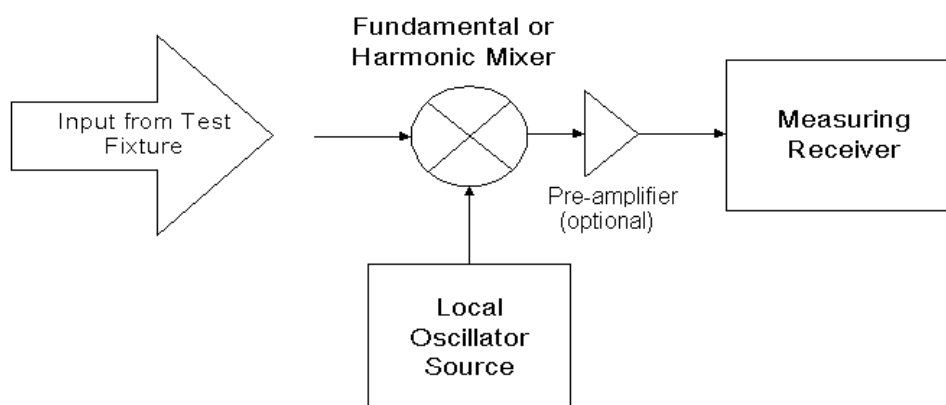

Figure 5: Using a down-converter in front of a measuring receiver

### 6.4.1 Frequency-selective voltmeter or spectrum analyzer

For measuring simple quantities like occupied bandwidth, a frequency-selective voltmeter or a spectrum analyzer are suitable measurement receivers.

The measurement bandwidth of the measuring receiver shall, where possible, be according to CISPR 16 [1]. In order to obtain the required sensitivity, a narrower measurement bandwidth may be necessary, and in such cases, this shall be stated in the test report form. The bandwidth of the measuring receiver shall be as given in table 2.

Table 2: Measuring receiver characteristic

Frequency range: (f)	Measuring receiver bandwidth
$30 \text{ MHz} \leq f \leq 1\,000 \text{ MHz}$	100 kHz to 120 kHz
$f > 1\,000 \text{ MHz}$	1 MHz

## 6.4.2 Signal analyzer

For measuring complex parameters like frequency versus time, a signal analyzer is a suitable measuring receiver. Alternative approaches giving comparable information may also be used.

Signal analyzers are either available as a stand-alone instrument or as a combination of several components (multi-box, see table 3).

**Table 3: Example of a signal analyzer measurement equipment set-up if composed of several components**

50 Ohm input port	A/D conversion and memory	Data cable	Personal computer with spectrogram software
-------------------	---------------------------	------------	---

The result of measurements using a signal analyzer is the spectrogram, showing time on the x-axis, frequency on the y-axis and the amplitude as colour-coded dots (see example in figure 6). Using a marker, also quantitative power levels can be read out for a certain time, frequency-position.

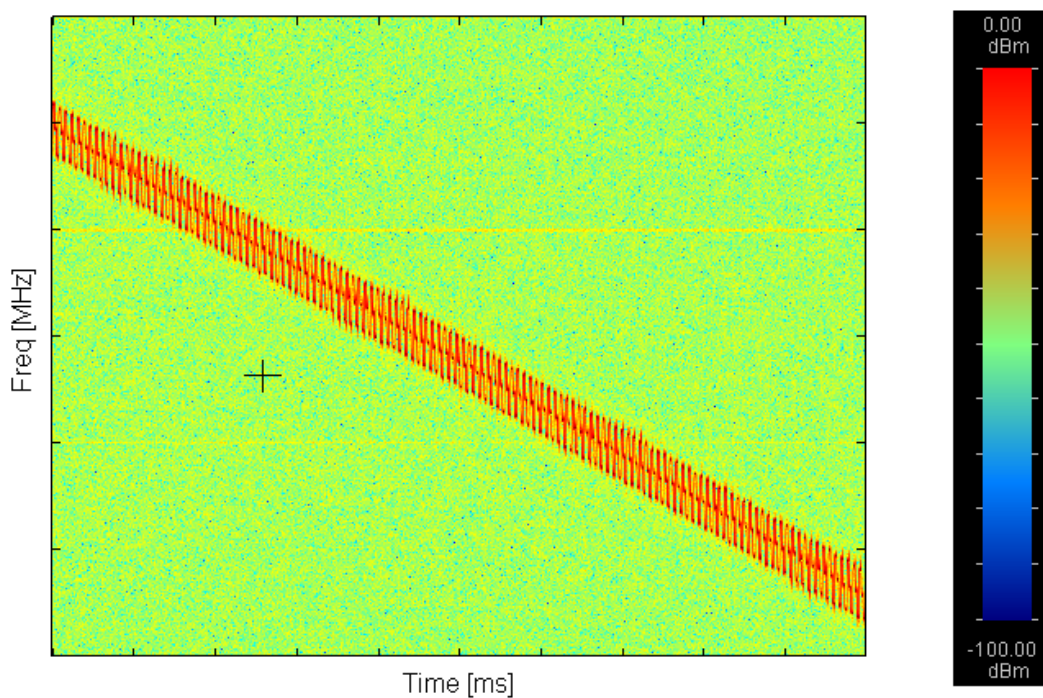

Marker +: 2.74 ms, 24127.04 MHz, -48.3dBm

**Figure 6: Example of spectrogram measurement result**

## 6.4.3 Amplitude calibration

To determine e.i.r.p. values, the readings from the measuring receiver (including a possible down-converter) have to be calibrated to include gains and losses, e.g. antenna gain, free space loss etc. The amount of required correction is obtained by the substitution approach (see also annex A).



## 7 Limits for transmitter parameters and methods of measurements

### 7.1 Introduction

For NB SRRs, a variety of different signal modulation types and characteristics are feasible. Modulation examples are a slow linear frequency sweep, a stepped frequency sweep, fast linear frequency sweeps or pulses with a spread frequency spectrum, multi-tone signals or a general time dependent emission (see figure 7).

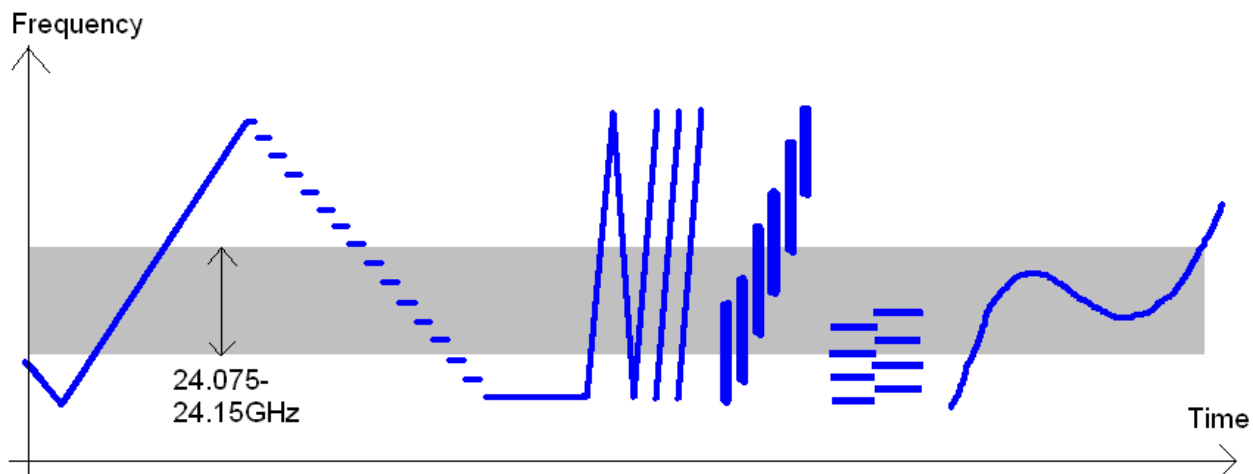

**Figure 7: Examples of NB SRR transmit frequency signals versus time**

Furthermore, the signal modulations of a NB SRR may change from one time period to another time period (for example change between measuring and calibration signals).

The complexity and variety of possible signal modulation types and characteristics is handled by categorizing the permitted frequency ranges, limits and including the spectrum access parameters of table 4 and defined in the measurement procedure table 5.

### 7.2 Frequency, power limits and spectrum access conditions

The overview of frequency bands, power limits and spectrum access conditions is given in table 4.

**Table 4: Emission limits for peak e.i.r.p. in the frequency band from 24,05 GHz to 24,25 GHz**

Frequency band GHz	Power limit, e.i.r.p. mW	Spectrum access conditions	Comments	Test category
24,050 to 24,075	100	No restrictions		A
24,075 to 24,150	0,1	No restrictions		B
	100	Fast modulation condition: ≤ 4 μs / 40 kHz dwell time cumulated over every 3 ms (see note)	The spectrum access and mitigation requirement for devices mounted behind a bumper. If mounted without a bumper, the requirement should be 3 μs / 40 kHz maximum dwell time every 3 ms.	C1 (for a single dwell time event in 40 kHz per 3 ms), C2 (for more than one dwell time event in 40 kHz per 3 ms)
		Slow modulation condition: ≤ 1 ms / 40 kHz dwell time every 40 ms (see note)	The spectrum access and mitigation requirement for devices mounted either behind a bumper or mounted without a bumper.	D
24,150 to 24,250	100	No restrictions		E
NOTE: A requirement for minimum frequency modulation range (applicable to FMCW or stepped frequency signals) or minimum instantaneous bandwidth (applicable to pulsed signals) of 250 kHz applies in addition to the requirement on maximum dwell time.				

For the fast modulation condition, the expression "cumulated" means that within the same 40 kHz range the sum of individual dwell times in a 3 ms interval has to be smaller than 4 μs.

For the slow modulation condition, access to a 40 kHz range is allowed during max.1 ms with a minimum repetition time of 40 ms. Since during the 1 ms duration, the 40 kHz range may be left and re-entered, the respective dwell time is considered as an absolute dwell time. Outside of the 1 ms period, access at any other time to the same 40 kHz range is only allowed with less than -10 dBm e.i.r.p. or with fulfilling the fast modulation condition.

For further information and explanation of the parameters and the limits of table 4 please refer to the summary and conclusions of the ECC report 134 [i.2] and the ERC/Rec 70-03, annex 5 [i.1].

Table 5 defines the required measurements for the different signal conditions.

**Table 5: Measurement procedures and signal categories**

Clause	Measurement procedure	Signal category					
		A	B	C1	C2	D	E
7.3	Permitted range of frequencies	X	X	X	X	X	X
7.4	Maximum radiated peak power (e.i.r.p.)	X	X	X	X	X	X
7.5	7.5.2.1 Signal analysis measurement	-	-	X	X	X	-
7.5	7.5.2.2 Measurement of dwell time for a single dwell time event per 40 kHz in 3 ms	-	-	X	-	-	-
7.5	7.5.2.3 Measurement of cumulated dwell time for more than one dwell time events per 40 kHz in 3 ms	-	-	-	X	-	-
7.5	7.5.2.4 Measurement of absolute dwell time per 40 kHz	-	-	-	-	X	-
7.5	7.5.2.5 Measurement of repetition time for absolute dwell time per 40 kHz	-	-	-	-	X	-
7.6	Frequency modulation range	-	-	X	X	X	-

Alternative measurement procedures to those described within the present document may be used with the agreement of the manufacturer and the accredited test laboratory.

The EUT shall fulfil the limits of clauses 7.3, 7.4, 7.5 and 7.6 of the stated measurements.

Other emissions (see clause 7.7).

## 7.3 Permitted range of operating frequencies

### 7.3.1 Definition

The occupied frequency range of the equipment is determined by the lowest ( $f_L$ ) and highest frequency ( $f_H$ ) as occupied by the power envelope in accordance with table 4.

### 7.3.2 Method of measurement

The NB SRR is powered on and set up to transmit its normal signal modulation sequence(s).

A spectrum analyzer with the following settings is used as measuring receiver in the test fixture described in clause 6:

- Start frequency = 24,0 GHz.
- Stop frequency = 24,3 GHz.
- RBW = 1 MHz.
- VBW  $\geq$  3 MHz.
- RMS detector (see ITU-R Recommendation SM.328-10 [i.7]).
- Maxhold function.
- Appropriate sweep time.
- 99 % OBW function (within the Occupied BandWidth the power envelope shall contain 99 % of the emissions).

The test shall be performed under both normal and extreme test conditions, declared by the manufacturer.

An example of a measurement of the occupied frequency is shown in figure 8.

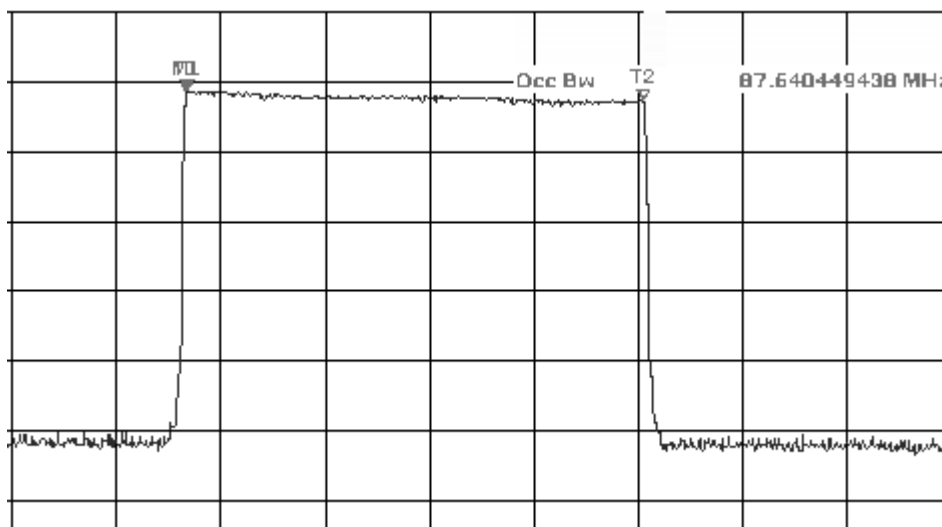

**Figure 8: Example measurement result for determining the occupied frequency range**

- $f_H$  is determined.  $f_H$  is the frequency of the upper marker resulting from the OBW.
- $f_L$  is determined.  $f_L$  is the frequency of the lower marker resulting from the OBW.

### 7.3.3 Limits

The frequency range requirements shall be fulfilled if all of the following conditions (see also table 4) are met:

- $f_H$  is smaller than or equal to 24,25 GHz.
- $f_L$  is larger than or equal to 24,05 GHz.

## 7.4 Maximum radiated peak power (e.i.r.p.)

### 7.4.1 Definition

The e.i.r.p. is defined as the maximum radiated power of the transmitter and its antenna.

### 7.4.2 Method of measurement

The NB SRR is powered on and set up to transmit its normal signal modulation sequence(s).

A spectrum analyzer with the following settings is used as measuring receiver in the test fixture described in clause 6:

- Start frequency = 24,0 GHz.
- Stop frequency = 24,3 GHz.
- The RBW = 1 MHz
- $VBW \geq RBW$ .
- Peak or auto peak detector.
- Maxhold function.
- Appropriate sweep time.

The test shall be performed under both normal and extreme test conditions, declared by the manufacturer.

An example of the maximum radiated peak power (e.i.r.p.) measurement is shown in figure 9.

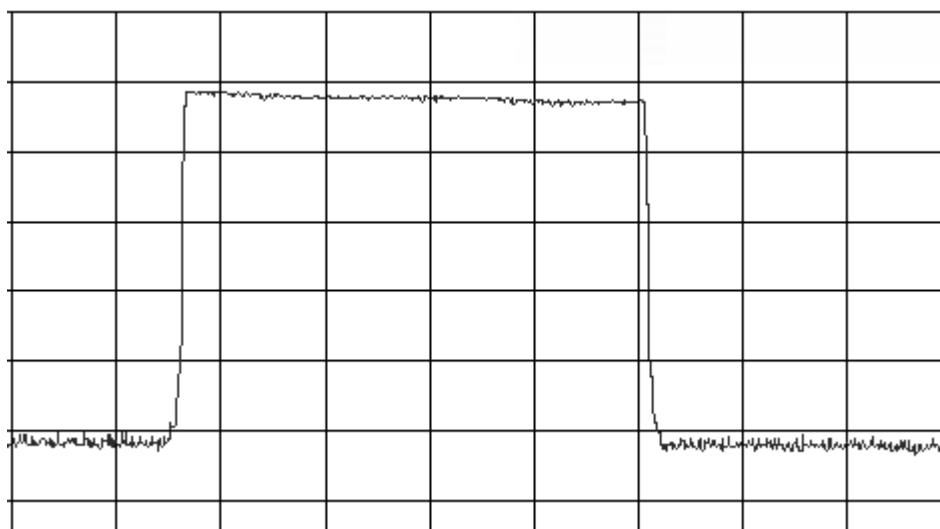

Figure 9: Example measurement result for determining the e.i.r.p.

### 7.4.3 Limits

The maximum radiated peak power levels are given in table 6.

**Table 6: Limits for maximum radiated peak power (e.i.r.p.)**

Frequency range	Maximum radiated peak power (e.i.r.p.)	Comment
24,05 GHz to 24,075 GHz	20 dBm	
24,075 GHz to 24,15 GHz	-10 dBm	
24,075 GHz to 24,15 GHz	20 dBm	See note below
24,15 GHz to 24,25 GHz	20 dBm	
NOTE: Additional conditions and limits for dwell time and repetition time according to clause 7.5 shall be met.		

## 7.5 Dwell time and repetition time

### 7.5.1 Definition

The definition of dwell time and repetition time is different for type C1, C2 and type D signals. For details see clause 7.2.

### 7.5.2 Methods of measurement

The NB SRR provider shall supply the type of NB SRR and relevant signal condition information together with the EUTs for testing. The signal shall represent the normal operational signal modulation sequence(s).

As a first step, signal analysis measurements shall be performed to identify all relevant categories as explained in table 4.

For each identified category, the quantitative dwell time and repetition time results shall be measured according to table 5.

If the signal analysis measurements show a random modulation behaviour, then the respective procedures in table 5, following after the signal analysis shall be performed five times. From the obtained individual dwell time values the maximum value is taken and from the obtained individual repetition time values the minimum value shall be reported.

This test shall be performed under normal test conditions.

#### 7.5.2.1 Signal analysis measurement

The NB SRR is powered on and set up to transmit its normal signal modulation sequence(s).

A signal analyzer is used as measuring receiver in the test fixture as described in clause 6.

The signal analyzer is operated with the following settings:

- Measurement time (x-axis) = 50 ms.
- Number of time measurement points: 500 (gives a time step size of 100  $\mu$ s).
- Frequency range (y-axis) = 24,075 GHz to 24,15 GHz or with external down-converter to convert the signal into the range 75 MHz to 150 MHz. If the bandwidth of the available signal analyzer is smaller than 75 MHz then several separate measurements have to be done to cover the complete 75 MHz band of interest.
- Frequency step size (y-axis) = 200 kHz.

This translates into the following settings for analog-to-digital conversion and FFT:

- Sampling rate = 500 MHz (to cover 2 x of the maximum occurring IF frequency range of 250 MHz).
- FFT size = 2 500 consecutive measurement samples (gives a frequency step size of  $500 \text{ MHz} / 2\,500 = 200 \text{ kHz}$ ).
- Frequency range (y-axis) = 24,075 GHz to 24,15 GHz or with external down-converter the range 75 MHz to 150 MHz.
- Time difference between consecutive FFTs (x-axis) = 100  $\mu\text{s}$ . This means that the first FFT is performed on samples 0 to 2499, the second FFT on samples 50 000 to 52 499 and so on.
- Number of FFTs = 500 (gives 50 ms measurement time).

In general, the above parameters are considered as a guidance. They may be adjusted to better capture the special EUT signals. Alternative approaches giving comparable information may also be used. This shall be agreed with the NB SRR provider and the test laboratory.

Figures 10 and 11 show example spectrograms of a signal analysis measurement.

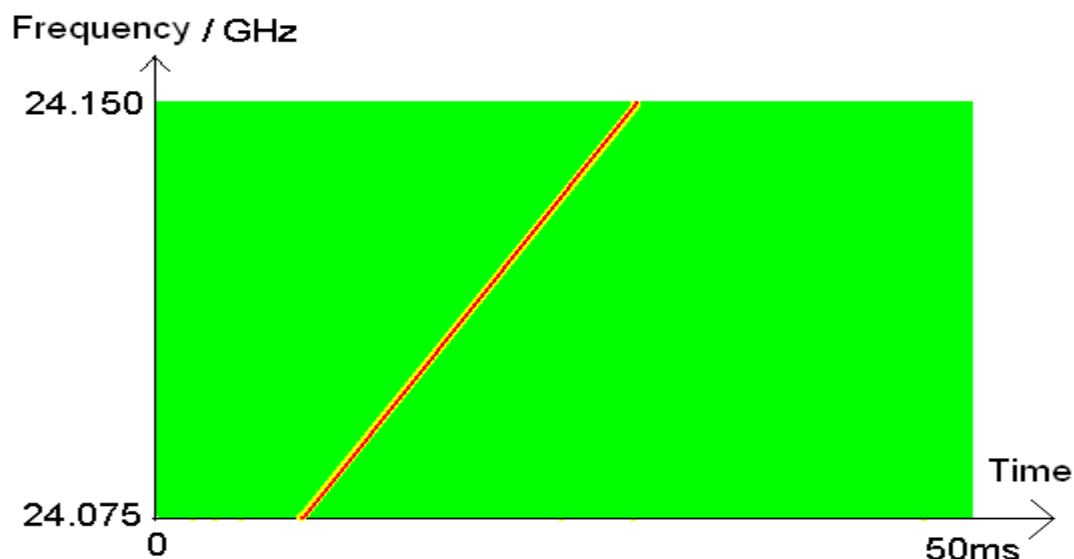
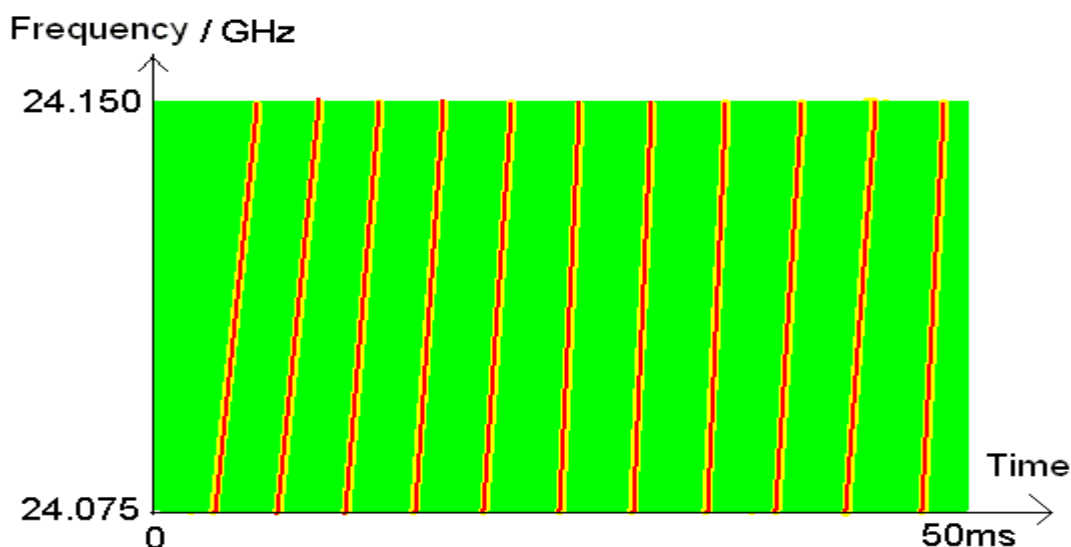

Figure 10: Example of a spectrogram of a signal analysis measurement for a slow modulation signal



**Figure 11: Example of a spectrogram of a signal analysis measurement for a fast modulation signal**

Using markers, from the result the relevant signal category shall be identified as B, C1, C2 or D and noted in the test report.

The signal analysis shall be repeated at least nine times until all different relevant signal categories named by the NB SRR provider are identified.

#### 7.5.2.2 Measurement of dwell time for a single dwell time event per 40 kHz in 3 ms (category C1)

As a guidance, the signal analyzer shall be operated with the following settings. They may be adjusted to better capture the special EUT signals in agreement with the NB SRR provider and the test laboratory.

- Measurement time (x-axis) = 50  $\mu$ s.
- Number of time measurement points = 500 (gives a time step size of 0,1  $\mu$ s).
- Frequency range (y-axis) = 24,075 GHz to 24,090 GHz or with external down-converter to convert the signal into the range 75 MHz to 90 MHz.
- Frequency step size = 40 kHz.

That translates to the following settings for analog-to-digital conversion and FFT:

- Sampling rate = 500 MHz (to cover 2 x of the maximum occurring IF frequency range of 250 MHz).
- FFT size = 12 500 consecutive measurement samples (gives a frequency step size of 500 MHz / 12 500 = 40 kHz).
- Frequency range (y-axis) = 24,075 GHz to 24,090 GHz or with external down-converter the range 75 MHz to 90 MHz.
- Time difference between consecutive FFTs (x-axis) = 0,1  $\mu$ s. This means that the first FFT is performed on samples 0 to 12 499, the second FFT on samples 50 to 12 549 and so on.
- Number of FFTs = 500 (gives a measurement time of 50  $\mu$ s).

The measurement procedure shall be repeatedly performed until the obtained result shows a representative C1 signal portion. Figure 12 shows an example spectrogram of a respective measurement.

Alternative approaches giving comparable information may also be used in agreement with the NB SRR provider and the test laboratory.

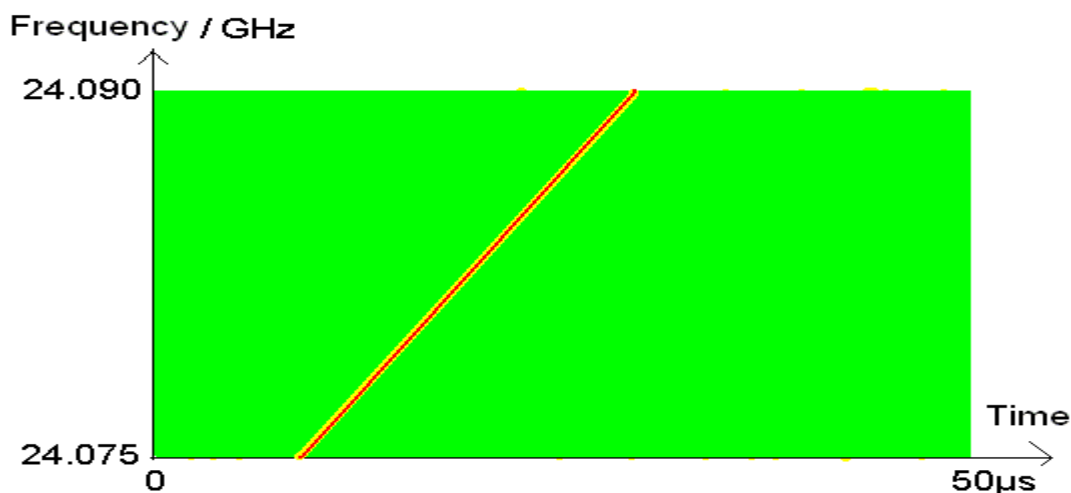

**Figure 12: Example spectrogram of dwell time measurement**

For determining dwell times, only signal portions with an e.i.r.p. amplitude of larger than -10 dBm shall be considered. If supported by the used signal analyzer, power level values below -10 dBm shall not be shown in the spectrogram at all.

The maximum occurring dwell time is directly determined using markers. For a linear modulated frequency, the dwell time in a 40 kHz range shall be calculated from the slope of the curve.

The obtained maximum dwell time is noted in the test report as DT\_fast1.

The measurement is repeated for the frequency ranges:

- 24,090 GHz to 24,105 GHz;
- 24,105 GHz to 24,120 GHz;
- 24,120 GHz to 24,135 GHz;
- 24,135 GHz to 24,150 GHz;

and the obtained maximum dwell times are noted in the test report as DT\_fast2, DT\_fast3, DT\_fast4, DT\_fast5.

### 7.5.2.3 Measurement of cumulated dwell time for more than one dwell time event per 40 kHz in 3 ms (category C2)

Comment: For this condition, a signal analyzer would have to take a measurement of 3 ms length (to accurately define all occurring individual dwell times in a 40 kHz range) with 0,1 μs time step sizes which is equivalent to 30 000 time points. Since this is not feasible an alternative (2-step) measurement shall be applied.

#### 7.5.2.3.1 Statistical measurement procedure

First, the following statistical procedure is applied:

- 1) The instrument setup as in clause 7.5.2.2 is used to measure a maximum occurring dwell time in each of the five frequency ranges:
  - 24,075 GHz to 24,090 GHz;
  - 24,090 GHz to 24,105 GHz;
  - 24,105 GHz to 24,120 GHz;
  - 24,120 GHz to 24,135 GHz;
  - 24,135 GHz to 24,150 GHz.



- 2) All measurements of item 1. shall be repeated four times.
- 3) The obtained 25 dwell time values are summed up and divided by 25, giving the average dwell time value DT0.
- 4) The measurement setup as in 7.5.2.1 shall be used to count the number of dwell times occurring in 3 ms. For ease of testing, the measurement time shall be chosen such that the number of dwell times in a defined time interval can be easily counted, and after this setting, the number is scaled up or down for a time interval of 3 ms. This yields the parameter N1.
- 5) The same measurement as in 4. shall be repeated four times yielding N2, N3, N4, N5.
- 6) The cumulated dwell time DT in 3 ms is obtained as:

$$DT = DT0 * (N1 + N2 + N3 + N4 + N5) / 5.$$

### 7.5.2.3.2 Verification procedure

The obtained result shall be verified to be representative by an equivalent duty cycle measurement. For this, a spectrum analyzer is used in the measuring receiver mode and in conjunction with the test fixture. The spectrum analyzer is operated with the following settings:

- Center frequency = 24,1125 GHz.
- Span = 75 MHz.
- RBW = 50 kHz (3 dB Gaussian filter).
- VBW  $\geq$  RBW.
- Peak detector.
- Appropriate sweep time.
- Maxhold function.

The EUT is powered on and set up to transmit its normal signal modulation sequence.

The peak e.i.r.p. at the center frequency is read as P<sub>50</sub>.

The value of DT as obtained from step 6 above is confirmed to be representative if:

$$P_{50} \leq 20\text{dBm} + 10 * \log (DT / 3 \text{ ms}) + 20 * \log (50 \text{ kHz} / 40 \text{ kHz}).$$

Figure 13 shows an example measurement result.

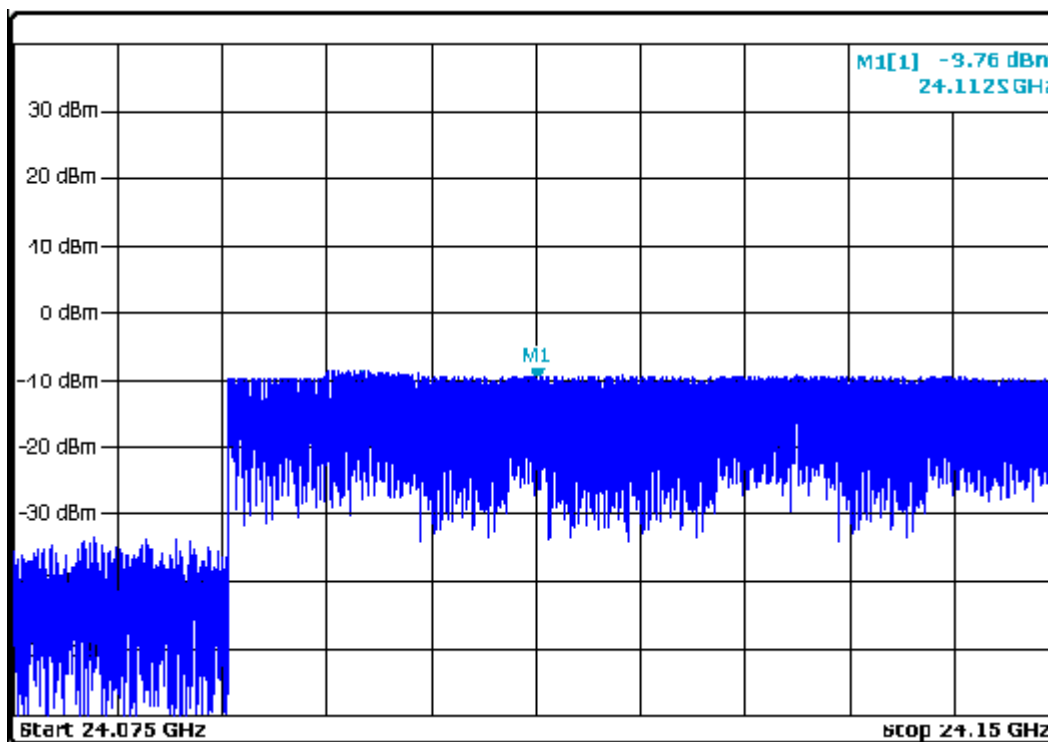

Figure 13: Spectrum analyzer result

EXAMPLE:

$P_{vp} = -9,76 \text{ dBm}$  and assuming a DT of  $4 \mu\text{s}$  gives a true statement:

$$-9,76 \text{ dBm} \leq 20,0 \text{ dBm} - 28,75 \text{ dB} + 1,93 \text{ dB} = -6,82 \text{ dBm}.$$

If the verification failed, the procedure in clause 7.5.2.3.1 shall be repeated, until the obtained value of DT is successfully verified in clause 7.5.2.3.2.

The final obtained value of DT is noted in the test report as DT\_fast\_rep.

#### 7.5.2.4 Measurement of absolute dwell time per 40 kHz (category D)

As a guidance, for measuring slow modulation dwell time, the signal analyzer shall be operated with the following settings. They may be adjusted to better capture the special EUT signals in agreement with the NB SRR provider and the test laboratory.

- Measurement time (x-axis) = 10 ms.
- Number of time measurement points = 500 (gives a time step size of  $20 \mu\text{s}$ ).
- Frequency range (y-axis) = 24,075 GHz to 24,090 GHz or with external down-converter to convert the signal into the range 75 MHz to 90 MHz.
- Frequency step size = 40 kHz.

That translates to the following settings for analog-to-digital conversion and FFT:

- Sampling rate = 500 MHz (to cover 2 x of the maximum occurring IF frequency of 250 MHz).
- FFT size = 12 500 consecutive measurement samples (gives a frequency step size of  $500 \text{ MHz} / 12\,500 = 40 \text{ kHz}$ ).
- Frequency range (y-axis) = 24,075 GHz to 24,090 GHz or with external down-converter to convert the signal into the range 75 MHz to 90 MHz.

- Time difference between consecutive FFTs (x-axis) = 20  $\mu$ s. This means that the first FFT is performed on samples 0 to 12 499, the second FFT on samples 10 000 to 22 499 and so on.
- Number of FFTs = 500 (gives 10 ms measurement time).

Alternative approaches giving comparable information may also be used in agreement with the NB SRR provider and the test laboratory.

The measurement shall be performed until the result shows a representative signal portion from the signal analysis measurements (see clause 7.5.2.1). Figure 14 shows an example spectrogram result of a respective measurement.

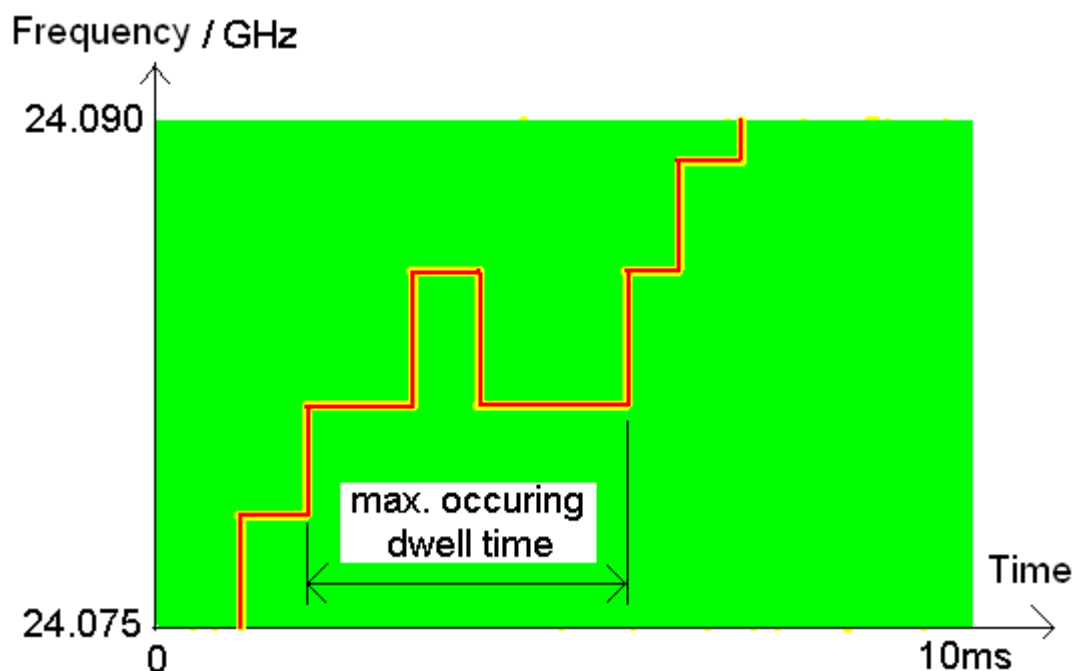

**Figure 14: Example spectrogram of absolute dwell time measurement**

For reading dwell times, only signal portions with an e.i.r.p. amplitude of larger than -10 dBm are relevant. If supported by the used signal analyzer, power level values below -10 dBm are not shown in the spectrogram at all.

The maximum occurring dwell time is directly determined using markers. For a linear modulated frequency, the dwell time in a 40 kHz range can be calculated from the slope of the curve.

The obtained maximum dwell time is noted in the test report as DT\_slow1.

The dwell time measurements are repeated for the frequency ranges:

- 24,090 GHz to 24,105 GHz;
- 24,105 GHz to 24,120 GHz;
- 24,120 GHz to 24,135 GHz;
- 24,135 GHz to 24,150 GHz.

The obtained maximum dwell times shall be noted in the test report as DT\_slow2, DT\_slow3, DT\_slow4, DT\_slow5.

#### 7.5.2.5 Measurement of repetition time for absolute dwell times per 40 kHz (category D)

As a guidance, for measuring the repetition time, the signal analyzer shall be operated with the following settings. They may be adjusted to better capture the special EUT signals based on the results from the signal analysis measurement or in agreement with the NB SRR provider and the test laboratory.

- Measurement time (x-axis) = 50 ms.
- Number of time measurement points = 500 (gives a time step size of 100  $\mu$ s).
- Frequency range (y-axis) = 24,075 GHz to 24,090 GHz or with external down-converter to convert the signal into the range 75 MHz to 90 MHz.
- Frequency step size = 40 kHz.

That translates to the following settings for analog-to-digital conversion and FFT:

- Sampling rate = 500 MHz (to cover 2 x of the maximum occurring IF frequency of 250 MHz).
- FFT size = 12 500 consecutive measurement samples (gives a frequency step size of 500 MHz / 12 500 = 40 kHz).
- Frequency range (y-axis) = 24,075 GHz to 24,090 GHz or with external down-converter to convert the signal into the range 75 MHz to 90 MHz.
- Time difference between consecutive FFTs (x-axis) = 100  $\mu$ s. This means that the first FFT is performed on samples 0 to 12 499, the second FFT on samples 50 000 to 62 499 and so on.
- Number of FFTs = 500 (gives 50 ms measurement time).

Alternative approaches giving comparable information may also be used in agreement with the NB SRR provider and the test laboratory.

The measurement shall be repeatedly performed until the obtained result allows to evaluate the time gap between two occupancies of the same 40 kHz range. Figure 15 shows an example spectrogram result of a respective measurement.

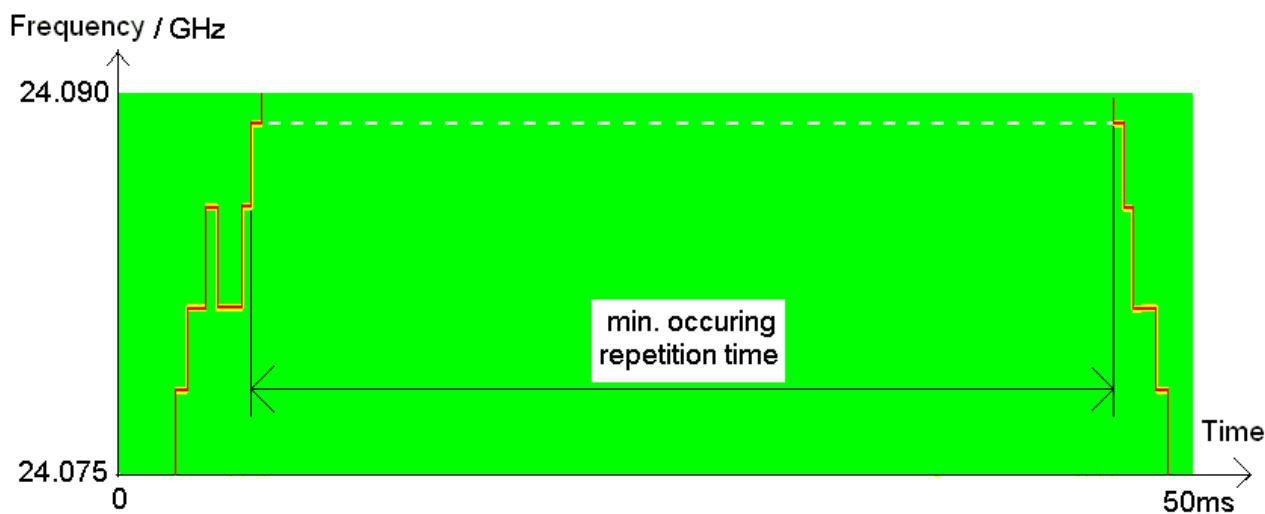

**Figure 15: Example of a spectrogram for repetition time measurement**

For determining of the minimum repetition time, only signal portions with an e.i.r.p. amplitude of larger than -10 dBm are relevant. If supported by the used signal analyzer, the power level values below -10 dBm are not shown in the spectrogram.

The minimum occurring repetition time shall be directly determined using markers and noted in the test report as RT\_slow1.

The repetition time measurements are repeated for the frequency ranges:

- 24,090 GHz to 24,105 GHz;
- 24,105 GHz to 24,120 GHz;
- 24,120 GHz to 24,135 GHz;
- 24,135 GHz to 24,150 GHz.

The obtained minimum repetition times shall be noted in the test report as RT\_slow2, RT\_slow3, RT\_slow4, RT\_slow5.

### 7.5.3 Limits

Limits for dwell time and repetition time are only relevant to signal categories C1, C2 and D.

The limits of dwell time and repetition time according to table 7 shall be met.

**Table 7: Limits for dwell time and repetition time**

Category	Frequency range	Dwell time	Repetition time	Comment
C1	24,075 GHz to 24,15 GHz	NB SRR mounted behind a bumper: Max (DT_fast1, DT_fast2, DT_fast3, DT_fast4, DT_fast5) ≤ 4 μs  NB SRR mounted without a bumper: Max (DT_fast1, DT_fast2, DT_fast3, DT_fast4, DT_fast5) ≤ 3 μs	3 ms (is implicitly fulfilled in meeting the dwell time)	Additionally the limits for power, operating frequency range and modulation range shall be met (see table 4).
C2	24,075 GHz to 24,15 GHz	NB SRR mounted behind a bumper: DT_fast_rep ≤ 4 μs  NB SRR mounted without a bumper: DT_fast_rep ≤ 3 μs	3 ms (is implicitly fulfilled in meeting the dwell time )	Additional limits for power, operating frequency range and modulation range shall be met (see table 4).
D	24,075 GHz to 24,15 GHz	Max (DT_slow1, DT_slow2, DT_slow3, DT_slow4, DT_slow5) ≤ 1 ms	Min (RT_slow1, RT_slow2, RT_slow3, RT_slow4, RT_slow5) ≥ 40 ms	Additional limits for power, operating frequency range and modulation range shall be met (see table 4).

## 7.6 Frequency modulation range

### 7.6.1 Definition

The frequency modulation range denotes the frequency range which is covered during a complete modulation sequence of a radar transmit cycle.

## 7.6.2 Method of measurement

The NB SRR is powered up and set up to transmit its normal signal modulation sequence(s).

The same measurement setup as for the signal analysis measurement (see clause 7.5.2.1) is used.

From the resulting spectrogram, the frequency range covered by the modulation cycle shall be determined with the use of frequency markers and noted as  $f_{\text{mod\_range}}$  in the test report.

This test shall be performed under normal test conditions.

## 7.6.3 Limits

The frequency modulation limits are given in table 4 as:

$f_{\text{mod\_range}}$  shall be larger than or equal to 250 kHz.

## 7.7 Radiated spurious emissions

### 7.7.1 Definition

Emission on a frequency or frequencies which are outside the necessary bandwidth and the level of which may be reduced without affecting the corresponding transmission of information. Spurious emissions include harmonic emissions, parasitic emissions, intermodulation products and frequency conversion products, but exclude out-of-band emissions.

Spurious emissions are measured as spectral power density under normal operating conditions.

According to CEPT/ERC/REC 74-01 [i.6] and ITU-R Recommendation SM.329 [i.8], the boundary between the out-of-band and spurious domains is  $\pm 250\%$  of the necessary bandwidth (OBW) from the centre frequency of the emission. To limit unwanted emissions in the spurious domain at frequencies beyond the limit of 250 % of the necessary bandwidth (OBW) above and below the centre frequency of the emission, CEPT/ERC/REC 74-01 [i.6] applies.

### 7.7.2 Method of measurement

A test site such as one selected from annex A, which fulfils the requirements of the specified frequency range of this measurement shall be used. The test method employed should be as described in clause 6.

A spectrum analyzer is used as a measuring receiver. The bandwidth of the measuring receiver shall be set to a suitable value to correctly measure the spurious or out-of-band emissions. This bandwidth shall be recorded in the test report. For frequencies above 40 GHz a downconverter may be used. The local oscillator used to downconvert the received signals shall be stable and with a phase noise of better than -80 dBc/Hz at 100 kHz offset. The local oscillator frequency shall be selected such that the downconverted signal is within the accepted band of the spectrum analyzer, and maintaining an adequate Intermediate Frequency (IF) bandwidth to capture the full spectrum of the signal.

The e.i.r.p. of the EUT shall be measured and recorded. For these measurements it is strongly recommended to use a LNA (low noise amplifier) before the spectrum analyzer input to achieve the required sensitivity.

### 7.7.3 Limits

The effective radiated power of any radiated spurious emission shall not exceed the values given in table 8.

**Table 8: Limits of radiated spurious emissions**

Frequency range (MHz)	Limit values for spurious radiation (Measuring receiver bandwidths see table 2)	Detector type
47 to 74	-54 dBm e.r.p.	Quasi peak
87,5 to 118	-54 dBm e.r.p.	Quasi peak
174 to 230	-54 dBm e.r.p.	Quasi peak
470 to 862	-54 dBm e.r.p.	Quasi peak
otherwise in band 30 to 1 000	-36 dBm e.r.p.	Quasi peak
f > 1 000 to 50 000	-30 dBm e.i.r.p.	Peak

According to CEPT/ERC/REC 74-01 [i.6], spurious emission is measured up to the 2<sup>nd</sup> harmonic of the fundamental frequency (in this case, the upper frequency limit up to which measurements are performed is 50 GHz).

The following reference bandwidths shall be used:

- 100 kHz between 30 MHz and 1 GHz;
- 1 MHz above 1 GHz.

---

## 8 Methods of measurement and limits for receiver parameters

### 8.1 Receiver spurious emissions

#### 8.1.1 Definition

Separate radiated spurious measurements need not be made on receivers co-located with transmitters. The definitions from clause 7.7 on transmitter spurious emissions apply.

#### 8.1.2 Method of measurement - radiated spurious emissions

This method of measurement applies to receivers having an integral antenna.

- a) A test site selected from annex A which fulfils the requirements of the specified frequency range of this measurement shall be used. The test antenna shall be oriented initially for vertical polarization and connected to a measuring receiver. The bandwidth of the measuring receiver shall be adjusted until the sensitivity of the measuring receiver is at least 6 dB below the spurious emission limit given in clause 7.7. This bandwidth shall be recorded in the test report.

The receiver under test shall be placed on the support in its standard position.

- b) The frequency of the measuring receiver shall be adjusted over the frequency range from 25 MHz to 50 GHz. The frequency of each spurious component shall be noted. If the test site is disturbed by radiation coming from outside the site, this qualitative search may be performed in a screened room with reduced distance between the transmitter and the test antenna.
- c) At each frequency at which a component has been detected, the measuring receiver shall be tuned and the test antenna shall be raised or lowered through the specified height range until the maximum signal level is detected on the measuring receiver.
- d) The receiver shall be rotated up to 360° about a vertical axis, to maximize the received signal.

- e) The test antenna shall be raised or lowered again through the specified height range until a maximum is obtained. This level shall be noted.
- f) The substitution antenna (see clause A.3.2) shall replace the receiver antenna in the same position and in vertical polarization. It shall be connected to the signal generator.
- g) At each frequency at which a component has been detected, the signal generator, substitution antenna and measuring receiver shall be tuned. The test antenna shall be raised or lowered through the specified height range until the maximum signal level is detected on the measuring receiver. The level of the signal generator giving the same signal level on the measuring receiver as in step e) shall be noted. This level, after correction due to the gain of the substitution antenna and the cable loss, is the radiated spurious component at this frequency.
- h) The frequency and level of each spurious emission measured and the bandwidth of the measuring receiver shall be recorded in the test report.
- i) Measurements b) to h) shall be repeated with the test antenna oriented in horizontal polarization.

### 8.1.3 Limit

The maximum Equivalent Isotropically Radiated Power (max. e.i.r.p.) of any spurious emission outside the permitted range of frequencies, shall not exceed 2 nW ( $\approx -57$  dBm) in the frequency range  $30 \text{ MHz} \leq f \leq 1 \text{ GHz}$  and shall not exceed 20 nW ( $\approx -47$  dBm) for  $f > 1 \text{ GHz}$ .

---

## 9 Interpretation of test results and measurement uncertainty

### 9.1 Interpretation of the measurement results

The interpretation of the results recorded on the appropriate test report for the measurements described in the present document shall be as follows:

- the measured value relating to the corresponding limit shall be used to decide whether an equipment meets the requirements of the present document;
- the measurement uncertainty value for the measurement of each parameter shall be included in the test report;
- the recorded value of the maximum expanded measurement uncertainty shall, for each measurement, be equal to, or lower than, the figures in the table of maximum expanded measurement uncertainty (table 9).

**Table 9: Maximum expanded measurement uncertainty**

Parameters	Expanded measurement uncertainty
Radio frequency	$\pm 1 \times 10^{-7}$
Time interval	$\pm 1 \times 10^{-7}$
Radiated emission, valid to 26,5 GHz	$\pm 6$ dB
Radiated emission, valid between 26,5 GHz and 50 GHz	$\pm 8$ dB
Temperature	$\pm 1$ °C
Humidity	$\pm 5$ %
Voltage (DC)	$\pm 1$ %
Voltage (AC, < 10 kHz)	$\pm 2$ %



For the test methods, according to the present document the uncertainty figures shall be calculated according to the methods described in the TR 100 028 [2] and shall correspond to an expansion factor (coverage factor)  $k = 1,96$  or  $k = 2$  (which provide confidence levels of respectively 95 % and 95,45 % in case where the distributions characterizing the actual measurement uncertainties are normal (Gaussian)). Table 9 is based on such expansion factors.

The particular expansion factor used for the evaluation of the measurement uncertainty shall be stated.

## 9.2 Absolute measurement uncertainty

The accumulated expanded measurement uncertainties of the test system in use, for the parameters to be measured, shall not exceed those given in table 9 to ensure that the measurements remain within an acceptable standard.

---

## Annex A (normative): Radiated measurements

This Annex introduces three test sites, an anechoic chamber, an anechoic chamber with a ground plane and an Open Area Test Site (OATS), which may be used for radiated tests. These test sites are generally referred to as free field test sites. Both absolute and relative measurements can be performed in these sites. Where absolute measurements are to be carried out, the chamber should be verified. A detailed verification procedure is described in the relevant parts of TR 102 273 [3] or equivalent.

---

### A.1 General requirements for measurements involving the use of radiated fields

Measurements involving radiated fields require a prepared test site, well-characterized antenna equipment, calibrated test instrumentation, appropriate ancillary equipment such as cabling and filters, and appropriate test plans and methods. This annex provides minimum requirements and examples of suitable practice.

Test sites shall be suitable for radiated measurements and shall be designed to eliminate significant effects of objects or materials capable of influencing the interaction between test sample or substitute antenna and test antenna and instrumentation.

Test sites may consist of:

- outdoor test sites;
- indoor sites;
- anechoic test sites.

The nature of the test site, precautions taken and evidence of suitability shall be recorded with the results of the tests.

Principal items of equipment are:

- Equipment under test with associated cabling.
- Antennas:
  - a test antenna with a sufficient aperture angle;
  - substitution antenna;
  - artificial antenna.
- Test equipment:
  - calibrated measuring receiver (spectrum analyzer, signal analyzer or other appropriate receiving instrument);
  - calibrated filtering equipment;
  - calibrated recording equipment.

The provisions below describe minimum acceptable standards for test sites, test methods and equipment and scope of testing.

The provisions below are appropriate for measurements in the far-field. Test result must record where the near-field conditions are entered and the additional measurement uncertainty shall be evaluated, recorded and added to the test result.

## A.2 Test Sites

### A.2.1 Outdoor test site

An outdoor test site, see figure A.1, shall provide:

- Measured support positions at least 3 m or  $\lambda/2$  (at the test frequency) apart for the test item or substitution antenna and the test antenna, and a measured midpoint.
- A clear area greater than a circle of diameter twice the separation of the test item or substitution antenna from the test antenna, centred at the midpoint.
- Substantially level ground surface treated to render its effect either negligible (treatment to minimize reflection) or deterministic (treatment with flat reflecting material) and including the whole of the clear area.
- Sufficient precautions to ensure that reflections from extraneous objects beyond the clear area and within or adjacent to the site do not degrade the measurement results in accordance with CISPR 16 [1].
- Non-conducting supports for the test item or substitution antenna and the test antenna.
- Provision for free-mounting equipment under test to be supported 1,5 m above the ground and rotated through 360° in the horizontal plane.
- Provision for floor-standing equipment to be mounted 100 mm above the ground and rotated through 360° in the horizontal plane.
- Provision for the test antenna to be moved between heights of at least 1 m to 4 m above the treated ground surface and rotated for operation in any plane of polarization.

Key:

- 1) equipment under test;
- 2) test antenna;
- 3) high pass filter (if necessary);
- 4) lyzermeasuring receiver (spectrum analyzer, signal analyzer, etc.).

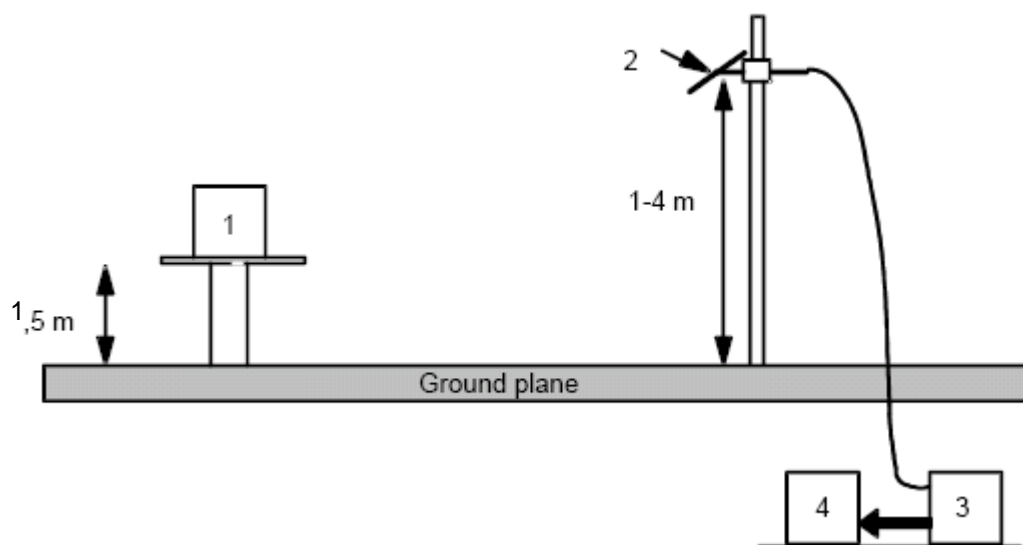

Figure A.1: Outdoor test site

## A.2.2 Indoor test site

An indoor site may be used for test frequencies above 80 MHz. If an indoor site is used, this shall be recorded in the test report.

An indoor test site, see figure A.2, shall provide:

- Floor, ceiling above 2,7 m, test sample wall and test antenna wall separated by at least 7 m and side walls separated by at least 6 m.
- A test antenna providing adequate sensitivity over the range of test frequencies and also providing adequate isolation from the effects of floor, ceiling, test antenna wall and side walls.

EXAMPLE: A corner reflector antenna.

- A test sample wall treated with anechoic material to render its effect negligible.
- Non-conducting supports for the test item or substitution antenna and the test antenna.
- Measured support positions on the long axis of the site and at least 3 m apart for the test item or substitution antenna and the test antenna.
- Sufficient precautions to ensure that the presence of objects within the room does not degrade the measurement results in accordance with CISPR 16 [1].
- Provision for free-mounting test samples to be supported 1,5 m above the ground and rotated through 360° in the horizontal plane.
- Provision for floor-standing equipment to be mounted 100 mm above the ground and rotated through 360° in the horizontal plane.
- Provision for the test antenna to be centred at a height more than 1,35 m above the floor and more than 1,35 m below the ceiling, and to be rotated for operation in any plane of polarization.
- Provision for a substitution antenna to replace the equipment under test and to be moved up to  $\pm 0,1$  m in any direction.

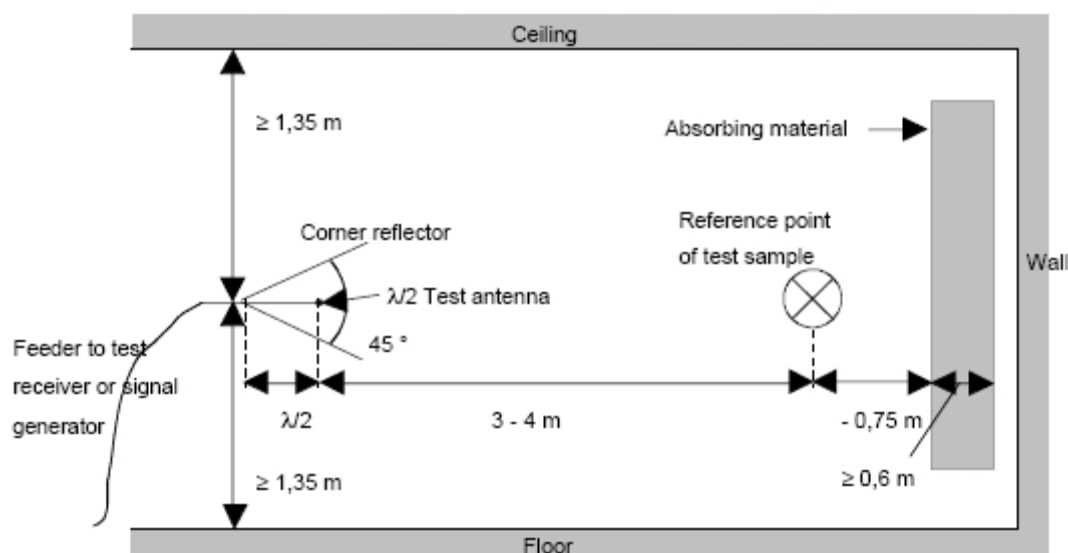

Figure A.2: Indoor site arrangement (shown for horizontal polarization)

## A.2.3 Shielded anechoic test site

"Anechoic" means that the walls, floor and ceiling of the enclosed test site are treated to substantially reduce radio reflections.

For radiation measurements under the present document a shielded, calibrated anechoic chamber may be used to simulate a free space environment. Such use shall be frequencies above 100 MHz unless specific treatment and calibration evidence at lower frequencies is provided. Calibration by a competent body shall confirm reflection attenuation at the walls to meet the limits provided in figure A.3. Shielding better than the limits provided by figure A.3 is desirable. An example of the construction of an anechoic chamber is shown in figure A.4.

The chamber shall provide sufficient space to carry out tests as in the general method. If such a chamber is used, this shall be recorded in the test report.

The test antenna, measuring receiver, substitution antenna and calibrated signal generator are used in a way similar to that of the general method.

### A.2.3.1 Influence of parasitic reflections in anechoic chambers

With an anechoic chamber of the dimensions suggested in clause A.1.3 at low frequencies up to 100 MHz far field conditions are not met and specific calibration procedures will be required. Careful attention is also required to the chamber calibration for frequencies above 1 GHz.

### A.2.3.2 Calibration of the shielded RF anechoic chamber

The chamber shall be calibrated over the range 30 MHz to 50 GHz.

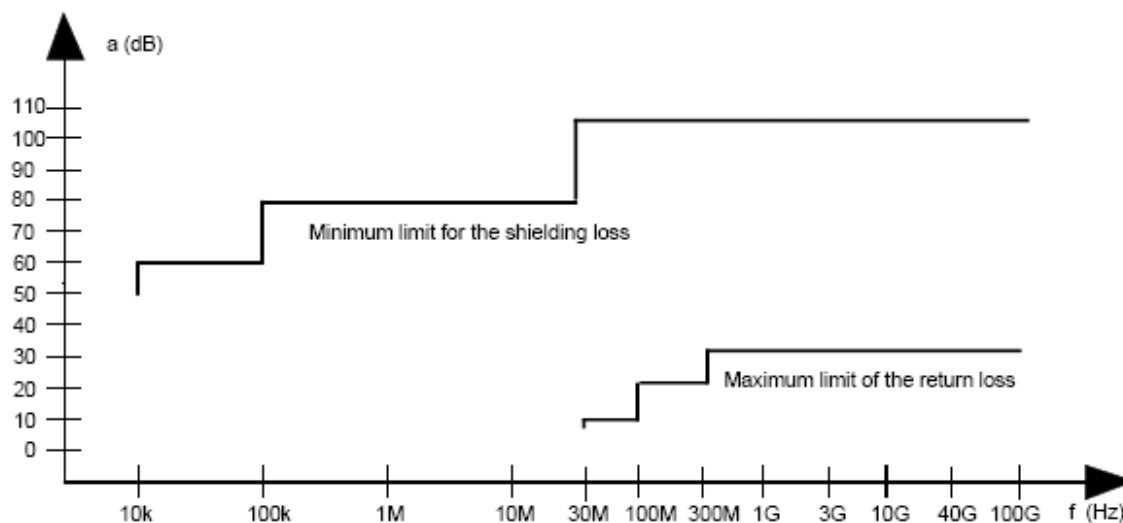

Figure A.3: Specification for shielding and reflections

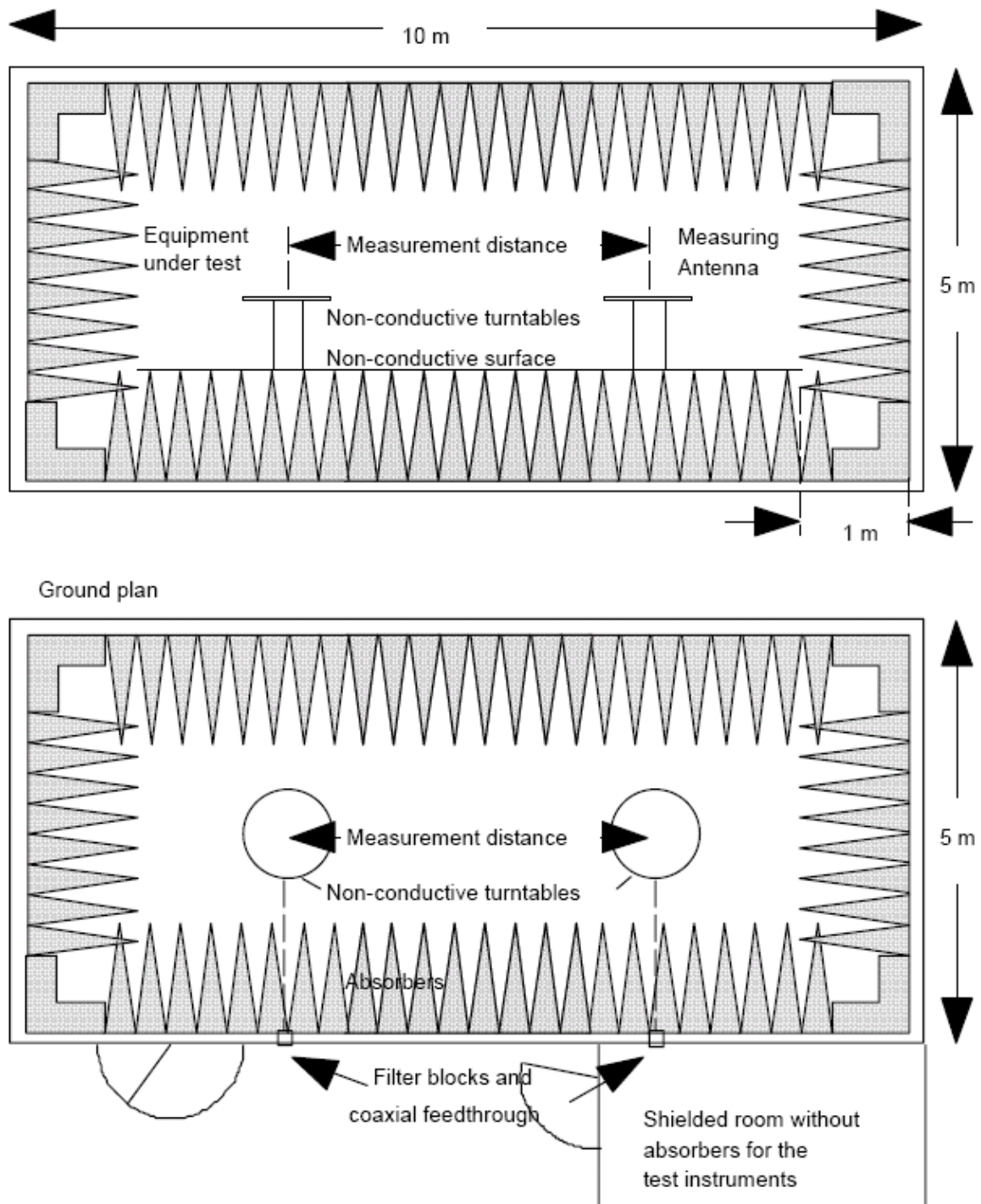

Figure A.4: Example of construction of an anechoic shielded chamber

---

## A.3 Antennas

Antennas shall be selected in such way, that their performance allows obtaining sufficiently accurate results and that in connection with other test equipment the requirements of table 9 are fulfilled.

### A.3.1 Test antenna

The test antenna is used to detect the radiation from both the test sample and the substitution antenna for emission measurements. It is used as a transmitting antenna for the measurement of receiver characteristics.

The test antenna support provides for either horizontal or vertical polarization and for the height of its centre above ground to be varied over the range 1 m to 4 m or to the ceiling of an indoor or anechoic chamber, whichever is less. The test antenna shall provide boresight directivity equal to at least half the wall reflectivity limit prescribed in figure A.3. The length of the test antenna along the measurement axis shall not exceed 20 % of the measuring distance.

For emission measurements, the test antenna is connected to a calibrated measuring receiver capable of being tuned to any frequency under investigation.

For receiver sensitivity measurements, the test antenna is connected to a calibrated signal generator capable of being tuned to any frequency under investigation.

Height variation shall be used to find the point at which the radiation is a maximum near the initial position.

### A.3.2 Substitution antenna

A substitution antenna may be used in place of the equipment under test when comparing equipment emissions with standard emissions.

When measuring in the frequency range up to 1 GHz the substitution antenna shall be a  $\lambda/2$  dipole, resonant at the operating frequency, or a shortened dipole, calibrated to the  $\lambda/2$  dipole. When measuring in the frequency range above 4 GHz, a horn radiator shall be used. For measurements between 1 GHz and 4 GHz either a  $\lambda/2$  or a horn radiator may be used. The centre of this antenna shall coincide with the reference point of the test sample it has replaced. This reference point shall be the volume centre of the sample when its antenna is mounted internally, or the phase centre of an external antenna.

The distance between the lower extremity of the dipole and the ground shall not be less than 0,3 m.

The substitution antenna shall be connected to a calibrated signal generator when the site is used for spurious radiation measurements and transmitter effective radiated power measurements. The substitution antenna shall be connected to a calibrated measuring receiver when the site is used for the measurement of receiver sensitivity.

The signal generator and the receiver shall be connected to the antenna through suitable matching and balancing networks.

Where a shortened dipole antenna is used at these frequencies, details of the type of antenna used shall be included with the results of the tests and correction factors shall be taken into account.

The substitution antenna shall be moved through a distance of  $\pm 0,1$  m in the direction of the test antenna as well as in the two directions perpendicular to this first direction to find the position of maximum response. If these changes of position cause a signal change of greater than 2 dB, the test sample should be re-sited and measurements repeated until a change of less than 2 dB with the substitution antenna is obtained.

### A.3.3 Artificial antenna

An artificial antenna may be connected to the equipment output port when cabinet or enclosure emissions are being tested and shall be substantially non-radiating.

Where possible, a direct connection should be used between the artificial antenna and the test sample. In cases where it is necessary to use a connecting cable, precautions should be taken to reduce the radiation from this cable by, for example, the use of ferrite cores or double screened cables.

---

## A.4 Test practice and auxiliary test equipment

Antenna characteristics and positions and test equipment settings shall be recorded with each test result.

Test equipment calibration shall be traceable to appropriate European standards. Test equipment, antenna and cable types or characteristics shall be recorded with the results of the tests.

Test methods shall comply with operator instructions for each item of equipment, with the measurements and limits described in the present document, and with the provisions and guidelines given below.

All test equipment shall be calibrated with traceability to European standards. Furthermore the performance of the test equipment shall be of such quality that sufficiently accurate results are obtained and that the requirements of table 9 are fulfilled.

---

## A.5 Measuring distance

Under the conditions provided in this annex, measurement frequencies will be above 25 MHz and the measuring distance should be greater than  $2D^2/\lambda$  or  $\lambda/2$ , whichever is greater, at the frequency of measurement where D is the largest transmitting aperture dimension (far-field conditions). Outdoor sites will be required for low frequency measurements unless special provisions are made at an indoor, anechoic or near field site.

### A.5.1 Standard position

The standard position in all test sites, except for equipment which is intended to be worn on a person, shall be as follows:

- for equipment with an integral antenna, it shall be placed in the position closest to normal use as declared by the manufacturer;
- for equipment with a rigid external antenna, the antenna shall be vertical;
- for equipment with non-rigid external antenna, the antenna shall be supported by a non-conducting support at the initial height of the test antenna.

### A.5.2 Auxiliary cables

The position of auxiliary cables (power supply and microphone cables etc.) which are not adequately de-coupled, may cause variations in the measurement results. In order to get reproducible results, cables and wires of auxiliaries should be arranged vertically downwards (through a hole in the non conducting support), or as specified in the technical documentation supplied with the equipment.

Care shall be taken to ensure that test cables do not adversely affect the measuring result.



---

## Annex B (normative): Installation requirements

### B.1 Installation requirements of 24 GHz Narrow Band Short Range Radar (NB SRR) systems

This annex provides the installation requirements for 24 GHz NB SRR equipment manufacturers and installers to install the equipment as follows.

- a) 24 GHz NB SRR to be installed at a permanent fixed position on a vehicle.
- b) If mounted without a bumper or in front of the bumper, the 4  $\mu$ s/40 kHz dwell time every 3 ms condition will be reduced to 3  $\mu$ s/40 kHz dwell time every 3 ms.

---

## Annex C (informative): Conversion of power density to e.i.r.p.

This annex offers an example of the conversion from "power/unit area" (power density) to e.i.r.p.

---

### C.1 Assumptions

e.i.r.p. is the product of "power into the antenna" multiplied by the "antenna gain".

e.i.r.p. is the total power transmitted, assuming an isotropic radiator.

Area of a sphere =  $\pi d^2$ .

---

### C.2 Example

For a power density of 200 nW/cm<sup>2</sup> (measured at 3 m):

200 nW/cm<sup>2</sup> (at 3 m) = power measured in a 1 cm<sup>2</sup> area at 3 m distance.

e.i.r.p. = total radiated power over the whole area of a sphere.

e.i.r.p. = [power measured in a 1cm<sup>2</sup> area at 3 m distance (W)] × [area of sphere at 3 m (in cm<sup>2</sup>)].

e.i.r.p. = [(200 × 10<sup>-9</sup>) × (π × 36 × 10<sup>4</sup>)] W.

e.i.r.p. = 226,19 mW.

**Hence:** 200 nW/cm<sup>2</sup> (at 3 m) ≅ 23,54 dBm.

---

## Annex D (informative): Bibliography

- ETSI EN 301 489-3 (V1.2.1): "Electromagnetic compatibility and Radio spectrum Matters (ERM); ElectroMagnetic Compatibility (EMC) standard for radio equipment and services; Part 3: Specific conditions for Short-Range Devices (SRD) operating on frequencies between 9 kHz and 40 GHz".
- ETSI EN 300 440 (Parts 1 and 2): "Electromagnetic compatibility and Radio spectrum Matters (ERM); Short range devices; Radio equipment to be used in the 1 GHz to 40 GHz frequency range".

---

## History

<b>Document history</b>		
V1.1.1	April 2010	Public Enquiry PE 20100810: 2010-04-12 to 2010-08-10
V1.2.1	May 2011	Vote V 20110705: 2011-05-06 to 2011-07-05