

Draft **ETSI EN 302 550-1-3** V1.1.0 (2009-07)

---

*European Standard (Telecommunications series)*

**Satellite Earth Stations and Systems (SES);  
Satellite Digital Radio (SDR) Systems;  
Part 1: Physical Layer of the Radio Interface;  
Sub-part 3: Inner Physical Layer Multi Carrier Modulation**

---



---

**Reference**DEN/SES-00312-1-3

---

---

**Keywords**digital, layer 1, radio, satellite

---

**ETSI**

650 Route des Lucioles  
F-06921 Sophia Antipolis Cedex - FRANCE

---

Tel.: +33 4 92 94 42 00 Fax: +33 4 93 65 47 16

Siret N° 348 623 562 00017 - NAF 742 C  
Association à but non lucratif enregistrée à la  
Sous-Préfecture de Grasse (06) N° 7803/88

---

**Important notice**

---

Individual copies of the present document can be downloaded from:

<http://www.etsi.org>

The present document may be made available in more than one electronic version or in print. In any case of existing or perceived difference in contents between such versions, the reference version is the Portable Document Format (PDF). In case of dispute, the reference shall be the printing on ETSI printers of the PDF version kept on a specific network drive within ETSI Secretariat.

Users of the present document should be aware that the document may be subject to revision or change of status. Information on the current status of this and other ETSI documents is available at

<http://portal.etsi.org/tb/status/status.asp>

If you find errors in the present document, please send your comment to one of the following services:

[http://portal.etsi.org/chaicor/ETSI\\_support.asp](http://portal.etsi.org/chaicor/ETSI_support.asp)

---

**Copyright Notification**

---

No part may be reproduced except as authorized by written permission.  
The copyright and the foregoing restriction extend to reproduction in all media.

© European Telecommunications Standards Institute 2009.  
All rights reserved.

**DECT™**, **PLUGTESTS™**, **UMTS™**, **TIPHON™**, the TIPHON logo and the ETSI logo are Trade Marks of ETSI registered for the benefit of its Members.

**3GPP™** is a Trade Mark of ETSI registered for the benefit of its Members and of the 3GPP Organizational Partners.

**LTE™** is a Trade Mark of ETSI currently being registered

for the benefit of its Members and of the 3GPP Organizational Partners.

**GSM®** and the GSM logo are Trade Marks registered and owned by the GSM Association.

# Contents

Intellectual Property Rights .....	4
Foreword.....	4
Introduction .....	4
1 Scope .....	5
2 References .....	5
2.1 Normative references .....	5
2.2 Informative references.....	5
3 Definitions, symbols and abbreviations .....	6
3.1 Definitions.....	6
3.2 Symbols.....	6
3.3 Abbreviations .....	6
4 Inner physical layer - Multi Carrier.....	6
4.1 Interfacing to OPL (Outer Physical Layer) .....	7
4.2 The profile approach - different multi carrier modes .....	8
4.2.1 Profile definition.....	8
4.2.2 Modes definition.....	8
4.2.3 Parameters for QPSK subcarrier mapping .....	9
4.2.4 Parameters for 16QAM subcarrier mapping .....	9
4.3 Generation of one Phy section.....	10
4.3.1 Overview .....	10
4.3.1.1 Overview of Mode 2, 2s, 3 and 4 .....	11
4.3.2 RFU section insertion .....	11
4.3.3 Energy dispersal (scrambling) .....	12
4.3.4 Accumulation of CU into one Phy section.....	12
4.4 Pilot tone insertion and signalling .....	12
4.4.1 Mode 2 and Mode 2s: 2k@5MHz.....	12
4.4.1.1 Preamble insertion.....	13
4.4.1.2 Scattered pilots .....	14
4.4.1.3 Continuous pilots .....	15
4.4.2 Mode 3: 1k@1,7MHz .....	16
4.4.2.1 Preamble insertion.....	16
4.4.2.2 Scattered pilots .....	17
4.4.2.3 Continuous pilots .....	18
4.4.3 Mode 4: 0,5k@1,7MHz .....	19
4.4.3.1 Preamble insertion.....	20
4.4.3.2 Scattered pilots .....	20
4.4.3.3 Continuous pilots .....	21
4.5 Bit mapping to constellation.....	22
4.5.1 QPSK Modulation .....	22
4.5.2 16QAM Modulation (non-hierarchical).....	22
4.5.3 16QAM Modulation (hierarchical) .....	23
4.5.4 Normalization of power levels.....	24
4.6 Pulse shaping and guard interval insertion .....	24
History .....	26

---

## Intellectual Property Rights

IPRs essential or potentially essential to the present document may have been declared to ETSI. The information pertaining to these essential IPRs, if any, is publicly available for **ETSI members and non-members**, and can be found in ETSI SR 000 314: "*Intellectual Property Rights (IPRs); Essential, or potentially Essential, IPRs notified to ETSI in respect of ETSI standards*", which is available from the ETSI Secretariat. Latest updates are available on the ETSI Web server (<http://webapp.etsi.org/IPR/home.asp>).

Pursuant to the ETSI IPR Policy, no investigation, including IPR searches, has been carried out by ETSI. No guarantee can be given as to the existence of other IPRs not referenced in ETSI SR 000 314 (or the updates on the ETSI Web server) which are, or may be, or may become, essential to the present document.

---

## Foreword

This European Standard (Telecommunications series) has been produced by ETSI Technical Committee Satellite Earth Stations and Systems (SES), and is now submitted for the Public Enquiry phase of the ETSI standards Two-step Approval Procedure.

The present document is part 1, sub-part 3 of a multi-part deliverable. Full details of the entire series can be found in part 1, sub-part 1 [i.4].

<b>Proposed national transposition dates</b>	
Date of latest announcement of this EN (doa):	3 months after ETSI publication
Date of latest publication of new National Standard or endorsement of this EN (dop/e):	6 months after doa
Date of withdrawal of any conflicting National Standard (dow):	6 months after doa

---

## Introduction

An SDR system enables broadcast to fixed and mobile receivers through satellites and complementary terrestrial transmitters. Functionalities, architecture and technologies of such systems are described in TR 102 525 [i.5].

Several existing and planned ETSI standards specify parts of the SDR system, with the aim of interoperable implementations. The physical layer of the radio interface (air interface) is divided up into the outer physical layer, the inner physical layer with single carrier modulation, and the inner physical layer with multi carrier modulation. These parts can be used all together in SDR compliant equipment, or in conjunction with other existing and future specifications.

The present document specifies the inner physical layer with multi carrier modulation. The inner physical layer with single carrier modulation is specified in EN 302 550-1-2 [i.3], and the outer physical layer in EN 302 550-1-1 [i.4]. Guidelines for using the physical layer standard can be found in TR 102 604 [i.6].

The physical layer specifications have previously been published as "Technical Specification (TS)" type ETSI deliverables. The present document supersedes TS 102 551-2 [i.7] and is recommended for new implementations. The functional differences between the previous TS and the present document are: Exclusion of Mode 1, introduction of Mode 2s and introduction of bandwidth flexibility.

---

# 1 Scope

The present document concerns the radio interface of SDR broadcast receivers. It specifies functionality of the inner physical layer with multi carrier modulation. It allows implementing this part of the system in an interoperable way.

---

## 2 References

References are either specific (identified by date of publication and/or edition number or version number) or non-specific.

- For a specific reference, subsequent revisions do not apply.
- Non-specific reference may be made only to a complete document or a part thereof and only in the following cases:
  - if it is accepted that it will be possible to use all future changes of the referenced document for the purposes of the referring document;
  - for informative references.

Referenced documents which are not found to be publicly available in the expected location might be found at <http://docbox.etsi.org/Reference>.

NOTE: While any hyperlinks included in this clause were valid at the time of publication ETSI cannot guarantee their long term validity.

### 2.1 Normative references

The following referenced documents are indispensable for the application of the present document. For dated references, only the edition cited applies. For non-specific references, the latest edition of the referenced document (including any amendments) applies.

Not applicable.

### 2.2 Informative references

The following referenced documents are not essential to the use of the present document but they assist the user with regard to a particular subject area. For non-specific references, the latest version of the referenced document (including any amendments) applies.

- [i.1] ETSI EN 300 744 (V1.5.1): "Digital Video Broadcasting (DVB); Framing structure, channel coding and modulation for digital terrestrial television".
- [i.2] ITU-T Recommendation O.153 (1992): "Basic parameters for the measurement of error performance at bit rates below the primary rate".
- [i.3] ETSI EN 302 550-1-2 (V1.1.1): "Satellite Earth Stations and Systems (SES); Satellite Digital Radio (SDR) Systems; Part 1: Physical Layer of the Radio Interface; Sub-part 2: Inner Physical Layer Single Carrier Modulation".
- [i.4] ETSI EN 302 550-1-1 (V1.1.1): "Satellite Earth Stations and Systems (SES); Satellite Digital Radio (SDR) Systems; Part 1: Physical Layer of the Radio Interface; Sub-part 1: Outer Physical Layer".
- [i.5] ETSI TR 102 525 (V1.1.1): "Satellite Earth Stations and Systems (SES); Satellite Digital Radio (SDR) service; Functionalities, architecture and technologies".
- [i.6] ETSI TR 102 604: "Satellite Earth Stations and Systems (SES); Satellite Digital Radio (SDR) Systems; Guidelines for the Use of the Physical Layer Standards".

- [i.7] ETSI TS 102 551-2 (V2.1.1): "Satellite Earth Stations and Systems (SES); Satellite Digital Radio (SDR) Systems; Inner Physical Layer of the Radio Interface; Part 2: Multiple Carrier Transmission".

---

## 3 Definitions, symbols and abbreviations

### 3.1 Definitions

For the purposes of the present document, the following terms and definitions apply:

**hierarchical constellation scaling factor:** constellation ratio which determines the QAM constellation for the modulation for hierarchical transmission

### 3.2 Symbols

For the purposes of the present document, the following symbols apply:

2k@5MHz	OFDM with 2k (i.e. 2 048 length) IFFT in 5 MHz channel spacing
$\alpha$	hierarchical constellation scaling factor

### 3.3 Abbreviations

For the purposes of the present document, the following abbreviations apply:

16QAM	16 Quadrature Amplitude Modulation
C-TS	Channel Transport Stream
CU	Capacity Unit
FFT	Fast Fourier Transform
IFFT	Inverse Fast Fourier Transform
IPL	Inner Physical Layer
IPL-MC	Inner Physical Layer, Multi Carrier
IPL-SC	Inner Physical Layer, Single Carrier
OFDM	Orthogonal Frequency Division Multiplex
OPL	Outer Physical Layer
QPSK	Quaternary Phase Shift Keying
RF	Radio Frequency
RFU	Reserved for Future Use
XOR	Exclusive OR

---

## 4 Inner physical layer - Multi Carrier

The functionality of the Inner Physical Layer (Multi Carrier), in the following denoted IPL-MC, is to provide a robust modulation scheme for multi carrier modulation. The multi carrier modulation is applicable either to satellite or terrestrial transmission.

The IPL-MC is embedded between the OPL (C-TS delivery) and the RF frontend (modulation) as depicted in figure 1.

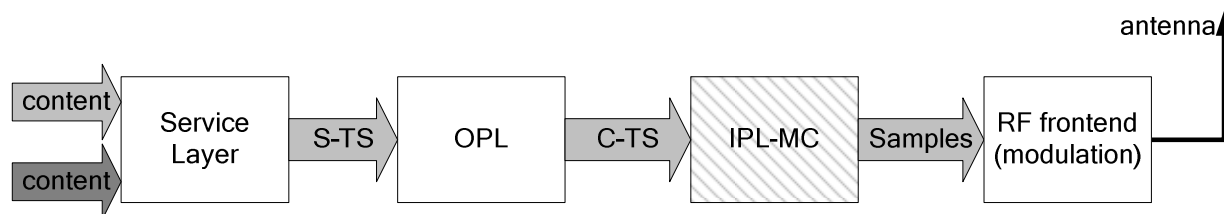

**Figure 1: General block diagram of the ETSI SES SDR system concept with selection of IPL-MC**

The general block diagram of the IPL-MC functionality for modes 2, 2s, 3 and 4 are given in figure 2.

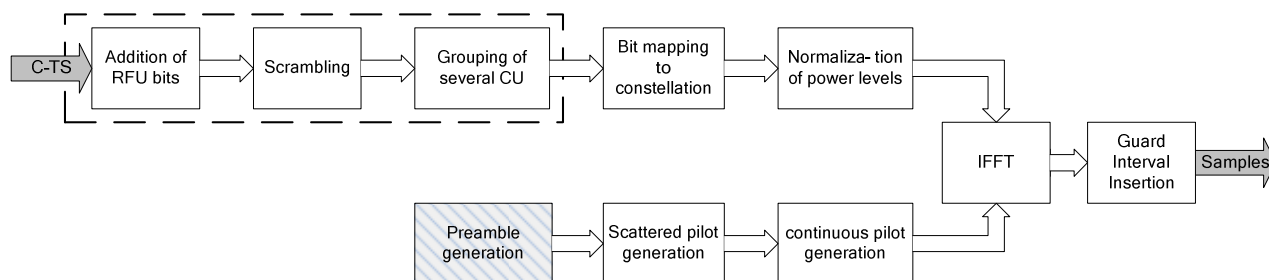

**Figure 2: Block diagram of the ETSI SES SDR compliant IPL-MC in Mode 2, 2s, 3 and 4**

For high robustness in rapidly changing channels or high delay spread scenarios, three modes (FFT512, FFT1024 and FFT2048) using a high pilot density together with a distinct frequency-domain preamble are introduced.

## 4.1 Interfacing to OPL (Outer Physical Layer)

Its interface to the OPL (Outer Physical Layer) is the C-TS (channel transport stream), which is defined in EN 302 550-1-1 [i.4]. For this special IPL-MC, the parameters which are passed to the OPL are derived within EN 302 550-1-1 [i.4].

Two types of IPL-MC exist: One providing a single-input C-TS interface, another providing double-input interface to allow hierarchical modulation. In the latter case, both C-TS need to be aligned in time, framing and throughput.

If more than one carrier needs to be supported, multiple instances of the IPL-MC need to be instantiated in parallel.

The parameters that are passed to the OPL are as follows:

- IPL-MC frame length in integer number of CU (capacity units);
- number of inputs (to distinguish between normal and hierarchical transmission).

For modes 2, 2s, 3 and 4, one IPL-MC frame is composed of five Phy sections and preceded by one preamble. Their parameters are defined in clause 4.2.2.

With these parameters, the exact throughput of the IPL-MC can be derived in CU per time. The smallest unit to be processed by the IPL-MC is one CU.

To be able to benefit from the gain of hybrid configurations (e.g. using IPL-SC together with IPL-MC), it is mandatory to have equal frame lengths on both IPLs.

If modes 2, 2s, 3 or 4 of the IPL-MC are used, a joint frame length of 432 ms is chosen.

## 4.2 The profile approach - different multi carrier modes

### 4.2.1 Profile definition

To cope with different design constraints that arise from the possible use scenarios of the IPL-MC, it has been decided within SES SDR to define different profiles. The main target frequency bands and channel bandwidths are:

**Table 1: Definition of different profiles**

Profile name	IPL-MC-B	IPL-MC-C	IPL-MC-D
Typical use	S-Band SDR	L-Band SDR	S-Band SDR
Supported modes	2 and 2s	3 and 4	3 and 4
Carrier frequency	2,0 GHz to 2,3 GHz	1,4 GHz to 1,5 GHz	2,0 GHz to 2,3 GHz
Channel bandwidth	4,76 MHz	1,536 MHz	1,536 MHz
Channel spacing	5 MHz	1,712 MHz	1,712 MHz

The present document does not restrict its use to the application scenarios as denoted above. Other frequency bands or channel bandwidths may be used but the parameter selection may not be optimal.

Bandwidth flexibility has been introduced to widely scale the modes 2, 2s, 3 or 4 according to different bandwidth requirements. This allows to use modes as follows:

- Mode 2 (FFT2048, guard interval 1/4): Between 6/9 and 18/9 times the specified bandwidth of 4,755 MHz with stepping of 1/9 of specified bandwidth, i.e. from 3,17 MHz up to 9,51 MHz in step sizes of 528,3 kHz.
- Mode 2s (FFT2048, guard interval 1/8): Between 6/10 and 20/10 times the specified bandwidth of 4,755 MHz with stepping of 1/10 of specified bandwidth, i.e. from 2,853 MHz up to 9,51 MHz in step sizes of 475,5 kHz.
- Mode 3 (FFT1024, guard interval 1/4): Between 4/6 and 20/6 times the specified bandwidth of 1,531 MHz with stepping of 1/6 of specified bandwidth, i.e. from 1,021 MHz up to 5,105 MHz in step sizes of 255,2 kHz.
- Mode 4 (FFT512, guard interval 1/4): Between 8/12 and 24/12 times the specified bandwidth of 1,534 MHz with stepping of 1/12 of specified bandwidth, i.e. from 1,022 MHz up to 3,067 MHz in step sizes of 127,8 kHz.

This flexibility has been introduced in a very careful way to always ensure interoperability with all specified IPL-SC modes, especially the common frame length between IPL-MC and IPL-SC of 432 ms has not been touched.

This flexibility relies purely on discrete changes in the sampling frequency.

### 4.2.2 Modes definition

The different modes that are defined are as follows.

**Table 2: Definition of different modes**

<b>Mode 2s (guard interval 1/8)</b> 2k@5MHz Optimized pilot pattern	Mode optimized for requirements of frequency bands using channel spacing of 5 MHz with 2k number of carriers. Parameter set recommended for networks with medium delay spread and high vehicle speed.
<b>Mode 2 (guard interval 1/4)</b> 2k@5MHz Optimized pilot pattern	Mode optimized for requirements of frequency bands using channel spacing of 5 MHz with 2k number of carriers. Parameter set recommended for networks with high delay spread and high vehicle speed.
<b>Mode 3 (guard interval 1/4)</b> 1k@1,7MHz Optimized pilot pattern	Mode optimized for requirements of frequency bands using channel spacing of 1,7 MHz. Parameter set recommended for networks with very high delay spread (e.g. SFN network with high power repeater), 1k number of carriers, preamble symbol, continuous and scattered pilots with pilot density of approximately 17 %.
<b>Mode 4 (guard interval 1/4)</b> 0,5k@1,7MHz Optimized pilot pattern	Similar to Mode 3. Support of higher vehicle speed (carrier spacing doubled, shorter guard interval), 0,5k number of carriers.



The parameters for all modes are denoted in table 3 and table 4.

### 4.2.3 Parameters for QPSK subcarrier mapping

Table 3 displays the parameters defined for the QPSK modulation of the OFDM subcarriers.

**Table 3: Parameters derived in modes 2, 2s, 3 or 4 for QPSK modulation of the OFDM subcarriers**

	unit	SES SDR 2k Guard 1/8	SES SDR 2k Guard 1/4	SES SDR 1k Guard 1/4	SES SDR 0,5k Guard 1/4
Mode Identifier		<b>2s</b>	<b>2</b>	<b>3</b>	<b>4</b>
FFT length		2 048	2 048	1 024	512
Used sub-carriers		1 509	1 509	729	365
Guard interval ratio		0,125	0,25	0,25	0,25
nFlx: BW flexibility (default)		10	9	6	12
nFlx: BW flexibility (range)		6...20	6...18	4...20	8...24
Sampling Frequency (fractional)	MHz	$484/75 \times nFlx/10$	$484/75 \times nFlx/9$	$484/225 \times nFlx/6$	$484/225 \times nFlx/12$
Sampling Frequency (rounded)	MHz	$6,4533 \times nFlx/10$	$6,4533 \times nFlx/9$	$2,1511 \times nFlx/6$	$2,1511 \times nFlx/12$
Pilots per OFDM symbol		262	262	127	64
Capacity unit size incl. RFU	bits	2 064	2 064	2 064	2 064
Modulation index		2	2	2	2
Signal Bandwidth	MHz	$4,7549 \times nFlx/10$	$4,7549 \times nFlx/9$	$1,5314 \times nFlx/6$	$1,5335 \times nFlx/12$
Samples per symbol		2 304	2 560	1 280	640
Symbol length incl. guard interval	$\mu$ s	$357,03 \times 10/nFlx$	$396,69 \times 9/nFlx$	$595,04 \times 6/nFlx$	$297,52 \times 12/nFlx$
Guard interval length	$\mu$ s	$39,67 \times 10/nFlx$	$79,34 \times 9/nFlx$	$119,01 \times 6/nFlx$	$59,50 \times 12/nFlx$
sub-carrier distance in kHz	kHz	$3,15 \times nFlx/10$	$3,15 \times nFlx/9$	$2,10 \times nFlx/6$	$4,20 \times nFlx/12$
Data sub-carriers per symbol		1 247	1 247	602	301
OFDM Symbols per Phy section		24	24	24	24
Data sub-carriers per Phy section		29 928	29 928	14 448	7 224
Bit per Phy section		59 856	59 856	28 896	14 448
<b>CU per Phy section</b>		<b>29</b>	<b>29</b>	<b>14</b>	<b>7</b>
Length of Phy section	ms	$8,59 \times 10/nFlx$	$9,52 \times 9/nFlx$	$14,28 \times 6/nFlx$	$7,14 \times 12/nFlx$
Padding bits		0	0	0	0
preamble per IPL-MC frame		1	1	1	1
Phy sections per IPL-MC frame		5	5	5	5
sub-carrier per IPL-MC frame		150 887	150 887	72 842	36 421
Bit per IPL-MC frame		301 774	301 774	145 684	72 842
Length of IPL-MC frame	ms	$43,20 \times 10/nFlx$	$48,00 \times 9/nFlx$	$72,00 \times 6/nFlx$	$36,00 \times 12/nFlx$
<b>CU per IPL-MC frame</b>		<b>145</b>	<b>145</b>	<b>70</b>	<b>35</b>
Padding bits (informative only)		0	0	0	0

### 4.2.4 Parameters for 16QAM subcarrier mapping

Table 4 displays the parameters defined for the 16QAM modulation of the OFDM subcarriers.

Table 4: Parameters derived in modes 2, 2s, 3 or 4 for 16QAM modulation of the OFDM subcarriers

	unit	SES SDR 2k Guard 1/8	SES SDR 2k Guard 1/4	SES SDR 1k Guard 1/4	SES SDR 0.5k Guard 1/4
Mode Identifier		<b>2s</b>	<b>2</b>	<b>3</b>	<b>4</b>
FFT length		2 048	2 048	1 024	512
Used sub-carriers		1 509	1 509	729	365
Guard interval ratio		0,125	0,25	0,25	0,25
nFlx: BW flexibility (default)		10	9	6	12
nFlx: BW flexibility (range)		6...20	6...18	4...20	8...24
Sampling Frequency (fractional)	MHz	$484/75 \times nFlx/10$	$484/75 \times nFlx/9$	$484/225 \times nFlx/6$	$484/225 \times nFlx/12$
Sampling Frequency (rounded)	MHz	$6,4533 \times nFlx/10$	$6,4533 \times nFlx/9$	$2,1511 \times nFlx/6$	$2,1511 \times nFlx/12$
Pilots per OFDM symbol		262	262	127	64
Capacity unit size incl. RFU	bits	2 064	2 064	2 064	2 064
Modulation index		4	4	4	4
Signal Bandwidth	MHz	$4,7549 \times nFlx/10$	$4,7549 \times nFlx/9$	$1,5314 \times nFlx/6$	$1,5335 \times nFlx/12$
Samples per symbol		2 304	2 560	1 280	640
Symbol length incl. guard interval	$\mu$ s	$357,03 \times 10/nFlx$	$396,69 \times 9/nFlx$	$595,04 \times 6/nFlx$	$297,52 \times 12/nFlx$
Guard interval length	$\mu$ s	$39,67 \times 10/nFlx$	$79,34 \times 9/nFlx$	$119,01 \times 6/nFlx$	$59,50 \times 12/nFlx$
sub-carrier distance in kHz	kHz	$3,15 \times nFlx/10$	$3,15 \times nFlx/9$	$2,10 \times nFlx/6$	$4,20 \times nFlx/12$
Data sub-carriers per symbol		1 247	1 247	602	301
OFDM Symbols per Phy section		24	24	24	24
Data sub-carriers per Phy section		29 928	29 928	14 448	7 224
Bit per Phy section		119 712	119 712	57 792	28 896
<b>CU per Phy section</b>		<b>58</b>	<b>58</b>	<b>28</b>	<b>14</b>
Length of Phy section	ms	$8,59 \times 10/nFlx$	$9,52 \times 9/nFlx$	$14,28 \times 6/nFlx$	$7,14 \times 12/nFlx$
Padding bits		0	0	0	0
preamble per IPL-MC frame		1	1	1	1
Phy sections per IPL-MC frame		5	5	5	5
sub-carrier per IPL-MC frame		150 887	150 887	72 842	36 421
Bit per IPL-MC frame		603 548	603 548	291 368	145 684
Length of IPL-MC frame	ms	$43,20 \times 10/nFlx$	$48,00 \times 9/nFlx$	$72,00 \times 6/nFlx$	$36,00 \times 12/nFlx$
<b>CU per IPL-MC frame</b>		<b>290</b>	<b>290</b>	<b>140</b>	<b>70</b>
Padding bits (informative only)		0	0	0	0

## 4.3 Generation of one Phy section

### 4.3.1 Overview

The generation of one Phy section is performed as follows:

- handling of data payload (capacity units, CU, etc.);
- handling of signalling bits (RFU: reserved for future use), applicable to modes 2, 2s, 3 and 4;
- scrambling for energy dispersal;
- accumulation of CU for one Phy section.

### 4.3.1.1 Overview of Mode 2, 2s, 3 and 4

Figure 3 displays the generation of one Phy section in Mode 2, 2s, 3 and 4.

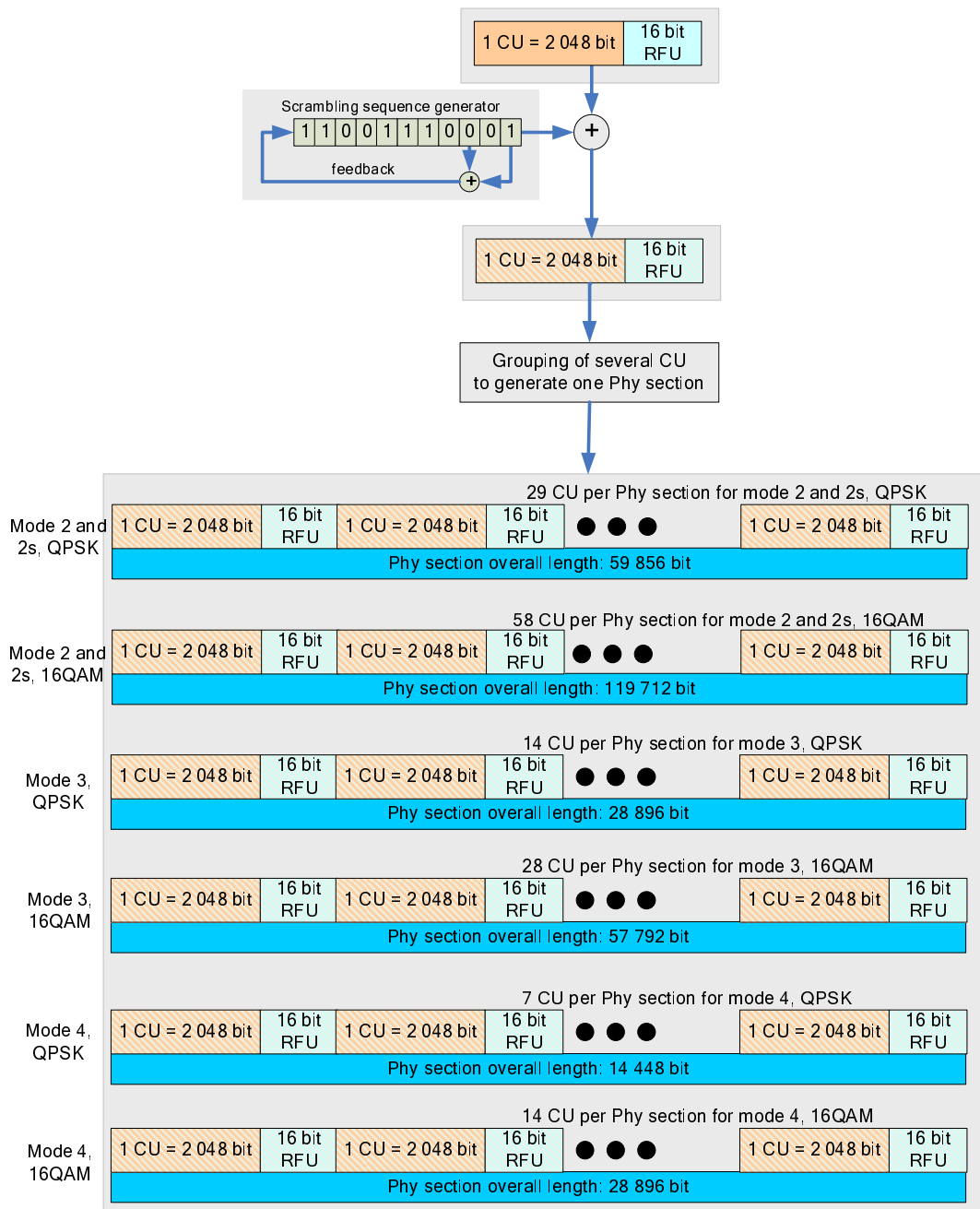

Figure 3: Overview of the generation of one Phy section for modes 2, 2s, 3 and 4

### 4.3.2 RFU section insertion

The present clause applies to Mode 2, 2s, 3 or 4 transmission.

In modes 2, 2s, 3 and 4, each CU is followed by 16 signalling bits which are currently not used but are reserved for future use. All bits are set to zero. The block size for one CU after RFU insertion is 2 064 bits, see also figure 3.

### 4.3.3 Energy dispersal (scrambling)

Energy dispersal is applied to the data payload and the RFU bits. The energy dispersal is performed using a length 2 047 ( $2^{11} - 1$ ) scrambler with an internal shift register of length 11. The scrambler is described using the following generator polynomial as derived from ITU-T Recommendation O.153 [i.2].

$X^{11} + X^9 + 1$ , initial state is set to "11001110001" (see figure 7)

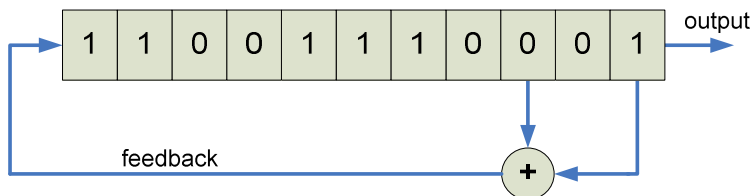

**Figure 4: Scrambler used for energy dispersal**

The output of the scrambler of length 2 064 (in Mode 2-4) is XOR-ed with the first 2 064 bit of the bitstream as depicted in figure 3. The scrambler is initialized at each start of one CU. If the size of the data that has to be scrambled exceeds one cycle of the scrambler, then the scrambler just continues periodically.

### 4.3.4 Accumulation of CU into one Phy section

According to the transport capability of the different modes and different modulation orders, the Phy sections are generated. Refer to table 3 and table 4 for details.

CU padding at the end of the IPL-MC frame: As it is a mandatory requirement of the C-TS multiplexer at the output of the OPL to adapt the number of CU to the transport capability of the IPL-MC frame, no additional padding of empty CU is necessary; however, padding of empty CU may be foreseen to support such erroneous situations.

## 4.4 Pilot tone insertion and signalling

The present clause specifies the reference signals for the different modes.

### 4.4.1 Mode 2 and Mode 2s: 2k@5MHz

Mode 2 and Mode 2s are designed to work in a channel grid of 5 MHz. Using an FFT of 2 048 points with 1 509 active carriers, this leads to a carrier spacing of roughly 3,2 kHz and a guard interval length of 79  $\mu$ s (Mode 2) or 40  $\mu$ s (Mode 2s). Both Mode 2 and 2s provide a pilot density of approximately 17 %. The pilots are arranged in groups, each having a length of 52 carriers.

The parameters given in the previous paragraph apply to the "original" bandwidth without flexibility. Due to the introduction of the bandwidth flexibility parameter  $nFlx$ , other bandwidths are possible in modes 2 and 2s, namely:

- Mode 2 (FFT2048, guard interval 1/4): Between 6/9 and 18/9 times the specified bandwidth of 4,755 MHz with stepping of 1/9 of specified bandwidth, i.e. from 3,17 MHz up to 9,51 MHz in step sizes of 528,3 kHz.
- Mode 2s (FFT2048, guard interval 1/8): Between 6/10 and 20/10 times the specified bandwidth of 4,755 MHz with stepping of 1/10 of specified bandwidth, i.e. from 2,853 MHz up to 9,51 MHz in step sizes of 475,5 kHz.

The bandwidth scaling mechanism is a pure change of sampling frequency and changes parameters like signal bandwidth, symbol length, guard interval length, carrier distance, phy section length and IPL-MC frame length. All other parameters (related to the number of sub-carriers) remain identical. For details, refer to table 3 and table 4.

Each IPL-MC frame is generated by the combination of one frequency domain preamble (one entire OFDM symbol) and five Phy sections, each having a length of 24 OFDM symbols. Therefore, each IPL-MC frame consists of 121 OFDM symbols that are denoted from index  $l = 0$  to  $l = 120$ .



```

0, -1, 0, 1, 0, -1, 0, -1,    0, -1, 0, 1, 0, -1, 0, 1,    0, -1, 0, 1, 0, -1, 0, 1,    0, -1, 0, -1, 0, -1, 0, -1,
0, 1, 0, 1, 0, 1, 0, 1,      0, -1, 0, -1, 0, -1, 0, -1,    0, 1, 0, 1, 0, 1, 0, 1,      0, -1, 0, -1, 0, 1, 0, 1,
0, 1, 0, 1, 0, -1, 0, -1,    0, -1, 0, 1, 0, 1, 0, -1,    0, -1, 0, -1, 0, 1, 0, -1,    0, 1, 0, -1, 0, -1, 0, -1,
0, 1, 0, -1, 0;

```

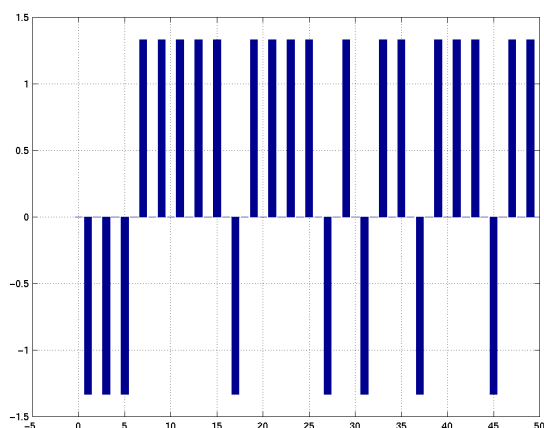

**First carriers of the preamble  
around  $K_{min} = 0$  (start)**

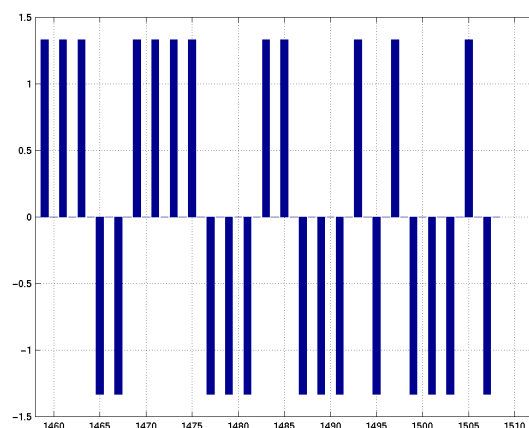

**Last carriers of the preamble  
around  $K_{max} = 1\ 508$  (end)**

**Figure 5a**

#### 4.4.1.2 Scattered pilots

Scattered pilots are introduced with a repetition pattern of 24 OFDM symbols into the Phy sections. Therefore this pilot pattern repeats five times within the 120 OFDM symbols (excluding the preamble) that form one IPL-MC frame.

In the frequency domain, the scattered pilots have a period of 52 symbols. Following the notation introduced before, the parameters for pilot tone insertion are as stated below:

Number of different segments in the frequency domain:	<b>NumberOfSegments</b> = 29;
Carrier increment per segment:	<b>SegmentIncrement</b> = 52;
Carrier offset per OFDM symbol:	<b>SymbolOffset</b> = ...
	{2, 4, 6, 2, 4, 6, 2, 4, 6, 2, 4, 6,
	2, 4, 6, 2, 4, 6, 2, 4, 6, 2, 4, 6};
OFDM symbol count (per OFDM frame):	<b>l</b> = {1, 2, 3, ..., 118, 119, 120};

The index of scattered pilots of segment  $m$  in an OFDM symbol at time index  $l$  is denoted using the following formula:

$$Idx(l, m) = [1\ 7\ 13\ 19\ 25\ 31\ 37\ 43] + SymbolOffset[(l-1) \bmod 24] + m \times SegmentIncrement;$$

$\{m \in [0; 28]; l \in [1; 120]\}$

The amplitude of the scattered pilots is chosen to  $4/3$ . The average power of the scattered pilots ( $E[c \times c^*] = 16/9$ ) is higher than the average power of the data symbols which are normalized to power 1, therefore the pilots are denoted as boosted pilots.

The phase of the scattered pilots (within one segment) is described using the following vector:

$$ScatPilotPhase = [0\ 0\ \pi\ \pi\ 0\ \pi\ 0\ \pi]$$

The entity of all scattered pilots per segment are further phase-rotated by the vector **GroupPhase**, dependent on the selection of the mapping scheme of the data subcarriers as defined in table 5.

**Table 5: GroupPhase definition for Mode 2 and Mode 2s**

GroupPhase	Selected mapping scheme
[ 0 $\pi$ 0 0 $\pi$ 0 0 $\pi$ 0 0 $\pi$ $\pi$ 0 $\pi$ $\pi$ ... 0 0 $\pi$ 0 $\pi$ $\pi$ $\pi$ $\pi$ 0 $\pi$ 0 $\pi$ 0 0 $\pi$ ]	QPSK
[ $\pi$ $\pi$ $\pi$ 0 $\pi$ 0 $\pi$ $\pi$ $\pi$ 0 0 $\pi$ 0 $\pi$ 0 ... 0 0 $\pi$ 0 0 $\pi$ 0 0 $\pi$ $\pi$ $\pi$ 0 $\pi$ 0 $\pi$ ]	16QAM, non-hierarchical
[ $\pi$ 0 0 0 0 $\pi$ 0 $\pi$ 0 $\pi$ 0 $\pi$ 0 $\pi$ 0 ... $\pi$ 0 $\pi$ $\pi$ $\pi$ 0 $\pi$ 0 0 0 $\pi$ 0 $\pi$ $\pi$ 0]	16QAM, hierarchical, $\alpha=2$
[ $\pi$ 0 0 0 $\pi$ $\pi$ 0 $\pi$ $\pi$ $\pi$ 0 $\pi$ 0 $\pi$ $\pi$ ... 0 0 $\pi$ 0 $\pi$ $\pi$ 0 $\pi$ 0 0 $\pi$ $\pi$ 0 $\pi$ 0]	16QAM, hierarchical, $\alpha=4$

For informative purpose, the whole vector of the position of the scattered pilots for an OFDM symbol at time index  $l=1$  (first OFDM with scattered pilots after the preamble symbol) is denoted here:

```
Idx = {
    3      9      15      21      27      33      39      45
    55     61     67     73     79     85     91     97
    107    113    119    125    131    137    143    149
    159    165    171    177    183    189    195    201
    211    217    223    229    235    241    247    253
    263    269    275    281    287    293    299    305
    315    321    327    333    339    345    351    357
    367    373    379    385    391    397    403    409
    419    425    431    437    443    449    455    461
    471    477    483    489    495    501    507    513
    523    529    535    541    547    553    559    565
    575    581    587    593    599    605    611    617
    627    633    639    645    651    657    663    669
    679    685    691    697    703    709    715    721
    731    737    743    749    755    761    767    773
    783    789    795    801    807    813    819    825
    835    841    847    853    859    865    871    877
    887    893    899    905    911    917    923    929
    939    945    951    957    963    969    975    981
    991    997    1003  1009  1015  1021  1027  1033
    1043  1049  1055  1061  1067  1073  1079  1085
    1095  1101  1107  1113  1119  1125  1131  1137
    1147  1153  1159  1165  1171  1177  1183  1189
    1199  1205  1211  1217  1223  1229  1235  1241
    1251  1257  1263  1269  1275  1281  1287  1293
    1303  1309  1315  1321  1327  1333  1339  1345
    1355  1361  1367  1373  1379  1385  1391  1397
    1407  1413  1419  1425  1431  1437  1443  1449
    1459  1465  1471  1477  1483  1489  1495  1501};
```

#### 4.4.1.3 Continuous pilots

The index of continuous pilots does not change from OFDM symbol  $l$  to OFDM symbol  $l+1$ . Its indices are denoted using the following description:

$Idx = 0 : \text{SegmentIncrement} : K_{\max};$

which is equivalent to:

```
Idx = [ 0      52     104     156     208     260     312     364     416     468
        520     572     624     676     728     780     832     884     936     988
        1040    1092    1144    1196    1248    1300    1352    1404    1456    1508];
```

The amplitude of the continuous pilots is chosen to  $4/3$ . The average power of the continuous pilots ( $E[c \times c^*] = 16/9$ ) is higher than the average power of the data symbols which are normalized to power 1, therefore the pilots are denoted as boosted pilots.

The phase of the continuous pilot (within one segment) is set to the following value:

$\text{ContPilotPhase} = [ 0 ]$

Each continuous pilot (one per segment) is phase-rotated by the vector  $\text{GroupPhase}$ , dependent on the selection of the mapping scheme of the data subcarriers. The definition of  $\text{GroupPhase}$  can be derived from table 5.

An illustration of the scattered and continuous pilots is given in figure 6.

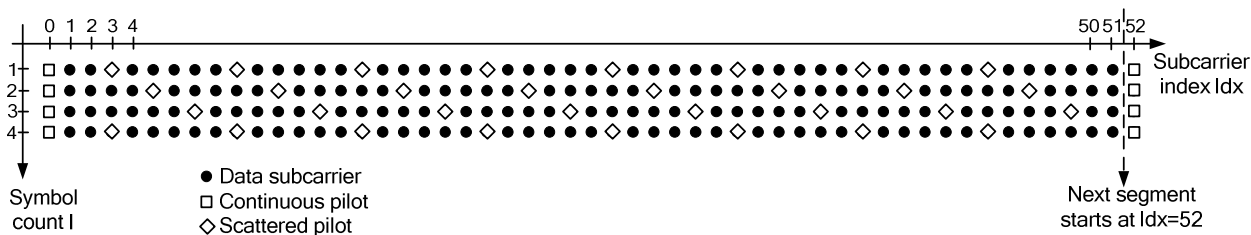

**Figure 6: Pilot pattern (scattered and continuous pilots) for the first segment and the first symbols  $l=1$  to  $l=4$**

### 4.4.2 Mode 3: 1k@1,7MHz

Mode 3 is designed to work in a channel spacing of 1,7 MHz. Using an FFT of 1 024 points with 729 active carriers, this leads to a carrier spacing of roughly 2,1 kHz and a guard interval length of 120  $\mu$ s. Mode 3 provides a pilot density of approximately 17 %. The pilots are arranged in groups, each having a length of 52 carriers.

The parameters given in the previous paragraph apply to the "original" bandwidth without flexibility. Due to the introduction of the bandwidth flexibility parameter  $nFlx$ , other bandwidths are possible in Mode 3, namely:

- Mode 3 (FFT1024, guard interval 1/4): Between 4/6 and 20/6 times the specified bandwidth of 1,531 MHz with stepping of 1/6 of specified bandwidth, i.e. from 1,021 MHz up to 5,105 MHz in step sizes of 255,2 kHz.

The bandwidth scaling mechanism is a pure change of sampling frequency and changes parameters like signal bandwidth, symbol length, guard interval length, carrier distance, phy section length and IPL-MC frame length. All other parameters (related to the number of sub-carriers) remain identical. For details, refer to table 3 and table 4.

Each IPL-MC frame is generated by the combination of one frequency domain preamble (one entire OFDM symbol) and five Phy sections, each having a length of 24 OFDM symbols. Therefore, each IPL-MC frame consists of 121 OFDM symbols that are denoted from index  $l = 0$  to  $l = 120$ .

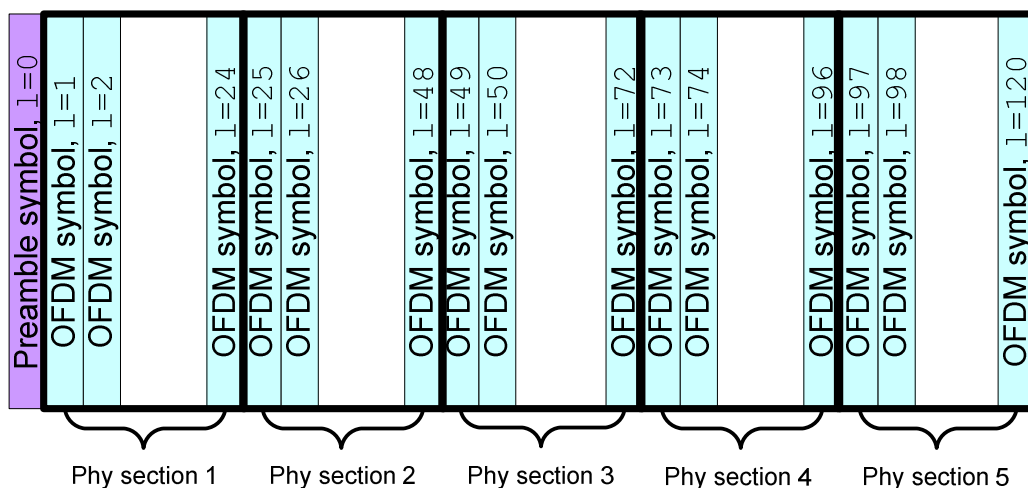

**Figure 7: Framing structure of one IPL-MC frame consisting of one preamble and five Phy sections**

#### 4.4.2.1 Preamble insertion

The first OFDM symbol ( $l = 0$ ) of each IPL-MC frame is dedicated to be used as a preamble sequence. This preamble is the so-called "frequency domain preamble".

The following sequence is inserted. The notation is made in the frequency domain. Each subcarrier of this preamble is a priori known to the receiver.



The preamble is defined as a vector of modulation symbols in the frequency domain from carrier  $K_{min}$  to  $K_{max}$ . The parameters are as follows:

First active carrier:  $K_{min} = 0;$   
 Last active carrier:  $K_{max} = 728.$

The preamble is set to the following values in the frequency domain; the amplitude of each active subcarrier is then boosted by 4/3. The average power of one active subcarrier of the preamble symbol is  $E[c \times c^*] = 16/9.$

0, -1, 0, 1, 0, -1, 0, -1,	0, 1, 0, -1, 0, -1, 0, -1,	0, 1, 0, 1, 0, -1, 0, 1,	0, 1, 0, -1, 0, 1, 0, 1,
0, -1, 0, 1, 0, -1, 0, 1,	0, 1, 0, -1, 0, -1, 0, 1,	0, 1, 0, 1, 0, 1, 0, -1,	0, 1, 0, 1, 0, 1, 0, -1,
0, 1, 0, -1, 0, -1, 0, -1,	0, 1, 0, -1, 0, -1, 0, 1,	0, -1, 0, -1, 0, 1, 0, -1,	0, 1, 0, -1, 0, -1, 0, -1,
0, 1, 0, -1, 0, 1, 0, -1,	0, 1, 0, -1, 0, -1, 0, 1,	0, -1, 0, 1, 0, 1, 0, 1,	0, -1, 0, -1, 0, -1, 0, 1,
0, -1, 0, -1, 0, -1, 0, 1,	0, 1, 0, 1, 0, -1, 0, 1,	0, 1, 0, 1, 0, 1, 0, -1,	0, 1, 0, -1, 0, -1, 0, -1,
0, 1, 0, 1, 0, -1, 0, -1,	0, -1, 0, 1, 0, -1, 0, 1,	0, -1, 0, 1, 0, 1, 0, -1,	0, -1, 0, -1, 0, 1, 0, 1,
0, 1, 0, 1, 0, 1, 0, 1,	0, -1, 0, -1, 0, 1, 0, 1,	0, -1, 0, -1, 0, -1, 0, 1,	0, -1, 0, 1, 0, 1, 0, -1,
0, 1, 0, 1, 0, -1, 0, -1,	0, 1, 0, -1, 0, 1, 0, 1,	0, -1, 0, -1, 0, 1, 0, 1,	0, -1, 0, 1, 0, 1, 0, 1,
0, 1, 0, 1, 0, 1, 0, 1,	0, 1, 0, -1, 0, 1, 0, 1,	0, 1, 0, -1, 0, 1, 0, 1,	0, -1, 0, -1, 0, 1, 0, -1,
0, 1, 0, 1, 0, -1, 0, 1,	0, -1, 0, -1, 0, 1, 0, 1,	0, 1, 0, -1, 0, 1, 0, -1,	0, 1, 0, 1, 0, -1, 0, -1,
0, 1, 0, 1, 0, -1, 0, -1,	0, -1, 0, 1, 0, -1, 0, -1,	0, 1, 0, 1, 0, 1, 0, -1,	0, -1, 0, 1, 0, 1, 0, -1,
0, -1, 0, -1, 0, -1, 0, 1,	0, 1, 0, 1, 0, -1, 0, -1,	0, 1, 0, 1, 0, 1, 0, -1,	0, -1, 0, 1, 0, -1, 0, 1,
0, -1, 0, -1, 0, 1, 0, -1,	0, 1, 0, 1, 0, 1, 0, -1,	0, 1, 0, 1, 0, 1, 0, 1,	0, -1, 0, -1, 0, -1, 0, -1,
0, 1, 0, 1, 0, -1, 0, -1,	0, -1, 0, -1, 0, 1, 0, 1,	0, -1, 0, -1, 0, -1, 0, -1,	0, -1, 0, 1, 0, 1, 0, 1,
0, 1, 0, 1, 0, 1, 0, 1,	0, -1, 0, -1, 0, -1, 0, -1,	0, 1, 0, -1, 0, 1, 0, -1,	0, -1, 0, -1, 0, 1, 0, 1,
0, -1, 0, -1, 0, 1, 0, -1,	0, 1, 0, 1, 0, 1, 0, -1,	0, 1, 0, -1, 0, 1, 0, -1,	0, -1, 0, -1, 0, 1, 0, -1,
0, -1, 0, -1, 0, -1, 0, 1,	0, -1, 0, -1, 0, 1, 0, -1,	0, 1, 0, 1, 0, 1, 0, 1,	0, -1, 0, -1, 0, 1, 0, -1,
0, 1, 0, 1, 0, -1, 0, 1,	0, 1, 0, -1, 0, 1, 0, 1,	0, -1, 0, 1, 0, 1, 0, -1,	0, -1, 0, -1, 0, -1, 0, -1,
0, 1, 0, 1, 0, -1, 0, -1,	0, 1, 0, 1, 0, -1, 0, -1,	0, -1, 0, -1, 0, -1, 0, -1,	0, -1, 0, 1, 0, 1, 0, 1,
0, 1, 0, 1, 0, 1, 0, 1,	0, -1, 0, -1, 0, 1, 0, -1,	0, 1, 0, -1, 0, 1, 0, 1,	0, 1, 0, -1, 0, -1, 0, 1,
0, -1, 0, -1, 0, 1, 0, -1,	0, 1, 0, 1, 0, -1, 0, -1,	0, -1, 0, 1, 0, 1, 0, -1,	0, -1, 0, -1, 0, 1, 0, -1,
0, -1, 0, -1, 0, -1, 0, 1,	0, 1, 0, 1, 0, -1, 0, 1,	0, -1, 0, 1, 0, 1, 0, -1,	0;

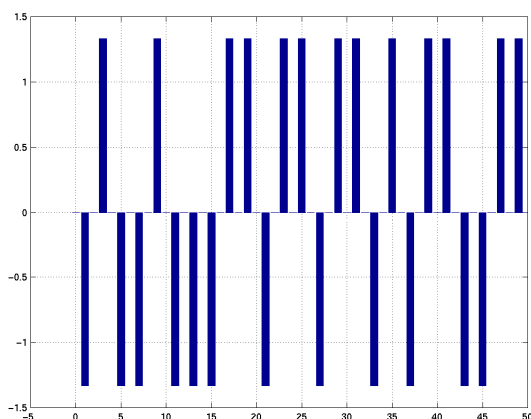

First carriers of the preamble around  $K_{min} = 0$  (start)

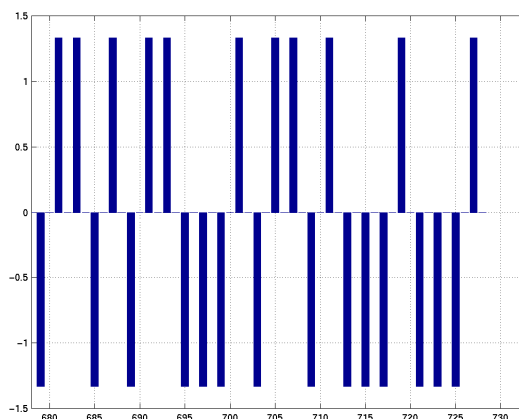

Last carriers of the preamble around  $K_{max} = 728$  (end)

Figure 7a

#### 4.4.2.2 Scattered pilots

Scattered pilots are introduced with a repetition pattern of 24 OFDM symbols into the Phy sections. Therefore this pilot pattern repeats five times within the 120 OFDM symbols (excluding the preamble) that form one IPL-MC frame.

In the frequency domain, the scattered pilots have a period of 52 symbols. Following the notation introduced before, the parameters for pilot tone insertion are as stated below:

Number of different segments in the frequency domain:	<b>NumberOfSegments</b> = 14;
Carrier increment per segment:	<b>SegmentIncrement</b> = 52;
Carrier offset per OFDM symbol:	<b>SymbolOffset</b> = ...
	{2, 4, 6, 2, 4, 6, 2, 4, 6, 2, 4, 6, 2, 4, 6, 2, 4, 6};
OFDM symbol count (per OFDM frame):	<b>l</b> = {1, 2, 3, ..., 118, 119, 120}.

The index of scattered pilots of segment  $m$  in an OFDM symbol at time index  $l$  is denoted using the following formula:

$$\text{Idx}(l,m) = [1 \ 7 \ 13 \ 19 \ 25 \ 31 \ 37 \ 43] + \text{SymbolOffset}[(l-1) \bmod 24] + m \times \text{SegmentIncrement};$$

$$\{m \in [0; 13]; l \in [1; 120]\}$$

The amplitude of the scattered pilots is chosen to  $4/3$ . The average power of the scattered pilots ( $E[c \times c^*] = 16/9$ ) is higher than the average power of the data symbols which are normalized to power 1, therefore the pilots are denoted as boosted pilots.

The phase of the scattered pilots (within one segment) is described using the following vector:

$$\text{ScatPilotPhase} = [0 \ 0 \ \pi \ \pi \ 0 \ \pi \ 0 \ \pi]$$

The entity of all scattered pilots per segment are further phase-rotated by the vector  $\text{GroupPhase}$ , dependent on the selection of the mapping scheme of the data subcarriers as defined in table 6.

**Table 6: GroupPhase definition for Mode 3**

GroupPhase	Selected mapping scheme
[ $\pi \ \pi \ 0 \ 0 \ \pi \ 0 \ \pi \ \pi \ 0 \ \pi \ 0 \ \pi \ 0 \ 0 \ \pi$ ]	QPSK
[ $0 \ \pi \ 0 \ \pi \ 0 \ 0 \ \pi \ 0 \ \pi \ 0 \ \pi \ \pi \ 0 \ \pi$ ]	16QAM, non-hierarchical
[ $0 \ 0 \ \pi \ \pi \ 0 \ 0 \ \pi \ \pi \ 0 \ 0 \ 0 \ \pi \ \pi \ 0$ ]	16QAM, hierarchical, $\alpha=2$
[ $0 \ \pi \ 0 \ 0 \ \pi \ \pi \ 0 \ 0 \ \pi \ 0 \ \pi \ \pi \ 0 \ 0$ ]	16QAM, hierarchical, $\alpha=4$

For informative purpose, the whole vector of the positions of the scattered pilots for the OFDM symbol at time index  $l=1$  (first OFDM with scattered pilots after the preamble symbol) is denoted here:

$$\text{Idx} = \{ \begin{array}{cccccccc} & 3 & 9 & 15 & 21 & 27 & 33 & 39 & 45 \\ 55 & 61 & 67 & 73 & 79 & 85 & 91 & 97 & \\ 107 & 113 & 119 & 125 & 131 & 137 & 143 & 149 & \\ 159 & 165 & 171 & 177 & 183 & 189 & 195 & 201 & \\ 211 & 217 & 223 & 229 & 235 & 241 & 247 & 253 & \\ 263 & 269 & 275 & 281 & 287 & 293 & 299 & 305 & \\ 315 & 321 & 327 & 333 & 339 & 345 & 351 & 357 & \\ 367 & 373 & 379 & 385 & 391 & 397 & 403 & 409 & \\ 419 & 425 & 431 & 437 & 443 & 449 & 455 & 461 & \\ 471 & 477 & 483 & 489 & 495 & 501 & 507 & 513 & \\ 523 & 529 & 535 & 541 & 547 & 553 & 559 & 565 & \\ 575 & 581 & 587 & 593 & 599 & 605 & 611 & 617 & \\ 627 & 633 & 639 & 645 & 651 & 657 & 663 & 669 & \\ 679 & 685 & 691 & 697 & 703 & 709 & 715 & 721 \end{array} \};$$

#### 4.4.2.3 Continuous pilots

The index of continuous pilots does not change from OFDM symbol  $l$  to OFDM symbol  $l+1$ . Its indices are denoted using the following description:

$$\text{Idx} = 0 : \text{SegmentIncrement} : K_{\text{max}};$$

which is equivalent to:

$$\text{Idx} = [0 \ 52 \ 104 \ 156 \ 208 \ 260 \ 312 \ 364 \ 416 \ 468 \ 520 \ 572 \ 624 \ 676 \ 728];$$

The amplitude of the continuous pilots is chosen to  $4/3$ . The average power of the continuous pilots ( $E[c \times c^*] = 16/9$ ) is higher than the average power of the data symbols which are normalized to power 1, therefore the pilots are denoted as boosted pilots.

The phase of the continuous pilot is set to the following value:

$$\text{ContPilotPhase} = [0]$$

Each continuous pilot (one per segment) is phase-rotated by the vector  $\text{GroupPhase}$ , dependent on the selection of the mapping scheme of the data subcarriers. The definition of  $\text{GroupPhase}$  can be derived from table 6.

An illustration of the scattered and continuous pilots is given in figure 8.

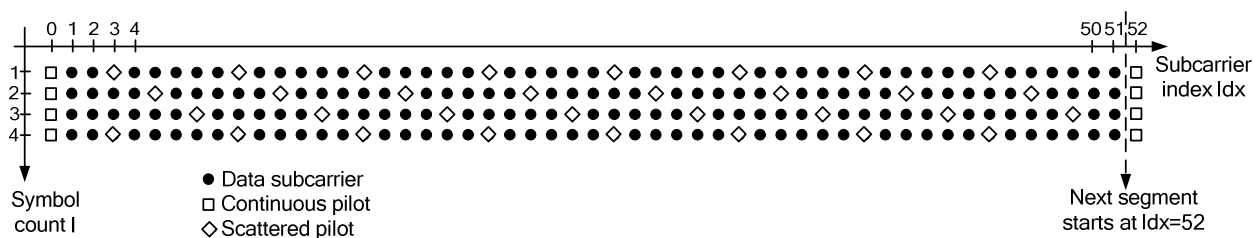

**Figure 8: Pilot pattern (scattered and continuous pilots) for the first segment and the first symbols  $l=1$  to  $l=4$**

### 4.4.3 Mode 4: 0,5k@1,7MHz

Mode 4 is designed to work in a channel spacing of 1,7 MHz. Using an FFT of 512 points with 365 active carriers, this leads to a carrier spacing of roughly 4,2 kHz and a guard Interval length of 60  $\mu$ s. Mode 4 provides a pilot density of approximately 17 %. The pilots are arranged in groups, each having a length of 52 carriers.

The parameters given in the previous paragraph apply to the "original" bandwidth without flexibility. Due to the introduction of the bandwidth flexibility parameter  $nFlx$ , other bandwidths are possible in Mode 4, namely:

- Mode 4 (FFT512, guard interval 1/4): Between 8/12 and 24/12 times the specified bandwidth of 1,534 MHz with stepping of 1/12 of specified bandwidth, i.e. from 1,022 MHz up to 3,067 MHz in step sizes of 127,8 kHz.

The bandwidth scaling mechanism is a pure change of sampling frequency and changes parameters like signal bandwidth, symbol length, guard interval length, carrier distance, phy section length and IPL-MC frame length. All other parameters (related to the number of sub-carriers) remain identical. For details, refer to table 3 and table 4.

Each IPL-MC frame is generated by the combination of one frequency domain preamble (one entire OFDM symbol) and five Phy sections, each having a length of 24 OFDM symbols. Therefore, each IPL-MC frame consists of 121 OFDM symbols that are denoted from index  $l = 0$  to  $l = 120$ .

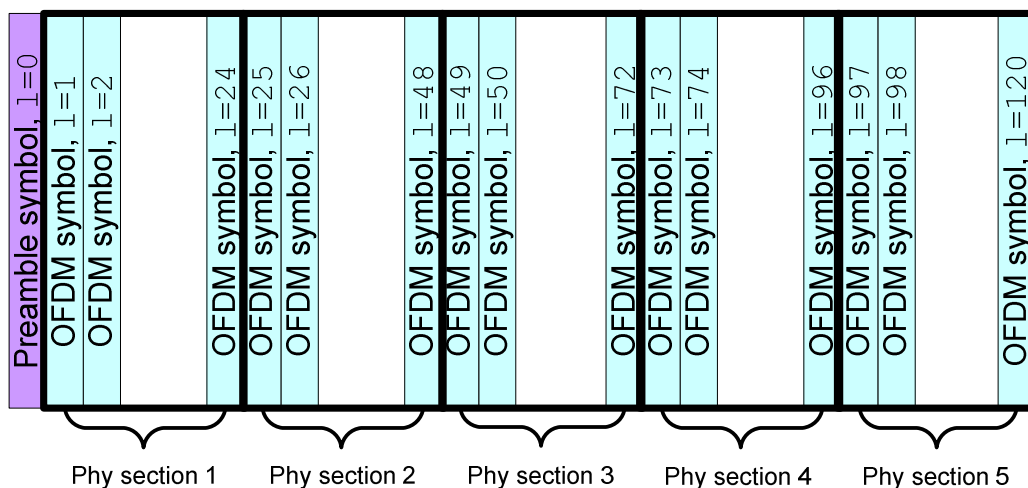

**Figure 9: Framing structure of one IPL-MC frame consisting of one preamble and five Phy sections**

### 4.4.3.1 Preamble insertion

The first OFDM symbol ( $L = 0$ ) of each IPL-MC frame is dedicated to be used as a preamble sequence. This preamble is called "frequency domain preamble".

The following sequence is inserted. The notation is made in the frequency domain. Each subcarrier of this preamble is a priori known to the receiver.

The preamble is defined as a vector of modulation symbols in the frequency domain from carrier  $K_{min}$  to  $K_{max}$ . The parameters are as follows:

First active carrier:  $K_{min} = 0;$   
Last active carrier:  $K_{max} = 364.$

The preamble is set to the following values in the frequency domain; the amplitude of each active subcarrier is then boosted by  $4/3$ . The average power of one active subcarrier of the preamble symbol is  $E[c \times c^*] = 16/9$ .

0, -1, 0, 1, 0, 1, 0, 1,	0, 1, 0, -1, 0, -1, 0, -1,	0, -1, 0, 1, 0, 1, 0, -1,	0, -1, 0, 1, 0, 1, 0, 1,
0, -1, 0, -1, 0, -1, 0, 1,	0, 1, 0, -1, 0, -1, 0, -1,	0, -1, 0, -1, 0, -1, 0, -1,	0, -1, 0, 1, 0, -1, 0, 1,
0, 1, 0, 1, 0, -1, 0, 1,	0, 1, 0, -1, 0, 1, 0, 1,	0, 1, 0, -1, 0, 1, 0, 1,	0, -1, 0, -1, 0, -1, 0, 1,
0, -1, 0, 1, 0, 1, 0, 1,	0, 1, 0, -1, 0, 1, 0, -1,	0, 1, 0, 1, 0, -1, 0, 1,	0, -1, 0, -1, 0, -1, 0, 1,
0, -1, 0, -1, 0, -1, 0, 1,	0, -1, 0, 1, 0, -1, 0, -1,	0, 1, 0, 1, 0, -1, 0, 1,	0, -1, 0, 1, 0, -1, 0, 1,
0, -1, 0, -1, 0, 1, 0, -1,	0, 1, 0, -1, 0, -1, 0, 1,	0, -1, 0, -1, 0, 1, 0, 1,	0, 1, 0, 1, 0, 1, 0, 1,
0, 1, 0, 1, 0, -1, 0, -1,	0, -1, 0, 1, 0, -1, 0, 1,	0, 1, 0, -1, 0, -1, 0, -1,	0, 1, 0, 1, 0, -1, 0, 1,
0, -1, 0, -1, 0, -1, 0, 1,	0, 1, 0, 1, 0, -1, 0, 1,	0, -1, 0, 1, 0, -1, 0, 1,	0, 1, 0, 1, 0, -1, 0, 1,
0, 1, 0, -1, 0, 1, 0, -1,	0, 1, 0, 1, 0, -1, 0, 1,	0, 1, 0, 1, 0, -1, 0, 1,	0, 1, 0, -1, 0, 1, 0, 1,
0, 1, 0, 1, 0, -1, 0, -1,	0, -1, 0, -1, 0, 1, 0, -1,	0, 1, 0, 1, 0, 1, 0, -1,	0, -1, 0, -1, 0, 1, 0, -1,
0, -1, 0, 1, 0, 1, 0, -1,	0, -1, 0, -1, 0, 1, 0, 1,	0, 1, 0, 1, 0, 1, 0, -1,	0, 1, 0, -1, 0, -1, 0, 1,
0, -1, 0, -1, 0, 1, 0, -1,	0, 1, 0, 1, 0,		

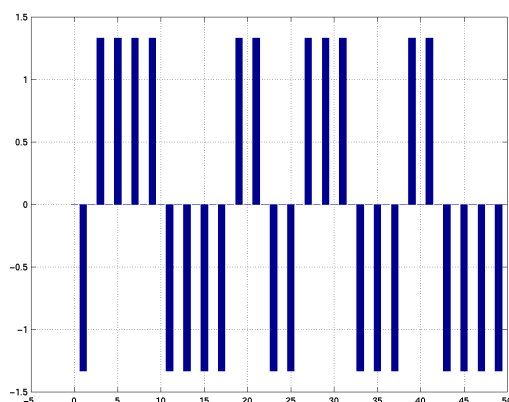

First carriers of the preamble  
around  $K_{min} = 0$  (start)



Last carriers of the preamble  
around  $K_{max} = 364$  (end)

Figure 9a

### 4.4.3.2 Scattered pilots

Scattered pilots are introduced with a repetition pattern of 24 OFDM symbols into the Phy sections. Therefore this pilot pattern repeats five times within the 120 OFDM symbols (excluding the preamble) that form one IPL-MC frame.

In the frequency domain, the scattered pilots have a period of 52 symbols. Following the notation introduced before, the parameters for pilot tone insertion are as stated below:

First active carrier:	$K_{min} = 0;$
Last active carrier:	$K_{max} = 364;$
Number of different segments in the frequency domain:	$NumberOfSegments = 7;$
Carrier increment per segment:	$SegmentIncrement = 52;$
Carrier offset per OFDM symbol:	$SymbolOffset = \dots$
	$\{2, 4, 6, 2, 4, 6, 2, 4, 6, 2, 4, 6,$
	$2, 4, 6, 2, 4, 6, 2, 4, 6, 2, 4, 6\};$
OFDM symbol count (per OFDM frame):	$1 = \{1, 2, 3, \dots, 118, 119, 120\}.$

The index of scattered pilots of segment  $m$  in an OFDM symbol at time index  $l$  is denoted using the following formula:

$$\text{Idx}(l,m) = [1 \ 7 \ 13 \ 19 \ 25 \ 31 \ 37 \ 43] + \text{SymbolOffset}[(l-1) \bmod 24] + m \times \text{SegmentIncrement};$$

$$\{m \in [0; 6]; l \in [1; 120]\}$$

The amplitude of the scattered pilots is chosen to  $4/3$ . The average power of the scattered pilots ( $E[c \times c^*] = 16/9$ ) is higher than the average power of the data symbols which are normalized to power 1, therefore the pilots are denoted as boosted pilots.

The phase of the scattered pilots (within one segment) is described using the following vector:

$$\text{ScatPilotPhase} = [0 \ 0 \ \pi \ \pi \ 0 \ \pi \ 0 \ \pi]$$

The entity of all scattered pilots per segment are further phase-rotated by the vector  $\text{GroupPhase}$ , dependent on the selection of the mapping scheme of the data subcarriers as defined in table 7.

**Table 7: GroupPhase definition for Mode 4**

GroupPhase	Selected mapping scheme
[ 0 0 $\pi$ 0 $\pi$ $\pi$ $\pi$ 0 ]	QPSK
[ $\pi$ 0 0 0 $\pi$ 0 $\pi$ 0 ]	16QAM, non-hierarchical
[ 0 $\pi$ $\pi$ 0 0 $\pi$ 0 $\pi$ ]	16QAM, hierarchical, $\alpha=2$
[ $\pi$ $\pi$ 0 $\pi$ $\pi$ 0 0 $\pi$ ]	16QAM, hierarchical, $\alpha=4$

For informative purpose, the whole vector of scattered pilots for the OFDM symbol at time index  $l=1$  (first OFDM with scattered pilots after the preamble symbol) is denoted here:

$$\text{Idx} = \{ \begin{array}{cccccccc} & 3 & 9 & 15 & 21 & 27 & 33 & 39 & 45 \\ 55 & 61 & 67 & 73 & 79 & 85 & 91 & 97 & \\ 107 & 113 & 119 & 125 & 131 & 137 & 143 & 149 & \\ 159 & 165 & 171 & 177 & 183 & 189 & 195 & 201 & \\ 211 & 217 & 223 & 229 & 235 & 241 & 247 & 253 & \\ 263 & 269 & 275 & 281 & 287 & 293 & 299 & 305 & \\ 315 & 321 & 327 & 333 & 339 & 345 & 351 & 357 \end{array} \}.$$

#### 4.4.3.3 Continuous pilots

The index of continuous pilots does not change from OFDM symbol  $l$  to OFDM symbol  $l+1$ . Its indices are denoted using the following description:

$$\text{Idx} = 0 : \text{SegmentIncrement} : K_{\text{max}}.$$

which is equivalent to:

$$\text{Idx} = [0 \ 52 \ 104 \ 156 \ 208 \ 260 \ 312 \ 364];$$

The amplitude of the continuous pilots is chosen to  $4/3$ . The average power of the continuous pilots ( $E[c \times c^*] = 16/9$ ) is higher than the average power of the data symbols which are normalized to power 1, therefore the pilots are denoted as boosted pilots.

The phase of the continuous pilot (within one segment) is set to the following value:

$$\text{ContPilotPhase} = [0]$$

Each continuous pilot (one per segment) is phase-rotated by the vector  $\text{GroupPhase}$ , dependent on the selection of the mapping scheme of the data subcarriers. The definition of  $\text{GroupPhase}$  can be derived from table 7.

An illustration of the scattered and continuous pilots is given in figure 10.

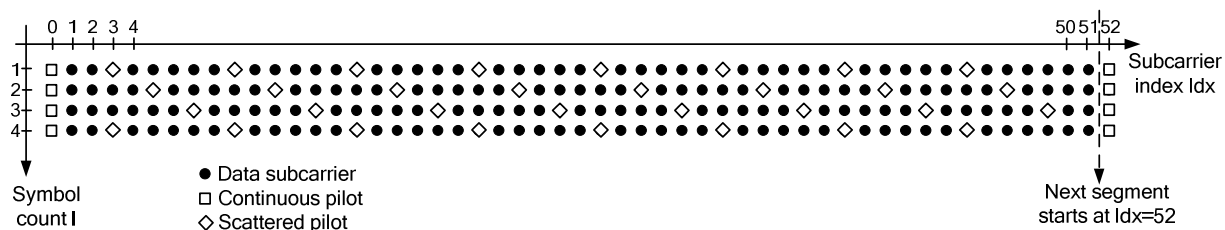

**Figure 10: Pilot pattern (scattered and continuous pilots) for the first segment and the first symbols  $l=1$  to  $l=4$**

## 4.5 Bit mapping to constellation

The remaining carriers which are not indexed to be scattered or continuous pilots, are loaded with data symbols according to the mapping scheme derived from [i.1]. The notation of the bits is as follows:

The leftmost bit is to be extracted from the input bitstream first, whereas the rightmost bit is to be extracted from the input bitstream as the last one.

### 4.5.1 QPSK Modulation

The following mapping scheme is used in QPSK modulation mode, denoted as modulation index 2. The transmission order is  $\{\text{bit}[i] \text{ bit}[i+1]\}$  where  $i$  denotes the current time index.

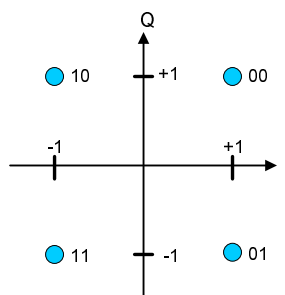

**Figure 11: QPSK modulation**

### 4.5.2 16QAM Modulation (non-hierarchical)

The following mapping scheme is used in 16QAM non-hierarchical modulation mode, denoted as modulation index 4. The transmission order is  $\{\text{bit}[i] \text{ bit}[i+1] \text{ bit}[i+2] \text{ bit}[i+3]\}$  where  $i$  denotes the current time index.

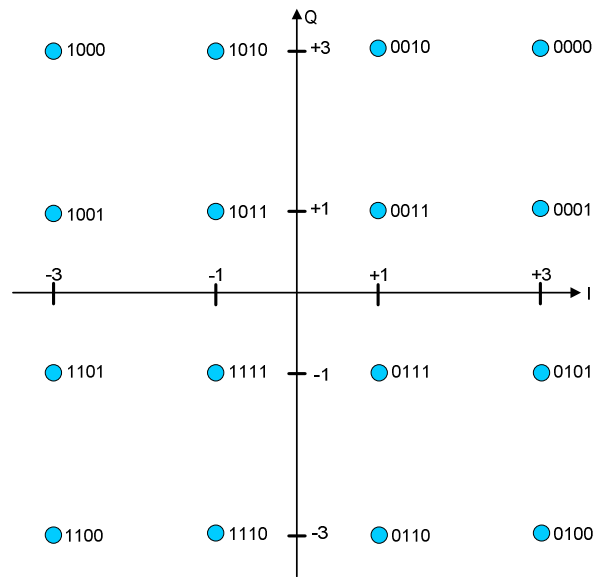

Figure 12: 16QAM modulation

### 4.5.3 16QAM Modulation (hierarchical)

The following mapping scheme is used in 16QAM hierarchical modulation mode and  $\alpha = 2$ . The transmission order is  $\{\text{bit}[i] \text{ bit}[i+1] \text{ bit}[i+2] \text{ bit}[i+3]\}$  where  $i$  denotes the current time index.

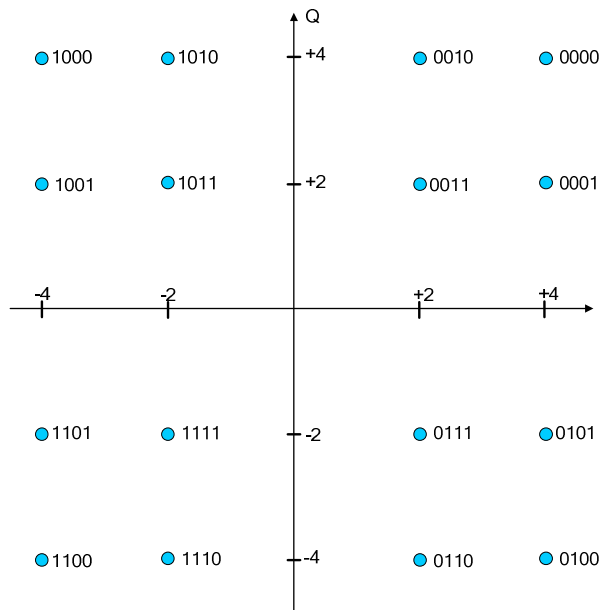

Figure 13: 16QAM hierarchical modulation with  $\alpha = 2$

The following mapping scheme is used in 16QAM hierarchical modulation mode and  $\alpha = 4$ . The transmission order is  $\{\text{bit}[i] \text{ bit}[i+1] \text{ bit}[i+2] \text{ bit}[i+3]\}$  where  $i$  denotes the current time index.

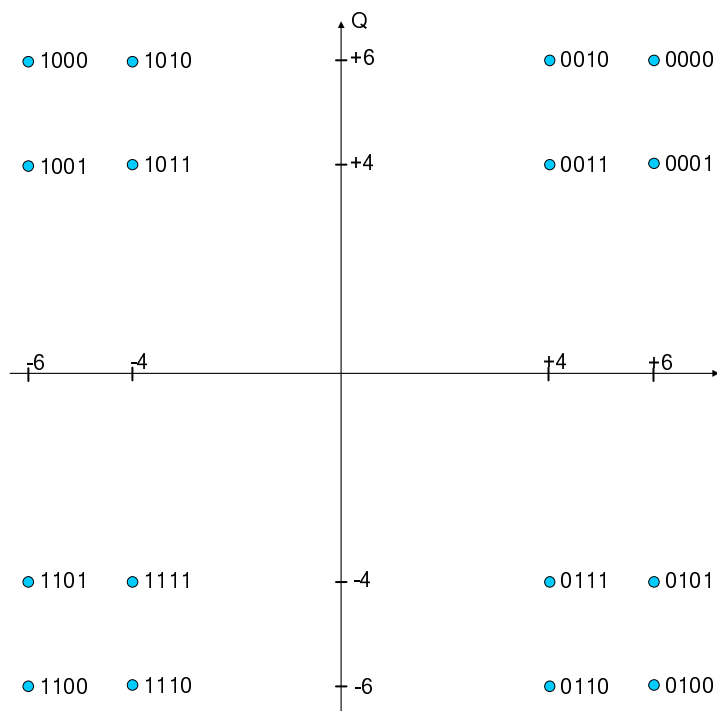

Figure 14: 16QAM hierarchical modulation with  $\alpha = 4$

#### 4.5.4 Normalization of power levels

To ensure equal average power of the data subcarriers, all modulated symbols need to be normalized. Normalization is performed by multiplying the mapped symbol with a normalization factor  $c$ . This normalization factor depends on the modulation and the hierarchical scaling factor  $\alpha$ , if applicable, according to table 8.

Please notify that this normalization is only applied to the data subcarriers.

Table 8: Normalization factors for different modulations

Modulation	Normalization factor
QPSK	$c = 1/\sqrt{2}$
16QAM non-hierarchical	$c = 1/\sqrt{10}$
16QAM hierarchical, $\alpha = 2$	$c = 1/\sqrt{20}$
16QAM hierarchical, $\alpha = 4$	$c = 1/\sqrt{52}$

#### 4.6 Pulse shaping and guard interval insertion

Pulse shaping is performed using an IFFT of length 512, 1 024 or 2 048, dependent on the chosen mode. The subcarriers are arranged so that the following subcarrier numbers coincide with the RF carrier frequency (or DC in the complex baseband representation).

Table 9: Mode-dependent active subcarriers and center frequency

Mode	FFTLenght	$K_{\min}$	$K_{\max}$	Number of active carriers	carrier number at DC or RF frequency
2	2 048	0	1 508	1 509	754
2s	2 048	0	1 508	1 509	754
3	1 024	0	728	729	364
4	512	0	364	365	182



Dependent on the choice of the guard interval length, the last  $\text{GuardIntervalRatio} \times \text{FFTLength}$  time domain samples of each OFDM symbol are transmitted first, directly consecuted by the  $\text{FFTLength}$  time domain samples.

Additional guard interval ratios may be included in future versions of this specification resulting in other frame lengths than specified herein.

The parameter  $\text{GuardIntervalRatio}$  can be extracted from table 10. Using these parameters, the following OFDM symbol lengths apply.

**Table 10: Guard Interval Ratios and their respective time duration**

Mode	FFTLength	GuardIntervalRatio	Guard Interval length (in time domain samples)	OFDM symbol length (in time domain samples)
2	2 048	1/4	512	2 560
2s	2 048	1/8	256	2 304
3	1 024	1/4	256	1 280
4	512	1/4	128	640

---

## History

<b>Document history</b>		
V1.1.1	December 2006	Publication as TS 102 551-2
V2.1.1	August 2007	Publication as TS 102 551-2
V1.1.0	July 2009	Public Enquiry PE 20091122: 2009-07-25 to 2009-11-23