

Final draft **ETSI EN 302 502** V1.1.1 (2006-08)

---

*Harmonized European Standard (Telecommunications series)*

**Broadband Radio Access Networks (BRAN);  
5,8 GHz fixed broadband data transmitting systems;  
Harmonized EN covering essential requirements  
of article 3.2 of the R&TTE Directive**

---



---

Reference

DEN/BRAN-0040006

---

Keywords

broadband, digital, HIPERMAN, multipoint

**ETSI**

650 Route des Lucioles  
F-06921 Sophia Antipolis Cedex - FRANCE

Tel.: +33 4 92 94 42 00 Fax: +33 4 93 65 47 16

Siret N° 348 623 562 00017 - NAF 742 C  
Association à but non lucratif enregistrée à la  
Sous-Préfecture de Grasse (06) N° 7803/88

---

**Important notice**

Individual copies of the present document can be downloaded from:

<http://www.etsi.org>

The present document may be made available in more than one electronic version or in print. In any case of existing or perceived difference in contents between such versions, the reference version is the Portable Document Format (PDF). In case of dispute, the reference shall be the printing on ETSI printers of the PDF version kept on a specific network drive within ETSI Secretariat.

Users of the present document should be aware that the document may be subject to revision or change of status. Information on the current status of this and other ETSI documents is available at

<http://portal.etsi.org/tb/status/status.asp>

If you find errors in the present document, please send your comment to one of the following services:

[http://portal.etsi.org/chaicor/ETSI\\_support.asp](http://portal.etsi.org/chaicor/ETSI_support.asp)

---

**Copyright Notification**

No part may be reproduced except as authorized by written permission.  
The copyright and the foregoing restriction extend to reproduction in all media.

© European Telecommunications Standards Institute 2006.  
All rights reserved.

DECT™, PLUGTESTS™ and UMTS™ are Trade Marks of ETSI registered for the benefit of its Members.  
TIPHON™ and the TIPHON logo are Trade Marks currently being registered by ETSI for the benefit of its Members.  
3GPP™ is a Trade Mark of ETSI registered for the benefit of its Members and of the 3GPP Organizational Partners.

# Contents

Intellectual Property Rights .....	6
Foreword.....	6
Introduction .....	6
1 Scope .....	7
2 References .....	7
3 Definitions, symbols and abbreviations .....	8
3.1 Definitions .....	8
3.2 Symbols.....	9
3.3 Abbreviations .....	9
4 Technical requirements specification .....	10
4.1 Designation of centre frequencies and frequency error .....	10
4.1.1 Definition.....	10
4.1.2 Limits.....	10
4.1.3 Conformance.....	10
4.2 Transmitter RF output power, EIRP and EIRP spectral density.....	10
4.2.1 Definition.....	10
4.2.2 Limits.....	10
4.2.3 Conformance.....	11
4.3 Transmitter unwanted emissions .....	11
4.3.1 Transmitter unwanted emissions outside the 5 725 MHz to 5 875 MHz band .....	11
4.3.1.1 Definition .....	11
4.3.1.2 Limits .....	11
4.3.1.3 Conformance .....	11
4.3.2 Transmitter unwanted emissions within the 5 725 MHz to 5 875 MHz band.....	11
4.3.2.1 Definition .....	11
4.3.2.2 Limits .....	12
4.3.2.3 Conformance.....	12
4.4 Transmitter Power Control (TPC).....	12
4.4.1 Definition.....	12
4.4.2 Limit .....	12
4.4.3 Conformance.....	13
4.5 Receiver spurious emissions.....	13
4.5.1 Definition.....	13
4.5.2 Limit .....	13
4.5.3 Conformance.....	13
4.6 Dynamic Frequency Selection (DFS).....	13
4.6.1 Introduction.....	13
4.6.2 DFS Technical requirements specifications.....	14
4.6.2.1 Channel availability check and channel revalidation period .....	14
4.6.2.1.1 Definition.....	14
4.6.2.1.2 Limit .....	14
4.6.2.1.3 Conformance .....	14
4.6.2.2 In-Service Monitoring.....	14
4.6.2.2.1 Definition.....	14
4.6.2.2.2 Limit .....	14
4.6.2.2.3 Conformance .....	14
4.6.2.3 Channel Shutdown .....	15
4.6.2.3.1 Definition.....	15
4.6.2.3.2 Limit .....	15
4.6.2.3.3 Conformance .....	15
4.6.2.4 Non-Occupancy Period .....	15
4.6.2.4.1 Definition.....	15
4.6.2.4.2 Limit .....	15

4.6.2.4.3	Conformance .....	15
5	Testing for compliance with technical requirements.....	15
5.1	Conditions of Testing .....	15
5.1.1	Environmental specifications.....	15
5.1.2	Test sequences and Traffic load.....	16
5.1.2.1	General test transmission sequences .....	16
5.1.2.2	Test transmission sequences for DFS tests.....	16
5.1.3	Test frequencies .....	16
5.1.4	Presentation of Equipment .....	16
5.1.4.1	Integrated and Dedicated antennas.....	16
5.1.4.2	Testing of host connected equipment and plug-in radio devices.....	16
5.1.4.2.1	The use of a host or test jig for testing Plug-In radio devices.....	17
5.1.4.2.2	Testing of combinations .....	17
5.2	Interpretation of the measurement results .....	18
5.3	Essential radio test suites.....	18
5.3.1	Product information .....	18
5.3.2	Frequency error.....	19
5.3.2.1	Test conditions .....	19
5.3.2.2	Test methods .....	19
5.3.2.2.1	Conducted measurement.....	19
5.3.2.2.2	Radiated measurement.....	19
5.3.3	Transmitter RF Output Power, EIRP, TPC and EIRP Spectral Density .....	20
5.3.3.1	Test conditions .....	20
5.3.3.2	Test method.....	20
5.3.3.2.1	Conducted measurement.....	20
5.3.3.2.2	Radiated measurement.....	22
5.3.4	Transmitter unwanted emissions.....	22
5.3.4.1	Transmitter unwanted emissions outside the 5 725 MHz to 5 875 MHz band.....	22
5.3.4.1.1	Test conditions .....	22
5.3.4.1.2	Test method .....	23
5.3.4.2	Transmitter unwanted emissions within the 5 725 MHz to 5 875 MHz band.....	24
5.3.4.2.1	Test conditions .....	24
5.3.4.2.2	Test method .....	24
5.3.4.2.2.1	Conducted measurement.....	24
5.3.5	Receiver spurious emissions .....	25
5.3.5.1	Test conditions .....	25
5.3.5.2	Test method.....	25
5.3.5.2.1	Conducted tests.....	25
5.3.5.2.2	Radiated tests.....	25
5.3.6	Dynamic Frequency Selection (DFS) .....	25
5.3.6.1	Test conditions .....	25
5.3.6.1.1	Selection of Radar Test Signals.....	26
5.3.6.1.2	Test Set-Up.....	26
5.3.6.2	Test Method .....	26
5.3.6.2.1	Conducted measurement.....	26
5.3.6.2.2	Radiated measurement.....	31
<b>Annex A (normative):</b>	<b>HS Requirements and conformance Test specifications Table (HS-RTT).....</b>	<b>32</b>
<b>Annex B (normative):</b>	<b>Test sites and arrangements for radiated measurements.....</b>	<b>34</b>
B.1	Test sites.....	34
B.1.1	Open air test sites .....	34
B.1.2	Anechoic chamber .....	35
B.1.2.1	General.....	35
B.1.2.2	Description.....	35
B.1.2.3	Influence of parasitic reflections.....	35
B.1.2.4	Calibration and mode of use .....	36
B.2	Test antenna.....	37

B.3	Substitution antenna .....	38
<b>Annex C (normative):</b>	<b>General description of measurement .....</b>	<b>39</b>
C.1	Conducted measurements .....	39
C.2	Radiated measurements .....	39
C.3	Substitution measurement .....	40
<b>Annex D (normative):</b>	<b>DFS parameters .....</b>	<b>41</b>
<b>Annex E (informative):</b>	<b>The EN title in the official languages .....</b>	<b>44</b>
History .....		45

---

## Intellectual Property Rights

IPRs essential or potentially essential to the present document may have been declared to ETSI. The information pertaining to these essential IPRs, if any, is publicly available for **ETSI members and non-members**, and can be found in ETSI SR 000 314: "*Intellectual Property Rights (IPRs); Essential, or potentially Essential, IPRs notified to ETSI in respect of ETSI standards*", which is available from the ETSI Secretariat. Latest updates are available on the ETSI Web server (<http://webapp.etsi.org/IPR/home.asp>).

Pursuant to the ETSI IPR Policy, no investigation, including IPR searches, has been carried out by ETSI. No guarantee can be given as to the existence of other IPRs not referenced in ETSI SR 000 314 (or the updates on the ETSI Web server) which are, or may be, or may become, essential to the present document.

---

## Foreword

This Harmonized European Standard (Telecommunications series) has been produced by ETSI Technical Committee Broadband Radio Access Networks (BRAN), and is now submitted for the Vote phase of the ETSI standards Two-step Approval Procedure.

The present document has been produced by ETSI in response to a mandate from the European Commission issued under Council Directive 98/34/EC (as amended) laying down a procedure for the provision of information in the field of technical standards and regulations.

The present document is intended to become a Harmonized Standard, the reference of which will be published in the Official Journal of the European Communities referencing the Directive 1999/5/EC [1] of the European Parliament and of the Council of 9 March 1999 on radio equipment and telecommunications terminal equipment and the mutual recognition of their conformity ("the R&TTE Directive").

Technical specifications relevant to Directive 1999/5/EC [1] are given in annex A.

<b>Proposed national transposition dates</b>	
Date of latest announcement of this EN (doa):	3 months after ETSI publication
Date of latest publication of new National Standard or endorsement of this EN (dop/e):	6 months after doa
Date of withdrawal of any conflicting National Standard (dow):	18 months after doa

---

## Introduction

The present document is part of a set of standards developed by ETSI and is designed to fit in a modular structure to cover all radio and telecommunications terminal equipment within the scope of the R&TTE Directive. The modular structure is shown in EG 201 399 [9].

---

# 1 Scope

The present document is applicable to radio equipment for Fixed Broadband Data Transmitting Systems intended to operate in the 5,8 GHz band (5 725 MHz to 5 875 MHz). The document is equally applicable to systems utilizing integral or dedicated antennas.

The present document is intended to cover the provisions of Directive 1999/5/EC [1] (R&TTE Directive) Article 3.2, which states that: "... radio equipment shall be so constructed that it effectively uses the spectrum allocated to terrestrial/space radio communications and orbital resources so as to avoid harmful interference".

---

# 2 References

The following documents contain provisions which, through reference in this text, constitute provisions of the present document.

- References are either specific (identified by date of publication and/or edition number or version number) or non-specific.
- For a specific reference, subsequent revisions do not apply.
- For a non-specific reference, the latest version applies.

Referenced documents which are not found to be publicly available in the expected location might be found at <http://docbox.etsi.org/Reference>.

- [1] Directive 1999/5/EC of the European Parliament and of the Council of 9 March 1999 on radio equipment and telecommunications terminal equipment and the mutual recognition of their conformity (R&TTE Directive).
- [2] ETSI EN 300 019-1-0 (V2.1.2) (2003-09): "Environmental Engineering (EE); Environmental conditions and environmental tests for telecommunications equipment; Part 1-0: Classification of environmental conditions; Introduction".
- [3] ETSI TR 100 028-1 (V1.4.1) (2001-12): "Electromagnetic compatibility and Radio spectrum Matters (ERM); Uncertainties in the measurement of mobile radio equipment characteristics; Part 1".
- [4] ETSI TR 100 028-2 (V1.4.1) (2001-12): "Electromagnetic compatibility and Radio spectrum Matters (ERM); Uncertainties in the measurement of mobile radio equipment characteristics; Part 2".
- [5] CISPR 16-1-1 Second Edition 2006-03: "Specification for radio disturbance and immunity measuring apparatus and methods - Part 1-1: Radio disturbance and immunity measuring apparatus - Measuring apparatus".
- [6] CISPR 16-2-1 Edition 1.1 2005-09: "Specification for radio disturbance and immunity measuring apparatus and methods - Part 2-1: Methods of measurement of disturbances and immunity - Conducted disturbance measurements".
- [7] CISPR 16-3 Second Edition 2003-11: "Specification for radio disturbance and immunity measuring apparatus and methods - Part 3: CISPR technical reports".
- [8] CEPT/ECC Report 68 on compatibility studies in the band 5 725 - 5 875 MHz between Fixed Wireless Access (FWA) systems and other systems (Riga, June 2005).
- [9] ETSI EG 201 399 (V2.1.1): "Electromagnetic compatibility and Radio spectrum Matters (ERM); A guide to the production of candidate Harmonized Standards for application under the R&TTE Directive".
- [10] CEPT/ERC Recommendation 74-01: "Unwanted Emissions in the Spurious Domain" (Siófok 98, Nice 99, Sesimbra 02, Hradec Kralove 05).

## 3 Definitions, symbols and abbreviations

### 3.1 Definitions

For the purposes of the present document, the terms and definitions given in the R&TTE Directive [1] and the following apply:

**antenna assembly:** combination of the antenna (integral or dedicated), its coaxial cable and if applicable, its antenna connector and associated switching components

**available channel:** channel identified as usable as an *Operating Channel*

**burst:** period during which radio waves are intentionally transmitted, preceded and succeeded by periods during which no intentional transmission is made

**dedicated antenna:** antenna external to the equipment, using an antenna connector with a cable or a wave-guide

NOTE: The antenna has been designed or developed for one or more specific types of equipment. It is the combination of dedicated antenna and radio equipment that is expected to be compliant with the regulations.

**environmental profile:** declared range of environmental conditions under which equipment within the scope of EN 302 502 is required to be compliant

**in-service monitoring:** mechanism to check a channel in use by the device for the presence of a radar signal with a level above the Interference Detection Threshold

**integral antenna:** antenna designed as a fixed part of the equipment, without the use of an external connector and as such which can not be disconnected from the equipment by a user with the intend to connect another antenna

NOTE 1: An integral antenna may be fitted internally or externally. In the case where the antenna is external, a non-detachable cable or wave-guide can be used.

NOTE 2: Even when equipment with an integral antenna is concerned, it might still be possible to separate the antenna from the equipment using a special tool. In such cases the assessment of the radio equipment and of the antenna against requirements of the present document may be done separately.

**manufacturer:** manufacturer or his authorized representative established in the Community

NOTE 1: See R&TTE Directive [1], annex II.

NOTE 2: Or the person responsible for placing the apparatus on the market (R&TTE Directive [1], article 6.3).

**operating channel:** *Available Channel* on which the FWA device has started transmissions. An *Operating Channel* becomes again an *Available Channel* if the FWA device stopped all transmissions on that channel and no radar signal was detected by the *In-Service Monitoring*.

**operating nominal RF channel width:** nominal amount of spectrum used by a single device operating on an identified centre frequency

**Transmit Power Control (TPC):** technique in which the transmitter output power is controlled resulting in reduced interference to other systems

**Transmit Power Control Range:** power range over which the TPC is able to control the transmitter output power

**Unavailable Channel:** channel which can not be considered by the FWA device for a certain period of time (*Non-Occupancy Period*) after a radar signal was detected on that channel



## 3.2 Symbols

For the purposes of the present document, the following symbols apply:

A	Measured power output (dBm)
B	Radar burst period
Ch <sub>f</sub>	Channel free from radars
Ch <sub>r</sub>	Channel occupied by a radar
ChS	Nominal occupied channel bandwidth
D	Measured power density
E	Field strength
E <sub>o</sub>	Reference field strength
f <sub>c</sub>	Carrier frequency
G	Antenna gain (dBi)
L	Radar burst length
n	Number of channels
P <sub>cond</sub>	The conducted power level of the equipment
P <sub>cond_1</sub>	The maximum useable conducted power level from the equipment
P <sub>cond_2</sub>	The maximum conducted power level from the power range associated with the highest useable antenna assembly gain
P <sub>cond_3</sub>	The minimum conducted power level from the equipment
P <sub>EIRP</sub>	The EIRP of the equipment
PD	Calculated power density
R	Distance
R <sub>o</sub>	Reference distance
S <sub>0</sub>	Signal power
T <sub>0</sub>	Time instant
T <sub>1</sub>	Time instant
T <sub>2</sub>	Time instant
T <sub>3</sub>	Time instant
W	Radar pulse width
x	Observed duty cycle

## 3.3 Abbreviations

For the purposes of the present document, the following abbreviations apply:

CW	Continuous Wave
D	measured Power Density
DFS	Dynamic Frequency Selection
EIRP	Equivalent Isotropically Radiated Power
EMC	Electro-Magnetic Compatibility
ERP	Effective Radiated Power
FWA	Fixed Wireless Access
PD	mean Power Density EIRP
ppm	parts per million
pps	pulses per second
PRF	Pulse Repetition Frequency
R&TTE	Radio and Telecommunications Terminal Equipment
RF	Radio Frequency
TPC	Transmit Power Control
Tx	Transmit, Transmitter
UUT	Unit Under Test

## 4 Technical requirements specification

With reference to Article 3.2 of Directive 1999/5/EC [1] the technical requirements in this clause have been identified as relevant to presume compliance with the essential requirements.

### 4.1 Designation of centre frequencies and frequency error

#### 4.1.1 Definition

The nominal channel centre frequencies  $f_c$ , identified by the following expression:

$$5\,725 + (n \times 2,5) \text{ MHz, where } n = 2 \text{ to } 58 \text{ for ChS} = 10 \text{ MHz}$$

$$\text{where } n = 4 \text{ to } 56 \text{ for ChS} = 20 \text{ MHz.}$$

Frequency error is the difference between the nominal channel centre frequency and the actual channel centre frequency.

#### 4.1.2 Limits

The manufacturer shall declare the centre frequencies on which the equipment can operate. The equipment shall only operate in channels centred on any of those frequencies identified in clause 4.1.1.

The actual carrier centre frequency shall be maintained within the range  $f_c \pm 20$  ppm of the nominal channel centre frequency.

#### 4.1.3 Conformance

Conformance tests as defined in clause 5.3.2 shall be carried out.

### 4.2 Transmitter RF output power, EIRP and EIRP spectral density

#### 4.2.1 Definition

The RF output power is the mean conducted power applied to the antenna assembly, during a transmission burst.

The EIRP is the maximum radiated power of the equipment relative to an isotropic antenna.

The EIRP spectral density is the mean EIRP evaluated within a specified measurement bandwidth during a transmission burst.

#### 4.2.2 Limits

The mean EIRP, RF power and EIRP spectral density when configured to operate at the highest stated power level ( $P_{\text{cond}_1}$ ) shall not exceed the limits in table 1.

**Table 1: Mean RF output power, EIRP and power density limits at the highest power level**

Channel Width ChS	Mean RF power into antenna (dBm)	mean EIRP (dBm)	Mean EIRP spectral density (dBm/MHz)
10 MHz	27	33	23
20 MHz	30	36	23

### 4.2.3 Conformance

Conformance tests as defined in clause 5.3.3 shall be carried out.

## 4.3 Transmitter unwanted emissions

Equipment that, in addition to a transmit mode, has also a standby or idle mode, shall in this mode meet the requirements defined in clause 4.5.

### 4.3.1 Transmitter unwanted emissions outside the 5 725 MHz to 5 875 MHz band

#### 4.3.1.1 Definition

These are radio frequency emissions outside the band 5 725 MHz to 5 875 MHz.

#### 4.3.1.2 Limits

The level of unwanted emission shall not exceed the limits given in table 2.

**Table 2: Transmitter unwanted emission limits**

Frequency range (MHz)	Limit (dBm)	Bandwidth (KHz) (see note)
30 to 1 000	-36	100
1 000 to 5 725	-30	1 000
5 875 to 26 500	-30	1 000
NOTE: At frequencies just below 5 725 MHz or just above 5 875 MHz, account shall be taken of the spacing between the emission centre frequency and the measurement centre frequency to evaluate the appropriate reference bandwidth given in annex 2 of CEPT/ERC Recommendation 74-01 [10].		

#### 4.3.1.3 Conformance

Conformance tests as defined in clause 5.3.4.1 shall be carried out.

### 4.3.2 Transmitter unwanted emissions within the 5 725 MHz to 5 875 MHz band

#### 4.3.2.1 Definition

These are radio frequency emissions within the band 5 725 MHz to 5 875 MHz.

### 4.3.2.2 Limits

The average level of the transmitted spectrum based on the declared ChS shall not exceed the limits given in figure 1 when operating under highest output power conditions.

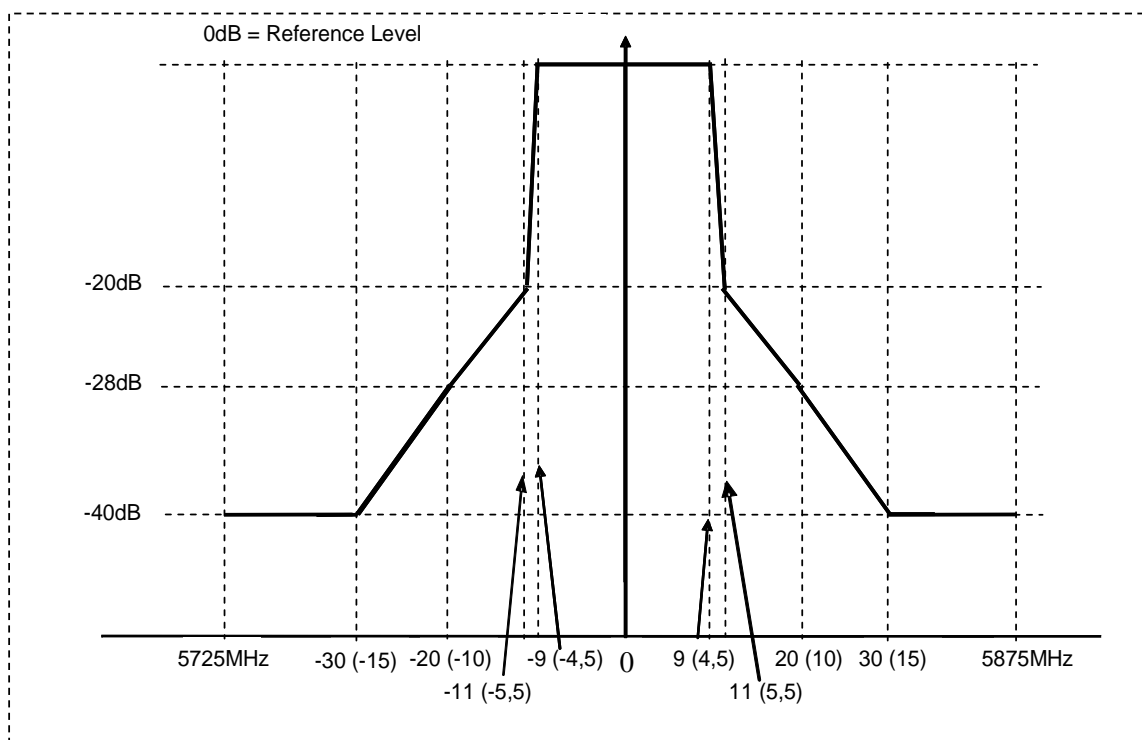

NOTE 1: 0 dB Reference Level is the spectral density relative to the maximum spectral power density of the transmitted signal.

NOTE 2: On the Frequency Offset axis, the figures apply to ChS = 20 MHz whereas the figures in parentheses apply to ChS = 10 MHz.

NOTE 3: Emissions that fall outside the lower and upper band frequency limits of 5 725 MHz and 5 875 MHz respectively shall instead meet the unwanted emission limits of clause 4.3.1.

**Figure 1: Emission Mask**

### 4.3.2.3 Conformance

Conformance tests as defined in clause 5.3.4.2 shall be carried out.

## 4.4 Transmitter Power Control (TPC)

### 4.4.1 Definition

Transmit Power Control (TPC) is a mechanism to reduce the aggregate power from a large number of devices to improve the spectrum sharing conditions [8].

### 4.4.2 Limit

The FWA device shall have the capability to reduce the operating mean EIRP level to a level not exceeding 24 dBm for ChS = 20 MHz and 21 dBm for ChS = 10 MHz.

NOTE: The mean EIRP and the mean EIRP spectral density limits apply to a device and not to each radio of a device.

### 4.4.3 Conformance

Conformance tests as defined in clause 5.3.3 shall be carried out.

## 4.5 Receiver spurious emissions

### 4.5.1 Definition

Receiver spurious emissions are emissions at any frequency when the equipment is in receive mode.

### 4.5.2 Limit

The spurious emissions of the receiver shall not exceed the limits given in table 3.

**Table 3: Spurious radiated emission limits**

Frequency range	Maximum power	ERP measurement bandwidth
30 MHz to 1 GHz	-57 dBm	100 KHz
1 GHz to 26,5 GHz	-47 dBm	1 MHz

### 4.5.3 Conformance

Conformance tests as defined in clause 5.3.5 shall be carried out.

## 4.6 Dynamic Frequency Selection (DFS)

### 4.6.1 Introduction

**All devices in a FWA deployment** shall employ full Dynamic Frequency Selection (DFS) functionality to detect transmissions from other systems and to avoid co-channel operation with these systems, notably radar systems.

Radar detection (DFS) is not required in the frequency range 5 850 MHz to 5 875 MHz.

The operational behaviour and DFS requirements for all equipment are as follows:

- a) the equipment shall use a Radar Interference Detection function in order to detect radar signals;
- b) before transmitting on a channel, which has not been identified as an *Available Channel*, the equipment shall perform a *Channel Availability Check* (see clause 4.6.2.1) to ensure that there is no radar operating on the channel;
- c) during normal operation, the equipment shall monitor the Operating Channel (*In-Service Monitoring*) to ensure that there is no radar operating on the channel;
- d) if the equipment has detected a radar signal during *In-Service Monitoring*, the Channel Shutdown shall be initiated and the Operating Channel becomes an Unavailable Channel;
- e) the equipment shall not resume any transmissions on this Unavailable Channel during a period of time after a radar signal was detected. This period is referred to as the *Non-Occupancy Period* (see clause 4.6.2.4);
- f) after the end of a Non-Occupancy Period, a Channel Availability Check is required before an Unavailable Channel can be identified as an Available Channel again;
- g) a channel can only have one status at any specific time.

## 4.6.2 DFS Technical requirements specifications

### 4.6.2.1 Channel availability check and channel revalidation period

#### 4.6.2.1.1 Definition

The *Channel Availability Check* is defined as the mechanism by which a device checks a channel for the presence of radar signals.

There shall be no transmissions by the device within the channel being checked during this process.

If no radars have been detected by this mechanism, the channel becomes an *Available Channel*.

Following a channel availability check during which no radars were detected, the *Channel Revalidation Period* is defined as the period of time during which a channel identified as an Available Channel remains valid as such.

The device shall only start transmissions on Available Channels.

At each power-up, the device is assumed to have no Available Channels.

#### 4.6.2.1.2 Limit

The *Channel Availability Check* shall be performed during a continuous period in time (*Channel Availability Check Time*) which shall not be less than the value defined in table D.1.

During the *Channel Availability Check*, the device shall be capable of detecting any of the radar signals that fall within the range given by tables D.3.1 and D.3.2 with a level above the *Interference Detection Threshold* defined in table D.2.

The detection probability for a given radar signal shall be greater than the value defined in tables D.3.1 and D.3.2.

The Channel Revalidation Period for Available Channels remains valid for a maximum period as defined in table D.1.

#### 4.6.2.1.3 Conformance

Conformance tests for this requirement are defined in clause 5.3.6.

### 4.6.2.2 In-Service Monitoring

#### 4.6.2.2.1 Definition

The *In-Service Monitoring* is defined as the process by which a device monitors the Operating Channel for the presence of radar signals.

#### 4.6.2.2.2 Limit

The *In-Service Monitoring* shall be used to continuously monitor an Operating Channel.

The *In-Service-Monitoring* shall start immediately after the device has started transmissions on an *Operating Channel*.

During the *In-Service Monitoring*, the device shall be capable of detecting any of the radar signals that fall within the range given by tables D.3.1 and D.3.2 with a level above the *Interference Detection Threshold* defined in table D.2.

The detection probability for a given radar signal shall be greater than the value defined in tables D.3.1 and D.3.2.

#### 4.6.2.2.3 Conformance

Conformance tests for this requirement are defined in clause 5.3.6.

### 4.6.2.3 Channel Shutdown

#### 4.6.2.3.1 Definition

The *Channel Shutdown* is defined as the process initiated by the equipment immediately after a radar signal has been detected on an Operating Channel.

The equipment shall stop transmitting on this channel, which it shall do within the *Channel Move Time*.

The aggregate duration of all transmissions of the equipment on this channel during the *Channel Move Time* shall be limited to the *Channel Closing Transmission Time*. The aggregate duration of all transmissions shall not include quiet periods in between transmissions.

#### 4.6.2.3.2 Limit

The *Channel Shutdown* process shall start immediately after a radar signal has been detected.

The *Channel Move Time* shall not exceed the limit defined in table D.1.

The *Channel Closing Transmission Time* shall not exceed the limit defined in table D.1.

#### 4.6.2.3.3 Conformance

Conformance tests for this requirement are defined in clause 5.3.6.

### 4.6.2.4 Non-Occupancy Period

#### 4.6.2.4.1 Definition

The *Non-Occupancy Period* is defined as the time during which the device shall not make any transmissions on a channel after a radar signal was detected on that channel by either the *Channel Availability Check* or the *In-Service Monitoring*.

NOTE: A new Channel Availability Check is required before the channel can be identified again as an *Available Channel*.

#### 4.6.2.4.2 Limit

The *Non-Occupancy Period* shall not be less than the value defined in table D.1.

#### 4.6.2.4.3 Conformance

Conformance tests for this requirement are defined in clause 5.3.6.

---

## 5 Testing for compliance with technical requirements

### 5.1 Conditions of Testing

#### 5.1.1 Environmental specifications

Unless otherwise stated in the test procedures for essential radio test suites (see clause 5.3), the tests defined in the present document shall be carried out at representative points within the boundary limits of the declared operational environmental profile (see clause 5.3.1).

The environmental profile may be determined by the environmental class of the equipment according to the guidance given in EN 300 019-1-0 [2].

The combination of the equipment and its antennas shall comply with all the requirements of the present document at all times when operating within the boundary limits of the declared operational environmental profile.

## 5.1.2 Test sequences and Traffic load

### 5.1.2.1 General test transmission sequences

Except for the DFS tests or if mentioned otherwise, all the tests in the present document shall be performed by using a test transmission sequence that shall consist of regularly transmitted packets with an interval of e.g. 2 ms. The test transmissions shall be fixed in length in a sequence and shall exceed the transmitter minimum activity ratio of 10 %. The minimum duration of the sequence shall be adequate for the test purposes.

An example of the test transmission sequence is shown in figure 2.

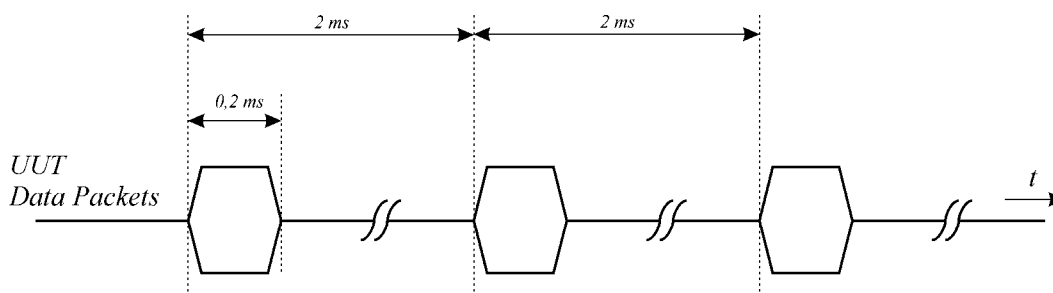

Figure 2: An example of the test transmission sequences

### 5.1.2.2 Test transmission sequences for DFS tests

The DFS tests in the present document shall be performed by using a test transmission sequence that shall consist of packet transmissions that together exceed the transmitter minimum activity ratio of 30 % measured over an interval of 100 milliseconds. The duration of the sequence shall be adequate for the DFS test purposes.

## 5.1.3 Test frequencies

For all tests except those for DFS, the test frequencies to be used shall correspond to the lowest and highest nominal RF channel centre frequency from the operating centre frequency range declared by the manufacturer.

DFS tests shall be carried out on one nominal RF channel centre frequency from the range 5 725 MHz to 5 850 MHz as declared for the equipment.

## 5.1.4 Presentation of Equipment

### 5.1.4.1 Integrated and Dedicated antennas

The equipment can have either integral antennas or dedicated antennas. Dedicated antennas, further referred to as *dedicated external antennas*, are antennas that are physically external to the equipment and are assessed in combination with the equipment against the requirements in the present document.

NOTE: It should be noted that assessment does not necessarily imply testing.

An antenna assembly referred to in the present document is understood as the combination of the antenna (integral or dedicated), its coaxial cable and if applicable, its antenna connector and associated switching components.

### 5.1.4.2 Testing of host connected equipment and plug-in radio devices

For combined equipment and for radio parts for which connection to or integration with host equipment is required to offer functionality to the radio, different alternative test approaches are permitted. Where more than one such combination is intended, testing shall not be repeated for combinations of the radio part and various host equipment where the latter are substantially similar.



Where more than one such combination is intended and the combinations are not substantially similar, one combination shall be tested against all requirements of the present document and all other combinations shall be tested separately for radiated spurious emissions only.

#### 5.1.4.2.1 The use of a host or test jig for testing Plug-In radio devices

Where the radio part is a plug-in radio device which is intended to be used within a variety of combinations, a suitable test configuration consisting of either a test jig or a typical host equipment shall be used. This shall be representative for the range of combinations in which the device may be used. The test jig shall allow the radio equipment part to be powered and stimulated as if connected to or inserted into host or combined equipment. Measurements shall be made to all requirements of the present document.

#### 5.1.4.2.2 Testing of combinations

##### 5.1.4.2.2.1 Alternative A: General approach for combinations

Combined equipment or a combination of a plug-in radio device and a specific type of host equipment may be used for testing according to the full requirements of the present document.

##### 5.1.4.2.2.2 Alternative B: For host equipment with a plug-in radio device

A combination of a plug-in radio device and a specific type of host equipment may be used for testing according to the full requirements of the present document.

For radiated spurious emission tests the most appropriate standard shall be applied to the host equipment. The plug-in radio device shall meet the radiated spurious emissions requirements as described in the present document.

##### 5.1.4.2.2.3 Alternative C: For combined equipment with a plug-in radio device

Combined equipment may be used for testing according to the full requirements of the present document.

For radiated spurious emissions the requirements of the most appropriate harmonized EMC standard shall be applied to the non-radio equipment. The plug-in radio device shall meet the radiated spurious emissions requirements as described in the present document.

In the case where the plug-in radio device is totally integrated and cannot operate independently, radiated spurious emissions for the combination shall be tested using the most appropriate harmonized standard with the radio part in receive and/or standby mode. If the frequency range is less than the one defined in the present document, additional measurements according to the requirements in the present document shall be performed to cover the remaining parts of the frequency range. With the radio in transmit mode, the radiated spurious emissions requirements of the present document shall be applied.

##### 5.1.4.2.2.4 Alternative D: For equipment with multiple radios

Multi-radio equipment, where at least one of the radio parts is within the scope of the present document, may be used for testing according to the full requirements of the present document. Additional requirements and limits for multi-radio equipment are set out in the relevant harmonized radio product standards applicable to the other radio parts.

When measuring spurious emissions in the receive and/or standby mode, it is essential that none of the transmitters within the combined equipment are transmitting.

##### 5.1.4.2.2.4.1 The spurious emissions from each radio can be identified

Where the spurious emissions from each radio can be identified, then the spurious emissions from each radio are assessed to the relevant harmonized radio standard.

##### 5.1.4.2.2.4.2 The spurious emissions from each radio cannot be identified

Where the spurious emissions from each radio cannot be identified, then the combined equipment is assessed to the spurious emission requirements contained in all of the relevant harmonized radio standards applicable to the radios contained within the combined product.

Where the applicable harmonized radio standards contain different limits and measuring conditions, then the combined product is assessed to the harmonized radio standard that specifies the least stringent limits for the common part of the frequency measurement ranges. To assess the remaining parts of the frequency measurement ranges the limits from the relevant harmonized radio standard should be used.

## 5.2 Interpretation of the measurement results

The interpretation of the results recorded in a test report for the measurements described in the present document shall be as follows:

- the measured value related to the corresponding limit will be used to decide whether an equipment meets the requirements of the present document;
- the value of the measurement uncertainty for the measurement of each parameter shall be included in the test report;
- the recorded value of the measurement uncertainty shall be, for each measurement, equal to or lower than the figures in table 4;
- the shared risk approach shall be applied for the interpreting of all measurement results.

For the test methods to determine RF power levels, according to the present document, the measurement uncertainty figures shall be calculated in accordance with TR 100 028-1 [3] and TR 100 028-2 [4] and shall correspond to an expansion factor (coverage factor)  $k = 1,96$  or  $k = 2$  (which provide confidence levels of respectively 95 % and 95,45 % in the case where the distributions characterizing the actual measurement uncertainties are normal (Gaussian)).

Table 4 is based on such expansion factors.

**Table 4: Maximum measurement uncertainty**

Parameter	Uncertainty
RF frequency	$\pm 1 \times 10^{-5}$
RF power conducted	$\pm 1,5$ dB
RF power radiated	$\pm 6$ dB
Spurious emissions, conducted	$\pm 3$ dB
Spurious emissions, radiated	$\pm 6$ dB
Temperature	$\pm 1$ °C
Humidity	$\pm 5$ %
Time	$\pm 10$ %

## 5.3 Essential radio test suites

### 5.3.1 Product information

The following information shall be stated by the manufacturer in order to carry out the test suites:

- the operating RF channel centre frequency range of the equipment;
- the nominal occupied channel bandwidth ChS (ChS = 10 MHz or 20 MHz);
- the modulation format(s) employed by the equipment;
- declare the maximum useable conducted power level from the equipment ( $P_{\text{cond}_1}$ ) and the associated maximum useable antenna gain at this power level;
- declare the maximum conducted power level from the TPC range associated with the highest useable antenna assembly gain ( $P_{\text{cond}_2}$ );
- declare the minimum conducted power level from the equipment ( $P_{\text{cond}_3}$ );

- the intended range of antennas together with their respective antenna assembly gain(s) and for each of the specific antennas, the corresponding minimum and maximum conducted RF power settings for the equipment consistent with the TPC requirement;
- the test sequence(s) to be used during the tests (see clause 5.1.2);
- the normal and extreme operating conditions (e.g. voltage and temperature) that apply to the equipment.
- whether the equipment has an idle or standby mode.

## 5.3.2 Frequency error

### 5.3.2.1 Test conditions

The frequencies at which the conformance requirements in clause 4.1 shall be verified are defined in clause 5.1.3.

The UUT shall be set to operate at a normal RF power output level.

For a UUT with antenna connector(s) and using external antenna(s), or for a UUT with integral antenna(s) but with a temporary antenna connector provided, conducted measurements shall be used.

For a UUT with integral antenna(s) and without a temporary antenna connector, radiated measurements shall be used.

### 5.3.2.2 Test methods

#### 5.3.2.2.1 Conducted measurement

##### **Equipment operating without modulation:**

This test method requires that the UUT can be operated in an unmodulated test mode.

The UUT shall be connected to a frequency counter and operated in an unmodulated mode. The actual carrier centre frequency shall be recorded and shall be compared to the nominal channel centre frequency.

##### **Equipment operating with modulation:**

This method is an alternative to the above method in case the UUT can not be operated in an un-modulated mode.

The UUT shall be connected to spectrum analyser.

The settings of the spectrum analyser shall be adjusted to optimize the instrument's frequency accuracy.

Max Hold shall be selected and the centre frequency adjusted to that of the UUT.

The peak value of the power envelope shall be measured and noted. The span shall be reduced and the marker moved in a positive frequency increment until the upper, (relative to the centre frequency), -10 dBc point is reached. This value shall be noted as f1.

The marker shall then be moved in a negative frequency increment until the lower, (relative to the centre frequency), -10 dBc point is reached. This value shall be noted as f2.

The actual carrier centre frequency is calculated as  $(f1 + f2) / 2$  and shall be compared to the nominal channel centre frequency.

#### 5.3.2.2.2 Radiated measurement

The test set up as described in annex B shall be used with a spectrum analyser of sufficient accuracy attached to the test antenna (see clause 5.2).

The test procedure is as described under clause 5.3.2.2.1.

### 5.3.3 Transmitter RF Output Power, EIRP, TPC and EIRP Spectral Density

#### 5.3.3.1 Test conditions

The conformance requirements in clause 4.2 shall be verified at those carrier centre frequencies defined in clause 5.1.3. The measurements shall be performed using normal operation of the equipment with test signal applied (see clause 5.1.2.1).

NOTE: Special test functions may be needed in the UUT to make this test possible.

For a UUT with antenna connector(s) and using external antenna(s), or for a UUT with integral antenna(s) but with a temporary antenna connector provided, conducted measurements shall be used in conjunction with the stated antenna assembly gain(s).

For a UUT with integral antenna(s) and without a temporary antenna connector, radiated measurements shall be used.

#### 5.3.3.2 Test method

##### 5.3.3.2.1 Conducted measurement

###### 5.3.3.2.1.1 RF output power, EIRP and TPC

###### Step 1:

The equipment shall be configured to operate with the  $P_{\text{cond}_1}$ .

###### Step 2:

- a) using suitable attenuators, the output power of the transmitter shall be coupled to a matched diode detector or equivalent thereof. The output of the diode detector shall be connected to the vertical channel of an oscilloscope;
- b) the combination of the diode detector and the oscilloscope shall be capable of faithfully reproducing the duty cycle of the transmitter output signal;
- c) the observed duty cycle of the transmitter (Tx on/(Tx on + Tx off)) shall be noted as  $x$  ( $0 < x \leq 1$ ), and recorded in the test report. For the purpose of testing, the equipment shall be operated with a duty cycle that is equal to or greater than 0,1 (see clause 5.1.2.1).

###### Step 3:

- a) the RF output power of the transmitter shall be determined using a wideband calibrated RF power meter with a matched thermocouple detector or an equivalent thereof and with an integration period that exceeds the repetition period of the transmitter by a factor 5 or more. The observed value shall be noted as "A" (in dBm);
- b) calculate  $P_{\text{cond}} = A + 10 \log(1/x)$  (dBm) where  $x$  is the observed duty cycle;
- c) the EIRP shall be calculated from the above measured power output  $P_{\text{cond}}$  (in dBm) using the antenna assembly gain  $G$  according to the formula  $P_{\text{EIRP}} = P_{\text{cond}} + G$  (dBm). If more than one antenna assembly is intended for this power setting, the gain of the antenna assembly with the highest gain shall be used. If no specific antenna assemblies have been declared, the declared maximum usable antenna gain for this power setting shall be used;
- d)  $P_{\text{cond}}$  and  $P_{\text{EIRP}}$  shall be recorded in the test report and shall be compared to the relevant limits.

###### Step 4:

- a) if the equipment has only one TPC range, Step 4 should be skipped;
- b) the equipment shall be configured to operate with the conducted power setting  $P_{\text{cond}_2}$ ;

- c) Steps 2 to 3 shall be repeated.

**Step 5:**

- a) the equipment shall be configured to operate with the conducted power setting  $P_{\text{cond}_3}$ ;
- b) Steps 2 and 3 shall be repeated.

**Step 6:**

- a) if the configurations described in Step 1 and Step 4b) do not cover the configuration resulting in the overall highest EIRP for the FWA device, Step 2 and 3 shall be repeated for the configuration resulting in the highest EIRP.

**5.3.3.2.1.2 EIRP Spectral Power Density**

The UUT shall be operated as described in clause 5.3.3.2.1.1 Step 1 although any intermediate power setting associated with a specific antenna assembly gain resulting in operation at the maximum EIRP can be used. Furthermore, for the purpose of this test, the minimum transmitter on-time should be 10  $\mu$ s.

In the case of radiated measurements, using a test site as described in annex B and applicable measurement procedures as described in annex C, the power density as defined in clause 4.2 shall be measured and recorded.

In case of conducted measurements, the transmitter shall be connected to the measuring equipment via a suitable attenuator and the power density as defined in clause 4.2 shall be measured and recorded.

The power density shall be determined using a spectrum analyser of adequate bandwidth in combination with an RF power meter.

Connect an RF power meter to the narrow IF output of the spectrum analyser and correct its reading using a known reference source, e.g. a signal generator.

NOTE: The IF output of the spectrum analyser may be 20 dB or more below the input level of the spectrum analyser. Unless the power meter has adequate sensitivity, a wideband amplifier may be required.

The test procedure shall be as follows:

**Step 1:**

- the measurement set-up shall be calibrated with a CW signal from a calibrated source; the reference signal shall be set to a level equal to the value for the applicable limit for EIRP power density (reduced by the highest applicable antenna gain) and at a frequency equal to the centre frequency of the channel being tested;
- the settings of the spectrum analyser shall be:
  - centre Frequency: equal to the signal source;
  - resolution BW: 1 MHz;
  - video BW: 1 MHz;
  - detector mode: positive peak;
  - averaging: off;
  - span: zero Hz;
  - reference level: equal to the level of the reference signal.

**Step 2:**

- the calibrating signal power shall be reduced by 10 dB and it shall be verified that the power meter reading also reduces by 10 dB.

**Step 3:**

- connect the UUT. Using the following settings of the spectrum analyser in combination with "max hold" function, find the frequency of highest power output in the power envelope:
  - centre Frequency: equal to operating frequency;
  - resolution BW: no change to the setting in Step 1;
  - video BW: no change to the setting in Step 1;
  - detector mode: no change to the setting in Step 1;
  - averaging: no change to the setting in Step 1;
  - span: 1,5 times ChS;
  - reference level: no change to the setting in Step 1.
- the frequency found shall be recorded;
- the centre frequency of the spectrum analyser shall be set to the recorded frequency, the span shall be further reduced to 1 MHz and the frequency of the highest power output shall be found. If this frequency is different from the previous recorded frequency, the new frequency shall be recorded.

**Step 4:**

- set the centre frequency of the spectrum analyser to the found frequency and switch to zero span. The power meter indicates the measured Power Density (D). The mean Power Density EIRP (PD) is calculated from the above measured power density (D), the observed duty cycle x (see clause 5.3.3.2.1.1 Step 1), and the applicable antenna assembly gain "G" in dBi, according to the formula below. If more than one antenna assembly is intended for this power setting or TPC range, the gain of the antenna assembly with the highest gain shall be used:
  - $PD = D + G + 10 \log (1/x)$ ;
  - PD shall be recorded in the test report.

The above procedure shall be repeated for each of the frequencies identified in clause 5.1.3.

Where the spectrum analyser bandwidth is non-Gaussian, a suitable correction factor shall be determined and applied.

Where a spectrum analyser is equipped with a facility to measure power density, this facility may be used instead of the above procedure to measure the power density across the occupied channel bandwidth.

#### 5.3.3.2.2 Radiated measurement

The test set up as described in annexes B and C shall be used with a RF power meter of sufficient accuracy attached to the test antenna (see clause 5.2).

The test procedure is as described under clause 5.3.3.2.1.

### 5.3.4 Transmitter unwanted emissions

#### 5.3.4.1 Transmitter unwanted emissions outside the 5 725 MHz to 5 875 MHz band

##### 5.3.4.1.1 Test conditions

The conformance requirements in clause 4.3.1 shall be verified under normal operating conditions, and at those carrier centre frequencies defined in clause 5.1.3. The UUT shall be configured to operate at  $P_{\text{cond}_1}$ .

For UUT without an integral antenna and for a UUT with an integral antenna but with a temporary antenna connector, one of the following options shall be used:

- the level of unwanted emissions shall be measured as their power in a specified load (conducted spurious emissions) and their effective radiated power when radiated by the cabinet or structure of the equipment with the antenna connector terminated by a specified load (cabinet radiation); or
- the level of unwanted emissions shall be measured as their effective radiated power when radiated by cabinet and antenna.

In the case where the UUT has an integral antenna, but no temporary antenna connector, only radiated measurements shall be used.

### 5.3.4.1.2 Test method

#### 5.3.4.1.2.1 Conducted measurement

The UUT shall be connected to a spectrum analyser capable of RF power measurements. The test procedure shall be as follows:

- a) the settings of the spectrum analyser shall be as follows:
  - sensitivity: at least 6 dB below the limit given in table 2;
  - video bandwidth: 1 MHz;
  - video averaging on, or peak hold.

The video signal of the spectrum analyser shall be "gated" such that the spectrum measured shall be measured between 4,0 µs before the start of the burst to 4,0 µs after the end of the burst.

NOTE: The "start of the burst" is the centre of the first sample of the preamble heading the burst. The "end of the burst" is the centre of the last sample in the burst.

This gating may be analogue or numerical, dependent upon the design of the spectrum analyser.

- b) initially the power level shall be measured in the ranges:
  - 30 MHz to 1 GHz;

with a resolution bandwidth of 1 MHz and in a frequency scan mode.

- c) if any measurement in d) is greater than -36 dBm, then measurements shall be taken with a resolution bandwidth of 100 kHz, zero frequency scan, at the 11 frequencies spaced 100 kHz apart in a band  $\pm 0,5$  MHz centred on the failing frequency;

EXAMPLE: A UUT fails at 285 MHz. Measurements are made in a 100 kHz bandwidth on 284,5 MHz, 284,6 MHz, 284,7 MHz, etc. up to 285,5 MHz.

- d) the power level shall be measured in the ranges
  - 1 GHz to 5,725 GHz;
  - 5,875 GHz to 26,5 GHz;

with a resolution bandwidth of 1 MHz and in a frequency scan mode.

#### 5.3.4.1.2.2 Radiated measurement

The test set up as described in annex B shall be used with a spectrum analyser of sufficient accuracy attached to the test antenna (see clause 5.2).

The test procedure is as described under clause 5.3.4.1 2.1.

### 5.3.4.2 Transmitter unwanted emissions within the 5 725 MHz to 5 875 MHz band

#### 5.3.4.2.1 Test conditions

The conformance requirements in clause 4.3.2 shall be verified under normal operating conditions and at those carrier centre frequencies defined in clause 5.1.3. The UUT shall be configured to operate at  $P_{\text{cond}_1}$ .

For UUT without an integral antenna and for a UUT with an integral antenna but with a temporary antenna connector, one of the following options shall be used:

- the level of unwanted emissions shall be calculated from their measured power in a specified load (conducted spurious emissions); or
- the level of unwanted emissions shall be measured as their effective radiated power when radiated by cabinet and antenna.

In the case where the UUT has an integral antenna, but no temporary antenna connector, only radiated measurements shall be used.

#### 5.3.4.2.2 Test method

##### 5.3.4.2.2.1 Conducted measurement

The settings of the spectrum analyser shall be as follows:

- resolution bandwidth: 1 MHz;
- video bandwidth: 30 kHz;
- video averaging on.

The video signal of the spectrum analyser shall be "gated" such that the spectrum measured shall be measured between 4,0  $\mu$ s before the start of the burst to 4,0  $\mu$ s after the end of the burst.

NOTE: The "start of the burst" is the centre of the first sample of the preamble heading the burst. The "end of the burst" is the centre of the last sample in the burst.

This gating may be analogue or numerical, dependent upon the design of the spectrum analyser.

#### **Determination of the reference average power level**

The spectrum analyser shall be tuned to measurement frequencies at every 1 MHz interval within  $f_c - 9$  (-4,5) MHz to  $f_c + 9$  (4,5) MHz, with zero frequency scan. The maximum average power within  $f_c - 9$  (-4,5) MHz to  $f_c + 9$  (4,5) MHz (except  $f_c$ ) is the reference level for relative power measurements on the channel centred at  $f_c$  and shall be recorded to compute relative power levels as described below.

#### **Determination of the relative average power levels**

The power level shall be measured in the range:

- 5 725 MHz to 5 875 MHz;

excluding the interval  $f_c - 9$  (-4,5) MHz to  $f_c + 9$  (4,5) MHz with a resolution bandwidth of 1 MHz and in a frequency scan mode. The average value of power relative to the reference average power level for the channel shall be noted.

NOTE: The figures in parenthesis apply to ChS = 10 MHz, whereas the figures not in parenthesis apply to ChS = 20 MHz.

##### 5.3.4.2.2.2 Radiated measurement

The test set up as described in annex B shall be used with a spectrum analyser of sufficient accuracy attached to the test antenna (see clause 5.2).



The test procedure is as described under clause 5.3.4.2 2.1.

## 5.3.5 Receiver spurious emissions

### 5.3.5.1 Test conditions

The conformance requirements in clause 4.5 shall be verified under normal operating conditions, and at those carrier centre frequencies defined in clause 5.1.3.

For UUT without an integral antenna and for a UUT with an integral antenna but with a temporary antenna connector, one of the following options shall be used:

- the level of unwanted emissions shall be measured as their power in a specified load (conducted spurious emissions) and their effective radiated power when radiated by the cabinet or structure of the equipment with the antenna connector terminated by a specified load (cabinet radiation); or
- the level of unwanted emissions shall be measured as their effective radiated power when radiated by cabinet and antenna.

In the case where the UUT has an integral antenna, but no temporary antenna connector, only radiated measurements shall be used.

Test sequence (see clause 5.1.2.1) shall be applied to the receiver input at the reference sensitivity level according to the nominal bit rate.

### 5.3.5.2 Test method

#### 5.3.5.2.1 Conducted tests

Using a directional coupler, circulator or gating to remove the test data transmissions (and/or other means to isolate the emissions measurements instrument from the test data signals transmitted) the radio emissions from the UUT shall be measured while the UUT receives test data.

The settings of the spectrum analyser shall be as follows:

- frequency scan allowed;
- resolution bandwidth: 1 MHz or 100 kHz as appropriate (see table 3);
- video bandwidth: 1 MHz;
- video averaging on, or peak hold.

Tuning the spectrum analyser centre frequency over the measurement frequency bands specified in table 3, the power level of UUT receiver emissions shall be measured during test data transmissions. If gating is used to remove the unwanted energy from the test data transmissions, the tuning of the spectrum analyser shall not change during the gated-out time interval.

#### 5.3.5.2.2 Radiated tests

The test set up as described in annex B shall be used with a spectrum analyser of sufficient accuracy attached to the test antenna (see clause 5.2).

The test procedure is as described under clause 5.3.5.2.1.

## 5.3.6 Dynamic Frequency Selection (DFS)

### 5.3.6.1 Test conditions

The conformance requirements in clause 4.6 shall be verified under normal operating conditions and at a carrier centre frequency defined in clause 5.1.3.

Some of the tests may be facilitated by disabling the *Non-Occupancy Period*.

It should be noted that once a UUT is powered on, it will not start its normal operating functions immediately, as it will have to finish its power-up cycle first ( $T_{\text{power\_up}}$ ). As such, the UUT, as well as any other device used in the set-up, may be equipped with a feature that will indicate its status during the testing, e.g. power-up mode, normal operation mode, channel check status, radar detection event, etc.

### 5.3.6.1.1 Selection of Radar Test Signals

The radar test signals to be used during the DFS testing are defined in tables D.3.1 and D.3.2.

For each of the test signals simulating fixed frequency radars in table D 3.1, an arbitrary combination of Pulse Width and Pulse Repetition Frequency shall be chosen from the options given in the table D.3.1 and recorded in the test report.

For each of the test signals simulating frequency hopping radars in table D 3.2, test trials shall be constructed based on the pulse width, pulse repetition frequency and pulses per burst to create the required burst length. The Radar Test Signal Generator shall be configured to supply the required number of bursts per trial commencing with the lowest burst interval and increasing the time interval for each trial as directed in table D 3.2.

### 5.3.6.1.2 Test Set-Up

For the purposes of the test, the UUT as well as other devices used in the set-up may be equipped with a specific user interface to allow monitoring of the behaviour of the different devices of the set-up during the tests.

The UUT is capable of transmitting a test transmission sequence as described in clause 5.1.2.2. The signal generator is capable of generating any of the radar test signals defined in tables D.3.1 and D.3.2.

Adequate measurement equipment, e.g. spectrum analyser, shall be used to measure the aggregate transmission time of the UUT.

Radar test signals are injected into the UUT. The set-up also contains a device which is associated with the UUT.

Figure 3 shows an example test set-up.

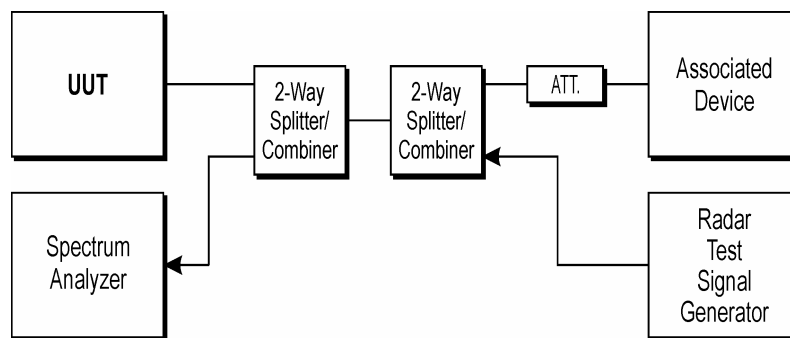

NOTE: UUT can be any type of FWA Device under test. An Associated Device is the equipment required for the UUT to establish a communication link.

**Figure 3: Test Set-up**

## 5.3.6.2 Test Method

### 5.3.6.2.1 Conducted measurement

For a UUT with antenna connector(s) and using dedicated external antenna(s), or for a UUT with integral antenna(s) but with a temporary antenna connector provided, conducted measurements shall be used.

The UUT shall be configured to operate at  $P_{\text{cond}_1}$ .

The output power of the signal generator producing the radar test signals, as selected using clause 5.3.6.1.1, shall (unless otherwise specified) provide a received signal power at the antenna connector of the UUT with a level equal to (*Interference Detection Threshold* + G), see table D.2. Parameter G [dBi] corresponds to the gain of the antenna assembly stated by the manufacturer. If more than one antenna assembly is intended for this power setting, the gain of the antenna assembly with the lowest gain shall be used.

A channel shall be selected in accordance with clause 5.1.3. This channel is designated as  $Ch_r$  (channel occupied by a radar). The UUT shall be configured to select  $Ch_r$  as the first Operating Channel.

#### 5.3.6.2.1.1 Channel Availability Check

The clauses below define the procedure to verify the *Channel Availability Check* and the *Channel Availability Check Time* ( $T_{ch\_avail\_check}$ ) by ensuring that the UUT is capable of detecting radar pulses at the beginning and at the end of the *Channel Availability Check Time*.

#### 5.3.6.2.1.2 Tests with a radar burst at the beginning of the Channel Availability Check Time

The Steps below define the procedure to verify the radar detection capability on the selected channel when a radar burst occurs at the beginning of the *Channel Availability Check Time*. This is illustrated in figure 4.

- a) the signal generator and UUT are connected in the test set up as described in clause 5.3.6.1.2. and the power of the UUT is switched off;
- b) the UUT is powered on at T0. T1 denotes the instant when the UUT has completed its power-up sequence ( $T_{power\_up}$ ) and is ready to start the radar detection. The *Channel Availability Check* is expected to commence on  $Ch_r$  at instant T1 and is expected to end no sooner than  $T1 + T_{ch\_avail\_check}$  unless a radar is detected sooner;

NOTE: Additional verification may be needed to define T1 in case it is not exactly known or indicated by the UUT.

- c) a radar burst is generated on  $Ch_r$  using radar test signal #1 defined in table D.3.1 at a level of 10 dB above the level defined in clause 5.3.6.2.1. This single-burst radar test signal shall commence within 2 seconds after time T1;
- d) it shall be recorded whether the radar test signal is detected;
- e) a timing trace or description of the observed timing and behaviour of the UUT shall be recorded.

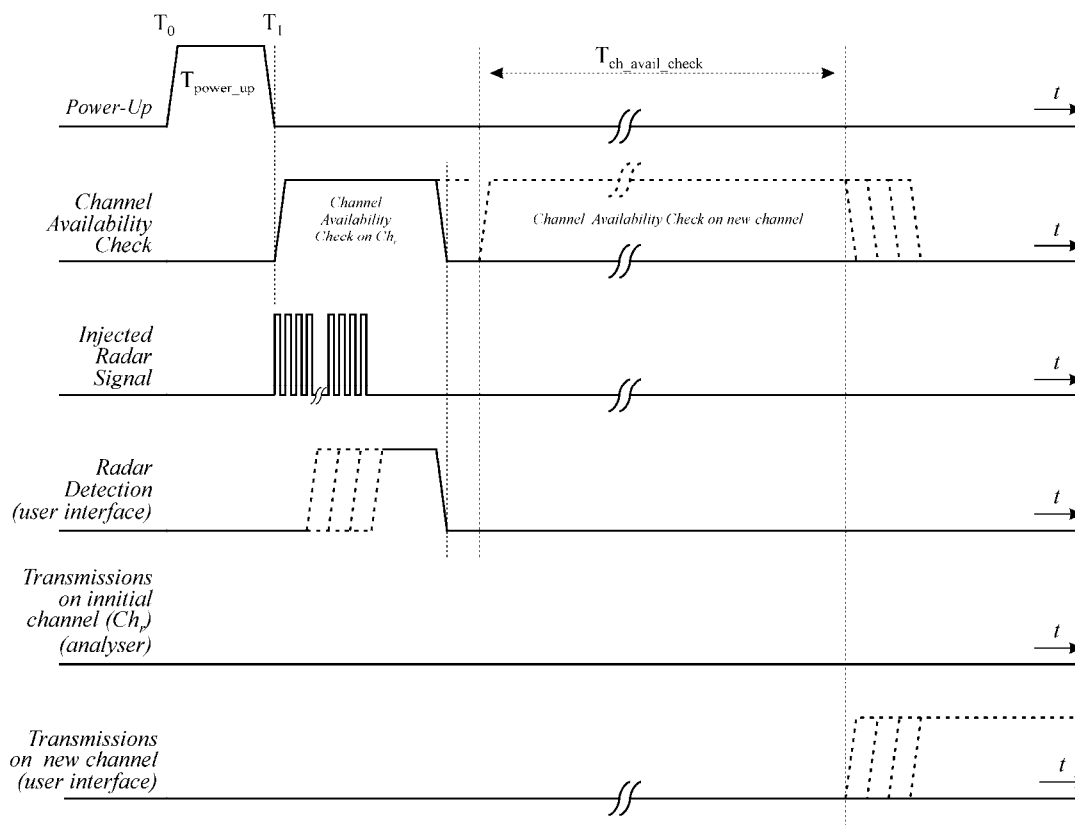

**Figure 4: Example of timing for radar testing at the beginning of the Channel Availability Check Time**

#### 5.3.6.2.1.3 Tests with radar burst at the end of the Channel Availability Check Time

The Steps below define the procedure to verify the radar detection capability on the selected channel when a radar burst occurs at the end of the *Channel Availability Check Time*. This is illustrated in figure 5.

- the signal generator and UUT are connected using the test set up described in clause 5.3.6.1.2 and the power of the UUT is switched off;
- the UUT is powered up at  $T_0$ .  $T_1$  denotes the instant when the UUT has completed its power-up sequence ( $T_{\text{power\_up}}$ ) and is ready to start the radar detection. The Channel Availability Check is expected to commence on  $Ch_i$  at instant  $T_1$  and is expected to end no sooner than  $T_1 + T_{\text{ch\_avail\_check}}$  unless a radar is detected sooner;

NOTE: Additional verification may be needed to define  $T_1$  in case it is not exactly known or indicated by the UUT.

- a radar burst is generated on  $Ch_i$  using radar test signal #1 defined in table D.3.1 at a level of 10 dB above the level defined in clause 5.3.6.2.1. This single-burst radar test signal shall commence towards the end of the minimum required Channel Availability Check Time but not before time  $T_1 + T_{\text{ch\_avail\_check}} - 2$  seconds;
- it shall be recorded whether the radar test signal is detected;
- a timing trace or description of the observed timing and behaviour of the UUT shall be recorded.

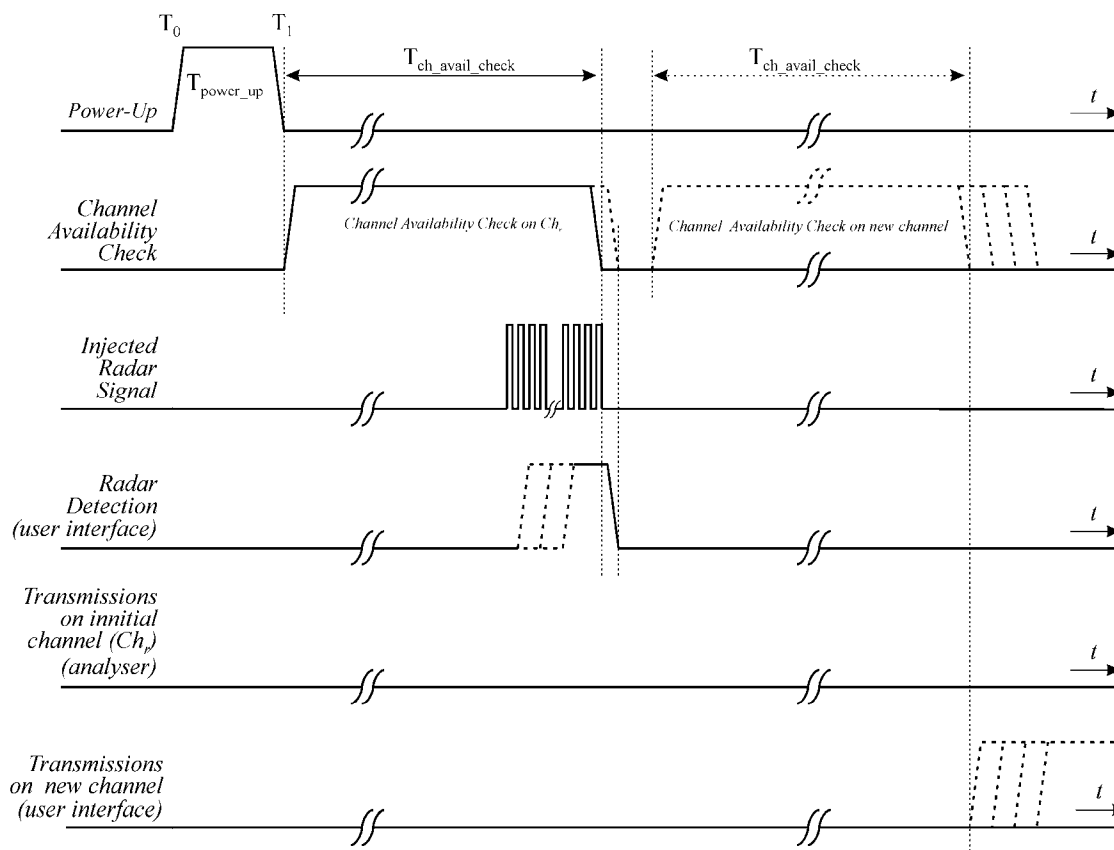

**Figure 5: Example of timing for radar testing towards the end of the Channel Availability Check Time**

#### 5.3.6.2.1.4 Interference Detection Threshold (during the Channel Availability Check)

The different Steps below define the procedure to verify the *Interference Detection Threshold* during the *Channel Availability Check Time*. This is illustrated in figure 6.

- the signal generator and UUT are connected using the test set up described in clause 5.3.6.1.2 and the power of the UUT is switched off;
- the UUT is powered on at  $T_0$ .  $T_1$  denotes the instant when the UUT has completed its power-up sequence ( $T_{power\_up}$ ) and is ready to start the radar detection. The Channel Availability Check is expected to commence on  $Ch_r$  at instant  $T_1$  and is expected to end no sooner than  $T_1 + T_{ch\_avail\_check}$  unless a radar is detected sooner;

NOTE: Additional verification may be needed to define  $T_1$  in case it is not exactly known or indicated by the UUT.

- a radar signal is generated on  $Ch_r$  using radar test signal #1 defined in table D.3.1 at a level defined in clause 5.3.6.2.1. This radar test signal shall commence at approximately 10 seconds after  $T_1$ ;
- it shall be recorded whether the radar test signal is detected;
- the Steps c) to d) shall be repeated at least 20 times in the case of test signals simulating fixed frequency radars or 30 times in the case of test signals simulating frequency hopping radars in order to determine the detection probability for the selected radar test signal. The detection probability shall be compared with the limit specified in table D.3.1 or D 3.2 as appropriate;
- the Steps c) to e) shall be repeated for each of the radar test signals defined in table D.3.1 (identified and as described in clause 5.3.6.1.1.) and for each of the radar test signals defined in table D 3.2 where the single-burst radar signal is replaced by the multi-burst sequence defined in clause 5.3.6.1.1.

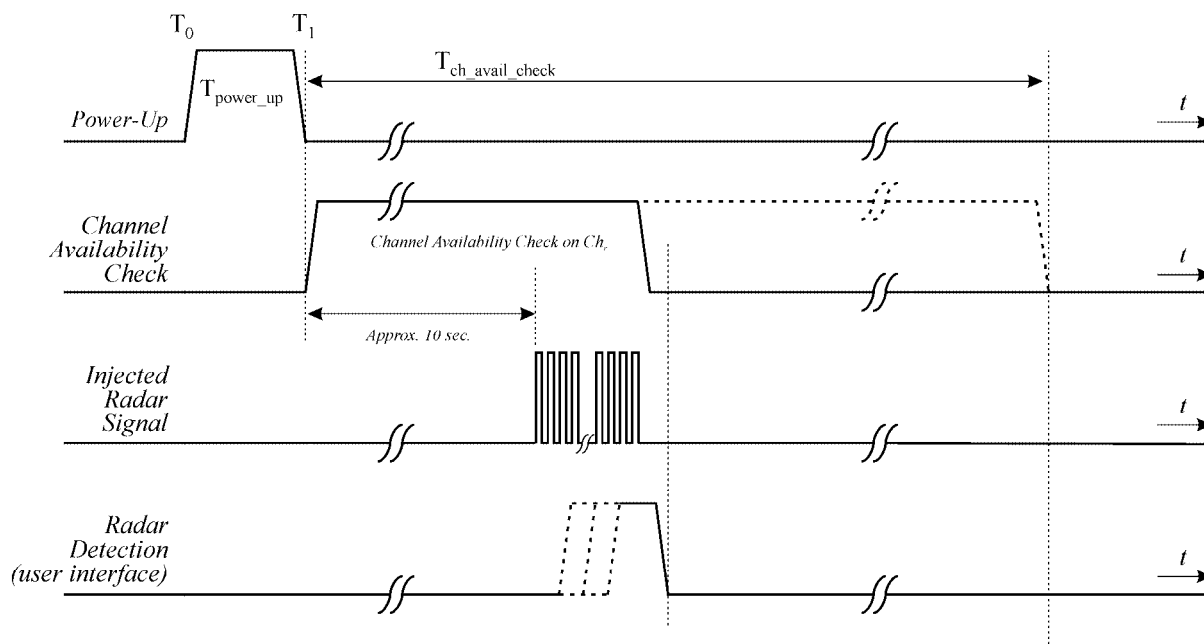
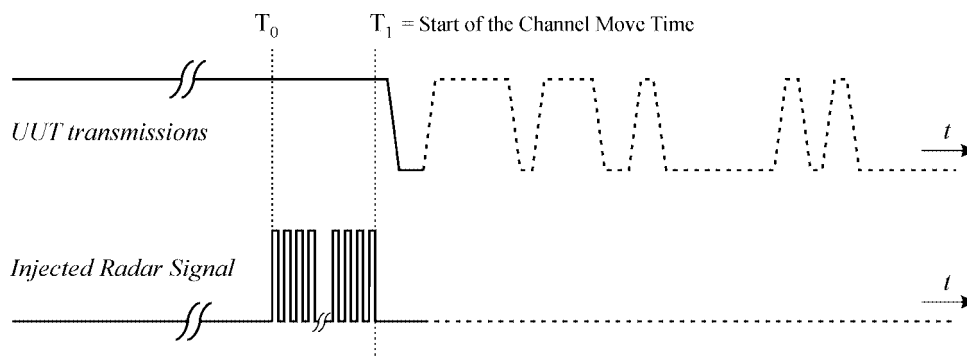

**Figure 6: Example of timing for radar testing during the Channel Availability Check**

#### 5.3.6.2.1.5 In-Service Monitoring

The Steps below define the procedure to verify the *In-Service Monitoring* and the *Interference Detection Threshold* during the *In-Service Monitoring*. This is illustrated in figure 8.

- the signal generator and the UUT are connected using the test set up described in clause 5.3.6.1.2;
- the UUT shall transmit a test transmission sequence in accordance with clause 5.1.2.2. on the selected channel  $Ch_r$ ;
- at a certain time  $T_0$ , a radar signal is generated on  $Ch_r$  using radar test signal #1 defined in table D.3.1 and at a level defined in clause 5.3.6.2.1.  $T_1$  denotes the end of the radar test signal;
- it shall be recorded whether the radar test signal is detected;
- the Steps c) to d) shall be repeated at least 20 times in the case of test signals simulating fixed frequency radars or 30 times in the case of test signals simulating frequency hopping radars in order to determine the detection probability for the selected radar test signal. The detection probability shall be compared with the limit specified in either table D.3.1 or D.3.2 as appropriate;
- the Steps b) to e) shall be repeated for each of the radar test signals defined in table D.3.1 (identified and as described in clause 5.3.6.1.1.) and for each of the radar test signals 1 and 2 in table D 3.2 where the single-burst radar signal is replaced by the multi-burst sequence defined in clause 5.3.6.1.1.



**Figure 7: Example of timing for radar testing during In-Service Monitoring**

### 5.3.6.2.1.6 Channel Shutdown and Non-Occupancy period

The Steps below define the procedure to verify the *Channel Shutdown* process and to determine the *Channel Closing Transmission Time*, the *Channel Move Time* and the *Non-Occupancy Period*. This is illustrated in figure 8.

- the signal generator and the UUT shall be connected using the test set up described in clause 5.3.6.1.2;
- the UUT shall transmit a test transmission sequence in accordance with clause 5.1.2.2 on the selected channel  $Ch_r$ ;
- at a certain time  $T_0$ , a radar signal is generated on  $Ch_r$  using radar test signal #1 defined in table D.3.1 and at a level of 10 dB above the level defined in clause 5.3.6.2.1 on the selected channel.  $T_1$  denotes the end of the radar test signal;
- the transmissions of the UUT following instant  $T_1$  on the selected channel shall be observed for a period greater than or equal to the Channel Move Time defined in table D.1. The aggregate duration (*Channel Closing Transmission Time*) of all transmissions from the UUT during the Channel Move Time shall be compared to the limit defined in table D.1;

NOTE: The aggregate duration of all transmissions of the UUT does not include quiet periods in between transmissions of the UUT.

- $T_2$  denotes the instant when the UUT has ceased all transmissions on the channel. The time difference between  $T_1$  and  $T_2$  shall be measured. This value (*Channel Move Time*) shall be noted and compared with the limit defined in table D.1;
- following instant  $T_2$ , the selected channel shall be observed for a period equal to the *Non-Occupancy Period* ( $T_3 - T_2$ ) to verify that the UUT does not resume any transmissions on this channel.

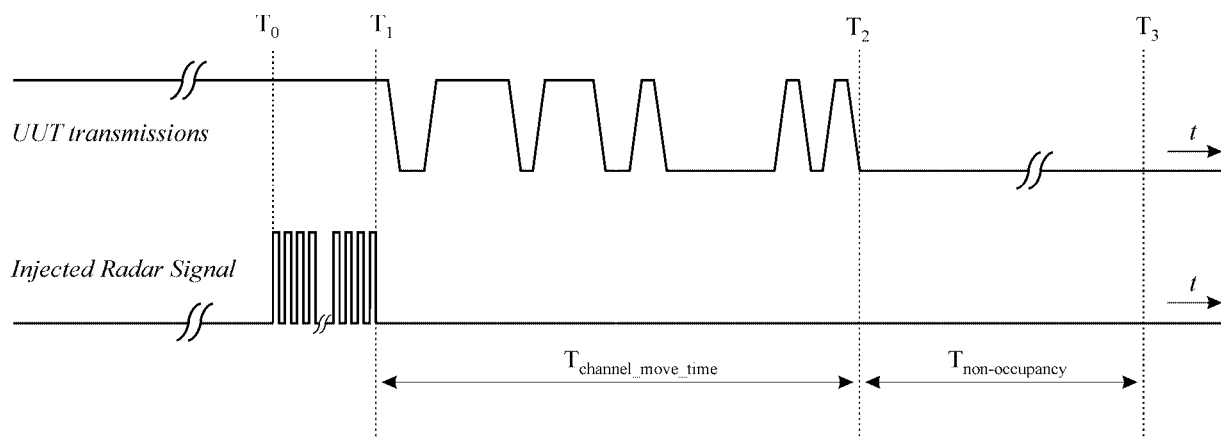

**Figure 8: Channel Closing Transmission Time, Channel Move Time and Non-Occupancy Period**

### 5.3.6.2.2 Radiated measurement

For a UUT with integral antenna(s) and without temporary antenna connector, radiated measurements shall be used.

The output power of the signal generator shall (unless otherwise specified) provide a signal power at the antenna of the UUT with a level equal to *Interference Detection Threshold* (table D.2).

The test set up as described in annex B and applicable measurement procedures as described in annex C shall be used to test the different DFS features of the UUT. The test procedure is further as described under clause 5.3.6.2.1.

## Annex A (normative): HS Requirements and conformance Test specifications Table (HS-RTT)

The HS Requirements and conformance Test specifications Table (HS-RTT) in table A.1 serves a number of purposes, as follows:

- it provides a statement of all the essential requirements in words and by cross reference to a specific clause in the present document or to a specific clause in a specific referenced document;
- it provides a statement of all the test procedures corresponding to those essential requirements by cross reference to specific clause(s) in the present document or to a specific clause(s) in specific referenced document(s);
- it qualifies each requirement to be either:
  - Unconditional: meaning that the requirement applies in all circumstances, or
  - Conditional: meaning that the requirement is dependent on the manufacturer having chosen to support optional functionality defined within the schedule.
- in the case of Conditional requirements, it associates the requirement with the particular optional service or functionality;
- it qualifies each test procedure to be either:
  - Essential: meaning that it is included with the Essential Radio Test Suite and therefore the requirement shall be demonstrated to be met in accordance with the referenced procedures;
  - Other: meaning that the test procedure is illustrative but other means of demonstrating compliance with the requirement are permitted.

**Table A.1: HS Requirements & conformance Test specifications Table (HS-RTT)**

<b>Harmonized Standard EN 302 502</b>						
The following essential requirements and test specifications are relevant to the presumption of conformity under Article 3.2 of the R&TTE Directive						
<b>Essential Requirement</b>			<b>Requirement Conditionality</b>		<b>Test Specification</b>	
<b>No</b>	<b>Description</b>	<b>Reference: Clause No</b>	<b>U/C</b>	<b>Condition</b>	<b>E/O</b>	<b>Reference: Clause No</b>
1	Designation of Centre Frequencies and frequency error	4.1	U		E	5.3.2
2	Transmitter RF Output Power, EIRP and EIRP Spectral Density	4.2	U		E	5.3.3
3	Transmitter unwanted emissions	4.3	U		E	5.3.4
4	Transmitter Power Control	4.4	U		E	5.3.3
5	Receiver Spurious Emissions	4.5	U		E	5.3.5
6	Dynamic Frequency Selection (DFS)	4.6	U		E	5.3.6



**Key to columns:****Essential Requirement:**

**No** A unique identifier for one row of the table which may be used to identify a requirement or its test specification.

**Description** A textual reference to the requirement.

**Clause Number** Identification of clause(s) defining the requirement in the present document unless another document is referenced explicitly.

**Conditionality:**

**U/C** Indicates whether the requirement is to be *unconditionally* applicable (U) or is *conditional* upon the manufacturers claimed functionality of the equipment (C).

**Condition** Explains the conditions when the requirement shall or shall not be applicable for a technical requirement which is classified "conditional".

**Test Specification:**

**E/O** Indicates whether the test specification forms part of the Essential Radio Test Suite (E) or whether it is one of the Other Test Suite (O).

**NOTE:** All tests whether "E" or "O" are relevant to the requirements. Rows designated "E" collectively make up the Essential Radio Test Suite; those designated "O" make up the Other Test Suite; for those designated "X" there is no test specified corresponding to the requirement. All tests classified "E" shall be performed as specified with satisfactory outcomes is a necessary condition for a presumption of conformity. Requirements associated with tests classified "O" or "X" must be complied with as a necessary condition for presumption of conformity, although conformance with the requirement may be claimed by an equivalent test or by manufacturer's assertion supported by appropriate entries in the technical construction file.

**Clause Number** Identification of clause(s) defining the test specification in the present document unless another document is referenced explicitly Where no test is specified (that is, where the previous field is "X") this field remains blank.

## Annex B (normative): Test sites and arrangements for radiated measurements

### B.1 Test sites

#### B.1.1 Open air test sites

The term "open air" should be understood from an electromagnetic point of view. Such a test site may be really in open air or alternatively with walls and ceiling transparent to the radio waves at the frequencies considered.

An open air test site may be used to perform the measurements using the radiated measurement methods described in clause 5. Absolute or relative measurements may be performed on transmitters or on receivers; absolute measurements of field strength require a calibration of the test site. Above 1 GHz, measurements should be done in anechoic conditions. This may be met by semi anechoic sites provided reflections are avoided.

For measurements at frequencies below 1 GHz, a measurement distance appropriate to the frequency shall be used. For frequencies above 1 GHz, any suitable measuring distance may be used. The equipment size (excluding the antenna) shall be less than 20 % of the measuring distance. The height of the equipment or of the substitution antenna shall be 1,5 m; the height of the test antenna (transmit or receive) shall vary between 1 m and 4 m.

Sufficient precautions shall be taken to ensure that reflections from extraneous objects adjacent to the site do not degrade the measurement results, in particular:

- No extraneous conducting objects having any dimension in excess of a quarter wavelength of the highest frequency tested shall be in the immediate vicinity of the site according to CISPR 16 [5], [6], [7]:
  - All cables shall be as short as possible; as much of the cables as possible shall be on the ground plane or preferably below; and the low impedance cables shall be screened.

The general measurement arrangement is shown in figure B.1.

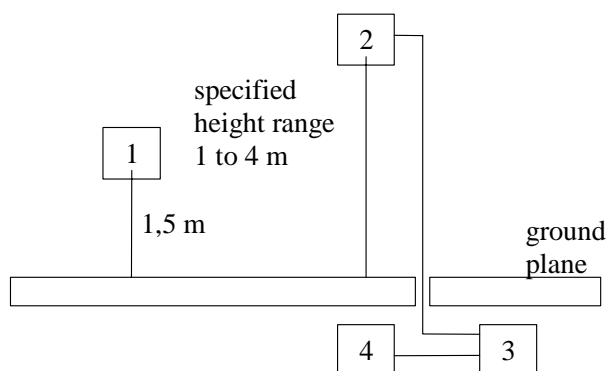

- 1: Equipment under test.
- 2: Test antenna.
- 3: High pass filter (as required).
- 4: Spectrum analyser or measuring receiver.

**Figure B.1: Measuring arrangement**

## B.1.2 Anechoic chamber

### B.1.2.1 General

An anechoic chamber is a well shielded chamber covered inside with radio frequency absorbing material and simulating a free space environment. It is an alternative site on which to perform the measurements using the radiated measurement methods described in clause 5.7. Absolute or relative measurements may be performed on transmitters or on receivers. Absolute measurements of field strength require a calibration of the anechoic chamber. The test antenna, equipment under test and substitution antenna are used in a way similar to that at the open air test site, but are all located at the same fixed height above the floor.

### B.1.2.2 Description

An anechoic chamber should meet the requirements for shielding loss and wall return loss as shown in figure B.2. Figure B.3 shows an example of the construction of an anechoic chamber having a base area of 5 m by 10 m and a height of 5 m. The ceiling and walls are coated with pyramidically formed absorbers approximately 1 m high. The base is covered with special absorbers which form the floor. The available internal dimensions of the chamber are 3 m x 8 m x 3 m, so that a maximum measuring distance of 5 m in the middle axis of this chamber is available. The floor absorbers reject floor reflections so that the antenna height need not be changed. Anechoic chambers of other dimensions may be used.

### B.1.2.3 Influence of parasitic reflections

For free-space propagation in the far field, the relationship of the field strength  $E$  and the distance  $R$  is given by  $E = E_0 \times (R_0/R)$ , where  $E_0$  is the reference field strength and  $R_0$  is the reference distance. This relationship allows relative measurements to be made as all constants are eliminated within the ratio and neither cable attenuation nor antenna mismatch or antenna dimensions are of importance.

If the logarithm of the foregoing equation is used, the deviation from the ideal curve may be easily seen because the ideal correlation of field strength and distance appears as a straight line. The deviations occurring in practice are then clearly visible. This indirect method shows quickly and easily any disturbances due to reflections and is far less difficult than the direct measurement of reflection attenuation.

With an anechoic chamber of the dimensions given above at low frequencies below 100 MHz there are no far field conditions, but the wall reflections are stronger, so that careful calibration is necessary. In the medium frequency range from 100 MHz to 1 GHz the dependence of the field strength to the distance meets the expectations very well. Above 1 GHz, because more reflections will occur, the dependence of the field strength to the distance will not correlate so closely.

### B.1.2.4 Calibration and mode of use

The calibration and mode of use is the same as for an open air test site, the only difference being that the test antenna does not need to be raised and lowered whilst searching for a maximum, which simplifies the method of measurement.

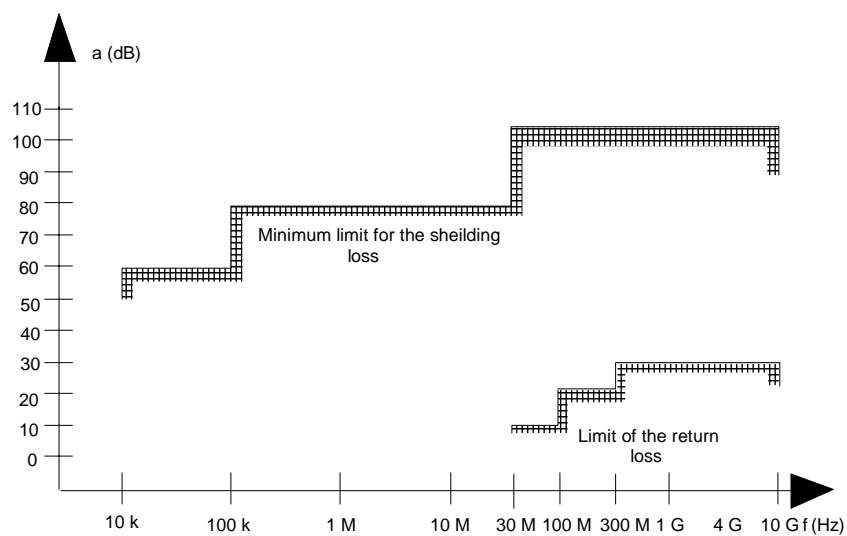

Figure B.2: Specification for shielding and reflections

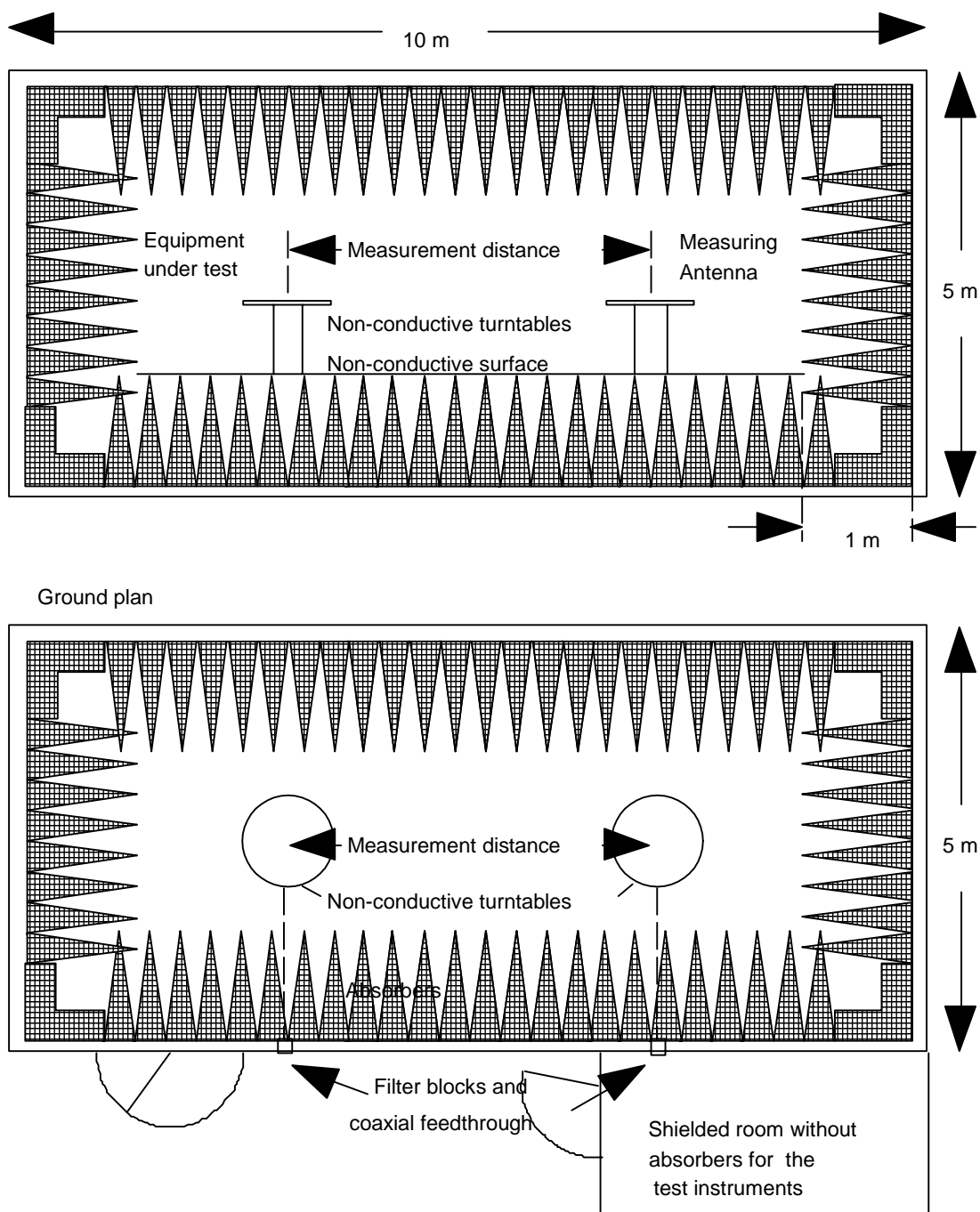

Figure B.3: Anechoic shielded chamber for simulated free space measurements

## B.2 Test antenna

When the test site is used for radiation measurements the test antenna shall be used to detect the field from both the test sample and the substitution antenna. When the test site is used for the measurement of receiver characteristics the antenna shall be used as a transmitting antenna. This antenna shall be mounted on a support capable of allowing the antenna to be used in either horizontal or vertical polarization and for the height of its centre above the ground to be varied over the specified range. Preferably test antennas with pronounced directivity should be used. The size of the test antenna along the measurement axis shall not exceed 20 % of the measuring distance.

---

## B.3 Substitution antenna

The substitution antenna shall be used to replace the UUT in substitution measurements. For measurements below 1 GHz the substitution antenna shall be a half wavelength dipole resonant at the frequency under consideration, or a shortened dipole, calibrated to the half wavelength dipole. For measurements between 1 GHz and 4 GHz either a half wavelength dipole or a horn radiator may be used. For measurements above 4 GHz a horn radiator shall be used. The centre of this antenna shall coincide with the reference point of the test sample it has replaced. This reference point shall be the volume centre of the sample when its antenna is mounted inside the cabinet, or the point where an outside antenna is connected to the cabinet.

The distance between the lower extremity of the dipole and the ground shall be at least 30 cm.

NOTE: The gain of a horn antenna is generally expressed relative to an isotropic radiator.

## Annex C (normative): General description of measurement

This annex gives the general methods of measurements for RF signals using the test sites and arrangements described in annex B.

### C.1 Conducted measurements

Conducted measurements may be applied to equipment provided with an antenna connector e.g. by means of a spectrum analyser.

### C.2 Radiated measurements

Radiated measurements shall be performed with the aid of a test antenna and measurement instruments as described in annex B. The test antenna and measurement instrument shall be calibrated according to the procedure defined in this annex. The equipment to be measured and the test antenna shall be oriented to obtain the maximum emitted power level. This position shall be recorded in the measurement report. The frequency range shall be measured in this position.

Radiated measurements should be performed in an anechoic chamber. For other test sites corrections may be needed (see annex B). The following test procedure applies:

- a) a test site which fulfils the requirements of the specified frequency range of this measurement shall be used. The test antenna shall be oriented initially for vertical polarization unless otherwise stated and the transmitter under test shall be placed on the support in its standard position (clause B.1.1) and switched on;
- b) for average power measurements a non-selective voltmeter or wideband spectrum analyser shall be used. For other measurements a spectrum analyser or selective voltmeter shall be used and tuned to the measurement frequency.

In either case a) or b) the test antenna shall be raised or lowered, if necessary, through the specified height range until the maximum signal level is detected on the spectrum analyser or selective voltmeter. See figure C.1.

The test antenna need not be raised or lowered if the measurement is carried out on a test site according to clause B.1.2.

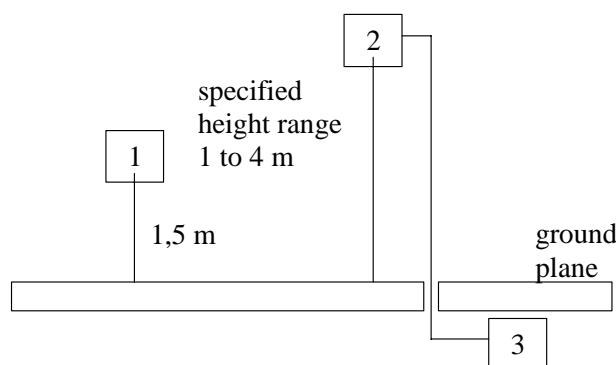

- 1: Equipment under test.
- 2: Test antenna.
- 3: Spectrum analyser or measuring receiver.

**Figure C.1: Measurement arrangement 1**

- the transmitter shall be rotated through 360° about a vertical axis until a higher maximum signal is received;
- the test antenna shall be raised or lowered again, if necessary, through the specified height range until a maximum is obtained. This level shall be recorded.

NOTE: This maximum may be a lower value than the value obtainable at heights outside the specified limits.

The test antenna need not be raised or lowered if the measurement is carried out on a test site according to clause B.1.2. This measurement shall be repeated for horizontal polarization. The result of the measurement is the higher power obtained from the two measurements with the indication of the corresponding polarization.

## C.3 Substitution measurement

The actual signal generated by the measured equipment may be determined by means of a substitution measurement in which a known signal source replaces the device to be measured, see figure C.2. This method of measurement should be used in an anechoic chamber. For other test sites corrections may be needed, see annex B.

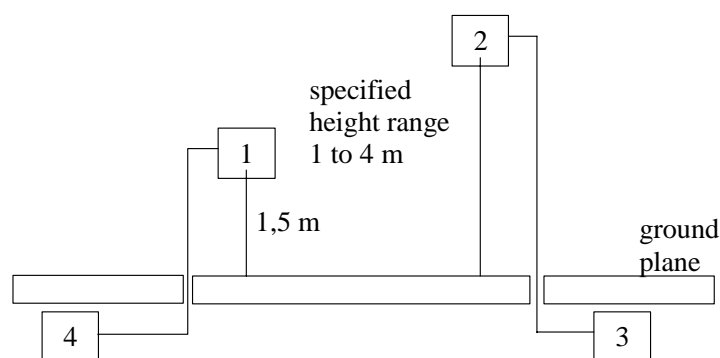

- 1: Substitution antenna.
- 2: Test antenna.
- 3: Spectrum analyser or selective voltmeter.
- 4: Signal generator.

**Figure C.2: Measurement arrangement 2**

Using measurement arrangement 2, figure C.2, the substitution antenna shall replace the transmitter antenna in the same position and in vertical polarization. The frequency of the signal generator shall be adjusted to the measurement frequency. The test antenna shall be raised or lowered, if necessary, to ensure that the maximum signal is still received. The input signal to the substitution antenna shall be adjusted in level until an equal or a known related level to that detected from the transmitter is obtained in the test receiver.

The test antenna need not be raised or lowered if the measurement is carried out on a test site according to clause B.1.2.

The radiated power is equal to the power supplied by the signal generator, increased by the known relationship if necessary and after corrections due to the gain of the substitution antenna and the cable loss between the signal generator and the substitution antenna.

This measurement shall be repeated with horizontal polarization. The result of the measurement is the higher power obtained from the two measurements with the indication of the corresponding polarization.



## Annex D (normative): DFS parameters

**Table D.1: DFS requirement values**

Parameter	Value
Channel Availability Check Time	60 s
Channel Move Time	10 s
Channel Closing Transmission Time	260 ms
Non-Occupancy Period	30 min
Channel Revalidation Period	24 hrs

**Table D.2: Interference Threshold values**

Spectral Density dBm/MHz	Value (see notes 1 and 2)
23	-69 dBm
NOTE 1: This is the level at the input of the receiver assuming a 0 dBi receive antenna. NOTE 2: For FWA devices employing lower EIRP spectral density and a receive antenna gain G (dBi) the threshold follows the following relationships: DFS Detection Threshold (dBm) = -69 + 23 - EIRP Spectral Density (dBm/MHz) + G (dBi). See table D.4 for example calculations.	

Table D.3.1: DFS Test Signals simulating fixed frequency radars

Radar test signal (see note 2)	Pulse width W [ $\mu$ s] (see note 5) choose one value	Pulse repetition frequency PRF [pps] choose one value	Pulses per burst (see notes 1 and 3)	Detection probability with 30 % channel load (see note 4)
1 - Fixed	1	750	15	$P_d > 60\%$
2 - Variable	1, 2, 5	200, 300, 500, 800, 1 000	10	$P_d > 60\%$
3 - Variable	10, 15	200, 300, 500, 800, 1 000	15	$P_d > 60\%$
4 - Variable	1, 2, 5, 10, 15	1 200, 1 500, 1 600	15	$P_d > 60\%$
5 - Variable	1, 2, 5, 10, 15	2 300, 3 000, 3 500, 4 000	25	$P_d > 60\%$
6 - Variable modulated (see note 6)	20, 30	2 000, 3 000, 4 000	20	$P_d > 60\%$

NOTE 1: This represents the number of pulses seen at the device per radar scan:

$$N = \left[ \frac{\text{antenna beamwidth (deg)} \times \text{pulse repetition rate (pps)}}{\text{scan rate (deg/s)}} \right]$$

NOTE 2: The test signals above only contain a single burst of pulses. See figure D.1.

NOTE 3: The number of pulses per burst given in this table simulate real radar systems and take into account the effects of pulse repetition rate and pulse width on the detection probability for a single burst.

NOTE 4:  $P_d$  gives the probability of detection per simulated radar burst and represents a minimum level of detection performance under defined conditions - see clause 5.1.2.2.

Therefore  $P_d$  does not represent the overall detection probability for any particular radar under real life conditions. In general 5 sequential bursts are needed to achieve a real life detection rate of better than 99 % for any radar that falls within the scope of the above table.

NOTE 5: The pulse width used in these tests is assumed to be representative of real radar systems with different pulse widths and different modulations. The pulse width is assumed to have an accuracy of  $\pm 5\%$ .

NOTE 6: The modulation to be used for the radar test signal 6 is a chirp modulation with a  $\pm 2,5$  MHz frequency deviation which is illustrated below.

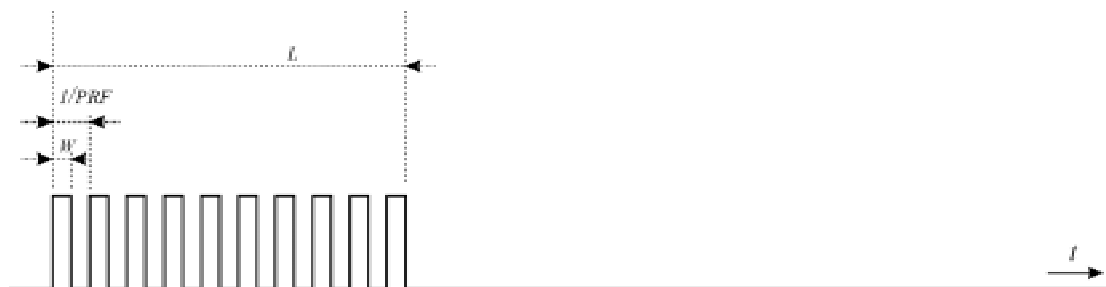
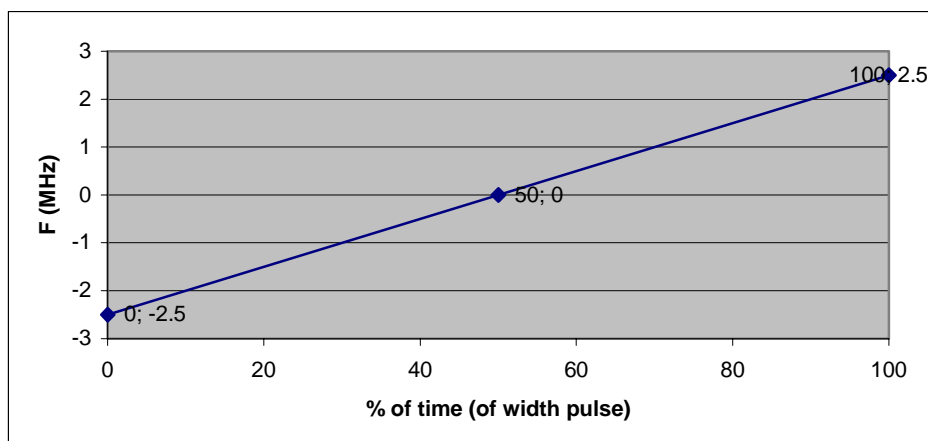

Figure D.1: General structure of a single burst DFS test transmission

Table D.3.2: DFS Test Signals simulating Frequency Hopping radars

Radar test signal	Pulse width W [ $\mu$ s]	Pulse repetition frequency PRF [pps]	Pulses per burst	Burst length [ms]	Bursts per Trial (see note 4)	Pulse modulation (see note 1)	Detection probability Pd with 30 % channel load (see note 2)
1	1	3 000	9	3	8	none	(see note 3)
2	20	4 500	9	2	2	chirp	(see note 3)

NOTE 1: Modulation used is defined in note 6, table D.3.1.

NOTE 2: Pd gives the probability of detection per simulated radar test signal and represents a minimum level of detection performance under defined conditions - see clause 5.1.2.2.

The test is performed using a minimum of 30 trials per test signal. The probability of detection is calculated by

$$Pd = \frac{TotalSetDetections}{TotalSetTrials} \times 100.$$

NOTE 3: For ChS = 10 MHz, Pd > 60 %; for ChS = 20 MHz, Pd > 70 %.

NOTE 4: For each of the trials, the burst interval will increase from 1,25 ms to 37,5 ms in Steps of 1,25 ms for radar signal 1 and from 5 ms to 150 ms in Steps of 5 ms for radar signal 2.

Table D.4: Example Interference Threshold values

Maximum EIRP (dBm)	Channel Width (MHz) ChS	EIRP Spectral Density (dBm/MHz)	Interference Threshold (dBm)	Antenna Gain (dBi)	DFS Detection Threshold (dBm)
36	20	23	-69	0	-69
36	20	23	-69	10	-59
33	20	20	-66	0	-66
33	10	23	-69	10	-59
30	20	17	-63	0	-63
30	10	20	-66	10	-56

## Annex E (informative): The EN title in the official languages

Language	EN title
Czech	Přístupové sítě širokopásmového rádia (BRAN) – Pevné širokopásmové datové přenosové systémy 5,8 GHz – Harmonizovaná EN pokrývající základní požadavky článku 3.2 Směrnice R&TTE
Danish	Bredbåndsradiaccessnet (BRAN); 5,8 GHz faste bredbånd datatransmissionssystemer; Harmoniseret EN, der dækker de væsentlige krav i R&TTE direktivets artikel 3.2
Dutch	
English	Broadband Radio Access Networks (BRAN); 5,8 GHz fixed broadband data transmitting systems; Harmonized EN covering essential requirements of article 3.2 of the R&TTE Directive
Estonian	Lairiba raadiojuurdepääsuvõrgud (BRAN); Raadiosagedusalas 5,8 GHz töötavad paiksed lairiba andmeedastussüsteemid; harmoneeritud EN R&TTE direktiivi artikli 3.2 põhinõuete alusel
Finnish	Laajakaistaiset radioliityntäverkot (BRAN); 5,8 GHz:n taajuudella toimivat kiinteät laajakaistaiset datasiirtojärjestelmät; Yhdenmukaistettu standardi (EN), joka kattaa R&TTE-direktiivin artiklan 3.2 mukaiset olennaiset vaatimukset.
French	
German	Breitbandige Funkzugangnetze (BRAN); Festinstallierte breitbandige Datenübertragungssysteme im 5,8-GHz-Band; Harmonisierte EN, die wesentliche Anforderungen nach Artikel 3.2 der R&TTE Richtlinie enthält
Greek	Ευρυζωνικά Δίκτυα Ραδιοπρόσβασης (BRAN) – Σταθερά συστήματα μετάδοσης δεδομένων ευρείας ζώνης 5,8 GHz - Εναρμονισμένο EN για την κάλυψη των ουσιωδών απαιτήσεων του Άρθρου 3.2 της Οδηγίας R&TTE
Hungarian	
Icelandic	
Italian	
Latvian	
Lithuanian	
Maltese	
Norwegian	
Polish	Szerokopasmowe radiowe sieci dostępowe (BRAN) – Szerokopasmowe systemy transmisji danych łączności stałej pracujące w paśmie częstotliwości 5,8 GHz – Zharmonizowana EN zapewniająca spełnienie zasadniczych wymagań zgodnie z artykułem 3.2 dyrektywy R&TTE
Portuguese	
Slovak	Širokopásmové rádiové prístupové siete (BRAN). Pevné širokopásmové dátové prenosové systémy v pásme 5,8 GHz. Harmonizovaná EN vzťahujúca sa na základné požiadavky podľa článku 3.2 smernice R&TTE
Slovenian	Širokopasovna radijska dostopovna omrežja (BRAN) – Fiksni širokopasovni oddajni sistemi, ki delujejo v pasu 5,8 GHz – Harmonizirani EN, ki zajema bistvene zahteve člena 3.2 direktive R&TTE
Spanish	
Swedish	Bredbandsradioaccessnät; Fasta sändarsystem för bredbandsdata i 5,8 GHz; Harmoniserad EN omfattande väsentliga krav enligt artikel 3.2 i R&TTE-direktivet

---

## History

<b>Document history</b>			
V1.1.1	August 2005	Public Enquiry	PE 20051223: 2005-08-24 to 2005-12-23
V1.1.1	August 2006	Vote	V 20061027: 2006-08-28 to 2006-10-27