

ETSI EN 302 480 V2.1.2 (2017-02)



**Mobile Communication On Board Aircraft (MCOBA) systems;
Harmonised Standard covering the essential requirements
of article 3.2 of Directive 2014/53/EU**

Reference

REN/MSG-TFES-11-30-RED-C1

Keywords

3G, 3GPP, cellular, digital, E-UTRA, GSM, LTE, mobile, radio, regulation, UMTS, UTRA, WCDMA

ETSI

650 Route des Lucioles
F-06921 Sophia Antipolis Cedex - FRANCE

Tel.: +33 4 92 94 42 00 Fax: +33 4 93 65 47 16

Siret N° 348 623 562 00017 - NAF 742 C
Association à but non lucratif enregistrée à la
Sous-Préfecture de Grasse (06) N° 7803/88

Important notice

The present document can be downloaded from:
<http://www.etsi.org/standards-search>

The present document may be made available in electronic versions and/or in print. The content of any electronic and/or print versions of the present document shall not be modified without the prior written authorization of ETSI. In case of any existing or perceived difference in contents between such versions and/or in print, the only prevailing document is the print of the Portable Document Format (PDF) version kept on a specific network drive within ETSI Secretariat.

Users of the present document should be aware that the document may be subject to revision or change of status. Information on the current status of this and other ETSI documents is available at
<https://portal.etsi.org/TB/ETSIDeliverableStatus.aspx>

If you find errors in the present document, please send your comment to one of the following services:
<https://portal.etsi.org/People/CommiteeSupportStaff.aspx>

Copyright Notification

No part may be reproduced or utilized in any form or by any means, electronic or mechanical, including photocopying and microfilm except as authorized by written permission of ETSI.

The content of the PDF version shall not be modified without the written authorization of ETSI.
The copyright and the foregoing restriction extend to reproduction in all media.

© European Telecommunications Standards Institute 2017.
All rights reserved.

DECT™, **PLUGTESTS™**, **UMTS™** and the ETSI logo are Trade Marks of ETSI registered for the benefit of its Members.
3GPP™ and **LTE™** are Trade Marks of ETSI registered for the benefit of its Members and of the 3GPP Organizational Partners.
GSM® and the GSM logo are Trade Marks registered and owned by the GSM Association.

Contents

Intellectual Property Rights	7
Foreword.....	7
Modal verbs terminology.....	7
Introduction	7
1 Scope.....	8
2 References	9
2.1 Normative references	9
2.2 Informative references.....	10
3 Definitions, symbols and abbreviations	10
3.1 Definitions.....	10
3.2 Symbols.....	11
3.3 Abbreviations	11
4 Technical requirements specifications	12
4.1 General	12
4.1.1 Environmental profile	12
4.1.2 MCOBA system states.....	12
4.2 Conformance requirements	13
4.2.1 Introduction.....	13
4.2.2 GSM-OBTS performance	15
4.2.2.1 GSM-OBTS maximum output power	15
4.2.2.1.1 Definition.....	15
4.2.2.1.2 Limits	15
4.2.2.1.3 Conformance	15
4.2.2.2 GSM-OBTS output RF spectrum.....	15
4.2.2.2.1 Spectrum due to modulation and wideband noise	15
4.2.2.2.2 Spectrum due to switching transients	16
4.2.2.3 GSM-OBTS radio frequency tolerance.....	16
4.2.2.3.1 Definition.....	16
4.2.2.3.2 Limits	16
4.2.2.3.3 Conformance	16
4.2.2.4 GSM-OBTS controlled MS RF power.....	16
4.2.2.4.1 Definition.....	16
4.2.2.4.2 Limits	16
4.2.2.4.3 Conformance	17
4.2.2.5 GSM-OBTS reference sensitivity level.....	17
4.2.2.5.1 Definition.....	17
4.2.2.5.2 Limits	17
4.2.2.5.3 Conformance	17
4.2.2.6 GSM-OBTS unwanted emissions in the spurious domain	17
4.2.2.6.1 Definition.....	17
4.2.2.6.2 Limits	17
4.2.2.6.3 Conformance	17
4.2.3 UTRA-OBTS performance.....	17
4.2.3.0 Conformance compliance.....	17
4.2.3.1 UTRA-OBTS Spectrum Mask	18
4.2.3.1.1 Definition.....	18
4.2.3.1.2 Limits	18
4.2.3.1.3 Conformance	18
4.2.3.2 UTRA-OBTS Adjacent Channel Leakage power Ratio (ACLR).....	18
4.2.3.2.1 Definition.....	18
4.2.3.2.2 Limits	18
4.2.3.2.3 Conformance	19
4.2.3.3 UTRA-OBTS Transmitter spurious emissions.....	19

4.2.3.3.1	Definition.....	19
4.2.3.3.2	Limits	19
4.2.3.3.3	Conformance	19
4.2.3.4	UTRA-OBTS maximum output power	19
4.2.3.4.1	Definition.....	19
4.2.3.4.2	Limits	20
4.2.3.4.3	Conformance	20
4.2.3.5	UTRA-OBTS Transmit intermodulation.....	20
4.2.3.5.1	Definition.....	20
4.2.3.5.2	Limits	20
4.2.3.5.3	Conformance	20
4.2.3.6	UTRA-OBTS Receiver spurious emissions	21
4.2.3.6.1	Definition.....	21
4.2.3.6.2	Limits	21
4.2.3.6.3	Conformance	21
4.2.3.7	UTRA-OBTS Blocking characteristics	21
4.2.3.7.1	Definition.....	21
4.2.3.7.2	Limits	21
4.2.3.7.3	Conformance	21
4.2.3.8	UTRA-OBTS Receiver intermodulation characteristics	22
4.2.3.8.1	Definition.....	22
4.2.3.8.2	Limits	22
4.2.3.8.3	Conformance	22
4.2.3.9	UTRA-OBTS Receiver adjacent channel selectivity	22
4.2.3.9.1	Definition.....	22
4.2.3.9.2	Limits	22
4.2.3.9.3	Conformance	23
4.2.3.10	UTRA-OBTS controlled UE RF power	23
4.2.3.10.1	Definition.....	23
4.2.3.10.2	Limits	23
4.2.3.10.3	Conformance	23
4.2.4	E-UTRA-OBTS performance	23
4.2.4.0	Conformance compliance.....	23
4.2.4.1	E-UTRA-OBTS operating band unwanted emissions	23
4.2.4.1.1	Definition.....	23
4.2.4.1.2	Limits	24
4.2.4.1.3	Conformance	24
4.2.4.2	E-UTRA-OBTS Adjacent Channel Leakage power Ratio (ACLR).....	24
4.2.4.2.1	Definition.....	24
4.2.4.2.2	Limits	24
4.2.4.2.3	Conformance	24
4.2.4.3	E-UTRA-OBTS transmitter spurious emissions	25
4.2.4.3.1	Definition.....	25
4.2.4.3.2	Limits	25
4.2.4.3.3	Conformance	25
4.2.4.4	E-UTRA-OBTS maximum output power	25
4.2.4.4.1	Definition.....	25
4.2.4.4.2	Limits	25
4.2.4.4.3	Conformance	25
4.2.4.5	E-UTRA-OBTS transmit intermodulation	26
4.2.4.5.1	Definition.....	26
4.2.4.5.2	Limits	26
4.2.4.5.3	Conformance	26
4.2.4.6	E-UTRA-OBTS receiver spurious emissions.....	26
4.2.4.6.1	Definition.....	26
4.2.4.6.2	Limits	26
4.2.4.6.3	Conformance	26
4.2.4.7	E-UTRA-OBTS Blocking characteristics	26
4.2.4.7.1	Definition.....	26
4.2.4.7.2	Limits	26
4.2.4.7.3	Conformance	27
4.2.4.8	E-UTRA-OBTS receiver intermodulation characteristics.....	27

4.2.4.8.1	Definition.....	27
4.2.4.8.2	Limits	27
4.2.4.8.3	Conformance	27
4.2.4.9	E-UTRA-OBTS Adjacent Channel Selectivity (ACS) and narrow-band blocking.....	27
4.2.4.9.1	Definition.....	27
4.2.4.9.2	Limits	27
4.2.4.9.3	Conformance	27
4.2.4.10	E-UTRA-OBTS controlled UE RF power	27
4.2.4.10.1	Definition.....	27
4.2.4.10.2	Limits	28
4.2.4.10.3	Conformance	28
4.2.5	NCU Transmitter Performance.....	28
4.2.5.1	NCU maximum mean power spectral density.....	28
4.2.5.1.1	Definition.....	28
4.2.5.1.2	Limits	28
4.2.5.1.3	Conformance	28
4.2.5.2	NCU power flatness	28
4.2.5.2.1	Definition.....	28
4.2.5.2.2	Limits	29
4.2.5.2.3	Conformance	29
4.2.5.3	NCU out-of-band emissions.....	29
4.2.5.3.1	Definition.....	29
4.2.5.3.2	Limits	29
4.2.5.3.3	Conformance	29
4.2.5.4	NCU spurious emissions	29
4.2.5.4.1	Definition.....	29
4.2.5.4.2	Limits	30
4.2.5.4.3	Conformance	30
4.2.6	MCOBA system performance.....	30
4.2.6.1	MCOBA Unwanted emissions in the out-of-band domain	30
4.2.6.1.1	Definition.....	30
4.2.6.1.2	Limits	30
4.2.6.2	MCOBA Unwanted emissions in the spurious domain.....	30
4.2.6.2.1	Definition.....	30
4.2.6.2.2	Limits	31
4.2.6.3	MCOBA Cessation of emission	31
4.2.6.3.1	Definition.....	31
4.2.6.3.2	Specification.....	31
5	Testing for compliance with technical requirements.....	31
5.1	Interpretation of results and measurement uncertainty.....	31
5.1.1	Environmental conditions for testing	31
5.1.2	Interpretation of the measurement results	31
5.1.3	Measurement options.....	33
5.2	Essential radio test suites.....	33
5.2.1	GSM-OBTS Performance.....	33
5.2.1.1	GSM-OBTS controlled MS RF power.....	33
5.2.1.1.1	Test purpose	33
5.2.1.1.2	Methods of measurement.....	33
5.2.2	UTRA-OBTS Transmitter Performance	34
5.2.2.1	UTRA-OBTS controlled UE RF power	34
5.2.2.1.1	Test purpose	34
5.2.2.1.2	Methods of measurement.....	35
5.2.3	E-UTRA-OBTS Transmitter Performance	35
5.2.3.1	E-UTRA-OBTS-controlled UE RF power	35
5.2.3.1.1	Test Purpose	35
5.2.3.1.2	Test Procedure.....	35
5.2.4	NCU Transmitter Performance.....	36
5.2.4.1	NCU maximum mean power spectral density.....	36
5.2.4.1.1	Test purpose	36
5.2.4.1.2	Methods of measurement.....	36
5.2.4.2	NCU power flatness	37

5.2.4.2.1	Test purpose	37
5.2.4.2.2	Methods of measurement.....	37
5.2.5	MCOBA Transmitter Performance.....	38
5.2.5.1	Unwanted emissions in the out-of-band domain	38
5.2.5.1.1	Test purpose	38
5.2.5.1.2	Methods of measurement.....	38
5.2.5.2	Unwanted emissions in the spurious domain	40
5.2.5.2.1	Test purpose	40
5.2.5.2.2	Methods of measurement.....	40
5.2.5.3	Cessation of emissions	41
5.2.5.3.1	Test purpose	41
5.2.5.3.2	Methods of measurement.....	41
Annex A (normative):	Relationship between the present document and the essential requirements of Directive 2014/53/EU	43
Annex B (normative):	Environmental conditions	45
B.1	General	45
B.2	Environmental conformance requirements.....	45
B.3	Environmental test conditions	45
Annex C (informative):	System Description	46
C.1	High level System Description.....	46
C.2	OBTS.....	47
C.3	RF Screening.....	47
C.4	Dedicated antenna system	47
C.5	Dedicated antenna installation.....	48
Annex D (informative):	Bibliography.....	49
History		50

Intellectual Property Rights

IPRs essential or potentially essential to the present document may have been declared to ETSI. The information pertaining to these essential IPRs, if any, is publicly available for **ETSI members and non-members**, and can be found in ETSI SR 000 314: "*Intellectual Property Rights (IPRs); Essential, or potentially Essential, IPRs notified to ETSI in respect of ETSI standards*", which is available from the ETSI Secretariat. Latest updates are available on the ETSI Web server (<https://ipr.etsi.org>).

Pursuant to the ETSI IPR Policy, no investigation, including IPR searches, has been carried out by ETSI. No guarantee can be given as to the existence of other IPRs not referenced in ETSI SR 000 314 (or the updates on the ETSI Web server) which are, or may be, or may become, essential to the present document.

Foreword

This Harmonised European Standard (EN) has been produced by ETSI Technical Committee Mobile Standards Group (MSG).

For non EU countries the present document may be used for regulatory (Type Approval) purposes.

The present document has been prepared under the Commission's standardisation request C(2015) 5376 final [i.9] to provide one voluntary means of conforming to the essential requirements of Directive 2014/53/EU on the harmonisation of the laws of the Member States relating to the making available on the market of radio equipment and repealing Directive 1999/5/EC [i.1].

Once the present document is cited in the Official Journal of the European Union under that Directive, compliance with the normative clauses of the present document given in table A.1 confers, within the limits of the scope of the present document, a presumption of conformity with the corresponding essential requirements of that Directive, and associated EFTA regulations.

National transposition dates	
Date of latest announcement of this EN (doa):	31 May 2017
Date of latest publication of new National Standard or endorsement of this EN (dop/e):	31 October 2017
Date of withdrawal of any conflicting National Standard (dow):	31 October 2018

Modal verbs terminology

In the present document "**shall**", "**shall not**", "**should**", "**should not**", "**may**", "**need not**", "**will**", "**will not**", "**can**" and "**cannot**" are to be interpreted as described in clause 3.2 of the [ETSI Drafting Rules](#) (Verbal forms for the expression of provisions).

"**must**" and "**must not**" are **NOT** allowed in ETSI deliverables except when used in direct citation.

Introduction

The present document is part of a set of standards developed by ETSI that are designed to fit in a modular structure to cover radio equipment within the scope of the Radio Equipment Directive 2014/53/EU [i.1]. The present document is produced following the guidance in ETSI EG 203 336 [i.2] as applicable.

1 Scope

The present document applies to the following equipment types:

- 1) An Onboard Base Transceiver System (OBTS) supporting GSM, UMTS or LTE communication protocols including specific functions for restricting the transmit power of the MSs or UEs, respectively associated with the OBTS.
- 2) Network Control Unit (NCU) preventing direct connection of the onboard mobile terminals with mobile networks on the ground by raising the noise floor in the cabin.

These Base stations are capable of operating in all or any part of the frequency bands given in table 1-1.

Table 1-1: Base station operating bands

Band designation	Direction of transmission	Base Station operating bands
UTRA I	BS Transmit	2 110 MHz to 2 170 MHz (UMTS)
	BS Receive	1 920 MHz to 1 980 MHz (UMTS)
E-UTRA 3	BS Transmit	1 805 MHz to 1 880 MHz (LTE)
	BS Receive	1 710 MHz to 1 785 MHz (LTE)
DCS 1800	BS Transmit	1 805 MHz to 1 880 MHz (GSM)
	BS Receive	1 710 MHz to 1 785 MHz (GSM)

These NCU is capable of operating in all of the frequency bands given in table 1-2.

Table 1-2: NCU operating bands

NCU operating bands	Comment
460 MHz to 470 MHz	
791 MHz to 821 MHz	LTE
921 MHz to 960 MHz	GSM
1 805 MHz to 1 880 MHz	GSM / LTE
2 110 MHz to 2 170 MHz	UMTS
2 570 MHz to 2 620 MHz	LTE
2 620 MHz to 2 690 MHz	LTE

It applies to equipment for continuous and discontinuous transmission of data and digital speech.

The present document applies only to radio equipment using a dedicated transmitting antenna that is designed as an indispensable part of the system for usage on board an aircraft.

Within the European Union, the system covered by the present document operates in accordance with the operational requirements as outlined in the Commission Decision 2013/654/EU [i.3].

The present document contain requirements to demonstrate that Radio equipment both effectively uses and supports the efficient use of radio spectrum in order to avoid harmful interference.

In addition to the present document, other ENs that specific technical requirements in respect of essential requirements under other parts of Article 3 of the Radio Equipment Directive may apply to equipment within the scope of the present document.

The present document does not cover equipment compliance with relevant civil aviation regulations. In this respect, a MCOBA system, for its installation and operation on board an aircraft is subject to additional national or international civil aviation airworthiness certification requirements, for example to EUROCAE ED-14G [i.6].

2 References

2.1 Normative references

References are either specific (identified by date of publication and/or edition number or version number) or non-specific. For specific references, only the cited version applies. For non-specific references, the latest version of the referenced document (including any amendments) applies.

Referenced documents which are not found to be publicly available in the expected location might be found at <http://docbox.etsi.org/Reference>.

NOTE: While any hyperlinks included in this clause were valid at the time of publication, ETSI cannot guarantee their long term validity.

The following referenced documents are necessary for the application of the present document.

- [1] ETSI EN 301 908-14 (V11.1.1) (05-2016): "IMT cellular networks; Harmonised Standard covering the essential requirements of article 3.2 of the Directive 2014/53/EU; Part 14: Evolved Universal Terrestrial Radio Access (E-UTRA) Base Stations (BS)".
- [2] ETSI TS 145 005 (V12.5.0) (04-2015): "Digital cellular telecommunications system (Phase 2+); Radio transmission and reception (3GPP TS 45.005 version 12.5.0 Release 12)".
- [3] ETSI TS 145 010 (V12.0.0) (10-2014): "Digital cellular telecommunications system (Phase 2+); Radio subsystem synchronization (3GPP TS 45.010 version 12.0.0 Release 12)".
- [4] ETSI TS 145 008 (V12.4.0) (01-2015): "Digital cellular telecommunications system (Phase 2+); Radio subsystem link control (3GPP TS 45.008 version 12.4.0 Release 12)".
- [5] ETSI TS 136 141 (V12.9.0) (10-2015): "LTE; Evolved Universal Terrestrial Radio Access (E-UTRA); Base Station (BS) conformance testing (3GPP TS 36.141 version 12.9.0 Release 12)".
- [6] ETSI TS 151 021 (V12.3.0) (01-2015): "Digital cellular telecommunications system (Phase 2+); Base Station System (BSS) equipment specification; Radio aspects (3GPP TS 51.021 version 12.3.0 Release 12)".
- [7] ETSI EN 301 908-3 (V11.1.2) (07-2016): "IMT cellular networks; Harmonized Standard covering the essential requirements of article 3.2 of the Directive 2014/53/EU; Part 3: CDMA Direct Spread (UTRA FDD) Base Stations (BS)".
- [8] ETSI EN 301 908-18 (V11.1.1) (07-2016): "IMT cellular networks; Harmonized Standard covering the essential requirements of article 3.2 of the Directive 2014/53/EU; Part 18: E-UTRA, UTRA and GSM/EDGE Multi-Standard Radio (MSR) Base Station (BS)".
- [9] ETSI TS 125 141 (V12.7.0) (10-2015): "Universal Mobile Telecommunications System (UMTS); Base Station (BS) conformance testing (FDD) (3GPP TS 25.141 version 12.7.0 Release 12)".
- [10] ETSI TS 125 331 (V12.7.0) (10-2015): "Universal Mobile Telecommunications System (UMTS); Radio Resource Control (RRC); Protocol specification (3GPP TS 25.331 version 12.7.0 Release 12)".
- [11] ETSI TS 136 101 (V12.9.0) (10-2015): "LTE; Evolved Universal Terrestrial Radio Access (E-UTRA); User Equipment (UE) radio transmission and reception (3GPP TS 36.101 version 12.7.0 Release 12)".
- [12] ETSI TS 136 331 (V12.7.0) (10-2015): "LTE; Evolved Universal Terrestrial Radio Access (E-UTRA); Radio Resource Control (RRC); Protocol specification (3GPP TS 36.331 version 12.7.0 Release 12)".
- [13] ETSI TS 125 133 (V12.8.0) (07-2015): "Universal Mobile Telecommunications System (UMTS); Requirements for support of radio resource management (FDD) (3GPP TS 25.133 version 12.8.0 Release 12)".

2.2 Informative references

References are either specific (identified by date of publication and/or edition number or version number) or non-specific. For specific references, only the cited version applies. For non-specific references, the latest version of the referenced document (including any amendments) applies.

NOTE: While any hyperlinks included in this clause were valid at the time of publication, ETSI cannot guarantee their long term validity.

The following referenced documents are not necessary for the application of the present document but they assist the user with regard to a particular subject area.

- [i.1] Directive 2014/53/EU of the European Parliament and of the Council of 16 April 2014 on the harmonisation of the laws of the Member States relating to the making available on the market of radio equipment and repealing Directive 1999/5/EC (Radio Equipment Directive).
- [i.2] ETSI EG 203 336 (V1.1.1) (08-2015): "Electromagnetic compatibility and Radio spectrum Matters (ERM); Guide for the selection of technical parameters for the production of Harmonised Standards covering article 3.1(b) and article 3.2 of Directive 2014/53/EU".
- [i.3] Commission Decision 2013/654/EU amending Decision 2008/294/EC to include additional access technologies and frequency bands for mobile communications services on aircraft (MCA services), 12.11.2013.
- [i.4] CEPT/ERC/REC 74-01 (01-2011) (equivalent to Recommendation ITU-R SM.329-12): "Unwanted emissions in the spurious domain".
- [i.5] ETSI TR 100 028 (all parts) (V1.4.1) (12-2001): "Electromagnetic compatibility and Radio spectrum Matters (ERM); Uncertainties in the measurement of mobile radio equipment characteristics".
- [i.6] EUROCAE ED-14G (05-2011): "Environmental Conditions and Test Procedures for Airborne Equipment".
- [i.7] 3GPP2 C.S0011-C (V2.0): "Recommended Minimum Performance Standards for cdma2000 Spread Spectrum Mobile Stations".
- [i.8] ETSI TS 125 104 (V12.6.0) (10-2015): "Universal Mobile Telecommunications System (UMTS); Base Station (BS) radio transmission and reception (FDD) (3GPP TS 25.104 version 12.6.0 Release 12)".
- [i.9] Commission Implementing Decision C(2015) 5376 final of 4.8.2015 on a standardisation request to the European Committee for Electrotechnical Standardisation and to the European Telecommunications Standards Institute as regards radio equipment in support of Directive 2014/53/EU of the European Parliament and of the Council.
- [i.10] ETSI EN 301 908-1 (V11.1.1) (07-2016): "IMT cellular networks; Harmonized Standard covering the essential requirements of article 3.2 of the Directive 2014/53/EU; Part 1: Introduction and common requirements".

3 Definitions, symbols and abbreviations

3.1 Definitions

For the purposes of the present document, the following terms and definitions apply:

Base Station System Test Equipment (BSSTE): functional tool for the purpose of acceptance testing of GSM, UMTS or LTE Base Station Systems

NOTE: The BSSTE functionally carries out all tests described in the OBTS specification.

environmental profile: range of environmental conditions under which equipment within the scope of the present document is required to comply with the provisions of the present document

Mobile Communication OnBoard Aircraft system (MCOBA): system comprising the functions provided by the NCU and the OBTS

Network Control Unit (NCU): component of the GSM, UTRA or E-UTRA onboard aircraft system preventing direct connection of the onboard mobile terminals with mobile networks on the ground by raising the noise floor in the cabin

Onboard Base Transceiver Station (OBTS): component of the GSM, UTRA or E-UTRA onboard aircraft system responsible for radio transmission and reception to or from the onboard mobile terminals

3.2 Symbols

For the purposes of the present document, the following symbols apply:

Bw	Bandwidth of one band
dB	decibel
dBm	decibel relative to 1 mW
Fc	centre frequency of the band
P _{max}	Maximum output power (per band)
P _{max,c}	Maximum output power (per carrier)

3.3 Abbreviations

For the purposes of the present document, the following abbreviations apply:

ACLR	Adjacent Channel Leakage power Ratio
ACS	Adjacent Channel Selectivity
ACU	Antenna Coupler Unit
AGL	Above Ground Level
BCCH	Broadcast Control CHannel
BCH	Broadcast Channel
BER	Bit Error Rate
BLER	Block Error Rate
BS	Base Station
BSSTE	Base Station System Test Equipment
BTS	Base Transceiver Station
BW	Bandwidth
CACLR	Cumulative Adjacent Channel Leakage Ratio
CW	Continuous Wave
DCS	Digital Cellular System
DL-SCH	DownLink Shared Channel
DTM	Dual Transfer Mode
e.i.r.p.	equivalent isotropically radiated power
ECC	Electronic Communications Committee
EFTA	European Free Trade Association
EMC	ElectroMagnetic Compatibility
FDD	Frequency Division Duplexing
FER	Frame Error Rate
GPRS	General Packet Radio Service
GSM	Global System for Mobile communications
IMT	International Mobile Telecommunications
LTE	Long Term Evolution
MCOBA	Mobile Communication OnBoard Aircraft
MS	Mobile Station
NCU	Network Control Unit
OBTS	Onboard Base Transceiver Station
PBCCH	Packet Broadcast Control CHannel
RACH	Random Access CHannel
RBER	Residual BER

RBW	Resolution BandWidth
RF	Radio Frequency
rms	root mean square
RRC	Radio Resource Control
SIB	System Information Block
STE	Special Test Equipment
TCH	Traffic CHannel
UE	User Equipment
UL	UpLink
UMTS	Universal Mobile Telecommunications System
UTRA	Universal Terrestrial Radio Access
UTRAN	Universal Terrestrial Radio Access Network
VBW	Video BandWidth
WCDMA	Wide band Code Division Multiple Access

4 Technical requirements specifications

4.1 General

4.1.1 Environmental profile

The technical requirements of the present document apply under the environmental profile for operation of the equipment, which shall be declared by the manufacturer. The equipment shall comply with all the technical requirements of the present document at all times when operating within the boundary limits of the declared operational environmental profile and for the environmental conditions (as specified in clause B.3).

4.1.2 MCOBA system states

Figure 4.1.2-1 represents the state diagram of the MCOBA system.

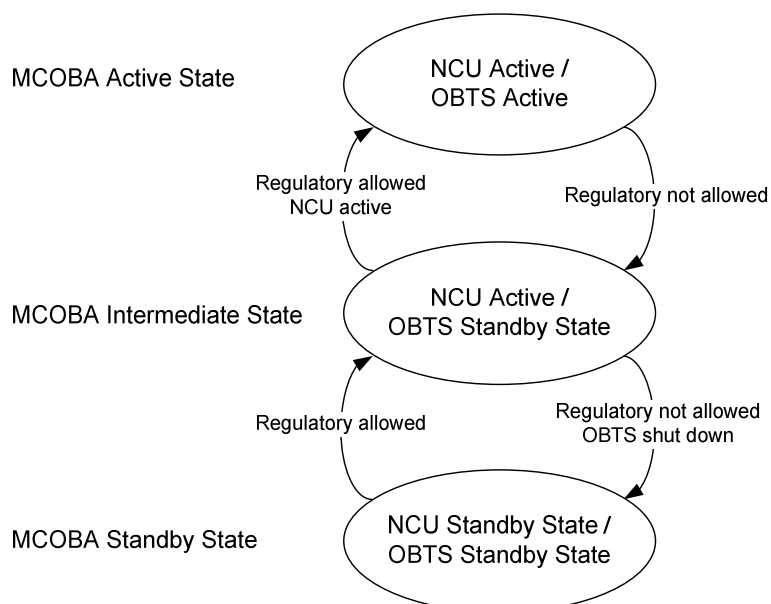

Figure 4.1.2-1: State diagram of an MCOBA system which includes an NCU

When the NCU function of the MCOBA system is in NCU Active state the Transmitter of the NCU is transmitting, whereas when the NCU function of the MCOBA system is in NCU Standby state the Transmitter of the NCU is not transmitting.

When the OBTS function of the MCOBA system is in OBTS Active state the Transmitter of the OBTS is transmitting, whereas when the OBTS function of the MCOBA system is in OBTS Standby state the Transmitter of the OBTS is not transmitting.

When the MCOBA system is in Active state, both the OBTS and the NCU are in Active state, whereas when the MCOBA system is in Standby state, both OBTS and NCU are in Standby state. When the MCOBA system is in Intermediate State, the NCU is in Active state and the OBTS is in Standby state. The Intermediate State is introduced to ensure a stable going-into-service of the MCOBA system with the NCU running first and the OBTS afterwards. The NCU function for the relevant frequency band(s) of the MCOBA system is allowed to enter the "Active" state after take-off or to remain in the "Active" state during the flight only when the regulatory conditions for the service operation as authorized by the regulatory administration of the country passed over are satisfied.

The OBTS function of the MCOBA system is allowed to enter the "Active" state after the take-off or to remain in the "Active" state during the flight only when the regulatory condition for the service operation as authorized by the regulatory administration of the country passed over are satisfied and proper NCU initialization has been reached.

The OBTS function of the MCOBA system enters the "Standby" state:

- when the aircraft reaches the regulatory condition as authorized by the regulatory authority of the country/countries passed over which do not allow to operate a MCOBA system; or
- if the OBTS functionality of the MCOBA service is intentionally deactivated.

The NCU function of the MCOBA system enters the "Standby" state:

- when the aircraft reaches the regulatory condition as authorized by the regulatory authority of the country/countries passed over which do not allow to operate a MCOBA system. In both cases it has to be ensured by operational means, that all user equipment radio functionality has been deactivated at the time the NCU function enters the "Standby" state.

The evaluation of the regulatory condition is outside of this MCOBA system defined here, and given as input trigger to the MCOBA system shown above. This includes e.g. the evaluation of the 3000m above ground requirement defined in Commission Decision 2013/654/EU [i.3].

4.2 Conformance requirements

4.2.1 Introduction

The requirements in the present document are based on the assumption that the operating band (see table 1-1) is shared between systems of the IMT family (for band III and VIII also GSM) or systems having compatible characteristics.

To meet the essential requirement under article 3.2 of Directive 2014/53/EU [i.1] for IMT Base Stations (BS), a set of essential parameters in addition to those in ETSI EN 301 908-1 [i.10] have been identified. Table 4.2.1-1 provides a cross reference between these essential parameters and the corresponding technical requirements for equipment within the scope of the present document.

Table 4.2.1-1: Cross references

Essential parameter	Corresponding technical requirements	Corresponding test suite
Transmitter spectrum mask	4.2.2.2 GSM-OBTS output RF spectrum	Note
Transmitter unwanted emissions in the out-of-band domain	4.2.3.1 UTRA-OBTS Spectrum Mask	Note
	4.2.3.2 UTRA-OBTS Adjacent Channel Leakage power Ratio (ACLR)	Note
	4.2.4.1 E-UTRA-OBTS operating band unwanted emissions	Note
	4.2.4.2 E-UTRA-OBTS Adjacent Channel Leakage power Ratio (ACLR)	Note
	4.2.5.3 NCU out-of-band emissions	5.2.5.1
	4.2.6.1 MCOBA Unwanted emissions in the out-of-band domain	5.2.5.1
Transmitter unwanted emissions in the spurious domain	4.2.2.6 GSM-OBTS spurious emissions	Note
	4.2.3.3 UTRA-OBTS Transmitter spurious emissions	Note
	4.2.4.3 E-UTRA-OBTS transmitter spurious emissions	Note
	4.2.5.4 NCU spurious emissions	5.2.5.2
	4.2.6.2 MCOBA Unwanted emissions in the spurious domain	5.2.5.2
	4.2.6.3 MCOBA Cessation of emission	5.2.5.3
Transmitter power accuracy	4.2.2.1 GSM-OBTS maximum output power	Note
	4.2.2.4 GSM-OBTS controlled MS RF power	5.2.1
	4.2.3.4 UTRA-OBTS maximum output power	Note
	4.2.3.10 UTRA-OBTS controlled UE RF power	5.2.2
	4.2.4.4 E-UTRA-OBTS maximum output power	Note
	4.2.4.10 E-UTRA-OBTS controlled UE RF power	5.2.3
	4.2.5.1 NCU maximum mean power spectral density	5.2.4.1
	4.2.5.2 NCU power flatness	5.2.4.2
Transmitter frequency stability	4.2.2.3 GSM-OBTS radio frequency tolerance	Note
Transmitter intermodulation attenuation	4.2.3.5 UTRA-OBTS Transmit intermodulation	Note
	4.2.4.5 E-UTRA-OBTS transmit intermodulation	Note
Receiver unwanted emissions in the spurious domain	4.2.3.6 UTRA-OBTS Receiver spurious emissions	Note
	4.2.4.6 E-UTRA-OBTS receiver spurious emissions	Note
Receiver blocking	4.2.3.7 UTRA-OBTS Blocking characteristics	Note
Receiver desensitization	4.2.4.7 E-UTRA-OBTS Blocking characteristics	Note
Receiver radio-frequency intermodulation	4.2.3.8 UTRA-OBTS Receiver intermodulation characteristics	Note
	4.2.4.8 E-UTRA-OBTS receiver intermodulation characteristics	Note
Receiver adjacent signal selectivity	4.2.3.9 UTRA-OBTS Receiver adjacent channel selectivity	Note
	4.2.4.9 E-UTRA-OBTS Adjacent Channel Selectivity (ACS) and narrow-band blocking	Note
Receiver sensitivity	4.2.2.5 GSM-OBTS reference sensitivity level	Note
NOTE: Conformance of technical requirements not defined in this table are defined in table 4.2.1-2.		

The manufacturer shall declare the following:

- The operating band(s) supported by the Base Station according to table 1-1.
- The intended class of the BS under test.

Table 4.2.1-2: Test suites for demonstrating BS conformance

Corresponding technical requirements	Corresponding test suite
4.2.2.2 GSM-OBTS output RF spectrum	6.5.1.2 of ETSI TS 151 021 [6] 4.2.2 of ETSI TS 145 005 [2]
4.2.3.1 UTRA-OBTS Spectrum Mask	5.3.1 of ETSI EN 301 908-3 [7]
4.2.3.2 UTRA-OBTS Adjacent Channel Leakage power Ratio (ACLR)	5.3.2 of ETSI EN 301 908-3 [7]
4.2.4.1 E-UTRA-OBTS operating band unwanted emissions	5.3.1 of ETSI EN 301 908-14 [1]
4.2.4.2 E-UTRA-OBTS Adjacent Channel Leakage power Ratio (ACLR)	5.3.2 of ETSI EN 301 908-14 [1]
4.2.2.6 GSM-OBTS spurious emissions	7.9.2 of ETSI TS 151 021 [6]
4.2.3.3 UTRA-OBTS Transmitter spurious emissions	5.3.3 of ETSI EN 301 908-3 [7]
4.2.4.3 E-UTRA-OBTS transmitter spurious emissions	5.3.3 of ETSI EN 301 908-14 [1]
4.2.2.1 GSM-OBTS maximum output power	6.3.2 of ETSI TS 151 021 [6]
4.2.3.4 UTRA-OBTS maximum output power	5.3.4 of ETSI EN 301 908-3 [7]
4.2.4.4 E-UTRA-OBTS maximum output power	5.3.4 of ETSI EN 301 908-14 [1]
4.2.2.3 GSM-OBTS radio frequency tolerance	6.2.2 of ETSI TS 151 021 [6]
4.2.3.5 UTRA-OBTS Transmit intermodulation	5.3.5 of ETSI EN 301 908-3 [7]
4.2.4.5 E-UTRA-OBTS transmit intermodulation	5.3.5 of ETSI EN 301 908-14 [1]
4.2.3.6 UTRA-OBTS Receiver spurious emissions	5.3.6 of ETSI EN 301 908-3 [7]
4.2.4.6 E-UTRA-OBTS receiver spurious emissions	5.3.6 of ETSI EN 301 908-14 [1]
4.2.3.7 UTRA-OBTS Blocking characteristics	5.3.7 of ETSI EN 301 908-3 [7]
4.2.4.7 E-UTRA-OBTS Blocking characteristics	5.3.7 of ETSI EN 301 908-14 [1]
4.2.3.8 UTRA-OBTS Receiver intermodulation characteristics	5.3.8 of ETSI EN 301 908-3 [7]
4.2.4.8 E-UTRA-OBTS receiver intermodulation characteristics	5.3.8 of ETSI EN 301 908-14 [1]
4.2.3.9 UTRA-OBTS Receiver adjacent channel selectivity	5.3.9 of ETSI EN 301 908-3 [7]
4.2.4.9 E-UTRA-OBTS Adjacent Channel Selectivity (ACS) and narrow-band blocking	5.3.9 of ETSI EN 301 908-14 [1]
4.2.2.5 GSM-OBTS reference sensitivity level	7.3.2 of ETSI TS 151 021 [6]

4.2.2 GSM-OBTS performance

4.2.2.1 GSM-OBTS maximum output power

4.2.2.1.1 Definition

Output power refers to the measure of the power when averaged over the useful part of the burst (see clause 4.1.2 of ETSI TS 145 005 [2]).

4.2.2.1.2 Limits

The limit for the OBTS maximum output power shall conform to the maximum limit in clause 4.1.2 of ETSI TS 145 005 [2] for the DCS 1800 BTS power class P1 (pico BTS).

NOTE: Conformance to the power limits in clause 4.1.2 of ETSI TS 145 005 [2] for the BTS power class P1 should not be interpreted as conformance of e.i.r.p. authorization limits as defined in the Decision 2013/654/EU [i.3].

4.2.2.1.3 Conformance

Conformance tests described in clause 6.3.2 of ETSI TS 151 021 [6] shall be carried out.

4.2.2.2 GSM-OBTS output RF spectrum

4.2.2.2.1 Spectrum due to modulation and wideband noise

4.2.2.2.1.1 Definition

The spectrum due to modulation and wideband noise is the spectral spread caused by the modulation process in the transmitter.

4.2.2.2.1.2 Limits

The limit for the OBTS output RF modulation spectrum shall conform to the limits in clause 4.2.1 of ETSI TS 145 005 [2] for the applicable DCS 1800 BTS power class P1 (pico BTS).

4.2.2.2.1.3 Conformance

Conformance tests described in clause 6.5.1.2 of ETSI TS 151 021 [6] shall be carried out for the DCS 1800 BTS power class P1 (pico BTS).

4.2.2.2.2 Spectrum due to switching transients

4.2.2.2.2.1 Definition

The spectrum due to switching transients is the undesirable spectrum components in the transmission if the RF power is ramped too quickly.

4.2.2.2.2.2 Limits

The limit for the OBTS RF switching transients spectrum shall conform to the limits in clause 4.2.2 of ETSI TS 145 005 [2] for the applicable DCS 1800 BTS.

4.2.2.2.2.3 Conformance

Conformance tests described in clause 6.5.2.2 of ETSI TS 151 021 [6] shall be carried out for the DCS 1800 BTS.

4.2.2.3 GSM-OBTS radio frequency tolerance

4.2.2.3.1 Definition

The radio frequency tolerance of the transmitter is the difference between the unmodulated carrier frequency and the nominal frequency selected for the test.

4.2.2.3.2 Limits

The limit for the radio frequency tolerance shall conform to the limits in clause 5.1 of ETSI TS 145 010 [3] for the applicable DCS 1800 BTS power class P1 (pico BTS).

4.2.2.3.3 Conformance

Conformance tests described in clause 6.2.2 of ETSI TS 151 021 [6] shall be carried out.

4.2.2.4 GSM-OBTS controlled MS RF power

4.2.2.4.1 Definition

When an MS is switched on, it first scans its RF environment, then selects one GSM cell to camp on and then decodes the System Information transmitted on the BCCH channel of that cell. One of the parameters (MS_TXPWR_MAX_CCH) contained in the System Information (SI3) indicates to MS the maximum transmit power level that can be used by an MS during the initial access.

4.2.2.4.2 Limits

The following parameters shall be set to the power control level 15 i.e. 0 dBm as stated for DCS 1800 MS (ETSI TS 145 005 [2], clause 4.1.1):

- MS_TXPWR_MAX_CCH;
- POWER_LEVEL; and

- GPRS_MS_TXPWR_MAX_CCH (if PBCCH is implemented).

POWER OFFSET shall be set to the value "0" i.e. 0 dB (ETSI TS 145 008 [4], clause 9 only applicable for class 3 DCS1800 MS).

4.2.2.4.3 Conformance

Conformance tests described in clause 5.2.1.1 shall be carried out.

4.2.2.5 GSM-OBTS reference sensitivity level

4.2.2.5.1 Definition

The static reference sensitivity level of the receiver is the level of signal at the receiver input with a standard test signal at which the receiver will produce after demodulation and channel decoding data with a Frame Erasure Ratio (FER), Residual Bit Error Ratio (RBER) Bit Error Ratio (BER) or Block Error Ratio (BLER) better than or equal to that specified for a specific logical channel type under static propagation conditions.

4.2.2.5.2 Limits

The limit for the OBTS reference sensitivity level shall conform to the limits in clause 6.2 of ETSI TS 145 005 [2] for the applicable DCS 1800 BTS power class P1 (pico BTS).

4.2.2.5.3 Conformance

Conformance tests described in clause 7.3.2 of ETSI TS 151 021 [6] shall be carried out for the DCS 1800 BTS power class P1 (pico BTS).

4.2.2.6 GSM-OBTS unwanted emissions in the spurious domain

4.2.2.6.1 Definition

Unwanted emissions in the spurious domain are emissions at frequencies, other than those of the transmitter carrier and sidebands associated with normal modulation at the adjacent frequencies.

4.2.2.6.2 Limits

The limit for the spurious emissions for the OBTS Receiver shall conform to the limits in clause 5.4 of ETSI TS 145 005 [2].

4.2.2.6.3 Conformance

Conformance tests described in clause 7.9.2 of ETSI TS 151 021 [6] shall be carried out.

4.2.3 UTRA-OBTS performance

4.2.3.0 Conformance compliance

Conformance to the clauses below is a necessary precondition for compliance with EC Decision 2013/654/EU [i.3] but shall not be interpreted as automatic conformance to EC Decision 2013/654/EU [i.3]. The limitations, in particular with respect to allowed frequency bands, e.i.r.p. authorization limits and operational requirements from EC Decision 2013/654/EU [i.3] apply.

4.2.3.1 UTRA-OBTS Spectrum Mask

4.2.3.1.1 Definition

Out-of-band emissions are unwanted emissions immediately outside the channel bandwidth resulting from the modulation process and non-linearity in the transmitter but excluding spurious emissions. This out-of-band emission limit is specified in terms of a spectrum emission mask and adjacent channel leakage power ratio for the transmitter.

For a UTRA-OBTS additionally conforming to ETSI EN 301 908-18 [8], either the requirement of the present clause or the Operating band unwanted emissions requirement in clause 4.2.2 of ETSI EN 301 908-18 [8] can be equally applied.

For a UTRA-OBTS additionally conforming to ETSI EN 301 908-3 [7], either the requirement of the present clause or the Spectrum emissions mask requirements in clause 4.2.2 of ETSI EN 301 908-3 [7] can be equally applied.

4.2.3.1.2 Limits

The limit for the UTRA-OBTS Spectrum Emission Mask shall conform to the limits in clause 4.2.2.2 of ETSI EN 301 908-3 [7] for UTRA FDD single-band operation ≤ 3 GHz and for the BS maximum output power category corresponding to the indicated UTRA-OBTS maximum output power of applicable BS class.

4.2.3.1.3 Conformance

Conformance tests described in clause 5.3.1 of ETSI EN 301 908-3 [7] for UTRA FDD single-band operation ≤ 3 GHz and for the BS maximum output power category corresponding to the indicated UTRA-OBTS maximum output power of applicable BS class shall be carried out.

For a UTRA-OBTS additionally conforming to ETSI EN 301 908-3 [7], either the test suite of the present clause or the Spectrum emission mask test suite in clause 5.3.1 of ETSI EN 301 908-3 [7] can be equally applied.

4.2.3.2 UTRA-OBTS Adjacent Channel Leakage power Ratio (ACLR)

4.2.3.2.1 Definition

Adjacent Channel Leakage power Ratio (ACLR) is the ratio of the RRC filtered mean power centred on the assigned channel frequency to the RRC filtered mean power centred on an adjacent channel frequency.

The requirements shall apply outside the BS RF bandwidth edges or maximum radio bandwidth edges whatever the type of transmitter considered (single carrier or multi-carrier). It shall apply for all transmission modes foreseen by the manufacturer's specification.

For a BS operating in non-contiguous spectrum, ACLR requirement also shall apply for the first adjacent channel, inside any sub-block gap with a gap size $W_{\text{gap}} \geq 15$ MHz. The ACLR requirement for the second adjacent channel shall apply inside any sub-block gap with a gap size $W_{\text{gap}} \geq 20$ MHz. The CACLR requirement in clause 6.5.2.2.2 of ETSI EN 301 908-3 [7] shall apply in sub-block gaps for the frequency ranges defined in table 4.2.3.2-2 of ETSI EN 301 908-3 [7].

For a UTRA-OBTS additionally conforming to ETSI EN 301 908-3 [7], either the requirement of the present clause or the Adjacent Channel Leakage Power Ratio (ACLR) requirement in clause 4.2.3 of ETSI EN 301 908-3 [7] can be equally applied.

4.2.3.2.2 Limits

The limit for the UTRA-OBTS Adjacent Channel Leakage Power Ratio (ACLR) shall conform to the limits in clause 4.2.3.2 of ETSI EN 301 908-3 [7] for the applicable BS class and for single-band operation.

4.2.3.2.3 Conformance

Conformance tests described in clause 5.3.2 of ETSI EN 301 908-3 [7] for UTRA FDD single-band shall be carried out.

For a UMTS-OBTS additionally conforming to ETSI EN 301 908-3 [7], either the test suite of the present clause or the Adjacent Channel Leakage Power Ratio (ACLR) test suite in clause 5.3.3 of ETSI EN 301 908-3 [7] can be equally applied.

4.2.3.3 UTRA-OBTS Transmitter spurious emissions

4.2.3.3.1 Definition

Spurious emissions are emissions which are caused by unwanted transmitter effects such as harmonics emission, parasitic emission, intermodulation products and frequency conversion products, but exclude out-of-band emissions. This is measured at the BS antenna connector.

For a UTRA-OBTS BS additionally conforming to ETSI EN 301 908-18 [8], either the requirement of the present clause or the Transmitter spurious emissions requirement in clause 4.2.4 of ETSI EN 301 908-18 [8] can be equally applied.

For a UTRA-OBTS additionally conforming to ETSI EN 301 908-3 [7], either the requirement of the present clause or the transmitter spurious emissions requirement in clause 4.2.4 of ETSI EN 301 908-3 [7] can be equally applied.

The requirement shall apply at frequencies within the specified frequency ranges, which are more than 12,5 MHz under the first carrier frequency transmitted or more than 12,5 MHz above the last carrier frequency transmitted.

The requirement of clause 4.2.3.3.2 shall apply whatever the type of transmitter considered (single carrier or multi carrier). It shall apply for all transmission modes foreseen by the manufacturer's specification.

Unless otherwise stated, all requirements shall be measured as mean power.

4.2.3.3.2 Limits

The limit for the UTRA-OBTS transmitter spurious emissions shall conform to the limits in clause 4.2.4.2 of ETSI EN 301 908-3 [7] applicable for frequency band I.

The limits for the coexistence with other systems shall conform to the limits in clause 4.2.4.2.2 of ETSI EN 301 908-3 [7] applicable for DSC1800 and E-UTRA band 3 protected systems.

The limits for co-existence with services in adjacent frequency bands shall conform for operating band I.

The limits for the protection of the BS receiver of own or different BS shall conform for the indicated power class of the UMTS-OBTS in operating band I.

4.2.3.3.3 Conformance

Conformance tests described in clause 5.3.3 of ETSI EN 301 908-3 [7] shall be carried out for single-band operation.

For a UMTS-OBTS additionally conforming to ETSI EN 301 908-3 [7], either the test suite of the present clause or the Transmitter spurious emissions test suite in clause 5.3.3 of ETSI EN 301 908-3 [7] can be equally applied.

4.2.3.4 UTRA-OBTS maximum output power

4.2.3.4.1 Definition

Maximum output power, P_{\max} , of the Base Station is the mean power level per carrier measured at the antenna connector in specified reference condition.

For a UTRA FDD BS additionally conforming to ETSI EN 301 908-18 [8], either the requirement of the present clause or the Base Station maximum output power requirement in clause 4.2.5 of ETSI EN 301 908-18 [8] can be equally applied.

For a UTRA-OBTS additionally conforming to ETSI EN 301 908-3 [7], either the requirement of the present clause or the base station maximum output power requirement in clause 4.2.5 of ETSI EN 301 908-3 [7] can be equally applied.

4.2.3.4.2 Limits

The limit for the UTRA-OBTS maximum output power shall conform to the limits in clause 4.2.5.2 of ETSI EN 301 908-3 [7] applicable for carrier frequency $\leq 3,0$ GHz.

4.2.3.4.3 Conformance

Conformance tests described in clause 5.3.4 of ETSI EN 301 908-3 [7] for single-band operation, shall be carried out.

For a UTRA-OBTS additionally conforming to ETSI EN 301 908-3 [7], either the test suite of the present clause or the base station maximum output power test suite in clause 5.3.4 of ETSI EN 301 908-3 [7] can be equally applied.

4.2.3.5 UTRA-OBTS Transmit intermodulation

4.2.3.5.1 Definition

The transmitter intermodulation requirement is a measure of the capability of the transmitter to inhibit the generation of signals in its non-linear elements caused by presence of the wanted signal and an interfering signal reaching the transmitter via the antenna.

The transmitter intermodulation level is the power of the intermodulation products when a WCDMA interfering signal is injected into an antenna connector at a mean power level of 30 dB lower than that of the mean power of the wanted signal.

For a UTRA FDD BS additionally conforming to ETSI EN 301 908-18 [8], either the requirement of the present clause or the Transmitter intermodulation requirement in clause 4.2.6 of ETSI EN 301 908-18 [8] can be equally applied.

For a UTRA-OBTS additionally conforming to ETSI EN 301 908-3 [7], either the requirement of the present clause or the Transmitter intermodulation requirement in clause 4.2.6 of ETSI EN 301 908-3 [7] can be equally applied.

For multi-carrier operation, the interfering signal offset is defined relative to the lower (upper) edge of the wanted signal or edge of sub-block inside a gap.

The interfering signal frequency offset shall be as in table 4.2.6.1-1 of ETSI EN 301 908-3 [7].

For a BS operating in non-contiguous spectrum, the requirement is also applicable inside a sub-block gap for interfering signal offsets where the interfering signal falls completely within the sub-block gap. The interfering signal offset is defined relative to the sub-block edges.

The measurements for out-of-band emission or spurious emission requirement due to intermodulation can be limited to the frequency ranges of all third and fifth order intermodulation products, considering the width of these products and excluding the bandwidths of the wanted and interfering signals.

4.2.3.5.2 Limits

The limit for the UTRA-OBTS transmitter intermodulation shall conform to the limits in clause 4.2.6.2 of ETSI EN 301 908-3 [7] for UTRA FDD single-band operation ≤ 3 GHz, for the BS maximum output power category corresponding to the UTRA-OBTS maximum output power of the applicable BS class.

4.2.3.5.3 Conformance

Conformance tests described in clause 5.3.5 of ETSI EN 301 908-3 [7] for single-band operation, shall be carried out.

For a UTRA-OBTS additionally conforming to ETSI EN 301 908-3 [7], either the requirement of the present clause or the Transmitter intermodulation conformance test in clause 5.3.5 of ETSI EN 301 908-3 [7] can be equally applied.

4.2.3.6 UTRA-OBTS Receiver spurious emissions

4.2.3.6.1 Definition

The spurious emission power is the power of the emissions, generated or amplified in a receiver, which appear at the BS antenna connector. The requirements shall apply to all BS with separate Rx and Tx antenna port. The test shall be performed when both Tx and Rx are on with the Tx port terminated.

For all BS with common Rx and Tx antenna port the transmitter spurious emission as specified in clause 4.2.2.3 is valid.

For a UTRA FDD BS additionally conforming to ETSI EN 301 908-18 [8], either the requirement of the present clause or the Receiver spurious emissions requirement in clause 4.2.7 of ETSI EN 301 908-18 [8] can be equally applied.

For a UTRA-OBTS additionally conforming to ETSI EN 301 908-3 [7], either the requirement of the present clause or the receiver spurious emissions requirement in clause 4.2.7 of ETSI EN 301 908-3 [7] can be equally applied.

4.2.3.6.2 Limits

The power of any spurious emission shall not exceed the limit specified in clause 4.2.7.2 of ETSI EN 301 908-3 [7] for single-band operation in band I in frequency range 1 GHz to 12,75 GHz.

4.2.3.6.3 Conformance

Conformance tests described in clause 5.3.6 of ETSI EN 301 908-3 [7] for single-band operation shall be carried out.

For a UTRA-OBTS additionally conforming to ETSI EN 301 908-3 [7], either the tests of the present clause or the receiver spurious emissions conformance test in clause 5.3.6 of ETSI EN 301 908-3 [7] can be equally applied.

4.2.3.7 UTRA-OBTS Blocking characteristics

4.2.3.7.1 Definition

The blocking characteristics are a measure of the receiver ability to receive a wanted signal at its assigned channel frequency in the presence of an unwanted interferer on frequencies other than those of the adjacent channels. The interferences are either a WCDMA signal for in-band blocking or a CW signal for out-of-band blocking.

The blocking performance requirement shall apply as specified in tables 4.2.8.2-2 or 4.2.8.2-3 of ETSI EN 301 908-3 [7] for the indicated UTRA-OBTS power class and for operating band I.

For a UTRA FDD BS additionally conforming to ETSI EN 301 908-18 [8], either the requirement of the present clause or the In-band and Out-of-band blocking requirements in clauses 4.2.8 and 4.2.9 of ETSI EN 301 908-18 [8] can be equally applied.

For a UTRA-OBTS additionally conforming to ETSI EN 301 908-3 [7], either the requirement of the present clause or the blocking characteristics requirements in clause 4.2.8 of ETSI EN 301 908-3 [7] can be equally applied.

4.2.3.7.2 Limits

The limit for the UTRA-OBTS blocking characteristics shall conform to the limits in clause 4.2.8.2 of ETSI EN 301 908-3 [7] for the indicated UTRA-OBTS power class for operating band I and for single-band operation.

4.2.3.7.3 Conformance

Conformance tests described in clause 5.3.7 of ETSI EN 301 908-3 [7] for single-band operation shall be carried out.

For a UTRA-OBTS additionally conforming to ETSI EN 301 908-3 [7], either the requirement of the present clause or the blocking characteristics conformance test in clause 5.3.7 of ETSI EN 301 908-3 [7] can be equally applied.

4.2.3.8 UTRA-OBTS Receiver intermodulation characteristics

4.2.3.8.1 Definition

Third and higher order mixing of the two interfering RF signals can produce an interfering signal in the band of the desired channel.

Intermodulation response rejection is a measure of the capability of the receiver to receive a wanted signal on its assigned channel frequency in the presence of two or more interfering signals which have a specific frequency relationship to the wanted signal.

For a UTRA FDD BS additionally conforming to ETSI EN 301 908-18 [8], either the requirement of the present clause or the Receiver intermodulation requirement in clause 4.2.10 of ETSI EN 301 908-18 [8] can be equally applied.

For a UTRA-OBTS additionally conforming to ETSI EN 301 908-3 [7], either the requirement of the present clause or the receiver intermodulation characteristics in clause 4.2.9 of ETSI EN 301 908-3 [7] can be equally applied.

4.2.3.8.2 Limits

The limits for the UTRA-OBTS receiver intermodulation characteristics shall conform to the limits in clause 4.2.9.2 of ETSI EN 301 908-3 [7] for the declared UTRA-OBTS Base Station class band I and single-band operation.

4.2.3.8.3 Conformance

Conformance tests described in clause 5.3.8 of ETSI EN 301 908-3 [7] for single-carrier operation and single-band operation shall be carried out.

For a UTRA-OBTS additionally conforming to ETSI EN 301 908-3 [7], either the requirement of the present clause or the receiver intermodulation characteristics conformance test in clause 5.3.8 of ETSI EN 301 908-3 [7] can be equally applied.

4.2.3.9 UTRA-OBTS Receiver adjacent channel selectivity

4.2.3.9.1 Definition

Adjacent Channel Selectivity (ACS) is a measure of the receiver's ability to receive a wanted signal at its assigned channel frequency in the presence of an adjacent channel signal at a given frequency offset from the centre frequency of the assigned channel. ACS is the ratio of the receiver filter attenuation on the assigned channel frequency to the receive filter attenuation on the adjacent channel(s).

The interference signal is offset from the wanted signal by the frequency offset F_{uw} . The interference signal shall be a WCDMA signal as specified in ETSI TS 125 141 [9], annex I.

For a UTRA FDD BS additionally conforming to ETSI EN 301 908-18 [8], either the requirement of the present clause or the Narrowband blocking requirement in clause 4.2.11 of ETSI EN 301 908-18 [8] can be equally applied, as listed in table 4.2.1-2.

For a UTRA-OBTS additionally conforming to ETSI EN 301 908-3 [7], either the requirement of the present clause or the Receiver adjacent channel selectivity in clause 4.2.10 of ETSI EN 301 908-3 [7] can be equally applied.

4.2.3.9.2 Limits

The limits for the UTRA-OBTS Receiver adjacent channel selectivity shall conform to the limits in clause 4.2.10.2 of ETSI EN 301 908-3 [7] for the declared UTRA-OBTS Base Station class and single-band operation.

4.2.3.9.3 Conformance

Conformance tests described in clause 5.3.9 of ETSI EN 301 908-3 [7] for single-band BS shall be carried out.

For a UTRA-OBTS additionally conforming to ETSI EN 301 908-3 [7], either the requirement of the present clause or the adjacent channel selectivity (ACS) conformance testing test in clause 5.3.9 of ETSI EN 301 908-3 [7] can be equally applied.

4.2.3.10 UTRA-OBTS controlled UE RF power

4.2.3.10.1 Definition

When a UE is switched on, it first scans its RF environment to find a suitable cell for initial cell selection. One of the parameters used in the selection process, UE_TXPWR_MAX_RACH, defined in clause 10.3.2.3 in ETSI TS 125 331 [10], indicates to the UE the maximum transmit power level, specified in dBm, that an UE is authorized to transmit when accessing the cell on RACH.

When a UE receives a "Maximum allowed UL Tx power" parameter in SIB3, SIB4, a handover to UTRAN command or any dedicated message, the UE has to keep the uplink transmit power at or below the indicated power value and in case the current UE uplink transmit power is above the indicated power value, the UE has to decrease the power to a level at or below the power value, as specified in clause 8.6.6.8 in ETSI TS 125 331 [10].

The parameter "Maximum allowed UL Tx power" is defined in clause 10.3.6.39 in ETSI TS 125 331 [10].

The maximum UE TX power is defined as the lower of the maximum output power of the UE power class and the maximum allowed UL TX power indicated in this UE, according to clause 6.5 in ETSI TS 125 133 [13].

4.2.3.10.2 Limits

The UE_TXPWR_MAX_RACH parameter, according to clause 10.3.2.3 in ETSI TS 125 331 [10] shall be set to -6 dBm.

The "Maximum allowed UL Tx power" according to 10.3.6.39 in ETSI TS 125 331 [10] shall be set to -6 dBm.

4.2.3.10.3 Conformance

Conformance tests described in clause 5.2.2.1 shall be carried out.

4.2.4 E-UTRA-OBTS performance

4.2.4.0 Conformance compliance

Conformance to the clauses below is a necessary precondition for compliance with EC Decision 2013/654/EU [i.3] but shall not be interpreted as automatic conformance to EC Decision 2013/654/EU [i.3]. The limitations, in particular with respect to allowed frequency bands, e.i.r.p. authorization limits and operational requirements from EC Decision 2013/654/EU [i.3] apply.

4.2.4.1 E-UTRA-OBTS operating band unwanted emissions

4.2.4.1.1 Definition

Unwanted emissions consist of out-of-band emissions and spurious emissions (Recommendation ITU-R SM.329-12 [i.4]). Out-of-band emissions are emissions immediately outside the channel bandwidth resulting from the modulation process and non-linearity in the transmitter but excluding spurious emissions. The out-of-band emissions requirement for the E-UTRA-OBTS transmitter is specified both in terms of Adjacent Channel Leakage power Ratio (ACLR) and Operating band unwanted emissions.

Unless otherwise stated, the Operating band unwanted emission limits are defined from 10 MHz below the lowest frequency of each supported downlink operating band up to 10 MHz above the highest frequency of each supported downlink operating band (see table 1-1).

The requirements shall apply whatever the type of transmitter considered (single carrier or multi-carrier) and for all transmission modes foreseen by the manufacturer's specification. In addition, for a E-UTRA-OBTS operating in non-contiguous spectrum, it shall apply inside any sub-block gap.

For an E-UTRA-OBTS supporting multi-carrier, the unwanted emissions requirements apply to channel bandwidths of the outermost carrier larger than or equal to 5 MHz.

For a multi-carrier E-UTRA-OBTS configured for intra-band contiguous or non-contiguous carrier aggregation the definitions above apply to the lower edge of the carrier transmitted at the lowest carrier frequency and the higher edge of the carrier transmitted at the highest carrier frequency within a specified operating band.

4.2.4.1.2 Limits

The limits for the E-UTRA-OBTS operating band unwanted emissions shall conform to the limits in clause 4.2.2.2 of ETSI EN 301 908-14 [1] for the indicated E-UTRA-OBTS class for operating band 3 and for single-band operation.

4.2.4.1.3 Conformance

Conformance tests described in clause 5.3.1 of ETSI EN 301 908-14 [1] shall be carried out.

4.2.4.2 E-UTRA-OBTS Adjacent Channel Leakage power Ratio (ACLR)

4.2.4.2.1 Definition

Unwanted emissions consist of out-of-band emissions and spurious emissions (Recommendation ITU-R SM.329-12 [i.4]). Out-of-band emissions are emissions immediately outside the channel bandwidth resulting from the modulation process and non-linearity in the transmitter but excluding spurious emissions. The out-of-band emissions requirement for the E-UTRA-OBTS transmitter is specified both in terms of Adjacent Channel Leakage power Ratio (ACLR) and Operating band unwanted emissions.

Adjacent Channel Leakage power Ratio (ACLR) is the ratio of the filtered mean power centered on the assigned channel frequency to the filtered mean power centered on an adjacent channel frequency.

The requirements shall apply outside the E-UTRA-OBTS RF bandwidth or maximum radio bandwidth edges whatever the type of transmitter considered (single carrier or multi-carrier). The interfering signal offset is defined relative to the lower (upper) edge. It shall apply for all transmission modes foreseen by the manufacturer's specification.

For an E-UTRA-OBTS operating in non-contiguous spectrum, the ACLR shall also apply for the first adjacent channel inside any sub-block gap with a gap size $W_{\text{gap}} \geq 15$ MHz. The ACLR requirement for the second adjacent channel shall apply inside any sub-block gap with a gap size $W_{\text{gap}} \geq 20$ MHz. The ACLR requirement in table 4.2.3.4.2-1 in clause 4.2.3.4.2 of ETSI EN 301 908-14 [1] shall apply in sub-block gaps.

The requirement shall apply during the transmitter ON period.

4.2.4.2.2 Limits

4.2.4.2.2.1 ACLR Limits

The limits for the E-UTRA-OBTS ACLR shall conform to the limits in tables 4.2.3.4-1 and 4.2.3.4-3 in clause 4.2.3.4.1 of ETSI EN 301 908-14 [1] for E-UTRA-OBTS operated in contiguous or non-contiguous paired spectrum, respectively.

4.2.4.2.2.2 Cumulative ACLR test requirement in non-contiguous spectrum limits

The limits for the E-UTRA-OBTS cumulative ACLR shall conform to the limits given in clause 4.2.3.4.2 of ETSI EN 301 908-14 [1] for operation in non-contiguous paired spectrum applicable power class declared by the manufacturer.

4.2.4.2.3 Conformance

Conformance tests described in clause 5.3.2 of ETSI EN 301 908-14 [1] shall be carried out.

4.2.4.3 E-UTRA-OBTS transmitter spurious emissions

4.2.4.3.1 Definition

Unwanted emissions consist of out-of-band emissions and spurious emissions (Recommendation ITU-R SM.329-12 [i.4]). Spurious emissions are emissions which are caused by unwanted transmitter effects such as harmonics emission, parasitic emission, intermodulation products and frequency conversion products, but exclude out-of-band emissions. This is measured at the E-UTRA-OBTS antenna connector.

The transmitter spurious emission limits shall apply from 9 kHz to 12,75 GHz, excluding the frequency range from 10 MHz below the lowest frequency of the downlink operating band up to 10 MHz above the highest frequency of the downlink operating band (see table 1-1).

For an E-UTRA-OBTS supporting multi-carrier, the unwanted emissions requirements shall apply to channel bandwidths of the outermost carrier larger than or equal to 5 MHz.

The requirements shall apply whatever the type of transmitter considered (single carrier or multi-carrier). It shall apply for all transmission modes foreseen by the manufacturer's specification. Unless otherwise stated, all requirements are measured as mean power (RMS).

4.2.4.3.2 Limits

4.2.4.3.2.1 Spurious emissions

The limits for the E-UTRA-OBTS transmitter spurious emissions shall conform to the limits in table 4.2.4.2.1-1 in clause 4.2.4.2.1 of ETSI EN 301 908-14 [1].

4.2.4.3.2.2 Co existence with other systems

For the protection of other systems the E-UTRA-OBTS transmitter spurious emissions shall conform to the limits in table 4.2.4.2.2-1 in clause 4.2.4.2.2 of ETSI EN 301 908-14 [1].

4.2.4.3.2.3 Protection of the E-UTRA-OBTS receiver or receiver of different BS

For protecting the E-UTRA-OBTS receiver or the receiver of a different BS from being desensitized by emissions from the E-UTRA-OBTS transmitter, the power of any spurious emission shall not exceed the limits in table 4.2.4.2.3-1 in clause 4.2.4.2.3 of ETSI EN 301 908-14 [1] for the declared E-UTRA-OBTS class.

4.2.4.3.3 Conformance

Conformance tests described in clause 5.3.3 of ETSI EN 301 908-14 [1] shall be carried out.

4.2.4.4 E-UTRA-OBTS maximum output power

4.2.4.4.1 Definition

The maximum output power, $P_{\max,c}$ of the E-UTRA-OBTS is the mean power level per carrier measured at the antenna connector during the transmitter ON period in a specified reference condition.

4.2.4.4.2 Limits

The limits for the E-UTRA-OBTS maximum output power shall conform to the limits for carrier frequency $f \leq 3,0$ GHz in clause 4.2.5.2 of ETSI EN 301 908-14 [1].

4.2.4.4.3 Conformance

Conformance tests described in clause 5.3.4 of ETSI EN 301 908-14 [1] shall be carried out.

4.2.4.5 E-UTRA-OBTS transmit intermodulation

4.2.4.5.1 Definition

The transmitter intermodulation requirement is a measure of the capability of the transmitter to inhibit the generation of signals in its non-linear elements caused by presence of the wanted signal and an interfering signal reaching the transmitter via the antenna. The requirement shall apply during the transmitter ON period and the transmitter transient period.

The transmitter intermodulation level is the power of the intermodulation products when an interfering signal is injected into the antenna connector.

The requirements shall apply whatever the type of transmitter considered (single carrier or multi-carrier). It shall apply for all transmission modes foreseen by the manufacturer's specification.

4.2.4.5.2 Limits

The limits for the E-UTRA-OBTS transmitter intermodulation shall conform to the limits in clause 4.2.6.2 of ETSI EN 301 908-14 [1].

4.2.4.5.3 Conformance

Conformance tests described in clause 5.3.5 of ETSI EN 301 908-14 [1] shall be carried out.

4.2.4.6 E-UTRA-OBTS receiver spurious emissions

4.2.4.6.1 Definition

The spurious emissions power is the power of emissions generated or amplified in a receiver that appear at the E-UTRA-OBTS receiver antenna connector. The requirements apply to all the E-UTRA-OBTS with separate RX and TX antenna ports. The test shall be performed when both TX and RX are on, with the TX port terminated.

For FDD E-UTRA-OBTS with common RX and TX antenna port the transmitter spurious emission limits as, specified in clause 4.2.3.3, apply.

4.2.4.6.2 Limits

The limits for the E-UTRA-OBTS receiver spurious emissions shall conform to the limits in clause 4.2.7.2 of ETSI EN 301 908-14 [1].

4.2.4.6.3 Conformance

Conformance tests described in clause 5.3.6 of ETSI EN 301 908-14 [1] shall be carried out.

4.2.4.7 E-UTRA-OBTS Blocking characteristics

4.2.4.7.1 Definition

The blocking characteristics is a measure of the receiver ability to receive a wanted signal at its assigned channel in the presence of an unwanted interferer, which are either a 1 MHz, 4 MHz, 3 MHz or 5 MHz E-UTRA signal for in-band blocking or a CW signal for out-of-band blocking. The interfering E-UTRA signal shall be as specified in ETSI TS 136 141 [5], annex C.

4.2.4.7.2 Limits

The limits for the E-UTRA-OBTS blocking characteristics shall conform to the limits in clause 4.2.8.2 of ETSI EN 301 908-14 [1] for the Medium applicable power class declared by the manufacturer.

4.2.4.7.3 Conformance

Conformance tests described in clause 5.3.7 of ETSI EN 301 908-14 [1] shall be carried out.

4.2.4.8 E-UTRA-OBTS receiver intermodulation characteristics

4.2.4.8.1 Definition

Third and higher order mixing of the two interfering RF signals can produce an interfering signal in the band of the desired channel. Intermodulation response rejection is a measure of the capability of the receiver to receive a wanted signal on its assigned channel frequency in the presence of two interfering signals which have a specific frequency relationship to the wanted signal. Interfering signals shall be a CW signal and an E-UTRA signal as specified in ETSI TS 136 141 [5], annex C.

4.2.4.8.2 Limits

The limits for the E-UTRA-OBTS blocking characteristics shall conform to the limits in clause 4.2.9.2 of ETSI EN 301 908-14 [1] for the applicable power class declared by the manufacturer.

4.2.4.8.3 Conformance

Conformance tests described in clause 5.3.8 of ETSI EN 301 908-14 [1] shall be carried out.

4.2.4.9 E-UTRA-OBTS Adjacent Channel Selectivity (ACS) and narrow-band blocking

4.2.4.9.1 Definition

Adjacent Channel Selectivity (ACS) and narrow-band blocking are measures of the receiver's ability to receive a wanted signal at its assigned channel frequency in the presence of an adjacent channel signal with a specified centre frequency offset of the interfering signal to the channel edge of a victim system. The interfering signal shall be an E-UTRA signal as specified in ETSI TS 136 141 [5], annex C. For narrowband blocking, the interfering signal is an E-UTRA single Resource Block.

4.2.4.9.2 Limits

The limits for the E-UTRA-OBTS blocking characteristics shall conform to the limits in clause 4.2.10.2 of ETSI EN 301 908-14 [1] for the applicable power class declared by the manufacturer.

4.2.4.9.3 Conformance

Conformance tests described in clause 5.3.9 of ETSI EN 301 908-14 [1] shall be carried out.

4.2.4.10 E-UTRA-OBTS controlled UE RF power

4.2.4.10.1 Definition

According to EC Decision 2013/654/EU [i.3] the E-UTRA-OBTS while in operation, shall limit the transmit power of all LTE UEs transmitting in band 3 (see table 1-1) to a nominal value of 5 dBm/5 MHz at all stages of communication.

In order to ensure that all UEs onboard the aircraft which are attached to the E-UTRA-OBTS are commanded to a maximum power level which satisfies the above maximum power limit in all states of communication, it has to be verified that the Information Element "P-MAX" in the System Information Block Type 1 (SIB 1) is broadcasted on the BCCH, i.e. via the transport channels BCH or DL-SCH and that the value for P-MAX is the set accordingly.

4.2.4.10.2 Limits

The Information Element "P-MAX" according to clause 6.2.2 in ETSI TS 136 331 [12] corresponding to the parameter $P_{EMAX,c}$ as defined in clause 6.2.5 in ETSI TS 136 101 [11] shall be set such that the UE transmit power spectral density does not exceed -2 dBm/MHz. Depending on the selected channel bandwidth this leads to different settings of "P-MAX" (e.g. 5 dB min a channel bandwidth of 5 MHz). The setting for Information Element "P-MAX" shall not exceed the value contained in table 4.2.3.10.2-1 corresponding to the supported E-UTRA OBTS channel bandwidth.

Table 4.2.4.10.2-1: Limits for Information Element "P-MAX" / Parameter $P_{EMAX,c}$ setting vs. supported E-UTRA OBTS channel bandwidth

Supported E-UTRA OBTS channel bandwidth	1,4 MHz	3 MHz	5 MHz	10 MHz	15 MHz	20 MHz
P-MAX ($P_{EMAX,c}$)	-0,5 dBm	2,8 dBm	5,0 dBm	8, 0dBm	9,8 dBm	11,0 dBm

4.2.4.10.3 Conformance

Conformance tests described in clause 5.2.3.1 shall be carried out.

4.2.5 NCU Transmitter Performance

4.2.5.1 NCU maximum mean power spectral density

4.2.5.1.1 Definition

The mean power spectral density for a given reference bandwidth represents the ratio of the mean value of the measured power over the reference bandwidth and the reference bandwidth itself.

4.2.5.1.2 Limits

The maximum mean power spectral density shall not exceed the value contained in table 4.2.5.1.2-1.

Table 4.2.5.1.2-1: NCU power spectral density limit

Frequency band	Reference Bandwidth	Power (within reference bandwidth) (dBm)
460 MHz to 470 MHz	1,25 MHz	25
791 MHz to 821 MHz	9MHz	23
921 MHz to 960 MHz	200 kHz	20
1 805 MHz to 1 880 MHz	200 kHz	23
2 110 MHz to 2 170 MHz	3,84 MHz	24
2 570 MHz to 2 620 MHz	9MHz	23
2 620 MHz to 2 690 MHz	9MHz	23
NOTE 1: The values for frequency bands 900 MHz (20 dBm) and 1 800 MHz (23 dBm) have been taken from the upper limit of the power class P1 (see ETSI TS 145 005 [2], clause 4.1.2), for the 450 MHz (25 dBm) in C.S0011-C [i.7] and for the 2 110 MHz (24 dBm) in ETSI TS 125 104 [i.8].		
NOTE 2: Conformance to the power limits should not be interpreted as conformance of e.i.r.p. authorization limits as defined in the Commission Decision 2013/654 [i.3].		

4.2.5.1.3 Conformance

Conformance tests described in clause 5.2.4.1 shall be carried out.

4.2.5.2 NCU power flatness

4.2.5.2.1 Definition

The power flatness is the variation of the power over each operating frequency band.

4.2.5.2.2 Limits

The power flatness shall be within ± 3 dB over each operating frequency band.

4.2.5.2.3 Conformance

Conformance tests described in clause 5.2.4.2 shall be carried out.

4.2.5.3 NCU out-of-band emissions

4.2.5.3.1 Definition

Out-of-band emissions are emissions immediately outside the channel bandwidth resulting from the modulation process and non-linearity in the transmitter but excluding spurious emissions.

4.2.5.3.2 Limits

Out-of-band emission power spectral density measured in 100 kHz bandwidth shall be attenuated relative to the maximum power spectral density in each operating frequency band by the minimum attenuation values and for the frequency bands in table 4.2.5.3.2-1.

Table 4.2.5.3.2-1: NCU out-of-band emission limits

		6 dB minimum attenuation		25 dB minimum attenuation		45 dB minimum attenuation	
Lower band limit f1 (MHz)	Upper band limit f2 (MHz)	Lower band limit fc- Bw*58 % (MHz)	Upper band limit fc+ Bw*58 % (MHz)	Lower band limit fc- Bw*75 % (MHz)	Upper band limit fc+ Bw*75 % (MHz)	Lower band limit fc- Bw*250 % (MHz)	Upper band limit fc+ Bw*250 % (MHz)
460	470	459,2	470,8	457,5	472,5	440	490
791	821	788,6	823,4	783,5	828,5	731	881
921	960	917,88	963,12	911,25	969,75	843	1 038
1 805	1 880	1 799,0	1 886,0	1 786,25	1 898,75	1 665	2 030
2 110	2 170	2 105,2	2 174,8	2 095,0	2 185,0	1 990	2 290
2 570	2 620	2 566,0	2 624,0	2 557,5	2 632,5	2 470	2 720
2 620	2 690	2 614,4	2695,6	2 2602,5	2 707,5	2 480	2 830

4.2.5.3.3 Conformance

Conformance tests described in clause 5.2.5.2 shall be carried out.

4.2.5.4 NCU spurious emissions

4.2.5.4.1 Definition

Spurious emissions are emissions which are caused by unwanted transmitter effects such as harmonics emission, parasitic emission, intermodulation products and frequency conversion products, but exclude out-of-band emissions. This is measured at the Base Station antenna connector.

The transmitter spurious emission limits shall apply from 9 kHz to 12,75 GHz, excluding the frequency range from 10 MHz below the lowest frequency of the downlink operating band up to 10 MHz above the highest frequency of the downlink operating band. For the NCU this exclusion shall apply for each supported operating band. For the highest operating band of the NCU, the upper frequency limit is higher than 12,75 GHz.

The requirements shall apply whatever the type of transmitter considered. It shall apply for all transmission modes foreseen by the manufacturer's specification. Unless otherwise stated, all requirements are measured as mean power (RMS).

4.2.5.4.2 Limits

The power of any spurious emission shall not exceed the limits in table 4.2.5.4.2-1.

Table 4.2.5.4.2-1: NCU Spurious emissions limits

Frequency range	Maximum Level	Measurement Bandwidth	Note
9 kHz ↔ 150 kHz	-36 dBm	1 kHz	Note 1
150 kHz ↔ 30 MHz	-36 dBm	10 kHz	Note 1
30 MHz ↔ 1 GHz	-36 dBm	100 kHz	Note 1
1 GHz ↔ 12,75 GHz	-30 dBm	1 MHz	Note 2
NOTE 1: Bandwidth as in Recommendation ITU-R SM.329-12 [i.4], section 4.1.			
NOTE 2: Bandwidth as in Recommendation ITU-R SM.329-12 [i.4], section 4.1. Upper frequency as in Recommendation ITU-R SM.329-12 [i.4], section 2.5, table 1.			

4.2.5.4.3 Conformance

Conformance tests described in clause 5.2.5.1 shall be carried out.

4.2.6 MCOBA system performance

4.2.6.1 MCOBA Unwanted emissions in the out-of-band domain

4.2.6.1.1 Definition

Unwanted emissions in the out-of-band domain are defined as the unwanted emissions outside the channel bandwidth resulting from the modulation process and non-linearity of the power amplifier in the transmitter and exclude the spurious emissions.

4.2.6.1.2 Limits

Out-of-band emission power spectral density measured in 100 kHz bandwidth shall be attenuated relative to the maximum power spectral density in each operating frequency band by the minimum attenuation values and for the frequency bands in table 4.2.6.1.2-1.

Table 4.2.6.1.2-1: Frequency parameters

		6 dB minimum attenuation		25 dB minimum attenuation		45 dB minimum attenuation	
Lower band limit f1 (MHz)	Upper band limit f2 (MHz)	Lower band limit fc- Bw × 58 % (MHz)	Upper band limit fc+ Bw × 58 % (MHz)	Lower band limit fc- Bw × 75 % (MHz)	Upper band limit fc+ Bw × 75 % (MHz)	Lower band limit fc- Bw × 250 % (MHz)	Upper band limit fc+ Bw × 250 % (MHz)
460	470	459,2	470,8	457,5	472,5	440	490
791	821	788,6	823,4	783,5	828,5	731	881
921	960	917,88	963,12	911,25	969,75	843	1 038
1 805	1 880	1 799,0	1 886,0	1 786,25	1 898,75	1 665	2 030
2 110	2 170	2 105,2	2 174,8	2 095,0	2 185,0	1 990	2 290
2 570	2 620	2 566,0	2 624,0	2 557,5	2 632,5	2 470	2 720
2 620	2 690	2 614,4	2695,6	2 2602,5	2 707,5	2 480	2 830

4.2.6.2 MCOBA Unwanted emissions in the spurious domain

4.2.6.2.1 Definition

Unwanted emissions in the spurious domain are emissions at frequencies, other than those of the transmitter carrier and sidebands associated with normal modulation at the adjacent frequencies.

4.2.6.2.2 Limits

The maximum power shall not exceed:

- 1) when the system is in standby state:
 - -57 dBm for $30 \text{ MHz} \leq f \leq 1 \text{ GHz}$ in 100 kHz bandwidth;
 - -47 dBm for $1 \text{ GHz} < f \leq 12,75 \text{ GHz}$ in 1 MHz bandwidth;
- 2) when the system is in active state:
 - -36 dBm for $30 \text{ MHz} \leq f \leq 1 \text{ GHz}$ in 100 kHz bandwidth;
 - -30 dBm for $1 \text{ GHz} < f \leq 12,75 \text{ GHz}$ in 1 MHz bandwidth.

NOTE: The frequency boundary and the detailed transitions of the limits between the requirement for out-of-band emissions and spectrum emissions are based on CEPT/ERC/REC 74-01 [i.4].

4.2.6.3 MCOBA Cessation of emission

4.2.6.3.1 Definition

When the MCOBA system is in the active state and a condition to the altitude and the geographical position of the aircraft requiring cessation of emissions occurs, the MCOBA system shall automatically cease transmissions and enter into the standby state.

4.2.6.3.2 Specification

When in the active state a condition to the altitude and the geographical position of the aircraft requiring cessation of emissions occurs, the MCOBA system shall cease transmissions as described in figure 4.1.2-1 contained in clause 4.1.2 and enters the standby state.

5 Testing for compliance with technical requirements

5.1 Interpretation of results and measurement uncertainty

5.1.1 Environmental conditions for testing

Tests defined in the present document shall be carried out at representative points within the boundary limits of the declared operational environmental profile (see clause B.3).

Where the technical performance varies subject to environmental conditions, tests shall be carried out under a sufficient variety of environmental conditions (within the boundary limits of the declared operational environmental profile) to give confidence of compliance to the associated technical requirements.

5.1.2 Interpretation of the measurement results

The interpretation of the measurement results recorded in a test report for the compliance testing described in the present document shall be as follows:

- the measured value related to the corresponding limit shall be used to decide whether an equipment meets the requirements of the present document;
- the value of the measurement uncertainty for the measurement of each parameter shall be included in the test report;
- the recorded value of the measurement uncertainty shall be, for each measurement, equal to or better than the figures in table 5.1.2-1.

For the test methods, according to the present document, the measurement uncertainty figures shall be calculated and shall correspond to an expansion factor (coverage factor) $k = 1,96$ or $k = 2$ (which provide confidence levels of respectively 95 % and 95,45 % in the case where the distributions characterising the actual measurement uncertainties are normal (Gaussian)). Principles for the calculation of measurement uncertainty are contained in ETSI TR 100 028 [i.5], in particular in annex D of the ETSI TR 100 028-2 [i.5].

Table 5.1.2-1 is based on such expansion factors.

Table 5.1.2-1: Maximum measurement uncertainty

Parameter	Conditions	Uncertainty
Temperature		± 1 K
Humidity		± 5 %
Radio Frequency tolerance		$\pm 1 \times 10^{-7}$
Conducted power		$\pm 0,75$ dB
OBTS output power		± 2 dB
OBTS spectrum due to modulation and wideband noise		± 2 dB
OBTS spectrum due to switching transients		$\pm 1,5$ dB
OBTS reference sensitivity level		± 3 dB
OBTS spurious emissions from the receiver antenna connector		± 3 dB
NCU mean power spectral density		± 3 dB
NCU power flatness		± 3 dB
MCOBA out-of-band emissions		± 3 dB
MCOBA transmitter spurious emissions		± 3 dB
Adjacent Channel Leakage power Ratio (ACLR)	ACLR limit CACLR Adjacent channel power limit Absolute limit for Home BS $\pm 1,5$ dB, $f \leq 3,0$ GHz Absolute limit for Home BS $\pm 1,8$ dB, $3,0$ GHz $< f \leq 4,2$ GHz	$\pm 0,8$ dB $\pm 0,8$ dB $\pm 2,0$ dB
Transmitter spurious emissions	For general requirements: $f \leq 2,2$ GHz $2,2$ GHz $< f \leq 4$ GHz 4 GHz $< f < 19$ GHz For co-existence requirements for > -60 dBm: $f \leq 3,0$ GHz $3,0$ GHz $< f \leq 4,2$ GHz for ≤ -60 dBm: $f \leq 3,0$ GHz $3,0$ GHz $< f \leq 4,2$ GHz For protection of the BS receiver	$\pm 1,5$ dB $\pm 2,0$ dB $\pm 4,0$ dB $\pm 2,0$ dB $\pm 2,5$ dB, $\pm 3,0$ dB $\pm 3,5$ dB $\pm 3,0$ dB
Transmit intermodulation	For spectrum emissions mask For ACLR For "Spurious emissions": $f \leq 2,2$ GHz $2,2$ GHz $< f \leq 4$ GHz $f > 4$ GHz For co-existence requirements Interference signal	$\pm 2,5$ dB $\pm 2,2$ dB $\pm 2,5$ dB $\pm 2,8$ dB $\pm 4,5$ dB $\pm 2,8$ dB $\pm 1,0$ dB

5.1.3 Measurement options

Unless explicitly stated, the tests below can be performed either at the MCOBA reference point (port 3 in figure 5.1.3-1) or at NCU and OBTS reference points (port 1 and port 2 in figure 5.1.3-1). Testing at unit reference points (1 and 2) may be applied to all tests in clause 5 except spurious emissions (clause 5.2.4.2) and out-of-band emissions (clause 5.2.4.1). If the testing is performed at reference point 1 and 2, losses in combiner, cables and other passive components, inserted between these test points and System reference point, need to be considered.

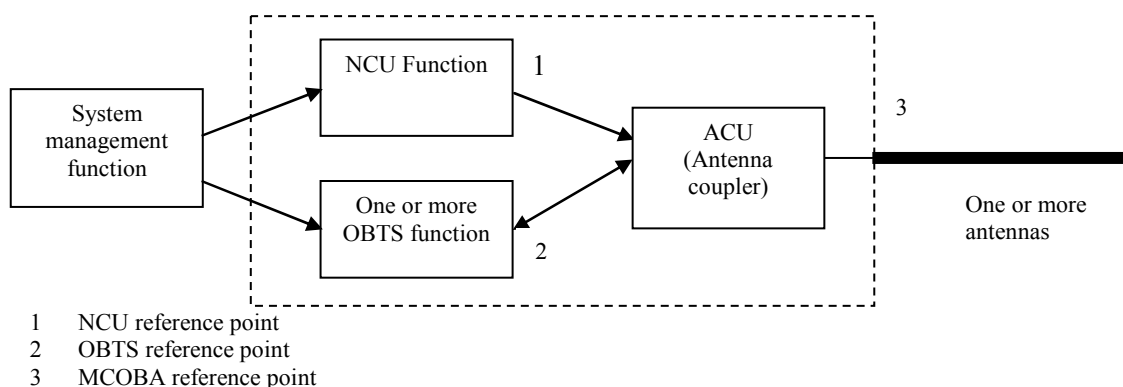

Figure 5.1.3-1: System reference points

NOTE: The system reference points in figure 5.1.3-1 above show the antenna coupler as separate functional block. It should be noted that the antenna coupler functionality can be integrated in the NCU functional block as well as the OBTS functional block as well. This does however not affect the definition of the measurement reference points above.

5.2 Essential radio test suites

5.2.1 GSM-OBTS Performance

5.2.1.1 GSM-OBTS controlled MS RF power

5.2.1.1.1 Test purpose

To verify that the OBTS send the right command to the MS connected to the MCOBA system in order to the UE to set its RF output power for initial access at the lowest nominal power and to maintain this in dedicated mode.

5.2.1.1.2 Methods of measurement

The measurement shall cover the following modes:

- access burst on the RACH;
- speech burst on a TCH;
- GPRS data burst;
- DTM with combined TCH and GPRS.

Equipment required:

- base station system test equipment (BSSTE);
- Step attenuator.

Initial state:

The attenuator is set to 0 dB.

The MCOBA system is on standby state.

Measurement procedure:

Step 1: Connect the equipment as shown in figure 5.2.1.1.2-1.

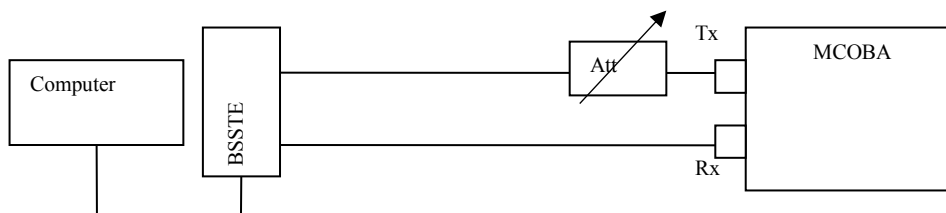

Figure 5.2.1.1.2-1: sample measurement setup

- Step 2: Set the MCOBA system into the active state.
- Step 3: Initiate the procedure to attach the BSSTE to the MCOBA system; apply the appropriate procedure to assure that all received power commands can be monitored.
- Step 4: Record the value of the MS_TXPWR_MAX_CCH given by the BSSTE; If PBCCH is implemented, record the value of GPRS_MS_TXPWR_MAX_CCH as well.
- Step 5: Initiate a call.
- Step 6: Record the POWER LEVEL used by the BSSTE at initial access.
- Step 7: Increase the attenuation by one step (i.e. 6 dB).
- Step 8: Record the POWER LEVEL given by the BSSTE.
- Step 9: Repeat step 7 and step 8 until the connection is lost.
- Step 10: If MCOBA system supports more than one simultaneous RF channel, step 12 to 16 are performed.
- Step 11: During a call set the attenuator to 10 dB.
- Step 12: Activate a second carrier with 10 dB higher output power than the used channel and initiate an intra-BSC handover.
- Step 13: Record the MS_TXPWR_MAX_CCH and POWER LEVEL given by the BSSTE.
- Step 14: Switch-off the second carrier and increase the attenuation to the highest value in step 10 with the call maintained.
- Step 15: Repeat step 13 and step 14.
- Step 16: Check that the recorded parameters are set in all cases to the values as defined in clause 4.2.2.4.2.

5.2.2 UTRA-OBTS Transmitter Performance

5.2.2.1 UTRA-OBTS controlled UE RF power

5.2.2.1.1 Test purpose

To verify that the OBTS sends the right command to the UE connected to the MCOBA system in order to ensure that the UE will set its RF output power at maximum to the specified values.

5.2.2.1.2 Methods of measurement

Test equipment required:

Base Station System Test Equipment (BSSTE).

Initial Conditions:

The UTRA-MCOBA system is in standby state.

BSSTE is in standby state.

Measurement Procedure:

Step 1: Connect the equipment as shown in figure 5.2.2.1.2-1.

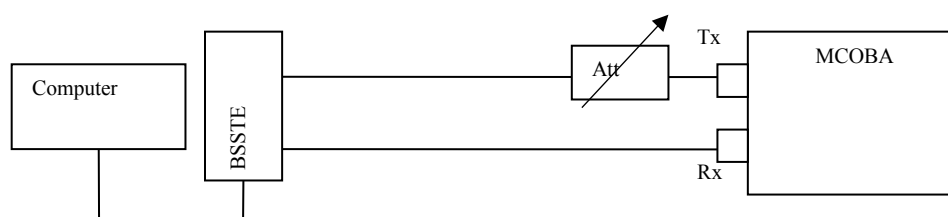

Figure 5.2.2.1.2-1: UTRA-OBTS Measurement Setup

Step 2: Set the UTRA-MCOBA system into the active state.

Step 3: Initiate the procedure to attach the BSSTE to the MCOBA system; apply the appropriate procedure to assure that all received power commands and information elements can be monitored.

Step 4: Record the received values for Information Element UE_TXPWR_MAX_RACH and Information Element "Maximum allowed UL Tx power" provided by the BSSTE.

Step 5: Check that all the received parameter values comply with the limits defined in clause 4.2.3.10.2.

Step 6: Initiate a call.

Step 7: Record the value of Information Element "Maximum allowed UL Tx power".

Step 8: Check that all of the received parameter values comply with the limits defined in clause 4.2.3.10.2.

5.2.3 E-UTRA-OBTS Transmitter Performance

5.2.3.1 E-UTRA-OBTS-controlled UE RF power

5.2.3.1.1 Test Purpose

This test is to verify that the E-UTRA OBTS provides the correct higher layer signalling to all UEs attached to the MCOBA system in order to limit their nominal RF output power in RRC_IDLE as well as in RRC_CONNECTED states (see clause 4.2.1 in ETSI TS 136 331 [12]) such that the maximum UE transmit power value "P-MAX" given in clause 4.2.3.10.2 for the supported E-UTRA OBTS channel bandwidth is never exceeded.

5.2.3.1.2 Test Procedure

Test equipment required:

Base Station System Test Equipment (BSSTE).

Initial conditions:

The E-UTRA-MCOBA system is in standby state.

Test procedure:

Step 1: Connect the equipment as shown in figure 5.2.3.1.2-1.

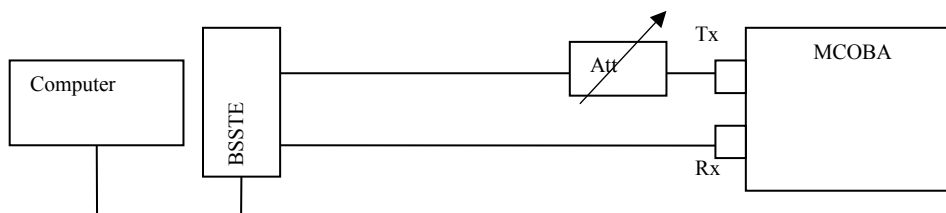

Figure 5.2.3.1.2-1: Test setup

- Step 2: Set the MCOBA system into the active state.
- Step 3: Initiate the procedure to set the BSSTE into RRC_IDLE state so that it acquires system information from the MCOBA system.
- Step 4: Record the value of the Information Element "P-MAX" transmitted from the MCOBA system on the BCCH via the BCH and provided by the BSSTE.
- Step 5: If the MCOBA system supports system information signalling on the BCCH via the DL-SCH, set the MCOBA system into the RCC_CONNECTED state by initiating a connection.
- Step 6: If the MCOBA system supports system information signalling on the BCCH via the DL-SCH, record the value of the parameter "P-MAX" transmitted on the BCCH via the DL-SCH and provided by the BSSTE.
- Step 7: Check that the recorded values of the parameter "P-MAX" comply with the limits defined in clause 4.2.4.10.2.

5.2.4 NCU Transmitter Performance

5.2.4.1 NCU maximum mean power spectral density

5.2.4.1.1 Test purpose

To verify that the power spectral density is set to a specific range according the operating frequency band while the OBTS function is in standby state.

5.2.4.1.2 Methods of measurement

Equipment required:

- Spectrum analyser;
- 50 Ω power attenuator.

Initial state:

The NCU shall be in standby state.

Measurement procedure:

The NCU function of the MCOBA system shall be active in all the supported frequency bands while the OBTS function is in standby state.

- Step 1: Connect the spectrum analyser to the NCU output port via through a 50 Ω power attenuator.
- Step 2: Set the NCU output power for each operating frequency band to the maximum output declared by the manufacturer.
- Step 3: Select one of the operating frequency bands of the NCU function to be measured (see table 5.2.4.1.2-1).
- Step 4: Set the "center" frequency of the spectrum analyser to the centre frequency of the selected operating frequency band (see table 5.2.4.1.2-1).
- Step 5: Set the frequency span of the spectrum analyser according to the bandwidth of the selected operating frequency band (see table 5.2.4.1.2-1).
- Step 6: Set the resolution bandwidth to 100 kHz.
Set the video bandwidth to 1 MHz or greater the value of the resolution bandwidth.
- Step 7: Activate the "rms" detector.
- Step 8: Measure the power spectral density by searching the maximum power in band.
- Step 9: Repeat step 3 to 8 for all frequency bands.
- Step 10: Check that the maximum mean power spectral density measurements do not exceed the limit contained in clause 4.2.3.1.2 in all cases by adding the following conversion factors to the measurement values:
- 11,0 dB for a reference bandwidth of 1,25 MHz;
 - 3 dB for a reference bandwidth of 200 kHz; and
 - 15,8 dB for a reference bandwidth of 3,84 MHz.

Table 5.2.4.1.2-1: Frequency Parameters

Frequency band (MHz)	Centre frequency (MHz)	Frequency span (MHz)
460 to 470	465	10
791 to 821	806	30
921 to 960	940,5	39
1 805 to 1 880	1 842,5	75
2 110 to 2 170	2 140	60
2 570 to 2 620	2 595	50
2 620 to 2 690	2 655	70

5.2.4.2 NCU power flatness

5.2.4.2.1 Test purpose

To verify that the NCU power flatness of the MCOBA system is maintained within a specified limit for each NCU frequency band while the OBTS function is in standby state.

5.2.4.2.2 Methods of measurement

Equipment required:

- Spectrum analyser.
- 50 Ω power attenuator.

Initial state:

The NCU shall be in standby state.

Measurement procedure:

The NCU functions of the MCOBA system shall be active in all the supported frequency bands while the OBTS function is in standby state. The output power of the NCU for each operating frequency shall be set to the maximum output power.

- Step 1: Connect the spectrum analyser to the NCU output port through a 50 Ω power attenuation.
- Step 2: Select one of the NCU operating frequency bands to be measured (see table 5.2.4.2.2-1).
- Step 3: Set the "center" frequency of the spectrum analyser to the centre frequency of the selected frequency band (see table 5.2.4.2.2-1).
- Step 4: Set the frequency span of the spectrum analyser according to the bandwidth of the selected frequency band (see table 5.2.4.2.2-1).
- Step 5: Set the resolution bandwidth to 100 kHz.
Set the video bandwidth to 1 MHz or greater.
- Step 6: Measure the minimum value within the selected frequency band.
- Step 7: Measure the maximum value within the selected frequency band.
- Step 8: Calculate the difference between the minimum and maximum value.
- Step 9: Repeat step 2 to 6 for the other frequency bands.
- Step 10: Check that the power flatness requirement (clause 4.2.3.2.2) is satisfied in all cases.

Table 5.2.4.2.2-1: Frequency Parameters

Frequency band (MHz)	Centre frequency (MHz)	Frequency span (MHz)
460 to 470	465	10
791 to 821	806	30
921 to 960	940,5	39
1 805 to 1 880	1 842,5	75
2 110 to 2 170	2 140	60
2 570 to 2 620	2 595	50
2 620 to 2 690	2 655	70

5.2.5 MCOBA Transmitter Performance

5.2.5.1 Unwanted emissions in the out-of-band domain

5.2.5.1.1 Test purpose

To verify that the out-of-band emissions are below a certain limit when the output power of the NCU function is set to its maximum value.

5.2.5.1.2 Methods of measurement

Equipment required:

- Spectrum analyser.
- 50 Ω power attenuator.

Initial state:

The MCOBA system shall be in standby state.

5.2.5.1.2.1 Unwanted emissions in the out-of-band domain when OBTS is in standby state

Measurement procedure:

- Step 1: Connect the MCOBA antenna output port to the spectrum analyser through a 50 Ω power attenuator.
- Step 2: Select one of the operating frequency bands of the NCU (see table 5.2.4.2.2-1): the NCU shall be active in the selected band, while the NCU should be in standby state for all other operating frequency bands.
- Step 3: Set the Resolution bandwidth (RBW) to 100 kHz.
Set the Video bandwidth (VBW) to 1 MHz or greater.
- Step 4: The measurements shall be made from F_c (centre frequency) - 50 % of the frequency bandwidth to F_c (centre frequency) - 250 % of the frequency bandwidth and from $F_c + 50$ % of the frequency bandwidth to $F_c + 250$ % of the frequency bandwidth (see table 5.2.5.1.2.2-1).
- Step 5: Measure the power by activating the "rms" detector.
- Step 6: Repeat step 2 to 6 for all other frequency bands.
- Step 7: Check that the out-of-band emissions requirement (clause 4.2.5.1.2) is satisfied in all cases.

5.2.5.1.2.2 Unwanted emissions in the out-of-band domain when OBTS is in active state

Measurement procedure:

- Step 1: Connect the MCOBA antenna output port to the spectrum analyser through a 50 Ω power attenuator.
- Step 2: Activate all the operating frequency bands of the NCU (see table 5.2.5.1.2.2-1).
- Step 3: Activate the OBTS at lowest configurable GSM, UTRA or E-UTRA channel transmitting at maximum output power.
- Step 4: Set the Resolution bandwidth (RBW) to 100 kHz.
Set the Video bandwidth (VBW) to 1 MHz or greater.
- Step 5: The measurements shall be made from F_c (centre frequency) - 50 % of the frequency bandwidth to F_c (centre frequency) - 250 % of the frequency bandwidth and from $F_c + 50$ % of the frequency bandwidth to $F_c + 250$ % of the frequency bandwidth (see table 5.2.5.1.2.2-1).
- Step 6: Measure the power by activating the "rms" detector.
- Step 7: Check that the out-of-band emissions requirement (clause 4.2.5.1.2) is satisfied in all cases.
- Step 8: Activate the OBTS on the highest configurable GSM, UTRA or E-UTRA channel transmitting at maximum output power.
- Step 9: Repeat step 3 to 7.

Table 5.2.5.1.2.2-1: Frequency Parameters

Frequency band (MHz)	Lower frequency band (MHz)		Upper Frequency band (MHz)	
	Fc - 50 % of BW	Fc - 250 % of BW	Fc + 50 % of BW	Fc + 250 % of BW
460 to 470	460	440	470	490
791 to 821	791	731	821	881
921 to 960	921	843	960	1 038
1 805 to 1 880	1 805	1 655	1 880	2 030
2 110 to 2 170	2 110	1 990	2 170	2 290
2 570 to 2 620	2 570	2 470	2 620	2 720
2 620 to 2 690	2 620	2 480	2 690	2 830

5.2.5.2 Unwanted emissions in the spurious domain

5.2.5.2.1 Test purpose

To verify that the MCOBA system does not cause spurious emissions above defined limits in both standby and active states.

5.2.5.2.2 Methods of measurement

Equipment required:

- Spectrum analyser;
- 50 Ω power attenuator;
- Variable filter (optional).

Initial state:

The MCOBA system shall be in standby state.

5.2.5.2.2.1 Unwanted emissions in the spurious domain when system is in standby state

Measurement procedure:

- Step 1: Connect the MCOBA antenna output port to the spectrum analyser through a 50 Ω power attenuator.
- Step 2: Enable transmitting with its maximum output power.
- Step 3: Set the MCOBA system to standby state.
- Step 4: Check that the MCOBA system does not transmit in any of the operating frequency bands.
- Step 5: Set the Resolution bandwidth (RBW) to 100 kHz for frequencies below 1 GHz otherwise set the Resolution bandwidth (RBW) to 1 MHz.
Set the Video bandwidth (VBW) to 1 MHz or greater.
- Step 6: Measure the spurious emissions by activating the quasi peak detector for frequencies below 1 GHz, and the peak detector for frequencies above 1 GHz.
- Step 7: Check that the spurious emissions requirements (clause 4.2.4.2.2) are satisfied for the frequency range in question.

5.2.5.2.2.2 Unwanted emissions in the spurious domain when system is in active state

Measurement procedure:

- Step 1: Connect the MCOBA antenna output port to the measuring receiver input through to a 50 Ω power attenuator and if necessary, an appropriate filter to avoid overloading of the spectrum analyser.
- Step 2: Activate all the MCOBA operating frequency bands.
- Step 3: The detecting device shall be configured as defined in the table 5.2.5.2.2.2-1. The video bandwidth shall be configured to 1 MHz or greater.
- Step 4: Measure the power by activating the quasi peak detector below 1 GHz and the peak detector above 1 GHz.
- Step 5: Check that the spurious emissions requirement (clause 4.2.5.2.2) is satisfied in all cases.

Table 5.2.5.2.2.2-1: Spurious emissions measurements outside the MCOBA transmit bands

From frequency	To frequency	Resolution bandwidth
30 MHz	440 MHz	100 kHz
490 MHz	716MHz	100 kHz
1 038 MHz	1 655 MHz	1 MHz
2 290 MHz	2 445 MHz	1 MHz
2 865 MHz	12,75 GHz	1 MHz

5.2.5.3 Cessation of emissions

5.2.5.3.1 Test purpose

To verify that the MCOBA system ceases emissions as described in figure 4.1.2-1 contained in clause 4.1.2 and enters into the standby state when a condition requiring cessation of emissions occurs. The tests shall confirm that transmission cease:

- i) when a MCOBA system is in a geographical position where emissions are prohibited, and both OBTS and NCU enter automatically the standby state;
- ii) when a MCOBA system is at an altitude (Above Ground Level, AGL) where emissions are prohibited, and both OBTS and NCU enter automatically the standby state.

5.2.5.3.2 Methods of measurement

Equipment required:

- spectrum analyser;
- 50 Ω power attenuator;
- STE.

Initial state:

The MCOBA system shall be on standby state.

Measurement procedure:

Geographical position where to cease emissions:

- Step 1: Connect the MCOBA antenna output port to the spectrum analyser through the 50 Ω power attenuator.
- Step 2: Connect the STE to the MCOBA system via a suitable interface.

- Step 3: Set the MCOBA system into the transmission state.
- Step 4: Initiate a condition requiring cessation of emissions by the STE, which simulates the geographical location of the aircraft.
- Step 5: Check that the MCOBA system enters into the standby state in a controlled manner as represented in the state diagram in figure 4.1.2-1 contained in clause 4.1.2.

Altitude (AGL) where to cease emissions:

- Step 1: Connect the MCOBA antenna output port to the spectrum analyser through the 50 Ω power attenuator.
- Step 2: Connect the STE to the MCOBA system via a suitable interface.
- Step 3: Set the MCOBA system into the transmission state.
- Step 4: Initiate a condition requiring cessation of emission by the STE, which simulates the altitude of the aircraft.
- Step 5: Check that the MCOBA system enters into the standby state in a controlled manner as represented in the state diagram in figure 4.1.2-1 contained in clause 4.1.2.

Annex A (normative): Relationship between the present document and the essential requirements of Directive 2014/53/EU

The present document has been prepared under the Commission's standardisation request C(2015) 5376 final [i.9] to provide one voluntary means of conforming to the essential requirements of Directive 2014/53/EU on the harmonisation of the laws of the Member States relating to the making available on the market of radio equipment and repealing Directive 1999/5/EC [i.1].

Once the present document is cited in the Official Journal of the European Union under that Directive, compliance with the normative clauses of the present document given in table A.1 confers, within the limits of the scope of the present document, a presumption of conformity with the corresponding essential requirements of that Directive, and associated EFTA regulations.

Table A.1: Relationship between the present document and the essential requirements of Directive 2014/53/EU

Harmonised Standard ETSI EN 302 480				
The following requirements are relevant to the presumption of conformity under the article 3.2 of Directive 2014/53/EU [i.1]				
Requirement			Requirement Conditionality	
No	Description	Reference: Clause No	U/C	Condition
1	GSM-OBTS maximum output power	4.2.2.1	U	
2	GSM-OBTS output RF spectrum	4.2.2.2	U	
3	GSM-OBTS radio frequency tolerance	4.2.2.3	U	
4	GSM-OBTS controlled UE RF power	4.2.2.4	U	
5	GSM-OBTS reference sensitivity level	4.2.2.5	U	
6	GSM-OBTS unwanted emissions in the spurious domain	4.2.2.6	U	
7	UTRA-OBTS Spectrum Emissions Mask	4.2.3.1	U	
8	UTRA-OBTS Adjacent Channel Leakage Power Ratio (ACLR)	4.2.3.2	U	
9	UTRA-OBTS Transmitter spurious emissions	4.2.3.3	U	
10	UTRA-OBTS Base Station maximum output power	4.2.3.4	U	
11	UTRA-OBTS Transmitter intermodulation	4.2.3.5	U	
12	UTRA-OBTS Receiver spurious emissions	4.2.3.6	U	
13	UTRA-OBTS Blocking characteristics	4.2.3.7	U	
14	UTRA-OBTS Receiver intermodulation characteristics	4.2.3.8	U	
15	UTRA-OBTS Receiver adjacent channel selectivity	4.2.3.9	U	
16	UTRA-OBTS controlled MS RF Power	4.2.3.10	U	
17	E-UTRA-OBTS operating band unwanted emissions	4.2.4.1	U	
18	E-UTRA-OBTS Adjacent Channel Leakage power Ratio (ACLR)	4.2.4.2	U	
19	E-UTRA-OBTS transmitter spurious emissions	4.2.4.3	U	
20	E-UTRA-OBTS maximum output power	4.2.4.4	U	
21	E-UTRA-OBTS transmitter intermodulation	4.2.4.5	U	
22	E-UTRA-OBTS receiver spurious emissions	4.2.4.6	U	

Harmonised Standard ETSI EN 302 480				
The following requirements are relevant to the presumption of conformity under the article 3.2 of Directive 2014/53/EU [i.1]				
Requirement			Requirement Conditionality	
No	Description	Reference: Clause No	U/C	Condition
23	E-UTRA-OBTS Blocking characteristics	4.2.4.7	U	
24	E-UTRA-OBTS receiver intermodulation characteristics	4.2.4.8	U	
25	E-UTRA-OBTS Adjacent Channel Selectivity (ACS) and narrow-band blocking	4.2.4.9	U	
26	E-UTRA-OBTS-controlled UE RF power	4.2.4.10	U	
27	NCU maximum mean power spectral density	4.2.5.1	U	
28	NCU power flatness	4.2.5.2	U	
29	NCU out-of-band emissions	4.2.5.3	U	
30	NCU spurious emissions	4.2.5.4	U	
31	MCOBA Unwanted emissions in the out-of-band domain	4.2.6.1	U	
32	MCOBA Unwanted emissions in the spurious domain	4.2.6.2	U	
33	MCOBA Cessation of emission	4.2.6.3	U	

Key to columns:**Requirement:**

No A unique identifier for one row of the table which may be used to identify a requirement.

Description A textual reference to the requirement.

Clause Number Identification of clause(s) defining the requirement in the present document unless another document is referenced explicitly.

Requirement Conditionality:

U/C Indicates whether the requirement shall be unconditionally applicable (U) or is conditional upon the manufacturer's claimed functionality of the equipment (C).

Condition Explains the conditions when the requirement shall or shall not be applicable for a requirement which is classified "conditional".

Presumption of conformity stays valid only as long as a reference to the present document is maintained in the list published in the Official Journal of the European Union. Users of the present document should consult frequently the latest list published in the Official Journal of the European Union.

Other Union legislation may be applicable to the product(s) falling within the scope of the present document.

Annex B (normative): Environmental conditions

B.1 General

The present annex specifies the environmental conditions under which the relevant requirements of the present document shall be fulfilled.

B.2 Environmental conformance requirements

Testing under aircraft specific environmental and EMC conditions will be undertaken by manufacturers according to the requirements of EUROCAE ED-14 [i.6], and need not be repeated as it is not a requirement of the present document.

B.3 Environmental test conditions

The MCOBA equipment may be subject to different environmental and EMC conditions and is required to maintain its performance in accordance with the present document under all environmental circumstances for the Equipment Categories applicable to them as defined in EUROCAE ED-14 [i.6]. Tests specified in the present document shall be maintained within the following range of environmental conditions (or otherwise as specified by the manufacturer):

temperature: +15 °C to +35 °C;

relative humidity: ≤ 85 %;

pressure: 840 hPa to 1 070 hPa (equivalent to +1 525 m to -460 m altitude).

Tests made at environmental conditions other than ambient as specified above shall be conducted subject to the following tolerances:

Temperature: ±3 °C;

Pressure: ±5 %.

The power supply will be set in accordance with EUROCAE ED-14 [i.6] Normal Operating Conditions (nominal), for the Equipment Category applicable to the MCOBA system.

Annex C (informative): System Description

C.1 High level System Description

The MCOBA system comprises of an onboard BTS (OBTS) and a Network Control Unit (NCU). These are connected to a dedicated antenna system. The whole system is then connected to the ground network via a satellite link. Figure C.1 represents the high level system description.

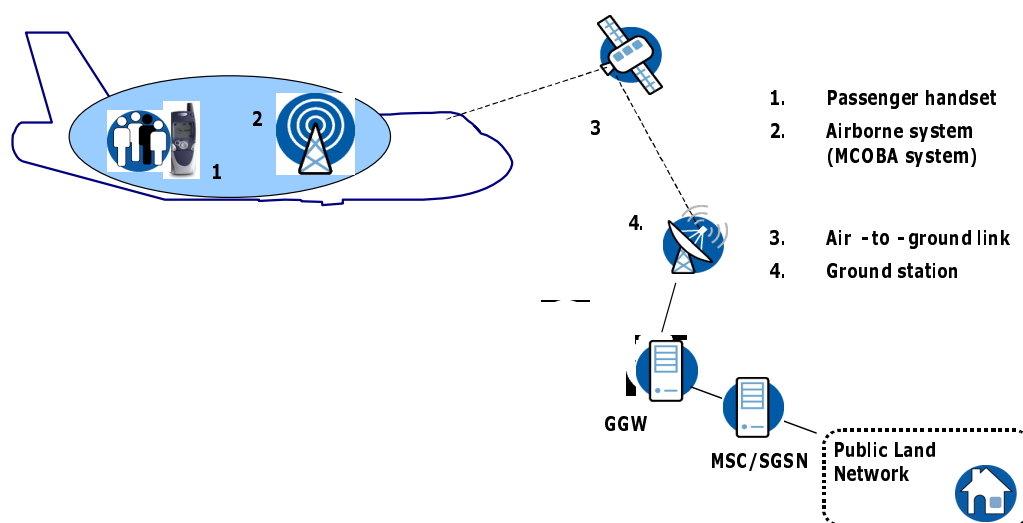

Figure C.1: Overview of the MCOBA system and associated transmission components

The scope of the present document covers the onboard elements; OBTS, NCU and the transmission antenna only.

Figure C.2 represents the functional organization of the MCOBA system, which is limited by the dotted box. This system may comprise one or more NCUs, one or more BTS functions and antenna coupling units (ACU).

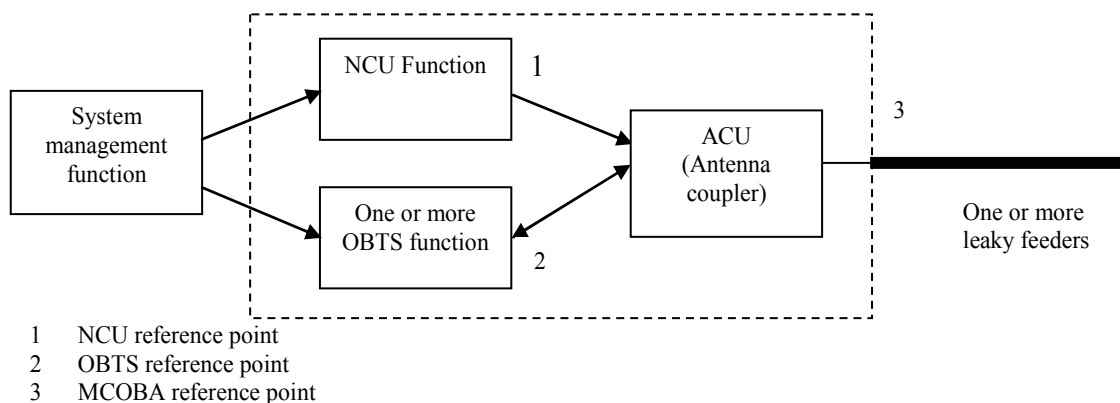

Figure C.2: System description

C.2 OBTS

The OBTS establishes the communication access to the UE in the aircraft and supports all necessary system features such as radio access and radio resource management.

The OBTS has the following characteristics:

- Support of GSM, UMTS and LTE services.
- Operates in the 1 800 MHz frequency band for GSM and LTE services and in the 2 100 MHz band for UMTS services.
- Operates at a sufficient margin over the NCU level.
- Ensures that an UE communicating with the OBTS transmits at the nominal minimum power level.

C.3 RF Screening

Onboard aircraft mobile terminals are prevented from attempting to access networks on the ground. This could be done:

- By passive means e.g. through RF shielding of the aircraft fuselage to further attenuate the signal entering and leaving the fuselage.
- By the inclusion of a Network Control Unit (NCU), which raises the noise floor inside the cabin in mobile receive bands by transmitting a broadband signal within those operating frequency bands.

These methods can be combined to minimize the active NCU power level.

The RF Screening will cover the appropriate frequency ranges, the frequency bands of which are as listed in table C-1.

Table C-1: Frequency bands

Frequency bands
460 MHz to 470 MHz
791 MHz to 821 MHz
921 MHz to 960 MHz
1 805 MHz to 1 880 MHz
2 110 MHz to 2 170 MHz
2 570 MHz to 2 620 MHz
2 620 MHz to 2 690 MHz

NOTE: Any NCU will only be operational above the minimum height above the ground at which the system is permitted to be operated.

C.4 Dedicated antenna system

In most cases, transmission of the signals is distributed in the cabin by a leaky cable antenna system. This leaky cable is specially designed for use onboard aircraft. The leaky cable RF characteristics can be defined by the following parameters:

- Method of transmission.
- Insertion loss.
- Coupling loss.

In case of an antenna system based on discrete antennas, the following parameters have to be defined:

- Antenna Gain.

- Polarisation of the antenna(s).
- Horizontal and vertical antenna diagram.

C.5 Dedicated antenna installation

Transmission of the signals distributed in the cabin may be affected by the type of installation used. The characteristics for the dedicated installation type are defined by the following parameters:

- Number of antennas in use.
- Length of cable(s) in case of leaky lines and position of antennas in case of dedicated antennas.
- Required radial coverage.
- Placement of the installation.
- Additional characteristics of installation.

Annex D (informative): Bibliography

- CEPT/ECC Report 93: "Report on the compatibility between GSM equipment onboard aircraft and terrestrial networks".
- ECC Report 187: "Compatability study between mobile communication services on board aircraft (MCA) and ground-based systems".
- Directive 98/34/EC of the European Parliament and of the Council of 22 June 1998 laying down a procedure for the provision of information in the field of technical standards and regulations.
- CEPT/ECC/DEC/(06)07: "ECC Decision of 1 December 2006 on the harmonized use of airborne GSM systems in the frequency bands 1710-1785 and 1805-1880 MHz".
- Commission Decision of 7 April 2008 on harmonised conditions of spectrum use for the operation of mobile communication services on aircraft (MCA services) in the Community.

History

Document history		
V1.1.2	April 2008	Publication
V2.1.1	July 2016	Publication
V2.1.2	February 2017	Publication