

ETSI EN 302 435-1 V1.2.1 (2008-04)

European Standard (Telecommunications series)

**Electromagnetic compatibility
and Radio spectrum Matters (ERM);
Short Range Devices (SRD);
Technical characteristics for SRD equipment using
Ultra WideBand technology (UWB);
Building Material Analysis and Classification equipment applications
operating in the frequency band from 2,2 GHz to 8 GHz;
Part 1: Technical characteristics and test methods**



Reference

DEN/ERM-TG31C-001-1

Keywords

radar, radio, SRD, testing, UWB

ETSI

650 Route des Lucioles
F-06921 Sophia Antipolis Cedex - FRANCE

Tel.: +33 4 92 94 42 00 Fax: +33 4 93 65 47 16

Siret N° 348 623 562 00017 - NAF 742 C
Association à but non lucratif enregistrée à la
Sous-Préfecture de Grasse (06) N° 7803/88

Important notice

Individual copies of the present document can be downloaded from:

<http://www.etsi.org>

The present document may be made available in more than one electronic version or in print. In any case of existing or perceived difference in contents between such versions, the reference version is the Portable Document Format (PDF). In case of dispute, the reference shall be the printing on ETSI printers of the PDF version kept on a specific network drive within ETSI Secretariat.

Users of the present document should be aware that the document may be subject to revision or change of status. Information on the current status of this and other ETSI documents is available at

<http://portal.etsi.org/tb/status/status.asp>

If you find errors in the present document, please send your comment to one of the following services:

http://portal.etsi.org/chaicor/ETSI_support.asp

Copyright Notification

No part may be reproduced except as authorized by written permission.
The copyright and the foregoing restriction extend to reproduction in all media.

© European Telecommunications Standards Institute 2008.
All rights reserved.

DECT™, **PLUGTESTS™**, **UMTS™**, **TIPHON™**, the TIPHON logo and the ETSI logo are Trade Marks of ETSI registered for the benefit of its Members.

3GPP™ is a Trade Mark of ETSI registered for the benefit of its Members and of the 3GPP Organizational Partners.

Contents

Intellectual Property Rights	5
Foreword.....	5
1 Scope	7
2 References	7
2.1 Normative references	8
2.2 Informative references.....	8
3 Definitions, symbols and abbreviations	8
3.1 Definitions.....	8
3.2 Symbols.....	9
3.3 Abbreviations	10
4 Technical requirement specifications	10
4.1 General requirements	10
4.2 Presentation of equipment for testing purposes.....	10
4.2.1 Choice of model for testing	11
4.2.2 Auxiliary test equipment.....	11
4.2.3 Declarations by the provider.....	11
4.2.4 Marking and equipment identification.....	11
4.3 Mechanical and electrical design.....	11
4.3.1 General.....	11
4.3.2 Controls	11
4.3.3 Transmitter shut-off facility.....	11
4.4 Other device emissions.....	12
5 Test conditions, power sources and ambient temperatures	12
5.1 Test conditions	12
5.2 Test power source.....	12
5.2.1 External test power source	12
5.2.2 Internal test power source	12
5.3 Normal test conditions.....	13
5.3.1 Normal temperature and humidity	13
5.3.2 Normal test power source	13
5.3.2.1 Internal battery power source	13
5.3.2.2 Regulated lead-acid battery power sources	13
5.3.2.3 Other power sources.....	13
6 General conditions.....	13
6.1 Radiated measurement arrangements	13
6.2 Modes of operation of the transmitter	14
6.3 Measuring receiver	14
7 Interpretation of results	14
7.1 Measurement uncertainty	14
7.1.1 Measurement uncertainty is equal to or less than maximum acceptable uncertainty.....	15
7.1.2 Measurement uncertainty is greater than the maximum acceptable uncertainty.....	15
7.2 Other emissions from device circuitry.....	16
8 Methods of measurement and limits for transmitter parameters	16
8.1 General	16
8.2 Permitted range of operating frequencies	16
8.2.1 Definition.....	16
8.2.2 Method of measurement	17
8.2.3 Frequency range.....	18
8.3 Emissions	18
8.3.1 Undesired UWB emissions from the transmitter	18
8.3.1.1 Definitions.....	18

8.3.1.2	Method of measurement.....	18
8.3.1.2.1	Method of measurement of the Total Emissions (TE).....	19
8.3.1.2.2	Method of measurement of the Other Emissions (OE).....	21
8.3.1.2.3	Method of calculation of the maximum mean undesired UWB emission of the equipment (UE).....	21
8.3.1.3	Limits	22
8.3.2	Other Emissions (OE).....	22
8.3.2.1	Definition	22
8.3.2.2	Method of measurement.....	22
8.3.2.3	Limits	22
8.3.3	Total Power spectral density (UE-TP).....	22
8.3.3.1	Definitions.....	22
8.3.3.2	Method of measurement.....	23
8.3.3.3	Limits	23
8.4	Pulse Repetition Frequency (PRF)	24
8.4.1	Definitions	24
8.4.2	Declaration.....	24
8.4.3	Limits.....	24
8.5	Listen Before Talk (LBT).....	24
8.5.1	Definition.....	24
8.5.2	Function of LBT	25
8.5.3	Method of measurement	27
8.5.3.1	Measurement procedure	27
8.5.3.2	Test set-up.....	27
8.5.4	Limits.....	29
8.5.5	Test signal definition for LBT-mechanism.....	30
8.5.6	Design requirements	31
9	Methods of measurement and limits for receiver parameters.....	31
9.1	Receiver spurious emissions.....	31
Annex A (normative): Radiated measurements		32
A.1	Test sites and general arrangements for measurements involving the use of radiated fields	32
A.1.1	Anechoic chamber.....	32
A.1.2	Anechoic chamber with a conductive ground plane.....	33
A.1.3	Test antenna.....	34
A.1.4	Measuring antenna	34
A.2	Guidance on the use of radiation test sites	35
A.2.1	Verification of the test site	35
A.2.2	Preparation of the DUT	35
A.2.3	Power supplies to the DUT.....	35
A.2.4	Range length.....	35
A.2.5	Site preparation	36
A.2.6	General requirements for RF cables	36
Annex B (normative): Design requirements.....		37
Annex C (informative): Measurement antenna and preamplifier specifications		38
Annex D (normative): Definition of the representative wall and procedure for measurement of the undesired emissions.....		39
D.1	Representative wall definition for measuring the undesired emissions and LBT function.....	39
D.2	Procedure for measurement the wall attenuation	40
D.3	Typical representative wall measurement result	41
Annex E (informative): Bibliography.....		42
History		43

Intellectual Property Rights

IPRs essential or potentially essential to the present document may have been declared to ETSI. The information pertaining to these essential IPRs, if any, is publicly available for **ETSI members and non-members**, and can be found in ETSI SR 000 314: "*Intellectual Property Rights (IPRs); Essential, or potentially Essential, IPRs notified to ETSI in respect of ETSI standards*", which is available from the ETSI Secretariat. Latest updates are available on the ETSI Web server (<http://webapp.etsi.org/IPR/home.asp>).

Pursuant to the ETSI IPR Policy, no investigation, including IPR searches, has been carried out by ETSI. No guarantee can be given as to the existence of other IPRs not referenced in ETSI SR 000 314 (or the updates on the ETSI Web server) which are, or may be, or may become, essential to the present document.

Foreword

This European Standard (Telecommunications series) has been produced by ETSI Technical Committee Electromagnetic compatibility and Radio spectrum Matters (ERM).

Equipment covered by the present document operates in accordance with ECC Decision ECC/DEC(07)01 on Building Material Analysis (BMA) devices.

For non EU countries the present document may be used for regulatory (Type Approval) purposes.

The present document is part 1 of a multi-part deliverable covering Ultra WideBand (UWB) Building Material Analysis (BMA) and Classification equipment applications operating in the frequency band from 2,2 GHz to 8 GHz, as identified below:

Part 1: "Technical characteristics and test methods";

Part 2: "Harmonized EN covering the essential requirements of article 3.2 of the R&TTE Directive".

Clauses 1 and 3 provide a general description on the types of equipment covered by the present document and the definitions and abbreviations used.

Clauses 4 and 5 provide the technical requirements for the conduction of the tests and information for equipment to be presented.

Clauses 6 and 7 give guidance on the general conditions for testing of the device and the interpretation of results and maximum measurement uncertainty values.

Clause 8 specifies the transmitter spectrum utilization parameters. The clause provides details on how the equipment should be tested and the conditions which should be applied.

Annex A (normative) provides specifications concerning radiated measurements.

Annex B (normative) provides specifications concerning the design requirements.

Annex C (informative) gives information for the measurement antenna and the preamplifier specifications.

Annex D (normative) provides a representative wall definition for emission measurements and the LBT function.

Annex E (informative) Bibliography covers other supplementary information.

National transposition dates

Date of adoption of this EN:	11 April 2008
Date of latest announcement of this EN (doa):	31 July 2008
Date of latest publication of new National Standard or endorsement of this EN (dop/e):	31 January 2009
Date of withdrawal of any conflicting National Standard (dow):	31 January 2009

1 Scope

The present document specifies the requirements for Building Material Analysis and Classification (BMA) applications using UWB technology operating in all or part of the frequency band from 2,2 GHz to 8 GHz. Additionally, it specifies reduced emissions in the ranges from 0,96 GHz to 2,2 GHz and 8 GHz to 10,6 GHz.

The present document applies to:

- a) UWB building material analysis and classification equipment for imaging and object detection applications;
- b) equipment fitted with an integral antenna;
- c) handheld devices.

The present document does not apply to:

- UWB communication devices; and
- Ground penetrating radar devices; and
- through-wall radar imaging devices;

as defined in ITU-R Recommendation SM.1754 [6].

The present document specifies the equipment which is designed to not radiate into the free space. It is designed to function only when positioned such that it radiates directly into the absorptive material such as walls and other building materials which absorb emissions.

The present document does not necessarily include all the characteristics which may be required by a user, nor does it necessarily represent the optimum performance achievable.

2 References

References are either specific (identified by date of publication and/or edition number or version number) or non-specific.

- For a specific reference, subsequent revisions do not apply.
- Non-specific reference may be made only to a complete document or a part thereof and only in the following cases:
 - if it is accepted that it will be possible to use all future changes of the referenced document for the purposes of the referring document;
 - for informative references.

Referenced documents which are not found to be publicly available in the expected location might be found at <http://docbox.etsi.org/Reference>.

For online referenced documents, information sufficient to identify and locate the source shall be provided. Preferably, the primary source of the referenced document should be cited, in order to ensure traceability. Furthermore, the reference should, as far as possible, remain valid for the expected life of the document. The reference shall include the method of access to the referenced document and the full network address, with the same punctuation and use of upper case and lower case letters.

NOTE: While any hyperlinks included in this clause were valid at the time of publication ETSI cannot guarantee their long term validity.

2.1 Normative references

The following referenced documents are indispensable for the application of the present document. For dated references, only the edition cited applies. For non-specific references, the latest edition of the referenced document (including any amendments) applies.

- [1] CISPR 16-1 (2003): "Specification for radio disturbance and immunity measuring apparatus and methods - Part 1: Radio disturbance and immunity measuring apparatus".
- [2] CEN EN 206-1 (2000): "Concrete - Part 1: Specification, Performance, Production and Conformity".
- [3] ETSI TR 100 028 (all parts) (V1.4.1): "Electromagnetic compatibility and Radio spectrum Matters (ERM); Uncertainties in the measurement of mobile radio equipment characteristics".
- [4] ETSI TR 102 273 (all parts) (V1.2.1): "Electromagnetic compatibility and Radio spectrum Matters (ERM); Improvement on Radiated Methods of Measurement (using test site) and evaluation of the corresponding measurement uncertainties".
- [5] ANSI C63.5 (2006): "American National Standard for Calibration of Antennas Used for Radiated Emission Measurements in Electromagnetic Interference (EMI)".

2.2 Informative references

The following referenced documents are not essential to the use of the present document but they assist the user with regard to a particular subject area. For non-specific references, the latest version of the referenced document (including any amendments) applies.

- [6] ITU-R Recommendation SM.1754: "Measurement techniques of ultra-wideband transmissions".
- [7] ITU-R Recommendation SM 1538: "Technical and operating parameters and spectrum requirements for short-range radiocommunication devices".
- [8] ETSI TR 102 070-2: "Electromagnetic compatibility and Radio spectrum Matters (ERM); Guide to the application of harmonized standards to multi-radio and combined radio and non-radio equipment; Part 2: Effective use of the radio frequency spectrum".
- [9] CEPT/ERC/REC 74-01E (2005): "Unwanted emissions in the spurious domain".
- [10] CENELEC EN 55022: "Information technology equipment - Radio disturbance characteristics - Limits and methods of measurement".

3 Definitions, symbols and abbreviations

3.1 Definitions

For the purposes of the present document, the following terms and definitions apply:

activity factor: effective transmission time ratio, actual on-the-air time divided by active session time or actual on-the-air emission time within a given time window

clutter: undesired radar reflections (echoes) e.g. from inhomogenities, interfaces, gravel stones, cavities in building material structures

integral antenna: permanent fixed antenna, which may be built-in, designed as an indispensable part of the equipment

Listen Before Talk (LBT): mechanism to avoid signal transmission in the presence of other radio service signals

Pulse Repetition Frequency (PRF): inverse of the Pulse Repetition Interval, averaged over a sufficiently long time to cover all PRI variations

radiated measurements: measurements which involve the absolute measurement of a radiated field

spatial resolution: ability to discriminate between two adjacent targets

SRD: Equipment defined to operate on a non-interference, no protection from interference basis (as also defined in ITU-R Recommendation SM.1538 [7])

Total Power (TP): integration of the undesired emissions in the whole area around the BM&A-scenario

NOTE: The integration is over a sphere (same procedure as for Total Radiated Power (TRP)). This value is comparable to an equivalent isotropic radiator.

undesired emissions: any emissions into free space during operation of the equipment when equipment is faced to a wall or other absorptive material to be investigated

NOTE: Undesired emissions are:

- leaked emissions from the side or backside of the antenna; and/or
- scattered/reflected emissions from the building material to be investigated; and/or
- residual emissions through the building material.

3.2 Symbols

For the purposes of the present document, the following symbols apply:

$c1$	cable loss 1
$c2$	cable loss 2
E	Electrical field strength
E_R	relative dielectric constant of earth materials
E_{rms}	Average electrical field strength measured as root mean square
f	frequency
f_c	frequency at which the emission is the peak power at maximum
$GLNA$	Gain of the measurement LNA
GA	Gain of the measurement antenna
$G(f)$	Antenna gain over frequency
f_H	Highest frequency of the frequency band of operation
f_L	Lowest frequency of the frequency band of operation
P	Power
$P_{e.i.r.p.}$	spectral power density
P_m	measured spectral power
$P_{wall, e.i.r.p.}$	undesired spectral power density
P_{victim}	power of a different device at the BMA
R	Distance
rms	Root mean square
t	time
T_P	pulse rise time
Z_{F0}	Free space wave impedance
λ	wavelength
c	velocity of light in a vacuum
δR	range resolution
δt	time interval between the arrivals of two signals from targets separated in range by δR

3.3 Abbreviations

For the purposes of the present document, the following abbreviations apply:

BMA	Building Material Analysis
CEPT	Conférence Européenne des administrations de Postes et des Télécommunications
CW	Continuous Wave
dB	deciBel
dBi	gain in deciBel relative to an isotropic antenna
dBm	deciBel reference to 1 mW
DUT	Device Under Test
e.i.r.p.	equivalent isotropically radiated power
ECC	Electronic Communications Committee
EMC	Electro-Magnetic Compatibility
ERC	European Radiocommunication Committee
IT	Information Technology
LBT	Listen Before Talk
LNA	Low Noise Amplifier
MSS	Mobile Satellite Service
OE	Other Emissions
PRF	Pulse Repetition Frequency
PRI	Pulse Repetition Interval
PSD	Power Spectral Density
R&TTE	Radio and Telecommunications Terminal Equipment
RBW	Resolution BandWidth
RF	Radio Frequency
SRD	Short Range Device
TE	Total maximum Emissions
TH	ThresHold
TP	Total Power
TP-UE	Total Power of Undesired (UWB) Emissions
TRP	Total Radiated Power
UE	Undesired (UWB) Emissions
UMTS	Universal Mobile Telecommunication System
UWB	Ultra WideBand
VBW	Video BandWidth
VSWR	Voltage Standing Wave Ratio

4 Technical requirement specifications

4.1 General requirements

Equipment to be tested against the present document shall be fitted with an integral antenna.

4.2 Presentation of equipment for testing purposes

Each equipment to be tested shall fulfil the requirements of the present document on all frequencies over which it is intended to operate.

The provider shall provide one or more samples of the equipment, as appropriate for testing.

Additionally, technical documentation and operating manuals, sufficient to allow testing to be performed, shall be supplied.

The performance of the equipment to be tested shall be representative of the performance of the corresponding production model. In order to avoid any ambiguity, the present document contains instructions for the preparation of equipment for testing purposes, conditions of testing (clause 5) and the measurement methods (clause 8).

Equipment shall be offered by the provider complete with any ancillary equipment needed for testing. The provider shall declare the frequency range(s), the range of operation conditions and power requirements, as applicable, in order to establish the appropriate test conditions.

4.2.1 Choice of model for testing

If an equipment has several optional features, considered not to affect the RF parameters then the tests need only to be performed on the equipment configured with that combination of features considered to be the most complex, as proposed by the provider and agreed by the test laboratory.

4.2.2 Auxiliary test equipment

All necessary set-up information, means for activation and hardware necessary (e.g. standardized wall structure for testing, see annex D) shall accompany the equipment when it is submitted for testing.

4.2.3 Declarations by the provider

The provider shall submit the necessary information regarding the equipment with respect to all technical requirements set by the present document.

4.2.4 Marking and equipment identification

The equipment shall be marked in a visible place. This marking shall be legible and durable.

The marking shall include as a minimum:

- the name of the manufacturer or his trademark;
- the type designation. This is the manufacturer's numeric or alphanumeric code or name that is specific to particular equipment.

4.3 Mechanical and electrical design

4.3.1 General

The equipment submitted by the provider shall be designed, constructed and manufactured in accordance with good engineering practice and with the aim of minimizing harmful interference to other equipment and services.

4.3.2 Controls

The equipment shall be equipped with controls as defined in annex B.

4.3.3 Transmitter shut-off facility

For the automatic transmitter shut-off facility it shall be possible to disable this feature for the purposes of testing.

Controls for testing purposes, which, if maladjusted, may increase the interfering potential of the equipment, shall not be easily accessible to the user.

4.4 Other device emissions

The equipment may contain digital circuit elements, radio circuit elements and other elements whose performance is not covered by the present document. These elements of the equipment shall meet the appropriate performance requirements for those components, as specified in other standards.

For example the requirements of a standard for EMC compatibility of IT equipment, such as EN 55022 [10] (for the elements of the device which are not concerned with radio communications but are considered to be IT equipment).

NOTE: For further information on this topic, see TR 102 070-2 [8].

5 Test conditions, power sources and ambient temperatures

5.1 Test conditions

Testing shall be performed under normal test conditions. The test conditions and procedures shall be as specified in clauses 5.2 to 5.3.

5.2 Test power source

The equipment shall be tested using the appropriate test power source as specified in clauses 5.2.1 or 5.2.2. Where equipment can be powered using either external or internal power sources, then equipment shall be tested using the external test power source as specified in clause 5.2.1 then repeated using the internal power source as specified in clause 5.2.2.

The test power source used shall be recorded and stated.

5.2.1 External test power source

During tests, the power source of the equipment shall be replaced by an external test power source capable of producing normal test voltages as specified in clause 5.3.2. The internal impedance of the external test power source shall be low enough for its effect on the test results to be negligible. For the purpose of the tests, the voltage of the external test power source shall be measured at the input terminals of the equipment. The external test power source shall be suitably de-coupled and applied as close to the equipment battery terminals as practicable. For radiated measurements any external power leads should be so arranged so as not to affect the measurements.

During tests, the external test power source voltages shall be within a tolerance $< \pm 1$ % relative to the voltage at the beginning of each test.

5.2.2 Internal test power source

For radiated measurements on portable equipment with integral antenna, fully charged internal batteries shall be used. The batteries used should be as supplied or recommended by the provider. If internal batteries are used, at the end of each test the voltage shall be within a tolerance of $< \pm 5$ % relative to the voltage at the beginning of each test.

If appropriate, the external test power source may replace the supplied or recommended internal batteries at the required voltage - this shall be recorded and stated. In this case, the battery should remain present, electrically isolated from the rest of the equipment, possibly by putting tape over its contacts.

5.3 Normal test conditions

5.3.1 Normal temperature and humidity

The normal temperature and humidity conditions for tests shall be any convenient combination of temperature and humidity within the following ranges:

- temperature: +15 °C to +35 °C;
- relative humidity: 20 % to 75 %.

When it is impracticable to carry out tests under these conditions, a note to this effect stating the ambient temperature and relative humidity during the tests, shall be recorded and stated.

5.3.2 Normal test power source

5.3.2.1 Internal battery power source

The normal test voltage for equipment shall be a regulated battery power source. For the purpose of the present document, the nominal voltage shall be the declared voltage, or any of the declared voltages, for which the equipment was designed.

When the radio equipment is intended for operation with the usual types of regulated battery power source, the normal test voltage shall be 1,1 multiplied by the nominal voltage of the battery (e.g. 6 V, 12 V, etc.).

5.3.2.2 Regulated lead-acid battery power sources

When the radio equipment is intended for operation from the usual types of regulated lead-acid battery power source, the normal test voltage shall be 1,1 multiplied by the nominal voltage of the battery (6 V, 12 V, etc.).

5.3.2.3 Other power sources

For operation from other power sources or types of battery (primary or secondary), the normal test voltage shall be the one declared by the equipment provider. Such values shall be recorded and stated.

6 General conditions

6.1 Radiated measurement arrangements

For guidance on radiation test sites and general arrangements for radiated measurements, see annex A.

Detailed descriptions of radiated measurement arrangements for UWB devices can be found in ITU-R Recommendation SM.1754 [6].

All reasonable efforts should be made to clearly demonstrate that emissions from the UWB transmitter do not exceed the specified levels, with the transmitter in the far field. To the extent practicable, the device under test should be measured at the distance specified in annex A and with the specified measurement bandwidths. However, in order to obtain an adequate signal-to-noise ratio in the measurement system, radiated measurements may have to be made at distances less than those specified in annex A and/or with reduced measurement bandwidths. The revised measurement configuration should be stated on the test report, together with an explanation of why the signal levels involved necessitated measurement at the distance employed or with the measurement bandwidth used in order to be accurately detected by the measurement equipment, and calculations demonstrating compliance.

Where it is not practical to further reduce the measurement bandwidth (either because of limitations of commonly-available test equipment or difficulties in converting readings taken using one measurement bandwidth to those used by the limits in tables 3 and 5), and the required measurement distance would be so short that the device would not clearly be within the far field, the test report shall state this fact, the measurement distance and bandwidth used, the near field/far field distance for the measurement setup (see clause A.2.4), the measured device emissions, the achievable measurement noise floor and the frequency range(s) involved.

6.2 Modes of operation of the transmitter

For the purpose of the measurements according to the present document, there shall be a facility to operate the transmitter in a continuous state, whereby the signal with modulation is transmitted repeatedly.

If pulse gating is employed where the transmitter is quiescent for intervals that are long compared to the nominal pulse repetition interval, measurements shall be made with the pulse train gated on.

6.3 Measuring receiver

The term measuring receiver refers to a spectrum analyser. The reference bandwidth of the measuring receiver as defined in CISPR 16-1 [1] shall be as given in table 1.

Table 1: Reference bandwidth of measuring receiver

Frequency being measured: f	Spectrum analyser bandwidth (3 dB)
$30 \text{ MHz} \leq f < 1\,000 \text{ MHz}$	100 kHz
$1\,000 \text{ MHz} \leq f$	1 MHz

7 Interpretation of results

7.1 Measurement uncertainty

Interpretation of the results recorded in the test report for the measurements described in the present document shall be as follows:

- the measured value related to the corresponding limit shall be used to decide whether an equipment meets the requirements of the present document;
- the value of the measurement uncertainty for the measurement of each parameter shall be separately included in the test report;
- the value of the measurement uncertainty shall be wherever possible equal for each measurement, equal to or lower than the figures in table 2, and the interpretation procedure specified in clause 7.1.1. shall be used.

Table 2: Measurement uncertainty

Parameter	Uncertainty
RF frequency	$\pm 1 \times 10^{-7}$
RF power, radiated	± 6 dB
Temperature	± 1 K
Humidity	± 5 %
Azimuth and elevation during TRP measurement	$\pm 5^\circ$
NOTE: For radiated emissions measurements below 2,2 GHz and above 8 GHz it may not be possible to reduce measurement uncertainty to the levels specified in table 2 (due to the very low signal level limits and the consequent requirement for high levels of amplification across wide bandwidths). In these cases alone it is acceptable to employ the alternative interpretation procedure specified in clause 7.1.2.	

For the test methods, according to the present document the uncertainty figures shall be calculated according to the methods described in TR 100 028 [3] and shall correspond to an expansion factor (coverage factor) $k = 1,96$ or $k = 2$ (which provide confidence levels of respectively 95 % and 95,45 % in cases where the distributions characterizing the actual measurement uncertainties are normal (Gaussian)).

Table 2 is based on such expansion factors.

The particular expansion factor used for the evaluation of the measurement uncertainty shall be stated.

NOTE: Information on uncertainty contributions, and verification procedures are detailed in TR 102 273 [4].

7.1.1 Measurement uncertainty is equal to or less than maximum acceptable uncertainty

The interpretation of the results when comparing measurement values with specification limits shall be as follows:

- When the measured value does not exceed the limit value the equipment under test meets the requirements of the present document.
- When the measured value exceeds the limit value the equipment under test does not meet the requirements of the present document.
- The measurement uncertainty calculated by the test technician carrying out the measurement shall be recorded in the test report.
- The measurement uncertainty calculated by the test technician may be a maximum value for a range of values of measurement, or may be the measurement uncertainty for the specific measurement undertaken. The method used shall be recorded in the test report.

7.1.2 Measurement uncertainty is greater than the maximum acceptable uncertainty

The interpretation of the results when comparing measurement values with specification limits should be as follows:

- When the measured value plus the difference between the maximum acceptable measurement uncertainty and the measurement uncertainty calculated by the test technician does not exceed the limit value the equipment under test meets the requirements of the standard.
- When the measured value plus the difference between the maximum acceptable measurement uncertainty and the measurement uncertainty calculated by the test technician exceeds the limit value the equipment under test does not meet the requirements of the standard.
- The measurement uncertainty calculated by the test technician carrying out the measurement should be recorded in the test report.

- d) The measurement uncertainty calculated by the test technician may be a maximum value for a range of values of measurement, or may be the measurement uncertainty for the specific measurement undertaken. The method used should be recorded in the test report.

This procedure is only applicable for measuring very low power levels.

7.2 Other emissions from device circuitry

UWB transmitters emit very low power radio signals, comparable with the power of spurious emissions from digital and analog circuitry. If it can be clearly demonstrated that an emission from an Ultra WideBand device is unintentional and is not radiated from the transmitter's antenna (e.g. by disabling the device's UWB transmitter or internally disconnecting the UWB antenna), such emissions shall be considered as emitted from the receiver or from other digital or analog circuitry.

8 Methods of measurement and limits for transmitter parameters

8.1 General

Where the transmitter is designed with adjustable carrier power, then all transmitter parameters shall be measured using the maximum average power density.

All measurements shall be performed using normal modulation representing normal operation of the equipment.

If the transmitter is equipped with an automatic transmitter shut-off facility, it shall be made inoperative for the duration of the test.

8.2 Permitted range of operating frequencies

8.2.1 Definition

The permitted range of operating frequencies is the frequency range over which the equipment is authorized to operate.

8.2.2 Method of measurement

The minimum and maximum frequencies outside of the permitted range of frequencies of clause 8.2.3 shall be measured using the method shown in figure 1.

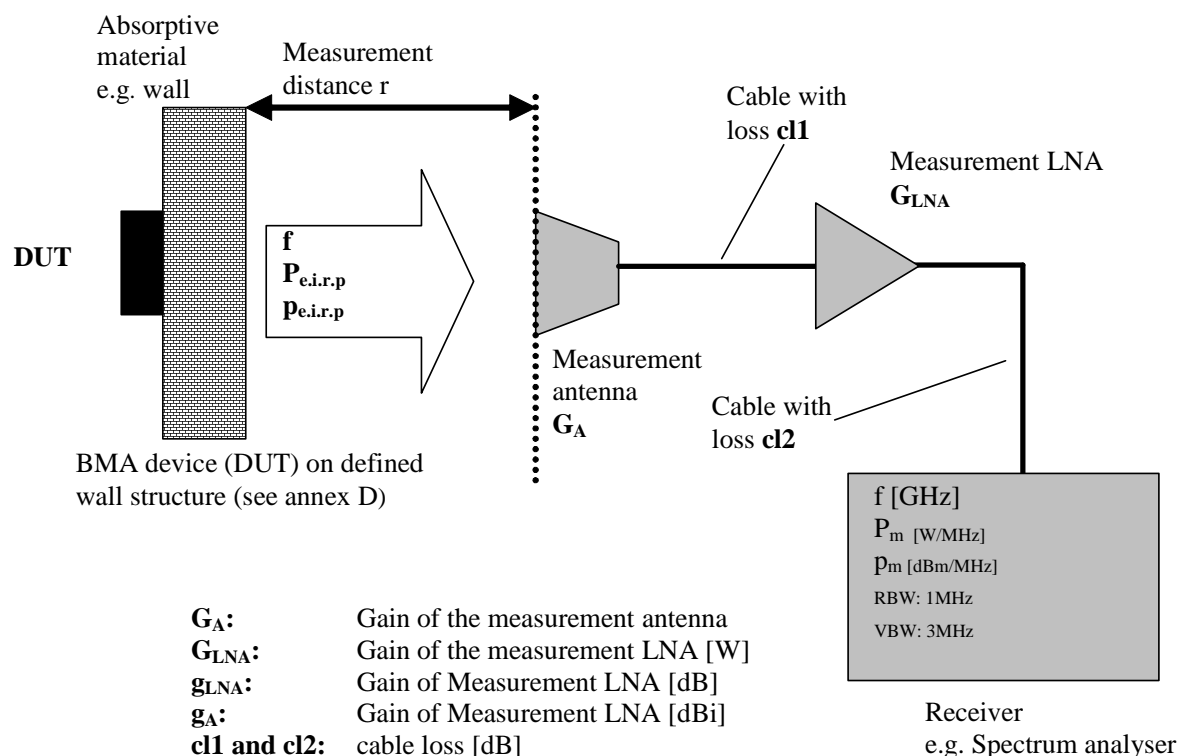

Figure 1: Test set-up for measuring the operating frequency range

The $P_{e.i.r.p}$ is the power density referenced to the surface of the wall taking the frequency dependent, free space attenuation and the measurement equipment into account.

Conversion

$$g_{LNA} = 20 \log(G_{LNA})$$

$$g_A = 10 \log(G_A)$$

$$cl_x = 10 \left(\frac{cl_x}{20} \right)$$

Equation 1 (Values [dB]):

$$P_{e.i.r.p} = P_m - g_A - cl1 - cl2 - g_{LNA} + 20 \cdot \log\left(\frac{4\pi r}{\lambda}\right) \quad [\text{dBm/MHz}]$$

Equation 2 (Values linear)

$$P_{e.i.r.p} = \frac{P_m \cdot (4\pi r)^2}{G_{LNA} \cdot \lambda^2 \cdot G_A \cdot Cl1 \cdot Cl2} \quad [\text{mW/MHz}]$$

The values of the cable loss $Cl1$ and $Cl2$ are smaller than one. Consequently the logarithmic values $cl1$ and $cl2$ are negative!

A test site such as one selected from annex A (i.e. indoor test site or open area test site), which fulfils the requirements of the specified frequency range and undisturbed lowest specified emission levels of this measurement shall be used.

8.2.3 Frequency range

The permitted range of operating frequencies is 2,2 GHz to 8 GHz with reduced emissions from 0,96 GHz to 2,2 GHz and 8 GHz to 10,6 GHz (see table 3).

8.3 Emissions

8.3.1 Undesired UWB emissions from the transmitter

8.3.1.1 Definitions

The total measured maximum emissions (TE) of the equipment are the sum of:

- 1) Undesired UWB Emissions (UE) from the transmitter.
- 2) Other Emissions (OE) from the transmitter, receiver and other analogue or digital circuitry.

The undesired UWB emissions (UE) are the UWB emissions which are any emissions into free space (around a sphere) during operation of the equipment when the equipment is faced to the defined wall.

The undesired UWB emissions cannot be measured directly because the other emissions (OE) (e.g. narrow-band spurious emissions and the analogue or digital control circuitry emissions) are simultaneously present and emitted.

The undesired UWB emissions and other emissions from the equipment for the purpose of the test are defined as the total maximum emissions (TE).

The other emissions can be determined by disabling the transmitter UWB emissions. Both UE and TE are measured as digital datasets.

The difference of TE and OE represent to the undesired UWB emissions UE.

general:

$$p \text{ [dBm/MHz]} = 10 * \log P \text{ [mW/MHz]}$$

$$ue[\text{dBm/MHz}] = 10 \cdot \log(TE[\text{mW/MHz}] - OE[\text{mW/MHz}])$$

$$ue[\text{dBm/MHz}] = 10 \cdot \log \left(10^{\frac{te[\text{dBm/MHz}]}{10}} - 10^{\frac{oe[\text{dBm/MHz}]}{10}} \right)$$

8.3.1.2 Method of measurement

First step:

- The total emissions including the UWB signal and the spurious and other emissions (TE) shall be measured.

Second step:

- The Other Emissions (OE) shall be measured by disabling the UWB transmitter or switching off the antenna.

In order to be able to conduct all the measurements for a longer period of time, the implemented mechanisms to avoid continuous emission shall be deactivated for test purposes (e.g. timeout, movement sensor, manual push button action), (see clause 6.2).

8.3.1.2.1 Method of measurement of the Total Emissions (TE)

The DUT shall be tested on a defined normalized building material structure as defined in normative annex D.

In all measurements the normal operational signal according to clause 6.2 shall be used.

Using a spectrum analyser with rms average detector the following settings are applicable:

- a) Set the centre frequency of the spectrum analyzer to the frequency of interest.
- b) Set the frequency span to examine the spectrum across a convenient frequency segment.
- c) Set the RBW to 1 MHz and the VBW to 3 MHz.
- d) Set the detector to rms.
- e) Set the sweep time so that there is no more than a one msec or less integration period per measurement point.

Other applicable measurement methods are described in "Antenna Pattern Measurement, Theory and Equations" (see bibliography).

In order to obtain the required sensitivity for the lowest levels to be measured, a narrower bandwidth setting may be necessary. This shall be stated in the test report form.

During the measurement, the DUT shall be placed on the building structure with its antenna pointing directly into the structure and the test antenna is placed 1,5 m away from the device under test, see figure 2.

The polarization of the measurement antenna must meet the polarization of the main field component at each measurement point. Therefore the measurement antenna can be rotated at each point until the highest value is obtained. Another possible method is to use a measurement antenna with two orthogonal polarization directions.

The relevant measurement value is the maximum value over the sphere and over all polarization angles.

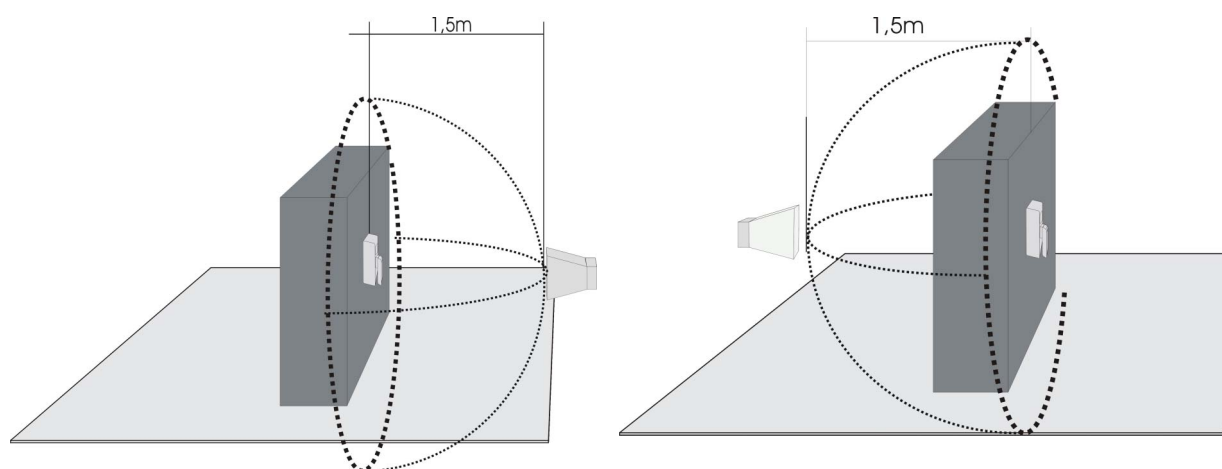

Figure 2: Measurement arrangement for all emission measurements (TE, UE, OE, UE-TP)

The measuring receiver configuration uses a low noise preamplifier and a dipole antenna (for frequencies below 1 GHz) or horn antenna (for frequencies above 1 GHz). For the spurious emission measurements, outside the permitted range of frequencies, a combination of bicones and log periodic dipole array antennas (commonly termed "log periodic") could also be used to cover the entire 30 MHz to 1 000 MHz band. The test set-up is shown in figure 3.

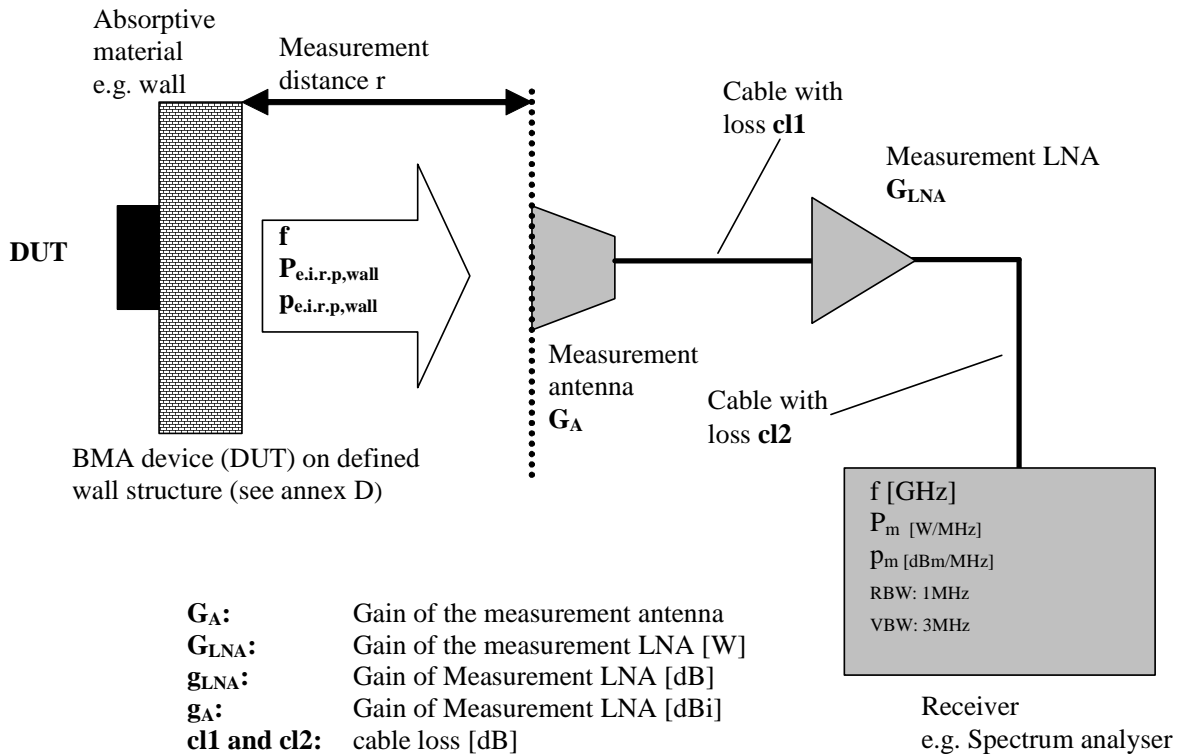

Figure 3: Test set-up for e.i.r.p measurement

The $P_{e.i.r.p.}$ is the power density referenced to the surface of the wall taking the frequency depending free space attenuation and the measurement equipment into account.

Conversion

$$g_{LNA} = 20 \log(G_{LNA})$$

$$g_A = 10 \log(G_A)$$

$$c1_x = 10 \left(\frac{c1_x}{20} \right)$$

Equation 1 (Values [dB]):

$$P_{e.i.r.p.,wall} = P_m - g_A - c11 - c12 - g_{LNA} + 20 \cdot \log \left(\frac{4\pi r}{\lambda} \right) \quad [\text{dBm/MHz}]$$

Equation 2 (Values linear):

$$P_{e.i.r.p.,wall} = \frac{P_m \cdot (4\pi r)^2}{G_{LNA} \cdot \lambda^2 \cdot G_A \cdot C11 \cdot C12} \quad [\text{mW/MHz}]$$

The values of the cable loss C11 and C12 are smaller than one. Consequently the logarithmic values c11 and c12 are negative!

A test site such as one selected from annex A (i.e. indoor test site or open area test site), which fulfils the requirements of the specified frequency range and undisturbed lowest specified emission levels of this measurement shall be used.

The bandwidth of the measuring receiver shall be set to a suitable value to correctly measure the undesired emissions. This bandwidth shall be recorded in the test report.

The total maximum emission (TE) level of the DUT shall be measured and recorded. For these measurements it is recommended to use a Low Noise Amplifier (LNA) before the spectrum analyser input to achieve the required sensitivity.

The frequency of the measuring receiver shall be adjusted over the frequency range from 30 MHz to 26 GHz. The frequency of each spurious component shall be noted. If the test site is disturbed by radiation coming from outside the site, this qualitative search may be performed in a screened room with reduced distance between the transmitter and the test antenna if necessary.

Proper pre-select filtering can be incorporated to protect the measurement system low-noise pre-amplifier from overload. In addition, all ambient signals can be detected prior to the activation of the transmitter in order to remove the ambient signal contributions present in the measured spectra. This will require post-processing of the measurement data utilizing a computer and data analysis software. The value in dBm/MHz of the emissions (TE-measurement) shall be stored as a digital dataset as function of the measured frequencies in the range of 960 MHz to 10,6 GHz and the measurement position.

8.3.1.2.2 Method of measurement of the Other Emissions (OE)

The UWB signal transmission is disabled and/or the antenna shall be switched off. The method of measurement for TE is identical to clause 8.3.1.2.1. The value in dBm/MHz of the emissions (TE-measurement) shall be stored as a digital dataset as function of the measured frequencies in the range of 960 MHz to 10,6 GHz and the measurement position.

8.3.1.2.3 Method of calculation of the maximum mean undesired UWB emission of the equipment (UE)

The recorded e.i.r.p. limits of clause 8.3.1.2.1 shall be reduced by the limits of clause 8.3.1.2.2 at the same measurement positions, represent the values of the total maximum undesired UWB emissions from the equipment (UE).

The calculation of $P_{e.i.r.p.}$ from the measured E-Field shall be done with the following equation:

$$P_{e.i.r.p.} = \frac{|E_{rms}|^2 \times 4 \times \pi \times r^2}{Z_{F0}}$$

where r is the distance in metres between the equipment under test and the measurement point.

$$Z_{F0} = 120\pi \Omega$$

8.3.1.3 Limits

The $P_{e.i.r.p.}$ measured value of the undesired UWB emissions (UE) shall not exceed the limit values in table 3.

Table 3: Limits for undesired emissions

Frequency range (GHz)	Limit values of undesired emissions (dBm/MHz) - without LBT	Limit values of undesired emissions (dBm/MHz) - with LBT
$f < 1,215$	-85	-85
$1,215 \leq f < 1,73$	-85	-70
$1,73 \leq f < 2,2$	-65	-65
$2,2 \leq f < 2,5$	-50	-50
$2,5 \leq f < 2,69$	-65	-50
$2,69 \leq f < 2,7$	-55	-55
$2,7 \leq f < 3,4$	-82	-50
$3,4 \leq f < 4,8$	-50	-50
$4,8 \leq f < 5,0$	-55	-55
$5,0 \leq f < 8,0$	-50	-50
$8,0 \leq f < 8,5$	-70	-70
$f \geq 8,5$	-85	-85

8.3.2 Other Emissions (OE)

8.3.2.1 Definition

Other emissions (e.g. narrow-band spurious emissions and the analogue or digital control circuitry emissions) are emissions radiated by the antenna of the DUT or its cabinet on a frequency, or frequencies, outside the permitted range of frequencies occupied by the transmitter. Such spurious emissions include harmonic emissions, parasitic emissions, intermodulation products and frequency conversion products.

8.3.2.2 Method of measurement

The method of measurement is identical to clause 8.3.1.2.1.

8.3.2.3 Limits

The equivalent isotropically radiated power of any of these unwanted emissions in the spurious domain shall not exceed the values given in accordance with CEPT/ERC/REC 74-01E [9].

Table 4: Limits of radiated unwanted emissions in the spurious domain

Frequency range	Limit values for spurious emissions
47 MHz to 74 MHz	-54 dBm/100 kHz
87,5 MHz to 118 MHz	-54 dBm/100 kHz
174 MHz to 230 MHz	-54 dBm/100 kHz
470 MHz to 862 MHz	-54 dBm/100 kHz
otherwise in band 30 MHz to 1 000 MHz	-36 dBm/100 kHz
1 000 MHz to 100 000 MHz (see note)	-30 dBm/1 MHz
NOTE: Not applicable within the permitted range of frequencies.	

8.3.3 Total Power spectral density (UE-TP)

8.3.3.1 Definitions

The Total Powerspectraldensity of undesired UWB emissions (UE-TP) is the integration of the time-averaged power density S of the undesired UWB emissions (UE) from clause 8.3.1.1 across the entire spherical surface enclosing the UWB sensor under test (DUT).

Measuring the field strength of the electric field, the average power flux density is given by:

$$PSD = \frac{|E_{rms}|^2}{Z_{F0}}$$

where $Z_{F0} = 120\pi\Omega$ represents the wave impedance of free space.

The RMS value of the field strength can be obtained using:

$$E_{rms} = \frac{|E|}{\sqrt{2}}$$

where $|E|$ is the amplitude of the electric field.

Using a spectrum analyser, the power flux is given by:

$$S = \frac{P_r}{A_r}$$

where P_r is the power at the connector of the receiving antenna and A_r is the effective area of the receiving antenna.

The Total Power is then given by:

$$TP = \int_{\Theta=0}^{\pi} \int_{\Phi=0}^{2\pi} S \times r^2 \times \sin(\Theta) d\Theta d\Phi$$

where r is the radius of the sphere, Θ is the elevation angle, and Φ is the azimuth angle.

8.3.3.2 Method of measurement

The measurement procedure is identical to clause 8.3.1.2.1.

For both the measurement of the electric field strength as well as for the measurement of the power, the RBW shall be set to 1 MHz and the VBW to 3 MHz.

Measurements shall be done every max 15° (for both angles) on the spherical surface in a distance of max 1,5 m (far field distance of the used measurement antenna is necessary).

8.3.3.3 Limits

The e.i.r.p. limit of the total power spectral density (UE-TP) shall not exceed the limits in table 5.

Table 5: Limits of Total Power spectral density (UE-TP)

Frequency range (GHz)	Limit values (dBm/MHz) - without LBT	Limit values (dBm/MHz) - with LBT
$f < 1,215$	-90	-90
$1,215 \leq f < 1,73$	-90	-75
$1,73 \leq f < 2,2$	-70	-70
$2,2 \leq f < 2,5$	-55	-55
$2,5 \leq f < 2,69$	-70	-55
$2,69 \leq f < 2,7$	-65	-65
$2,7 \leq f < 3,4$	-87	-55
$3,4 \leq f < 4,8$	-55	-55
$4,8 \leq f < 5,0$	-65	-65
$5,0 \leq f < 8,0$	-55	-55
$8,0 \leq f < 8,5$	-75	-75
$f \geq 8,5$	-90	-90

8.4 Pulse Repetition Frequency (PRF)

8.4.1 Definitions

For the purposes of the present document the Pulse Repetition Frequency (PRF) is defined as the minimum number of UWB pulses transmitted per second by the device when it is continuously transmitting.

8.4.2 Declaration

The provider shall give a description of the timing of pulses transmitted by the device when it is transmitting the normal test signal (as given in clause 6.1) and shall declare the PRF for the transmitter.

8.4.3 Limits

The PRF of the device under test shall not be less than 5 MHz.

8.5 Listen Before Talk (LBT)

8.5.1 Definition

Listen before talk is a mechanism to protect other operating services from interference in the same band.

The LBT function identifies the presence of signals within the band of operation and only allows activation of BMA devices when no signals are detected.

8.5.2 Function of LBT

Figures 4 and 5 explain the operation of LBT.

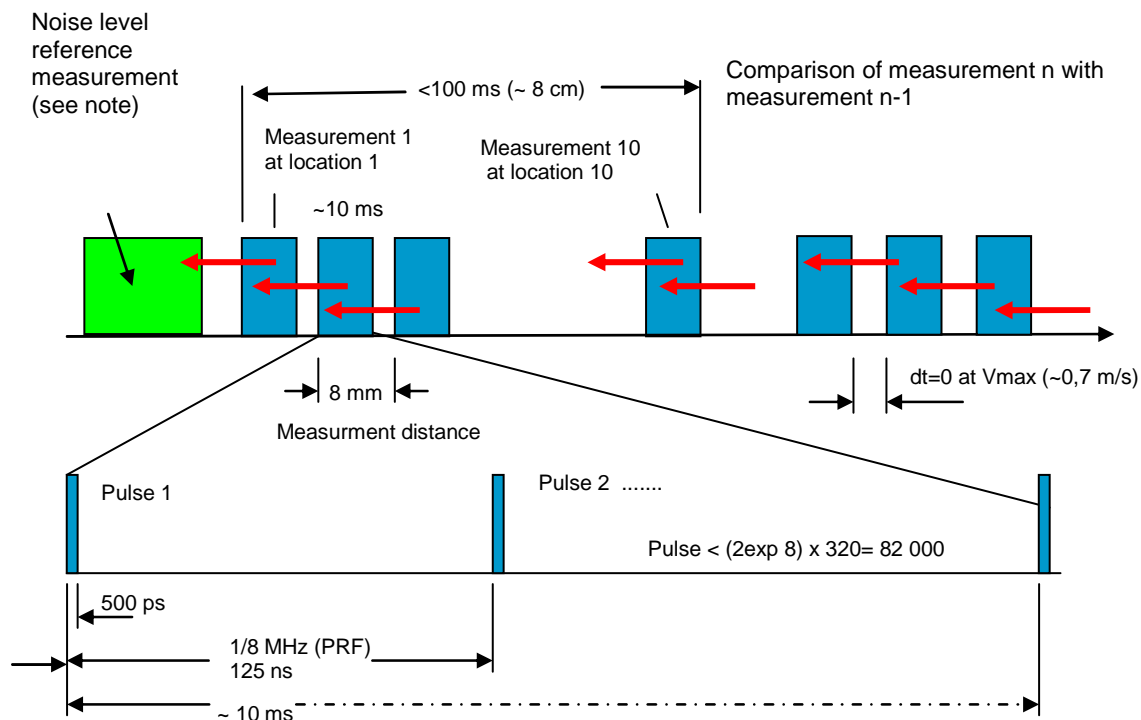

NOTE: Internal equipment noise measurement is done without antenna. In a second step the antenna will be switched on and an additional noise measurement will be done which is compared to the measurement without antenna. No transmitting included so far. Hereafter the intrinsic material measurement will be done transmitting included.

Figure 4: Principle of LBT mechanism, timing example

The listen time shall be ~40 ms.

The receiver of the BMA equipment monitors the frequency band with regard to the limits of clause 8.5.4.

According to figure 4 the equipment initially and then intermittently checks the permitted frequency range of operation for an active use by other services prior to release the UWB transmitter emissions.

After each measurement, a plausibility check between the internal noise reference and the measurement done before shall be executed.

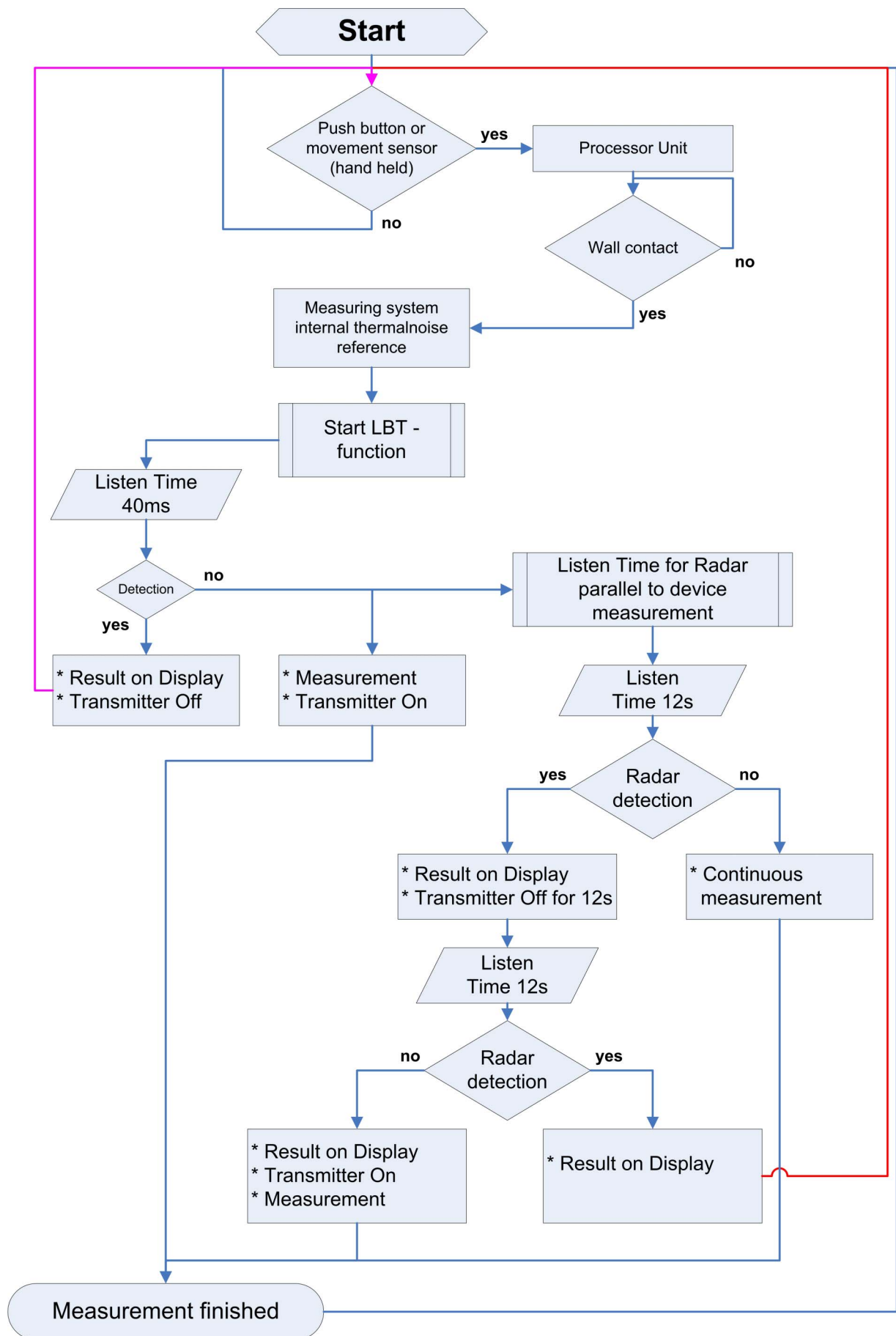

Figure 5: Flow diagram of LBT mechanism

8.5.3 Method of measurement

8.5.3.1 Measurement procedure

A test transmitter simulating the victim (e.g. UMTS) shall transmit a calibrated signal of the threshold levels of clause 8.5.4 towards the UWB DUT receiver.

With the equipment operated in a continuous mode, the individual frequency ranges and levels according to clause 8.5.4 shall be applied to the DUT.

For each frequency range and around the sphere (as per figure 2), the DUT shall be tested for the deactivation threshold to stop UWB emissions at the defined threshold levels of clause 8.5.4.

8.5.3.2 Test set-up

Figure 6 shows the test set-up for the LBT measurements

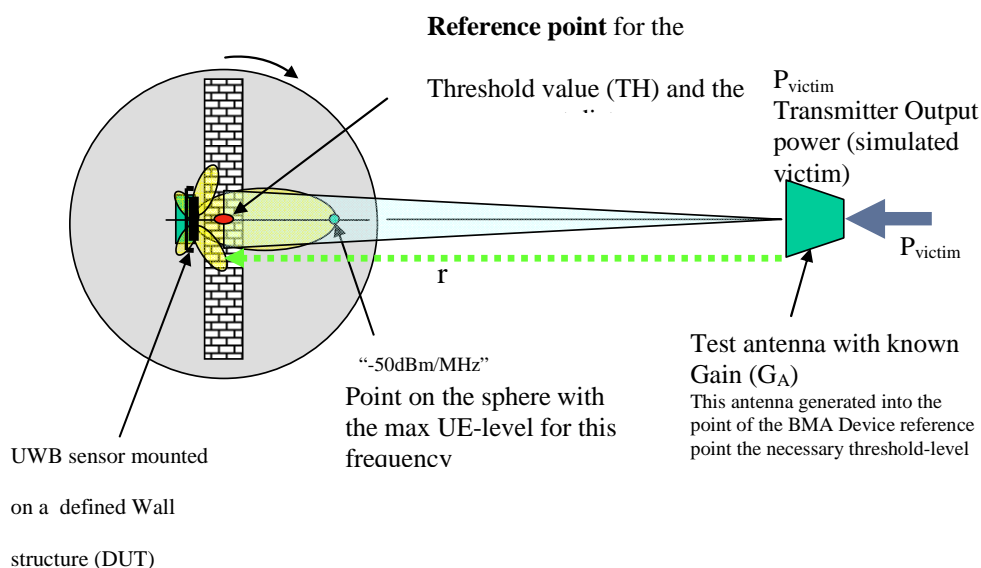

Figure 6: Test set-up for LBT function

Power Flux Density at the BMA [W/m^2]:

[$mW/(m^2 \text{ MHz})$]

$$TH = \frac{P_{victim} \cdot G_{A(f)}}{4 \cdot r^2 \cdot \pi}$$

Equation 1 (Values linear)

Power Flux Spectral Density at the BMA [dBm/m^2]:

Equation 2 (Values [dB])

$$g_A = 10 \cdot \log(G_A)$$

$$p_{victim} = 10 \cdot \log(P_{victim})$$

$$th = p_{victim} + g_A - 10 \cdot \log(4 \cdot \pi \cdot r^2)$$

Verification procedure for the LBT threshold levels:

Figures 7 and 8 explain the two possible calculation principles for the threshold levels.

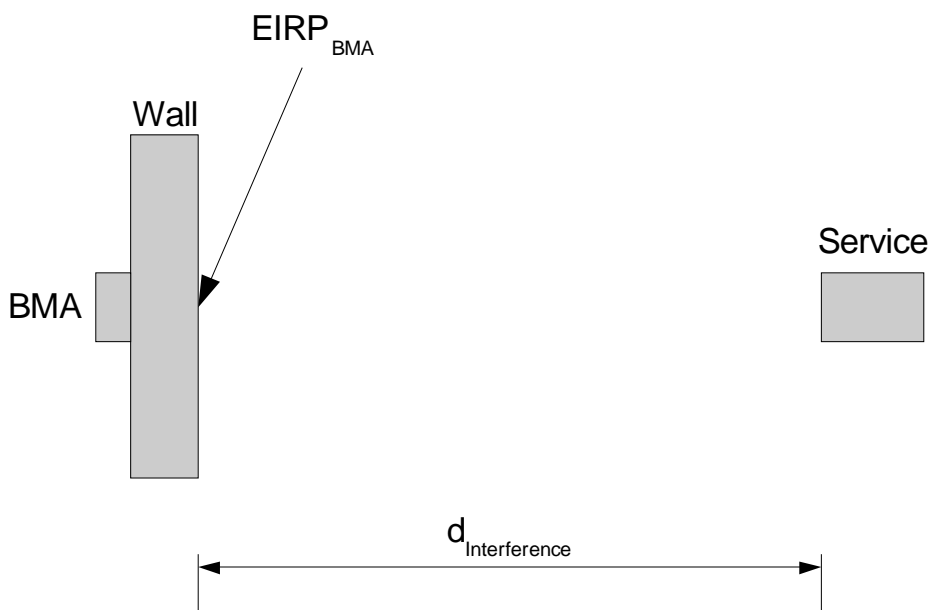

Figure 7: Calculation principle (1)

The BMA device emits an $EIRP_{BMA}$ through the wall. If a service is located within a distance of $d_{Interference}$, it will be at the threshold of being interfered. This distance can be calculated using:

$$d_{Interference} = 10^{\frac{EIRP_{BMA} - EIRP_{Interference}}{20}} \frac{\lambda}{4\pi}$$

With a service radiating in this distance, the BMA device must switch off. The position of the service to the BMA device is irrelevant for the functionality of the LBT mechanism, as the BMA antenna is reciprocal regarding receive and transmit. However, within one measurement the position must be fixed.

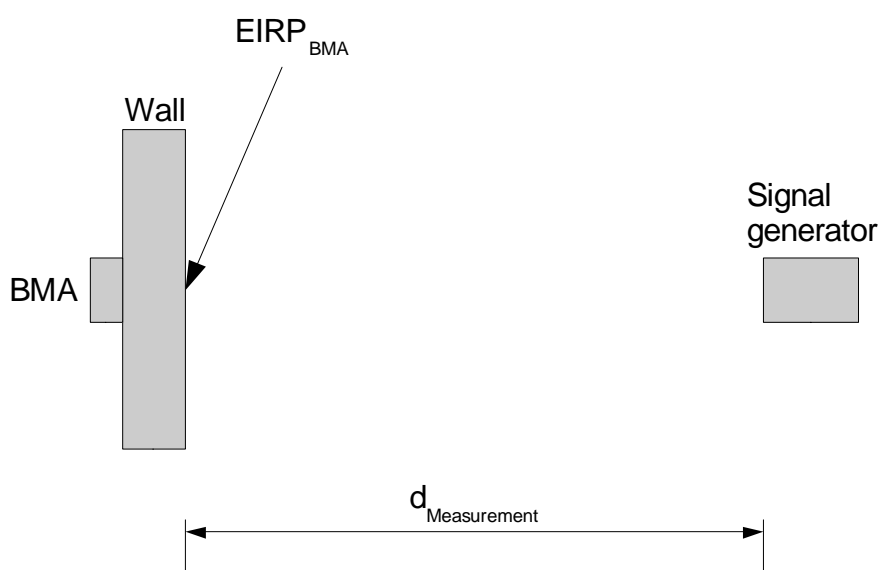

Figure 8: Calculation principle (2)

To check the LBT functionality of the BMA device, a distance of $d_{\text{Interference}}$ is not practical. Therefore, a measurement distance of $d_{\text{Measurement}} = 3 \text{ m}$ shall be selected. The output power of the signal generator is attenuated by:

$$a = 20 \log_{10} \left(\frac{d_{\text{Interference}}}{d_{\text{Measurement}}} \right)$$

Listen Before Talk (LBT) requirements for radar: threshold levels and reception times to protect Radar services.

For radar services the LBT mechanism has to be as quick as possible to avoid the second suppression of an echo of a target at the 2nd rotation of the antenna dish. Normally, the air traffic control uses 3 consecutive echoes each received during the next consecutive rotation to validate a target as "true" (the response of a transponder by a secondary radar is not taken into account here). Radar devices emit its PSD with a certain PRF (for example with a PRF of 1 100 Hz and a rotational speed of 0,25 Hz (1 rotation per 4 seconds)). The shortest pulse duration is 1 μs . The radar main beam width is 1,5°. Every 0,9 μs the radar device emits 1 impulse. In this example the BMA beam width may be 20° (with a directivity/gain of 5 dB it is approximately 60°). The receiving time frame of the BMA until the next switch off decision may be repetitive 20 ms. The criteria to switch off the sensor is to receive 5 times the main beam of the radar ($5 \times 1/\text{PRF}$). In this example $5 \times 1/1\ 100 \sim 5 \text{ ms}$ during 1 dish rotation. That means after 4 ms the sensor switches off (display will show a hint, e.g.: "interference signal"). Now a latency time of 12 seconds has to be introduced during which the UWB sensor device only receives (no transmission, i.e. to cover the window for the slowest rotation rate of radar device). If during this 12 s the main beam is detected again, the display hint will continue. If not, the measurement procedure can start again, because the interferer does not belong to a radar service.

The radar pulse train has to be detected after max. 10 ms. Then the transmitter shall be switched off. After detecting the radar signal a waiting time of > 12 seconds shall be implemented in which the UWB sensor is only receiving. If a next radar signal is detected the timer (12 seconds) shall be triggered again.

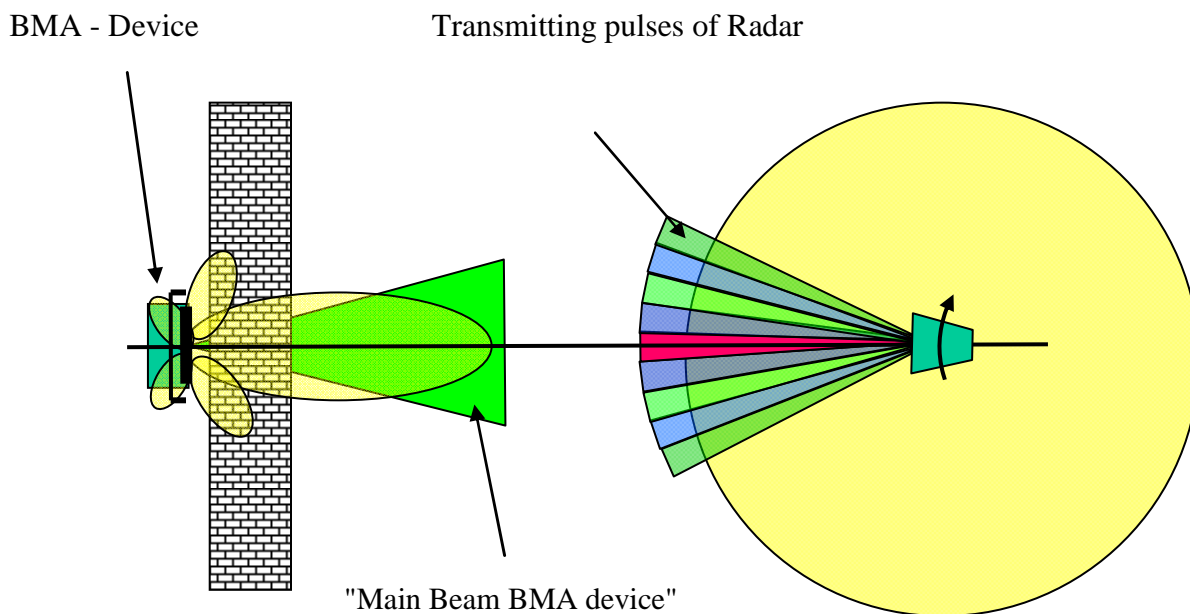

Figure 9: BMA - radar scenario

8.5.4 Limits

The LBT mechanism of the UWB receiver shall meet the minimum threshold values of table 6. In case the UWB equipment covers only part of the frequency range of table 6, the LBT function shall only cover the actually used UWB range.

A "Listen Before Talk" (LBT) mechanism is mandatory with threshold levels at the input of the UWB receiver as defined within table 6.

Table 6: LBT threshold limits

Frequency range	Threshold value	Reaction time
Radar L-Band 1,215 GHz to 1,35 GHz	+8 dBm/MHz	Continuous listening of 12 seconds is required and automatic switch-off feasible each 10 ms if the threshold value is exceeded. In the case of detecting and switching off the transmitter, a silent time of at least 12 seconds while listening continuously is necessary.
MSS 1,55 GHz to 1,66 GHz	-43 dBm/MHz	Minimum continuous listening time of 40 ms before initial transmission of the device.
UMTS 2,5 GHz to 2,69 GHz	-44 dBm/3,84 MHz -50 dBm/MHz	Minimum continuous listening time of 140 ms before initial transmission of the device.
Radar S-Band 2,7 GHz to 3,4 GHz	-7 dBm/MHz	Continuous listening of 12 seconds is required and automatic switch-off feasible each 10 ms if the threshold value is exceeded. In the case of detecting and switching off the transmitter, a silent time of at least 12 seconds while listening continuously is necessary.

8.5.5 Test signal definition for LBT-mechanism

Radar test signal:

- Pulse length: 0,4 μ s to 90 μ s.
- Pulse repetition time: 0,8 to 1,5 ms (670 Hz to 1 300Hz).
- Pulse power: see clause 8.5.3.2 test setup.

Table 7: Radar test signals

	L-Band	S-Band
f/GHz	1,30	2,70
Power flux density at the BMA [W/m ²]	7,56E+00	1,03E+00
Power flux density at the BMA [dBm/m ²]	15,00	0,00
Received power at the BMA [dBm]	8,01	-6,99

UMTS test signal:

- Signal power: see clause 8.5.3.2 test setup.

Table 8: UMTS test signal

f/GHz (CW-Signal)	2,6
Power flux density at the BMA (W/m ²)	4,11E-05
Power flux density at the BMA (dBm/m ²)	-13,86

MSS test signal:

- Signal power: see clause 8.5.3.2 test setup.

Table 9: MSS test signal

f/GHz (CW-Signal)	1,64
Power flux density at the BMA (W/m ²)	2,15E-05
Power flux density at the BMA (dBm/m ²)	-16,67

8.5.6 Design requirements

The equipment in the present document shall comply with the design requirements as defined in annex B.

9 Methods of measurement and limits for receiver parameters

9.1 Receiver spurious emissions

Separate radiated spurious measurements need not to be made on receivers co-located with transmitters.

Annex A (normative): Radiated measurements

This annex covers test sites and methods to be used with integral antenna equipment.

A.1 Test sites and general arrangements for measurements involving the use of radiated fields

This clause introduces two commonly available test sites, an anechoic chamber and an anechoic chamber with a ground plane, which may be used for radiated tests. These test sites are generally referred to as free field test sites. Both absolute and relative measurements can be performed in these sites. Where absolute measurements are to be carried out, the chamber should be verified. A detailed verification procedure is described in the relevant parts of TR 102 273 [4] or equivalent.

NOTE: To ensure reproducibility and tractability of radiated measurements only these test sites should be used in measurements in accordance with the present document.

A.1.1 Anechoic chamber

An anechoic chamber is an enclosure, usually shielded, whose internal walls, floor and ceiling are covered with radio absorbing material, normally of the pyramidal urethane foam type. The chamber usually contains an antenna support at one end and a turntable at the other. A typical anechoic chamber is shown in figure A.1.

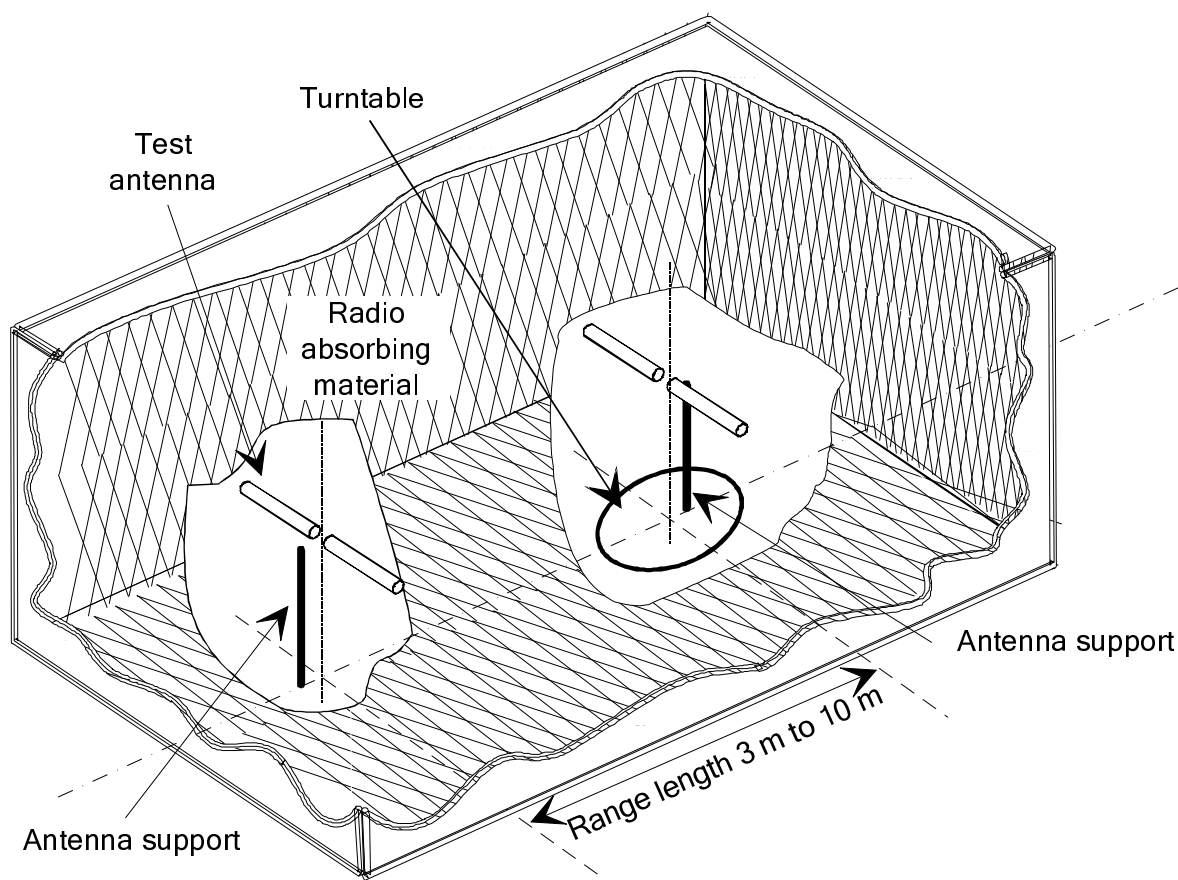

Figure A.1: A typical anechoic chamber

The chamber shielding and radio absorbing materials work together to provide a controlled environment for testing purposes. This type of test chamber attempts to simulate free space conditions.

The shielding provides a test space, with reduced levels of interference from ambient signals and other outside effects, whilst the radio absorbing material minimizes unwanted reflections from the walls and ceiling which can influence the measurements. In practice it is relatively easy for shielding to provide high levels (80 dB to 140 dB) of ambient interference rejection, normally making ambient interference negligible.

A turntable is capable of rotation through 360° in the horizontal plane and it is used to support the test sample (DUT) at a suitable height (e.g. 1 m) above the ground plane. The chamber shall be large enough to allow the measuring distance of at least 3 m or $2(d_1+d_2)^2 / \lambda$ (m), whichever is greater (see clause A.2.5). The distance used in actual measurements shall be recorded with the test results.

The anechoic chamber generally has several advantages over other test facilities. There is minimal ambient interference, minimal floor, ceiling and wall reflections and it is independent of the weather. It does however have some disadvantages which include limited measuring distance and limited lower frequency usage due to the size of the pyramidal absorbers. To improve low frequency performance, a combination structure of ferrite tiles and urethane foam absorbers is commonly used.

All types of emission, sensitivity and immunity testing can be carried out within an anechoic chamber without limitation.

A.1.2 Anechoic chamber with a conductive ground plane

An anechoic chamber with a conductive ground plane is an enclosure, usually shielded, whose internal walls and ceiling are covered with radio absorbing material, normally of the pyramidal urethane foam type. The floor, which is metallic, is not covered and forms the ground plane. The chamber usually contains an antenna mast at one end and a turntable at the other. A typical anechoic chamber with a conductive ground plane is shown in figure A.2.

This type of test chamber attempts to simulate an ideal Open Area Test Site whose primary characteristic is a perfectly conducting ground plane of infinite extent.

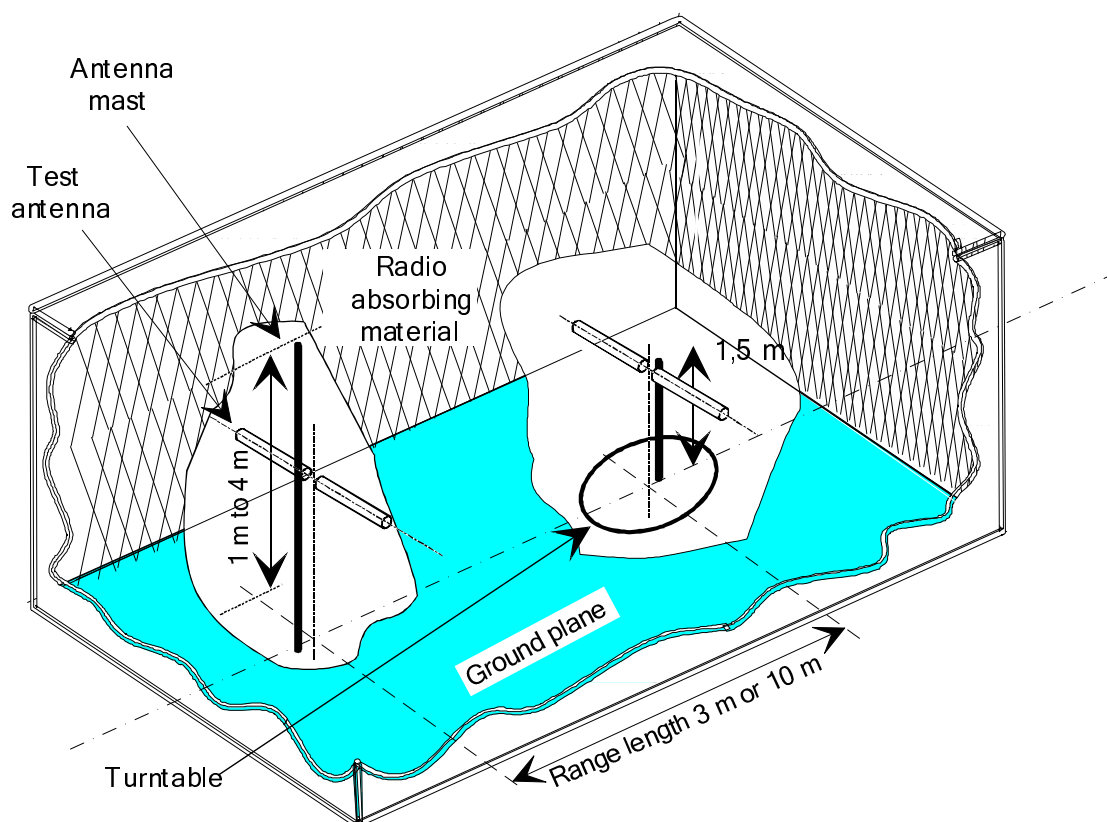

Figure A.2: A typical anechoic chamber with a conductive ground plane

In this facility the ground plane creates the wanted reflection path, such that the signal received by the receiving antenna is the sum of the signals from both the direct and reflected transmission paths. This creates a unique received signal level for each height of the transmitting antenna (or DUT) and the receiving antenna above the ground plane.

The antenna mast provides a variable height facility (from 1 m to 4 m) so that the position of the test antenna can be optimized for maximum coupled signal between antennas or between an DUT and the test antenna.

A turntable is capable of rotation through 360° in the horizontal plane and it is used to support the test sample (DUT) at a specified height, usually 1,5 m above the ground plane. The chamber shall be large enough to allow the measuring distance of at least 3 m or $2(d_1+d_2)^2/\lambda$ (m), whichever is greater (see clause A.2.5). The distance used in actual measurements shall be recorded with the test results.

Emission testing involves firstly "peaking" the field strength from the DUT by raising and lowering the receiving antenna on the mast (to obtain the maximum constructive interference of the direct and reflected signals from the DUT) and then rotating the turntable for a "peak" in the azimuth plane. At this height of the test antenna on the mast, the amplitude of the received signal is noted. Secondly the DUT is replaced by a substitution antenna (positioned at the DUT's phase or volume centre) which is connected to a signal generator. The signal is again "peaked" and the signal generator output adjusted until the level, noted in stage one, is again measured on the receiving device.

Receiver sensitivity tests over a ground plane also involve "peaking" the field strength by raising and lowering the test antenna on the mast to obtain the maximum constructive interference of the direct and reflected signals, this time using a measuring antenna which has been positioned where the phase or volume centre of the DUT will be during testing. A transform factor is derived. The test antenna remains at the same height for stage two, during which the measuring antenna is replaced by the DUT. The amplitude of the transmitted signal is reduced to determine the field strength level at which a specified response is obtained from the DUT.

A.1.3 Test antenna

A test antenna is always used in radiated test methods. In emission tests (i.e. effective radiated power, spurious emissions, etc.) the test antenna is used to detect the field from the DUT in one stage of the measurement and from the substitution antenna in the other stage. When the test site is used for the measurement of receiver characteristics (i.e. sensitivity and various immunity parameters) the antenna is used as the transmitting device.

The test antenna should be mounted on a support capable of allowing the antenna to be used in either horizontal or vertical polarization which should additionally allow the height of its centre above the ground to be varied over the specified range (usually 1 m to 4 m).

In the frequency band 30 MHz to 1 000 MHz, dipole antennas (constructed in accordance with ANSI C63.5 [5]) are generally recommended. For frequencies of 80 MHz and above, the dipoles should have their arm lengths set for resonance at the frequency of test. Below 80 MHz, shortened arm lengths are recommended. For spurious emission testing, however, a combination of bicones and log periodic dipole array antennas (commonly termed "log periodic") could be used to cover the entire 30 MHz to 1 000 MHz band. Above 1 000 MHz, waveguide horns are recommended although, again, log periodic could be used.

NOTE: The gain of a horn antenna is generally expressed relative to an isotropic radiator.

A.1.4 Measuring antenna

The measuring antenna is used in tests on a DUT in which a receiving parameter (i.e. sensitivity and various immunity tests) is being measured. Its purpose is to enable a measurement of the electric field strength in the vicinity of the DUT. For measurements in the frequency band 30 MHz to 1 000 MHz, the measuring antenna should be a dipole antenna (constructed in accordance with ANSI C63.5 [5]). For frequencies of 80 MHz and above, the dipoles should have their arm lengths set for resonance at the frequency of test. Below 80 MHz, shortened arm lengths are recommended. The centre of this antenna should coincide with either the phase centre or volume centre (as specified in the test method) of the DUT.

A.2 Guidance on the use of radiation test sites

This clause details procedures, test equipment arrangements and verification that should be carried out before any of the radiated tests are undertaken. These schemes are common to all types of test sites described in annex A.

A.2.1 Verification of the test site

Verification procedures, as far as applicable, for different types of test sites are given in TR 102 273 [4].

A.2.2 Preparation of the DUT

The manufacturer should supply information about the DUT covering the operating frequency, polarization, supply voltage(s) and the reference face. Additional information, specific to the type of DUT should include, where relevant, carrier power and whether different operating modes are available (e.g. high and low power modes) and if operation is continuous or is subject to a maximum test duty cycle (e.g. 1 min on, 4 min off).

Where necessary, a mounting bracket of minimal size should be available for mounting the DUT on the turntable. This bracket should be made from low conductivity, low relative dielectric constant (i.e. less than 1,5) material(s) such as expanded polystyrene, balsawood, etc.

A.2.3 Power supplies to the DUT

All tests should be performed using power supplies wherever possible, including tests on DUT designed for battery-only use. In all cases, power leads should be connected to the DUT's supply terminals (and monitored with a digital voltmeter) but the battery should remain present, electrically isolated from the rest of the equipment, possibly by putting tape over its contacts.

The presence of these power cables can, however, affect the measured performance of the DUT. For this reason, they should be made to be "transparent" as far as the testing is concerned. This can be achieved by routing them away from the DUT and down to either the screen, ground plane or facility wall (as appropriate) by the shortest possible paths. Precautions should be taken to minimize pick-up on these leads (e.g. the leads could be twisted together, loaded with ferrite beads at 0,15 m spacing or otherwise loaded).

A.2.4 Range length

The range length for all these types of test facility should be adequate to allow for testing in the far field of the DUT i.e. it should be equal to or exceed:

$$\frac{2(d_1 + d_2)^2}{\lambda}$$

where:

d_1 is the largest dimension of the DUT/dipole after substitution (m);

d_2 is the largest dimension of the test antenna (m);

λ is the test frequency wavelength (m).

It should be noted that in the substitution part of this measurement, where both test and substitution antennas are half wavelength dipoles, this minimum range length for far-field testing would be:

$$2\lambda$$

It should be noted in test reports when either of these conditions is not met so that the additional measurement uncertainty can be incorporated into the results.

A.2.5 Site preparation

The cables for both ends of the test site should be routed horizontally away from the testing area for a minimum of 2 m and then allowed to drop vertically and out through either the ground plane or screen (as appropriate) to the test equipment. Precautions should be taken to minimize pick up on these leads (e.g. dressing with ferrite beads, or other loading). The cables, their routing and dressing should be identical to the verification set-up.

Calibration data for all items of test equipment should be available and valid. For test, substitution and measuring antennas, the data should include gain relative to an isotropic radiator (or antenna factor) for the frequency of test. Also, the VSWR of the substitution and measuring antennas should be known.

The calibration data on all cables and attenuators should include insertion loss and VSWR throughout the entire frequency range of the tests. All VSWR and insertion loss figures should be recorded in the logbook results sheet for the specific test.

Where correction factors/tables are required, these should be immediately available.

For all items of test equipment, the maximum errors they exhibit should be known along with the distribution of the error e.g.:

- cable loss: $\pm 0,5$ dB with a rectangular distribution;
- measuring receiver: 1,0 dB (standard deviation) signal level accuracy with a Gaussian error distribution.

At the start of measurements, system checks should be made on the items of test equipment used on the test site.

A 2.6 General requirements for RF cables

Due to the low power levels involved in the measurements, all RF cables including their connectors at both ends used within the measurement arrangements and set-ups shall be of coaxial type featuring within the frequency range they are used:

- a nominal characteristic impedance of 50 Ω ;
- a VSWR of less than 1,2 at either end;
- a shielding loss in excess of 60 dB.

NOTE: Further details are provided in TR 102 273 [4].

Annex B (normative): Design requirements

The following design requirements shall be implemented:

- the equipment shall be designed in a way that undesired emissions into the air shall be kept to minimum possible;
- the equipment shall be manually controlled using a non-locking switch;
- emissions shall only occur when the equipment is in contact or close proximity to the investigated material;
- the equipment shall be equipped with a movement detector to automatically cease transmission after a time of 10 seconds has elapsed after the last movement has occurred.

Annex C (informative): Measurement antenna and preamplifier specifications

The radiated measurements set-up in clause 8 specifies the use of the wide-band horn antenna and a wide-band, high gain preamplifier in order to measure the very low radiated power density level from the DUT.

Table C.1 gives examples of recommended data and features for the horn antenna and preamplifier to be used for the test set-up.

Table C.1: Recommended performance data for preamplifier and horn antenna

Pre-amplifier	
Parameter	Data
Bandwidth	< 1 GHz to > 15 GHz
Noise figure	< 2 dB
Output at 1 dB compression	> +10 dBm
Gain	> 30 dB
Gain flatness across band	±1,5 dB
Phase response	Linear across frequency range
Impulse response overshoot	< 10 %
Impulse response damping ratio	0,3 to 0,5
VSWR in/out across band	2:1
Nominal impedance	50 Ω
Horn antenna	
Parameter	Data
Gain	> 4 dBi
1 dB bandwidth	< 1 GHz to > 15 GHz
Nominal impedance	50 Ω
VSWR across band	< 1,5:1
Cross polarization	> 20 dB
Front to back ratio	> 20 dB
Tripod mountable	Yes
Robust precision RF connector	Yes

Measuring the complete emission spectrum of the operating frequency range, several measurement antennas will be required, each optimized over a distinct frequency range.

Table C.2: Recommended measurement antennas

Antenna type	Frequency range
$\lambda/2$ - dipole or biconical	30 MHz to 200 MHz
$\lambda/2$ - dipole or log periodic	200 MHz to 1 000 MHz
Horn	> 1 000 MHz

Annex D (normative): Definition of the representative wall and procedure for measurement of the undesired emissions

D.1 Representative wall definition for measuring the undesired emissions and LBT function

Undesired emissions are caused by leaked emissions from the antenna/device, and/or scattered/reflected emissions from the investigated material, and/or transmitted emissions through the investigated material. Therefore, a measurement scenario with a representative wall has to be defined within the present document. The representative wall shall meet the wall attenuation values within table D.1.

Table D.1: Wall attenuation values

Frequency (GHz)	Wall attenuation values for the representative wall in dB		
	min	average	max
1	5,00	7,00	9,00
2	8,00	10,00	12,00
3	10,00	12,00	14,00
4	12,00	14,00	16,00
5	14,00	16,00	18,00
6	16,00	18,00	20,00
7	18,00	20,00	22,00
8	20,00	22,00	24,00

Based on a study from Fraunhofer Institute, an explanatory wall which fulfils the normative wall attenuation values shall be used for the measurements.

For a practical handling the size of the wall should be about 1×1 meter.

The wall shall consists of 150 mm to 180 mm deep concrete material, following the standardization of the type C2242/C2025 and with limesplit additive as in EN 206-1 [2].

The wall thickness can vary depending on the composition of the concrete to realize the attenuation in table D.1.

After preparation, the representative wall shall be stored for a minimum of 8 weeks at an indoor environment with typical indoor conditions (see clause 5.3.1).

D.2 Procedure for measurement the wall attenuation

The measurement principle is shown in figures D.1 and D.2. In a first step, calibration is performed using the setup shown in figure D.1.

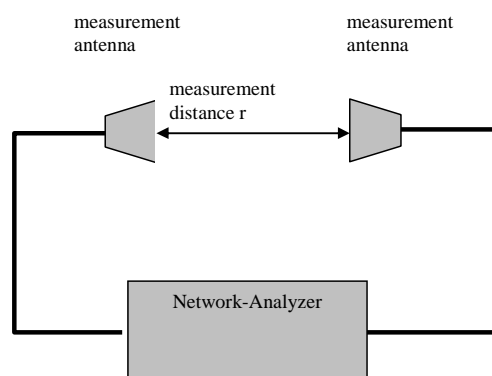

Figure D.1: Calibration setup

It is important that both antennae are aligned to each other exactly and the distance between the two identical antennae must be larger than $2 \times$ minimal far field distance.

The antenna beamwidth of the measurement antennas shall be lower than:

$$\frac{ant_beam(f)}{2} < \arctan\left(\frac{size_of_the_wall}{r}\right)$$

Calibration Steps:

- 1) Set the network analyzer to the minimum and maximum frequency range (960 MHz to 10,6 GHz). The frequency range depends on the measurement antennas.
- 2) Calibrate the system in the S21 Mode.

In the second step the wall attenuation measurement is performed.

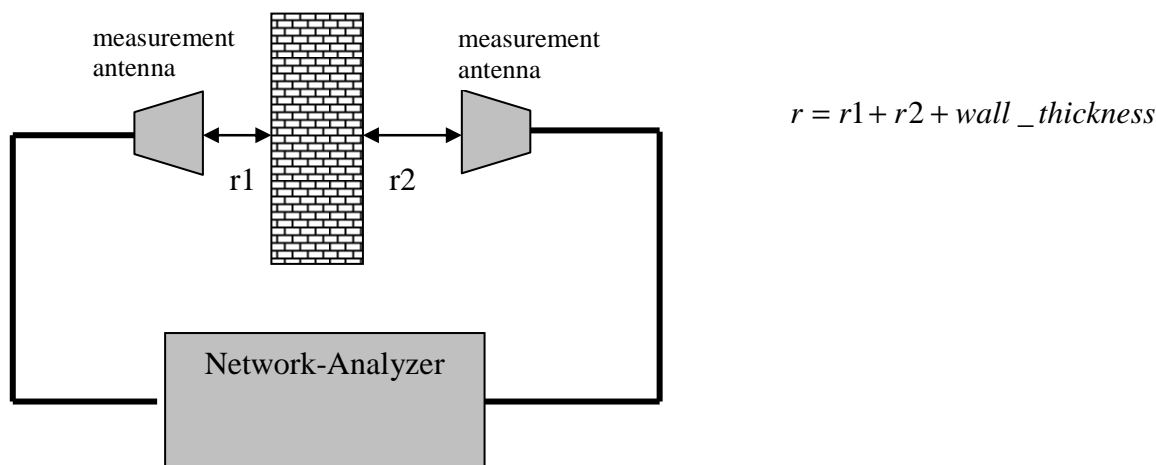

Figure D.2: Attenuation measurement

After calibration of the setup, the representative wall shall be placed between the two antennas.

The network analyzer shall then be used with the time gating option. This is important because with this option it is possible to obtain the necessary signal parts for the attenuation measurement (more signal components or more signal reflexions can yield to wrong results).

D.3 Typical representative wall measurement result

Measurement result of such a representative wall, as described in D.1

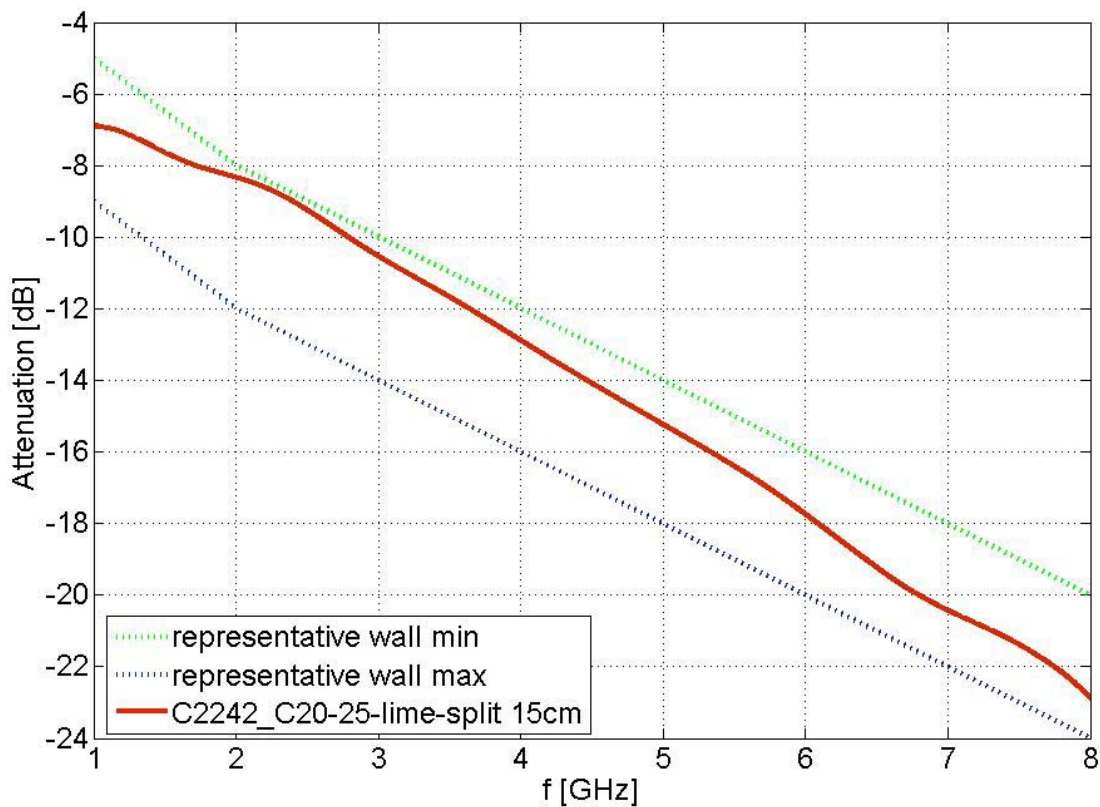

Figure D.3: Typical result

Annex E (informative): Bibliography

- CISPR 22: "Information technology equipment - Radio disturbance characteristics - Limits and methods of measurement", including proposed modification of CISPR 22 on emission limits and methods of measurement from 1 GHz to 6 GHz from December 2003".
- ETSI TR 102 495-1: "Technical characteristics for SRD equipment using Ultra WideBand Sensor technology (UWB); System Reference Document; Part 1: Building material analysis and classification applications operating in the frequency band from 2,2 GHz to 8 GHz".
- "Antenna Pattern Measurement, Theory and Equations", Michael D. Foegelle, ETS Lindgreen, Compliance Engineering, Annual Reference Guide 2002.ECC/DEC/(07)01 Decision of 30 March 2007 on Building Material Analysis (BMA) devices using UWB technology.
- IPG Report GB 174e/2006: "Market Enquiry: Typical Wall Constructions in Germany, England and France " TG3#14_11, Fraunhofer Institut Bauphysik.

History

Document history			
V1.1.1	May 2006	Public Enquiry	PE 20060922: 2006-05-24 to 2006-09-22
V1.2.1	May 2007	Public Enquiry	PE 20070831: 2007-05-02 to 2007-08-31
V1.2.1	February 2008	Vote	V 20080411: 2008-02-11 to 2008-04-11
V1.2.1	April 2008	Publication	