

Final draft **ETSI EN 302 426** V1.1.1 (2006-05)

---

*Candidate Harmonized European Standard (Telecommunications series)*

**Electromagnetic compatibility  
and Radio spectrum Matters (ERM);  
Harmonized EN for CDMA spread spectrum Repeaters  
operating in the 450 MHz cellular band (CDMA450) and  
the 410 MHz, 450 MHz and 870 MHz PAMR bands  
(CDMA-PAMR) covering essential requirements of  
article 3.2 of the R&TTE Directive**

---



---

Reference

DEN/ERM-TG39-001A

---

Keywords

CDMA, cellular, radio, regulation, repeater

**ETSI**

650 Route des Lucioles  
F-06921 Sophia Antipolis Cedex - FRANCE

Tel.: +33 4 92 94 42 00 Fax: +33 4 93 65 47 16

Siret N° 348 623 562 00017 - NAF 742 C  
Association à but non lucratif enregistrée à la  
Sous-Préfecture de Grasse (06) N° 7803/88

---

**Important notice**

Individual copies of the present document can be downloaded from:

<http://www.etsi.org>

The present document may be made available in more than one electronic version or in print. In any case of existing or perceived difference in contents between such versions, the reference version is the Portable Document Format (PDF). In case of dispute, the reference shall be the printing on ETSI printers of the PDF version kept on a specific network drive within ETSI Secretariat.

Users of the present document should be aware that the document may be subject to revision or change of status. Information on the current status of this and other ETSI documents is available at

<http://portal.etsi.org/tb/status/status.asp>

If you find errors in the present document, please send your comment to one of the following services:

[http://portal.etsi.org/chaicor/ETSI\\_support.asp](http://portal.etsi.org/chaicor/ETSI_support.asp)

---

**Copyright Notification**

No part may be reproduced except as authorized by written permission.  
The copyright and the foregoing restriction extend to reproduction in all media.

© European Telecommunications Standards Institute 2006.  
All rights reserved.

**DECT**<sup>TM</sup>, **PLUGTESTS**<sup>TM</sup> and **UMTS**<sup>TM</sup> are Trade Marks of ETSI registered for the benefit of its Members.  
**TIPHON**<sup>TM</sup> and the **TIPHON logo** are Trade Marks currently being registered by ETSI for the benefit of its Members.  
**3GPP**<sup>TM</sup> is a Trade Mark of ETSI registered for the benefit of its Members and of the 3GPP Organizational Partners.

# Contents

Intellectual Property Rights .....	6
Foreword.....	6
Introduction .....	7
1 Scope .....	9
2 References .....	9
3 Definitions, symbols and abbreviations .....	10
3.1 Definitions .....	10
3.2 Symbols.....	11
3.3 Abbreviations .....	11
4 Technical requirements specifications .....	12
4.1 Environmental profile.....	12
4.2 Conformance requirements .....	12
4.2.1 Introduction.....	12
4.2.2 Transmitter conducted unwanted emissions .....	12
4.2.2.1 Definition .....	12
4.2.2.2 Limit.....	12
4.2.2.2.1 Limits for band class 5 and 11 equipment .....	12
4.2.2.2.2 Limits for band class 12 equipment.....	13
4.2.2.3 Conformance.....	14
4.2.3 Accuracy of maximum output power.....	14
4.2.3.1 Definition .....	14
4.2.3.2 Limit.....	14
4.2.3.3 Conformance .....	14
4.2.4 Radiated spurious emissions .....	14
4.2.4.1 Definition .....	14
4.2.4.2 Limits .....	14
4.2.4.3 Conformance.....	15
4.2.5 Input intermodulation .....	15
4.2.5.1 Definition .....	15
4.2.5.2 Limit.....	15
4.2.5.3 Conformance.....	15
4.2.6 Out of band gain .....	15
4.2.6.1 Definition .....	15
4.2.6.2 Limits .....	16
4.2.6.3 Conformance.....	16
4.2.7 Adjacent Channel Rejection Ratio (ACRR) .....	16
4.2.7.1 Definition .....	16
4.2.7.2 Limit.....	16
4.2.7.3 Conformance.....	17
4.2.8 Output intermodulation.....	17
4.2.8.1 Definition .....	17
4.2.8.2 Limit.....	17
4.2.8.3 Conformance.....	17
5 Testing for compliance with technical requirements.....	17
5.1 Conditions for testing .....	17
5.1.1 Introduction.....	17
5.1.2 Standard equipment under test.....	18
5.1.2.1 Basic equipment.....	18
5.1.3 CDMA test signal definition.....	18
5.2 Interpretation of the measurement results .....	18
5.3 Essential radio test suites.....	19
5.3.1 Transmitter conducted unwanted emissions .....	19
5.3.1.1 Initial conditions .....	19

5.3.1.2	Procedures .....	20
5.3.2	Accuracy of maximum output power.....	20
5.3.2.1	Initial conditions .....	20
5.3.2.2	Procedure .....	21
5.3.3	Radiated spurious emissions .....	21
5.3.3.1	Test method.....	21
5.3.3.2	Test configurations.....	21
5.3.4	Input intermodulation .....	22
5.3.4.1	Initial conditions .....	22
5.3.4.2	Procedures.....	22
5.3.5	Out of band gain .....	22
5.3.5.1	Initial conditions .....	22
5.3.5.2	Procedure .....	23
5.3.6	Adjacent Channel Rejection Ratio (ACRR) .....	23
5.3.6.1	Initial conditions .....	23
5.3.6.2	Procedures.....	23
5.3.7	Output intermodulation.....	24
5.3.7.1	Initial conditions .....	24
5.3.7.2	Procedures.....	24
<b>Annex A (normative):</b>	<b>HS Requirements and conformance Test specifications Table (HS-RTT).....</b>	<b>25</b>
<b>Annex B (normative):</b>	<b>Repeater configurations .....</b>	<b>27</b>
B.1	Power supply options .....	27
B.2	Combining of repeaters .....	27
<b>Annex C (normative):</b>	<b>Environmental profile specification .....</b>	<b>28</b>
C.1	Test conditions, power supply and ambient temperatures.....	28
C.1.1	Normal and extreme test conditions .....	28
C.1.2	Power sources.....	28
C.1.2.1	Power sources for stand-alone equipment .....	28
C.1.3	Normal test conditions.....	28
C.1.3.1	Normal temperature and humidity .....	28
C.1.3.2	Normal power source.....	29
C.1.3.2.1	Mains voltage .....	29
C.1.3.2.2	Lead-acid battery power sources used on vehicles.....	29
C.1.3.2.3	Other power sources.....	29
C.1.4	Extreme test conditions .....	29
C.1.4.1	Extreme temperatures .....	29
C.1.4.2	Extreme power source voltages .....	29
C.1.4.2.1	Mains voltage .....	29
C.1.4.2.2	Power sources using other types of batteries.....	29
C.1.4.2.3	Other power sources.....	30
C.1.4.3	Procedure for tests at extreme temperatures .....	30
C.2	Declared environmental operating conditions of equipment.....	30
<b>Annex D (informative):</b>	<b>Repeater measurement system set-up.....</b>	<b>31</b>
D.1	Transmitter conducted unwanted emission .....	31
D.2	Maximum output power .....	31
D.3	Input intermodulation .....	31
D.4	Out of band gain.....	32
D.5	Adjacent Channel Rejection Ratio (ACRR).....	32
D.6	Output intermodulation .....	32
<b>Annex E (informative):</b>	<b>Bibliography.....</b>	<b>33</b>

<b>Annex F (informative):</b>	<b>The EN title in the official languages .....</b>	<b>34</b>
History .....		36

---

## Intellectual Property Rights

IPRs essential or potentially essential to the present document may have been declared to ETSI. The information pertaining to these essential IPRs, if any, is publicly available for **ETSI members and non-members**, and can be found in ETSI SR 000 314: "*Intellectual Property Rights (IPRs); Essential, or potentially Essential, IPRs notified to ETSI in respect of ETSI standards*", which is available from the ETSI Secretariat. Latest updates are available on the ETSI Web server (<http://webapp.etsi.org/IPR/home.asp>).

Pursuant to the ETSI IPR Policy, no investigation, including IPR searches, has been carried out by ETSI. No guarantee can be given as to the existence of other IPRs not referenced in ETSI SR 000 314 (or the updates on the ETSI Web server) which are, or may be, or may become, essential to the present document.

---

## Foreword

This Candidate Harmonized European Standard (Telecommunications series) has been produced by ETSI Technical Committee Electromagnetic compatibility and Radio spectrum Matters (ERM), and is now submitted for the Vote phase of the ETSI standards Two-step Approval Procedure.

The present document has been produced by ETSI in response to a mandate from the European Commission issued under Council Directive 98/34/EC (as amended) laying down a procedure for the provision of information in the field of technical standards and regulations.

The present document is intended to become a Harmonized Standard, the reference of which will be published in the Official Journal of the European Communities referencing the Directive 1999/5/EC [1] of the European Parliament and of the Council of 9 March 1999 on radio equipment and telecommunications terminal equipment and the mutual recognition of their conformity ("the R&TTE Directive").

<b>Proposed national transposition dates</b>	
Date of latest announcement of this EN (doa):	3 months after ETSI publication
Date of latest publication of new National Standard or endorsement of this EN (dop/e):	6 months after doa
Date of withdrawal of any conflicting National Standard (dow):	18 months after doa

## Introduction

The present document is part of a set of standards designed to fit in a modular structure to cover all radio and telecommunications terminal equipment under the R&TTE Directive [1]. Each standard is a module in the structure. The modular structure is shown in figure 1.

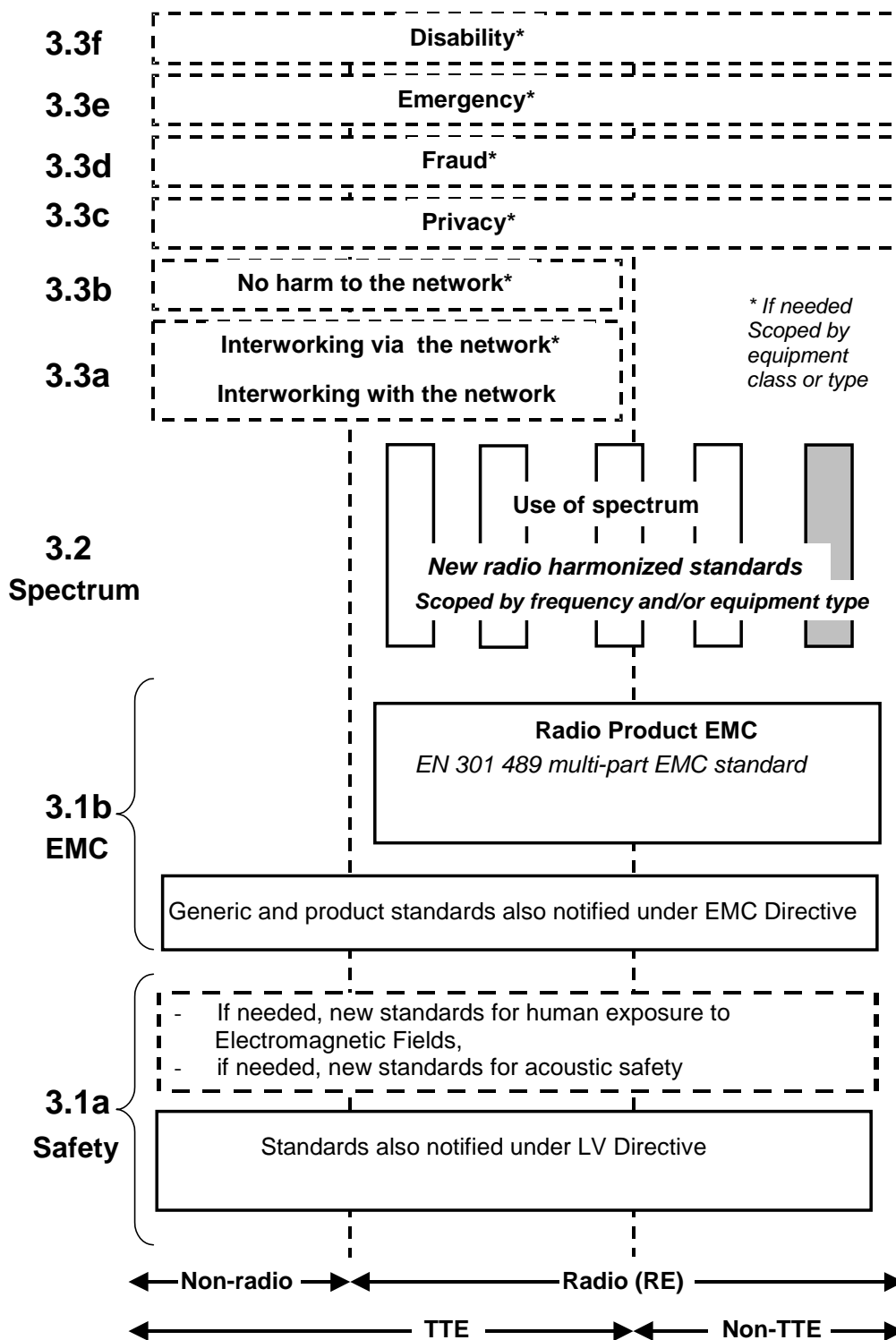

Figure 1: Modular structure for the various standards used under the R&TTE Directive [1]

The left hand edge of the figure 1 shows the different clauses of article 3 of the R&TTE Directive [1].

For article 3.3 various horizontal boxes are shown. Dotted lines indicate that at the time of publication of the present document essential requirements in these areas have to be adopted by the Commission. If such essential requirements are adopted, and as far and as long as they are applicable, they will justify individual standards whose scope is likely to be specified by function or interface type.

The vertical boxes show the standards under article 3.2 for the use of the radio spectrum by radio equipment. The scopes of these standards are specified either by frequency (normally in the case where frequency bands are harmonized) or by radio equipment type.

For article 3.1b, figure 1 shows EN 301 489 [5], the multi-part product EMC standard for radio used under the EMC Directive [2].

For article 3.1a, figure 1 shows the existing safety standards currently used under the LV Directive [3] and new standards covering human exposure to electromagnetic fields. New standards covering acoustic safety may also be required.

The bottom of figure 1 shows the relationship of the standards to radio equipment and telecommunications terminal equipment. A particular equipment may be radio equipment, telecommunications terminal equipment or both. A radio spectrum standard will apply if it is radio equipment. An article 3.3 standard will apply as well only if the relevant essential requirement under the R&TTE Directive [1] is adopted by the Commission and if the equipment in question is covered by the scope of the corresponding standard. Thus, depending on the nature of the equipment, the essential requirements under the R&TTE Directive [1] may be covered in a set of standards.

The modularity principle has been taken because:

- It minimizes the number of standards needed. Because equipment may, in fact, have multiple interfaces and functions it is not practicable to produce a single standard for each possible combination of functions that may occur in an equipment.
- It provides scope for standards to be added:
  - under article 3.2, when new frequency bands are agreed; or
  - under article 3.3, should the Commission take the necessary decisions without requiring alteration of standards that are already published.
- It clarifies, simplifies and promotes the usage of Harmonized Standards as the relevant means of conformity assessment.

The product specifications upon which this present multi-part deliverable is based differ in presentation, and this is reflected in the present document.



---

# 1 Scope

The present document applies to cdma450 repeaters using CDMA 1x spread spectrum technology, i.e. band class 5 or band class 11 equipment as defined in TIA-1030 [16] capable of operating in the frequency bands defined in footnote EU34 from the European Common Allocation table, ERC report 25 [8].

- EU34 states "Parts of the bands 450 MHz to 457,5 MHz / 460 MHz to 467,5 MHz may also be used for existing and evolving public cellular networks on a National basis".

The present document also applies to CDMA-PAMR repeaters covering, in accordance with ECC decision ECC/DEC/(04)06 [9], the frequency bands:

- Band class 11: Operating within the bands 410 MHz to 430 MHz and 450 MHz to 470 MHz with 10 MHz duplex spacing between the transmit frequencies of mobile stations (410 MHz to 420 MHz and 450 MHz to 460 MHz) and the transmit frequencies of base stations (420 MHz to 430 MHz and 460 MHz to 470 MHz).
- Band class 12: Operating within the band 870 MHz to 876 MHz paired with 915 MHz to 921 MHz with 45 MHz duplex spacing between the transmit frequencies of mobile stations (870 MHz to 876 MHz) and the transmit frequencies of base stations (915 MHz to 921 MHz).

The present document is intended to cover the provisions of the R&TTE Directive[1] article 3.2, which states that "[...] radio equipment shall be so constructed that it effectively uses the spectrum allocated to terrestrial/space radio communications and orbital resources so as to avoid harmful interference".

In addition to the present document, other ENs that specify technical requirements in respect of essential requirements under other parts of article 3 of the R&TTE Directive [1] will apply to equipment within the scope of the present document.

NOTE: A list of such ENs is included on the web site <http://www.newapproach.org/>.

---

# 2 References

The following documents contain provisions which, through reference in this text, constitute provisions of the present document.

- References are either specific (identified by date of publication and/or edition number or version number) or non-specific.
- For a specific reference, subsequent revisions do not apply.
- For a non-specific reference, the latest version applies.

Referenced documents which are not found to be publicly available in the expected location might be found at <http://docbox.etsi.org/Reference>.

- [1] Directive 1999/5/EC of the European Parliament and of the Council of 9 March 1999 on radio equipment and telecommunications terminal equipment and the mutual recognition of their conformity (R&TTE Directive).
- [2] Council Directive 89/336/EEC of 3 May 1989 on the approximation of the laws of the Member States relating to electromagnetic compatibility (EMC Directive).
- [3] Council Directive 73/23/EEC of 19 February 1973 on the harmonization of the laws of Member States relating to electrical equipment designed for use within certain voltage limits (LV Directive).
- [4] ANSI/TIA-97-F (2005): "Recommended Minimum Performance Standard for cdma2000 Spread Spectrum Base Stations".
- [5] ETSI EN 301 489 (all parts): "Electromagnetic compatibility and Radio spectrum Matters (ERM); ElectroMagnetic Compatibility (EMC) standard for radio equipment and services".

- [6] TIA-864 (2002): "Recommended Minimum Performance Standards for cdma2000® High Rate Packet Data Access Network Equipment".
- [7] ITU-R Recommendation SM.329-10 (2003): "Unwanted emissions in the spurious domain".
- [8] ERC Report 25, Copenhagen 2004: "The European table of frequency allocations and utilisations covering the frequency range 9 kHz to 275 GHz".
- [9] ECC/DEC/(04)06 ECC: "Decision of 19 March 2004 on the availability of frequency bands for the introduction of Wide Band Digital Land Mobile PMR/PAMR in the 400 MHz and 800/900 MHz bands".
- [10] ETSI TR 100 028 (V1.4.1) (all parts): "Electromagnetic compatibility and Radio spectrum Matters (ERM); Uncertainties in the measurement of mobile radio equipment characteristics".
- [11] CEPT/ERC Recommendation 74-01E, Hradec Kralove 2005: "Unwanted emissions in the spurious domain".
- [12] TIA-1030 (2004): "Band Class Specification for cdma2000® Spread Spectrum Systems".

## 3 Definitions, symbols and abbreviations

### 3.1 Definitions

For the purposes of the present document, the following terms and definitions apply:

**1X:** mode of operation of a base station or access network using spreading rate 1

**band class:** set of frequency channels and a numbering scheme for these channels

NOTE: Band classes are defined in TIA-1030 [12].

**CDMA frequency assignment:** 1,23 MHz segment of spectrum

NOTE: For band classes 11 and 12, the channel is centred on one of the 25 kHz channels.  
For band class 5, the channel is centred on one of the 20 kHz or 25 kHz channels.

**channel gain:** average gain measured in a 1,23 MHz bandwidth around the centre frequency of a channel

**Code Division Multiple Access (CDMA):** technique for spread-spectrum multiple-access digital communications that creates channels through the use of unique code sequences

**donor coupling loss:** coupling loss between the repeater and the donor base station

**down-link:** signal path where base station or repeater transmits and the mobile receives

NOTE: Also referred to as the forward link.

**effective radiated power (e.r.p.):** product of the power supplied to the antenna and the antenna gain in a direction relative to a half-wave dipole

**enclosure port:** also known as cabinet radiation

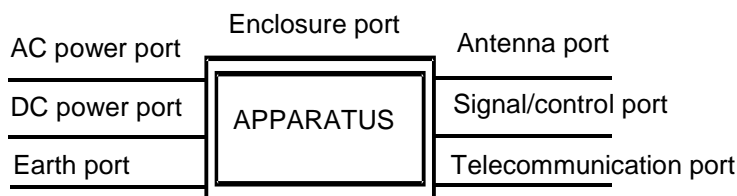

**equivalent isotropically radiated power (e.i.r.p.):** product of the power supplied to the antenna and the antenna gain in a direction relative to an isotropic antenna

**maximum output power (P<sub>max</sub>):** maximum value of the mean power per carrier over any specific time interval, delivered to a load with resistance equal to the nominal load impedance of the repeater

**mobile station:** station intended to be used while in motion or during halts at unspecified points

NOTE: Mobile stations include portable units (e.g. hand-held personal units) and units installed in vehicles and HRPD access terminals.

**multiple carrier:** system set to operate with 2 or more contiguous carriers

**pass band:** frequency range that the repeater operates in with operational configuration

NOTE 1: This frequency range can correspond to one or several consecutive nominal 1,25 MHz channels. If they are not consecutive each subset of channels shall be considered as an individual pass band.

NOTE 2: The repeater can have one or several pass bands.

**repeater:** device that receives, amplifies and transmits the radiated or conducted RF carrier both in the down-link direction (from the base station to the mobile area) and in the up-link direction (from the mobile to the base station)

**representative configuration:** equipment is set up in a manner which is typical for normal operation, where practical

**spurious emissions:** as defined by ITU-R recommendation SM.329-10 [7]

**up-link:** signal path where the mobile or repeater transmits and the base station receives

NOTE: Also referred to as the reverse link.

## 3.2 Symbols

For the purposes of the present document, the following symbols apply:

dBc	ratio (in dB) of the sideband power of a signal, measured in a given bandwidth at a given frequency offset from the centre frequency of the same signal, to the total inband power of the signal. For CDMA, the total inband power of the signal is measured in a 1,23 MHz bandwidth around the centre frequency of the CDMA signal
dBm	measure of power expressed in terms of its ratio (in dB) to 1 mW
F <sub>c</sub>	Nominal center frequency
P <sub>max</sub>	maximum output power

## 3.3 Abbreviations

For the purposes of the present document, the following abbreviations apply:

ACRR	Adjacent Channel Rejection Ratio
AWGN	Additive White Gaussian Noise
CDMA	Code Division Multiple Access
CW	Continuous Waveform
e.i.r.p.	equivalent isotropic radiated power
e.r.p.	effective radiated power
EMC	ElectroMagnetic Compatibility
EUT	Equipment Under Test
GSM	Global System for Mobile
HRPD	High Rate Packet Data
HS-RTT	HS Requirements and conformance Test specifications Table
R&TTE	Radio and Telecommunications Terminal Equipment
RMS	Root Mean Square

## 4 Technical requirements specifications

### 4.1 Environmental profile

The technical requirements of the present document apply under the environmental profile for operation of the equipment, which shall be declared by the supplier. The equipment shall comply with all the technical requirements of the present document at all times when operating within the boundary limits of the declared operational environmental profile.

For guidance on how a supplier can declare the environmental profile see annex C.

### 4.2 Conformance requirements

#### 4.2.1 Introduction

To satisfy the essential requirement under article 3.2 of the R&TTE Directive [1] for repeater the following essential parameters have been identified. Table 1 provides a cross-reference between these essential parameters and the corresponding technical requirements for equipment within the scope of the present document.

The equipment shall be in compliance with all the technical requirements in table 1 for each of the corresponding essential parameters in order to fulfil the essential requirement.

**Table 1: Cross references**

<b>Essential parameter</b>	<b>Corresponding technical requirements</b>
Spectrum emissions mask	4.2.2 Transmitter conducted unwanted emissions
Conducted spurious emissions from the antenna connector	4.2.2 Transmitter conducted unwanted emissions
Accuracy of maximum output power	4.2.3 Accuracy of maximum output power
Radiated emissions	4.2.4 Radiated spurious emissions
Receiver immunity	4.2.5 Input intermodulation
	4.2.6 Out of band gain
	4.2.7 Adjacent Channel Rejection Ratio
Intermodulation attenuation of the output	4.2.8 Output intermodulation

The manufacturer or person responsible for placing the equipment on the market shall declare the operating band class(es) of the equipment. The operating band class(es) shall be recorded in the documentation. The applicable set of technical requirements for each band class is defined in the HS-RTT in annex A.

#### 4.2.2 Transmitter conducted unwanted emissions

##### 4.2.2.1 Definition

Transmitter conducted unwanted emissions are emissions at frequencies that are outside the assigned channel, measured at the repeater RF output port.

##### 4.2.2.2 Limit

If the pass band corresponds to two or more consecutive nominal 1,25 MHz channels, the requirement shall be met with any combination of two CDMA 1x modulated signals of equal power in the repeaters pass band.

##### 4.2.2.2.1 Limits for band class 5 and 11 equipment

The transmitter conducted unwanted emissions shall be less than the limits specified in table 2.

**Table 2: Transmitter conducted unwanted emission limits for band class 5 and 11**

For $ \Delta f $ within the range	Applicability	Emission limit is the higher level of these two columns	
750 kHz to 885 kHz	Single carrier	$-45-15( \Delta f -750) / 135$ dBc in 30 kHz	-41 dBm / 30kHz
885 kHz to 1 125 kHz	Single carrier	$-60-5( \Delta f -885) / 240$ dBc in 30 kHz	-41 dBm / 30kHz
1,125 MHz to 1,98 MHz	Single carrier	-65 dBc / 30kHz	-41 dBm / 30kHz
1,98 MHz to 4,00 MHz	Single carrier	-75 dBc / 30kHz	-41 dBm / 30kHz
4,00 MHz to 6,00 MHz	Single and multiple carrier	-36 dBm / 100kHz	-
6,00 MHz to 10,00 MHz	Single and multiple carrier	-45 dBm / 100kHz	-
> 10,00 MHz	Single and multiple carrier	-36 dBm / 1 kHz -36 dBm / 10 kHz -36 dBm / 100 kHz -30 dBm / 1 MHz	9 kHz < f < 150 kHz 150 kHz < f < 30 MHz 30 MHz < f < 1 GHz 1 GHz < f < 12,5 GHz

NOTE 1: All frequencies in the measurement bandwidth should satisfy the restrictions on  $|\Delta f|$  where  $\Delta f$  = center frequency - closer measurement edge frequency (f).

NOTE 2: For multiple-carrier testing,  $\Delta f$  is defined for positive  $\Delta f$  as the center frequency of the highest carrier - closer measurement edge frequency (f) and for negative  $\Delta f$  as the center frequency of the lowest carrier - closer measurement edge frequency (f).

#### 4.2.2.2.2 Limits for band class 12 equipment

The transmitter conducted unwanted emissions shall be less than the limits specified in tables 3 and 4.

**Table 3: Transmitter conducted unwanted emission limits for band class 12**

For $ \Delta f $ within the range	Applicability	Emission limit is the higher level of these two columns	
750 kHz to 885 kHz	Single carrier	$-45-15( \Delta f -750) / 135$ dBc in 30 kHz	-41 dBm / 30kHz
885 kHz to 1 125 kHz	Single carrier	$-60-5( \Delta f -885) / 240$ dBc in 30 kHz	-41 dBm / 30kHz
1,125 MHz to 1,98 MHz	Single carrier	-65 dBc / 30kHz	-41 dBm / 30kHz
1,98 MHz to 4,00 MHz	Single carrier	-75 dBc / 30kHz	-41 dBm / 30kHz
4,00 MHz to 6,00 MHz	Single and multiple carrier	-36 dBm / 100kHz	-
6,00 MHz to 45,00 MHz	Single and multiple carrier	-45 dBm / 100kHz	-
> 45,00 MHz	Single and multiple carrier	-36 dBm / 1 kHz -36 dBm / 10 kHz -36 dBm / 100 kHz -30 dBm / 1 MHz	9 kHz < f < 150 kHz 150 kHz < f < 30 MHz 30 MHz < f < 1 GHz 1 GHz < f < 12,5 GHz

NOTE 1: All frequencies in the measurement bandwidth should satisfy the restrictions on  $|\Delta f|$  where  $\Delta f$  = center frequency - closer measurement edge frequency (f).

NOTE 2: For multiple-carrier testing,  $\Delta f$  is defined for positive  $\Delta f$  as the center frequency of the highest carrier - closer measurement edge frequency (f) and for negative  $\Delta f$  as the center frequency of the lowest carrier - closer measurement edge frequency (f).

NOTE 3: In the frequency range 876 MHz to 915 MHz the limits of table 4 take precedence.

The table 4 contains additional requirements for frequency range from 876 MHz to 915 MHz to protect GSM services in adjacent band.

**Table 4: Additional transmitter conducted unwanted emission limits within the frequency range 876 MHz to 915 MHz for band class 12 equipment**

For $ \Delta f $ within the range	Applicability	Emission limit is the higher level of these two columns	
1,98 MHz to 4,00 MHz	Single carrier	-100 dBc / 30kHz	-61 dBm / 100kHz
4,00 MHz to 6,00 MHz	Single and multiple carrier	-	-61 dBm / 100kHz
> 6,00 MHz	Single and multiple carrier	-	-61 dBm / 100kHz
NOTE 1: All frequencies in the measurement bandwidth should satisfy the restrictions on $ \Delta f $ where $\Delta f = \text{center frequency} - \text{closer measurement edge frequency (f)}$ .			
NOTE 2: For multiple-carrier testing, $\Delta f$ is defined for positive $\Delta f$ as the center frequency of the highest carrier - closer measurement edge frequency (f) and for negative $\Delta f$ as the center frequency of the lowest carrier - closer measurement edge frequency (f).			

#### 4.2.2.3 Conformance

Conformance tests described in clause 5.3.1 shall be carried out.

### 4.2.3 Accuracy of maximum output power

#### 4.2.3.1 Definition

The maximum output power is the maximum value of the mean power per carrier over any specific time interval, delivered to a load with resistance equal to the nominal load impedance of the repeater.

The manufacturer or person responsible for placing the equipment on the market shall declare the maximum value of the mean output power of the repeater. The maximum value of the mean output power shall be recorded in the documentation.

#### 4.2.3.2 Limit

In normal conditions (see clause C.1.3) and in extreme conditions (see clause C.1.4), the repeater maximum output power shall remain within +2 dB and -4 dB of the manufacturer's declared output power for the equipment.

#### 4.2.3.3 Conformance

Conformance tests described in clause 5.3.2 shall be carried out.

### 4.2.4 Radiated spurious emissions

#### 4.2.4.1 Definition

The radiated spurious emissions are the radiated spurious emissions from the enclosure port.

The test for radiated spurious emissions shall be performed on a representative configuration of the equipment under test.

#### 4.2.4.2 Limits

The frequency boundary reference bandwidths and the limits are based on CEPT/ERC Recommendation 74-01E [11].

The requirements are shown in table 5.

The repeater shall not exceed the limits given in table 5.

**Table 5: Radiated spurious emissions requirements**

Frequency	Maximum (e.r.p.) / reference bandwidth
$30 \text{ MHz} \leq f < 1\,000 \text{ MHz}$	-36 dBm / 100 kHz
$1 \text{ GHz} \leq f < 12,75 \text{ GHz}$	-30 dBm / 1 MHz
$Fc1 - 4 \text{ MHz} < f < Fc2 + 4 \text{ MHz}$	Not applicable
NOTE 1: Centre frequency of first carrier frequency (Fc1) used by the repeater.	
NOTE 2: Centre frequency of last carrier frequency (Fc2) used by the repeater.	
NOTE 3: Notes 1 and 2 assume contiguous frequencies otherwise multiple exclusions bands for the occupied bandwidth and out of band emissions will apply.	

#### 4.2.4.3 Conformance

Conformance tests described in clause 5.3.3 shall be carried out.

### 4.2.5 Input intermodulation

#### 4.2.5.1 Definition

The input intermodulation is a measure of the capability of the Repeater to inhibit the generation of interference in the pass band, in the presence of interfering signals on frequencies other than the pass band.

Third and higher order mixing of the two interfering RF signals can produce an interfering signal in the band of the desired channel. Intermodulation response rejection is a measure of the capability of the repeater to maintain the wanted frequency free of internally created interference.

This test applies to up-link path of the repeater.

#### 4.2.5.2 Limit

The intermodulation performance should be met when the following signals are applied to the repeater.

**Table 6: Input intermodulation requirement**

Interfering signal levels	Type of signals	Measurement bandwidth
-40 dBm	2 CW carriers	1 MHz

For the parameters specified in table 6, the power in the pass band shall not increase with more than the limit in table 7 at the output of the repeater as measured in the centre of the pass band, compared to the level obtained without interfering signals applied.

**Table 7: General input intermodulation limit**

Limit for the increase of power in the pass band
+11,2 dB

#### 4.2.5.3 Conformance

Conformance tests described in clause 5.3.4 shall be carried out.

### 4.2.6 Out of band gain

#### 4.2.6.1 Definition

Out of band gain refers to the gain of the repeater immediately outside the pass band. The measurements shall apply to both paths up-link and down-link of the repeater.

#### 4.2.6.2 Limits

The intended use of a repeater in a system is to amplify the in band signals and not to amplify the out of band emission of the donor base station.

The out of band gain of the repeater shall be equal to or less than the manufacture declared minimum donor coupling loss.

The gain outside the pass band shall not exceed the maximum level specified in table 8.

**Table 8: Out of band gain**

For $ \Delta f $ within the Range	For repeater with a mid pass band channel gain $\leq 40$ dB
	Out of band gain
2,50 MHz to 3,75 MHz	Pass band channel gain
3,75 MHz to 12,50 MHz	$\leq 35$ dB
12,50 MHz to 50 MHz	$\leq 30$ dB
> 50 MHz	$\leq -10$ dB

NOTE: For pass bands that only support a single channel:  
 $\Delta f$  = center frequency of supported channel - measurement frequency (f).  
 For pass bands supporting two or more channels:  
 $\Delta f$  is defined for positive  $\Delta f$  as the center frequency of the highest supported channel - measurement frequency (f) and for negative  $\Delta f$  as the center frequency of the lowest supported channel - measurement frequency (f).  
 The limits shall apply for all values of  $\Delta f$  regardless of whether the measurement frequency falls inside or outside of the band or block.

#### 4.2.6.3 Conformance

Conformance tests described in clause 5.3.5 shall be carried out.

### 4.2.7 Adjacent Channel Rejection Ratio (ACRR)

#### 4.2.7.1 Definition

Adjacent Channel Rejection Ratio (ACRR) is the ratio of the RRC weighted gain per carrier in the passband to the RRC weighted gain per carrier immediately outside the passband.

The measurements shall apply to both paths up-link and down-link of the repeater.

#### 4.2.7.2 Limit

The intended use of a repeater in a system is to amplify the in band signals and not to amplify the out of band emission of the donor base station.

The repeater shall not exceed the limits given in table 9.



**Table 9: Adjacent Channel Rejection Ratio (ACRR)**

For $ \Delta f $ within the range	For repeater with a mid pass band channel gain > 40 dB.
	Minimum Adjacent Channel Rejection Ratio
2,50 MHz to 3,75 MHz	$\geq 40$ dB
3,75 MHz to 12,50 MHz	$\geq 40$ dB
12,50 MHz to 50 MHz	$\geq 40$ dB
> 50 MHz	$\geq 40$ dB
NOTE: For pass bands that only support a single channel: $\Delta f$ = center frequency of supported channel - measurement center frequency (f). For pass bands supporting two or more channels: $\Delta f$ is defined for positive $\Delta f$ as the center frequency of the highest supported channel - measurement center frequency (f) and for negative $\Delta f$ as the center frequency of the lowest supported channel - measurement center frequency (f). The limits shall apply for all values of $\Delta f$ regardless of whether the measurement frequency falls inside or outside of the band or block.	

#### 4.2.7.3 Conformance

Conformance tests described in clause 5.3.6 shall be carried out.

### 4.2.8 Output intermodulation

#### 4.2.8.1 Definition

The output intermodulation requirement is a measure of the ability of the repeater to inhibit the generation of intermodulation products signals created by the presence of an interfering signal reaching the repeater via the output port.

The output intermodulation level is the power of the intermodulation products when a CDMA 1x modulated interference signal is injected into the output port at a level of 30 dB lower than that of the wanted signal. The frequency of the interference signal shall be  $\pm 1,25$  MHz,  $\pm 2,5$  MHz and  $\pm 3,75$  MHz offset from the wanted signal, but within the frequency band allocated for the down-link.

The requirement is applicable for down-link signals.

#### 4.2.8.2 Limit

The output intermodulation level shall not exceed the transmitter conducted unwanted emissions clause 4.2.2.2.

#### 4.2.8.3 Conformance

Conformance tests described in clause 5.3.7 shall be carried out.

## 5 Testing for compliance with technical requirements

### 5.1 Conditions for testing

#### 5.1.1 Introduction

Tests defined in the present document shall be carried out at representative points within the boundary limits of the declared operational environmental profile.

Where technical performance varies subject to environmental conditions, tests shall be carried out under a sufficient variety of environmental conditions (within the boundary limits of the declared operational environmental profile) to give confidence of compliance for the affected technical requirements.

All tests shall be conducted using standard test conditions except where otherwise stated (see TIA-1037). For a definition of standard test conditions and for guidance on the use of other test conditions to be used in order to show compliance reference can be made to annex C.

## 5.1.2 Standard equipment under test

### 5.1.2.1 Basic equipment

The equipment under test shall be assembled and any necessary adjustments shall be made in accordance with the manufacturer's instructions for the mode of operation required. When alternative modes are available, the equipment shall be assembled and adjusted in accordance with the relevant instructions. A complete series of measurements shall be made for each mode of operation.

### 5.1.3 CDMA test signal definition

For the repeater tests that require a CDMA signal source be applied to the repeater, the configuration shown in Table°9a shall be used. This waveform is used for both down-link and up-link signal path directions of the repeater.

**Table°9a: CDMA Signal Waveform Requirements**

Channel Type	Number of Channels (1)	Fraction of Power (linear)	Fraction of Power (dB)	Comments
Forward Pilot	1	0,2000	-7,0	Code channel $W_0^{64}$
Sync	1	0,0471	-13,3	Code channel $W_{32}^{64}$ ; always 1/8 rate
Paging	1	0,1882	-7,3	Code channel $W_1^{64}$ ; full rate only
Traffic	$M$	$0,5647 / M$	$-2.48 - 10 * \log(M)$	Variable code channel assignments; full rate only
NOTE:	For the transmitter conducted unwanted emissions (clause 5.3.1) and the maximum output power (clause 5.3.2), $M$ shall be 37. For all other tests, $M$ shall be 6.			

## 5.2 Interpretation of the measurement results

The interpretation of the results recorded in a test report for the measurements described in the present document shall be as follows:

- the measured value related to the corresponding limit will be used to decide whether an equipment meets the requirements of the present document;
- the value of the measurement uncertainty or the accuracy of each piece of test equipment used for the measurement of each parameter shall be included in the test report; only test equipment meeting the performance requirements for standard test equipment as defined in ANSI/TIA-97-F [4], clause 6.4 or TIA-864 [6], clause 11.4, shall be used;
- the test set-up of each test shall be equivalent to the test set-up descriptions in annex D;
- the recorded value of the measurement uncertainty or the recorded value of the accuracy of each piece of test equipment shall be equal to or better than the figures in ANSI/TIA-97-F [4], clause 6.4 or TIA-864 [6], clause 11.4.

NOTE 1: For convenience in interpreting the present document, some of the more important limits on the acceptable uncertainty of test equipment are reproduced in table 10.

**Table 10: Maximum measurement uncertainty**

Equipment used for testing	Uncertainty
Spectrum Analyser Absolute power accuracy	$\pm 1$ dB over the range of -40 dBm to +20 dBm $\pm 1,3$ dB over the range of -70 dBm to +20 dBm
CW Generator Absolute output power accuracy	$\pm 1$ dB
AWGN Generator Absolute output power accuracy	$\pm 2$ dB

For the essential test suites "Maximum output power" and "Radiated spurious emissions" (see clauses 5.3.2 and 5.3.3) the measurement uncertainty figures shall also be calculated in accordance with TR 100 028 [13] and shall correspond to an expansion factor (coverage factor)  $k = 1,96$  (which provides a confidence level of 95 % in the case where the distributions characterizing the actual measurement uncertainties are normal (Gaussian)). The calculated values shall be within the values shown in table 11.

**Table 11: Maximum measurement uncertainty**

Parameter	Uncertainty for EUT dimension $\leq 1$ m	Uncertainty for EUT dimension $> 1$ m
Effective radiated RF power between 30 MHz to 180 MHz	$\pm 6$ dB	$\pm 6$ dB
Effective radiated RF power between 180 MHz to 4 GHz	$\pm 4$ dB	$\pm 6$ dB
Effective radiated RF power between 4 GHz to 12,75 GHz	$\pm 6$ dB	$\pm 9$ dB (see note)
Conducted RF power	$\pm 1$ dB	$\pm 1$ dB
NOTE: This value may be reduced to $\pm 6$ dB when further information on the potential radiation characteristic of the EUT is available.		

NOTE 2: If the test system for a test is known to have a measurement uncertainty greater than that specified in tables 10 and 11, this equipment can still be used, provided that an adjustment is made follows:

- Any additional uncertainty in the test system over and above that specified in the table is used to tighten the test requirements - making the test harder to pass (for some tests, e. g. receiver tests, this may require modification of stimulus signals). This procedure will ensure that a test system not compliant with tables 10 or 11 does not increase the probability of passing an EUT that would otherwise have failed a test.

## 5.3 Essential radio test suites

### 5.3.1 Transmitter conducted unwanted emissions

#### 5.3.1.1 Initial conditions

Test environment: Normal; see clause C.1.

- 1) Set-up the equipment as shown in annex D.
- 2) Connect a signal generator to the input port of the repeater for tests of repeaters with an operating band corresponding to one 1,25 MHz channel. If the operating band corresponds to two or more 1,25 MHz carriers, two signal generators with a combining circuit or one signal generator with the ability to generate several CDMA 1x carriers is connected to the input.
- 3) Detection mode: True RMS.

### 5.3.1.2 Procedures

The test procedures described in this clause apply to both up-link and down-link. The tests are to be conducted sequentially.

- 1) Connect a spectrum analyzer (or other suitable test equipment) to a repeater RF output port, using an attenuator or directional coupler if necessary.
- 2) For each pass band that the repeater supports, configure the repeater to operate in that pass band and perform steps 3 through 13. The tests are to be conducted sequentially.
- 3) Set the repeater at its maximum rated gain.
- 4) Configure the repeater, where necessary, to transmit a single carrier and perform steps 5 through 8.
- 5) Input a CDMA channel as defined in clause 5.1.3.
- 6) Set the input amplitude of the signal such that the output signal is at the declared maximum power rated by the manufacturer.
- 7) Measure the power level at the carrier frequency.
- 8) Measure the transmitter conducted unwanted emission levels using appropriate resolution bandwidth at the offset frequencies specified in the relevant table in clause 4.2.2 for the band class under assessment.
- 9) Increase the power level of the input signal by 10 dB and repeat steps 7 and 8.
- 10) If the repeater supports two or more carriers, input two CDMA channels in any combination of supported carriers as defined in clause 5.3.1.
- 11) Set the input amplitude of the signals such that the output signals are at the declared maximum power rated by the manufacturer taking into consideration the ratings for multiple carrier operation and perform steps 12 and 13.
- 12) Measure the transmitter conducted unwanted emission levels using appropriate resolution bandwidth at the offset frequencies specified in the relevant table in clause 4.2.2 for the band class under assessment.
- 13) Increase the power level of the input signals by 10 dB and measure the transmitter conducted unwanted emission levels.

The results obtained shall be compared to the limits in clause 4.2.2.2 in order to prove compliance.

## 5.3.2 Accuracy of maximum output power

### 5.3.2.1 Initial conditions

Test environment:      Normal: see clause C.1.3; and  
                                 Extreme: see clause C.1.4.

In addition, on one CDMA frequency assignment only, the test shall be performed under extreme power supply conditions as defined in clause C.1.4.2.

NOTE: Tests under extreme power supply also test extreme temperature.

- 1) Set-up the equipment as shown in annex D.
- 2) Connect the signal generator equipment to the repeater input port.
- 3) Connect the power measuring equipment to the repeater output port.

### 5.3.2.2 Procedure

- 1) For each pass band that the repeater supports, configure the repeater to operate in that pass band and perform steps 2 through 6. The tests are to be conducted sequentially.
- 2) Set the signal generator to transmit a CDMA channel as defined in clause 5.3.1.
- 3) Adjust the input power to the repeater to create the maximum nominal repeater output power at maximum gain.
- 4) Measure the mean power at the RF output port.
- 5) Increase the power with 10 dB compared to the level obtained in step 2).
- 6) Measure the mean power at the RF output port.

The results obtained shall be compared to the limits in clause 4.2.3.2 in order to prove compliance.

## 5.3.3 Radiated spurious emissions

### 5.3.3.1 Test method

- a) A test site fulfilling the requirements of ITU-R Recommendation SM.329-10 [7] shall be used. The EUT shall be placed on a non-conducting support and shall be operated from a power source via a RF filter to avoid radiation from the power leads.

Average power of any spurious components shall be detected by the test antenna and measuring receiver (e.g. a spectrum analyser). At each frequency at which a component is detected, the EUT shall be rotated and the height of the test antenna adjusted to obtain maximum response, and the effective radiated power (e.r.p.) of that component determined by a substitution measurement. The measurement shall be repeated with the test antenna in the orthogonal polarization plane.

NOTE: Effective radiated power (e.r.p.) refers to the radiation of a half wave tuned dipole instead of an isotropic antenna. There is a constant difference of 2,15 dB between e.i.r.p. and e.r.p.  

$$\text{e.r.p. (dBm)} = \text{e.i.r.p. (dBm)} - 2,15 \text{ (ITU-R Recommendation SM.329-10 [7], annex 1).}$$

- b) The gain and the output power shall be adjusted to the maximum value as declared by the manufacturer. Use an input signal as defined in the applicable part for the measurement of spurious emissions.
- c) The video bandwidth shall be approximately three times the resolution bandwidth. If this video bandwidth is not available on the measuring receiver, it shall be the maximum available and at least 1 MHz.

### 5.3.3.2 Test configurations

This clause defines the configurations for emission tests as follows:

- the equipment shall be tested under normal test conditions as specified in the functional standards;
- the test configuration shall be as close to normal intended use as possible;
- if the equipment is part of a system, or can be connected to ancillary equipment, then it shall be acceptable to test the equipment while connected to the minimum configuration of ancillary equipment necessary to exercise the ports;
- if the equipment has a large number of ports, then a sufficient number shall be selected to simulate actual operation conditions and to ensure that all the different types of termination are tested;
- the test conditions, test configuration and mode of operation shall be recorded in the test report;
- ports which in normal operation are connected shall be connected to an ancillary equipment or to a representative piece of cable correctly terminated to simulate the input/output characteristics of the ancillary equipment, Radio Frequency (RF) input/output ports shall be correctly terminated;

- ports which are not connected to cables during normal operation, e.g. service connectors, programming connectors, temporary connectors etc. shall not be connected to any cables for the purpose of this test. Where cables have to be connected to these ports, or interconnecting cables have to be extended in length in order to exercise the EUT, precautions shall be taken to ensure that the evaluation of the EUT is not affected by the addition or extension of these cables.

For an EUT which contains more than one repeater, it is sufficient to perform tests relating to connectors of each representative type of the repeater forming part of the EUT.

At the manufacturer's discretion the test may be performed on the ancillary equipment separately or a representative configuration of the combination of radio and ancillary equipment. In each case the EUT is tested against all applicable emission clauses of the present document and in each case, compliance enables the ancillary equipment to be used with different radio equipment.

The results obtained shall be compared to the limits in clause 4.2.4.2 in order to prove compliance.

## 5.3.4 Input intermodulation

### 5.3.4.1 Initial conditions

Test environment: Normal: see clause C.1.3.

- 1) Set-up the equipment as shown in annex D.
- 2) Set the repeater to maximum gain.
- 3) Connect two signal generators with a combining circuit or one signal generator with the ability to generate several CW carriers to the input.
- 4) Connect a spectrum analyser to the output of the repeater. Set the resolution bandwidth to 1 MHz in the centre of the operating band. Set averaging to 1 s.

### 5.3.4.2 Procedures

- 1) For each up-link pass band that the repeater supports, configure the repeater to operate in that pass band and perform steps 2 and 3. The tests are to be conducted sequentially.
- 2) Adjust the repeater to its maximum gain setting and apply two CW tones at a level of -40 dBm at frequencies outside the pass band of the repeater such that the 3rd order intermodulation products are located in the center of the pass band.
- 3) Measure the increase in output power at the centre of the pass band, using a 1 MHz resolution bandwidth, relative to the output power before the CW signals were applied (The 1 MHz measurement bandwidth may be calculated by integrating multiple 50 kHz or narrower filter measurements).

The results obtained shall be compared to the limits in clause 4.2.5.2 in order to prove compliance.

## 5.3.5 Out of band gain

### 5.3.5.1 Initial conditions

Test environment: Normal: see clause C.1.3.

- 1) Set-up the equipment as shown in annex D.

### 5.3.5.2 Procedure

The test procedures described in this clause apply to both up-link and down-link. The tests are to be conducted sequentially.

- 1) Set the repeater at its maximum gain setting.
- 2) For each pass band that the repeater supports, configure the repeater to operate in that pass band and perform steps 3 through 8. The tests are to be conducted sequentially.
- 3) Input a CW tone at the repeater input port approximately 5 dB below the level that would cause the maximum rated output from the repeater at the center of its pass band.
- 4) Set the CW frequency according to the specified frequency offsets ( $\Delta f$ ) according to table 8 below the lowest carrier frequency supported in the carrier pass band and input the CW tone at the repeater input port at the same level as in step 3.
- 5) Measure the repeater gain at these frequency offsets ( $\Delta f$ ) according to table 8 at the output port of the repeater.
- 6) Set the CW frequency according to the specified frequency offsets ( $\Delta f$ ) according to table 8 above the highest carrier frequency supported in the carrier pass band and input the CW tone at the repeater input port at the same level as in step 3.
- 7) Measure the repeater gain at these frequency offsets ( $\Delta f$ ) according to table 8 at the output port of the repeater.

The results obtained shall be compared to the limits in clause 4.2.6.2 in order to prove compliance.

## 5.3.6 Adjacent Channel Rejection Ratio (ACRR)

### 5.3.6.1 Initial conditions

Test environment: Normal: see clause C.1.3.

- 1) Set-up the equipment as shown in annex D.
- 2) Connect the signal generator equipment to the repeater input port.
- 3) Connect the power measuring equipment to the repeater output port.
- 4) Detection mode: True RMS.

### 5.3.6.2 Procedures

- 1) Set the repeater at its maximum rated gain.
- 2) For each pass band that the repeater supports, configure the repeater to operate in that pass band and perform steps 3 through 9. The tests are to be conducted sequentially.
- 3) Input a CDMA channel as defined in clause 5.3.1.
- 4) Adjust the center frequency of the input signal to the center frequency of the passband.
- 5) Adjust the input power to the repeater to create the maximum nominal repeater output power at maximum gain.
- 6) Measure the mean power at the RF output port.
- 7) Set the signal generator to transmit the same signal as in step 3 with the same input power as in step 5 at carrier centre frequency of the adjacent channel according to table 9.
- 8) Measure the mean power at the RF output port and compare it to the result from step 6.
- 9) Repeat steps 7 and 8 until all adjacent channels according to table 9 are measured.

The results obtained shall be compared to the limits in clause 4.2.7.2 in order to prove compliance.

## 5.3.7 Output intermodulation

### 5.3.7.1 Initial conditions

Test environment: Normal: see clause C.1.3.

- 1) Set-up the equipment as shown in annex D.
- 2) Detection mode: True RMS.

### 5.3.7.2 Procedures

- 1) Set the repeater to maximum gain.
- 2) Set the signal generator at the repeater input port (subject signal) to generate a signal in accordance to in clause 5.3.1, at the level which produce the manufacturer specified maximum output power at maximum gain.
- 3) Set the signal generator at the repeater output port (interference signal) to generate a signal in accordance to in clause 5.3.1, at the level producing signal power corresponding to 30 dB below the manufacturer specified maximum output power at the repeater output port with a frequency offset from the wanted signal of  $\pm 1,25$  MHz,  $\pm 2,5$  MHz and  $\pm 3,75$  MHz.
- 4) Measure the emission at the specified frequencies with specified measurement bandwidth and note that the measured value does not exceed the specified value. Measurements in the band of the interfering signal shall be excluded. The measurements can be limited to the power of all third and fifth order intermodulation products.

The results obtained shall be compared to the limits in clause 4.2.8.2 in order to prove compliance.



## Annex A (normative): HS Requirements and conformance Test specifications Table (HS-RTT)

Notwithstanding the provisions of the copyright clause related to the text of the present document, ETSI grants that users of the present document may freely reproduce the EN-RT proforma in this annex so that it can be used for its intended purposes and may further publish the completed EN-RT.

This EN Requirements table (EN-RT) serves a number of purposes, as follows:

- It provides a tabular summary of the requirements for this part.
- It shows the status of each EN-R, whether it is essential to implement in all circumstances (Mandatory), or whether the requirement is dependent on the supplier having chosen to support a particular optional service or functionality (Optional). In particular it enables the EN-Rs associated with a particular optional service or functionality to be grouped and identified.
- When completed in respect of a particular equipment it provides a means to undertake the static assessment of conformity with this part of the EN.

**Table A.1: HS Requirements and conformance Test specifications Table (HS-RTT)**

<b>Harmonized Standard EN 302 426</b>						
The following technical requirements and test specifications are relevant to the presumption of conformity under article 3.2 of the R&TTE Directive						
Technical Requirement reference			Technical Requirement Conditionality		Test Specification	
No	Description	Reference: Clause No	U/C	Condition	E/O	Reference: Clause No
1	Transmitter conducted unwanted emissions	4.2.2.2.1	C	Applies to band class 5 and 11 equipment	E	5.3.1
2	Transmitter conducted unwanted emissions	4.2.2.2.2	C	Applies to band class 12 equipment	E	5.3.1
3	Accuracy of maximum output power	4.2.3	U		E	5.3.2
4	Radiated spurious emissions	4.2.4	U		E	5.3.3
5	Input inter-modulation	4.2.5	U		E	5.3.4
6	Out of band gain	4.2.6	U		E	5.3.5
7	Adjacent Channel Rejection Ratio	4.2.7	U		E	5.3.6
	Output inter-modulation	4.2.8	U		E	5.3.7

**Key to columns:**

**Essential Requirement:**

**No** A unique identifier for one row of the table which may be used to identify an essential requirement or its test specification.

**Description** A textual reference to the Technical Requirement

**Clause Number:**

Identification of clause(s) defining the technical requirement in the present document unless another document is referenced explicitly

**Conditionality:**

**U/C** Indicates whether the requirement is to be *unconditionally* applicable (U) or is *conditional* upon the manufacturers claimed functionality of the equipment (C)

**Condition** Explains the conditions when the requirement shall or shall not be applicable for a technical requirement which is classified "conditional"

**Test Specification:**

**E/O** Indicates whether the test specification forms part of the *Essential Radio Test Suite* (E) or whether it is one of the *Other Test Suite* (O)

NOTE: All tests whether "E" or "O" are relevant to technical requirements. Rows designated "E" collectively make up the *Essential Radio Test Suite*; those designated "O" make up the *Other Test Suite*; for those designated "X" there is no test specified corresponding to the technical requirements. All tests classified "E" shall be performed as specified with satisfactory outcomes is a necessary condition for a presumption of conformity. Technical requirements associated with tests classified "O" or "X" must be complied with as a necessary condition for presumption of conformity, although conformance with the requirement may be claimed by an equivalent test or by manufacturer's assertion supported by appropriate entries in the technical construction file.

**Clause Number:**

Identification of clause(s) defining the test specification in the present, document unless another document is referenced explicitly. Where no test is specified (that is, where the previous field is "X") this field remains blank.

---

## Annex B (normative): Repeater configurations

### B.1 Power supply options

If the repeater is supplied with a number of different power supply configurations, it may not be necessary to test RF parameters for each of the power supply options, provided that it can be demonstrated that the range of conditions over which the equipment is tested is at least as great as the range of conditions due to any of the power supply configurations.

---

### B.2 Combining of repeaters

If the repeater is intended for combination with additional apparatus connected to a repeater port and this combination is supplied as a system, the combination of repeater together with the additional apparatus must also fulfil the repeater requirements. E.g. if the repeater is intended for combination such that multiple repeaters amplify the same signals into the same ports the combination must also fulfil the repeater requirements.

An example of such a configuration is shown in figure B.1.

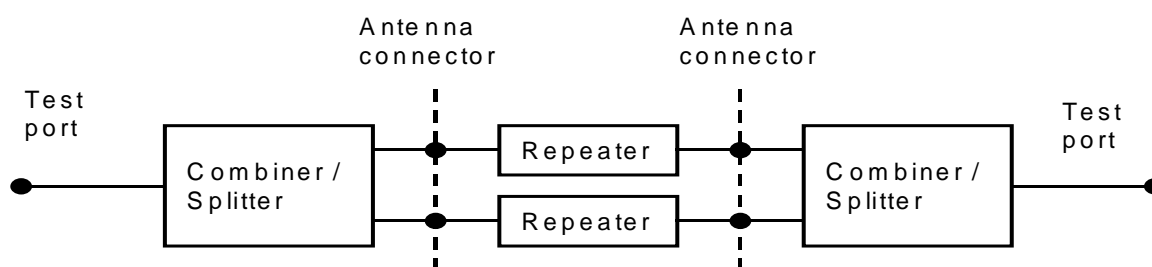

**Figure B.1: Example of repeater configuration**

---

## Annex C (normative): Environmental profile specification

### C.1 Test conditions, power supply and ambient temperatures

#### C.1.1 Normal and extreme test conditions

Testing shall be performed under normal test conditions and where stated in the test procedures for all radio test suites (see clause C.1.3), under extreme conditions (see clause C.1.4).

Exceptions to the measurement procedures given in this clause shall be recorded.

#### C.1.2 Power sources

##### C.1.2.1 Power sources for stand-alone equipment

During testing, the power source of the equipment shall be replaced by a test power source capable of producing normal and extreme test voltages as specified in clauses C.1.3.2 and C.1.4.2. The internal impedance of the test power source shall be low enough for its effect on the test results to be negligible. For the purpose of tests, the voltage of the power source shall be measured at the input terminals of the equipment.

For battery operated equipment the battery shall be removed and the test power source shall be applied as close to the battery terminals as practicable.

During tests the power source voltages shall be maintained within a tolerance of  $\pm 1$  % relative to the voltage at the beginning of each test. The value of this tolerance is critical to power measurements; using a smaller tolerance will provide better measurement uncertainty values.

#### C.1.3 Normal test conditions

##### C.1.3.1 Normal temperature and humidity

The normal temperature and humidity conditions for tests shall be any convenient combination of temperature and humidity within the following ranges:

- temperature: +15°C to +35°C;
- relative humidity: 20 % to 75 %.

When it is impracticable to carry out the tests under these conditions, a note to this effect, stating the ambient temperature and relative humidity during the tests, shall be recorded.

The actual values during the tests shall be recorded.

The maximum measurement uncertainty shall be:

- temperature:  $\leq \pm 1$  K;
- relative humidity:  $\leq \pm 5$  %.

## C.1.3.2 Normal power source

### C.1.3.2.1 Mains voltage

The normal test voltage for equipment to be connected to the mains shall be the nominal mains voltage. For the purpose of the present document, the nominal voltage shall be the voltage(s) for which the equipment was designed.

The frequency of the test power source corresponding to the AC mains shall be between 49 Hz and 51 Hz.

### C.1.3.2.2 Lead-acid battery power sources used on vehicles

When radio equipment is intended for operation from the usual, alternator fed lead-acid battery power source used on vehicles, then the normal test voltage shall be 1,1 times the nominal voltage of the battery (6 V, 12 V, etc.).

### C.1.3.2.3 Other power sources

For operation from other power sources or types of battery (primary or secondary), the nominal test voltage shall be as stated by the equipment manufacturer. This shall be recorded.

## C.1.4 Extreme test conditions

### C.1.4.1 Extreme temperatures

For tests at extreme temperatures, measurements shall be made in accordance with the procedures specified in clause C.1.4.3, at the upper and lower temperatures of the range as follows:

- temperature: -20°C to +55°C;

Where the manufacturer's stated operating range does not include the range of -20°C to +55°C, the equipment shall be tested over the following temperature ranges:

- a) 0°C to +35°C for equipment intended for indoor use only, or intended for use in areas where the temperature is controlled within this range;
- b) over the extremes of the operating temperature range(s) of the stated combination(s) or host equipment(s) in case of plug-in radio devices.

The output power limit (clause 5.3.2) shall not be exceeded.

The temperature range used during testing shall be recorded and shall be stated in the test report.

### C.1.4.2 Extreme power source voltages

Tests at extreme power source voltages specified below are not required when the equipment under test is designed for operation as part of and powered by another system or piece of equipment. Where this is the case, the limit values of the host equipment or combined equipment shall apply. The appropriate limit values shall be stated by the provider and recorded.

#### C.1.4.2.1 Mains voltage

The extreme test voltage for equipment to be connected to an AC mains source shall be the nominal mains voltage  $\pm 15\%$ .

#### C.1.4.2.2 Power sources using other types of batteries

The lower extreme test voltages for equipment with power sources using the following types of battery shall be:

- for the Leclanché or lithium type battery: 0,85 times the nominal voltage of the battery;
- for the mercury or nickel-cadmium type of battery: 0,9 times the nominal voltage of the battery.

In both cases, the upper extreme test voltage shall be 1,15 times the nominal voltage of the battery.

#### C.1.4.2.3 Other power sources

For equipment using other power sources, or capable of being operated from a variety of power sources (primary or secondary), the extreme test voltages shall be those stated by the manufacturer and shall be recorded.

#### C.1.4.3 Procedure for tests at extreme temperatures

Before measurements are made the equipment shall have reached thermal balance in the test chamber.

The equipment shall be switched off during the temperature stabilizing period. In the case of equipment containing temperature stabilizing circuits designed to operate continuously, these circuits shall be switched on for 15 minutes after thermal balance has been reached. After this time the equipment shall meet the specified requirements. For this type of equipment the manufacturer shall provide for the power source circuit feeding these circuits to be independent of the power source of the rest of the equipment.

If thermal balance is not checked by measurements, a temperature stabilizing period of at least one hour, or such period as may be decided by the testing laboratory, shall be allowed. The sequence of measurements shall be chosen and the humidity content in the test chamber shall be controlled so that excessive condensation does not occur.

Before tests at the upper extreme temperature, the equipment shall be placed in the test chamber and left until thermal balance is attained.

For tests at the lower extreme temperature, the equipment shall be left in the test chamber until thermal balance is attained, then switched to the standby or receive condition for a period of one minute after which the equipment shall meet the specified requirements.

---

## C.2 Declared environmental operating conditions of equipment

The following environmental conditions shall be declared by the supplier:

- barometric pressure: minimum and maximum;
- temperature: minimum and maximum;
- relative humidity: minimum and maximum;
- power supply: lower and upper voltage limit.

## Annex D (informative): Repeater measurement system set-up

Example of measurement system set-ups are attached below as an informative annex.

### D.1 Transmitter conducted unwanted emission

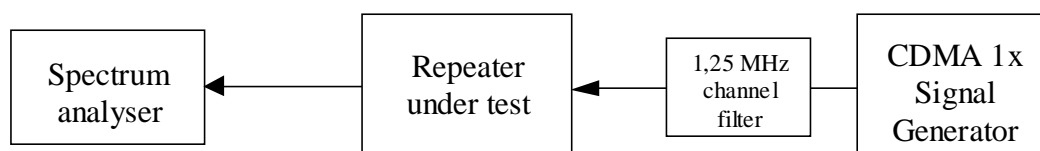

Figure D.1: Measuring system set-up for transmitter conducted unwanted emission

### D.2 Maximum output power

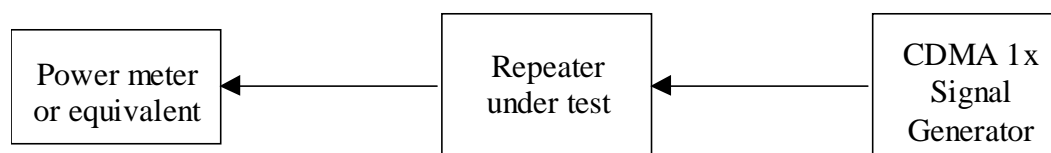

Figure D.2: Measuring system set-up for maximum output power

### D.3 Input intermodulation

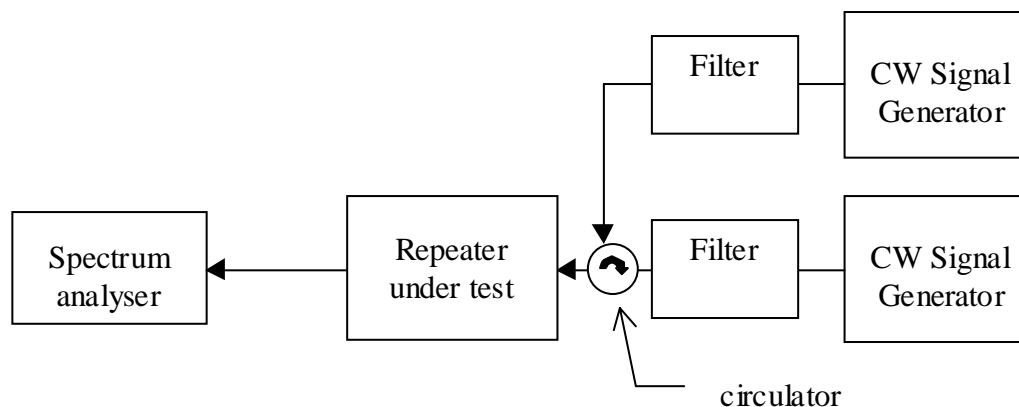

Figure D.3: Measuring system set-up for input intermodulation

## D.4 Out of band gain

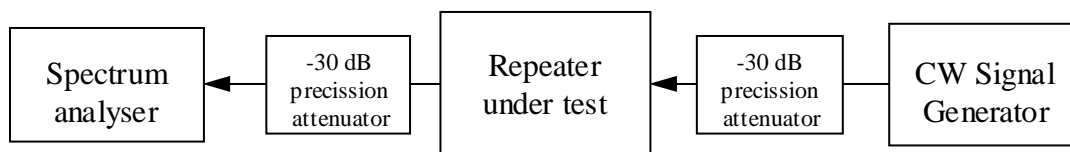

Figure D.4: Measuring system set-up for out of band gain

## D.5 Adjacent Channel Rejection Ratio (ACRR)

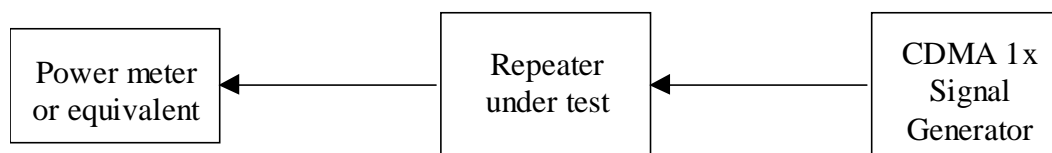

Figure D.5: Measuring system set-up for Adjacent Channel Rejection Ratio (ACRR)

## D.6 Output intermodulation

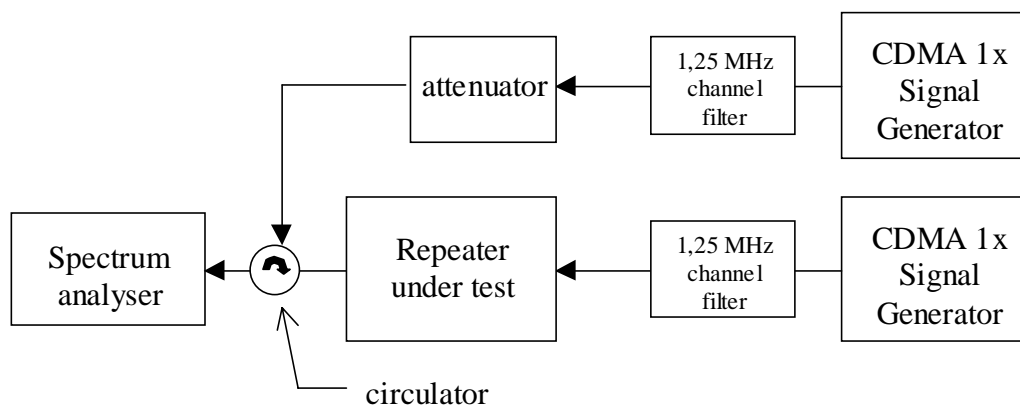

Figure D.6: Measuring system set-up for output intermodulation

The 1,25 MHz channel filters may be required to avoid influencing the result of the test.



---

## Annex E (informative): Bibliography

- Directive 98/34/EC of the European Parliament and of the Council of 22 June 1998 laying down a procedure for the provision of information in the field of technical standards and regulations.
- TIA/EIA/IS-856-1 (2002): "cdma2000® High Rate Packet Data Air Interface Specification - Addendum 1".
- TIA-1037: "Recommended Minimum Performance Standard for cdma2000 Spread Spectrum Repeater".

## Annex F (informative): The EN title in the official languages

Language	EN title
Czech	Elektromagnetická kompatibilita a rádiové spektrum (ERM) - Harmonizovaná EN pro opakovace CDMA s rozprostřeným spektrem pracující v bunkovém pásmu 450 MHz (CDMA450) a v pásmech PAMR 410 MHz, 450 MHz a 870 MHz (CDMA-PAMR), pokrývající základní požadavky článku 3.2 Smernice R&TTE
Danish	Elektromagnetisk kompatibilitet og spektrumanliggender (ERM) – Harmoniseret EN for CDMA direkte spredt (UTRA) relæstationer, der benytter frekvensbåndet for cellulære radionet omkring 450 MHz (CDMA 450) og frekvensbånd for offentlige radionet (PAMR) ved 410, 450 og 870 MHz (CDMA-PAMR), der dækker de væsentlige krav i R&TTE direktivets artikel 3.2
Dutch	Elektromagnetische compatibiliteit en radiospectrumaangelegenheden (ERM); Geharmoniseerde EN voor CDMA spread spectrum versterkers werkend in de 450 MHz cellulair band (CDMA450) en de 410, 450 en 870 MHz PAMR banden (CDMA-PAMR) die de essentiële eisen dekken van artikel 3.2 van de R&TTE richtlijn
English	Electromagnetic compatibility and Radio spectrum Matters (ERM); Harmonized EN for CDMA spread spectrum repeaters operating in the 450 MHz cellular band (CDMA450) and the 410, 450 and 870 MHz PAMR bands (CDMA-PAMR) covering essential requirements of article 3.2 of the R&TTE Directive
Estonian	Elektromagnetilise ühilduvuse ja raadiospektri küsimused (ERM); Kärghside raadiosagedusalas 450 MHz töötavate (CDMA 450) ja PAMR raadiosagedusalades 410 MHz, 450 MHz ja 870 MHz töötavate (CDMA-PAMR) hajaspektri CDMA repiiterite põhinõuded, harmoneeritud EN R&TTE direktiivi artikli 3.2 alusel.
Finnish	Sähkömagneettinen yhteensopivuus ja radiospektriasiat (ERM); Yhdenmukaistettu standardi (EN), joka kattaa R&TTE-direktiivin artiklan 3.2 mukaiset olennaiset vaatimukset CDMA-hajaspektritekniikkaa käyttäville 450 MHz:n matkaviestinverkkojen taajuuskaistalla toimiville toistimille (CDMA 450) ja 410, 450 ja 870 MHz:n PAMR-taajuuskaistoilla toimiville toistimille (CDMA-PAMR)
French	Compatibilité électromagnétique et Radioélectrique (ERM);
German	Elektromagnetische Verträglichkeit und Funkspektrumangelegenheiten (ERM) - Harmonisierte EN für CDMA-Spread-spectrum-Repeater zum Betrieb im 450-MHz-Zellularband (CDMA 450) und in den 410-, 450- und 870-MHz-PAMR-Bändern (CDMA-PAMR), die wesentliche Anforderungen nach Artikel 3.2 der R&TTE-Richtlinie enthält
Greek	Ηλεκτρονική Συμβατότητα και Θέματα Ραδιοφάσματος (ERM) - Εναρμονισμένο EN για επαναλήπτες φασματικής εξάπλωσης CDMA που λειτουργούν στην κυψελoειδή ζώνη 450 MHz (CDMA450) και στις ζώνες PAMR 410, 450 και 870 MHz (CDMA-PAMR) για την κάλυψη των ουσιωδών απαιτήσεων του άρθρου 3.2 της Οδηγίας R&TTE
Hungarian	
Icelandic	
Italian	Compatibilità elettromagnetica e problematiche di Spettro Radio (ERM); Norma Europea armonizzata per ripetitori CDMA a spettro espanso operanti nella banda di frequenza a 450 MHz delle reti cellulari (CDMA 450) e nelle bande PAMR a 410, 450 e 870 MHz (CDMA-PAMR) relativa ai requisiti essenziali dell'articolo 3.2 della direttiva R & TTE
Latvian	
Lithuanian	Elektromagnetinio suderinamumo ir radijo dažnių spektro dalykai. Darnusis daugkartinės kodinio tankinimo prieigos (CDMA) išplėstojo spektro kartotuvų, veikiančių 450 MHz korinėje juostoje (CDMA 450) ir 410 MHz, 450 MHz ir 870 MHz PAMR juostose (CDMA – PAMR) Europos standartas, apimantis esminius 1999/5/EC direktyvos 3.2 straipsnio reikalavimus
Maltese	Kompatibilità elettromanjetika u materji relatati ma' spettru radjofoniku (ERM); EN armonizzata għal Ripetitori bi spettru mferrex li jopera fil-medda cellulari ta' 450 MHz (CDMA 450) u fil-meded 410, 450 u 870 MHz PAMR (CDMA-PAMR) li jkopri rekwiżiti essenzjali taħt l-artiklu 3.2 tad-Direttiva R&TTE
Norwegian	Elektromagnetisk kompatibilitet og radiospektrumspørsmål (ERM); Harmonisert EN for CDMA fordelt spektrumforsterkere som opererer i det celledelte båndet 450 MHz (CDMA450) og i PAMR båndene 410, 450 og 870 MHz (CDMA-PAMR) som dekker de grunnleggende krav i R&TTE-direktivets artikkel 3.2"
Polish	Kompatybilność elektromagnetyczna i zagadnienia widma radiowego (ERM) – Zharmonizowana EN dla stacji przekaźnikowych CDMA o rozproszonym widmie pracujących w paśmie częstotliwości komórkowej 450 MHz (CDMA 450) oraz w pasmach 410, 450 i 870 MHz PAMR (CDMA-PAMR) zapewniająca spełnienie zasadniczych wymagań zgodnie z artykułem 3.2 dyrektywy R&TTE
Portuguese	Assuntos de Espectro Radioelétrico e Compatibilidade Electromagnética (ERM);
Slovak	Elektromagnetická kompatibilita a závislosti rádiového spektra (ERM). Harmonizovaná EN na opakovače CDMA s rozprestretým spektrom pracujúce v bunkovom pásme 450 MHz (CDMA450) a v pásmach PAMR 410 MHz, 450 MHz a 870 MHz (CDMA-PAMR), vzťahujúca sa na základné požiadavky podľa článku 3.2 smernice R&TTE

<b>Language</b>	<b>EN title</b>
Slovenian	Elektromagnetna združljivost in zadeve v zvezi z radijskim spektrom (ERM) – Harmonizirani EN za repitorje sistema CDMA (kodno porazdeljeni sodostop) z razpršenim spektrom, delujoče v celičnem frekvenčnem pasu 450 MHz (CDMA450) in frekvenčnih pasovih PAMR (javni mobilni radiokomunikacijski sistem) 410, 450 in 870 MHz (CDMA-PAMR), ki zajema bistvene zahteve člena 3.2 direktive R&TTE
Spanish	Compatibilidad electromagnética y espectro radio (ERM);
Swedish	Elektromagnetisk kompatibilitet och radiospektrumfrågor (ERM); Harmoniserad EN för repetrar med CDMA bandspridning arbetande i cellulära bandet 450 MHz (CDMA450) och PAMR-banden 410, 450 och 870 MHz (CDMA-PAMR) omfattande väsentliga krav enligt artikel 3.2 i R&TTE-direktivet

---

## History

<b>Document history</b>			
V1.1.1	June 2005	Public Enquiry	PE 20051028: 2005-06-29 to 2005-10-28
V1.1.1	May 2006	Vote	V 20060714: 2006-05-15 to 2006-07-14