

**Electromagnetic compatibility
and Radio spectrum Matters (ERM);
Short Range Devices (SRD);
Equipment for Detection and Movement;
Tanks Level Probing Radar (TLPR) operating in the
frequency bands 5,8 GHz, 10 GHz,
25 GHz, 61 GHz and 77 GHz;
Part 1: Technical characteristics and test methods**



Reference

REN/ERM-TGTLPR-0117-1

Keywords

EHF, radar, regulation, SHF, short range, SRD,
testing, UWB

ETSI

650 Route des Lucioles
F-06921 Sophia Antipolis Cedex - FRANCE

Tel.: +33 4 92 94 42 00 Fax: +33 4 93 65 47 16

Siret N° 348 623 562 00017 - NAF 742 C
Association à but non lucratif enregistrée à la
Sous-Préfecture de Grasse (06) N° 7803/88

Important notice

Individual copies of the present document can be downloaded from:

<http://www.etsi.org>

The present document may be made available in more than one electronic version or in print. In any case of existing or perceived difference in contents between such versions, the reference version is the Portable Document Format (PDF). In case of dispute, the reference shall be the printing on ETSI printers of the PDF version kept on a specific network drive within ETSI Secretariat.

Users of the present document should be aware that the document may be subject to revision or change of status. Information on the current status of this and other ETSI documents is available at

<http://portal.etsi.org/tb/status/status.asp>

If you find errors in the present document, please send your comment to one of the following services:

http://portal.etsi.org/chaicor/ETSI_support.asp

Copyright Notification

No part may be reproduced except as authorized by written permission.
The copyright and the foregoing restriction extend to reproduction in all media.

© European Telecommunications Standards Institute 2010.
All rights reserved.

DECT™, **PLUGTESTS™**, **UMTS™**, **TIPHON™**, the TIPHON logo and the ETSI logo are Trade Marks of ETSI registered for the benefit of its Members.

3GPP™ is a Trade Mark of ETSI registered for the benefit of its Members and of the 3GPP Organizational Partners.

LTE™ is a Trade Mark of ETSI currently being registered

for the benefit of its Members and of the 3GPP Organizational Partners.

GSM® and the GSM logo are Trade Marks registered and owned by the GSM Association.

Contents

| | |
|---|----|
| Intellectual Property Rights | 6 |
| Foreword..... | 6 |
| 1 Scope | 7 |
| 2 References | 7 |
| 2.1 Normative references | 7 |
| 2.2 Informative references..... | 8 |
| 3 Definitions, symbols and abbreviations | 8 |
| 3.1 Definitions..... | 8 |
| 3.2 Symbols..... | 9 |
| 3.3 Abbreviations | 9 |
| 4 Technical requirements specifications | 10 |
| 4.1 Presentation of equipment for testing purposes..... | 10 |
| 4.2 Choice of model for testing | 10 |
| 4.3 Mechanical and electrical design..... | 10 |
| 4.3.1 Marking (equipment identification)..... | 11 |
| 4.3.1.1 Equipment identification..... | 11 |
| 4.4 Auxiliary test equipment and product information..... | 11 |
| 4.5 General requirements for RF cables | 11 |
| 4.6 RF waveguides | 12 |
| 4.6.1 Wave Guide Attenuators..... | 13 |
| 4.7 External harmonic mixers | 13 |
| 4.7.1 Introduction..... | 13 |
| 4.7.2 Signal identification..... | 14 |
| 4.7.3 Measurement hints..... | 14 |
| 4.8 Preamplifier..... | 14 |
| 4.9 Interpretation of the measurement results | 15 |
| 5 Test conditions, power sources and ambient temperatures | 15 |
| 5.1 Normal and extreme test conditions | 15 |
| 5.2 External test power source..... | 15 |
| 5.3 Normal test conditions..... | 15 |
| 5.3.1 Normal temperature and humidity..... | 15 |
| 5.3.2 Normal test power source | 16 |
| 5.3.2.1 Mains voltage..... | 16 |
| 5.3.2.2 Regulated lead-acid battery power source..... | 16 |
| 5.3.2.3 Other power sources..... | 16 |
| 6 General conditions..... | 16 |
| 6.1 Radiated measurement arrangements | 16 |
| 6.2 Measuring receiver | 17 |
| 7 Measurement uncertainty | 17 |
| 7.1 Conversion loss data and measurement uncertainty..... | 18 |
| 8 Methods of measurement and limits..... | 19 |
| 8.1 Frequency band of operation | 19 |
| 8.1.1 Definition..... | 19 |
| 8.1.2 Method of measurement | 19 |
| 8.1.3 Limits..... | 20 |
| 8.2 Duty cycle | 20 |
| 8.2.1 Duty cycle resulting from application..... | 20 |
| 8.2.2 Duty cycle resulting from modulation | 21 |
| 8.2.2.1 Method of measurement..... | 21 |
| 8.2.3 Limits..... | 21 |
| 8.3 Equivalent isotropically radiated power (e.i.r.p.) | 21 |

| | | |
|--|--|-----------|
| 8.3.1 | Definition..... | 21 |
| 8.3.2 | Method of measurement | 22 |
| 8.3.3 | Limits..... | 23 |
| 8.4 | Emissions | 23 |
| 8.4.1 | Definition..... | 23 |
| 8.4.2 | Method of measurement | 23 |
| 8.4.3 | Limits..... | 26 |
| 8.5 | Range of modulation parameters..... | 26 |
| Annex A (normative): Radiated measurement..... | | 27 |
| A.1 | Test sites and general arrangements for measurements involving the use of radiated fields..... | 27 |
| A.1.1 | Anechoic Chamber | 27 |
| A.1.2 | Anechoic Chamber with a conductive ground plane..... | 28 |
| A.1.3 | Open Area Test Site (OATS) | 29 |
| A.1.4 | Minimum requirements for test sites for measurements above 18 GHz..... | 30 |
| A.1.5 | Test antenna..... | 32 |
| A.1.6 | Substitution antenna | 32 |
| A.1.7 | Measuring antenna | 32 |
| A.2 | Guidance on the use of radiation test sites | 32 |
| A.2.1 | Verification of the test site | 32 |
| A.2.2 | Preparation of the EUT..... | 33 |
| A.2.3 | Power supplies to the EUT..... | 33 |
| A.2.4 | Range length..... | 33 |
| A.2.5 | Site preparation | 34 |
| A.3 | Coupling of signals..... | 34 |
| A.3.1 | General | 34 |
| Annex B (normative): Installation requirements of Tank Level Probing Radar (TLPR) Equipment | | 35 |
| Annex C (informative): Measurement antenna and preamplifier specifications | | 36 |
| Annex D (informative): Electromagnetic leakage from a EUT | | 37 |
| D.1 | General | 37 |
| D.2 | Survey of sources of leakage..... | 37 |
| Annex E (normative): Requirements on Test Tank..... | | 39 |
| Annex F (informative): Practical test distances for accurate measurements | | 40 |
| F.1 | Introduction | 40 |
| F.2 | Conventional near-field measurements distance limit | 40 |
| F.3 | Near-field conditions outside a test tank | 40 |
| Annex G (normative): Range of modulation parameters | | 41 |
| G.1 | Pulse modulation | 41 |
| G.1.1 | Definition | 41 |
| G.1.2 | Operating parameters | 42 |
| G.2 | Frequency modulated continuous wave | 42 |
| G.2.1 | Definition | 42 |
| G.2.2 | Operating parameters | 43 |

| | | |
|-------------------------------|---|-----------|
| Annex H (informative): | Atmospheric absorptions and material dependent attenuations..... | 44 |
| H.1 | Atmospheric absorptions..... | 44 |
| H.2 | Material dependent attenuations..... | 46 |
| History | | 48 |

Intellectual Property Rights

IPRs essential or potentially essential to the present document may have been declared to ETSI. The information pertaining to these essential IPRs, if any, is publicly available for **ETSI members and non-members**, and can be found in ETSI SR 000 314: "*Intellectual Property Rights (IPRs); Essential, or potentially Essential, IPRs notified to ETSI in respect of ETSI standards*", which is available from the ETSI Secretariat. Latest updates are available on the ETSI Web server (<http://webapp.etsi.org/IPR/home.asp>).

Pursuant to the ETSI IPR Policy, no investigation, including IPR searches, has been carried out by ETSI. No guarantee can be given as to the existence of other IPRs not referenced in ETSI SR 000 314 (or the updates on the ETSI Web server) which are, or may be, or may become, essential to the present document.

Foreword

This European Standard (Telecommunications series) has been produced by ETSI Technical Committee Electromagnetic compatibility and Radio spectrum Matters (ERM), and is now submitted for the Vote phase of the ETSI standards Two-step Approval Procedure.

For non-EU countries, the present document may be used for regulatory (Type Approval) purposes.

The present document is part 1 of a multi-part deliverable covering Electromagnetic compatibility and Radio spectrum Matters (ERM); Short Range Devices (SRD); Equipment for Detection and Movement; Tanks Level Probing Radar (TLPR) operating in the frequency bands 5,8 GHz, 10 GHz, 25 GHz, 61 GHz and 77 GHz, as identified below:

Part 1: "Technical characteristics and test methods";

Part 2: "Harmonized EN covering the essential requirements of article 3.2 of the R&TTE Directive".

| Proposed national transposition dates | |
|--|---------------------------------|
| Date of latest announcement of this EN (doa): | 3 months after ETSI publication |
| Date of latest publication of new National Standard or endorsement of this EN (dop/e): | 6 months after doa |
| Date of withdrawal of any conflicting National Standard (dow): | 6 months after doa |

1 Scope

The present document specifies the requirements for Tank Level Probing Radar (TLPR) applications based on pulse RF, FMCW, or similar wideband techniques, operating in the following frequency bands or part hereof as specified in table 1.

Table 1: Frequency bands designated to Tank Level Probing Radars (TLPR)

| | Frequency Bands/frequencies (GHz) |
|----------------------|-----------------------------------|
| Transmit and Receive | 4,5 to 7 |
| Transmit and Receive | 8,5 to 10,6 |
| Transmit and Receive | 24,05 to 26,5 |
| Transmit and Receive | 57 to 64 |
| Transmit and Receive | 75 to 85 |

Table 1 shows a list of the frequency bands as designated to Tank Level Probing Radars in the EC-Decision 2009/381 [i.4] and Recommendation CEPT/ERC/REC 70-03 [i.1] as known at the date of publication of the present document. TLPRs are used for tank level measurement applications.

The scope is limited to TLPRs operating as Short Range Devices, in which the devices are installed in closed metallic tanks or reinforced concrete tanks, or similar enclosure structures made of comparable attenuating material, holding a substance, liquid or powder.

The radar applications in the present document are not intended for communications purposes. Their intended usage excludes any intended radiation into free space.

The present document applies to TLPRs radiating RF signals directly from the tank top downwards to the surface of a substance contained in a closed tank. Any radiation outside of the tank is caused by leakage and is considered as unintentional emission. It applies only to TLPRs fitted with dedicated antennas. The present document does not necessarily include all the characteristics, which may be required by a user, nor does it necessarily represent the optimum performance achievable.

2 References

References are either specific (identified by date of publication and/or edition number or version number) or non-specific. For specific references, only the cited version applies. For non-specific references, the latest version of the reference document (including any amendments) applies.

Referenced documents which are not found to be publicly available in the expected location might be found at <http://docbox.etsi.org/Reference>.

NOTE: While any hyperlinks included in this clause were valid at the time of publication ETSI cannot guarantee their long term validity.

2.1 Normative references

The following referenced documents are necessary for the application of the present document.

- [1] CISPR 16 (2006) (parts 1-1, 1-4 and 1-5): "Specification for radio disturbance and immunity measuring apparatus and methods; Part 1: Radio disturbance and immunity measuring apparatus".
- [2] ETSI TR 100 028 (all parts) (V1.4.1): "Electromagnetic compatibility and Radio spectrum Matters (ERM); Uncertainties in the measurement of mobile radio equipment characteristics".
- [3] ANSI C63.5 (2006): "American National Standard for Calibration of Antennas Used for Radiated Emission Measurements in Electro Magnetic Interference".

- [4] ETSI TR 102 273 (all parts) (V1.2.1): "Electromagnetic compatibility and Radio spectrum Matters (ERM); Improvement on Radiated Methods of Measurement (using test site) and evaluation of the corresponding measurement uncertainties".
- [5] ETSI EN 302 372-2 (V1.2.1): "Electromagnetic compatibility and Radio spectrum Matters (ERM); Short Range Devices (SRD); Equipment for Detection and Movement; Tanks Level Probing Radar (TLPR) operating in the frequency bands 5,8 GHz, 10 GHz, 25 GHz, 61 GHz and 77 GHz; Part 2: Harmonized EN under article 3.2 of the R&TTE Directive".

2.2 Informative references

The following referenced documents are not necessary for the application of the present document but they assist the user with regard to a particular subject area.

- [i.1] CEPT/ERC/Recommendation 70-03: "Relating to the use of Short Range Devices (SRD)".
- [i.2] ITU-R Recommendation SM.1754: "Measurement techniques of Ultra-wideband transmissions".
- [i.3] ETSI TS 103 051: "Electromagnetic compatibility and Radio spectrum Matters (ERM); Expanded measurement uncertainty for the measurement of radiated electromagnetic fields".
- [i.4] Commission Decision 2006/771/EC on harmonization of the radio spectrum for use by short range devices as amended by commission decision 2009/381/EC.
- [i.5] ETSI TS 103 052: "Electromagnetic compatibility and Radio spectrum Matters (ERM); Radiated measurement methods and general arrangements for test sites up to 100 GHz".
- [i.6] ITU-R Recommendation P.676-5 (2001): "Attenuation by atmospheric gases".

3 Definitions, symbols and abbreviations

3.1 Definitions

For the purposes of the present document, the following terms and definitions apply:

dedicated antenna: antenna that is designed as an indispensable part of the equipment

Device Under Test (DUT): TLPR under test without a test tank

DU: Activity Factor which is used to describe different modulation parameters and activity levels of TLPR devices and defined as the ratio of active measurement periods (bursts, sweeps, scans) within the overall repetitive measurement cycle, i.e. $T_{\text{meas}}/T_{\text{meas_cycle}}$

duty cycle: ratio of the total on time of the transmitter to the total time in any one-hour period reflecting normal operational mode

emissions: signals that leaked or are scattered into the air within the frequency range (that includes harmonics) which depend on equipment's frequency band of operation

NOTE: For TLPRs there is no intended emission outside the tank.

Equipment Under Test (EUT): TLPR under test mounted on a test tank

equivalent isotropically radiated power (e.i.r.p.): total power transmitted, assuming an isotropic radiator

NOTE: e.i.r.p. is conventionally the product of "power into the antenna" and "antenna gain". e.i.r.p. is used for both peak and average power.

Frequency Modulated Continuous Wave (FMCW) radar: radar where the transmitter power is fairly constant but possibly zero during periods giving a big duty cycle (such as 0,1 to 1)

NOTE: The frequency is modulated in some way giving a very wideband spectrum with a power versus time variation which is clearly not pulsed.

integral antenna: permanent fixed antenna, which may be built-in, designed as an indispensable part of the equipment

operating frequency (operating centre frequency): nominal frequency at which equipment is operated

pulsed radar (or here simply "pulsed TLPR"): radar where the transmitter signal has a microwave power consisting of short RF pulses

power spectral density (psd): amount of the total power inside the measuring receiver bandwidth expressed in dBm/MHz

Pulse Repetition Frequency (PRF): inverse of the Pulse Repetition Interval, averaged over a sufficiently long time to cover all PRF variations

radiated measurements: measurements that involve the absolute measurement of a radiated field

radiation: signals emitted intentionally inside a tank for level measurements

3.2 Symbols

For the purposes of the present document, the following symbols apply:

| | |
|------------|--|
| f | Frequency |
| f_C | Frequency at which the emission is the peak power at maximum |
| f_H | Highest frequency of the frequency band of operation |
| f_L | Lowest frequency of the frequency band of operation |
| t | Time |
| k | Boltzmann constant |
| T | Temperature |
| G | Efficient antenna gain of radiating structure |
| G_a | Declared measurement antenna gain |
| d | Largest dimension of the antenna aperture of the TLPR |
| d_1 | Largest dimension of the DUT/dipole after substitution (m) |
| d_2 | Largest dimension of the test antenna (m) |
| D | Duty cycle |
| D_U | Duty cycle determined by the users transmission time |
| D_X | Duty cycle determined by the transmitters modulation type |
| P_s | Output power of the signal generator measured by power meter |
| Δf | Bandwidth |
| X | Minimum radial distance (m) between the DUT and the test antenna |
| λ | Wavelength |

3.3 Abbreviations

For the purposes of the present document, the following abbreviations apply:

| | |
|----------|---|
| dB | decibel |
| dBi | antenna gain in decibels relative to an isotropic antenna |
| DUT | Device Under Test |
| e.i.r.p. | equivalent isotropically radiated power |
| EMC | ElectroMagnetic Compatibility |
| ERC | European Radiocommunication Committee |
| EUT | Equipment Under Test |
| FMCW | Frequency Modulated Continuous Wave |
| IF | Intermediate Frequency |

| | |
|-------|---|
| LNA | Low Noise Amplifier |
| LO | Local Oscillator |
| OATS | Open Area Test Site |
| PRF | Pulse Repetition Frequency |
| PRI | Pulse Repetition Interval |
| PSD | Power Spectral Density |
| R&TTE | Radio and Telecommunications Terminal Equipment |
| RBW | Resolution BandWidth |
| RF | Radio Frequency |
| RMS | Root Mean Square |
| SA | Spectrum Analyser |
| SRD | Short Range Device |
| TLPR | Tank Level Probing Radar |
| Tx | Transmitter |
| UWB | Ultra WideBand |
| VBW | Video BandWidth |
| VSWR | Voltage Standing Wave Ratio |

4 Technical requirements specifications

4.1 Presentation of equipment for testing purposes

Equipment submitted for testing, where applicable, shall fulfil the requirements of the present document on all frequencies over which it is intended to operate.

The provider shall submit one or more samples of the equipment as appropriate for testing.

Additionally, technical documentation and operating manuals, sufficient to allow testing to be performed, shall be supplied.

The performance of the equipment submitted for testing shall be representative of the performance of the corresponding production model. In order to avoid any ambiguity in that assessment, the present document contains instructions for the presentation of equipment for testing purposes (clause 4), conditions of testing (clauses 5 and 6) and the measurement methods (clause 8).

The provider shall offer equipment complete with any auxiliary equipment needed for testing. The provider shall also submit a suitable test tank, as described in annex E.

The provider shall declare the frequency range(s), the range of operation conditions and power requirements, as applicable, in order to establish the appropriate test conditions.

4.2 Choice of model for testing

If an equipment has several optional features, considered not to affect the RF parameters then the tests need only to be performed on the equipment configured with that combination of features considered to create the highest unintentional emissions outside the tank structure.

In addition, when a device has the capability of using different dedicated antennas, tank connections or other features that affect the RF parameters, at least the worst combination of features from an emission point of view as agreed between the provider and the test laboratory shall be tested.

The choice of model(s) for testing shall be recorded in the test report.

4.3 Mechanical and electrical design

The equipment submitted by the provider shall be designed, constructed and manufactured in accordance with good engineering practice and with the aim of minimizing harmful interference to other equipment and services.

4.3.1 Marking (equipment identification)

The equipment shall be marked in a visible place. This marking shall be legible and durable. Where this is not possible due to physical constraints, the marking shall be included in the user's manual.

4.3.1.1 Equipment identification

The marking shall include as a minimum:

- the name of the manufacturer or his trademark;
- the type designation.

4.4 Auxiliary test equipment and product information

All necessary set-up information shall accompany the TLPR equipment when it is submitted for testing.

The following product information shall be provided by the manufacturer:

- the type of UWB technology implemented in the TLPR equipment (e.g. FMCW or pulsed);
- the operating frequency range(s) of the equipment;
- the intended combination of the TLPR transceiver and its antenna and their corresponding e.i.r.p. levels;
- the nominal power supply voltages of the TLPR radio equipment;
- for FMCW, FH, FSK, stepped frequency hopping or similar carrier based modulation schemes, it is important to describe the modulation parameters in order to ensure that the right settings of the measuring receiver are used. Important parameters are the modulation period, deviation or dwell times within a modulation period, rate of modulation (Hz/s);
- the implementation of features such as gating;
- for pulsed equipment, the Pulse Repetition Frequency PRF is to be stated.

All necessary test signal sources, set-up information, and the test tank shall accompany the equipment when it is submitted for testing.

4.5 General requirements for RF cables

All RF cables including their connectors at both ends used within the measurement arrangements and set-ups shall be of coaxial or waveguide type featuring within the frequency range they are used:

- a VSWR of less than 1,2 at either end;
- a shielding loss in excess of 60 dB.

When using coaxial cables for frequencies above 40 GHz attenuation features increase significantly and decrease of return loss due to mismatching caused by joints at RF connectors and impedance errors shall be considered.

All RF cables and waveguide interconnects shall be routed suitably in order to reduce impacts on antenna radiation pattern, antenna gain, antenna impedance. Table 2 provides some information about connector systems that can be used in connection with the cables.

Table 2: Connector systems

| Connector System | Frequency | Recommended coupling torque |
|------------------|-------------------------------|-----------------------------|
| N | 18 GHz | 0,68 Nm to 1,13 Nm |
| SMA | 18 GHz (some up to 26 GHz) | ~ 0,56 Nm |
| 3,50 mm | 26,5 GHz | 0,8 Nm to 1,1 Nm |
| 2,92 mm | 40 GHz (some up to 46 GHz) | 0,8 Nm to 1,1 Nm |
| 2,40 mm | 50 GHz (some up to 60 GHz) | 0,8 Nm to 1,1 Nm |
| 1,85 mm | 65 GHz (some up to 75 GHz) | 0,8 Nm to 1,1 Nm |

4.6 RF waveguides

Wired signal transmission in the millimeter range is preferably realized by means of waveguides because they offer low attenuation and high reproducibility. Unlike coaxial cables, the frequency range in which waveguides can be used is limited also towards lower frequencies (highpass filter characteristics). Wave propagation in the waveguide is not possible below a certain cutoff frequency where attenuation of the waveguide is very high. Beyond a certain upper frequency limit, several wave propagation modes are possible so that the behaviour of the waveguide is no longer unambiguous. In the unambiguous range of a rectangular waveguide, only H10 waves are capable of propagation.

The dimensions of rectangular and circular waveguides are defined by international standards such as 153-IEC for various frequency ranges. These frequency ranges are also referred to as waveguide bands. They are designated using different capital letters depending on the standard. Table 3 provides an overview of the different waveguide bands together with the designations of the associated waveguides and flanges.

For rectangular waveguides, which are mostly used in measurements, harmonic mixers with matching flanges are available for extending the frequency coverage of measuring receivers. Table 3 provides some information on waveguides.

Table 3: Waveguide bands and associated waveguides

| Band | Frequency | Designations | | | | Internal dimensions of waveguide | | Designations of frequently used flanges | | |
|------|------------------|--------------|-------|---------|----------------|----------------------------------|------------------|---|---------------------------------|-------------------------------------|
| | | MIL-W-85 | EIA | 153-IEC | RCSC (British) | in mm | in inches | MIL-F-3922 | UG-XXX/U equivalent (reference) | Remarks |
| Ka | 26,5 to 40,0 | 3-006 | WR-28 | R320 | WG-22 | 7,11 x 3,56 | 0,280 x 0,140 | 54-006 68-002 67B-005 | UG-559/U - UG-381/U | Rectangular Rectangular Round |
| Q | 33,0 to 55,0 | 3-010 | WR-22 | R400 | WG-23 | 5,69 x 2,84 | 0,224 x 0,112 | 67B-006 | UG-383/U | Round |
| U | 40,0 to 60,0 | 3-014 | WR-19 | R500 | WG-24 | 4,78 x 2,388 | 0,188 x 0,094 | 67B-007 | UG-383/U-M | Round |
| V | 50,0 to 75,0 | 3-017 | WR-15 | R620 | WG-25 | 3,759 x 1,879 | 0,148 x 0,074 | 67B-008 | UG-385/U | Round |
| E | 60,0 to 90,0 | 3-020 | WR-12 | R740 | WG-26 | 3,099 x 1,549 | 0,122 x 0,061 | 67B-009 | UG-387/U | Round |
| W | 75,0 to 110,0 | 3-023 | WR-10 | R900 | WG-27 | 2,540 x 1,270 | 0,100 x 0,050 | 67B-010 | UG-383/U-M | Round |

As waveguides are rigid, it is unpractical to set up connections between antenna and measuring receiver with waveguides. Either a waveguide transition to coaxial cable is used or - at higher frequencies - the harmonic mixer is used for frequency extension of the measuring receiver and is directly mounted at the antenna.

4.6.1 Wave Guide Attenuators

Due to the fact that external harmonic mixers can only be fed with low RF power it may be necessary to attenuate input powers in defined manner using wave guide attenuators. These attenuators shall be calibrated and suitable to handle corresponding powers.

4.7 External harmonic mixers

4.7.1 Introduction

Measuring receivers (test receivers or spectrum analyzers) with coaxial input are commercially available up to 67 GHz. The frequency range is extended from 26,5 GHz / 67 GHz up to 100 GHz and beyond by means of external harmonic mixers. Harmonic mixers are used because the fundamental mixing commonly employed in the lower frequency range is too complex and expensive or requires components such as preselectors which are not available. Harmonic mixers are waveguide based and have a frequency range matching the waveguide bands. They must not be used outside these bands for calibrated measurements.

In harmonic mixers, a harmonic of the local oscillator (LO) is used for signal conversion to a lower intermediate frequency (IF). The advantage of this method is that the frequency range of the local oscillator may be much lower than with fundamental mixing, where the LO frequency must be of the same order (with low IF) or much higher (with high IF) than the input signal (RF). The harmonics are generated in the mixer because of its nonlinearity and are used for conversion. The signal converted to the IF is coupled out of the line which is also used for feeding the LO signal.

To obtain low conversion loss of the external mixer, the order of the harmonic used for converting the input signal should be as low as possible. For this, the frequency range of the local oscillator must be as high as possible. LO frequency ranges are for example 3 GHz to 6 GHz or 7 GHz to 15 GHz. IF frequencies are in the range from 320 MHz to about 700 MHz. If the measured air interface is wider than the IF bandwidth, then it is advisable to split the measurement in several frequency ranges, i.e. a one step total RF output power measurement should not be performed.

Because of the great frequency spacing between the LO and the IF signal, the two signals can be separated by means of a simple diplexer. The diplexer may be realized as part of the mixer or the spectrum analyzer, or as a separate component. Mixers with an integrated diplexer are also referred to as three-port mixers, mixers without diplexers as two-port mixers. Figure 1 shows an example where a diplexer is used to convey both, the IF and LO frequencies.

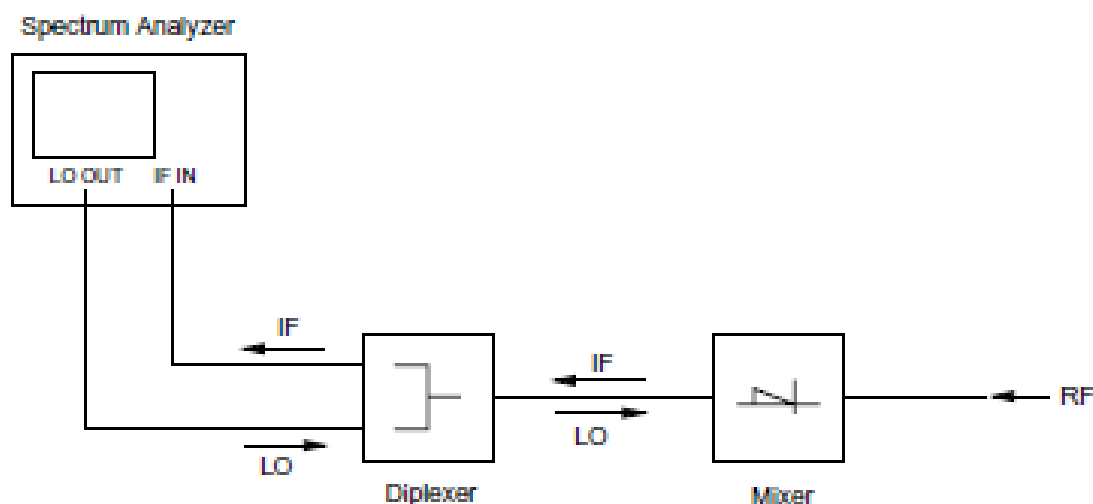

Figure 1: Set-up of measurement receiver, diplexer and mixer

Coaxial cable connections to an external mixer (diplexer) shall be calibrated as well and in conjunction when calibrating the mixer and the measuring receiver. Those cables shall not be replaced in concrete measurements. In particular the cable length shall not be varied.

It shall be regarded that the mixer inputs are sufficiently insulated towards the antenna port with regard to the injected signal (mixed signal) so that the mixed signal, multiplied by the LO, is sufficiently absorbed.

4.7.2 Signal identification

A setup with Harmonic mixers without pre-selection displays always a pair of signals with a spacing of $2 \times f_{IF}$, as there is no image suppression. For a modulated signal with a bandwidth of $> 2 \times f_{IF}$ both, wanted and image response overlap and cannot be separated any more.

Depending on the width of the analyzed frequency bands additional responses created from other harmonics may be displayed. In these cases it has to be determined by signal identification techniques, which of the displayed responses are false responses. Signal identification techniques implemented in spectrum analyzers are based on the fact that only responses corresponding to the selected number of harmonic show a frequency spacing of $2 \times f_{IF}$.

This can be used for automated signal identification: Apart from the actual measurement sweep, in which the lower sideband is defined as "wanted", a reference sweep is performed. For the reference sweep, the frequency of the LO signal is tuned such that the user-selected harmonic of the LO signal (order m) is shifted downwards by $2 \times f_{IF}$ relative to the measurement sweep.

Parameters which influence the signal identification routines are:

- Number of harmonic: The higher the harmonic number the more false responses will be created. A high LO frequency range which results in a lower harmonic number for a given frequency range is desirable.
- IF Frequency: The higher the IF frequency of the spectrum analyzer, the greater the spacing at which image frequency response is displayed on the frequency axis. For a single modulated or unmodulated input signal displayed on the frequency axis, an image-free range of $2 \times f_{IF}$ is obtained around this signal in which no signal identification is necessary.

4.7.3 Measurement hints

To obtain accurate and reproducible results, the following points should be observed:

- A low-loss cable with a substantially flat frequency response should be used for feeding the LO signal to the mixer. The conversion loss of the mixer is normally specified for a defined LO level. It is therefore important to maintain this level at the LO port of the mixer in order to achieve the desired accuracy. This is especially essential if the antenna/ mixer combination is located away from the measuring receiver.
- In level correction on the spectrum analyzer, the insertion loss of the cable used for tapping the IF signal is to be taken into account.
- If an external diplexer is used for connecting a two-port mixer, the insertion loss of the IF path of the diplexer is to be taken into account in level correction on the spectrum analyzer.

Additional information on radiated measurements up to 100 GHz is available in TS 103 052 [i.5].

4.8 Preamplifier

Preamplifiers shall have asymmetric inputs and outputs with an impedance of 50Ω . Preamplifier shall be sufficiently calibrated with regard to frequency response, amplification factor, linearity and compression. Should this not be obtainable, the amplification factor shall be determined at a certain frequency with a certain input power by substitution with a certain signal which is similarly defined as the original signal.

When using a preamplifier it shall be regarded that the amplifier has sufficient impulse response and that it is not overloaded with a too high input signal, which can lead to erroneous measurement results.

4.9 Interpretation of the measurement results

The interpretation of the results for the measurements described in the present document shall be as follows:

- 1) the measured value related to the corresponding limit shall be used to decide whether an equipment meets the requirements of the present document;
- 2) the measurement uncertainty value for the measurement of each parameter shall be recorded;
- 3) the recorded value of the measurement uncertainty shall be wherever possible, for each measurement, equal to or lower than the figures in clause 7, table 4.

For the test methods, according to the present document, the measurement uncertainty figures shall be calculated in accordance with the guidance provided in TR 100 028 [2] and shall correspond to an expansion factor (coverage factor) $k = 1,96$ or $k = 2$ (which provide confidence levels of respectively 95 % and 95,45 % in the case where the distributions characterizing the actual measurement uncertainties are normal (Gaussian)).

Table 4 in clause 7 is based on such expansion factors.

5 Test conditions, power sources and ambient temperatures

5.1 Normal and extreme test conditions

Testing shall be made under normal test conditions.

The TLPR equipment is for professional applications to which installation and maintenance are performed by professionally trained individuals only. In addition, due to its usage of UWB technology there are no strict requirements on frequency stability. The power supply is normally provided via the mains. Consequently, there is no need for testing at extreme temperature and/or extreme low voltage conditions specified in the present document.

The test conditions and procedures shall be as specified in clauses 5.2 to 5.3.

5.2 External test power source

During tests, the power source of the equipment shall be an external test power source, capable of producing normal and extreme test voltages. The internal impedance of the external test power source shall be low enough for its effect on the test results to be negligible.

The test voltage shall be measured at the point of connection of the power cable to the equipment.

During tests, the external test power source voltages shall be within a tolerance of ± 1 % relative to the voltage at the beginning of each test. The level of this tolerance can be critical for certain measurements. Using a smaller tolerance provides a reduced uncertainty level for these measurements.

5.3 Normal test conditions

5.3.1 Normal temperature and humidity

The normal temperature and humidity conditions for tests shall be any convenient combination of temperature and humidity within the following ranges:

- temperature: +15 °C to +35 °C;
- relative humidity: 20 % to 75 %.

When it is impracticable to carry out tests under these conditions, a note to this effect, stating the ambient temperature and relative humidity during the tests, shall be added to the test report.

5.3.2 Normal test power source

The internal impedance of the test power source shall be low enough for its effect on the test results to be negligible. For the purpose of the tests, the voltage of the external test power source shall be measured at the input terminals of the equipment.

5.3.2.1 Mains voltage

The normal test voltage for equipment to be connected to the mains shall be the nominal mains voltage. For the purpose of the present document, the nominal voltage shall be the declared voltage, or any of the declared voltages, for which the equipment was designed.

The frequency of the test power source corresponding to the ac mains shall be between 49 Hz and 51 Hz.

5.3.2.2 Regulated lead-acid battery power source

When the radio equipment is intended for operation with the usual types of regulated lead-acid battery power source, the normal test voltage shall be 1,1 multiplied by the nominal voltage of the battery (e.g. 6 V, 12 V, etc.).

5.3.2.3 Other power sources

For operation from power sources or types of battery other than lead acid (primary or secondary), the normal test voltage and frequency shall be that declared by the provider. Such values shall be stated in the test report.

6 General conditions

6.1 Radiated measurement arrangements

Detailed descriptions of the radiated measurement arrangements are included in annex A. In general, measurements shall be carried out under far field conditions. The far field condition requires a minimum radial distance "X" that shall be a minimum of $2 d^2/\lambda$, where d = largest dimension of the antenna aperture. An equivalent formulation of $2 d^2/\lambda$ is $0,2 \lambda G$ where G is the efficient antenna gain of the radiating structure. The diffuse emission outside of the tank has a low gain G (~ a few dB) and thus measurements on a small distance does not violate the $2 d^2/\lambda$ condition in spite of rather big size of tank, for further details see annex F.

Absolute power measurements shall be made only in the far field. The test site shall meet the appropriate requirements as defined in published guidelines/standards (e.g. for OATS, the requirements are described in CISPR 16 [1]).

It may not be possible to measure at the power limits without low-noise amplification to reduce the overall noise figure of the overall measurement system at a separation of approximately 3 meters in an RF quiet environment. A move to lower separation distance or reduced measurement bandwidth may be required since the instrumentation noise floor should be below the limit within the instrument bandwidth.

Detailed descriptions of radiated measurement arrangements for UWB devices can be found in ITU-R Recommendation SM.1754 [i.2].

All reasonable efforts should be made to clearly demonstrate that emissions from the UWB transmitter do not exceed the specified levels, with the transmitter in the far field. To the extent practicable, the device under test shall be measured at the distance specified in clause A.2.4 and with the specified measurement bandwidths. However, in order to obtain an adequate signal-to-noise ratio in the measurement system, radiated measurements may have to be made at distances less than those specified in clause A.2.4 and/or with reduced measurement bandwidths. The revised measurement configuration should be stated on the test report, together with an explanation of why the signal levels involved necessitated measurement at the distance employed or with the measurement bandwidth used in order to be accurately detected by the measurement equipment and calculations demonstrating compliance.

Where it is not practical to further reduce the measurement bandwidth either because of limitations of commonly available test equipment or difficulties in converting readings taken using one measurement bandwidth to those used by the emission limits in clause 8, and the required measurement distance would be so short that the device would not clearly be within the far field, the test report shall state this fact, the measurement distance and bandwidth used, the near field/far field distance for the measurement setup (see clause A.2.4), the measured device emissions, the achievable measurement noise floor and the frequency range(s) involved.

NOTE: This is called "best measurement practise".

6.2 Measuring receiver

The term "measuring receiver" refers to a frequency-selective voltmeter or a spectrum analyser. The measurement bandwidth of the measuring receiver shall, where possible, be according to CISPR 16 [1]. In order to obtain the required sensitivity, a narrower measurement bandwidth may be necessary. In such cases, this shall be stated in the test report form. The bandwidth of the measuring receiver and the deployed detectors shall be as given in table 3a.

Table 3a: Measurement receiver parameters

| Frequency range: (f) | Measuring receiver bandwidth | Detector |
|--|------------------------------|-----------------------|
| $30 \text{ MHz} \leq f \leq 1\,000 \text{ MHz}$ | 100 kHz or 120 kHz | peak/RMS (see note 1) |
| $1\,000 \text{ MHz} < f \leq 40 \text{ GHz}$ | 1 MHz | peak/RMS |
| $f > 40 \text{ GHz}$ | 1 MHz (see note 2) | peak/RMS |
| NOTE 1: With the values from the peak and the RMS detector the quasi peak value can be calculated for particular measurement applications. | | |
| NOTE 2: The actual frequency accuracy shall be taken into account to determine the minimum measurement bandwidth possible. | | |

In case a narrower measurement bandwidth was used, the following conversion formula has to be applied:

$$B = A + 10 \log \frac{BW_{ref}}{BW_{MEASURED}}$$

Where:

- A is the value at the narrower measurement bandwidth;
- B is the value referred to the reference bandwidth; or
- use the measured value, A, directly if the measured spectrum is a discrete spectral line. (A discrete spectrum line is defined as a narrow peak with a level of at least 6 dB above the average level inside the measurement bandwidth.)

7 Measurement uncertainty

Interpretation of the results recorded in the test report for the measurements described in the present document shall be as follows:

- The measured value related to the corresponding limit shall be used to decide whether equipment meets the requirements of the present document.

Table 4: Maximum measurement uncertainties

| Parameter | Maximum expanded measurement Uncertainty |
|--|--|
| Radio frequency | $\pm 1 \times 10^{-7}$ |
| Radiated RF power (up to 40 GHz) | ± 6 dB |
| Radiated RF power (above 40 GHz up to 66 GHz) | ± 8 dB |
| Radiated RF power (above 66 GHz up to 100 GHz) | ± 10 dB (see note 1) |
| Radiated RF power (above 100 GHz) | See note 2 |
| Temperature | ± 1 °C |
| Humidity | ± 5 % |
| DC and low frequency voltages | ± 3 % |
| <p>NOTE 1: Achieved sensitivity and measurement uncertainty are a direct result of the chosen test suites. The values mentioned together with the concerns should therefore be considered illustrational rather than absolute for measurements above 66 GHz, given the absence of some relevant information. For radiated emissions above 66 GHz the given measurement uncertainties are based on the assumption of the deployment of a cable based measurement set-up.</p> <p>NOTE 2: For measurements above 100 GHz, the expanded measurement uncertainty shall also be recorded in the test report and a detailed calculation be added. A future revision of the present document may include a value for frequencies for expanded measurement uncertainty that is still under development.</p> | |

"Standard" measurement equipment is only available up to a frequency range of around 66 GHz with a sensitivity of -72 dBm at 18 GHz down to around -64 dBm at 40 GHz (1 MHz RBW, 3 MHz VBW, 100 MHz span). For higher frequencies the sensitivity will further decrease.

The commercially available calibration capability (only equipment specific calibration, no closed loop to an international norm) is currently limited to around 66 GHz. Thus no such possibility is freely available on the market above that limit. As a consequence measurement results above 66 GHz of different laboratories are not fully comparable since the equipment will not be calibrated for the needed operational range.

The measurement uncertainty of measurements in the range above 40 GHz (millimetre domain) will be clearly above the initially assumed 6 dB for radiated measurements below 40 GHz. A value of 8 dB seems to be more adequate. Precise values of measurement uncertainty require calibration, and there are limitations as mentioned on above.

This maximum uncertainty value above 40 GHz is also dependent upon the maximum dimensions of the antenna of the equipment under test and is also dependent upon gain specifications of antennae.

7.1 Conversion loss data and measurement uncertainty

Calibrated conversion loss data for harmonic mixers are given for a dedicated number of harmonic, IF frequency and LO power. They cannot be used for a different number of harmonic. It is equally essential that the LO level at the harmonic mixer matches the LO level for which the conversion loss data have been derived.

The above conditions adhered to a measurement uncertainty including the measuring receiver of $< \pm 3$ dB to 5 dB at the frequency of the calibration points can be expected, depending on the waveguide band. (Example 75 GHz to 110 GHz 3-port harmonic mixer: $< 4,5$ dB (K = 2,5 °C to 45 °C.)

Harmonic mixers frequently have a low return loss (typ. 6 dB to 7 dB), which increases the measurement uncertainty. It is therefore expedient to insert an attenuator or isolator between the mixer and the antenna in order to improve measurement uncertainty. However, the insertion loss caused by such a component will reduce the sensitivity of the spectrum analyzer and mixer setup. This insertion loss has also to be taken into account for level measurements.

Mixers with integrated isolator are preferable, as they are already calibrated with the isolator included.

As frequency ranges increase it may be difficult to conclude a maximum allowable value for the expanded measurement uncertainty due to lack of knowledge of the new methods of test and determining the uncertainty components:

- The commercially available calibration capability is limited to around 66 GHz. Thus no such possibility is freely available on the market above that limit. As a consequence measurement results above 66 GHz of different labs are not fully comparable since the equipment will not be calibrated for the needed operational range and also for radiated unwanted emission measurements above the operational range.

- The expanded measurement uncertainty of measurements in the range between 66 GHz and 100 GHz will be clearly above the values valid for below 66 GHz. Precise values of expanded measurement uncertainty require calibration, and there are limitations as mentioned above.
- In general it has to be mentioned that these values become the higher the frequency will become the more a guideline.
- Starting from around 66 GHz the limits of coaxial systems are reached and the frontend has to switch to wave guide based technologies adding an additional attenuation and also decreasing the sensitivity. Commercially available analyzers can only measure up to around 67 GHz, thus making the use of external mixers unavoidable.

Guidance is provided in TS 103 051 [i.3] that presents an evaluation of maximum acceptable measurement uncertainty for Radio Frequency (RF) electromagnetic field (emf) measurements for the frequency range from 30 MHz to 100 GHz for inclusion within ETSI documents on radio products used for compliance testing.

8 Methods of measurement and limits

Where the transmitter is designed with adjustable carrier power, then all transmitter parameters shall be measured using the highest peak power level, as declared by the provider. The duty cycle of the transmitter as declared by the provider shall not be exceeded. The actual duty cycle used during the measurements shall be recorded in the test report.

8.1 Frequency band of operation

8.1.1 Definition

The range of operating frequencies includes all frequencies on which the equipment operates within one or more of the assigned frequency bands.

f_C is the point in the radiation where the power is at maximum. The frequency points where the power falls 10 dB below the f_C level and above f_C level are designated as f_L and f_H respectively.

The operating frequency range (i.e. the frequency band of operation) is defined as $f_H - f_L$.

8.1.2 Method of measurement

Measurements for the TLPR frequency bands from 57 GHz to 64 GHz as well as 75 GHz to 85 GHz may use down mixing. The local oscillator used to downconvert the received signals shall be stable and with a phase noise of better than -80 dBc/Hz at 100 kHz offset. (Measurement practice will use the LO signal from the Spectrum Analyzer) The local oscillator frequency shall be selected such that the downconverted signal is within the accepted band of the spectrum analyzer, and maintaining an adequate IF bandwidth to capture the full spectrum of the signal.

If the measuring receiver is capable of measuring the signals directly without any down mixing, the fundamental or harmonic mixer can be omitted.

Radiated measurements shall be conducted under far field conditions.

Testing shall be conducted under normal test conditions.

In both measurements for the lower and upper frequency bound, f_L and f_H , there shall be no point in the radiation below f_L and above f_H where the level increases above the level recorded at f_L and f_H . This ensures that peaks and valleys occurring near f_C are not used prematurely as the upper and lower bounds of the radiation.

The maximum of the radiation is determined by a power measurement that indicates the maximum of the radiation at f_C .

The maximum power of the radiation is measured by:

- a) Set the spectrum analyser detector to positive peak.
- b) Centre the span on the peak of the radiation and set the span to zero.
- c) Set the RBW to no less than 1 MHz and the VBW to no less than the RBW. A VBW of three times the RBW is preferred to eliminate video averaging.

f_C shall be recorded in the test report. The DUT is tested by directly coupling the normal operational transmitted signal, via a free-line-of-sight towards the measuring test antenna in a manner to ensure the test antenna receives a sufficient signal.

For the lower frequency bound f_L , the radiation is searched from a frequency lower than the peak that has, by inspection, a much lower PSD than the peak PSD -10 dB and increasing in frequency towards the peak until the PSD indicates a level of -10 dB less than at the peak of the radiation.

The process is repeated for the upper frequency bound f_H , beginning at a frequency higher than the peak that has, by inspection, a much lower PSD than peak PSD -10 dB.

The values for f_L and f_H shall be recorded in the test report.

8.1.3 Limits

The permitted ranges of operating frequencies for radiation are given in table 5. Outside the permitted ranges of operating frequencies the radiations shall be reduced by no less than 10 dB.

Table 5: Frequency bands of operation

| Frequency bands of operation |
|------------------------------|
| 4,5 GHz to 7 GHz |
| 8,5 GHz to 10,6 GHz |
| 24,05 GHz to 27 GHz |
| 57 GHz to 64 GHz |
| 75 GHz to 85 GHz |

8.2 Duty cycle

Duty cycle, D , is defined as:

$$D = \frac{t_{on}}{t_{on} + t_{off}}$$

where:

- t_{on} is the time where the transmitter is active;
- t_{off} is the time where the transmitter is switched off.

The total equipment duty cycle is the result from the duty cycle, D_U , by the application, see clause 8.2.1 and the duty cycle, D_X , by the modulation, see clause 8.2.2.

8.2.1 Duty cycle resulting from application

The duty cycle D_U , is under control of the user, determined by the users transmission time and is normally declared by the user or applicant.

The provider shall declare the duty cycle D_U and the respective duty cycle category for the DUT as indicated in table 6. This declaration shall be stated in the test report.

Table 6: Duty Cycle, D_U

| Duty cycle Category | Duty cycle ratio |
|---------------------|------------------|
| 1 | $\leq 0,1 \%$ |
| 2 | $\leq 1,0 \%$ |
| 3 | $\leq 10 \%$ |
| 4 | Up to 100 % |

8.2.2 Duty cycle resulting from modulation

8.2.2.1 Method of measurement

The duty cycle D_X , is determined by the transmitters modulation type and shall be measured by means a diode detector and an oscilloscope or another appropriate instrument. The duty cycle D_X is important when the radiated power is measured and the modulation cannot be switched off. This is specifically the case when the equipment is using a pulsed type of modulation:

- Using suitable attenuators, the output power of the transmitter shall be coupled to a matched diode detector. The output of the matched diode detector shall be connected to the vertical channel of an oscilloscope.
- The combination of the matched diode detector and the oscilloscope shall be capable of faithfully reproducing the envelope peaks and the duty cycle of the transmitter output signal.
- The observed duty cycle of the transmitter (Tx on/(Tx on +Tx off)) shall be noted as D_X ($0 < D_X \leq 100 \%$), and recorded in the test report. For the purpose of testing, the equipment shall be operated with a duty cycle that is equal to or greater than 10 %. Where this duty cycle is not possible, then this shall be stated on the test report and the actual duty cycle shall be declared.

8.2.3 Limits

The duty cycle limits are given in table 7.

Table 7: Duty Cycle, D_X

| Duty cycle Categories | Duty cycle ratio |
|---|------------------|
| 1 | $\leq 0,1 \%$ |
| 2 | $\leq 1,0 \%$ |
| 3 | $\leq 10 \%$ |
| 4 | Up to 100 % |
| Pulsed systems shall only be duty cycle, D_X , category 1 or 2. The limit for the duty cycle is observed over any one-hour period. | |

8.3 Equivalent isotropically radiated power (e.i.r.p.)

8.3.1 Definition

The radiated power (e.i.r.p.) is defined as the emitted power of the transmitter including antenna gain according to the procedure given in the following clause.

The measurement shall be performed under normal test conditions.

8.3.2 Method of measurement

Measurements for the TLPR frequency bands from 57 GHz to 64 GHz as well as 75 GHz to 85 GHz may use down mixing. The local oscillator used to downconvert the received signals shall be stable and with a phase noise of better than -80 dBc/Hz at 100 kHz offset. (Measurement practice will use the LO signal from the Spectrum Analyzer.) The local oscillator frequency shall be selected such that the downconverted signal is within the accepted band of the spectrum analyser, and maintaining an adequate IF bandwidth to capture the full spectrum of the signal.

If the measuring receiver is capable of measuring the signals directly without any down mixing, the fundamental or harmonic mixer can be omitted.

The measurement shall be performed in an anechoic chamber using normal operation of the equipment, i.e. for FMCW modulated TLPR the sweep is not suspended and for the pulsed TLPR the pulse gating is not suspended.

The TLPR is not mounted on a tank for this test.

The test set-up is shown in figure 2.

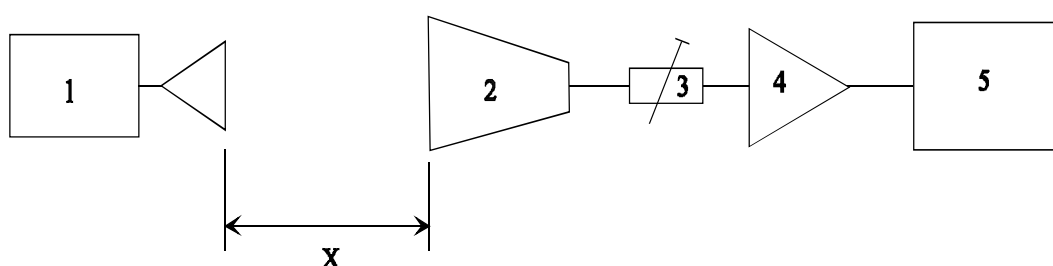

Key:

1. Device under test with integrated or dedicated antenna.
2. Wideband test antenna.
3. Variable step attenuator (optional).
4. Low noise, pulse rated, high gain, wideband preamplifier.
5. Power meter.

Figure 2: Measurement set-up

The minimum performance data for preamplifier (key 4) and horn antenna (key 2) are shown in annex C.

The test procedure is the following:

- a) The tests shall be made in an anechoic chamber.
- b) Set the DUT in normal operation mode.
- c) The test antenna (2) is positioned at a measurement distance, X, of approximately 3 m from the DUT (1). The distance shall be stated in the test report.
- d) The device under test (1) and the wide band test antenna (2) are orientated for maximum reading at the power meter (5).
- e) The average output power of the transmitter shall be determined using a wideband calibrated RF power meter with a matched thermocouple detector or an equivalent thereof and with an integration period that exceeds the repetition period of the transmitter by a factor 5 or more. The observed value shall be noted as "A" (in dBm).
- f) The device under test (1) is substituted by a unmodulated signal generator connected to a measurement antenna having gain, G_a . The antenna is positioned in front of the test wide band antenna (2) at the same measurement distance, X, as for c) above and is orientated for maximum reading at the power meter. The signal generator frequency is adjusted to f_c and its output power adjusted until the power meter (5) reading is identical with the maximum level of the radiated power according to point e) above (observed power A). The radiated power (e.i.r.p.) shall be calculated from the above measured power from the signal generator, P_s , the observed duty cycle, D_X , and the declared measurement antenna's gain " G_a " in dBi, according to the formula:

$$P = P_s + G_a + 10 \log (1/D_X) \text{ (dBm)}.$$

The above measurement may also be performed as a conducted measurement. For this purpose, the DUT needs a temporary or permanent antenna connector. The provider shall declare the maximum antenna gain and this shall be stated in the test report. The equivalent isotropically radiated power is then calculated from the measured value, the known antenna gain, relative to an isotropic antenna, and if applicable, any losses due to cables and connectors in the measurement system.

The Voltage Standing Wave Ratio (VSWR) at the 50 Ω connector shall not be greater than 1,5: 1 over the frequency range of the measurement. For the purpose of the present document, conducted measurements are limited to the intended TLPR frequency band of operation.

8.3.3 Limits

The radiated power (e.i.r.p.), under normal conditions, shall not exceed the values given in table 8.

Table 8: Radiated power limit

| Frequency band of operation | Max. radiated power (e.i.r.p.) |
|-----------------------------|--------------------------------|
| 4,5 GHz to 7 GHz | +24 dBm |
| 8,5 GHz to 10,6 GHz | +30 dBm |
| 24,05 GHz to 27 GHz | +43 dBm |
| 57 GHz to 64 GHz | +43 dBm |
| 75 GHz to 85 GHz | +43 dBm |

8.4 Emissions

8.4.1 Definition

Emissions are leakage signals from a tank structure including an installed TLPR.

8.4.2 Method of measurement

Measurements shall be performed in the frequency ranges given in table 9.

Table 9: Frequency ranges within which the emission shall be measured

| Frequency band of operation | Frequency range within which the emissions shall be measured |
|-----------------------------|--|
| 4,5 GHz to 7 GHz | 30 MHz to 26 GHz |
| 8,5 GHz to 10,6 GHz | 30 MHz to 26 GHz |
| 24,05 GHz to 27 GHz | 30 MHz to 2 \times carrier frequency |
| 57 GHz to 64 GHz | 30 MHz to 2 \times carrier frequency |
| 75 GHz to 85 GHz | 30 MHz to 2 \times carrier frequency |

See clause 5.3 for the test conditions.

For this test, the EUT is defined as a TLPR mounted on a test tank as described in annex E. Relevant information concerning leakage from the EUT is given in annex D.

The dimensions of the test tank shall be recorded in the test report.

An example of the test set-up is illustrated in figure 3.

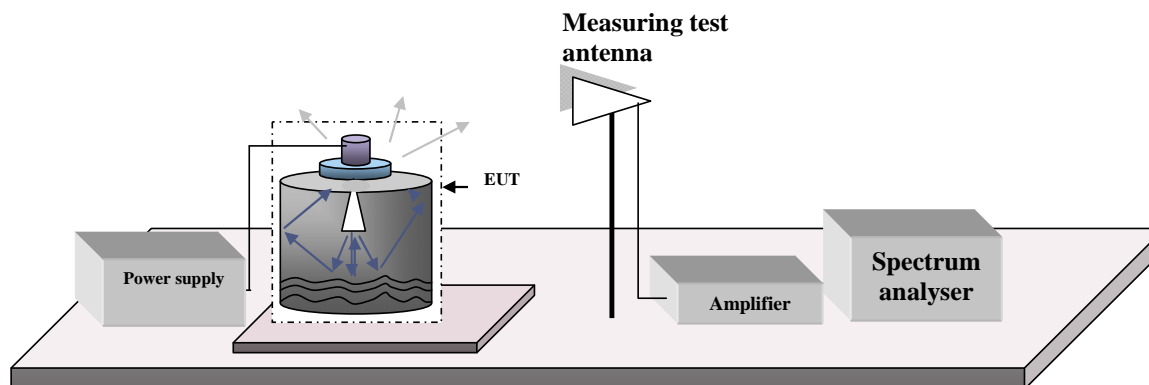

Figure 3: An example of test set-up for emission measurement

It may be necessary for specific EUTs to perform this measurement by inserting a low noise amplifier in the measuring arrangement to ensure sufficient signal level.

Measurements for the TLPR frequency bands from 57 GHz to 64 GHz as well as 75 GHz to 85 GHz may use down mixing. The local oscillator used to downconvert the received signals shall be stable and with a phase noise of better than -80 dBc/Hz at 100 kHz offset. (Measurement practice will use the LO signal from the Spectrum Analyser) The local oscillator frequency shall be selected such that the downconverted signal is within the accepted band of the spectrum analyser, and maintaining an adequate IF bandwidth to capture the full spectrum of the signal.

If the measuring receiver is capable of measuring the signals directly without any down mixing, the harmonic mixer can be omitted.

The recommended performance data for the measurement antenna and preamplifier are given in annex C.

The measurement shall be performed under normal test condition.

The measurement shall be performed using normal operation of the equipment.

The frequency of the spectrum analyser shall be adjusted over frequency bands given in table 7.

For measurements below 1 GHz, a CISPR 16 [1] quasi peak detector shall be used.

Using a spectrum analyser (SA), the following settings are applicable:

- a) Set the centre frequency of the SA to the frequency of interest.
- b) Set the RBW to 100 kHz and the VBW to be at least equal or greater than the RBW.

For measurements above 1 GHz, a spectrum analyzer with an average detector is used.

When measuring the emissions above 1 GHz, the spectrum analyser shall be configured as follows unless otherwise stated:

Resolution bandwidth: 1 MHz

NOTE 1: To the extent practicable, the radio device under test is measured using a spectrum analyser configured using the setting described above. However, in order to obtain an adequate signal-to-noise ratio in the measurement system, radiated measurements may have to be made using narrower resolution bandwidths where it is practical. In these cases, the revised measurement configuration should be stated in the test report, together with calculations which permit the measurements taken to be compared with the appropriate limits and an explanation of why the signal levels involved necessitated measurement using the resolution bandwidth employed in order to be accurately determined by the measurement equipment.

Video bandwidth: Not less than the resolution bandwidth.

Detector mode: RMS.

NOTE 2: RMS average measurements can be accomplished directly using a spectrum analyser which incorporates an RMS detector. Alternatively, a true RMS level can be measured using a spectrum analyser that does not incorporate an RMS detector (see ITU-R Recommendation SM.1754 [i.2] for details).

Average time (per point on spectrum analyser scan): 1 ms or less.

A measurement time (averaging time) of 1 ms per measurement point is not sufficient to measure UWB FMCW signals. The maximum signal time must be taken into account to set the sweep time of the spectrum analyser.

$$sweeptime \geq tp \times \frac{total_measurement_BW}{RBW}$$

To ensure coincidence, the measurement should also be repeated using different analyzer sweep times fulfilling the condition stated above. The FMCW period of time for modulation used in the formula above is (t_p).

Frequency Span: Equal to or less than the number of displayed samples multiplied by the resolution bandwidth. The measurement results shall be determined and recorded over the frequency ranges as shown in table 9.

In order to obtain the required sensitivity a narrower bandwidth may be necessary, this shall be stated in the test report form.

The test procedure shall be the following:

- A test site such as one selected from annex A (i.e. indoor test site or open area test site), which fulfils the requirements of the specified frequency range of this measurement shall be used.
- The frequency of the measuring receiver shall be adjusted over the frequency range in accordance to table 9. The frequency of each spurious component shall be noted. If the test site is disturbed by radiation coming from outside the site, this qualitative search may be performed in a screened room with reduced distance between the transmitter and the test antenna.
- During the measurement, the test antenna is placed three metres away from the EUT. It may be necessary for specific EUTs to perform this measurement with the test antenna placed closer to the EUT. The distance between EUT and the test antenna shall be recorded in the test report.
- Measurements must be taken at a sufficient number of radials and polarizations to ensure that the maximum unintentional emission is measured.

The measuring receiver configuration uses a low noise preamplifier and a dipole antenna (for frequencies below 1 GHz) or horn antenna (for frequencies above 1 GHz). Details are given in annex C. For the unintentional emission measurements, a combination of biconical and log periodic dipole array antennas (commonly termed "log periodic") could also be used to cover the entire 30 MHz to 1 000 MHz band.

- The measured spectrum curve at the spectrum analyser shall be recorded. For these measurements it is strongly recommended to use a LNA (low noise amplifier) before the spectrum analyser input to achieve the required sensitivity. Measurements below -60 dBm e.i.r.p. (measured in a 1 MHz bandwidth) are not required.

8.4.3 Limits

The effective radiated power of any emission shall not exceed the values given in table 10.

Table 10: Power limits of radiated emissions

| Frequency band of operation (GHz) | Frequency band of SA | Max. emissions outside the tank enclosure structure inside the band of operation | Max. emissions outside the tank enclosure structure and outside the band of operation |
|--|---------------------------------|--|---|
| 4,5 to 7 | 30 MHz to 26 GHz | < 1 GHz: -51,3 dBm ≥ 1 GHz: -41,3 dBm | < 1 GHz: -61,3 dBm ≥ 1 GHz: -51,3 dBm (see note) |
| 8,5 to 10,6 | 30 MHz to 26 GHz | | |
| 24,05 to 27 | 30 MHz to 2 × carrier frequency | | |
| 57 to 64 | 30 MHz to 2 × carrier frequency | | |
| 75 to 85 | 30 MHz to 2 × carrier frequency | | |
| NOTE: For the frequency range 10,6 GHz to 10,7 GHz, the emission shall be ≤ -60 dBm. | | | |

8.5 Range of modulation parameters

The permitted range of modulation parameters is shown in annex G. Manufacturers shall declare the parameters and the respective values for their equipment in case of impulsive technology, FMCW or similar wideband modulation schemes such as frequency hopping or stepped frequency modulation.

Annex A (normative): Radiated measurement

This annex has been drafted so it covers test sites and methods to be used with integral antenna equipment or dedicated antenna for equipment having an antenna connector. In the present annex the word "EUT" is representing both EUT and DUT.

A.1 Test sites and general arrangements for measurements involving the use of radiated fields

This annex introduces three most commonly available test sites, an anechoic chamber, an anechoic chamber with a ground plane and an Open Area Test Site (OATS), which may be used for radiated tests. These test sites are generally referred to as free field test sites. Both absolute and relative measurements can be performed in these sites. Where absolute measurements are to be carried out, the chamber should be verified. A detailed verification procedure is described in the relevant parts of TR 102 273 [4] or equivalent.

NOTE: To ensure reproducibility and tractability of radiated measurements only these test sites should be used in measurements in accordance with the present document.

A.1.1 Anechoic Chamber

An anechoic chamber is an enclosure, usually shielded, whose internal walls, floor and ceiling are covered with radio absorbing material, normally of the pyramidal urethane foam type. The chamber usually contains an antenna support at one end and a turntable at the other. A typical anechoic chamber is shown in figure A.1.

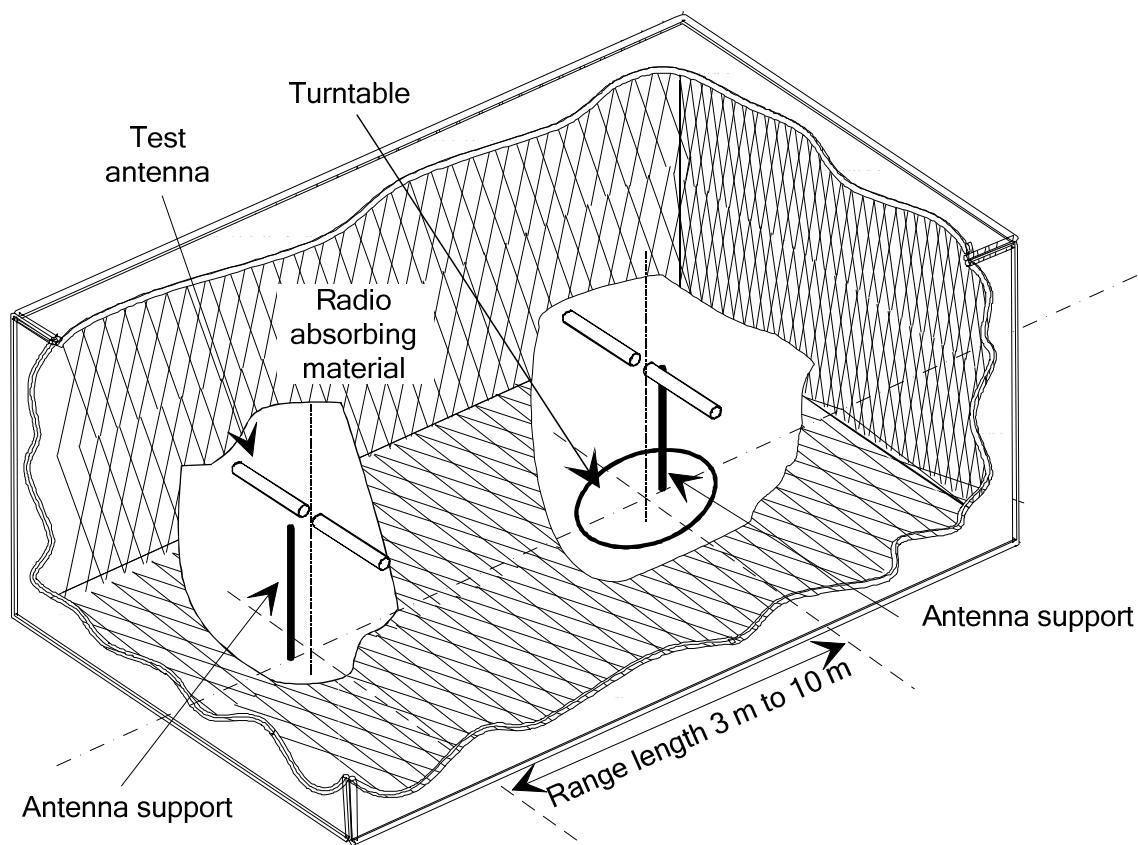

Figure A.1: A typical Anechoic Chamber

The chamber shielding and radio absorbing material work together to provide a controlled environment for testing purposes. This type of test chamber attempts to simulate free space conditions.

The shielding provides a test space, with reduced levels of interference from ambient signals and other outside effects, whilst the radio absorbing material minimizes unwanted reflections from the walls and ceiling which can influence the measurements. In practice it is relatively easy for shielding to provide high levels (80 dB to 140 dB) of ambient interference rejection, normally making ambient interference negligible.

A turntable is capable of rotation through 360° in the horizontal plane and it is used to support the test sample (EUT) at a suitable height (e.g. 1 m) above the ground plane. The chamber shall be large enough to allow the measuring distance of at least 3 m or $2(d_1 + d_2)^2/\lambda$ (m), whichever is greater (see clause A.2.4). For further information on measurements at shorter distances see annex F. The distance used in actual measurements shall be recorded with the test results.

The anechoic chamber generally has several advantages over other test facilities. There is minimal ambient interference, minimal floor, ceiling and wall reflections and it is independent of the weather. It does however have some disadvantages which include limited measuring distance and limited lower frequency usage due to the size of the pyramidal absorbers. To improve low frequency performance, a combination structure of ferrite tiles and urethane foam absorbers is commonly used.

All types of emission, sensitivity and immunity testing can be carried out within an anechoic chamber without limitation.

A.1.2 Anechoic Chamber with a conductive ground plane

An anechoic chamber with a conductive ground plane is an enclosure, usually shielded, whose internal walls and ceiling are covered with radio absorbing material, normally of the pyramidal urethane foam type. The floor, which is metallic, is not covered and forms the ground plane. The chamber usually contains an antenna mast at one end and a turntable at the other. A typical anechoic chamber with a conductive ground plane is shown in figure A.2.

This type of test chamber attempts to simulate an ideal Open Area Test Site whose primary characteristic is a perfectly conducting ground plane of infinite extent.

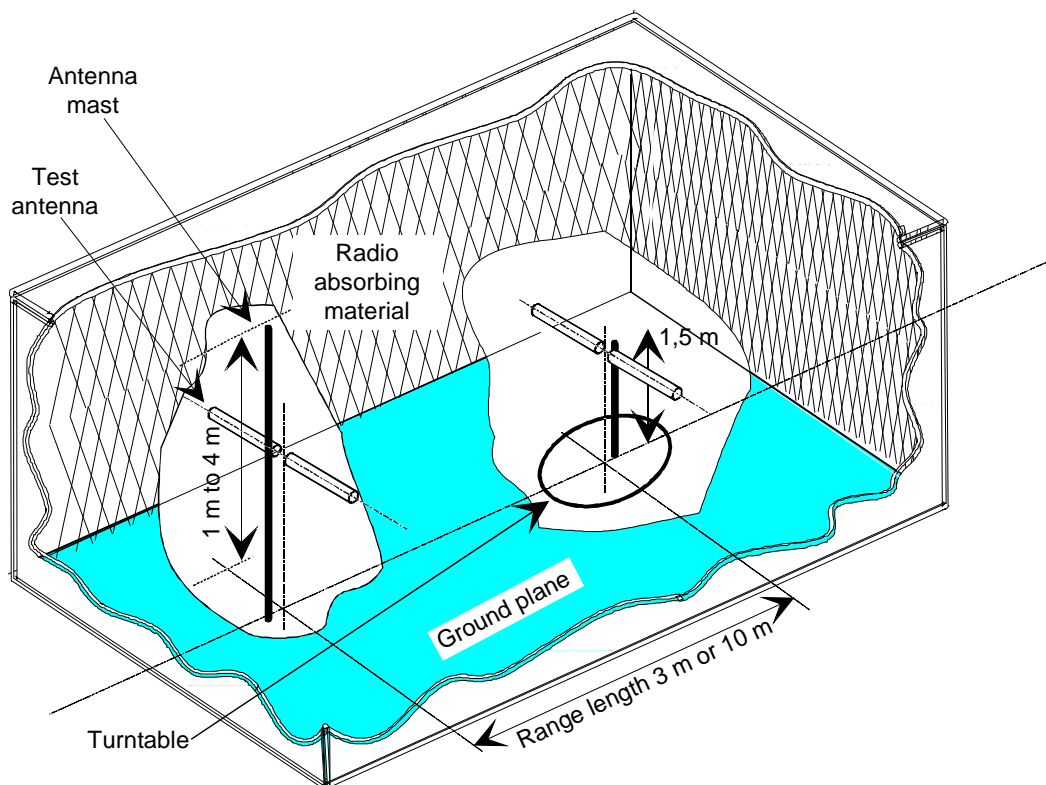

Figure A.2: A typical Anechoic Chamber with a conductive ground plane

In this facility the ground plane creates the wanted reflection path, such that the signal received by the receiving antenna is the sum of the signals from both the direct and reflected transmission paths. This creates a unique received signal level for each height of the transmitting antenna (or EUT) and the receiving antenna above the ground plane.

The antenna mast provides a variable height facility (from 1 m to 4 m) so that the position of the test antenna can be optimized for maximum coupled signal between antennas or between an EUT and the test antenna.

A turntable is capable of rotation through 360° in the horizontal plane and it is used to support the test sample (EUT) at a specified height, usually 1,5 m above the ground plane. The chamber shall be large enough to allow the measuring distance of at least 3 m or $2(d_1 + d_2)^2/\lambda$ (m), whichever is greater (see clause A.2.4). For further information on measurements at shorter distances see annex F. The distance used in actual measurements shall be recorded with the test results.

Emission testing involves firstly "peaking" the field strength from the EUT by raising and lowering the receiving antenna on the mast (to obtain the maximum constructive interference of the direct and reflected signals from the EUT) and then rotating the turntable for a "peak" in the azimuth plane. At this height of the test antenna on the mast, the amplitude of the received signal is noted. Secondly the EUT is replaced by a substitution antenna (positioned at the EUT's phase or volume centre) which is connected to a signal generator. The signal is again "peaked" and the signal generator output adjusted until the level, noted in stage one, is again measured on the receiving device.

Receiver sensitivity tests over a ground plane also involve "peaking" the field strength by raising and lowering the test antenna on the mast to obtain the maximum constructive interference of the direct and reflected signals, this time using a measuring antenna which has been positioned where the phase or volume centre of the EUT will be during testing. A transform factor is derived. The test antenna remains at the same height for stage two, during which the measuring antenna is replaced by the EUT. The amplitude of the transmitted signal is reduced to determine the field strength level at which a specified response is obtained from the EUT.

A.1.3 Open Area Test Site (OATS)

An Open Area Test Site comprises a turntable at one end and an antenna mast of variable height at the other end above a ground plane which, in the ideal case, is perfectly conducting and of infinite extent. In practice, whilst good conductivity can be achieved, the ground plane size has to be limited. A typical Open Area Test Site is shown in figure A.3.

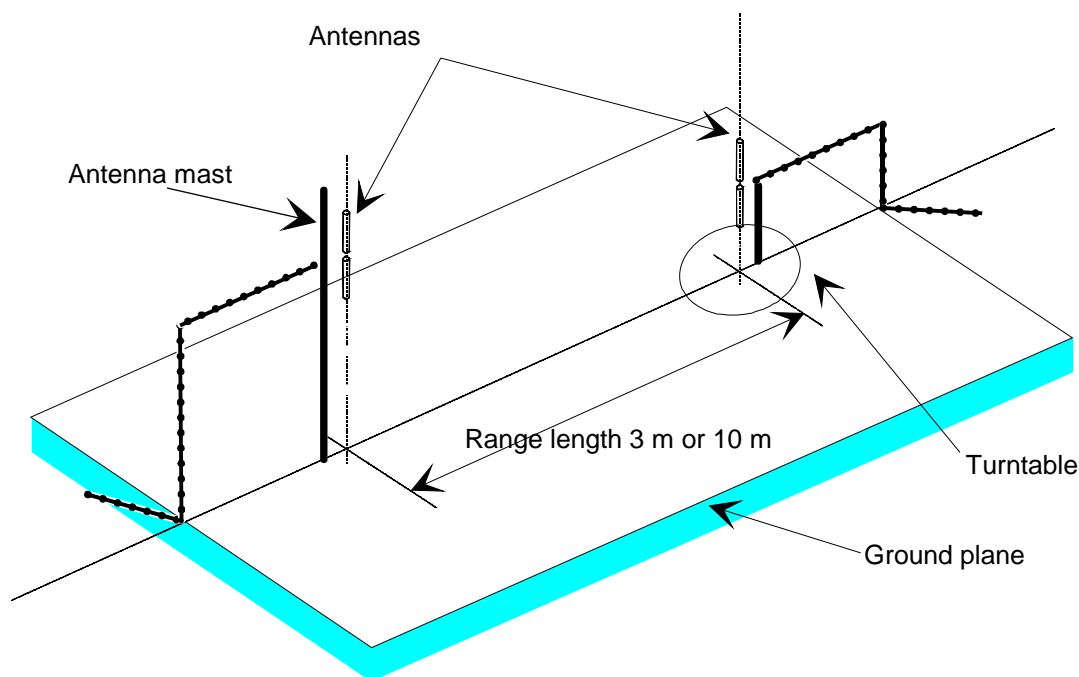

Figure A.3: A typical Open Area Test Site

The ground plane creates a wanted reflection path, such that the signal received by the receiving antenna is the sum of the signals received from the direct and reflected transmission paths. The phasing of these two signals creates a unique received level for each height of the transmitting antenna (or EUT) and the receiving antenna above the ground plane.

Site qualification concerning antenna positions, turntable, measurement distance and other arrangements are same as for anechoic chamber with a ground plane. In radiated measurements an OATS is also used by the same way as anechoic chamber with a ground plane.

Typical measuring arrangement common for ground plane test sites is presented in the figure A.4.

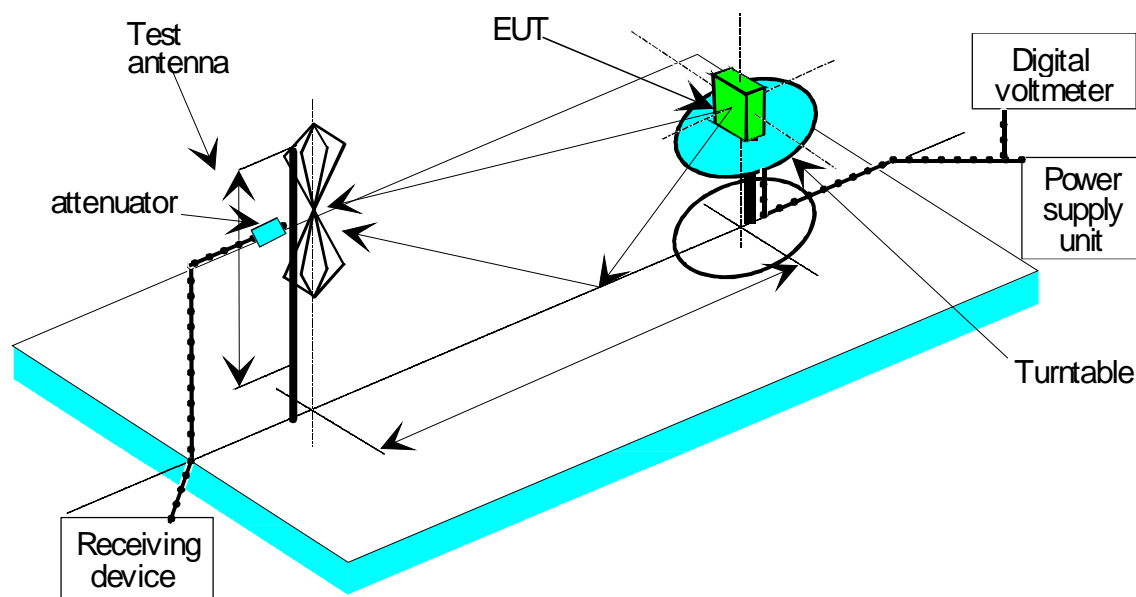

Figure A.4: Measuring arrangement on ground plane test site (OATS set-up for spurious emission testing)

A.1.4 Minimum requirements for test sites for measurements above 18 GHz

Generally the test site shall be adequate to allow for testing in the far field of the EUT. The test site should therefore consist of an electromagnetic anechoic room where either at least the ground surface is covered with radio absorbing material or up to six surrounding surfaces are covered with radio absorbing material. The absorbing material shall have a minimum attenuation of 30 dB. It shall be verified that reflections are sufficiently reduced. The test site shall have the following dimensions:

- Width of 2 meters.
- Length of 3 meters.
- Height of 2 meters (only applicable for a room with more than one reflecting surface).

Highly directional receiving antennas help in reducing reflections. The use of standard gain horn antennas is recommended. It shall be noted that if the antenna aperture is smaller than the EUT, sufficient measurements in both azimuth and elevation shall be conducted in order to ensure that the maximum radiation is determined.

The measuring distance shall be selected in such way that antenna coupling effects are avoided. A distance of at least 0,5 m is therefore recommended. The EUT may be positioned at any height that minimizes reflections from the floor.

Due to high loss of coaxial cables at higher frequencies, the connection from the receiving antenna to the measuring receiver should not exceed 1 m, thus making it necessary to place the measuring receiver very close. This is especially the case when using external harmonic mixers with very short connections to the measuring receiver. Therefore the measuring receiver should somehow be covered with radio absorbing material in direction to the measuring field in order to reduce reflections. Figure A.5 shows an example of a test site above 18 GHz with one reflecting surface.

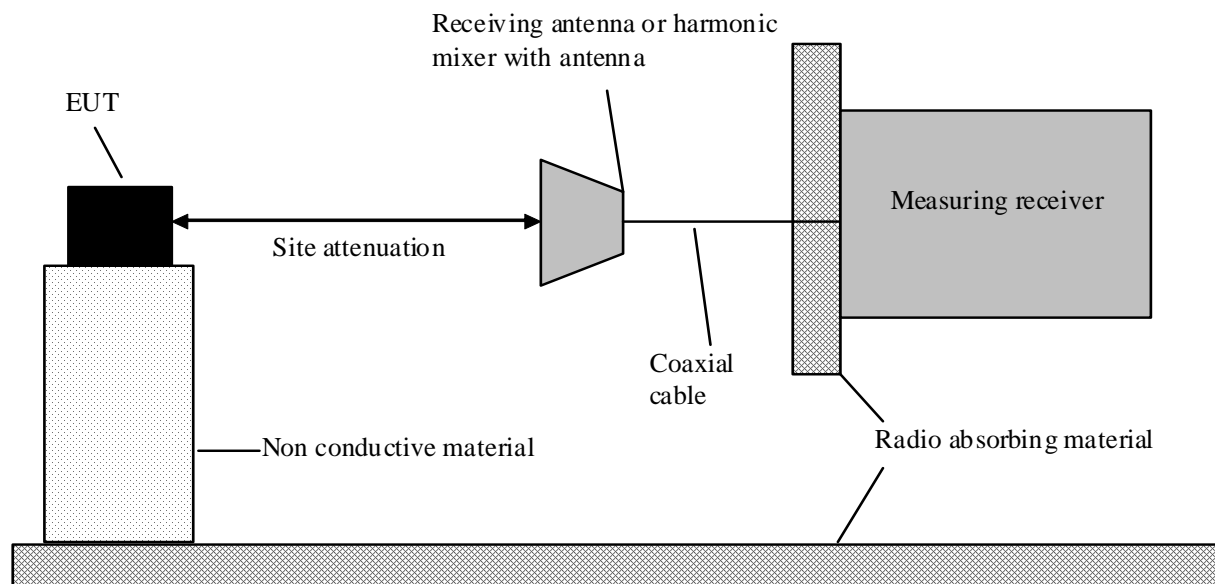

Figure A.5: Example of a test site above 18 GHz with one reflecting surface

The site attenuation of the test site can be determined. Should the test site in its characteristics be nearly ideal, it may be possible to use the theoretical Free Space Loss (FSL) as site attenuation as shown in the examples in the tables A.1 to A.3.

Table A.1: Example of Free Space Loss at 1 m distance

| Measuring distance/m | f/GHz | $\lambda / 1 \text{ m}$ | [FSL]/dB |
|----------------------|-------|-------------------------|----------|
| 1 | 24,2 | 0,012397 | 60,12 |
| | 48,4 | 0,006198 | 66,14 |
| | 72,6 | 0,004132 | 69,66 |
| | 96,8 | 0,003099 | 72,16 |

Table A.2: Example of Free Space Loss at 0,5 m distance

| Measuring distance/m | f/GHz | $\lambda / 1 \text{ m}$ | [FSL]/dB |
|----------------------|-------|-------------------------|----------|
| 0,5 | 24,2 | 0,012397 | 54,1 |
| | 48,4 | 0,006198 | 60,12 |
| | 72,6 | 0,004132 | 63,64 |
| | 96,8 | 0,003099 | 66,14 |

Table A.3: Example of Free Space Loss at 0,25 m distance

| Measuring distance/m | f/GHz | $\lambda / 1 \text{ m}$ | [FSL]/dB |
|----------------------|-------|-------------------------|----------|
| 0,25 | 72,6 | 0,004132 | 57,62 |
| | 96,8 | 0,003099 | 60,12 |

Whereas:

$$\lambda = c/f.$$

$$[\text{FSL}] = 10 \log (4 \pi r/\lambda)^2.$$

A.1.5 Test antenna

A test antenna is always used in radiated test methods. In emission tests (i.e. frequency error, effective radiated power, spurious emissions and adjacent channel power) the test antenna is used to detect the field from the EUT in one stage of the measurement and from the substitution antenna in the other stage. When the test site is used for the measurement of receiver characteristics (i.e. sensitivity and various immunity parameters) the antenna is used as the transmitting device.

The test antenna should be mounted on a support capable of allowing the antenna to be used in either horizontal or vertical polarization which, on ground plane sites (i.e. anechoic chambers with ground planes and Open Area Test Sites), should additionally allow the height of its centre above the ground to be varied over the specified range (usually 1 metre to 4 metres).

In the frequency band 30 MHz to 1 000 MHz, dipole antennas (constructed in accordance with ANSI C63.5 [3]) are generally recommended. For frequencies of 80 MHz and above, the dipoles should have their arm lengths set for resonance at the frequency of test. Below 80 MHz, shortened arm lengths are recommended. For spurious emission testing, however, a combination of bicones and log periodic dipole array antennas (commonly termed "log periodics") could be used to cover the entire 30 MHz to 1 000 MHz band. Above 1 000 MHz, waveguide horns are recommended although, again, log periodics could be used.

NOTE: The gain of a horn antenna is generally expressed relative to an isotropic radiator.

A.1.6 Substitution antenna

The substitution antenna is used to replace the EUT for tests in which a transmitting parameter (i.e. frequency error, effective radiated power, spurious emissions and adjacent channel power) is being measured. For measurements in the frequency band 30 MHz to 1 000 MHz, the substitution antenna should be a dipole antenna (constructed in accordance with ANSI C63.5 [3]). For frequencies of 80 MHz and above, the dipoles should have their arm lengths set for resonance at the frequency of test. Below 80 MHz, shortened arm lengths are recommended. For measurements above 1 000 MHz, a waveguide horn is recommended. The centre of this antenna should coincide with either the phase centre or volume centre.

A.1.7 Measuring antenna

The measuring antenna is used in tests on an EUT in which a receiving parameter (i.e. sensitivity and various immunity tests) is being measured. Its purpose is to enable a measurement of the electric field strength in the vicinity of the EUT. For measurements in the frequency band 30 MHz to 1 000 MHz, the measuring antenna should be a dipole antenna (constructed in accordance with ANSI C63.5 [3]). For frequencies of 80 MHz and above, the dipoles should have their arm lengths set for resonance at the frequency of test. Below 80 MHz, shortened arm lengths are recommended. The centre of this antenna should coincide with either the phase centre or volume centre (as specified in the test method) of the EUT.

A.2 Guidance on the use of radiation test sites

This clause details procedures, test equipment arrangements and verification that should be carried out before any of the radiated test are undertaken. These schemes are common to all types of test sites described in annex A.

A.2.1 Verification of the test site

No test should be carried out on a test site, which does not possess a valid certificate of verification. The verification procedures for the different types of test sites described in annex A (i.e. anechoic chamber, anechoic chamber with a ground plane and Open Area Test Site) are given in the relevant parts of TR 102 273 [4] or equivalent.

A.2.2 Preparation of the EUT

The provider should supply information about the EUT covering the operating frequency, polarization, supply voltage(s) and the reference face. Additional information, specific to the type of EUT should include, where relevant, carrier power, channel separation, whether different operating modes are available (e.g. high and low power modes) and if operation is continuous or is subject to a maximum test duty cycle (e.g. 1 minute on, 4 minutes off).

Where necessary, a mounting bracket of minimal size should be available for mounting the EUT on the turntable. This bracket should be made from low conductivity, low relative dielectric constant (i.e. less than 1,5) material(s) such as expanded polystyrene, balsa wood, etc.

A.2.3 Power supplies to the EUT

All tests should be performed using power supplies wherever possible, including tests on EUT designed for battery-only use. In all cases, power leads should be connected to the EUT's supply terminals (and monitored with a digital voltmeter) but the battery should remain present, electrically isolated from the rest of the equipment, possibly by putting tape over its contacts.

The presence of these power cables can, however, affect the measured performance of the EUT. For this reason, they should be made to be "transparent" as far as the testing is concerned. This can be achieved by routing them away from the EUT and down to either the screen, ground plane or facility wall (as appropriate) by the shortest possible paths. Precautions should be taken to minimize pick-up on these leads (e.g. the leads could be twisted together, loaded with ferrite beads at 0,15 m spacing or otherwise loaded).

A.2.4 Range length

The range length for all these types of test facility should be adequate to allow for testing in the far-field of the EUT i.e. it should be equal to or exceed:

$$\frac{2(d_1 + d_2)^2}{\lambda}$$

where:

d_1 is the largest dimension of the EUT/dipole after substitution (m);

d_2 is the largest dimension of the test antenna (m);

λ is the test frequency wavelength (m).

It should be noted that in the substitution part of this measurement, where both test and substitution antennas are half wavelength dipoles, this minimum range length for far-field testing would be:

$$2\lambda$$

It should be noted in the test report when either of these conditions is not met so that the additional measurement uncertainty can be incorporated into the results.

For further information on measurements at shorter distances see annex F.

NOTE 1: For the fully anechoic chamber, no part of the volume of the EUT should, at any angle of rotation of the turntable, fall outside the "quiet zone" of the chamber at the nominal frequency of the test.

NOTE 2: The "quiet zone" is a volume within the anechoic chamber (without a ground plane) in which a specified performance has either been proven by test, or is guaranteed by the designer/manufacture. The specified performance is usually the reflectivity of the absorbing panels or a directly related parameter (e.g. signal uniformity in amplitude and phase). It should be noted however that the defining levels of the quiet zone tend to vary.

NOTE 3: For the anechoic chamber with a ground plane, a full height scanning capability, i.e. 1 m to 4 m, should be available for which no part of the test antenna should come within 1 m of the absorbing panels. For both types of Anechoic Chamber, the reflectivity of the absorbing panels should not be worse than -5 dB.

NOTE 4: For both the anechoic chamber with a ground plane and the Open Area Test Site, no part of any antenna should come within 0,25 m of the ground plane at any time throughout the tests. Where any of these conditions cannot be met, measurements should not be carried out.

A.2.5 Site preparation

The cables for both ends of the test site should be routed horizontally away from the testing area for a minimum of 2 m (unless, in the case either type of anechoic chamber, a back wall is reached) and then allowed to drop vertically and out through either the ground plane or screen (as appropriate) to the test equipment. Precautions should be taken to minimize pick up on these leads (e.g. dressing with ferrite beads, or other loading). The cables, their routing and dressing should be identical to the verification set-up.

NOTE: For ground reflection test sites (i.e. anechoic chambers with ground planes and Open Area Test Sites) which incorporate a cable drum with the antenna mast, the 2 m requirement may be impossible to comply with.

Calibration data for all items of test equipment should be available and valid. For test, substitution and measuring antennas, the data should include gain relative to an isotropic radiator (or antenna factor) for the frequency of test. Also, the VSWR of the substitution and measuring antennas should be known.

The calibration data on all cables and attenuators should include insertion loss and VSWR throughout the entire frequency range of the tests. All VSWR and insertion loss figures should be recorded in the log book results sheet for the specific test.

Where correction factors/tables are required, these should be immediately available.

For all items of test equipment, the maximum errors they exhibit should be known along with the distribution of the error e.g.:

- cable loss: $\pm 0,5$ dB with a rectangular distribution;
- measuring receiver: 1,0 dB (standard deviation) signal level accuracy with a Gaussian error distribution.

At the start of measurements, system checks should be made on the items of test equipment used on the test site.

A.3 Coupling of signals

A.3.1 General

The presence of leads in the radiated field may cause a disturbance of that field and lead to additional measurement uncertainty. These disturbances can be minimized by using suitable coupling methods, offering signal isolation and minimum field disturbance (e.g. optical and acoustic coupling).

Annex B (normative): Installation requirements of Tank Level Probing Radar (TLPR) Equipment

This annex provides the information for TLPR equipment manufacturers and installers to design the equipment and the installation in the tank in such a way, that the essential requirements as stated in EN 302 372-2 [5], are fulfilled.

The following installation requirements shall be fulfilled:

- a) TLPR are required to be installed at a permanent fixed position at a closed (not open) metallic tank or reinforced concrete tank, or similar enclosure structure made of comparable attenuating material;
- b) flanges and attachments of the TLPR equipment shall provide the necessary microwave sealing by design;
- c) sight glasses shall be coated with a microwave proof coating when necessary (i.e. electrically conductive coating);
- d) manholes or connection flanges at the tank shall be closed to ensure a low-level leakage of the signal into the air outside the tank;
- e) whenever possible, mounting of the TLPR equipment shall be on top of the tank structure with the orientation of the antenna to point in a downward direction;
- f) installation and maintenance of the TLPR equipment shall be performed by professionally trained individuals only.

The provider is required to inform the users and installers of TLPR equipment about the installation requirements and, if applicable, the additional special mounting instructions (e.g. by putting it in the product manual).

Annex C (informative): Measurement antenna and preamplifier specifications

The radiated measurements set-up in clause 8 specifies the use of the wide-band horn antenna and a wide-band, high gain preamplifier in order to measure the very low radiated power density level from the EUT mounted in a metallic tank.

Table C.1 give examples of minimum recommended data and features for the horn antenna and preamplifier to be used for the test set-up.

Table C.1: Recommended minimum performance data for preamplifier and antenna

| Pre-amplifier | | | | | |
|--|-------------------|------------------|------------------|------------------|-------------------|
| Bandwidth | 0,1 GHz to 26 GHz | 26 GHz to 40 GHz | 40 GHz to 60 GHz | 50 GHz to 75 GHz | 75 GHz to 110 GHz |
| Noise figure | < 3 dB | < 3 dB | < 6 dB | < 5 dB | < 5,5 dB |
| Output at 1 dB compression | 5 dBm | 8 dBm | 0 dBm | -1 dBm | -8 dBm |
| Gain | 27 dB | 25 dB | 18 dB | 17 dB | 15 dB |
| Gain flatness across band | ±2,5 dB | ±2,5 dB | ±2,5 dB | ±3 dB | ±5 dB |
| Phase response | Linear | Linear | Linear | Linear | Linear |
| VSWR in/out across band | 2,5:1 | 2:1 | 2,75:1 | 2,5:1 | 2,5:1 |
| Nominal impedance RF Connector or waveguide size | 50 Ω | 50 Ω | WR19 | WR15 | WR10 |

| Antenna | | | | | |
|-----------------------------------|---------------------------|------------------|------------------|------------------|-------------------|
| Type of Antenna | Log. Periodic/Horn | Horn | Horn | Horn | Horn |
| Bandwidth | 0,1 GHz to 26 GHz | 26 GHz to 40 GHz | 40 GHz to 60 GHz | 50 GHz to 75 GHz | 75 GHz to 110 GHz |
| Gain | 8,5 dBi | 15 dBi | 24 dBi | 24 dBi | 24 dBi |
| Nominal Impedance | 50 Ω | 50 Ω | 50 Ω | 50 Ω | 50 Ω |
| VSWR across band | < 2,5:1 | < 1,5:1 | < 1,5:1 | < 1,5:1 | < 1,5:1 |
| Connector or waveguide connection | PC 3,5 (SMA) | PC 2,4 (K) | WR19 | WR15 | WR10 |

Measuring the complete emission spectrum, several measurement antennas will be required, each optimized over a distinct frequency range:

Table C.2: Recommended measurement antennas

| Antenna type | Frequency range |
|--------------------------------------|------------------------|
| $\lambda/2$ - dipole or biconical | 30 MHz to 200 MHz |
| $\lambda/2$ - dipole or log periodic | 200 MHz to 1 000 MHz |
| Horn | > 1 000 MHz |

Annex D (informative): Electromagnetic leakage from a EUT

D.1 General

EUT is defined as a tank with an installed TLPR.

The most common mounting of a TLPR is a flange on a top of a tank with the antenna lobe pointing downwards (in order to allow the vertical line to be contained within the main lobe of the antenna). The main part of the discussion below is around leakage of the radar frequency and its harmonics but leakage at lower frequency (clock frequencies, etc.) is measured as a part of the EMC-testing.

D.2 Survey of sources of leakage

Generally, the electromagnetic leakage measured outside the EUT can conceptually be divided as coming from four sources:

- 1) Leakage from the TLPR enclosure and cabling including components measured in a standard EMC test. Most leakage here is at frequencies below the radar frequency.
- 2) Leakage around the mounting flange of the TLPR. Typically, this is the dominating part of the total leakage for the radar frequency and its harmonics as there will be comparatively strong fields close to the antenna. The flange gasket typically allows some leakage. Frequencies far below radar frequency have small possibilities to be radiated by the radar antenna.
- 3) Leakage through other flanges on the tank than the mounting flange of the TLPR. The radar beam will bounce around inside the tank, be scattered and soon absorbed by the tank content or the tank walls. Some scattered radar beam may hit other flanges. However, the bigger the tank the less leakage will occur. This can be understood by a comparison between the areas of the flange gasket (as seen from the inside) with the total area of the inside of the tank.
- 4) Leakage through the tank wall. For a metal tank this is negligible as the attenuation through a metal is 5 dB to 10 dB per μm . For a tank made of concrete with or without reinforcement the attenuation in the wall, according to experience, make the leakage negligible. This is explained by the thickness of the material and the high attenuation not the least due to the natural moisture content in the concrete.

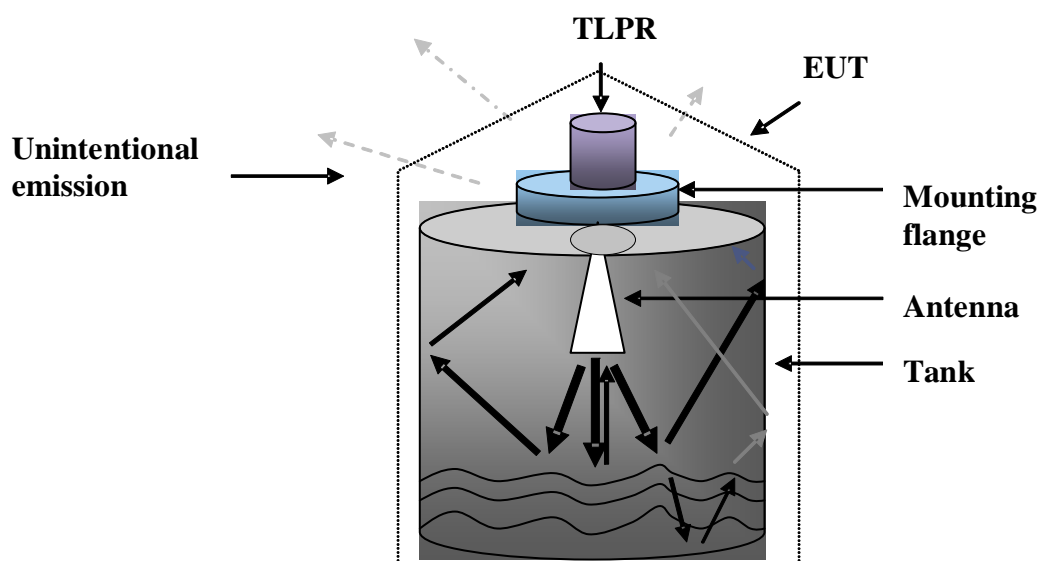

Figure D.1: A typical unintentional emission pattern from the EUT

Thus, the total leakage outside of the tank will have the character of a diffuse leakage with small directivity. During the test procedure the total leakage can be measured essentially following standard EMC-procedures (with extended frequency range) searching for the direction of maximum radiation where the e.i.r.p. is measured.

Annex E (normative): Requirements on Test Tank

The following requirements shall apply for a test tank:

- The test tank material shall be metal to demonstrate worst case for resonances and any unwanted tank radiation leakage.
- Test tank shall provide at least one mechanical connection for installing the TLPR. The method of mounting including the recommended product sealing used during the measurement shall be described in the Test report.
- The test tank shall be of cubic or cylinder shape with height/diameter ratio of 2 to 3 and volume shall not exceed 500 litres to demonstrate worst case power density inside the tank.

It shall be noted:

The dimension of a real-life tank is several orders of magnitude larger than the wavelength and thereby minimizes any resonance effect in the tank. The TLPR providers have not experienced high narrow band resonance effects for test tanks.

The test tank specified is used as a worst-case scenario for measuring the total emission outside the tank including the flange coupling and/or any potential tank resonance.

Annex F (informative): Practical test distances for accurate measurements

F.1 Introduction

Conventional antenna-pattern measurement practice may imply impossible distances for accurate measurements. For this purpose, a lower distance limit is discussed. When measuring outside of the tank smaller distances can be used without loss of accuracy as long as the measurements are restricted to maximum power or amplitude.

F.2 Conventional near-field measurements distance limit

A measurement of radiated power is made in front of an antenna. If the measurements are made too close to an antenna this will result in erroneous power readings. To avoid this, a minimum distance for antenna pattern measurements in an anechoic chamber should be in accordance with table F.1.

Table F.1: Uncertainty contribution: range length (test methods)

| Range length (i.e. the horizontal distance between phase centres) | Standard uncertainty of the contribution |
|---|--|
| $(d_1 + d_2)^2/4\lambda \leq \text{range length} < (d_1 + d_2)^2/2\lambda$ | 1,26 dB |
| $(d_1 + d_2)^2/2\lambda \leq \text{range length} < (d_1 + d_2)^2/\lambda$ | 0,30 dB |
| $(d_1 + d_2)^2/\lambda \leq \text{range length} < 2(d_1 + d_2)^2/\lambda$ | 0,10 dB |
| $\text{range length} \geq 2(d_1 + d_2)^2/\lambda$ | 0,00 dB |
| NOTE: d_1 and d_2 are the maximum dimensions of the EUT and the test antenna used in one stage and are the maximum dimensions of the two antennas in the other stage. | |

Two or even four times distance reduction may be applied. A further reduction will cause severe decrease of the accuracy. Further information can be found in TS 103 051 [i.3].

F.3 Near-field conditions outside a test tank

Like any radiating structure, the outside of a test tank has an equivalent antenna gain G (with corresponding directivity). A well-focused antenna may have a small physical area, while a less effective radiating structure, with a larger area, may give the same gain. In the case of a low directivity radiator (such as a closed tank containing a TLPR), the gain seldom exceeds 10 dBi. Assuming a minimum test distance of $2 G\lambda/\pi^2$ (or $0,2 G\lambda$), the minimum distance is therefore between one and only a few wavelengths. This is not a practical limitation for radar frequencies and in any case far below the nominal EMC measuring distance of 3 m. In many practical cases the low leakage outside of the tank makes it necessary for sensitivity reasons to measure at much smaller distance than 3 m and this will not cause accuracy problems as the product $0,2 G\lambda$ hardly ever will exceed 0,1 m in practical TLPR test cases.

Annex G (normative): Range of modulation parameters

G.1 Pulse modulation

G.1.1 Definition

For pulse modulation, the Tx "amplitude" is periodically switched on for a short time (called pulse duration) and switched off during the subsequent reception period. A typical example is shown in figure G.1.

The time between the rising edges of the pulsed output power is called the Pulse Repetition Interval (PRI). The PRI may vary between subsequent pulses, in which case the modulation is called staggered PRI.

The Pulse Repetition Frequency (PRF) is the inverse of the PRI averaged over a time sufficiently long to cover all PRI variations.

The duty cycle is the product of the PRF and the pulse duration.

The radiated power averaged over the pulse duration is called the peak output power.

The peak output power multiplied by the average duty cycle is called the average output power.

Subsequent pulses may be on different frequencies (i.e. stepped frequency).

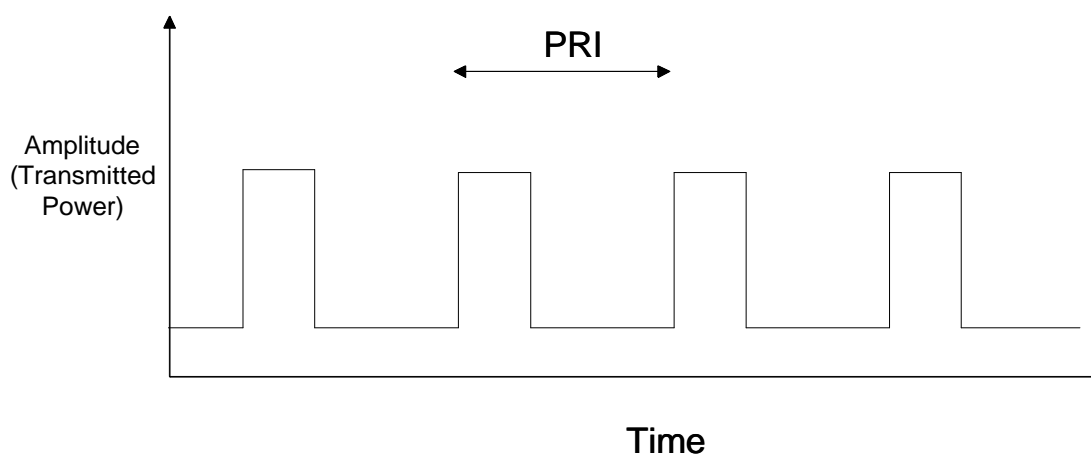

Figure G.1: Typical pulse modulation scheme

The duty cycle defined here is also sometimes referred to as "duty cycle resulting from modulation" in some sources dealing with UWB devices. This duty cycle is important for defining the relation between mean and peak power of transmitter. The Duty Cycle described above but also the additional consideration on Activity Factor (DU) are the terms used to completely describe different activity levels of TLPR devices. This additional DU defined here is also sometimes referred to as "duty cycle resulting from user" in some sources dealing with UWB devices:

- Activity Factor (DU) - is the ratio of active measurement periods (bursts, sweeps, scans) within the overall repetitive measurement cycle, i.e. $T_{\text{meas}}/T_{\text{meas_cycle}}$.

The DU as well as spreading of subsequent pulses on different frequencies can be used as additional mitigation technique.

G.1.2 Operating parameters

The average (RMS) power limits are given in clauses 8.2.3 and 8.3.3. Operating parameters are given in table G.1.

Table G.1: Operating parameters for pulse modulation

| Parameter | Value |
|------------------------|------------------------------|
| PRF | shall not exceed 5 MHz |
| PRI | shall be 0,2 μ s or more |
| Pulse length (typical) | 1,5 ns |

Examples of DX and DU values for various types of previously existing TLPR devices are shown below in table G.2.

Table G.2: AF examples for various TLPR types

| | Pulsed TLPR | |
|-------|-------------|--|
| DX, % | 0,05 to 1 | |
| DU, % | 0,5 to 50 | |

G.2 Frequency modulated continuous wave

G.2.1 Definition

For FMCW, FH, FSK, stepped frequency hopping or similar carrier based modulation schemes, it is important to describe the modulation parameters in order to ensure that the right settings of the measuring receiver are used. Important parameters are the modulation period, deviation or dwell times within a modulation period, rate of modulation (Hz/s).

For Frequency Modulated Continuous Wave (FMCW) modulation, the transmitted waveform is frequency modulated over a period of time (P). This period of time may be constant, or may be varied. An example of a typical modulation scheme is shown in figure G.2. During the time (P), the frequency may either increase or decrease. The modulation may assume (but is not limited to) the form of a "saw tooth", "triangular" or a "sinusoidal" waveform. Also a constant frequency may be maintained and transmitted during one or more periods of time. Furthermore, the transmitted power may be switched off during one or more periods of time (e.g. Frequency Modulated Interrupted Continuous Wave (FMCW)). The modulation waveform may be repeated or varied over several periods of time, and at the beginning or end of each period of time (P), there may be a time "G" (the "blanking period") where the transmitted waveform is adjusting to the requirements of the beginning of the next period.

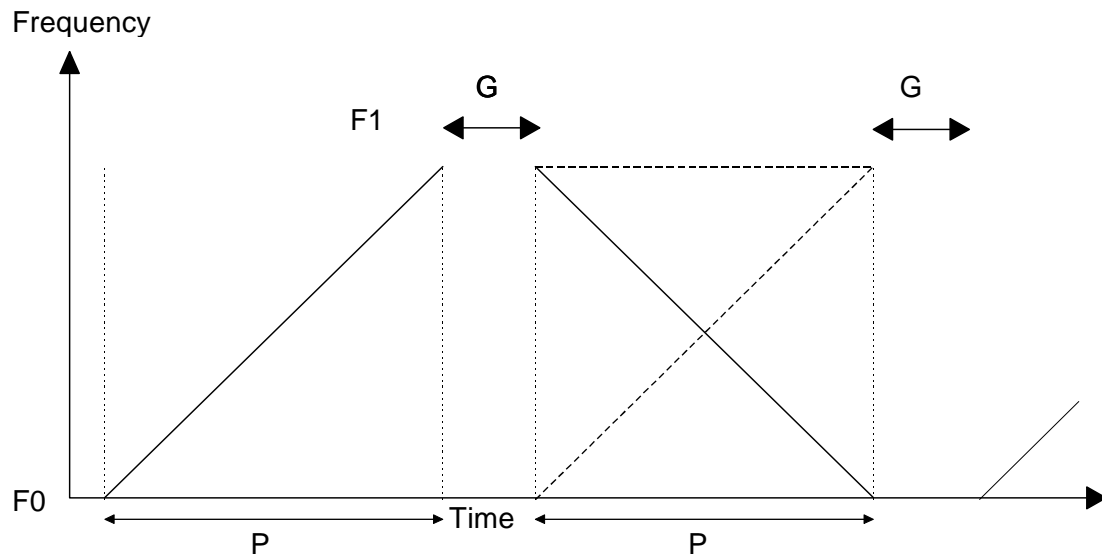

Figure G.2: Typical FMCW modulation scheme

G.2.2 Operating parameters

The peak and average (RMS) power limits are given in clauses 8.2.3 and 8.3.3. Operating parameters are given in table G.3.

Table G.3: operating parameters for FMCW modulation

| Parameter | Minimum Limit | Maximum Limit |
|--|---------------|---------------|
| Frequency deviation in one period | 0 Hz | 4 000 MHz |
| Rate of frequency modulation during a period (t_p) | 0 Hz/ms | 800 MHz/ms |
| Period of time for modulation (t_p) | 50 μ s | 400 ms |

Annex H (informative): Atmospheric absorptions and material dependent attenuations

In the frequency range between 40 GHz and 246 GHz the specific absorptions and material attenuations are an important factor for the compatibility of the different services potentially sharing the same operational band. In this annex an overview over the relevant parameters will be given for different materials and the atmospheric absorption.

H.1 Atmospheric absorptions

With higher frequencies the effect of the atmospheric absorption gets more and more important in the investigation of the coexistence behaviour of short range wireless systems. In figure H.1 the specific absorption in the band between 1 GHz and 350 GHz is depicted. The diagram shows the absorption behaviour of dry air, of H₂O and the combination of both. It can be seen that under normal conditions the absorption due to H₂O is the most significant effect. Only in two spectral regions around 60 GHz and 120 GHz the dry air already shows a very significant absorption behaviour. That means these absorptions are independent of the amount of H₂O in the air. Especially the absorption peak around 60 GHz will be used to increase the isolation behaviour between different wireless systems. The absorption peak around 60 GHz originates from several oxygen absorption lines. A more detailed description of the behaviour around 60 GHz is depicted in figure H.2 for different altitudes between 0 km (see level) and 20 km. Especially the 20 km diagram shows nicely the different absorption lines. The absorption peak around 60 GHz reaches 16 dB/km.

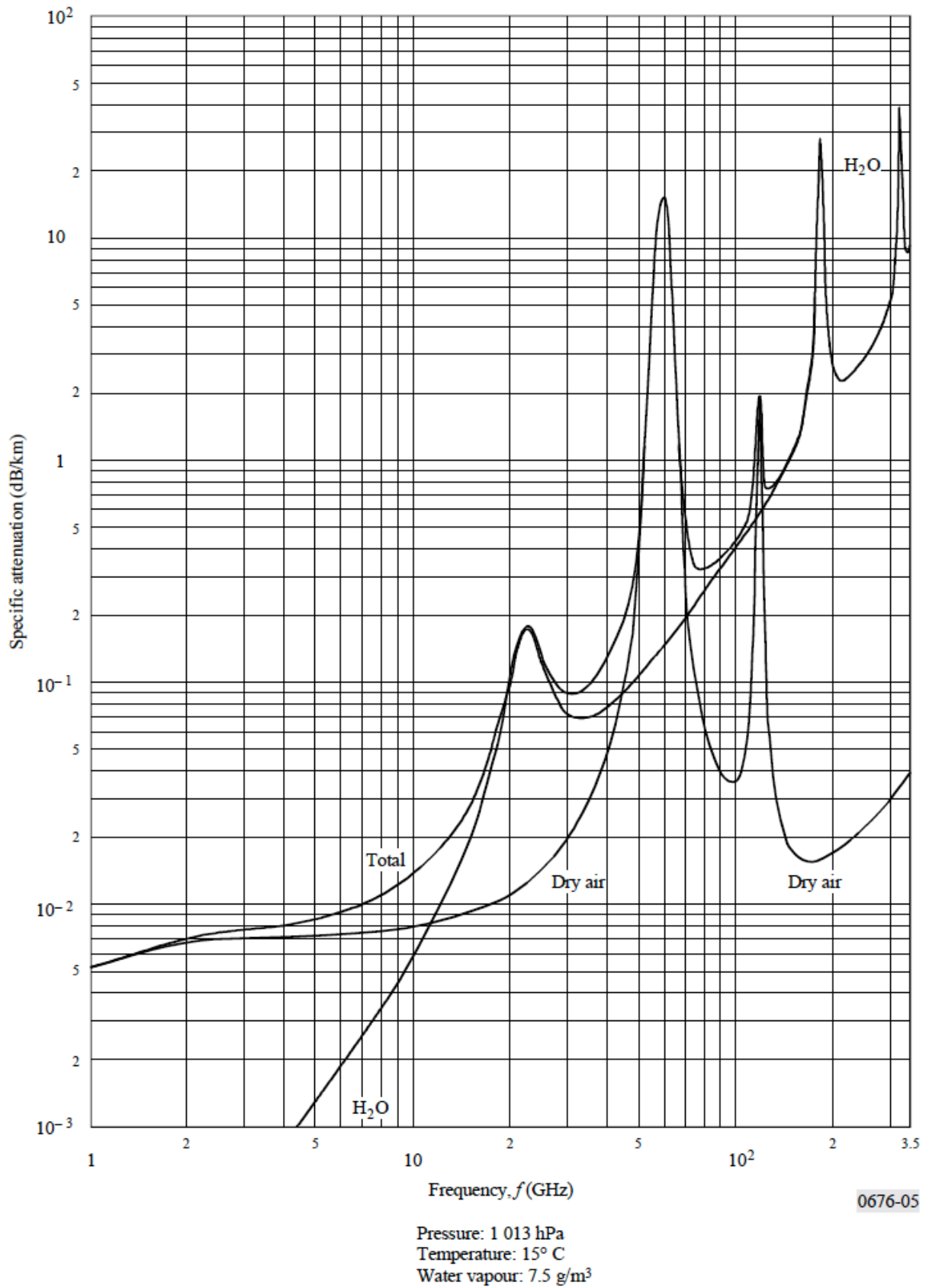

Figure H.1: Specific attenuation due to atmospheric gases in the band 1 GHz to 350 GHz in dB/km

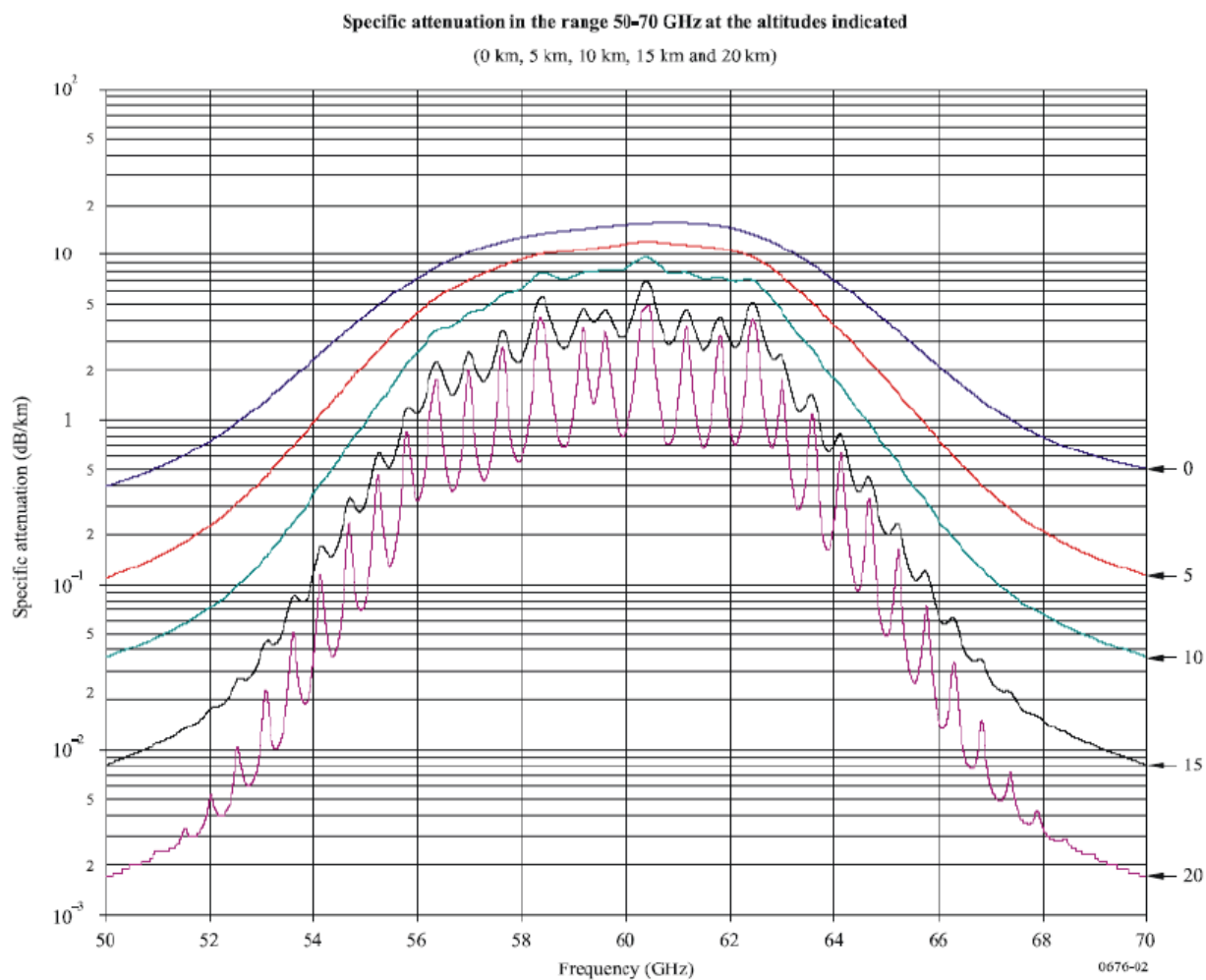

Figure H.2: Specific Atmospheric attenuation in the band 50 GHz to 70 GHz for different altitudes (0 km, 5 km, 10 km, 15 km and 20 km) [i.6]

H.2 Material dependent attenuations

The material dependent attenuation does also increase with the operational frequency. Typical attenuations for different materials are depicted in figure H.3 for the frequency range between 3 GHz and 200 GHz. These effects are important when coexistence scenarios are investigated between indoor and outdoor systems.

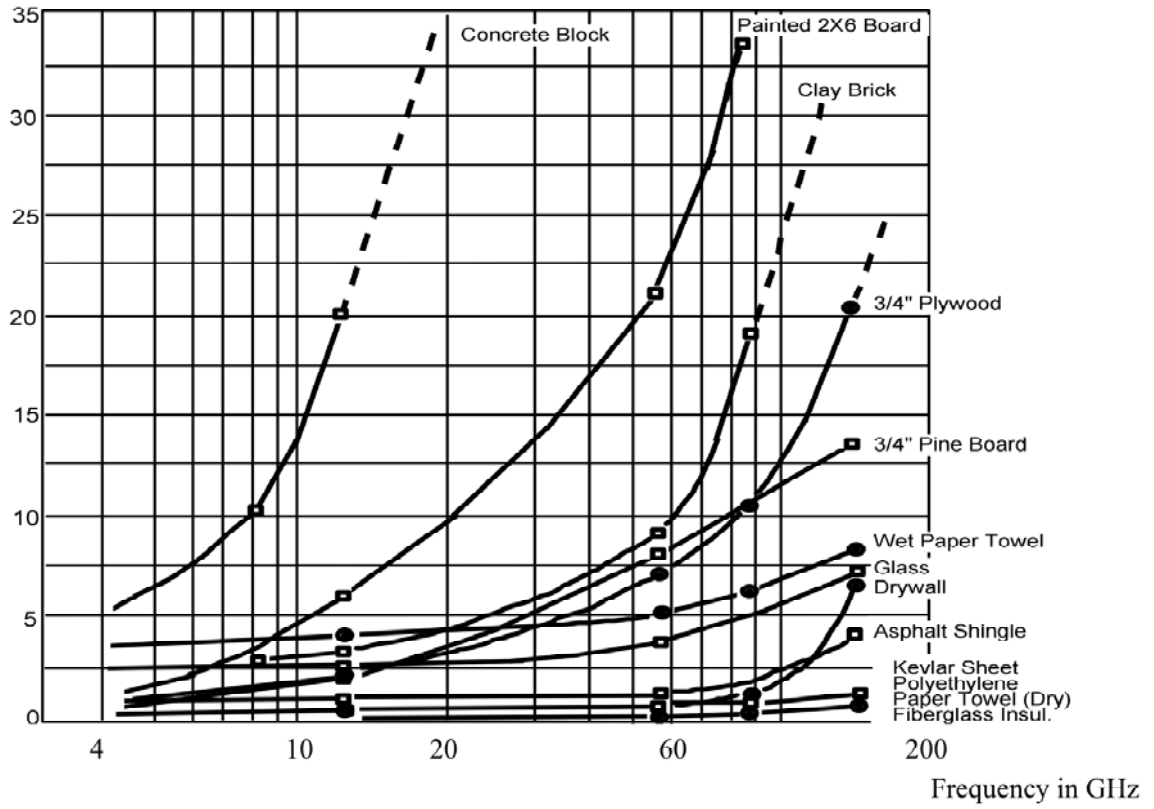

Figure H.3: Material Absorption at High Frequency in the frequency range from 3 GHz to 200 GHz in dB

History

| Document history | | |
|-------------------------|---------------|--|
| V1.1.1 | April 2006 | Publication |
| V1.2.1 | August 2010 | Public Enquiry PE 20101214: 2010-08-16 to 2010-12-14 |
| V1.2.1 | December 2010 | Vote V 20110219: 2010-12-21 to 2011-02-21 |
| | | |
| | | |