

Final draft **ETSI EN 302 326-2** V1.2.1 (2007-01)

Harmonized European Standard (Telecommunications series)

**Fixed Radio Systems;
Multipoint Equipment and Antennas;
Part 2: Harmonized EN covering the essential requirements
of article 3.2 of the R&TTE Directive
for Digital Multipoint Radio Equipment**



Reference

REN/TM-04170-2

Keywords

access, antenna, DFRS, DRRS, FWA, multipoint,
radio, system

ETSI

650 Route des Lucioles
F-06921 Sophia Antipolis Cedex - FRANCE

Tel.: +33 4 92 94 42 00 Fax: +33 4 93 65 47 16

Siret N° 348 623 562 00017 - NAF 742 C
Association à but non lucratif enregistrée à la
Sous-Préfecture de Grasse (06) N° 7803/88

Important notice

Individual copies of the present document can be downloaded from:

<http://www.etsi.org>

The present document may be made available in more than one electronic version or in print. In any case of existing or perceived difference in contents between such versions, the reference version is the Portable Document Format (PDF). In case of dispute, the reference shall be the printing on ETSI printers of the PDF version kept on a specific network drive within ETSI Secretariat.

Users of the present document should be aware that the document may be subject to revision or change of status. Information on the current status of this and other ETSI documents is available at

<http://portal.etsi.org/tb/status/status.asp>

If you find errors in the present document, please send your comment to one of the following services:

http://portal.etsi.org/chaicor/ETSI_support.asp

Copyright Notification

No part may be reproduced except as authorized by written permission.
The copyright and the foregoing restriction extend to reproduction in all media.

© European Telecommunications Standards Institute 2007.
All rights reserved.

DECTTM, **PLUGTESTS**TM and **UMTS**TM are Trade Marks of ETSI registered for the benefit of its Members.
TIPHONTM and the **TIPHON logo** are Trade Marks currently being registered by ETSI for the benefit of its Members.
3GPPTM is a Trade Mark of ETSI registered for the benefit of its Members and of the 3GPP Organizational Partners.

Contents

Intellectual Property Rights	6
Foreword.....	6
0 Introduction	7
0.1 General	7
0.2 Relationship with the R&TTE essential requirements	7
1 Scope	9
1.1 General	9
1.2 Classification of equipment	10
1.3 Profiles	10
1.3.1 General.....	10
1.3.2 Equipment profiles.....	10
1.3.3 Antenna profiles.....	12
1.3.4 System profiles	13
1.4 Frequency ranges.....	13
1.5 Access methods	13
1.6 Other relevant system characteristics	14
1.7 Bit rates	14
2 References	15
3 Definitions, symbols and abbreviations	16
3.1 Definitions	16
3.2 Symbols.....	19
3.3 Abbreviations	19
4 RF reference architecture	20
5 Technical requirements specifications	21
5.1 General	21
5.2 Environmental profile.....	22
5.3 Transmitting phenomena.....	22
5.3.1 General.....	22
5.3.2 Transmitter output power.....	23
5.3.2.1 General	23
5.3.2.2 Maximum power	23
5.3.2.3 Output power tolerance	23
5.3.3 Transmitter output frequency error/stability (output frequency tolerance).....	24
5.3.4 Adjacent channel power.....	24
5.3.4.1 Transmitter spectrum density masks	24
5.3.4.2 Discrete (CW) spectral lines exceeding the spectrum mask (all stations).....	27
5.3.5 Transmitter spurious emissions.....	28
5.3.6 Transmitter power control (ATPC and RTPC)	29
5.3.6.1 General	29
5.3.6.2 Automatic Transmitter Power Control (ATPC)	29
5.3.6.3 Remote Transmitter Power Control (RTPC).....	29
5.3.7 Remote Frequency Control (RFC).....	29
5.3.8 Dynamic Change of Modulation Order	30
5.4 Receiving phenomena	30
5.4.1 General.....	30
5.4.2 Receiver spurious emissions	30
5.4.3 Minimum RSL	30
5.4.3.1 General	30
5.4.3.2 Single signal performance.....	30
5.4.3.3 Performance at maximum loading (EqC-PET = D only)	32
5.4.4 Interference sensitivity.....	33
5.4.4.1 Co-channel interference	33
5.4.4.2 Adjacent channel interference.....	35

5.4.4.3	CW interference	37
5.5	Special requirements for equipment with integral antennas	38
5.5.1	General.....	38
5.5.2	Radiation Pattern Envelope (Off-axis EIRP density).....	38
5.5.3	Antenna Gain	38
6	Testing for conformance with technical requirements	38
6.1	General	38
6.2	Environmental profile.....	39
6.3	Transmitting phenomena.....	40
6.3.1	General.....	40
6.3.1.1	Summary table for transmitter test conditions	40
6.3.1.2	Spectrum analyser settings.....	41
6.3.2	Transmitter output power.....	42
6.3.2.1	General	42
6.3.2.2	Maximum power	42
6.3.2.3	Nominal output power tolerance	42
6.3.3	Transmitter output frequency error/stability (output frequency tolerance).....	42
6.3.4	Adjacent channel power (transmitter spectrum density masks).....	42
6.3.4.1	Transmitter spectrum density masks	42
6.3.4.2	Discrete (CW) spectral lines exceeding the spectrum mask (all stations).....	43
6.3.5	Transmitter spurious emissions.....	43
6.3.6	Transmitter power control (ATPC and RTPC).....	44
6.3.6.1	General	44
6.3.6.2	Automatic Transmitter Power Control (ATPC)	44
6.3.6.3	Remote Transmitter Power Control (RTPC).....	44
6.3.7	Remote Frequency Control (RFC).....	45
6.3.8	Dynamic Change of Modulation Order	46
6.4	Receiving phenomena	46
6.4.1	General.....	46
6.4.2	Receiver spurious emissions	46
6.4.3	Minimum RSL	47
6.4.3.1	General	47
6.4.3.2	Single signal performance	47
6.4.3.3	Performance at maximum loading (EqC-PET = D only)	47
6.4.4	Interference sensitivity.....	47
6.4.4.1	Co-channel interference	47
6.4.4.2	Adjacent channel interference.....	48
6.4.4.3	CW interference	48
6.5	Special requirements for equipment with integral antennas	48
6.5.1	General.....	48
6.5.2	Radiation Pattern Envelope (Off-axis EIRP density).....	49
6.5.3	Antenna Gain	49

Annex A (normative):	HS Requirements and conformance Test specifications Table (HS-RTT).....	50
-----------------------------	--	-----------

Annex B (normative):	Test report in relation to flexible systems applications	52
-----------------------------	---	-----------

B.1	Wide radio-frequency band covering units specification and tests	52
B.1.1	Radio equipment	52
B.1.2	Antennas for DFRS	54
B.2	Multirate/Multiformat covering equipment specification and tests	54

Annex C (normative):	System capacity	55
-----------------------------	------------------------------	-----------

C.1	General	55
C.2	Capacity of equipment with EqC-PET = T, O or M.....	55
C.3	Capacity of equipment with EqC-PET = F	55
C.4	Capacity of equipment with EqC-PET = D.....	56

C.5	Capacity of equipment with EqC-PET = H.....	56
Annex D (informative):	Spectrum mask requirements when ATPC and/or RTPC are implemented	57
D.1	ATPC impact.....	57
D.2	RTPC Impact.....	58
Annex E (informative):	Summary Table of EqC subject to conformance declaration.....	59
Annex F (informative):	The EN title in the official languages	60
Annex G (informative):	Bibliography	61
History	62

Intellectual Property Rights

IPRs essential or potentially essential to the present document may have been declared to ETSI. The information pertaining to these essential IPRs, if any, is publicly available for **ETSI members and non-members**, and can be found in ETSI SR 000 314: "*Intellectual Property Rights (IPRs); Essential, or potentially Essential, IPRs notified to ETSI in respect of ETSI standards*", which is available from the ETSI Secretariat. Latest updates are available on the ETSI Web server (<http://webapp.etsi.org/IPR/home.asp>).

Pursuant to the ETSI IPR Policy, no investigation, including IPR searches, has been carried out by ETSI. No guarantee can be given as to the existence of other IPRs not referenced in ETSI SR 000 314 (or the updates on the ETSI Web server) which are, or may be, or may become, essential to the present document.

Foreword

This Harmonized European Standard (Telecommunications series) has been produced by ETSI Technical Committee Transmission and Multiplexing (TM), and is now submitted for the ETSI standards One-step Approval Procedure.

The present document has been produced by ETSI in response to a mandate from the European Commission issued under Council Directive 98/34/EC (as amended) laying down a procedure for the provision of information in the field of technical standards and regulations.

The present document is intended to become a Harmonized Standard, the reference of which will be published in the Official Journal of the European Communities referencing the Directive 1999/5/EC [2] of the European Parliament and of the Council of 9 March 1999 on radio equipment and telecommunications terminal equipment and the mutual recognition of their conformity ("the R&TTE Directive") [2].

Technical specifications relevant to Directive 1999/5/EC [2] are given in annex A.

This multi-part deliverable covers characteristics and requirements for fixed multipoint radio equipment and antennas using a variety of access and duplex methods and operating at a variety of bit rates in frequency bands as specified in the present document.

The present document is part 2 of a multi-part deliverable covering the Fixed Radio Systems; Multipoint Equipment and Antennas, as identified below:

- Part 1: "Overview and Requirements for Digital Multipoint Radio Systems";
- Part 2: "Harmonized EN covering the essential requirements of article 3.2 of the R&TTE Directive for Digital Multipoint Radio Equipment";**
- Part 3: "Harmonized EN covering the essential requirements of article 3.2 of the R&TTE Directive for Multipoint Radio Antennas".

The present document and EN 302 326-3 [12] are Harmonized ENs and essential requirements are those requirements which are essential under article 3.2 of the R&TTE Directive [2].

In the above, "equipment" includes equipment with integral antennas, and "antennas" include requirements for antennas whether they are integral or non-integral.

Besides its previous version V1.1.1, the present document with EN 302 326-3 [12] replaces and supersedes the harmonized EN 301 753 (see bibliography) for all MP equipment and antennas under its scope.

Proposed national transposition dates	
Date of latest announcement of this EN (doa):	3 months after ETSI publication
Date of latest publication of new National Standard or endorsement of this EN (dop/e):	6 months after doa
Date of withdrawal of any conflicting National Standard (dow):	18 months after doa

0 Introduction

0.1 General

For the general background, rationale and structure of the present document see also the clause "Introduction" in EN 302 326-1 [11].

With respect to previous version of the present document, provisions for TS omnidirectional antennas for indoor NWA applications.

0.2 Relationship with the R&TTE essential requirements

The present document is part of a set of standards developed by ETSI and is designed to fit in a modular structure to cover all radio and telecommunications terminal equipment within the scope of the R&TTE Directive [2]. The modular structure is described in EG 201 399 (see bibliography) and shown in figure 1.

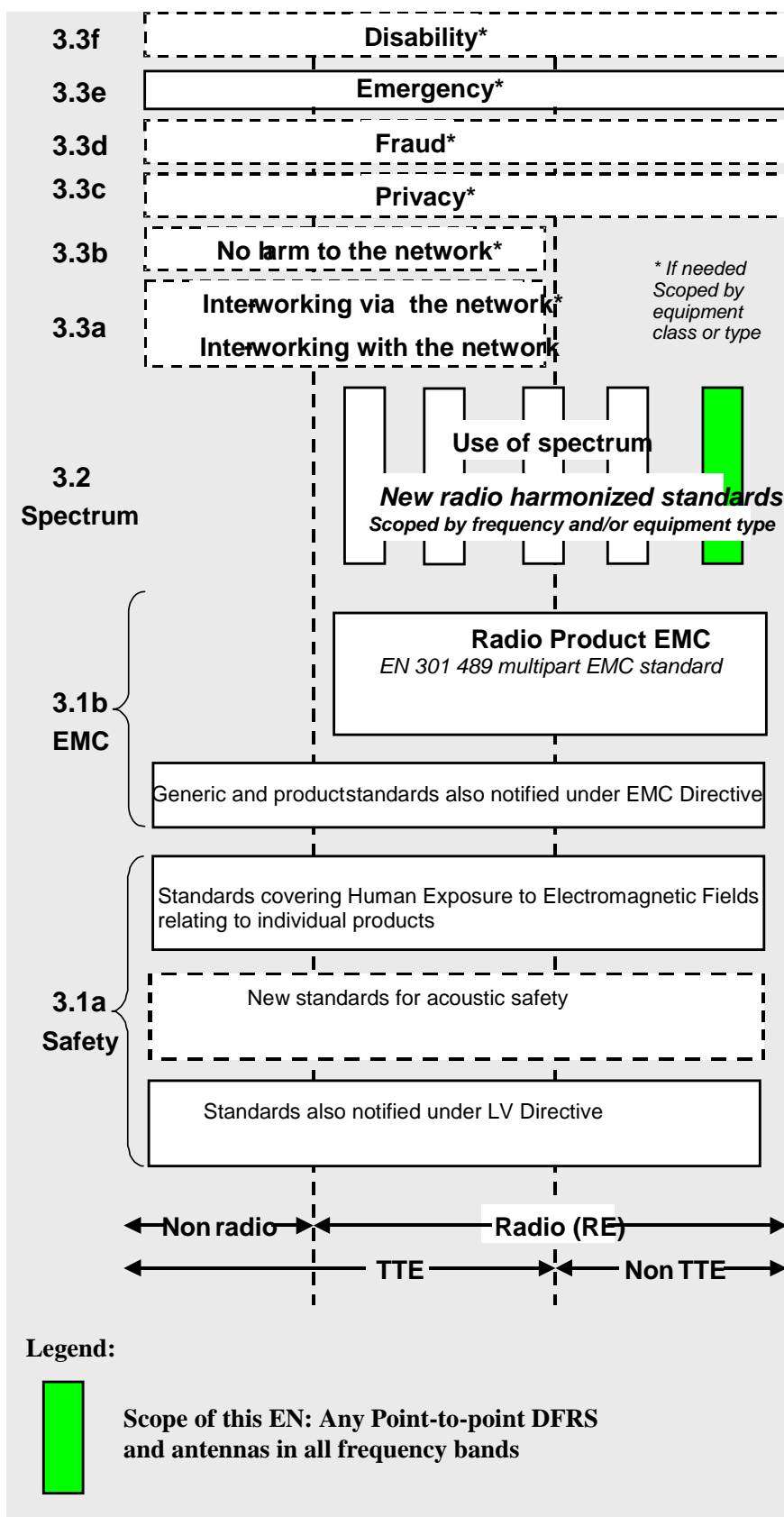

Figure 1: Modular structure for the various standards used under the R&TTE Directive [2]

NOTE: For article 3.1b the diagram shows EN 301 489 (see bibliography), the multi-part product EMC standard for radio used under the EMC Directive 89/336/EEC (see bibliography). For Fixed Radio Systems EN, EN 301 489-1 (see bibliography) and EN 301 489-4 (see bibliography) are relevant.

1 Scope

1.1 General

The present document is intended to cover the provisions of the R&TTE Directive [2] regarding article 3.2, which states that "[...] radio equipment shall be so constructed that it effectively uses the spectrum allocated to terrestrial/space radio communications and orbital resources so as to avoid harmful interference".

The present document is applicable to the essential requirements of equipment (including equipment with integral antennas) used in MultiPoint (MP) Digital Fixed Radio Systems (DFRS) (see note) intended for use in the frequency bands identified in EN 302 326-1 [11].

NOTE 1: Applications intended for offering in the bands 3,4 GHz to 3,8 GHz the option of Nomadic Wireless Access (NWA), according to the NWA definition in ITU-R Recommendation F.1399 (see bibliography), are also considered in the scope of this EN.

Besides its previous versions, The present document, together with EN 302 326-3 [12] replaces and supersedes, after a suitable transition period, the harmonized EN 301 753 (see bibliography) for all multipoint equipment and antennas under its scope.

The present document and EN 302 326-3 [12] introduce rationalization among systems conforming to previous EN 301 753 (see bibliography) referencing a number of ENs which, being developed at different times, might have specified slightly different requirements. However, care has been taken so that such variations will not affect any frequency planning assumption for already deployed networks. Therefore, unless specifically mentioned, these new requirements, whenever different from those single ENs, are considered completely "equivalent". Therefore mixed use of equipment conforming to the present document and to those previous ones will not change, in practice, any frequency planning rule in any network.

Therefore, from a strictly technical point of view, in most cases it is expected that equipment already conforming to the previous versions of Harmonized EN 301 753 (see bibliography), would not need re-assessment of essential requirements according to the present document. The legal implications of the declaration of conformity and equipment labelling are, however, outside the scope of this whole multi-part deliverable. Cases, where additional conformance assessment is anyhow required, will be specifically mentioned in the present document and also EN 302 326-3 [12].

In addition to the present document, other ENs specify technical requirements in respect of essential requirements under other parts of article 3 of the R&TTE Directive [2] and which will apply to equipment within the scope of the present document.

NOTE 2: A list of such ENs is included on the web site <http://www.newapproach.org>.

In order to (technically) cover different market and network requirements, with an appropriate balance of performance to cost and effective and appropriate use of the radio spectrum, the present document, together with EN 302 326-3 [12], offers a number of system types and antennas alternatives, for selection by administrations, operators and manufacturers dependent on the desired use of the radio spectrum and network/market requirements; those options include:

- channel separation alternatives (as provided by the relevant CEPT Recommendation);
- spectral efficiency class alternatives (different modulation formats provided in radio equipment standards);
- antenna sectorization alternatives and directivity classes for CS;
- antenna directivity class alternatives for TS and/or RS, as well as omnidirectional alternative for TS intended for Nomadic Wireless Access (NWA);
- antenna basic polarization (linear or circular).

The applicability of this whole multi-part deliverable to MP equipment is governed by the definition of a number of system profiles that define the set of consistent requirements as described in EN 302 326-1 [11] to which equipment shall conform.

The present document is considered applicable to fixed radio systems products with integral antennas, for which all the technical requirements included in the present document and in EN 302 326-3 [12] apply, and to separate equipment products, to which only the relevant technical requirements apply, and which might therefore be subject to separate declarations of conformity with respect to the essential requirements of the R&TTE Directive [2].

1.2 Classification of equipment

The present document is applicable, in principle to multipoint radio system equipment using any access method, operating in some combinations of frequency bands, equipment variations on the above access methods (referred to as secondary equipment type), equivalent modulation orders and channel separation.

The applicability of this whole multi-part deliverable to MP equipment is governed by the definition of a number of system profiles that define the set of consistent requirements (see clause 1.3) to which equipment shall conform. The supplier shall uniquely identify in the technical construction file which Equipment Classification(s) (EqC) (among those limited sets defined in clause 1.3) apply to his equipment and assess it consequently.

Those sets of parameters, relevant to article 3.2 of the R&TTE Directive [2], have been derived from a set of previous ENs that historically included only parameters derived from a finite number of combinations of basic system characteristics.

However, from the article 3.2 of R&TTE Directive [2] point of view, it is not required that the systems to be assessed physically conform to a specific system description. It is, however, necessary that the equipment should conform to a consistent set of parameters as designated in the present document. The set of parameters for conformance shall be indicated by the supplier, according to the classification method described in annex A to EN 302 326-1 [11].

The basic system characteristics are described in the introduction of EN 302 326-1 [11].

1.3 Profiles

1.3.1 General

This whole multi-part deliverable allows many distinct types of equipment, several different antenna types and several ways in which they might be interconnected to form a network. However, within this whole multi-part deliverable these are restricted to certain combination of attributes and these combinations of attributes are called "profiles". The following clauses address:

- Equipment profiles.
- Antenna profiles.
- System profiles.

1.3.2 Equipment profiles

The applicability of the present document is limited to alternative consistent sets of recommendations and requirements, each for identified equipment profiles, which are defined in terms of their Equipment Classification (EqC) which classify equipments in terms of key characteristics. The profiles (or indeed any specific equipment) within the scope of this whole multi-part deliverable may be classified as discussed in normative annex A of EN 302 326-1 [11] in terms of the various fields of EqC, which are:

- Frequency Range (EqC-FR);
- Primary Equipment Type (EqC-PET);
- Secondary Equipment Type (EqC-SET), (where needed to distinguish variants of EqC-PET);
- Equivalent Modulation Order (EqC-EMO);
- Channel separation (EqC-ChS) - or range of separations;
- Station type (EqC-STN).

Table 1 shows the complete list of equipment profiles within the scope of this multi-part deliverable in terms of the allowed values (or ranges of values) of the various fields of EqC. The manufacturer shall indicate, in the Technical Construction File or elsewhere, the profile that the specific equipment shall comply with, by defining the values of those fields of EqC shown in table 1 that are applicable to the equipment. The equipment shall then comply with *all* requirements in EN 302 326-1 [11] and the present document relevant to that EqC.

In the case of asymmetric MP implementations (see clause 1.6 of EN 302 326-1 [11]), the supplier shall identify separately the profiles of the equipment in the two alternate directions in terms of the various EqC fields, and the present document shall apply independently to each direction.

Table 1: Equipment Profiles within the scope of this multi-part deliverable defined by their Equipment Classification (see notes 1 and 2)

EqC-FR Frequency Range (Basic ranges) (note 7)	EqC-PET Primary Equipment Type (note 3)	EqC-EMO Equivalent Modulation Order (note 4)	EqC-SET Secondary Equipment Type (note 5)	EqC-ChS Channel Separation (MHz) (Basic Ranges) (note 6)
< 1 GHz	T	2	QP, DQ, or GM	No restriction
	O	2, 4, 6	DM or MA	No restriction
	F (note 8)	2, 3, 4	Null	No restriction
	D	Not applicable	OR or PR	3,5 to 20
	H	Not applicable	Null	1 to 14
1 GHz to 3 GHz	T	1,2	Null	1,75 to 4
	O	2, 4, 6	DM or MA	1,75 to 14
	F (note 8)	2,3,4	Null	1 to 14
	D	Not applicable	OR or PR	3,5 to 14
	H	Not applicable	Null	1 to 14
3 GHz to 11 GHz	T	2	Null	0,025 to 30
			HC	1,75 to 30
			LC	0,025 to < 2
		4	Null	0,025 to 30
	O	6	Null	1,75 to 30
		2, 4	DM or MA	0,025 to 30
	F (note 8)	6	DM or MA	1,75 to 30
		2, 3, 4	Null	1 to 30
	D	Not applicable	OR or PR	1 to 30
			Null	1 to 30
24,25 GHz to 29,5 GHz	T	2	Null or HC	3,5 to 112
		4,6	Null	3,5 to 112
	M	2, 4, 6	Null	3,5 to 112
	F (note 8)	2, 3, 4, 6	Null	3,5 to 112
	D	Not applicable	OR or PR	3,5 to 112
31,0 GHz to 33,4 GHz	T	2, 4, 6	Null	3,5 to 56
	M	2, 4, 6	Null	3,5 to 56
	F (note 8)	2, 3, 4	Null	3,5 to 56
NOTE 1: A description of the fields of EqC appears in annex A of EN 302 326-1 [11], and the relationship between EqC fields and the previous equipment types described in the superseded ENs appears in annex B of EN 302 326-1 [11].				
NOTE 2: In the earlier standards a number of system types were defined (e.g. A, B, C, etc.). Annex B of EN 302 326-1 [11] indicates the relationship between the earlier system types and the present EqC.				
NOTE 3: Although EqC-PET historically has a relationship with a specific multiple access method, any access method, or combination of access methods, may be used provided that the entire set of requirements relevant to article 3.2 of the R&TTE Directive [2] in the present document and, if desired, also other complimentary requirements in EN 302 326-1 [11] are met for the stated EqC-PET value.				
NOTE 4: In the EqC-EMO column, the reference made to the modulation order is only indicative, and any equivalent modulation scheme is allowed provided that the whole set of requirements relevant to article 3.2 of the R&TTE Directive [2] in the present document and, if desired, also other complimentary requirements in EN 302 326-1 [11] are met for the manufacturer's stated EqC-EMO value. For mixed-mode systems EqC-EMO=1 might also be provided, among other more efficient EMO, within the same channel separations.				

NOTE 5:	For certain primary equipment types (EqC-PET) it has historically been necessary to sub-divide the equipments according to further characteristics which have different consistent sets of requirements. Although no longer tied to specific characteristics, this subdivision is reflected in Secondary Equipment Type (EqC-SET) classifications which are represented by various two-letter codes. (See annex A of EN 302 326-1 [11]).
NOTE 6:	The EqC-ChS column indicates range of ChS values for which the present document is applicable. Several parameters in the present document are given for discrete values of ChS only. For intermediate ChS values, methods are given for deriving the required characteristics with the default being by interpolation between the two nearest adjacent ChS values.
NOTE 7:	The EqC-FR column represents the basic frequency range for which the present document is applicable. For assessment purpose the specific frequency band of the equipment/antenna operation should be defined (e.g. EqC-FR = 3,5 or EqC - FR = 3,4 - 3,6) according to the assessment rules for wide band equipment and antennas defined in annex B of the present document.
NOTE 8:	Systems of EqC-PET = H, implementing an actual FH-CDMA access method with hopping period exceeding 400 ms, are not considered within the scope of the present document.

For defining the coherent set of essential test suites for conformity assessment, a number of declared EqC codes and other parameters are needed as declaration from the supplier. Standing the considerable number of possibilities under the scope of the present document summarized in table 1 and, for systems with integral antennas in table 3, it is recommended to consider the production of a summary table, such as table E.1 proposed in informative annex E, to be attached as header of the technical construction file and/or test documentation for aid the correct identification of the equipment/system profile by any interested third party.

1.3.3 Antenna profiles

According to their characteristics, multipoint systems use different types of antennas as indicated in clause 1.3.4. Table 2 outlines the multipoint antenna types described in EN 302 326-3 [12].

Table 2: Antenna Types

Frequency Range	Types	Polarization	Notes
1 GHz to 3 GHz	Directional Sectored single beam Omni directional	Linear	The sectored and omni directional antennas may have a symmetric or asymmetric radiation pattern in the elevation plane.
3 GHz to 11 GHz	Directional Sectored single beam Sectored multibeam (up to 5,9 GHz only) Omni directional	Linear	The sectored single and omni directional antennas may have a symmetric or asymmetric radiation pattern in the elevation plane. The sectored multi beam antennas have a symmetric radiation pattern only.
1 GHz to 11 GHz	Directional Sectored single beam Omni directional	Circular	The sectored and omni directional antennas may have a symmetric or asymmetric radiation pattern in the elevation plane.
24,25 GHz to 30 GHz	Directional Sectored single beam	Linear	
30 GHz to 40,5 GHz	Directional Sectored single beam Omni directional	Linear	The omni directional antennas may have a symmetric or asymmetric radiation pattern in the elevation plane.

The present document is applicable to multipoint radio system antennas of both linear (single or dual) polarization and circular (single or dual) polarization. Linear polarization antennas may support either or both of two mutually perpendicular planes of polarization. These planes are frequently, though not always, horizontal and vertical. Circular polarization antennas may support either right hand or left hand polarization or, for dual polarization, both.

The RPE directional characteristics and polarization characteristics (co-polar and cross-polar and for either linear or circular polarized antennas) impact the interference considerations in network planning. A number of antenna options are defined in EN 302 326-3 [12] to allow a trade-off between highly demanding RPE directivity and the cost/size/weight of the antennas. The antenna choice should take into account the constraints of present and future networks requirements and constraints.

Annex B of EN 302 326-3 [12] discusses Antenna Profiles for multipoint systems.

1.3.4 System profiles

This multi-part deliverable applies only to Multipoint systems using the following antenna type to station type combinations according to whether the network topology is P-MP or MP-MP (Mesh). Table 3 indicates which system profiles are within the scope of this multi-part deliverable.

**Table 3: System Profiles within the scope of this multi-part deliverable:
Antenna types - Station types combinations**

Network topology	Station types	Antenna types		
		Omni directional	Sectored	Directional
P-MP	Central Station (CS)	Yes	Yes (see note 1)	No (see note 1)
	Repeater Station (RS)			
	Facing CS Facing TS or further RS	No Yes	No Yes	Yes Yes
	Terminal Station (TS)	Yes (see note 2)	No	Yes
MP-MP	Repeater Station (RS)	No	No	Yes

NOTE 1: Sectored antennas with beamwidth < 15° shall conform to the specification otherwise applicable to a directional antenna.

NOTE 2: Omnidirectional TS antennas are limited to typically indoor deployment (e.g. desk antennas) for NWA applications in 3,4 GHz to 3,8 GHz bands. Nor outdoor deployable at fixed location, neither integral to handheld TS, are considered antennas within the scope of this multi-part deliverable.

1.4 Frequency ranges

The present document is applicable to multipoint radio systems operating in bands allocated to Fixed Service and assigned by national regulations to MP applications, at the date of publication of the present document, within the following frequency ranges:

- 30 MHz to 11,00 GHz.
- 24,25 GHz to 29,50 GHz.
- 31,00 GHz to 33,40 GHz.

NOTE: Attention is drawn to the fact that the specific operating bands are subject to CEPT or national licensing rules.

Currently applicable Fixed Service bands and channel plans are described in EN 302 326-1 [11], although the applicability of these Fixed Service bands is at the discretion of the national administrations and it is intended that this whole multi-part deliverable shall be applied only to frequency bands which are co-ordinated, whether such co-ordination is on a national or CEPT basis.

Antenna characteristics are not specified at frequencies below 1,0 GHz. Therefore, for either non-integral antennas below this limit or for equipment with integral antennas below this limit, the present document and EN 302 326-3 [12] are not sufficient for the Declaration of Conformity, according to article 3.2 of the R&TTE Directive [2], and additional essential test suites for antenna requirements shall be agreed with the Notified Body.

1.5 Access methods

The present document is applicable, in principle, to multipoint radio system equipment using any access method.

From the article 3.2 of R&TTE Directive [2] point of view, it is not required that any specific multiplexing or multiple access technique be declared.

However, it may be noted that a number of consistent system profiles are required to assess equipment of different technical characteristics. These profiles replace the technology dependent classification in earlier standards, but do not now imply any particular implementation. In general, the Equipment Classification Primary Equipment Type (EqC-PET) replaces the earlier concept of differentiation by access method.

The supplier shall uniquely identify in the technical construction file which Equipment Classification(s) (EqC) (among those limited sets defined in clause 6 and annex A of EN 302 326-1 [11]) apply to his equipment and assess it consequently.

1.6 Other relevant system characteristics

Equipment using either Frequency Division Duplex (including H-FDD) or Time Division Duplex is within the scope of the present document. For the purpose of declaring conformity with the EN it is not necessary for the supplier to declare neither the duplex method used nor the duplex frequency separation in the case of FDD. However, such information will need to be known by third parties undertaking tests to demonstrate compliance. Furthermore, as indicated above, National Regulatory Authorities may restrict applicable duplex methods and FDD frequency separation through interface regulations.

Equipment within the scope of the present document may be intended to be configured with other equipment in a system to form any multipoint architecture, typically either Point-to-Multipoint or Multipoint-to-Multipoint (also referred to as Mesh). Such architectures are illustrated in EN 302 326-1 [11].

In general, P-MP systems will use corresponding multiplexing methods and multiple access methods in both CS-transmit and CS-receive directions, but nothing in the present document prevents dissimilar methods being applied in the alternate directions. Likewise, different radio characteristics (such as different modulation methods, different modulation orders) may be employed in the alternate directions, potentially resulting in asymmetrical capacities and performance.

Further, some systems may be designed to operate with different channel separations in up- and down-link directions.

NOTE: This asymmetry of channel separation is not intended to cover the case (e.g. in FDMA systems) where some TSs use a subset of the channels assigned to the CS.

In all asymmetric cases, the provisions of the present document shall apply independently to the transmit and receive directions of a given equipment and a separate EqC shall be declared for each direction.

The requirements for antennas of equipment with integral antennas are addressed by the present document (by indirect reference to EN 302 326-3 [12]). Antennas which are non-integral with equipment are addressed by EN 302 326-3 [12].

As indicated above, National Regulatory Authorities may restrict certain antenna types or equipment-antenna combinations through interface regulations.

1.7 Bit rates

The scope of the present document is not restricted to any range of traffic bit rates. However, for any specific equipment type declared by the supplier (in terms of such characteristics as Primary Equipment Type, Sub-Type, Modulation order and Channel Separation, etc.), in accordance with annex A of EN 302 326-1 [11] the traffic carried will be subject to certain minimum bit rate requirements.

2 References

The following documents contain provisions which, through reference in this text, constitute provisions of the present document.

- References are either specific (identified by date of publication and/or edition number or version number) or non-specific.
- For a specific reference, subsequent revisions do not apply.
- For a non-specific reference, the latest version applies.

Referenced documents which are not found to be publicly available in the expected location might be found at <http://docbox.etsi.org/Reference>.

NOTE: While any hyperlinks included in this clause were valid at the time of publication ETSI cannot guarantee their long term validity.

- [1] CEPT/ERC/REC 74-01: "Spurious emissions".
- [2] Directive 1999/5/EC of the European Parliament and of the Council of 9 March 1999 on radio equipment and telecommunications terminal equipment and the mutual recognition of their conformity (R&TTE Directive).
- [3] ETSI EN 301 126-2-1: "Fixed Radio Systems; Conformance testing; Part 2-1: Point-to-Multipoint equipment; Definitions and general requirements".
- [4] ETSI EN 301 126-2-2: "Fixed Radio Systems; Conformance testing; Part 2-2: Point-to-Multipoint equipment; Test procedures for FDMA systems".
- [5] ETSI EN 301 126-2-3: "Fixed Radio Systems; Conformance testing; Part 2-3: Point-to-Multipoint equipment; Test procedures for TDMA systems".
- [6] ETSI EN 301 126-2-4: "Fixed Radio Systems; Conformance testing; Part 2-4: Point-to-Multipoint equipment; Test procedures for FH-CDMA systems".
- [7] ETSI EN 301 126-2-5: "Fixed Radio Systems; Conformance testing; Part 2-5: Point-to-Multipoint equipment; Test procedures for DS-CDMA systems".
- [8] ETSI EN 301 126-2-6: "Fixed Radio Systems; Conformance testing; Part 2-6: Point-to-Multipoint equipment; Test procedures for Multi Carrier Time Division Multiple Access (MC-TDMA) systems".
- [9] ETSI EN 301 126-3-2: "Fixed Radio Systems; Conformance testing; Part 3-2: Point-to-Multipoint antennas - Definitions, general requirements and test procedures".
- [10] ETSI EN 301 390: "Fixed Radio Systems; Point-to-point and Multipoint Systems; Spurious emissions and receiver immunity limits at equipment/antenna port of Digital Fixed Radio Systems".
- [11] ETSI EN 302 326-1: "Fixed Radio Systems; Multipoint Equipment and Antennas; Part 1: Overview and Requirements for Digital Multipoint Radio Systems".
- [12] ETSI EN 302 326-3: "Fixed Radio Systems; Multipoint Equipment and Antennas; Part 3: Harmonized EN covering the essential requirements of article 3.2 of the for Multipoint Radio Antennas".
- [13] ITU-R Radio Regulations.
- [14] ITU-R Recommendation F.1249: "Maximum equivalent isotropically radiated power of transmitting stations in the fixed service operating in the frequency band 25,25 - 27,5 GHz shared with the inter-satellite service".

3 Definitions, symbols and abbreviations

3.1 Definitions

For the purposes of the present document, the following terms and definitions apply:

antenna: part of the transmitting or receiving system that is designed to transmit or receive electromagnetic radiation

assigned band: frequency block or the aggregation of all RF channels assigned to a MP system

NOTE: The assigned band may consist also of several non-contiguous RF channels (see figure 2).

Automatic Transmit Power Control (ATPC): function implemented to offer a dynamic power control that delivers maximum power only during deep fading; in this way for most of the time the interference is reduced and the transmitter operates in a higher linearity mode

NOTE 1: When this function is used, the transmit power is dynamically changed with respect the propagation conditions. In principle, when ATPC is implemented, three different level of power may be identified:

- maximum available power (delivered only in conditions of deep fading);
- maximum nominal power (useable on a permanent basis when ATPC is disabled); it should be noted that this power is "nominal for the equipment" and is not to be confused with the "nominal level set link by link" by the frequency co-ordinating body. This is achieved through passive RF attenuators or use of the RTPC type 1 function;
- minimum power (delivered in unfaded conditions).

NOTE 2: Maximum nominal and maximum available power levels may be coincident or, in case of multi-state modulation formats, the maximum available power may be used to overdrive the transmitter (losing linearity but gaining fade margin when the fade conditions have already impaired the expected RBER). Performance predictions are usually made with the maximum "available power".

Central Station (CS): base station which communicates with Terminal Stations and in some cases Repeater Stations

Channel Separation (ChS): separation between the centre frequencies of neighbouring RF channels according ITU-R Recommendation F.746 (see bibliography) and used for adjacent channel interference requirements

NOTE 1: In some access methodologies the whole channel given to the system is subdivided in sub-channels for use by subsets of terminal stations; however also in this case the channel separation is still intended in the same way as the above definition (minimum continuous segment of bandwidth made available to the system).

NOTE 2: In this whole multi-part deliverable Channel Separation (ChS) is a free variable the value(s) of which the supplier declares. Limiting values of some other parameters which are requirements of the present document are expressed as functions of ChS. CEPT Recommendations and national administrations may replace restrictions on which ChS values are permitted.

DS-CDMA Full Capacity Load (FCL): maximum number of 64 kbit/s signals or equivalent which can be transmitted and received by a single CS within a specified RF-bandwidth, fulfilling given performance and availability objectives in respect to fading conditions

DS-CDMA maximum system loading: maximum possible payload data rate on a single RF channel for the class of operation declared by the manufacturer

Downlink: direction of traffic flow from Central Station towards a Terminal Station

Equipment Classification (EqC): multi-field classification which indicates the principal characteristics of a particular equipment within the scope of EN 302 326 and indicates which alternative consistent sets of requirements of EN 302 326 apply to that equipment

FDMA signal: signal comprising all permitted carriers in a channel at full system load

FH-CDMA Frequency Hopping (FH): spread spectrum technique whereby individual radio links are continually switched from one sub-channel to another

NOTE: Such links are not constrained to a single RF channel.

FH-CDMA hopping sequence: sequence of sub-channels which a particular link follows

FH-CDMA slow frequency hopping: FH technique where the hopping period is larger than the symbol period

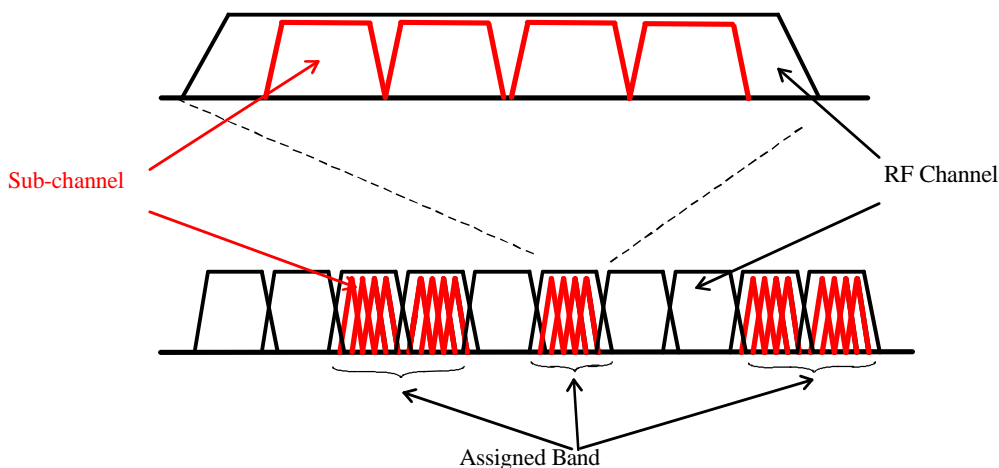

Figure 2: Relationship between "sub-channel", "RF channel" and "assigned channels"

Full Capacity Load (FCL): (only defined for DS-CDMA systems) See **DS-CDMA Full Capacity Load (FCL)**.

Frequency Hopping (FH): See **FH-CDMA Frequency Hopping (FH)**.

gain (of an antenna): ratio of the radiation intensity, in a given direction, to the radiation intensity that would be obtained if the power accepted by the antenna was radiated isotropically

gross bit rate: transmission bit rate over the air. In case of a transmitter working in burst mode, the gross bit rate is the instantaneous maximum transmission bit rate during the burst

NOTE: The gross bit rate has a unique relationship to the symbol rate through the implemented modulation format. In the case of OFDMA this relationship is unique when all OFDMA sub-carriers are in use. Gross bit rate for TDMA/OFDMA systems is the aggregate bit rate of all OFDMA sub-carriers transmitting simultaneously; (e.g. for a TDMA/OFDMA system, in any single TDMA burst any single OFDMA TS may be dynamically assigned a subset of the OFDMA-sub-channels. Multiple TS are allowed to transmit at the same time on disjoint sets of OFDM-sub-carriers, so the MGBR is defined when all available OFDM-sub-carriers are in use at the same time).

hopping sequence: See **FH-CDMA hopping sequence**.

integral antenna: antenna which is declared as part of the radio equipment by the supplier

NOTE: Even when equipment with integral antenna is concerned, it may still be possible to separate the antenna from the equipment using a special tool. In such cases the assessment of the radio equipment and of the antenna against requirements of this whole multi-part deliverable could be done separately by the actual supplier(s).

Maximum System Loading (MSL): (only defined for DS-CDMA systems) See **"DS-CDMA maximum system loading"**.

mixed-mode system: system having the capability for stations (CS or TS or RS) to operate on different modulation orders and/or switch dynamically between different modulation orders

NOTE: This capability may be used to improve deployment and capacity capabilities or to adaptively adjust for varying channel impairments, or to improve spectral efficiency by dynamically allocating transmission capacity. The switching between modulation orders may occur as frequently as appropriate to the system, (e.g. on a per-burst or per-timeslot or per-carrier basis).

multi-carrier system: system where more than one modulated sub-carrier is radiated from the same transmitter

NOTE 1: A system that uses several transmitters into a non-active antenna is not considered as a multi-carrier system. Systems using FDM/OFDM modulation formats are also not considered multi-carrier unless more than one separate FDM/OFDM signal set is transmitted from the same transmitter.

NOTE 2: FDMA systems are intrinsically multicarrier, because any single sub-carrier may be easily discriminated at RF level (unlike OFDM modulations) and activated according to the traffic requirements. However, for the purpose of the present document, a FDMA system are also considered as a whole (fully loaded) single signal set (comprised of multiple carriers), unless more than one FDMA signal set is transmitted from the same transmitter.

Nomadic Wireless Access (NWA): "Wireless access" application in which the location of the "end-user termination" may be in different places but it must be stationary while in use

NOTE: See ITU-R Recommendation F.1399 in bibliography.

nominal output power: maximum output power of the Central Station (CS), Terminal Station (TS) or Repeater Station (RS) referred to point C' of figure 3 under the full load condition declared by the manufacturer

NOTE: This power may, however, be exceeded by the action of ATPC (see above) during conditions of deep fading.

OFDM-sub-carrier: physical sub-division of the channel as determined by the manufacturer for OFDM and OFDMA systems

NOTE: The complete set of discrete sub-carriers is distributed throughout the assigned channel. With OFDM (and OFDMA), individual symbols are represented by all (or some) of the sub-carriers operating in concert rather than by individual sub-carriers.

Orthogonal Frequency Division Multiplexing (OFDM): transmission method where the transmitted signal is composed of multiple narrow band OFDM-sub-carriers, all modulated in parallel

Orthogonal Frequency Division Multiple Access (OFDMA): variant of OFDM where only a subset of the OFDM-sub-carriers are used by any single transmitter, allowing multiple transmitters to transmit at the same time on disjoint sets of OFDM-sub-carriers

NOTE: When used in conjunction with TDMA this applies burst by burst.

preset-mode (multi-format) system: system that can be statically configured or preset to operate on a permanent basis with one among several possible modulation orders

NOTE: Signals transmitted from any station use the single modulation order which has been preset. The presetting could be fixed, or if the licence permits, may be changed from time to time according to the operator's needs.

Radio Frequency channel (RF channel): partition of a radio frequency band which may be assigned by the authorities in accordance with CEPT, ITU-R Recommendations or national authorities regulations on channel arrangement

radome (of an antenna): cover of material which is nominally transparent to electromagnetic radiation and is intended to protect the antenna from the effects of its physical environment

reference signals: used for the transmission of framing, training and supervisory signals and do not carry user payload

NOTE: These signals may use a lower modulation order than that used for the transmission of user payload. The reference signals may, for example, have a short time duration (such as TDMA training bursts), occupy a small proportion of the available bandwidth (such as pilot signals) or, in principle, occupy a small proportion of the available power (such as might be the case in a CDMA system).

Repeater Station (RS): radio station providing an intermediate connection via the air to the central station(s), the terminal stations and other repeater stations

NOTE: The repeater station may also provide the interfaces to the subscriber equipment if applicable.

Remote Transmit Power Control (RTPC): facility whereby the transmitter output power can be controlled remotely

Remote Transmit Power Control type 1 (RTPC-1): RTPC which is used for the purpose of interference balancing

NOTE: However it does not control exclusively the output power of CSs.

Remote Transmit Power Control type 2 (RTPC-2): RTPC which is used for the purpose of intra-system power balancing of TSs close to the CS or for the shortest hops in Mesh architectures

single-mode system: system designed to operate with a single modulation order only

slow frequency hopping: See **FH-CDMA Slow frequency hopping**.

sub-channel: integer sub-division of one RF channel(s) as determined by the equipment manufacturer for subsets of terminal stations

NOTE: For OFDMA systems it is intended as the logical channel for transmission or control purposes, comprising a set of physical OFDM sub-carriers. The specific sub-carriers associated with a particular sub-channel are usually dynamically distributed throughout the whole channel bandwidth. The minimum number of sub-carriers that may comprise a sub-channel is dependent on the system design.

system loading: total payload data rate on a single RF channel

Terminal Station (TS): remote (out) station, which communicates with a Central Station or Repeater Station

uplink: direction of traffic flow from Terminal Station to Central Station

3.2 Symbols

For the purposes of the present document, the following symbols apply:

ChS _{min}	Minimum practical channel separation for the given radio frequency arrangement
dB	deciBel
dBm	deciBel relative to 1 mW
f ₀	Actual carrier centre frequency
GHz	GigaHertz
Hz	Hertz
kbit/s	kilobit per second
kHz	kiloHertz
log ₁₀	logarithm to the base 10
MHz	MegaHertz
mW	milliWatt
ppm	parts per million
µS	microSecond

3.3 Abbreviations

For the purposes of the present document, the following abbreviations apply:

ATPC	Automatic Transmit Power Control
BER	Bit Error Rate
CDMA	Code Division Multiple Access
ChS	Channel Separation
CS	Central Station
CW	Continuous Wave
DFRS	Digital Fixed Radio Systems
DS-CDMA	Direct Sequence - Code Division Multiple Access

EIRP	Equivalent Isotropically Radiated Power
EqC	Equipment Classification
EqC-ChS	EqC-Channel Separation
EqC-FR	EqC-Frequency Range
EqC-EMO	EqC-Equivalent Modulation Order
EqC-PET	EqC-Primary Equipment Type
EqC-SET	EqC-Secondary Equipment Type
EqC-STN	EqC-STation type
EMC	ElectroMagnetic Compatibility
FCL	Full Capacity Load
FDD	Frequency Division Duplex
FDMA	Frequency Division Multiple Access
FH-CDMA	Frequency Hopping - Code Division Multiple Access
FSK	Frequency Shift Keying
GBR	Gross Bit Rate
H-FDD	Half duplex - Frequency Division Duplex
IF	Intermediate Frequency
IFbw	spectrum analyser (Intermediate Frequency) resolution bandwidth
IPR	Intellectual Property Rights
LV	Low Voltage
MGBR	Minimum Gross Bit Rate
MP	MultiPoint
MP-MP	MultiPoint-to-MultiPoint
MSL	Maximum System Loading
NFD	Net Filter Discrimination
NWA	Nomadic Wireless Access
OFDM	Orthogonal Frequency Division Multiplexing
OFDMA	Orthogonal Frequency Division Multiple Access
P-MP	Point-to-MultiPoint
QAM	Quadrature Amplitude Modulation
RF	Radio Frequency
RFC	Remote Frequency Control
RPE	Radiation Performance Envelope
RS	Repeater Station
RSL	Received Signal Level
RTPC	Remote Transmit Power Control
RTPC-1	Type 1 RTPC

NOTE: See Remote Transmit Power Control under 3.1 Definitions.

RTPC-2 Type 2 RTPC

NOTE: See Remote Transmit Power Control under 3.1 Definitions.

R&TTE	Radio and Telecommunications Terminal Equipment
S/I	Signal to Interference ratio
SF	Symbol Frequency
T _{BER}	receiver BER Threshold
TDD	Time Division Duplex
TDMA	Time Division Multiple Access
TDMA/OFDMA	Time Division Multiple Access used in combination with Orthogonal Frequency Division Multiple Access
TS	Terminal Station

4 RF reference architecture

The RF system block diagram shown in figure 3 shows the connection path between any two stations.

The "Payload Processing" block contains the mapping functionalities required for transforming between the baseband interface data format and the raw data stream sent to the modulator and received from the demodulator. It includes, but is not limited to transforming between packet data protocols and the raw data stream.

The points shown are reference points only.

Where no payload processing function is present, the following pairs of points may coincide:

- X'_n and Z'.
- X_n and Z.

Where no branching network is present, the following pairs of points may coincide:

- B' and C'.
- B and C.

Where neither branching network nor feeder network is present, the following pairs of points may coincide:

- B' and D'.
- B and D.

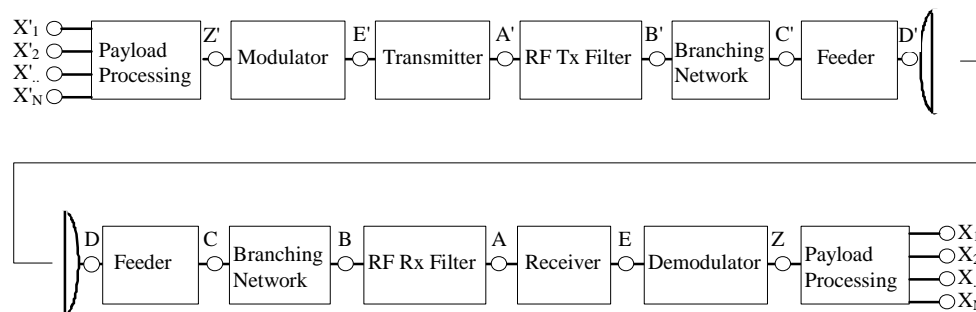

Figure 3: RF system block diagram

NOTE 1: For RS which do not re-modulate blocks Modulator, Demodulator and Payload Processing and relevant reference points are not part of the equipment to be assessed. However for assessment of this RS some specific reference modulator, demodulator and payload processing should be provided. Therefore, the reference points referred to in the present document are still applicable also in this case with the assumption that they may belong to the test set.

NOTE 2: The system represented by figure 3 may be physically split between indoor and outdoor units. Their interconnection, commonly made by cable(s), is not represented by the interfaces shown in the diagram. Those units are nevertheless intended as being part of the whole system.

5 Technical requirements specifications

5.1 General

Guidance and description of the phenomena relevant to "essential requirements" under article 3.2 is given in EG 201 399 (see bibliography). Specific applications and descriptions for DFRS are given in TR 101 506 (see bibliography).

In the following clauses, limits are required to be met at specific reference points of the system block diagram. Reference points and the system block diagram are set out in figure 3.

All requirements are set considering that the equipment is a single transceiver with a common antenna port (basic 1+0 configuration). For more complex implementations (e.g. 1+1 protection either in frequency or hot-standby configuration) the additional losses in the branching network (e.g. additional circulators or power splitters/couplers) shall also be taken into account.

In the case of wide radio-frequency bands covering units and multirate/multiformat equipment, these specifications shall be met at any frequency and at any rate and/or format.

Testing methods and conditions for assessing all requirements are specified in clause 6, within which each clause number directly refers to a corresponding clause number in clause 5 (e.g. clause 6.3.6.2 refers to the ATPC test according the ATPC requirement in clause 5.3.6.2).

The traffic carried will be subject to certain minimum bit rate requirements as defined in annex C.

Unless otherwise stated, the requirements are intended for fully loaded systems (according to the maximum loading provided by the equipment).

The requirements of this clause are strictly dependent on the adoption of specific definitions and EqC so that when required should be declared by the manufacturer according to the definition in clause 3.1 and to annex A of EN 302 326-1 [11].

NOTE: For each technical requirement in the present document, there may be additional characteristics, not considered relevant to article 3.2 of the R&TTE Directive [2]. Nevertheless they are considered important for the system's own operation. These additional requirements, when identified, may be found in EN 302 326-1 [11].

5.2 Environmental profile

The technical requirements of the present document apply under the environmental profile for operation of the equipment or the equipment-antenna assembly (in the case of systems with integral antenna), which shall be declared by the supplier.

NOTE: Within the present document, the generic term of environmental profile is deemed to include any variation of the "external" conditions (e.g. climatic and external primary/secondary power supply sources feeding the equipment to be assessed) that might affect the system parameters relevant to the "essential requirements" of article 3.2 of R&TTE Directive [2].

The equipment shall comply with all the technical requirements of the present document at all times when operating within the boundary limits of the declared operational environmental profile.

An integrated equipment-antenna assembly which employs a radome shall meet the requirements of the present document with the radome in place.

5.3 Transmitting phenomena

5.3.1 General

All transmitter parameters are referred to reference point B' or C' (at the supplier's choice) of the RF system block diagram, figure 3. This shows the generic Point-to-Point connection between multipoint stations.

The parameters stated below shall be met under any system load conditions. Measurements shall be made under full load conditions (as declared by the manufacturer) and with appropriate input signals presented at point Z' of the RF system block diagram, figure 3.

5.3.2 Transmitter output power

5.3.2.1 General

The transmitter output power is the value measured by a power meter or spectrum analyser, when the transmitter output is connected to a dummy load, or the equivalent level, derived from the radiated power, for equipment with integral antenna; the transmitter shall be modulated with a test data signal which simulates traffic of all loads and with all representative services.

In case of burst transmission (e.g. TS for TDMA applications) the output power is intended as the mean power during the burst duration.

For mixed-mode and preset-mode systems, the nominal power and power tolerance shall be declared for each modulation order offered.

5.3.2.2 Maximum power

The maximum power shall be limited, in terms of EIRP of the systems by the provisions given in the ITU-R Radio Regulations [13] (e.g. in article S21 and, for some specific frequency bands, in footnotes under article 5 of the 2001 edition) or in terms of maximum output power density fed to the antenna (e.g. footnote S5.482 of the 2001 edition for the 10,6 GHz to 10,68 GHz band). Those limits shall be inclusive of tolerances and, if applicable, ATPC/RTPC influence.

Assessment of EIRP requirements, wherever these are identified, is necessary for equipment with integral antennas only. However equipment placed on the market without antennas should define the means by which compliance with EIRP limitations may be achieved (e.g. defining the maximum associated antenna gain).

The output power shall be appropriate to the mode of use. For CS or TS in "broadcast mode", the power output shall comply with the provisions given in the Radio Regulations [13]. For CS or TS operating in TDMA burst mode, the power output during a burst shall comply with the provisions given in the Radio Regulations. The power may be controlled by ATPC.

In the case of EqC-PET = M, with N similar sub-carriers, the nominal output power for each sub-carrier would be 1/N of the total nominal output power of the CS referred to point C'. In the case of N dissimilar sub-carriers, the relative power of each sub-carrier would depend upon the actual Symbol Frequencies (SF) and differ by a factor $10 \log (SF_1/SF_2)$. Therefore, under operational conditions, the output power of some sub-carriers may be greater than 1/N of the nominal output power provided that, for the band 25,25 GHz to 27,5 GHz, the requirements of ITU-R Recommendation F.1249 [14] are fulfilled.

For equipment operating in frequency ranges at, or above, 1 GHz, an internal or external means of attenuating output power shall be provided. For equipment operating in frequency ranges at, or above, 24,25 GHz, the range of adjustment, either by fixed or automatic attenuators, should be in increments of 5 dB or less.

5.3.2.3 Output power tolerance

The nominal output power shall be declared by the supplier.

The power tolerance around the declared value shall be equal to or better than the values given in table 4.

Table 4: Power tolerance when operating within the declared environmental conditions

Frequency Range	Power tolerance
Below 11,00 GHz	±2 dB
24,25 GHz to 34,50 GHz	±3 dB

NOTE: In some source ENs the power tolerance was not defined; consequently it appears that those systems were "exempted" from this requirement. However, in the interests of rationalization of parameters relevant to article 3.2 "essential requirements" across all technologies, this has been introduced in the present document. Therefore, for claiming compliance to the present document, systems that have already claimed conformance to R&TTE using former EN 301 753 (see bibliography) should undergo additional assessment for the power tolerance (unless compliance could be already demonstrated indirectly in current test reports).

5.3.3 Transmitter output frequency error/stability (output frequency tolerance)

The radio frequency tolerance includes both short-term effects (including environmental effects and tuning accuracy) and long term ageing effects. For the purpose of type testing, the manufacturer shall state the guaranteed short-term part and the expected ageing part.

The radio frequency tolerance shall not exceed the limits shown in table 5.

Table 5: Maximum radio frequency tolerance

Frequency Range (EqC-FR)	Frequency tolerance
All cases below 11 GHz	± 20 ppm
All cases equal to or above 24 GHz	± 15 ppm

5.3.4 Adjacent channel power

5.3.4.1 Transmitter spectrum density masks

The transmitter spectrum density mask is defined as the spectral power density mask, within ± 250 % of the relevant ChS, which is not exceeded under any combination of service types and any loading. This generally corresponds to a fully loaded system as declared by the manufacturer, with the maximum number of sub-carriers for the declared equipment type (if applicable) operational.

The spectrum mask to which the equipment shall conform depends on the equipment classification stated by the supplier, the relevant fields being Primary Equipment Type (EqC-PET), which shall be one of the following: T, D, H, O, M or F, Equivalent Modulation Order (EqC-EMO), the Secondary Equipment Type (EqC-SET) and the Frequency Range (EqC-FR).

The relevant ChS is that defined by the actual channel separation(s) to which the system is designed (e.g. that defined by the CS in any P-MP system).

In the case where the up-link (from CS to TS or RS) ChS is identical in size to that for down-link (TS or RS to CS), i.e. a symmetric FDD assignment, then the transmit output power density spectrum of the TS or RS must comply with the mask defined for a CS for the same EqC-EMO and with homogeneous EqC PET.

In the case where the TS or RS radiates a subset of the number of carriers required for full traffic capacity (e.g. in a system whose declared EqC-PET = M, F or O), the TS or RS, when radiating the maximum number of sub-carriers for the TS or RS and with any permitted placement of sub-carriers within the channel, shall comply with the same mask as that defined for the CS. In this case, the manufacturer shall declare which signal loading/configuration produces the worst case result. This declaration will be used in producing the test report.

For mixed-mode and preset-mode systems, the manufacturer shall declare which combination of EqC-EMOs the equipment offers, and for each EqC-EMO shall be compliant with the relevant mask. The output power of the different EqC-EMOs shall be equal to the nominal transmitted output power declared by the manufacturer for each EqC-EMO.

NOTE: These requirements apply only for the assessment of essential requirements under article 3.2 of the R&TTE Directive [2]. It is assumed that, when operational, the system should be subject to different considerations, see informative annex F of EN 302 326-1 [11].

The equipment shall conform with the mask with the total output power set to the nominal output power declared by the manufacturer.

When ATPC and/or RTPC are implemented see also clause 5.3.6.

Spectrum analyser settings are to be used as per the table 14 in clause 6.3.1.2.

The spectrum masks are defined by a number of turning points in the mask, between which the mask is linearly interpolated. The number of points varies according to the EqC-PET and EqC-EMO.

The frequency of each turning point is expressed as F/ChS , where F is the frequency offset from the carrier centre frequency (f_0) and ChS is the supplier stated Channel Separation (EqC-ChS).

The 0 dB level shown on the spectrum masks is the maximum of the modulated spectrum density excluding any residual carrier resulting from imperfection in the modulation process.

The mask does not include frequency tolerances, therefore the mask is related to the actual carrier centre frequency (f_0).

Figure 4 shows the general form of such a spectrum mask having N turning points.

Table 6 defines the points corresponding to the spectrum mask with which an equipment, with stated values of EqC-PET and EqC-EMO, shall comply.

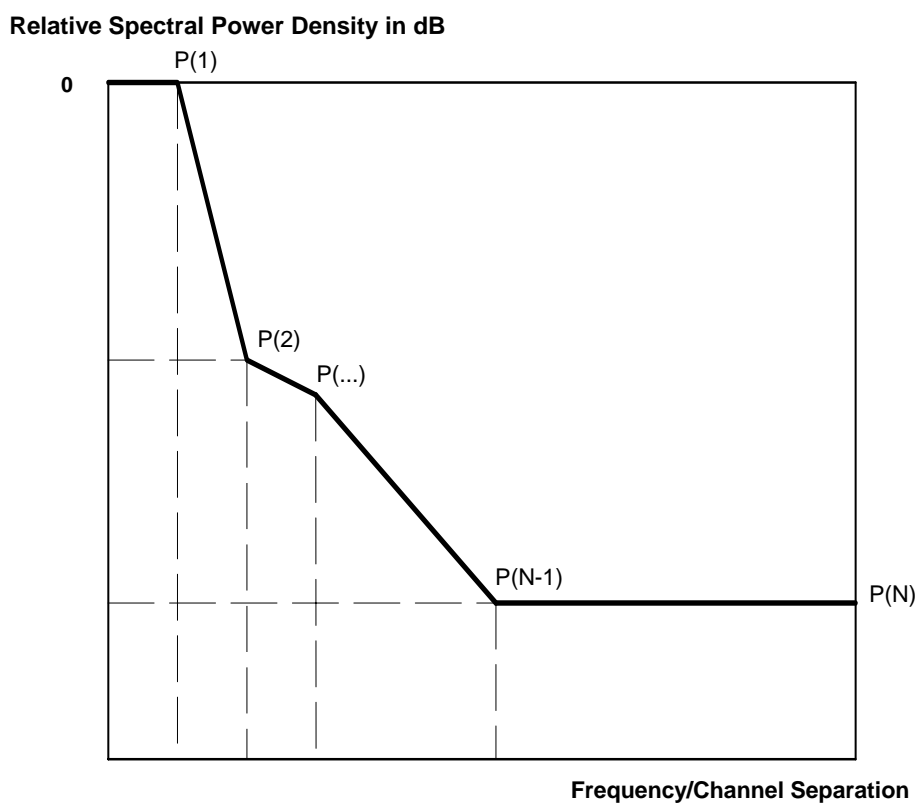

Figure 4: Power spectrum mask - Generalized Form

Table 6: Power Spectrum Reference Points

EqC-PET = T									
F/ChS ⇨	0	0,43	0,5	0,5	0,8		1,06	2	2,5
EqC-EMO ⇩									
2									
For EqC-SET ≠ HC	0 dB	0 dB			-25 dB		-25 dB	-45 dB	-45 dB
For EqC-SET = HC	0 dB	0 dB			-27 dB		-27 dB	-45 dB	-45 dB
4	0 dB	0 dB			-32 dB		-37 dB	-45 dB	-45 dB
6	0 dB		0 dB	-13 dB	-34 dB		-42 dB	-45 dB	-45 dB

EqC-PET = C or H									
F/ChS ⇨	0		0,5		0,8		1,0	1,5	2,5
EqC-EMO ⇩									
Not applicable	0		0		-25 dB		-25 dB	-45 dB	-45 dB

EqC-PET = O									
F/ChS ⇨	0		0,5	0,5	0,71		1,06	2	2,5
EqC-EMO ⇩									
2	0 dB		0 dB	-8 dB	-25 dB		-27 dB	-50 dB	-50 dB
4	0 dB		0 dB	-8 dB	-27 dB		-32 dB	-50 dB	-50 dB
6	0 dB		0 dB	-8 dB	-32 dB		-38 dB	-50 dB	-50 dB

EqC-PET = M									
F/ChS ⇨	0		0,5	0,5	0,54	0,64	1	2	2,5
EqC-EMO ⇩									
2	0 dB		0 dB	-8 dB	-18 dB	-23 dB	-23 dB	-45 dB	-45 dB
4	0 dB		0 dB	-10 dB	-23 dB	-32 dB	-37 dB	-45 dB	-45 dB
6	0 dB		0 dB	-13 dB	-26 dB	-37 dB	-42 dB	-45 dB	-45 dB

EqC-PET = F									
F/ChS ⇨	0		0,5	0,5	0,6	0,85		1,5	2,5
EqC-EMO ⇩									
2	0		0	-23 dB	-25 dB	-25 dB		-45 dB	-45 dB
3	0		0	-27 dB	-29 dB	-29 dB		-45 dB	-45 dB
4 or 6	0		0	-31 dB	-33 dB	-33 dB		-45 dB	-45 dB

With regard to table 6, the following particular cases shall be taken into account:

- Equipment with EqC-PET = T and EqC-FR = 3 GHz to 11 GHz and EqC-ChS < 1,75 MHz is permitted under EN 301 753 (see bibliography) a substantially wider Tx spectrum mask. Equipment of this type whose spectrum masks have been declared as in compliance with EN 301 753 (see bibliography) may still declare conformity, for legacy purpose, with the present document and hence with article 3.2 of the R&TTE Directive [2] without additional assessment of the spectrum mask.
- In some other cases for sake of harmonization within the present document, the above spectrum mask specifications may differ in some minor respects from those specified by source standard references in EN 301 753 (see bibliography) for certain bands, channel separations and access methods. These differences, either slight tightening or relaxation, will not affect, in practice, any frequency co-ordination assumptions. Equipment, whose spectrum masks have been assessed as in compliance with EN 301 753 (see bibliography) may still declare conformity with the present document and hence with article 3.2 of the R&TTE Directive [2] without additional assessment of the spectrum mask.
- Mixed-mode systems only may also provide EqC-EMO=1 option, among other more efficient EMOs; in this case the spectrum mask requirement remains that of the EqC-EMO=2 case.
- For systems where EqC-PET = M, the 0 dB level is relative to the maximum of the modulated spectrum of the sub-carrier with the lowest spectral density, disregarding residual carriers which may be present due to modulation imperfections. When applying the spectrum mask, the spectral density of all sub-carriers shall be within 0 dB to +2 dB of the reference level as shown in the generic example in figure 5. In this case, the above differential tolerance of spectrum density of the sub-carriers could require, in addition to the combined output power tolerance reported in clause 5.3.2.3, a coherent output power tolerance for each of the sub-carriers.

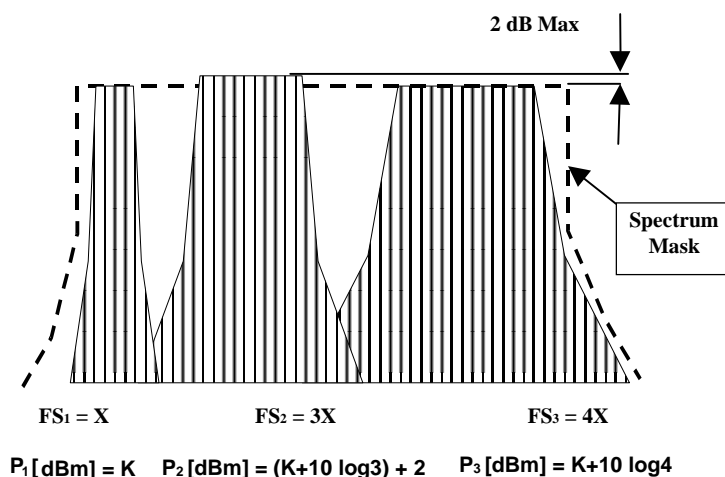

Figure 5: Example of equipment with EqC-PET = M, with three sub-carriers, each with a different Symbol Frequency (SF)

The symbol frequency is the frequency of transmission of discrete symbols, each carrying one or more bits of information according to the modulation order of the system.

In the above example, if the power of the first carrier is K in dBm then the power of the second carrier in dBm is $(K + 10 \log 3 + 2)$ because it occupies 3 times the spectrum with respect of the first carrier and its power density is 2 dB higher. Similarly the power of the third carrier in dBm is $(K + 10 \log 4)$ because the carrier occupies 4 times the spectrum of the first with equal power density.

5.3.4.2 Discrete (CW) spectral lines exceeding the spectrum mask (all stations)

For systems operating above 1 GHz only, in the case where some CW components exceed the spectrum mask, an additional allowance is given.

These lines shall not:

- exceed the mask by a factor more than $\{10 \log (\text{ChS}_{\min}/\text{IFbw}) - 10\}$ dB (see note 2);
- be spaced from each other in frequency by less than ChS_{\min} .

Where:

- ChS_{\min} is the minimum practical channel separation for the given radio-frequency channel arrangement:
 - $\text{ChS}_{\min} = 25$ kHz for the band 1,5 GHz;
 - $\text{ChS}_{\min} = 500$ kHz for the band 2,2 GHz, 2,4 GHz and 2,6 GHz;
 - $\text{ChS}_{\min} = 500$ kHz for the bands 3,5 GHz and 3,7 GHz;
 - $\text{ChS}_{\min} = 1\,500$ kHz for the band 10,5 GHz;
 - $\text{ChS}_{\min} = 1\,750$ kHz for the bands 26 GHz, 28 GHz and 32 GHz.
- IFbw is the recommended resolution bandwidth, expressed in kHz as given in table 14 in clause 6.3.1.2.

The following particular cases shall be taken into account:

- Where minimum ChS values are defined by CEPT recommendations for bands other than those listed above, these ChS values may be used.
- In the case where the calculation of the allowance factor results in a negative value, no additional allowance is then permitted and the mask applies.

- For mixed-mode and preset-mode systems, the specification for discrete spectral lines shall meet the specification independently for each EqC-EMO offered.

Figure 6 shows a typical example of this requirement.

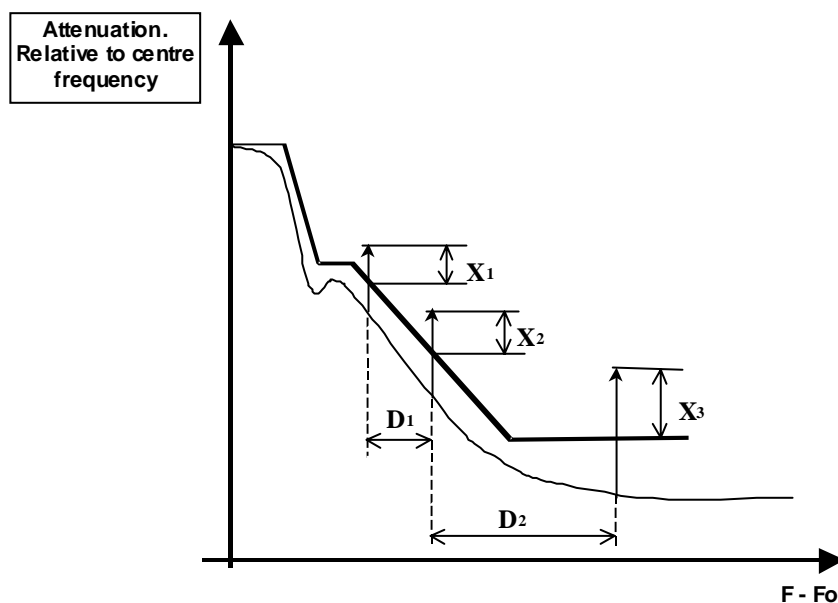

$$X_1, X_2, X_3 \text{ [dB]} \leq 10\log(\text{CSmin}/\text{IFbw})-10$$

$$D_1, D_2 \geq \text{CSmin}$$

Figure 6: CW lines exceeding the spectrum mask (typical example)

5.3.5 Transmitter spurious emissions

For Fixed Service systems, spurious emissions are defined by CEPT/ERC/REC 74-01 [1] as those emissions at frequencies that are removed from the nominal carrier frequency by more than $\pm 250\%$ of the relevant channel separation.

NOTE 1: ITU-R Recommendation SM.329 (see bibliography) and CEPT/ERC/REC 74-01 [1], prefer the phrase "unwanted emissions in the spurious domain" to "spurious emissions". The definitions are technically equivalent but the preferred phrase solves some inconsistency with current Radio Regulations definitions.

The equipment shall comply with the requirements of clause 4.1 of EN 301 390 [10] under any ATPC and RTPC operating condition if applicable.(see note 2).

NOTE 2: EN 301 390 [10] includes, for MP systems coexistence purpose, limits that, in some frequency bands, are tighter than those of CEPT/ERC/REC 74-01 [1].

For mixed-mode and preset-mode systems, the specification for transmitter spurious emissions shall meet the specification independently for each EqC-EMO offered.

5.3.6 Transmitter power control (ATPC and RTPC)

5.3.6.1 General

ATPC and RTPC are commonly optional features. From the point of view of hardware implementation both these functions are made by an electronic attenuator implemented along the transmitting chain (e.g. at IF level, RF level or both levels) and can be realized in a mixed configuration, e.g.:

- ATPC is implemented only;
- RTPC is implemented only;
- ATPC + RTPC are implemented with separate attenuator functions;
- ATPC + RTPC are implemented with a single attenuator comprising both functions, with different command functions (either hardware or software), and the ranges of both may be traded-off from a maximum available attenuation.

NOTE: For the relevant power level definitions of ATPC operation see clause 3.1 while for additional clarification on ATPC and RTPC requirements see annex D.

For mixed-mode and preset-mode systems, the specification for ATPC and RTPC shall meet the specification independently for each EqC-EMO offered.

5.3.6.2 Automatic Transmitter Power Control (ATPC)

Equipment with ATPC will be subject to manufacturer declaration of ATPC ranges and related tolerances.

The equipment shall comply with the requirements of spectrum masks of table 6 above with ATPC operating in the range between maximum available power and maximum nominal power including the attenuation introduced by RTPC-1 function (if applicable) but not by any attenuation related to RTPC-2.

NOTE: RTPC-1 and RTPC-2 are introduced in clause 5.3.6.3 and in annex D.

5.3.6.3 Remote Transmitter Power Control (RTPC)

A description of the different functions and requirements for RTPC is provided in annex D which distinguishes two distinct purposes for employing RTPC:

- RTPC-1 which is for inter-operator interference balancing.
- RTPC-2 which is for intra-system power balancing of TSs close to the CS or for the shortest hops in Mesh architectures.

Equipment with RTPC-1 and/or RTPC-2 will be subject to manufacturer declaration of the RTPC range(s) and related tolerance(s).

This RTPC range subdivision, if applicable, should also be reflected in the equipment documentation.

The equipment shall comply with the requirements of spectrum masks of table 6 with ATPC operating in the range between maximum available power and maximum nominal power under any attenuation condition within the RTPC-1 range (if applicable).

5.3.7 Remote Frequency Control (RFC)

This functionality is commonly an optional feature.

Equipment with RFC will be subject to manufacturer declaration of RFC ranges and related procedure for the change frequency.

RFC setting procedure shall not produce emissions outside the requirements of the appropriate previous and final centre frequencies' spectrum masks of table 6.

For mixed-mode and preset-mode systems, the transient behaviour of the transmitter when RFC operates shall meet the specification independently for each EqC-EMO offered.

5.3.8 Dynamic Change of Modulation Order

For mixed-mode systems, the transient behaviour of the transmitter when a transition from any EqC-EMO to another occurs shall meet the specification for the mask of the lowest applicable EqC-EMO and its associated CW spectral lines allowance. Additionally, such transitions shall not cause the specifications for spurious emissions to be exceeded. See informative annex F of EN 302 326-1 [11].

5.4 Receiving phenomena

5.4.1 General

All receiver parameters are referred to reference point B' or C' (at the supplier's choice) of the RF system block diagram, figure 3. This shows the generic Point-to-Point connection between multipoint stations.

The parameters stated below shall be met under any system load conditions.

5.4.2 Receiver spurious emissions

Spurious emissions from receivers are defined as for the transmitter in clause 5.3.5 with the exception that they are defined and limited also within the ± 250 % of ChS across the nominal carrier frequency.

The equipment shall comply with the provisions of clause 5 of EN 301 390 [10].

5.4.3 Minimum RSL

5.4.3.1 General

The minimum Receiver Signal Level (RSL) at the receiver (or equivalent for systems with integrated antennas) is that for which the Bit Error Rate (BER) (measured at a point determined by the manufacturer in accordance with the guidance in annex E of EN 302 326-1 [11]) must be less than or equal to 10^{-6} . It should be noted, however that the definition of this phenomenon is dependent on the system type as indicated in the clauses following.

For mixed-mode and preset-mode systems, the specification for minimum RSL shall be met independently for each EqC-EMO offered.

5.4.3.2 Single signal performance

The receiver Bit Error Rate (BER) threshold shall be equal to or lower than the values of Received Signal Level (RSL) as given in table 7, either as a number expressed in dBm, or as a function:

$$T_{\text{BER}}(A, B) = (A + 10 \log_{10}(B)) \text{ dBm}$$

where A is a constant and B is either GBR, the gross bit rate in Mbit/s or ChS, the channel separation in MHz, according the specific requirement in table 7.

The RSL is referenced to point C in the system diagram, figure 3, with no multipath signal distortion.

Table 7: Limiting values of RSL to yield BER better than 10^{-6}

Primary Equipment Type (EqC-PET)	Frequency Range (EqC-FR)	Equivalent Modulation Order (EqC-EMO) (Note 2)	Secondary Equipment Type (EqC-SET)	RSL for BER $\leq 10^{-6}$ (dBm) ($T_{BER}(A,B)$)	Note
D	Any	Not applicable	Any	-101	5
F	< 1 GHz	2	Any	$T_{BER}(-89, GBR)$	
		3	Any	$T_{BER}(-86, GBR)$	
		4	Any	$T_{BER}(-82, GBR)$	
	1 GHz to 11 GHz	2	FA	$T_{BER}(-100,5, GBR)$	
		3	FA	$T_{BER}(-99,5, GBR)$	
		4	FA	$T_{BER}(-94,5, GBR)$	
		2	FB	$T_{BER}(-89, GBR)$	
		3	FB	$T_{BER}(-86, GBR)$	
		4	FB	$T_{BER}(-82, GBR)$	
	26 GHz, 28 GHz and 32 GHz	2	Any	$T_{BER}(-95,5, GBR)$	
		3	Any	$T_{BER}(-94,5, GBR)$	
		4	Any	$T_{BER}(-89,5, GBR)$	
	26 GHz and 28 GHz	6	Any	$T_{BER}(-83,5, GBR)$	
H	< 11 GHz	Not applicable	Any	$T_{BER}(-87, GBR)$	1
M	26 GHz, 28 GHz and 32 GHz	2	Any	$T_{BER}(-88, GBR)$	4
		4	Any	$T_{BER}(-83, GBR)$	4
		6	Any	$T_{BER}(-78,8, GBR)$	4
T	< 1 GHz	2	QP	$T_{BER}(-89, GBR)$	
			GM	$T_{BER}(-83, GBR)$	
			DQ	$T_{BER}(-86, GBR)$	
	1 GHz to 3 GHz	2	2 Mbits	-88	
			4 Mbits	-85	
			8 Mbits	-79	
	3 GHz to 11 GHz	2	LC	$T_{BER}(-81, GBR)$	
			HC	$T_{BER}(-92,5, ChS)$	
			≥ 2 Mbits	$T_{BER}(-88,5, ChS)$	
			< 2 Mbits (not LC or HC)	$T_{BER}(-89, GBR)$	
		4	≥ 4 Mbits	$T_{BER}(-80,5, ChS)$	
			< 4 Mbits	$T_{BER}(-81, GBR)$	
		6	Any	$T_{BER}(-74,5, ChS)$	
	26 GHz, 28 GHz and 32 GHz	2	HC	$T_{BER}(-91, GBR)$	
			Not HC	$T_{BER}(-85, GBR)$	
4		Any	$T_{BER}(-79, GBR)$		
6		Any	$T_{BER}(-76, GBR)$		
O	≤ 11 GHz	2	Any	$T_{BER}(-88,5, ChS)$	3
		4	Any	$T_{BER}(-80,5, ChS)$	3
		6	Any	$T_{BER}(-74,5, ChS)$	3

NOTE 1:	Incoherent demodulation may be used for packet data applications. When incoherent demodulation and modulation states higher than 2 are used, the signal levels specified in this table row are increased by 7 dB for 4 FSK modulation and 15 dB for 8 FSK modulation.
NOTE 2:	Mixed-mode systems may also provide EqC-EMO=1 option, among other more efficient EMOs; for this case the requirement shall be 3 dB more tighter than that for EqC-EMO=2 case.
NOTE 3:	In the case of EqC PET = O / EqC SET = MA (true TDMA/OFDMA) systems, the above figures apply when all OFDMA sub-channels are in use and the above equations shall be modified as follows: <ul style="list-style-type: none"> - the values for RSL in the table are increased by 1 dB; - the effective bandwidth, ChS_{EFF} is substituted for ChS, (where $ChS_{EFF} = ChS \times n/m$, - and "m" denotes the total number of available OFDMA sub-channels and "n" denotes the number of active OFDMA sub-channels, received from one or more transmitters).
NOTE 4:	The effect of differential attenuation of the sub-carriers, due to rain intensity within the sector and/or ATPC shall be taken into account. Therefore the above requirements shall be met with the adjacent sub-carrier transmitter(s) operating at the maximum declared power level and the adjacent sub-carrier(s) RSL set to the higher differential power with respect to the sub-carrier under actual measurement, permitted by the system implementation, as declared by the supplier.
NOTE 5:	For EqC PET = D systems, these figures represent the situation for a single 64 kbit channel, the performance under maximum loaded conditions is specified in clause 5.4.3.3.

5.4.3.3 Performance at maximum loading (EqC-PET = D only)

EqC-PET = D may use orthogonal (EqC-SET = OR) or pseudo random (EqC-SET = PR) code sequences. For both, the BER for a single traffic channel will degrade as the number of simultaneous traffic channels increases.

NOTE: SET = OR systems degrade only slightly because of physical implementation; SET = PR systems degrade more quickly because all traffic channels interfere with each other as noise. Thus the capacity of a SET = PR system will be significantly less than that of a SET = OR system in a single cell environment but may, when deployed in a reuse environment, provide similar network capacity.

For PET = D equipment, the manufacturer shall declare a Maximum System Loading (MSL), a Channel Separation (EqC-ChS) and the Secondary Equipment Type EqC-SET = OR or PR (The MSL is the maximum supported payload expressed as the number of simultaneous 64 kbit/s users operating on an RF channel. For equipment which does not support exact traffic which can be expressed in multiples of 64 kbit/s, the declaration must be for $n \times 64$ kbit/s, and the equipment must support at least the equivalent total traffic measured in kbit/s.)

The RSL levels at which the BER shall be better than 10^{-6} depends upon the channel separation (EqC-ChS), whether the coding is orthogonal or pseudo random (EqC-SET = OR or PR) and the declared MSL. The formulae for determining the limiting RSL level are shown in table 8.

Table 8: Formulae for determining RSL for which BER must be better than 10^{-6} for EqC-PET = D at various MSL values, channel separations and EqC-SET variants

	EqC-SET	RSL value (dB) (see notes 1 and 2)
Generalized EqC-ChS	OR	integer $(101,66 - 0,1895 \times q - 0,0606 \times q^2)$
	PR	integer $(102,45 - 2,3211 \times q)$
EqC-ChS = 5,10 or 15 MHz only (see note 3)	OR	integer $(101,66 - 0,2706 \times q - 0,1237 \times q^2)$
	PR	integer $(102,13 - 2,3037 \times q)$
NOTE 1: $q = MSL / EqC-ChS$.		
NOTE 2: integer (x) means largest integer not exceeding x .		
NOTE 3: The concession for systems operating in a 5 MHz raster with 5 MHz, 10 MHz and 15 MHz spacing is for historical reasons and to allow such equipment, which complied with standards superseded by the present document, to remain compliant.		
NOTE 4: The formulae are derived from interpolating agreed tabulated values in previous standards and are not based upon analysis of the physical properties of the EqC-PET = D (e.g. DS-CDMA) systems.		

5.4.4 Interference sensitivity

5.4.4.1 Co-channel interference

Co-channel rejection is the ability of the receiver to receive a wanted signal in the presence of a like unwanted signal on the same frequency.

For mixed-mode systems, the co-channel interference specification shall be met for all combinations of modulation orders for the wanted and interfering signals. The applicable specification for each combination of EqC-EMOs shall be that of the wanted EqC-EMO (i.e. that of the receiving equipment).

For preset-mode systems, each mode shall meet the interference sensitivity requirements independently (as a separate single-mode system).

The channel bandwidth and the adjacent channel frequency separation are considered to be those defined by the actual channel width used by the system (e.g. that defined by the CS in any P-MP system). In the case of a TS operating on a selectable portion of such ChS (e.g. some TS in FDMA and MC-TDMA applications), however, the requirement shall be met for whichever portion of that channel the TS uses. The requirement shall be met with an interfering signal, at maximum loading, occupying any portion of ChS, up to its whole. In such cases, for assessment purpose, the manufacturer shall declare which victim/interfering signal loading/configuration will produce the worst case when used for producing the test report.

The requirement for co-channel interference rejection, is that the degradation of the RSL threshold for $BER \leq 10^{-6}$ shall not exceed 1 dB or 3 dB respectively, in the presence of two predefined levels of interference. When a wanted signal, with RSL enhanced by 1 dB and 3 dB with respect to the appropriate $BER \leq 10^{-6}$ entry in the BER/RSL threshold tables in clause 5.4.3, is combined with a like modulated (see note) unwanted signal with RSL level as defined (as S/I or absolute interference level) by the appropriate 1 dB or 3 dB entries in table 9 or 10, then the BER with the combined signals shall not be worse than 10^{-6} . The unwanted signal shall have like modulation (see note) and bandwidth as the wanted signal but shall be uncorrelated with it.

NOTE: For mixed mode the requirement is extended to any combination of possible modulation of wanted and unwanted signal provided by the system.

For equipment with EqC-PET = F, T, O, M or D, the appropriate wanted signal level is the $BER \leq 10^{-6}$ entry in table 7 and the level of the unwanted signal to be applied is shown in table 9. Where the entry for 3 dB degradation is absent there is no requirement corresponding to 3 dB.

For equipment with EqC-PET = H, for a system with all sub-channels in the RF channel occupied, each at a level greater by 1 dB or 3 dB than the level specified in table 7 for $BER \leq 10^{-6}$, an applied additional co-channel interferer with uncorrelated like-modulation, at the levels indicated in table 10, shall not cause the BER to exceed 10^{-6} .

For equipment with EqC-PET = D, for a declared loading of N signals applied to the receiver each at a level greater by 1 dB or 3 dB than the relevant level derived from the formulas specified in table 8, an applied additional co channel interferer with uncorrelated like modulation in the same bandwidth at the relevant level specified in table 10 shall not cause the BER to exceed 10^{-6} .

**Table 9: Co-channel interference rejection limits for BER $\leq 10^{-6}$
for equipment with Primary Equipment Type F, T, O or M**

Primary Equipment Type (EqC-PET)	Frequency Range (EqC-FR)	Modulation Order (EqC-EMO) (Note 3)	Secondary Equipment Types (EqC-SET)	Signal to Interference level (S/I)	
				For 1 dB	For 3 dB
				Threshold Degradation	
F	< 1 GHz	2	Any	24	20
		3	Any	27	23
		4	Any	30	26
	1 GHz to 11 GHz	2	FA	17,5	13,5
		3	FA	19,5	15,5
		4	FA	26,5	22,5
	1 GHz to 3 GHz	2	FB	24	20
		3	FB	27	23
		4	FB	30	26
	3 GHz to 11 GHz	2	FB	22,5	18,5
		3	FB	24,5	20,5
		4	FB	31,5	27,5
	26 GHz, 28 GHz and 32 GHz	2	Any	17,5	13,5
		3	Any	19,5	15,5
4		Any	26,5	22,5	
26 GHz and 28 GHz	6	Any	38	34	
T, M	< 1 GHz	2	QP	19	13
		2	GM	14	12
		2	DQ	14	12
	1 GHz to 3 GHz	Any	Any	23	Note 2
	3 GHz to 11 GHz	2	HC	19	16
		2	Not HC	23	Note 2
		4	Any	30	Note 2
	26 GHz and 28 GHz	6	Any	37	Note 2
		2	HC	19	16
		2	Not HC	23	19
	26 GHz, 28 GHz and 32 GHz	4	Any	30	26,5
6		Any	36	32,5	
2		Any	23	Note 2	
O	≤ 11 GHz	4	Any	30	Note 2
		6	Any	37	Note 2
		2	Any	23	Note 2

NOTE 1: For multi-carrier equipment, these limits shall be met for each sub-carrier.

NOTE 2: For these equipment profiles, earlier equipment standards, for corresponding equipment, specify co-channel performance in terms of BER degradation up to 10^{-5} , rather than RSL degradation for BER $\leq 10^{-6}$ which is more usual and more appropriate in the context of modern broadband systems. In these cases, the requirement of the earlier standards has been translated to a degradation of RSL threshold of 1 dB, which is considered equivalent from the point of view of the essential requirements under article 3.2 of the R&TTE Directive [2] and the figures adjusted accordingly. Equipment already assessed according to the previous requirement does not need reassessment.

NOTE 3: Mixed-mode systems may also provide EqC-EMO=1 option, among other more efficient EMOs; for this case the requirement shall be 3 dB tighter than that for EqC-EMO=2 case.

Table 10: Co-channel interference rejection limits for BER $\leq 10^{-6}$ for equipment with Primary Equipment Type D or H

Nominal Access Method (EqC-PET)	Frequency Range (EqC-FR)	Channel Separation (MHz) (EqC-ChS)	Minimum RSL of unwanted signal	
			For 1 dB	For 3 dB
			RSL degradation	
D	< 1 GHz	3,5	-112	-106
		5	-110	-104
		7	-109	-103
		10	-107	-101
		14	-106	-100
		15	-105	-99
	1 GHz to 3 GHz	3,5	-112	-106
		7	-109	-103
		10,5	-108	-102
		14	-106	-100
	3 GHz to 11 GHz	3,5	-112	-106
		5	-110	-104
		7	-109	-103
		10	-107	-101
		14	-106	-100
	26 GHz and 28 GHz	3,5	-112	-106
		7	-109	-103
		14	-106	-100
		28	-103	-97
56		-100	-94	
112		-97	-91	
H	≤ 11 GHz	1	-117	-111
		2	-114	-108
		3,5	-112	-106
		7	-109	-103
		14	-106	-100
NOTE: For Channel Separations (EqC-ChS) not included in the present table the S/I levels should be determined by linear interpolation (rounded up to the nearest tenth of dB) between from the two nearest values of EqC-ChS tabulated.				

5.4.4.2 Adjacent channel interference

Adjacent channel rejection is defined as the ability of the receiver to receive a wanted signal in the presence of a like unwanted signal which is one channel away.

For mixed-mode systems, the adjacent channel interference specification shall be met for all combinations of EqC-EMOs for the wanted and interfering signals. The applicable specification for each combination of EqC-EMOs shall be that of the wanted EqC-EMO (i.e. that of the receiving equipment).

For preset-mode systems, each mode shall meet the interference sensitivity requirements independently (as a separate single-mode system).

The channel bandwidth and the adjacent channel frequency separation are considered to be those defined by the actual channel width used by the system (e.g. that defined by the CS in any P-MP system). In the case of a TS operating on a selectable portion of such ChS (e.g. some TS in FDMA and MC-TDMA applications), however, the requirement shall be met for whichever portion of that channel the TS uses. The requirement shall be met with an interfering signal, at maximum loading, occupying any portion of ChS, up to its whole. In such cases, for assessment purposes, the manufacturer shall declare which victim/interfering signal loading/configuration will produce the worst case when used for producing the test report.

The requirement for adjacent channel interference rejection of systems with PET = F, T, O or M, is that the degradation of the RSL threshold for $BER \leq 10^{-6}$ shall not exceed 1 dB or 3 dB respectively, in the presence of two predefined levels of interference. When a wanted signal, with RSL enhanced by 1 dB and 3 dB with respect to the appropriate $BER \leq 10^{-6}$ entry in the BER/RSL threshold tables, is combined with a like modulated (see note) unwanted signal, but displaced by the channel separation with RSL level as defined (as S/I or absolute interference level) in the appropriate 1 dB or 3 dB entries, respectively, in table 11 or 12, then the BER of the combined shall not be worse than 10^{-6} . The interfering signal shall have like modulation (see note) and bandwidth as the wanted signal, but be uncorrelated with it. This requirement shall be met with the unwanted signal on either side of the wanted signal's frequency.

NOTE: For mixed mode the requirement is extended to any combination of possible modulation of wanted and unwanted signal provided by the system.

Table 11: Limits of adjacent channel interference rejection for $BER \leq 10^{-6}$ for equipment with Primary Equipment Types F, T, O or M

Primary Equipment Type (EqC-PET)	Frequency Range (EqC-FR)	Modulation Order (EqC-EMO) (Note 3)	Sub-type (EqC-ST)	Signal to Interference level (S/I)	
				For 1 dB	For 3 dB
				Threshold Degradation	
F Note 1	< 1 GHz	2	Any	0	-4
		3	Any	0	-4
		4	Any	0	-4
	1 GHz to 11 GHz	2	FA	-15,5	-19,5
		3	FA	-13,5	-17,5
		4	FA	-6,5	-10,5
	1 GHz to 3 GHz	2	FB	-3	-7
		3	FB	-3	-7
		4	FB	-3	-7
	3 GHz to 11 GHz	2	FB	-10,5	-14,5
		3	FB	-8,5	-12,5
		4	FB	-1,5	-5,5
	26 GHz, 28 GHz and 32 GHz	2	Any	-15,5	-19,5
3		Any	-13,5	-17,5	
4		Any	-6,5	-10,5	
26 GHz and 28 GHz	6	Any	0	-4	
M Note 4	26 GHz, 28 GHz and 32 GHz	2	Any	0	-4
		4	Any	0	-4
		6	Any	0	-4
T	< 1 GHz	2	QP	11	9
		2	GM	11	9
		2	DQ	11	9
	1 GHz to 3 GHz	Any	Any	0	Note 2
	3 GHz to 11 GHz	2	HC	-10	-13
		2, 4, 6	Not HC	0	Note 2
	26 GHz and 28 GHz	2	HC	-10	-13
	26 GHz, 28 GHz and 32 GHz	2	Not HC	0	-4
		4	Any	0	-4
6		Any	0	-4	
O	≤ 11 GHz	Any	Any	0	Note 2

NOTE 1: The unwanted signal is one ChS channel away.

NOTE 2: Earlier equipment standards corresponding to the equipment types annotated by note 2 specify co-channel performance in terms of BER degradation up to 10^{-5} , rather than the more usual RSL degradation for $BER \leq 10^{-6}$ which is more usual and more appropriate in the context of modern broadband systems. In these cases, the requirement of the earlier standards has been translated to a degradation of RSL threshold of 1 dB, which is considered equivalent from the point of view of the essential requirements under article 3.2 of the R&TTE Directive [2] and the figures adjusted accordingly. Equipment already assessed according to the previous requirement do not need reassessment.

NOTE 3: Mixed-mode systems may also provide EqC-EMO=1 option, among other more efficient EMOs; for this case the requirement shall be 3 dB tighter than that for EqC-EMO=2 case.

NOTE 4: For multi-carrier equipment, the limits shall be met for each sub-carrier. The requirement shall be met for an interfering signal on either side of the multi-carrier system centre frequency.

Table 12: Limits of adjacent channel interference rejection for BER $\leq 10^{-6}$ for equipment with Primary Equipment Type D or H

Nominal Access Method (EqC-PET)	Frequency Range (EqC-FR)	Channel Separation (MHz) (EqC-ChS) (see note)	Minimum RSL of unwanted signal	
			For 1 dB	For 3 dB
			RSL degradation	
D	< 1 GHz	3,5	-96	-90
		5	-94	-88
		7	-93	-87
		10	-91	-85
		14	-90	-84
	1 GHz to 3 GHz	3,5	-96	-90
		7	-93	-87
		10,5	-92	-88
		14	-90	-84
		3 GHz to 11 GHz	3,5	-96
	5		-94	-88
	7		-93	-87
	10		-91	-85
	10,5		-92	-88
	26 GHz and 28 GHz	3,5	-96	-90
		7	-93	-87
		14	-90	-84
		28	-87	-81
		56	-84	-78
	H	≤ 11 GHz	1	-101
2			-98	-92
3,5			-96	-90
7			-93	-87
14			-90	-84

NOTE: For Channel Separations (EqC-ChS) not included in the present table the S/I levels should be determined by linear interpolation between the two nearest values of EqC-ChS tabulated.

5.4.4.3 CW interference

The immunity of the receiver(s) to CW spurious interference is defined in EN 301 390 [10].

For a receiver operating at the RSL specified in table 7 for BER $\leq 10^{-6}$ threshold, the introduction of a CW interferer at a level of +30 dB with respect to the wanted signal and at any frequency up to the relevant upper and lower frequency limits derived from the table set out in clause 7.1 of EN 301 390 [10], but excluding frequencies either side of the wanted frequency by up to 500 % of the ChS, shall not result in a BER greater than 10^{-5} .

NOTE 1: For PET = D equipment, the appropriate reference RSL is that for the declared maximum system loading according to the relevant EqC-SET and ChS derived from the formulas in table 8.

This requirement is designed to identify specific frequencies at which the receiver may have a spurious response; e.g. image frequency, harmonics of the receive filter, etc. The actual test range shall be that according to clause 7.1 of EN 301 390 [10]. The test is not intended to imply a relaxed specification at all out of band frequencies elsewhere specified in the present document.

NOTE 2: Two instances in the table of previous standards referenced by EN 301 753 (see bibliography) (EN 300 636 and EN 301 055 in bibliography) are silent on requirements for CW interference. Such silence on a matter of general immunity is no longer acceptable and the rationalization of the present document now sets common requirements for all systems, derived from EN 301 390 [10]. Therefore, for claiming compliance to the present document, systems that have already claimed conformance to R&TTE using former EN 301 753 (see bibliography) should undergo additional assessment in respect of CW interference immunity.

5.5 Special requirements for equipment with integral antennas

5.5.1 General

The present document is mainly intended to cover fixed radio equipment without integral antennas. However, it also applies to fixed radio systems products with integral antennas, for which all the technical requirements included in the present document and those of EN 302 326-3 [12] both apply.

An integral antenna is one that is declared as part of the radio equipment by the supplier. Even equipment with an integral antenna may still allow separation of the antenna from the equipment using a special tool. In such cases the assessment of the radio equipment and of the antenna against the requirements of this whole multi-part deliverable may be done separately by the actual supplier(s). In this case the declaration of conformity may be composed of a declaration of conformity for the equipment and a declaration of conformity for the antenna, done separately by the actual supplier(s), according to the present document and to EN 302 326-3 [12], respectively.

Testing of EIRP requirements, wherever identified, is necessary for the assessment of equipment with integral antennas only. However equipment placed on the market without antennas should identify limitations which must be applied such that the overall system meets EIRP requirements, wherever identified (e.g. defining the maximum associated antenna gain).

RPE, co-polar and cross polar, and the gain of antennas are essential requirements for equipment with integral antennas, but not only for the transmit direction. Since receiver parameters are essential for the Fixed Service, in the case of receive only antenna (e.g. in space diversity applications), the antenna parameters are as essential on the receive side as they are on the transmitter side. Antenna essential requirements should be clearly described without distinction to transmit or receive.

5.5.2 Radiation Pattern Envelope (Off-axis EIRP density)

In the case of radio equipment with an integral antenna, the radiation pattern (off-axis EIRP density) is essential under article 3.2 of the R&TTE Directive [2]. Limits for co-polar and cross-polar envelope are set out in clause 4.4 of EN 302 326-3 [12].

5.5.3 Antenna Gain

In the case of radio equipment with an integral antenna, the antenna gain is essential under article 3.2 of the R&TTE Directive [2]. Limits are set out in clause 4.5 of EN 302 326-3 [12].

6 Testing for conformance with technical requirements

NOTE: Void clauses are incorporated throughout clause 6 to preserve consistency of clause numbering between clauses 5 and 6.

6.1 General

Testing methods and conditions for assessing all requirements are specified in this clause.

In the following clauses, limits are required to be met at specific reference points of the system block diagram. Reference points and the system block diagram are set out in figure 3.

In the case of wide radio-frequency bands covering units and multirate/multiformat equipment, these specifications shall be met at any frequency, at any rate/format. However the tests, required for generating a test report and/or declaration of conformity, in order to fulfil any conformity assessment procedure with respect to the R&TTE Directive [2], shall be carried-out in accordance with the principles set out in annex B.

The system under assessment, generically represented by the block diagram in figure 3, may be physically split between indoor and outdoor units. Their interconnection, commonly made by cable(s), is not represented by the interfaces shown in the block diagram in figure 3. Those units are nevertheless intended as being part of the whole system. The test should be carried out with separate environmental conditions for each part as defined in EN 301 126-2-1 [3] clause 4.3.

The traffic carried by the system shall be declared by the manufacturer.

Unless otherwise stated, all requirements are intended for systems fully loaded (according to the maximum loading provided by the equipment).

For defining the coherent set of essential test suites for conformity assessment, a number of declared EqC codes and other parameters are needed as declaration from the supplier. Standing the considerable number of possibilities under the scope of the present document summarized in table 1 and, for systems with integral antennas in table 3, it is recommended to consider the production of a summary table, such as table E.1 proposed in Informative annex E, to be attached as header of the test documentation for aid the correct identification of the equipment/system profile by any interested third party.

NOTE 1: For each technical requirement in the present document, there may be additional characteristics, not considered relevant to article 3.2 of the R&TTE Directive [2]. Nevertheless they are considered important for the system's operation. These additional requirements, when identified, may be found in EN 302 326-1 [11].

NOTE 2: As indicated in clause 1.1 the present document rationalizes earlier specifications. Unless specifically mentioned, both previous and new requirements are completely equivalent. It is expected that equipment already conforming to the previous EN 301 753 (see bibliography), would not need a new test report for re-assessment of essential requirements according to the present document. Suppliers may claim conformance to the present document, even in the case of formally tighter requirements. However, legal implications of any declaration of conformity are outside the scope of the present document.

6.2 Environmental profile

The equipment, or the equipment-antenna assembly (in the case of systems with integral antenna), shall comply with all the technical requirements of the present document at all times when operating within the boundary limits of the declared operational environmental profile, including those limits of any primary/secondary power supply external to the equipment under assessment.

An integrated equipment-antenna assembly which employs a radome shall meet the requirements of the present document with the radome in place.

Additional parameters appropriate to system implementation are not relevant to declaration of conformity to article 3.2 of R&TTE Directive [2]. They may only be subject to private commercial agreement between the equipment purchaser and supplier.

Tests defined in the present document shall be carried out at representative points within the boundary limits of the declared operational environmental profile.

Boundary limits of environmental climatic conditions, which are part of the environmental profile, may be determined by the environmental class of the equipment according to the guidance given in clause 4.4 of EN 301 126-2-1 [3].

Any test, requested to generate the test report and/or declaration of conformity in order to fulfil any Conformity assessment procedure with respect to the R&TTE Directive [2] shall be carried-out:

- a) For radio equipment, with respect to the same principles and procedures, for reference and extreme conditions, set out in clause 4.4 of EN 301 126-2-1 [3] for climatic conditions and in table 1 of EN 301 126-2-1 [3] and clause 5.2 and note 1 in table 13 of the present document for power supply conditions.

NOTE: The requirement to test at reference or extreme conditions is set out in clauses 6.3 and 6.4 of the present document according to the principles for similar requirements set out in EN 301 126-2-1 [3].

- b) For integral DFRS antennas (directional phenomena of clause 5.5 of the present document), at reference environmental conditions of the test field according to clause 4.1 of EN 301 126-3-2 [9].

For testing equipment for compliance with technical requirements, EN 301 126-2-1 [3], EN 301 126-2-2 [4], EN 301 126-2-3 [5], EN 301 126-2-4 [6], EN 301 126-2-5 [7] and EN 301 126-2-6 [8] shall apply.

6.3 Transmitting phenomena

6.3.1 General

6.3.1.1 Summary table for transmitter test conditions

Table 13: Essential transmitter test suites, clauses and conditions

Clause (note 2)	Parameter (note 2)	EN 301 126-2-x reference for the test methods	Climatic conditions (note 1)		Channels to be tested (note 4) B = Bottom M = Middle T = Top	Other specific conditions
			Ref	Extreme		
6.3.2	Transmitter output power					
6.3.2.2	Transmitter maximum power	Table 15	X	X	BMT	Note 3
6.3.2.3	Nominal power tolerance	Table 15	X	X	BMT	Note 3
6.3.3	Output frequency tolerance	Table 16	X	X	BMT	Note 3
6.3.4	Adjacent channel power					
6.3.4.1	Transmitter spectrum density mask	Table 17	X	X	BMT	Note 3
6.3.4.2	Discrete CW components exceeding the spectrum masks limits	Table 18	X	X	BMT	Note 3
6.3.8	Dynamic change of Modulation Order	Table 17	X	X	BMT	Required for mixed-mode systems only according clause 6.3.8 of the present document
6.3.5	Spurious emissions-external	Table 19	X		BMT	The tests shall be carried-out with ATPC, if any, set to maximum available power and RTPC-1, if any, set at minimum attenuation. Actual test shall be limited to the practical frequency range set out by clause A.1 of EN 301 390 [10]
6.3.6	Transmitter power control					
6.3.6.2	Automatic Transmit Power Control (ATPC)	Table 20	X		M	
6.3.6.3	Remote Transmit Power Control (RTPC)	Table 21	X		BMT	Shall be carried-out at three operating conditions (lowest, medium, and highest delivered power) of the RTPC power range and with ATPC (if any) set to maximum nominal power

Clause (note 2)	Parameter (note 2)	EN 301 126-2-x reference for the test methods	Climatic conditions (note 1)		Channels to be tested (note 4) B = Bottom M = Middle T = Top	Other specific conditions
			Ref	Extreme		
6.3.7	Remote Frequency Control (RFC)	Table 22	X		BMT	Tests shall be carried for RFC setting procedure for three frequencies (i.e. frequencies frequency settings from lower to centre, centre to higher and back to the lower frequency within the covered range). The test shall be carried-out at reference climatic conditions
<p>NOTE 1: This refers to climatic conditions only; for other environmental and power supply conditions, please refer to EN 301 126-2-1 [3], which provides, for testing some parameters, combined variations also of the power supply source, see table 1 of EN 301 126-2-1 [3]; however, DC regulators on all the DC sources actually used for carrier generation are commonly integral to the radio equipment. When this is the case, such additional tests are considered redundant and not necessary to assess the compliance to the essential requirements of article 3.2 of the R&TTE Directive [2]. This will not imply any reduction to the supplier responsibility related to the conformance declaration, which, in any case, shall be valid for the whole declared environmental profile.</p> <p>NOTE 2: For equipment with integral antennas, the essential transmitter test suite clauses include the antenna parameters, test clauses and conditions contained in table 29, clause 6.5.</p> <p>NOTE 3: This clause requires, besides extremes of temperature, testing also at extremes of voltage (see note 1).</p> <p>NOTE 4: Annex B provides more detailed information on channels to be tested, depending on the type of equipment.</p>						

6.3.1.2 Spectrum analyser settings

Spectrum analyser settings to be used in measuring spectral power density are shown in table 14.

Table 14: Spectrum analyser settings for RF power spectrum measurement

		Channel separation (EqC-ChS) MHz					
		0,003 to 0,03	0,03 to 0,3	0,3 to 0,9	0,9 to 12	12 to 36	> 36
Centre frequency		f_0	f_0	f_0	f_0	f_0	f_0
Sweep width	MHz	6 x ChS	6 x ChS	6 x ChS	6 x ChS	6 x ChS	6 x ChS
Scan time		auto	auto	auto	auto	auto	Auto
IF resolution bandwidth	kHz	1	3	10	30	100	300
Video bandwidth	kHz	0,03	0,1	0,1	0,3	0,3	0,3
<p>NOTE 1: It should be noted that, having separate limits for spectral density and CW lines, IF resolution bandwidth is not essential for showing conformance; nevertheless it should still be selected as the most appropriate as possible for the system under test.</p> <p>NOTE 2: The settings proposed in this table are suitable when continuous emissions are concerned. When burst emissions are considered, the IF resolution and video bandwidths should be matched to the time characteristics (burst and frame durations) of the signal. The measurement of burst emission should also be carried on using the maximum-hold or gating functionality. The manufacturer shall declare the burst time characteristics and the settings used for burst emission test, insuring that they suitably represent the worst situation. As general guidance only, for having raise-time fast enough for the burst to be tested, the IFbw should be selected as $IFbw \cong k/Bd$ (where Bd is the burst duration and 'k' is a factor depending on the spectrum analyser, typically between 2 and 3); for the same reason, video filtering should be kept equal to IFbw. This approach might be adopted when burst duration is sensibly lower than the frame duration; when Bd approaches the frame duration, the emission tend to become continuous and the setting in table above might still be adopted if convenient and suitably accurate. When more complex access methodology are concerned, the IF and video bandwidths might be optimized taking into account all the time durations of the signal burst (e.g. mixed OFDMA/TDMA systems also on the OFDMA symbols duration might be considered).</p> <p>NOTE 3: For FH-CDMA systems, the spectrum analyser setting is to be synchronised to the hopping sequence where practical.</p>							

6.3.2 Transmitter output power

6.3.2.1 General

For mixed-mode and preset-mode systems, the nominal power and power tolerance shall be declared for each EqC-EMO offered.

6.3.2.2 Maximum power

Test methods for the maximum transmitter power are referred to in table 15.

Table 15: Test methods for the maximum transmitter power

Primary Equipment Type (EqC-PET)	Conformance testing standard	Clause number(s)
F	EN 301 126-2-2 [4]	4.2.1
T or O	EN 301 126-2-3 [5]	4.2.1
H	EN 301 126-2-4 [6]	4.2.1
D	EN 301 126-2-5 [7]	4.2.1
M	EN 301 126-2-6 [8]	4.2.1

NOTE 1: Testing EIRP requirements is necessary for assessment of equipment with integral antenna only; however also equipment placed on the market without antennas should, in principle, refer, when relevant in common practice, to such limitation (e.g. defining the maximum associated antenna gain).

NOTE 2: Actual test reports are needed only if the nominal declared power, with positive tolerance added, comes within 3 dB of any maximum level foreseen in clause 5.3.2.2.

6.3.2.3 Nominal output power tolerance

Test methods for the output power tolerance on the declared nominal level shall be as for maximum power in clause 5.3.2.3.

6.3.3 Transmitter output frequency error/stability (output frequency tolerance)

Output frequency tolerance shall be measured in accordance with the following provisions of conformance standards according to the Primary Equipment Type.

Table 16: Test methods for the output frequency tolerance

Primary Equipment Type (EqC-PET)	Conformance testing standard	Clause number(s)
F	EN 301 126-2-2 [4]	4.2.5
T or O	EN 301 126-2-3 [5]	4.2.5
H	EN 301 126-2-4 [6]	4.2.5
D	EN 301 126-2-5 [7]	4.2.5
M	EN 301 126-2-6 [8]	4.2.5

6.3.4 Adjacent channel power (transmitter spectrum density masks)

6.3.4.1 Transmitter spectrum density masks

For mixed-mode and preset-mode systems, the manufacturer shall declare which combination of EqC-EMOs the equipment offers, and for each EqC-EMO shall be compliant with the relevant mask.

EXAMPLE: A system offering 4 QAM, 16 QAM and 64 QAM shall comply with the transmit mask specification separately for each of the three EqC-EMOs.

Spectrum masks for single carrier systems (Primary Equipment Types T, O, H, and D) shall be measured in accordance with the following provisions of conformance standards according to the Primary Equipment Type.

Table 17: Test methods for the Spectrum masks

Primary Equipment Type (EqC-PET)	Conformance testing standard	Clause number(s)
F	EN 301 126-2-2 [4]	4.2.6
T or O	EN 301 126-2-3 [5]	4.2.6
H	EN 301 126-2-4 [6]	4.2.6
D	EN 301 126-2-5 [7]	4.2.6
M	EN 301 126-2-6 [8]	4.2.6

The following test conditions should be applied when measuring the power spectrum density for systems where EqC-PET = M:

- the total output power level should be according to clause 5.3.2;
- all sub-carriers are modulated according to the input bit rate (referred to Z' in figure 3) declared by the manufacturer. The input signal shall be in accordance to the interfaces stated in EN 302 326-1 [11];
- for systems that use mixed-mode, refer to annex F of EN 302 326-1 [11].

The following test conditions should be applied when measuring the power spectrum density for EqC-PET = F:

- The number (N) of carriers transmitted over one CS transceiver should correspond with the full capacity load (FCL) of the measured CS. The number N shall be declared by the manufacturer.
- The nominal output power for each carrier shall be 1/N of the total nominal output power of the equipment referred to point C' of the RF reference diagram, figure 3.
- For systems operating in bands below 3 GHz, the capacity of the equipment shall be equally distributed among the N single carriers.
- For systems operating in bands above 3 GHz, all carriers are modulated according to the input bit rate declared by the manufacturer.

6.3.4.2 Discrete (CW) spectral lines exceeding the spectrum mask (all stations)

Output frequency tolerance shall be measured in accordance with the following provisions of conformance standards according to the Primary Equipment Type.

Table 18: Test methods for the CW spectral lines

Primary Equipment Type (EqC-PET)	Conformance testing standard	Clause number(s)
F	EN 301 126-2-2 [4]	4.2.8
T or O	EN 301 126-2-3 [5]	4.2.8
H	EN 301 126-2-4 [6]	4.2.8
D	EN 301 126-2-5 [7]	4.2.8
M	EN 301 126-2-6 [8]	4.2.8

6.3.5 Transmitter spurious emissions

Transmitter spurious emissions shall be measured in accordance with the following provisions of conformance standards according to the Primary Equipment Type.

Table 19: Test methods for the transmitter spurious emissions

Primary Equipment Type (EqC-PET)	Conformance testing standard	Clause number(s)
F	EN 301 126-2-2 [4]	4.2.9
T or O	EN 301 126-2-3 [5]	4.2.9
H	EN 301 126-2-4 [6]	4.2.9
D	EN 301 126-2-5 [7]	4.2.9
M	EN 301 126-2-6 [8]	4.2.9

The tests shall be carried out to produce the test report and/or declaration of conformity required (R&TTE Directive [2]) with ATPC if applicable, set to maximum available power. The RTPC, if applicable, shall be set to give maximum available power. The actual test shall be limited to the practical frequency ranges foreseen by clause A.1 of EN 301 390 [10].

The tests shall be carried out at reference climatic conditions according to EN 301 126-2-1 [3] clause 4.2, table 1.

6.3.6 Transmitter power control (ATPC and RTPC)

6.3.6.1 General

Void

6.3.6.2 Automatic Transmitter Power Control (ATPC)

Equipment with ATPC will be subject to manufacturer declaration of ATPC ranges and related tolerances.

ATPC shall be measured in accordance with the following provisions of conformance standards according to the Primary Equipment Type.

Table 20: Test methods for the ATPC function requirements

Primary Equipment Type (EqC-PET)	Conformance testing standard	Clause number(s)
F	EN 301 126-2-2 [4]	4.2.3
T or O	EN 301 126-2-3 [5]	4.2.3
H	EN 301 126-2-4 [6]	4.2.3
D	EN 301 126-2-5 [7]	4.2.3
M	EN 301 126-2-6 [8]	4.2.3

Testing shall be carried out with transmitter power level corresponding to:

- ATPC set manually to a fixed value for receiver requirements;
- ATPC set at maximum available power for transmitter requirements.

For the relevant power level definitions of ATPC operation see EN 302 326-1 [11] while for additional clarification on ATPC and RTPC requirements see annex D of the present document.

The test shall be carried out at reference climatic conditions according to EN 301 126-2-1 [3] clause 4.2, table 1.

6.3.6.3 Remote Transmitter Power Control (RTPC)

RTPC shall be measured in accordance with the following provisions of conformance standards according to the Primary Equipment Type.

Table 21: Test methods for the RTPC function requirements

Primary Equipment Type (EqC-PET)	Conformance testing standard	Clause number(s)
F	EN 301 126-2-2 [4]	4.2.4
T or O	EN 301 126-2-3 [5]	4.2.4
H	EN 301 126-2-4 [6]	4.2.4
D	EN 301 126-2-5 [7]	4.2.4
M	EN 301 126-2-6 [8]	4.2.4

The transmit spectrum shall be demonstrated to comply with the spectrum mask at three points (lower, medium and upper) points in the declared frequency band with the transmit power control, where applicable, set to a maximum value and with:

- RTPC-1 set manually to the maximum, middle and to the minimum values;
- RTPC-2 set at a maximum provided output power.

The tests, carried out to generate the test report and/or declaration of conformity, required in order to fulfil any Conformity assessment procedure with respect to the R&TTE Directive [2], shall be carried-out at three operating conditions (lowest, medium, and highest delivered power) of the RTPC power range and with ATPC (if any) set to maximum nominal power. The test shall be carried-out at reference and extreme climatic conditions.

Even if all of the procedures set out in the clause of the appropriate conformance testing standard are followed, the actual tests, at the lower RTPC power levels, may fall outside of the available sensitivity of test instruments currently available on the market. In this event the supplier shall produce an attachment to the test report containing:

- calculated evidence that the noise floor of the actual test bed is higher than the mask requirement;
- calculated evidence that the actual noise floor, generated by the transmitter with respect to the noise figure and implemented amplification/attenuation chain; is lower than the mask requirement.

Tests for other transmit and receive requirements shall be made with RTPC set at highest delivered power.

6.3.7 Remote Frequency Control (RFC)

Tests shall be carried out for RFC setting process between three frequencies: the lower and upper extremes and the centre of the declared range.

Applying the RFC setting procedure for those three frequencies (i.e. frequencies settings from lower to centre, centre to higher and back to the lower frequency in the covered range) the equipment shall not produce emissions outside the spectrum masks for either the previous or final centre radio frequency.

The test shall be carried out at reference climatic conditions according to EN 301 126-2-1 [3] clause 4.2, table 1.

RFC shall be measured in accordance with the following provisions of conformance standards according to the Primary Equipment Type.

Table 22: Test methods for the RFC function requirements

Primary Equipment Type (EqC-PET)	Conformance testing standard	Clause number(s)
F	EN 301 126-2-2 [4]	4.2.7
T or O	EN 301 126-2-3 [5]	4.2.7
H	EN 301 126-2-4 [6]	4.2.7
D	EN 301 126-2-5 [7]	4.2.7
M	EN 301 126-2-6 [8]	4.2.7

6.3.8 Dynamic Change of Modulation Order

For mixed-mode systems only; this test shall be carried out for transient behaviour with the spectrum analyser in "max hold" mode. The equipment shall be configured to operate with continuous modulation mode switching at the maximum switching speed permitted by the system (e.g. within the same frame for a TDMA system), with equal duty cycle for all modulation orders, and with all training bursts or reference signals active as in normal operation. The 0 dB reference mask shall be the maximum spectral density in the "max-hold" condition, disregarding, if any, residual of the carrier due to modulation imperfection.

6.4 Receiving phenomena

6.4.1 General

Measurements shall be made under full load conditions (as declared by the manufacturer) and with appropriate input signals presented at point C of the RF system block diagram, figure 3.

Table 23: Essential receiver test suites clauses and conditions

Clause (note 2)	Parameter (note 2)	EN 301 126-2-x reference and clause for test methods	Climatic conditions (note 1)		Channels to be tested (note 4) B = Bottom M = Middle T = Top	Other specific conditions (note 3)
			Ref	Extreme		
6.4.2	Receiver spurious emissions	Table 24	X		BMT	Actual test shall be limited to the practical frequency range specified by clause A.1 of EN 301 390 [10]
6.4.3	Minimum RSL					
6.4.3.2	Single signal performance	Table 25	X	X	BMT at Nominal M at Extreme	
6.4.3.3	Performance at maximum loading	EN 301 126-2-5 [7] clauses 4.3.5.2.2 (TS→CS) or 4.3.5.2.4 (CS→TS)	X	X	BMT at Nominal M at Extreme	For systems with EqC-PET = D only
6.4.4	Minimum RSL					
6.4.4.1	Co-channel interference	Table 26	X		M	
6.4.4.2	Adjacent channel interference sensitivity	Table 27	X		M	To be produced for the lower or for the upper frequency adjacent channel, arbitrarily selected by supplier
6.4.4.3	CW interference	Table 28	X		M	Actual test shall be limited to the practical frequency range specified by clause 7.1 of EN 301 390 [10]
NOTE 1: This refers to climatic conditions only; for other environmental and power supply conditions, please refer to EN 301 126-2-1 [3].						
NOTE 2: For receiving equipment with integral antennas, the essential receiver test suite clauses include the antenna parameters, test clauses and conditions contained in table 29, clause 6.5.						
NOTE 3: All receiver test suite clauses are performed at nominal voltage only.						
NOTE 4: Annex B provides more detailed information on channels to be tested, depending on the type of equipment.						

6.4.2 Receiver spurious emissions

Receiver spurious emissions shall be measured in accordance with the following provisions of conformance standards according to the Primary Equipment Type.

Table 24: Test methods for the receiver spurious emissions

Primary Equipment Type (EqC-PET)	Conformance testing standard	Clause number(s)
F	EN 301 126-2-2 [4]	4.3.2
T or O	EN 301 126-2-3 [5]	4.3.2
H	EN 301 126-2-4 [6]	4.3.2
D	EN 301 126-2-5 [7]	4.3.4
M	EN 301 126-2-6 [8]	4.3.2

The tests shall be carried out to produce the test report and/or declaration of conformity required (R&TTE Directive [2]) with ATPC if applicable, set to maximum available power. The RTPC, if applicable, shall be set at minimum attenuation. The actual test shall be limited to the practical frequency ranges foreseen by clause A.1 of EN 301 390 [10].

The tests shall be carried out at reference climatic conditions according to EN 301 126-2-1 [3] clause 4.2, table 1.

6.4.3 Minimum RSL

6.4.3.1 General

Void.

6.4.3.2 Single signal performance

Minimum RSL under single signal conditions shall be measured in accordance with the following provisions of conformance standards according to the Primary Equipment Type.

Table 25: Test methods for the minimum RSL

Primary Equipment Type (EqC-PET)	Conformance testing standard	Clause number(s)
F	EN 301 126-2-2 [4]	4.4.2
T or O	EN 301 126-2-3 [5]	4.4.2
H	EN 301 126-2-4 [6]	4.4.2
D	EN 301 126-2-5 [7]	4.3.5.2.1 and 4.3.5.2.3
M	EN 301 126-2-6 [8]	4.4.2

6.4.3.3 Performance at maximum loading (EqC-PET = D only)

BER as a function of RSL for equipment with EqC- PET = D shall be measured in accordance with the provisions of EN 301 126-2-5 [7] clauses 4.3.5.2.2 or 4.3.5.2.4 according to station type.

6.4.4 Interference sensitivity

6.4.4.1 Co-channel interference

For mixed-mode systems, the co-channel interference specification shall be met for all combinations of EqC-EMOs for the wanted and interfering signals.

For test report purposes, the co-channel interference specification shall be tested for all wanted modulation orders with interfering signals of like modulation only.

Co-channel interference sensitivity shall be measured in accordance with the following provisions of conformance standards according to the Primary Equipment Type.

Table 26: Test methods for the co-channel interference

Primary Equipment Type (EqC-PET)	Conformance testing standard	Clause number(s)
F	EN 301 126-2-2 [4]	4.4.4.1
T or O	EN 301 126-2-3 [5]	4.4.4.1
H	EN 301 126-2-4 [6]	4.4.4.1
D	EN 301 126-2-5 [7]	4.3.6.1
M	EN 301 126-2-6 [8]	4.4.4.1

6.4.4.2 Adjacent channel interference

For mixed-mode systems, the adjacent channel interference specification shall be met for all combinations of EqC-EMOs for the wanted and interfering signals. The applicable specification for each combination of EqC-EMOs shall be that of the wanted EqC-EMO. For test report purposes, the test shall be performed for all wanted modulation orders, but only with the lowest modulation order interferer.

Adjacent interference sensitivity shall be measured in accordance with the following provisions of conformance standards according to the Primary Equipment Type.

Table 27: Test methods for the adjacent channel interference

Primary Equipment Type (EqC-PET)	Conformance testing standard	Clause number(s)
F	EN 301 126-2-2 [4]	4.4.4.2
T or O	EN 301 126-2-3 [5]	4.4.4.2
H	EN 301 126-2-4 [6]	4.4.4.2
D	EN 301 126-2-5 [7]	4.3.6.2
M	EN 301 126-2-6 [8]	4.4.4.2

6.4.4.3 CW interference

CW interference sensitivity shall be measured in accordance with the following provisions of conformance standards according to the Primary Equipment Type.

Table 28: Test methods for the CW interference

Primary Equipment Type (EqC-PET)	Conformance testing standard	Clause number(s)
F	EN 301 126-2-2 [4]	4.4.4.3
T or O	EN 301 126-2-3 [5]	4.4.4.3
H	EN 301 126-2-4 [6]	4.4.4.3
D	EN 301 126-2-5 [7]	4.3.6.3
M	EN 301 126-2-6 [8]	4.4.4.3

The test shall be limited to the practical frequency ranges specified in clause 7.1 of EN 301 390 [10].

The test shall be carried-out at reference climatic conditions

6.5 Special requirements for equipment with integral antennas

6.5.1 General

The present document is mainly intended to cover fixed radio equipment without integral antennas. However, it also applies to fixed radio systems products with integral antennas, for which all the technical requirements included in the present document and those of EN 302 326-3 [12] both apply.

For equipment with an integral antenna an appropriate RF interface (and test fixture if required) is commonly provided. In this case the assessment of the radio equipment and of the antenna against the requirements of this whole multi-part deliverable can be done separately and the declaration of conformity may be composed of a declaration of conformity for the equipment to the present document and a declaration of conformity for the antenna to EN 302 326-3 [12]. Alternatively, if the required parameters can be measured directly, an RF interface is not required and a single declaration of conformity applies.

Testing of EIRP requirements, wherever identified, is necessary for the assessment of equipment with an integral antenna only. However equipment placed on the market without antennas should identify limitations which must be applied such that the overall system meets EIRP requirements, wherever identified. (e.g. defining the maximum associated antenna gain).

RPE, co-polar and cross-polar, and gain of antennas are essential requirements for equipment with integral antennas, but not only for the transmit direction. Since receiver parameters are essential for the Fixed Service, in the case of receive only antenna (e.g. in space diversity applications) antenna parameters are as essential on the receive side as they are on the transmit side. Antenna essential requirements should be clearly described without distinction between transmit or receive.

Table 29: Essential transmitter/receiver antenna test suites, clauses and conditions parameters

Clause	Parameter	EN 301 126-3-2 [9] reference clause for test methods	Climatic conditions		Other specific conditions
			Reference	extreme	
6.5	Special requirements for equipment with integral antennas				
6.5.2	Radiation Pattern Envelope (Off-axis EIRP density)	EN 301 126-3-2 [9], clause 6.1	X		
6.5.3	Antenna Gain	EN 301 126-3-2 [9], clause 6.2	X		

NOTE: This refers to climatic conditions only; for other environmental conditions, please refer to EN 301 126-3-2 [9].

6.5.2 Radiation Pattern Envelope (Off-axis EIRP density)

The Radiation Pattern Envelope, co-polar and cross-polar, shall be determined in accordance with the procedures set out in EN 301 126-3-2 [9], clause 6.1.

6.5.3 Antenna Gain

The antenna gain shall be determined in accordance with the procedures set out in EN301 126-3-2 [9], clause 6.2.

For test report purpose of omnidirectional TS antennas, the gain shall be measured along 360° over three perpendicular planes (one azimuth plane and two elevation planes).

Annex A (normative): HS Requirements and conformance Test specifications Table (HS-RTT)

The HS Requirements and conformance Test specifications Table (HS-RTT) in table A.1 serves a number of purposes, as follows:

- it provides a statement of all the essential requirements in words and by cross reference to a specific clause in the present document or to a specific clause in a specific referenced document;
- it provides a statement of all the test procedures corresponding to those essential requirements by cross reference to specific clause(s) in the present document or to a specific clause(s) in specific referenced document(s);
- it qualifies each requirement to be either:
 - Unconditional: meaning that the requirement applies in all circumstances, or
 - Conditional: meaning that the requirement is dependent on the manufacturer having chosen to support optional functionality defined within the schedule.
- in the case of Conditional requirements, it associates the requirement with the particular optional service or functionality;
- it qualifies each test procedure to be either:
 - Essential: meaning that it is included with the Essential Radio Test Suite and therefore the requirement shall be demonstrated to be met in accordance with the referenced procedures;
 - Other: meaning that the test procedure is illustrative but other means of demonstrating compliance with the requirement are permitted.

Table A.1: HS Requirements and conformance Test specifications Table (HS-RTT)

Harmonized Standard EN 302 326-2						
The following essential requirements and test specifications are relevant to the presumption of conformity under Article 3.2 of the R&TTE Directive						
Essential Requirement			Requirement Conditionality		Test Specification	
No	Description	Reference Clause No	U/C	Condition	E/O	Reference: Clause No
1	Transmitter output power	5.3.2	U		E	6.3.2
2	Transmitter output frequency	5.3.3	U		E	6.3.3
3	Transmitter spectrum density masks	5.3.4	U		E	6.3.4
4	Transmitter spurious emissions	5.3.5	U		E	6.3.5
5	Receiver input level range	5.4.3	U		E	6.4.3
6	Receiver emissions	5.4.2	U		E	6.4.2
7	BER as a function of RSL	5.4.3	U		E	6.4.3
8	Receiver interference sensitivity	5.4.4	U		E	6.4.4
9	Radiation pattern envelope	5.5.2	C	Only if integral antenna is used	E	6.5.2
10	Antenna gain	5.5.3	C	Only if integral antenna is used	E	6.5.3

Key to columns:**Essential Requirement:**

No A unique identifier for one row of the table which may be used to identify a requirement or its test specification.

Description A textual reference to the requirement.

Clause Number Identification of clause(s) defining the requirement in the present document unless another document is referenced explicitly.

Conditionality:

U/C Indicates whether the requirement is to be *unconditionally* applicable (U) or is *conditional* upon the manufacturers claimed functionality of the equipment (C).

Condition Explains the conditions when the requirement shall or shall not be applicable for a technical requirement which is classified "conditional".

Test Specification:

E/O Indicates whether the test specification forms part of the Essential Radio Test Suite (E) or whether it is one of the Other Test Suite (O).

NOTE: All tests whether "E" or "O" are relevant to the requirements. Rows designated "E" collectively make up the Essential Radio Test Suite; those designated "O" make up the Other Test Suite; for those designated "X" there is no test specified corresponding to the requirement. All tests classified "E" shall be performed as specified with satisfactory outcomes is a necessary condition for a presumption of conformity. Requirements associated with tests classified "O" or "X" must be complied with as a necessary condition for presumption of conformity, although conformance with the requirement may be claimed by an equivalent test or by manufacturer's assertion supported by appropriate entries in the technical construction file.

Clause Number Identification of clause(s) defining the test specification in the present document unless another document is referenced explicitly Where no test is specified (that is, where the previous field is "X") this field remains blank.

Annex B (normative): Test report in relation to flexible systems applications

B.1 Wide radio-frequency band covering units specification and tests

B.1.1 Radio equipment

Even if radio frequency front-ends for DFRS are commonly designed for covering all or part(s) of the possible operating channels within a specific radio frequency channel arrangement, equipment can provide single radio frequency channel operation (e.g. when the RF duplexer filters is tuned to a specific channel) or offer a wider operating frequency range (e.g. wide-band RF duplexer and frequency agility by the RFC function). Figures B.1 and B.2 show how real operating channels of radio equipment may be mapped onto existing channel arrangements or parts thereof.

The equipment shall comply with all the requirements of the present document at any possible operating frequency.

The tests shall be carried-out in the following way to produce the test report and/or declaration of conformity (R&TTE Directive [2]):

- 1) in the case where the equipment is intended for single channel operation the test report shall be produced for one radio frequency channel arbitrarily chosen by the supplier (see figure B.1);
- 2) in the case where the equipment is intended for covering an operating frequency range the test report shall be produced for the lowest, intermediate and highest possible radio frequency channel within that operating frequency range (see figure B.2).

It is not required that all the tests necessary for the test report be done on the same sample of equipment and at the same time provided that the test report includes all the tests required by the present document. Each test may be performed on different samples of the same equipment at different channel frequencies or frequency ranges and at different times.

NOTE 1: It should be noted that, in principle, all tests are carried out on the same equipment in a single test session. However, the allowance for different test sessions and equipment under test is made to cope with unpredictable events (e.g. equipment or test instruments failure during the tests, not immediately repairable) or for future revision of the present document that might introduce new or different requirement due for additional test reports. In any case this allowance is not intended as a possibility to overcome failed tests without corrective actions.

Where applicable the following additional provisions shall also apply to the production of the test report:

- In the case where the equipment covers a radio frequency channel arrangement with more than one operating frequency range the test report shall be produced for one of the operating frequency ranges. This range may be arbitrarily chosen by the supplier using the above procedures for equipment intended for single channel operation or for covering an operating frequency range (see figures B.1 and B.2).
- In the case where the equipment is designed to cover, with the same requirements under the same ETSI standard, a number of fully or partially overlapping recommended and/or national radio frequency channel arrangements, similarly established across contiguous radio frequency bands allocated to Fixed Service, the test report shall be produced for one radio frequency channel arrangement. This range may be arbitrarily chosen by the supplier using the above procedures for equipment intended for single channel operation or for covering an operating frequency range (see figures B.1 and B.2).

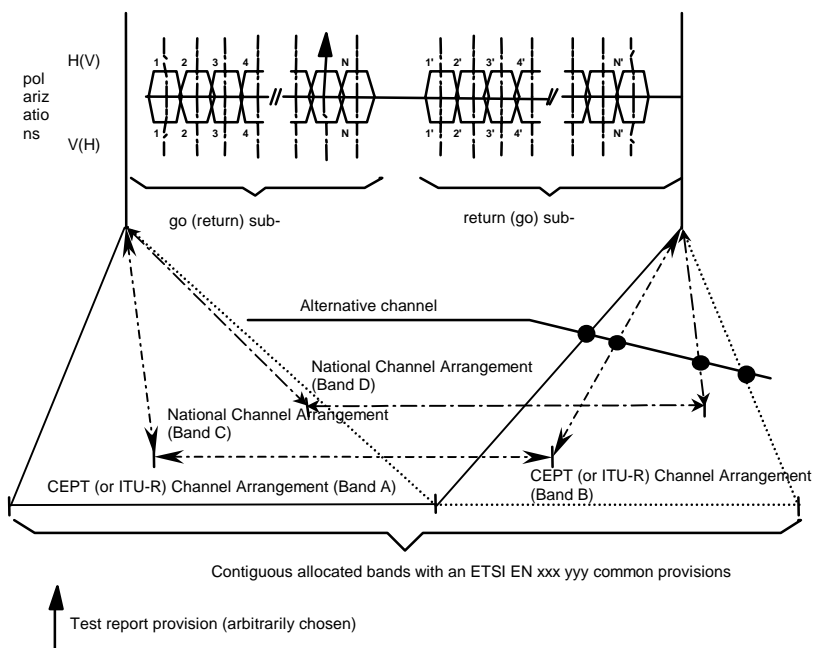

Figure B.1: Test report frequency requirement for equipment intended for single channel operation

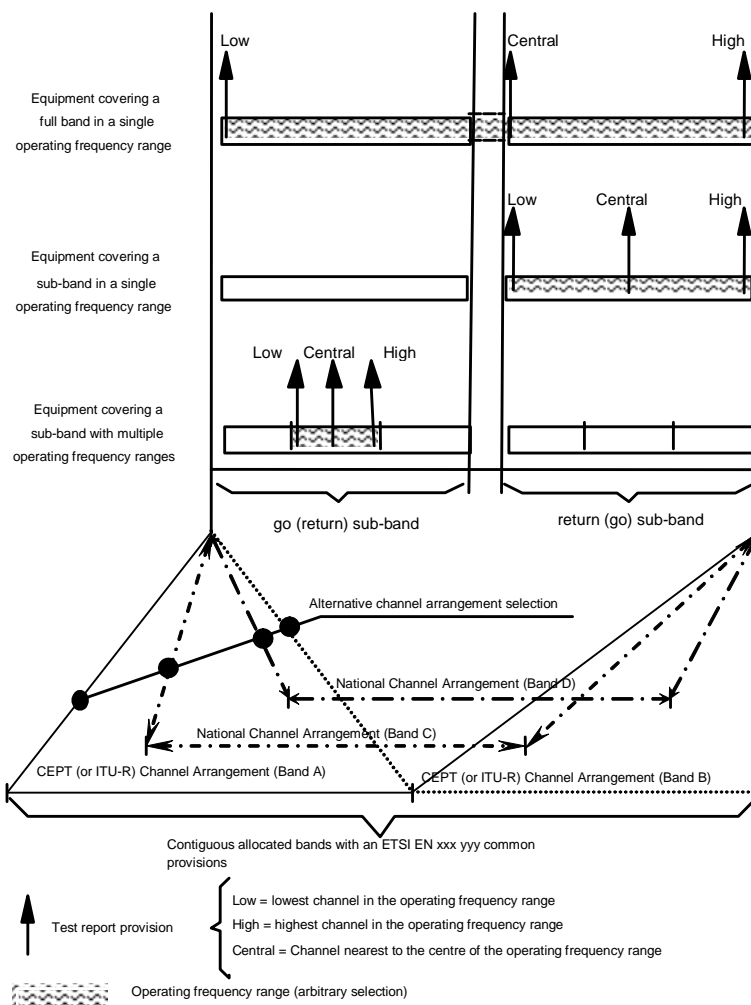

Figure B.2: Test report frequency requirements for equipment intended for covering an operating frequency range

NOTE 2: The go (return) channels in figures B.1 and B.2 are often referred to as down-link (up-link) or as outbound (inbound) channels when used in multipoint systems.

NOTE 3: The above example of a frequency arrangement showing go and return channels is related to point-to-multipoint systems applying Frequency Division Duplex (FDD). Multipoint systems applying Time Division Duplex (TDD) transmit and receive at the same frequency channel in time sequence thus only one frequency channel, either a go or a return channel, is sufficient.

B.1.2 Antennas for DFRS

Commonly, DFRS antennas cover an operating frequency range declared by the supplier. The antenna parameters shall comply with all the requirements of the present document within the declared operating frequency range.

The tests shall be carried out at the lowest, middle and highest frequency of the relevant frequency range to produce the test report and/or declaration of conformity required (R&TTE Directive [2]).

B.2 Multirate/Multiformat covering equipment specification and tests

DFRS equipment can cover a number of different payload-rates and, for preset-mode or mixed-mode systems, also different modulation formats and different error correction codes through software settings.

In such cases the equipment shall comply with all the requirements of the present document at any intended payload, modulation format and error correction code operation.

When more than one bit-rate is concerned, the required tests to be carried out as follows:

- transmitting phenomena (see clause 5.3) at any intended bit rate and modulation format (EqC-EMO) operation (see note);
- receiving phenomena (see clause 5.4) and control and monitoring functions, if present, shall be tested only at the lowest and the highest bit rate for any modulation format to produce the test report and/or declaration of conformity required (R&TTE Directive [2]).

NOTE: Applicable when discrete number of bit rates is offered; cases where bit rate could be preset within a range with larger resolution, five bit rates (spread in the range offered as uniformly as possible) are only required to be tested for each Modulation format.

For preset-mode or mixed-mode systems, specific provisions are stated in specific parts of the present document; in addition, when different error correction codes are provided for the same bit rate and modulation format, the above provisions for different bit-rates and modulation formats still apply, but any test should be made with the selected worst cases error correction code, defined by the manufacturer as follows:

- the expected worst case (e.g. with the higher redundant error correction code) for transmitting phenomena tests (see clause 5.3) or, if equivalent, to one case only (e.g. when the symbol rate is kept constant);
- the expected worst case (e.g. with the less redundant error correction code) for the minimum RSL (see clause 5.4.3) and co-channel interference (see clause 5.4.4.1);
- the expected mixed worst case (e.g. with the higher redundant error correction code on the interfering signal and the less redundant error correction code for the wanted signal) for adjacent-channel interference (see clause 5.4.4.2).

Annex C (normative): System capacity

C.1 General

The system capacity is the traffic capacity of the system per radio channel of a given size.

Although not explicitly considered an "essential requirement" for equipment under article 3.2 of the R&TTE Directive [2], there is a relationship between system capacity and efficient spectrum use. This implies a limitation to the minimum value of system capacity for applicability of the present document is necessary. Therefore only equipment that supports at least the minimum capacity defined in this annex may apply the present document for assessment of R&TTE article 3.2 essential requirements.

For historical reasons, this capacity has been expressed differently for different primary equipment types (EqC-PET) and in different frequency ranges (EqC-FR). In the interests of maintaining continuity with the previous standards, the current version of the present document retains this diversity of definition. It may be expected that future versions of the present document will express the system capacity in a more uniform manner.

C.2 Capacity of equipment with EqC-PET = T, O or M

For EqC-PET = T, O systems operating below 1 GHz, the system capacity shall be declared by the manufacturer.

For EqC-PET = T, O or M systems operating at 1 GHz or above, the gross bit rate per Hz of channel width expressed as bits per second per Hz must equal or exceed: $0,5 \times \text{EqC-EMO bit/s/Hz}$.

For equipment with EqC-PET = O, EqC-SET = MA systems, the manufacturer shall declare the actual system traffic carrying capacity and the gross bit rate (MGBR) for a fully loaded system. For an EqC-PET = O, EqC-SET = MA system, in any single burst any single TS may be dynamically assigned a subset of the OFDMA-sub-channels. Multiple TS are allowed to transmit at the same time on disjoint sets of OFDM-sub-carriers, so the MGBR is defined when all available OFDM-sub-carriers are in use.

C.3 Capacity of equipment with EqC-PET = F

For EqC-PET = F systems operating below 1 GHz, the system capacity shall be declared by the manufacturer.

For EqC-PET = F equipment operating at or above 1 GHz, the payload capacity for given channel widths must equal or exceed the values given in table C.1 in units of 64 kbit/s.

Table C.1: Minimum payload capacity of EqC-PET = F equipment operating at 1 GHz or above

Channel separation (MHz) EqC-ChS	1	1,75	2	3,5	7	14	28	30	56	112
EqC-EMO Equivalent Modulation Order	Minimum capacity / 64 kbits									
2	12	21	24	42	84	256	512	544	1 024	2 048
3	18	31	36	62	160	320	640	704	1 280	2 430
4	24	42	48	84	256	512	1 024	1 088	2 048	4 096
6				192	384	768	1 536		2 430	4 860

With regard to table C.1, the following shall also be taken into account:

- Allocated RF channels may be occupied by systems using smaller RF-channel separation as long as the spectrum mask for the allocated RF channel is not exceeded.
- For convenience, the minimum payload capacity is defined in units of 64 kbit/s. The system may offer any payload capacity provided the above limits are met or exceeded, and the traffic presented to the equipment need not be segmented in units of 64 kbit/s.
- For EqC-ChS values other than those indicated in table C.1 (e.g. achieved by subdivision of the channel separation in table C.1 or by other national/proprietary means) the minimum capacity shall be scaled accordingly and rounded down to the nearest 64 kbit/s multiple.

C.4 Capacity of equipment with EqC-PET = D

For EqC-PET = D systems, the minimum system capacity is defined as the number of 64 kbit/s channels which may be supported for any given channel separation. Capacities of equivalent total bit rate are permitted.

The system capacity shall meet or exceed the following requirements:

- for EqC-SET = OR, $N \geq \text{EqC-ChS} \times 40 / 7$;
- for EqC-SET = PR, $N \geq \text{EqC-ChS} \times 16 / 7$;

where N is the number of 64 kbit/s channels.

This equates to a minimum system loading of:

- 0,366 bps/Hz for EqC-SET = OR systems; and
- 0,146 bps/Hz for EqC-SET = PR systems.

As an example, equipment with EqC-SET = OR and EqC-ChS = 10 MHz must support, at least:

- $10 \times 40 / 7 = 57$ data channels of 64 kbit/s each.

C.5 Capacity of equipment with EqC-PET = H

For EqC-PET = H systems operating below 1 GHz, the system capacity shall be declared by the manufacturer.

For EqC-PET = H systems operating at or above 1 GHz, the supplier shall declare the maximum number of simultaneous duplex 64 kbit/s channels or the bit rates which the equipment is designed to carry for each channel separation supported. Such declared capacity shall not be less than either 8×64 kbit/s channels or 500 kbit/s for each 1 MHz of channel separation. Examples of the required capacity appear in table C.2.

Table C.2: Minimum capacity of EqC-PET = H equipment for some typical channel separations

Channel separation (MHz) EqC-ChS	1,0	2,0	3,5	7,0	14,0
Minimum number of 64 kbit/s channels	8	16	28	56	112
Equivalent Bit Rate (Mbit/s)	0,5	1,0	1,75	3,5	7,0

NOTE: Any other equivalent transmission capacity may be transported, e.g. instead of 112×64 kbit/s a capacity of 56×128 kbit/s can be transmitted.

Annex D (informative): Spectrum mask requirements when ATPC and/or RTPC are implemented

It is worth explaining that, in most practical applications, ATPC and RTPC are realized by a single function software programmable system, therefore it is the manufacturer that should declare how the available range of attenuation should be subdivided (and possibly limited) in order to meet the requirements described below.

D.1 ATPC impact

Amongst other requirements, set out in the present document as "non essential" to fulfil article 3.2 of the R&TTE Directive [2], figure D.1 clarifies the ATPC requirements that are considered "essential".

The equipment shall comply with the requirements of spectrum masks in clause 5.3.4 with ATPC operating in the range between "maximum nominal power" and "maximum available power" (see note below) including the attenuation introduced by the RTPC function (type 1, if any).

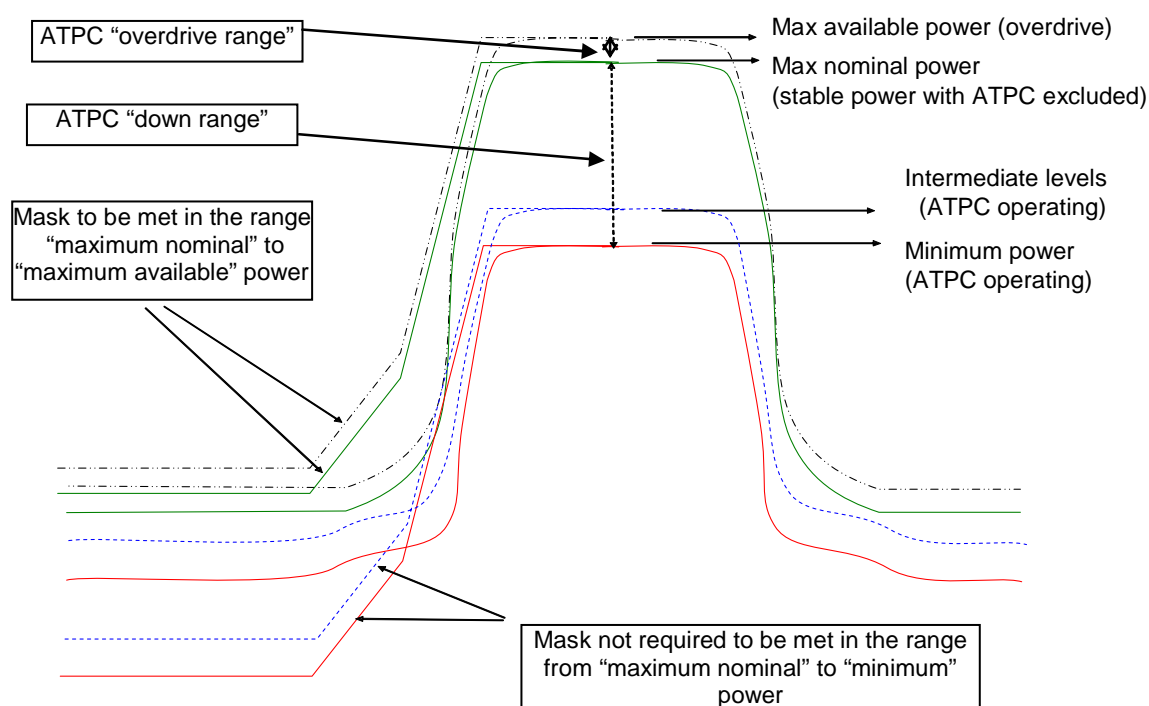

Figure D.1: Relationship between spectrum mask requirement and ATPC operation

NOTE: The Rationale for the requirement is that while the mask is a "relative attenuation", the actual interference potential is given by the absolute power spill-over into adjacent channels. Therefore the NFD should be guaranteed when transmitters operate at maximum nominal power or in the overdrive region (i.e. when maximum absolute power is produced in adjacent channels), which are the conditions commonly used for frequency planning. In all lower power conditions, even where the NFD may be degraded by the (apparent) increase of the noise floor (due to the actual drop in carrier power), resulting in the mask level being exceeded (see figure D.1), however, the absolute interference power on adjacent channels will in any case be equal to or less than that used for planning (i.e. the planned C/I on adjacent channels will not be exceeded).

D.2 RTPC Impact

It should be considered that, when RTPC is used as alternative to conventional RF attenuators (used in the past for a similar purpose) for setting the maximum power established in the network when planning for each single link (PP) or each cell (MP) in order to restrict inter-system interference into other links/cells (of other operators only), the NFD shall be maintained (because it is used for frequency planning and associated with a rated power). Therefore the mask should be met throughout the operating range offered (manufacturers should limit the range of RTPC accordingly).

However there are differences between Point-to-Point systems and Multipoint systems that shall be taken into account:

- a) Point-to-Point: RTPC (if any) is used only for inter/link interference and link-budget balancing; therefore the above statement applies to all RTPC systems.
- b) Multipoint: RTPC (if any) might be used for two different purposes:
 - b1) RTPC type1 for inter-operators interference balancing (in particular but not limited to master stations). In this application it is similar to Point-to-Point RTPC, therefore the same concept applies (mask shall be met).
 - b2) RTPC type 2 for intra-system power balancing of TSs close to the CS or for the shortest hops in Mesh architectures. In this case the masks do not need to be met because it is an intra system issue (interference balancing with other operators is done by taking account of the power levels associated with the most distant TSs).

In conclusion, in MP systems, the RTPC should be subdivided in the manufacturer declaration in two different ranges (type 1 and type 2 above) and the mask should be met only in range corresponding to type 1.

NOTE: Rationale is that some CEPT SE19 recommendations and coexistence reports are made assuming a certain values of NFD for defining the guard-band. However, in cases when block-mask is defined, this is no longer necessary (e.g. in 40 GHz MWS band). It should also be noted that no specific difference in this concept is identified between P-MP and Mesh architecture.

Annex E (informative): Summary Table of EqC subject to conformance declaration

Notwithstanding the provisions of the copyright clause related to the text of the present document, ETSI grants that users of the present document may freely reproduce the table E.1 proforma in this annex so that it can be used for its intended purposes and may further publish the completed table E.1.

A considerable number of EqC (defined in annex A of EN 302 326-1 [11]) and other parameters, need supplier declaration for the appropriate selection of the coherent set of requirements according the scope of the present document summarized in table 1 and, for systems with integral antennas in table 3. It is then recommended (even if not considered mandatory) that the supplier fill the following table E.1 with those parameters and uses this table as general header of the technical construction file and of the collection of essential test suites eventually produced under the obligation of the R&TTE Directive [2]; it would enable third parties (e.g. test houses or Regulatory authorities) for a quick identification of the actual equipment/system profiles.

Table E.1: Summary of EqC codes and other relevant parameters for equipment/system identification

Equipment commercial denomination (note 1):				
Station type (EqC = STN) (note 2):				
Actual operational frequency range (GHz) (note 3):				
Integral antenna (if applicable)		Antenna type (note 4):		
		Antenna polarization (note 5):		
		Antenna class (note 5):		
EqC-FR Frequency Range (Basic or operational range) (note 2)	EqC-PET Primary Equipment Type (note 2)	EqC-SET Secondary Equipment Type (note 2)	EqC-EMO Equivalent Modulation Order (note 2)	EqC-ChS Channel Separation (MHz) (note 2)
.....	Multirate <input type="checkbox"/> Multiformat <input type="checkbox"/> Mixed-mode <input type="checkbox"/> (note 6)
		
		
<p>NOTE 1: This is the formal system name reported on the Declaration of Conformity to R&TTE article 3.2 through the present document.</p> <p>NOTE 2: According definitions in annex A of EN 302 326-1 [11]. Some EqC are shown to likely require single entry, however, if it is the case, new rows should be added for other applicable entries.</p> <p>NOTE 3: Includes the actual frequency range(s) of the system covered by the Declaration of Conformity to R&TTE Directive [2] article 3.2 through the present document.</p> <p>NOTE 4: According the classification given in clause 1.3.3 of EN 302 326-3 [12] (e.g. directional, sectored-single beam, sectored multibeam, omnidirectional). CS antennas for sector angles less than 15° should be labelled as "sectored 2α < 15°". Symmetric or asymmetric elevation RPE should also be mentioned.</p> <p>NOTE 5: According the polarization possibility given in clause 1.3.3 of EN 302 326-3 [12] (e.g. linear, circular) including single or dual polarization and actual V and/or H or tilted axes information.</p> <p>NOTE 6: Multirate and/or multiformat systems (see annex B) or mixed mode systems should tick the appropriate box(es) and list the offered combinations of EMO and ChS for each capacity (bit rate) offered.</p>				

Annex F (informative): The EN title in the official languages

Language	EN title
Bulgarian	
Czech	Pevné rádiové systémy - Zařízení a antény mezi více body - Část 2: Harmonizovaná EN pokrývající základní požadavky článku 3.2 Směrnice R&TTE na digitální rádiová zařízení mezi více body
Danish	Faste radiokædesystemer - udstyr og antenner for multipunkt-forbindelser - Del 2: Harmoniseret EN, som dækker de væsentlige krav i R&TTE-direktivets artikel 3.2 for faste digitale radiokædeudstyr for multipunkt-forbindelser
Dutch	Vaste radiosystemen; Uitrustingen en antennes met meerdere poorten; Deel 2: Geharmoniseerde EN welke invulling geeft aan de essentiële eisen van artikel 3.2 van de R&TTE richtlijn voor digitale radioapparatuur met meerdere poorten
English	Fixed Radio Systems; Multipoint Equipment and Antennas; Part 2: Harmonized EN covering the essential requirements of article 3.2 of the R&TTE Directive for Digital Multipoint Radio Equipment
Estonian	Paiksed raadiosidesüsteemid; Mitmikside seadmed ja antennid; Osa 2: Digitaalsete mitmikpunktside raadioseadmete harmoneeritud EN R&TTE direktiivi artikli 3.2 põhinõuete alusel
Finnish	Radiolinkkijärjestelmät; Monisuuntaradiolinkit ja niiden antennit; Osa 2: Yhdenmukaistettu standardi (EN), joka kattaa R&TTE-direktiivin artiklan 3.2 mukaiset olennaiset vaatimukset
French	Télécommunications - Systèmes radioélectriques fixes - Équipements multipoint et antennes - Partie 2 : EN harmonisée couvrant les exigences essentielles de l'article 3.2 de la Directive R&TTE pour les équipements radio numérique multipoint
German	Fester Funkdienst; Geräte und Antennen für Mehrpunkt Systeme; Teil 2: Harmonisierte Europäische Norm bezüglich der grundlegenden Anforderungen des Artikels 3.2 der R&TTE Richtlinie für Digitale Mehrpunkt Richtfunk Geräte
Greek	Σταθερά Ραδιοσυστήματα - Πολυσημειακές Συσκευές και Κεραίες - Μέρος 2: Εναρμονισμένο EN για την κάλυψη των ουσιαστών απαιτήσεων του Άρθρου 3.2 της Οδηγίας R&TTE για Ψηφιακό Πολυσημειακό Ραδιοεξοπλισμό
Hungarian	Állandóhelyű rádiórendszerek; Többpont berendezések és antennák; 2. rész: Digitális többpont rádióberendezéseknek az R&TTE-irányelv 3.2 cikkelyének lényegi követelményeit tartalmazó, harmonizált európai szabványa
Icelandic	Föst útvarpskerfi; Búnaður og loftnet fyrir fast samband milli margra staða; 2. hluti: Samræmdur Evrópustaðall um grunnkröfur 2. mgr. 3. gr. í tilskipun 1999/5/EC um fjarskiptabúnað og endabúnað til fjarskipta varðandi búnað fyrir fast samband milli margra staða
Italian	Sistemi radio per il Servizio Fisso; Apparati ed antenne per sistemi multipunto; Parte 2: Norma armonizzata riguardante i requisiti essenziali per l'articolo 3.2 della Direttiva R&TTE dei sistemi digitali multipunto
Latvian	Fiksētās radiosistēmas. Daudzpunktu iekārtas un antenas. 2.daļa: Harmonizēts Eiropas standarts (EN), kas atbilst ciparu daudzpunktu radio iekārtu R&TTE Direktīvas 3.2.punkta būtiskām prasībām
Lithuanian	Fiksuotojo radijo ryšio sistemos. Ryšio tarp vieno ir daugelio punktų įranga ir antenos. Skaitmeninio radijo ryšio tarp vieno ir daugelio punktų įrangos darnasis Europos standartas, apimantis esminius reikalavimus pagal 1999/5/EC* direktyvos 3.2 straipsnį
Maltese	Sistemi ta' Radju Fissi; Tagħmir Multipunti u Antenni; Parti 2: EN armonizzata li jkopri r-rekwiżiti essenzjali ta' l-artiklu 3.2 tad-Direttiva R&TTE għal Tagħmir Digitali Multipunti tar-Radju
Norwegian	Radiolinjesystemer; Multipunktutstyr og antenner; Del 2: Harmonisert EN som dekker de grunnleggende krav i artikkel 3.2 i R&TTE-direktivet angående digitalt multipunkt radioutstyr
Polish	Radiowe systemy łączności stałej - Anteny i urządzenia łączności wielopunktowej - Część 2: Zharmonizowana EN zapewniająca spełnienie zasadniczych wymagań artykułu 3.2 dyrektywy R&TTE dotycząca cyfrowych urządzeń wielopunktowej łączności radiowej
Portuguese	Sistemas Fixos de Rádio; Antenas e Equipamento Multiponto; Parte 2: EN Harmonizada cobrindo os requisitos essenciais no âmbito do artigo 3.2 da Directiva R&TTE para equipamento Rádio Multiponto
Romanian	
Slovak	Pevné rádiové systémy. Viacbodové zariadenia a antény. Časť 2: Harmonizovaná EN vzťahujúca sa na základné požiadavky podľa článku 3.2 smernice R&TTE pre viacbodové rádiové zariadenia
Slovenian	Fiksni radijski sistemi - Večtočkovna oprema in antene - 2. del: Harmonizirani EN, ki zajema bistvene zahteve člena 3.2 direktive R&TTE za digitalno večtočkovno radijsko opremo
Spanish	Sistemas fijos de radiocomunicaciones. Equipos y antenas multipunto. Parte 2: EN armonizada que cubre los requisitos esenciales bajo el artículo 3.2 de la Directiva RTTE para equipos para radiocomunicaciones multipunto
Swedish	Fasta radiolänksystem; Multipunkt-utrustning och antenner; Del 2: Harmoniserad EN omfattande väsentliga krav enligt artikel 3.2 i R&TTE-direktivet för radio-utrustning för multipunkt-tillämpningar

Annex G (informative): Bibliography

- Council Directive 89/336/EEC of 3 May 1989 on the approximation of the laws of the Member States relating to electromagnetic compatibility (EMC Directive).
- Council Directive 73/23/EEC of 19 February 1973 on the harmonization of the laws of Member States relating to electrical equipment designed for use within certain voltage limits (LV Directive).
- ETSI EG 201 399: "Electromagnetic compatibility and Radio spectrum Matter (ERM); A guide to the production of candidate Harmonized Standards for application under the R&TTE Directive".
- ETSI EN 300 636: "Fixed Radio Systems; Point-to-multipoint equipment; Time Division Multiple Access (TDMA); Point-to-multipoint digital radio systems in frequency bands in the range 1 GHz to 3 GHz".
- ETSI EN 301 055: "Fixed Radio Systems; Point-to-multipoint equipment; Direct Sequence Code Division Multiple Access (DS-SS); Point-to-multipoint digital radio systems in frequency bands in the range 1 GHz to 3 GHz".
- ETSI EN 301 489-1: "Electromagnetic compatibility and Radio spectrum Matters (ERM); ElectroMagnetic Compatibility (EMC) standard for radio equipment and services; Part 1: Common technical requirements".
- ETSI EN 301 489-4: "Electromagnetic compatibility and Radio spectrum Matters (ERM); ElectroMagnetic Compatibility (EMC) standard for radio equipment and services; Part 4: Specific conditions for fixed radio links and ancillary equipment and services".
- ETSI EN 301 753: "Fixed Radio Systems; Multipoint equipment and antennas; Generic harmonized standard for multipoint Digital Fixed Radio Systems and antennas covering the essential requirements under article 3.2 of the Directive 1999/5/EC".
- ETSI TR 101 506: "Fixed Radio Systems; Generic definitions, terminology and applicability of essential requirements under the article 3.2 of 99/05/EC Directive to Fixed Radio Systems".
- ITU-R Recommendation F.746: "Radio-frequency arrangements for fixed service systems".
- ITU-R Recommendation F.1399: "Vocabulary of terms for wireless access".
- ITU-R Recommendation SM.329: "Unwanted emissions in the spurious domain".

History

Document history		
V1.1.1	December 2005	Publication
V1.1.2	March 2006	Publication
V1.2.1	January 2007	One-step Approval Procedure OAP 20070601: 2007-01-31 to 2007-06-01