



**Fixed Radio Systems;
Characteristics and requirements for
point-to-point equipment and antennas;
Part 1: Overview, common characteristics and
system-dependent requirements**

Reference

REN/ATTM-04028

Keywords

antenna, DFRS, DRRS, FWA, point-to-point,
radio, transmission

ETSI

650 Route des Lucioles
F-06921 Sophia Antipolis Cedex - FRANCE

Tel.: +33 4 92 94 42 00 Fax: +33 4 93 65 47 16

Siret N° 348 623 562 00017 - NAF 742 C
Association à but non lucratif enregistrée à la
Sous-Préfecture de Grasse (06) N° 7803/88

Important notice

The present document can be downloaded from:
<http://www.etsi.org/standards-search>

The present document may be made available in electronic versions and/or in print. The content of any electronic and/or print versions of the present document shall not be modified without the prior written authorization of ETSI. In case of any existing or perceived difference in contents between such versions and/or in print, the only prevailing document is the print of the Portable Document Format (PDF) version kept on a specific network drive within ETSI Secretariat.

Users of the present document should be aware that the document may be subject to revision or change of status. Information on the current status of this and other ETSI documents is available at
<https://portal.etsi.org/TB/ETSIDeliverableStatus.aspx>

If you find errors in the present document, please send your comment to one of the following services:
<https://portal.etsi.org/People/CommitteeSupportStaff.aspx>

Copyright Notification

No part may be reproduced or utilized in any form or by any means, electronic or mechanical, including photocopying and microfilm except as authorized by written permission of ETSI.

The content of the PDF version shall not be modified without the written authorization of ETSI.
The copyright and the foregoing restriction extend to reproduction in all media.

© European Telecommunications Standards Institute 2016.
All rights reserved.

DECT™, **PLUGTESTS™**, **UMTS™** and the ETSI logo are Trade Marks of ETSI registered for the benefit of its Members.
3GPP™ and **LTE™** are Trade Marks of ETSI registered for the benefit of its Members and of the 3GPP Organizational Partners.
GSM® and the GSM logo are Trade Marks registered and owned by the GSM Association.

Contents

Intellectual Property Rights	6
Foreword.....	6
Modal verbs terminology.....	6
Introduction	7
1 Scope	14
2 References	15
2.1 Normative references	15
2.2 Informative references.....	17
3 Definitions, symbols and abbreviations	19
3.1 Definitions	19
3.2 Symbols.....	25
3.3 Abbreviations	25
4 General characteristics	28
4.1 Frequency bands and channel arrangements	28
4.2 Special compatibility requirements between systems	28
4.3 Transmission capacity and spectral efficiency	28
4.4 Performance and availability requirements	28
4.5 Environmental profiles	29
4.5.0 Introduction.....	29
4.5.1 Environmental profile declared under Directive 2014/53/EU	29
4.5.2 ETSI environmental profiles.....	29
4.5.2.0 Generality.....	29
4.5.2.1 Equipment within weather-protected locations (indoor locations).....	30
4.5.2.2 Equipment for not-weather-protected locations (outdoor locations).....	30
4.5.3 Test environment profiles	30
4.6 Power supply	30
4.6.0 Introduction.....	30
4.6.1 Power supply profile declared under Directive 2014/53/EU	30
4.6.2 ETSI power supply profile.....	31
4.7 System block diagram	31
5 Baseband interfaces and parameters.....	31
5.0 Introduction	31
5.1 Ethernet interfaces.....	32
5.2 Plesiochronous interfaces	32
5.3 Synchronous digital hierarchy interfaces	32
5.4 Other baseband data interfaces.....	32
6 Main requirements.....	33
6.0 Introduction	33
6.1 General requirements	33
6.1.1 System identification	33
6.1.2 System nominal loading.....	33
6.1.3 Environmental profile	33
6.2 Transmitter characteristics.....	34
6.2.1 Transmitter power and power tolerance.....	34
6.2.1.1 Maximum power and EIRP.....	34
6.2.1.2 Combined TX power and EIRP limits	34
6.2.1.3 Output power tolerance	34
6.2.2 Transmitter power and frequency control.....	35
6.2.2.1 Transmitter power control (ATPC and RTPC)	35
6.2.2.1.1 Automatic Transmitter Power Control (ATPC).....	35
6.2.2.1.2 Remote Transmitter Power Control (RTPC)	35
6.2.2.2 Remote Frequency Control (RFC).....	36

6.2.3	Radio Frequency (RF) spectrum mask.....	36
6.2.4	Discrete CW components exceeding the spectrum mask limit	36
6.2.4.1	Discrete CW components at the symbol rate	36
6.2.4.2	Other discrete CW components exceeding the spectrum mask limit	36
6.2.5	Unwanted emissions in the spurious domain - external.....	36
6.2.6	Dynamic change of modulation order.....	36
6.2.7	Radio frequency tolerance	36
6.2.8	Emission limitations outside the allocated band	36
6.3	Receiver characteristics	37
6.3.1	Unwanted emissions in the spurious domain - external.....	37
6.3.2	BER as a function of receiver signal level.....	37
6.3.3	Receiver selectivity.....	37
6.3.3.1	Introduction.....	37
6.3.3.2	Co-channel "external", first and second adjacent channel interference sensitivity	37
6.3.3.3	CW spurious interference (blocking and spurious response)	37
6.4	Antenna characteristics.....	37
7	Complementary requirements	38
7.0	Introduction	38
7.1	Branching/feeder requirements	38
7.1.1	Waveguide flanges (or other connectors)	38
7.1.2	Return loss of feeder/antenna systems at equipment antenna port (C/C' reference point).....	39
7.2	Intermodulation products	39
7.3	Transmitter characteristics.....	40
7.3.1	Unwanted emissions - internal.....	40
7.3.2	Radio Frequency (RF) spectrum mask when mixed manufacturer compatibility is required.....	40
7.4	Receiver characteristics.....	41
7.4.1	Maximum input level and input level range	41
7.4.2	Spurious emissions - internal	42
7.4.3	Image rejection	42
7.4.4	Innermost channel selectivity	43
7.5	System performance without diversity	43
7.5.1	Equipment Residual BER (RBER)	43
7.5.2	Distortion sensitivity.....	45
7.5.2.1	Introduction	45
7.5.2.2	Requirement	45
7.5.2.3	Assessment.....	46
7.5.3	Interference sensitivity for CCDP with XPIC operation.....	47
7.5.3.1	General	47
7.5.3.2	Co-channel "internal" interference sensitivity in flat fading conditions.....	47
7.6	System characteristics with diversity	47
7.6.0	Introduction.....	47
7.6.1	Differential delay compensation	47
7.6.2	BER performance	47

Annex A (normative): Spectrum masks and receiver selectivity when mixed manufacturer compatibility is required48

A.0	Introduction	48
A.1	TX masks assessment.....	49
A.2	Normal channels - Emission mask floor	49
A.2.1	RBER impact.....	49
A.2.2	Local TX to RX compatibility.....	49
A.2.2.1	Spectrum mask.....	49
A.2.2.2	Receiver selectivity.....	50
A.3	Innermost channels for channel arrangements from about 4 GHz to about 8,5 GHz with channel separation of 28 MHz to 30 MHz.....	50
A.3.0	Introduction	50
A.3.1	Innermost channels spectrum masks	50
A.3.2	Receiver innermost channel selectivity	52

A.4	Innermost channels for channel arrangements from about 4 GHz to 11 GHz with channel separation of 40 MHz.....	53
A.4.0	Introduction	53
A.4.1	Innermost channels spectrum masks	53
A.4.2	Receiver innermost channels selectivity.....	54
A.5	Innermost channels for 18 GHz channel arrangements with channel separation of 55 MHz	55
A.5.0	Introduction	55
A.5.1	Innermost channels spectrum masks	55
A.5.2	Receiver innermost channels selectivity.....	56
Annex B (normative): Definition of equivalent data rates for packet data, PDH/SDH and other signals on the traffic interface.....		58
Annex C (informative): Information on <i>Multi-channel</i> and <i>Channel-aggregation</i> differences and operation.....		59
Annex D (informative): Additional information.....		61
D.1	Residual Bit Error Ratio (RBER) and Residual Frame Error Ratio (RFER)	61
D.2	Measurement test set for XPI characteristics	62
D.3	Differential delay compensation range.....	63
D.4	FER/BER equivalence and FER performance measurement equipment settings (example).....	64
D.4.1	FER/BER equivalence.....	64
D.4.2	FER equipment settings and measurement techniques (example).....	65
D.5	Automatic Transmitter Power Control (ATPC)	65
Annex E (informative): Mechanical characteristics		67
Annex F (informative): Mitigation techniques referred in ERC/DEC(00)07 (18 GHz band)		68
Annex G (informative): Notification of interfaces under article 8 of Directive 2014/53/EU		69
G.0	Introduction	69
G.1	Applicability of TCAM-RIS model of radio interface specifications to Fixed Service	69
G.2	Proposed list of radio interface specifications for Fixed Service	70
Annex H (informative): Change History		71
Annex I (informative): Bibliography		72
History		73

Intellectual Property Rights

IPRs essential or potentially essential to the present document may have been declared to ETSI. The information pertaining to these essential IPRs, if any, is publicly available for **ETSI members and non-members**, and can be found in ETSI SR 000 314: "*Intellectual Property Rights (IPRs); Essential, or potentially Essential, IPRs notified to ETSI in respect of ETSI standards*", which is available from the ETSI Secretariat. Latest updates are available on the ETSI Web server (<https://ipr.etsi.org>).

Pursuant to the ETSI IPR Policy, no investigation, including IPR searches, has been carried out by ETSI. No guarantee can be given as to the existence of other IPRs not referenced in ETSI SR 000 314 (or the updates on the ETSI Web server) which are, or may be, or may become, essential to the present document.

Foreword

This draft European Standard (EN) has been produced by ETSI Technical Committee Access, Terminals, Transmission and Multiplexing (ATTM), and is now submitted for the combined Public Enquiry and Vote phase of the ETSI standards EN Approval Procedure.

The present document is part 1 of a multi-part deliverable covering the Fixed Radio Systems; Characteristics and requirements for point-to-point equipment and antennas, as identified below (see note):

Part 1: "Overview, common characteristics and system-dependent requirements";

Part 2: "Digital systems operating in frequency bands from about 1,3 GHz to 86 GHz; Harmonized Standard covering the essential requirements of article 3.2 of Directive 2014/53/EU";

Part 4: "Antennas".

NOTE: In previous regulatory regime of harmonised standards under Directive 1999/5/EC more parts were published, which have been superseded since Directive 2014/53/EU repealed Directive 1999/5/EC; they are:

Part 2-1: which technical content merged in the present document (Part 1)

Part 2-2: which technical content is merged in Part 2

Part 3: which technical content is merged in Part 2 (with addition of a complete set of receiver parameters)

Part 4-1: which technical content is merged in Part 4

Part 4-2: which technical content is merged in Part 4

Proposed national transposition dates	
Date of latest announcement of this EN (doa):	3 months after ETSI publication
Date of latest publication of new National Standard or endorsement of this EN (dop/e):	6 months after doa
Date of withdrawal of any conflicting National Standard (dow):	18 months after doa

Modal verbs terminology

In the present document "**shall**", "**shall not**", "**should**", "**should not**", "**may**", "**need not**", "**will**", "**will not**", "**can**" and "**cannot**" are to be interpreted as described in clause 3.2 of the [ETSI Drafting Rules](#) (Verbal forms for the expression of provisions).

"**must**" and "**must not**" are **NOT** allowed in ETSI deliverables except when used in direct citation.

Introduction

(i) Generality and historical background

Digital Fixed Radio Systems (DFRS), used in European countries, had been historically specified in a relatively large number of specific European Norms produced by ETSI.

Those previous documents, already superseded by first publication of this ETSI EN 302 217 series, contained both essential requirements and other requirements that, even if not considered essential under Directive 2014/53/EU [i.1] of 16 April 2014 on the harmonisation of the laws of the Member States relating to the making available on the market of radio equipment and repealing Directive 1999/5/EC, may still be applicable.

For the correct understanding and application of the requirements in the whole ETSI EN 302 217 multipart series, the definitions summarized in clause 3.1 of the present document are also relevant; those definitions are generally hereby identified with the use of *italic characters* (e.g. *mixed-mode*).

Standards for point-to-point systems, including antennas, cover a very large range of traffic capacities, channel separations (CS), modulation formats and applications over a very wide range of frequency bands that are summarized in table 1.

Table 1: Digital Fixed Radio Systems (DFRS) parameters

Parameter	Range
Frequency bands	from 1 GHz to 86 GHz (see note)
Traffic capacities	from 9,6 kbit/s to 622 Mbit/s and to Gbit/s and above in the highest bands
Channel separations	from 25 kHz to 112 MHz and to GHz and above in the highest bands
Modulation formats	from 2 states to 2 048 states (amplitude and/or phase and/or frequency modulated states)
Typical applications	<p>POINT-TO-POINT (P-P) CONNECTIONS: rural and urban low/medium/high capacity links for mobile access infrastructure (backhaul), transport/trunk (long haul), FWA/BWA/ access, fixed LAN extensions (FLANE) governmental (non-military) links, private fixed networks, SAP/SAB P-P audio and video links with <i>integral</i> or <i>dedicated antenna</i>.</p> <p>STAND ALONE ANTENNAS: for all of the above applications when <i>integral</i> or <i>dedicated antennas</i> are not employed</p>
NOTE:	Market demand will likely extend the upper limits.

The regulatory framework for placing radio systems on the market, established by Directive 2014/53/EU [i.1] also requires the availability of Harmonised Standards covering the essential requirements under article 3.2 of Directive 2014/53/EU [i.1]. ETSI EN 302 217 series meet this demand by providing a rational subdivision of technical characteristics into:

- general system independent parameters, defined in the present document;
- system dependent "main" parameters relevant to the "essential" requirements of art 3.2 of Directive 2014/53/EU [i.1], briefly summarized in the present document but specifically defined in ETSI EN 302 217-2 [18];
- system dependent "complementary" parameters NOT relevant to the "essential" requirements of art 3.2 of Directive 2014/53/EU [i.1]. Nevertheless they have been commonly agreed for proper system operation and deployment when specific deployment conditions or compatibility requirements are present; they are also defined in the present document.

ETSI EN 302 217-4 [19] includes electrical and mechanical characteristics for development of any kind of DFRS P-P antenna and represent relevant reference in ETSI EN 302 217-2 [18] defining directional parameters of P-P radio relevant to essential requirements under article 3.2 of Directive 2014/53/EU [i.1] for *integral* and *dedicated antennas*.

In the present document, equipment is grouped into families of either similar frequency bands or applications. Nine families are identified for frequency bands corresponding, in ETSI EN 302 217-2 [18], to annexes referenced from annex B to annex J and one family associated with applications of packet data and combination of other signals mapped into proprietary transport modules, detailed in annex N.

- B frequency bands from 1,4 GHz to 2,4 GHz;
- C frequency bands from 3 GHz to 11 GHz (channel separation around 60 MHz and from 1,75 MHz up to around 30 MHz);
- D frequency bands from 3 GHz to 11 GHz (channel separation 40 MHz);
- E frequency bands 13 GHz, 15 GHz and 18 GHz;
- F frequency bands from 23 GHz to 42 GHz;
- G frequency bands from 50 GHz to 55 GHz;
- H frequency bands from 57 GHz to 66 GHz;
- I frequency bands from 64 GHz to 66 GHz;
- J frequency bands from 71 GHz to 76 GHz and 81 GHz to 86 GHz;
- N definition of equivalent data rates for packet data, PDH/SDH and other signals on the traffic interface.

(ii) Cross references to previously relevant ENs and TSs

The ETSI EN 302 217 series replaced and superseded a number of older standards (frequency and/or capacity oriented), which remained, only as "historical" documents, in the ETSI data base. Provided that they may still be referenced in some documentation, previous version of the present document (ETSI EN 302 217-1 V2.1.1 [i.12]) provides their list.

(iii) Summary of system options provided

A number of options for equipment implementation are identified in ETSI EN 302 217 series; the set of characteristics applicable to each option is uniquely identified through three parameters:

- operating frequency band;
- operating radio frequency channel separation (CS);
- spectral efficiency class (as defined in ETSI EN 302 217-2 [18]).

Each option so identified has a "nominal" payload requirement in term of minimum RIC (Radio Interface Capacity) to be fulfilled when packet payloads are used (e.g. Ethernet, ATM, etc.); in case PDH/SDH traffic are alternatively provided, annex N of ETSI EN 302 217-2 [18] gives the translation from the minimum RIC to the minimum hierarchic interfaces.

Table 2 and table 3 summarize the relevant cross-references between channel separation in various Fixed Service frequency bands and the available options of equipment provided in ETSI EN 302 217 series. They are shown in term of the minimum RIC payload, which, depending on the channel separation, correspond to a specific spectral efficiency class detailed in clause 1.2 of ETSI EN 302 217-2 [18] (identified, with increasing spectral efficiency, as classes 1, 2, 3, 4L, 4H, 5L, 5H, 6L, 6H 7 and 8). In classes from 5L to 8, two further sub-classes suffix (i.e. A and B) are provided for the same channel separation depending on whether ACAP or CCDP operation is, respectively, considered for the equipment use.

The minimum RIC payload in table 2 and table 3 are the minimum required for conformance to the present document and are based on the "minimum RIC density" defined, for each spectral efficiency class, in clause 1.2 of ETSI EN 302 217-2 [18] (see note).

NOTE: In ETSI EN 302 217-2 [18] only some cases of systems in annex B, due to the smaller channel separation provided, are (exceptionally) labelled with typical *gross bit rate* rather than minimum RIC capacity rates.

However, equipment may offer a variety of base band interfaces, e.g. typical hierarchical rates PDH or SDH, ISDN, Ethernet as well as mixture of these or other standardized interfaces. Mapping/multiplexing of the various base-band interfaces into common frame(s) suitable for radio transmission may be done using standardized higher hierarchical frames or other proprietary methods.

Table N.1a through table N.1h in annex N of ETSI EN 302 217-2 [18] summarize the "minimum RIC" considered in the present document and, when only PDH or SDH interfaces are provided, give the equivalent capacity in term of number of 2 048 Mbit/s streams provided as multiple or single multiplexed PDH or SDH interfaces. These minimum capacities are associated to the relevant channel separation and spectral efficiency classes defined.

The cells in table 2 and table 3 are filled only on the basis of available physical single equipment transmission capacity (up to a minimum RIC of 862 Mbit/s for class 8 systems in conventional channel arrangements with CS up to 112 MHz or even up to about 3 Gbit/s in bands above 57 GHz where larger CS are possible), which is relevant for Directive 2014/53/EU [i.1] article 3.2 assessment. Doubled capacity is, in principle, possible for any option using CCDP operation or, more in general, subdividing the payload over two channels; however, specific test procedures are provided in ETSI EN 302 217-2 [18] only for STM-4 interface or other high speed data interfaces when their payload is split over two or more equipment or on *channels-aggregation* equipment.

**Table 2: Cross reference of available equipment and antenna requirements in parts and annexes of ETSI EN 302 217 series:
bands from 1,4 GHz to 18 GHz**

ETSI EN 302 217 series																	
General requirements⇒		Part 1 (present document) (System common characteristics and system-independent requirements)															
Antenna requirements⇒		Part 4 [19] (Antenna general and complementary requirements)															
Equipment main requirements⇒		Part 2 [18] (HS for equipment characteristics relevant to article 3.2 of Directive 2014/53/EU [i.1])															
Relevant annex in Part 2 [18]⇒		B				C or E								D			
Frequency band (GHz)⇒		1,4; 2,4	2,1	1,4; 2,1	2,1		Annex C : 3,5 ; 4 ; U4 ; L6 ; U6 ; 7 ; 8 ; 10,5 ; 11 Annex E : 13 ; 15 ; 18								Annex C : U6	4, U4, U6, 8, 11	
Minimum RIC (Mbit/s) provided with relevant equipment characteristics	Channel separation (MHz) ⇒		CS < 1,75 and 2	1,75	3,5	7	14	1,75	3,5	7	13,75 / 14 / 15	27,5 / 28 / 29 / 29,65 / 30	55 / 56 / 58 / 59,3 / 60	110 (note 1)	20	40	
	Spectral efficiency ↓																
	Reference index ↓	Class ↓															
		1	1	(note 2)		2											
		2	2	(note 2)	2	4	8	16	2	4	8	16	32	64	128		
		3	3						3	6	12	24	48	96	191		
		4	4L	(note 2)	4	8	16	32	4	8	16	32	64	128	256	45	
		5	4H							12 (a)	24	49	98	196	392		
		6	5L								29	58					
		6	5LA, 5LB										117	235	470		168
		7	5H							17 (a)	34	68					
		7	5HA, 5HB										137	274 (b)	548		137 (c) 196
		8	6L								39	78					
	8	6LA, 6LB										156	313	627		224	
	9	6H									88						
	9	6HA, 6HB										176	352	705		252 (b)	
	10	7									98						
	10	7A, 7B										196	392	784		280	
	11	8									107						
	11	8A, 8B										215	431	862		308	
Equivalent capacity for hierarchic-only systems		Annex D of the present document and annex N of Part 2 [18]															

NOTE 1: CS 110 MHz available only in 18 GHz band.
NOTE 2: For channel separations of 2 MHz and other various smaller than 1,75 MHz, only typical "gross bit rates" are defined.
(a): These systems are intended only for the transport of subSTM-0 capacities only in 18 GHz band.
(b): STM-4 capacity as combination of two 2 × STM-1 equipment operating on two channels in ACAP or CCDP or even non adjacent operation is also described.
(c): Minimum RIC 137 Mbit/s option is special provision only for commonality of use of 5HB/28 MHz like equipment modulation also into 40 MHz channel arrangements.

**Table 3: Cross reference of available equipment and antenna requirements in parts and annexes of ETSI EN 302 217 series:
bands from 23 GHz to 80 GHz**

ETSI EN 302 217 series																									
Common requirements ↴		Part 1 (present document) (System common characteristics and system-independent requirements)																							
Antenna requirements ↴		Part 4 [19] (Antenna general and complementary requirements)																							
Equipment requirements ↴		Part 2 [18] (HS for equipment characteristics relevant to article 3.2 of Directive 2014/53/EU [i.1])																							
Relevant annex Part 2 [18] ↴		F						G					J										I	H	
Frequency band (GHz) ↴		23, 26, 28, 31, 32, 38, 42						50, 52, 55					71 to 76 and 81 to 86 (note)										64 to 66	57 to 66 (note)	
Minimum RIC (Mbit/s) provided with relevant equipment characteristics	Spectral efficiency ↴		Channel separation (MHz)					Channel separation (MHz)					Channel separation (MHz)										Channel size free or multiple of predefined slots from 30/50 MHz to 2 000 MHz		
	Reference index ↴	Class ↴	3,5	7	14	28	56	112	3,5	7	14	28	56	62,5	125	250	500	750	1 000	1 250	1 500	1 750			2 000
	1	1							2	4(c)	8(c)	16(c)	32	35	71	142	285	427	570	712	855	997	1 140	See minimum spectral efficiency reported in Tables H.2 and I.2 of the relevant annexes.	
	2	2	4(b)	8	16	32	64	128	4	8	16	32	64	71	142	285	570	855	1 140(a)	1 425	1 710	1 995	2 280		
	3	3	6(b)	12	24	48	96	191	6	12	24	48	96	106	212	425	850	1 275	1 700	2 125(a)	2 550	2 975	3 400		
	4	4L	8(b)	16	32	64	128	256		16	32	64	128	142	285	570	1 140(a)	1 710	2 280(a)	2 850					
	5	4H		24	49	98	196	392						219	438	875	1 750	2 625							
	6	5L		29	58																				
	6	5LA, 5LB				117	235	470						262	525	1 050(a)	2 100(a)	3 150(a)							
	7	5H		34	68																				
	7	5HA, 5HB				137	274(c)	548						306	612	1 225	2 450								
	8	6L		39	78																				
	8	6LA, 6LB				156	313	627						350	700	1 400	2 800								
9	6H			88																					
9	6HA, 6HB				176	352	705																		
10	7			98																					
10	7A, 7B				196	392	784																		
11	8			107																					
11	8A, 8B				215	431	862																		
Equivalent capacity for hierarchic only systems		Annex D of the present document and annex N of Part 2 [18]																							
NOTE:		Alternative, in overlapping band, to annex I.																							
(a):		RIC rounded down to closest $N \times 1$ Gbit/s rate are also considered valid.																							
(b):		Not provided in 42 GHz band.																							
(c):		STM-4 capacity as combination of two $2 \times$ STM-1 equipment operating on two channels in ACAP or CCDP or even non adjacent operation is also described.																							

(iv) User's guide

The symbols abbreviations and definitions, which apply to the whole ETSI EN 302 217 series, are listed in the present document. In particular, correct understanding of the definitions is necessary for the correct application of all the requirements.

The requirements applicable to a specific point to point digital fixed radio systems (including its antenna) are summarized in table 4 showing the major structure of the whole ETSI EN 302 217 series. The requirements are subdivided across the three parts of the EN series corresponding to their four major categories.

The first category (the present document) corresponds to "common" system independent characteristics which are either common to the whole family of equipment, i.e. performance and availability, environmental profiles, power supply, system block diagram, mechanical characteristics and baseband interfaces and parameters. The present document defines those requirements and characteristics set out in the other parts of ETSI EN 302 217 series.

The second category (also described in the present document) corresponds to "complementary" characteristics and requirements, which are NOT relevant to article 3.2 of Directive 2014/53/EU [i.1] but may guarantee better performance to the actual deployed links. Therefore, the manufacturer may wish to claim compliance to all or some of these requirements for showing enhanced characteristics of its product.

Complementary requirements are requirements that are not related to essential requirements under article 3.2 of Directive 2014/53/EU [i.1]. Nevertheless they are considered, having been commonly agreed for proper system operation and deployment when specific deployment conditions or compatibility requirements are present. Compliance to all or some of these requirements is made on a voluntary basis.

The limits for main and complementary requirements that are not common or parameterized for all of the equipment covered by one part, but specific to one frequency range, one RIC or PDH/SDH capacity, etc., are located in annexes.

The third category (summarized in the present document and detailed in ETSI EN 302 217-2 [18]) is for equipment in any frequency bands; it corresponds to essential characteristics, with respect to article 3.2 of Directive 2014/53/EU [i.1] and are consequently defined in a harmonised standard. A complete set of TX and RX parameters is retained essential. The limiting values associated with the essential requirements which are not common to all of the equipment covered by one part, but specific to one frequency range, one RIC or PDH/SDH capacity, etc., are located in annexes. In annex A of ETSI EN 302 217-2 [18] a correspondence table between the technical requirements and article 3.2 of Directive 2014/53/EU [i.1] summarizes those requirements to be addressed in order to claim compliance.

The fourth category (ETSI EN 302 217-4 [19]) provides the antenna characteristics to be used for any P-P system in all operating bands; some of these characteristics are also referenced in ETSI EN 302 217-2 [18] as being "essential parameters" for radio equipment with *integral* or *dedicated antenna*. These latter characteristics might also be used by the manufacturer of radio equipment placed on the market with external *dedicated antenna* or other *stand-alone* antenna (possibly independently substituted or purchased by the user itself), for respecting obligations in other articles of Directive 2014/53/EU [i.1] (e.g. article 10 recital 8 of Directive 2014/53/EU [i.1]), ETSI EN 302 217-2 [18] provides suitable guidelines for the description in the user instruction of the antenna characteristics "*information required to use radio equipment in accordance with its intended use*".

To conclude, ETSI EN 302 217 series is used as a comprehensive document that, starting from the present document down to the relevant annexes of parts ETSI EN 302 217-2 [18] and ETSI EN 302 217-4 [19]. Table 4 shows the major clauses and annexes of the series.

Table 4: Structure of the ETSI EN 302 217 series

ETSI EN 302 217-1 (present document) Overview, common characteristics and system-dependent requirements		ETSI EN 302 217-2 [18] (Harmonised Standard) Digital systems operating in frequency bands from 1,3 GHz to 86 GHz; Harmonised Standard covering the essential requirements of article 3.2 of Directive 2014/53/EU	
3	Definitions, symbols and abbreviations	4	Technical requirements specifications
4	General characteristics	4.1	General requirements
5	Baseband interfaces and parameters	4.1.1	Requirements framework
6	Main requirements	4.1.2	System identification and traffic loading
7	Complementary requirements	4.1.3	Environmental profile
Annex A (normative)	Spectrum masks and receiver selectivity when mixed manufacturer compatibility is required	4.2	Transmitter requirements
Annex B (normative)	Definition of equivalent data rates for packet data, PDH/SDH and other signals on the traffic interface	4.3	Receiver requirements
Annex C (informative)	Additional information:	4.4	Antenna characteristics
C.1	Residual Bit Error Ratio (RBER) and Residual Frame Error Ratio (RFER)	5	Testing for compliance with technical requirements
C.2	Measurement test set for XPI characteristics	Annex A (normative)	Relationship between the present document and the essential requirements of Directive 2014/53/EU
C.3	Differential delay compensation range	Annex B (normative)	Frequency bands 1,4 GHz to 2,6 GHz
C.4	FER/BER equivalence and FER performance measurement	Annex C (normative)	Frequency bands from 3 GHz to 11 GHz (CS up to 30 MHz and 56/60 MHz)
C.5	Automatic Transmitter Power Control (ATPC)	Annex D (normative)	Frequency bands from 3 GHz to 11 GHz (CS 40 MHz)
Annex D (informative)	Information on Multi-channel and Channel-aggregation differences and operation	Annex E (normative)	Frequency bands 13 GHz, 15 GHz and 18 GHz
Annex E (informative)	Mechanical characteristics	Annex F (normative)	Frequency bands from 23 GHz to 42 GHz
ETSI EN 302 217-4 Antennas		Annex G (normative)	Frequency bands from 50 GHz to 55 GHz
4	Technical requirements specifications	Annex H (normative)	Frequency band 57 GHz to 66 GHz
4.3	Environmental profile	Annex I (normative)	Frequency band 64 GHz to 66 GHz
4.4	Radiation Pattern Envelope (RPE)	Annex J (normative)	Frequency bands 71 GHz to 86 GHz
4.5	Cross-Polar Discrimination (XPD)	Annexes K, L and M	Void (for future use)
4.6	Antenna gain	Annex N (normative)	Definition of equivalent data rates for packet data, PDH/SDH and other signals on the traffic interface
5	Testing for compliance with technical requirements	Annex O (normative)	Test report in relation to flexible systems applications
Annex A (informative)	Additional information	Annex P (informative)	Impact of power control (ATPC and/or RTPC), mixed mode and bandwidth adaptive operation on spectrum mask and link design requirements
A.1	Mechanical characteristics	Annex Q (informative)	Typical interference sensitivity behaviour for frequency planning purpose
A.2	Antenna input connectors	Annex R (informative)	Receiver selectivity evaluation
A.3	Return loss at the input ports		
A.4	Inter-port isolation		
Annex B (informative)	Antenna gain and radiation pattern information		
B.1	Impact of antenna gain on the frequency planning		
B.2	Gain and typical radiation pattern for circular symmetric antennas		

1 Scope

The present document applies to the following digital fixed radio systems (DFRS), including equipment with integral antenna and other antenna types relevant to:

- point-to-point systems intended for operation in frequency bands that require co-ordination;
- point-to-point systems intended for operation in frequency bands that do not require co-ordination;
- antennas for point-to-point operation.

The present document summarizes:

- all characteristics, principles and, of utmost importance, terms and definitions that are common to all P-P equipment and antennas and its consultation is necessary when using all other parts of ETSI EN 302 217 series;
- all system-dependent requirements for Point-to-Point (P-P) equipment in applications deployed in bands where frequency co-ordination is generally applied. These requirements are introduced in two different clauses sub-sets:
 - **Main requirements** are requirements that are also related to the "essential requirements" under article 3.2 of Directive 2014/53/EU [i.1] and further detailed in the Harmonised Standard ETSI EN 302 217-2 [18].
 - **Complementary requirements** are requirements that are not related to essential requirements under article 3.2 of Directive 2014/53/EU [i.1]. Nevertheless they have been commonly agreed for proper system operation and deployment when specific deployment conditions or compatibility requirements are present. Compliance to all or some of these requirements is left to manufacturer decision.

Description and limits for parameters relevant to essential requirements under article 3.2 of Directive 2014/53/EU [i.1] are given in the Harmonised Standard ETSI EN 302 217-2 [18].

ETSI EN 302 217-4 [19] provides the antenna characteristics to be used, in all operating bands, by any P-P system with *integral antennas* when assessed under article 3.2 of Directive 2014/53/EU [i.1]. It constitutes also the reference for the equipment manufacturer for developing *dedicated antennas* and may be used as reference characteristics in the user instruction of equipment supplied without antenna so that the equipment can be operated as intended (e.g. according article 10 recital 8 of Directive 2014/53/EU [i.1]) with a *stand-alone* antenna.

As the maximum transmission rate in a given bandwidth depends on system spectral efficiency, equipment are subdivided in different spectral efficiency classes as defined in ETSI EN 302 217-2 [18].

The spectral efficiency classes are indicative only and do not imply any constraint to the actual modulation format, provided that all the requirements in the relevant parts of this multi-part deliverable for the declared class are met.

Guidance on the definition of radio parameters relevant to the essential requirements under article 3.2 of Directive 2014/53/EU [i.1] for DFRS may be found in ETSI TR 101 506 [i.16].

Technical background for most of the parameters and requirements referred to in this multi-part deliverable may be found in ETSI TR 101 036-1 [i.15].

Health and safety requirements, relevant to article 3.1a of Directive 2014/53/EU [i.1] are not considered in any part of this ETSI EN 302 217 series. CENELEC is responsible for the relevant standards.

EMC conditions and requirements, relevant to article 3.1b of Directive 2014/53/EU [i.1] and any other essential requirement relevant to article 3.3 of Directive 2014/53/EU [i.1] are not in the scope of any part of this ETSI EN 302 217 series. EMC requirements may be found in ETSI EN 301 489-1 [i.10] and ETSI EN 301 489-4 [i.11].

NOTE: A list of such harmonised standards is available on the web site <http://www.newapproach.org>.

For administration's guidance when notifying their regulated interfaces in accordance with article 8 of Directive 2014/53/EU [i.1], annex B provides explanatory considerations on the applicability of the TCAM-RIS format for P-P fixed links. An example of such a notification is also provided. Annex B has been elaborated in co-ordination with the CEPT ECC WGSE.

2 References

2.1 Normative references

References are either specific (identified by date of publication and/or edition number or version number) or non-specific. For specific references, only the cited version applies. For non-specific references, the latest version of the referenced document (including any amendments) applies.

Referenced documents which are not found to be publicly available in the expected location might be found at <http://docbox.etsi.org/Reference>.

NOTE: While any hyperlinks included in this clause were valid at the time of publication, ETSI cannot guarantee their long term validity.

The following referenced documents are necessary for the application of the present document.

- [1] CENELEC EN 122150: "Sectional Specification: Radio frequency coaxial connectors - Series EIA flange".
- [2] ERC/DEC(00)07: "ERC Decision of 19 October 2000 on the shared use of the band 17.7 - 19.7 GHz by the fixed service and Earth stations of the fixed-satellite service (space-to-Earth)".
- [3] ETSI EN 300 019-1-0: "Environmental Engineering (EE); Environmental conditions and environmental tests for telecommunications equipment; Part 1-0: Classification of environmental conditions; Introduction".
- [4] ETSI EN 300 019-2-0: "Environmental Engineering (EE); Environmental conditions and environmental tests for telecommunications equipment; Part 2-0: Specification of environmental tests; Introduction".
- [5] ETSI EN 300 019-1-1: "Environmental Engineering (EE); Environmental conditions and environmental tests for telecommunications equipment; Part 1-1: Classification of environmental conditions; Storage".
- [6] ETSI EN 300 019-2-1: "Environmental Engineering (EE); Environmental conditions and environmental tests for telecommunications equipment; Part 2-1: Specification of environmental tests; Storage".
- [7] ETSI EN 300 019-1-2: "Environmental Engineering (EE); Environmental conditions and environmental tests for telecommunications equipment; Part 1-2: Classification of environmental conditions; Transportation".
- [8] ETSI EN 300 019-2-2: "Environmental Engineering (EE); Environmental conditions and environmental tests for telecommunications equipment; Part 2-2: Specification of environmental tests; Transportation".
- [9] ETSI EN 300 019-1-3: "Environmental Engineering (EE); Environmental conditions and environmental tests for telecommunications equipment; Part 1-3: Classification of environmental conditions; Stationary use at weather protected locations".
- [10] ETSI EN 300 019-2-3: "Environmental Engineering (EE); Environmental conditions and environmental tests for telecommunications equipment; Part 2-3: Specification of environmental tests; Stationary use at weather protected locations".
- [11] ETSI EN 300 019-1-4: "Environmental Engineering (EE); Environmental conditions and environmental tests for telecommunications equipment; Part 1-4: Classification of environmental conditions; Stationary use at non-weather protected locations".

- [12] ETSI EN 300 019-2-4: "Environmental Engineering (EE); Environmental conditions and environmental tests for telecommunications equipment; Part 2-4: Specification of environmental tests; Stationary use at non-weather protected locations".
- [13] ETSI EN 300 132-2: "Environmental Engineering (EE); Power supply interface at the input to telecommunications and datacom (ICT) equipment; Part 2: Operated by -48 V direct current (dc)".
- [14] ETSI EN 300 132-3: "Environmental Engineering (EE); Power supply interface at the input to telecommunications and datacom (ICT) equipment; Part 3: Operated by rectified current source, alternating current source or direct current source up to 400 V".
- [15] ETSI EN 301 126-1: "Fixed Radio Systems; Conformance testing; Part 1: Point-to-Point equipment - Definitions, general requirements and test procedures".
- [16] ETSI EN 302 099: "Environmental Engineering (EE); Powering of equipment in access network".
- [17] ETSI EN 301 126-3-1: "Fixed Radio Systems; Conformance testing; Part 3-1: Point-to-Point antennas; Definitions, general requirements and test procedures".
- [18] ETSI EN 302 217-2 (V3.0.8): "Fixed Radio Systems; Characteristics and requirements for point-to-point equipment and antennas; Part 2: Digital systems operating in frequency bands from 1,3 GHz to 86 GHz; Harmonised Standard covering the essential requirements of article 3.2 of Directive 2014/53/EU".
- [19] ETSI EN 302 217-4 (V2.0.3): "Fixed Radio Systems; Characteristics and requirements for point-to-point equipment and antennas; Part 4: Antennas".
- [20] IEC 60835-2-4: "Methods of measurement for equipment used in digital microwave radio transmission systems - Part 2: Measurements on terrestrial radio-relay systems - Section 4: Transmitter/receiver including modulator/demodulator".
- [21] IEC 60835-2-8: "Methods of measurement for equipment used in digital microwave radio transmission systems - Part 2: Measurements on terrestrial radio-relay systems - Section 8: Adaptive equalizer".
- [22] IEEE 802.3-2012: "IEEE Standard for Ethernet".
- [23] Recommendation ITU-R F.746: "Radio-frequency arrangements for fixed service systems".
- [24] Recommendation ITU-R F.1668: "Error performance objectives for real digital fixed wireless links used in 27 500 km hypothetical reference paths and connections".
- [25] Recommendation ITU-R F.1703: "Availability objectives for real digital fixed wireless links used in 27 500 km hypothetical reference paths and connections".
- [26] Recommendation ITU-R P.530: "Propagation data and prediction methods required for the design of terrestrial line-of-sight systems".
- [27] Recommendation ITU-T G.703: "Physical/electrical characteristics of hierarchical digital interfaces".
- [28] Recommendation ITU-T G.704: "Synchronous frame structures used at 1544, 6312, 2048, 8448 and 44 736 kbit/s hierarchical levels".
- [29] Recommendation ITU-T G.707: "Network node interface for the synchronous digital hierarchy (SDH)".
- [30] Recommendation ITU-T G.708: "Sub STM-0 network node interface for the synchronous digital hierarchy (SDH)".
- [31] Recommendation ITU-T G.826: "End-to-end error performance parameters and objectives for international, constant bit-rate digital paths and connections".
- [32] Recommendation ITU-T G.828: "Error performance parameters and objectives for international, constant bit-rate synchronous digital paths".

- [33] Recommendation ITU-T G.829: "Error performance events for SDH multiplex and regenerator sections".
- [34] Recommendation ITU-T G.957: "Optical interfaces for equipment and systems relating to the synchronous digital hierarchy".
- [35] Recommendation ITU-T I.356: "B-ISDN ATM layer cell transfer performance".
- [36] Recommendation ITU-T I.357: "B-ISDN semi-permanent connection availability".
- [37] Recommendation ITU-T O.151: "Error performance measuring equipment operating at the primary rate and above".
- [38] Recommendation ITU-T O.181: "Equipment to assess error performance on STM-N interfaces".
- [39] Recommendation ITU-T O.191: "Equipment to measure the cell transfer performance of ATM connections".
- [40] Recommendation ITU-T V.11: "Electrical characteristics for balanced double-current interchange circuits operating at data signalling rates up to 10 Mbit/s".
- [41] Recommendation ITU-T V.24: "List of definitions for interchange circuits between data terminal equipment (DTE) and data circuit-terminating equipment (DCE)".
- [42] Recommendation ITU-T V.28: "Electrical characteristics for unbalanced double-current interchange circuits".
- [43] Recommendation ITU-T Y.1540: "Internet protocol data communication service - IP packet transfer and availability performance parameters".

2.2 Informative references

References are either specific (identified by date of publication and/or edition number or version number) or non-specific. For specific references, only the cited version applies. For non-specific references, the latest version of the referenced document (including any amendments) applies.

NOTE: While any hyperlinks included in this clause were valid at the time of publication, ETSI cannot guarantee their long term validity.

The following referenced documents are not necessary for the application of the present document but they assist the user with regard to a particular subject area.

- [i.1] Directive 2014/53/EU of the European Parliament and of the Council of 16 April 2014 on the harmonisation of the laws of the Member States relating to the making available on the market of radio equipment and repealing Directive 1999/5/EC.
- [i.2] ETSI TR 101 035: "Transmission and Multiplexing (TM); Synchronous Digital Hierarchy (SDH) aspects regarding Digital Radio Relay Systems (DRRS)".
- [i.3] ETSI TR 102 243-1: "Fixed Radio Systems; Representative values for transmitter power and antenna gain to support inter- and intra-compatibility and sharing analysis; Part 1: Digital point-to-point systems".
- [i.4] CEPT/ERC/REC 12-03: "Harmonized radio frequency channel arrangements for digital terrestrial fixed systems operating in the band 17,7 GHz to 19,7 GHz".
- [i.5] ECC/REC(01)05: "List of parameters of digital point-to-point fixed radio links used for national planning".
- [i.6] ECC/REC(02)06: "Channel arrangements for digital Fixed Service Systems operating in the frequency range 7 125-8 500 MHz".
- [i.7] ECC/REP 80: "Enhancing harmonisation and introducing flexibility in the spectrum regulatory framework".

- [i.8] ERC/REC 14-01: "Radio-frequency channel arrangements for high capacity analogue and digital radio-relay systems operating in the band 5 925 MHz - 6 425 MHz".
- [i.9] ERC/REC 14-02: "Radio-frequency channel arrangements for high, medium and low capacity digital fixed service systems operating in the band 6 425-7 125 MHz".
- [i.10] ETSI EN 301 489-1: "Electromagnetic compatibility and Radio spectrum Matters (ERM); ElectroMagnetic Compatibility (EMC) standard for radio equipment and services; Part 1: Common technical requirements".
- [i.11] ETSI EN 301 489-4: "Electromagnetic compatibility and Radio spectrum Matters (ERM); ElectroMagnetic Compatibility (EMC) standard for radio equipment and services; Part 4: Specific conditions for fixed radio links and ancillary equipment".
- [i.12] ETSI EN 302 217-1 (V2.2.1): "Fixed Radio Systems; Characteristics and requirements for point-to-point equipment and antennas; Part 1: Overview and system-independent common characteristics".
- NOTE: Previous superseded version of the present document not applicable in Directive 2014/53/EU [i.1] regime.
- [i.13] ETSI EN 302 217-2-2 (V2.2.1): "Fixed Radio Systems; Characteristics and requirements for point-to-point equipment and antennas; Part 2-2: Digital systems operating in frequency bands where frequency co-ordination is applied; Harmonized EN covering the essential requirements of article 3.2 of the R&TTE Directive".
- NOTE: Previous superseded version of ETSI EN 302 217-2 [18] not applicable in Directive 2014/53/EU [i.1] regime.
- [i.14] ETSI EN 300 119 (all parts): "Environmental Engineering (EE); European telecommunication standard for equipment practice".
- [i.15] ETSI TR 101 036-1: "Fixed Radio Systems; Generic wordings for standards on DFRS (Digital Fixed Radio Systems) characteristics; Part 1: General aspects and point-to-point equipment parameters".
- [i.16] ETSI TR 101 506 (V2.1.1): "Fixed Radio Systems; Generic definitions, terminology and applicability of essential requirements covering article 3.2 of Directive 2014/53/EU to Fixed Radio Systems".
- [i.17] ETSI TR 101 854: "Fixed Radio Systems; Point-to-point equipment; Derivation of receiver interference parameters useful for planning fixed service point-to-point systems operating different equipment classes and/or capacities".
- [i.18] ETSI TR 103 103: "Fixed Radio Systems; Point-to-point systems; ATPC, RTPC, Adaptive Modulation (mixed-mode) and Bandwidth Adaptive functionalities; Technical background and impact on deployment, link design and coordination".
- [i.19] IEC 60153-2: "Hollow metallic waveguides. Part 2: Relevant specifications for ordinary rectangular waveguides".
- [i.20] IEC 60154-2: "Flanges for waveguides. Part 2: Relevant specifications for flanges for ordinary rectangular waveguides".
- [i.21] IEC 60169-1: "Radio-frequency connectors. Part 1: General requirements and measuring methods".
- [i.22] IEC 60339 (all parts): "General purpose rigid coaxial transmission lines and their associated flange connectors".
- [i.23] Recommendation ITU-R F.383-9: "Radio-frequency channel arrangements for high capacity fixed wireless systems operating in the lower 6 GHz (5 925 to 6 425 MHz) band".
- [i.24] Recommendation ITU-R F.384-11: "Radio -frequency channel arrangements for medium- and high-capacity digital fixed wireless systems operating in the 6 425-7 125 MHz band".

- [i.25] Recommendation ITU-R F.385-10: "Radio-frequency channel arrangements for fixed wireless systems operating in the 7 110-7 900 MHz band".
- [i.26] Recommendation ITU-R F.595-10: "Radio-frequency channel arrangements for fixed wireless systems operating in the 17.7-19.7 GHz frequency band".
- [i.27] Recommendation ITU-R F.750: "Architectures and functional aspects of radio-relay systems for synchronous digital hierarchy (SDH)-based network".
- [i.28] Void.
- [i.29] Recommendation ITU-R F.752: "Diversity techniques for point-to-point fixed wireless systems".
- [i.30] Recommendation ITU-R F.1093: "Effects of multipath propagation on the design and operation of line-of-sight digital fixed wireless systems".
- [i.31] Recommendation ITU-R F.1101: "Characteristics of digital fixed wireless systems below about 17 GHz".
- [i.32] Recommendation ITU-R F.1102: "Characteristics of fixed wireless systems operating in frequency bands above about 17 GHz".
- [i.33] Recommendation ITU-R F.1191: "Bandwidths and unwanted emissions of digital fixed service systems".
- [i.34] Void.
- [i.35] Recommendation ITU-T G.783: "Characteristics of synchronous digital hierarchy (SDH) equipment functional blocks".
- [i.36] Recommendation ITU-T G.784: "Management aspects of the synchronous digital hierarchy (SDH) transport network element".
- [i.37] Recommendation ITU-T I.414: "Overview of Recommendations on layer 1 for ISDN and B-ISDN customer accesses".
- [i.38] The Radio Regulations, Edition of 2012.
- [i.39] J. Redd: "Calculating Statistical Confidence Levels for Error-Probability Estimates" Lightwave Magazine, pp. 110-114, April 2000.

NOTE: Available on the web at <http://www.lightwaveonline.com/>.

3 Definitions, symbols and abbreviations

3.1 Definitions

For the purposes of the present document and of the other ETSI EN 302 217 series parts (i.e. part 2 [18] and part 4 [19]), the following terms and definitions apply:

aggregated channel: one of the two channels used in "channel-aggregation" equipment

NOTE: There is no relationship with the "aggregation" terminology used in some ITU-R and ECC recommendations on radio frequency channel arrangements; there, the "aggregation" of contiguous channels is used for determine wider channels positions.

allocated radio frequency band: Derived from the definition of "allocation (of a frequency band)" (Radio Regulations [i.38], article 1.16): "entry in the Table of Frequency Allocations of a given frequency band for the purpose of its use by one or more terrestrial or space radiocommunication services or the radio astronomy service under specific conditions. This term is also applicable to the frequency band concerned".

NOTE: From the regulatory point of view three different applications might be envisaged and used in the whole allocated band or in its dedicated segments:

- **Frequency band where frequency co-ordination is applied:** in these bands, in the licensing process, regulatory bodies enforce co-ordination rules to ensure that all links work on an "acceptable interference" bases.
- **Frequency band where frequency co-ordination is not applied:** in these bands, irrespective of any licensing process or with no licensing at all, the deployment is freely made by the user on a "first on-first served" bases without any warrantee of "acceptable interference" from the regulatory body.
- **Frequency band where self-coordination is applied:** in these bands an approach similar to the "light licensing", described in ECC Report 80 [i.7], is used. Such regimes do not mean "licence exempt" use, but rather using a simplified set of conventional licensing mechanisms and attributes within the scope decided by the administration. This planning is delegated to the licensee.

antenna: part of the transmitting or receiving system that is designed to radiate and/or receive electromagnetic waves

Automatic Transmit Power Control (ATPC): function implemented to offer a dynamic power control that delivers maximum power only during deep fading; in this way for most of the time the interference is reduced and the transmitter operates in a higher linearity mode

NOTE: When this function is used, the transmit power is dynamically changed with respect to the propagation conditions. In principle, when ATPC is implemented, three different levels of power may be identified:

- **maximum available power** (delivered, when licensing conditions permits it, only in conditions of deep fading);
- **maximum nominal power** (useable on a permanent basis when ATPC is disabled); it should be noted that this power is "nominal for the equipment" and is not to be confused with the "nominal level set link by link" by the frequency co-ordinating body. This is achieved through the use of the RTPC function or passive RF attenuators;
- **minimum power** (delivered in unfaded conditions).

Maximum nominal and maximum available power levels may be coincident or, in case of multi-state modulation formats, the maximum available power may be used to overdrive the transmitter (loosing linearity but gaining fade margin when the fade conditions have already impaired the expected RBER). Performance predictions are usually made with the maximum "available power".

However, this could be done respecting licensing conditions and seldom this is the case; more detailed information on ATPC operation can be found in ETSI TR 103 103 [i.18].

bandwidth adaptive systems: system, the capacity of which may be dynamically changed by mean of bandwidth reduction during adverse propagation conditions

block assignment: application of block of spectrum assigned to one or more stations of an operator under a single exclusive licence

channels-aggregation: equipment where two radio channels (*aggregated channels*) are transmitted/received by the same radio equipment.

NOTE 1: Under this category different applications are possible, to which the following more detailed definitions apply:

- 1) **channels-aggregation (single-band):** where the two *aggregated-channels* operate on the same or overlapping bands (see note 2)

NOTE 2: The two bands can also be contiguous provided that their requirements are included in the same frequency specific annex of EN 302 217-2 [18] (see also annex O.1 of EN 302 217-2 [18]).

- 2) **channels-aggregation (dual-band):** where the two *aggregated-channels* operate on non-contiguous bands.

- 3) **channels-aggregation/dual-port (equipment):** equipment where the payload capacity is transmitted through the same radio equipment at two different antenna ports over two different (in frequency and/or in polarization and/or direction) assigned radio frequency channels (see annex C) in the same or different frequency bands.
- 4) **channels-aggregation/single-port (equipment):** equipment where the payload capacity is transmitted from the same radio equipment and antenna port over two different assigned frequency channels (see annex C) in the same or different frequency bands.

channel separation (CS): distance between adjacent channels in a radio frequency channels arrangement; it represents one of the major parameter for the identification of the radio equipment use and relevant requirements

conformity assessment procedure: See Directive 2014/53/EU [i.1] annexes II to IV.

co-polar radiation pattern: diagram representing the radiation pattern of a test antenna when the reference antenna is similarly polarized, scaled in dBi or dB relative to the measured antenna gain

cross-Polar Discrimination (XPD): difference in dB between the co-polarized main beam gain and the cross-polarized one, measured within a defined angular region

cross-polar radiation pattern: diagram representing the radiation pattern of a test antenna when the reference antenna is orthogonally polarized, scaled in dBi or dB relative to the measured antenna gain

dedicated antenna: antenna specifically designed for being attached to the radio equipment (i.e. with special mechanical fixing to the antenna port of the specific radio supplied), but can be separated from the equipment (typically for transport purpose) using normal tools

environmental profile: range of environmental conditions under which equipment within the scope of the ETSI EN 302 217 series is required to comply with the provisions of the ETSI EN 302 217 series

essential characteristic: radio frequency characteristic related to the essential requirements under article 3.2 of Directive 2014/53/EU [i.1] that is capable of expression in terms of quantifiable technical essential parameters

frequency band: band of frequencies over which the performance characteristics of the equipment/antenna are set within specified limits

frequency block: portion of a radio-frequency band licensed or auctioned to a user

NOTE: It is commonly assumed that the user can freely deploy radio systems inside the block, complying only with few inter-block coexistence rules and possibly with operational constraints given in the license/auction.

frequency slot: basis on which one or more slots can be aggregated to form a channel or a block

gain (of an antenna): ratio of the radiation intensity, in a given direction, to the radiation intensity that would be obtained if the power accepted by the antenna were radiated isotropically

NOTE: Value measured in dBi.

gross bit rate: total number of bit/s actually transmitted on the air; when divided by the actual modulation index it corresponds to the *symbol rate*

NOTE: In case of a transmitter working in burst mode, the *gross bit rate* is the instantaneous maximum transmission bit rate during the burst.

half power beamwidth (of an antenna): angle, relative to the main beam axis, between the two directions at which the measured co-polar pattern is 3 dB below the value on the main beam axis

input port(s): flange(s) or connector(s) through which access to the antenna system is provided

NOTE 1: These are shown in the following figure 1 at points D and D'.

NOTE 2: The points in figure 1 are reference points only; points B, C and D, B', C' and D' may coincide.

integral (integrated) antenna: antenna which is declared as part of the radio equipment by the manufacturer; it is not physically separable from the equipment, unless it is returned to the manufacturer premises

NOTE: Even when equipment with integral antenna is concerned, the manufacturer might still be able to separate the antenna from the equipment using special tools. In such cases the assessment of the radio equipment and of the antenna against requirements of this ETSI EN 302 217 series could be done separately by the actual manufacturer(s).

Inter Port Isolation (IPI) (of an antenna): ratio in dB of the power level applied to one port of a multi-port antenna (e.g. dual polarization ports or multi-band ports) to the power level received in any other port of the same antenna as a function of frequency

isotropic radiator: hypothetical, lossless antenna having equal radiation intensity in all directions

main beam (of an antenna): radiation lobe containing the direction of maximum radiation

main beam axis (of an antenna): direction for which the radiation intensity is the maximum

manufacturer: See definition in article 1 recital 1 (12) of Directive 2014/53/EU [i.1].

maximum available power: See Automatic Transmit Power Control (ATPC).

maximum nominal power: See Automatic Transmit Power Control (ATPC).

mixed-mode system (see note): system having the capability for stations to operate, according network and operator needs (e.g. according propagation variations), on different modulation orders and/or different error correction coding, switching dynamically between them within the same assigned radio frequency channel, adapting the system capacity accordingly (*multirate* operation)

NOTE: These systems are also identified as Adaptive Coding and Modulation (ACM). This capability may be used to improve capacity capabilities, with variable availability objectives, by adaptive adjustment for time-variant channel impairments. The switching between modulation orders and/or coding may occur as frequently as the propagation conditions dictate and as appropriate to the system dynamic behaviour management, (e.g. on a per-symbol and/or, in *multi-carrier* systems, per-carrier basis).

multi-carrier (equipment): equipment where more than one modulated sub-carrier is radiated from the same transmitter within one polarization of the assigned radio frequency channel

NOTE: For the purpose of this ETSI EN 302 217 series, all sub-carriers are assumed to be nominally equal in terms of modulation format, bandwidth and output power; dissimilar sub-carriers systems are not in the scope of the present EN series. In addition, OFDM modulated signals are not considered multi-carrier unless few equal OFDM modulated sub-carriers can be identified within the assigned radio frequency channel bandwidth.

multi-channel (system): system where the payload capacity is transmitted through two or more radio equipment operating over different (in frequency or in polarization) assigned radio frequency channels (see annex C)

multirate systems: systems that can operate with multiple payload rates; the actual rate can either be statically preset (possibly coupled also with *Preset-mode* operation) or, when coupled with *Mixed-mode* operation, dynamically change according to the change in modulation format

national radio frequency channel arrangement: predefined centre frequencies raster, used on a national basis, for a number of radio frequency channels, covered by a national regulation in a frequency band in absence of, or different from, existing ECC or ITU-R recommended channel arrangements

NOTE: May all or in part overlap with other national or recommended radio frequency channel arrangements.

Network Interface Capacity (NIC): sum of the maximum bit rates of the implemented base band interfaces at reference point X/X'

nominal (channel) bandwidth: bandwidth, defined by the manufacturer, which the system will use when deployed in bands where no specific radio frequency channel arrangement is defined (or it is defined only in term of aggregation of basic slots)

NOTE: Its value can be defined as a free value (nominal bandwidth) or in term of the used aggregation of basic frequency slots to form the used channel (nominal channel bandwidth). This value, if required, may represent the reference for defining parametric requirements (e.g. spectrum density mask, spectrum efficiency, etc.).

occupied bandwidth: width of a frequency band such that, below the lower and above the upper frequency limits, the mean powers emitted are each equal to a specified percentage $\beta/2$ of the total mean power of a given emission (Radio Regulations [i.38], article 1.153)

NOTE: For the purpose of the present document, $\beta/2$ is assumed to be equal to 0,5 % (Recommendation ITU-R F.1191 [i.33]).

operating frequency range: range(s) of radio frequency channels covered by the Equipment Under Test (EUT) without any change of Hardware (HW) units

out-of-band domain: See Radio Regulations [i.38] article 1.146A.

preset-mode system: multi-rate and multi-format system that can be statically configured or preset to operate on a semi-permanent basis with one among several possible modulation orders within the same assigned radio frequency channel, changing consequently the payload rate

NOTE: Signals transmitted from any station use the single modulation order which has been preset. The presetting, if the licence permits, may be changed from time to time according to the operator's needs.

radiation pattern (of an antenna): diagram relating power flux density at a constant distance from the antenna at off-axis angles (non intentional antenna radiation) relative to a direction of the antenna main beam axis (intentional antenna radiation)

Radiation Pattern Envelope (RPE) (of an antenna): envelope below which the radiation pattern fits; diagrams representing the radiation pattern of a test antenna measured with a reference antenna, scaled in dBi or dB relative to the measured antenna gain

NOTE: For linearly polarized antennas, two different RPE are generally identified:

- **co-polar radiation pattern envelope:** diagram representing the radiation pattern of a test antenna when the reference antenna is similarly polarized, scaled in dBi or dB relative to the measured antenna gain;
- **cross-polar radiation pattern envelope:** diagram representing the radiation pattern of a test antenna when the reference antenna is orthogonally polarized, scaled in dBi, or dB relative to the measured antenna gain.

radio equipment: According to Directive 2014/53/EU [i.1], it "*means an electrical or electronic product, which intentionally emits and/or receives radio waves for the purpose of radio communication and/or radiodetermination, or an electrical or electronic product which must be completed with an accessory, such as antenna, so as to intentionally emit and/or receive radio waves for the purpose of radio communication and/or radiodetermination*".

radio frequency channel: portion of a radio frequency band, where a radio frequency channel arrangement has been established, dedicated to one fixed radio link

radio frequency channel arrangement: predefined (centre frequencies) raster for a number of radio frequency channels

NOTE 1: Used by administrations for co-ordination in the same geographical area.

NOTE 2: As defined by Recommendation ITU-R F.746 [23].

Radio Interface Capacity (RIC): maximum user net capacity (in term of system capability), defined at Z/Z' reference points, that can be transmitted over the radio interface defined at reference point C'

NOTE: RIC is defined at Z/Z' reference points and includes additional capacity added for framing and multiplexing/demultiplexing different baseband signals (at X/X' points) into a transport module, eventually integrated in the baseband processing of the radio system, virtually defined at the Z/Z' reference points (e.g. the STM-N for the standardized SDH case or the higher level PDH frames for the transport of $N \times 2$ Mbit/s or similar declared proprietary multiplexing frames of different signals). It does not include other additional proprietary algorithms and signals used for specific radio systems purposes (typically error correction codes and radio system service channels).

radome (of an antenna): cover of dielectric material, intended to protect an antenna from the effects of its physical environment

recommended (or harmonized) radio frequency channel arrangement: predefined centre frequencies raster for a number of radio frequency channels, covered by an ITU-R and/or ECC (or CEPT/ERC) Recommendation in a frequency band that is recommended (but not imposed) for harmonisation to the member countries where they use the relevant frequency band for the Fixed Service

reference mode (reference equipment class and channel separation): in *mixed-mode* systems, it identifies the operative mode which characteristics (i.e. system capacity, *spectral efficiency class* over a given *channel separation*) are used (i.e. declared in the licensing process) in the link per link coordination analysis (see note)

NOTE: It provides the reference availability objective commonly used for the whole network (i.e. the typical 99,99 % or any other generally used by the administration concerned for the frequency coordination of licensed P-P links). When also *bandwidth adaptive* operation is active, the *reference mode* is always related to the widest *channel separation* used.

Remote Frequency Control (RFC): many fixed digital radio systems offer this functionality as a qualifying aid to deployment

NOTE: When this function is used, the transmit centre frequency/channel can be set either by a local control unit, connected to the system control unit, or by a remote network management terminal. The frequency variation is static and usually made at the activation or re-commissioning of links in order to easily obtain the licensed frequency assigned by the co-ordinating body to the network operator for that link, in order to control network interference in the same geographical area.

Remote Transmit Power Control (RTPC): many fixed digital radio systems offer this functionality as a qualifying aid to the deployment

NOTE: When this function is used, the transmit power can be set either by a local control unit, connected to the system control unit, or by a remote network management terminal. The power variation is static and usually made at the activation or re-commissioning of links in order to easily obtain the EIRP required by the frequency co-ordinating body for that link, to control co-channel and adjacent channel interference in the same geographical area. In principle, this function is equivalent to the requirement power regulation capability (e.g. by fixed attenuators) commonly required in fixed systems.

Residual Bit Error Ratio (RBER): Bit Error Ratio observed over suitably long period (as specified by the test requirement) at a RSL where the thermal noise contribution is negligible (e.g. at least 10 dB RSL higher than the BER = 10^{-6} threshold)

signature: test methodology, based on two ray path simulator, defined in Recommendation ITU-R F.1093 [i.30] for characterizing digital radio receiver resistance to multipath phenomena

NOTE: First introduced by Bellcore work (Lundgren, Rummler - BSTJ 58 pp 1073-1100), the so defined signature of a point-to-point radio system is used in Recommendation ITU-R P.530 [26] for prediction of the selective outage probability due to multipath occurrence on a given link.

single-mode system: system designed to operate with a single modulation order only

spectral efficiency: defined as the ratio between the peak *gross-bit-rate* and the Occupied Bw or occupied ChS (whichever is applicable)

spectral efficiency class: formal subdivision of increasing modulation efficiency introduced in ETSI EN 302 217-2 [18] as major parameter for the identification of the radio equipment use and relevant requirements

NOTE: Actual modulation format used is not relevant in this definition; any modulation format can be used provided that the requirements of the class are met.

spectral efficiency reference index: indicates the "n" value for an ideal modulation format with 2^n different states

spurious domain: See Radio Regulations [1.38] article 1.146B.

stand-alone antenna: antenna designed independently from the fixed radio equipment, by the same or a different manufacturer and connected to the radio equipment in the field through standard cables or waveguide

symbol rate: total number of symbols/s actually transmitted on the air; it is equal to the *gross bit rate* divided by the actual modulation index

3.2 Symbols

For the purposes of the present document and of the other ETSI EN 302 217 series parts (i.e. part 2 [18] and part 4 [19]), the following symbols apply:

°	degree
Ω	Ohm
CSmin	minimum practical Channel Separation (for a given radio-frequency channel arrangement)
dB	deciBel
dBc	deciBel relative to mean carrier power
dB _i	deciBel relative to an isotropic radiator
dB _m	deciBel relative to 1 mW
dB _u	deciBel relative to 1 microVolt
dBW	deciBel relative to 1 Watt
GHz	GigaHertz
kg	kilogramme
kHz	kiloHertz
km	kilometre
kN	kiloNewton
m/s	metres per second
Mbit/s	Mega-bits per second
MHz	MegaHertz
mW	milliWatt
ns	nanosecond
ppm	parts per million
V	Volts
W/m ²	Watts per square metre

3.3 Abbreviations

For the purposes of the present document and of the other ETSI EN 302 217 series parts (i.e. part 2 [18] and part 4 [19]), the following abbreviations apply:

ACAP	Adjacent Channel Alternate Polarization
ACCP	Adjacent Channel Co-Polarization
ACM	Adaptive Coding and Modulation
APSK	Amplitude and Phase Shift Keying (modulation)
ARQ	Automatic Repeat Request
ATM	Asynchronous Transport Module
ATPC	Automatic Transmit Power Control
ATTM	ETSI TC-Access Terminals, Transmission and Multiplexing
BB	Base Band
BBER	Background Block Error Ratio
BER	Bit Error Ratio
BW	BandWidth
BWA	Broadband Wireless Access

NOTE: Intended as any mixture of fixed, nomadic, mobile application.

C/I	Carrier to Interference ratio
CCDP	Co-Channel Dual Polarized
CEPT	Conférence Européenne des administrations des Postes et des Télécommunications (European Conference of Postal and Telecommunications administrations)
CL	Confidence Level
CMI	Coded Mark Inversion
CS	Channel Separation

NOTE: Sometimes referred in literature as Channel Spacing.

CSmin minimum practical Channel Separation

NOTE: Defined for each given radio-frequency channel arrangement.

CW	Continuous Wave
DC	Direct Current
DFRS	Digital Fixed Radio System
DRRS	Digital Radio Relay System
DTE	Data Terminal Equipment
EB	Errored Blocks
EC	European Community
ECC	Electronic Communication Committee of the CEPT
EIRP	Equivalent Isotropically Radiated Power
EMC	ElectroMagnetic Compatibility
ERC	European Radiocommunications Committee of the CEPT, presently become ECC
ES	Errored Seconds
ESR	Errored Second Ratio
EUT	Equipment Under Test
FLANE	Fixed Local Area Network Extension
FDD	Frequency Division Duplex
FEC	Forward Error Correction
FER	Frame Error Ratio
FRS	Fixed Radio Systems
FS	Fixed Service
FSK	Frequency-Shift Keying (modulation)
FSS	Fixed Satellite Service
FWA	Fixed Wireless Access
HDB2	High Density Bipolar coding order 2
HDB3	High Density Bipolar coding order 3
HDFS	High Density Fixed Service
IDU	InDoor Unit
IEC	International Electrotechnical Committee
IEEE	Institute of Electrical and Electronics Engineers
IF	Intermediate Frequency
IFbw	IF bandwidth

NOTE: Indicating the noise resolution bandwidth of a spectrum analyser

IP	Internet Protocol
IPI	Inter-Port Isolation
ISDN	Integrated Services Digital Network
ISO	International Standards Organization
ITU-R	International Telecommunication Union - Radiocommunications standardization sector
ITU-T	International Telecommunication Union - Telecommunications standardization sector
L6	Lower 6

NOTE: 5 925 GHz to 6 425 GHz frequency band.

LAN	Local Area Network
MIMO	Multiple Input - Multiple Output
MP	Multi Point
MP-MP	Multipoint-to-Multipoint
N	Noise
NF	Noise Figure
NFD	Net Filter Discrimination
NIC	Network Interface Capacity
OJEU	Official Journal of the European Union
OOB	Out-Of-Band
OSI	Open Systems Interconnection
PDH	Plesiochronous Digital Hierarchy
PFD	Power Flux Density
P-MP	Point-to-Multipoint
P-P	Point-to-Point
PRBS	Pseudo Random Binary Sequence
PSK	Phase-Shift Keying (modulation)
QAM	Quadrature Amplitude Modulation
RBER	Residual BER

RCSOH	Radio Complementary Section OverHead
RF	Radio Frequency
RFC	Remote Frequency Control
RFCOH	Radio Frame Complementary OverHead
RFER	Residual FER
RIC	Radio Interface Capacity
RPE	Radiation Pattern Envelope
RR	Radio Regulation
RSL	Receiver Signal Level
RTPC	Remote Transmit Power Control
RX	Receive or Receiver
S/(N+I)	Signal to Noise plus Interference ratio
S/N	Signal to Noise ratio
SAB	Services Auxiliary to Broadcasting
SAP	Services Auxiliary to Programme making
SDH	Synchronous Digital Hierarchy
SOH	Section OverHead
SR	Symbol Rate
sSTM-1k	Synchronous Transport Module of k times VC-12 equivalent payload (k = 1, 2, 4, 8, 16)

NOTE: Defined by Recommendation ITU-T G.708 [30].

sSTM-2n Synchronous Transport Module of n times VC2 equivalent payload (n = 1, 2, 4)

NOTE: Defined by Recommendation ITU-T G.708 [30].

STM	Synchronous Transport Module
STM-0	Synchronous Transport Module Level 0

NOTE: 51,840 Mbit/s AU-3 equivalent payload.

STM-1	Synchronous Transport Module Level 1
-------	--------------------------------------

NOTE: 155,520 Mbit/s.

STM-4	Synchronous Transport Module Level 4
-------	--------------------------------------

NOTE: 622,080 Mbit/s.

STM-N	Synchronous Transport Module, level N
TCAM	Telecommunication Conformity Assessment and Market surveillance committee
TCAM-RIS	TCAM Radio Interface Specification
TDD	Time Division Duplex
TX	Transmit or Transmitter
U4	Upper 4

NOTE: 4,4 GHz to 5,0 GHz frequency band.

U6	Upper 6
----	---------

NOTE: 6 425 GHz to 7 125 GHz frequency band.

VSWR	Voltage Standing Wave Ratio
WBSEL	Wide Band SElectivity
WGSE	Working Group Spectrum Engineering
XPD	Cross-Polar Discrimination
XPI	Cross-Polar Interference
XPIC	Cross-Polar Interference Canceller

4 General characteristics

4.1 Frequency bands and channel arrangements

Frequency bands and channel arrangements, which are relevant for equipment covered by the present document, are defined by Recommendations ITU-R and/or ECC (or CEPT/ERC) Recommendations and are referenced in the first table of each annex B through annex J (i.e. table B.1 through table J.1) of ETSI EN 302 217-2 [18].

Recommendations ITU-R and ECC (or CEPT/ERC Recommendation, see note) recommended frequency channel arrangements, known at the date of publication of this multi-part deliverable, are set out for reference only. In general, the channel arrangement is relevant neither to article 3.2 of Directive 2014/53/EU [i.1] nor for other requirements in the present document; only the frequency band, actual channel separation and, in some cases innermost channels separation are relevant for defining the set of parameters and test suites relevant to each system.

NOTE: CEPT Recommendations were published until 2002 as CEPT/ERC Recommendations; consequently to the restructuring of ERC under new ECC organization, Recommendations developed after that date formally changed their reference as ECC Recommendations, without changing their applicability.

Other national or future Recommendations ITU-R or ECC Recommendations, set around the same or close to the frequency range of present Recommendations ITU-R or ECC Recommendations, are considered applicable to systems assessed against this multi-part deliverable, provided that they use the same channel separation.

Specification and tests of wide radio-frequency band covering units and *multirate* or *mixed-mode* equipment are placed in normative annex O of ETSI EN 302 217-2 [18]. Whenever applicable, it is also valid for assessing parameters specified in the present document.

4.2 Special compatibility requirements between systems

There shall be no requirement to operate transmitting equipment from one manufacturer with receiving equipment from another and, depending on the deployment conditions.

To be compatible with certain constraints given by existing installations and/or deployments already made with systems from other manufacturer or for different FS applications, new systems on the same path may be subject to additional requirements, other than those derived for a single manufacturer or same application environment.

NOTE: This does not imply that when a single manufacturer is involved there are no similar requirements; however, they do not need standardization because many other technical and cost-effective solutions might be flexibly adopted under manufacturer's own responsibility only.

For the purposes of this multi-part deliverable the following set of compatibility requirements between systems has been defined:

- a) There may be a requirement to multiplex different manufacturers' equipment on the same polarization of the same antenna. This will not apply to systems with an integral antenna.
- b) There may be a requirement to multiplex different manufacturers' equipment on different polarizations of the same antenna. This will not apply to systems with an integral antenna.

4.3 Transmission capacity and spectral efficiency

See clause 1.2, clause 1.5, clause 4.1.2 and clause 4.1.3 of ETSI EN 302 217-2 [18].

4.4 Performance and availability requirements

Equipment shall be designed in order to meet network performance and availability requirements appropriate for the type of traffic carried in a multimedia network. These network requirements (see note) are foreseen by Recommendations ITU-T G.826 [31] and G.828 [32], by Recommendations ITU-T I.356 [35] and I.357 [36] for ATM transmission and Y.1540 [43] for IP transmission. For transmission of Ethernet frames, network performance requirements of IEEE 802.3 [22] for Physical Layer Devices shall be referred to.

The events for SDH multiplex and regenerator sections have to be measured according to Recommendation ITU-T G.829 [33].

The performance and availability objectives for any overall radio connections, used in the international or national portion of the digital path, have to be based on the criteria defined in Recommendations ITU-R F.1668 [24] and F.1703 [25].

The effect of the link design on performance is recognized and the general design criteria specified in Recommendations ITU-R F.752 [i.29], F.1093 [i.30], F.1101 [i.31] and F.1102 [i.32] are to be applied to the digital connection with respect to the propagation scenarios set out in Recommendation ITU-R P.530 [26].

NOTE: An exhaustive list of recommendations for network performance and availability requirements is not in the scope of the present document. The Recommendations referred in this clause are the basic ones for the most common applications in the fixed networks. Due to continuous evolution of the communication technology, other payloads/network applications might require different or new requirements that should be taken into due account in the equipment and link design for such applications.

4.5 Environmental profiles

4.5.0 Introduction

There are three environmental profiles to be considered:

- environmental profile declared under Directive 2014/53/EU [i.1];

NOTE: With the generic term of environmental profile, it is here intended any variation of the "external" conditions (e.g. climatic and external primary/secondary power supply sources feeding the equipment to be assessed) that might affect the system parameters relevant to the "essential requirements" of article 3.2 of Directive 2014/53/EU [i.1].

- voluntary ETSI environmental profile;
- test environmental profiles.

4.5.1 Environmental profile declared under Directive 2014/53/EU

From the point of view of Directive 2014/53/EU [i.1], the essential parameters of ETSI EN 302 217-2 [18] apply under the environmental profile for intended operation of the equipment and antennas, which shall be declared by the manufacturer.

4.5.2 ETSI environmental profiles

4.5.2.0 Generality

If conformance is voluntarily sought also to an ETSI standardized environmental profile, the radio equipment shall be required to meet the environmental conditions and related tests set out in the appropriate part(s) of the multipart standard ETSI EN 300 019-1-0 [3] to ETSI EN 300 019-2-4 [12], which defines weather protected and non-weather protected locations, classes and test severity.

NOTE: The environmental profile declared for Directive 2014/53/EU [i.1] conformance may be different from any ETSI standardized one.

Environmental conditions for antennas are not generally included in the scope of ETSI EN 300 019 series (see [3] through [12]); environmental profiles are left to manufacturer declaration only. However annex A of ETSI EN 302 217-4 [19] gives some generic guidance.

The equipment shall comply with all of the relevant requirements of the ETSI EN 302 217 series at all times when operating within the boundary limits of the chosen operational environmental profile of the equipment.

4.5.2.1 Equipment within weather-protected locations (indoor locations)

Equipment intended for telecommunications applications and operating inside weather protected locations shall meet the requirements of an appropriate environmental class characterized in the ETSI EN 300 019-1-3 [9] for such purpose. The manufacturer shall declare the selected class(es).

4.5.2.2 Equipment for not-weather-protected locations (outdoor locations)

Equipment intended for telecommunications applications and operating in non-weather protected locations shall meet the requirements of an appropriate environmental class characterized in the ETSI EN 300 019-1-4 [11] for such purpose. The manufacturer shall declare the selected class(es).

4.5.3 Test environment profiles

In the case of Directive 2014/53/EU [i.1], any test, carried out to generate the test report and/or declaration of conformity, required to fulfil any conformity assessment procedure set out by Directive 2014/53/EU [i.1] for radio equipment, shall be carried out with the same principles and procedures, for reference and extreme conditions, specified in:

- clause 4.4 of ETSI EN 301 126-1 [15] for climatic conditions;
- table 1 of ETSI EN 301 126-1 [15] and relevant clauses of ETSI EN 302 217-2 [18] for power supply conditions.

Requirements for testing at reference or extreme conditions, specified in relevant clauses of the ETSI EN 302 217 series, are set out according to the principles for similar requirements in ETSI EN 301 126-1 [15].

In the case of voluntary ETSI environmental profiles, the technical requirements of the ETSI EN 302 217 series apply under the environmental profile for operation of the equipment, which shall be determined by the environmental class of the equipment according to clause 4.4 of ETSI EN 301 126-1 [15]. Testing shall be in accordance with ETSI EN 300 019-2-3 [10] or ETSI EN 300 019-2-4 [12] for weather-protected and not-weather-protected profiles, respectively.

Any test, carried out to generate the test report and/or declaration of conformity, required to fulfil any conformity assessment procedure specification by Directive 2014/53/EU [i.1] for *integral, dedicated or stand-alone* DFRS antennas (directional phenomena of ETSI EN 302 217-4 [19]), shall be carried out at reference environmental conditions at the test field according to clause 4.1 of ETSI EN 301 126-3-1 [17].

The test report shall be produced according to the procedure specified by article 17 of Directive 2014/53/EU [i.1].

4.6 Power supply

4.6.0 Introduction

There are two power supply profiles to be considered:

- power supply profile declared under Directive 2014/53/EU [i.1];
- voluntary ETSI power supply profile.

4.6.1 Power supply profile declared under Directive 2014/53/EU

From the point of view of Directive 2014/53/EU [i.1], the essential parameters of ETSI EN 302 217-2 [18] apply under the limits of any primary/secondary power supply external to the equipment under assessment, in accordance with the environment profile for intended operation of the equipment, which shall be declared by the manufacturer. See clause 4.5.1.

4.6.2 ETSI power supply profile

If conformance is voluntarily sought also to an ETSI standardized power supply profile, the power supply interface shall be in accordance with the characteristics of one or more of the secondary voltages specified in ETSI EN 300 132-2 [13] and ETSI EN 300 132-3 [14]. When appropriate, in case of remote or local powering of user stations, also ETSI EN 302 099 [16] shall apply.

4.7 System block diagram

The reference points of the system block diagram shown in figure 1 are used in the descriptions of requirements and of test points in the ETSI EN 302 217-2 [18].

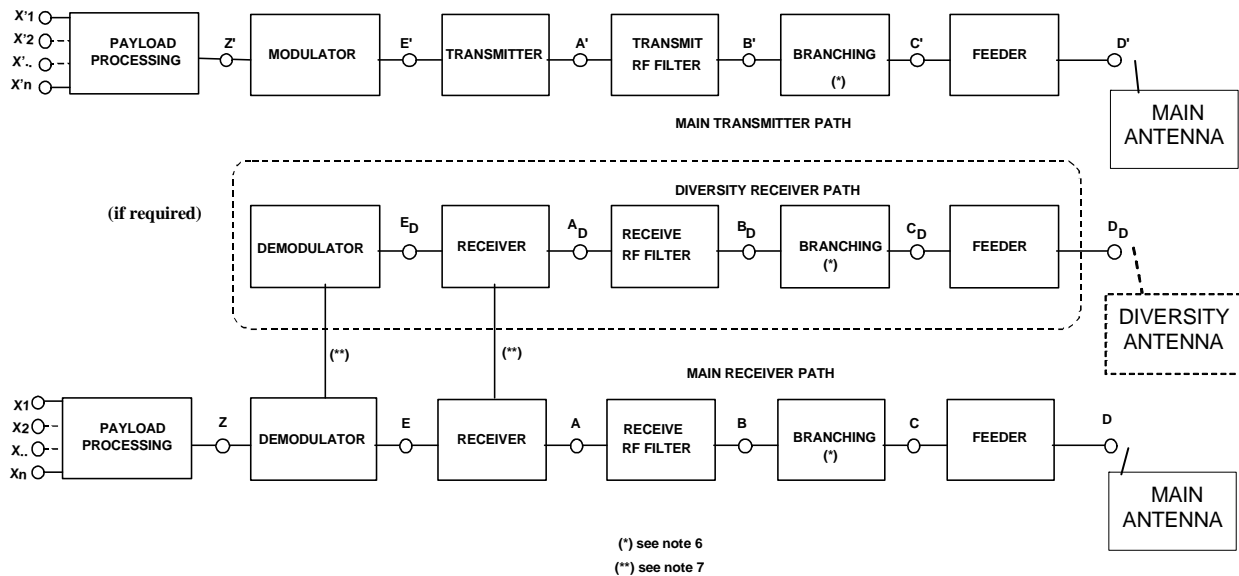

- NOTE 1: For the purpose of defining the measurement points, the branching network does not include a combiner.
- NOTE 2: The points shown above are reference points only and do not mandate any implementation; points C and C', D and D' in general coincide.
- NOTE 3: Points B, C, B' and C' may coincide when a simple duplexer is used.
- NOTE 4: Points X1, X2, ... Xn and points X'1, X'2, ... X'n correspond to one or more digital or analogue signal input reference points. They are generically referred to as X and X'.
- NOTE 5: The subdivision of "Payload processing" and the "Modulator/demodulator" blocks is functional and not physical. The first functionally contains the payload processing needed for building up the transport module (e.g. framing, multiplexing and or concentration), the latter functionally contains mo-demodulation, coding-decoding and service signals processing needed for transmission (e.g. error correction algorithms and service channels). Points Z and Z', that might not be physically available, represent the virtual points where the radio interface capacity (RIC), referred in the provisions of annex D of the present document and annex N of ETSI EN 302 217-2 [18], shall be defined.
- NOTE 6: No filtering included.
- NOTE 7: Alternative connection at RF, IF or Baseband level.

Figure 1: System block diagram

5 Baseband interfaces and parameters

5.0 Introduction

The baseband parameters, specified in following clauses, refer to point X and X' of figure 1. Parameters for service channels and wayside traffic channels are outside the scope of the ETSI EN 302 217 series.

One or more of the following clauses is applicable.

5.1 Ethernet interfaces

Ethernet data interface (for e.g. 10 Mbit/s, 100 Mbit/s, 1 Gbit/s and 10 Gbit/s rates) shall be in accordance with the ISO/OSI and physical layer requirements of IEEE 802.3 [22].

5.2 Plesiochronous interfaces

If applicable, Plesiochronous interfaces at 64 kbit/s, 2 Mbit/s, 8 Mbit/s, 34 Mbit/s and 140 Mbit/s shall comply with Recommendation ITU-T G.703 [27]. Parameters for service channels and wayside traffic channels are outside the scope of this ETSI EN 302 217 series.

5.3 Synchronous digital hierarchy interfaces

If applicable, the SDH baseband interface shall be in accordance with Recommendations ITU-T G.703 [27], G.707 [29], G.708 [30], G.783 [i.35], G.784 [i.36] and G.957 [34].

The following STM physical interfaces are possible:

- sSTM-1k and sSTM-2n (Recommendation ITU-T G.708 [30]);
- STM-0 CMI, HDB2, HDB3 electrical (Recommendation ITU-T G.703 [27]);
- STM-1 CMI electrical (Recommendation ITU-T G.703 [27]);
- STM-N optical (Recommendation ITU-T G.957 [34]).

The use of reserved bytes contained in the Section OverHead (SOH), and their termination should preferably be in accordance with Recommendation ITU-R F.750 [i.27]. Further details on the possible use of the SOH bytes including additional RFCOH or RCOH are given in ETSI TR 101 035 [i.2].

5.4 Other baseband data interfaces

Other standardized base band data interfaces are possible; for equipment assessment when other base band interfaces are foreseen see annex N in ETSI EN 302 217-2 [18] and clause D.4 of the present document. Those annexes provide the conditions under which the present document specifications can be used for systems with traffic interface combinations other than those specifically mentioned in the present document.

Examples of most common such interfaces are:

- low speed data interfaces in accordance to Recommendations ITU-T V.11 [40], V.24 [41] and/or V.28 [42];
- ISDN interfaces: the transmission of 2 Mbit/s signals using the structure and functions of ISDN primary multiplex signals is to be in accordance with Recommendations ITU-T G.703 [27], G.704 [28] and the requirements summarized in Recommendation ITU-T I.414 [i.37].

The data interface offered by the equipment shall be declared by the manufacturer together with the relevant set of applicable international standards in agreement with the network operator.

6 Main requirements

6.0 Introduction

The following clauses summarize requirements related to the "essential requirements" under article 3.2 of Directive 2014/53/EU [i.1] that are further detailed in ETSI EN 302 217-2 [18]. However, for some requirements, besides the relevant essential limits set out in ETSI EN 302 217-2 [18] for the purpose of their separate publishing in the Official Journal of the European Union (OJEU) under Directive 2014/53/EU [i.1], additional, non-essential, more stringent limits are here set out in response to specific compatibility requirements by network operators when deploying new systems on the same routes with existing systems from other manufacturers.

6.1 General requirements

6.1.1 System identification

Equipment in the scope of the present document shall refer to a coherent set of transmitter and receiver requirements uniquely defined on the basis of the following identifying parameters:

- Operating frequency band.
- Operating radio frequency channel separation.
- Spectral efficiency class, to which the minimum RIC density, defined in clause 1.2 of ETSI EN 302 217-2 [18], is associated.
- Actual declared maximum total RIC transmitted over the channel with the selected spectral efficiency class.

6.1.2 System nominal loading

The specified transmitter and receiver characteristics shall be met with the appropriate baseband signals summarized in table 5 applied at reference point X' and received from reference point X of figure 1.

Table 5: Baseband test signals

Type of baseband signal interface at X/X'	Test signal to be applied according to...
PDH	PRBS Recommendation ITU-T O.151 [37]
SDH	Recommendation ITU-T O.181 [38]
ATM	Recommendation ITU-T O.191 [39]
Ethernet interface (packet data)	IEEE 802.3 [22],
Other than the above	Relevant standards which the interface refers to

6.1.3 Environmental profile

The required environmental profile for operation of the equipment shall be declared by the manufacturer. The equipment shall comply with all the technical requirements of the present document at all times when operating within the boundary limits of the required operational environmental profile.

Preferably, the selected environmental profiles should be one of more ETSI profiles in ETSI EN 300 019 series (see [3] through [12]), standardized for various operating, transport and storage situations.

6.2 Transmitter characteristics

6.2.1 Transmitter power and power tolerance

6.2.1.1 Maximum power and EIRP

The Maximum Output Power and EIRP are essential parameters under article 3.2 of RE Directive [i.1] and are specified in ETSI EN 302 217-2 [18].

For guidance, in addition to the absolute maximum transmitter power, typical values of transmitter highest power for real equipment, of feeder loss and length, and of antenna diameter and gain are provided in ETSI TR 102 243-1 [i.3] in order to support inter-systems and intra-system compatibility and sharing analysis.

In some frequency bands, or parts of frequency bands, Recommendations ITU-R define specific limits in terms of output power and/or EIRP (or output power and/or EIRP density) in order to improve the compatibility with other Radio Services sharing these frequency bands with the FS.

An additional capability for output power level adjustment may be required, for regulatory purposes, in the interface regulations according to article 8 of Directive 2014/53/EU [i.1], in which case the range of adjustment, either by fixed or automatic attenuators, should be in increments of 5 dB or less.

In particular, for the band 18 GHz, the FS shall, where practical, implement the appropriate mitigation techniques as required in ERC/DEC(00)07 [2]. See annex F.

6.2.1.2 Combined TX power and EIRP limits

When relevant in some frequency bands, these combined limits are an essential parameter under article 3.2 of Directive 2014/53/EU [i.1] and are specified in ETSI EN 302 217-2 [18].

6.2.1.3 Output power tolerance

The power tolerance around the nominal output power within the associated environmental profile, declared by the manufacturer, is considered essential under article 3.2 of Directive 2014/53/EU [i.1]. For relevant limits see ETSI EN 302 217-2 [18].

Additional, voluntary limitation:

It should be taken into consideration that, in general, the declared profile for Directive 2014/53/EU [i.1] assessment might not be coincident with the ETSI standardized ones in ETSI EN 300 019 series (see references [3] through [12]), which have been specifically designed for telecommunication equipment in various deployment situations. Therefore, the manufacturer may decide to comply with equal or more stringent limits for operation of the system over some ETSI standardized environmental condition for which the system is designed to operate. Limits for this case are reported below.

The tolerance of the nominal output power shall be:

- a) Systems operating within class 3.1 or class 3.2 of weather protected locations defined in ETSI EN 300 019-1-0 [3] and ETSI EN 300 019-1-3 [9].

The nominal output power, when specified, shall be within $\pm A$ dB value reported in table 6.

- b) Systems operating within one or more of non-weather protected locations class 4.1 and class 4.1E, defined in ETSI EN 300 019-1-0 [3] and ETSI EN 300 019-1-4 [11], and/or within class 3.3, class 3.4 and class 3.5 (particular extreme conditions of weather protected locations) defined in ETSI EN 300 019-1-0 [3], ETSI EN 300 019-1-3 [9]:

The nominal output power shall remain within $\pm B$ dB value, reported in table 6, within one or more of the above environment classes, specified by the manufacturer.

Table 6: Power tolerance for indoor operation

Operating frequency band (GHz)	$\pm A$ (dB)	$\pm B$ (dB)
1 to 2,7	Not defined	+2/-1
3 to 30	± 1	± 2
> 31	± 2	± 3

6.2.2 Transmitter power and frequency control

6.2.2.1 Transmitter power control (ATPC and RTPC)

6.2.2.1.1 Automatic Transmitter Power Control (ATPC)

This functionality is relevant to essential requirements under article 3.2 of Directive 2014/53/EU [i.1] and its assessment is specified in ETSI EN 302 217-2 [18].

Besides those essential parameters specified in ETSI EN 302 217-2 [18], ATPC may be requested as mandatory functionality in the licensing conditions (see note 1) for the following purposes (see note 2):

- a) to enhance network density;
- b) as a mitigation factor for sharing with other Services due to ECC Decisions (see note 3).

NOTE 1: User information: it is expected that Administrations explicitly state whether ATPC is used as a regulatory measure for either frequency coordination or as a mitigation technique to protect other services in its radio regulation interface for notification according to article 8 of Directive 2014/53/EU [i.1].

NOTE 2: User information: License conditions are under administration responsibility; in principle, from technical point of view, when used as mitigation factor, ATPC would not be used to enhance network density because this could invalidate the expected mitigation.

NOTE 3: User information: for example is in the 18 GHz band, where there is sharing between FS and FSS, ATPC will become a mandatory feature for all new equipment to be deployed after the date referred by ERC/DEC(00)07 [2], however, that Decision clarify also that actual usage of ATPC will be required by administrations only where practical and depending on local sharing conditions with satellite services and local deployment conditions in existing networks. The ATPC range is not subject to standardization.

In case a), the administration might specify that the transmitter output emission meets the spectrum mask limits set out in clause 4.2.3 of ETSI EN 302 217-2 [18] throughout an ATPC range specified in the license conditions. The manufacturer may choose to comply also with this parameter that in no case is considered essential to the assessment of article 3.2 of Directive 2014/53/EU [i.1].

In case b), the administration might require that the equipment operate with ATPC enabled. This does not imply any additional constraint besides the presence of the optional ATPC functionality, which in no case is considered essential to the assessment of article 3.2 of Directive 2014/53/EU [i.1].

The manufacturer shall declare the ATPC range within which the spectrum mask is still fulfilled; the declaration should take into account, if relevant, that the ATPC range is often interlaced and interchangeable with the available RTPC range (see note 4).

The spectrum mask shall be tested (additionally to the tests required in ETSI EN 302 217-2 [18] and with the same test method) also with the maximum ATPC attenuation and, if applicable, of the associated maximum RTPC attenuation included (see note 4). This is not applicable for testing the masks for compatibility under the same antenna systems described in annex A; in that case, the maximum TX power should be used, while RTPC can be taken into account on a station-by-station term.

NOTE 4: Further guidance on ATPC and RTPC operation can be found in ETSI TR 103 103 [i.18].

6.2.2.1.2 Remote Transmitter Power Control (RTPC)

This parameter is relevant to essential requirements under article 3.2 of Directive 2014/53/EU [i.1] and is specified in ETSI EN 302 217-2 [18].

6.2.2.2 Remote Frequency Control (RFC)

This parameter is relevant to essential requirements under article 3.2 of Directive 2014/53/EU [i.1] and is specified in ETSI EN 302 217-2 [18].

6.2.3 Radio Frequency (RF) spectrum mask

The radio frequency spectrum density mask is relevant to essential requirements under article 3.2 of Directive 2014/53/EU [i.1], the limits for the essential portion of RF spectrum density masks are found in ETSI EN 302 217-2 [18].

Additional requirements, not relevant to essential requirements under article 3.2 of Directive 2014/53/EU [i.1], for spectrum density masks may be necessary in cases where there is a requirement for internal system dependent reasons related only to TX/RX compatibility between equipment from different manufacturers operating on the innermost channels of some channel arrangements (see compatibility requirements in clause 4.2). These more stringent requirements are reported in clause 7.3.2.

6.2.4 Discrete CW components exceeding the spectrum mask limit

6.2.4.1 Discrete CW components at the symbol rate

This parameter is relevant to essential requirements under article 3.2 of Directive 2014/53/EU [i.1] and is specified in ETSI EN 302 217-2 [18].

6.2.4.2 Other discrete CW components exceeding the spectrum mask limit

This parameter is relevant to essential requirements under article 3.2 of Directive 2014/53/EU [i.1] and is specified in ETSI EN 302 217-2 [18].

6.2.5 Unwanted emissions in the spurious domain - external

"External" limit for spurious emissions from transmitters are necessary in order to limit interference into other systems operating wholly externally to the system under consideration (external emissions).

This parameter is relevant to essential requirements under article 3.2 of Directive 2014/53/EU [i.1] and is specified in ETSI EN 302 217-2 [18].

6.2.6 Dynamic change of modulation order

This parameter is relevant to essential requirements under article 3.2 of Directive 2014/53/EU [i.1] and is specified in ETSI EN 302 217-2 [18].

6.2.7 Radio frequency tolerance

This parameter is relevant to essential requirements under article 3.2 of RE Directive [i.1] and is specified in ETSI EN 302 217-2 [18].

6.2.8 Emission limitations outside the allocated band

When relevant in some frequency bands, those limits are an essential parameter under article 3.2 of Directive 2014/53/EU [i.1] and are specified in ETSI EN 302 217-2 [18].

6.3 Receiver characteristics

6.3.1 Unwanted emissions in the spurious domain - external

This parameter is relevant to essential requirements under article 3.2 of Directive 2014/53/EU [i.1] and is specified in ETSI EN 302 217-2 [18].

6.3.2 BER as a function of receiver signal level

This parameter is relevant to essential requirements under article 3.2 of Directive 2014/53/EU [i.1] and is specified in ETSI EN 302 217-2 [18].

6.3.3 Receiver selectivity

6.3.3.1 Introduction

The receiver selectivity is defined in term of receiver BER performance in presence of different C/I situations over the a wide range of spectrum including co-channel situation as reference condition.

6.3.3.2 Co-channel "external", first and second adjacent channel interference sensitivity

"External" co-channel interference is considered to be that interference from a system fully independent from the one under test (i.e. a system deployed by another operator in the same geographical area and is not related to the "internal" requirement for equipment using XPIC, specified in clause 7.5.3 of the present document).

This parameter is relevant to essential requirements under article 3.2 of Directive 2014/53/EU [i.1] and is specified in ETSI EN 302 217-2 [18].

First adjacent channel sensitivity is relevant to essential requirements under article 3.2 of Directive 2014/53/EU [i.1] and is specified in ETSI EN 302 217-2 [18] (see note).

NOTE: User information: for ACCP/CCDP applications of spectral efficiency classes higher than 4L systems in frequency bands below 15 GHz with CS \geq 14 MHz, to cope with differential fading effects on the longer hops in systems operating on adjacent channels on the same route but using different antennas, some literature report that C/I values up to about 10 dB tighter than those reported in ETSI EN 302 217-2 [18] may be necessary. However, additional burden to the assessment is not considered necessary, because this actually depends, link by link, on the hop fading occurrence factor and the ATPC range implemented on all adjacent systems (i.e. the higher is the ATPC common range, the lower is the C/I sensitivity need). The relationship of these parameters on hop performance prediction is not identified.

Second adjacent channel sensitivity is relevant to essential requirements under article 3.2 of Directive 2014/53/EU [i.1] and is specified in ETSI EN 302 217-2 [18].

6.3.3.3 CW spurious interference (blocking and spurious response)

This parameter is relevant to essential requirements under article 3.2 of Directive 2014/53/EU [i.1] and is specified in ETSI EN 302 217-2 [18].

6.4 Antenna characteristics

In case *integral* or *dedicated antenna* is used, antenna parameters are relevant to essential requirements under article 3.2 of Directive 2014/53/EU [i.1] and are specified in ETSI EN 302 217-2 [18].

In cases where detachable antenna (*dedicated* or *stand-alone*) is foreseen (possibly independently substituted or purchased by the user himself) they may be associated to obligations in other articles of Directive 2014/53/EU [i.1], ETSI EN 302 217-2 [18] provides suitable guidelines.

7 Complementary requirements

7.0 Introduction

Complementary requirements are those not related to essential requirements under article 3.2 of Directive 2014/53/EU [i.1]. Nevertheless, all or some of these requirements are considered useful for proper system operation and deployment when specific deployment conditions or compatibility requirements, as defined in clause 4.2, are present. Compliance to all or some of these requirements is left to manufacturer decision.

7.1 Branching/feeder requirements

7.1.1 Waveguide flanges (or other connectors)

When flanges (or coaxial types) are required at reference point(s) B, B', C and C' of figure 1 of, the following types shall be used:

- UBR/PBR/CBR/CAR (Square flanges) or UDR/PDR/UER (Rectangular flanges) or UAR/PAR (Circular flanges)-XXX (waveguide type reference number) flanges according to IEC 60154-2 [i.20] shall be used for the bands and waveguides specified in table 7; for reader convenience figure 2 shows the representative shapes of the above flanges. When the same band appears covered by two different options, both are admitted, provided that adaptors are available.
- Coaxial connectors can be used, as an option, for all frequency bands (see note). The impedance of the coaxial ports shall be nominally 50 Ω .

NOTE: User information: For coaxial connectors, a number of popular standards exist; for example, a range of coaxial connectors referred to in parts 1 and 2 of IEC 60339 [i.22], IEC 60169-1 [i.21], CENELEC EN 122150 [1]. However, it should be noted that these standards are not exhaustive.

Table 7: Waveguides useable for various frequency bands

Frequency band(s)	"R XXX" waveguide designation (and its frequency range in GHz) according to IEC 60153-2 [i.19]
1,4 GHz and 2,5 GHz bands 2,1 GHz to 2,5 GHz bands	None (Only coaxial connections are commonly used)
3,5 GHz band	Either R 32 (2,6 to 3,95) or R 40 (3,3 to 4,9)
4 GHz band	R 40 (3,3 to 4,9)
5 GHz band	R 48 (3,95 to 5,85)
L6/U6 GHz band	R 70 (5,85 to 8,2)
7 GHz band(s)	Either R 70 (5,85 to 8,2) or R 84 (7,05 to 10)
8 GHz band	R 84 (7,05 to 10)
10,5 GHz and 11 GHz bands	Either R 100 (8,2 to 12,4) or R 120 (10 to 15)
13 GHz band	Either R 120 (10 to 15) or R 140 (12,4 to 18)
15 GHz band	R 140 (12,4 to 18)
18 GHz band	Either R 180 (15 to 22) or R 220 (18 to 26)
23 GHz band	R 220 (18 to 26)
26 GHz band	Either R 220 (18 to 26) or R 260 (22 to 33)
28 GHz band	Either R 260 (22 to 33) or R 320 (26,5 to 40)
31 GHz and 32 GHz bands	R 320 (26,5 to 40)
38 GHz band	R 320 (26,5 to 40)
42 GHz band	Either R 400 (33 to 50) or R 500 (40 to 60)
50 GHz band	R 500 (40 to 60)
52 GHz, 55 GHz and 57 GHz to 66 GHz bands	Either R 500 (40 to 60) or R 620 (50 to 75)
70 GHz and 80 GHz bands	R 740 (60 to 90)

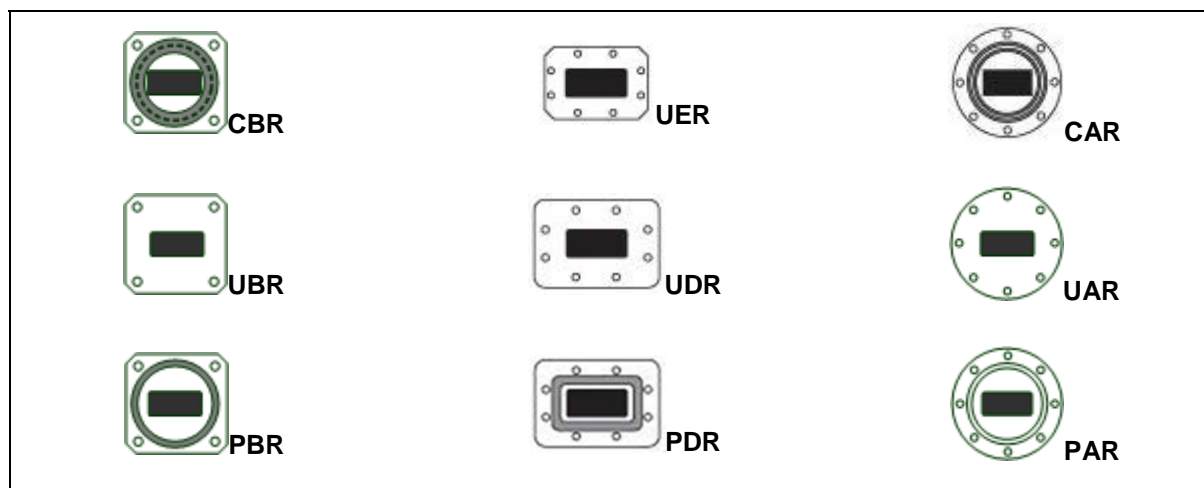

Figure 2: Waveguide Flange Shapes

7.1.2 Return loss of feeder/antenna systems at equipment antenna port (C/C' reference point)

It is frequent practice that equipment without integral antennas is connected to feeder/antenna systems from other manufacturer.

For equipment in the scope of the present document, that uses outdoor radio frequency units, which are likely to have integral antennas or similar technical solutions, without long feeder connections, the impact of return loss at the antenna port on system performance is negligible and does not require standardized limits.

For fully indoor systems, which are generally deployed with longer feeder connections to an external antenna, and may be required to operate with respect to compatibility requirements specified in clause 4.2 list items a and b, the minimum return loss, for negligibly affecting BER and RBER performances, depends on the signal bandwidth and modulation complexity used or, in case of *mixed-mode* systems, chosen as *reference mode*. However, the effectiveness of the used error correction technology also plays a significant effect.

The manufacturer shall declare the minimum required return loss of the feeder/antenna systems connected at the antenna port (point C and C' of figure 1).

The manufacturer shall also declare the guaranteed return loss of the equipment antenna port (i.e. towards the equipment), see note.

NOTE: For guidance only, this is typically around 20 dB for waveguide connections and around 15 dB when coaxial connections are considered.

For feeder/antenna return loss information, see ETSI EN 302 217-4 [19].

7.2 Intermodulation products

Where multi-channels branching system is concerned and where the system is intended to comply with compatibility requirement in clause 4.2, each odd order intermodulation product, caused by different transmitters linked to the same branching system, shall be less than -110 dBm referenced to reference point B of figure 1 with an output power per transmitter limited to the maximum power stated by the manufacturer for the equipment.

The reference power shall be the maximum power stated by the manufacturer for the equipment. This clause is not intended for use with conformance tests, but only, if required, for type tests agreed between user and manufacturer. The measurement, if any, shall be carried out with un-modulated signals of the same power of the average level of the digital signals.

7.3 Transmitter characteristics

7.3.1 Unwanted emissions - internal

This category covers emissions that, only for compatibility of TX and RX digital systems of different manufacturers connected to the same antenna (see clause 4.2), may be required to be more stringent than the "external" emissions detailed in clause 6.2.5.

The levels of the unwanted emissions from the transmitter, referenced to reference point B' of figure 1 are specified in table 8.

The level of spurious emission will be the total average level integrated over the bandwidth of the channel under consideration.

Table 8: Internal levels for the transmitter unwanted emissions

Controlling factor for requirement application	Spurious emission frequency relative to channel assigned frequency	Specification limit
Within receive half band, digital into digital interference on the same local multi-channel branching/antenna system, for digital systems with compatibility requirements as specified in clause 4.2a) (co-polar operation).	All spurious signals within the receive half band	≤ -90 dBm
Within receive half band, digital into digital interference for digital systems without branching network (i.e. single transceivers with duplexer), for digital systems with compatibility requirements as specified in clause 4.2b) (cross-polar operation).		≤ -70 dBm

7.3.2 Radio Frequency (RF) spectrum mask when mixed manufacturer compatibility is required

For systems, which are intended to comply with compatibility requirement under clause 4.2, to guarantee normal and innermost TX to RX channel compatibility, the TX noise floor and inner side of the innermost transmitter shall offer sufficient attenuation to the locally interfered receiver.

For this purpose the overall Net Filter Discrimination (NFD) should be enough for giving an acceptable threshold degradation to the local receiver; this can be accomplished only with suitable combined filtering of both interfering TX and victim RX (see background in ETSI TR 101 036-1 [i.15]).

Examples of suitable spectrum masks (TX filtering) insofar defined for most common system and channel arrangement are given in annex A of the present document. For corresponding RX filtering see clause 7.4.4.

Their attenuation/frequency parameters are defined in the same way as in clause 4.2.3 of ETSI EN 302 217-2 [18].

The spectrum analyser settings for measuring the RF spectrum mask are shown in table 7 of clause 5.2.3 of ETSI EN 302 217-2 [18].

Since it might be difficult or not practical to make direct measurement of this characteristic, in alternative, the manufacturer shall give the attenuation data of all RF filters, implemented in the TX chain after the transmit power amplifier output, to be eventually added to the spectrum tested in that point (reference point A' in figure 1).

7.4 Receiver characteristics

7.4.1 Maximum input level and input level range

The input Receiver Signal Level (RSL) range, under flat fading condition, where the BER is kept lower than a specified level (typically 10^{-6} for availability purpose and, for quality purpose, 10^{-8} for system RIC ≤ 100 Mbit/s or 10^{-10} for system RIC > 100 Mbit/s) depends on various parameters such as, but not limited to, frequency band, hop length and spectrum efficiency class. In principle, the higher is the range, the more flexible is the use of the equipment; however, high capacity systems with complex modulations (e.g. classes 5L and higher) suffer from one side of relatively higher RSL/BER thresholds and from the other side from more sensitivity to non-linear distortion caused by RX chain saturations.

It is also recognized that the higher modes (e.g. class 7 and class 8 and, in some cases, also class 6H or lower classes) are hardly suitable as reference-mode because their very limited fade margin might not be enough to guarantee the required performance and availability objectives in typical links. Therefore, they are likely to be used only during dynamic operation with a lower class reference-mode. Nevertheless, their systems characteristics are also reported for possible use by special equipment or for reference in administrative licensing procedures.

A unique standardized approach is not therefore advisable, nevertheless the necessary fade-margin shall be accommodated (see note); the following "design objectives" are given for guidance only.

NOTE: Enhanced input level range for sensitive modulation formats is currently obtained through ATPC activation.

The limits for the RSL threshold for a BER $\leq 10^{-6}$ and BER $\leq 10^{-8}$ or BER $\leq 10^{-10}$ are specified in the relevant annex of ETSI EN 302 217-2 [18]. The upper limit for the RSL, where the same BER values is experienced, due to non-linear distortions, should be equal to or higher than the values shown in table 9.

However, when the lower BER thresholds, compared to the upper limit levels in table 9, result in a total RSL range of:

≥ 50 dB for BER $\leq 10^{-6}$

≥ 47 dB for BER $\leq 10^{-8}$

≥ 44 dB for BER $\leq 10^{-10}$

the maximum RSL given in table 9 may be reduced accordingly.

When *mixed-mode* systems are concerned the above limits are intended relevant to the *reference mode(s)* only.

These limits apply without interference and are referenced to point B (point B and point C may coincide when simple duplexer is used) of figure 1.

For equipment designed to operate only with ATPC as a fixed permanent feature the above maximum input levels are reduced by an amount up to the ATPC range.

Table 9: Minimum upper input received signal level

Spectral efficiency		BER (see note 1 and note 2)	Minimum upper value of RSL (dBm) (see note 2 and note 3)		
			Frequency Range (GHz)		
Reference index	Class		Up to 18 GHz	23 GHz to 55 GHz	57 GHz to 66 GHz 71 GHz to 86 GHz
1, 2, 3, 4, 5	1, 2, 3, 4L, 4H	$\leq 10^{-6}$	-21	-23	-23
		$\leq 10^{-8}$	-22	-24	-
		$\leq 10^{-10}$ (see note 4)	-23	-25	-25
6, 7	5L, 5H	$\leq 10^{-6}$	-22	-24	-24
		$\leq 10^{-8}$	-24	-25	-
		$\leq 10^{-10}$ (see note 4)	-25	-26	-26
8, 9	6L, 6H	$\leq 10^{-6}$	-23	-25	-25
		$\leq 10^{-8}$	-24	-26	-
		$\leq 10^{-10}$ (see note 4)	-25	-27	-27
10, 11	7, 8	$\leq 10^{-6}$	-24	-26	-26
		$\leq 10^{-8}$	-25	-27	-
		$\leq 10^{-10}$ (see note 4)	-26	-28	-28

NOTE 1: BER = 10^{-6} range for all systems, BER = 10^{-8} range for system RIC \leq 100 Mbit/s or BER = 10^{-10} range for system RIC > 100 Mbit/s.

NOTE 2: In case of *multi-channel* systems, when carrying STM-4 or when carrying payload interface capacity spread on different channels, the test shall be made changing the RSL of all channels simultaneously. For more details see clause O.3 in ETSI EN 302 217-2 [18].

NOTE 3: When ATPC is used as permanent feature, the requirement is intended with ATPC enabled. In this case the values in the column shall be relaxed by the ATPC minimum attenuation.

EXAMPLE: A system with permanent ATPC in the range between 6 dB (minimum) and 20 dB (maximum) is subject to a maximum RSL 6 dB lower than the values in the table (e.g. the -23 dBm become -29 dBm).

NOTE 4: BER $\leq 10^{-9}$ for non Ethernet-based systems with 64 kbit/s \leq minimum RIC \leq 192 kbit/s.

7.4.2 Spurious emissions - internal

For systems without the compatibility requirements of clause 4.2 there is no requirement.

When equipment is required to share the same antenna with other equipment, the unwanted emissions limits, referenced to point B of figure 1, are specified in table 10.

The required level is the total average level integrated over the bandwidth of the channel under consideration.

Table 10: Limits of unwanted emissions-internal

Controlling factor	Specification limit
Spurious falling in the same receive half-band for systems with compatibility requirements of clause 4.2a).	≤ -110 dBm
Spurious falling in the same receive half-band for systems with compatibility requirements of clause 4.2b).	≤ -70 dBm

7.4.3 Image rejection

The requirement for a minimum receiver image rejection is not applicable to receivers with direct demodulation.

When down conversion is used, the receiver image(s) rejection shall be as listed in table 11.

Table 11: Receiver image rejection

Controlling factor	Image rejection
a) For any image frequency falling within the receive half band while using branching on different polarizations as defined under the compatibility requirements in clause 4.2b).	≥ 90 dB
b) For systems not intended to fulfil any compatibility requirements in clause 4.2a) and/or 4.2b).	Not Applicable
c) For any image frequency falling within the receive half band, while using branching on same polarization as defined in clause 4.2a, or in the transmit half band on different polarization, as defined by the compatibility requirements in clause 4.2b).	≥ 100 dB
d) For any image(s) frequency(ies) falling within transmit half band, while using branching on same polarization as defined by the compatibility requirements in clause 4.2a).	≥ 120 dB

In addition, due to particular conditions of frequency channel arrangements in bands below 3 GHz, independently from requirements in table 11, the receiver image(s) rejection shall be:

- Class 1 and class 2: 75 dB minimum.
- Class 4L: 85 dB minimum.

7.4.4 Innermost channel selectivity

For systems, which are intended to comply with compatibility requirement under clause 4.2, to guarantee innermost TX to RX channel compatibility, the inner side of the innermost receiver shall offer sufficient selectivity on the locally interfering transmitter.

Examples of selectivity mask insofar defined for most common system and channel arrangement are given in annex A of the present document.

Since it is not considered feasible to make a practical measurement of this characteristic, the manufacturer shall give the design data of all filters (at RF, IF and baseband levels) implemented on the receiver chain of the innermost channels.

7.5 System performance without diversity

7.5.1 Equipment Residual BER (RBER)

The RBER limits under simulated operating conditions without interference (see note 1) shall be maintained within the following RSL range:

- Lower RSL limit: 10 dB above the BER threshold 10^{-6} (as specified in clause 6.3.2).
- Upper RSL limit: 5 dB less than the minimum upper limit of RSL for BER 10^{-6} derived from clause 7.4.1.

All limiting conditions in clause 7.4.1, such as maximum RSL range and permanent ATPC feature, should be taken into account (see following examples).

EXAMPLE 1: 7 GHz class 2 system with minimum RIC = 2 Mbit/s, CS = 1,75 MHz,
RSL threshold BER $10^{-6} \leq -93$ dBm (but any declared better value should be used for this example).
Maximum required RSL range for BER $10^{-6} \geq 50$ dBm
Upper RSL limit for BER 10^{-6} (from table 9) ≥ -21 dBm
Upper RSL limit for BER 10^{-6} (from RSL range) $\leq -93 + 50 = -43$ dBm
Actual minimum RSL limit for BER $10^{-6} = -43$ dBm
Maximum RSL requirement (RBER) $\geq -43 - 5 = -48$ dBm (no permanent ATPC functionality)
Maximum RSL requirement (RBER) with permanent ATPC functionality ≥ -48 dBm - ATPC
(e.g. -54 dBm assuming minimum 6 dB attenuation).

EXAMPLE 2: 80 GHz class 4L system with minimum RIC = 2 Gbit/s, CS = 1 000 MHz,
 RSL threshold BER $10^{-6} \leq -51,5$ dBm (but any declared better value should be used for this example).
 Maximum required RSL range for BER $10^{-6} \geq 50$ dB
 Upper RSL limit for BER 10^{-6} (from table 9) ≥ -23 dBm
 Upper RSL limit for BER 10^{-6} (from RSL range) $\leq -51,5 + 50 = -1,5$ dBm
 Actual minimum RSL limit for BER $10^{-6} = -23$ dBm
 Maximum RSL requirement (RBER) ≥ -28 dBm (no permanent ATPC functionality)
 Maximum RSL requirement (RBER) with permanent ATPC functionality ≥ -28 dBm - ATPC
 (e.g. -34 dBm assuming minimum 6 dB attenuation).

The requirement is intended between base-band ports at reference points X' and X shown in figure 1. As the measurement is made on the tributaries, the clause relative to one rate is also applicable to systems for $n \times$ the same rate (e.g. requirement for 2 Mbit/s is applicable to $n \times 2$ Mbit/s); however, when the system can be configured with different tributary capacities (e.g. STM-1 or 63×2 Mbit/s), the more stringent requirement applies.

NOTE 1: User information: To guarantee the degree of service, see clause D.1, the RBER limit is assumed to be met also in presence of adjacent channel interferer at C/I ratio ~ 0 dB or less for ACCP systems and ~ 10 dB or less for ACAP systems. This has not been considered worth of additional requirement in the present document, because modern systems, even the most simple, usually implement highly efficient error correction codes, which render this additional interference burden irrelevant with respect to the RBER. Therefore, additional burden to the assessment is not necessary.

In the above conditions the RBER shall be:

- Ethernet and other packet data interface capacity: RBER $< 10^{-12}$. However, it is recognized that test equipment on copper-line interface might not have the capability of testing such low BER. In this case alternative methodology could be needed.
- PDH and SDH hierarchic interface capacity:
 - For systems capacity between 64 kbit/s and 192 kbit/s: RBER $< 10^{-9}$.
 - For systems capacity above 192 kbit/s and less than 34 Mbit/s: RBER $< 10^{-10}$.
 - For PDH systems capacity equal to 34 Mbit/s and less than 140 Mbit/s: RBER $< 10^{-11}$.
 - For systems capacity at PDH 140 Mbit/s and SDH up to STM-4 (see note 2): RBER $< 10^{-12}$.

NOTE 2: User information: For STM-4 capacity on multi-channel trunk systems at or below 11 GHz (for long radio connections) some operator may require a RBER $< 10^{-13}$; however, this has not been considered as general requirement in the present document.

This requirement is intended for the payload bit rates defined in clause 5 or equivalent payload rates as defined in annex B.

Systems designed for CCDP operation, shall guarantee RBER with its own cross-polar corresponding equipment active and set at a RSL difference, with respect to that under test, of less than 5 dB.

In case of *multi-channel* systems (e.g. *two-channel* system when carrying STM-4 or when carrying $4 \times$ STM-1, with each STM-1 mixed on both carriers), or similar *channels-aggregation* equipment, the test shall be made changing simultaneously the RSL of all equipment operating on all channels. For more details see clause O.3 in ETSI EN 302 217-2 [18].

ETSI EN 301 126-1 [15] recognizes that this requirement is subject to a manufacturer declaration only. However, in clause D.1 some background information relating to the actual test methods and test confidence is given.

Annex D also provides information for defining the minimum recording time and the maximum numbers of errors not to be exceeded.

7.5.2 Distortion sensitivity

7.5.2.1 Introduction

Transmission channel distortion due to multipath propagation typically affects the performance and availability of P-P links as function of four parameters:

- The system bandwidth (wider bands are more affected).
- The hop length (longer hops are more affected).
- The operating frequency (lower frequency bands are, in general, more affected because hop lengths are usually longer than in higher bands), see note.
- The modulation format (higher states modulations are more affected).

NOTE: Actually, the formulas in Recommendation ITU-R P.530 [26] imply that, on the same hop length, higher frequencies are more sensitive; however, the opposite effect of reduced length is much more effective.

Therefore, for counteracting multipath effects, P-P receivers, depending on the target operational ranges of those parameters, implement digital adaptive equalizer, which complexity is generally tailored to their operational needs.

It was commonly understood that systems with bandwidth lower than about 14 MHz and with operating frequency higher than about 18 GHz are not significantly affected by multipath. However, the recent standardization in this multi-part deliverable of wider system bandwidth (110/112 MHz from 18 GHz band and above) associated to higher spectral efficiency classes (512/1024/2048 QAM with channel separation ≥ 14 MHz) suggests that the multipath sensitivity might sometimes extend beyond 18 GHz.

7.5.2.2 Requirement

Reference is made to the signature concept, measurement and the representative parameters width (W), depth (B_c) and normalized system parameter (K_n) defined in Recommendation ITU-R F.1093 [i.30] (see note).

Equipment for nominal CS ≥ 14 MHz and operating frequency up to the whole 18 GHz band (17,7 GHz to 19,7 GHz) shall have a *signature* (see definition in clause 3.1) within one of the limits provided hereafter.

The *signature* limits are defined as follows:

- For a reference delay (τ_r) of 6,3 ns and a BER of 10^{-6} the *signature* shall exhibit a normalized system parameter (K_n) (see note), calculated with the actually declared *signature* parameters (W and B_c) and symbol rate (SR) of the system under test, equal to or less than the K_n limits defined in table 12 or table 13, as appropriate.
- The limits are intended as the mean value (i.e. arithmetical sum divided by 2) of K_n separately calculated for the minimum and the non-minimum phase cases.
- The actual *signatures* shall also contain in their area the loss of synchronization and re-acquisition signatures (see IEC 60835-2-4 [20] and IEC 60835-2-8 [21]).
- The limits are valid also with a notch sweep speed declared by the manufacturer.
- For *mixed-mode* systems the limits apply only for the *reference modes*.

NOTE: For reader convenience, the relationships between W , B_c and Kn defined in Recommendation ITU-R F.1093 [i.30] are here summarized:

$$Kn = (T^2 \times W \times \lambda_a) / \tau_r$$

where:

T : system baud period (ns) (i.e. equal to $1/SR$ expressed in Gbaud/s)

W : *signature* width (GHz)

τ_r : reference delay (ns) for λ_a

λ_a : average of (linear) *signature* depth (λ_c) variable with frequency (f) as:

$$\lambda_a = \frac{\int_{f=-W/2}^{f=+W/2} \lambda_c(f) df}{W}$$

where:

$$\lambda_c(f) = 1 - b_c(f),$$

$$b_c = 1 - 10^{-B_c(dB)/20}$$

B_c : *signature* depth expressed in dB

Table 12 gives the limits for SDH single-mode or preset-mode systems, i.e. STM-1/N \times STM-1/STM4 or equivalent traffic, in 28 MHz, 40 MHz or 56 MHz nominal CS.

Table 13 gives the limits for generic mixed-mode systems (e.g. suitably scaled for constant equalization structure from 4QAM to 2048QAM).

Table 12: Kn limits for single or preset mode equipment of SDH or equivalent PDH traffic

Spectral efficiency		Nominal payload Bit-Rate	Nominal CS (MHz)	Maximum Kn (reference to ITU-R F.1093 [i.30])
Reference index	Class			
5	4H	STM-1	56	1,0
6	5L	STM-1	40	1,15
7	5H	STM-1	28	1,3
7	5H	2 \times STM-1	56	1,3

Table 13: Kn limits for the reference modes of mixed-mode equipment

Spectral efficiency		Maximum Kn (reference to ITU-R F.1093 [i.30])
Reference index	Class	
2	2	0,30
3	3	0,45
4	4L	0,6
5	4H	0,75
6	5L	0,9
7	5H	1,05
8	6L	1,2
9	6H	Manufacturer declaration
10	7	
11	8	

7.5.2.3 Assessment

It is recognized that dedicated test equipment for signature is hardly available and might likely completely disappear in future; other nonspecific test setups are possible, but they could be complex, bulky and hardly suitable for standardization. On the other hand, the present digital equalizer technology has solved most of the possible hardware problematic that sometimes affected older equalizers techniques.

Therefore, the formal assessment of Kn limits set in previous clause is subject only to manufacturer declaration.

7.5.3 Interference sensitivity for CCDP with XPIC operation

7.5.3.1 General

The level and impact of Cross Polar Co-channel Interference depends on the frequency band, class of equipment, climatic conditions, antenna discrimination and hop length. When these factors are favourable, CCDP can be achieved without the use of an XPIC.

Whenever XPIC is implemented for systems operating (permanently or as *reference-mode*) on classes equal to or higher than 5L, with channel separations from 27,5 MHz to 60 MHz the following applies.

The "internal interference" notation is hereby considered to be that given by the twin systems sharing the same XPIC system in absence of any other "external interference".

7.5.3.2 Co-channel "internal" interference sensitivity in flat fading conditions

The limits of the co-channel self-interference sensitivity for the system with XPIC functionality activated are given in table 14.

Table 14: Degradation versus C/I (co-channel "internal" interference)

Reference BER →	10 ⁻⁶	
	RSL Degradation →	
	1 dB	3 dB
C/I (dB) for class 5L and class 5H equipment	17	13
C/I (dB) for class 6L and class 6H equipment	24	20
C/I (dB) for class 7 and class 8 equipment	Manufacturer declaration	Manufacturer declaration

Referring to the measurement test bench in clause D.2, the measurements shall be made adding the same values of noise and interference to both the paths, and varying the phase shifter of the interfering path in order to find the worst condition for this characteristic.

7.6 System characteristics with diversity

7.6.0 Introduction

Clause 7.6 defines requirements where space, angle and frequency diversity techniques are applicable. Only combining techniques are considered.

7.6.1 Differential delay compensation

It shall be possible to compensate for differential absolute delays due to antennas, feeders and cable connections on the two diversity paths. The limit shall be at least 75 ns of differential absolute delay.

7.6.2 BER performance

When both receiver inputs (main and diversity, reference point B and D of figure 1) are fed with the same signal level with an arbitrary phase difference, the input level limits for the specified BER values defined under clause 6.3.2, shall be lower than those given under clause 6.3.2 for the case without diversity:

- More than 2,5 dB for IF or baseband combining systems.
- More than 1,5 dB for RF combining systems.
- No improvement for baseband switch systems.

Annex A (normative): Spectrum masks and receiver selectivity when mixed manufacturer compatibility is required

A.0 Introduction

When only one manufacturer provides all the equipment attached to a single antenna, it is responsibility of that manufacturer to adopt the appropriate measures so as to guarantee local TX and RX compatibility.

When different manufacturers' equipment is expected to be connected to the same antenna system, clause 4.2 defines the possible compatibility requirements.

In the latter case, this annex defines the requirements for the noise floor of the normal channels and, for the most common cases of innermost channels of some well-known channel arrangements, the limits for the combined innermost channels spectrum masks and receiver selectivity already standardized.

It should be noted that the limits reported in this annex are necessary only when the innermost TX and RX channels are physically present on the same antenna and they are from different manufacturers. Whenever they are from the same manufacturer, they are not mandatory, but the manufacturer in generally declares the maximum degradation [in dB] expected on the BER = 10^{-6} threshold of the receiver under the assumptions reported in clause A.2.

ETSI TR 101 854 [i.17] provides the background for the practical calculation of the NFD derived from the TX spectrum mask and RX selectivity, including the possible refined improvement considering the typical spectrum shaping.

For information, the further calculation of the expected BER = 10^{-6} threshold degradation can be made from the following equations:

$$\text{Assuming that } K \text{ (dB) represents the I/N ratio } \frac{\text{TX interference into RX bandwidth}}{\text{RX noise power}} \text{ (dB)} \quad (\text{A.1})$$

Where the RX bandwidth spans, in principle, to the overall operating band, and includes residual of all local TX carriers connected to the same antenna.

$$K(\text{dB}) = \{P_{\text{tx}} (\text{dBm}) - \text{TX/RX decoupling} - \text{Other losses} - \text{NFD}\} - \{-114 + 10\log(\text{RX Symbol rate in MHz}) + \text{NF}\} \quad (\text{A.2})$$

Other losses are branching and feeder losses, for instance.

TX/RX decoupling depends on antenna, feeder and equipment antenna port characteristics; the following typical reference values are assumed:

- TX and RX on same antenna port: 25 dB
- TX and RX on cross-polar antenna ports: 45 dB
- TX and RX on separate antennas: 70 dB

Then the BER = 10^{-6} threshold degradation is calculated as:

$$\text{Threshold Degradation (dB)} = 10\log\left(1 + \frac{1}{10^{-K/10}}\right) \quad (\text{A.3})$$

EXAMPLE: Commonly used values:
 K = -10 dB → Degradation \cong 0,4 dB
 K = -6 dB → Degradation \cong 1 dB
 K = -3 dB → Degradation \cong 1,8 dB
 K = 0 dB → Degradation \cong 3 dB

A.1 TX masks assessment

Since it is not possible to measure spectrum attenuation values up to 105 dB directly, the relative power spectral density below -65 dB level, shown in figure A.1, figure A.2, figure A.4 and figure A.5 of the present annex should be subject to a manufacturer declaration (see note).

NOTE: User guidance: the values beyond -65 dB may be indirectly evaluated by adding a measured filter characteristic to the spectrum measured at reference point A' (Power amplifier output) of figure 1. Due to the limitations of some spectrum analysers, difficulties may be experienced when testing high capacity/wideband systems. In this event, the following options may be considered: measurement using high performance spectrum analyser, use of notch filters (for blocking the TX carrier power for improving the dynamic range of the analyser) and the two step measurement technique.

A.2 Normal channels - Emission mask floor

A.2.1 RBER impact

In 18 GHz band and higher bands, for spectral efficiency classes 5H (subclass B) and above systems, ETSI EN 302 217-2 [18] does not require attenuation greater than 50 dB or 45 dB for the spectrum mask floor relevant to Directive 2014/53/EU [i.1] compliance. However, for guaranteeing RBER performance in the presence of multiple (i.e. 2nd, 3rd, etc.) adjacent channels on the same route regardless of the FEC algorithm implemented, a mask floor at -55 dB might be required. The corresponding frequency corner may be derived extending the last slanted segment of the mask (provided in ETSI EN 302 217-2 [18]) down to intercept the -55 dB ordinate.

However, actual performance depends on the interference-limited efficiency of the error correction algorithm and from the actual number of adjacent channels foreseen; therefore this requirement may be substituted by a manufacturer declaration of the interference-limited RBER capability of the equipment.

A.2.2 Local TX to RX compatibility

A.2.2.1 Spectrum mask

For all channels but the innermost one, the only additional requirement with respect to the spectrum mask defined in ETSI EN 302 217-2 [18] is that the mask floor of the TX emission within the receiver sub-band should, if necessary, be improved until the formulas (A.2) and (A.3) above, calculated with NFD equal to the expected noise floor attenuation, gives an acceptable (see note) BER threshold degradation.

NOTE: Acceptable, means commonly agreed between customer and manufacturer.

EXAMPLE: Assuming:
 TX output power = +30 dBm,
 Copolar TX/RX decoupling (antenna circulator) = 25 dB (compatibility clause 4.2a))
 Additional losses (branching circulators) = 1,5 dB
 NF = 5 dB
 RX Symbol Rate = 22,4 Mbit/s
 Acceptable BER threshold degradation ≤ 1 dB (i.e. K = -6 dB)
 Applying formula (A.2) above results in NFD ≥ 105 dB
 Hence, the TX mask floor spectral density in the RX sub-band should also be extended down to:
 Relative Spectral density = - NFD = -105 dB
 Similarly, when considering:
 Cross-polar decoupling (antenna diplexer) = 45 dB (compatibility clause 4.2b)),
 Relative Spectral density = -85 dB.

Most significant examples of spectral density masks limits for normal channels fulfilling clause 4.2a) (co-polar operation under the same antenna) or clause 4.2b) (cross-polar operation under the same antenna) compatibility requirement are shown together those for innermost channels in figure A.1, figure A.2, figure A.4 and figure A.5 of the present annex.

A.2.2.2 Receiver selectivity

Applying the same formulas and example in clause A.0 above, it is easily understood that the required NFD (105 dB in the example) can only be obtained when the contribution of the residual of the innermost TX carrier is sufficiently reduced by the RX filter so as not to increase the interference generated by the off-carrier spectrum falling directly into the innermost RX band.

Therefore, the total RX filters attenuation on the TX sub-band should be at least of the same entity of the TX spectrum attenuation in the RX sub-band.

Figures A.3, A.5 and A.7 show the required selectivity for all channels and that for the innermost channel for the different bands covered.

A.3 Innermost channels for channel arrangements from about 4 GHz to about 8,5 GHz with channel separation of 28 MHz to 30 MHz

A.3.0 Introduction

The following clauses refer requirements when channel separation between 28 MHz and 30 MHz are considered. However, it is recognized that, in some cases, it is possible to combine two 28/30 MHz channels for the use of a single 56/60 MHz system. This case has not been addressed with specific mask limits. Nevertheless, the general concepts still apply and suitable masks can be studied and agreed among the concerned actors.

A.3.1 Innermost channels spectrum masks

This clause reports only the limits for the most significant and common cases of innermost channel compatibility.

For the lower 6 GHz (L6) band, where the centre gap is 44,49 MHz, figure A.1 shows the limits of masks for normal channels, which are intended to comply with the most stringent compatibility requirement, for normal channels under clause 4.2a) (co-polar operation on the same antenna) and for the inner edges of the centre gap channels 8 and 1' under clause 4.2b) (cross-polar operation of both channels on the same antenna). The masks are specified for equipment with spectral efficiencies equal to or higher than 5L and for sub-classes A and B (see note 1).

When compatibility of the innermost channels under clause 4.2a) is necessary, see note 2.

NOTE 1: This arrangement is defined in ERC/REC 14-01 [i.8] and Recommendation F.383 [i.23]. It is commonly understood that in this band only high capacity systems are employed; however, if lower spectral efficiency classes are used, the mask are considered valid as well.

NOTE 2: For equipment exploiting CCDP operation, figure A.1 shows that the compatibility, according clause 4.2a), of the co-polarized innermost systems is not possible (i.e. the required 105 dB spectrum attenuation is not met with conventional single channel filter practice) unless different antennas for H and V channels are used, or additional, high complexity, filtering (typically stop-band) are properly designed and placed on the TX and RX chains. This additional filtering has not been considered suitable for standardization.

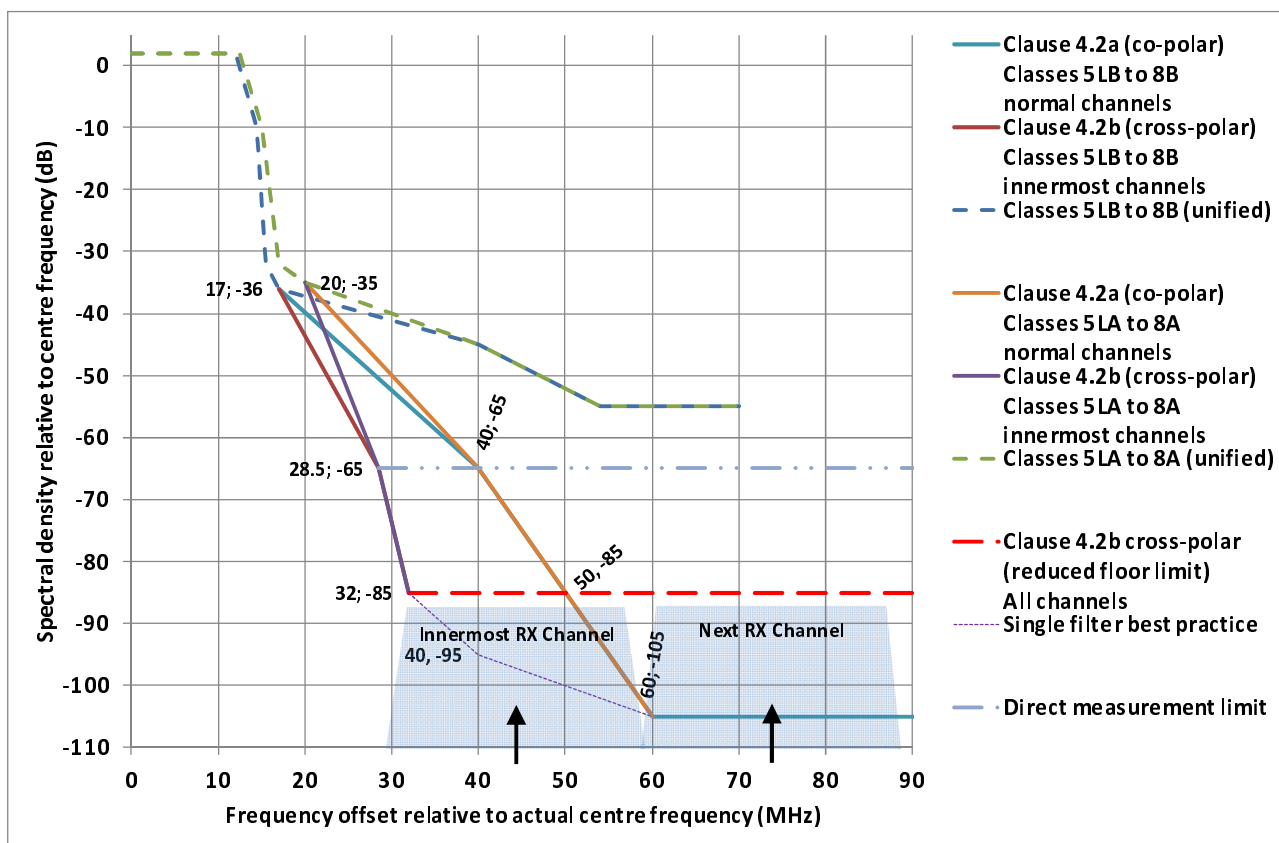

Figure A.1: L6 GHz band, limits of power spectral density for normal channels and the inner edges of the innermost channels (reference point B' of figure 1 of the present document)

For the 7 GHz and 8 GHz bands, various innermost channels separations are reported ranging from 42 MHz to 63 MHz or larger width. The 42 MHz case foresees only co-polar operations; therefore, the innermost channel compatibility falls in the case described in note 2 above and has not been standardized.

When the centre gap is 56 MHz (channel arrangement according to annex 3 of Recommendation ITU-R F.385-10 [i.25]), for guaranteeing compatibility between co-polarized signals innermost channels on the same antenna, a mask is specified for the innermost edges of the centre gap channels, the mask is given in figure A.2.

Other innermost separations such as 49 MHz, 58 MHz, 59,5 MHz or 63 MHz (reported in ECC/REC(02)06 [i.5]) may be properly derived by scaling figure A.1 or figure A.2.

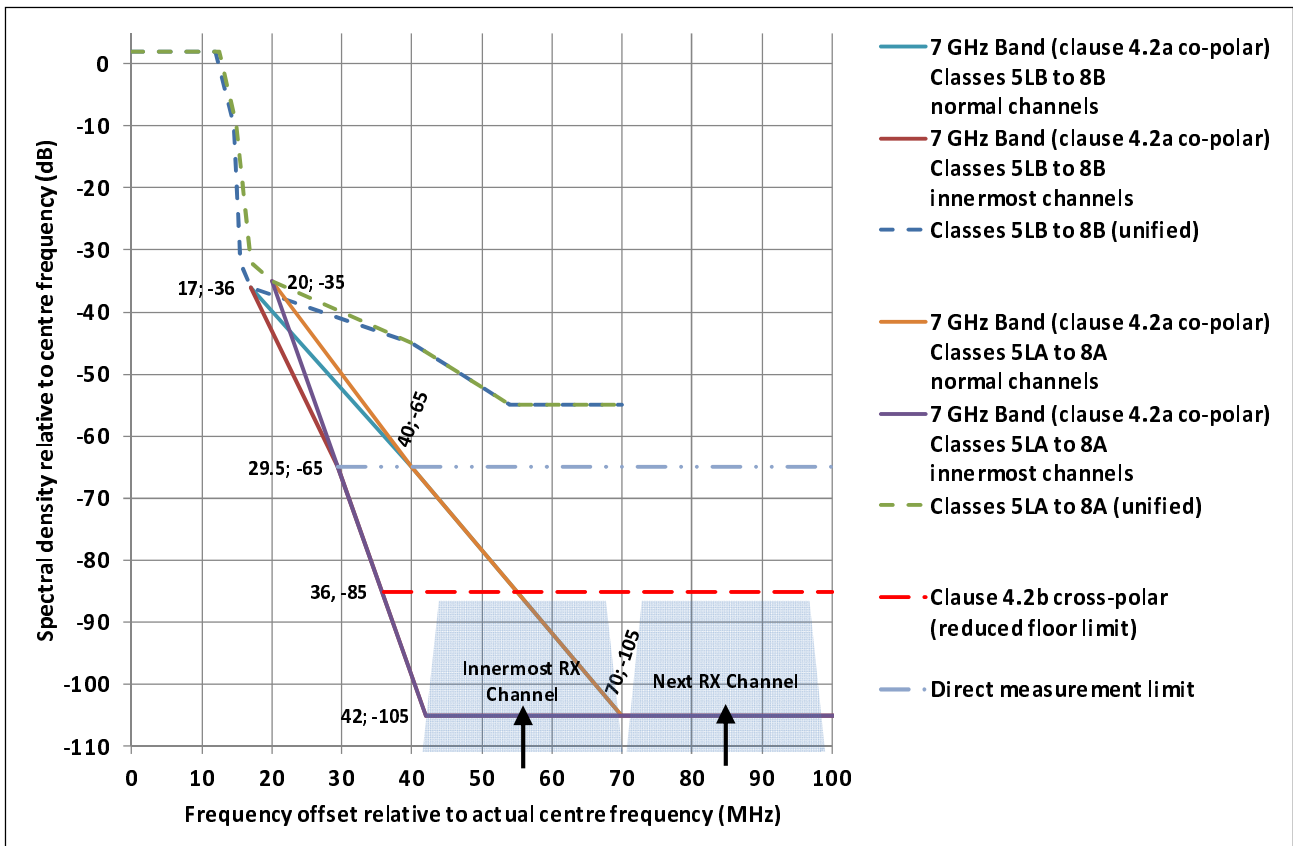

Figure A.2: 7 GHz band with 56 MHz co-polar centre gap, limits of power spectral density for normal channels and the inner edges of the innermost channels (reference point B' of figure 1 of the present document)

A.3.2 Receiver innermost channel selectivity

Only two general purpose selectivity, variable according the possible in-band different shaping between "A" and "B" sub-classes, are standardized. Due to the fact that most of the selectivity is usually obtained at IF and BB level, no detailed variants according the actual centre gap is retained necessary.

For systems which are intended to comply with compatibility requirements under clause 4.2 list item a) and/or list item b), to guarantee innermost TX/RX channel compatibility in L6 GHz band, the inner side of the innermost receiver selectivity (combination of all RF, IF and Base-band filters) shall be within the mask given in figure A.3; figure A.3 shows also the possibly relaxed selectivity for other normal channels.

Since it is not considered feasible to make a practical measurement of this characteristic, the manufacturer shall give the design data of the filters implemented on this receiver.

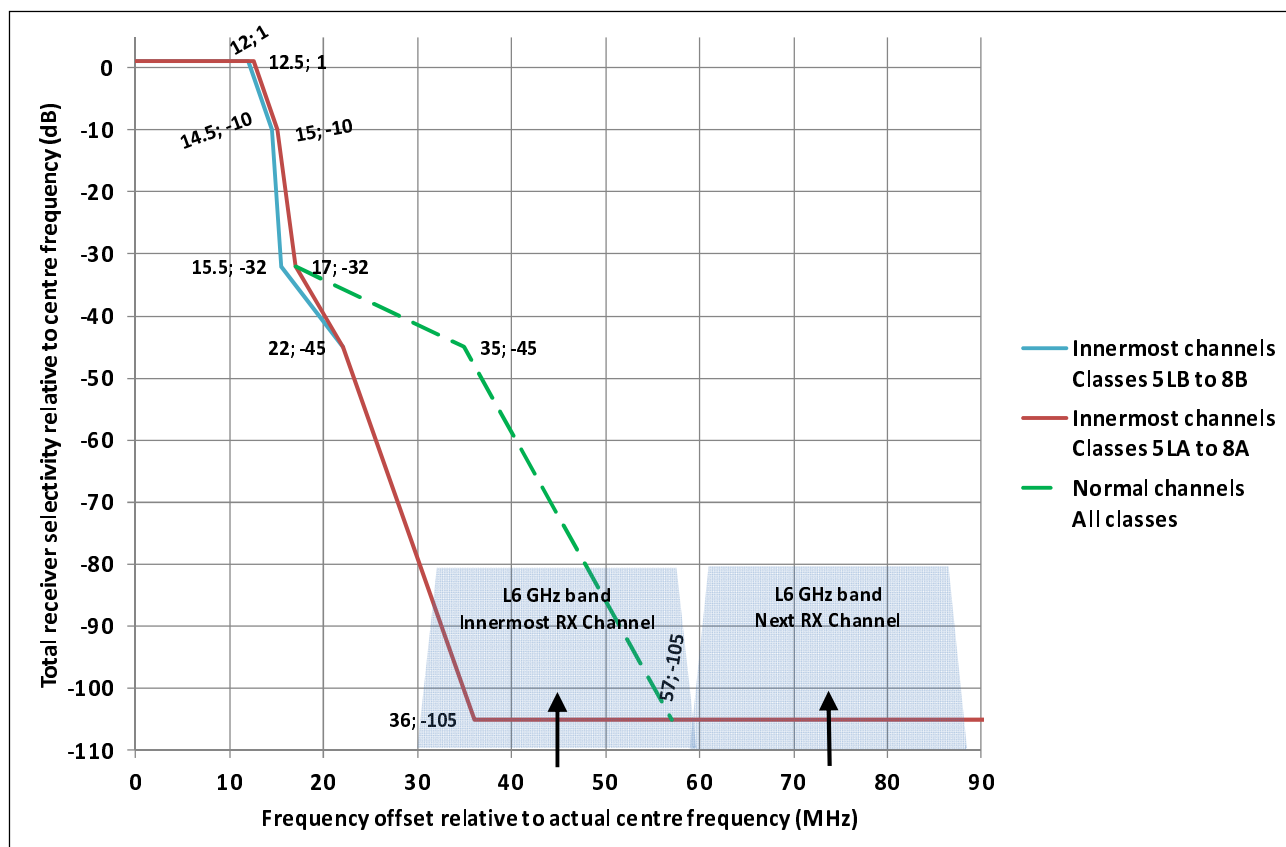

NOTE: The corner points of the main lobe filter are the same of the relevant spectrum masks a part from the +2 dB (K1 value) brought down to 0 dB; see ETSI EN 302 217-2 [18].

Figure A.3: Overall minimum receiver selectivity of normal channels and of the inner side of innermost receivers for L6 GHz band (reference point B of figure 1 of the present document)

A.4 Innermost channels for channel arrangements from about 4 GHz to 11 GHz with channel separation of 40 MHz

A.4.0 Introduction

The following clauses refer requirements when channel separation 40 MHz is considered. However, it is recognized that, in some cases, it is possible to combine two 40 MHz channels for the use of a single 80 MHz system. This case has not been addressed with specific mask limits. However, the general concepts still apply and suitable masks can be studied and agreed among the concerned actors.

A.4.1 Innermost channels spectrum masks

This clause reports only the limits for the most significant and common cases of innermost channel compatibility.

For the upper 6 GHz (U6) band, where the centre gap is 60 MHz, figure A.4 shows the limits of masks for normal channels, which are intended to comply with the most stringent compatibility requirement under clause 4.2a) (co-polar operation on the same antenna) and for the inner edges of the centre gap channels 8 and 1' under clause 4.2b) (cross-polar operation of both channels on the same antenna). The masks are specified for equipment with spectral efficiencies equal to or higher than 5L and for sub-classes A and B (see note 1).

When compatibility of the innermost channels under clause 4.2a) is necessary, see note 2.

NOTE 1: This arrangement is defined in ERC/REC(14)02 [i.9] and Recommendation ITU-R F.384-11 [i.24]. It is commonly understood that, in this band, 40 MHz channel arrangement is used only for high capacity systems; however, if lower spectral efficiency classes are used, the masks are considered valid as well.

NOTE 2: For equipment exploiting CCDP operation, figure A.4 shows that the compatibility, according clause 4.2 item a), of the co-polarized innermost systems is not possible (i.e. the required -105 dB spectrum attenuation is not met with conventional single channel filter practice) unless different antennas for H and V channels are used, or additional, high complexity, filtering (typically stop-band) are properly designed and placed on the TX and RX chains. This additional filtering has not been considered suitable for standardization.

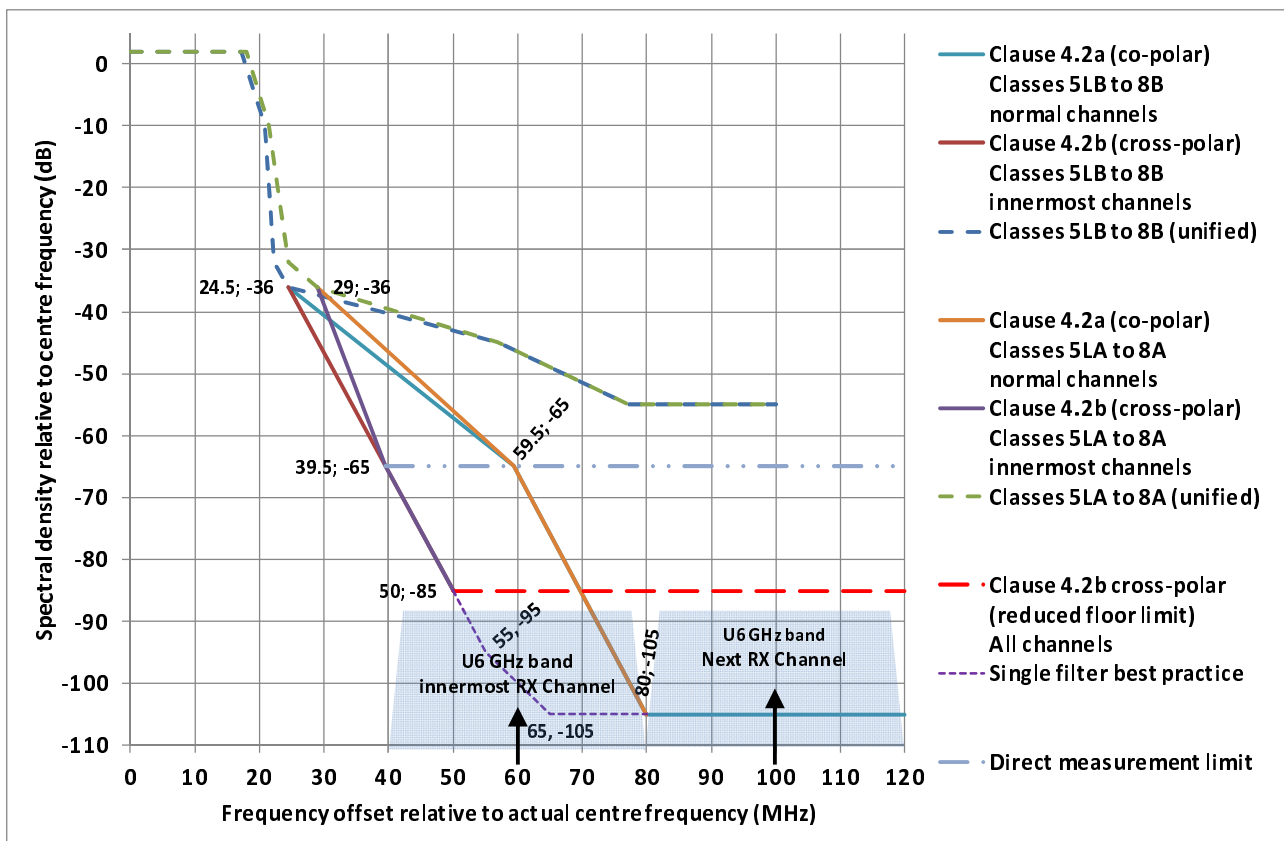

Figure A.4: U6 GHz band, limits of power spectral density for normal channels and the inner edges of the innermost channels (reference point B' of figure 1 of the present document)

A.4.2 Receiver innermost channels selectivity

Only two general purpose selectivity, variable according the possible in-band different shaping between "A" and "B" sub-classes, are standardized. Due to the fact that most of the selectivity is usually obtained at IF and BB level, no detailed variants according the actual centre gap is retained necessary.

For systems which are intended to comply with compatibility requirements under clause 4.2 list item a) and/or list item b), to guarantee innermost TX/RX channel compatibility in U6 GHz band, the inner side of the innermost receiver selectivity (combination of all RF, IF and Base-band filters) shall be within the mask given in figure A.5; figure A.5 shows also the possibly relaxed selectivity for other normal channels.

Since it is not considered feasible to make a practical measurement of this characteristic, the manufacturer shall give the design data of the filters implemented on this receiver.

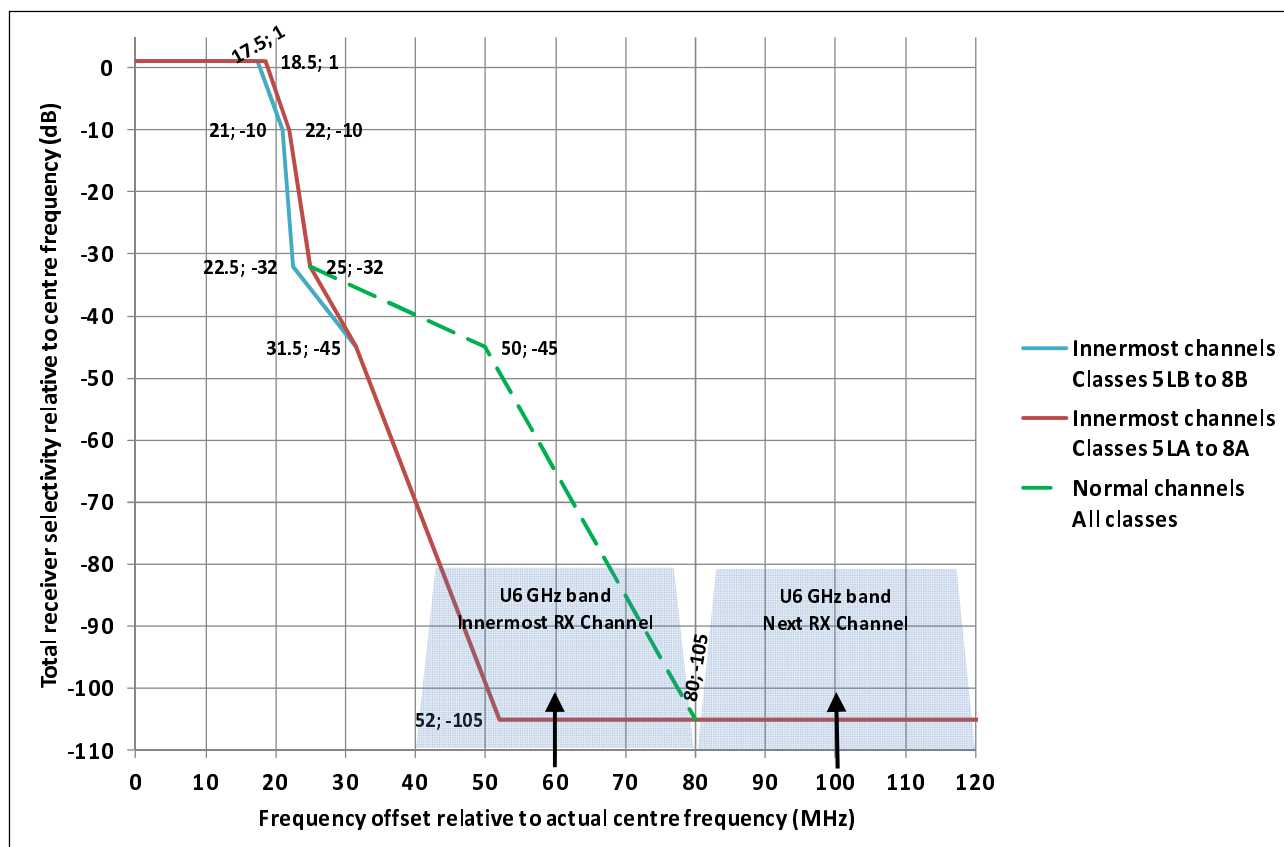

NOTE: The corner points of the main lobe filter are the same of the relevant spectrum masks a part from the +2 dB (K1 value) brought down to 0 dB; see ETSI EN 302 217-2 [18].

Figure A.5: Overall minimum receiver selectivity of normal channels and of the inner side of innermost receivers for U6 GHz band (reference point B of figure 1 of the present document)

A.5 Innermost channels for 18 GHz channel arrangements with channel separation of 55 MHz

A.5.0 Introduction

The following clauses refer requirements when channel separation 40 MHz is considered. However, it is recognized that, in some cases, it is possible to combine two 55 MHz channels for the use of a single 110 MHz system. This case has not been addressed with specific mask limits. However, the general concepts still apply and suitable masks can be studied and agreed among the concerned actors.

A.5.1 Innermost channels spectrum masks

For the upper 18 GHz band, where, for the 55 MHz channel separation, the centre gap is 130 MHz, figure A.6 shows the limits of masks for normal channels, which are intended to comply with the most stringent compatibility requirement under clause 4.2a) (co-polar operation on the same antenna) and for the inner edges of the centre gap channels 17 and 1' also under clause 4.2a) (co-polar operation of both channels on the same antenna). Two more relaxed masks are also given whenever those channels are subject only to less stringent clause 4.2b) (cross-polar operation on the same antenna). The masks are specified for equipment with spectral efficiencies equal to or higher than 4H and for sub-classes A and B (see note).

NOTE: This arrangement is defined in ERC/REC 12-03 [i.4] and Recommendation ITU-R F.595-10 [i.26]. It is commonly understood that, in this band, 55 MHz channel arrangement is used only for high capacity systems; however, if lower spectral efficiency classes are used, the masks are considered valid as well.

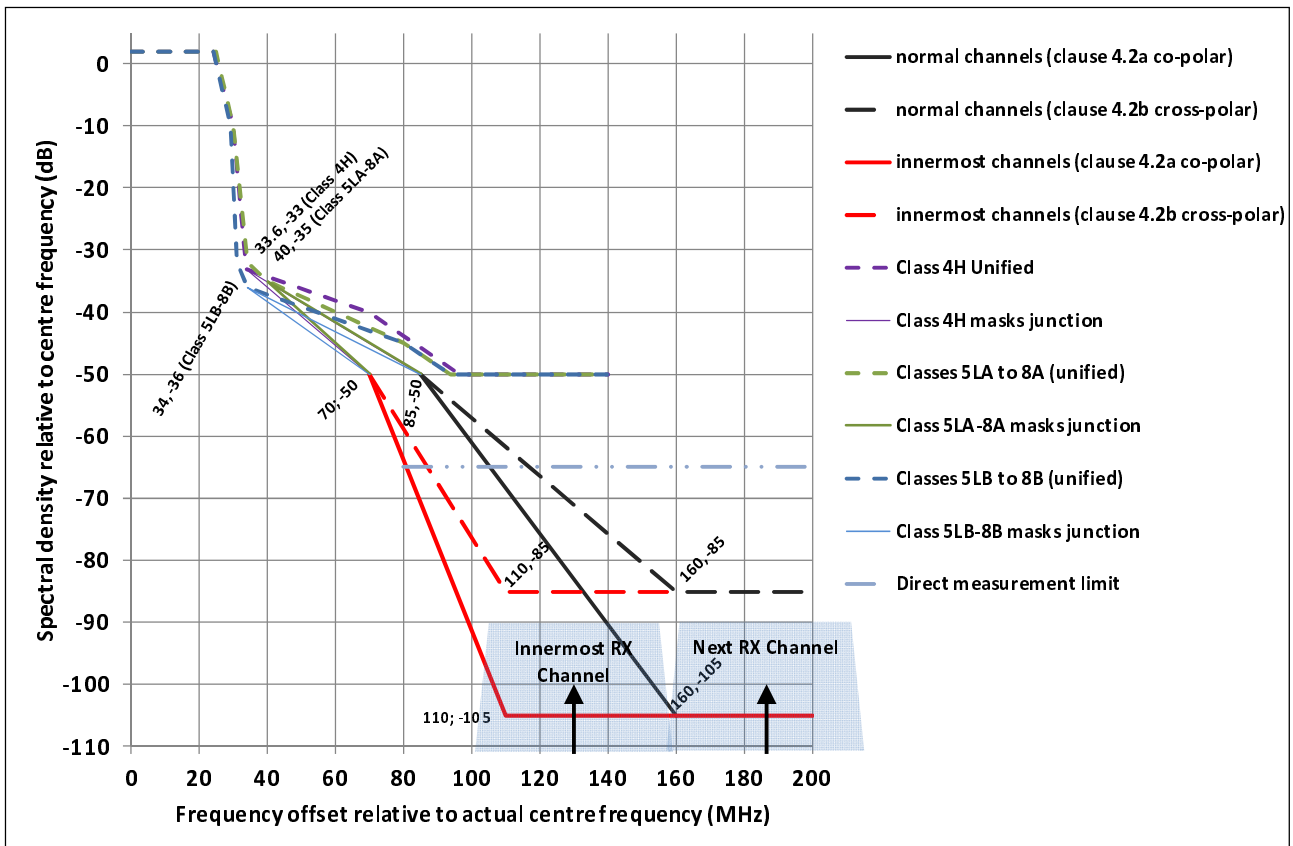
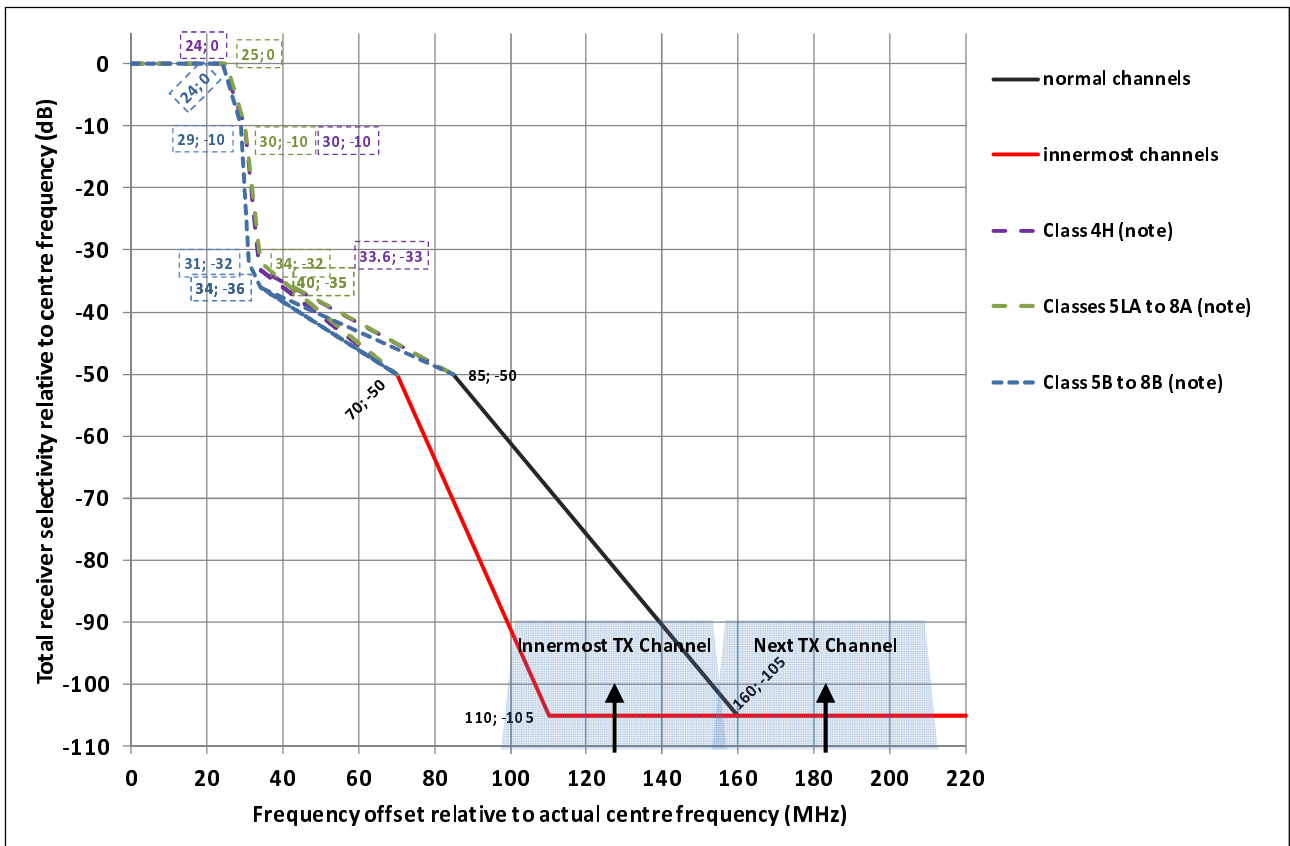

Figure A.6: 18 GHz band, Limits of spectral power density for normal channels and for the inner edges of the innermost channels (at reference point B' of figure 1 of the present document)

A.5.2 Receiver innermost channels selectivity

Only two general purpose selectivity, variable according the possible in-band different shaping among equipment classes, are standardized. No detailed variants are retained necessary because most of the selectivity is usually obtained at IF and BB level.

For systems which are intended to comply with compatibility requirements under clause 4.2a) and/or clause 4.2b), to guarantee innermost TX/RX channel compatibility in 18 GHz band, the inner side of the innermost receiver selectivity (combination of all RF, IF and Base-band filters) shall be within the mask given in figure A.7.



NOTE: The corner points of the main lobe filter are the same of the relevant spectrum masks a part from the +2 dB (K1 value) brought down to 0 dB; see ETSI EN 302 217-2 [18].

Figure A.7: Overall minimum receiver selectivity of normal channels and of the inner side of innermost receivers for 18 GHz band (at reference point B of figure 1 of the present document)

Annex B (normative): Definition of equivalent data rates for packet data, PDH/SDH and other signals on the traffic interface

Annex N of ETSI EN 302 217-2 [18] provides the conditions under which the BER oriented specifications in the present document can be used for systems with traffic interface other than PDH/SDH.

Clause D.4 of the present document gives also information on the BER/FER equivalence.

Annex C (informative): Information on *Multi-channel* and *Channel-aggregation* differences and operation

Figures C.1, C.2 and C.3 show the physical and operative differences between "*multi-channels*" and "*channel-aggregation*" (*single or dual-port*) systems.

NOTE: *Multi-carrier* systems are not specifically mentioned because, from their definition, any *multi-channel* or *channel-aggregation* equipment and systems can also be multi-carriers in each of the used channel; therefore, *multi-carrier* characteristic is not significant from operative point of view.

Figure C.1 shows the example of a presently defined *Multi-channel* system: TWO equipment share the same IN/OUT traffic (generally from a common IDU) over two different channels co-polar or cross-polar (including co-channel CCDP reuse) from a suitable antenna system.

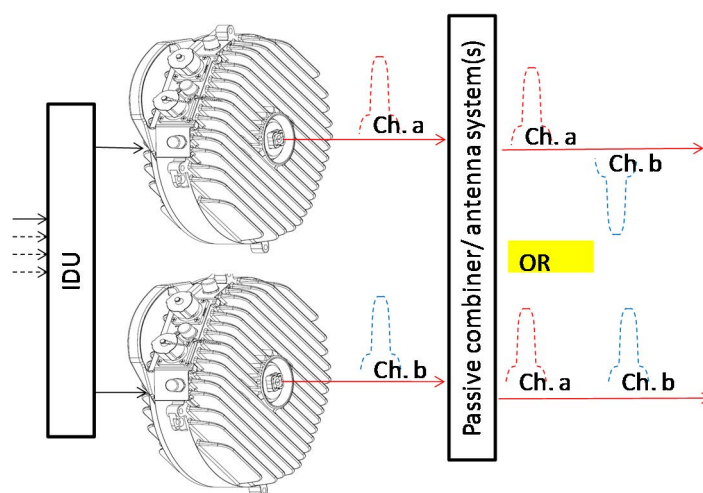

Figure C.1: Examples of *Multi-channel* system

Figure C.2 shows the example of new defined *Channel aggregation/Single-port* equipment: ONE equipment split/combine the IN/OUT traffic (with or without an IDU) produced at single antenna port over two different channels co-polar (from common antenna).

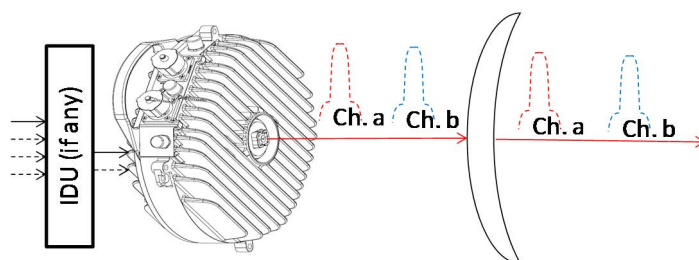

Figure C.2: Example of *channels aggregation/single-port* equipment

Figure C.3 shows the example of new defined *Channel aggregation/dual-port* equipment: ONE equipment split/combine the IN/OUT traffic (with or without an IDU) produced at TWO separate antenna ports over two different channels co-polar or cross-polar (including co-channel reuse) or even on two directions at arbitrary polarization (from a suitable antennas systems). In principle, the two channels can be transmitted within the same band (intra-band operation) or in different bands (inter-band operation)

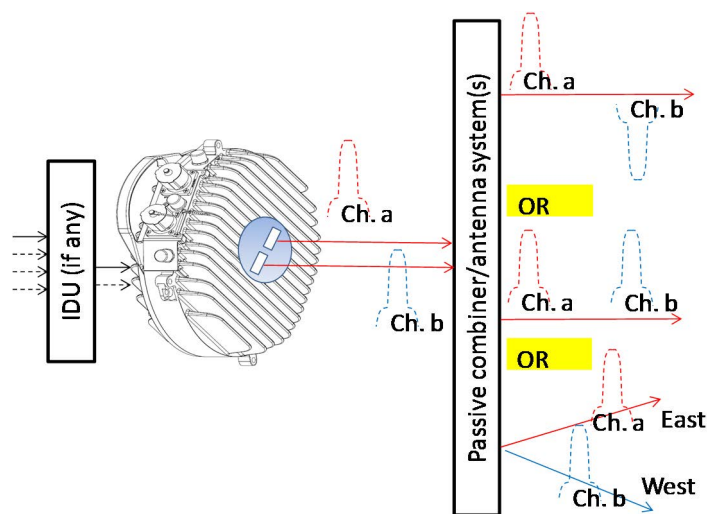

Figure C.3: Example of *Channels aggregation/dual-port* equipment

Annex D (informative): Additional information

D.1 Residual Bit Error Ratio (RBER) and Residual Frame Error Ratio (RFER)

In particular applications, where there is a high density of radio links in a specific area, e.g. nodal site, closely located radios may use adjacent channels. Therefore, to guarantee the grade of service, the equipment needs to meet the RBER criteria in the presence of adjacent channel interference.

The RBER is standardized in order to match the ESR (or the BER) performance required by ITU-R transmission performance recommendations.

To have sufficient confidence in the measurement, where the BER is relatively low compared to the actual payload, the test time is very long. To have sufficient confidence in measuring RBER where it is relatively low compared to the actual payload bit rate, the testing period becomes significantly long.

It may be estimated from the formula given in "Calculating Statistical Confidence Levels for Error-Probability Estimates" [i.39]:

$$N = \frac{1}{BER} \left[-\ln(1-CL) + \ln \left(\sum_{k=0}^E \frac{(N \times BER)^k}{k!} \right) \right] \quad (D.1)$$

Where: $N = \text{Bit-rate (Hz)} \times \text{recording time (s)}$ is number of bits received with "E" errors detected giving "CL" confidence level of having the given BER.

Formula (D.1) can also be resolved in term of the CL relative to the numbers (x) of error detected, the following formula is obtained:

$$CL_{(E=x)} = 1 - e^{-\left\{ \ln \left[\sum_{k=0}^x \frac{(N \times BER)^k}{k!} \right] - (N \times BER) \right\}} \quad (D.2)$$

The formula (D.2) above assumes errors are not created in burst (as usual happens when error correction is implemented); longer recording times can be used as declared by manufacturer depending on actual error distribution due to different modulation and error correction implemented on the system.

When error correction feature is implemented it may be possible to reduce the measurement time by estimating the RBER, from the value tested without error correction, using the relevant BER improvement formula declared by the manufacturer.

The equipment maximum allowed number of errors level under simulated operating conditions is measured with a signal level at reference point B (or C) of figure 1 of the present document, which is 10 dB above the RSL which gives $BER \leq 10^{-6}$ (as specified in clause 3.3.2 and in ETSI EN 302 217-2 [18]). All measurements should be made at the payload bit rate defined in clause 5.

For a $CL \approx 50\%$ confidence, the measurement period and maximum number of errors allowed are given in table D.1.

Table D.1: Maximum permitted number of bit errors

Bit rate (Network interface)	RBBER objective	Minimum recording time (hours) (confidence ~ 50 %)	Maximum allowed number of bit Errors
Packet 10 Mbit/s	10 ⁻¹²	102	3
Packet 100 Mbit/s		24	8
Packet 1 000 Mbit/s		3	10
PDH 2 Mbit/s	10 ⁻¹⁰	17,25	12
PDH 8 Mbit/s	10 ⁻¹⁰	4,25	12
PDH 34 Mbit/s	10 ⁻¹¹	9,5	11
PDH 140 Mbit/s	10 ⁻¹²	23,5	11
SDH up to STM-1	10 ⁻¹²	23	12
SDH STM-4	10 ⁻¹²	5	10
	10 ⁻¹³	50	10

Another more practical option is to ensure that no errors (or any defects) occur during the minimum recording time. It can be calculated with the formula (D.2); when putting $E = 0$ the formula is highly simplified and the results with $CL \sim 63\%$ confidence (see note) are shown in table D.2 for PDH and SDH signals and table D.3 for packet data signals; for other rates (possibly used under the provision of annex F) values may be extrapolated from the closest ones.

NOTE: While this method is faster, the confidence level drops sharply when one single error is detected.

Table D.2: PDH and SDH rates - Zero errors/defects recording times

Bit rate (Mbit/s) (Network interface)	RBBER objective	Minimum recording time (minutes) (confidence ~ 63 %)	Errors/defects
PDH 2	10 ⁻¹⁰	82	0
PDH 8	10 ⁻¹⁰	20	0
PDH 34	10 ⁻¹¹	50	0
PDH 140	10 ⁻¹²	113	0
SDH STM-1	10 ⁻¹²	108	0
SDH STM-4	10 ⁻¹²	27	0
SDH STM-4	10 ⁻¹³	270	0

Table D.3: Packet data rates - Zero errors/defects recording times

Bit rate under test (Mbit/s) (see note 2)	RBBER objective	Equivalent FER (see note 1)	Minimum recording time (minutes) (confidence ~ 63 %) (full loading) (see note 2)	Errors/defects
10	10 ⁻¹⁰	5×10^{-8}	17	0
	10 ⁻¹¹	5×10^{-9}	170	0
	10 ⁻¹²	5×10^{-10}	1 700 (28 hours)	0
100	10 ⁻¹¹	5×10^{-9}	17	0
	10 ⁻¹²	5×10^{-10}	170	0
1 000	10 ⁻¹²	5×10^{-10}	17	0
	10 ⁻¹³	5×10^{-11}	170	0

NOTE 1: 64 octets Ethernet frame calculated according formulas in clause D.4.

NOTE 2: In case the actual system capacity does not allow full load capacity the recording time is increased by a factor calculated $\frac{\text{full load capacity}}{\text{actual system capacity}}$ (e.g. for a 10baseT load transported on a 8 Mbit/s system rate the recording time will become $17 \times 10/8 \approx 21$ minutes).

D.2 Measurement test set for XPI characteristics

In figure D.1, a measurement set-up is defined that allows simulating wanted signals affected by flat and/or dispersive fading conditions in the presence of XPI (Cross Polar Interference) where level and phase can be varied.

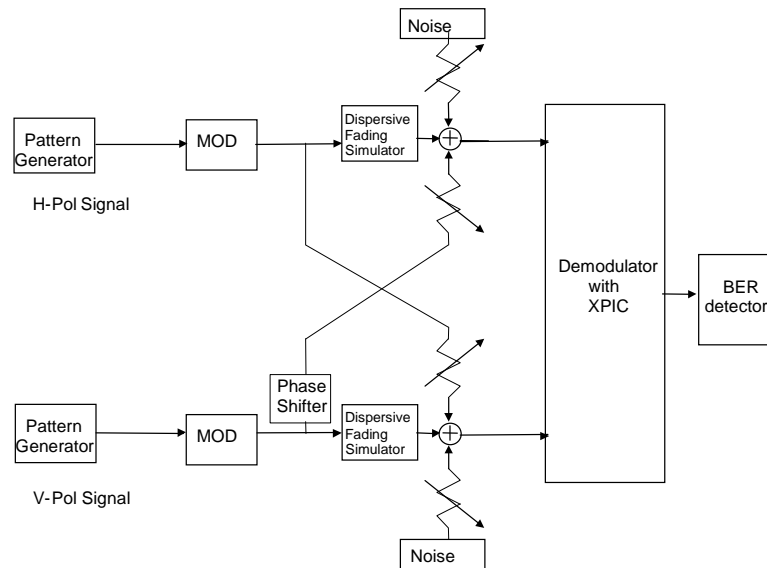

Figure D.1: IF measurement test set

When only not-dispersive tests are considered, an alternative, full RF, test set-up, that allows simulating wanted signals affected by flat fading conditions in presence of cross polar interference, which level and phase can also be varied, may be used as shown in figure D.2.

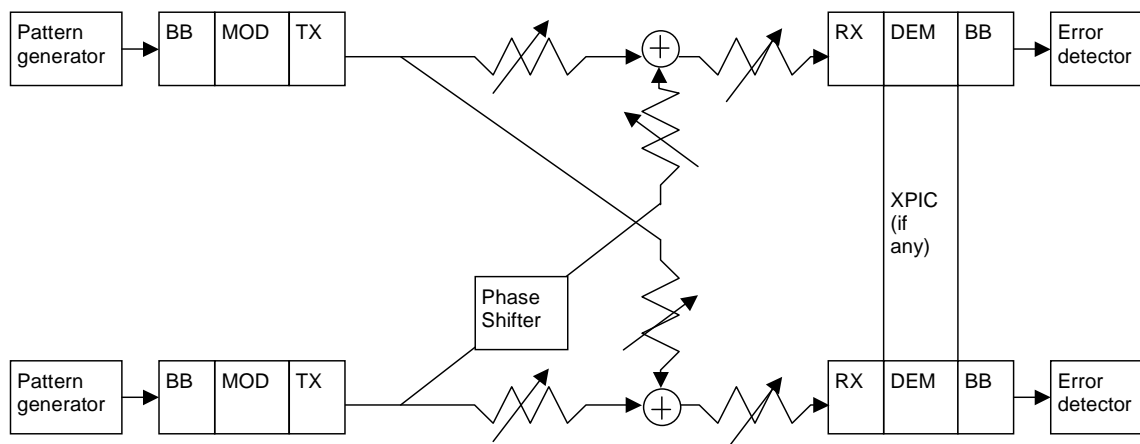

Figure D.2: RF measurement test set

D.3 Differential delay compensation range

When frequency diversity hitless protection is integrated within the radio system it is desirable to provide the means to compensate for differential absolute delays due to antennas, feeders, cable connections, and relative velocities on different RF channels.

For indoor systems with multitrack and multi-vendor physical structure, the range of adjustment of differential absolute delay in the order of about 600 ns with a minimum step size equivalent to the symbol period is considered adequate for most applications. For outdoor and more compact single-vendor structure systems, this capability is under the responsibility of the manufacturer.

D.4 FER/BER equivalence and FER performance measurement equipment settings (example)

D.4.1 FER/BER equivalence

FER and BER can be translated as described herein. The "useful" part (i.e. excluding preamble, delimiter and interframe gap) of Ethernet frames can range from 64 octets up to 1 522 octets. For this analysis 64 octet frames are used, based on errors uniformly distributed over the bit stream (see note 1).

NOTE 1: When frames become longer the actual distribution of errors becomes more important. From one hand the probability of errored frames is higher; from the other hand, due to the fact that error correction codes tend to concentrate errors in bursts, the higher probability of having frames affected by more than one error would reduce again the overall probability of errored frames. Therefore, the 64 octets case is the one that more closely fits with the theory in uniform error distribution; BER/FER translation for longer frames may be produced through specific comparison tests on actual equipment.

An Ethernet frame is considered errored if at least one bit in the "useful" part of the frame is errored. The probability of having errored frames (FER) is the probability of having frames with one error/frame ($p_{e=1}$) plus the probabilities of having two errors/frame ($p_{e=2}$) and so on (see example).

EXAMPLE: For 64 octet frame, assuming a uniform distribution of errors, the probability FER would be:

$$FER = \sum_{i=1}^{i=64 \times 8 = 512} p_{e=i}$$

the probability of having exactly one errored bit in a 64 octet frame $p_{e=1}$ is:

$$p_{e=1} = BER \times (1 - BER)^{[(64 \times 8) - 1]} \times (64 \times 8)$$

the probability that a frame contains exactly two errors $p_{e=2}$ is:

$$p_{e=2} = \frac{BER^2 \times (1 - BER)^{[(64 \times 8) - 2]} \times (64 \times 8) \times [(64 \times 8) - 1]}{2}$$

As it can be seen in table D.4 that, at least for $BER < 10^{-5}$, $p_{e=2}$ is already negligible with respect to $p_{e=1}$; the addenda for higher number of errors/frame are definitely irrelevant. Therefore, it can be assumed that:

$$FER \cong p_{e=1}$$

The formulas above determine (see note 2) the probabilities and the equivalent FER shown in table D.4.

NOTE 2: The FER so calculated may be considered "worst case" because, besides the positive impact of error concentration, the probability that errors happen outside the "useful" part would also improve the real FER (e.g. if Ethernet physical layer is transmitted transparently, the 64 octets frames are actually part of at least 84 octets basic time slots).

Table D.4: FER/BER equivalence (64 octets per frame)

Channel BER	Probability of 1 bit error per frame ($p_{e=1}$)	Probability of 2 bit errors per frame ($p_{e=2}$)	FER ($\cong p_{e=1} + p_{e=2}$)
1×10^{-4}	$4,86 \times 10^{-2}$	$1,24 \times 10^{-3}$	$4,98 \times 10^{-2}$
1×10^{-5}	$5,09 \times 10^{-3}$	$1,30 \times 10^{-5}$	$5,10 \times 10^{-3}$
1×10^{-6}	$5,12 \times 10^{-4}$	$1,31 \times 10^{-7}$	$5,12 \times 10^{-4}$
1×10^{-8}	$5,12 \times 10^{-6}$	$1,31 \times 10^{-11}$	$5,12 \times 10^{-6}$
1×10^{-10}	$5,12 \times 10^{-8}$	$1,31 \times 10^{-15}$	$5,12 \times 10^{-8}$
1×10^{-12}	$5,12 \times 10^{-10}$	$1,31 \times 10^{-19}$	$5,12 \times 10^{-10}$
1×10^{-13}	$5,12 \times 10^{-11}$	$1,31 \times 10^{-21}$	$5,12 \times 10^{-11}$

D.4.2 FER equipment settings and measurement techniques (example)

Equipment used: IEEE 802.3 [22] compliant Ethernet frame test equipment.

The transmitting Ethernet port of the test equipment should be configured to the following settings:

- Mode: Single burst.
- Count: 10 000 000 frames.
- Length: Fixed, 64 bytes.
- Interframe Gap: 96 ns for 1 Gbit/s, 0,96 µs for 100 Mbit/s, 9,6 µs for 10 Mbit/s.

FER can be calculated by the following formula after using the above measurements:

- $FER = 1 - (\text{number of non-errored frames received}) / (\text{number of frames transmitted})$.

For example if 50 frames are lost or errored then the number of non-errored frames indicated by the test equipment is 9 999 950. The resulting FER = $1 - 9\,999\,950 / 10\,000\,000 = 5 \times 10^{-6}$.

D.5 Automatic Transmitter Power Control (ATPC)

Automatic Transmitter Power Control (ATPC) may be useful in some circumstances, e.g.:

- To reduce interference between neighbouring systems or adjacent channels of the same system, while maintaining a high system gain as a countermeasure against multipath or rainfall attenuation.
- To improve compatibility with analogue and digital systems at nodal stations.
- As a mitigation factor for improving sharing with other services.
- To improve residual BER or BBER performance.
- To reduce up-fading problems.
- To reduce transmitter power consumption.
- To reduce digital to digital and digital to analogue distant interference between hops which re-use the same frequency.
- To increase system gain (with possible overdrive conditions with reduced linearity) as a countermeasure against extreme rainfall attenuation.
- In frequency bands where multipath is the dominant propagation factor, to improve adjacent channel protection to differential fading conditions caused by operation of adjacent channels on different antennas on parallel routes (e.g. operated by different operators).

According to the definitions of ATPC power conditions in clause 3.1, ATPC, as an optional feature, is aimed at driving the TX power amplifier output level from a proper "minimum power" which facilitates the radio network planning requirements and which is used under normal propagation conditions up to a "maximum nominal power" value which fulfils all the specifications defined in the present document.

ATPC may also be used to increase the output power above the "maximum nominal power" up to a "maximum available power" specified by the manufacturer, with the agreement of administrations and operators, during fading conditions. Therefore, when ATPC is disabled, the nominal output power for stable operation is lower than the maximum in dynamic operation with ATPC enabled; this can be useful because in frequency ranges above 13 GHz the main limiting factors are given by non selective fading events. In such cases ATPC may be employed as a fixed feature (i.e. the ATPC may not be disabled) in order to reach a higher nominal system gain (i.e. defined by the "maximum available power").

For planning considerations in a nodal environment a system equipped with ATPC can be considered to operate at "minimum power".

Care should be taken of the fact that the use of ATPC increases the percentage of time in which the system operates at low receiver signal level; care should also be taken that the threshold of ATPC intervention is designed to be in a RSL region where the BBER is still met, so that, even if the system would remain at constant RSL for higher percentage of time, an increase of Errored Blocks (EB), Background Block Error Ratio (BBER) or Residual BER (RBER) objectives is avoided with respect to a system without ATPC function enabled; additional information may be found in ETSI TR 101 036-1 [i.15].

Annex E (informative): Mechanical characteristics

The mechanical dimensions for indoor installations should be in agreement with ETSI EN 300 119 [i.14].

For outdoor installations each of the outdoor units should be weatherproof or weather protected.

NOTE: The following parameters should be taken into account in the design of equipment incorporating an external unit:

- a) maximum weight of external unit;
- b) size of external unit for wind loading considerations;
- c) maximum weight of replaceable units;
- d) ease of access of replaceable units.

Annex F (informative): Mitigation techniques referred in ERC/DEC(00)07 (18 GHz band)

In accordance to the ERC/DEC(00)07 [2] the FS should, where practical, implement the following mitigation techniques:

- a) Automatic Transmitter Power Control.
- b) EIRP limited to the minimum necessary to fulfil the performance objectives of the fixed link.
- c) Antennas: use of high performance (low sidelobe) antennas in areas of dense FS deployment.

Equipment manufacturers should consult national regulatory authorities to know which mitigation techniques may need to be implemented (which in some cases are presented also in ECC web site: <http://www.cept.org/ecc>).

Annex G (informative): Notification of interfaces under article 8 of Directive 2014/53/EU

G.0 Introduction

This informative annex provides in table G.1 explanations on the applicability of the TCAM-RIS model to the notification of the regulated P-P fixed links Interfaces by the Administrations. Table G.2 gives an illustrative example of such a notification.

G.1 Applicability of TCAM-RIS model of radio interface specifications to Fixed Service

Table G.1: Compliance of TCAM-RIS model for P-P fixed links

	Nr.	TCAM-RIS proposed parameter	CEPT ECC WGSE conclusions on applicability to FS
Normative Part	1	Radiocommunication service	Applicable, should be set to "Fixed Service" in this case.
	2	Application	Applicable, for FS should specify whether this frequency band is assigned for P-P, P-MP, MP-MP; for infrastructure, access or other, or combination.
	3	Frequency band	Applicable, for FS should mean limits of allocated band, which e.g. may include guard bands of the channel plan and duplex centre gap.
	4	Channelling	Applicable - the channelling arrangements should be specified, e.g. ref. to CEPT/ITU recommendation/annex and/or National (the latter to be explained or attached). National restrictions/modifications to CEPT/ITU plans to be described.
	5	Modulation / Occupied bandwidth	Not applicable: Modulation for FS is technology specific, so should not be mentioned as a requirement, but suitable modulations may be derived from channel arrangements/EN classes, see also "Channel access and occupation rules".
	6	Direction/separation	Applicable, for FS should read "Duplex type/spacing", in some cases reference to the specified channel arrangement may be sufficient, in other - should be explained, for FDD MP systems the uplink/downlink bands could be specified.
	7	Transmit power / Power density	Applicable, depends on type of FS application, etc. Actual meaning (output power and/or EIRP) may vary.
	8	Channel access and occupation rules	Applicable in some cases (not for block assignments), may mean transmission capacity, minimum hop length, etc.
	9	Authorisation regime	Applicable, for FS could be Individual licence, block assignment, general licence. Other peculiarities should be mentioned if any (e.g. geographical limitations).
	10	Additional essential requirements	Not applicable for FS for the time being.
	11	Frequency planning assumptions	Applicable, for FS could be expanded into: Antenna radiation pattern (ref EN), Emission spectrum mask (ref EN), Receiver parameters (ref EN) Minimum antenna gain, ATPC.
Informative Part	12	Planned changes	Applicable, if relevant on specific case
	13	Reference	Applicable.
	14	Notification number	Applicable. (might help to trace back to the notification procedure and it is a requirement to give this reference number in the published regulation)
	15	Remarks	Applicable.

G.2 Proposed list of radio interface specifications for Fixed Service

It should be noted that the proposed list of radio interface specifications in table G.2 should be used in the framework of Directive 2014/53/EU [i.1] when deciding on eligibility of FS equipment to be placed on the market and brought into service.

The list of parameters that are relevant to national spectrum management functions (e.g. for frequency assignment process) is wider/different, as e.g. described in ECC/REC(01)05 [i.5]. Administrations may request those parameters from the applicant/licensee during the licensing procedure.

It is understood that the proposed FS radio interface requirements provide a list of parameters, allowing individual Administrations to select those parameters necessary to the case, depending on the information in the European harmonized standards and the level of detail in their national frequency allocation tables.

Table G.2: Example of interface requirements for P-P fixed links notification

Parameter	Value (examples)	Filling instructions
Radiocommunication service	Fixed Service	
Application	Infrastructure P-P (System type)	Infrastructure, access or other, or combination, etc.; P-P, P-MP, MP-MP.
Frequency band (GHz)	17,7 to 19,7	Limits of FS allocated band.
Channelling	CEPT/ERC/REC 12-03 [i.4] 27,5 MHz channels only (see note)	Either reference to CEPT/ITU recommendation/annex and/or National plan (the latter to be explained or attached). National restrictions/modifications to CEPT/ITU plans to be described.
Modulation / Occupied bandwidth	Not applicable	
Direction/separation	CEPT/ERC/REC 12-03 [i.4] FDD (see note)	Either reference to the specified channel arrangement or explained, for FDD MP systems the uplink/downlink bands could be specified.
Transmit power / Power density	XX dBm EIRP	Should be specified whether it is an output power and/or EIRP; in accordance with RR provisions. For block assignment it may be complemented by additional provisions (e.g. border PFD limits).
Channel access and occupation rules	Min hop 10 km	May mean transmission capacity (possibly linked to channel width), minimum hop length, equipment class, etc.
Authorisation regime	Link-by-link assignment	Could be Link-by-link assignment, block assignment, and general licence. Other specifics should be mentioned, if any (e.g. geographical limitations).
Additional essential requirements	Not applicable	
Frequency planning assumptions	ATPC: XX dB	Could include requirements in accordance with articles 3.2 and 7 of Directive 2014/53/EU [i.1] Antenna radiation pattern (ref EN), Emission spectrum mask (ref EN), Receiver parameters (ref EN), Minimum antenna gain, ATPC. For block assignment additional/alternative provisions may be set: PFD masks/limits, inter-operator co-ordination procedures, block edge mask, etc.
Planned changes	if relevant on specific case
Reference	ETSI EN 302 217-2 [18] (see note)	Reference to harmonized standard, selected equipment class, etc.
Notification number		For administrative reference purposes.
Remarks		Any relevant remarks, additional info.
NOTE:	Cross references ([i.4] and [18] to clause 2.2) in the table are included for ETSI purpose only. ETSI EN 302 217-2 [18] has superseded, for Directive 2014/53/EU [i.1] applicability, previous ETSI EN 302 217-2-2 [i.13].	

Annex H (informative): Change History

Version	Major variants with respect to previous version
1.1.3	First Publication
1.1.4	Editorial changes
1.2.1	Overall updating (e.g. definitions relevant to adaptive modulation operation, summary tables with new systems and covered bands, references) consequent to significant revisions of Part 2-2 and Part 3 of the ETSI EN 302 217 series
1.3.1	New overall updating (e.g. definitions relevant to band adaptive operation, summary tables with new systems and covered bands, references split into normative and informative) consequent to further revisions of Part 2-2 and Part 3 of the ETSI EN 302 217 series and changes in ETSI drafting rules
2.1.1	<ul style="list-style-type: none"> • System options identification has been changed, in line with corresponding changes in Parts 2-1 and 2-2 of ETSI EN 302 217. Old systems notations (A.1, ... B.1, ... C.1, ... D.1, ... E.1) have been removed and the system capacity is defined in term of minimum Radio Interface Capacity (RIC) rather than previous hierarchic PDH/SDH interfaces. Each equipment in the scope of the present document refers to a coherent set of transmitter and receiver requirements uniquely defined on the basis of the following identifying parameters: <ol style="list-style-type: none"> 1) operating frequency band; 2) operating radio frequency channel separation; 3) spectral efficiency class, to which the minimum RIC density is associated. • Cross reference to older "historical" source ENs, no longer of interest has been moved to an annex. • Required new and updated "definitions". • Alignment of summary tables of frequency bands and equipment options introduced in other parts of ETSI EN 302 217 series.
3.1.1	<ul style="list-style-type: none"> • Alignment of equipment options (CS smaller than 250 MHz in 71 GHz to 86 GHz band) introduced in other parts of ETSI EN 302 217 series. • New definitions and new informative annex C for "<i>channels aggregation</i>" equipment • Merging the technical content of late ETSI EN 302 217-2-1 v2.1.1 to be superseded. • Complete review for application under Directive 2014/53/EU [i.1] and publication of new part 4 (as combination of parts 4-1 and 4-2 to be superseded) • Change of Title and scope accordingly

Annex I (informative): Bibliography

- Recommendation ITU-R F.751: "Transmission characteristics and performance requirements of radio-relay systems for SDH-based networks".
- Recommendation ITU-T G.773: "Protocol suites for Q-interfaces for management of transmission systems".

History

Document history		
V1.1.3	December 2004	Publication
V1.1.4	November 2005	Publication
V1.2.1	June 2007	Publication
V1.3.1	January 2010	Publication
V2.1.1	July 2013	Publication
V3.0.5	June 2016	EN Approval Procedure AP 20160915: 2016-06-17 to 2016-09-15