

**Electromagnetic compatibility  
and Radio spectrum Matters (ERM);  
Radio Frequency Identification Equipment operating in the  
band 865 MHz to 868 MHz with power levels up to 2 W;  
Part 1: Technical requirements and  
methods of measurement**

---



---

Reference

REN/ERM-TG34-003-1

---

Keywords

ID, radio, short range, terrestrial

**ETSI**

650 Route des Lucioles  
F-06921 Sophia Antipolis Cedex - FRANCE

Tel.: +33 4 92 94 42 00 Fax: +33 4 93 65 47 16

Siret N° 348 623 562 00017 - NAF 742 C  
Association à but non lucratif enregistrée à la  
Sous-Préfecture de Grasse (06) N° 7803/88

---

**Important notice**

Individual copies of the present document can be downloaded from:

<http://www.etsi.org>

The present document may be made available in more than one electronic version or in print. In any case of existing or perceived difference in contents between such versions, the reference version is the Portable Document Format (PDF). In case of dispute, the reference shall be the printing on ETSI printers of the PDF version kept on a specific network drive within ETSI Secretariat.

Users of the present document should be aware that the document may be subject to revision or change of status. Information on the current status of this and other ETSI documents is available at

<http://portal.etsi.org/tb/status/status.asp>

If you find errors in the present document, please send your comment to one of the following services:

[http://portal.etsi.org/chaicor/ETSI\\_support.asp](http://portal.etsi.org/chaicor/ETSI_support.asp)

---

**Copyright Notification**

No part may be reproduced except as authorized by written permission.  
The copyright and the foregoing restriction extend to reproduction in all media.

© European Telecommunications Standards Institute 2006.  
All rights reserved.

**DECT**<sup>TM</sup>, **PLUGTESTS**<sup>TM</sup> and **UMTS**<sup>TM</sup> are Trade Marks of ETSI registered for the benefit of its Members.  
**TIPHON**<sup>TM</sup> and the **TIPHON logo** are Trade Marks currently being registered by ETSI for the benefit of its Members.  
**3GPP**<sup>TM</sup> is a Trade Mark of ETSI registered for the benefit of its Members and of the 3GPP Organizational Partners.

# Contents

Intellectual Property Rights .....	6
Foreword.....	6
1 Scope .....	7
2 References .....	7
3 Definitions, symbols and abbreviations .....	8
3.1 Definitions .....	8
3.2 Symbols.....	9
3.3 Abbreviations .....	9
4 Technical requirement specifications .....	9
4.1 General requirements .....	9
4.1.1 General performance criteria .....	9
4.1.1.1 Receiver functional specification .....	9
4.1.1.1.1 Listen mode .....	10
4.1.1.1.2 Talk mode.....	10
4.1.2 Receiver classification .....	10
4.2 Presentation of equipment for testing purposes.....	10
4.2.1 Choice of model for testing .....	10
4.2.2 Operational frequency ranges .....	11
4.2.2.1 Choice of frequencies.....	11
4.2.2.2 Sub-band range .....	11
4.2.2.3 Testing of operational frequencies .....	11
4.2.3 Number of samples for testing.....	11
4.2.4 Test mode.....	11
4.2.5 Testing of equipment with alternative power levels .....	12
4.2.6 Testing of equipment that does not have an external 50 $\Omega$ RF connector (integral antenna equipment) .....	12
4.2.6.1 Equipment with an internal permanent or temporary antenna connector .....	12
4.2.6.2 Equipment with a temporary antenna connector .....	12
4.3 Mechanical and electrical design.....	12
4.3.1 General.....	12
4.3.2 Controls .....	12
4.3.3 Transmitter shut-off facility.....	13
4.3.4 CE Marking .....	13
4.3.4.1 Equipment identification, additional marking.....	13
4.4 Declarations by the provider .....	13
4.5 Auxiliary test equipment .....	13
4.6 Interpretation of the measurement results .....	13
5 Test conditions, power sources and ambient temperatures .....	13
5.1 Normal and extreme test conditions .....	13
5.2 Test power sources .....	14
5.2.1 External test power source.....	14
5.2.2 Internal test power source .....	14
5.3 Normal test conditions.....	14
5.3.1 Normal temperature and humidity.....	14
5.3.2 Normal test power source .....	14
5.3.2.1 Mains voltage.....	14
5.3.2.2 Regulated lead-acid battery power sources .....	14
5.3.2.3 Other power sources.....	15
5.4 Extreme test conditions .....	15
5.4.1 Extreme temperatures .....	15
5.4.1.1 Procedure for tests at extreme temperatures.....	15
5.4.1.1.1 Procedure for equipment designed for continuous operation .....	15
5.4.1.1.2 Procedure for equipment designed for intermittent operation .....	15

5.4.1.2	Extreme temperature ranges.....	16
5.4.2	Extreme test source voltages.....	16
5.4.2.1	Mains voltage.....	16
5.4.2.2	Regulated lead-acid battery power sources.....	16
5.4.2.3	Power sources using other types of batteries.....	16
5.4.2.4	Other power sources.....	16
6	General conditions.....	17
6.1	Normal test signals and test modulation.....	17
6.1.1	Normal test signals for data.....	17
6.2	Artificial antenna.....	17
6.3	Test fixture.....	17
6.4	Test sites and general arrangements for radiated measurements.....	17
6.5	Modes of operation of the transmitter.....	18
6.6	Measuring receiver.....	18
7	Measurement uncertainty.....	18
8	Methods of measurement and limits for transmitter parameters.....	19
8.1	Frequency error for mains operated equipment.....	19
8.1.1	Definition.....	19
8.1.2	Method of measurement of frequency error.....	19
8.1.3	Limits.....	19
8.2	Frequency stability under low voltage conditions.....	19
8.2.1	Definition.....	19
8.2.2	Method of measurement.....	19
8.2.3	Limits.....	20
8.3	Radiated power (e.r.p.).....	20
8.3.1	Definition.....	20
8.3.2	Method of measurement.....	20
8.3.2.1	Radiated measurement.....	20
8.3.2.2	Conducted measurement.....	21
8.3.3	Limits.....	21
8.4	Transmitter spectrum mask.....	22
8.4.1	Definition.....	22
8.4.2	Method of measurement.....	22
8.4.3	Limits.....	23
8.5	Spurious emissions.....	23
8.5.1	Definition.....	23
8.5.2	Method of measurement.....	23
8.5.2.1	Method of measuring the power level in a specified load, clause 8.5.2, a) i).....	24
8.5.2.2	Method of measuring the effective radiated power, clause 8.5.2, a) ii).....	24
8.5.2.3	Method of measuring effective radiated power, clause 8.5.2, b).....	25
8.5.3	Limits.....	25
8.6	Transmission times.....	25
8.6.1	Definition.....	25
8.6.2	Method of measurement.....	26
8.6.3	Limits.....	26
9	Receiver parameters.....	26
9.1	Receiver threshold in listen mode.....	26
9.1.1	Definition.....	27
9.1.2	Method of measurement.....	27
9.1.3	Limits.....	28
9.2	Listen time.....	28
9.3	Blocking or desensitisation in listen mode.....	28
9.3.1	Definition.....	28
9.3.2	Method of measurement.....	29
9.3.2.1	Method of measuring radiated signals.....	29
9.3.2.2	Conducted method of measurement.....	30
9.3.3	Limits.....	32
9.4	Adjacent sub-band selectivity in talk mode.....	32
9.4.1	Definition.....	32

9.4.2	Method of measurement .....	32
9.4.2.1	Method of measuring radiated signals.....	32
9.4.2.2	Method of measuring using power splitter.....	32
9.4.3	Limits.....	33
9.5	Blocking or desensitisation in talk mode.....	33
9.5.1	Definition.....	33
9.5.2	Method of measurement .....	33
9.5.2.1	Method of measuring radiated signals.....	33
9.5.2.2	Method of measuring using power splitter.....	34
9.5.3	Limits.....	34
9.6	Spurious emissions .....	35
9.6.1	Definition.....	35
9.6.2	Method of measurement .....	35
9.6.2.1	Method of measuring the power level in a specified load, clause 9.6.1, a) i).....	35
9.6.2.2	Method of measuring the effective radiated power, clause 9.6.1, a) ii).....	35
9.6.2.3	Method of measuring the effective radiated power, clause 9.6.1, b).....	36
9.6.3	Limits.....	36
10	Limits and methods of measurement for tag emissions outside the sub-band edges .....	36
10.1	Definition .....	36
10.2	Method of measurement.....	37
10.3	Limits .....	37
<b>Annex A (normative): Radiated measurement.....</b>		<b>39</b>
A.1	Test sites and general arrangements for measurements involving the use of radiated fields.....	39
A.1.1	Anechoic chamber.....	39
A.1.2	Anechoic Chamber with a conductive ground plane.....	40
A.1.3	Open Area Test Site (OATS) .....	41
A.1.4	Test antenna.....	42
A.1.5	Substitution antenna .....	43
A.1.6	Measuring antenna .....	43
A.1.7	Stripline arrangement .....	43
A.1.7.1	General.....	43
A.1.7.2	Description.....	43
A.1.7.3	Calibration .....	43
A.1.7.4	Mode of use .....	43
A.2	Guidance on the use of radiation test sites .....	44
A.2.1	Verification of the test site .....	44
A.2.2	Preparation of the EUT.....	44
A.2.3	Power supplies to the EUT .....	44
A.2.4	Range length.....	44
A.2.5	Site preparation .....	45
A.3	Coupling of signals.....	46
A.3.1	General .....	46
A.3.2	Data signals .....	46
A.4	Standard test position .....	46
A.5	Test fixture .....	47
A.5.1	Description .....	47
A.5.2	Calibration.....	47
A.5.3	Mode of use.....	48
<b>Annex B (normative): Technical performance of the spectrum analyser.....</b>		<b>49</b>
<b>Annex C (informative): Determination and use of the measurement bandwidth.....</b>		<b>50</b>
<b>Annex D (informative): Bibliography.....</b>		<b>51</b>
History .....		52

---

## Intellectual Property Rights

IPRs essential or potentially essential to the present document may have been declared to ETSI. The information pertaining to these essential IPRs, if any, is publicly available for **ETSI members and non-members**, and can be found in ETSI SR 000 314: "*Intellectual Property Rights (IPRs); Essential, or potentially Essential, IPRs notified to ETSI in respect of ETSI standards*", which is available from the ETSI Secretariat. Latest updates are available on the ETSI Web server (<http://webapp.etsi.org/IPR/home.asp>).

Pursuant to the ETSI IPR Policy, no investigation, including IPR searches, has been carried out by ETSI. No guarantee can be given as to the existence of other IPRs not referenced in ETSI SR 000 314 (or the updates on the ETSI Web server) which are, or may be, or may become, essential to the present document.

---

## Foreword

This European Standard (Telecommunications series) has been produced by ETSI Technical Committee Electromagnetic compatibility and Radio spectrum Matters (ERM), and is now submitted for the ETSI standards One-step Approval Procedure.

Every EN prepared by ETSI is a voluntary standard. The present document contains technical characteristics and test methods for the equipment to which it relates. This text should be considered as guidance only and does not make the present document mandatory.

The present document has been produced by ETSI in response to a mandate from the European Commission issued under Council Directive 98/34/EC (as amended) laying down a procedure for the provision of information in the field of technical standards and regulations.

Annex A provides normative specifications concerning radiated measurements.

Annex B provides normative guidelines on the technical performance of the spectrum analyser used for measurement of the EUT.

Annex C provides informative guidelines on the relationship between reference bandwidths and resolution bandwidths` for measuring receivers.

The present document is part 1 of a multi-part deliverable covering Radio Frequency Identification Equipment operating in the band 865 MHz to 868 MHz with power levels up to 2 W, as identified below:

**Part 1: "Technical requirements and methods of measurement";**

Part 2: "Harmonized EN under article 3.2 of the R&TTE Directive".

<b>Proposed national transposition dates</b>	
Date of latest announcement of this EN (doa):	3 months after ETSI publication
Date of latest publication of new National Standard or endorsement of this EN (dop/e):	6 months after doa
Date of withdrawal of any conflicting National Standard (dow):	6 months after doa

---

# 1 Scope

The present document covers the minimum characteristics considered necessary in order to make the best use of the available frequencies. It does not necessarily include all the characteristics that may be required by a user, nor does it necessarily represent the optimum performance achievable.

Radio frequency identification products covered within the present document are considered by definition short-range devices. Power limits up to a maximum e.r.p. of 2 W are specified for this equipment in the frequency range 865 MHz to 868 MHz.

The present document applies to RFID interrogators and tags operating together as a system. The interrogators transmit within 200 kHz sub-bands using a modulated carrier. The tags respond with a modulated signal. Interrogators may be used with either integral or external antennas.

ElectroMagnetic Compatibility (EMC) requirements are covered by EN 301 489-1 [4] and EN 301 489-3 [7].

The types of equipment covered by the present document are as follows:

- fixed interrogators;
- hand portable interrogators;
- batteryless tags;
- battery assisted tags;
- battery powered tags.

---

# 2 References

The following documents contain provisions which, through reference in this text, constitute provisions of the present document.

- References are either specific (identified by date of publication and/or edition number or version number) or non-specific.
- For a specific reference, subsequent revisions do not apply.
- For a non-specific reference, the latest version applies.

Referenced documents which are not found to be publicly available in the expected location might be found at <http://docbox.etsi.org/Reference>.

- [1] ETSI TR 100 028 (all parts): "Electromagnetic compatibility and Radio spectrum Matters (ERM); Uncertainties in the measurement of mobile radio equipment characteristics".
- [2] CEPT/ERC/REC 70-03: "Relating to the use of Short Range Devices (SRD)".
- [3] CISPR 16-1: "Specification for radio disturbance and immunity measuring apparatus and methods; Part 1: Radio disturbance and immunity measuring apparatus".
- [4] ETSI EN 301 489-1: "Electromagnetic compatibility and Radio spectrum Matters (ERM); ElectroMagnetic Compatibility (EMC) standard for radio equipment and services; Part 1: Common technical requirements".
- [5] ETSI TR 102 273 (all parts): "Electromagnetic compatibility and Radio spectrum Matters (ERM); Improvement on Radiated Methods of Measurement (using test site) and evaluation of the corresponding measurement uncertainties".

- [6] ANSI C63.5: "American National Standard for Calibration of Antennas Used for Radiated Emission Measurements in Electromagnetic Interference (EMI) Control - Calibration of Antennas (9 kHz to 40 GHz)".
- [7] ETSI EN 301 489-3: "Electromagnetic compatibility and Radio spectrum Matters (ERM); ElectroMagnetic Compatibility (EMC) standard for radio equipment and services; Part 3: Specific conditions for Short-Range Devices (SRD) operating on frequencies between 9 kHz and 40 GHz".

---

## 3 Definitions, symbols and abbreviations

### 3.1 Definitions

For the purposes of the present document, the following terms and definitions apply:

**assigned frequency band:** frequency band within which the device is authorized to operate

**battery assisted tag:** transponder that includes a battery to enhance its receive performance and power its internal circuitry

**batteryless tag:** transponder that derives all of the power necessary for its operation from the field generated by an interrogator

**battery powered tag:** transponder that uses the power from its battery to perform all of its operational functions

**conducted measurements:** measurements which are made using a direct 50  $\Omega$  connection to the equipment under test

**dedicated antenna:** removable antenna supplied and type tested with the radio equipment, designed as an indispensable part of the equipment

**frequency agile technique:** the technique used to determine an unoccupied sub-band in order to minimize interference with other users of the same band

**full tests:** all tests specified in EN 302 208-1

**global scroll:** a mode in which an interrogator is able continuously to read the same tag

**integral antenna:** permanent fixed antenna, which may be built-in, designed as an indispensable part of the equipment

**interrogator:** equipment that will activate an adjacent tag and read its data. It may also enter or modify the information in a tag

**limited tests:** limited tests (see clauses 4.2.1 to 4.2.2.3 of EN 302 208-1) are as follows:

- transmitter frequency error, see clauses 8.1 and 8.2 of EN 302 208-1;
- transmitter effective radiated power, see clause 8.3 of EN 302 208-1.

**listen before talk:** action taken by an interrogator to detect an unoccupied sub-band prior to transmitting (also known as "listen before transmit")

**provider:** means the manufacturer, or his authorized representative or the person responsible for placing on the market

**radiated measurements:** measurements which involve the absolute measurement of a radiated field

**scan mode:** a specific test mode of an interrogator that detects a signal on a pre-selected sub-band and transmits automatically on another sub-band

NOTE: See clause 4.2.4, section 5.

**tag:** transponder that holds data and responds to an interrogation signal

**talk mode:** transmission of intentional radiation by an interrogator



## 3.2 Symbols

For the purposes of the present document, the following symbols apply:

dB	decibel
d	distance
$\lambda$	wavelength

## 3.3 Abbreviations

For the purposes of the present document, the following abbreviations apply:

ANSI	American National Standards Institute
BER	Bit Error Rate
CEPT	European Conference of Postal and Telecommunications Administrations
EMC	ElectroMagnetic Compatibility
emf	electromotive force
ERC	European Radio communication Committee
e.r.p.	effective radiated power
EUT	Equipment Under Test
FT	Full Tests
LT	Limited Tests
OATS	Open Area Test Site
R&TTE	Radio and Telecommunications Terminal Equipment
RF	Radio Frequency
RFID	Radio Frequency IDentification
SRD	Short Range Device
VSWR	Voltage Standing Wave Ratio

---

# 4 Technical requirement specifications

## 4.1 General requirements

Interrogators are only permitted where they employ frequency agile techniques using "listen before talk".

### 4.1.1 General performance criteria

To minimise interference to other users, the receivers of interrogators must be able to detect emissions from other radio devices in the band according to the following criteria:

- a) Where the receiver of an interrogator detects that a sub-band is already occupied by another device, the interrogator will automatically switch to an unused sub-band before transmitting its carrier.
- b) In situations where the receiver of an interrogator detects that all of the sub-bands in the permitted band are occupied by other devices the interrogator shall remain in the idle mode. The interrogator shall not transmit its carrier until its receiver has detected a sub-band that is unused.

#### 4.1.1.1 Receiver functional specification

To ensure that the interrogator detects the presence of other devices with which it could potentially interfere, the receiver of the interrogator shall conform to the requirements of clauses 4.1.1.1.1 and 4.1.1.1.2.

#### 4.1.1.1.1 Listen mode

Immediately prior to each transmission by an interrogator, its receiver shall switch to the listen mode and monitor a selected sub-band for a period of not less than the limit defined in clause 9.2. While in the listen mode the sensitivity of the receiver in the interrogator shall be set to enable detection at the appropriate threshold level as defined in clause 9.1.3. Any signal detected by the receiver in excess of the threshold level shall indicate that another equipment already occupies the sub-band. In such a situation the interrogator shall not transmit but monitor other sub-bands within the permitted band until it detects one in which the received signals are below the threshold level. Alternatively, the interrogator may remain on the same sub-band until it is clear. The interrogator shall then implement the listen time in accordance with clause 9.2.

#### 4.1.1.1.2 Talk mode

An interrogator that has detected an unoccupied sub-band shall be permitted to transmit on that sub-band in accordance with the requirements of clause 8.6. At the same time the receiver of the interrogator shall switch to the "talk" mode. The provider shall determine the sensitivity of the receiver in the "talk" mode in accordance with the needs of the application (see clause 9.1.3).

In the event that an interrogator, which is engaged in a dialogue with a tag, is subjected to interference, it may switch to another sub-band having first determined that this sub-band is unoccupied.

An interrogator may transmit a continuous carrier for a period not exceeding the period defined in clause 8.6.3. At the end of the transmission the interrogator shall not transmit again on the same sub-band for the period defined in clause 8.6.3. Alternatively the interrogator may immediately listen on each of the other sub-bands for a period of not less than the limit specified in clause 9.2 to locate one that is unoccupied. If the interrogator determines that a sub-band is vacant it may send a further continuous transmission in accordance with the requirements of clause 8.6.3. There is no limit to the number of times that this process may be repeated.

The interrogator shall be so designed as to ensure that its length of transmission is no greater than is necessary to perform the intended operation.

### 4.1.2 Receiver classification

Since "listen before talk" is mandatory, the receiver of the interrogator shall comply with all of the requirements specified for the "listen mode" contained in clause 9.

## 4.2 Presentation of equipment for testing purposes

Equipment submitted for testing shall fulfil the requirements of the present document on all frequencies over which it is intended to operate.

Providers shall select frequencies of operation in accordance with the plan for sub-bands defined in clause 4.2.2.1 and in accordance with the power levels defined in table 4.

If equipment is designed to operate with different carrier powers, measurement of each transmitter parameter shall be performed at the highest power level at which the transmitter is intended to operate.

To simplify and harmonize the testing procedures between the different testing laboratories, measurements shall be performed according to the present document on samples of equipment as defined in clauses 4.2.1 to 4.5. These clauses are intended to give confidence that the requirements set out in the present document have been met without the necessity of performing measurements at all frequencies.

### 4.2.1 Choice of model for testing

The provider shall provide one or more samples of the equipment, as appropriate, for testing.

If an equipment has several optional features considered not to affect the RF parameters then tests need only be performed on the equipment configured with that combination of features considered to be the most complex, as proposed by the provider and agreed by the test laboratory.

In the case of hand portable equipment without a 50  $\Omega$  external antenna connector, see clause 4.2.6.

## 4.2.2 Operational frequency ranges

### 4.2.2.1 Choice of frequencies

Interrogators shall operate within the band 865 MHz to 868 MHz in multiple sub-bands of 200 kHz. The centre frequency of the lowest sub-band shall be 865,1 MHz.

### 4.2.2.2 Sub-band range

When submitting equipment for testing, the provider shall state the frequencies of the sub-bands over which the interrogator will operate. The provider shall also confirm that the interrogator shall operate over all of the declared sub-bands without any change to the circuit or trimming of discrete components.

Trimming is an act by which the value (in this case relating to frequency) of a component is changed within the circuit. This act may include the physical alteration, substitution (by components of similar size and type) or activation/de-activation (via the setting of soldered bridges) of components.

### 4.2.2.3 Testing of operational frequencies

Figure 1 shows the permitted maximum power within the band. Full (FT) and Limited (LT) Tests, as defined in clause 3.1, shall be carried out within the applicable sub-band at the frequencies shown in figure 1.

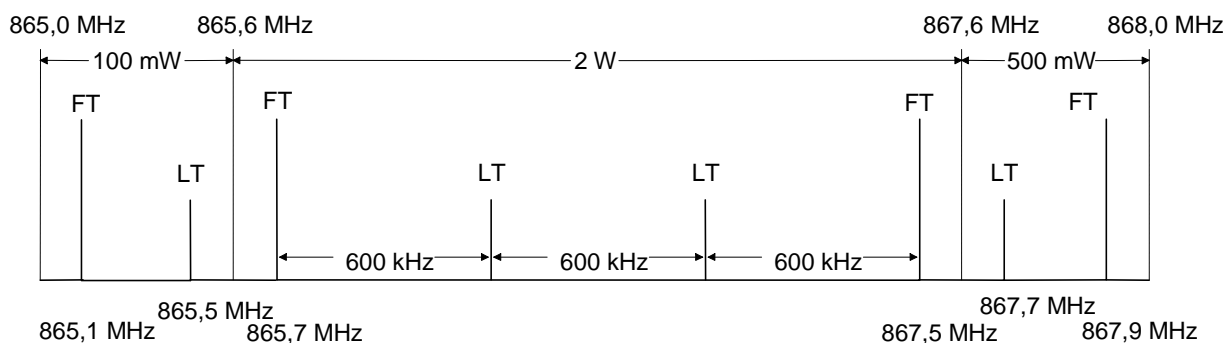

Legend: LT: Limited tests, see clause 3.1.  
FT: Full tests, see clause 3.1.

**Figure 1: Tests on a single sample for equipment within the band 865,0 MHz to 868,0 MHz**

### 4.2.3 Number of samples for testing

Interrogators shall be submitted for test such that they may be configured to operate at the highest and lowest sub-band and at each of the intermediate sub-bands as specified in figure 1. It is only necessary for one sample of equipment to be tested.

The provider shall supply a quantity of at least 3 pre-programmed tags with each interrogator that is submitted for test.

### 4.2.4 Test mode

The interrogator shall include a suitable test mode to permit testing of the parameters defined in clauses 8, 9 and 10. The test mode shall be readily controlled by means, for example, of an external PC or terminal unit.

The test mode shall include the features listed below:

- 1) It shall be possible to set the interrogator to transmit a continuously un-modulated carrier on any one of the declared sub-bands of operation.
- 2) While the interrogator is transmitting on a preset sub-band, it shall be possible to read and log the identity of any valid tags that are present in the interrogation field.

- 3) It shall be possible to cause the interrogator continuously to transmit normal test signals as defined in clause 6.1 at its maximum data rate as declared by the provider.
- 4) It shall be possible to configure a tag in a test mode such that in the presence of an interrogation field it transmits a continuous modulated response. Alternatively this requirement may be satisfied by a suitably configured test tag with an output that is representative of the production version.
- 5) In order to test the "listen before talk" feature, it shall be possible initially to pre-select a sub-band of operation for the interrogator. In the event that the interrogator, prior to transmission, detects another station on the pre-selected sub-band, the interrogator will move automatically to the next higher sub-band. If the highest sub-band in the operating band has been pre-selected, the interrogator shall switch to its lowest sub-band.

## 4.2.5 Testing of equipment with alternative power levels

If a family of equipment has alternative output power levels provided by the use of separate power modules or add-on stages, then each module or add-on stage shall be tested in combination with the equipment. The necessary number of samples and additional tests can be proposed by the provider and shall be agreed by the test laboratory based on the requirements of clause 4.2.

## 4.2.6 Testing of equipment that does not have an external 50 $\Omega$ RF connector (integral antenna equipment)

### 4.2.6.1 Equipment with an internal permanent or temporary antenna connector

The means to access and/or implement the internal permanent or temporary antenna connector shall be stated by the provider with the aid of a diagram. The fact that use has been made of the internal antenna connection, or of a temporary connection, to facilitate measurements shall be recorded in the test report.

No connection shall be made to any internal permanent or temporary antenna connector during the performance of radiated emissions measurements, unless such action forms an essential part of the normal intended operation of the equipment, as declared by the provider.

### 4.2.6.2 Equipment with a temporary antenna connector

The provider may submit one set of equipment with the normal antenna connected, to enable the radiated measurements to be made. The provider shall attend the test laboratory at conclusion of the radiated measurements, to disconnect the antenna and fit the temporary connector. The testing laboratory staff shall not connect or disconnect any temporary antenna connector.

Alternatively, the provider may submit two sets of equipment to the test laboratory, one fitted with a temporary antenna connector with the antenna disconnected and the other with the antenna connected. Equipment shall be used for the appropriate tests. The provider shall declare that the two sets of equipment are identical in all respects.

## 4.3 Mechanical and electrical design

### 4.3.1 General

The equipment submitted by the provider shall be designed, constructed and manufactured in accordance with good engineering practice, and with the aim of minimizing harmful interference to other equipment and services.

Interrogators shall operate with the correct power source.

### 4.3.2 Controls

Those controls, which if maladjusted, may increase the interfering potential of the equipment, shall not be easily accessible to the user.

### 4.3.3 Transmitter shut-off facility

If the interrogator is equipped with an automatic transmitter shut-off facility, where appropriate, it should be made inoperative for the duration of the test.

### 4.3.4 CE Marking

The equipment shall be marked in a visible place. This marking shall be legible and durable.

In cases where the devices are too small to carry legible marking, it is sufficient to provide the relevant information in the user's manual and on the product packaging.

#### 4.3.4.1 Equipment identification, additional marking

The marking should be based on the CEPT/ERC/REC 70-03 [2] e.g.: and in addition include:

- receiver classification, see clause 4.1.2;
- temperature range, see clause 5.4.1;
- other relevant information.

## 4.4 Declarations by the provider

The provider shall declare all necessary information concerning the equipment in respect of the technical requirements set out in the present document. In particular the provider shall supply a written description of the "frequency agile listen before talk" operation of the interrogator and explain how it conforms to the requirements of clauses 8.6 and 9.2.

## 4.5 Auxiliary test equipment

All necessary test signal sources including sample tags and setting up information shall accompany the equipment when it is submitted for testing.

## 4.6 Interpretation of the measurement results

Interpretation of the results recorded in the test report for the measurements described in the present document shall be as follows:

- the measured value related to the corresponding limit shall be used to decide whether an equipment meets the requirements of the present document;
- the value used for measurement uncertainty for each measured parameter shall be included in the test report;
- the recorded value of the measurement uncertainty shall be, for each measurement, equal to or lower than the figures in table 3 (see clause 7).

---

# 5 Test conditions, power sources and ambient temperatures

## 5.1 Normal and extreme test conditions

Testing shall be performed under normal test conditions, and also, where stated, under extreme test conditions.

The test conditions and procedures shall be as specified in clauses 5.2 to 5.4.

## 5.2 Test power sources

The equipment shall be tested using the appropriate test power source as specified in clauses 5.2.1 or 5.2.2. Where equipment can be powered using either external or internal power sources, then equipment shall be tested using the external test power source as specified in clause 5.2.1 then repeated using the internal power source as specified in clause 5.2.2.

The test power source used shall be stated.

### 5.2.1 External test power source

During tests the power source of the equipment shall be replaced by an external test power source capable of producing normal and extreme test voltages as specified in clauses 5.3.2 and 5.4.2. The internal impedance of the external test power source shall be low enough for its effect on the test results to be negligible. For the purpose of the tests, the voltage of the external test power source shall be measured at the input terminals of the equipment. The external test power source shall be suitably de-coupled and applied as close to the equipment battery terminals as practicable. For radiated measurements any external power leads should be so arranged so as not to affect the measurements.

During tests the voltages of the external test power source shall be within a tolerance  $< \pm 1$  % relative to the voltage at the beginning of each test.

### 5.2.2 Internal test power source

For radiated measurements on portable equipment with an integral antenna, fully charged internal batteries shall be used. The batteries used should be as supplied or recommended by the provider. If internal batteries are used, at the end of each test the voltage shall be within a tolerance of  $< \pm 5$  % relative to the voltage at the beginning of each test.

If appropriate, the external test power source may replace the supplied or recommended internal batteries at the required voltage. For conducted measurements or where a test fixture is used, this shall be stated in the test report.

## 5.3 Normal test conditions

### 5.3.1 Normal temperature and humidity

The normal temperature and humidity conditions for tests shall be any convenient combination of temperature and humidity within the following ranges:

- temperature:  $+15^{\circ}\text{C}$  to  $+35^{\circ}\text{C}$ ;
- relative humidity: 20 % to 75 %.

When it is impracticable to carry out tests under these conditions, a note to this effect stating the ambient temperature and relative humidity during the tests shall be recorded in the test report.

### 5.3.2 Normal test power source

#### 5.3.2.1 Mains voltage

The normal test voltage for equipment to be connected to the mains shall be the nominal mains voltage. For the purpose of the present document, the nominal voltage shall be the declared voltage, or any of the declared voltages, for which the equipment was designed.

The frequency of the test power source corresponding to the ac mains shall be between 49 Hz and 51 Hz.

#### 5.3.2.2 Regulated lead-acid battery power sources

When the radio equipment is intended for operation with the usual types of regulated lead-acid battery power source, the normal test voltage shall be 1,1 multiplied by the nominal voltage of the battery (6 V, 12 V, etc.).

### 5.3.2.3 Other power sources

For operation from other power sources or types of battery (primary or secondary), the normal test voltage shall be that declared by the equipment provider and where appropriate agreed by the accredited test laboratory. Such values shall be stated.

## 5.4 Extreme test conditions

### 5.4.1 Extreme temperatures

#### 5.4.1.1 Procedure for tests at extreme temperatures

Before measurements are made, the equipment shall have reached thermal balance in the test chamber. The equipment shall be switched off during the temperature-stabilizing period.

In the case of equipment containing temperature stabilization circuits designed to operate continuously, the temperature stabilization circuits shall be switched on for 15 min after thermal balance has been obtained, and the equipment shall then meet the specified requirements.

If thermal balance is not checked by measurements, a temperature-stabilizing period of at least one hour, or such period as may be decided by the accredited test laboratory, shall be allowed. The sequence of measurements shall be chosen, and the humidity content in the test chamber shall be controlled so that excessive condensation does not occur.

##### 5.4.1.1.1 Procedure for equipment designed for continuous operation

If the provider states that the equipment is designed for continuous operation, the test procedure shall be as follows:

- before tests at the upper extreme temperature, the equipment shall be placed in the test chamber and left until thermal balance is attained. The equipment shall then be switched on in the "tag not present" condition for a period of half an hour after which the equipment shall meet the specified requirements in its operational mode;
- for tests at the lower extreme temperature, the equipment shall be left in the test chamber until thermal balance is attained, then switched to the "tag not present" condition for a period of one minute after which the equipment shall meet the specified requirements in its operational mode.

##### 5.4.1.1.2 Procedure for equipment designed for intermittent operation

If the provider states that the equipment is designed for intermittent operation, the test procedure shall be as follows:

- prior to tests at the upper extreme temperature, the equipment shall be placed in the test chamber and left until thermal balance is attained in the oven. The equipment shall then either:
  - transmit on and off according to the intended operational cycle of the interrogator for a period of five minutes; or

if the providers declared "on" period exceeds one minute:

- transmit in the on condition for a period not exceeding one minute, followed by a period in the off or standby mode for four minutes;

after which the equipment shall meet the specified requirements.

- for tests at the lower extreme temperature the equipment shall be left in the test chamber until thermal balance is attained, after which the equipment shall meet the specified requirements when switched on in the transmit mode.

### 5.4.1.2 Extreme temperature ranges

For tests at extreme temperatures, measurements shall be made in accordance with the procedures specified in clause 5.4.1.1, at the upper and lower temperatures of one of the ranges specified in table 1.

**Table 1: Extreme temperature ranges**

Category	Temperature range
Category I (General):	-20°C to +55°C
Category II (Portable equipment):	-10°C to +55°C
Category III (Equipment for normal indoor use):	0°C to +55°C
NOTE: The term "equipment for normal indoor use" is taken to mean that the room temperature is controlled and the minimum indoor temperature is equal to or greater than 5°C.	

In order to comply with the present document, the device shall meet the requirements over the appropriate temperature range stated in table 1. However, the provider may specify a wider temperature range than those stated in table 1.

## 5.4.2 Extreme test source voltages

### 5.4.2.1 Mains voltage

The extreme test voltages for equipment to be connected to an ac mains source shall be the nominal mains voltage  $\pm 10\%$ .

### 5.4.2.2 Regulated lead-acid battery power sources

When the radio equipment is intended for operation with the usual type of regulated lead-acid battery power sources, the extreme test voltages shall be 1,3 and 0,9 multiplied by the nominal voltage of the battery (6 V, 12 V, etc.).

For float charge applications using "gel-cell" type batteries, the extreme test voltages shall be 1,15 and 0,85 multiplied by the nominal voltage of the declared battery voltage.

### 5.4.2.3 Power sources using other types of batteries

The lower extreme test voltages for equipment with power sources using batteries shall be as follows:

- for equipment with a battery indicator, the end point voltage as indicated;
- for equipment without a battery indicator, the following end point voltage shall be used:
  - for the Leclanché or the lithium type of battery:
    - 0,85 multiplied by the nominal voltage of the battery;
  - for the nickel-cadmium type of battery:
    - 0,9 multiplied by the nominal voltage of the battery;
  - for other types of battery, the lower extreme test voltage for the discharged condition shall be declared by the equipment provider.

The nominal voltage is considered to be the upper extreme test voltage in this case.

### 5.4.2.4 Other power sources

For equipment using other power sources, or capable of being operated from a variety of power sources, the extreme test voltages shall be those agreed between the equipment provider and the accredited test laboratory and shall be recorded in the test report.



---

## 6 General conditions

### 6.1 Normal test signals and test modulation

The test-modulating signal is a signal that modulates a carrier and is dependent upon the type of equipment under test and also the measurement to be performed.

#### 6.1.1 Normal test signals for data

Normal test signals shall represent the normal modulated carriers received both by the receiver of an interrogator and by a tag. They correspond to a single message triggered either manually or automatically. They are used for receiver methods of measurement where there is a need to transmit repeatedly a single message. This is achieved using a combined encoder and signal generator (for example a tag or interrogator) that shall be capable of supplying the test signal. Details of the test signal shall be supplied by the provider and included in the test report.

### 6.2 Artificial antenna

Where applicable, tests shall be carried out using an artificial antenna, which shall be a substantially non-reactive non-radiating load of 50  $\Omega$  connected to the antenna connector. The Voltage Standing Wave Ratio (VSWR) at the 50  $\Omega$  connector shall not be greater than 1,2: 1 over the frequency range of the measurement.

### 6.3 Test fixture

With equipment intended for use with an integral antenna, and not equipped with a 50  $\Omega$  RF output connector, the provider may supply a test fixture (see also clause 4.2.6). This test fixture is a radio frequency coupling device for substituting the integral antenna with a 50  $\Omega$  radio frequency terminal at the working frequencies of the equipment under test. This allows certain measurements to be performed using conducted measurement methods. However, only relative measurements may be performed. In addition, the test fixture shall provide, where applicable:

- a connection to an external power supply;
- a connection to a data interface.

The performance characteristics of the test fixture shall conform to the following basic parameters:

- the circuitry associated with the RF coupling shall contain no active or non-linear devices;
- the coupling loss shall not influence the measuring results;
- the coupling loss shall be independent of the position of the test fixture and be unaffected by the proximity of surrounding objects or people;
- the coupling loss shall be reproducible when the equipment under test is removed and replaced;
- the coupling loss shall remain substantially constant when the environmental conditions are varied.

### 6.4 Test sites and general arrangements for radiated measurements

For guidance on radiation test sites see annex A. Detailed descriptions of the radiated measurement arrangements are included in this annex.

## 6.5 Modes of operation of the transmitter

For the purposes of the measurements according to the present document there should be a facility to operate the transmitter in an un-modulated state. The provider may also decide the method of achieving an un-modulated carrier, or special types of modulation patterns, the details of which shall be described in the test report. It may involve suitable temporary internal modifications of the equipment under test. If it is not possible to provide an un-modulated carrier then this shall be stated.

For purposes of testing, the interrogator under test shall internally generate the normal test signal as defined in clause 6.1.

## 6.6 Measuring receiver

The term measuring receiver as described in annex B refers to either a frequency selective voltmeter or a spectrum analyser. The reference bandwidth of the measuring receiver as defined in CISPR 16-1 [3] shall be as given in table 2.

**Table 2: Reference bandwidth of measuring receiver**

Frequency being measured: f	Measuring receiver bandwidth (6 dB)	Spectrum analyser bandwidth (3 dB)
$25 \text{ MHz} \leq f < 1\,000 \text{ MHz}$	120 kHz	100 kHz
$1\,000 \text{ MHz} \leq f$	1 MHz	1 MHz

An example of how to determine the resolution bandwidth from the reference bandwidth is given in annex C.

---

## 7 Measurement uncertainty

Interpretation of the results recorded in the test report for the measurements described in the present document shall be as follows:

- the measured value related to the corresponding limit shall be used to decide whether an equipment meets the requirements of the present document;
- the value of the measurement uncertainty for the measurement of each parameter shall be separately included in the test report;
- the value of the measurement uncertainty shall be, for each measurement, equal to or lower than the figures in table 3.

**Table 3: Measurement uncertainty**

Parameter	Uncertainty
RF frequency	$\pm 1 \times 10^{-7}$
RF power, conducted	$\pm 0,75 \text{ dB}$
RF power, radiated, valid up to 12,75 GHz	$\pm 6 \text{ dB}$
Maximum frequency deviation for FM	$\pm 5 \%$
Two-signal measurements	$\pm 4 \text{ dB}$
Time	$\pm 5 \%$
Temperature	$\pm 1 \text{ K}$
Humidity	$\pm 5 \%$

For the test methods, according to the present document the uncertainty figures shall be calculated according to the methods described in TR 100 028 [1] and shall correspond to an expansion factor (coverage factor)  $k = 1,96$  or  $k = 2$  (which provide confidence levels of respectively 95 % and 95,45 % in cases where the distributions characterizing the actual measurement uncertainties are normal (Gaussian)). Table 3 is based on such expansion factors.

The particular expansion factor used for the evaluation of the measurement uncertainty shall be stated.

---

## 8 Methods of measurement and limits for transmitter parameters

Where the interrogator is designed with an adjustable carrier, then all transmitter parameters shall be measured using the highest power level. The equipment shall then be set to the lowest carrier power setting and the measurements for spurious emissions shall be repeated (see clause 8.5).

### 8.1 Frequency error for mains operated equipment

#### 8.1.1 Definition

The frequency error, known as frequency drift, is the difference between the frequency of the device under test measured under normal test conditions (see clause 5.3) and the frequency measured under extreme conditions (see clause 5.4).

#### 8.1.2 Method of measurement of frequency error

The measurements shall be made with the interrogator set to transmit a continuous modulated carrier and performed at each of the applicable frequencies specified in clause 4.2.2.3.

a) Under normal conditions:

- The signal transmitted by the interrogator shall be connected by suitable means to the input of a frequency counter. The frequency displayed on the frequency counter shall be recorded.

b) Under extreme conditions:

- For each combination of extreme voltage and temperature (see clause 5.4) the frequency displayed on the frequency counter shall be recorded. Four values shall be measured.

#### 8.1.3 Limits

The maximum permitted frequency drift, defined as the absolute value of  $f_e - f$ , shall not exceed  $\pm 20$  ppm relative to the centre frequency of each of the applicable sub-bands, where:

- $f$  = the frequency measured under normal conditions (see clause 8.1.2, a)).
- $f_e$  = the maximum frequency drift as measured in clause 8.1.2, b).

### 8.2 Frequency stability under low voltage conditions

This test is for battery operated equipment. The measurement shall be made under normal temperature and humidity conditions (see clause 5.3.1).

#### 8.2.1 Definition

The frequency stability under low voltage conditions is the ability of the equipment to remain within its permitted frequency limits when the battery voltage falls below the lower extreme voltage level.

#### 8.2.2 Method of measurement

- Step 1: An interrogator shall be set up to transmit a continuous un-modulated carrier. The signal transmitted by the interrogator shall be connected by suitable means to the input of a frequency counter.
- Step 2: The frequency displayed on the frequency counter shall be recorded.

Step 3: The voltage from the test power source shall be reduced below the lower extreme test voltage limit towards zero. Whilst the voltage is reduced the carrier frequency shall be monitored.

### 8.2.3 Limits

The equipment shall either:

- transmit with a carrier frequency within the limits of  $\pm 20$  ppm whilst the radiated or conducted power is below the spurious emission limits; or
- automatically cease to function below the provider's declared operating voltage.

## 8.3 Radiated power (e.r.p.)

This measurement applies to equipment with an integral antenna and to equipment supplied with a dedicated antenna. Both radiated and conducted methods of measurement are permitted. Where the conducted method is used the conducted power shall be adjusted to take into account the gain of the antenna and be stated as e.r.p.

If the equipment is designed to operate with different carrier powers, the provider shall declare the rated power for each level or range of levels.

### 8.3.1 Definition

The effective radiated power is the power radiated by the antenna of an interrogator in its direction of maximum gain under specified conditions of measurement and in the absence of modulation.

### 8.3.2 Method of measurement

These measurements shall be performed with an un-modulated carrier at the highest power level at which the transmitter is intended to operate.

For both methods of measurement the measuring receiver shall be set up in accordance with the requirements of clause 6.6.

#### 8.3.2.1 Radiated measurement

This measurement shall be carried out under normal test conditions only (see clause 5.3).

- Step 1: On a test site, selected from annex A, the equipment shall be placed at the specified height on a support, as specified in annex A, and in the position closest to normal use as declared by the provider.
- Step 2: A test antenna shall be oriented initially for vertical polarization and shall be chosen to correspond to the carrier frequency of the interrogator. The output of the test antenna shall be connected to a measuring receiver.
- Step 3: The interrogator shall be set to transmit continuously, without modulation, and the measuring receiver shall be tuned to the frequency of the transmission under test.
- Step 4: The test antenna shall be raised and lowered through the specified heights until the maximum signal level is detected by the measuring receiver.
- Step 5: The interrogator shall then be rotated through 360 degrees in the horizontal plane, until the maximum signal level is detected by the measuring receiver.
- Step 6: The test antenna shall be raised and lowered again through the specified heights until the maximum signal level is detected by the measuring receiver. The maximum signal level detected by the measuring receiver shall be noted.

- Step 7: The antenna of the interrogator shall be rotated in the horizontal plane in both directions to positions where the signal at the measuring receiver is reduced by 3 dB. The total angle of rotation (which is the horizontal beamwidth of the antenna) shall be recorded.
- Step 8: The antenna of the interrogator shall be re-positioned in order to measure the vertical beamwidth and step 7 shall be repeated.
- Step 9: The interrogator shall be replaced by a substitution antenna as defined in clause A.1.5. The substitution antenna shall be connected to a calibrated signal generator. The substitution antenna shall be orientated for vertical polarization and the length of the substitution antenna shall be adjusted to correspond to the frequency of transmission of the interrogator. If necessary, the setting of the input attenuator of the measuring receiver shall be adjusted in order to increase the sensitivity of the measuring receiver.
- Step 10: The test antenna shall be raised and lowered through the specified heights to ensure that the maximum signal is received.
- Step 11: The input signal to the substitution antenna shall be adjusted to give a level at the measuring receiver that is equal to the radiated power previously measured from the interrogator, corrected for any change to the setting of the input attenuator to the measuring receiver.
- Step 12: The input level to the substitution antenna shall be recorded as power level, corrected for any change of input attenuator setting of the measuring receiver.
- Step 13: The measurement shall be repeated with the test antenna and the substitution antenna orientated for horizontal polarization.
- Step 14: The measure of the effective radiated power is the larger of the two levels recorded at the input to the substitution antenna, corrected if necessary for the gain of the substitution antenna.
- Step 15: With the interrogator fitted into a suitable test fixture, the relative change of the effective radiated power between normal and extreme test conditions (see clauses 5.4.1 and 5.4.2 applied simultaneously) shall be compared. Any increase in the radiated power under extreme conditions shall not cause the level to exceed the appropriate limit in table 4 of clause 8.3.3.

### 8.3.2.2 Conducted measurement

Where an interrogator is fitted with an external antenna connector it is permissible to measure the conducted power. In this case the provider shall declare the maximum gain and beamwidth(s) of the dedicated antenna(s) at the time that the equipment is presented for test.

- Step 1: The transmitter shall be connected to an artificial antenna (see clause 6.2) and the carrier or mean power delivered to this artificial antenna shall be measured under normal test conditions (see clause 5.3).
- Step 2: The measurement shall be repeated under extreme test conditions (see clauses 5.4.1 and 5.4.2 applied simultaneously).
- Step 3: The recorded value shall be corrected for each of the antenna gains and be stated in e.r.p.

### 8.3.3 Limits

The effective radiated power shall not exceed the power class value given in table 4.

**Table 4**

Power class	Frequency band	Power level (e.r.p)
11	865,0 MHz to 868,0 MHz	+20 dBm
12	865,6 MHz to 868,0 MHz	+27 dBm
13	865,6 MHz to 867,6 MHz	+33 dBm

The beamwidth(s) of the dedicated antenna(s) in both horizontal and vertical orientations shall comply with the following limits:

- For transmissions  $\leq 500$  mW beamwidths shall be  $\leq 90$  degrees.
- For transmissions 500 mW to 2 000 mW beamwidths shall be  $\leq 70$  degrees.

## 8.4 Transmitter spectrum mask

### 8.4.1 Definition

The transmitter spectrum mask defines the limits for all modulated signals including all side bands associated with the carrier above the permitted spurious level measured under normal and extreme conditions.

### 8.4.2 Method of measurement

The RF output of the equipment shall be connected to a spectrum analyser via a  $50 \Omega$  connector. In the case of equipment with an integral antenna, the equipment shall be placed in the test fixture (see clause 6.3) and the test fixture shall be connected to the spectrum analyser.

Measurements shall be made within the declared sub-bands of operation of the interrogator on those sub-bands requiring full tests as defined in figure 1.

- Step 1: The interrogator shall be operated at the carrier power measured under normal test conditions in clause 8.3. The attenuator shall be adjusted to give an appropriate display on the spectrum analyser screen.
- Step 2: The transmission from the interrogator shall be modulated by the normal test signal (see clause 6.1).
- Step 3: The output power of the interrogator, with or without a test fixture, shall be measured using a spectrum analyser, which shall be set to the following values:
- Resolution bandwidth: 3 kHz
  - Video bandwidth: 300 Hz
  - Sweep Time: AUTO
  - Span: 600 kHz
- Step 4: Using the method described in annex C, calibration of the power level displayed on the spectrum analyser shall be related to the power level measured in clause 8.3. The calculated relationship shall be used to determine absolute levels of RF power.
- Step 5: The absolute levels of RF power shall be compared to the spectrum mask at figure 2.

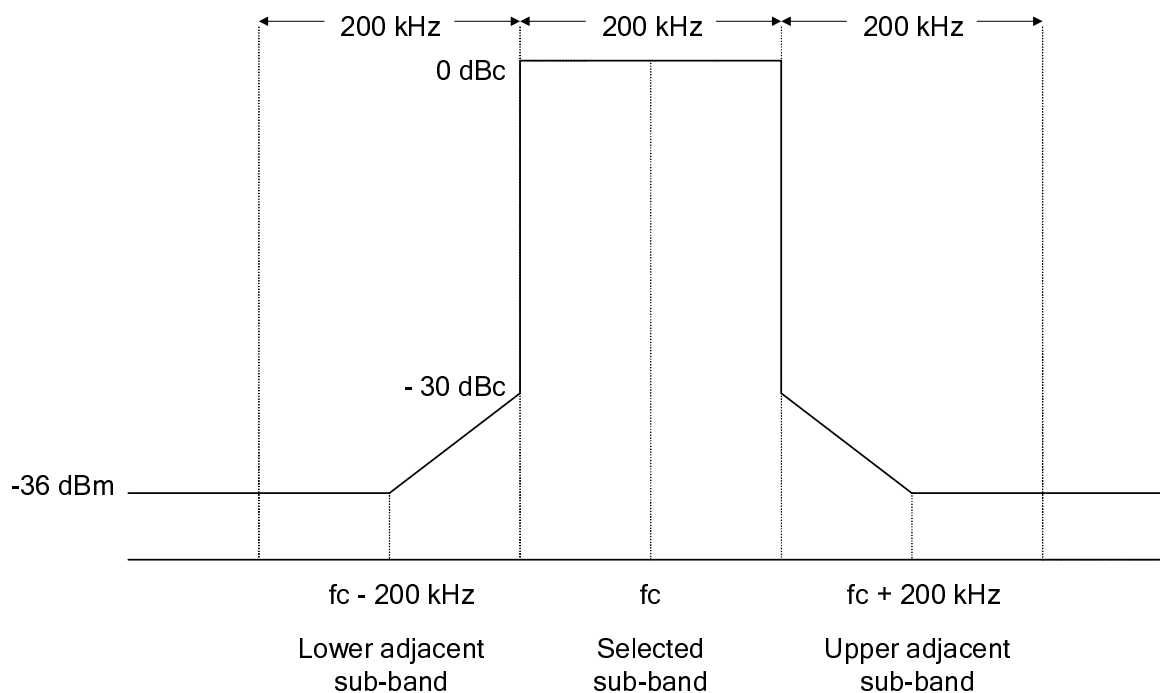

NOTE 1: Where  $f_c$  is the centre frequency of the carrier transmitted by the interrogator.

NOTE 2: The level outside  $\pm 300$  kHz from the carrier shall not exceed -36 dBm. For frequency components above 1 GHz the limit shall be -30 dBm.

**Figure 2: Spectrum mask for modulated signals**

### 8.4.3 Limits

The absolute levels of RF power at any frequency shall not exceed the limits defined in the spectrum mask at figure 2.

## 8.5 Spurious emissions

### 8.5.1 Definition

Spurious emissions are emissions at frequencies other than those of the carrier and intended sidebands associated with normal test modulation.

### 8.5.2 Method of measurement

Spurious emissions shall be measured at frequencies outside the band  $f_c \pm 600$  kHz where  $f_c$  is the carrier frequency of the interrogator. The level of spurious emissions shall be measured as:

either:

- a) i) their power level in a specified load (conducted spurious emission); and
- ii) their effective radiated power when radiated by the cabinet and structure of the equipment (cabinet radiation);

or:

- b) their effective radiated power when radiated by the cabinet and the integral antenna, in the case of equipment fitted with such an antenna and no external RF connector.

### 8.5.2.1 Method of measuring the power level in a specified load, clause 8.5.2, a) i)

This method applies only to equipment with an external antenna connector.

- Step 1: The interrogator shall be connected to a 50  $\Omega$  power attenuator. The output of the power attenuator shall be connected to a measuring receiver. The interrogator shall be set up to transmit a continuous carrier with normal test modulation.
- Step 2: The measuring receiver, (see clause 6.6) shall be tuned over the frequency range of 9 kHz to 12,75 GHz. To improve the accuracy of the measurement, a RF pre-selector may be added in order to avoid harmonic components being introduced by the mixer in the receiver.
- Step 3: At each frequency outside the band defined by  $f_c \pm 600$  kHz at which a spurious component is detected, the power level shall be recorded as the conducted spurious emission level delivered into the specified load.
- Step 4: The measurements shall be repeated with the interrogator on stand-by.

### 8.5.2.2 Method of measuring the effective radiated power, clause 8.5.2, a) ii)

This method applies only to equipment with an external antenna connector.

- Step 1: On a test site, selected from annex A, the equipment shall be placed at the specified height on a non-conducting support and in the position closest to normal use as declared by the provider.
- Step 2: The antenna connector of the interrogator shall be connected to an artificial antenna (see clause 6.2).
- Step 3: A test antenna shall be orientated for vertical polarization and the length of the test antenna shall be chosen to correspond to the instantaneous frequency of the measuring receiver. The output of the test antenna shall be connected to a measuring receiver.
- Step 4: The interrogator shall be set up to transmit a continuous carrier with normal test modulation.
- Step 5: The measuring receiver shall be tuned over the frequency range 25 MHz to 12,75 GHz, but excluding the band defined by  $f_c \pm 600$  kHz. The measurements shall be conducted with the measuring receiver set to the following values:
  - a) Resolution bandwidth:
    - For measurements at  $< 1$  GHz, set to 120 kHz.
    - For measurements at  $> 1$  GHz, set to 1 MHz.
  - b) Video bandwidth: 1 MHz (video averaging on).
  - c) Span: Frequency scan mode.
- Step 6: At each frequency at which a spurious component is detected, the test antenna shall be raised and lowered through the specified heights until a maximum signal level is detected by the measuring receiver.
- Step 7: The interrogator shall then be rotated through 360 degrees in the horizontal plane, until the maximum signal level is detected by the measuring receiver and the test antenna height shall be adjusted again for maximum signal level.
- Step 8: The maximum signal level detected by the measuring receiver shall be noted.
- Step 9: The interrogator shall be replaced by a substitution antenna as defined in clauses A.1.4 and A.1.5.
- Step 10: The substitution antenna shall be orientated for vertical polarization and calibrated for the frequency of the spurious component detected.
- Step 11: The substitution antenna shall be connected to a calibrated signal generator.



- Step 12: The frequency of the calibrated signal generator shall be set in turn to the frequency of each of the spurious components detected. If necessary the input attenuator setting of the measuring receiver shall be adjusted in order to increase the sensitivity of the measuring receiver.
- Step 13: The test antenna shall be raised and lowered through the specified range of heights to ensure that the maximum signal is received. (When a test site according to clause A.1.1 is used, the height of the antenna need not be varied).
- Step 14: The input signal to the substitution antenna shall be adjusted to give a level at the measuring receiver, that is equal to the level noted while the spurious component was measured, corrected for any change to the setting of the input attenuator of the measuring receiver.
- Step 15: The input level to the substitution antenna shall be recorded as a power level, corrected for any change of input attenuator setting of the measuring receiver.
- Step 16: The measurement shall be repeated with the test antenna and the substitution antenna orientated for horizontal polarization.
- Step 17: The measure of the effective radiated power of the spurious components is the larger of the two power levels recorded for each spurious component at the input to the substitution antenna, corrected if necessary for the gain of the substitution antenna.
- Step 18: If applicable, the measurements shall be repeated with the interrogator on standby.

### 8.5.2.3 Method of measuring effective radiated power, clause 8.5.2, b)

This method applies only to equipment without an external antenna connector. The method of measurement shall be performed according to clause 8.5.2.2, except that the interrogator output shall be connected to the integral antenna and not to an artificial antenna.

## 8.5.3 Limits

The power of any spurious emission, conducted or radiated, shall not exceed the values given in table 5.

**Table 5**

State	47 MHz to 74 MHz 87,5 MHz to 118 MHz 174 MHz to 230 MHz 470 MHz to 862 MHz	Other frequencies below 1 000 MHz	Frequencies above 1 000 MHz
Operating	4 nW	250 nW	1 $\mu$ W
Standby	2 nW	2 nW	20 nW

## 8.6 Transmission times

### 8.6.1 Definition

The transmission time is the period of continuous transmission generated by an interrogator following a "listen before talk" sequence.

The maximum period of continuous transmission and the period between consecutive transmissions on the same sub-band are specified in order to ensure most efficient use of available sub-bands for the general benefit of all users.

## 8.6.2 Method of measurement

This test is designed to verify that the interrogator shall transmit no longer than is necessary to perform the intended operation.

- Step 1: On a test site, selected from annex A, the equipment shall be placed at the specified height on a non-conducting support and in the position closest to normal use as declared by the provider. A small quantity of tags (typically up to 3) shall be positioned within the interrogation field of the interrogator.
- Step 2: A probe shall be positioned close to the antenna of the interrogator and arranged such that it will trigger a digital storage oscilloscope.
- Step 3: The interrogator shall initiate an interrogation sequence and the trace generated by the transmission shall be recorded on the digital storage scope. The length of the transmission shall be measured.
- Step 4: The interrogator shall then be configured to demonstrate reading an unlimited number of tags in the interrogation field. This may be achieved either by setting the interrogator to its "global scroll" mode with a single tag in the field or by replacing the tags with a test fixture that simulates an infinite number of tags.
- Step 5: The transmission from the interrogator shall be monitored on a digital storage oscilloscope using a probe positioned close to the antenna of the interrogator.
- Step 6: The maximum length of continuous transmission and the interval between repeated transmissions recorded on the digital storage oscilloscope shall comply with the limits in figure 3.

## 8.6.3 Limits

The manufacturer shall declare that the measured length of transmission at step 3 is no greater than is required to read the tags present in the field and to verify that there are no additional tags present.

In addition, the maximum length of continuous transmission and the interval between repeated transmissions measured at step 6 shall comply with the two limits in figure 3.

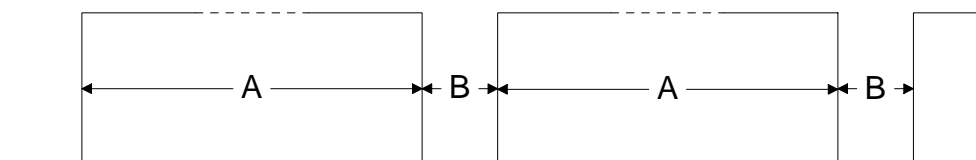

Figure 3: Repeated transmissions on the same sub-band

where:

- the duration of A shall not exceed 4 s;
- the duration of B shall be not less than 100 ms.

---

## 9 Receiver parameters

### 9.1 Receiver threshold in listen mode

It is a requirement that the interrogator shall be tested for satisfactory operation of the "listen before talk" feature.

### 9.1.1 Definition

The receiver threshold in the listen mode is defined as the minimum level of un-modulated carrier at the antenna of the interrogator that can be detected by its receiver.

### 9.1.2 Method of measurement

This measurement shall be conducted under normal conditions. The procedure to be adopted is described below.

- Step 1: A measurement antenna shall be positioned at a known point on a test site selected from annex A and connected either to a measurement receiver or spectrum analyser.
- Step 2: A signal source shall be positioned at a distance of 3 m from the measurement antenna in its direction of maximum gain in accordance with the layout in figure 4. The signal source shall be set to transmit a continuous carrier and its frequency tuned to the mid-point of the intended sub-band of operation of the interrogator. The signal from the signal source shall be adjusted to give a level at the measuring receiver equal to the appropriate threshold limit taken from table 6. The limit selected shall correspond to the tabulated threshold level associated with the maximum transmitted power of the interrogator under test.

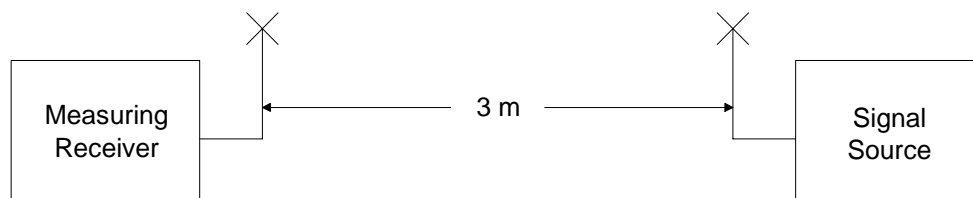

**Figure 4: Calibration of field level**

- Step 3: The measurement antenna shall be replaced by the interrogator under test. The antenna of the interrogator shall be orientated so that its direction of maximum gain is aligned with the signal source.
- Step 4: The measurement receiver shall be positioned at a convenient distance from the interrogator in accordance with the layout in figure 5. The sensitivity of the measurement receiver shall be adjusted to measure transmissions from the interrogator while not detecting transmissions from the signal source.

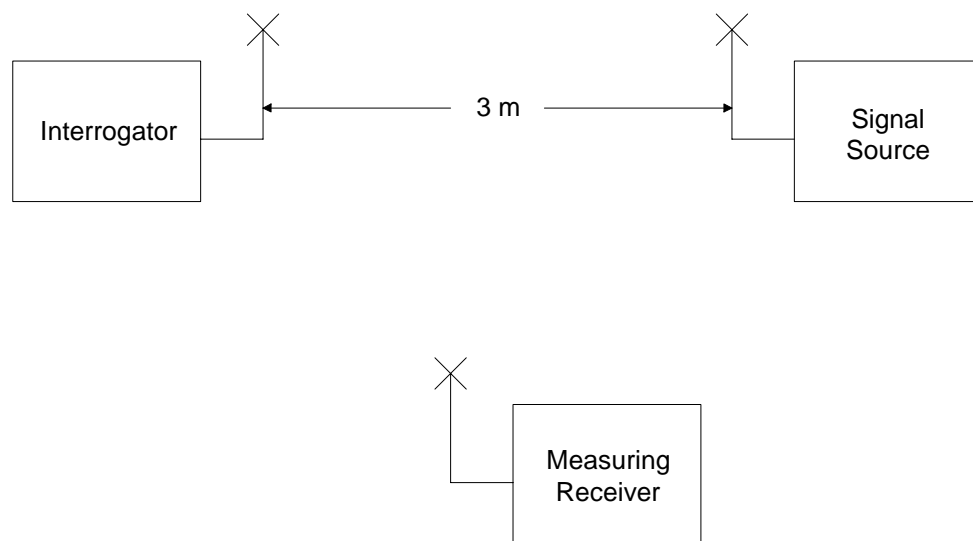

**Figure 5: Measurement of threshold level**

- Step 5: With the signal source switched off the interrogator shall be set up using the test software described in clause 4.2.4 to transmit at the lowest sub-band within its permitted band of operation. The interrogator shall be switched to scan mode.

- Step 6: The frequency of transmission of the interrogator shall be monitored to verify that it lies within the pre-selected sub-band.
- Step 7: The transmission from the interrogator shall be switched off.
- Step 8: The signal source shall be switched to transmit the calibrated signal at the centre frequency  $f_c$  of the pre-selected sub-band of operation of the interrogator. The interrogator shall be switched to scan mode. The carrier from the interrogator shall be monitored to verify that its centre frequency of transmission lies within the sub-band immediately above the pre-selected sub-band.
- Step 9: Transmission by the interrogator at the next higher sub-band demonstrates that the threshold level of its receiver successfully meets the permitted limit selected from the table in clause 9.1.3.
- Step 10: The test shall be repeated with the frequency of the signal source set to  $f_c + 75$  kHz and  $f_c - 75$  kHz.
- Step 11: The tests at steps 2 to 10 shall be repeated with the interrogator set to transmit at its highest permitted sub-band of operation. In the presence of a signal from the signal source, the centre frequency of the carrier from the interrogator shall lie within the lowest sub-band in its band of operation.
- Step 12: At its own discretion the test house may elect to verify correct operation of the "listen before talk" feature at other intermediate sub-bands.

### 9.1.3 Limits

The minimum permitted levels for the threshold of the receiver in the interrogator while in the "listen" mode are defined in table 6.

**Table 6: Levels of receiver threshold**

Transmit power	Threshold (e.r.p.)
Up to 100 mW	$\leq -83$ dBm
101 mW to 500 mW	$\leq -90$ dBm
501 mW to 2 W	$\leq -96$ dBm

It is permissible for the interrogator to operate at a lower threshold during the "talk" mode.

## 9.2 Listen time

The manufacturer shall declare that immediately prior to each transmission the receiver associated with the interrogator shall first monitor in accordance with the defined listen time for the presence of another signal within its intended sub-band of transmission. The listen time shall comprise a minimum period of 5 ms plus a random time of 0 ms to 5 ms in 11 steps of approximately 0,5 ms.

If the intended sub-band is free at the start of the listen time and remains free throughout the listen time, the random time shall be set to 0 ms.

If the intended sub-band is occupied either when the interrogator starts to listen or during the listen period, the listen time, which shall include the random time, shall commence after the sub-band becomes available. If, upon detection of the original sub-band being occupied, the interrogator changes to an unoccupied sub-band, then the listen time on the new sub-band shall commence with the random time set to 0 ms.

If the interrogator is permitted to transmit, it shall initiate transmission within 1 ms of completion of the listen time.

## 9.3 Blocking or desensitisation in listen mode

### 9.3.1 Definition

Blocking or desensitisation in the listen mode is a measure of the capability of the receiver to detect satisfactorily a transmission from another user on the wanted sub-band while rejecting an unwanted signal at frequencies other than those of the spurious responses or the adjacent sub-bands or bands.

### 9.3.2 Method of measurement

This measurement shall be conducted under normal conditions.

#### 9.3.2.1 Method of measuring radiated signals

- Step 1: A measurement antenna shall be positioned at a known point on a test site selected from annex A and connected either to a measurement receiver or spectrum analyser.
- Step 2: A signal source A shall be positioned at a distance of 3 m from the measurement antenna in its direction of maximum gain.
- Step 3: A second signal source B shall be positioned at a distance of 3 m from the measurement antenna and within its beam-width in accordance with the layout in figure 6. The position of signal source B shall be so arranged as to minimise any interference with signal source A (e.g. near field coupling shall be avoided).
- Step 4: Signal source A shall be set to transmit a continuous carrier and its frequency tuned to the mid-point of the intended sub-band of operation of the interrogator. The signal from signal source A shall be adjusted to give a level at the measurement receiver that is 3 dB above the appropriate threshold limit taken from table 6. The limit selected shall correspond to the tabulated threshold level associated with the maximum transmitted power of the interrogator under test.
- Step 5: With signal source A switched off, signal source B shall be adjusted to radiate an un-modulated signal at a test frequency that lies 1 MHz to 10 MHz above the selected carrier frequency of source A. The signal from signal source B shall be adjusted to give a level at the measurement receiver of not less than the limit in clause 9.3.3.

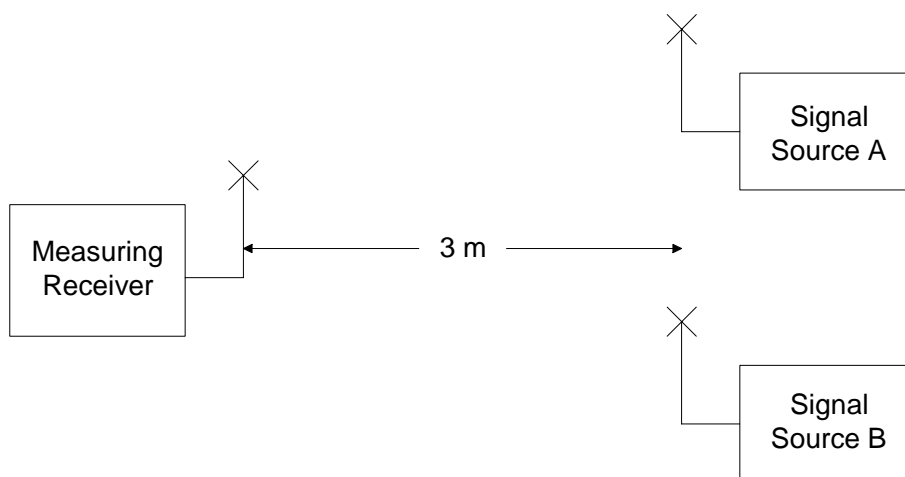

**Figure 6: Calibration of field levels**

- Step 6: The measurement antenna shall be replaced by the interrogator under test. The antenna of the interrogator shall be orientated so that its direction of maximum gain is aligned with the signal sources A and B.

- Step 7: The measurement receiver shall be positioned at a convenient distance from the interrogator in accordance with the layout in figure 7. The sensitivity of the measurement receiver shall be adjusted to measure transmissions from the interrogator while not detecting transmissions from the signal sources A and B.

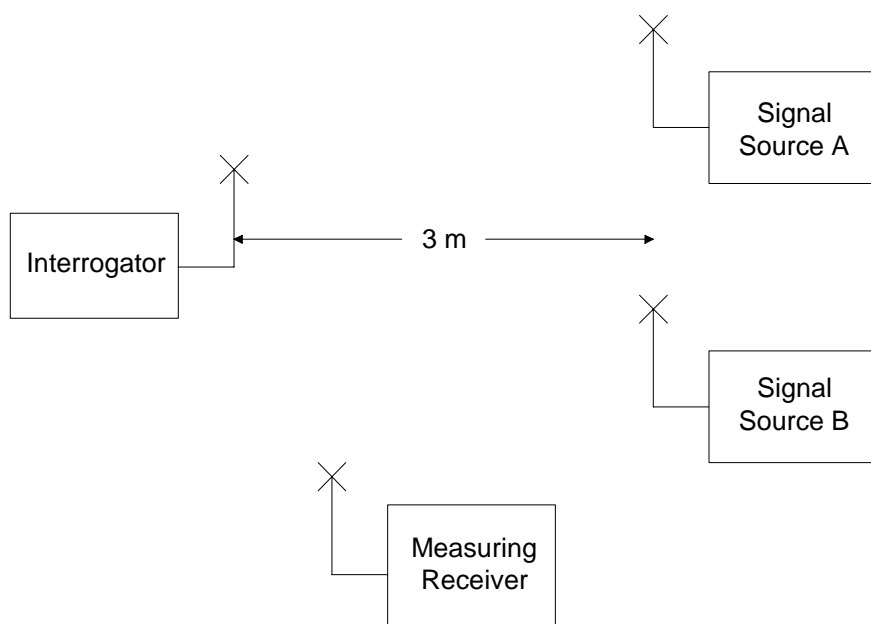

**Figure 7: Radiated measurement of blocking**

- Step 8: The interrogator shall be set up using the test software described in clause 4.2.4 to transmit at its intended sub-band of operation. With signal source A switched on and signal source B switched off, the interrogator shall be switched to scan mode.
- Step 9: The transmission from the interrogator shall be monitored to verify that its centre frequency lies within the sub-band immediately above the pre-selected sub-band. Note that in the special case where the uppermost sub-band is selected, an interrogator, which has correctly detected the signal source A, shall transmit on the lowest permitted sub-band.
- Step 10: The transmission from the interrogator shall be switched off.
- Step 11: With both signal sources switched on the interrogator shall be switched to scan mode. The frequency of transmission from the interrogator shall be monitored.
- Step 12: If the frequency of transmission from the interrogator lies within the sub-band immediately above the pre-selected sub-band, the interrogator has successfully detected the signal from source A in the presence of a blocking signal. If transmission by the interrogator lies within the pre-selected sub-band, the interrogator has failed to detect the signal from source A in the presence of a blocking signal.
- Step 13: The measurements shall be made with signal source B set to transmit at approximately +1 MHz, +2 MHz, +5 MHz and +10 MHz from the selected carrier frequency of source A.
- Step 14: The measurements shall be repeated with signal source B set to transmit at approximately -1 MHz, -2 MHz, -5 MHz and -10 MHz from the selected carrier frequency of source A.

### 9.3.2.2 Conducted method of measurement

Where the interrogator is fitted with an external antenna connector, the measurement may be made using power splitters.

- Step 1: The interrogator shall be set up using the test software described in clause 4.2.4 to transmit at its intended sub-band of operation. The external antenna connector shall be connected to a power splitter. One input to the power splitter shall be connected via an attenuator to a measurement receiver. The other input shall be connected to a second power splitter.

- Step 2: One input to the second power splitter shall be connected to a signal generator A. The second input shall be connected to signal generator B. A diagram of the test configuration is shown at figure 8.

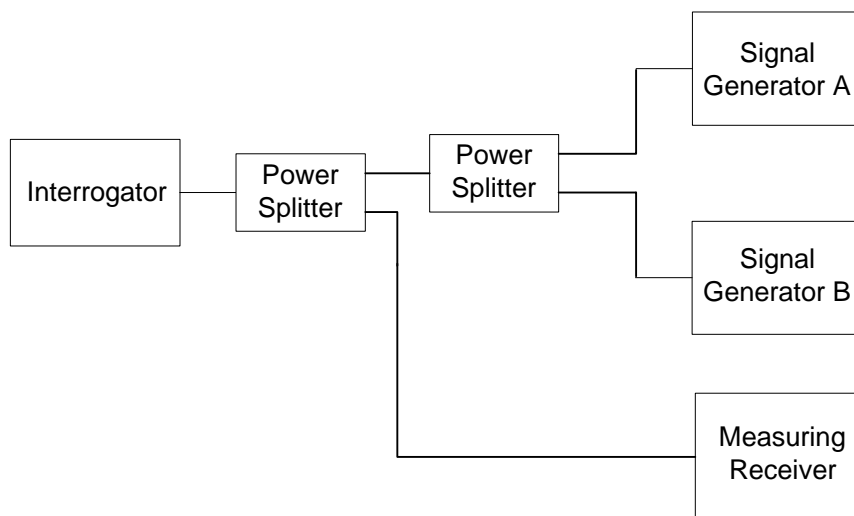

**Figure 8: Conducted measurement of blocking**

- Step 3: Signal generator A shall be adjusted to produce an un-modulated continuous carrier with its frequency tuned to the mid-point of the intended sub-band of operation of the interrogator. The signal shall be adjusted to give a level at the input to the receiver of the interrogator that is 3 dB above the appropriate threshold limit taken from table 6. The limit selected shall correspond to the tabulated threshold level associated with the maximum transmitted power of the interrogator under test. The level of signal from the signal generator shall be adjusted for any loss in the power splitters and for the antenna gain of the interrogator to give the corrected signal received by the interrogator.
- Step 4: Signal generator B shall be set up to produce an un-modulated signal at a test frequency that lies 1 MHz to 10 MHz above the selected frequency of source A. The signal from signal generator B shall be adjusted to give a level at the input to the receiver of the interrogator that is not less than the limit in clause 9.3.3. The level of signal from the signal generator shall be adjusted for any loss in the power splitters and for the antenna gain of the interrogator to give the corrected signal received by the interrogator.
- Step 5: With signal generator A switched on and signal generator B switched off, the interrogator shall be switched to scan mode.
- Step 6: The transmission from the interrogator shall be monitored by the measuring receiver to verify that its centre frequency lies within the sub-band immediately above the pre-selected sub-band. Note that in the special case where the uppermost sub-band is selected, an interrogator, which has correctly detected the wanted signal, shall transmit on the lowest permitted sub-band.
- Step 7: The transmission from the interrogator shall be switched off.
- Step 8: With both signal generators switched on the interrogator shall be switched to scan mode. The frequency of transmission from the interrogator shall be monitored.
- Step 9: If the frequency of transmission from the interrogator lies within the sub-band immediately above the pre-selected sub-band, the interrogator has successfully detected the signal from source A in the presence of the blocking signal. Where transmission by the interrogator lies within the pre-selected sub-band, the interrogator failed to detect the signal from source A in the presence of the blocking signal.
- Step 10: The measurements shall be made with signal source B set to transmit at approximately +1 MHz, +2 MHz, +5 MHz and +10 MHz from the selected frequency of source A.
- Step 11: The measurements shall be repeated with signal source B set to transmit at approximately -1 MHz, -2 MHz, -5 MHz and -10 MHz from the selected frequency of source A.

### 9.3.3 Limits

The blocking level of the equipment under the above specified conditions shall be equal to or greater than -35 dBm.

## 9.4 Adjacent sub-band selectivity in talk mode

This measurement is required to ensure satisfactory operation of equipment in accordance with the sub-band plan.

### 9.4.1 Definition

The adjacent sub-band selectivity in the talk mode is a measure of the capability of the receiver to identify a tag while rejecting an unwanted signal in the adjacent sub-band.

### 9.4.2 Method of measurement

This measurement shall be conducted under normal conditions.

#### 9.4.2.1 Method of measuring radiated signals

- Step 1: An interrogator shall be set up to operate on a known sub-band either in an anechoic chamber or on an open air test site as specified in annex A.
- Step 2: A tag in its preferred orientation shall be moved slowly towards the interrogator in the direction of maximum gain of its antenna to a point where it is just identified. The distance  $d$  between the antenna of the interrogator and the tag shall be measured.
- Step 3: The tag shall then be moved to a new position that is at a distance of  $0,7 \times d$  from the interrogator in the direction of maximum gain of its antenna.
- Step 4: A signal generator shall be set up at a distance of 3 m from the interrogator in the direction of maximum gain of its antenna.
- Step 5: The signal generator shall be adjusted to radiate an unmodulated signal at a test frequency that lies at the mid-point of the upper adjacent sub-band.
- Step 6: The level of the signal generator shall be increased until the interrogator just ceases to identify the tag. The level of the signal generator shall then be reduced in 1 dB steps until the interrogator just identifies the tag again.
- Step 7: The interrogator shall be removed and replaced by a measurement antenna connected to a measurement receiver. The level of signal from the signal generator received at the measurement receiver shall be recorded.
- Step 8: The measurement shall be repeated for the lower adjacent sub-band.
- Step 9: The absolute level of the signals received by the measurement receiver from the signal generator shall be not less than the limit specified in clause 9.4.3.

#### 9.4.2.2 Method of measuring using power splitter

Where the interrogator is fitted with an external antenna connector, the measurement may be made using a power splitter.

- Step 1: An interrogator shall be set up to operate on a known sub-band either in an anechoic chamber or on an open air test site. One input to a power splitter shall be connected to the antenna of the interrogator. The second input shall be connected to a signal generator and the third input shall be connected to the antenna connector of the interrogator.
- Step 2: With the signal generator switched off a tag in its preferred orientation shall be moved slowly towards the interrogator in the direction of maximum gain of its antenna to a point where it is just identified. The distance  $d$  between the antenna of the interrogator and the tag shall be measured.



- Step 3: The tag shall then be moved to a new position that is at a distance of  $0,7 \times d$  from the interrogator in the direction of maximum gain of its antenna.
- Step 4: The signal generator shall be adjusted to produce an un-modulated signal at a test frequency that lies at the mid-point of the upper adjacent sub-band.
- Step 5: The level of the signal generator shall be increased until the interrogator just ceases to identify the tag. The level of the signal generator shall then be reduced in 1 dB steps until the interrogator just identifies the tag again. The level of signal from the signal generator shall be recorded.
- Step 6: The level of signal from the signal generator shall be adjusted to compensate for any loss in the power splitter and for the antenna gain of the interrogator to give the corrected signal received by the interrogator.
- Step 7: The measurement shall be repeated for the lower adjacent sub-band.
- Step 8: At the discretion of the test house the measurement may be repeated on other sub-bands.
- Step 9: The absolute level of the corrected signals received by the interrogator from the signal generator shall be not less than the limit specified in clause 9.4.3.

### 9.4.3 Limits

The adjacent sub-band selectivity of the equipment under the above specified conditions shall be equal to or greater than -35 dBm.

## 9.5 Blocking or desensitisation in talk mode

### 9.5.1 Definition

Blocking or desensitisation in the talk mode is a measure of the capability of the receiver to identify a tag in the presence of an unwanted input signal at frequencies other than those of the spurious responses or the adjacent sub-bands or bands, see clause 9.1.

### 9.5.2 Method of measurement

This measurement shall be conducted under normal conditions.

#### 9.5.2.1 Method of measuring radiated signals

- Step 1: An interrogator shall be set up to operate on a known sub-band either in an anechoic chamber or on an open air test site.
- Step 2: A tag in its preferred orientation shall be moved slowly towards the interrogator in the direction of maximum gain of its antenna to a point where it is just identified. The distance  $d$  between the antenna of the interrogator and the tag shall be measured.
- Step 3: The tag shall then be moved to a new position that is at a distance of  $0,7 \times d$  from the interrogator in the direction of maximum gain of its antenna.
- Step 4: A signal generator shall be set up at a distance of 3 m from the interrogator in the direction of maximum gain of its antenna.
- Step 5: The signal generator shall be adjusted to radiate an un-modulated signal at a test frequency that lies 1 MHz to 10 MHz above the carrier frequency of the interrogator.
- Step 6: The level of the signal generator shall be increased until the interrogator just ceases to identify the tag. The level of the signal generator shall then be reduced in 1 dB steps until the interrogator just identifies the tag again.

- Step 7: The interrogator shall be removed and replaced by a measurement antenna connected to a measurement receiver. The level of signal from the signal generator received at the measurement receiver shall be recorded.
- Step 8: The measurements shall be at approximately +1 MHz, +2 MHz, +5 MHz and +10 MHz from the carrier frequency of the interrogator.
- Step 9: The tests shall be repeated at approximately -1 MHz, -2 MHz, -5 MHz and -10 MHz from the carrier frequency of the interrogator.
- Step 10: The blocking or desensitization shall be recorded as the highest level in dBm of the unwanted signal at which it is just possible to identify a tag.

### 9.5.2.2 Method of measuring using power splitter

Where the interrogator is fitted with an external antenna connector, the measurement may be made using a power splitter.

- Step 1: An interrogator shall be set up to operate on a known sub-band either in an anechoic chamber or on an open air test site. One input to a power splitter shall be connected to the antenna of the interrogator. The second input shall be connected to a signal generator and the third input shall be connected to the antenna connector of the interrogator.
- Step 2: With the signal generator switched off a tag in its preferred orientation shall be moved slowly towards the interrogator in the direction of maximum gain of its antenna to a point where it is just identified. The distance  $d$  between the antenna of the interrogator and the tag shall be measured.
- Step 3: The tag shall then be moved to a new position that is at a distance of  $0,7 \times d$  from the interrogator in the direction of maximum gain of its antenna.
- Step 4: The signal generator shall be adjusted to produce an un-modulated signal at a test frequency that lies 1 MHz to 10 MHz above the carrier frequency of the interrogator.
- Step 5: The level of the signal generator shall be increased until the interrogator just ceases to identify the tag. The level of the signal generator shall then be reduced in 1 dB steps until the interrogator just identifies the tag again. The level of signal from the signal generator shall be recorded.
- Step 6: The measurements shall be at approximately +1 MHz, +2 MHz, +5 MHz and +10 MHz from the carrier frequency of the interrogator.
- Step 7: The tests shall be repeated at approximately -1 MHz, -2 MHz, -5 MHz and -10 MHz from the carrier frequency of the interrogator.
- Step 8: The recorded signals from the signal generator shall be adjusted to compensate for any loss in the power splitter and for the antenna gain of the interrogator to give the corrected signals received by the interrogator.
- Step 9: The blocking or desensitisation shall be recorded as the highest level in dBm of the unwanted signal at which it is just possible to identify a tag.

### 9.5.3 Limits

The blocking level of the equipment under the above specified conditions shall be equal to or greater than -35 dBm.

## 9.6 Spurious emissions

### 9.6.1 Definition

Spurious emissions from the receiver of an interrogator are components at any frequency, radiated by the equipment and antenna.

The level of spurious emissions shall be measured by:

either:

- a) i) their power level in a specified load (conducted spurious emission); and
- ii) their effective radiated power when radiated by the cabinet and structure of the equipment (cabinet radiation);

or:

- b) their effective radiated power when radiated by the cabinet and the integral antenna, in the case of equipment fitted with such an antenna and no external RF connector.

### 9.6.2 Method of measurement

This measurement shall be conducted under normal conditions.

#### 9.6.2.1 Method of measuring the power level in a specified load, clause 9.6.1, a) i)

This method applies only to equipment with an external antenna connector.

- Step 1: The interrogator shall be connected to a 50  $\Omega$  attenuator. The output of the attenuator shall be connected to a measuring receiver.
- Step 2: The receiver of the interrogator shall be switched on and the measuring receiver shall be tuned over the frequency range of 9 kHz to 12,75 GHz.
- Step 3: At each frequency at which a spurious component is detected, the power level shall be recorded as the spurious level delivered into the specified load.

#### 9.6.2.2 Method of measuring the effective radiated power, clause 9.6.1, a) ii)

This method applies only to equipment with an external antenna socket.

- Step 1: On a test site, selected from annex A, the interrogator shall be placed at the specified height on a non-conducting support and in the position closest to normal use as declared by the provider. The antenna connector shall be connected to an artificial antenna (see clause 6.2).
- Step 2: A test antenna shall be orientated for vertical polarization and the length of the test antenna shall be chosen to correspond to the instantaneous frequency of a measuring receiver. The output of the test antenna shall be connected to the measuring receiver.
- Step 3: The receiver in the interrogator (but not the transmitter) shall be switched on and the measuring receiver shall be tuned over the frequency range 25 MHz to 12,75 GHz. At each frequency at which a spurious component is detected, the test antenna shall be raised and lowered through the specified heights until a maximum signal level is detected by the measuring receiver. When a test site according to clause A.1.1 is used, there is no need to vary the height of the antenna.
- Step 4: The transmitter shall then be rotated through 360 degrees in the horizontal plane, until the maximum signal level is detected by the measuring receiver. The test antenna height shall be adjusted again for maximum signal level.
- Step 5: The maximum signal level detected by the measuring receiver shall be noted.
- Step 6: The interrogator shall be replaced by a substitution antenna as defined in clause A.1.5.

- Step 7: The substitution antenna shall be orientated for vertical polarization and calibrated for the frequency of the spurious component detected.
- Step 8: The substitution antenna shall be connected to a calibrated signal generator.
- Step 9: The frequency of the calibrated signal generator shall be set to the frequency of the spurious component detected. If necessary the input attenuator setting of the measuring receiver shall be adjusted in order to increase the sensitivity of the measuring receiver.
- Step 10: The test antenna shall be raised and lowered through the specified range of height to ensure that the maximum signal is received. The input signal to the substitution antenna shall be adjusted to give a level at the measuring receiver that is equal to the level noted while the spurious component was measured, corrected for any change to the setting of the input attenuator of the measuring receiver.
- Step 11: The input level to the substitution antenna shall be recorded as power level, corrected for any change of input attenuator setting of the measuring receiver.
- Step 12: The measurement shall be repeated with the test antenna and the substitution antenna orientated for horizontal polarization.
- Step 13: The measure of the effective radiated power of the spurious components is the larger of the two power levels recorded for each spurious component at the input to the substitution antenna, corrected for the gain of the substitution antenna if necessary.

### 9.6.2.3 Method of measuring the effective radiated power, clause 9.6.1, b)

This method applies only to equipment without an external antenna connector.

The method of measurement shall be performed according to clause 9.6.2.2, except that the receiver input shall be connected to the integral antenna and not to an artificial antenna.

### 9.6.3 Limits

The power of any spurious emission, radiated or conducted, shall not exceed the values given below:

- 2 nW below 1 000 MHz;
- 20 nW above 1 000 MHz.

---

## 10 Limits and methods of measurement for tag emissions outside the sub-band edges

### 10.1 Definition

Tag emissions outside the sub-band edges are the spurious emissions from a continuously modulated tag measured outside the upper and lower edges of its sub-band of operation when orientated for optimum coupling at a defined distance from the antenna of an interrogator that is transmitting a continuous un-modulated carrier at its maximum power level as declared by the provider.

## 10.2 Method of measurement

This method applies both to interrogators with an external or an integral antenna. The measurement shall be conducted under normal conditions.

The measurement shall be performed using the same interrogator and antenna under the same set-up conditions as used for the measurement of effective radiated power in clause 8.3.

- Step 1: On a test site, selected from annex A, the interrogator shall be placed at the specified height on a non-conducting support and in the position closest to normal use as declared by the provider.
- Step 2: The tag under test shall be positioned at a distance of 20 cm from the antenna of the interrogator in its direction of maximum gain and in an orientation that provides optimum coupling with the transmitted signal. The tag shall be set up to transmit a continuous modulated response as described in clause 4.2.4, section 4. The interrogator shall be set to operate at a single carrier frequency on a sub-band determined by the test house. The interrogator shall provide an initial "wake up response" to activate the tag followed by a continuous carrier at the maximum transmission level of the equipment.
- Step 3: The measurement shall be carried out using a measuring receiver set to the following values:
- a) Resolution bandwidth: 3 kHz;
  - b) Video bandwidth: 300 Hz;
  - c) Sweep time: AUTO;
  - d) Span: 10 MHz.
- Step 4: A test antenna shall be positioned at a distance of 2 m from the tag in the direction of maximum gain of the antenna of the interrogator. The test antenna shall be connected to the measurement receiver. The test antenna shall be orientated to obtain maximum signal.
- Step 5: A plot of the combined emissions from both the tag and interrogator shall then be recorded. This plot shall cover the band from 861 MHz to 871 MHz.
- Step 6: The tag shall be removed from the proximity of the interrogator. Without moving the test antenna and the interrogator a plot shall again be taken across the same frequency range.
- Step 7: The absolute level of radiated power from the interrogator shall be assumed to be the same as the figure recorded during the measurement in clause 8.3. The difference in levels between the two plots is the level of emissions from the tag.

## 10.3 Limits

The emissions from the tag at any frequency outside the sub-band edges of the interrogator shall not exceed the levels defined in the spectrum mask in figure 9.

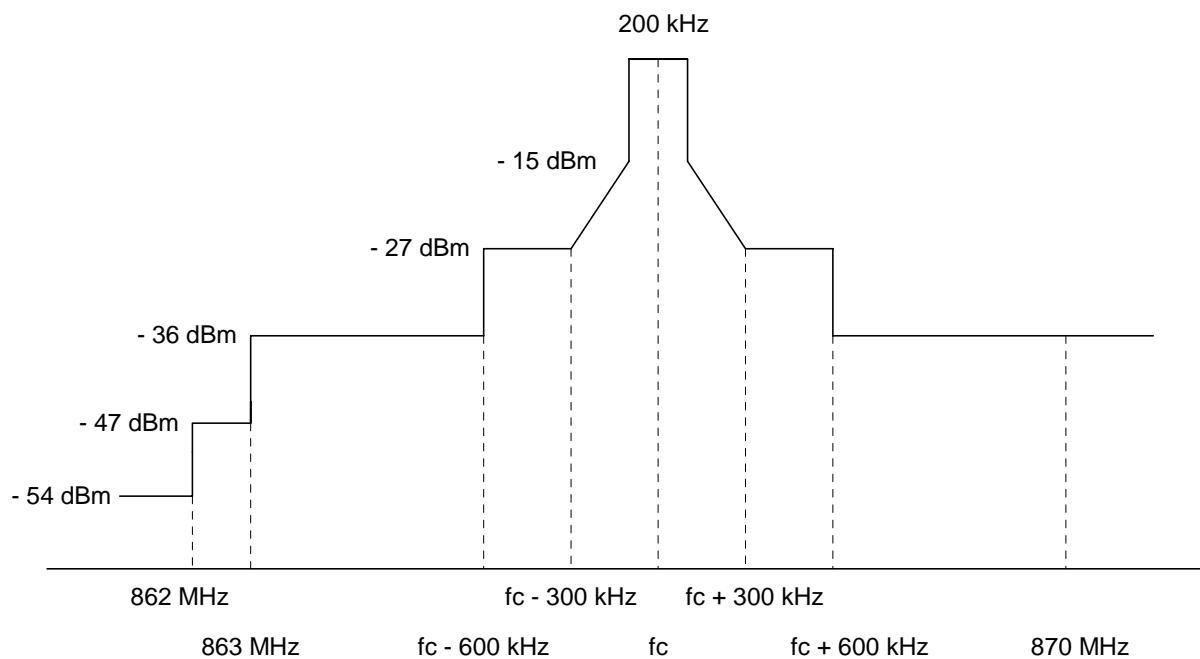

NOTE: Where  $f_c$  is the centre frequency of the carrier transmitted by the interrogator.

**Figure 9: Spectrum mask for tag emissions outside sub-band edges**

## Annex A (normative): Radiated measurement

This annex is applicable to the assessment of data or equipment providing a specific response.

It covers test sites and methods to be used with integral antenna equipment or equipment having an antenna connector.

### A.1 Test sites and general arrangements for measurements involving the use of radiated fields

This annex introduces three most commonly available test sites, an anechoic chamber, an anechoic chamber with a ground plane and an Open Area Test Site (OATS), which may be used for radiated tests. These test sites are generally referred to as free field test sites. Both absolute and relative measurements can be performed in these sites. Where absolute measurements are to be carried out, the chamber should be verified. A detailed verification procedure is described in TR 102 273 [5] relevant parts 2, 3 and 4.

**NOTE:** To ensure reproducibility and tractability of radiated measurements only these test sites should be used in measurements in accordance with the present document.

#### A.1.1 Anechoic chamber

An anechoic chamber is an enclosure, usually shielded, whose internal walls, floor and ceiling are covered with radio absorbing material, normally of the pyramidal urethane foam type. The chamber usually contains an antenna support at one end and a turntable at the other. A typical anechoic chamber is shown in figure A.1.

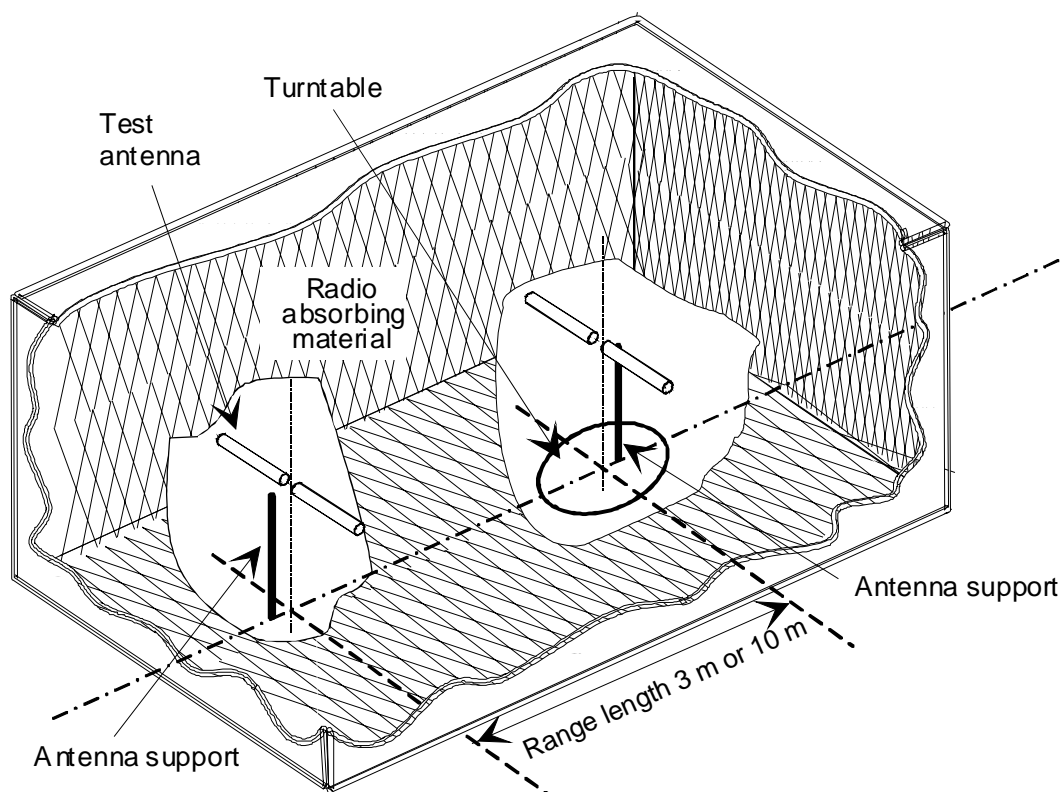

Figure A.1: A typical anechoic chamber

The chamber shielding and radio absorbing material work together to provide a controlled environment for testing purposes. This type of test chamber attempts to simulate free space conditions.

The shielding provides a test space, with reduced levels of interference from ambient signals and other outside effects, whilst the radio absorbing material minimizes unwanted reflections from the walls and ceiling which can influence the measurements. In practice it is relatively easy for shielding to provide high levels (80 dB to 140 dB) of ambient interference rejection, normally making ambient interference negligible.

A turntable is capable of rotation through 360 degrees in the horizontal plane and it is used to support the test sample (EUT) at a suitable height (e.g. 1 m) above the ground plane. The chamber shall be large enough to allow the measuring distance of at least 3 m or  $2(d_1+d_2)^2/\lambda$  (m), whichever is greater (see clause A.2.4). The distance used in actual measurements shall be recorded with the test results.

The anechoic chamber generally has several advantages over other test facilities. There is minimal ambient interference, minimal floor, ceiling and wall reflections and it is independent of the weather. It does however have some disadvantages which include limited measuring distance and limited lower frequency usage due to the size of the pyramidal absorbers. To improve low frequency performance, a combination structure of ferrite tiles and urethane foam absorbers is commonly used.

All types of emission, sensitivity and immunity testing can be carried out within an anechoic chamber without limitation.

## A.1.2 Anechoic chamber with a conductive ground plane

An anechoic chamber with a conductive ground plane is an enclosure, usually shielded, whose internal walls and ceiling are covered with radio absorbing material, normally of the pyramidal urethane foam type. The floor, which is metallic, is not covered and forms the ground plane. The chamber usually contains an antenna mast at one end and a turntable at the other. A typical anechoic chamber with a conductive ground plane is shown in figure A.2.

This type of test chamber attempts to simulate an ideal Open Area Test Site whose primary characteristic is a perfectly conducting ground plane of infinite extent.

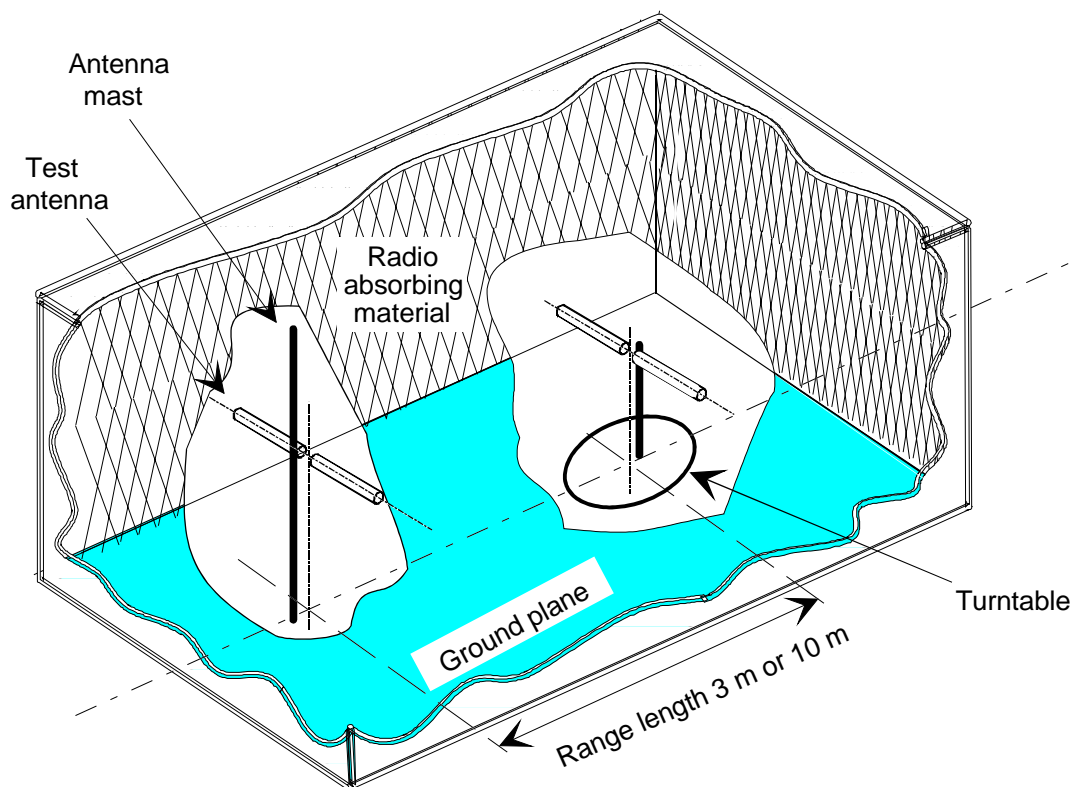

**Figure A.2: A typical Anechoic Chamber with a conductive ground plane**



In this facility the ground plane creates the wanted reflection path, such that the signal received by the receiving antenna is the sum of the signals from both the direct and reflected transmission paths. This creates a unique received signal level for each height of the transmitting antenna (or EUT) and the receiving antenna above the ground plane.

The antenna mast provides a variable height facility (from 1 m to 4 m) so that the position of the test antenna can be optimized for maximum coupled signal between antennas or between an EUT and the test antenna.

A turntable is capable of rotation through 360 degrees in the horizontal plane and it is used to support the test sample (EUT) at a specified height, usually 1,5 m above the ground plane. The chamber shall be large enough to allow the measuring distance of at least 3 m or  $2(d_1+d_2)^2/\lambda$  (m), whichever is greater (see clause A.2.4). The distance used in actual measurements shall be recorded with the test results.

Emission testing involves firstly "peaking" the field strength from the EUT by raising and lowering the receiving antenna on the mast (to obtain the maximum constructive interference of the direct and reflected signals from the EUT) and then rotating the turntable for a "peak" in the azimuth plane. At this height of the test antenna on the mast, the amplitude of the received signal is noted. Secondly the EUT is replaced by a substitution antenna (positioned at the EUT's phase or volume centre) which is connected to a signal generator. The signal is again "peaked" and the signal generator output adjusted until the level, noted in stage one, is again measured on the receiving device.

Receiver sensitivity tests over a ground plane also involve "peaking" the field strength by raising and lowering the test antenna on the mast to obtain the maximum constructive interference of the direct and reflected signals, this time using a measuring antenna which has been positioned where the phase or volume centre of the EUT will be during testing. A transform factor is derived. The test antenna remains at the same height for stage two, during which the measuring antenna is replaced by the EUT. The amplitude of the transmitted signal is reduced to determine the field strength level at which a specified response is obtained from the EUT.

### A.1.3 Open Area Test Site (OATS)

An Open Area Test Site comprises a turntable at one end and an antenna mast of variable height at the other end above a ground plane, which in the ideal case, is perfectly conducting and of infinite extent. In practice, whilst good conductivity can be achieved, the ground plane size has to be limited. A typical Open Area Test Site is shown in figure A.3.

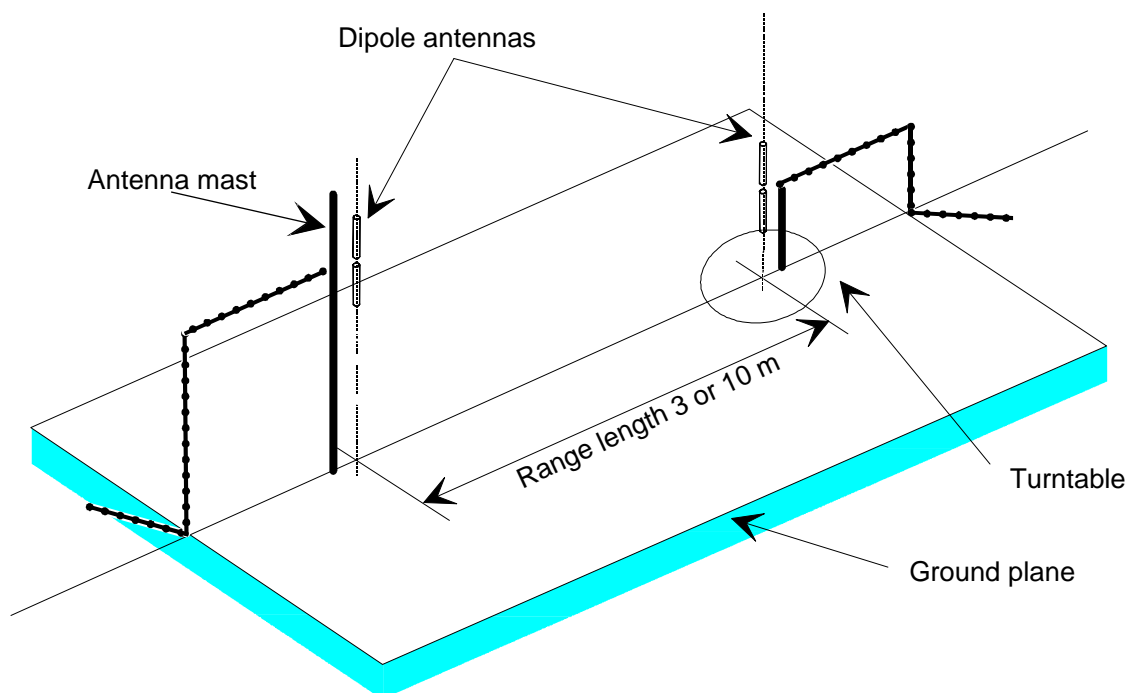
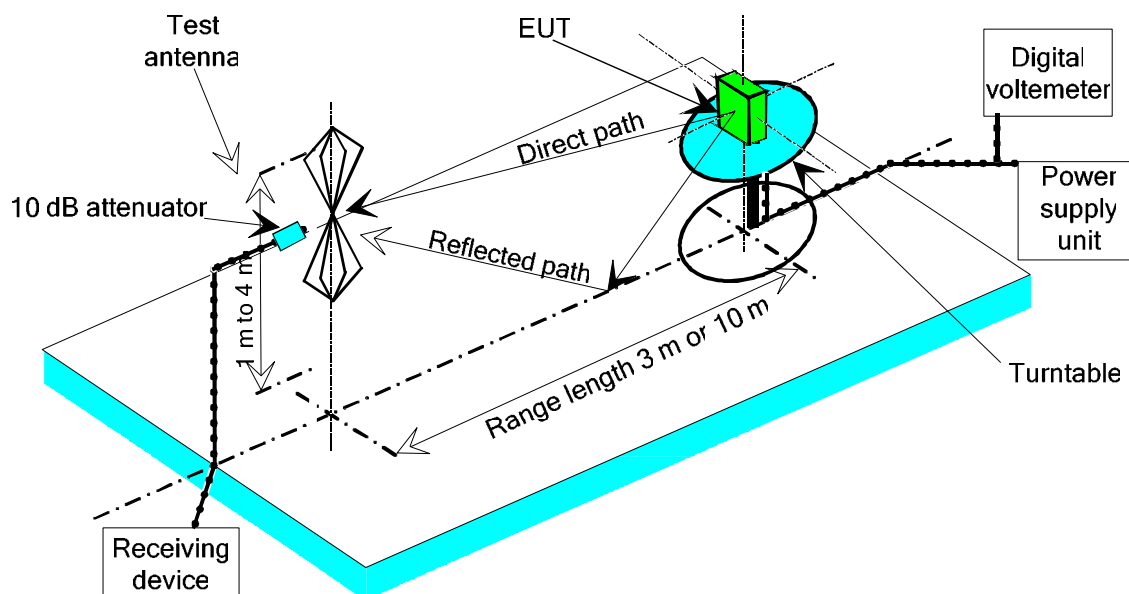

Figure A.3: A typical Open Area Test Site

The ground plane creates a wanted reflection path, such that the signal received by the receiving antenna is the sum of the signals received from the direct and reflected transmission paths. The phasing of these two signals creates a unique received level for each height of the transmitting antenna (or EUT) and the receiving antenna above the ground plane.

Site qualification concerning antenna positions, turntable, measurement distance and other arrangements are same as for anechoic chamber with a ground plane. In radiated measurements an OATS is also used by the same way as anechoic chamber with a ground plane.

Typical measuring arrangement common for ground plane test sites is presented in the figure A.4.



**Figure A.4: Measuring arrangement on ground plane test site (OATS set-up for spurious emission testing)**

## A.1.4 Test antenna

A test antenna is always used in radiated test methods. In emission tests (i.e. frequency error, effective radiated power, spurious emissions and adjacent sub-band power) the test antenna is used to detect the field from the EUT in one stage of the measurement and from the substitution antenna in the other stage. When the test site is used for the measurement of receiver characteristics (i.e. sensitivity and various immunity parameters) the antenna is used as the transmitting device.

The test antenna should be mounted on a support capable of allowing the antenna to be used in either horizontal or vertical polarization which, on ground plane sites (i.e. anechoic chambers with ground planes and Open Area Test Sites), should additionally allow the height of its centre above the ground to be varied over the specified range (usually 1 m to 4 m).

In the frequency band 30 MHz to 1 000 MHz, dipole antennas (constructed in accordance with ANSI C63.5 [6] are generally recommended. For frequencies of 80 MHz and above, the dipoles should have their arm lengths set for resonance at the frequency of test. Below 80 MHz, shortened arm lengths are recommended. For spurious emission testing, however, a combination of bicones and log periodic dipole array antennas (commonly termed "log periodics") could be used to cover the entire 30 MHz to 1 000 MHz band. Above 1 000 MHz, waveguide horns are recommended although, again, log periodics could be used.

NOTE: The gain of a horn antenna is generally expressed relative to an isotropic radiator.

## A.1.5 Substitution antenna

The substitution antenna is used to replace the EUT for tests in which a transmitting parameter (i.e. frequency error, effective radiated power, spurious emissions and adjacent sub-band power) is being measured. For measurements in the frequency band 30 MHz to 1 000 MHz, the substitution antenna should be a dipole antenna (constructed in accordance with ANSI C63.5 [6]). For frequencies of 80 MHz and above, the dipoles should have their arm lengths set for resonance at the frequency of test. Below 80 MHz, shortened arm lengths are recommended. For measurements above 1 000 MHz, a waveguide horn is recommended. The centre of this antenna should coincide with either the phase centre or volume centre.

## A.1.6 Measuring antenna

The measuring antenna is used in tests on an EUT in which a receiving parameter (i.e. sensitivity and various immunity tests) is being measured. Its purpose is to enable a measurement of the electric field strength in the vicinity of the EUT.

For measurements in the frequency band 30 MHz to 1000 MHz, the measuring antenna should be a dipole antenna (constructed in accordance with ANSI C63.5 [6]). For frequencies of 80 MHz and above, the dipoles should have their arm lengths set for resonance at the frequency of test. Below 80 MHz, shortened arm lengths are recommended. The centre of this antenna should coincide with either the phase centre or volume centre (as specified in the test method) of the EUT.

## A.1.7 Stripline arrangement

### A.1.7.1 General

The stripline arrangement is a RF coupling device for coupling the integral antenna of an equipment to a 50  $\Omega$  radio frequency terminal. This allows the radiated measurements to be performed without an open air test site but in a restricted frequency range. Absolute or relative measurements can be performed; absolute measurements require a calibration of the stripline arrangement.

### A.1.7.2 Description

The stripline is made of three highly conductive sheets forming part of a transmission line which allows the equipment under test to be placed within a known electric field. They shall be sufficiently rigid to support the equipment under test.

Two examples of stripline characteristics are given below:

		<b>IEC 489-3 App. J</b>	<b>FTZ N°512 TB 9</b>
Useful frequency range	MHz	1 to 200	0,1 to 4 000
Equipment size limits (antenna included):	length	200 mm	1 200 mm
	width	200 mm	1 200 mm
	height	250 mm	400 mm

### A.1.7.3 Calibration

The aim of calibration is to establish at any frequency a relationship between the voltage applied by the signal generator and the field strength at the designated test area inside the stripline.

### A.1.7.4 Mode of use

The stripline arrangement may be used for all radiated measurements within its calibrated frequency range.

The method of measurement is the same as the method using an open air test site with the following change. The stripline arrangement input socket is used instead of the test antenna.

## A.2 Guidance on the use of radiation test sites

This clause details procedures, test equipment arrangements and verification that should be carried out before any of the radiated tests are undertaken. These schemes are common to all types of test sites described in annex A.

### A.2.1 Verification of the test site

No test should be carried out on a test site which does not possess a valid certificate of verification. The verification procedures for the different types of test sites described in annex A (i.e. anechoic chamber, anechoic chamber with a ground plane and Open Area Test Site) are given in TR 102 273 [5] Parts 2, 3 and 4, respectively.

### A.2.2 Preparation of the EUT

The provider should supply information about the EUT covering the operating frequency, polarization, supply voltage(s) and the reference face. Additional information, specific to the type of EUT should include, where relevant, carrier power, sub-band separation, whether different operating modes are available (e.g. high and low power modes) and if operation is continuous or is subject to a maximum test duty cycle (e.g. 1 minute on, 4 minutes off).

Where necessary, a mounting bracket of minimal size should be available for mounting the EUT on the turntable. This bracket should be made from low conductivity, low relative dielectric constant (i.e. less than 1,5) material(s) such as expanded polystyrene, balsa wood, etc.

### A.2.3 Power supplies to the EUT

All tests should be performed using power supplies wherever possible, including tests on EUT designed for battery-only use. In all cases, power leads should be connected to the EUT's supply terminals (and monitored with a digital voltmeter) but the battery should remain present, electrically isolated from the rest of the equipment, possibly by putting tape over its contacts.

The presence of these power cables can, however, affect the measured performance of the EUT. For this reason, they should be made to be "transparent" as far as the testing is concerned. This can be achieved by routing them away from the EUT and down to the either the screen, ground plane or facility wall (as appropriate) by the shortest possible paths. Precautions should be taken to minimize pick-up on these leads (e.g. the leads could be twisted together, loaded with ferrite beads at 0,15 metres spacing or otherwise loaded).

### A.2.4 Range length

The range length for all these types of test facility should be adequate to allow for testing in the far-field of the EUT i.e. it should be equal to or exceed:

$$\frac{2(d_1 + d_2)^2}{\lambda}$$

where:

$d_1$  is the largest dimension of the EUT/dipole after substitution (m);

$d_2$  is the largest dimension of the test antenna (m);

$\lambda$  is the test frequency wavelength (m).

It should be noted that in the substitution part of this measurement, where both test and substitution antennas are half wavelength dipoles, this minimum range length for far-field testing would be:

$$2\lambda$$

It should be noted in the test report when either of these conditions is not met so that the additional measurement uncertainty can be incorporated into the results.

NOTE 1: **For the fully anechoic chamber**, no part of the volume of the EUT should, at any angle of rotation of the turntable, fall outside the "quiet zone" of the chamber at the nominal frequency of the test.

NOTE 2: The "quiet zone" is a volume within the anechoic chamber (without a ground plane) in which a specified performance has either been proven by test, or is guaranteed by the designer/manufacture. The specified performance is usually the reflectivity of the absorbing panels or a directly related parameter (e.g. signal uniformity in amplitude and phase). It should be noted however that the defining levels of the quiet zone tend to vary.

NOTE 3: **For the anechoic chamber with a ground plane**, a full height scanning capability, i.e. 1 m to 4 m, should be available for which no part of the test antenna should come within 1 m of the absorbing panels. For both types of Anechoic Chamber, the reflectivity of the absorbing panels should not be worse than -5 dB.

NOTE 4: **For both the anechoic chamber with a ground plane and the Open Area Test Site**, no part of any antenna should come within 0,25 m of the ground plane at any time throughout the tests. Where any of these conditions cannot be met, measurements should not be carried out.

## A.2.5 Site preparation

The cables for both ends of the test site should be routed horizontally away from the testing area for a minimum of 2 m (unless, in the case both types of anechoic chamber, a back wall is reached) and then allowed to drop vertically and out through either the ground plane or screen (as appropriate) to the test equipment. Precautions should be taken to minimize pick up on these leads (e.g. dressing with ferrite beads, or other loading). The cables, their routing and dressing should be identical to the verification set-up.

NOTE: For ground reflection test sites (i.e. anechoic chambers with ground planes and Open Area Test Sites) which incorporate a cable drum with the antenna mast, the 2 m requirement may be impossible to comply with.

Calibration data for all items of test equipment should be available and valid. For test, substitution and measuring antennas, the data should include gain relative to an isotropic radiator (or antenna factor) for the frequency of test. Also, the VSWR of the substitution and measuring antennas should be known.

The calibration data on all cables and attenuators should include insertion loss and VSWR throughout the entire frequency range of the tests. All VSWR and insertion loss figures should be recorded in the log book results sheet for the specific test.

Where correction factors/tables are required, these should be immediately available.

For all items of test equipment, the maximum errors they exhibit should be known along with the distribution of the error e.g.:

- cable loss:  $\pm 0,5$  dB with a rectangular distribution;
- measuring receiver: 1,0 dB (standard deviation) signal level accuracy with a Gaussian error distribution.

At the start of measurements, system checks should be made on the items of test equipment used on the test site.

---

## A.3 Coupling of signals

### A.3.1 General

The presence of leads in the radiated field may cause a disturbance of that field and lead to additional measurement uncertainty. These disturbances can be minimized by using suitable coupling methods, offering signal isolation and minimum field disturbance (e.g. optical and acoustic coupling).

### A.3.2 Data signals

Isolation can be provided by the use of optical, ultrasonic or infrared means. Field disturbance can be minimized by using a suitable fibre optic connection. Ultra sonic or infrared radiated connections require suitable measures for the minimization of ambient noise.

---

## A.4 Standard test position

The standard position in all test sites, except the stripline arrangement, for equipment which is not intended to be worn on a person, including hand-held equipment, shall be on a non conducting support, height 1,5 m, capable of rotating about a vertical axis through the equipment. The standard position of the equipment shall be the following:

- a) for equipment with an internal antenna, it shall be placed in the position closest to normal use as declared by the provider;
- b) for equipment with a rigid external antenna, the antenna shall be vertical;
- c) for equipment with a non-rigid external antenna, the antenna shall be extended vertically upwards by a non-conducting support.

Equipment which is intended to be worn on a person may be tested using a simulated man as support. The simulated man comprises a rotatable acrylic tube filled with salt water, placed on the ground.

The container shall have the following dimensions:

- Height: 1,7 m  $\pm$  0,1 m;
- Inside diameter: 300 mm  $\pm$  5 mm;
- Sidewall thickness: 5 mm  $\pm$  0,5 mm.

The container shall be filled with a salt (NaCl) solution of 1,5 g per litre of distilled water.

The equipment shall be fixed to the surface of the simulated man, at the appropriate height for the equipment.

NOTE: To reduce the weight of the simulated man it may be possible to use an alternative tube which has a hollow centre of 220 mm maximum diameter.

In the stripline arrangement the equipment under test or the substitution antenna is placed in the designated test area in the normal operational position, relative to the applied field, on a pedestal made of a low dielectric material (dielectric constant less than 2).

---

## A.5 Test fixture

The test fixture is only needed for the assessment of integral antenna equipment.

### A.5.1 Description

The test fixture is a radio frequency coupling device associated with an integral antenna equipment for coupling the integral antenna to a 50  $\Omega$  radio frequency terminal at the working frequencies of the equipment under test. This allows certain measurements to be performed using the conducted measurement methods. Only relative measurements may be performed and only those at or near frequencies for which the test fixture has been calibrated.

In addition, the test fixture may provide:

- a) a connection to an external power supply;
- b) in the case of assessment of speech equipment, an audio interface either by direct connection or by an acoustic coupler.

In the case of non-speech equipment, the test fixture can also provide the suitable coupling means e.g. for the data output.

The test fixture shall normally be provided by the provider.

The performance characteristics of the test fixture shall be approved by the testing laboratory and shall conform to the following basic parameters:

- a) the coupling loss shall not be greater than 30 dB;
- b) a coupling loss variation over the frequency range used in the measurement which does not exceed 2 dB;
- c) circuitry associated with the RF coupling shall contain no active or non-linear devices;
- d) the VSWR at the 50  $\Omega$  socket shall not be more than 1,5 over the frequency range of the measurements;
- e) the coupling loss shall be independent of the position of the test fixture and be unaffected by the proximity of surrounding objects or people. The coupling loss shall be reproducible when the equipment under test is removed and replaced;
- f) the coupling loss shall remain substantially constant when the environmental conditions are varied.

The characteristics and calibration shall be included in the test report.

### A.5.2 Calibration

The calibration of the test fixture establishes a relationship between the output of the signal generator and the field strength applied to the equipment placed in the test fixture.

The calibration is valid only at a given frequency and for a given polarization of the reference field.

The actual set-up used depends on the type of the equipment (e.g. data, speech, etc.)

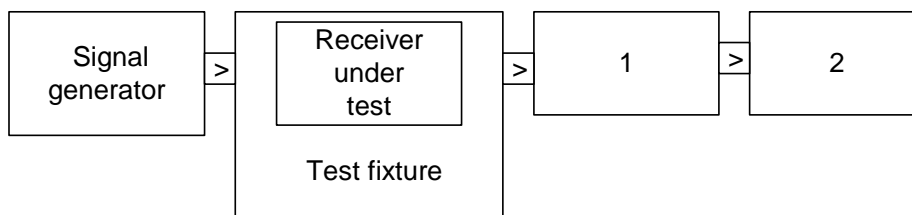

- 1) Coupling device.
- 2) Device for assessing the performance, e.g. distortion factor, BER measuring device, etc.

**Figure A.5: Measuring arrangement for calibration**

#### Method of calibration:

- a) Measure the sensitivity expressed as a field strength, as specified in the present document and note the value of this field strength in dB $\mu$ V/m and the polarization used.
- b) Place the receiver in the test fixture, which is connected to the signal generator. The level of the signal generator producing:
  - a bit error ratio of 0,01; or
  - a message acceptance ratio of 80 %, as appropriate;
 shall be noted.

The calibration of the test fixture is the relationship between the field strength in dB $\mu$ V/m and the signal generator level in dB $\mu$ V emf. This relationship is expected to be linear.

### A.5.3 Mode of use

The test fixture may be used to facilitate some of the measurements in the case of equipment having an integral antenna.

It is used in particular for the measurement of the radiated carrier power and usable sensitivity expressed as a field strength under extreme conditions.

For the transmitter measurements calibration is not required as relative measuring methods are used.

For the receiver measurements calibration is necessary in order to determine absolute measurement levels.

To apply the specified wanted signal level expressed in field strength, convert it into the signal generator level (emf) using the calibration of the test fixture. Apply this value to the signal generator.



---

## Annex B (normative): Technical performance of the spectrum analyser

It shall be possible, using a resolution bandwidth of 1 kHz, to measure the amplitude of a signal or noise at a level 3 dB or more above the noise level of the spectrum analyser as displayed on the screen, to an accuracy of  $\pm 2$  dB in the presence of a signal separated in frequency by 10 kHz, at a level 90 dB above that of the signal to be measured.

The reading accuracy of the frequency marker shall be within  $\pm 2$  % of the sub-band separation.

The accuracy of relative amplitude measurements shall be within  $\pm 1$  dB.

It shall be possible to adjust the spectrum analyser to allow the separation, on the display, of two components with a frequency difference of 1 kHz.

---

## Annex C (informative): Determination and use of the measurement bandwidth

CISPR 16-1 [3] specifies a reference bandwidth for the measurement of unwanted emissions by measurement receivers and spectrum analysers.

The reference bandwidth ( $BW_{REFERENCE}$ ) cannot always be used as the measurement bandwidth ( $BW_{MEASUREMENT}$ ). This is particularly the case if the measurement is to be made for example on the slope of a spectrum mask or a receiver selectivity curve. In such situations the measurement shall be made with a sufficiently low bandwidth in order not to distort the reading.

The actual measured value, A, shall be referred back to the reference bandwidth by either:

Correcting the measured value, A, for any signal having a flat level spectrum with the following formula:

$$B = A + 10 \log \frac{BW_{REFERENCE}}{BW_{MEASURED}}$$

Where:

- B is the measured level, A, transferred to the reference bandwidth;

or

- Use the measured value, A, directly if the measured spectrum is a discrete spectral line.

A discrete spectrum line is defined as a narrow peak with a level of at least 6 dB above the average level inside the measurement bandwidth.

---

## Annex D (informative): Bibliography

- IEC Publication 489-3 Second edition (1988) Appendix F pages 130 to 133.
- IEC Publication 489-3 Second edition (1988) Appendix J pages 156 to 164.
- Construction of a Stripline. Technical Report FTZ N° 512 TB 9.
- Ketterling, H-P: "Verification of the performance of fully and semi-anechoic chambers for radiation measurements and susceptibility/immunity testing", 1991, Leatherhead/Surrey.
- Council Directive 98/34/EC laying down a procedure for the provision of information in the field of technical standards and regulations (EMC Directive).
- Directive 1999/5/EC of the European Parliament and of the Council of 9 March 1999 on radio equipment and telecommunications terminal equipment and the mutual recognition of their conformity (R&TTE Directive).
- CEPT/ERC Recommendation 01-06: "Procedure for mutual recognition of type testing and type approval for radio equipment".
- ITU-R Recommendation BS.559-2: "Objective measurement of radio-frequency protection ratios in LF, MF and HF broadcasting".
- ETSI TR 100 027: "ElectroMagnetic Compatibility and Radio Spectrum Matters (ERM); Methods of measurement for private mobile radio equipment".
- ETSI EN 300 220 (all parts): "Electromagnetic compatibility and Radio spectrum Matters (ERM); Short Range Devices (SRD); Radio equipment to be used in the 25 MHz to 1 000 MHz frequency range with power levels ranging up to 500 mW".
- IEC 60489-3: "Methods of measurement for radio equipment used in the mobile services. Part 3: Receivers for A3E or F3E emissions".

---

## History

<b>Document history</b>		
V1.1.1	September 2004	Publication
V1.1.2	March 2006	One-step Approval Procedure OAP 20060714: 2006-03-15 to 2006-07-14