

Final draft **ETSI EN 302 017-2** V1.1.1 (2005-06)

Candidate Harmonized European Standard (Telecommunications series)

**Electromagnetic compatibility
and Radio spectrum Matters (ERM);
Transmitting equipment for the Amplitude Modulated (AM)
sound broadcasting service;
Part 2: Harmonized EN under article 3.2
of the R&TTE Directive**



Reference

DEN/ERM-TG17-004-2A

Keywords

AM, transmitter, broadcasting, audio, regulation,
terrestrial, radio

ETSI

650 Route des Lucioles
F-06921 Sophia Antipolis Cedex - FRANCE

Tel.: +33 4 92 94 42 00 Fax: +33 4 93 65 47 16

Siret N° 348 623 562 00017 - NAF 742 C
Association à but non lucratif enregistrée à la
Sous-Préfecture de Grasse (06) N° 7803/88

Important notice

Individual copies of the present document can be downloaded from:

<http://www.etsi.org>

The present document may be made available in more than one electronic version or in print. In any case of existing or perceived difference in contents between such versions, the reference version is the Portable Document Format (PDF). In case of dispute, the reference shall be the printing on ETSI printers of the PDF version kept on a specific network drive within ETSI Secretariat.

Users of the present document should be aware that the document may be subject to revision or change of status. Information on the current status of this and other ETSI documents is available at

<http://portal.etsi.org/tb/status/status.asp>

If you find errors in the present document, please send your comment to one of the following services:

http://portal.etsi.org/chaicor/ETSI_support.asp

Copyright Notification

No part may be reproduced except as authorized by written permission.
The copyright and the foregoing restriction extend to reproduction in all media.

© European Telecommunications Standards Institute 2005.
All rights reserved.

DECT™, **PLUGTESTS™** and **UMTS™** are Trade Marks of ETSI registered for the benefit of its Members.
TIPHON™ and the **TIPHON logo** are Trade Marks currently being registered by ETSI for the benefit of its Members.
3GPP™ is a Trade Mark of ETSI registered for the benefit of its Members and of the 3GPP Organizational Partners.

Contents

| | |
|--|-----------|
| Intellectual Property Rights | 5 |
| Foreword..... | 5 |
| Introduction | 6 |
| 1 Scope | 8 |
| 2 References | 8 |
| 3 Definitions, symbols and abbreviations | 9 |
| 3.1 Definitions | 9 |
| 3.2 Symbols..... | 10 |
| 3.3 Abbreviations | 10 |
| 4 Technical requirements Specifications..... | 10 |
| 4.1 Environmental profile..... | 10 |
| 4.2 Antenna port measurements | 10 |
| 4.2.1 Spurious emissions | 10 |
| 4.2.1.1 Definition | 10 |
| 4.2.1.2 Method of measurement (essential test suite) | 11 |
| 4.2.1.2.1 Initial conditions..... | 11 |
| 4.2.1.2.2 Procedure..... | 11 |
| 4.2.1.2.3 Test requirements | 11 |
| 4.2.1.3 Limit..... | 11 |
| 4.2.2 Transmitter muting during frequency shift | 12 |
| 4.2.2.1 Definition | 12 |
| 4.2.2.2 Method of measurement (essential test suite) | 12 |
| 4.2.2.2.1 Initial conditions | 12 |
| 4.2.2.2.2 Procedure..... | 13 |
| 4.2.2.2.3 Test requirements | 13 |
| 4.2.2.3 Limit..... | 13 |
| 4.2.3 Out-of-band emissions..... | 13 |
| 4.2.3.1 Definition | 13 |
| 4.2.3.2 Method of measurement (essential test suite) | 13 |
| 4.2.3.2.1 Initial conditions | 13 |
| 4.2.3.2.2 Procedure..... | 13 |
| 4.2.3.2.3 Test requirements | 13 |
| 4.2.3.3 Limit..... | 14 |
| 4.3 Enclosure port measurements (radiated emissions)..... | 16 |
| 4.3.1 Cabinet radiation..... | 16 |
| 4.3.1.1 Definition | 16 |
| 4.3.1.2 Method of measurement (essential test suite) | 16 |
| 4.3.1.2.1 Initial conditions | 16 |
| 4.3.1.2.2 Procedure..... | 16 |
| 4.3.1.3 Limits | 17 |
| 4.4 Measurement uncertainties | 18 |
| Annex A (normative): General measuring arrangements | 19 |
| A.1 Testing arrangements for antenna port measurements | 19 |
| A.2 Test frequency range | 19 |
| A.3 Test modulating signal | 20 |
| A.4 Testing arrangements for radiated measurements | 21 |
| A.5 Test load characteristics | 21 |
| Annex B (informative): Bibliography..... | 22 |

| | | |
|-------------------------------|---|-----------|
| Annex C (informative): | The EN title in the official languages | 23 |
| History | | 24 |

Intellectual Property Rights

IPRs essential or potentially essential to the present document may have been declared to ETSI. The information pertaining to these essential IPRs, if any, is publicly available for **ETSI members and non-members**, and can be found in ETSI SR 000 314: *"Intellectual Property Rights (IPRs); Essential, or potentially Essential, IPRs notified to ETSI in respect of ETSI standards"*, which is available from the ETSI Secretariat. Latest updates are available on the ETSI Web server (<http://webapp.etsi.org/IPR/home.asp>).

Pursuant to the ETSI IPR Policy, no investigation, including IPR searches, has been carried out by ETSI. No guarantee can be given as to the existence of other IPRs not referenced in ETSI SR 000 314 (or the updates on the ETSI Web server) which are, or may be, or may become, essential to the present document.

Foreword

This Candidate Harmonized European Standard (Telecommunications series) has been produced by ETSI Technical Committee Electromagnetic compatibility and Radio spectrum Matters (ERM), and is now submitted for the Vote phase of the ETSI standards Two-step Approval Procedure.

The present document has been produced by ETSI in response to a mandate from the European Commission issued under Council Directive 98/34/EC [1] (as amended) laying down a procedure for the provision of information in the field of technical standards and regulations.

The present document is intended to become a Harmonized Standard, the reference of which will be published in the Official Journal of the European Communities referencing the Directive 1999/5/EC [2] of the European Parliament and of the Council of 9 March 1999 on radio equipment and telecommunications terminal equipment and the mutual recognition of their conformity ("the R&TTE Directive").

Technical specifications relevant to Directive 1999/5/EC [2] are given in annex A.

The present document is part 2 of a multi-part deliverable covering the transmitting equipment for the Amplitude Modulated (AM) sound broadcasting service, as identified below:

Part 1: "Technical characteristics and test methods";

Part 2: "Harmonized EN under article 3.2 of the R&TTE Directive".

| Proposed national transposition dates | |
|--|---------------------------------|
| Date of latest announcement of this EN (doa): | 3 months after ETSI publication |
| Date of latest publication of new National Standard or endorsement of this EN (dop/e): | 6 months after doa |
| Date of withdrawal of any conflicting National Standard (dow): | 36 months after doa |

Introduction

The present document is part of a set of standards designed to fit in a modular structure to cover all radio and telecommunications terminal equipment under the R&TTE Directive [2]. Each standard is a module in the structure. The modular structure is shown in figure 1.

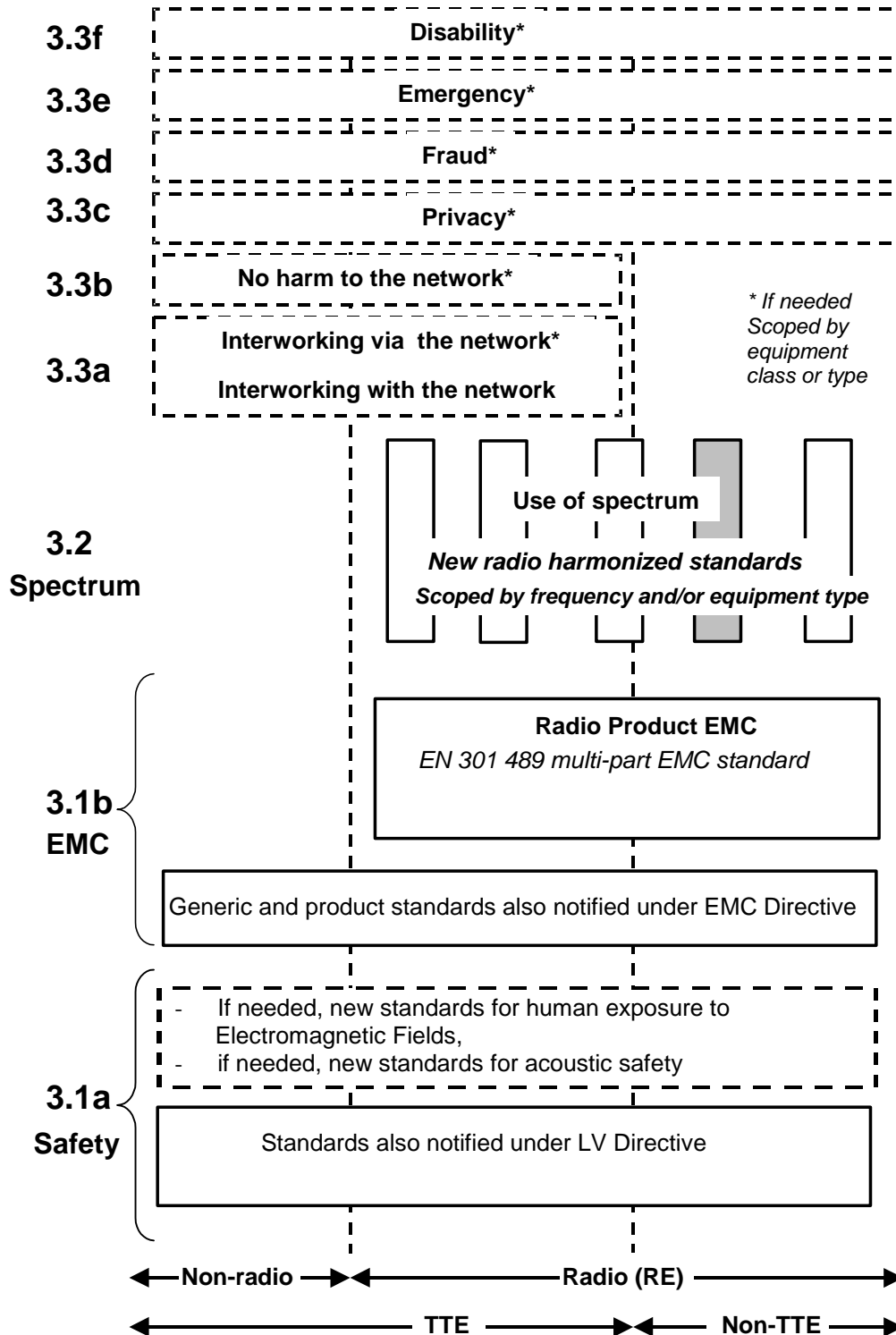

Figure 1: Modular structure for the various standards used under the R&TTE Directive [2]

The left hand edge of figure 1 shows the different clauses of article 3 of the R&TTE Directive [2].

For article 3.3 various horizontal boxes are shown. Dotted lines indicate that at the time of publication of the present document essential requirements in these areas have to be adopted by the Commission. If such essential requirements are adopted, and as far and as long as they are applicable, they will justify individual standards whose scope is likely to be specified by function or interface type.

The vertical boxes show the standards under article 3.2 for the use of the radio spectrum by radio equipment. The scopes of these standards are specified either by frequency (normally in the case where frequency bands are harmonized) or by radio equipment type.

For article 3.1b the diagram shows EN 301 489, the multi-part product EMC standard for radio used under the EMC Directive [3].

For article 3.1a the diagram shows the existing safety standards currently used under the LV Directive [4] and new standards covering human exposure to electromagnetic fields. New standards covering acoustic safety may also be required.

The bottom of figure 1 shows the relationship of the standards to radio equipment and telecommunications terminal equipment. A particular equipment may be radio equipment, telecommunications terminal equipment or both. A radio spectrum standard will apply if it is radio equipment. An article 3.3 standard will apply as well only if the relevant essential requirement under the R&TTE Directive [2] is adopted by the Commission and if the equipment in question is covered by the scope of the corresponding standard. Thus, depending on the nature of the equipment, the essential requirements under the R&TTE Directive [2] may be covered in a set of standards.

The modularity principle has been taken because:

- it minimizes the number of standards needed. Because equipment may, in fact, have multiple interfaces and functions it is not practicable to produce a single standard for each possible combination of functions that may occur in equipment;
- it provides scope for standards to be added:
 - under article 3.2 when new frequency bands are agreed; or
 - under article 3.3 should the Commission take the necessary decisionswithout requiring alteration of standards that are already published;
- it clarifies, simplifies and promotes the usage of Harmonized Standards as the relevant means of conformity assessment.

Other documents directly associated with the present document:

- EN 302 017-1 [5];
- EN 301 489-11 [6].

1 Scope

The present document applies to Double Side Band Transmitting equipment for the Amplitude-modulated sound broadcasting service.

The types of equipment covered by the present document are as follows:

- Transmitting equipment for Amplitude Modulated sound broadcasting service operating in the LF, MF and HF bands.

The present document is intended to cover the provisions of article 3.2 of Directive 1999/5/EC [2] (R&TTE Directive), which states that "... radio equipment shall be so constructed that it effectively uses the spectrum allocated to terrestrial/space radio communications and orbital resources so as to avoid harmful interference".

In addition to the present document, other ENs that specify technical requirements in respect of essential requirements under other parts of article 3 of the R&TTE Directive [2] apply to equipment within the scope of the present document.

NOTE: A list of such ENs is included on the web site <http://www.newapproach.org/>.

2 References

The following documents contain provisions which, through reference in this text, constitute provisions of the present document.

- References are either specific (identified by date of publication and/or edition number or version number) or non-specific.
- For a specific reference, subsequent revisions do not apply.
- For a non-specific reference, the latest version applies.

Referenced documents which are not found to be publicly available in the expected location might be found at <http://docbox.etsi.org/Reference>.

- [1] Directive 98/34/EC of the European Parliament and of the Council of 22 June 1998 laying down a procedure for the provision of information in the field of technical standards and regulations.
- [2] Directive 1999/5/EC of the European Parliament and of the Council of 9 March 1999 on radio equipment and telecommunications terminal equipment and the mutual recognition of their conformity (R&TTE Directive).
- [3] Council Directive 89/336/EEC of 3 May 1989 on the approximation of the laws of the Member States relating to electromagnetic compatibility (EMC Directive).
- [4] Council Directive 73/23/EEC of 19 February 1973 on the harmonization of the laws of Member States relating to electrical equipment designed for use within certain voltage limits (LV Directive).
- [5] ETSI EN 302 017-1 (V1.1.1): "Electromagnetic compatibility and Radio spectrum Matters (ERM); Transmitting equipment for the Amplitude Modulated (AM) sound broadcasting service; Part 1: Technical characteristics and test methods".
- [6] ETSI EN 301 489-11 (V1.2.1): "Electromagnetic compatibility and Radio spectrum Matters (ERM); ElectroMagnetic Compatibility (EMC) standard for radio equipment and services; Part 11: Specific conditions for terrestrial sound broadcasting service transmitters".
- [7] CENELEC EN 55011 (1998): "Industrial, scientific and medical (ISM) radio-frequency equipment - Radio disturbance characteristics - Limits and methods of measurement".

- [8] IEC 60489-1 (1983 - including amendments 1 and 2): "Methods of measurement for radio equipment used in the mobile services. Part 1: General definitions and standard conditions of measurement".
- [9] ETSI TR 100 028 (V1.4.1 - all parts): "Electromagnetic compatibility and Radio spectrum Matters (ERM); Uncertainties in the measurement of mobile radio equipment characteristics".
- [10] ITU-R Recommendation SM.329-10 (2003): "Unwanted emissions in the spurious domain".

3 Definitions, symbols and abbreviations

3.1 Definitions

For the purposes of the present document, the following terms and definitions apply:

antenna port: port of an apparatus which is designed, in normal operation, to be connected to an antenna using coaxial cable

broadcasting service: radiocommunication service in which the transmissions are intended for direct reception by the general public

NOTE: This service may include sound transmissions, television transmissions or other types of transmission.

cabinet radiation: radiation from an enclosure containing, equipment, excluding radiation from connected antennas or cables

channel bandwidth: frequency band of defined width (as a multiple of the carrier grid) including safety margin for operation on adjacent channels, located symmetrically around a carrier frequency in the carrier grid

carrier power: average power supplied to the antenna port by a transmitter during one cycle taken under the condition of no modulation

class of emission: set of characteristics of an emission, designated by standard symbols, e.g. type of modulation of the main carrier, modulating signal, type of information to be transmitted, and also, if appropriate, any additional signal characteristics

dBc: decibels relative to the unmodulated carrier power of the emission

NOTE: In the cases which do not have a carrier, for example in some digital modulation schemes where the carrier is not accessible for measurement, the reference level equivalent to dBc is decibels relative to the mean power P.

enclosure port: physical boundary of the apparatus through which electromagnetic fields may radiate or impinge

NOTE: In the case of integral antenna equipment, this port is inseparable from the antenna port.

environmental profile: range of environmental conditions under which equipment within the scope of EN 302 017-2 is required to comply with the provisions of EN 302 017-2

harmonic: component of order greater than 1 of the Fourier series of a periodic quantity

harmonic number: integral number given by the ratio of the frequency of a harmonic to the fundamental frequency (2nd harmonic = 2 × fundamental frequency)

intermodulation products: unwanted frequencies resulting from intermodulation between carriers or harmonics of emission, or between any oscillations generated to produce the carrier

mean power: average power supplied to the antenna port by a transmitter during an interval of time sufficiently long compared with the lowest frequency encountered in the modulation envelope taken under normal operating conditions

necessary bandwidth: for a given class of emission, the width of the frequency band which is sufficient to ensure the transmission of information at the rate and with the quality required under specified conditions

out-of-band emissions: emission on a frequency or frequencies immediately outside the necessary bandwidth which results from the modulation process, but excluding spurious emissions

reference bandwidth: bandwidth in which the spurious emission level is specified

spurious emissions: emission on a frequency or frequencies which are outside the necessary bandwidth and the level of which may be reduced without affecting the corresponding transmission of information

NOTE: Spurious emissions include harmonic emissions, parasitic emissions, intermodulation products and frequency conversion products but exclude out of band emissions.

unwanted emissions: spurious emissions and out of band emissions

3.2 Symbols

For the purposes of the present document, the following symbols apply:

μ micro (10^{-6})

3.3 Abbreviations

For the purposes of the present document, the following abbreviations apply:

| | |
|-------|---|
| AF | Audio Frequency |
| AM | Amplitude Modulation |
| dB | deciBel, logarithmic ratio (tenths of a "Bel") |
| dBm | dB relative to one milliwatt |
| EMC | ElectroMagnetic Compatibility |
| EUT | Equipment Under Test |
| F | Farad |
| H | Henry |
| HF | High Frequency |
| LF | Low Frequency |
| LV | Low Voltage |
| MF | Medium Frequency |
| R&TTE | Radio equipment and Telecommunications Terminal Equipment |
| rms | root mean square |
| V | V |
| W | Watt |

4 Technical requirements specifications

4.1 Environmental profile

The environmental profile for operation of the equipment shall be declared by the supplier. The equipment shall comply with all the technical requirements of the present document at all times when operating within the boundary limits of the required operational environmental profile.

4.2 Antenna port measurements

4.2.1 Spurious emissions

4.2.1.1 Definition

Emission on a frequency or frequencies which are outside the necessary bandwidth and the level of which may be reduced without affecting the corresponding transmission of information. Spurious emissions include harmonic emissions, parasitic emissions, intermodulation products and frequency conversion products but exclude out of band emissions.

4.2.1.2 Method of measurement (essential test suite)

4.2.1.2.1 Initial conditions

Test environment:

- the normal operating environment, as declared by the equipment manufacturer.

Test frequencies:

- a) the lowest operating frequency of the EUT;
- b) the highest operating frequency of the EUT;
- c) a frequency mid-way between a) and b) above.

Test arrangement (see figure A.1):

- 1) the measurement shall be done without any modulation ;
- 2) connect the EUT to the Test Load, via the Coupling Device;
- 3) connect the Spectrum Analyser to the Coupling Device.

4.2.1.2.2 Procedure

- 1) terminate the input of the transmitter as specified by the manufacturer;
- 2) operate the EUT at each of the test frequencies as defined in clause 4.2.1.2.1;
- 3) measure the results on the Spectrum Analyser.

4.2.1.2.3 Test requirements

The results obtained shall be compared to the limits in clause 4.2.1.3 in order to demonstrate compliance.

4.2.1.3 Limit

Spurious emissions shall not exceed the values set out in table 4.1, additionally shown in figure 4.1, for the frequency range 9 kHz to 1 GHz.

Table 4.1: Spurious emission limits

| Mean power of the transmitter | Limits Mean power absolute levels (dBm) or relative levels (dBc) below the mean power supplied to the antenna port in the reference bandwidth (see annex A) |
|----------------------------------|--|
| All power ranges | -50 dBc, without exceeding the absolute mean power of 50 mW (17 dBm) |

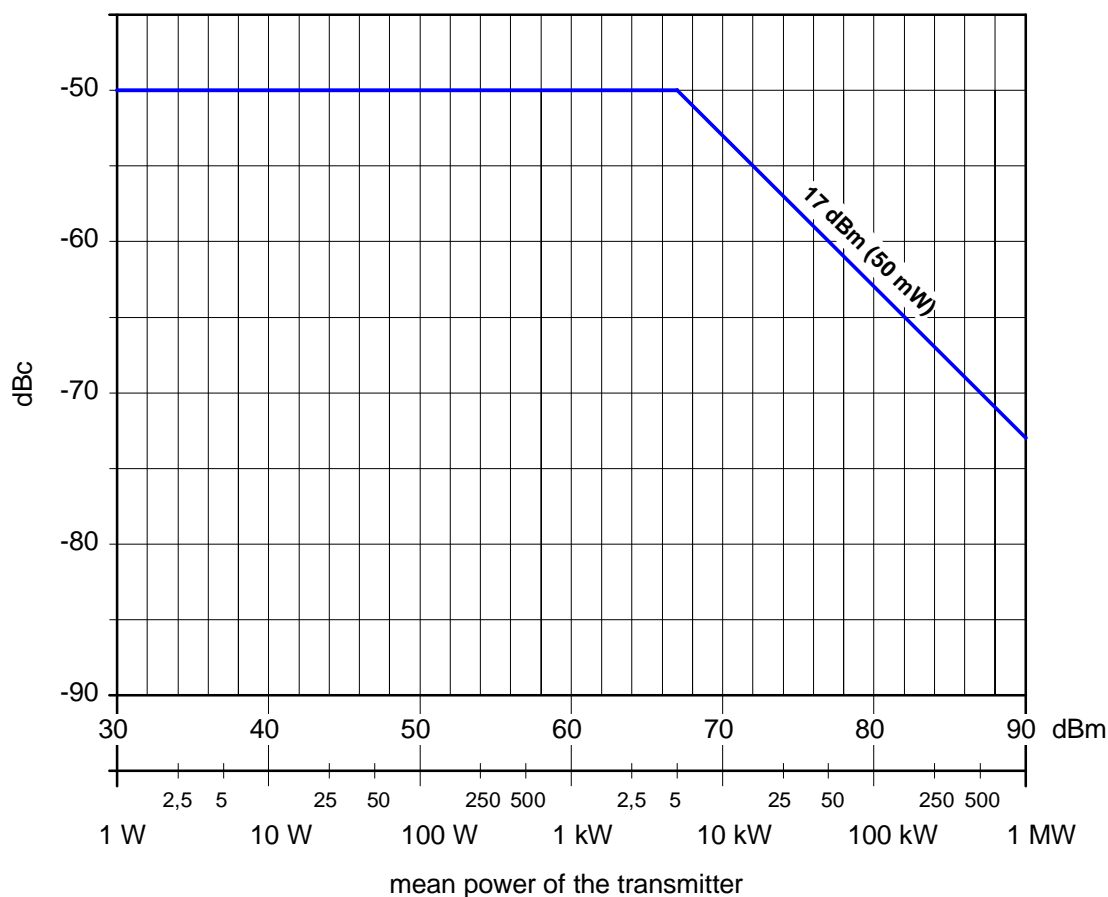

Figure 4.1: Spurious emission limits

4.2.2 Transmitter muting during frequency shift

4.2.2.1 Definition

The suppression of emissions during the re-tuning of transmitters.

4.2.2.2 Method of measurement (essential test suite)

4.2.2.2.1 Initial conditions

Test environment:

- the normal operating environment, as declared by the equipment manufacturer.

Test frequencies:

- present frequency to desired frequency.

Test arrangement (see figure A.1):

- 1) all ports unused at the time of testing shall be correctly terminated;
- 2) connect the EUT to the test load, via the coupling device;
- 3) connect the measuring device to the coupling device.

4.2.2.2.2 Procedure

- 1) operate the EUT at the present frequency;
- 2) initiate frequency change;
- 3) observe the output signal on an oscilloscope.

4.2.2.2.3 Test requirements

The results obtained shall be compared to the limits in clause 4.2.2.3 in order to demonstrate compliance.

4.2.2.3 Limit

The muting shall be as defined in clause 4.2.1.3.

4.2.3 Out-of-band emissions

4.2.3.1 Definition

Emission on a frequency or frequencies immediately outside the necessary bandwidth, which results from the modulation process, but excludes spurious emissions.

4.2.3.2 Method of measurement (essential test suite)

4.2.3.2.1 Initial conditions

Test environment:

- the normal operating environment, as declared by the equipment manufacturer.

Test frequencies:

- a) the lowest operating frequency of the EUT;
- b) the highest operating frequency of the EUT;
- c) a frequency mid-way between a) and b) above.

Test arrangement (see figure A.1):

- 1) connect the AF Signal Generator to the EUT;
- 2) connect the EUT to the Test Load, via the Coupling Device;
- 3) connect the Spectrum Analyser to the Coupling Device.

4.2.3.2.2 Procedure

- 1) set the AF Signal Generator to deliver a test signal as defined in clause A.3;
- 2) operate the EUT at each of the test frequencies as defined in clause 4.2.3.2.1;
- 3) measure the results on the Spectrum Analyser: the measurement shall be repeated for at least 5 times and the results shall be averaged.

The spectrum limits described in this clause for amplitude-modulated emissions for sound broadcasting have been deduced from measurements performed on transmitters which were modulated by weighted noise to an rms modulation factor of 35 % in the absence of any dynamic compression of the signal amplitudes (see clause A.3).

4.2.3.2.3 Test requirements

The results obtained shall be compared to the limits in clause 4.2.3.3 in order to demonstrate compliance.

4.2.3.3 Limit

Out of band emissions shall not exceed the values set out in table 4.2. Additionally the limits shown in figure 4.2 on a logarithmic frequency axis and in figure 4.3 on a linear axis.

Relationship between the 0dB reference level and the carrier level:

The reference level 0 dB corresponds to power density that would exist if the total RF power, excluding the power of the carrier, were distributed uniformly over the necessary bandwidth.

The ratio α_B (dB) of 0 dB reference level to the carrier is given by the equation:

$$\alpha_B = 10 \log \frac{m_{rms}^2 B_{eff}}{2 F}$$

where: m_{rms} = rms modulation factor of the transmitter

B_{eff} = effective noise bandwidth of the analyser

F = necessary bandwidth for the emission

Hence the reference level depends on the power of the sideband P_s , given by the formula:

$$P_s = \frac{m_{rms}^2}{2} P_c$$

where: P_c = carrier power

If frequency is plotted as the abscissa in logarithmic units and if the power densities are plotted as ordinates (dB) the curve representing the out-of-band spectrum should lie below two straight lines starting at point $(0,5 F; 0 \text{ dB})$ or at point $(-0,5 F; 0 \text{ dB})$ and finishing at point $(0,7 F; -35 \text{ dB})$ or $(-0,7 F; -35 \text{ dB})$ respectively. Beyond these points and down to the level of -60 dB, this curve should lie below two straight lines starting from the latter points and having a slope of 12 dB/octave. Thereafter, the same curve should lie below the level -60 dB. The ordinate of the curve so defined represents the average power intercepted by an analyser with an rms noise bandwidth of 100 Hz, the frequency of which is tuned to the frequency plotted on the abscissa.

Table 4.2: Out-of-band emission limits

| Relative Frequency (f/F) | Frequency difference (f) from the centre frequency at different channel bandwidths (F) (kHz) | | | | Relative level (dB) |
|-----------------------------|--|-------|-------|-------|---------------------|
| | F=4,5 | F=5 | F=9 | F=10 | |
| ±0,1 | 0,45 | 0,5 | 0,9 | 1 | 0 |
| ±0,5 | 2,25 | 2,5 | 4,5 | 5 | 0 |
| ±0,7 | 3,15 | 3,50 | 6,3 | 7 | -35 |
| ±1,4 | 6,3 | 7 | 12,6 | 14 | -47 |
| ±2,8 | 12,6 | 14 | 25,2 | 28 | -59 |
| ≥ ±2,952 | 13,28 | 14,76 | 26,57 | 29,52 | -60 |

NOTE: Figure 4.2 is only a additional representation of the limits given in table 4.2. It is not representative of the output of a spectrum analyser. The slope outside $\pm 0,7 F$ is 12 dB per octave until the value of -60 dB is reached.

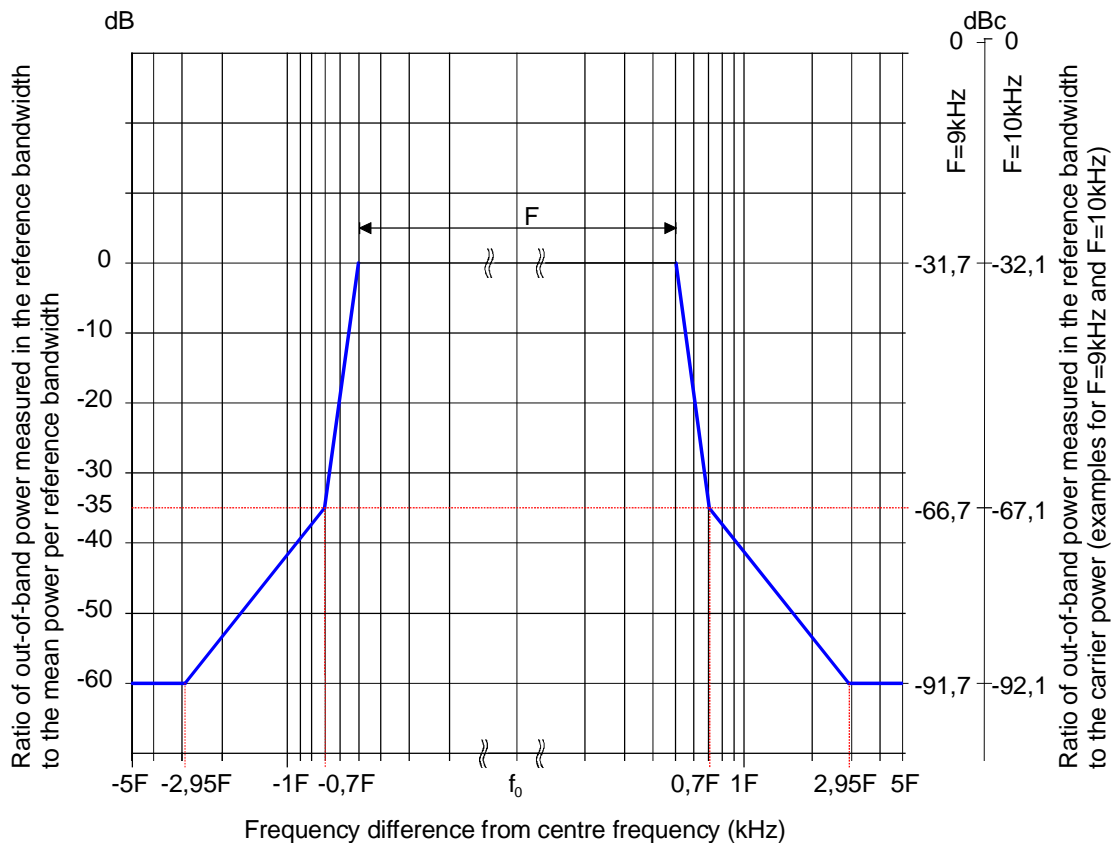

Figure 4.2: Out of band emission limits shown on a logarithmic axis

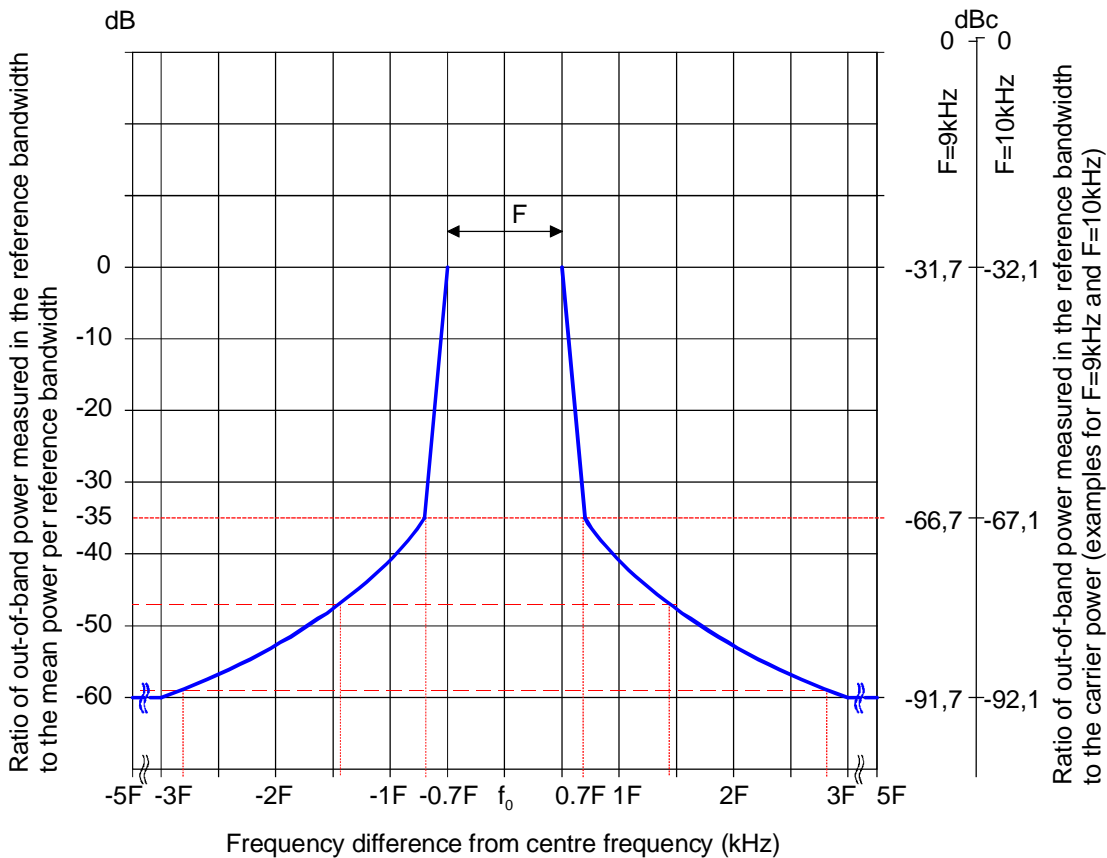

Figure 4.3: Out of band emission limits shown on a linear axis

4.3 Enclosure port measurements (radiated emissions)

4.3.1 Cabinet radiation

4.3.1.1 Definition

Emissions from the equipment, radiated from the enclosure port, other than those present at the antenna port.

4.3.1.2 Method of measurement (essential test suite)

4.3.1.2.1 Initial conditions

Test environment:

- the normal operating environment, as declared by the equipment manufacturer.

Test frequencies:

- a) the lowest operating frequency of the EUT;
- b) the highest operating frequency of the EUT;
- c) a frequency mid-way between a) and b) above.

Test arrangement (see figure A.1):

- 1) connect the AF Signal Generator to the EUT;
- 2) connect the EUT to the Test Load;
- 3) connect the Spectrum Analyser to the measuring antenna.

4.3.1.2.2 Procedure

- 1) set the AF Signal Generator to deliver a test signal as defined in clause A.3;
- 2) operate the EUT at each of the test frequencies as defined in clause 4.3.1.2.1;
- 3) measure the results on the Spectrum Analyser.

NOTE: Testing shall be carried out at a suitably calibrated test site, unless physical size is a restriction, in which case the test method shall be in accordance with EN 55011 [7].

- Measurements shall be made outside ± 500 % of the necessary bandwidth of the transmission.
- Measurements shall be made in the operational mode producing the largest emission in the frequency band being investigated consistent with normal applications.
- The equipment shall be configured in a manner which is representative of a normal/typical operation, where practical.
- An attempt shall be made to maximize the detected radiated emission, e.g. by moving the cables of the equipment.
- The configuration and mode of operation during measurements shall be precisely noted in the test report.
- RF input/output ports shall be correctly terminated.
- The tests shall be carried out at a point within the specified normal operating environmental range and at the rated supply voltage for the equipment.

4.3.1.3 Limits

Radiated emissions shall not exceed the values set out in table 4.3, shown additionally in figure 4.4, for the frequency range 30 MHz to 1 GHz.

This test shall be performed at a distance of 10 m, where feasible. When size and/or power requirements necessitate testing in a manufacturing facility, other distances may be used (see notes 1, 2 and 3 below).

Table 4.3: Cabinet radiation limits

| Quasi-peak limits (dB μ V/m) at 10 m (see note) | Frequency range |
|--|--------------------|
| $30 \text{ dB}\mu\text{V/m} \leq 60 + 10 \log_{10} (P_0/2\,000) \leq 70 \text{ dB}\mu\text{V/m}$ | 30 MHz to 230 MHz |
| $37 \text{ dB}\mu\text{V/m} \leq 67 + 10 \log_{10} (P_0/2\,000) \leq 77 \text{ dB}\mu\text{V/m}$ | > 230 MHz to 1 GHz |

NOTE: P_0 = RF carrier power in W.

NOTE 1: The measurements can be carried out at other distances. In that case limits are modified according to the relation:

$$L(x\text{m}) = L(10\text{m}) + 20 \log (10/x) \quad \text{where } x = \text{distance.}$$

NOTE 2: Care should be taken if measuring at test distances below 10 m as this may be in the near field.

NOTE 3: In cases of dispute the measurement distance of 10 m shall take precedence.

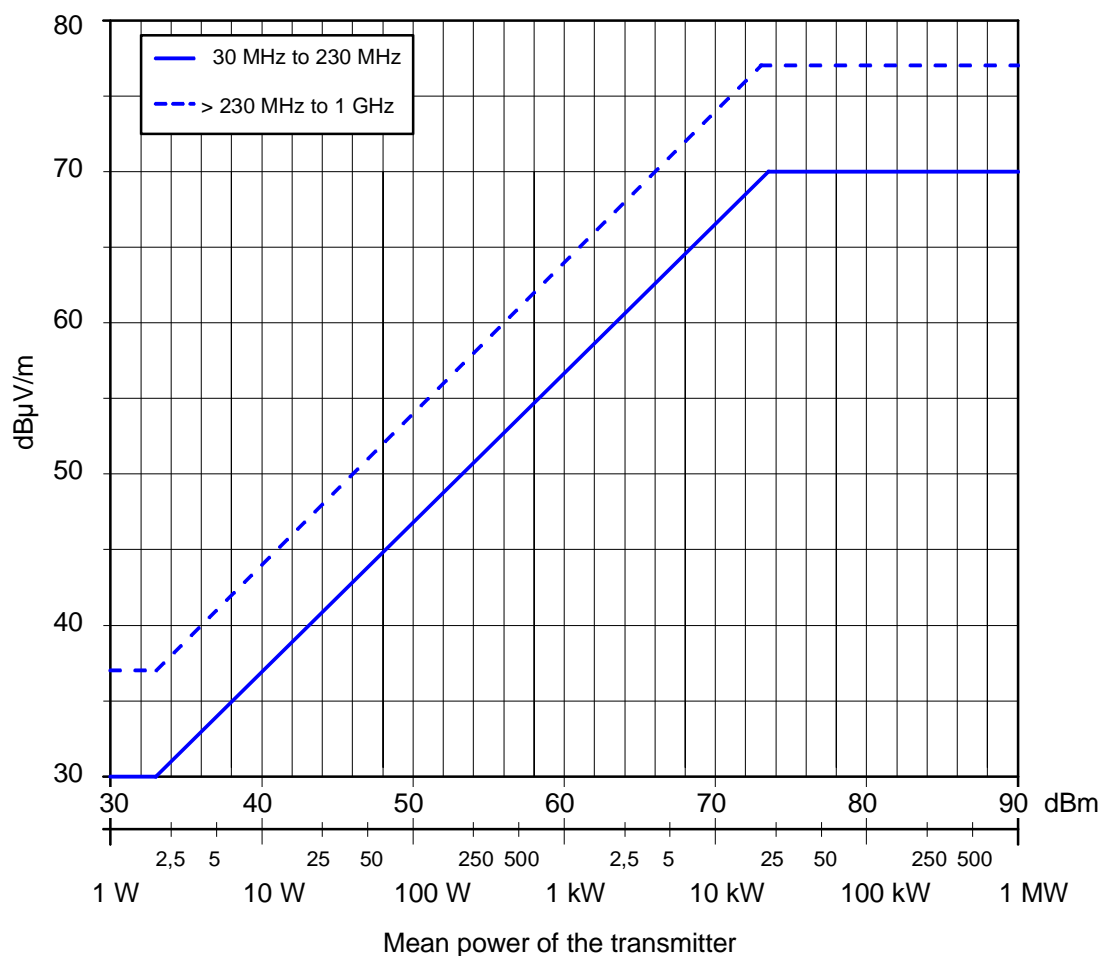

Figure 4.4: Cabinet radiation limits for sound broadcasting transmitters

4.4 Measurement uncertainties

Measurement uncertainty should be calculated and techniques employed to minimize its range. This uncertainty should be applied to the limit and any measurement falling below the range is deemed acceptable (TR 100 028 [9]).

Annex A (normative): General measuring arrangements

A.1 Testing arrangements for antenna port measurements

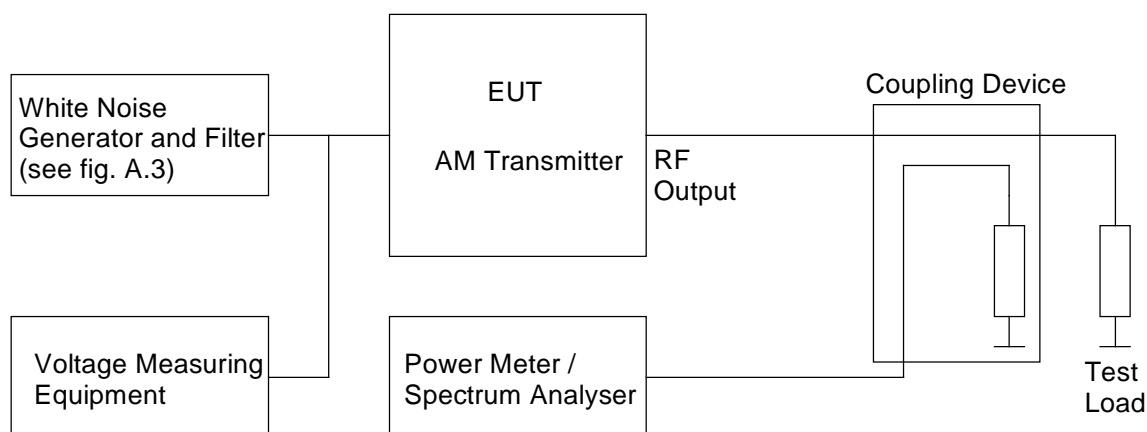

NOTE: In the case of spurious emissions the White Noise Generator and Filter are not used.

Figure A.1: Testing arrangement

A.2 Test frequency range

Limits on unwanted emissions for radio equipments are considered to be applicable to the range 9 kHz to 300 GHz. However, for practical measurement purposes, the frequency range of spurious emissions may be restricted. As guidance for practical purposes, the following measurement parameters in table A.1 are recommended.

Table A.1: Test frequency range

| Transmitter fundamental frequency range | Unwanted emission frequency measurement range | |
|---|---|-----------------|
| | Lower frequency | Upper frequency |
| 9 kHz to 30 MHz | 9 kHz | 1 GHz |

The following reference bandwidths are to be used:

For spurious emissions:

- 1 kHz between 9 kHz and 150 kHz;
- 10 kHz between 150 kHz and 30 MHz;
- 100 kHz between 30 MHz and 1 GHz.

For out of band emissions:

- 100 Hz.

For definition of reference bandwidth, see ITU-R Recommendation SM.329-10 [10].

A.3 Test modulating signal

The noise is weighted in accordance with the curves shown in figure A.2.

Two conditions should be fulfilled by the standardized signal to simulate programme modulation:

- its spectral constitution must correspond to that of a representative broadcast programme;
- its dynamic range must small to result in a constant unequivocal reading on the instrument.

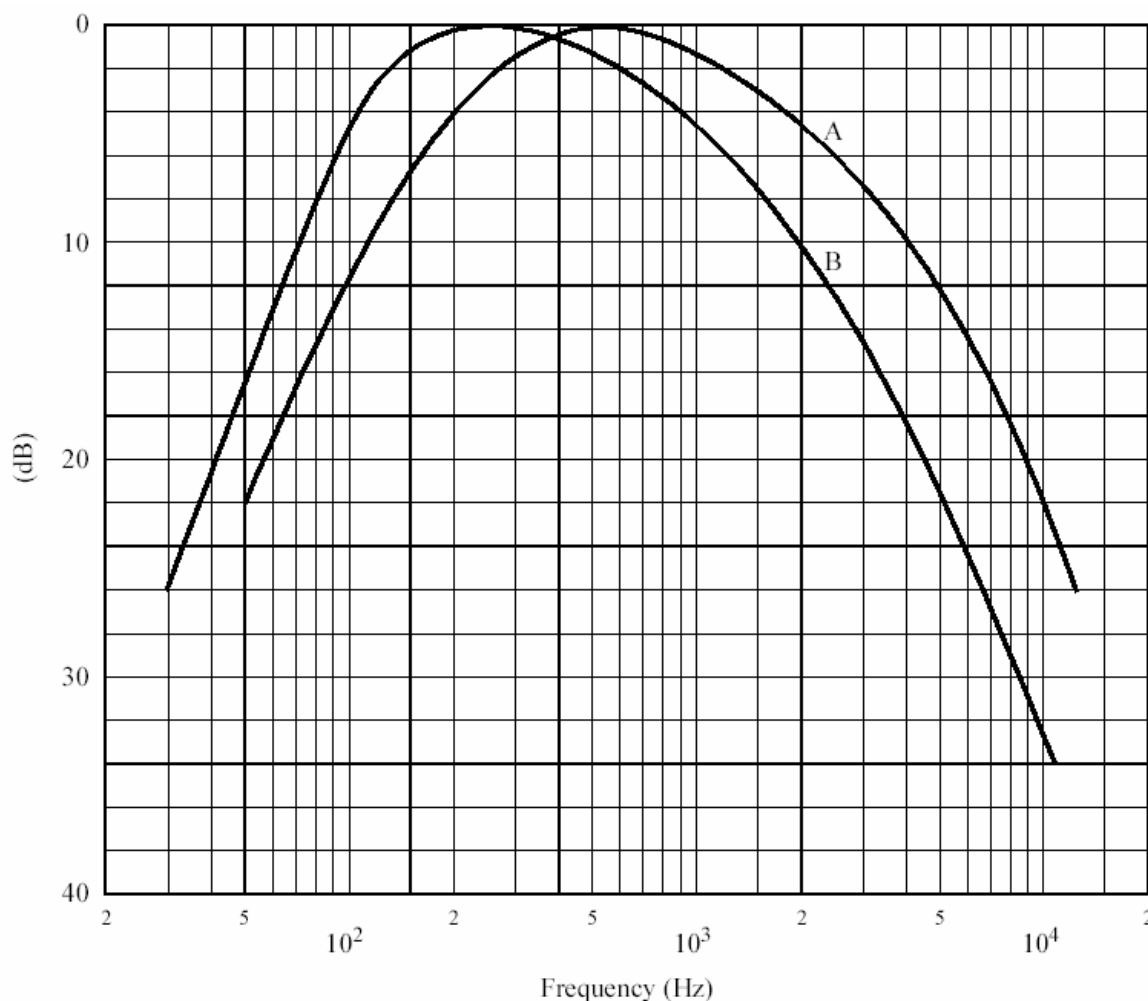

Curves A: frequency spectrum of standardized noise (measured with one-third octave filters).
 B: frequency response characteristic of filter-circuit.

Figure A.2: Coloured noise modulation

The amplitude distribution of modern dance music was taken as a basis, as it is a type of programme with a considerable proportion of high audio-frequencies, which occur most frequently. However, the dynamic range of this type of programme is too wide and does not fulfil, therefore, the second requirement mentioned above. A signal which is appropriate for this purpose is a standardized coloured noise signal, the spectral amplitude distribution of which is fairly close to that of modern dance music (see curve A of figure A.2, which is measured using one-third octave filters).

This standardized coloured noise signal may be obtained from a white-noise generator by means of a passive filter circuit as shown in figure A.3. The frequency-response characteristic of this filter is reproduced as curve B of figure A.2. (It should be noted that the difference between curves A and B of figure A.2 is due to the fact that curve A is based on measurements with one-third octave filters which pass greater amounts of energy as the bandwidth of the filter increases with frequency.)

The spectrum beyond the required bandwidth of the standardized coloured noise should be restricted by a low-pass filter having a cut-off frequency and a slope such that the bandwidth of the modulating signal is approximately equal to half the standardized bandwidth of emission. The audio-frequency amplitude/frequency characteristic of the modulating stage of the signal generator shall not vary by more than 2 dB up to the cut-off frequency of the low-pass filter.

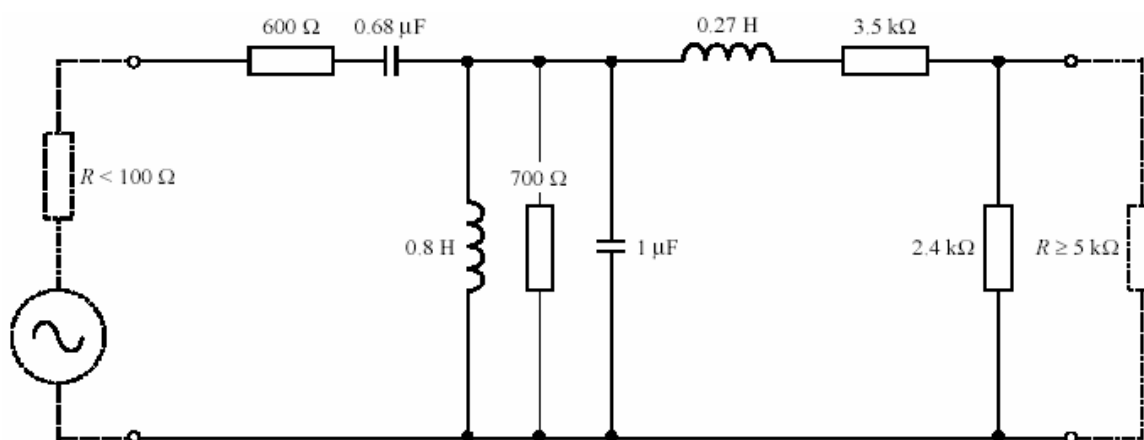

Figure A.3: White Filter circuit

A.4 Testing arrangements for radiated measurements

Examples of typical test sites can be found in IEC 60489-1 [8].

A.5 Test load characteristics

The transmitter may be required to operate into a precision load with return loss of > 26 dB in the frequency band in which the transmitter is designed to operate.

Annex B (informative): Bibliography

- ITU-R Recommendation BS.639 (1986): "Necessary bandwidth of emission in LF, MF and HF broadcasting".
- ITU-R Recommendation SM.328: "Spectra and bandwidth of emission".
- CEPT/ERC Recommendation 74-01: "Spurious emissions".
- CISPR 16-1: "Specification for radio disturbance and immunity measuring apparatus and methods - Part 1: Radio disturbance and immunity measuring apparatus".
- CISPR 16-2: "Specification for radio disturbance and immunity measuring apparatus and methods - Part 2: "Methods of measurement of disturbances and immunity".
- CENELEC EN 60244-1 (2000): "Methods of measurements for radio transmitters - Part 1: General characteristics for broadcast transmitters".
- CENELEC EN 60244-12-1 (1993): "Methods of measurements for radio transmitters - Part 12-1: Guideline for drawing up descriptive leaflets for transmitters and transposers for sound and television broadcasting - Characteristics to be specified".
- CENELEC EN 60244-12-2 (1993): "Methods of measurements for radio transmitters - Part 12-2: Guideline for drawing up descriptive leaflets for transmitters and transposers for sound and television broadcasting - Specification sheets".
- CENELEC EN 60244-15 (2000): "Methods of measurements for radio transmitters - Part 15: Amplitude-modulated transmitter for sound broadcasting".

Annex C (informative): The EN title in the official languages

| Language | EN title |
|------------|---|
| Czech | Elektromagnetická kompatibilita a rádiové spektrum (ERM) - Vysílací zařízení pro amplitudově modulovanou (AM) rozhlasovou službu - Část 2: Harmonizovaná EN podle článku 3.2 Směrnice R&TTE |
| Danish | |
| Dutch | Elektromagnetische compatibiliteit en radiospectrumzaken (ERM); Zendapparatuur voor amplitude gemoduleerde (AM) radio-omroepdiensten; Deel 2: Geharmoniseerde Europese Norm die invulling geeft aan de wezenlijke vereisten, neergelegd in artikel 3.2 van de R&TTE Richtlijn |
| English | Electromagnetic compatibility and Radio spectrum Matters (ERM); Transmitting equipment for the Amplitude Modulated (AM) sound broadcasting service; Part 2: Harmonized EN under article 3.2 of the R&TTE Directive |
| Estonian | Elektromagnetilise ühilduvuse ja raadiospektri küsimused (ERM); Maapealse digitaalse raadioringhäälingusüsteemi (T-DAB) raadiosaateseadmed; Osa 2: Harmoneeritud EN R&TTE direktiivi artikli 3.2 alusel |
| Finnish | Sähkömagneettinen yhteensopivuus ja radiospektriasiat (ERM); Amplitudimodulaatiota käyttävät ääniyleisradiolähettimet; Osa 2: R&TTE-direktiivin artiklaan 3.2 perustuva yhdenmukaistettu standardi |
| French | CEM et spectre radioélectrique (ERM); Equipements de transmission pour le service de diffusion radio en modulation d'amplitude (AM): Partie 2: EN harmonisée couvrant l'article 3.2 de la Directive R&TTE. |
| German | Elektromagnetische Verträglichkeit und Funkspektrumsangelegenheiten (ERM); Sendertechnische Einrichtungen für den amplitudenmodulierten (AM) Ton-Rundfunkdienst; Teil 2: Harmonisierte Europäische Norm (EN) nach R&TTE Richtlinie Artikel 3.2 |
| Greek | |
| Hungarian | Elektromágneses összeférhetőségi és rádióspektrumügyek (ERM). Az amplitudómodulált (AM) hágmúsorszóró szolgálat adóberendezései. 2. rész: Az R&TTE-irányelv 3.2. cikkelye alá tartozó harmonizált európai szabvány |
| Icelandic | |
| Italian | Compatibilità elettromagnetica e Questioni relative allo spettro delle radiofrequenze (ERM); Trasmettitori del servizio di radiodiffusione audio; Parte 2: EN armonizzata relativa ai requisiti essenziali dell'articolo 3, paragrafo 2, della direttiva R&TTE |
| Latvian | |
| Lithuanian | |
| Maltese | |
| Norwegian | |
| Polish | Kompatybilność Elektromagnetyczna i Zagadnienia Widma Radiowego (ERM) - Urządzenia nadawcze stosowane w radiofonii z modulacją amplitudy (AM) - Zharmonizowana EN zgodna z artykułu 3.2 dyrektywy R&TTE |
| Portuguese | Assuntos de Espectro Radioelétrico e Compatibilidade Electromagnética (ERM); Transmissores do Serviço Terrestre de Radiodifusão Sonora com modulação de Amplitude (AM); Parte 2: EN Harmonizada cobrindo os requisitos essenciais no âmbito do artigo 3º, nº 2 da directiva R&TTE |
| Slovak | Elektromagnetická kompatibilita a závislosti rádiového spektra (ERM). Vysielacie zariadenia pre rozhlasové vysielanie s amplitúdovou moduláciou (AM). Časť 2: Harmonizovaná EN podľa článku 3.2 smernice R&TTE |
| Slovenian | Elektromagnetna združljivost (EMC) in zadeve v zvezi z radijskim spektrom (ERM) – Oddajniška oprema za amplitudno modulirano (AM) storitev zvokovne radiodifuzije - 2. del: Harmonizirani EN v skladu s členom 3.2 direktive R&TTE |
| Spanish | Compatibilidad electromagnética y cuestiones de espectro de radiofrecuencia(ERM); Equipos transmisores para el servicio de radiodifusión de sonido trabajando en Modulación de Amplitud (AM) Parte 2: EN armonizada cubriendo los requisitos esenciales según el artículo 3.2 de la Directiva 1999/5/CE (R&TTE) |
| Swedish | Elektromagnetisk kompatibilitet och radiospektrumfrågor (ERM); Amplitudmodulerad (AM) sändarutrustning för ljudrundradiotjänst; Del 2: Harmoniserad EN omfattande väsentliga krav enligt artikel 3.2 i R&TTE-direktivet |

History

| Document history | | | | |
|-------------------------|---------------|----------------|--------------|--------------------------|
| V1.1.1 | November 2004 | Public Enquiry | PE 20050318: | 2004-11-17 to 2005-03-18 |
| V1.1.1 | June 2005 | Vote | V 20050826: | 2005-06-27 to 2005-08-26 |
| | | | | |
| | | | | |
| | | | | |