

ETSI EN 301 929 V2.1.1 (2017-03)



HARMONISED EUROPEAN STANDARD

**VHF transmitters and receivers as Coast Stations for GMDSS
and other applications in the maritime mobile service;
Harmonised Standard covering the essential requirements
of article 3.2 of Directive 2014/53/EU**

Reference

REN/ERM-TG26-140

Keywords

harmonised standard, maritime, radio, VHF

ETSI

650 Route des Lucioles
F-06921 Sophia Antipolis Cedex - FRANCE

Tel.: +33 4 92 94 42 00 Fax: +33 4 93 65 47 16

Siret N° 348 623 562 00017 - NAF 742 C
Association à but non lucratif enregistrée à la
Sous-Préfecture de Grasse (06) N° 7803/88

Important notice

The present document can be downloaded from:
<http://www.etsi.org/standards-search>

The present document may be made available in electronic versions and/or in print. The content of any electronic and/or print versions of the present document shall not be modified without the prior written authorization of ETSI. In case of any existing or perceived difference in contents between such versions and/or in print, the only prevailing document is the print of the Portable Document Format (PDF) version kept on a specific network drive within ETSI Secretariat.

Users of the present document should be aware that the document may be subject to revision or change of status. Information on the current status of this and other ETSI documents is available at
<https://portal.etsi.org/TB/ETSIDeliverableStatus.aspx>

If you find errors in the present document, please send your comment to one of the following services:
<https://portal.etsi.org/People/CommitteeSupportStaff.aspx>

Copyright Notification

No part may be reproduced or utilized in any form or by any means, electronic or mechanical, including photocopying and microfilm except as authorized by written permission of ETSI.

The content of the PDF version shall not be modified without the written authorization of ETSI.
The copyright and the foregoing restriction extend to reproduction in all media.

© European Telecommunications Standards Institute 2017.
All rights reserved.

DECT™, **PLUGTESTS™**, **UMTS™** and the ETSI logo are Trade Marks of ETSI registered for the benefit of its Members.
3GPP™ and **LTE™** are Trade Marks of ETSI registered for the benefit of its Members and of the 3GPP Organizational Partners.
GSM® and the GSM logo are Trade Marks registered and owned by the GSM Association.

Contents

Intellectual Property Rights	7
Foreword.....	7
Modal verbs terminology.....	7
1 Scope	8
2 References	8
2.1 Normative references	8
2.2 Informative references.....	9
3 Definitions, symbols and abbreviations	9
3.1 Definitions	9
3.2 Symbols.....	9
3.3 Abbreviations	9
4 General requirements	10
4.1 Construction	10
4.2 Controls and indicators.....	10
4.3 Safety precautions	11
4.4 Labelling.....	11
5 Technical requirements	11
5.1 Switching time.....	11
5.2 Class of emission and modulation characteristics	11
5.3 Use of Channel 70	11
5.4 Audio line	11
5.5 DSC Controller Interfaces	12
6 General conditions of measurement	12
6.1 Arrangements for test signals applied to the receiver input.....	12
6.2 Squelch.....	12
6.3 Normal test modulation	12
6.4 Artificial antenna.....	12
6.5 Standard test signals for DSC.....	12
6.5.1 References to standard test signals	12
6.5.2 Standard test signal	12
6.6 Determination of the symbol error rate in the output of the receiving part	13
6.7 DSC Decoder.....	13
6.8 Test channels.....	13
6.9 Reference Bandwidths for emissions measurements.....	13
7 Test conditions and power sources.....	13
7.1 Normal and extreme test conditions	13
7.2 Test power source.....	14
7.3 Normal test conditions.....	14
7.3.1 Normal temperature and humidity	14
7.3.2 Normal power sources	14
7.3.2.1 Mains voltage and frequency	14
7.3.2.2 Lead Acid Battery power source.....	14
7.3.2.3 Other power sources.....	14
7.4 Test under extreme test conditions	14
7.4.1 General.....	14
7.4.2 Extreme temperatures	14
7.4.3 Extreme values of test power sources	15
7.4.3.1 Mains voltage.....	15
7.4.3.2 Battery power source.....	15
7.4.3.3 Other power sources.....	15
7.5 Procedure for tests at extreme temperatures.....	15
8 Transmitter	15
8.1 Frequency Error.....	15

8.1.1	Definition.....	15
8.1.2	Method of measurement	15
8.1.3	Limits.....	15
8.2	Carrier power.....	15
8.2.1	Definitions	15
8.2.2	Method of measurement	16
8.2.3	Limits.....	16
8.2.3.1	Normal test conditions	16
8.2.3.2	Extreme test conditions	16
8.3	Frequency deviation	16
8.3.1	Definition.....	16
8.3.2	Maximum permissible frequency deviation.....	16
8.3.2.1	Method of measurement.....	16
8.3.2.2	Limits	16
8.3.3	Reduction of frequency deviation at modulation frequencies above 3 kHz.....	16
8.3.3.1	Method of measurement.....	16
8.3.3.2	Limits	17
8.4	Audio frequency response	17
8.4.1	Definition.....	17
8.4.2	Method of measurement	18
8.4.3	Limit	18
8.5	Audio frequency harmonic distortion of the emission.....	18
8.5.1	Definition.....	18
8.5.2	Method of measurement	19
8.5.3	Limits.....	19
8.6	Adjacent channel power	19
8.6.1	Definition.....	19
8.6.2	Method of measurement	19
8.6.3	Limit	20
8.7	Conducted spurious emissions conveyed to the antenna	20
8.7.1	Definition.....	20
8.7.2	Method of measurement	20
8.7.3	Limit	20
8.8	Cabinet radiation and conducted spurious emissions other than those conveyed to the antenna	20
8.8.1	Definitions	20
8.8.2	Method of measurement	21
8.8.3	Limits.....	21
8.9	Residual modulation of the transmitter	22
8.9.1	Definition.....	22
8.9.2	Method of measurement	22
8.9.3	Limit	22
8.10	DSC transmitter modulation index.....	22
8.10.1	Definition.....	22
8.10.2	Method of measurement	22
8.10.3	Limits.....	22
8.11	DSC audio input limitation.....	23
8.11.1	Definition.....	23
8.11.2	Method of measurement	23
8.11.3	Limit	23
8.12	Modulation attack time.....	23
8.12.1	Definition.....	23
8.12.2	Method of measurement	23
8.12.3	Limit	23
8.13	Transient frequency behaviour of the transmitter.....	24
8.13.1	Definitions	24
8.13.2	Method of measurement	25
8.13.3	Limits.....	27
8.14	Intermodulation attenuation.....	27
8.14.1	Definition.....	27
8.14.2	Method of measurement	27
8.14.3	Limits.....	28
8.15	Testing of generated call sequences	28

8.15.1	Definition.....	28
8.15.2	Method of measurement	28
8.15.3	Requirement.....	28
8.16	Modulation rate for DSC.....	28
8.16.1	Definition.....	28
8.16.2	Method of measurement	29
8.16.3	Limits.....	29
8.17	Frequency error (demodulated DSC signal).....	29
8.17.1	Definition.....	29
8.17.2	Method of measurement	29
8.17.3	Limits.....	29
9	Receiver.....	29
9.1	Harmonic distortion.....	29
9.1.1	Definition.....	29
9.1.2	Method of measurement	29
9.1.2.1	Audio line output	29
9.1.2.2	Under normal test conditions	30
9.1.2.3	Under extreme test conditions.....	30
9.1.3	Limits.....	30
9.2	Audio frequency response.....	30
9.2.1	Definition.....	30
9.2.2	Method of measurement	30
9.2.3	Limits.....	30
9.3	Amplitude characteristic of the receiver.....	31
9.3.1	Definition.....	31
9.3.2	Method of measurement	31
9.3.3	Limits.....	31
9.4	Maximum usable sensitivity.....	32
9.4.1	Definition.....	32
9.4.2	Method of measurement	32
9.4.3	Limits.....	32
9.5	Co-channel rejection.....	32
9.5.1	Definition.....	32
9.5.2	Method of measurement	32
9.5.3	Limits.....	33
9.6	Adjacent channel selectivity.....	33
9.6.1	Definition.....	33
9.6.2	Method of measurement	33
9.6.3	Limits.....	33
9.7	Spurious response.....	33
9.7.1	Definition.....	33
9.7.2	Method of measurement	34
9.7.3	Limit	34
9.8	Intermodulation response	34
9.8.1	Definition.....	34
9.8.2	Method of measurement	34
9.8.3	Limit	34
9.9	Blocking or desensitization	35
9.9.1	Definition.....	35
9.9.2	Method of measurement	35
9.9.3	Limit	35
9.10	Receiver noise and hum level.....	35
9.10.1	Definition.....	35
9.10.2	Method of measurement	35
9.10.3	Limit	35
9.11	Spurious emissions	36
9.11.1	Definition.....	36
9.11.2	Conducted spurious emissions.....	36
9.11.2.1	Method of measurement.....	36
9.11.2.2	Limit.....	36
9.11.3	Radiated spurious emissions.....	36

9.11.3.1	Method of measurement.....	36
9.11.3.2	Limit.....	37
9.12	DSC audio output characteristic.....	37
9.12.1	Definition.....	37
9.12.2	Methods of measurement.....	37
9.12.3	Limit.....	37
9.13	DSC receiver maximum usable sensitivity.....	38
9.13.1	Definition.....	38
9.13.2	Method of measurement.....	38
9.13.3	Limits.....	38
9.14	DSC receiver co-channel rejection.....	38
9.14.1	Definition.....	38
9.14.2	Method of measurement.....	38
9.14.3	Limits.....	38
9.15	DSC receiver adjacent channel selectivity.....	39
9.15.1	Definition.....	39
9.15.2	Method of measurement.....	39
9.15.3	Limits.....	39
9.16	DSC receiver dynamic range.....	39
9.16.1	Definition.....	39
9.16.2	Method of measurement.....	39
9.16.3	Limit.....	39
9.17	Duplex operation for 25kHz channels.....	39
9.17.1	Introduction.....	39
9.17.2	Receiver desensitization with simultaneous transmission and reception.....	40
9.17.2.1	Definition.....	40
9.17.2.2	Method of measurement.....	40
9.17.2.3	Limits.....	40
9.17.3	Duplex transceiver internal mixing.....	40
9.17.3.1	Definition.....	40
9.17.3.2	Method of measurement.....	40
9.17.3.3	Limits.....	41
9.18	Verification of correct decoding of various types of DSC calls.....	41
9.18.1	Definition.....	41
9.18.2	Method of measurement.....	41
9.18.3	Requirement.....	41
9.19	DSC spurious response and blocking immunity.....	41
9.19.1	Definition.....	41
9.19.2	Method of measurement.....	41
9.19.3	Limits.....	42
9.20	DSC Intermodulation response.....	42
9.20.1	Definition.....	42
9.20.2	Method of measurement.....	42
9.20.3	Limits.....	42
10	Testing for compliance with technical requirements.....	42
10.1	Environmental conditions for testing.....	42
10.2	Interpretation of the measurement results.....	42
Annex A (informative):	Relationship between the present document and the essential requirements of Directive 2014/53/EU.....	44
Annex B (normative):	Measuring receiver for adjacent channel power measurement.....	46
B.1	Power measuring receiver specification.....	46
B.1.0	General.....	46
B.1.1	IF filter.....	46
B.1.2	Attenuation indicator.....	47
B.1.3	rms value indicator.....	47
B.1.4	Oscillator and amplifier.....	47
Annex C (informative):	Change history.....	48
History.....		49

Intellectual Property Rights

IPRs essential or potentially essential to the present document may have been declared to ETSI. The information pertaining to these essential IPRs, if any, is publicly available for **ETSI members and non-members**, and can be found in ETSI SR 000 314: "*Intellectual Property Rights (IPRs); Essential, or potentially Essential, IPRs notified to ETSI in respect of ETSI standards*", which is available from the ETSI Secretariat. Latest updates are available on the ETSI Web server (<https://ipr.etsi.org/>).

Pursuant to the ETSI IPR Policy, no investigation, including IPR searches, has been carried out by ETSI. No guarantee can be given as to the existence of other IPRs not referenced in ETSI SR 000 314 (or the updates on the ETSI Web server) which are, or may be, or may become, essential to the present document.

Foreword

This Harmonised European Standard (EN) has been produced by ETSI Technical Committee Electromagnetic compatibility and Radio spectrum Matters (ERM).

The present document has been prepared under the Commission's standardisation request C(2015) 5376 final [i.1] to provide one voluntary means of conforming to the essential requirements of Directive 2014/53/EU on the harmonisation of the laws of the Member States relating to the making available on the market of radio equipment and repealing Directive 1999/5/EC [i.2].

Once the present document is cited in the Official Journal of the European Union under that Directive, compliance with the normative clauses of the present document given in table A.1 confers, within the limits of the scope of the present document, a presumption of conformity with the corresponding essential requirements of that Directive, and associated EFTA regulations.

National transposition dates	
Date of adoption of this EN:	27 February 2017
Date of latest announcement of this EN (doa):	31 May 2017
Date of latest publication of new National Standard or endorsement of this EN (dop/e):	30 November 2017
Date of withdrawal of any conflicting National Standard (dow):	30 November 2018

Modal verbs terminology

In the present document "**shall**", "**shall not**", "**should**", "**should not**", "**may**", "**need not**", "**will**", "**will not**", "**can**" and "**cannot**" are to be interpreted as described in clause 3.2 of the [ETSI Drafting Rules](#) (Verbal forms for the expression of provisions).

"**must**" and "**must not**" are **NOT** allowed in ETSI deliverables except when used in direct citation.

1 Scope

The present document specifies the minimum requirements for transmitters, receivers and transceivers fitted with external antenna connectors, used as coast stations, operating in the VHF band of the maritime mobile service. This includes:

- equipment operating under local or remote control;
- equipment operating on 12,5 kHz or 25 kHz channel spacing;
- equipment capable of analogue speech, Digital Selective Calling (DSC), or both;
- equipment operating in Simplex, Semi-Duplex (Half Duplex) and Duplex modes;
- equipment which may consist of more than one unit;
- equipment which may be single-channel or multi-channel;
- equipment operating on shared radio sites;
- equipment operating in isolation from other radio equipment.

Where the equipment is not intended for DSC operation, only those clauses relevant to non-DSC tests are applicable.

The present document covers the essential requirements of article 3.2 of Directive 2014/53/EU [i.2] under the conditions identified in annex A.

2 References

2.1 Normative references

References are specific, identified by date of publication and/or edition number or version number. Only the cited version applies.

Referenced documents which are not found to be publicly available in the expected location might be found at <http://docbox.etsi.org/Reference>.

NOTE: While any hyperlinks included in this clause were valid at the time of publication, ETSI cannot guarantee their long term validity.

The following referenced documents are necessary for the application of the present document.

- [1] Recommendation ITU-T O.41 (1994): "Psophometer for use on telephone-type circuits".
- [2] Recommendation ITU-R M.493-14 (2015): "Digital selective-calling system for use in the maritime mobile service".
- [3] Recommendation ITU-T V.11/X27 (1996): "Electrical characteristics for balanced double-current interchange circuits operating at data signalling rates up to 10 Mbit/s".
- [4] Recommendation ITU-R M.1084-5 (2012): "Interim solutions for improved efficiency in the use of the band 156-174 MHz by stations in the maritime mobile service".
- [5] ETSI TS 103 052 (V1.1.1) (03-2011): "Electromagnetic compatibility and Radio spectrum Matters (ERM); Radiated measurement methods and general arrangements for test sites up to 100 GHz".
- [6] ITU Radio Regulations (2016).

2.2 Informative references

References are either specific (identified by date of publication and/or edition number or version number) or non-specific. For specific references, only the cited version applies. For non-specific references, the latest version of the referenced document (including any amendments) applies.

NOTE: While any hyperlinks included in this clause were valid at the time of publication, ETSI cannot guarantee their long term validity.

The following referenced documents are not necessary for the application of the present document but they assist the user with regard to a particular subject area.

- [i.1] Commission Implementing Decision C(2015) 5376 final of 4.8.2015 on a standardisation request to the European Committee for Electrotechnical Standardisation and to the European Telecommunications Standards Institute as regards radio equipment in support of Directive 2014/53/EU of the European Parliament and of the Council.
- [i.2] Directive 2014/53/EU of the European Parliament and of the Council of 16 April 2014 on the harmonisation of the laws of the Member States relating to the making available on the market of radio equipment and repealing Directive 1999/5/EC.
- [i.3] ETSI TR 100 028-1 (V1.4.1) (12-2001): "Electromagnetic compatibility and Radio spectrum Matters (ERM); Uncertainties in the measurement of mobile radio equipment characteristics; Part 1".
- [i.4] ETSI TR 100 028-2 (V1.4.1) (12-2001): "Electromagnetic compatibility and Radio spectrum Matters (ERM); Uncertainties in the measurement of mobile radio equipment characteristics; Part 2".

3 Definitions, symbols and abbreviations

3.1 Definitions

For the purposes of the present document, the following terms and definitions apply:

block: to inhibit a function by making it inaccessible from the user interface

G3E: phase-modulation (frequency modulation with a pre-emphasis of 6 dB/octave) for analogue speech

G2B: phase-modulation with digital information, with a sub-carrier for Digital Selective Calling (DSC) operation

modulation index: ratio between the frequency deviation and the modulation frequency

3.2 Symbols

For the purposes of the present document, the following symbols apply:

Hz Hertz

3.3 Abbreviations

For the purposes of the present document, the following abbreviations apply:

ac	alternating current
ad	amplitude difference
CSP	Channel SPacing
dBd	the forward gain of an antenna compared to a half-wave dipole antenna in decibel
dc	direct current
DSC	Digital Selective Calling

EFTA	European Free Trade Area
emf	electromotive force
ERP	Effective Radiated Power
EUT	Equipment Under Test
fd	frequency difference
FM	Frequency Modulation
IF	Intermediate Frequency
MUS	Maximum Useable Sensitivity
RBW	Reference BandWidth
RF	Radio Frequency
rms	root mean square
SINAD	Signal + Noise + Distortion/Noise + Distortion
Tx	transmitter
V	Volt
VHF	Very High Frequency

4 General requirements

4.1 Construction

The mechanical and electrical construction and finish of the equipment shall conform in all respects to good engineering practice.

Technical documentation shall be supplied with the equipment.

The equipment shall be able to operate on appropriate channels defined in appendix 18 to the Radio Regulations [6] noting in particular footnotes m) and e).

Additional VHF channels outside those defined by appendix 18 to the Radio Regulations [6] may also be provided.

If 12,5 kHz channels are implemented in the equipment it shall be in accordance with annex 4 of Recommendation ITU-R M.1084-5 [4].

Additional VHF channels for maritime use outside those defined by Appendix 18 to the Radio Regulations may also be provided where permitted by relevant administrations. These channels shall be clearly identified for use as relating to the relevant administration(s) and accessed through a positive action(s) for enabling use of these channel(s) but means shall be provided to block any or all of these additional channels if required by the relevant administration(s).

It shall not be possible to transmit while any frequency synthesizer used within the transmitter is out of lock.

It shall not be possible to transmit during channel switching operations.

The equipment shall be equipped with a squelch or mute circuit.

4.2 Controls and indicators

At the operator position from which the coast station is controlled, the following facilities shall be available:

- if the equipment is intended to be used on channel 16, this channel shall be clearly marked and shall be readily accessible;
- if the equipment is intended to be used on channel 70, there shall be a distinctive indication when this channel is in use;
- a visual indication that the installation is in operation;
- where more than one radio channel is available, there shall be a visual indication of the radio channel selected for transmission;
- a manual non-locking push-to-talk switch to operate the transmitter (except on equipment designed to operate on channel 70 only);

- a volume control;
- a visual indication that the transmitter is activated;
- the operator shall not have access to any control which, if wrongly set, might impair the technical characteristics of the equipment;
- when there is more than one control unit, indication of the equipment status (e.g. transmit, busy) shall be given to all control units.

4.3 Safety precautions

Measures shall be taken to protect the equipment against the effects of excessive current and excessive voltage.

Measures shall be taken to prevent damage to the equipment that might arise from an accidental reversal of polarity of the electrical power source.

Means shall be provided for earthing exposed metallic parts of the equipment.

No damage to the equipment shall occur when the antenna terminals are placed on open circuit or short circuit for a period of at least 5 min in each case.

In order to provide protection against damage due to the build-up of static voltages at the antenna terminals, there shall be a dc path from the antenna terminals to chassis not exceeding 100 k Ω .

The information in any volatile memory device shall be protected from interruptions in the power supply of up to 60 s duration.

4.4 Labelling

The voltage of the power supply that the equipment is intended to operate from, shall be clearly indicated on the equipment.

5 Technical requirements

5.1 Switching time

The channel switching arrangement shall be such that the time necessary to change over from using one of the channels to using any other channel does not exceed 5 s.

The time necessary to change over from transmission to reception or vice versa, shall not exceed 0,3 s.

5.2 Class of emission and modulation characteristics

The equipment shall use phase modulation, G3E (frequency modulation with a pre-emphasis of 6 dB/octave) for speech, and G2B for DSC signalling as specified in clause 1.3.2 of Recommendation ITU-R M.493-14 [2].

5.3 Use of Channel 70

Only Digital Selective Calling (DSC) is permitted on channel 70.

5.4 Audio line

The equipment shall have audio line input and output with 600 Ω impedance, symmetrical and free of earth. The audio lines shall operate with voltage levels adjustable within the range 0,775 V rms to 0,078 V rms, this is equivalent to 0 dBm to -20 dBm.

5.5 DSC Controller Interfaces

If the equipment is designed for connection to an external DSC controller via audio frequency terminals, the input and output impedances shall be 600 Ω free of earth.

If the equipment is designed for connection to an external DSC controller via binary inputs and outputs, the logic level shall comply with Recommendation ITU-T V.11 [3].

The transmitter key input interface shall be a 2-wire circuit closure to transmit with a maximum open circuit voltage of 50 V and a maximum closed circuit current of 100 mA.

6 General conditions of measurement

6.1 Arrangements for test signals applied to the receiver input

Test signal sources shall be connected to the receiver input in such a way that the impedance presented to the receiver input is 50 Ω non-reactive, irrespective of whether one or more test signals are applied to the receiver simultaneously.

The levels of the test signals shall be expressed in terms of the emf at the terminals to be connected to the receiver.

The nominal frequency of the receiver is the carrier frequency of the selected channel.

6.2 Squelch

The squelch or mute circuit shall be switched off for the duration of the conformance tests.

6.3 Normal test modulation

For normal test modulation, the modulation frequency shall be:

- 25 kHz channels: 1 kHz and the frequency deviation shall be ± 3 kHz.
- 12,5 kHz channels: 1 kHz and the frequency deviation shall be $\pm 1,5$ kHz.

6.4 Artificial antenna

When tests are carried out with an artificial antenna, this shall be a non-reactive, non-radiating 50 Ω load.

6.5 Standard test signals for DSC

6.5.1 References to standard test signals

Standard test signals consist of a series of identical call sequences, each of which contains a known number of information symbols, format specifier, address, category, identification, etc. as defined in Table A1-4.1 to Table A1-4.9 of Recommendation ITU-R M.493-14 [2] see also clause 6.6. Standard test signals should be of sufficient length for the measurements to be performed or it should be possible to repeat them without interruption to make the measurements.

6.5.2 Standard test signal

The standard test signal for the VHF DSC decoder shall be a phase-modulated signal at VHF channel 70 (or other suitable channel where channel 70 is not available within this equipment) with modulation index = 2. The modulating signal shall have a nominal frequency of 1 700 Hz and a frequency shift of ± 400 Hz with a modulation rate of 1 200 Baud. For non-integrated equipment, the standard test signal shall be the modulating signal only.

6.6 Determination of the symbol error rate in the output of the receiving part

The information content of the decoded call sequence to which forward error correction, interleaving technique and check-sum information is applied, shall be divided into blocks, each of which, corresponds to one information symbol in the applied test signal (see clause 6.5). The total number of incorrect information symbols relative to the total number of information symbols shall be registered.

6.7 DSC Decoder

Where the equipment under test is intended to receive DSC calls using an external DSC controller, the manufacturer shall supply as a part of the test equipment a suitable stand-alone DSC decoder to be used in carrying out the receiver tests dealing with DSC related parameters.

6.8 Test channels

Conformance tests for 25 kHz channel operation shall be made on channel 16 if available, or a channel as close to the centre of the frequency range of the equipment unless otherwise stated.

Conformance tests for 12,5 kHz channel operation shall be made on channel 276 if available, or a channel as close to the centre of the frequency range of the equipment unless otherwise stated.

Conformance tests for DSC operation shall be made on channel 70.

6.9 Reference Bandwidths for emissions measurements

The reference bandwidths used shall be as stated in tables 1 to 2.

Table 1: Reference bandwidths to be used for the measurement of spurious emission

Frequency range	RBW
9 kHz to 150 kHz	1 kHz
150 kHz to 30 MHz	10 kHz
30 MHz to 1 GHz	100 kHz
1 GHz to 12,75 GHz	1 MHz

Table 2: Reference bandwidths to be used close to the wanted emission for equipment operating below 1 GHz

Frequency offset from carrier	RBW
250 % of the CSP to 100 kHz	1 kHz
100 kHz to 500 kHz	10 kHz

7 Test conditions and power sources

7.1 Normal and extreme test conditions

Conformance tests shall be made under normal test conditions and also, where stated, under extreme test conditions (clauses 7.4.2 and 7.4.3 applied simultaneously).

7.2 Test power source

During conformance testing, the equipment shall be supplied from a test power source capable of producing normal and extreme test voltages as specified in clauses 7.3.2 and 7.4.3.

The internal impedance of the test power source shall be low enough for its effect on the test results to be negligible. For the purpose of testing the power source voltage shall be measured at the input terminals of the equipment.

During testing, the power source voltages shall be maintained within a tolerance of $\pm 3\%$ relative to the voltage level at the beginning of each test.

7.3 Normal test conditions

7.3.1 Normal temperature and humidity

The normal temperature and humidity conditions for tests shall be a combination of temperature and humidity within the following ranges:

- temperature: +15 °C to +35 °C;
- relative humidity: 20 % to 75 %.

When the relative humidity is lower than 20 %, it shall be stated in the test report.

7.3.2 Normal power sources

7.3.2.1 Mains voltage and frequency

The normal test voltage for equipment to be connected to the ac mains shall be the nominal mains voltage. For the purpose of the present document, the nominal voltage shall be the declared voltage or any of the declared voltages for which the equipment is indicated as having been designed. The frequency of the test voltage shall be $50 \text{ Hz} \pm 1 \text{ Hz}$.

7.3.2.2 Lead Acid Battery power source

If the equipment is designed to operate from a lead acid battery, the normal test voltage shall be 1,1 times the nominal voltage of the battery.

7.3.2.3 Other power sources

For operation from other power sources the normal test voltage shall be that declared by the manufacturer.

7.4 Test under extreme test conditions

7.4.1 General

Unless otherwise stated, tests under extreme tests conditions mean that the Equipment Under Test (EUT) shall be tested at the upper temperature and at the high extreme value of the supply voltage applied simultaneously, and at the low temperature and the low extreme value of the supply voltage applied simultaneously.

7.4.2 Extreme temperatures

For tests at extreme temperatures, measurements shall be made in accordance with clause 7.5, at a lower temperature of -20 °C and an upper temperature of $+55 \text{ °C}$.

7.4.3 Extreme values of test power sources

7.4.3.1 Mains voltage

The extreme test voltages for equipment to be connected to the ac mains shall be the nominal mains voltage $\pm 10\%$. The frequency of the test voltage shall be $50\text{ Hz} \pm 1\text{ Hz}$.

7.4.3.2 Battery power source

Where the equipment is designed to operate from a battery, the extreme test voltages shall be 1,3 and 0,9 times the nominal voltage of the battery.

7.4.3.3 Other power sources

For operation from other power sources the extreme test voltages shall be that declared by the equipment manufacturer.

7.5 Procedure for tests at extreme temperatures

The equipment shall be switched off during the temperature stabilizing periods. Before conducting tests at the upper temperature, the equipment shall be placed in the test chamber and left until thermal equilibrium is reached. The equipment shall then be switched on for half an hour in the high power transmit condition at the normal voltage and shall then meet the requirements of the specification.

For tests at the lower temperature, the equipment shall be left in the test chamber until thermal equilibrium is reached and shall then be switched to the standby or receive position for one minute and shall then meet the requirements of the specification.

8 Transmitter

8.1 Frequency Error

8.1.1 Definition

The frequency error is the difference between the measured carrier frequency and its nominal value.

8.1.2 Method of measurement

The carrier frequency shall be measured in the absence of modulation, with the transmitter connected to an artificial antenna (see clause 6.4). Measurements shall be made under normal test conditions (see clause 7.3) and under extreme test conditions (see clause 7.4).

8.1.3 Limits

The frequency error shall be within $\pm 800\text{ Hz}$.

8.2 Carrier power

8.2.1 Definitions

The carrier power is the mean power delivered to the artificial antenna during one radio frequency cycle in the absence of modulation.

The rated output power is the carrier power declared by the manufacturer.

8.2.2 Method of measurement

The transmitter shall be connected to an artificial antenna (see clause 6.4) and the power delivered to this artificial antenna shall be measured. The measurements shall be made under normal test conditions (see clause 7.3) and also under extreme test conditions (see clause 7.4).

8.2.3 Limits

8.2.3.1 Normal test conditions

The carrier power shall be within $\pm 1,5$ dB from the rated output power.

8.2.3.2 Extreme test conditions

The carrier power shall be within +2 dB, -3 dB of the rated output power.

8.3 Frequency deviation

8.3.1 Definition

Frequency deviation is the difference between the instantaneous frequency of the modulated radio frequency signal and the carrier frequency.

8.3.2 Maximum permissible frequency deviation

8.3.2.1 Method of measurement

Arrangements for modulating the transmitter are specified in clause 6.3. The transmitter shall be connected to an artificial antenna as specified in clause 6.4.

The transmitter shall be modulated with an audio tone at a level 20 dB above that required to produce normal test modulation as specified in clause 6.3. The frequency of this tone shall then be varied between 100 Hz and 3 kHz while its level is kept constant.

The peak frequency deviation shall be measured over this range.

Measurements shall be made with the output power set at maximum and also with the output power set at minimum.

8.3.2.2 Limits

The maximum permissible frequency deviation shall be:

- 25 kHz channels: ± 5 kHz.
- 12,5 kHz channels: $\pm 2,5$ kHz.

8.3.3 Reduction of frequency deviation at modulation frequencies above 3 kHz

8.3.3.1 Method of measurement

Arrangements for modulating the transmitter are specified in clause 6.3. The transmitter shall be connected to an artificial antenna as specified in clause 6.4.

The transmitter shall be modulated with an audio tone at a level required to produce normal test modulation as specified in clause 6.3. The frequency of this tone shall then be varied between 3 kHz (see note) and a frequency equal to the channel separation for which the equipment is intended while its level is kept constant.

The peak frequency deviation shall be measured over this range.

NOTE: 2,55 kHz for transmitters intended for 12,5 kHz channel separation.

8.3.3.2 Limits

The frequency deviation at modulation frequencies between 3,0 kHz (for equipment operating with 25 kHz channel separations) or 2,55 kHz (for equipment operating with 12,5 kHz channel separation) and 6,0 kHz shall not exceed the frequency deviation at a modulation frequency of 3,0 kHz or 2,55 kHz. At 6,0 kHz the deviation shall be not more than 30,0 % of the maximum permissible frequency deviation.

The frequency deviation at modulation frequencies between 6,0 kHz and a frequency equal to the channel separation for which the equipment is intended shall not exceed that given by a linear representation of the frequency deviation (dB) relative to the modulation frequency, starting at the 6,0 kHz limit and having a slope of -14,0 dB per octave. These limits are illustrated in figure 1.

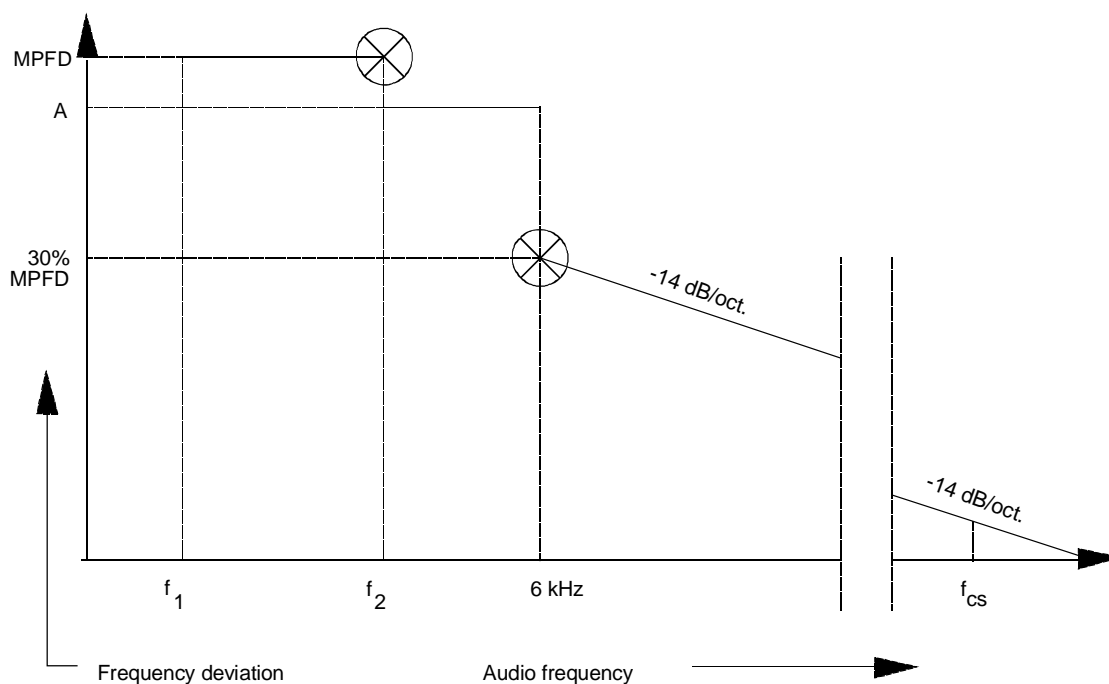

NOTE:

Abbreviations:

f_1 lowest appropriate frequency

f_2 3,0 kHz (for 25 kHz channel separation), or
2,55 kHz (for 12,5 kHz channel separation)

MPFD maximum permissible frequency deviation, clause 8.3.2.1

A measured frequency deviation at f_2

f_{cs} frequency equal to channel separation

Figure 1: Frequency deviation

8.4 Audio frequency response

8.4.1 Definition

The audio frequency response is the peak frequency deviation of the transmitter as a function of the modulating frequency.

8.4.2 Method of measurement

Arrangements for modulating the transmitter are specified in clause 6.3. The transmitter shall be connected to an artificial antenna as specified in clause 6.4.

A modulating tone at 1 kHz shall be applied to the transmitter and the audio input level shall be adjusted so that the peak frequency deviation of the transmitter is ± 1 kHz. This is the reference point in figure 2 (i.e. 1 kHz corresponds to 0 dB).

The modulating tone shall then be varied between 300 Hz and 3 kHz (see note), while its level is kept constant. The peak frequency deviation shall be measured over this range.

NOTE: 2,55 kHz for transmitters intended for 12,5 kHz channel separation.

8.4.3 Limit

The audio frequency response shall be within +1 dB and -3 dB of a 6 dB/octave line passing through the reference point, as shown in figure 2. The upper limit frequency shall be 2,55 kHz for 12,5 kHz channels.

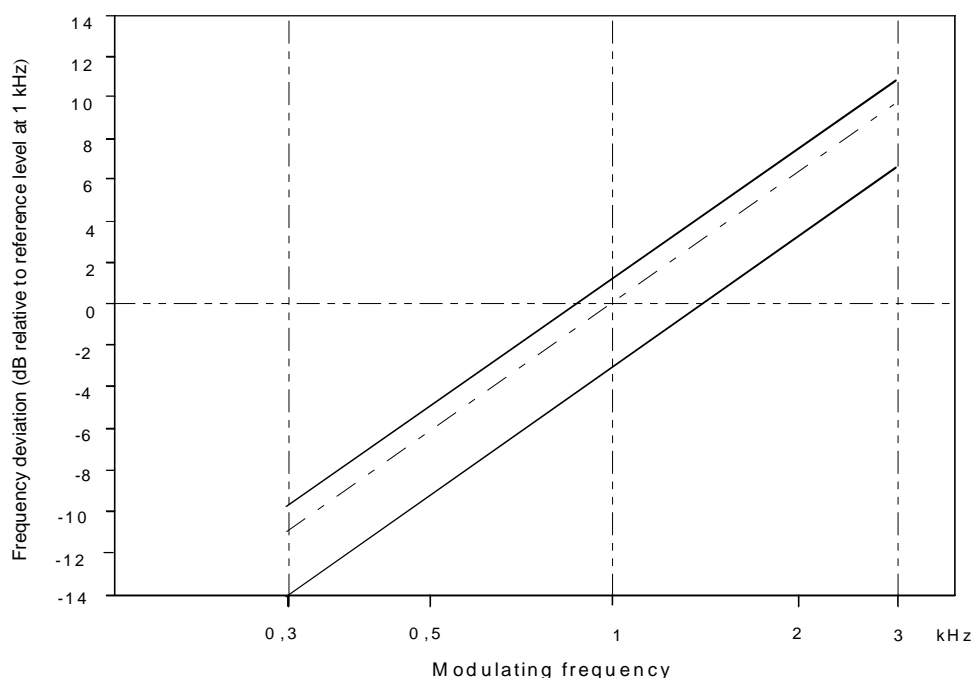

Figure 2: Audio frequency response

8.5 Audio frequency harmonic distortion of the emission

8.5.1 Definition

Harmonic distortion of the emission, with the transmitter modulated by an audio tone, is a parameter of the recovered audio signal after linear demodulation of the transmitter output, and is defined as the percentage ratio of the rms voltage of all the harmonics (of the audio tone fundamental frequency) within the recovered audio signal to its total rms voltage.

8.5.2 Method of measurement

Arrangements for modulating the transmitter are specified in clause 6.3. Measurements shall be made with the output power set at maximum and also with the output power set at minimum.

This test shall be carried out under normal test conditions and under extreme test conditions, as specified in clauses 7.3 and 7.4 respectively.

Under normal test conditions the transmitter shall be modulated with audio tones at 300 Hz, 500 Hz and 1 kHz successively, with a constant modulation index of 3. The distortion of the audio frequency signal shall be measured in each case.

Under extreme test conditions the transmitter shall be modulated with an audio tone at 1 kHz, with a modulation index of 3. The distortion of the audio frequency signal shall be measured.

8.5.3 Limits

The harmonic distortion shall not exceed 5 %.

8.6 Adjacent channel power

8.6.1 Definition

The adjacent channel power is that part of the total output power of a transmitter under defined conditions of modulation, which falls within a specified passband centred on the nominal frequency of either of the adjacent channels.

This power is the sum of the mean power produced by the modulation, hum and noise of the transmitter.

8.6.2 Method of measurement

The adjacent channel power can be measured with a power measuring receiver which conforms to annex A (referred to below as the "receiver"):

- a) The transmitter shall be operated at the carrier power determined in clause 8.2 under normal test conditions. The output of the transmitter shall be linked to the input of the "receiver" by a connecting device such that the impedance presented to the transmitter is 50 Ω and the level at the "receiver" input is appropriate.
- b) With the transmitter unmodulated, the tuning of the "receiver" shall be adjusted so that a maximum response is obtained. This is the 0 dB response point. The "receiver" attenuator setting and the reading of the meter shall be recorded.

The measurement may be made with the transmitter modulated with normal test modulation, in which case this fact shall be recorded with the test results.

- c) The tuning of the "receiver" shall be adjusted away from the carrier so that the "receiver" -6 dB response nearest to the transmitter carrier frequency is located at a displacement from the nominal carrier frequency of 17 kHz for 25 kHz channels or 8,25 kHz for 12,5 kHz channels.
- d) The transmitter shall be modulated with 1,25 kHz at a level which is 20 dB higher than that required to produce ± 3 kHz deviation for 25 kHz channels or $\pm 1,5$ kHz deviation for 12,5 kHz channels.
- e) The "receiver" variable attenuator shall be adjusted to obtain the same meter reading as in step b) or a known relation to it.
- f) The ratio of adjacent channel power to carrier power is the difference between the attenuator settings in steps b) and e), corrected for any differences in the reading of the meter.
- g) The measurement shall be repeated with the "receiver" tuned to the other side of the carrier.

8.6.3 Limit

The adjacent channel power shall not exceed a value of:

- 25 kHz channel: 80 dB below the carrier power of the transmitter.
- 12,5 kHz channel: 70 dB below the carrier power of the transmitter.

8.7 Conducted spurious emissions conveyed to the antenna

8.7.1 Definition

Conducted spurious emissions are emissions on a frequency or frequencies which are outside the necessary bandwidth and the level of which may be reduced without affecting the corresponding transmission of information. Spurious emissions include harmonic emissions, parasitic emissions, intermodulation products and frequency conversion products, but exclude out of band emissions.

8.7.2 Method of measurement

Conducted spurious emissions shall be measured with the unmodulated transmitter connected to an artificial antenna (see clause 6.4).

The measurements shall be made over a range from 9 kHz to 4 GHz, excluding the channel on which the transmitter is operating and its adjacent channels.

The measurements for each spurious emission shall be made using a tuned radio measuring instrument or a spectrum analyser.

The measurement shall be repeated with the transmitter on standby.

8.7.3 Limit

The power of any conducted spurious emission on any discrete frequency shall not exceed the value given in table 3.

Table 3: Conducted spurious emissions

Mode	Frequency	Level in Watts	Level in dBm
Tx operating	9 kHz ≤ 1 GHz	0,25 μW	-36 dBm
Tx operating	> 1 GHz to 4 GHz	1 μW	-30 dBm
Tx standby	9 kHz ≤ 1 GHz	2 nW	-57 dBm
Tx standby	> 1 GHz to 4 GHz	20 nW	-47 dBm

8.8 Cabinet radiation and conducted spurious emissions other than those conveyed to the antenna

8.8.1 Definitions

Cabinet radiation consists of emissions at frequencies, other than those of the carrier and the sideband components resulting from the wanted modulation process, which are radiated by the equipment cabinet and structures.

Conducted spurious emissions other than those conveyed to the antenna are emissions at frequencies, other than those of the carrier and the sideband components resulting from the wanted modulation process, which are produced by conduction in the wiring and accessories used with the equipment.

8.8.2 Method of measurement

On a test site, selected from clause 5 of ETSI TS 103 052 [5], the equipment shall be placed at the specified height on a non-conducting support and in a position which is closest to normal use as declared by the manufacturer.

The transmitter antenna connector shall be connected to an artificial antenna, see clause 6.4. The test antenna shall be orientated for vertical polarization and the length of the test antenna shall be chosen to correspond to the instantaneous frequency of the measuring receiver.

The output of the test antenna shall be connected to a measuring receiver. The transmitter shall be switched on without modulation, and measuring receiver shall be tuned over the frequency range 30 MHz to 4 GHz, except for the channel on which the transmitter is intended to operate and its adjacent channels.

At each frequency at which a spurious component is detected:

- a) the test antenna shall be raised and lowered through the specified range of heights until a maximum signal level is detected on the measuring receiver;
- b) the transmitter shall be rotated through 360° in the horizontal plane, until the maximum signal level is detected by the measuring receiver;
- c) the maximum signal level detected by the measuring receiver shall be noted;
- d) the transmitter shall be replaced by a calibrated substitution antenna as defined in clause 5.3.2 of ETSI TS 103 052 [5];
- e) the substitution antenna shall be orientated for vertical polarization and the length of the substitution antenna shall be adjusted to correspond to the frequency of the spurious component detected;
- f) the substitution antenna shall be connected to a calibrated signal generator;
- g) the frequency of the calibrated signal generator shall be set to the frequency of the spurious component detected;
- h) the input attenuator setting of the measuring receiver shall be adjusted in order to increase the sensitivity of the measuring receiver, if necessary;
- i) the test antenna shall be raised and lowered through the specified range of heights to ensure that the maximum signal is received;
- j) the input signal to the substitution antenna shall be adjusted to the level that produces a level detected by the measuring receiver that is equal to the level noted while the spurious component was measured, corrected for the change of input attenuator setting of the measuring receiver;
- k) the input level to the substitution antenna shall be recorded as power level, corrected for the change of input attenuator setting of the measuring receiver;
- l) the measurement shall be repeated with the test antenna and the substitution antenna orientated for horizontal polarization;
- m) the measure of the effective radiated power of the spurious components is larger of the two power levels recorded for spurious component at the input to the substitution antenna, corrected for the gain of the antenna if necessary;
- n) the measurements shall be repeated with the transmitter on stand-by.

8.8.3 Limits

The power of any cabinet radiation and conducted spurious emission on any discrete frequency shall not exceed the value given in table 4.

Table 4: Cabinet radiation and conducted spurious emissions

Mode	Frequency	Level in Watts	Level in dBm
Tx operating	30 MHz ≤ 1 GHz	0,25 μW	-36 dBm
Tx operating	> 1 GHz to 4 GHz	1 μW	-30 dBm
Tx standby	30 MHz ≤ 1 GHz	2 nW	-57 dBm
Tx standby	> 1 GHz to 4 GHz	20 nW	-47 dBm

8.9 Residual modulation of the transmitter

8.9.1 Definition

The residual modulation of the transmitter is the ratio, in dB, of the demodulated RF signal in the absence of wanted modulation, to the demodulated RF signal produced when the normal test modulation is applied.

8.9.2 Method of measurement

The normal test modulation defined in clause 6.3 shall be applied to the transmitter. The high frequency signal produced by the transmitter shall be applied, via an appropriate coupling device, to a linear demodulator with a de-emphasis network of 6 dB per octave. The time constant of this de-emphasis network shall be at least 750 μs.

Precautions shall be taken to avoid the effects of emphasizing the low audio frequencies produced by internal noise.

The signal shall be measured at the demodulator output using a rms voltmeter.

The modulation shall then be switched off and the level of the residual audio frequency signal at the output shall be measured again.

8.9.3 Limit

The residual modulation shall not exceed -40 dB.

8.10 DSC transmitter modulation index

8.10.1 Definition

This test is to ensure the transmitter's ability to correctly modulate a DSC audio signal.

8.10.2 Method of measurement

The test shall be performed on channel 70.

The transmitter shall be set into transmission using the DSC key lines.

The line input level adjustment shall be set for 0 dBm input.

The transmitter shall be modulated, using the DSC audio input terminal, by a single tone of 1 300 Hz with a level of $0,775 \text{ V} \pm 0,075 \text{ V}$ rms. The modulation index of the transmitter shall be measured. The test shall be repeated with an audio tone of 2 100 Hz having the same level.

8.10.3 Limits

The modulation index shall in both cases be $2,0 \pm 10 \%$.

8.11 DSC audio input limitation

8.11.1 Definition

This test is to ensure that the transmitter is able to limit deviation in case of excessive DSC input signals.

8.11.2 Method of measurement

The test shall be performed on channel 70.

The transmitter shall be set into transmission using the DSC key lines.

The transmitter shall be modulated, using the DSC audio input terminal, by a single tone of 2 100 Hz with a level of $2,45 \text{ V} \pm 0,3 \text{ V}$.

The modulation index of the transmitter shall be measured.

8.11.3 Limit

The modulation index shall be below 2,4.

8.12 Modulation attack time

8.12.1 Definition

The modulator attack time is the time elapsed between keying the transmitter and the transmitter being correctly modulated.

8.12.2 Method of measurement

The test shall be performed at channel 70. A signal of 1 300 Hz and an amplitude of $0,775 \text{ V} \pm 0,075 \text{ V rms}$ shall be connected to the transmitter DSC input terminals. The transmitter shall be connected by suitable means to a wideband FM-modulation meter.

The recovered audio from the FM-modulation meter shall be applied to a storage oscilloscope.

An arrangement shall be provided to key the transmitter using the DSC key lines and at the same time trigger the oscilloscope, see figure 3. The oscilloscope shows the modulation behaviour of the transmitter and shows when the transmitter's modulation circuits have settled, see figure 4.

The settling time t_{set} is the time elapsed from when triggering occurs, i.e. the time from when the transmitter is keyed until the recovered audio remains constant in amplitude.

The test shall be repeated with the transmitter modulated by a 2 100 Hz tone at the same amplitude.

8.12.3 Limit

The settling time shall be less than 90 ms.

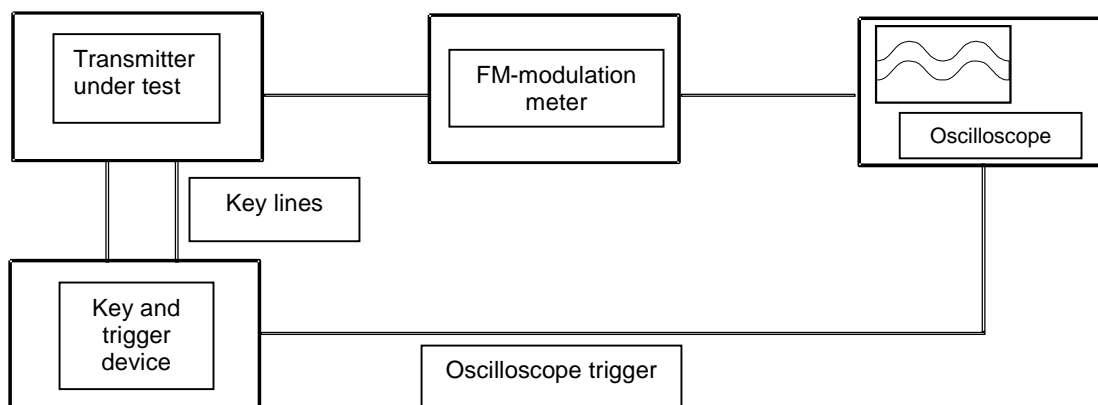

Figure 3: Measurement arrangement

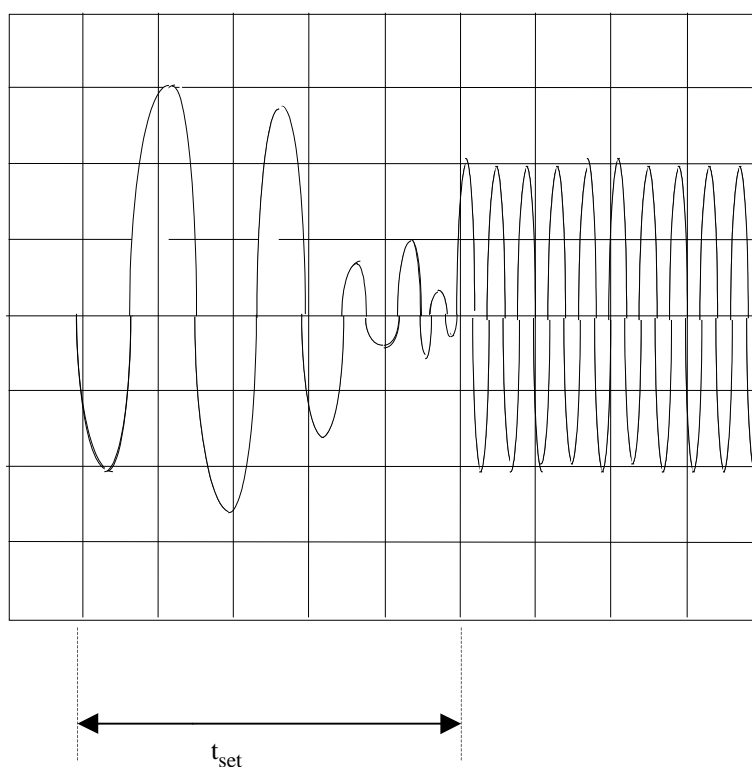

Figure 4: Oscilloscope trace

8.13 Transient frequency behaviour of the transmitter

8.13.1 Definitions

The transient frequency behaviour of the transmitter is the variation in time of the transmitter frequency difference from the nominal frequency of the transmitter when the RF output power is switched on and off.

t_{on} : according to the method of measurement described in clause 8.13.2 the switch-on instant t_{on} of a transmitter is defined by the condition when the output power, measured at the antenna terminal, exceeds 0,1 % of the nominal power;

t_1 : period of time starting at t_{on} and finishing according to table 5;

t_2 : period of time starting at the end of t_1 and finishing according to table 5;

t_{off} : switch-off instant defined by the condition when the nominal power falls below 0,1 % of the nominal power;

t_3 : period of time that finishing at t_{off} and starting according to table 5.

Table 5 : Time periods

t_1 (ms)	5,0
t_2 (ms)	20,0
t_3 (ms)	5,0

8.13.2 Method of measurement

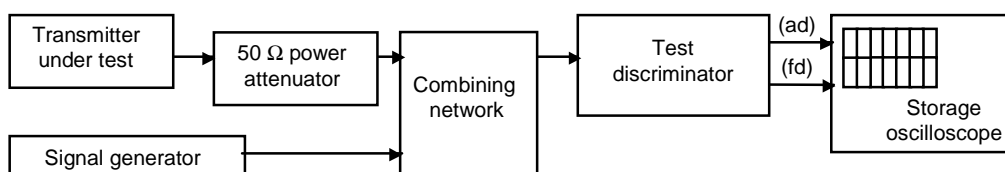

Figure 5: Measurement arrangement

Two signals shall be connected to the test discriminator via a combining network (see clause 6.1).

The transmitter shall be connected to a 50 Ω power attenuator.

A test signal generator shall be connected to the second input of the combining network.

The test signal shall be adjusted to the nominal frequency of the transmitter.

The test signal shall be modulated by a frequency of 1 kHz with a deviation of ± 25 kHz.

The test signal level shall be adjusted to correspond to 0,1 % of the power of the transmitter under test measured at the input of the test discriminator. This level shall be maintained throughout the measurement.

The amplitude difference (ad) and the frequency difference (fd) output of the test discriminator shall be connected to a storage oscilloscope.

The storage oscilloscope shall be set to display the channel corresponding to the (fd) input up to ± 25 kHz.

The storage oscilloscope shall be set to a sweep rate of 10 ms/division and set so that the triggering occurs at one division from the left edge of the display.

The display shall show the 1 kHz test signal continuously.

The storage oscilloscope shall then be set to trigger on the channel corresponding to the amplitude difference (ad) input at a low input level, rising.

The transmitter shall then be switched on, without modulation, to produce the trigger pulse and a picture on the display.

The result of the change in the ratio of power between the test signal and the transmitter output will, due to the capture ratio of the test discriminator, produce two separate sides on the picture, one showing the 1 kHz test signal, the other the frequency difference of the transmitter versus time.

The moment when the 1 kHz test signal is completely suppressed is considered to provide t_{on} .

The periods of time t_1 and t_2 as defined in table 5 shall be used to define the appropriate template.

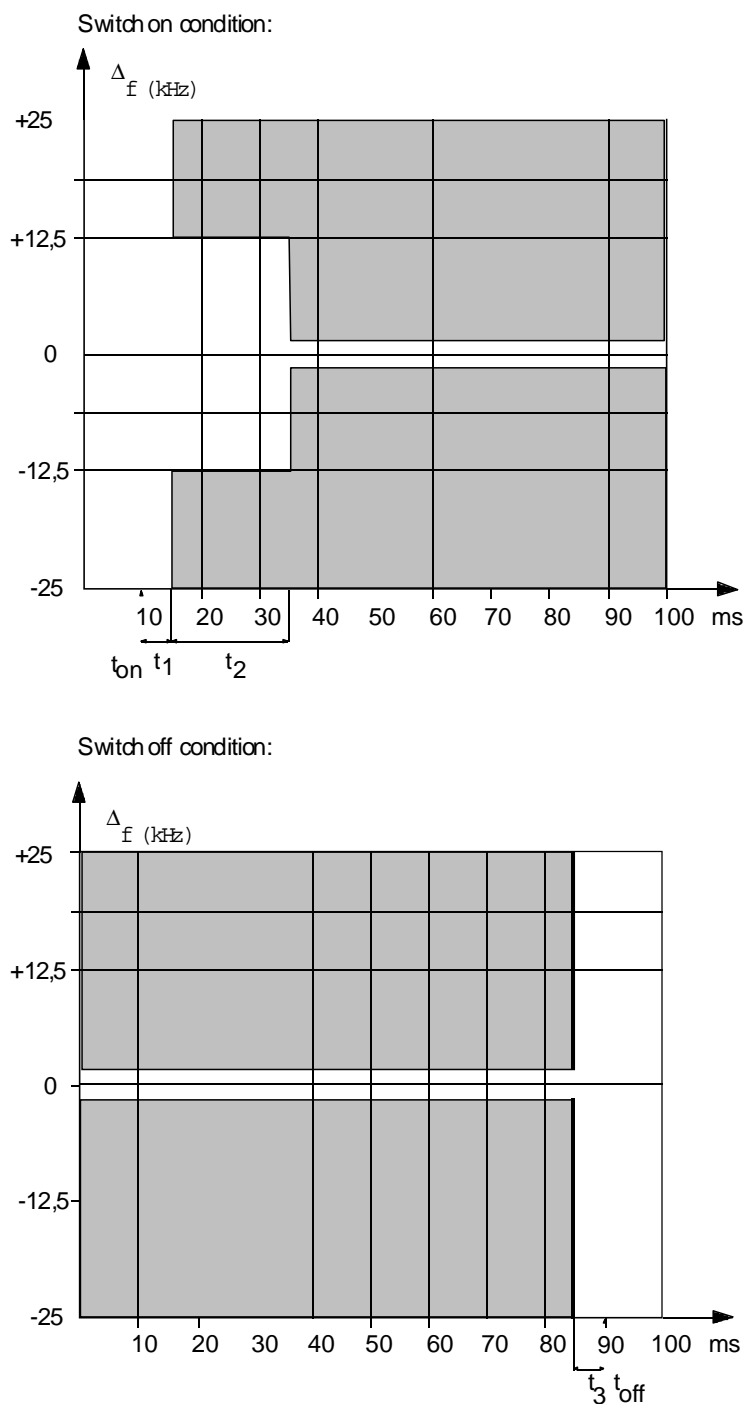

Figure 6: Storage oscilloscope view t_1 , t_2 and t_3

The result shall be recorded as frequency difference versus time.

The transmitter shall remain switched on.

The storage oscilloscope shall be set to trigger on the channel corresponding to the amplitude difference (ad) input at a high input level, decaying and set so that the triggering occurs at 1 division from the right edge of the display.

The transmitter shall then be switched off.

The moment when the 1 kHz test signal starts to rise is considered to provide t_{off} .

The period of time t_3 as defined in table 5 shall be used to define the appropriate template.

The result shall be recorded as frequency difference versus time.

8.13.3 Limits

During the periods of time t_1 and t_3 the frequency difference shall not exceed ± 25 kHz.

The frequency difference after the end of t_2 shall be within the limit of the frequency error given in clause 8.1.

During the period of time t_2 the frequency difference shall not exceed $\pm 12,5$ kHz.

Before the start of t_3 the frequency difference shall be within the limit of the frequency error given in clause 8.1.

8.14 Intermodulation attenuation

8.14.1 Definition

Intermodulation attenuation is the capability of a transmitter to avoid the generation of signals in the non-linear elements caused by the presence of the carrier and an interfering signal entering the transmitter via the antenna.

It is specified as the ratio, in dB, of the power level of the third order intermodulation product to the carrier power level.

8.14.2 Method of measurement

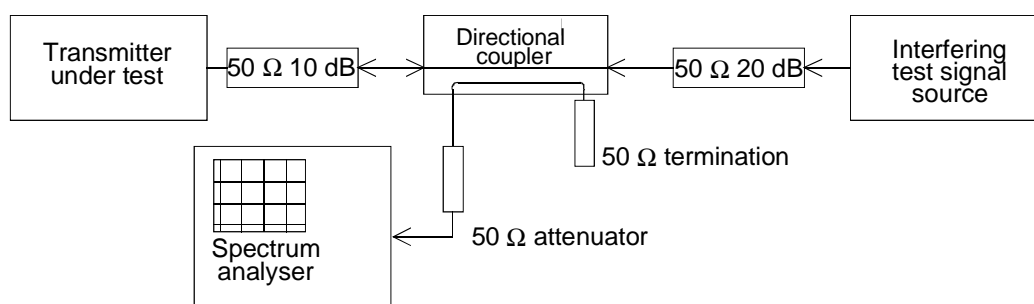

Figure 7: Measurement arrangement

The measurement arrangement shown in figure 7 shall be used.

The transmitter shall be connected to a 50 Ω 10 dB power attenuator and via a directional coupler to a spectrum analyser. An additional attenuator may be required between the directional coupler and the spectrum analyser to avoid overloading the spectrum analyser.

In order to reduce the influence of mismatch errors it is important that the 10 dB power attenuator is coupled to the transmitter under test with the shortest possible connection.

The interfering test signal source is connected to the other end of the directional coupler via a 50 Ω 20 dB power attenuator.

The interfering signal source may be either a transmitter providing the same power output as the transmitter under test and be of a similar type or a signal generator and a linear power amplifier capable of delivering the same output power as the transmitter under test.

The directional coupler shall have an insertion loss of less than 1 dB, a sufficient bandwidth and a directivity of more than 20 dB.

The transmitter under test and the test signal source shall be physically separated in such a way that the measurement is not influenced by direct radiation.

The transmitter under test shall be unmodulated and the spectrum analyser adjusted to give a maximum indication with a frequency scan width of 500 kHz.

The interfering test signal source shall be unmodulated and the frequency shall be within 50 kHz to 100 kHz above the frequency of the transmitter under test.

The frequency shall be chosen in such a way that the intermodulation components to be measured do not coincide with other spurious components.

The power output of the interfering test signal source shall be adjusted to the carrier power level of the transmitter under test by the use of a power meter.

The intermodulation component shall be measured by direct observation on the spectrum analyser and the ratio of the largest third order intermodulation component to the carrier recorded.

This measurement shall be repeated with the interfering test signal source at a frequency within 50 kHz to 100 kHz below the frequency of the transmitter under test.

8.14.3 Limits

Two classes of transmitter intermodulation attenuation are defined, the equipment shall fulfil one of the requirements as follows:

- the intermodulation attenuation ratio shall be at least 40 dB for any intermodulation component;
- for coast stations to be used in special service conditions (e.g. at sites where more than one transmitter will be in service) or when the regulatory authority makes it a condition of the licence, the intermodulation attenuation ratio shall be at least 80 dB for any intermodulation component. In the case where the performance is achieved by additional internal or external isolating devices (such as circulators) these shall be used for the measurements.

8.15 Testing of generated call sequences

8.15.1 Definition

Generated call sequences are calls which comply with the Table A1-4.1 to Table A1-4.10 of Recommendation ITU-R M.493-14 [2].

8.15.2 Method of measurement

The output of the transmitter shall be suitably connected to a calibrated apparatus for decoding and printing out the information content of the call sequences generated by the equipment.

The transmitter shall be set to transmit, in turn, DSC calls with all combinations of format specifiers and categories as specified by the manufacturer together with samples of 1st and 2nd Telecommands and frequency information.

8.15.3 Requirement

The generated call shall be decoded and shall comply with Table A1-4.1 to Table A1-4.10 of Recommendation ITU-R M.493-14 [2] regarding message composition and content.

The generated calls shall be analysed with the calibrated apparatus for correct configuration of the signal format, including time diversity.

The telecommands used and the channels tested for switching shall be recorded.

8.16 Modulation rate for DSC

8.16.1 Definition

The modulation rate is the bit stream speed measured in bits per second.

8.16.2 Method of measurement

The transmitter shall be set to transmit continuous dot pattern.

The RF output terminal of the transmitter, via a suitable attenuator, shall be connected to a linear FM-modulation meter. The output of the discriminator shall be limited in bandwidth by a low pass filter with a cut-off frequency of 1 kHz and a slope of 12 dB/octave.

The frequency of the output shall be measured.

8.16.3 Limits

The frequency shall be $600 \text{ Hz} \pm 30 \text{ ppm}$ corresponding to a modulation rate of 1 200 baud.

8.17 Frequency error (demodulated DSC signal)

8.17.1 Definition

The frequency error for the B- and the Y-state is the difference between the measured frequency from the FM-modulation meter and the nominal values.

8.17.2 Method of measurement

The transmitter shall be connected to the artificial antenna as specified in clause 6.4 and a suitable FM-modulation meter. The transmitter shall be set to channel 70.

The transmitter shall be set to transmit a continuous B- or Y- state.

The measurement shall be performed by measuring the demodulated output, for both the continuous B- and Y-state.

The measurements shall be carried out under normal test conditions (see clause 7.3) and extreme test conditions (clauses 7.4.2 and 7.4.3 applied simultaneously).

8.17.3 Limits

The measured frequency from the discriminator at any time for the B-state shall be within $2\,100 \text{ Hz} \pm 10 \text{ Hz}$ and for the Y-state within $1\,300 \text{ Hz} \pm 10 \text{ Hz}$.

9 Receiver

9.1 Harmonic distortion

9.1.1 Definition

The harmonic distortion at the receiver output is defined as the ratio, expressed as a percentage, of the total rms voltage of all the harmonic components of the modulation audio frequency to the total rms voltage of the signal delivered by the receiver.

9.1.2 Method of measurement

9.1.2.1 Audio line output

The audio line output shall be terminated with a 600Ω resistive load and the test shall be performed at a line output level of 0 dBm.

9.1.2.2 Under normal test conditions

A test signal at a level of 100 dB μ V, at a carrier frequency equal to the nominal frequency of the receiver, shall be applied to the receiver input under the conditions specified in clause 7.3. The test signal shall be modulated successively at 300 Hz, 500 Hz and 1 kHz with a constant modulation index of 3 for 25 kHz channels, or 2 for 12,5 kHz channels (ratio between the frequency deviation and the modulation frequency). The harmonic distortion shall be measured for each modulation frequency.

9.1.2.3 Under extreme test conditions

A test signal at a level of 100 dB μ V, modulated by the normal test modulation, clause 6.3, shall be applied to the receiver input under the conditions specified in clauses 6.1 and 7.4. The carrier frequency of the test signal shall be set successively to the nominal frequency of the receiver and 1,5 kHz above and below the nominal frequency for 25 kHz channels, or 1 kHz above and below the nominal for 12,5 kHz channels. The harmonic distortion shall be measured for each carrier frequency.

9.1.3 Limits

The harmonic distortion shall not exceed 5 %.

9.2 Audio frequency response

9.2.1 Definition

The audio frequency response is the variation in receiver audio frequency output level as a function of the modulation frequency of a constant deviation test signal applied to the input.

9.2.2 Method of measurement

A test signal of 60 dB μ V at a carrier frequency equal to the nominal frequency of the receiver and modulated with an audio frequency of 1 kHz to a frequency deviation of 1 kHz shall be applied to the receiver antenna port (see clause 6.1).

The signal level into a matched load at the receiver line output shall then provide the reference point in figure 8.

The modulation frequency of the test signal shall be varied over the range 300 Hz to 3 kHz (see note), whilst maintaining the frequency deviation constant. The audio output level shall be measured over this modulation frequency range.

The measurement shall be repeated with the test signal be set 1,5 kHz above and below the nominal frequency for 25 kHz channels, or 1 kHz above and below the nominal frequency for 12,5 kHz channels.

NOTE: 2,55 kHz for transmitters intended for 12,5 kHz channel separation.

9.2.3 Limits

The audio frequency response shall not deviate by more than +1 dB or -3 dB from a characteristic giving the output level as a function of the audio frequency, decreasing by 6 dB per octave and passing through the measured point at 1 kHz (see figure 8).

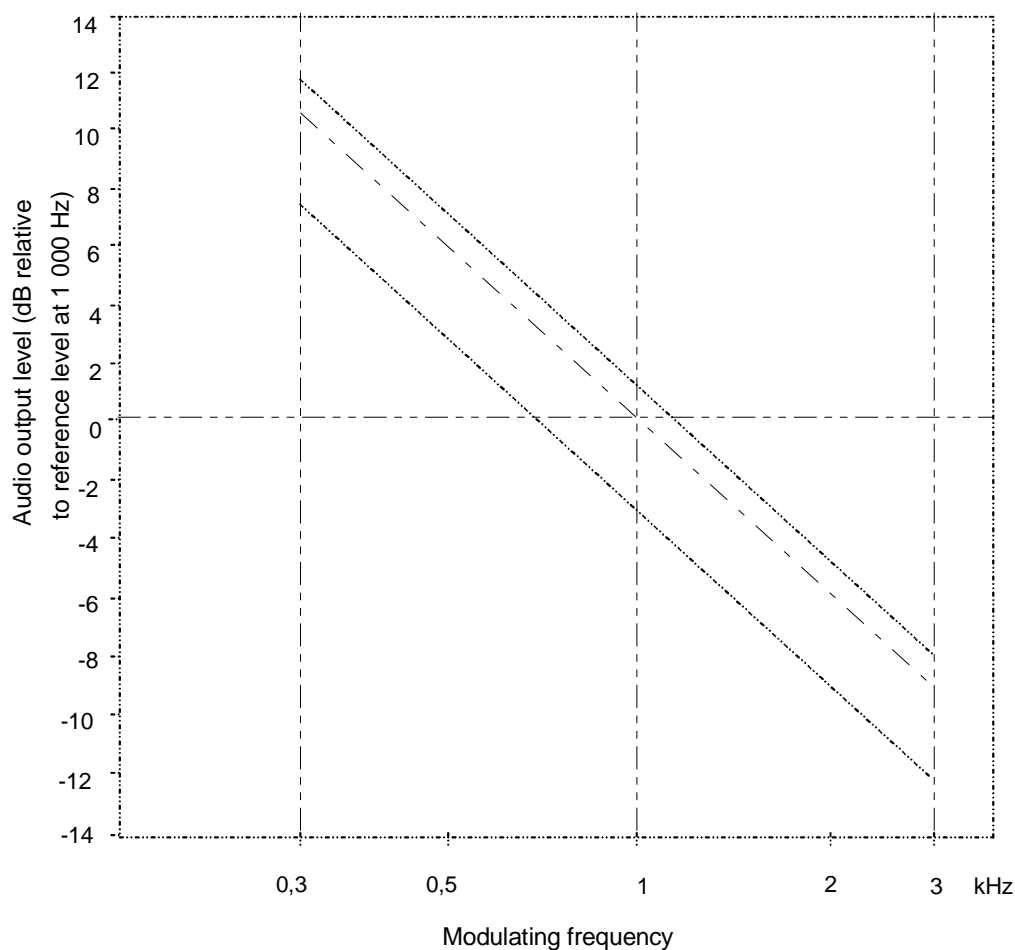

Figure 8: Audio frequency response

9.3 Amplitude characteristic of the receiver

9.3.1 Definition

The amplitude characteristic of the receiver is the relationship between the radio frequency input level of a specified modulated signal and the audio frequency level at the receiver output.

9.3.2 Method of measurement

The test signal at the nominal frequency of the receiver, with normal test modulation, clause 6.3, shall have a level of 6 dB μ V emf. The audio output level shall then be recorded.

The input signal level shall be increased to an emf of 100 dB μ V and the audio output level shall be recorded.

The measure of the amplitude characteristic of the receiver is the ratio, in dB, between the two recorded audio output levels.

9.3.3 Limits

Within the specified change in radio frequency input signal level, the change of audio output level shall not exceed 3 dB.

9.4 Maximum usable sensitivity

9.4.1 Definition

The maximum usable sensitivity of the receiver is the minimum level of the signal (emf) at the receiver input, at the nominal frequency of the receiver which, and with normal test modulation, clause 6.3, which will produce:

- a SINAD ratio of 20 dB, measured at the receiver output through a psophometric telephone weighting network as described in Recommendation ITU-T O.41 [1]. With the receivers set to an audio frequency output power of 50 % of the rated output power.

9.4.2 Method of measurement

A test signal at a carrier frequency equal to the nominal frequency of the receiver, modulated by the normal test modulation (see clause 6.3) shall be applied to the receiver input. An audio frequency load, SINAD meter and a psophometric network as specified in clause 9.4.1 shall be connected to the receiver output terminals and the receivers audio frequency power control adjusted to produce 50 % of the rated output power.

The level of the test signal shall be adjusted until a SINAD ratio of 20 dB is obtained.

Under these conditions, the level of the test signal at the receiver input is the value of the maximum usable sensitivity.

The measurements shall be made under normal test conditions (see clause 7.3) and under extreme test conditions (see clause 7.4).

9.4.3 Limits

The maximum usable sensitivity for either 25 kHz or 12,5 kHz channels shall not exceed +6 dB μ V (emf) under normal test conditions and +12 dB μ V (emf) under extreme test conditions.

9.5 Co-channel rejection

9.5.1 Definition

The co-channel rejection is a measure of the capability of the receiver to receive a wanted modulated signal without exceeding a given degradation due to the presence of an unwanted modulated signal, both signals being at the nominal frequency of the receiver.

9.5.2 Method of measurement

The two input signals shall be connected to the receiver via a combining network, clause 6.1.

The unwanted signal at the nominal frequency of the receiver shall be modulated by 400 Hz with a deviation of ± 3 kHz (see note).

The wanted input signal level shall be set to the value corresponding to the maximum usable sensitivity as measured in clause 9.4. The amplitude of the unwanted input signal shall then be adjusted until the SINAD ratio (psophometrically weighted) at the output of the receiver is reduced to 14 dB.

The co-channel rejection ratio shall be expressed as the ratio in dB of the level of the unwanted signal to the level of the wanted signal at the receiver input for which the specified reduction in SINAD ratio occurs.

The measurements shall be repeated for displacements of the unwanted signal carrier frequency of ± 3 kHz (see note).

NOTE: For 12,5 kHz channels the frequency deviation and the displacement of the unwanted signal is $\pm 1,5$ kHz.

9.5.3 Limits

The co-channel rejection ratio, at any frequency of the unwanted signal within the specified range, shall be between:

- -10 dB and 0 dB for 25 kHz channels;
- -12 dB and 0 dB for 12,5 kHz channels.

9.6 Adjacent channel selectivity

9.6.1 Definition

The adjacent channel selectivity is a measure of the capability of the receiver to receive a wanted modulated signal at the nominal frequency without exceeding a given degradation due to the presence of an unwanted modulated signal in the adjacent channel.

9.6.2 Method of measurement

The two input signals shall be connected to the receiver via a combining network (see clause 6.1).

The wanted signal, at the nominal frequency of the receiver, with normal test modulation, clause 6.3, shall have a level set to the value corresponding to the maximum useable sensitivity as measured in clause 9.4.

The unwanted signal shall be modulated by 400 Hz with a deviation of ± 3 kHz for 25 kHz channels or $\pm 1,5$ kHz for 12,5 kHz channels, and shall be at the frequency of the channel immediately above that of the wanted signal.

The amplitude of the unwanted input signal shall then be adjusted until the SINAD ratio at the receiver output, psophometrically weighted, is reduced to 14 dB. The measurement shall be repeated with the unwanted signal at the frequency of the channel below that of the wanted signal.

The adjacent channel selectivity ratio shall be expressed as the ratio in dB of the level of the unwanted signal to the level of the wanted signal at the receiver input for which the specified reduction in SINAD ratio occurs, taking the lower of the two values obtained for the upper and lower adjacent channels.

The measurements shall then be repeated under extreme test conditions (see clause 7.4.) with the wanted signal set to the value corresponding to the maximum usable sensitivity as measured under these conditions.

9.6.3 Limits

25 kHz channels: The adjacent channel selectivity shall be not less than 70 dB under normal test conditions and not less than 60 dB under extreme test conditions.

12,5 kHz channels: The adjacent channel selectivity shall be not less than 60 dB under normal test conditions and not less than 50 dB under extreme test conditions.

9.7 Spurious response

9.7.1 Definition

The spurious response rejection is a measure of the capability of the receiver to discriminate between the wanted modulated signal at the nominal frequency and an unwanted signal at any other frequency at which a response is obtained.

9.7.2 Method of measurement

Two input signals shall be applied to the receiver via a combining network (see clause 6.1).

The wanted signal, at the nominal frequency of the receiver, with normal test modulation, clause 6.3, shall be set to the value corresponding to the Maximum Useable Sensitivity (MUS).

The unwanted signal shall be modulated by 400 Hz with a deviation of ± 3 kHz for 25 kHz channels or $\pm 1,5$ kHz for 12,5 kHz channels. The level of the unwanted signal shall be set to an emf of 96 dB μ V.

The unwanted signal shall be swept in frequency from 100 kHz to 4 GHz. At any frequency at which a response is obtained, the input level shall be adjusted until the SINAD ratio psophometrically weighted, is reduced to 14 dB.

The spurious response rejection ratio shall be expressed as the ratio in dB between the level of the unwanted signal and the level of the wanted signal at the receiver input for which the specified reduction in the SINAD ratio occurs.

9.7.3 Limit

At any frequency separated from the nominal frequency of the receiver by more than one channel, the spurious response rejection ratio shall be not less than 80 dB.

9.8 Intermodulation response

9.8.1 Definition

The intermodulation response is a measure of the capability of a receiver to receive a wanted modulated signal without exceeding a given degradation due to the presence of two or more unwanted signals with a specific frequency relationship to the wanted signal frequency.

9.8.2 Method of measurement

Three input signals shall be connected to the receiver via a combining network (see clause 6.1).

The wanted signal A, at the nominal frequency of the receiver, with normal test modulation, clause 6.3, shall be set to the value corresponding to the maximum useable sensitivity.

The unwanted signal B, unmodulated, shall be set to a carrier frequency 50 kHz above (or below) the nominal frequency of the receiver.

The unwanted signal C, shall be modulated by 400 Hz with a deviation of ± 3 kHz for 25 kHz channels or $\pm 1,5$ kHz for 12,5 kHz channels, shall be set to a carrier frequency 100 kHz above the nominal frequency of the receiver.

The amplitude of the two unwanted signals B and C shall be maintained equal and adjusted until the SINAD ratio at the receiver output, psophometrically weighted, is reduced to 14 dB.

The frequency of signal generator B shall be adjusted slightly to produce the maximum degradation of the SINAD ratio. The level of the two unwanted test signals shall be readjusted to restore the SINAD ratio of 14 dB.

The intermodulation response ratio shall be expressed as the ratio in dB between the level of the two unwanted signals and the level of the wanted signal at the receiver input, for which the specified reduction in SINAD ratio occurs.

9.8.3 Limit

The intermodulation response ratio shall not be less than 85 dB.

9.9 Blocking or desensitization

9.9.1 Definition

Blocking is a change (generally a reduction) in the wanted output power of the receiver or a reduction of the SINAD ratio due to an unwanted signal on another frequency.

9.9.2 Method of measurement

Two input signals shall be applied to the receiver via a combining network (see clause 6.1).

The modulated wanted signal shall be at the nominal frequency of the receiver, and shall have normal test modulation, (see clause 6.3). Initially the unwanted signal shall be switched off and the wanted signal set to the value corresponding to the maximum usable sensitivity.

The output power of the wanted signal shall be adjusted, where possible, to 50 % of the rated output power and in the case of stepped volume controls, to the first step that provides an output power of at least 50 % of the rated output power. The unwanted signal shall be unmodulated and the frequency shall be swept between +1 MHz and +10 MHz, and also between -1 MHz and -10 MHz, relative to the nominal frequency of the receiver. For practical reasons the measurements will be carried out at frequency offsets of the unwanted signal at approximately 1 MHz, 2 MHz, 5 MHz and 10 MHz.

The input level of the unwanted signal, at all frequencies in the specified ranges, shall be so adjusted that the unwanted signal causes:

- a) a reduction of 3 dB in the audio output level of the wanted signal; or
- b) a reduction to 14 dB of the SINAD ratio at the receiver output using a psophometric telephone filtering network such as described in Recommendation ITU-T O.41 [1] whichever occurs first. This level shall be noted.

9.9.3 Limit

The blocking level for any of the specified ranges shall be not less than 95 dB μ V(emf), except at frequencies on which spurious responses are found (see clause 9.7).

9.10 Receiver noise and hum level

9.10.1 Definition

The receiver noise and hum level is defined as the ratio, in dB, of the audio frequency power of the noise and hum resulting from spurious effects of the power supply system or from other causes, to the audio frequency power produced by a high frequency signal of average level, modulated by the normal test modulation and applied to the receiver input.

9.10.2 Method of measurement

A test signal with a level of +30 dB μ V (emf) at a carrier frequency equal to the nominal frequency of the receiver, and modulated by the normal test modulation specified in clause 6.3, shall be applied to the receiver input. An audio frequency load shall be connected to the output terminals of the receiver. The audio frequency power control shall be set so as to produce the rated output power level conforming to clause 9.1.

The output signal shall be measured by an rms voltmeter having a -6 dB bandwidth of at least 20 kHz.

The modulation shall then be switched off and the audio frequency output level measured again.

9.10.3 Limit

The receiver noise and hum level shall not exceed -40 dB, relative to the modulated signal.

9.11 Spurious emissions

9.11.1 Definition

Spurious emissions from the receiver are components at any frequency radiated by the equipment.

Spurious emissions from the antenna are measured by their power level in a specified load, connected to the antenna port of the receiver (conducted spurious emissions).

Spurious emissions from the cabinet and structure of the equipment are measured by their effective radiated power, ERP (radiated spurious emissions).

9.11.2 Conducted spurious emissions

9.11.2.1 Method of measurement

The receiver input terminals shall be connected to a spectrum analyser or measuring receiver in such a way that an effective terminating impedance of 50Ω is presented to the EUT terminals. The EUT shall be switched on and the measuring frequency of the analyser shall be swept over the frequency range 9 kHz to 4 GHz.

At each frequency at which a spurious component is detected, the level of the spurious signal shall be recorded as the level delivered into the specified load.

9.11.2.2 Limit

The power of any conducted spurious emission on any discrete frequency shall not exceed the value in table 6.

Table 6: Conducted Spurious Emissions

Frequency Range	Level
9 kHz \leq 1 GHz	2,0 nW (-57 dBm)
> 1 GHz - 4 GHz	20 nW (-47 dBm)

9.11.3 Radiated spurious emissions

9.11.3.1 Method of measurement

On a test site, selected from clause 5 of ETSI TS 103 052 [5], the equipment shall be placed at the specified height on a non-conducting support and in a position which is closest to normal use as declared by the manufacturer.

The receiver antenna connector shall be terminated in a non-radiating artificial antenna.

The output of the test antenna shall be connected to a spectrum analyser or measuring receiver.

The test antenna shall be orientated for vertical polarization.

The EUT shall be switched on, and the analyser shall be swept over the range 30 MHz to 4 GHz.

At each frequency at which a spurious component is detected:

- a) the test antenna shall be raised and lowered through the specified range of height until a maximum signal level is detected on the analyser;
- b) the receiver shall be rotated through 360° in the horizontal plane, until the maximum signal level is detected on the analyser;
- c) this maximum signal level shall be noted;
- d) the EUT shall be replaced by a calibrated substitution antenna as defined in clause 5.3.2 of ETSI TS 103 052 [5];

- e) the substitution antenna shall be orientated for vertical polarization and the length of the substitution antenna shall be adjusted to correspond to the frequency of the spurious component detected;
- f) the substitution antenna shall be connected to a calibrated signal generator;
- g) the frequency of the signal generator shall be set to the frequency of the spurious component detected;
- h) the input attenuation of the analyser shall be adjusted in order to increase the sensitivity of the analyser as necessary;
- i) the test antenna shall be raised and lowered through the specified range of height to ensure that the maximum signal is received;
- j) the level of the input signal to the substitution antenna shall be adjusted to produce the same indication on the analyser as that produced by the spurious component being measured, noted above;
- k) the level of the input signal to the substitution antenna shall be noted, together with any adjustment of the input attenuation of the analyser;
- l) the measurement shall be repeated with the test antenna and the substitution antenna orientated for horizontal polarization.

The ERP of the spurious component is expressed as the level of the input signal to the substitution antenna, corrected for any adjustment to the input attenuation of the analyser, and corrected for the gain of the antenna in dBd as necessary. The larger of the two power levels obtained for vertical and horizontal polarization shall be recorded as the ERP of the spurious component.

9.11.3.2 Limit

The power of any radiated spurious emission on any discrete frequency shall not exceed the value given in table 7.

Table 7: Radiated Spurious Emissions

Frequency Range	Level
30 MHz ≤ 1 GHz	2 nW (-57 dBm)
> 1 GHz to 4 GHz	20 nW (-47 dBm)

9.12 DSC audio output characteristic

9.12.1 Definition

DSC audio characteristic is the level of the two DSC tones at the DSC audio output terminal when the receiver is receiving a correctly modulated DSC signal.

9.12.2 Methods of measurement

The test shall be performed on channel 70.

The test signal at the nominal carrier frequency shall be applied to the receiver input. The signal shall be modulated by a 1 300 Hz tone to a modulation index of 2. The signal level of the generator shall be set to +26 dBμV.

The DSC audio output terminals shall be terminated with a 600 Ω load.

The audio level at the terminals shall be measured.

The test shall be repeated with the test signal modulated by a 2 100 Hz tone maintaining the modulation index of 2.

9.12.3 Limit

The level of the audio signal developed across the load of the DSC output terminals shall be between 0,55 V rms and 1,1 V rms.

9.13 DSC receiver maximum usable sensitivity

9.13.1 Definition

The maximum usable sensitivity of the receiver is the minimum level of the signal (emf) at the nominal frequency of the receiver which when applied to the receiver input with a test modulation will produce a symbol error rate of 10^{-2} .

9.13.2 Method of measurement

Standard test signal (see clause 6.5) containing DSC calls shall be applied to the receiver input.

The symbol error rate in the decoder output shall be determined as described in clause 6.6.

The input level shall be reduced until the symbol error rate is 10^{-2} , this level shall be recorded.

The measurement shall be carried out under normal test conditions (see clause 7.3) and under extreme test conditions (see clause 7.4.2).

The measurement shall be repeated under normal test conditions at the nominal carrier frequency $\pm 1,5$ kHz.

9.13.3 Limits

The maximum usable sensitivity shall be better than or equal to $0 \text{ dB}\mu\text{V}$ under normal test conditions and better than $+6 \text{ dB}\mu\text{V}$ under extreme test conditions.

9.14 DSC receiver co-channel rejection

9.14.1 Definition

The co-channel rejection is a measure of the capability of the receiver to receive a wanted modulated signal without exceeding a given degradation due to the presence of an unwanted modulated signal, both signals being at the nominal frequency of the receiver.

9.14.2 Method of measurement

The two input signals shall be connected to the receiver input terminal via a combining network (see clause 6.1). The wanted signal shall be the DSC standard test signal (clause 6.5) containing DSC calls. The level of the wanted signal shall be $+3 \text{ dB}\mu\text{V}$.

The unwanted signal shall be modulated by 400 Hz with a deviation of ± 3 kHz.

Both input signals shall be at the nominal frequency of the receiver under test and the measurement shall be repeated for displacements of the unwanted signal of up to ± 3 kHz.

The symbol error ratio in the decoder output shall be determined as described in clause 6.6.

The input level of the unwanted signal shall be increased until the symbol error rate is 10^{-2} , this level shall be recorded.

9.14.3 Limits

The unwanted signal shall be at a level of at least $-5 \text{ dB}\mu\text{V}$.

9.15 DSC receiver adjacent channel selectivity

9.15.1 Definition

The adjacent channel selectivity is a measure of the capability of the receiver to receive a wanted modulated signal without exceeding a given degradation due to the presence of an unwanted modulated signal which differs in frequency from the wanted signal by 25 kHz.

9.15.2 Method of measurement

The two input signals shall be connected to the receiver input terminal via a combining network (see clause 6.1).

The wanted signal shall be the DSC standard test signal (see clause 6.5) containing DSC calls. The level of the wanted signal shall be +3 dB μ V.

The unwanted signal shall be modulated to 400 Hz with a deviation of ± 3 kHz. The unwanted signal shall be tuned to the centre frequency of the upper adjacent channel.

The symbol error ratio in the decoder output shall be determined as described in clause 6.6.

The input level of the unwanted signal shall be increased until the symbol error rate is 10^{-2} , this level shall be recorded.

The measurement shall be repeated with the unwanted signal tuned to the centre frequency of the lower adjacent channel.

The measurement shall be carried out under normal test conditions (clauses 7.3 and 9.1.2.2 applied simultaneously) and under extreme test conditions (clauses 7.4 and 9.1.2.3 applied simultaneously).

9.15.3 Limits

The unwanted signal shall be at a level of at least 73 dB μ V under normal test conditions and at least 63 dB μ V under extreme test conditions.

9.16 DSC receiver dynamic range

9.16.1 Definition

The dynamic range of the equipment is the range from the minimum to the maximum level of a radio frequency input signal at which the symbol error rate in the output of the decoder does not exceed a specified value.

9.16.2 Method of measurement

A test signal in accordance with the DSC standard test signal (see clause 6.5) containing consecutive DSC calls shall be applied to the receiver input. The level of the test signal shall alternate between 100 dB μ V and 0 dB μ V.

The symbol error rate in the decoder output shall be determined as described in clause 6.6.

9.16.3 Limit

The symbol error rate in the decoded call sequence shall be 10^{-2} or less.

9.17 Duplex operation for 25kHz channels

9.17.1 Introduction

If the equipment is designed for duplex operation, when submitted for conformance testing it shall be fitted with a duplex filter and the following additional measurements shall be carried out to ensure satisfactory duplex operation.

9.17.2 Receiver desensitization with simultaneous transmission and reception

9.17.2.1 Definition

The desensitization is the degradation of the sensitivity of the receiver resulting from the transfer of power from the transmitter to the receiver due to coupling effects.

It is expressed as the difference in dB of the maximum usable sensitivity levels with simultaneous transmission and without.

9.17.2.2 Method of measurement

The antenna terminal of the equipment comprising the receiver, transmitter and duplex filter shall be connected through a coupling device to the artificial antenna specified in clause 6.4.

A signal generator with normal test modulation (see clause 6.3) shall be connected to the coupling device so that it does not affect the impedance matching.

The transmitter shall be brought into operation at the carrier output power as defined in clause 8.2, modulated by 400 Hz with a deviation of ± 3 kHz.

- the receiver sensitivity shall then be measured in accordance with clause 9.4;
- the output level of the signal generator shall be recorded as C in dB μ V (emf);
- the transmitter shall be switched off and the receiver sensitivity is again measured;
- the output level of the signal generator shall be recorded as D in dB μ V (emf);
- the desensitization is the difference between the values of C and D.

9.17.2.3 Limits

The desensitization shall not exceed 3 dB. The maximum usable sensitivity under conditions of simultaneous transmission and reception shall not exceed the limits specified in clause 9.4.3.

9.17.3 Duplex transceiver internal mixing

9.17.3.1 Definition

The duplex transceiver internal mixing will result in an unwanted receiver sensitivity at certain frequencies.

9.17.3.2 Method of measurement

The antenna terminal of the equipment comprising of the receiver, the transmitter and duplex filter shall be connected through a coupling device to the artificial antenna specified in clause 6.4.

A test port enabling signal to be connected to the receiver shall be provided.

The equipment shall be tuned to channel 18 or the channel corresponding to the nearest frequencies to channel 18 and the transmitter be brought in to unmodulated operation at the carrier output as defined in clause 9.2.

The test defined in clause 9.7.3 using the test port as the receiver port shall be performed. Notwithstanding the frequency mentioned in clause 8.7 the test shall only be performed in the following bands:

- $\{f_{\text{rx}} - (2 \times f_{\text{f}}) - 1\}$ MHz to $\{f_{\text{rx}} - (2 \times f_{\text{f}}) + 1\}$ MHz;
- $\{f_{\text{rx}} + (2 \times f_{\text{f}}) - 1\}$ MHz to $\{f_{\text{rx}} + (2 \times f_{\text{f}}) + 1\}$ MHz;
- $\{f_{\text{rx}} + f_{\text{f}} - 1\}$ MHz to $\{f_{\text{rx}} + f_{\text{f}} + 1\}$ MHz;

- $\{f_{tx} - f_I - 1\}$ MHz to $\{f_{tx} - f_I + 1\}$ MHz;
- $\{f_{tx} - 4,6 - 1\}$ MHz to $\{f_{tx} + 4,6 + 1\}$ MHz.

Where f_{tx} , f_{rx} correspond to the transmit and receive frequencies respectively, which should be on channel 18 (161,5 MHz/156,9 MHz), or the channel available corresponding to the nearest frequencies to channel 18.

9.17.3.3 Limits

At any frequency at which a response is detected the ratio defined in clause 9.7.3 shall not be less than 80 dB.

9.18 Verification of correct decoding of various types of DSC calls

9.18.1 Definition

DSC call sequences are calls that comply with Tables A1-4.1 to A1-4.10 of Recommendation ITU-R M.493-14 [2].

9.18.2 Method of measurement

The input terminal of the receiver shall be suitably connected to a calibrated apparatus for generation of digital selective call signals.

DSC calls, in turn, with all combinations of format specifiers and categories as specified by the manufacturer together with samples of 1st and 2nd telecommands and frequency information shall be applied to the receiver.

9.18.3 Requirement

The requirements of Tables A1-4.1 to A1-4.10 of Recommendation ITU-R M.493-14 [2] regarding message composition and content shall be met.

The DSC equipment shall be so designed that in the decoding process use shall be made of parity bits for error detection, time diversity repetitions and error check characters in the received call as specified in annex 1 of Recommendation ITU-R M.493-14 [2].

When receiver measurements are made by use of a printer or a computer, a check shall be made to ensure accordance between printer output and display indication.

The telecommands used shall be recorded.

9.19 DSC spurious response and blocking immunity

9.19.1 Definition

The spurious response and blocking immunity is a measure of the capability of the receiver to receive a wanted modulated signal without exceeding a given degradation due to the presence of an unwanted modulated signal with frequencies outside the pass band of the receiver.

9.19.2 Method of measurement

The two input signals shall be connected to the receiver input terminal via a combining network (see clause 6.1).

The wanted signal shall be the DSC standard test signal (see clause 6.5) containing DSC calls. The level of the wanted signal shall be +3 dB μ V.

For the spurious response test the unwanted signal shall be unmodulated. The frequency shall be varied over the range 9 kHz to 4 GHz with the exception of the channel of the wanted signal and its adjacent channels. The unwanted signal level shall be 73 dB μ V. Where spurious response occurs, the bit error ratio shall be determined.

For the blocking test the unwanted signal shall be unmodulated. The frequency shall be varied between -10 MHz and -1 MHz and also between +1 MHz and +10 MHz relative to the nominal frequency of the wanted signal. The unwanted signal shall be at a level of 93 dB μ V. Where blocking occurs, the bit error ratio shall be determined.

The bit error ratio in the decoder output shall be determined as described in clause 6.6.

9.19.3 Limits

The bit error ratio shall be equal to or less than 10^{-2} .

9.20 DSC Intermodulation response

9.20.1 Definition

The intermodulation response is a measure of the capability of the receiver to receive a wanted modulated signal without exceeding a given degradation due to the presence of two or more unwanted signals with a specific frequency relationship to the wanted signal frequency.

9.20.2 Method of measurement

The three input signals shall be connected to the receiver input terminal via a combining network (see clause 6.1).

The wanted signal represented by signal generator A shall be at the nominal frequency of the receiver and shall be the DSC standard test signal (see clause 6.5) containing DSC calls. The level of the wanted signal shall be +3 dB μ V.

The unwanted signals shall be applied, both at the same level. The unwanted signal from signal generator B shall be unmodulated and adjusted to a frequency 50 kHz above (or below) the nominal frequency of the receiver. The second unwanted signal from signal generator C shall be modulated by 400 Hz with a deviation of ± 3 kHz and adjusted to a frequency 100 kHz above (or below) the nominal frequency of the receiver.

The input level of the unwanted signals shall be 85 dB μ V.

The bit error ratio in the decoder output shall be determined as described in clause 6.9.

9.20.3 Limits

The bit error ratio shall be equal to or less than 10^{-2} .

10 Testing for compliance with technical requirements

10.1 Environmental conditions for testing

These shall be as described clause 7.

10.2 Interpretation of the measurement results

The interpretation of the results recorded in a test report for the measurements described in the present document shall be as follows:

- the measured value related to the corresponding limit will be used to decide whether an equipment meets the requirements of the present document;

- the value of the measurement uncertainty for the measurement of each parameter shall be included in the test report;
- the recorded value of the measurement uncertainty shall be, for each measurement, equal to or less than the figures in table 8.

For the test methods, according to the present document, the measurement uncertainty figures shall be calculated and shall correspond to an expansion factor (coverage factor) $k = 1,96$ or $k = 2$ (which provide confidence levels of respectively 95 % and 95,45 % in the case where the distributions characterizing the actual measurement uncertainties are normal (Gaussian)). Principles for the calculation of measurement uncertainty are contained in ETSI TR 100 028 (parts 1 and 2) [i.3] and [i.4], in particular in annex D of the ETSI TR 100 028-2 [i.4].

Table 8 is based on such expansion factors.

Table 8: Maximum measurement uncertainty

Parameter	Uncertainty
RF frequency	$\pm 1 \times 10^{-7}$
RF power	$\pm 0,75$ dB
Maximum frequency deviation:	
- within 300 Hz to 6 kHz of audio frequency	± 5 %
- within 6 kHz to 25 kHz of audio frequency	± 3 dB
Deviation limitation	± 5 %
Adjacent channel power	± 5 dB
Conducted spurious emissions of transmitter	± 4 dB
Conducted spurious emissions of transmitter, valid to 12,75 GHz	± 7 dB
Audio output power	$\pm 0,5$ dB
Amplitude characteristics of receiver limiter	$\pm 1,5$ dB
Sensitivity at 20 dB SINAD	± 3 dB
Conducted emission of receiver	± 3 dB
Conducted emission of receiver, valid to 12,75 GHz	± 6 dB
Two-signal measurement, valid to 4 GHz	± 4 dB
Three-signal measurement	± 3 dB
Radiated emissions of transmitter, valid to 4 GHz	± 6 dB
Radiated emissions of receiver, valid to 4 GHz	± 6 dB
Transmitter transient time	± 20 %
Transmitter transient frequency	± 250 Hz
Transmitter intermodulation	± 3 dB
Receiver desensitization (duplex operation)	$\pm 0,5$ dB

Annex A (informative): Relationship between the present document and the essential requirements of Directive 2014/53/EU

The present document has been prepared under the Commission's standardisation request C(2015) 5376 final [i.1] to provide one voluntary means of conforming to the essential requirements of Directive 2014/53/EU on the harmonisation of the laws of the Member States relating to the making available on the market of radio equipment and repealing Directive 1999/5/EC [i.2].

Once the present document is cited in the Official Journal of the European Union under that Directive, compliance with the normative clauses of the present document given in table A.1 confers, within the limits of the scope of the present document, a presumption of conformity with the corresponding essential requirements of that Directive, and associated EFTA regulations.

**Table A.1: Relationship between the present document and
the essential requirements of Directive 2014/53/EU**

Harmonised Standard ETSI EN 301 929				
Requirement			Requirement Conditionality	
No	Description	Reference: Clause No	U/C	Condition
1	Transmitter frequency error	8.1	U	
2	Transmitter carrier power	8.2	U	
3	Transmitter frequency deviation	8.3.2	U	
4	Frequency deviation at modulation frequencies above 3 kHz	8.3.3	U	
5	Transmitter adjacent channel power	8.6	U	
6	Transmitter conducted spurious emissions conveyed to the antenna	8.7	U	
7	Transmitter cabinet radiation and conducted spurious emissions other than those conveyed to the antenna	8.8	U	
8	Transmit modulation index	8.10	C	For use with DSC
9	Modulation attack time	8.12	C	For use with DSC
10	Transient frequency behaviour of the transmitter	8.13	U	
11	Intermodulation attenuation	8.14	U	
12	Receiver maximum usable sensitivity	9.4	U	
13	Receiver co-channel rejection	9.5	U	
14	Receiver adjacent channel selectivity	9.6	U	
15	Receiver spurious response rejection	9.7	U	
16	Receiver intermodulation response	9.8	U	
17	Receiver blocking or desensitization	9.9	U	
18	Receiver conducted spurious emissions conveyed to the antenna	9.11.2	U	
19	Receiver radiated spurious emissions	9.11.3	U	
20	DSC Receiver maximum usable sensitivity	9.13	C	Equipment with a dedicated DSC CH70 receiver
21	DSC Receiver co-channel rejection	9.14	C	Equipment with a dedicated DSC CH70 receiver
22	DSC Receiver adjacent channel selectivity	9.15	C	Equipment with a dedicated DSC CH70 receiver
23	Receiver desensitization with simultaneous transmit and receive	9.17.2	C	Full duplex equipment only
24	Duplex transceiver internal mixing	9.17.3	C	Full duplex equipment only
25	DSC spurious response and blocking immunity	9.19	C	Equipment with a dedicated DSC CH70 receiver
26	DSC Receiver intermodulation response	9.20	C	Equipment with a dedicated DSC CH70 receiver

Key to columns:**Requirement:**

No A unique identifier for one row of the table which may be used to identify a requirement.

Description A textual reference to the requirement.

Clause Number Identification of clause(s) defining the requirement in the present document unless another document is referenced explicitly.

Requirement Conditionality:

U/C Indicates whether the requirement is unconditionally applicable (U) or is conditional upon the manufacturer's claimed functionality of the equipment (C).

Condition Explains the conditions when the requirement is or is not applicable for a requirement which is classified "conditional".

Presumption of conformity stays valid only as long as a reference to the present document is maintained in the list published in the Official Journal of the European Union. Users of the present document should consult frequently the latest list published in the Official Journal of the European Union.

Other Union legislation may be applicable to the product(s) falling within the scope of the present document.

Annex B (normative): Measuring receiver for adjacent channel power measurement

B.1 Power measuring receiver specification

B.1.0 General

The power measuring receiver is used for the measurement of the transmitter adjacent channel power. It consists of a mixer and oscillator, an IF filter, an amplifier, a variable attenuator and a level indicator as shown below (figure B.1).

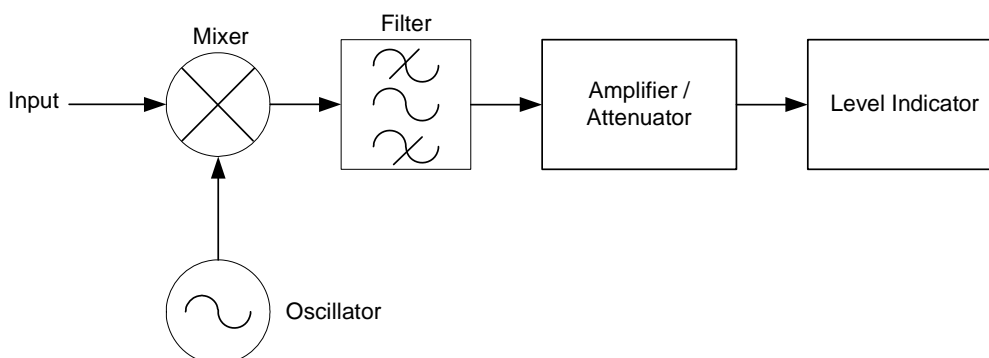

Figure B.1: Power measuring receiver

Instead of the Variable attenuator with the rms value indicator it is also possible to use a rms voltmeter calibrated in dB. The technical characteristics of the power measuring receiver are given in clauses B.1.1 to B.1.4.

B.1.1 IF filter

The IF filter shall be within the limits of the following selectivity characteristics.

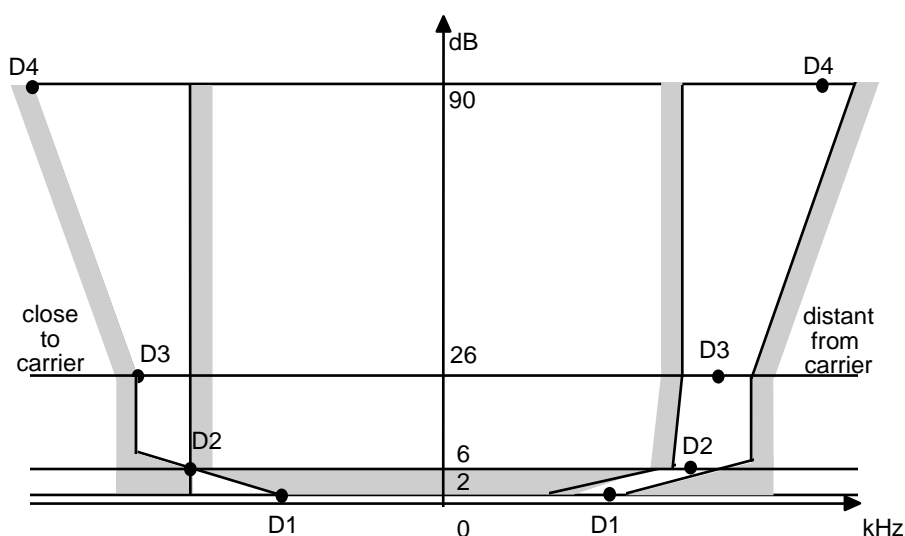

Figure B.2: IF filter characteristics

The selectivity characteristics shall keep the frequency separations shown in table B.1 from the nominal centre frequency of the adjacent channel.

Table B.1: Selectivity characteristic

Channel separation (kHz)	Frequency separation of filter curve from nominal centre frequency of adjacent channel (kHz)			
	D1	D2	D3	D4
12,5	3	4,25	5,5	9,5
25	5	8,0	9,25	13,25

The attenuation points shall not exceed following tolerances shown in table B.2.

Table B.2: Tolerance of attenuation points close to carrier

Channel separation (kHz)	Tolerance range (kHz)			
	D1	D2	D3	D4
12,5	+1,35	±0,1	-1,35	-5,35
25	+3,1	±0,1	-1,35	-5,35

Table B.3: Tolerance of attenuation points distant from the carrier

Channel separation (kHz)	Tolerance range (kHz)			
	D1	D2	D3	D4
12,5	±2,0	±2,0	±2,0	+2,0 -6,0
25	±3,5	±3,5	±3,5	+3,5 -7,5

The minimum attenuation of the filter outside the 90 dB attenuation points shall be equal to or greater than 90 dB.

B.1.2 Attenuation indicator

The attenuation indicator shall have a minimum range of 80 dB and a reading accuracy of 1 dB. With a view to future regulations an attenuation of 90 dB or more is recommended.

B.1.3 rms value indicator

The instrument shall accurately indicate non-sinusoidal signals in ratio of up to 10:1 between peak value and rms value.

B.1.4 Oscillator and amplifier

The oscillator and the amplifier shall be designed in such a way that the measurement of the adjacent channel power of a low-noise unmodulated transmitter, whose self-noise has a negligible influence on the measurement result, yields a measured value of less than -90 dB.

Annex C (informative): Change history

Version	Information about changes
2.1.1	First version aligned with the new Radio Equipment Directive (Directive 2014/53/EU)

History

Document history		
V1.1.1	January 2002	Publication as ETSI EN 301 919 parts 1 and 2
V1.2.1	February 2007	Publication as ETSI EN 301 919 parts 1 and 2
V2.1.1	November 2016	EN Approval Procedure AP 20170227: 2016-11-29 to 2017-02-27
V2.1.1	March 2017	Publication