

ETSI EN 301 893 V1.7.1 (2012-06)



**Broadband Radio Access Networks (BRAN);
5 GHz high performance RLAN;
Harmonized EN covering the essential requirements
of article 3.2 of the R&TTE Directive**

ReferenceREN/BRAN-0060009

Keywordsaccess, broadband, LAN, layer 1, radio,
regulation, testing**ETSI**650 Route des Lucioles
F-06921 Sophia Antipolis Cedex - FRANCE

Tel.: +33 4 92 94 42 00 Fax: +33 4 93 65 47 16

Siret N° 348 623 562 00017 - NAF 742 C
Association à but non lucratif enregistrée à la
Sous-Préfecture de Grasse (06) N° 7803/88

Important notice

Individual copies of the present document can be downloaded from:

<http://www.etsi.org>

The present document may be made available in more than one electronic version or in print. In any case of existing or perceived difference in contents between such versions, the reference version is the Portable Document Format (PDF). In case of dispute, the reference shall be the printing on ETSI printers of the PDF version kept on a specific network drive within ETSI Secretariat.

Users of the present document should be aware that the document may be subject to revision or change of status. Information on the current status of this and other ETSI documents is available at

<http://portal.etsi.org/tb/status/status.asp>

If you find errors in the present document, please send your comment to one of the following services:

http://portal.etsi.org/chaicor/ETSI_support.asp

Copyright Notification

No part may be reproduced except as authorized by written permission.
The copyright and the foregoing restriction extend to reproduction in all media.

© European Telecommunications Standards Institute 2012.
All rights reserved.

DECT™, **PLUGTESTS™**, **UMTS™** and the ETSI logo are Trade Marks of ETSI registered for the benefit of its Members.
3GPP™ and **LTE™** are Trade Marks of ETSI registered for the benefit of its Members and
of the 3GPP Organizational Partners.
GSM® and the GSM logo are Trade Marks registered and owned by the GSM Association.

Contents

Intellectual Property Rights	7
Foreword.....	7
Introduction	7
1 Scope	8
2 References	8
2.1 Normative references	8
2.2 Informative references.....	9
3 Definitions, symbols and abbreviations	9
3.1 Definitions	9
3.2 Symbols.....	12
3.3 Abbreviations	13
4 Technical requirements specifications	13
4.1 Environmental profile.....	13
4.2 Centre frequencies.....	13
4.2.1 Definition.....	14
4.2.2 Limits.....	14
4.2.3 Conformance.....	14
4.3 Nominal Channel Bandwidth and Occupied Channel Bandwidth.....	14
4.3.1 Definition.....	14
4.3.2 Limits.....	14
4.3.3 Conformance.....	14
4.4 RF output power, Transmit Power Control (TPC) and power density	14
4.4.1 Definitions	14
4.4.1.1 RF Output Power	14
4.4.1.2 Transmit Power Control (TPC).....	15
4.4.1.3 Power Density	15
4.4.2 Limits.....	15
4.4.2.1 RF output power and power density at the highest power level.....	15
4.4.2.2 RF output power at the lowest power level of the TPC range.....	15
4.4.3 Conformance.....	16
4.5 Transmitter unwanted emissions	16
4.5.1 Transmitter unwanted emissions outside the 5 GHz RLAN bands.....	16
4.5.1.1 Definition	16
4.5.1.2 Limits	16
4.5.1.3 Conformance.....	16
4.5.2 Transmitter unwanted emissions within the 5 GHz RLAN bands	16
4.5.2.1 Definition	16
4.5.2.2 Limits	17
4.5.2.3 Conformance.....	17
4.6 Receiver spurious emissions.....	17
4.6.1 Definition.....	17
4.6.2 Limits.....	18
4.6.3 Conformance.....	18
4.7 Dynamic Frequency Selection (DFS).....	18
4.7.1 Introduction.....	18
4.7.1.1 Applicable frequency range	18
4.7.1.2 DFS operational modes	18
4.7.1.3 DFS operation	19
4.7.2 DFS technical requirements specifications	20
4.7.2.1 Channel Availability Check	20
4.7.2.1.1 Definition.....	20
4.7.2.1.2 Limit	20
4.7.2.1.3 Conformance	20

4.7.2.2	Off-Channel CAC (Off-Channel Channel Availability Check) (optional).....	21
4.7.2.2.1	Definition.....	21
4.7.2.2.2	Limit.....	21
4.7.2.2.3	Conformance.....	21
4.7.2.3	In-Service Monitoring.....	21
4.7.2.3.1	Definition.....	21
4.7.2.3.2	Limit.....	21
4.7.2.3.3	Conformance.....	21
4.7.2.4	Channel Shutdown.....	21
4.7.2.4.1	Definition.....	21
4.7.2.4.2	Limit.....	22
4.7.2.4.3	Conformance.....	22
4.7.2.5	Non-Occupancy Period.....	22
4.7.2.5.1	Definition.....	22
4.7.2.5.2	Limit.....	22
4.7.2.5.3	Conformance.....	22
4.7.2.6	Uniform Spreading.....	22
4.7.2.6.1	Definition.....	22
4.7.2.6.2	Limit.....	23
4.8	Void.....	23
4.9	Adaptivity (Channel Access Mechanism).....	23
4.9.1	Definition.....	23
4.9.2	Requirements & limits.....	23
4.9.2.1	Frame Based Equipment.....	23
4.9.2.2	Load Based Equipment.....	24
4.9.2.3	Short Control Signalling Transmissions.....	25
4.9.2.3.1	Definition.....	25
4.9.2.3.2	Limits.....	25
4.9.3	Conformance.....	25
4.10	User Access Restrictions.....	26
4.10.1	Definition.....	26
4.10.2	Requirement.....	26
5	Testing for compliance with technical requirements.....	26
5.1	Conditions for testing.....	26
5.1.1	Normal and extreme test conditions.....	26
5.1.2	Test sequences and traffic load.....	26
5.1.2.1	General test transmission sequences.....	26
5.1.2.2	Test transmission sequences for DFS tests.....	27
5.1.3	Test channels.....	27
5.1.4	Antennas.....	28
5.1.4.1	Integrated and dedicated antennas.....	28
5.1.4.2	Transmit operating modes.....	28
5.1.4.2.1	Operating mode 1 (single antenna).....	28
5.1.4.2.2	Operating mode 2 (multiple antennas, no beamforming).....	28
5.1.4.2.3	Operating mode 3 (multiple antennas, with beamforming).....	28
5.1.5	Presentation of equipment.....	28
5.1.5.1	Testing of host connected equipment and plug-in radio devices.....	28
5.1.5.1.1	The use of a host or test jig for testing plug-in radio devices.....	29
5.1.5.1.2	Testing of combinations.....	29
5.2	Interpretation of the measurement results.....	30
5.3	Essential radio test suites.....	30
5.3.1	Product information.....	30
5.3.2	Carrier frequencies.....	32
5.3.2.1	Test conditions.....	32
5.3.2.2	Test methods.....	32
5.3.2.2.1	Conducted measurement.....	32
5.3.2.2.2	Radiated measurement.....	33
5.3.3	Occupied Channel Bandwidth.....	33
5.3.3.1	Test conditions.....	33
5.3.3.2	Test method.....	33
5.3.3.2.1	Conducted measurement.....	33

5.3.3.2.2	Radiated measurement.....	34
5.3.4	RF output power, Transmit Power Control (TPC) and power density.....	34
5.3.4.1	Test conditions.....	34
5.3.4.2	Test method.....	34
5.3.4.2.1	Conducted measurement.....	34
5.3.4.2.2	Radiated measurement.....	44
5.3.5	Transmitter unwanted emissions outside the 5 GHz RLAN bands.....	44
5.3.5.1	Test conditions.....	44
5.3.5.2	Test method.....	44
5.3.5.2.1	Conducted measurement.....	44
5.3.5.2.2	Radiated measurement.....	47
5.3.6	Transmitter unwanted emissions within the 5 GHz RLAN bands.....	47
5.3.6.1	Test conditions.....	47
5.3.6.2	Test method.....	47
5.3.6.2.1	Conducted measurement.....	47
5.3.6.2.2	Radiated measurement.....	48
5.3.7	Receiver spurious emissions.....	48
5.3.7.1	Test conditions.....	48
5.3.7.2	Test method.....	49
5.3.7.2.1	Conducted measurement.....	49
5.3.7.2.2	Radiated measurement.....	50
5.3.8	Dynamic Frequency Selection (DFS).....	50
5.3.8.1	Test conditions.....	50
5.3.8.1.1	Selection of radar test signals.....	50
5.3.8.1.2	Test set-ups.....	51
5.3.8.2	Test method.....	52
5.3.8.2.1	Conducted measurement.....	52
5.3.8.2.2	Radiated measurement.....	60
5.3.9	Adaptivity (channel access mechanism).....	60
5.3.9.1	Test conditions.....	60
5.3.9.2	Test method.....	60
5.3.9.2.1	Conducted measurements.....	60
5.3.9.2.2	Generic test procedure for measuring channel/frequency usage.....	62
5.3.9.2.3	Radiated measurements.....	63

Annex A (normative):	HS Requirements and conformance Test specifications Table (HS-RTT).....	64
-----------------------------	--	-----------

Annex B (normative):	Test sites and arrangements for radiated measurements.....	66
-----------------------------	---	-----------

B.1	Test sites.....	66
B.1.1	Open air test sites.....	66
B.1.2	Anechoic chamber.....	67
B.1.2.1	General.....	67
B.1.2.2	Description.....	67
B.1.2.3	Influence of parasitic reflections.....	67
B.1.2.4	Calibration and mode of use.....	67

B.2	Test antenna.....	69
-----	-------------------	----

B.3	Substitution antenna.....	69
-----	---------------------------	----

Annex C (normative):	General description of measurement.....	70
-----------------------------	--	-----------

C.1	Conducted measurements.....	70
-----	-----------------------------	----

C.2	Radiated measurements.....	70
-----	----------------------------	----

C.3	Substitution measurement.....	71
-----	-------------------------------	----

Annex D (normative):	DFS parameters.....	72
-----------------------------	----------------------------	-----------

Annex E (informative):	Guidance for testing IEEE 802.11n™ Devices.....	76
-------------------------------	--	-----------

E.1	Introduction.....	76
-----	-------------------	----

E.2	Possible Modulations	76
E.2.1	Guidance for Testing	76
E.2.1.1	Modulation Used for Conformance Testing	76
E.3	Possible Operating Modes	77
E.3.1	Guidance for Testing	77
Annex F (informative):	Application form for testing.....	78
F.1	Information as required by EN 301 893 (V1.7.1), clause 5.3.1.....	78
F.2	Additional information provided by the manufacturer.....	86
F.2.1	Modulation:	86
F.2.2	Duty Cycle.....	86
F.2.3	About the UUT	86
F.2.4	List of ancillary and/or support equipment provided by the manufacturer.....	87
Annex G (informative):	Void	88
Annex H (informative):	Bibliography	89
History		90

Intellectual Property Rights

IPRs essential or potentially essential to the present document may have been declared to ETSI. The information pertaining to these essential IPRs, if any, is publicly available for **ETSI members and non-members**, and can be found in ETSI SR 000 314: "*Intellectual Property Rights (IPRs); Essential, or potentially Essential, IPRs notified to ETSI in respect of ETSI standards*", which is available from the ETSI Secretariat. Latest updates are available on the ETSI Web server (<http://ipr.etsi.org>).

Pursuant to the ETSI IPR Policy, no investigation, including IPR searches, has been carried out by ETSI. No guarantee can be given as to the existence of other IPRs not referenced in ETSI SR 000 314 (or the updates on the ETSI Web server) which are, or may be, or may become, essential to the present document.

Foreword

This Harmonized European Standard (EN) has been produced by ETSI Technical Committee Broadband Radio Access Networks (BRAN).

The present document has been produced by ETSI in response to a mandate from the European Commission issued under Directive 98/34/EC [i.1] as amended by Directive 98/48/EC [i.1].

The title and reference to the present document are intended to be included in the publication in the Official Journal of the European Union of titles and references of Harmonized Standard under the Directive 1999/5/EC [1].

See article 5.1 of Directive 1999/5/EC [1] for information on presumption of conformity and Harmonised Standards or parts thereof the references of which have been published in the Official Journal of the European Union.

The requirements relevant to Directive 1999/5/EC [1] are summarised in annex A.

National transposition dates	
Date of adoption of this EN:	30 May 2012
Date of latest announcement of this EN (doa):	31 August 2012
Date of latest publication of new National Standard or endorsement of this EN (dop/e):	28 February 2013
Date of withdrawal of any conflicting National Standard (dow):	31 December 2014

Introduction

The present document is part of a set of standards developed by ETSI and is designed to fit in a modular structure to cover all radio and telecommunications terminal equipment within the scope of the R&TTE Directive [1]. The modular structure is shown in EG 201 399 [i.3].

1 Scope

The present document applies to 5 GHz high performance wireless access systems (WAS) including RLAN equipment which is used in wireless local area networks. Such networks provide high speed data communications in between devices connected to the wireless infrastructure. The present document also applies to ad-hoc networking where these devices communicate directly with each other, without the use of a wireless infrastructure.

The present document also describes spectrum access requirements to facilitate spectrum sharing with other equipment.

5 GHz high performance wireless access systems (WAS) including RLAN equipment are further referred to as RLAN equipment in the present document.

The spectrum usage conditions for this RLAN equipment are set in the ECC Decision (04)08 [5] and the Commission Decision 2005/513/EC [6] as amended by the Commission Decision 2007/90/EC [7].

The equipment is intended to operate in the frequency ranges 5 150 MHz to 5 350 MHz and 5 470 MHz to 5 725 MHz which have been allocated by WRC-03 to the *mobile service* on a primary basis for the implementation of WAS/RLANs covered by the present document.

The present document is intended to cover the provisions of article 3.2 of R&TTE Directive [1], which states that: "...radio equipment shall be so constructed that it effectively uses the spectrum allocated to terrestrial/space radio communications and orbital resources so as to avoid harmful interference".

2 References

References are either specific (identified by date of publication and/or edition number or version number) or non-specific. For specific references, only the cited version applies. For non-specific references, the latest version of the referenced document (including any amendments) applies.

Referenced documents which are not found to be publicly available in the expected location might be found at <http://docbox.etsi.org/Reference>.

NOTE: While any hyperlinks included in this clause were valid at the time of publication, ETSI cannot guarantee their long term validity.

2.1 Normative references

The following referenced documents are necessary for the application of the present document.

- [1] Directive 1999/5/EC of the European Parliament and of the Council of 9 March 1999 on radio equipment and telecommunications terminal equipment and the mutual recognition of their conformity (R&TTE Directive).
- [2] ETSI TR 100 028-1 (V1.4.1): "Electromagnetic compatibility and Radio spectrum Matters (ERM); Uncertainties in the measurement of mobile radio equipment characteristics; Part 1".
- [3] ETSI TR 100 028-2 (V1.4.1): "Electromagnetic compatibility and Radio spectrum Matters (ERM); Uncertainties in the measurement of mobile radio equipment characteristics; Part 2".
- [4] CISPR 16-1-1 (2010-11 Ed. 3.1 Consolidated Edition with am1): "Specification for radio disturbance and immunity measuring apparatus and methods - Part 1-1: Radio disturbance and immunity measuring apparatus - Measuring apparatus".
- [5] ECC/DEC/(04)08 ECC Decision of 9 July 2004 on the harmonised use of the 5 GHz frequency bands for the implementation of Wireless Access Systems including Radio Local Area Networks (WAS/RLANs) (30/10/2009).
- [6] Commission Decision 2005/513/EC of 11 July 2005 on the harmonised use of radio spectrum in the 5 GHz frequency band for the implementation of wireless access systems including radio local area networks (WAS/RLANs).

- [7] Commission Decision 2007/90/EC of 12 February 2007 amending Decision 2005/513/EC on the harmonized use of radio spectrum in the 5 GHz frequency band for the implementation of Wireless Access Systems including Radio Local Area Networks (WAS/RLANs).
- [8] Void.
- [9] IEEE Std. 802.11™-2007: "IEEE Standard for Information Technology - Telecommunications and information exchange between systems - Local and metropolitan area networks - Specific requirements - Part 11: Wireless LAN Medium Access Control (MAC) and Physical Layer (PHY) Specifications".
- [10] IEEE Std. 802.11n™-2009: "IEEE Standard for Information Technology - Telecommunications and information exchange between systems - Local and Metropolitan networks - Specific requirements-Part 11: Wireless LAN Medium Access Control (MAC) and Physical Layer (PHY) Specifications. Amendment 5: Enhancements for Higher Throughput".

2.2 Informative references

The following referenced documents are not necessary for the application of the present document but they assist the user with regard to a particular subject area.

- [i.1] Directive 98/48/EC of the European Parliament and of the Council of 20 July 1998 amending Directive 98/34/EC laying down a procedure for the provision of information in the field of technical standards and regulations.
- [i.2] IEEE Std. 802.11ac™: "Draft Standard for Information Technology - Telecommunications and information exchange between systems - Local and Metropolitan networks - Specific requirements - Part 11: Wireless LAN Medium Access Control (MAC) and Physical Layer (PHY) specifications. Amendment 5: Enhancements for Higher Throughput for Operation in Bands below 6 GHz".
- [i.3] ETSI EG 201 399 (V2.1.1): "Electromagnetic compatibility and Radio spectrum Matters (ERM); A guide to the production of Harmonized Standards for application under the R&TTE Directive".

3 Definitions, symbols and abbreviations

3.1 Definitions

For the purposes of the present document, the terms and definitions given in the R&TTE Directive [1] and the following apply:

5 GHz RLAN bands: total frequency range that consists of 2 sub-bands:

- 5 150 MHz to 5 350 MHz; and
- 5 470 MHz to 5 725 MHz

adaptive equipment: equipment operating in an adaptive mode

adaptive mode: mechanism by which equipment can adapt to its environment by identifying other transmissions present in the band

ad-hoc mode: operating mode in which an RLAN device establishes a temporary wireless connection with other RLAN devices without a controlling network infrastructure

antenna array: two or more antennas connected to a single device and operating simultaneously

antenna assembly: combination of the antenna (integral or dedicated), its coaxial cable and if applicable, its antenna connector and associated switching components

NOTE 1: This term (antenna assembly) refers to an antenna connected to one transmit chain.

NOTE 2: The gain of an antenna assembly (G) in dBi, does not include the additional gain that may result out of beamforming.

available channel: channel identified as available for immediate use as an *Operating Channel*

NOTE: *Usable Channels* whose nominal bandwidth falls completely within the band 5 150 MHz to 5 250 MHz can be considered as *Available Channels* without further testing.

beamforming gain: additional (antenna) gain realized by using beamforming techniques in smart antenna systems

NOTE: Beamforming gain as used in the present document, does not include the gain of the antenna assembly.

burst: period during which radio waves are intentionally transmitted, preceded and succeeded by periods during which no intentional transmission is made

channel: minimum amount of spectrum used by a single RLAN device

NOTE: An RLAN device is permitted to operate (transmit/receive) in one or more adjacent or non-adjacent channels simultaneously.

EXAMPLE: For the purpose of the present document, an IEEE 802.11n™ [10] device operating in a 40 MHz mode may be considered as operating in 2 adjacent 20 MHz channels simultaneously.

channel plan: combination of the centre frequencies and for each of the centre frequencies, the declared nominal bandwidth(s)

clear channel assessment: mechanism used by an equipment to identify other transmissions in the channel

combined equipment: any combination of non-radio equipment that requires a plug-in radio device to offer full functionality

dedicated antenna: antenna external to the equipment, using an antenna connector with a cable or a wave-guide and which has been designed or developed for one or more specific types of equipment

NOTE: It is the combination of dedicated antenna and radio equipment that is expected to be compliant with the regulations.

energy detect: mechanism used by an adaptive system to determine the presence of another device operating on the channel based on detecting the signal level of that other device

environmental profile: range of environmental conditions under which equipment within the scope of the present document is required to comply with the provisions of the present document

Frame Based Equipment (FBE): equipment where the transmit/receive structure is not directly demand-driven but has fixed timing

NOTE: I.e. it may be altered by configuration changes but there is always a minimum Idle Period following a transmit period

host equipment: any equipment which has complete user functionality when not connected to the radio equipment part and to which the radio equipment part provides additional functionality and to which connection is necessary for the radio equipment part to offer functionality

integral antenna: antenna designed as a fixed part of the equipment (without the use of an external connector) which cannot be disconnected from the equipment by a user with the intent to connect another antenna

NOTE: An integral antenna may be fitted internally or externally. In the case where the antenna is external, a non-detachable cable or wave-guide can be used.

Listen Before Talk (LBT): mechanism by which an equipment applies clear channel assessment (CCA) before using the channel

Load Based Equipment (LBE): equipment where the transmit/receive structure is not fixed in time but demand-driven

manufacturer: company that has manufactured the equipment and who submits it for test

NOTE: Alternatively, the importer or any other person or entity that submits the equipment for test can be considered as the manufacturer for the purpose of the present document.

master mode: mode which relates to the DFS functionality where the RLAN device uses a Radar Interference Detection function and controls the transmissions of RLAN devices operating in slave mode

NOTE: In this mode it is able to select a channel and initiate a network by sending enabling signals to other RLAN devices. An RLAN network always has at least one RLAN device operating in master mode when operating in the bands 5 250 MHz to 5 350 MHz and 5 470 MHz to 5 725 MHz.

multi-radio equipment: radio, host or combined equipment using more than one radio transceiver

operating channel: *Available Channel* on which the RLAN has started transmissions

NOTE: An *Operating Channel* becomes again an *Available Channel* if the RLAN stopped all transmissions on that channel and no radar signal was detected by the *In-Service Monitoring*.

plug-in radio device: radio equipment module intended to be used with or within host, combined or multi-radio equipment, using their control functions and power supply

receive chain: receiver circuit with an associated antenna

NOTE: Two or more receive chains are combined in a smart antenna system.

RLAN devices: 5 GHz high performance wireless access systems (WAS) including RLAN equipment

simulated radar burst: series of periodic radio wave pulses for test purposes

slave mode: mode which relates to the DFS functionality where the transmissions of the RLAN are under control of an RLAN device operating in master mode

NOTE: An RLAN device in slave mode may use a Radar Interference Detection function.

smart antenna systems: equipment that combines multiple transmit and/or receive chains with a signal processing function to increase the throughput and/or to optimize its radiation and/or reception capabilities

NOTE: E.g. techniques such as spatial multiplexing, beamforming, cyclic delay diversity, MIMO, etc.

stand-alone radio equipment: equipment that is intended primarily as communications equipment and that is normally used on a stand-alone basis

sub-band: portion of the 5 GHz RLAN bands (see definition for "5 GHz RLAN bands")

total occupied bandwidth: total of the Nominal Channel Bandwidths in case of simultaneous transmissions in adjacent or non-adjacent channels

NOTE: The Total Occupied Bandwidth may change with time/payload.

transmit chain: transmitter circuit with an associated antenna

NOTE: Two or more transmit chains are combined in a smart antenna system.

Transmit Power Control (TPC): technique in which the transmitter output power is controlled resulting in reduced interference to other systems

unavailable channel: channel which cannot be considered by the RLAN device for a certain period of time (*Non Occupancy Period*) after a radar signal was detected on that channel

unusable channel: channel from the declared channel plan which may be declared as permanently unavailable due to one or more radar detections on the channel

usable channel: any channel from the declared channel plan, which may be considered by the RLAN for possible use, unless it is precluded by either:

- 1) the intended outdoor usage of the RLAN; or
- 2) previous detection of a radar on the channel (*Unavailable Channel or Unusable Channel*); or
- 3) national regulations; or
- 4) the restriction to only operate in the band 5 150 MHz to 5 250 MHz for RLAN devices without a radar detection capability.

3.2 Symbols

For the purposes of the present document, the following symbols apply:

A	Measured power output
AC	Alternating Current
T_{ch}	Number of active transmit chains
B	Radar burst period
Ch_r	Channel in which radar test signals are inserted to simulate the presence of a radar
D	Measured power density
dBm	dB relative to 1 milliwatt
DC	Direct Current
E	Field strength
E_o	Reference field strength
f_c	Carrier frequency
G	Antenna gain
GHz	GigaHertz
Hz	Hertz
kHz	kiloHertz
L	Radar burst length
MHz	MegaHertz
ms	millisecond
MS/s	Mega Samples per second
mW	milliWatt
n	Number of channels
P_H	Calculated e.i.r.p. at highest power level
P_L	Calculated e.i.r.p. at lowest power level
P_{burst}	RMS (mean) power over the transmission burst
PD	Calculated power density
P_d	Detection Probability
R	Distance
R_{ch}	Number of active receive chains
R_o	Reference distance
S0	Signal power
T0	Time instant
T1	Time instant
T2	Time instant
T3	Time instant
W	Radar pulse width
x	Observed duty cycle
Y	Beamforming (antenna) gain

3.3 Abbreviations

For the purposes of the present document, the following abbreviations apply:

ACK	Acknowledgement
BIT	Burst Interval Time
CAC	Channel Availability Check
CCA	Clear Channel Assessment
CISPR	International Special Committee on Radio Interference (Comité International Spécial des Perturbations Radioélectriques)
CSD	Cyclic Shift Diversity
dB/div	dB per division
DFS	Dynamic Frequency Selection
e.i.r.p.	equivalent isotropically radiated power
e.r.p.	effective radiated power
EMC	Electro-Magnetic Compatibility
HT20	High Throughput in a 20 MHz channel
HT40	High Throughput in a 40 MHz channel
IEEE	Institute of Electrical and Electronic Engineers
LBT	Listen Before Talk
MCS	Modulation Coding Scheme
MIMO	Multiple Input, Multiple Output
NACK	Not Acknowledged
PPB	Pulses Per Burst
ppm	parts per million
PPS	Pulses Per Second
PRF	Pulse Repetition Frequency
R&TTE	Radio and Telecommunications Terminal Equipment
RBW	Resolution Bandwidth
RF	Radio Frequency
RLAN	Radio Local Area Network
RMS	Root Mean Square
TL	Threshold Level
TPC	Transmit Power Control
Tx	Transmit, Transmitter
UUT	Unit Under Test
VBW	Video Bandwidth
WAS	Wireless Access Systems
WRC-03	World Radiocommunications Conference 2003

4 Technical requirements specifications

4.1 Environmental profile

The technical requirements of the present document apply under the environmental profile for operation of the equipment, which shall be stated by the manufacturer.

The equipment shall comply in any of the operating modes with all the technical requirements of the present document at all times when operating within the boundary limits of the stated operational environmental profile.

Where multiple combinations of radio equipment and antenna (antenna assemblies) are intended, each combination shall comply with all the technical requirements of the present document.

4.2 Centre frequencies

RLAN equipment typically operates on a fixed frequency. The equipment is allowed to change its normal operating frequency when interference is detected, or to prevent causing interference into other equipment or for frequency planning purposes.

4.2.1 Definition

The centre frequency is the centre of the channel declared by the manufacturer as part of the declared channel plan(s).

4.2.2 Limits

The actual centre frequency for any given channel declared by the manufacturer shall be maintained within the range $f_c \pm 20$ ppm.

4.2.3 Conformance

Conformance tests as defined in clause 5.3.2 shall be carried out.

4.3 Nominal Channel Bandwidth and Occupied Channel Bandwidth

4.3.1 Definition

The Nominal Channel Bandwidth is the widest band of frequencies, inclusive of guard bands, assigned to a single channel.

The Occupied Channel Bandwidth is the bandwidth containing 99 % of the power of the signal.

NOTE: A device is permitted to operate in one or more adjacent or non-adjacent channels simultaneously.

When equipment has simultaneous transmissions in adjacent channels, these transmissions may be considered as one signal with an actual Nominal Channel Bandwidth of "n" times the individual Nominal Channel Bandwidth where "n" is the number of adjacent channels. When equipment has simultaneous transmissions in non-adjacent channels, each power envelope shall be considered separately.

4.3.2 Limits

The Nominal Channel Bandwidth shall be at least 5 MHz at all times.

The Occupied Channel Bandwidth shall be between 80 % and 100 % of the declared Nominal Channel Bandwidth. In case of smart antenna systems (devices with multiple transmit chains) each of the transmit chains shall meet this requirement.

NOTE: During an established communication, a device is allowed to operate temporarily in a mode where its Occupied Channel Bandwidth may be reduced to as low as 40 % of its Nominal Channel Bandwidth with a minimum of 4 MHz.

4.3.3 Conformance

Conformance tests as defined in clause 5.3.3 shall be carried out to determine the occupied channel bandwidth.

4.4 RF output power, Transmit Power Control (TPC) and power density

4.4.1 Definitions

4.4.1.1 RF Output Power

The RF Output Power is the mean equivalent isotropically radiated power (e.i.r.p.) during a transmission burst.

4.4.1.2 Transmit Power Control (TPC)

Transmit Power Control (TPC) is a mechanism to be used by the RLAN device to ensure a mitigation factor of at least 3 dB on the aggregate power from a large number of devices. This requires the RLAN device to have a TPC range from which the lowest value is at least 6 dB below the values for mean e.i.r.p. given in table 1 for devices with TPC.

4.4.1.3 Power Density

The Power Density is the mean Equivalent Isotropically Radiated Power (e.i.r.p.) density during a transmission burst.

4.4.2 Limits

The limits below are applicable to the system as a whole and in any possible configuration. This includes smart antenna systems (devices with multiple transmit chains).

In case of multiple (adjacent or non-adjacent) channels within the same sub-band, the total RF output power of all channels in that sub-band shall not exceed the limits defined below.

In case of multiple, non-adjacent channels operating in separate sub-bands, the total RF output power in each of the sub-bands shall not exceed the limits defined below.

4.4.2.1 RF output power and power density at the highest power level

TPC is not required for channels whose nominal bandwidth falls completely within the band 5 150 MHz to 5 250 MHz.

For devices with TPC, the RF output power and the power density when configured to operate at the highest stated power level of the TPC range shall not exceed the levels given in table 1.

Devices are allowed to operate without TPC. See table 1 for the applicable limits in this case.

Table 1: Mean e.i.r.p. limits for RF output power and power density at the highest power level

Frequency range [MHz]	Mean e.i.r.p. limit [dBm]		Mean e.i.r.p. density limit [dBm/MHz]	
	with TPC	without TPC	with TPC	without TPC
5 150 to 5 350	23	20/23 (see note 1)	10	7/10 (see note 2)
5 470 to 5 725	30 (see note 3)	27 (see note 3)	17 (see note 3)	14 (see note 3)
NOTE 1: The applicable limit is 20 dBm, except for transmissions whose nominal bandwidth falls completely within the band 5 150 MHz to 5 250 MHz, in which case the applicable limit is 23 dBm.				
NOTE 2: The applicable limit is 7 dBm/MHz, except for transmissions whose nominal bandwidth falls completely within the band 5 150 MHz to 5 250 MHz, in which case the applicable limit is 10 dBm/MHz.				
NOTE 3: Slave devices without a Radar Interference Detection function shall comply with the limits for the band 5 250 MHz to 5 350 MHz.				

4.4.2.2 RF output power at the lowest power level of the TPC range

For devices using TPC, the RF output power during a transmission burst when configured to operate at the lowest stated power level of the TPC range shall not exceed the levels given in table 2. For devices without TPC, the limits in table 2 do not apply.

Table 2: Mean e.i.r.p. limits for RF output power at the lowest power level of the TPC range

Frequency range	Mean e.i.r.p. [dBm]
5 250 MHz to 5 350 MHz	17
5 470 MHz to 5 725 MHz	24 (see note)
NOTE: Slave devices without a Radar Interference Detection function shall comply with the limits for the band 5 250 MHz to 5 350 MHz.	

4.4.3 Conformance

Conformance tests as defined in clause 5.3.4 shall be carried out.

4.5 Transmitter unwanted emissions

4.5.1 Transmitter unwanted emissions outside the 5 GHz RLAN bands

4.5.1.1 Definition

These are radio frequency emissions outside the 5 GHz RLAN bands.

4.5.1.2 Limits

The level of unwanted emission shall not exceed the limits given in table 3.

Table 3: Transmitter unwanted emission limits outside the 5 GHz RLAN bands

Frequency range	Maximum power	Bandwidth
30 MHz to 47 MHz	-36 dBm	100 kHz
47 MHz to 74 MHz	-54 dBm	100 kHz
74 MHz to 87,5 MHz	-36 dBm	100 kHz
87,5 MHz to 118 MHz	-54 dBm	100 kHz
118 MHz to 174 MHz	-36 dBm	100 kHz
174 MHz to 230 MHz	-54 dBm	100 kHz
230 MHz to 470 MHz	-36 dBm	100 kHz
470 MHz to 862 MHz	-54 dBm	100 kHz
862 MHz to 1 GHz	-36 dBm	100 kHz
1 GHz to 5,15 GHz	-30 dBm	1 MHz
5,35 GHz to 5,47 GHz	-30 dBm	1 MHz
5,725 GHz to 26 GHz	-30 dBm	1 MHz

4.5.1.3 Conformance

Conformance tests as defined in clause 5.3.5 shall be carried out.

4.5.2 Transmitter unwanted emissions within the 5 GHz RLAN bands

4.5.2.1 Definition

These are radio frequency emissions within the 5 GHz RLAN bands.

4.5.2.2 Limits

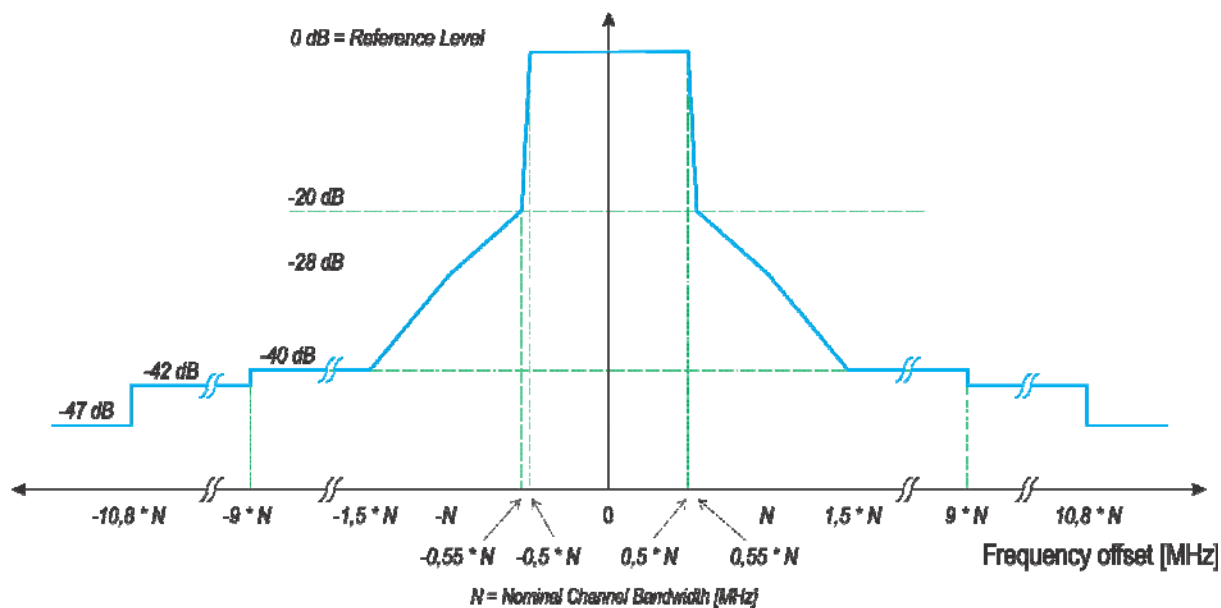

NOTE: dBc is the spectral density relative to the maximum spectral power density of the transmitted signal.

Figure 1: Transmit spectral power mask

The average level of transmitter unwanted emissions within the 5 GHz RLAN bands shall not exceed the limit of the mask provided in figure 1 or the limit for unwanted emissions provided in table 3, whichever is the higher.

It has to be noted that the mask is only applicable within the band of operation. Beyond the band edges the requirements of clause 4.5.1 apply.

In case of smart antenna systems (devices with multiple transmit chains) each of the transmit chains shall meet this requirement.

For transmitter unwanted emissions within the 5 GHz RLAN bands, simultaneous transmissions in adjacent channels may be considered as one signal with an actual Nominal Channel Bandwidth of "n" times the individual Nominal Channel Bandwidth where "n" is the number of adjacent channels used simultaneously.

For simultaneous transmissions in multiple non-adjacent channels, the overall transmit spectral power mask is constructed in the following manner. First, a mask as provided in figure 1 is applied to each of the channels. Then, for each frequency point, the highest value from the spectral masks of all the channels assessed shall be taken as the overall spectral mask requirement at that frequency.

4.5.2.3 Conformance

Conformance tests as defined in clause 5.3.6 shall be carried out.

4.6 Receiver spurious emissions

4.6.1 Definition

Receiver spurious emissions are emissions at any frequency when the equipment is in receive mode.

4.6.2 Limits

The spurious emissions of the receiver shall not exceed the limits given in table 4.

Table 4: Spurious radiated emission limits

Frequency range	Maximum power	Measurement bandwidth
30 MHz to 1 GHz	-57 dBm	100 kHz
1 GHz to 26 GHz	-47 dBm	1 MHz

4.6.3 Conformance

Conformance tests as defined in clause 5.3.7 shall be carried out.

4.7 Dynamic Frequency Selection (DFS)

4.7.1 Introduction

An RLAN shall employ a Dynamic Frequency Selection (DFS) function to:

- detect interference from radar systems (radar detection) and to avoid co-channel operation with these systems;
- provide on aggregate a near-uniform loading of the spectrum (*Uniform Spreading*).

The DFS function as described in the present document is not tested for its ability to detect frequency hopping radar signals.

Whilst the DFS function described in this clause defines conditions under which the equipment may transmit, transmissions are only allowed providing they are not prohibited by either the Medium Access Protocol requirement in clause 4.8 or the Adaptivity requirement in clause 4.9.

4.7.1.1 Applicable frequency range

Radar detection is required when operating on channels whose nominal bandwidth falls partly or completely within the frequency ranges 5 250 MHz to 5 350 MHz or 5 470 MHz to 5 725 MHz. This requirement applies to all types of RLAN devices regardless of the type of communication between these devices.

Uniform Spreading is required across the frequency ranges 5 150 MHz to 5 350 MHz and 5 470 MHz to 5 725 MHz. *Uniform Spreading* is not applicable for equipment that only operates in the band 5 150 MHz to 5 250 MHz.

4.7.1.2 DFS operational modes

Within the context of the operation of the DFS function, an RLAN device shall operate as either a master or a slave. RLAN devices operating as a slave shall only operate in a network controlled by an RLAN device operating as a master. A device which is capable of operating as either a master or a slave shall comply with the requirements applicable to the mode in which it operates.

Some RLAN devices are capable of communicating in ad-hoc manner without being attached to a network. Devices operating in this manner on channels whose nominal bandwidth falls partly or completely within the range 5 250 MHz to 5 350 MHz or 5 470 MHz to 5 725 MHz shall employ DFS and shall be tested against the requirements applicable to a master.

4.7.1.3 DFS operation

The operational behaviour and individual DFS requirements that are associated with master and slave devices are as follows:

Master devices:

- a) The master device shall use a Radar Interference Detection function in order to detect radar signals.

The master device may rely on another device, associated with the master, to implement the Radar Interference Detection function. In such a case, the combination shall comply with the requirements applicable to a master.

- b) A master device shall only start operations on *Available Channels*. At installation (or reinstallation) of the equipment, the RLAN is assumed to have no *Available Channels* within the band 5 250 MHz to 5 350 MHz and/or 5 470 MHz to 5 725 MHz. In such a case, before starting operations on one or more of these channels, the master device shall perform either a *Channel Availability Check* or an *Off-Channel CAC* to ensure that there are no radars operating on any selected channel. If no radar has been detected, the channel(s) becomes an *Available Channel(s)* and remains as such until a radar signal is detected during the *In-Service Monitoring*. The *Channel Availability Check* or the *Off-Channel CAC* may be performed over a wider bandwidth such that all channels within the tested bandwidth become *Available Channels*.

NOTE 1: The initial *Channel Availability Check* may be activated manually at installation or reinstallation of the equipment.

- c) Once the RLAN has started operations on an *Available Channel*, then that channel becomes an *Operating Channel*. During normal operation, the master device shall monitor all *Operating Channels (In-Service Monitoring)* to ensure that there is no radar operating within these channel(s). If no radar was detected on an *Operating Channel* but the RLAN stops operating on that channel, then the channel becomes an *Available Channel*.

NOTE 2: An RLAN is allowed to start transmissions on multiple (adjacent or non-adjacent) *Available Channels*. In this case all these channels become *Operating Channels*.

- d) If the master device has detected a radar signal on an *Operating Channel* during *In-Service Monitoring*, the master device shall instruct all its associated slave devices to stop transmitting on this channel which becomes an *Unavailable Channel*. For devices operating on multiple (adjacent or non-adjacent) *Operating Channels* simultaneously, only the *Operating Channel* containing the frequency on which radar was detected shall become an *Unavailable Channel*.
- e) An *Unavailable Channel* can become a *Usable Channel* again after the *Non-Occupancy Period*. A new *Channel Availability Check* or an *Off-Channel CAC* is required to verify there is no radar operating on this channel before it becomes an *Available Channel* again.
- f) In all cases, if radar detection has occurred, then the channel containing the frequency on which radar was detected becomes an *Unavailable Channel*. Alternatively the channel may be marked as an *Unusable Channel*.

Slave devices:

- a) A slave device shall not transmit before receiving an appropriate enabling signal from an associated master device.
- b) A slave device shall stop its transmissions on a channel whenever instructed by a master device. The slave device shall not resume any transmissions on this channel until it has received an appropriate enabling signal from an associated master device.
- c) A slave device which is required to perform radar detection (see table D.2, note 2), shall stop its own transmissions on an *Operating Channel* if it has detected a radar on that channel. That *Operating Channel* becomes an *Unavailable Channel* for the slave device. It shall not resume any transmissions on this *Unavailable Channel* for a period of time equal to the *Non-Occupancy Period*. A *Channel Availability Check* or an *Off-Channel CAC* is required by the slave device to verify there is no radar operating on this channel before the slave may use it again.

4.7.2 DFS technical requirements specifications

Table 5 lists the DFS related technical requirements and their applicability for every operational mode. If the RLAN device is capable of operating in more than one operational mode then every operating mode shall be assessed separately.

Table 5: Applicability of DFS requirements

Requirement	DFS Operational mode		
	Master	Slave without radar detection (see table D.2, note 2)	Slave with radar detection (see table D.2, note 2)
Channel Availability Check	✓	Not required	✓ (see note 2)
Off-Channel CAC (see note 1)	✓	Not required	✓ (see note 2)
In-Service Monitoring	✓	Not required	✓
Channel Shutdown	✓	✓	✓
Non-Occupancy Period	✓	Not required	✓
Uniform Spreading	✓	Not required	Not required
NOTE 1: Where implemented by the manufacturer.			
NOTE 2: A slave with radar detection is not required to perform a CAC or <i>Off-Channel CAC</i> at initial use of the channel but only after the slave has detected a radar signal on the <i>Operating Channel</i> by <i>In-Service Monitoring</i> .			

The radar detection requirements specified in clauses 4.7.2.1 to 4.7.2.3 assume that the centre frequencies of the radar signals fall within the central 80 % of the *Occupied Channel Bandwidth* of the RLAN channel (see clause 4.3).

4.7.2.1 Channel Availability Check

4.7.2.1.1 Definition

The *Channel Availability Check (CAC)* is defined as a mechanism by which an RLAN device checks channels for the presence of radar signals. This mechanism is used for identifying *Available Channels*.

There shall be no transmissions by the device within the channels being checked during this process.

If no radars have been detected on a channel, then that channel becomes an *Available Channel*.

NOTE: For devices that support multiple Nominal Channel Bandwidths, the *Channel Availability Check* may be performed once using the widest Nominal Channel Bandwidth. All narrower channels within the tested bandwidth become *Available Channels* providing no radar was detected.

4.7.2.1.2 Limit

The *Channel Availability Check* shall be performed during a continuous period in time (*Channel Availability Check Time*) which shall not be less than the value defined in table D.1.

During the *Channel Availability Check*, the RLAN shall be capable of detecting any of the radar test signals that fall within the ranges given by table D.4 with a level above the *Radar Detection Threshold* defined in table D.2.

The minimum required detection probability is defined in table D.5.

4.7.2.1.3 Conformance

Conformance tests for this requirement are defined in clause 5.3.8.

4.7.2.2 Off-Channel CAC (Off-Channel Channel Availability Check) (optional)

4.7.2.2.1 Definition

Off-Channel CAC is defined as an optional mechanism by which an RLAN monitors channel(s), different from the *Operating Channel(s)*, for the presence of radar signals. The *Off-Channel CAC* may be used in addition to the *Channel Availability Check* defined in clause 4.7.2.1, for identifying *Available Channels*.

Off-Channel CAC is performed by a number of non-continuous checks spread over a period in time. This time, which is required to determine the presence of radar signals, is defined as the *Off-Channel CAC Time*.

If no radars have been detected in a channel, then that channel becomes an *Available Channel*.

4.7.2.2.2 Limit

Where implemented, the *Off-Channel CAC Time* shall be declared by the manufacturer. However, the declared *Off-Channel CAC Time* shall be within the range specified in table D.1.

During the *Off-Channel CAC*, the RLAN shall be capable of detecting any of the radar test signals that fall within the ranges given by table D.4 with a level above the *Radar Detection Threshold* defined in table D.2.

The minimum required detection probability is defined in table D.5.

4.7.2.2.3 Conformance

Conformance tests for this requirement are defined in clause 5.3.8.

4.7.2.3 In-Service Monitoring

4.7.2.3.1 Definition

The *In-Service Monitoring* is defined as the process by which an RLAN monitors each *Operating Channel* for the presence of radar signals.

4.7.2.3.2 Limit

The *In-Service Monitoring* shall be used to monitor each *Operating Channel*.

The *In-Service-Monitoring* shall start immediately after the RLAN has started transmissions on a channel.

During the *In-Service Monitoring*, the RLAN shall be capable of detecting any of the radar test signals that fall within the ranges given by table D.4 with a level above the *Radar Detection Threshold* defined in table D.2.

The minimum required detection probability associated with a given radar test signal is defined in table D.5.

4.7.2.3.3 Conformance

Conformance tests for this requirement are defined in clause 5.3.8.

4.7.2.4 Channel Shutdown

4.7.2.4.1 Definition

The *Channel Shutdown* is defined as the process initiated by the RLAN device on an *Operating Channel* after a radar signal has been detected during the *In-Service Monitoring* on that channel.

The master device shall instruct all associated slave devices to stop transmitting on this channel, which they shall do within the *Channel Move Time*.

Slave devices with a Radar Interference Detection function, shall stop their own transmissions on an *Operating Channel* within the *Channel Move Time* upon detecting a radar signal within this channel.

The aggregate duration of all transmissions of the RLAN device on this channel during the *Channel Move Time* shall be limited to the *Channel Closing Transmission Time*. The aggregate duration of all transmissions shall not include quiet periods in between transmissions.

NOTE: For equipment having simultaneous transmissions on multiple (adjacent or non-adjacent) operating channels, only the channel(s) containing the frequency on which radar was detected is subject to the *Channel Shutdown* requirement. The equipment is allowed to continue transmissions on other *Operating Channels*.

4.7.2.4.2 Limit

The *Channel Move Time* shall not exceed the limit defined in table D.1.

The *Channel Closing Transmission Time* shall not exceed the limit defined in table D.1.

4.7.2.4.3 Conformance

Conformance tests for this requirement are defined in clause 5.3.8.

4.7.2.5 Non-Occupancy Period

4.7.2.5.1 Definition

The *Non-Occupancy Period* is defined as the time during which the RLAN device shall not make any transmissions on a channel after a radar signal was detected on that channel.

NOTE 1: For equipment having simultaneous transmissions on multiple (adjacent or non-adjacent) operating channels, only the channel(s) containing the frequency on which radar was detected is subject to the *Non-Occupancy Period* requirement. The equipment is allowed to continue transmissions on other *Operating Channels*.

NOTE 2: After the *Non-Occupancy Period*, the channel needs to be identified again as an *Available Channel* before the RLAN device may start transmitting again on this channel.

4.7.2.5.2 Limit

The *Non-Occupancy Period* shall not be less than the value defined in table D.1.

4.7.2.5.3 Conformance

Conformance tests for this requirement are defined in clause 5.3.8.

4.7.2.6 Uniform Spreading

4.7.2.6.1 Definition

The *Uniform Spreading* is a mechanism to be used by the RLAN to provide, on aggregate, a uniform loading of the spectrum across all devices. The *Uniform Spreading* is limited to the channels being declared as part of the channel plan.

NOTE: The required spreading may be achieved by various means. These means include network management functions controlling large numbers of RLAN devices as well as the channel selection function in an individual RLAN device.

4.7.2.6.2 Limit

Each of the declared Channel Plans (see clause 3.1) shall make use of at least 60 % of the spectrum available in the applicable sub-band(s).

Each of the *Usable Channels* shall be used with approximately equal probability. RLAN equipment for which the declared channel plan includes channels whose nominal bandwidth falls completely or partly within the band 5 600 MHz to 5 650 MHz may omit these channels from the list of *Usable Channels* at initial power up or at initial installation. Channels being used by other RLAN equipment may be omitted from the list of *Usable Channels*.

4.8 Void

4.9 Adaptivity (Channel Access Mechanism)

4.9.1 Definition

Adaptivity is an automatic channel access mechanism by which a device avoids transmissions in a channel in the presence of transmissions from other RLAN systems in that channel.

NOTE: Adaptivity is not intended to be used as an alternative to DFS to detect radar transmissions, but to detect transmissions from other RLAN systems operating in the band. DFS requirements are covered by clause 4.7.

4.9.2 Requirements & limits

This requirement applies to all equipment within the scope of the present document.

The present document defines 2 types of Adaptive equipment: Frame Based Equipment and Load Based Equipment.

Whilst the mechanisms described in this clause define conditions under which the equipment may transmit, transmissions are only allowed providing they are not prohibited by any of the DFS requirements in clause 4.7.

4.9.2.1 Frame Based Equipment

Frame Based Equipment shall comply with the following requirements:

- 1) Before starting transmissions on an *Operating Channel*, the equipment shall perform a *Clear Channel Assessment (CCA)* check using "energy detect". The equipment shall observe the *Operating Channel(s)* for the duration of the CCA observation time which shall be not less than 20 μ s. The CCA observation time used by the equipment shall be declared by the manufacturer. The *Operating Channel* shall be considered occupied if the energy level in the channel exceeds the threshold corresponding to the power level given in point 5 below. If the equipment finds the *Operating Channel(s)* to be clear, it may transmit immediately (see point 3 below).

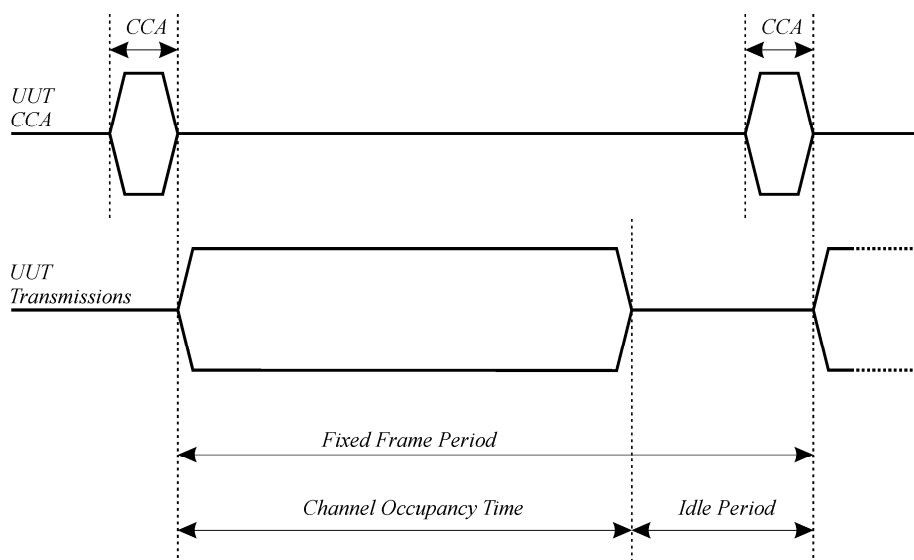

Figure 2: Example of timing for Frame Based Equipment

- 2) If the equipment finds an *Operating Channel* occupied, it shall not transmit on that channel during the next Fixed Frame Period.

NOTE 1: The equipment is allowed to continue Short Control Signalling Transmissions on this channel providing it complies with the requirements in clause 4.9.2.3.

NOTE 2: For equipment having simultaneous transmissions on multiple (adjacent or non-adjacent) *Operating Channels*, the equipment is allowed to continue transmissions on other *Operating Channels* providing the CCA check did not detect any signals on those channels.

- 3) The total time during which an equipment has transmissions on a given channel without re-evaluating the availability of that channel, is defined as the Channel Occupancy Time.

The Channel Occupancy Time shall be in the range 1 ms to 10 ms and the minimum Idle Period shall be at least 5 % of the Channel Occupancy Time used by the equipment for the current Fixed Frame Period. Towards the end of the Idle Period, the equipment shall perform a new CCA as described in point 1 above.

- 4) The equipment, upon correct reception of a packet which was intended for this equipment, can skip CCA and immediately (see note 3) proceed with the transmission of management and control frames (e.g. ACK and Block ACK frames). A consecutive sequence of such transmissions by the equipment, without it performing a new CCA, shall not exceed the *Maximum Channel Occupancy Time* as defined in point 3 above.

NOTE 3: For the purpose of multi-cast, the ACK transmissions (associated with the same data packet) of the individual devices are allowed to take place in a sequence.

- 5) The energy detection threshold for the CCA shall be proportional to the maximum transmit power (P_H) of the transmitter: for a 23 dBm e.i.r.p. transmitter the CCA threshold level (TL) shall be equal or lower than -73 dBm/MHz at the input to the receiver (assuming a 0 dBi receive antenna). For other transmit power levels, the CCA threshold level TL shall be calculated using the formula: $TL = -73 \text{ dBm/MHz} + 23 - P_H$ (assuming a 0 dBi receive antenna and P_H specified in dBm e.i.r.p.).

4.9.2.2 Load Based Equipment

Load based Equipment may implement an LBT based spectrum sharing mechanism based on the Clear Channel Assessment (CCA) mode using "energy detect", as described in IEEE 802.11TM-2007 [9], clauses 9 and 17, in IEEE 802.11nTM-2009 [10], clauses 9, 11 and 20 providing they comply with the conformance requirements referred to in clause 4.9.3 (see note 1).

NOTE 1: It is intended also to allow a mechanism based on the Clear Channel Assessment (CCA) mode using "energy detect" as described in IEEE 802.11acTM [i.2], clauses 8, 9, 10 and 22, when this becomes available.

Load Based Equipment not using any of the mechanisms referenced above shall comply with the following minimum set of requirements:

- 1) Before a transmission or a burst of transmissions on an *Operating Channel*, the equipment shall perform a *Clear Channel Assessment (CCA)* check using "energy detect". The equipment shall observe the *Operating Channel(s)* for the duration of the CCA observation time which shall be not less than 20 μ s. The CCA observation time used by the equipment shall be declared by the manufacturer. The *Operating Channel* shall be considered occupied if the energy level in the channel exceeds the threshold corresponding to the power level given in point 5 below. If the equipment finds the channel to be clear, it may transmit immediately (see point 3 below).
- 2) If the equipment finds an *Operating Channel* occupied, it shall not transmit in that channel. The equipment shall perform an *Extended CCA* check in which the *Operating Channel* is observed for the duration of a random factor N multiplied by the CCA observation time. N defines the number of clear idle slots resulting in a total *Idle Period* that need to be observed before initiation of the transmission. The value of N shall be randomly selected in the range 1..q every time an *Extended CCA* is required and the value stored in a counter. The value of q is selected by the manufacturer in the range 4..32. This selected value shall be declared by the manufacturer (see clause 5.3.1 q)). The counter is decremented every time a CCA slot is considered to be "unoccupied". When the counter reaches zero, the equipment may transmit.

NOTE 2: The equipment is allowed to continue Short Control Signalling Transmissions on this channel providing it complies with the requirements in clause 4.9.2.3.

NOTE 3: For equipment having simultaneous transmissions on multiple (adjacent or non-adjacent) operating channels, the equipment is allowed to continue transmissions on other *Operating Channels* providing the CCA check did not detect any signals on those channels.

- 3) The total time that an equipment makes use of an *Operating Channel* is the *Maximum Channel Occupancy Time* which shall be less than $(13/32) \times q$ ms, with q as defined in point 2 above, after which the device shall perform the *Extended CCA* described in point 2 above.
- 4) The equipment, upon correct reception of a packet which was intended for this equipment, can skip CCA and immediately (see note 4) proceed with the transmission of management and control frames (e.g. ACK and Block ACK frames). A consecutive sequence of transmissions by the equipment, without it performing a new CCA, shall not exceed the *Maximum Channel Occupancy Time* as defined in point 3 above.

NOTE 4: For the purpose of multi-cast, the ACK transmissions (associated with the same data packet) of the individual devices are allowed to take place in a sequence

- 5) The energy detection threshold for the CCA shall be proportional to the maximum transmit power (P_H) of the transmitter: for a 23 dBm e.i.r.p. transmitter the CCA threshold level (TL) shall be equal or lower than -73 dBm/MHz at the input to the receiver (assuming a 0 dBi receive antenna). For other transmit power levels, the CCA threshold level TL shall be calculated using the formula: $TL = -73 \text{ dBm/MHz} + 23 - P_H$ (assuming a 0 dBi receive antenna and P_H specified in dBm e.i.r.p.).

4.9.2.3 Short Control Signalling Transmissions

4.9.2.3.1 Definition

Short Control Signalling Transmissions are transmissions used by Adaptive equipment to send management and control frames (e.g. ACK/NACK signals) without sensing the channel for the presence of other signals.

NOTE: Adaptive equipment may or may not have Short Control Signalling Transmissions.

4.9.2.3.2 Limits

If implemented, Short Control Signalling Transmissions of Adaptive equipment shall have a maximum duty cycle of 5 % within an observation period of 50 ms.

4.9.3 Conformance

The conformance tests for this requirement are defined in clause 5.3.9.

4.10 User Access Restrictions

4.10.1 Definition

User Access Restrictions are restraints implemented in the RLAN to restrict access for the user to certain hardware and/or software settings of the equipment.

4.10.2 Requirement

DFS controls (hardware or software) related to radar detection shall not be accessible to the user so that the DFS requirements described in clauses 4.7.2.1 to 4.7.2.6 can neither be disabled nor altered.

5 Testing for compliance with technical requirements

5.1 Conditions for testing

5.1.1 Normal and extreme test conditions

Unless otherwise stated in the test procedures for essential radio test suites (see clause 5.3), the tests defined in the present document shall be carried out at representative points within the boundary limits of the declared operational environmental profile (see clause 5.3.1 m)).

Where technical performance varies subject to environmental conditions, tests shall be carried out under a sufficient variety of environmental conditions (within the boundary limits of the declared operational environmental profile) to give confidence of compliance for the affected technical requirements.

5.1.2 Test sequences and traffic load

5.1.2.1 General test transmission sequences

Except for the DFS tests or if mentioned otherwise, all the tests in the present document shall be performed by using a test transmission sequence that shall consist of regularly transmitted packets with an interval of e.g. 2 ms. The test transmissions shall be fixed in length in a sequence and shall exceed the transmitter minimum activity ratio of 10 %. The minimum duration of the sequence shall be adequate for the test purposes.

The general structure of the test transmission sequence is shown in figure 3.

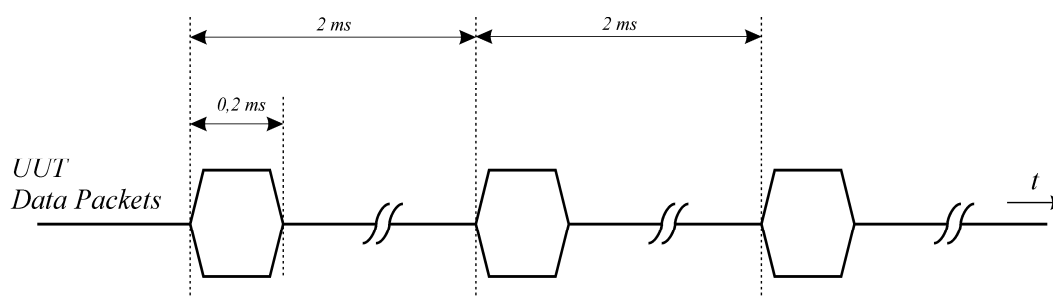

Figure 3: General structure of the test transmission sequences

5.1.2.2 Test transmission sequences for DFS tests

The DFS tests related to the *Off-Channel CAC Check* (clause 5.3.8.2.1.3) and the *In-Service Monitoring* (clause 5.3.8.2.1.4) shall be performed by using a test transmission sequence on the *Operating Channel* that shall consist of packet transmissions that together exceed the transmitter minimum activity ratio of 30 % measured over an interval of 100 ms. The duration of the sequence shall be adequate for the DFS test purposes.

There shall be no transmissions on channels being checked during a *Channel Availability Check* or during an *Off Channel CAC check*.

5.1.3 Test channels

Unless otherwise stated in the test procedures for essential radio test suites (see clause 5.3), the channels to be used for testing shall be as given in table 6.

NOTE: When testing devices that support simultaneous transmissions in adjacent or non-adjacent channels, DFS testing does not need to be performed simultaneously in these different channels.

Table 6: Test channels

Test	Clause	Test channels		
		Lower sub-band (5 150 MHz to 5 350 MHz)		Higher sub-band 5 470 MHz to 5 725 MHz
		5 150 MHz to 5 250 MHz	5 250 MHz to 5 350 MHz	
Centre frequencies	5.3.2	C7 (see note 1)		C8 (see note 1)
Occupied Channel Bandwidth	5.3.3	C7		C8
Power, power density	5.3.4	C1	C2	C3, C4
Transmitter unwanted emissions outside the 5 GHz RLAN bands	5.3.5	C7 (see note 1)		C8 (see note 1)
Transmitter unwanted emissions within the 5 GHz RLAN bands	5.3.6	C1	C2	C3, C4
Receiver spurious emissions	5.3.7	C7 (see note 1)		C8 (see note 1)
Transmit Power Control (TPC)	5.3.4	n.a. (see note 2)	C2 (see note 1)	C3, C4 (see note 1)
Dynamic Frequency Selection (DFS)	5.3.8	n.a. (see note 2)	C5	C6 (see note 3)
Adaptivity	5.3.9	C7		C8
C1, C3: The lowest declared channel for every declared nominal channel bandwidth within this band. C2, C4: The highest declared channel for every declared nominal channel bandwidth within this band. C5, C6: One channel out of the declared channels for this frequency range. If more than one nominal channel bandwidth has been declared for this sub-band, testing shall be performed using the lowest and highest nominal channel bandwidth. C7, C8: One channel out of the declared channels for this sub-band. For Occupied Channel Bandwidth, testing shall be repeated for every declared nominal channel bandwidth within this sub-band. For Adaptivity, testing shall be performed using the highest nominal channel bandwidth.				
NOTE 1: In case of more than 1 channel plan has been declared, testing of these specific requirements need only be performed using one of the declared channel plans.				
NOTE 2: Testing is not required for nominal channel bandwidths that fall completely within the frequency range 5 150 MHz to 5 250 MHz.				
NOTE 3: Where the declared channel plan includes channels whose nominal channel bandwidth falls completely or partly within the 5 600 MHz to 5 650 MHz band, the tests for the <i>Channel Availability Check</i> (and where implemented, for the <i>Off-Channel CAC</i>) shall be performed on one of these channels in addition to a channel within the band 5 470 MHz to 5 600 MHz or 5 650 MHz to 5 725 MHz band.				

5.1.4 Antennas

5.1.4.1 Integrated and dedicated antennas

The equipment can have either integral antennas or dedicated antennas. Dedicated antennas, further referred to as *dedicated external antennas*, are antennas that are physically external to the equipment and are assessed in combination with the equipment against the requirements in the present document.

NOTE: It should be noted that assessment does not necessarily lead to testing.

An antenna assembly referred to in the present document is understood as the combination of the antenna (integral or dedicated), its coaxial cable and if applicable, its antenna connector and associated switching components. The gain of an antenna assembly (G) in dBi, does not include the additional gain that may result out of beamforming.

Smart antenna systems may use beamforming techniques which may result in additional (antenna) gain. This beamforming gain (Y) is specified in dB. Beamforming gain does not include the gain of the antenna assembly (G).

Although the measurement methods in the present document allow conducted measurements to be performed, it should be noted that the equipment together with all its intended antenna assemblies shall comply with the applicable technical requirements defined in the present document.

5.1.4.2 Transmit operating modes

5.1.4.2.1 Operating mode 1 (single antenna)

The equipment uses only one antenna when operating in this mode.

The following types of equipment and/or operating modes are examples covered by this category:

- Equipment with only one antenna.
- Equipment with two diversity antennas but at any moment in time only one antenna is used.
- Smart antenna system with two or more antennas, but operating in a mode where only one antenna is used.

5.1.4.2.2 Operating mode 2 (multiple antennas, no beamforming)

The equipment that can operate in this mode contains a smart antenna system using two or more transmit chains simultaneously but without beamforming.

5.1.4.2.3 Operating mode 3 (multiple antennas, with beamforming)

The equipment that can operate in this mode contains a smart antenna system using two or more transmit chains simultaneously with beamforming.

In addition to the antenna assembly gain (G), the beamforming gain (Y) may have to be taken into account when performing the measurements described in the present document.

5.1.5 Presentation of equipment

5.1.5.1 Testing of host connected equipment and plug-in radio devices

For combined equipment and for radio parts for which connection to or integration with host equipment is required to offer functionality to the radio, different alternative test approaches are permitted. Where more than one such combination is intended, testing shall not be repeated for combinations of the radio part and various host equipment where the latter are substantially similar.

Where more than one such combination is intended and the combinations are not substantially similar, one combination shall be tested against all requirements of the present document and all other combinations shall be tested separately for radiated spurious emissions only.

5.1.5.1.1 The use of a host or test jig for testing plug-in radio devices

Where the radio part is a plug-in radio device which is intended to be used within a variety of combinations, a suitable test configuration consisting of either a test jig or a typical host equipment shall be used. This shall be representative for the range of combinations in which the device may be used. The test jig shall allow the radio equipment part to be powered and stimulated as if connected to or inserted into host or combined equipment. Measurements shall be made to all requirements of the present document.

5.1.5.1.2 Testing of combinations

5.1.5.1.2.1 Alternative A: General approach for combinations

Combined equipment or a combination of a plug-in radio device and a specific type of host equipment may be used for testing according to the full requirements of the present document.

5.1.5.1.2.2 Alternative B: For host equipment with a plug-in radio device

A combination of a plug-in radio device and a specific type of host equipment may be used for testing according to the full requirements of the present document.

For radiated spurious emission tests the most appropriate standard shall be applied to the host equipment. The plug-in radio device shall meet the radiated spurious emissions requirements as described in the present document.

5.1.5.1.2.3 Alternative C: For combined equipment with a plug-in radio device

Combined equipment may be used for testing according to the full requirements of the present document.

For radiated spurious emissions the requirements of the most appropriate harmonized EMC standard shall be applied to the non-radio equipment. The plug-in radio device shall meet the radiated spurious emissions requirements as described in the present document.

In the case where the plug-in radio device is totally integrated and cannot operate independently, radiated spurious emissions for the combination shall be tested using the most appropriate harmonized standard with the radio part in receive and/or standby mode. If the frequency range is less than the one defined in the present document, additional measurements according to the requirements in the present document shall be performed to cover the remaining parts of the frequency range. With the radio in transmit mode, the radiated spurious emissions requirements of the present document shall be applied.

5.1.5.1.2.4 Alternative D: For equipment with multiple radios

Multi-radio equipment, where at least one of the radio parts is within the scope of the present document, may be used for testing according to the full requirements of the present document. Additional requirements and limits for multi-radio equipment are set out in the relevant harmonized radio product standards applicable to the other radio parts.

When measuring spurious emissions in the receive and/or standby mode, it is essential that none of the transmitters within the combined equipment are transmitting.

5.1.5.1.2.4.1 The spurious emissions from each radio can be identified

Where the spurious emissions from each radio can be identified, then the spurious emissions from each radio are assessed to the relevant harmonized radio standard.

5.1.5.1.2.4.2 The spurious emissions from each radio cannot be identified

Where the spurious emissions from each radio cannot be identified, then the combined equipment is assessed to the spurious emission requirements contained in all of the relevant harmonized radio standards applicable to the radios contained within the combined product.

Where the applicable harmonized radio standards contain different limits and measuring conditions, then the combined product is assessed to the harmonized radio standard that specifies the least stringent limits for the common part of the frequency measurement ranges. To assess the remaining parts of the frequency measurement ranges the limits from the relevant harmonized radio standard should be used.

5.2 Interpretation of the measurement results

The interpretation of the results recorded in a test report for the measurements described in the present document shall be as follows:

- The measured value related to the corresponding limit will be used to decide whether an equipment meets the requirements of the present document.
- The value of the measurement uncertainty for the measurement of each parameter shall be included in the test report.
- The recorded value of the measurement uncertainty shall be, for each measurement, equal to or lower than the figures in table 7.
- The shared risk approach shall be applied for the interpreting of all measurement results.

For the test methods to determine RF power levels, according to the present document, the measurement uncertainty figures shall be calculated in accordance with TR 100 028-1 [2] and TR 100 028-2 [3] and shall correspond to an expansion factor (coverage factor) $k = 1,96$ or $k = 2$ (which provide confidence levels of respectively 95 % and 95,45 % in the case where the distributions characterizing the actual measurement uncertainties are normal (Gaussian)).

Table 7 is based on such expansion factors.

Table 7: Maximum measurement uncertainty

Parameter	Uncertainty
RF frequency	$\pm 1 \times 10^{-5}$
RF power conducted	$\pm 1,5$ dB
RF power radiated	± 6 dB
Spurious emissions, conducted	± 3 dB
Spurious emissions, radiated	± 6 dB
Humidity	± 5 %
Temperature	± 1 °C
Time	± 10 %

5.3 Essential radio test suites

5.3.1 Product information

The following information shall be stated by the manufacturer. The form included in Annex F can be used for this purpose. This information is required in order to carry out the test suites and/or to declare compliance to technical requirements (e.g. technical requirements for which no conformance test is included in the present document):

- a) The channel plan(s), being the centre frequencies and associated Nominal Channel Bandwidth(s).
- b) If the equipment can support simultaneous transmissions in one or more channels, the following shall be provided:
 - the number of channels used for these simultaneous transmissions;
 - whether or not these channels are adjacent or non-adjacent;
 - whether or not these channels are in different sub-bands.
- c) The different transmit operating modes in which the equipment can operate (see clause 5.1.4.2).

- d) For each of the modes declared under c) the following shall be provided:
- the number of transmit chains;
 - if more than one transmit chain is active, whether the power is distributed equally or not;
 - the number of receive chains;
 - whether or not antenna beamforming is implemented, and if so the maximum beamforming gain (Y) for this transmit operating mode.
- e) Whether or not the device has a TPC feature containing one or more TPC ranges.

NOTE 1: The equipment can have more than one TPC range to accommodate different antennas and/or the different applicable power limits.

- f) For devices with a TPC feature, for each TPC range:
- The lowest and highest transmitter output power level (or lowest and highest e.i.r.p level in case of integrated antenna equipment). If the equipment supports simultaneous transmissions in both sub-bands, the lowest and highest transmitter output power or e.i.r.p. level for each of the sub-bands.

NOTE 2: In case of smart antenna systems with different transmit operating modes (see clause 5.1.4.2) the transmitter power levels may differ depending on the transmitter operating mode.

- The intended antenna assembly(ies), their corresponding gain(s) (G), the resulting e.i.r.p. values (taking also into account the beamforming gain (Y) if applicable) and the corresponding DFS threshold level(s).
- The applicable operating frequency range(s).

- g) For devices operating in a mode without a TPC feature:
- The maximum transmitter output power level (or maximum e.i.r.p. level in case of integrated antenna equipment). If the equipment supports simultaneous transmissions in both sub-bands, the maximum transmitter output power or e.i.r.p. level for each of the sub-bands.

NOTE 3: In case of smart antenna systems with different transmitter operating modes (see clause 5.1.4.2) the transmitter output power levels may differ depending on the operating mode.

- The intended antenna assembly(ies), their corresponding gain(s) (G), the resulting e.i.r.p. values (taking also into account the beamforming gain (Y) if applicable) and the corresponding DFS threshold level(s).
- The applicable operating frequency range(s).

NOTE 4: The manufacturer may decide to declare that his equipment can operate with and without a TPC feature in which case he may provide details in response to both clause f) and g).

- h) With regard to DFS, the DFS operational modes in which the equipment can operate (master, slave with radar detection, slave without radar detection).
- i) With regard to DFS, to confirm that the DFS controls (hardware or software) related to radar detection have been made inaccessible to the user (see clause 4.10).
- j) With regard to DFS, to confirm if the equipment has implemented the *Off-Channel CAC* function as given in clause 4.7.2.2. If an *Off-Channel CAC* function is implemented, the manufacturer shall specify the *Off-Channel CAC Time* required to determine the presence of a radar on a given channel. The *Off-Channel CAC Time* for channels whose nominal bandwidth falls partly or completely within the band 5 600 MHz to 5 650 MHz (equivalent to the 10 minutes CAC) may be different than for other channels (equivalent to the 60 s CAC) in which case both values shall be specified.
- k) Whether or not the device can operate in ad-hoc mode, and if so, the operating frequency range when operating in ad-hoc mode.
- l) The operating frequency range(s) of the equipment.

- m) The normal and the extreme operating conditions (e.g. voltage and temperature) that apply to the equipment.
- n) The test sequence/test software used by the UUT.
- o) Type of Equipment, for example: stand-alone equipment, plug-in radio device, combined equipment, etc.
- p) The medium access protocol implemented by the UUT and whether or not an adaptive mechanism is implemented.
- q) The CCA time implemented by the equipment. For Load Based Equipment, the value "q" referred to in clause 4.9.2.2 point 2.

5.3.2 Carrier frequencies

5.3.2.1 Test conditions

These measurements shall be performed under both normal and extreme test conditions (see clause 5.1.1).

The channels on which the conformance requirements in clause 4.2 shall be verified are defined in clause 5.1.3.

The UUT shall be configured to operate at a normal RF Output Power level. In addition, the UUT shall be configured to operate on a single channel.

For a UUT with antenna connector(s) and using dedicated external antenna(s), or for a UUT with integral antenna(s) but with a temporary antenna connector(s) provided, conducted measurements shall be used.

In case of conducted measurements on smart antenna systems (devices with multiple transmit chains) the measurements shall be performed on only one of the active transmit chains.

For a UUT with integral antenna(s) and without a temporary antenna connector(s), radiated measurements shall be used.

5.3.2.2 Test methods

5.3.2.2.1 Conducted measurement

5.3.2.2.1.1 Equipment operating without modulation

This test method requires that the UUT can be operated in an unmodulated test mode.

The UUT shall be connected to a frequency counter and operated in an unmodulated mode. The result shall be recorded.

5.3.2.2.1.2 Equipment operating with modulation

This method is an alternative to the above method in case the UUT cannot be operated in an un-modulated mode.

The UUT shall be connected to spectrum analyser.

The settings of the spectrum analyser shall be adjusted to optimize the instruments frequency accuracy.

Max Hold shall be selected and the centre frequency adjusted to that of the UUT.

The peak value of the power envelope shall be measured and noted. The span shall be reduced and the marker moved in a positive frequency increment until the upper, (relative to the centre frequency), -10 dBc point is reached. This value shall be noted as f1.

The marker shall then be moved in a negative frequency increment until the lower, (relative to the centre frequency), -10 dBc point is reached. This value shall be noted as f2.

The centre frequency is calculated as $(f1 + f2) / 2$.

5.3.2.2.2 Radiated measurement

The test set up as described in annex B shall be used with a spectrum analyser of sufficient accuracy attached to the test antenna (see clause 5.2).

The test procedure is as described under clause 5.3.2.2.1.

5.3.3 Occupied Channel Bandwidth

5.3.3.1 Test conditions

The conformance requirements in clause 4.3 shall be verified only under normal operating conditions, and on those channels and channel bandwidths defined in clause 5.1.3.

The measurements shall be performed using normal operation of the equipment with the test signal applied (see clause 5.1.2.1).

The UUT shall be configured to operate at a typical RF power output level.

When equipment has simultaneous transmissions in adjacent channels, these transmissions may be considered as one signal with an actual Nominal Channel Bandwidth of "n" times the individual Nominal Channel Bandwidth where "n" is the number of adjacent channels. When equipment has simultaneous transmissions in non-adjacent channels, each power envelope shall be considered separately.

For a UUT with antenna connector(s) and using dedicated external antenna(s), or for a UUT with integral antenna(s) but with a temporary antenna connector(s) provided, conducted measurements shall be used.

In case of conducted measurements on smart antenna systems (devices with multiple transmit chains) measurements need only to be performed on one of the active transmit chains (antenna outputs).

For a UUT with integral antenna(s) and without a temporary antenna connector(s), radiated measurements shall be used.

5.3.3.2 Test method

5.3.3.2.1 Conducted measurement

The measurement procedure shall be as follows:

Step 1:

- Connect the UUT to the spectrum analyser and use the following settings:
 - Centre Frequency: The centre frequency of the channel under test
 - Resolution Bandwidth: 100 kHz
 - Video Bandwidth: 300 kHz
 - Frequency Span: $2 \times$ Nominal Bandwidth (e.g. 40 MHz for a 20 MHz channel)
 - Detector Mode: Peak
 - Trace Mode: Max Hold

Step 2:

- When the trace is complete, capture the trace, for example using the "View" option on the spectrum analyser.
- Find the peak value of the trace and place the analyser marker on this peak.

Step 3:

- Use the 99 % bandwidth function of the spectrum analyser to measure the Occupied Channel Bandwidth of the UUT. This value shall be recorded.

The measurement described in steps 1 to 3 above shall be repeated in case of simultaneous transmissions in non-adjacent channels.

5.3.3.2.2 Radiated measurement

The test set up as described in annex B and the applicable measurement procedures described in annex C shall be used.

The test procedure is as described under clause 5.3.3.2.1.

5.3.4 RF output power, Transmit Power Control (TPC) and power density

5.3.4.1 Test conditions

The conformance requirements in clause 4.4 shall be verified on those channels and channel bandwidths defined in clause 5.1.3.

The measurements described in the present clause may need to be repeated to cover:

- each of the TPC ranges (or transmitter output power levels for equipment without TPC) and corresponding antenna assemblies declared by the manufacturer (see clauses 5.3.1 e), f) and g));
- each of the transmit operating modes declared by the manufacturer (see clauses 5.1.4.2 and 5.3.1.c)).

The measurements shall be performed with test signal specified in clause 5.1.2.1 applied. Alternatively, the equipment may also be configured in a continuous transmit mode or with a constant duty cycle (e.g. frame based systems) which is at least 10 %.

NOTE: Special test functions may be needed in the UUT to make this test possible.

For a UUT with antenna connector(s) and using dedicated external antenna(s), or for a UUT with integral antenna(s) but with a temporary antenna connector(s) provided, conducted measurements shall be used in conjunction with the stated antenna assembly gain(s).

For a UUT with integral antenna(s) and without a temporary antenna connector(s), radiated measurements shall be used.

5.3.4.2 Test method

5.3.4.2.1 Conducted measurement

5.3.4.2.1.1 RF output power at the highest power - P_H

These measurements shall be performed under both normal and extreme test conditions (see clause 5.1.1).

The UUT shall be configured to operate at:

- the highest stated transmitter output power level of the TPC range; or
- the maximum stated transmitter output power level in case the equipment has no TPC feature.

5.3.4.2.1.1.1 Option 1: For equipment with continuous transmission capability or for equipment operating (or with the capability to operate) with a constant duty cycle (e.g. Frame Based equipment)

This option is for equipment that operates only in one sub-band or that is capable for operation in 2 sub-bands simultaneously but, for the purpose of the testing, the equipment can be configured to:

- operate in a continuous transmit mode or with a constant duty cycle (x), and
- operate only in one sub-band.

Step 1:

For equipment configured into a continuous transmit mode ($x = 1$), proceed immediately with step 2.

- The output power of the transmitter shall be coupled to a matched diode detector or equivalent thereof. The output of the diode detector shall be connected to the vertical channel of an oscilloscope.
- The combination of the diode detector and the oscilloscope shall be capable of faithfully reproducing the duty cycle of the transmitter output signal.
- The observed duty cycle of the transmitter ($Tx\ on / (Tx\ on + Tx\ off)$) shall be noted as x ($0 < x \leq 1$), and recorded in the test report.

Step 2:

- The RF output power shall be determined using a wideband RF power meter with a thermocouple detector or an equivalent thereof and with an integration period that exceeds the repetition period of the transmitter by a factor 5 or more. The observed value shall be noted as "A" (in dBm).
- In case of conducted measurements on smart antenna systems operating in a mode with multiple transmit chains active simultaneously, the output power of each transmit chain shall be measured separately to calculate the total power (value "A" in dBm) for the UUT.

Step 3:

- The RF output power at the highest power level P_H (e.i.r.p.) shall be calculated from the above measured power output A (in dBm), the observed duty cycle x , the stated antenna gain "G" in dBi and if applicable the beamforming gain "Y" in dB, according to the formula below. This value shall be recorded in the test report. If more than one antenna assembly is intended for this power setting or TPC range, the gain of the antenna assembly with the highest gain shall be used.

$$P_H = A + G + Y + 10 \log (1/x) \text{ (dBm)}$$

- This value P_H shall be compared to the applicable limit contained in table 1 of clause 4.4.2.

5.3.4.2.1.1.2 Option 2: For equipment without continuous transmission capability and operating (or with the capability to operate) in only one sub-band

This option is for equipment that is either:

- equipment capable of operation in both sub-bands, but not simultaneously; or
- equipment capable of operation in both sub-bands simultaneously but which, for the purpose of the testing, can be configured to transmit only in one sub-band.

Equipment having simultaneous transmissions in both sub-bands and which cannot be configured to transmit only in one sub-band, shall be tested using Option 3 given in clause 5.3.4.2.1.1.3.

The test procedure shall be as follows:

Step 1:

- Sample the transmit signal from the device using a fast power sensor suitable for 6 GHz. Save the raw samples. The samples must represent the RMS power of the signal.
- Settings:
 - Sample speed: 1 MS/s or faster.
 - Measurement duration: Sufficient to capture multiple transmitter bursts. (see clause 5.1.2.1).

Step 2:

- For conducted measurements on devices with multiple transmit chains:
 - Sample all transmit ports simultaneously.
 - Sum the power of all ports for each individual sample and save them. Use these summed samples in all following steps.

Step 3:

- Find the start and stop times of each burst in the stored measurement samples.

NOTE: The start and stop times are defined as the -20 dBc points of the RMS burst power.

Step 4:

- Between the start and stop times of each individual burst calculate the RMS (mean) power over the burst (P_{burst}). The highest of all P_{burst} values is the value "A" in dBm.

Step 5:

- The RF output power (e.i.r.p) at the highest power level " P_H " shall be calculated from the above measured power output "A" (in dBm), the stated antenna assembly gain "G" in dBi and if applicable the beamforming gain "Y" in dB, according to the formula below. If more than one antenna assembly is intended for this power setting, the gain of the antenna assembly with the highest gain shall be used:

$$P_H = A + G + Y \text{ (dBm)}.$$

- This value P_H shall be compared to the applicable limit contained in table 1 of clause 4.4.2 and shall be recorded in the report.

5.3.4.2.1.1.3 Option 3: For equipment without continuous transmission capability and having simultaneous transmissions in both sub-bands

This option is for equipment having simultaneous transmissions in both sub-bands but which cannot be configured to transmit only in one sub-band.

This procedure first measures the peak power in each sub-band separately, then measures the Peak to Mean Power ratio for the overall transmission and uses this to calculate the RF Output Power (e.i.r.p.) in each sub-band separately using the measured values for peak power.

The test procedure shall be as follows:

Step 1: Measuring the Total Peak Power within the lower sub-band.

- Connect the UUT to the spectrum analyser and use the following settings:
 - Start Frequency: 5 100 MHz
 - Stop Frequency: 5 400 MHz
 - RBW: 1 MHz
 - VBW: 3 MHz
 - Detector Mode: Peak
 - Trace Mode: Max Hold
 - Sweep Time: Auto

- When the trace is complete, use the "Channel Power" function to measure the total peak power of the transmissions within the band 5 150 MHz to 5 350 MHz.

NOTE 1: Ensure that the noise floor of the spectrum analyser is at least 30 dB to 40 dB below the peak of the power envelope. If this is not possible (e.g. radiated measurements) reduce the bandwidth of the channel power function to a value which is still slightly above the Nominal Channel Bandwidth (e.g. +10 %) to avoid the noise floor influencing the measurement result.

- For conducted measurements on devices with multiple transmit chains, the procedure above shall be repeated for each of the active transmit chains. The results shall be summed to provide the total peak power of the transmissions within the band 5 150 MHz to 5 350 MHz.

Step 2: Measuring the Total Peak Power within the upper sub-band.

- Change the Start Frequency to 5 420 MHz and the Stop Frequency to 5 775 MHz.
- When the trace is complete, use the "Channel Power" function to measure the total peak power of all transmissions with the band 5 470 MHz to 5 725 MHz.

NOTE 2: Ensure that the noise floor of the spectrum analyser is at least 30 dB to 40 dB below the peak of the power envelope. If this is not possible (e.g. radiated measurements) reduce the bandwidth of the channel power function to a value which is still slightly above the Nominal Channel Bandwidth (e.g. +10 %) to avoid the noise floor influencing the measurement result.

- For conducted measurements on devices with multiple transmit chains, the procedure above shall be repeated for each of the active transmit chains. The results shall be summed to provide the total peak power of the transmissions within the band 5 470 MHz to 5 725 MHz.

Step 3: Calculating the Total Peak Power.

- Calculate the total peak power by adding the measured value for the band 5 150 MHz to 5 350 MHz in step 1 to the value measured for the band 5 470 MHz to 5 725 MHz in step 2.

NOTE 3: Modern spectrum analysers may be able to measure the peak power in both sub-bands in one measurement in which case step 1 and step 2 can be combined.

Step 4: Measuring Total Mean Output Power.

- Sample the transmit signal from the device using a fast power sensor suitable for 6 GHz. Save the raw samples. The samples must represent the RMS power of the signal.
- Settings:
 - Sample speed: 1 MS/s or faster.
 - Measurement duration: Sufficient to capture multiple transmitter bursts. (see clause 5.1.2.1).
- For conducted measurements on devices with multiple transmit chains:
 - Sample all transmit ports simultaneously.
 - Sum the power of all ports for each individual sample and save them. Use these summed samples in all following steps.
- Find the start and stop times of each burst in the stored measurement samples.

NOTE 4: The start and stop times are defined as the -20 dBc points of the RMS burst power.

- Between the start and stop times of each individual burst calculate the RMS (mean) power over the burst (Pburst). The highest of all Pburst values is the Total Mean Output Power and this value will be used for further calculations.

Step 5: Calculating the Peak to Mean Power Ratio.

- Using the value for Total Peak Power calculated in step 3 and the highest value for Total Mean Output Power measured in step 4, calculate the Peak to Average Power ratio in dB.

Step 6: Calculating the RF Output Power (e.i.r.p.) for each sub-band.

- The RF output power (e.i.r.p) at the highest power level " P_H " shall be calculated for each of the sub-bands from the Peak to Mean Power Ratio obtained in step 5 and the measured values for Peak Power in each of the sub-bands (see step 1 and step 2). These values (values "A" in dBm) will be used for maximum e.i.r.p. calculations.
 - Add the (stated) antenna assembly gain "G" in dBi of the individual antenna element.
 - If applicable, add the additional beamforming gain "Y" in dB.
 - If more than one antenna assembly is intended for this power setting, the maximum overall antenna gain (G or G + Y) shall be used:
 - For each sub-band, P_H (e.i.r.p.) shall be calculated using the formula below.

$$P_H = A + G + Y$$

- These values for P_H shall be compared to the applicable limits contained in table 1 of clause 4.4.2 and shall be recorded in the report.

5.3.4.2.1.2 RF output power at the lowest power level of the TPC range - P_L

This test is only required for equipment with a TPC feature.

These measurements shall be performed under both normal and extreme test conditions (see clause 5.1.1).

The UUT shall be configured to operate at the lowest stated transmitter output power level of the TPC range.

5.3.4.2.1.2.1 Option 1: For equipment with continuous transmission capability or for equipment operating (or with the capability to operate) with a constant duty cycle (e.g. Frame Based equipment)

This option is for equipment that operates only in one sub-band or that is capable for operation in 2 sub-bands simultaneously but, for the purpose of the testing, the equipment can be configured to:

- operate in a continuous transmit mode or with a constant duty cycle (x); and
- operate only in one sub-band.

Steps 1 and 2:

- See steps 1 and 2 in clause 5.3.4.2.1.1.1.

NOTE: The duty cycle measurement done in step 1 of clause 5.3.4.2.1.1.1 may not need to be repeated.

Step 3:

- The RF output power at the lowest power level P_L (e.i.r.p.) shall be calculated from the above measured power output A (in dBm), the observed duty cycle x, the stated antenna gain "G" in dBi and if applicable the beamforming gain "Y" in dB, according to the formula below. This value shall be recorded in the test report. If more than one antenna assembly is intended for this power setting or TPC range, the gain of the antenna assembly with the highest gain shall be used.

$$P_L = A + G + Y + 10 \log (1/x) \text{ (dBm)}.$$

- This value P_L shall be compared to the applicable limit contained in table 2 of clause 4.4.2.

5.3.4.2.1.2.2 Option 2: For equipment without continuous transmission capability and operating (or with the capability to operate) in only one sub-band

This option is for equipment that is either:

- equipment capable of operation in both sub-bands, but not simultaneously; or
- equipment capable of operation in both sub-bands simultaneously but which, for the purpose of the testing, can be configured to transmit only in one sub-band.

Equipment having simultaneous transmissions in both sub-bands and which cannot be configured to transmit only in one sub-band, shall be tested using Option 3 given in clause 5.3.4.2.1.2.3.

The test procedure shall be as follows:

Steps 1 to 4:

- See steps 1 to 4 in clause 5.3.4.2.1.1.2.

Step 5:

- The RF output power (e.i.r.p.) at the lowest power level " P_L " shall be calculated from the above measured power output "A" (in dBm), the stated antenna assembly gain "G" in dBi and if applicable the beamforming gain "Y" in dB, according to the formula below. This value shall be recorded in the test report. If more than one antenna assembly is intended for this TPC range, the gain of the antenna assembly with the highest gain shall be used:

$$P_L = A + G + Y \text{ (dBm)}.$$

- This value P_L shall be compared to the applicable limit contained in table 2 of clause 4.4.2.

5.3.4.2.1.2.3 Option 3: For equipment without continuous transmission capability and having simultaneous transmissions in both sub-bands

This option is for equipment having simultaneous transmissions in both sub-bands but which cannot be configured to transmit only in one sub-band.

This procedure first measures the peak power in each sub-band separately, then measures the Peak to Mean Power ratio for the overall transmission and uses this to calculate the RF Output Power (e.i.r.p.) in each sub-band separately using the measured values for peak power.

The test procedure shall be as follows:

Step 1: Measuring the Total Peak Power within the lower sub-band.

- Connect the UUT to the spectrum analyser and use the following settings:
 - Start Frequency: 5 100 MHz
 - Stop Frequency: 5 400 MHz
 - RBW: 1 MHz
 - VBW: 3 MHz
 - Detector Mode: Peak
 - Trace Mode: Max Hold
 - Sweep Time: Auto

- When the trace is complete, use the "Channel Power" function to measure the total peak power of all transmissions with the band 5 150 MHz to 5 350 MHz.

NOTE 1: Ensure that the noise floor of the spectrum analyser is at least 30 dB to 40 dB below the peak of the power envelope. If this is not possible (e.g. radiated measurements) reduce the bandwidth of the channel power function to a value which is still slightly above the Nominal Channel Bandwidth (e.g. + 10 %) to avoid the noise floor influencing the measurement result.

- For conducted measurements on devices with multiple transmit chains, the procedure above shall be repeated for each of the active transmit chains. The results shall be summed to provide the total peak power of the transmissions within the band 5 150 MHz to 5 350 MHz.

Step 2: Measuring the Total Peak Power within the upper sub-band.

- Change the Start Frequency to 5 420 MHz and the Stop Frequency to 5 775 MHz.
- When the trace is complete, use the "Channel Power" function to measure the total peak power of all transmissions with the band 5 470 MHz to 5 725 MHz.

NOTE 2: Ensure that the noise floor of the spectrum analyser is at least 30 dB to 40 dB below the peak of the power envelope. If this is not possible (e.g. radiated measurements) reduce the bandwidth of the channel power function to a value which is still slightly above the Nominal Channel Bandwidth (e.g. + 10 %) to avoid the noise floor influencing the measurement result.

- For conducted measurements on devices with multiple transmit chains, the procedure above shall be repeated for each of the active transmit chains. The results shall be summed to provide the total peak power of the transmissions within the band 5 470 MHz to 5 725 MHz.

Step 3: Calculating the Total Peak Power.

- Calculate the total peak power by adding the measured value for the band 5 150 MHz to 5 350 MHz in step 1 to the value measured for the band 5 470 MHz to 5 725 MHz in step 2.

NOTE 3: Modern spectrum analysers may be able to measure the peak power in both sub-bands in one measurement in which case step 1 and step 2 can be combined.

Step 4: Measuring Total Mean Output Power.

- Sample the transmit signal from the device using a fast power sensor suitable for 6 GHz. Save the raw samples. The samples must represent the RMS power of the signal.
- Settings:
 - Sample speed: 1 MS/s or faster.
 - Measurement duration: Sufficiently to capture multiple transmitter bursts (see clause 5.1.2.1).
- For conducted measurements on devices with multiple transmit chains:
 - Sample all transmit ports simultaneously.
 - Sum the power of all ports for each individual sample and save them. Use these summed samples in all following steps.
- Find the start and stop times of each burst in the stored measurement samples.

NOTE 4: The start and stop times are defined as the -20 dBc points of the RMS burst power.

- Between the start and stop times of each individual burst calculate the RMS (mean) power over the burst (Pburst). The highest of all Pburst values is the Total Mean Output Power and this value will be used for further calculations.

Step 5: Calculating the Peak to Mean Power ratio.

- Using the value for Total Peak Power calculated in step 3 and the highest value for Total Mean Output Power measured in step 4, calculate the Peak to Average Power ratio in dB.

Step 6: Calculating the RF Output Power (e.i.r.p.) for each sub-band.

- The RF output power (e.i.r.p.) at the lowest power level " P_L " of the TPC range shall be calculated for each of the sub-bands from the Peak to Mean Power Ratio obtained in step 5 and the measured values for Peak Power in each of the sub-bands (see step 1 and step 2). These values (values "A" in dBm) will be used for maximum e.i.r.p. calculations.
 - Add the (stated) antenna assembly gain "G" in dBi of the individual antenna element.
 - If applicable, add the additional beamforming gain "Y" in dB.
 - If more than one antenna assembly is intended for this power setting, the maximum overall antenna gain (G or G + Y) shall be used.
 - For each sub-band, P_L (e.i.r.p.) shall be calculated using the formula below. These values shall be recorded in the test report.

$$P_L = A + G + Y$$

- These values shall be compared to the applicable limits contained in table 2 of clause 4.4.2.

5.3.4.2.1.3 Power density

These measurements shall only be performed at normal test conditions (see clause 5.1.1).

The UUT shall be configured to operate at:

- the highest stated transmitter output power level of the TPC range; or
- the maximum stated transmitter output power level in case the equipment has no TPC feature.

5.3.4.2.1.3.1 Option 1: For equipment with continuous transmission capability or for equipment operating (or with the capability to operate) with a constant duty cycle (e.g. Frame Based equipment)

This option is for equipment that can be configured to operate in a continuous transmit mode or with a constant duty cycle (x).

Step 1:

- Connect the UUT to the spectrum analyser and use the following settings:
 - Centre Frequency: The centre frequency of the channel under test
 - RBW: 1 MHz
 - VBW: 3 MHz
 - Frequency Span: $2 \times$ Nominal Bandwidth (e.g. 40 MHz for a 20 MHz channel)
 - Detector Mode: Peak
 - Trace Mode: Max Hold

Step 2:

- When the trace is complete, find the peak value of the power envelope and record the frequency.

Step 3:

- Make the following changes to the settings of the spectrum analyser:
 - Centre Frequency: Equal to the frequency recorded in step 2
 - Frequency Span: 3 MHz
 - RBW: 1 MHz
 - VBW: 3 MHz
 - Sweep Time: 1 minute
 - Detector Mode: RMS
 - Trace Mode: Max Hold

Step 4:

- When the trace is complete, the trace shall be captured using the "Hold" or "View" option on the spectrum analyser.
- Find the peak value of the trace and place the analyser marker on this peak. This level is recorded as the highest mean power (power density) D in a 1 MHz band.
- Alternatively, where a spectrum analyser is equipped with a function to measure spectral power density, this function may be used to display the power density D in dBm/MHz.
- In case of conducted measurements on smart antenna systems operating in a mode with multiple transmit chains active simultaneously, the power density of each transmit chain shall be measured separately to calculate the total power density (value "D" in dBm/MHz) for the UUT.

Step 5:

- The maximum spectral power density e.i.r.p. is calculated from the above measured power density (D), the observed duty cycle x (see clause 5.3.4.2.1.1.1, step 1), the applicable antenna assembly gain "G" in dBi and if applicable the beamforming gain "Y" in dB, according to the formula below. This value shall be recorded in the test report. If more than one antenna assembly is intended for this power setting, the gain of the antenna assembly with the highest gain shall be used.

$$PD = D + G + Y + 10 \log (1/x).$$

5.3.4.2.1.3.2 Option 2: For equipment without continuous transmission capability and without the capability to transmit with a constant duty cycle

This method can be used if the equipment has non-continuous transmissions and cannot be configured to transmit continuously or with a constant duty cycle.

For devices having simultaneous transmissions in both sub-bands, the Power Density in each of the sub-bands shall be measured separately and compared with the applicable limits contained in table 1 of clause 4.4.2.

The test procedure shall be as follows:

Step 1:

- Connect the UUT to the spectrum analyser and use the following settings:
 - Start Frequency: lower band edge of applicable sub-band (e.g. 5 150 MHz or 5 470 MHz)
 - Stop Frequency: upper band edge of applicable sub-band (e.g. 5 350 MHz or 5 725 MHz)
 - RBW: 10 kHz
 - VBW: 30 kHz
 - Sweep Points: > 20 000 (for 5 150 MHz to 5 350 MHz)
> 25 500 (for 5 470 MHz to 5 725 MHz)

NOTE: For spectrum analysers not supporting this number of sweep points, the frequency band may be segmented.

- Detector: RMS
- Trace Mode: Max Hold
- Sweep time: Auto
- For non-continuous signals, wait for the trace to be completed. Save the (trace) data set to a file.

Step 2:

- For conducted measurements on smart antenna systems using either operating mode 2 or 3 (see clause 5.1.4.2), repeat the measurement for each of the transmit ports. For each frequency point, add up the amplitude (power) values for the different transmit chains and use this as the new data set.

Step 3:

- Add up the values for amplitude (power) for all the samples in the file.

Step 4:

- Normalize the individual values for amplitude so that the sum is equal to the RF Output Power (e.i.r.p.) (P_H) measured in clause 5.3.4.2.1.1. for this sub-band.

Step 5:

- Starting from the first sample in the file (lowest frequency), add up the power of the following samples representing a 1 MHz segment and record the results for power and position (i.e. sample #1 to #100). This is the Power Density (e.i.r.p.) for the first 1 MHz segment which shall be saved.

Step 6:

- Shift the start point of the samples added up in step 5 by 1 sample and repeat the procedure in step 5 (i.e. sample #2 to #101).

Step 7:

- Repeat step 6 until the end of the data set and save the radiated power density values for each of the 1 MHz segments.
- From all the saved results, the highest value is the maximum Power Density (e.i.r.p.) for the UUT. This value, which shall comply with the limit contained in table 1 of clause 4.4.2, shall be recorded in the test report.

5.3.4.2.2 Radiated measurement

When performing radiated measurements on a UUT with a directional antenna (including smart antenna systems and systems capable of beamforming), the UUT shall be configured/positioned for maximum e.i.r.p. in the horizontal plane.

A test site as described in annex B and using the applicable measurement procedures as described in annex C shall be used.

The test procedure is further as described under clause 5.3.4.2.1.

For measuring the RF output power at the highest and lowest power level, it is likely that a radiated measurement would be performed using a spectrum analyser or measurement receiver, rather than a wide band power sensor. If this is the case and if the resolution bandwidth capability of the measurement device is narrower than the Occupied Channel Bandwidth of the UUT signal measured, then the method of measurement shall be documented in the test report.

5.3.5 Transmitter unwanted emissions outside the 5 GHz RLAN bands

5.3.5.1 Test conditions

The conformance requirements in clause 4.5.1 shall be verified only under normal operating conditions, and when operating on those channels defined in clause 5.1.3.

The equipment shall be configured to operate under its worst case situation with respect to unwanted emissions outside the 5 GHz RLAN bands.

For UUT without an integral antenna and for a UUT with an integral antenna but with a temporary antenna connector(s), one of the following options shall be used:

- The level of unwanted emissions shall be measured as their power in a specified load (conducted spurious emissions) and their effective radiated power when radiated by the cabinet or structure of the equipment with the antenna connector(s) terminated by a specified load (cabinet radiation).
- The level of unwanted emissions shall be measured as their effective radiated power when radiated by cabinet and antenna.

In the case where the UUT has an integral antenna, but no option for temporary antenna connector(s), only radiated measurements shall be used.

5.3.5.2 Test method

5.3.5.2.1 Conducted measurement

The UUT shall be connected to a spectrum analyser capable of RF power measurements.

If possible, the UUT shall be set to continuous transmit (duty cycle = 1) for the duration of this test.

If continuous transmit is not possible, the UUT should be configured to operate at its maximum duty cycle.

5.3.5.2.1.1 Pre-scan

The test procedure below shall be used to identify potential unwanted emissions of the UUT.

Step 1:

- The sensitivity of the spectrum analyser should be such that the noise floor is at least 12 dB below the limits given in clause 4.5.1.2, table 3.

Step 2:

- The unwanted emissions over the range 30 MHz to 1 000 MHz shall be identified.
- Spectrum analyser settings:
 - Resolution bandwidth: 100 kHz
 - Video bandwidth: 300 kHz
 - Detector mode: Peak
 - Trace Mode: Max Hold
 - Sweep Points: $\geq 9\,970$
 - Sweep time: For non continuous transmissions (duty cycle less than 100 %), the sweep time shall be sufficiently long, such that for each 100 kHz frequency step, the measurement time is greater than two transmissions of the UUT.

NOTE 1: E.g. for non continuous transmissions, if the UUT is using a test sequence as described in clause 5.1.2.1 (transmitter on + off time of 2 ms), then the sweep time has to be greater than 4 ms per 100 kHz.

- Allow the trace to stabilize. Any emissions identified that are higher than the "applicable limit - 6 dB", shall be individually measured using the procedure in clause 5.3.5.2.1.2 and compared to the limits given in clause 4.5.1.2, table 3.

Step 3:

- The unwanted emissions over the range 1 GHz to 26 GHz shall be identified.
- Spectrum analyser settings:
 - Resolution bandwidth: 1 MHz
 - Video bandwidth: 3 MHz
 - Detector mode: Peak
 - Trace Mode: Max Hold
 - Sweep points: 25 000

NOTE 2: For spectrum analysers not supporting this number of sweep points, the frequency band may be segmented.

- Sweep time: For non continuous transmissions (duty cycle less than 100 %), the sweep time shall be sufficiently long, such that for each 1 MHz frequency step, the measurement time is greater than two transmissions of the UUT.

NOTE 3: E.g. for non continuous transmissions, if the UUT is using a test sequence as described in clause 5.1.2.1 (transmitter on + off time of 2 ms), then the sweep time has to be greater than 4 ms per 1 MHz.

- Allow the trace to stabilize. Any emissions identified that are higher than the "applicable limit - 6 dB", shall be individually measured using the procedure in clause 5.3.5.2.1.2 and compared to the limits given in clause 4.5.1.2, table 3.

5.3.5.2.1.2 Measurement of the emissions identified during the pre-scan

The limits for unwanted emissions in clause 4.5.1 refer to average power levels.

The steps below shall be used to accurately measure the individual unwanted emissions identified during the pre-scan measurements above.

The signal to noise ratio shall be sufficient to allow an accurate measurement.

Continuous transmit signals:

For continuous transmit signals, a simple measurement using the RMS detector of the spectrum analyser is permitted. The measured values shall be recorded and compared with the limits in clause 4.5.1.2, table 3.

Non-continuous transmit signals:

For non-continuous transmit signals, the measurement shall be made only over the "on" part of the burst.

Step 1:

- The level of the emissions shall be measured in the time domain, using the following spectrum analyser settings:
 - Centre Frequency: Frequency of emission identified during the pre-scan
 - RBW: 100 kHz (< 1 GHz) / 1 MHz (> 1 GHz)
 - VBW: 300 kHz (< 1 GHz) / 3 MHz (> 1 GHz)
 - Frequency Span: 0 Hz
 - Sweep mode: Continuous
 - Sweep Time: Suitable to capture one transmission burst
 - Trigger: Video Trigger
 - Detector: RMS
 - Trace Mode: Clear/Write
- Adjust the centre frequency (fine tune) to capture the highest level of one burst of the emission to be measured.

Step 2:

- Change the following setting on the spectrum analyser:
 - Sweep Points: 5 000
 - Sweep Time: Suitable to capture one transmission burst

Step 3:

- Adjust the trigger level to select the transmissions with the highest power level.
- Set a window (start and stop lines) to match with the start and end of the burst and in which the RMS power shall be measured using the Time Domain Power function.
- Select RMS power to be measured within the selected window and note the result which is the RMS power of this particular spurious emission. Compare this value with the applicable limit provided by clause 4.5.1.2, table 3.

Repeat this procedure for every emission identified during the pre-scan. The values and corresponding frequencies shall be recorded.

In case of conducted measurements on smart antenna systems (equipment with multiple transmit chains), the measurements need to be repeated for each of the active transmit chains. Comparison with the applicable limits shall be done using either of the options given below:

- Option 1: the results for each of the transmit chains for the corresponding 1 MHz segments shall be added and compared with the limits provided by table 3 in clause 4.5.1.2.
- Option 2: the results for each of the transmit chains shall be individually compared with the limits provided by table 3 in clause 4.5.1.2 after these limits have been reduced by $10 \times \log_{10} (T_{ch})$ (number of active transmit chains).

5.3.5.2.2 Radiated measurement

The test set up as described in annex B shall be used with a spectrum analyser of sufficient accuracy attached to the test antenna (see clause 5.2).

The test procedure is as described under clause 5.3.5.2.1.

5.3.6 Transmitter unwanted emissions within the 5 GHz RLAN bands

5.3.6.1 Test conditions

The conformance requirements in clause 4.5.2 shall be verified only under normal operating conditions, and when operating on those channels and channel bandwidths defined in clause 5.1.3.

The equipment shall be configured to operate under its worst case situation with respect to unwanted emissions within the 5 GHz RLAN bands.

For UUT without an integral antenna and for a UUT with an integral antenna but with a temporary antenna connector(s), one of the following options shall be used:

- the level of unwanted emissions shall be calculated from their measured power in a specified load (conducted spurious emissions); or
- the level of unwanted emissions shall be measured as their effective radiated power when radiated by cabinet and antenna.

In case of conducted measurements on smart antenna systems (devices with multiple transmit chains) operating in a mode with more than 1 transmit chain active simultaneously, measurements need only to be performed on one of the transmit chains (antenna outputs).

In the case where the UUT has an integral antenna, but no temporary antenna connector(s), only radiated measurements shall be used.

5.3.6.2 Test method

5.3.6.2.1 Conducted measurement

5.3.6.2.1.1 Option 1: For equipment with continuous transmission capability

The UUT shall be configured for continuous transmit mode (duty cycle equal to 100 %). If this is not possible, then option 2 shall be used.

Step 1: Determination of the reference average power level.

- Spectrum analyser settings:
 - Resolution bandwidth: 1 MHz
 - Video bandwidth: 30 kHz
 - Detector mode: Peak
 - Trace mode: Video Average
 - Sweep Time: Coupled
 - Centre Frequency: Centre frequency of the channel being tested
 - Span: 2 times the Nominal Channel Bandwidth
- Use the marker to find the highest average power level of the power envelope of the UUT. This level shall be used as the reference level for the relative measurements.

Step 2: Determination of the relative average power levels.

- Adjust the frequency range of the spectrum analyser to allow the measurement to be performed within the sub-bands 5 150 MHz to 5 350 MHz and 5 470 MHz to 5 725 MHz. No other parameter of the spectrum analyser should be changed.
- Compare the relative power envelope of the UUT with the limits defined in clause 4.5.2.2.

5.3.6.2.1.2 Option 2: For equipment without continuous transmission capability

This method shall be used if the UUT is not capable of operating in a continuous transmit mode (duty cycle less than 100 %). In addition, this option can also be used as an alternative to option 1 for systems operating in a continuous transmit mode.

Step 1: Determination of the reference average power level.

- Spectrum analyser settings:
 - Resolution bandwidth: 1 MHz
 - Video bandwidth: 30 kHz
 - Detector mode: RMS
 - Trace Mode: Max Hold
 - Sweep time: ≥ 1 minute
 - Centre Frequency: Centre frequency of the channel being tested
 - Span: 2 times the Nominal Channel Bandwidth
- Use the marker to find the highest average power level of the power envelope of the UUT. This level shall be used as the reference level for the relative measurements.

Step 2: Determination of the relative average power levels.

- Adjust the frequency range of the spectrum analyser to allow the measurement to be performed within the sub-bands 5 150 MHz to 5 350 MHz and 5 470 MHz to 5 725 MHz. No other parameter of the spectrum analyser should be changed.
- Compare the relative power envelope of the UUT with the limits defined in clause 4.5.2.2.

5.3.6.2.2 Radiated measurement

The test set up as described in annex B shall be used with a spectrum analyser of sufficient accuracy attached to the test antenna.

The test procedure is as described under clause 5.3.6.2.1.

5.3.7 Receiver spurious emissions**5.3.7.1 Test conditions**

The conformance requirements in clause 4.6 shall be verified only under normal operating conditions, and when operating on those channels defined in clause 5.1.3.

For equipment having different operating modes (see clause 5.1.4.2) the measurements described in the present clause may not need to be repeated for all the operating modes.

For UUT without an integral antenna and for a UUT with an integral antenna but with a temporary antenna connector(s), one of the following options shall be used:

- the level of unwanted emissions shall be measured as their power in a specified load (conducted spurious emissions) and their effective radiated power when radiated by the cabinet or structure of the equipment with the antenna connector(s) terminated by a specified load (cabinet radiation); or
- the level of unwanted emissions shall be measured as their effective radiated power when radiated by cabinet and antenna.

In the case where the UUT has an integral antenna, but no option for temporary antenna connector(s), only radiated measurements shall be used.

5.3.7.2 Test method

5.3.7.2.1 Conducted measurement

The test method below assumes, that for the duration of the test, the UUT is configured into a continuous receive mode, or is operated in a mode where no transmissions occur.

5.3.7.2.1.1 Pre-scan

The test procedure below shall be used to identify potential receiver spurious emissions of the UUT.

Step 1:

- The sensitivity of the spectrum analyser should be such that the noise floor is at least 12 dB below the limits given in clause 4.6.2, table 4.

Step 2:

- The emissions shall be measured over the range 30 MHz to 1 000 MHz.
- Spectrum analyser settings:
 - Resolution bandwidth: 100 kHz
 - Video bandwidth: 300 kHz
 - Detector mode: Peak
 - Trace Mode: Max Hold
- Any emissions identified that are higher than the "applicable limit - 6 dB", shall be individually measured using the procedure in clause 5.3.7.2.1.2 and compared to the limits given in clause 4.6.2, table 4.

Step 3:

- The emissions shall now be measured over the range 1 GHz to 26 GHz.
- Spectrum analyser settings:
 - Resolution bandwidth: 1 MHz
 - Video bandwidth: 3 MHz
 - Detector mode: Peak
 - Trace mode: Max Hold
- Any emissions identified that are higher than the "applicable limit - 6 dB", shall be individually measured using the procedure in clause 5.3.7.2.1.2 and compared to the limits given in clause 4.6.2, table 4.

5.3.7.2.1.2 Measurement of the emissions identified during the pre-scan

The limits for receiver spurious emissions in clause 4.6 refer to average power levels.

A simple measurement using the RMS detector using Trace Averaging of the spectrum analyser is permitted. The measured values shall be recorded and compared with the limits contained in table 4 in clause 4.6.

In case of conducted measurements on smart antenna systems (equipment with multiple receive chains), the measurements need to be repeated for each of the active receive chains. Comparison with the applicable limits shall be done using either of the options given below:

- Option 1: the results for each of the receive chains for the corresponding 1 MHz segments shall be added and compared with the limits provided by table 3 in clause 4.5.1.2.
- Option 2: the results for each of the receive chains shall be individually compared with the limits provided by table 3 in clause 4.5.1.2 after these limits have been reduced by $10 \times \log_{10} (R_{ch})$ (number of active receive chains).

5.3.7.2.2 Radiated measurement

The test set up as described in annex B shall be used with a spectrum analyser of sufficient accuracy attached to the test antenna (see clause 5.2).

The test procedure is as described under clause 5.3.7.2.1.

5.3.8 Dynamic Frequency Selection (DFS)

5.3.8.1 Test conditions

The conformance requirements in clause 4.7 shall be verified only under normal operating conditions.

The channels and the channel bandwidths to be used for testing are defined in clause 5.1.3.

Some of the tests may be facilitated by disabling certain operational features of the UUT for the duration of the test.

It should be noted that once a UUT is powered on, it will not start its normal operating functions immediately, as it will have to finish its power-up cycle first (T_{power_up}). As such, the UUT, as well as any other device used in the set-up, may be equipped with a feature that will indicate its status during the testing, e.g. power-up mode, normal operation mode, channel check status, radar detection event, etc.

5.3.8.1.1 Selection of radar test signals

The radar test signals to be used during the DFS testing are defined in tables D.3 and D.4.

For each of the variable radar test signals in table D.4, an arbitrary combination of Pulse Width, Pulse Repetition Frequency and if applicable the number of different PRFs, shall be chosen from the ranges given in the table and recorded in the test report.

The radar test signals given in table D.4 simulate real radar systems. They take into account the combined effect of antenna rotation speed, antenna beam width and pulse repetition frequency for a particular type of radar. The given values for Pulses Per Burst (PPB) represent the number of pulses for a given PRF, seen at the RLAN for each scan of the radar.

NOTE: $PPB = \frac{\{\text{antenna beamwidth (deg)}\} \times \{\text{pulse repetition rate (PPS)}\}}{\{\text{scan rate (deg/s)}\}}$.

Table D.5 provides for each radar test signal the required detection probability (P_d). P_d represents a minimum level of detection performance under defined conditions. Therefore P_d does not represent the overall detection probability for any particular radar under real life conditions.

The pulse widths given in the tables D.3 and D.4 are assumed to have an accuracy of $\pm 5\%$.

The tests related to the Channel Availability Check, In-Service Monitoring, Channel Shut Down and Non-Occupancy Period (clauses 5.3.8.2.1.1, 5.3.8.2.1.2, 5.3.8.2.1.4 and 5.3.8.2.1.5) are performed with a single burst radar test signal while the tests related to the Off-Channel CAC (clause 5.3.8.2.1.3) are performed with a repetitive burst radar test signal (see note 4 in table D.4).

5.3.8.1.2 Test set-ups

For the purposes of the test, the UUT as well as other RLAN devices used in the set-up may be equipped with a specific user interface to allow monitoring of the behaviour of the different devices of the set-up during the tests.

The UUT is capable of transmitting a test transmission sequence as described in clause 5.1.2.2. The signal generator is capable of generating any of the radar test signals defined in tables D.3 and D.4.

Adequate measurement equipment, e.g. spectrum analyser, shall be used to measure the aggregate transmission time of the UUT.

Clauses 5.3.8.1.2.1 to 5.3.8.1.2.3 describe the different set-ups to be used during the measurements.

5.3.8.1.2.1 Set-up A

Set-up A is a set-up whereby the UUT is an RLAN device operating in master mode. Radar test signals are injected into the UUT. This set-up also contains an RLAN device operating in slave mode which is associated with the UUT.

Figure 4 shows an example for *Set-up A*. The set-up used shall be documented in the test report.

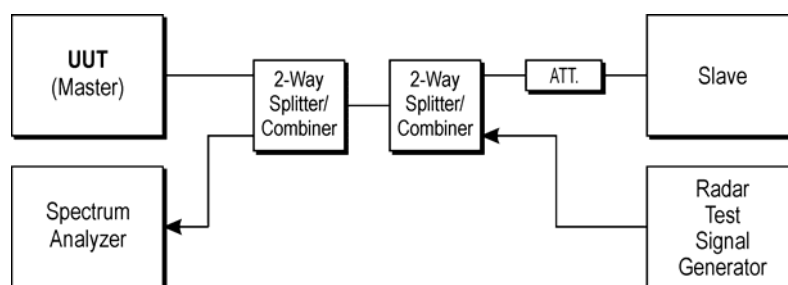

Figure 4: Set-up A

5.3.8.1.2.2 Set-up B

Set-up B is a set-up whereby the UUT is an RLAN device operating in slave mode, with or without Radar Interference Detection function. This set-up also contains an RLAN device operating in master mode. The radar test signals are injected into the master device. The UUT (slave device) is associated with the master device.

Figure 5 shows an example for *Set-up B*. The set-up used shall be documented in the test report.

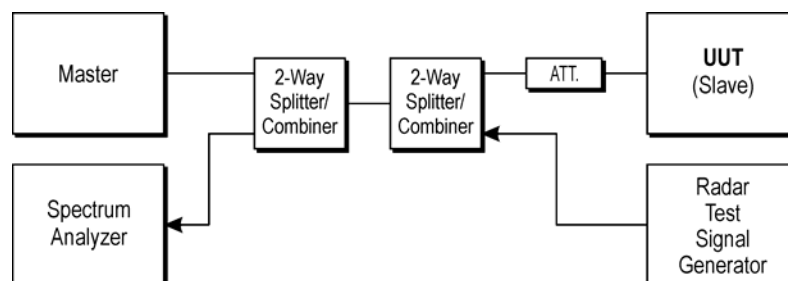

Figure 5: Set-up B

5.3.8.1.2.3 Set-up C

The UUT is an RLAN device operating in slave mode with Radar Interference Detection function. Radar test signals are injected into the slave device. This set-up also contains an RLAN device operating in master mode. The UUT (slave device) is associated with the master device.

Figure 6 shows an example for *Set-up C*. The set-up used shall be documented in the test report.

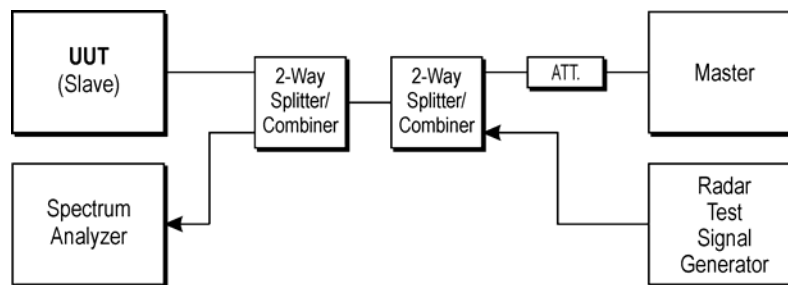

Figure 6: Set-up C

5.3.8.2 Test method

5.3.8.2.1 Conducted measurement

For a UUT with antenna connector(s) and using dedicated external antenna(s), or for a UUT with integral antenna(s) but with a temporary antenna connector(s) provided, conducted measurements shall be used.

When performing DFS testing on smart antenna systems, a power splitter/combiner shall be used to combine all the receive chains (antenna inputs) into a single test point. The insertion loss of the splitter/combiner shall be taken into account.

The UUT shall be configured to operate at the highest transmitter output power setting.

If the UUT has a Radar Interference Detection function, the output power of the signal generator producing the radar test signals, as selected using clause 5.3.8.1.1, shall (unless otherwise specified) provide a received signal power at the antenna connector of the UUT with a level equal to applicable *Radar Detection Threshold* level defined in table D.2. Parameter G [dBi] in table D.2 corresponds to the gain of the antenna assembly stated by the manufacturer. If more than one antenna assembly is intended for this power setting, the gain of the antenna assembly with the lowest gain shall be used.

NOTE: Beamforming gain (Y) of smart antenna systems, operating in a mode where beamforming is active, is ignored in order to test the worse case.

The centre frequencies of the radar test signals used in the test procedures below shall fall within the central 80 % of the *Occupied Channel Bandwidth* of the RLAN channel under test.

5.3.8.2.1.1 Channel Availability Check

The clauses below define the procedure to verify the *Channel Availability Check* and the *Channel Availability Check Time* ($T_{\text{ch_avail_check}}$) on the selected channel Ch_r by ensuring that the UUT is capable of detecting radar pulses at the beginning and at the end of the *Channel Availability Check Time*. This is illustrated in figure 7. There shall be no transmissions by the UUT on Ch_r during this time.

A test channel shall be identified in accordance with clause 5.1.3. This channel is designated as Ch_r (see clause 3.2). For the purpose of the test, the UUT shall be configured to ensure that the *Channel Availability Check* is performed on Ch_r .

5.3.8.2.1.1.1 Tests with a radar burst at the beginning of the Channel Availability Check Time

The steps below define the procedure to verify the radar detection capability on the selected channel Ch_r when a radar burst occurs at the beginning of the *Channel Availability Check Time*.

- The signal generator and UUT are connected using *Set-up A* as described in clause 5.3.8.1.2.1. The power of the UUT is switched off.
- The UUT is powered on at T_0 . T_1 denotes the instant when the UUT has completed its power-up sequence ($T_{\text{power_up}}$) and is ready to start the radar detection. The *Channel Availability Check* is expected to commence on Ch_r at instant T_1 and is expected to end no sooner than $T_1 + T_{\text{ch_avail_check}}$ unless a radar is detected sooner.

NOTE: Additional verification may be needed to define T_1 in case it is not exactly known or indicated by the UUT.

- A single radar burst is generated on Ch_r using the reference test signal defined in table D.3 at a level of up to 10 dB above the level defined in clause 5.3.8.2.1. This single-burst radar test signal shall commence within 2 s after time T_1 .
- It shall be recorded if the radar test signal was detected.
- A timing trace or description of the observed timing and behaviour of the UUT shall be recorded.

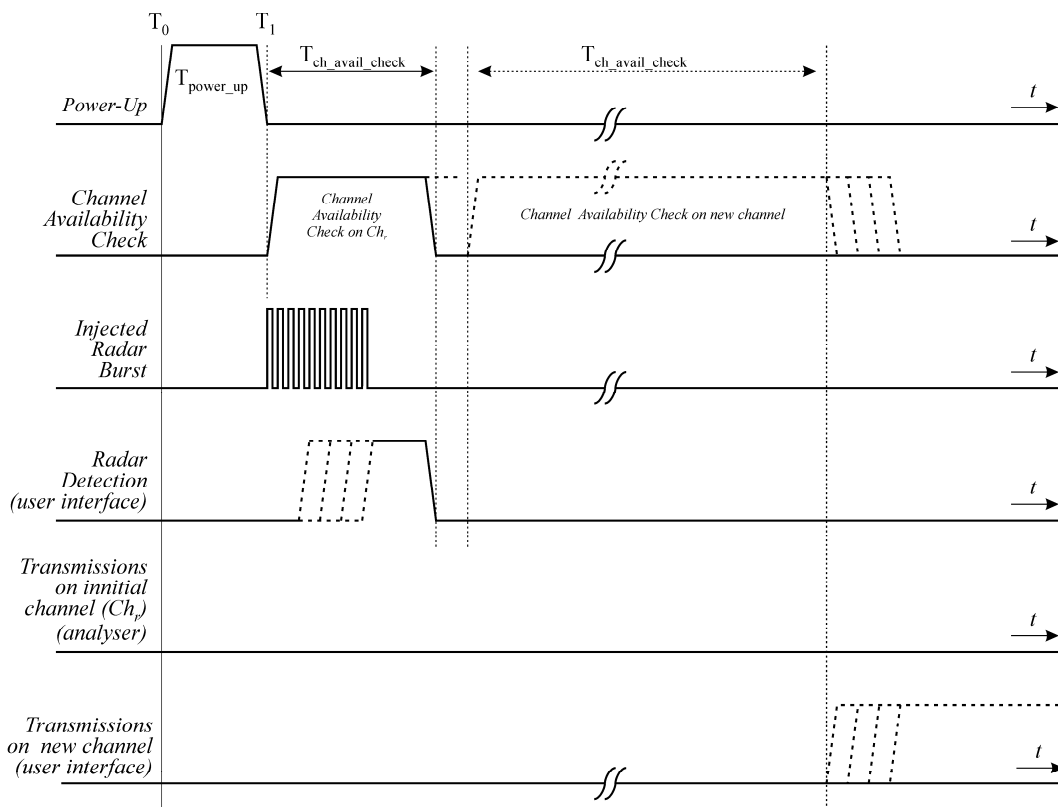

Figure 7: Example of timing for radar testing at the beginning of the Channel Availability Check Time

5.3.8.2.1.1.2 Tests with radar burst at the end of the Channel Availability Check Time

The steps below define the procedure to verify the radar detection capability on the selected channel Ch_r when a radar burst occurs at the end of the *Channel Availability Check Time* (see note 1). This is illustrated in figure 8.

NOTE 1: The applicable *Channel Availability Check Times* are given by table D.1.

- a) The signal generator and UUT are connected using *Set-up A* described in clause 5.3.8.1.2.1. The power of the UUT is switched off.
- b) The UUT is powered up at T_0 . T_1 denotes the instant when the UUT has completed its power-up sequence ($T_{\text{power_up}}$) and is ready to start the radar detection. The *Channel Availability Check* is expected to commence on Ch_r at instant T_1 and is expected to end no sooner than $T_1 + T_{\text{ch_avail_check}}$ unless a radar is detected sooner.

NOTE 2: Additional verification may be needed to define T_1 in case it is not exactly known or indicated by the UUT.

- c) A single radar burst is generated on Ch_r using the reference test signal defined in table D.3 at a level of up to 10 dB above the level defined in clause 5.3.8.2.1. This single-burst radar test signal shall commence towards the end of the minimum required *Channel Availability Check* Time but not before time $T_1 + T_{\text{ch_avail_check}} - 2$ s.
- d) It shall be recorded if the radar test signal was detected.
- e) A timing trace or description of the observed timing and behaviour of the UUT shall be recorded.

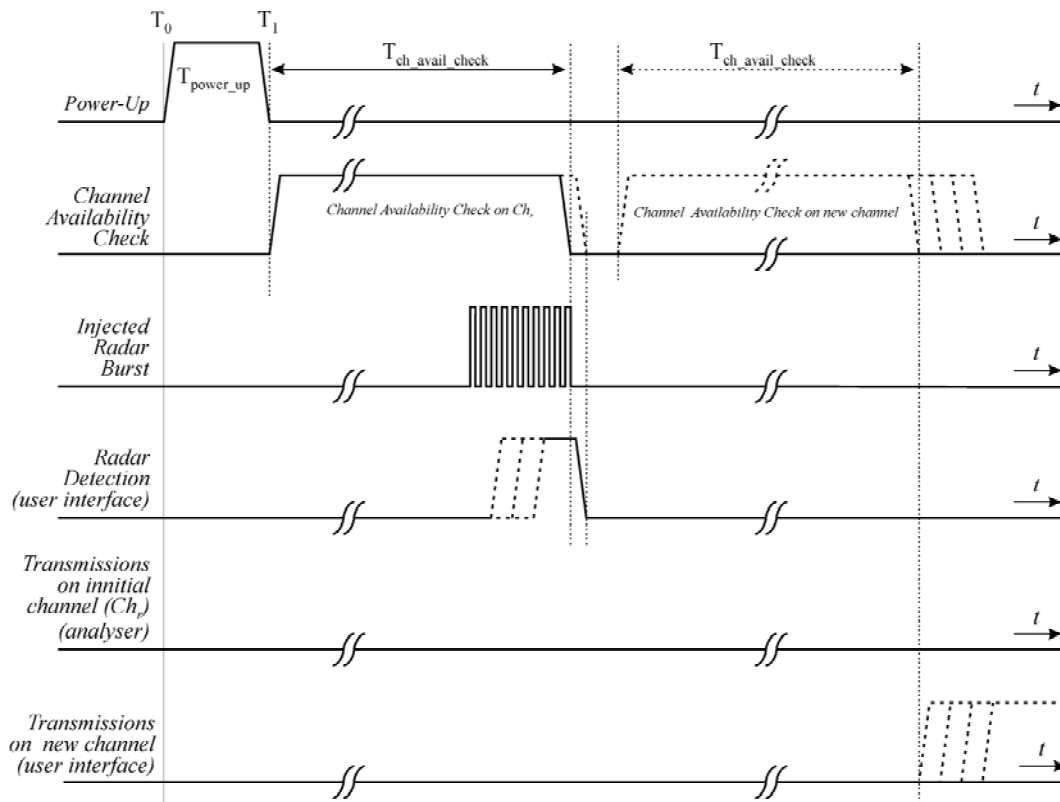

Figure 8: Example of timing for radar testing towards the end of the Channel Availability Check Time

5.3.8.2.1.2 Radar Detection Threshold (during the Channel Availability Check)

The different steps below define the procedure to verify the *Radar Detection Threshold* during the *Channel Availability Check Time* for channels outside the 5 600 MHz to 5 650 MHz band. This is illustrated in figure 9.

- a) The signal generator and UUT are connected using *Set-up A* described in clause 5.3.8.1.2.1. The power of the UUT is switched off.
- b) The UUT is powered on at T0. T1 denotes the instant when the UUT has completed its power-up sequence ($T_{\text{power_up}}$) and is ready to start the radar detection. The *Channel Availability Check* on Ch_r is expected to commence at instant T1 and is expected to end no sooner than $T1 + T_{\text{ch_avail_check}}$ unless a radar is detected sooner.

NOTE 1: Additional verification may be needed to define T1 in case it is not exactly known or indicated by the UUT.

- c) A single burst radar test signal is generated on Ch_r using any of the radar test signals defined in table D.4 at a level defined in clause 5.3.8.2.1. This single-burst radar test signal may commence at any time within the applicable *Channel Availability Check Time*.

NOTE 2: For the purpose of reducing test time, it is recommended that the single-burst radar test signal starts approximately 10 s after T1.

- d) It shall be recorded if the radar test signal was detected.
- e) The steps c) to d) shall be performed 20 times and each time a different radar test signal shall be generated from options provided in table D.4. The radar test signals used shall be recorded in the report. The radar test signal shall be detected at least 12 times out of the 20 trials in order to comply with the detection probability specified for this frequency range in table D.5.

Where the declared channel plan includes channels whose nominal bandwidth falls completely or partly within the 5 600 MHz to 5 650 MHz band, additional testing as described in the steps below shall be performed on a channel within this band.

- f) A single burst radar test signal is generated on Ch_r using any of the radar test signals defined in table D.4 (except signals #3 and #4) at a level of 10 dB above the level defined in clause 5.3.8.2.1. This single burst radar test signal may commence at any time within the applicable *Channel Availability Check Time*.

NOTE 3: For the purpose of reducing test time, it is recommended that the single burst radar test signal starts approximately 10 s after T1.

- g) Step f) shall be performed 20 times, each time a different radar test signal shall be generated from options provided in table D.4 (except signals #3 and #4). The radar test signals used shall be recorded in the report. The radar test signal shall be detected during each of these trials and this shall be recorded.

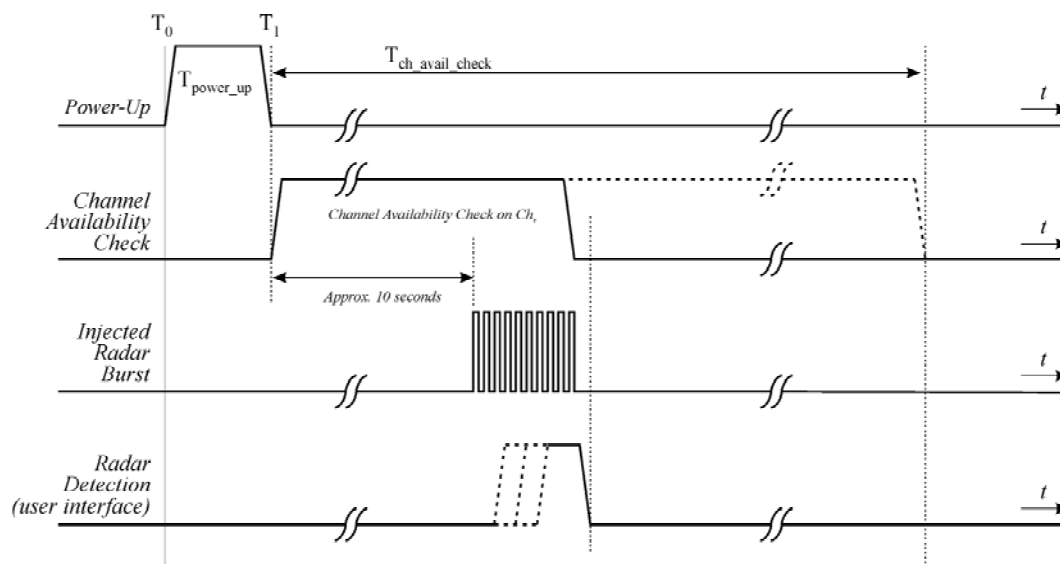

Figure 9: Example of timing for radar testing during the Channel Availability Check

5.3.8.2.1.3 Off-Channel CAC

The channel, on which the *Off-Channel CAC* test will be performed, shall be selected in accordance with clause 5.1.3. This channel is designated as Ch_r .

For the purpose of the test, the UUT shall be configured to select the *Operating Channel(s)* different from Ch_r . There shall be no transmissions by the UUT on Ch_r during the *Off-Channel CAC Time*.

5.3.8.2.1.3.1 Radar Detection Threshold (during Off-Channel CAC)

The different steps below define the procedure to verify the *Radar Detection Threshold* during the *Off-Channel CAC*.

Where the declared channel plan includes channels whose nominal bandwidth falls completely or partly within the 5 600 MHz to 5 650 MHz band, the test shall be performed on one of these channels in addition to a channel outside this band. See clause 5.1.3.

- The signal generator, the UUT (master device) and a slave device associated with the UUT, are connected using *Set-up A* described in clause 5.3.8.1.2.1.
- The UUT shall transmit a test transmission sequence in accordance with clause 5.1.2.2 on (all) the *Operating Channel(s)*.
- A multi burst radar test signal is generated on Ch_r using any of the radar test signals defined in table D.4 at a level defined in clause 5.3.8.2.1. The radar test signal used shall be recorded in the report. This multi burst radar test signal shall commence at T_3 and shall continue for the total duration of the *Off-Channel CAC Time* ($T_{Off-Channel_CAC}$) as declared by the manufacturer in accordance with table D.1. For channels within the 5 600 MHz to 5 650 MHz band test signals #3 and #4 shall not be used and the Burst Interval Time (BIT) during the test shall be varied between 8 minutes and 10 minutes. For channels outside this band, the Burst Interval Time (BIT) during the test shall be varied between 45 s and 60 s.
- The UUT shall detect the radar test signal before the end of the *Off-Channel CAC Time* and this shall be recorded.

NOTE: For the purpose of reducing test time, the test may be terminated immediately once the UUT has reported detection of the radar test signal.

5.3.8.2.1.3.2 Detection Probability (P_d)

This test may be facilitated by disabling the *Channel Shutdown* feature for the duration of the test.

For channels outside the 5 600 MHz to 5 650 MHz band, the test in clause 5.3.8.2.1.3.1 is sufficient to demonstrate that the UUT meets the Detection Probability (P_d) defined in table D.5.

Where the declared channel plan includes channels whose nominal bandwidth falls completely or partly within the 5 600 MHz to 5 650 MHz band, the procedure in the steps below has to be performed on one of these channels. See clause 5.1.3.

- a) A multi burst radar test signal is generated on Ch_r using any of the radar test signals defined in table D.4 (except signals #3 and #4) at a level of 10 dB above the level defined in clause 5.3.8.2.1. The radar test signal used shall be recorded in the report. This multi burst radar test signal shall commence at T3 and shall continue for the total duration of the Off-Channel CAC Time ($T_{\text{Off-Channel_CAC}}$) as declared by the manufacturer in accordance with table D1. The Burst Interval Time (BIT) during the test shall be varied between 8 minutes and 10 minutes.
- b) It shall be recorded how many bursts have been detected by the UUT at the end of the *Off-Channel CAC Time*. The minimum number of bursts that the UUT shall detect in order to comply with the detection probability defined for this frequency range in table D.5 is given by table 8.

Table 8: Minimum number of burst detections for channels within the 5 600 MHz to 5 650 MHz band

Off-Channel CAC Time (Minutes)	Number of Bursts generated assuming a BIT of 10 minutes	Minimum Number of burst detections
60	6	5
90	9	6
160	16	7
320	32	8
1 440	144	9

NOTE: For the purpose of reducing test time, the test may be terminated immediately the UUT has reported the minimum number of burst detections required.

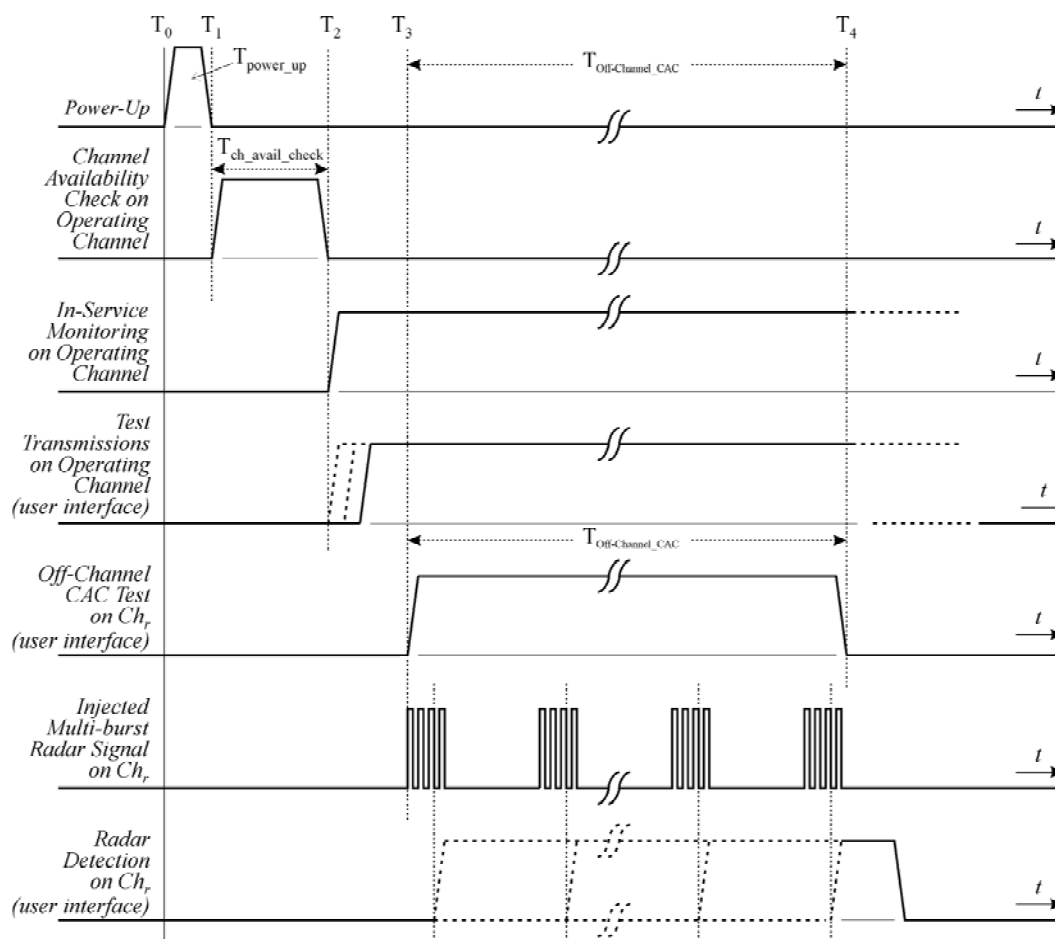

Figure 10: Example of timing for radar testing during the Off-Channel CAC

5.3.8.2.1.4 In-Service Monitoring

The steps below define the procedure to verify the In-Service Monitoring and the Radar Detection Threshold during the In-Service Monitoring.

The channel, on which the In-Service Monitoring test will be performed, shall be selected in accordance with clause 5.1.3. This channel, designated as Ch_r , is an Operating Channel.

- a) When the UUT is a master device, a slave device will be used that associates with the UUT. The signal generator and the UUT are connected using *Set-up A* described in clause 5.3.8.1.2.1.

When the UUT is a slave device with a Radar Interference Detection function, the UUT shall associate with a master device. The signal generator and the UUT are connected using *Set-up C* described in clause 5.3.8.1.2.3.

- b) The UUT shall transmit a test transmission sequence in accordance with clause 5.1.2.2 on the selected channel Ch_r . While the testing is performed on Ch_r , the equipment is allowed to have simultaneous transmissions on other adjacent or non-adjacent operating channels.
- c) At a certain time T_0 , a single burst radar test signal is generated on Ch_r using radar test signal #1 defined in table D.4 and at a level defined in clause 5.3.8.2.1. T_1 denotes the end of the radar burst.
- d) It shall be recorded if the radar test signal was detected.
- e) The steps b) to d) shall be performed 20 times. The radar test signal shall be detected at least 12 times out of the 20 trials in order to comply with the detection probability specified in table D.5.
- f) The steps b) to e) shall be repeated for each of the radar test signals defined in table D.4 and as described in clause 5.3.8.1.1.

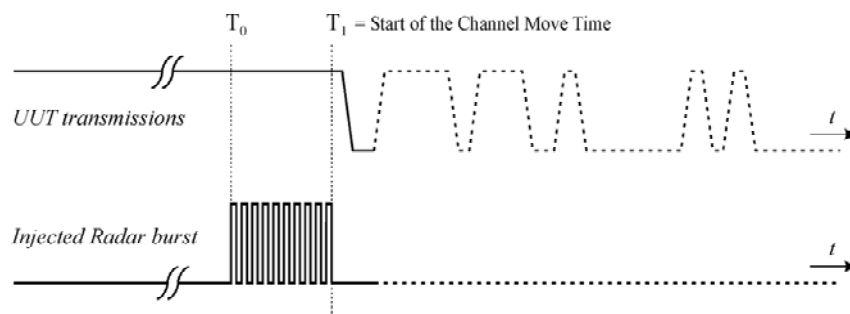

Figure 11: Example of timing for radar testing during In-Service Monitoring

5.3.8.2.1.5 Channel Shutdown and Non-Occupancy period

The steps below define the procedure to verify the *Channel Shutdown* process and to determine the *Channel Closing Transmission Time*, the *Channel Move Time* and the *Non-Occupancy Period*. This is illustrated in figure 12.

The channel, on which these tests will be performed, shall be selected in accordance with clause 5.1.3. This channel, designated as Ch_r , is an *Operating Channel*.

- a) When the UUT is a master device, a slave device will be used that associates with the UUT. The signal generator and the UUT shall be connected using *Set-up A* described in clause 5.3.8.1.2.1.

When the UUT is a slave device (with or without a Radar Interference Detection function), the UUT shall associate with a master device. The signal generator and the UUT shall be connected using *Set-up B* described in clause 5.3.8.1.2.2.

In both cases, it is assumed that the channel selection mechanism for the *Uniform Spreading* requirement is disabled in the master.
 - b) The UUT shall transmit a test transmission sequence in accordance with clause 5.1.2.2 on the selected channel Ch_r . While the testing is performed on Ch_r , the equipment is allowed to have simultaneous transmissions on other adjacent or non-adjacent operating channels.
 - c) At a certain time T_0 , a single burst test signal is generated on Ch_r using the reference DFS test signal defined in table D.3 and at a level of up to 10 dB above the level defined in clause 5.3.8.2.1 on the selected channel. T_1 denotes the end of the radar burst.
 - d) The transmissions of the UUT following instant T_1 on the selected channel Ch_r shall be observed for a period greater than or equal to the *Channel Move Time* defined in table D.1. The aggregate duration (*Channel Closing Transmission Time*) of all transmissions from the UUT on Ch_r during the *Channel Move Time* shall be compared to the limit defined in table D.1. For equipment capable of having simultaneous transmissions on multiple (adjacent or non-adjacent) operating channels, the equipment is allowed to continue transmissions on other *Operating Channels* (different from Ch_r).
- NOTE: The aggregate duration of all transmissions of the UUT does not include quiet periods in between transmissions of the UUT.
- e) T_2 denotes the instant when the UUT has ceased all transmissions on the channel Ch_r . The time difference between T_1 and T_2 shall be measured. This value (*Channel Move Time*) shall be noted and compared with the limit defined in table D.1.
 - f) Following instant T_2 , the selected channel Ch_r shall be observed for a period equal to the *Non-Occupancy Period* ($T_3 - T_2$) to verify that the UUT does not resume any transmissions on this channel.
 - g) When the UUT is a slave device with a Radar Interference Detection function the steps b) to f) shall be repeated with the generator connected to the UUT using *Set-up C* as described in clause 5.3.8.1.2.3. See also note 2 in table D.2.

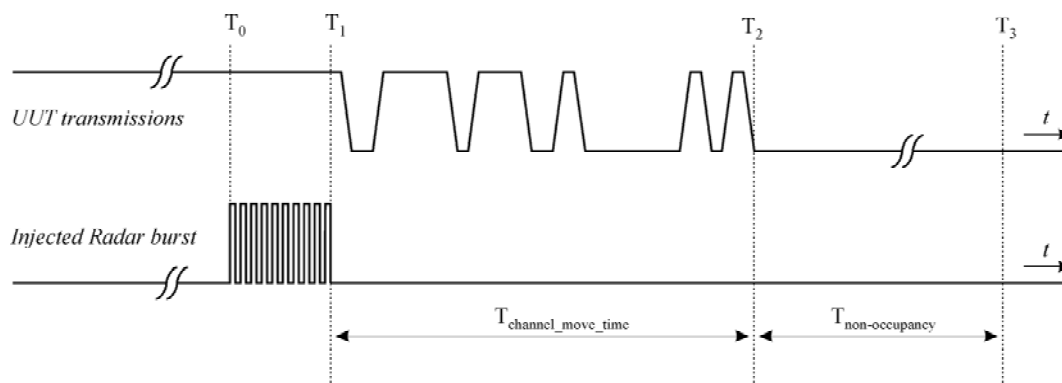

Figure 12: Channel Closing Transmission Time, Channel Move Time and Non-Occupancy Period

5.3.8.2.2 Radiated measurement

For a UUT with integral antenna(s) and without temporary antenna connector(s), radiated measurements shall be used.

If the UUT has a Radar Interference Detection function, the output power of the signal generator shall (unless otherwise specified) provide a signal power at the antenna of the UUT with a level equal to *Radar Detection Threshold* level defined in table D.2.

When performing radiated DFS testing on a UUT with a directional antenna (including smart antenna systems and systems capable of beamforming), the wanted communications link (between the UUT and the associated device) and the DFS radar test signals shall be aligned to the direction corresponding to the UUT's maximum antenna gain.

The test set up as described in annex B and applicable measurement procedures as described in annex C shall be used to test the different DFS features of the UUT. The test procedure is further as described under clause 5.3.8.2.1.

5.3.9 Adaptivity (channel access mechanism)

5.3.9.1 Test conditions

See clause 5.1 for the test conditions. These measurements shall only be performed at normal test conditions.

The channels and the channel bandwidths to be used for testing are defined in clause 5.1.3. The device shall be configured to operate at its maximum output power level.

This test may be facilitated by disabling certain operational features of the UUT for the duration of the test.

5.3.9.2 Test method

5.3.9.2.1 Conducted measurements

Figure 13 shows an example of the test set-up.

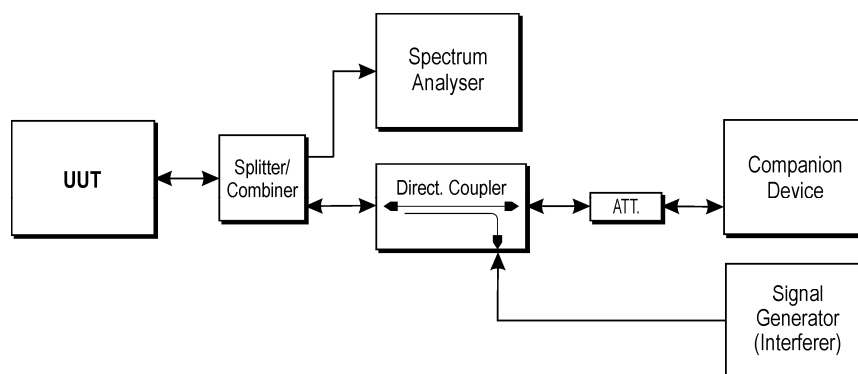

Figure 13: Example Test Set-up for verifying the adaptivity of an equipment

The different steps below define the procedure to verify the efficiency of the adaptivity mechanism of the equipment.

Step 1:

- The UUT may connect to a companion device during the test. The signal generator, spectrum analyser, UUT and the companion device are connected using a Set-up equivalent to the example given by figure 13 although the signal generator does not generate any signals at this point in time. The spectrum analyser is used to monitor the transmissions of the UUT in response to the interference signal.
- The received signal level (wanted signal from the companion device) at the UUT shall be sufficient to maintain a reliable link for the duration of the test.
- The analyser shall be set as follows:
 - RBW: \geq Occupied Channel Bandwidth (if the analyser does not support this setting, the highest available setting shall be used)
 - VBW: $3 \times$ RBW (if the analyser does not support this setting, the highest available setting shall be used)
 - Detector Mode: RMS
 - Centre Frequency: Equal to the centre frequency of the operating channel
 - Span: 0 Hz
 - Sweep time: $>$ Channel Occupancy Time
 - Trace Mode: Clear/Write
 - Trigger Mode: Video or External

Step 2:

- Configure the UUT for normal transmissions with a sufficiently high payload (transmitter activity ratio $> 30\%$) to allow demonstration of compliance of the adaptive mechanism on the channel being tested.
- For Frame Based Equipment, using the procedure defined in clause 5.3.9.2.2, it shall be verified that the UUT complies with the maximum Channel Occupancy Time and the minimum Idle Period defined in clause 4.9.2.1.
- For Load Based equipment, using the procedure defined in clause 5.3.9.2.2, it shall be verified that the UUT complies with the maximum Channel Occupancy Time defined in clause 4.9.2.2. It shall also be verified (if necessary by repeating the test) that the measured Idle Period varies between CCA and $q \times$ CCA as defined in clause 4.9.2.2.

NOTE 1: For IEEE 802.11 [9] equipment (see first paragraph of clause 4.9.2.2) the Idle Period and the maximum Channel Occupancy Time are as defined for other types of Load Based Equipment (see clause 4.9.2.2 points 2 and 3). The CCA observation time is declared by the manufacturer (see clause 5.3.1.q)).

Step 3: Adding the interference signal.

- A 100 % duty cycle interference signal is injected on the current operating channel of the UUT. This interference signal shall be a band limited noise signal which has a flat power density (maximum ripple $\pm 1,5$ dB), and shall have a bandwidth of at least 10 MHz. The total power level of this interference signal shall be equal to the power density value defined in clause 4.9.2.1 point 5 or clause 4.9.2.2 point 5, multiplied by the Occupied Channel Bandwidth of the UUT.

Step 4: Verification of reaction to the interference signal.

- The spectrum analyser shall be used to monitor the transmissions of the UUT on the selected operating channel after the interference signal was injected. This may require the spectrum analyser sweep to be triggered by the start of the interfering signal.

- Using the procedure defined in clause 5.3.9.2.2, it shall be verified that:

- The UUT stops transmissions on the current operating channel.

NOTE 2: The UUT is assumed to stop transmissions within a period equal to the maximum Channel Occupancy Time defined in clause 4.9.2.1 for Frame Based Equipment or clause 4.9.2.2 for Load Based Equipment. The UUT is allowed to have Short Control Signalling Transmissions on the current operating channel (see ii) and iii).

NOTE 3: For equipment having simultaneous transmissions on multiple (adjacent or non-adjacent) operating channels, the equipment is allowed to continue transmissions on other *Operating Channels*.

- Apart from Short Control Signalling Transmissions there shall be no subsequent transmissions while the interfering signal is present.
- The Short Control Signalling Transmissions shall comply with the limits defined in clause 4.9.2.3.

NOTE 4: The verification of the Short Control Signalling transmissions may require the analyser settings to be changed (e.g. sweep time).

NOTE 5: On removal of the interference signal the UUT may start transmissions again on this channel however this is not a requirement and therefore does not require testing.

Step 5:

- The steps 2 to 4 shall be repeated for each of the channels to be tested.

5.3.9.2.2 Generic test procedure for measuring channel/frequency usage

This is a generic test method to evaluate transmissions on the operating channel being investigated. This test is only performed as part of the procedure described in clause 5.3.9.2.1.

The test procedure shall be as follows:

Step 1:

- The analyser shall be set as follows:
 - Centre Frequency: equal to the centre frequency of the channel being investigated
 - Frequency Span: 0 Hz
 - RBW: approx. 50 % of the Occupied Channel Bandwidth (if the analyser does not support this setting, the highest available setting shall be used)
 - VBW: $3 \times \text{RBW}$ (if the analyser does not support this setting, the highest available setting shall be used)
 - Detector Mode: RMS
 - Sweep time: > the Channel Occupancy Time
 - Number of sweep points: see note

NOTE: The time resolution has to be sufficient to meet the maximum measurement uncertainty for the period to be measured. In most cases, the Idle Period is the shortest period to be measured and thereby defining the time resolution.

EXAMPLE: For a Channel Occupancy Time of 2 ms, the minimum Idle Period is 100 μs , hence the minimum time resolution should be < 10 μs .

- Trace mode: Clear/Write
- Trigger: Video or External

Step 2:

- Save the trace data to a file for further analysis by a computing device using an appropriate software application or program.

Step 3:

- Identify the data points related to the channel being investigated by applying a threshold.
- Count the number of consecutive data points identified as resulting from a single transmission on the channel being investigated and multiply this number by the time difference between two consecutive data points.
- Repeat this for all the transmissions within the measurement window.
- For measuring idle or silent periods, count the number of consecutive data points identified as resulting from a single transmitter off period on the channel being investigated and multiply this number by the time difference between two consecutive data points.
- Repeat this for all the transmitter off periods within the measurement window.

5.3.9.2.3 Radiated measurements

For a UUT with integral antenna(s) and without temporary antenna connector(s), radiated measurements shall be used.

The output power of the signal generator simulating the interference signal shall provide a signal power at the antenna of the UUT with a level equal to level defined in clause 4.9.2.1 point 5 or clause 4.9.2.2 point 5).

When performing radiated testing on a UUT with a directional antenna (including smart antenna systems and systems capable of beamforming), the wanted communications link (between the UUT and the companion device) and the interference test signals shall be aligned to the direction corresponding to the UUT's maximum antenna gain.

The test set up as described in annex B and applicable measurement procedures as described in annex C shall be used to test the adaptivity of the UUT. The test procedure is further as described under clause 5.3.9.2.1.

Annex A (normative): HS Requirements and conformance Test specifications Table (HS-RTT)

The HS Requirements and conformance Test specifications Table (HS-RTT) in table A.1 serves a number of purposes, as follows:

- it provides a statement of all the requirements in words and by cross reference to (a) specific clause(s) in the present document or to (a) specific clause(s) in (a) specific referenced document(s);
- it provides a statement of all the test procedures corresponding to those essential requirements by cross reference to (a) specific clause(s) in the present document or to (a) specific clause(s) in (a) specific referenced document(s);
- it qualifies each requirement to be either:
 - Unconditional: meaning that the requirement applies in all circumstances; or
 - Conditional: meaning that the requirement is dependent on the manufacturer having chosen to support optional functionality defined within the schedule.
- in the case of Conditional requirements, it associates the requirement with the particular optional service or functionality;
- it qualifies each test procedure to be either:
 - Essential: meaning that it is included with the Essential Radio Test Suite and therefore the requirement shall be demonstrated to be met in accordance with the referenced procedures;
 - Other: meaning that the test procedure is illustrative but other means of demonstrating compliance with the requirement are permitted.

Table A.1: HS Requirements and conformance Test specifications Table (HS-RTT)

Harmonized Standard EN 301 893						
The following requirements and test specifications are relevant to the presumption of conformity under the article 3.2 of the R&TTE Directive [1]						
Requirement			Requirement Conditionality		Test Specification	
No	Description	Reference: Clause No	U/C	Condition	E/O	Reference: Clause No
1	Carrier frequencies	4.2	U		E	5.3.2
2	Nominal, and occupied, channel bandwidth	4.3	U		E	5.3.3
3	RF output power	4.4	U		E	5.3.4
	Transmit Power Control (TPC)	4.4	C	Note 1	E	5.3.4
	Power Density	4.4	U		E	5.3.4
4	Transmitter unwanted emissions outside the 5 GHz RLAN bands	4.5.1	U		E	5.3.5
5	Transmitter unwanted emissions within the 5 GHz RLAN bands	4.5.2	U		E	5.3.6
6	Receiver spurious emissions	4.6	U		E	5.3.7
7	DFS: Channel Availability Check	4.7.2.1	C	Notes 2 and 3	E	5.3.8.2.1.1 and 5.3.8.2.1.2
8	DFS: Off-Channel CAC - Radar Detection Threshold	4.7.2.2	C	Notes 2, 3 and 4	E	5.3.8.2.1.3.1
9	DFS: Off-Channel CAC - Detection Probability	4.7.2.2	C	Notes 2, 3 and 4	O	5.3.8.2.1.3.2
10	DFS: In service Monitoring	4.7.2.3	C	Notes 2 and 3	E	5.3.8.2.1.4
11	DFS: Channel shutdown	4.7.2.4	C	Note 2	E	5.3.8.2.1.5
12	DFS: Non-occupancy period	4.7.2.5	C	Notes 2 and 3	E	5.3.8.2.1.5
13	DFS: Uniform spreading	4.7.2.6	C	Notes 2 and 5	X	

Harmonized Standard EN 301 893						
The following requirements and test specifications are relevant to the presumption of conformity under the article 3.2 of the R&TTE Directive [1]						
Requirement			Requirement Conditionality		Test Specification	
No	Description	Reference: Clause No	U/C	Condition	E/O	Reference: Clause No
14	Adaptivity	4.9	U		E	5.3.9
15	User Access Restrictions	4.10	U		X	
NOTE 1: Transmit Power Control (TPC) is not required for channels whose nominal bandwidth falls completely within the band 5 150 MHz to 5 250 MHz. TPC is also not required for devices that operate at a maximum mean e.i.r.p. of 3 dB below the limits defined in table 1.						
NOTE 2: DFS is not required for channels whose nominal bandwidth falls completely within the band 5 150 MHz to 5 250 MHz.						
NOTE 3: Slave devices with a maximum transmit power of less than 200 mW e.i.r.p. do not have to implement the <i>Channel Availability Check</i> , the <i>Off-Channel CAC</i> , the <i>In-service Monitoring</i> and the <i>Non-Occupancy Period</i> . Slave devices with a maximum transmit power of 200 mW e.i.r.p. or more do not have to perform <i>Channel Availability Check</i> or <i>Off-Channel CAC</i> at initial use of a channel.						
NOTE 4: Where implemented by the manufacturer.						
NOTE 5: Uniform Spreading is not required for Slave devices.						

Key to columns:**Requirement:**

No A unique identifier for one row of the table which may be used to identify a requirement or its test specification.

Description A textual reference to the requirement.

Clause Number Identification of clause(s) defining the requirement in the present document unless another document is referenced explicitly.

Requirement Conditionality:

U/C Indicates whether the requirement is to be *unconditionally* applicable (U) or is *conditional* upon the manufacturers claimed functionality of the equipment (C).

Condition Explains the conditions when the requirement shall or shall not be applicable for a technical requirement which is classified "conditional".

Test Specification:

E/O Indicates whether the test specification forms part of the Essential Radio Test Suite (E) or whether it is one of the Other Test Suite (O).

NOTE: All tests whether "E" or "O" are relevant to the requirements. Rows designated "E" collectively make up the Essential Radio Test Suite; those designated "O" make up the Other Test Suite; for those designated "X" there is no test specified corresponding to the requirement. The completion of all tests classified "E" as specified with satisfactory outcomes is a necessary condition for a presumption of conformity. Compliance with requirements associated with tests classified "O" or "X" is a necessary condition for presumption of conformity, although conformance with the requirement may be claimed by an equivalent test or by manufacturer's assertion supported by appropriate entries in the technical construction file.

Clause Number Identification of clause(s) defining the test specification in the present document unless another document is referenced explicitly. Where no test is specified (that is, where the previous field is "X") this field remains blank.

Annex B (normative): Test sites and arrangements for radiated measurements

B.1 Test sites

B.1.1 Open air test sites

The term "open air" should be understood from an electromagnetic point of view. Such a test site may be really in open air or alternatively with walls and ceiling transparent to the radio waves at the frequencies considered.

An open air test site may be used to perform the measurements using the radiated measurement methods described in clause 5. Absolute or relative measurements may be performed on transmitters or on receivers; absolute measurements of field strength require a calibration of the test site. Above 1 GHz, measurements should be done in anechoic conditions. This may be met by semi anechoic sites provided reflections are avoided.

For measurements at frequencies below 1 GHz, a measurement distance appropriate to the frequency shall be used. For frequencies above 1 GHz, any suitable measuring distance may be used. The equipment size (excluding the antenna) shall be less than 20 % of the measuring distance. The height of the equipment or of the substitution antenna shall be 1,5 m; the height of the test antenna (transmit or receive) shall vary between 1 m and 4 m.

Sufficient precautions shall be taken to ensure that reflections from extraneous objects adjacent to the site do not degrade the measurement results, in particular:

- No extraneous conducting objects having any dimension in excess of a quarter wavelength of the highest frequency tested shall be in the immediate vicinity of the site according to CISPR 16-1-1 [4].
- All cables shall be as short as possible; as much of the cables as possible shall be on the ground plane or preferably below; and the low impedance cables shall be screened.

The general measurement arrangement is shown in figure B.1.

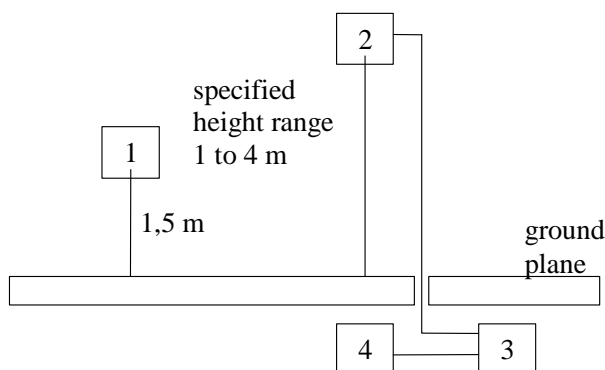

- 1: Equipment under test.
 2: Test antenna.
 3: High pass filter (as required).
 4: Spectrum analyser or measuring receiver.

Figure B.1: Measuring arrangement

B.1.2 Anechoic chamber

B.1.2.1 General

An anechoic chamber is a well shielded chamber covered inside with radio frequency absorbing material and simulating a free space environment. It is an alternative site on which to perform the measurements using the radiated measurement methods described in clause 5.3. Absolute or relative measurements may be performed on transmitters or on receivers. Absolute measurements of field strength require a calibration of the anechoic chamber. The test antenna, equipment under test and substitution antenna are used in a way similar to that at the open air test site, but are all located at the same fixed height above the floor.

B.1.2.2 Description

An anechoic chamber should meet the requirements for shielding loss and wall return loss as shown in figure B.2. Figure B.3 shows an example of the construction of an anechoic chamber having a base area of 5 m by 10 m and a height of 5 m. The ceiling and walls are coated with pyramidically formed absorbers approximately 1 m high. The base is covered with special absorbers which form the floor. The available internal dimensions of the chamber are 3 m × 8 m × 3 m, so that a maximum measuring distance of 5 m in the middle axis of this chamber is available. The floor absorbers reject floor reflections so that the antenna height needs not be changed. Anechoic chambers of other dimensions may be used.

B.1.2.3 Influence of parasitic reflections

For free-space propagation in the far field, the relationship of the field strength E and the distance R is given by $E = E_0 \times (R_0/R)$, where E_0 is the reference field strength and R_0 is the reference distance. This relationship allows relative measurements to be made as all constants are eliminated within the ratio and neither cable attenuation nor antenna mismatch or antenna dimensions are of importance.

If the logarithm of the foregoing equation is used, the deviation from the ideal curve may be easily seen because the ideal correlation of field strength and distance appears as a straight line. The deviations occurring in practice are then clearly visible. This indirect method shows quickly and easily any disturbances due to reflections and is far less difficult than the direct measurement of reflection attenuation.

With an anechoic chamber of the dimensions given above at low frequencies below 100 MHz there are no far field conditions, but the wall reflections are stronger, so that careful calibration is necessary. In the medium frequency range from 100 MHz to 1 GHz the dependence of the field strength to the distance meets the expectations very well. Above 1 GHz, because more reflections will occur, the dependence of the field strength to the distance will not correlate so closely.

B.1.2.4 Calibration and mode of use

The calibration and mode of use is the same as for an open air test site, the only difference being that the test antenna does not need to be raised and lowered whilst searching for a maximum, which simplifies the method of measurement.

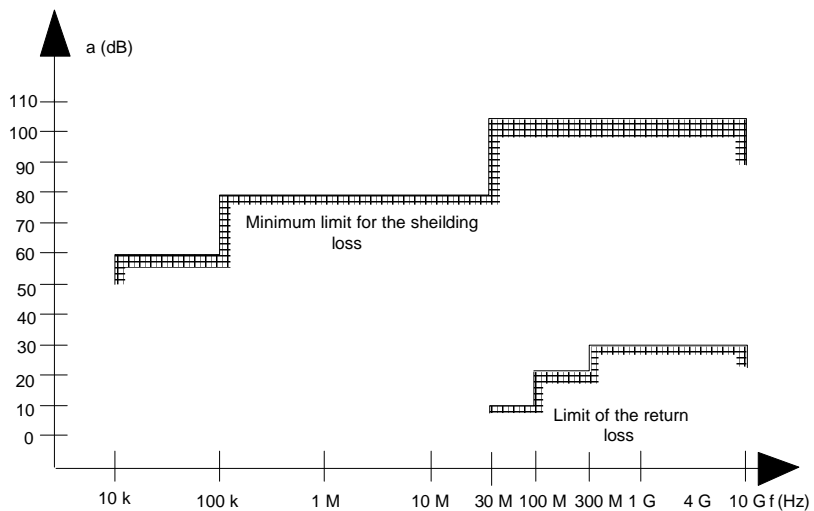

Figure B.2: Specification for shielding and reflections

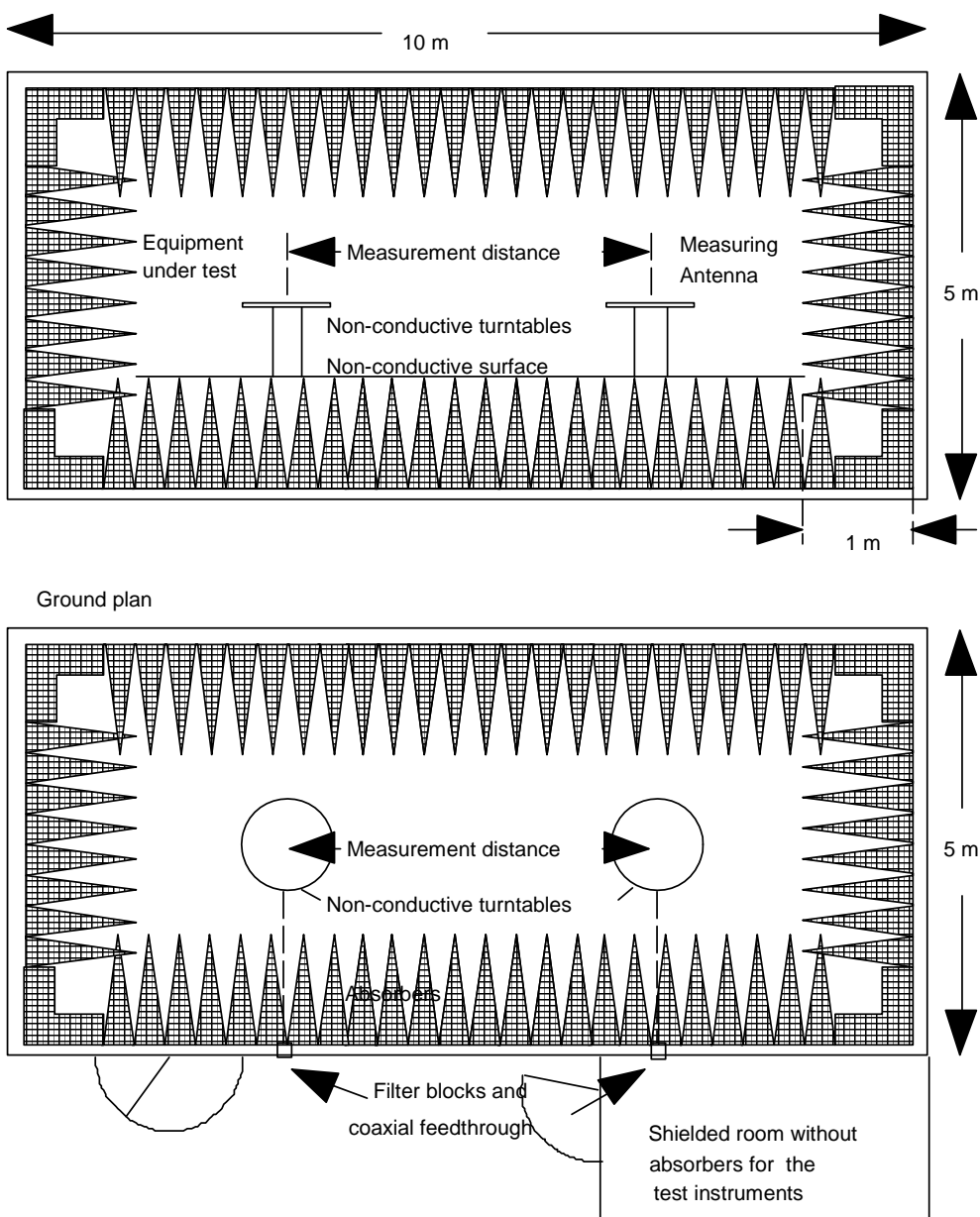

Figure B.3: Anechoic shielded chamber for simulated free space measurements

B.2 Test antenna

When the test site is used for radiation measurements the test antenna shall be used to detect the field from both the test sample and the substitution antenna. When the test site is used for the measurement of receiver characteristics the antenna shall be used as a transmitting antenna. This antenna shall be mounted on a support capable of allowing the antenna to be used in either horizontal or vertical polarization and for the height of its centre above the ground to be varied over the specified range. Preferably test antennas with pronounced directivity should be used. The size of the test antenna along the measurement axis shall not exceed 20 % of the measuring distance.

B.3 Substitution antenna

The substitution antenna shall be used to replace the UUT in substitution measurements. For measurements below 1 GHz the substitution antenna shall be a half wavelength dipole resonant at the frequency under consideration, or a shortened dipole, calibrated to the half wavelength dipole. For measurements between 1 GHz and 4 GHz either a half wavelength dipole or a horn radiator may be used. For measurements above 4 GHz a horn radiator shall be used. The centre of this antenna shall coincide with the reference point of the test sample it has replaced. This reference point shall be the volume centre of the sample when its antenna is mounted inside the cabinet, or the point where an outside antenna is connected to the cabinet.

The distance between the lower extremity of the dipole and the ground shall be at least 30 cm.

NOTE: The gain of a horn antenna is generally expressed relative to an isotropic radiator.

Annex C (normative): General description of measurement

This annex gives the general methods of measurements for RF signals using the test sites and arrangements described in annex B.

C.1 Conducted measurements

Conducted measurements may be applied to equipment provided with an antenna connector(s) e.g. by means of a spectrum analyser.

C.2 Radiated measurements

Radiated measurements shall be performed with the aid of a test antenna and measurement instruments as described in annex B. The test antenna and measurement instrument shall be calibrated according to the procedure defined in this annex. The equipment to be measured and the test antenna shall be oriented to obtain the maximum emitted power level. This position shall be recorded in the measurement report. The frequency range shall be measured in this position.

Radiated measurements should be performed in an anechoic chamber. For other test sites corrections may be needed (see annex B). The following test procedure applies:

- a) A test site which fulfils the requirements of the specified frequency range of this measurement shall be used. The test antenna shall be oriented initially for vertical polarization unless otherwise stated and the transmitter under test shall be placed on the support in its standard position (clause B.1.1) and switched on.
- b) For average power measurements a non-selective voltmeter or wideband spectrum analyser shall be used. For other measurements a spectrum analyser or selective voltmeter shall be used and tuned to the measurement frequency.

In either case a) or b), the test antenna shall be raised or lowered, if necessary, through the specified height range until the maximum signal level is detected on the spectrum analyser or selective voltmeter.

The test antenna need not be raised or lowered if the measurement is carried out on a test site according to clause B.1.2.

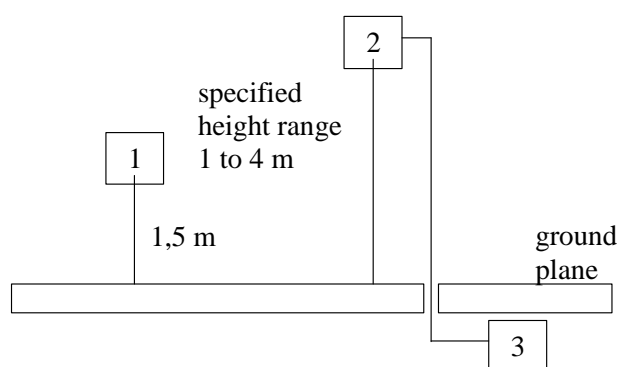

- 1: Equipment under test.
- 2: Test antenna.
- 3: Spectrum analyser or measuring receiver.

Figure C.1: Measurement arrangement 1

- The transmitter shall be rotated through 360° about a vertical axis until a higher maximum signal is received.
- The test antenna shall be raised or lowered again, if necessary, through the specified height range until a maximum is obtained. This level shall be recorded.

NOTE: This maximum may be a lower value than the value obtainable at heights outside the specified limits.

The test antenna need not be raised or lowered if the measurement is carried out on a test site according to clause B.1.2. This measurement shall be repeated for horizontal polarization. The result of the measurement is the higher power obtained from the two measurements with the indication of the corresponding polarization.

C.3 Substitution measurement

The actual signal generated by the measured equipment may be determined by means of a substitution measurement in which a known signal source replaces the device to be measured, see figure C.2. This method of measurement should be used in an anechoic chamber. For other test sites corrections may be needed, see annex B.

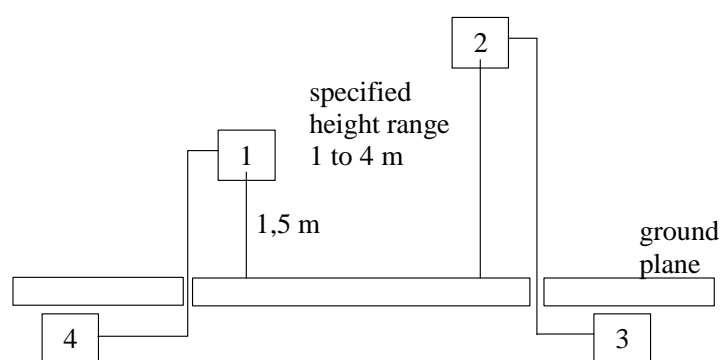

- 1: Substitution antenna.
- 2: Test antenna.
- 3: Spectrum analyser or selective voltmeter.
- 4: Signal generator.

Figure C.2: Measurement arrangement 2

Using measurement arrangement 2, figure C.2, the substitution antenna shall replace the transmitter antenna in the same position and in vertical polarization. The frequency of the signal generator shall be adjusted to the measurement frequency. The test antenna shall be raised or lowered, if necessary, to ensure that the maximum signal is still received. The input signal to the substitution antenna shall be adjusted in level until an equal or a known related level to that detected from the transmitter is obtained in the test receiver.

The test antenna need not be raised or lowered if the measurement is carried out on a test site according to clause B.1.2.

The radiated power is equal to the power supplied by the signal generator, increased by the known relationship if necessary and after corrections due to the gain of the substitution antenna and the cable loss between the signal generator and the substitution antenna.

This measurement shall be repeated with horizontal polarization. The result of the measurement is the higher power obtained from the two measurements with the indication of the corresponding polarization.

Annex D (normative): DFS parameters

Table D.1: DFS requirement values

Parameter	Value
Channel Availability Check Time	60 s (see note 1)
Minimum Off-Channel CAC Time	6 minutes (see note 2)
Maximum Off-Channel CAC Time	4 hours (see note 2)
Channel Move Time	10 s
Channel Closing Transmission Time	1 s
Non-Occupancy Period	30 minutes
NOTE 1: For channels whose nominal bandwidth falls completely or partly within the band 5 600 MHz to 5 650 MHz, the <i>Channel Availability Check Time</i> shall be 10 minutes.	
NOTE 2: For channels whose nominal bandwidth falls completely or partly within the band 5 600 MHz to 5 650 MHz, the <i>Off-Channel CAC Time</i> shall be within the range 1 to 24 hours.	

Table D.2: Interference threshold values

e.i.r.p. Spectral Density dBm/MHz	Value (see notes 1 and 2)
10	-62 dBm
NOTE 1: This is the level at the input of the receiver of an RLAN device with a maximum e.i.r.p. density of 10 dBm/MHz and assuming a 0 dBi receive antenna. For devices employing different e.i.r.p. spectral density and/or a different receive antenna gain G (dBi) the DFS threshold level at the receiver input follows the following relationship: DFS Detection Threshold (dBm) = -62 + 10 · e.i.r.p. Spectral Density (dBm/MHz) + G (dBi), however the DFS threshold level shall not be lower than -64 dBm assuming a 0 dBi receive antenna gain.	
NOTE 2: Slave devices with a maximum e.i.r.p. of less than 23 dBm do not have to implement radar detection.	

Table D.3: Parameters of the reference DFS test signal

Pulse width W [μ s]	Pulse repetition frequency PRF [PPS]	Pulses per burst [PPB]
1	700	18

Table D.4: Parameters of radar test signals

Radar test signal # (see notes 1 to 3)	Pulse width W [μ s]		Pulse repetition frequency PRF (PPS)		Number of different PRFs	Pulses per burst for each PRF (PPB) (see note 5)
	Min	Max	Min	Max		
1	0,5	5	200	1 000	1	10 (see note 6)
2	0,5	15	200	1 600	1	15 (see note 6)
3	0,5	15	2 300	4 000	1	25
4	20	30	2 000	4 000	1	20
5	0,5	2	300	400	2/3	10 (see note 6)
6	0,5	2	400	1 200	2/3	15 (see note 6)

NOTE 1: Radar test signals 1 to 4 are constant PRF based signals. See figure D.1. These radar test signals are intended to simulate also radars using a packet based Staggered PRF. See figure D.2.

NOTE 2: Radar test signal 4 is a modulated radar test signal. The modulation to be used is a chirp modulation with a $\pm 2,5$ MHz frequency deviation which is described below.

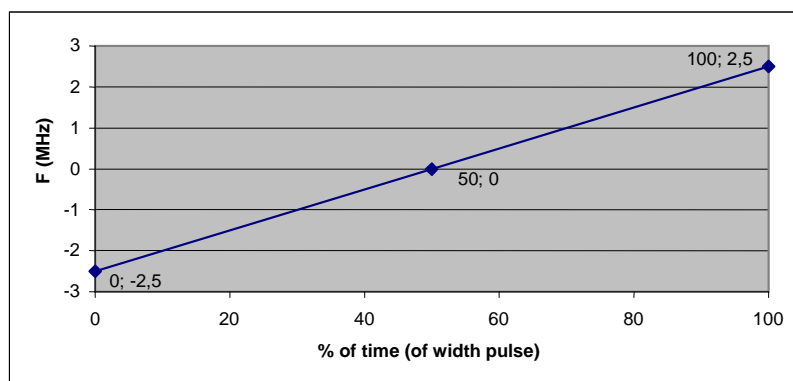

NOTE 3: Radar test signals 5 and 6 are single pulse based Staggered PRF radar test signals using 2 or 3 different PRF values. For radar test signal 5, the difference between the PRF values chosen shall be between 20 PPS and 50 PPS. For radar test signal 6, the difference between the PRF values chosen shall be between 80 PPS and 400 PPS. See figure D.3.

NOTE 4: Apart for the Off-Channel CAC testing, the radar test signals above shall only contain a single burst of pulses. See figures D.1, D.3 and D.4. For the Off-Channel CAC testing, repetitive bursts shall be used for the total duration of the test. See figures D.2 and D.5. See also clauses 4.7.2.2, 5.3.8.2.1.3.1 and 5.3.8.2.1.3.2.

NOTE 5: The total number of pulses in a burst is equal to the number of pulses for a single PRF multiplied by the number of different PRFs used.

NOTE 6: For the CAC and Off-Channel CAC requirements, the minimum number of pulses (for each PRF) for any of the radar test signals to be detected in the band 5 600 MHz to 5 650 MHz shall be 18.

Table D.5: Detection probability

Parameter	Detection Probability (P_d)	
	Channels whose nominal bandwidth falls partly or completely within the 5 600 MHz to 5 650 MHz band	Other channels
CAC, Off-Channel CAC	99,99 %	60 %
In-Service Monitoring	60 %	60 %

NOTE: P_d gives the probability of detection per simulated radar burst and represents a minimum level of detection performance under defined conditions. Therefore P_d does not represent the overall detection probability for any particular radar under real life conditions.

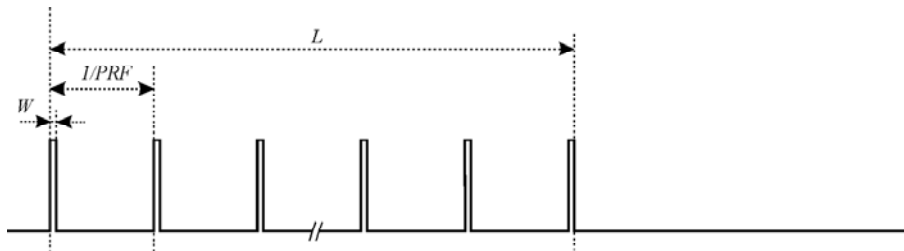

Figure D.1: General structure of a single burst/constant PRF based radar test signal

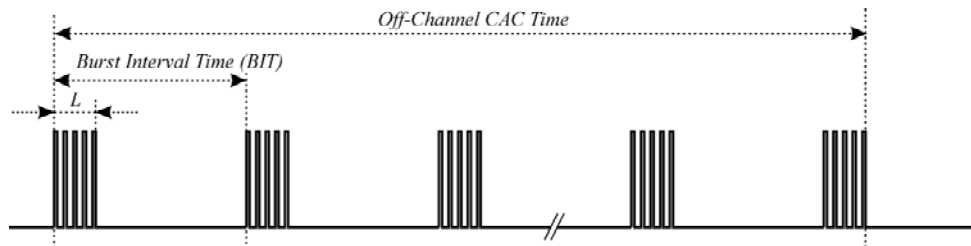

Figure D.2: General structure of a multiple burst/constant PRF based radar test signal

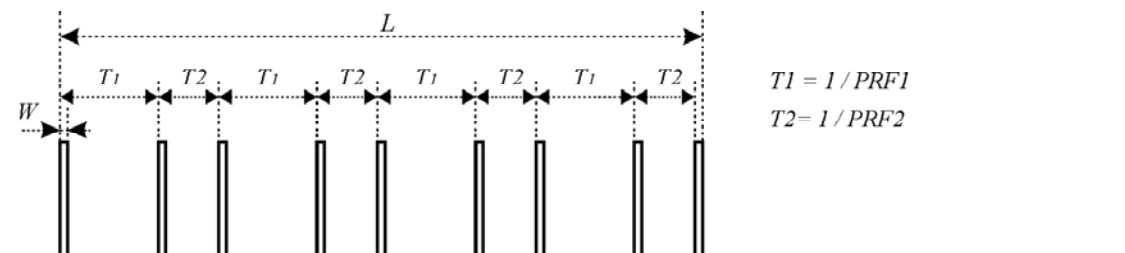

Figure D.3: General structure of a single burst/single pulse based staggered PRF radar test signal

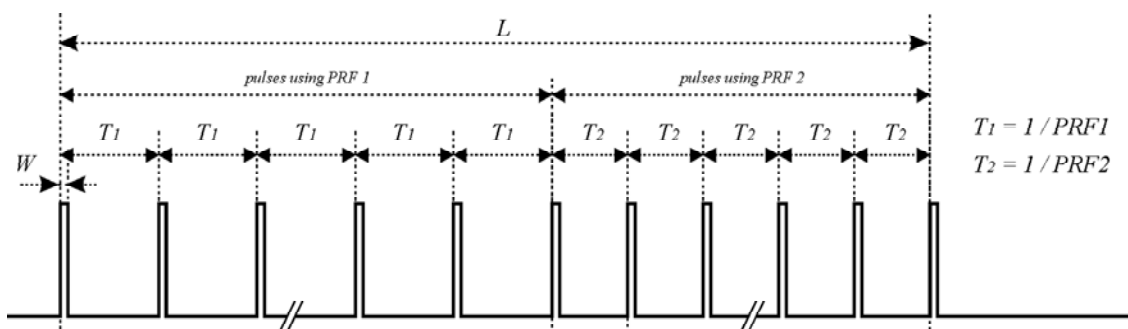

Figure D.4: General structure of a single burst/packet based staggered PRF radar test signal

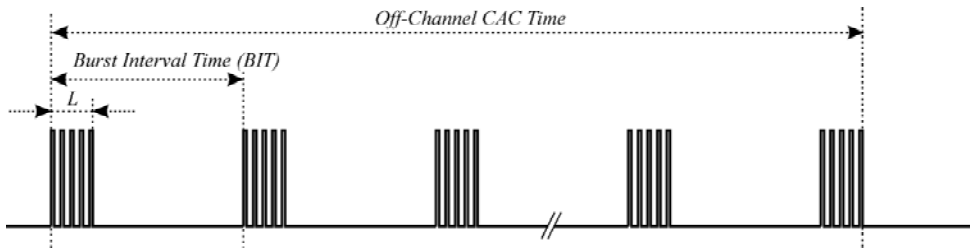

Figure D.5: General structure of a multiple burst/packet based staggered PRF based radar test signal

Annex E (informative): Guidance for testing IEEE 802.11n™ Devices

E.1 Introduction

The following guidance may be used by test labs and manufacturers when evaluating compliance of IEEE 802.11n™ [10] radio devices to the present document. The technology-specific information in this annex *does not* constitute additional requirements and *does not* modify the technical requirements of the present document.

In addition to the mandatory and optional modes defined in the IEEE 802.11n™ [10] technology standard, Smart Antenna Systems may utilize additional modes of operation not defined in the IEEE 802.11n™ [10] standard. Therefore, this annex presents a non-exhaustive list of the most commonly expected modes and operating states for IEEE 802.11n™-based devices [10] with the associated references to the appropriate categories for testing in the present document.

The guidance provided in this informative annex assumes that the product utilizes two or more transmit and receive chains.

E.2 Possible Modulations

Listed below are the most common modulation types and channel widths used by 5 GHz IEEE 802.11n™ [10] devices:

- IEEE 802.11™ [9] modulations using a single or multiple transmitters with or without transmit CSD.
- HT20: 20 MHz channels with one to four spatial streams (MCS 0 through MCS 76).
- HT40: 40 MHz channels with one to four spatial streams (MCS 0 through MCS 76).

NOTE: A spatial stream is a stream of bits transmitted over a separate spatial dimension. The number of spatial streams is not necessarily equivalent to the number of transmit chains.

E.2.1 Guidance for Testing

The objective is to test the equipment in configurations which result in the highest e.i.r.p. and e.i.r.p. density. These configurations are further referred to as the worst-case.

E.2.1.1 Modulation Used for Conformance Testing

One worst case modulation type for 20 MHz operation (and one worst case modulation type for 40 MHz operation, if supported) should be identified and used for conformance testing per the present document.

Where the 20 MHz and 40 MHz modes support different numbers of transmit chains and spatial streams, testing may need to be performed to identify the worst case modes.

Comparison measurements of mean RF output power (or mean e.i.r.p.) and power density (or e.i.r.p. density), across all modulations can be used to establish the worst case modulation type for 20 MHz operation (and the worse case modulation type for 40 MHz if supported).

EXAMPLE 1: If comparison measurements determine that HT20 MCS 0 (6,5 Mbit/s, one spatial stream) is worst-case, then this mode should be used for conformance testing (and not 802.11 modulations and not HT20 MCS 1 through MCS 15). One worst-case modulation for HT40 operation should be identified and used for the conformance testing.

EXAMPLE 2: However, if the product has transmit power levels different for IEEE 802.11™ [9] vs. HT20 operation, then worst-case modulation type should be identified for both modes and used for testing the e.i.r.p. and e.i.r.p. density which need to be repeated for both IEEE 802.11™ [9] and HT20 operation.

The e.i.r.p. and e.i.r.p. density conformance tests should be repeated using the worst-case IEEE 802.11™ [9] and HT20 modes, respectively. In this case three sets of e.i.r.p. and e.i.r.p. density conformance testing should be performed:

- Worst-case IEEE 802.11™ [9] modulation.
- Worst-case HT20 modulation.
- Worst-case HT40 modulation.

NOTE: In some operating modes, the CSD feature may be disabled. Comparison testing between CSD enabled and CSD disabled will determine the worse-case configuration, and this configuration will then be used during the conformance testing.

E.3 Possible Operating Modes

Listed below are the most common operating states of multiple transmit/receive chains within Smart Antenna Systems:

- Beamforming feature implemented and enabled or disabled.
- All *available* transmit and receive chains enabled.
- A subset of the present transmit/receive chains temporarily disabled during normal operation (i.e. dynamically, based on link conditions or power requirements). In this case, a vendor may implement higher transmit power settings (dynamically) for the active transmit chains.
- Although not commonly expected, it is possible that a device may utilize different transmit power settings between one or more of the present transmit chains.

E.3.1 Guidance for Testing

The e.i.r.p. and e.i.r.p. density tests should be repeated using the worst-case Modulations described above and in the following operating states when supported by the device:

- Where one or more of the transmit chains is manually or automatically disabled during normal operation and different target RF output power levels are used depending on the number of active transmit chains, then e.i.r.p. and e.i.r.p. density conformance testing should be performed using each configuration.

EXAMPLE 1: A device with three transmit chains may support an operating mode using three transmit chains at one power level and another operating mode in which one transmit chain is using a higher power level while the other transmit chains are disabled. The e.i.r.p. and e.i.r.p. density conformance testing should be repeated (using the worst-case modulation types described above) for both of the above mentioned (three-transmit and single-transmit) operating modes.

EXAMPLE 2: A device with three transmit chains which does not change its (per transmit chain) RF output power based on the number of active chains, need not undergo repeat testing for all the transmit chains.

- Where a beamforming feature is implemented, conformance testing should be performed as indicated for a device with a beamforming feature:
 - Where the beamforming feature may be disabled manually or automatically, conformance testing does not need to be repeated if the (per transmit chain) RF output power settings remain unchanged.
 - Where the beamforming feature may be disabled manually or automatically, conformance testing needs to be repeated if different (per transmit chain) RF output power settings will be used.

Annex F (informative): Application form for testing

The form contained in this annex may be used by the manufacturer to comply with the requirements contained in clause 5.3.1 to provide the necessary information about the equipment to the test laboratory prior to the testing. It contains product information as well as other information which might be required to define which configurations shall be tested, which tests shall be performed as well as the test conditions.

If used, this application form should form an integral part of the test report.

F.1 Information as required by EN 301 893 (V1.7.1), clause 5.3.1

In accordance with EN 301 893, clause 5.3.1, the following information is provided by the manufacturer.

a) The Nominal Channel Bandwidth(s):

Nominal Channel Bandwidth 1: MHz

Nominal Channel Bandwidth 2: MHz

Nominal Channel Bandwidth 3: MHz

The associated centre frequencies:

For Nominal Channel Bandwidth 1:

for the band 5 150 - 5 350 MHz: MHz; MHz; MHz; MHz;

for the band 5 470 - 5 725 MHz: MHz; MHz; MHz; MHz;

For Nominal Channel Bandwidth 2:

for the band 5 150 - 5 350 MHz: MHz; MHz; MHz; MHz;

for the band 5 470 - 5 725 MHz: MHz; MHz; MHz; MHz;

For Nominal Channel Bandwidth 3:

for the band 5 150 - 5 350 MHz: MHz; MHz; MHz; MHz;

for the band 5 470 - 5 725 MHz: MHz; MHz; MHz; MHz;

b) For equipment that support simultaneous transmissions in one or more channels:

The (maximum) number of channels used for these simultaneous transmissions:

These channels are adjacent channels: Yes No

In case of non-adjacent channels, whether or not these channels are in different sub-bands:

Yes No

NOTE 1: In case of simultaneous transmissions, further information defining the channels used for these simultaneous transmissions may be required.

c) **The different transmit operating modes (see clause 5.1.4.2) (tick all that apply):**

- Operating mode 1:** Single Antenna Equipment
- a) Equipment with only 1 antenna
 - b) Equipment with diversity antennas but only 1 antenna active at any moment in time
 - c) Smart Antenna Systems with 2 or more antennas, but operating in a (legacy) mode where only 1 antenna is used. (e.g. IEEE 802.11a legacy mode in smart antenna systems)
- Operating mode 2:** Smart Antenna Systems - Multiple Antennas without beamforming
- a) Single spatial stream/Standard throughput (e.g. IEEE 802.11a legacy mode)
 - b) High Throughput (>1 spatial stream) using Nominal Channel Bandwidth 1
 - c) High Throughput (>1 spatial stream) using Nominal Channel Bandwidth 2
- Operating mode 3:** Smart Antenna Systems - Multiple Antennas with beamforming
- a) Single spatial stream/Standard throughput (e.g. IEEE 802.11a legacy mode)
 - b) High Throughput (>1 spatial stream) using Nominal Channel Bandwidth 1
 - c) High Throughput (>1 spatial stream) using Nominal Channel Bandwidth 2

d) **In case of Smart Antenna Systems or multiple antenna systems**

- The number of Receive chains:
- The number of Transmit chains:
- Equal power distribution among the transmit chains: Yes No
- In case of beamforming, the maximum (additional) beamforming gain: dB

NOTE 2: Beamforming gain does not include the basic gain of a single antenna (assembly).

e) **TPC feature available:**

- Yes
- No

f) **For equipment with TPC range:**

The lowest and highest power level (or lowest and highest e.i.r.p. level in case of integrated antenna equipment), intended antenna assemblies and corresponding operating frequency range for the TPC range (or for each of the TPC ranges if more than one is implemented).

TPC range 1: Applicable Frequency Range:

- 5 150 MHz to 5 350 MHz and 5 470 MHz to 5 725 MHz (Indoor)
 Simultaneous transmissions in both sub-bands: Yes No
- 5 470 MHz to 5 725 MHz only (Outdoor only)

Applicable power levels (see note): Tx out e.i.r.p

NOTE 3: Indicate whether the power levels specified are Transmitter Output Power levels or e.i.r.p. levels in case of integrated antenna equipment.

If more than 1 transmit chain is present (e.g. in the case of smart antenna systems), the power levels below represent the power settings per active transmit chain (and per sub-band in case of simultaneous transmissions).

Table F.1: Power levels for TPC range 1

	Sub-band (MHz)	Operating Mode 1 (dBm)	Operating Mode 2 (dBm)	Operating Mode 3 (dBm)
Lowest setting (P_{low})	5 150 to 5 350
	5 470 to 5 725
Highest setting (P_{high})	5 150 to 5 350
	5 470 to 5 725

Beamforming possible: Yes No

Intended Antenna Assemblies:

Table F.2: Intended Antenna Assemblies for TPC range 1

Antenna Assembly name	Antenna Gain (dBi)	Operating Mode	Sub-band (MHz)	Beam forming gain (dB)	e.i.r.p. for P_{low} (dBm)	e.i.r.p. for P_{high} (dBm)
<Antenna 1>	Mode 1	5 150 to 5 350
			5 470 to 5 725
		Mode 2	5 150 to 5 350
			5 470 to 5 725
		Mode 3	5 150 to 5 350
			5 470 to 5 725
<Antenna 2>	Mode 1	5 150 to 5 350
			5 470 to 5 725
		Mode 2	5 150 to 5 350
			5 470 to 5 725
		Mode 3	5 150 to 5 350
			5 470 to 5 725
<Antenna 3>	Mode 1	5 150 to 5 350
			5 470 to 5 725
		Mode 2	5 150 to 5 350
			5 470 to 5 725
		Mode 3	5 150 to 5 350
			5 470 to 5 725

DFS Threshold level: dBm at the antenna connector
 in front of the antenna

TPC range 2: Applicable Frequency Range:

- 5 150 MHz to 5 350 MHz and 5 470 MHz to 5 725 MHz (Indoor)
 Simultaneous transmissions in both sub-bands: Yes No
- 5 470 MHz to 5 725 MHz only (Outdoor only)

Applicable power levels (see note): Tx out e.i.r.p

NOTE 4: Indicate whether the power levels specified are Transmitter Output Power levels or e.i.r.p. levels in case of integrated antenna equipment.

If more than 1 transmit chain is present (e.g. in the case of smart antenna systems), the power levels below represent the power settings per active transmit chain (and per sub-band in case of simultaneous transmissions).

Table F.3: Power levels for TPC range 2

	Sub-band (MHz)	Operating Mode 1 (dBm)	Operating Mode 2 (dBm)	Operating Mode 3 (dBm)
Lowest setting (P_{low})	5 150 to 5 350
	5 470 to 5 725
Highest setting (P_{high})	5 150 to 5 350
	5 470 to 5 725

Beamforming possible: Yes No

Intended Antenna Assemblies:

Table F.4: Intended Antenna Assemblies for TPC range 2

Antenna Assembly name	Antenna Gain (dBi)	Operating Mode	Sub-band (MHz)	Beam forming gain (dB)	EIRP for P _{low} (dBm)	EIRP for P _{high} (dBm)
<Antenna 1>	Mode 1	5 150 to 5 350
			5 470 to 5 725
		Mode 2	5 150 to 5 350
			5 470 to 5 725
		Mode 3	5 150 to 5 350
			5 470 to 5 725
<Antenna 2>	Mode 1	5 150 to 5 350
			5 470 to 5 725
		Mode 2	5 150 to 5 350
			5 470 to 5 725
		Mode 3	5 150 to 5 350
			5 470 to 5 725
<Antenna 3>	Mode 1	5 150 to 5 350
			5 470 to 5 725
		Mode 2	5 150 to 5 350
			5 470 to 5 725
		Mode 3	5 150 to 5 350
			5 470 to 5 725

DFS Threshold level: dBm at the antenna connector

in front of the antenna

g) For equipment without a TPC range:

Power Setting 1: Applicable Frequency Range:

5 150 MHz to 5 350 MHz and 5 470 MHz to 5 725 MHz (Indoor)
 Simultaneous transmissions in both sub-bands: Yes No

5 470 MHz to 5 725 MHz only (Outdoor only)

Applicable power levels (see note): Tx out e.i.r.p.

NOTE 5: Indicate whether the power levels specified are Transmitter Output Power levels or e.i.r.p. levels in case of integrated antenna equipment.

If more than 1 transmit chain is present (e.g. in the case of smart antenna systems), the power levels below represent the power settings per active transmit chain (and per sub-band in case of simultaneous transmissions).

Table F.5: Maximum Transmitter Output Power for Power Setting 1

Sub-band (MHz)	Operating Mode 1 (dBm)	Operating Mode 2 (dBm)	Operating Mode 3 (dBm)
5 150 to 5 350
5 470 to 5 725

Beamforming possible: Yes No

Intended Antenna Assemblies:

Table F.6: Intended Antenna Assemblies for Power Setting 1

Antenna Assembly name	Antenna Gain (dBi)	Operating Mode	Sub-band (MHz)	Beam forming gain (dB)	e.i.r.p. (dBm)
<Antenna 1>	Mode 1	5 150 to 5 350
			5 470 to 5 725
		Mode 2	5 150 to 5 350
			5 470 to 5 725
		Mode 3	5 150 to 5 350
			5 470 to 5 725
<Antenna 2>	Mode 1	5 150 to 5 350
			5 470 to 5 725
		Mode 2	5 150 to 5 350
			5 470 to 5 725
		Mode 3	5 150 to 5 350
			5 470 to 5 725
<Antenna 3>	Mode 1	5 150 to 5 350
			5 470 to 5 725
		Mode 2	5 150 to 5 350
			5 470 to 5 725
		Mode 3	5 150 to 5 350
			5 470 to 5 725

DFS Threshold level: dBm at the antenna connector

in front of the antenna

Power Setting 2: Applicable Frequency Range:

5 150 MHz to 5 350 MHz and 5 470 MHz to 5 725 MHz (Indoor)
Simultaneous transmissions in both sub-bands: Yes No

5 470 MHz to 5 725 MHz only (Outdoor only)

Applicable power levels (see note): Tx out e.i.r.p.

NOTE 6: Indicate whether the power levels specified are Transmitter Output Power levels or e.i.r.p. levels in case of integrated antenna equipment.

If more than 1 transmit chain is present (e.g. in the case of smart antenna systems), the power levels below represent the power settings per active transmit chain (and per sub-band in case of simultaneous transmissions).

Table F.7: Maximum Transmitter Output Power for Power Setting 2

Sub-band (MHz)	Operating Mode 1 (dBm)	Operating Mode 2 (dBm)	Operating Mode 3 (dBm)
5 150 to 5 350
5 470 to 5 725

Beamforming possible: Yes No

Intended Antenna Assemblies:

Table F.8: Intended Antenna Assemblies for Power Setting 2

Antenna Assembly name	Antenna Gain (dBi)	Operating Mode	Sub-band (MHz)	Beam forming gain (dB)	e.i.r.p. (dBm)
<Antenna 1>	Mode 1	5 150 to 5 350
			5 470 to 5 725
		Mode 2	5 150 to 5 350
			5 470 to 5 725
		Mode 3	5 150 to 5 350
			5 470 to 5 725
<Antenna 2>	Mode 1	5 150 to 5 350
			5 470 to 5 725
		Mode 2	5 150 to 5 350
			5 470 to 5 725
		Mode 3	5 150 to 5 350
			5 470 to 5 725
<Antenna 3>	Mode 1	5 150 to 5 350
			5 470 to 5 725
		Mode 2	5 150 to 5 350
			5 470 to 5 725
		Mode 3	5 150 to 5 350
			5 470 to 5 725

DFS Threshold level: dBm at the antenna connector
 in front of the antenna

h) The DFS related operating mode(s) of the equipment

- Master
 Slave with radar detection
 Slave without radar detection

NOTE 7: If the equipment has more than 1 operating mode, tick all that apply.

i) User access restrictions (please check box below to confirm)

- DFS controls (hardware or software) related to radar detection are NOT accessible to the user

j) For equipment with Off-Channel CAC functionality

The equipment has an "Off-Channel CAC" function: Yes No

If yes, specify the "Off-Channel CAC Time"

- For channels outside the 5 600 MHz to 5 650 MHz range: hours
- If applicable, for channels (partially) within the 5 600 MHz to 5 650 MHz range: hours

k) The equipment can operate in ad-hoc mode

- no ad-hoc operation
 ad-hoc operation in the frequency range 5 150 MHz to 5 250 MHz without DFS
 ad-hoc operation with DFS

NOTE 8: If more than 1 is applicable, tick all that apply.

l) Operating Frequency Range(s):Range 1: 5 150 MHz to 5 350 MHz and 5 470 MHz to 5 725 MHzRange 2: 5 470 MHz to 5 725 MHzRange 3: 5 150 MHz to 5 250 MHz (ad-hoc without DFS)Range 4: other, please specify:

NOTE 9: If the equipment has more than 1 Operating Frequency Range, tick all that apply.

m) The extreme operating temperature and supply voltage range that apply to the equipment: -20 °C to +55 °C (Outdoor & Indoor usage) 0 °C to +35 °C (Indoor usage only) Other:

The supply voltages of the stand-alone radio equipment or the supply voltages of the combined (host) equipment or test jig in case of plug-in devices:

Details provided are for the: stand-alone equipment combined (or host) equipment test jigSupply Voltage AC mains State AC voltage: Minimum: ... Nominal: ... Maximum: ... DC State DC voltage Minimum: ... Nominal: ... Maximum: ...

In case of DC, indicate the type of power source:

 Internal Power Supply External Power Supply or AC/DC adapter Battery Nickel Cadmium Alkaline Nickel-Metal Hydride Lithium-Ion Lead acid (Vehicle regulated) Other**n) The test sequence/test software used (see also EN 301 893 (V1.7.1), clause 5.1.2)**

.....

.....

.....

o) Type of Equipment Stand-alone Combined Equipment (Equipment where the radio part is fully integrated within another type of equipment) Plug-in radio device (Equipment intended for a variety of host systems) Other

- p) **Adaptivity (Channel Access Mechanism)** Yes No
- Frame Based Equipment
- Load Based Equipment
- Specify which protocol has been implemented: 802.11 Other:

q) **Clear Channel Assessment**

The CCA time implemented by the equipment:

In case of Load Based Equipment, the value "q" referred to in EN 301 893 (V1.7.1) clause 4.9.2.2 point 1: ...

F.2 Additional information provided by the manufacturer

F.2.1 Modulation:

Can the transmitter operate un-modulated? Yes No

F.2.2 Duty Cycle

The transmitter is intended for : Continuous duty
 Intermittent duty
 Continuous operation possible for testing purposes

F.2.3 About the UUT

- The equipment submitted are representative production models.
- If not, the equipment submitted are pre-production models?
- If pre-production equipment are submitted, the final production equipment will be identical in all respects with the equipment tested.
- If not, supply full details:
.....
.....
- The equipment submitted is CE marked:
- The CE marking does include the Class-II identifier (Alert Sign).
- The CE marking does include a 4 digit number referring to the Notified Body involved.

Annex G (informative):
Void

Annex H (informative): Bibliography

- ITU-R Recommendation M.1652: "Dynamic frequency selection (DFS) in wireless access systems including radio local area networks for the purpose of protecting the radiodetermination service in the 5 GHz band".
- Directive 2004/108/EC of the European Parliament and of the Council of 15 December 2004 on the approximation of the laws of the Member States relating to electromagnetic compatibility and repealing Directive 89/336/EEC (EMC Directive).
- Directive 2006/95/EC of the European Parliament and of the Council of 12 December 2006 on the harmonisation of the laws of Member States relating to electrical equipment designed for use within certain voltage limits (LV Directive).

History

Document history		
V1.2.3	August 2003	Publication
V1.3.1	August 2005	Publication
V1.4.1	July 2007	Publication
V1.5.1	December 2008	Publication
V1.6.1	November 2011	Publication
V1.7.0	January 2012	One-step Approval Procedure OAP 20120530: 2012-01-31 to 2012-05-30
V1.7.1	June 2012	Publication