

Draft **ETSI EN 301 839-1** V1.3.1 (2009-01)

European Standard (Telecommunications series)

**Electromagnetic compatibility
and Radio spectrum Matters (ERM);
Short Range Devices (SRD);
Ultra Low Power Active Medical Implants (ULP-AMI)
and Peripherals (ULP-AMI-P)
operating in the frequency range 402 MHz to 405 MHz;
Part 1: Technical characteristics and test methods**



Reference

REN/ERM-TG30-263-1

Keywords

radio, SRD, testing

ETSI

650 Route des Lucioles
F-06921 Sophia Antipolis Cedex - FRANCE

Tel.: +33 4 92 94 42 00 Fax: +33 4 93 65 47 16

Siret N° 348 623 562 00017 - NAF 742 C
Association à but non lucratif enregistrée à la
Sous-Préfecture de Grasse (06) N° 7803/88

Important notice

Individual copies of the present document can be downloaded from:

<http://www.etsi.org>

The present document may be made available in more than one electronic version or in print. In any case of existing or perceived difference in contents between such versions, the reference version is the Portable Document Format (PDF). In case of dispute, the reference shall be the printing on ETSI printers of the PDF version kept on a specific network drive within ETSI Secretariat.

Users of the present document should be aware that the document may be subject to revision or change of status. Information on the current status of this and other ETSI documents is available at

<http://portal.etsi.org/tb/status/status.asp>

If you find errors in the present document, please send your comment to one of the following services:

http://portal.etsi.org/chaicor/ETSI_support.asp

Copyright Notification

No part may be reproduced except as authorized by written permission.
The copyright and the foregoing restriction extend to reproduction in all media.

© European Telecommunications Standards Institute 2009.
All rights reserved.

DECT™, **PLUGTESTS™**, **UMTS™**, **TIPHON™**, the TIPHON logo and the ETSI logo are Trade Marks of ETSI registered for the benefit of its Members.

3GPP™ is a Trade Mark of ETSI registered for the benefit of its Members and of the 3GPP Organizational Partners.

LTE™ is a Trade Mark of ETSI currently being registered

for the benefit of its Members and of the 3GPP Organizational Partners.

GSM® and the GSM logo are Trade Marks registered and owned by the GSM Association.

Contents

Intellectual Property Rights	6
Foreword.....	6
Introduction	6
1 Scope	8
2 References	8
2.1 Normative references	9
2.2 Informative references.....	9
3 Definitions, symbols and abbreviations	10
3.1 Definitions	10
3.2 Symbols.....	12
3.3 Abbreviations	12
4 Technical requirements and specifications.....	13
4.1 General requirements	13
4.1.1 Transmitter requirements	13
4.1.2 Receiver requirements	13
4.2 Presentation of equipment for testing purposes.....	13
4.2.1 Choice of model for testing	13
4.2.2 Testing of equipment with alternative power levels	13
4.2.3 Presentation of equipment that does not have an external RF connector (integral antenna equipment)	13
4.2.3.1 Equipment with an internal permanent or temporary antenna connector	13
4.2.3.2 Equipment with a temporary antenna connector	14
4.2.3.3 Equipment intended to be implanted in a human body	14
4.3 Mechanical and electrical design.....	14
4.3.1 General.....	14
4.3.2 Controls	14
4.3.3 Transmitter shut-off facility	14
4.3.4 Marking	14
4.3.5 Equipment identification.....	14
4.4 Declarations by the Applicant	14
4.5 Auxiliary test equipment	15
4.6 Interpretation of the measurement results	15
5 Test conditions, power sources and ambient temperatures	15
5.1 Normal and extreme test conditions	15
5.2 Test power source.....	15
5.2.1 External test power source	15
5.2.2 Internal test power source	16
5.3 Normal test conditions.....	16
5.3.1 Normal temperature and humidity	16
5.3.2 Normal test power source	16
5.3.2.1 Mains voltage	16
5.3.2.2 Regulated lead-acid battery power sources	16
5.3.2.3 Other power sources.....	16
5.4 Extreme test conditions	17
5.4.1 Extreme temperatures	17
5.4.1.1 Procedure for tests at extreme temperatures.....	17
5.4.1.1.1 Procedure for equipment designed for continuous operation	17
5.4.1.1.2 Procedure for equipment designed for intermittent operation	17
5.4.1.2 Extreme temperature ranges.....	18
5.4.2 Extreme test source voltages.....	18
5.4.2.1 Mains voltage	18
5.4.2.2 Regulated lead-acid battery power sources	18
5.4.2.3 Power sources using other types of batteries.....	18
5.4.2.4 Other power sources.....	19

6	General conditions.....	19
6.1	Normal test signals and test modulation.....	19
6.1.1	Normal modulation test signals for data.....	19
6.2	Antennas.....	19
6.3	Artificial antenna.....	19
6.3.1	Artificial antenna for transmitters with 50 Ω impedance connector.....	20
6.4	Test fixture for ULP-AMI-P.....	20
6.5	Test fixture for ULP-AMI.....	20
6.6	Test sites and general arrangements for radiated measurements.....	20
6.7	Modes of operation of the transmitter.....	21
6.8	Measuring receiver.....	21
7	Measurement uncertainty.....	21
8	Methods of measurement and limits for transmitter parameters.....	22
8A	Introduction.....	22
8.1	Frequency error.....	22
8.1.1	Definition.....	23
8.1.1.1	Method of measurement for systems with an unmodulated carrier frequency operating mode.....	23
8.1.1.2	Method of measurement for systems with a modulated carrier frequency.....	23
8.1.2	Limit.....	23
8.2	Emission bandwidth measurement.....	24
8.2.1	Definition.....	24
8.2.1.1	Method of measurement.....	24
8.2.2	Limits.....	24
8.3	Effective radiated power of the fundamental emission.....	24
8.3.1	Definition.....	24
8.3.1.1	Methods of measurement.....	25
8.3.2	Limits.....	26
8.4	Spurious emissions.....	26
8.4.1	Definition.....	26
8.4.1.1	Method of measuring the effective radiated power of spurious emissions.....	26
8.4.2	Limits.....	27
8.5	Frequency stability under low voltage conditions.....	27
8.5.1	Definition.....	27
8.5.1.1	Method of measurement.....	28
8.5.2	Limits.....	28
8.6	ULP-AMI with restricted power and duty cycle.....	28
8.6.1	Definitions.....	28
8.6.2	Declaration of Duty Cycle.....	28
8.6.3	Limit for duty cycle and maximum number of transmissions.....	28
9	Methods of measurement and limits for receiver parameters.....	28
9.1	Spurious radiation.....	29
9.1.1	Definition.....	29
9.1.1.1	Method of measuring the effective radiated power of spurious radiations.....	29
9.1.2	Limits.....	30
10	Requirements and Measuring Methods for Monitoring Systems.....	30
10A	Purpose.....	30
10B	General Remarks on the Measurement Configuration.....	31
10.1	LBT threshold power level.....	31
10.1.1	Measurement method using out-of-operating-region disturbance.....	32
10.1.2	Measurement method using frequency administration commands.....	32
10.1.3	Results based on above test method.....	32
10.1.4	Limit.....	33
10.2	Monitoring system bandwidth.....	33
10.2.1	Measurement method using out-of-operating-region disturbance.....	33
10.2.2	Measurement method using frequency administration commands.....	34
10.2.3	Results based on above test method.....	34
10.3	Monitoring system scan cycle time and minimum channel monitoring period.....	34
10.3.1	Measurement method using out-of-operating-region disturbance.....	34
10.3.1.1	Scan cycle time.....	34

10.3.1.2	Minimum channel monitoring period	35
10.3.2	Measurement method using frequency administration commands	35
10.3.3	Results based on above test method.....	35
10.3.3.1	Scan cycle time	35
10.3.3.2	Minimum Channel Monitoring Period.....	35
10.4	Channel access based on ambient levels relative to the calculated access LBT threshold level, P_{Th}	36
10.4.1	Access based on lowest ambient level above P_{Th} using out-of-operating-region disturbance.....	36
10.4.2	Access based on lowest ambient level above P_{Th} using frequency administration commands	36
10.4.3	Results based on above test method.....	37
10.5	Discontinuation of MICS session if a silent period greater than or equal to 5 s occurs	37
10.5.1	Measurement method.....	37
10.5.2	Results based on above test method.....	37
10.6	Use of pre-scanned alternate channel	37
10.6.1	Measurement method for alternate channel selection using out-of-operating-region disturbance.....	38
10.6.2	Measurement method for alternate channel selection using frequency administration commands	39
10.6.3	Results based on above test method.....	39
Annex A (normative): Radiated measurements		40
A.1	Test sites and general arrangements for measurements involving the use of radiated fields	40
A.1.1	Outdoor test site	40
A.1.1.1	Standard position	40
A.1.1.2	Equipment in close proximity to the human body but external to it	41
A.1.1.3	Human torso simulator for ULP-AMI	41
A.1.2	Test antenna.....	42
A.1.3	Substitution antenna	42
A.1.4	Optional additional indoor site	43
A.2	Guidance on the use of radiation test sites	44
A.2.1	Measuring distance.....	44
A.2.2	Test antenna.....	44
A.2.3	Substitution antenna	44
A.2.4	Artificial antenna.....	44
A.2.5	Auxiliary cables.....	44
A.3	Further optional alternative indoor test site using an anechoic chamber	45
A.3.1	Example of the construction of a shielded anechoic chamber	45
A.3.2	Influence of parasitic reflections in anechoic chambers	45
A.3.3	Calibration of the shielded RF anechoic chamber	46
Annex B (normative): Technical performance of the spectrum analyser.....		48
Annex C (informative): Strategy for ULP-AMI/ULP-AMI-P in the band 402 MHz to 405 MHz (source ERM_TG30 see URL: http://www.etsi.org/)		49
Annex D (informative): Bibliography.....		50
History		51

Intellectual Property Rights

IPRs essential or potentially essential to the present document may have been declared to ETSI. The information pertaining to these essential IPRs, if any, is publicly available for **ETSI members and non-members**, and can be found in ETSI SR 000 314: "*Intellectual Property Rights (IPRs); Essential, or potentially Essential, IPRs notified to ETSI in respect of ETSI standards*", which is available from the ETSI Secretariat. Latest updates are available on the ETSI Web server (<http://webapp.etsi.org/IPR/home.asp>).

Pursuant to the ETSI IPR Policy, no investigation, including IPR searches, has been carried out by ETSI. No guarantee can be given as to the existence of other IPRs not referenced in ETSI SR 000 314 (or the updates on the ETSI Web server) which are, or may be, or may become, essential to the present document.

Foreword

This European Standard (Telecommunications series) has been produced by ETSI Technical Committee Electromagnetic compatibility and Radio spectrum Matters (ERM), and is now submitted for the Public Enquiry phase of the ETSI standards Two-step Approval Procedure.

For non EU countries the present document may be used for regulatory purposes.

The present document is part 1 of a multi-part deliverable covering Short Range Devices (SRD); Ultra Low Power Active Medical Implants (ULP-AMI) and Peripherals (ULP-AMI-P) operating in the frequency range 402 MHz to 405 MHz, as identified below:

Part 1: "Technical characteristics and test methods";

Part 2: "Harmonized EN covering essential requirements of article 3.2 of the R&TTE Directive".

Proposed national transposition dates	
Date of latest announcement of this EN (doa):	3 months after ETSI publication
Date of latest publication of new National Standard or endorsement of this EN (dop/e):	6 months after doa
Date of withdrawal of any conflicting National Standard (dow):	6 months after doa

Introduction

ULP-AMI/ULP-AMI-P equipment in the MICS service is a unique new technology, available world wide in the medical field, that will provide high speed communications capability between individuals with AIMDs and medical practitioners engaged in utilizing these AIMDs for the purposes of diagnosing and delivering therapy to individuals with various illnesses. Equipment in the MICS service consists of active medical implants that communicate to other active medical implants and/or to ULP-AMI-P as e.g. external programmer/control transmitters.

The present document includes methods of measurement for Ultra Low Power Active Medical Implants (ULP-AMI) and Peripherals (ULP-AMI-P), fitted with antenna connector and/or integral antenna. Equipment designed for use with an integral antenna may be supplied with a temporary or permanent internal connector for the purpose of testing, providing the characteristics being measured are not expected to be affected.

If equipment, which is available on the market, is required to be checked it should be tested in accordance with the methods of measurement specified in the present document.

Clauses 1 through 3 provide a general description on the types of equipment covered by the present document and the definitions, symbols and abbreviations used.

Clause 4 provides a guide to requirements, the number of samples required in order that tests may be carried out and any markings on the equipment that the provider has to supply.

Clauses 5 and 6 provide general test conditions to be used.

Clause 7 gives the maximum measurement uncertainty values.

Clauses 8, 9 and 10 specify spectrum utilization parameters and the measurement methods that are required for the protection of the spectrum and patient. Clause 10 describes channel access requirements and methods. In particular clause 10.1 describes the monitoring system performance specifications that have been chosen to minimize harmful interference to other equipment or services, reduce the potential for disturbance to this equipment from ambient sources or other medical device users in the band and provide a high degree of link reliability in the interest of the patient.

Annex A (normative) provides specifications concerning radiated measurements.

Annex B (normative) provides specifications for test equipment.

Annex C (informative) Strategy for ULP-AMI/ULP-AMI-P in the band 402 MHz to 405 MHz (source ERM_TG30 see URL: <http://www.etsi.org>).

Annex D (informative) bibliography; provides additional information.

1 Scope

The present document covers, for Ultra Low Power Active Medical Implants (ULP-AMI) and Peripherals (ULP-AMI-P) used in a Medical Implant Communications Service (MICS), the required characteristics considered necessary to efficiently use the available spectrum and serve the interests of implant users. The specifications contained in the present document were developed to ensure that the health and safety of the patients that are using this equipment under the direction of medical practitioners is protected. Of particular importance is the inclusion of spectrum monitoring and access requirements (listen before talk protocol) designed to significantly reduce any interference potential between MICS systems operating in the band or between a MICS system and the primary users of the band. Also included in the present document is the capability of Low Duty Cycle/Low Power Access in the 403,5 MHz to 403,8 MHz frequency band.

An AIMD is regulated under the AIMD Directive 90/385/EEC: radio parts contained therein (referred to herein as ULP-AMI and ULP-AMI-P for peripheral devices) are regulated under the Directive 1999/5/EC (R&TTE Directive) [i.1].

It is intended that the present document applies to operation in the band 402 MHz to 405 MHz only and that devices that can also operate in spectrum outside this band also meet any applicable requirements for operation in such bands.

The present document contains the technical characteristics for ULP-AMI radio equipment which is also addressed by CEPT/ERC/REC 70-03 [i.2] and annex 12 to that document. It does not necessarily include all the characteristics, which may be required by a user, nor does it necessarily represent the optimum performance achievable.

It applies to ULP-AMI devices and accessories operating in the band 402 MHz to 405 MHz:

- for telecommand and telemetry to/from an AIMD in a patient's body to an ULP-AMI-P; or
- for telecommand and telemetry to/from an AIMD to another AIMD within the human body;
- with or without an integral antenna; and/or
- with an antenna connection provided only for the purpose of connecting an external dedicated antenna.

The present document covers requirements for radiated emissions above 25 MHz.

2 References

References are either specific (identified by date of publication and/or edition number or version number) or non-specific.

- For a specific reference, subsequent revisions do not apply.
- Non-specific reference may be made only to a complete document or a part thereof and only in the following cases:
 - if it is accepted that it will be possible to use all future changes of the referenced document for the purposes of the referring document;
 - for informative references.

Referenced documents which are not found to be publicly available in the expected location might be found at <http://docbox.etsi.org/Reference>.

For online referenced documents, information sufficient to identify and locate the source shall be provided. Preferably, the primary source of the referenced document should be cited, in order to ensure traceability. Furthermore, the reference should, as far as possible, remain valid for the expected life of the document. The reference shall include the method of access to the referenced document and the full network address, with the same punctuation and use of upper case and lower case letters.

NOTE: While any hyperlinks included in this clause were valid at the time of publication ETSI cannot guarantee their long term validity.

2.1 Normative references

The following referenced documents are indispensable for the application of the present document. For dated references, only the edition cited applies. For non-specific references, the latest edition of the referenced document (including any amendments) applies.

- [1] CISPR 16-2-3 (2003): "Specification for radio disturbance and immunity measuring apparatus and methods - Part 2-3: Methods of measurement of disturbances and immunity - Radiated disturbance measurements".
- [2] ANSI C63.17 (1998): "American National Standard for Methods of Measurement of the Electromagnetic and Operational Compatibility of Unlicensed Personal Communications Services (PCS) Devices".

NOTE: See http://www.techstreet.com/cgi-bin/detail?product_id=43013.

- [3] ETSI TR 100 028 (all parts) (V1.4.1): "Electromagnetic compatibility and Radio spectrum Matters (ERM); Uncertainties in the measurement of mobile radio equipment characteristics".

2.2 Informative references

The following referenced documents are not essential to the use of the ETSI deliverable but they assist the user with regard to a particular subject area. For non-specific references, the latest version of the referenced document (including any amendments) applies.

- [i.1] Directive 1999/5/EC of the European Parliament and of the Council of 9 March 1999 on radio equipment and telecommunications terminal equipment and the mutual recognition of their conformity (R&TTE Directive).
- [i.2] CEPT/ERC/REC 70-03 (02-2007): "Relating to the use of Short Range Devices (SRD)".
- [i.3] ITU-T Recommendation O.153: "Basic parameters for the measurement of error performance at bit rates below the primary rate".
- [i.4] ITU-R Recommendation RS.1346: "Sharing between the meteorological aids service and medical implant communication systems (MICS) operating in the mobile service in the frequency band 401-406 MHz".
- [i.5] Radiofrequency Radiation Dosimetry Handbook (October 1986), USAF School of Aerospace Medicine, Aerospace Medical Division (AFSC), Brooks Air Force Base, TX 78235-5301.

NOTE: See <http://niremf.ifac.cnr.it/docs/HANDBOOK/home.htm>.

- [i.6] CEPT/ERC/REC 74-01: "Unwanted Emissions in the Spurious Domain".
- [i.7] ERC/DEC(01)17: "ERC Decision of 12 March 2001 on harmonised frequencies, technical characteristics and exemption from individual licensing of short Range Devices used for Ultra Low Power Active Medical Implants operating in the frequency band 402 - 405 MHz".
- [i.8] ETSI EN 301 839-2: "Electromagnetic compatibility and Radio spectrum Matters (ERM); Short Range Devices (SRD); Ultra Low Power Active Medical Implants (ULP-AMI) and Peripherals (ULP-AMI-P) operating in the frequency range 402 MHz to 405 MHz; Part 2: Harmonized EN covering essential requirements of article 3.2 of the R&TTE Directive".
- [i.9] "Simulated Biological Materials for Electromagnetic Radiation Absorption Studies", by G. Hartsgrrove, A. Kraszewski, and A. Surowiec as published in Bioelectromagnetics 8:29-36 (1987).

3 Definitions, symbols and abbreviations

3.1 Definitions

For the purposes of the present document, the following terms and definitions apply:

access protocol: specification for measuring natural and man-made ambient background levels for the purpose of providing a technique for spectrum access that reduces the potential for harmful interference to/from other users of the spectrum

Active Implantable Medical Device (AIMD): any active medical device (AMD) which is intended to be totally or partially introduced, surgically or medically, into the human body or by medical intervention into a natural orifice, and which is intended to remain after the procedure

Adaptive Frequency Agility (AFA): ability to determine an unoccupied sub-band or channel of operation in order to maximize spectrum utilization

artificial antenna: reduced-radiating dummy load equal to the nominal impedance specified by the applicant

conducted measurements: measurements that are made using a direct connection to the equipment under test

dedicated antenna: removable antenna supplied and tested with the radio equipment, designed as an indispensable part of the equipment

duty cycle: ratio, expressed as a percentage, of the maximum transmitter "on" time monitored over one hour, relative to a one hour period

NOTE: See clause 8.6.1.

effective radiated power: power radiated within the emission bandwidth of the EUT in the direction of the maximum level under specified conditions of measurements in the presence of modulation or without modulation as appropriate

NOTE: See clause 8.3.1.

emission bandwidth: measured as the width of the signal between the points on either side of carrier centre frequency that are 20 dB down relative to the maximum level of the modulated carrier

NOTE: See clause 8.2.1.1 for details on how to determine compliance.

frequency error: difference between the nominal frequency as measured on the devices under test and under normal test conditions and the frequency under extreme conditions

NOTE: See also clause 8.1.1.

frequency stability under low voltage condition: ability of the equipment to remain on the nominal operating frequency when the battery voltage falls below the lower extreme voltage level

NOTE: See also clause 8.5.1.

integral antenna: permanent fixed antenna, which may be built-in, designed as an indispensable part of the equipment

LBT threshold power level: ambient signal power level above which the monitoring system shall select spectrum for use in a MICS communication session according to the next available channel with the lowest level of ambient signal power or least interfered channel (LIC)

Least Interfered Channel (LIC): channel, among the available channels that has the lowest potential for causing disturbance to or receiving disturbance from other users of the band

Listen Before Talk (LBT): combination of the listen mode followed by the talk mode

listen mode: action taken by an interrogator to detect an unoccupied sub-band or channel

Medical Device (MD): any instrument, apparatus, appliance, material or other article, whether used alone or in combination, together with any accessories or software for its proper functioning, intended by the manufacturer to be used for human beings in the:

- diagnosis, prevention, monitoring, treatment or alleviation of disease or injury;
- investigation, replacement or modification of the anatomy or of a physiological process;
- control of conception;

and which does not achieve its principal intended action by pharmacological, chemical, immunological or metabolic means, but which may be assisted in its function by such means

medical implant communication channel: any continuous segment of spectrum that is equal to the emission bandwidth of the device with the largest bandwidth that is to participate in a MICL session

NOTE 1: As stated in CEPT/ERC/REC 70-03 [i.2], annex 12 Band a, it is permitted to aggregate 25 kHz segments up to a maximum of 300 kHz for each channel bandwidth.

NOTE 2: Two types of devices for Medical Implant Communications Systems are covered by the present document:

- (i) Frequency agile devices designed to access a minimum of nine channels evenly distributed across the 402 MHz to 405 MHz band.
- (ii) Single frequency devices restricted to the 403,5 MHz to 403,8 MHz centre channel.

Medical Implant Communication Link (MICL): collection of transmissions that may or may not be continuous, between ULP-AMIs and ULP-AMI-Ps, including programmer/controllers, transferring patient related information in a communications service

Medical Implant Communications System (MICS): system specifically for the purpose of providing non-voice digital communications between one or several ULP-AMI and one ULP-AMI-P or between ULP-AMI

Medical Implant Communications System (MICS) session: collection of transmissions that may or may not be continuous, between co-operating ULP-AMI and ULP-AMI-P

medical implant event: occurrence or the lack of an occurrence recognized by a medical implant device or duly authorized health care professional that requires the immediate transmission of data from a medical implant transmitter in order to protect the safety of the person in whom the medical implant transmitter has been placed

NOTE: It is not permitted that this is the only mechanism a medical implant transmitter can use to access spectrum.

monitoring system: circuitry in an ULP-AMI and/or ULP-AMI-P that assures conformity with the spectrum access protocol requirements based on Listen before Talk, Adaptive Frequency Agility and selection of the least interfered channel for operation (LIC)

radiated measurements: measurements, which involve the absolute measurement of a radiated field

spurious emissions: emissions at frequencies other than those of the carrier and sidebands associated with normal test modulation

NOTE: See clause 8.4.1.

spurious radiations from the receiver: components at any frequency, generated and radiated by active receiver circuitry and the antenna

NOTE: See clause 9.1.1.

talk mode: transmission of intentional radiation by a transmitter

telecommand: use of radio communication for the transmission of signals to initiate, modify or terminate functions of equipment at a distance

telemetry: use of radio communication for indicating or recording data at a distance

time-critical data: data which if not transferred immediately will result in compromising the health and/or safety of the patient

Ultra Low Power Active Medical Implant (ULP-AMI): the radio part of an AIMD

Ultra Low Power Active Medical Implant Peripheral (ULP-AMI-P) device: the radio part of equipment outside the human body that communicates with an ULP-AMI to establish a MICL

3.2 Symbols

For the purposes of the present document, the following symbols apply:

B	bandwidth
dB	decibel
E	electrical field strength
E _o	reference electrical field strength (see annex A)
f	frequency
f _c	channel centre frequency
f _e	frequency under extreme conditions
G	Antenna Gain
NaCl	sodium chloride
P	power
R	distance
R _o	Reference distance (see annex A)
P _{Th}	maximum threshold power level (see clause 10)
t	time
λ	wavelength

3.3 Abbreviations

For the purposes of the present document, the following abbreviations apply:

AFA	Adaptive Frequency Agility
AIMD	Active Implantable Medical Device
CW	Continuous Wave
e.r.p.	effective radiated power
EUT	Equipment Under Test
LBT	Listen Before Talk
LDC	Low Duty Cycle
LIC	Least Interfered Channel

NOTE: See definitions.

LP	Low Power
MD	Medical Device
MICL	Medical Implant Communication Link
MICS	Medical Implant Communications System
RF	Radio Frequency
r.m.s.	root mean square
SRD	Short Range Device
ULP-AMI	Ultra Low Power Active Medical Implant
ULP-AMI-P	Ultra Low Power Active Medical Implant Peripheral
VSWR	Voltage Standing Wave Ratio

4 Technical requirements and specifications

4.1 General requirements

4.1.1 Transmitter requirements

See clause 8 for transmitter requirements.

4.1.2 Receiver requirements

See clause 9.

4.2 Presentation of equipment for testing purposes

Each equipment submitted for testing shall fulfil the requirements of the present document on all frequencies over which it is intended to operate. Compliance with this requirement should be shown by testing each unit on a frequency near 403,5 MHz.

The provider shall complete the appropriate application form when submitting the equipment for testing. In addition, the provider shall declare the range of operating conditions and power requirements, as applicable; to establish the appropriate test conditions.

Additionally, technical documentation and operating manuals, sufficient to make the test, shall be supplied for all ULP-AMI-P and ULP-AMI.

A human torso simulator and tissue substitute material for testing ULP-AMI shall be used (see clause 6.5).

Measurements shall be performed, according to the present document, on samples of equipment defined in clauses 4.2.1 to 4.2.3.3.

4.2.1 Choice of model for testing

The provider shall supply one or more samples of each model or type of transmitter (ULP-AMI and/or ULP-AMI-P), as appropriate for testing. Any ancillary equipment needed for testing shall be provided as requested by the testing laboratory.

If an equipment has several optional features, considered not to affect the RF parameters, then the tests need only to be performed on the equipment configured with that combination of features considered to be the most complex or most likely to affect the RF parameters, as proposed by the provider and agreed to by the test laboratory.

4.2.2 Testing of equipment with alternative power levels

Equipment designed to operate with different carrier powers shall have each transmitter parameter tested on samples of equipment defined in clause 4.2.1. See clause 8 for details on testing. Spurious emissions tests shall be performed in accordance with requirements in clause 8.4.1.1.

4.2.3 Presentation of equipment that does not have an external RF connector (integral antenna equipment)

4.2.3.1 Equipment with an internal permanent or temporary antenna connector

The means to access and/or implement the internal permanent or temporary connector shall be stated by the provider with the aid of a diagram. The fact that use has been made of the internal antenna connection, or of a temporary connection, to facilitate measurements shall be recorded in the test report.

4.2.3.2 Equipment with a temporary antenna connector

The provider may submit one set of equipment with the normal antenna connected, to enable the radiated measurements to be made. He shall attend the test laboratory at the conclusion of the radiated measurements, to disconnect the antenna and fit the temporary connector. The testing laboratory staff shall not connect or disconnect any temporary antenna connector.

Alternatively, the provider may submit two sets of equipment to the test laboratory, one fitted with a temporary antenna connector with the antenna disconnected and the other with the antenna connected. Each equipment shall be used for the appropriate tests. The provider shall declare that two sets of equipment are identical in all respects.

4.2.3.3 Equipment intended to be implanted in a human body

The provider shall submit the equipment, a human torso simulator as described in clause 6.5 and annex A, and a sufficient quantity of tissue substitute material to fill the test fixture. The provider and/or test laboratory shall determine and agree on the arrangement of the equipment antenna and any additional device leads on the AIMD holding grid within the fixture as prescribed in annex A.

4.3 Mechanical and electrical design

4.3.1 General

The equipment submitted by the provider should be designed, constructed and manufactured in accordance with sound engineering practice and with the aim of minimizing harmful interference to other equipment and services.

Transmitters and receivers may be individual or combination units.

4.3.2 Controls

Those controls that, if maladjusted, might increase the interference potentialities of the equipment shall not be easily accessible to the user.

4.3.3 Transmitter shut-off facility

Transmitters may be equipped with an automatic transmitter shut-off facility or battery-saving feature. In this case please refer to clause 8 for specific regarding testing requirements.

4.3.4 Marking

The equipment shall be marked in a visible place. This marking shall be legible and durable. If impossible the marking shall be in the users' manual, according to the provisions of the Directive 1999/5/EC (R&TTE Directive) [i.1].

4.3.5 Equipment identification

AIMD may also have a unique electronic identification that prevents unauthorized access to the telecommand and telemetry functions of the ULP-AMI.

4.4 Declarations by the Applicant

When submitting equipment for testing, the applicant shall supply the necessary information required by the test laboratory.

The performance of the equipment submitted for testing shall be a representative sample of the equipment.

4.5 Auxiliary test equipment

All necessary test signal sources, test fixtures, specialized test apparatus and set-up information shall accompany the equipment when it is submitted for type testing unless alternative arrangements are agreed to by the test laboratory and the manufacturer.

4.6 Interpretation of the measurement results

The interpretation of the results recorded on the appropriate test report for the measurements described in the present document shall be as follows:

- the measured value relating to the corresponding limit shall be used to decide whether an equipment meets the requirements of the present document;
- the measurement uncertainty value for the measurement of each parameter shall be included in the test report;
- the recorded value of the measurement uncertainty shall, for each measurement, be equal to, or lower than, the figures in the table of measurement uncertainty (see clause 7).

5 Test conditions, power sources and ambient temperatures

5.1 Normal and extreme test conditions

Testing shall be made under normal test conditions, and also, where stated, under extreme test conditions. It should be noted that emissions test on ULP-AMI shall be performed using the human torso simulator with the tissue substitute material at nominal room temperature. Measured emission levels are not expected to vary significantly from the nominal temperature of 37 °C.

The test conditions and procedures shall be as specified in clauses 5.2 to 5.4.

5.2 Test power source

The equipment shall be tested using the appropriate test power source as specified in clauses 5.2.1 or 5.2.2. Where equipment can be powered using either external or internal power sources, the equipment shall be tested using the external power source as specified in clause 5.2.1 then repeated using the internal power source as specified in clause 5.2.2.

The test power source used shall be stated in the test report.

5.2.1 External test power source

During tests, the power source of equipment shall be replaced by an external test power source capable of producing normal and extreme test voltages as specified in clauses 5.3.2 and 5.4.2 if possible. The internal impedance of the external test power source shall be low enough for its effect on the test results to be negligible. For the purpose of the tests, the voltage of the external test power source shall be measured at the input terminals of the equipment. The external test power source shall be suitably de-coupled as close to the equipment battery terminals as practicable. For radiated measurements any external power leads should be so arranged so as not to affect the measurements.

During tests the test power source voltages shall be within a tolerance of $< \pm 1$ % relative to the voltage at the beginning of each test. The value of this tolerance can be critical for certain measurements. Using a smaller tolerance will provide a better uncertainty value for these measurements.

5.2.2 Internal test power source

For radiated measurements on equipment with an internal power source, fully charged internal batteries should be used. The batteries used should be as supplied or recommended by the provider. If internal batteries are used, at the end of each test, the voltage shall be within a tolerance of $< \pm 5\%$ relative to the voltage at the beginning of each test.

If appropriate, for conducted measurements or where a test fixture is used, an external power supply at the required voltage may replace the supplied or recommended internal batteries. This shall be stated on the test report.

For AIMDs that are hermetically sealed it may not be possible to measure the battery voltage directly or indirectly. For this type of equipment, it is not necessary to measure the voltage at the end of each test; however, care shall be taken to ensure that the internal battery supply voltage does not fall below the manufacturer's specification for normal operating voltage range. For battery operated devices, it is acceptable to read the battery voltage via telemetry readout.

5.3 Normal test conditions

5.3.1 Normal temperature and humidity

The normal temperature and humidity conditions for ULP-AMI-P shall be any convenient combination of temperature and humidity within the following ranges:

- temperature +15 °C to +37 °C;
- relative humidity 20 % to 75 %.

ULP-AMI operate after implant in a human body. Accordingly, the body tends to serve as an oven to maintain the implant temperature near 35 °C. Therefore, the normal temperature and humidity conditions for ULP-AMI shall be within the following ranges:

- temperature +36 °C to +38 °C;
- relative humidity does not apply.

When it is impracticable to carry out tests under these conditions, a note to this effect, stating the ambient temperature and relative humidity during the tests shall be added to the test report.

5.3.2 Normal test power source

5.3.2.1 Mains voltage

The normal test voltage for equipment to be connected to the mains shall be the nominal mains voltage. For the purpose of the present document, the nominal voltage shall be the declared voltage, or any of the declared voltages, for which the equipment was designed.

The frequency of the test power source corresponding to the ac mains shall be between 49 Hz and 51 Hz.

5.3.2.2 Regulated lead-acid battery power sources

When the radio equipment is intended for operation with the usual types of regulated lead-acid battery power source, the normal test voltage shall be 1,1 multiplied by the nominal voltage of the battery (e.g. 6 V, 12 V, etc.).

5.3.2.3 Other power sources

For operation from other power sources or types of battery (primary or secondary), the normal test voltage shall be that declared by the equipment provider and agreed by the test laboratory. Such values shall be stated in the test report.

5.4 Extreme test conditions

5.4.1 Extreme temperatures

5.4.1.1 Procedure for tests at extreme temperatures

Before measurements are made, the equipment shall have reached thermal balance in the test chamber. The equipment shall be switched off during the temperature-stabilizing period.

In the case of equipment containing temperature stabilization circuits designed to operate continuously, the temperature stabilization circuits shall be switched on for 15 minutes after thermal balance has been obtained, and the equipment shall then meet the specified requirements.

If the thermal balance is not checked by measurements, a temperature-stabilizing period of at least one hour, or such period as may be decided by the test laboratory, shall be allowed. The sequence of measurements shall be chosen, and the humidity content in the test chamber shall be controlled so that excessive condensation does not occur.

If the equipment is incapable of transmitting an unmodulated carrier, an actual digital data sequence or a pseudorandom sequence representative of an actual digital data transmission shall be used to modulate the carrier (see clauses 6.1 and 6.1.1).

5.4.1.1.1 Procedure for equipment designed for continuous operation

If the provider states that the equipment is designed for continuous operation, the test procedure shall be as follows:

- before conducting tests at the upper extreme temperature the equipment shall be placed in the test chamber and left until thermal balance is attained. The equipment shall then be switched on in the transmit condition for a period of time specified by the manufacturer to be the maximum time the equipment will transmit in normal operation after which the equipment shall meet the specified requirements;
- for tests at the lower extreme temperature, the equipment shall be left in the test chamber until thermal balance is attained, then switched on for a period of one minute after which the equipment shall meet the specified requirements.

5.4.1.1.2 Procedure for equipment designed for intermittent operation

If the provider states that the equipment is designed for intermittent operation, the test procedure shall be as follows:

- Before conducting tests at the upper extreme temperature the equipment shall be placed in the test chamber and left until thermal balance is attained in the oven. The equipment shall then either:
 - transmit on and off according to the provider's declared duty cycle or transmission protocol, as appropriate, for a period of five minutes or for the duration of an expected communications session as declared by the manufacturer and agreed by the test facility; or
 - if the provider's declared on period exceeds one minute, then:
 - transmit in the on condition for a period not exceeding one minute, followed by a period in the off or standby mode for four minutes; after which the equipment shall meet the specified requirements.
- For tests at the lower extreme temperature, the equipment shall be left in the test chamber until thermal balance is attained, then switched to the standby or receive condition for one minute after which the equipment shall meet the specified requirements.

5.4.1.2 Extreme temperature ranges

For tests at extreme temperatures, measurements shall be made in accordance with the procedures specified in clause 5.4.1.1, at the upper and lower temperatures of one of the following ranges.

Table 1: Extreme temperature ranges

Category I (General):	-20 °C to +55 °C
Category II (Portable equipment):	-10 °C to +55 °C
Category III (Equipment for normal indoor use) (see note 1):	0 °C to +55 °C
Category IV (ULP-AMI) (see note 2):	+25 °C to +45 °C
NOTE 1: The term "equipment for normal indoor use" is taken to mean that the room temperature is controlled and the minimum indoor temperature is equal to or greater than 5 °C.	
NOTE 2: The range of +25 °C to +45 °C is the core body temperature variation over which a human body can survive [i.5].	

The manufacturer may define a different temperature range than specified above for any category provided the EUT meets the conditions set forth below. For specific applications, the manufacturer can specify wider temperature ranges than given as a minimum above. In this case the test report shall show compliance with the limits in the present document over the extended ranges specified by the manufacturer. This shall be reflected in the manufacturers' product literature. Narrower temperature ranges than given above may be implemented provided the reduced range is reflected in the manufacturers' product literature and the test report shows that the device implements techniques which do not allow it to exceed the limits specified in the present document over the minimum ranges given above.

The equipment shall comply with all the technical requirements of the present document at all times when operating within the boundary limits of the required operational temperature profile.

The test report shall state which range is used.

5.4.2 Extreme test source voltages

5.4.2.1 Mains voltage

The extreme test voltages for equipment to be connected to an ac mains source shall be the nominal mains voltage $\pm 10\%$. For equipment that operates over a range of mains voltages, clause 5.4.2.4 applies.

5.4.2.2 Regulated lead-acid battery power sources

When the radio equipment is intended for operation from the usual type of regulated lead-acid battery power sources the extreme test voltages shall be 1,3 and 0,9 multiplied by the nominal voltage of the battery (6 V, 12 V, etc.).

For float charge applications using "gel-cell" type batteries the extreme voltage shall be 1,15 and 0,85 multiplied by the nominal voltage of the declared battery voltage.

5.4.2.3 Power sources using other types of batteries

The lower extreme test voltages for equipment with power sources using other types of batteries shall be as follows:

- For ULP-AMI the lower extreme test voltage is the level specified by the manufacturer at which the device battery should be replaced in order to continue the medical effectiveness of the device.
- For equipment with a battery indicator, the end point voltage as indicated.

- For equipment without a battery indicator the following end point voltages shall be used:
 - for the Leclanché or the lithium type of battery:
 - 0,85 multiplied by the nominal voltage of the battery;
 - for the nickel-cadmium type of battery:
 - 0,9 multiplied by the nominal voltage of the battery.
- For other types of batteries or equipment, the lower extreme test voltage for the discharged condition shall be declared by the equipment provider.

The nominal voltage is considered to be the upper extreme test voltage in this case.

5.4.2.4 Other power sources

For equipment using other power sources, or capable of being operated from a variety of power sources, the extreme test voltages shall be those agreed between the equipment provider and the test laboratory. This shall be recorded in the test report.

6 General conditions

6.1 Normal test signals and test modulation

The test-modulating signal shall be a digital signal that modulates the carrier. It may be dependent upon the type of equipment under test and the measurement to be performed. Modulation test signals only apply to products with an external modulation connector. For equipment without an external modulation connector, normal operating digital modulation shall be used.

6.1.1 Normal modulation test signals for data

Normal test signals for data are specified as follows:

- D-M2: A test signal representing a pseudorandom bit sequence of at least 511 bits in accordance with ITU-T Recommendation O.153 [i.3]. This sequence shall be continuously repeated. If the sequence cannot be continuously repeated, the actual method used shall be stated in the test report.
- D-M3: A test signal shall be agreed between the test laboratory and the provider that is representative of normal transmitter operation if the above pseudorandom sequence cannot be used.

For angle modulation, the normal level of the test signal D-M3 shall produce a deviation value as declared by the provider as the normal operating level.

6.2 Antennas

Equipment operating in the 402 MHz to 405 MHz band shall have an integral antenna, an external dedicated antenna or both. If provision for an external antenna connection is made, the manufacturer or provider shall make provision to prevent the use of an antenna other than that authorized by the manufacturer or provider.

6.3 Artificial antenna

Where applicable, tests may be carried out using an artificial antenna that simulates the actual antenna configuration specified by the provider for the specific equipment.

6.3.1 Artificial antenna for transmitters with 50 Ω impedance connector

For measurements on transmitters with a normal 50 Ω antenna impedance, tests shall be carried out using an artificial antenna which shall be a substantially non-reactive non-radiating 50 Ω load connected to the antenna connector. The Voltage Standing Wave Ratio (VSWR) at the 50 Ω connector shall not be greater than 1,2:1 over the frequency range of the measurement.

6.4 Test fixture for ULP-AMI-P

With equipment intended for use with an integral antenna, and not equipped with a 50 Ω RF output connector, a suitable test fixture may be used as agreed with the test laboratory.

This fixture is a RF coupling device for coupling the integral antenna to a 50 Ω RF terminal at the working frequencies of the equipment under test. This allows certain measurements to be performed using conducted measuring methods. However, only relative measurements may be performed. The test fixture is normally only required for extreme temperature measurements and shall be calibrated only with the equipment under test.

The test fixture shall be fully described by the provider. The test laboratory shall calibrate the test fixture by carrying out the required field measurements at normal temperatures at the prescribed test site. Then the same measurements shall be repeated on the equipment under test using the test fixture for all identified frequency components.

In addition, the test fixture may provide:

- a connection to an external power supply;
- a connection to a data interface.

The performance characteristics of the test fixture shall be agreed upon with the test laboratory and shall conform to the following basic parameters:

- the circuit associated with the RF coupling shall contain no active or non linear devices;
- the coupling loss shall not influence the measuring results;
- the coupling loss shall be independent of the position of the test fixture and be unaffected by the proximity of the surrounding objects or people;
- the coupling loss shall be reproducible when the equipment under test is removed and replaced;
- the coupling loss shall remain substantially constant when the environmental conditions are varied.

6.5 Test fixture for ULP-AMI

For measurement purposes, to determine compliance with all emission limits, AIMD shall be tested in a fixture that approximates the physical conditions of an ULP-AMI placed in a human body. This fixture, a human torso simulator, with the ULP-AMI mounted inside, shall be filled with a tissue substitute material and placed on the radiated emissions test site turntable with the ULP-AMI at a height of 1,5 m above the ground plane for testing purposes. The tissue substitute material shall be sufficiently fluid that it will flow around the ULP-AMI without creating any voids. Please refer to annex A for further guidance.

6.6 Test sites and general arrangements for radiated measurements

For guidance on radiation test sites, see annex A. Detailed descriptions of radiated measurement arrangements are included in this annex.

6.7 Modes of operation of the transmitter

For the purpose of the measurements according to the present document, there should preferably be a facility to operate the transmitter in an unmodulated state. The method of achieving an unmodulated carrier frequency or special types of modulation patterns may also be decided by agreement between the provider and the test laboratory. It shall be described in the test report and it may involve suitable temporary internal modifications of the equipment under test. If it is not possible to provide an unmodulated carrier then this shall be stated in the test report.

For the purpose of testing, the normal test signal, see clauses 6.1 and 6.1.1, shall be applied to the input of the transmitter under test with the normal input device disconnected, if applicable.

6.8 Measuring receiver

The term "measuring receiver" refers to a selective voltmeter or a spectrum analyser. The bandwidth and detector type of the measuring receiver is given in table 2. Some measurements specified in the present document require the use of a measuring receiver with a peak detector function and an adjustable resolution bandwidth capability typical of most spectrum analysers.

Table 2: Measurement receiver specifications

Frequency: (f)	Detector type:	Bandwidth (see note):
$9 \text{ kHz} \leq f < 150 \text{ kHz}$	r.m.s. and Peak detector	200 Hz to 300 Hz
$150 \text{ kHz} \leq f < 30 \text{ MHz}$	r.m.s. and Peak detector	9 kHz to 10 kHz
$30 \text{ MHz} \leq f \leq 1\,000 \text{ MHz}$	r.m.s. and Peak detector	100 kHz to 120 kHz
$1\,000 \text{ MHz} \leq f$	Peak	1 MHz or \geq emission bandwidth
NOTE: When making emissions measurements of modulated emissions, it is permissible to smooth the analogue waveform of the detected modulation characteristic using a video filter setting approximately equal to the resolution bandwidth/30. If the emissions measurements are performed using this method, they shall be aligned with ANSI C63.17 [2], clause 6.1.2.2.2.		

7 Measurement uncertainty

The accumulated measurement uncertainties of the test system in use for the parameters to be measured should not exceed those given below, this is in order to ensure that the measurements remain within an acceptable standard.

Table 3: Measurement uncertainties

Parameter	Maximum Measurement Uncertainty
Radio Frequency	$\pm 1 \times 10^{-7}$
Adjacent channel power	$\pm 3 \text{ dB}$
RF power, conducted	$\pm 0,75 \text{ dB}$
Conducted emission of transmitter	$\pm 4 \text{ dB}$
Conducted emission of receivers	$\pm 3 \text{ dB}$
Radiated emission of transmitter, valid up to 4 GHz	$\pm 6 \text{ dB}$
Radiated emission of receiver, valid up to 4 GHz	$\pm 6 \text{ dB}$
Conducted monitoring test system	$\pm 4 \text{ dB}$
Radiated monitoring test system	$\pm 6 \text{ dB}$
Temperature	$\pm 1 \text{ }^\circ\text{C}$
Humidity	$\pm 5 \%$

For the test methods according to the present document the uncertainty figures are valid to a confidence level of 95 % calculated according to the methods described in TR 100 028 [3].

8 Methods of measurement and limits for transmitter parameters

8A Introduction

In order to conduct transmitter measurements, the manufacturer shall provide a means for causing the equipment under test to operate on a frequency near 403,5 MHz or provide samples that have been modified to operate on 403,5 MHz when activated. Frequency administration commands that place the device in the correct operating mode may be used if available. Where the transmitter is designed with an adjustable carrier power, then all transmitter parameters shall be measured using the highest power level (e.r.p.), as declared by the provider. The equipment shall then be set to the lower carrier power setting(s) (e.r.p.), as declared by the provider, and the measurements for spurious emissions shall be repeated (see clause 8.4).

Two modes of operation are permitted:

- a) ULP-AMI and ULP-AMI-P using LBT and AFA for selection of the operating frequency; and
- b) ULP-AMI that transmit under the provisions of low duty cycle and low power operation. ULP-AMI that is operating under the provisions for low duty cycle and low power operation for accessing spectrum within the band 403,5 MHz to 403,8 MHz are subject to a duty cycle restriction, low power output, and a limit on the number of transmissions within an hour.

For ULP-AMI, all emissions measurements require the use of the human torso simulator described in clause A.1.1.3. Clause A.1.1.3 specifies the temperature of the tissue substitute material in the simulator to be 22 °C to 38 °C for emission tests. This temperature range is specified for emissions tests in order to eliminate the absolute necessity of preheating and maintaining the temperature of the tissue substitute material at a higher temperature, thus greatly facilitating conducting the tests. Because the nominal conductivity and dielectric constant characteristics of the tissue substitute material vary only slightly with temperature from 22 °C to the nominal temperature of 37 °C, test results will not be materially affected by temperature variance of the tissue substitute material. Neither is it expected that the transmitter emission levels would vary over the limited temperature range from 22 °C to the nominal temperature of 37 °C. Based on these considerations, it is reasonable to conduct emission tests with the tissue substitute material at a temperature within the range of 22 °C to 38 °C. However, if agreed by the testing laboratory and the manufacturer, emissions tests may be conducted with the tissue substitute material at the nominal temperature of (37 ± 1) °C.

When making transmitter tests on equipment designed for intermittent operation, the duty cycle of the transmitter if applicable, as declared by the provider on the application form, shall not normally be exceeded. However, if it is necessary to exceed the duty cycle for the purpose of testing, this is permissible as long as the RF parameters of the transmitter are not degraded or compromised. The actual duty cycle used for the purpose of testing shall be stated on the test report form.

Compliance with transmitter output power and spurious emissions limits shall be determined by measuring radiated fields or using substitution techniques (see clauses 8.3 and 8.4.1.1). For equipment with more than one antenna, either dedicated or permanently attached, measurements shall be performed with each antenna.

The frequency and drift under extreme conditions shall be measured as defined in clause 8.1. In addition, the adjacent band or sub-bands spurious emission measurement shall be made as defined in clause 8.4.

No connection shall be made to any internal permanent or temporary antenna connector during the performance of radiated emissions measurements, unless such action forms an essential part of the normal intended operation of the equipment, as declared by the provider.

If a transmitter is equipped with an automatic transmitter shut-off facility or battery-saving feature, and it interferes with testing of the device, it should be made inoperative for the duration of the test.

8.1 Frequency error

This measurement shall be made for all equipment operating in the 402 MHz to 405 MHz band. If possible, measurements shall be made with an unmodulated carrier using an artificial antenna. It may be necessary to use a test fixture (see clauses 6.4 and 6.5) connected to an artificial antenna for some equipment. ULP-AMI are not required to use the human torso simulator for this test.

8.1.1 Definition

The frequency error, also known as frequency drift, is the difference between the nominal frequency as measured on the devices under test and under normal test conditions (see clause 5.3) and the frequency under extreme conditions (see clause 5.4), see also clause 3.1.

8.1.1.1 Method of measurement for systems with an unmodulated carrier frequency operating mode

The carrier frequency shall be measured (in the absence of modulation) with the transmitter connected to an artificial antenna if appropriate. A transmitter without a 50 Ω output connector may be placed in the test fixture (see clause 6.4) connected to an artificial antenna. The measurement shall be made under normal test conditions (see clause 5.3) and extreme test conditions (see clause 5.4), (extreme temperature and supply voltage simultaneously). Due to the design of equipment for various applications in this service, a suitable artificial antenna or test fixture may not be available. For this case, the radiated carrier signal from the device may be used for making these measurements.

8.1.1.2 Method of measurement for systems with a modulated carrier frequency

It may be necessary to use a test fixture (see clauses 6.4 and 6.5) connected to an artificial antenna for some equipment. The carrier frequency shall be measured (in the presence of modulation) with the transmitter connected to an artificial antenna if appropriate. A transmitter without a 50 Ω output connector may be placed in the test fixture (see clause 6.4) connected to an artificial antenna. The measurement shall be made under normal test conditions (see clause 5.3) and extreme test conditions (extreme temperature and supply voltage simultaneously, see clause 5.4). Due to the design of equipment for various applications in this service, a suitable artificial antenna or test fixture may not be available. For this case, the radiated carrier signal from the device may be used for making these measurements. The frequency error is determined as follows:

- under normal conditions according to clause 5.3 the reference frequency f is measured and recorded;
- under all extreme conditions according to clause 5.4 the frequency f_e is measured and recorded.

The absolute value of $(f_e - f)$ is the drift. The limit of 100 ppm is relative to 405 MHz:

where: f = the frequency measured under normal conditions,
 f_e = the maximum drift frequency under extreme conditions.

The frequencies, f and f_e , can be determined by a spectrum analyser which is put in "max hold" position with the transmitting device modulated or unmodulated. For equipment that can only operate in a modulated carrier mode a reference point, f_{ref} , for f and f_e can be used and either set on the slope or determined from the averaging of the two 3 dB frequency points. The 3 dB reference point f_{ref} is determined by $(f_{max} - f_{min}) / 2$, where f_{max} and f_{min} are the frequencies corresponding to the 3 dB frequencies.

8.1.2 Limit

The frequency error for equipment operating in the 402 MHz to 405 MHz band shall not exceed ± 100 ppm under normal, extreme or any intermediate set of conditions.

In addition, the transmitted emission from a device operating in the low duty cycle low power mode in the band 403,5 MHz to 403,8 MHz in any operational configuration shall be maintained in the band 403,5 MHz to 403,8 MHz at all times.

8.2 Emission bandwidth measurement

8.2.1 Definition

The emission bandwidth of a ULP-AMI or ULP-AMI-P device is measured as the width of the signal between the points on either side of carrier centre frequency that are 20 dB down relative to the maximum level of the modulated carrier. Compliance is determined using instrumentation employing a peak detector function and a resolution bandwidth approximately equal to 1 % of the emission bandwidth of the EUT.

8.2.1.1 Method of measurement

The equipment may be directly connected to a spectrum analyser if it has a 50 Ω connector or using a test fixture (see clause 6.4) if needed. If the equipment has an integral antenna or unique connector for a dedicated antenna and cannot be connected to the spectrum analyser, a signal from the equipment may be coupled to the spectrum analyser using an antenna connected to the spectrum analyser.

The transmitter shall be operated at its maximum carrier power measured under normal test conditions (see clause 8.3).

The transmitter shall be modulated by the normal test signal (see clause 6.1).

The output power of the transmitter, with or without a test fixture, shall be recorded using a spectrum analyser set to a frequency span of 1 MHz and a resolution bandwidth large enough to accept all major modulation side bands. The detector function shall be set to peak hold with the video bandwidth setting \geq the resolution bandwidth. The two furthest frequencies, one above (f_{high}) and one below (f_{low}), the frequency of the maximum measured level of the modulated carrier where the signal level is 20 dB below the maximum measured level of the modulated carrier shall be determined. If it is found that the resolution bandwidth used was not approximately 1 % of the emission bandwidth, then the resolution bandwidth shall be adjusted and the procedure repeated until the resolution bandwidth used is approximately 1 % of the emission bandwidth that was measured with that resolution bandwidth setting. For spectrum analysers that have fixed values of resolution bandwidth, the setting that is nearest to 1 % of the emission bandwidth is acceptable, provided that it is no less than 0,5 % of the emission bandwidth and no greater than 2 % of the emission bandwidth.

The frequencies f_{high} and f_{low} for each device shall be recorded for later use. The difference in frequency between f_{high} and f_{low} is the emission bandwidth.

For systems designed to utilize multiple devices in a MICS communications session, the emission bandwidth procedure shall be repeated for each device intended to operate in a session.

8.2.2 Limits

The maximum permitted emission bandwidth shall be 300 kHz. If two or more devices that operate in a given MICS communications session operate in different portions of the 402 MHz to 405 MHz band, their combined emission bandwidths shall not exceed 300 kHz. This limits spectrum usage to a maximum of 300 kHz in any single MICS communications session. The 300 kHz limitation may be exceeded briefly due to intermittent transmissions that may occur when operating channel acquisitions or changes are required to maintain a communications session.

All emissions from each device that fall outside its emission bandwidth but do fall within the 402 MHz to 405 MHz band shall be attenuated at least 20 dB.

In addition, emissions from a device operating in the low duty cycle low power mode in the band 403,5 MHz to 403,8 MHz must be attenuated at least 20 dB at the band edges, 403,5 MHz and 403,8 MHz.

8.3 Effective radiated power of the fundamental emission

8.3.1 Definition

The effective radiated power is the power radiated within the emission bandwidth of the EUT in the direction of the maximum level under specified conditions of measurements in the presence of modulation or without modulation as appropriate, see also clause 3.1.

8.3.1.1 Methods of measurement

This measurement applies to equipment provided with an integral antenna and to equipment supplied with a dedicated antenna. Measurements shall be made with each type of antenna provided by the manufacturer that attaches to the equipment.

If the equipment is designed to operate with different carrier powers, the rated power for each level, or range of levels, shall be declared by the provider.

These measurements shall be performed at the highest power level at which the transmitter is intended to operate.

The measurement for each type of transmitter operation shall be carried out under normal test conditions only (see clause 5.3) or as specified in clause A.1.1.3 in the case of ULP-AMI.

On a test site, selected from annex A that is appropriate for the EUT, the equipment shall be placed at the specified height on a support, as explained in annex A, and in the position closest to normal use as declared by the provider. AIMDs shall be mounted and arranged in the human torso simulator as described in annex A.

The test antenna shall be oriented initially for vertical polarization and shall be chosen to correspond to the frequency of the transmitter. The output of the test antenna shall be connected to the measuring receiver.

The transmitter shall be switched on, if possible without modulation and the measuring receiver shall be tuned to the frequency of the transmitter under test. In case of equipment where it is not possible to make the measurement in the absence of modulation, the measurement shall be carried out by the use of a spectrum analyser using a peak detector function with a resolution bandwidth setting \geq the emission bandwidth (see clause 8.2). For this measurement, analogue smoothing of the displayed waveform is permitted using a video filter set to approximately the resolution bandwidth/30 (see clause 6.8). The measurement shall be made over an interval of time when transmission is continuous and at its maximum power level. The test antenna shall be raised and lowered through the specified range of height until the maximum signal level is detected by the measuring receiver.

The transmitter shall then be rotated through 360° in the horizontal plane, until the maximum signal level is detected by the measuring receiver. The test antenna shall be raised and lowered again through the specified range of height until a maximum signal level is detected by the measuring receiver.

The maximum signal level detected by the measuring receiver for vertical polarization shall be noted.

The transmitter shall be replaced by a substitution antenna as defined in clause A.2.3.

The substitution antenna shall be orientated for vertical polarization as noted above and the length of the substitution antenna shall be adjusted to correspond to the frequency of the transmitter. The substitution antenna shall be connected to a calibrated signal generator.

If necessary, the input attenuator setting of the measuring receiver shall be adjusted in order to increase the sensitivity of the measuring receiver.

The test antenna shall be raised and lowered through the specified range of height to ensure that the maximum signal is received.

The input signal to the substitution antenna shall be adjusted to the level that produces a level detected by the measuring receiver, that is equal to the level noted while the transmitter radiated power was measured.

The input level to the substitution antenna, corrected for any change of input attenuator setting of the measuring receiver, shall be recorded as the power level.

The measurement shall be repeated with the test antenna and the substitution antenna orientated for horizontal polarization.

The measure of the effective radiated power is the larger of the two levels recorded at the input to the substitution antenna, corrected for gain variance of the substitution antenna relative to the gain of a dipole.

8.3.2 Limits

The effective radiated power of ULP-AMI and/or ULP-AMI-P equipment that operates as part of system that incorporates a monitoring system to select the frequency of operation using LBT and AFA (as specified in clause 10) shall not exceed 25 μ W e.r.p.

The effective radiated power of ULP-AMI transmitters operating on any frequency in the band 403,5 MHz to 403,8 MHz shall not exceed 100 nW e.r.p. unless the frequency of operation in this band has been selected by a monitoring system using LBT and AFA (as specified in clause 10). The duty cycle for any transmitter operating in the LDC mode is limited to 0,01 % (see clause 8.6).

8.4 Spurious emissions

8.4.1 Definition

Spurious emissions are emissions at frequencies other than those of the carrier and sidebands associated with normal test modulation, see also clause 3.1.

8.4.1.1 Method of measuring the effective radiated power of spurious emissions

The level of spurious emissions shall be measured as:

- their effective radiated power when radiated by the cabinet and the integral antenna;
- their effective radiated power when radiated by the cabinet and any dedicated antenna provided by the manufacturer.

Measurements shall be made with the transmitter in operating and stand-by modes. ULP-AMI shall have the effective radiated power of their spurious emissions measured using the test fixture specified in clause 6.5.

This measurement applies to equipment provided with an integral antenna and to equipment supplied with a dedicated antenna. Measurements shall be made with each type of antenna provided with the equipment attached to it.

If the equipment is designed to operate with different carrier powers, the rated power for each level or range of levels shall be declared by the provider.

These measurements shall be performed at all power levels at which the transmitter is intended to operate.

The measurement shall be carried out by the use of a measuring receiver with bandwidth as stated in clause 6.8 and quasi-peak detector set in accordance with the specification of CISPR 16-2-3 [1] section 1 for the bands C and D. For measurements above 1 000 MHz, the peak value shall be measured using a spectrum analyser with a resolution bandwidth setting greater than or equal to the emission bandwidth or 1 MHz whichever is less. Analogue smoothing of the displayed modulation is permitted (see clause 6.8). Different measurement bandwidth may be used if necessary and the results shall be adjusted to the reference bandwidth.

The following reference bandwidths should be used (CEPT/ERC/REC 74-01 [i.6]):

- 1 kHz between 9 kHz and 150 kHz;
- 10 kHz between 150 kHz and 30 MHz;
- 100 kHz between 30 MHz and 1 GHz;
- 1 MHz above 1 GHz.

On a test site, selected from annex A that is appropriate for the EUT, the equipment shall be placed at the specified height on a support, as specified in annex A, and in the position closest to normal use as declared by the provider. AIMDs shall be mounted and arranged in the human torso simulator as described in annex A.

The test antenna shall be oriented initially for vertical polarization and shall be tuned to each spurious emission frequency from the transmitter. The output of the test antenna shall be connected to the measuring receiver. The transmitter shall have the normal modulation applied (see clause 6.1) and the measuring receiver shall be tuned over the frequency range 25 MHz to 4 GHz, except for the maximum emission bandwidth measured according to clause 8.2.1.

At each frequency at which a spurious component is detected, the test antenna shall be raised and lowered through the specified range of heights until a maximum signal level is detected on the measuring receiver. The transmitter shall then be rotated through 360° in the horizontal plane, until the maximum signal level is detected by the measuring receiver and the test antenna height shall be adjusted again for maximum signal level. The test antenna shall be raised and lowered again through the specified range of height until a maximum signal level is detected by the measuring receiver.

The maximum signal level detected by the measuring receiver for vertical polarization shall be noted.

The transmitter shall be replaced by a substitution antenna as defined in clauses A.2.2. and A.2.3.

The substitution antenna shall be orientated for the vertical polarization as noted above and the length of the substitution antenna shall be adjusted to correspond to the frequency of the spurious emission from the transmitter. The substitution antenna shall be connected to a calibrated signal generator. If necessary, the input attenuator setting of the measuring receiver shall be adjusted in order to increase the sensitivity of the measuring receiver.

The test antenna shall be raised and lowered through the specified range of height to ensure that the maximum signal is received. The input signal to the substitution antenna shall be adjusted to the level that produces a level detected by the measuring receiver, which is equal to the level noted while the transmitter spurious emissions were measured.

The input level to the substitution antenna, corrected for any change of input attenuator setting of the measuring receiver, shall be recorded as the power level.

The measurement shall be repeated with the test antenna and the substitution antenna orientated for horizontal polarization.

The maximum signal level detected by the measuring receiver for both vertical and horizontal polarization shall be noted.

The measure of the effective radiated power for each spurious emission is the larger of the levels recorded at the input to the substitution antenna, corrected for any gain variance of the substitution antenna relative to the gain of a dipole.

8.4.2 Limits

The power in the reference bandwidth of any spurious emission shall not exceed the following values given in table 4 or the level of the fundamental power of the device whichever is lower.

Table 4

State	47 MHz to 74 MHz 87,5 MHz to 118 MHz 174 MHz to 230 MHz 470 MHz to 862 MHz	Other frequencies below 1 000 MHz	Frequencies above 1 000 MHz
Operating	4 nW	250 nW	1 µW
Standby	2 nW	2 nW	20 nW

8.5 Frequency stability under low voltage conditions

This test applies to battery-operated ULP-AMI-P and ULP-AMI equipment.

8.5.1 Definition

The frequency stability under low voltage condition is the ability of the equipment to remain on the nominal operating frequency when the battery voltage falls below the lower extreme voltage level, see also clause 3.1.

8.5.1.1 Method of measurement

The procedures in clause 8.1 shall be repeated except the measurement shall be made under normal temperature and humidity conditions (see clause 5.3.1), and the voltage from the test power source shall be reduced below the lower extreme test voltage limit towards zero. As the voltage is reduced, the nominal carrier frequency shall be monitored.

8.5.2 Limits

The equipment shall either:

- remain on the nominal operating frequency, within the limits stated in clause 8.1.2 whilst the radiated or conducted power is greater than the spurious emission limits; or
- the equipment shall cease to function below the provider's declared operating voltage.

8.6 ULP-AMI with restricted power and duty cycle

This clause applies to ULP-AMI that is operating under the provisions for low duty cycle and low power operation for accessing spectrum within the band 403,5 MHz to 403,8 MHz. ULP-AMI operating under the provisions of this clause are subject to a duty cycle restriction, very low power (see clause 8.3), and a limit on the number of transmissions within an hour. ULP-AMI-P shall not use the provisions for LP/LDC.

8.6.1 Definitions

For the purposes of the present document the duty cycle is defined as the ratio, expressed as a percentage, of the maximum transmitter "on" time monitored over one hour, relative to a one hour period, see also clause 3.1. The device may be triggered either automatically or manually and depending on how the device is triggered will also depend on whether the duty cycle is fixed or random.

8.6.2 Declaration of Duty Cycle

For automatic operated devices, either software controlled or pre-programmed devices, the manufacturer shall declare the duty cycle for the equipment under test.

For manual operated or event dependant devices, with or without software controlled functions, the manufacturer shall declare the pre-programmed duty cycle.

The manufacturer shall also give a description of the application for the device and include a typical usage pattern for maximizing duty cycle that would occur in a period of 1 hour. The typical usage pattern as declared by the manufacturer shall be used to determine the duty cycle.

8.6.3 Limit for duty cycle and maximum number of transmissions

In a period of 1 hour the duty cycle as defined in clause 8.6.1 shall not exceed 0,01 % and the maximum number of transmissions within a one hour time frame shall be limited to 10.

9 Methods of measurement and limits for receiver parameters

This clause provides spurious receiver radiation requirements for receivers or receiver sections of transceivers used in the MICS service. Medical Implant Communications Systems utilize the transmission and reception capability of ULP-AMI-P and ULP-AMI in order to transmit programming control messages and data streams in a communications session. Implant control messages are typically transmitted from the ULP-AMI-P to the implant. Data streams are typically transmitted from an ULP-AMI to a ULP-AMI-P. As this technology develops, it is expected that other forms of information transmission will evolve.

In order to conduct receiver measurements, the manufacturer shall provide a means for causing the equipment under test to operate on a frequency near 403,5 MHz or provide a sample or samples that have been modified to operate on this frequency when activated. One technique is to use frequency administration commands that place the device in the correct operating mode.

No connection shall be made to any internal permanent or temporary antenna connector during the performance of radiated emissions measurements, unless such action forms an essential part of the normal intended operation of the equipment, as declared by the provider.

The present document does not allow the use of Super-Regenerative Receivers.

9.1 Spurious radiation

This measurement applies to equipment provided with an integral antenna and to equipment supplied with a dedicated antenna.

9.1.1 Definition

Spurious radiations from the receiver are components at any frequency, generated and radiated by active receiver circuitry and the antenna.

9.1.1.1 Method of measuring the effective radiated power of spurious radiations

The level of spurious radiation shall be measured by:

- their effective radiated power when radiated by the cabinet and the integral antenna; or
- their effective radiated power when radiated by the cabinet and any dedicated antenna provided by the manufacturer.

If a modulated signal from a signal generator is required to conduct a test for receiver spurious radiations measurements as specified in this clause, the appropriate test modulation, D-M2 or D-M3 (see clause 6.1.1), as it relates to the receive function of the transceiver under test shall be used as the modulation source. Modulated signal bandwidths of the signal generators shall be equivalent to the signal bandwidths that are normally used by the MICS equipment. D-M2 is used to simulate the reception of bit stream information and D-M3 is defined as the control signal and instruction set format that the MICS equipment is designed to use.

Measurements shall be made with each type of antenna provided by the manufacturer that attaches to the equipment.

The measurement shall be carried out by the use of a measuring receiver with a bandwidth as stated in clause 6.8 and quasi-peak detector set in accordance with the specification of CISPR 16-2-3 [1] section 1 for the bands C and D. For measurements above 1 000 MHz, the peak value shall be measured using a spectrum analyser. Analogue smoothing of the displayed modulation is permitted (see clause 6.8).

On a test site, selected from annex A that is appropriate for the EUT, the equipment shall be placed at the specified height on a support, as specified in annex A, and in the position closest to normal use as declared by the provider. AIMDs shall be mounted and arranged in the human torso simulator as described in clause A.1.1.3.

The test antenna shall be oriented initially for vertical polarization and shall be tuned to each spurious radiation frequency from the equipment receiver. The output of the test antenna shall be connected to the measuring receiver. The equipment receiver shall be switched on and the measuring receiver shall be tuned over the frequency range 25 MHz to 4 GHz.

At each frequency at which a spurious component is detected, the test antenna shall be raised and lowered through the specified range of heights until a maximum signal level is detected on the measuring receiver. The receiver shall then be rotated through 360° in the horizontal plane, until the maximum signal level is detected by the measuring receiver and the test antenna height shall be adjusted again for maximum signal level. The test antenna shall be raised and lowered again through the specified range of height until the maximum signal level is detected by the measuring receiver.

The maximum signal level detected by the measuring receiver for vertical polarization shall be noted.

The equipment receiver shall be replaced by a substitution antenna as defined in clause A.2.3.

The substitution antenna shall be orientated for vertical polarization as noted above and the length of the substitution antenna shall be adjusted to correspond to the frequency of the spurious radiation from the equipment receiver. The substitution antenna shall be connected to a calibrated signal generator. If necessary, the input attenuator setting of the measuring receiver shall be adjusted in order to increase the sensitivity of the measuring receiver. The test antenna shall be raised and lowered through the specified range of height to ensure that the maximum signal is received.

The input signal to the substitution antenna shall be adjusted to the level that produces a level detected by the measuring receiver that is equal to the level noted while the equipment receiver spurious radiations were measured.

The input level to the substitution antenna, corrected for any change of input attenuator setting of the measuring receiver, shall be recorded as the power level for vertical polarization.

The measurement procedure shall be repeated with the test antenna and the substitution antenna oriented for horizontal polarization and the power level recorded.

The measure of the effective radiated power for each spurious radiation is the larger of the two power levels recorded at the input to the substitution antenna, corrected for any gain variance of the substitution antenna relative to the gain of a dipole.

Different measurement bandwidth may be used if necessary and the results shall be adjusted to the reference bandwidth.

The following reference bandwidths should be used (CEPT/ERC/REC 74-01 [i.6]):

- 1 kHz between 9 kHz and 150 kHz;
- 10 kHz between 150 kHz and 30 MHz;
- 100 kHz between 30 MHz and 1 GHz;
- 1 MHz above 1 GHz.

9.1.2 Limits

The power in the reference bandwidth of any spurious radiation of the receiver, radiated or conducted, shall not exceed the values given below:

- 2 nW below 1 000 MHz;
- 20 nW above 1 000 MHz.

10 Requirements and Measuring Methods for Monitoring Systems

NOTE: ULP-AMI using low duty cycle and low power and meeting the technical specification of clause 8.6 are exempt from the provisions of the present clause.

10A Purpose

Manufacturers of MICS systems share the 402 MHz to 405 MHz band with other manufacturers on an equal basis in order to protect the safety and health of the patients these systems are designed to serve. The following clauses set forth a LBT requirement designed to minimize the possibility of disturbance among MICS devices and to other users of the band. The use of such a technique was envisioned in the ITU-R Recommendation RS.1346 [i.4] that determined that MICS operations could be compatible with existing users in the band and prove to be a feasible communications service. Annex A of ITU-R Recommendation RS.1346 [i.4] addresses the need for a mechanism to minimize the potential for interference to MICS devices from the existing users of the band. The provisions of this clause shall not be used for the purposes of denying fair access to spectrum to other MIC systems. For example, the Medical Implant Event provision for emergency transmission shall not be used for routine spectrum access.

Except in the case of a Medical Implant Event, MICS communications sessions shall be initiated via LBT (LBT can be performed either by the ULP-AMI-P or by a ULP-AMI). Before a MICS communications session is initiated the requirements as stated specifically in clauses 10.1 to 10.6 shall be met.

If a Medical Implant Event occurs, the implant may immediately transmit time critical data associated with that Medical Implant Event (see definitions) to a ULP-AMI-P without regard to channel occupancy. The length of a transmission on a channel as a result of a single Medical Implant Event is limited to 30 seconds per hour. The 30 seconds per hour may be distributed as desired.

If the same Medical Implant Event persists and the previous transmission of that Medical Implant Event is not acknowledged by a ULP-AMI-P, then the implant may retransmit the identical information. Each subsequent retransmission shall not exceed the 30 second per hour limit. Once an acknowledgement of the successful transmission of the occurrence of the Medical Implant Event is received, no subsequent transmission of the Medical Implant Event is allowed. If multiple Medical Implant Events are concurrent, then the same 30 second per hour limit applies.

All transmissions not covered by the above requires the establishment of a MICS communications session meeting all the requirements as stated specifically in clauses 10.1 to 10.6.

10B General Remarks on the Measurement Configuration

The measurement processes generally described below are written for conducted test arrangements and should be applicable to any system submitted for testing or for post market surveillance purposes. If equipment does not permit-conducted tests to be performed, the equivalent conditions can be established using radiated signal techniques. If radiated signal techniques are used, the monitoring system antenna shall be oriented in the direction of maximum reception of the radiated broadband and CW RF disturbing fields and the radiated broadband and CW RF disturbance fields should be aligned to produce the maximum RF voltage in the monitoring system antenna.

Out-of-operating-region disturbance can be generated by using either a source capable of generating wideband disturbance with square spectral notches having a variable width that can be adjusted to the emission bandwidth of the EUT or using a disturbance source that can generate a sufficient number (approximately $2 \times 3\,000$ /emission bandwidth in kHz) of independently-controlled CW signals across the 402 MHz to 405 MHz band to block access to the band except for a notch or notches equal to the emission bandwidth of the EUT. Depending on an individual manufacturer's implementation, frequency administration commands may be used in performing some or all of the tests in this clause.

NOTE: If frequency administration commands (i.e. commands which place the unit under test in a specific configuration) are used, care needs to be taken to ensure the effect of any monitoring system antenna gain relative to an isotropic antenna is accounted for.

Depending on the specific implementation of an individual manufacturer, some modification of these procedures may be required. In this case, the test facility and the manufacturer should agree on any modification of the monitoring system measurement procedure. When the test facility and the manufacturer agree that a modified procedure or procedures are required to test a system or component of the system due to a specific implementation of the MICS system, a showing that the MICS system meets the technical parameter under investigation using the modified procedure is acceptable in lieu of using out-of-operating region interference or administrative commands to show compliance. For newly developed products the report shall document the procedure used.

The monitoring system antenna used to determine the power level of any ambient signals shall be the antenna normally used by the ULP-AMI-P/ULP-AMI for a MICS communications session.

10.1 LBT threshold power level

There are two possibilities for channel selection: A manufacturer may elect to use a threshold power level that is below the permitted maximum level. Alternatively the manufacturer may elect to use the least interfered channel method of channel selection.

It is not necessary to measure the actual threshold power level of a MICS system; however, it shall be determined that the system uses the LIC selection process if no channel is available with an ambient power level at or below the calculated threshold power level. This test shows the system has sufficient sensitivity to recognize and accurately compare the ambient signals to the calculated threshold power level.

10.1.1 Measurement method using out-of-operating-region disturbance

Calculate the LBT threshold power level, P_{Th} , for the EUT using the formula above and the emission bandwidth determined in clause 8.2 and record the value as P_{Th} . For purposes of calculating the LBT threshold power level, the manufacturer may specify or the test facility may measure the monitoring system antenna gain above isotropic as agreed between the manufacturer and the laboratory facility. Using a disturbance source, generate the spectrum pattern shown in figure 1 with the EUT operating region centred on f_c . The width of the spectral notch shall be twice the emission bandwidth measured in clause 8.2. Verify that the EUT will transmit and that it transmits only on f_c . If it transmits on a frequency other than f_c , narrow the notch until it transmits only on f_c . Raise the level of the out-of-operating-region disturbance by 20 dB and determine that the EUT transmits on f_c . Set the notch width, if necessary, to the point where the EUT transmits only on f_c . Lower the level of the out-of-operating-region disturbance by 20 dB but do not readjust the notch width. Verify that the EUT transmits only on f_c . This process minimizes the effects of the monitoring system filter bandwidth on the following measurement. Using a CW signal source, inject a signal with frequency, f_c , at a level 6 dB below the calculated LBT threshold level. Determine if the EUT transmits on f_c . If the EUT transmits on f_c , cease transmission and raise the level of the CW signal one dB. Determine if the EUT transmits on f_c . This process is repeated until the EUT does not transmit on f_c but does transmit on a channel in the out-of-operating-region disturbance area. Note the level of the CW signal source.

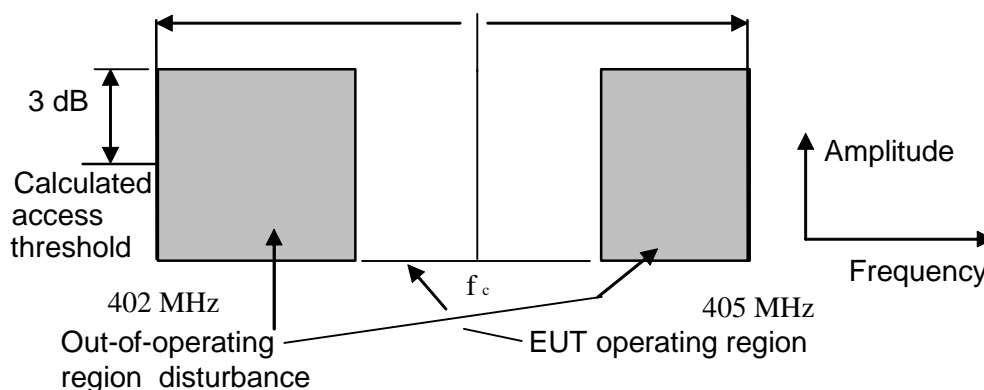

Figure 1: Spectrum Mask for Test of clauses 10.1.1 and 10.1.2

10.1.2 Measurement method using frequency administration commands

Using frequency administration commands, force all channels in the out-of-operating-region above, to have a recognized ambient power level equivalent to 3 dB above the calculated LBT threshold power level. Using a CW signal source, inject a signal at f_c at a level 6 dB below the calculated LBT threshold power level and determine if the EUT transmits on f_c . The EUT should transmit on f_c . If the EUT transmits on f_c , cease transmission and raise the level of the CW signal one dB. Determine if the EUT transmits on f_c . This process is repeated until the EUT will not transmit on f_c but does transmit on a channel in the out-of-operating-region disturbance area. Note the level of the CW signal source.

10.1.3 Results based on above test method

Using the level of the CW signal source noted in either clauses 10.1.1 or 10.1.2, subtract 4 dB and record the power level. Compare the recorded power level with the calculated LBT threshold level for the EUT. The recorded power level shall be less than or equal to the calculated LBT threshold power level.

10.1.4 Limit

The monitoring system threshold power level, P_{Th} (in dBm) shall not be greater than the calculated level given by the equation:

$$10 \log B \text{ (Hz)} - 150 + G \text{ (dB}_i\text{)},$$

where B is the emission bandwidth of the MICS communication session transmitter having the widest emission bandwidth and G is the ULP-AMI-P monitoring system antenna gain relative to an isotropic antenna.

If an ULP-AMI device is used to select the frequency of operation for a MICS system, the above LBT threshold level requirement may be adjusted higher by 1 dB for every 1 dB the e.r.p. of the device performing the LBT and AFA function is below the maximum permitted level of -16 dBm e.r.p.. However, no other device operating in the MICL shall have an e.r.p. greater than the device that selects the frequency of operation for the MICL. Thus, for a specific system a device whose output e.r.p. is 10 dB lower than the maximum permitted level of -16 dBm may add +10 dB to the above equation. This adjustment will permit implanted devices to provide the LBT and AFA function where antenna gain and body absorption significantly affect monitoring system sensitivity relative to external programmer/controllers.

10.2 Monitoring system bandwidth

The intent of this requirement is to ensure that the EUT measures the power in a bandwidth that is equal to or greater than the emission bandwidth of the transmitter with the widest emission that it will participate with in a MICS communications session. If an EUT is capable of adjusting its monitoring system bandwidth to correspond to differing emission bandwidths of devices participating in a MICS communications session, this procedure shall be repeated for each emission bandwidth the EUT can use for communication. In order to ensure the monitoring system bandwidth requirement is met; the operation of the EUT shall be restricted to a single system carrier frequency within the 402 MHz to 405 MHz band using frequency-administration commands, out-of-operating-region disturbance, or other techniques agreed upon by the test facility and the manufacturer. When using out-of-operating-region disturbance, care should be taken to ensure that the generated disturbance does not cause errors in measurement due to the slope of the monitoring system bandwidth filter.

10.2.1 Measurement method using out-of-operating-region disturbance

The emission bandwidth of the device with the greatest bandwidth shall be used or if the programmer/controller monitoring system bandwidth is adjustable to correspond to the emission bandwidth of each device, the following process shall be repeated for each emission bandwidth. Using a disturbance source, generate the spectrum pattern shown in figure 2 with the EUT operating region centred on f_c . The width of the spectral notch shall be twice the emission bandwidth measured in clause 8.2. Verify that the EUT transmits only on f_c . If it transmits on a frequency other than f_c , narrow the notch until it transmits only on f_c . A CW signal at frequency f_c shall be injected at a level sufficient to block operation on the channel with centre frequency f_c . Verify that the EUT does not transmit on f_c and does transmit on a frequency f_i in the out-of-operating-region disturbance area. Stop communications and initiate a new request for a communications link while reducing the CW signal level in one-dB steps to a level where the EUT just transmits on f_c and record the level as P_a . The CW frequency shall be adjusted to f_{low} , see clause 8.2.1.1, and its amplitude increased sufficiently to just cause the EUT to transmit on a frequency in the out-of-operating frequency region, f_i , and the level recorded at P_b . The CW signal level shall be reduced to P_a and its frequency shall be adjusted to f_{high} . Stop communications and initiate a new request for a communications link and verify the EUT transmits on frequency f_c , see clause 8.2.1.1. Increase the amplitude of the CW signal sufficiently to cause the EUT to transmit on a frequency in the out-of-operating frequency region, f_i , and record the level as P_c . During the above process, as the levels are stepped it may be necessary to allow the system to scan the entire band in order to select the specified operating frequency.

Subtract P_b from P_a and record the difference as D 1.

Subtract P_c from P_a and record the difference as D 2.

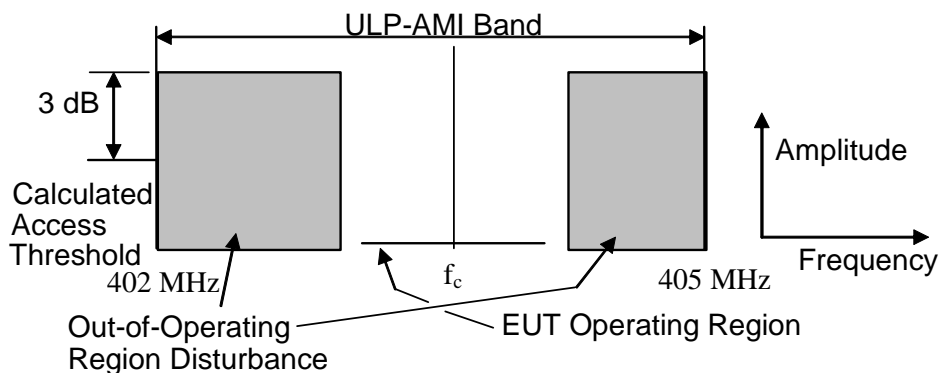

Figure 2: Spectrum Mask for Test of clauses 10.2.1 and 10.2.2

10.2.2 Measurement method using frequency administration commands

The procedure above is used with the exception that out-of-operating-region disturbance generating equipment is not used to force the EUT to operate on a single channel. The EUT operation is controlled through use of frequency administration commands that force the unit to recognize levels 3 dB above the LBT threshold power level (see clause 10.1) for all channels except the intended operating channel. A CW signal is utilized in a manner similar to the process in clause 10.2.1 to determine the difference levels, D 1 and D 2.

10.2.3 Results based on above test method

The monitoring system bandwidth measured at its 20 dB down points shall be equal to or greater than the emission bandwidth of the intended transmission.

Using the procedure above, the requirement is met if D 1 and D 2 are less than or equal to 20 dB.

10.3 Monitoring system scan cycle time and minimum channel monitoring period

The intent of these requirements is to ensure that when the monitoring system updates the detected power levels in the 402 MHz to 405 MHz band, it scans the ULP-AMI band at a rate less than or equal to 5 s and that the monitoring period on each channel is 10 ms or longer in order to detect transmissions that may have silent periods that are less than 10 ms in duration.

10.3.1 Measurement method using out-of-operating-region disturbance

10.3.1.1 Scan cycle time

Using a disturbance source generate the spectrum pattern shown in figure 2 with the EUT operating region centred on f_c . The width of the spectral notch shall be twice the emission bandwidth measured in clause 8.2. Increase the level of the out-of-operating-region sufficiently high to prevent operation under any circumstances on a channel other than f_c . Adjust the width of the notch as necessary to allow transmission on f_c . A CW signal at frequency f_c shall be injected at a level 3 dB above the out-of-operating-region disturbance level. Verify that communications do not occur on f_c .

Place the EUT in a state where it is seeking to initiate a communications session to a ULP-AMI. At the same time the EUT is placed in this state, remove the CW signal and measure the time period between the removal of the CW signal and the beginning of transmission of the EUT. Verify that the transmission is at f_c . If the EUT does not always transmit at f_c , add a 1 second delay between the removal of the CW and placing the EUT in a state where it is seeking to initiate a communications session to a ULP-AMI. Repeat adding a 1 second delay until the EUT always transmits at f_c . Record the time period from removing the CW until the beginning of transmission of the EUT and repeat this process a sufficient number of times to establish a pattern for the cycle time. Subtract 1 second and record the time period each time the process is repeated, t_p , t_{p1} , t_{p2} , etc.

10.3.1.2 Minimum channel monitoring period

In order to determine that the channel monitoring period conforms to the requirement, the set-up is similar to the above. Using a disturbance source generate the spectrum pattern shown in figure 2 with the EUT operating region centred on f_c . The width of the spectral notch shall be twice the emission bandwidth measured in clause 8.2. Increase the level of the out-of-operating-region disturbance sufficiently high to prevent operation under any circumstances on a channel other than f_c as specified by the manufacturer. Verify that the EUT transmits on f_c and adjust the width of the notch as necessary to allow transmission only on f_c . A CW signal at frequency f_c shall be injected at a level equal to the out-of-operating-region disturbance level. Temporarily remove the out-of-operating-region disturbance, restart the initiation process and verify that communications do not occur on f_c . Reinsert the out-of-operating-region disturbance at a level 3 dB above the level used before. Verify that the EUT never communicates outside the EUT operating region at f_c after reinitiating communication.

The out-of-operating-region disturbance signal source should then be modulated with a 0,1 ms pulse whose repetition frequency can be adjusted to 100 Hz corresponding to a silent period between pulses of 9,9 ms. Place the EUT in a state where it is seeking to initiate a communications session to a ULP-AMI. The EUT shall not initiate a communications session on a frequency different from f_c . This condition should be monitored several times, at least 10, in order to make sure the EUT is not able to initiate a communications session on a frequency different from f_c . This test assures that the EUT monitoring period is at least 10 ms long. Monitoring several times is necessary because channel monitoring and subsequent transmission is a variable function related to the band scanning cycle period of the EUT and the 100 Hz repetition rate of the 0,1 ms pulse.

10.3.2 Measurement method using frequency administration commands

The procedure above is used except that out-of-operating-region disturbance generating equipment is not used to force the EUT to operate on a single channel. The EUT operation is controlled through use of frequency administration commands that force the unit to operate only on the intended operating frequency, f_c . A CW signal is utilized in a manner similar to the process in clause 10.3.1.1 to record the cycle time periods, t_p , t_{p1} , t_{p2} , etc.

Disturbance signals modulated as specified in clause 10.3.1.2 are used to ensure that the minimum channel monitoring period is at least 10 ms long. When this signal is applied the EUT shall not be able to initiate a communications session on a frequency different from f_c .

10.3.3 Results based on above test method

10.3.3.1 Scan cycle time

Within 5 s prior to initiating a communications session, circuitry associated with a ULP-AMI-P shall monitor all the channels in the 402 MHz to 405 MHz band.

The requirement is met if all values of t_p , t_{p1} , t_{p2} , t_{pn} , etc., are less than or equal to 5 s.

10.3.3.2 Minimum Channel Monitoring Period

Each MICS channel shall be monitored for a minimum of 10 ms during each scan cycle of 5 s or less duration.

Conformity with this requirement is shown if, during testing, the EUT is unable to initiate a communications session on a frequency different from f_c when the disturbance signals, modulated as specified in clause 10.3.1.2, are injected outside f_c .

10.4 Channel access based on ambient levels relative to the calculated access LBT threshold level, P_{Th}

MICS programmer/control transmitters are permitted to initiate a MICS communications session to an ULP-AMI immediately on any channel where the ambient signal level is below the maximum permitted LBT threshold power level, P_{Th} , referenced to the emission bandwidth of the MICS device with the widest emission bandwidth that will participate in a MICS communications session initiated by the EUT. If no channel is available with an ambient power level at or below the maximum permitted P_{Th} , spectrum access is permitted based on the channel with the lowest ambient power level referred to as the LIC or "least interfered channel". If the manufacturer chooses not to use the LBT threshold power level provisions, spectrum access is permitted based on the LIC referenced to the emission bandwidth of the MICS device with the widest emission bandwidth that will participate in a MICS communications session initiated by the EUT.

10.4.1 Access based on lowest ambient level above P_{Th} using out-of-operating-region disturbance

Using a disturbance source generate the spectrum pattern shown in figure 3 with the EUT operating region centred on f_c . The width of the spectral notches centred on f_c and on the LIC channel shall be twice the emission bandwidth measured in clause 8.2. Verify that the EUT transmits on f_c . If it transmits on a frequency other than f_c , narrow the notch until it transmits only on f_c . A CW signal at frequency f_c shall be injected at a level 3 dB below the calculated LBT threshold power level, P_{Th} . Initiate a communications session and determine that transmission occurs on f_c . Cease transmission and increase the CW signal level by 9 dB. Initiate a communications session and determine that transmission occurs on the centre frequency of the LIC channel indicated in figure 3. In setting up the LIC channel, it should be determined if the programmer/control transmitter uses a predetermined channelization plan. If it uses a predetermined channelization plan, the centre frequency of the LIC channel should coincide with the centre frequency of one of its channels. If the system does not employ a predetermined channelling plan, this step is not necessary.

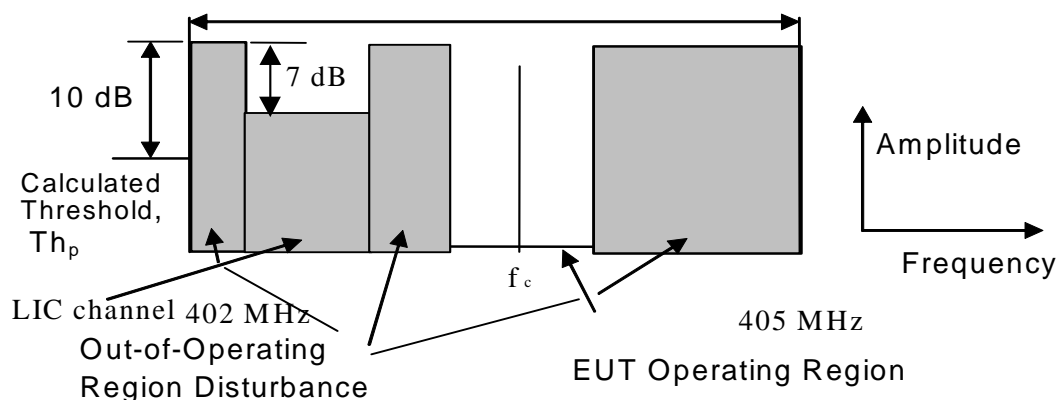

Figure 3: Spectrum Mask for Test of clause 10.4.1

10.4.2 Access based on lowest ambient level above P_{Th} using frequency administration commands

The procedure in clause 10.4.1 is used except that out-of-operating-region disturbance generating equipment is not used to force the EUT to operate on a single channel. The EUT operation is controlled through use of frequency administration commands that force the out-of-operating-region ambient levels, the LIC channel level, and the intended operating frequency, f_c , channel level to be recognized by the system. A CW signal at frequency f_c shall be injected at a level 3 dB below the access LBT threshold, P_{Th} . Initiate a communications session and determine that transmission occurs on f_c . Increase the CW signal level by 9 dB. Initiate a communications session and determine that transmission occurs on the centre frequency of the LIC channel selected by the frequency administration commands.

10.4.3 Results based on above test method

The EUT shall access and transmit on the Least Interfered Channel (LIC) after the CW signal at frequency, f_c , has been increased by 9 dB from its initial level of 3 dB below the calculated access threshold.

10.5 Discontinuation of MICS session if a silent period greater than or equal to 5 s occurs

MICS systems shall cease transmission in the event the communications session is interrupted for a period of 5 s or more. Once a MICS session is established, it may continue as long as the silent period in two-way communication between co-operating devices does not exceed 5 s.

10.5.1 Measurement method

Using either of the procedures in clauses 10.4.1 or 10.4.2, establish a communications link from the ULP-AMI-P to a ULP-AMI in the LIC channel by setting the CW signal source at frequency, f_c , to a level that is 9 dB above its initial value of 3 dB below the calculated access threshold. Verify that the ULP-AMI is communicating with the ULP-AMI-P on the LIC channel. Reduce the CW signal generator level to 3 dB below the calculated access threshold and immediately turn off the ULP-AMI or block the LIC channel for a period of time greater than 5 s. Measure and record the time required for the ULP-AMI-P to end its transmission (i.e. the EUT ceases to try to continue transmission or re-establish transmission) in the LIC channel. Enable the ULP-AMI. The communications session should not restart in the previous LIC channel. The ULP-AMI-P may restart the session on f_c .

10.5.2 Results based on above test method

Emission from the programmer/control transmitter on the initial LIC channel shall cease in an amount of time less than or equal to 5 s after the ULP-AMI is turned off or blocked and the session should not restart on the initial LIC channel. If the time recorded above is less than or equal to 5 s and communication does not restart on the initial LIC channel, the requirement is met.

10.6 Use of pre-scanned alternate channel

At the time a channel for operation is initially selected and accessed, it is permissible for the monitoring system to select one additional channel for alternate operation for use if the initially selected channel becomes unavailable due to blockage of the channel from unknown disturbing ambient signals. The procedures in this clause determine if the system uses this feature and, if so, if it complies with the requirements for alternate channel selection. MICS programmer/controllers that do not use the alternate channel provision are required to meet the other parts of clause 10 of the present document.

It is necessary to conduct a test to determine if the alternate channel provision is used. The test set-up in clause 10.4.1 or clause 10.4.2 may be used. Using a signal from the CW source on f_c at a level 3 dB below the calculated access threshold level, establish a communications link from the ULP-AMI-P to a ULP-AMI on frequency f_c as indicated in figure 3. This will permit the system to place in memory a channel, designated as the LIC channel in figure 3, as the alternate channel. Verify that the programmer/control and ULP-AMI are in communication. Open an additional channel, designated as LIC₂, with an ambient level 12 dB below the level of the out of operating region interference level. Increase the CW signal source operating on f_c , sufficiently high to block the communications session and measure the time required for the programmer/control transmitter to initiate a new communications link on the alternate channel.

If the programmer/controller transmitter does not access spectrum or accesses LIC₂ the system does not use the provision for use of a pre-scanned alternate channel and no further tests are necessary. If the programmer/control transmitter accesses the designated alternate channel it uses the alternate channel provision and tests to determine compliance with the following requirements must be made:

- 1) Before transmitting on the alternate channel, the channel must be monitored for a period of at least 10 ms.
- 2) The detected power level during this 10 ms or greater monitoring period must be no higher than 6 dB above the power level detected when the channel was chosen as the alternate channel.

10.6.1 Measurement method for alternate channel selection using out-of-operating-region disturbance

Set up the disturbance signals as shown in figure 4.

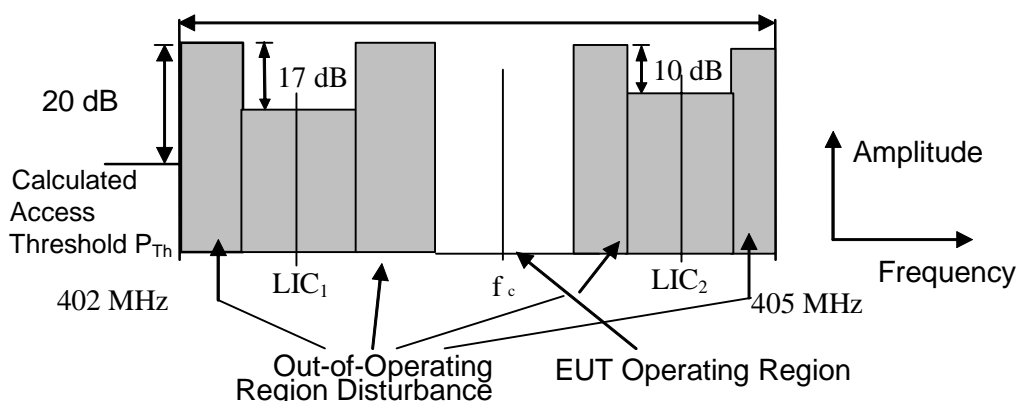

Figure 4: Spectrum Mask for Test of clause 10.6.1

Using the procedure in clause 10.4.1, establish a communications link from the programmer/control transmitter to a ULP-AMI on the intended operating frequency, f_c , as indicated in figure 4 with the CW signal source operating on frequency f_c at a level 3 dB below P_{Th} . This will permit the system to place in its memory the ambient power levels in the LIC₁ and LIC₂ channels. Verify that the programmer/control transmitter and ULP-AMI are in communication on the channel with centre frequency f_c . Using a CW signal source operating on f_c , inject a signal at a level sufficient to block operation on the channel with centre frequency, f_c . Verify that the EUT establishes a new communications session on the LIC₁ channel. Reduce the CW signal source power level to its previous value, initiate a new communications session, and verify communications session operation is on the channel with centre frequency f_c . This allows mapping into memory the ambient power levels in the LIC₁ and LIC₂ channels. With the system operating, using a CW signal source operating on f_c , inject a signal at a level sufficient to block operation on f_c . Simultaneously with the injection of this high level CW signal on f_c , inject a signal source on the centre frequency of the LIC₁ channel that is modulated with a 0,1 ms pulse whose repetition frequency can be adjusted to 100 Hz corresponding to a silent time interval between pulses of 9,9 ms. The amplitude of this signal should be 6 dB above the calculated access threshold level, P_{Th} . The programmer/control transmitter shall establish a new communications link to the ULP-AMI on the LIC₁ channel. Record the time difference between applying the high level CW signal and the programmer/controller transmitter signal appearing on LIC₁ as T_1 . T_1 should always be much less than the maximum band scanning cycle time; t_{pn} recorded in clause 10.3.1.1. Repeat the above process and establish communication on f_c . Inject a CW signal on f_c high enough to block operation on f_c and simultaneously inject the pulse-modulated signal on LIC₁ as above except the amplitude of the signal should be 12 dB above P_{Th} . This condition should be monitored for several minutes, or until a new session is initiated in LIC₂. The programmer/control transmitter shall not establish a connection on LIC₁ or in the out-of-operating-region disturbance portions of the band. Repeat this last process at least 5 times to 10 times to ensure that random variables associated with applying signals and session activation sequences do not permit access to occur in the LIC₁ channel. If access occurs on LIC₂, record the time difference between the application of the high level CW signal and channel access on LIC₂ as T_2 , T_{2a} , etc.

10.6.2 Measurement method for alternate channel selection using frequency administration commands

The procedure in clause 10.6.1 is used except that out-of-operating-region disturbance generating equipment is not used to force the EUT to operate on a single channel. The EUT operation is controlled through use of frequency administration commands that force the out-of-operating-region ambient levels, the LIC₁ and LIC₂ channel levels, and the intended operating frequency, f_c , channel level to be recognized by the system. Disturbances from the CW signal and pulse modulated sources are injected in a manner similar to clause 10.6.1. With the 0,1 ms pulse modulated signal at a level of 6 dB above P_{Th} in the LIC₁ channel, the programmer/controller transmitter shall access LIC₁. With the pulse-modulated signal at a level of 12 dB above P_{Th} , the programmer/controller shall not access spectrum except in the LIC₂ channel. This last process should be repeated 5 to 10 times to ensure access on LIC₁ does not occur. Record the time differentials as above.

10.6.3 Results based on above test method

Systems using the alternate channel provision shall monitor the alternate channel for at least 10 ms prior to transmitting on the alternate channel. The detected power level during this minimum 10 ms monitoring period shall be no higher than 6 dB above the power level detected when the channel was chosen as the alternate channel. Successful completion of the test using the procedure in either clause 10.6.1 or clause 10.6.2, is indicated by ability to establish a connection on the LIC₁ channel in a time interval much less than the scan cycle time with the pulse modulated signal at an amplitude of 6 dB above the calculated threshold power level. With the pulse modulated signal amplitude at 12 dB above the calculated threshold power level, access on LIC₁ is not permitted and access on LIC₂ is permitted only after the entire ULP-AMI band is re-scanned.

Systems using this provision are not allowed to select more than one alternate channel. In this case the desired alternate channel is defined as LIC₁. For any occurrences of access on the channel designated as LIC₂, subtract the recorded time T_2 , T_{2a} , etc., from T_1 . In all cases the difference between the two should be approximately equal to or greater than the scanning cycle time for the system. If the difference is short compared to the scan cycle time, the system is not re-scanning the entire band before accessing the LIC₂ channel, which is unacceptable. Any operation in the out-of-operating-region area is not acceptable.

Annex A (normative): Radiated measurements

A.1 Test sites and general arrangements for measurements involving the use of radiated fields

A.1.1 Outdoor test site

The outdoor test site shall be on a reasonably level surface or ground. For measurements at frequencies 25 MHz and above, a conducting ground plane of at least 5 m diameter shall be provided at one point on the site. In the middle of this ground plane, a non-conducting support, capable of rotation through 360° in the horizontal plane, shall be used to support the test sample in its standard position, at 1 m above the ground plane. The test site shall be large enough to allow the erection of a measuring or transmitting antenna at a distance of $\lambda/2$ m or 3 m whichever is greater. The distance actually used shall be recorded with the results of the tests carried out on the site.

Sufficient precautions shall be taken to ensure that reflections from extraneous objects adjacent to the site do not degrade the measurement results according to the specification of CISPR 16-2-3 [1].

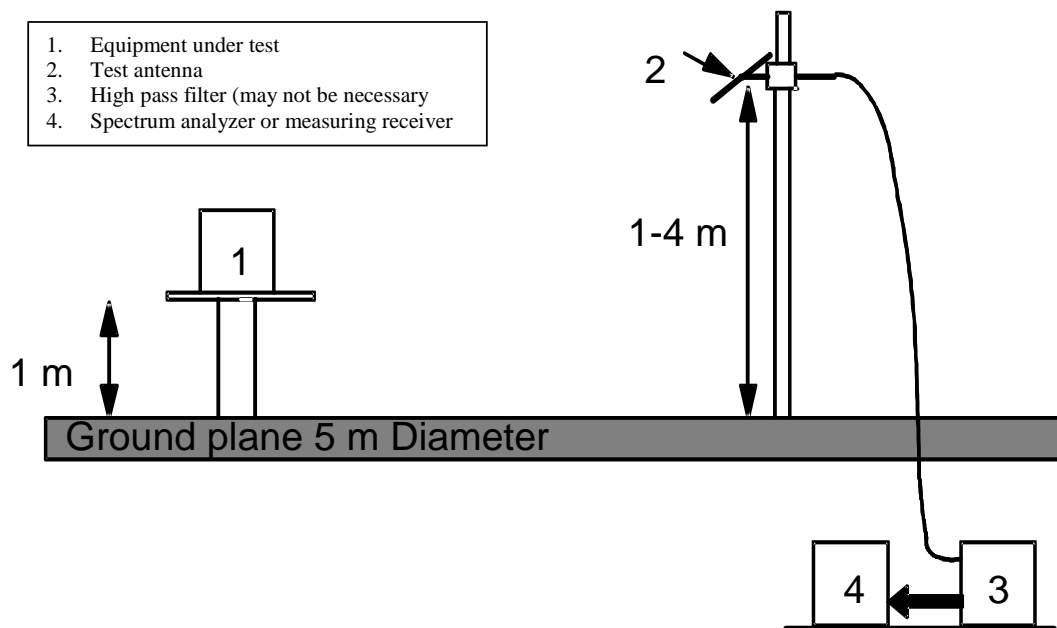

Figure A.1

A.1.1.1 Standard position

The standard position for all programmer/control transmitters used in the Medical Implant Communications Service, except for equipment that is intended to be worn on a person or implanted in a human body shall be as follows:

- for equipment with an integral antenna or dedicated antenna, it shall be placed in the position closest to normal use as declared by the manufacturer;
- for equipment with a rigid or semi-rigid external antenna, the antenna shall be vertical;
- for equipment with non-rigid external antenna, the antenna shall be extended vertically upwards by a non-conducting support.

A.1.1.2 Equipment in close proximity to the human body but external to it

The following provisions apply to equipment designed to be external to but in very close proximity to a human body.

For programmer/control equipment intended to be worn close to the body or hand held, the non-conducting support may, at the request of the provider be replaced with a simulated man, if appropriate. The use of the simulated man shall be stated in the test report.

The simulated man for equipment external to the body shall consist of an acrylic tube, filled with salt water (1,5 g NaCl per litre of distilled water). The tube shall have a length of 1,7 m \pm 0,1 m and an internal diameter of 300 mm \pm 5 mm with side wall thickness of 1,5 mm \pm 0,5 mm.

To reduce the weight of the simulated man it may be possible to use an alternative tube that has a hollow centre of 200 mm maximum diameter.

The sample shall be fixed to the surface of the simulated man, at the appropriate height for the equipment.

The following provisions apply to equipment designed to be implanted in a human body.

A.1.1.3 Human torso simulator for ULP-AMI

ULP-AMIs shall be tested in a simulated man constructed as follows in order to simulate operation of the ULP-AMI under actual operation conditions as shown in figure A.2.

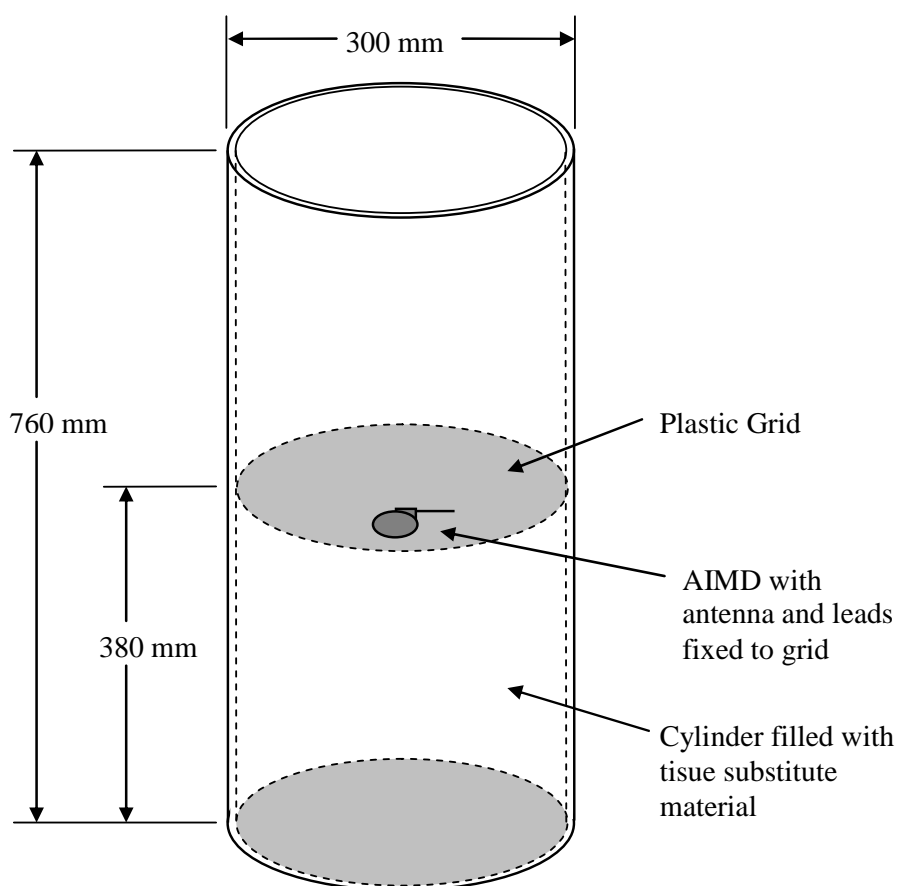

Figure A.2

An appropriate simulator for testing ULP-AMI consists of a cylindrical acrylic container with an outside diameter of 300 mm \pm 5 mm, a sidewall thickness of 6 mm \pm 2,1 mm, and a fluid-filled height of 760 mm \pm 5 mm. It shall be filled with a material that is sufficiently fluid that it will flow around the AIMD without any voids. The dielectric and conductivity properties of this material shall match the dielectric and conductivity properties of human muscle tissue at 403,5 MHz (conductivity = 0,93 and relative permittivity = 57,2). Simple saline solutions do not meet the dielectric and conductivity requirements for use as a substitute for human tissue. All emissions measurements will be made using the above specification with the tissue substitute material at a nominal temperature between 22 °C and 38 °C. This temperature will facilitate testing because it is typical of ambient conditions at many test sites. A mounting grid for the AIMD inside the container shall be provided that permits the radiating element or elements of the AIMD to be positioned vertically and horizontally. The grid should also support any additional AIMD leads associated with the therapeutic function of the AIMD in a fixed repeatable manner such that they do not influence the measurement. The AIMD antenna shall be mounted 60 mm \pm 5 mm from the sidewall and centred vertically within the container. When switching from vertical to horizontal positioning, it may be necessary to reposition the antenna to maintain a separation of 60 mm \pm 5 mm from the sidewall of the test fixture along its length. AIMD leads will be coiled and placed away from the AIMD antenna while maintaining a nominal 60 mm from the sidewall. The above fixture shall be placed on a turntable such that the AIMD will be located at a nominal 1,5 m height above ground and at a 3 m distance from the measurement antenna. Radiated emissions measurements shall then be performed to ensure compliance with the applicable technical specifications.

A formula for a suitable tissue substitute material is defined in the paper "Simulated Biological Materials for Electromagnetic Radiation Absorption Studies [i.9]".

A.1.2 Test antenna

The test antenna is used to detect the radiation from both the test sample and the substitution antenna, when the site is used for radiation measurements. Where necessary, it may be used as a transmitting antenna, when the site is used for the measurement of receiver characteristics provided its radiation characteristics are similar to the antenna normally used with the medical device.

This antenna is mounted on a support such as to allow the antenna to be used in either horizontal or vertical polarization and for the height of its centre above ground to be varied over the range 1 m to 4 m. Preferably a test antenna with a gain characteristic similar to a dipole antenna should be used. The size of the test antenna along the measurement axis shall not exceed 20 % of the measuring distance.

For receiver and transmitter radiation measurements, the test antenna is connected to a measuring receiver, capable of being tuned to any frequency under investigation and of measuring accurately the relative levels of signals at its input. For receiver radiated sensitivity measurements, the test antenna is connected to a signal generator.

A.1.3 Substitution antenna

When measuring in the frequency range up to 1 GHz the substitution antenna shall be a $\lambda/2$ dipole, resonant at the operating frequency, or a shortened dipole, calibrated to the $\lambda/2$ dipole. When measuring in the frequency range above 4 GHz, a horn radiator shall be used. For measurements between 1 GHz and 4 GHz, either a $\lambda/2$ dipole or a horn radiator may be used. The centre of this antenna shall coincide with the reference point of the test sample it has replaced including the torso simulator if used. This reference point shall be the volume centre of the sample when its antenna is mounted inside the cabinet, or the point where an external antenna is connected to the cabinet.

The distance between the lower extremity of the dipole and the ground shall not be less than 0,3 m.

The substitution antenna shall be connected to a calibrated signal generator when the site is used for spurious radiation measurements and transmitter effective radiated power measurements. The substitution antenna shall be connected to a calibrated measuring receiver when the site is used for access protocol measurements and the measurement of receiver sensitivity.

The signal generator and the receiver shall operate at the frequencies under investigation and shall be connected to the antenna through suitable matching and balancing networks, as appropriate.

NOTE: The gain of a horn antenna is generally expressed relative to an isotropic radiator.

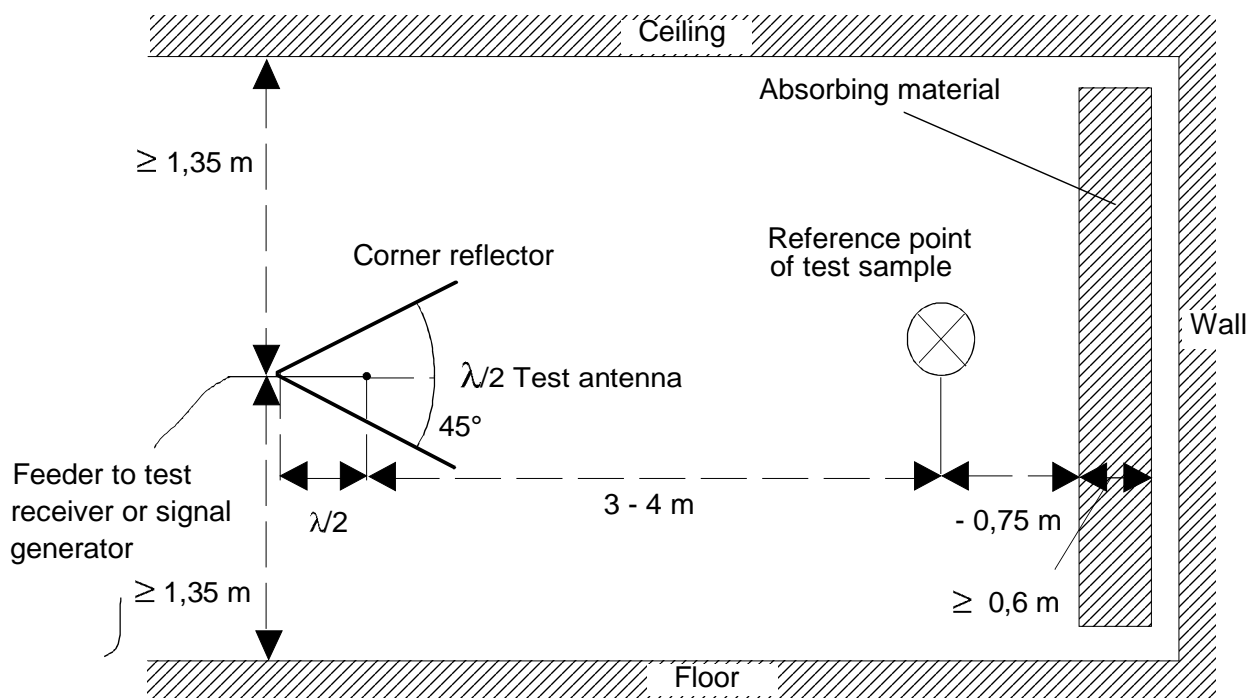

Figure A.3: Indoors site arrangement (shown for horizontal polarization)

A.1.4 Optional additional indoor site

When the frequency of the signals being measured is greater than 80 MHz, use may be made of an indoor test site. If this alternative site is used, this shall be recorded in the test report.

The measurement site may be a laboratory room with a minimum area of 6 m by 7 m and at least 2,7 m in height.

Apart from the measuring apparatus and the operator, the room shall be as free as possible from reflecting objects other than the walls, floor and ceiling.

The potential reflections from the wall behind the equipment under test are reduced by placing a barrier of absorbent material in front of it. The corner reflector around the test antenna is used to reduce the effect of reflections from the opposite wall and from the floor and ceiling, in the case of horizontally polarized measurements. Similarly, the corner reflector reduces the effects of reflections from the sidewalls for vertically polarized measurements. For the lower part of the frequency range (below approximately 175 MHz), no corner reflector or absorbent barrier is needed. For practical reasons, the $\lambda/2$ antenna in figure A.3 may be replaced by an antenna of constant length, provided that this length is between $\lambda/4$ and λ at the frequency of measurement, and the sensitivity of the measuring system is sufficient. In the same way, the distance of $\lambda/2$ to the apex may be varied.

The test antenna, measuring receiver, substitution antenna and calibrated signal generator are used in a way similar to that of the general method. To ensure that errors are not caused by the propagation path approaching the point at which phase cancellation between the direct and the remaining reflected signals occurs, the substitution antenna shall be moved through a distance of $\pm 0,1$ m in the direction of the test antenna as well as in the two directions perpendicular to this first direction.

If these changes of distance cause a signal change of greater than 2 dB, the test sample should be re-sited until a change of less than 2 dB is obtained.

A.2 Guidance on the use of radiation test sites

For measurements involving the use of radiated fields, use may be made of a test site in conformity with the requirements of clause A.1. When using such a test site, the following conditions should be observed to ensure consistency of measuring results.

NOTE: If this technique is used, the ground reflected component of the measured field strength needs to be accounted for. For purposes of computing e.r.p. levels, the contribution to the measured level that is due to the ground reflected ray is considered to be 5 dB if measurements are performed on an open area test site or equivalent.

A.2.1 Measuring distance

Evidence indicates that the measuring distance is not critical and does not significantly affect the measuring results, provided that the distance is not less than $\lambda/2$ at the frequency of measurement, and that the precautions described in this annex are observed. Measuring distances of 3 m, 5 m, 10 m and 30 m are in common use in European test laboratories.

A.2.2 Test antenna

If performing substitution measurements, different types of test antenna may be used, since the substitution technique reduces the effect of the errors on the measuring results. If performing radiated field strength measurements, a calibrated $\lambda/2$ dipole antenna shall be used.

Height variation of the test antenna over a range of 1 m to 4 m is essential in order to find the point at which the radiation is at a maximum.

Height variation of the test antenna may not be necessary at the lower frequencies below approximately 100 MHz.

A.2.3 Substitution antenna

Variations in the measuring results may occur with the use of different types of substitution antenna at the lower frequencies below approximately 80 MHz. Where a shortened dipole antenna is used at these frequencies, details of the type of antenna used should be included with the results of the tests carried out on the test site. Correction factors shall be taken into account when shortened dipole antennas are used.

A.2.4 Artificial antenna

The dimensions of the artificial antenna used during radiated measurements should be small in relation to the sample under test.

Where possible, a direct connection should be used between the artificial antenna and the test sample. In cases where it is necessary to use a connecting cable, precautions should be taken to reduce the radiation from this cable by, for example, the use of ferrite cores or double-screened cables.

A.2.5 Auxiliary cables

The position of auxiliary cables (power supply and microphone cables etc.), which are not adequately de-coupled, may cause variations in the measurement results. In order to get reproducible results, cables and wires of auxiliaries should be arranged vertically downwards (through a hole in the non-conducting support), or as specified in the technical documentation supplied with the equipment.

Care shall be taken to ensure that test cables do not adversely effect the measuring result.

A.3 Further optional alternative indoor test site using an anechoic chamber

For radiation measurements, when the test frequency of the signals being measured is greater than 30 MHz, use may be made of an indoor test site being a well-shielded anechoic chamber simulating a free space environment. If such a chamber is used, this shall be recorded in the test report.

The test antennas, measuring receiver, substitution antenna and calibrated signal generator are used in a way similar to that of the general method, clause A.1. In the range 30 MHz to 100 MHz, some additional calibration may be necessary.

An example of a typical measurement site may be an electrically shielded anechoic chamber being 10 m long, 5 m broad and 5 m high. Walls and ceiling should be coated with RF absorbers of 1 m height. The base should be covered with absorbing material 1 m thick and a wooden floor, capable of carrying test equipment and operators. The construction of the anechoic chamber is described in the following clauses.

A.3.1 Example of the construction of a shielded anechoic chamber

Free-field measurements can be simulated in a shielded measuring chamber where the walls are coated with RF absorbers. Figure A.4 shows the requirements for shielding loss and wall return loss of such a room. As dimensions and characteristics of usual absorber materials are critical below 100 MHz (height of absorbers < 1 m, reflection attenuation < 20 dB) such a room is more suitable for measurements above 100 MHz. Figure A.5 shows the construction of an anechoic shielded measuring chamber having a base area of 5 m by 10 m and a height of 5 m.

Ceilings and walls are coated with pyramidal formed RF absorbers approximately 1 m high. The base is covered with absorbers forming a non-conducting sub-floor or with special ground floor absorbers. The available internal dimensions of the room are 3 m × 8 m × 3 m, so that a maximum measuring distance of 5 m length in the middle axis of this room is available.

At 100 MHz, the measuring distance can be extended up to a maximum of 2λ .

The floor absorbers reduce floor reflections so that the antenna height need not be changed and floor reflection influences need not be considered.

All measuring results can therefore be checked with simple calculations and the measurement uncertainties have the smallest possible values due to the simple measuring configuration.

A.3.2 Influence of parasitic reflections in anechoic chambers

For free-space propagation in the far field condition the correlation $E = E_0 (R_0/R)$ is valid for the dependence of the field strength E on the distance R , whereby E_0 is the reference field strength in the reference distance R_0 .

It is useful to use this correlation for comparison measurements, as all constants are eliminated with the ratio and neither cable attenuation, nor antenna mismatch, or antenna dimensions are of importance.

Deviations from the ideal curve can be seen easily if the logarithm of the above equation is used, because the ideal correlation of field strength and distance can then be shown as a straight line and the deviations occurring in practice are clearly visible. This indirect method more readily shows the disturbances due to reflections and is far less problematical than the direct measurement of reflection attenuation.

With an anechoic chamber of the dimensions suggested in clause A.3 at low frequencies up to 100 MHz, there are no far field conditions and therefore reflections are stronger so that careful calibration is necessary; in the medium frequency range from 100 MHz to 1 GHz the dependence of the field strength on the distance meets the expectations very well.

A.3.3 Calibration of the shielded RF anechoic chamber

Careful calibration of the chamber shall be performed over the range 30 MHz to 1 GHz.

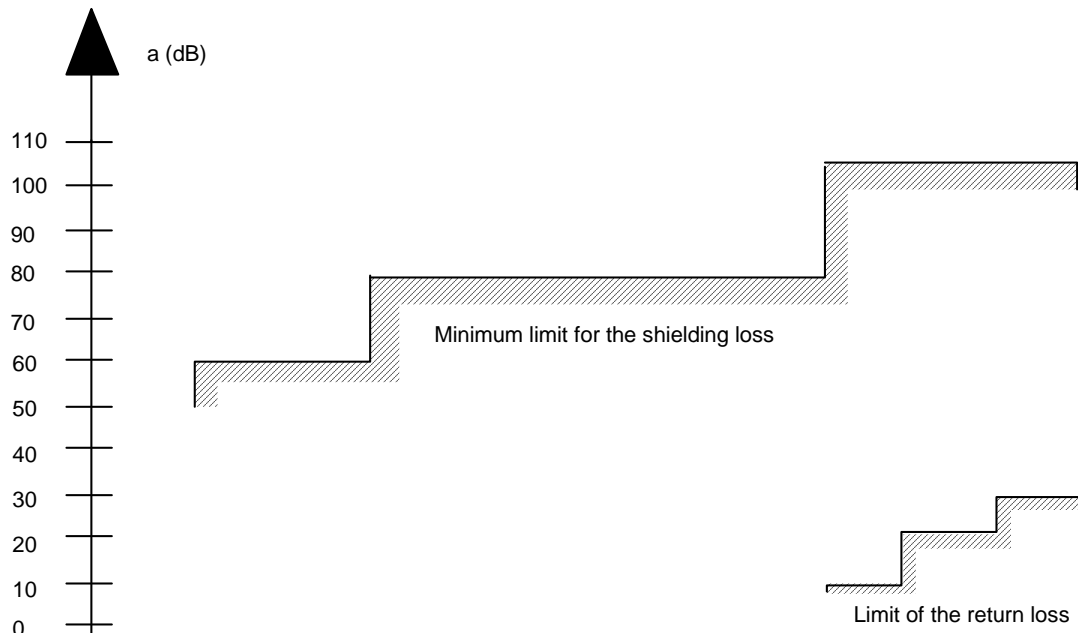
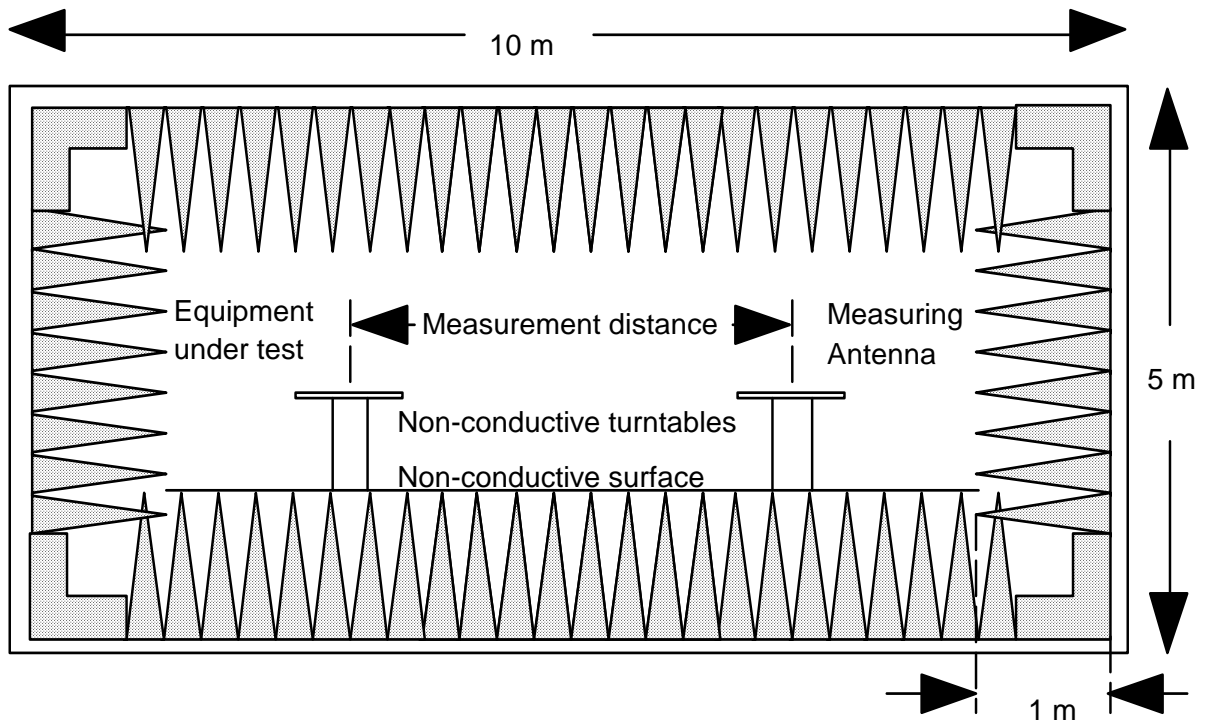

Figure A.4: Specification for shielding and reflections



Ground plan

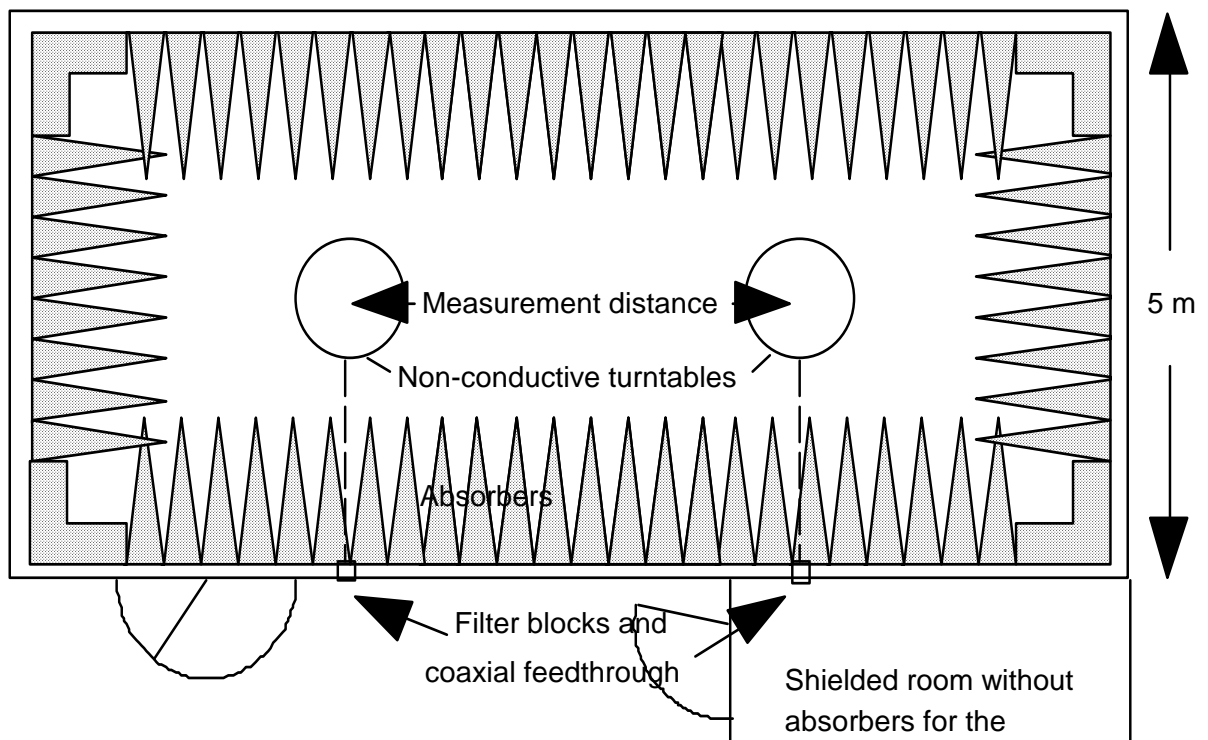

Figure A.5: Example of construction of an anechoic shielded chamber

Annex B (normative): Technical performance of the spectrum analyser

The specification of the spectrum analyser shall include the following requirements:

It shall be possible, using a resolution bandwidth of 1 kHz, to measure the amplitude of a signal or noise at a level 3 dB or more above the noise level of the spectrum analyser as displayed on the screen, to an accuracy of ± 2 dB in the presence of a signal separated in frequency by:

- a) 10 kHz, at a level 90 dB above that of the signal to be measured for 25 kHz and 20 kHz channel separations; and
- b) 6,25 kHz, at a level 80 dB above that of the signal to be measured for a 12,5 kHz channel separation; and
- c) 5 kHz, at a level 80 dB above that of the signal to be measured for a 10 kHz channel separation.

The reading accuracy of the frequency marker shall be within ± 2 % of the channel separation.

The accuracy of relative amplitude measurements shall be within $\pm 0,5$ dB in the measurement frequency range.

The spectrum analyser shall have a resolution bandwidth setting of 1 MHz or greater.

It shall be possible to adjust the spectrum analyser to allow the separation, on the display, of two components with a frequency difference of 1 kHz.

Annex C (informative): Strategy for ULP-AMI/ULP-AMI-P in the band 402 MHz to 405 MHz (source ERM_TG30 see URL: <http://www.etsi.org/>)

ETSI ERM_TG30 agreed on the following principles for the use of ULP-AMI and ULP-AMI-P in the 402 MHz to 405 MHz band.

Considering that:

- a) ULP-AMI and ULP-AMI-P operating in the 402 MHz to 405 MHz band are Class 1 devices under the R&TTE Directive [i.1];
- b) the current regulation does not impose any restriction on the duty cycle or the use of LBT/AFA in the band 402 MHz to 405 MHz;
- c) low duty cycle (0.01 %) and low power (100 nanowatts) with operation on 403,5 MHz to 403,8 MHz could be introduced as an alternative to LBT/AFA.

However, ERC/DEC(01)17 [i.7] clearly states that LBT and AFA are used by MICS equipment operating in the band, based on ITU-R Recommendation RS.1346 [i.4]. CEPT/ERC/REC 70-03 annex 12 [i.2] for the band 402 MHz to 405 MHz, lists ERC/DEC(01)17 [i.7] as the basis for Class 1 status.

ULP-AMI devices cannot be treated in the same way as conventional SRDs insofar as ULP-AMI radio-communications links have a relationship to patient health and safety. In order to improve the reliability of the communication link, an appropriate method of interference mitigation technique and channel access protocol is required.

Loss of the ULP-AMI radio-communications links due to interference in specific applications could easily result in loss of time critical patient data.

Patient safety has been recognized by the ITU-R in ITU-R Recommendation RS.1346 [i.4] which states that "Clearly, it is vital patients suffer no harmful effects from interference". The ITU-R Recommendation RS.1346 [i.4] also recommends "that interference mitigation techniques, as discussed in annex 1 of that document, should be used by Medical Implant Communication Systems to protect their operation".

Further, the R&TTE Directive [i.1] states in article 3.1(a): "The following essential requirements are applicable to all apparatus", followed by (a) "the protection of the health and safety of the users and any other person". Article 3.1(a) is not limited in scope. Thus the R&TTE Directive [i.1] confirms that any issue related to user safety is an essential requirement. The position of TG30 is therefore aligned with that of the ITU-R as stated in ITU-R Recommendation RS.1346 [i.4] and the R&TTE Directive [i.1] as stated in article 3.1(a).

ERM_TG30 is of the opinion that technical requirements (to meet Essential Requirements of RTTE Directive [i.1]) for wireless medical implant devices (e.g. those utilizing the 402 MHz to 405 MHz band) should be developed by participating members of ETSI ERM TG30 to comply with the R&TTE Directive [i.1] and remain in alignment with related ITU-R Recommendations. These technical requirements include provisions for LBT, AFA, and/or LDC operation in order to comply with article 3.1(a) of the R&TTE Directive [i.1].

Based on the ITU-R Recommendation RS.1346 [i.4] and the RTTE directive [i.1], ERM_TG30 (formerly ERM_RP08) elaborated Harmonized Standards for ULP-AMI (EN 301 839-1 and EN 301 839-2 [i.8]) that address "the protection of the health and the safety of the user and any other person". These standards implemented a requirement to use a technology neutral monitoring system in order to guarantee the technically most feasible link reliability and immunity against interference from other users in the band, such as Metacids and other medical implant systems. The same technology neutral requirement that was adopted in those standards (LBT) is now recognized as a technology neutral requirement e.g. in specific bands in annex 1 and annex 11 of CEPT/ERC/REC 70-03 [i.2].

ERM_TG30 continues to elaborate the ULP-AMI/ULP-AMI-P standards in line with above statement.

Annex D (informative): Bibliography

ETSI EN 301 839-2 (V1.2.1): "Electromagnetic compatibility and Radio spectrum Matters (ERM); Radio equipment in the frequency range 402 MHz to 405 MHz for Ultra Low Power Active Medical Implants and Accessories; Part 2: Harmonized EN covering essential requirements of article 3.2 of the R&TTE Directive".

ICNIRP: "Guidelines for Limiting Exposure to Time-Varying Electric, Magnetic, and Electromagnetic Fields (up to 300 GHz)", International Commission on Non-Ionizing Radiation Protection, Health Physics Vol. 74, No 4, pp 494-522, 1998.

Council Recommendation 1999/519/EC on limitation of exposure of the general public to electromagnetic fields 0 Hz-300 GHz.

Council Directive 90/385/EEC of 20 June 1990 on the approximation of the laws of the Member States relating to active implantable medical devices (AIMD Directive).

History

Document history		
V1.1.1	June 2002	Publication
V1.2.1	July 2007	Publication
V1.3.1	January 2009	Public Enquiry PE 20090506: 2009-01-06 to 2009-05-06