



**ElectroMagnetic Compatibility (EMC)
standard for radio equipment and services;
Part 50: Specific conditions for Cellular Communication
Base Station (BS), repeater and ancillary equipment;
Harmonised Standard for ElectroMagnetic Compatibility**

Reference

REN/ERM-EMC-407

Keywords5G, EMC, GSM, harmonised standard, LTE,
MSR, NR, OFDMA, WCDMA, WMAN**ETSI**

650 Route des Lucioles
F-06921 Sophia Antipolis Cedex - FRANCE

Tel.: +33 4 92 94 42 00 Fax: +33 4 93 65 47 16

Siret N° 348 623 562 00017 - NAF 742 C
Association à but non lucratif enregistrée à la
Sous-Préfecture de Grasse (06) N° 7803/88

Important notice

The present document can be downloaded from:

<http://www.etsi.org/standards-search>

The present document may be made available in electronic versions and/or in print. The content of any electronic and/or print versions of the present document shall not be modified without the prior written authorization of ETSI. In case of any existing or perceived difference in contents between such versions and/or in print, the prevailing version of an ETSI deliverable is the one made publicly available in PDF format at www.etsi.org/deliver.

Users of the present document should be aware that the document may be subject to revision or change of status.

Information on the current status of this and other ETSI documents is available at

<https://portal.etsi.org/TB/ETSIDeliverableStatus.aspx>

If you find errors in the present document, please send your comment to one of the following services:

<https://portal.etsi.org/People/CommiteeSupportStaff.aspx>

Copyright Notification

No part may be reproduced or utilized in any form or by any means, electronic or mechanical, including photocopying and microfilm except as authorized by written permission of ETSI.

The content of the PDF version shall not be modified without the written authorization of ETSI.

The copyright and the foregoing restriction extend to reproduction in all media.

© ETSI 2020.

All rights reserved.

DECT™, **PLUGTESTS™**, **UMTS™** and the ETSI logo are trademarks of ETSI registered for the benefit of its Members.

3GPP™ and **LTE™** are trademarks of ETSI registered for the benefit of its Members and of the 3GPP Organizational Partners.

oneM2M™ logo is a trademark of ETSI registered for the benefit of its Members and of the oneM2M Partners.

GSM® and the GSM logo are trademarks registered and owned by the GSM Association.

Contents

Intellectual Property Rights	5
Foreword.....	5
Modal verbs terminology.....	5
1 Scope	6
2 References	7
2.1 Normative references	7
2.2 Informative references.....	9
3 Definition of terms, symbols and abbreviations.....	10
3.1 Terms.....	10
3.2 Symbols.....	12
3.3 Abbreviations	12
4 Test conditions	14
4.1 General	14
4.2 Arrangements for establishing a communication link	15
4.2.0 Specification of Channel Number.....	15
4.2.1 Arrangements for test signals at the input of transmitters.....	15
4.2.2 Arrangements for test signals at the output of transmitters.....	15
4.2.3 Arrangements for test signals at the input of receivers	16
4.2.3.0 General	16
4.2.3.1 UTRA.....	16
4.2.3.2 E-UTRA	16
4.2.3.3 E-UTRA BS operating in band 46 (LAA).....	16
4.2.3.4 E-UTRA with in band or guard band NB-IoT.....	16
4.2.3.5 OFDMA WMAN	16
4.2.3.6 Standalone NB-IoT	17
4.2.3.7 GSM/EDGE	17
4.2.3.8 CDMA.....	17
4.2.3.9 MSR	17
4.2.3.10 NR.....	17
4.2.3.10.1 NR BS type 1-C and 1-H.....	17
4.2.3.10.2 NR BS type 1-O.....	17
4.2.3.10.3 NR BS type 2-O.....	17
4.2.4 Arrangements for test signals at the output of receivers	17
4.2.5 Arrangements for test signals for repeaters.....	17
4.3 Exclusion bands.....	18
4.3.0 General.....	18
4.3.1 Transmitter exclusion band.....	18
4.3.1.0 General	18
4.3.1.1 OTA type BS for FR1	18
4.3.2 Receiver exclusion band	18
4.3.2.0 General	18
4.3.2.1 Non-AAS BS, Hybrid AAS BS and NR BS Type 1-C	18
4.3.2.2 OTA AAS BS and NR BS Type 1-O	18
4.3.3 Multi-band BS	19
4.4 Narrow band responses of receivers	19
4.5 Void.....	20
4.6 Test configurations	20
4.6.1 Emission	20
4.6.2 Immunity	20
4.6.3 MSR.....	21
5 Performance assessment.....	21
5.0 General	21
5.1 UTRA	22
5.1.1 BLER on DL.....	22

5.1.2	BLER on UL.....	22
5.2	E-UTRA, E-UTRA with LAA, inband or guard band NB-IoT, Standalone NB-IoT.....	22
5.2.1	Throughput on DL.....	22
5.2.2	Throughput on UL.....	22
5.3	OFDMA WMAN.....	22
5.3.1	Throughput on DL.....	22
5.3.2	Throughput on UL.....	22
5.4	NR.....	22
5.4.1	Throughput on DL.....	22
5.4.2	Throughput on UL.....	22
5.5	GSM/EDGE.....	23
5.5.1	BER on DL.....	23
5.5.1.0	General.....	23
5.5.1.1	Assessment of BER using static layer 1 functions.....	23
5.5.1.2	Assessment of BER using RXQUAL.....	23
5.5.2	BER on UL.....	23
5.5.2.0	General.....	23
5.5.2.1	Assessment of BER using RXQUAL.....	23
5.5.2.2	Assessment of BER using reported BER.....	23
5.6	CDMA.....	23
5.6.1	FER on DL.....	23
5.6.2	FER on UL.....	23
5.7	Assessment of RF gain variations of repeaters.....	24
5.8	Ancillary equipment.....	24
5.9	Equipment classification.....	24
6	Performance criteria.....	24
6.1	Performance criteria for continuous phenomena.....	24
6.1.0	General.....	24
6.1.1	Base Stations.....	24
6.1.1.1	UTRA.....	24
6.1.1.2	E-UTRA, E-UTRA with LAA, inband or guard band NB-IoT.....	24
6.1.1.3	Standalone NB-IoT.....	25
6.1.1.4	GSM/EDGE.....	25
6.1.1.5	CDMA.....	26
6.1.1.6	NR.....	26
6.1.2	Repeaters.....	27
6.2	Performance criteria for transient phenomena.....	27
6.2.0	General.....	27
6.2.1	Repeaters.....	27
7	Requirements.....	28
7.1	Emission.....	28
7.2	Immunity.....	28
7.2.1	General.....	28
7.2.2	Modified requirements.....	29
Annex A (informative):	Relationship between the present document and the essential requirements of Directive 2014/53/EU.....	30
Annex B (informative):	Change history.....	32
History.....		33

Intellectual Property Rights

Essential patents

IPRs essential or potentially essential to normative deliverables may have been declared to ETSI. The information pertaining to these essential IPRs, if any, is publicly available for **ETSI members and non-members**, and can be found in ETSI SR 000 314: "*Intellectual Property Rights (IPRs); Essential, or potentially Essential, IPRs notified to ETSI in respect of ETSI standards*", which is available from the ETSI Secretariat. Latest updates are available on the ETSI Web server (<https://ipr.etsi.org/>).

Pursuant to the ETSI IPR Policy, no investigation, including IPR searches, has been carried out by ETSI. No guarantee can be given as to the existence of other IPRs not referenced in ETSI SR 000 314 (or the updates on the ETSI Web server) which are, or may be, or may become, essential to the present document.

Trademarks

The present document may include trademarks and/or tradenames which are asserted and/or registered by their owners. ETSI claims no ownership of these except for any which are indicated as being the property of ETSI, and conveys no right to use or reproduce any trademark and/or tradename. Mention of those trademarks in the present document does not constitute an endorsement by ETSI of products, services or organizations associated with those trademarks.

Foreword

This draft Harmonised European Standard (EN) has been produced by ETSI Technical Committee Electromagnetic compatibility and Radio spectrum Matters (ERM), and is now submitted for the combined Public Enquiry and Vote phase of the ETSI standards EN Approval Procedure.

The present document has been prepared under the Commission's standardisation request C(2015) 5376 final [i.15] to provide one voluntary means of conforming to the essential requirements of Directive 2014/53/EU on the harmonisation of the laws of the Member States relating to the making available on the market of radio equipment and repealing Directive 1999/5/EC [i.1].

Once the present document is cited in the Official Journal of the European Union under that Directive, compliance with the normative clauses of the present document given in table A.1 confers, within the limits of the scope of the present document, a presumption of conformity with the corresponding essential requirements of that Directive, and associated EFTA regulations.

Proposed national transposition dates	
Date of latest announcement of this EN (doa):	3 months after ETSI publication
Date of latest publication of new National Standard or endorsement of this EN (dop/e):	6 months after doa
Date of withdrawal of any conflicting National Standard (dow):	18 months after doa

Modal verbs terminology

In the present document "**shall**", "**shall not**", "**should**", "**should not**", "**may**", "**need not**", "**will**", "**will not**", "**can**" and "**cannot**" are to be interpreted as described in clause 3.2 of the [ETSI Drafting Rules](#) (Verbal forms for the expression of provisions).

"**must**" and "**must not**" are **NOT** allowed in ETSI deliverables except when used in direct citation.

1 Scope

The present document specifies technical characteristics and methods of measurements in respect of ElectroMagnetic Compatibility (EMC) for the following equipment types:

- 1) digital cellular base station equipment, including BS with antenna ports and BS without antenna ports;
- 2) repeaters;
- 3) associated ancillary equipment.

Including individual and combinations of technologies listed in table 1.

Table 1: Cellular Mobile Communication Technologies

Technology (Air technology)	Technology Generation	Standard SET	ETSI Standard
GSM (GSM/EDGE)	2G/3G	IMT-2000 SC (single carrier)	ETSI EN 301 502 [8] ETSI TS 137 104 [21] ETSI TS 137 141 [12]
CDMA 2000	3G	CDMA2000 (IMT-MC multi carrier)	ETSI EN 301 526 [i.2] ETSI EN 301 908-5 [i.7] ETSI EN 301 908-7 [i.8] ETSI EN 301 449 [i.11] ETSI EN 302 426 [i.12]
UMTS (UTRA, W-CDMA)	3G	IMT-2000 Direct Spread	ETSI TS 125 104 [i.3] ETSI TS 125 105 [i.4] ETSI TS 125 106 [i.5]
LTE (see note 1) (E-UTRA)	4G	IMT-advanced	ETSI TS 136 104 [5] ETSI TS 136 141[6] ETSI TS 136 106 [i.6] ETSI TS 136 143 [25]
LTE (see note 1) (E-UTRA), AAS	4G	IMT-advanced	ETSI TS 136 104 [5] ETSI TS 137 114 [31] ETSI TS 137 145-1 [13] ETSI TS 137 145-2 [14]
MSR (see note 2) AAS	4G	IMT-advanced	ETSI TS 137 104 [21] ETSI TS 137 141 [12] ETSI TS 137 114 [31] ETSI TS 137 145-1 [13] ETSI TS 137 145-2 [14]
WMAN (OFDMA)	3G	IMT-2000 OFDMA	ETSI EN 301 908-22 [16]
NR OTA	5G	IMT-advanced	ETSI TS 138 104 [20] ETSI TS 138 141-1 [10] ETSI TS 138 141-2 [17]
Standalone NB-IoT	4G	IMT-2000	ETSI TS 136 104 [5]

NOTE 1: Including LAA, inband NB-IoT or guard band NB-IoT.
NOTE 2: Combination of technologies GSM, W-CDMA, LTE and NR.

Technical specifications related to the antenna port and emissions from the enclosure port of Base Station (BS), combinations of radio and associated ancillary equipment or repeaters are not included in the present document. Such technical specifications are found in the relevant product standards for the effective use of the radio spectrum.

The environmental classification and the emission and immunity requirements used in the present document are as stated in ETSI EN 301 489-1 [1], except for any special conditions included in the present document.

NOTE: The relationship between the present document and essential requirements of article 3.1(b) of Directive 2014/53/EU [i.1] is given in Annex A.

2 References

2.1 Normative references

References are either specific (identified by date of publication and/or edition number or version number) or non-specific. For specific references, only the cited version applies. For non-specific references, the latest version of the referenced document (including any amendments) applies.

Referenced documents which are not found to be publicly available in the expected location might be found at <https://docbox.etsi.org/Reference>.

NOTE: While any hyperlinks included in this clause were valid at the time of publication, ETSI cannot guarantee their long term validity.

The following referenced documents are necessary for the application of the present document.

- [1] ETSI EN 301 489-1 (V2.2.3) (11-2019): "ElectroMagnetic Compatibility (EMC) standard for radio equipment and services; Part 1: Common technical requirements; Harmonised Standard for ElectroMagnetic Compatibility".
- [2] ETSI TS 125 141 (V15.4.0) (04-2019): "Universal Mobile Telecommunications System (UMTS); Base Station (BS) conformance testing (FDD) (3GPP TS 25.141 version 15.4.0 Release 15)".
- [3] ETSI TS 125 142 (V15.0.1) (07-2018): "Universal Mobile Telecommunications System (UMTS); Base Station (BS) conformance testing (TDD) (3GPP TS 25.142 version 15.0.1 Release 15)".
- [4] ETSI TS 125 143 (V15.0.0) (07-2018): "Universal Mobile Telecommunications System (UMTS); UTRA repeater conformance testing (3GPP TS 25.143 version 15.0.0 Release 15)".
- [5] ETSI TS 136 104 (V15.8.0) (10-2019): "LTE; Evolved Universal Terrestrial Radio Access (E-UTRA); Base Station (BS) radio transmission and reception (3GPP TS 36.104 version 15.8.0 Release 15)".
- [6] ETSI TS 136 141 (V15.8.0) (10-2019): "LTE; Evolved Universal Terrestrial Radio Access (E-UTRA); Base Station (BS) conformance testing (3GPP TS 36.141 version 15.8.0 Release 15)".
- [7] ETSI TS 145 008 (V15.6.0) (04-2020): "Digital cellular telecommunications system (Phase 2+) (GSM); GSM/EDGE Radio subsystem link control (3GPP TS 45.008 version 15.6.0 Release 15)".
- [8] ETSI EN 301 502 (V12.5.2) (03-2017): "Global System for Mobile communications (GSM); Base Station (BS) equipment; Harmonised Standard covering the essential requirements of article 3.2 of the Directive 2014/53/EU".
- [9] ETSI TS 151 021 (V15.3.0) (04-2020): "Digital cellular telecommunications system (Phase 2+) (GSM); Base Station System (BSS) equipment specification; Radio aspects (3GPP TS 51.021 version 15.3.0 Release 15)".
- [10] ETSI TS 138 141-1 (V15.5.0) (04-2020): "5G; NR; Base Station (BS) conformance testing Part 1: Conducted conformance testing (3GPP TS 38.141-1 version 15.5.0 Release 15)".
- [11] ETSI TS 138 101-4 (V15.5.0) (04-2020): "5G; NR; User Equipment (UE) radio transmission and reception; Part 4: Performance requirements (3GPP TS 38.101-4 version 15.5.0 Release 15)".
- [12] ETSI TS 137 141 (V15.10.0) (04-2020): "Digital cellular telecommunications system (Phase 2+) (GSM); Universal Mobile Telecommunications System (UMTS); LTE; 5G; NR, E-UTRA, UTRA and GSM/EDGE; Multi-Standard Radio (MSR) Base Station (BS) conformance testing (3GPP TS 37.141 version 15.10.0 Release 15)".
- [13] ETSI TS 137 145-1 (V15.6.0) (01-2020): "Universal Mobile Telecommunications System (UMTS); LTE; Active Antenna System (AAS) Base Station (BS) conformance testing; Part 1: conducted conformance testing (3GPP TS 37.145-1 version 15.6.0 Release 15)".

- [14] ETSI TS 137 145-2 (V15.6.0) (01-2020): "Universal Mobile Telecommunications System (UMTS); LTE; Active Antenna System (AAS) Base Station (BS) conformance testing; Part 2: radiated conformance testing (3GPP TS 37.145-2 version 15.6.0 Release 15)".
- [15] ETSI EN 301 908-20 (V6.3.1) (05-2016): "IMT cellular networks; Harmonised Standard covering the essential requirements of article 3.2 of the Directive 2014/53/EU; Part 20: OFDMA TDD WMAN (Mobile WiMAX™) TDD Base Stations (BS)".
- [16] ETSI EN 301 908-22 (V6.1.1) (07-2016): "IMT cellular networks; Harmonised Standard covering the essential requirements of article 3.2 of the Directive 2014/53/EU; Part 22: OFDMA TDD WMAN (Mobile WiMAX™) FDD Base Stations (BS)".
- [17] ETSI TS 138 141-2 (V15.5.0) (04-2020): "5G; NR; Base Station (BS) conformance testing; Part 2: Radiated conformance testing (3GPP TS 38.141-2 version 15.5.0 Release 15)".
- [18] TIA-97 (2014): "Recommended Minimum Performance Standard for cdma2000 Spread Spectrum Base Stations".
- [19] TIA-2000 Series, Revision F (2014): "Introduction to CDMA2000 spread spectrum systems **Includes TIA-2000.1 (2013), TIA-2000.2 (2014), TIA-2000.3 (2014), TIA-2000.4 (2014), and TIA-2000.5 **".
- [20] ETSI TS 138 104 (V15.9.0) (04-2020): "5G; NR; Base Station (BS) radio transmission and reception (3GPP TS 38.104 version 15.9.0 Release 15)".
- [21] ETSI TS 137 104 (V15.10.0) (04-2020): "Digital cellular telecommunications system (Phase 2+) (GSM); Universal Mobile Telecommunications System (UMTS); LTE; 5G; NR, E-UTRA, UTRA and GSM/EDGE; Multi-Standard Radio (MSR) Base Station (BS) radio transmission and reception (3GPP TS 37.104 version 15.10.0 Release 15)".
- [22] ETSI TS 125 101 (V15.3.0) (05-2019): "Universal Mobile Telecommunications System (UMTS); User Equipment (UE) radio transmission and reception (FDD) (3GPP TS 25.101 version 15.3.0 Release 15)".
- [23] ETSI TS 125 102 (V15.0.0) (10-2018): "Universal Mobile Telecommunications System (UMTS); User Equipment (UE) radio transmission and reception (TDD) (3GPP TS 25.102 version 15.0.0 Release 15)".
- [24] ETSI TS 136 101 (V15.10.0) (04-2020): "LTE; Evolved Universal Terrestrial Radio Access (E-UTRA); User Equipment (UE) radio transmission and reception (3GPP TS 36.101 version 15.10.0 Release 15)".
- [25] ETSI TS 136 143 (V15.0.0) (09-2018): "LTE; Evolved Universal Terrestrial Radio Access (E-UTRA); FDD repeater conformance testing (3GPP TS 36.143 version 15.0.0 Release 15)".
- [26] ETSI TS 151 010-1 (V13.8.0) (07-2019): "Digital cellular telecommunications system (Phase 2+) (GSM); Mobile Station (MS) conformance specification; Part 1: Conformance specification (3GPP TS 51.010-1 version 13.8.0 Release 13)".
- [27] ETSI TS 137 105 (V15.8.0) (01-2020): "Universal Mobile Telecommunications System (UMTS); LTE; Active Antenna System (AAS) Base Station (BS) transmission and reception (3GPP TS 37.105 version 15.8.0 Release 15)".
- [28] Void.
- [29] Void.
- [30] ETSI TS 137 113 (V15.8.0) (01-2020): "Digital cellular telecommunications system (Phase 2+) (GSM); Universal Mobile Telecommunications System (UMTS); LTE; NR, E-UTRA, UTRA and GSM/EDGE; Multi-Standard Radio (MSR) Base Station (BS) Electromagnetic Compatibility (EMC) (3GPP TS 37.113 version 15.8.0 Release 15)".
- [31] ETSI TS 137 114 (V15.8.0) (04-2020): "Universal Mobile Telecommunications System (UMTS); LTE; Active Antenna System (AAS) Base Station (BS) Electromagnetic Compatibility (EMC) (3GPP TS 37.114 version 15.8.0 Release 15)".

2.2 Informative references

References are either specific (identified by date of publication and/or edition number or version number) or non-specific. For specific references, only the cited version applies. For non-specific references, the latest version of the referenced document (including any amendments) applies.

NOTE: While any hyperlinks included in this clause were valid at the time of publication, ETSI cannot guarantee their long term validity.

The following referenced documents are not necessary for the application of the present document but they assist the user with regard to a particular subject area.

- [i.1] Directive 2014/53/EU of the European Parliament and of the Council of 16 April 2014 on the harmonisation of the laws of the Member States relating to the making available on the market of radio equipment and repealing Directive 1999/5/EC.
- [i.2] ETSI EN 301 526 (V1.1.1) (07-2006): "Electromagnetic compatibility and Radio spectrum Matters (ERM); Harmonized EN for CDMA spread spectrum mobile stations operating in the 450 MHz cellular band (CDMA 450) and 410, 450 and 870 MHz PAMR bands (CDMA-PAMR) covering essential requirements of article 3.2 of the R&TTE Directive".
- [i.3] ETSI TS 125 104 (V15.5.0) (04-2019): "Universal Mobile Telecommunications System (UMTS); Base Station (BS) radio transmission and reception (FDD) (3GPP TS 25.104 version 15.5.0 Release 15)".
- [i.4] ETSI TS 125 105 (V15.0.0) (07-2018): "Universal Mobile Telecommunications System (UMTS); Base Station (BS) radio transmission and reception (TDD) (3GPP TS 25.105 version 15.0.0 Release 15)".
- [i.5] ETSI TS 125 106 (V15.0.0) (07-2018): "Universal Mobile Telecommunications System (UMTS); UTRA repeater radio transmission and reception (3GPP TS 25.106 version 15.0.0 Release 15)".
- [i.6] ETSI TS 136 106 (V15.0.0) (09-2018): "LTE; Evolved Universal Terrestrial Radio Access (E-UTRA); FDD repeater radio transmission and reception (3GPP TS 36.106 version 15.0.0 Release 15)".
- [i.7] ETSI EN 301 908-5 (V5.2.1) (09-2011): "IMT cellular networks; Harmonized EN covering the essential requirements of article 3.2 of the R&TTE Directive; Part 5: CDMA Multi-Carrier (cdma2000) Base Stations (BS)".
- [i.8] ETSI EN 301 908-7 (V4.2.1) (03-2010): "Electromagnetic compatibility and Radio spectrum Matters (ERM); Base Stations (BS), Repeaters and User Equipment (UE) for IMT-2000 Third-Generation cellular networks; Part 7: Harmonized EN for IMT-2000, CDMA TDD (UTRA TDD and E-UTRA TDD) (BS) covering the essential requirements of article 3.2 of the R&TTE Directive".
- [i.9] Void.
- [i.10] Void.
- [i.11] ETSI EN 301 449 (V1.1.1) (07-2006): "Electromagnetic compatibility and Radio spectrum Matters (ERM); Harmonized EN for CDMA spread spectrum base stations operating in the 450 MHz cellular band (CDMA 450) and 410, 450 and 870 MHz PAMR bands (CDMA-PAMR) covering essential requirements of article 3.2 of the R&TTE Directive".
- [i.12] ETSI EN 302 426 (V1.1.1) (09-2006): "Electromagnetic compatibility and Radio spectrum Matters (ERM); Harmonized EN for CDMA spread spectrum Repeaters operating in the 450 MHz cellular band (CDMA450) and the 410 MHz, 450 MHz and 870 MHz PAMR bands (CDMA-PAMR) covering essential requirements of article 3.2 of the R&TTE Directive".
- [i.13] Void.
- [i.14] Void.

- [i.15] Commission Implementing Decision C(2015) 5376 final of 4.8.2015 on a standardisation request to the European Committee for Electrotechnical Standardisation and to the European Telecommunications Standards Institute as regards radio equipment in support of Directive 2014/53/EU of the European Parliament and of the Council.

3 Definition of terms, symbols and abbreviations

3.1 Terms

For the purposes of the present document, the terms given in ETSI EN 301 489-1 [1] and the following apply:

active antenna system base station: base station system which combines an antenna array with a transceiver unit array and a radio distribution network

antenna array: group of radiating elements characterized by the geometry and the properties of the array elements

base station: radio equipment intended for operation at a fixed location which is not defined as portable equipment

base station type 1-C: base station operating at FR1 with requirements set consisting only of conducted requirements defined at individual antenna port

base station type 1-H: base station operating at FR1 with a requirement set consisting of conducted requirements defined at individual TAB connectors and OTA requirements defined at RIB

NOTE: BS type 1-H is treated as a BS type 1-C in EMC assessment. See figure 1b.

base station type 1-O: base station operating at FR1 with a requirement set consisting only of OTA requirements defined at the RIB

base station type 2-O: base station operating at FR2 with a requirement set consisting only of OTA requirements defined at the RIB

bearer: information transmission path of defined characteristics for transfer of user data or predefined test data

CDMA-PAMR: Public Access Mobile Radio system based on TIA-2000 [19] Spreading Rate 1 specifications

channel bandwidth: RF bandwidth supporting a single E-UTRA RF carrier with the transmission bandwidth configured in the uplink or downlink of a cell

NOTE: The channel bandwidth is measured in MHz and is used as a reference for transmitter and receiver RF requirements.

downlink: unidirectional radio link for the transmission of signals from a UTRAN access point to a UE

International Mobile Telecommunications-2000 (IMT-2000): third generation mobile systems which provide access, by means of one or more radio links, to a wide range of telecommunications services supported by the fixed telecommunication networks (e.g. PSTN, ISDN or IP), and to other services which are specific to mobile users

License Assisted Access (LAA): License Assisted Access LTE based base station operating in unlicensed frequency spectrum

maximum throughput: maximum achievable throughput for a reference measurement channel

MB Base Station: base station which is characterized by the ability of its transmitter and/or receiver to process two or more carriers in common active RF components simultaneously, where at least one carrier is configured at a different non-overlapping operating band than the other carrier(s)

MSR Base Station: base station which is characterized by the ability of its receiver and transmitter to process two or more carriers in common active RF components simultaneously in a declared RF bandwidth, where at least one carrier is of a different RAT than the other carrier(s)

multiple unit BS: radio base station consisting of separate radio digital unit and the radio unit

NOTE: See figure 1a.

NB-IoT guard band operation: operation of NB-IOT guard band utilizing the unused resource block(s) within an E-UTRA carrier's guard-band

NB-IoT In-band operation: operation of NB-IOT in-band utilizing the resource block(s) within a normal E-UTRA carrier

NB-IoT standalone operation: operation of NB-IOT standalone utilizing its own spectrum, for example the spectrum currently being used by GERAN systems as a replacement of one or more GSM carriers, as well as scattered spectrum for potential IoT deployment

operating band: frequency range in which a wireless service operates (paired or unpaired), that is defined with a specific set of technical requirements

OTA AAS BS: AAS BS which has ≥ 8 transceiver units for E-UTRA, NR or MSR and ≥ 4 transceiver units for UTRA per cell and has a radiated RF interface only and conforms to the OTA requirements set

NOTE: OTA AAS BS has no accessible antenna port. See figure 1c.

Radio Configuration (RC): set of Forward Traffic Channel and Reverse Traffic Channel transmission formats that are characterized by physical layer parameters such as transmission rates, modulation characteristics, and spreading rate

radio digital unit: equipment which contains base band and functionality for controlling Radio unit

NOTE: See figures 1a and 1b.

Radio Distribution Network (RDN): linear passive network which distributes the RF power generated by the transceiver unit array to the antenna array, and/or distributes the radio signals collected by the antenna array to the transceiver unit array

radio equipment: "An electrical or electronic product, which intentionally emits and/or receives radio waves for the purpose of radio communication and/or radio determination, or an electrical or electronic product which must be completed with an accessory, such as antenna, so as to intentionally emit and/or receive radio waves for the purpose of radio communication and/or radio determination", definition from Directive 2014/53/EU [i.1].

NOTE 1: It can be operated with ancillary equipment but if so, is not dependent on it for basic functionality.

NOTE 2: It contains radio digital unit and radio unit.

radio unit: equipment which contains transmitter and receiver

NOTE: See figures 1a and 1b.

repeater: device with two RF ports, both of which are intended to be connected to antennas, which is capable of receiving, amplifying and transmitting simultaneously in one direction a signal in a BSS transmit band and in the other direction a signal in the corresponding BSS receive band

reverse CDMA channel: CDMA channel from the mobile station to the base station

NOTE: From the base station's perspective, the Reverse CDMA Channel is the sum of all mobile station transmissions on a CDMA frequency assignment.

RXQUAL: measure of the received signal quality, which is generated by the base station for use as a criterion in the RF power control and handover processes

NOTE: The characteristics and requirements are specified in ETSI TS 145 008 [7], clause 8.2.

TAB port: conducted interface between the transceiver unit array and the composite antenna

throughput: number of payload bits successfully received per second for a reference measurement channel in a specified reference condition

uplink: unidirectional radio link for the transmission of signals from a UE to a base station, from a Mobile Station to a mobile base station or from a mobile base station to a base station

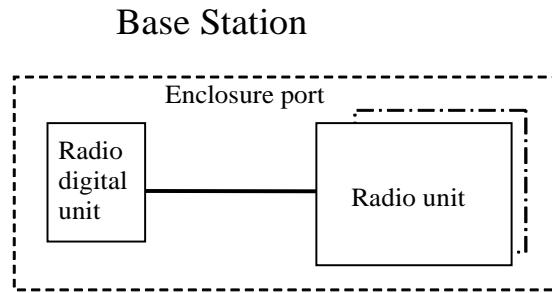

Figure 1a: Example of BS with multiple units

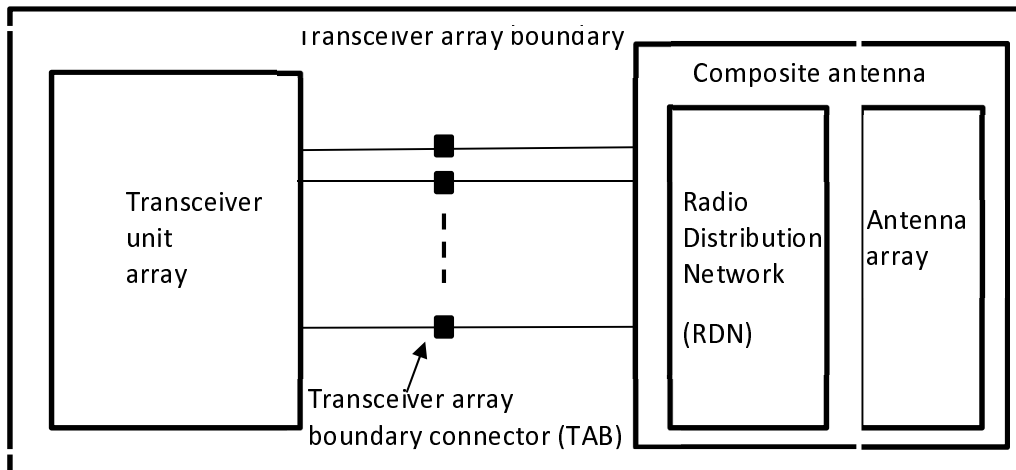

Figure 1b: Radio Unit for AAS BS type 1-C and 1-H

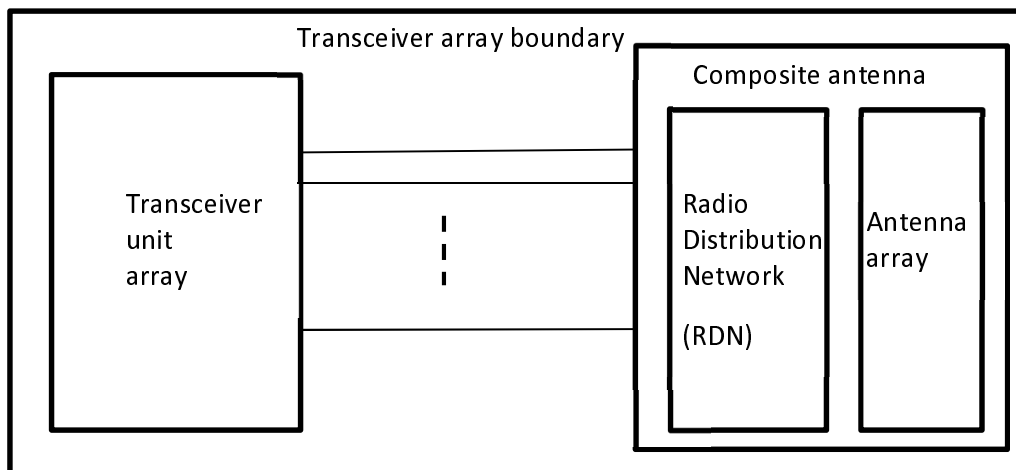

Figure 1c: Radio Unit for OTA AAS BS type and 1-O or 2-O

3.2 Symbols

Void.

3.3 Abbreviations

For the purposes of the present document, the abbreviations given in ETSI EN 301 489-1 [1] and the following apply:

AAS Active Antenna System

ARFCN	Absolute Radio Frequency Channel Number
BER	Bit Error Ratio
BLER	Block Error Ratio
BSC	Base Station Controller
BSS	Base Station System
BTS	Base Transceiver Station
BW _{Channel}	Channel bandwidth
CDMA	Code Division Multiple Access
CRC	Cyclic Redundancy Check
CS	Capability Set
DL	Downlink
EARFCN	E-UTRA Absolute Radio Frequency Channel Number
EPC	Evolved Packet Core
E-UTRA	Evolved Universal Terrestrial Radio Access
FDD	Frequency Division Duplex
FER	Frame Error Rate
FR1	Frequency range 450 MHz to 6 000 MHz
FR2	Frequency range 2 4250 MHz to 52 600 MHz
FRC	Fixed Reference Channel
GSM	Global System for Mobile communications
HW	HardWare
IMT	International Mobile Telecommunications
IMT-2000	International Mobile Telecommunications 2000
IP	Internet Protocol
ISDN	Integrated Services Digital Network
Iub	Interface between RNC and BS
LAA	License Assisted Access
LTE	Long Term Evolution
MB	Multi-Band
MC	Multi-Carrier
MSR	Multi Standard Radio
NB-IoT	Narrow Band Internet of Things
NR	New Radio
OFDMA	Orthogonal Frequency-Division Multiple Access
OTA	Over The Air
PAMR	Public Access Mobile Radio
PSTN	Public Switched Telephone Network
RAT	Radio Access Technology
RC	Radio Configuration
RDN	Radio Distribution Network
RIB	Radiated Interface Boundary
RNC	Radio Network Controller
RXQUAL	Received Signal Quality
SC	Single Carrier
TAB	Transceiver Array Boundary
TCH	Traffic Channel
TCH/FS	Full rate Speech TCH
TDD	Time Division Duplex
TM	Test Model
UARFCN	UTRA Absolute Radio Frequency Channel Number
UE	User Equipment
UL	Uplink
UMTS	Universal Mobile Telecommunications System
UTRA	Universal Terrestrial Radio Access
UTRAN	Universal Terrestrial Radio Access Network
WCDMA	Wide Code Division Multiple Access
WMAN	Wireless Metropolitan Area Network

4 Test conditions

4.1 General

For the purpose of the present document, the test conditions of ETSI EN 301 489-1 [1], clause 4, shall apply as appropriate. Further product related test conditions for base station equipment are specified in the present document.

The equipment shall be tested in the normal test environment defined in the appropriate conformance testing specification as specified below:

Base station:

- UTRA (FDD) base station ETSI TS 125 141 [2];
- UTRA (TDD) base station ETSI TS 125 142 [3];
- E-UTRA or E-UTRA including LAA, inband NB-IoT or guard band NB-IoT base station ETSI TS 136 141 [6];
- GSM/EDGE base station ETSI EN 301 502 [8];
- MSR (NR, E-UTRA, UTRA and GSM/EDGE) base station ETSI TS 137 141 [12];
- Hybrid AAS MSR BS base station ETSI TS 137 145-1 [13];
- OTA AAS MSR BS base station (without antenna port) ETSI TS 137 145-2 [14];
- OFDMA WMAN TDD base station ETSI EN 301 908-20 [15];
- OFDMA WMAN FDD base station ETSI EN 301 908-22 [16];
- CDMA Multi-Carrier base station TIA-97 [18];
- Standalone NB-IoT base station ETSI TS 136 141 [6];
- NR BS type 1-C and 1-H base station ETSI TS 138 141-1 [10];
- NR BS type 1-O and 2-O base station (without antenna ports) ETSI TS 138 141-2 [17].

Repeater:

- UTRA repeater ETSI TS 125 143 [4];
- E-UTRA repeater ETSI TS 136 143 [25].

For a EUT which contains more than one BS, it is sufficient to perform tests relating to each type of port of each representative type of the BS forming part of the EUT.

For BS capable of multi-band operation, the requirements in the present document apply for each supported operating band unless otherwise stated. Operating bands and RATs shall be activated according to the test configuration in clause 4.6. Tests shall be performed relating to each type of port and all RATs per band shall be assessed during the tests.

For multiple unit BS the test on digital and radio unit may be applied separately. Overall communication link shall be set up in the same way as if they are in single enclosure.

The test configuration and mode of operation shall represent the intended use and shall be recorded in the test report.

4.2 Arrangements for establishing a communication link

4.2.0 Specification of Channel Number

The provisions of ETSI EN 301 489-1 [1], clause 4.2 shall apply, with the following modifications.

The wanted RF signal nominal frequency shall be selected by setting the channel number according to the following:

- The Absolute Radio Frequency Channel Number (EARFCN) for E-UTRA. E-UTRA with LAA carrier or E-UTRA with standalone NB-IoT or guard band NB-IoT carrier.
- The Absolute Radio Frequency Channel Number (UARFCN) for UTRA carrier.
- The Absolute Radio Frequency Channel Number (ARFCN) for GSM/EDGE carrier.
- The Absolute Radio Frequency Channel Number (combination of ARFCN, UARFCN or EARFCN) for MSR carrier.
- The Absolute Radio Frequency Channel Number (EARFCN) for Standalone NB-IoT.
- The Absolute Radio Frequency Channel Number (NR-ARFCN) for NR carrier.

A communication link shall be set up with a suitable test system capable of evaluating the required performance criteria for all applicable ports.

Adequate measures shall be taken to avoid the effect of the unwanted signal on the measuring equipment.

4.2.1 Arrangements for test signals at the input of transmitters

The provisions of ETSI EN 301 489-1 [1], clause 4.2.1 shall apply.

4.2.2 Arrangements for test signals at the output of transmitters

The provisions of ETSI EN 301 489-1 [1], clause 4.2.2 shall apply with the following exception:

- For immunity ESD test the level of the wanted RF output signal in transmit mode of operation shall be set to a minimum needed RF power level at the input of the monitoring receiver.

NOTE: This is to ensure protection of test personal from excessive RF exposure.

Transmitter carriers shall be configured as follows:

- UTRA FDD carriers shall be configured according to TM1 as defined in ETSI TS 125 141 [2], clause 6.1.1.1.
- UTRA TDD carriers shall be configured according to table 6.1A as defined in ETSI TS 125 142 [3], clause 6.2.4.1.2.
- E-UTRA carriers shall be configured according to E-TM1.1 as defined in ETSI TS 136 141 [6], clause 6.1.1.1. For BC3 CS3, BC3 CS16 and BC3 CS17 BS testing, E-UTRA carriers shall be configured according to E-TM1.1_BC3CS3 defined in Annex E. For BC3 CS2 BS testing with NB-IoT inband and/or guard band.
- GSM carriers shall use GMSK modulation as defined in ETSI TS 151 021 [9], clause 6.2.2.
- NB-IoT carriers shall be configured according to N-TM as defined in ETSI TS 136 141 [6], clauses 6.1.3, 6.1.4, 6.1.5 and 6.1.6.
- NR carriers shall be configured according to NR-FR1-TM1.1 as defined in ETSI TS 138 141-1 [10], clause 4.9.2.

4.2.3 Arrangements for test signals at the input of receivers

4.2.3.0 General

The provisions of ETSI EN 301 489-1 [1], clause 4.2.3 shall apply with the following modification.

The wanted RF input signal level shall be set to a level where the performance is not limited by the receiver noise floor or strong external signal effects. A communication link shall be set up with suitable base station system test equipment.

To provide a stable communication link, the wanted RF input signal level shall be set to a certain level above the reference sensitivity level.

The reference sensitivity power level P_{REFSENS} is the minimum mean power received at the antenna connector at which a reference performance requirement shall be met for a specified reference measurement channel.

4.2.3.1 UTRA

The level of the wanted signal at the input of the receiver shall be not greater than 15 dB above the reference sensitivity level for the EUTs.

- The wanted signal shall be 15 dB \pm 3 dB above the reference sensitivity level as defined in ETSI TS 125 141 [2], clause 7.2 for FDD.
- The wanted signal shall be 15 dB \pm 3 dB above the reference sensitivity level as defined in ETSI TS 125 142 [3], clause 7.2 for TDD.
- For I Hybrid AAS BS TDD and FDD the wanted signal shall be 15 dB \pm 3 dB above the reference sensitivity level as defined in ETSI TS 137 145-1 [13], clause 7.2.
- For OTA AAS BS FDD the wanted signal shall be 15 dB \pm 3 dB above the reference sensitivity level as defined in ETSI TS 137 145-2 [14], clause 7.2, to ensure a stable communication link is maintained.

4.2.3.2 E-UTRA

- The wanted signal shall be 15 dB \pm 3 dB above the reference sensitivity level as defined in ETSI TS 136 141 [6], clause 7.2.5 for different areas BS.
- For I Hybrid AAS BS the wanted signal shall be 15 dB \pm 3 dB above the reference sensitivity level as defined in ETSI TS 137 145-1 [13], clause 7.2.
- For OTA AAS BS the wanted signal shall be 15 dB \pm 3 dB above the reference sensitivity level as defined in ETSI TS 137 145-2 [14], clause 7.3.

4.2.3.3 E-UTRA BS operating in band 46 (LAA)

The wanted signal shall be 15 dB \pm 3 dB above the reference sensitivity level as defined in ETSI TS 136 141 [6], clause 7.2.5 for local and medium areas BS only.

4.2.3.4 E-UTRA with in band or guard band NB-IoT

The wanted signal shall be 15 dB \pm 3 dB above the reference sensitivity level as defined in ETSI TS 136 141 [6], clause 7.2.5 for different areas BS.

4.2.3.5 OFDMA WMAN

The wanted signal(s) shall be (a) representative baseband input signal(s) corresponding to normal operation. The input signal level shall be 15 dB \pm 3 dB above the receiver input level for a Bit Error Ratio (BER) of 1×10^{-5} .

4.2.3.6 Standalone NB-IoT

The wanted signal shall be 15 dB \pm 3 dB above the reference sensitivity level as defined in ETSI TS 136 141 [6], clause 7.2.5.

4.2.3.7 GSM/EDGE

The wanted receiver input signal level shall be set to a nominal value of -47 dBm \pm 3 dB.

4.2.3.8 CDMA

- For immunity testing the wanted RF signal level at the input of the EUT shall be 15 dB \pm 3 dB above the reference sensitivity level as defined in TIA-97 [18], clause 3.4.1.
- Set the CDMA channel to an appropriate number. A communication link shall be set up with a suitable mobile station simulator (hereafter called "the test system") according to the Radio Configuration (RC) supported by the base station (see clause 1.3 in TIA-97 [18] using full data rate only).

4.2.3.9 MSR

- The wanted signal shall be 15 dB \pm 3 dB above the reference sensitivity level for each RAT the levels are specified in ETSI TS 137 141 [12], clause 7.2.
- For I Hybrid AAS BS the wanted signal shall be 15 dB \pm 3 dB above the reference sensitivity level for each RAT specified in ETSI TS 137 145-1 [13], clause 7.2.
- For OTA AAS BS the wanted signal shall be 15 dB \pm 3 dB above the reference sensitivity level each RAT specified in ETSI TS 137 145-2 [14], clause 7.2.

4.2.3.10 NR

4.2.3.10.1 NR BS type 1-C and 1-H

The wanted signal shall be 15 dB \pm 3 dB above the reference sensitivity level as defined in ETSI TS 138 104 [20], clause 7.2.

4.2.3.10.2 NR BS type 1-O

The wanted signal shall be 15 dB \pm 3 dB above the reference sensitivity level as defined in ETSI TS 138 104 [20], clause 10.3.

4.2.3.10.3 NR BS type 2-O

The wanted signal shall be 15 dB \pm 3 dB above the reference sensitivity level as defined in ETSI TS 138 104 [20], clause 10.3.

4.2.4 Arrangements for test signals at the output of receivers

The provisions of ETSI EN 301 489-1 [1], clause 4.2.4 shall apply.

4.2.5 Arrangements for test signals for repeaters

For immunity tests of repeaters, the wanted RF input signal shall be coupled to one antenna port at a level which will result, when measured, in the maximum rated RF output power per channel. The test shall either be repeated with a wanted signal coupled to the other antenna port, or a single test shall be performed with the specified input signals being simultaneously coupled to both antenna ports.

4.3 Exclusion bands

4.3.0 General

The exclusion band is the band of frequencies over which no tests of radiated immunity are made.

For BS containing different technologies according to table 1, the exclusion band for each radio technology is only applicable if the radio technology is active.

4.3.1 Transmitter exclusion band

4.3.1.0 General

The range of the exclusion band for transmitter (downlink DL) is defined as:

$$F_{DL_low} - EB < f < F_{DL_high} + EB$$

Where:

F_{DL_low}	The lowest frequency of the downlink operating band
F_{DL_high}	The highest frequency of the downlink operating band
EB	Exclusion band defined according to the type of BS

4.3.1.1 OTA type BS for FR1

The BS transmitter exclusion band is the band of frequencies over which no tests of radiated immunity on transmitter are made.

For BS with a transmitter operating bandwidth < 100 MHz, EB is equal to BS channel bandwidth or 60 MHz, whichever is greater.

For BS with a transmitter operating bandwidth \geq 100 MHz, EB is equal to BS channel bandwidth or 200 MHz, whichever is greater.

4.3.2 Receiver exclusion band

4.3.2.0 General

The range of the exclusion band for receiver (uplink UL) is defined as:

$$F_{UL_low} - EB < f < F_{UL_high} + EB$$

Where:

F_{UL_low}	The lowest frequency of the uplink operating band
F_{UL_high}	The highest frequency of the uplink operating band
EB	Exclusion band defined according to the type of BS

4.3.2.1 Non-AAS BS, Hybrid AAS BS and NR BS Type 1-C

The exclusion bands shall be calculated using the operating bands as set out in ETSI TS 137 104 [21], clause 4.4.2 EB is equal to BS channel bandwidth or 20 MHz, whichever is greater.

4.3.2.2 OTA AAS BS and NR BS Type 1-O

The exclusion bands shall be calculated using the operating bands as set out in ETSI TS 137 105 [27], clause 5.

For BS with a receiver operating bandwidth < 100 MHz, EB is equal to BS channel bandwidth or 60 MHz, whichever is greater.

For BS with a receiver operating bandwidth ≥ 100 MHz, EB is equal to BS channel bandwidth or 200 MHz, whichever is greater.

4.3.3 Multi-band BS

For BS capable of multi-band operation, the exclusion band shall be the combination of the exclusion bands for each band, i.e. an exclusion band for each band according to clauses 4.3.2 and 4.3.3, shall be applied.

The total exclusion band extends from the lowest frequency of the lowest operating band up to the highest frequency of the highest operating band.

Where the operating bands are separated, the result will be a multiple separate exclusion bands.

4.4 Narrow band responses of receivers

Responses on receivers or duplex transceivers occurring during the immunity test at discrete frequencies which are narrow band responses - spurious responses, are identified by the following method:

- If during an immunity test the quantity being monitored goes outside the specified tolerances (clause 6 in the present document), it is necessary to establish whether the deviation is due to a narrow band response or to a wide band (EMC) phenomenon. Therefore, the test shall be repeated with the unwanted signal frequency first increased, and then decreased by an offset f_{offset} , where:
 - For UTRA, $f_{\text{offset}} = 10$ MHz.
 - For E-UTRA and LAA, $f_{\text{offset}} = 2 \times BW_{\text{Channel}}$, where BW_{Channel} is the channel bandwidth as defined in ETSI TS 136 104 [5], clause 5.6.
 - For GSM/EDGE, $f_{\text{offset}} = 400$ kHz.
 - For CDMA, $f_{\text{offset}} = 10$ MHz, $f_{\text{offset}} = 12,5$ MHz.
 - For OFDMA WMAN, $f_{\text{offset}} = 2 \times BW_{\text{Channel}}$, where BW_{Channel} is the channel bandwidth.
 - For NB-IoT, $f_{\text{offset}} = 400$ kHz.
 - For NR, $f_{\text{offset}} = 2 \times BW_{\text{Channel}}$, where BW_{Channel} is the channel bandwidth as defined in ETSI TS 138 104 [20], clause 5.6.
- If the deviation disappears in either or both of the above offset cases, then the response is considered as a narrow band response.
- If the deviation does not disappear, this may be due to the fact that the offset has made the frequency of the unwanted signal correspond to the frequency of another narrow band response. Under these circumstances, the procedure is repeated with the increase and decrease of the frequency of the unwanted signal set to $1,25 \times f_{\text{offset}}$.
- If the deviation does not disappear with the increased and/or decreased frequency, the phenomenon is considered wide band and therefore an EMC problem and the equipment fails the test.

Narrow band responses are disregarded.

For an MSR BS or other BS supporting more than one RAT, the method above shall be applied for each RAT supported. For BS capable of multi-band operation, all supported operating bands shall be tested for narrow band responses.

4.5 Void

4.6 Test configurations

4.6.1 Emission

- Emission tests on the entire base station shall be performed by establishing stable communication links.
- Emission tests on the MSR base station shall be performed by activating all supported RATs concurrently.
- The test signal with an appropriate test modulation should be delivered by a suitable mobile unit (UE) or base station system test equipment.

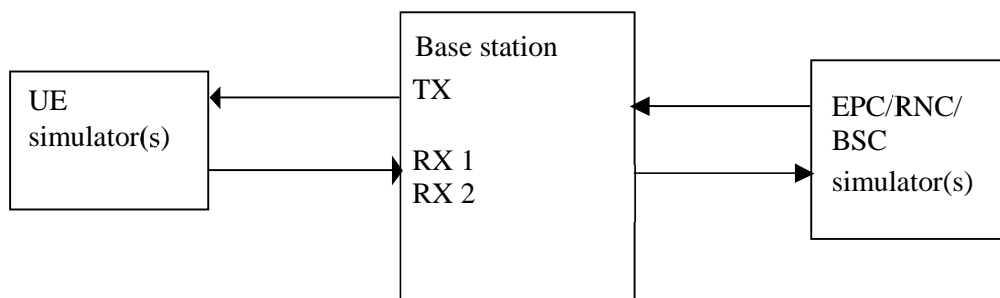

Figure 2a: Communication link set up for emission measurement on base stations with access to antenna ports

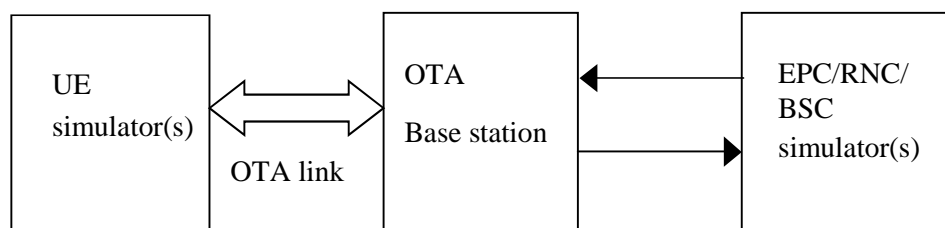

Figure 2b: Communication link set up for immunity test on base OTA stations with antenna ports not accessible

4.6.2 Immunity

- Immunity tests on the entire base station shall be performed by establishing stable communication links.
- Immunity tests shall be performed on both the Uplink and Downlink paths.
- Immunity tests on the MSR base station shall be performed by activating all supported RATs concurrently.

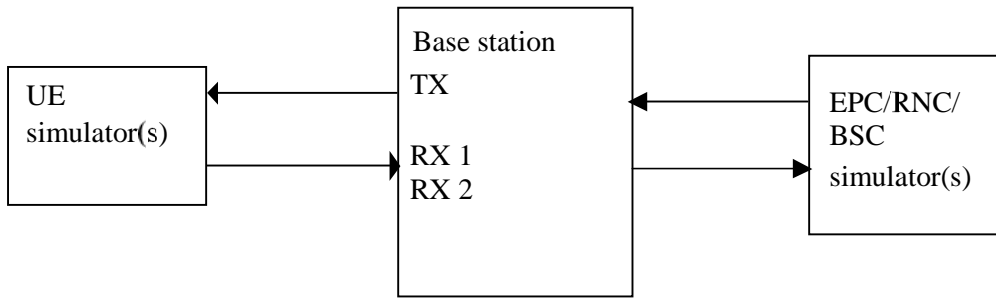

Figure 3a: Communication link set up for immunity tests on base stations with access to antenna ports

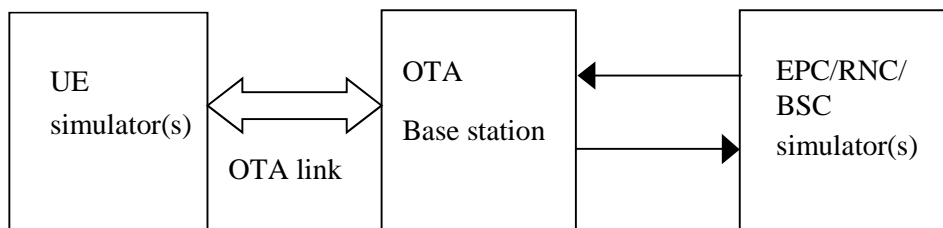

Figure 3b: Communication link set up for immunity test on OTA base stations with antenna ports not accessible

4.6.3 MSR

MSR BS tests shall be performed with RATs activated according to the test configuration in ETSI TS 137 113 [30], clause 4.5.

Hybrid and OTA AAS BS tests shall be performed with RATs activated according to the test configuration in ETSI TS 137 114 [31], clause 4.4.

A communication link used by more than one RAT or more than one operating band, shall be assessed on one narrow band and one broad band RAT and all operating bands. Communication link(s) and/or radio performance parameters for the RATs and operating bands can during the test be assessed simultaneously or separately for each RAT and band, depending on the test environment capability.

Tests shall be performed relating to each type of port, and need not be repeated for each RAT if operating RATs are assessed simultaneously during the test.

5 Performance assessment

5.0 General

The provision of ETSI EN 301 489-1 [1], clause 5.1 shall apply with the following additions:

- Information about the common and/or RAT-specific active RF components and other HW blocks for a communication link in MSR BS or other BS supporting more than one RAT shall be recorded in or annexed to the test report.
- Information about the common and/or band-specific active RF components and other HW blocks for a communication link in BS capable of multi-band operation shall be recorded in or annexed to the test report.
- Where a communication link is used by more than one RAT or more than one operating band, it shall be assessed on every RAT and operating band. Communication link(s) and/or radio performance parameters for the RATs and operating bands may be assessed either simultaneously or separately for each RAT and band, depending on the test environment capability.

- The information about the bandwidth of the IF amplifier immediately preceding the demodulator as set out in ETSI EN 301 489-1 [1], clause 5.1 is not applicable for radio equipment in the scope of the present document.

5.1 UTRA

5.1.1 BLER on DL

BLER of the bearer used shall be assessed during the immunity tests. The output of the transmitter shall be connected to an equipment which meets the requirements for the BLER assessment of ETSI TS 125 101 [22] in case of FDD and ETSI TS 125 102 [23] in case of TDD.

5.1.2 BLER on UL

The value of the BLER at the output of the receiver reported by the BS shall be monitored at the Iub interface by using suitable test equipment.

5.2 E-UTRA, E-UTRA with LAA, inband or guard band NB-IoT, Standalone NB-IoT

5.2.1 Throughput on DL

The output of the transmitter shall be connected to an equipment which meet the requirements for the throughput assessment of ETSI TS 136 101 [24] for the bearer used in the immunity tests.

5.2.2 Throughput on UL

The value of the throughput at the output of the receiver shall be monitored at S1 interface by using suitable test equipment.

5.3 OFDMA WMAN

5.3.1 Throughput on DL

The output of the transmitter shall be connected to equipment which meets the requirements for throughput assessment.

5.3.2 Throughput on UL

The value of the throughput at the output of the receiver shall be monitored at the backhaul interface by using suitable test equipment.

5.4 NR

5.4.1 Throughput on DL

A communication link shall be established between the transmitter (via port for the *BS type 1-C* and *BS type 1-H*, or via RIB for the *BS type 1-O* and *BS type 2-O*) and the test equipment. Test equipment shall meet the requirements for the throughput assessment defined in ETSI TS 138 101-4 [11] for the bearer used in the immunity tests. The level of the signal supplied to the equipment should be within the range for which the assessment of throughput is not impaired.

5.4.2 Throughput on UL

The value of the throughput at the output of the receiver shall be monitored using suitable test equipment.

5.5 GSM/EDGE

5.5.1 BER on DL

5.5.1.0 General

The BER at the output of the transmitter may be assessed using either of the techniques described in clauses 5.5.1.1 and 5.5.1.2.

5.5.1.1 Assessment of BER using static layer 1 functions

The transmitter under test shall be operated according to the test case of ETSI TS 151 021 [9], clause 6.1.2.

The bit sequence from the output of the transmitter shall be monitored by the test system according to the test case of ETSI TS 151 021 [9], clause 7.1.2, and the BER of the class 2 bits for TCH/FS assessed. The BER shall not exceed the values specified in clause 6.1 of the present document.

5.5.1.2 Assessment of BER using RXQUAL

The output of the transmitter shall be connected to an equipment which meets the requirements of ETSI TS 151 010-1 [26] for the assessment of RXQUAL. The RXQUAL shall be monitored during the test. The RXQUAL shall not exceed the values specified in clause 6.1 of the present document.

NOTE: This equipment can be a GSM mobile station with suitable provision for the monitoring of RXQUAL.

5.5.2 BER on UL

5.5.2.0 General

The BER at the output of the receiver may be assessed using either of the techniques described in clauses 5.5.2.1 and 5.5.2.2.

5.5.2.1 Assessment of BER using RXQUAL

The value of the RXQUAL reported by the BTS or BSS shall be monitored using suitable test equipment.

5.5.2.2 Assessment of BER using reported BER

The BER of the class 2 bits at the output of the receiver shall be assessed using suitable test equipment.

5.6 CDMA

5.6.1 FER on DL

For immunity testing, the output of the transmitter shall be connected to a test system which meets the requirements for the FER assessment in accordance with TIA-2000.2 [19], clause 2.2 and TIA-97 [18], clause 6. The level of the signal supplied to the test system shall be attenuated such that it is within the range for which the assessment of FER is not impaired.

5.6.2 FER on UL

The value of the FER at the output of the receiver reported by the BS shall be monitored using a suitable test system.

5.7 Assessment of RF gain variations of repeaters

The parameter used for the performance assessment of a repeater is the RF gain within the operating frequency band.

5.8 Ancillary equipment

The provision of ETSI EN 301 489-1 [1], clause 5.4 shall apply.

5.9 Equipment classification

The provision of ETSI EN 301 489-1 [1], clause 5.5 shall apply.

6 Performance criteria

6.1 Performance criteria for continuous phenomena

6.1.0 General

The provision of ETSI EN 301 489-1 [1], clause 6.1 shall apply.

6.1.1 Base Stations

6.1.1.1 UTRA

Uplink and Downlink paths the observed BLER shall be less than 1×10^{-2} and the BS shall operate as intended.

The BLER calculation shall be based on evaluating the CRC on each transport block.

6.1.1.2 E-UTRA, E-UTRA with LAA, inband or guard band NB-IoT

The test shall be performed using one or more bearers with the characteristics as stated in table 2 and should be representative of the EUTs intended use.

Uplink and Downlink paths shall each meet the performance criteria defined in table 2.

The throughput in table 2 is stated relative to the maximum throughput of the Frame Error Rate (FER). The maximum throughput for an FRC is equal to the Payload size \times Number of uplink sub-frames per second. For NB-IoT the Maximum throughput for an FRC equals the Payload size / (Number of resource unit \times Time to send one resource unit).

Table 2: BS Performance Criteria for continuous phenomena

E-UTRA Channel Bandwidth [MHz]	Bearer Information Data Rate	Performance Criteria (see note 3)
1,4	FRC A1-1 in clause A.1 in ETSI TS 136 104 [5]	Throughput > 95 %
3	FRC A1-6 in clause A.1 in ETSI TS 136 104 [5] for E-UTRA with NB-IoT in-band operation	Throughput > 95 %
5	FRC A1-7 in clause A.1 in ETSI TS 136 104 [5] for E-UTRA with NB-IoT in-band operation	Throughput > 95 %
10	FRC A1-3 in clause A.1 in ETSI TS 136 104 [5] (see note 1)	Throughput > 95 %
15	FRC A1-3 in clause A.1 in ETSI TS 136 104 [5] (see note 1)	Throughput > 95 %
20	FRC A1-3 in clause A.1 in ETSI TS 136 104 [5] (see note 1) FRC A1-9 in clause A.1 in ETSI TS 136 104 [5] (see note 2)	Throughput > 95 %
NOTE 1: This is the information data rate of a single instance of the bearer mapped to 25 resource blocks. The performance criteria shall be met for each consecutive application of a single instance of the bearer mapped to disjoint frequency ranges with a width of 25 resource blocks each. This reference measurement channel is not applied for LAA Band 46.		
NOTE 2: This is the information data rate of a single instance of the bearer mapped to a single interlace. The performance criteria shall be met for each application of a single instance of the bearer mapped to each single interlace. This reference measurement channel is only applied for LAA Band 46.		
NOTE 3: Applies also if a bearer with another characteristic is used in the test.		

6.1.1.3 Standalone NB-IoT

Uplink and Downlink paths shall each meet the performance criteria defined in table 3.

The throughput in table 3 is stated relative to the maximum throughput of the FRC. Sub-carrier spacing should be representative of the EUTs intended use.

If a bearer with another characteristics is used in the test it should be recorded in the test report.

The Maximum throughput for an FRC equals the Payload size / (Number of resource unit × Time to send one resource unit).

Table 3: NB-IoT BS Performance criteria for continuous phenomena

NB-IoT Sub-carrier spacing [kHz]	Reference measurement channel	Performance Criteria (see note)
15	FRC A14-1 in clause A.14 in ETSI TS 136 104 [5]	Throughput > 95 %
3,75	FRC A14-2 in clause A.14 in ETSI TS 136 104 [5]	Throughput > 95 %
NOTE: Applies also if a bearer with another characteristic is used in the test.		

6.1.1.4 GSM/EDGE

Downlink

The BER of the downlink shall be assessed during the test according to one of the test methods of clause 5.5.1 in the present document.

If the test method of clause 5.5.1.1 in the present document is used, the measured BER of the class 2 bits of TCH/FS shall not exceed 1,6 % during the test.

NOTE 1: This BER is the upper limit in ETSI TS 145 008 [7], clause 8.2.4 for RXQUAL = 3.

If the test method of clause 5.5.1.2 in the present document is used, the value of RXQUAL shall not exceed 3 during the test.

At the conclusion of the test the EUT shall operate as intended with no loss of user control functions or stored data, and the communication link shall have been maintained.

Uplink

The BER of the uplink shall be assessed during the test according to one of the test methods of clause 5.5.2 in the present document.

If the test method of clause 5.5.2.1 in the present document is used, the value of RXQUAL shall not exceed 3 during the test.

If the test method of clause 5.5.2.2 in the present document is used, the measured BER of the class 2 bits of TCH/FS shall not exceed 1,6 % during the test.

NOTE 2: This BER is the upper limit in ETSI TS 145 008 [7], clause 8.2.4 for RXQUAL = 3.

For a base station the RXQUAL of the uplink shall not exceed three (3) measured during the test sequence.

At the conclusion of the test the EUT shall operate as intended with no loss of user control functions or stored data, and the communication link shall have been maintained.

6.1.1.5 CDMA

The observed Frame Error Rate (FER) of the BS forward link and reverse link shall not exceed 1,0 % with 95 % confidence (see clause 6.8 in TIA-97 [18]).

In the case of PAMR base stations the observed Frame Error Rate (FER) of the BS forward link and reverse link shall not exceed 2,0 % with 95 % confidence (see clause 6.8 in TIA-97 [18]).

The test shall be performed using one or more bearers with the characteristics of data rate and throughput as stated in table 4, they should be representative of the EUTs intended use.

If a bearer with another characteristics is used in the test it should be recorded in the test report.

Table 4: Mobile OFDMA WMAN

Mobile OFDMA WMAN Channel Bandwidth [MHz]	Performance Criteria (see note)
5	Throughput > 95 %
10	Throughput > 95 %
NOTE: Applies also if a bearer with another characteristics is used in the test.	

Table 5: Void

6.1.1.6 NR

The test shall be performed using one or more bearers with the characteristics as stated in tables 6a or 6b and should be representative of the EUTs intended use.

The throughput in tables 6a and 6b is stated relative to the maximum throughput of the FRC.

Uplink and downlink paths shall each meet the performance criteria defined in tables 6a and 6b during the test.

Table 6a: FR1 performance criteria for continuous phenomena

NR channel bandwidth [MHz]	Sub-carrier spacing [kHz]	Bearer information data rate	Performance criteria (see note)
5, 10, 15	15	G-FR1-A1-1 in clause A.1 in ETSI TS 138 104 [20]	Throughput > 95 %
10, 15	30	G-FR1-A1-2 in clause A.1 in ETSI TS 138 104 [20]	
10, 15	60	G-FR1-A1-3 in clause A.1 in ETSI TS 138 104 [20]	
20, 25, 30, 40, 50	15	G-FR1-A1-4 in clause A.1 in ETSI TS 138 104 [20]	
20, 25, 30, 40, 50, 60, 70, 80, 90, 100	30	G-FR1-A1-5 in clause A.1 in ETSI TS 138 104 [20]	
20, 25, 30, 40, 50, 60, 70, 80, 90, 100	60	G-FR1-A1-6 in clause A.1 in ETSI TS 138 104 [20]	

NOTE: Applies also if a bearer with another characteristics is used in the test.

Table 6b: FR2 performance criteria for continuous phenomena

NR channel bandwidth [MHz]	Sub-carrier spacing [kHz]	Bearer information data rate	Performance criteria (see note)
50, 100, 200	60	G-FR2-A1-1 in clause A.1 in ETSI TS 138 104 [20]	Throughput > 95 %, no loss of service
50	120	G-FR2-A1-2 in clause A.1 in ETSI TS 138 104 [20]	
100, 200, 400	120	G-FR2-A1-3 in clause A.1 in ETSI TS 138 104 [20]	

NOTE: Applies also if a bearer with another characteristics is used in the test.

6.1.2 Repeaters

The RF gain of the EUT shall be measured throughout the period of exposure to the phenomenon. The RF gain measured during the test shall not deviate from the gain measured before the test by more than ± 1 dB.

At the conclusion of the test the EUT shall operate as intended with no loss of user control functions or stored data.

6.2 Performance criteria for transient phenomena

6.2.0 General

The provision of ETSI EN 301 489-1 [1], clause 6.2 shall apply.

6.2.1 Repeaters

The RF gain of the EUT shall be measured before the test and after each exposure.

At the conclusion of each exposure the gain of the EUT shall not have changed by more than ± 1 dB.

At the conclusion of the total test comprising the series of individual exposures, the EUT shall operate as intended with no loss of user control functions or stored data, and the gain of the EUT shall not have changed by more than ± 1 dB.

7 Requirements

7.1 Emission

Table 7 below contains the applicability of EMC emission requirements to the relevant ports of equipment within the scope of present document.

Table 7: Emission requirements

Phenomenon	Port	Applicability		Reference clause
		Fixed use (e.g. base station equipment)	Vehicular use (e.g. mobile equipment)	
Radiated emission	Enclosure of ancillary equipment	Applicable for standalone testing	Applicable for standalone testing	ETSI EN 301 489-1 [1], clause 8.2
Conducted emission	DC power input/output port	Applicable	Applicable	ETSI EN 301 489-1 [1], clause 8.3
Conducted emission	AC mains input/output port	Applicable	Not applicable	ETSI EN 301 489-1 [1], clause 8.4
Harmonic current emissions	AC mains input port	Applicable	Not applicable	ETSI EN 301 489-1 [1], clause 8.5
Voltage fluctuations and flicker	AC mains input port	Applicable	Not applicable	ETSI EN 301 489-1 [1], clause 8.6
Conducted emission	Wired network port	Applicable	Not applicable	ETSI EN 301 489-1 [1], clause 8.7

7.2 Immunity

7.2.1 General

Table 8 below contains the applicability of EMC immunity requirements to the relevant ports of equipment within the scope of present document.

Table 8: Immunity requirements

Phenomenon	Port	Equipment test requirement		Reference clause	Performance Criteria clause
		Fixed use (e.g. base station equipment)	Vehicular use (e.g. mobile equipment)		
RF electromagnetic field (80 MHz to 6 000 MHz)	Enclosure port	Applicable	applicable	7.2.2	6.1
Electrostatic discharge	Enclosure	Applicable	Applicable	ETSI EN 301 489-1 [1], clauses 9.3.1 and 9.3.2	6.2
Fast transients common mode	Signal/control ports	Applicable	Not applicable	ETSI EN 301 489-1 [1], clauses 9.4.1 and 9.4.2	6.2
	Wired network ports	Applicable	Not applicable	ETSI EN 301 489-1 [1], clauses 9.4.1 and 9.4.2	6.2
	DC power ports	Applicable	Not applicable	ETSI EN 301 489-1 [1], clauses 9.4.1 and 9.4.2	6.2
	AC power ports	Applicable	Not applicable	ETSI EN 301 489-1 [1], clauses 9.4.1 and 9.4.2	6.2
RF common mode 0,15 MHz to 80 MHz	Signal/control ports	Applicable	Applicable	ETSI EN 301 489-1 [1], clauses 9.5.1 and 9.5.2	6.1
	Wired network ports	Applicable	Applicable	ETSI EN 301 489-1 [1], clauses 9.5.1 and 9.5.2	6.1
	DC power ports	Applicable	Applicable	ETSI EN 301 489-1 [1], clauses 9.5.1 and 9.5.2	6.1
	AC power ports	Applicable	Applicable	ETSI EN 301 489-1 [1], clauses 9.5.1 and 9.5.2	6.1
Transients and surges	DC power input ports	Not applicable	Applicable	ETSI EN 301 489-1 [1], clauses 9.6.1 and 9.6.2	6.2
Voltage dips and interruptions	AC mains power input ports	Applicable	Not applicable	ETSI EN 301 489-1 [1], clauses 9.7.1 and 9.7.2	6.2
Surges, line to line and line to ground	AC mains power input ports	Applicable	Not applicable	ETSI EN 301 489-1 [1], clauses 9.8.1 and 9.8.2	6.2
	Wired network ports	Applicable	Not applicable	ETSI EN 301 489-1 [1], clauses 9.8.1 and 9.8.2	6.2

7.2.2 Modified requirements

The following modified requirements set out in table 9 relate to the immunity requirements set out in ETSI EN 301 489-1 [1], clause 9.

Table 9: Modified immunity requirements

Reference to clauses in ETSI EN 301 489-1 [1]	Special product-related conditions, additional to or modifying the test configuration in ETSI EN 301 489-1 [1], clause 9.1
9. Test methods and levels for immunity tests 9.2 Radio frequency electromagnetic field (80 MHz to 6 000 MHz) 9.2.2 Test method	Test level <ul style="list-style-type: none"> • Equipment with EIRP greater than 30 dBm (1 W): <ul style="list-style-type: none"> – For the frequency range 80 MHz to 690 MHz, test level shall be 3 V/m. – For the frequency range 690 MHz to 6 000 MHz test level shall be 10 V/m. • Equipment with EIRP less than or equal to 30 dBm (1 W) (see note): <ul style="list-style-type: none"> – For the frequency range 80 MHz to 6 000 MHz, test level shall be 3 V/m.
NOTE: These systems are intended to form private networks not carrying public services.	

Annex A (informative): Relationship between the present document and the essential requirements of Directive 2014/53/EU

The present document has been prepared under the Commission's standardisation request C(2015) 5376 final [i.15] to provide one voluntary means of conforming to the essential requirements of Directive 2014/53/EU on the harmonisation of the laws of the Member States relating to the making available on the market of radio equipment and repealing Directive 1999/5/EC [i.1].

Once the present document is cited in the Official Journal of the European Union under that Directive, compliance with the normative clauses of the present document given in table A.1 confers, within the limits of the scope of the present document, a presumption of conformity with the corresponding essential requirements of that Directive, and associated EFTA regulations.

Table A.1: Relationship between the present document and the essential requirements of Directive 2014/53/EU

Harmonised Standard ETSI EN 301 489-50					
Requirement				Requirement Conditionality	
No	Description	Essential requirements of Directive	Clause(s) of the present document	U/C	Condition
1	Emissions: Enclosure of ancillary equipment measured on a standalone basis	3.1(b)	7.1	U	
2	Emissions: DC power input/output ports	3.1(b)	7.1	C	Only where equipment has DC power input and/or output ports with a cable length greater than 3 m or from a vehicle power supply.
3	Emissions: AC mains power input/output ports	3.1(b)	7.1	C	Only where equipment has AC mains power input and/or output ports.
4	Emissions: Harmonic current emission (AC mains input port)	3.1(b)	7.1	C	Only where equipment has AC mains power input ports.
5	Emissions: Voltage fluctuations and flicker (AC mains input ports)	3.1(b)	7.1	C	Only where equipment has AC mains power input ports.
6	Emissions: Wired network ports	3.1(b)	7.1	C	Only where equipment has wired network ports.
7	Immunity: Radio frequency electromagnetic field (80 MHz to 6 000 MHz)	3.1(b)	7.2	U	
8	Immunity: Electrostatic discharge	3.1(b)	7.2	U	
9	Immunity: Fast transients common mode	3.1(b)	7.2	C	Only where equipment has AC mains power input ports or DC power ports or signal/control ports or wired network ports with cables longer than 3 m.
10	Immunity: Radio frequency common mode	3.1(b)	7.2	C	Only where equipment has AC mains power input ports or DC power ports or signal/control ports or wired network ports with cables longer than 3 m.
11	Immunity: Transients and surges in the vehicular environment	3.1(b)	7.2	C	Only where equipment is connected to vehicle power supply.
12	Immunity: Voltage dips and interruptions	3.1(b)	7.2	C	Only where equipment has AC mains power input ports.
13	Immunity: Surges, line to line and line to ground	3.1(b)	7.2	C	Only where equipment has AC mains power input ports and/or wired network ports.

Key to columns:**Requirement:**

No A unique identifier for one row of the table which may be used to identify a requirement.

Description A textual reference to the requirement.

Essential requirements of Directive

Identification of article(s) defining the requirement in the Directive.

Clause(s) of the present document

Identification of clause(s) defining the requirement in the present document unless another document is referenced explicitly.

Requirement Conditionality:

U/C Indicates whether the requirement is unconditionally applicable (U) or is conditional upon the manufacturer's claimed functionality of the equipment (C).

Condition Explains the conditions when the requirement is or is not applicable for a requirement which is classified "conditional".

Presumption of conformity stays valid only as long as a reference to the present document is maintained in the list published in the Official Journal of the European Union. Users of the present document should consult frequently the latest list published in the Official Journal of the European Union.

Other Union legislation may be applicable to the product(s) falling within the scope of the present document.

Annex B (informative): Change history

Version	Information about changes
1.2.1	First publication.
	New edition for RED; Updates for multi-band BS.
2.1.1	Radiated immunity testing to a continuous sweep between 80 MHz and 690 MHz at 3 V/m and 690 MHz and 6 000 MHz at 10 V/m as opposed to the previous frequency range of 80 MHz to 1 000 MHz and 1 400 MHz to 2 700 MHz at 3 V/m in earlier editions.
2.2.1	Small editorial corrections.
2.3.1	Updated with requirements for new technologies LTE LAA, LTE with NB-IoT, NB-IoT standalone and NR. Added special requirements for OTA AAS type of BS. Split up RF radiated immunity requirement into two power classes.

History

Document history		
V1.2.1	March 2013	Publication
V2.1.1	February 2017	Publication
V2.2.1	April 2019	Publication
V2.2.2	December 2020	EN Approval Procedure AP 20210307: 2020-12-07 to 2021-03-08