

Final draft **EN 301 357** V1.1.1 (1999-04)

European Standard (Telecommunications series)

**Electromagnetic compatibility
and Radio spectrum Matters (ERM);
Technical characteristics and test methods
for analogue cordless wideband audio devices
using integral antennas operating in the CEPT recommended
863 MHz to 865 MHz frequency range**



Reference

DEN/ERM-RP08-0307 (ckc00ico.PDF)

Keywords

Radio, testing

ETSI

Postal address

F-06921 Sophia Antipolis Cedex - FRANCE

Office address

650 Route des Lucioles - Sophia Antipolis
Valbonne - FRANCE
Tel.: +33 4 92 94 42 00 Fax: +33 4 93 65 47 16
Siret N° 348 623 562 00017 - NAF 742 C
Association à but non lucratif enregistrée à la
Sous-Préfecture de Grasse (06) N° 7803/88

Internet

secretariat@etsi.fr
Individual copies of this ETSI deliverable
can be downloaded from
<http://www.etsi.org>
If you find errors in the present document, send your
comment to: editor@etsi.fr

Copyright Notification

No part may be reproduced except as authorized by written permission.
The copyright and the foregoing restriction extend to reproduction in all media.

© European Telecommunications Standards Institute 1999.
All rights reserved.

Contents

Intellectual Property Rights	6
Foreword	6
Introduction	6
1 Scope	8
2 References	8
3 Definitions, abbreviations and symbols	9
3.1 Definitions	9
3.2 Abbreviations	9
3.3 Symbols	10
4 Functional characteristics	10
4.1 Cordless wideband audio	10
4.2 In-ear monitoring	10
4.3 In-vehicle cordless	10
4.4 Personal cordless	11
5 General	11
5.1 Presentation of equipment for testing purposes	11
5.1.1 Choice of model for type testing	11
5.1.2 Definitions of alignment and switching ranges	11
5.1.3 Alignment Range	12
5.1.4 Choice of frequencies	12
5.1.5 Testing of single channel equipment	12
5.1.6 Testing of two channel equipment	12
5.1.7 Testing of multi-channel equipment (more than two channels)	12
5.1.8 Testing of equipment with an external frequency rotary control	12
5.1.9 Testing of equipment with an integral antenna	12
5.1.9.1 Equipment with a permanent internal RF port	12
5.1.9.2 Equipment with a temporary RF port	13
5.2 Mechanical and electrical design	13
5.2.1 General	13
5.2.2 Controls	13
5.2.3 Integral antenna	13
5.2.4 Marking	13
5.2.4.1 Equipment identification	13
5.2.4.2 Regulatory marking	13
5.3 Interpretation of the measurement results	13
6 Test conditions, power sources and ambient conditions	14
6.1 Normal and extreme test-conditions	14
6.2 Test power source	14
6.3 Normal test conditions	14
6.3.1 Normal temperature and humidity	14
6.3.2 Normal test power source voltage	14
6.3.2.1 Mains voltage	14
6.3.2.2 Nickel-cadmium cells	15
6.3.2.3 Other power sources	15
6.4 Extreme test conditions	15
6.4.1 Extreme temperatures	15
6.4.1.1 Procedures for tests at extreme temperatures	15
6.4.2 Extreme test power source voltages	15
6.4.2.1 Mains voltage	15
6.4.2.2 Re-chargeable battery power sources	15
6.4.2.3 Power sources using other types of batteries	16

6.4.2.4	Other power sources	16
7	General conditions.....	16
7.1	Normal test modulation.....	16
7.2	Test fixture.....	17
7.3	Test site and general arrangements for radiated measurements	18
7.4	Modes of operation of the transmitter.....	18
7.5	Arrangement for test signals at the input of the transmitter	18
8	Methods of measurement and limits for transmitter parameters	18
8.1	Frequency error.....	18
8.1.1	Definition	18
8.1.2	Method of measurement.....	19
8.1.3	Limit.....	19
8.2	Carrier power	19
8.2.1	Definition	19
8.2.2	Method of measurement for equipment with integral antenna	19
8.2.2.1	Method of measurement under normal test conditions	19
8.2.2.2	Method of measurement under extreme test conditions.....	20
8.2.3	Limit.....	20
8.3	Channel bandwidth	20
8.3.1	Definition	20
8.3.2	Measurement of Necessary Bandwidth (BN).....	20
8.3.3	Limits	21
8.3.4	Edge of Band Limits	21
8.4	Spurious emissions.....	21
8.4.1	Definitions.....	21
8.4.2	Method of measuring the effective radiated power	21
8.4.3	Limits	22
8.4.4	Measuring receiver.....	22
8.5	Transmitter shutoff.....	22
8.5.1	Definition	22
8.5.2	Method of measurement.....	22
8.5.3	Limits	22
9	Receiver	23
9.1	Spurious emissions.....	23
9.1.1	Definitions.....	23
9.1.2	Method of measuring the power level in a specified load	23
9.1.3	Method of measuring the effective radiated power of the enclosure.....	23
9.1.4	Method of measuring the effective radiated power	24
9.1.5	Limits	24
10	Measurement uncertainty	24
Annex A (normative): Radiated measurement		25
A.1	Test sites and general arrangements for measurements involving the use of radiated fields.....	25
A.1.1	Outdoor test site.....	25
A.1.1.1	Test support for body worn equipment	25
A.1.1.2	Standard position.....	26
A.1.2	Test antenna.....	26
A.1.3	Substitution antenna.....	26
A.1.4	Optional additional indoor site	27
A.2	Guidance on the use of radiation test sites	27
A.2.1	Measuring distance	28
A.2.2	Test antenna.....	28
A.2.3	Substitution antenna.....	28
A.2.4	Artificial antenna	28
A.2.5	Auxiliary cables	28

A.3	Further optional alternative indoor test site using an anechoic chamber	28
A.3.1	Example of the construction of a shielded anechoic chamber.....	29
A.3.2	Influence of parasitic reflections in anechoic chambers.....	29
A.3.3	Calibration of the shielded anechoic chamber	30
	Bibliography	32
	History.....	33

Intellectual Property Rights

IPRs essential or potentially essential to the present document may have been declared to ETSI. The information pertaining to these essential IPRs, if any, is publicly available for **ETSI members and non-members**, and can be found in SR 000 314: "*Intellectual Property Rights (IPRs); Essential, or potentially Essential, IPRs notified to ETSI in respect of ETSI standards*", which is available **free of charge** from the ETSI Secretariat. Latest updates are available on the ETSI Web server (<http://www.etsi.org/ipr>).

Pursuant to the ETSI IPR Policy, no investigation, including IPR searches, has been carried out by ETSI. No guarantee can be given as to the existence of other IPRs not referenced in SR 000 314 (or the updates on the ETSI Web server) which are, or may be, or may become, essential to the present document.

Foreword

This European Standard (Telecommunications series) has been produced by ETSI Technical Committee Electromagnetic compatibility and Radio spectrum Matters (ERM), and is now submitted for the Voting phase of the ETSI standards Two-step Approval Procedure.

Every EN prepared by ETSI is a voluntary standard. The present document may contain text concerning conformance testing of the equipment to which it relates. This text should be considered as guidance only and does not make the present document mandatory.

Annex A provides normative specifications concerning radiated measurements.

Annex B provides a graphic representation of the equipment and frequencies for the testing of single and multi frequency equipment.

Proposed national transposition dates	
Date of latest announcement of this EN (doa):	3 months after ETSI publication
Date of latest publication of new National Standard or endorsement of this EN (dop/e):	6 months after doa
Date of withdrawal of any conflicting National Standard (dow):	6 months after doa

Introduction

In preparing the present document, much attention has been given to assure a low interference probability, while at the same time allowing a maximum flexibility and service to the end-user.

The present document provides the necessary parameters for equipment to obtain common approval throughout Europe. Common technical specifications and harmonized frequency allocations are expected to reduce the present problems of interference and illegal use.

The present document is a type-testing standard based on spectrum utilization parameters and does not include performance characteristics that may be required by the user or requirements for interfacing equipment.

The present document is intended to specify the minimum performance and the methods of measurement of, wideband cordless audio equipment as specified in the scope. In-ear monitoring equipment may be tested to either EN 300 422 [8] for equipment with maximum occupied bandwidth < 200 kHz or the present document for equipment with maximum occupied bandwidth < 300 kHz with due consideration of power and operating frequency.

Type test measurements should be performed in one of the accredited test laboratories, accepted by the various national regulatory authorities in order to grant type approval, provided the national regulatory requirements are met. This is in compliance with CEPT/ERC/REC 01-06 [1] and CEPT/ERC/DEC (97) 10 [2].

In addition, national administrations may accept a "certificate of conformity" based on a type test report. If equipment available on the market is required to be checked, it should be tested in accordance with the methods of measurement specified in the present document.

1 Scope

The present document covers the minimum characteristics considered necessary in order to make the best use of the available frequencies. It does not necessarily include all the characteristics that may be required by a user, nor does it necessarily represent the optimum performance achievable.

The present document applies to wideband cordless audio and in-ear monitoring equipment operating in the CEPT recommended band 863 MHz to 865 MHz using analogue frequency modulation. In some countries this equipment may be used in other frequency bands as specified in their national regulations.

The present document does not apply to wideband cordless audio or in-ear monitoring systems employing digital modulation, Time Division Multiple Access (TDMA), frequency hopping and spread spectrum or similar forms of modulation

EN 300 422 [8] applies to consumer radio microphones operating in the CEPT recommended band 863 MHz to 865 MHz with a maximum power level of 10mW.

Electromagnetic Compatibility (EMC) requirements are covered by ETS 300 445 [7].

The present document may be used by accredited test laboratories for type testing of the equipment. The performance of the equipment submitted for type testing should be representative of the performance of the corresponding production models.

The present document contains instructions for the presentation of equipment for type testing purposes.

Power limits recommended in the present document have been chosen to allow maximum simultaneous re-usage of frequency allocations. National regulations on power output may apply up to the limits quoted in table 1:

Table 1

Equipment	max effective radiated power (erp)
Wideband cordless audio	10 mW
In-ear monitoring	10 mW
In-vehicle cordless	2 mW
Personal cordless	1 mW

The types of equipment covered by the present document are as follows:

- cordless headphones;
- cordless loudspeakers;
- in-ear monitoring;
- in-vehicle cordless;
- personal cordless.

2 References

The following documents contain provisions which, through reference in this text, constitute provisions of the present document.

- References are either specific (identified by date of publication, edition number, version number, etc.) or non-specific.
- For a specific reference, subsequent revisions do not apply.
- For a non-specific reference, the latest version applies.

- A non-specific reference to an ETS shall also be taken to refer to later versions published as an EN with the same number.
- [1] CEPT/ERC/REC 01–06: "Procedure for mutual recognition of type testing and type approval for radio equipment".
- [2] CEPT/ERC/DEC (97) 10: "ERC Decision of 30 June 1997 on the mutual recognition of conformity assessment procedures including marking of radio equipment and radio terminal equipment".
- [3] ITU-R Recommendation BS.559-2: "Objective measurement of radio-frequency protection ratios in LF, MF and HF broadcasting".
- [4] IEC 60244: "Methods of measurement for radio transmitters".
- [5] ETR 028: "Radio Equipment and Systems (RES); Uncertainties in the measurement of mobile radio equipment characteristics".
- [6] CEPT/ERC/REC 70–03: "Relating to the use of Short Range Devices (SRD)".
- [7] ETS 300 445, including amendment 1: "Radio Equipment and Systems (RES); ElectroMagnetic Compatibility (EMC) standard for wireless microphones and similar Radio Frequency (RF) audio link equipment".
- [8] EN 300 422 (V.1.2): "Electromagnetic compatibility and Radio spectrum Matters (ERM); Technical characteristics and test methods for wireless microphones in the 25 MHz to 3 GHz frequency range".

3 Definitions, abbreviations and symbols

3.1 Definitions

For the purposes of the present document, the following terms and definitions apply:

integral antenna: permanent fixed antenna, which may be built-in, designed as an indispensable part of the equipment

artificial antenna: tuned reduced-radiating dummy load equal to the nominal impedance specified by the applicant

radiated measurements: measurements that involve the absolute measurement of a radiated electromagnetic field

channel bandwidth: frequency band of defined width including safety margin for operation on adjacent channels, located symmetrically around the carrier frequency

port: any connection point on or within the Equipment Under Test (EUT) intended for the connection of cables to or from that equipment

3.2 Abbreviations

For the purposes of the present document, the following abbreviations apply:

ac	alternating current
B	Channel Bandwidth
BN	Necessary Bandwidth
dc	direct current
erp	effective radiated power
EUT	Equipment Under Test
HF	High Frequency
LF	Low Frequency
MF	Medium Frequency
RBW	Resolution BandWidth

RF	Radio Frequency
SRD	Short Range Devices
TDMA	Time Division Multiple Access
Tx	Transmitter
VBW	Video BandWidth

3.3 Symbols

For the purposes of the present document, the following symbols apply:

λ	wavelength in metres
μF	microFarad
μW	microWatt
dBc	dB relative to the carrier level
E	field strength
E_0	reference field strength (see annex A)
f_c	carrier frequency
f_o	operating frequency
GHz	GigaHertz
kHz	kiloHertz
MHz	MegaHertz
mW	milliWatt
nW	nanoWatt
R	distance (see annex A)
R_0	reference distance (see annex A)

4 Functional characteristics

4.1 Cordless wideband audio

Cordless wideband audio equipment encompasses radio linked headphones and loudspeakers. The transmitters may be installed in a building, fitted in a vehicle or body worn. The term cordless is also used to describe infra red and other non RF "wireless" links, but in the context of the present document it is restricted to RF operating systems only. Stereo equipment can be designed for required channel bandwidths of 200 kHz or less but only with a high cost penalty, however consumer wideband (multichannel) audio equipment and stereo equipment using Zenith-GE pilot tone systems need to declare wider bandwidths as defined in this part of the present document.

Other equipment that may be connected to cordless audio equipment shall fulfil the standards applicable to that equipment (if any).

4.2 In-ear monitoring

In-ear monitoring equipment is used by stage and studio performers to receive personal fold back (monitoring) of the performance. This can be just their own voice or a complex mix of sources.

Other equipment that may be connected to in-ear monitoring equipment shall fulfil the standards applicable to that equipment (if any).

4.3 In-vehicle cordless

In vehicle systems are used for private listening in automobiles and other methods of transport (where permitted).

4.4 Personal cordless

Personal cordless transmitters are to enable the body worn personal stereo equipment to be wire free.

5 General

5.1 Presentation of equipment for testing purposes

Each equipment submitted for type testing shall fulfil the requirements of the present document on all channels over which it is intended to operate.

The applicant shall complete the appropriate application form when submitting equipment for type testing.

The applicant shall state the channel bandwidth(s) within which the equipment is designed to operate.

The applicant shall also supply all relevant interface information to allow:

- direct current (dc) power connection;
- audio connection;
- the deviation limiting of the transmitter; and
- the setting of any input audio level controls and input signal level for normal operation, for a sinusoidal input signal of 500 Hz. The manufacturer shall specify the settings of any other controls necessary to avoid invalidating the test measurements.

Besides the technical documentation, the applicant should also supply an operating manual for the device(s).

To simplify and harmonize the type testing procedures between the different test laboratories, measurement shall be performed, according to the present document, on samples of equipment defined in subclauses 5.1.1 to 5.1.9.2

These subclauses are intended to give confidence that the requirements set out in the present document have been met without the necessity of performing measurements on all channels.

5.1.1 Choice of model for type testing

The applicant shall provide one sample of each model to be tested.

If type approval is given on the basis of tests on a preliminary model, the corresponding production models shall be identical in all respects with the preliminary model tested.

5.1.2 Definitions of alignment and switching ranges

The alignment range is defined as the frequency range over which the receiver and the transmitter can be programmed and/or re-aligned to operate with a single oscillator frequency multiplication, without any physical change of components other than:

- programmable read only memories supplied by the manufacturer or the manufacturer's nominee;
- crystals;
- frequency setting elements (for the receiver and transmitter). These elements shall not be accessible to the end user and shall be declared by the applicant in the application form.

The switching range is the maximum frequency range over which the receiver or the transmitter can be operated without re-programming or realignment.

The applicant shall, when submitting equipment for test, state the alignment ranges for the receiver and transmitter. The applicant shall also state the switching range of the receiver and the transmitter (which may differ).

5.1.3 Alignment Range

The alignment range for the receiver and transmitter, which may be different, is within the band 863 MHz to 865 MHz.

5.1.4 Choice of frequencies

The frequencies for testing shall be chosen by the applicant, in accordance with subclauses 5.1.5 to 5.1.7.

5.1.5 Testing of single channel equipment

Full tests shall be carried out on a channel within 100 kHz of the centre frequency of the alignment range on one sample of the equipment.

5.1.6 Testing of two channel equipment

One sample shall be submitted to enable tests to be carried out on both channels.

The frequency of the upper channel shall be within 100 kHz of the highest frequency of the switching range. The frequency of the lower channel shall be within 100 kHz of the lowest frequency of the switching range. In addition, the average of the frequencies of the two channels shall be within 100 kHz of the centre frequency of the alignment range.

Full tests shall be carried out on both channels.

5.1.7 Testing of multi-channel equipment (more than two channels)

One sample of the equipment shall be submitted to enable tests to be carried out on three channels. The centre frequency of the switching range of the sample shall correspond to the centre frequency of the alignment range.

Full tests shall be carried out on a frequency within 100 kHz of the centre, lowest and highest frequencies of the switching range.

5.1.8 Testing of equipment with an external frequency rotary control.

One sample shall be submitted to enable tests to be performed across the entire frequency band allowed by the rotary control.

The following tests shall be performed at either edge of the tuneable range of the equipment:

- subclause 8.1: Frequency Error;
- subclause 8.2: Carrier Power;
- subclause 8.3: Channel Bandwidth.

The following tests shall be performed with the frequency set to the middle of the tuneable range of the equipment:

- subclause 8.4: Spurious Emissions;
- subclause 8.5: Transmitter shutoff.

5.1.9 Testing of equipment with an integral antenna

To facilitate relative measurements, use may be made of a test fixture as described in subclause 7.3, or the equipment may be supplied with a permanent internal or temporary internal/external RF port.

5.1.9.1 Equipment with a permanent internal RF port

The way to access a permanent internal RF port shall be stated by the applicant with the aid of a diagram. The fact that use has been made of a permanent internal RF port shall be recorded in the test report.

5.1.9.2 Equipment with a temporary RF port

The applicant shall submit two sets of equipment to the test laboratory, one fitted with a temporary 50 Ω RF connector with the antenna disconnected and the other with the antenna connected. Each equipment shall be used for the appropriate tests.

The way the temporary RF port is implemented shall be stated by the applicant with the aid of a diagram. The fact that use has been made of the temporary RF port to facilitate measurements shall be stated in the test report. The addition of a temporary RF port should not influence the performance of the EUT.

5.2 Mechanical and electrical design

5.2.1 General

The equipment submitted by the applicant shall be designed, constructed and manufactured in accordance with sound engineering practice, and with the aim of minimizing harmful interference to other equipment and services.

5.2.2 Controls

Those controls that, if maladjusted, might increase the interfering potentialities of the equipment shall only be accessible by partial or complete disassembly of the device and requiring the use of tools.

5.2.3 Integral antenna

Type approval of equipment with integral antenna only applies to that equipment together with the antenna originally provided by the manufacturer for type testing.

5.2.4 Marking

The equipment shall be marked in a visible place. This marking shall be legible and durable.

5.2.4.1 Equipment identification

The marking shall include as a minimum:

- the name of the applicant or his trade mark;
- the type designation.

5.2.4.2 Regulatory marking

The equipment shall be marked, where applicable, in accordance with CEPT/ERC Recommendation 70-03 [6]. Where this is not applicable the equipment shall be marked in accordance with national regulatory requirements.

5.3 Interpretation of the measurement results

The interpretation of the results recorded in the appropriate test report for the measurements described in the present document shall be as follows:

- the measured value related to the corresponding limit shall be used to decide whether an equipment meets the requirements of the present document;
- the measurement uncertainty value for the measurement of each parameter shall be separately included in the test report;
- the recorded value of the measurement uncertainty shall be, for each measurement, equal to or lower than the figures in the table of measurement uncertainty as in clause 10.

6 Test conditions, power sources and ambient conditions

6.1 Normal and extreme test-conditions

Type tests shall be made under normal test conditions, and also, where stated, under extreme test conditions.

The test conditions and procedures shall be as specified in subclauses 6.2 to 6.4.2.4.

6.2 Test power source

During type tests the power source of the equipment shall be replaced by a test power source, capable of producing normal and extreme test voltages as specified in subclauses 6.3.2 and 6.4.2. The internal impedance of the test power source shall be low enough for its effect on the test results to be negligible. For the purpose of the tests, the voltage of the power source shall be measured at the input terminals of the equipment.

For battery operated equipment, the battery shall be removed and the test power source shall be suitably decoupled and applied as close to the equipment battery terminals as practicable. For radiated measurements any external power leads should be arranged so as not to affect the measurements. If necessary the external power supply may be replaced with the equipment's own internal batteries at the required voltage, this shall be stated on the test report.

If the equipment is provided with a power cable or power socket, the test voltage shall be that measured at the point of connection of the power cable to the equipment.

During tests the power source voltages shall be within a tolerance of $< \pm 1$ % relative to the voltage at the beginning of each test. The value of this tolerance can be critical for certain measurements. Using a smaller tolerance provides a better uncertainty value for these measurements. If internal batteries are used, at the end of each test the voltage shall be within a tolerance of $< \pm 1$ % relative to the voltage at the beginning of each test.

6.3 Normal test conditions

6.3.1 Normal temperature and humidity

The normal temperature and humidity conditions for tests shall be any convenient combination of temperature and humidity within the following ranges:

- temperature: +15°C to +35°C;
- relative humidity: 20 % to 75 %.

When it is impracticable to carry out the tests under the conditions stated above, a note to this effect, stating the actual temperature and relative humidity during the tests, shall be added to the test report.

6.3.2 Normal test power source voltage

6.3.2.1 Mains voltage

The normal test voltage for equipment to be connected to the mains shall be the nominal mains voltage. For the purpose of the present document, the nominal voltage shall be the declared mains voltage, or any of the declared mains voltages, for which the equipment was designed.

The frequency of the test power source corresponding to the alternating current (ac) mains shall be between 49 Hz and 51 Hz.

6.3.2.2 Nickel-cadmium cells

When the radio equipment is intended for operation from the usual types of nickel-cadmium cell the nominal test voltage shall be 1,2 V per cell.

6.3.2.3 Other power sources

For operation from other power sources or types of battery (primary or secondary), the normal test voltage shall be that declared by the equipment manufacturer and approved by the test laboratory. The values shall be stated in the test report.

6.4 Extreme test conditions

6.4.1 Extreme temperatures

For tests at extreme temperatures, measurements shall be made in accordance with the procedures specified in subclause 6.4.1.1, at:

- a) -10°C and $+45^{\circ}\text{C}$. for in-vehicle equipment;
- b) $+5^{\circ}\text{C}$ and $+45^{\circ}\text{C}$. for all other types of equipment.

6.4.1.1 Procedures for tests at extreme temperatures

Before measurements are made the equipment shall have reached thermal balance in the test chamber. The equipment shall be switched off during the temperature stabilizing period. If the thermal balance is not checked by measurements, a temperature stabilizing period of at least one hour shall be allowed.

The sequence of measurements shall be chosen and the humidity content in the test chamber shall be controlled so that excessive condensation does not occur.

Before tests at the higher temperatures, the equipment shall be placed in the test chamber and left until thermal balance is attained. The equipment shall then be switched on for one minute in the transmit condition, after which the equipment shall meet the specified requirements.

For tests at the lower extreme temperature the equipment shall be left in the test chamber until thermal balance is attained, then switched to the standby or receive condition for one minute after which the equipment shall meet the specified requirements.

6.4.2 Extreme test power source voltages

6.4.2.1 Mains voltage

The extreme test voltages for equipment to be connected to an ac mains source shall be the nominal mains voltage $+10\%$.

The frequency of the test power source corresponding to the ac mains shall be between 49 Hz and 51 Hz.

6.4.2.2 Re-chargeable battery power sources

When the radio equipment is intended for operation from nickel-cadmium cells, the extreme test voltage shall be 1,3 and 0,9 times the nominal voltage of the battery. For other types of battery the lower extreme test voltage for discharged condition shall be declared by the equipment manufacturer.

6.4.2.3 Power sources using other types of batteries

The lower extreme test voltages for equipment with power sources using primary batteries shall be as follows:

- for Leclanché or lithium type of battery:
 - 0,85 times the nominal voltage of the battery;
- for mercury type of battery:
 - 0,9 times the nominal voltage of the battery;
- for other types of primary batteries:
 - end-point voltage declared by the equipment manufacturer.

The nominal voltage is considered to be the upper extreme test voltage in this case.

6.4.2.4 Other power sources

For equipment using other power sources, or capable of being operated from a variety of power sources, the extreme test voltages shall be those agreed between the equipment manufacturer and the testing laboratory and shall be recorded with the results.

7 General conditions

7.1 Normal test modulation

The normal test modulation to produce the declared nominal deviation shall be a sinusoidal tone of 500 Hz, set at an input level to the transmitter as defined by the manufacturer.

For the purpose of determining the transmitter necessary bandwidth, coloured noise according to ITU-R Recommendation BS.559-2 [3] shall be used, according to the method laid down in subclause 8.3.2. The resulting spectral distribution is shown in figure 1. This noise may be generated by a white noise source followed by a passive filter shown in figure 2.

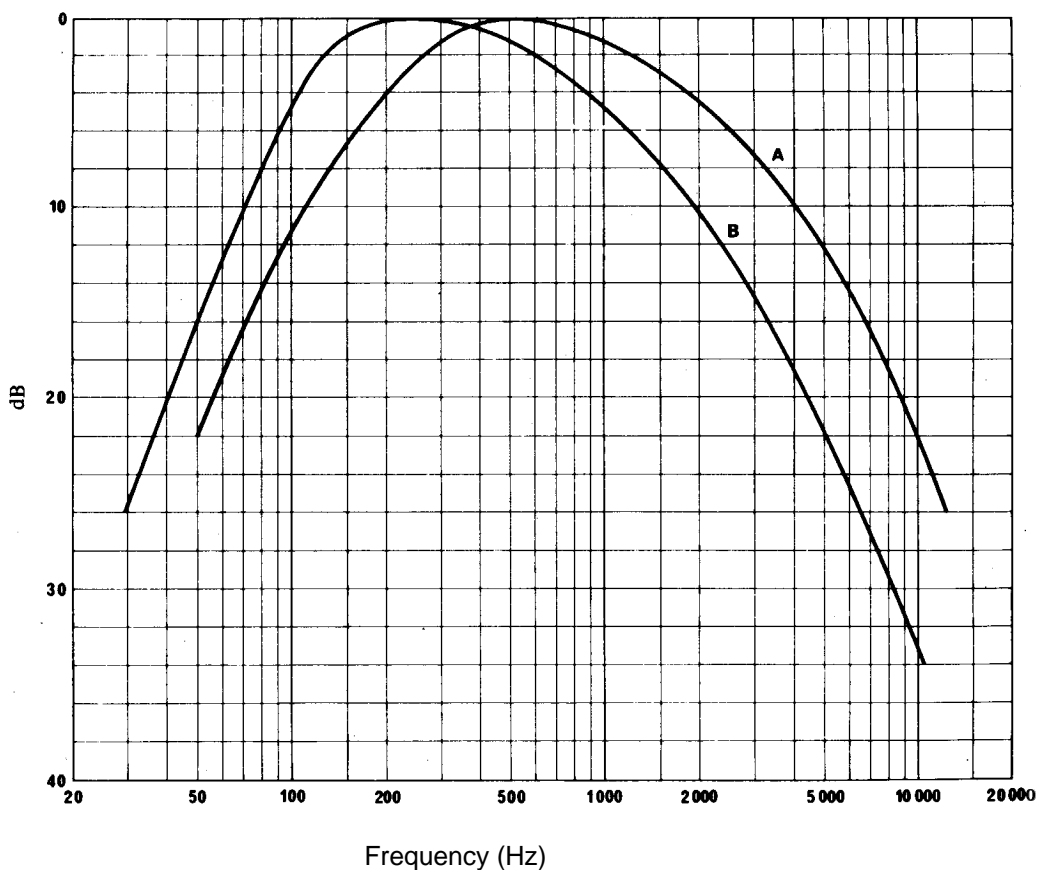

Curve A = Frequency spectrum of standardized noise (measured with one-third octave filters).
 Curve B = Frequency response characteristics of filter circuit.

Figure 1: Spectral distribution for determining transmitter necessary bandwidth

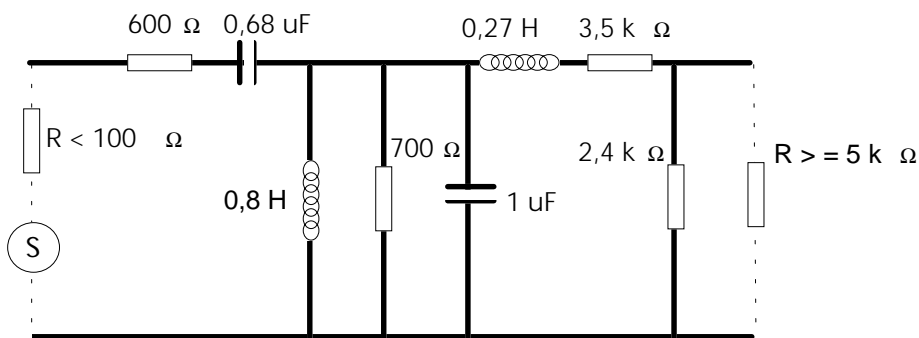

Figure 2: Filter circuit

7.2 Test fixture

The applicant may be required to supply a test fixture suitable to allow relative measurements to be made on the submitted sample.

In all cases, the test fixture shall provide:

- a connection to an external power supply;
- an audio interface.

In addition, the test fixture for integral antenna equipment shall contain a radio frequency coupling device associated with an integral antenna equipment for coupling the integral antenna to an RF port at the working frequencies of the (EUT). This allows certain measurements to be performed using the conducted measurement methods. Only relative measurements may be performed and only those at or near frequencies for which the test fixture has been calibrated.

The performance characteristics of the test fixture shall be agreed upon with the accredited test laboratory and shall conform to the following basic parameters:

- the circuitry associated with the RF coupling shall contain no active or non-linear devices;
- the coupling loss shall not influence the measuring results;
- the coupling loss shall be independent of the position of the test fixture and be unaffected by the proximity of surrounding objects or people;
- the coupling loss shall be reproducible when the EUT is removed and replaced;
- the coupling loss shall remain substantially constant when the environmental conditions are varied.

7.3 Test site and general arrangements for radiated measurements

For guidance on radiation test sites, see annex A. Detailed descriptions of the radiated measurement arrangements are included in this annex.

7.4 Modes of operation of the transmitter

For the purpose of the measurements according to the present document there should preferably be a facility to operate the transmitter in an unmodulated state. The method of achieving an unmodulated carrier frequency or special types of modulation patterns may also be decided by agreement between the manufacturer and the testing laboratory. It shall be described in the test report. It may involve suitable temporary internal modifications of the EUT. If it is not possible to provide an unmodulated carrier then this shall be stated in the test report.

7.5 Arrangement for test signals at the input of the transmitter

For the purpose of the present document, the transmitter audio frequency modulation signal to produce the manufacturer's declared nominal deviation shall be supplied by a generator at the correct impedance applied at the connections of the stated audio input, unless otherwise stated.

8 Methods of measurement and limits for transmitter parameters

All tests shall be carried out under normal conditions unless otherwise stated.

8.1 Frequency error

8.1.1 Definition

The frequency error of the transmitter is the difference between the measured unmodulated carrier frequency and its nominal value.

8.1.2 Method of measurement

The carrier frequency shall be measured (in the absence of modulation) with the transmitter placed in a test fixture (see subclause 7.2) connected to an artificial antenna. For equipment with an external frequency rotary control the nominal frequencies are taken as the measured frequency under normal test conditions at each end of the tuning range (see subclause 8.3.4). The measurement shall be made under normal test conditions (see subclause 6.3), and extreme test conditions (subclauses 6.4.1 and 6.4.2 applied simultaneously).

8.1.3 Limit

The frequency error shall not exceed the values given in table 2.

Table 2: Frequency error (kHz)

Normal test conditions	Extreme test conditions
±40 kHz	±50 kHz

8.2 Carrier power

8.2.1 Definition

The transmitter carrier power is defined as the effective radiated power in the direction of maximum field strength, under specified conditions of measurement, (see subclause 7.5), if possible in the absence of modulation. The stated output power is the carrier power declared by the manufacturer.

8.2.2 Method of measurement for equipment with integral antenna

8.2.2.1 Method of measurement under normal test conditions

On a test site fulfilling the requirements of subclause 7.3, the sample shall be placed on the support in the following position:

- for equipment with an internal antenna, it shall stand vertically, with that axis vertical which is closest to vertical in normal use;
- for equipment with rigid external antenna, the antenna shall be vertical;
- for equipment with non-rigid external antenna, with the antenna extended vertically upwards by a non-conducting support.

The transmitter shall be switched on, without modulation, and the test receiver shall be tuned to the frequency of the signal being measured. The test antenna shall be oriented for vertical polarization and shall be raised or lowered through the specified height range until a maximum signal level is detected on the test receiver.

The transmitter shall be rotated horizontally through 360° until the highest maximum signal is received.

NOTE: This maximum may be a lower value than the value obtainable at heights outside the specified limits.

The transmitter shall be replaced by a substitution antenna, as defined in subclause A.1.3 and the test antenna raised or lowered as necessary to ensure that the maximum signal is still received. The input signal to the substitution antenna shall be adjusted in level until an equal or a known related level to that detected from the transmitter is obtained in the test receiver.

The carrier power is equal to the power supplied to the substitution antenna, increased by the known relationship if necessary.

A check should be made in the horizontal plane of polarization to ensure that the value obtained above is the maximum. If larger values are obtained, this fact should be recorded in the test report.

8.2.2.2 Method of measurement under extreme test conditions

The equipment shall be placed in a test fixture (see subclause 7.2) and the relative power deviation delivered to the artificial antenna shall be measured. The measurement shall be made under normal test conditions (subclause 6.3) and extreme test conditions (subclauses 6.4.1 and 6.4.2 applied simultaneously).

8.2.3 Limit

The carrier power under normal test conditions (subclause 6.3) and extreme test conditions (subclause 6.4), (subclauses 6.4.1 and 6.4.2 applied simultaneously) shall not exceed the limits in table 3:

Table 3: Carrier power

Equipment	Max erp
Wideband cordless audio	10 mW
In-ear monitoring	10 mW
In-vehicle cordless	2 mW
Personal cordless	1 mW

The power of the test sample under normal test conditions shall be within +3 to -3dB of the power level declared by the applicant, without exceeding the values in table 3. The declared and measured levels shall be recorded in the test report.

8.3 Channel bandwidth

8.3.1 Definition

For the purpose of the present document the 300 kHz channel Bandwidth (B) is defined as the maximum bandwidth, within which the transmitter's necessary bandwidth is contained. The necessary bandwidth of the transmitter shall be measured under the conditions laid down in subclause 8.3.2.

8.3.2 Measurement of Necessary Bandwidth (BN)

With a weighted noise source to ITU-R Recommendation BS.559-2 [3], band-limited to 15 kHz as described in IEC 244 Part 13 [4], the audio input level to the EUT shall be adjusted to give the manufacturer's declared nominal deviation as measured by a deviation meter. If no nominal deviation is declared the stated 500 Hz nominal audio input level shall be used for the weighted noise input level.

The audio input level shall be increased until a maximum peak deviation reading is obtained on a deviation meter.

The input level is then increased by 10dB. The transmitter RF output spectrum shall be measured, using a spectrum analyser with the following settings:

- centre frequency: fc: Transmitter (Tx) nominal frequency;
- dispersion (Span): fc - 1 MHz to fc + 1 MHz;
- Resolution BandWidth (RBW): 1 kHz;
- Video BandWidth (VBW): 1 kHz;
- detector: Peak hold.

NOTE 1: If the transmitter incorporates any ancillary coding or signalling channels (e.g. pilot-tones), these should be enabled prior to any spectral measurements.

NOTE 2: If the transmitter incorporates more than one audio input, e.g. stereo systems, the second and subsequent channels should be simultaneously driven from the same noise source, attenuated to a level of -10 dB relative to the primary input.

8.3.3 Limits

The transmitter output spectrum shall be within the mask defined in figure 3 where B is the 300 kHz channel bandwidth.

8.3.4 Edge of Band Limits

At no time shall any part of the occupied bandwidth mask above the -46 dBc point fall outside the edges of the band 863 MHz to 865 MHz.

For Switched frequency equipment the switching range shall be limited so that this condition is met allowing for the maximum frequency error measured under normal or extreme test conditions in subclause 8.1.

For equipment with an external frequency control the tuning range shall be limited so that this condition is met allowing for the maximum frequency error measured under normal or extreme test conditions in subclause 8.1.

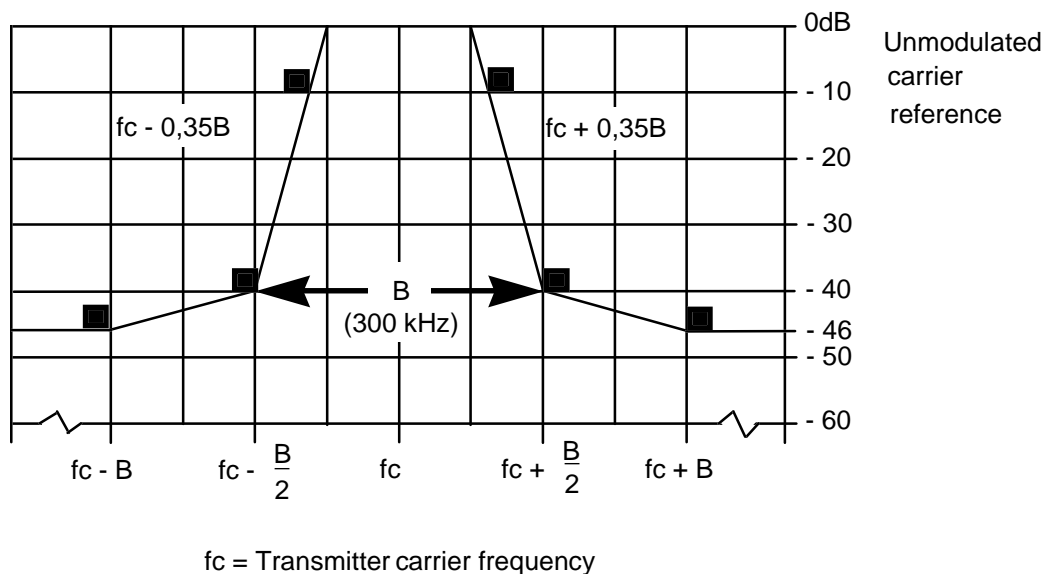

Figure 3: Spectral mask

The measurement of Tx broad band noise floor shall be carried out in accordance with subclause 8.3.2. The -46 dBc point shall be ± 300 kHz from fc measured with an average detector.

8.4 Spurious emissions

8.4.1 Definitions

Spurious emissions are emissions at frequencies other than those of the carrier and sidebands associated with test modulation, radiated by the equipment and its antenna. For these tests radiated measurements only shall be carried out.

8.4.2 Method of measuring the effective radiated power

On a test site fulfilling the requirements of annex A, the sample shall be placed at the specified height on a non-conducting support. The transmitter shall be operated at the carrier power as specified under subclause 8.2. Without modulation, where possible.

Radiation of any spurious components shall be detected by the test antenna and receiver, over the frequency range specified below, excluding a 600 kHz band of frequencies centred on the channel on which the transmitter is intended to operate.

NOTE: The 600 kHz exclusion is covered by measurements carried out in subclause 8.3.3.

The measuring receiver shall be tuned over the frequency range 25 MHz to 4 GHz.

At each frequency at which a component is detected, the sample shall be rotated to obtain maximum response and the effective radiated power of that component determined by a substitution measurement.

If the transmitter allows for stand-by operation the tests shall be repeated with the transmitter in standby mode.

8.4.3 Limits

The power of the spurious emissions shall not exceed the limits of table 4.

Table 4: Radiated measurements

State	Frequency		
	47 MHz to 74 MHz 87,5 MHz to 118 MHz 174 MHz to 230 MHz 470 MHz to 862 MHz	Other Frequencies below 1 000 MHz	Frequencies above 1 000 MHz
Operation	4 nW	250 nW	1 µW
Standby	2 nW	2 nW	20 nW

8.4.4 Measuring receiver

The term measuring receiver refers to either a selective voltmeter or a spectrum analyser using a peak detector. The bandwidth of the measuring receiver is given in table 5.

Table 5: Measuring receiver bandwidth

Frequency being measured	Measuring receiver bandwidth
25 MHz to < 30 MHz	9 kHz to 10 kHz
30 MHz to < 1 000 MHz	100 kHz to 120 kHz
> 1 000 MHz	1 MHz

8.5 Transmitter shutoff

8.5.1 Definition

The transmitter shall have a built in timer facility that automatically switches off the RF carrier after a period of no input audio signal.

8.5.2 Method of measurement

The output of the transmitter shall be connected to a power meter with modulation applied. When the modulation is removed a timer is started and the power level recorded. When the switch off occurs the time period and new power level are noted.

8.5.3 Limits

The carrier output power shall be reduced by ≥ 30 dB less than 5 minutes after the modulation is removed.

9 Receiver

9.1 Spurious emissions

9.1.1 Definitions

Spurious emissions from the receiver are radio frequency emissions at any frequency, generated by the equipment, antenna, aerial amplifier, down converters or filter.

Manufacturers shall provide a representative sample of the receiver system. The level of spurious emissions shall be measured by either:

- a) the power level from an external RF port; and
- b) their effective radiated power when radiated by the cabinet and structure of the equipment (cabinet radiation); or
- c) their effective radiated power when radiated by the cabinet and the integral antenna, in the case of equipment fitted with such an antenna and no external RF port.

9.1.2 Method of measuring the power level in a specified load

This method applies only to equipment with an external RF port.

The external RF port of the receiver under test shall be connected to a measuring receiver (see subclause 8.4.4). The receiver under test shall be switched on, and the measuring receiver shall be tuned over the frequency range 25 MHz to 4 GHz.

At each frequency at which a spurious component is detected, the power level shall be recorded as the spurious level delivered into the specified load.

9.1.3 Method of measuring the effective radiated power of the enclosure

This method applies only to equipment with an external RF port.

On a test site, selected from annex A, the equipment shall be placed at the specified height on a non-conducting support and in the position closest to normal use as declared by the manufacturer. The receiver antenna connector shall be connected to an artificial antenna.

The test antenna shall be oriented for vertical polarization and the length of the test antenna shall be chosen to correspond to the instantaneous frequency of the measuring receiver (see subclause 8.4.4). The output of the test antenna shall be connected to a measuring receiver. The receiver shall be switched on and the measuring receiver shall be tuned over the frequency range as specified in subclause 9.1.2. At each frequency at which a spurious component is detected, the test antenna shall be raised and lowered through the specified range of height until a maximum signal level is detected by the measuring receiver. When a test site according to clause A.3 is used there is no need to vary the height of the antenna. The receiver shall then be rotated through 360° in the horizontal plane until the maximum signal level is detected by the measuring receiver. The maximum signal level detected by the measuring receiver shall be noted.

The receiver shall be replaced by a substitution antenna as defined in subclause A.1.3.

The substitution antenna shall be oriented for vertical polarization and the length of the substitution antenna shall be adjusted to correspond to the frequency of the spurious component detected.

The substitution antenna shall be connected to a calibrated signal generator.

The frequency of the calibrated signal generator shall be set to the frequency of the spurious component detected.

The input attenuator setting of the measuring receiver shall be adjusted in order to increase the sensitivity of the measuring receiver, if necessary.

The test antenna shall be raised and lowered through the specified range of height to ensure that the maximum signal is received. The input signal to the substitution antenna shall be adjusted to the level that produces a level detected by the measuring receiver, that is equal to the level noted while the spurious component was measured, corrected for the change of input attenuator setting of the measuring receiver. The input level to the substitution antenna shall be recorded as power level, corrected for the change of input attenuator setting of the measuring receiver.

The measurement shall be repeated with the test antenna and the substitution antenna oriented for horizontal polarization.

The measure of the effective radiated power of the spurious components is the larger of the two power levels recorded for each spurious component at the input to the substitution antenna, corrected for the gain of the antenna if necessary.

9.1.4 Method of measuring the effective radiated power

This method applies only to equipment with an integral antenna.

The method of measurement shall be performed according to subclause 9.1.3, except that the receiver input shall be connected to the integral antenna and not to an artificial antenna.

9.1.5 Limits

The power of the spurious emissions shall not exceed the limits of table 6.

Table 6: Limits for receiver spurious emissions

Measurement	25 MHz to 1 000 MHz	Frequencies above 1 000 MHz
erp	2 nW	20 nW

10 Measurement uncertainty

The accumulated measurement uncertainties of the test system in use for the parameters to be measured shall not exceed those given in table 7. This is in order to ensure that the measurements remain within an acceptable standard. Uncertainty values for the RF parameters are valid to 1 GHz unless otherwise stated.

Table 7: Measurement uncertainty

Parameter	Uncertainty
RF frequency	$< \pm 1 \times 10^{-7}$
Audio Output power	$< \pm 0,5$ dB
Radiated RF power	$< \pm 6$ dB
Conducted RF power variations using a test fixture	$< \pm 0,75$ dB
Maximum frequency deviation:	
- within 300 Hz and 6 kHz of audio frequency	$< \pm 5$ %
- within 6 kHz and 25 kHz of audio frequency	$< \pm 3$ dB
Deviation limitation	$< \pm 5$ %
Radiated emission of transmitter, valid up to 12,75 GHz	$< \pm 6$ dB
Radiated emission of receiver, valid up to 12,75 GHz	$< \pm 6$ dB
Transmitter switch off time	$< \pm 5$ %

For the test methods, according to the present document, the uncertainty figures are valid to a confidence level of 95 % calculated according to the methods described in ETR 028 [5].

Annex A (normative): Radiated measurement

A.1 Test sites and general arrangements for measurements involving the use of radiated fields

A.1.1 Outdoor test site

The outdoor test site shall be on a reasonably level surface or ground. At one point on the site, a ground plane of at least 5 m diameter shall be provided. In the middle of this ground plane, a non-conducting support, capable of rotation through 360° in the horizontal plane, shall be used to support the test sample at 1,5 m above the ground plane. The test site shall be large enough to allow the erection of a measuring or transmitting antenna at a distance of $\lambda/2$ or 3 m whichever is the greater. The distance actually used shall be recorded with the results of the tests carried out on the site.

Sufficient precautions shall be taken to ensure that reflections from extraneous objects adjacent to the site and ground reflections do not degrade the measurement result.

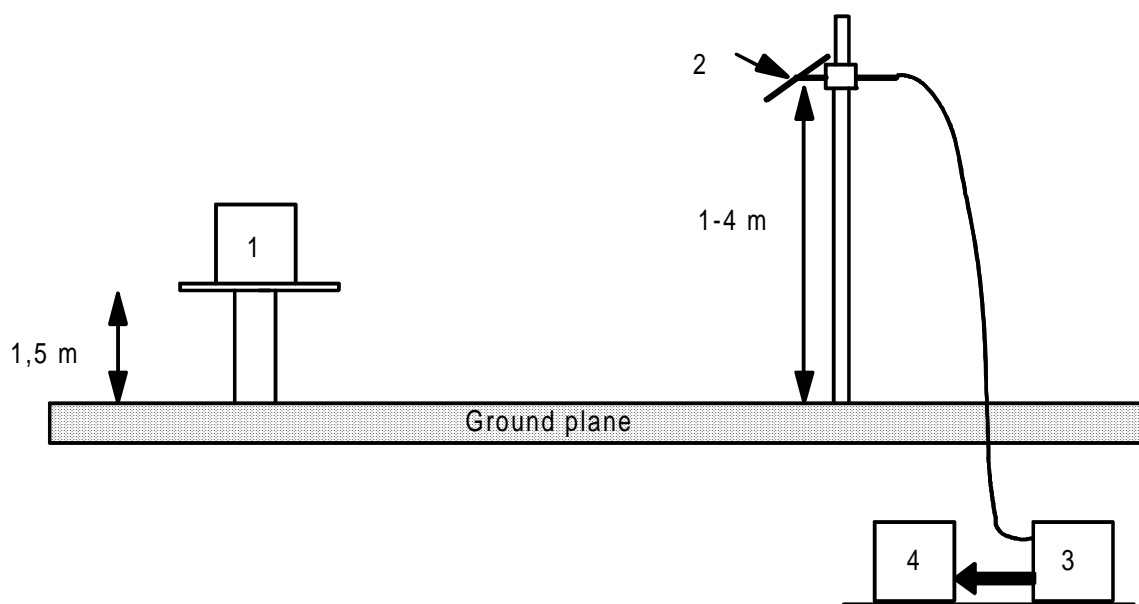

NOTE 1: EUT.

NOTE 2: test antenna.

NOTE 3: high pass filter (necessary for strong fundamental Tx radiation).

NOTE 4: spectrum analyser or measuring receiver.

Figure A.1: Outdoor test site

A.1.1.1 Test support for body worn equipment

For equipment intended to be worn close to the body and operating on frequencies below 50 MHz, but excluding hand-held equipment, the non-conducting support shall be replaced with the simulated man.

The simulated man shall consist of a plastic tube, filled with salt water (9 g NaCl per litre). The tube shall have a length of 1,5 m and an internal diameter of $10 \pm 0,5$ cm. The upper end of the tube is closed by a metal plate with a diameter of 15 cm, which is in contact with the water. To meet the requirements made on equipment with rigid outside antenna that this antenna shall be in a vertical position during the measurement, the metal plate shall, if necessary, be prepared in such a way that a second hinged metal plate of $10 \text{ cm} \times 15 \text{ cm}$ can be fastened to its narrow side. It should be possible to change the supporting point of the hinged plate as far as the centre.

The position of the hinged plate shall be adjusted within 0° to 90° with respect to the lower metal plate.

The sample shall be fastened in such a way that:

- a) the centre of its largest area rests on the revolving metal plate; and
- b) this centre, on its part, is located above the centre of the lower metal plate by changing the supporting point of the revolving plate.

In the case of samples, whose largest area is smaller than 10 cm × 15 cm, the centre of the sample shall (deviating from point a) above) be so changed in its longitudinal axis that the antenna base is at the edge outside the metal plate.

A.1.1.2 Standard position

The standard position on all test sites, except for equipment that is intended to be worn on a person, shall be as follows:

- for equipment with an integral antenna, it shall be placed in the position closest to normal use as declared by the applicant;
- for equipment with rigid external antenna, the antenna shall be vertical;
- for equipment with non-rigid external antenna, the antenna shall be extended vertically upwards by a non conducting support.

A.1.2 Test antenna

The test antenna is used to detect the radiation from both the test sample and the substitution antenna, when the site is used for radiation measurements; where necessary, it is used as a transmitting antenna, when the site is used for the measurement of receiver characteristics.

This antenna is mounted on a support such as to allow the antenna to be used in either horizontal or vertical polarization and for the height of its centre above ground to be varied over the range 1m to 4 m. Preferably a test antenna with pronounced directivity should be used. The size of the test antenna along the measurement axis shall not exceed 20 % of the measuring distance.

For receiver and transmitter radiation measurements, the test antenna is connected to a measuring receiver, capable of being tuned to any frequency under investigation and of measuring accurately the relative levels of signals at its input. For receiver radiated sensitivity measurements the test antenna is connected to a signal generator.

A.1.3 Substitution antenna

When measuring in the frequency range up to 1 GHz, the substitution antenna shall be a $\lambda/2$ dipole, resonant at the frequency under consideration, or a shortened dipole, calibrated to the $\lambda/2$ dipole. The centre of this antenna shall coincide with the reference point of the test sample it has replaced. This reference point shall be the volume centre of the sample when its antenna is mounted inside the cabinet, or the point where an external antenna is connected to the cabinet.

The distance between the lower extremity of the dipole and the ground shall be at least 30 cm.

The substitution antenna shall be connected to a calibrated signal generator when the site is used for spurious radiation measurements and transmitter effective radiated power measurements. The substitution antenna shall be connected to a calibrated measuring receiver when the site is used for the measurement of receiver sensitivity.

The signal generator and the receiver shall be operating at the frequencies under investigation and shall be connected to the antenna through suitable matching and balancing networks.

NOTE: The gain of a horn antenna is generally expressed relative to an isotropic radiator.

A.1.4 Optional additional indoor site

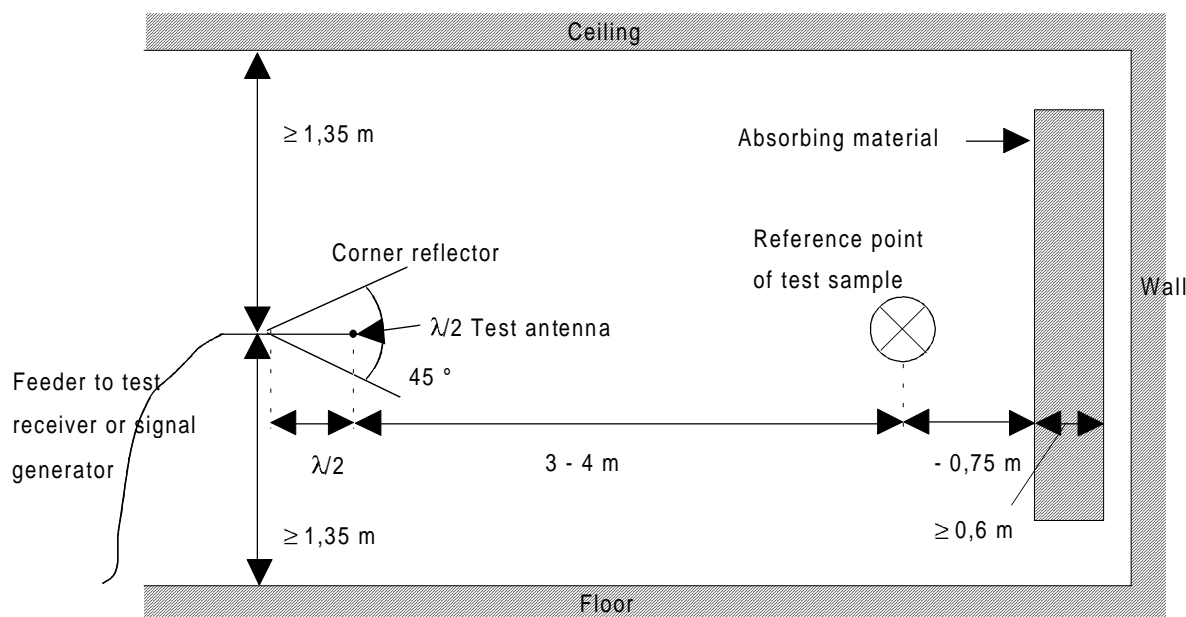

Figure A.2: Indoor site arrangement (shown in horizontal polarization)

When the frequency of the signals being measured is greater than 80 MHz, use may be made of an indoor site. If this alternative site is used, this shall be recorded in the test report.

The measurement site may be a laboratory room with a minimum area of 6 m by 7 m and at least 2,7 m in height.

Apart from the measuring apparatus and the operator, the room shall be as free as possible from reflecting objects other than the walls, floor and ceiling.

The potential reflections from the wall behind the EUT are reduced by placing a barrier of absorbent material in front of it. The corner reflector around the test antenna is used to reduce the effect of reflections from the opposite wall and from the floor and ceiling in the case of horizontally polarized measurements. Similarly, the corner reflector reduces the effects of reflections from the side walls for vertically polarized measurements. For the lower part of the frequency range (below approximately 175 MHz) no corner reflector or absorbent barrier is needed. For practical reasons, the $\lambda/2$ antenna in figure A.2 may be replaced by an antenna of constant length, provided that this length is between $\lambda/4$ and λ at the frequency of measurement and the sensitivity of the measuring system is sufficient. In the same way the distance of $\lambda/2$ to the apex may be varied.

The test antenna, measuring receiver, substitution antenna and calibrated signal generator are used in a way similar to that of the general method. To ensure that errors are not caused by the propagation path approaching the point at which phase cancellation between direct and the remaining reflected signals occurs, the substitution antenna shall be moved through a distance of ± 10 cm in the direction of the test antenna as well as in the two directions perpendicular to this first direction.

If these changes of distance cause a signal change of greater than 2 dB, the test sample should be re-sited until a change of less than 2 dB is obtained.

A.2 Guidance on the use of radiation test sites

For measurements involving the use of radiated fields, use may be made of a test site in conformity with the requirements of clause A.1. When using such a test site, the conditions in the following subclauses should be observed to ensure consistency of measuring results.

A.2.1 Measuring distance

Evidence indicates that the measuring distance is not critical and does not significantly affect the measuring results, provided that the distance is not less than $\lambda/2$ at the frequency of measurement, and the precautions described in this annex are observed. Measuring distances of 3 m, 5 m, 10 m and 30 m are in common use in European test laboratories.

A.2.2 Test antenna

Different types of test antenna may be used, since performing substitution measurements reduces the effect of the errors on the measuring results.

Height variation of the test antenna over a range of 1 m to 4 m is essential in order to find the point at which the radiation is a maximum.

Height variation of the test antenna may not be necessary at the lower frequencies below about 100 MHz.

A.2.3 Substitution antenna

Variations in the measuring results may occur with the use of different types of substitution antenna at the lower frequencies below about 80 MHz. Where a shortened dipole antenna is used at these frequencies, details of the type of antenna used should be included with the results of the tests carried out on the site. Correction factors shall be taken into account when shortened dipole antennas are used.

A.2.4 Artificial antenna

The dimensions of the artificial antenna used during radiated measurements should be small in relation to the sample under test.

Where possible, a direct connection should be used between the artificial antenna and the test sample.

In cases where it is necessary to use a connecting cable, precautions should be taken to reduce the radiation from this cable by, for example, the use of ferrite cores or double screened cables.

A.2.5 Auxiliary cables

The position of auxiliary cables (power supply and microphone cables, etc.) which are not adequately de-coupled may cause variations in the measuring results. In order to get reproducible results, cables and wires of auxiliaries should be arranged vertically downwards (through a hole in the non-conducting support).

A.3 Further optional alternative indoor test site using an anechoic chamber

For radiation measurements when the frequency of the signals being measured is greater than 30 MHz, use may be made of an indoor site being a well-shielded anechoic chamber simulating free space environment. If such a chamber is used, this shall be recorded in the test report.

The test antenna, measuring receiver, substitution antenna and calibrated signal generator are used in a way similar to that of the general method, see clause A.1. In the range between 25 MHz and 100 MHz some additional calibration may be necessary.

An example of a typical measurement site may be an electrically shielded anechoic chamber being 10 m long, 5 m broad and 5 m high. Walls and ceiling should be coated with RF absorbers of 1 m height. The base should be covered with absorbing material 1 m thick, and a wooden floor, able to carry test equipment and operators. A measuring distance of 3 m to 5 m in the long middle axis of the chamber can be used for measurements up to 12,75 GHz. The construction of the anechoic chamber is described in the following subclauses.

A.3.1 Example of the construction of a shielded anechoic chamber

Free-field measurements can be simulated in a shielded measuring chamber where the walls are coated with RF absorbers. Figure A.3 shows the requirements for shielding loss and wall return loss of such a room. As dimensions and characteristics of usual absorber materials are critical below 100 MHz (height of absorbers < 1 m, reflection attenuation < 20 dB) such a room is preferably suitable for measurements above 100 MHz. Figure A.4 shows the construction of a shielded measuring chamber having a base area of 5 m by 10 m and a height of 5 m.

Ceilings and walls are coated with pyramidal formed absorbers approximately 1 m high. The base is covered with absorbers that are able to support a form of floor. The available internal dimensions of the room are 3 m × 8 m × 3 m, so that a measuring distance of maximum 5 m length in the middle axis of this room is available.

At 100 MHz, the measuring distance can be extended up to a maximum of 2λ .

The floor absorbers reject floor reflections so that the antenna height need not be changed and floor reflection influences need not be considered.

All measuring results can therefore be checked with simple calculations and the measuring tolerances have the smallest possible values due to the simple measuring configuration.

A.3.2 Influence of parasitic reflections in anechoic chambers

For free-space propagation in the far field condition the correlation $E = E_0(R_0/R)$ is valid for the dependence of the field strength E on the distance R , whereby E_0 is the reference field strength in the reference distance R_0 .

It is useful to use just this correlation for comparison measurements, as all constants are eliminated with the ratio and neither cable attenuation nor antenna mismatch or antenna dimensions are of importance.

Deviations from the ideal curve can be seen easily if the logarithm of the above equation is used, because the ideal correlation of field strength and distance can then be shown as a straight line and the deviations occurring in practice are clearly visible. This indirect method shows the disturbances due to reflections more readily and is far less problematical than the direct measurement of reflection attenuation.

With an anechoic chamber of the dimensions suggested in clause A.3 at low frequencies up to 100 MHz there are no far field conditions, and therefore reflections are stronger so that careful calibration is necessary. In the medium frequency range from 100 MHz to 1 GHz the dependence of the field strength on the distance meets the expectations very well. In the frequency range of 1 GHz to 12,75 GHz, because more reflections will occur, the dependence of the field strength on the distance will not correlate so closely.

A.3.3 Calibration of the shielded anechoic chamber

Careful calibration of the chamber shall be performed over the range 25 MHz to 12,75 GHz.

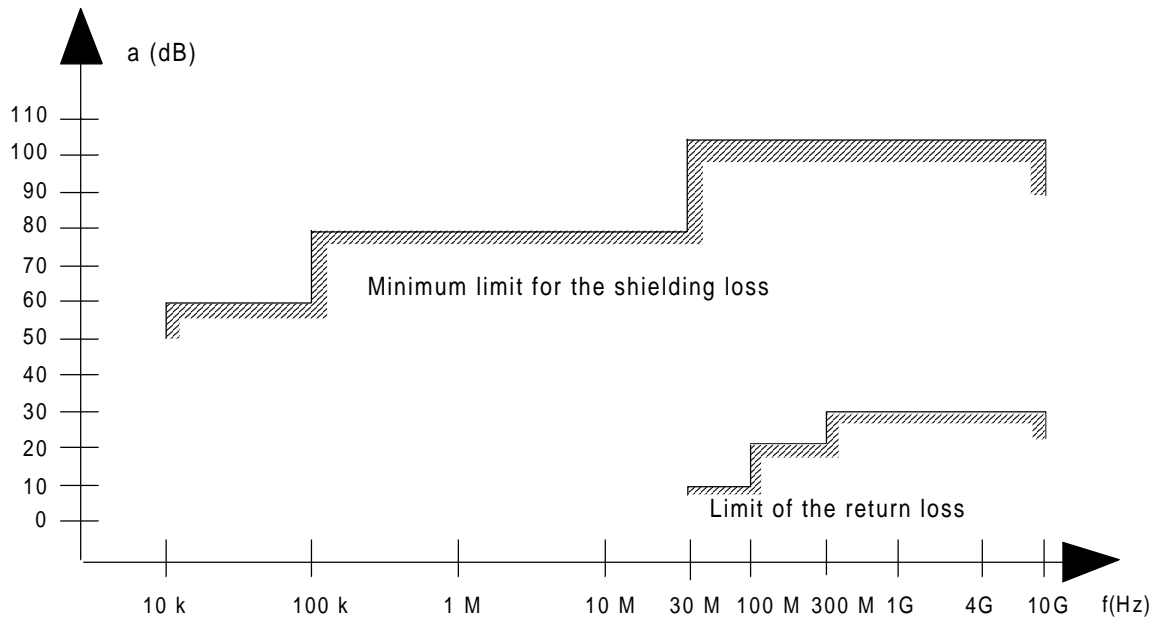

Figure A.3: Specifications for shielding and reflections

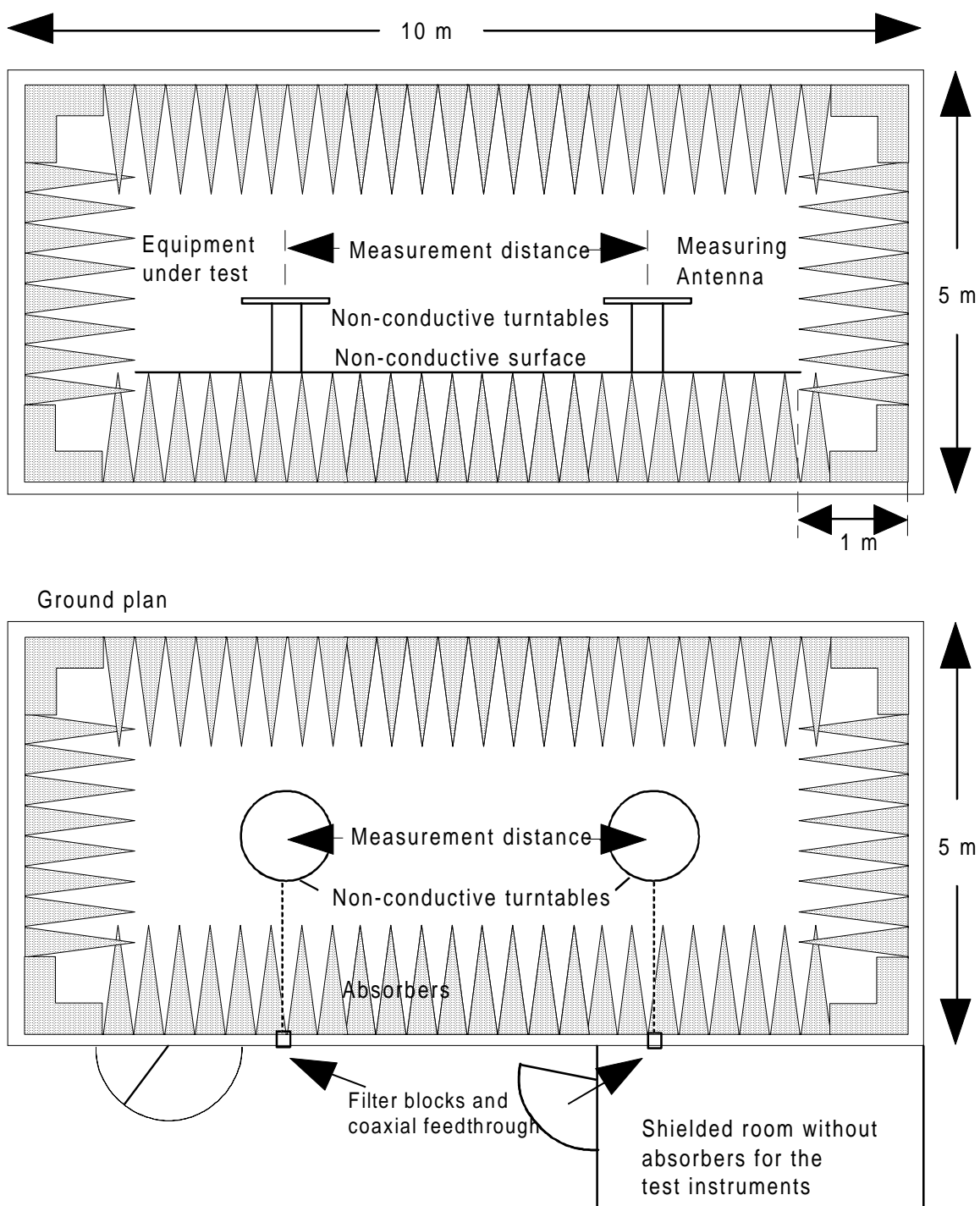

Figure A.4: Example of construction of an anechoic shielded chamber

Bibliography

- ETS 300 454, including amendment 1: "Radio Equipment and Systems (RES); Wide band audio links; Technical characteristics and test methods".

History

Document history				
V1.1.1	September 1998	Public Enquiry	PE 9902:	1998-09-11 to 1999-01-08
V1.1.1	April 1999	Vote	V 9925:	1999-04-20 to 1999-06-18