

ETSI EN 301 347 V7.1.1 (2000-01)

European Standard (Telecommunications series)

**Digital cellular telecommunications system (Phase 2+);
General Packet Radio Service (GPRS);
GPRS Tunnelling Protocol (GTP)
across the Gn and Gp Interface
(GSM 09.60 version 7.1.1 Release 1998)**



GSM®
GLOBAL SYSTEM FOR
MOBILE COMMUNICATIONS

ETSI 

Reference

REN/SMG-030960Q7

Keywords

Digital cellular telecommunications system,
Global System for Mobile communications (GSM)

ETSI

Postal address

F-06921 Sophia Antipolis Cedex - FRANCE

Office address

650 Route des Lucioles - Sophia Antipolis
Valbonne - FRANCE
Tel.: +33 4 92 94 42 00 Fax: +33 4 93 65 47 16
Siret N° 348 623 562 00017 - NAF 742 C
Association à but non lucratif enregistrée à la
Sous-Préfecture de Grasse (06) N° 7803/88

Internet

secretariat@etsi.fr
Individual copies of this ETSI deliverable
can be downloaded from
<http://www.etsi.org>
If you find errors in the present document, send your
comment to: editor@etsi.fr

Important notice

This ETSI deliverable may be made available in more than one electronic version or in print. In any case of existing or perceived difference in contents between such versions, the reference version is the Portable Document Format (PDF). In case of dispute, the reference shall be the printing on ETSI printers of the PDF version kept on a specific network drive within ETSI Secretariat.

Copyright Notification

No part may be reproduced except as authorized by written permission.
The copyright and the foregoing restriction extend to reproduction in all media.

© European Telecommunications Standards Institute 2000.
All rights reserved.

Contents

Intellectual Property Rights	6
Foreword	6
1 Scope	7
2 References	7
3 Definitions and abbreviations	8
3.1 Definitions	8
3.2 Abbreviations	9
4 General	9
5 Transmission order and bit definitions	10
6 GTP header.....	10
7 Signalling Plane	12
7.1 Signalling protocol	12
7.2 Signalling Message Formats.....	13
7.3 Usage of the GTP Header.....	13
7.4 Path Management messages	14
7.4.1 Echo Request	14
7.4.2 Echo Response.....	15
7.4.3 Version Not Supported	15
7.5 Tunnel Management messages	15
7.5.1 Create PDP Context Request	15
7.5.2 Create PDP Context Response.....	17
7.5.3 Update PDP Context Request	19
7.5.4 Update PDP Context Response.....	19
7.5.5 Delete PDP Context Request	21
7.5.6 Delete PDP Context Response.....	21
7.5.7 Create AA PDP Context Request.....	22
7.5.8 Create AA PDP Context Response	23
7.5.9 Delete AA PDP Context Request.....	24
7.5.10 Delete AA PDP Context Response	25
7.5.11 Error Indication.....	25
7.5.12 PDU Notification Request	26
7.5.13 PDU Notification Response.....	26
7.5.14 PDU Notification Reject Request	27
7.5.15 PDU Notification Reject Response.....	27
7.6 Location Management messages	28
7.6.1 Send Routeing Information for GPRS Request.....	28
7.6.2 Send Routeing Information for GPRS Response	29
7.6.3 Failure Report Request	29
7.6.4 Failure Report Response.....	30
7.6.5 Note MS GPRS Present Request	30
7.6.6 Note MS GPRS Present Response.....	31
7.7 Mobility Management messages.....	31
7.7.1 Identification Request	31
7.7.2 Identification Response.....	32
7.7.3 SGSN Context Request.....	32
7.7.4 SGSN Context Response	33
7.7.5 SGSN Context Acknowledge.....	34
7.8 Reliable delivery of signalling messages	35
7.9 Information elements	35
7.9.1 Cause	36
7.9.2 International Mobile Subscriber Identity (IMSI)	38

7.9.3	Routeing Area Identity (RAI)	38
7.9.4	Temporary Logical Link Identity (TLLI).....	39
7.9.5	Packet TMSI (P-TMSI)	39
7.9.6	Quality of Service (QoS) Profile.....	40
7.9.7	Spare	40
7.9.8	Reordering Required.....	40
7.9.9	Authentication Triplet.....	40
7.9.10	Spare	41
7.9.11	MAP Cause	41
7.9.12	P-TMSI Signature.....	41
7.9.13	MS Validated.....	41
7.9.14	Recovery.....	42
7.9.15	Selection mode.....	42
7.9.16	Flow Label Data I	43
7.9.17	Flow Label Signalling.....	43
7.9.18	Flow Label Data II.....	43
7.9.19	Charging ID	44
7.9.20	End User Address	44
7.9.21	MM Context.....	47
7.9.22	PDP Context	48
7.9.23	Access Point Name	51
7.9.24	Protocol Configuration Options	51
7.9.25	GSN Address	51
7.9.26	Charging Gateway Address.....	52
7.9.27	Private Extension	52
8	Transmission Plane	52
8.1	Protocol Stack	53
8.1.1	Usage of the GTP Header	53
8.1.1.1	Usage of the Sequence Number	53
8.2	Tunnelling between SGSNs.....	54
8.3	Tunnelling between GGSNs	54
9	Path Protocols	54
9.1	UDP/IP	54
9.1.1	UDP Header.....	54
9.1.1.1	Signalling request messages	54
9.1.1.2	Signalling response messages.....	54
9.1.1.3	Encapsulated T-PDUs	54
9.1.2	IP Header	54
9.1.2.1	Signalling request messages and Encapsulated T-PDUs	55
9.1.2.2	Signalling response messages.....	55
9.2	TCP/IP.....	55
9.2.1	TCP Header	55
9.2.2	IP Header	55
10	Error handling	55
10.1	Protocol errors	55
10.1.1	Different GTP versions.....	56
10.1.2	GTP Message too short.....	56
10.1.3	Unknown GTP signalling message	56
10.1.4	Unexpected GTP signalling message.....	56
10.1.5	Missing mandatorily present information element	56
10.1.6	Invalid Length.....	56
10.1.7	Invalid mandatory information element.....	56
10.1.8	Invalid optional information element.....	57
10.1.9	Unknown information element.....	57
10.1.10	Out of sequence information elements.....	57
10.1.11	Unexpected information element	57
10.1.12	Repeated information elements.....	57
10.1.13	Incorrect optional information elements	57

10.2 Path failure57

10.3 MS detach.....57

10.4 Restoration and Recovery.....58

11 Inter-PLMN GTP communication over the Gp interface.....58

12 IP, the networking technology used by GTP.....58

12.1 IP version58

12.2 IP fragmentation.....58

12.2.1 MO direction.....58

12.2.2 MT direction.....59

12.2.3 Tunnelling from old to new SGSN59

13 GTP parameters.....59

13.1 Timers59

13.2 Others59

Annex A (informative): Naming convention64

Annex B (informative): A method for sequence number checking65

Annex C (informative): Document change history.....66

History67

Intellectual Property Rights

IPRs essential or potentially essential to the present document may have been declared to ETSI. The information pertaining to these essential IPRs, if any, is publicly available for **ETSI members and non-members**, and can be found in SR 000 314: "*Intellectual Property Rights (IPRs); Essential, or potentially Essential, IPRs notified to ETSI in respect of ETSI standards*", which is available from the ETSI Secretariat. Latest updates are available on the ETSI Web server (<http://www.etsi.org/ipr>).

Pursuant to the ETSI IPR Policy, no investigation, including IPR searches, has been carried out by ETSI. No guarantee can be given as to the existence of other IPRs not referenced in SR 000 314 (or the updates on the ETSI Web server) which are, or may be, or may become, essential to the present document.

Foreword

This European Standard (Telecommunications series) has been produced by the Special Mobile Group (SMG).

The present document defines the Gn and Gp interfaces for the General Packet Radio Service (GPRS) within the digital cellular telecommunications system (Phase 2+).

The contents of the present document are subject to continuing work within SMG and may change following formal SMG approval. Should SMG modify the contents of the present document, it will then be re-submitted for OAP by ETSI with an identifying change of release date and an increase in version number as follows:

Version 7.x.y

where:

- 7 indicates Release 1998 of GSM Phase 2+
- x the second digit is incremented for all changes of substance, i.e. technical enhancements, corrections, updates, etc.
- y the third digit is incremented when editorial only changes have been incorporated in the specification.

National transposition dates	
Date of adoption of this EN:	7 January 2000
Date of latest announcement of this EN (doa):	30 April 2000
Date of latest publication of new National Standard or endorsement of this EN (dop/e):	31 October 2000
Date of withdrawal of any conflicting National Standard (dow):	31 October 2000

1 Scope

The present document defines the Gn and Gp interfaces for the General Packet Radio Service (GPRS).

2 References

The following documents contain provisions which, through reference in this text, constitute provisions of the present document.

- References are either specific (identified by date of publication, edition number, version number, etc.) or non-specific.
- For a specific reference, subsequent revisions do not apply.
- For a non-specific reference, the latest version applies.
- A non-specific reference to an ETS shall also be taken to refer to later versions published as an EN with the same number.
- For this Release 1998 document, references to GSM documents are for Release 1998 versions (version 7.x.y).

- [1] GSM 01.04: "Digital cellular telecommunications system (Phase 2+); Abbreviations and acronyms".
- [2] GSM 03.03: "Digital cellular telecommunications system (Phase 2+); Numbering, addressing and identification".
- [3] GSM 03.07: "Digital cellular telecommunications system (Phase 2+); Restoration Procedures".
- [4] GSM 03.20: "Digital cellular telecommunications system (Phase 2+); Security related network functions".
- [5] GSM 03.60: "Digital cellular telecommunications system (Phase 2+); General Packet Radio Service (GPRS); Service Description; Stage 2".
- [6] GSM 03.64: "Digital cellular telecommunications system (Phase 2+); General Packet Radio Service (GPRS); Overall description of the GPRS Radio Interface; Stage 2".
- [7] GSM 04.08: "Digital cellular telecommunications system (Phase 2+); Mobile radio interface layer 3 - specification".
- [8] GSM 04.64: "Digital cellular telecommunications system (Phase 2+); Mobile Station - Serving GPRS Support Node (MS-SGSN) Logical Link Control (LLC) Layer Specification".
- [9] GSM 09.02: "Digital cellular telecommunications system (Phase 2+); Mobile Application Part (MAP) specification".
- [10] STD 0005: "Internet Protocol", J. Postel.
- [11] STD 0006: "User Datagram Protocol", J. Postel.
- [12] STD 0007: "Transmission Control Protocol", J. Postel.
- [13] RFC 1700: "Assigned Numbers", J. Reynolds and J. Postel.
- [14] RFC 2181: "Clarifications to the DNS Specification", R. Elz and R. Bush.
- [15] ITU-T Recommendation X.25: "Interface between data terminal equipment (DTE) and data circuit-terminating equipment (DCE) for terminals operating in the packet mode and connected to public data networks by dedicated circuit".

[16] ITU-T Recommendation X.121: "International Numbering Plan for Public Data Networks".

3 Definitions and abbreviations

3.1 Definitions

For the purpose of the present document, the following definitions apply:

Conditional	When the presence requirement for the information element is conditional, the receiving protocol level can check the presence or absence of an IE based on the received information.
G-PDU:	A T-PDU plus a GTP header. A G-PDU is sent in a path.
GTP-Flow:	A GTP flow is defined by the unidirectional virtual aggregation of G-PDUs and/or signalling messages related to one or more GTP tunnels. A GTP flow is identified by a Flow Label included in the GTP header. The meaning of the Flow Label is transparent for the transmitter side, only the receiver may evaluate the Flow Label.
GTP tunnel:	A GTP tunnel is defined by two associated PDP Contexts in different GSN nodes and is identified with a Tunnel ID. A GTP tunnel is necessary to forward packets between an external packet data network and a MS user.
MM Context:	The information sets held in MS and GSNs for a GPRS subscriber related to mobility management (MM) (please refer to the MM Context Information Element).
MM Context ID:	IMSI or equivalent for use in conjunction with Anonymous Access (please refer to section GTP Header).
NSAPI:	Network Service Access Point Identifier. An integer value in the range [0; 15], identifying a certain PDP Context. It identifies a PDP context belonging to a specific MM Context ID.
Path:	The UDP/IP path and TCP/IP path are examples of paths that may be used to multiplex GTP tunnels.
Path Protocol:	The Path Protocol is the protocol(s) used as a bearer of GTP between GSNs.
PDP:	A Packet Data Protocol (PDP) is a network protocol used by an external packet data network interfacing to GPRS.
PDP Context:	The information sets held in MS and GSNs for a PDP address (please refer to the PDP Context Information Element).
Quality of Service:	Quality of Service may be applicable for the GPRS backbone if the path media supports it. Separate paths with different priorities may be defined between a GSN pair. However, the possible use of QoS in the GGSN is outside the scope of the GTP specification.
Signalling message:	GTP signalling messages are exchanged between GSN pairs in a path. The signalling messages are used to transfer GSN capability information between GSN pairs and to create, update and delete GTP tunnels.
TCP/IP path:	A TCP/IP path is a reliable connection-oriented path defined by two end-points and an end-point is defined by an IP address and a TCP port number. TCP/IP paths should be used when the T-PDUs are based on connection-oriented protocols, such as the X.25 packet layer protocol.
T-PDU:	An original packet, for example an IP datagram, from a MS or a network node in an external packet data network. A T-PDU is the payload that is tunnelled in the GTP tunnel.
TID:	A Tunnel ID (TID) consists of a MM Context ID and a NSAPI.

UDP/IP path: A UDP/IP path is a connection-less path defined by two end-points and an end-point is defined by an IP address and a UDP port number. A UDP/IP path carries G-PDUs between GSN nodes related to one or more GTP tunnels. A UDP/IP path should be used when the T-PDUs are based on connection-less protocols, such as IP.

3.2 Abbreviations

Abbreviations used in the present document are listed in GSM 01.04.

For the purpose of the present document the following additional abbreviations apply:

BB	Backbone Bearer
DF	Don't Fragment
FFS	For Further Study
GTP	GPRS Tunneling Protocol
IANA	Internet Assigned Number Authority
ICMP	Internet Control Message Protocol
IP	Internet Protocol
IPv4	Internet Protocol version 4
IPv6	Internet Protocol version 6
MTU	Maximum Transmission Unit
QoS	Quality of Service
TID	Tunnel Identifier
TCP	Transmission Control Protocol
UDP	User Datagram Protocol
Gn interface	Interface between GPRS Support Nodes (GSNs) within a PLMN
Gp interface	Interface between GPRS Support Nodes (GSNs) in different PLMNs

4 General

This document defines the GPRS Tunnelling Protocol (GTP), i.e. the protocol between GSN nodes in the GPRS backbone network. It includes both the GTP signalling and data transfer procedures. It also lists the messages and information elements used by the GTP based charging protocol GTP', which is described in GSM 12.15.

GTP is defined both for the Gn interface, i.e. the interface between GSNs within a PLMN, and the Gp interface between GSNs in different PLMNs. GTP' is defined for the interface between CDR generating functional network elements and Charging Gateway(s) within a PLMN. Charging Gateway(s) and GTP' protocol are optional, as the Charging Gateway Functionalities may either be located in separate network elements (Charging Gateways), or alternatively be embedded into the CDR generating network elements (GSNs) when the GSN-CGF interface is not necessarily visible outside the network element. These interfaces relevant to GTP are between the grey boxes shown in the figure below.

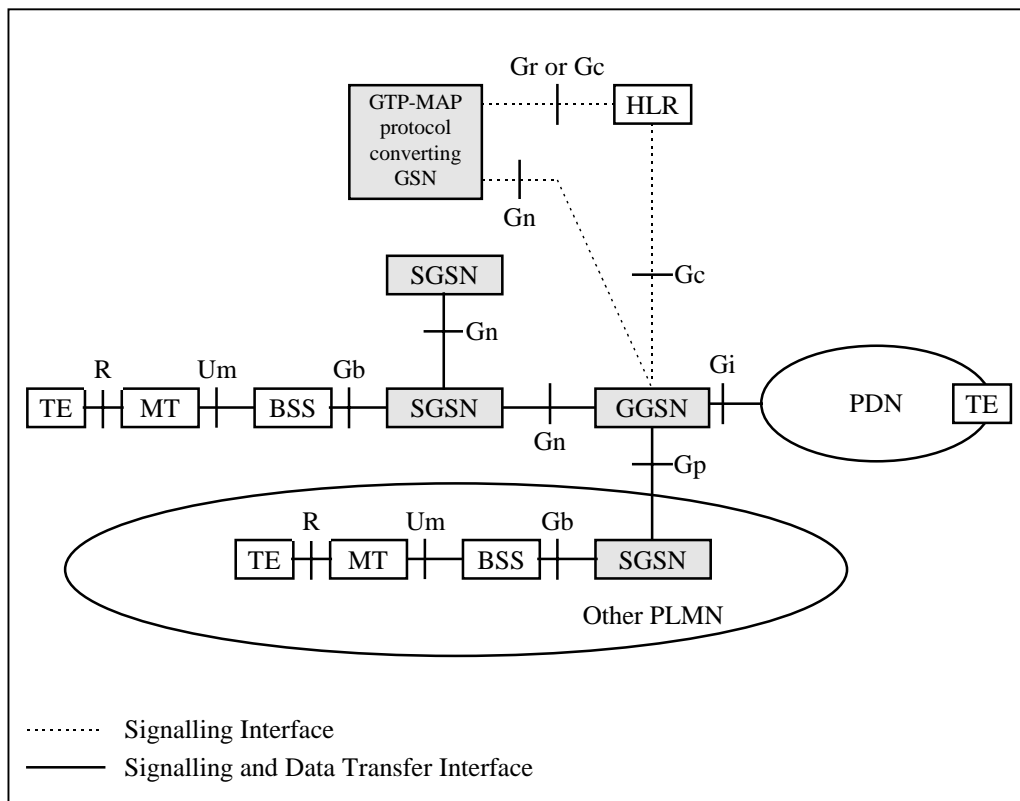

Figure 1: GPRS Logical Architecture with interface name denotations

GTP allows multiprotocol packets to be tunnelled through the GPRS Backbone between GPRS Support Nodes (GSNs).

In the signalling plane, GTP specifies a tunnel control and management protocol which allows the SGSN to provide GPRS network access for a MS. Signalling is used to create, modify and delete tunnels.

In the transmission plane, GTP uses a tunnelling mechanism to provide a service for carrying user data packets. The choice of path is dependent on whether the user data to be tunnelled requires a reliable link or not.

The GTP protocol is implemented only by SGSNs and GGSNs. No other systems need to be aware of GTP. GPRS MSs are connected to a SGSN without being aware of GTP.

It is assumed that there will be a many-to-many relationship between SGSNs and GGSNs. A SGSN may provide service to many GGSNs. A single GGSN may associate with many SGSNs to deliver traffic to a large number of geographically diverse mobile stations.

5 Transmission order and bit definitions

The messages in this document shall be transmitted in network octet order starting with octet 1.

The most significant bit of an octet in a GTP message is bit 8. If a value in a GTP message spans several octets and nothing else is stated, the most significant bit is bit 8 of the octet with the lowest number.

6 GTP header

The GTP header shall be a fixed format 20-octet header used for all GTP messages.

- Version bits: If the PT bit is '1' (indicating a GTP message), the Version shall be set to 0 to indicate this, the first version of GTP. For the treatment of other versions, see section 10.1.1, "Different GTP versions".

- PT (Protocol Type) bit indicates whether the message is a GTP message (when PT is '1') or a GTP' message (when PT is '0'). GTP is described in this document and the GTP' protocol in GSM 12.15. Note that the interpretation of the header fields may be different in GTP' than in GTP.
- Spare '1': These unused bits shall be set to '1' by the sending side and shall not be evaluated by the receiving side.
- SNN is a flag indicating if SNDCCP N-PDU Number is included or not.
- Message Type indicates the type of GTP message.
- Length indicates the length in octets of the GTP message (G-PDU), excluding the GTP header. Bit 8 of octet 3 is the most significant bit and bit 1 of octet 4 is the least significant bit of the length field.
- Sequence Number is a transaction identity for signalling messages and an increasing sequence number for tunnelled T-PDUs.
- SNDCCP N-PDU Number is used at the Inter SGSN Routeing Area Update procedure to co-ordinate the data transmission between the MS and SGSN.
- TID is the tunnel identifier that points out MM and PDP contexts (see Figure 3: Tunnel ID (TID) format).
- The flow label identifies unambiguously a GTP flow.

All fields in the GTP header shall always be present but the content of the fields differs depending on if the header is used for signalling messages (see the sub-section Usage of the GTP Header in the section Signalling Plane) or T-PDUs (see the sub-section Usage of the GTP Header in the section Transmission Plane).

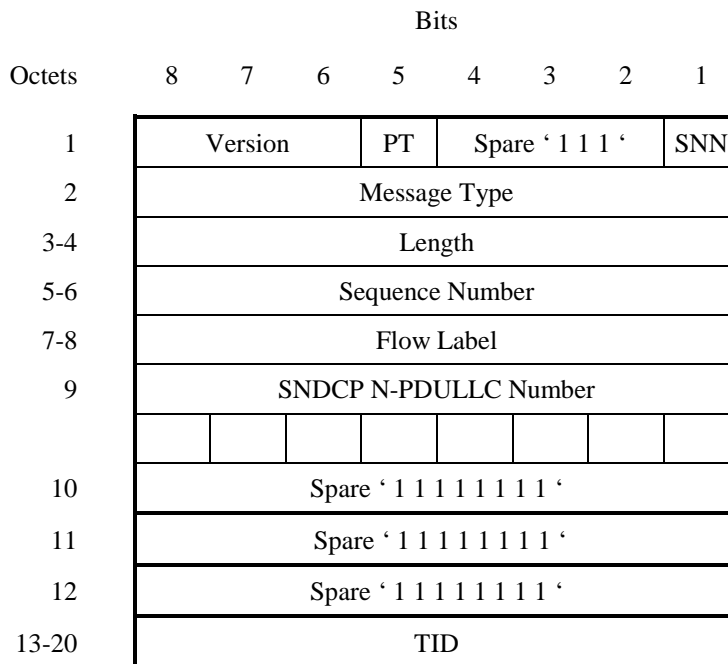

1) LLC frame number (continued)

Figure 2: Outline of GTP header

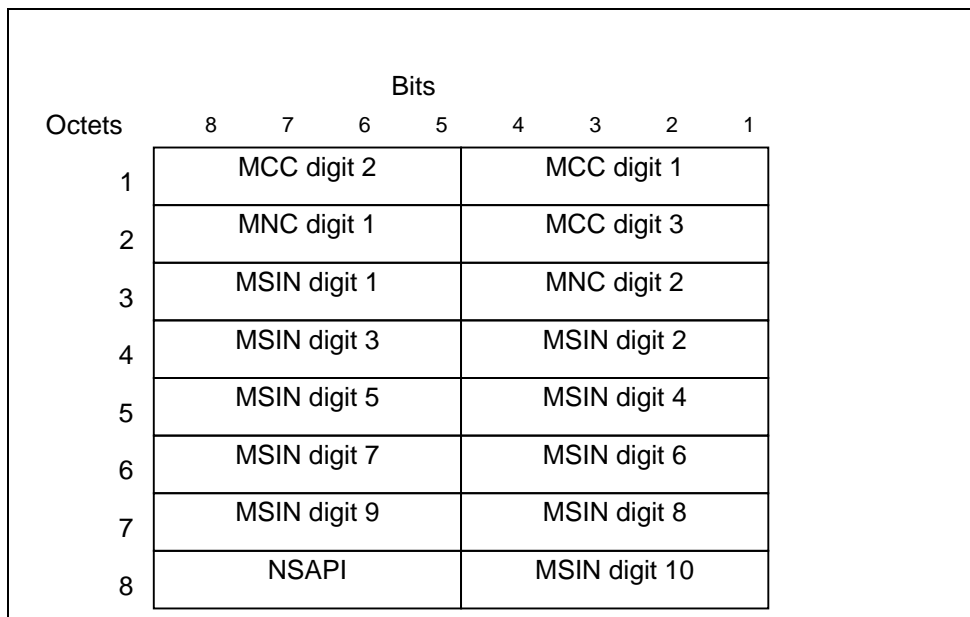

NOTE 1: The MCC, MNC and MSIN are parts of the IMSI defined in GSM 03.03. For Anonymous Access, the MSIN shall be replaced by a number assigned by the particular PLMN. The assigned number shall not collide with any MSIN used in the PLMN and shall be unique within the PLMN.

NOTE 2: MSIN digits not used shall be set to F (HEX).

Figure 3: Tunnel ID (TID) format

7 Signalling Plane

The signalling plane in this case relates to GPRS Mobility Management functions like for example GPRS Attach, GPRS Routeing Area Update and Activation of PDP Contexts. The signalling between GSN nodes shall be performed by the GPRS Tunnelling Protocol (GTP).

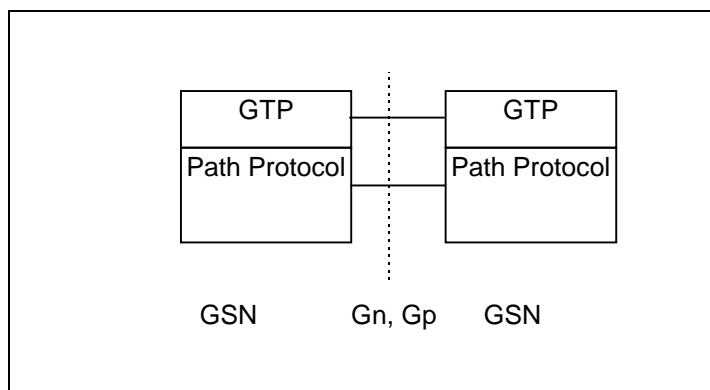

Figure 4: Signalling Plane - Protocol stack

7.1 Signalling protocol

The GTP signalling flow shall be logically associated with, but separate from, the GTP tunnels. For each GSN-GSN pair one or more paths exist. One or more tunnels may use each path. GTP shall be the means by which tunnels are established, used, managed and released. A path may be maintained by keep-alive echo messages. This ensures that a connectivity failure between GSNs can be detected in a timely manner.

7.2 Signalling Message Formats

GTP defines a set of signalling messages between two associated GSNs. The signalling messages to be used are defined in the table below.

Table 1: Signalling messages

Message Type value (Decimal)	Signalling message	Reference
0	For future use. Shall not be sent. If received, shall be treated as an Unknown message.	
1	Echo Request	7.4.1
2	Echo Response	7.4.2
3	Version Not Supported	7.4.3
4	Node Alive Request	GSM 12.15
5	Node Alive Response	GSM 12.15
6	Redirection Request	GSM 12.15
7	Redirection Response	GSM 12.15
8-15	For future use. Shall not be sent. If received, shall be treated as an Unknown message.	
16	Create PDP Context Request	7.5.1
17	Create PDP Context Response	7.5.2
18	Update PDP Context Request	7.5.3
19	Update PDP Context Response	7.5.4
20	Delete PDP Context Request	7.5.5
21	Delete PDP Context Response	7.5.6
22	Create AA PDP Context Request	7.5.7
23	Create AA PDP Context Response	7.5.8
24	Delete AA PDP Context Request	7.5.9
25	Delete AA PDP Context Response	7.5.10
26	Error Indication	7.5.11
27	PDU Notification Request	7.5.12
28	PDU Notification Response	7.5.13
29	PDU Notification Reject Request	7.5.14
30	PDU Notification Reject Response	7.5.15
31	For future use. Shall not be sent. If received, shall be treated as an Unknown message.	
32	Send Routing Information for GPRS Request	7.6.1
33	Send Routing Information for GPRS Response	7.6.2
34	Failure Report Request	7.6.3
35	Failure Report Response	7.6.4
36	Note MS GPRS Present Request	7.6.5
37	Note MS GPRS Present Response	7.6.6
38-47	For future use. Shall not be sent. If received, shall be treated as an Unknown message.	
48	Identification Request	7.7.1
49	Identification Response	7.7.2
50	SGSN Context Request	7.7.3
51	SGSN Context Response	7.7.4
52	SGSN Context Acknowledge	7.7.5
53-239	For future use. Shall not be sent. If received, shall be treated as an Unknown message.	
240	Data Record Transfer Request	GSM 12.15
241	Data Record Transfer Response	GSM 12.15
242-254	For future use. Shall not be sent. If received, shall be treated as an Unknown message.	
255	T-PDU	8.1.1

7.3 Usage of the GTP Header

For signalling messages the GTP header shall be used as follows:

- SNN shall be set to 0.
- Message Type shall be set to the unique value that is used for each type of signalling message.
- Length shall be the length, in octets, of the signalling message excluding the GTP header.
- SNDCP N-PDU Number: this field is not yet used in signalling messages. It shall be set to 255 by the sender and shall be ignored by the receiver.
- Sequence Number shall be a message number valid for a path or a tunnel. Within a given set of contiguous Sequence Numbers from 0 to 65535, a given Sequence Number shall, if used, unambiguously define a GTP signalling request message sent on the path or tunnel (see section Reliable delivery of signalling messages). The Sequence Number in a signalling response message shall be copied from the signalling request message that the GSN is replying to.
- TID (see Figure 3: Tunnel ID (TID) format) shall be set to 0 in all Path Management messages (see section Path Management messages), Location Management messages (see section Location Management messages) and Mobility Management messages (see section Mobility Management messages). In the Tunnel Management messages (see section Tunnel Management messages), TID shall be used to point out the MM and PDP Contexts in the destination GSN.
- In all Path Management messages (see section Path Management messages) and Location Management messages (see section Location Management messages) the Flow Label is not used and shall be set to 0 . In case of Tunnel Management message and Mobility Management messages the Flow Label is set to the requested value and points out the GTP flow except for the Create PDP Context Request message as well as Identification Request/Response and SGSN Context Request message (see section Mobility Management messages).

The GTP header may be followed by subsequent information elements dependent on the type of signalling message. Only one information element of each type is allowed in a single signalling message, except for the Authentication Triplet, the PDP Context and the Flow Label Data II information element where several occurrences of each type are allowed.

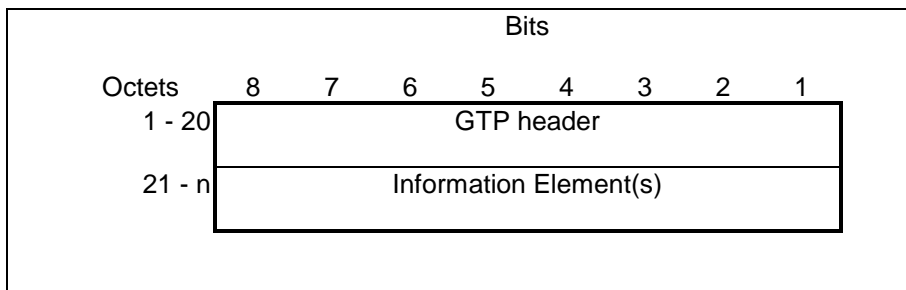

Figure 5: GTP header followed by subsequent Information Elements

7.4 Path Management messages

The Path Management messages may be sent between any type of GSN pair.

7.4.1 Echo Request

An Echo Request may be sent on a path to another GSN to find out if the peer GSN is alive (see section Path Failure). Echo Request messages may be sent for each path in use. A path is considered to be in use if at least one PDP context uses the path to the other GSN. When and how often an Echo Request message may be sent is implementation specific but an Echo Request shall not be sent more often than every 60 seconds on each path.

A GSN shall be prepared to receive an Echo Request at any time and it shall reply with an Echo Response. A GSN may optionally send Echo Request messages.

The optional Private Extension contains vendor or operator specific information.

Table 2: Information elements in an Echo Request

Information element	Presence requirement	Reference
Private Extension	Optional	7.9.27

7.4.2 Echo Response

The message shall be sent as a response of a received Echo Request.

The Recovery information element contains the local Restart Counter (see section Restoration and Recovery) value for the GSN that sends the Echo Response message.

The GSN that receives an Echo Response from a peer GSN shall compare the Restart Counter value received with the previous Restart Counter value stored for that peer GSN. If no previous value was stored, the Restart Counter value received in the Echo Response shall be stored for the peer GSN.

If the value of a Restart Counter previously stored for a peer GSN differs from the Restart Counter value received in the Echo Response from that peer GSN, the GSN that sent the Echo Response shall be considered as restarted by the GSN that received the Echo Response. The new Restart Counter value received shall be stored by the receiving entity, replacing the value previously stored for the sending GSN. If the sending GSN is a GGSN and the receiving GSN is a SGSN, the SGSN shall notify an affected MS next time the MS contacts the SGSN. An affected MS is an MS that has at least one activated PDP context that was using the restarted GGSN. The SGSN shall consider all PDP contexts using the path as inactive.

The optional Private Extension contains vendor or operator specific information.

Table 3: Information elements in an Echo Response

Information element	Presence requirement	Reference
Recovery	Mandatory	7.9.14
Private Extension	Optional	7.9.27

7.4.3 Version Not Supported

This message contains only the GTP header and indicates the latest GTP version that the GTP entity on the identified UDP/IP address can support.

7.5 Tunnel Management messages

The Tunnel Management messages are the control and management messages, defined in GSM 03.60, used to create, update and delete tunnels to be able to route T-PDUs between a MS and an external packet data network via SGSN and GGSN. The GMM/SM messages that may trigger the sending of the Tunnel Management messages are defined in GSM 04.08.

7.5.1 Create PDP Context Request

A Create PDP Context Request shall be sent from a SGSN node to a GGSN node as a part of the GPRS PDP Context Activation procedure. The GGSN IP address where the SGSN sends the Create PDP Context Request is the first IP address in the list of IP addresses provided by the DNS server. After sending the Create PDP Context Request message, the SGSN marks the PDP context as 'waiting for response'. In this state the SGSN shall accept G-PDUs from the GGSN but shall not send these G-PDUs to the MS. A valid request initiates the creation of a tunnel between a PDP Context in a SGSN and a PDP Context in a GGSN. If the procedure is not successfully completed, the SGSN repeats the Create PDP Context Request message to the next GGSN address in the list of IP addresses, if there is one. If the list is exhausted the activation procedure fails.

The Flow Label Data I field specifies a downlink flow label for G-PDUs which is chosen by the SGSN. The GGSN shall include this flow label in the GTP header of all subsequent downlink G-PDUs which are related to the requested PDP context.

The Flow Label Signalling field specifies a downlink flow label for signalling messages which is chosen by the SGSN. The GGSN shall include this flow label in the GTP header of all subsequent downlink signalling messages which are related to the requested PDP context.

The MSISDN of the MS is passed to the GGSN inside the Create PDP Context Request; This additional information can be used when a secure access to a remote application residing on a server is needed. The GGSN would be in fact able to provide the user identity (i. e. the MSISDN) to the remote application server, providing it with the level of trust granted to users through successfully performing the GPRS authentication procedures, without having to re-authenticate the user at the application level.

If the MS requests a dynamic PDP address and a dynamic PDP address is allowed, then the PDP Address field in the End User Address information element shall be empty. If the MS requests a static PDP Address then the PDP Address field in the End User Address information element shall contain the static PDP Address. In case the PDP addresses carried in the End User Address and optionally in the Protocol Configuration Option information element contain contradicting information, the PDP address carried in the End User Address information element takes the higher precedence. The Quality of Service Profile information element shall be the QoS values to be negotiated between the MS and the SGSN at PDP Context activation.

The SGSN shall include an SGSN Address for signalling and an SGSN address for user traffic, which may differ from that provided by the underlying network service (e.g. IP). The GGSN shall store these SGSN Addresses and use them when sending signalling on this GTP tunnel or G-PDUs to the SGSN for the MS.

The SGSN shall include a Recovery information element into the Create PDP Context Request if the SGSN is in contact with the GGSN for the very first time or if the SGSN has restarted recently and the new Restart Counter value has not yet been indicated to the GGSN. The GGSN that receives a Recovery information element in the Create PDP Context Request message element shall handle it in the same way as when receiving an Echo Response message. The Create PDP Context Request message shall be considered as a valid activation request for the PDP context included in the message.

The SGSN shall include either the MS provided APN, a subscribed APN or an SGSN selected APN in the message; the Access Point Name may be used by the GGSN to differentiate accesses to different external networks. The Selection Mode information element shall indicate the origin of the APN in the message.

The optional Protocol Configuration Options information element is applicable for the end user protocol 'IP' only.

The SGSN shall select one GGSN based on the user provided or SGSN selected APN. The GGSN may have a logical name that is converted to an address. The conversion may be performed with any name-to-address function. The converted address shall be stored in the "GGSN Address in Use" field in the PDP context and be used during the entire lifetime of the PDP context.

NOTE: A DNS query may be used as the name-to-IP address mapping of the GGSN. The IP address returned in the DNS response is then stored in the "GGSN Address in Use" field in the PDP context.

The SGSN may send a Create PDP Context Request even if the PDP context is already active.

The GGSN shall check if a PDP context already exists for the TID. The existing parameters in the PDP context shall then be replaced with the parameters in the Create PDP Context Request message. If a dynamic PDP address has already been allocated for the existing context, this address should be used and copied to the Create PDP Context Response message.

If the GGSN uses the MNRG flag and the flag is set, the GGSN should treat the Create PDP Context Request as a Note MS Present Request and clear the MNRG flag.

The optional Private Extension contains vendor or operator specific information.

Table 4: Information elements in a Create PDP Context Request

Information element	Presence requirement	Reference
Quality of Service Profile	Mandatory	7.9.6
Recovery	Optional	7.9.14
Selection mode	Mandatory	7.9.15
Flow Label Data I	Mandatory	7.9.16
Flow Label Signalling	Mandatory	7.9.17
MSISDN	Mandatory	
End User Address	Mandatory	7.9.20
Access Point Name	Mandatory	7.9.23
Protocol Configuration Options	Optional	7.9.24
SGSN Address for signalling	Mandatory	GSN Address 7.9.25
SGSN Address for user traffic	Mandatory	GSN Address 7.9.25
Private Extension	Optional	7.9.27

7.5.2 Create PDP Context Response

The message shall be sent from a GGSN node to a SGSN node as a response of a Create PDP Context Request. When the SGSN receives a Create PDP Context Response with the Cause value indicating 'Request Accepted', the SGSN activates the PDP context and may start to forward T-PDUs to/from the MS from/to the external data network.

The Cause value indicates if a PDP context has been created in the GGSN or not. A PDP context has not been created in the GGSN if the Cause differs from 'Request accepted'. Possible Cause values are:

- 'Request Accepted'
- 'No resources available'
- 'Service not supported'
- 'User authentication failed'
- 'System failure'
- 'Mandatory IE incorrect'
- 'Mandatory IE missing'
- 'Optional IE incorrect'
- 'Invalid message format'
- 'Version not supported'

'No resources available' indicates e.g. that all dynamic PDP addresses occupied or no memory available 'Service not supported' indicates e.g. when the GGSN does not support the PDP type, PDP address or Access Point Name.

'User authentication failed' indicates that the external packet network has rejected the service requested by the user.

Only the Cause information element, optionally Protocol Configuration Options and optionally the Recovery information element shall be included in the response if the Cause contains another value than 'Request accepted'.

All information elements, except Recovery, Protocol Configuration Options, and Private Extension, are mandatory if the Cause contains the value 'Request accepted'.

The Flow Label Data I field specifies an uplink flow label for G-PDUs which is chosen by the GGSN. The SGSN shall include this flow label in the GTP header of all subsequent uplink G-PDUs which are related to the requested PDP context.

The Flow Label Signalling field specifies an uplink flow label for signalling messages which is chosen by the GGSN. The SGSN shall include this flow label in the GTP header of all subsequent uplink signalling messages which are related to the requested PDP context.

The GGSN shall include a GGSN Address for signalling and a GGSN address for user traffic, which may differ from that provided by the underlying network service (e.g. IP). The SGSN shall store these GGSN Addresses and use them when sending signalling on this GTP tunnel or G-PDUs to the GGSN for the MS.

If the MS requests a dynamic PDP address and a dynamic PDP address is allowed, then the End User Address information element shall be included and the PDP Address field in the End User Address information element shall contain the dynamic PDP Address allocated by the GGSN. In case the PDP addresses carried in the End User Address and optionally in the Protocol Configuration Option information element contain contradicting information, the PDP address carried in the End User Address information element takes the higher precedence.

The QoS values supplied in the Create PDP Context Request may be negotiated downwards by the GGSN. The negotiated values or the original values from SGSN are inserted in the Quality of Service Profile information element of the Create PDP Context Response message.

If a connection-less path is to be used to tunnel T-PDUs for the given PDP context or a reliable connection-oriented path is to be used and a connection already exists, the GGSN may start to forward T-PDUs after the Create PDP Context Response has been sent and the SGSN may start to forward T-PDUs when the Create PDP Context Response has been received. In this case the SGSN shall also be prepared to receive T-PDUs from the GGSN after it has sent a Create PDP Context Request but before a Create PDP Context Response has been received.

If a reliable connection-oriented path is to be used to tunnel T-PDUs for the given PDP context and a connection does not exist between the GSN pair, the SGSN shall establish a connection and the GGSN shall wait for the connection before forwarding of T-PDUs may start.

Only one connection shall be used between any given GSN-pair, and this connection shall be used to tunnel end user traffic in both directions.

The Reordering Required value supplied in the Create PDP Context Response indicates whether the end user protocol benefits from packet in sequence delivery and whether the SGSN and the GGSN therefore shall perform reordering or not, i.e. if reordering is required by the GGSN the SGSN and the GGSN shall perform reordering of incoming T-PDUs on this path.

The GGSN shall include the Recovery information element into the Create PDP Context Response if the GGSN is in contact with the SGSN for the first time or the GGSN has restarted recently and the new Restart Counter value has not yet been indicated to the SGSN. The SGSN receiving the Recovery information element shall handle it as when an Echo Response message is received but shall consider the PDP context being created as active if the response indicates a successful context activation at the GGSN.

The Charging ID is used to identify all charging records produced in SGSN(s) and the GGSN for this PDP context. The Charging ID is generated by the GGSN and shall be unique within the GGSN.

The Charging Gateway Address is the IP address of the recommended Charging Gateway Functionality to which the SGSN should transfer the Charging Detail Records (CDR) for this PDP Context.

The optional Private Extension contains vendor or operator specific information.

Table 5: Information elements in a Create PDP Context Response

Information element	Presence requirement	Reference
Cause	Mandatory	7.9.1
Quality of Service Profile	Conditional	7.9.6
Reordering required	Conditional	7.9.8
Recovery	Optional	7.9.14
Flow Label Data I	Conditional	7.9.16
Flow Label Signalling	Conditional	7.9.17
Charging ID	Conditional	7.9.19
End user address	Conditional	7.9.20
Protocol Configuration Options	Optional	7.9.24
GGSN Address for signalling	Conditional	GSN Address 7.9.25
GGSN Address for user traffic	Conditional	GSN Address 7.9.25
Charging Gateway Address	Optional	7.9.26
Private Extension	Optional	7.9.27

7.5.3 Update PDP Context Request

An Update PDP Context Request message shall be sent from a SGSN to a GGSN as part of the GPRS Inter SGSN Routing Update procedure or the PDP Context Modification procedure or to redistribute contexts due to load sharing. It shall be used to change the QoS and the path. The message shall be sent by the new SGSN at the Inter SGSN Routing Update procedure.

The Flow Label Data I field specifies a downlink flow label for G-PDUs which is chosen by the SGSN. The GGSN shall include this flow label in the GTP header of all subsequent downlink G-PDUs which are related to the requested PDP context.

The Flow Label Signalling field specifies a downlink flow label for signalling messages which is chosen by the SGSN. The GGSN shall include this flow label in the GTP header of all subsequent downlink signalling messages which are related to the requested PDP context.

The Quality of Service Profile information element shall include the QoS negotiated between the MS and SGSN at PDP Context activation or the new QoS negotiated in the PDP Context Modification procedure.

The SGSN shall include an SGSN Address for signalling and an SGSN address for user traffic, which may differ from that provided by the underlying network service (e.g. IP). The GGSN shall store these SGSN Addresses and use them when sending subsequent signalling on this GTP tunnel or G-PDUs to the SGSN for the MS. When active contexts are being redistributed due to load sharing, G-PDUs that are in transit across the Gn-interface are in an undetermined state and may be lost.

The SGSN shall include a Recovery information element into the Update PDP Context Request if the SGSN is in contact with the GGSN for the very first time or if the SGSN has restarted recently and the new Restart Counter value has not yet been indicated to the GGSN. The GGSN that receives a Recovery information element in the Update PDP Context Request message element shall handle it in the same way as when receiving an Echo Response message. The Update PDP Context Request message shall be considered as a valid update request for the PDP context indicated in the message.

The optional Private Extension contains vendor or operator specific information.

Table 6: Information elements in an Update PDP Context Request

Information element	Presence requirement	Reference
Quality of Service Profile	Mandatory	7.9.6
Recovery	Optional	7.9.14
Flow Label Data I	Mandatory	7.9.16
Flow Label Signalling	Mandatory	7.9.17
SGSN Address for signalling	Mandatory	GSN Address 7.9.25
SGSN Address for user traffic	Mandatory	GSN Address 7.9.25
Private Extension	Optional	7.9.27

7.5.4 Update PDP Context Response

The message shall be sent from a GGSN node to a SGSN node as a response of an Update PDP Context Request.

If the SGSN receives an Update PDP Context Response with a Cause value other than 'Request accepted', it shall deactivate the PDP context.

Only the Cause information element and optionally the Recovery information element shall be included in the response if the Cause contains another value than 'Request accepted'.

Possible Cause values are:

- 'Request Accepted'
- 'Non-existent'
- 'Service not supported'
- 'System failure'
- 'Mandatory IE incorrect'
- 'Mandatory IE missing'
- 'Optional IE incorrect'
- 'Invalid message format'
- 'Version not supported'

The Flow Label Data I field specifies an uplink flow label for G-PDUs which is chosen by the GGSN. The SGSN shall include this flow label in the GTP header of all subsequent uplink G-PDUs which are related to the requested PDP context.

The Flow Label Signalling field specifies an uplink flow label for signalling messages which is chosen by the GGSN. The SGSN shall include this flow label in the GTP header of all subsequent uplink signalling messages which are related to the requested PDP context.

The QoS values supplied in the Update PDP Context Request may be negotiated downwards by the GGSN. The negotiated values or the original value from SGSN is inserted in the Quality of Service Profile information element. This information element shall be included if the Cause contains the value 'Request accepted'.

If a connection-less path is to be used to tunnel T-PDUs for the given PDP context or a reliable connection-oriented path is to be used and a connection already exists, the GGSN may start to forward T-PDUs after the Update PDP Context Response has been sent and the SGSN may start to forward T-PDUs when the Update PDP Context Response has been received. In this case the SGSN shall also be prepared to receive T-PDUs from the GGSN after it has sent a Update PDP Context Request but before an Update PDP Context Response has been received.

If a reliable connection-oriented path is to be used to tunnel T-PDUs for the given PDP context and a connection does not exist between the GSN pair, the SGSN shall establish a connection and the GGSN shall wait for the connection before forwarding of T-PDUs may start.

Only one connection shall be used between any given GSN-pair, and this connection shall be used to tunnel end user traffic in both directions.

The GGSN shall include a GGSN Address for signalling and an GGSN address for user traffic, which may differ from that provided by the underlying network service (e.g. IP). The SGSN shall store these GGSN Addresses and use them when sending subsequent signalling on this GTP tunnel or G-PDUs to the GGSN for the MS. When active contexts are being redistributed due to load sharing, G-PDUs that are in transit across the Gn-interface are in an undetermined state and may be lost.

The GGSN shall include the Recovery information element into the Update PDP Context Response if the GGSN is in contact with the SGSN for the first time or if the GGSN has restarted recently and the new Restart Counter value has not yet been indicated to the SGSN. The SGSN receiving the Recovery information element shall handle it as when an Echo Response message is received but shall consider the PDP context as updated and active if the response cause indicates a successful operation at the GGSN.

The Charging ID is used to identify all charging records produced in SGSN(s) and the GGSN for this PDP context. The Charging ID has been previously generated by the GGSN and is unique for this PDP context. If an inter-SGSN routing area update occurs, it is transferred to the new SGSN as part of each active PDP context.

The Charging Gateway Address is the IP address of the recommended Charging Gateway Functionality to which the SGSN should transfer the Charging Detail Records (CDR) for this PDP Context.

The optional Private Extension contains vendor or operator specific information.

Table 7: Information elements in an Update PDP Context Response

Information element	Presence requirement	Reference
Cause	Mandatory	7.9.1
Quality of Service Profile	Conditional	7.9.6
Recovery	Optional	7.9.14
Flow Label Data I	Conditional	7.9.16
Flow Label Signalling	Conditional	7.9.17
Charging ID	Conditional	7.9.19
GGSN Address for signalling	Conditional	GSN Address 7.9.25
GGSN Address for user traffic	Conditional	GSN Address 7.9.25
Charging Gateway Address	Optional	7.9.26
Private Extension	Optional	7.9.27

7.5.5 Delete PDP Context Request

A Delete PDP Context Request shall be sent from a SGSN node to a GGSN node as part of the GPRS Detach procedure or the GPRS PDP Context Deactivation procedure or from a GGSN node to a SGSN node as part of the PDP Context Deactivation Initiated by GGSN procedure. A request shall be used to deactivate an activated PDP Context.

A GSN shall be prepared to receive a Delete PDP Context Request at any time and shall always reply regardless if the PDP context exists or not.

If any collision occurs, the Delete PDP Context Request takes precedence over any other Tunnel Management message.

The optional Private Extension contains vendor or operator specific information.

Table 8: Information elements in a Delete PDP Context Request

Information element	Presence requirement	Reference
Private Extension	Optional	7.9.27

7.5.6 Delete PDP Context Response

The message shall be sent as a response of a Delete PDP Context Request.

A GSN shall ignore a Delete PDP Context Response for a non-existing PDP context.

Possible Cause value is:

- 'Request Accepted'

The optional Private Extension contains vendor or operator specific information.

Table 9: Information elements in a Delete PDP Context Response

Information element	Presence requirement	Reference
Cause	Mandatory	7.9.1
Private Extension	Optional	7.9.27

7.5.7 Create AA PDP Context Request

A Create AA PDP Context Request shall be sent from a SGSN node to a GGSN node as a part of the GPRS Anonymous Access PDP Context Activation procedure. It shall be used to create a tunnel between a PDP Context in a SGSN and a PDP Context in a GGSN. The GGSN IP address where the SGSN sends the Create AA PDP Context Request is the first IP address in the list of IP addresses provided by the DNS server. After sending the Create AA PDP Context Request message, the SGSN marks the PDP context as ‘waiting for response’. In this state the SGSN shall accept G-PDUs from the GGSN but shall not send these G-PDUs to the MS. If the procedure is not successfully completed, the SGSN repeats the Create AA PDP Context Request message to the next GGSN address in the list of IP addresses, if there is one. If the list is exhausted the activation procedure fails.

The Flow Label Data I field specifies a downlink flow label for G-PDUs which is chosen by the SGSN. The GGSN shall include this flow label in the GTP header of all subsequent downlink G-PDUs which are related to the requested PDP context.

The Flow Label Signalling field specifies a downlink flow label for signalling messages which is chosen by the SGSN. The GGSN shall include this flow label in the GTP header of all subsequent downlink signalling messages which are related to the requested PDP context.

The Quality of Service Profile information element shall be the QoS values to be negotiated by the MS and SGSN at Anonymous Access PDP Context activation.

The SGSN shall include a Recovery information element into the Create AA PDP Context Request if the SGSN is in contact with the GGSN for the very first time or if the SGSN has restarted recently and the new Restart Counter value has not yet been indicated to the GGSN. The GGSN that receives a Recovery information element in the Create AA PDP Context Request message element shall handle it in the same way as when receiving an Echo Response message. The Create AA PDP Context Request message shall be considered as a valid activation request for a new AA context of the indicated PDP type.

The Selection mode IE shall be set to either ‘MS provided APN, subscription not verified’ or ‘Network provided APN, subscription not verified’ depending on the origin of the APN which is included in the message.

The SGSN shall include an SGSN Address for signalling and an SGSN address for user traffic, which may differ from that provided by the underlying network service (e.g. IP). The GGSN shall store these SGSN Addresses and use them when sending signalling on this GTP tunnel or G-PDUs to the SGSN for the MS.

The End User Address contains the requested PDP Type with the PDP Address field left empty. In case the PDP addresses carried in the End User Address and optionally in the Protocol Configuration Option information element contain contradicting information, the PDP address carried in the End User Address information element takes the higher precedence.

The optional Protocol Configuration Options information element is applicable for the end user protocol ‘IP’ only. The GGSN may discard the Protocol Configuration Options information element or may use it for user authentication and configuration, depending on configuration data.

The optional Private Extension contains vendor or operator specific information.

Table 10: Information elements in a Create AA PDP Context Request

Information element	Presence requirement	Reference
Quality of Service Profile	Mandatory	7.9.6
Recovery	Optional	7.9.14
Selection mode	Mandatory	7.9.15
Flow Label Data I	Mandatory	7.9.16
Flow Label Signalling	Mandatory	7.9.17
End User Address	Mandatory	7.9.20
Access Point Name	Mandatory	7.9.23
Protocol Configuration Options	Optional	7.9.24
SGSN Address for signalling	Mandatory	GSN Address 7.9.25
SGSN Address for user traffic	Mandatory	GSN Address 7.9.25
Private Extension	Optional	7.9.27

7.5.8 Create AA PDP Context Response

The message shall be sent from a GGSN node to a SGSN node as a response of a Create AA PDP Context Request. When the SGSN receives a Create AA PDP Context Response with the Cause value indicating 'Request Accepted', the SGSN activates the PDP context and may start to forward T-PDUs to/from the MS from/to the external data network.

Only the Cause information element, optionally Protocol Configuration Options and optionally the Recovery information element shall be included in the response if the Cause contains another value than 'Request accepted'.

All information elements, except Recovery, Protocol Configuration Options and Private Extension, are mandatory if the Cause contains the value 'Request accepted'.

Possible Cause values are:

- 'Request Accepted'
- 'No resources available'
- 'Service not supported'
- 'User authentication failed'
- 'System failure'
- 'Mandatory IE incorrect'
- 'Mandatory IE missing'
- 'Optional IE incorrect'
- 'Invalid message format'
- 'Version not supported'

The Flow Label Data I field specifies an uplink flow label for G-PDUs which is chosen by the GGSN. The SGSN shall include this flow label in the GTP header of all subsequent uplink G-PDUs which are related to the requested PDP context.

The Flow Label Signalling field specifies an uplink flow label for signalling messages which is chosen by the GGSN. The SGSN shall include this flow label in the GTP header of all subsequent uplink signalling messages which are related to the requested PDP context.

The GGSN shall include a GGSN Address for signalling and a GGSN address for user traffic, which may differ from that provided by the underlying network service (e.g. IP). The SGSN shall store these GGSN Addresses and use them when sending signalling on this tunnel or G-PDUs to the GGSN for the MS.

The QoS values supplied in the Create AA PDP Context Request may be negotiated downwards by the GGSN. The negotiated values or the original values from SGSN are inserted in the Quality of Service Profile information element.

If a connection-less path is to be used to tunnel T-PDUs for the given PDP context or a reliable connection-oriented path is to be used and a connection already exists, the GGSN may start to forward T-PDUs after the Create AA PDP Context Response has been sent and the SGSN may start to forward T-PDUs when the Create AA PDP Context Response has been received. In this case the SGSN shall also be prepared to receive T-PDUs from the GGSN after it has sent a Create AA PDP Context Request but before a Create AA PDP Context Response has been received.

If a reliable connection-oriented path is to be used to tunnel T-PDUs for the given PDP context and a connection does not exist between the GSN pair, the SGSN shall establish a connection and the GGSN shall wait for the connection before forwarding of T-PDUs may start.

Only one connection shall be used between any given GSN-pair, and this connection shall be used to tunnel end user traffic in both directions.

The Reordering Required value supplied in the Create AA PDP Context Response indicates whether the end user protocol benefits from packet in sequence delivery and whether the SGSN and the GGSN therefore shall perform reordering or not.

The GGSN shall include the Recovery information element into the Create AA PDP Context Response if the GGSN is in contact with the SGSN for the first time or the GGSN has restarted recently and the new Restart Counter value has not yet been indicated to the SGSN. The SGSN receiving the Recovery information element shall handle it as when an Echo Response message is received but shall consider the AA PDP context being created as active if the response indicates a successful AA context activation at the GGSN.

The Charging ID is used to identify all charging records produced in SGSN(s) and the GGSN for this PDP context. The Charging ID is generated by the GGSN and shall be unique within the GGSN.

The Charging Gateway Address is the IP address of the recommended Charging Gateway Functionality to which the SGSN should transfer the Charging Detail Records (CDR) for this PDP Context.

The PDP Address field in the End User Address information element contains the dynamic PDP Address allocated by the GGSN. In case the PDP addresses carried in the End User Address and optionally in the Protocol Configuration Option information element contain contradicting information, the PDP address carried in the End User Address information element takes the higher precedence.

The optional Private Extension contains vendor or operator specific information.

Table 11: Information elements in a Create AA PDP Context Response

Information element	Presence requirement	Reference
Cause	Mandatory	7.9.1
Quality of Service Profile	Conditional	7.9.6
Reordering Required	Conditional	7.9.8
Recovery	Optional	7.9.14
Flow Label Data I	Conditional	7.9.16
Flow Label Signalling	Conditional	7.9.17
Charging ID	Conditional	7.9.19
End User Address	Conditional	7.9.20
Protocol Configuration Options	Optional	7.9.24
GGSN Address for signalling	Conditional	GSN Address 7.9.25
GGSN Address for user traffic	Conditional	GSN Address 7.9.25
Charging Gateway Address	Optional	7.9.26
Private Extension	Optional	7.9.27

7.5.9 Delete AA PDP Context Request

A Delete AA PDP Context Request shall be sent from a SGSN node to a GGSN node as part of the GPRS PDP Anonymous Access Context Deactivation procedure. The GGSN may also send the request to the SGSN if it detects malicious usage of the service. The request shall be used to deactivate an activated PDP Context.

The Cause information element indicates whether the SGSN shall request the real identities (i.e. IMSI or IMEI) of the anonymous MS. One of the following Cause values shall be used:

- 'Request IMSI'
- 'Request IMEI'
- 'Request IMSI and IMEI'
- 'No identity needed'

The optional Private Extension contains vendor or operator specific information.

Table 12: Information elements in a Delete AA PDP Context Request

Information element	Presence requirement	Reference
Cause	Mandatory	7.9.1
Private Extension	Optional	7.9.27

7.5.10 Delete AA PDP Context Response

The message shall be sent as a response of a Delete AA PDP Context Request.

Possible Cause values are:

- 'Request Accepted'
- 'Mandatory IE incorrect'
- 'Mandatory IE missing'
- 'Optional IE incorrect'
- 'Invalid message format'

If the received Delete AA PDP Context Response contains a cause value other than 'Request accepted', the PDP context shall be kept active.

The optional Private Extension contains vendor or operator specific information.

Table 13: Information elements in a Delete AA PDP Context Response

Information element	Presence requirement	Reference
Cause	Mandatory	7.9.1
Private Extension	Optional	7.9.27

7.5.11 Error Indication

The SGSN may send an Error Indication to the GGSN if no PDP context exists or the PDP context is inactive for a received G-PDU. The SGSN shall also send an Error Indication to the GGSN if no MM context exists for a received G-PDU.

The new SGSN sends an Error Indication to the old SGSN if no active PDP context exists for a received G-PDU.

The GGSN may send an Error Indication to the SGSN if no PDP context exists for a received G-PDU.

The GGSN shall delete its PDP context and may notify the Operation and Maintenance network element when an Error Indication is received.

The SGSN shall indicate to the MS when a PDP context has been deleted due to the reception of an Error Indication message. The MS may then request the re-establishment of the PDP context.

The old SGSN shall delete its PDP context and may notify the Operation and Maintenance network element when an Error Indication is received.

The TID used in the Error Indication message shall be fetched from the G-PDU that triggered this procedure

The optional Private Extension contains vendor or operator specific information.

Table 14: Information elements in an Error Indication

Information element	Presence requirement	Reference
Private Extension	Optional	7.9.27

7.5.12 PDU Notification Request

When receiving a T-PDU the GGSN checks if a PDP context is established for that PDP address. If no PDP context has been previously established, the GGSN may try to deliver the T-PDU by initiating the Network-Requested PDP Context Activation procedure. The criteria, used by the GGSN to determine whether trying to deliver the T-PDU to the MS or not, may be based on subscription information in the GGSN and are outside the scope of GPRS standardisation.

As part of the Network-Requested PDP Context Activation procedure the GGSN sends a PDU Notification Request message to the SGSN indicated by the HLR, i.e. the current location of the MS. When receiving this message, the SGSN shall be responsible for requesting the MS to activate the indicated PDP Context.

The IMSI is inserted in the IMSI part of the TID in the GTP header of the PDU Notification Request message. The NSAPI part of the TID is not used and shall be filled with HEX(F) by GGSN and SGSN shall ignore it.

The End User Address information element contains the PDP type and PDP address that the SGSN shall request the MS to activate.

If the GGSN receives a Create PDP Context Request before the PDU Notification Response, the GGSN shall handle the Create PDP Context Request as a normal context activation and ignore the following PDU Notification Response.

If the SGSN receives a PDU Notification Request after a Create PDP Context Request has been sent but before a Create PDP Context Response has been received, the SGSN shall only send a PDU Notification Response with Cause 'Request accepted' without any further processing and then wait for the Create PDP Context Response.

The optional Private Extension contains vendor or operator specific information.

Table 15: Information elements in a PDU Notification Request

Information element	Presence requirement	Reference
End User Address	Mandatory	7.9.15
Private Extension	Optional	7.9.27

7.5.13 PDU Notification Response

The message is sent by a SGSN to GGSN as a response of a PDU Notification Request.

The Cause value 'Request accepted' indicates if the PDP context activation will proceed. The PDP context activation procedure will not proceed for other Cause values.

Possible Cause values are:

- 'Request Accepted'
- 'No resources available'
- 'Service not supported'
- 'System failure'
- 'IMSI not known'
- 'MS is GPRS Detached'
- 'GPRS connection suspended'
- 'Mandatory IE incorrect'

- 'Mandatory IE missing'
- 'Optional IE incorrect'
- 'Invalid message format'
- 'Version not supported'
- 'Roaming restriction'

After an unsuccessful activation attempt the GSNs may perform some actions to prevent unnecessary enquires to the HLR as described in the section Unsuccessful Network-Requested PDP Context Activation procedure in GSM 03.60.

The optional Private Extension contains vendor or operator specific information.

Table 16: Information elements in a PDU Notification Response

Information element	Presence requirement	Reference
Cause	Mandatory	7.9.1
Private Extension	Optional	7.9.27

7.5.14 PDU Notification Reject Request

If the PDP context activation proceeds after the PDU Notification Response, but the PDP context was not established, the SGSN sends a PDU Notification Reject Request message. The Cause value indicates the reason why the PDP Context could not be established:

- 'MS Not GPRS Responding'.
- 'MS Refuses'.

When receiving the PDU Notification Reject Request message the GGSN may reject or discard the stored T-PDU(s) depending on the PDP type.

After an unsuccessful activation attempt the GSNs may perform some actions to prevent unnecessary enquires to the HLR as described in the section Unsuccessful Network-Requested PDP Context Activation procedure in GSM 03.60.

The TID of the PDU Notification Reject Request message shall be the same as the TID of the PDU Notification Request that triggered the reject.

The End User Address information element contains the PDP type and PDP address of the PDP context that could not be activated.

The optional Private Extension contains vendor or operator specific information.

Table 17: Information elements in a PDU Notification Reject Request

Information element	Presence requirement	Reference
Cause	Mandatory	7.9.1
End User Address	Mandatory	7.9.20
Private Extension	Optional	7.9.27

7.5.15 PDU Notification Reject Response

The message is sent by a GGSN to SGSN as a response of a PDU Notification Reject Request.

Possible Cause values are:

- 'Request Accepted'
- 'Mandatory IE incorrect'

- 'Mandatory IE missing'
- 'Optional IE incorrect'
- 'Invalid message format'

The optional Private Extension contains vendor or operator specific information.

Table 18: Information elements in a PDU Notification Reject Response

Information element	Presence requirement	Reference
Cause	Mandatory	7.9.1
Private Extension	Optional	7.9.27

7.6 Location Management messages

The optional Location Management messages are defined to support the case when Network-Requested PDP Context Activation procedures are used and a GGSN does not have a SS7 MAP interface, i.e. a Gc interface. GTP is then used to transfer signalling messages between the GGSN and a GTP-MAP protocol-converting GSN in the GPRS backbone network. The GTP-MAP protocol-converting GSN converts the signalling messages described in this section between GTP and MAP. The MAP messages are sent to and received from the HLR. The GTP-MAP protocol-converting function is described in GSM 03.60. The MAP protocol describing the corresponding procedures and messages is described in GSM 09.02. This alternative method is illustrated in Figure 6.

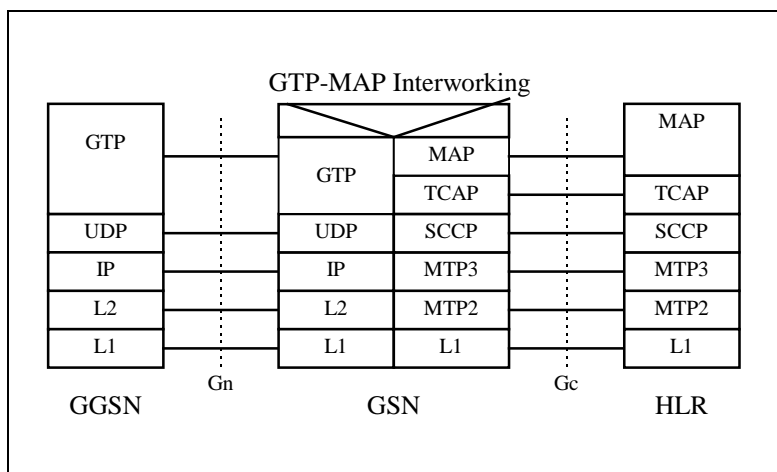

Figure 6: GGSN - HLR Signalling via a GTP-MAP protocol-converter in a GSN

When receiving a T-PDU the GGSN checks if a PDP Context is established for that PDP address. If no PDP context has been previously established the GGSN may store the T-PDU, try to initiate the Network-Requested PDP Context Activation procedure and, when the activation procedure is completed, deliver the T-PDU.

To support Network-Requested PDP Context Activation the GGSN has to have static PDP information about the PDP address.

7.6.1 Send Routing Information for GPRS Request

The GGSN may send a Send Routing Information for GPRS Request message to a GTP-MAP protocol-converting GSN, to obtain the IP address of the SGSN where the MS is located, when no PDP context is established.

The IMSI information element contains the IMSI to be used as a key to get the IP address of the SGSN.

If the GGSN receives a Create PDP Context Request after a Send Routing Information for GPRS Request has been sent but before a Send Routing Information for GPRS Response has been received, the GGSN shall handle the Create PDP Context Request as a normal context activation and ignore the following Send Routing Information for GPRS Response.

The optional Private Extension contains vendor or operator specific information.

Table 19: Information elements in a Send Routing Information for GPRS Request

Information element	Presence requirement	Reference
IMSI	Mandatory	7.9.2
Private Extension	Optional	7.9.27

7.6.2 Send Routing Information for GPRS Response

The GTP-MAP protocol-converting GSN sends a Send Routing Information for GPRS Response message as a response to the Send Routing Information for GPRS Request message to the GGSN that sent the request.

The Cause value indicates if the GTP-MAP protocol-converting GSN accepted the request or not.

Possible Cause values are:

- 'Request Accepted'
- 'No resources available'
- 'Service not supported'
- 'System failure'
- 'Mandatory IE incorrect'
- 'Mandatory IE missing'
- 'Optional IE incorrect'
- 'Invalid message format'
- 'Version not supported'

The MAP Cause information element contains the MAP cause value from the HLR and shall not be included if the Cause contains another value than 'Request accepted'.

The GSN Address information element contains the IP address of the SGSN and shall not be included if the Cause contains another value than 'Request accepted'.

It is an implementation issue what to do if the Cause or MAP Cause indicates that no location information is available.

The optional Private Extension contains vendor or operator specific information.

Table 20: Information elements in a Send Routing Information for GPRS Response

Information element	Presence requirement	Reference
Cause	Mandatory	7.9.1
IMSI	Mandatory	7.9.2
MAP Cause	Optional	7.9.11
GSN Address	Optional	7.9.25
Private Extension	Optional	7.9.27

7.6.3 Failure Report Request

The GGSN may send this message to the GTP-MAP protocol-converting GSN to set the MNRG flag for the IMSI in the HLR.

The IMSI information element contains the IMSI for which the MNRG shall be set.

The optional Private Extension contains vendor or operator specific information.

Table 21: Information elements in a Failure Report Request

Information element	Presence requirement	Reference
IMSI	Mandatory	7.9.2
Private Extension	Optional	7.9.27

7.6.4 Failure Report Response

The GTP-MAP protocol-converting GSN sends a Failure Report Response message as a response to the Failure Report Request message to the GGSN that sent the request.

The Cause value indicates if the GTP-MAP protocol-converting GSN accepted the request or not.

Possible Cause values are:

- 'Request Accepted'
- 'No resources available'
- 'Service not supported'
- 'System failure'
- 'Mandatory IE incorrect'
- 'Mandatory IE missing'
- 'Optional IE incorrect'
- 'Invalid message format'
- 'Version not supported'

The MAP Cause information element contains the MAP cause value from the HLR and shall not be included if the Cause contains another value than 'Request accepted'

It is an implementation issue what to do if the Cause or MAP Cause indicates that the HLR has not received the request or rejected the request.

The optional Private Extension contains vendor or operator specific information.

Table 22: Information elements in a Failure Report Response

Information element	Presence requirement	Reference
Cause	Mandatory	7.9.1
MAP Cause	Optional	7.9.11
Private Extension	Optional	7.9.27

7.6.5 Note MS GPRS Present Request

The GTP-MAP protocol-converting GSN sends a Note MS GPRS Present message to notify that an MS should be reachable for GPRS again.

The GGSN shall use the IMSI in the request and find all PDP contexts for the IMSI. The MNRG shall be cleared and the SGSN IP address from the request shall be stored in each found PDP context.

The IMSI information element contains the IMSI for the PDP contexts.

The GSN Address information element contains the IP address of the SGSN.

The optional Private Extension contains vendor or operator specific information.

Table 23: Information elements in a Note MS Present Request

Information element	Presence requirement	Reference
IMSI	Mandatory	7.9.2
GSN Address	Mandatory	7.9.7
Private Extension	Optional	7.9.27

7.6.6 Note MS GPRS Present Response

The GGSN sends a Note MS GPRS Present Response message to the GTP-MAP protocol-converting GSN as a response to the Note MS GPRS Present Request.

Possible Cause values are:

- 'Request Accepted'
- 'Mandatory IE incorrect'
- 'Mandatory IE missing'
- 'Optional IE incorrect'
- 'Invalid message format'

The optional Private Extension contains vendor or operator specific information.

Table 24: Information elements in a Note MS Present Response

Information element	Presence requirement	Reference
Cause	Mandatory	7.9.1
Private Extension	Optional	7.9.27

7.7 Mobility Management messages

The Mobility Management messages are the signalling messages, defined in GSM 03.60 and 04.08, that are sent between SGSNs at the GPRS Attach and Inter SGSN Routeing Update procedures. The new SGSN derives the address of the old SGSN from the old routeing area identity. The address translation mechanism is implementation specific. Some possible translation mechanisms are found in Annex A.

Generally, the purpose of the signalling is to transfer data associated with the MS from the old SGSN to the new SGSN.

7.7.1 Identification Request

If the MS, at GPRS Attach, identifies itself with P-TMSI and it has changed SGSN since detach, the new SGSN shall send an Identification Request message to the old SGSN to request the IMSI.

The P-TMSI and RAI is a P-TMSI and an RAI in the old SGSN. The P-TMSI Signature is conditionally provided by the MS to the new SGSN for identification checking purposes as defined in GSM 03.60 and 04.08. If the MS has provided the P-TMSI Signature, the new SGSN shall include this parameter in the Identification Request message.

The optional Private Extension contains vendor or operator specific information.

Table 25: Information elements in an Identification Request

Information element	Presence requirement	Reference
Routeing Area Identity (RAI)	Mandatory	7.9.3
Packet TMSI	Mandatory	7.9.5
P-TMSI Signature	Optional	7.9.12
Private Extension	Optional	7.9.27

7.7.2 Identification Response

The old SGSN shall send an Identification Response to the new SGSN as a response to a previous Identification Request.

Possible Cause values are:

- 'Request Accepted'
- 'IMSI not known'
- 'System failure'
- 'Mandatory IE incorrect'
- 'Mandatory IE missing'
- 'Optional IE incorrect'
- 'Invalid message format'
- 'Version not supported'
- 'P-TMSI Signature mismatch'

Only the Cause information element shall be included in the response if the Cause contains another value than 'Request accepted'.

The IMSI information element is mandatory if the Cause contains the value 'Request accepted'.

One or several Authentication Triplet information elements may be included in the message if the Cause contains the value 'Request accepted'.

The optional Private Extension contains vendor or operator specific information.

Table 26: Information elements in an Identification Response

Information element	Presence requirement	Reference
Cause	Mandatory	7.9.1
IMSI	Conditional	7.9.2
Authentication Triplet	Optional	7.9.9
Private Extension	Optional	7.9.27

7.7.3 SGSN Context Request

The new SGSN shall send an SGSN Context Request to the old SGSN to get the MM and PDP Contexts for the MS. The MS is identified by its old RAI and old TLLI values. The TLLI and RAI is a TLLI and an RAI in the old SGSN.

The old SGSN responds with an SGSN Context Response.

The Flow Label Signalling field specifies a flow label for signalling messages which is chosen by the new SGSN. The old SGSN shall include this flow label in the GTP header of all subsequent signalling messages which are sent from the old SGSN to the new SGSN and related to the PDP context(s) requested.

The MS Validated indicates that the new SGSN has successfully authenticated the MS. IMSI shall be included if MS Validated indicates 'Yes'.

The P-TMSI Signature is conditionally provided by the MS to the new SGSN for identification checking purposes as defined in GSM 03.60 and 04.08. If the MS has provided the P-TMSI Signature, the new SGSN shall include this parameter in the SGSN Context Request message.

The optional Private Extension contains vendor or operator specific information.

Table 27: Information elements in a SGSN Context Request

Information element	Presence requirement	Reference
IMSI	Conditional	7.9.2
Routing Area Identity (RAI)	Mandatory	7.9.3
Temporary Logical Link Identifier (TLLI)	Mandatory	7.9.4
P-TMSI Signature	Optional	7.9.12
MS Validated	Optional	7.9.13
Flow Label Signalling	Mandatory	7.9.17
Private Extension	Optional	7.9.27

7.7.4 SGSN Context Response

The old SGSN shall send an SGSN Context Response to the new SGSN as a response to a previous SGSN Context Request.

Possible Cause values are:

- 'Request Accepted'
- 'IMSI not known'
- 'System failure'
- 'Mandatory IE incorrect'
- 'Mandatory IE missing'
- 'Optional IE incorrect'
- 'Invalid message format'
- 'Version not supported'
- 'P-TMSI Signature mismatch'

Only the Cause information element shall be included in the response if the Cause contains another value than 'Request accepted'.

All information elements are mandatory, except PDP Context, and Private Extension, if the Cause contains the value 'Request accepted'.

The Flow Label Signalling field specifies a flow label which is chosen by the old SGSN. The new SGSN shall include this flow label in the GTP header of all subsequent signalling messages which are sent from the new SGSN to the old SGSN and related to the PDP context(s) requested.

The IMSI information element contains the IMSI matching the TLLI and RAI in the SGSN Context Request.

The MM Context contains necessary mobility management and security parameters.

All active PDP contexts in the old SGSN shall be included as PDP Context information elements.

If there is at least one active PDP context, the old SGSN shall start the T3-TUNNEL timer and store the address of the new SGSN in the "New SGSN Address" field of the MM context. The old SGSN shall wait for SGSN Context Acknowledge before sending T-PDUs to the new SGSN. If the old SGSN has one or more active PDP contexts for the subscriber and SGSN Context Acknowledge message is not received within a time defined by T3-RESPONSE, the old SGSN shall retransmit the SGSN Context Response to the new SGSN for as long as the total number of attempts is less than N3-REQUESTS. After N3-REQUESTS unsuccessfully attempts, the old SGSN shall proceed as described in section 'Reliable delivery of signalling messages' in case the transmission of a signalling message fails N3-REQUESTS times.

The optional Private Extension contains vendor or operator specific information.

Table 28: Information elements in a SGSN Context Response

Information element	Presence requirement	Reference
Cause	Mandatory	7.9.1
IMSI	Conditional	7.9.2
Flow Label Signalling	Conditional	7.9.17
MM Context	Conditional	7.9.21
PDP Context	Conditional	7.9.22
Private Extension	Optional	7.9.27

7.7.5 SGSN Context Acknowledge

The new SGSN shall send an SGSN Context Acknowledge message to the old SGSN as a response to the SGSN Context Response message. Only after receiving the SGSN Context Acknowledge message, shall the old SGSN start to forward user data packets. SGSN Context Acknowledge indicates to the old SGSN that the new SGSN is ready to receive user data packets identified by the corresponding TID values.

Possible cause values are:

- 'Request accepted'
- 'System failure'
- 'Mandatory IE incorrect'
- 'Mandatory IE missing'
- 'Optional IE incorrect'
- 'No resources available'
- 'Invalid message format'
- 'Version not supported'
- 'Authentication failure'

Only the Cause information element shall be included in the acknowledge if the Cause contains a value other than 'Request accepted'.

For each active PDP context the new SGSN shall include a Flow Label Data II information element. The Flow Label Data II field specifies a flow label which is chosen by the new SGSN for a particular PDP context. The old SGSN shall include this flow label in the GTP header of all subsequent G-PDUs which are sent from the old SGSN to the new SGSN and related to the particular PDP context.

If any of the PDP contexts has a QoS reliability class which indicates that a reliable connection-oriented path should be used to forward T-PDUs coming via the old route and no connection has already been established, the old SGSN shall set-up a connection to the new SGSN after receiving SGSN Context Acknowledge message.

T-PDUs associated with PDP contexts that require a reliable link shall be sent over the reliable connection-oriented path and the other T-PDUs shall be sent over the connection-less path. T-PDUs shall be sent over a connectionless path if connection-oriented resources are exhausted.

The new SGSN shall include an SGSN Address for user traffic, which may differ from that provided by the underlying network service (e.g. IP). The old SGSN shall store this SGSN Address and use it when sending G-PDUs to the new SGSN for the MS.

The optional Private Extension contains vendor or operator specific information.

Table 29: Information elements in a SGSN Context Acknowledge

Information element	Presence requirement	Reference
Cause	Mandatory	7.9.1
Flow Label Data II	Conditional	7.9.18
SGSN Address for user traffic	Conditional	GSN Address 7.9.25
Private Extension	Optional	7.9.27

7.8 Reliable delivery of signalling messages

Each path maintains a queue with signalling messages to be sent to the peer. The message at the front of the queue shall be sent with a Sequence Number, and shall be held in a path list until a response is received. Each path has its own list. The Sequence Number shall be unique for each outstanding message in a single path list. A GSN may have several outstanding requests while waiting for responses.

The T3-RESPONSE timer shall be started when a signalling request message is sent. A signalling message request or response has probably been lost if a response has not been received before the T3-RESPONSE timer expires. The request is then retransmitted if the total number of request attempts is less than N3-REQUESTS times. The timer shall be implemented in the signalling application. The wait time for a response (T3-RESPONSE timer value) and the number of retries (N3-REQUESTS) shall be configurable per procedure. The total wait time shall be shorter than the MS wait time between retries of Attach and RA Update messages.

All received request messages shall be responded to and all response messages associated with a certain request shall always include the same information. Duplicated response messages shall be discarded. A response message without a matching outstanding request should be considered as a duplicate.

If a GSN is not successful with the transfer of a signalling message, e.g. a Create PDP Context Request message, it shall inform the upper layer of the unsuccessful transfer so that the controlling upper entity may take the necessary measures.

7.9 Information elements

A signalling message may contain several information elements. The TLV (Type, Length, Value) or TV (Type, Value) encoding format shall be used for the GTP information elements. The information elements shall be sorted, with the Type fields in ascending order, in the signalling messages. The Length field contains the length of the information element excluding the Type and Length field.

For all the length fields, bit 8 of the lowest numbered octet is the most significant bit and bit 1 of the highest numbered octet is the least significant bit.

Within information elements, certain fields may be described as spare. These bits shall be transmitted with the value defined for them. To allow for future features, the receiver shall not evaluate these bits.

The most significant bit in the Type field is set to 0 when the TV format is used and set to 1 for the TLV format.

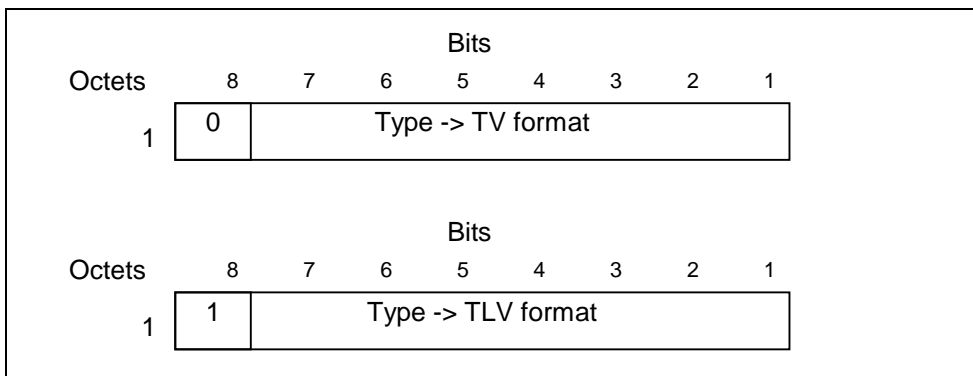

Figure 7: Type field for TV and TLV format

NOTE: Type value 7 (Decimal) is currently not used.

The following TLV Information Element type number ranges are reserved for GPRS charging protocol use (see GTP' in GSM 12.15): 239-250; 252-254.

The following TV Information Element type number range is reserved for GPRS charging protocol use (see GTP' in GSM 12.15): 117-127.

7.9.1 Cause

In a request, the Cause Value indicates the reason for the request. The Cause shall be included in the request message.

In a response, the Cause Value indicates the acceptance or the rejection of the corresponding request. In addition, the Cause Value may indicate what was the reason for the corresponding request. The Cause value shall be included in the response message.

'Request accepted' is returned when a GSN has accepted a signalling request.

'Non-existent' indicates a non-existent or an inactive PDP context.

'IMSI not known' indicates a non-existent MM context.

'MS is GPRS Detached' indicates an idle MM context.

'MS is not GPRS Responding' and 'MS Refuses' may be used by SGSN to reject a Network-Requested PDP Context Activation.

'Version not supported' is returned when the recipient does not recognise the version number in the request message.

'Request IMSI', 'Request IMEI', 'Request IMSI and IMEI' and 'No identity needed' are used by GGSN to notify SGSN what to do.

'No resources available' is a generic temporary error condition e.g. all dynamic PDP addresses occupied or no memory available.

'Service not supported' is a generic error indicated that the GSN do not support the requested service.

'User authentication failed' indicates that the external packet network has rejected the user's service request.

'System failure' is a generic permanent error condition.

'Roaming restriction' indicates that the SGSN cannot activate the requested PDP context because of the roaming restrictions.

'P-TMSI Signature mismatch' is returned either if the P-TMSI Signature stored in the old SGSN does not match the value sent by the MS via the new SGSN or if the MS does not provide the P-TMSI Signature to the new SGSN while the old SGSN has stored the P-TMSI Signature for that MS.

'Invalid message format', 'Mandatory IE incorrect', 'Mandatory IE missing' and 'Optional IE incorrect' are indications of protocol errors described in the section Error handling.

'GPRS connection suspended' indicates that the GPRS activities of the mobile station are suspended.

'Authentication failure' indicates that the user authentication failed in the new SGSN.

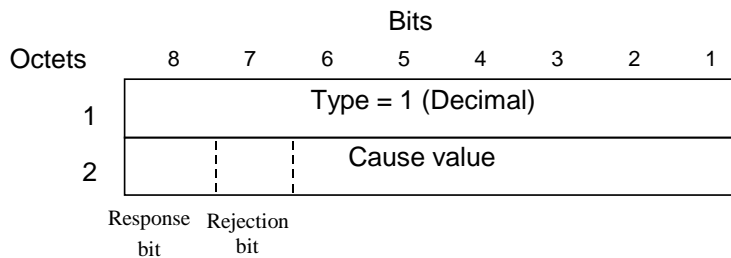

Figure 8: Cause information element

Table 30: Cause values

Cause		Value (Decimal)	
request	Request IMSI	0	
	Request IMEI	1	
	Request IMSI and IMEI	2	
	No identity needed	3	
	MS Refuses	4	
	MS is not GPRS Responding	5	
For future use		6-48	
Cause values reserved for GPRS charging protocol use (see GTP' in GSM 12.15)		49-63	
For future use		64-127	
response	acc	Request accepted	128
		For future use	129-176
		Cause values reserved for GPRS charging protocol use (see GTP' in GSM 12.15)	177-191
	rej	Non-existent	192
		Invalid message format	193
		IMSI not known	194
		MS is GPRS Detached	195
		MS is not GPRS Responding	196
		MS Refuses	197
		Version not supported	198
		No resources available	199
		Service not supported	200
		Mandatory IE incorrect	201
		Mandatory IE missing	202
		Optional IE incorrect	203
		System failure	204
		Roaming restriction	205
		P-TMSI Signature mismatch	206
		GPRS connection suspended	207
		Authentication failure	208
		User authentication failed	209
		For future use	210-240
		Cause values reserved for GPRS charging protocol use (see GTP' in GSM 12.15)	241-255

NOTE: With this coding, bits 8 and 7 of the Cause Value respectively indicate whether the message was a request or a response, and whether the request was accepted or rejected.

Table 31: Use of the Cause values

Cause 8	value bits 7	Result
0	0	Request
0	1	For future use (Note)
1	0	Acceptance
1	1	Rejection

NOTE: The value '01' is for future use and shall not be sent. If received in a response, it shall be treated as a rejection.

7.9.2 International Mobile Subscriber Identity (IMSI)

The IMSI shall be the subscriber identity of the MS.

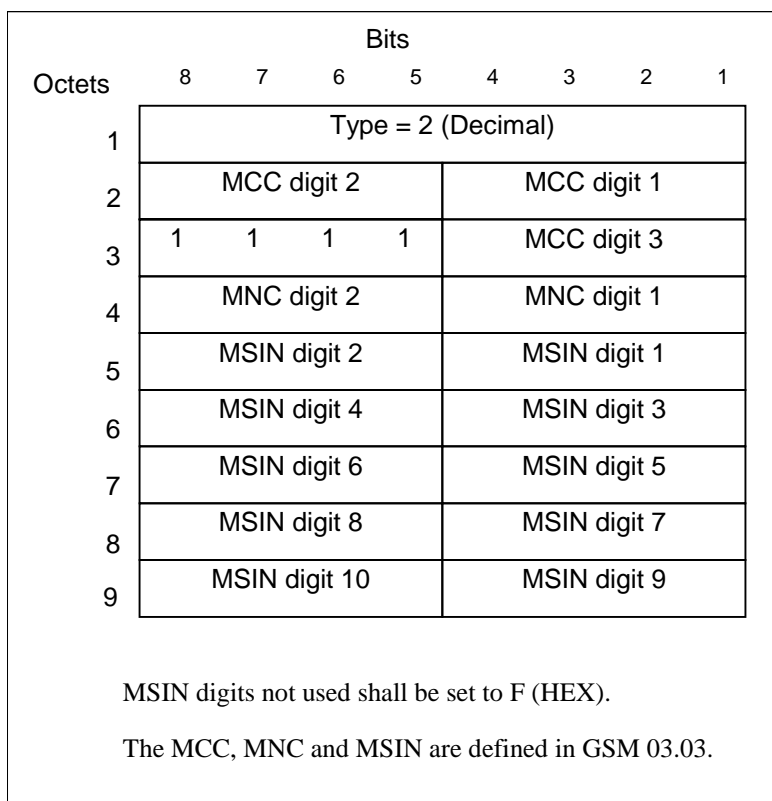

Figure 9: IMSI information element

7.9.3 Routeing Area Identity (RAI)

The RAI information element is given by:

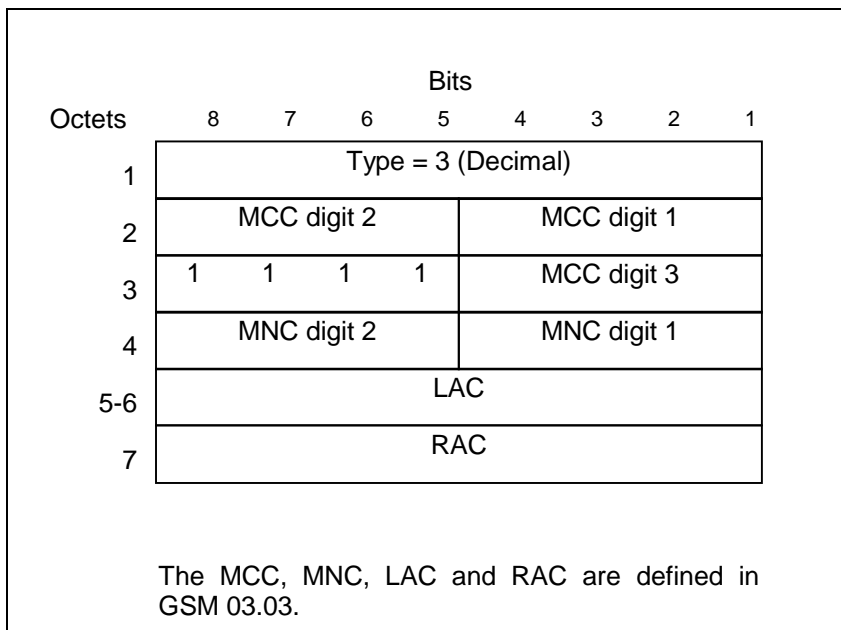

Figure 10: RAI information element

7.9.4 Temporary Logical Link Identity (TLLI)

The information element of the TLLI associated with a given MS and routeing area is given by:

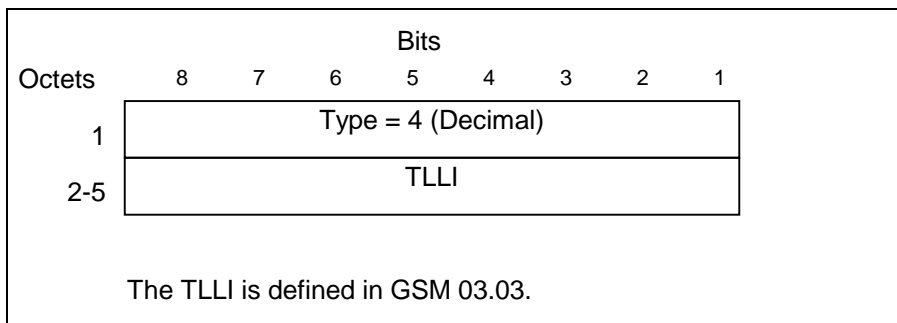

Figure 11: TLLI information element

7.9.5 Packet TMSI (P-TMSI)

The Packet TMSI, unambiguously associated with a given MS and routeing area, is given by:

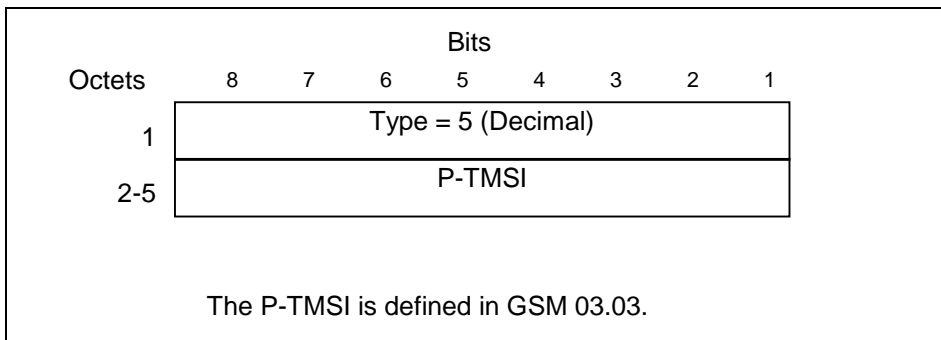

Figure 12: The Packet TMSI information element

7.9.6 Quality of Service (QoS) Profile

The Quality of Service (QoS) Profile shall include the values of the defined QoS parameters. The content and the coding of the QoS Profile is defined in GSM 04.08.

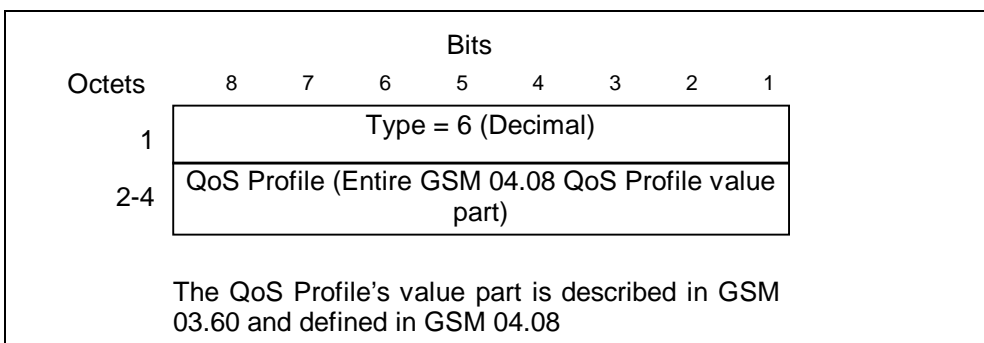

Figure 13: Quality of Service (QoS) Profile information element

7.9.7 Spare

7.9.8 Reordering Required

The Reordering Required information element states whether reordering by GTP is required or not.

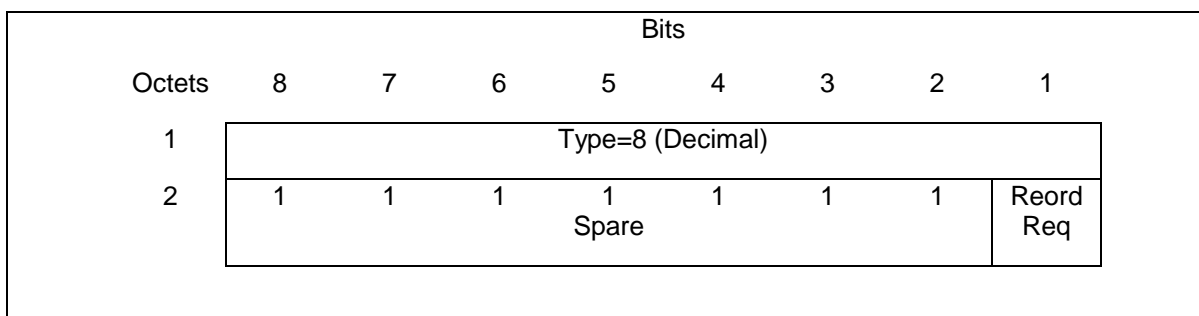

Figure 15: Reordering Required information element

Table 32: Reordering Required values

Reordering required	Value (Decimal)
No	0
Yes	1

7.9.9 Authentication Triplet

An Authentication triplet consists of a random string (RAND), a signed response (SRES) and a ciphering key (Kc) (see GSM 03.20).

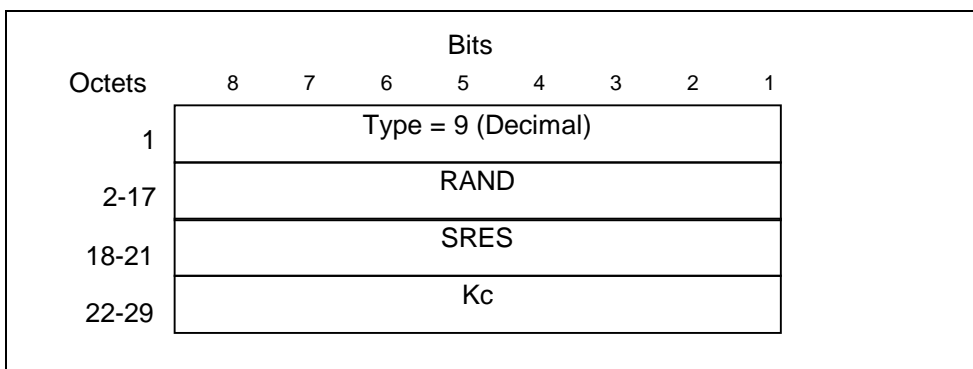

Figure 16: Authentication Triplet information element

7.9.10 Spare

7.9.11 MAP Cause

The MAP Cause is a value that the GTP-MAP protocol-converting GSN relays transparently from HLR to the GGSN. The possible MAP Cause values for the appropriate messages are described in GSM 09.02.

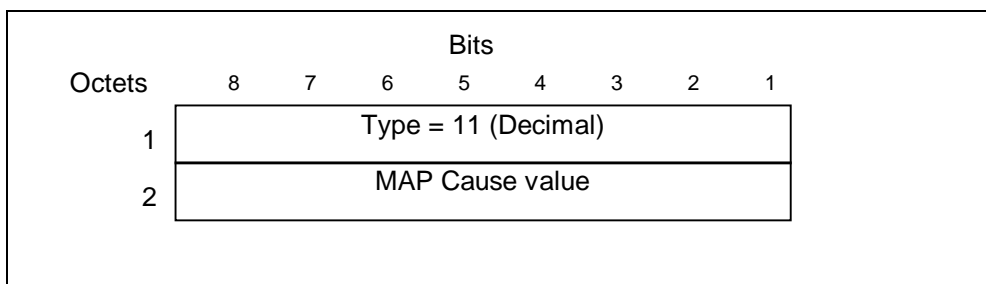

Figure 18: MAP Cause information element

7.9.12 P-TMSI Signature

The P-TMSI Signature information element is provided by the MS in the Routing Area Update Request and Attach Request messages to the SGSN for identification checking purposes. The content and the coding of the P-TMSI Signature information element is defined in GSM 04.08.

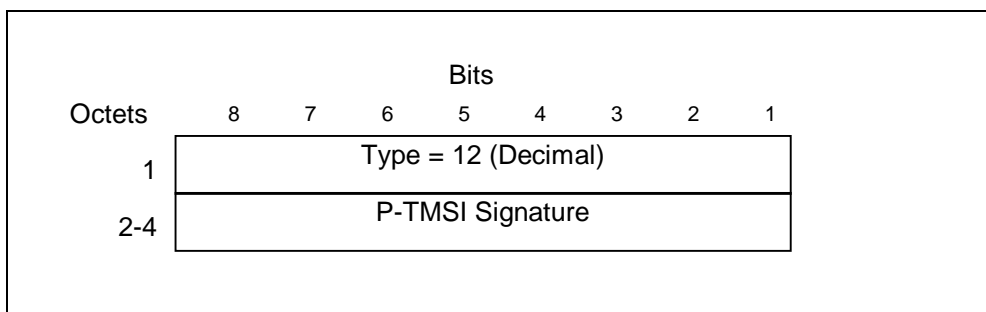

Figure 19: P-TMSI Signature information element

7.9.13 MS Validated

The MS Validated information element indicates whether the new SGSN has successfully authenticated the MS.

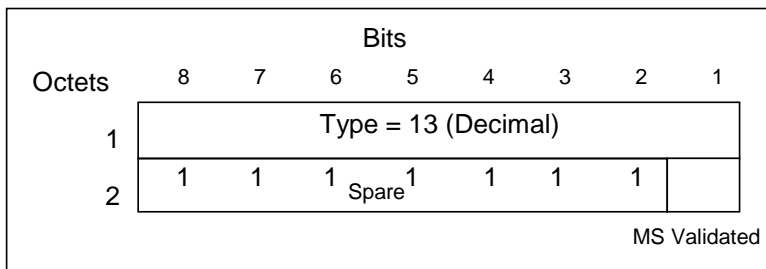

Figure 20: MS Validated information element

Table 33: MS Validated values

MS Validated	Value
No	0
Yes	1

7.9.14 Recovery

The Recovery information element indicates if the peer GSN has restarted. The Restart Counter shall be the value described in the section Restoration and Recovery.

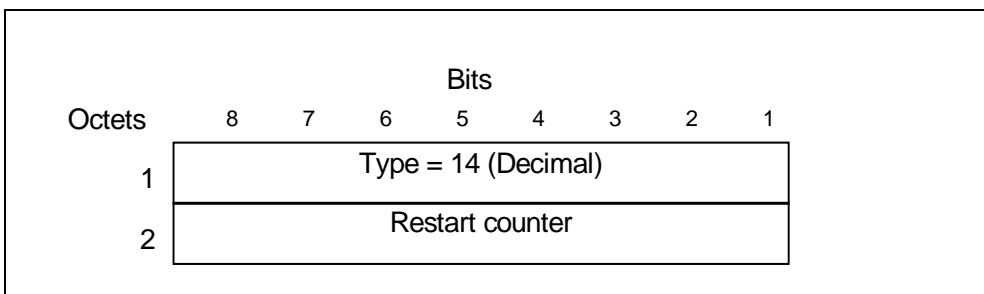

Figure 21: Restart counter information element

7.9.15 Selection mode

The Selection mode information element indicates the origin of the APN in the message.

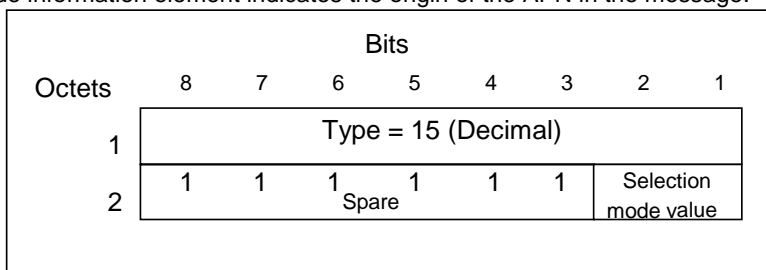

Figure 22: Selection mode information element

Table 34: Selection mode values

Selection mode value	Value (Decimal)
MS or network provided APN, subscribed verified	0
MS provided APN, subscription not verified	1
Network provided APN, subscription not verified	2
For future use. Shall not be sent. If received, shall be interpreted as the value '2'.	3

7.9.16 Flow Label Data I

The Flow Label Data I information element contains the Flow label for data transmission requested by the receiver of the flow.

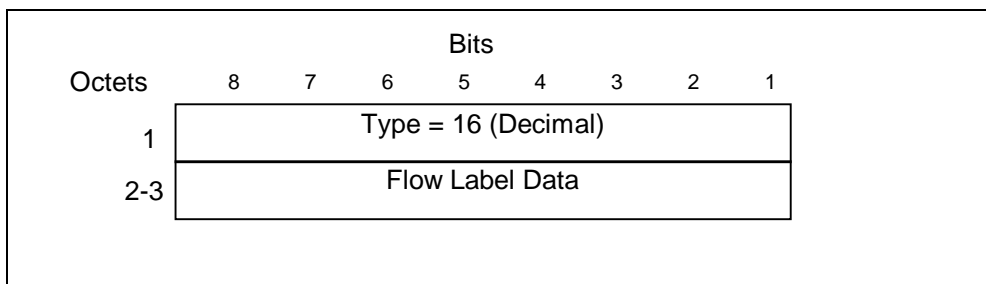

Figure 23: Flow Label Data information element

7.9.17 Flow Label Signalling

The Flow Label Signalling information element contains the Flow label for signalling requested by the receiver of the flow.

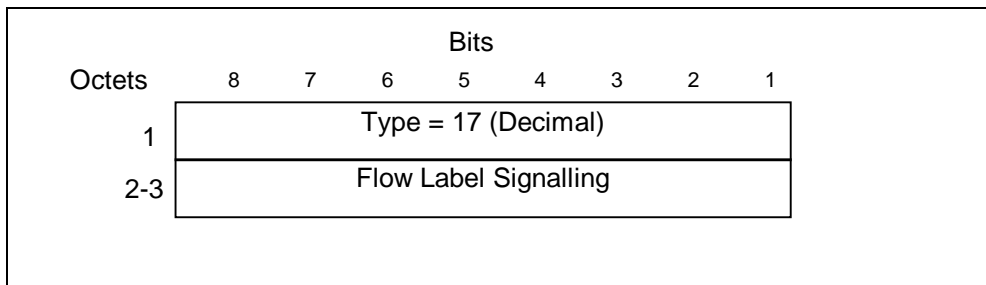

Figure 24: Flow Label Signalling information element

7.9.18 Flow Label Data II

The Flow Label Data II information element contains the Flow label for data transmission between old and new SGSN for a particular PDP context and is requested by the new SGSN.

The spare bits x indicate unused bits which shall be set to 0 by the sending side and which shall not be evaluated by the receiving side.

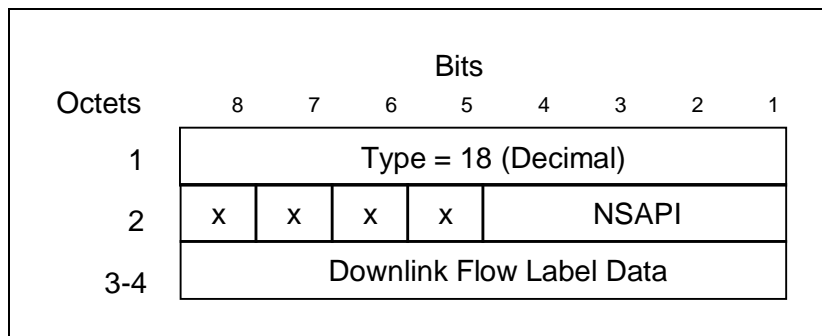

Figure 25: Flow Label Data II information element

7.9.19 Charging ID

The Charging ID is a unique four octet value generated by the GGSN when a PDP context is activated. A Charging ID is generated for each activated context. The Charging ID value 0 is reserved and shall not be assigned by the GGSN.

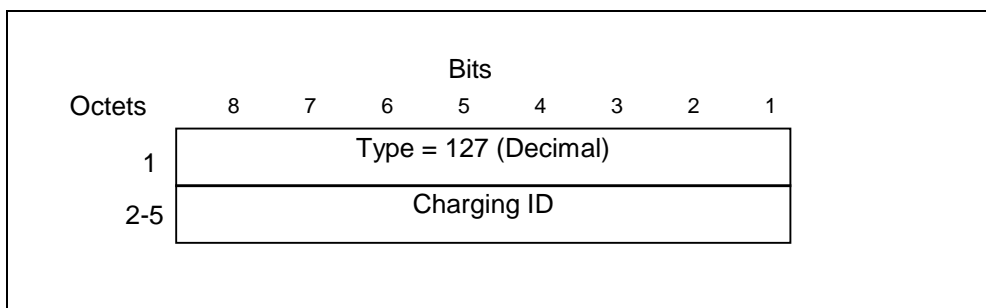

Figure 26: Charging ID information element

7.9.20 End User Address

The purpose of the End User Address information element shall be to supply protocol specific information of the external packet data network accessed by the GPRS subscriber.

The Length field value shall be 2 in an End User Address information element with an empty PDP Address.

The PDP Type defines the end user protocol to be used between the external packet data network and the MS and is divided into an Organization field and a Number field.

The PDP Type Organization is the organization that is responsible for the PDP Type Number field and the PDP Address format.

For X.25 the PDP Type Organization is ETSI and the PDP Type Number is 0 . The PDP Address shall be in the X.121 format for X.25. For PPP the PDP Type Organization is ETSI and the PDP Type Number is 1 and there shall be no address in the End User Address IE. In this case the address is negotiated later as part of the PPP protocol. For OSP:IHOSS the PDP Type Organisation is ETSI and the PDP Type Number is 2 and there shall be no address in the End User Address IE. For OSP:IHOSS the PDP Type Organisation is ETSI and the PDP Type Number is 2 and there shall be no address in the End User Address IE.

If the PDP Type Organization is IETF, the PDP Type Number is a compressed number (i.e. the most significant HEX(00) is skipped) in the "Assigned PPP DLL Protocol Numbers" list in the most recent "Assigned Numbers" RFC (RFC 1700 or later). The most recent "Assigned PPP DLL Protocol Numbers" can also be found using the URL = <ftp://ftp.isi.edu/in-notes/iana/assignments/ppp-numbers>.

The PDP Address shall be the address that this PDP context of the MS is identified with from the external packet data network.

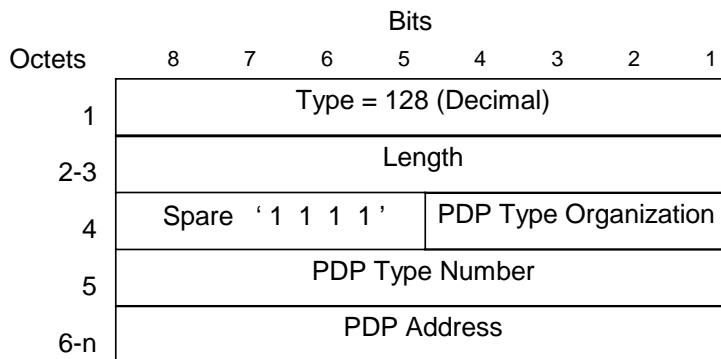

Figure 27: End User Address information element

Table 35: PDP Type Organization values

PDP Type Organization	Value (Decimal)
ETSI	0
IETF	1
All other values are reserved	

Table 36: ETSI defined PDP Type values

PDP Type Number	Value (Decimal)
X.25	0
PPP	1
OSP:IHOSS	2
All other values are reserved	

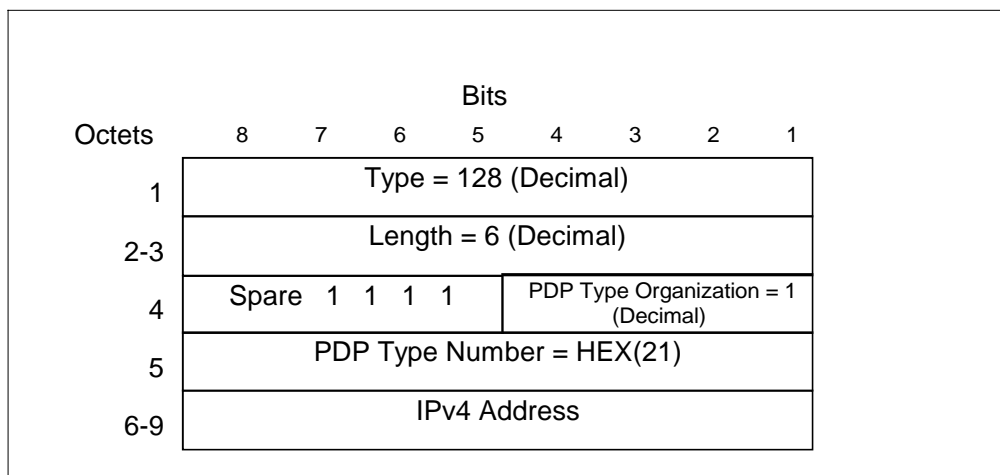

Figure 28: End User Address information element for IPv4

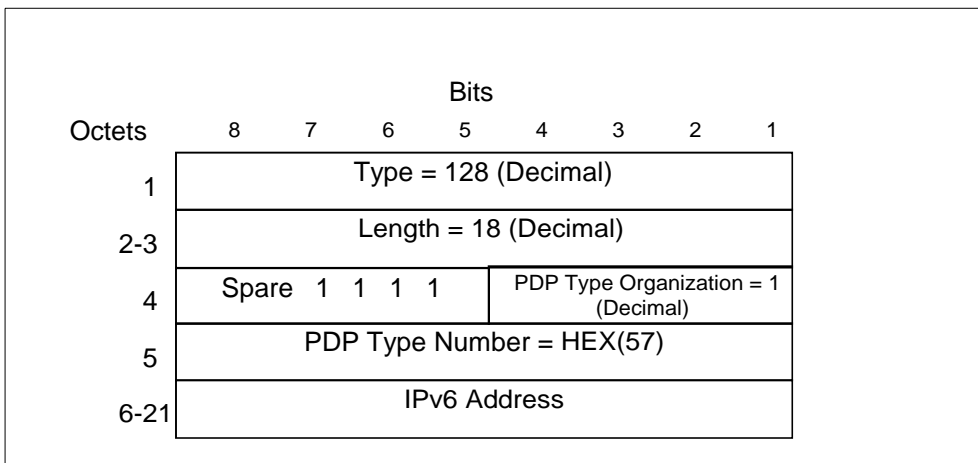
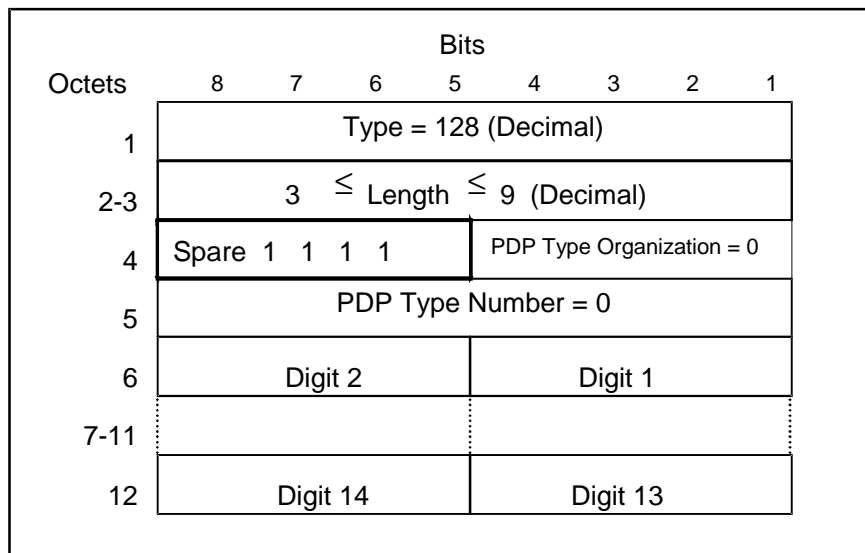

Figure 29: End User Address information element for IPv6



NOTE: Digit 1 contains the first BCD coded digit of the X.121 address. If the X.121 address has an odd number of digits, the last BCD digit shall be padded with HEX(F).

Figure 30: End User Address information element for X.25

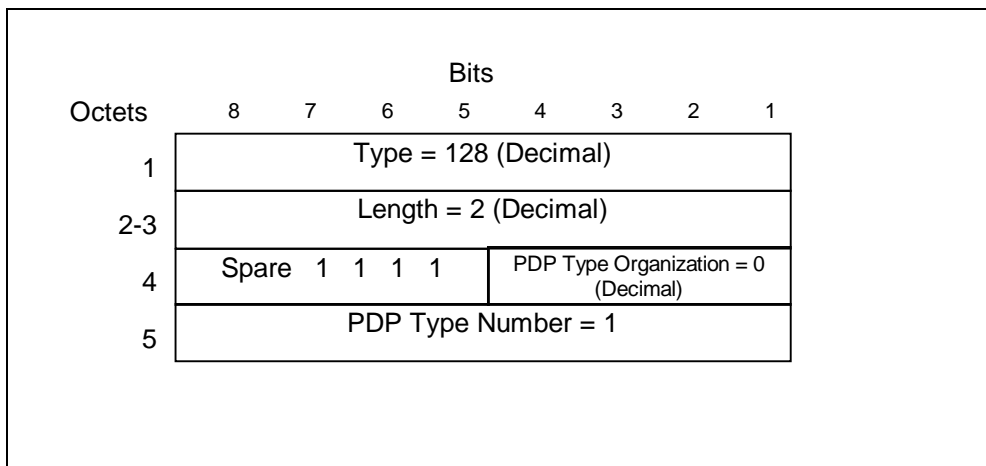

Figure 31: End User Address information element for PPP

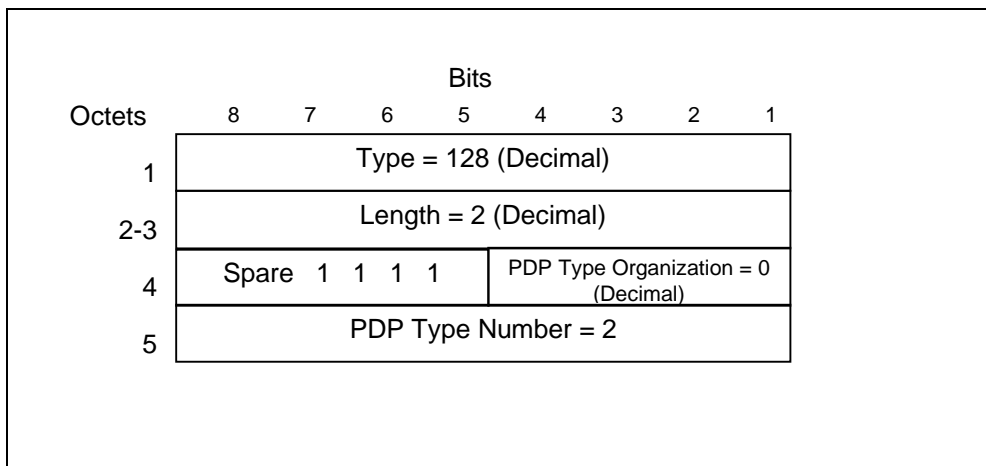

Figure 32: End User Address information element for OSP:IHOSS

7.9.21 MM Context

The MM Context information element contains the Mobility Management, MS and security parameters that are necessary to transfer between SGSNs at the Inter SGSN Routeing Update procedure.

The Ciphering Key Sequence Number (CKSN) is described in GSM 04.08. Possible values are integers in the range [0; 6]. The value 7 is reserved.

The Used Cipher indicates the ciphering algorithm that is in use.

Kc is the ciphering key currently used by the old SGSN.

The Triplet array contains triplets encoded as the value in the Authentication Triplet information element.

The DRX parameter indicates whether the MS uses DRX mode or not.

MS Network Capability provides the network with information concerning aspects of the MS related to GPRS.

The DRX parameter and the MS Network Capability are coded as described in GSM 04.08.

The two octet Container Length holds the length of the Container, excluding the Container Length octets.

The Container contains one or several optional information elements as described in the sub-clause 'Overview', from the clause 'General message format and information elements coding' in GSM 04.08.

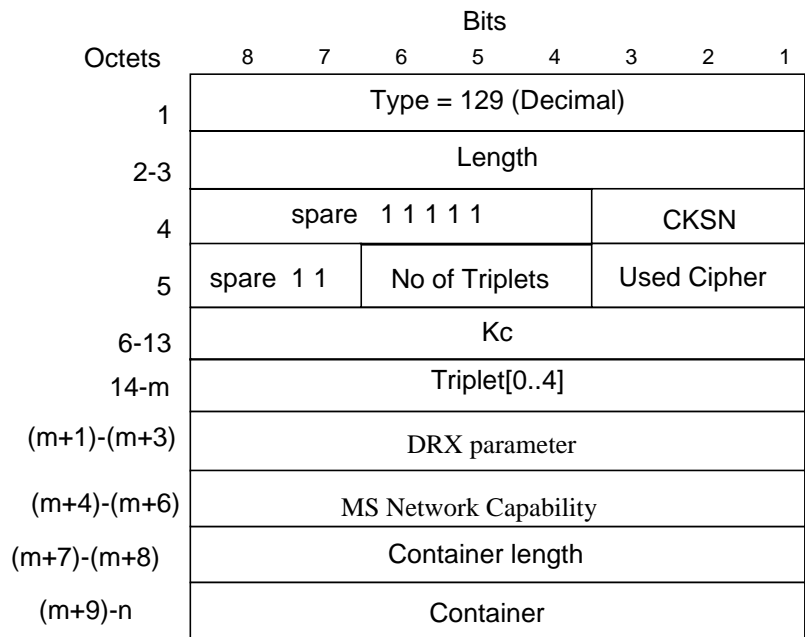

Figure 33: MM Context element

Table 37: Used Cipher values

Cipher Algorithm	Value (Decimal)
No ciphering	0
GEA/1	1

7.9.22 PDP Context

The PDP Context information element contains the Session Management parameters, defined for an external packet data network address, that are necessary to transfer between SGSNs at the Inter SGSN Routeing Area Update procedure.

NSAPI is an integer value in the range [0; 15].

The NSAPI points out the affected PDP context.

The SAPI indicates the LLC SAPI which is associated with the NSAPI.

Transaction Identifier is the 4 bit Transaction Identifier used in the GSM 04.08 Session Management messages which control this PDP Context.

Reordering Required (Order) indicates whether the SGSN shall reorder T-PDUs before delivering the T-PDUs to the MS.

VPLMN Address Allowed (VAA) indicates whether the MS is allowed to use the APN in the domain of the HPLMN only, or additionally the APN in the domain of the VPLMN.

Quality of Service Subscribed (QoS Sub), Quality of Service Requested (QoS Req) and Quality of Service Negotiated (QoS Neg) are encoded as described in section ‘Quality of Service (QoS) Profile’.

The Sequence Number Down is the number of the next T-PDU that shall be sent from the new SGSN to the MS. The number is associated to the Sequence Number from the GTP Header of an encapsulated T-PDU.

The Sequence Number Up is the number that new SGSN shall use as the Sequence Number in the GTP Header for the next encapsulated T-PDU from the MS to the GGSN.

The Send N-PDU Number is used only when acknowledged peer-to-peer LLC operation is used for the PDP context. The Send N-PDU Number is the N-PDU number to be assigned by SNDCCP to the next downlink N-PDU received from the GGSN. It shall be set to 255 if unacknowledged peer-to-peer LLC operation is used for the PDP context.

The Receive N-PDU Number is used only when acknowledged peer-to-peer LLC operation is used for the PDP context. The Receive N-PDU Number is the N-PDU number expected by SNDCCP from the next uplink N-PDU to be received from the MS. It shall be set to 255 if unacknowledged peer-to-peer LLC operation is used for the PDP context.

The Uplink Flow Label Signalling is the Flow Label used between the old SGSN and the GGSN in uplink direction for signalling purpose. It shall be used by the new SGSN within the GTP header of the Update PDP Context Request message.

The PDP Type Organization and PDP Type Number are encoded as in the End User Address information element.

The PDP Address Length represents the length of the PDP Address field, excluding the PDP Address Length octet.

The PDP Address is an octet array with a format dependent on the PDP Type. The PDP Address is encoded as in the End User Address information element if the PDP Type is IPv4, IPv6 or X.25.

The GGSN Address Length represents the length of the GGSN Address field, excluding the GGSN Address Length octet.

The old SGSN includes the GGSN Address for signalling that it has received from GGSN at PDP context activation or update.

The APN is the APN in use in the old SGSN. I.e. the APN sent in the Create PDP Context request message.

The spare bits x indicate unused bits which shall be set to 0 by the sending side and which shall not be evaluated by the receiving side.

1	Type = 130 (Decimal)				
2-3	Length				
4	Res- rved	AA	Res- rved	rder	NSAPI
5	X	X	X	X	SAPI
6-8	QoS Sub				
9-11	QoS Req				
12-14	QoS Neg				
15-16	Sequence Number Down (SND)				
17-18	Sequence Number Up (SNU)				
19	Send N-PDU Number				
20	Receive N-PDU Number				
21-22	Uplink Flow Label Signalling				
23	Spare 1 1 1 1			PDP Type Organization	
24	PDP Type Number				
25	PDP Address Length				
26-m	PDP Address [1..63]				
m+1	GGSN Address for signalling Length				
(m+2)-n	GGSN Address for signalling [4..16]				
n+1	APN length				
(n+2)-o	APN				
o+1	Spare (sent as 0 0 0 0)			Transaction Identifier	

Figure 34: PDP Context information element

Table 38: Reordering Required values

Reordering Required	Value (Decimal)
No	0
Yes	1

Table 39: VPLMN Address Allowed values

VPLMN Address Allowed	Value (Decimal)
No	0
Yes	1

7.9.23 Access Point Name

The Access Point Name is information from the MS or SGSN, that may be used by the GGSN to differentiate between accesses to different external packet data networks using the same PDP Type.

The Access Point Name contains a logical name which is the APN Network Identifier (see GSM 03.60). It is coded as in the value part defined in GSM 04.08 (i.e. the GSM 04.08 IEI and GSM 04.08 octet length indicator are not included).

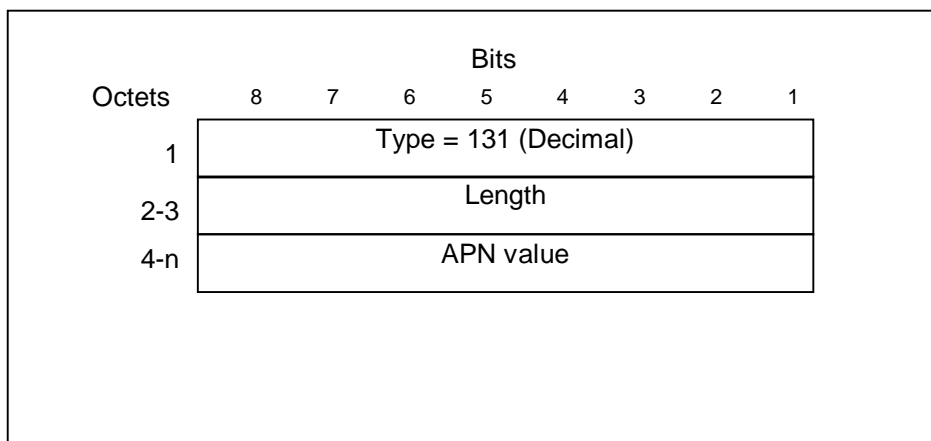

Figure 35: Access Point Name information element

7.9.24 Protocol Configuration Options

The Protocol Configuration Options contains external network protocol options that may be necessary to transfer between the GGSN and the MS. The content and the coding of the Protocol Configuration is defined in octet 3-z of the Protocol Configuration Options in GSM 04.08.

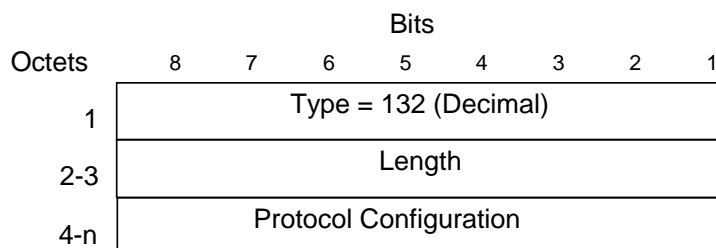

Figure 36: Protocol Configuration Options information element

7.9.25 GSN Address

The GSN Address information element contains the address of a GSN as defined in GSM 03.03.

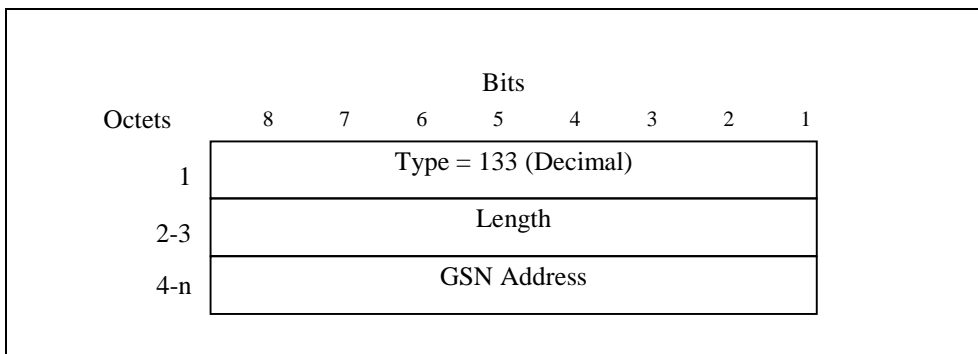

Figure 37: GSN Address information element

7.9.26 Charging Gateway Address

The Charging Gateway Address information element contains an IP address of a Charging Gateway.

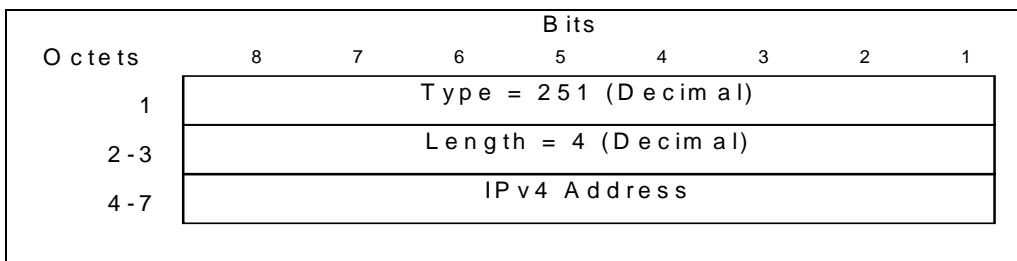

Figure 38: Charging Gateway Address information element

7.9.27 Private Extension

The Private Extension information element contains vendor specific information. The Extension Identifier is a value defined in the Private Enterprise number list in the most recent "Assigned Numbers" RFC (RFC 1700 or later).

This is an optional information element that may be included in any signalling message. A signalling message may include more than one information element of the Private Extension type.

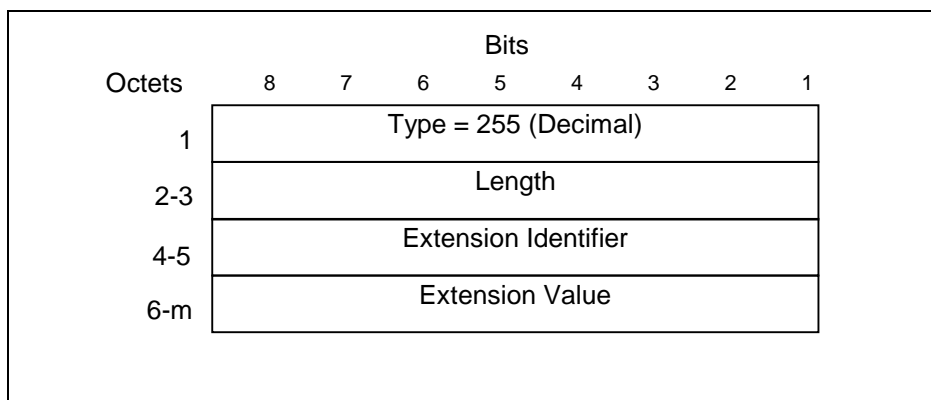

Figure 39: Private Extension information element

8 Transmission Plane

Tunnels are used to carry encapsulated T-PDUs between a given GSN pair for individual MSs. The key Tunnel ID (TID) which is present in the GTP header shall indicate which tunnel a particular T-PDU belongs to. In this manner, packets are multiplexed and demultiplexed by GTP between a given GSN-GSN pair. The Tunnel ID value to use in the

key field shall be established by the Create PDP Context establishment procedure which takes place on the signalling plane.

The maximum size of a T-PDU that may be transmitted without fragmentation by GGSN or the MS is defined in GSM 03.60. The GGSN shall fragment, reject or discard T-PDUs, depending on the PDP type and implementation decisions, directed to the MS if the T-PDU size exceeds the maximum size. The decision if the T-PDUs shall be fragmented or discarded is dependent on the external packet data network protocol.

8.1 Protocol Stack

The GTP protocol carries T-PDUs through the GPRS backbone. T-PDUs are carried in a tunnel between GSN pairs, encapsulated in G-PDUs. A G-PDU is a packet with a GTP header and a T-PDU. The Path Protocol defines the path and the GTP header defines the tunnel. Several tunnels may be multiplexed on a single path. The frames have the following general structure:

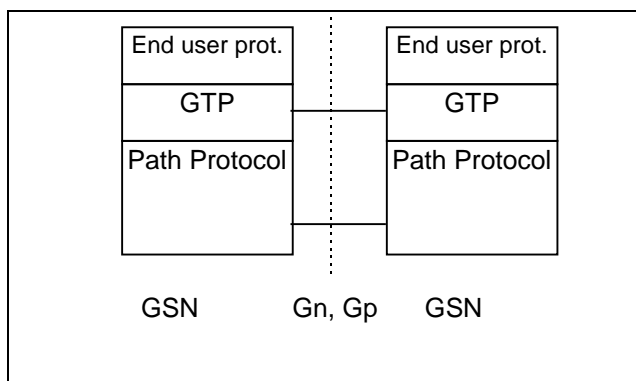

Figure 40: Transmission Plane - Protocol Stack

8.1.1 Usage of the GTP Header

For the transmission plane messages the GTP header shall be used as follows:

- SNN flag: The GTP header includes the optional SNDCP N-PDU Number field if the LFN flag is set to 1.
- Message Type shall be set to the decimal value 255 indicating a T-PDU.
- Length: Size of the T-PDU excluding the GTP header size.
- Sequence Number: This value shall be used in order to decide whether or not to discard a received T-PDU, as specified in sub-clause 8.1.1.1 Usage of the Sequence Number.
- SNDCP N-PDU Number: This field shall be included if and only if the SNN flag is set to 1. In this case, it is used by the old SGSN, at the Inter SGSN Routeing Area Update procedure, to inform the new SGSN of the N-PDU number assigned to T-PDU. If an N-PDU number was not assigned to the T-PDU by SNDCP, or if the T-PDU is to be transferred using unacknowledged peer-to-peer LLC operation, then SNN shall be set to 0. The SNDCP N-PDU Number shall be set to 255 if the SNN flag is 0.
- The Flow Label identifies the flow which the T-PDU belongs to. The Flow Label is chosen by the receiver of the flow during the context establishment, update or SGSN change procedure.
- TID: Contains the tunnel identifier for the tunnel to which this T-PDU belongs. The TID shall be used by the receiving GSN to find the MM and PDP contexts.

8.1.1.1 Usage of the Sequence Number

The sending GSN shall use 0 for the value of the Sequence Number of the first T-PDU in a tunnel and shall increment the Sequence Number for each following T-PDU. The value shall wrap to zero after 65535.

When a dialogue is opened between GSNs, the receiving GSN shall set the content of a counter to zero. When the receiving GSN receives a valid T-PDU, it shall increment this counter by one. This counter shall wrap to zero after 65535. It defines the 'Expected Sequence Number'.

Based on the received and Expected Sequence Number values, the receiving GSN may decide whether or not to discard the received T-PDU. Annex B (Informative) describes a method to determine whether a received T-PDU is valid.

The receiving GSN shall reorder the incoming T-PDUs in sequence if the Reordering Required flag in the PDP context is set. In this case, if needed, the receiving GSN shall take into account a maximum number of valid received frames and a maximum elapsed time to assume that a T-PDU was lost.

8.2 Tunnelling between SGSNs

T-PDUs, stored in the old SGSN and not yet sent to the MS, shall be tunnelled to the new SGSN as a part of the Inter SGSN Routing Update procedure described in GSM 03.60. Some T-PDUs may still be on their way from the GGSN to the old SGSN because they have been sent before the tunnels change. These T-PDUs shall also be tunnelled to the new SGSN.

8.3 Tunnelling between GGSNs

GTP shall not specify tunnelling between GGSNs. Transfer of MS-to-MS traffic between GGSNs shall use the Gi interface.

9 Path Protocols

9.1 UDP/IP

UDP/IP is the only path protocol defined to transfer GTP signalling messages in this, the first version of GTP. UDP/IP is also the recommended choice as a connection-less path to tunnel connection-less T-PDUs. A User Datagram Protocol (UDP) compliant with STD 0006 shall be used.

9.1.1 UDP Header

9.1.1.1 Signalling request messages

The UDP Destination Port is the server port number 3386 . It shall be reserved for GTP.

The UDP Source Port is a locally allocated port number at the sending GSN.

9.1.1.2 Signalling response messages

The UDP Destination Port value shall be the value of the UDP Source Port of the corresponding signalling request message.

The UDP Source Port shall be the value from the UDP Destination Port of the corresponding signalling request message.

9.1.1.3 Encapsulated T-PDUs

The UDP Destination Port shall be the server port number 3386. It shall be reserved for GTP. The UDP Source Port is a locally allocated port number at the sending GSN.

9.1.2 IP Header

An Internet Protocol (IP) compliant with STD 0005 shall be used.

9.1.2.1 Signalling request messages and Encapsulated T-PDUs

The IP Source Address shall be an IP address of the source GSN from which the message is originating.

The IP Destination Address in a GTP signalling request message shall be an IP address of the destination GSN. The IP Destination Address in an encapsulated T-PDU GTP shall be an IP address of the destination GSN.

9.1.2.2 Signalling response messages

The IP Source Address shall be copied from the IP Destination Address of the corresponding signalling request message.

The IP Destination Address shall be copied from the IP Source Address of the GTP signalling request message to which this GSN is replying to.

9.2 TCP/IP

TCP/IP is the recommended choice as a reliable connection-oriented path to tunnel connection-oriented T-PDUs. A Transmission Control Protocol (TCP) compliant with STD 0007 shall be used.

9.2.1 TCP Header

The TCP Destination Port shall be the server port number 3386. This value shall be reserved for G-PDUs. Extra implementation specific destination ports are possible but all GSNs shall support the server port number 3386.

The TCP Source Port can be arbitrarily selected and is locally assigned at the sending GSN.

9.2.2 IP Header

The IP Source Address shall be an IP address of the source GSN from which the message is originating.

The IP Destination Address shall be an IP address of the destination GSN.

10 Error handling

10.1 Protocol errors

A protocol error is defined as a message with unknown, unforeseen or erroneous content. The term silently discarded used in the following sub-sections means that the implementation shall discard the message without further processing and should log the event including the erroneous message and should include the error in a statistical counter.

An information element with 'Mandatory' in the 'Presence requirement' column of a message definition is always mandatorily present in that message.

The conditions for a conditional information element define whether the information element is semantically:

- mandatorily present
- optionally present
- mandatorily absent

An information element which is semantically mandatorily present but is omitted from the message is treated as missing data.

An information element which is semantically mandatorily absent but is present in the message is treated as unexpected data.

A GTP signalling Request is distinguished from a GTP signalling Response by the Signalling message names (sub-clause 7.2, Signalling Message Formats). The Error Indication, the Version Not Supported and the SGSN Context Acknowledge messages shall be considered as Responses for the purpose of this Section.

The subsections 10.1.1 to 10.1.13 shall be applied in decreasing priorities.

10.1.1 Different GTP versions

If a receiving node receives a GTP signalling message of an unsupported version, that node shall return a GTP Version Not Supported message indicating in the Version field of the GTP header the latest GTP version that that node supports. The received G-PDU shall then be discarded. All GSNs shall be able to support all earlier GTP versions.

10.1.2 GTP Message too short

When a GTP message is received that is too short to contain the GTP header for the GTP version that the sender claims to use, the G-PDU message shall be silently discarded.

10.1.3 Unknown GTP signalling message

When a message using a Message Type value defining an Unknown GTP signalling message is received, it shall be silently discarded.

10.1.4 Unexpected GTP signalling message

When an unexpected GTP signalling message is received, e.g. a Response message for which there is no corresponding outstanding Request, or a GTP signalling message sent in the wrong direction, it shall be silently discarded.

10.1.5 Missing mandatorily present information element

The receiver of a GTP signalling Request message with a missing mandatorily present information element shall discard the request, should log the error, and shall send a Response with Cause set to 'Mandatory IE missing'. The receiver of a Response with a missing mandatory information element shall notify the upper layer and should log the error.

10.1.6 Invalid Length

In a received GTP signalling message Request, if a mandatory TLV format information element has a Length different from the Length defined in the version that this message claims to use, then this information element shall be discarded, the error should be logged, and a Response shall be sent with Cause set to 'Mandatory IE incorrect'.

In a received GTP signalling message Response, if a mandatory TLV format information element has a Length different from the Length defined in the version that this message claims to use, then the requesting entity shall treat the GTP signalling procedure as having failed.

10.1.7 Invalid mandatory information element

The receiver of a GTP signalling message Request including a mandatory information element with a Value that is not in the range defined for this information element value shall discard the request, should log the error, and shall send a response with Cause set to 'Mandatory IE incorrect'.

The receiver of a GTP signalling message Response including a mandatory information element with a Value that is not in the range defined for this information element shall notify the upper layer that a message with this sequence number has been received and should log the error.

If a GSN receives an information element with a value which is shown as reserved, it shall treat that information element as not being in the range defined for the information element.

NOTE: The receiver does not check the content of an information element field which is defined as 'spare'.

10.1.8 Invalid optional information element

The receiver of a GTP signalling message including an optional information element with a Value that is not in the range defined for this information element value shall discard this IE, should log the error, and shall treat the rest of the message as if this IE was absent.

If a GSN receives an information element with a value which is shown as reserved, it shall treat that information element as not being in the range defined for the information element.

NOTE: The receiver does not check the content of an information element field which is defined as 'spare'.

10.1.9 Unknown information element

An information element with an unknown Type value shall be ignored by the receiver of the message. If this is a TLV element, this information element shall be skipped using its Length value. If this is a TV element, the receiver shall discard the rest of the message.

If the receiving GSN cannot interpret the rest of the message because of the ignored information element, the receiving GSN shall discard the message and should log the error. If the message was a Request, it shall, in addition, return a response with Cause set to 'Invalid message format'.

10.1.10 Out of sequence information elements

If two or more information elements are out of sequence in a message, the receiving GSN shall discard the message and should log the error. In addition, if the message was a Request, the receiving GSN shall return a Response with Cause set to 'Invalid message format'.

10.1.11 Unexpected information element

An information element with a Type value which is defined in GTP but is not expected in the received GTP signalling message shall be ignored (skipped) and the rest of the message processed as if this information element was not present.

10.1.12 Repeated information elements

If an information element is repeated in a GTP signalling message in which repetition of the information element is not specified, only the contents of the information element appearing first shall be handled and all subsequent repetitions of the information element shall be ignored. When repetition of information elements is specified, only the contents of specified repeated information elements shall be handled.

10.1.13 Incorrect optional information elements

All optional information elements that are incorrect in a GTP signalling message shall be treated as not present in the message. However, if the receiving GSN may not handle the message correctly because of the incorrect information element, the receiving GSN should log the error and shall return a response with Cause set to 'Optional IE incorrect'.

10.2 Path failure

A path counter shall be reset each time a signalling response is received on the path and incremented when the T3-RESPONSE timer expires for any signalling message sent on the path. The path shall be considered to be down if the counter exceeds N3-REQUESTS. In this case, the GSN may notify the Operation and Maintenance network element. GTP shall also notify the upper layer of the path failure, so that PDP contexts associated with this path may be deleted.

10.3 MS detach

When an MS detaches, all ongoing GTP signalling procedures related to the MS being attached shall be aborted. The SGSN shall send Delete PDP Context Request messages for all active PDP contexts to the peer GGSNs.

10.4 Restoration and Recovery

All GSNs shall maintain in non-volatile memory a Restart Counter of local significance. A GSN that restarts shall change the Restart Counter value immediately after the restart procedure has been completed. The value shall be incremented by 1 modulo 256 (see TS GSM 03.07).

All GSNs shall also maintain in volatile memory a Restart Counter for each GSN that it is in contact with. The Restart Counters stored for all GSNs that it is in contact with shall be cleared after the restart procedure has been completed (see TS GSM 03.07).

11 Inter-PLMN GTP communication over the Gp interface

No security is provided in GTP to protect the communication between different GPRS networks. The security is provided, if needed, between the Border Gateways in different GPRS networks by operator agreements. A security mechanism that may be considered is for example IP Security.

12 IP, the networking technology used by GTP

12.1 IP version

In this, the first phase of GPRS, Internet Protocol version 4 (IPv4) shall be the networking technology on which GTP tunneling shall be based.

12.2 IP fragmentation

Here it is described how the fragmentation mechanism shall work together with GTP, when the GPRS backbone is based on IPv4.

However, fragmentation should be avoided if possible. Examples of fragmentation drawbacks are, e.g.:

- Fragmentation is inefficient, since the complete IP header is duplicated in each fragment.
- If one fragment is lost, the complete packet has to be discarded. The reason is that no selective retransmission of fragments is possible.

By using Path MTU discovery the application may find out the MTU, and thereby utilise more efficient segmentation mechanisms in other protocol layers than IP.

The maximum size of a T-PDU that may be transmitted without fragmentation by GGSN or the MS is defined in GSM 03.60. All backbone links should have MTU values that exceeds the sum of the maximum value plus the size of the tunnel headers (IP header, UDP or TCP header and GTP header) in order to avoid fragmentation in the backbone.

12.2.1 MO direction

SGSN: A packet from an MS shall be encapsulated at the SGSN with a GTP header, UDP or TCP header, and IP header. If the resulting IP packet is larger than the MTU of the first link towards the GGSN, fragmentation of the IP packet shall be performed by the SGSN. The SGSN should preferably fragment the IP packet if it is larger than the MTU of any link between SGSN and GGSN.

Backbone router: Any router in the backbone may fragment the GTP packet if needed, according to IPv4.

GGSN: The GGSN shall assemble any IP fragments received from SGSNs, according to IPv4. Note that if any fragment is lost, the whole packet shall be discarded.

12.2.2 MT direction

GGSN: A packet from an external host shall be encapsulated at the GGSN with a GTP header, UDP or TCP header, and IP header. If the resulting IP packet is larger than the MTU on the first link towards the SGSN, fragmentation of the IP packet shall be performed by the GGSN. The GGSN should preferably fragment the IP packet if it is larger than the MTU of any link between GGSN and SGSN.

Backbone router: Any router in the backbone may fragment the GTP packet if needed, according to IPv4.

SGSN: The SGSN shall assemble any IP fragments received from the GGSN, according to IPv4. Note that if any fragment is lost, the whole packet shall be discarded.

12.2.3 Tunnelling from old to new SGSN

Old SGSN: A user packet shall be encapsulated with a GTP header, UDP or TCP header, and IP header. If the resulting IP packet is larger than the MTU on the first link towards the new SGSN, fragmentation of the IP packet shall be performed by the old SGSN. The old SGSN should preferably fragment the IP packet if it is larger than the MTU of any link between old and new SGSN.

Backbone router: Any router in the backbone may fragment the GTP packet if needed, according to IPv4.

New SGSN: The new SGSN shall assemble any IP fragments received from the old SGSN, according to IPv4. Note that if any fragment is lost, the whole packet shall be discarded.

13 GTP parameters

The GTP system parameters defined here and their recommended values shall not be fixed, but shall be possible to configure as described in section 'Reliable delivery of signalling messages'.

13.1 Timers

The timer T3-RESPONSE holds the maximum wait time for a response of a signalling request message.

The timer T3-TUNNEL holds the time when PDUs shall be forwarded from the old SGSN to the new SGSN. The timer is started in the old SGSN when it receives a GTP SGSN Context Request message and there is at least one active PDP context. GTP shall indicate to the upper layer when the timer has expired. The recommended timer value is 20 seconds.

13.2 Others

The counter N3-REQUESTS holds the maximum number of attempts made by GTP to send a signalling request message. The recommended value is 5.

The N3-BUFFER-SIZE is the size of the receive buffer for G-PDUs and signalling request messages. The recommended value is 8192.

Tables

Table 1: Signalling messages	13
Table 2: Information elements in an Echo Request	15
Table 3: Information elements in an Echo Response.....	15
Table 4: Information elements in a Create PDP Context Request.....	17
Table 5: Information elements in a Create PDP Context Response.....	19
Table 6: Information elements in an Update PDP Context Request.....	19
Table 7: Information elements in an Update PDP Context Response	21
Table 8: Information elements in a Delete PDP Context Request.....	21
Table 9: Information elements in a Delete PDP Context Response.....	22
Table 10: Information elements in a Create AA PDP Context Request	23
Table 11: Information elements in a Create AA PDP Context Response	24
Table 12: Information elements in a Delete AA PDP Context Request	25
Table 13: Information elements in a Delete AA PDP Context Response	25
Table 14: Information elements in an Error Indication	26
Table 15: Information elements in a PDU Notification Request	26
Table 16: Information elements in a PDU Notification Response.....	27
Table 17: Information elements in a PDU Notification Reject Request.....	27
Table 18: Information elements in a PDU Notification Reject Response	28
Table 19: Information elements in a Send Routeing Information for GPRS Request	29
Table 20: Information elements in a Send Routeing Information for GPRS Response	29
Table 21: Information elements in a Failure Report Request	30
Table 22: Information elements in a Failure Report Response.....	30
Table 23: Information elements in a Note MS Present Request	31
Table 24: Information elements in a Note MS Present Response.....	31
Table 25: Information elements in an Identification Request.....	31
Table 26: Information elements in an Identification Response	32
Table 27: Information elements in a SGSN Context Request.....	33
Table 28: Information elements in a SGSN Context Response	34
Table 29: Information elements in a SGSN Context Acknowledge	35
Table 30: Cause values.....	37
Table 31: Use of the Cause values	38
Table 32: Reordering Required values	40

Table 33: MS Validated values42

Table 34: Selection mode values43

Table 35: PDP Type Organization values45

Table 36: ETSI defined PDP Type values.....45

Table 37: Used Cipher values48

Table 38: Reordering Required values50

Table 39: VPLMN Address Allowed values50

Figures

Figure 1: GPRS Logical Architecture with interface name denotations	10
Figure 2: Outline of GTP header	11
Figure 3: Tunnel ID (TID) format	12
Figure 4: Signalling Plane - Protocol stack	12
Figure 5: GTP header followed by subsequent Information Elements	14
Figure 6: GGSN - HLR Signalling via a GTP-MAP protocol-converter in a GSN	28
Figure 7: Type field for TV and TLV format	35
Figure 8: Cause information element	37
Figure 9: IMSI information element	38
Figure 10: RAI information element	39
Figure 11: TLLI information element	39
Figure 12: The Packet TMSI information element	39
Figure 13: Quality of Service (QoS) Profile information element	40
Figure 15: Reordering Required information element	40
Figure 16: Authentication Triplet information element	41
Figure 18: MAP Cause information element	41
Figure 19: P-TMSI Signature information element	41
Figure 20: MS Validated information element	42
Figure 21: Restart counter information element	42
Figure 22: Selection mode information element	42
Figure 23: Flow Label Data information element	43
Figure 24: Flow Label Signalling information element	43
Figure 25: Flow Label Data II information element	44
Figure 26: Charging ID information element	44
Figure 27: End User Address information element	45
Figure 28: End User Address information element for IPv4	45
Figure 29: End User Address information element for IPv6	46
Figure 30: End User Address information element for X.25	46
Figure 31: End User Address information element for PPP	47
Figure 32: End User Address information element for OSP:IHOSS	47
Figure 33: MM Context element	48
Figure 34: PDP Context information element	50

Figure 35: Access Point Name information element51

Figure 36: Protocol Configuration Options information element51

Figure 37: GSN Address information element52

Figure 38: Charging Gateway Address information element.....52

Figure 39: Private Extension information element52

Figure 40: Transmission Plane - Protocol Stack.....53

Annex A (informative): Naming convention

A naming convention that will make it possible for DNS servers to translate logical names for GSNs and RAs to physical IP addresses is described in this informative annex. The use of logical names is optional, but if the option is used, it shall comply with the naming convention described in this annex.

A.1 Routing Area Identities

A possible way to support inter-PLMN roaming is discussed very briefly in this sub-section.

When an MS roams between two SGSNs within the same PLMN, the new SGSN finds the address to the old SGSN by the association old RA - old SGSN. Thus, each SGSN knows the address to every other SGSN in the PLMN.

When an MS roams from an SGSN to an SGSN in another PLMN, the new SGSN may not itself have access to the address to the old SGSN. Instead, the SGSN transforms the old RA information to a logical name of the form:

RACxxx.LACyyyy.MNCzzzz.MCCwwww.GPRS; x,y,z and w shall be Hex coded digits.

The SGSN may then acquire the IP address of the old SGSN from a DNS server, using the logical address. Every PLMN should include one DNS server each. Note that these DNS servers are GPRS internal entities, unknown outside the GPRS system.

The above implies that at least MCC + MNC + RAC + LAC (= RAI) is sent as RA parameter over the radio when an MS roams to another RA.

If the new SGSN for any reason fails to obtain the address of the old SGSN, the same actions as when the corresponding event occurs within one PLMN are taken.

Introducing the DNS concept in GPRS gives a general possibility to use logical names instead of IP addresses when referring to e.g. GSNs, thus providing flexibility in addressing of PLMN nodes.

Another way to support seamless inter-PLMN roaming is to store the SGSN IP addresses in HLR and request them when necessary.

A.2 GPRS Support Nodes

In this sub-section a naming convention for GSNs is described.

It shall be possible to refer to a GSN by a logical name that shall then be translated into a physical IP address. Here a GSN naming convention is proposed which would make it possible for an internal GPRS DNS server to make the translation.

An example of how a logical name of a SGSN could look like is:

SGSNxxxx.MNCyyyy.MCCzzzz.GPRS; x,y and z shall be Hex coded digits.

Annex B (informative): A method for sequence number checking

This annex describes a method to determine whether or not a received T-PDU is valid, for the Usage of the Sequence Number section, 8.1.1.1 .

This method deals with two distinct problems.

The first one is the 'drifting' between the Sequence Number value that we expect to receive in the light of the total number of T-PDU received for this tunnel (the Expected value), and the effective received value. The probability that the received T-PDU is not correct because not awaited is higher if the distance between Expected and received Sequence Numbers is high than if this distance is low. This leads to Condition 1. Its left part represents the distance between the Expected and received values, in a circular 65536 dimension.

The second one is the duplication of T-PDU frames within a given number of last received frames which have been accepted by the condition 1.

This leads to the following actions:

This operation shall start when the dialogue is established between the GSNs. When each T-PDU is received during the dialogue, if this T-PDU is valid, its Sequence Number shall be saved. The last 'A' saved Sequence Numbers represent the 'Recorded Sequence Number Set'.

A received T-PDU sequence number is valid only if it satisfies both of the following conditions:

- 1) $\text{Min}(\text{Abs}(E - r), \text{Abs}(r - 65536 - E), \text{Abs}(E - 65536 - r)) < 'B'$ Condition 1
Where: 'E' is the Expected Sequence Number and 'r' is the received Sequence Number.
- 2) The received Sequence Number is not a member of the Recorded Sequence Number Set. Condition 2

'A' and 'B' are parameters. The receiving GSN shall discard a received T-PDU with an invalid Sequence Number.

Abs(X) represents the absolute value of the number X.

Min(X,Y,Z) represents the lowest value taken from the numbers X, Y, and Z.

Annex C (informative): Document change history

Document history		
V5.0.0	January 1998	not published
V6.0.0	April 1998	Updated with SMG#25. CR's A001r2, A004r1, A005r2, A006r2, A007 and A010 are included.
V6.1.0	July 1998	Updated with SMG#26. CR's A012r2, A013r1, A014r2, A015r1, A016r2, A017r1, A018r2, A20r1 and A021 are included.
V6.2.0	October 1998 after SMG#27	CR A022r1 Modification of the coding of the Cause values of the Cause information elements.
V7.1.0	September 1999	One-step Approval Procedure OAP 9957: 1999-09-01 to 1999-12-31
		CR A024r1 Corrections and clarifications.
		CR A025r1 Charging ID to three GTP message types
		CR A026 Modification of the definition of the length of the protocol messages.
		CR A027r2 Information Elements: Clarification of the handling of the unused bits, re-definition of range.
		CR A028r2 Clarification of the handling of protocol errors in the Error handling section.
		CR A029 Update of the Protocol Configuration Options IE
V6.2.1	November 1998	Editorial correction to figures
V6.2.2	November 1998	Editorial correction to figures
V6.3.0	April 1999	CR A043 Removal of not defined cause 'TLLI Signature mismatch
		CR A042 PDP Context IE
		CR A041 PDP context establishment and restoration
		CR A040r1 Correction of the value of parameter LLC Frame number within GTP header
		CRA039r2 Alignment of the GSM 09.60 with GSM 09.02
		CRA038r1 Addition of IMSI to SGSN Context Request
		CRA037r1 Corrections and clarifications of the GSM 09.60 specification
		CRA036r1 Addition of IMSI to SGSN Context Request
		CRA035r2 Improving restoration procedure between SGSN and GGSN
		CRA034r1 Correction of used cipher IE
V7.0.0	April 1999	CR A032r6 GPRS Charging enhancements to GTP
		CR A045r1 GTP/GTP' Protocol Type bit
		CR A044r1 Introduction of the PDP-type PPP
		CR A048 Introduction of the PDP type OSH:IHOSS
V7.1.0	August 1999 after SMG#29	CR A052 Clarification of ambiguous/superfluous information
		CR A054 Timer handling in GTP
		CR A055r1 Codepoint for PDP type OSP:IHOSS
		CR A062 Removal of changes in PDP context establishment and restoration
		CR A063 Mandatory info in MM Context IE
		CR A064 APN to be transferred in the PDP context at inter SGSN RA update
		CR A065 Consistency on implemented CRs from SMG#28
		CR A066 Replacing the V(R) transfer mechanism with the N-PDU number transfer mechanism in routing area update
		CR A067 Mandatory SGSN Context Acknowledge message
		CR A068 MSISDN in the Create PDP Context request
V7.1.0		Update to version 7.1.1 for Publication

History

Document history		
V7.1.0	September 1999	One-step Approval Procedure OAP 9957: 1999-09-01 to 1999-12-31
V7.1.1	January 2000	Publication