

Draft **EN 301 165** V1.1.1 (1998-03)

---

*European Standard (Telecommunications series)*

**Transmission and Multiplexing (TM);  
Synchronous Digital Hierarchy (SDH);  
SDH leased lines - network and terminal interface presentation**

---



*European Telecommunications Standards Institute*

---

---

**Reference**

DEN/TM-03073 (asc00ico.PDF)

---

**Keywords**

Leased line, ONP, SDH, transmission

***ETSI Secretariat***

---

**Postal address**

F-06921 Sophia Antipolis Cedex - FRANCE

---

**Office address**

650 Route des Lucioles - Sophia Antipolis  
Valbonne - FRANCE  
Tel.: +33 4 92 94 42 00 Fax: +33 4 93 65 47 16  
Siret N° 348 623 562 00017 - NAF 742 C  
Association à but non lucratif enregistrée à la  
Sous-Préfecture de Grasse (06) N° 7803/88

---

**Internet**

secretariat@etsi.fr  
<http://www.etsi.fr>  
<http://www.etsi.org>

---

***Copyright Notification***

No part may be reproduced except as authorized by written permission.  
The copyright and the foregoing restriction extend to reproduction in all media.

---

# Contents

Intellectual Property Rights .....	4
Foreword .....	4
1 Scope.....	5
2 Normative references.....	6
3 Definitions, symbols and abbreviations.....	7
3.1 Definitions .....	7
3.2 Symbols .....	9
3.3 Abbreviations.....	10
4 Network and terminal interfaces for Virtual Container (VC) leased line connection.....	11
4.1 Section layer functions for Network Termination (NT) and Terminal Equipment (TE).....	11
4.1.1 STM-1 section layers functions for NT and TE .....	11
4.1.2 STM-4 section layers functions for NT and TE .....	14
4.2 Path layer functions for NT.....	15
4.2.1 Network path layer functions for VC-4 leased line connections .....	15
4.2.2 Network path layer functions for lower order VC leased line connections .....	15
4.3 Path layers functions for TE .....	15
4.3.1 Terminal path layer functions for VC-4 leased line connections.....	15
4.3.2 Terminal path layer functions for lower order VC leased line connections.....	16
4.4 Mechanical characteristics for NT and TE interfaces .....	17
4.4.1 Connectors for the electrical STM-1 interface .....	17
4.4.2 Connectors for optical STM-N interfaces .....	17
4.5 Safety .....	18
4.6 AU/TU numbering scheme .....	18
5 Application of ETS 300 417-2-1 .....	18
6 Application of ETS 300 417-3-1 .....	20
7 Application of ETS 300 417-4-1 .....	22
8 Application of ETS 300 417-6-1 .....	28
<b>Annex A (informative): Bibliography .....</b>	<b>30</b>
History.....	31

---

## Intellectual Property Rights

IPRs essential or potentially essential to the present document may have been declared to ETSI. The information pertaining to these essential IPRs, if any, is publicly available for **ETSI members and non-members**, and can be found in ETR 314: "*Intellectual Property Rights (IPRs); Essential, or potentially Essential, IPRs notified to ETSI in respect of ETSI standards*", which is available **free of charge** from the ETSI Secretariat. Latest updates are available on the ETSI Web server (<http://www.etsi.fr/ipr> or <http://www.etsi.org/ipr>).

Pursuant to the ETSI Interim IPR Policy, no investigation, including IPR searches, has been carried out by ETSI. No guarantee can be given as to the existence of other IPRs not referenced in ETR 314 (or the updates on the ETSI Web server) which are, or may be, or may become, essential to the present document.

---

## Foreword

This European Standard (Telecommunications series) has been produced by ETSI Technical Committee Transmission and Multiplexing (TM), and is now submitted for the Public Enquiry phase of the ETSI standards Two-step Approval Procedure.

<b>Proposed national transposition dates</b>	
Date of latest announcement of this EN (doa):	3 months after ETSI publication
Date of latest publication of new National Standard or endorsement of this EN (dop/e):	6 months after doa
Date of withdrawal of any conflicting National Standard (dow):	6 months after doa

---

# 1 Scope

The present document defines the atomic functions relevant for the interface presentations of Synchronous Digital Hierarchy (SDH) leased lines at the Network Termination Point (NTP) and the Terminal Equipment (TE). It specifies the technical requirements for electrical, optical, regenerator and multiplex section layer and SDH path layers. The specification is presented as a delta information of the equipment specification of:

- ETS 300 417-2-1 [9] for STM-1 electrical and optical and STM-4 optical section layer;
- ETS 300 417-3-1 [10] for STM-1 and STM-4 regenerator section and multiplex section layer;
- ETS 300 417-4-1 [11] for SDH path layers (VC-4, VC-3, VC-2 and VC-12);
- ETS 300 417-6-1 [12] for synchronization layer functions.

The following physical section layers are used:

- STM-1 electrical interface;
- STM-1 optical intra-office interface;
- STM-1 optical short haul interfaces at 1 300 nm;
- STM-4 optical intra-office interface;
- STM-4 optical short haul interfaces at 1 300 nm.

The interface margins are defined such, that interconnection of different optical interfaces is possible when an appropriate attenuation is inserted.

A connection is presented via interfaces at NTPs. The present document defines the network interface as presented by the leased line provider and should be used in conjunction with the companion standard, EN 301 164 [5], specifying the connection characteristics between NTPs of the leased line. The present document and the connection characteristic standard together describe the technical characteristics of the leased line.

The present document is applicable for leased lines, including part time leased lines, for which the establishment or release does not require any protocol exchange or other intervention at the NTP.

The present document is to ensure that the interface of the terminal equipment is compatible with the SDH leased line interface. The present document is applicable to all interfaces designed for connection to the SDH leased lines.

Customer premises wiring and installation between terminal equipment and the NTP are outside the scope of the present document.

The conformance test of the section and path layer functions will be addressed under work items ETS 300 417-x-3 (x = 2, 3, 4 and 6). Some of the tests described in those ETSs are not designed to be applied to the interface of an installed leased line; such tests may be applied to equipment of the kind used to provide the interface. The present document does not include extra details concerning the implementation of tests, nor does it include information of any relevant regulations. The present document does not specify the circumstances in which the tests given in ETS 300 417-x-3 (x = 2, 3, 4 and 6) are to be performed.

---

## 2 Normative references

References may be made to:

- a) specific versions of publications (identified by date of publication, edition number, version number, etc.), in which case, subsequent revisions to the referenced document do not apply; or
- b) all versions up to and including the identified version (identified by "up to and including" before the version identity); or
- c) all versions subsequent to and including the identified version (identified by "onwards" following the version identity); or
- d) publications without mention of a specific version, in which case the latest version applies.

A non-specific reference to an ETS shall also be taken to refer to later versions published as an EN with the same number.

- [1] EN 60950 (1992): "Safety of information technology equipment, including electrical business equipment".
- [2] IEC 169-8 (1978): "Radio-frequency connectors - Part 8: R.F. coaxial connectors with inner diameter of outer conductor 6.5 mm (0.256 in) with bayonet lock - Characteristic impedance 50 ohms (Type BNC)".
- [3] IEC 169-13 (1976): "Radio-frequency connectors - Part 13: R.F. coaxial connectors with inner diameter of outer conductor 5.6 mm (0.22 in) - Characteristic impedance 75 ohms (Type 1.6/5.6). - Characteristic impedance 50 ohms (Type 1.8/5.6) with similar mating dimensions".
- [4] ISO/IEC 10173 (1991): "Information technology - Integrated Services Digital Network (ISDN) primary access connector at reference points S and T".
- [5] EN 301 164: "Transmission and Multiplexing (TM); SDH leased lines; Connection characteristics".
- [6] ETS 300 147 (1997): "Transmission and Multiplexing (TM); Synchronous Digital Hierarchy (SDH); Multiplexing structure".
- [7] ETS 300 232 (1993): "Transmission and Multiplexing (TM); Optical interfaces for equipments and systems relating to the Synchronous Digital Hierarchy [ITU-T Recommendation G.957 (1993) modified]".
- [8] ETS 300 417-1-1 (1996): "Transmission and Multiplexing (TM); Generic functional requirements for Synchronous Digital Hierarchy (SDH) equipment; Part 1-1: Generic processes and performance".
- [9] ETS 300 417-2-1 (1996): "Transmission and Multiplexing (TM); Generic functional requirements of transport functionality of equipment; Part 2-1: SDH and PDH physical section layer functions".
- [10] ETS 300 417-3-1 (1996): "Transmission and Multiplexing (TM); Generic functional requirements of transport functionality of equipment; Part 3-1: STM-N regenerator and multiplex section layer functions".
- [11] ETS 300 417-4-1 (1996): "Transmission and Multiplexing (TM); Generic functional requirements of transport functionality of equipment; Part 4-1: SDH path layer functions".
- [12] ETS 300 417-6-1 (1996): "Transmission and Multiplexing (TM); Generic functional requirements of transport functionality of equipment; Part 6-1: Synchronization layer functions".
- [13] ITU-T Recommendation G.825 (1993): "The control of jitter and wander within digital networks which are based on the synchronous digital hierarchy (SDH)".
- [14] ITU-T Recommendation G.704 (1995): "Synchronous frame structures used at 1 544, 6 312, 2 048, 8 488 and 44 736 kbit/s hierarchical levels".

## 3 Definitions, symbols and abbreviations

### 3.1 Definitions

For the purposes of the present document, the following definitions apply:

**process:** A generic term for an action or a collection of actions.

**function:** A "process" defined for digital transmission hierarchies (e.g. Plesiochronous Digital Hierarchy (PDH), Synchronous Digital Hierarchy (SDH)) which acts on a collection of input information to produce a collection of output information. A function is distinguished by the way in which characteristics of the collection, or of members of the collection of output information differ from characteristics of members of the collection of input information.

**atomic function:** A "function" which if divided into simpler "functions" would cease to be uniquely defined for digital transmission hierarchies. It is therefore indivisible from a network point of view. The following atomic functions are defined in each network layer:

- bi-directional Trail Termination function (...\_TT), Trail Termination Source function (...\_TT\_So), Trail Termination Sink function (...\_TT\_Sk) and Connection function (...\_C);
- between client and server layer networks three adaptation functions are defined: Adaptation Sink function ...\_A\_Sk, Adaptation Source function ...\_A\_So, and the bi-directional Adaptation function ...\_A.

**adaptation function:** An "atomic function" which passes a collection of information between layer networks by changing the way in which the collection of information is represented.

**trail termination function:** An "atomic function" within a "layer" which generates, adds, and monitors information concerning the integrity and supervision of "adapted information".

**connection function:** An "atomic function" within a layer which, if connectivity exists, relays a collection of items of information between groups of atomic functions. It does not modify the members of this collection of items of information although it may terminate any switching protocol information and act upon it. Any connectivity restrictions between inputs and outputs shall be stated.

**layer:** A concept used to allow the transport network functionality to be described hierarchically as successive levels; each layer being solely concerned with the generation and transfer of its "characteristic information".

**client/server layer:** Any two adjacent network layers are associated in a client/server relationship. Each transport network layer provides transport to the layer above and uses transport from the layers below. The layer providing transport is termed a "server", the layer using transport is termed "client".

**Remote Defect Indication (RDI):** A signal which conveys the defect status of the characteristic information received by the Trail Termination sink function back to the network element which contains the characteristic information originating trail termination source function.

Examples of RDI signals are the Far End Receive Failure (FERF) bit(s) in SDH signals, the A-bit in ITU-T Recommendation G.704 [14] structured 2 048 kbit/s signals and the alarm indication bit in other PDH multiplex signals.

**Remote Error Indication (REI):** A signal which conveys either the exact or truncated number of error detection code violations within the characteristic information (as detected by the trail termination sink function) back to the network element which contains the characteristic information originating trail termination source function.

Examples of REI signals are the Far End Block Error (FEBE) bit(s) in SDH signals and the E-bit in ITU-T Recommendation G.704 [14] structured 2 048 kbit/s signals.

**all-ONES:** The entire capacity of the adapted or characteristic information is set to logic "1".

**AU-4-AIS:** An STM-N signal in which the entire capacity of an Administrative Unit 4 (AU-4) is set to logic "1".

**TU-m-AIS:** An STM-N signal in which the entire capacity of a TU-m is set to logic "1".

**Characteristic Information (CI):** A signal of specific rate and format which is transferred within and between "sub-networks", and presented to an "adaptation" function for "transport" by the server layer network.

**Remote Information (RI):** Information flow from sink direction to source direction of the same atomic function in unidirectional representation, containing information to be transported to the remote end, such as RDI and REI.

**Access Point (AP):** A "reference point" where the output of an "adaptation" source function is bound to the input of a "Trail Termination (TT) source", or where the output of a "trail termination sink" is bound to the input of an "adaptation" sink function. The "access point" is characterized by the adapted client layer "characteristic information" which passes across it. A bi-directional "access point" is formed by an associated contra-directional pair.

**Connection Point (CP):** A "reference point" where the output of a "trail termination source" or a "connection" is bound to the input of another "connection", or where the output of a "connection" is bound to the input of a "trail termination sink". The "connection point" is characterized by the information which passes across it. A bi-directional "connection point" is formed by the association of a contra-directional pair.

NOTE 1: In the information model the connection point is called Connection Termination Point (CTP).

**Termination Connection Point (TCP):** A special case of a "connection point" where a "trail termination" function is bound to an "adaptation" function or a "connection" function.

NOTE 2: In the information model the termination connection point is called Trail Termination Point (TTP).

**defect:** The density of anomalies has reached a level where the ability to perform a required function has been interrupted. Defects are used as input for performance management, the control of consequent actions, and the determination of fault cause.



## 3.2 Symbols

For the purposes of the present document, the following symbols apply:

The diagrammatic conventions and nomenclature used in the present document for adaptation, termination and connection functions (used to describe the atomic functions) are taken from ETS 300 417-1-1 [8] and are shown in Figure 1.

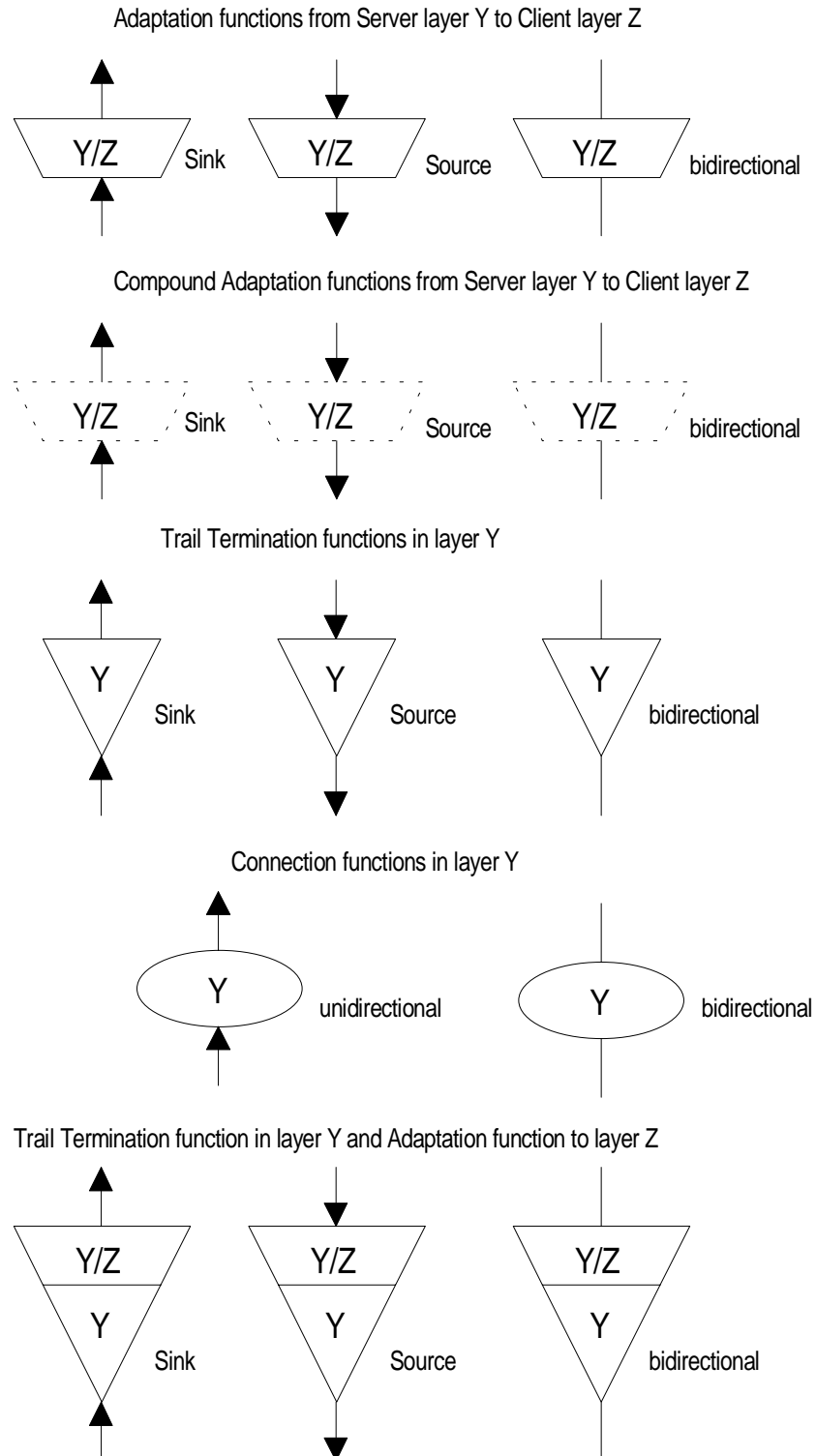

NOTE: If the above symbols are used for generic figures, i.e. not for specific layers, the layer references Y and Z may be omitted. Alternatively, the references may be to the type of function or layer, e.g. supervision, protection.

**Figure 1: Symbols and diagrammatic conventions**

### 3.3 Abbreviations

For the purposes of the present document, the following abbreviations apply:

A	Adaptation function
AI	Adapted Information
AIS	Alarm Indication Signal
AP	Access Point
AU	Administrative Unit
AU-n	Administrative Unit, level n
AUG	Administrative Unit Group
C	Connection function
CI	Characteristic Information
CP	Connection Point
CTP	Connection Termination Point
ES	Electrical Section
ES1	STM-1 Electrical Section
FEBE	Far End Block Error
FERF	Far End Receive Failure
I	Informative
LC	Layer Clock
LOF	Loss Of Frame
LOM	Loss Of Multiframe
LOP	Loss Of Pointer
LOS	Loss Of Signal
MS	Multiplex Section
MS1	STM-1 Multiplex Section
MS4	STM-4 Multiplex Section
N	Normative
N/R	Not Relevant
NNI	Network Node Interface
NT	Network Termination
NTP	Network Termination Point
OS	Optical Section
OS1	STM-1 Optical Section
OS4	STM-4 Optical Section
PLM	PayLoad Mismatch
RDI	Remote Defect Indication
REI	Remote Error Indication
RI	Remote Information
RS	Regenerator Section
RS1	STM-1 Regenerator Section
RS4	STM-4 Regenerator Section
RSOH	Regenerator Section Overhead
S12	VC-12 path layer
S2	VC-2 path layer
S3	VC-3 path layer
S4	VC-4 path layer
S4/SX	VC-4 path layer to lower order VC path layer
SDH	Synchronous Digital Hierarchy
Sk	Sink
So	Source
SELV	Safety Extra Low Voltage
SSF	Server Signal Fail
STM	Synchronous Transport Module
STM-N	Synchronous Transport Module, level N
TCP	Termination Connection Point
TE	Terminal Equipment
TI	Timing Information
TSF	Trail Signal Fail

TT	Trail Termination function
TTs	Trail Termination supervisory function
TTP	Trail Termination Point
TU	Tributary Unit
TU-m	Tributary Unit, level m
TUG	Tributary Unit Group
TUG-m	Tributary Unit Group, level m
UNEQ	UNEQuipped
VC	Virtual Container
VC-n	Virtual Container, level n

---

## 4 Network and terminal interfaces for Virtual Container (VC) leased line connection

### 4.1 Section layer functions for Network Termination (NT) and Terminal Equipment (TE)

#### 4.1.1 STM-1 section layers functions for NT and TE

The relevant section layer functions of electrical and optical STM-1 interfaces for NT and TE are shown in Figure 2 and Figure 3 respectively. The details of the atomic functions shown in these figures are given in clauses 5 and 6 of the present document. Two types of optical interfaces are relevant for leased line connections. These are the intra office interface (I1) and the short haul interface at 1 300 nm (S1.1)

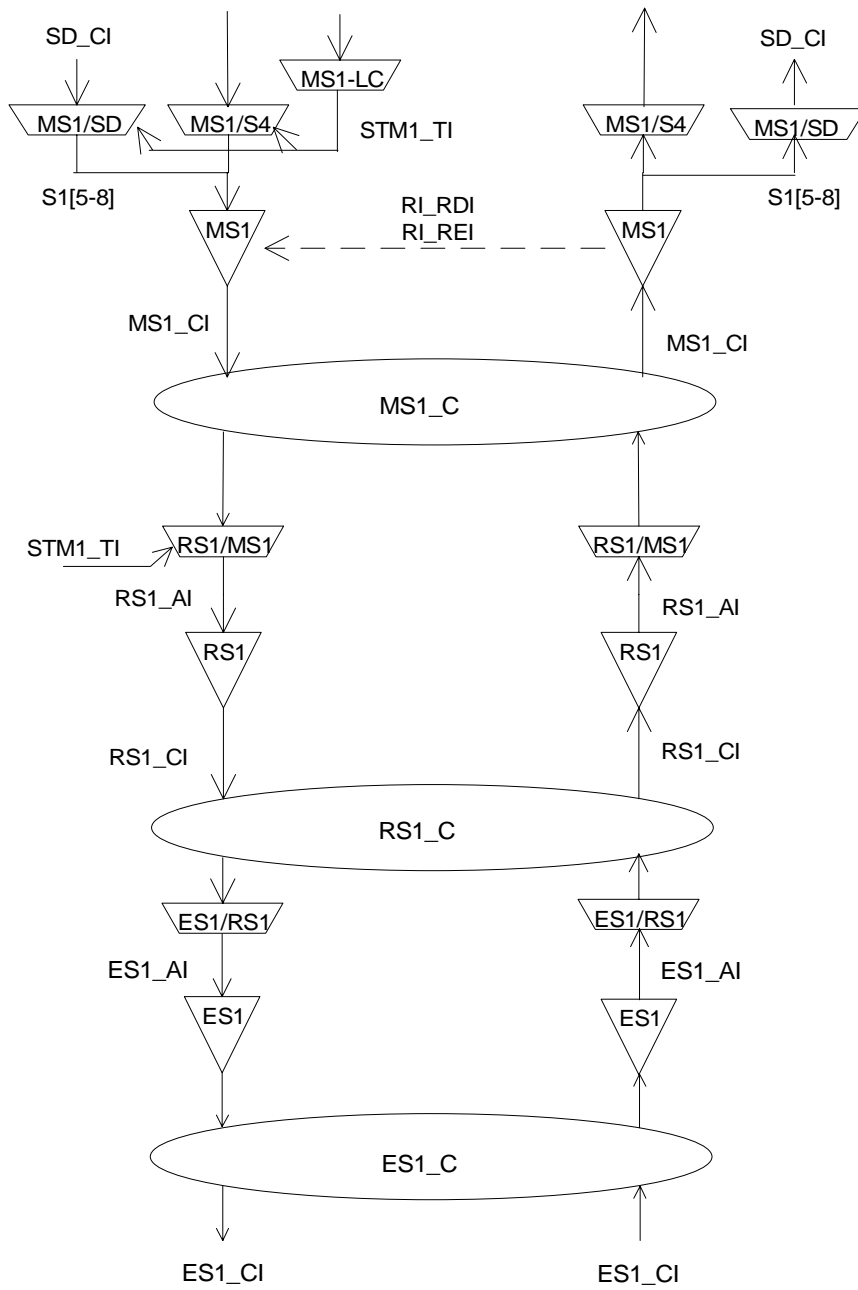

Figure 2: Section layers of a STM-1 electrical interface for NT and TE

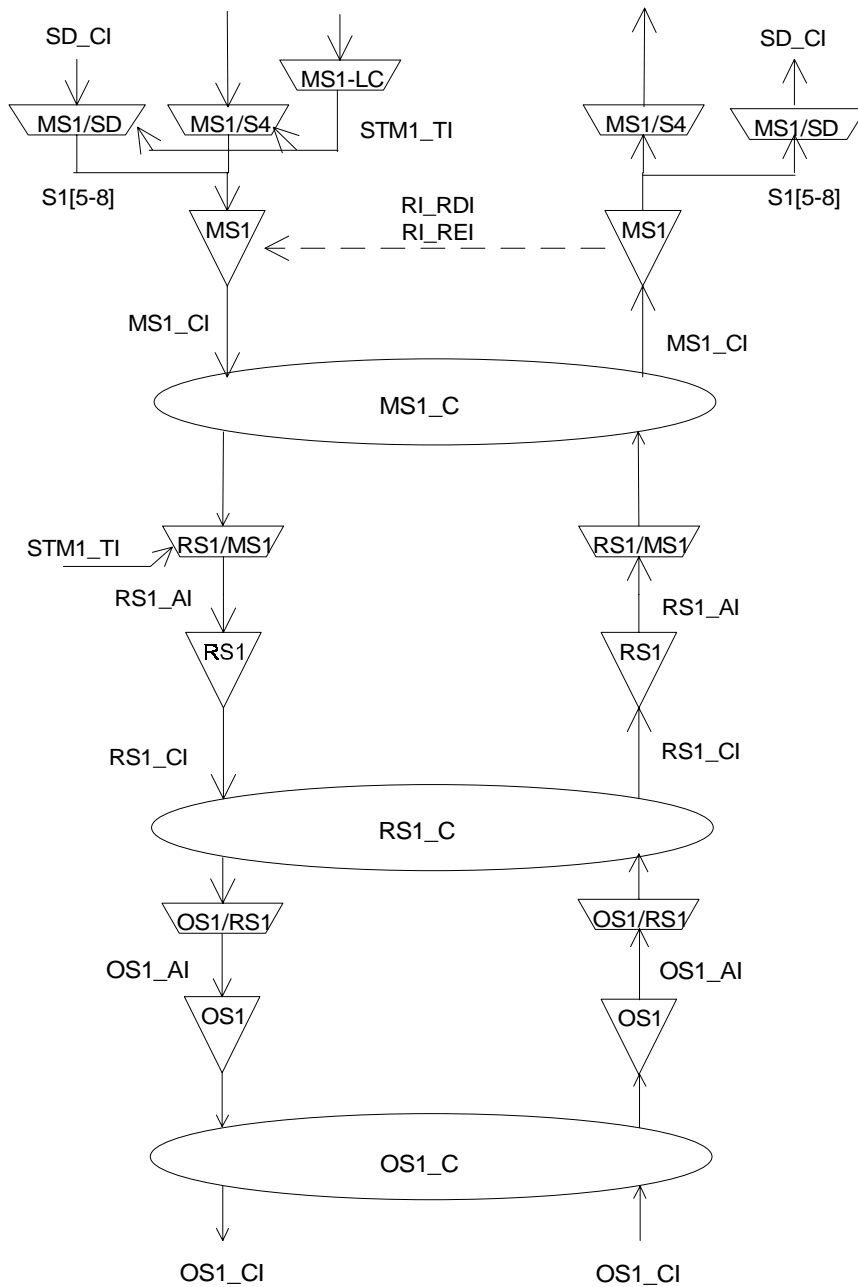
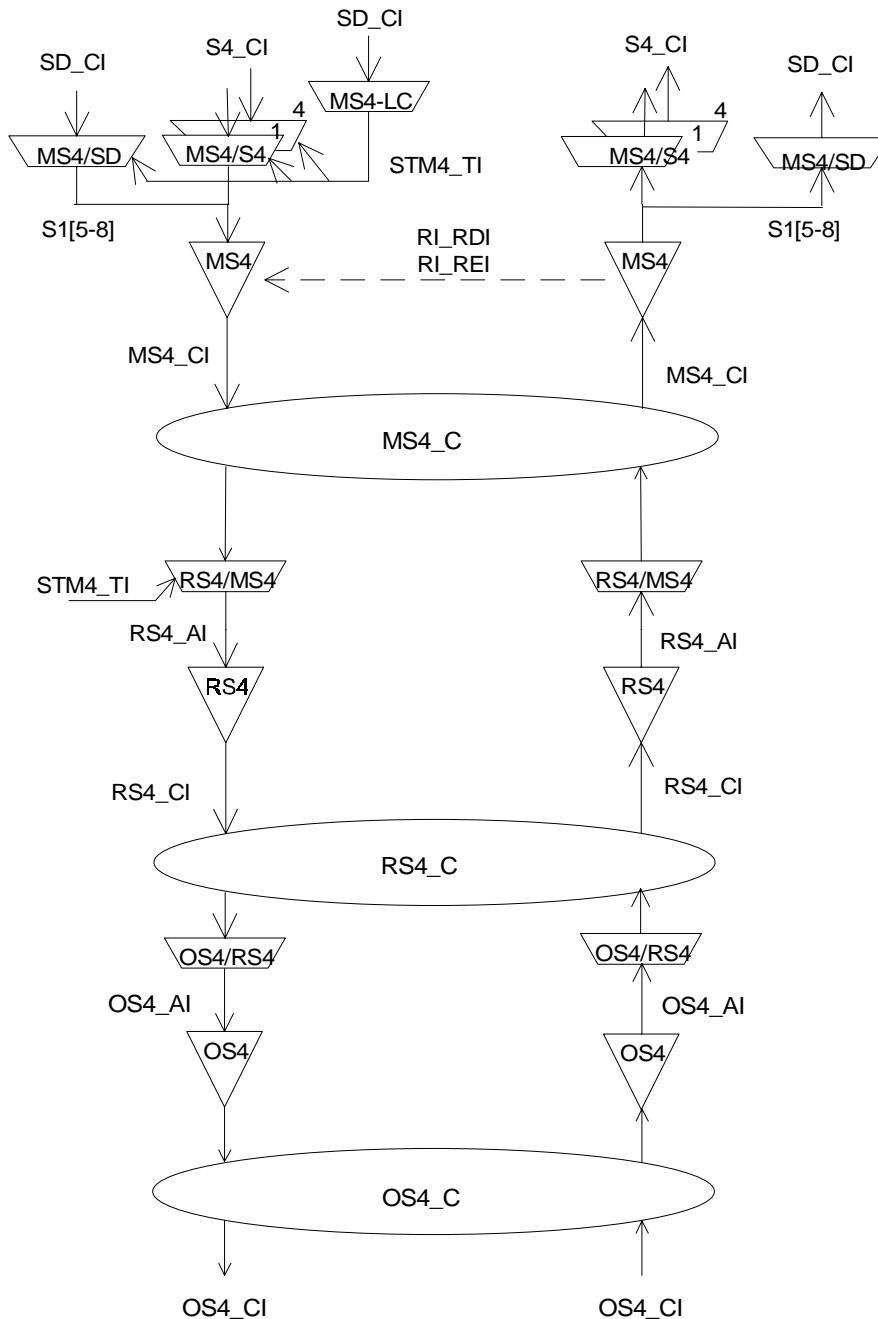

Figure 3: Section layers of an optical STM-1 interface for NT and TE

### 4.1.2 STM-4 section layers functions for NT and TE

The relevant section layer functions of optical STM-4 interfaces for NT and TE are shown in Figure 4. The details of the atomic functions shown in these figures are given in clauses 5 and 6 of the present document. Two types of optical interfaces are relevant for leased line connections. These are the intra office interface (I4) and the short haul interface at 1 300 nm (S4.1).



**Figure 4: Section layers of an STM-4 interface for NT and TE**

## 4.2 Path layer functions for NT

### 4.2.1 Network path layer functions for VC-4 leased line connections

There are no requirements on the VC-4 path layer functions for VC-4 leased line connections under the present document.

NOTE: The connection characteristics of the VC-4 path layer are specified in the companion standard EN 301 164 [5].

### 4.2.2 Network path layer functions for lower order VC leased line connections

The relevant VC-4 path layer functions of an NT are shown in Figure 5. Their details are specified in clause 7 of the present document.

The time taken for appearance of remote indication of defects and block errors depends on the processing time of the equipment terminating the VC-4 and the round trip delay between that equipment and the leased line interface. Therefore the timing criteria for setting and clearing of VC-4-RDI and VC-4-REI as given in the equipment specification ETS 300 417-4-1 [11] cannot be directly applied to the present document.

There are no requirements on the lower order VC path layer functions for lower order VC leased line connections under the present document.

NOTE: The connection characteristics of the lower order VC path layers are specified in the companion standard EN 301 164 [5].

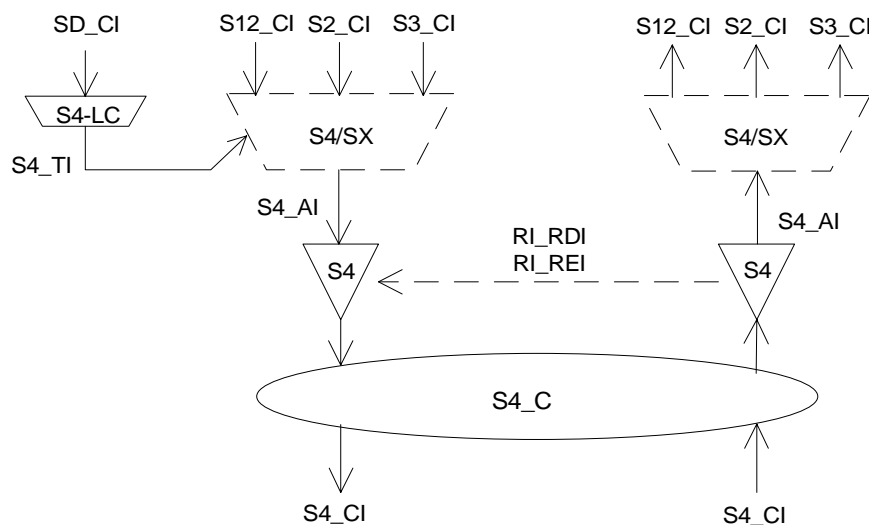

Figure 5: NT path layer for lower order VC connections

## 4.3 Path layers functions for TE

### 4.3.1 Terminal path layer functions for VC-4 leased line connections

The relevant VC-4 path layer functions of a TE are shown in Figure 6. Their details are specified in clause 7 of the present document. There are no requirements on the adaptation functions with two exceptions:

- They shall be timed by the S4-TI signal.

- VC-4 payload signals the mapping of which is not defined in ETS 300 147 [6] shall be scrambled when emulation of the STM-N scrambler polynomial  $1 + x^6 + x^7$  in more than 8 consecutive bytes of the VC-4 payload could occur. Scrambling is not necessary when the client layer take actions to exclude the emulation of the scrambler polynomial in more than 8 consecutive bytes of the VC-4 payload.

NOTE: Scrambling provides security against malicious emulation of the SDH set-reset scrambler pattern. Without scrambling a specific pattern could generate a long sequence of binary "0" which may be detected as Loss Of Signal (LOS) or replicate the STM-N frame alignment word.

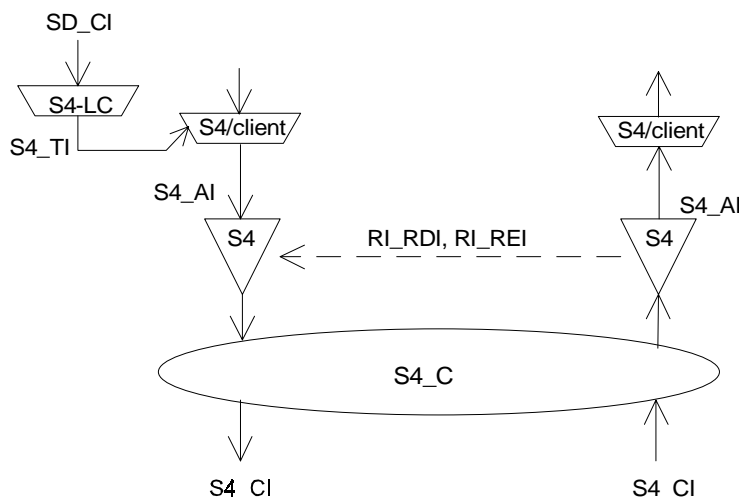

Figure 6: Terminal equipment path layer for VC-4 leased line connections

#### 4.3.2 Terminal path layer functions for lower order VC leased line connections

The relevant path layer functions of a TE are shown in Figure 7. Their details are specified in clause 7 of the present document. There are no requirements on the adaptation functions from the lower order path layers to their client layers except that they shall be timed by the associate Sm-TI signal ( $m = 12, 2, 3$ ).

The path layers may not be terminated at the equipment providing the physical interface. They may also be originated at different equipment. The appearance time of remote indication of defects and block errors depends the processing time of the equipment terminating the VC path layer and the round trip delay between that equipment and the leased line interface. Therefore the timing criteria for setting and clearing of VC-RDI and VC-REI as given in the equipment specification ETS 300 417-4-1 [11] cannot be directly applied to the present document.





## 4.5 Safety

The network and the terminal interface shall comply with the requirements for accessible parts of an Safety Extra Low Voltage (SELV) circuit. The test shall be conducted according to EN 60950 [1].

NOTE: The test associated with this requirement is not suitable for use on installed leased lines. Such tests may be applied to equipment of the kind used to provide the interface.

## 4.6 AU/TU numbering scheme

The numbering of AU-4s (VC-4s) in an STM-N and of TU-12s (VC-12s), TU-2s (VC-2s) and TU-3s (VC-3s) in a VC-4 is specified in subclause 3.3.3 of ETS 300 417-1-1 [8].

---

# 5 Application of ETS 300 417-2-1

The requirements of ETS 300 417-2-1 [9] shall be applied except as indicated in tables 1 and 2, where N = Normative, I = Informative, and N/R = Not Relevant.

**Table 1: Global differences with respect to ETS 300 417-2-1 [9]**

clause/ subclause	Title	state- ment
All	All management information "..._MI_..." in the tables for input and output tables.	N/R
All	Defect correlations	N/R
All	Performance monitoring	N/R

Table 2: Application of ETS 300 417-2-1 [9]

clause/ subclause	Title	state- ment
	Foreword	I
1	Scope	I
2	Normative references	N
3	Definitions, abbreviations and symbols	N
3.1	Definitions	N
3.2	Abbreviations	N
3.3	Symbols and diagrammatic conventions	N
3.4	Introduction	I
4	STM-1 Optical Section Layer Functions	N
4.1	Optical Section Connection functions	N/R
4.2	Optical Section Trail Termination functions	I
4.2.1	Optical Section Trail Termination Source OS1-Xy.z_TT_So Replace note 1 by "Only I.1 and S.1.1 are relevant" Replace the text of the defects section by "None"	N
4.2.2	Optical Section Trail Termination Sink OS1-Xy.z_TT_Sk Replace note 1 by "Only I.1 and S.1.1 are relevant" Processes: Port Mode	N N/R
4.3	Optical Section Adaptation functions	I
4.3.1	Optical Section to Regenerator Section Adaptation Source OS1/RS1_A_So Replace the text of the process section by: "The output jitter shall not exceed the limits given in ITU-T recommendation G.825"	N
4.3.2	Optical Section to Regenerator Section Adaptation Sink OS1/RS1_A_Sk	N
5	STM-4 Optical Section Layer Functions	N
5.1	Optical Section Connection functions	N/R
5.2	Optical Section Trail Termination functions	I
5.2.1	Optical Section Trail Termination Source OS4-Xy.z_TT_So Replace note 1 by "Only I.4 and S.4.1 are relevant" Replace the text of the defect sections by "None"	N
5.2.2	Optical Section Trail Termination Sink OS4-Xy.z_TT_Sk Replace note 1 by "Only 4.1 and S.4.1 are relevant" Processes: Port Mode	N N/R
5.3	Optical Section Adaptation functions	N
5.3.1	Optical Section to Regenerator Section Adaptation Source OS4/RS4_A_So Replace the text of the process section by: "The output jitter shall not exceed the limits given in ITU-T recommendation G.825"	N
5.3.2	Optical Section to Regenerator Section Adaptation Sink OS4/RS4_A_Sk	N
6	STM-16 Optical Section Layer Functions	N/R
7	STM-64 Optical Section Layer Functions	N/R
8	STM-1 Electrical Section Layer Functions	N
8.1	STM-1 Electrical Section Connection function ES1_C	N/R
8.2	STM-1 Electrical Section Trail Termination functions	I
8.2.1	STM-1 Electrical Section Trail Termination Source ES1_TT_So	N
8.2.2	STM-1 Electrical Section Trail Termination Sink ES1_TT_Sk Processes: Port Mode	N N/R
8.3	STM-1 Electrical Section Adaptation functions	I
8.3.1	STM-1 Electrical Section to Regenerator Section Adaptation Source ES1/RS1_A_So Replace under the process section "The CMI encoding process ....." to the end of that section by "The output jitter shall not exceed the limits given in ITU-T recommendation G.825"	N
8.3.2	STM-1 Electrical Section to Regenerator Section Adaptation Sink ES1/RS1_A_Sk	N
9	E4 Section Layer Functions	N/R
10	E31 Section Layer Functions	N/R
11	E22 Section Layer Functions	N/R
12	E12 Section Layer Functions	N/R
13	T12 Section Layer Functions	N/R
14	E0 Section Layer Functions	N/R
Annex A	E32 Section Layer Functions	N/R
Annex B	E11 Section Layer Functions	N/R

## 6 Application of ETS 300 417-3-1

The requirements of ETS 300 417-3-1 [10] shall be applied except as indicated in tables 3 and 4, where N = Normative, I = Informative, and N/R = Not Relevant.

**Table 3: Global differences with respect to ETS 300 417-3-1 [10]**

clause/ subclause	Title	state- ment
All	All management information "..._MI_..." in the tables for input and output tables.	N/R
All	Defect correlations	N/R
All	Performance monitoring	N/R

**Table 4: Application of ETS 300 417-3-1 [10]**

clause/ subclause	Title	state- ment
	Foreword	I
1	Scope	I
2	Normative references	N
3	Definitions, abbreviations and symbols	N
3.1	Definitions	N
3.2	Abbreviations	N
3.3	Symbols and diagrammatic conventions	N
3.4	Introduction	I
4	STM-1 Regenerator Section Layer Functions	I
4.1	STM-1 Regenerator Section Connection functions	N/R
4.2	STM-1 Regenerator Section Trail Termination functions	I
4.2.1	STM-1 Regenerator Section Trail Termination Source RS1_TT_So Add to the J0 paragraph of the process section: "The use of the RS trail trace identifier is optional."	N
4.2.2	STM-1 Regenerator Section Trail Termination Sink RS1_TT_Sk Add to the J0 paragraph of the process section: "The use of the RS trail trace identifier is optional."	N
4.3	STM-1 Regenerator Section Adaptation functions	I
4.3.1	STM-1 Regenerator Section to Multiplex Section Adaptation Source RS1/MS1_A_So	N
4.3.2	STM-1 Regenerator Section to Multiplex Section Adaptation Sink RS1/MS1_A_Sk	N
4.3.3	STM-1 Regenerator Section to DCC Adaptation Source RS1/DCC_A_So	N/R
4.3.4	STM-1 Regenerator Section to DCC Adaptation Sink RS1/DCC_A_Sk	N/R
4.3.5	STM-1 Regenerator Section to P0s Adaptation Source RS1/P0s_A_So/N	N/R
4.3.6	STM-1 Regenerator Section to P0s Adaptation Sink RS1/P0s_A_Sk/N	N/R
4.3.7	STM-1 Regenerator Section to V0x Adaptation Source RS1/V0x_A_So	N/R
4.3.8	STM-1 Regenerator Section to V0x Adaptation Sink RS1/V0x_A_Sk	N/R
5	STM-1 Multiplex Section Layer Functions	N
5.1	STM-1 Multiplex Section Connection functions	N/R
5.2	STM-1 Multiplex Section Trail Termination functions	I
5.2.1	STM-1 Multiplex Section Trail Termination Source MS1_TT_So Add at the end of the M1 process: "The insertion of MS-REI is optional." NOTE: Present equipment may not support the M1 coding due to its late definition."	N
5.2.2	STM-1 Multiplex Section Trail Termination Sink MS1_TT_Sk Add at the end of the M1 process: "The M1 process is optional."	N
5.3	STM-1 Multiplex Section Adaptation functions	I
5.3.1	STM-1 Multiplex Section to S4 Layer Adaptation Source MS1/S4_A_So	N
5.3.2	STM-1 Multiplex Section to S4 Layer Adaptation Sink MS1/S4_A_Sk	N
5.3.3	STM-1 Multiplex Section to DCC Adaptation Source MS1/DCC_A_So	N/R
5.3.4	STM-1 Multiplex Section to DCC Adaptation Sink MS1/DCC_A_Sk	N/R
5.3.5	STM-1 Multiplex Section to P0s Adaptation Source MS1/P0s_A_So	N/R
5.3.6	STM-1 Multiplex Section to P0s Adaptation Sink MS1/P0s_A_Sk	N/R
5.3.7	STM-1 Multiplex Section to Synchronization Distribution Adaptation Source MS1/SD_A_So	N
5.3.8	STM-1 Multiplex Section to Synchronization Distribution Adaptation Sink MS1/SD_A_Sk	N
5.3.9	STM-1 Multiplex Section Layer Clock Adaptation Source MS1-LC_A_So	N

(continued)

Table 4 (concluded): Application of ETS 300 417-3-1 [10]

clause/ subclause	Title	state- ment
5.4	STM-1 Multiplex Section Layer Monitoring Functions	N/R
5.5	STM-1 Multiplex Section Linear Trail Protection Functions	N/R
6	STM-4 Regenerator Section Layer Functions	I
6.1	STM-4 Regenerator Section Connection functions	N/R
6.2	STM-4 Regenerator Section Trail Termination functions	I
6.2.1	STM-4 Regenerator Section Trail Termination Source RS4_TT_So Add to the J0 paragraph of the process section: "The use of the RS trail trace identifier is optional."	N
6.2.2	STM-4 Regenerator Section Trail Termination Sink RS4_TT_Sk Add to the J0 paragraph of the process section: "The use of the RS trail trace identifier is optional."	N
6.3	STM-4 Regenerator Section Adaptation functions	I
6.3.1	STM-4 Regenerator Section to Multiplex Section Adaptation Source RS4/MS4_A_So	N
6.3.2	STM-4 Regenerator Section to Multiplex Section Adaptation Sink RS4/MS4_A_Sk	N
6.3.3	STM-4 Regenerator Section to DCC Adaptation Source RS4/DCC_A_So	N/R
6.3.4	STM-4 Regenerator Section to DCC Adaptation Sink RS4/DCC_A_Sk	N/R
6.3.5	STM-4 Regenerator Section to P0s Adaptation Source RS4/P0s_A_So/N	N/R
6.3.6	STM-4 Regenerator Section to P0s Adaptation Sink RS4/P0s_A_Sk/N	N/R
6.3.7	STM-4 Regenerator Section to V0x Adaptation Source RS4/V0x_A_So	N/R
6.3.8	STM-4 Regenerator Section to V0x Adaptation Sink RS4/V0x_A_Sk	N/R
7	STM-4 Multiplex Section Layer Functions	N
7.1	STM-4 Multiplex Section Connection functions	N/R
7.2	STM-4 Multiplex Section Trail Termination functions	I
7.2.1	STM-4 Multiplex Section Trail Termination Source MS4_TT_So Add at the end of the M1 process: "The insertion of MS-REI is optional." NOTE: Present equipment may not support the M1 coding due to its late definition."	N
7.2.2	STM-4 Multiplex Section Trail Termination Sink MS4_TT_Sk Add at the end of the M1 process: "The M1 process is optional."	N
7.3	STM-4 Multiplex Section Adaptation functions	I
7.3.1	STM-4 Multiplex Section to S4 Layer Adaptation Source MS4/S4_A_So/N	N
7.3.2	STM-4 Multiplex Section to S4 Layer Adaptation Sink MS4/S4_A_Sk/N	N
7.3.3	STM-4 Multiplex Section to S4-4c Layer Adaptation Source MS4/S4-4c_A_So	N/R
7.3.4	STM-4 Multiplex Section to S4-4c Layer Adaptation Sink MS4/S4-4c_A_Sk	N/R
7.3.5	STM-4 Multiplex Section to DCC Adaptation Source MS4/DCC_A_So	N/R
7.3.6	STM-4 Multiplex Section to DCC Adaptation Sink MS4/DCC_A_Sk	N/R
7.3.7	STM-4 Multiplex Section to P0s Adaptation Source MS4/P0s_A_So	N/R
7.3.8	STM-4 Multiplex Section to P0s Adaptation Sink MS4/P0s_A_Sk	N/R
7.3.9	STM-4 Multiplex Section to Synchronization Distribution Adaptation Source MS4/SD_A_So	N
7.3.10	STM-4 Multiplex Section to Synchronization Distribution Adaptation Sink MS4/SD_A_Sk	N
7.3.11	STM-4 Multiplex Section Layer Clock Adaptation Source MS4-LC_A_So	N
7.4	STM-4 Multiplex Section Layer Monitoring Functions	N/R
7.5	STM-4 Multiplex Section Linear Trail Protection Functions	N/R
8	STM-16 Regenerator Section Layer Functions	N/R
10	STM-64 Regenerator Section layer functions	N/R
11	STM-64 Multiplex Section layer functions	N/R
Annex A	Generic specification of linear protection switching operation	N/R
Annex B	STM-16 regenerator functional model (example)	N/R
Annex C	AU-4-Xc numbering scheme & pointer allocation	N/R
Annex D	MS protection examples	N/R
Annex E	Bibliography	N/R
History		N/R

## 7 Application of ETS 300 417-4-1

The requirements of ETS 300 417-4-1 [11] shall be applied except as indicated in tables 5 and 6, where N = Normative, I = Informative, and N/R = Not Relevant.

**Table 5: Global differences with respect to ETS 300 417-4-1 [11]**

clause/ subclause	Title	state- ment
All	All management information "..._MI_..." in the tables for input and output tables.	N/R
All	Defect correlations	N/R
All	Performance monitoring	N/R

**Table 6: Application of ETS 300 417-4-1 [11]**

clause/ subclause	Title	state- ment
	Foreword	I
1	Scope	I
2	Normative references	N
3	Definitions, abbreviations and symbols	N
3.1	Definitions	N
3.2	Abbreviations	N
3.3	Symbols and diagrammatic conventions	N
3.4	Introduction	I
4	<p>VC-4 Path Layer Functions</p> <p>Add at the beginning of the clause:</p> <p>"For lower order VC connections a TE shall use and the leased line connection may use the functions shown in figure 1a. There are no requirements on the VC-4 layer to POs adaptation function.</p> <p>For a VC-4 connection a TE shall use either the functions shown in figure 1b or figure 1c."</p> <p>Replace figure 1 by:</p> <p>Figure 1a: VC-4 Higher order Path layer atomic functions relevant for lower order VC of network and terminal</p>	N

(continued)

Table 6 (continued): Application of ETS 300 417-4-1 [11]

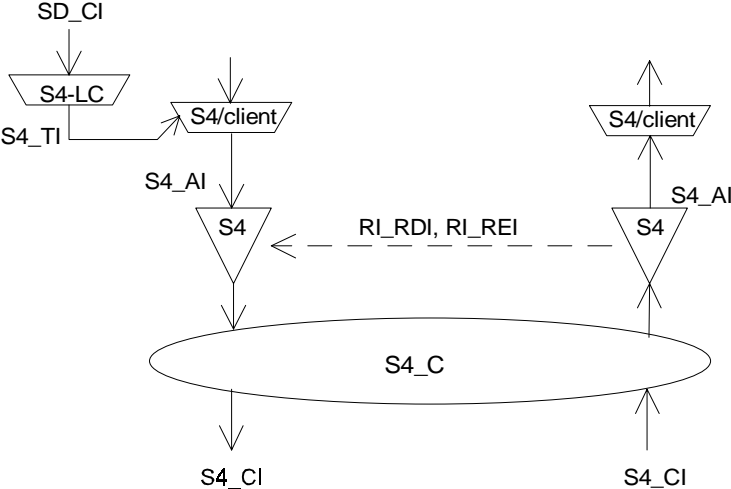
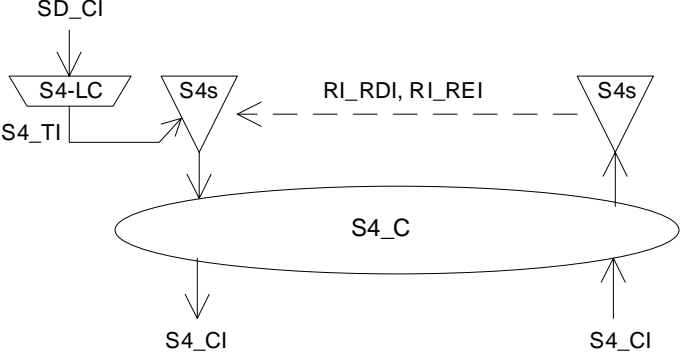
clause/ subclause	Title	state- ment
	 <p data-bbox="435 831 1222 857">Figure 1b: VC-4 Higher order Path layer atomic functions relevant for TEs</p>	
	 <p data-bbox="517 1272 1136 1299">Figure 1c: VC-4 Supervisory-unequipped relevant for TEs</p>	
	<p data-bbox="325 1355 1249 1406">The paragraphs "A VC-4 comprises one of the following payloads" up to and including Figure 5.</p>	N/R
4.1	VC-4 Layer Connection Function S4_C	N
4.1.1	SNC Protection	N/R
4.2	VC-4 Layer Trail Termination Functions	I
4.2.1	VC-4 Layer Trail Termination Source S4_TT_So	N
	Add to the process section:	
	"NOTE: The time taken for appearance of remote indication of defects and block errors at the leased line interface depends on the processing time of the equipment terminating the VC-4 and the round trip delay between that equipment and the leased line interface.	
4.2.2	VC-4 Layer Trail Termination Sink S4_TT_Sk	N
4.3	VC-4 Layer Adaptation Functions	I
4.3.1	VC-4 Layer to P4x Layer Adaptation Source S4/P4x_A_So	N/R
4.3.2	VC-4 Layer to P4x Layer Adaptation Sink S4/P4x_A_Sk	N/R
4.3.3	VC-4 Layer to P4e Layer Adaptation Source S4/P4e_A_So	N/R
4.3.4	VC-4 Layer to P4e Layer Adaptation Sink S4/P4e_A_Sk	N/R
4.3.5	VC-4 Layer to VC-3, VC-2, VC-12, and VC-11 Layer Compound Adaptation Source Function S4/SX_A_So	N
4.3.5.1	VC-4 Layer to TUG Adaptation Source Function S4/TUG_A_So	N
4.3.5.2	TUG Termination Source Function TUG_T_So	N
4.3.5.3	TUG to VC-3 Layer Adaptation Source Function TUG/S3_A_So/K.0.0	N

(continued)

Table 6 (continued): Application of ETS 300 417-4-1 [11]

clause/ subclause	Title	state- ment
4.3.5.4	TUG to VC-2 Layer Adaptation Source Function TUG/S2_A_So/K.L.0	N
4.3.5.5	TUG to VC-12 Layer Adaptation Source Function TUG/S12_A_So/K.L.M	N
4.3.5.6	TUG to VC-11 Layer Adaptation Source Function TUG/S11*_A_So/K.L.M	N/R
4.3.6	VC-4 Layer to VC-3, VC-2, VC-12, and VC-11 Layer Compound Adaptation Sink Function S4/SX_A_Sk	N
4.3.6.1	VC-4 Layer to TUG Adaptation Sink Function S4/TUG_A_Sk	N
4.3.6.2	TUG Termination Sink Function TUG_T_Sk	N
4.3.6.3	TUG to VC-3 Layer Adaptation Sink Function TUG/S3_A_Sk/K.0.0	N
4.3.6.4	TUG to VC-2 Layer Adaptation Sink Function TUG/S2_A_Sk	N
4.3.6.5	TUG to VC-12 Layer Adaptation Sink Function TUG/S12_A_Sk/K.L.M	N
4.3.6.6	TUG to VC-11 Layer Adaptation Sink Function TUG/S11*_A_Sk/K.L.M	N/R
4.3.7	VC-4 Layer to P0s Layer Adaptation Source S4/P0s_A_So	N/R
4.3.8	VC-4 Layer to P0s Layer Adaptation Sink S4/P0s_A_Sk	N/R
4.3.9	VC-4 Layer to DQDB Layer Adaptation Source S4/DQDB_A_So	N/R
4.3.10	VC-4 Layer to DQDB Layer Adaptation Sink S4/DQDB_A_Sk	N/R
4.3.11	VC-4 Layer to TSS1 Adaptation Source S4/TSS1_A_So	N/R
4.3.12	VC-4 Layer to TSS1 Adaptation Sink S4/TSS1_A_Sk	N/R
4.3.13	VC-4 Layer to ATM Virtual Path Layer Compound Adaptation Source function S4/Avp_A_So	N/R
4.3.14	VC-4 Layer to ATM Virtual Path Layer Compound Adaptation Sink function S4/Avp_A_Sk	N/R
4.3.15	VC-4 Layer Clock Adaptation Source S4-LC_A_So	N
4.4	VC-4 Layer Monitoring Functions	I
4.4.1	VC-4 Layer Non-intrusive Monitoring Function S4m_TT_Sk	N/R
4.4.2	VC-4 Layer Supervisory-Unequipped Termination Source S4s_TT_So	N
4.4.3	VC-4 Layer Supervisory-unequipped Termination Sink S4s_TT_Sk	N
4.5	VC-4 Layer Trail Protection Functions	N/R
4.6	VC-4 Tandem Connection Sublayer Functions	N/R
5	VC-3 Path Layer Functions Add at the beginning of the clause:  A TE shall use either the functions shown in figure 68a or figure 68b."  Replace figure 68 by:	N

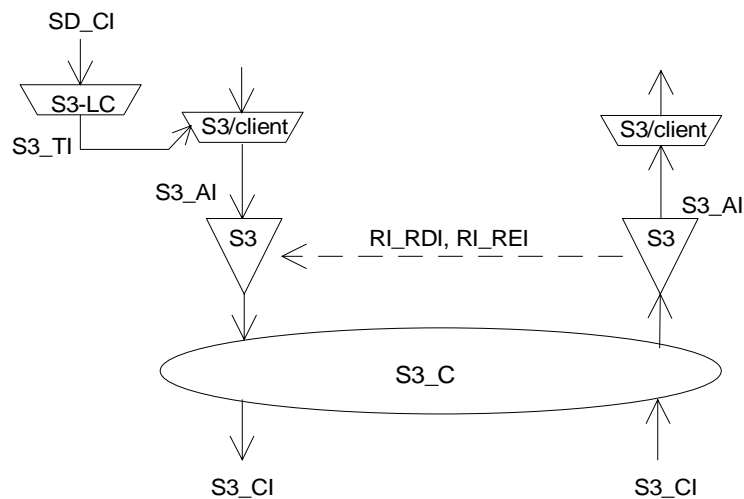
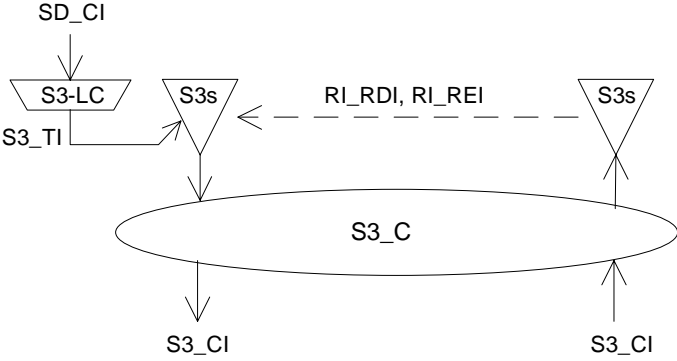

Figure 68a: VC-3 path layer atomic functions relevant for VC-3 connections

(continued)



Table 6 (continued): Application of ETS 300 417-4-1 [11]

clause/ subclause	Title	state- ment
	 <p data-bbox="598 701 1054 730">Figure 68b: VC-3 Supervisory-unequipped</p>	
	The paragraphs "A VC-3 comprises one of the following payloads" up to and including Figure 72.	N/R
5.1	VC-3 Layer Connection Function S3_C	N
5.1.1	SNC Protection	N/R
5.2	VC-3 Layer Trail Termination Functions	I
5.2.1	VC-3 Layer Trail Termination Source S3_TT_So Add to the process section: "NOTE: The time taken for appearance of remote indication of defects and block errors at the leased line interface depends on the processing time of the equipment terminating the VC-3 and the round trip delay between that equipment and the leased line interface.	N
5.2.2	VC-3 Layer Trail Termination Sink S3_TT_Sk	N
5.3	VC-3 Layer Adaptation Functions	I
5.3.3	VC-3 Layer to P31x Layer Adaptation Source S3/P31x_A_So	N/R
5.3.4	VC-3 Layer to P31x Layer Adaptation Sink S3/P31x_A_Sk	N/R
5.3.5	VC-3 Layer to P31e Layer Adaptation Source S3/P31e_A_So	N/R
5.3.6	VC-3 Layer to P31e Layer Adaptation Sink S3/P31e_A_Sk	N/R
5.3.7	VC-3 Layer to P0s Layer Adaptation Source S3/P0s_A_So	N/R
5.3.8	VC-3 Layer to P0s Layer Adaptation Sink S3/P0s_A_Sk	N/R
5.3.9	VC-3 Layer to TSS3 Adaptation Source S3/TSS3_A_So	N/R
5.3.10	VC-3 Layer to TSS3 Adaptation Sink S3/TSS3_A_Sk	N/R
5.3.11	VC-3 Layer to ATM Virtual Path Layer Compound Adaptation Source function S3/Avp_A_So	N/R
5.3.12	VC-3 Layer to ATM Virtual Path Layer Compound Adaptation Sink function S3/Avp_A_Sk	N/R
5.3.13	VC-3 Layer Clock Adaptation Source S3-LC_A_So	N
5.4	VC-3 Layer Monitoring Functions	I
5.4.1	VC-3 Layer Non-intrusive Monitoring Function S3m_TT_Sk	N/R
5.4.2	VC-3 Layer Supervisory-Unequipped Termination Source S3s_TT_So	N
5.4.3	VC-3 Layer Supervisory-unequipped Termination Sink S3s_TT_Sk	N
5.5	VC-3 Layer Trail Protection Functions	N/R
5.6	VC-3 Tandem Connection Sublayer Functions	N/R
6	VC-2 Path Layer Functions	N

(continued)

Table 6 (continued): Application of ETS 300 417-4-1 [11]

clause/ subclause	Title	state- ment
	<p>Add at the beginning of the clause: A TE shall use either the functions shown in figure 107a or figure 107b." Replace figure 107 by:</p>  <p>Figure 107a: VC-2 path layer atomic functions relevant for VC-2 connections</p>  <p>Figure 107b: VC-2 Supervisory-unequipped</p>	
	The paragraphs "A VC-2 comprises one of the following payloads" up to and including Figure 111.	N/R
6.1	VC-2 Layer Connection Function S2_C	N
6.1.1	SNC Protection	N/R
6.2	VC-2 Layer Trail Termination Functions	I
6.2.1	VC-2 Layer Trail Termination Source S2_TT_So	N
	Add to the process section: "NOTE: The time taken for appearance of remote indication of defects and block errors at the leased line interface depends on the processing time of the equipment terminating the VC-2 and the round trip delay between that equipment and the leased line interface."	
6.2.2	VC-2 Layer Trail Termination Sink S2_TT_Sk	N
6.3	VC-2 Layer Adaptation Functions	I
6.3.1	VC-2 Layer to TSS4 Adaptation Source S2/TSS4_A_So	N/R
6.3.2	VC-2 Layer to TSS4 Adaptation Sink S2/TSS4_A_Sk	N/R
6.3.3	VC-2 Layer to ATM Virtual Path Layer Compound Adaptation Source function S2/Avp_A_So	N/R
6.3.4	VC-2 Layer to ATM Virtual Path Layer Compound Adaptation Sink function S2/Avp_A_Sk	N/R
6.3.5	VC-2 Layer Clock Adaptation Source S2-LC_A_So	N/R
	(continued)	

Table 6 (continued): Application of ETS 300 417-4-1 [11]

clause/ subclause	Title	state- ment
6.4 6.4.1 6.4.2 6.4.3 6.5 6.6 7	VC-2 Layer Monitoring Functions VC-2 Layer Non-intrusive Monitoring Function S2m_TT_Sk VC-2 Layer Supervisory-Unequipped Termination Source S2s_TT_So VC-2 Layer Supervisory-unequipped Termination Sink S2s_TT_Sk VC-2 Layer Trail Protection Functions VC-2 Tandem Connection Sublayer Functions VC-12 Path Layer Functions Add at the beginning of the clause:  A TE shall use either the functions shown in figure 135a or figure 135b."  Replace figure 135 by:	N N/R N N N/R N/R N
	 <p>Figure 135a: VC-12 path layer atomic functions relevant for VC-12 connections</p>	
	 <p>Figure 135b: VC-12 Supervisory-unequipped</p>	
	The paragraphs "A VC-12 comprises one of the following payloads" up to and including Figure 139.	N/R
7.1	VC-12 Layer Connection Function S12_C	N
7.1.1	SNC Protection	N/R

(continued)

**Table 6 (concluded): Application of ETS 300 417-4-1 [11]**

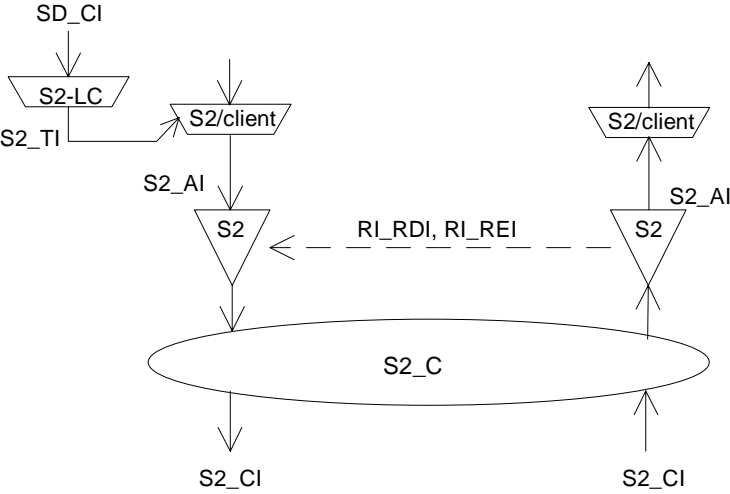
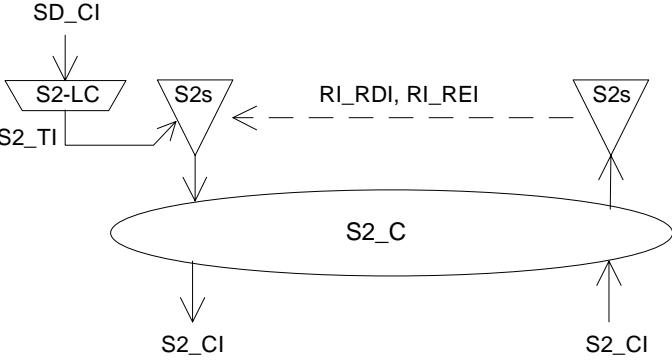
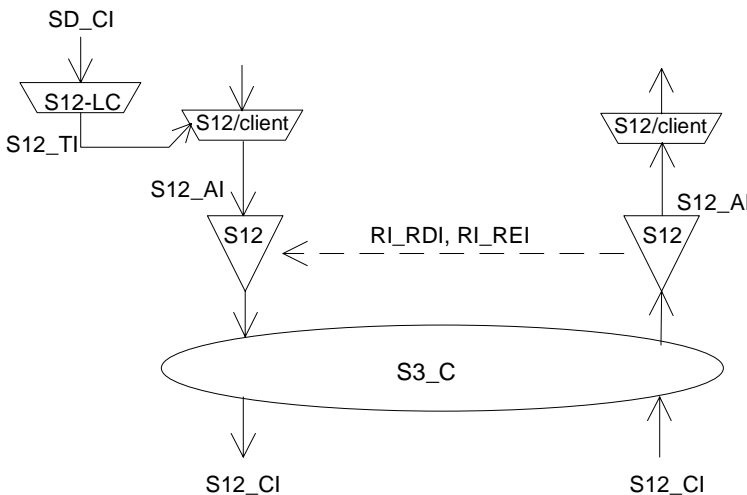
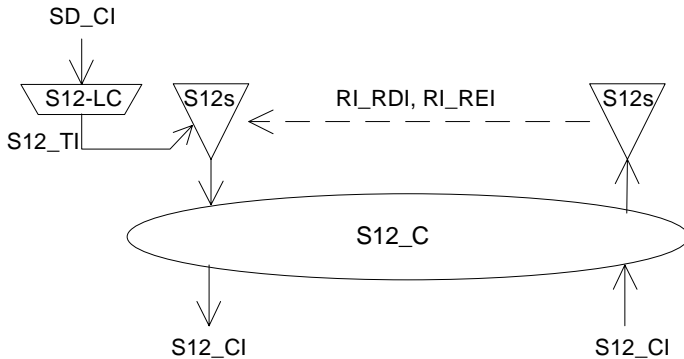
clause/ subclause	Title	state- ment
7.2	VC-12 Trail Termination Functions	I
7.2.1	VC-12 Trail Termination Source S12_TT_So Add to the process section: "NOTE: The time taken for appearance of remote indication of defects and block errors at the leased line interface depends on the processing time of the equipment terminating the VC-12 and the round trip delay between that equipment and the leased line interface.	N
7.2.2	VC-12 Trail Termination Sink S12_TT_Sk	N
7.3	VC-12 Adaptation Functions	I
7.3.1	VC-12 to P12x Adaptation Source S12/P12x_A_So	N/R
7.3.2	VC-12 to P12x Adaptation Sink S12/P12x_A_Sk	N/R
7.3.3	VC-12 to P12s Adaptation Source S12/P12s_A_So	N/R
7.3.3.1	Type 1 VC-12 to P12s Adaptation Source S12/P12s-b_A_So	N/R
7.3.3.2	Type 2 VC-12 to P12s Adaptation Source S12/P12s-a_A_So	N/R
7.3.4	VC-12 to P12s Adaptation Sink S12/P12s_A_Sk	N/R
7.3.4.1	Type 1 VC-12 to P12s Adaptation Sink S12/P12s-x_A_Sk	N/R
7.3.4.2	Type 2 VC-12 to P12s Adaptation Sink S12/P12s-b_A_Sk	N/R
7.3.4.3	Type 3 VC-12 to P12s Adaptation Sink S12/P12s-a_A_Sk	N/R
7.3.5	VC-12 to P0-31c Adaptation Source S12/P0-31c_A_So	N/R
7.3.6	VC-12 to P0-31c Adaptation Sink S12/P0-31c_A_Sk	N/R
7.3.7	VC-12 Layer to TSS4 Adaptation Source S12/TSS4_A_So	N/R
7.3.8	VC-12 Layer to TSS4 Adaptation Sink S12/TSS4_A_Sk	N/R
7.3.9	VC-12 Layer to ATM Virtual Path Layer Compound Adaptation Source function S12/Avp_A_So	N/R
7.3.10	VC-12 Layer to ATM Virtual Path Layer Compound Adaptation Sink function S12/Avp_A_Sk	N/R
7.3.11	VC-12 Layer Clock Adaptation Source S12-LC_A_So	N
7.4	VC-12 Layer Monitoring Functions	I
7.4.1	VC-12 Layer Non-intrusive Monitoring Function S12m_TT_Sk	N/R
7.4.2	VC-12 Layer Supervisory-Unequipped Termination Source S12s_TT_So	N
7.4.3	VC-12 Layer Supervisory-unequipped Termination Sink S12s_TT_Sk	N
7.5	VC-12 Layer Trail Protection Functions	N/R
7.6	VC-12 Tandem Connection Sublayer Functions	N/R
8	VC-4-4c Path Layer Functions	N/R
Annex A	Jitter/wander in justification processes	I
Annex B	SDH/PDH interconnection examples	N/R
Annex C	Interaction between 2 Mbit/s and VC 12 signals for the case of byte synchronous mapping	N/R
Annex D	Examples of linear trail and SNC protection models	N/R
Annex E	VC-3 to 44 736 kbit/s adaptation functions	N/R
Annex F	VC-11 Path Layer Functions	N/R

## 8 Application of ETS 300 417-6-1

The requirements of ETS 300 417-6-1 [12] shall be applied except as indicated in tables 7 and 8, where N = Normative, I = Informative, and N/R = Not Relevant.

**Table 7: Global differences with respect to ETS 300 417-6-1 [12]**

clause/ subclause	Title	state- ment
All	All management information "..._MI_..." in the tables for input and output tables.	N/R
All	Defect correlations	N/R
All	Performance monitoring	N/R

Table 8: Application of ETS 300 417-6-1 [12]

clause/ subclause	Title	state- ment
	Foreword	I
1	Scope	I
2	Normative references	N
3	Definitions, abbreviations and symbols	N
3.1	Definitions	N
3.2	Abbreviations	N
3.3	Symbols and diagrammatic conventions	N
3.4	Introduction	I
4	Synchronization principles	I
5	Synchronization Distribution Layer atomic functions	I
6	Network Synchronization Layer atomic functions	N/R
7	Transport layer to SD layer atomic function	I
7.1	STM-1 Multiplex Section Adaptation Functions	N
7.2	STM-4 Multiplex Section Adaptation Functions	N
7.3	STM-16 Multiplex Section Adaptation Functions	N/R
7.4	P31s Adaptation Functions	N/R
7.5	P4s Adaptation Functions	N/R
7.6	P12s Layer Adaptation Functions	N/R
7.7	T12 Layer Adaptation Functions	N/R
8	Equipment clock to transport layers clock adaptation functions	I
8.1	STM-N layer	I
8.1.1	STM-1 Layer Clock Adaptation Source MS1-LC_A_So Delete the jitter limiter section	N
8.1.2	STM-4 Layer Clock Adaptation Source MS4-LC_A_So Delete the jitter limiter section	N
8.1.3	STM-16 Layer Clock Adaptation Source MS16-LC_A_So	N/R
8.2	VC layers	I
8.2.1	VC-4 Layer Clock Adaptation Source S4-LC_A_So	N
8.2.2	VC-3 Layer Clock Adaptation Source S3-LC_A_So	N
8.2.3	VC-2 Layer Clock Adaptation Source S2-LC_A_So	N
8.2.4	VC-12 Layer Clock Adaptation Source S12-LC_A_So	N
8.2.5	VC-11 Layer Clock Adaptation Source S11-LC_A_So	N/R
8.3	Pxx layers	N/R
8.4	T12 layer	N/R
Annex A	Synchronization Selection Process	N/R
Annex B	Transport layer models for synchronization information	N/R
Annex C	Examples of Network Synchronization	N/R
Annex D	Examples of Synchronization functionality in the NE	N/R
Annex E	Delay time allocation	N/R
Annex F	Overview of inputs/outputs to the atomic functions	N/R

---

## Annex A (informative): Bibliography

- MI/EE-2004: "Earthing for functional and safety aspects and bonding techniques of information technology equipment inside a subscriber s building".
- ETS 300 417-2-3: "Transmission and Multiplexing (TM); Generic functional requirements of transport functionality of equipment; Part 2-3: SDH and PDH physical section layer functions; Abstract test suite (ATS)".
- ETS 300 417-3-3: "Transmission and Multiplexing (TM); Generic functional requirements of transport functionality of equipment; Part 3-3: STM-N regenerator and multiplex section layer functions; Abstract test suite (ATS)".
- ETS 300 417-4-3 "Transmission and Multiplexing (TM); Generic functional requirements of transport functionality of equipment; Part 4-3: SDH path layer functions; Abstract test suite (ATS)".
- ETS 300 417-6-3 "Transmission and Multiplexing (TM); Generic functional requirements of transport functionality of equipment; Part 6-3: Synchronization layer functions; Abstract test suite (ATS)".

---

## History

<b>Document history</b>		
V1.1.1	March 1998	Public Enquiry PE 9829: 1998-03-20 to 1998-07-17