

**Electromagnetic compatibility
and Radio spectrum Matters (ERM);
Short Range Devices;
Road Transport and Traffic Telematics (RTTT);
Radar equipment operating in the 76 GHz to 77 GHz range;
Part 1: Technical characteristics and test methods for
radar equipment operating in the 76 GHz to 77 GHz range**



Reference

REN/ERM-TG31B-047-1

Keywords

radar, radio, testing, SRD, RTTT, short range

ETSI

650 Route des Lucioles
F-06921 Sophia Antipolis Cedex - FRANCE

Tel.: +33 4 92 94 42 00 Fax: +33 4 93 65 47 16

Siret N° 348 623 562 00017 - NAF 742 C
Association à but non lucratif enregistrée à la
Sous-Préfecture de Grasse (06) N° 7803/88

Important notice

Individual copies of the present document can be downloaded from:

<http://www.etsi.org>

The present document may be made available in more than one electronic version or in print. In any case of existing or perceived difference in contents between such versions, the reference version is the Portable Document Format (PDF). In case of dispute, the reference shall be the printing on ETSI printers of the PDF version kept on a specific network drive within ETSI Secretariat.

Users of the present document should be aware that the document may be subject to revision or change of status. Information on the current status of this and other ETSI documents is available at

<http://portal.etsi.org/tb/status/status.asp>

If you find errors in the present document, send your comment to:

editor@etsi.org

Copyright Notification

Reproduction is only permitted for the purpose of standardization work undertaken within ETSI.
The copyright and the foregoing restrictions extend to reproduction in all media.

© European Telecommunications Standards Institute 2004.
All rights reserved.

DECT™, **PLUGTESTS™** and **UMTS™** are Trade Marks of ETSI registered for the benefit of its Members.
TIPHON™ and the **TIPHON logo** are Trade Marks currently being registered by ETSI for the benefit of its Members.
3GPP™ is a Trade Mark of ETSI registered for the benefit of its Members and of the 3GPP Organizational Partners.

Contents

Intellectual Property Rights	6
Foreword.....	6
1 Scope	7
2 References	7
3 Definitions, symbols and abbreviations	8
3.1 Definitions	8
3.2 Symbols.....	10
3.3 Abbreviations	10
4 Technical requirements specifications	11
4.1 Presentation of equipment for testing purposes.....	11
4.1.1 Choice of model for testing	11
4.2 Mechanical and electrical design.....	11
4.3 Auxiliary test equipment	11
4.4 Interpretation of the measurement results	11
5 Test conditions, power sources and ambient temperatures	12
5.1 Normal and extreme test conditions	12
5.2 External test power source.....	12
5.3 Normal test conditions.....	12
5.3.1 Normal temperature and humidity	12
5.3.2 Normal test power source	12
5.3.2.1 Mains voltage	12
5.3.2.2 Other power sources.....	12
5.4 Extreme test conditions	13
5.4.1 Extreme temperatures	13
5.4.1.1 Procedure for tests at extreme temperatures.....	13
5.4.1.2 Extreme temperature ranges.....	13
5.4.2 Extreme test source voltages.....	13
5.4.2.1 Mains voltage	13
5.4.2.2 Other power sources.....	13
6 General conditions.....	13
6.1 Test fixture	13
6.1.1 Calibration	14
6.1.2 General requirements for RF cables and waveguides	15
6.1.3 Shielded anechoic chamber.....	15
7 Methods of measurement and limits for transmitter parameters	16
7.1 Permitted range of operating frequencies	17
7.1.1 Definition.....	17
7.1.2 Method of measurement	17
7.1.3 Limits.....	17
7.2 Radiated spatial power density	18
7.2.1 Definition.....	18
7.2.2 Method of measurement	18
7.2.2.1 Equipment with a fixed beam antenna (i.e. non-steerable by either mechanical or electronic means)	18
7.2.2.2 Equipment with (electronically or mechanically) steerable antenna(s).....	18
7.2.3 Limits.....	19
7.2.3.1 Equipment with fixed beam antenna	19
7.2.3.2 Equipment with (electronically or mechanically) steerable antennas	19
7.3 Out-of-band emissions	19
7.3.1 Definitions	19
7.3.2 Measuring receiver	19
7.3.3 Method of measurement	20

7.3.4	Limits.....	20
7.4	Radiated spurious	21
7.4.1	Definition.....	21
7.4.2	Measuring receiver	21
7.4.3	Method of measurement for radiated spurious.....	21
7.4.4	Limits.....	22
8	Receiver.....	22
8.1	Receiver spurious and out-of-band emissions	22
8.1.1	Definition.....	22
8.1.2	Method of measurement - radiated spurious and out-of-band emissions.....	22
8.1.3	Limit	23
9	Measurement uncertainty	23
Annex A (normative): Radiated measurements		24
A.1	Test sites and general arrangements for measurements involving the use of radiated fields.....	24
A.1.1	Open Area Test Site (OATS)	24
A.1.2	Test antenna.....	25
A.1.3	Standard position.....	25
A.1.4	Indoor Test Site	25
A.2	Guidance on the use of radiation test sites	26
A.2.1	Measuring distance.....	26
A.2.2	Test antenna.....	26
A.2.3	Substitution antenna	27
A.2.4	Auxiliary cables.....	27
A.3	Alternative test site using a fully anechoic RF chamber	27
A.3.1	Example of the construction of a shielded anechoic chamber	27
A.3.2	Influence of parasitic reflections in anechoic chambers.....	28
A.3.3	Calibration of the shielded RF anechoic chamber	28
Annex B (normative): General description of measurement methods.....		30
B.1	Radiated measurements.....	30
Annex C (informative): Maximum safe level of radiated power density.....		32
C.1	Definition	32
C.2	Method of measurement.....	32
C.2.1	Equipment with a fixed beam antenna(s) (i.e. non-steerable by either mechanical or electronic means)	32
C.2.2	Equipment with (electronically or mechanically) steerable antenna	32
C.3	Limit.....	32
Annex D (informative): Examples of modulation schemes.....		33
D.1	Pulse modulation	33
D.1.1	Definition	33
D.1.2	Typical operating parameters	33
D.2	Frequency modulated continuous wave	34
D.2.1	Definition	34
D.2.2	Typical operating parameters	34
D.3	Frequency Shift Keying (FSK).....	35
D.3.1	Definition	35
D.3.2	Typical operating parameters	36
D.4	PN-ASK (Pseudo-Noise Amplitude Shift Keying) 77 GHz.....	36
D.4.1	Definition	36
D.4.2	Typical operating parameters	37
Annex E (informative): Conversion of power density to e.i.r.p.....		38

E.1 Assumptions	38
E.2 Example	38
Annex F (informative): Bibliography	39
History	40

Intellectual Property Rights

IPRs essential or potentially essential to the present document may have been declared to ETSI. The information pertaining to these essential IPRs, if any, is publicly available for **ETSI members and non-members**, and can be found in ETSI SR 000 314: "*Intellectual Property Rights (IPRs); Essential, or potentially Essential, IPRs notified to ETSI in respect of ETSI standards*", which is available from the ETSI Secretariat. Latest updates are available on the ETSI Web server (<http://webapp.etsi.org/IPR/home.asp>).

Pursuant to the ETSI IPR Policy, no investigation, including IPR searches, has been carried out by ETSI. No guarantee can be given as to the existence of other IPRs not referenced in ETSI SR 000 314 (or the updates on the ETSI Web server) which are, or may be, or may become, essential to the present document.

Foreword

This European Standard (Telecommunications series) has been produced by ETSI Technical Committee Electromagnetic compatibility and Radio spectrum Matters (ERM), and is now submitted for the ETSI standards One-step Approval Procedure.

For non EU countries the present document may be used for regulatory (Type Approval) purposes.

Where equipment compliant with the present document is intended for fitment into vehicles, then it is subject to automotive EMC type approval and has to comply with directive 95/54/EC [6]. For use on vehicles outside the scope of 95/54/EC [6] compliance with an EMC directive/standard appropriate for that use is required.

The present document is part 1 of a multi-part deliverable covering Electromagnetic compatibility and Radio spectrum Matters (ERM); Short Range Devices; Road Transport and Traffic Telematics (RTTT); Radar equipment operating in the 76 GHz to 77 GHz range, as identified below:

- Part 1: "Technical characteristics and test methods for radar equipment operating in the 76 GHz to 77 GHz range";**
- Part 2: "Harmonized EN covering essential requirements of article 3.2 of the R&TTE Directive".

Proposed national transposition dates	
Date of latest announcement of this EN (doa):	3 months after ETSI publication
Date of latest publication of new National Standard or endorsement of this EN (dop/e):	6 months after doa
Date of withdrawal of any conflicting National Standard (dow):	6 months after doa

1 Scope

The present document specifies the requirements for Short Range Devices (SRD) operating in the frequency range from 76 GHz to 77 GHz intended for Road Transport and Traffic Telematics (RTTT) applications such as Automotive Cruise Control (ACC), Collision Warning (CW), Anti-Collision (AC) systems, obstacle detection, Stop and Go, blind spot detection, parking aid, backup aid and other automotive applications.

The document applies to:

- a) transmitters operating in range from 76 GHz to 77 GHz;
- b) receivers operating in the range from 76 GHz to 77 GHz.

The present document contains the technical characteristics and test methods for radar equipment fitted with integral antennas operating in the frequency range from 76 GHz to 77 GHz and references CEPT/ERC/ECC Recommendation for SRDs, CEPT/ERC/ECC Recommendation 70-03 [1] and CEPT/ECC Decision (02)01 [2].

The present document does not necessarily include all the characteristics which may be required by a user, nor does it necessarily represent the optimum performance achievable.

The present document covers radars for mobile applications in the frequency range from 76 GHz to 77 GHz. It covers integrated transceivers and separate transmit/receive modules.

The present document covers only equipment for road vehicles.

NOTE: It is necessary for the equipment to comply with the current regulations regarding safe levels for radiated power. Information is given in the informative annex C.

2 References

The following documents contain provisions which, through reference in this text, constitute provisions of the present document.

- References are either specific (identified by date of publication and/or edition number or version number) or non-specific.
- For a specific reference, subsequent revisions do not apply.
- For a non-specific reference, the latest version applies.

Referenced documents which are not found to be publicly available in the expected location might be found at <http://docbox.etsi.org/Reference>.

- [1] CEPT/ERC Recommendation 70-03 (Latest edition): "Relating to the use of Short Range Devices (SRD)".
- [2] CEPT/ECC/DEC(02)01: "ECC Decision of 15 March 2002 on the frequency bands to be designated for the coordinated introduction of Road Transport and Traffic Telematic Systems".
- [3] CISPR 16-1: "Specifications for radio disturbance and immunity measuring apparatus and methods; Part 1: Radio disturbance and immunity measuring apparatus".
- [4] ETSI TR 100 028 (all parts): "Electromagnetic compatibility and Radio spectrum Matters (ERM); Uncertainties in the measurement of mobile radio equipment characteristics".
- [5] Council Recommendation 1999/519/EC of 12 July 1999 on the limitation of exposure of the general public to electromagnetic fields (0 Hz to 300 GHz).

- [6] Commission Directive 95/54/EC of 31 October 1995 adapting to technical progress Council Directive 72/245/EEC on the approximation of the laws of the Member States relating to the suppression of radio interference produced by spark-ignition engines fitted to motor vehicles and amending Directive 70/156/EEC on the approximation of the laws of the Member States relating to the type-approval of motor vehicles and their trailers.
- [7] ETSI TR 102 273-2: "Electromagnetic compatibility and Radio spectrum Matters (ERM); Improvement on Radiated Methods of Measurement (using test site) and evaluation of the corresponding measurement uncertainties; Part 2: Anechoic chamber".
- [8] CEPT/ERC Recommendation 01-06: "Procedure for mutual recognition of type testing approval for radio equipment".

3 Definitions, symbols and abbreviations

3.1 Definitions

For the purposes of the present document, the following terms and definitions apply:

antenna scan duty factor: ratio of the area of the beam (measured at its 3 dB point) to the total area scanned by the antenna (as measured at its 3 dB point)

assigned frequency band: frequency band within which the device is authorized to operate

associated antenna: antenna and all its associated components which are designed as an indispensable part of the equipment

average time: time interval on which a mean measurement is integrated

blanking period: time period where no intentional emission occurs

channel dwell duty: ratio of the time of uninterrupted continuous transmission within a given frequency channel to the channel repetition interval (= channel dwell time/channel repetition interval)

channel dwell time: accumulated amount of transmission time of uninterrupted continuous transmission within a single given frequency channel and within one channel repetition interval

duty cycle: the ratio of the total on time of the "message" to the total off-time in any one hour period

Equipment Under Test (EUT): radar sensor including the integrated antenna together with any external antenna components which affect or influence its performance

equivalent isotropically radiated power (e.i.r.p.): total power or power density transmitted, assuming an isotropic radiator

NOTE: e.i.r.p. is conventionally the product of "power or power density into the antenna" and "antenna gain".
e.i.r.p. is used for both peak or average power and peak or average power density.

equivalent pulse power duration: duration of an ideal rectangular pulse which has the same content of energy compared with the pulse shape of the EUT with pulsed modulation or time gating

far field measurements: distance "X" should be a minimum of $2d^2/\lambda$, where d = largest dimension of the antenna aperture of the EUT

maximum safe level for radiated power density: level which can be transmitted in accordance with the current recommended safety levels in EN 50166-2 should be done on the vehicle

mean power: supplied from the antenna during an interval of time sufficiently long compared with the lowest frequency encountered in the modulation taken under normal operating conditions (see Radio Regulations [8])

NOTE: For pulsed systems the mean power is equal the peak envelope power multiplied by the time gating duty factor. For CW systems without further time gating the mean power is equal the transmission power without modulation.

on-off gating: methods of transmission with fixed or randomly quiescent period that is much larger than the PRF

operating frequency (operating centre frequency): nominal frequency at which equipment is operated

NOTE: Equipment may be able to operate at more than one operating frequency.

operating frequency range: range of operating frequencies over which the equipment can be adjusted through switching or reprogramming or oscillator tuning

NOTE 1: For pulsed or phase shifting systems without further carrier tuning the operating frequency range is fixed on a single carrier line.

NOTE 2: For analogue or discrete frequency modulated systems (FSK, FMCW) the operating frequency range covers the difference between minimum and maximum of all carrier frequencies on which the equipment can be adjusted.

peak envelope power: mean power (round mean square for sinusoidal carrier wave type) supplied from the antenna during one radio frequency cycle at the crest of the modulation envelope taken under normal operating conditions (see Radio Regulations)

Power Spectral Density (PSD): ratio of the amount of power to the used radio measurement bandwidth

NOTE: It is expressed in units of dBm/Hz or as a power in unit dBm with respect to the used bandwidth. In case of measurement with a spectrum analyser the measurement bandwidth is equal the RBW.

Pulse Repetition Frequency (PRF): inverse of the Pulse Repetition Interval, averaged over a time sufficiently long as to cover all PRI variations

Pulse Repetition Interval (PRI): time between the rising edges of the transmitted (pulsed) output power

quiescent period: time instant where no emission occurs

radiated spurious emissions: emissions at frequencies other than those of the carrier and sidebands associated with normal modulation

radome: external protective cover which is independent of the associated antenna, and which may contribute to the overall performance of the antenna (and hence, the EUT)

spatial radiated power density: power per unit area normal to the direction of the electromagnetic wave propagation

NOTE: It is expressed in units of W/m².

spread spectrum: modulation technique in which the energy of a transmitted signal is spread throughout a large portion

3.2 Symbols

For the purposes of the present document, the following symbols apply:

λ	Wavelength
1/P	repetition rate of the modulation wave form
ac	alternating current
B	Bandwidth
d	largest dimension of the antenna aperture
D	antenna scan Duty factor
dB	decibel
dBi	gain in decibels relative to an isotropic antenna
df	spectral distance between 2 lines with similar power levels
Δf_{\max}	maximum frequency shift between any two frequency steps
Δf_{\min}	minimum frequency shift between any two frequency steps
E	Field strength
E_o	Reference field strength
G	Blank time period
P	Period of time during in which one cycle of the modulation wave form is completed
P_a	mean power within the BW
P_L	Power of an individual spectral Line
P_{rad}	Radiated power
R	distance
R_o	Reference distance
τ	Pulse width
T_c	Chip period

3.3 Abbreviations

For the purposes of the present document, the following abbreviations apply:

ASK	Amplitude Shift Keying
CW	Continuous Wave
DSS	Direct Sequence Signal
e.i.r.p.	equivalent isotropically radiated power
ECC	Electronic Communications Committee
EMC	ElectroMagnetic Compatibility
ERC	European Radiocommunication Committee
EUT	Equipment Under Test
FM	Frequency Modulation
FMCW	Frequency Modulated Continuous Wave
FMICW	Frequency Modulated Interrupted Continuous Wave
FSK	Frequency Shift Keying
FSK	Frequency Shift Keying
IF	Intermediate Frequency
IFSK	Interrupted Frequency Shift Keying
OATS	Open Area Test Site
PN	Pseudo Noise
PRF	Pulse Repetition Frequency
PRI	Pulse Repetition Interval
R&TTE	Radio and Telecommunications Terminal Equipment
RBW	Resolution BandWidth
RF	Radio Frequency
RMS	Root Mean Square
Rx	Receiver
SRD	Short Range Device
Tx	Transmitter
VSWR	Voltage Standing Wave Ratio

4 Technical requirements specifications

4.1 Presentation of equipment for testing purposes

Each equipment submitted for testing, where applicable, shall fulfil the requirements of the present document on all frequencies over which it is intended to operate. EMC type approval testing to Directive 95/54/EEC [6] shall be done on the vehicle.

The provider shall provide one or more samples of the equipment, as appropriate for testing.

Additionally, technical documentation and operating manuals, sufficient to allow testing to be performed, shall be supplied.

The performance of the equipment submitted for testing shall be representative of the performance of the corresponding production model. In order to avoid any ambiguity in that assessment, the present document contains instructions for the presentation of equipment for testing purposes, conditions of testing (see clause 5) and the measurement methods (see clauses 7 and 8).

Stand alone equipment for testing shall be offered by the provider complete with any ancillary equipment needed for testing. The provider shall declare the frequency range(s), the range of operation conditions and power requirements, as applicable, in order to establish the appropriate test conditions.

The EUT will comprise the sensor, antenna and radome if needed and will be tested as a stand alone assembly. The EUTs test fixtures may be supplied by the provider to facilitate the tests (see clause 6.1).

These clauses are intended to give confidence that the requirements set out in the document have been met without the necessity of performing measurements on all frequencies.

4.1.1 Choice of model for testing

If an equipment has several optional features, considered not to affect the RF parameters then the tests need only to be performed on the equipment configured with that combination of features considered to be the most complex, as proposed by the provider and agreed by the test laboratory.

4.2 Mechanical and electrical design

The equipment submitted by the provider shall be designed, constructed and manufactured in accordance with good engineering practice and with the aim of minimizing harmful interference to other equipment and services.

Transmitters and receivers may be individual or combination units.

4.3 Auxiliary test equipment

All necessary test signal sources and set-up information shall accompany the equipment when it is submitted for testing.

4.4 Interpretation of the measurement results

The interpretation of the results recorded on the appropriate test report for the measurements described in the present document shall be as follows:

- the measured value relating to the corresponding limit shall be used to decide whether an equipment meets the requirements of the present document;
- the measurement uncertainty value for the measurement of each parameter shall be included in the test report;
- the recorded value of the measurement uncertainty shall, for each measurement, be equal to, or lower than, the figures in the table of measurement uncertainty (see clause 9).

5 Test conditions, power sources and ambient temperatures

5.1 Normal and extreme test conditions

Testing shall be made under normal test conditions, and also, where stated, under extreme test conditions.

The test conditions and procedures shall be as specified in clauses 5.2 to 5.4.

5.2 External test power source

During tests the power source of the equipment shall be an external test power source, capable of producing normal and extreme test voltages as specified in clauses 5.3.2 and 5.4.2. The internal impedance of the external test power source shall be low enough for its effect on the test results to be negligible.

The test voltage shall be measured at the point of connection of the power cable to the equipment.

During tests the external test power source voltages shall be within a tolerance of ± 1 % relative to the voltage at the beginning of each test. The level of this tolerance can be critical for certain measurements. Using a smaller tolerance provides a reduced uncertainty level for these measurements.

5.3 Normal test conditions

5.3.1 Normal temperature and humidity

The normal temperature and humidity conditions for tests shall be any convenient combination of temperature and humidity within the following ranges:

- temperature: $+15^{\circ}\text{C}$ to $+35^{\circ}\text{C}$;
- relative humidity: 20 % to 75 %.

When it is impracticable to carry out tests under these conditions, a note to this effect, stating the ambient temperature and relative humidity during the tests, shall be added to the test report.

5.3.2 Normal test power source

The internal impedance of the test power source shall be low enough for its effect on the test results to be negligible. For the purpose of the tests, the voltage of the external test power source shall be measured at the input terminals of the equipment.

5.3.2.1 Mains voltage

The normal test voltage for equipment shall be the nominal mains voltage. For the purpose of the present document, the nominal voltage shall be the declared voltage, or any of the declared voltages, for which the equipment was designed.

The frequency of the test power source corresponding to the ac mains shall be between 49 Hz and 51 Hz.

5.3.2.2 Other power sources

For operation from other power sources the normal test voltage shall be that declared by the provider. Such values shall be stated in the test report.

5.4 Extreme test conditions

5.4.1 Extreme temperatures

5.4.1.1 Procedure for tests at extreme temperatures

Before measurements are made, the equipment shall have reached thermal balance in the test chamber. The equipment shall not be switched off during the temperature stabilizing period.

If the thermal balance is not checked by measurements, a temperature stabilizing period of at least one hour, or such period as may be decided by the accredited test laboratory, shall be allowed. The sequence of measurements shall be chosen, and the humidity content in the test chamber shall be controlled so that excessive condensation does not occur.

5.4.1.2 Extreme temperature ranges

For tests at extreme temperatures, measurements shall be made in accordance with the procedures specified in clause 5.4.1.1, at the upper and lower temperatures of the following limits:

- temperature: -20°C to $+55^{\circ}\text{C}$.

5.4.2 Extreme test source voltages

5.4.2.1 Mains voltage

The extreme test voltages for equipment to be connected to an ac mains source shall be the nominal mains voltage $\pm 10\%$.

5.4.2.2 Other power sources

For equipment using other power sources, or capable of being operated from a variety of power sources, the extreme test voltages shall be that declared by the provider. These shall be recorded in the test report.

6 General conditions

Detailed descriptions of the radiated measurement arrangements are included in annexes A and B. In general, measurements should be carried out under far field conditions; however, relative power measurements in the 76 GHz to 77 GHz frequency band could be carried out in the near field by using the test fixture as described in clause 6.1 and shown in figure 1.

The far field condition for the EUTs is considered to be fulfilled in a minimum radial distance "X" that shall be a minimum of $2d^2/\lambda$, where d = largest dimension of the antenna aperture of the EUT, for a single device measurement.

Absolute power measurements shall be made only in the far field. This prohibits the use of the test fixture shown in figure 1.

Each test site shall meet the appropriate requirements as defined in published guidelines/standards (e.g. for OATS, the requirements are defined in CISPR 16-1 [3]).

6.1 Test fixture

The test fixture for radio equipment operating in the 76 GHz to 77 GHz range enables the EUT to be physically supported, together with a wave guide horn antenna (which is used to couple/sample the transmitted energy), in a fixed physical relationship. The test fixture shall be designed for use in an anechoic environment and allows certain measurements to be performed in the near field. Only relative or comparative measurements may be performed, and only those at the frequencies in the 76 GHz to 77 GHz band over which the test fixture has been calibrated. A sketch of a test fixture is depicted in figure 1.

The test fixture incorporates at least one 50 Ω RF connector and a device for electromagnetic coupling to the EUT. It incorporates a means for repeatable positioning of the EUT. Its compactness enables the whole assembly to be accommodated within a test chamber, usually a climatic facility. Only after it has been verified that the test fixture does not affect performance of the EUT, can the EUT be confidently tested.

At set-up, the EUT shall be aligned in the test fixture so that the maximum power is detected at the coupled output. Orientation of the horn antenna will take into account the polarization of the EUT.

In addition, the test fixture shall provide a connection to an external power supply.

The test fixture shall be provided by the provider together with a full description, which shall meet the approval of the selected accredited test laboratory.

The performance characteristics of the test fixture shall be measured and shall be approved by the accredited test laboratory. It shall conform to the following basic parameters:

- the gain of the waveguide horn shall not exceed 20 dB;
- the physical distance between the front face of the EUT and the waveguide horn shall be between 50 cm and 60 cm;
- the physical height between the centre of the EUT and the supporting structure of the test fixture shall be between 50 cm and 60 cm;

NOTE: Information on uncertainty contributions, and verification procedures are detailed in clauses 5 and 6, respectively, of TR 102 273-2 [7].

- circuitry associated with the RF coupling shall contain no active or non-linear devices;
- the Voltage Standing Wave Ratio (VSWR) at the waveguide flange at which measurements are made shall not be greater than 1,5: 1 over the frequency range of the measurements;
- the performance of the test fixture when mounted in the anechoic environment, on an open test site, or in a temperature chamber, shall be unaffected by the proximity of surrounding objects or people outside the environment. The performance shall be reproducible if the EUT is removed and then replaced;
- the performance of the test fixture shall remain within the defined limits of the calibration report, when the test conditions are varied over the limits described in clauses 5.3 and 5.4.

6.1.1 Calibration

The calibration of the test fixture establishes the relationship between the detected output from the test fixture, and the transmitted power (as sampled at the position of the antenna) from the EUT in the test fixture. This can be achieved by using a calibrated horn with a gain of equal to or less than 20 dB, fed from an external signal source, in place of the EUT to determine the variations in detected power with temperature and over frequency.

The calibration of the test fixture shall be carried out by either the provider or the accredited test laboratory. The results shall be approved by the accredited test laboratory.

The calibration should be carried out over the operating frequency band, at least three frequencies, for the declared polarization of the EUT, and over the temperature ranges specified in clause 5.4.1.2.

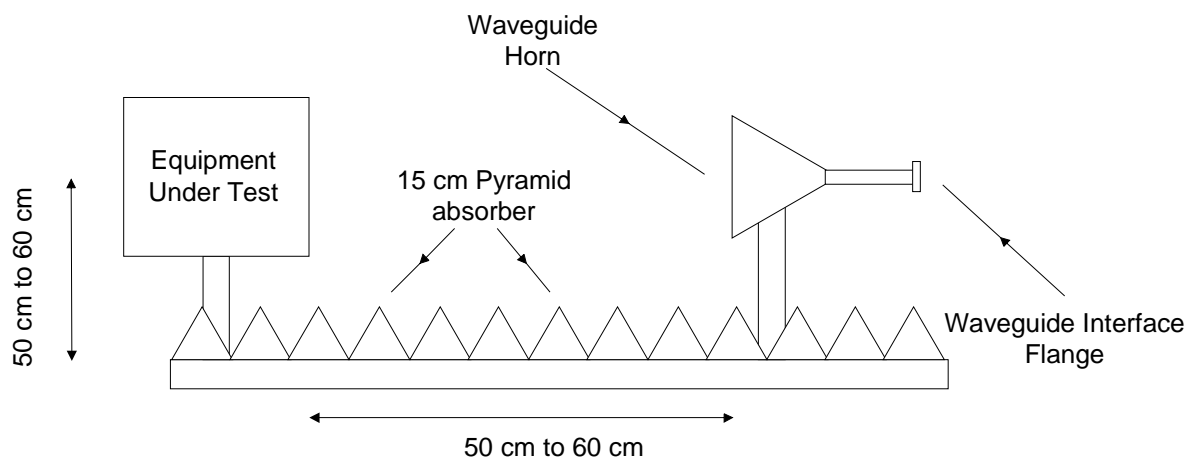

Figure 1: Test fixture

6.1.2 General requirements for RF cables and waveguides

All RF cables or waveguide interconnects, including their connectors at both ends, used within the measurement arrangements and set-ups shall adhere to the following characteristics:

- a nominal characteristic impedance of 50 Ω ;
- a VSWR of less than 1,5 at either end;
- a shielding loss in excess of 60 dB.

All RF cables exposed to radiation shall be loaded with ferrite beads spaced at distance D_{fb} apart from each other along the entire length of the cable. Such cables are referred to as ferrited cables. The distance D_{fb} shall be smaller than half of the signal wavelength under test.

All RF cables and waveguide interconnects shall be routed suitably in order to reduce impacts on antenna radiation pattern, antenna gain, antenna impedance.

NOTE: Further details are provided in TR 102 273-2 [7].

6.1.3 Shielded anechoic chamber

A recommended test environment to be used as a test site is the shielded anechoic chamber.

A typical anechoic chamber is shown in figure 2. This type of test chamber attempts to simulate free space conditions.

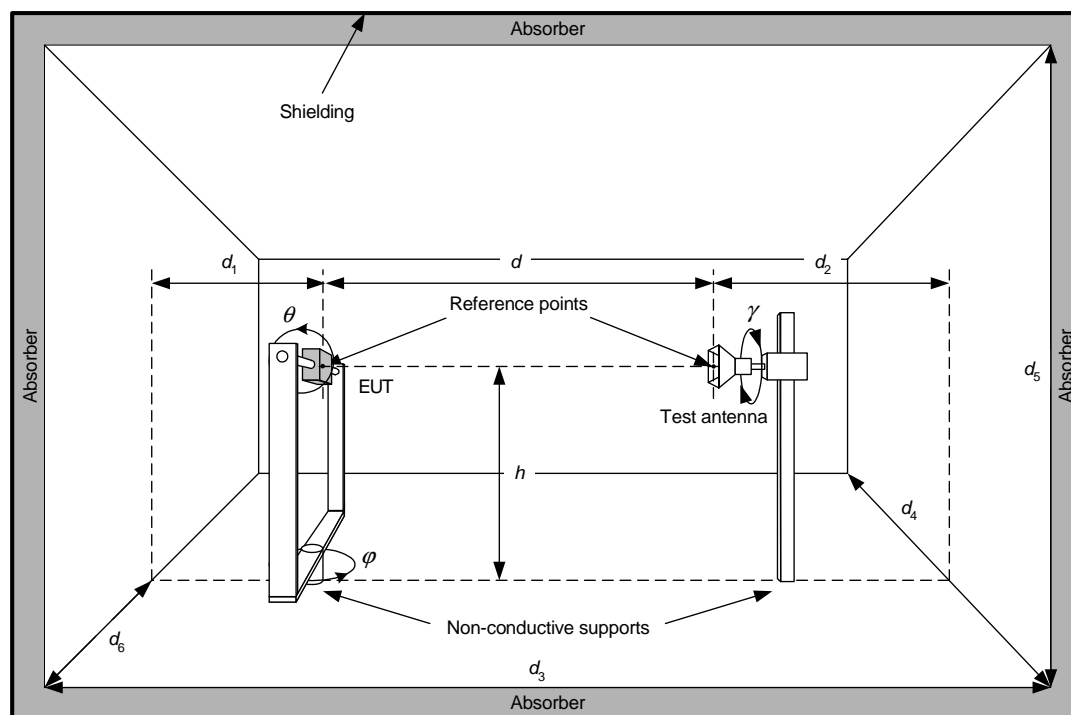

Figure 2: Typical anechoic chamber

The chamber contains suitable antenna supports on both ends.

The supports carrying the test antenna and EUT shall be made of a non-permeable material featuring a low value of its relative permittivity.

The anechoic chamber shall be shielded. Internal walls, floor and ceiling shall be covered with radio absorbing material. The shielding and return loss for perpendicular wave incidence vs. frequency in the measurement frequency range shall meet:

- 105 dB shielding loss;
- 30 dB return loss.

Both absolute and relative measurements can be performed in an anechoic chamber. Where absolute measurements are to be carried out the chamber shall be verified. The shielded anechoic chamber test site shall be calibrated and validated for the frequency range being applicable.

NOTE: Information on uncertainty contributions, and verification procedures are detailed in clauses 5 and 6, respectively, of TR 102 273-2 [7].

Further information on shielded anechoic chambers is given in clause A.3.

7 Methods of measurement and limits for transmitter parameters

To meet the requirements for all applications the EUT shall be measured at its maximum peak and mean output power level and maximum antenna gain. Antenna polar diagrams, together with any antenna sweep profiles (for systems with antenna beam steering capability) and details of polarization, shall be presented and agreed with the accredited test laboratory if they are necessary to enable the measurements described in clause 7 to be performed.

The type of modulation has to be stated in the test specification.

Alternative test methods to those described within the present document may be used with the agreement of the manufacturer, and at the discretion of the accredited test laboratory. Procedures shall comply with CEPT/ERC Recommendation 01-06 [8] and CISPR 16-1 [3].

There are two classes defined within the present document: class 1 (e.g. FM, CW or FSK) and class 2 (pulsed doppler radar only). The only difference between the two class numbers is the permitted level average power. The class is to be stated in the test specification.

7.1 Permitted range of operating frequencies

7.1.1 Definition

The permitted range of operating frequencies is the frequency range over which the equipment is authorized to operate.

7.1.2 Method of measurement

The minimum and maximum output frequencies at which the permitted spurious and out-of-band emission levels as specified in clause 7.3 are exceeded due to intentional emission from the radio transmitter shall be measured using the method shown in figure 3. If the Measuring Receiver is capable of measuring the signals directly without any down mixing, the fundamental or harmonic Mixer can be omitted. If more than one modulation scheme can be generated by the EUT, then the maximum and minimum frequencies generated by each modulation scheme shall be measured and recorded separately.

The measuring receiver may be a spectrum analyser, oscilloscope, selective power meter or any measuring receiver which is appropriate to perform the intended measurement of the EUT.

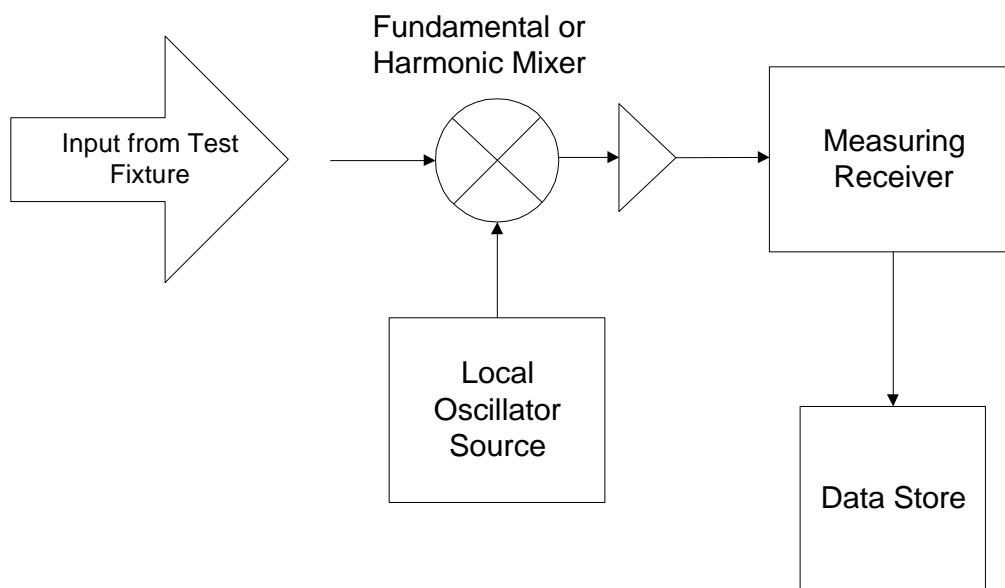

Figure 3: Test equipment for measuring the operating frequency range

This measurement shall be performed at normal and at extreme test conditions (see clauses 5.3 and 5.4).

The method of measurement shall be documented in the test report.

7.1.3 Limits

The permitted range of operating frequency for intentional emissions shall be from 76 GHz to 77 GHz.

7.2 Radiated spatial power density

7.2.1 Definition

The radiated spatial power density is defined as the power per unit area normal to the direction of the electromagnetic wave propagation measured in the permitted range of operating frequencies (see clause 7.1) and is expressed as an e.i.r.p. (dBm).

7.2.2 Method of measurement

7.2.2.1 Equipment with a fixed beam antenna (i.e. non-steerable by either mechanical or electronic means)

Using an applicable measurement procedure, such as described in annexes A and B, the power output shall be measured and recorded in the test report. Absolute power measurements should be carried out under far field conditions, however measurements over temperature may be carried out using comparative measurements in the near field by using the test fixture as described in clause 6.1.

The method of measuring the spatial power density may be carried out either by the use of a calibrated power meter or by using a calibrated receiver. For all methods, the substitution technique described in annex B shall be used to calibrate the measuring equipment.

The polar diagram together with details of the polarization for the transmit beam (if required to enable the measurement to be carried out) shall be submitted by the provider and approved by the accredited test laboratory.

The maximum e.i.r.p. shall be recorded.

The e.i.r.p. shall be measured under far field conditions under normal test conditions (see clause 5.3). The limits for the e.i.r.p. are shown in table 1.

The e.i.r.p. under extreme test conditions (see clause 5.4) may be measured in the near field by using, for example, the test fixture defined in clause 6.1.

This measurement shall be carried out in an anechoic environment or may also be carried out at an OATS where no physical obstruction shall be within a sector defined as "three times the 3 dB beamwidth of the antenna" during this test.

This measurement shall be performed at normal and at extreme test conditions (see clauses 5.3 and 5.4).

The method of measurement shall be documented in the test report.

7.2.2.2 Equipment with (electronically or mechanically) steerable antenna(s)

Using an applicable measurement procedure, such as described in annexes A and B, the power output shall be measured and recorded in the test report. Absolute power measurements should be carried out under far field conditions, however measurements over temperature may be carried out using comparative measurements in the near field by using the test fixture as described in clause 6.1.

The method of measuring the spatial power density may be carried out either by the use of a calibrated power meter or by using a calibrated receiver. For all methods, the substitution technique described in annex B shall be used to calibrate the measuring equipment.

Peak e.i.r.p. is to be measured using a standard gain horn and spectrum analyser set to slow sweep and peak hold mode. This enables the EUT to be fully tested according to clause 7.2.2.1. The peak e.i.r.p. shall be recorded. The manufacturer shall provide information relating to the scanning.

The e.i.r.p. shall be measured under far field conditions under normal test conditions (see clause 5.3). The limits for the e.i.r.p. are shown in table 2.

The e.i.r.p. under extreme test conditions (see clause 5.4) may be measured in the near field by using, for example, the test fixture defined in clause 6.1.

This measurement shall be carried out in an anechoic environment or may also be carried out at an OATS where no physical obstruction shall be within a sector defined as "three times the 3 dB beamwidth of the antenna" during this test.

This measurement shall be performed at normal and at extreme test conditions (see clauses 5.3 and 5.4).

The method of measurement shall be documented in the test report.

7.2.3 Limits

7.2.3.1 Equipment with fixed beam antenna

The transmitted power for equipment with fixed beam antennas shall be less than the limits shown in table 1.

Table 1: Limits for transmitted power (fixed antenna)

	Class 1	Class 2
Mean Power (e.i.r.p.)	50 dBm	23,5 dBm
Peak Power (e.i.r.p.)	55 dBm	55 dBm

7.2.3.2 Equipment with (electronically or mechanically) steerable antennas

The transmitted power for equipment with steerable antennas shall be less than the limits shown in table 2.

Table 2: Limits for transmitted power (steerable antenna)

	Class 1		Class 2	
	t < 100 ms	t > 100 ms	t < 100 ms	t > 100 ms
maximum antenna signal dwell time				
Mean Power (e.i.r.p.) (see note 1)	[55 dBm - 10 log(D)] or 50 dBm (whichever is the smaller)	50 dBm	[55 dBm - 10 log(D)] or 23,5 dBm (whichever is the smaller)	23,5 dBm
Peak Power (e.i.r.p.)	55 dBm	55 dBm	55 dBm	55 dBm
NOTE 1: The duty factor (D) is the ratio of the area of the beam (measured at its 3 dB point) to the total area scanned by the antenna.				
NOTE 2: The dwell time (t) is the largest dwell time at any angle.				

7.3 Out-of-band emissions

7.3.1 Definitions

Out-of-band emissions are residual emissions related to the intentional emissions radiated by the antenna of the EUT on the frequencies immediately outside the permitted range of frequencies which results from the modulation process.

Out-of-band emissions are measured as spectral power density under normal operating conditions.

7.3.2 Measuring receiver

The term "measuring receiver" refers to either a selective voltmeter or spectrum analyser. The bandwidth of the measuring receiver shall, where possible, be according to CISPR 16-1 [3]. In order to obtain the required sensitivity a narrower bandwidth may be necessary, this shall be stated in the test report form.

The bandwidth of the measuring receiver shall be less than the maximum given in table 3.

Table 3: Maximum receiver bandwidths

Frequency being measured	Maximum measuring receiver bandwidth
$f < 1\,000$ MHz	100 kHz to 120 kHz
$f \geq 1\,000$ MHz	1 MHz

7.3.3 Method of measurement

A test site such as one selected from annex A, which fulfils the requirements of the specified frequency range of this measurement shall be used. The test method employed should be as described in annex B. The bandwidth of the measuring receiver shall be set to a suitable value to correctly measure the unwanted emission. This bandwidth shall be recorded in the test report. For frequencies above 40 GHz a downconverter shall be used as shown in figure 3a. The local oscillator used to downconvert the received signals shall be stable and with a phase noise of better than -80 dBc/Hz at 100 kHz offset. The local oscillator frequency shall be selected such that the downconverted signal is within the accepted band of the spectrum analyser, and maintaining an adequate IF bandwidth to capture the full spectrum of the signal. The EIRP of the EUT shall be measured and recorded.

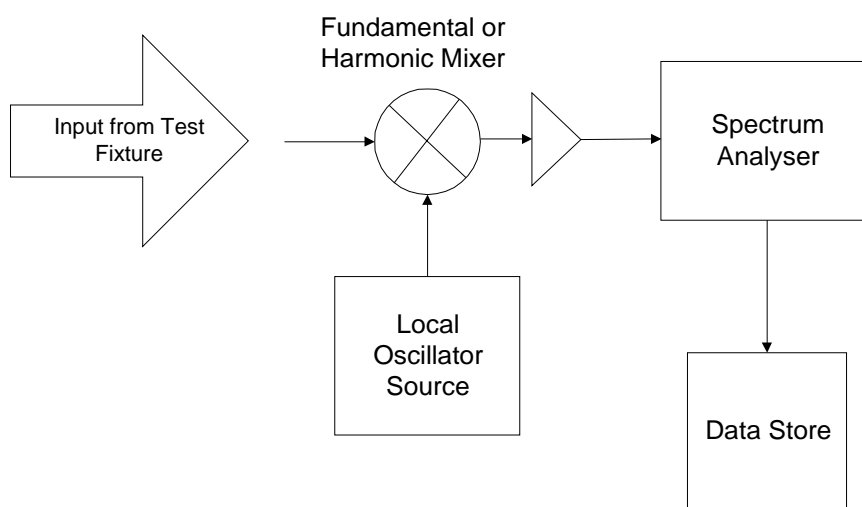
**Figure 3a: Test equipment for measuring out of band radiation**

For 77 GHz EUT's the spectral power density of the signal with normal modulation shall be measured and recorded in frequency bands adjacent to the 76 GHz to 77 GHz band, up to the frequencies where the spectral density is 40 dB below its maximum value.

7.3.4 Limits

The mean power density radiated outside the 76 GHz to 77 GHz band shall not exceed the values shown in table 4.

Table 4: Limits for out of band radiation

Frequency	Maximum mean power density (dBm/MHz)
73,5 GHz to 76 GHz	0
77 GHz to 79,5 GHz	0

7.4 Radiated spurious

7.4.1 Definition

Spurious emissions are emissions radiated by the antenna of the EUT or its cabinet on a frequency, or frequencies, outside the permitted range of frequencies occupied by the transmitter. Spurious emissions include harmonic emissions, parasitic emissions, intermodulation products and frequency conversion products, but exclude out-of-band emissions.

Spurious emissions are measured as spectral power density under normal operating conditions.

7.4.2 Measuring receiver

Refer to clause 7.3.2.

7.4.3 Method of measurement for radiated spurious

A test site such as one selected from annex A, which fulfils the requirements of the specified frequency range of this measurement shall be used. The test method employed should be as described in annex B. The bandwidth of the measuring receiver shall be set to a suitable value to correctly measure the spurious or out-of-band emissions. This bandwidth shall be recorded in the test report. For frequencies above 40 GHz a downconverter may be used as shown in figure 4. The local oscillator used to downconvert the received signals shall be stable and with a phase noise of better than -80 dBc/Hz at 100 kHz offset. The local oscillator frequency shall be selected such that the downconverted signal is within the accepted band of the spectrum analyser, and maintaining an adequate Intermediate Frequency (IF) bandwidth to capture the full spectrum of the signal. The e.i.r.p. of the EUT shall be measured and recorded. For these measurements it is strongly recommended to use an LNA (low noise amplifier) before the spectrum analyser input to achieve the required sensitivity.

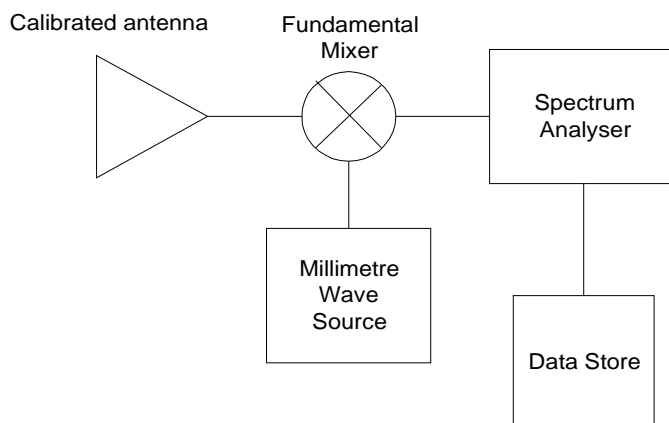

Figure 4: Test equipment for measuring spurious above 40 GHz

7.4.4 Limits

The effective radiated power of any radiated spurious emission shall not exceed the values given in table 5.

Table 5: Limits of radiated spurious emissions

Frequency range (MHz)	Limit values for spurious radiation (dBm)
47 to 74	-54
87,5 to 118	-54
174 to 230	-54
470 to 862	-54
otherwise in band 30 to 1 000	-36
1 000 to 25 000	-30
25 000 to 40 000	-25
40 000 to 100 000 (see note)	-20
NOTE: Not applicable within the permitted range of frequencies for the 76 GHz to 77 GHz SRR Radar.	

8 Receiver

8.1 Receiver spurious and out-of-band emissions

8.1.1 Definition

Separate radiated spurious measurements need not be made on receivers co-located with transmitters. The definitions from clauses 7.3 and 7.4 on transmitter out-of-band emissions and radiated spurious apply.

8.1.2 Method of measurement - radiated spurious and out-of-band emissions

This method of measurement applies to receivers having an integral antenna:

- a) A test site selected from annex A which fulfils the requirements of the specified frequency range of this measurement shall be used. The test antenna shall be oriented initially for vertical polarization and connected to a measuring receiver. The bandwidth of the measuring receiver shall be adjusted until the sensitivity of the measuring receiver is at least 6 dB below the spurious emission limit given in clause 7.4.4. This bandwidth shall be recorded in the test report.

The receiver under test shall be placed on the support in its standard position.

- b) The frequency of the measuring receiver shall be adjusted over the frequency range from 25 MHz up to 100 GHz. The frequency of each spurious component shall be noted. If the test site is disturbed by radiation coming from outside the site, this qualitative search may be performed in a screened room with reduced distance between the transmitter and the test antenna.
- c) At each frequency at which a component has been detected, the measuring receiver shall be tuned and the test antenna shall be raised or lowered through the specified height range until the maximum signal level is detected on the measuring receiver.
- d) The receiver shall be rotated up to 360° about a vertical axis, to maximize the received signal.
- e) The test antenna shall be raised or lowered again through the specified height range until a maximum is obtained. This level shall be noted.
- f) The substitution antenna (see clause A.2.3) shall replace the receiver antenna in the same position and in vertical polarization. It shall be connected to the signal generator.

- g) At each frequency at which a component has been detected, the signal generator, substitution antenna and measuring receiver shall be tuned. The test antenna shall be raised or lowered through the specified height range until the maximum signal level is detected on the measuring receiver. The level of the signal generator giving the same signal level on the measuring receiver as in step e) shall be noted. This level, after correction due to the gain of the substitution antenna and the cable loss, is the radiated spurious component at this frequency.
- h) The frequency and level of each spurious emission measured and the bandwidth of the measuring receiver shall be recorded in the test report.
- i) Measurements b) to h) shall be repeated with the test antenna oriented in horizontal polarization.

8.1.3 Limit

The power of any spurious emissions shall not exceed 2 nW in the range 25 MHz to 1 GHz and shall not exceed 20 nW on frequencies above 1 GHz.

9 Measurement uncertainty

The accumulated measurement uncertainties of the test system in use, for the parameters to be measured, should not exceed those given in table 3 to ensure that the measurements remain within an acceptable standard.

Table 6: Absolute measurement uncertainty

Parameter	Uncertainty
Radio Frequency (out of band)	$\pm 1 \times 10^{-7}$
Radiated Emission (valid to 100 GHz)	± 6 dB
Temperature	± 1 K
Humidity	± 10 %

The interpretation of the results recorded in the test report for the measurements described in the present document shall be as follows:

- the measured value related to the corresponding limit shall be used to decide whether an equipment meets the requirements of the present document:
 - a) the value of the measurement uncertainty for the measurement of each parameter shall be separately included in the test report;
 - b) the value of the measurement uncertainty shall be, for each measurement, equal to or lower than the figures in table 6.

For the test methods, according to the present document the uncertainty figures shall be calculated according to the methods described in the TR 100 028 [4] and shall correspond to an expansion factor (coverage factor) $k = 1,96$ or $k = 2$ (which provide confidence levels of respectively 95 % and 95,45 % in case where the distributions characterizing the actual measurement uncertainties are normal (Gaussian)).

Table 6 is based on such expansion factors.

The particular expansion factor used for the evaluation of the measurement uncertainty shall be stated.

Annex A (normative): Radiated measurements

A.1 Test sites and general arrangements for measurements involving the use of radiated fields

A.1.1 Open Area Test Site (OATS)

The OATS shall be on a reasonably level surface or ground. At one point on the site, an elliptical ground plane conforming to CISPR 16-1 [3] shall be provided. At one of the foci of this ground plane, a non-conducting support shall be located, capable of rotation in the horizontal and vertical planes, which is used to support the EUT in its standard position, between 0,75 m and 1,5 m above the ground plane. The test antenna shall be sited at the other focus. For measurements below 40 GHz, the test site shall be large enough to allow the erection of a measuring or transmitting antenna at a distance of $\lambda/2$ or 3 m whichever is greater. For measurements above 40 GHz an anechoic environment should be used, which should be large enough to allow the erection of a test antenna in the far field (i.e. at a distance of not less than $2d^2/\lambda$). The distance actually used shall be recorded with the results of the tests carried out on the site. The suitability of a test site shall be verified by the procedure recommended in CISPR 16-1 [3] and its amendments where applicable.

Sufficient precautions shall be taken to ensure that reflections from extraneous objects adjacent to the site do not degrade the measurements results.

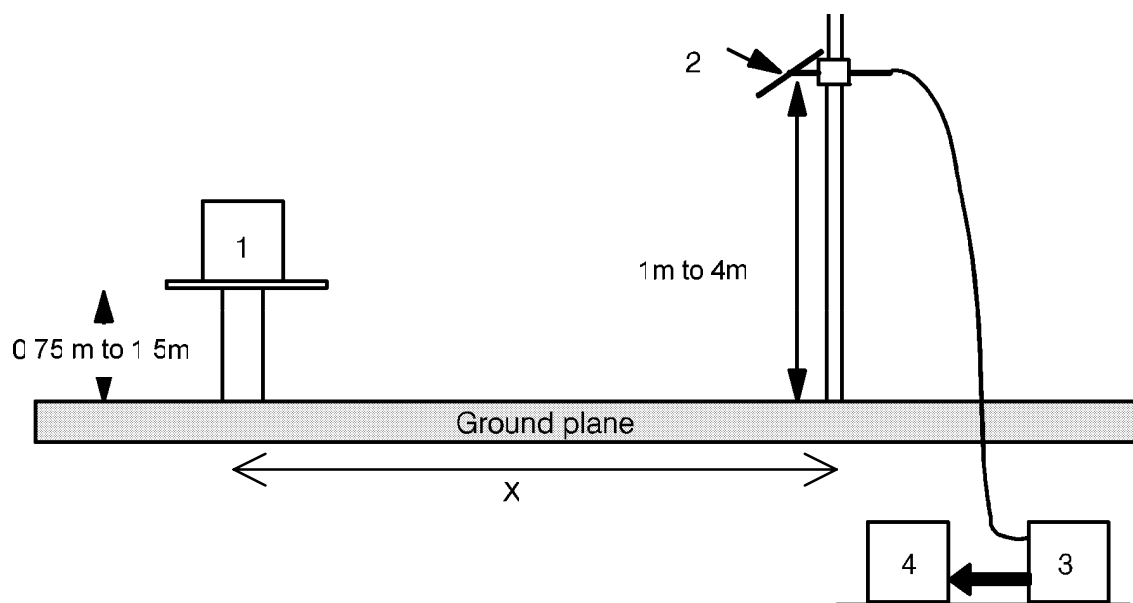

- NOTE 1: Equipment under test.
 NOTE 2: Test antenna.
 NOTE 3: High pass filter (may not be necessary).
 NOTE 4: Spectrum analyser or measuring receiver.

Figure A.1: Measuring arrangement

A.1.2 Test antenna

The test antenna is used to detect the radiation from the EUT, when the site is used for radiation measurements.

This antenna shall be mounted on a support such as to allow the antenna to be used in either horizontal or vertical polarization and for the height of its centre above ground to be varied over the range 1 m to 4 m. A test antenna with pronounced directivity should be used. The size of the test antenna along the measurement axis shall not exceed 20 % of the measuring distance.

For radiation measurements, the test antenna shall be connected to a measuring receiver, capable of being tuned to any frequency under investigation and of measuring accurately the relative levels of signals at its input.

When measuring in the frequency range up to 1 GHz the test antenna shall be a $\lambda/2$ dipole, resonant at the operating frequency, or a shortened dipole, calibrated to the $\lambda/2$ dipole. When measuring in the frequency range above 4 GHz a horn radiator shall be used. For measurements between 1 GHz and 4 GHz either a $\lambda/2$ dipole or a horn radiator may be used.

NOTE: The gain of a horn antenna is generally expressed relative to an isotropic radiator.

For far field measurements, distance "X" should be a minimum of $2d^2/\lambda$, where d = largest dimension of the antenna aperture of the EUT.

Calibrated test antennae shall be used in all measurements.

The distance between the lower extremity of the test antenna and the ground shall not be less than 0,3 m.

A.1.3 Standard position

The standard position in all test sites, shall be as follows:

- for equipment with integral antenna, it shall be placed in the position closest to normal use as declared by the manufacturer;
- the polarization of the test antenna and the equipment antenna shall be identical within the bandwidth of the equipment antenna; at other frequencies the test antenna shall be vertical.

A.1.4 Indoor Test Site

When the frequency of the signals being measured is greater than 80 MHz, use may be made of an indoor site. If this alternative site is used, this shall be recorded in the test report.

Care should be taken as it may not be appropriate to conduct far field measurements above 40 GHz on such a test site.

The measurement site shall be a laboratory room with a minimum area of 6 m by 7 m and at least 2,7 m in height.

Apart from the measuring apparatus and the operator, the room shall be as free as possible from reflecting objects other than the walls, floor and ceiling.

The potential reflections from the wall behind the EUT shall be reduced by placing a barrier of absorbent material in front of it. The corner reflector around the test antenna shall be used to reduce the effect of reflections from the opposite wall and from the floor and ceiling in the case of horizontally polarized measurements.

Similarly, the corner reflector reduces the effects of reflections from the side walls for vertically polarized measurements. For the lower part of the frequency range (below approximately 175 MHz) no corner reflector or absorbent barrier is needed. For practical reasons, the $\lambda/2$ antenna in figure A.2 may be replaced by an antenna of constant length, provided that this length is between $\lambda/4$ and λ at the frequency of measurement and the sensitivity of the measuring system is sufficient. In the same way the distance of $\lambda/2$ to the apex may be varied.

The test antenna and measuring receiver, are used in a way similar to that of the general method.

A.2 Guidance on the use of radiation test sites

For general guidance on the use of radiation test sites refer to CISPR 16-1 [3].

For measurements involving the use of radiated fields, use may be made of a test site in conformity with the requirements of clause A.1. For measurements above 40 GHz care shall be taken to ensure that the selected test site is appropriate. When using such a test site, the following conditions should be observed to ensure consistency of measuring results.

A.2.1 Measuring distance

Evidence indicates that the measuring distance is not critical and does not significantly affect the measuring results, provided that the distance is not less than $\lambda/2$ at the frequency of measurement and the precautions described in this annex are observed. Measuring distances of 3 m, 5 m, 10 m and 30 m are in common use in european test laboratories.

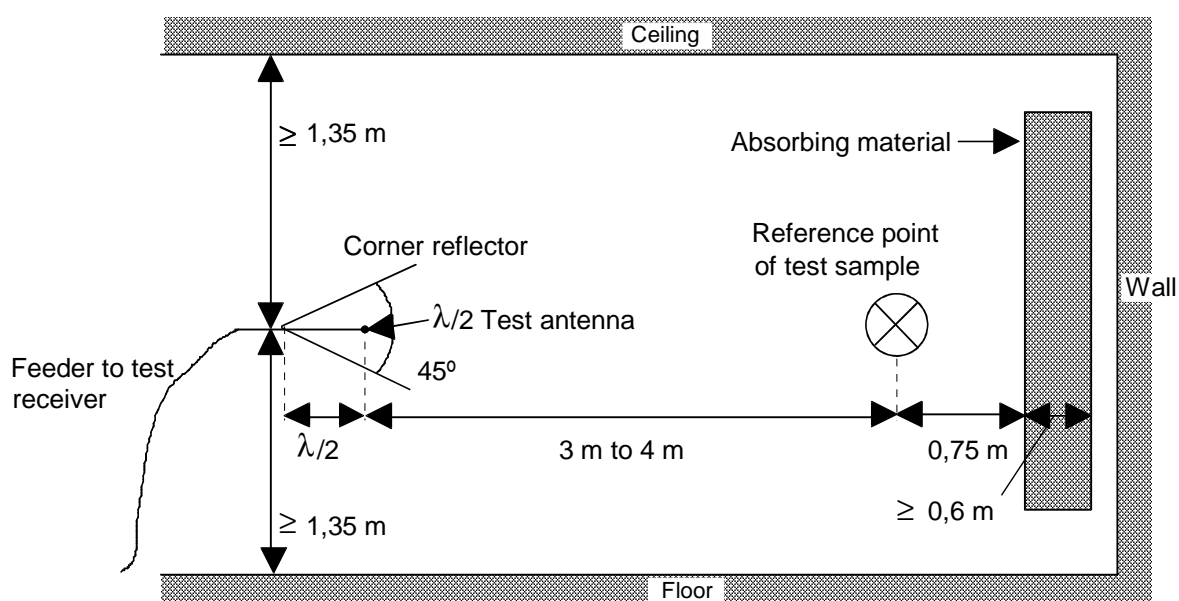

Figure A.2: Indoor site arrangement (shown for horizontal polarization)

A.2.2 Test antenna

Different types of test antenna may be used, since performing substitution measurements reduces the effect of the errors on the measuring results.

Height variation of the test antenna over a range of 1 m to 4 m is essential in order to find the point at which the radiation is a maximum.

Height variation of the test antenna may not be necessary at the lower frequencies below about 100 MHz.

A.2.3 Substitution antenna

The substitution antenna and signal generator is used to replace the EUT in substitution measurements. For measurements below 1 GHz the substitution antenna shall be half wavelength dipole resonant at the frequency under consideration, or a shortened dipole, calibrated to the half wavelength dipole. For measurements between 1 GHz and 4 GHz either a half wavelength dipole or a horn radiator may be used. For measurements above 4 GHz a horn radiator shall be used. The centre of this antenna shall coincide with the reference point of the EUT it has replaced. This reference point shall be the volume centre of the sample when its antenna is mounted inside the cabinet, or the point where an outside antenna is connected to the cabinet. The distance between the lower extremity of the dipole and the ground shall be at least 300 mm.

A.2.4 Auxiliary cables

The position of auxiliary cables (power supply, etc.) which are not adequately decoupled may cause variations in the measuring results. In order to get reproducible results, cables and wires of auxiliaries should be arranged vertically downwards (through a hole in the non conducting support).

A.3 Alternative test site using a fully anechoic RF chamber

For radiation measurements when the frequency of the signals being measured is greater than 30 MHz, use may be made of an indoor site being a well-shielded anechoic chamber simulating free space environment. If such a chamber is used, this shall be recorded in the test report.

The test antenna and measuring receiver, are used in a way similar to that of the general method, clause A.1. In the range between 30 MHz and 100 MHz some additional calibration may be necessary.

An example of a typical measurement site may be an electrically shielded anechoic chamber being 10 m long, 5 m broad and 5 m high. Walls and ceiling should be coated with RF absorbers of 1 m height. The base should be covered with absorbing material 1 m thick, and a wooden floor, able to carry test equipment and operators. A measuring distance of 3 m to 5 m in the long middle axis of the chamber can be used for measurements up to 12,75 GHz. For frequencies above 12,75 GHz the chamber may be used provided it has been calibrated for use at the frequency being measured. The construction of the anechoic chamber is described in the following clauses.

A.3.1 Example of the construction of a shielded anechoic chamber

Free-field measurements can be simulated in a shielded measuring chamber where the walls are coated with RF absorbers. Figure A.3 shows the requirements for shielding loss and wall return loss of such a room. As dimensions and characteristics of usual absorber materials are critical below 100 MHz (height of absorbers < 1 m, reflection attenuation < 20 dB) such a room is preferably suitable for measurements above 100 MHz. Figure A.4 shows the construction of a shielded measuring chamber having a base area of 5 m by 10 m and a height of 5 m.

Ceilings and walls are coated with pyramidal formed RF absorbers approximately 1 m high or equivalent material with the same performance. The base is covered with absorbers which form a non-conducting sub-floor, or with special ground floor absorbers. The available internal dimensions of the room are 3 m × 8 m × 3 m, so that a measuring distance of maximum 5 m length in the middle axis of this room is available.

At 100 MHz the measuring distance can be extended up to a maximum of 2λ .

The floor absorbers reduce floor reflections so that the antenna height need not be changed and floor reflection influences need not be considered.

All measuring results can therefore be checked with simple calculations and the measurement uncertainties have the smallest possible values due to the simple measuring configuration.

A.3.2 Influence of parasitic reflections in anechoic chambers

For free-space propagation in the far field condition the correlation $E = E_0 \cdot (R_0/R)$ is valid for the dependence of the field strength E on the distance R , whereby E_0 is the reference field strength in the reference distance R_0 .

It is useful to use just this correlation for comparison measurements, as all constants are eliminated with the ratio and neither cable attenuation nor antenna mismatch or antenna dimensions are of importance.

Deviations from the ideal curve can be seen easily if the logarithm of the above equation is used, because the ideal correlation of field strength and distance can then be shown as a straight line and the deviations occurring in practice are clearly visible. This indirect method shows the disturbances due to reflections more readily and is far less problematical than the direct measurement of reflection attenuation.

With an anechoic chamber of the dimensions suggested in clause A.3 at low frequencies up to 100 MHz there are no far field conditions, and therefore reflections are stronger so that careful calibration is necessary. In the medium frequency range from 100 MHz to 1 GHz the dependence of the field strength on the distance meets the expectations very well. In the frequency range of 1 GHz to 100 GHz, because more reflections will occur, the dependence of the field strength on the distance will not correlate so closely.

A.3.3 Calibration of the shielded RF anechoic chamber

Calibration of the chamber shall be performed over the range 30 MHz to 100 GHz.

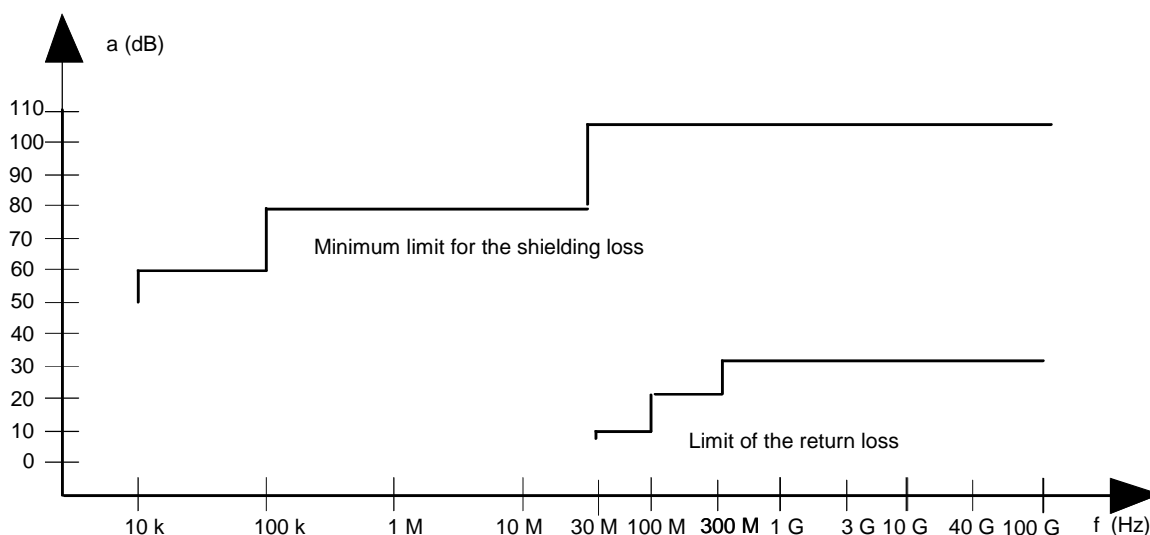

Figure A.3: Specification for shielding and reflections

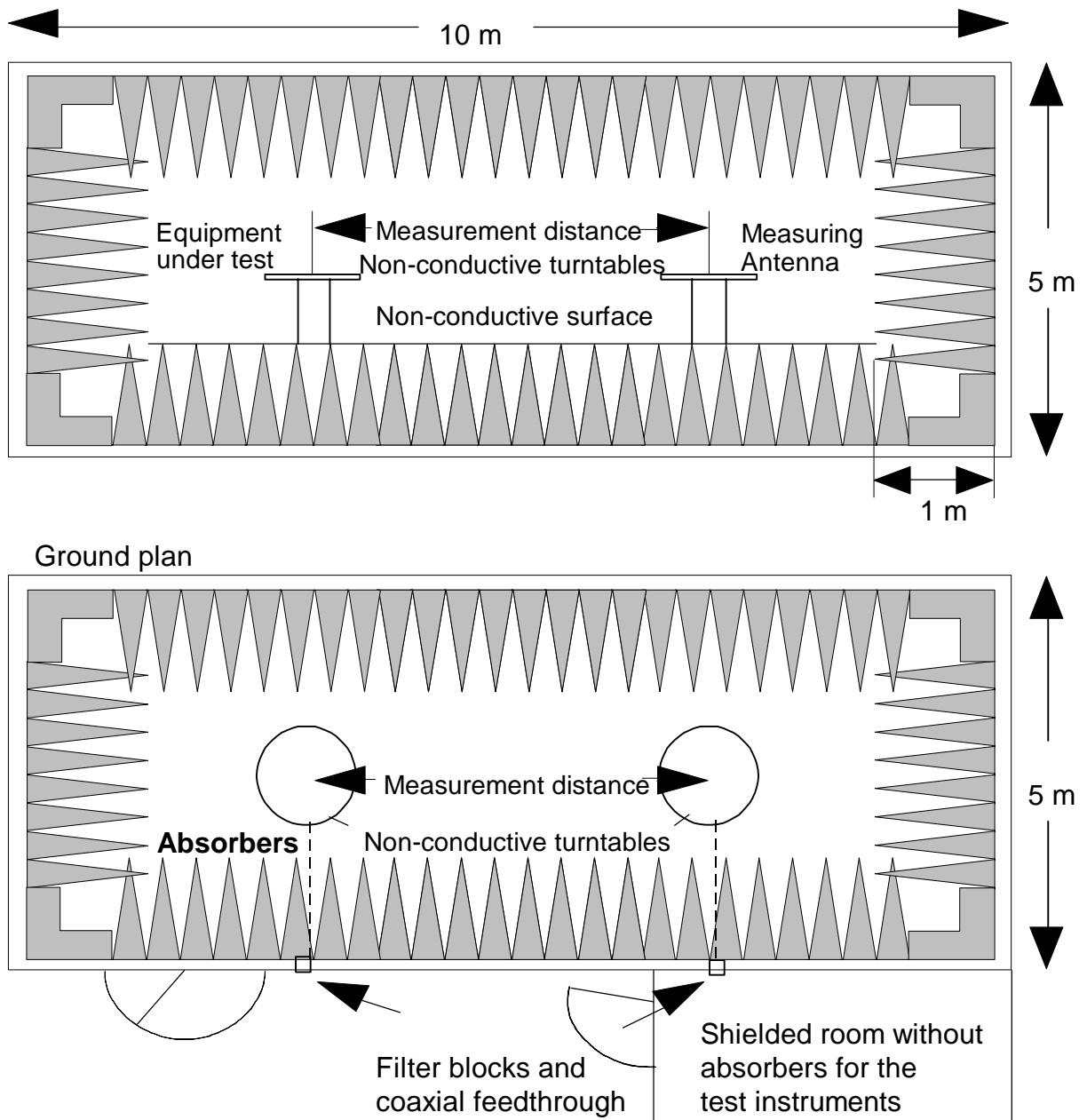

Figure A.4: Example of construction of an anechoic shielded chamber

Annex B (normative): General description of measurement methods

B.1 Radiated measurements

Radiated measurements shall be performed with the aid of a test antenna and measuring receiver as described in annex A. The test antenna and measurement receiver, spectrum analyser or selective voltmeter (including all cables) shall be calibrated according to the procedure defined in this annex. The EUT and the test antenna shall be oriented to obtain the maximum emitted power level. This position shall be recorded in the measurement report. The frequency range shall be measured in this position.

For equipment with multiple fixed beam antennas, the tests shall be carried out with the test antenna oriented to obtain the maximum emitted power level, and repeated for each beam position. If the equipment transmits more than one beam at a time, then the maximum e.i.r.p. shall be recorded.

If the equipment has an antenna which is either mechanically or electronically scanned, then the scanning shall be inhibited for these tests. With the scanning stopped, the e.i.r.p. for the EUT shall be measured with the antenna in its position of highest gain (i.e. highest output power) as stated by the provider.

Measurements of absolute power levels below 40 GHz shall be carried out at a distance of $\lambda/2$ or 3 m, whichever is greater. For measurements of absolute power above 40 GHz an anechoic environment or test site is necessary which should be large enough to allow the erection of a test antenna in the far field (i.e. at a distance of not less than $2d^2/\lambda$).

Radiated measurements should be performed either with the EUT in the approved test fixture in an anechoic environment, or using the OATS as described in annex A.

The following conditions shall be fulfilled if an OATS is used for measurements:

- a) an OATS which fulfils the requirements of the specified frequency range of this measurement (CISPR 16-1 [3]) shall be used;
- b) the EUT shall be placed on the support in its standard position (see clause A.1.3) and switched on;
- c) the test antenna shall be oriented initially for vertical polarization unless otherwise stated. The test antenna shall be raised or lowered, through the specified height range until the maximum signal level is detected on the measuring receiver;
- d) the EUT shall be capable of rotation through 360° about a vertical axis to maximize the received signal;
- e) the test antenna shall be raised or lowered again, if necessary, through the specified height range until a maximum is obtained. This level shall be recorded:
(this maximum may be a lower value than the value obtainable at heights outside the specified limits);
- f) this measurement shall be repeated for horizontal polarization;
- g) the substitution (calibrated) antenna shall replace the EUT, in the same position and in vertical polarization. The frequency of the signal generator shall be adjusted to the Tx (carrier) frequency;
- h) steps c) to f) shall be repeated as necessary;
- i) the input signal to the substitution (calibrated) antenna shall be adjusted in level via a calibrated attenuator/signal generator until an equal or a known related level to that detected from the Tx is obtained in the test receiver;
- j) this measurement shall be repeated with horizontal polarization;
- k) the radiated power is equal to the power supplied by the signal generator, increased by the gain of the substitution antenna and the cable losses between the signal generator and the substitution antenna.

If an anechoic chamber is used as opposed to an OATS, the following change to this procedure applies:

- the test antenna shall be oriented initially for vertical polarization unless otherwise stated.

Annex C (informative): Maximum safe level of radiated power density

It is necessary for every EUT to comply with the current regulations regarding safe levels for radiated power. This is detailed in this annex.

C.1 Definition

The maximum safe level for the radiated power density is defined as that level which can be transmitted in accordance with the *current* recommended safety levels (see of Council Recommendation of 12 July 1999 [5]).

C.2 Method of measurement

The EUT should be tested as per clause 7.2.2.

C.2.1 Equipment with a fixed beam antenna(s) (i.e. non-steerable by either mechanical or electronic means)

The polar diagram together with details of the polarization for the transmit beam (if required to enable the measurement to be carried out) should be submitted by the provider and approved by the accredited test laboratory.

The maximum e.i.r.p. is then recorded.

C.2.2 Equipment with (electronically or mechanically) steerable antenna

It is necessary to engage a mode in the EUT whereby the antenna steering is disabled i.e. the unit operates with a fixed beam. This will enable the EUT to be fully tested as per clause 7.2.2.1.

With the scanning stopped, the e.i.r.p. for the EUT should be measured with the antenna in its position of highest gain (i.e. highest output power) as stated by the provider.

The provider should provide all necessary information relating to the scanning.

C.3 Limit

The maximum safe level for the mean radiated power density is defined in annex 3 of Council Recommendation of 12 July 1999 [5].

The maximum safe level for the peak radiated power density is defined in annex 3 of Council Recommendation of 12 July 1999 [5].

The power density should not exceed the value given in this clause at any point accessible without partial or complete disassembly of the device requiring the use of tools.

Annex D (informative): Examples of modulation schemes

D.1 Pulse modulation

D.1.1 Definition

For pulse modulation, the Tx "amplitude" is periodically switched on for a short time (called pulse duration) and switched off during the subsequent reception period. A typical example is shown in figure D.1.

The time between the rising edges of the pulsed output power is called the Pulse Repetition Interval (PRI). The PRI may vary between subsequent pulses, in which case the modulation is called staggered PRI.

The Pulse Repetition Frequency (PRF) is the inverse of the PRI averaged over a time sufficiently long to cover all PRI variations.

The duty cycle is the product of the PRF and the pulse duration.

The radiated power averaged over the pulse duration is called the peak output power.

The peak output power multiplied by the average duty cycle is called the average output power.

Subsequent pulses may be on different frequencies (i.e. stepped frequency).

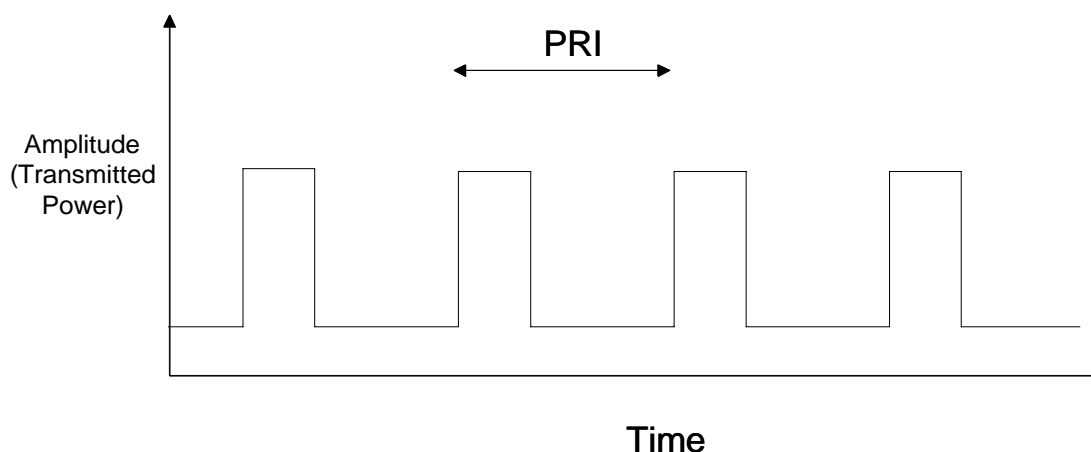

Figure D.1: Typical pulse modulation scheme

D.1.2 Typical operating parameters

The peak and average (RMS) power limits are given in clause 7.2.3. Typical operating parameters are given in table D.1.

Table D.1: Typical operating parameters for pulse modulation

Parameter	Typical value
PRF	1 MHz
PRI	1 μ S
Pulse length	3,5 nS
Frequency step	100 MHz/ns
Duty cycle	10 %

D.2 Frequency modulated continuous wave

D.2.1 Definition

For Frequency Modulated Carrier Wave (FMCW) modulation, the transmitted waveform is frequency modulated over a period of time (P). This period of time may be constant, or may be varied. An example of a typical modulation scheme is shown in figure D.2. During the time (P), the frequency may either increase or decrease. The modulation may assume (but is not limited to) the form of a "sawtooth", "triangular" or a "sinusoidal" waveform. Also a constant frequency may be maintained and transmitted during one or more periods of time. Furthermore, the transmitted power may be switched off during one or more periods of time (e.g. Frequency Modulated Interrupted Continuous Wave (FMICW)). The modulation waveform may be repeated or varied over several periods of time, and at the beginning or end of each period of time (P), there may be a time " G " (the "blanking period") where the transmitted waveform is adjusting to the requirements of the beginning of the next period.

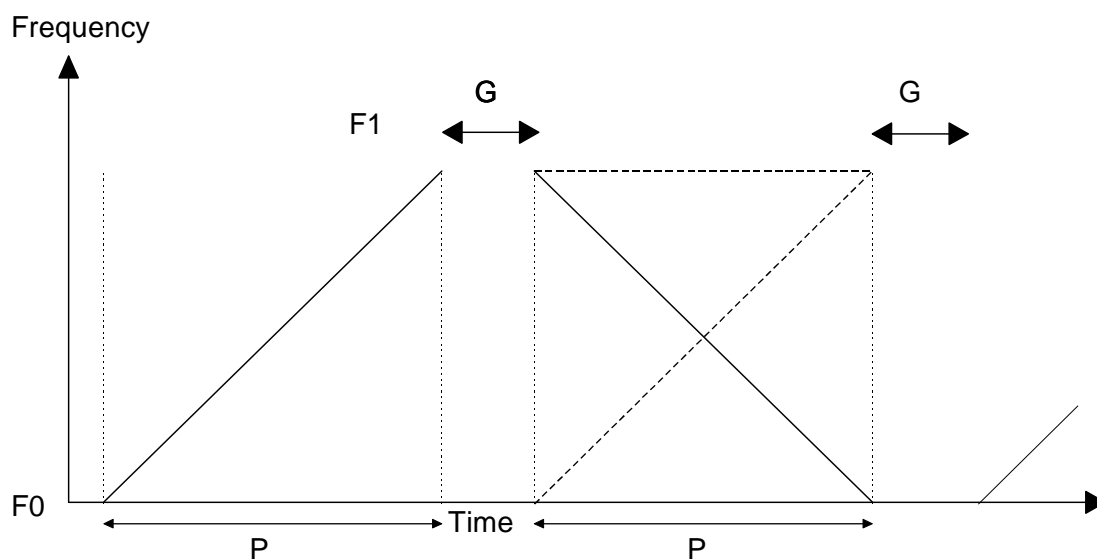

Figure D.2: Typical FMCW modulation scheme

D.2.2 Typical operating parameters

The peak and average (RMS) power limits are given in clause 7.2.3. Typical operating parameters are given in table D.2.

Table D.2: Typical operating parameters for FMCW

Parameter	Typical value
Frequency deviation in one period	150 MHz
Modulation period (P)	10 mS
Blanking period (G)	1 mS
Number of different frequency slopes	3

D.3 Frequency Shift Keying (FSK)

D.3.1 Definition

With typical FSK modulation, an interleaved continuous FSK waveform is transmitted according to a pattern during a period of time known as a frame. During each frequency step the transmitted signal has a constant frequency.

One example of a generic modulation scheme is characterized by the parameters shown in figures D.3 and D.4. In this example, during one frame the sequence of transmitted frequencies are:

$$f_{01}, f_{02}, \dots, f_{0j}, \dots, f_{0p}, f_{11}, f_{12}, \dots, f_{1j}, \dots, f_{1p}, \dots, f_{n1}, f_{n2}, \dots, f_{nj}, \dots, f_{np}.$$

Where:

P is the number of interleaved FSK waveforms;

$n + 1$ is the number of steps per FSK waveform;

f_{aj} and $f_{(a+1)j}$ are sequential steps in the waveform identified by the "j" index.

Where:

Δf_j is the frequency deviation step of the waveform identified by the "j" index.

With:

τ = frequency step duration;

ΔF_{\max} = maximum frequency deviation of one stepped frequency waveform;

T = frame repetition period (constant).

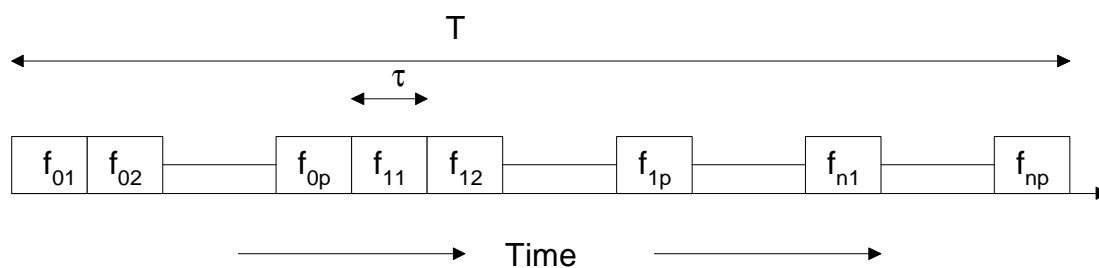

Figure D.3: Typical FSK modulation scheme

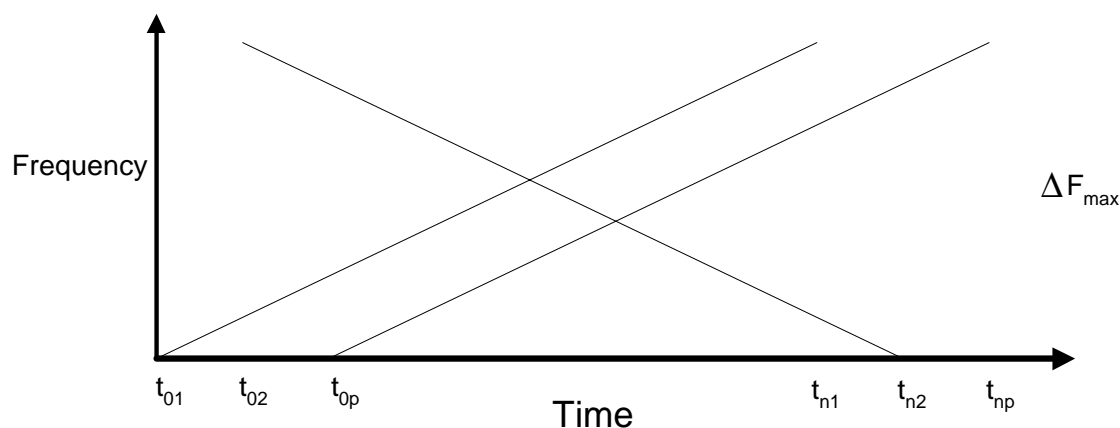

Figure D.4: Typical FSK modulation sequence

D.3.2 Typical operating parameters

The peak and average (RMS) power limits are given in clause 7.2.3. Typical operating parameters are given in table D.3.

Table D.3: Typical operating parameters for FSK modulation

Parameter	Typical value
τ	5 μ s
ΔF_{\max}	150 MHz
T	7 ms
n	511
P	3
$(\Delta f_j/T)_{\max}$	100 MHz/ μ s

D.4 PN-ASK (Pseudo-Noise Amplitude Shift Keying) 77 GHz

D.4.1 Definition

For PN-ASK modulation, the transmitted wave radiation is modulated in amplitude by a pseudo noise code, i.e. the Direct Sequence Signal (DSS), that represents the states of the base band signal of an ASK modulation.

A generic binary DSS impulse $c(t)$ (red) and the corresponding transmitted signal $s(t)$ (blue) are shown in figure D.5. The binary DSS impulse $c(t)$ and the transmitted signal $s(t)$ can be expressed as:

$$c(t) = \sum_{i=0}^{L-1} C_i \times u(t - i \times T_c);$$

$$s(t) = c(t) \times \sin(2\pi \times f_T \times t).$$

Where:

C_i defines the states $\{0, +1\}$ of the elementary signals (chips);

$u(t)$ defines the rectangular signal: $u(t) = \begin{cases} 1 & \text{for } 0 \leq t < T_c \\ 0 & \text{else} \end{cases}$;

f_T defines the carrier frequency;

T_c defines the duration of a chip (chip period);

L defines number of chips per PN-sequence.

The bandwidth (B) of the transmitted signal $s(t)$ is defined by the bandwidth of the main lobe and corresponds to twice the inverse of the chip rate, from null to null:

$$B = 2 \times \frac{1}{T_c}$$

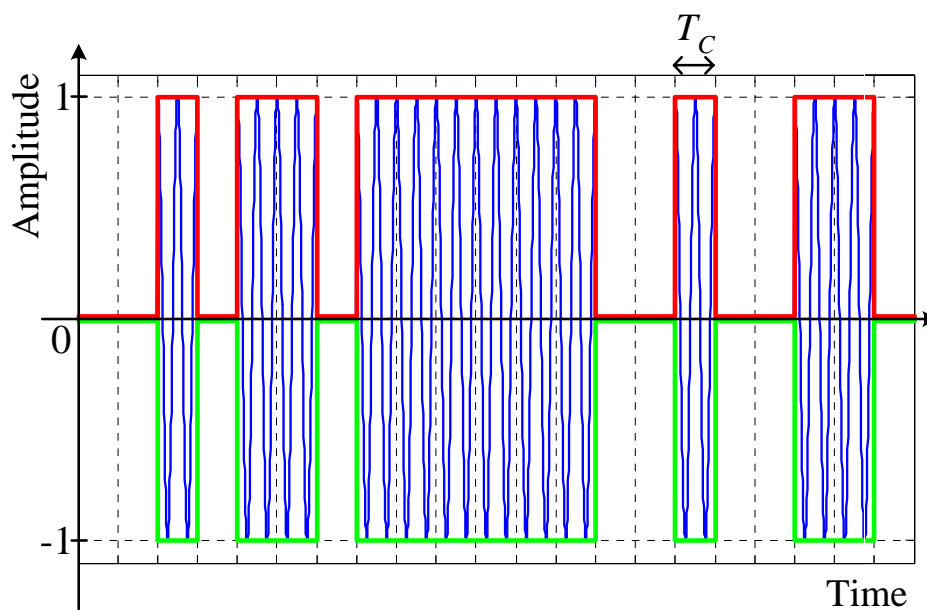

Figure D.5: Typical PN-ASK modulation scheme

D.4.2 Typical operating parameters

Typical operating parameters are given in table D.4.

Table D.4: Typical operating parameters for PN-ASK Modulation

Parameter	Minimum
Chip period T_c	2 ns
PN-sequence period ($L \times T_c$)	10 μ s
Occupied bandwidth B (DSB _{-10 dB})	1 GHz

Annex E (informative): Conversion of power density to e.i.r.p.

This annex offers an example of the conversion from "power/unit area" (power density) to e.i.r.p.

E.1 Assumptions

e.i.r.p. is the product of "power into the antenna" multiplied by the "antenna gain".

e.i.r.p. is the total power transmitted, assuming an isotropic radiator.

Area of a sphere = πd^2 .

E.2 Example

For a power density of 200 nW/cm² (measured at 3 m):

200 nW/cm² (at 3 m) = power measured in a 1 cm² area at 3 m distance.

e.i.r.p. = total radiated power over the whole area of a sphere.

e.i.r.p. = [power measured in a 1 cm² area at 3 m distance (W)] × [area of sphere at 3 m (in cm²)].

e.i.r.p. = [(200 × 10⁻⁹) × (π × 36 × 10⁴)] W.

e.i.r.p. = 226,19 mW.

Hence: = 200 nW/cm² (at 3 m) ≅ 23,54 dBm.

Annex F (informative): Bibliography

- ETSI EN 301 489-3 (V1.2.1): "Electromagnetic compatibility and Radio spectrum Matters (ERM); ElectroMagnetic Compatibility (EMC) standard for radio equipment and services; Part 3: Specific conditions for Short-Range Devices (SRD) operating on frequencies between 9 kHz and 40 GHz".
- ENV 50166-2: "Human exposure to electromagnetic fields. High frequency (10 kHz to 300 GHz)".

History

Document history		
V1.1.1	July 2004	One-step Approval Procedure OAP 20041105: 2004-07-07 to 2004-11-05